

Lawrence Berkeley National Laboratory

Lawrence Berkeley National Laboratory

Title

RADIO FREQUENCY PHASE IN THE FEL SECTION OF A TBA

Permalink

<https://escholarship.org/uc/item/6cx303kd>

Author

Kuenning, R.W.

Publication Date

2008-09-15

c. 2



Lawrence Berkeley Laboratory

UNIVERSITY OF CALIFORNIA

Accelerator & Fusion Research Division

RECEIVED
LAWRENCE
BERKELEY LABORATORY

OCT 27 1986

LIBRARY AND
DOCUMENTS SECTION

Presented at the Symposium on Advance Accelerator Concept,
Madison, WI, August 21-27, 1986

RADIO FREQUENCY PHASE IN THE FEL SECTION OF A TBA

R.W. Kuenning, A.M. Sessler, and E.J. Sternbach

August 1986

TWO-WEEK LOAN COPY

*This is a Library Circulating Copy
which may be borrowed for two weeks.*

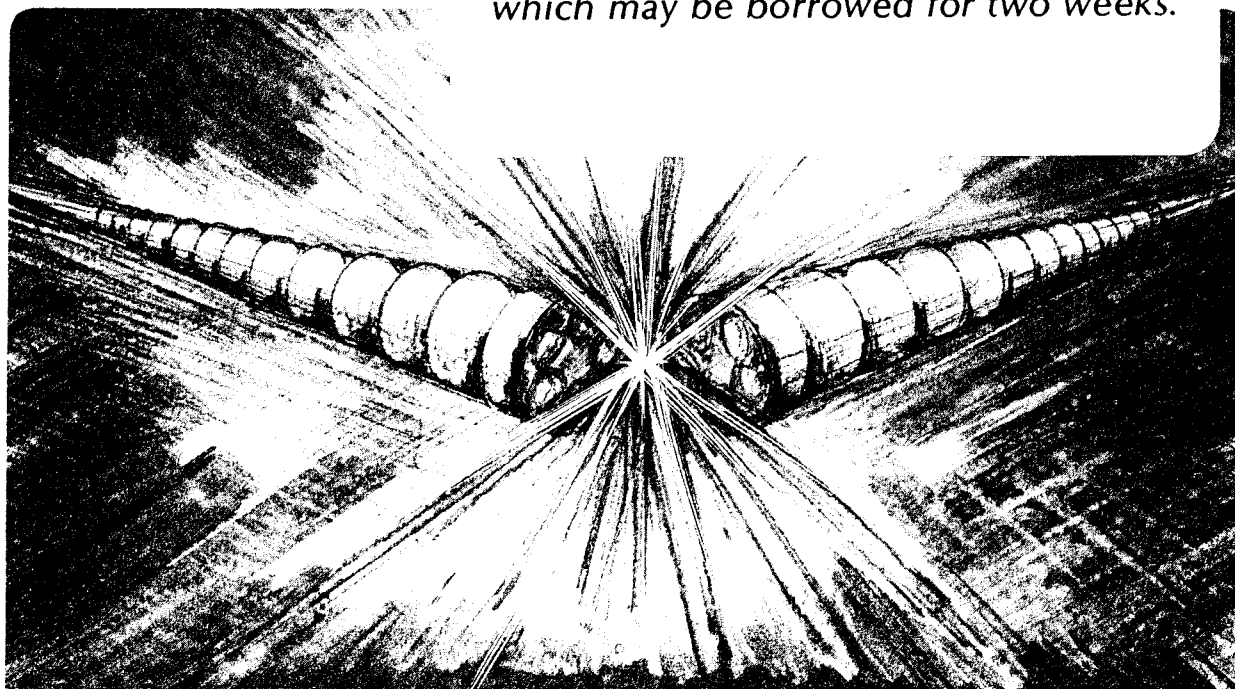

LBL-22301

c. 2

RADIO FREQUENCY PHASE IN THE FEL SECTION OF A TBA*

R. W. Kuenning, A. M. Sessler and E. J. Sternbach

Lawrence Berkeley Laboratory
University of California
Berkeley, CA 94720

August 1986

* This work was supported by the High Energy Physics Division, Office of Energy Research, U.S. Department of Energy under Contract No. DE-AC03-76SF00098.

RADIO FREQUENCY PHASE IN THE FEL SECTION OF A TBA*

Robert W. Kuenning, Andrew M. Sessler and Efrem J. Sternbach

Lawrence Berkeley Laboratory
Berkeley, CA 94720I. INTRODUCTION

The Two-Beam Accelerator (TBA) concept was first introduced a few years ago and, subsequently, described in a number of review papers [1]. More detailed treatments can be found in four recent articles [2,3,4,5].

Basically the idea is simply to have a low-energy beam travel through an undulator magnet and, hence, by the free electron laser (FEL) mechanism generate microwave radiation. The energy of the low-energy beam is repeatedly resupplied by induction units and the microwave radiation is employed to accelerate, to very high energies, the desired particles ("the high-energy beam"). The device is proposed for future linear colliders where high gradients (and hence reduced overall length and, consequently, reduced capital cost) and high power efficiency (and hence reduced operating cost) are important considerations. A schematic is shown in Fig. 1 and a set of possible parameters (taken from Ref. [3]) is given in Table I.

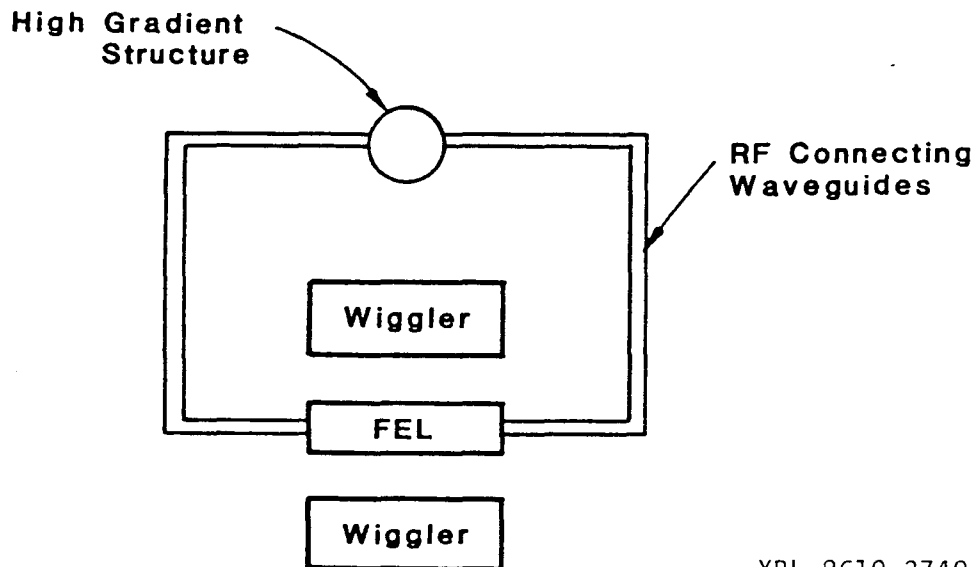

XBL 8610-3740

Figure 1a. Conceptual configuration of the Two-Beam Accelerator (TBA)

*This work was supported by the High Energy Physics Division, Office of Energy Research, U. S. Department of Energy under Contract No. DE-AC03-76SF00098.

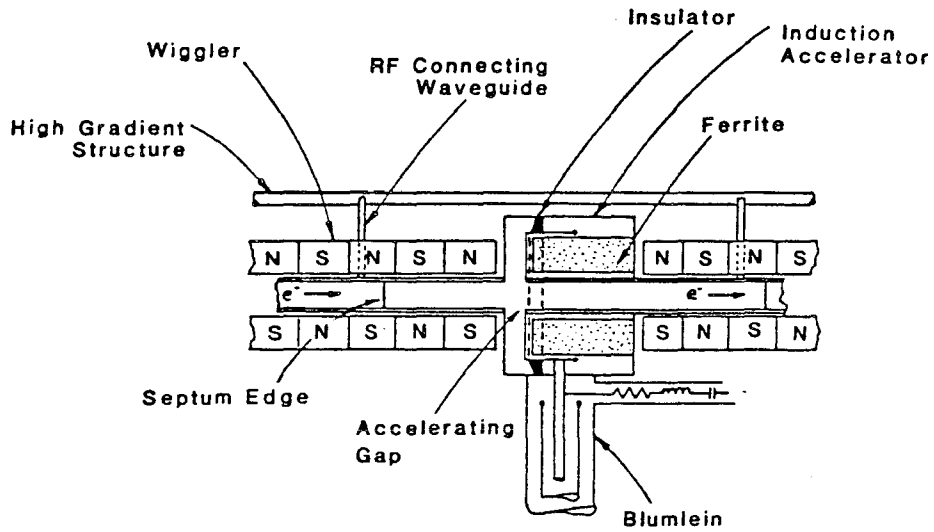

Figure 1b. (Continued).

XBL 8610-3741

Table I. Parameters for a 1 TeV Two-Beam Accelerator Collider

Low Energy Beam

Average beam energy (units of mc^2)	40
Beam current	2.15 kA
Bunch length	6 m
Wiggler wavelength	27 cm
Average peak wiggler field	2.4 kG
Beam power	43 GW
Beam energy	0.8 kJ
Power production	2.2 GW/m
Number of FEL injectors	2 x 2
Power from mains	160 MW

High Gradient Structure

Wavelength	1 cm
Gradient	500 MeV/m
Stored energy	40 J/m
Fill time	18 ns

Table I. Continued.

High Energy Beam

Injection energy	2 GeV
Repetition rate (f)	0.5 kHz
Final energy	1 TeV
Length	2 x 2 km
Luminosity	$4 \times 10^{32} \text{ cm}^{-2} \text{ sec}^{-1}$
Beam height (σ_w)	0.14 μ
Beam width (σ_z)	1.4 μ
Single beam power	8.0 MW
Number of particles	10^{11}
Disruption (D)	1.3
Beamstrahlung (δ)	0.2
Overall efficiency (from mains to HEB)	10%

In order to operate well (i.e., to produce high energy particles with a well-defined, and repeatable, energy) the TBA must incorporate, in its FEL portion, tight control of the rf wave amplitude and phase. An identification of this need, and a rough bounding of the magnitude of the effect, was given in previous papers [6,7]. A more comprehensive treatment of the subject, using a 1D resonant particle approximation, was given in a previous paper [8] with details in an unpublished note [9]. Subsequently, a steady state many particle simulation was developed and published in [10].

It is the point of this paper to extend the many particle simulation to include non-equilibrium conditions, to correct some errors in the 1D resonant particle analysis, Ref. [8], and to discuss several feedback systems to correct phase errors. Employing the standard notation of Kroll, Morton, and Rosenbluth [11] we may describe the FEL in the resonant particle approximation by the following equations:

$$\frac{d\gamma}{dz} = - \frac{\omega_w a_s \sin \psi}{c\gamma} + \frac{2\alpha_0 \omega_w^2 a_s^2}{\omega_{p0}^2}, \quad (1)$$

$$\frac{d\psi}{dz} = (k_w - \delta k_s) - \frac{1}{2c\gamma^2} (1 + a_w^2 - 2a_s a_w \cos \psi) + \frac{d\phi}{dz}, \quad (2)$$

$$\frac{da_s}{dz} = \frac{\omega_p^2 a_w \sin \psi}{2\omega c \gamma} - \alpha a_s, \quad (3)$$

$$\frac{d\phi}{dz} = \frac{\omega_p^2 a_w \cos \psi}{2\omega c a_s \gamma}. \quad (4)$$

In these equations, γ is the energy of the resonant particle, ψ is the phase of this particle with respect to the rf wave, a_s is the normalized intensity of the rf wave, and ϕ is the phase of the rf wave. The normalized undulator amplitude, the normalized rf field, and the beam plasma frequency, ω_p , are given by:

$$a_w = 0.093 \lambda_w (\text{cm}) B_w (\text{kG}), \quad (5)$$

$$a_s = 6.05 \times 10^{-6} \lambda (\text{cm}) \sqrt{\frac{P(w)}{a(\text{cm})b(\text{cm})/2}}, \quad (6)$$

$$\omega_p^2 = \frac{6.6 \times 10^{20} I (\text{kA})}{a(\text{cm})b(\text{cm})/2}, \quad (7)$$

where the FEL waveguide dimensions are $a \times b$. The quantity δk_s is:

$$\delta k_s = \left(k_s^2 + \frac{\pi^2 m^2}{a^2} + \frac{\pi^2 n^2}{b^2} \right)^{1/2} - k_s, \quad (8)$$

where ω is the frequency of the rf and k_s , the wave number of the rf, is ω/c .

The energy taken out of the FEL is represented by the parameter α and the α_0 -term in the first equation represents the replenishing of the FEL electron's energy by the induction units. In this model, the energy gain and loss is continuous; i.e., the discrete, and periodic, nature of the TBA is neglected.

It was found that the results given in Ref. [8] for the initial non-equilibrium dynamical variables, γ , a_s , and ψ , were in error. The corrected results show that the phase deviation does not continually increase but reaches an equilibrium value. The corrected Fig. 4, shown as Fig. 2 and Tables III and IV are included here.

II. THE MANY PARTICLE SIMULATION

In this section a many-particle simulation is used to study the evolution of the radiation phase and amplitude, details of which can be found in Ref. [10]. The results are compared with the 1D resonant particle analysis in Ref. [12]. It is shown that a

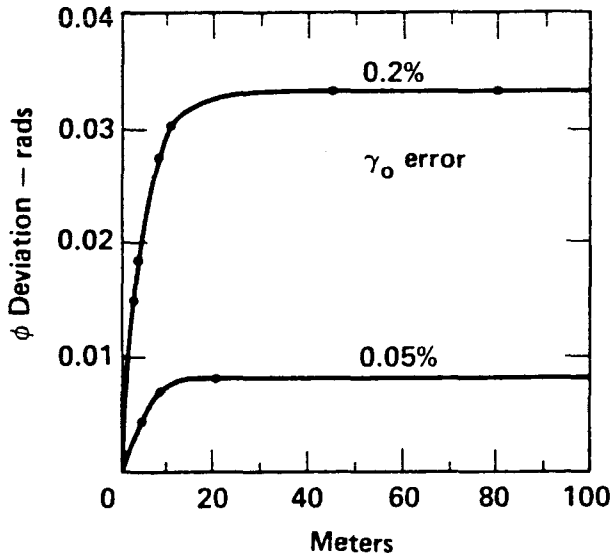

XBL 8610-3742

Figure 2. Corrected Fig. 4 of Ref. [8]. Phase error for an initial error in the particle beam energy.

the many-particle simulation, ψ_r was calculated to be 0.1662, and the resonant energy started at $\gamma = 42$ and was reduced to $\gamma = 38$ before reacceleration to $\gamma = 42$. The loss factor α in the electric field equation was chosen to be 0.2084 to achieve the power of 5 Gigawatts in the waveguide.

Corrected Table III of Ref. [8] Allowable Initial Non-equilibrium Errors (Percent) for 0.05 Radians Phase Deviation

Type of Error

$\Delta\gamma_0/\gamma_0$	- 0.3
$\Delta\psi_0/\psi_0$	+ 90
$\Delta a_{s0}/a_{s0}$	- 1.3

resonant particle analysis gives results consistent with a many-particle simulation. The many particle simulation uses discrete replenishment of the energy in the FEL beam, and averages over the particles to follow the evolution of the radiation-amplitude and phase. This procedure involves averaging over $\sin \psi/\gamma$ for the amplitude evolution and averaging over $\cos \psi/\gamma$ for the phase evolution. It is important to note that while $\langle \sin \psi/\gamma \rangle \approx \sin \psi_r/\gamma_r$ for reasonable bucket fillings, the $\cos \psi$ term in the phase evolution equation should be kept as an average. Only for very tight bunching does $\langle \cos \psi/\gamma \rangle \approx \cos \psi/\gamma_r$.

The parameters used in the simulation are the same as those of Ref. [8]. The notable exceptions are that in

Corrected Table IV of Ref. [8] Errors in the Quantities Listed, of 0.1% for 100 Meters, Resulted in the Given Values of $\Delta\phi$ and $\Delta a_s/a_s$

	$\Delta\phi(\text{rad})$	$\Delta a_s/a_s (\%)$
$\Delta\omega_p^2/\omega_p^2$	0.09	0.1 max
$\Delta a_w/a_w$	0.02	0.2 max
$\Delta\gamma_0/\gamma_0$	- 0.017	-
$\Delta a_{s0}/a_{s0}$	- 0.004	-
Estimate from Ref. [6]	0.14	2.1

Figures 3, 4 and 5 show the ϕ deviations for an ω_p^2 error of 0.2%, for cases with equal currents, but different bucket fillings. The areas of the bucket filled are respectively 33%, 67%, and 90%. Naively one would expect that the tighter the bunching (i.e. the smaller the bucket area filled), the greater the phase deviations would become. One observes, however, that the phase deviations seem to be a rather insensitive function of the bucket filling. Only when particles begin to be detrapped, as in the 90% filling case, does the phase deviation begin to vary. Thus for any distribution reasonably well centered in the bucket, a resonant particle analysis should give good results.

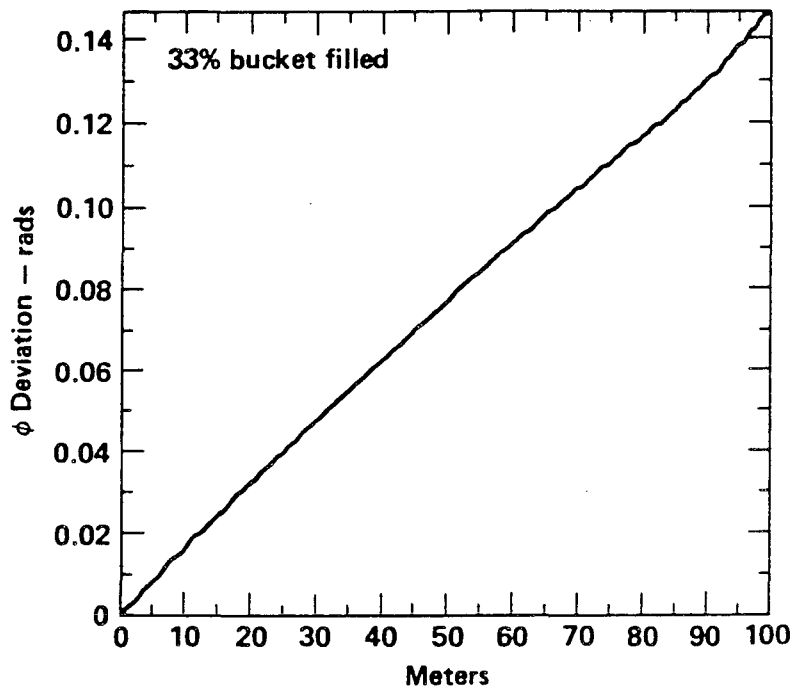

XBL 8610-3743

Figure 3. Phase error for 0.2% error in ω_p^2 with 33% of the bucket filled.

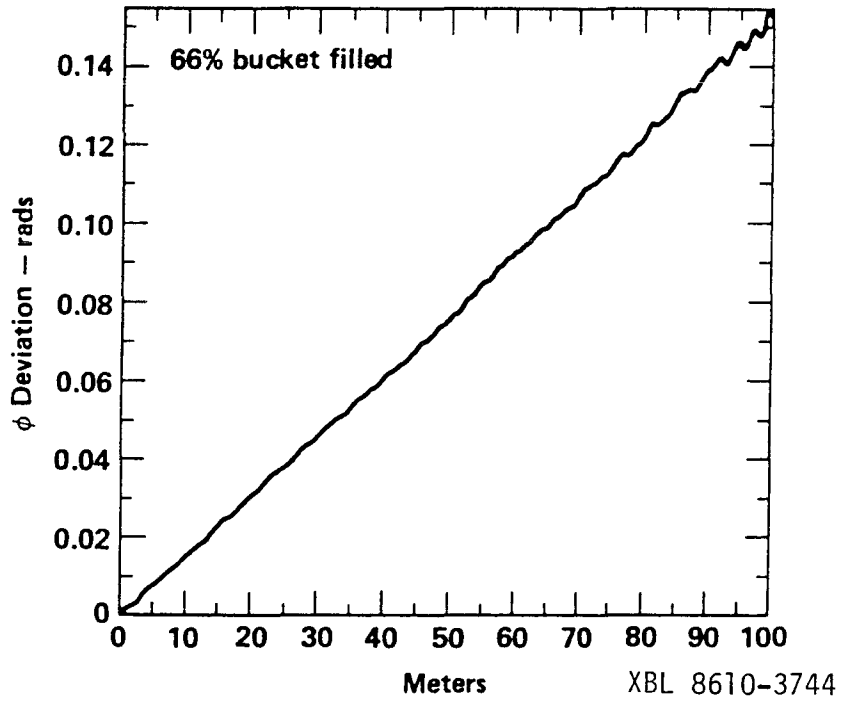

Figure 4. Phase error for 0.2% error in ω_p^2 with 67% of the bucket filled.

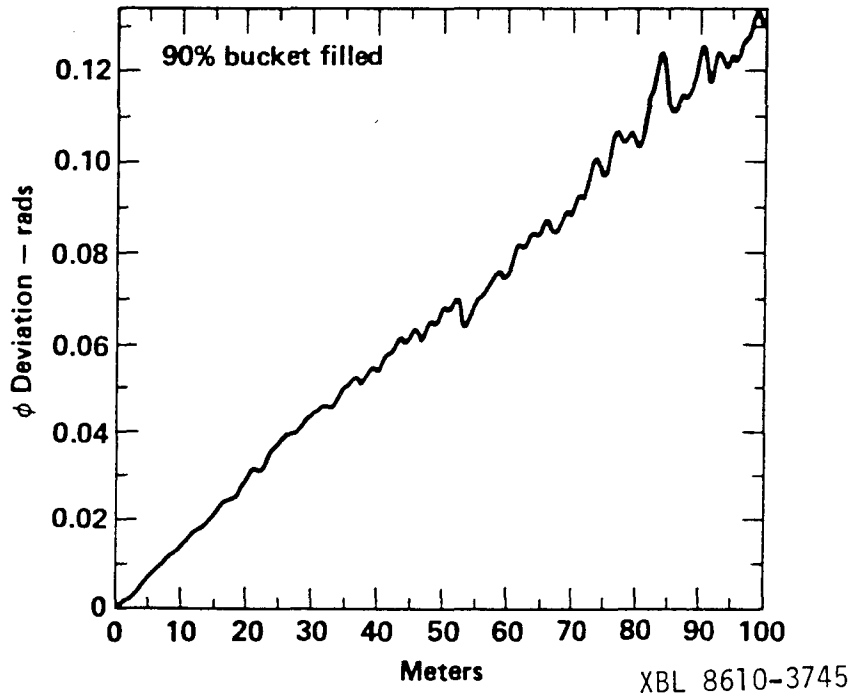

Figure 5. Phase error for 0.2% error in ω_p^2 with 90% of the bucket filled.

III. THE ELECTRIC FIELD EVOLUTION

The equation describing the electric field evolution is

$$\begin{aligned} \frac{da_s}{dz} &= \frac{\omega^2}{2\omega c} a_w \left\langle \frac{\sin \psi}{\gamma} \right\rangle - \alpha a_s, \\ &\approx \frac{\omega^2}{2\omega c} a_w \frac{\sin \psi_r}{\gamma_r} - \alpha a_s. \end{aligned} \quad (9)$$

The latter equation is a good approximation even for a many-particle distribution.

Since the TBA is run at a constant ψ_r , the factors in the first term that vary are just a_w and γ_r . The ratio a_w/γ_r is so nearly a constant that it can be considered not to vary at all. This is born out in the computer simulations and can also be understood from the resonance relation. This is

$$\gamma_r^2 = \frac{\omega}{2c(k_w - \delta k_s + \frac{d\phi}{dz})} (1 + a_w^2 - 2a_w a_s \cos \psi_r). \quad (10)$$

If $a_w^2 \gg 1$ and $a_w \gg a_s$ then

$$\frac{\gamma_r}{a_w} \approx \left[\frac{\omega}{2c(k_w - \delta k_s + \frac{d\phi}{dz})} \right]^{1/2}, \quad (11)$$

which is a constant in the TBA.

The implications of this are as follows. The a_s equation now has a definite fixed point. This is determined by

$$0 = \frac{\omega^2}{2c\omega} \frac{a_w}{\gamma_r} \sin \psi_r - \alpha a_{s0},$$

$$a_{s0} = \frac{\omega^2}{2c\omega} \frac{a_w}{\gamma_r} \frac{\sin \psi_r}{\alpha}. \quad (12)$$

If we substitute $a_s = a_{s0} + \delta a_s$, we get

$$\frac{d\delta a_s}{dz} = -\alpha \delta a_s,$$

with solution

$$\delta a_s = \delta a_{s0} e^{-\alpha z} \quad (13)$$

This implies that any change in a_s from its equilibrium value will return to its equilibrium exponentially. For the parameters used in

this report, $\alpha = 0.2084 \text{ m}^{-1}$. Thus in around 5 meters the variation from a_{s0} will die down by e^{-1} .

This is shown in Fig. 6 where an initial error in a_s of 10% is seen to decay to within e^{-1} of the equilibrium value in about 5 meters. There are synchrotron oscillations superimposed on the decay. Figure 7 shows that the ϕ deviation due to an initial a_s error comes within e^{-1} of its final value in about 5 meters.

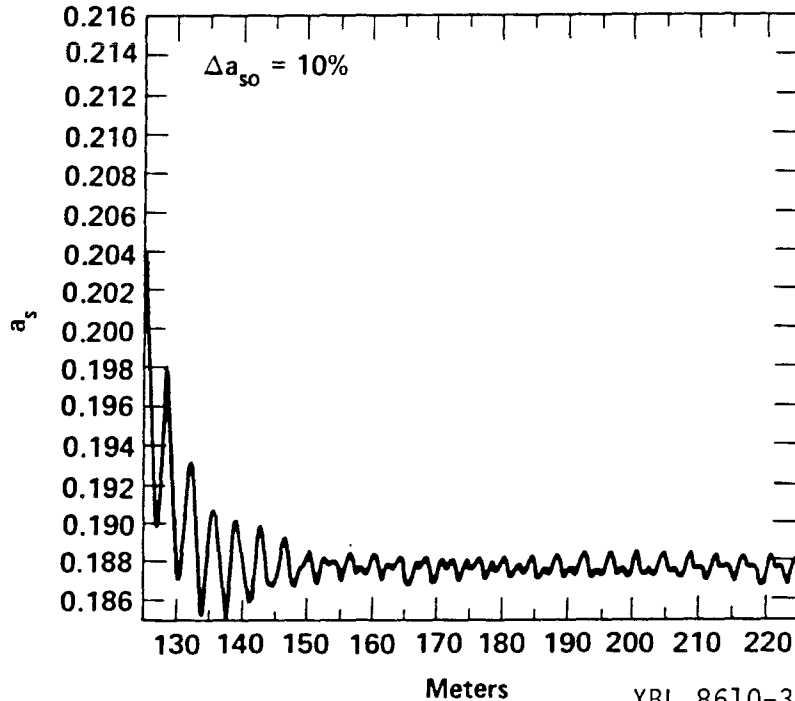

Figure 6. Decay of a_s .

XBL 8610-3746

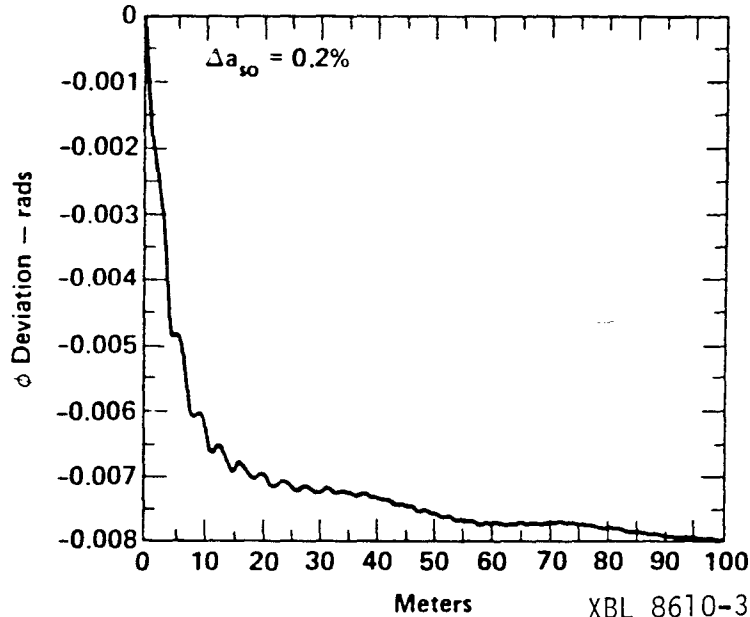

Figure 7. ϕ deviation due to an initial error in a_s of 0.2%.

XBL 8610-3747

IV. ALTERNATE FORMULA FOR PH1 DEVIATIONS

The second term in Eq. (1) represents the continuous energy replenishment to the beam, which is not done in the many particle simulation or in a real machine. So to compare with the many particle simulation and a real machine, we drop the second term in Eq. (1) and solve Eq. (1) for $\sin \psi$.

$$\sin \psi = - \frac{c}{\omega} \frac{d\gamma}{dz} \frac{\gamma}{a_w a_s} .$$

We then substitute for $\sin \psi$ in Eq. (12) to get

$$a_s = \frac{\omega_p}{\omega} \left[\frac{-d\gamma/dz}{2\alpha} \right]^{1/2} .$$

We then substitute for a_s and γ_r/a_w from Eq. (11) into Eq. (4) to get

$$\frac{d\phi}{dz} = \omega_p \langle \cos \psi \rangle \left[\frac{\alpha(k_w - \delta k_s + \frac{d\phi}{dz})}{c \omega (-d\gamma/dz)} \right]^{1/2} .$$

The $\cos \psi$ term is given as an average since in the many particle simulations we write $\langle \cos \psi / \gamma \rangle \approx \langle \cos \psi \rangle / \gamma_r$. This equation can be solved for $dz/d\phi$ or we can note that $dz/d\phi \ll k_w - \delta k_s$ in general and we can therefore drop the $dz/d\phi$ term on the right side. We then find that the ϕ deviation is only a function of ω_p and $\alpha^{1/2}$.

For the parameters used and for $\Delta\omega_p^2 = 0.2\%$, and $d\phi/dz = 0.00127\text{m}^{-1}$, we get a ϕ deviation of 0.127 radian for 100 meters. This is in good agreement with Fig. 3, which shows a value of 0.147.

V. FEEDBACK CONTROL BY USING THE FIELD AMPLITUDE

As mentioned in the previous paper [8], regular feedback using error detection, amplification, and application of a correcting signal at the same location is not workable. Amplifier delay will be on the order of 15 to 20 ns. This means that the error detected from the head of the rf pulse cannot cause a correcting signal until 5 to 6 meters of the rf has passed.

We have devised a correction scheme which is automatic and essentially instantaneous, modified from the one given in [8]. A method which appears workable is to change the amplitude of a_s as a function of $\Delta\phi$, by the addition of a phase stable reference rf to the FEL rf, at a number of correction stations spaced along the FEL. The addition would be by directional couplers, as shown on Fig. 8. The reference rf is added at 90° phase difference with respect to the FEL rf, as shown on Fig. 9a. As the FEL rf changes phase by $\Delta\phi$, the reference rf then has a component in phase with the FEL rf which changes the amplitude of a_s as a function of $\Delta\phi$, as shown in Fig. 9b.

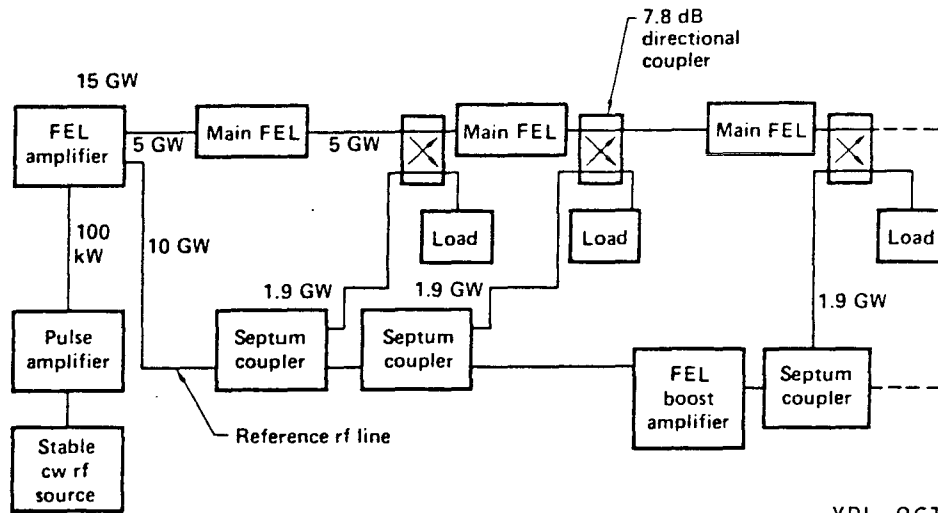

Figure 8. Phase correction scheme.

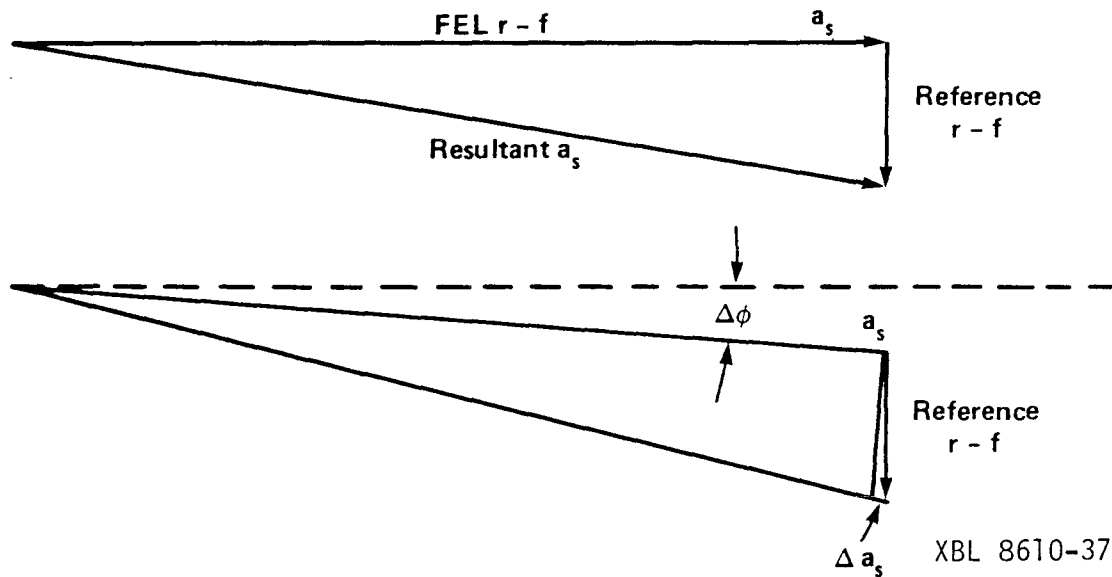

Figure 9. Phasor diagram of the addition of the FEL rf and the reference rf to get a change in a_s .

Directional couplers couple both directions, so power will also be coupled out of the FEL into the reference rf line. There will be a small change in amplitude and phase of the FEL rf as a result of the coupling, which can be corrected by adjusting the FEL waveguide parameters slightly.

The power extracted from the FEL by the directional coupler will go into the reference rf feed line. Directional coupler

characteristics are such that if the coupled reference rf feeds into the FEL in the forward direction, the coupled FEL power feeds into the reference rf line also in the forward direction. In order not to contaminate the necessarily highly phase stable reference rf, blocks of rf will be split off by septum couplers and terminated at the correcting station.

For a $\Delta\phi = 0.05$ radian, $\frac{\Delta a_s}{a_{s0}} = -0.0125$ is needed to get full

correction. The added reference rf power, $\sim C^2$, is given by

$$\frac{\Delta a_s}{a_{s0}} = \frac{C \sin \Delta\phi}{a_{s0}}$$

$$\frac{C}{a_{s0}} = \frac{\Delta a_s}{a_{s0} \sin \Delta\phi} = \frac{0.0125}{\sin 0.05} = 0.25 .$$

The power ratio of the reference rf to FEL rf is then $(0.25)^2 = 0.0625$. The reference rf = $0.0625 \times 5 \text{ GW} = 312 \text{ MW}$. This is the amount coupled into the FEL. With a 7.8 db directional coupler, 1.9 GW is required in the reference rf line.

The reference rf has to be phase stable to a few degrees over 2 km, which implies a frequency stability of 10^{-8} . In order to measure the frequency this accurately, from a practical standpoint, the clock reference has to be cw.

The reference rf power is too high to be cw, so a pulsed FEL amplifier is used to go from a reasonable cw level (say 100 kW from a gyrotron amplifier) up to 15 GW. 5 GW will be used to drive the main FEL, and 10 GW will flow in the reference rf line. This FEL amplifier has to be phase stable to a few degrees during the pulse, but pulse-to-pulse phase stability is not important, since its output feeds both the main FEL and the reference rf.

The reference rf will flow in a waveguide parallel to the FEL, with 1.9 GW extracted at each correction station with a septum coupler. 1.9 GW would be extracted at each of four correcting stations. Then an FEL amplifier would be required to raise the power to 10 GW again. For the small 7 db gain required, these amplifiers should have adequate phase stability.

Temperature control will be needed on the reference waveguide and the FEL waveguide to keep phase change due to length change within allowable limits.

VI. FEED FORWARD SYSTEM

The rf in the FEL travels at less than the speed of light. If the wave-guide is two wavelengths wide, the group velocity is $0.968c$. A signal can travel in a rigid coaxial line (that is built with a minimum of dielectric) at $0.998c$. So a phase error could be detected at one location, amplified with some time delay, and the

correcting signal fed into the FEL downstream at the same time as the section of the rf arrives which had the original detected phase error.

The difference in transit time for a distance, d , of the rf and the correcting signal in the coax is

$$\Delta t = \frac{d}{v_{rf}} - \frac{d}{v_{sig}}$$

$$d = \frac{\Delta t}{1/v_{rf} - 1/v_{sig}}$$

With an amplifier delay of 20 nanoseconds

$$d = \frac{20 \times 10^{-9} \text{ sec} \times 3 \times 10^8 \text{ m/sec}}{1/0.968 - 1/0.998}$$

$$\approx 200\text{m}$$

Thus the phase correction can be applied 200m downstream from the detection location. The phase error accumulated in the first 200m can be detected at 200m and corrected at 400m. Thus one gets 400m of error accumulation before a correction can be made. In the worst case, the phase error would be all in the same direction. At 400m, the phase error would again be detected. It would contain two components of error, that from 0m to 200m, and that from 200m to 400m. It is then necessary to remove the detected error components from 0m to 200m, since it will be corrected at 400m, by subtracting a portion of the correcting signal from the detected error at 400m. The remaining detected error would represent the error accumulated from 200m to 400m and would be amplified and the correcting signal fed in at 600m. If the delay were only 10 ns, these distances could be halved.

These considerations apply no matter what the method of error correction. One method of error correction would be to give the FEL beam a variable additional energy of the proper amount. About 200 kV additional energy would be required to correct the error due to $\Delta\omega_p = 0.1\%$ for 200m.

This is an open loop system where the error correction is a factor times the error detected.

VII. ALTERNATE METHOD OF ERROR CORRECTION

Non-linear materials like ferrites or barium titanate have been used as phase shifters. There is a possibility that a material which has a dielectric constant or permeability that varies with field amplitude could be used to correct phase deviation errors. It would be put in the FEL waveguide, and variations in a_s would result in variations in guide wavelength, or phase shift.

The variations in a_s , as a function of the phase deviation, would be obtained exactly as described above under section IV. The full complexity of the system would be retained, reference rf line, septum couplers, directional couplers, etc. The hope is that lower reference power would be required. No detailed calculations have been made since we have not identified a suitable material yet.

These non-linear materials could also be controlled by an applied bias amplifier as the error correction method of the feed forward system of Section V.

REFERENCES

1. A. M. Sessler, "The Free Electron Laser as a Power Source for a High-Gradient Accelerating Structure," in Laser Acceleration of Particles, AIP Conf. Proc. No. 91, New York (1982); A. M. Sessler, IEEE Trans. on Nucl. Sci. NS-30, No. 4, 3145 (1983); A. M. Sessler, Proc. of the 12th Int. Conf. on High Energy Accelerators, Fermilab, p. 445 (1983).
2. D. B. Hopkins, A. M. Sessler and J. S. Wurtele, "The Two-Beam Accelerator," LBL-17800, Nuc. Inst. & Meth. for Phys. Res., 228, 15-19 (1984).
3. J. S. Wurtele, "On Acceleration by the Transfer of Energy Between Two Beams," in Laser Acceleration of Particles, C. Joshi and T. Katsouleas ed. (AIP Conf. Proc. No. 130, American Institute of Physics, New York, 1985), p. 305-323.
4. D. B. Hopkins and R. W. Kuenning, "The Two-Beam Accelerator: Structure Studies and 35 GHz Experiments," IEEE Trans. Nuc. Sci., NS-32, 3476-3480, October (1985).
5. High-power 35 GHz testing of a Free-Electron Laser and Two-Beam Accelerator structures. Presented at the 1986 Quebec International Symposium on Optical and Optoelectronic Applied Sciences and Engineering, June 2-6, 1986, Quebec City, Canada.
6. R. W. Kuenning, "TBA Phase Considerations," Lawrence Berkeley Laboratory Internal Report, TBA Note 12 (1984) (unpublished).
7. R. W. Kuenning, A. M. Sessler and J. S. Wurtele, "Phase and Amplitude Considerations for the Two-Beam Accelerator," in Laser Acceleration of Particles II, AIP Conf. Proc. (to be published), New York (1985).
8. R. W. Kuenning and A. M. Sessler, "Phase and Amplitude Control of the Radio Frequency Wave in the Two-Beam Accelerator," submitted to Nuc. Inst. and Meth. in Phys. Res., LBL-20235, July (1985).
9. R. W. Kuenning and A. M. Sessler, "Phase and Amplitude Studies of an FEL: Steady State, 1D, Resonant Particle Analysis," Lawrence Berkeley Laboratory Internal Report, TBA Note 18 (1985) (unpublished).
10. E. J. Sternbach and A. M. Sessler, "A Steady-State FEL: Particle Dynamics in the FEL Portion of a Two-Beam Accelerator," Proc. of 7th Int. Free-Electron Laser Conf., Tahoe City, CA, LBL-19939, September (1985).

11. N. M. Kroll, P. L. Morton and M. W. Rosenbluth, IEEE Journal of Quantum Electronics, QE-17, 1436 (1981).
12. E. J. Sternbach, "Phase Stability in a TBA: Many-Particle Simulation," Lawrence Berkeley Laboratory Internal Report, TBA Note 32 (1986) (unpublished).