

UC Berkeley

HVAC Systems

Title

Underfloor vs. overhead: a comparative analysis of air distribution systems using the EnergyPlus simulation software

Permalink

<https://escholarship.org/uc/item/6x3731q2>

Author

Daly, A.

Publication Date

2006-08-01

Peer reviewed

Underfloor vs. Overhead:
A Comparative Analysis of Air Distribution Systems using the
EnergyPlus Simulation Software

by

Allan Wesley Daly

M.S. (University of California, Berkeley) 1998
B.S. (Stanford University) 1993
A.B. (Stanford University) 1993

A thesis submitted in partial satisfaction of the
requirements for the degree of

Master of Science

in

Architecture

in the

Graduate Division

of the

University of California, Berkeley

Committee in charge:

Professor Gail S. Brager, Chair
Professor Edward Arens
Professor Iris D. Tommelein

Fall 2006

The thesis of Allan Wesley Daly is approved:

Chair	_____	Date:	_____
	_____	Date:	_____
	_____	Date:	_____

University of California, Berkeley

Fall 2006

Contents

1. Executive Summary.....	1
2. Introduction and Background.....	2
2.1 Underfloor Air Distribution.....	2
2.1.1 UFAD System Operation.....	3
2.1.2 UFAD System Components	7
2.1.3 Thermal Comfort in Uniform and Stratified Environments	10
2.1.4 Energy Implications of UFAD Systems	12
2.2 EnergyPlus.....	12
2.2.1 EnergyPlus Simulation Advantages	15
2.2.2 EnergyPlus Simulation Limitations.....	17
2.3 UFAD Energy Model Development.....	18
2.3.1 Theoretical Room Air Stratification Modeling	20
2.3.2 Bench Scale RAS Validation.....	22
2.3.3 Full Scale RAS Validation	24
2.3.4 R.Plenum Model Development and Validation.....	29
2.4 Statement of Research Need.....	31
2.5 Research Objective.....	32
2.6 Research Significance	32
3. Methods	33
3.1 Development of the EnergyPlus Model of the UFAD Lab Chamber	34
3.1.1 UFAD Model Development and Calibration.....	34
3.1.2 RoomAir Model Options	37
3.2 EnergyPlus Interface Development.....	38
3.2.1 EnergyPlus Input File Structure, Macros, and Parameters.....	39
3.2.2 Output capture	42
3.2.3 Visualization.....	44
3.2.4 Energy Balance.....	45
3.2.5 Multiple Runs	47
3.3 Comparison Between Overhead Mixing and UFAD System Performance	49
3.3.1 OH Model Development	50
3.3.2 Parametric Runs.....	53
3.3.3 Equivalent Comfort Comparisons	56
4. Results	57
4.1 Single Run Results	58
4.1.1 Results Presentation Format	58
4.1.2 INT 6_8 Validation Run Results	70
4.1.3 Typical Simulated Overhead Mixing Case.....	72
4.1.4 Typical Simulated UFAD Case.....	75
4.2 Multiple Run Results.....	79
4.2.1 Run Input data and Output Results Summary	79
4.2.2 Occupied Zone Temperature Results	83
4.2.3 Occupied Zone Temperature Gradient Results	85
4.2.4 OH and UFAD Results Comparison	88

5. Discussion.....	94
5.1 UFAD vs. OH System Design Comparison	94
5.1.1 Airflow Comparison.....	95
5.1.2 Supply Air Temperature (SAT) Comparison	98
5.2 Implications of Thermal Comfort Guidance on UFAD System Design	99
5.3 Comparison with UFAD Design Guidance to Date	101
5.4 Comparison with UFAD Performance in Real Buildings	103
5.5 Implications for UFAD System Energy Performance.....	103
5.6 Model Applicability	105
5.6.1 Larger Interior Zones.....	105
5.6.2 Interior versus Perimeter Zones.....	107
5.6.3 Stacked and Series Zones	108
6. Conclusion.....	108
6.1 Understanding of UFAD System Performance	108
6.2 Energy Implications	109
6.3 Further Work	109
7. Acknowledgements	112
8. References	112
9. Appendices	115
9.1 Appendix A: EnergyPlus IMF Files.....	116

List of Tables

Table 2-1 UFAD Diffuser Comparison Data	9
Table 4-1 Summary of OH and UFAD Simulation Cases	57
Table 4-2 Simulation Results Summary Table Parameters and Descriptions	58
Table 4-3 UFAD Simulation Run Results (1 of 2).....	80
Table 4-4 UFAD Simulation Run Results (2 of 2).....	81
Table 4-5 OH Simulation Run Results.....	82
Table 4-6 UFAD Simulation Run Summary, Occupied Zone Temperature (Toz) Results	83
Table 4-7 UFAD Simulation Run Summary, TozGradient Results, “High” Results...	86
Table 4-8 UFAD Simulation Run Summary, TozGradient Results, “Low” Results ...	87
Table 4-9 Interpolated OH Simulation Results for Toz = 72°F and 75°F.....	89
Table 4-10 Interpolated UFAD Simulation Results for Toz = 72°F	89
Table 4-11 Interpolated UFAD Simulation Results for Toz = 75°F	89
Table 4-12 OH vs UFAD Design Comparison for Equivalent Comfort Conditions ...	92
Table 5-1 Revised OH vs UFAD Design Comparison for TozGradient = 7°F.....	100

List of Equations

Equation 4-1 Cooling Distribution Calculations	67
Equation 5-1 Fan Energy Equation	104

List of Figures

Figure 2-1 Overhead Mixing System Schematic.....	4
Figure 2-2 Displacement Ventilation System Schematic.....	4
Figure 2-3 Underfloor Air Distribution System Schematic	6
Figure 2-4 Typical Raised Floor Construction.....	7
Figure 2-5 Swirl Diffusers.....	8
Figure 2-6 Variable Area Diffuser	8
Figure 2-7 Acceptable Stratification based on a 16-Part Human Thermal Comfort Model.....	12
Figure 2-8 EnergyPlus Information Flow Diagram.....	14
Figure 2-9 EnergyPlus Internal Calculation Modules	15
Figure 2-10 EnergyPlus Implementation of an OH Mixing System	17
Figure 2-11 Overview of EnergyPlus UFAD Module Development Effort	19
Figure 2-12 EnergyPlus Implementation of a UFAD System.....	20
Figure 2-13 Excerpt Diagram from UCSD Theoretical work (Qing 2006)	21
Figure 2-14 Salt-Tank Testing showing Simulated Heat Sources at Different Heights	23
Figure 2-15 Comparison of Theoretical and Experimental Results from Salt-Tank Studies	24
Figure 2-16 UFAD Lab Plan View showing Layout and Equipment	25
Figure 2-17 UFAD Lab Floor Construction.....	26
Figure 2-18 Image of the Interior Layout of the UFAD Lab	26
Figure 2-19 Example of Time-Series Data Collected in the UFAD Lab	28
Figure 2-20 Computational Fluid Dynamics Validation of Plenum Model.....	30
Figure 2-21 Experimental Test Equipment for Plenum Model Validation	30
Figure 3-1 Diagram of the EnergyPlus IDF Definition of the UFAD Lab	35

Figure 3-2 Perspective view of Surface Geometry in the EnergyPlus UFAD Lab Model.....	36
Figure 3-3 Schematic of UFAD Lab EnergyPlus System Definition.....	37
Figure 3-4 Energy Simulation Information Flow and Role of EnergyPlus Excel Interface.....	39
Figure 3-5 Interface Excerpt showing Parameter Definitions.....	41
Figure 3-6 Interface Excerpt showing Parameter Value User Inputs.....	41
Figure 3-7 EnergyPlus Simulation Output in Tabular Format in the Interface.....	44
Figure 3-8 Example of Results Visualization generated in the EnergyPlus Interface.....	45
Figure 3-9 Energy Balance Summary Calculations performed by the Interface Program.....	46
Figure 3-10 Conduction Energy Flows Graph from the Interface Program.....	47
Figure 3-11 Run Control Interface Directory and File Inputs.....	48
Figure 3-12 Run Control Interface Input Variable Example.....	48
Figure 3-13 Run Control Interface - Output Variable Definition.....	49
Figure 3-14 Multiple Run Output Data Excerpt.....	49
Figure 3-15 Excerpt from the EnergyPlus Interface showing the Airflow Direction Options.....	51
Figure 3-16 Excerpt from the EnergyPlus Interface showing the Airflow Type Options.....	51
Figure 3-17 Schematic of UFAD Lab EnergyPlus System Definition Modified for the OH case.....	53
Figure 4-1 INT 6_8 Validation Run Results – Summary Table and Temperature Graph.....	63
Figure 4-2 INT 6_8 Validation Run Results – Cooling Distribution and Energy Flows.....	68
Figure 4-3 Comparison of Measured Results with Two Different Approaches to Interpreting EnergyPlus Simulation Results.....	69
Figure 4-4 Run INT 6_8 Calculated Conduction Energy Flows.....	72
Figure 4-5 OH-58-400 Simulation Run Results – Summary Table and Temperature Graph.....	73
Figure 4-6 OH-58-400 Simulation Run Results – Cooling Distribution and Energy Flows.....	75
Figure 4-7 UF-58-7-400 Simulation Run Results – Summary Table and Temperature Graph.....	76

Figure 4-8 UF-58-7-400 Simulation Run Results – Cooling Distribution and Energy Flows	78
Figure 4-9 UFAD Simulation Run Summary, Airflow vs Occupied Zone Temperature (Toz)	84
Figure 4-10 UFAD Simulation Run Summary, Airflow vs Occupied Zone Temperature Gradient (TozGradient), “High Results”	86
Figure 4-11 UFAD Simulation Run Summary, Airflow vs Occupied Zone Temperature Gradient (TozGradient), “Low Results”	88
Figure 4-12 Simulation Run Summary, OH and UFAD runs, Supply Air Temperature vs. Airflow	91

1. Executive Summary

Underfloor air distribution (UFAD) is an air-conditioning method that fundamentally differs from the conventional overhead mixing approach found in most commercial buildings. UFAD systems create stratified thermal environments where mixing systems create spaces that have uniform temperatures. UFAD proponents assert that there are many benefits of UFAD over conventional systems, but because the fundamental performance characteristics of UFAD systems have not been well understood, it has been difficult to validate these claims.

A research project performed by the Center for the Built Environment and a team of researchers from the University of California, San Diego, Lawrence Berkeley National Laboratories, York International Corporation, and others has undertaken the task to perform fundamental modeling of UFAD systems, validate the models with real-world testing, and create a UFAD energy simulation module for the EnergyPlus software. As a part of this larger context, this thesis project developed and implemented a research and analytical tool to make possible the testing and validation of the UFAD energy simulation module. The tool consists of a flexible user interface to EnergyPlus that manages data input and output and creates summary calculations and graphics.

With the UFAD energy simulation module running and validated, the EnergyPlus interface was used to perform multiple parametric runs in an effort to compare conventional overhead systems with UFAD systems. Results and analysis show that indeed there are significant differences between OH and UFAD system

performance characteristics. Some of the results suggest that the asserted energy benefits of UFAD systems may be overstated due to the high amount of heat transfer into the supply plenum that is revealed by these runs.

2. Introduction and Background

2.1 Underfloor Air Distribution

Underfloor air distribution (UFAD) is an approach to air-conditioning offices and other commercial buildings where air is delivered from the “bottom up” rather than the “top down” as in conventional heating, ventilating, and air-condition (HVAC) systems. This system employs a supply-air plenum between the structural floor and a second raised floor to deliver conditioned air to the occupied zone of the building through diffusers located in the raised floor.

UFAD systems have been installed in buildings in Europe over the last 20 to 30 years, and in the last 10 year they have grown in popularity in the United States (CBE n.d.). The reason for their increased usage has largely to do with a number of asserted benefits over conventional overhead HVAC systems. These potential benefits include improved thermal comfort, improved indoor air quality, and reduced energy use as well as increased system flexibility and reduced cost of churn (York 2006, 5-6; Trox n.d., 6; CBE n.d.; Bauman 2003, 11).

2.1.1 UFAD System Operation

A common approach to describing the operation of UFAD systems is to compare them to conventional overhead mixing systems and “true” displacement ventilation systems, which are described in the following sections.

Figure 2-1 shows a simple system schematic for an HVAC zone that is part of an overhead (OH) mixing system (Bauman 2003, 23). The system in this approach supplies conditioned air through ducts at the ceiling and typically takes return air back through a plenum above the ceiling. The diffusers, or air outlets, connected to the supply duct system are designed to throw the air around the room in such a manner to induce full mixing of the air in the occupied space. For this reason, these systems are called “mixing” systems.

The desired result of mixing systems is the complete mixing of supply air with room air, thereby creating a uniform thermal environment across the entire space. The temperature of the uniform environment is controlled with HVAC equipment to a desired setpoint. Typical operating temperatures for overhead mixing systems include supply air temperatures in the range of 55°F to 57°F and thermostat setpoints in the range of 72°F to 78°F.

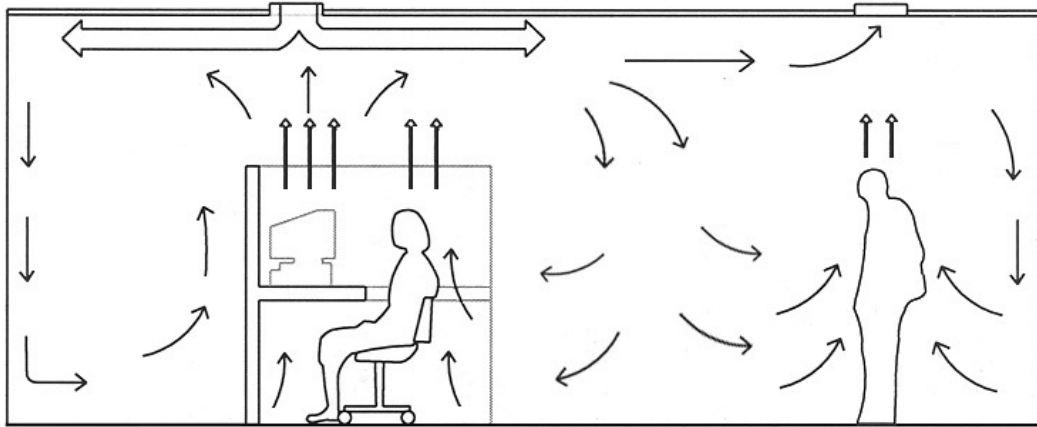

Figure 2-1 Overhead Mixing System Schematic

“True” displacement systems are an alternative approach to providing space conditioning systems in HVAC zones that operate on a completely different principle than overhead mixing systems. Figure 2-2 shows a simple system schematic for a displacement system (Bauman 2003, 26).

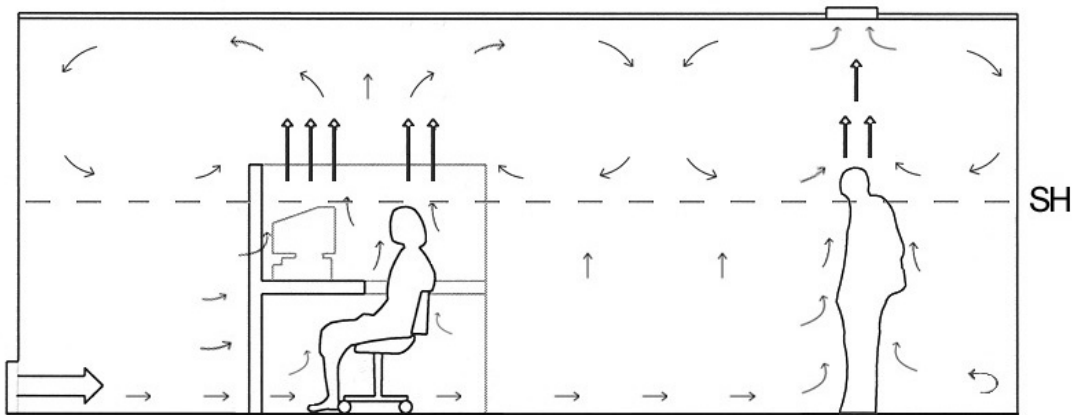

Figure 2-2 Displacement Ventilation System Schematic

In a displacement ventilation (DV) system, supply air is provided at relatively warm temperatures at very low velocities close to the floor. Typical supply air temperatures are in the range of 65°F to 70°F and supply diffuser discharge velocities are in the range of 50 feet/minute. The principles behind air-conditioning in this manner involve the air pooling across the floor and then rising along with heat plumes

throughout the space. The diagram uses arrows to depict airflow and shows air rising near the people and computers.

The temperature profile that develops in DV systems is stratified in that the air at the top of the room is warmer than the air at the bottom of the room. Displacement ventilation systems create a non-uniform thermal environment. Up to a level called the “stratification height” (labeled SH in the diagram), the temperatures increase with increasing height. Above the stratification height, the zone is relatively well mixed (as indicated by the circular arrow pattern in the diagram) and a more uniform temperature profile is created (Skistad 2002).

Because of the low air delivery velocities in DV systems, the total quantity of air that can be delivered to an HVAC zone is typically limited by physical constraints. At the same time, the relatively warm air that is needed to avoid cold ankles is not able to provide much cooling. The warm air coupled with the low airflow volumes means that displacement ventilation systems have a limited cooling capacity that is typically below what is required in modern commercial buildings. As such, displacement ventilation systems are not in wide use in commercial spaces today. They are often used in auditoriums or libraries, where the internal loads tend to be lower than office spaces.

UFAD systems are a hybrid between OH and DV systems. They exhibit some properties of each; the air is supplied from the floor, similar to a DV system, but rather than coming into the room low on the side wall, a UFAD system uses diffusers placed in the raised floor above the supply plenum. Further, the diffusers used in UFAD systems are mixing diffusers similar to OH systems. Figure 2-3 shows a UFAD system

schematic and the swirling arrows at the floor indicate rapid mixing, or high induction, that is the goal as the air leaves the supply diffusers.

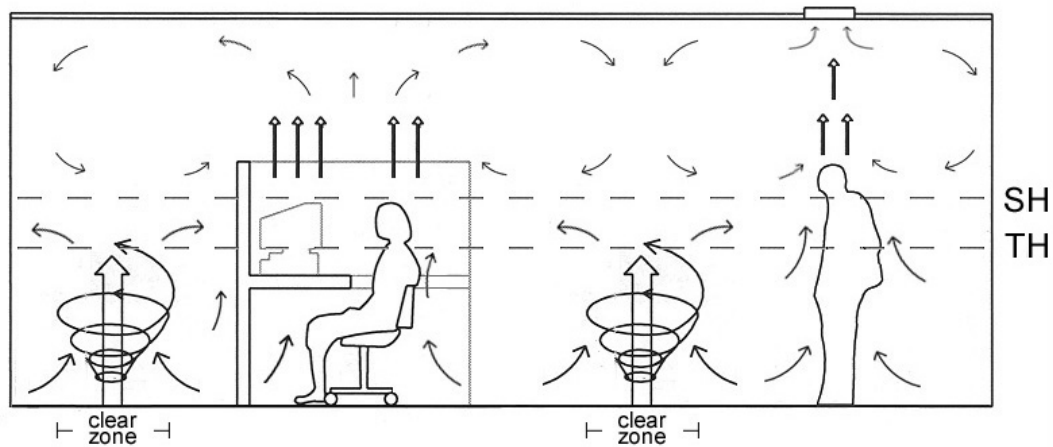

Figure 2-3 Underfloor Air Distribution System Schematic

The rapid mixing of supply air and room air allows for supply air temperatures to be much cooler than in DV systems since the mixing rapidly tempers the air entering the room. At the same time, the mixing zone is relatively compact and most of the momentum of the supply air is spent quickly, so that large scale mixing in the room does not develop. Away from the local effects of the supply diffusers, an overall stratified temperature profile develops similar to a DV system. The UFAD diagram (Figure 2-3) indicates the SH stratification height level just as in the DV diagram. The TH level indicated here refers to the throw height of the diffusers.

Typical supply air temperatures of air leaving the supply diffusers in UFAD systems are in the range of 60°F to 65°F, midway between those found in OH and DV systems. Typical return air temperatures are in the range of 75°F to 80°F, higher than OH systems due to stratification.

UFAD system performance can be seen as a balance between the effects of warm air buoyancy creating a stratified environment and the mixing momentum

effects of airflow forced through mixing or jet diffusers (Qing 2006). UFAD systems are typically implemented as a type of variable air volume (VAV) system, where the airflow changes to meet the thermal load in a zone. As the airflow quantity changes, the amount of mixing and stratification will vary with the airflow delivered to the space. This interplay of buoyancy/stratification forces against momentum/mixing forces determines the resulting vertical temperature profile in a space.

2.1.2 UFAD System Components

The key UFAD system components that are unique to this system type are the raised floor and the floor diffusers. Figure 2-4 a shows typical raised floor construction where 24 inch-square concrete or steel tiles are supported on each corner by steel pedestals. Typical heights for raised floors are in the range of 12 to 24 inches from top of the structural floor to top of the raised floor. Many times the raised floor is made accessible so that data and other building services can be run in the supply plenum, although this is not always the case.



Figure 2-4 Typical Raised Floor Construction

The diffusers are the other unique element of UFAD systems. There are basically two major types of UFAD diffusers: swirl and variable area. Figure 2-5 shows typical swirl diffusers and Figure 2-6 shows a typical variable area diffuser.

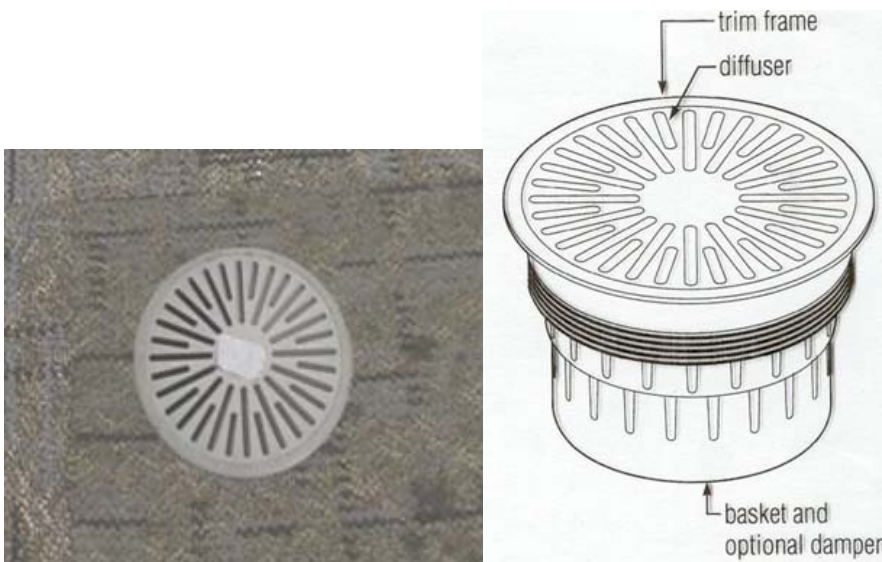

Figure 2-5 Swirl Diffusers



Figure 2-6 Variable Area Diffuser

Swirl diffusers are passive HVAC elements that have no moving parts. The blades of the diffuser are arranged in a radial pattern and are designed with an outward throw angle. The concept behind the swirl is a high induction characteristic that mixes

cold supply air quickly with room air. The design airflow quantity for a swirl diffuser is usually around 85 cfm per diffuser at roughly 0.5” pressure drop. Air discharged through the diffuser generally reaches a velocity of 50 feet per minute somewhere in the range of 4 to 5 feet above the diffuser. This distance is considered the characteristic “throw” for a swirl diffuser.

Variable area (VA) diffusers, though used in the same role in UFAD systems, are quite different from swirl diffusers. VA diffusers have a plate that slides back and forth powered by an actuator to change the amount of diffuser plate area that is exposed to the pressurized supply plenum. When more area is exposed, more air comes out of the diffuser, and when less area is exposed, less air comes out. The position of the plate varies based on a signal from a controller or thermostat in the space it serves. The nominal airflow for a VA diffuser is roughly 150 cfm at 0.05” pressure drop, or double the flow rate of a swirl diffuser. Table 2-1 provides comparison data between swirl and VA diffusers.

Table 2-1 UFAD Diffuser Comparison Data

Model	Discharge Setting	Airflow [ft ³ /min]	Vertical Throw to 50 fpm [ft]	Clear Zone Radius [ft]
Swirl	Vertical	100	4 - 6	1.5
	Vertical	75	2.5 - 4.5	1.5
Variable Area	Vertical	150	8	2.0
	Full Spread	110	5	4.5

Both VA diffusers and swirl diffusers can be used in VAV applications of UFAD systems. With a VA diffuser, because the exposed area of diffuser plate varies proportionally to the airflow demand, the discharge velocity of the air leaving the

diffuser stays relatively constant as the diffuser turns down. The momentum, mixing vs. buoyancy, and stratification characteristic of a VA diffuser does not change nearly as much as a swirl diffuser as described above.

At the current time within the HVAC design profession, there is active debate over the merits of using swirl or VA diffusers. The two diffuser types clearly result in different space temperature profiles and neither approach has gained a clear consensus with either building owners or designers. Manufacturers of these products assert that they are equivalent and often one type is used on a project in place of the other. Generally the differences between the diffuser performance characteristics are ignored by the HVAC design industry at this time.

2.1.3 Thermal Comfort in Uniform and Stratified Environments

Conventional overhead mixing systems in buildings aim to create uniform thermal environments in each building HVAC zone. These systems have been the standard in commercial buildings for more than 30 years, and industry comfort standards have evolved in this context.

Current comfort standards, ASHRAE Standard 55-2004 (ASHRAE 2004) and ISO Standard 7730 (ISO 1994), specify a “comfort zone” that represents a combination of thermal factors (air temperature, radiant temperature, air velocity, humidity) and personal factors (clothing and activity level) that satisfies at least 80% of the building occupants. These standards are based on laboratory studies in which subjects were asked to evaluate their comfort in steady-state environments over which they had little or no control.

These standards set a limit for the amount of temperature difference an occupant can experience between his neck and ankles. This limit is defined in section 5.2.4.3 of the ASHRAE 55-2004 standard as the difference between the temperature at 67 inches above the floor (neck height) and 4 inches above the floor (ankle height), and the limit is set at 5.4°F (ASHRAE 2004).

The ASHRAE Standard 55 limit on occupied zone temperature stratification is based on a human comfort research in environments with uniform temperatures. There is new comfort research that takes a more sophisticated look at human thermal comfort in asymmetrical conditions. This new approach uses a 16 part model of the human body and is based on human subject research in asymmetrical conditions (Zhang et al. 2005). It shows that there are many conditions where an occupied zone temperature gradient above 5°F will create comfortable thermal conditions. Primarily these conditions occur when the overall thermal sensation is neutral, or the body is in a stable balance with the environment. When the overall thermal sensation moves away from neutral, less stratification is deemed acceptable and when the overall sensation is neutral, more stratification can be tolerated and considered acceptable. Figure 2-7 shows this relationship (Zhang et al. 2005).

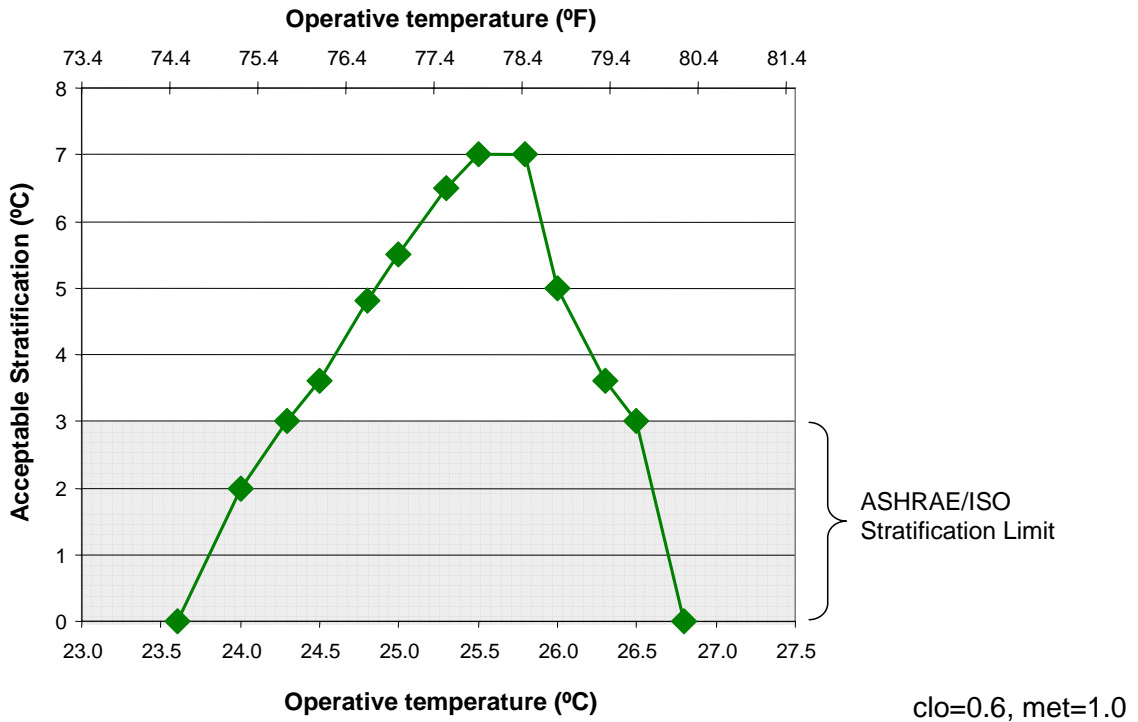

Figure 2-7 Acceptable Stratification based on a 16-Part Human Thermal Comfort Model

2.1.4 Energy Implications of UFAD Systems

The potential for reduced energy consumption of UFAD systems is one often cited benefit (Bauman 2003, 12) when comparing UFAD to OH systems. These energy benefits generally include extended economizer operation (both 100 percent free cooling and partial free cooling), increased chiller efficiency and decreased chiller work, and fan energy savings due to reduced air quantities and reduced fan static pressure requirements.

2.2 EnergyPlus

EnergyPlus is an energy analysis and thermal load simulation program. Based on a user’s description of a building’s climate, construction, systems, and internal loads, EnergyPlus will calculate the heating and cooling energy flows through the

building. EnergyPlus is considered a second generation energy simulation program since it builds on many of the best features from its predecessors, BLAST and DOE-2 (DOE 2004).

Key features of EnergyPlus relevant to this analysis are the following:

- Integrated, simultaneous solution where the building response and the primary and secondary systems are tightly coupled (iteration performed when necessary)
- Sub-hourly, user-definable time steps for the interaction between the thermal zones and the environment; variable time steps for interactions between the thermal zones and the HVAC systems (automatically varied to ensure solution stability)
- Heat balance based solution technique for building thermal loads that allows for simultaneous calculation of radiant and convective effects at both in the interior and exterior surface during each time step
- Transient heat conduction through building elements such as walls, roofs, floors, etc. using conduction transfer functions
- Loop based configurable HVAC systems (conventional and radiant) that allow users to model typical systems and slightly modified systems without recompiling the program source code

Figure 2-8 below describes the information flow and calculation data pathways required for an EnergyPlus simulation. The large block at the right of the diagram labeled “Third-Party User Interfaces” indicates that no user interface simultaneously was developed along with the EnergyPlus calculation engine. The software

development approach taken by the Department of Energy in creating EnergyPlus was to spend effort and resources developing the fundamental calculation structure and algorithms, but to leave the development of user interfaces to third-party developers.

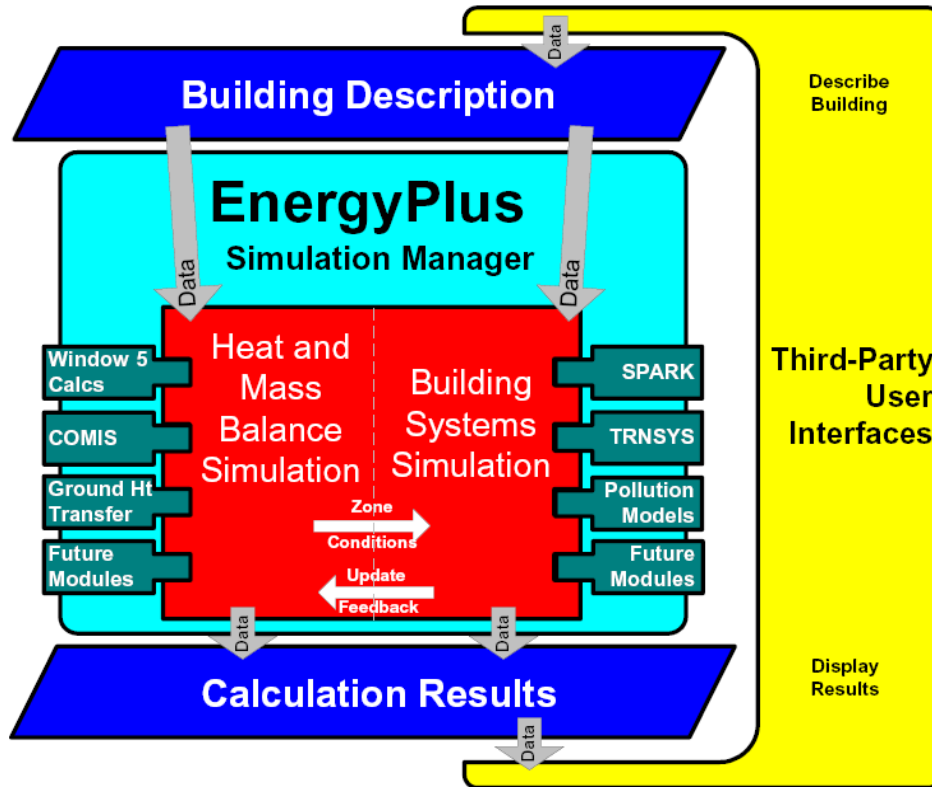

Figure 2-8 EnergyPlus Information Flow Diagram

Figure 2-9 below provides a sense of the information flow pathways and relationships inside the EnergyPlus calculation engine. It is clear from the block diagram that EnergyPlus has a modular structure, where information is passed from one module to the next as required by the simulation manager master program.

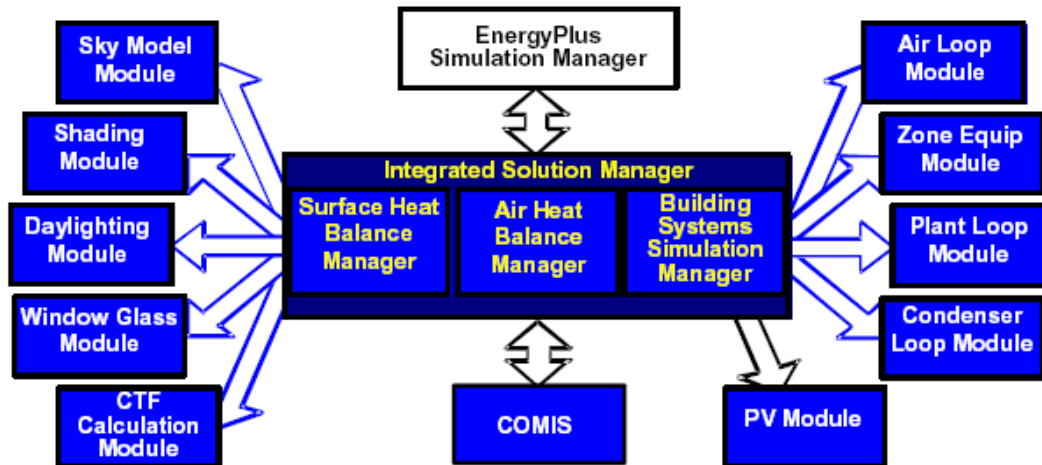

Figure 2-9 EnergyPlus Internal Calculation Modules

2.2.1 EnergyPlus Simulation Advantages

The EnergyPlus simulation software has a number of key features that make it an excellent tool for research. First and foremost, it implements a rigorous heat balance based solution technique for building thermal load calculation that allows for simultaneous calculation of radiant and convective effects at each time step. This feature alone provides significant advantages over DOE-2 based energy simulations that are the industry standards today. This is particularly important in considering UFAD system performance because the radiant exchange between surfaces can be examined and explored directly.

The modular nature of EnergyPlus also proves to be advantageous for this work. As described below, it is the modular “plug and play” nature of the air heat balance managers that will facilitate the development and implementation of a UFAD module for EnergyPlus.

EnergyPlus carries forward the use of a simple programming language called EnergyPlus Input Macros from the DOE-2 simulation engine legacy. This

programming language allows the otherwise “static” input text files to be able to define and use variables as well as perform simple branching. The variable features can be used with careful programming to allow parameterization of key input values, and this facilitates multiple runs and managing the evolution of the simulation input files.

EnergyPlus at its current level of development has a number of system applications that are suitable for use in simulating real-world building projects. For example, the program contains code and modules suitable for modeling OH mixing systems. Figure 2-10 below provides a schematic representation of the OH mixing calculation approach in EnergyPlus. The diagram on the left shows a typical HVAC zone with supply ducts and a return plenum above the ceiling. The diagram at the right graphically shows how EnergyPlus will calculate the conditioned space and ceiling plenum as independent fully-mixed HVAC zones. The vertical lines represent the assumed uniform vertical temperature profile created by the fully mixed airflow. The dot represents the average temperature in each zone.

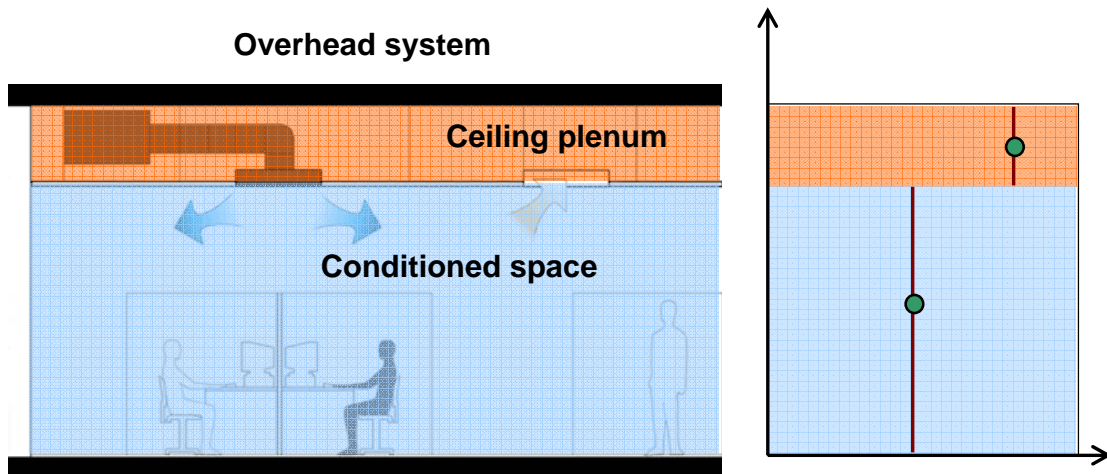

**Well-mixed, uniform temperature
in conditioned space**

Figure 2-10 EnergyPlus Implementation of an OH Mixing System

2.2.2 EnergyPlus Simulation Limitations

Although EnergyPlus is an excellent research simulation tool, it does have some limitations that are relevant to this analysis. The primary limitation is that there was no UFAD model of any kind at the start of this research project. In fact, it is developing a UFAD model for EnergyPlus that forms the context of this research work.

Another significant and somewhat surprising limitation of EnergyPlus is that, while its heat balance engine is set up to deal with radiant energy exchange between surfaces explicitly, it is not programmed to perform explicit view factor calculations between surfaces. Instead, it uses a simple weighted average of the view factor areas to approximate the view factors between surfaces. There are some simple exclusions so that surfaces in the same plane do not see each other, but otherwise only the areas are used when determining radiant exchange between surfaces (DOE, 2004, *Input-Output Reference*, 108)

Last, the lack of a fully-developed user interface is a significant hurdle at this stage in the development of EnergyPlus. The data structure of the EnergyPlus input files is significantly more complicated than the predecessor DOE-2 input files, and this is particularly true when it comes to defining controllers, systems, air loops, and water loops. A user interface to help manage the complexity of the required input would be a valuable tool.

At the same time, the output data format for EnergyPlus is also somewhat difficult to use in its raw format. A user interface that helped read data from EnergyPlus simulations and turn it into useful tabular or graphical information will certainly be needed before EnergyPlus goes into wide industry use.

Beyond interfaces that would suit an architect or engineer using EnergyPlus, there are special research needs that would be unusual to see in more mainstream interfaces. For example, the ability to use specialized EnergyPlus features such as the ability to set “Other Side Coefficients,” where temperatures can be specified to match simulation to measured conditions, would be very useful for research tools, but probably would be little used in building design.

2.3 UFAD Energy Model Development

The Center for the Built Environment (CBE) recognized the need for a UFAD simulation tool and proposed a research project to the California Energy Commission to perform the fundamental research, development, and validation of such a tool. The project that resulted aims to develop a fundamental theoretical model of UFAD system behavior, to validate this model against bench scale and full scale testing, and to

implement and test the model in the EnergyPlus simulation environment. Research groups involved on the project include the Center for the Built Environment (CBE), Lawrence Berkeley National Laboratory (LBNL), the University of California, San Diego (UCSD), and York International Corporation.

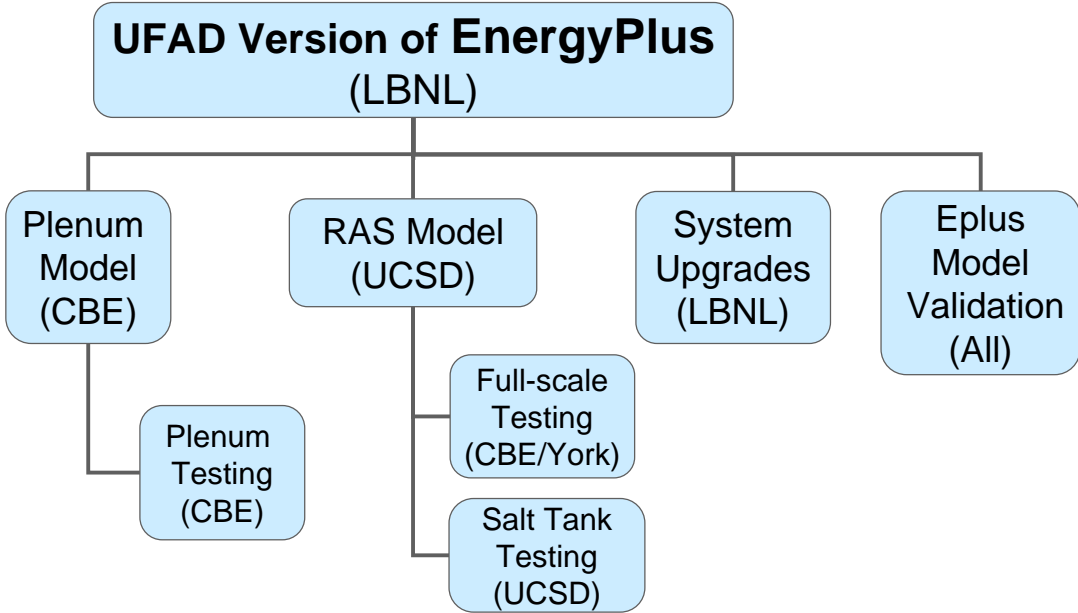

Figure 2-11 Overview of EnergyPlus UFAD Module Development Effort

The basic concept was to go beyond EnergyPlus’ single, fully mixed HVAC zone concept described in 2.2.1 above and create a UFAD model more like that shown in Figure 2-12 below. Instead of only a single uniform temperature profile for each HVAC zone, the UFAD model would divide the HVAC zone up into sub-zones, one representing the lower, occupied zone and the other representing the upper, unoccupied zone. These zones would be separated at some stratification height, h , by a stratification height boundary.

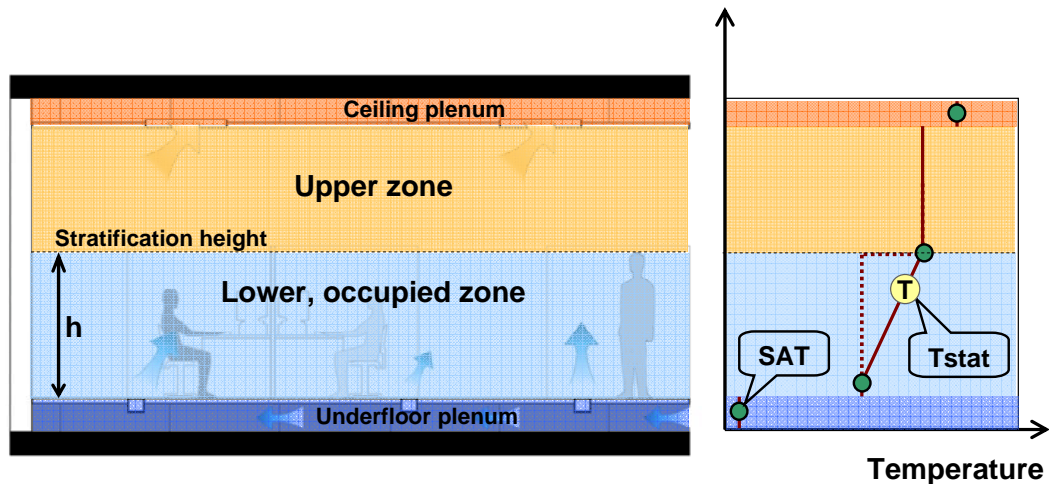

Figure 2-12 EnergyPlus Implementation of a UFAD System

The sub-zone division in the left diagram and the temperature profile in the right diagram look much more like the fundamental UFAD system performance as described in Section 2.1.1 above, which is of course the goal of the larger collaborative research project to develop a UFAD model for EnergyPlus.

2.3.1 Theoretical Room Air Stratification Modeling

Thermal plumes are fundamental drivers of stratification in UFAD and displacement ventilation systems. Plumes are natural convective flows that are generated by heat sources, but these plumes are quickly dispersed in mixed systems due to turbulent mixing. The balance between stratification created by the air buoyancy due to heat in the plumes, against the mixing and momentum effects of diffuser introduced airflow, determines the final temperature profile for a space (Qing 2006).

The UCSD research team was assigned the task of developing fundamental mathematical models to describe the fluid dynamics of UFAD systems in interior and perimeter zones. A second key task assigned to this group was to deliver a model in a

format that would be suitable for use during every time step in an EnergyPlus simulation.

Figure 2-13 shows the final structure of the theoretical UFAD model. It displays a typical room with multiple heat sources and UFAD diffusers. The airflow (Q) through the room is provided through some number of diffusers (Cooling Diffuser 1, 2, etc), each providing some momentum (M) to the delivered air. The flow through each diffuser (Q_f) is equal. A heat source plume (B) is located at some height above the floor (h_s) away from the diffusers. The resulting stratification height is indicated (h) as well as the overall room height (H). Some airflow penetrates the stratification plan (Q_i) and induces or entrains some additional airflow (Q_e) back down with it.

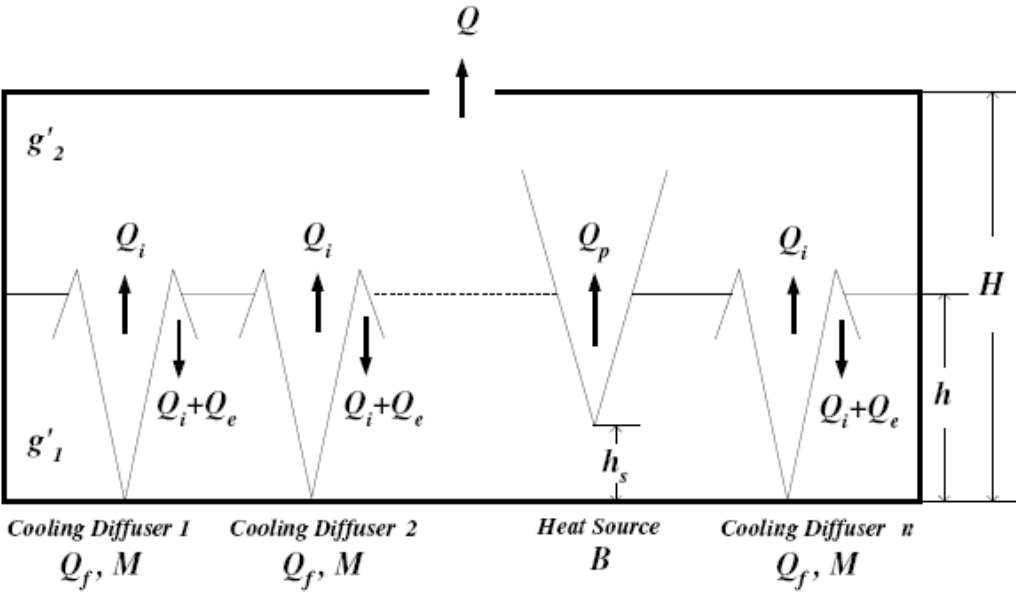

Figure 2-13 Excerpt Diagram from UCSD Theoretical work (Qing 2006)

The UCSD team developed models suitable for both interior HVAC zone UFAD system performance as well as perimeter zone UFAD performance. The primary difference between interior and perimeter zones is the thermal characteristic

of solar gain coming through windows and the surface temperatures of the exterior wall.

2.3.2 Bench Scale RAS Validation

The first level of experimental validation of the UCSD theoretical models was performed with salt-bath water tank testing. The approach involves approximating the buoyancy driving force of warm air in real buildings with differing concentrations of salt-water in scaled-down two-dimensional tanks. By varying the concentration of salt in the water that is injected to a tank and the ambient concentration of salt in the tank, various levels of buoyancy can be simulated. The results are then mapped back to full scale through mathematical transformations (Qing 2006).

The salt-bath technique used for this validation was first implemented to study heat convection and buoyancy in fluids (Bachelor 1954). The technique has been extended to be able to model both buoyancy driven flows as well as momentum driven flows by injecting fresh water into a tank of salt solution (Lin 2003).

Figure 2-14 below shows some example images from the salt-tank testing and validation of the UFAD theoretical stratification model. The grayscale gradients in the images relate to the density of the fluid, which corresponds to the temperature of the air in the scaled-up real world analogy. This set of tests shows the effect of varying the entry height of a single heat plume on the overall stratification profile.

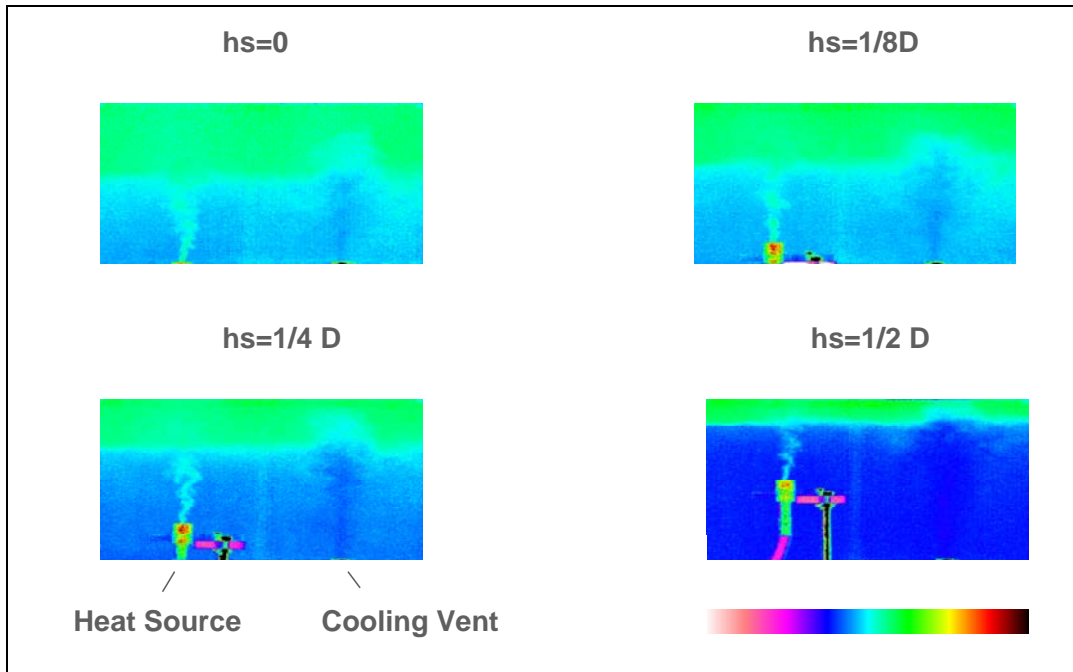

Figure 2-14 Salt-Tank Testing showing Simulated Heat Sources at Different Heights

Numerical comparisons are then made to the predicted theoretical results by measuring the salt concentration at various levels in the resulting stratified salt-concentration cross section. Figure 2-15 shows one example of the experimental / numerical comparison that is possible with the theoretical predictions using the salt-tank testing. In the figure, the stars represent measurement values taken at various levels in the tank. The lines are the theoretical predictions for the measurements and the horizontal transition line in the middle represents the predicted stratification height for this condition (Qing 2006).

UCSD Validation of Theoretical UFAD Model, Predicted vs. Measured Data

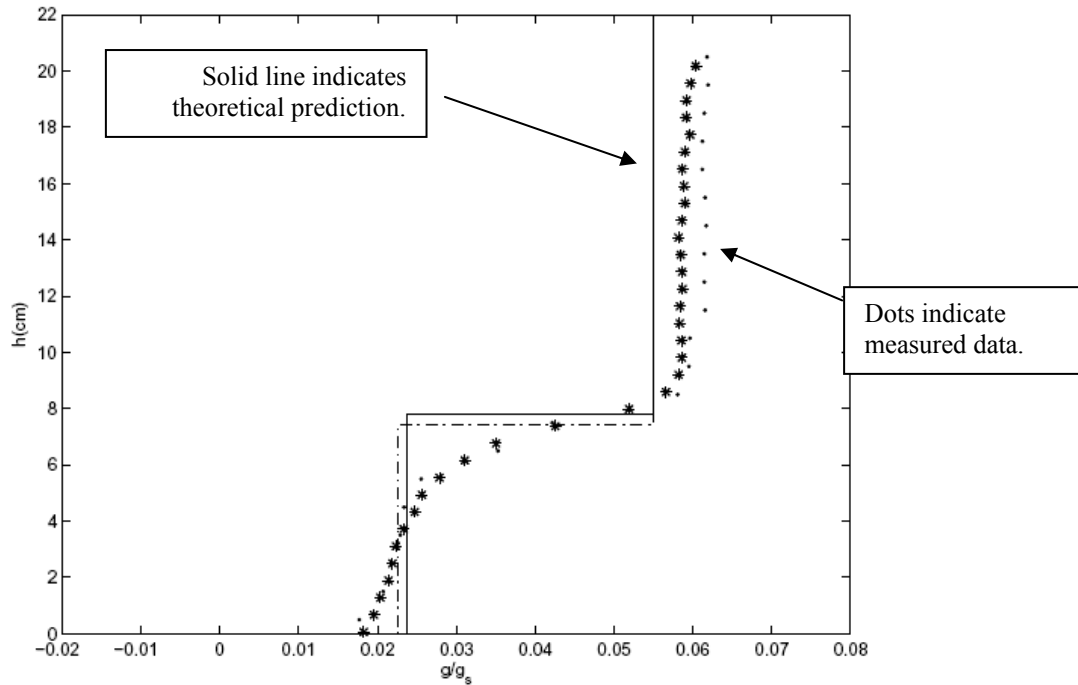

Figure 2-15 Comparison of Theoretical and Experimental Results from Salt-Tank Studies

The salt-tank testing was used to validate and improve the theoretical models of UFAD system behavior. One important difference between the theoretical models / salt-tank testing and the real world is that this theoretical and experimental approach can only model convective heat flows. It has no capacity to model radiant or conductive heat transfer, since heat strength is simulated by varying salt-concentrations.

2.3.3 Full Scale RAS Validation

Full scale testing was also a key component in developing the room air stratification (RAS) models for use in EnergyPlus. To accomplish the full scale testing, researchers used the UFAD Test Laboratory (UFAD lab) located at the

headquarters of York International Corporation located in York, Pennsylvania. The York Corporation is a manufacturer of HVAC products including a UFAD system called the “FlexSys” system. Among other components, it features a variable area diffuser product (York 2006).

The UFAD lab consists of a 26 by 26 foot room in plan dimensions with a supply plenum below a raised access floor and a return plenum above a dropped acoustic ceiling. The subfloor and roof of the room as well as all the exterior walls are heavily insulated to isolate the experimental chamber from the surrounding warehouse where the UFAD lab is located. Figure 2-16 shows a plan view of the UFAD lab and indicates some key dimensions, room layout, and equipment placement inside the lab (Webster et al. 2005).

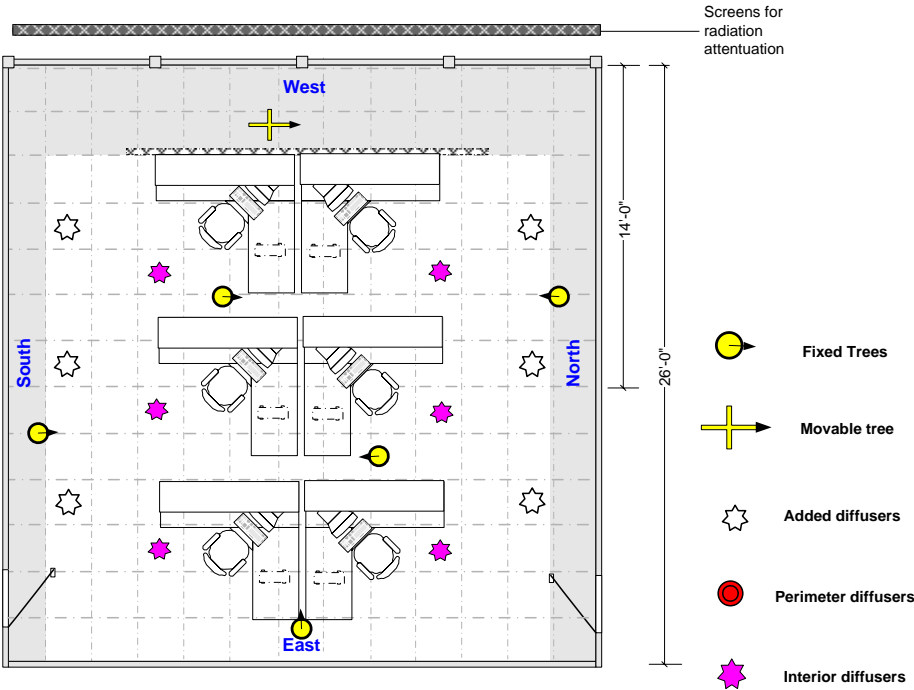

Figure 2-16 UFAD Lab Plan View showing Layout and Equipment

Figure 2-17 shows a typical section through the floor of the UFAD lab. It details how the UFAD lab is thermally separated from the 6 inch concrete slab-on-grade construction of the York warehouse with the R-30 batt insulation.

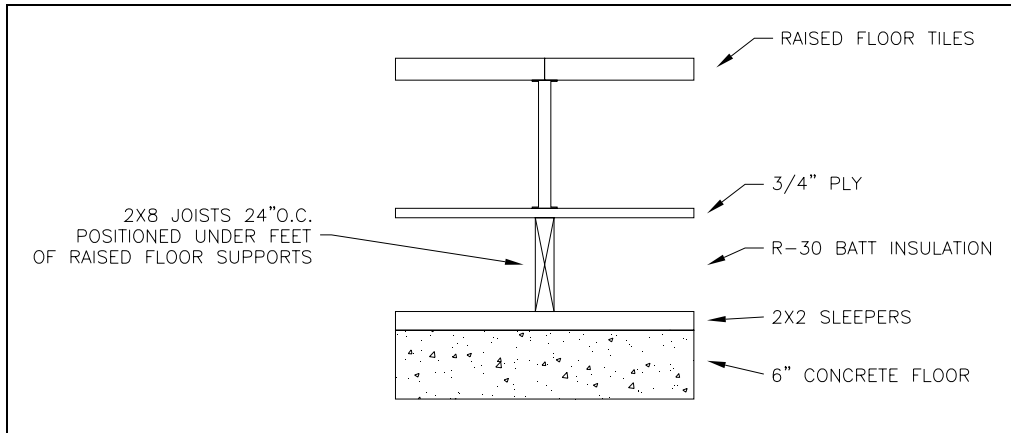

Figure 2-17 UFAD Lab Floor Construction

The UFAD lab is outfitted to resemble a commercial office space, and includes desks, carpet, and furniture similar to typical office environments. It is also configured with computers, lighting, and thermal manikins to simulate typical office internal heat loads. In Figure 2-18, an image of the interior of the UFAD lab shows these features.



Figure 2-18 Image of the Interior Layout of the UFAD Lab

The UFAD lab has an “environmental chamber” next to it that is separated from the office area by glazing. The environmental chamber contains a series of high-power lamps that can be used to simulate solar gain into the room. The windows can be covered and insulated, or they can be open with the lights on. In these modes, the room can be configured to represent a perimeter zone with solar gain, or an interior zone with no solar gain.

The lab is installed with an HVAC system and computer controls that allow a wide range of thermal environments to be simulated. It is outfitted with an instrument grade data acquisition system that monitors and records time-series data for a number of points, including temperatures, airflows, electric power flows, and other configurable inputs. Figure 2-19 shows an example of the time-series data collected in the UFAD lab.

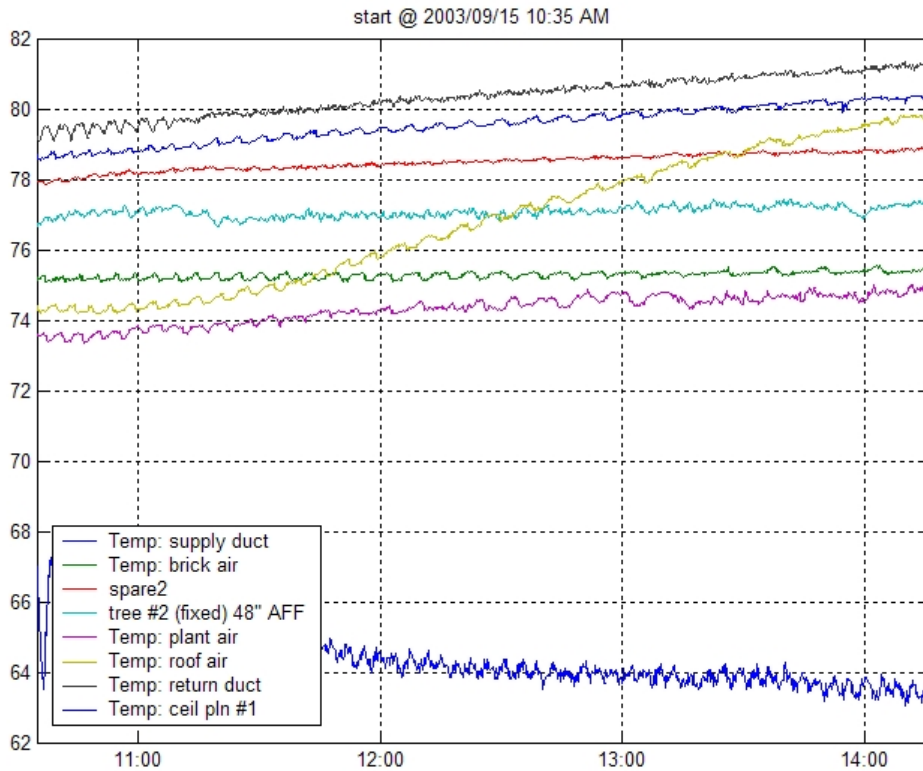

Figure 2-19 Example of Time-Series Data Collected in the UFAD Lab

The ultimate goal of the full scale testing is to validate the RAS model developed by the UCSD research team. To establish a basis for this validation, a series of calibration runs were performed to explore and document the performance of the key independent components in the UFAD lab. These include the following.

- Solar quartz lamp array
- Room lighting fixtures, heat output to room and return plenum
- Chamber physical calibration, insulation values, convection coefficients
- Ceiling heat transfer characteristics
- Floor heat transfer characteristics
- Test chamber time constant

Following on the calibration testing, a series of test were performed in the chamber in order to calibrate the RAS models. These included the following.

- Single heat plume, UFAD, open loop
- Diffuser clear zone
- Fully configured tests – realistic office environments, internal and perimeter loads

2.3.4 R.Plenum Model Development and Validation

Just as the RAS models were developed and validated for the performance of UFAD systems above the raised floor, a parallel research effort developed and validated the performance of a UFAD system below the raised floor in the supply plenum. The basic approach involved developing a computational fluid dynamics (CFD) model of a typical plenum that could be used to create a simplified model for use in EnergyPlus. The CFD model was then validated against full scale testing results (Jin Bauman Webster 2006). Figure 2-20 and Figure 2-21 show images of the CFD model and the full scale plenum testing.

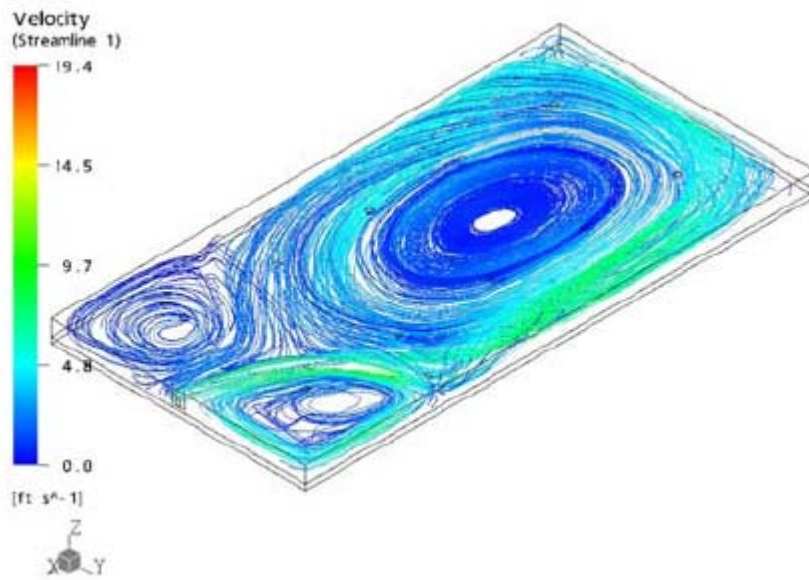

Figure 2-20 Computational Fluid Dynamics Validation of Plenum Model



Figure 2-21 Experimental Test Equipment for Plenum Model Validation

2.4 Statement of Research Need

The larger context of this thesis project is the development of a UFAD simulation model suitable for use in the EnergyPlus simulation software. That project, proposed by the Center for the Built Environment and funded by the California Energy Commission, addresses a basic need for fundamentals-based and empirically-validated methods to simulate UFAD system performance.

To date, there has been some work in this area, but it focuses on modifying fully mixed zone models in DOE-2 to assign heat loads directly to the return, and completely ignores the radiant exchange between the room and the cold floor surface (EDR 2006).

The specific need for this thesis work can be seen within the context of the UFAD model development. As Figure 2-11 shows, this larger collaborative research effort contains a number of smaller research projects that all feed together into the EnergyPlus UFAD module. To develop and test this model and its constituents requires many repeated runs with the EnergyPlus engine where the inputs to and outputs from the simulations can be carefully managed and interpreted. Given that no suitable EnergyPlus interface exists to use for this type of work, there is significant need for a detailed, usable interface that documents both the inputs to and outputs from multiple EnergyPlus simulations, and is flexible enough to adapt with the needs of the research project as it evolves.

Once the EnergyPlus UFAD module and its interface is working and validated, there is also a clear need to exercise the model and start to explore the system

performance and design issues that the HVAC design industry has been guessing and “fudging” for the past 10 years.

2.5 Research Objective

This thesis work has two objectives following from the research needs identified above. First, it aims to develop a new research and analysis tool that provides a flexible, easy to use interface to the EnergyPlus simulation engine and the new UFAD module. The tool needs to be able to manage input and output data clearly, facilitate comparisons with measured data for the purposes of calibration studies, and allow for multiple parametric runs and documentation of results.

Second, the project aims to apply the tool to help calibrate and validate the EnergyPlus UFAD modules. It also aims to investigate UFAD system performance using the new simulation module by comparing UFAD system performance with OH system performance, which is well understood. UFAD system performance analysis and the comparison to OH system performance will be distilled to help explain UFAD performance in real buildings and to inform the next generation of UFAD system design.

2.6 Research Significance

Manufacturers and other proponents of UFAD systems assert that there are multiple benefits for building owners and occupants related to this somewhat novel HVAC approach. UFAD systems are becoming more popular based on these potential benefits, but many existing buildings are experiencing issues with their performance and they are not necessarily realizing all the potential benefits. One possible reason for

this mismatch is that UFAD system performance characteristics have not been well understood and properly applied.

The larger UFAD model development effort seeks to provide a detailed understanding of how UFAD systems work and a usable energy simulation tool for quantifying system performance. The user interface developed as part of this thesis and the subsequent use of that interface and new UFAD simulation tools provide a key component in the process of developing the UFAD model and disseminating the lessons we can learn based on this new understanding.

As the UFAD model and this interface are used further, they may also be able to help explain and possibly correct some UFAD performance issues in real buildings and provide solid guidance to HVAC engineers for future system designs.

3. Methods

The methods used in this thesis project to accomplish the research objectives stated above consist of 1) developing a model of the UFAD lab chamber in the EnergyPlus input language, 2) developing a user interface to access the UFAD model, 3) calibrating the model definition against the full scale measured data, and 4) running the interface across a range of simulations to compare the performance of OH and UFAD systems. Each of these steps is described further in this section.

3.1 Development of the EnergyPlus Model of the UFAD Lab Chamber

3.1.1 UFAD Model Development and Calibration

The first step required to perform an EnergyPlus simulation is to develop an “Input Data File” (IDF) for the building or space to be simulated. The IDF contains all the required information about the building geometry, constructions, internal gains, schedules, systems, and utility rates among other requirements. Figure 3-1 contains a 3 dimensional diagram of the EnergyPlus definition surfaces and geometry created to model the UFAD lab. The room is modeled as 26 feet by 26 feet, with a supply plenum below, test chamber room in the middle, and return plenum above. The supply plenum is 1 foot high, the test chamber is 9 feet high, and the return plenum is roughly 3 feet high. These dimensions as well as the wall constructions were chosen to match the real UFAD lab based on the construction drawings of the lab. The large window between the test chamber and the environmental chamber (where the solar lamps are located) is modeled to the west side of the room.

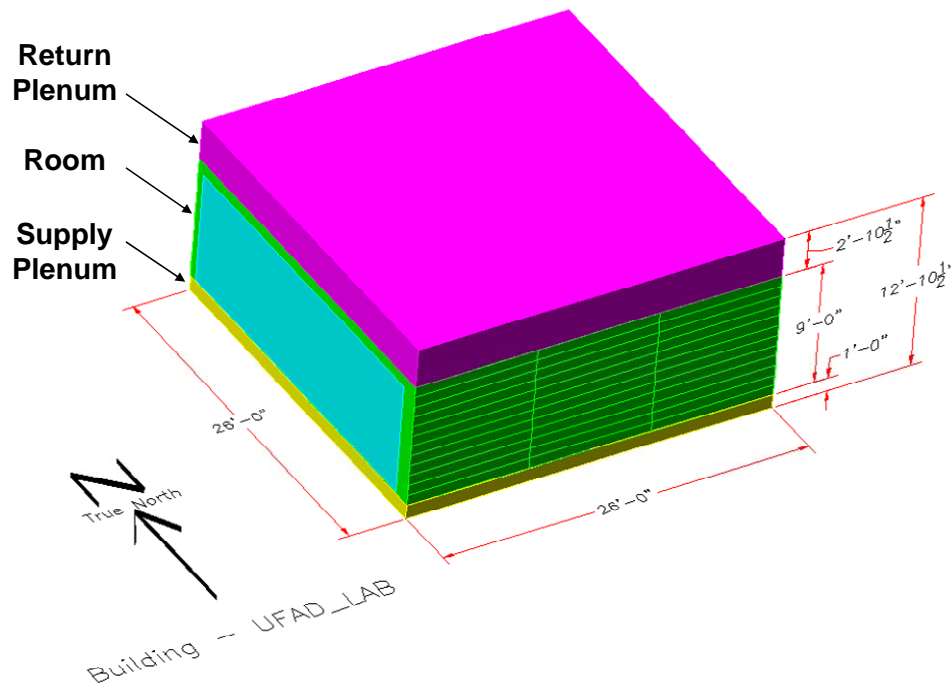

Figure 3-1 Diagram of the EnergyPlus IDF Definition of the UFAD Lab

Figure 3-1 and Figure 3-2 both show the surface definition geometry of the UFAD lab model. The north and south walls are divided horizontally into three segments, and each of these segments is divided vertically into 12 slices. The east wall (opposite the large window to the environmental chamber) is divided into two horizontal slices. The floor surface is divided into 15 segments. The surfaces were defined in this way to match insolation measurement locations inside the UFAD lab when simulating solar gain in the space.

The five segments that make up the narrow floor band in the middle of the raised floor are designed to model the furniture in the space. The surface area of these segments equals the surface area of the furniture and desks in plan view. See Figure 2-16 and Figure 2-18 for views of the furniture layout in the space.

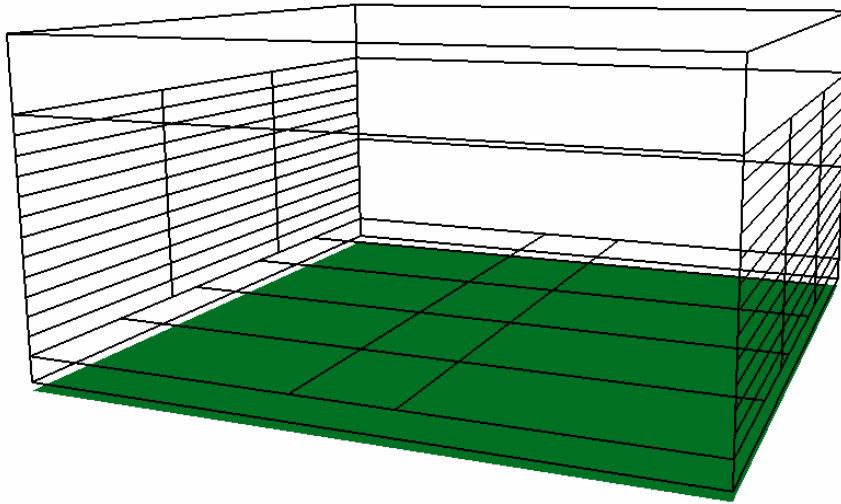

Figure 3-2 Perspective view of Surface Geometry in the EnergyPlus UFAD Lab Model

The furniture floor surfaces are modeled with a high level of insulation from the floor plenum in order to simulate the amount of surface that is blocked from radiant exchange between the floor and the ceiling.

All boundary surfaces are defined using EnergyPlus “other side coefficients” on each. By using these coefficients, the surface temperature on the outside of each surface can be manually set rather than calculating these temperatures based on the weather data used in an energy simulation run. This is a research capability built into EnergyPlus that allows the model to receive surface temperature inputs directly in order to match up with measured data in calibration studies.

Similarly, the interior convection coefficients are manually input rather than being based on the standard EnergyPlus convection coefficient calculation algorithms to allow these values to be adjusted through the model calibration process.

Figure 3-3 provides a graphical description of the HVAC system definition and air loop equipment used in this file. Air flows through from the air handling unit (shown at the left in the diagram) into the supply air plenum, then into the test

chamber zone, then into the return plenum, and finally back to the air handling unit.

The nodes listed along the air path are used by EnergyPlus as points at which to perform the heat balance calculations at each time step.

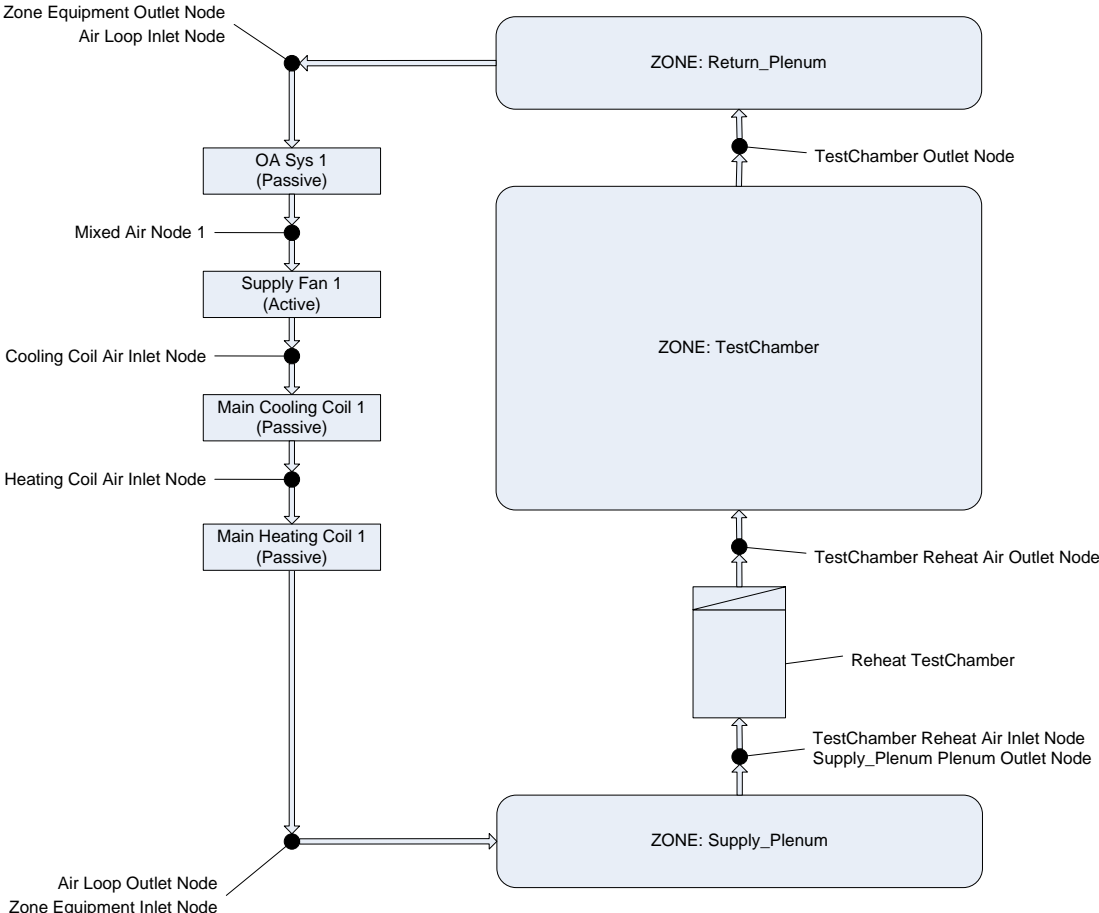

Figure 3-3 Schematic of UFAD Lab EnergyPlus System Definition

The complete EnergyPlus input file listing used in this thesis analysis is provided in Appendix A (Section 9.1).

3.1.2 RoomAir Model Options

EnergyPlus features a set of simulation options intended to allow for non-uniform air temperatures within a zone. This capacity was specifically included to be able to address thermal stratification inside HVAC zones. RoomAir models are not

general airflow solutions that can account for any airflow patterns the way a CFD analysis would. Instead, they are simplified, more limited modeling options that are intended to account for a specific type of air temperature distribution within a zone. It is up to the user to select the appropriate RoomAir model type when defining the EnergyPlus input file.

Prior to the development of the UFAD model for EnergyPlus, the available options for RoomAir Model type were MIXED, MUNDT (a displacement ventilation model), and UCSD DISPLACEMENT VENTILATION. The result of the UFAD development project is a fourth option, the UCSD UFAD INTERIOR model. Future work will also make available a UCSD UFAD PERIMETER model. (A note about syntax: EnergyPlus keywords are listed in all caps, consistent with the EnergyPlus documentation and industry convention with respect to energy modeling software.)

3.2 EnergyPlus Interface Development

At the start of the project no commercially available interface existed. In early 2006 Design Builder became available, but it is targeted to serve architects and engineers designing buildings and is not well suited to be a research tool.

This research project required a flexible interface that could be adapted as research needs evolved. A primary need of the interface was to manage the information flow between measured data from the full scale UFAD lab testing putting, it into a form that is usable by EnergyPlus, then capturing the results of the simulation and presenting them in a meaningful way. The software program Microsoft Excel was chosen as a platform in which to develop this tool because Excel is designed to

manage large amounts of numerical information and calculations, and because it is designed to allow automated macros to run using Visual Basic, which is a powerful, modern programming language. Figure 3-4 describes the information flow for the simulation runs performed as a part of this research project.

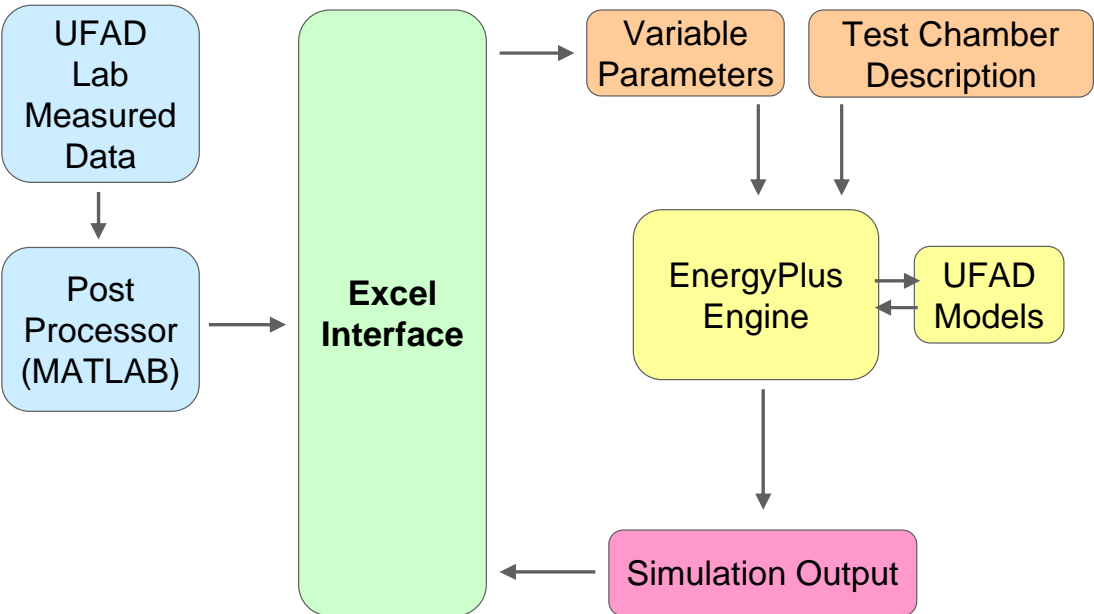

Figure 3-4 Energy Simulation Information Flow and Role of EnergyPlus Excel Interface

3.2.1 EnergyPlus Input File Structure, Macros, and Parameters

This author has had extensive experience performing DOE-2 simulations on a wide variety of commercial projects for the purposes of design approach testing and life-cycle cost analysis among others. This experience has shown that as an energy model simulation evolves, unless the user keeps careful control over the input file definitions, it is very easy for there to quickly come into existence multiple versions of the input files with the changes between the files difficult to distinguish and manage. It can quickly lead to a mess, and is often a significant source of errors and problems with runs.

To avoid these problems on this complex energy modeling task, from the beginning of the energy modeling work the entire research team kept working on a single input file with version controls built in to avoid any confusion. The structure of the input file was modified throughout the analysis to provide flexibility to simulate different RoomAir Model approaches as needed, with branching IF/THEN statements and other programming code embedded into the input file.

The code below provides an example of how the EnergyPlus macro language is used to select between different RoomAir model options.

```
! ===== ALL OBJECTS IN CLASS: ROOMAIR MODEL =====
ROOMAIR MODEL,
  UFAD_LAB_ROOMAIRMODEL,      ! Room-Air Model Name
  TestChamber,                ! Zone Name

  ##if #[AirFlowType[] EQS MIXED ]
    MIXING,                    ! Room-Air Modeling Type

  ##elseif #[AirFlowType[] EQS DV ]
    UCSD_DISPLACEMENT_VENTILATION, ! Room-Air Modeling Type

  ##elseif #[AirFlowType[] EQS UFAD ]
    UCSD_UFAD_INTERIOR,        ! Room-Air Modeling Type

  ##endif
```

The commands `##if`, `##elseif`, and `##endif` are used to select between different options based on the user-defined variable `AirFlowType[]`.

EnergyPlus macro variables, as used in the example above, provide the link between the Excel interface and the EnergyPlus input file. In Excel, variables are defined for important information that will be passed between the interface and EnergyPlus. Figure 3-5 shows an excerpt from the interface showing how parameters are defined.

PARAMETERS START				Parameter Text	Value	Format	Units
##SET1 OST-North[]	24.87	!	[C]	OST-North[]	24.86678	0.00	C
##SET1 OST-South[]	24.01	!	[C]	OST-South[]	24.00594	0.00	C
##SET1 OST-West []	24.27	!	[C]	OST-West[]	24.27439	0.00	C
##SET1 OST-East []	25.00	!	[C]	OST-East[]	25.00264	0.00	C
##SET1 OST-Flr []	16.08	!	[C]	OST-Flr[]	16.08467	0.00	C
##SET1 OST-Clg []	27.17	!	[C]	OST-Clg[]	27.1725	0.00	C
##SET1 SysFlowRate []	0.22899	!	[m3/s]	SysFlowRate[]	0.228989	0.00000	m3/s
##SET1 SupplyAirTemp []	15.33	!	[C]	SupplyAirTemp[]	15.33444	0.00	C
##SET1 OST-ConfPlnm []	16.33	!	[C]	OST-ConfPlnm[]	16.33444	0.00	C
##SET1 LightingPwr []	799.58	!	[W]	LightingPwr[]	799.582	0.00	W
##SET1 LightingRAFraction []	0.15	!	[-]	LightingRAFraction[]	0.15	0.00	-
##SET1 LightingRad []	0.20	!	[-]	LightingRad[]	0.20	0.00	-
##SET1 LightingVis []	0.22	!	[-]	LightingVis[]	0.22	0.00	-
##SET1 EquipmentPwr []	1134	!	[W]	EquipmentPwr[]	1134.2	0	W
##SET1 EquipmentRadFraction []	0.36	!	[-]	EquipmentRadFraction[]	36%	0.00	-
##SET1 PeoplePwr []	73	!	[W]	PeoplePwr[]	73.0	0	W
##SET1 PeopleRadFraction []	0.40	!	[-]	PeopleRadFraction[]	40%	0.00	-

Figure 3-5 Interface Excerpt showing Parameter Definitions

Many of the parameter values are taken directly from the measured data that was post-processed into a standard format (see Figure 3-4). Some of the parameter values are provided through direct user input in the interface. Figure 3-6 shows how user input is taken in to be used in the parameter definitions.

Lighting Convected Fraction	43%
Lighting Return Air Fraction	15%
Lighting Radiant Fraction	20%
Lighting Visible Fraction	22%
	100%
Equipment Gains Radiant Fraction	36%
Equipment Gains Convected Fraction	64%
This is for a single person. Total people power / # people.	
People Gains Radiant Fraction	40%
People Gains Convected Fraction	60%

Figure 3-6 Interface Excerpt showing Parameter Value User Inputs

Throughout the interface, colors are used to characterize the data source. Blue is used throughout to reference values that are drawn from the calibration values that are applied across all the simulation runs. Green values are those that are required to be input by the user for each individual run.

Once the parameters are defined in the interface, a Visual Basic program writes the parameters to a text file, which is then appended to the EnergyPlus input file before the simulation is executed. With this approach, the parameters text file can dynamically change from run to run while the base EnergyPlus input file can be static and stay the same from run to run. The example code below shows the parameters after they are written to a text file.

```
##SET1 OST-North[]          24.87    ! [C]
##SET1 OST-South[]         24.01    ! [C]
##SET1 OST-West []        24.27    ! [C]
##SET1 OST-East []        25.00    ! [C]

##SET1 OST-Flr []         16.08    ! [C]
##SET1 OST-Clg []         27.17    ! [C]

##SET1 SysFlowRate []     0.22899 ! [m3/s]
##SET1 SupplyAirTemp []   15.33    ! [C]

##SET1 OST-ConfPlnm []    16.33    ! [C]

##SET1 LightingPwr []     799.58   ! [W]
##SET1 LightingRAFraction[] 0.15    ! [-]
##SET1 LightingRad []     0.20    ! [-]
##SET1 LightingVis []     0.22    ! [-]

##SET1 EquipmentPwr []    1134     ! [W]
##SET1 EquipmentRadFraction[] 0.36    ! [-]
```

The code example below shows how the parameters file is appended to the static EnergyPlus input file using the `##include` macro command.

```
! ===== PARAMETER DEFINITIONS (VIA INCLUDE) =====
##include c:\EnergyPlus\CBE\UFAD_Lab\parameters_general.imf
##include c:\EnergyPlus\CBE\UFAD_Lab\parameters_solar.imf
```

3.2.2 Output capture

Another key feature of the interface is the ability for it to capture the results from the EnergyPlus simulation and store it in a usable format. As the EnergyPlus simulation proceeds, it dumps requested output data into an “Energy Simulation

Output” (ESO) file. The format of this ESO file is difficult to use and understand directly because the format is first a list of all the variables to be output, then a list of the variable values for the first hour, then the second hour, and so on. The results is a single very long text file that is impossible to use directly.

The interface again uses some Visual Basic code to read this ESO file into a spreadsheet tabular format that is much easier to comprehend. The code example below shows the data format of the ESO file. Figure 3-7 shows the format of similar data in the user interface program.

```
.  
. .  
. .  
1576,2,TC-SOUTHWALL-G4,Surface Int Convection Coeff[W/m2-K] !Hourly  
1577,2,TC-SOUTHWALL-G4,Surface Ext Convection Coeff[W/m2-K] !Hourly  
1581,2,TC-SOUTHWALL-G4,Opaque Surface Inside Face Conduction[W] !Hourly  
1586,2,TC-SOUTHWALL-G5,Surface Inside Temperature[C] !Hourly  
1587,2,TC-SOUTHWALL-G5,Surface Outside Temperature[C] !Hourly  
1589,2,TC-SOUTHWALL-G5,Surface Int Convection Coeff[W/m2-K] !Hourly  
1590,2,TC-SOUTHWALL-G5,Surface Ext Convection Coeff[W/m2-K] !Hourly  
1594,2,TC-SOUTHWALL-G5,Opaque Surface Inside Face Conduction[W] !Hourly  
1599,2,TC-SOUTHWALL-G6,Surface Inside Temperature[C] !Hourly  
  
. .  
. .  
2127,0.16127408114094  
2132,23.2199903202809  
2133,24.87  
2135,3.  
2136,0.0  
2140,0.16127408114094  
2145,23.2199903202809  
2146,24.87  
2148,3.  
2149,0.0  
2153,0.16127408114094  
2158,22.2218578765943  
  
. .  
. .
```

	1, 9,13, 0, 1, 0.00,60.00,Tuesday	1, 9,13, 0, 2, 0.00,60.00,Tuesday	
Environment,Outdoor Dry Bulb [C]	!Hourly	13.44166667	13.55
TESTCHAMBER,Zone Transmitted Solar[W]	!Hourly	0.00E+00	0.00E+00
TESTCHAMBER,Zone Window Heat Gain[W]	!Hourly	0.00E+00	0.00E+00
TESTCHAMBER,Zone Window Heat Loss[W]	!Hourly	0.00E+00	0.00E+00
TC-WESTWALL,Surface Inside Temperature[C]	!Hourly	22.64521366	22.64518453
TC-WESTWALL,Surface Outside Temperature[C]	!Hourly	24.27	24.27
TC-WESTWALL,Surface Int Convection Coeff[W/m2-K]	!Hourly	3	3
TC-WESTWALL,Surface Ext Convection Coeff[W/m2-K]	!Hourly	0.00E+00	0.00E+00
TC-WESTWALL,Opaque Surface Inside Face Conduction[W]	!Hourly	1.91E+00	1.91E+00
ENVCHAMBERWINDOW,Surface Inside Temperature[C]	!Hourly	22.6980219	22.69799293
ENVCHAMBERWINDOW,Surface Outside Temperature[C]	!Hourly	24.27	24.27
ENVCHAMBERWINDOW,Surface Int Convection Coeff[W/m2-K]	!Hourly	3.076	3.076
ENVCHAMBERWINDOW,Surface Ext Convection Coeff[W/m2-K]	!Hourly	0.00E+00	0.00E+00
ENVCHAMBERWINDOW,Opaque Surface Inside Face Conduction[W]	!Hourly	4.88E+00	4.88E+00
TC-SOUTHWALL-G1,Surface Inside Temperature[C]	!Hourly	22.2053306	22.20530101
TC-SOUTHWALL-G1,Surface Outside Temperature[C]	!Hourly	24.01	24.01
TC-SOUTHWALL-G1,Surface Int Convection Coeff[W/m2-K]	!Hourly	3.00E+00	3.00E+00
TC-SOUTHWALL-G1,Surface Ext Convection Coeff[W/m2-K]	!Hourly	0.00E+00	0.00E+00
TC-SOUTHWALL-G1,Opaque Surface Inside Face Conduction[W]	!Hourly	1.76E-01	1.76E-01

Figure 3-7 EnergyPlus Simulation Output in Tabular Format in the Interface

3.2.3 Visualization

With the output results captured in the user interface, graphs and other visual tools can be generated based on this data to help interpret the results. With the thousands of data points generated with each run, visualization of the outputs provides an effective and fast way to evaluate the simulation. Figure 3-8 provides two examples of graphical data representations generated by the user interface program. The left example shows the resulting vertical temperature profile in a UFAD simulation case, and compares the measured data (solid line) to the simulated results (dashed line). The right example shows the distribution of thermal load between the supply plenum, room, and return plenum. Figure 4-1 and Figure 4-2 presented later further describe the data presented in these graphs.

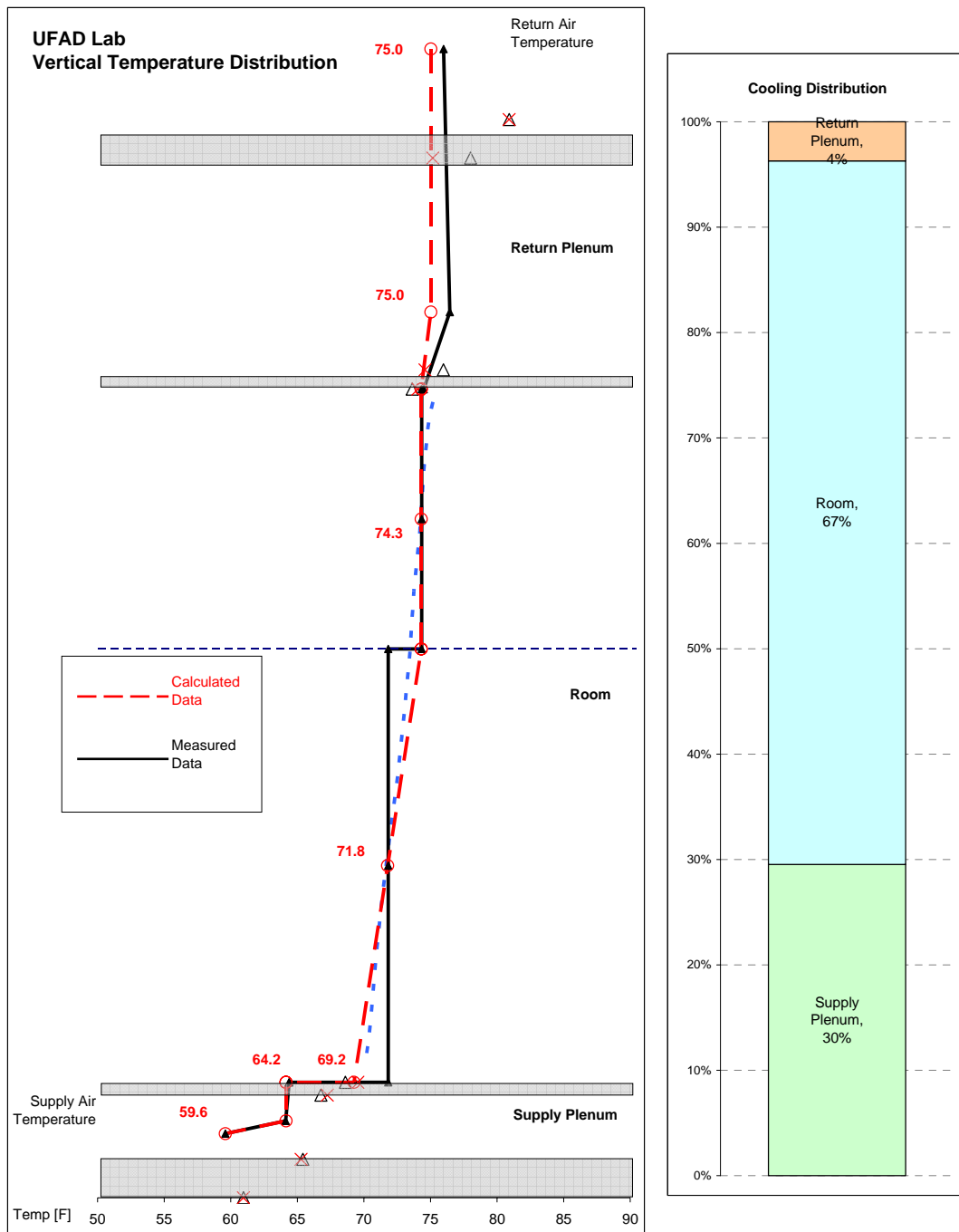

Figure 3-8 Example of Results Visualization generated in the EnergyPlus Interface

3.2.4 Energy Balance

An important role that EnergyPlus played in the validation of the EnergyPlus UFAD model was to confirm that a net zero energy balance was being maintained at

all times by the UFAD module as well as the large EnergyPlus simulation engine. The user interface program was designed to generate the tables shown in Figure 3-9 to confirm with each run that any errors were small or zero.

Return Plenum Energy Balance				
Conduction	-7.41	[W]	-25	[Btu/hr]
Internal Loads - Lights	119.94	[W]	409	[Btu/hr]
Internal Loads - Equipment				
Internal Loads - People				
Airflow	-89.73	[W]	-306	[Btu/hr]
Error	22.80	[W]	78	[Btu/hr]
Test Chamber Energy Balance				
Conduction	-659.67	[W]	-2,251	[Btu/hr]
Internal Loads - Lights	679.64	[W]	2,319	[Btu/hr]
Internal Loads - Equipment	1,134.00	[W]	3,869	[Btu/hr]
Internal Loads - People	438.00	[W]	1,494	[Btu/hr]
Airflow	-1,585.97	[W]	-5,411	[Btu/hr]
Error	6.00	[W]	20	[Btu/hr]
Supply Plenum Energy Balance				
Conduction	711.56	[W]	2,428	[Btu/hr]
Internal Loads - Lights				
Internal Loads - Equipment				
Internal Loads - People				
Airflow	-713.79	[W]	-2,435	[Btu/hr]
Error	-2.23	[W]	-8	[Btu/hr]
Sum of Errors	26.57	[W]	91	[Btu/hr]

Total Room / System Energy Balance				
Conduction	44.49	[W]	152	[Btu/hr]
Internal Loads - Lights	799.58	[W]	2,728	[Btu/hr]
Internal Loads - Equipment	1,134.00	[W]	3,869	[Btu/hr]
Internal Loads - People	438.00	[W]	1,494	[Btu/hr]
Airflow	-2,442.68	[W]	-8,334	[Btu/hr]
Error	-26.62	[W]	-91	[Btu/hr]

Figure 3-9 Energy Balance Summary Calculations performed by the Interface Program

Other graphs were created to examine the relative magnitudes of energy flows through the various heat transfer surfaces. One example is shown in Figure 3-10. Graphs such as this helped the research team focus calibration efforts on the thermal properties of the surfaces with the highest heat transfer, since errors in these surfaces could have a significant effect on the results, while errors on other surfaces would not be as significant.

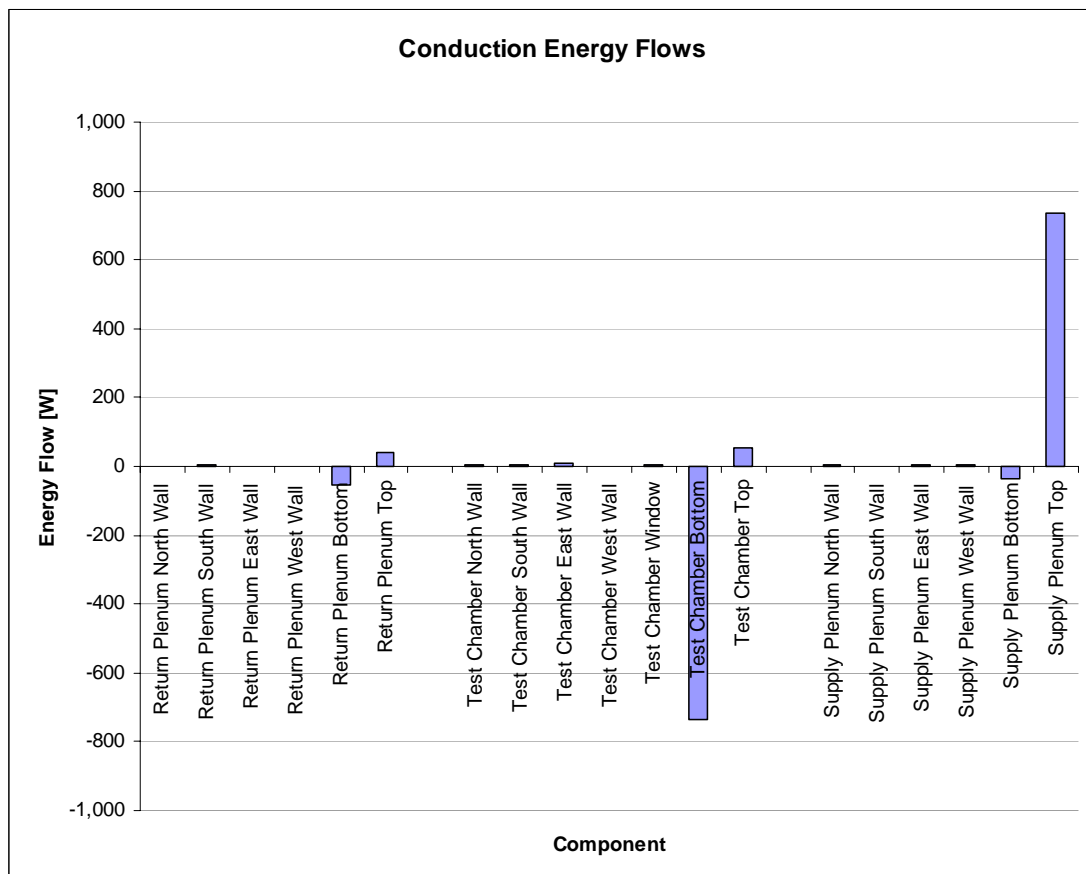

Figure 3-10 Conduction Energy Flows Graph from the Interface Program

3.2.5 Multiple Runs

A final feature that I built into the interface is to allow for multiple simulation runs to be performed across a set of varying inputs with the results captured at the end

of each run. To accomplish this, a separate Excel sheet and Visual Basic code is used to “run” the standard user interface sheet and its connections to EnergyPlus. Figure 3-11 shows some of the the required user input to perform multiple runs.

Run File	
Directory	X:\CBE\UFAD_Eplus\calculations\Eplus\sensitivity
File	UFAD_Lab_analysis--INT_6-8.xls
Output File	
Directory	X:\CBE\UFAD_Eplus\calculations\Eplus\sensitivity
File	output.xls
PDF Files	
Directory	X:\CBE\UFAD_Eplus\calculations\Eplus\sensitivity\OH vs UF\PDFs
yes	print PDFs?
3	seconds wait time

Figure 3-11 Run Control Interface Directory and File Inputs

Figure 3-12 gives an example of the input data format to perform multiple runs. Variables that will be varied over the runs are listed as column headings, then the input for each run is represented as a row. As the code executes, it proceeds through each row inputting data to the single-run interface file, then running the simulation.

Variables Start	use_overrides	SupplyAirDirection	AirFlowType	override_SAT	override_numDiffusers	override_airflow	Variables End
	input start						
	yes	OH	Mixed	54	1	200	
	yes	OH	Mixed	54	1	300	
	yes	OH	Mixed	54	1	400	
	yes	OH	Mixed	54	1	500	
	yes	OH	Mixed	54	1	600	
	yes	OH	Mixed	54	1	700	
	yes	OH	Mixed	54	1	800	
	yes	OH	Mixed	56	1	200	
	yes	OH	Mixed	56	1	300	

Figure 3-12 Run Control Interface Input Variable Example

Figure 3-13 shows the format required for the user to select the output variables that will be extracted and recorded after each simulation. The names listed here refer to named cells in the single-run interface spreadsheet. The number of output data points requested to be recorded after each run can be extended to any number of outputs.

```

Outputs Start
output_SupplyAirDirection
output_airflowtype
output_SAT
output_numdiffusers
output_airflow
output_airflowdensity
output_Tocc
output_ToZGradient
Outputs End

```

Figure 3-13 Run Control Interface - Output Variable Definition

Figure 3-14 shows the output data results after the multiple simulation runs have been performed. The columns are defined by the output variables selected by the user, as shown in Figure 3-13 above. Each row represents the results from a single run. If more variables were selected to be output, additional columns would appear to contain that data.

output_SupplyAirDirection	output_airflowtype	output_SAT	output_numdiffusers	output_airflow	output_airflowdensity	output_Tocc	output_ToZGradient
OH	Mixed	53.99709033	1	200.2696927	0.296256942	83.67244927	0
OH	Mixed	53.99444415	1	300.3939305	0.44436972	75.38766039	0
OH	Mixed	53.99608965	1	400.5393854	0.592513884	70.68958578	0
OH	Mixed	53.99719269	1	500.6636232	0.740626661	67.67245338	0
OH	Mixed	53.99682979	1	600.8090782	0.888770826	65.57313497	0
OH	Mixed	53.99670779	1	700.9333159	1.036883603	64.03039518	0
OH	Mixed	53.99589785	1	801.0787709	1.185027768	62.84904728	0
OH	Mixed	55.99546598	1	200.2696927	0.296256942	85.18705086	0
OH	Mixed	55.99227626	1	300.3939305	0.44436972	77.04294599	0
OH	Mixed	55.9931171	1	400.5393854	0.592513884	72.41893983	0
OH	Mixed	55.9934195	1	500.6636232	0.740626661	69.45455032	0
OH	Mixed	55.99511607	1	600.8090782	0.888770826	67.3909396	0
OH	Mixed	55.99333776	1	700.9333159	1.036883603	65.87186508	0
OH	Mixed	55.99324233	1	801.0787709	1.185027768	64.70941974	0
OH	Mixed	57.99112647	1	200.2696927	0.296256942	86.70040723	0
OH	Mixed	57.9916831	1	300.3939305	0.44436972	78.69852854	0
OH	Mixed	57.9917277	1	400.5393854	0.592513884	74.15662113	0

Figure 3-14 Multiple Run Output Data Excerpt

3.3 Comparison Between Overhead Mixing and UFAD System

Performance

One significant topic related to the performance of UFAD systems is the quantity of air that needs to be delivered to a space to meet its thermal load. This is addressed frequently in publications and is a major topic in the UFAD Design Guide (Bauman 2003) because it is a primary system design parameter and affects fan energy

and duct sizes. This single quantity also represents a straightforward way to compare OH and UFAD systems. Chapter 12 of the UFAD design guide asks the question, “Does UFAD Require More Air?,” and presents a method for determining space thermal loads and airflows using a 2-zone load calculation method based on a simple assignment of heat sources to the lower occupied zone or the upper unoccupied zone (Bauman 2003, 159).

With the development of the EnergyPlus UFAD model, we no longer need to rely on simple assumptions of how energy flows in UFAD systems because EnergyPlus now calculates this for us directly. The method used here to investigate airflow requirements in OH versus UFAD systems is to develop an OH model in EnergyPlus that is equivalent to the UFAD model so the results can be compared directly. Both models are then simulated multiple times with various parameters changing in each run to develop a result set that represents system performance for each case over a range of conditions. Finally, the resulting space temperatures are analyzed and compared to find “equivalent occupant comfort” conditions in the OH and UFAD cases, and in these “apples to apples” cases the airflow quantities are compared to see which system approach needs more air. The sections below provide further detail into each step of this analysis method.

3.3.1 OH Model Development

The EnergyPlus UFAD input file needed to be modified to allow it to run as an OH mixing system. Specifically, the HVAC system definitions were modified to eliminate the supply plenum. The interface was modified to allow the user to select

either airflow from the ceiling (OH) or from the floor (UF), and for each case to select the correct EnergyPlus Room Air Manager, which will perform the internal zone energy flow calculations correctly. The choices for airflow type are MIXED, DV (displacement ventilation), or UFAD.

DV Occupied Zone Gain Fraction	62%	fraction of the convective portion of the
Supply Airflow Direction?	UF	
Mixed, DV, or UFAD	OH	OH above, this must be "Mixed"
Number of People	0	also used for number of plumes
Run Type	INT	interior, perimeter, or calibration run

Figure 3-15 Excerpt from the EnergyPlus Interface showing the Airflow Direction

Options

DV Occupied Zone Gain Fraction	62%	fraction of the convective portion of the
Supply Airflow Direction?	UF	
Mixed, DV, or UFAD Run?	UFAD	OH above, this must be "Mixed"
Number of People	0	so used for number of plumes
Run Type	INT	interior, perimeter, or calibration run

Figure 3-16 Excerpt from the EnergyPlus Interface showing the Airflow Type Options

In the EnergyPlus input file, the following macro code and system definitions are used to allow the system to be run in the correct air flow mode. The macro code IF-THEN statements allow the original UFAD system description file to model a fully mixed OH system instead of a UFAD system as selected through the user interface. See Appendix A: EnergyPlus IMF File for a full listing of the EnergyPlus input file code.

There are only two code modifications that are required. The first is to define the ROOMAIR MODEL as MIXED for the OH mixing case, as can be seen in the code excerpt below.

```

! ===== ALL OBJECTS IN CLASS: ROOMAIR MODEL =====

ROOMAIR MODEL,
  UFAD_LAB_ROOMAIRMODEL,      ! Room-Air Model Name
  TestChamber,                ! Zone Name

##if #[AirFlowType[] EQS MIXED ]
  MIXING,                     ! Room-Air Modeling Type

##elseif #[AirFlowType[] EQS DV ]
  UCSD DISPLACEMENT VENTILATION, ! Room-Air Modeling Type

##elseif #[AirFlowType[] EQS UFAD ]
  UCSD UFAD INTERIOR,        ! Room-Air Modeling Type

##endif

```

The second required input file modification is to remove the supply plenum from the ZONE SUPPLY AIR PATH definition. The code below shows how the supply plenum definition is used only in UFAD cases, and is consequently omitted in OH cases.

```

!- ===== ALL OBJECTS IN CLASS: ZONE SUPPLY AIR PATH
=====

ZONE SUPPLY AIR PATH,
  TermReheatSupplyPath,      !- Supply Air Path Name
  Zone Equipment Inlet Node,  !- Supply Air Path Inlet Node

##if #[SupplyAirDirection[] EQS UFAD ]

  Zone Supply Plenum,        !- KEY--System Component Type
  Supply_Plenum Plenum,     !- Component Name

##endif

  Zone Splitter,             !- KEY--System Component Type
  Zone Supply Air Splitter;  !- Component Name

```

The figure below graphically shows how the EnergyPlus system definitions have been modified from the UFAD case to eliminate the supply air plenum and to model the OH mixing case.

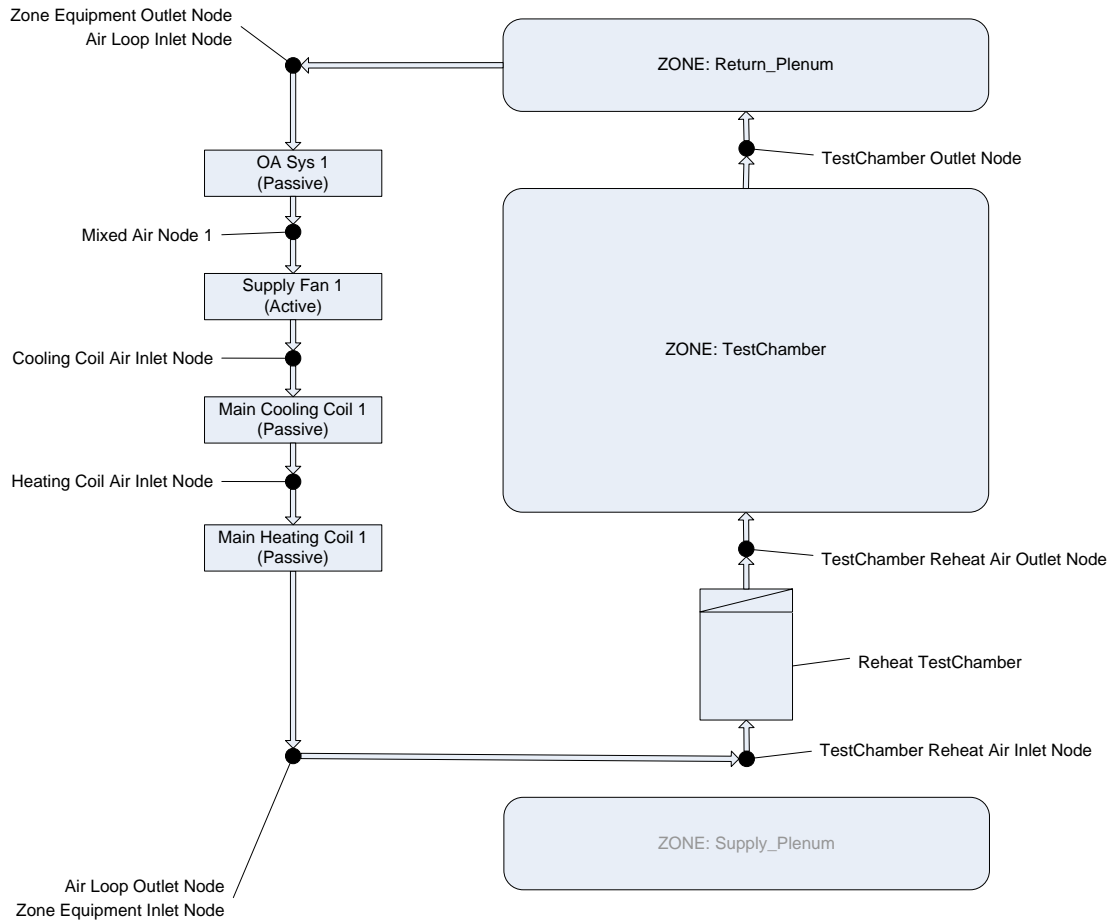

Figure 3-17 Schematic of UFAD Lab EnergyPlus System Definition Modified for the OH case

Even though the supply plenum is not used as an air pathway in the OH cases, the supply plenum geometry and surface definitions remain in the EnergyPlus model. This zone is treated as an unconditioned floor cavity. There are only minor energy flows through this unconditioned zone, so its presence does not affect the overall performance of the model.

3.3.2 Parametric Runs

To compare the OH case to the UFAD case, a number of EnergyPlus runs were simulated using both the UFAD and OH system arrangements. For each run, input

parameters were varied as described below. Parameters and inputs to the runs were established in an effort to be true to the real HVAC design process. When a designer is planning out the components to a system, there are some items that he has control over and many that he does not. In this case, considering basic design parameters of these OH and UFAD systems, the basic parameters that would be under the designer's control are the supply air temperature (SAT) leaving the air handling unit (AHU), the number of diffusers located in the room, and the type of diffusers. It is these parameters that are varied in the multiple simulations that were performed.

The temperature of the supply air leaving the air handling unit was varied from 54°F to 66°F in 2°F increments. 54°F was chosen as the low end for this range because it is a supply air temperature (SAT) value that could be found in typical HVAC systems, and it is slightly below the commonly used 55°F supply air temperature often seen in HVAC system design. On the high end, 66°F was chosen since it is a reasonable temperature that might be found in an operating HVAC system, and is one that is slightly above the 65°F SAT that is commonly discussed in existing UFAD design literature.

This range was also chosen to bracket SAT values in use in real buildings today. In practice at my professional engineering office, we typically design our OH systems to use 57°F supply air temperature and our UFAD systems to use 61°F or 63°F supply air temperatures.

The next design parameter varied in the parametric runs is the number of diffusers in the room. For the OH cases, the number of diffusers is simply modeled to be one. The EnergyPlus MIXING RoomAir Manager does not have an input for the

number of diffusers so the quantity of diffusers entered into the interface is not used by the simulation engine. The MIXING airflow type simply assumes a fully mixed zone.

For the UFAD cases, two different diffusers quantities are modeled: 7 diffusers and 14 diffusers. These two cases were chosen based on typical practice today, and then double the quantity typically used. seven diffusers in this 676 ft² room would correspond to roughly 100 ft² per diffuser. Typical swirl diffusers have a nominal design airflow capacity of roughly 85 cfm, so using one diffuser per 100 ft² would mean a design airflow to that space of 0.85 cfm/ft², which is a reasonable design value and is consistent with current practice.

The high end of the range at 14 diffusers is selected as simply double the current value, or 50 ft² per diffuser. Although this quantity is much higher than what is common, it was chosen to be able to see the effects of increased stratification in the space. A greater number of diffusers means less airflow per diffuser for a given airflow quantity to the space. Less airflow per diffuser means less mixing and more resulting stratification in the space. A higher number of diffusers pushes the space airflow characteristic more toward displacement ventilation (DV), and DV airflow patterns will develop the highest stratification levels.

The type of diffusers is also a parameter under the control of designers. This is an input that is not used on the OH mixing EnergyPlus model, so it is ignored in those runs. For the UFAD cases, the EnergyPlus UFAD model has the ability to model both SWIRL and VARIABLE AREA (VA) diffusers, but at this time only the SWIRL diffuser type has been validated and the VA diffuser type still continues to require

debugging and further work. For this parametric analysis, only the SWIRL diffuser type is used in the UFAD runs.

One additional parameter that was varied is the amount of airflow delivered to the room. This is a parameter that would in real life be determined by the system design and operation as well as the space thermal load and thermostat control point. In this simulation, the model is not running under “automatic” control as it would be in real life. Here, we are varying the airflow manually to see the resulting room temperatures and stratification profiles across a range of conditions.

The airflow quantities are varied from 200 cfm to 800 cfm in 100 cfm increments. Since the UFAD Lab is 26 feet by 26 feet, or 676 ft², these airflows correspond to a range of roughly 0.3 cfm/ft² to 1.2 cfm/ft². These values bracket a reasonable low airflow rate to a reasonable high airflow rate. In practice, interior zone peak airflows are usually in the 0.85 cfm/ft² range and might be 0.3 cfm/ft² at the lowest.

3.3.3 Equivalent Comfort Comparisons

Occupant comfort is one of the primary purposes for HVAC systems. In order to compare the results of the OH runs against the UFAD runs, the ideal comparison would be to find cases in each regime that created equivalent occupant comfort. This is slightly complicated here because the OH case generates a completely uniform temperature environment and the UFAD case creates a temperature environment with a vertical temperature gradient due to stratification. This dissimilar thermal environments make the cases difficult to compare directly.

In this analysis, equivalent comfort is assumed between an OH case and a UFAD case when the uniform OH space temperature equals the UFAD average temperature in the occupied zone, defined as 0 to 6 feet above the floor, where the vertical temperature gradient does not exceed the ASHRAE Standard 55 limit of 5°F. In the tables and graphs presenting the results of the parametric runs and analysis, this quantity is referred to as TozGradient.

4. Results

Based on the parametric variations described in Section 3, multiple runs of the EnergyPlus model were performed to observe the system performance across a range of operating conditions. A case from the York UFAD Lab testing where there was good agreement between the measured and simulated results was selected as a basis for these runs. This run was selected for two additional reasons. First, the internal loads in this case are reasonable when compared to a typical real office building. Second, this run showed good agreement between the measured values from the laboratory testing and the predicted EnergyPlus values. The validation run results for this case are presented later in this section.

The table below presents a summary of the cases that were simulated.

Table 4-1 Summary of OH and UFAD Simulation Cases

Parameter	Number of Options	Low	High	Increment
Supply Air Temperature	7	54°F	66°F	2°F
Number of Diffusers – OH Cases	1	1	1	na
Number of Diffusers – UFAD Cases	2	7	14	7
Airflow	7	200 cfm	800 cfm	100 cfm

For the OH cases, 7 SAT options x 1 diffuser option x 7 airflow options resulted in 49 runs. For the UFAD cases, 7 SAT options x 2 diffuser options x 7 airflow options resulted in 98 runs. 49 OH runs plus 98 UFAD runs equals 147 total runs.

The sections below first present the run validation results, then they show some typical single run results for an OH case and a UFAD case. These sections explain the output summary tables and graphics. Finally, the results for all the 147 runs are presented together.

4.1 Single Run Results

4.1.1 Results Presentation Format

This section describes the approach and logic behind the presentation format for single-run results. Figure 4-1 presented after Table 4-2 below shows a summary table and a graph of the space temperatures for the validation run case. The actual results for this run are presented in the next section. The data is used here only as a relevant example. This same format is used for the summary results of each simulated case. Summary pages for all simulated cases are located in **Error! Reference source not found.**

Table 4-2 describes the values presented in the results summary table.

Table 4-2 Simulation Results Summary Table Parameters and Descriptions

Summary Table Parameter	Description
Run	The case from the UFAD Lab testing sessions on which the run is based.

Overrides	Whether or not any values from the UFAD Lab testing sessions are being overridden in the current run. For the validation runs this value is “no.” For all other simulated runs this value is “yes.”
Supply Airflow Direction	Describes if the airflow is from the floor (UF) or from the ceiling (OH).
Mixed, DV, or UFAD Run	The EnergyPlus RoomAir Manager to be used in the simulation. Choices are MIXED, DV (Displacement Ventilation), or UFAD.
Airflow	Airflow quantity used in this run. Values are input in 100 cfm increments when overrides are used, but sometimes display with an extra 1 cfm due to rounding errors.
Airflow Density	Assuming a 676 ft ² room (UFAD lab dimensions), this quantity is the airflow divided by the room area.
Supply Air Temp	SAT used for this run.
Supply Diffuser Air Temp	Resulting temperature of the supply air coming out of the diffusers for UFAD cases. This is calculated by EnergyPlus and is a result of all the heat-balance equations.
Return Grille Air Temp	EnergyPlus calculated temperature of the air entering the return grilles at the top of the TestChamber zone.
Return Air Temp	EnergyPlus calculated temperature of the air leaving the return air plenum going back to the air handling unit.
Upper Zone temp (calc'd)	For UFAD cases, this is the EnergyPlus calculated temperature for the upper (unoccupied) zone. For OH cases this is the same as the uniform TestChamber temperature.
Occ Zone temp (calc'd)	For UFAD cases, this is the EnergyPlus calculated temperature for the lower (occupied) zone. For OH cases this is the same as the uniform TestChamber temperature.
4" temp	For UFAD cases, this is the EnergyPlus calculated temperature at 4 inches above the floor. For OH cases this is the same as the uniform TestChamber temperature.
UFAD transition height	For UFAD cases, this is the EnergyPlus calculated transition height (in inches) above the floor. For OH

	cases this value is not applicable.
Heat Loads	
Lights to Plenum	Watts of lighting load assigned to the Return_Plenum zone.
Lights to Room	Watts of lighting load assigned to the TestChamber zone.
Equipment	Watts of equipment heat load assigned to the TestChamber zone.
People	Watts of occupant heat load (sensible only since occupants were simulated with thermal manikins) assigned to the TestChamber zone.
Room Total	Watts of total heat gain in this run. This value includes light heat to the return plenum.
Lights	Watts per ft ² of lighting power in this run. This value includes light heat to the return plenum.
Equipment	Watts per ft ² of equipment power in this run.
People	Watts per ft ² of occupant heat load in this run.
Total	Watts per ft ² of total heat load in this run.
UFAD Values	
# Diffusers	In UFAD runs, shows the number of diffusers simulated in the room. Ignored in OH runs.
# People	The number of people (occupants) simulated in the runs. Corresponds to the number of active workstations from the UFAD Lab test runs.
OZ Gains Fraction (knob)	In UFAD runs, this is the percentage of convective equipment and people heat gains that are assigned to the lower (occupied) zone. This value is input as a function of the calculated gamma for each run. Ignored in OH runs.
Plumes Per Occupant	Number of heat plumes per occupant. Value is used in the UFAD RoomAir manager calculations. Ignored in OH runs.
Diffusers Per Plume	Metric for the number of diffusers divided by the number of heat plumes. Ignored in OH runs.
Diffuser Effective Area	Free area of each diffuser being modeled. Ignored in OH runs.
Diffuser Slot Angle	Throw angle for the diffuser being modeled. Ignored

	in OH runs.
Diffuser Type	Type of diffuser being modeled. Options are SWIRL or VARIABLE AREA. Ignored in OH runs.
Measured Values	
T @ 67 inches	The average measured temperature at 67 inches above the floor in the UFAD Lab testing for the run that is the basis for this simulation (run name listed in “Run” above).
T @ 4 inches	The average measured temperature at 4 inches above the floor in the UFAD Lab testing for the run that is the basis for this simulation (run name listed in “Run” above).
T-67" minus T-4"	Difference between the 67 inch temperature and the 4 inch temperature.
Tavg to 6ft	Average measured temperature between the floor and the 6 foot high level in the room in the UFAD Lab test.
Calculations	
Room Delta-T	Difference between the temperature of the air entering the return grilles at the ceiling and the temperature of the air leaving the supply grilles at the floor.
System Delta-T	Difference between the temperature of the air leaving the return plenum (entering the air-handling unit) and the temperature of the air entering the supply plenum (leaving the air-handling unit)
Comfort Calculations – High Estimate Method	
T-67	The simulated temperature at 67 inches above the floor using the “high” estimate method, or upper bound calculation method. Value is based on the calculated stratification height (h) in UFAD runs and the simulated 4 inch temperature and the simulated upper zone temperature. If h is above 67 inches, this value is linearly interpolated between the upper zone temperature at h and the temperature at 4 inches. If h is below 67 inches, it is assumed to be equal to the upper zone temperature. In OH runs this is simply the mixed zone temperature.
T occupied	The average of the simulated temperature at 67

	inches and the simulated temperature at 4 inches.
T-4	The EnergyPlus simulated temperature at 4 inches. In OH runs this is simply the mixed zone temperature.
T-67 minus T-4	The difference between the simulated temperature at 67 inches and the simulated temperature at 4 inches.
Comfort Calculations – Low Estimate Method	
T-67	The simulated temperature at 67 inches above the floor using the “low” estimate method, or the lower bound calculation method. Value is based on the calculated temperature at the return grilles in UFAD runs and the simulated 4 inch temperature. The temperature profile is assumed to be a straight line between the 4” temperature and the return grille temperature at 108”. The temperature at 67” is a linear interpolation between the two. In OH runs this is simply the mixed zone temperature.
T occupied	The average of the simulated temperature at 67 inches and the simulated temperature at 4 inches.
T-4	The EnergyPlus simulated temperature at 4 inches. In OH runs this is simply the mixed zone temperature.
T-67 minus T-4	The difference between the simulated temperature at 67 inches and the simulated temperature at 4 inches.

Figure 4-1 below shows the summary table and temperature graph for the calibration run. The summary table values are described in Table 4-2 above. The temperature graph depicts a section through the room with the vertical spacing of the temperature plot values to scale.

Run: INT_6-8
 Overrides: no

Supply Airflow Direction: UF
 Mixed, DV, or UFAD Run: UFAD

Airflow: 486 cfm
 Airflow Density: 0.72 cfm/ft³

Supply Air Temp: 59.6 F
 Supply Diffuser Air Temp: 64.2 F
 Return Grille Air Temp: 74.5 F
 Return Air Temp: 75.0 F

Upper Zone temp (calc'd): 74.3 F
 Occ Zone temp (calc'd): 71.8 F
 4" temp: 69.2 F
 UFAD transition height: 68 in

Heat Loads

Lights to Plenum	119.94	W
Lights to Room	679.6	W
Equipment	1,134.0	W
People	438.00	W
Room Total	2,371.6	W
Lights	1.18	W/ft ²
Equipment	1.68	W/ft ²
People	0.65	W/ft ²
Total	3.51	W/ft²

UFAD Values

# Diffusers	10
# People	6
OZ Gains Fraction (knob)	50%
Plumes Per Occupant	2
Diffusers Per Plume	0.83
Diffuser Effective Area	0.01103 m ²
Diffuser Slot Angle	28 deg
Diffuser Type	SWIRL

Measured Values (refer to original base run)

T @ 67 inches	73.46	F
T @ 4 inches	70.17	F
T-67" minus T-4"	3.29	F
Tavg to 6ft	71.9	F

Calculations

Room Delta-T	10.9	F
System Delta-T	15.4	F

Comfort Calculations - high estimate method

T-67	74.3	F
T occupied	71.8	F
T-4	69.2	F
T-67 minus T-4	5.0	F

Comfort Calculations - low estimate method

T-67	72.5	F
T occupied	70.9	F
T-4	69.2	F
T-67 minus T-4	3.2	F

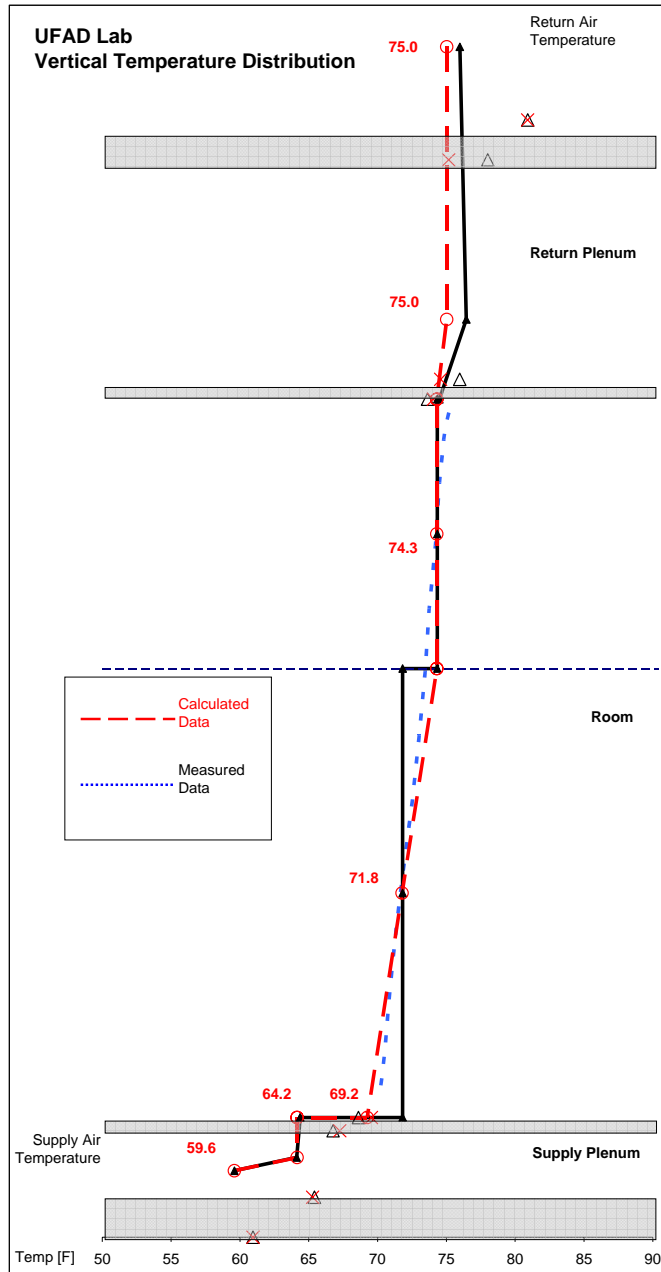

Figure 4-1 INT 6_8 Validation Run Results – Summary Table and Temperature Graph

The temperature graph is formatted with temperature shown on the X-axis in degrees Fahrenheit, and height on the Y-axis. The values shown on the graph are placed to scale along the X and Y axes, showing the temperatures at appropriate heights.

On the temperature graph, the gray background blocks represent the physical separations in the UFAD Lab test chamber. At the very bottom, a thick slab and associated insulation is represented. Above that level the supply plenum is shown with the raised floor represented as another gray segment above. Above the raised floor the room is represented and then the ceiling is shown in gray as the separation between the room and the return plenum. Finally, the top boundary of the UFAD Lab is shown as another thick gray block representing the roof assembly and associated insulation.

On top of the gray background that represents the physical layout of the UFAD Lab, I show the measured and calculated results from the specific run under consideration. These results that are presented show the measured temperature profile from the laboratory testing, the EnergyPlus calculated temperature profile, and the EnergyPlus calculated stratification height (h) as well as the measured and calculated surface temperatures at various surfaces throughout the space.

The solid black line that runs from the bottom to the top of the graph represents a simplification of the measured temperatures from the UFAD Lab run under consideration. The simplification represents the measured temperatures as a single uniform temperature below the calculated stratification height and another uniform temperature above the stratification height. This simplification was used during validation of the model.

The bottom point of the solid black line (in this case labeled as 59.6) shows the temperature of the air in °F that is leaving the air-handling unit and entering the supply plenum. The next point indicates the average air temperature in the supply plenum. From here, the temperature line goes straight up to just above the raised floor, and the

temperature point there represents the temperature of the air leaving the supply diffusers.

After the supply diffuser temperature, the solid black line goes to the right then straight up vertically through the lower (occupied) zone. The measured data for the lower zone temperature is presented here as a single temperature and the vertical line indicates that the temperature in this zone is fully mixed and is an idealized approach that does not indicate any temperature stratification in the lower (occupied) zone. At the stratification level (h), the temperature line moves directly to the right and then goes up vertically through the upper zone to the level at the bottom of the dropped ceiling, again suggesting that this zone is a fully mixed zone at a single average temperature.

The thick dashed curving line also shows the measured temperature data from the top of the raised floor to the bottom of the dropped ceiling, but in this case it is not represented as two mixed zones and instead is shown as a stratified gradient passing through the space. By representing the measured temperature data in both an idealized format (2 mixed zones) and a realistic format (stratified throughout the space), this graphic presentation facilitated the calibration of the EnergyPlus UFAD calculation module and subsequent interpretation of the calculated results.

To complete the description of the solid black temperature profile, from the level at the bottom of the dropped ceiling the line moves up and diagonally to the right. This change in temperature is caused by air temperature gains in the return plenum so that the value in the center of the return plenum represents the average air temperature in the return plenum. From this level to the top, the temperature profile

line progresses to above the upper boundary of the space, and the final top temperature point represents the temperature of the air returning to the air-handling unit.

The dashed vertical line drawn from the bottom of the graph to the top of the graph presents the same data points as the measure temperature black line, but shows the EnergyPlus calculated temperatures rather than the measured temperature data. In the lower (occupied) zone, the dashed calculated temperature line shows a stratified profile, which starts at the calculated temperature at 4 inches and goes to the calculated temperature at the stratification height (h). Other methods for interpreting the calculated stratification profile are presented below.

Other data shown on the graph are the stratification height and surface temperatures. The blue dashed horizontal line running through the middle of the space represents the calculated stratification height (h). The black triangles and red Xs on the graph represent the measured surface temperatures and the calculated surface temperatures respectively.

Figure 4-2 below presents further graphical data related to the performance of this case. It shows bar charts related to the “cooling distribution” and the energy flows through the supply plenum, room, and return plenum.

The cooling distribution graph is formatted to line up horizontally next to the temperature profile shown in Figure 4-1. The quantities shown are defined as follows.

Equation 4-1 Cooling Distribution Calculations

$$\text{Calculated System Cooling} = 1.1 * \text{cfm} * (T_{\text{systemreturn}} - T_{\text{systemsupply}})$$

$$\text{Calculated Return Plenum Cooling} = 1.1 * \text{cfm} * (T_{\text{systemreturn}} - T_{\text{returngrilles}})$$

$$\text{Calculated Test Chamber Cooling} = 1.1 * \text{cfm} * (T_{\text{returngrilles}} - T_{\text{supplydiffusers}})$$

$$\text{Calculated Supply Plenum Cooling} = 1.1 * \text{cfm} * (T_{\text{supplydiffusers}} - T_{\text{systemsupply}})$$

$$\text{Return Plenum \%} = \frac{\text{Calculated Return Plenum Cooling}}{\text{Calculated System Cooling}}$$

$$\text{Room \%} = \frac{\text{Calculated Test Chamber Cooling}}{\text{Calculated System Cooling}}$$

$$\text{Supply Plenum \%} = \frac{\text{Calculated Supply Plenum Cooling}}{\text{Calculated System Cooling}}$$

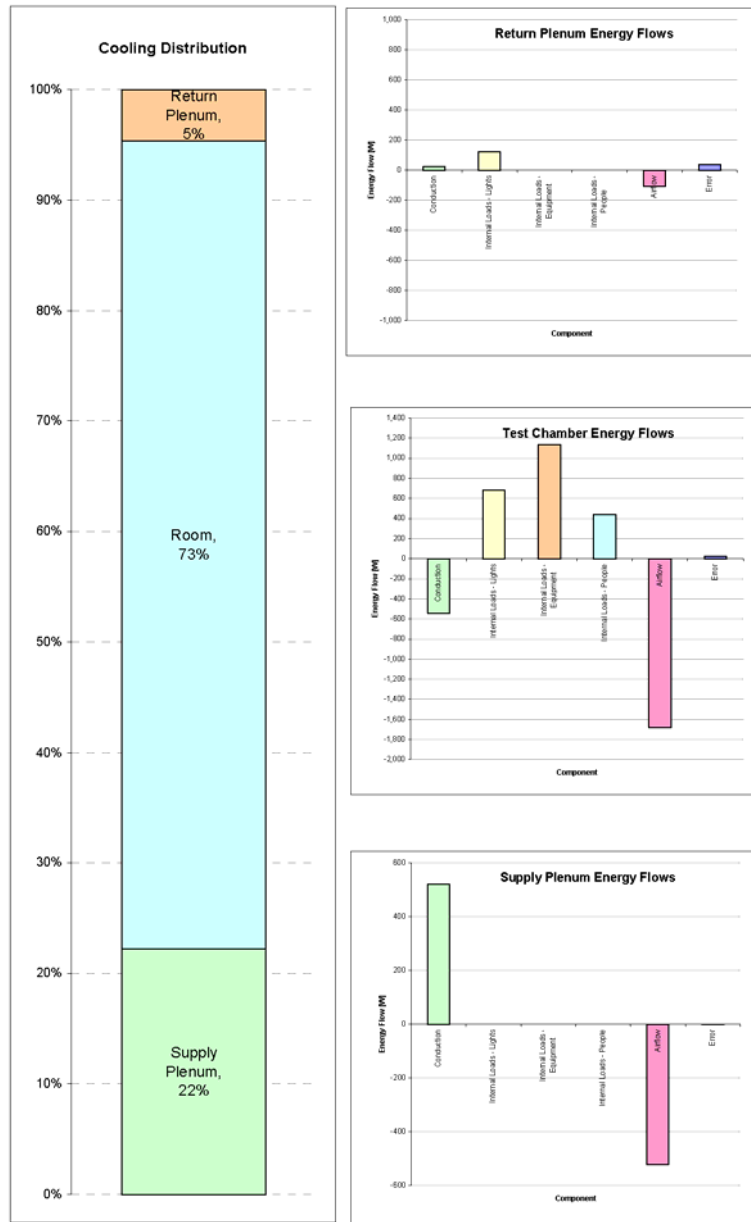

Figure 4-2 INT 6_8 Validation Run Results – Cooling Distribution and Energy Flows

Also presented in Figure 4-2 are graphs showing the energy flows through the supply plenum, the test chamber, and the return plenum. The energy flow components presented are (from left to right) for conduction, internal loads (lights, equipment, and people), and airflow. An “error” component is also defined so that in the process of testing and validating the EnergyPlus interface and calculation modules this graphic

presentation would highlight any energy sum errors that occurred. As long as the error bar is small, then the sum of the energy flowing into one of these zones equals the energy flowing out of the zone.

The EnergyPlus UFAD model predicts a single temperature for the lower zone and a single temperature for the upper zone. There are various ways to interpret how these two point temperatures can be used to generate a stratification profile in the space. Figure 4-3 shows two different approaches to interpreting the EnergyPlus point temperatures.

Comparison of Measured Results with Two Different Approaches to Interpreting EnergyPlus Simulation Results

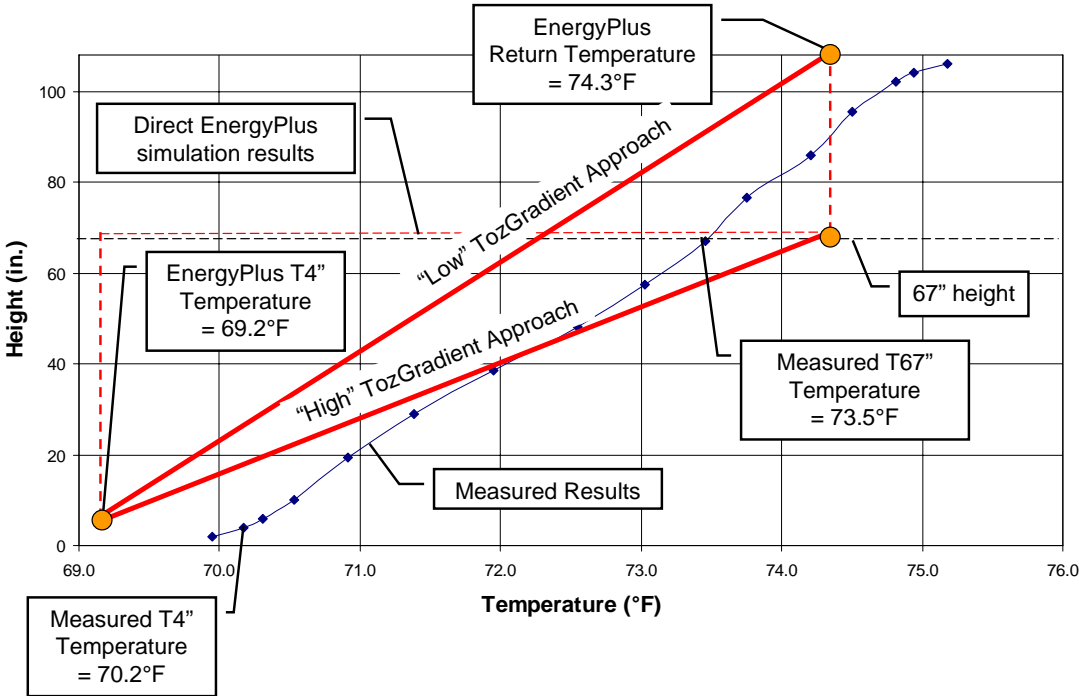

Figure 4-3 Comparison of Measured Results with Two Different Approaches to Interpreting EnergyPlus Simulation Results

The “high” occupied zone temperature gradient (TozGradient) approach shown in this figure corresponds to the method described in Table 4-2 and Figure 4-1. It

assumes that the temperature EnergyPlus calculates is constant in the upper zone. A second approach assumes that the upper zone temperature only occurs at the return grilles, and that the temperature gradient continues through the upper zone.

For one of the validation runs, the measured data from an actual laboratory run is presented in this figure as well as graphical representations of the two differing approaches to interpreting the EnergyPlus calculations. Figure 4-3 show that neither approach clearly matches the measured data in this case, but that each represents the measured data better in different ways. The “low” approach line appears in this case to do a better job matching up with the measured data (with a slight offset to the left). The “high” approach line is included because the performance represented by this profile does a better job matching what displacement theory tells us should happen, as well as matching what the bench-scale validation experiments showed.

The interpretation approaches are called “high” and “low” here because the “high” approach represents a reasonable upper bound for the highest the occupied zone temperature stratification could reach. The “low” approach represents a reasonable lower bound. The “high” approach line graphically shows a shallower slope, while the “low” approach line shows a steeper slope. Both the high and low approaches will used later in this analysis to give a reasonable range of stratification conditions for consideration.

4.1.2 INT 6_8 Validation Run Results

Figure 4-1 shows a graphical comparison between the measured data from the INT 6_8 tests in the UFAD Lab and the corresponding EnergyPlus simulation and

calculated results for that case. Graphically, it is clear that there is excellent agreement between the measured data and the temperatures predicted by the EnergyPlus calculations. The good agreement between the measured and calculated values for this case is the reason this case was chosen as a basis for the extended simulations of the OH and UFAD cases presented in this analysis.

The graphs in Figure 4-2, which also relates to the INT 6_8 run, show that for this scenario, 22% of the heat load from the room is being transferred through the raised floor and into the supply plenum air. Figure 4-4 below summarizes the conduction energy flows through all UFAD lab surfaces. This graph shows clearly that the largest single conduction energy flow is energy flowing down through the raised floor from the test chamber into the supply plenum.

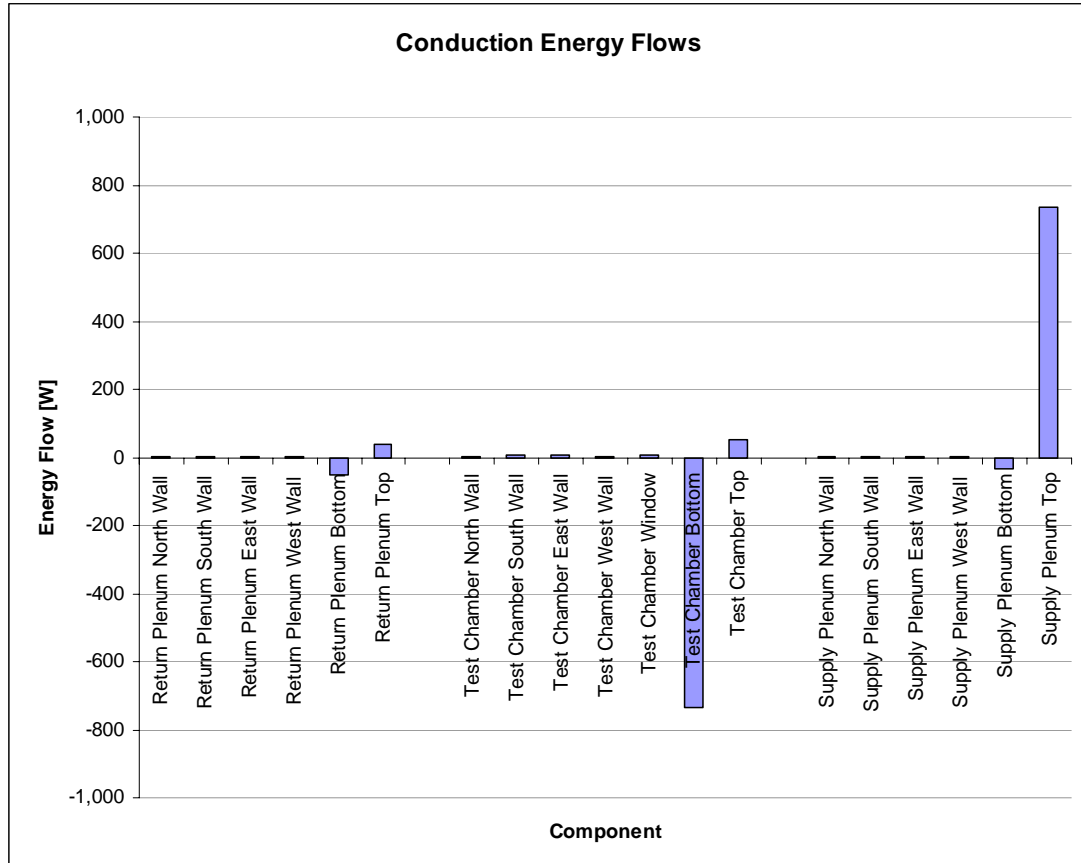

Figure 4-4 Run INT 6_8 Calculated Conduction Energy Flows

Figure 4-4 also shows that very little energy is conducting out of the boundary of the UFAD Lab due to the high level of insulation provided around the walls, floor, and roof of the chamber.

4.1.3 Typical Simulated Overhead Mixing Case

Figure 4-5 and Figure 4-6 present results for a typical OH mixing case. The case that has been selected uses a SAT of 58°F and an airflow of 400 cfm. The resulting occupied zone temperature is 74.2°F.

Run:	INT_6-8
Overrides:	yes
Supply Airflow Direction:	OH
Mixed, DV, or UFAD Run:	Mixed
Airflow	401 cfm
Airflow Density	0.59 cfm/ft ³
Supply Air Temp	58.0 F
Supply Diffuser Air Temp	58.0 F
Return Grille Air Temp	74.2 F
Return Air Temp	75.6 F
Upper Zone temp (calc'd)	74.2 F
Occ Zone temp (calc'd)	74.2 F
4" temp	74.2 F
UFAD transition height	#N/A in

Heat Loads	
Lights to Plenum	119.94 W
Lights to Room	679.6 W
Equipment	1,134.0 W
People	438.00 W
Room Total	2,371.6 W
Lights	1.18 W/ft ²
Equipment	1.68 W/ft ²
People	0.65 W/ft ²
Total	3.51 W/ft ²

UFAD Values	
# Diffusers	1
# People	6
OZ Gains Fraction (knob)	100%
Plumes Per Occupant	2
Diffusers Per Plume	0.08
Diffuser Effective Area	0.01103 m ²
Diffuser Slot Angle	28 deg
Diffuser Type	SINRL

Measured Values (refer to original base run)	
T @ 67 inches	73.46 F
T @ 4 inches	70.17 F
T-67" minus T-4"	3.29 F
Tavg to 6ft	71.3 F

Calculations	
Room Delta-T	17.1 F
System Delta-T	17.6 F

Comfort Calculations - high estimate method	
T-67	74.2 F
T occupied	74.2 F
T-4	74.2 F
T-67 minus T-4	0.0 F

Comfort Calculations - low estimate method	
T-67	74.2 F
T occupied	74.2 F
T-4	74.2 F
T-67 minus T-4	0.0 F

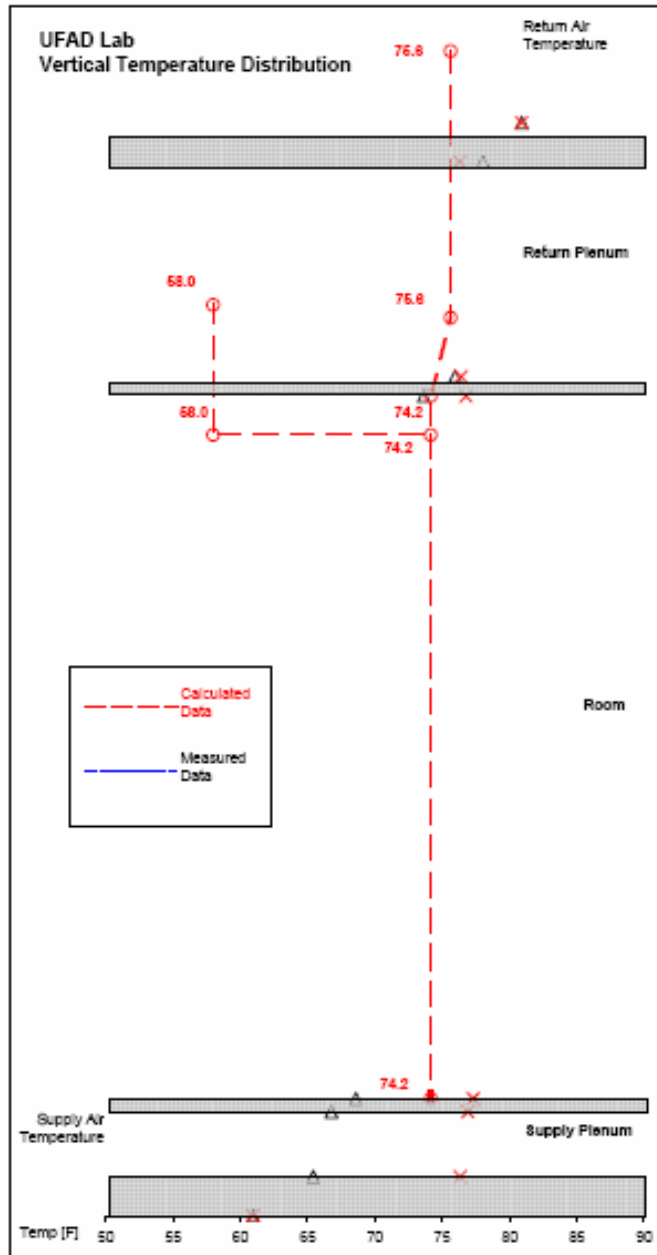

Figure 4-5 OH-58-400 Simulation Run Results – Summary Table and Temperature Graph

The summary temperature graph for runs that are simulated only and do not have a measured case to compare against do not show the black solid measured data line on the graph. They only show the red dashed calculated temperature data.

The graphic presentation for the OH temperature profiles graphs is different from that used for the UFAD graphs. For the OH cases, the supply air temperature is shown in the upper left and the supply diffuser temperature is shown going straight down through the dropped ceiling. From there, the temperature line moves to the right to the temperature of the fully mixed uniform temperature calculated for the room. A vertical line at this mixed temperature is shown from the raised floor level to the dropped ceiling level.

Above the dropped ceiling the temperature line is the same as in the UFAD graphs. The return plenum temperature gain and return air temperature back to the AHU are represented the same as before.

The summary table at the left side of Figure 4-5 shows that the internal loads for this simulated OH case are identical to those used in the INT 6_8 calibration/validation run case.

The results presented in Figure 4-6 for this typical OH case are in the same format as in the UFAD graph (Figure 4-2), but here we can see some significant differences. First, since there is no airflow through the supply plenum below the raised floor, there is no cooling provided to the room in this zone. The Supply Plenum Cooling percentage is zero. Second, the energy flows in the supply plenum are zero since there is no airflow here and there are no driving forces for energy flow in this zone.

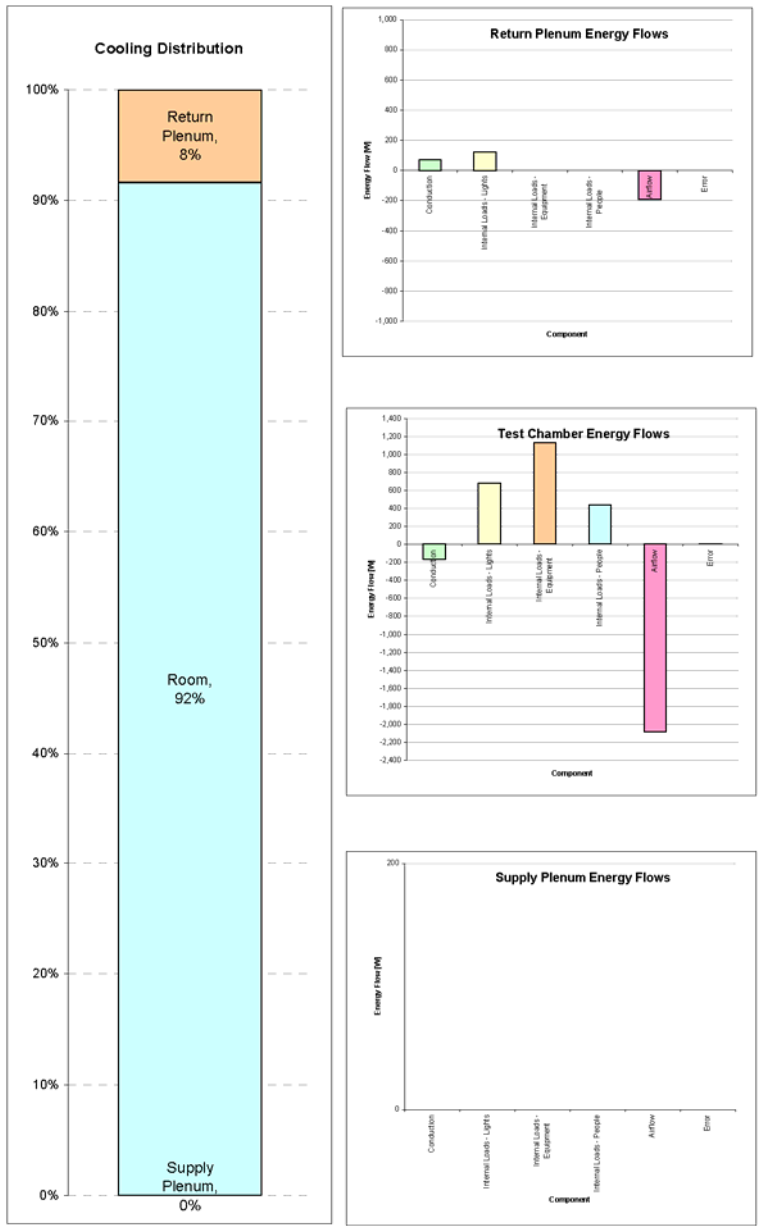

Figure 4-6 OH-58-400 Simulation Run Results – Cooling Distribution and Energy Flows

4.1.4 Typical Simulated UFAD Case

Figure 4-7 and Figure 4-8 present results for a UFAD case. This case uses a SAT of 58°F and an airflow of 400 cfm, which match the OH case already described.

This UFAD case is run with 7 diffusers. The resulting occupied zone temperature is 73.1°F.

Run:	INT_6-8
Override:	yes
Supply Airflow Direction:	UF
Mixed, DV, or UFAD Run:	UFAD
Airflow	401 cfm
Airflow Density	0.59 cfm/ft ²
Supply Air Temp	60.0 F
Supply Diffuser Air Temp	66.0 F
Return Grille Air Temp	77.7 F
Return Air Temp	78.2 F
Upper Zone temp (calc'd)	77.6 F
Occ Zone temp (calc'd)	74.8 F
4" temp	72.1 F
UFAD transition height	59 in

Heat Loads		
Lights to Plenum	119.94	W
Lights to Room	679.6	W
Equipment	1,134.0	W
People	438.00	W
Room Total	2,371.6	W
Lights	1.18	W/ft ²
Equipment	1.68	W/ft ²
People	0.65	W/ft ²
Total	3.51	W/ft²

UFAD Values		
# Diffusers	7	
# People	6	
OZ Gains Fraction (knob)	55%	
Plumes Per Occupant	2	
Diffusers Per Plume	0.58	
Diffuser Effective Area	0.01103	m ²
Diffuser Slot Angle	28	deg
Diffuser Type	SWIRL	

Measured Values (refer to original base run)		
T @ 67 inches	73.46	F
T @ 4 inches	70.17	F
T-67" minus T-4"	3.29	F
Tavg to 6ft	71.9	F

Calculations		
Room Delta-T	12.5	F
System Delta-T	18.2	F

Comfort Calculations - high estimate method		
T-67	77.6	F
T occupied	74.8	F
T-4	72.1	F
T-67 minus T-4	5.5	F

Comfort Calculations - low estimate method		
T-67	75.6	F
T occupied	73.8	F
T-4	72.1	F
T-67 minus T-4	3.5	F

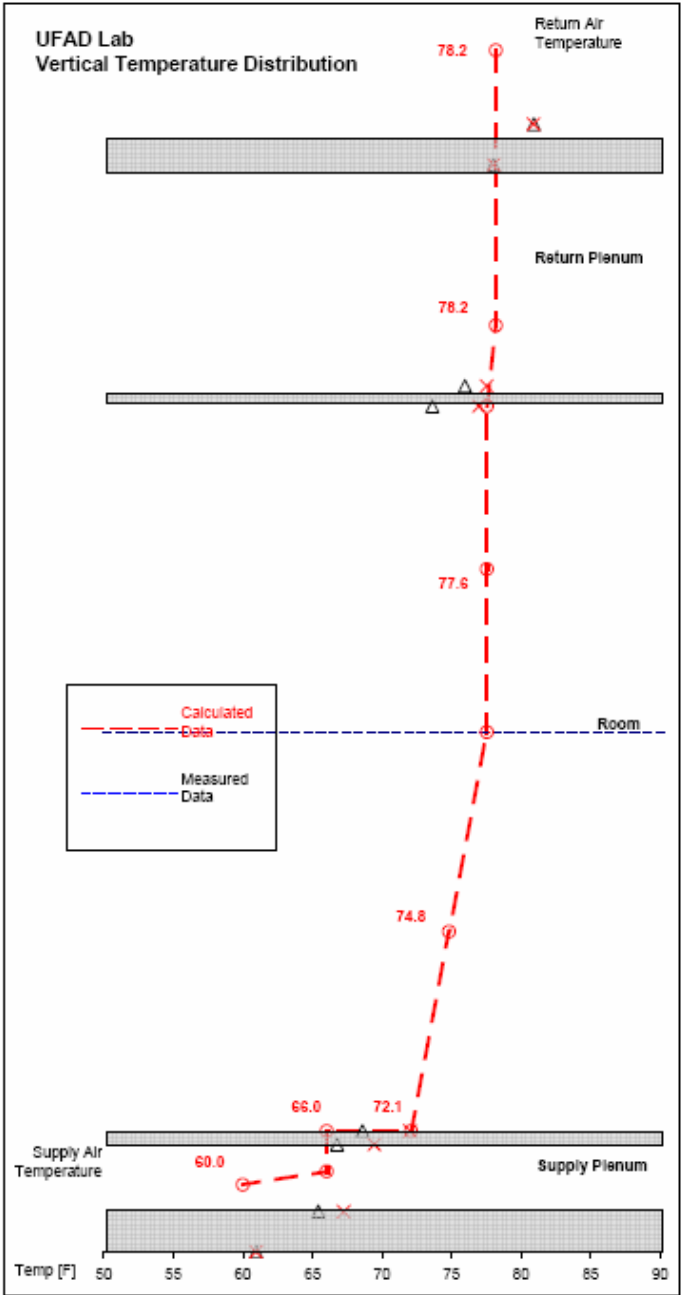

Figure 4-7 UF-58-7-400 Simulation Run Results – Summary Table and Temperature Graph

The temperature graph in Figure 4-7 follows the format described in Section 4.1.1. The measured data solid line is not shown here because this is a simulation run and there is no measured data to compare against.

The resulting occupied zone temperature (Toz) in this UFAD case (73.1°F) is lower than the OH run Toz with the same SAT and airflow (74.2°F). This result is due to the stratification created by the UFAD air flow pattern.

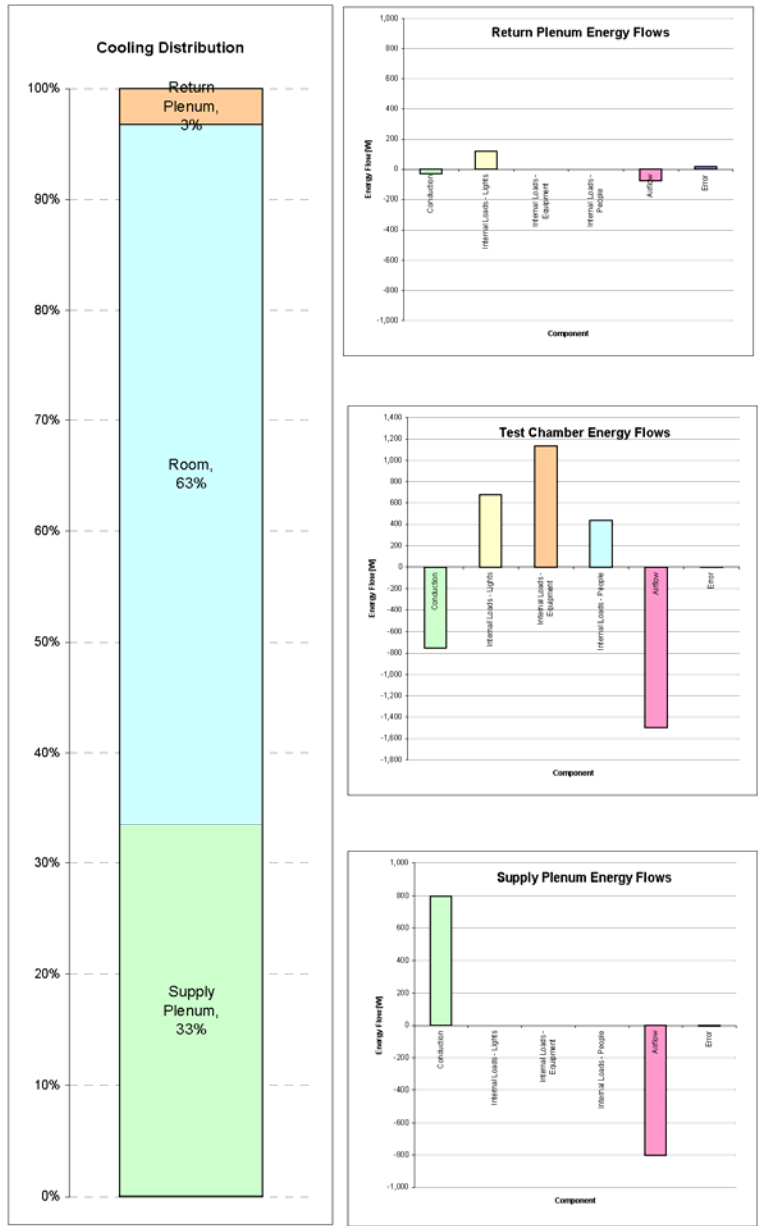

Figure 4-8 UF-58-7-400 Simulation Run Results – Cooling Distribution and Energy Flows

Figure 4-8 shows that in this UFAD case, 33% of the heat load from the room transfers through the raised floor and into the supply air before the air enters the room. The supply air enters the plenum at 58°F and gains more than 6°F before leaving the supply plenum at 64.2°F. In this UFAD case, the temperature gain in the return

plenum accounts for only 3% of the load while in the analogous OH case, the return plenum accounts for 8% of the cooling load.

4.2 Multiple Run Results

As described in Section 3.3.2 Parametric Runs, 147 individual simulation runs were performed across a range of airflow type, supply air temperature, airflow quantity, and diffuser quantity conditions to exercise the EnergyPlus model. The results from these runs are presented in this section.

4.2.1 Run Input data and Output Results Summary

Table 4-3, Table 4-4, and Table 4-5 contain selected input and output data from all of the EnergyPlus simulation runs. The data in these tables present only a small excerpt of the input and output data required for and generated with each run. The input data listed for each run are the airflow distribution type (OH-Mixing or UFAD), the supply air temperature, the number of diffusers (only relevant for UFAD cases), and the airflow quantity. The output values provided for each case are the Toz (mixed room temperature for OH cases and the average temperature to 6 feet for UFAD cases) and the TozGradient (difference in temperatures between 4 inches above the raised floor to 67 inches above the raised floor). The TozGradient values shown here include both the “low” and “high” estimates per the descriptions in Section 4.1.1.

Table 4-3 UFAD Simulation Run Results (1 of 2)

Airflow Type	Supply Air Temperature	Number of Diffusers	Airflow	Tocc	TozGradient High	TozGradient Low
[-]	[°F]	[-]	[ft3/min]	[°F]	[°F]	[°F]
UFAD	54	7	200	83	9.8	5.9
UFAD	54	7	300	74.3	7.5	4.7
UFAD	54	7	400	69.6	5.6	3.6
UFAD	54	7	500	66.9	4	2.6
UFAD	54	7	600	64.9	2.6	1.8
UFAD	54	7	700	63.6	1.6	1.3
UFAD	54	7	800	62.4	1.3	1.1
UFAD	54	14	200	82.7	10.5	6.2
UFAD	54	14	300	73.9	8.5	5.3
UFAD	54	14	400	69.1	6.9	4.3
UFAD	54	14	500	66.2	5.5	3.5
UFAD	54	14	600	64	3.9	2.9
UFAD	54	14	700	62.6	2.9	2.4
UFAD	54	14	800	61.6	2.2	1.9
UFAD	56	7	200	84.5	9.7	5.9
UFAD	56	7	300	75.9	7.4	4.6
UFAD	56	7	400	71.4	5.6	3.5
UFAD	56	7	500	68.6	4	2.6
UFAD	56	7	600	66.7	2.5	1.8
UFAD	56	7	700	65.4	1.6	1.2
UFAD	56	7	800	64.2	1.3	1.1
UFAD	56	14	200	84.2	10.4	6.2
UFAD	56	14	300	75.5	8.4	5.2
UFAD	56	14	400	70.9	6.8	4.3
UFAD	56	14	500	68	5.4	3.5
UFAD	56	14	600	65.8	3.9	2.9
UFAD	56	14	700	64.4	2.9	2.3
UFAD	56	14	800	63.4	2.2	1.9
UFAD	58	7	200	86	9.6	5.8
UFAD	58	7	300	77.6	7.4	4.6
UFAD	58	7	400	73.1	5.5	3.5
UFAD	58	7	500	70.4	3.9	2.5
UFAD	58	7	600	68.5	2.5	1.8
UFAD	58	7	700	67.3	1.5	1.2
UFAD	58	7	800	66.1	1.3	1.1
UFAD	58	14	200	85.7	10.3	6.1
UFAD	58	14	300	77.2	8.4	5.2
UFAD	58	14	400	72.6	6.8	4.3
UFAD	58	14	500	69.8	5.4	3.5
UFAD	58	14	600	67.6	3.9	2.9
UFAD	58	14	700	66.3	2.8	2.3
UFAD	58	14	800	65.3	2.1	1.9
UFAD	60	7	200	87.5	9.5	5.7
UFAD	60	7	300	79.2	7.3	4.5
UFAD	60	7	400	74.8	5.5	3.5
UFAD	60	7	500	72.2	3.9	2.5
UFAD	60	7	600	70.4	2.5	1.8
UFAD	60	7	700	69.1	1.5	1.2
UFAD	60	7	800	68	1.3	1.1

Table 4-4 UFAD Simulation Run Results (2 of 2)

Airflow Type	Supply Air Temperature	Number of Diffusers	Airflow	Tocc	TozGradient High	TozGradient Low
[-]	[°F]	[-]	[ft3/min]	[°F]	[°F]	[°F]
UFAD	60	14	200	87.2	10.2	6.1
UFAD	60	14	300	78.9	8.3	5.1
UFAD	60	14	400	74.3	6.7	4.2
UFAD	60	14	500	71.5	5.3	3.5
UFAD	60	14	600	69.5	3.8	2.8
UFAD	60	14	700	68.1	2.8	2.3
UFAD	60	14	800	67.2	2.1	1.9
UFAD	62	7	200	89	9.4	5.7
UFAD	62	7	300	80.9	7.2	4.5
UFAD	62	7	400	76.6	5.4	3.4
UFAD	62	7	500	74	3.8	2.5
UFAD	62	7	600	72.2	2.4	1.8
UFAD	62	7	700	71	1.5	1.2
UFAD	62	7	800	69.8	1.3	1.1
UFAD	62	14	200	88.7	10.1	6
UFAD	62	14	300	80.5	8.2	5.1
UFAD	62	14	400	76.1	6.7	4.2
UFAD	62	14	500	73.3	5.3	3.4
UFAD	62	14	600	71.3	3.8	2.8
UFAD	62	14	700	70	2.8	2.3
UFAD	62	14	800	69	2.1	1.9
UFAD	64	7	200	90.5	9.4	5.6
UFAD	64	7	300	82.5	7.2	4.5
UFAD	64	7	400	78.3	5.4	3.4
UFAD	64	7	500	75.8	3.8	2.5
UFAD	64	7	600	74	2.4	1.7
UFAD	64	7	700	72.8	1.5	1.2
UFAD	64	7	800	71.7	1.2	1
UFAD	64	14	200	90.2	10	5.9
UFAD	64	14	300	82.2	8.2	5
UFAD	64	14	400	77.8	6.6	4.2
UFAD	64	14	500	75.1	5.2	3.4
UFAD	64	14	600	73.1	3.8	2.8
UFAD	64	14	700	71.8	2.8	2.3
UFAD	64	14	800	70.9	2.1	1.9
UFAD	66	7	200	92	9.3	5.6
UFAD	66	7	300	84.2	7.1	4.4
UFAD	66	7	400	80	5.3	3.4
UFAD	66	7	500	77.5	3.8	2.4
UFAD	66	7	600	75.8	2.4	1.7
UFAD	66	7	700	74.6	1.5	1.2
UFAD	66	7	800	73.5	1.2	1
UFAD	66	14	200	91.7	9.9	5.9
UFAD	66	14	300	83.8	8.1	5
UFAD	66	14	400	79.5	6.6	4.1
UFAD	66	14	500	76.9	5.2	3.4
UFAD	66	14	600	74.9	3.7	2.8
UFAD	66	14	700	73.6	2.7	2.3
UFAD	66	14	800	72.7	2.1	1.9

Table 4-5 OH Simulation Run Results

Airflow Type	Supply Air Temperature	Number of Diffusers	Airflow	Tocc	Toz Gradient
[-]	[°F]	[-]	[ft3/min]	[°F]	[°F]
OH-Mixed	54	1	200	83.7	0
OH-Mixed	54	1	300	75.4	0
OH-Mixed	54	1	400	70.7	0
OH-Mixed	54	1	500	67.7	0
OH-Mixed	54	1	600	65.6	0
OH-Mixed	54	1	700	64	0
OH-Mixed	54	1	800	62.8	0
OH-Mixed	56	1	200	85.2	0
OH-Mixed	56	1	300	77	0
OH-Mixed	56	1	400	72.4	0
OH-Mixed	56	1	500	69.5	0
OH-Mixed	56	1	600	67.4	0
OH-Mixed	56	1	700	65.9	0
OH-Mixed	56	1	800	64.7	0
OH-Mixed	58	1	200	86.7	0
OH-Mixed	58	1	300	78.7	0
OH-Mixed	58	1	400	74.2	0
OH-Mixed	58	1	500	71.2	0
OH-Mixed	58	1	600	69.2	0
OH-Mixed	58	1	700	67.7	0
OH-Mixed	58	1	800	66.6	0
OH-Mixed	60	1	200	88.2	0
OH-Mixed	60	1	300	80.4	0
OH-Mixed	60	1	400	75.9	0
OH-Mixed	60	1	500	73	0
OH-Mixed	60	1	600	71	0
OH-Mixed	60	1	700	69.6	0
OH-Mixed	60	1	800	68.4	0
OH-Mixed	62	1	200	89.7	0
OH-Mixed	62	1	300	82	0
OH-Mixed	62	1	400	77.6	0
OH-Mixed	62	1	500	74.8	0
OH-Mixed	62	1	600	72.9	0
OH-Mixed	62	1	700	71.4	0
OH-Mixed	62	1	800	70.3	0
OH-Mixed	64	1	200	91.3	0
OH-Mixed	64	1	300	83.7	0
OH-Mixed	64	1	400	79.4	0
OH-Mixed	64	1	500	76.6	0
OH-Mixed	64	1	600	74.7	0
OH-Mixed	64	1	700	73.3	0
OH-Mixed	64	1	800	72.2	0
OH-Mixed	66	1	200	92.8	0
OH-Mixed	66	1	300	85.3	0
OH-Mixed	66	1	400	81.1	0
OH-Mixed	66	1	500	78.4	0
OH-Mixed	66	1	600	76.5	0
OH-Mixed	66	1	700	75.1	0
OH-Mixed	66	1	800	74	0

4.2.2 Occupied Zone Temperature Results

In the figures that follow, the numerical data from the tables is presented in graphical format. Table 4-6 below summarizes the Toz results for the UFAD simulation runs. Figure 4-9 shows, for all the UFAD cases, the relationship between airflow and the resulting occupied zone average temperature. The sets of curves shown on the graph represent varying SAT and number of diffuser cases. The SAT is indicated by the label at the left of each curve, and ranges from 66°F at the highest to 54°F at the lowest. For each SAT, there are two curves shown, one for the run with 14 diffusers and the other for the run with 7 diffusers.

Table 4-6 UFAD Simulation Run Summary, Occupied Zone Temperature (Toz) Results

SAT [F]	54		56		58		60		62		64		66	
# Diffusers	7	14	7	14	7	14	7	14	7	14	7	14	7	14
Airflow	Tocc [F]													
200	83	82.6	84.5	84.1	86	85.6	87.5	87.2	89	88.7	90.5	90.2	92	91.7
300	74.2	73.8	75.9	75.5	77.5	77.1	79.2	78.8	80.8	80.5	82.5	82.1	84.1	83.7
400	69.5	69.1	71.3	70.8	73	72.5	74.7	74.3	76.5	76	78.2	77.7	79.9	79.5
500	66.7	66.1	68.5	67.9	70.3	69.7	72.1	71.5	73.8	73.2	75.6	75	77.4	76.8
600	64.7	64	66.5	65.8	68.3	67.6	70.2	69.4	72	71.2	73.8	73	75.6	74.8
700	63.4	62.5	65.2	64.3	67.1	66.2	68.9	68	70.8	69.8	72.6	71.7	74.5	73.5
800	62.4	61.4	64.2	63.3	66.1	65.2	68	67	69.8	68.9	71.7	70.7	73.5	72.6

The results in Figure 4-9 show that for a given airflow, as the SAT decreases the resulting Toz decreases. It also shows that for a given SAT, as the airflow increases, the resulting Toz decreases. Both of these results are explained and confirmed by our understanding and experience with HVAC systems in buildings. For a given room load, as we provide more air or cooler air, the resulting room air temperature decreases.

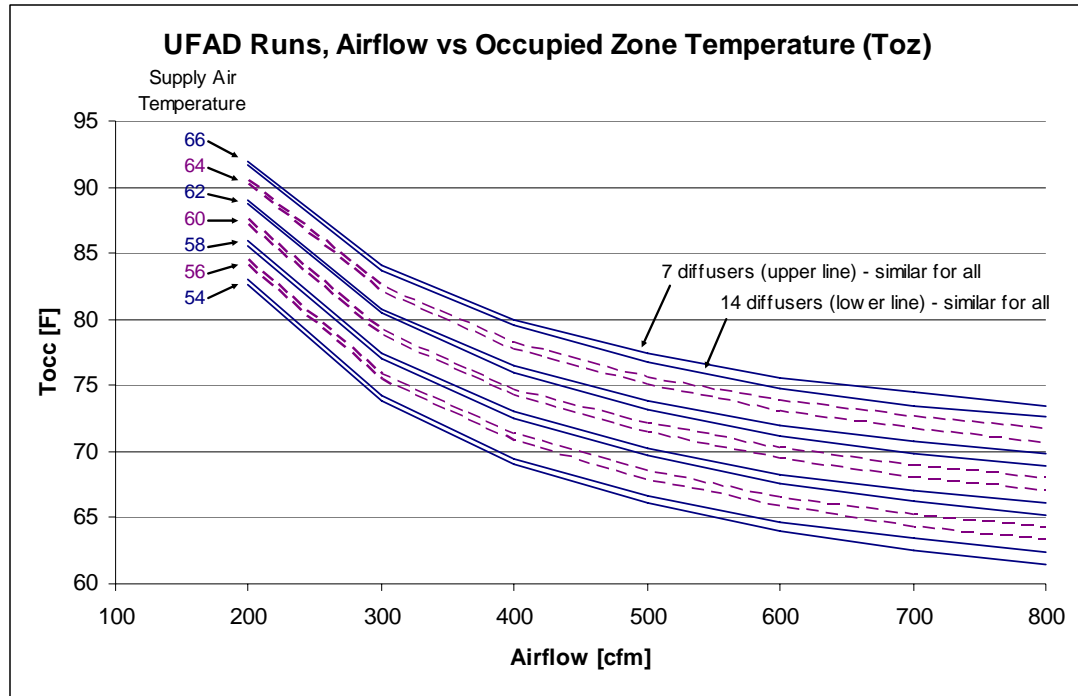

Figure 4-9 UFAD Simulation Run Summary, Airflow vs Occupied Zone Temperature (Toz)

The number of diffusers used in the UFAD runs clearly affects the resulting Toz for a given airflow and SAT. When more diffusers are used for a given airflow, there is less airflow per diffuser, so the discharge velocities are lower and there is less induction and mixing caused by the diffuser. This case is more towards a true displacement ventilation system rather than a mixing system. It is characteristic of displacement ventilation system performance to see increased stratification, which is what we are seeing here. As we use more diffusers, the resulting airflow patterns create more stratification, which results in a room temperature profile with higher temperatures and more heat at the top of the room. Increased heat at the top of the room for a given load means that the lower part of the room has less heat, so the Toz is lower for the cases with more stratification and more diffusers. The data from the

UFAD runs as shown on the graph bears this out – the 14 diffuser case line is below (cooler) than the 7 diffuser case line for each SAT.

4.2.3 Occupied Zone Temperature Gradient Results

Table 4-7 and Figure 4-10 below present a different subset of the data from the UFAD runs. This graph shows the resulting upper bound (high estimate) TozGradient across all of the UFAD cases that were simulated. SAT variations are shown from 54°F to 66°F, airflow is varied from 200 cfm to 800 cfm, and diffuser quantity is varied between 7 and 14 for the 626 ft² room.

The results from this graph show a similar result to that established in the comparison of the 7 and 14 diffuser runs discussed above. Here we can see that the number of diffusers has a strong influence on the amount of stratification that develops in the room. When more diffusers are used for a given airflow and SAT, there is less airflow per diffuser, which pushes the performance of the room more towards a displacement regime. With increased displacement behavior comes increased stratification, shown here as an increased difference between the temperature 4 inches above the floor to 67 inches above the floor, which is the definition of TozGradient. When the airflow to the room is 800 cfm (in the bottom row of the table) the gradients are in the range of 1.2 to 2.3°F. When the airflow to the room is much lower at 200 cfm (top row of the table), the gradients are much higher – in the range of 9.4 to 10.6°F.

Table 4-7 UFAD Simulation Run Summary, TozGradient Results, “High” Results

SAT [F]	54		56		58		60		62		64		66	
# Diffusers	7	14	7	14	7	14	7	14	7	14	7	14	7	14
Airflow	TozGradient [F]													
200	9.9	10.6	9.8	10.5	9.7	10.4	9.6	10.3	9.5	10.2	9.5	10.1	9.4	10.0
300	7.7	8.6	7.7	8.6	7.6	8.5	7.5	8.4	7.5	8.4	7.4	8.3	7.4	8.3
400	5.9	7.0	5.8	7.0	5.8	6.9	5.7	6.9	5.7	6.8	5.6	6.8	5.6	6.7
500	4.4	5.6	4.3	5.6	4.3	5.5	4.3	5.5	4.2	5.4	4.2	5.4	4.1	5.3
600	2.9	4.0	2.9	4.0	2.9	4.0	2.8	3.9	2.8	3.9	2.8	3.9	2.8	3.9
700	1.9	3.0	1.9	3.0	1.8	3.0	1.8	3.0	1.8	2.9	1.8	2.9	1.8	2.9
800	1.3	2.3	1.3	2.3	1.3	2.3	1.3	2.3	1.3	2.3	1.2	2.3	1.2	2.2

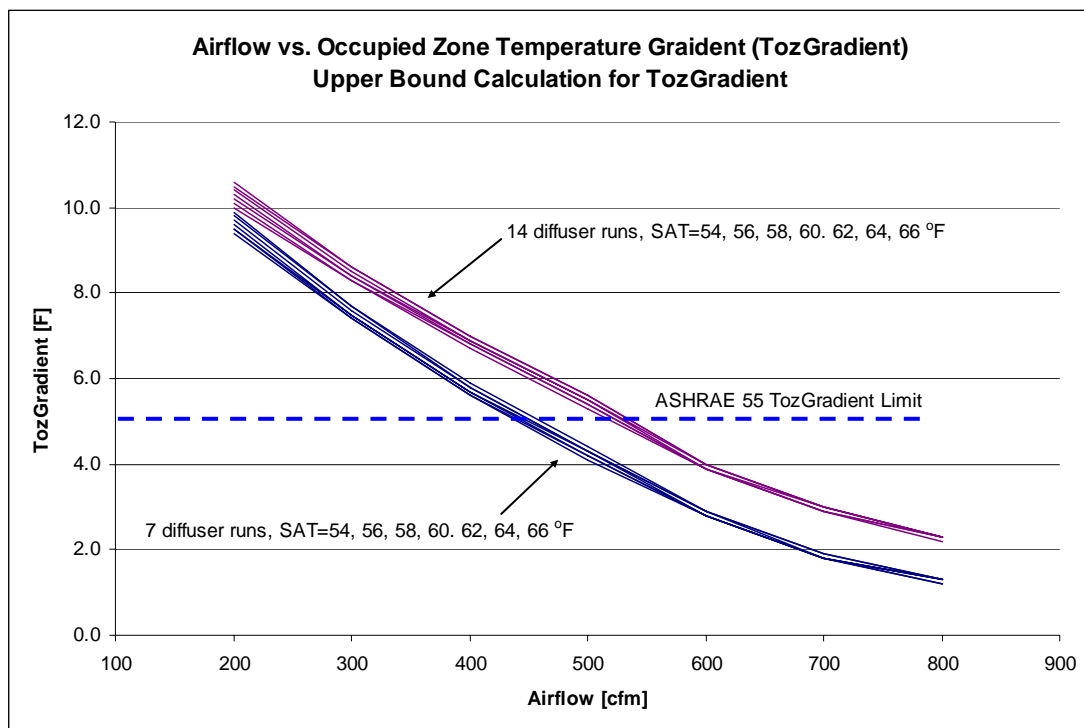

Figure 4-10 UFAD Simulation Run Summary, Airflow vs Occupied Zone Temperature Gradient (TozGradient), “High Results”

The curves resulting from the multiple EnergyPlus runs cluster themselves neatly into two groups – those from the 14 diffuser runs and those from the 7 diffuser runs.

It is interesting to note that supply air temperature has very little effect on the amount of stratification created in the room. The runs for SAT values of 54°F through

66°F show little difference. It appears that the SAT does not directly affect stratification. Instead, the balance between mixing behavior and heat plume behavior is the primary driver for stratification.

Airflow does have a noticeable effect on stratification, as discussed already. As the airflow to the room is reduced, there is less airflow per diffuser, less mixing, and more stratification, which is represented by higher TozGradient values.

Another item worth noting on the TozGradient graph is the airflow quantity that equates to 5°F TozGradient for both the 7 diffuser and the 14 diffuser cases. The 5°F level of stratification is interesting to consider since this is the threshold of allowable stratification in ASHRAE Standard 55. Stratification above this limit is deemed to be outside a comfortable range for occupants.

For the 7 diffuser case, a TozGradient of 5°F occurs at roughly 450 cfm. For the 14 diffuser case, a TozGradient of 5°F occurs at roughly 540 cfm. Since using more diffusers results in higher stratification, the 14 diffuser case requires more air than the 7 diffuser case to achieve the same stratification level.

Table 4-8 and Figure 4-11 present the same data as described above, but show the results when the reasonable lower bound interpretation is considered.

Table 4-8 UFAD Simulation Run Summary, TozGradient Results, “Low” Results

SAT [F]	54		56		58		60		62		64		66	
# Diffusers	7	14	7	14	7	14	7	14	7	14	7	14	7	14
Airflow	TozGradient [F]													
200	5.9	6.2	5.9	6.2	5.8	6.1	5.7	6.1	5.7	6.0	5.6	5.9	5.6	5.9
300	4.7	5.3	4.6	5.2	4.6	5.2	4.5	5.1	4.5	5.1	4.5	5.0	4.4	5.0
400	3.6	4.3	3.5	4.3	3.5	4.3	3.5	4.2	3.4	4.2	3.4	4.2	3.4	4.1
500	2.6	3.5	2.6	3.5	2.5	3.5	2.5	3.5	2.5	3.4	2.5	3.4	2.4	3.4
600	1.8	2.9	1.8	2.9	1.8	2.9	1.8	2.8	1.8	2.8	1.7	2.8	1.7	2.8
700	1.3	2.4	1.2	2.3	1.2	2.3	1.2	2.3	1.2	2.3	1.2	2.3	1.2	2.3
800	1.1	1.9	1.1	1.9	1.1	1.9	1.1	1.9	1.1	1.9	1.0	1.9	1.0	1.9

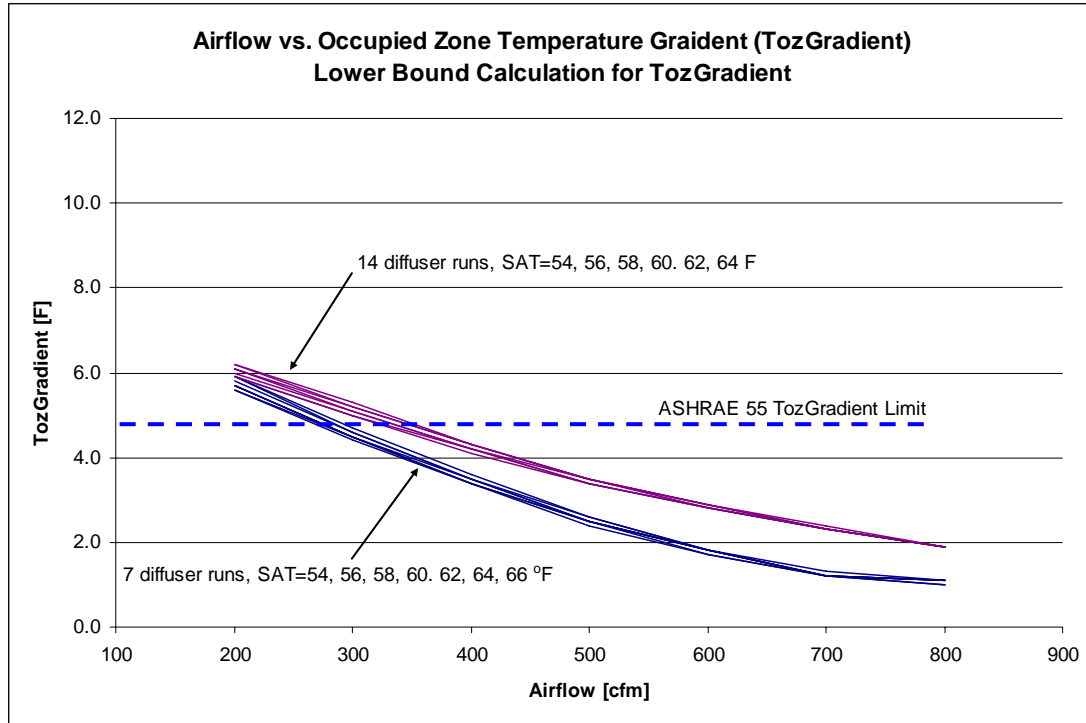

Figure 4-11 UFAD Simulation Run Summary, Airflow vs Occupied Zone Temperature Gradient (TozGradient), “Low Results”

The results shown here vary significantly from the “high” or upper bound results presented previously. Occupied zone temperature stratification is reduced as much as 4°F at the lower airflows, which has a significant impact on the extent of the runs that are above the 5°F ASHRAE-55 stratification limit.

These results show many fewer conditions above the stratification limit. In the 7 diffuser runs, the airflow corresponding to the 5°F limit is 280 cfm. In the 14 diffuser cases it is 340 cfm.

4.2.4 OH and UFAD Results Comparison

The approach used to directly compare OH and UFAD cases is to consider rooms with “equivalent” comfort conditions and see how much airflow is required in the OH case and various UFAD cases. The simulation results have been transformed

in Table 4-9, Table 4-10, and Table 4-11 below to capture both OH and UFAD cases where the Toz is equal to 72°F and 75°F. These are intended to be typical conditions that might be found in an office building. To create these tables, the data presented in Section 4.2.1 has been interpolated for the cases of Toz = 75°F and 72°F.

Table 4-9 Interpolated OH Simulation Results for Toz = 72°F and 75°F

SAT [F]	Tocc = 75°F	Tocc = 72°F
	Airflow [cfm]	Airflow [cfm]
54	309	372
56	343	414
58	382	473
60	431	550
62	493	660
64	584	818
66	707	982

Table 4-10 Interpolated UFAD Simulation Results for Toz = 72°F

SAT [F]	Tocc = 72 °F	
	7 diffusers	14 diffusers
	Airflow [cfm]	Airflow [cfm]
54	347	338
56	385	374
58	437	418
60	505	482
62	600	560
64	767	677
66	950	867

Table 4-11 Interpolated UFAD Simulation Results for Toz = 75°F

SAT [F]	Tocc = 75 °F	
	7 diffusers	14 diffusers
	Airflow [cfm]	Airflow [cfm]
54	291	286
56	320	311
58	356	346
60	393	384
62	456	436
64	533	500
66	655	590

Figure 4-12 below presents this data graphically and shows how supply air temperature (X axis) and system airflow (Y axis) must vary to maintain a Toz of 72°F or 75°F. The upper set of three curves describes the conditions for Toz = 72°F and the lower set of three curves show the conditions where Toz = 75°F.

In each set of curves, the three lines represent the OH case (dashed, upper line), a UFAD case with 7 diffusers (solid, middle line), and a UFAD case with 14 diffusers (solid, bottom line).

The graph also shows the conditions where the TozGradient is equal to 5°F with a solid black line across each of the UFAD curves. In Section 4.2.3, the 5°F TozGradient condition was shown to vary primarily with number of diffusers and airflow. For the 7 diffuser cases, an airflow of roughly 450 cfm created a TozGradient of 5°F. For the 14 diffuser cases, an airflow of roughly 540 cfm created a TozGradient of 5°F. On the graph below, solid black lines are placed on top of the UFAD lines at 450 cfm for the 7 diffuser cases and 540 cfm for the 14 diffuser cases. To the right and above these black lines, the TozGradient is less than 5°F, and to the left and below these lines the TozGradient is above 5°F.

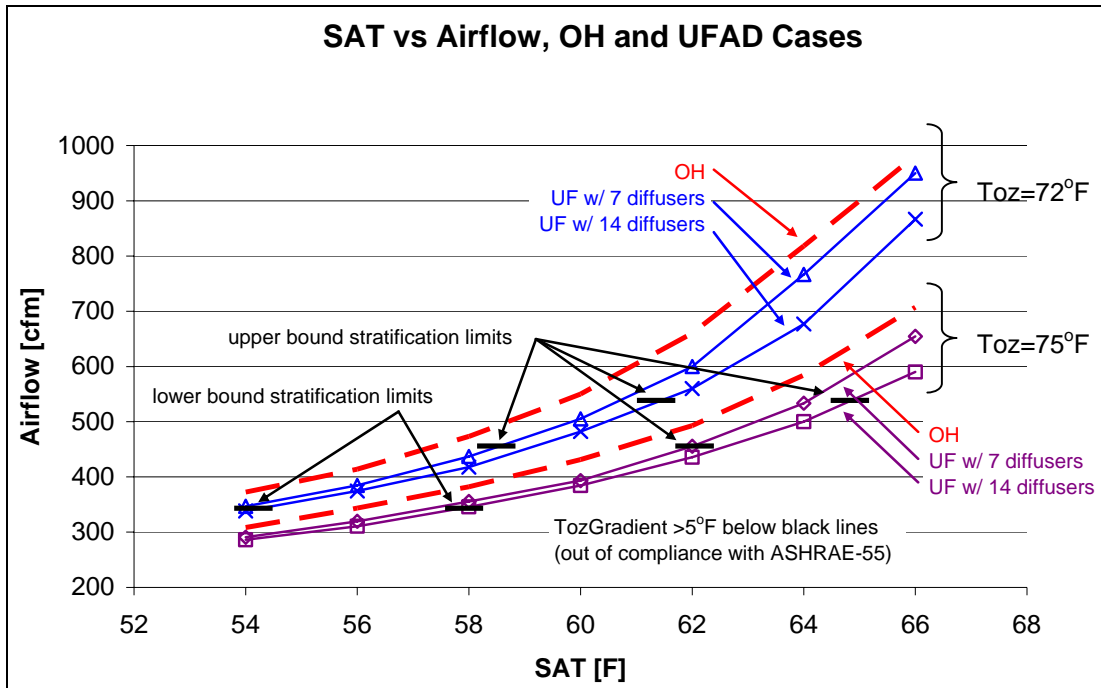

Figure 4-12 Simulation Run Summary, OH and UFAD runs, Supply Air Temperature vs. Airflow

By looking at this graph, it is now possible to directly compare an OH case to a UFAD case for an equivalent occupant comfort condition. For example, if we select a design condition that corresponds to typical HVAC design parameters (Toz of 75°F and OH SAT of 57°F), the required airflow for the thermal load under consideration is about 360 cfm (this data can also be seen in Table 4-9). For a UFAD system, a starting point might not be to simply pick a desired SAT, as we did for the OH system. Instead, the goal might be to minimize airflow as much as possible, while keeping the vertical temperature gradient within the maximum limit allowed by ASHRAE-55. With these design goals and assuming the upper bound stratification values, the UF-7 case would be optimized at a SAT of 62°F and an airflow of 450 cfm. The UF-14 case would be optimized at a SAT of 65°F and an airflow of 540 cfm. For the lower bound

stratification values, there is no limit on airflow in the UF-7 case and the UF-14 case would be optimized at a SAT of 58°F with an airflow of 340 cfm.

If the desired space temperature T_{oz} was equal to 72°F instead of 75°F, the room would require either more airflow or a cooler SAT to maintain the cooler space temperature as compared to the case where T_{oz} is equal to 75°F. In an OH case, if we fix the SAT equal to 57°F, the airflow required is 445 cfm. For the UFAD cases, if we fix the T_{oz} Gradient to 5°F and assume the upper bound stratification values, the UF-7 case requires 450 cfm again, but with a cooler SAT of 58.5°F, and the UF-14 case would require 540 cfm with a SAT of 61.5°F. Using the lower bound stratification values, there is no limit on SAT due to stratification, so there is no constraint on either SAT or airflow. If we pick the airflow quantity to be the same as in the OH case (445 cfm), then the required SAT for the UFAD cases is roughly 58.5°F, or 1.5°F warmer than the OH SAT.

Table 4-12 summarizes these three design cases and shows the resulting SAT and airflow values for each.

Table 4-12 OH vs UFAD Design Comparison for Equivalent Comfort Conditions

T_{occ}	OH Case		UF - 7 diffuser case			UF - 14 diffuser case		
	SAT	Airflow	TozGradient = 5°F			TozGradient = 5°F		
[F]	[F]	[cfm]	SAT	Airflow	% of OH	SAT	Airflow	% of OH
			[F]	[cfm]	[-]	[F]	[cfm]	[-]
upper bound stratification assumptions								
75	57	360	62	450	125%	65	540	150%
72	57	445	58.5	450	101%	61.5	540	121%
lower bound stratification assumptions								
75			57	340	94%	58	340	94%
72			57	420	94%	57	400	90%

This comparison shows that the TozGradient is clearly a function of airflow and that picking one quantity will set the other. Once the 5°F TozGradient is set, then the airflow can be determined. Once the airflow is determined, the required SAT to meet the room thermal load is the only remaining variable to solve for. In practice, the 5°F TozGradient maximum is an important driver in selecting the SAT for both the UFAD case with 7 diffuser and with 14 diffusers. Because the TozGradient is dependent only on the airflow quantity (see Figure 4-10), the SAT is the remaining system design variable to be selected when calculating the system design parameters for each UFAD case considered. In both UFAD cases with 7 diffusers, the airflow is 450 cfm regardless of SAT. In both UFAD cases with 14 diffusers, the airflow is 540 cfm regardless of SAT.

When Toz is desired to be 75°F, the UF-7 and upper bound stratification assumptions case requires a minimum SAT of 62°F, which is 5°F higher than the OH SAT of 57°F used here. The airflow required to limit the TozGradient to 5°F is 450 cfm, which is 125% of the airflow required in the OH case. With 14 diffusers and upper bound stratification assumptions used, higher stratification is created and more airflow is needed to keep the TozGradient to 5°F. In this case 540 cfm is needed, which is 150% of the OH airflow requirement.

With a Toz value of 72°F, more air or colder air is needed than in the Toz = 75°F case. There is always a driver to push the SAT as high as possible to maximize free cooling, so in practice increased air volumes are typically seen. The higher airflow rates for cooler Toz setpoints cause more mixing and less stratification than in the warmer Toz cases. For this condition, the minimum SAT requirement to achieve a

5°F TozGradient in the UFAD case with 7 diffusers is 58.5°F and the airflow required is again 450 cfm. With 14 diffusers, the SAT that creates the 5°F TozGradient is 61.5°F and the required airflow is again 540 cfm. For these conditions the UF-7 airflow is roughly to the OH case, and the UF-14 airflow is 121% of the OH case.

5. Discussion

5.1 UFAD vs. OH System Design Comparison

The most typical HVAC system approach used today for new commercial construction is the OH variable volume reheat system approach. Designing these systems is the meat and potatoes of engineers working in new commercial construction. As such, comparing the key design parameters of UFAD systems against those for OH systems is a common and useful approach to characterize UFAD systems because the OH system designs are so well known and understood.

Two key parameters for consideration when comparing OH and UFAD systems are the required airflow and the design supply air temperature (SAT). The required airflow directly relates to the size of the fans and ducts and other air-side system components and the required SAT relates to how the cooling systems in the building are selected and sized. Both parameters strongly influence the energy performance of the HVAC system, and have implications for fan energy use and economizer cooling. Because airflow and SAT are such important system design parameters, it is interesting to look at these quantities in this comparative analysis.

5.1.1 Airflow Comparison

Figure 4-12 and Table 4-12 show that for the internal zone case considered here, the airflow quantity required when trying to achieve a Toz temperature of 75°F is significantly higher in the UFAD cases than in the OH cases using the upper bound stratification values. Specifically, UF-7 case requires 25% more air and the UF-14 case requires 50% more air than OH.

This result directly relates to the amount of stratification created in the space by the UFAD floor supply and the diffusers. Stratification occurs as the buoyancy and momentum forces at work in the space resolve themselves as discussed in Section 2.1.1. Buoyancy directly relates to the heat sources in a space, which for this analysis were held constant across all runs. Buoyancy forces work to increase stratification. Momentum forces serve to increase mixing and decrease stratification in a space. Momentum strength in this analysis directly relates to the airflow and number of diffusers being used. Higher airflow creates more mixing because more air is being delivered to the space and the momentum of that air has the strength to overcome the buoyancy forces at work.

Using fewer diffusers for a given airflow (for example, consider a single UFAD run with the same airflow, but one employing 7 diffusers and the other 14 diffusers) also creates more momentum and more mixing and consequently results in reduced stratification. For a given airflow quantity, if that air is delivered to the room through fewer diffusers in one case than another, the discharge velocity of the air will be higher and so the momentum of the air will be higher. The momentum of the air has a strong effect on the resulting temperature conditions.

Figure 4-10 clearly shows the strong link between momentum and stratification. The Y-axis on this graph shows TozGradient, which is a measure of stratification. There is a strong effect on this variable as the airflow is increased or decreased, as can be seen by the high slope of the performance curves. It is also clear that the number of diffusers used in a room has a strong impact on the momentum and stratification. The 7 diffuser cases cluster together closely and the 14 diffuser cases cluster together closely. At all times, for a given airflow, the stratification exhibited in the 14 diffuser cases is higher than that in the 7 diffuser cases. This is due to the increased momentum imparted to the air when fewer diffusers are used.

Figure 4-10 also shows that there is little effect of varying SAT on the amount of stratification exhibited in the model. A range of SAT values from 54°F to 66°F is presented, and very little distinction can be seen between the lines representing different SAT values.

When comparing the OH case and the UFAD cases for equivalent comfort conditions, the stratification level is the key determinant of the airflow required due to the strong link between stratification, airflow, and number of diffusers discussed above. For a given number of diffusers, the 5°F TozGradient limit sets the minimum amount of airflow needed in the room to keep the stratification down to an acceptable level. Once the airflow is determined, the only variable left that needs to be determined is the SAT required to meet the thermal load in the space.

For the 75°F Toz condition considered here in this internal zone analysis, it appears that buoyancy forces are significant relative to the OH mixing case. The OH mixing case can be considered to be dominated by mixing and momentum effects

since it employs a single diffuser for this type of space, and that diffuser is designed specifically to impart momentum to the air and mix the air in the room completely. Were we to deliver the same quantity of air and the same supply air temperature but from the floor instead of the ceiling, we can see that significant stratification would develop. To keep the stratification level to below the 5°F acceptable limit using upper bound stratification assumptions, more air is needed to counteract the stratification. With 7 diffusers (more mixing), 125% of the airflow quantity is required. With 14 diffusers (less mixing, more stratification), 150% of the airflow is required.

To keep the room at a Toz condition of 72°F, both the OH and UFAD systems require more airflow than the Toz condition of 75°F to make the space cooler. This additional air quantity creates more mixing, which naturally reduces the stratification levels in the room in the UFAD cases. For the UF-7 case, roughly the same quantity of air is required as in the OH case. For the UF-14 case, 121% of the air is required.

The requirement for more air in the UFAD cases compared to OH cases can be seen as a negative attribute of UFAD, since higher airflow quantities will require physically larger fan systems, ducts, and other air-side components. In the best case when comparing UFAD to OH modeled here, the UFAD case required the same amount of air as the OH case, which can be considered a neutral comparison between the two.

Using the lower-bound stratification assumptions makes the comparison of OH and UFAD systems much less different from an airflow standpoint. The lower bound stratification assumptions effectively do not place any limits on the airflow quantities that can be used. When the same SAT is assumed as in OH systems, then the airflow

quantities are less in UFAD systems by about 10 percent due to the stratified temperature profile.

Since the EnergyPlus UFAD model is still new, one clear area of focus for further refinement will be trying to come to an understanding of how the single temperature for the lower zone and single temperature for the upper zone that EnergyPlus predicts can best be interpreted to create a stratified temperature profile for the room. The resulting stratification can have a significant creating limits on system design when upper bound assumptions are used, and have little effect when lower bound assumptions are used.

5.1.2 Supply Air Temperature (SAT) Comparison

To meet the thermal load in a space an HVAC system designer has two primary parameters to vary in planning for system operation: airflow quantity and supply air temperature (SAT). Because the airflow quantities in the UFAD cases are usually set by the allowable stratification, the SAT is the only remaining variable that can be adjusted to meet the thermal load of the space.

Table 4-12 summarizes two cases of OH and UFAD designs that are equivalent in terms of comfort conditions. It shows that where an OH system would use a SAT of 57°F, the equivalent UFAD case with 7 diffusers designed to minimize airflow (and maximize the allowable TozGradient) would require a SAT of 62°F to maintain a Toz of 75°F. With 14 diffusers, the required SAT rises to 65°F. If the desired Toz is 72°F, the UF-7 case requires a SAT of 58.5°F and the UF-14 case requires a SAT of 61.5°F.

The difference between the required SAT in the OH and UFAD cases is 5°F and 8°F for the UF-7 and UF-14 cases respectively, where Toz is 75°F. The difference between the required SAT in the OH and UFAD cases is 1.5°F and 4.5°F for the UF-7 and UF-14 cases where Toz is 72°F.

The finding that UFAD systems require warmer SAT values is significant. SAT is an important consideration when evaluating system performance with respect to economizer free cooling, reheat, and dehumidification, to name three important examples. Economizer free cooling will be increased with higher supply air temperatures – there are more hours where full and partial free cooling using outdoor air can be accomplished when the SAT is higher. Reheat energy is also reduced as the SAT increases. At the same time, dehumidification capacity is reduced as the supply air temperature increases.

5.2 Implications of Thermal Comfort Guidance on UFAD System

Design

The analysis of this single interior UFAD zone points out that the 5°F allowable TozGradient as mandated by ASHRAE Standard 55 is the single most important driving factor in determining the airflow and resulting SAT quantities for the space. Figure 4-10 clearly shows the strong connection between stratification and both airflow and number of diffusers used. UFAD system design in this light can be seen as a balance of airflow against load to limit the amount of stratification that is allowed to occur. The airflow quantities need to increase over equivalent OH scenarios in order to keep the stratification levels within acceptable limits.

Clearly the 5°F stratification limit has a strong effect on UFAD system design. If more stratification were allowed, then the airflow quantities could be reduced, which would have a system sizing impact as well as an energy performance impact.

New comfort research (Zhang et al. 2005) has some promising implications for UFAD system design. It suggests that higher values for TozGradient can be found comfortable by occupants. Figure 2-7 shows that as much as a 12.6°F (7°C) gradient can be found acceptable.

Were the TozGradient limit to be increased a modest 2°F, to a value of 7°F, for example, Figure 4-10 tells us that for the 7 diffuser case roughly 325 cfm would be required and for the 14 diffuser case 380 cfm would be needed using the upper bound stratification assumptions. Table 5-1 below summarizes the new design conditions if a TozGradient of 7°F were to be allowed.

Table 5-1 Revised OH vs UFAD Design Comparison for TozGradient = 7°F

Tocc	OH Case		UF - 7 diffuser case TozGradient = 7°F			UF - 14 diffuser case TozGradient = 7°F		
	SAT	Airflow	SAT	Airflow	% of OH	SAT	Airflow	% of OH
[F]	[F]	[cfm]	[F]	[cfm]	[-]	[F]	[cfm]	[-]
75	57	360	56.5	325	90%	57	380	106%
72	57	445	55.8	325	73%	56.2	380	85%

The impacts of a higher allowable TozGradient are significant. Instead of the UFAD cases requiring more air as they did previously, now they require less air, even with the upper bound stratification assumptions, and in the case with 7 diffusers and a Toz of 72°F, the reduction in airflow over the OH equivalent case is quite significant.

Only 73% of the airflow is required, which is a 27% reduction in airflow over the equivalent OH case.

If more stratification can be thermally acceptable to occupants, there is a real potential to reduce airflows, which can have an overall strongly positive impact on HVAC system cost and energy use.

5.3 Comparison with UFAD Design Guidance to Date

The new UFAD model in EnergyPlus, the supporting bench scale and full scale validation testing, and the analysis presented here, all together start to shed some light on how UFAD systems perform in a justifiable, quantitative manner. Prior to this work, individual components of UFAD system performance had been evaluated, but putting all the pieces together relied primarily on judgment and anecdotal evidence from a body of built projects. The analytical / quantitative results now present data that are in some ways in strong contrast with the design guidance established to date in the HVAC design community.

The single largest difference that this analysis points out compared to conventional UFAD design practice today is that the required SAT values are much lower than previously thought. Most of the UFAD designs that my office has created or reviewed have had supply air temperatures (leaving the air-handling unit) in the range of 61°F to 65°F. The UFAD Design Guide (Bauman 2003, 6) calls out this range as the desired temperature of the air leaving the supply outlets, which is advice that still makes sense given this new analysis (i.e., Table 4-12 shows SAT values in the range of 58°F to 65°F). Figure 4-7 shows that for a typical UFAD case where the

Toz is a reasonable 73.1°F, the temperature of the air leaving the supply diffusers is 64.2°F. However, the UFAD Design guide in Section 4.4 talks about a thermal decay value in the range of roughly 0.1°F / ft, which if applied using the “50 foot rule” (which means to limit the air travel distance to 50 ft inside a supply air plenum) implies that 5°F thermal decay could be expected. Designers typically worked backward from a recommended 65°F diffuser supply temperature and subtracted roughly 5°F to arrive at air handling unit supply temperatures (SAT) in the range of 60°F.

This analysis is of a 26 foot by 26 foot room, and the plenum model predicts 6.2°F of thermal decay between the time the air enters the supply plenum and the time it leaves the supply diffusers. This results in roughly 0.24°F/ft temperature increase, or about 2.5 times the levels assumed previously. Figure 4-8 shows that, in this case, 33 percent of the thermal load from the room is being absorbed by the floor and supply air before that air enters the room. The result is that SAT values need to be much cooler than previous guidance suggests.

Other research based on calculated heat transfer quantities through the raised floor suggest that the percentage of thermal load from the room that is absorbed by the floor under typical office conditions is roughly half of what the EnergyPlus UFAD model currently predicts (Bauman Hui Webster 2006). As the EnergyPlus UFAD model is further developed over time, it will hopefully come into better agreement with, or perhaps further inform, these independent heat flow calculations. At the present time, the independent calculation suggest that the EnergyPlus model is over-predicting heat transfer through the floor.

One contributing factor to the higher rates of thermal decay in the UFAD Lab chamber is the relatively higher air velocities in the underfloor plenum since this plenum is small compared to sizes of real-world supply plenums. When air is blown into the plenum that is much smaller than typical, the effect of the plenum walls tends to push the air around and keep it at a higher average value as compared to when it is blown into a large plenum zone. Higher velocities, of course, are directly tied to higher convection coefficients along the slab and underside of the floor panels. (Bauman Hui Webster 2006)

5.4 Comparison with UFAD Performance in Real Buildings

The predictions and results of this analysis certainly resonate with what we are seeing in real buildings. Thermal decay of the supply air from the time it leaves the shaft to the time it comes out the furthest diffuser has proved to be a significant and perplexing problem. In our operating buildings we are seeing as much as 10°F temperature increases as the air travels through the plenum over distances of 50 to 75 feet. The result is that we are pushing the SAT setpoints lower in an effort to get colder air out to the perimeter. Unfortunately, this results in colder air under the floor, which means higher heat pickup as the air travels through the floor due to lower surface temperatures and increased radiant exchange.

5.5 Implications for UFAD System Energy Performance

Unfortunately, virtually every one of the potential UFAD energy benefits cited in Section 2.1.4 is affected by the results of this analysis. Given the current ASHRAE 55 TozGradient limits, airflow quantities are at best the same and possibly up to 25%

more for UFAD systems as compared to OH. The higher supply air temperatures that are needed to increase 100 percent economizer cooling we are now finding must be much lower due to the high amount of heat transfer through the raised floor. In my professional HVAC design practice, we are also not seeing high return temperatures, which limits the amount of extended partial free cooling that a UFAD system might see over an OH system. Lastly, increased chiller efficiency and reduced chiller work rely on higher chilled water temperatures, which are only made possible by higher SAT values. If the SAT needs to be much closer to typical OH values of 55°F or 57°F, then the potential for reduced chiller energy use goes down substantially.

The one energy saving feature remaining of UFAD systems is the reduced static pressure demand that the fan sees as it moves air throughout a building. There are two potential areas where this benefit may also be offset. First, if more airflow is required, that increase in airflow will increase fan energy even though the static pressure requirement is less. Equation 5-1 shows the relationship between fan work, airflow, and pressure requirement.

Equation 5-1 Fan Energy Equation

$$W_{fan} = \frac{CFM(TP_2 - TP_1)}{6345 \eta_f}$$

Where:

W_{fan} = fan work (energy), bhp

CFM = airflow, cfm

TP_1, TP_2 = total pressure before and after the fan, inches water column

η_f = total fan efficiency

Second, one common approach to deal with thermal decay in UFAD plenums is to extend the ductwork under the plenum to minimize the time that air flows through the plenum in an attempt to minimize heat gain. As ducts become longer, the pressure

required to move air through the ducts increases, and the potential for fan energy savings is eroded.

One final potential energy impact to evaluate is the effect on reheat energy when UFAD systems are designed to employ reheat, as they typically are. Higher SAT values generally reduce the reheat energy consumed, but as the supply air temperatures for UFAD systems approach those for OH systems, this benefit also is reduced. Offsetting this impact on reheat energy is that reheat energy is only typically added to supply air in perimeter zones, and generally the perimeter zones have very warm supply air due to the thermal decay discussed above.

Overall, the picture for energy savings potential of UFAD systems is substantially reduced. The potential TozGradient limit and the high amount of heat transfer into the supply air through the raised floor combine to limit the potential for UFAD energy savings. If the TozGradient limit were to be increased (or if more optimistic stratification profiles prove justified) and if designers could find a way to limit heat transfer through the floor and the associated thermal decay, it would be more feasible to realize energy benefits from UFAD systems.

5.6 Model Applicability

5.6.1 Larger Interior Zones

The UFAD model used in this analysis is of a 26 foot by 26 foot test chamber, which represents an interior zone much smaller than is typically found in commercial buildings. The EnergyPlus input file was calibrated against measured data to ensure that for this single room the EnergyPlus predictions match the real-world measured

data. One question that can be asked of this approach is, “How valid will the model be if applied to larger zones?”

This is a common but important question in the field of energy modeling and building performance simulation. Certainly there is an aspect of this work that suggests the model results are only applicable for the specific model under consideration. In this case, because the model was calibrated extensively for construction thermal resistances, internal load breakdowns, convection coefficients, and the effects of furniture on the energy flows in the space, it does seem that these results can be considered specific to this case only.

The validity of applying this model more widely and generally to larger interior zones rests on the large amount of fundamental work that underlies both EnergyPlus broadly and the UFAD model specifically. As presented in Section 2.2, EnergyPlus relies on a heat balance calculation method that is theoretically sound and approved by independent national organizations such as ASHRAE. The EnergyPlus model has also undergone extensive testing and validation against independent benchmarking methods. The UFAD model similarly has a strong theoretical basis as seen in the work by UCSD (Qing 2005), and it has been validated through a whole series of both bench-scale and full-scale experimental measured data.

The strong theoretical foundation coupled with the success of the validation and testing performed to date suggests that this model will do a good job predicting energy flows and building performance more generally than just the model of the UFAD lab chamber presented here.

At the same time, there are aspects of the calibrated model of the UFAD lab chamber that are not directly extensible to other spaces. For example, the high amount of heat transfer that this model predicts through the raised floor may be partly due to the smaller-than-typical supply plenum at use in this model. Since there are more “walls” in this supply plenum relative to the open area than would be found in a large, open, interior zone in a real building, the walls here effectively push the air around more than might be generally found. These extra wall interactions serve to keep the supply plenum convection coefficients high, which could account for some of the high heat transfer seen through the supply plenum surfaces, namely the raised floor (Bauman August 2006).

5.6.2 Interior versus Perimeter Zones

One serious limit to the applicability of this model and the results is that at present the EnergyPlus UFAD model has only been validated for use in interior zones. An EnergyPlus UFAD model for perimeter zones exists, but it has not been tested and validated yet. Further, the EnergyPlus implementation of the UFAD model does not yet include a perimeter zone application.

Due to the much higher heat gains from solar and conduction loads in perimeter zones, the airflow characteristics and performance results are likely to be quite different from the interior zones modeled so far. Once the perimeter models are up and running and validated, a similar analysis to this one can be performed look specifically at the perimeter zone cases.

5.6.3 Stacked and Series Zones

At this time, the performance of only a single zone has been modeled, which although interesting and revealing does not directly relate to many operating UFAD systems. Typically, UFAD systems are installed in large commercial buildings where single zone models are simply not appropriate. These single zones will need to be modeled in series and stacked on top of each other to be able to assess the impact of the resulting different energy flow paths that will be created. With the interior zone models that exist, these series and stacked simulations can be performed, but they are outside the scope of this analysis.

6. Conclusion

6.1 Understanding of UFAD System Performance

The research project to develop a UFAD energy simulation tool clearly has significantly contributed to our understanding of how UFAD systems perform. With this quantitative tool now available, this thesis project is hopefully just the first of many interesting and revealing studies to come discussing the implication of UFAD system design and performance.

In particular, we now have a better understanding of the energy flows in UFAD systems. Radiant energy exchange between the ceiling and the floor appears to be a significant energy pathway that was not fully recognized previously. With this recognition comes the realization that in the neighborhood of 30 to 40% of the heat load in a space is transferring through the floor into the supply air before it enters the room. This understanding greatly informs the high levels of thermal decay we are

seeing in real buildings, and should help engineers to design more effective and hopefully better performing UFAD systems in the future.

6.2 Energy Implications

The effect of all that heat transfer through the floor is that the temperature of the air entering supply plenums must be much cooler than previously thought. This analysis suggests that 58°F air or cooler may be needed in order to create appropriately comfortable thermal conditions. Even at supply air temperatures this cool, UFAD systems required as much or slightly more air than OH systems to keep stratification levels below the ASHRAE-55 allowable limits given pessimistic (upper bound) assumptions about room stratification levels.

The cooler required supply air temperatures and airflow requirements have many energy implications. The extended economizer operation that we thought was possible with UFAD will be diminished greatly if we need to supply 58°F air rather than 61°F or higher temperature supply air. Also, the chiller efficiency that was gained by creating warmer air will also be reduced. Finally, there does not appear to be much if any reduction in airflow volumes in UFAD versus OH systems.

6.3 Further Work

There are many ways in which this study is limited at this time and where further work will be able to make progress. One clear example is that we're not even sure yet the best way to interpret the EnergyPlus model temperature predictions, as can be seen in the discussion and significant impact of using reasonable upper versus lower bound approaches to interpreting the results. Further work to understand and

refine this model should go a long way toward creating a better understanding of how to apply this model.

At this time, the UFAD energy model only applies to interior zones and certainly when it is extended to perimeter zones there is the potential for greater impact. Perimeter zones generally have much higher loads and airflow rates, so the system performance dynamics in these types of spaces should be quite different than in interior zones.

This study only looks at a single HVAC zone in isolation. It will be interesting to see the effect of placing zones like these in series and stacking them and evaluating the impacts these arrangements will have on system performance.

One potentially interesting area of work may be to further explore new developments in human thermal comfort in stratified environments, which shows that the 5°F limit on vertical temperature stratification may be overly restrictive. If higher amounts of vertical stratification are allowable, UFAD systems may be able to take advantage of the reduced airflow requirements that are possible with greater stratification in the occupied zones.

This study looked at the effects of temperature stratification on thermal comfort in the context of the current ASHRAE-55 standard's guidance. ASHRAE-55 also provides guidance on an acceptable range of temperatures for floor surfaces to avoid cold feet. Examining the performance of UFAD systems in this regard also would make sense and seems like a worthwhile future study.

The UFAD energy modeling module makes possible annual simulations of energy flows in buildings with these systems, so it is also now possible to look at the

life-cycle cost impacts of placing thermal insulation on various surfaces in UFAD systems. Perhaps locating insulation on the slab or under the raised floor will significantly reduce heat transfer and improve system performance to the point where the cost of these changes is life-cycle cost effective.

Finally, this work has just scratched the surface of the useful design advice that can be distilled out of UFAD energy simulation runs to help engineers understand and design these systems more effectively. Certainly there is much further work to do in this area.

7. Acknowledgements

It has been a pleasure to be a part of the research team on this project. I gratefully acknowledge the assistance and support of the following people who have played key roles in designing and performing this research project.

Center for the Built Environment, University of California, Berkeley

- Tom Webster
- Fred Bauman
- Hui Jin
- Wolfgang Lukachek

Lawrence Berkeley National Laboratories

- Fred Buhl
- Darryl Dickerhoff
- Fred Winkleman

University of California, San Diego

- Qing (Anna) Liu
- Paul Linden

8. References

ASHRAE. 2004. *ASHRAE Standard 55-2004: Thermal environmental conditions for human occupancy*. Atlanta: American Society of Heating, Refrigerating, and Air-Conditioning Engineers, Inc.

Bachelor, G. K. 1954. *Heat convection and buoyancy effects in fluids*. Quarterly Journal of the Royal Meteorological Society, Volume 80. Pages 339-358.

- Bauman, Fred S. and Allan Daly. 2003. *Underfloor Air Distribution (UFAD) Design Guide*. Atlanta: American Society of Heating, Refrigerating, and Air-Conditioning Engineers, Inc.
- Bauman, Fred S., Hui Jin, and Tom Webster. 2006. *Heat Transfer Pathways in Underfloor Air Distribution (UFAD) Systems*. ASHRAE Transactions, Vol. 112, Part 2. Atlanta: American Society of Heating, Refrigerating, and Air-Conditioning Engineers, Inc.
- Bauman, Fred S. August 2006. Personal communication.
- Center for the Built Environment (CBE). N.d. *Underfloor Air Technology Website*. <http://www.cbe.berkeley.edu/underfloorair/> (accessed August 1, 2006).
- DOE. 2004. *EnergyPlus Manual*. Documentation version 1.2.0, April 2004. United States Department of Energy.
- EDR. 2006. *HVAC Simulation Guidelines – Underfloor Air Distribution and Thermal Displacement Ventilation*. <http://www.energydesignresources.com/resource/201/> (Accessed August 1, 2006). Energy Design Resources.
- ISO. 1994. *International Standard 7730, "Moderate thermal environments-determination of the PMV and PPD indices and specification of the conditions for thermal comfort."* Geneva: International Standards Organization.
- Jin, Hui, Fred S. Bauman, and Tom Webster. 2006. *Testing and Modeling of Underfloor Air Supply Plenums*. ASHRAE Transactions, Vol. 112, Part 2. Atlanta: American Society of Heating, Refrigerating, and Air-Conditioning Engineers, Inc.
- Lin, Y.J. 2003. *Plumes and Jets in Semi-Confined Spaces*. Ph.D. thesis, University of California, San Diego.
- Liu, Qing. 2006. *The Fluid Dynamics of an Underfloor Air Distribution System*. Ph.D. thesis, University of California, San Diego.
- Skistad, Hakon. 2002. *Displacement Ventilation in non-industrial premises*. Belgium: Federation of European Heating and Air-Conditioning Associations.
- Trox® Technik. N.d. *Underfloor Air Distribution for Office Applications*. Technical Bulletin TB060501. Alpharetta, Georgia. http://www.troxusa.com/usa/download/pdf/produktePdf/underfloor_air_dist/tb_060501.pdf (accessed August 1, 2006).

- Webster, Tom, Wolfgang Lukaschek, Fred Bauman, Darryl Dickerhoff, Hui Jin, Allan Daly, & Ian Doebber. 2005. *Energy performance of underfloor air distribution (UFAD) systems*. Project Final Report. Center for the Built Environment.
- YORK®. 2006. *FlexSys™ Underfloor Air System, Sales Guide*. Johnson Controls, Inc. Form 130.16-SG1 (506). York, Pennsylvania.
<http://www.york.com/products/esg/YorkEngDocs/846.pdf> (accessed August 1, 2006).
- Zhang, Hui, Charlie Huizenga, Ed Arens, & T. Yu. 2005. *Modelling thermal comfort in stratified environments*. Proceedings, Indoor Air 2005 : 10th International Conference on Indoor Air Quality and Climate, Beijing, China.

9. Appendices

- Appendix A (Section 9.1) contains the complete EnergyPlus input file listing developed for the UFAD Lab.

9.1 Appendix A: EnergyPlus IMF Files

```

! UFAD_Lab EnergyPlus Input File
! Developed by the Center for the Built Environment, UC Berkeley, www.cbe.berkeley.edu
! and Taylor Engineering, www.taylor-engineering.com
! and Arup, www.arup.com

! Version: 016
! Revision Date: 07/06/2006

! Author: Allan Daly, Taylor Engineering, adaly@taylor-engineering.com
! Author: Fred Buhl, LBL, WFBuhl@lbl.gov
! Author: Ian Doebber, Arup, ian.doebber@arup.com

! ===== CHANGE HISTORY =====

! Version: 016
! Revision Date: 07/06/2006
! Modified imf structure to allow simulation of "standard" overhead mixing airflow as well as UFAD.

! Version: 015
! Revision Date: 04/07/2006
! Added parameters to allow the radiant properties of the TC wall surfaces to be different from the
! radiant properties of the other TC surfaces (ceiling, floor). Idea is to use these properties to do
! rough view factor adjustment since eplus does such a simple job calculating view factors.
! Created a new material called TC-Wall with variable absorptance properties taken from parameter values.
! Created new constructions for the TC-Walls with this new material as the inner surface.
! Assigned these new constructions to the appropriate TC wall heat transfer surfaces.

! Version: 014
! Revision Date: 02/09/2006
! Revised to allow width of furniture floor elements to be changed through the Excel interface.
! Added NorthFurnDim[] and SouthFurnDim[] parameters.

! Version: 013
! Revision Date: 01/19/2006
! Revised imf to allow for new user specified transition height in UFAD module. Parameters are UFAD_SpecTransHeight[] and UFAD_TransitionHeight[]
! Revised imf to parameterize equipment radiant fraction. Parameter is EquipmentRadFraction[]
! Revised to use People objects directly for heat from manikins. Set sensible fraction to 1.0 since all electric heat.

! Version: 012
! Revision Date: 01/06/2006
! Added syntax and macro code to allow for UCSD UFAD Interior room modeling.
! Renamed schedule DV_Occ_Zone_Gains and associated parts to DV_UFAD_Occ_Zone_Gains
! Added the following parameters in support of UFAD definitions.
! UFAD_PlumesPerOcc[]
! UFAD_DiffsPerPlume[]
! UFAD_DiffEffectiveArea[]
! UFAD_DiffSlotAngle[]
! UFAD_HeatSourceHeight[]
! UFAD_TStatHeight[]
! UFAD_ComfortHeight[]
! UFAD_TempDiffReporting[]
! UFAD_DiffType[]

! Version: 011
! Revision Date: 01/05/2006
! Revised equipment convective split to be 42% convective.

! Version: 010

```

```

! Revision Date: 01/04/2006
! Added in south door (to conference room) and north door (to plant).

! Version: 009
! Revision Date: 12/13/2005
! Finished if/then/else statement to select correct definition and type of window for EnvChamber window. Uses transparent subsurface (window) if perimeter run. Uses opaque subsurface (door) if perimeter run.
! Added name fields for people, lights, equipment definitions to comply with v123 requirements.
! Made changes necessary to revise imf to work with EP123x.

! Version: 008
! Revision Date: 12/1/2005
! Parameterized custom furniture material thickness.
! Created a new parameter RunType[] to specify if this is a calibration (CAL), interior (INT), or perimeter (PER) run.
! Use the RunType parameter to decide whether or not to include the MeasuredUFADWindow object definitions, which are only for PER runs.
! Use the RunType parameter to select between opaque or transparent definition for EnvChamberWindow (west wall window).
! Changed parameters path to a standard for all CBE users. "c:\EnergyPlus\CBE\UFAD_Lab\"
"

! Version: 007
! Revision Date: 11/21/2005
! Revised run period to one day instead of two.

! Version: 006
! Revision Date: 10/13/2005
! General: Incorporate changes to allow for perimeter zone runs.
! Updated Eplus version reference from 1.2.0 to 1.2.1 (to allow Winkleman solar allocation calcs)
! Added VariableR-Furniture material and associated parameters.
! Added CLEAR 6MM WindowGlass material.
! Added AIR 6MM WindowGas material.
! Added Furniture-Room construction.
! Added Furniture-Plenum construction.
! Changed Window-EnvChamber from VariableR-EnvChWindow (opaque construction) to a transparent window construction.
! Replaced all zone definitions and heat transfer surface definitions with those provided by Ian Doebber on 10/6/2005.
! Added Measured Solar Data section -- includes required definitions for running Winkleman solar allocation calcs.
! Replaced all ConvectionCoefficients with those provided by Ian Doebber, 10/6/2005.
! Changed name of parameters.imf file to be included to "parameters_general.imf"
! Added "parameters_solar.imf" as a second include file (to contain all solar fraction values)
! Added NumPeople[] parameter to be able to force the DV model into mixed mode (no people = no plumes = mixed mode)

! Version: 005
! Revision Date: 8/29/05
! First attempt at incorporating the RoomAir Model syntax -- goal is to create generic input file that can be used for mixed or UCSD displacement model.
! Set ground view factors for all heat transfer surfaces to 0 -- no diffuse solar should be included on any wall.
! TestChamber height set to 9 feet. Was mistakenly set at 10 feet.
! ReturnPlenum height set to 3 feet.
! Moved west wall window down 0.1 meter.
! Changed equipment power heat input to 40% radiant.

! Version: 004
! Revision Date: 7/27/05
! redefined west wall to hold the window to the environmental chamber (was mistakenly in south wall)
! redefined south wall to hold the window to the conference room (was mistakenly in west wall)

```

```

! confirmed south window dimensions: 20' wide x 4' high -- revised model
! confirmed west window dimensions: 24' wide x 8' high -- revised model

! Version: 003
! Revision Date: 7/22/05
! revised subsurfaces in west wall and south wall to be doors instead of windows (cannot use OSCs with windows)
! revised locations of west window and south window to center in wall

! Version: 002
! Revision Date: 7/21/05
! improved naming consistency
! added conference room window to south wall -- single glazing, opaque, variable conductivity parameter -- assumed 23' wide x 9' tall -- need to confirm
! added environmental chamber to west wall -- single glazing, opaque, variable conductivity parameter -- assumed 16' wide (4.877m) x 4' (1.219m) tall -- need to confirm
! split up convection coeffs into SP walls, TC walls, and RP walls (rather than north, south, east, west)
! metadata title block added to file
! updated parameters file -- filename and path changed to be generic across runs

! Version: 001
! Revision Date: 6/16/05
! improved naming consistency
! assigned OSC-ConfPlnm to SP-SouthWall (supply plnm south wall has the conf room plenum on the other side)
! assigned OSC-Clg to RP-SouthWall (return plnm south wall sees the attic temp on the other side)

! ===== NAMING CONVENTIONS =====

! TC      = test chamber
! SP      = supply plenum
! RP      = return plenum

! DC      = dropped ceiling
! RF      = raised floor

! flr     = floor
! clg     = ceiling
! top     = top
! bot     = bottom
! wall    = wall

! north   = north
! south   = south
! east    = east
! west    = west

! ConvCoeff = Convection Coefficient

! OSC      = Other Side Coefficient
! OST      = Other Side Temperature
! SF       = Solar Fraction

! ===== PARAMETER DEFINITIONS (VIA INCLUDE) =====

##include c:\EnergyPlus\CBE\UFAD_Lab\parameters_general.imf
##include c:\EnergyPlus\CBE\UFAD_Lab\parameters_solar.imf

! ===== BODY OF ENERGYPLUS INPUT FILE =====

!-NOTE: All comments with '!-' are ignored by the IDFEditor and are generated automatically.
!-      Use '!' comments if they need to be retained when using the IDFEditor.

```

```

!- ===== ALL OBJECTS IN CLASS: VERSION =====
VERSION,
  1.2.3;          !- Version Identifier

!- ===== ALL OBJECTS IN CLASS: BUILDING =====
BUILDING,
  UFAD_Lab,          !- Building Name
  0.000000E+00,     !- Building Azimuth
  Suburbs,          !- Building Terrain
  .04,              !- Loads Convergence Tolerance Value {w}
  .4,               !- Temperature Convergence Tolerance Value {deltaC}
  FullInteriorAndExterior, !- Solar Distribution
  25,               !- Maximum Number of Warmup Days
  No;               !- Calculate Solar Reflection From Exterior Obstructions

!- ===== ALL OBJECTS IN CLASS: TIMESTEP IN HOUR =====
TIMESTEP IN HOUR,
  6;                !- Time Step in Hour

!- ===== ALL OBJECTS IN CLASS: INSIDE CONVECTION ALGORITHM =====
INSIDE CONVECTION ALGORITHM,
  Simple;           !- InsideConvectionValue

!- ===== ALL OBJECTS IN CLASS: OUTSIDE CONVECTION ALGORITHM =====
OUTSIDE CONVECTION ALGORITHM,
  Detailed;         !- OutsideConvectionValue

!- ===== ALL OBJECTS IN CLASS: SOLUTION ALGORITHM =====
SOLUTION ALGORITHM,
  CTF;              !- SolutionAlgo

!- ===== ALL OBJECTS IN CLASS: DEBUG OUTPUT =====
DEBUG OUTPUT,
  0,                !- YesNo
  0;                !- EvenDuringWarmup

!- ===== ALL OBJECTS IN CLASS: ZONE VOLUME CAPACITANCE MULTIPLIER =====
ZONE VOLUME CAPACITANCE MULTIPLIER,
  1;                !- Capacitance Multiplier

!- ===== ALL OBJECTS IN CLASS: RUN CONTROL =====
RUN CONTROL,
  No,               !- Do the zone sizing calculation
  No,               !- Do the system sizing calculation
  No,               !- Do the plant sizing calculation
  Yes,              !- Do the design day simulations
  Yes;              !- Do the weather file simulation

!- ===== ALL OBJECTS IN CLASS: RUNPERIOD =====

```



```

RunPeriod,
  9,          !- Begin Month
  13,        !- Begin Day Of Month
  9,          !- End Month
  13,        !- End Day Of Month
  Tuesday,   !- Day Of Week For Start Day
  No,        !- Use WeatherFile Holidays/Special Days
  No,        !- Use WeatherFile DaylightSavingPeriod
  Yes,       !- Apply Weekend Holiday Rule
  Yes,       !- Use WeatherFile Rain Indicators
  Yes;       !- Use WeatherFile Snow Indicators

```

```
!- ===== ALL OBJECTS IN CLASS: LOCATION =====
```

```

Location,
  Harrisburg, !- LocationName
  40.2,       !- Latitude {deg}
  -76.77,    !- Longitude {deg}
  -5,        !- TimeZone {hr}
  94;        !- Elevation {m}

```

```
!- ===== ALL OBJECTS IN CLASS: GROUNDTEMPERATURES =====
```

```

GroundTemperatures,
  18.89,     !- January Ground Temperature {C}
  18.92,     !- February Ground Temperature {C}
  19.02,     !- March Ground Temperature {C}
  19.12,     !- April Ground Temperature {C}
  19.21,     !- May Ground Temperature {C}
  19.23,     !- June Ground Temperature {C}
  19.07,     !- July Ground Temperature {C}
  19.32,     !- August Ground Temperature {C}
  19.09,     !- September Ground Temperature {C}
  19.21,     !- October Ground Temperature {C}
  19.13,     !- November Ground Temperature {C}
  18.96;     !- December Ground Temperature {C}

```

```
!- ===== ALL OBJECTS IN CLASS: MATERIAL:REGULAR =====
```

```

MATERIAL:REGULAR,
  BLBD - PLYWOOD 3 / 4 IN, !- Name
  MediumSmooth,           !- Roughness
  .0099999998,           !- Thickness {m}
  .11,                    !- Conductivity {W/m-K}
  544.62,                 !- Density {kg/m3}
  1210,                   !- Specific Heat {J/kg-K}
  0.9,                    !- Absorptance:Thermal
  .78,                    !- Absorptance:Solar
  .78;                    !- Absorptance:Visible

```

```

MATERIAL:REGULAR,
  E8 - 5 / 8 IN PLASTER OR GYP BOARD, !- Name
  Smooth,                  !- Roughness
  .0099999998,           !- Thickness {m}
  .0599999999,          !- Conductivity {W/m-K}
  480.55,                !- Density {kg/m3}
  830,                    !- Specific Heat {J/kg-K}
  0.9,                    !- Absorptance:Thermal
  .32,                    !- Absorptance:Solar
  .32;                    !- Absorptance:Visible

```

```

MATERIAL:REGULAR,
  TC-Wall-Material,      !- Name
  Smooth,                !- Roughness
  .0099999998,          !- Thickness {m}

```

```

.059999999,          !- Conductivity {W/m-K}
480.55,              !- Density {kg/m3}
830,                 !- Specific Heat {J/kg-K}
TC-Wall-ThermalAbs[], !- Absorptance:Thermal
TC-Wall-SolarAbs[],  !- Absorptance:Solar
TC-Wall-VisibleAbs[]; !- Absorptance:Visible

MATERIAL:REGULAR,
  BLBD - PLYWOOD 1 / 2 IN, !- Name
  MediumSmooth,           !- Roughness
  .0099999998,           !- Thickness {m}
  .11,                    !- Conductivity {W/m-K}
  544.62,                 !- Density {kg/m3}
  1210,                   !- Specific Heat {J/kg-K}
  0.9,                    !- Absorptance:Thermal
  .78,                    !- Absorptance:Solar
  .78;                    !- Absorptance:Visible

MATERIAL:REGULAR,
  B10 - 2 IN WOOD,       !- Name
  MediumSmooth,           !- Roughness
  .050000001,            !- Thickness {m}
  .12,                    !- Conductivity {W/m-K}
  592.68,                 !- Density {kg/m3}
  2510,                   !- Specific Heat {J/kg-K}
  0.9,                    !- Absorptance:Thermal
  .78,                    !- Absorptance:Solar
  .78;                    !- Absorptance:Visible

MATERIAL:REGULAR,
  E5 - ACOUSTIC TILE,   !- Name
  MediumSmooth,           !- Roughness
  .0099999998,           !- Thickness {m}
  .059999999,            !- Conductivity {W/m-K}
  480.55,                 !- Density {kg/m3}
  830,                    !- Specific Heat {J/kg-K}
  0.9,                    !- Absorptance:Thermal
  .32,                    !- Absorptance:Solar
  .32;                    !- Absorptance:Visible

MATERIAL:REGULAR,
  CONCRETE - 120 LB / CU FT 4 IN, !- Name
  MediumRough,           !- Roughness
  .1,                     !- Thickness {m}
  .74,                    !- Conductivity {W/m-K}
  1922.21,                !- Density {kg/m3}
  830,                    !- Specific Heat {J/kg-K}
  0.9,                    !- Absorptance:Thermal
  .65,                    !- Absorptance:Solar
  .65;                    !- Absorptance:Visible

MATERIAL:REGULAR,
  FlrTile,               !- Name
  VerySmooth,            !- Roughness
  .04445,                !- Thickness {m}
  1.311,                  !- Conductivity {W/m-K}
  1922.21,                !- Density {kg/m3}
  830,                    !- Specific Heat {J/kg-K}
  0.9,                    !- Absorptance:Thermal
  .65,                    !- Absorptance:Solar
  .65;                    !- Absorptance:Visible

MATERIAL:Regular,
  VariableR-Furniture,   ! Name: Carpet With Rubber Pad
  VerySmooth,            !- Roughness
  FurnitureThickness[],  !- Thickness {m}
  FurniturekValue[],     !- Conductivity {W/m-K}
  FurniturepValue[],     !- Density {kg/m3}

```

```

FurnitureCpValue [],                !- Specific Heat {J/kg-K}
FurnitureThermalAbs [],             !- Absorptance:Thermal
FurnitureSolarAbs [],              !- Absorptance:Solar
FurnitureVisibleAbs [];            !- Absorptance:Visible

!- ===== ALL OBJECTS IN CLASS: MATERIAL:REGULAR-R =====

MATERIAL:REGULAR-R,
  VariableR-NorthDoor,              !- Name
  Rough,                            !- Roughness
  NorthDoorRValue [],              !- Thermal Resistance {m2-K/W}
  0.9000000,                       !- Absorptance:Thermal
  0.7500000,                       !- Absorptance:Solar
  0.7500000;                       !- Absorptance:Visible

MATERIAL:REGULAR-R,
  VariableR-ConfRmDoor,            !- Name
  Rough,                            !- Roughness
  ConfRmDoorRValue [],            !- Thermal Resistance {m2-K/W}
  0.9000000,                       !- Absorptance:Thermal
  0.7500000,                       !- Absorptance:Solar
  0.7500000;                       !- Absorptance:Visible

MATERIAL:REGULAR-R,
  VariableR-ConfRmWindow,          !- Name
  Rough,                            !- Roughness
  ConfRmWindowRValue [],          !- Thermal Resistance {m2-K/W}
  0.9000000,                       !- Absorptance:Thermal
  0.7500000,                       !- Absorptance:Solar
  0.7500000;                       !- Absorptance:Visible

MATERIAL:REGULAR-R,
  VariableR-EnvChWindow,           !- Name
  Rough,                            !- Roughness
  EnvChWindowRValue [],           !- Thermal Resistance {m2-K/W}
  0.9000000,                       !- Absorptance:Thermal
  0.7500000,                       !- Absorptance:Solar
  0.7500000;                       !- Absorptance:Visible

MATERIAL:REGULAR-R,
  VariableR-Clg,                   !- Name
  Rough,                            !- Roughness
  ClgRValue [],                   !- Thermal Resistance {m2-K/W}
  0.9000000,                       !- Absorptance:Thermal
  0.7500000,                       !- Absorptance:Solar
  0.7500000;                       !- Absorptance:Visible

MATERIAL:REGULAR-R,
  VariableR-SouthWall,             !- Name
  Rough,                            !- Roughness
  SouthWallRValue [],             !- Thermal Resistance {m2-K/W}
  0.9000000,                       !- Absorptance:Thermal
  0.7500000,                       !- Absorptance:Solar
  0.7500000;                       !- Absorptance:Visible

MATERIAL:REGULAR-R,
  VariableR-NorthWall,             !- Name
  Rough,                            !- Roughness
  NorthWallRValue [],             !- Thermal Resistance {m2-K/W}
  0.9000000,                       !- Absorptance:Thermal
  0.7500000,                       !- Absorptance:Solar
  0.7500000;                       !- Absorptance:Visible

MATERIAL:REGULAR-R,
  VariableR-EastWall,             !- Name
  Rough,                            !- Roughness
  EastWallRValue [],             !- Thermal Resistance {m2-K/W}

```

```

0.9000000,      !- Absorptance:Thermal
0.7500000,      !- Absorptance:Solar
0.7500000;      !- Absorptance:Visible

MATERIAL:REGULAR-R,
  VariableR-WestWall,      !- Name
  Rough,                    !- Roughness
  WestWallRValue [],      !- Thermal Resistance {m2-K/W}
  0.9000000,              !- Absorptance:Thermal
  0.7500000,              !- Absorptance:Solar
  0.7500000;              !- Absorptance:Visible

MATERIAL:REGULAR-R,
  VariableR-SubFlr,      !- Name
  Rough,                    !- Roughness
  SubFlrRValue [],      !- Thermal Resistance {m2-K/W}
  0.9000000,              !- Absorptance:Thermal
  0.7500000,              !- Absorptance:Solar
  0.7500000;              !- Absorptance:Visible

MATERIAL:REGULAR-R,
  R30-INSULATION,        !- Name
  Rough,                    !- Roughness
  5.283,                    !- Thermal Resistance {m2-K/W}
  0.9000000,              !- Absorptance:Thermal
  0.7500000,              !- Absorptance:Solar
  0.7500000;              !- Absorptance:Visible

MATERIAL:REGULAR-R,
  R5-INSULATION,         !- Name
  Rough,                    !- Roughness
  .881,                      !- Thermal Resistance {m2-K/W}
  0.9000000,              !- Absorptance:Thermal
  0.7500000,              !- Absorptance:Solar
  0.7500000;              !- Absorptance:Visible

MATERIAL:REGULAR-R,
  R11-INSULATION,        !- Name
  Rough,                    !- Roughness
  1.937,                      !- Thermal Resistance {m2-K/W}
  0.9,                      !- Absorptance:Thermal
  0.7,                      !- Absorptance:Solar
  0.7;                      !- Absorptance:Visible

MATERIAL:REGULAR-R,
  R19-INSULATION,        !- Name
  Rough,                    !- Roughness
  3.346,                      !- Thermal Resistance {m2-K/W}
  0.9000000,              !- Absorptance:Thermal
  0.7500000,              !- Absorptance:Solar
  0.7500000;              !- Absorptance:Visible

MATERIAL:REGULAR-R,
  R-TateFlr,              !- Name
  Rough,                    !- Roughness
  .281,                      !- Thermal Resistance {m2-K/W}
  0.9,                      !- Absorptance:Thermal
  0.7,                      !- Absorptance:Solar
  0.7;                      !- Absorptance:Visible

MATERIAL:Regular-R,
  Carpet,                  !- Name: Carpet With Rubber Pad
  Rough,                    !- Roughness
  0.2472000 ,              !- Resistance {m2-K/w}
  0.9000000 ,              !- Thermal Emittance
  0.7500000 ,              !- Solar Absorptance
  0.7500000 ;              !- Visible Absorptance

```

```

MATERIAL:Regular-R,
  VariableR-Carpet,    ! Name: Carpet With Rubber Pad
  Rough,              ! Roughness
  CarpetRValue[],    ! Resistance {m2-K/w}
  CarpetSolarAbs[],  ! Solar Absorptance
  CarpetVisibleAbs[], ! Visible Absorptance
  CarpetThermalAbs[]; ! Thermal Absorptance

MATERIAL:Regular-R,
  VariableR-ACT,     ! Name: Carpet With Rubber Pad
  Rough,            ! Roughness
  ACTRValue[],      ! Resistance {m2-K/w}
  ACTSolarAbs[],    ! Solar Absorptance
  ACTVisibleAbs[],  ! Visible Absorptance
  ACTThermalAbs[]; ! Thermal Absorptance

MATERIAL:WindowGlass,CLEAR 6MM,SpectralAverage,      ,.006,.775,.071,.071,.8
81,.080,.080,.0,.84,.84,.9; ! ID 3

MATERIAL:WindowGas, AIR 6MM,
  Air,      !- Type
  .0063 ;   !- Thickness {m}

!- ===== ALL OBJECTS IN CLASS: CONSTRUCTION =====

CONSTRUCTION,
  Wall-ExtSouth,          ! Name
  VariableR-SouthWall,    ! Outside Layer
  E8 - 5 / 8 IN PLASTER OR GYP BOARD; ! Layer #3

CONSTRUCTION,
  Wall-TC-ExtSouth,      ! Name
  VariableR-SouthWall,    ! Outside Layer
  TC-Wall-Material;     ! Layer #3

CONSTRUCTION,
  Door-ExtSouth,         ! Name
  VariableR-ConfRmWindow; ! Outside Layer

CONSTRUCTION,
  Wall-ExtNorth,        ! Name
  VariableR-NorthWall,   ! Outside Layer
  E8 - 5 / 8 IN PLASTER OR GYP BOARD; ! Layer #3

CONSTRUCTION,
  Wall-TC-ExtNorth,     ! Name
  VariableR-NorthWall,   ! Outside Layer
  TC-Wall-Material;     ! Layer #3

CONSTRUCTION,
  Door-ExtNorth,        ! Name
  VariableR-NorthDoor;   ! Outside Layer

CONSTRUCTION,
  Wall-ExtEast,         ! Name
  VariableR-EastWall,    ! Outside Layer
  E8 - 5 / 8 IN PLASTER OR GYP BOARD; ! Layer #3

CONSTRUCTION,
  Wall-TC-ExtEast,      ! Name
  VariableR-EastWall,    ! Outside Layer
  TC-Wall-Material;     ! Layer #3

CONSTRUCTION,
  Wall-ExtWest,         ! Name
  VariableR-WestWall,    ! Outside Layer
  E8 - 5 / 8 IN PLASTER OR GYP BOARD; ! Layer #3

```

```

CONSTRUCTION,
  Wall-TC-ExtWest,          ! Name
  VariableR-WestWall,      ! Outside Layer
  TC-Wall-Material; ! Layer #3

CONSTRUCTION,
  Wall-ExtClg,             ! Name
  VariableR-Clg,          ! Outside Layer
  E8 - 5 / 8 IN PLASTER OR GYP BOARD; ! Layer #2

CONSTRUCTION,
  Wall-ExtSubFlr,         ! Name
  CONCRETE - 120 LB / CU FT 4 IN, ! Outside Layer
  VariableR-SubFlr,      ! Layer #2
  BLBD - PLYWOOD 3 / 4 IN; ! Layer #3

CONSTRUCTION,
  Suspended Clg,         !- Name
  VariableR-ACT;         !- Outside Layer

CONSTRUCTION,
  RaisedFlr-Room,        !- Name
  FlrTile,              !- Outside Layer
  VariableR-Carpet;     !- Inside Layer

CONSTRUCTION,
  RaisedFlr-Plenum,     !- Name
  VariableR-Carpet,     !- Outside Layer
  FlrTile;             !- Inside Layer

CONSTRUCTION,
  Furniture-Room,       !- Name
  VariableR-Furniture;  !- Outside Layer

CONSTRUCTION,
  Furniture-Plenum,     !- Name
  VariableR-Furniture;  !- Outside Layer

CONSTRUCTION,
  Window-EnvChamber-Transparent, ! 2003 U=3.16 SC= .81 SHGC=.69
  TSOL=.60 TVIS=.78
  CLEAR 6MM,
  AIR 6MM,
  CLEAR 6MM;

CONSTRUCTION,
  Window-EnvChamber-Opaque, !- Name
  VariableR-EnvChWindow;    !- Outside Layer

CONSTRUCTION,
  Window-ConfRoom,       !- Name
  VariableR-ConfRmWindow; !- Outside Layer

!- ===== ALL OBJECTS IN CLASS: ZONE =====

ZONE,
  TestChamber,          !- Zone Name.
  0.00000,              !- Angle Relative to Building.
  0.0, 0.0, 0.0,       !- Origin Point.
  1, 1.0,               !- Type and Multiplier.
  2.74320,              !- WALL Height.
  172.27960;           !- Volume.

ZONE,
  Return_Plenum,       !- Zone Name.
  0.00000,              !- Angle Relative to Building.

```

```

0.0, 0.0, 0.0,           !- Origin Point.
1, 1.0,                 !- Type and Multiplier.
0.8763,                !- Ceiling Height.
62.80320;              !- Volume.

ZONE,
  Supply_Plenum,       !- Zone Name.
  0.00000,            !- Angle Relative to Building.
  0.0, 0.0, 0.0,     !- Origin Point.
  1, 1.0,             !- Type and Multiplier.
  0.3048,            !- Ceiling Height.
  19.1422;           !- Volume.

! ===== ALL OBJECTS IN CLASS: ROOMAIR MODEL =====

ROOMAIR MODEL,
  UFAD_LAB_ROOMAIRMODEL, ! Room-Air Model Name
  TestChamber,          ! Zone Name

##if #[AirFlowType[] EQS MIXED ]
  MIXING,              ! Room-Air Modeling Type
##elseif #[AirFlowType[] EQS DV ]
  UCSD_DISPLACEMENT_VENTILATION, ! Room-Air Modeling Type
##elseif #[AirFlowType[] EQS UFAD ]
  UCSD_UFAD_INTERIOR, ! Room-Air Modeling Type
##endif

  DIRECT;              ! Air Temperature Coupling Strategy [AD: will always use direct -- default for UCSD DV model]

! ===== ALL OBJECTS IN CLASS: UCSD DISPLACEMENT VENTILATION MODEL CONTROLS ===
=====

##if #[AirFlowType[] EQS DV ]

UCSD_DISPLACEMENT_VENTILATION_MODEL_CONTROLS,
  TestChamber,        !- Zone Name
  DV_UFAD_Occ_Zone_Gains, !- Gain Distribution Schedule
  1,                  !- Number of plumes per occupant
  1.22,              !- Thermostat height [1.22 m = 48 in]
  0.762,            !- Comfort Height [0.762 m = 30 in]
  .1;               !- Temp. Difference Threshold for Displacement Ventilation

##elseif #[AirFlowType[] EQS UFAD ]

UCSD_UFAD_INTERIOR_MODEL_CONTROLS,
  TestChamber,        !- Zone Name
  DV_UFAD_Occ_Zone_Gains, !- Gain Distribution Schedule
  UFAD_PlumesPerOcc[], !- Number of plumes per occupant
  UFAD_DiffsPerPlume[], !- Number of diffusers per plume
  UFAD_DiffEffectiveArea[], !- Effective area of diffuser {m2}
  UFAD_DiffSlotAngle[], !- angle between diffuser slots and the vertical {deg}
  UFAD_HeatSourceHeight[], !- Height of heat sources {m}
  UFAD_TStatHeight[], !- Thermostat height {m}
  UFAD_ComfortHeight[], !- Comfort Height {m}
  UFAD_TempDiffReporting[], !- Temp. Difference Threshold for Reporting {deltaC}
##endif

##if #[#[AirFlowType[] EQS UFAD] AND #[UFAD_SpecTransHeight[] EQS NO]]
  UFAD_DiffType[]; !- Diffuser type
##endif

##if #[#[AirFlowType[] EQS UFAD] AND #[UFAD_SpecTransHeight[] EQS YES]]
  UFAD_DiffType[], !- Diffuser type

```

```

    UFAD_TransitionHeight[]; ! User specified transition height {m}
##endif

!- ===== ALL OBJECTS IN CLASS: SURFACEGEOMETRY =====

SurfaceGeometry,
    UpperLeftCorner,      !- SurfaceStartingPosition
    CounterClockWise,    !- VertexEntry
    WorldCoordinateSystem; !- SurfaceGeometryKey

!- ===== ALL OBJECTS IN CLASS: SURFACE:HEATTRANSFER =====

! ===== Supply Plenum Surfaces =====

SURFACE:HeatTransfer,
    SP-Flr,                !- Object Index.
    FLOOR,                 !- Surface Type.
    Wall-ExtSubFlr,        !- Construction Name.
    Supply_Plenum,        !- InsideFaceEnvironment.
    OtherSideCoeff,        !- OutsideFaceEnvironment.
    OSC-Flr,               !- Target (if applicable).
    NoSun,                 !- Solar Exposure.
    NoWind,                !- Wind Exposure.
    0.00000,              !- Ground View Factor.
    4,
    0.00000, 7.92480, 0.00000,
    7.92480, 7.92480, 0.00000,
    7.92480, 0.00000, 0.00000,
    0.00000, 0.00000, 0.00000;

SURFACE:HeatTransfer,
    SP-SouthWall,         !- Object Index.
    WALL,                 !- Surface Type.
    Wall-ExtSouth,        !- Construction Name.
    Supply_Plenum,        !- InsideFaceEnvironment.
    OtherSideCoeff,        !- OutsideFaceEnvironment.
    OSC-SouthWall,        !- Target (if applicable).
    NoSun,                 !- Solar Exposure.
    NoWind,                !- Wind Exposure.
    0.50000,              !- Ground View Factor.
    4,
    7.92480, 0.00000, 0.00000,
    0.00000, 0.00000, 0.00000,
    0.00000, 0.00000, 0.30480,
    7.92480, 0.00000, 0.30480;

SURFACE:HeatTransfer,
    SP-EastWall,          !- Object Index.
    WALL,                 !- Surface Type.
    Wall-ExtEast,         !- Construction Name.
    Supply_Plenum,        !- InsideFaceEnvironment.
    OtherSideCoeff,        !- OutsideFaceEnvironment.
    OSC-EastWall,         !- Target (if applicable).
    NoSun,                 !- Solar Exposure.
    NoWind,                !- Wind Exposure.
    0.50000,              !- Ground View Factor.
    4,
    7.92480, 7.92480, 0.00000,
    7.92480, 0.00000, 0.00000,
    7.92480, 0.00000, 0.30480,
    7.92480, 7.92480, 0.30480;

SURFACE:HeatTransfer,
    SP-NorthWall,         !- Object Index.
    WALL,                 !- Surface Type.
    Wall-ExtNorth,        !- Construction Name.
    Supply_Plenum,        !- InsideFaceEnvironment.

```



```

OtherSideCoeff,
OSC-NorthWall,
NoSun,
NoWind,
0.50000,
4,
0.00000, 7.92480, 0.00000,
7.92480, 7.92480, 0.00000,
7.92480, 7.92480, 0.30480,
0.00000, 7.92480, 0.30480;

SURFACE:HeatTransfer,
SP-WestWall,
WALL,
Wall-ExtWest,
Supply_Plenum,
OtherSideCoeff,
OSC-WestWall,
NoSun,
NoWind,
0.50000,
4,
0.00000, 0.00000, 0.00000,
0.00000, 7.92480, 0.00000,
0.00000, 7.92480, 0.30480,
0.00000, 0.00000, 0.30480;

SURFACE:HeatTransfer,
SP-Clg-1,
CEILING,
RaisedFlr-Plenum,
Supply_Plenum,
OtherZoneSurface,
TC-Flr-1,
NoSun,
NoWind,
0.00000,
4,
1.58496, 7.92480, 0.30480,
0.00000, 7.92480, 0.30480,
0.00000, NorthFurnDim[], 0.30480,
1.58496, NorthFurnDim[], 0.30480;

SURFACE:HeatTransfer,
Sp-Clg-2,
CEILING,
RaisedFlr-Plenum,
Supply_Plenum,
OtherZoneSurface,
TC-Flr-2,
NoSun,
NoWind,
0.00000,
4,
3.16992, 7.92480, 0.30480,
1.58496, 7.92480, 0.30480,
1.58496, NorthFurnDim[], 0.30480,
3.16992, NorthFurnDim[], 0.30480;

SURFACE:HeatTransfer,
Sp-Clg-3,
CEILING,
RaisedFlr-Plenum,
Supply_Plenum,
OtherZoneSurface,
TC-Flr-3,
NoSun,
NoWind,

```

```

!- OutsideFaceEnvironment.
!- Target (if applicable).
!- Solar Exposure.
!- Wind Exposure.
!- Ground View Factor.

!- Object Index.
!- Surface Type.
!- Construction Name.
!- InsideFaceEnvironment.
!- OutsideFaceEnvironment.
!- Target (if applicable).
!- Solar Exposure.
!- Wind Exposure.
!- Ground View Factor.

!- Object Index.
!- Surface Type.
!- Construction Name.
!- InsideFaceEnvironment.
!- OutsideFaceEnvironment.
!- Target (if applicable).
!- Solar Exposure.
!- Wind Exposure.
!- Ground View Factor.

!- Object Index.
!- Surface Type.
!- Construction Name.
!- InsideFaceEnvironment.
!- OutsideFaceEnvironment.
!- Target (if applicable).
!- Solar Exposure.
!- Wind Exposure.
!- Ground View Factor.

!- Object Index.
!- Surface Type.
!- Construction Name.
!- InsideFaceEnvironment.
!- OutsideFaceEnvironment.
!- Target (if applicable).
!- Solar Exposure.
!- Wind Exposure.
!- Ground View Factor.

```

```

0.00000,                !- Ground View Factor.
4,
4.75488, 7.92480, 0.30480,
3.16992, 7.92480, 0.30480,
3.16992, NorthFurnDim[], 0.30480,
4.75488, NorthFurnDim[], 0.30480;

SURFACE:HeatTransfer,
Sp-Clg-4,                !- Object Index.
CEILING,                !- Surface Type.
RaisedFlr-Plenum,      !- Construction Name.
Supply_Plenum,         !- InsideFaceEnvironment.
OtherZoneSurface,     !- OutsideFaceEnvironment.
TC-Flr-4,              !- Target (if applicable).
NoSun,                 !- Solar Exposure.
NoWind,                !- Wind Exposure.
0.00000,                !- Ground View Factor.
4,
6.33984, 7.92480, 0.30480,
4.75488, 7.92480, 0.30480,
4.75488, NorthFurnDim[], 0.30480,
6.33984, NorthFurnDim[], 0.30480;

SURFACE:HeatTransfer,
Sp-Clg-5,                !- Object Index.
CEILING,                !- Surface Type.
RaisedFlr-Plenum,      !- Construction Name.
Supply_Plenum,         !- InsideFaceEnvironment.
OtherZoneSurface,     !- OutsideFaceEnvironment.
TC-Flr-5,              !- Target (if applicable).
NoSun,                 !- Solar Exposure.
NoWind,                !- Wind Exposure.
0.00000,                !- Ground View Factor.
4,
7.92480, 7.92480, 0.30480,
6.33984, 7.92480, 0.30480,
6.33984, NorthFurnDim[], 0.30480,
7.92480, NorthFurnDim[], 0.30480;

SURFACE:HeatTransfer,
Sp-Clg-6,                !- Object Index.
CEILING,                !- Surface Type.
Furniture-Plenum,     !- Construction Name.
Supply_Plenum,         !- InsideFaceEnvironment.
OtherZoneSurface,     !- OutsideFaceEnvironment.
TC-Flr-6,              !- Target (if applicable).
NoSun,                 !- Solar Exposure.
NoWind,                !- Wind Exposure.
0.00000,                !- Ground View Factor.
4,
1.58496, NorthFurnDim[], 0.30480,
0.00000, NorthFurnDim[], 0.30480,
0.00000, SouthFurnDim[], 0.30480,
1.58496, SouthFurnDim[], 0.30480;

SURFACE:HeatTransfer,
Sp-Clg-7,                !- Object Index.
CEILING,                !- Surface Type.
Furniture-Plenum,     !- Construction Name.
Supply_Plenum,         !- InsideFaceEnvironment.
OtherZoneSurface,     !- OutsideFaceEnvironment.
TC-Flr-7,              !- Target (if applicable).
NoSun,                 !- Solar Exposure.
NoWind,                !- Wind Exposure.
0.00000,                !- Ground View Factor.
4,
3.16992, NorthFurnDim[], 0.30480,

```

```

1.58496, NorthFurnDim[], 0.30480,
1.58496, SouthFurnDim[], 0.30480,
3.16992, SouthFurnDim[], 0.30480;

SURFACE:HeatTransfer,
Sp-Clg-8,                !- Object Index.
CEILING,                !- Surface Type.
Furniture-Plenum,      !- Construction Name.
Supply_Plenum,         !- InsideFaceEnvironment.
OtherZoneSurface,     !- OutsideFaceEnvironment.
TC-Flr-8,              !- Target (if applicable).
NoSun,                 !- Solar Exposure.
NoWind,                !- Wind Exposure.
0.00000,               !- Ground View Factor.
4,
4.75488, NorthFurnDim[], 0.30480,
3.16992, NorthFurnDim[], 0.30480,
3.16992, SouthFurnDim[], 0.30480,
4.75488, SouthFurnDim[], 0.30480;

SURFACE:HeatTransfer,
Sp-Clg-9,                !- Object Index.
CEILING,                !- Surface Type.
Furniture-Plenum,      !- Construction Name.
Supply_Plenum,         !- InsideFaceEnvironment.
OtherZoneSurface,     !- OutsideFaceEnvironment.
TC-Flr-9,              !- Target (if applicable).
NoSun,                 !- Solar Exposure.
NoWind,                !- Wind Exposure.
0.00000,               !- Ground View Factor.
4,
6.33984, NorthFurnDim[], 0.30480,
4.75488, NorthFurnDim[], 0.30480,
4.75488, SouthFurnDim[], 0.30480,
6.33984, SouthFurnDim[], 0.30480;

SURFACE:HeatTransfer,
Sp-Clg-10,              !- Object Index.
CEILING,                !- Surface Type.
Furniture-Plenum,      !- Construction Name.
Supply_Plenum,         !- InsideFaceEnvironment.
OtherZoneSurface,     !- OutsideFaceEnvironment.
TC-Flr-10,             !- Target (if applicable).
NoSun,                 !- Solar Exposure.
NoWind,                !- Wind Exposure.
0.00000,               !- Ground View Factor.
4,
7.92480, NorthFurnDim[], 0.30480,
6.33984, NorthFurnDim[], 0.30480,
6.33984, SouthFurnDim[], 0.30480,
7.92480, SouthFurnDim[], 0.30480;

SURFACE:HeatTransfer,
Sp-Clg-11,              !- Object Index.
CEILING,                !- Surface Type.
RaisedFlr-Plenum,     !- Construction Name.
Supply_Plenum,         !- InsideFaceEnvironment.
OtherZoneSurface,     !- OutsideFaceEnvironment.
TC-Flr-11,             !- Target (if applicable).
NoSun,                 !- Solar Exposure.
NoWind,                !- Wind Exposure.
0.00000,               !- Ground View Factor.
4,
1.58496, SouthFurnDim[], 0.30480,
0.00000, SouthFurnDim[], 0.30480,
0.00000, 0.00000, 0.30480,
1.58496, 0.00000, 0.30480;

```

```

SURFACE:HeatTransfer,
  Sp-Clg-12,                !- Object Index.
  CEILING,                  !- Surface Type.
  RaisedFlr-Plenum,        !- Construction Name.
  Supply_Plenum,           !- InsideFaceEnvironment.
  OtherZoneSurface,        !- OutsideFaceEnvironment.
  TC-Flr-12,                !- Target (if applicable).
  NoSun,                    !- Solar Exposure.
  NoWind,                   !- Wind Exposure.
  0.00000,                  !- Ground View Factor.
  4,
  3.16992, SouthFurnDim[], 0.30480,
  1.58496, SouthFurnDim[], 0.30480,
  1.58496, 0.00000, 0.30480,
  3.16992, 0.00000, 0.30480;

```

```

SURFACE:HeatTransfer,
  Sp-Clg-13,                !- Object Index.
  CEILING,                  !- Surface Type.
  RaisedFlr-Plenum,        !- Construction Name.
  Supply_Plenum,           !- InsideFaceEnvironment.
  OtherZoneSurface,        !- OutsideFaceEnvironment.
  TC-Flr-13,                !- Target (if applicable).
  NoSun,                    !- Solar Exposure.
  NoWind,                   !- Wind Exposure.
  0.00000,                  !- Ground View Factor.
  4,
  4.75488, SouthFurnDim[], 0.30480,
  3.16992, SouthFurnDim[], 0.30480,
  3.16992, 0.00000, 0.30480,
  4.75488, 0.00000, 0.30480;

```

```

SURFACE:HeatTransfer,
  Sp-Clg-14,                !- Object Index.
  CEILING,                  !- Surface Type.
  RaisedFlr-Plenum,        !- Construction Name.
  Supply_Plenum,           !- InsideFaceEnvironment.
  OtherZoneSurface,        !- OutsideFaceEnvironment.
  TC-Flr-14,                !- Target (if applicable).
  NoSun,                    !- Solar Exposure.
  NoWind,                   !- Wind Exposure.
  0.00000,                  !- Ground View Factor.
  4,
  6.33984, SouthFurnDim[], 0.30480,
  4.75488, SouthFurnDim[], 0.30480,
  4.75488, 0.00000, 0.30480,
  6.33984, 0.00000, 0.30480;

```

```

SURFACE:HeatTransfer,
  Sp-Clg-15,                !- Object Index.
  CEILING,                  !- Surface Type.
  RaisedFlr-Plenum,        !- Construction Name.
  Supply_Plenum,           !- InsideFaceEnvironment.
  OtherZoneSurface,        !- OutsideFaceEnvironment.
  TC-Flr-15,                !- Target (if applicable).
  NoSun,                    !- Solar Exposure.
  NoWind,                   !- Wind Exposure.
  0.00000,                  !- Ground View Factor.
  4,
  7.92480, SouthFurnDim[], 0.30480,
  6.33984, SouthFurnDim[], 0.30480,
  6.33984, 0.00000, 0.30480,
  7.92480, 0.00000, 0.30480;

```

! ===== Return Plenum Surfaces =====

```

SURFACE:HeatTransfer,
  RP-Flr,                    !- Object Index.

```

```

FLOOR,
Suspended Clg,
Return_Plenum,
OtherZoneSurface,
TC-Clg,
NoSun,
NoWind,
0.00000,
4,
7.92481, 0.00000, 3.04800,
0.00000, 0.00000, 3.04800,
0.00000, 7.92480, 3.04800,
7.92481, 7.92480, 3.04800;

SURFACE:HeatTransfer,
RP-NorthWall,
WALL,
Wall-ExtNorth,
Return_Plenum,
OtherSideCoeff,
OSC-NorthWall,
NoSun,
NoWind,
0.50000,
4,
0.00000, 7.92480, 3.04800,
7.92481, 7.92480, 3.04800,
7.92481, 7.92480, 3.92430,
0.00000, 7.92480, 3.92430;

SURFACE:HeatTransfer,
RP-WestWall,
WALL,
Wall-ExtWest,
Return_Plenum,
OtherSideCoeff,
OSC-WestWall,
NoSun,
NoWind,
0.50000,
4,
0.00000, 0.00000, 3.04800,
0.00000, 7.92480, 3.04800,
0.00000, 7.92480, 3.92430,
0.00000, 0.00000, 3.92430;

SURFACE:HeatTransfer,
RP-SouthWall,
WALL,
Wall-ExtSouth,
Return_Plenum,
OtherSideCoeff,
OSC-Clg,
NoSun,
NoWind,
0.50000,
4,
7.92481, 0.00000, 3.04800,
0.00000, 0.00000, 3.04800,
0.00000, 0.00000, 3.92430,
7.92481, 0.00000, 3.92430;

SURFACE:HeatTransfer,
RP-EastWall,
WALL,
Wall-ExtEast,
Return_Plenum,
OtherSideCoeff,

```

```

!- Surface Type.
!- Construction Name.
!- InsideFaceEnvironment.
!- OutsideFaceEnvironment.
!- Target (if applicable).
!- Solar Exposure.
!- Wind Exposure.
!- Ground View Factor.

!- Object Index.
!- Surface Type.
!- Construction Name.
!- InsideFaceEnvironment.
!- OutsideFaceEnvironment.
!- Target (if applicable).
!- Solar Exposure.
!- Wind Exposure.
!- Ground View Factor.

!- Object Index.
!- Surface Type.
!- Construction Name.
!- InsideFaceEnvironment.
!- OutsideFaceEnvironment.
!- Target (if applicable).
!- Solar Exposure.
!- Wind Exposure.
!- Ground View Factor.

!- Object Index.
!- Surface Type.
!- Construction Name.
!- InsideFaceEnvironment.
!- OutsideFaceEnvironment.
!- Target (if applicable).
!- Solar Exposure.
!- Wind Exposure.
!- Ground View Factor.

!- Object Index.
!- Surface Type.
!- Construction Name.
!- InsideFaceEnvironment.
!- OutsideFaceEnvironment.

```

```

OSC-EastWall,                                     !- Target (if applicable).
NoSun,                                           !- Solar Exposure.
NoWind,                                          !- Wind Exposure.
0.50000,                                         !- Ground View Factor.
4,
7.92481, 7.92480, 3.04800,
7.92481, 0.00000, 3.04800,
7.92481, 0.00000, 3.92430,
7.92481, 7.92480, 3.92430;

SURFACE:HeatTransfer,
RP-Clg,                                         !- Object Index. CEILING
CEILING,                                       !- Surface Type.
Wall-ExtClg,                                   !- Construction Name.
Return_Plenum,                                 !- InsideFaceEnvironment.
OtherSideCoeff,                               !- OutsideFaceEnvironment.
OSC-Clg,                                       !- Target (if applicable).
NoSun,                                         !- Solar Exposure.
NoWind,                                        !- Wind Exposure.
1.00000,                                       !- Ground View Factor.
4,
7.92481, 0.00000, 3.92430,
7.92481, 7.92480, 3.92430,
0.00000, 7.92480, 3.92430,
0.00000, 0.00000, 3.92430;

! ===== Test Chamber Surfaces =====
SURFACE:HeatTransfer,
TC-Flr-1,                                       !- Object Index.
FLOOR,                                         !- Surface Type.
RaisedFlr-Room,                                !- Construction Name.
TestChamber,                                  !- InsideFaceEnvironment.
OtherZoneSurface,                             !- OutsideFaceEnvironment.
SP-Clg-1,                                     !- Target (if applicable).
NoSun,                                         !- Solar Exposure.
NoWind,                                        !- Wind Exposure.
0.00000,                                       !- Ground View Factor.
4,
0.00000, 7.92480, 0.30480,
1.58496, 7.92480, 0.30480,
1.58496, NorthFurnDim[], 0.30480,
0.00000, NorthFurnDim[], 0.30480;

SURFACE:HeatTransfer,
TC-Flr-2,                                       !- Object Index.
FLOOR,                                         !- Surface Type.
RaisedFlr-Room,                                !- Construction Name.
TestChamber,                                  !- InsideFaceEnvironment.
OtherZoneSurface,                             !- OutsideFaceEnvironment.
SP-Clg-2,                                     !- Target (if applicable).
NoSun,                                         !- Solar Exposure.
NoWind,                                        !- Wind Exposure.
0.00000,                                       !- Ground View Factor.
4,
1.58496, 7.92480, 0.30480,
3.16992, 7.92480, 0.30480,
3.16992, NorthFurnDim[], 0.30480,
1.58496, NorthFurnDim[], 0.30480;

SURFACE:HeatTransfer,
TC-Flr-3,                                       !- Object Index.
FLOOR,                                         !- Surface Type.
RaisedFlr-Room,                                !- Construction Name.
TestChamber,                                  !- InsideFaceEnvironment.
OtherZoneSurface,                             !- OutsideFaceEnvironment.
SP-Clg-3,                                     !- Target (if applicable).
NoSun,                                         !- Solar Exposure.
NoWind,                                        !- Wind Exposure.

```

```

0.00000,                !- Ground View Factor.
4,
3.16992, 7.92480, 0.30480,
4.75488, 7.92480, 0.30480,
4.75488, NorthFurnDim[], 0.30480,
3.16992, NorthFurnDim[], 0.30480;

SURFACE:HeatTransfer,
TC-Flr-4,                !- Object Index.
FLOOR,                  !- Surface Type.
RaisedFlr-Room,         !- Construction Name.
TestChamber,           !- InsideFaceEnvironment.
OtherZoneSurface,      !- OutsideFaceEnvironment.
SP-Clg-4,              !- Target (if applicable).
NoSun,                 !- Solar Exposure.
NoWind,                !- Wind Exposure.
0.00000,              !- Ground View Factor.
4,
4.75488, 7.92480, 0.30480,
6.33984, 7.92480, 0.30480,
6.33984, NorthFurnDim[], 0.30480,
4.75488, NorthFurnDim[], 0.30480;

SURFACE:HeatTransfer,
TC-Flr-5,                !- Object Index.
FLOOR,                  !- Surface Type.
RaisedFlr-Room,         !- Construction Name.
TestChamber,           !- InsideFaceEnvironment.
OtherZoneSurface,      !- OutsideFaceEnvironment.
SP-Clg-5,              !- Target (if applicable).
NoSun,                 !- Solar Exposure.
NoWind,                !- Wind Exposure.
0.00000,              !- Ground View Factor.
4,
6.33984, 7.92480, 0.30480,
7.92480, 7.92480, 0.30480,
7.92480, NorthFurnDim[], 0.30480,
6.33984, NorthFurnDim[], 0.30480;

SURFACE:HeatTransfer,
TC-Flr-6,                !- Object Index.
FLOOR,                  !- Surface Type.
Furniture-Room,        !- Construction Name.
TestChamber,           !- InsideFaceEnvironment.
OtherZoneSurface,      !- OutsideFaceEnvironment.
SP-Clg-6,              !- Target (if applicable).
NoSun,                 !- Solar Exposure.
NoWind,                !- Wind Exposure.
0.00000,              !- Ground View Factor.
4,
0.00000, NorthFurnDim[], 0.30480,
1.58496, NorthFurnDim[], 0.30480,
1.58496, SouthFurnDim[], 0.30480,
0.00000, SouthFurnDim[], 0.30480;

SURFACE:HeatTransfer,
TC-Flr-7,                !- Object Index.
FLOOR,                  !- Surface Type.
Furniture-Room,        !- Construction Name.
TestChamber,           !- InsideFaceEnvironment.
OtherZoneSurface,      !- OutsideFaceEnvironment.
SP-Clg-7,              !- Target (if applicable).
NoSun,                 !- Solar Exposure.
NoWind,                !- Wind Exposure.
0.00000,              !- Ground View Factor.
4,
1.58496, NorthFurnDim[], 0.30480,
3.16992, NorthFurnDim[], 0.30480,

```

```

3.16992, SouthFurnDim[], 0.30480,
1.58496, SouthFurnDim[], 0.30480;

SURFACE:HeatTransfer,
TC-Flr-8,                !- Object Index.
FLOOR,                  !- Surface Type.
Furniture-Room,        !- Construction Name.
TestChamber,           !- InsideFaceEnvironment.
OtherZoneSurface,     !- OutsideFaceEnvironment.
SP-Clg-8,              !- Target (if applicable).
NoSun,                 !- Solar Exposure.
NoWind,                !- Wind Exposure.
0.00000,              !- Ground View Factor.
4,
3.16992, NorthFurnDim[], 0.30480,
4.75488, NorthFurnDim[], 0.30480,
4.75488, SouthFurnDim[], 0.30480,
3.16992, SouthFurnDim[], 0.30480;

SURFACE:HeatTransfer,
TC-Flr-9,                !- Object Index.
FLOOR,                  !- Surface Type.
Furniture-Room,        !- Construction Name.
TestChamber,           !- InsideFaceEnvironment.
OtherZoneSurface,     !- OutsideFaceEnvironment.
SP-Clg-9,              !- Target (if applicable).
NoSun,                 !- Solar Exposure.
NoWind,                !- Wind Exposure.
0.00000,              !- Ground View Factor.
4,
4.75488, NorthFurnDim[], 0.30480,
6.33984, NorthFurnDim[], 0.30480,
6.33984, SouthFurnDim[], 0.30480,
4.75488, SouthFurnDim[], 0.30480;

SURFACE:HeatTransfer,
TC-Flr-10,              !- Object Index.
FLOOR,                  !- Surface Type.
Furniture-Room,        !- Construction Name.
TestChamber,           !- InsideFaceEnvironment.
OtherZoneSurface,     !- OutsideFaceEnvironment.
SP-Clg-10,            !- Target (if applicable).
NoSun,                 !- Solar Exposure.
NoWind,                !- Wind Exposure.
0.00000,              !- Ground View Factor.
4,
6.33984, NorthFurnDim[], 0.30480,
7.92480, NorthFurnDim[], 0.30480,
7.92480, SouthFurnDim[], 0.30480,
6.33984, SouthFurnDim[], 0.30480;

SURFACE:HeatTransfer,
TC-Flr-11,              !- Object Index.
FLOOR,                  !- Surface Type.
RaisedFlr-Room,       !- Construction Name.
TestChamber,           !- InsideFaceEnvironment.
OtherZoneSurface,     !- OutsideFaceEnvironment.
SP-Clg-11,            !- Target (if applicable).
NoSun,                 !- Solar Exposure.
NoWind,                !- Wind Exposure.
0.00000,              !- Ground View Factor.
4,
0.00000, SouthFurnDim[], 0.30480,
1.58496, SouthFurnDim[], 0.30480,
1.58496, 0.00000, 0.30480,
0.00000, 0.00000, 0.30480;

SURFACE:HeatTransfer,

```



```

TC-Flr-12,                !- Object Index.
FLOOR,                    !- Surface Type.
RaisedFlr-Room,          !- Construction Name.
TestChamber,             !- InsideFaceEnvironment.
OtherZoneSurface,       !- OutsideFaceEnvironment.
SP-Clg-12,               !- Target (if applicable).
NoSun,                   !- Solar Exposure.
NoWind,                  !- Wind Exposure.
0.00000,                 !- Ground View Factor.
4,
1.58496, SouthFurnDim[], 0.30480,
3.16992, SouthFurnDim[], 0.30480,
3.16992, 0.00000, 0.30480,
1.58496, 0.00000, 0.30480;

SURFACE:HeatTransfer,
TC-Flr-13,                !- Object Index.
FLOOR,                    !- Surface Type.
RaisedFlr-Room,          !- Construction Name.
TestChamber,             !- InsideFaceEnvironment.
OtherZoneSurface,       !- OutsideFaceEnvironment.
SP-Clg-13,               !- Target (if applicable).
NoSun,                   !- Solar Exposure.
NoWind,                  !- Wind Exposure.
0.00000,                 !- Ground View Factor.
4,
3.16992, SouthFurnDim[], 0.30480,
4.75488, SouthFurnDim[], 0.30480,
4.75488, 0.00000, 0.30480,
3.16992, 0.00000, 0.30480;

SURFACE:HeatTransfer,
TC-Flr-14,                !- Object Index.
FLOOR,                    !- Surface Type.
RaisedFlr-Room,          !- Construction Name.
TestChamber,             !- InsideFaceEnvironment.
OtherZoneSurface,       !- OutsideFaceEnvironment.
SP-Clg-14,               !- Target (if applicable).
NoSun,                   !- Solar Exposure.
NoWind,                  !- Wind Exposure.
0.00000,                 !- Ground View Factor.
4,
4.75488, SouthFurnDim[], 0.30480,
6.33984, SouthFurnDim[], 0.30480,
6.33984, 0.00000, 0.30480,
4.75488, 0.00000, 0.30480;

SURFACE:HeatTransfer,
TC-Flr-15,                !- Object Index.
FLOOR,                    !- Surface Type.
RaisedFlr-Room,          !- Construction Name.
TestChamber,             !- InsideFaceEnvironment.
OtherZoneSurface,       !- OutsideFaceEnvironment.
SP-Clg-15,               !- Target (if applicable).
NoSun,                   !- Solar Exposure.
NoWind,                  !- Wind Exposure.
0.00000,                 !- Ground View Factor.
4,
6.33984, SouthFurnDim[], 0.30480,
7.92480, SouthFurnDim[], 0.30480,
7.92480, 0.00000, 0.30480,
6.33984, 0.00000, 0.30480;

SURFACE:HeatTransfer,
TC-WestWall,             !- Object Index.
WALL,                    !- Surface Type.
Wall-TC-ExtWest,        !- Construction Name.
TestChamber,             !- InsideFaceEnvironment.

```

```

OtherSideCoeff,                !- OutsideFaceEnvironment.
OSC-WestWall,                  !- Target (if applicable).
NoSun,                         !- Solar Exposure.
NoWind,                        !- Wind Exposure.
0.50000,                       !- Ground View Factor.
4,
0.00000, 7.92480, 0.30480,
0.00000, 7.92480, 3.04800,
0.00000, 0.00000, 3.04800,
0.00000, 0.00000, 0.30480;

##if #[RunType[] EQS PER ]    ! only include this section if this is a perimeter run

SURFACE:HeatTransfer:Sub,
  EnvChamberWindow,           !- Object Index.
  WINDOW,                     !- Surface Type.
  Window-EnvChamber-Transparent, !- Construction Name.
  TC-WestWall,                !- Parent Object Name.
  ,                            !- Target (if applicable).
  0.50000,                   !- Ground View Factor.
  ,                           !- Shading Control.
  ,                           !- Frame/Divider.
  1.00000,                   !- Multiplier.
  4,
  0.00000, 7.62000, 0.45720,
  0.00000, 0.30480, 0.45720,
  0.00000, 0.30480, 2.89560,
  0.00000, 7.62000, 2.89560;

##else    ! use this opaque subsurface definition if it is not a perimeter run

SURFACE:HeatTransfer:Sub,
  EnvChamberWindow,           !- Object Index.
  DOOR,                       !- Surface Type.
  Window-EnvChamber-Opaque,   !- Construction Name.
  TC-WestWall,                !- Parent Object Name.
  ,                            !- Target (if applicable).
  0.50000,                   !- Ground View Factor.
  ,                           !- Shading Control.
  ,                           !- Frame/Divider.
  1.00000,                   !- Multiplier.
  4,
  0.00000, 7.62000, 0.45720,
  0.00000, 0.30480, 0.45720,
  0.00000, 0.30480, 2.89560,
  0.00000, 7.62000, 2.89560;

##endif

SURFACE:HeatTransfer,
  TC-SouthWall-G1,           !- Object Index.
  WALL,                      !- Surface Type.
  Wall-TC-ExtSouth,         !- Construction Name.
  TestChamber,              !- InsideFaceEnvironment.
  OtherSideCoeff,          !- OutsideFaceEnvironment.
  OSC-SouthWall,           !- Target (if applicable).
  NoSun,                   !- Solar Exposure.
  NoWind,                  !- Wind Exposure.
  0.50000,                 !- Ground View Factor.
  4,
  2.64160, 0.00000, 0.30480,
  2.64160, 0.00000, 0.53340,
  0.00000, 0.00000, 0.53340,
  0.00000, 0.00000, 0.30480;

SURFACE:HeatTransfer,
  TC-SouthWall-G2,           !- Object Index.

```

```

WALL,
Wall-TC-ExtSouth,
TestChamber,
OtherSideCoeff,
OSC-SouthWall,
NoSun,
NoWind,
0.50000,
4,
2.64160, 0.00000, 0.53340,
2.64160, 0.00000, 0.76200,
0.00000, 0.00000, 0.76200,
0.00000, 0.00000, 0.53340;

SURFACE:HeatTransfer,
TC-SouthWall-G3,
WALL,
Wall-TC-ExtSouth,
TestChamber,
OtherSideCoeff,
OSC-SouthWall,
NoSun,
NoWind,
0.50000,
4,
2.64160, 0.00000, 0.76200,
2.64160, 0.00000, 0.99060,
0.00000, 0.00000, 0.99060,
0.00000, 0.00000, 0.76200;

SURFACE:HeatTransfer,
TC-SouthWall-G4,
WALL,
Wall-TC-ExtSouth,
TestChamber,
OtherSideCoeff,
OSC-SouthWall,
NoSun,
NoWind,
0.50000,
4,
2.64160, 0.00000, 0.99060,
2.64160, 0.00000, 1.21920,
0.00000, 0.00000, 1.21920,
0.00000, 0.00000, 0.99060;

SURFACE:HeatTransfer,
TC-SouthWall-G5,
WALL,
Wall-TC-ExtSouth,
TestChamber,
OtherSideCoeff,
OSC-SouthWall,
NoSun,
NoWind,
0.50000,
4,
2.64160, 0.00000, 1.21920,
2.64160, 0.00000, 1.44780,
0.00000, 0.00000, 1.44780,
0.00000, 0.00000, 1.21920;

SURFACE:HeatTransfer,
TC-SouthWall-G6,
WALL,
Wall-TC-ExtSouth,
TestChamber,
OtherSideCoeff,

```

```

!- Surface Type.
!- Construction Name.
!- InsideFaceEnvironment.
!- OutsideFaceEnvironment.
!- Target (if applicable).
!- Solar Exposure.
!- Wind Exposure.
!- Ground View Factor.

!- Object Index.
!- Surface Type.
!- Construction Name.
!- InsideFaceEnvironment.
!- OutsideFaceEnvironment.
!- Target (if applicable).
!- Solar Exposure.
!- Wind Exposure.
!- Ground View Factor.

!- Object Index.
!- Surface Type.
!- Construction Name.
!- InsideFaceEnvironment.
!- OutsideFaceEnvironment.
!- Target (if applicable).
!- Solar Exposure.
!- Wind Exposure.
!- Ground View Factor.

!- Object Index.
!- Surface Type.
!- Construction Name.
!- InsideFaceEnvironment.
!- OutsideFaceEnvironment.
!- Target (if applicable).
!- Solar Exposure.
!- Wind Exposure.
!- Ground View Factor.

!- Object Index.
!- Surface Type.
!- Construction Name.
!- InsideFaceEnvironment.
!- OutsideFaceEnvironment.

```

```

OSC-SouthWall,                                !- Target (if applicable).
NoSun,                                         !- Solar Exposure.
NoWind,                                        !- Wind Exposure.
0.50000,                                       !- Ground View Factor.
4,
2.64160, 0.00000, 1.44780,
2.64160, 0.00000, 1.67640,
0.00000, 0.00000, 1.67640,
0.00000, 0.00000, 1.44780;

SURFACE:HeatTransfer,
TC-SouthWall-G7,                               !- Object Index.
WALL,                                         !- Surface Type.
Wall-TC-ExtSouth,                            !- Construction Name.
TestChamber,                                 !- InsideFaceEnvironment.
OtherSideCoeff,                              !- OutsideFaceEnvironment.
OSC-SouthWall,                               !- Target (if applicable).
NoSun,                                        !- Solar Exposure.
NoWind,                                       !- Wind Exposure.
0.50000,                                       !- Ground View Factor.
4,
2.64160, 0.00000, 1.67640,
2.64160, 0.00000, 1.90500,
0.00000, 0.00000, 1.90500,
0.00000, 0.00000, 1.67640;

SURFACE:HeatTransfer,
TC-SouthWall-G8,                               !- Object Index.
WALL,                                         !- Surface Type.
Wall-TC-ExtSouth,                            !- Construction Name.
TestChamber,                                 !- InsideFaceEnvironment.
OtherSideCoeff,                              !- OutsideFaceEnvironment.
OSC-SouthWall,                               !- Target (if applicable).
NoSun,                                        !- Solar Exposure.
NoWind,                                       !- Wind Exposure.
0.50000,                                       !- Ground View Factor.
4,
2.64160, 0.00000, 1.90500,
2.64160, 0.00000, 2.13360,
0.00000, 0.00000, 2.13360,
0.00000, 0.00000, 1.90500;

SURFACE:HeatTransfer,
TC-SouthWall-G9,                               !- Object Index.
WALL,                                         !- Surface Type.
Wall-TC-ExtSouth,                            !- Construction Name.
TestChamber,                                 !- InsideFaceEnvironment.
OtherSideCoeff,                              !- OutsideFaceEnvironment.
OSC-SouthWall,                               !- Target (if applicable).
NoSun,                                        !- Solar Exposure.
NoWind,                                       !- Wind Exposure.
0.50000,                                       !- Ground View Factor.
4,
2.64160, 0.00000, 2.13360,
2.64160, 0.00000, 2.36220,
0.00000, 0.00000, 2.36220,
0.00000, 0.00000, 2.13360;

SURFACE:HeatTransfer,
TC-SouthWall-G10,                             !- Object Index.
WALL,                                         !- Surface Type.
Wall-TC-ExtSouth,                            !- Construction Name.
TestChamber,                                 !- InsideFaceEnvironment.
OtherSideCoeff,                              !- OutsideFaceEnvironment.
OSC-SouthWall,                               !- Target (if applicable).
NoSun,                                        !- Solar Exposure.
NoWind,                                       !- Wind Exposure.
0.50000,                                       !- Ground View Factor.

```

```

4,
2.64160, 0.00000, 2.36220,
2.64160, 0.00000, 2.59080,
0.00000, 0.00000, 2.59080,
0.00000, 0.00000, 2.36220;

SURFACE:HeatTransfer,
TC-SouthWall-G11,
WALL,
Wall-TC-ExtSouth,
TestChamber,
OtherSideCoeff,
OSC-SouthWall,
NoSun,
NoWind,
0.50000,
4,
2.64160, 0.00000, 2.59080,
2.64160, 0.00000, 2.81940,
0.00000, 0.00000, 2.81940,
0.00000, 0.00000, 2.59080;

SURFACE:HeatTransfer,
TC-SouthWall-G12,
WALL,
Wall-TC-ExtSouth,
TestChamber,
OtherSideCoeff,
OSC-SouthWall,
NoSun,
NoWind,
0.50000,
4,
2.64160, 0.00000, 2.81940,
2.64160, 0.00000, 3.04800,
0.00000, 0.00000, 3.04800,
0.00000, 0.00000, 2.81940;

SURFACE:HeatTransfer,
TC-SouthWall-F1,
WALL,
Wall-TC-ExtSouth,
TestChamber,
OtherSideCoeff,
OSC-SouthWall,
NoSun,
NoWind,
0.50000,
4,
5.28320, 0.00000, 0.30480,
5.28320, 0.00000, 0.53340,
2.64160, 0.00000, 0.53340,
2.64160, 0.00000, 0.30480;

SURFACE:HeatTransfer,
TC-SouthWall-F2,
WALL,
Wall-TC-ExtSouth,
TestChamber,
OtherSideCoeff,
OSC-SouthWall,
NoSun,
NoWind,
0.50000,
4,
5.28320, 0.00000, 0.53340,
5.28320, 0.00000, 0.76200,
2.64160, 0.00000, 0.76200,

```

```

2.64160, 0.00000, 0.53340;

SURFACE:HeatTransfer,
  TC-SouthWall-F3,
  WALL,
  Wall-TC-ExtSouth,
  TestChamber,
  OtherSideCoeff,
  OSC-SouthWall,
  NoSun,
  NoWind,
  0.50000,
  4,
  5.28320, 0.00000, 0.76200,
  5.28320, 0.00000, 0.99060,
  2.64160, 0.00000, 0.99060,
  2.64160, 0.00000, 0.76200;

SURFACE:HeatTransfer,
  TC-SouthWall-F4,
  WALL,
  Wall-TC-ExtSouth,
  TestChamber,
  OtherSideCoeff,
  OSC-SouthWall,
  NoSun,
  NoWind,
  0.50000,
  4,
  5.28320, 0.00000, 0.99060,
  5.28320, 0.00000, 1.21920,
  2.64160, 0.00000, 1.21920,
  2.64160, 0.00000, 0.99060;

SURFACE:HeatTransfer,
  TC-SouthWall-F5,
  WALL,
  Wall-TC-ExtSouth,
  TestChamber,
  OtherSideCoeff,
  OSC-SouthWall,
  NoSun,
  NoWind,
  0.50000,
  4,
  5.28320, 0.00000, 1.21920,
  5.28320, 0.00000, 1.44780,
  2.64160, 0.00000, 1.44780,
  2.64160, 0.00000, 1.21920;

SURFACE:HeatTransfer,
  TC-SouthWall-F6,
  WALL,
  Wall-TC-ExtSouth,
  TestChamber,
  OtherSideCoeff,
  OSC-SouthWall,
  NoSun,
  NoWind,
  0.50000,
  4,
  5.28320, 0.00000, 1.44780,
  5.28320, 0.00000, 1.67640,
  2.64160, 0.00000, 1.67640,
  2.64160, 0.00000, 1.44780;

SURFACE:HeatTransfer,
  TC-SouthWall-F7,

```

```

WALL,
Wall-TC-ExtSouth,
TestChamber,
OtherSideCoeff,
OSC-SouthWall,
NoSun,
NoWind,
0.50000,
4,
5.28320, 0.00000, 1.67640,
5.28320, 0.00000, 1.90500,
2.64160, 0.00000, 1.90500,
2.64160, 0.00000, 1.67640;

SURFACE:HeatTransfer,
TC-SouthWall-F8,
WALL,
Wall-TC-ExtSouth,
TestChamber,
OtherSideCoeff,
OSC-SouthWall,
NoSun,
NoWind,
0.50000,
4,
5.28320, 0.00000, 1.90500,
5.28320, 0.00000, 2.13360,
2.64160, 0.00000, 2.13360,
2.64160, 0.00000, 1.90500;

SURFACE:HeatTransfer,
TC-SouthWall-F9,
WALL,
Wall-TC-ExtSouth,
TestChamber,
OtherSideCoeff,
OSC-SouthWall,
NoSun,
NoWind,
0.50000,
4,
5.28320, 0.00000, 2.13360,
5.28320, 0.00000, 2.36220,
2.64160, 0.00000, 2.36220,
2.64160, 0.00000, 2.13360;

SURFACE:HeatTransfer,
TC-SouthWall-F10,
WALL,
Wall-TC-ExtSouth,
TestChamber,
OtherSideCoeff,
OSC-SouthWall,
NoSun,
NoWind,
0.50000,
4,
5.28320, 0.00000, 2.36220,
5.28320, 0.00000, 2.59080,
2.64160, 0.00000, 2.59080,
2.64160, 0.00000, 2.36220;

SURFACE:HeatTransfer,
TC-SouthWall-F11,
WALL,
Wall-TC-ExtSouth,
TestChamber,
OtherSideCoeff,

```

!- Surface Type.
 !- Construction Name.
 !- InsideFaceEnvironment.
 !- OutsideFaceEnvironment.
 !- Target (if applicable).
 !- Solar Exposure.
 !- Wind Exposure.
 !- Ground View Factor.

!- Object Index.
 !- Surface Type.
 !- Construction Name.
 !- InsideFaceEnvironment.
 !- OutsideFaceEnvironment.
 !- Target (if applicable).
 !- Solar Exposure.
 !- Wind Exposure.
 !- Ground View Factor.

!- Object Index.
 !- Surface Type.
 !- Construction Name.
 !- InsideFaceEnvironment.
 !- OutsideFaceEnvironment.
 !- Target (if applicable).
 !- Solar Exposure.
 !- Wind Exposure.
 !- Ground View Factor.

!- Object Index.
 !- Surface Type.
 !- Construction Name.
 !- InsideFaceEnvironment.
 !- OutsideFaceEnvironment.
 !- Target (if applicable).
 !- Solar Exposure.
 !- Wind Exposure.
 !- Ground View Factor.

!- Object Index.
 !- Surface Type.
 !- Construction Name.
 !- InsideFaceEnvironment.
 !- OutsideFaceEnvironment.

```

OSC-SouthWall,                                !- Target (if applicable).
NoSun,                                         !- Solar Exposure.
NoWind,                                        !- Wind Exposure.
0.50000,                                       !- Ground View Factor.
4,
5.28320, 0.00000, 2.59080,
5.28320, 0.00000, 2.81940,
2.64160, 0.00000, 2.81940,
2.64160, 0.00000, 2.59080;

SURFACE:HeatTransfer,
TC-SouthWall-F12,                             !- Object Index.
WALL,                                         !- Surface Type.
Wall-TC-ExtSouth,                            !- Construction Name.
TestChamber,                                 !- InsideFaceEnvironment.
OtherSideCoeff,                              !- OutsideFaceEnvironment.
OSC-SouthWall,                               !- Target (if applicable).
NoSun,                                        !- Solar Exposure.
NoWind,                                       !- Wind Exposure.
0.50000,                                       !- Ground View Factor.
4,
5.28320, 0.00000, 2.81940,
5.28320, 0.00000, 3.04800,
2.64160, 0.00000, 3.04800,
2.64160, 0.00000, 2.81940;

SURFACE:HeatTransfer,
TC-SouthWall-E1,                             !- Object Index.
WALL,                                         !- Surface Type.
Door-ExtSouth,                               !- Construction Name.
TestChamber,                                 !- InsideFaceEnvironment.
OtherSideCoeff,                              !- OutsideFaceEnvironment.
OSC-SouthWall,                               !- Target (if applicable).
NoSun,                                        !- Solar Exposure.
NoWind,                                       !- Wind Exposure.
0.50000,                                       !- Ground View Factor.
4,
7.92481, 0.00000, 0.30480,
7.92481, 0.00000, 0.53340,
5.28320, 0.00000, 0.53340,
5.28320, 0.00000, 0.30480;

SURFACE:HeatTransfer,
TC-SouthWall-E2,                             !- Object Index.
WALL,                                         !- Surface Type.
Door-ExtSouth,                               !- Construction Name.
TestChamber,                                 !- InsideFaceEnvironment.
OtherSideCoeff,                              !- OutsideFaceEnvironment.
OSC-SouthWall,                               !- Target (if applicable).
NoSun,                                        !- Solar Exposure.
NoWind,                                       !- Wind Exposure.
0.50000,                                       !- Ground View Factor.
4,
7.92481, 0.00000, 0.53340,
7.92481, 0.00000, 0.76200,
5.28320, 0.00000, 0.76200,
5.28320, 0.00000, 0.53340;

SURFACE:HeatTransfer,
TC-SouthWall-E3,                             !- Object Index.
WALL,                                         !- Surface Type.
Door-ExtSouth,                               !- Construction Name.
TestChamber,                                 !- InsideFaceEnvironment.
OtherSideCoeff,                              !- OutsideFaceEnvironment.
OSC-SouthWall,                               !- Target (if applicable).
NoSun,                                        !- Solar Exposure.
NoWind,                                       !- Wind Exposure.
0.50000,                                       !- Ground View Factor.

```



```

4,
7.92481, 0.00000, 0.76200,
7.92481, 0.00000, 0.99060,
5.28320, 0.00000, 0.99060,
5.28320, 0.00000, 0.76200;

SURFACE:HeatTransfer,
TC-SouthWall-E4,
WALL,
Wall-TC-ExtSouth,
TestChamber,
OtherSideCoeff,
OSC-SouthWall,
NoSun,
NoWind,
0.50000,
4,
7.92481, 0.00000, 0.99060,
7.92481, 0.00000, 1.21920,
5.28320, 0.00000, 1.21920,
5.28320, 0.00000, 0.99060;

SURFACE:HeatTransfer,
TC-SouthWall-E5,
WALL,
Wall-TC-ExtSouth,
TestChamber,
OtherSideCoeff,
OSC-SouthWall,
NoSun,
NoWind,
0.50000,
4,
7.92481, 0.00000, 1.21920,
7.92481, 0.00000, 1.44780,
5.28320, 0.00000, 1.44780,
5.28320, 0.00000, 1.21920;

SURFACE:HeatTransfer,
TC-SouthWall-E6,
WALL,
Wall-TC-ExtSouth,
TestChamber,
OtherSideCoeff,
OSC-SouthWall,
NoSun,
NoWind,
0.50000,
4,
7.92481, 0.00000, 1.44780,
7.92481, 0.00000, 1.67640,
5.28320, 0.00000, 1.67640,
5.28320, 0.00000, 1.44780;

SURFACE:HeatTransfer,
TC-SouthWall-E7,
WALL,
Wall-TC-ExtSouth,
TestChamber,
OtherSideCoeff,
OSC-SouthWall,
NoSun,
NoWind,
0.50000,
4,
7.92481, 0.00000, 1.67640,
7.92481, 0.00000, 1.90500,
5.28320, 0.00000, 1.90500,

```

```

5.28320, 0.00000, 1.67640;

SURFACE:HeatTransfer,
  TC-SouthWall-E8,
  WALL,
  Wall-TC-ExtSouth,
  TestChamber,
  OtherSideCoeff,
  OSC-SouthWall,
  NoSun,
  NoWind,
  0.50000,
  4,
  7.92481, 0.00000, 1.90500,
  7.92481, 0.00000, 2.13360,
  5.28320, 0.00000, 2.13360,
  5.28320, 0.00000, 1.90500;

SURFACE:HeatTransfer,
  TC-SouthWall-E9,
  WALL,
  Wall-TC-ExtSouth,
  TestChamber,
  OtherSideCoeff,
  OSC-SouthWall,
  NoSun,
  NoWind,
  0.50000,
  4,
  7.92481, 0.00000, 2.13360,
  7.92481, 0.00000, 2.36220,
  5.28320, 0.00000, 2.36220,
  5.28320, 0.00000, 2.13360;

SURFACE:HeatTransfer,
  TC-SouthWall-E10,
  WALL,
  Wall-TC-ExtSouth,
  TestChamber,
  OtherSideCoeff,
  OSC-SouthWall,
  NoSun,
  NoWind,
  0.50000,
  4,
  7.92481, 0.00000, 2.36220,
  7.92481, 0.00000, 2.59080,
  5.28320, 0.00000, 2.59080,
  5.28320, 0.00000, 2.36220;

SURFACE:HeatTransfer,
  TC-SouthWall-E11,
  WALL,
  Wall-TC-ExtSouth,
  TestChamber,
  OtherSideCoeff,
  OSC-SouthWall,
  NoSun,
  NoWind,
  0.50000,
  4,
  7.92481, 0.00000, 2.59080,
  7.92481, 0.00000, 2.81940,
  5.28320, 0.00000, 2.81940,
  5.28320, 0.00000, 2.59080;

SURFACE:HeatTransfer,
  TC-SouthWall-E12,

```

```

WALL,
Wall-TC-ExtSouth,
TestChamber,
OtherSideCoeff,
OSC-SouthWall,
NoSun,
NoWind,
0.50000,
4,
7.92481, 0.00000, 2.81940,
7.92481, 0.00000, 3.04800,
5.28320, 0.00000, 3.04800,
5.28320, 0.00000, 2.81940;

SURFACE:HeatTransfer,
TC-NorthWall-A1,
WALL,
Wall-TC-ExtNorth,
TestChamber,
OtherSideCoeff,
OSC-NorthWall,
NoSun,
NoWind,
0.50000,
4,
2.64160, 7.92480, 0.30480,
2.64160, 7.92480, 0.53340,
0.00000, 7.92480, 0.53340,
0.00000, 7.92480, 0.30480;

SURFACE:HeatTransfer,
TC-NorthWall-A2,
WALL,
Wall-TC-ExtNorth,
TestChamber,
OtherSideCoeff,
OSC-NorthWall,
NoSun,
NoWind,
0.50000,
4,
2.64160, 7.92480, 0.53340,
2.64160, 7.92480, 0.76200,
0.00000, 7.92480, 0.76200,
0.00000, 7.92480, 0.53340;

SURFACE:HeatTransfer,
TC-NorthWall-A3,
WALL,
Wall-TC-ExtNorth,
TestChamber,
OtherSideCoeff,
OSC-NorthWall,
NoSun,
NoWind,
0.50000,
4,
2.64160, 7.92480, 0.76200,
2.64160, 7.92480, 0.99060,
0.00000, 7.92480, 0.99060,
0.00000, 7.92480, 0.76200;

SURFACE:HeatTransfer,
TC-NorthWall-A4,
WALL,
Wall-TC-ExtNorth,
TestChamber,
OtherSideCoeff,

```

```

!- Surface Type.
!- Construction Name.
!- InsideFaceEnvironment.
!- OutsideFaceEnvironment.
!- Target (if applicable).
!- Solar Exposure.
!- Wind Exposure.
!- Ground View Factor.

!- Object Index.
!- Surface Type.
!- Construction Name.
!- InsideFaceEnvironment.
!- OutsideFaceEnvironment.
!- Target (if applicable).
!- Solar Exposure.
!- Wind Exposure.
!- Ground View Factor.

!- Object Index.
!- Surface Type.
!- Construction Name.
!- InsideFaceEnvironment.
!- OutsideFaceEnvironment.
!- Target (if applicable).
!- Solar Exposure.
!- Wind Exposure.
!- Ground View Factor.

!- Object Index.
!- Surface Type.
!- Construction Name.
!- InsideFaceEnvironment.
!- OutsideFaceEnvironment.
!- Target (if applicable).
!- Solar Exposure.
!- Wind Exposure.
!- Ground View Factor.

!- Object Index.
!- Surface Type.
!- Construction Name.
!- InsideFaceEnvironment.
!- OutsideFaceEnvironment.
!- Target (if applicable).
!- Solar Exposure.
!- Wind Exposure.
!- Ground View Factor.

```

```

OSC-NorthWall,                                !- Target (if applicable).
NoSun,                                         !- Solar Exposure.
NoWind,                                        !- Wind Exposure.
0.50000,                                       !- Ground View Factor.
4,
2.64160, 7.92480, 0.99060,
2.64160, 7.92480, 1.21920,
0.00000, 7.92480, 1.21920,
0.00000, 7.92480, 0.99060;

SURFACE:HeatTransfer,
TC-NorthWall-A5,                               !- Object Index.
WALL,                                           !- Surface Type.
Wall-TC-ExtNorth,                             !- Construction Name.
TestChamber,                                  !- InsideFaceEnvironment.
OtherSideCoeff,                              !- OutsideFaceEnvironment.
OSC-NorthWall,                                !- Target (if applicable).
NoSun,                                         !- Solar Exposure.
NoWind,                                        !- Wind Exposure.
0.50000,                                       !- Ground View Factor.
4,
2.64160, 7.92480, 1.21920,
2.64160, 7.92480, 1.44780,
0.00000, 7.92480, 1.44780,
0.00000, 7.92480, 1.21920;

SURFACE:HeatTransfer,
TC-NorthWall-A6,                               !- Object Index.
WALL,                                           !- Surface Type.
Wall-TC-ExtNorth,                             !- Construction Name.
TestChamber,                                  !- InsideFaceEnvironment.
OtherSideCoeff,                              !- OutsideFaceEnvironment.
OSC-NorthWall,                                !- Target (if applicable).
NoSun,                                         !- Solar Exposure.
NoWind,                                        !- Wind Exposure.
0.50000,                                       !- Ground View Factor.
4,
2.64160, 7.92480, 1.44780,
2.64160, 7.92480, 1.67640,
0.00000, 7.92480, 1.67640,
0.00000, 7.92480, 1.44780;

SURFACE:HeatTransfer,
TC-NorthWall-A7,                               !- Object Index.
WALL,                                           !- Surface Type.
Wall-TC-ExtNorth,                             !- Construction Name.
TestChamber,                                  !- InsideFaceEnvironment.
OtherSideCoeff,                              !- OutsideFaceEnvironment.
OSC-NorthWall,                                !- Target (if applicable).
NoSun,                                         !- Solar Exposure.
NoWind,                                        !- Wind Exposure.
0.50000,                                       !- Ground View Factor.
4,
2.64160, 7.92480, 1.67640,
2.64160, 7.92480, 1.90500,
0.00000, 7.92480, 1.90500,
0.00000, 7.92480, 1.67640;

SURFACE:HeatTransfer,
TC-NorthWall-A8,                               !- Object Index.
WALL,                                           !- Surface Type.
Wall-TC-ExtNorth,                             !- Construction Name.
TestChamber,                                  !- InsideFaceEnvironment.
OtherSideCoeff,                              !- OutsideFaceEnvironment.
OSC-NorthWall,                                !- Target (if applicable).
NoSun,                                         !- Solar Exposure.
NoWind,                                        !- Wind Exposure.
0.50000,                                       !- Ground View Factor.

```

```

4,
2.64160, 7.92480, 1.90500,
2.64160, 7.92480, 2.13360,
0.00000, 7.92480, 2.13360,
0.00000, 7.92480, 1.90500;

SURFACE:HeatTransfer,
TC-NorthWall-A9,
WALL,
Wall-TC-ExtNorth,
TestChamber,
OtherSideCoeff,
OSC-NorthWall,
NoSun,
NoWind,
0.50000,
4,
2.64160, 7.92480, 2.13360,
2.64160, 7.92480, 2.36220,
0.00000, 7.92480, 2.36220,
0.00000, 7.92480, 2.13360;

SURFACE:HeatTransfer,
TC-NorthWall-A10,
WALL,
Wall-TC-ExtNorth,
TestChamber,
OtherSideCoeff,
OSC-NorthWall,
NoSun,
NoWind,
0.50000,
4,
2.64160, 7.92480, 2.36220,
2.64160, 7.92480, 2.59080,
0.00000, 7.92480, 2.59080,
0.00000, 7.92480, 2.36220;

SURFACE:HeatTransfer,
TC-NorthWall-A11,
WALL,
Wall-TC-ExtNorth,
TestChamber,
OtherSideCoeff,
OSC-NorthWall,
NoSun,
NoWind,
0.50000,
4,
2.64160, 7.92480, 2.59080,
2.64160, 7.92480, 2.81940,
0.00000, 7.92480, 2.81940,
0.00000, 7.92480, 2.59080;

SURFACE:HeatTransfer,
TC-NorthWall-A12,
WALL,
Wall-TC-ExtNorth,
TestChamber,
OtherSideCoeff,
OSC-NorthWall,
NoSun,
NoWind,
0.50000,
4,
2.64160, 7.92480, 2.81940,
2.64160, 7.92480, 3.04800,
0.00000, 7.92480, 3.04800,

```

```

0.00000, 7.92480, 2.81940;

SURFACE:HeatTransfer,
  TC-NorthWall-B1,
  WALL,
  Wall-TC-ExtNorth,
  TestChamber,
  OtherSideCoeff,
  OSC-NorthWall,
  NoSun,
  NoWind,
  0.50000,
  4,
  5.28320, 7.92480, 0.30480,
  5.28320, 7.92480, 0.53340,
  2.64160, 7.92480, 0.53340,
  2.64160, 7.92480, 0.30480;

SURFACE:HeatTransfer,
  TC-NorthWall-B2,
  WALL,
  Wall-TC-ExtNorth,
  TestChamber,
  OtherSideCoeff,
  OSC-NorthWall,
  NoSun,
  NoWind,
  0.50000,
  4,
  5.28320, 7.92480, 0.53340,
  5.28320, 7.92480, 0.76200,
  2.64160, 7.92480, 0.76200,
  2.64160, 7.92480, 0.53340;

SURFACE:HeatTransfer,
  TC-NorthWall-B3,
  WALL,
  Wall-TC-ExtNorth,
  TestChamber,
  OtherSideCoeff,
  OSC-NorthWall,
  NoSun,
  NoWind,
  0.50000,
  4,
  5.28320, 7.92480, 0.76200,
  5.28320, 7.92480, 0.99060,
  2.64160, 7.92480, 0.99060,
  2.64160, 7.92480, 0.76200;

SURFACE:HeatTransfer,
  TC-NorthWall-B4,
  WALL,
  Wall-TC-ExtNorth,
  TestChamber,
  OtherSideCoeff,
  OSC-NorthWall,
  NoSun,
  NoWind,
  0.50000,
  4,
  5.28320, 7.92480, 0.99060,
  5.28320, 7.92480, 1.21920,
  2.64160, 7.92480, 1.21920,
  2.64160, 7.92480, 0.99060;

SURFACE:HeatTransfer,
  TC-NorthWall-B5,

```

```

WALL,
Wall-TC-ExtNorth,
TestChamber,
OtherSideCoeff,
OSC-NorthWall,
NoSun,
NoWind,
0.50000,
4,
5.28320, 7.92480, 1.21920,
5.28320, 7.92480, 1.44780,
2.64160, 7.92480, 1.44780,
2.64160, 7.92480, 1.21920;

SURFACE:HeatTransfer,
TC-NorthWall-B6,
WALL,
Wall-TC-ExtNorth,
TestChamber,
OtherSideCoeff,
OSC-NorthWall,
NoSun,
NoWind,
0.50000,
4,
5.28320, 7.92480, 1.44780,
5.28320, 7.92480, 1.67640,
2.64160, 7.92480, 1.67640,
2.64160, 7.92480, 1.44780;

SURFACE:HeatTransfer,
TC-NorthWall-B7,
WALL,
Wall-TC-ExtNorth,
TestChamber,
OtherSideCoeff,
OSC-NorthWall,
NoSun,
NoWind,
0.50000,
4,
5.28320, 7.92480, 1.67640,
5.28320, 7.92480, 1.90500,
2.64160, 7.92480, 1.90500,
2.64160, 7.92480, 1.67640;

SURFACE:HeatTransfer,
TC-NorthWall-B8,
WALL,
Wall-TC-ExtNorth,
TestChamber,
OtherSideCoeff,
OSC-NorthWall,
NoSun,
NoWind,
0.50000,
4,
5.28320, 7.92480, 1.90500,
5.28320, 7.92480, 2.13360,
2.64160, 7.92480, 2.13360,
2.64160, 7.92480, 1.90500;

SURFACE:HeatTransfer,
TC-NorthWall-B9,
WALL,
Wall-TC-ExtNorth,
TestChamber,
OtherSideCoeff,

```

```

!- Surface Type.
!- Construction Name.
!- InsideFaceEnvironment.
!- OutsideFaceEnvironment.
!- Target (if applicable).
!- Solar Exposure.
!- Wind Exposure.
!- Ground View Factor.

!- Object Index.
!- Surface Type.
!- Construction Name.
!- InsideFaceEnvironment.
!- OutsideFaceEnvironment.
!- Target (if applicable).
!- Solar Exposure.
!- Wind Exposure.
!- Ground View Factor.

!- Object Index.
!- Surface Type.
!- Construction Name.
!- InsideFaceEnvironment.
!- OutsideFaceEnvironment.
!- Target (if applicable).
!- Solar Exposure.
!- Wind Exposure.
!- Ground View Factor.

!- Object Index.
!- Surface Type.
!- Construction Name.
!- InsideFaceEnvironment.
!- OutsideFaceEnvironment.
!- Target (if applicable).
!- Solar Exposure.
!- Wind Exposure.
!- Ground View Factor.

!- Object Index.
!- Surface Type.
!- Construction Name.
!- InsideFaceEnvironment.
!- OutsideFaceEnvironment.

```

```

OSC-NorthWall,                                !- Target (if applicable).
NoSun,                                         !- Solar Exposure.
NoWind,                                        !- Wind Exposure.
0.50000,                                       !- Ground View Factor.
4,
5.28320, 7.92480, 2.13360,
5.28320, 7.92480, 2.36220,
2.64160, 7.92480, 2.36220,
2.64160, 7.92480, 2.13360;

SURFACE:HeatTransfer,
TC-NorthWall-B10,                             !- Object Index.
WALL,                                         !- Surface Type.
Wall-TC-ExtNorth,                             !- Construction Name.
TestChamber,                                 !- InsideFaceEnvironment.
OtherSideCoeff,                              !- OutsideFaceEnvironment.
OSC-NorthWall,                               !- Target (if applicable).
NoSun,                                        !- Solar Exposure.
NoWind,                                       !- Wind Exposure.
0.50000,                                       !- Ground View Factor.
4,
5.28320, 7.92480, 2.36220,
5.28320, 7.92480, 2.59080,
2.64160, 7.92480, 2.59080,
2.64160, 7.92480, 2.36220;

SURFACE:HeatTransfer,
TC-NorthWall-B11,                             !- Object Index.
WALL,                                         !- Surface Type.
Wall-TC-ExtNorth,                             !- Construction Name.
TestChamber,                                 !- InsideFaceEnvironment.
OtherSideCoeff,                              !- OutsideFaceEnvironment.
OSC-NorthWall,                               !- Target (if applicable).
NoSun,                                        !- Solar Exposure.
NoWind,                                       !- Wind Exposure.
0.50000,                                       !- Ground View Factor.
4,
5.28320, 7.92480, 2.59080,
5.28320, 7.92480, 2.81940,
2.64160, 7.92480, 2.81940,
2.64160, 7.92480, 2.59080;

SURFACE:HeatTransfer,
TC-NorthWall-B12,                             !- Object Index.
WALL,                                         !- Surface Type.
Wall-TC-ExtNorth,                             !- Construction Name.
TestChamber,                                 !- InsideFaceEnvironment.
OtherSideCoeff,                              !- OutsideFaceEnvironment.
OSC-NorthWall,                               !- Target (if applicable).
NoSun,                                        !- Solar Exposure.
NoWind,                                       !- Wind Exposure.
0.50000,                                       !- Ground View Factor.
4,
5.28320, 7.92480, 2.81940,
5.28320, 7.92480, 3.04800,
2.64160, 7.92480, 3.04800,
2.64160, 7.92480, 2.81940;

SURFACE:HeatTransfer,
TC-NorthWall-C1,                             !- Object Index.
WALL,                                         !- Surface Type.
Door-ExtNorth,                               !- Construction Name.
TestChamber,                                 !- InsideFaceEnvironment.
OtherSideCoeff,                              !- OutsideFaceEnvironment.
OSC-NorthWall,                               !- Target (if applicable).
NoSun,                                        !- Solar Exposure.
NoWind,                                       !- Wind Exposure.
0.50000,                                       !- Ground View Factor.

```



```

4,
7.92481, 7.92480, 0.30480,
7.92481, 7.92480, 0.53340,
5.28320, 7.92480, 0.53340,
5.28320, 7.92480, 0.30480;

SURFACE:HeatTransfer,
TC-NorthWall-C2,
WALL,
Door-ExtNorth,
TestChamber,
OtherSideCoeff,
OSC-NorthWall,
NoSun,
NoWind,
0.50000,
4,
7.92481, 7.92480, 0.53340,
7.92481, 7.92480, 0.76200,
5.28320, 7.92480, 0.76200,
5.28320, 7.92480, 0.53340;

SURFACE:HeatTransfer,
TC-NorthWall-C3,
WALL,
Door-ExtNorth,
TestChamber,
OtherSideCoeff,
OSC-NorthWall,
NoSun,
NoWind,
0.50000,
4,
7.92481, 7.92480, 0.76200,
7.92481, 7.92480, 0.99060,
5.28320, 7.92480, 0.99060,
5.28320, 7.92480, 0.76200;

SURFACE:HeatTransfer,
TC-NorthWall-C4,
WALL,
Door-ExtNorth,
TestChamber,
OtherSideCoeff,
OSC-NorthWall,
NoSun,
NoWind,
0.50000,
4,
7.92481, 7.92480, 0.99060,
7.92481, 7.92480, 1.21920,
5.28320, 7.92480, 1.21920,
5.28320, 7.92480, 0.99060;

SURFACE:HeatTransfer,
TC-NorthWall-C5,
WALL,
Wall-TC-ExtNorth,
TestChamber,
OtherSideCoeff,
OSC-NorthWall,
NoSun,
NoWind,
0.50000,
4,
7.92481, 7.92480, 1.21920,
7.92481, 7.92480, 1.44780,
5.28320, 7.92480, 1.44780,

```

```

5.28320, 7.92480, 1.21920;

SURFACE:HeatTransfer,
  TC-NorthWallC6,
  WALL,
  Wall-TC-ExtNorth,
  TestChamber,
  OtherSideCoeff,
  OSC-NorthWall,
  NoSun,
  NoWind,
  0.50000,
  4,
  7.92481, 7.92480, 1.44780,
  7.92481, 7.92480, 1.67640,
  5.28320, 7.92480, 1.67640,
  5.28320, 7.92480, 1.44780;

SURFACE:HeatTransfer,
  TC-NorthWall-C7,
  WALL,
  Wall-TC-ExtNorth,
  TestChamber,
  OtherSideCoeff,
  OSC-NorthWall,
  NoSun,
  NoWind,
  0.50000,
  4,
  7.92481, 7.92480, 1.67640,
  7.92481, 7.92480, 1.90500,
  5.28320, 7.92480, 1.90500,
  5.28320, 7.92480, 1.67640;

SURFACE:HeatTransfer,
  TC-NorthWall-C8,
  WALL,
  Wall-TC-ExtNorth,
  TestChamber,
  OtherSideCoeff,
  OSC-NorthWall,
  NoSun,
  NoWind,
  0.50000,
  4,
  7.92481, 7.92480, 1.90500,
  7.92481, 7.92480, 2.13360,
  5.28320, 7.92480, 2.13360,
  5.28320, 7.92480, 1.90500;

SURFACE:HeatTransfer,
  TC-NorthWall-C9,
  WALL,
  Wall-TC-ExtNorth,
  TestChamber,
  OtherSideCoeff,
  OSC-NorthWall,
  NoSun,
  NoWind,
  0.50000,
  4,
  7.92481, 7.92480, 2.13360,
  7.92481, 7.92480, 2.36220,
  5.28320, 7.92480, 2.36220,
  5.28320, 7.92480, 2.13360;

SURFACE:HeatTransfer,
  TC-NorthWall-C10,

```

```

WALL,
Wall-TC-ExtNorth,
TestChamber,
OtherSideCoeff,
OSC-NorthWall,
NoSun,
NoWind,
0.50000,
4,
7.92481, 7.92480, 2.36220,
7.92481, 7.92480, 2.59080,
5.28320, 7.92480, 2.59080,
5.28320, 7.92480, 2.36220;

SURFACE:HeatTransfer,
TC-NorthWall-C11,
WALL,
Wall-TC-ExtNorth,
TestChamber,
OtherSideCoeff,
OSC-NorthWall,
NoSun,
NoWind,
0.50000,
4,
7.92481, 7.92480, 2.59080,
7.92481, 7.92480, 2.81940,
5.28320, 7.92480, 2.81940,
5.28320, 7.92480, 2.59080;

SURFACE:HeatTransfer,
TC-NorthWall-C12,
WALL,
Wall-TC-ExtNorth,
TestChamber,
OtherSideCoeff,
OSC-NorthWall,
NoSun,
NoWind,
0.50000,
4,
7.92481, 7.92480, 2.81940,
7.92481, 7.92480, 3.04800,
5.28320, 7.92480, 3.04800,
5.28320, 7.92480, 2.81940;

SURFACE:HeatTransfer,
TC-EastWall-Lower,
WALL,
Wall-TC-ExtEast,
TestChamber,
OtherSideCoeff,
OSC-EastWall,
NoSun,
NoWind,
0.50001,
4,
7.92480, 7.92480, 0.30480,
7.92480, 7.92480, 1.67640,
7.92480, 0.00000, 1.67640,
7.92480, 0.00000, 0.30480;

SURFACE:HeatTransfer,
TC-EastWall-Upper,
WALL,
Wall-TC-ExtEast,
TestChamber,
OtherSideCoeff,

```

```

!- Surface Type.
!- Construction Name.
!- InsideFaceEnvironment.
!- OutsideFaceEnvironment.
!- Target (if applicable).
!- Solar Exposure.
!- Wind Exposure.
!- Ground View Factor.

!- Object Index.
!- Surface Type.
!- Construction Name.
!- InsideFaceEnvironment.
!- OutsideFaceEnvironment.
!- Target (if applicable).
!- Solar Exposure.
!- Wind Exposure.
!- Ground View Factor.

!- Object Index.
!- Surface Type.
!- Construction Name.
!- InsideFaceEnvironment.
!- OutsideFaceEnvironment.
!- Target (if applicable).
!- Solar Exposure.
!- Wind Exposure.
!- Ground View Factor.

!- Object Index.
!- Surface Type.
!- Construction Name.
!- InsideFaceEnvironment.
!- OutsideFaceEnvironment.
!- Target (if applicable).
!- Solar Exposure.
!- Wind Exposure.
!- Ground View Factor.

!- Object Index.
!- Surface Type.
!- Construction Name.
!- InsideFaceEnvironment.
!- OutsideFaceEnvironment.

```

```

OSC-EastWall,                                     !- Target (if applicable).
NoSun,                                           !- Solar Exposure.
NoWind,                                          !- Wind Exposure.
0.50001,                                         !- Ground View Factor.
4,
7.92480, 7.92480, 1.67640,
7.92480, 7.92480, 3.04800,
7.92480, 0.00000, 3.04800,
7.92480, 0.00000, 1.67640;

SURFACE:HeatTransfer,
TC-Clg,                                         !- Object Index.
CEILING,                                       !- Surface Type.
Suspended Clg,                                !- Construction Name.
TestChamber,                                  !- InsideFaceEnvironment.
OtherZoneSurface,                             !- OutsideFaceEnvironment
RP-Flr,                                       !- Target (if applicable).
NoSun,                                         !- Solar Exposure.
NoWind,                                        !- Wind Exposure.
1.00000,                                       !- Ground View Factor.
4,
7.92481, 0.00000, 3.04800,
7.92481, 7.92480, 3.04800,
0.00000, 7.92480, 3.04800,
0.00000, 0.00000, 3.04800;

!- ===== ALL OBJECTS IN CLASS: OTHERSIDECEFFICIENTS =====

OtherSideCoefficients,
  OSC-Clg,                                     !- OtherSideCoeff Name
  0.,                                         !- Combined convective/radiative film coefficient
  OST-Clg[],                                 !- User selected Constant Temperature {C}
  1.,                                         !- Coefficient modifying the user selected constant temper
ature
  0.,                                         !- Coefficient modifying the external dry bulb temperature
  0.,                                         !- Coefficient modifying the ground temperature
  0.,                                         !- Coefficient modifying the wind speed term (s/m)
  0;                                         !- Coefficient modifying the zone air temperature part of
the equation

OtherSideCoefficients,
  OSC-NorthWall,                             !- OtherSideCoeff Name
  0.,                                         !- Combined convective/radiative film coefficient
  OST-North[],                               !- User selected Constant Temperature {C}
  1.,                                         !- Coefficient modifying the user selected constant temper
ature
  0.,                                         !- Coefficient modifying the external dry bulb temperature
  0.,                                         !- Coefficient modifying the ground temperature
  0.,                                         !- Coefficient modifying the wind speed term (s/m)
  0;                                         !- Coefficient modifying the zone air temperature part of
the equation

OtherSideCoefficients,
  OSC-SouthWall,                             !- OtherSideCoeff Name
  0.,                                         !- Combined convective/radiative film coefficient
  OST-South[],                               !- User selected Constant Temperature {C}
  1.,                                         !- Coefficient modifying the user selected constant temper
ature
  0.,                                         !- Coefficient modifying the external dry bulb temperature
  0.,                                         !- Coefficient modifying the ground temperature
  0.,                                         !- Coefficient modifying the wind speed term (s/m)
  0;                                         !- Coefficient modifying the zone air temperature part of
the equation

OtherSideCoefficients,
  OSC-WestWall,                              !- OtherSideCoeff Name
  0.,                                         !- Combined convective/radiative film coefficient

```

```

        OST-West[],          !- User selected Constant Temperature {C}
        1.,                  !- Coefficient modifying the user selected constant temper
ature
        0.,                  !- Coefficient modifying the external dry bulb temperature
        0.,                  !- Coefficient modifying the ground temperature
        0.,                  !- Coefficient modifying the wind speed term (s/m)
        0;                   !- Coefficient modifying the zone air temperature part of
the equation

OtherSideCoefficients,
    OSC-EastWall,          !- OtherSideCoeff Name
    0.,                    !- Combined convective/radiative film coefficient
    OST-East[],           !- User selected Constant Temperature {C}
    1.,                    !- Coefficient modifying the user selected constant temper
ature
    0.,                    !- Coefficient modifying the external dry bulb temperature
    0.,                    !- Coefficient modifying the ground temperature
    0.,                    !- Coefficient modifying the wind speed term (s/m)
    0;                     !- Coefficient modifying the zone air temperature part of
the equation

OtherSideCoefficients,
    OSC-Flr,              !- OtherSideCoeff Name
    0.,                    !- Combined convective/radiative film coefficient
    OST-Flr[],           !- User selected Constant Temperature {C}
    1.,                    !- Coefficient modifying the user selected constant temper
ature
    0.,                    !- Coefficient modifying the external dry bulb temperature
    0.,                    !- Coefficient modifying the ground temperature
    0.,                    !- Coefficient modifying the wind speed term (s/m)
    0;                     !- Coefficient modifying the zone air temperature part of
the equation

OtherSideCoefficients,
    OSC-ConfPlnm,        !- OtherSideCoeff Name
    0.,                    !- Combined convective/radiative film coefficient
    OST-ConfPlnm[],     !- User selected Constant Temperature {C}
    1.,                    !- Coefficient modifying the user selected constant temper
ature
    0.,                    !- Coefficient modifying the external dry bulb temperature
    0.,                    !- Coefficient modifying the ground temperature
    0.,                    !- Coefficient modifying the wind speed term (s/m)
    0;                     !- Coefficient modifying the zone air temperature part of
the equation

!- ===== Measured Solar Data =====

DAYSCHEDULE:Interval,    ! Calculated inside surface glass temps from regular ufad.i
df summer des day run
    GlassTempDay,        !- Name
    Temperature,        !- ScheduleType
    No,                  !- Interpolate Value
    24:00,               !- until time
    GlassTemp[];

WEEKSCHEDULE,
    GlassTempWeek,      !- Name
    GlassTempDay,      !- Sunday DAYSCHEDULE Name
    GlassTempDay,      !- Monday DAYSCHEDULE Name
    GlassTempDay,      !- Tuesday DAYSCHEDULE Name
    GlassTempDay,      !- Wednesday DAYSCHEDULE Name
    GlassTempDay,      !- Thursday DAYSCHEDULE Name
    GlassTempDay,      !- Friday DAYSCHEDULE Name
    GlassTempDay,      !- Saturday DAYSCHEDULE Name
    GlassTempDay,      !- Holiday DAYSCHEDULE Name
    GlassTempDay,      !- SummerDesignDay DAYSCHEDULE Name
    GlassTempDay,      !- WinterDesignDay DAYSCHEDULE Name
    GlassTempDay,      !- CustomDay1 DAYSCHEDULE Name

```

```

GlassTempDay;  !- CustomDay2 DAYSCHEDULE Name

SCHEDULE,
  SchMeasGlassTemp,  !- Name
  Temperature,      !- ScheduleType
  GlassTempWeek,    !- Name of WEEKSCHEDULE 1
  1,                !- Start Month 1
  1,                !- Start Day 1
  12,               !- End Month 1
  31;              !- End Day 1

DAYSCHEDULE:Interval,  ! Zone Transmitted Solar calculated values from regular summer
design day run (W)
  TransSolDay,  !- Name
  Any Number,  !- ScheduleType
  No,          !- Interpolate Value
  24:00,      !- until time
  GlassTransSol[];

WEEKSCHEDULE,
  TransSolWeek,  !- Name
  TransSolDay,  !- Sunday DAYSCHEDULE Name
  TransSolDay,  !- Monday DAYSCHEDULE Name
  TransSolDay,  !- Tuesday DAYSCHEDULE Name
  TransSolDay,  !- Wednesday DAYSCHEDULE Name
  TransSolDay,  !- Thursday DAYSCHEDULE Name
  TransSolDay,  !- Friday DAYSCHEDULE Name
  TransSolDay,  !- Saturday DAYSCHEDULE Name
  TransSolDay,  !- Holiday DAYSCHEDULE Name
  TransSolDay,  !- SummerDesignDay DAYSCHEDULE Name
  TransSolDay,  !- WinterDesignDay DAYSCHEDULE Name
  TransSolDay,  !- CustomDay1 DAYSCHEDULE Name
  TransSolDay;  !- CustomDay2 DAYSCHEDULE Name

SCHEDULE,
  SchMeasTransSol,  !- Name
  Any Number,      !- ScheduleType
  TransSolWeek,    !- Name of WEEKSCHEDULE 1
  1,                !- Start Month 1
  1,                !- Start Day 1
  12,               !- End Month 1
  31;              !- End Day 1

##if #[RunType[] EQS PER ]

MeasuredUFADWindowData,
  EnvChamberWindow,  !- Name of Window to which This Measured Data Applies
  SchMeasGlassTemp,  !- Name of Schedule of Measured Inside Surface Glass Temperat
ures (C)
  SchMeasTransSol,   !- Name of Schedule of Measured Transmitted Solar Values (W)
  ;                  !- Name of Schedule of Measured Blind Slat Temperatures (C)

MeasuredUFADSolarFraction,
  TC-Flr-1,          !- Object Index.
  SF-Flr-1[];        !- Object Index.

MeasuredUFADSolarFraction,
  TC-Flr-2,          !- Object Index.
  SF-Flr-2[];        !- Object Index.

MeasuredUFADSolarFraction,
  TC-Flr-3,          !- Object Index.
  SF-Flr-3[];        !- Object Index.

MeasuredUFADSolarFraction,
  TC-Flr-4,          !- Object Index.
  SF-Flr-4[];        !- Object Index.

```

```

MeasuredUFADSolarFraction,
  TC-Flr-5,
  SF-Flr-5 [];
!- Object Index.
!- Object Index.

MeasuredUFADSolarFraction,
  TC-Flr-6,
  SF-Flr-6 [];
!- Object Index.
!- Object Index.

MeasuredUFADSolarFraction,
  TC-Flr-7,
  SF-Flr-7 [];
!- Object Index.
!- Object Index.

MeasuredUFADSolarFraction,
  TC-Flr-8,
  SF-Flr-8 [];
!- Object Index.
!- Object Index.

MeasuredUFADSolarFraction,
  TC-Flr-9,
  SF-Flr-9 [];
!- Object Index.
!- Object Index.

MeasuredUFADSolarFraction,
  TC-Flr-10,
  SF-Flr-10 [];
!- Object Index.
!- Object Index.

MeasuredUFADSolarFraction,
  TC-Flr-11,
  SF-Flr-11 [];
!- Object Index.
!- Object Index.

MeasuredUFADSolarFraction,
  TC-Flr-12,
  SF-Flr-12 [];
!- Object Index.
!- Object Index.

MeasuredUFADSolarFraction,
  TC-Flr-13,
  SF-Flr-13 [];
!- Object Index.
!- Object Index.

MeasuredUFADSolarFraction,
  TC-Flr-14,
  SF-Flr-14 [];
!- Object Index.
!- Object Index.

MeasuredUFADSolarFraction,
  TC-Flr-15,
  SF-Flr-15 [];
!- Object Index.
!- Object Index.

MeasuredUFADSolarFraction,
  TC-WestWall,
  SF-WestWall [];
!- Object Index.
!- Object Index.

MeasuredUFADSolarFraction,
  TC-SouthWall-G1,
  SF-SouthWall-G1 [];
!- Object Index.
!- Object Index.

MeasuredUFADSolarFraction,
  TC-SouthWall-G2,
  SF-SouthWall-G2 [];
!- Object Index.
!- Object Index.

MeasuredUFADSolarFraction,
  TC-SouthWall-G3,
  SF-SouthWall-G3 [];
!- Object Index.
!- Object Index.

MeasuredUFADSolarFraction,
  TC-SouthWall-G4,
  SF-SouthWall-G4 [];
!- Object Index.
!- Object Index.

MeasuredUFADSolarFraction,
  TC-SouthWall-G5,
  SF-SouthWall-G5 [];
!- Object Index.
!- Object Index.

```

```

MeasuredUFADSolarFraction,
  TC-SouthWall-G6,
  SF-SouthWall-G6 [];
!- Object Index.
!- Object Index.

MeasuredUFADSolarFraction,
  TC-SouthWall-G7,
  SF-SouthWall-G7 [];
!- Object Index.
!- Object Index.

MeasuredUFADSolarFraction,
  TC-SouthWall-G8,
  SF-SouthWall-G8 [];
!- Object Index.
!- Object Index.

MeasuredUFADSolarFraction,
  TC-SouthWall-G9,
  SF-SouthWall-G9 [];
!- Object Index.
!- Object Index.

MeasuredUFADSolarFraction,
  TC-SouthWall-G10,
  SF-SouthWall-G10 [];
!- Object Index.
!- Object Index.

MeasuredUFADSolarFraction,
  TC-SouthWall-G11,
  SF-SouthWall-G11 [];
!- Object Index.
!- Object Index.

MeasuredUFADSolarFraction,
  TC-SouthWall-G12,
  SF-SouthWall-G12 [];
!- Object Index.
!- Object Index.

MeasuredUFADSolarFraction,
  TC-SouthWall-F1,
  SF-SouthWall-F1 [];
!- Object Index.
!- Object Index.

MeasuredUFADSolarFraction,
  TC-SouthWall-F2,
  SF-SouthWall-F2 [];
!- Object Index.
!- Object Index.

MeasuredUFADSolarFraction,
  TC-SouthWall-F3,
  SF-SouthWall-F3 [];
!- Object Index.
!- Object Index.

MeasuredUFADSolarFraction,
  TC-SouthWall-F4,
  SF-SouthWall-F4 [];
!- Object Index.
!- Object Index.

MeasuredUFADSolarFraction,
  TC-SouthWall-F5,
  SF-SouthWall-F5 [];
!- Object Index.
!- Object Index.

MeasuredUFADSolarFraction,
  TC-SouthWall-F6,
  SF-SouthWall-F6 [];
!- Object Index.
!- Object Index.

MeasuredUFADSolarFraction,
  TC-SouthWall-F7,
  SF-SouthWall-F7 [];
!- Object Index.
!- Object Index.

MeasuredUFADSolarFraction,
  TC-SouthWall-F8,
  SF-SouthWall-F8 [];
!- Object Index.
!- Object Index.

MeasuredUFADSolarFraction,
  TC-SouthWall-F9,
  SF-SouthWall-F9 [];
!- Object Index.
!- Object Index.

MeasuredUFADSolarFraction,
  TC-SouthWall-F10,
  SF-SouthWall-F10 [];
!- Object Index.
!- Object Index.

```



```

MeasuredUFADSolarFraction,
  TC-SouthWall-F11,
  SF-SouthWall-F11 [];
                                !- Object Index.
                                !- Object Index.

MeasuredUFADSolarFraction,
  TC-SouthWall-F12,
  SF-SouthWall-F12 [];
                                !- Object Index.
                                !- Object Index.

MeasuredUFADSolarFraction,
  TC-SouthWall-E1,
  SF-SouthWall-E1 [];
                                !- Object Index.
                                !- Object Index.

MeasuredUFADSolarFraction,
  TC-SouthWall-E2,
  SF-SouthWall-E2 [];
                                !- Object Index.
                                !- Object Index.

MeasuredUFADSolarFraction,
  TC-SouthWall-E3,
  SF-SouthWall-E3 [];
                                !- Object Index.
                                !- Object Index.

MeasuredUFADSolarFraction,
  TC-SouthWall-E4,
  SF-SouthWall-E4 [];
                                !- Object Index.
                                !- Object Index.

MeasuredUFADSolarFraction,
  TC-SouthWall-E5,
  SF-SouthWall-E5 [];
                                !- Object Index.
                                !- Object Index.

MeasuredUFADSolarFraction,
  TC-SouthWall-E6,
  SF-SouthWall-E6 [];
                                !- Object Index.
                                !- Object Index.

MeasuredUFADSolarFraction,
  TC-SouthWall-E7,
  SF-SouthWall-E7 [];
                                !- Object Index.
                                !- Object Index.

MeasuredUFADSolarFraction,
  TC-SouthWall-E8,
  SF-SouthWall-E8 [];
                                !- Object Index.
                                !- Object Index.

MeasuredUFADSolarFraction,
  TC-SouthWall-E9,
  SF-SouthWall-E9 [];
                                !- Object Index.
                                !- Object Index.

MeasuredUFADSolarFraction,
  TC-SouthWall-E10,
  SF-SouthWall-E10 [];
                                !- Object Index.
                                !- Object Index.

MeasuredUFADSolarFraction,
  TC-SouthWall-E11,
  SF-SouthWall-E11 [];
                                !- Object Index.
                                !- Object Index.

MeasuredUFADSolarFraction,
  TC-SouthWall-E12,
  SF-SouthWall-E12 [];
                                !- Object Index.
                                !- Object Index.

MeasuredUFADSolarFraction,
  TC-NorthWall-A1,
  SF-NorthWall-A1 [];
                                !- Object Index.
                                !- Object Index.

MeasuredUFADSolarFraction,
  TC-NorthWall-A2,
  SF-NorthWall-A2 [];
                                !- Object Index.
                                !- Object Index.

MeasuredUFADSolarFraction,
  TC-NorthWall-A3,
  SF-NorthWall-A3 [];
                                !- Object Index.
                                !- Object Index.

```

```

MeasuredUFADSolarFraction,
  TC-NorthWall-A4,
  SF-NorthWall-A4 [];
!- Object Index.
!- Object Index.

MeasuredUFADSolarFraction,
  TC-NorthWall-A5,
  SF-NorthWall-A5 [];
!- Object Index.
!- Object Index.

MeasuredUFADSolarFraction,
  TC-NorthWall-A6,
  SF-NorthWall-A6 [];
!- Object Index.
!- Object Index.

MeasuredUFADSolarFraction,
  TC-NorthWall-A7,
  SF-NorthWall-A7 [];
!- Object Index.
!- Object Index.

MeasuredUFADSolarFraction,
  TC-NorthWall-A8,
  SF-NorthWall-A8 [];
!- Object Index.
!- Object Index.

MeasuredUFADSolarFraction,
  TC-NorthWall-A9,
  SF-NorthWall-A9 [];
!- Object Index.
!- Object Index.

MeasuredUFADSolarFraction,
  TC-NorthWall-A10,
  SF-NorthWall-A10 [];
!- Object Index.
!- Object Index.

MeasuredUFADSolarFraction,
  TC-NorthWall-A11,
  SF-NorthWall-A11 [];
!- Object Index.
!- Object Index.

MeasuredUFADSolarFraction,
  TC-NorthWall-A12,
  SF-NorthWall-A12 [];
!- Object Index.
!- Object Index.

MeasuredUFADSolarFraction,
  TC-NorthWall-B1,
  SF-NorthWall-B1 [];
!- Object Index.
!- Object Index.

MeasuredUFADSolarFraction,
  TC-NorthWall-B2,
  SF-NorthWall-B2 [];
!- Object Index.
!- Object Index.

MeasuredUFADSolarFraction,
  TC-NorthWall-B3,
  SF-NorthWall-B3 [];
!- Object Index.
!- Object Index.

MeasuredUFADSolarFraction,
  TC-NorthWall-B4,
  SF-NorthWall-B4 [];
!- Object Index.
!- Object Index.

MeasuredUFADSolarFraction,
  TC-NorthWall-B5,
  SF-NorthWall-B5 [];
!- Object Index.
!- Object Index.

MeasuredUFADSolarFraction,
  TC-NorthWall-B6,
  SF-NorthWall-B6 [];
!- Object Index.
!- Object Index.

MeasuredUFADSolarFraction,
  TC-NorthWall-B7,
  SF-NorthWall-B7 [];
!- Object Index.
!- Object Index.

MeasuredUFADSolarFraction,
  TC-NorthWall-B8,
  SF-NorthWall-B8 [];
!- Object Index.
!- Object Index.

```

```

MeasuredUFADSolarFraction,
  TC-NorthWall-B9,
  SF-NorthWall-B9 [];
!- Object Index.
!- Object Index.

MeasuredUFADSolarFraction,
  TC-NorthWall-B10,
  SF-NorthWall-B10 [];
!- Object Index.
!- Object Index.

MeasuredUFADSolarFraction,
  TC-NorthWall-B11,
  SF-NorthWall-B11 [];
!- Object Index.
!- Object Index.

MeasuredUFADSolarFraction,
  TC-NorthWall-B12,
  SF-NorthWall-B12 [];
!- Object Index.
!- Object Index.

MeasuredUFADSolarFraction,
  TC-NorthWall-C1,
  SF-NorthWall-C1 [];
!- Object Index.
!- Object Index.

MeasuredUFADSolarFraction,
  TC-NorthWall-C2,
  SF-NorthWall-C2 [];
!- Object Index.
!- Object Index.

MeasuredUFADSolarFraction,
  TC-NorthWall-C3,
  SF-NorthWall-C3 [];
!- Object Index.
!- Object Index.

MeasuredUFADSolarFraction,
  TC-NorthWall-C4,
  SF-NorthWall-C4 [];
!- Object Index.
!- Object Index.

MeasuredUFADSolarFraction,
  TC-NorthWall-C5,
  SF-NorthWall-C5 [];
!- Object Index.
!- Object Index.

MeasuredUFADSolarFraction,
  TC-NorthWallC6,
  SF-NorthWallC6 [];
!- Object Index.
!- Object Index.

MeasuredUFADSolarFraction,
  TC-NorthWall-C7,
  SF-NorthWall-C7 [];
!- Object Index.
!- Object Index.

MeasuredUFADSolarFraction,
  TC-NorthWall-C8,
  SF-NorthWall-C8 [];
!- Object Index.
!- Object Index.

MeasuredUFADSolarFraction,
  TC-NorthWall-C9,
  SF-NorthWall-C9 [];
!- Object Index.
!- Object Index.

MeasuredUFADSolarFraction,
  TC-NorthWall-C10,
  SF-NorthWall-C10 [];
!- Object Index.
!- Object Index.

MeasuredUFADSolarFraction,
  TC-NorthWall-C11,
  SF-NorthWall-C11 [];
!- Object Index.
!- Object Index.

MeasuredUFADSolarFraction,
  TC-NorthWall-C12,
  SF-NorthWall-C12 [];
!- Object Index.
!- Object Index.

MeasuredUFADSolarFraction,
  TC-EastWall-Lower,
  SF-EastWall-Lower [];
!- Object Index.
!- Object Index.

```

```

MeasuredUFADSolarFraction,
    TC-EastWall-Upper,                !- Object Index.
    SF-EastWall-Upper[];              !- Object Index.

MeasuredUFADSolarFraction,
    TC-Clg,                            !- Object Index.
    SF-Clg[];                          !- Object Index.

##endif

!- ===== ALL OBJECTS IN CLASS: CONVECTIONCOEFFICIENTS =====

                                !Test Chamber
ConvectionCoefficients,
    TC-Flr-1,                          ! Surface Name
    Interior,                          ! Convection Type #1
    Value,                              ! Convection Value Type #1
    ConvCoeff-RFTop[],                 ! Convection Value #1
    ;
                                ! Convection Schedule #1 {blank because using value}
ConvectionCoefficients,
    TC-Flr-2,                          ! Surface Name
    Interior,                          ! Convection Type #1
    Value,                              ! Convection Value Type #1
    ConvCoeff-RFTop[],                 ! Convection Value #1
    ;
                                ! Convection Schedule #1 {blank because using value}
ConvectionCoefficients,
    TC-Flr-3,                          ! Surface Name
    Interior,                          ! Convection Type #1
    Value,                              ! Convection Value Type #1
    ConvCoeff-RFTop[],                 ! Convection Value #1
    ;
                                ! Convection Schedule #1 {blank because using value}
ConvectionCoefficients,
    TC-Flr-4,                          ! Surface Name
    Interior,                          ! Convection Type #1
    Value,                              ! Convection Value Type #1
    ConvCoeff-RFTop[],                 ! Convection Value #1
    ;
                                ! Convection Schedule #1 {blank because using value}
ConvectionCoefficients,
    TC-Flr-5,                          ! Surface Name
    Interior,                          ! Convection Type #1
    Value,                              ! Convection Value Type #1
    ConvCoeff-RFTop[],                 ! Convection Value #1
    ;
                                ! Convection Schedule #1 {blank because using value}
ConvectionCoefficients,
    TC-Flr-6,                          ! Surface Name
    Interior,                          ! Convection Type #1
    Value,                              ! Convection Value Type #1
    ConvCoeff-RFTop[],                 ! Convection Value #1
    ;
                                ! Convection Schedule #1 {blank because using value}
ConvectionCoefficients,
    TC-Flr-7,                          ! Surface Name
    Interior,                          ! Convection Type #1
    Value,                              ! Convection Value Type #1
    ConvCoeff-RFTop[],                 ! Convection Value #1
    ;
                                ! Convection Schedule #1 {blank because using value}
ConvectionCoefficients,
    TC-Flr-8,                          ! Surface Name
    Interior,                          ! Convection Type #1
    Value,                              ! Convection Value Type #1
    ConvCoeff-RFTop[],                 ! Convection Value #1
    ;

```

```

ConvectionCoefficients,
  TC-Flr-9,
  Interior,
  Value,
  ConvCoeff-RFTop[],
  ;
! Convection Schedule #1 {blank because using value}
! Surface Name
! Convection Type #1
! Convection Value Type #1
! Convection Value #1

ConvectionCoefficients,
  TC-Flr-10,
  Interior,
  Value,
  ConvCoeff-RFTop[],
  ;
! Convection Schedule #1 {blank because using value}
! Surface Name
! Convection Type #1
! Convection Value Type #1
! Convection Value #1

ConvectionCoefficients,
  TC-Flr-11,
  Interior,
  Value,
  ConvCoeff-RFTop[],
  ;
! Convection Schedule #1 {blank because using value}
! Surface Name
! Convection Type #1
! Convection Value Type #1
! Convection Value #1

ConvectionCoefficients,
  TC-Flr-12,
  Interior,
  Value,
  ConvCoeff-RFTop[],
  ;
! Convection Schedule #1 {blank because using value}
! Surface Name
! Convection Type #1
! Convection Value Type #1
! Convection Value #1

ConvectionCoefficients,
  TC-Flr-13,
  Interior,
  Value,
  ConvCoeff-RFTop[],
  ;
! Convection Schedule #1 {blank because using value}
! Surface Name
! Convection Type #1
! Convection Value Type #1
! Convection Value #1

ConvectionCoefficients,
  TC-Flr-14,
  Interior,
  Value,
  ConvCoeff-RFTop[],
  ;
! Convection Schedule #1 {blank because using value}
! Surface Name
! Convection Type #1
! Convection Value Type #1
! Convection Value #1

ConvectionCoefficients,
  TC-Flr-15,
  Interior,
  Value,
  ConvCoeff-RFTop[],
  ;
! Convection Schedule #1 {blank because using value}
! Surface Name
! Convection Type #1
! Convection Value Type #1
! Convection Value #1

ConvectionCoefficients,
  TC-WestWall,
  Interior,
  Value,
  ConvCoeff-TCWalls[],
  ;
! Convection Value #2
! Convection Schedule #1 {blank because using value}
!- Object Index.
!- Surface Type.

ConvectionCoefficients,
  TC-SouthWall-G1,
  Interior,
  Value,
  ConvCoeff-TCWalls[],
  ;
! Convection Value #2
! Convection Schedule #1 {blank because using value}
!- Object Index.
!- Surface Type.

ConvectionCoefficients,
  TC-SouthWall-G2,
  Interior,
  Value,
  ;
! Convection Value #2
! Convection Schedule #1 {blank because using value}
!- Object Index.
!- Surface Type.

```

```

ConvCoeff-TCWalls[],
;
! Convection Value #3
! Convection Schedule #1 {blank because using value}

ConvectionCoefficients,
TC-SouthWall-G3,
Interior,
Value,
ConvCoeff-TCWalls[],
;
! Convection Value #3
! Convection Schedule #1 {blank because using value}
!- Object Index.
!- Surface Type.

ConvectionCoefficients,
TC-SouthWall-G4,
Interior,
Value,
ConvCoeff-TCWalls[],
;
! Convection Value #4
! Convection Schedule #1 {blank because using value}
!- Object Index.
!- Surface Type.

ConvectionCoefficients,
TC-SouthWall-G5,
Interior,
Value,
ConvCoeff-TCWalls[],
;
! Convection Value #4
! Convection Schedule #1 {blank because using value}
!- Object Index.
!- Surface Type.

ConvectionCoefficients,
TC-SouthWall-G6,
Interior,
Value,
ConvCoeff-TCWalls[],
;
! Convection Value #5
! Convection Schedule #1 {blank because using value}
!- Object Index.
!- Surface Type.

ConvectionCoefficients,
TC-SouthWall-G7,
Interior,
Value,
ConvCoeff-TCWalls[],
;
! Convection Value #5
! Convection Schedule #1 {blank because using value}
!- Object Index.
!- Surface Type.

ConvectionCoefficients,
TC-SouthWall-G8,
Interior,
Value,
ConvCoeff-TCWalls[],
;
! Convection Value #6
! Convection Schedule #1 {blank because using value}
!- Object Index.
!- Surface Type.

ConvectionCoefficients,
TC-SouthWall-G9,
Interior,
Value,
ConvCoeff-TCWalls[],
;
! Convection Value #6
! Convection Schedule #1 {blank because using value}
!- Object Index.
!- Surface Type.

ConvectionCoefficients,
TC-SouthWall-G10,
Interior,
Value,
ConvCoeff-TCWalls[],
;
! Convection Value #7
! Convection Schedule #1 {blank because using value}
!- Object Index.
!- Surface Type.

ConvectionCoefficients,
TC-SouthWall-G11,
Interior,
Value,
ConvCoeff-TCWalls[],
;
! Convection Value #7
! Convection Schedule #1 {blank because using value}
!- Object Index.
!- Surface Type.

ConvectionCoefficients,
TC-SouthWall-G12,
;
!- Object Index.

```

```

Interior,                               !- Surface Type.
Value,
ConvCoeff-TCWalls[],                    ! Convection Value #8
;                                         ! Convection Schedule #1 {blank because using value}

ConvectionCoefficients,
TC-SouthWall-F1,                         !- Object Index.
Interior,                                 !- Surface Type.
Value,
ConvCoeff-TCWalls[],                    ! Convection Value #8
;                                         ! Convection Schedule #1 {blank because using value}

ConvectionCoefficients,
TC-SouthWall-F2,                         !- Object Index.
Interior,                                 !- Surface Type.
Value,
ConvCoeff-TCWalls[],                    ! Convection Value #9
;                                         ! Convection Schedule #1 {blank because using value}

ConvectionCoefficients,
TC-SouthWall-F3,                         !- Object Index.
Interior,                                 !- Surface Type.
Value,
ConvCoeff-TCWalls[],                    ! Convection Value #9
;                                         ! Convection Schedule #1 {blank because using value}

ConvectionCoefficients,
TC-SouthWall-F4,                         !- Object Index.
Interior,                                 !- Surface Type.
Value,
ConvCoeff-TCWalls[],                    ! Convection Value #10
;                                         ! Convection Schedule #1 {blank because using value}

ConvectionCoefficients,
TC-SouthWall-F5,                         !- Object Index.
Interior,                                 !- Surface Type.
Value,
ConvCoeff-TCWalls[],                    ! Convection Value #10
;                                         ! Convection Schedule #1 {blank because using value}

ConvectionCoefficients,
TC-SouthWall-F6,                         !- Object Index.
Interior,                                 !- Surface Type.
Value,
ConvCoeff-TCWalls[],                    ! Convection Value #11
;                                         ! Convection Schedule #1 {blank because using value}

ConvectionCoefficients,
TC-SouthWall-F7,                         !- Object Index.
Interior,                                 !- Surface Type.
Value,
ConvCoeff-TCWalls[],                    ! Convection Value #11
;                                         ! Convection Schedule #1 {blank because using value}

ConvectionCoefficients,
TC-SouthWall-F8,                         !- Object Index.
Interior,                                 !- Surface Type.
Value,
ConvCoeff-TCWalls[],                    ! Convection Value #12
;                                         ! Convection Schedule #1 {blank because using value}

ConvectionCoefficients,
TC-SouthWall-F9,                         !- Object Index.
Interior,                                 !- Surface Type.
Value,
ConvCoeff-TCWalls[],                    ! Convection Value #12
;                                         ! Convection Schedule #1 {blank because using value}

```

```

ConvectionCoefficients,
  TC-SouthWall-F10,
  Interior,
  Value,
  ConvCoeff-TCWalls[],
  ;
                                !- Object Index.
                                !- Surface Type.
! Convection Value #13
! Convection Schedule #1 {blank because using value}

ConvectionCoefficients,
  TC-SouthWall-F11,
  Interior,
  Value,
  ConvCoeff-TCWalls[],
  ;
                                !- Object Index.
                                !- Surface Type.
! Convection Value #13
! Convection Schedule #1 {blank because using value}

ConvectionCoefficients,
  TC-SouthWall-F12,
  Interior,
  Value,
  ConvCoeff-TCWalls[],
  ;
                                !- Object Index.
                                !- Surface Type.
! Convection Value #14
! Convection Schedule #1 {blank because using value}

ConvectionCoefficients,
  TC-SouthWall-E1,
  Interior,
  Value,
  ConvCoeff-TCWalls[],
  ;
                                !- Object Index.
                                !- Surface Type.
! Convection Value #14
! Convection Schedule #1 {blank because using value}

ConvectionCoefficients,
  TC-SouthWall-E2,
  Interior,
  Value,
  ConvCoeff-TCWalls[],
  ;
                                !- Object Index.
                                !- Surface Type.
! Convection Value #15
! Convection Schedule #1 {blank because using value}

ConvectionCoefficients,
  TC-SouthWall-E3,
  Interior,
  Value,
  ConvCoeff-TCWalls[],
  ;
                                !- Object Index.
                                !- Surface Type.
! Convection Value #15
! Convection Schedule #1 {blank because using value}

ConvectionCoefficients,
  TC-SouthWall-E4,
  Interior,
  Value,
  ConvCoeff-TCWalls[],
  ;
                                !- Object Index.
                                !- Surface Type.
! Convection Value #16
! Convection Schedule #1 {blank because using value}

ConvectionCoefficients,
  TC-SouthWall-E5,
  Interior,
  Value,
  ConvCoeff-TCWalls[],
  ;
                                !- Object Index.
                                !- Surface Type.
! Convection Value #16
! Convection Schedule #1 {blank because using value}

ConvectionCoefficients,
  TC-SouthWall-E6,
  Interior,
  Value,
  ConvCoeff-TCWalls[],
  ;
                                !- Object Index.
                                !- Surface Type.
! Convection Value #17
! Convection Schedule #1 {blank because using value}

ConvectionCoefficients,
  TC-SouthWall-E7,
  Interior,
  Value,
  ConvCoeff-TCWalls[],
  ;
                                !- Object Index.
                                !- Surface Type.
! Convection Value #17

```



```

;                                     ! Convection Schedule #1 {blank because using value}

ConvectionCoefficients,
  TC-SouthWall-E8,                       !- Object Index.
  Interior,                               !- Surface Type.
  Value,
  ConvCoeff-TCWalls[],                   ! Convection Value #18
;                                     ! Convection Schedule #1 {blank because using value}

ConvectionCoefficients,
  TC-SouthWall-E9,                       !- Object Index.
  Interior,                               !- Surface Type.
  Value,
  ConvCoeff-TCWalls[],                   ! Convection Value #18
;                                     ! Convection Schedule #1 {blank because using value}

ConvectionCoefficients,
  TC-SouthWall-E10,                      !- Object Index.
  Interior,                               !- Surface Type.
  Value,
  ConvCoeff-TCWalls[],                   ! Convection Value #19
;                                     ! Convection Schedule #1 {blank because using value}

ConvectionCoefficients,
  TC-SouthWall-E11,                      !- Object Index.
  Interior,                               !- Surface Type.
  Value,
  ConvCoeff-TCWalls[],                   ! Convection Value #19
;                                     ! Convection Schedule #1 {blank because using value}

ConvectionCoefficients,
  TC-SouthWall-E12,                      !- Object Index.
  Interior,                               !- Surface Type.
  Value,
  ConvCoeff-TCWalls[],                   ! Convection Value #20
;                                     ! Convection Schedule #1 {blank because using value}

ConvectionCoefficients,
  TC-NorthWall-A1,                       !- Object Index.
  Interior,                               !- Surface Type.
  Value,
  ConvCoeff-TCWalls[],                   ! Convection Value #20
;                                     ! Convection Schedule #1 {blank because using value}

ConvectionCoefficients,
  TC-NorthWall-A2,                       !- Object Index.
  Interior,                               !- Surface Type.
  Value,
  ConvCoeff-TCWalls[],                   ! Convection Value #21
;                                     ! Convection Schedule #1 {blank because using value}

ConvectionCoefficients,
  TC-NorthWall-A3,                       !- Object Index.
  Interior,                               !- Surface Type.
  Value,
  ConvCoeff-TCWalls[],                   ! Convection Value #21
;                                     ! Convection Schedule #1 {blank because using value}

ConvectionCoefficients,
  TC-NorthWall-A4,                       !- Object Index.
  Interior,                               !- Surface Type.
  Value,
  ConvCoeff-TCWalls[],                   ! Convection Value #22
;                                     ! Convection Schedule #1 {blank because using value}

ConvectionCoefficients,
  TC-NorthWall-A5,                       !- Object Index.
  Interior,                               !- Surface Type.

```

```

Value,
ConvCoeff-TCWalls[],
;
! Convection Value #22
! Convection Schedule #1 {blank because using value}

ConvectionCoefficients,
TC-NorthWall-A6,
Interior,
Value,
ConvCoeff-TCWalls[],
;
! Convection Value #23
! Convection Schedule #1 {blank because using value}
!- Object Index.
!- Surface Type.

ConvectionCoefficients,
TC-NorthWall-A7,
Interior,
Value,
ConvCoeff-TCWalls[],
;
! Convection Value #23
! Convection Schedule #1 {blank because using value}
!- Object Index.
!- Surface Type.

ConvectionCoefficients,
TC-NorthWall-A8,
Interior,
Value,
ConvCoeff-TCWalls[],
;
! Convection Value #24
! Convection Schedule #1 {blank because using value}
!- Object Index.
!- Surface Type.

ConvectionCoefficients,
TC-NorthWall-A9,
Interior,
Value,
ConvCoeff-TCWalls[],
;
! Convection Value #24
! Convection Schedule #1 {blank because using value}
!- Object Index.
!- Surface Type.

ConvectionCoefficients,
TC-NorthWall-A10,
Interior,
Value,
ConvCoeff-TCWalls[],
;
! Convection Value #25
! Convection Schedule #1 {blank because using value}
!- Object Index.
!- Surface Type.

ConvectionCoefficients,
TC-NorthWall-A11,
Interior,
Value,
ConvCoeff-TCWalls[],
;
! Convection Value #25
! Convection Schedule #1 {blank because using value}
!- Object Index.
!- Surface Type.

ConvectionCoefficients,
TC-NorthWall-A12,
Interior,
Value,
ConvCoeff-TCWalls[],
;
! Convection Value #26
! Convection Schedule #1 {blank because using value}
!- Object Index.
!- Surface Type.

ConvectionCoefficients,
TC-NorthWall-B1,
Interior,
Value,
ConvCoeff-TCWalls[],
;
! Convection Value #26
! Convection Schedule #1 {blank because using value}
!- Object Index.
!- Surface Type.

ConvectionCoefficients,
TC-NorthWall-B2,
Interior,
Value,
ConvCoeff-TCWalls[],
;
! Convection Value #27
! Convection Schedule #1 {blank because using value}
!- Object Index.
!- Surface Type.

ConvectionCoefficients,

```

```

TC-NorthWall-B3,                !- Object Index.
Interior,                       !- Surface Type.
Value,
ConvCoeff-TCWalls[],           ! Convection Value #27
;                               ! Convection Schedule #1 {blank because using value}

ConvectionCoefficients,
TC-NorthWall-B4,                !- Object Index.
Interior,                       !- Surface Type.
Value,
ConvCoeff-TCWalls[],           ! Convection Value #28
;                               ! Convection Schedule #1 {blank because using value}

ConvectionCoefficients,
TC-NorthWall-B5,                !- Object Index.
Interior,                       !- Surface Type.
Value,
ConvCoeff-TCWalls[],           ! Convection Value #28
;                               ! Convection Schedule #1 {blank because using value}

ConvectionCoefficients,
TC-NorthWall-B6,                !- Object Index.
Interior,                       !- Surface Type.
Value,
ConvCoeff-TCWalls[],           ! Convection Value #29
;                               ! Convection Schedule #1 {blank because using value}

ConvectionCoefficients,
TC-NorthWall-B7,                !- Object Index.
Interior,                       !- Surface Type.
Value,
ConvCoeff-TCWalls[],           ! Convection Value #29
;                               ! Convection Schedule #1 {blank because using value}

ConvectionCoefficients,
TC-NorthWall-B8,                !- Object Index.
Interior,                       !- Surface Type.
Value,
ConvCoeff-TCWalls[],           ! Convection Value #30
;                               ! Convection Schedule #1 {blank because using value}

ConvectionCoefficients,
TC-NorthWall-B9,                !- Object Index.
Interior,                       !- Surface Type.
Value,
ConvCoeff-TCWalls[],           ! Convection Value #30
;                               ! Convection Schedule #1 {blank because using value}

ConvectionCoefficients,
TC-NorthWall-B10,               !- Object Index.
Interior,                       !- Surface Type.
Value,
ConvCoeff-TCWalls[],           ! Convection Value #31
;                               ! Convection Schedule #1 {blank because using value}

ConvectionCoefficients,
TC-NorthWall-B11,               !- Object Index.
Interior,                       !- Surface Type.
Value,
ConvCoeff-TCWalls[],           ! Convection Value #31
;                               ! Convection Schedule #1 {blank because using value}

ConvectionCoefficients,
TC-NorthWall-B12,               !- Object Index.
Interior,                       !- Surface Type.
Value,
ConvCoeff-TCWalls[],           ! Convection Value #32
;                               ! Convection Schedule #1 {blank because using value}

```

```

ConvectionCoefficients,
  TC-NorthWall-C1,
  Interior,
  Value,
  ConvCoeff-TCWalls[],
;
!- Object Index.
!- Surface Type.
! Convection Value #32
! Convection Schedule #1 {blank because using value}

ConvectionCoefficients,
  TC-NorthWall-C2,
  Interior,
  Value,
  ConvCoeff-TCWalls[],
;
!- Object Index.
!- Surface Type.
! Convection Value #33
! Convection Schedule #1 {blank because using value}

ConvectionCoefficients,
  TC-NorthWall-C3,
  Interior,
  Value,
  ConvCoeff-TCWalls[],
;
!- Object Index.
!- Surface Type.
! Convection Value #33
! Convection Schedule #1 {blank because using value}

ConvectionCoefficients,
  TC-NorthWall-C4,
  Interior,
  Value,
  ConvCoeff-TCWalls[],
;
!- Object Index.
!- Surface Type.
! Convection Value #34
! Convection Schedule #1 {blank because using value}

ConvectionCoefficients,
  TC-NorthWall-C5,
  Interior,
  Value,
  ConvCoeff-TCWalls[],
;
!- Object Index.
!- Surface Type.
! Convection Value #34
! Convection Schedule #1 {blank because using value}

ConvectionCoefficients,
  TC-NorthWallC6,
  Interior,
  Value,
  ConvCoeff-TCWalls[],
;
!- Object Index.
!- Surface Type.
! Convection Value #35
! Convection Schedule #1 {blank because using value}

ConvectionCoefficients,
  TC-NorthWall-C7,
  Interior,
  Value,
  ConvCoeff-TCWalls[],
;
!- Object Index.
!- Surface Type.
! Convection Value #35
! Convection Schedule #1 {blank because using value}

ConvectionCoefficients,
  TC-NorthWall-C8,
  Interior,
  Value,
  ConvCoeff-TCWalls[],
;
!- Object Index.
!- Surface Type.
! Convection Value #36
! Convection Schedule #1 {blank because using value}

ConvectionCoefficients,
  TC-NorthWall-C9,
  Interior,
  Value,
  ConvCoeff-TCWalls[],
;
!- Object Index.
!- Surface Type.
! Convection Value #36
! Convection Schedule #1 {blank because using value}

ConvectionCoefficients,
  TC-NorthWall-C10,
  Interior,
  Value,
;
!- Object Index.
!- Surface Type.

```

```

ConvCoeff-TCWalls[],      ! Convection Value #37
;                          ! Convection Schedule #1 {blank because using value}

ConvectionCoefficients,
TC-NorthWall-C11,        !- Object Index.
Interior,                !- Surface Type.
Value,
ConvCoeff-TCWalls[],    ! Convection Value #37
;                          ! Convection Schedule #1 {blank because using value}

ConvectionCoefficients,
TC-NorthWall-C12,        !- Object Index.
Interior,                !- Surface Type.
Value,
ConvCoeff-TCWalls[],    ! Convection Value #38
;                          ! Convection Schedule #1 {blank because using value}

ConvectionCoefficients,
TC-EastWall-Lower,      !- Object Index.
Interior,                !- Surface Type.
Value,
ConvCoeff-TCWalls[],    ! Convection Value #38
;                          ! Convection Schedule #1 {blank because using value}

ConvectionCoefficients,
TC-EastWall-Upper,      !- Object Index.
Interior,                !- Surface Type.
Value,
ConvCoeff-TCWalls[],    ! Convection Value #39
;                          ! Convection Schedule #1 {blank because using value}

ConvectionCoefficients,
TC-Clg,                  ! Surface Name
Interior,                ! Convection Type #1
Value,                  ! Convection Value Type #1
ConvCoeff-DCBot[],      ! Convection Value #1
;                          ! Convection Schedule #1 {blank because using value}

!Supply Plenum

ConvectionCoefficients,
SP-Flr,                  ! Surface Name
Interior,                ! Convection Type #1
Value,                  ! Convection Value Type #1
ConvCoeff-SPFlr[],      ! Convection Value #1
;                          ! Convection Schedule #1 {blank because using value}

ConvectionCoefficients,
SP-NorthWall,           ! Surface Name
Interior,                ! Convection Type #1
Value,                  ! Convection Value Type #1
ConvCoeff-SPWalls[],    ! Convection Value #1
;                          ! Convection Schedule #1 {blank because using value}

ConvectionCoefficients,
SP-SouthWall,           ! Surface Name
Interior,                ! Convection Type #1
Value,                  ! Convection Value Type #1
ConvCoeff-SPWalls[],    ! Convection Value #1
;                          ! Convection Schedule #1 {blank because using value}

ConvectionCoefficients,
SP-EastWall,            ! Surface Name
Interior,                ! Convection Type #1
Value,                  ! Convection Value Type #1
ConvCoeff-SPWalls[],    ! Convection Value #1
;                          ! Convection Schedule #1 {blank because using value}

ConvectionCoefficients,

```

```

SP-WestWall,           ! Surface Name
Interior,              ! Convection Type #1
Value,                ! Convection Value Type #1
ConvCoeff-SPWalls[], ! Convection Value #1
;                    ! Convection Schedule #1 {blank because using value}

ConvectionCoefficients,
SP-Clg-1,             ! Surface Name
Interior,            ! Convection Type #1
Value,              ! Convection Value Type #1
ConvCoeff-RFBot[], ! Convection Value #1
;                    ! Convection Schedule #1 {blank because using value}

ConvectionCoefficients,
SP-Clg-2,             ! Surface Name
Interior,            ! Convection Type #1
Value,              ! Convection Value Type #1
ConvCoeff-RFBot[], ! Convection Value #1
;                    ! Convection Schedule #1 {blank because using value}

ConvectionCoefficients,
SP-Clg-3,             ! Surface Name
Interior,            ! Convection Type #1
Value,              ! Convection Value Type #1
ConvCoeff-RFBot[], ! Convection Value #1
;                    ! Convection Schedule #1 {blank because using value}

ConvectionCoefficients,
SP-Clg-4,             ! Surface Name
Interior,            ! Convection Type #1
Value,              ! Convection Value Type #1
ConvCoeff-RFBot[], ! Convection Value #1
;                    ! Convection Schedule #1 {blank because using value}

ConvectionCoefficients,
SP-Clg-5,             ! Surface Name
Interior,            ! Convection Type #1
Value,              ! Convection Value Type #1
ConvCoeff-RFBot[], ! Convection Value #1
;                    ! Convection Schedule #1 {blank because using value}

ConvectionCoefficients,
SP-Clg-6,             ! Surface Name
Interior,            ! Convection Type #1
Value,              ! Convection Value Type #1
ConvCoeff-RFBot[], ! Convection Value #1
;                    ! Convection Schedule #1 {blank because using value}

ConvectionCoefficients,
SP-Clg-7,             ! Surface Name
Interior,            ! Convection Type #1
Value,              ! Convection Value Type #1
ConvCoeff-RFBot[], ! Convection Value #1
;                    ! Convection Schedule #1 {blank because using value}

ConvectionCoefficients,
SP-Clg-8,             ! Surface Name
Interior,            ! Convection Type #1
Value,              ! Convection Value Type #1
ConvCoeff-RFBot[], ! Convection Value #1
;                    ! Convection Schedule #1 {blank because using value}

ConvectionCoefficients,
SP-Clg-9,             ! Surface Name
Interior,            ! Convection Type #1
Value,              ! Convection Value Type #1
ConvCoeff-RFBot[], ! Convection Value #1
;                    ! Convection Schedule #1 {blank because using value}

```

```

ConvectionCoefficients,
  SP-Clg-10,           ! Surface Name
  Interior,           ! Convection Type #1
  Value,              ! Convection Value Type #1
  ConvCoeff-RFBot [], ! Convection Value #1
  ;                  ! Convection Schedule #1 {blank because using value}

ConvectionCoefficients,
  SP-Clg-11,           ! Surface Name
  Interior,           ! Convection Type #1
  Value,              ! Convection Value Type #1
  ConvCoeff-RFBot [], ! Convection Value #1
  ;                  ! Convection Schedule #1 {blank because using value}

ConvectionCoefficients,
  SP-Clg-12,           ! Surface Name
  Interior,           ! Convection Type #1
  Value,              ! Convection Value Type #1
  ConvCoeff-RFBot [], ! Convection Value #1
  ;                  ! Convection Schedule #1 {blank because using value}

ConvectionCoefficients,
  SP-Clg-13,           ! Surface Name
  Interior,           ! Convection Type #1
  Value,              ! Convection Value Type #1
  ConvCoeff-RFBot [], ! Convection Value #1
  ;                  ! Convection Schedule #1 {blank because using value}

ConvectionCoefficients,
  SP-Clg-14,           ! Surface Name
  Interior,           ! Convection Type #1
  Value,              ! Convection Value Type #1
  ConvCoeff-RFBot [], ! Convection Value #1
  ;                  ! Convection Schedule #1 {blank because using value}

ConvectionCoefficients,
  SP-Clg-15,           ! Surface Name
  Interior,           ! Convection Type #1
  Value,              ! Convection Value Type #1
  ConvCoeff-RFBot [], ! Convection Value #1
  ;                  ! Convection Schedule #1 {blank because using value}

!Return Plenum
ConvectionCoefficients,
  RP-Flr,             ! Surface Name
  Interior,           ! Convection Type #1
  Value,              ! Convection Value Type #1
  ConvCoeff-DCTop [], ! Convection Value #1
  ;                  ! Convection Schedule #1 {blank because using value}

ConvectionCoefficients,
  RP-NorthWall,       ! Surface Name
  Interior,           ! Convection Type #1
  Value,              ! Convection Value Type #1
  ConvCoeff-RPWalls [], ! Convection Value #1
  ;                  ! Convection Schedule #1 {blank because using value}

ConvectionCoefficients,
  RP-SouthWall,       ! Surface Name
  Interior,           ! Convection Type #1
  Value,              ! Convection Value Type #1
  ConvCoeff-RPWalls [], ! Convection Value #1
  ;                  ! Convection Schedule #1 {blank because using value}

ConvectionCoefficients,
  RP-EastWall,        ! Surface Name
  Interior,           ! Convection Type #1

```

```

Value,
ConvCoeff-RPWalls[],
;
! Convection Value Type #1
! Convection Value #1
! Convection Schedule #1 {blank because using value}

ConvectionCoefficients,
RP-WestWall,
Interior,
Value,
ConvCoeff-RPWalls[],
;
! Surface Name
! Convection Type #1
! Convection Value Type #1
! Convection Value #1
! Convection Schedule #1 {blank because using value}

ConvectionCoefficients,
RP-Clg,
Interior,
Value,
ConvCoeff-RPCLg[],
;
! Surface Name
! Convection Type #1
! Convection Value Type #1
! Convection Value #1
! Convection Schedule #1 {blank because using value}

!- ===== ALL OBJECTS IN CLASS: SCHEDULETYPE =====

ScheduleType,
Any Number;
!- ScheduleType Name

ScheduleType,
Fraction,
0.0 : 1.0,
CONTINUOUS;
!- ScheduleType Name
!- range
!- Numeric Type

ScheduleType,
Temperature,
-60:200,
CONTINUOUS;
!- ScheduleType Name
!- range
!- Numeric Type

ScheduleType,
Control Type,
0:4,
DISCRETE;
!- ScheduleType Name
!- range
!- Numeric Type

ScheduleType,
On/Off,
0:1,
DISCRETE;
!- ScheduleType Name
!- range
!- Numeric Type

!- ===== ALL OBJECTS IN CLASS: DAYSCHEDULE =====

DAYSCHEDULE,
DV_UFAD_Occ_Zone_Gains_Day,
Fraction,
DVOccZoneGains [],
DVOccZoneGains [],
DVOccZoneGains [],
DVOccZoneGains [],
DVOccZoneGains [],
DVOccZoneGains [],
DVOccZoneGains [],
DVOccZoneGains [],
DVOccZoneGains [],
DVOccZoneGains [],
DVOccZoneGains [],
DVOccZoneGains [],
DVOccZoneGains [],
DVOccZoneGains [],
DVOccZoneGains [],
DVOccZoneGains [],
DVOccZoneGains [],
DVOccZoneGains [],
DVOccZoneGains [],
!- Name
!- ScheduleType
!- Hour 1
!- Hour 2
!- Hour 3
!- Hour 4
!- Hour 5
!- Hour 6
!- Hour 7
!- Hour 8
!- Hour 9
!- Hour 10
!- Hour 11
!- Hour 12
!- Hour 13
!- Hour 14
!- Hour 15
!- Hour 16
!- Hour 17
!- Hour 18
!- Hour 19

```



```

DVOccZoneGains [],      !- Hour 20
DVOccZoneGains [],      !- Hour 21
DVOccZoneGains [],      !- Hour 22
DVOccZoneGains [],      !- Hour 23
DVOccZoneGains [];      !- Hour 24

DAYSCHEDULE,
  LT-1,                  !- Name
  Fraction,              !- ScheduleType
  1.0,                   !- Hour 1
  1.0,                   !- Hour 2
  1.0,                   !- Hour 3
  1.0,                   !- Hour 4
  1.0,                   !- Hour 5
  1.0,                   !- Hour 6
  1.0,                   !- Hour 7
  1.0,                   !- Hour 8
  1.0,                   !- Hour 9
  1.0,                   !- Hour 10
  1.0,                   !- Hour 11
  1.0,                   !- Hour 12
  1.0,                   !- Hour 13
  1.0,                   !- Hour 14
  1.0,                   !- Hour 15
  1.0,                   !- Hour 16
  1.0,                   !- Hour 17
  1.0,                   !- Hour 18
  1.0,                   !- Hour 19
  1.0,                   !- Hour 20
  1.0,                   !- Hour 21
  1.0,                   !- Hour 22
  1.0,                   !- Hour 23
  1.0;                   !- Hour 24

DAYSCHEDULE,
  EQ-1,                  !- Name
  Fraction,              !- ScheduleType
  1.0,                   !- Hour 1
  1.0,                   !- Hour 2
  1.0,                   !- Hour 3
  1.0,                   !- Hour 4
  1.0,                   !- Hour 5
  1.0,                   !- Hour 6
  1.0,                   !- Hour 7
  1.0,                   !- Hour 8
  1.0,                   !- Hour 9
  1.0,                   !- Hour 10
  1.0,                   !- Hour 11
  1.0,                   !- Hour 12
  1.0,                   !- Hour 13
  1.0,                   !- Hour 14
  1.0,                   !- Hour 15
  1.0,                   !- Hour 16
  1.0,                   !- Hour 17
  1.0,                   !- Hour 18
  1.0,                   !- Hour 19
  1.0,                   !- Hour 20
  1.0,                   !- Hour 21
  1.0,                   !- Hour 22
  1.0,                   !- Hour 23
  1.0;                   !- Hour 24

DAYSCHEDULE,
  Day On Peak,          !- Name
  Fraction,              !- ScheduleType
  1.,                    !- Hour 1
  1.,                    !- Hour 2
  1.,                    !- Hour 3

```

```

1.,          !- Hour 4
1.,          !- Hour 5
1.,          !- Hour 6
1.,          !- Hour 7
1.,          !- Hour 8
1.,          !- Hour 9
1.,          !- Hour 10
1.,         !- Hour 11
1.,         !- Hour 12
1.,         !- Hour 13
1.,         !- Hour 14
1.,         !- Hour 15
1.,         !- Hour 16
1.,         !- Hour 17
1.,         !- Hour 18
1.,         !- Hour 19
1.,         !- Hour 20
1.,         !- Hour 21
1.,         !- Hour 22
1.,         !- Hour 23
1.;         !- Hour 24

```

```

DAYSCHEDULE,
  PEOPLEHEAT-DAY, !- Name
  Any Number,    !- ScheduleType
  PeoplePwr [], !- Hour 1
  PeoplePwr [], !- Hour 2
  PeoplePwr [], !- Hour 3
  PeoplePwr [], !- Hour 4
  PeoplePwr [], !- Hour 5
  PeoplePwr [], !- Hour 6
  PeoplePwr [], !- Hour 7
  PeoplePwr [], !- Hour 8
  PeoplePwr [], !- Hour 9
  PeoplePwr [], !- Hour 10
  PeoplePwr [], !- Hour 11
  PeoplePwr [], !- Hour 12
  PeoplePwr [], !- Hour 13
  PeoplePwr [], !- Hour 14
  PeoplePwr [], !- Hour 15
  PeoplePwr [], !- Hour 16
  PeoplePwr [], !- Hour 17
  PeoplePwr [], !- Hour 18
  PeoplePwr [], !- Hour 19
  PeoplePwr [], !- Hour 20
  PeoplePwr [], !- Hour 21
  PeoplePwr [], !- Hour 22
  PeoplePwr [], !- Hour 23
  PeoplePwr []; !- Hour 24

```

```

DAYSCHEDULE,
  Summer Supply Air Temp Day Sch, !- Name
  Temperature, !- ScheduleType
  SupplyAirTemp [], !- Hour 1
  SupplyAirTemp [], !- Hour 2
  SupplyAirTemp [], !- Hour 3
  SupplyAirTemp [], !- Hour 4
  SupplyAirTemp [], !- Hour 5
  SupplyAirTemp [], !- Hour 6
  SupplyAirTemp [], !- Hour 7
  SupplyAirTemp [], !- Hour 8
  SupplyAirTemp [], !- Hour 9
  SupplyAirTemp [], !- Hour 10
  SupplyAirTemp [], !- Hour 11
  SupplyAirTemp [], !- Hour 12
  SupplyAirTemp [], !- Hour 13
  SupplyAirTemp [], !- Hour 14
  SupplyAirTemp [], !- Hour 15

```

```

SupplyAirTemp[],      !- Hour 16
SupplyAirTemp[],      !- Hour 17
SupplyAirTemp[],      !- Hour 18
SupplyAirTemp[],      !- Hour 19
SupplyAirTemp[],      !- Hour 20
SupplyAirTemp[],      !- Hour 21
SupplyAirTemp[],      !- Hour 22
SupplyAirTemp[],      !- Hour 23
SupplyAirTemp[];      !- Hour 24

```

```

DAYSCHEDULE,
Winter Supply Air Temp Day Sch, !- Name
Temperature,                !- ScheduleType
25.76,                      !- Hour 1
25.76,                      !- Hour 2
25.76,                      !- Hour 3
25.76,                      !- Hour 4
25.76,                      !- Hour 5
25.76,                      !- Hour 6
25.76,                      !- Hour 7
25.76,                      !- Hour 8
25.76,                      !- Hour 9
25.76,                      !- Hour 10
25.76,                      !- Hour 11
25.76,                      !- Hour 12
25.76,                      !- Hour 13
25.76,                      !- Hour 14
25.76,                      !- Hour 15
25.76,                      !- Hour 16
25.76,                      !- Hour 17
25.76,                      !- Hour 18
25.76,                      !- Hour 19
25.76,                      !- Hour 20
25.76,                      !- Hour 21
25.76,                      !- Hour 22
25.76,                      !- Hour 23
25.76;                      !- Hour 24

```

```

DAYSCHEDULE,
Chilled Water Loop Daily, !- Name
Temperature,                !- ScheduleType
6.67,                      !- Hour 1
6.67,                      !- Hour 2
6.67,                      !- Hour 3
6.67,                      !- Hour 4
6.67,                      !- Hour 5
6.67,                      !- Hour 6
6.67,                      !- Hour 7
6.67,                      !- Hour 8
6.67,                      !- Hour 9
6.67,                      !- Hour 10
6.67,                      !- Hour 11
6.67,                      !- Hour 12
6.67,                      !- Hour 13
6.67,                      !- Hour 14
6.67,                      !- Hour 15
6.67,                      !- Hour 16
6.67,                      !- Hour 17
6.67,                      !- Hour 18
6.67,                      !- Hour 19
6.67,                      !- Hour 20
6.67,                      !- Hour 21
6.67,                      !- Hour 22
6.67,                      !- Hour 23
6.67;                      !- Hour 24

```

```

DAYSCHEDULE,
SystemOffDaySched,        !- Name

```

```

Fraction,          !- ScheduleType
0.,               !- Hour 1
0.,               !- Hour 2
0.,               !- Hour 3
0.,               !- Hour 4
0.,               !- Hour 5
0.,               !- Hour 6
0.,               !- Hour 7
0.,               !- Hour 8
0.,               !- Hour 9
0.,               !- Hour 10
0.,               !- Hour 11
0.,               !- Hour 12
0.,               !- Hour 13
0.,               !- Hour 14
0.,               !- Hour 15
0.,               !- Hour 16
0.,               !- Hour 17
0.,               !- Hour 18
0.,               !- Hour 19
0.,               !- Hour 20
0.,               !- Hour 21
0.,               !- Hour 22
0.,               !- Hour 23
0.;               !- Hour 24

```

```

DAYSCHEDULE,
SystemOnDaySched, !- Name
Fraction,          !- ScheduleType
1.,               !- Hour 1
1.,               !- Hour 2
1.,               !- Hour 3
1.,               !- Hour 4
1.,               !- Hour 5
1.,               !- Hour 6
1.,               !- Hour 7
1.,               !- Hour 8
1.,               !- Hour 9
1.,               !- Hour 10
1.,               !- Hour 11
1.,               !- Hour 12
1.,               !- Hour 13
1.,               !- Hour 14
1.,               !- Hour 15
1.,               !- Hour 16
1.,               !- Hour 17
1.,               !- Hour 18
1.,               !- Hour 19
1.,               !- Hour 20
1.,               !- Hour 21
1.,               !- Hour 22
1.,               !- Hour 23
1.;               !- Hour 24

```

```

DAYSCHEDULE,
ReheatCoilDaySched, !- Name
Fraction,          !- ScheduleType
0,                !- Hour 1
0,                !- Hour 2
0,                !- Hour 3
0,                !- Hour 4
0,                !- Hour 5
0,                !- Hour 6
0,                !- Hour 7
0,                !- Hour 8
0,                !- Hour 9
0,                !- Hour 10
0,                !- Hour 11

```

```

0,          !- Hour 12
0,          !- Hour 13
0,          !- Hour 14
0,          !- Hour 15
0,          !- Hour 16
0,          !- Hour 17
0,          !- Hour 18
0,          !- Hour 19
0,          !- Hour 20
0,          !- Hour 21
0,          !- Hour 22
0,          !- Hour 23
0;         !- Hour 24

```

```

DAYSCHEDULE,
Zone Setpoint Day Sch, !- Name
Temperature,          !- ScheduleType
22.,                  !- Hour 1
22.,                  !- Hour 2
22.,                  !- Hour 3
22.,                  !- Hour 4
22.,                  !- Hour 5
22.,                  !- Hour 6
22.,                  !- Hour 7
22.,                  !- Hour 8
22.,                  !- Hour 9
22.,                  !- Hour 10
22.,                  !- Hour 11
22.,                  !- Hour 12
22.,                  !- Hour 13
22.,                  !- Hour 14
22.,                  !- Hour 15
22.,                  !- Hour 16
22.,                  !- Hour 17
22.,                  !- Hour 18
22.,                  !- Hour 19
22.,                  !- Hour 20
22.,                  !- Hour 21
22.,                  !- Hour 22
22.,                  !- Hour 23
22.;                 !- Hour 24

```

```

DAYSCHEDULE,
Summer Control Type Day Sch, !- Name
Control Type,              !- ScheduleType
3,                          !- Hour 1
3,                          !- Hour 2
3,                          !- Hour 3
3,                          !- Hour 4
3,                          !- Hour 5
3,                          !- Hour 6
3,                          !- Hour 7
3,                          !- Hour 8
3,                          !- Hour 9
3,                          !- Hour 10
3,                          !- Hour 11
3,                          !- Hour 12
3,                          !- Hour 13
3,                          !- Hour 14
3,                          !- Hour 15
3,                          !- Hour 16
3,                          !- Hour 17
3,                          !- Hour 18
3,                          !- Hour 19
3,                          !- Hour 20
3,                          !- Hour 21
3,                          !- Hour 22
3,                          !- Hour 23

```

```

3;                                !- Hour 24

DAYSCHEDULE,
  Winter Control Type Day Sch,    !- Name
  Control Type,                   !- ScheduleType
3,                                !- Hour 1
3,                                !- Hour 2
3,                                !- Hour 3
3,                                !- Hour 4
3,                                !- Hour 5
3,                                !- Hour 6
3,                                !- Hour 7
3,                                !- Hour 8
3,                                !- Hour 9
3,                                !- Hour 10
3,                                !- Hour 11
3,                                !- Hour 12
3,                                !- Hour 13
3,                                !- Hour 14
3,                                !- Hour 15
3,                                !- Hour 16
3,                                !- Hour 17
3,                                !- Hour 18
3,                                !- Hour 19
3,                                !- Hour 20
3,                                !- Hour 21
3,                                !- Hour 22
3,                                !- Hour 23
3;                                !- Hour 24

DAYSCHEDULE,
  Min OA Day Sch,                !- Name
  Fraction,                      !- ScheduleType
1.,                               !- Hour 1
1.,                               !- Hour 2
1.,                               !- Hour 3
1.,                               !- Hour 4
1.,                               !- Hour 5
1.,                               !- Hour 6
1.,                               !- Hour 7
1.,                               !- Hour 8
1.,                               !- Hour 9
1.,                               !- Hour 10
1.,                               !- Hour 11
1.,                               !- Hour 12
1.,                               !- Hour 13
1.,                               !- Hour 14
1.,                               !- Hour 15
1.,                               !- Hour 16
1.,                               !- Hour 17
1.,                               !- Hour 18
1.,                               !- Hour 19
1.,                               !- Hour 20
1.,                               !- Hour 21
1.,                               !- Hour 22
1.,                               !- Hour 23
1.;                               !- Hour 24

!- ===== ALL OBJECTS IN CLASS: WEEKSCHEDULE =====

WEEKSCHEDULE,
  DV_UFAD_Occ_Zone_Gains_Week,   !- Name
  DV_UFAD_Occ_Zone_Gains_Day,    !- Sunday DAYSCHEDULE Name
  DV_UFAD_Occ_Zone_Gains_Day,    !- Monday DAYSCHEDULE Name
  DV_UFAD_Occ_Zone_Gains_Day,    !- Tuesday DAYSCHEDULE Name
  DV_UFAD_Occ_Zone_Gains_Day,    !- Wednesday DAYSCHEDULE Name
  DV_UFAD_Occ_Zone_Gains_Day,    !- Thursday DAYSCHEDULE Name

```

```

DV_UFAD_Occ_Zone_Gains_Day,    !- Friday DAYSCHEDULE Name
DV_UFAD_Occ_Zone_Gains_Day,    !- Saturday DAYSCHEDULE Name
DV_UFAD_Occ_Zone_Gains_Day,    !- Holiday DAYSCHEDULE Name
DV_UFAD_Occ_Zone_Gains_Day,    !- SummerDesignDay DAYSCHEDULE Name
DV_UFAD_Occ_Zone_Gains_Day,    !- WinterDesignDay DAYSCHEDULE Name
DV_UFAD_Occ_Zone_Gains_Day,    !- CustomDay1 DAYSCHEDULE Name
DV_UFAD_Occ_Zone_Gains_Day;    !- CustomDay2 DAYSCHEDULE Name

WEEKSCHEDULE,
  LT-WEEK,                      !- Name
  LT-1,                        !- Sunday DAYSCHEDULE Name
  LT-1,                        !- Monday DAYSCHEDULE Name
  LT-1,                        !- Tuesday DAYSCHEDULE Name
  LT-1,                        !- Wednesday DAYSCHEDULE Name
  LT-1,                        !- Thursday DAYSCHEDULE Name
  LT-1,                        !- Friday DAYSCHEDULE Name
  LT-1,                        !- Saturday DAYSCHEDULE Name
  LT-1,                        !- Holiday DAYSCHEDULE Name
  LT-1,                        !- SummerDesignDay DAYSCHEDULE Name
  LT-1,                        !- WinterDesignDay DAYSCHEDULE Name
  LT-1,                        !- CustomDay1 DAYSCHEDULE Name
  LT-1;                        !- CustomDay2 DAYSCHEDULE Name

WEEKSCHEDULE,
  PEOPLEHEAT-WEEK,             !- Name
  PEOPLEHEAT-DAY,              !- Sunday DAYSCHEDULE Name
  PEOPLEHEAT-DAY,              !- Monday DAYSCHEDULE Name
  PEOPLEHEAT-DAY,              !- Tuesday DAYSCHEDULE Name
  PEOPLEHEAT-DAY,              !- Wednesday DAYSCHEDULE Name
  PEOPLEHEAT-DAY,              !- Thursday DAYSCHEDULE Name
  PEOPLEHEAT-DAY,              !- Friday DAYSCHEDULE Name
  PEOPLEHEAT-DAY,              !- Saturday DAYSCHEDULE Name
  PEOPLEHEAT-DAY,              !- Holiday DAYSCHEDULE Name
  PEOPLEHEAT-DAY,              !- SummerDesignDay DAYSCHEDULE Name
  PEOPLEHEAT-DAY,              !- WinterDesignDay DAYSCHEDULE Name
  PEOPLEHEAT-DAY,              !- CustomDay1 DAYSCHEDULE Name
  PEOPLEHEAT-DAY;              !- CustomDay2 DAYSCHEDULE Name

WEEKSCHEDULE,
  EQ-WEEK,                     !- Name
  EQ-1,                        !- Sunday DAYSCHEDULE Name
  EQ-1,                        !- Monday DAYSCHEDULE Name
  EQ-1,                        !- Tuesday DAYSCHEDULE Name
  EQ-1,                        !- Wednesday DAYSCHEDULE Name
  EQ-1,                        !- Thursday DAYSCHEDULE Name
  EQ-1,                        !- Friday DAYSCHEDULE Name
  EQ-1,                        !- Saturday DAYSCHEDULE Name
  EQ-1,                        !- Holiday DAYSCHEDULE Name
  EQ-1,                        !- SummerDesignDay DAYSCHEDULE Name
  EQ-1,                        !- WinterDesignDay DAYSCHEDULE Name
  EQ-1,                        !- CustomDay1 DAYSCHEDULE Name
  EQ-1;                        !- CustomDay2 DAYSCHEDULE Name

WEEKSCHEDULE,
  Week on Peak,                !- Name
  Day On Peak,                 !- Sunday DAYSCHEDULE Name
  Day On Peak,                 !- Monday DAYSCHEDULE Name
  Day On Peak,                 !- Tuesday DAYSCHEDULE Name
  Day On Peak,                 !- Wednesday DAYSCHEDULE Name
  Day On Peak,                 !- Thursday DAYSCHEDULE Name
  Day On Peak,                 !- Friday DAYSCHEDULE Name
  Day On Peak,                 !- Saturday DAYSCHEDULE Name
  Day On Peak,                 !- Holiday DAYSCHEDULE Name
  Day On Peak,                 !- SummerDesignDay DAYSCHEDULE Name
  Day On Peak,                 !- WinterDesignDay DAYSCHEDULE Name
  Day On Peak,                 !- CustomDay1 DAYSCHEDULE Name
  Day On Peak;                 !- CustomDay2 DAYSCHEDULE Name

```

```

WEEKSCHEDULE,
    Summer Supply Air Temp Week Sch,    !- Name
    Summer Supply Air Temp Day Sch,    !- Sunday DAYSCHEDULE Name
    Summer Supply Air Temp Day Sch,    !- Monday DAYSCHEDULE Name
    Summer Supply Air Temp Day Sch,    !- Tuesday DAYSCHEDULE Name
    Summer Supply Air Temp Day Sch,    !- Wednesday DAYSCHEDULE Name
    Summer Supply Air Temp Day Sch,    !- Thursday DAYSCHEDULE Name
    Summer Supply Air Temp Day Sch,    !- Friday DAYSCHEDULE Name
    Summer Supply Air Temp Day Sch,    !- Saturday DAYSCHEDULE Name
    Summer Supply Air Temp Day Sch,    !- Holiday DAYSCHEDULE Name
    Summer Supply Air Temp Day Sch,    !- SummerDesignDay DAYSCHEDULE Name
    Summer Supply Air Temp Day Sch,    !- WinterDesignDay DAYSCHEDULE Name
    Summer Supply Air Temp Day Sch,    !- CustomDay1 DAYSCHEDULE Name
    Summer Supply Air Temp Day Sch;    !- CustomDay2 DAYSCHEDULE Name

```

```

WEEKSCHEDULE,
    Winter Supply Air Temp Week Sch,    !- Name
    Winter Supply Air Temp Day Sch,    !- Sunday DAYSCHEDULE Name
    Winter Supply Air Temp Day Sch,    !- Monday DAYSCHEDULE Name
    Winter Supply Air Temp Day Sch,    !- Tuesday DAYSCHEDULE Name
    Winter Supply Air Temp Day Sch,    !- Wednesday DAYSCHEDULE Name
    Winter Supply Air Temp Day Sch,    !- Thursday DAYSCHEDULE Name
    Winter Supply Air Temp Day Sch,    !- Friday DAYSCHEDULE Name
    Winter Supply Air Temp Day Sch,    !- Saturday DAYSCHEDULE Name
    Winter Supply Air Temp Day Sch,    !- Holiday DAYSCHEDULE Name
    Winter Supply Air Temp Day Sch,    !- SummerDesignDay DAYSCHEDULE Name
    Winter Supply Air Temp Day Sch,    !- WinterDesignDay DAYSCHEDULE Name
    Winter Supply Air Temp Day Sch,    !- CustomDay1 DAYSCHEDULE Name
    Winter Supply Air Temp Day Sch;    !- CustomDay2 DAYSCHEDULE Name

```

```

WEEKSCHEDULE,
    Chilled Water Loop Weekly,    !- Name
    Chilled Water Loop Daily,    !- Sunday DAYSCHEDULE Name
    Chilled Water Loop Daily,    !- Monday DAYSCHEDULE Name
    Chilled Water Loop Daily,    !- Tuesday DAYSCHEDULE Name
    Chilled Water Loop Daily,    !- Wednesday DAYSCHEDULE Name
    Chilled Water Loop Daily,    !- Thursday DAYSCHEDULE Name
    Chilled Water Loop Daily,    !- Friday DAYSCHEDULE Name
    Chilled Water Loop Daily,    !- Saturday DAYSCHEDULE Name
    Chilled Water Loop Daily,    !- Holiday DAYSCHEDULE Name
    Chilled Water Loop Daily,    !- SummerDesignDay DAYSCHEDULE Name
    Chilled Water Loop Daily,    !- WinterDesignDay DAYSCHEDULE Name
    Chilled Water Loop Daily,    !- CustomDay1 DAYSCHEDULE Name
    Chilled Water Loop Daily;    !- CustomDay2 DAYSCHEDULE Name

```

```

WEEKSCHEDULE,
    FanAndCoilAllOnWeekSched,    !- Name
    SystemOnDaySched,    !- Sunday DAYSCHEDULE Name
    SystemOnDaySched,    !- Monday DAYSCHEDULE Name
    SystemOnDaySched,    !- Tuesday DAYSCHEDULE Name
    SystemOnDaySched,    !- Wednesday DAYSCHEDULE Name
    SystemOnDaySched,    !- Thursday DAYSCHEDULE Name
    SystemOnDaySched,    !- Friday DAYSCHEDULE Name
    SystemOnDaySched,    !- Saturday DAYSCHEDULE Name
    SystemOnDaySched,    !- Holiday DAYSCHEDULE Name
    SystemOnDaySched,    !- SummerDesignDay DAYSCHEDULE Name
    SystemOnDaySched,    !- WinterDesignDay DAYSCHEDULE Name
    SystemOnDaySched,    !- CustomDay1 DAYSCHEDULE Name
    SystemOnDaySched;    !- CustomDay2 DAYSCHEDULE Name

```

```

WEEKSCHEDULE,
    FanAndCoilAllOffWeekSched,    !- Name
    SystemOffDaySched,    !- Sunday DAYSCHEDULE Name
    SystemOffDaySched,    !- Monday DAYSCHEDULE Name
    SystemOffDaySched,    !- Tuesday DAYSCHEDULE Name
    SystemOffDaySched,    !- Wednesday DAYSCHEDULE Name
    SystemOffDaySched,    !- Thursday DAYSCHEDULE Name
    SystemOffDaySched,    !- Friday DAYSCHEDULE Name

```



```

SystemOffDaySched,      !- Saturday DAYSCHEDULE Name
SystemOffDaySched,      !- Holiday DAYSCHEDULE Name
SystemOffDaySched,      !- SummerDesignDay DAYSCHEDULE Name
SystemOffDaySched,      !- WinterDesignDay DAYSCHEDULE Name
SystemOffDaySched,      !- CustomDay1 DAYSCHEDULE Name
SystemOffDaySched;      !- CustomDay2 DAYSCHEDULE Name

WEEKSCHEDULE,
  ReheatCoilWeekSched,   !- Name
  ReheatCoilDaySched,    !- Sunday DAYSCHEDULE Name
  ReheatCoilDaySched,    !- Monday DAYSCHEDULE Name
  ReheatCoilDaySched,    !- Tuesday DAYSCHEDULE Name
  ReheatCoilDaySched,    !- Wednesday DAYSCHEDULE Name
  ReheatCoilDaySched,    !- Thursday DAYSCHEDULE Name
  ReheatCoilDaySched,    !- Friday DAYSCHEDULE Name
  ReheatCoilDaySched,    !- Saturday DAYSCHEDULE Name
  ReheatCoilDaySched,    !- Holiday DAYSCHEDULE Name
  ReheatCoilDaySched,    !- SummerDesignDay DAYSCHEDULE Name
  ReheatCoilDaySched,    !- WinterDesignDay DAYSCHEDULE Name
  ReheatCoilDaySched,    !- CustomDay1 DAYSCHEDULE Name
  ReheatCoilDaySched;    !- CustomDay2 DAYSCHEDULE Name

WEEKSCHEDULE,
  Zone Setpoint Week Sch, !- Name
  Zone Setpoint Day Sch,  !- Sunday DAYSCHEDULE Name
  Zone Setpoint Day Sch,  !- Monday DAYSCHEDULE Name
  Zone Setpoint Day Sch,  !- Tuesday DAYSCHEDULE Name
  Zone Setpoint Day Sch,  !- Wednesday DAYSCHEDULE Name
  Zone Setpoint Day Sch,  !- Thursday DAYSCHEDULE Name
  Zone Setpoint Day Sch,  !- Friday DAYSCHEDULE Name
  Zone Setpoint Day Sch,  !- Saturday DAYSCHEDULE Name
  Zone Setpoint Day Sch,  !- Holiday DAYSCHEDULE Name
  Zone Setpoint Day Sch,  !- SummerDesignDay DAYSCHEDULE Name
  Zone Setpoint Day Sch,  !- WinterDesignDay DAYSCHEDULE Name
  Zone Setpoint Day Sch,  !- CustomDay1 DAYSCHEDULE Name
  Zone Setpoint Day Sch;  !- CustomDay2 DAYSCHEDULE Name

WEEKSCHEDULE,
  Summer Control Type Week Sch, !- Name
  Summer Control Type Day Sch,  !- Sunday DAYSCHEDULE Name
  Summer Control Type Day Sch,  !- Monday DAYSCHEDULE Name
  Summer Control Type Day Sch,  !- Tuesday DAYSCHEDULE Name
  Summer Control Type Day Sch,  !- Wednesday DAYSCHEDULE Name
  Summer Control Type Day Sch,  !- Thursday DAYSCHEDULE Name
  Summer Control Type Day Sch,  !- Friday DAYSCHEDULE Name
  Summer Control Type Day Sch,  !- Saturday DAYSCHEDULE Name
  Summer Control Type Day Sch,  !- Holiday DAYSCHEDULE Name
  Summer Control Type Day Sch,  !- SummerDesignDay DAYSCHEDULE Name
  Summer Control Type Day Sch,  !- WinterDesignDay DAYSCHEDULE Name
  Summer Control Type Day Sch,  !- CustomDay1 DAYSCHEDULE Name
  Summer Control Type Day Sch;  !- CustomDay2 DAYSCHEDULE Name

WEEKSCHEDULE,
  Winter Control Type Week Sch, !- Name
  Winter Control Type Day Sch,  !- Sunday DAYSCHEDULE Name
  Winter Control Type Day Sch,  !- Monday DAYSCHEDULE Name
  Winter Control Type Day Sch,  !- Tuesday DAYSCHEDULE Name
  Winter Control Type Day Sch,  !- Wednesday DAYSCHEDULE Name
  Winter Control Type Day Sch,  !- Thursday DAYSCHEDULE Name
  Winter Control Type Day Sch,  !- Friday DAYSCHEDULE Name
  Winter Control Type Day Sch,  !- Saturday DAYSCHEDULE Name
  Winter Control Type Day Sch,  !- Holiday DAYSCHEDULE Name
  Winter Control Type Day Sch,  !- SummerDesignDay DAYSCHEDULE Name
  Winter Control Type Day Sch,  !- WinterDesignDay DAYSCHEDULE Name
  Winter Control Type Day Sch,  !- CustomDay1 DAYSCHEDULE Name
  Winter Control Type Day Sch;  !- CustomDay2 DAYSCHEDULE Name

WEEKSCHEDULE,

```

```

Min OA Week Sch,          !- Name
Min OA Day Sch,          !- Sunday DAYSCHEDULE Name
Min OA Day Sch,          !- Monday DAYSCHEDULE Name
Min OA Day Sch,          !- Tuesday DAYSCHEDULE Name
Min OA Day Sch,          !- Wednesday DAYSCHEDULE Name
Min OA Day Sch,          !- Thursday DAYSCHEDULE Name
Min OA Day Sch,          !- Friday DAYSCHEDULE Name
Min OA Day Sch,          !- Saturday DAYSCHEDULE Name
Min OA Day Sch,          !- Holiday DAYSCHEDULE Name
Min OA Day Sch,          !- SummerDesignDay DAYSCHEDULE Name
Min OA Day Sch,          !- WinterDesignDay DAYSCHEDULE Name
Min OA Day Sch,          !- CustomDay1 DAYSCHEDULE Name
Min OA Day Sch,          !- CustomDay2 DAYSCHEDULE Name

!- ===== ALL OBJECTS IN CLASS: SCHEDULE =====

SCHEDULE,
  DV_UFAD_Occ_Zone_Gains,    !- Name
  Fraction,                 !- ScheduleType
  DV_UFAD_Occ_Zone_Gains_Week, !- Name of WEEKSCHEDULE 1
  1,                        !- Start Month 1
  1,                        !- Start Day 1
  12,                       !- End Month 1
  31;                       !- End Day 1

SCHEDULE,
  PEOPLEHEAT,              !- Name
  Any Number,              !- ScheduleType
  PEOPLEHEAT-WEEK,        !- Name of WEEKSCHEDULE 1
  1,                        !- Start Month 1
  1,                        !- Start Day 1
  12,                       !- End Month 1
  31;                       !- End Day 1

SCHEDULE,
  LIGHTS-1,                !- Name
  Fraction,                 !- ScheduleType
  LT-WEEK,                  !- Name of WEEKSCHEDULE 1
  1,                        !- Start Month 1
  1,                        !- Start Day 1
  12,                       !- End Month 1
  31;                       !- End Day 1

SCHEDULE,
  EQUIP-1,                  !- Name
  Fraction,                 !- ScheduleType
  EQ-WEEK,                  !- Name of WEEKSCHEDULE 1
  1,                        !- Start Month 1
  1,                        !- Start Day 1
  12,                       !- End Month 1
  31;                       !- End Day 1

SCHEDULE,
  On Peak,                  !- Name
  Fraction,                 !- ScheduleType
  Week On Peak,            !- Name of WEEKSCHEDULE 1
  1,                        !- Start Month 1
  1,                        !- Start Day 1
  12,                       !- End Month 1
  31;                       !- End Day 1

SCHEDULE,
  Seasonal_Reset_Supply_Air_Temp_Sch, !- Name
  Temperature,             !- ScheduleType
  Winter_Supply_Air_Temp_Week_Sch, !- Name of WEEKSCHEDULE 1
  1,                        !- Start Month 1
  1,                        !- Start Day 1

```

```

3,                !- End Month 1
31,               !- End Day 1
Summer Supply Air Temp Week Sch, !- Name of WEEKSCHEDULE 2
4,                !- Start Month 2
1,                !- Start Day 2
9,                !- End Month 2
30,               !- End Day 2
Winter Supply Air Temp Week Sch, !- Name of WEEKSCHEDULE 3
10,               !- Start Month 3
1,                !- Start Day 3
12,               !- End Month 3
31;               !- End Day 3

SCHEDULE,
  CW Loop Temp Schedule, !- Name
  Temperature,           !- ScheduleType
  Chilled Water Loop Weekly, !- Name of WEEKSCHEDULE 1
  1,                     !- Start Month 1
  1,                     !- Start Day 1
  12,                    !- End Month 1
  31;                    !- End Day 1

SCHEDULE,
  FanAndCoilAvailSched, !- Name
  Fraction,              !- ScheduleType
  FanAndCoilAllOnWeekSched, !- Name of WEEKSCHEDULE 1
  1,                     !- Start Month 1
  1,                     !- Start Day 1
  3,                     !- End Month 1
  31,                    !- End Day 1
  FanAndCoilAllOnWeekSched, !- Name of WEEKSCHEDULE 2
  4,                     !- Start Month 2
  1,                     !- Start Day 2
  9,                     !- End Month 2
  30,                    !- End Day 2
  FanAndCoilAllOnWeekSched, !- Name of WEEKSCHEDULE 3
  10,                    !- Start Month 3
  1,                     !- Start Day 3
  12,                    !- End Month 3
  31;                    !- End Day 3

SCHEDULE,
  ReheatCoilAvailSched, !- Name
  Fraction,              !- ScheduleType
  ReheatCoilWeekSched, !- Name of WEEKSCHEDULE 1
  1,                     !- Start Month 1
  1,                     !- Start Day 1
  12,                    !- End Month 1
  31;                    !- End Day 1

SCHEDULE,
  Zone Setpoints,       !- Name
  Temperature,          !- ScheduleType
  Zone Setpoint Week Sch, !- Name of WEEKSCHEDULE 1
  1,                     !- Start Month 1
  1,                     !- Start Day 1
  12,                    !- End Month 1
  31;                    !- End Day 1

SCHEDULE,
  Zone Control Type Sched, !- Name
  Control Type,          !- ScheduleType
  Winter Control Type Week Sch, !- Name of WEEKSCHEDULE 1
  1,                     !- Start Month 1
  1,                     !- Start Day 1
  3,                     !- End Month 1
  31,                    !- End Day 1
  Summer Control Type Week Sch, !- Name of WEEKSCHEDULE 2

```

```

4,                !- Start Month 2
1,                !- Start Day 2
9,                !- End Month 2
30,               !- End Day 2
Winter Control Type Week Sch, !- Name of WEEKSCHEDULE 3
10,               !- Start Month 3
1,                !- Start Day 3
12,               !- End Month 3
31;               !- End Day 3

SCHEDULE,
  Min OA Sched,   !- Name
  Fraction,       !- ScheduleType
  Min OA Week Sch, !- Name of WEEKSCHEDULE 1
  1,              !- Start Month 1
  1,              !- Start Day 1
  12,             !- End Month 1
  31;             !- End Day 1

!- ===== ALL OBJECTS IN CLASS: NODE LIST =====

NODE LIST,
  OutsideAirInletNodes, !- Node List Name
  Outside Air Inlet Node 1; !- Node_ID_1

NODE LIST,
  Zone1Inlets,         !- Node List Name
  TestChamber Reheat Air Outlet Node; !- Node_ID_1

NODE LIST,
  Supply Air Temp Nodes, !- Node List Name
  Heating Coil Air Inlet Node,
  Air Loop Outlet Node; !- Node_ID_1

!- ===== ALL OBJECTS IN CLASS: ELECTRIC EQUIPMENT =====

ELECTRIC EQUIPMENT,
  UFAD_Lab_Equip,      ! new name field for v123
  TestChamber,        !- Zone Name
  LIGHTS-1,           !- SCHEDULE Name
  EquipmentPwr[],     !- Design Level {W}
  0,                  !- Fraction Latent
  EquipmentRadFraction[], !- Fraction Radiant
  0,                  !- Fraction Lost
  0;                  !- End-Use Category

PEOPLE,
  UFAD_Lab_People,    ! Name
  TestChamber,        ! Zone Name
  NumPeople[],        ! Number of People
  LIGHTS-1,           ! Occupancy Schedule
  PeopleRadFraction[], ! Fraction Radiant
  PEOPLEHEAT,         ! Activity level SCHEDULE Name (units W/person, real)
  ,                   !- MRT Calculation Type
  ,                   !- Surface Name/Angle Factor List Name
  ,                   !- Work Efficiency SCHEDULE Name (0.0-1.0,real)
  ,                   !- Clothing Insulation SCHEDULE Name (real)
  ,                   !- Air Velocity SCHEDULE Name (units m/s, real)
  ,                   !- Thermal Comfort Report Type #1
  ,                   !- Thermal Comfort Report Type #2
  ,                   !- Thermal Comfort Report Type #3
  1.0;                !- user specified sensible fraction

!- ===== ALL OBJECTS IN CLASS: LIGHTS =====

```

```

LIGHTS,
  UFAD_Lab_Lights,          ! new name field for v123
  TestChamber,             !- Zone Name
  LIGHTS-1,                !- SCHEDULE Name
  LightingPwr[],           !- Design Level {W}
  LightingRAFraction[],    !- Return Air Fraction
  LightingRad[],           !- Fraction Radiant
  LightingVis[],           !- Fraction Visible
  0,                       !- Fraction Replaceable
  GeneralLights,           !- LightsEndUseKey
  No,                      !- Return Air Fraction Is Calculated from Plenum Temperatur
e
  0.4625,                  !- Coefficient #1 of Equation for Return Air Fraction vs.
  Plenum Temperature 0.4625 46.25
  0.00792;                 !- Coefficient #2 of Equation for Return Air Fraction vs
. Plenum Temperature 0.00792 0.792

!- ===== ALL OBJECTS IN CLASS: BRANCH LIST =====

BRANCH LIST,
  Air Loop Branches,       !- Branch List Name
  Air Loop Main Branch;    !- Branch Name 1

BRANCH LIST,
  Cooling Supply Side Branches, !- Branch List Name
  CW Pump Branch,          !- Branch Name 1
  Purchased Cooling Branch, !- Branch Name 2
  Supply Bypass Branch,    !- Branch Name 3
  Cooling Supply Outlet;   !- Branch Name 4

BRANCH LIST,
  Cooling Demand Side Branches, !- Branch List Name
  Cooling Demand Inlet,       !- Branch Name 1
  Cooling Coil Branch,        !- Branch Name 2
  Demand Bypass Branch,       !- Branch Name 3
  Cooling Demand Outlet;     !- Branch Name 4

!- ===== ALL OBJECTS IN CLASS: CONNECTOR LIST =====

CONNECTOR LIST,
  Cooling Supply Side Connectors, !- Connector List Name
  SPLITTER,                       !- Type of Connector 1
  CW Loop Splitter,                !- Name of Connector 1
  MIXER,                           !- Type of Connector 2
  CW Loop Mixer;                   !- Name of Connector 2

CONNECTOR LIST,
  Cooling Demand Side Connectors, !- Connector List Name
  SPLITTER,                       !- Type of Connector 1
  CW Demand Splitter,              !- Name of Connector 1
  MIXER,                           !- Type of Connector 2
  CW Demand Mixer;                !- Name of Connector 2

!- ===== ALL OBJECTS IN CLASS: BRANCH =====

BRANCH,
  Air Loop Main Branch,           !- Branch Name
  SysFlowRate[],                 !- Maximum Branch Flow Rate {m3/s}

  OUTSIDE AIR SYSTEM,            !- Comp1 Type
  OA Sys 1,                      !- Comp1 Name
  Air Loop Inlet Node,           !- Comp1 Inlet Node Name
  Mixed Air Node 1,              !- Comp1 Outlet Node Name
  PASSIVE,                       !- Comp1 Branch Control Type

  FAN:SIMPLE:VariableVolume,     !- Comp2 Type

```

```

Supply Fan 1,                !- Comp2 Name
Mixed Air Node 1,           !- Comp2 Inlet Node Name
Cooling Coil Air Inlet Node, !- Comp2 Outlet Node Name
ACTIVE,                     !- Comp2 Branch Control Type

COIL:Water:SimpleCooling,   !- Comp3 Type
Main Cooling Coil 1,        !- Comp3 Name
Cooling Coil Air Inlet Node, !- Comp3 Inlet Node Name
Heating Coil Air Inlet Node, !- Comp3 Outlet Node Name
PASSIVE,                    !- Comp3 Branch Control Type

COIL:Gas:Heating,          !- Comp4 Type
Main Heating Coil 1,        !- Comp4 Name
Heating Coil Air Inlet Node, !- Comp4 Inlet Node Name
Air Loop Outlet Node,       !- Comp4 Outlet Node Name
PASSIVE;                    !- Comp4 Branch Control Type

BRANCH,
Cooling Demand Inlet,       !- Branch Name
0,                           !- Maximum Branch Flow Rate {m3/s}
PIPE,                        !- Comp1 Type
Demand Side Inlet Pipe,     !- Comp1 Name
CW Demand Inlet Node,       !- Comp1 Inlet Node Name
CW Demand Entrance Pipe Outlet Node, !- Comp1 Outlet Node Name
PASSIVE;                     !- Comp1 Branch Control Type

BRANCH,
Cooling Coil Branch,        !- Branch Name
0,                           !- Maximum Branch Flow Rate {m3/s}
COIL:Water:SimpleCooling, !- Comp1 Type
Main Cooling Coil 1,        !- Comp1 Name
Cooling Coil Water Inlet Node, !- Comp1 Inlet Node Name
Cooling Coil Water Outlet Node, !- Comp1 Outlet Node Name
Active;                      !- Comp1 Branch Control Type

BRANCH,
Demand Bypass Branch,       !- Branch Name
0,                           !- Maximum Branch Flow Rate {m3/s}
PIPE,                        !- Comp1 Type
Demand Side Bypass,        !- Comp1 Name
CW Demand Bypass Inlet Node, !- Comp1 Inlet Node Name
CW Demand Bypass Outlet Node, !- Comp1 Outlet Node Name
BYPASS;                      !- Comp1 Branch Control Type

BRANCH,
Cooling Demand Outlet,      !- Branch Name
0,                           !- Maximum Branch Flow Rate {m3/s}
PIPE,                        !- Comp1 Type
CW Demand Side Outlet Pipe, !- Comp1 Name
CW Demand Exit Pipe Inlet Node, !- Comp1 Inlet Node Name
CW Demand Outlet Node,      !- Comp1 Outlet Node Name
PASSIVE;                     !- Comp1 Branch Control Type

BRANCH,
Cooling Supply Outlet,      !- Branch Name
0,                           !- Maximum Branch Flow Rate {m3/s}
PIPE,                        !- Comp1 Type
Supply Side Outlet Pipe,    !- Comp1 Name
Supply Side Exit Pipe Inlet Node, !- Comp1 Inlet Node Name
CW Supply Outlet Node,      !- Comp1 Outlet Node Name
PASSIVE;                     !- Comp1 Branch Control Type

BRANCH,
CW Pump Branch,             !- Branch Name
0,                           !- Maximum Branch Flow Rate {m3/s}
PUMP:VARIABLE SPEED,       !- Comp1 Type
Circ Pump,                  !- Comp1 Name
CW Supply Inlet Node,       !- Comp1 Inlet Node Name

```

```

    CW Pump Outlet Node,      !- Compl Outlet Node Name
    Active;                   !- Compl Branch Control Type

BRANCH,
    Purchased Cooling Branch, !- Branch Name
    0,                         !- Maximum Branch Flow Rate {m3/s}
    Purchased:Chilled Water,  !- Compl Type
    Purchased Cooling,        !- Compl Name
    Purchased Cooling Inlet Node, !- Compl Inlet Node Name
    Purchased Cooling Outlet Node, !- Compl Outlet Node Name
    Active;                   !- Compl Branch Control Type

BRANCH,
    Supply Bypass Branch,     !- Branch Name
    0,                         !- Maximum Branch Flow Rate {m3/s}
    PIPE,                     !- Compl Type
    Supply Side Bypass,       !- Compl Name
    CW Supply Bypass Inlet Node, !- Compl Inlet Node Name
    CW Supply Bypass Outlet Node, !- Compl Outlet Node Name
    BYPASS;                   !- Compl Branch Control Type

!- ===== ALL OBJECTS IN CLASS: PIPE =====

PIPE,
    Demand Side Inlet Pipe,   !- PipeName
    CW Demand Inlet Node,     !- Inlet Node Name
    CW Demand Entrance Pipe Outlet Node; !- Outlet Node Name

PIPE,
    Demand Side Bypass,       !- PipeName
    CW Demand Bypass Inlet Node, !- Inlet Node Name
    CW Demand Bypass Outlet Node; !- Outlet Node Name

PIPE,
    CW Demand Side Outlet Pipe, !- PipeName
    CW Demand Exit Pipe Inlet Node, !- Inlet Node Name
    CW Demand Outlet Node; !- Outlet Node Name

PIPE,
    Supply Side Outlet Pipe, !- PipeName
    Supply Side Exit Pipe Inlet Node, !- Inlet Node Name
    CW Supply Outlet Node; !- Outlet Node Name

PIPE,
    Supply Side Bypass,       !- PipeName
    CW Supply Bypass Inlet Node, !- Inlet Node Name
    CW Supply Bypass Outlet Node; !- Outlet Node Name

!- ===== ALL OBJECTS IN CLASS: PLANT LOOP =====

PLANT LOOP,
    Chilled Water Loop,      !- Plant Loop Name
    Water,                   !- Fluid Type
    CW Loop Operation,       !- Plant Operation Scheme List Name
    CW Supply Outlet Node,   !- Loop Temperature Setpoint Node Name
    98,                       !- Maximum Loop Temperature {C}
    1,                        !- Minimum Loop Temperature {C}
    0.0006,                  !- Maximum Loop Volumetric Flow Rate {m3/s}
    0,                       !- Minimum Loop Volumetric Flow Rate {m3/s}
    autosize,                !- volume of the plant loop {m3}
    CW Supply Inlet Node,    !- Plant Side Inlet Node Name
    CW Supply Outlet Node,   !- Plant Side Outlet Node Name
    Cooling Supply Side Branches, !- Plant Side Branch List Name
    Cooling Supply Side Connectors, !- Plant Side Connector List Name
    CW Demand Inlet Node,    !- Demand Side Inlet Node Name
    CW Demand Outlet Node,   !- Demand Side Outlet Nodes Name

```

```

Cooling Demand Side Branches,  !- Demand Side Branch List Name
Cooling Demand Side Connectors, !- Demand Side Connector List Name
Optimal;                       !- Load Distribution Scheme

SET POINT MANAGER:SCHEDULED,
Chilled Water Loop Setpoint Manager,  !- Name
TEMP,                                 !- Control variable
CW Loop Temp Schedule,                !- Schedule Name
CW Supply Outlet Node;                !- Name of the set point Node or Node List

!- ===== ALL OBJECTS IN CLASS: PLANT OPERATION SCHEMES =====

PLANT OPERATION SCHEMES,
  CW Loop Operation,                  !- PlantOperationSchemeName
  LOAD RANGE BASED OPERATION,         !- KEY--Control Scheme 1
  Peak Operation,                    !- Control Scheme Name 1
  On Peak;                            !- Control Scheme Schedule 1

!- ===== ALL OBJECTS IN CLASS: COOLING LOAD RANGE BASED OPERATION =====

COOLING LOAD RANGE BASED OPERATION,
  Peak Operation,                    !- Name
  0,                                  !- Load Range Lower Limit 1 {W}
  100000,                             !- Load Range Upper Limit 1 {W}
  Purchased Only;                    !- Priority Control Equip List Name 1

!- ===== ALL OBJECTS IN CLASS: LOAD RANGE EQUIPMENT LIST =====

PLANT EQUIPMENT LIST,
  Purchased Only,                    !- Equip List Name
  Purchased:Chilled Water,           !- KEY--Plant Equip 1
  Purchased Cooling;                 !- Equip Name 1

!- ===== ALL OBJECTS IN CLASS: SPLITTER =====

SPLITTER,
  CW Loop Splitter,                  !- SplitterName
  CW Pump Branch,                    !- Inlet Branch Name
  Purchased Cooling Branch,          !- Outlet Branch Name 1
  Supply Bypass Branch;              !- Outlet Branch Name 2

SPLITTER,
  CW Demand Splitter,                !- SplitterName
  Cooling Demand Inlet,              !- Inlet Branch Name
  Demand Bypass Branch,              !- Outlet Branch Name 1
  Cooling Coil Branch;               !- Outlet Branch Name 2

!- ===== ALL OBJECTS IN CLASS: MIXER =====

MIXER,
  CW Loop Mixer,                     !- MixerName
  Cooling Supply Outlet,             !- Outlet Branch Name
  Purchased Cooling Branch,          !- Inlet Branch Name 1
  Supply Bypass Branch;              !- Inlet Branch Name 2

MIXER,
  CW Demand Mixer,                   !- MixerName
  Cooling Demand Outlet,             !- Outlet Branch Name
  Cooling Coil Branch,               !- Inlet Branch Name 1
  Demand Bypass Branch;              !- Inlet Branch Name 2

!- ===== ALL OBJECTS IN CLASS: AIR PRIMARY LOOP =====

```



```

AIR PRIMARY LOOP,
  Typical Terminal Reheat 1,      !- Primary Air Loop Name
  Reheat System 1 Controllers,    !- Name: Controller List
  Reheat System 1 Avail List,     !- Name: System Availability Manager List
  SysFlowRate[],                 !- Primary air design volumetric flow rate {m3/s}
  Air Loop Branches,              !- Air Loop Branch List Name
  ,                                !- Air Loop Connector List Name
  Air Loop Inlet Node,            !- ReturnAir AirLoop Inlet Node
  Return Air Mixer Outlet,        !- ZoneEquipGroup Outlet Node
  Zone Equipment Inlet Node,      !- SupplyAirPath ZoneEquipGroup Inlet Nodes
  Air Loop Outlet Node;           !- AirLoop Outlet Nodes

!- ===== ALL OBJECTS IN CLASS: CONTROLLER LIST =====

CONTROLLER LIST,
  Reheat System 1 Controllers,    !- Name
  Controller:Simple,              !- Controller Type 1
  Main Cooling Coil Controller;   !- Controller Name 1

CONTROLLER LIST,
  OA Sys 1 Controllers,           !- Name
  CONTROLLER:OUTSIDE AIR,        !- Controller Type 1
  OA Controller 1;               !- Controller Name 1

!- ===== ALL OBJECTS IN CLASS: AIR LOOP EQUIPMENT LIST =====

AIR LOOP EQUIPMENT LIST,
  OA Sys 1 Equipment,             !- Name
  OUTSIDE AIR MIXER,              !- KEY--System Component 1
  OA Mixing Box 1;               !- Component Name 1

!- ===== ALL OBJECTS IN CLASS: OUTSIDE AIR SYSTEM =====

OUTSIDE AIR SYSTEM,
  OA Sys 1,                       !- Name
  OA Sys 1 Controllers,           !- Name: Controller List
  OA Sys 1 Equipment,             !- Name of an Air Loop Equipment List
  Reheat System 1 Avail List;     !- Name of a System Availability Manager List

!- ===== ALL OBJECTS IN CLASS: OUTSIDE AIR INLET NODE LIST =====

OUTSIDE AIR INLET NODE LIST,
  OutsideAirInletNodes;          !- 1st Node name or node list name

!- ===== ALL OBJECTS IN CLASS: OUTSIDE AIR MIXER =====

OUTSIDE AIR MIXER,
  OA Mixing Box 1,                !- Name
  Mixed Air Node 1,               !- Mixed_Air_Node
  Outside Air Inlet Node 1,       !- Outside_Air_Stream_Node
  Relief Air Outlet Node 1,       !- Relief_Air_Stream_Node
  Air Loop Inlet Node;           !- Return_Air_Stream_Node

!- ===== ALL OBJECTS IN CLASS: SYSTEM AVAILABILITY MANAGER LIST =====

SYSTEM AVAILABILITY MANAGER LIST,
  Reheat System 1 Avail List,     !- Name
  SYSTEM AVAILABILITY MANAGER:SCHEDULED, !- System Availability Manager type 1
  Reheat System 1 Avail;         !- System Availability Manager name 1

```

```

!- ===== ALL OBJECTS IN CLASS: SYSTEM AVAILABILITY MANAGER:SCHEDULED =====
==

SYSTEM AVAILABILITY MANAGER:SCHEDULED,
  Reheat System 1 Avail,    !- Name
  FanAndCoilAvailSched;    !- Schedule name

!- ===== ALL OBJECTS IN CLASS: SET POINT MANAGER:SCHEDULED =====

SET POINT MANAGER:SCHEDULED,
  Supply Air Temp Manager, !- Name
  TEMP,                    !- Control variable
  Seasonal Reset Supply Air Temp Sch, !- Schedule Name
  Supply Air Temp Nodes;   !- Name of the set point Node List

!- ===== ALL OBJECTS IN CLASS: CONTROLLER:SIMPLE =====

CONTROLLER:SIMPLE,
  Main Cooling Coil Controller, !- Name
  TEMP,                          !- Control variable
  Reverse,                        !- Action
  FLOW,                           !- Actuator variable
  Heating Coil Air Inlet Node,    !- Control_Node
  Cooling Coil Water Inlet Node,  !- Actuator_Node
  0.001,                          !- Controller Convergence Tolerance: delta temp from setp
oint temp {deltaC}
  0.0006,                          !- Max Actuated Flow {m3/s}
  0.0;                              !- Min Actuated Flow {m3/s}

!- ===== ALL OBJECTS IN CLASS: CONTROLLER:OUTSIDE AIR =====

CONTROLLER:OUTSIDE AIR,
  OA Controller 1,              !- Name
  NO ECONOMIZER,                !- EconomizerChoice
  NO RETURN AIR TEMP LIMIT,     !- ReturnAirTempLimit
  NO RETURN AIR ENTHALPY LIMIT, !- ReturnAirEnthalpyLimit
  NO LOCKOUT,                   !- Lockout
  FIXED MINIMUM,                !- MinimumLimit
  Mixed Air Node 1,             !- Control_Node
  Outside Air Inlet Node 1,     !- Actuated_Node
  .00001,                       !- minimum outside air flow rate {m3/s}
  SysFlowRate[],               !- maximum outside air flow rate {m3/s}
  19.,                          !- temperature limit {C}
  4.,                           !- temperature lower limit {C}
  0.0,                          !- enthalpy limit {J/kg}
  Relief Air Outlet Node 1,     !- Relief_Air_Outlet_Node
  Air Loop Inlet Node,         !- Return_Air_Node
  Min OA Sched;                !- Minimum Outside Air Schedule Name

!- ===== ALL OBJECTS IN CLASS: CONTROLLED ZONE EQUIP CONFIGURATION =====

CONTROLLED ZONE EQUIP CONFIGURATION,
  TestChamber,                 !- Zone Name
  Zone1Equipment,              !- List Name: Zone Equipment
  Zone1Inlets,                 !- List Name: Zone Air Inlet Nodes
  ,                             !- List Name: Zone Air Exhaust Nodes
  TestChamber Node,            !- Zone Air Node Name
  TestChamber Outlet Node;     !- Zone Return Air Node Name

!- ===== ALL OBJECTS IN CLASS: ZONE EQUIPMENT LIST =====

ZONE EQUIPMENT LIST,
  Zone1Equipment,              !- Name

```

```

AIR DISTRIBUTION UNIT,      !- KEY--Zone Equipment Type 1
Zone1TermReheat,          !- Type Name 1
1,                        !- Cooling Priority
1;                        !- Heating Priority

!- ===== ALL OBJECTS IN CLASS: AIR DISTRIBUTION UNIT =====

AIR DISTRIBUTION UNIT,
Zone1TermReheat,          !- Air Distribution Unit Name
TestChamber Reheat Air Outlet Node, !- Air Dist Unit Outlet Node Name
SINGLE DUCT:CONST VOLUME:REHEAT, !- KEY--System Component Type 1
Reheat TestChamber;      !- Component Name 1

!- ===== ALL OBJECTS IN CLASS: SINGLE DUCT:CONST VOLUME:REHEAT =====

SINGLE DUCT:CONST VOLUME:REHEAT,
Reheat TestChamber,      !- Name of System
FanAndCoilAvailSched,    !- System Availability schedule
TestChamber Reheat Air Outlet Node, !- Unit Air Outlet Node
TestChamber Reheat Air Inlet Node, !- Unit Air Inlet Node
SysFlowRate[],           !- Maximum air flow rate {m3/s}
,                          !- Control node
COIL:Gas:Heating,        !- Reheat Component Object
Reheat Coil TestChamber, !- Name of Reheat Component
0.0,                      !- Max Reheat Water Flow {m3/s}
0.0,                      !- Min Reheat Water Flow {m3/s}
0.001;                   !- Convergence Tolerance

!- ===== ALL OBJECTS IN CLASS: ZONE CONTROL:THERMOSTATIC =====

ZONE CONTROL:THERMOSTATIC,
TestChamber Thermostat,   !- Thermostat Name
TestChamber,              !- Zone Name
Zone Control Type Sched,  !- Control Type SCHEDULE Name
Single Heating Cooling Setpoint, !- Control Type #1
Single Setpoint;         !- Control Type Name #1

!- ===== ALL OBJECTS IN CLASS: SINGLE HEATING COOLING SETPOINT =====

SINGLE HEATING COOLING SETPOINT,
Single Setpoint,          !- Name
Zone Setpoints;          !- Setpoint Temperature SCHEDULE Name

!- ===== ALL OBJECTS IN CLASS: ZONE SUPPLY AIR PATH =====

ZONE SUPPLY AIR PATH,
TermReheatSupplyPath,    !- Supply Air Path Name
Zone Equipment Inlet Node, !- Supply Air Path Inlet Node

##if #[SupplyAirDirection[] EQS UF ]

Zone Supply Plenum,      !- KEY--System Component Type ***** THIS NEEDS TO BE
OMITTED FOR THE OH-MIXING CASE (NOT UFAD)
Supply_Plenum Plenum,    !- Component Name ***** THIS NEEDS TO BE
OMITTED FOR THE OH-MIXING CASE (NOT UFAD)

##endif

Zone Splitter,          !- KEY--System Component Type
Zone Supply Air Splitter; !- Component Name

```

```

!- ===== ALL OBJECTS IN CLASS: ZONE RETURN AIR PATH =====

ZONE RETURN AIR PATH,
  TermReheatReturnPath,      !- Return Air Path Name
  Return Air Mixer Outlet,    !- Return Air Path Outlet Node

  Zone Return Plenum,        !- KEY--System Component Type 1
  Return_Plenum Plenum,      !- Component Name 1

  Zone Mixer,                !- KEY--System Component Type 2
  Zone Return Air Mixer;     !- Component Name 2

!- ===== ALL OBJECTS IN CLASS: ZONE RETURN PLENUM =====

ZONE RETURN PLENUM,
  Return_Plenum Plenum,      !- Zone Plenum Name
  Return_Plenum,            !- Zone Name
  Return_Plenum Node,        !- Zone Node Name
  Return_Plenum Plenum Outlet Node, !- Outlet_Node
  TestChamber Outlet Node;   !- Inlet_Node_1

##if #[SupplyAirDirection[] EQS UF ]
!- ===== ALL OBJECTS IN CLASS: ZONE SUPPLY PLENUM =====      ***** THIS N
EEDS TO BE OMITTED FOR THE OH-MIXING CASE (NOT UFAD)

ZONE SUPPLY PLENUM,
  Supply_Plenum Plenum,      !- Zone Plenum Name
  Supply_Plenum,            !- Zone Name
  Supply_Plenum Node,        !- Zone Node Name
  Zone Equipment Inlet Node, !- Inlet_Node
  Supply_Plenum Plenum Outlet Node; !- Outlet_Node

##endif

!- ===== ALL OBJECTS IN CLASS: ZONE SPLITTER =====

ZONE SPLITTER,
  Zone Supply Air Splitter,  !- Splitter Name

##if #[SupplyAirDirection[] EQS UF ]
  Supply_Plenum Plenum Outlet Node, !- Inlet_Node      ***** THIS NEEDS TO BE CHANGED
  FOR THE OH-MIXING CASE (NOT UFAD)

##elseif #[SupplyAirDirection[] EQS OH ]
  Zone Equipment Inlet Node, !- Inlet_Node      ***** THIS NEEDS TO BE CHANGED FOR TH
E OH-MIXING CASE (NOT UFAD)

##endif

  TestChamber Reheat Air Inlet Node; !- Outlet_Node_1

!- ===== ALL OBJECTS IN CLASS: ZONE MIXER =====

ZONE MIXER,
  Zone Return Air Mixer,      !- Mixer Name
  Return Air Mixer Outlet,    !- Outlet_Node
  Return_Plenum Plenum Outlet Node; !- Inlet_Node_1

!- ===== ALL OBJECTS IN CLASS: PURCHASED:CHILLED WATER =====

PURCHASED:CHILLED WATER,
  Purchased Cooling,          !- Purchased Chilled Water Name
  Purchased Cooling Inlet Node, !- Plant_Loop_Inlet_Node
  Purchased Cooling Outlet Node, !- Plant_Loop_Outlet_Node
  10000;                      !- Nominal Capacity {W}

```

```

!- ===== ALL OBJECTS IN CLASS: PUMP:VARIABLE SPEED =====

PUMP:VARIABLE SPEED,
  Circ Pump,                !- Pump Name
  CW Supply Inlet Node,     !- Inlet_Node
  CW Pump Outlet Node,     !- Outlet_Node
  .0006,                   !- Rated Volumetric Flow Rate {m3/s}
  300000,                  !- Rated Pump Head {Pa}
  270,                     !- Rated Power Consumption {W}
  .87,                     !- Motor Efficiency
  0.0,                     !- Fraction of Motor Inefficiencies to Fluid Stream
  0,                       !- Coefficient1 of the Part Load Performance Curve
  1,                       !- Coefficient2 of the Part Load Performance Curve
  0,                       !- Coefficient3 of the Part Load Performance Curve
  0,                       !- Coefficient4 of the Part Load Performance Curve
  0,                       !- This value can be zero and will be defaulted to that if
not specified. {m3/s}
  INTERMITTENT;           !- Pump Control Type

!- ===== ALL OBJECTS IN CLASS: COIL:WATER:SIMPLECOOLING =====

COIL:Water:SimpleCooling,
  Main Cooling Coil 1,     !- Coil Name
  FanAndCoilAvailSched,   !- Available Schedule
  1600,                    !- UA of the Coil {W/K}
  .0006,                  !- Max Water Flow Rate of Coil {m3/s}
  0.95,                   !- Leaving Relative Humidity of Coil
  Cooling Coil Water Inlet Node, !- Coil_Water_Inlet_Node
  Cooling Coil Water Outlet Node, !- Coil_Water_Outlet_Node
  Cooling Coil Air Inlet Node, !- Coil_Air_Inlet_Node
  Heating Coil Air Inlet Node; !- Coil_Air_Outlet_Node

!- ===== ALL OBJECTS IN CLASS: COIL:GAS:HEATING =====

COIL:Gas:Heating,
  Reheat Coil TestChamber, !- Coil Name
  ReheatCoilAvailSched,    !- Available Schedule
  0.8,                     !- Gas Burner Efficiency of the Coil
  100000,                  !- Nominal Capacity of the Coil {W}
  TestChamber Reheat Air Inlet Node, !- Coil_Air_Inlet_Node
  TestChamber Reheat Air Outlet Node; !- Coil_Air_Outlet_Node

COIL:Gas:Heating,
  Main Heating Coil 1,
  FanAndCoilAvailSched,
  0.8,
  100000,
  Heating Coil Air Inlet Node,
  Air Loop Outlet Node,
  Air Loop Outlet Node;

!- ===== ALL OBJECTS IN CLASS: FAN:SIMPLE:VARIABLEVOLUME =====

FAN:SIMPLE:VariableVolume,
  Supply Fan 1,            !- Fan Name
  FanAndCoilAvailSched,   !- Available Schedule
  0.7,                    !- Fan Total Efficiency
  100.0,                  !- Delta Pressure {Pa}
  SysFlowRate[],         !- Max Flow Rate {m3/s}
  0.001,                  !- Min Flow Rate {m3/s}
  0.9,                    !- Motor Efficiency
  1.0,                    !- Motor In Airstream Fraction
  0.0015302446,          !- FanCoefficient 1
  0.0052080574,          !- FanCoefficient 2

```

```

1.1086242,          !- FanCoefficient 3
-0.11635563,       !- FanCoefficient 4
0.000,             !- FanCoefficient 5
Mixed Air Node 1,  !- Fan_Inlet_Node
Cooling Coil Air Inlet Node; !- Fan_Outlet_Node

!- ===== ALL OBJECTS IN CLASS: REPORT VARIABLE =====

Report Variable,
*,                !- Key_Value
Outdoor Dry Bulb, !- Variable_Name
hourly;          !- Reporting_Frequency

Report Variable,
TestChamber,     !- Key_Value
Zone Transmitted Solar, !- Variable_Name
hourly;          !- Reporting_Frequency

Report Variable,
TestChamber,     !- Key_Value
Zone Opaque Surface Inside Face Conduction, !- Variable_Name
hourly;          !- Reporting_Frequency

Report Variable,
TestChamber,     !- Key_Value
Zone Window Heat Gain, !- Variable_Name
hourly;          !- Reporting_Frequency

Report Variable,
TestChamber,     !- Key_Value
Zone Window Heat Loss, !- Variable_Name
hourly;          !- Reporting_Frequency

Report Variable,
*,                !- Key_Value
Opaque Surface Inside Face Conduction, !- Variable_Name
hourly;          !- Reporting_Frequency

Report Variable,
*,                !- Key_Value
Surface Inside Temperature, !- Variable_Name
hourly;          !- Reporting_Frequency

Report Variable,
*,                !- Key_Value
Surface Outside Temperature, !- Variable_Name
hourly;          !- Reporting_Frequency

Report Variable,
TestChamber,     !- Key_Value
Zone Electric Equipment Total Heat Gain, !- Variable_Name
hourly;          !- Reporting_Frequency

Report Variable,
TestChamber,     !- Key_Value
Zone Lights Total Heat Gain, !- Variable_Name
hourly;          !- Reporting_Frequency

Report Variable,
TestChamber,     !- Key_Value
Zone People Total Heat Gain, !- Variable_Name
hourly;          !- Reporting_Frequency

Report Variable,
TestChamber,     !- Key_Value
Zone/Sys Sensible Cooling Rate, !- Variable_Name
hourly;          !- Reporting_Frequency

```

```

Report Variable,
  TestChamber,                !- Key_Value
  Zone/Sys Sensible Heating Rate, !- Variable_Name
  hourly;                    !- Reporting_Frequency

Report Variable,
  *,                          !- Key_Value
  Zone/Sys Air Temperature,   !- Variable_Name
  hourly;                    !- Reporting_Frequency

Report Variable,
  TestChamber Outlet Node,
  System Node Temp,
  hourly;

Report Variable,
  Return_Plenum Node,
  System Node Temp,
  hourly;

Report Variable,
  Air Loop Outlet Node,      !- Key_Value
  System Node Temp,         !- Variable_Name
  hourly;                   !- Reporting_Frequency

Report Variable,
  Air Loop Outlet Node,      !- Key_Value
  System Node MassFlowRate,  !- Variable_Name
  hourly;                   !- Reporting_Frequency

Report Variable,
  Mixed Air Node 1,         !- Key_Value
  System Node Temp,        !- Variable_Name
  hourly;                  !- Reporting_Frequency

Report Variable,
  TestChamber Reheat Air Outlet Node, !- Key_Value
  System Node Temp,        !- Variable_Name
  hourly;                  !- Reporting_Frequency

Report Variable,
  TestChamber Reheat Air Outlet Node, !- Key_Value
  System Node Temp,        !- Variable_Name
  hourly;                  !- Reporting_Frequency

Report Variable,
  TestChamber Reheat Air Outlet Node, !- Key_Value
  System Node MassFlowRate, !- Variable_Name
  hourly;                  !- Reporting_Frequency

Report Variable,
  TestChamber Reheat Air Inlet Node, !- Key_Value
  System Node Temp,        !- Variable_Name
  hourly;                  !- Reporting_Frequency

Report Variable,
  Cooling Coil Water Inlet Node, !- Key_Value
  System Node Temp,        !- Variable_Name
  hourly;                  !- Reporting_Frequency

Report Variable,
  *,                          !- Key_Value
  Heating Coil Gas Consumption Rate, !- Variable_Name
  hourly;                    !- Reporting_Frequency

Report Variable,
  *,                          !- Key_Value

```

```

Total Water Cooling Coil Rate,  !- Variable_Name
hourly;                          !- Reporting_Frequency

Report Variable,
*,                                !- Key_Value
Sensible Water Cooling Coil Rate, !- Variable_Name
hourly;                          !- Reporting_Frequency

Report Variable,
*,                                !- Key_Value
Surface Int Convection Coeff,    !- Variable_Name
hourly;                          !- Reporting_Frequency

Report Variable,
*,                                !- Key_Value
Surface Ext Convection Coeff,    !- Variable_Name
hourly;                          !- Reporting_Frequency

! ===== DV VARIABLES =====

Report Variable,
*,                                !- Key_Value
DV Mixed Subzone Temperature,    !- Variable_Name
hourly;                          !- Reporting_Frequency

Report Variable,
*,                                !- Key_Value
DV Occupied Subzone Temperature, !- Variable_Name
hourly;                          !- Reporting_Frequency

Report Variable,
*,                                !- Key_Value
DV Floor Subzone Temperature,    !- Variable_Name
hourly;                          !- Reporting_Frequency

Report Variable,
*,                                !- Key_Value
DV Transition Height,           !- Variable_Name
hourly;                          !- Reporting_Frequency

Report Variable,
*,                                !- Key_Value
DV Fraction Min Recommended Flow Rate, !- Variable_Name
hourly;                          !- Reporting_Frequency

Report Variable,
*,                                !- Key_Value
DV Zone Is Mixed,              !- Variable_Name
hourly;                          !- Reporting_Frequency

Report Variable,
*,                                !- Key_Value
DV Average Temp Gradient,      !- Variable_Name
hourly;                          !- Reporting_Frequency

Report Variable,
*,                                !- Key_Value
DV Maximum Temp Gradient,     !- Variable_Name
hourly;                          !- Reporting_Frequency

Report Variable,
*,                                !- Key_Value
DV Effective Air Temperature for Comfort, !- Variable_Name
hourly;                          !- Reporting_Frequency

Report Variable,
*,                                !- Key_Value
DV Thermostat Temperature,    !- Variable_Name

```



```

        hourly;                                !- Reporting_Frequency

! ===== UFAD VARIABLES =====

##if #[AirFlowType[] EQS UFAD ]

Report Variable,
*,
UF Mixed Subzone Temperature,                !- Key_Value
hourly;                                       !- Variable_Name
                                                !- Reporting_Frequency

Report Variable,
*,
UF Occupied Subzone Temperature,             !- Key_Value
hourly;                                       !- Variable_Name
                                                !- Reporting_Frequency

Report Variable,
*,
UF Transition Height,                        !- Key_Value
hourly;                                       !- Variable_Name
                                                !- Reporting_Frequency

Report Variable,
*,
UF Zone Is Mixed,                            !- Key_Value
hourly;                                       !- Variable_Name
                                                !- Reporting_Frequency

Report Variable,
*,
UF Average Temp Gradient,                    !- Key_Value
hourly;                                       !- Variable_Name
                                                !- Reporting_Frequency

Report Variable,
*,
UF Effective Air Temperature for Comfort,    !- Key_Value
hourly;                                       !- Variable_Name
                                                !- Reporting_Frequency

Report Variable,
*,
UF Thermostat Temperature,                  !- Key_Value
hourly;                                       !- Variable_Name
                                                !- Reporting_Frequency

Report Variable,
*,
UF Gamma,                                   !- Key_Value
hourly;                                       !- Variable_Name
                                                !- Reporting_Frequency

Report Variable,
*,
UF UCSD Model Return Temperature,           !- Key_Value
hourly;                                       !- Variable_Name
                                                !- Reporting_Frequency

Report Variable,
*,
UF UCSD Model Occupied Temperature,         !- Key_Value
hourly;                                       !- Variable_Name
                                                !- Reporting_Frequency

Report Variable,
*,
UF UCSD Sys Flow Rate,                      !- Key_Value
hourly;                                       !- Variable_Name
                                                !- Reporting_Frequency

Report Variable,
*,
UF UCSD Power In Plumes,                    !- Key_Value
hourly;                                       !- Variable_Name
                                                !- Reporting_Frequency

Report Variable,
*,
                                                !- Key_Value

```

```

UF UCSD Supply Air Temp,          !- Variable_Name
hourly;                          !- Reporting_Frequency

Report Variable,
*,                                !- Key_Value
Phi,                             !- Variable_Name
hourly;                          !- Reporting_Frequency

##endif

!- ===== ALL OBJECTS IN CLASS: REPORT =====

Report,
surfaces,                        !- Type_of_Report
dx;                               !- Name_of_Report

Report,
Variable Dictionary;           !- Type_of_Report

DIAGNOSTICS, DisplayAdvancedReportVariables;

```

```

! parameters_general.imf

##SET1 OST-North[]          24.87      ! [C]
##SET1 OST-South[]         24.01      ! [C]
##SET1 OST-West[]          24.27      ! [C]
##SET1 OST-East[]          25.00      ! [C]

##SET1 OST-Flr[]           16.08      ! [C]
##SET1 OST-Clg[]           27.17      ! [C]

##SET1 SysFlowRate[]       0.37756    ! [m3/s]
##SET1 SupplyAirTemp[]    18.89      ! [C]

##SET1 OST-ConfPlnm[]     19.89      ! [C]

##SET1 LightingPwr[]       799.58     ! [W]
##SET1 LightingRAFraction[] 0.15       ! [-]
##SET1 LightingRad[]       0.20       ! [-]
##SET1 LightingVis[]       0.22       ! [-]

##SET1 EquipmentPwr[]     1134       ! [W]
##SET1 EquipmentRadFraction[] 0.36       ! [-]

##SET1 PeoplePwr[]        73         ! [W]
##SET1 PeopleRadFraction[] 0.40       ! [-]

##SET1 DVOccZoneGains[]   0.62       ! [-]
##SET1 SupplyAirDirection[] UF          ! [-]
##SET1 AirFlowType[]      UFAD          ! [-]
##SET1 NumPeople[]        6          ! [-]

##SET1 RunType[]          INT          ! [-]

##SET1 UFAD_PlumesPerOcc[] 2.0        ! [-]
##SET1 UFAD_DiffsPerPlume[] 1.17       ! [-]
##SET1 UFAD_DiffEffectiveArea[] 0.01103    ! [m2]
##SET1 UFAD_DiffSlotAngle[] 28         ! [deg]
##SET1 UFAD_HeatSourceHeight[] -0.26      ! [m]
##SET1 UFAD_TStatHeight[]  1.22         ! [m]
##SET1 UFAD_ComfortHeight[] 0.61        ! [m]
##SET1 UFAD_TempDiffReporting[] 0.001      ! [C]
##SET1 UFAD_DiffType[]     SWIRL
##SET1 UFAD_SpecTransHeight[] NO
##SET1 UFAD_TransitionHeight[] 1.10        ! [m]

##SET1 TC-Wall-SolarAbs[]  0.320       ! [-]
##SET1 TC-Wall-VisibleAbs[] 0.320       ! [-]
##SET1 TC-Wall-ThermalAbs[] 0.900       ! [-]

##SET1 ClgRValue[]        5.0367     ! [m2-K/W]

##SET1 NorthWallRValue[]  6.0124     ! [m2-K/W]
##SET1 NorthDoorRValue[]  0.3723     ! [m2-K/W]

##SET1 EastWallRValue[]   5.9138     ! [m2-K/W]

##SET1 SouthWallRValue[]  6.0124     ! [m2-K/W]
##SET1 ConfRmDoorRValue[] 0.3273     ! [m2-K/W]
##SET1 ConfRmWindowRValue[] 5.7412     ! [m2-K/W]

##SET1 WestWallRValue[]   3.1559     ! [m2-K/W]
##SET1 EnvChWindowRValue[] 5.7412     ! [m2-K/W]

```

##SET1 SubFlrRValue []	4.0840	!	[m2-K/W]
##SET1 CarpetRValue []	0.0616	!	[m2-K/W]
##SET1 CarpetSolarAbs []	0.950	!	[-]
##SET1 CarpetVisibleAbs []	0.950	!	[-]
##SET1 CarpetThermalAbs []	0.950	!	[-]
##SET1 ACTRValue []	0.3522	!	[m2-K/W]
##SET1 ACTSolarAbs []	0.32	!	[-]
##SET1 ACTVisibleAbs []	0.01	!	[-]
##SET1 ACTThermalAbs []	0.90	!	[-]
##SET1 ConvCoeff-RPWalls []	3.00	!	[W/m2-K]
##SET1 ConvCoeff-TCWalls []	3.00	!	[W/m2-K]
##SET1 ConvCoeff-SPWalls []	5.00	!	[W/m2-K]
##SET1 ConvCoeff-RPClg []	1.00	!	[W/m2-K]
##SET1 ConvCoeff-DCTop []	1.00	!	[W/m2-K]
##SET1 ConvCoeff-DCBot []	1.00	!	[W/m2-K]
##SET1 ConvCoeff-RFTop []	2.00	!	[W/m2-K]
##SET1 ConvCoeff-RFBot []	5.00	!	[W/m2-K]
##SET1 ConvCoeff-SPFlr []	5.00	!	[W/m2-K]
##SET1 GlassTemp []	-572.8	!	[C]
##SET1 GlassTransSol []	0	!	[W]
##SET1 FurniturekValue []	0.05	!	[W/m-K]
##SET1 FurniturepValue []	600.00	!	[kg/m3]
##SET1 FurnitureThickness []	0.076	!	[m]
##SET1 FurnitureCpValue []	3.54	!	[J/kg-K]
##SET1 FurnitureSolarAbs []	0.75	!	[-]
##SET1 FurnitureVisibleAbs []	0.90	!	[-]
##SET1 FurnitureThermalAbs []	0.90	!	[-]
##SET1 NorthFurnDim []	4.57200	!	[m]
##SET1 SouthFurnDim []	3.35280	!	[m]

! parameters_solar.imf

##SET1 SF-Flr-1 []	0.1294	! [-]
##SET1 SF-Flr-2 []	0.0619	! [-]
##SET1 SF-Flr-3 []	0.0382	! [-]
##SET1 SF-Flr-4 []	0.0274	! [-]
##SET1 SF-Flr-5 []	0.0208	! [-]
##SET1 SF-Flr-6 []	0.0316	! [-]
##SET1 SF-Flr-7 []	0.0267	! [-]
##SET1 SF-Flr-8 []	0.0181	! [-]
##SET1 SF-Flr-9 []	0.0070	! [-]
##SET1 SF-Flr-10 []	0.0008	! [-]
##SET1 SF-Flr-11 []	0.1339	! [-]
##SET1 SF-Flr-12 []	0.0561	! [-]
##SET1 SF-Flr-13 []	0.0478	! [-]
##SET1 SF-Flr-14 []	0.0348	! [-]
##SET1 SF-Flr-15 []	0.0195	! [-]
##SET1 SF-WestWall []	0.0000	! [-]
##SET1 SF-SouthWall-G1 []	0.0090	! [-]
##SET1 SF-SouthWall-G2 []	0.0093	! [-]
##SET1 SF-SouthWall-G3 []	0.0095	! [-]
##SET1 SF-SouthWall-G4 []	0.0099	! [-]
##SET1 SF-SouthWall-G5 []	0.0111	! [-]
##SET1 SF-SouthWall-G6 []	0.0117	! [-]
##SET1 SF-SouthWall-G7 []	0.0114	! [-]
##SET1 SF-SouthWall-G8 []	0.0108	! [-]
##SET1 SF-SouthWall-G9 []	0.0108	! [-]
##SET1 SF-SouthWall-G10 []	0.0108	! [-]
##SET1 SF-SouthWall-G11 []	0.0045	! [-]
##SET1 SF-SouthWall-G12 []	0.0044	! [-]
##SET1 SF-SouthWall-F1 []	0.0045	! [-]
##SET1 SF-SouthWall-F2 []	0.0048	! [-]
##SET1 SF-SouthWall-F3 []	0.0049	! [-]
##SET1 SF-SouthWall-F4 []	0.0048	! [-]
##SET1 SF-SouthWall-F5 []	0.0045	! [-]
##SET1 SF-SouthWall-F6 []	0.0053	! [-]
##SET1 SF-SouthWall-F7 []	0.0027	! [-]
##SET1 SF-SouthWall-F8 []	0.0024	! [-]
##SET1 SF-SouthWall-F9 []	0.0022	! [-]
##SET1 SF-SouthWall-F10 []	0.0021	! [-]
##SET1 SF-SouthWall-F11 []	0.0019	! [-]
##SET1 SF-SouthWall-F12 []	0.0017	! [-]
##SET1 SF-SouthWall-E1 []	0.0031	! [-]
##SET1 SF-SouthWall-E2 []	0.0027	! [-]
##SET1 SF-SouthWall-E3 []	0.0019	! [-]
##SET1 SF-SouthWall-E4 []	0.0014	! [-]
##SET1 SF-SouthWall-E5 []	0.0014	! [-]
##SET1 SF-SouthWall-E6 []	0.0013	! [-]
##SET1 SF-SouthWall-E7 []	0.0013	! [-]
##SET1 SF-SouthWall-E8 []	0.0012	! [-]
##SET1 SF-SouthWall-E9 []	0.0012	! [-]
##SET1 SF-SouthWall-E10 []	0.0013	! [-]
##SET1 SF-SouthWall-E11 []	0.0013	! [-]
##SET1 SF-SouthWall-E12 []	0.0012	! [-]
##SET1 SF-NorthWall-A1 []	0.0082	! [-]
##SET1 SF-NorthWall-A2 []	0.0084	! [-]
##SET1 SF-NorthWall-A3 []	0.0086	! [-]
##SET1 SF-NorthWall-A4 []	0.0090	! [-]
##SET1 SF-NorthWall-A5 []	0.0098	! [-]
##SET1 SF-NorthWall-A6 []	0.0106	! [-]
##SET1 SF-NorthWall-A7 []	0.0119	! [-]
##SET1 SF-NorthWall-A8 []	0.0125	! [-]
##SET1 SF-NorthWall-A9 []	0.0114	! [-]
##SET1 SF-NorthWall-A10 []	0.0099	! [-]
##SET1 SF-NorthWall-A11 []	0.0041	! [-]
##SET1 SF-NorthWall-A12 []	0.0039	! [-]
##SET1 SF-NorthWall-B1 []	0.0047	! [-]
##SET1 SF-NorthWall-B2 []	0.0047	! [-]

##SET1 SF-NorthWall-B3 []	0.0049	!	[-]
##SET1 SF-NorthWall-B4 []	0.0050	!	[-]
##SET1 SF-NorthWall-B5 []	0.0053	!	[-]
##SET1 SF-NorthWall-B6 []	0.0047	!	[-]
##SET1 SF-NorthWall-B7 []	0.0019	!	[-]
##SET1 SF-NorthWall-B8 []	0.0015	!	[-]
##SET1 SF-NorthWall-B9 []	0.0015	!	[-]
##SET1 SF-NorthWall-B10 []	0.0015	!	[-]
##SET1 SF-NorthWall-B11 []	0.0016	!	[-]
##SET1 SF-NorthWall-B12 []	0.0014	!	[-]
##SET1 SF-NorthWall-C1 []	0.0012	!	[-]
##SET1 SF-NorthWall-C2 []	0.0009	!	[-]
##SET1 SF-NorthWall-C3 []	0.0006	!	[-]
##SET1 SF-NorthWall-C4 []	0.0002	!	[-]
##SET1 SF-NorthWall-C5 []	0.0006	!	[-]
##SET1 SF-NorthWallC6 []	0.0007	!	[-]
##SET1 SF-NorthWall-C7 []	0.0009	!	[-]
##SET1 SF-NorthWall-C8 []	0.0010	!	[-]
##SET1 SF-NorthWall-C9 []	0.0011	!	[-]
##SET1 SF-NorthWall-C10 []	0.0012	!	[-]
##SET1 SF-NorthWall-C11 []	0.0012	!	[-]
##SET1 SF-NorthWall-C12 []	0.0010	!	[-]
##SET1 SF-EastWall-Lower []	0.0060	!	[-]
##SET1 SF-EastWall-Upper []	0.0310	!	[-]
##SET1 SF-Clg []	0.0000	!	[-]