

# Lawrence Berkeley National Laboratory

## Lawrence Berkeley National Laboratory

### **Title**

Heat Recovery in Building Envelopes

### **Permalink**

<https://escholarship.org/uc/item/89f7x4dg>

### **Authors**

Sherman, Max H.  
Walker, Iain S.

### **Publication Date**

2001

# HEAT RECOVERY IN BUILDING ENVELOPES

Max H. Sherman and Iain S. Walker  
Energy Performance of Buildings Group  
Indoor Environment Department  
Lawrence Berkeley National Laboratory  
Berkeley, CA. 94720

January 2001

This work was supported by the Assistant Secretary for Energy Efficiency and Renewable Energy, Office of Building technology, State and Community Programs under U.S. Department of Energy Contract no. DE-AC03-76SF00098.

**ABSTRACT**

Infiltration has traditionally been assumed to contribute to the energy load of a building by an amount equal to the product of the infiltration flow rate and the enthalpy difference between inside and outside. Application of such a simple formula may produce an unreasonably high contribution because of heat recovery within the building envelope. Previous laboratory and simulation research has indicated that such heat transfer between the infiltrating air and walls may be substantial. In this study, Computational Fluid Dynamics was used to simulate sensible heat transfer in typical envelope constructions. The results show that the traditional method may over-predict the infiltration energy load by up to 95 percent at low leakage rates. A simplified physical model has been developed and used to predict the infiltration heat recovery based on the Peclet number of the flow and the fraction of the building envelope active in infiltration heat recovery.

**KEY WORDS**

Air leakage, envelope, heat recovery, infiltration, load calculation, modeling, simulation

## INTRODUCTION

Infiltration, accidental air leakage through building envelopes, is a common phenomenon that affects both indoor air quality and building energy consumption. Infiltration can contribute significantly to the overall heating or cooling load of a building, but the magnitude of the effect depends on a host of factors, including environmental conditions, building design and operation, and construction quality. A small number of studies regarding the energy issues of infiltration have been found in the literature. (Caffey (1979), NIST (1996), Persily (1982), Sherman and Matson (1993)), and all concluded that the impact of infiltration can be sizeable.

The conventional method of accounting for the extra load due to infiltration is to add a simple convective transport term of the form  $mc_p \Delta T$  to the energy balance for the building. For single-zone building models the conventional infiltration load,  $Q_{infC}$ , shown in equation 1, is the product of the infiltrating air mass flow rate, the specific heat capacity of air, and the temperature difference between inside and outside.

$$Q_{infC} = mc_p (T_i - T_o) \quad (1)$$

This relation does not include the effects of moisture in the air and is strictly valid only if the leaking air does not interact thermally with the building walls. In reality, leaking air exchanges heat with the walls as it enters and leaves the building, which changes the thermal profile in the walls and warms or cools the infiltrating/exfiltrating air. This results in different values for the conduction, infiltration, and total heat losses than are predicted by the conventional method. Some studies have shown that this effect could be substantial suggesting that the conventional method over-predicts the energy impact of infiltration (Bhattacharyya and Claridge (1995), Buchanan and Sherman (2000), Claridge and Liu (1996), Claridge and Bhattacharyya (1990) and Kohonen and Virtanen (1987)).

An improved prediction of the energy load due to infiltration can be made by introducing a correction factor, the infiltration heat exchange effectiveness,  $\varepsilon$ , or the heat recovery factor (defined by equation 2), into the expression for the conventional load (Equation 1). In Equation 2,  $Q$  is the actual total energy load of the building with infiltration and  $Q_o$  is the conduction load when there is no infiltration. This heat recovery factor, introduced by Claridge and Bhattacharyya (1990), accounts for all the thermal interaction between leaking air and building walls including the effect on conductive heat loss. The actual infiltration load,  $Q_{inf}$ , is calculated using the heat recovery factor as shown in Equation 3.

$$\varepsilon \equiv 1 - \frac{Q - Q_o}{mc_p \Delta T} = 1 - \frac{Q - Q_o}{Q_{infC}} \quad (2)$$

$$Q_{inf} = (1 - \varepsilon) mc_p (T_i - T_o) = (1 - \varepsilon) Q_{infC} \quad (3)$$

The effect of infiltration heat recovery is important to consider when calculating the total load of the building. For the leaky stock of existing buildings, it suggests that estimations such as Sherman and Matson's (1993) over estimate the impact. More importantly, it could have significant impacts on the prioritization of heat recovery strategies for new, relatively more tight construction. Computational Fluid Dynamic approaches can be used to solve the simultaneous heat and mass transport phenomena, but it is far more useful to develop simplified physical models that have few parameters and which can be incorporated into load calculations. To develop such models without losing the important content requires a careful consideration of the physics of real buildings.

### **SIMPLIFIED MODEL OF INFILTRATION HEAT RECOVERY**

We have derived simple steady-state physical model of infiltration heat recovery based on consideration of one-dimensional coupled heat and mass transport and practical, physical limitations. The model is symmetric between infiltration and exfiltration and is a function of effective Peclet number ( $Pe_{inf}$  and  $Pe_{exf}$ ). The Peclet number is based on the whole-house values (over the whole building envelope) of conduction and infiltration:

$$Pe = \frac{mc_p}{UA} \quad (4)$$

The effective Peclet number depends on the fraction of the total conduction heat transfer for the building envelope that is actively coupled to the air leakage. The effective Peclet number is determined by dividing the whole house Peclet number (which assumes no heat recovery) by the participation. This “*participation*” is treated separately for infiltration and exfiltration. The participation,  $f$ , is not simply the physical area through which the infiltrating/exfiltrating area flows. It is adjusted to account for other effects on heat transfer through the envelope. For example, specific air flow paths (i.e., direction of air flow with respect to the heat flow) and the effect of conductance of different material properties. Another factor is the actual flow path in real walls, where the air does not spread out over the entire interior wall cavity and only small fraction (say 10%) of the wall has air flow through its cavities. There is the physical restriction that the sum of the two participations ( $f_{inf}$  and  $f_{exf}$ ) is always less than or equal to unity because a sum of unity indicates that all the building envelope is completely active.

A whole-house Peclet number of 0.5 would correspond to a house in which 1/3 of the space conditioning load was infiltration. Higher infiltration rates increase the Peclet number and houses are generally in the range of  $0.1 < Pe < 1.0$ . The effective Peclet number ( $Pe_{inf}$  and  $Pe_{exf}$ ) for infiltrating and exfiltrating flows is given by:

$$Pe_{inf} = Pe / f_{inf} \quad Pe_{exf} = Pe / f_{exf} \quad (5)$$

Thus the effective Peclet numbers can be large if  $f_{inf}$  or  $f_{exf}$  are small even at low whole-house Peclet number. The heat recovery factor is given by the sum of the infiltration and exfiltration contributions:

$$\varepsilon = \varepsilon_{inf} + \varepsilon_{exf} \quad (6)$$

Where  $\varepsilon_{inf}$  and  $\varepsilon_{exf}$  are of the form:

$$\varepsilon_{inf} = \frac{1}{Pe_{inf}} - \frac{1}{e^{Pe_{inf}} - 1} \quad \varepsilon_{exf} = \frac{1}{Pe_{exf}} - \frac{1}{e^{Pe_{exf}} - 1} \quad (7)$$

Appendix A contains a more detailed development of this model.

## ILLUSTRATIONS OF THE HEAT RECOVERY FACTOR

The range of potential values of the heat recovery factor (Equation 4) are shown in Figure 1. The curves shown in Figure 1 each have different values for the participation. In these cases the individual participations for infiltration and exfiltration are equal ( $f_{inf} = f_{exf}$ ). The curve with each participation equal to 0.5 corresponds to the theoretical maximum, where the sum of the participations is unity. As expected, Figure 1 shows that the heat recovery factor is high at small infiltration rates (low Pe) and drops as the infiltration rate increases (higher Pe). Also, the figure shows that the heat recovery drops with decreasing participation, i.e., less of the envelope surface area is affected by infiltration.

At low infiltration rates (and low whole-house Peclet number) the high heat recovery factor is applied to a small infiltration load. At higher infiltration rates a smaller heat recovery factor is applied to a high infiltration load. The net effect is that there is an optimum Peclet number for reduction in building load. The recovered infiltration load is determined by multiplying the heat recovery factor by the infiltration load from Equation 1. The recovered infiltration load is small at low Peclet numbers and increases asymptotically to the product of conduction load and total participation (i.e.,  $UA(f_{inf} + f_{exf})$ ). Thus the maximum infiltration load recovered increases with increasing participation to the limit where all the conduction load is recovered at high Peclet number. Dividing the recovered infiltration load by the total load (conduction plus non-heat recovery infiltration) gives the fraction reduction in building load. This is illustrated in Figure 2, where the reduction in load is small at low infiltration rates (Peclet number), rises to a peak and then decays at higher infiltration rates (Peclet number) as the heat recovery factor decreases. Both the reduction in building load and the optimum Peclet number are a strong function of the participation,  $f$ . Figure 2 shows how the high heat recovery factors at small Peclet number (low infiltration rates) have very little effect on building load. What is more important is the effect at typical whole house Peclet numbers. Typical houses have about one third of the building load due to infiltration (if no heat recovery is assumed) leading to a Peclet number of 0.5 (as shown in the Figure). At this Peclet number, the selection of the participation is critical. For a building envelope with highly diffuse leakage and half the envelope participating ( $f=0.25$ ) the reduction in building load is between 20% and 25%. For an envelope with localized leakage and low participation the effect is about 5% or less. Therefore a key aspect in

determining the effect of infiltration heat recovery is knowledge about the leakage distribution on the building envelope.

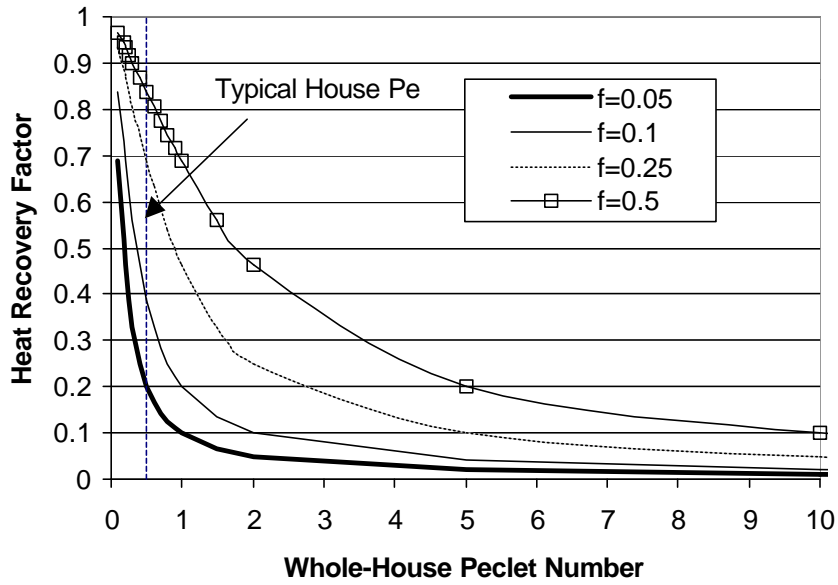

Figure 1: Heat recovery factor calculated with the simplified model using equal participations. The upper curve (with  $f = 0.5$ ) is the theoretical maximum.

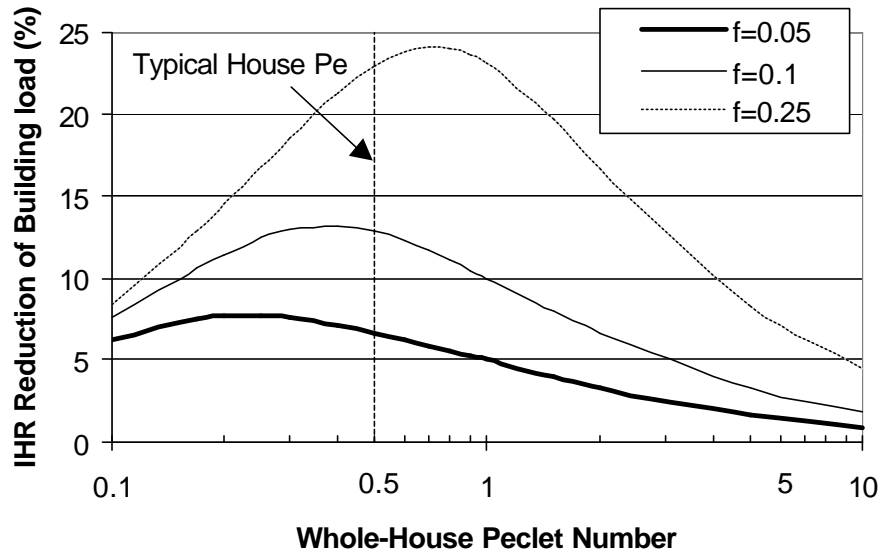

Figure 2. Reduction of building load using the simple model using equal participations. The typical house  $Pe$  is for the case where one third of the building load is due to infiltration with no heat recovery.

## **EVALUATION OF THE SIMPLIFIED MODEL USING CFD**

The simplified physical modeling must be verified to make sure none of the important building physics has been missed. Because of the difficulty in making sufficiently precise measurements, the validation has been done using Computational Fluid Dynamics (CFD). CFD offers many advantages for this task; including the ability to study simplified cases in a controlled precise manner, systematically change driving forces, heat transfer parameters and wall construction. The usual CFD requirements regarding physically complex boundary conditions (e.g., exact room/house dimensions) and turbulence (there is little turbulent or transitional flow inside the wall cavities or their boundary layers) are not particularly relevant for comparisons with simplified models that do not attempt to capture these effects. To start our comparison we set up a simple system in which there are two identical walls, one infiltrating and one exfiltrating. We will then use different leakage paths to evaluate the IHR. For simplicity and computational efficiency we use two-dimensional CFD simulations rather than three-dimensional. This means that the leaks in the examples given below need to be thought of as horizontal slots rather than round holes. In future work we plan to investigate some three-dimensional cases.

The walls in the CFD simulations are made up of a central cavity (either empty or filled with glass fiber insulation), an exterior plywood sheathing and an interior plywood layer. The cross-section of a hypothetical test room under a general infiltration scenario is shown in Figure 3. Small holes in the outer sheathing of the building envelope allow air to leak into the wall cavity and flow through the wall from outside to inside for the infiltrating wall and vice-versa for the exfiltrating wall. The driving force for leakage is a pressure differential due to wind and temperature differences between inside and outside. Leakage flows through the wall are varied and the inside/outside temperature difference is fixed at 24 K.



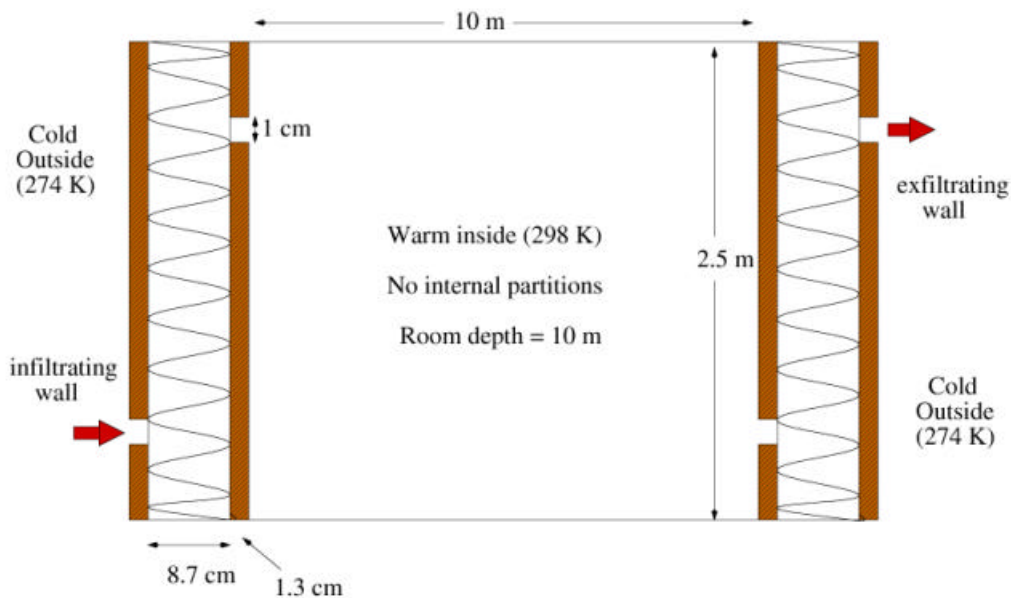

Figure 3: Cross-section of a hypothetical test room showing the general infiltration problem (wall geometry 1 shown). The infiltrating and exfiltrating walls have a conduction and convection energy flux, but all other walls have only a conduction flux.

Buchanan and Sherman (2000) have examined four wall configurations, shown in Figure 4 under various environmental conditions using two-dimensional CFD. Wall geometries 1 and 2 have insulation in the wall cavity, while geometries 3 and 4 have empty wall cavities. Combinations of these four wall types can be used to model particular building envelopes.

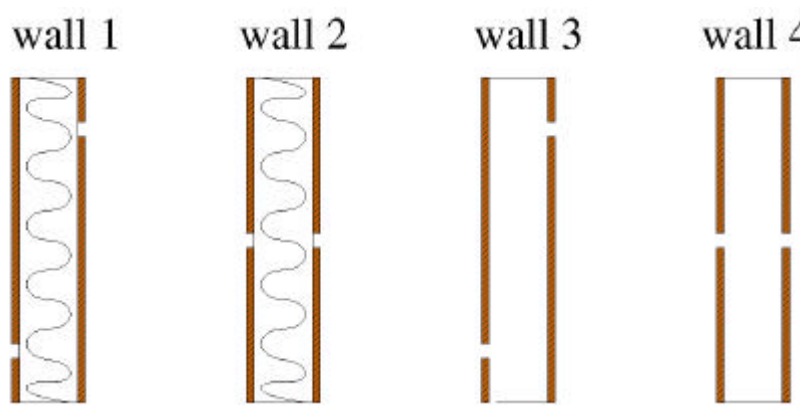

Figure 4: Wall geometries 1-4; 1 & 2 are insulated and 3 & 4 are empty.

### HEURISTIC DESCRIPTION

To use a simplified physical model, it is important to have a way to estimate the key parameter in the model, the participation,  $f$ . This participation is not simply the physical area through which the infiltrating/exfiltrating area flows. It must be adjusted to account for other effects on heat transfer through the envelope. For example, specific air flow paths (i.e., direction of air flow with respect to the heat flow) and the effect of conductance of different material properties. The participation must be estimated for all

parts of the building envelope and separately for infiltration and exfiltration. Another factor is the actual flow path in real walls. Anecdotal evidence suggests that air flowing through the typical holes in building walls does not spread out over the entire interior wall cavity. Common sense suggests that it is at least constrained to individual stud cavities. So a wall section of a room with 10 stud spaces and a single leakage site into one stud space would have at most 10% of the whole wall active in IHR. Because the CFD simulations are only two-dimensional and do not cover multiple stud spaces, we do not need to consider this factor when estimating the participation for the four wall examples shown above. However, for a real building this factor would tend to decrease the participation, increase effective Peclet number and therefore reduce IHR.

### **Wall 1**

If we examine the air flow path in wall 1, it is clear that the infiltrating air must traverse virtually all of the insulation. Because the insulation represents about 20% of the conductance (UA) of the envelope we can estimate the participation to be about 20%.

### **Wall 2**

Wall 2 has a counter-flow geometry, but only a small part of the insulation is actually taking part in the heat exchange. If we assume that the wall depth is indicative of the lateral participation in the heat exchange then the participation would be on the order of 3%, much lower than the 20% of wall 1.

### **Walls 3 and 4**

Walls 3 and 4 are uninsulated versions walls 1 and 2. Determining the participation is more complex for these walls because the unfilled cavity will experience significant heat transfer due to convection that interacts with the infiltrating and exfiltrating air. As a first approximation we propose to use the same participation as for the filled cavities. These effects of internal convection were not considered in our simplified modeling however, the CFD simulations of Buchanan and Sherman (2000) (discussed in the next section) showed that the IHR is functionally the same for the filled and empty cavities. This implies that the same functional form (and participation) of the simplified model can be applied to both filled and empty cavities.

## **COMPARISON OF THE SIMPLIFIED MODEL TO CFD**

We have used the CFD simulations of Buchanan and Sherman (2000) to calculate the IHR for these four wall types. Two distinct trends can be seen in Figure 5. Note that the results shown in Figure 5 cover a much wider range of Pe than the 0.1 to 1.0 range we expect for real buildings. This extended range allows us to better observe the trends in the data, but in determining how well the model performs we need to concentrate on Pe less than unity. One trend is that the walls with holes in a high/low configuration (walls 1 and 3) have a significantly higher heat recovery factor than the walls with holes that are straight through, but these straight through geometries still have a significant heat recovery effect. This is partly

because the high/low configuration has a longer leakage path and, for a given flow rate, the air remains within the wall cavity for a longer period of time. This allows for greater heat transfer and higher heat recovery compared to the straight through case.

The other trend is that results for the high/low configurations fall roughly on a single trend line, and the same is true for the straight through configurations. That is, insulated (1 & 2) and empty walls (3 & 4) with the same hole configuration have about the same heat recovery. Thus the physics within insulated and uninsulated walls is not sufficiently different to require an independent evaluation. This implies that our simplified model that does not include interior convection for the empty cavities should not produce large errors for these cases.

In comparing the data with our model, we notice some striking trends. The CFD data agrees acceptably well for wall 1 (and 3) with our heuristic participation of 0.2 for Peclet numbers below unity. Since few houses will have Peclet numbers above that the underestimate is not terribly significant. For wall 2 (and 4) our model under-estimates the IHR (compared to CFD) for virtually the whole range. One possible explanation is that a lot more of wall is participating in heat exchange than we estimated. To examine this we have reproduced the velocity fields of one of the CFD results in Figure 6. A qualitative examination of the velocity field shows that our assumption about the participation of the wall participating in the heat exchange is quite reasonable. To make the model approach the CFD data, the participation would have to be increased by a factor of three to five, which is clearly beyond what is justified from the velocity field.

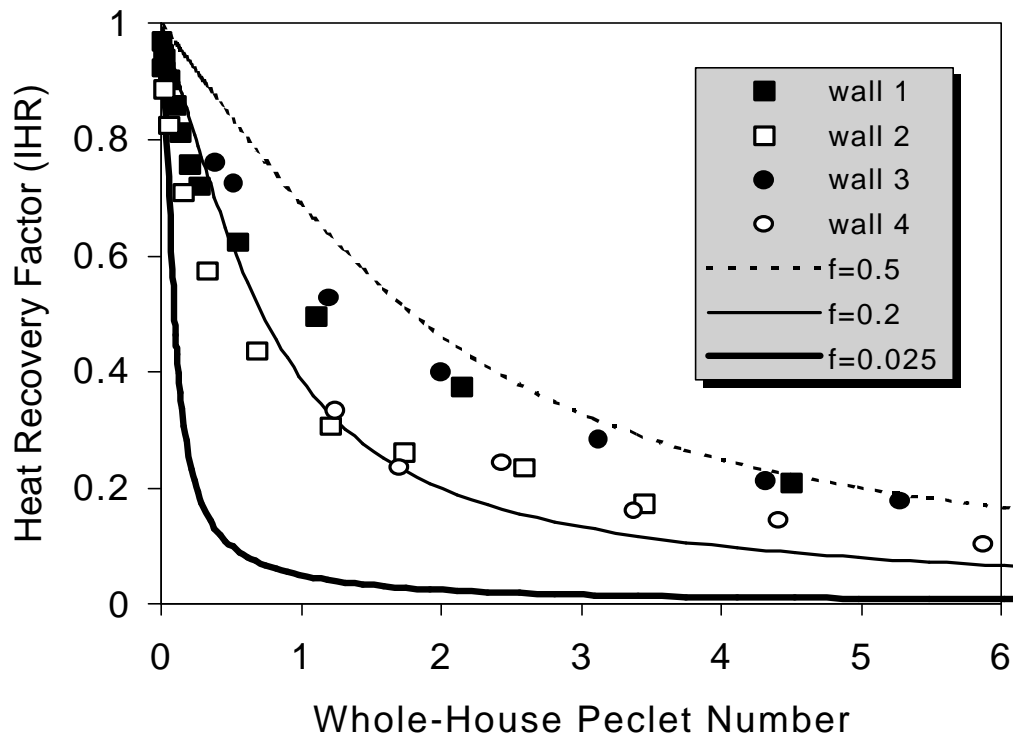

Figure 5: Heat recovery factor determined from 2D CFD simulations for walls 1-4. Solid symbols show data for walls with a high/low hole configuration (1 and 3) and hollow symbols show data for walls with a straight through hole configuration (2 and 4). Notice the two distinct trends—one for each hole configuration. The lines represent the simplified model for various values of participation.

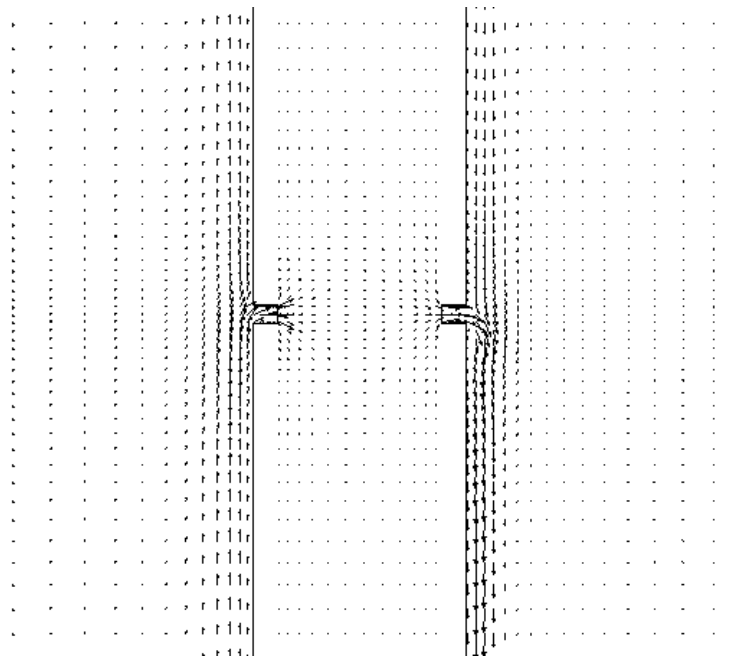

Figure 6. Air flow velocity vectors from a two-dimensional CFD simulation of the wall with a straight through leakage path (wall 2). Note that this figure concentrates on the areas around the leaks and represents only a fraction of the total wall height.

## **BOUNDARY LAYER IMPACTS**

Another interesting aspect of Figure 6, however, is the intermixing between the external boundary layers and the infiltrating air. Qualitative examination shows that the boundary layer is being sucked into the leak and the outgoing jet is being entrained into the boundary layer. This can cause an additional contribution to heat exchange. As an example consider an infiltrating wall during the winter. Air that is being sucked into the leak is coming from the boundary layer which is warmer than ambient conditions, thus recovering heat that would have nominally been lost through conduction. On the inside, the jet of air will fall down along the wall and reduce the temperature drop that wall sees, lowering the conductive loss (and increasing the incoming air temperature). This effect is not included in our one-dimensional modeling.

This heat exchange effect does not scale as our other ones do. Because it is dependent on the strength of convective boundary layers it will depend on both the thermal conductivity of the wall and the temperatures involved. Because this particular effect gets larger with increasing air flow, we would expect it to be increasingly important with increasing Peclet number. This effect is limited because at a high enough flow, the air jet on the exit side of the whole will punch through the boundary and not be entrained. This would lead to a reduction in IHR. If we look at the higher Peclet numbers of Figure 5 we may be seeing this boundary layer effect in action. The CFD modeling predicts IHR almost as high as our model would if all of the wall were participating (i.e.  $f = 0.5$ ).

It is possible that the underprediction of the wall 2 IHR is caused because most of the IHR determined from the CFD is due to boundary layer effects outside of the insulating layer and not heat exchange within the insulating layer. We are currently attempting CFD simulations to probe this effect in more detail. These boundary layer effects are very strong for the two-dimensional CFD simulations because all of the wall boundary layer is involved. For a real wall with localized leaks much less of the wall boundary layer would be affected. In addition, for real buildings, the exterior natural convection boundary layer will be disrupted by any external wind driven flows. Some three-dimensional CFD simulations will be attempted in the future to examine this issue. In the simplified model this three-dimensional boundary layer effect can be incorporated into the effective participation by reducing the participation.

## **FIELD DATA**

Although we have used CFD simulations to good advantage, field measurements of the IHR effect are necessary to have a high degree of confidence in the results, especially if boundary layers are believed to contribute significantly to the effect. Currently there are full-scale experiments going on at the University of Alberta, Canada. We hope to compare our simulation results to these detailed measurements in the future.

## SUMMARY AND CONCLUSIONS

CFD simulations have been used to investigate infiltration heat recovery for four simplified insulation/flow path cases. The results of the CFD simulations showed that infiltration heat recovery can be a substantial effect and that traditional methods for estimating infiltration load may greatly over-predict by 80-95 percent at low leakage rates and by about 20 percent at high leakage rates. Whilst the CFD simulations provided useful information for comparison purposes, a simplified physical model is needed by engineers and building designers when estimating the heating and cooling loads due to infiltration. Therefore, a simplified physical model was developed and used as an engineering tool to predict the infiltration heat recovery based on the Peclet number of the flow and the fraction of the building envelope active in infiltration heat recovery.

The simplified physical model was compared to the CFD results and found to work well for cases where boundary layer effects are small. Given the uncertainty in these boundary layer effects in real buildings (due to the flows being three-dimensional and external wind driven flows disrupting natural convection boundary layer formation), it is difficult to determine if this is a serious drawback or not. There remain other uncertainties in estimating IHR for real buildings that are not included in the CFD or simplified models due to exterior wind and solar effects and the difficulty in determining the fraction of the building envelope active in IHR. Additional CFD simulations and detailed field measurements are under way that should answer some of these questions.

## NOMENCLATURE

A = building envelope total surface area ( $\text{ft}^2(\text{m}^2)$ )  
Bi = Biot number (-)  
f = participation factor  
k = thermal conductivity ( $\text{Btu/hftf}(\text{W/mK})$ )  
L = wall thickness ( $\text{ft}(\text{m})$ )  
m = infiltration mass flow rate ( $\text{lb/s}(\text{kg/s})$ )  
Pe = Peclet number (-)  
Q = energy flux through envelope ( $\text{Btu/h}(\text{W})$ )  
T = temperature (R (K))  
u = flow velocity ( $\text{ft/s}(\text{m/s})$ )  
U = wall U-value ( $\text{Btu/hft}^2(\text{W/m}^2)$ )  
 $\epsilon$  = infiltration heat exchange effectiveness or heat recovery factor (-)

## REFERENCES

- Bhattacharyya, S., Claridge, D. E. .1995. The energy impact of air leakage through insulated walls. Transactions of the ASME, Vol. 112, pp. 132-139.
- Buchanan, C.R. And Sherman, M.H. 2000. A Mathematical Model For Infiltration Heat Recovery. Proceedings 21st Aivc Annual Conference, "Innovations In Ventilation Technology". 26-29 September 2000. Air Infiltration and Ventilation Centre, Coventry U.K. LBNL-44294.
- Burns, P. J., Chow, L. C., Tien, C. L. 1977. Convection in a vertical slot filled with porous insulation. Int. J. Heat Mass Transfer, Vol. 20, pp. 919-926.

Caffey, G. E. 1979. Residential air infiltration. ASHRAE Trans., Vol. 85, pp. 41-57.

Claridge, D. E., Liu, M. 1996. The measured energy impact of infiltration in an outdoor test cell. Transactions of the ASME, Vol. 118, pp. 162-167.

Claridge, D. E., Bhattacharyya, S. 1990. The measured impact of infiltration in a test cell. J. Solar Energy Engineering, Vol. 117, pp. 167-172.

Kohonen, R., Virtanen, M. 1987. Thermal coupling of leakage flow and heating load of buildings. ASHRAE Trans., Vol. 93, pp. 2303-2318.

Mills, A. F. 1992. Heat Transfer. Irwin, Burr Ridge, Illinois

NIST. 1996. NIST estimates nationwide energy impact of air leakage in U. S. buildings. J. Research of NIST, Vol. 101, No. 3, p. 413.

Persily, A. 1982. Understanding air infiltration in homes. Report PU/CEES No. 129, Princeton University Center for Energy and Environmental Studies, February, p. 335.

Sherman, M., Matson, N. 1993. Ventilation-Energy liabilities in U.S. dwellings. Proc. 14<sup>th</sup> AVIC Conference: Energy impact of ventilation and air infiltration, Copenhagen, September 21-23, pp. 23-41. Air Infiltration and Ventilation Centre, Coventry U.K..

Versteeg, H. K., Malalasekera, W. 1995. Introduction to Computational Fluid Dynamics. Longman Scientific & Technical, New York.

Brunsell, J T. 1994. The performance of dynamic insulation in two residential buildings. Proc. 15<sup>th</sup> AIVC Conference: The Role of Ventilation. pp. 285-288. Air Infiltration and Ventilation Centre, Coventry U.K.

## APPENDIX A: SIMPLIFIED MODEL DEVELOPMENT

The simplest combined heat and mass transport model to use, treats the IHR process as a one-dimensional heat transfer in a flowing fluid. The entire process can then be characterized by a Peclet number:

$$Pe = \frac{\rho u L}{k/c_p} = \frac{mc_p}{UA} \quad (A1)$$

where the first version characterizes the fluid in terms of local properties (e.g. velocity and conductivity), while the latter characterizes it in terms of the building properties of mass flow and conductance. The fundamental equation is

$$L \cdot T' - Pe \cdot T'' = 0 \quad (A2)$$

where the marks on temperature refer to spatial derivatives. Buchanan and Sherman (2000) have developed this one dimensional model from which the infiltration heat recovery can be derived. The model is symmetric between infiltration and exfiltration and is a function of effective Peclet number ( $Pe_{inf}$  and  $Pe_{exf}$ ). The heat recovery factor is given by the sum of the infiltration and exfiltration contributions:

$$\varepsilon = \varepsilon_{inf} + \varepsilon_{exf} \quad (A3)$$

Where  $\varepsilon_{inf}$  and  $\varepsilon_{exf}$  are of the form:

$$\varepsilon_{inf} = \frac{1}{Pe_{inf}} - \frac{1}{e^{Pe_{inf}} - 1} \quad \varepsilon_{exf} = \frac{1}{Pe_{exf}} - \frac{1}{e^{Pe_{exf}} - 1} \quad (A4)$$

This model predicts that at low flows (low Peclet numbers) the infiltration heat recovery approaches unity, while at high flows it drops towards zero as the inverse Peclet number. Although these are the right physical limits, and qualitatively match the behavior found from CFD modeling (Buchanan and Sherman (2000)), it is not a good physical description of the real situation in every case. The single-fluid assumption is a good one when the time it takes for the air to traverse the envelope is long compared to the time it takes for thermal equilibrium through diffusion. When the air itself is the insulation, as is the case for the typical low-density fiber insulation, the single-fluid assumption would be good when the Peclet number is below unity.

This simple model suffers from a few limitations. For example, we know that in a real building the infiltrating and exfiltrating air does not interact with the entire thermal envelope, but only a small part. Because of the single fluid assumption, this model predicts that infiltrating air will always arrive to the internal space at the internal temperature of the boundary layer, when we know from experience that leaks do not act like that.

Since the whole-house Peclet number is typically below unity, one might think the single-fluid assumption is appropriate. Unfortunately, it is the local Peclet number that is important, so that we would need the air to be uniformly distributed through the insulating material. If it were, it would take minutes to transverse the building envelope, which would give it the time needed to reach equilibrium. For real building



leaks, however, we know that this is not the case. There is one instance where this assumption of evenly distributed air flow is reasonable. Currently houses are being designed in Scandinavia to maximize this effect by drawing all of the ventilation air through the ceiling insulation. This approach is called “dynamic  
Brunsell (1994).

## TWO-FLOW MODEL

Infiltrating and exfiltrating air does not normally pass slowly and evenly through the building envelope but is often focused in specific areas or paths. The local Peclet number within the flows paths is usually quite high, but these flow paths may be in thermal contact with areas undergoing conduction. Thus, we expand the model to consider two heat flow paths. An air path, which is moving at a high enough velocity that we can ignore conduction along the path; and a conductive path which has negligible air flow through it. We then couple them together as follows:

$$Pe \cdot L \cdot T'_{air} = Bi \cdot (T_{cond} - T_{air}) = L^2 \cdot T''_{cond} \quad (A5)$$

Because this can be thought of as a heat exchanger where the air flow is exchanging heat with the conductive flow, we have cast the coupling as a Biot number, which is normally used when the ratio of surface heat transfer to bulk heat transfer is important. The Peclet number is based on the air flow and conductivity of the whole assembly. This coupling Biot number can be thought of as the heat transfer normalized by the overall conductance. When it is zero, the two flows are independent and we get the classical, non-interacting solution. When it is very large, the two temperatures must be equal and we recover the single-fluid expressions. These coupled equations, however, are a third order differential equation where the temperature change in the air as it moves through the assembly is

$$T_{air}(x) = \Delta T \frac{e^{r_1 x/L} + \frac{r_1^2}{Bi} e^{r_2 x/L} - (1 + \frac{r_1^2}{Bi})}{(1 + \frac{Pe}{Bi} r_1) e^{r_1} - (1 + \frac{r_1^2}{Bi}) + \frac{r_1^2}{Bi} (1 - \frac{Pe}{r_1}) e^{-Bi/r_1}} \quad (A6)$$

where we define the air temperature to be zero when the x-coordinate is zero and to be  $\Delta T$  when  $x=L$ . The roots of the solution show a change in behavior when the coupling is large (compared to the square of the Peclet number):

$$r_1 = \frac{Bi}{2Pe} \cdot \left( \sqrt{1 + 4Pe^2 / Bi} - 1 \right) \quad (A7)$$

$$r_2 = -\frac{Bi}{Pe} - r_1 = -\frac{Bi}{r} \quad (A8)$$

If we evaluate the expression when the coupling is not too high, we can see that infiltrating air shows that high values of the coupling the outdoor air enters at indoor conditions, but approaches the outdoor conditions for lower values of the coupling. We can solve for the single sided efficiency

$$\epsilon_*(Pe, Bi) = \frac{1}{Pe} - \frac{(1 + \frac{r_1^2}{Bi})}{(1 + \frac{Pe}{Bi} r_1) e^{r_1} - (1 + \frac{r_1^2}{Bi}) + \frac{r_1^2}{Bi} (1 - \frac{Pe}{r_1}) e^{-Bi/r_1}} \quad (A9)$$

We can plot this function for various values of the parameters in Figures A1 and A2 that shows that the efficiency approaches the single fluid efficiency for high values of coupling and is insignificant for higher Bi.

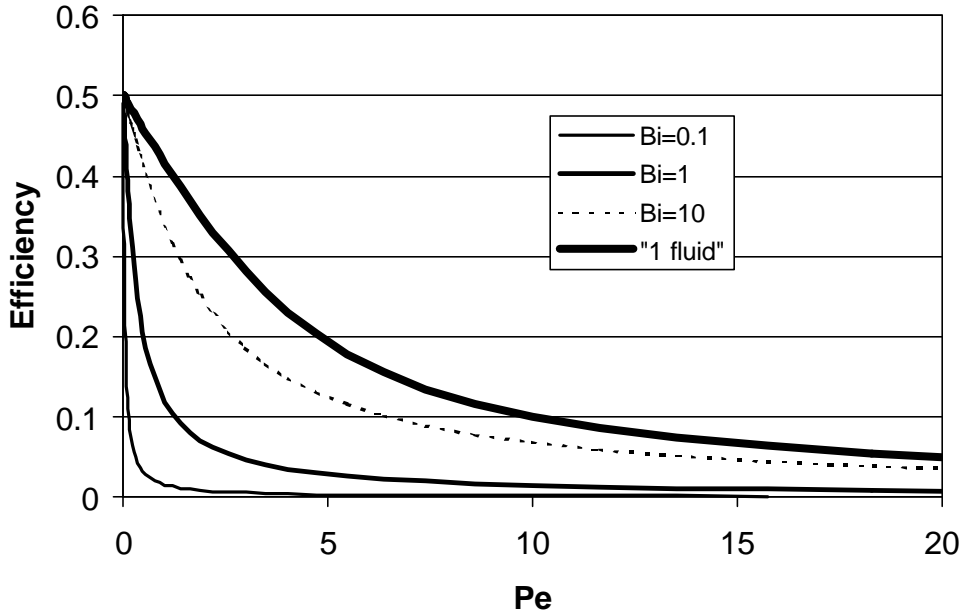

Figure A1. Single sided efficiency dependence on coupling (Bi) and infiltration rate (Pe)

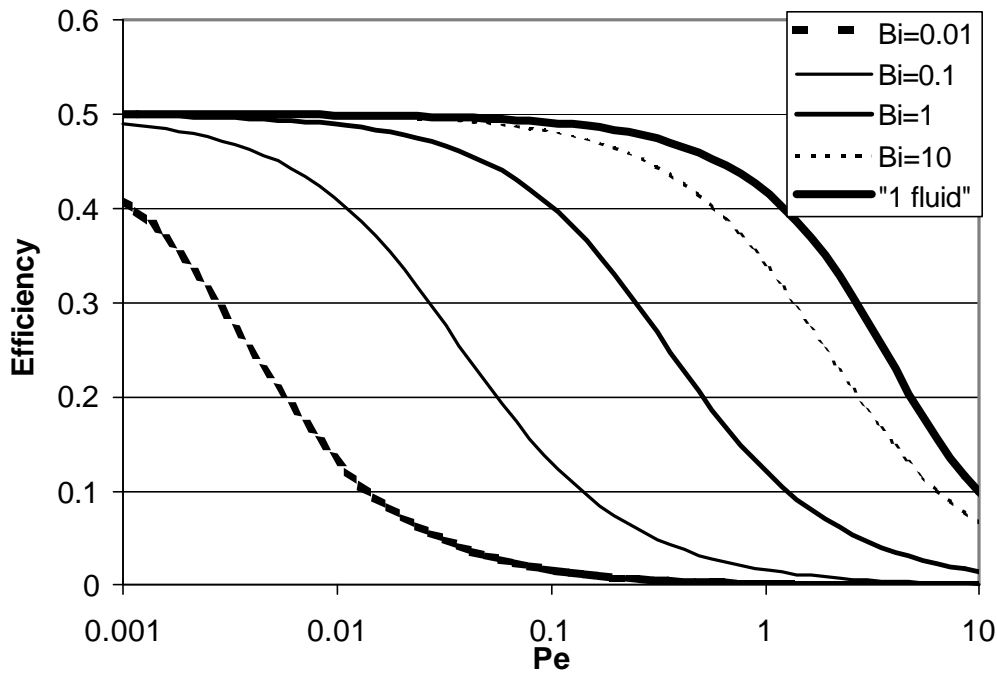

Figure A2. Single sided efficiency dependence on coupling (Bi) and infiltration rate (Pe), for low Pe.

The full solution is a rather cumbersome expression to use and given that we will never really know the value of the coupling it is tempting to use a simpler expression. We can reuse the single-fluid expression, at least approximately, if we define an effective Peclet number to account for the coupling:

$$Pe \Rightarrow Pe \cdot \left( 1 + \frac{8}{Bi} \right) \quad (A10)$$

A poorly coupled system has the same infiltration heat recovery as a single-fluid system of a higher Peclet number. While this expression is not exact, numerical analysis shows that it normally gives an error less than 0.01 in IHR and rarely gives an error above 0.02. In the vast majority of housing, the actual resistance to conduction through the envelope is supplied by air. For example, in a building with low-density fibrous insulation, the fibers themselves serve principally to keep the air from moving and therefore transporting air by convection. Rather than talk about the heat transfer coefficient between still and moving air, it is more intuitive to talk about the fraction of conducting material that is significantly involved in the IHR process.

$$f = \frac{1}{\left( 1 + \frac{8}{Bi} \right)} \quad (A11)$$

Figure A3 shows the heat recovery factor curves for four cases. In each case we assume that we are combining both infiltration and exfiltration. Two of the cases have equal values for the individual participations. The other two have unequal values for the individual ratios, but the sum of the ratios is equal to that of the corresponding curve with equal participations. Since the formulae are symmetric, either f1 or f2 could be associated with either infiltration or exfiltration. The top two curves in Figure A3 have a total effective area of 100 percent, and the bottom two curves have a total effective area of 20 percent. Actual values used for the ratios are shown in the legend.

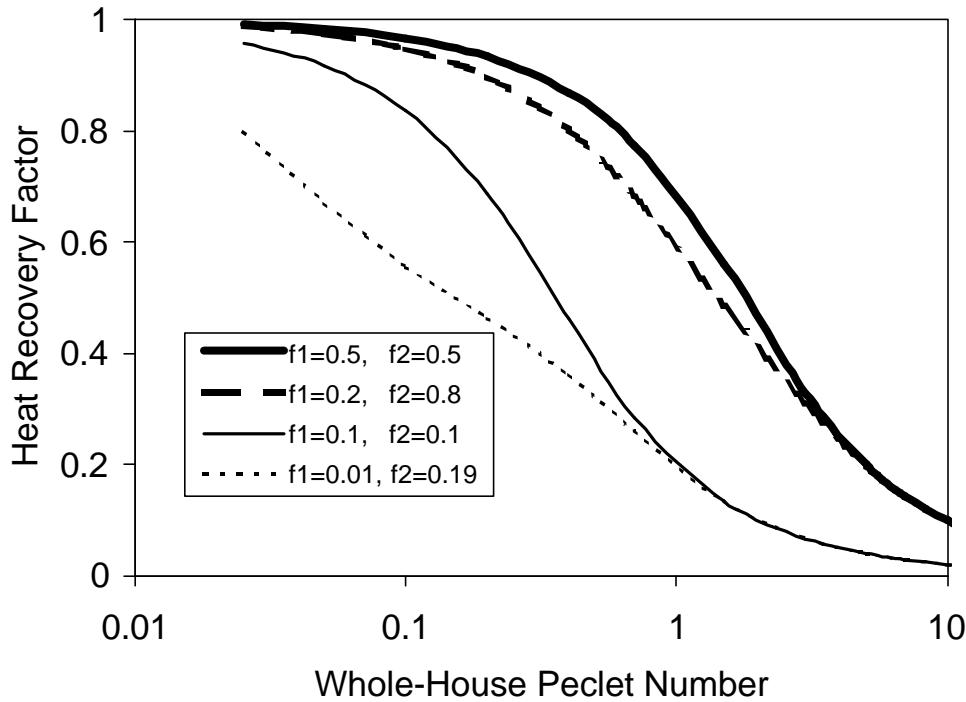

Figure A3: The combined heat recovery factor calculated with the simplified model using unequal participations. For a given sum of participations ( $f_1+f_2$ ) the heat recovery is highest when the individual ratios are equal.

The same overall behavior in the heat recovery factor is seen in all the curves. However, at higher Peclet numbers, there are small differences between curves that have the same total value for the participations but different individual values. In both comparisons, the cases with unequal ratios have a lower heat recovery than the corresponding case with equal ratios. These results indicate that for a given leakage rate heat recovery is highest when the effective area is large and the individual areas (infiltrating and exfiltrating) are equal.

### Series Leakage Paths

For a set of leaks in series, the mass flow of each leak is the same, but it can go through a different amount of thermal resistance. When adding two leaks together the thermal resistances add; similarly when adding two single-fluid leaks in series the Peclet numbers add. Following this logic, we can use a corresponding equation for series leaks to define a combined fraction:

$$f_i = \frac{\sum_{\text{series}} (UA_j)^{-1}}{\sum_{\text{series}} (f_j \cdot UA_j)^{-1}} \quad (\text{A12})$$

where we sum over the leaks in the series.

## Parallel Leakage Paths

Ostensibly this process should be performed for each independent piece of the envelope separately to find the effective Peclet number of that piece; finding its contribution to heat recovery and summing them. For local Peclet numbers much less than unity, the IHR asymptotically approaches unity, but for larger values it decreases inversely with the local Peclet number. Either of these limits makes it easy to find the combined Infiltration Heat Recovery. We can use this inverse Peclet number behavior to combine an ensemble of parallel leakage paths together. Taking the exfiltration side to be specific:

$$f_{\text{exf}} = \frac{\sum f_i \cdot UA_i}{UA} \quad (\text{A13})$$

Thus we are taking a UA-weighted average of the local fraction over all of the leaks that contribute to exfiltration. Not that the denominator includes all parts of the thermal envelope not just those undergoing exfiltration. This allows us to base our Peclet number calculations on the overall building values. Thus the sum of the infiltration and exfiltration fractions together cannot be more than unity and in general will be much less.

The effective Peclet number for exfiltration becomes,

$$Pe_{\text{exf}} = Pe / f_{\text{exf}} \quad (\text{A14})$$

There is a similar expression for infiltration. This expression will not be accurate when the system contains significant amounts of low Peclet number paths, but in most instances that will not be a problem.