

UC Irvine

UC Irvine Previously Published Works

Title

Toward terabyte two-photon 3D disk

Permalink

<https://escholarship.org/uc/item/22x1z1m0>

Journal

Optics Express, 15(19)

ISSN

1094-4087

Authors

Walker, Ed
Dvornikov, Alexander
Coblentz, Ken
et al.

Publication Date

2007

DOI

10.1364/OE.15.012264

Peer reviewed

Toward terabyte two-photon 3D disk

Ed Walker^{1*}, Alexander Dvornikov¹, Ken Coblentz¹, Sadik Esener², and Peter Rentzepis³

¹Call/Recall, Inc., 6160 Lusk Blvd., Suite C-206, San Diego CA, 92121

²Department of ECE, University of California, San Diego, La Jolla, CA 92093

³Department of Chemistry ECE, University of California, Irvine, CA 92617

*Corresponding author ewalker@call-recall.com

<http://www.call-recall.com>

Abstract: 253GB have been recorded in 300 layers inside the volume of one of our two-photon 3D disks. Each layer contains the equivalent of CD layer bit-densities recorded with a 0.5NA objective lens. A new 1.0NA lens with the desirable first order optical properties of long working distance and small diameter, 1.2mm and 4.5mm, and a self-compensating spherical aberration correction mechanism is designed, manufactured and integrated into our single beam two-photon 3D automated recording system. Experimental data obtained with the 1.0NA lens are presented. The resulting bit densities obtained with our new high-performance liquid immersion singlet (LIS) objective lens indicate that our system is capable of full disk recordings from 0.5 to 1 TB within a standard optical disk form factor of 120mm x 1.2mm thick utilizing our very stable and efficient materials. A compact optical head based on our new objective lens capable of TB storage is described.

©2007 Optical Society of America

OCIS codes: (210.0210) Optical data storage; (210.2860)volumetric optical data storage; (160.2900)optical storage materials; (210.4810)optical storage-recording materials; (210.4680)optical memories; (000.1570)chemistry; (220.3620)lens system design; (220.1000)aberration compensation; two photon absorption

References and links

1. D. A. Parthenopoulos and P. M. Rentzepis, "Three-Dimensional Optical Storage Memory," *Science* **245**, 843-845 (1989).
2. A. S. Dvornikov, I. Cokgor, M. Wang, F. B. McCormick, S. E. Esener and P. M. Rentzepis, "Materials and Systems for Two Photon 3D ROM Device," *IEEE TCPMT - Part A* **20**, 200-212 (1997).
3. Y. Liang, A. S. Dvornikov and P. M. Rentzepis, "Synthesis of novel photochromic fluorescing 2-indolylfulgimides," *Tetrahedron Lett.* **40**, 8067-8069 (1999).
4. A. S. Dvornikov, T. D. Milster, E. Walker, and P. M. Rentzepis, "Two-photon 3D high-density optical storage media: optical properties, temperature, radiation, and fatigue studies," *Proc. SPIE* **6308**, 630802 (2006).
5. M. Akiba, A. S. Dvornikov, and P. M. Rentzepis, "Formation of oxazine dye by photochemical reaction of N-acyl oxazine derivatives," *J. Photochem. Photobiol. A* **190**, 69-76 (2007).
6. A. S. Dvornikov, Y. Liang and P. M. Rentzepis, "Dependence of the Fluorescence of a Composite Photochromic Molecule on a Structure and Viscosity," *J. Mater. Chem.* **15**, 1072-1078 (2005).
7. Yi Zhang, A. Dvornikov, Y. Taketomi, E. P. Walker, P. Rentzepis, and S. Esener, "Towards ultra high density multi-layer disk recording by two-photon absorption," *Proc. SPIE* **5362**, 1-9 (2004).
8. A. S. Dvornikov, Y. C. Liang, and P. M. Rentzepis, "Ultra high density non-destructive readout, rewritable molecular memory," *Res. Chem. Intermed.* **30**, 545-561 (2004).
9. A. S. Dvornikov, Y. Liang, C. S. Cruse, and P. M. Rentzepis, "Spectroscopy and kinetics of a molecular memory with non-destructive readout for use in 2D and 3D storage systems," *J. Phys. Chem. B* **108**, 8652-8658 (2004).
10. E. P. Walker and T. D. Milster, "Beam shaping for optical data storage," in *Laser Beam Shaping Applications*, F. M. Dickey, S. C. Holswade, D. L. Shealy, eds., (CRC Press Taylor & Francis Group, 2006) 157-181.
11. H. Zhang, A. Dvornikov, E. Walker, N. Kim, F. B. McCormick, "Single-beam two-photon-recorded monolithic multi-layer optical disks," *Proc. SPIE* **4090**, 174-178 (2000).

12. E. Walker, W. Feng, Y. Zhang, H. Zhang, F. McCormick, and S. Esener, "3-D parallel readout in a 3-D multilayer optical data storage system," ISOM/ODS meeting Hawaii (2002) paper # TuB4.
13. E. P. Walker, J Duparre, H. Zhang, W Feng, Y. Zhang, A. S. Dvornikov, "Spherical aberration correction for 2-photon recorded monolithic multilayer optical data storage," ODS 2001 Proc. SPIE. (2001).
14. E Walker, Y. Taketomi, Y. Zhang, "Optical Storage with Ultra High Storage Capacity," U.S. Patent Pending, Submission No. 10/868,742, filed December 23, 2004.
15. S. Park, T. D. Milster, T. M. Miller, J. Butz and W. Bletscher, "Master and Slave Beam Servo Technique for Volumetric Bit-Wise Optical Data Storage," Jpn. J. Appl. Phys. **44**, 3442-3444 (2005).
16. E. Walker, X. Zheng, F. B. McCormick, H. Zhang, N. Kim, J. Costa, and A. Dvornikov, "Servo error signal generation for two-photon-recorded monolithic multilayer optical data storage," Proc. SPIE **4090**, 179-184 (2000).

1. Introduction

Call/Recall, Inc. has developed a series of efficient and stable two-photon 3D recording materials using photochromic fluorescence compounds that are well suited as media for 3D optical storage memory devices [1-9]. This paper summarizes some of the recent advances made at Call/Recall in optical volumetric media and systems. The media consist of photochromic organic molecules, designed and synthesized by us, that change their structure upon two-photon excitation at the absorption band of the molecule using a virtual intermediate excited state, as shown in the energy level diagram of Fig. 1 rather than one photon process or stepwise two photon through allowed intermediate states. The unwritten photochromic molecules are uniformly dispersed in a polymer matrix enabling the disks to be of low cost and formed by either compression or injection molding.

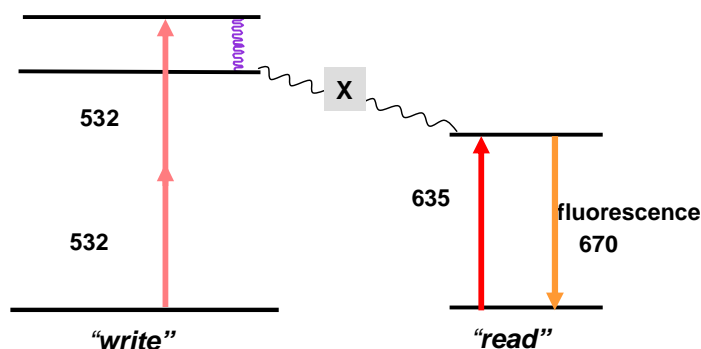

Fig. 1. energy band diagram picture of the single laser beam two-photon 3D recording.

A 3D bit is recorded in the volume of the media only at regions with sufficient temporal and spatial photon density. The recording efficiency depends on several factors including the two-photon absorption cross section of the unwritten form, and the temporal and spatial photon density inside the media. High temporal photon density is achieved by means of picosecond laser systems having several nJ/pulse energy and high spatial photon density. These are achieved through the use of a single tightly focused laser beam for recording using objective lenses having numerical apertures (NA) in the 0.5-1.0 range. Recording occurs only within a small volume around the focus of the objective lens due to the two-photon I^2 dependence. Where the irradiance, I , is proportional to the 3D point spread function of the objective lens and input recording laser wavefront [10]. The recording response of the material follows the square of the optical system point spread function (PSF). The recorded bits are read by fluorescence that is emitted when they are excited by a 635nm red laser diode in a single-photon absorption process within the written spot volume.

2. Materials

Currently we are utilizing 532nm wavelength laser pulses for two-photon recording that require materials with high two-photon absorption crosssection at the 266nm writing wavelength. In addition, it is important for the photochromic materials to have high solubility in the polymer host in order to achieve the concentrations required for high writing efficiency of 100 MB/sec and more.

Some of the WORM (Write Once Read Many) materials that we utilized to record and access information in 3D format were composed of two components: a photoacid generator (PAG) and a dye precursor (DP). Both were uniformly dispersed in a polymer host such as polymethyl methacrylate (PMMA) [3]. A few other molecules were added, sometimes, in order to improve the optical and write/read characteristics of the storage media.

The PAGs used are light sensitive compounds that are thermally stable, however when excited with light of the appropriate wavelength, two 532 nm photons in this case, undergoes photochemical reaction that results in the generation of acid [3, 4].

The dye precursor molecules are thermally stable, colorless non-fluorescing molecules, that react with the photo-induced acid and are transformed to strongly fluorescent dye molecules with absorption maximum at 650 nm. A compact 650 nm CW diode laser is used to excite the dye and induce the dye to fluoresce. The readout fluorescence is detected by a photodiode and used as the 1 in the computer code, while the non-fluorescing bits are used as zero. The schematic representation of the write and read process of the WORM material and the absorption and fluorescence spectra of the “write” and “read” forms are shown in Fig. 2.

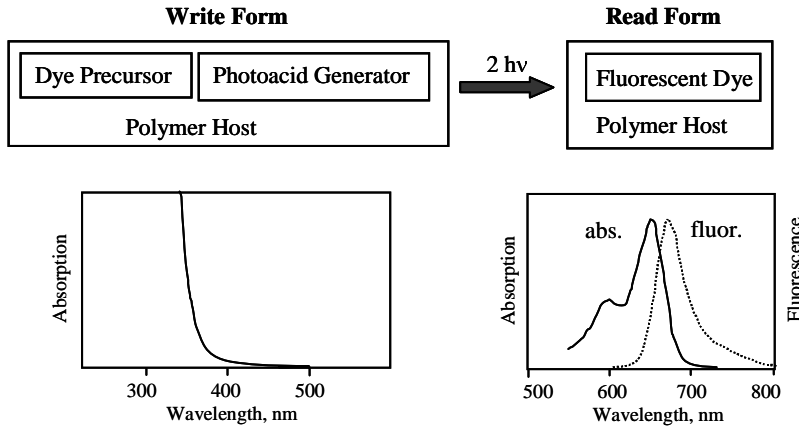

Fig. 2. Volumetric storage. WORM, media composition and spectra.

The “write”, or unwritten, form of the material is composed of a colorless dye precursor and PAG molecules uniformly dispersed in a transparent polymer matrix in the form of a 3 D disk. The PAG molecules absorb below 400 nm and therefore they are not sensitive to the ambient light making this material suitable for operation in room light conditions. However, prolonged exposure to room light (days) may develop background color due to weakening near UV emitted by typical fluorescent lights. The “write” form is thermally stable and our tests show that the materials can be stored in the dark for years without any change in their properties.

Two-photon excitation of the “write” form 532 nm laser pulses generates colored spots (bits) of the “read” form inside the volume of the disk where the laser beam was focused. The “read” form emits strong fluorescence, when excited with 630-650 nm light, which is used to access the stored information. The “read” form is very stable and more than 10^6 times readout cycles have been performed without noticeable decrease in signal strength. The “read” form is

also thermally stable and the written information may be stored for years without noticeable decay [4].

We have used several photoacid generators, to assist in the writing process of WORM devices, including onium salts such as commercially available triarylsulfonium salts, shown in Fig. 3 and others specially designed and synthesized in our laboratory. Several dye precursors that generate Rhodamine and Oxazine type fluorescent dyes have been used by us and we have developed new ones with optimum properties [3, 5].

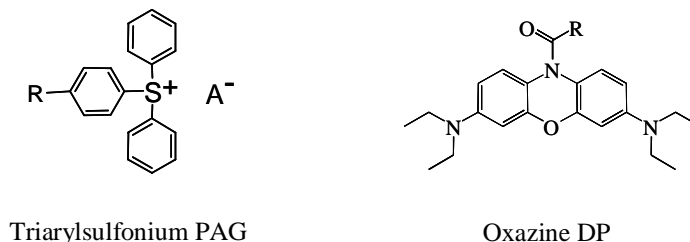

Fig. 3. Typical photoacid generators (PAG) used in the recording process.

To fabricate the WORM disk the PAG and DP were dissolved in methyl methacrylate monomer and the solution was filtered through 0.02 mm filter to remove solid particles. The filtered solution was placed into a specially designed polymerization cell and the dissolved oxygen was removed by bubbling Ar or vacuum. The cell was thereafter sealed and placed in a thermal bath for polymerization. After polymerization was completed, the polymer bulk that contained the storage media was shaped to a disk and polished to optical quality. Because polishing is a very time consuming and mass production requires molding process, we have also designed special molds and used compression molding for disk fabrication that doesn't require post polishing. Two-photon optical storage disk sizes varying from 25mm to 120mm diameter and 2mm to 10mm thickness have been fabricated, Fig. 4, and utilized for data storage.



Fig. 4. Polymerization cell, compression mold and fabricated WORM disk.

Other types of optical storage materials that we have used are rewritable materials where the information can be written, accessed, erased and rewritten again. For this purpose we have designed and synthesized fluorescing photochromic molecules with thermally stable forms that allow us to store and access written information for long, years, period of time. One of the rewritable materials belongs to the class of fluorescent fulgides and fulgimides [3] developed in our laboratory. Their general structure is shown in Fig. 5.

These photochromic molecules in Fig 5 exhibit two thermally stable isomeric forms that can be reversibly transformed from one form to another by light excitation of the appropriate wavelength. One form, E, is colorless with absorption maximum at 350-400 nm and does not fluoresce. When exposed to UV light it undergoes photochemical transformation to the colored C form that has its absorption maximum at 530-550 nm and emits fluorescence at ~650 nm with quantum yield of up to 20%. The C form can revert back to E form by exposure to visible light. The coloration-bleaching process can be cycled many times, in

the “Driver” absorbs, the 650 nm reading light does not induce any photochromic reaction in the “Driver” component making the readout process truly nondestructive [8,9].

3. Systems

Figure 7 shows the layout of our single-beam two-photon recording and readout spin-stand system. The system includes a readout path and detector for recording evaluation. This experimental 2-photon recording system allows testing of materials/media and system components and forms the basis of a commercial system. Experimentally, we use a HighQLaser system Picotrain series 532nm Nd:Vanadate laser which emits pulses with 6.5ps pulse width ~ 10 nJ/pulse energy at a repetition rate of 76MHz. An Isomet Acoustic-Optic modulator modulates the recording laser in the desired data pattern controlled through a standard LabView interface. An automated computer program controls the tracking/layer addressing, objective lens movements and motor speed control. The recording laser beam passes through a beam expander on its way to the objective lens assembly that focuses the recording laser on the media inside the volume of the spinning disk where data is recorded. Several motors are available to use to spin our media including a Seagull high precision air-bearing spindle, Chiba motor, and standard optical disk motors. After recording, a 635nm CW BlueSky circulator diode operating at <0.5 mW is used to excite fluorescence from the recorded data bits. The fluorescence is then picked up by the same objective lens and focused onto a detector such as a Hamamatsu R7400U PMT, with a $50\mu\text{m}$ confocal pinhole used to decrease layer and tracking crosstalk from adjacent tracks and layers, or custom built cmos detector arrays that we had previously developed [12]. Using our 0.5NA objective lens designed, built, and integrated into our automated recording teststand for multi-layer media [13], we were able to fully record 253GB of test patterns in one of our two-photon 3D disks.

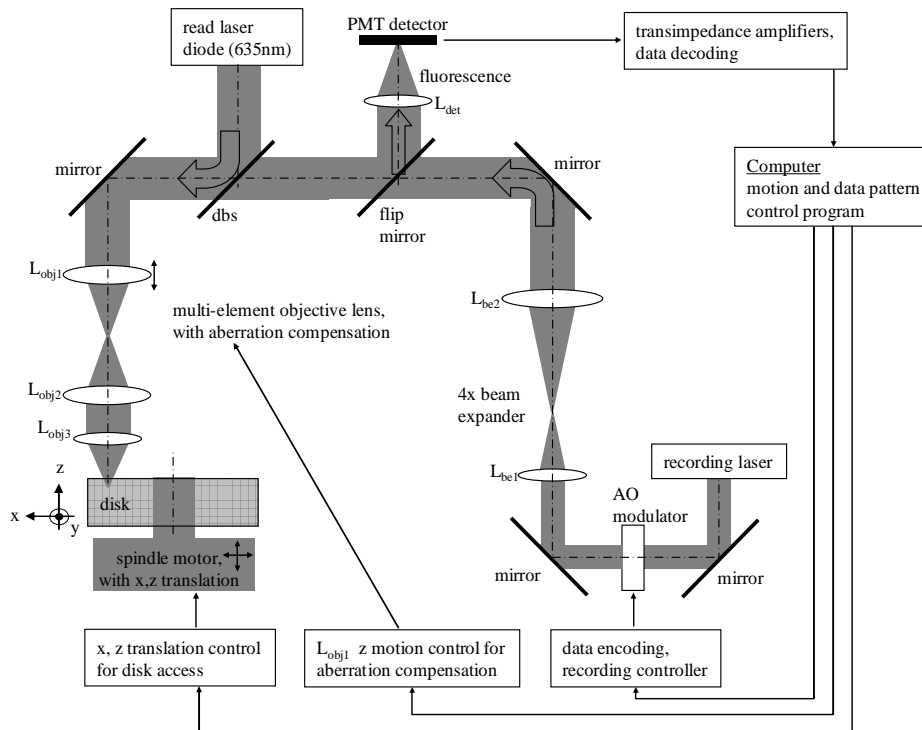

Fig. 7. Single-beam two-photon recording system diagram

4. Experiment

Utilizing the progress that we have made on materials and systems [1-9], we have recorded a total of 253GB in a 102mm diameter 4.5mm thick disk having a track pitch of $1.4\mu\text{m}$ and layer spacing of $15\mu\text{m}$, using the previously developed 0.5NA objective lens. This achievement is followed by full disk recording of $\sim 1\text{TB}$ or more in a 120mm diameter 1.2mm thick disk having $0.8\mu\text{m}$ track pitch and layer spacing of $5\mu\text{m}$ and using a new 1.0NA objective lens. This is the first time in the world, to the author's knowledge, that a two-photon 3-d disk is being fully recorded and reported, especially at such high bit density. Figure 8 shows the layout of track capacities and zonal capacities for a zoned CLV (constant linear velocity) approach where within each zone the bit pitch along the track varies from $0.7\mu\text{m}$ to $1\mu\text{m}/\text{bit}$, full CLV will be implemented later this year. Figure 9 shows a photograph of the 102mm diameter disk being recorded. Figure 9 shows the green background of the 532nm recording laser (HighQLaser picoTrain series) during a track recording in Zone 2 and during a track recording in Zone 5 where the energy to record a bit is $500\text{nJ}/\text{bit}$ for the 0.5NA objective lens. Each layer in the 253GB recording has the equivalent capacity of a CD.

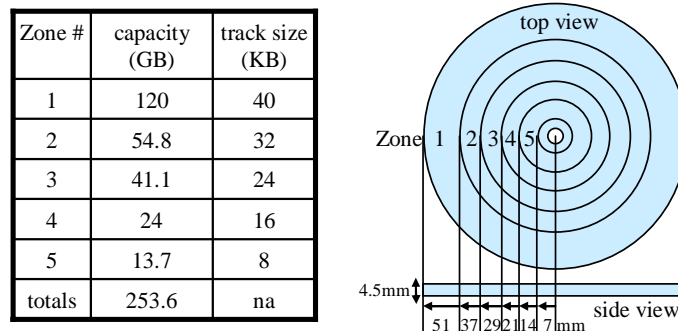

Fig. 8. Layout of tracks and zones in table form (a) and pictorial layout (b) for a zoned CLV (constant linear velocity) approach to maximize layer capacity in a 102mm diameter disk recording having a capacity of $\sim 253\text{GB}$ with a track pitch of $1.4\mu\text{m}$, layer pitch $15\mu\text{m}$, and 300 layers.

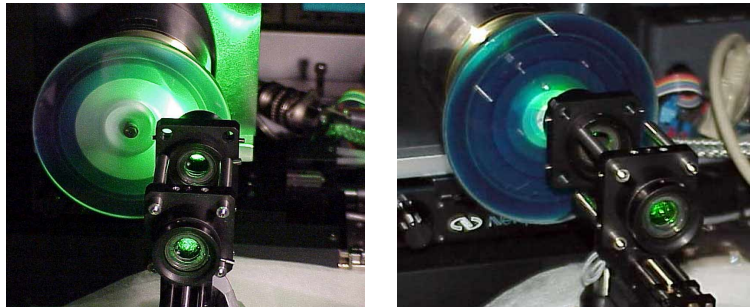

Fig. 9. Photograph of 102mm diameter disk Zone 2 during recording and Zone 5 during recording.

Figure 10(a) shows a typical xy confocal microscope scan of test tracks recorded in the 253GB recording of the 102mm diameter 4.5mm thick disk at an initial recording data rate of 2.5Mbit/s . The data recorded is a series of single tone pulse position modulated, ppm, test tracks of $2\text{T} \rightarrow 8\text{T}$ patterns at a recording energy of $500\text{nJ}/\text{bit}$ of recording energy with the 0.5NA objective lens. The readout signal quality of the 2T and 3T test patterns were found to have a CNR of $>40\text{dB}$ measured in a 3KHz rbw at readout data rates of 2.5Mbit/s . Figure 10(b) shows a typical xz confocal microscope scan of ~ 60 layers while Fig. 10(c) shows a zoomed in region of 24 layers separated by $15\mu\text{m}$. Testing at 10Mbit/s recording and readout

data rates have shown similar results, and testing at even higher single channel data rates of 25-100Mbit/s is in progress.

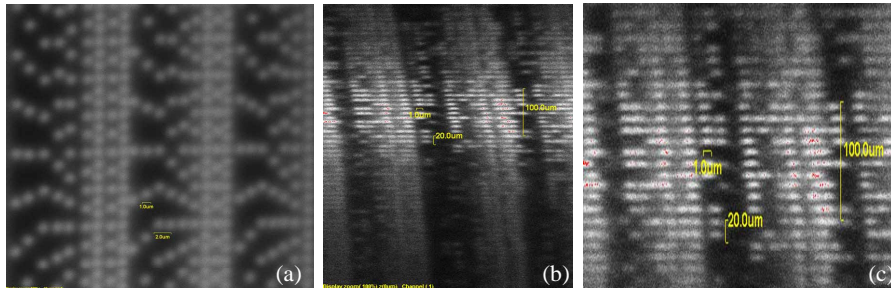

Fig. 10. (a). typical xy confocal microscope scan throughout the different layers (b) xz confocal microscope scan of ~60 layers (c) zoomed in region of 24 layer group, showing a track pitch of 1.4 μ m and layer spacing of 15 μ m recorded in the 102mm diameter disk.

5. Liquid Immersion Singlet (LIS) Objective lens and recording tests with LIS

Figure 11 shows a novel type of objective lens technology for a liquid immersion singlet (LIS) that uses a liquid interface between the lens and the spinning disk where the liquid is contained by a thin polyurethane membrane that is in contact with the lens on one side and in contact with the spinning disk on the other [14].

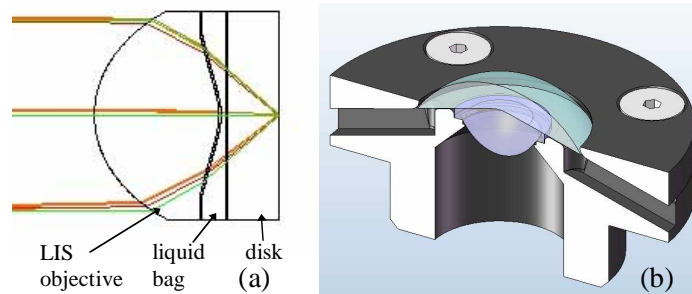

Fig. 11. (a). Zemax layout of Liquid Immersion Singlet (LIS) Objective lens, (b) SolidWorks design of prototype package for testing.

This lens possesses a numerical aperture (NA) of 1.0 and a working distance of 1.2mm. Fifteen annealed and fifteen non-annealed LIS objective lenses were received from AGC Micro Glass Co., Ltd. in early February 2007. The polyurethane membrane is composed of commercially available materials from Polyzen Inc. and Pacrim Inc and is typically 1-2mil, (25-50 μ m), thick that takes away ~100 μ m of the 1.286mm working distance of the LIS. The liquid used inside the polyurethane membrane is a commercially available index matching optical liquid from Cargille Laboratories that was modeled in Zemax. Figure 12 shows the package of 15 annealed samples and a lens integrated into a test fixture for testing in the recording system. The volume of the liquid bag is adjusted for the layer addressing function to allow access inside the disk volume without any change in spherical aberration. We are currently investigating passive and active liquid bag thickness control. With passive thickness control the bag is compressed with the result being a larger surface area in contact with the spinning disk when focused deep inside the disk. With active thickness control the liquid volume is hydraulically actuated where the liquid is pumped in and out to a reservoir and maintains a more controlled membrane surface area contact where maximum surface area is in contact when focused deep inside the disk and minimal contact when focused closer to the surface of the disk. The LIS has been integrated into the recording system for experimental testing to verify bit size and recording data rate increase expected from theory. With the

increase in numerical aperture (NA), from 0.5NA to 1.0NA a 16x improvement in recording speed is expected that will allow an increase in the single channel recording speed as well as improved recording energy efficiency. With recently developed more sensitive materials possessing higher two-photon cross section it is anticipated to be testing at 50-75Mbit/s data rate, on a single recording data channel. Recording results at 15mbit/s with recording energy per bit of 50nJ using existing hardware have shown very good results as indicated in Fig. 13. Being able to record bits at 50nJ/bit with projected recording at nJ levels later this year will open up a whole new class of recording laser systems that possess very desirable characteristics in terms of cost and package. Capacity calculations indicate that the 5 micron layer spacing and 0.8 track pitch enables DVD layer capacity/density that will provide >1 TB with ~200 layers in a disk of 1.06mm disk thickness that is within the 1.2mm working distance of the LIS. From Fig. 13 it is observed that the track pitch and layer pitch has room to be squeezed further to allow recordings at densities >1 TB. The LIS architecture is being designed and experimentally tested to maintain backward compatibility with existing high definition disk formats such as Blu-Ray and HD-DVD that could extend the optical storage roadmap.

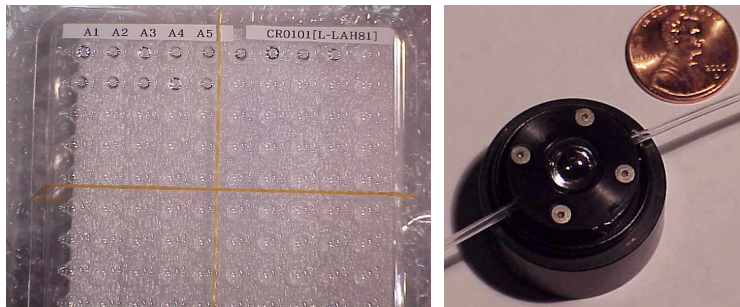

Fig. 12. Photo of received lenses from AGC Micro Glass Co., Ltd. and initial LIS laboratory assembly for testing in the recording system.

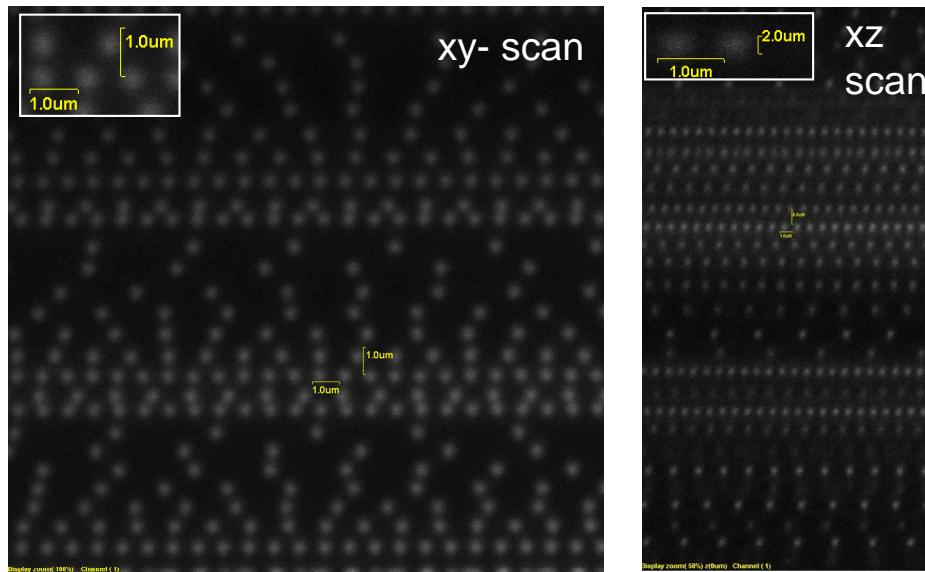

Fig. 13. Confocal microscope image showing a single layer XY scan of 3D data bits recorded with 50nJ/bit of recording energy within a 75layer group recorded at 15MHz data rate, ~5.5m/s linear velocity, track pitch of 0.8 μ m, showing bit dimension ~0.5 μ m as expected from the 1.0NA of the LIS. Multiple layer XZ scan showing 30 layers observed with the confocal microscope recorded at 15MHz data rate with layer spacing of ~4 μ m showing bit volumetric dimensions of ~0.5 x 0.5 x 2 μ m as expected.

5.1 Compact Optical Head system design

A compact optical head is designed in Zemax including dichroic beam splitters (DBS), diffractive optical elements (DOE), the LIS, and disk. Figure 14 shows a compact two-photon 3D Zemax optical head design layout showing a 4mm scale bar that illustrates just how small the head could be allowing further drive development along a traditional optical drive approach for random access where the optical head is moved radially across the disk. Figure 14 also indicates the recording, readout, and fluorescence paths. The DBS are used for directing the different wavelengths in the system and this particular architecture is chosen to minimize the cost on the DBS's as DBS coatings are less expensive and easier to manufacture when reflecting shorter wavelength's and transmitting longer wavelengths. The DOE's are used to precompensate and correct for the spherochromatism of the LIS away from the 532nm design wavelength and maintain parfocal performance of the different colors at the same layer in the disk. The DOE's are within manufacturing capabilities of several vendors and could be rather inexpensive in large quantities. The lens used to focus the fluorescence to the detector is a low cost injection molded cots lens from LightPath technologies (Geltech). Focus and tracking servos are presently being designed into the compact optical head based upon previous methods developed for generation, feedback, and actuation of the focus and tracking error signals utilizing standard voice coil type actuators [15, 16]. Also being considered as an alternative to the standard voice coil actuator for controlling the objective lens axial position is to control the fluid volume of the LIS with the focus error signal as a fluid volume driver for the high speed, small fluidic volume, small distance deviations associated with following a data layer. Layer addressing is implemented by controlling fluid volumes in increments corresponding to layer separations inside the spinning disk.

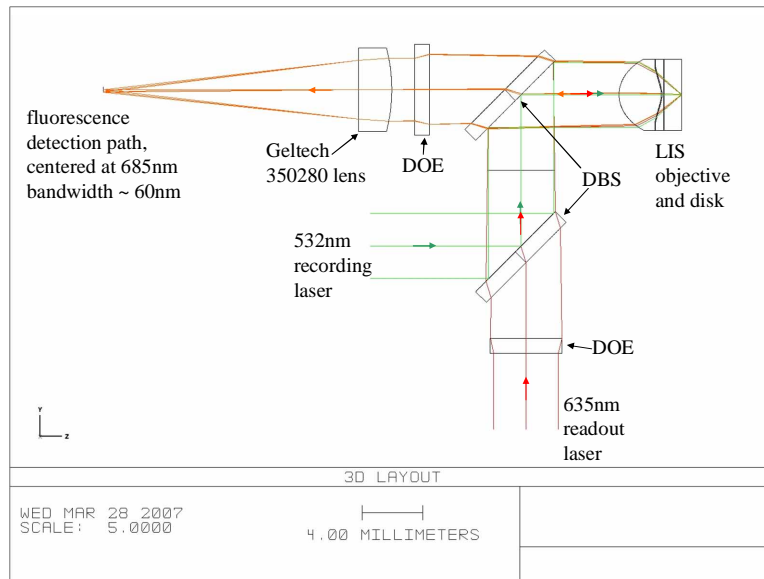

Fig. 14. Zemax design layout of compact two-photon 3D optical head indicating the recording, readout, and detection paths

Figure 15 shows the on-axis and ± 0.5 deg field of view wavefront aberration diagrams from Zemax of the compact optical head design indicating diffraction limited performance for the 532nm recording path, Fig. 15(a), showing a peak-to-valley- wavefront error of $\sim \lambda/100$, and the 635nm readout path showing a peak-to-valley- wavefront error of $\sim \lambda/10$, Fig. 15(b), and Fig. 15(c) the fluorescence path that has a bandwidth of ~ 70 nm centered at 680nm showing a peak-to-valley- wavefront error of $\sim \lambda/2$.

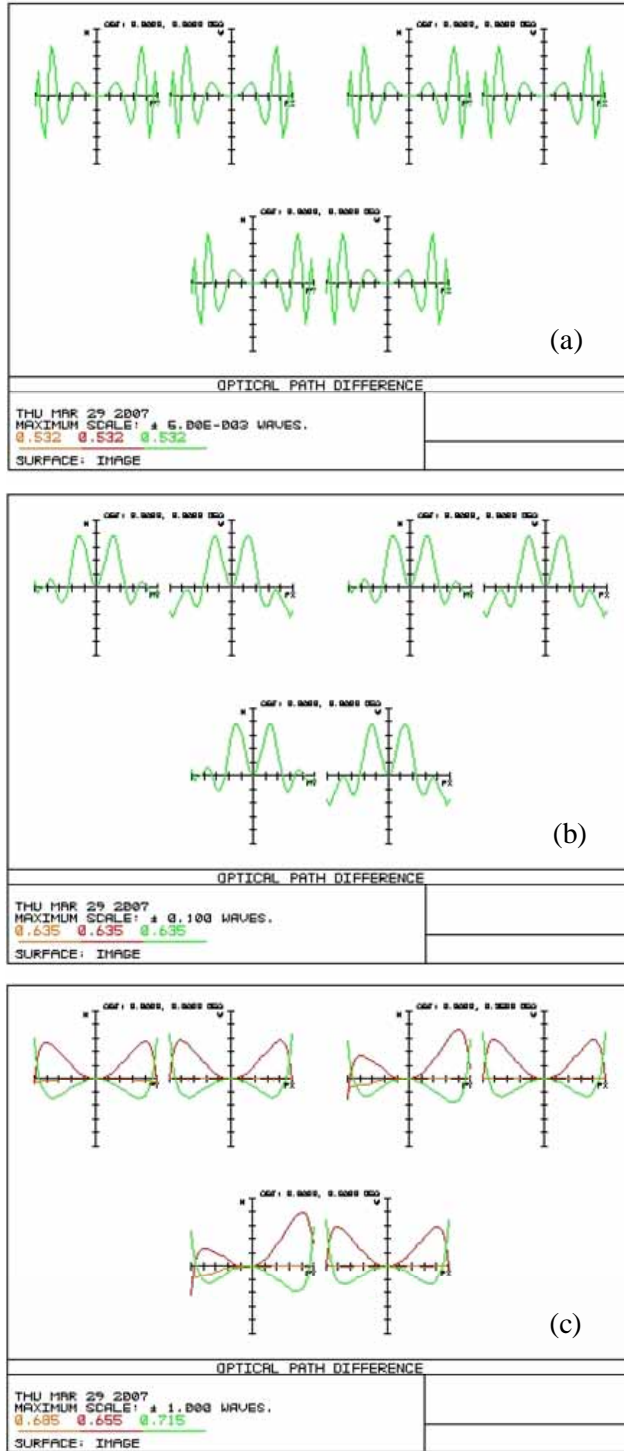

Fig. 15. On-axis and $\pm 0.5^\circ$ field of view wavefront aberration diagrams from Zemax of the compact optical head design indicating diffraction limited performance for the (a) recording, 532nm path, (b) the readout, 635nm path, and (c) the fluorescence path.

6. Conclusion

Considerable progress has been made fabricating large, 120 mm diameter WORM disks to be used in high capacity information storage that demonstrate capability to store 300 GB to 1TB level per disk. An advanced objective lens the LIS objective 1.0NA is integrated into the recording test-stand and initial experiments show at least a 10x increase in recording speed with excellent experimental results observed at 15Mbit/s data rate, and will be tested at 16x and higher in anticipation of single channel recording and readout data rates in the 50-75Mbit/s data rate with recently developed more sensitive materials. An array format, common to every high-end data storage device, is under development to be used to achieve > 300Mbit/s in future prototypes. The very first full disk recording of 253GB has been performed in two-photon 3-d optical data storage materials in anticipation of recording even more on the next disk, as demonstrated by the bit densities shown in the experimental recordings of the LIS at recording energies of 50nJ per bit that is projected to be at nJ/bit recording energy per bit very soon. Full disk recordings of 750GB and 1TB are planned out for this year.

Acknowledgments

This effort was partially supported as part of the High Density Optical Data Storage program, sponsored by the US Army Research Office under Contract DAAD19-03-C-0136. MDA sponsorship under Contract W9113M-04-C-0086 is gratefully acknowledged. The US government is authorized to reproduce and distribute reprints for governmental purposes notwithstanding any copyright annotation thereon.

We are very grateful to Yoshi Taketomi and Yi Zhang for valuable help with the optical system and to David Stroup for valuable help with the automated recording software/hardware.

