

UC Davis

Recent Work

Title

Reflective Cracking Study: First-level Report on HVS Testing on Section 591RF - 45 mm
MAC15TR-GOverlay

Permalink

<https://escholarship.org/uc/item/41j6z46g>

Authors

Jones, David
Wu, R.
Harvey, John T

Publication Date

2008-10-01

Peer reviewed

July 2007

Research Report: UCPRC-RR-2007-04

Reflective Cracking Study: First-Level Report on HVS Testing on Section 591RF — 45 mm MAC15TR-G Overlay

Authors:

D. Jones, R Wu and J. Harvey

Partnered Pavement Research Program (PPRC) Contract Strategic Plan Element 4.10:
Development of Improved Rehabilitation Designs for Reflective Cracking

PREPARED FOR:

California Department of Transportation
Division of Research and Innovation
Office of Roadway Research

PREPARED BY:

University of California
Pavement Research Center
UC Davis, UC Berkeley



DOCUMENT RETRIEVAL PAGE		Research Report: UCPRC-RR-2007-04							
Title: Reflective Cracking Study: First-level Report on HVS Testing on Section 591RF - 45 mm MAC15TR-G Overlay									
Authors: D. Jones, R Wu and J. Harvey									
Prepared for: Caltrans		FHWA No: CA091073K		Date: July 2007					
Contract No: 65A0172		Client Reference No: SPE 4.10		Status: Stage 6, Approved Version					
<p>Abstract: This report is the sixth in a series of first-level analysis reports that describe the results of HVS testing on a full-scale experiment being performed at the Richmond Field Station (RFS) to validate Caltrans overlay strategies for the rehabilitation of cracked asphalt concrete. It describes the results of the sixth HVS reflective cracking testing section, designated 591RF, carried out on a 45-mm half-thickness MAC15TR gap-graded overlay with 15 percent recycled tire rubber. The test forms part of Partnered Pavement Research Center Strategic Plan Element 4.10: "Development of Improved Rehabilitation Designs for Reflective Cracking."</p> <p>HVS trafficking on the section commenced on January 10, 2007, and was completed on June 25, 2007. A total of 2,554,335 load repetitions, equating to 90.8 million ESALs and a Traffic Index of 15.4, was applied during this period. Temperatures were maintained at 20°C±4°C for the first one million repetitions, then at 15°C±4°C for the remainder of the test. Caltrans and the UCPRC jointly agreed to halt HVS trafficking at this point as there was no indication of the failure criteria being reached in the near future. Findings and observations based on the data collected during this HVS study include:</p> <ul style="list-style-type: none"> • No cracking was observed on the section. This implies that the MAC15TR overlay successfully prevented reflective cracking. • The average deformation and average maximum rut depth across the entire test section was just 1.7 mm and 4.6 mm, respectively, considerably lower than the failure criterion of 12.5 mm. The maximum rut depth measured was 8.2 mm. The MAC15TR overlay thus did not appear susceptible to rutting at the temperature range under which the test was conducted. • Ratios of final-to-initial elastic surface deflections under a 60 kN wheel load increased by between 3.7 and 4.0 times along the length of the section. The ratios for in-depth deflections show that damage increased at all depths in the pavement structure by the end of trafficking. Loss of stiffness was highest in the area of most severe cracking in the underlying DGAC layer. • Analysis of surface profile and in-depth permanent deformation measurements indicates that most of the permanent deformation (55 and 60 percent) occurred in the asphalt-bound surfacing layers (overlay and cracked DGAC) with the remainder mostly in the aggregate base layer. <p>No recommendations as to the use of the modified binders in overlay mixes are made at this time. These recommendations will be included in the second-level analysis report, which will be prepared and submitted on completion of all HVS and laboratory testing.</p>									
<p>Keywords: Reflective cracking, overlay, modified binder, HVS test, MB Road</p>									
<p>Proposals for implementation:</p>									
<p>Related documents: UCPRC-RR-2005-03, RR-2006-04, RR-2006-05, RR-2006-06, RR-2006-07, RR-2006-12</p>									
<p>Signatures:</p> <table border="1" style="width: 100%; border-collapse: collapse;"> <tr> <td style="width: 20%; vertical-align: top;">D. Jones 1st Author</td> <td style="width: 20%; vertical-align: top;">J Harvey Technical Review</td> <td style="width: 20%; vertical-align: top;">D. Spinner Editor</td> <td style="width: 20%; vertical-align: top;">J. Harvey Principal Investigator</td> <td style="width: 20%; vertical-align: top;">M Samadian Caltrans Contract Manager</td> </tr> </table>					D. Jones 1st Author	J Harvey Technical Review	D. Spinner Editor	J. Harvey Principal Investigator	M Samadian Caltrans Contract Manager
D. Jones 1st Author	J Harvey Technical Review	D. Spinner Editor	J. Harvey Principal Investigator	M Samadian Caltrans Contract Manager					

DISCLAIMER

The contents of this report reflect the views of the authors who are responsible for the facts and accuracy of the data presented herein. The contents do not necessarily reflect the official views or policies of the State of California or the Federal Highway Administration. This report does not constitute a standard, specification, or regulation.

PROJECT OBJECTIVES

The objective of this project is to develop improved rehabilitation designs for reflective cracking for California.

This objective will be met after completion of four tasks identified by the Caltrans/Industry Rubber Asphalt Concrete Task Group (RACTG):

1. Develop improved mechanistic models of reflective cracking in California
2. Calibrate and verify these models using laboratory and HVS testing
3. Evaluate the most effective strategies for reflective cracking
4. Provide recommendations for reflective cracking strategies

This document is one of a series addressing Tasks 2 and 3.

ACKNOWLEDGEMENTS

The University of California Pavement Research Center acknowledges the assistance of the Rubber Pavements Association, Valero Energy Corporation, and Paramount Petroleum which contributed funds and asphalt binders for the construction of the Heavy Vehicle Simulator test track discussed in this study.

REFLECTIVE CRACKING STUDY REPORTS

The reports prepared during the reflective cracking study document data from construction, Heavy Vehicle Simulator (HVS) tests, laboratory tests, and subsequent analyses. These include a series of first- and second-level analysis reports and two summary reports. On completion of the study this suite of documents will include:

1. Reflective Cracking Study: Summary of Construction Activities, Phase 1 HVS Testing and Overlay Construction (UCPRC-RR-2005-03).
2. Reflective Cracking Study: First-level Report on the HVS Rutting Experiment (UCPRC-RR-2007-06).
3. Reflective Cracking Study: First-level Report on HVS Testing on Section 590RF — 90 mm MB4-G Overlay (UCPRC-RR-2006-04).
4. Reflective Cracking Study: First-level Report on HVS Testing on Section 589RF — 45 mm MB4-G Overlay (UCPRC-RR-2006-05).
5. Reflective Cracking Study: First-level Report on HVS Testing on Section 587RF — 45 mm RAC-G Overlay (UCPRC-RR-2006-06).
6. Reflective Cracking Study: First-level Report on HVS Testing on Section 588RF — 90 mm AR4000-D Overlay (UCPRC-RR-2006-07).
7. Reflective Cracking Study: First-level Report on HVS Testing on Section 586RF — 45 mm MB15-G Overlay (UCPRC-RR-2006-12).
8. Reflective Cracking Study: First-level Report on HVS Testing on Section 591RF — 45 mm MAC15TR-G Overlay (UCPRC-RR-2007-04).
9. Reflective Cracking Study: HVS Test Section Forensic Report (UCPRC-RR-2007-05).
10. Reflective Cracking Study: First-level Report on Laboratory Fatigue Testing (UCPRC-RR-2006-08).
11. Reflective Cracking Study: First-level Report on Laboratory Shear Testing (UCPRC-RR-2006-11).
12. Reflective Cracking Study: Backcalculation of FWD Data from HVS Test Sections (UCPRC-RR-2007-08).
13. Reflective Cracking Study: Second-level Analysis Report (UCPRC-RR-2007-09).
14. Reflective Cracking Study: Summary Report (UCPRC-SR-2007-01). Detailed summary report.
15. Reflective Cracking Study: Summary Report (UCPRC-SR-2007-03). Four-page summary report.

CONVERSION FACTORS

SI* (MODERN METRIC) CONVERSION FACTORS				
APPROXIMATE CONVERSIONS TO SI UNITS				
Symbol	Convert From	Multiply By	Convert To	Symbol
LENGTH				
in	inches	25.4	millimeters	mm
ft	feet	0.305	meters	m
AREA				
in ²	square inches	645.2	square millimeters	mm ²
ft ²	square feet	0.093	square meters	m ²
VOLUME				
ft ³	cubic feet	0.028	cubic meters	m ³
MASS				
lb	pounds	0.454	kilograms	kg
TEMPERATURE (exact degrees)				
°F	Fahrenheit	5 (F-32)/9 or (F-32)/1.8	Celsius	C
FORCE and PRESSURE or STRESS				
lbf	poundforce	4.45	newtons	N
lbf/in ²	poundforce/square inch	6.89	kilopascals	kPa
APPROXIMATE CONVERSIONS FROM SI UNITS				
Symbol	Convert From	Multiply By	Convert To	Symbol
LENGTH				
mm	millimeters	0.039	inches	in
m	meters	3.28	feet	ft
AREA				
mm ²	square millimeters	0.0016	square inches	in ²
m ²	square meters	10.764	square feet	ft ²
VOLUME				
m ³	cubic meters	35.314	cubic feet	ft ³
MASS				
kg	kilograms	2.202	pounds	lb
TEMPERATURE (exact degrees)				
C	Celsius	1.8C+32	Fahrenheit	F
FORCE and PRESSURE or STRESS				
N	newtons	0.225	poundforce	lbf
kPa	kilopascals	0.145	poundforce/square inch	lbf/in ²

*SI is the symbol for the International System of Units. Appropriate rounding should be made to comply with Section 4 of ASTM E380.
(Revised March 2003)

EXECUTIVE SUMMARY

This report is the sixth in a series of first-level analysis reports that describe the results of HVS testing on a full-scale experiment being performed at the Richmond Field Station (RFS) to validate Caltrans overlay strategies for the rehabilitation of cracked asphalt concrete. It describes the results of the sixth HVS reflective cracking testing section, designated 591RF, carried out on a 45-mm (1.7 in) half-thickness MAC15TR (with 15 percent recycled tire rubber) gap-graded overlay. The testing forms part of Partnered Pavement Research Center Strategic Plan Element 4.10: “Development of Improved Rehabilitation Designs for Reflective Cracking.”

The objective of this project is to develop improved rehabilitation designs for reflective cracking for California. This objective will be met after completion of the following four tasks:

1. Develop improved mechanistic models of reflective cracking in California
2. Calibrate and verify these models using laboratory and HVS testing
3. Evaluate the most effective strategies for reflective cracking
4. Provide recommendations for reflective cracking strategies

This report is one of a series addressing Tasks 2 and 3. It consists of three main chapters. Chapter 2 provides information on the experiment layout, pavement design, HVS trafficking of the underlying layer, and the test details, including test duration, pavement instrumentation and monitoring methods, loading program, test section failure criteria, and the environmental conditions recorded over the duration of the test. Chapter 3 summarizes the data collected and includes discussion of air and pavement temperatures during testing (measured with thermocouples), elastic deflection (measured on the surface with the Road Surface Deflectometer and at depth with Multi-depth Deflectometers), permanent deformation (measured on the surface with the Laser Profilometer and at depth with Multi-depth Deflectometers), and visual inspections. Chapter 4 provides a summary and lists key findings.

The underlying pavement was designed following standard Caltrans procedures and it incorporates a 410-mm (16.1 in) Class 2 aggregate base on subgrade with a 90-mm (3.5 in) dense-graded asphalt concrete (DGAC) surface. Design thickness was based on a subgrade R-value of 5 and a Traffic Index of 7 (~121,000 equivalent standard axles, or ESALs). This structure was trafficked with the HVS in 2003 to induce fatigue cracking then overlaid with six different treatments to assess their ability to limit reflective cracking. The treatments included:

- Half-thickness (45 mm) MB4 gap-graded overlay (referred to as “45 mm MB4-G” in this report)
- Full-thickness (90 mm) MB4 gap-graded overlay (referred to as “90 mm MB4-G” in this report)

- Half-thickness MB4 gap-graded overlay with minimum 15 percent recycled tire rubber (referred to as “MB15-G” in this report)
- Half-thickness MAC15TR gap-graded overlay with minimum 15 percent recycled tire rubber (referred to as “MAC15-G” in this report)
- Half-thickness rubberized asphalt concrete gap-graded overlay (RAC-G), included as a control for performance comparison purposes (the section discussed in this report)
- Full-thickness (90 mm) AR4000 dense-graded overlay (AR4000-D), included as a control for performance comparison purposes

The thickness for the AR4000-D overlay was determined according to Caltrans Test Method 356. The other overlay thicknesses were either the same or half of the AR4000-D overlay thickness. Details on construction and the first phase of trafficking are provided in an earlier report.

Laboratory fatigue and shear studies are being conducted in parallel with HVS testing. Results of these studies will be detailed in separate first-level reports. Comparison of the laboratory and test section performance, including the results of a forensic investigation to be conducted when all testing is complete, will be discussed in a second-level report once all the data from all of the studies has been collected and analyzed.

HVS trafficking on the section commenced on January 10, 2007, and was completed on June 25, 2007. During this period a total of 2,554,335 load repetitions at loads varying between 60 kN (13,500 lb) and 100 kN (22,500 lb) were applied, which equates to approximately 90.8 million Equivalent Standard Axle Loads (ESALs), using the Caltrans conversion of $(\text{axle load}/18,000)^{4.2}$, and to a Traffic Index of 15.4. A temperature chamber was used to maintain the pavement temperature at $20^{\circ}\text{C}\pm 4^{\circ}\text{C}$ ($68^{\circ}\text{F}\pm 7^{\circ}\text{F}$) for the first one million repetitions and at $15^{\circ}\text{C}\pm 4^{\circ}\text{C}$ ($59^{\circ}\text{F}\pm 7^{\circ}\text{F}$) for the remainder of the test. A dual tire (720 kPa [104 psi] pressure) and bidirectional loading with lateral wander was used.

The failure criteria set for the experiment were not reached. Given time and fund limitations, Caltrans and the UCPRC agreed to halt the experiment at 2.5 million repetitions.

Findings and observations based on the data collected during this HVS study include:

- No cracking was observed on the section after more than 2.5 million repetitions and testing was halted in the interest of completing the study. The MAC15-G overlay thus appeared to successfully prevent any cracking in the underlying layer from reflecting through to the surface,

despite final-to-initial deflections indicating that damage had occurred in the asphalt layers under loading.

- The average deformation and average maximum rut depth across the entire test section at the end of the test was just 1.7 mm (0.1 in) and 4.6 mm (0.2 in) respectively, with average maximum rut considerably lower than the Caltrans (and experiment) failure criterion of 12.5 mm (0.5 in). The maximum rut depth measured on the section was 8.2 mm (0.3 in). The MAC15-G overlay thus did not appear susceptible to rutting in the temperature range at which the test was conducted (20°C [68°F] for the first one million repetitions and 15°C [59°F] thereafter).
- Ratios of final-to-initial elastic surface deflections under a 60 kN (13,500 lb) wheel load increased by between 3.7 and 4.0 times along the length of the section. The ratios for in-depth deflections show that damage increased at all depths in the pavement structure by the end of trafficking. Loss of stiffness was highest in the area of most severe cracking in the underlying DGAC layer.
- Analysis of surface profile and in-depth permanent deformation measurements indicates that most of the permanent deformation (between 55 and 60 percent) occurred in the asphalt-bound surfacing layers (overlay and cracked DGAC) with the remainder mostly in the aggregate base layer. After the first one million repetitions had been applied, the permanent deformation in the surfacing layers was higher (between 80 and 90 percent).

No recommendations as to the use of modified binders in overlay mixes are made at this time. These recommendations will be included in the second-level analysis report, which will be prepared and submitted on completion of all HVS and laboratory testing.

TABLE OF CONTENTS

EXECUTIVE SUMMARY	v
LIST OF TABLES	xi
LIST OF FIGURES	xii
1. INTRODUCTION	1
1.1. Objectives	1
1.2. Overall Project Organization	1
1.3. Structure and Content of This Report.....	4
1.4. Measurement Units.....	4
2. TEST DETAILS	5
2.1. Experiment Layout	5
2.2. Test Section Layout	5
2.2.1 Pavement Instrumentation and Monitoring Methods.....	8
2.3. Underlying Pavement Design	8
2.4. Summary of Testing on the Underlying Layer	9
2.5. Fatigue Section Design	10
2.6. Summary of Testing on Reflective Cracking Section	11
2.6.1 Test Section Failure Criteria.....	11
2.6.2 Environmental Conditions.....	11
2.6.3 Test Duration.....	12
2.6.4 Loading Program.....	12
2.6.5 Measurement Summary.....	13
3. DATA SUMMARY	17
3.1. Temperatures	17
3.1.1 Air Temperatures in the Temperature Control Unit.....	17
3.1.2 Outside Air Temperatures	19
3.1.3 Temperature in the Asphalt Concrete Layer	19
3.2. Rainfall	20
3.3. Elastic Deflection	20
3.3.1 Surface Elastic Deflection from RSD	21
3.3.2 Surface Elastic Deflection from FWD	27
3.3.3 In-Depth Elastic Deflection from MDD.....	31
3.4. Permanent Deformation.....	33
3.4.1 Permanent Surface Deformation (Rutting).....	33

3.4.2	Permanent In-Depth Deformation	39
3.5.	Visual Inspection	42
3.6.	Forensic Evaluation	44
3.7.	Second-Level Analysis	44
4.	CONCLUSIONS	45
5.	REFERENCES.....	47

LIST OF TABLES

Table 2.1: Summary of HVS Loading Program.....	12
Table 2.2: Summary of MDD and RSD Measurements.....	15
Table 2.3: Summary of FWD Measurements.....	14
Table 3.1: Temperature Summary for Air and Pavement	19
Table 3.2: Average 60 kN RSD Centerline Deflections Before and After Testing.....	21
Table 3.3: Summary of FWD Measurements.....	28
Table 3.4: Summary of 60 kN In-Depth Elastic Deflections	31
Table 3.5: Vertical Permanent Deformation in Pavement Layers.....	40

LIST OF FIGURES

Figure 1.1: Timeline for the Reflective Cracking Study.	3
Figure 2.1: Layout of the Reflective Cracking Study project.....	6
Figure 2.2: Section 591RF layout and location of instruments.	7
Figure 2.3: Pavement design for the Reflective Cracking Study test track.	8
Figure 2.4: Cracking pattern on Section 573RF after Phase 1 HVS testing.....	9
Figure 2.5: Actual vs. target gradation for MAC15-G overlay.	11
Figure 2.6: Cumulative traffic applications and loading history.	13
Figure 3.1: Frequencies of recorded temperatures.	18
Figure 3.2: Daily average air temperatures inside the temperature control chamber.	18
Figure 3.3: Daily average air temperatures outside the temperature control chamber.	19
Figure 3.4: Daily average temperatures at pavement surface and various depths.....	20
Figure 3.5: Monthly rainfall for Richmond Field Station HVS site.....	21
Figure 3.6: RSD deflections at CL locations with 60 kN test load at test start.	22
Figure 3.7: RSD deflections at CL locations with 60 kN test load after 215,000 repetitions.	23
Figure 3.8: RSD deflections at CL locations with 60 kN test load after 410,000 repetitions.	23
Figure 3.9: RSD deflections at CL locations with 60 kN test load after 1,000,000 repetitions.	24
Figure 3.10: RSD deflections at CL locations with 60 kN test load after 1,500,000 repetitions.	24
Figure 3.11: RSD deflections at CL locations with 60 kN test load after 2,000,000 repetitions.	25
Figure 3.12: RSD deflections at CL locations with 60 kN test load at test completion.	25
Figure 3.13: Average RSD surface deflections with 60 kN test load (centerline and sides).....	26
Figure 3.14: Centerline RSD surface deflections with 60 kN test load (average and subsection).	27
Figure 3.15: Composite pavement stiffness (FWD Sensor 1) on section centerline.....	28
Figure 3.16: Subgrade pavement stiffness (FWD Sensor 6) on section centerline.	29
Figure 3.17: Composite pavement stiffness (FWD Sensor 1) outside trafficked area.	30
Figure 3.18: Subgrade pavement stiffness (FWD Sensor 6) outside trafficked area.....	30
Figure 3.19: Elastic deflections at MDD4 with 60 kN test load.....	31
Figure 3.20: Elastic deflections at MDD12 with 60 kN test load.....	32
Figure 3.21: Illustration of maximum rut depth and average deformation of a leveled profile.	33
Figure 3.22: Laser profilometer cross section at various stages of trafficking.....	34
Figure 3.23: Average deformation determined from Laser Profilometer data.	35
Figure 3.24: Average maximum rut determined from Laser Profilometer data.	35
Figure 3.25: Contour plot of permanent deformation after 215,000 repetitions.	36
Figure 3.26: Contour plot of permanent deformation after 410,000 repetitions.	36

Figure 3.27: Contour plot of permanent deformation after 1,000,000 repetitions. 37

Figure 3.28: Contour plot of permanent deformation after 1,500,000 repetitions. 37

Figure 3.29: Contour plot of permanent deformation after 2,000,000 repetitions. 38

Figure 3.30: Contour plot of permanent deformation at end of test (2.55 million repetitions). 38

Figure 3.31: Comparison of cracking pattern from Phase 1 and rutting in Phase 2. 39

Figure 3.32: In-depth permanent deformation at MDD4. 40

Figure 3.33: In-depth differential permanent deformation of various layers at MDD4. 41

Figure 3.34: In-depth permanent deformation at MDD12. 41

Figure 3.35: In-depth differential permanent deformation of various layers at MDD12. 42

Figure 3.36: Section surface viewed from Station 0. 43

Figure 3.37: Close-up of section surface between Stations 12 and 14. 44

1. INTRODUCTION

1.1. Objectives

The first-level analysis presented in this report is part of Partnered Pavement Research Center Strategic Plan Element 4.10 (PPRC SPE 4.10) being undertaken for the California Department of Transportation (Caltrans) by the University of California Pavement Research Center (UCPRC). The objective of the study is to evaluate the reflective cracking performance of asphalt binder mixes used in overlays for rehabilitating cracked asphalt concrete pavements in California. The study includes mixes modified with rubber and polymers, and it will develop tests, analysis methods, and design procedures for mitigating reflective cracking in overlays. This work is part of a larger study on modified binder (MB) mixes being carried out under the guidance of the Caltrans Pavement Standards Team (PST) (1), which includes laboratory and accelerated pavement testing using the Heavy Vehicle Simulator (carried out by the UCPRC), and the construction and monitoring of field test sections (carried out by Caltrans).

1.2. Overall Project Organization

This UCPRC project is a comprehensive study, carried out in three phases, involving the following primary elements (2):

- Phase 1
 - The construction of a test pavement and subsequent overlays;
 - Six separate Heavy Vehicle Simulator (HVS) tests to crack the pavement structure;
 - Placing of six different overlays on the cracked pavement;
- Phase 2
 - Six HVS tests to assess the susceptibility of the overlays to high-temperature rutting (Phase 2a);
 - Six HVS tests to determine the low-temperature reflective cracking performance of the overlays (Phase 2b);
 - Laboratory shear and fatigue testing of the various hot-mix asphalts (Phase 2c);
 - Falling Weight Deflectometer (FWD) testing of the test pavement before and after construction and before and after each HVS test;
 - Forensic evaluation of each HVS test section;
- Phase 3
 - Performance modeling and simulation of the various mixes using models calibrated with data from the primary elements listed above.

Phase 1

In this phase, a conventional dense-graded asphalt concrete (DGAC) test pavement was constructed at the Richmond Field Station (RFS) in the summer of 2001. The pavement was divided into six cells, and within each cell a section of the pavement was trafficked with the HVS until the pavement failed by either fatigue (2.5 m/m^2 [0.76 ft/ft²]) or rutting (12.5 mm [0.5 in]). This period of testing began in the summer of 2001 and was concluded in the spring of 2003. In June 2003 each test cell was overlaid with either conventional DGAC or asphalt concrete with modified binders as follows:

- Full-thickness (90 mm) AR4000-D dense graded asphalt concrete overlay, included as a control for performance comparison purposes (AR-4000 is approximately equivalent to a PG64-16 performance grade binder);
- Full-thickness (90 mm) MB4-G gap-graded overlay;
- Half-thickness (45 mm) rubberized asphalt concrete gap-graded overlay (RAC-G), included as a control for performance comparison purposes;
- Half-thickness (45 mm) MB4-G gap-graded overlay;
- Half-thickness (45 mm) MB4-G gap-graded overlay with minimum 15 percent recycled tire rubber (MB15-G), and
- Half-thickness (45 mm) MAC15-G gap-graded overlay with minimum 15 percent recycled tire rubber.

The conventional overlay was designed using the current (2003) Caltrans overlay design process. The various modified overlays were either full (90 mm) or half thickness (45 mm). Mixes were designed by Caltrans. The overlays were constructed in one day.

Phase 2

Phase 2 included high-temperature rutting and low-temperature reflective cracking testing with the HVS as well as laboratory shear and fatigue testing. The rutting tests were started and completed in the fall of 2003. For these tests, the HVS was placed above a section of the underlying pavement that had not been trafficked during Phase 1. A reflective cracking test was next conducted on each overlay from the winter of 2003-2004 to the summer of 2007. For these tests, the HVS was positioned precisely on top of the sections of failed pavement from the Phase 1 HVS tests to investigate the extent and rate of crack propagation through the overlay.

In conjunction with Phase 2 HVS testing, a full suite of laboratory testing, including shear and fatigue testing, was carried out on field-mixed, field-compacted, field-mixed, laboratory-compacted, and laboratory-mixed, laboratory-compacted specimens.

Phase 3

Phase 3 entailed a second-level analysis carried out on completion of HVS and laboratory testing (the focus of this report). This included extensive analysis and characterization of the mix fatigue and mix shear data, backcalculation of the FWD data, performance modeling of each HVS test, and a detailed series of pavement simulations carried out using the combined data.

An overview of the project timeline is shown in Figure 1.1.

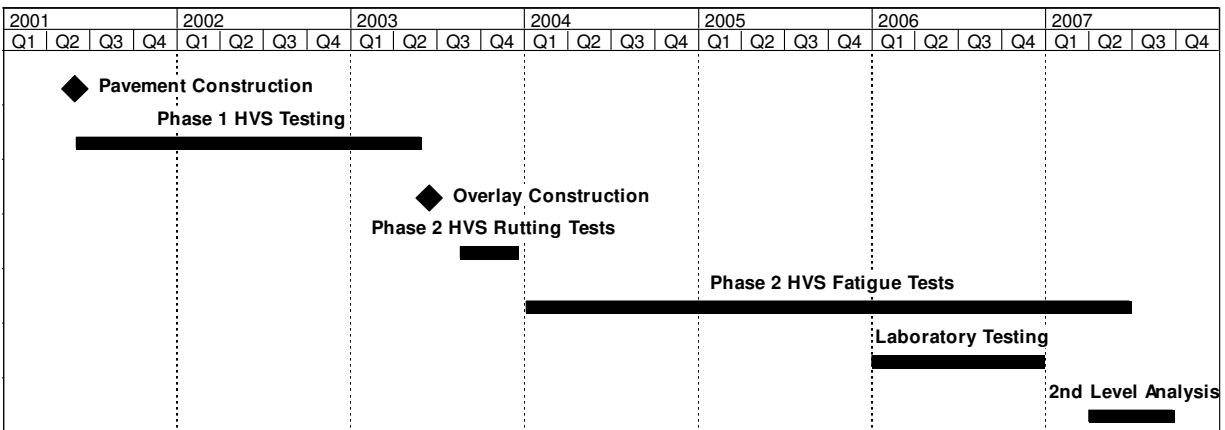

Figure 1.1: Timeline for the Reflective Cracking Study.

Reports

The reports prepared during the reflective cracking study document data from construction, HVS tests, laboratory tests, and subsequent analyses. These include a series of first- and second-level analysis reports and two summary reports. On completion of the study this suite of documents will include:

- One first-level report covering the initial pavement construction, the six initial HVS tests, and the overlay construction (Phase 1);
- One first-level report covering the six Phase 2 rutting tests (but offering no detailed explanations or conclusions on the performance of the pavements);
- Six first-level reports, each of which covers a single Phase 2 reflective cracking test (containing summaries and trends of the measured environmental conditions, pavement responses, and pavement performance but offering no detailed explanations or conclusions on the performance of the pavement);
- One first-level report covering laboratory shear testing;
- One first-level report covering laboratory fatigue testing;
- One report summarizing the HVS test section forensic investigation;
- One report summarizing the backcalculation analysis of deflection tests,

- One second-level analysis report detailing the characterization of shear and fatigue data, pavement modeling analysis, comparisons of the various overlays, and simulations using various scenarios (Phase 3), and
- One four-page summary report capturing the conclusions and one longer, more detailed summary report that covers the findings and conclusions from the research conducted by the UCPRC.

1.3. Structure and Content of This Report

This report presents the results of the HVS test on the half-thickness (45 mm) MAC15TR gap-graded overlay with minimum 15 percent recycled tire rubber (referred to as “MAC15-G” in this report), designated Section 591RF, with preliminary analyses relative to observed performance and is organized as follows:

- Chapter 2 contains a description of the test program including experiment layout, loading sequence, instrumentation, and data collection.
- Chapter 3 presents a summary and discussion of the data collected during the test.
- Chapter 4 contains a summary of the results together with conclusions and observations.

1.4. Measurement Units

Metric units have always been used in the design and layout of HVS test tracks, and for all the measurements, data storage, analysis, and reporting at the eight HVS facilities worldwide (as well as all other international accelerated pavement testing facilities). Continued use of the metric system facilitates consistency in analysis, reporting, and data sharing.

In this report, metric and English units are provided in the Executive Summary, Chapters 1 and 2, and the Conclusion. In keeping with convention, only metric units are used in Chapter 3. A conversion table is provided on Page iv at the beginning of this report.

2. TEST DETAILS

2.1. Experiment Layout

Six overlays, each with a rutting test section and a reflective cracking test section, were constructed as part of the second phase of the study as follows:

1. Sections 580RF and 586RF: Half-thickness (45 mm) MB4 gap-graded overlay with minimum 15 percent recycled tire rubber (referred to as “MB15-G” in this report);
2. Sections 581RF and 587RF: Half-thickness (45 mm) rubberized asphalt concrete gap-graded (RAC-G) overlay;
3. Sections 582RF and 588RF: Full-thickness (90 mm) AR4000 dense-graded asphalt concrete overlay (designed using CTM356 and referred to as “AR4000-D” in this report);
4. Sections 583RF and 589RF: Half-thickness (45 mm) MB4 gap-graded overlay (referred to as “45 mm MB4-G” in this report);
5. Sections 584RF and 590RF: Full-thickness (90 mm) MB4 gap-graded overlay (referred to as “90 mm MB4-G” in this report), and
6. Sections 585RF and 591RF: Half-thickness (45 mm) MAC15TR gap-graded overlay with minimum 15 percent recycled tire rubber (referred to as “MAC15-G” in this report).

These sections and the corresponding Phase 1 fatigue test sections are shown in Figure 2.1. Prior to the Phase 2 reflective cracking testing, a rutting study was carried out whereby HVS loading at high temperature was applied adjacent to the reflective cracking experiments to evaluate the rutting behavior of the overlay mixes. The rutting study will be discussed in a separate report.

2.2. Test Section Layout

The test section layout for Section 591RF is shown in Figure 2.2. Station numbers refer to fixed points on the test section and are used for measurements and as a reference for discussing performance.

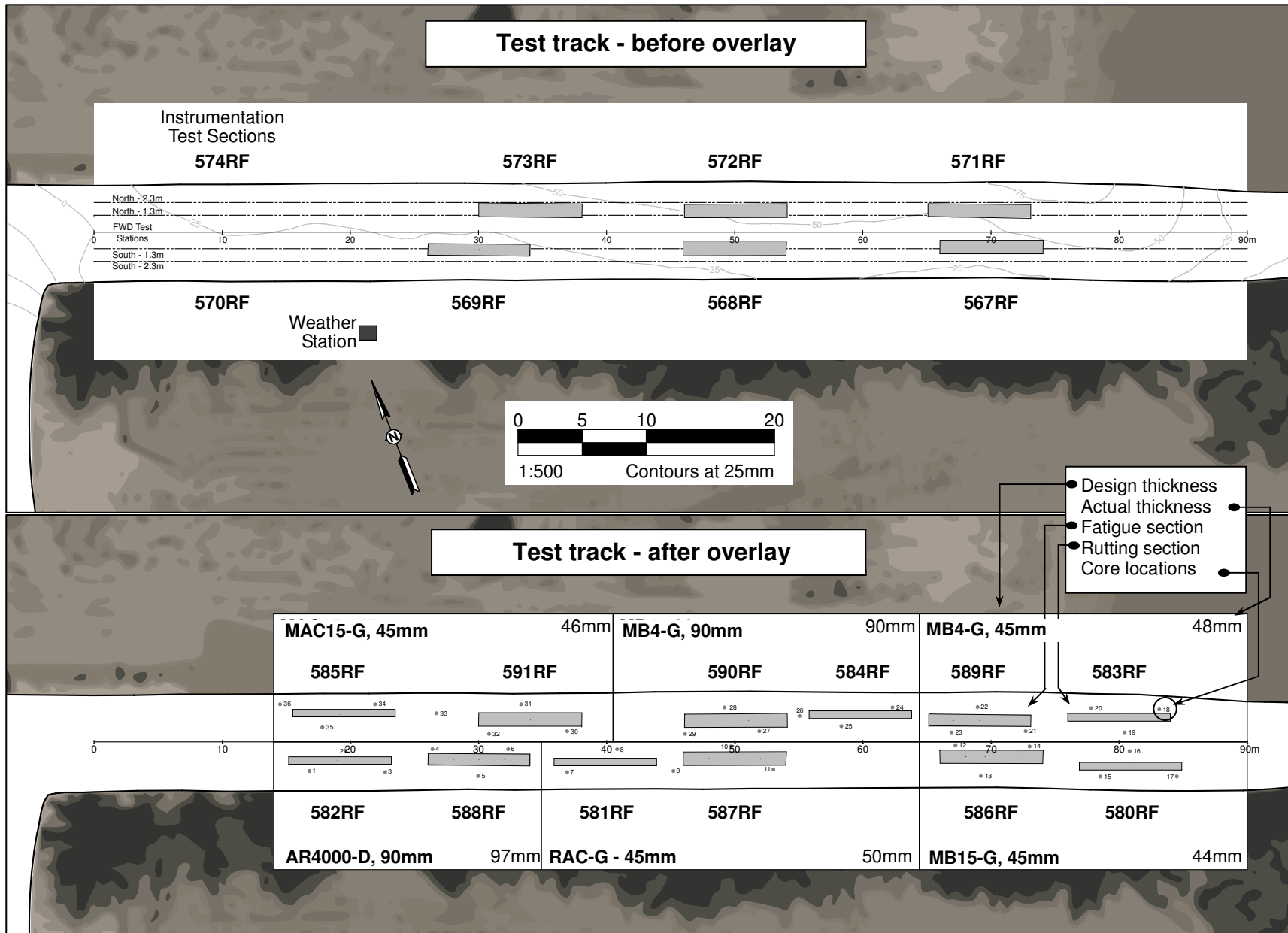
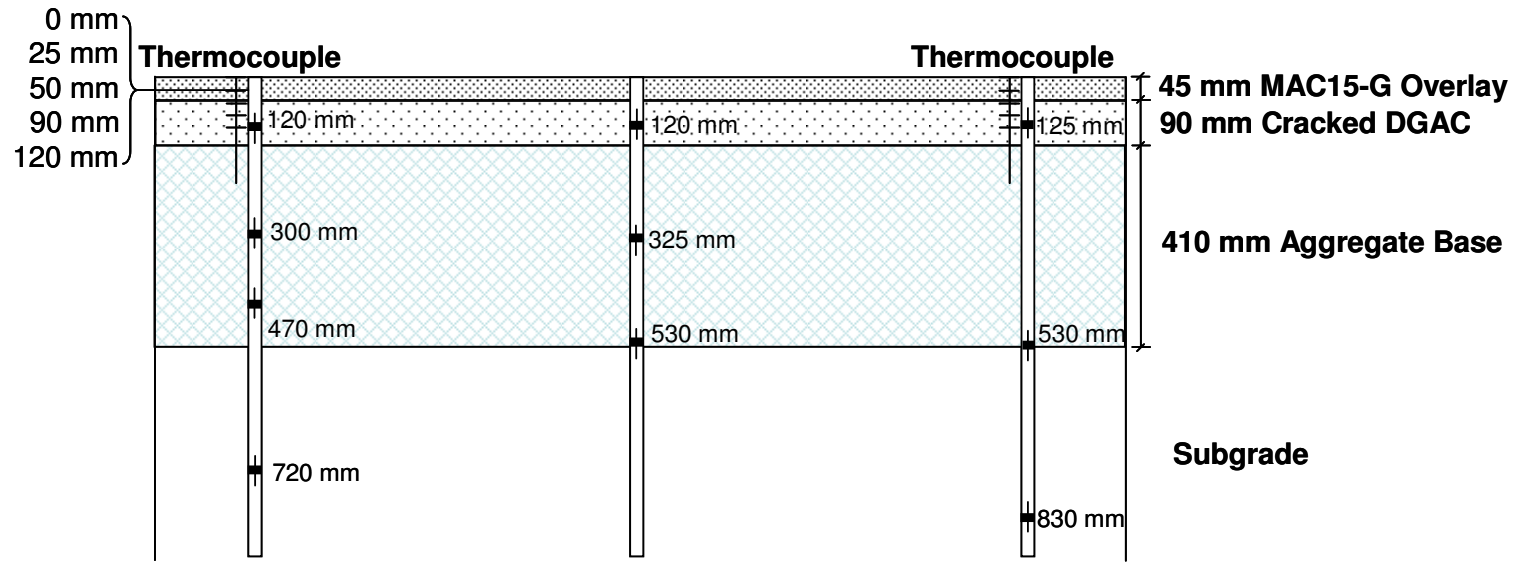
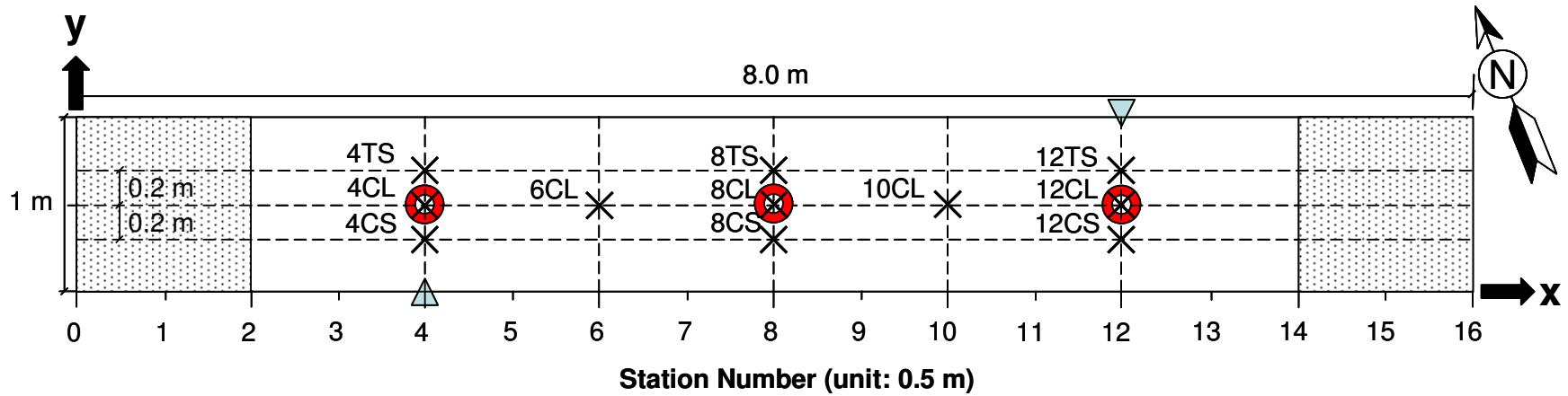

Figure 2.1: Layout of the Reflective Cracking Study project.



LEGEND **NOT TO SCALE**

MDD	RSD	Thermocouple	MDD LVDT module	TS Traffic Side CL Central Line CS Caravan Side
-----	-----	--------------	-----------------	--

(MDD – Multi-depth Deflectometer, RSD – Road Surface Deflectometer, LVDT – Linear Variable Displacement Transducer)

Figure 2.2: Section 591RF layout and location of instruments.

2.2.1 Pavement Instrumentation and Monitoring Methods

Measurements were taken with the following instruments:

- Road Surface Deflectometer (RSD), measuring surface deflection;
- Multi-depth Deflectometer (MDD), measuring elastic deflection and permanent deformation at different depths in the pavement;
- Laser Profilometer, measuring surface profile (at each station);
- Falling Weight Deflectometer (FWD), measuring elastic deflection before and after testing, and
- Thermocouples, measuring pavement temperature and ambient temperature.

Instrument positions are shown in Figure 2.2. Detailed descriptions of the instrumentation and measuring equipment are included in Reference 4. Intervals between measurements, in terms of load repetitions, were selected to enable adequate characterization of the pavement as damage developed.

2.3. Underlying Pavement Design

The pavement for the first phase of HVS trafficking was designed according to the Caltrans Highway Design Manual Chapter 600 using the computer program *NEWCON90*. Design thickness was based on a tested subgrade R-value of 5 and a Traffic Index of 7 (~121,000 ESALs) (3). The pavement design for the test road and the preliminary as-built pavement structure for Section 591RF (determined from cores removed from the edge of the section) are illustrated in Figure 2.3.

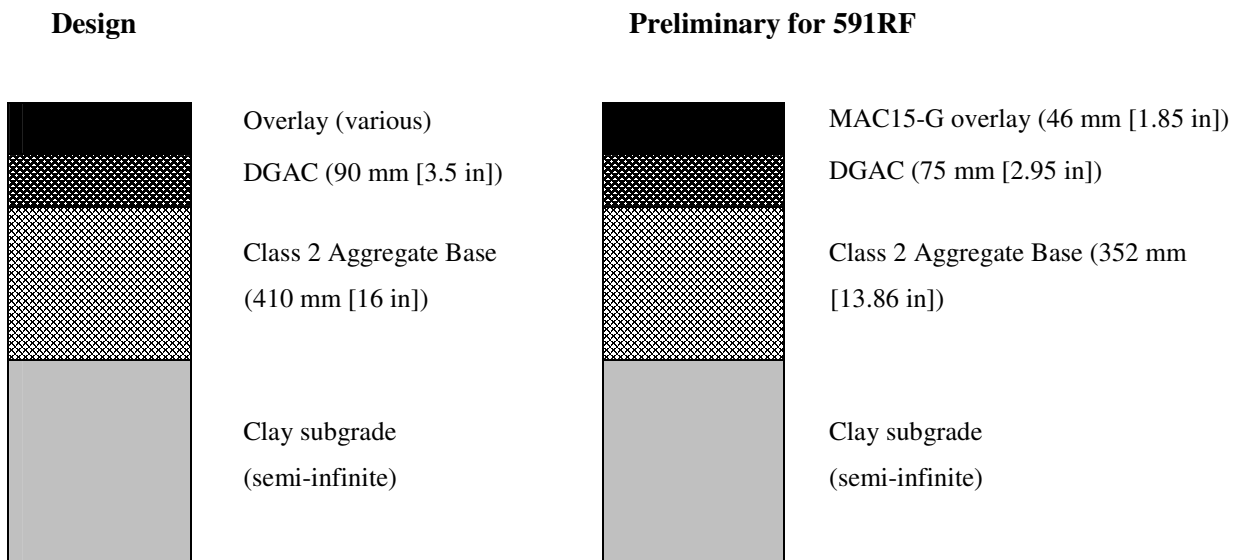

Figure 2.3: Pavement design for the Reflective Cracking Study test track.
(Design and preliminary actual for 591RF)

The existing subgrade was ripped and reworked to a depth of 200 mm (8 in) so that the optimum moisture content and the maximum wet density met the specification per Caltrans Test Method CTM 216. The average maximum wet density of the subgrade was 2,180 kg/m³ (136 pcf). The average relative compaction of the subgrade was 97 percent (3).

The aggregate base was constructed to meet the Caltrans compaction requirements for aggregate base Class 2 using CTM 231 nuclear density testing. The maximum wet density of the base determined according to CTM 216 was 2,200 kg/m³ (137 pcf). The average relative compaction was 98 percent.

The DGAC layer consisted of a dense-graded asphalt concrete (DGAC) with AR-4000 binder and aggregate gradation limits following Caltrans 19-mm (0.75 in) maximum size coarse gradation (3). The target asphalt content was 5.0 percent by mass of aggregate, while actual contents varied between 4.34 and 5.69 percent. Nuclear density measurements and extracted cores were used to determine a preliminary as-built mean air-void content of 9.1 percent with a standard deviation of 1.8 percent. The air-void content after traffic compaction and additional air-void contents from cores taken outside the trafficked area will be determined on completion of trafficking of all sections and will be reported in the second-level analysis report.

2.4. Summary of Testing on the Underlying Layer

Phase 1 trafficking of the underlying Section 573RF took place between March 19, 2002, and July 8, 2002, during which 983,982 repetitions were applied. Figure 2.4 presents the final cracking pattern after testing. A combination of alligator and transverse cracking was observed. Total crack length was 24.62 m (80.77 ft) and crack density was 4.1 m/m² (1.25 ft/ft²).

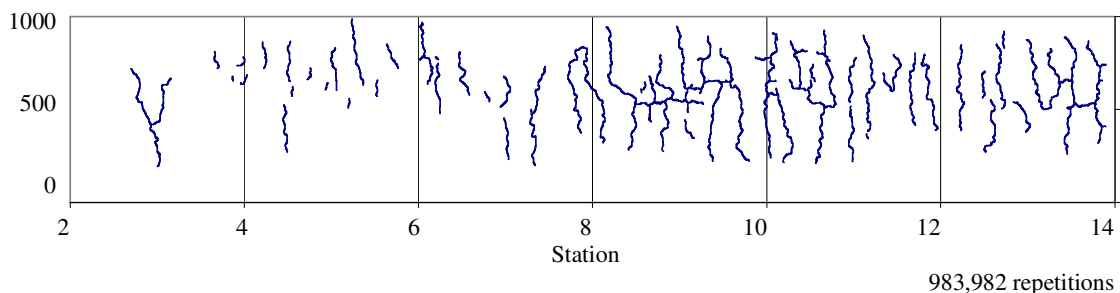

Figure 2.4: Cracking pattern on Section 573RF after Phase 1 HVS testing.

2.5. Fatigue Section Design

As noted, Section 591RF was located on the 45-mm MAC15-G overlay precisely on top of Section 573RF. Section 573RF had considerable transverse and some alligator cracking over most of the area subjected to HVS trafficking (Figure 2.4), with more severe cracking between Stations 8 and 14 compared to that between Stations 2 and 8. The overlay thickness for the experiment was determined according to Caltrans Test Method CTM 356 using Falling Weight Deflectometer data from Phase 1 of the experiment. The actual layer thickness of Section 591RF was measured from cores extracted from the edge of the test section and from Dynamic Cone Penetrometer (DCP) tests taken outside the trafficked area. The measured average thicknesses for the section were (Figure 2.3):

- MAC15-G overlay: 46 mm (min 42 mm; max 50 mm; standard deviation, 3.9 mm)
[1.8 in (min 1.7 in; max 2.0 in; standard deviation, 0.2 in)]
- Cracked DGAC layer: 75 mm (min 70 mm; max 80 mm; standard deviation, 3.8 mm)
[3.0 in (min 2.8 in; max 3.1 in; standard deviation, 0.1 in)]
- Aggregate base: 358 mm (14.1 in)

Exact layer thicknesses will be determined from measurements in test pits after HVS testing has been completed on all sections.

Laboratory testing was carried out by Caltrans and UCPRC on samples collected during construction to determine actual binder properties, binder content, aggregate gradation, and air-void content. The MAC15TR binder met the Caltrans modified binder specification, based on testing performed by Caltrans. The ignition-extracted binder content, corrected for aggregate ignition, showed an average value of 7.55 percent, somewhat higher than the design binder content of 7.4 percent. It is not clear whether this is a function of the test or contractor error. The aggregate gradation met Caltrans specifications for a 19.0 mm (3/4 in) maximum size gap gradation, with material passing the 0.6 mm (#30), 9.5 mm (3/8 in), 12.5 mm (1/2 in), and 19.0 mm (3/4 in) sieves on the upper envelope limit, while material passing the 2.36 mm (#8), 4.75 mm (#4), and 6.35 mm (1/4 in) sieves was outside the upper limit for course gradation. Gradation is illustrated in Figure 2.5. The preliminary as-built air-void content was 4.9 percent with a standard deviation of 1.0 percent, based on cores taken outside of the HVS sections. Final air-void contents will be determined from trenching and coring to be performed after trafficking of all sections.

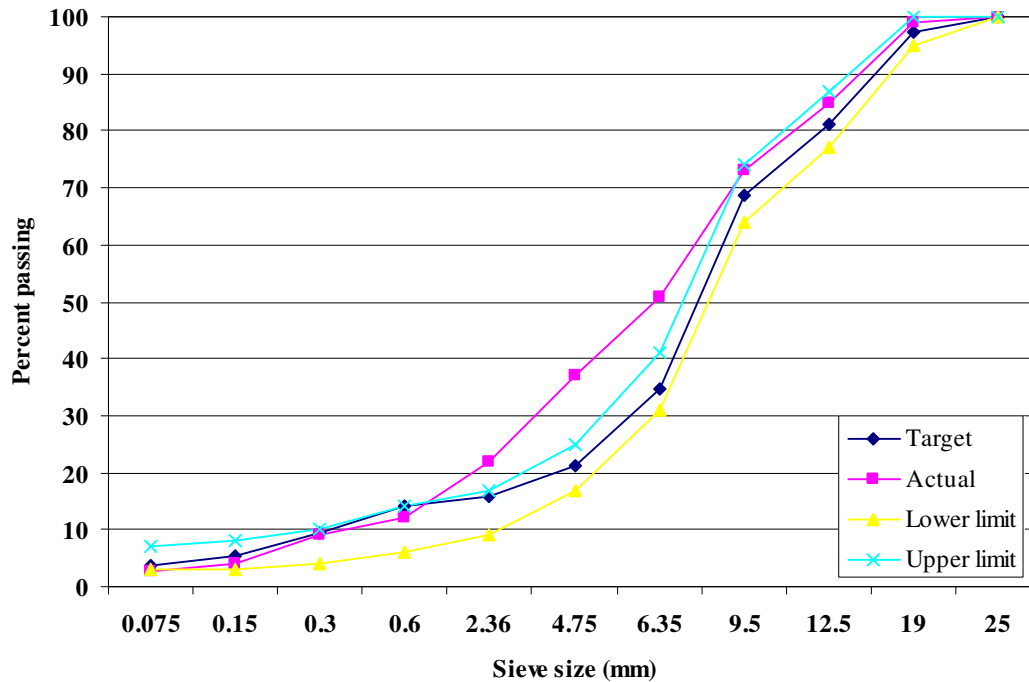

Figure 2.5: Actual vs. target gradation for MAC15-G overlay.

2.6. Summary of Testing on Reflective Cracking Section

2.6.1 Test Section Failure Criteria

Failure criteria for analyses were set at:

- Cracking density of 2.5 m/m^2 (0.76 ft/ft^2) or more, and/or
- Average maximum surface rut depth of 12.5 mm (0.5 in) or more.

2.6.2 Environmental Conditions

For the first one million repetitions, the pavement surface temperature was maintained at $20^\circ\text{C}\pm 4^\circ\text{C}$ ($68^\circ\text{F}\pm 7^\circ\text{F}$) to minimize rutting in the asphalt concrete and to promote fatigue damage. Thereafter, the pavement surface temperature was reduced to $15^\circ\text{C}\pm 4^\circ\text{C}$ ($59^\circ\text{F}\pm 7^\circ\text{F}$) to further accelerate fatigue damage. A temperature control chamber (5) was used to maintain the test temperatures.

The pavement surface received no direct rainfall as it was protected by the temperature control chamber. The section was tested during both wet and dry seasons (January through June) and hence water could have infiltrated the pavement from the side drains and through the raised groundwater table in the early phase of testing.

2.6.3 Test Duration

HVS trafficking on Section 591RF was initiated on January 10, 2007, and completed on June 25, 2007, after the application of just over 2.5 million (2,554,335) load repetitions. Testing was interrupted twice:

- During breakdowns in the first three weeks of trafficking, and
- During a breakdown between May 01 and May 06, 2007, when the cumulative traffic repetitions were approximately 1.5 million.

2.6.4 Loading Program

The HVS loading program is summarized in Table 2.1.

Table 2.1: Summary of HVS Loading Program

Start Date	Start Repetition	Wheel Load (kN) - [lb]		Wheel	Tire Pressure (kPa) - [psi]	Direction
		Planned	Actual			
01/10/07*	0	40 - [9,000]	60	Dual	720 - [104]	Bi
02/07/07	215,000	60 - [13,500]	90	Dual	720 - [104]	Bi
02/23/07	413,404	80 - [18,000]	80	Dual	720 - [104]	Bi
03/29/07	1,000,001	100 - [22,500]	100	Dual	720 - [104]	Bi

* Testing was interrupted during breakdowns at the beginning of the test and between 05/01/07 and 05/06/07.

The loading program followed differs from the original test plan due to an incorrect hydraulic control system setup on loads less than 65 kN (14,600 lb) in the Phase 1 experiment. The loading pattern from the Phase 1 experiment was thus retained to facilitate comparisons of performance between all tests in the Reflective Cracking Study. Testing was undertaken with a dual-wheel configuration, using radial truck tires (Goodyear G159 - 11R22.5 - steel belt radial) inflated to a pressure of 720 kPa (104 psi), in a bidirectional loading mode. Lateral wander over the one-meter (39.4 in) width of the test section was programmed to simulate traffic wander on a typical highway lane.

Cumulative traffic applications and the loading history are shown in Figure 2.6. The shorter 60 kN (13,500 lb) and 90 kN (20,250 lb) and longer 80 kN (18,000 lb) and 100 kN (22,500 lb) loading phases adopted for Section 589 (second HVS test) were also used in this test. A total of 2,554,335 load repetitions were applied consisting of:

- 215,000 repetitions of a 60 kN (13,500 lb) load
- 198,404 repetitions of a 90 kN (20,250 lb) load
- 586,596 repetitions of an 80 kN (18,000 lb) load, and
- 1,554,335 repetitions of a 100 kN (22,500 lb) load.

This loading equates to approximately 90.8 million Equivalent Standard Axle Loads (ESALs), using the Caltrans conversion of $(\text{axle load}/18000)^{4.2}$, which in turn equates to a Traffic Index of 15.4.

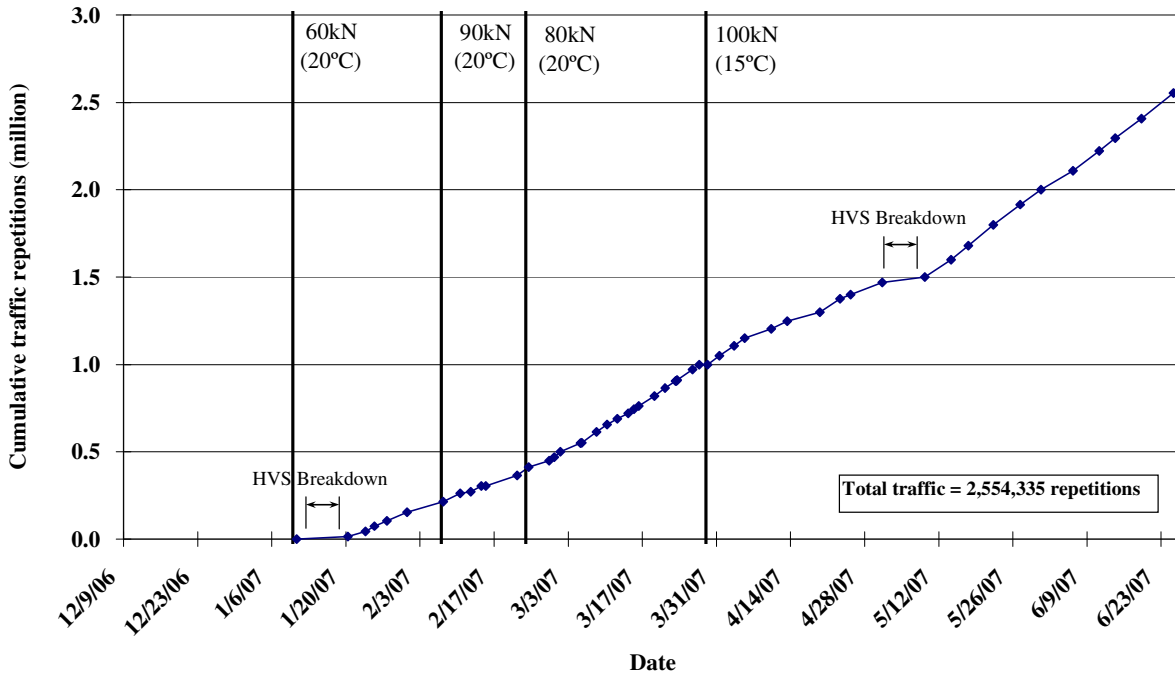

Figure 2.6: Cumulative traffic applications and loading history.

2.6.5 Measurement Summary

Table 2.2 (pages 15 and 16) lists the reading schedule of MDD and RSD measurements at various wheel loads. Surface deflection measurements with the RSD were obtained at the reference points along the centerline (CL) of the section and at locations 200 mm (8.0 in) on either side of the centerline (traffic and caravan side), as shown in Figure 2.2. MDD and RSD measurements were taken with a 60 kN (13,500 lb) load throughout the test as well as with the load being applied at the time of measurement (i.e., 80 kN [18,000 lb], 90 kN [22,500 lb], or 100 kN [22,500 lb]). The figures in Chapter 3 only show the measurements taken with the 60 kN (13,500 lb) load.

Measurements of surface rut depth taken by transverse scans with the Laser Profilometer were obtained at each station (Figure 2.2) on the same schedule as that of the MDD and RSD. The following rut parameters, which are discussed in more detail in Chapter 3, were determined from these measurements:

- Location and magnitude of the maximum rut depth,
- Average rut depth for the entire test section, and
- Rate of rut development.

Falling Weight Deflectometer (FWD) measurements were taken before and after testing at the center of and on the outside of the trafficked area. A summary of the measurement schedule is provided in Table 2.3.

Table 2.3: Summary of FWD Measurements

Date	Time	Location	Interval (m) - [ft]
12/13/06	09:00	Center	0.3 - [1.0]
12/15/06	09:00	Side	0.3 - [1.0]
12/16/06	15:00	Center	0.3 - [1.0]
12/17/06	15:00	Side	0.3 - [1.0]
06/27/07	14:00	Center	0.3 - [1.0]
06/27/07	16:00	Side	0.3 - [1.0]
06/28/07	10:00	Center	0.3 - [1.0]
06/28/07	11:00	Side	0.3 - [1.0]

Pavement temperature measurements were derived from thermocouples (depths and surface locations shown in Figure 2.2) at one-hour intervals during HVS operation. Air temperatures were measured in a weather station next to the test section and recorded at the same intervals as the thermocouples.

Fatigue crack development was monitored using visual inspection of the road surface and photographs.

Table 2.2: Summary of MDD and RSD Measurements

Date	Reps	MDD4				MDD8				MDD12				RSD Centerline ¹				RSD Sides ²			
		60*	90	80	100	60	90	80	100	60	90	80	100	60	90	80	100	60	90	80	100
01/10/07	0	✓				x				✓				✓				✓			
01/20/07	15,000	✓				x				✓				✓							
01/23/07	45,000	✓				x				✓				✓							
01/25/07	75,000	✓				x				✓				✓							
01/27/07	105,000	✓				x				✓				✓							
01/31/07	155,000	✓				x				✓				✓							
02/07/07	215,000	✓	✓			x	x			✓	✓			✓	✓			✓	✓		
02/10/07	263,000	✓	✓			x	x			✓	✓			✓	✓						
02/15/07	305,000	✓	✓			x	x			✓	✓			✓	✓						
02/21/07	365,000	✓	✓			x	x			✓	✓			✓	✓						
02/23/07	413,404	✓	✓	✓		x	x	x		✓	✓	✓		✓	✓	✓					
02/27/07	450,000	✓		✓		x		x		✓		✓		✓		✓					
02/28/07	470,000	✓		✓		x		x		x		x		✓		✓					
03/01/07	500,000	✓		✓		x		x		✓		✓		✓		✓					
03/05/07	550,000	✓		✓		x		x		✓		✓		✓		✓					
03/08/07	615,000	✓		✓		x		x		✓		✓		✓		✓					
03/10/07	655,000	✓		✓		x		x		✓		✓		✓	✓	✓		✓	✓	✓	
03/12/07	690,000	✓		✓		x		x		✓		✓		✓		✓					
03/14/07	720,018	✓		✓		x		x		✓		✓		✓		✓					
03/16/07	762,761	✓		✓		x		x		✓		✓		✓		✓					
03/19/07	820,000	✓		✓		x		x		✓		✓		✓		✓					
03/21/07	865,000	✓		✓		x		x		✓		✓		✓		✓					
03/23/07	906,025	✓		✓		x		x		✓		✓		✓		✓					
03/26/07	971,193	✓		✓		x		x		✓		✓		✓		✓					
03/27/07	1,000,000	✓		✓		x		x		✓		✓		✓		✓	✓	✓	✓	✓	
03/29/07	1,000,001	✓			✓	x			x	✓		✓		✓		✓	✓	✓	✓	✓	✓
03/31/07	1,049,309	✓			✓	x			x	✓		✓		✓		✓					
04/03/07	1,106,000	✓			✓	x			x	✓		✓		✓		✓					
04/05/07	1,150,000	✓			✓	x			x	✓		✓		✓		✓					
04/10/07	1,205,000	✓			✓	x			x	✓		✓		✓		✓					
04/13/07	1,247,738	✓			✓	x			x	✓		✓		✓		✓					
04/19/07	1,300,000	✓			✓	x			x	✓		✓		✓		✓					
04/23/07	1,375,000	✓			✓	x			x	✓		✓		✓		✓					
* Wheel load in kN						¹ Measurements at 4, 6, 8, 10, and 12						² Measurements at 4, 8, and 12									
✓	Data collected					x	Suspect data, not used						No data collection scheduled								

Table 2.2: Summary of MDD and RSD Measurements (cont)

Date	Reps	MDD4				MDD8				MDD12				RSD Centerline ¹			RSD Sides ²				
		60*	90	80	100	60	90	80	100	60	90	80	100	60	90	80	100	60	90	80	100
04/25/07	1,400,000	✓			✓	✗			✗	✓			✓	✓			✓				
05/01/07	1,470,000	✓			✓	✗			✗	✓			✓	✓			✓				
05/09/07	1,500,000	✓			✓	✗			✗	✓			✓	✓	✓	✓	✓	✓	✓	✓	✓
05/14/07	1,600,000	✓			✓	✗			✗	✓			✓	✓			✓				
05/17/07	1,680,000	✓			✓	✗			✗	✓			✓	✓			✓				
05/22/07	1,800,000	✓			✓	✗			✗	✓			✓	✓			✓				
05/27/07	1,915,169	✓			✓	✗			✗	✗			✓	✓			✓				
05/31/07	2,000,000	✓			✓	✗			✗	✓			✓	✓	✓	✓	✓	✓	✓	✓	✓
06/06/07	2,108,000	✓			✓	✗			✗	✓			✓	✓			✓				
06/11/07	2,222,200	✓			✓	✗			✗	✗			✓	✓			✓				
06/14/07	2,295,026	✓			✓	✗			✗	✓			✓	✓			✓				
06/19/07	2,408,000	✓			✓	✗			✗	✓			✓	✓			✓				
06/25/07	2,554,335	✓	✓	✓	✓	✗	✗	✗	✗	✓	✓	✓	✓	✓	✓	✓	✓	✓	✓	✓	✓
* Wheel load in kN						¹ Measurements at 4, 6, 8, 10, and 12						² Measurements at 4, 8, and 12									
✓	Data collected					✗	Suspect data, not used					No data collection scheduled									

3. DATA SUMMARY

This chapter provides a summary of the data collected from Section 591RF and a brief discussion of the first-level analysis. Interpretation of the data in terms of pavement performance will be discussed in a separate second-level analysis report.

3.1. Temperatures

Pavement temperatures were controlled using the temperature control chamber. Both air temperatures (inside and outside the temperature box) and pavement temperatures were monitored and recorded hourly during the entire loading period. Figure 3.1 illustrates the frequencies of recorded temperatures at each hour during the testing period. Hourly temperatures were collected for approximately 78 percent of the test period. No temperatures were recorded during the periods of breakdown or shutdown. As seen in the figure, the hour counts from 08:00 to 13:00 hours (on a 24-hour clock) are relatively low, this being the period when RSD, MDD and profile measurements were taken. As a consequence, temperature interpolation/extrapolation will be necessary when interpreting the backcalculation results from the MDD and RSD measurements (second-level analysis). In assessing fatigue performance, the temperature at the bottom of the asphalt concrete and the temperature gradient are the two important controlling temperature parameters used to evaluate the stiffness of the asphalt concrete and to compute the maximum tensile strain as accurately as possible.

3.1.1 Air Temperatures in the Temperature Control Unit

Air temperatures inside the temperature control chamber ranged from 8.8°C to 29°C during the testing period. Temperatures were adjusted to maintain a pavement temperature at 50 mm depth of 20°C±4°C for the first one million repetitions and 15°C±4°C for the remainder of the test. These pavement temperatures are expected to promote fatigue damage leading to reflective cracking while minimizing rutting of the asphalt concrete layer. Testing was stopped when the pavement temperature went out of range. The air temperature distributions in the control unit for the various stages of the test were:

- Zero to one million repetitions: mean of 20.4°C with a standard deviation of 2.4°C (minimum of 11.0°C, maximum of 29.0°C).
- One million to end of test: mean of 12.5°C with a standard deviation of 0.8°C (minimum of 8.8°C, maximum of 20.8°C).

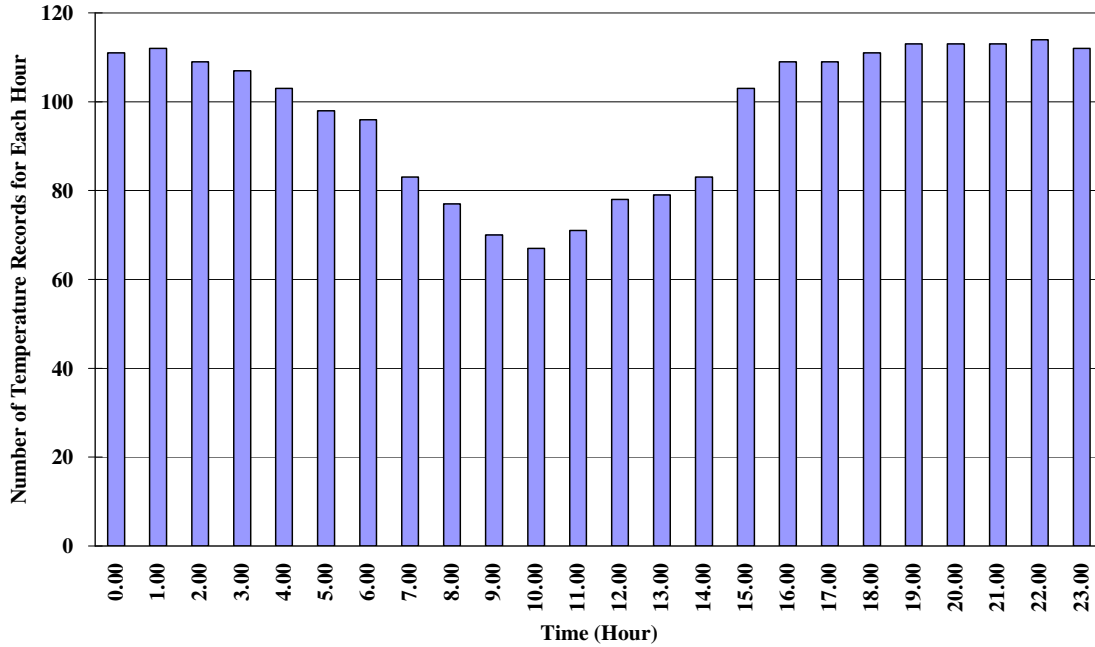

Figure 3.1: Frequencies of recorded temperatures.

The daily average air temperatures recorded in the temperature control unit, calculated from the hourly temperatures recorded during HVS operation, are shown in Figure 3.2. Vertical error bars on each point on the graph show daily temperature range.

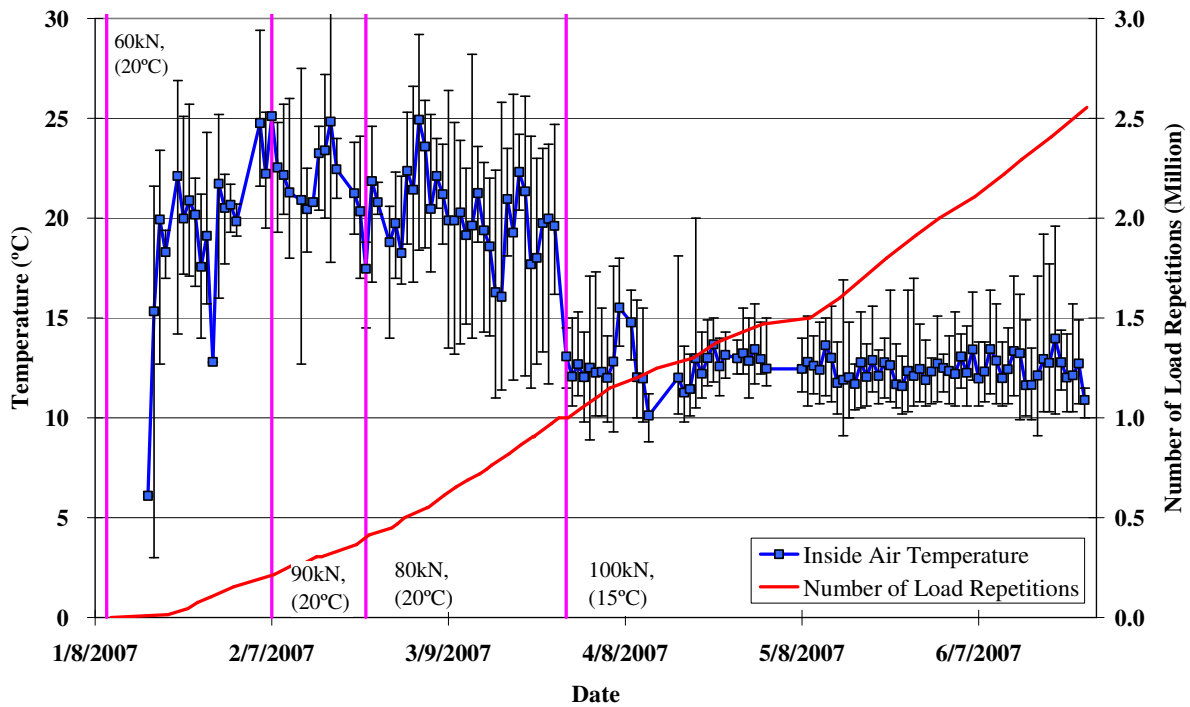

Figure 3.2: Daily average air temperatures inside the temperature control chamber.

3.1.2 Outside Air Temperatures

Outside air temperatures ranged from 0.8°C to 29.0°C with an average of 13.4°C and are summarized in Figure 3.3. Vertical error bars on each point of the graph show daily temperature range.

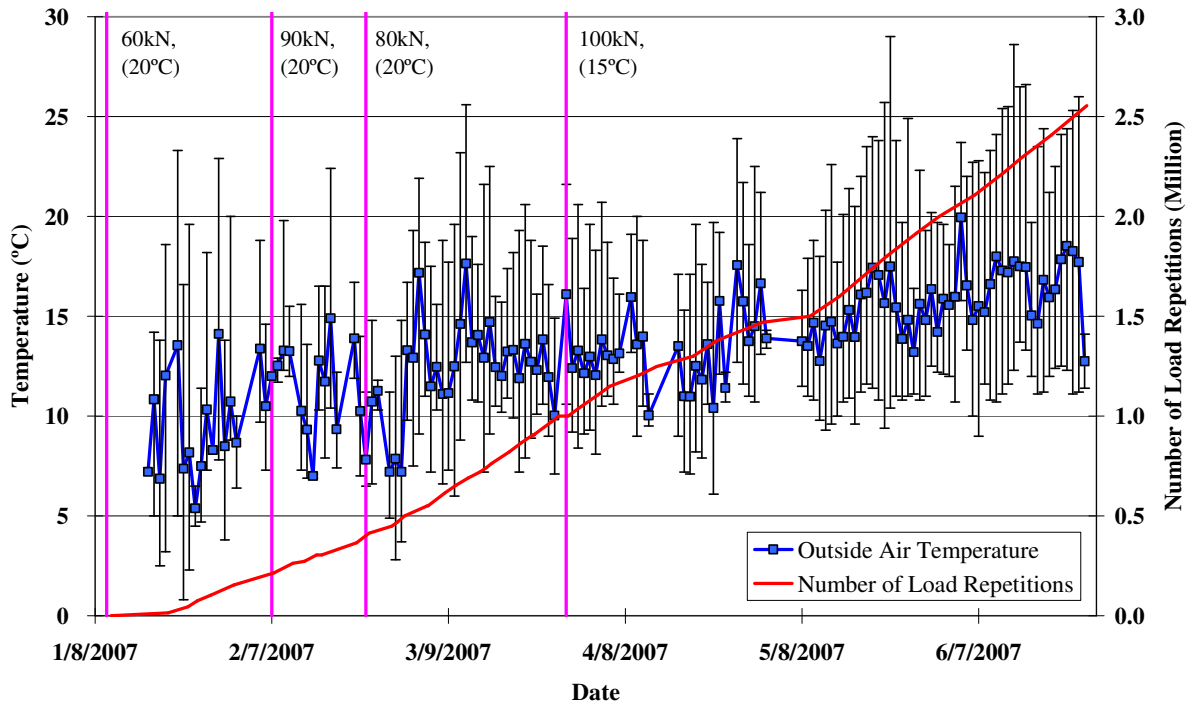

Figure 3.3: Daily average air temperatures outside the temperature control chamber.

3.1.3 Temperature in the Asphalt Concrete Layer

Daily averages of the surface and in-depth temperatures are listed in Table 3.1 and shown in Figure 3.4. Pavement temperatures increased during the early part of the test with very little difference in temperature at the various depths. After one million repetitions, pavement temperatures dropped sharply after conditioning, with temperatures at the various depths showing little variation. Pavement temperatures did not appear to be significantly influenced by outside air temperatures.

Table 3.1: Temperature Summary for Air and Pavement

Temperature	0–1,000,000		1,000,001–2,554,335	
	Average	Std Dev.	Average	Std Dev.
Outside Air	11.5	2.7	14.9	2.1
Inside Air	20.4	2.4	12.5	0.8
Pavement Surface	20.1	1.3	14.9	0.5
- 25 mm below surface	19.9	1.2	15.1	0.4
- 50 mm below surface	19.8	1.2	15.3	0.4
- 90 mm below surface	19.6	1.1	15.5	0.4
- 120 mm below surface	19.4	1.1	15.6	0.4

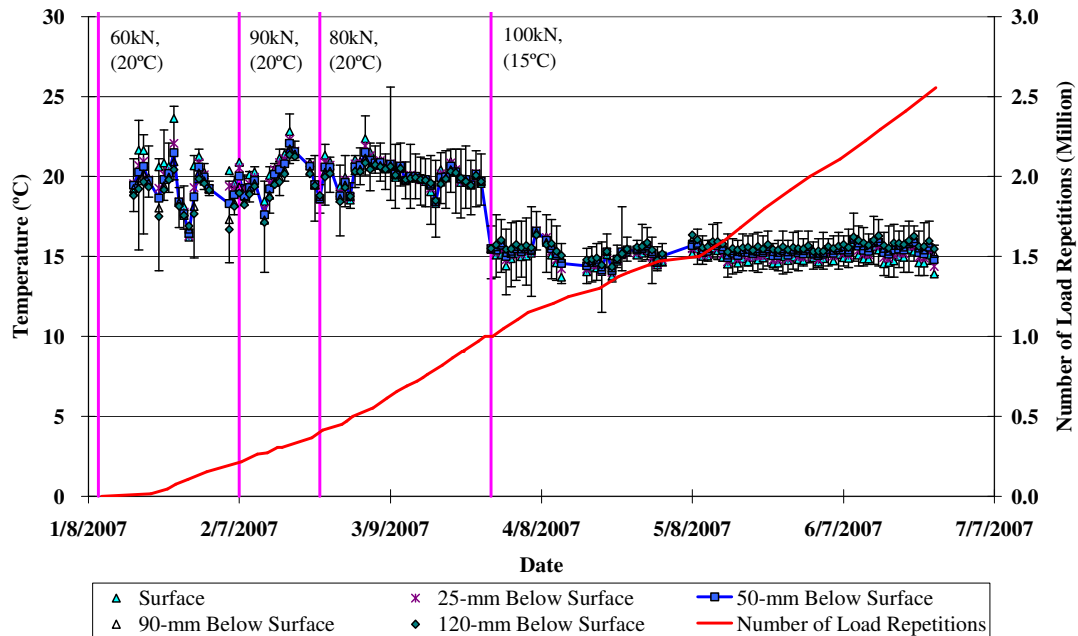

Figure 3.4: Daily average temperatures at pavement surface and various depths.

3.2. Rainfall

Figure 3.5 shows the monthly rainfall data for the Richmond Field Station HVS site for the duration of the test. As shown, most of the test was carried out during the wet season, with relatively high rainfall recorded in the two months prior to testing, and in the second month of testing. Relatively little rain was recorded in the last four months of the test.

3.3. Elastic Deflection

Elastic (recoverable) deflections provide an indication of the overall stiffness of the pavement structure and, therefore, a measure of the load-carrying capacity. As the stiffness of a pavement structure deteriorates, its ability to resist the deformation/deflection caused by a given load and tire pressure decreases. During HVS testing elastic deflections are measured with two instruments: the RSD, to measure surface deflections, and the MDD, to measure in-depth deflections. MDD modules could not be installed at the surface (0 mm) due to the limited thickness of the overlay and thus it is not possible to directly compare surface deflections between the two instruments. In addition to RSD and MDD measurements, FWD measurements were taken before and after HVS trafficking to evaluate the initial and final conditions of the pavement.

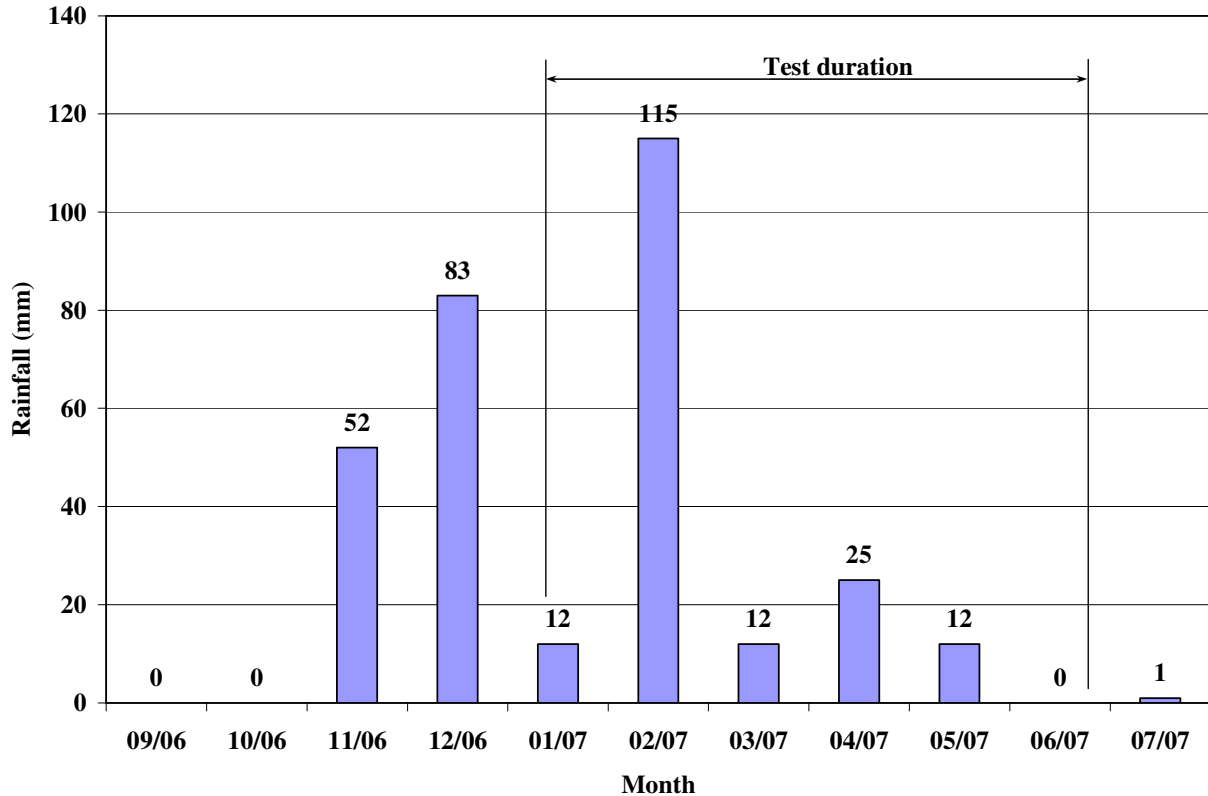

Figure 3.5: Monthly rainfall for Richmond Field Station HVS site.

3.3.1 Surface Elastic Deflection from RSD

In this section of the report, surface deflections as measured by the RSD under a load of 60 kN are summarized. (*Note:* although the load is increased during the test program, deflection measurements are always taken with a 60 kN load.)

Table 3.2 compares the average 60 kN RSD deflections for centerline locations 4CL, 6CL, 8CL, 10CL, and 12CL before and on completion of testing. The consistency of the deflections across the section and the low standard deviation for the average deflection after trafficking is attributed to the regularity of the cracking of the underlying DGAC layer and to support from the base, which is discussed below.

Table 3.2: Average 60 kN RSD Centerline Deflections Before and After Testing

Position	Parameter	Deflection (microns)		
		Before Trafficking	After Trafficking	Ratio of Final/Initial
All	Average	280	1,058	3.78
	Std. Deviation	23	132	-
4CL	Average	256	944	3.69
6CL	Average	298	999	3.35
8CL	Average	296	1,195	4.04
10CL	Average	283	1,103	3.90
12CL	Average	268	1,049	3.91

At the start of the test, initial deflections over most of the section (Station 6 to Station 12) were all within 0.04 mm of each other, with the lowest deflection (i.e., stronger pavement) recorded at Station 4CL, overlying that part of the DGAC with the lowest density of cracking. During the course of the test, substantial damage occurred on the overlay over the entire section under HVS trafficking, with the highest values recorded between Stations 8CL and 12CL. This is confirmed by the ratio of final-to-initial deflections for all RSD locations, which show that surface deflections increased by between 3.4 and 4.0 times along the length of the test section, indicating relatively significant damage in the pavement structure in terms of loss of stiffness. Although the ratio of final-to-initial deflections was fairly consistent across the section, when the results are considered in conjunction with Figure 2.4, lower deflections (Stations 4CL and 6CL) were recorded in the part of the section that had less cracking in the underlying pavement (stiffer pavement), while those with the highest deflections (Stations 8CL, 10CL, and 12CL) were over the more severely cracked area (weaker pavement).

Deflections and damage rates both increased with increase in load. Figures 3.6 to 3.12 compare the deflection bowls at the same centerline locations at test start, at the three load change intervals, at 1.5 million and 2.0 million repetitions, and at test completion. The same scale is used on all the figures, and the increasing deflection in the early part of the test is clear. However, deflections did not increase when the load was increased to 100 kN (Figure 3.9). This is partly attributed to drying back of the base material. The higher deflections at Stations 8CL, 10CL, and 12CL over the more densely cracked underlying DGAC can be observed in Figures 3.10 to 3.12.

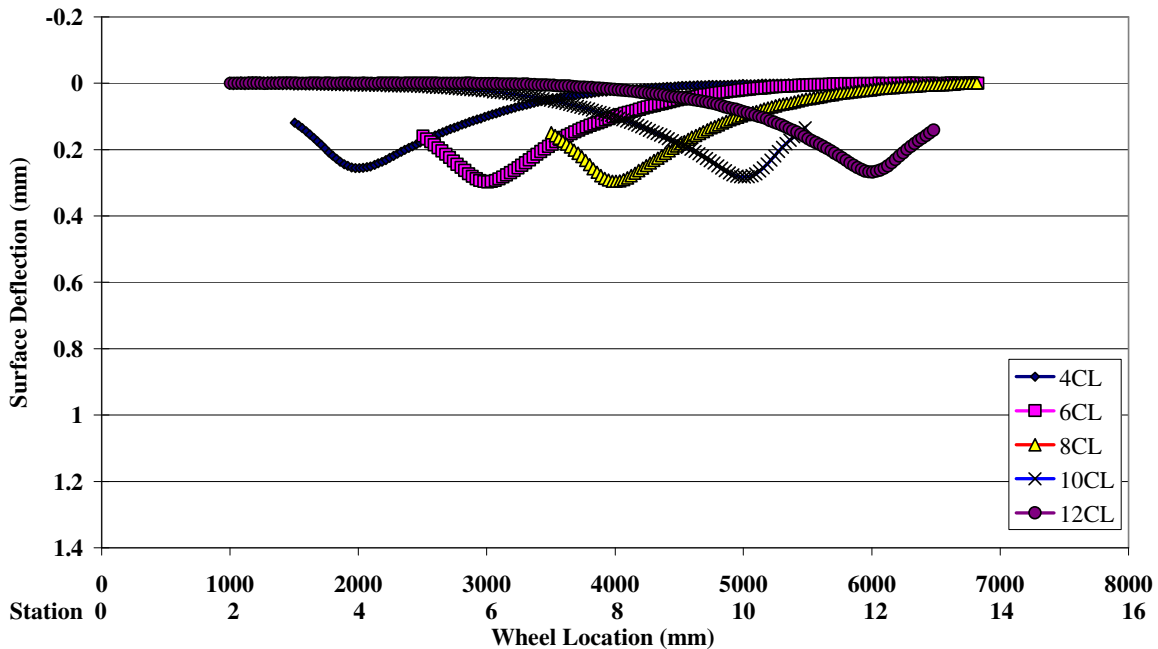

Figure 3.6: RSD deflections at CL locations with 60 kN test load at test start.

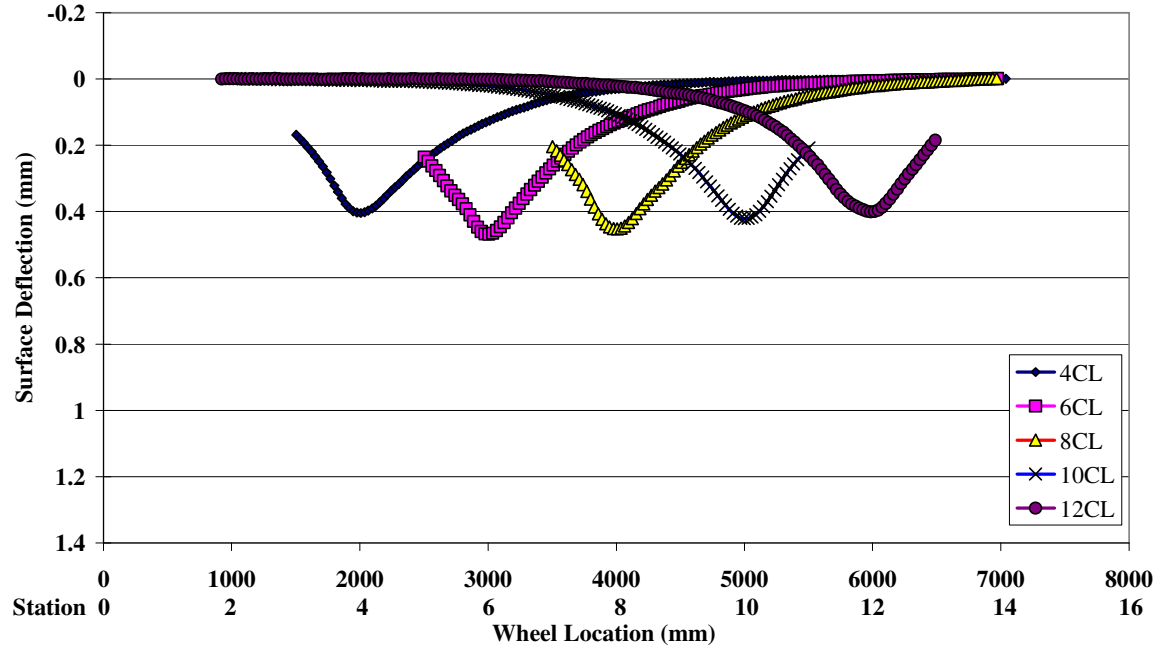

Figure 3.7: RSD deflections at CL locations with 60 kN test load after 215,000 repetitions. (90 kN load change)

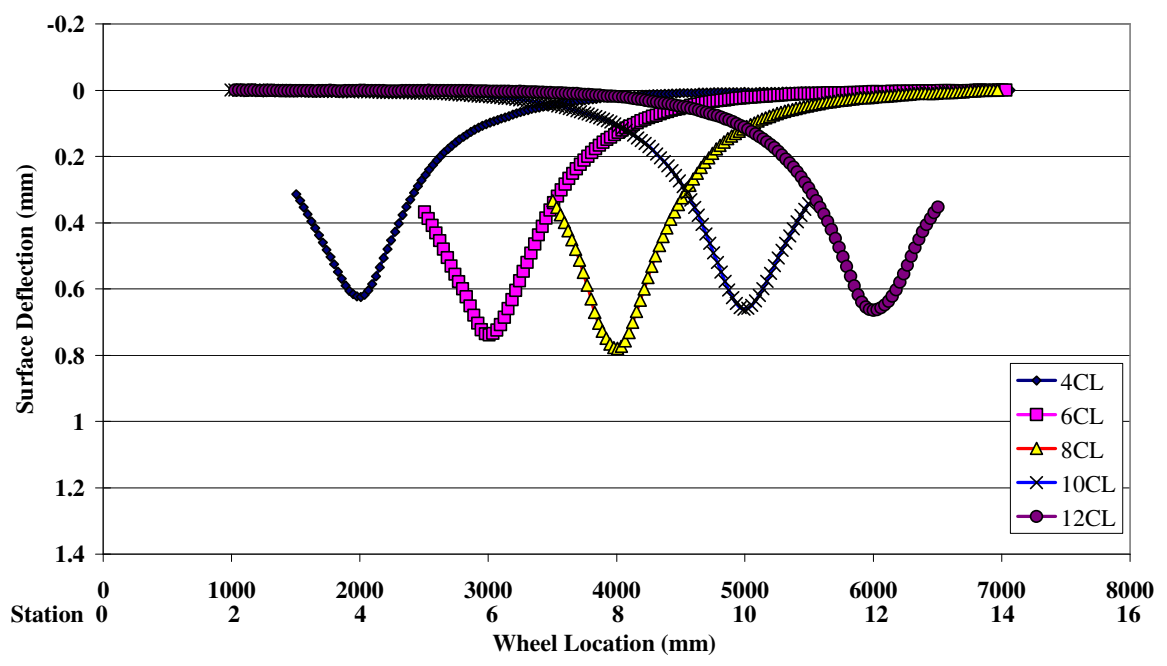

Figure 3.8: RSD deflections at CL locations with 60 kN test load after 410,000 repetitions. (80 kN load change)

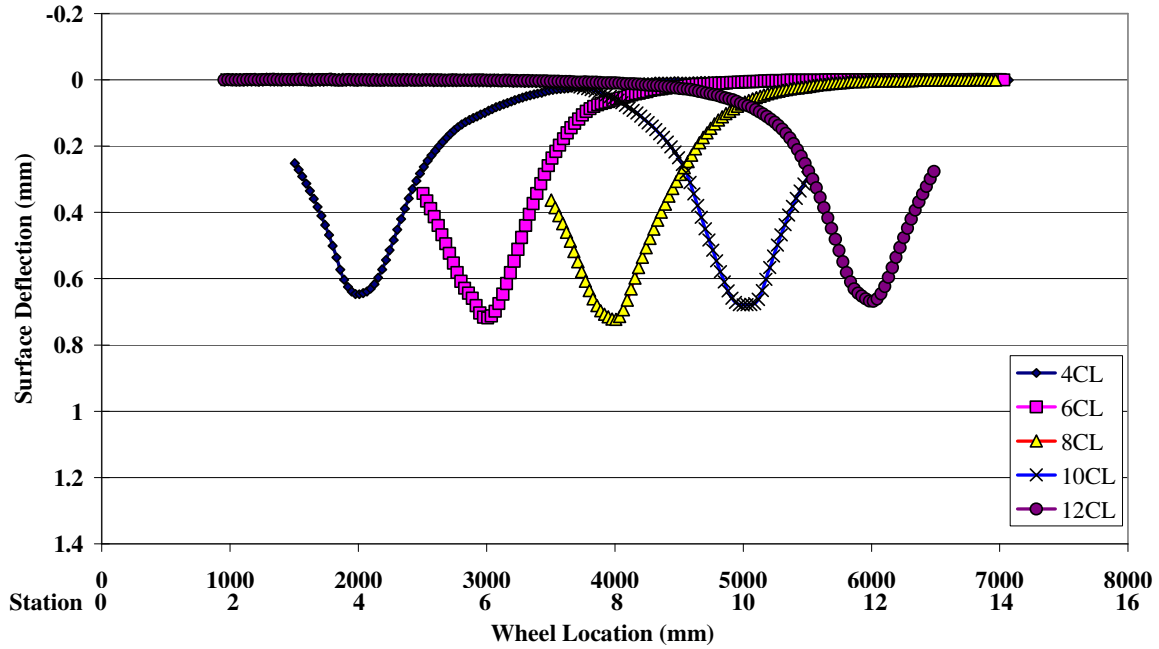

Figure 3.9: RSD deflections at CL locations with 60 kN test load after 1,000,000 repetitions. (100 kN load change)

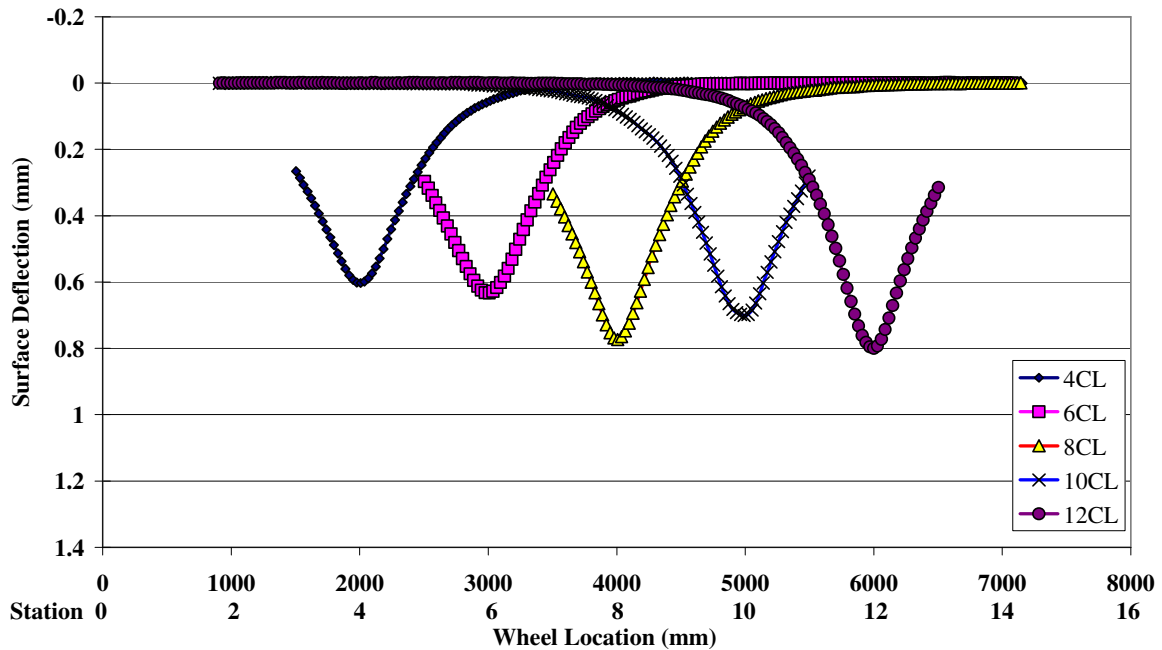

Figure 3.10: RSD deflections at CL locations with 60 kN test load after 1,500,000 repetitions.

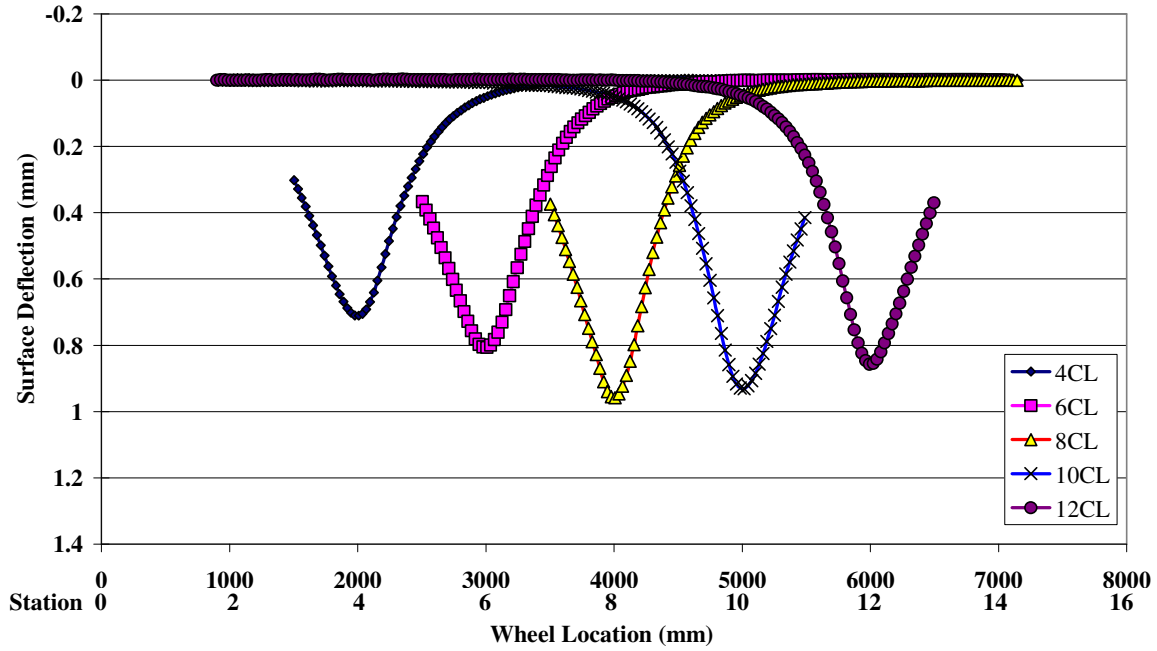

Figure 3.11: RSD deflections at CL locations with 60 kN test load after 2,000,000 repetitions.

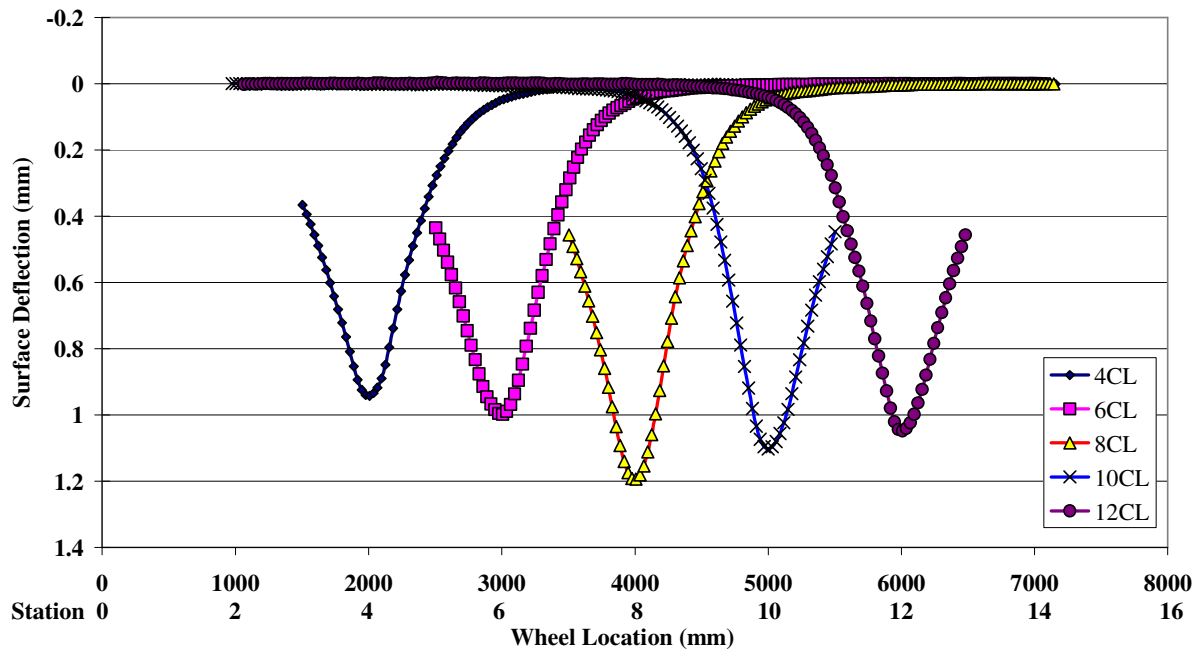

Figure 3.12: RSD deflections at CL locations with 60 kN test load at test completion.

The average 60 kN RSD deflections at centerline and side locations (200 mm from centerline within the trafficked area) are illustrated in Figure 3.13. These deflections are mostly all within 0.2 mm of each other, although as expected the side deflections are less than those of the centerline. Deflections increased sharply after the 90 kN load change, remained relatively constant during the 80 kN loading phase, and then increased marginally again after the 100 kN load change. Very little increase was recorded during the remainder of the test. The caravan side deflections are higher than the traffic side, which is attributed to the high water table on the side of the road. These results indicate that damage was generally greater in the vicinity of the centerline compared to the area away from the centerline where fewer repetitions were applied by the programmed wander of the HVS trafficking pattern.

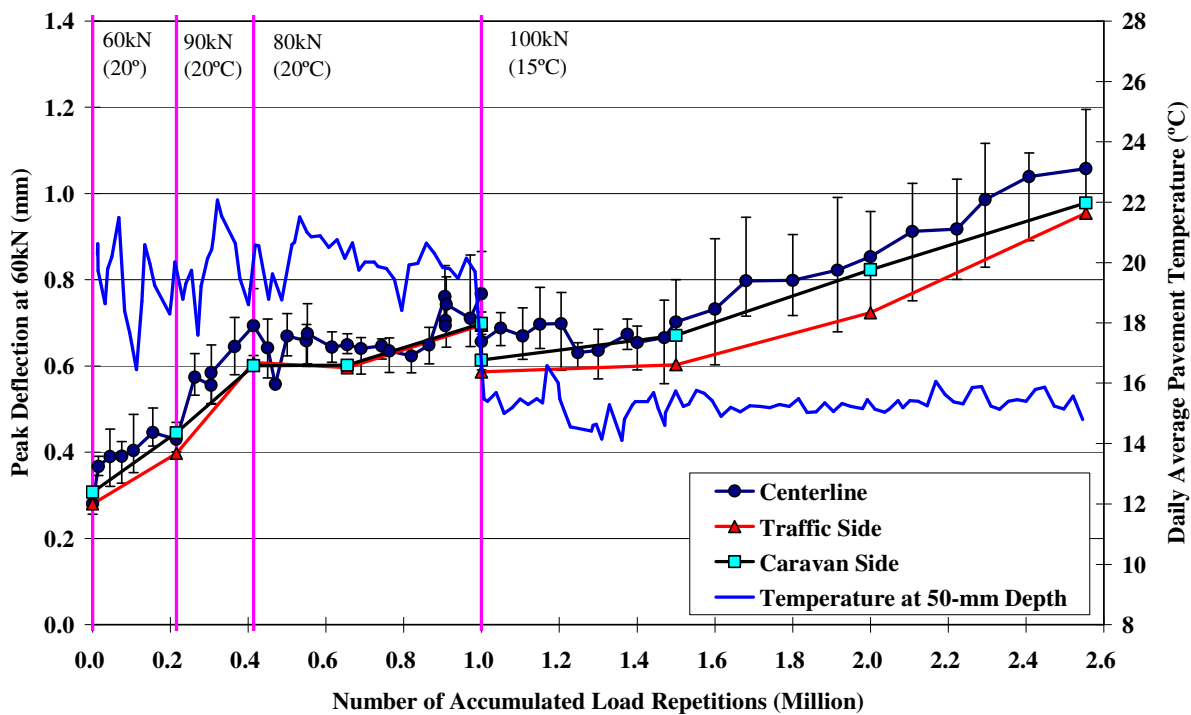

Figure 3.13: Average RSD surface deflections with 60 kN test load (centerline and sides).

Figure 3.14 shows the average 60 kN deflection at centerline as well as the averages for measurements taken at the end of the section with more severely cracked DGAC underneath (Stations 8CL, 10CL and 12CL) and the end with less severe cracking (Stations 4CL and 6CL). The difference in deflections is evident between the two ends. In Figures 3.13 and 3.14, some sensitivity of RSD deflection to temperature is apparent, for example at the load changes at 415,000 and 1,000,000 repetitions, and at approximately 850,000 and 1,300,000 repetitions. The influence of temperature on deflection will be discussed in the second-level analysis report. The sensitivity of the RSD to a load reduction is evident in the early phase of 80 kN loading.

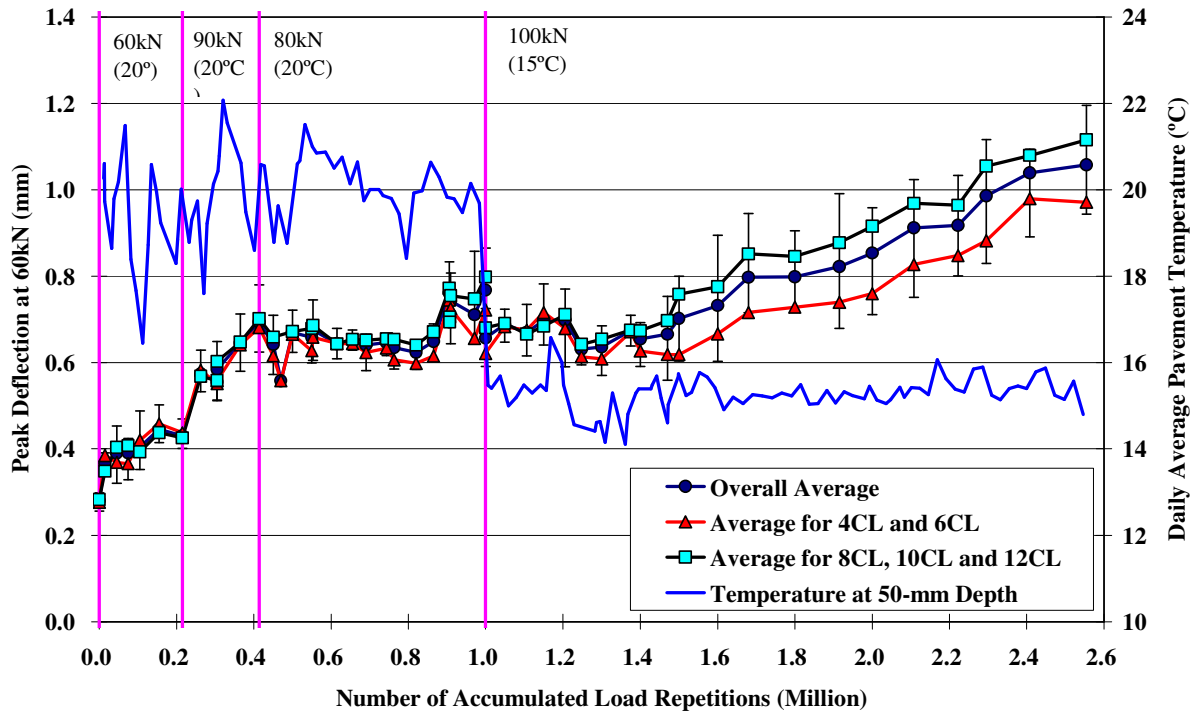

Figure 3.14: Centerline RSD surface deflections with 60 kN test load (average and subsection).

3.3.2 Surface Elastic Deflection from FWD

FWD testing was conducted on the section before and after HVS trafficking to monitor the changes in layer moduli. Table 3.3 summarizes the date, location, temperatures, and average deflections for the section. Temperatures listed are average temperatures. Recordings from two sensors (1 and 6) and two locations (section centerline and side of section) are shown. Sensor 1 (the sensor directly under the falling weight) provides an indication of the deflection of the composite pavement. Sensor 6 provides an indication of the deflection in the subgrade. Centerline readings show deflection on the trafficked area, while readings from the side of the section are used to compare trafficked and untrafficked areas. Figures 3.15 through 3.18 show the FWD deflection measurements recorded on the section. (*Note that scales differ between plots.*) Backcalculation of these results will be discussed in the second-level analysis report.

Figure 3.15 shows the effect of damage on the pavement over the course of the experiment. Deflection measured on Section 573RF prior to placing the overlay was relatively high, especially in the area of more severe cracking (Stations 8 and 14). Placement of the overlay considerably reduced the deflection. A similar damage pattern to that recorded on the underlying DGAC was observed after HVS trafficking, with the highest after-test damage recorded between Stations 8 through 12. The overlay does not appear to have provided any significant structural improvement. The figure also shows that deflections were

generally influenced by temperature, with lower deflections measured in the morning (lower temperature) compared to those measured in the afternoon (higher temperature) at the end of the test.

Table 3.3: Summary of FWD Measurements

Date	Location	Temperatures (°C)		FWD Deflection at 40 kN (microns) ¹			
				Sensor 1		Sensor 6	
		Air	Surface	Average	Std. Dev.	Average	Std. Dev.
After completion of Section 573RF							
07/19/02	Centerline	N/A	26.4	475	36	47	1
Before start of Section 591RF							
12/17/06	Centerline	9.0	14.7	116	3	43	2
12/16/06	Centerline	13.1	14.9	117	4	43	2
12/17/06	Side ²	1.4	1.5	148	12	60	5
12/15/06	Side	11.7	11.1	156	12	61	4
After completion of Section 591RF							
06/27/07	Centerline	19.1	25.9	457	46	53	4
06/28/07	Centerline	19.3	31.6	546	60	53	5
06/28/07	Side	19.8	27.1	260	17	77	4
06/27/07	Side	20.4	30.6	280	21	77	3

¹ Deflections derived from measurements between Stations 3 and 13 inclusive.
² Side location is 1.0 m from the test section, representing untrafficked area.

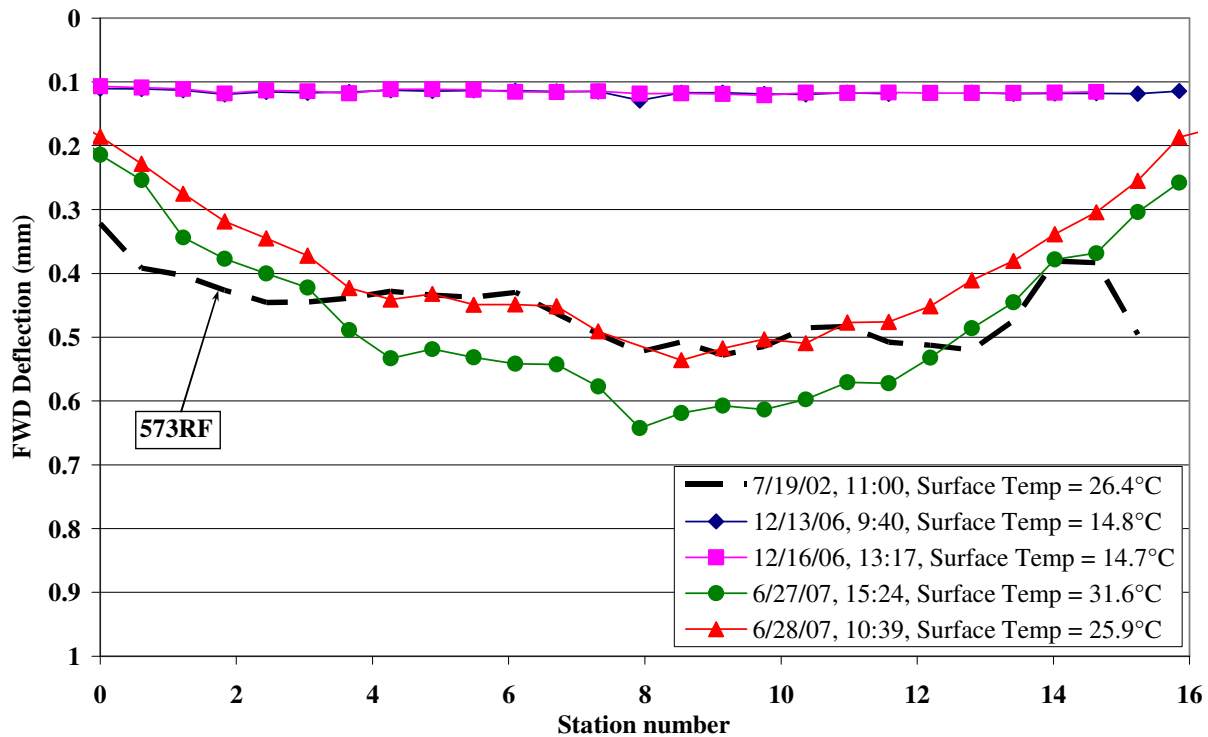

Figure 3.15: Composite pavement stiffness (FWD Sensor 1) on section centerline.

Figure 3.16 shows deflections in the subgrade before and after the test. These measurements indicate that there was no significant change (<0.02 mm) during the course of the experiment, although the subgrade

between Stations 10 and 14 appeared slightly less stiff than the remainder of the section. The overlay did not provide any significant structural improvement to the overall pavement structure in terms of protection of the subgrade. No temperature sensitivity was noted in the measurements.

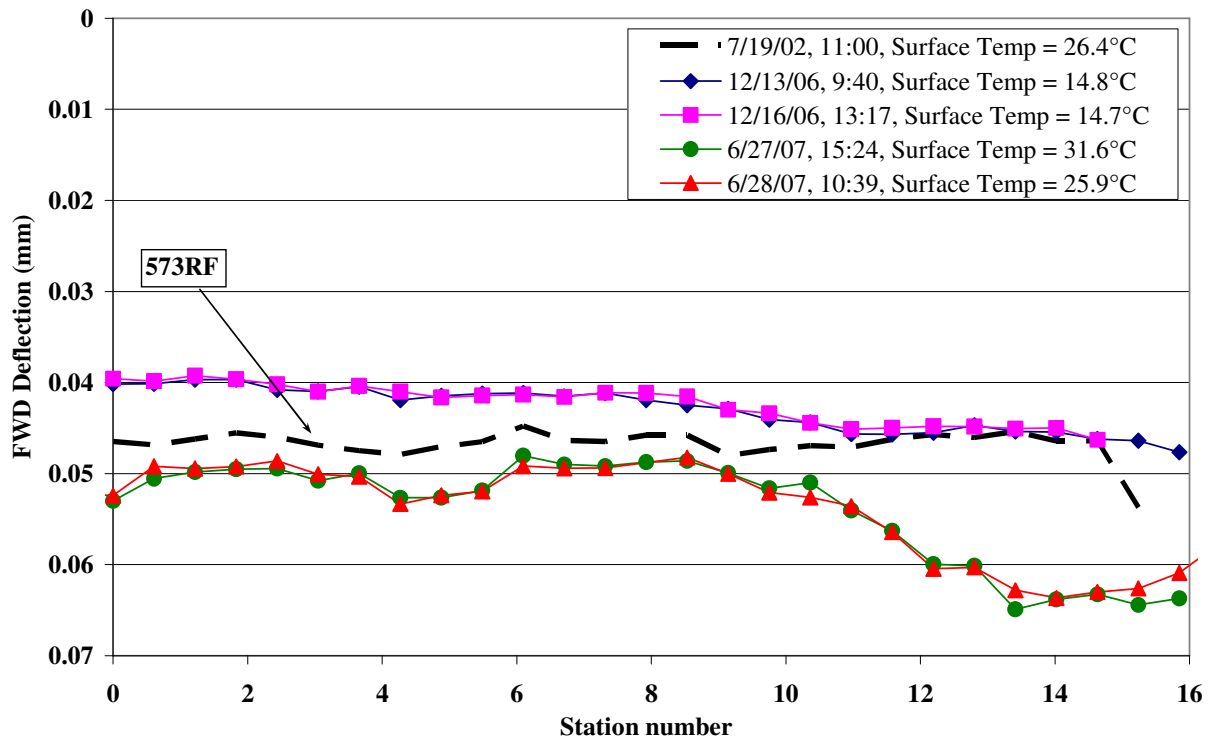

Figure 3.16: Subgrade pavement stiffness (FWD Sensor 6) on section centerline.

Figures 3.17 and 3.18 show FWD deflections taken along the side of the HVS test section but outside the trafficked area (i.e., the area tested did not have traffic damage). The figures can be used to understand the influence of environmental conditions on the performance of the section. The figures generally show slightly higher deflections after completion of testing compared to before testing. This is attributed to the effects of moisture (wetting and drying) over the course of testing. The off-section deflections did not appear to be significantly influenced by temperature.

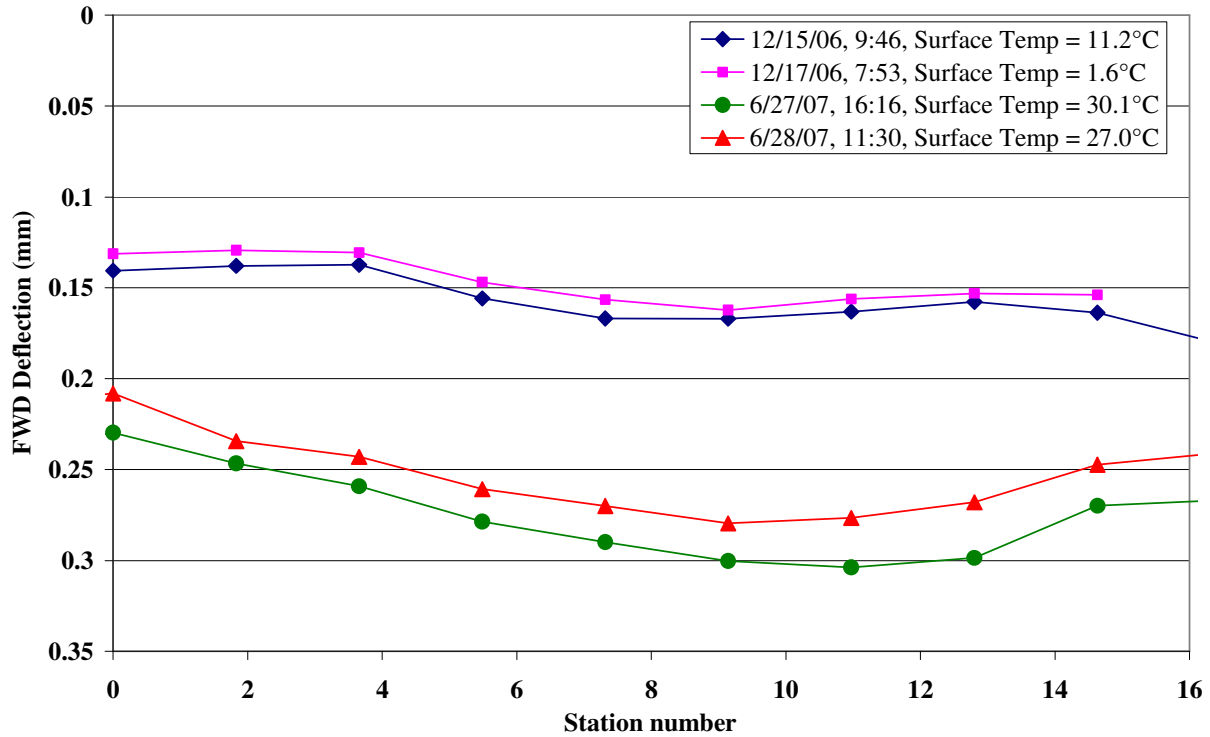

Figure 3.17: Composite pavement stiffness (FWD Sensor 1) outside trafficked area.

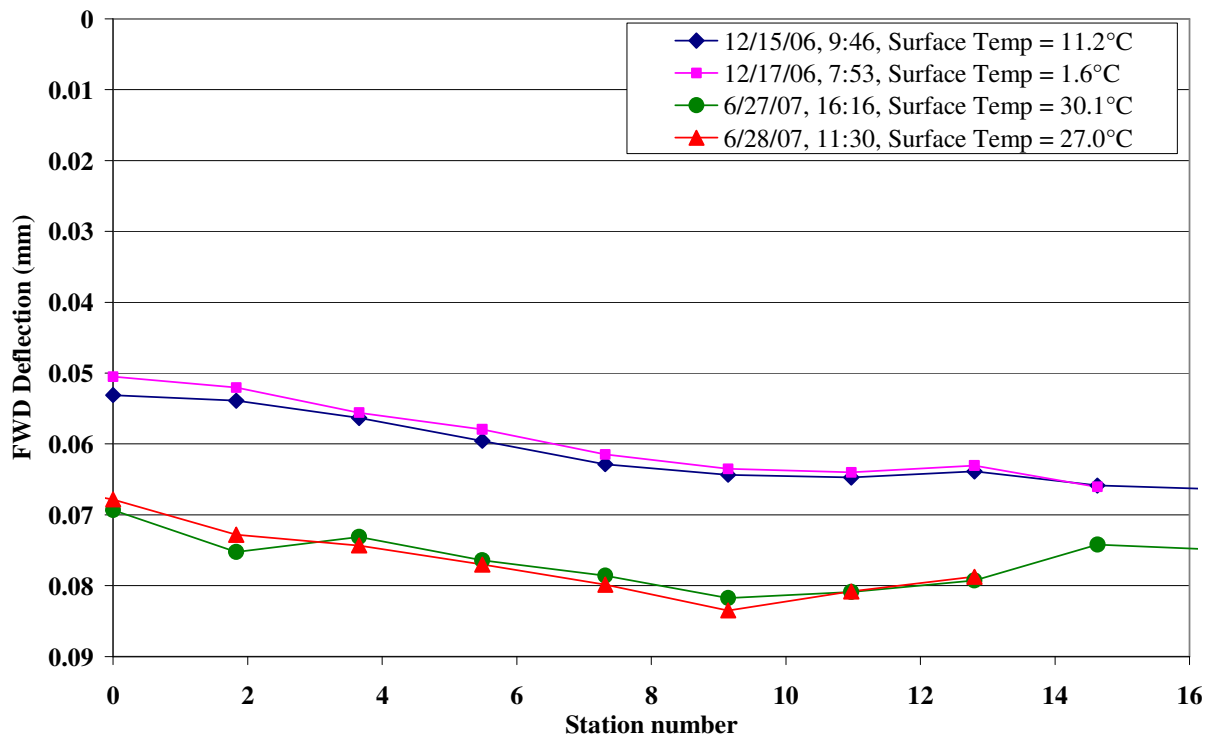

Figure 3.18: Subgrade pavement stiffness (FWD Sensor 6) outside trafficked area.

3.3.3 In-Depth Elastic Deflection from MDD

The schedule of MDD measurements with various test loads is listed in Table 2.2. In line with other reports in this study, the following discussion will focus on results obtained with the 60 kN load only.

Table 3.4 and Figures 3.19 and 3.20 summarize the in-depth elastic deflections measured at various depths with MDDs 4 and 12 respectively. The figures include RSD measurements taken on the surface at the same locations as the MDDs. Problems were noted with the anchoring of MDD8 in the soft clay subgrade and the results have not been included in this analysis.

Table 3.4: Summary of 60 kN In-Depth Elastic Deflections

Depth (mm)	Layer	Elastic Deflection (microns)		
		Before Trafficking	After Trafficking	Ratio of Final/Initial
MDD4				
0	Surface (from RSD)	256	944	3.69
120	Bottom of cracked DGAC	282	911	3.23
300	Middle of aggregate base	268	819	3.06
470	Bottom of aggregate base	232	570	2.46
720	Subgrade	139	280	2.01
MDD12				
0	Surface (from RSD)	268	1,049	3.91
125	Bottom of cracked DGAC	307	994	3.24
530	Bottom of aggregate base	241	527	2.19
830	Subgrade	109	229	2.10

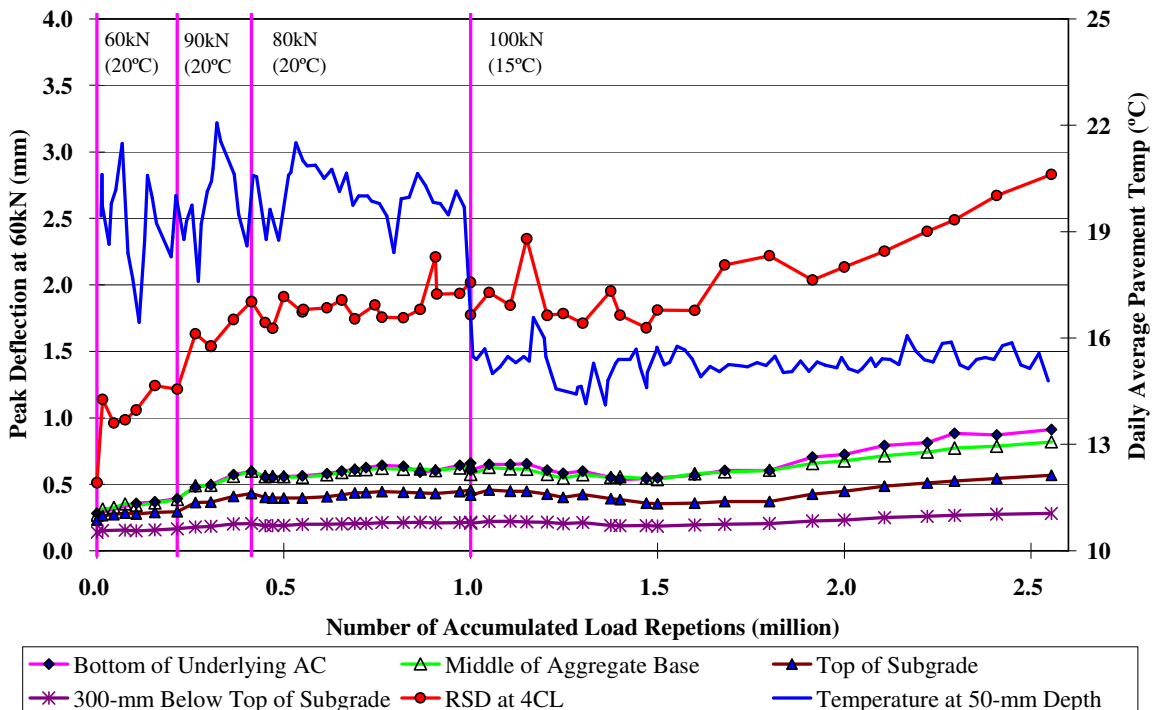

Figure 3.19: Elastic deflections at MDD4 with 60 kN test load.

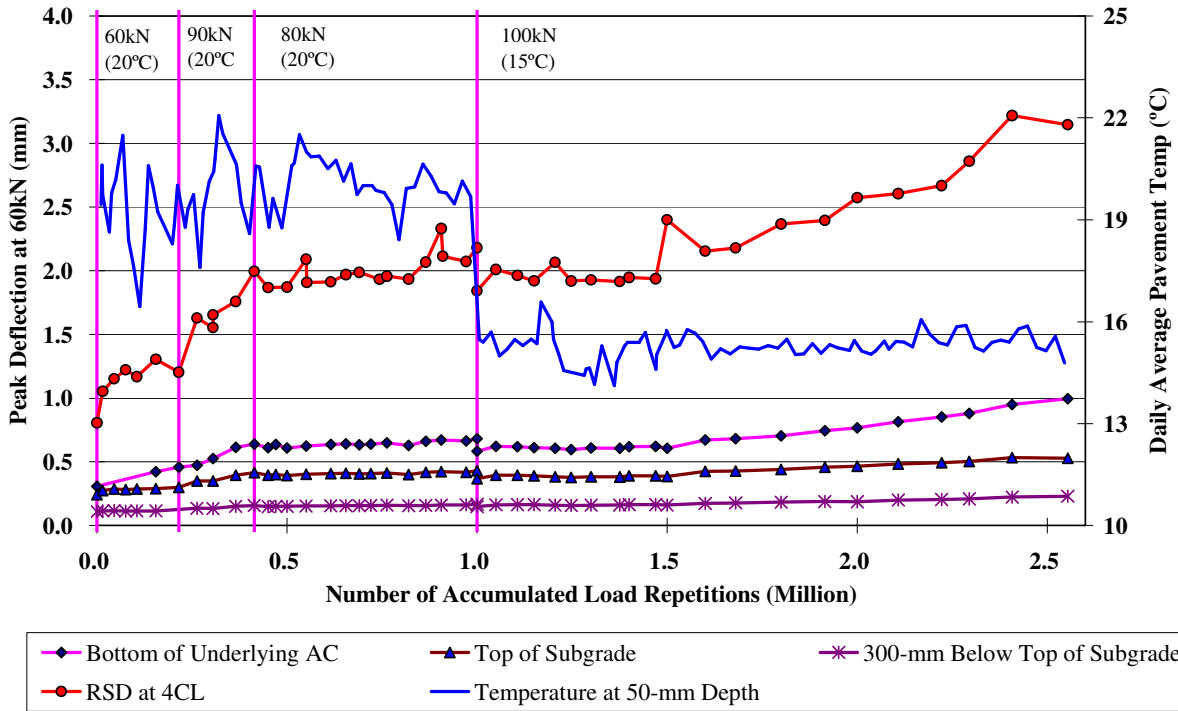

Figure 3.20: Elastic deflections at MDD12 with 60 kN test load.

The data indicate that most of the damage occurred in the asphalt concrete layers with similar performance recorded in the base and subgrade at both MDDs. A slightly higher damage rate was recorded at the top of the aggregate base at MDD12 compared to that recorded at MDD4, which was attributed to the higher crack density in the DGAC layer at this end of the section. Most damage occurred in the early stages of the test during the 60 kN and 90 kN loading phases. Very little increase in damage was recorded during the 80 kN and early stages of the 100 kN loading periods. The damage rate increased again after approximately 1.5 million repetitions had been applied. Some temperature sensitivity was noted at the top and middle of the aggregate base at the 100 kN load change when the pavement temperature was reduced to 15°C. Below the surfacing layers, the effect of trafficking load on elastic deflection decreased with increasing depth, as expected. Ratios of final-to-initial MDD deflections were similar for both MDDs with ratios at the bottom of the DGAC lower than at the surface. The ratios indicate that most damage occurred in the surfacing layers and top of the aggregate base. Some of the damage in the aggregate base could be attributed to recementation in the aggregate base materials (recycled construction waste) during wetting and drying cycles, and subsequent breakdown under trafficking.

3.4. Permanent Deformation

Permanent deformation at the pavement surface (rutting) was monitored with the Laser Profilometer and at various depths within the pavement with two Multi-depth Deflectometers (MDDs). These measurements are discussed below.

3.4.1 Permanent Surface Deformation (Rutting)

Deformation and rutting on HVS tests are usually analyzed using two definitions, namely maximum rut depth and average deformation (4), as illustrated in Figure 3.21. The Laser Profilometer is used to measure these distresses and provides sufficient information to evaluate the evolution of permanent surface deformation of the entire test section at various loading stages.

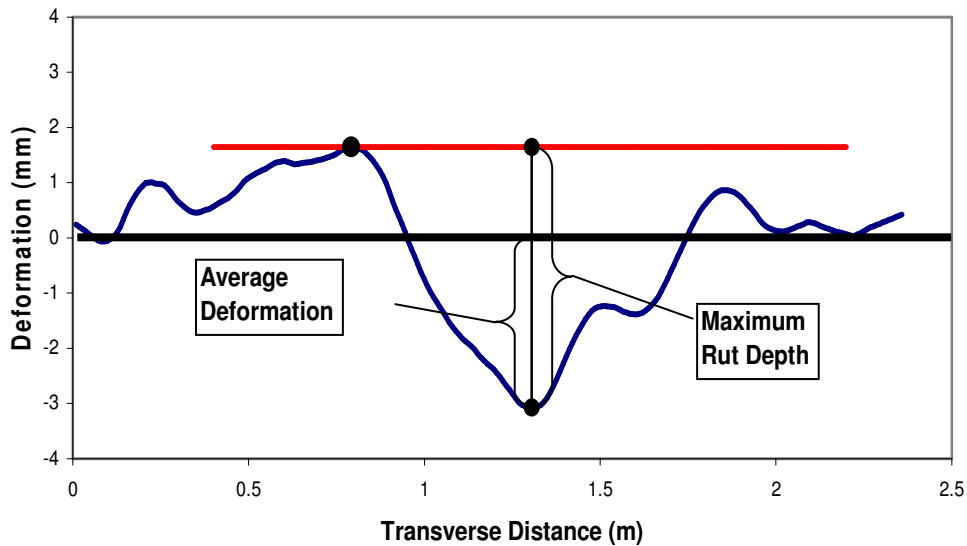

Figure 3.21: Illustration of maximum rut depth and average deformation of a leveled profile.

Figure 3.22 shows the average transverse cross section measured with the Profilometer at various stages of the test. This plot clearly shows the increase in rutting and deformation over the duration of the test.

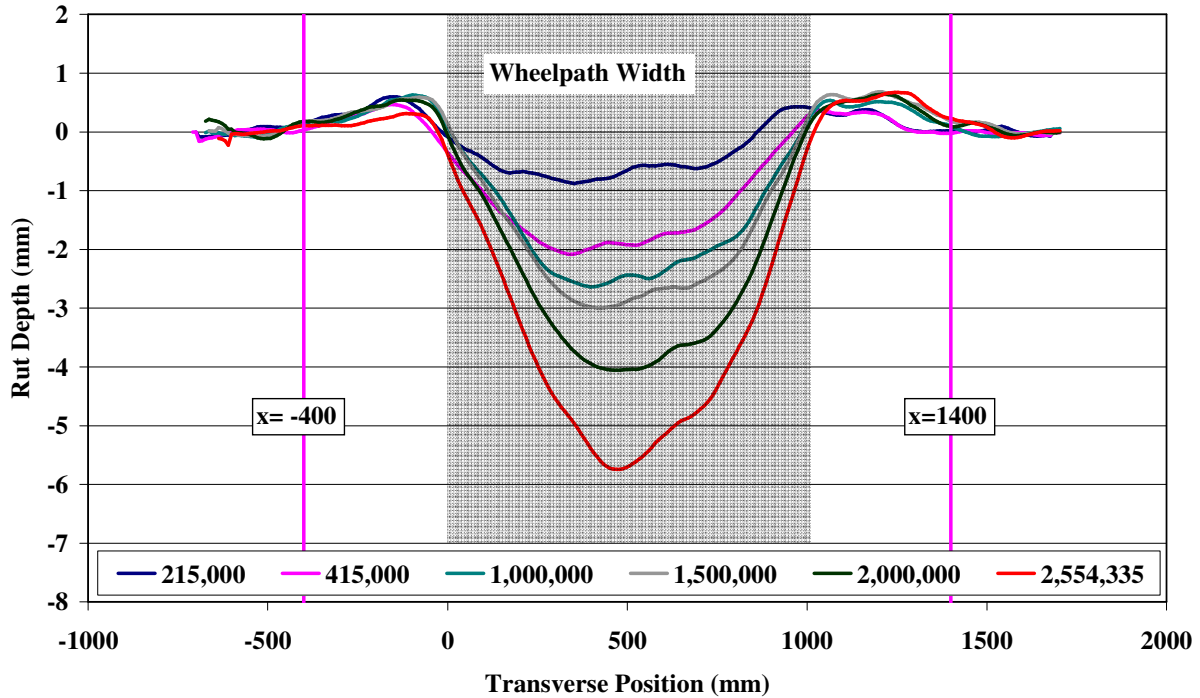

Figure 3.22: Laser profilometer cross section at various stages of trafficking.

During HVS testing, rutting usually occurs at a high rate initially, then typically diminishes as trafficking progresses until reaching a steady state. If the load level is subsequently increased, the pavement will undergo another phase of rapid rutting development until a steady phase for that new load level is reached. This initial phase is referred to as the “embedment” phase. Figures 3.23 and 3.24 show the development of permanent deformation (average deformation and maximum rut, respectively) with load repetitions as determined by the Laser Profilometer for the test section. *Note that the scales in the figures are different.* Embedment phases are apparent at the beginning of the experiment and at the 90 kN load change. Error bars on the average reading indicate variation along the length of the section and show a consistently increasing difference over the section over the duration of the test (3.0 mm at the end of the test). The figures also show average deformation and average maximum rut for Stations 3 to 7 and 8 to 13. There is very little difference between the two sub-sections, indicating that the cracking in the underlying layer did not have a significant influence on rutting performance. The rate of deformation remained relatively constant throughout the test indicating that the temperature change at the 100 kN load change did not influence rutting behavior.

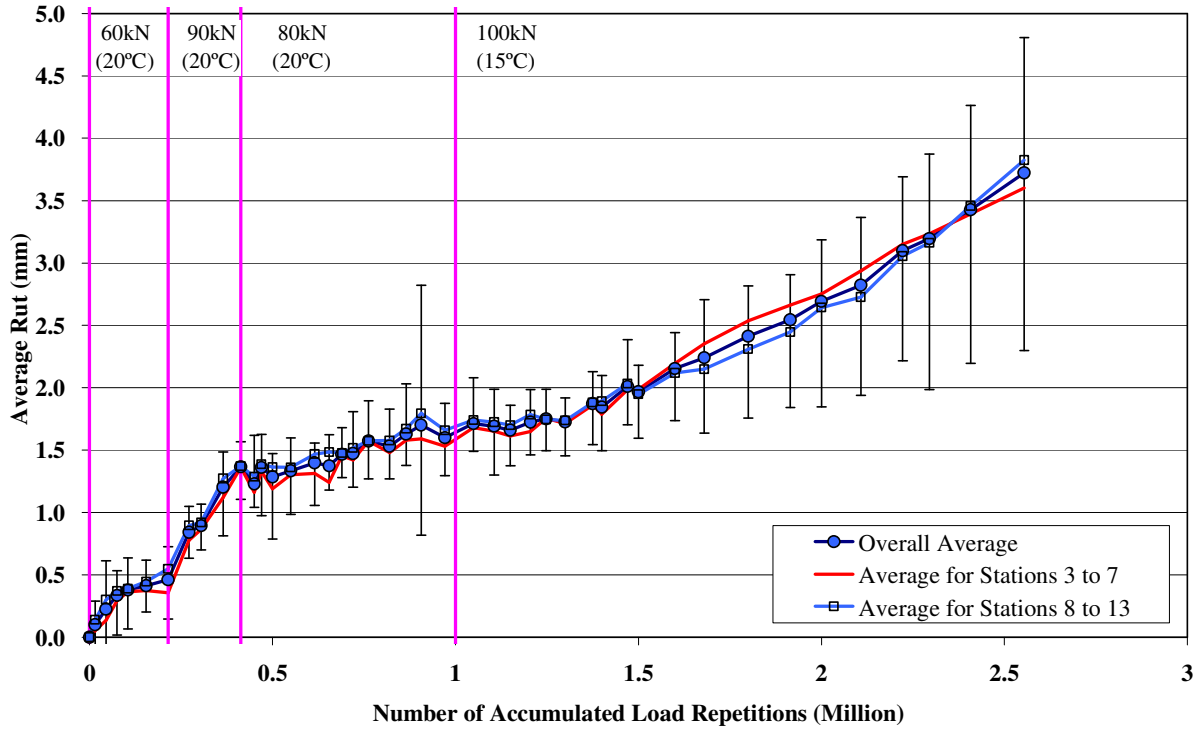

Figure 3.23: Average deformation determined from Laser Profilometer data.

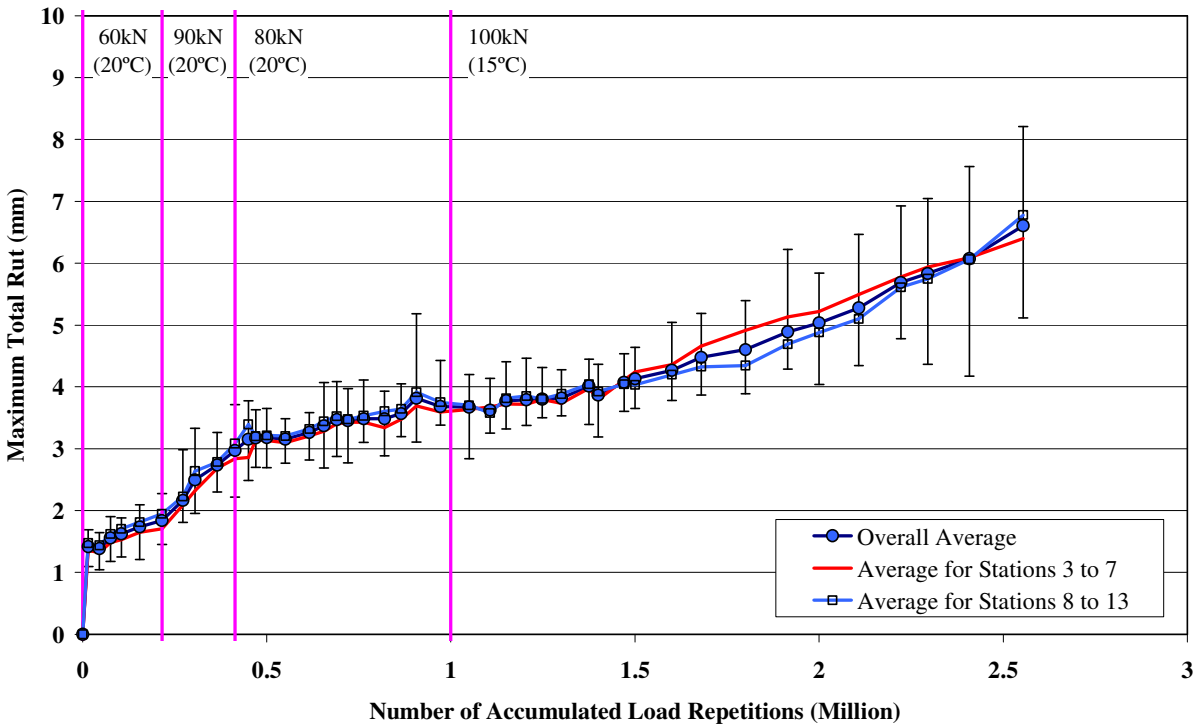

Figure 3.24: Average maximum rut determined from Laser Profilometer data.

Figure 3.25 shows a contour plot of the pavement surface at the 90 kN load change (215,000 repetitions), when a noticeable rut had started to appear at each end of the section.

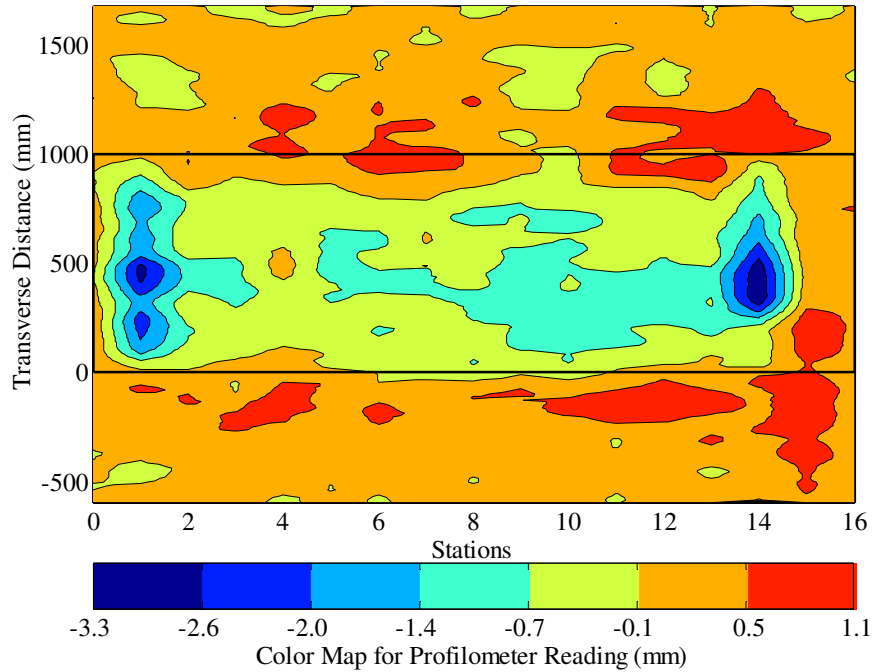

Figure 3.25: Contour plot of permanent deformation after 215,000 repetitions.

Figures 3.26 through 3.30 show contour plots of the rutting progression at the 80 kN (410,000 repetitions) and 100 kN (one million repetitions) load changes, at 1.5 and 2.0 million repetitions, and at the end of the test (2.55 million repetitions). The increase in rutting throughout the test is evident in the figures.

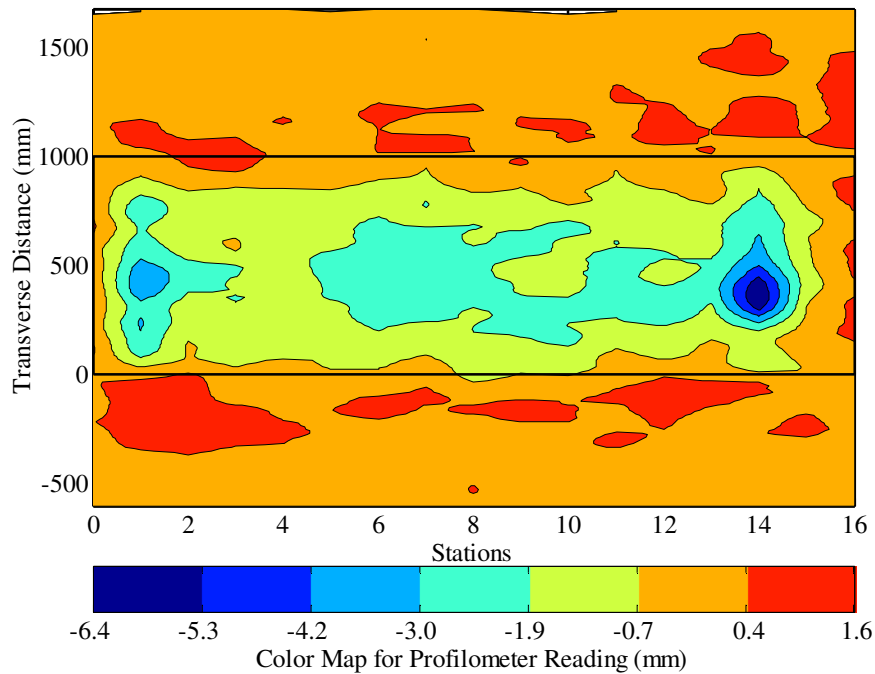

Figure 3.26: Contour plot of permanent deformation after 410,000 repetitions.

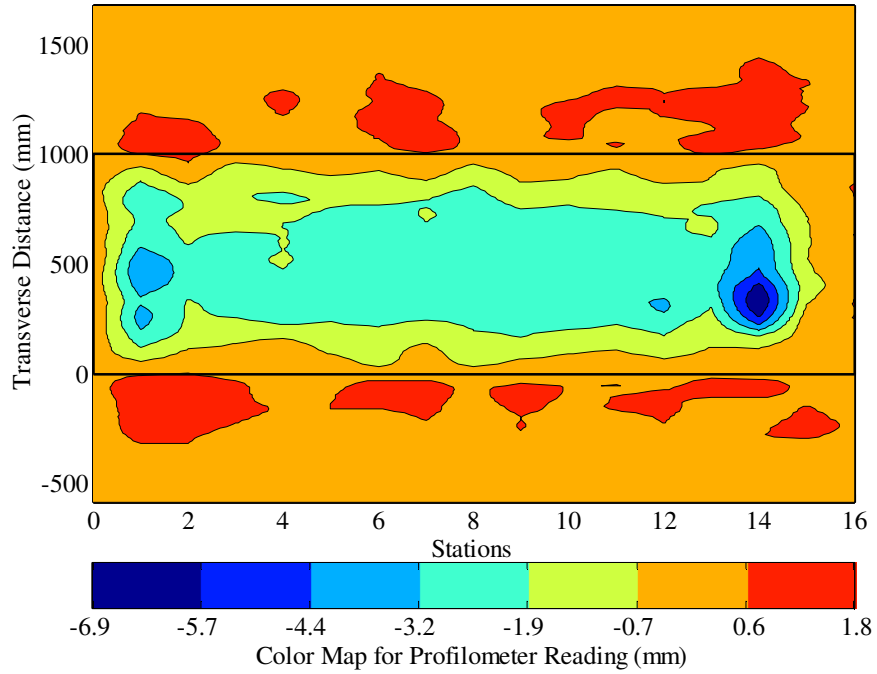

Figure 3.27: Contour plot of permanent deformation after 1,000,000 repetitions.

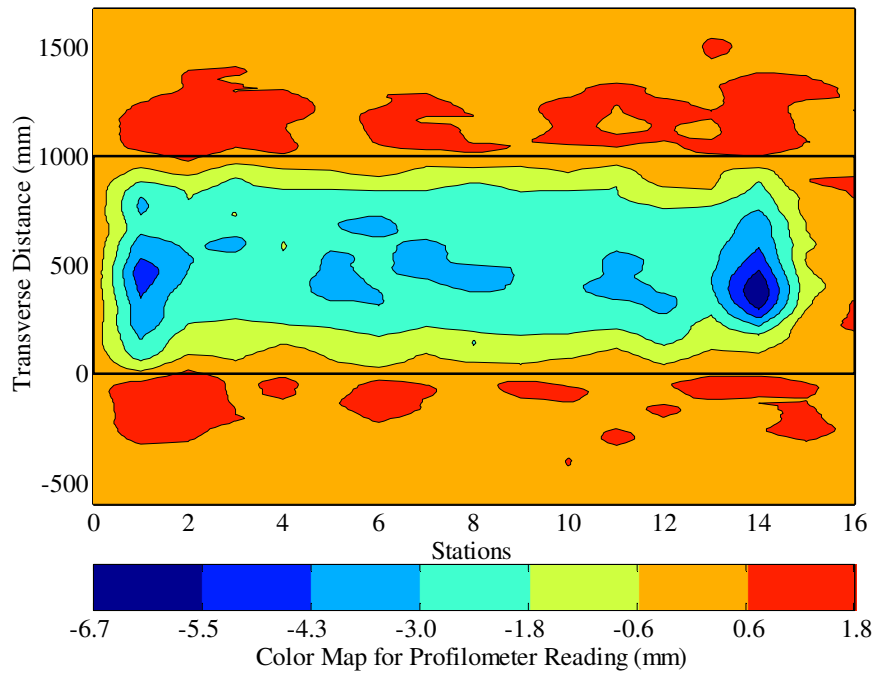

Figure 3.28: Contour plot of permanent deformation after 1,500,000 repetitions.

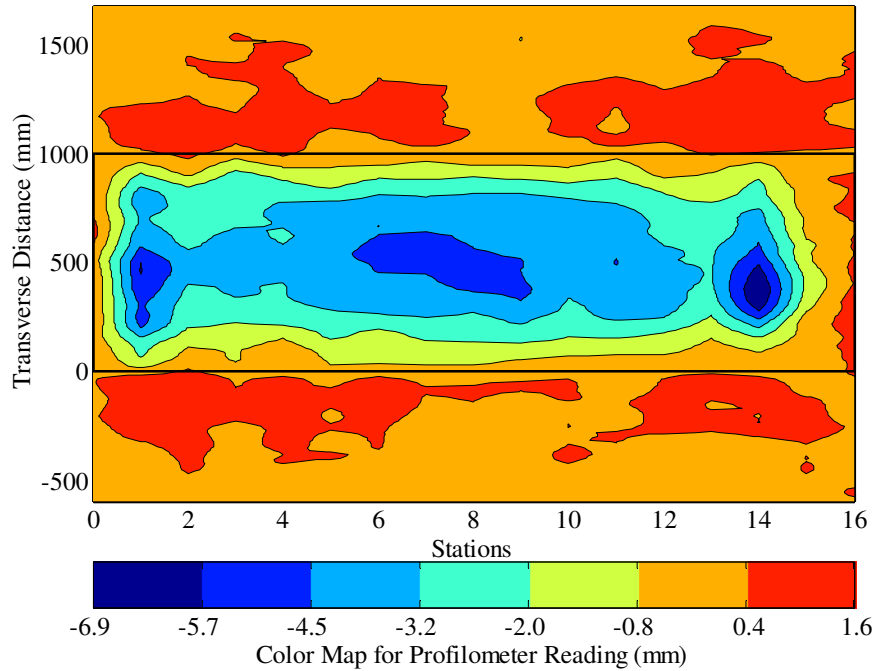

Figure 3.29: Contour plot of permanent deformation after 2,000,000 repetitions.

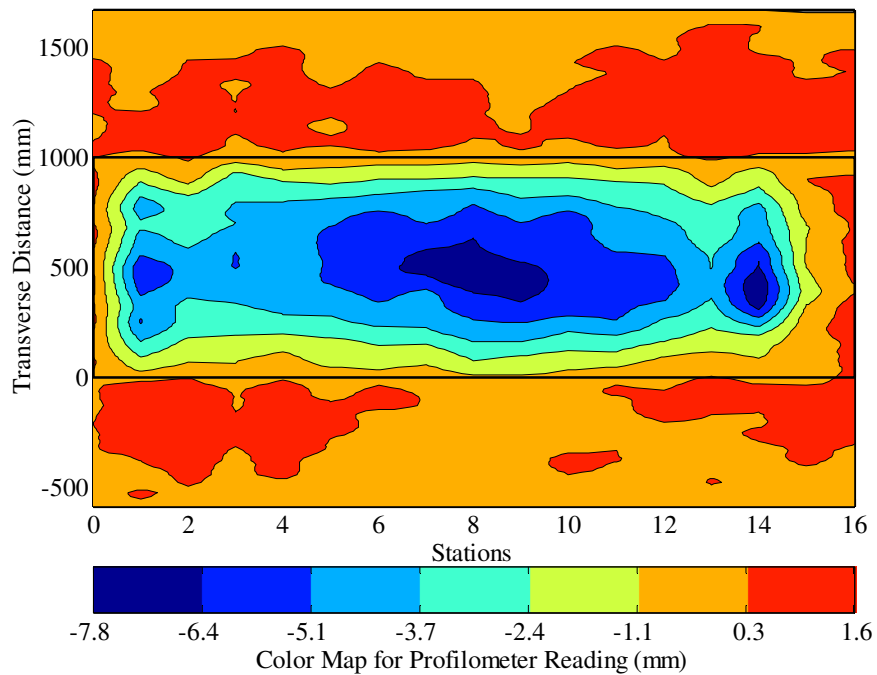

Figure 3.30: Contour plot of permanent deformation at end of test (2.55 million repetitions).

After completion of trafficking, the average deformation and the average maximum rut depth were just 1.7 mm and 4.6 mm respectively. The maximum rut depth measured on the section was 8.2 mm, at Station 8, which was in the vicinity of the most densely cracked area in the underlying DGAC. The

average maximum rut depth at the end of the test was significantly less than the failure criterion of 12.5 mm. However, in the interest of completing the reflective cracking study trafficking was stopped after discussion with Caltrans (6). The final surface rutting pattern of the overlay generally corresponds with the fatigue cracking pattern of the cracked DGAC layer, as shown in Figure 3.31, with the deepest rut occurring in the area with the most severe cracking in the underlying layer.

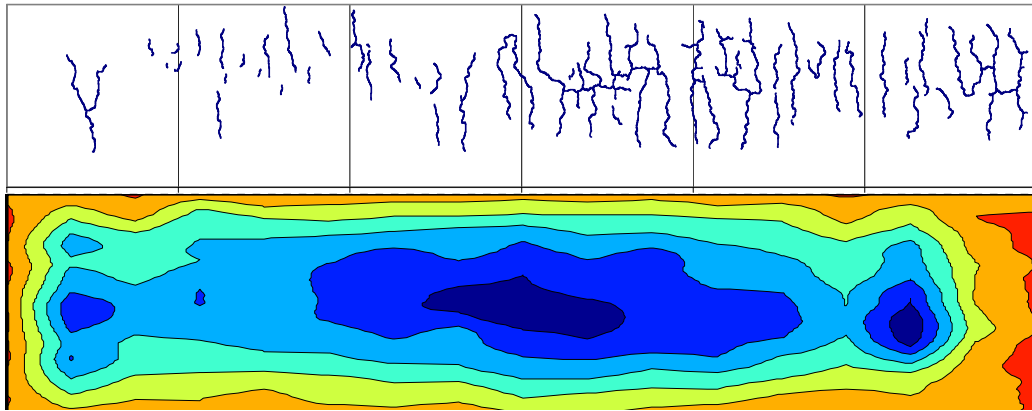

Figure 3.31: Comparison of cracking pattern from Phase 1 and rutting in Phase 2.

3.4.2 Permanent In-Depth Deformation

The accumulation of vertical deformation at various depths in the pavement was measured with MDD Linear Variable Displacement Transducer (LVDT) modules during the course of the HVS test. Permanent deformation measured by each LVDT is the total permanent deformation of the pavement between the anchoring depth (3.0 m) and the depth of the module. Accordingly, LVDT modules in the upper part of the pavement typically measure larger permanent deformation than those in the lower part. The difference in measured permanent deformation between two LVDT modules represents the permanent deformation accumulated in the layers between those two modules. This is known as differential permanent deformation. Module locations are shown in Figure 2.2. A module was not installed on the surface of the MAC15-G overlay due to thickness constraints.

Table 3.5 and Figures 3.32 through 3.35 provide an indication of the permanent deformation recorded at MDD4 and MDD12, respectively. Figures 3.32 and 3.34 show permanent deformation at the MDD modules, while Figures 3.33 and 3.35 show the differential deformation calculated for the various layers. Although the MDD data appears to be reliable, the deformations recorded are so small that measurement noise may have influenced the results. Firm conclusions about the permanent deformation in the various layers will only be obtained after excavation and assessment of the test pit.

Table 3.5: Vertical Permanent Deformation in Pavement Layers

Layer	Thickness (mm)	Vertical Permanent Deformation (mm)		Percentage Total Deformation (%)	
		MDD4	MDD12	MDD4	MDD12
After 1,000,000 load repetitions					
AC layers*	135	1.94	2.39	89.4	79.7
Aggregate base	410	0.23	0.43	10.6	14.3
Subgrade	Semi-infinite	0.00	0.18	0.0	6.0
Total (AC+base)		2.17	3.00	100	100
After 2,554,335 load repetitions (test completion)					
AC layers*	135	1.92	2.77	60.0	54.6
Aggregate base	410	1.00	2.00	31.3	39.4
Subgrade	Semi-infinite	0.28	0.30	8.7	6.0
Total (AC+base)		3.20	5.07	100	100

* Laser Profilometer measurement on MDD topcap - top MDD module measurement

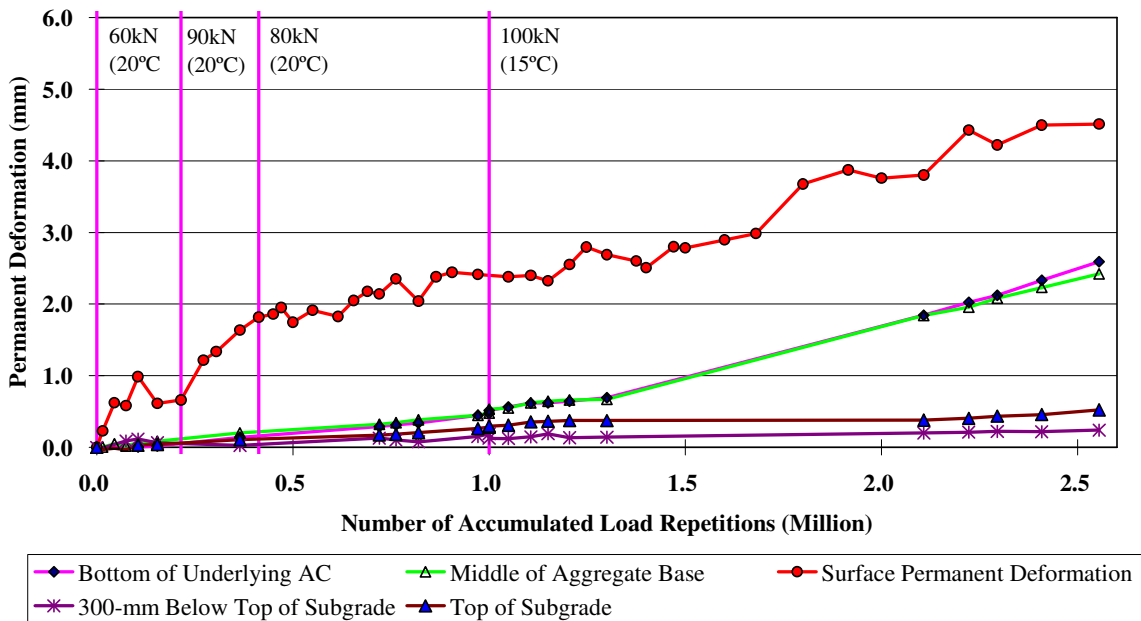

Figure 3.32: In-depth permanent deformation at MDD4.

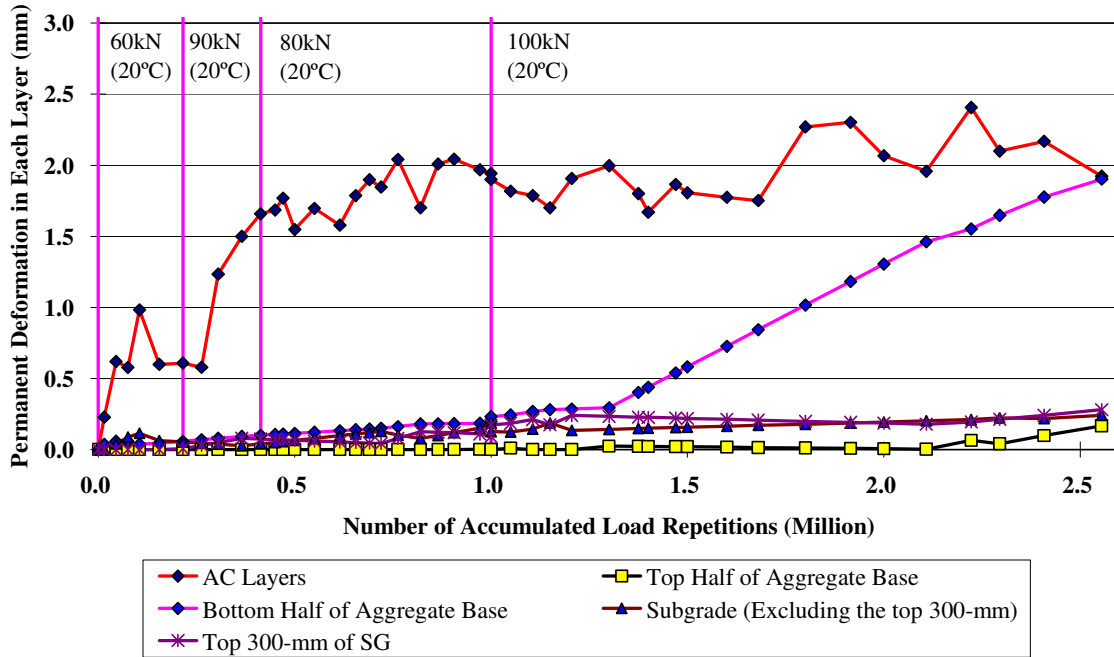

Figure 3.33: In-depth differential permanent deformation of various layers at MDD4.

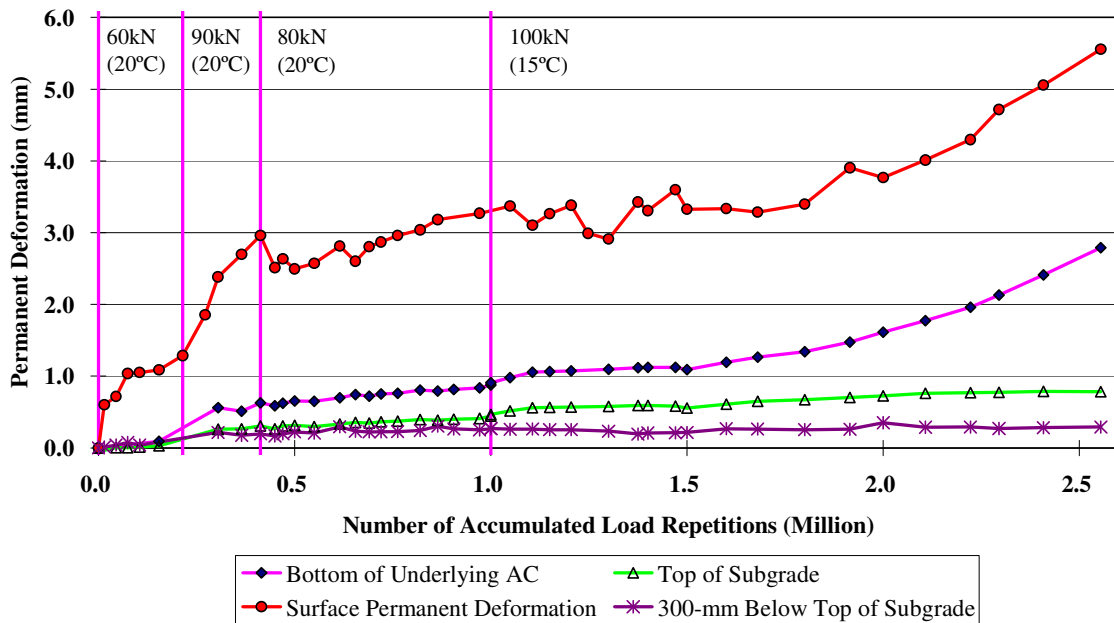

Figure 3.34: In-depth permanent deformation at MDD12.

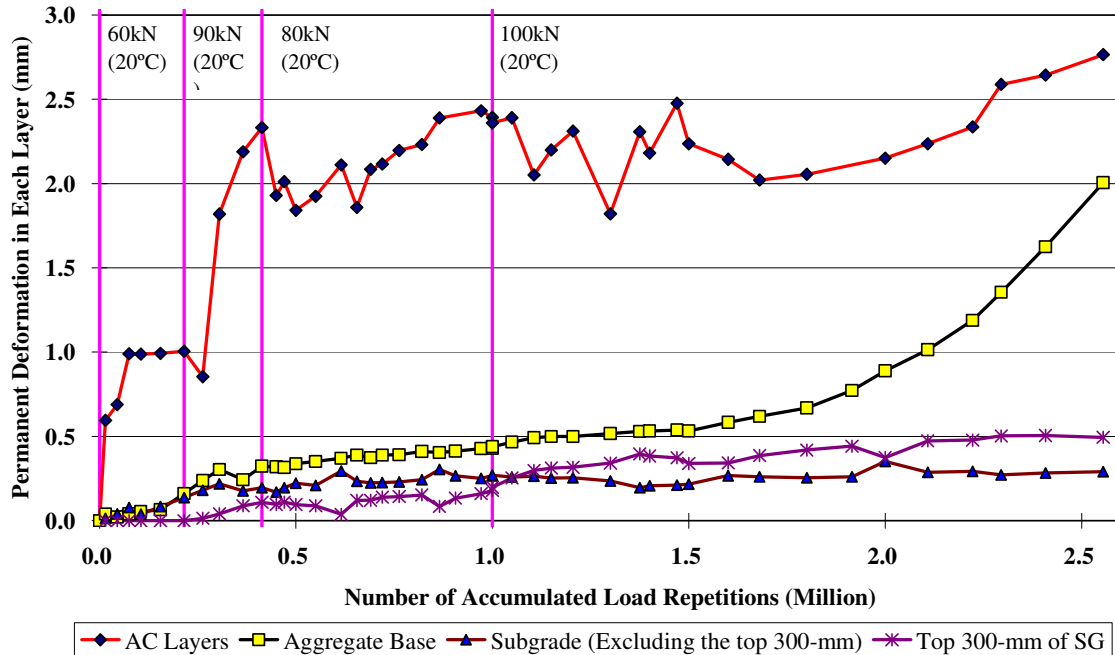

Figure 3.35: In-depth differential permanent deformation of various layers at MDD12.

Relatively little permanent deformation was recorded on this experiment. For the first one million repetitions, most of the permanent deformation recorded occurred in the overlay and cracked DGAC layers (between 80 and 90 percent), followed by the aggregate base (between 10 and 14 percent), and then the subgrade (between zero and 6 percent). At the end of the test, the deformation recorded in the base (between 30 and 40 percent) and subgrade (between 6 and 9 percent) was higher than that recorded in the earlier part of the test. Permanent deformation in the surface layers at the end of the test was consequently lower (between 55 and 60 percent). The highest permanent deformation occurred in the area with more cracking in the underlying DGAC (MDD12).

These trends confirm that the effect of increasing wheel load on permanent deformation diminishes with depth in the pavement structure. The planned forensic investigation will confirm these findings and will be reported on in the forensic investigation report.

3.5. Visual Inspection

Fatigue distress in an asphalt concrete pavement manifests itself in the form of surface cracks. Since this study centered on fatigue cracking and the ability of the overlay to limit reflective cracking from the underlying layer, crack monitoring was an essential component of the data collection program. This entailed:

- Visual inspections of the test section and marking of visible cracks;

- Photographic documentation of the marked cracks;
- Correction of the photographs for camera angle;
- Digitization of the photographs;
- Calculation of the crack length using *Optimas*TM software, and
- Presentation of the cracking in terms of crack length per area of pavement.

After 2,554,335 repetitions with increasing wheel loads (from 60 kN to 100 kN) under controlled pavement temperatures (20°C for the first one million repetitions and 15°C thereafter), no surface cracking was observed. The MAC15-G overlay thus appeared to successfully prevent any reflective cracking from the underlying layer from appearing on the surface, despite calculated ratios of final-to-initial deflections indicating that damage had occurred in the asphalt layers during the course of trafficking. Photographs of the section after trafficking are shown in Figures 3.36 and 3.37.



Figure 3.36: Section surface viewed from Station 0.



Figure 3.37: Close-up of section surface between Stations 12 and 14.

3.6. Forensic Evaluation

A forensic evaluation (coring and test pit) can only be undertaken when HVS testing on all of the six sections has been completed. Results of the forensic evaluation will be discussed in a separate report on completion of the tests.

3.7. Second-Level Analysis

A second-level analysis report will be prepared on completion of all HVS testing and a forensic evaluation. This report will include:

- Actual layer thicknesses;
- Backcalculation of moduli from RSD, MDD, and FWD measurements;
- Verification of data collected from in-depth measurements with visual observations from test pits;
- Comparison of performance between test sections;
- Comparisons of HVS test results with laboratory test results;
- Performance simulations; and
- Recommendations.

4. CONCLUSIONS

This first-level report is the fifth in a series of studies detailing the results of HVS testing being performed to validate Caltrans overlay strategies for the rehabilitation of cracked asphalt concrete. It describes the results of the sixth HVS reflective cracking testing section (591RF) carried out on a 45-mm (1.7 in) half-thickness MAC15TR (with 15 percent recycled tire rubber) gap-graded overlay. Other overlays tested during the course of the experiment include:

- Half-thickness (90 mm) MB4 gap-graded overlay (45 mm MB4-G);
- Full-thickness (90 mm) MB4 gap-graded overlay (90 mm MB4-G);
- Half-thickness (45 mm) MB4 gap-graded overlay with minimum 15 percent recycled tire rubber (MB15-G);
- Half-thickness rubberized asphalt concrete gap graded overlay (RAC-G) overlay, included as a control for performance comparison purposes, and
- Full-thickness (90 mm) AR4000-D overlay, included as a control for performance comparison purposes

The pavement was designed according to the Caltrans Highway Design Manual Chapter 600 using the computer program *NEWCON90*. Design thickness was based on a subgrade R-value of 5 and a Traffic Index of 7 (~121,000 ESALs). The overlay thickness was determined according to Caltrans Test Method (CTM) 356 using Falling Weight Deflectometer (FWD) deflections.

HVS trafficking on the section commenced on January 10, 2007, and was completed on June 25, 2007. A temperature chamber was used to maintain the pavement temperature at $20^{\circ}\text{C}\pm 4^{\circ}\text{C}$ for the first one million repetitions, then at $15^{\circ}\text{C}\pm 4^{\circ}\text{C}$ for the remainder of the test. During this period a total of 2,554,335 load repetitions (tire pressure of 720 kPa [104 psi], and bi-directional trafficking pattern with wander) were applied, consisting of:

- 215,000 repetitions of a 60 kN (13,500 lb) load,
- 198,404 repetitions of a 90 kN (20,250 lb) load,
- 586,596 repetitions of an 80 kN (18,000 lb) load, and
- 1,554,335 repetitions of a 100 kN (22,500 lb) load.

This loading equates to approximately 90.8 million equivalent standard axles, using the Caltrans conversion of $(\text{axle load}/18000)^{4.2}$, and to a Traffic Index of 15.4.

Testing was interrupted during breakdowns in the first three weeks of testing, and between May 01 and May 06 when the cumulative traffic repetitions were approximately 1.5 million.

Laboratory fatigue and shear studies have been conducted in parallel with HVS testing. Results of these studies will be detailed in separate reports. Comparison of the laboratory and test section performance, including the results of a forensic investigation to be conducted when all testing is complete, will be discussed in a second-level report once the data from each of the studies have been collected.

Findings and observations based on the data collected during this HVS study include:

- No cracking was observed on the section after more than 2.5 million repetitions, and testing was halted in the interest of completing the study. The MAC15-G overlay thus appeared to successfully prevent any cracking in the underlying layer from reflecting through to the surface, despite final-to-initial deflections indicating that damage had occurred in the asphalt layers under loading.
- The average deformation and average maximum rut depth across the entire test section at the end of the test was just 1.7 mm (0.1 in) and 4.6 mm (0.2 in) respectively, with average maximum rut considerably lower than the Caltrans (and experiment) failure criterion of 12.5 mm (0.5 in). The maximum rut depth measured on the section was 8.2 mm (0.3 in). The MAC15-G overlay thus did not appear susceptible to rutting in the temperature range at which the test was conducted (20°C [68°F] for the first one million repetitions and 15°C [59°F] thereafter).
- Ratios of final-to-initial elastic surface deflections under a 60 kN (13,500 lb) wheel load increased by between 3.7 and 4.0 times along the length of the section. The ratios for in-depth deflections show that damage increased at all depths in the pavement structure by the end of trafficking. Loss of stiffness was highest in the area of most severe cracking in the underlying DGAC layer.
- Analysis of surface profile and in-depth permanent deformation measurements indicates that most of the permanent deformation (between 55 and 60 percent) occurred in the asphalt-bound surfacing layers (overlay and cracked DGAC) with the remainder mostly in the aggregate base layer. After the first one million repetitions had been applied, the permanent deformation in the surfacing layers was higher (between 80 and 90 percent).

No recommendations as to the use of MAC15-G mixes are made at this time. These recommendations will be included in the second-level analysis report, which will be prepared and submitted on completion of all HVS and laboratory testing.

5. REFERENCES

1. **Generic experimental design for product/strategy evaluation — crumb rubber modified materials.** 2005. Sacramento, CA: Caltrans.
2. **Reflective Cracking Study: Workplan for the Comparison of MB, RAC-G, and DGAC Mixes Under HVS and Laboratory Testing.** 2003. Davis and Berkeley, CA: University of California Pavement Research Center. (UCPRC-WP-2003-01).
3. BEJARANO, M., Jones, D., Morton, B., and Scheffy, C. 2005. **Reflective Cracking Study: Summary of Construction Activities, Phase 1 HVS Testing, and Overlay Construction.** Davis and Berkeley, CA: University of California Pavement Research Center. (UCPRC-RR-2005-03).
4. HARVEY, J., Du Plessis, L., Long, F., Deacon, J., Guada, I., Hung, D. and Scheffy, C. 1997. **CAL/APT Program: Test Results from Accelerated Pavement Test on Pavement Structure Containing Asphalt Treated Permeable Base (ATPB) – Section 500RF.** Davis and Berkeley, CA: University of California Pavement Research Center. (Report Numbers UCPRC-RR-1999-02 and RTA-65W4845-3).
5. HARVEY, J., Du Plessis, L., Long, F., Deacon, J., Guada, I., Hung, D. and Scheffy, C. 1997. **CAL/APT Program: Test Results from Accelerated Pavement Test on Pavement Structure Containing Untreated Base – Section 501RF.** Davis and Berkeley, CA: University of California Pavement Research Center. (Report Numbers UCPRC-RR-1997-03 and RTA-65W4845-3).
6. BRESSETTE, T. 2006. **Personal communication on 21 November 2006.** Sacramento, CA: California Department of Transport.

