

# UC Berkeley

## Earlier Faculty Research

### Title

Practicability of Screening International Checked Baggage for U.S. Airlines

### Permalink

<https://escholarship.org/uc/item/4jr6s26n>

### Authors

Gosling, Geoffrey D.  
Hansen, Mark M.

### Publication Date

1990-07-01

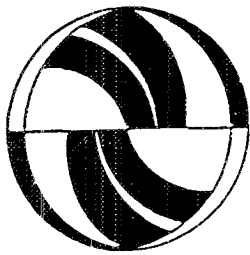

**Practicability of Screening International  
Checked Baggage for U.S. Airlines**

Geoffrey D. Gosling  
Mark M. Hansen

Working Paper  
UCTC No. 401

**The University of California  
Transportation Center**

University of California  
Berkeley, CA 94720

**The University of California  
Transportation Center**

The University of California Transportation Center (UCTC) is one of ten regional units mandated by Congress and established in Fall 1988 to support research, education, and training in surface transportation. The UC Center serves federal Region IX and is supported by matching grants from the U.S. Department of Transportation, the California Department of Transportation (Caltrans), and the University.

Based on the Berkeley Campus, UCTC draws upon existing capabilities and resources of the Institutes of Transportation Studies at Berkeley, Davis, Irvine, and Los Angeles; the Institute of Urban and Regional Development at Berkeley; and several academic departments at the Berkeley, Davis, Irvine, and Los Angeles campuses. Faculty and students on other University of California campuses may participate in

Center activities. Researchers at other universities within the region also have opportunities to collaborate with UC faculty on selected studies.

UCTC's educational and research programs are focused on strategic planning for improving metropolitan accessibility, with emphasis on the special conditions in Region IX. Particular attention is directed to strategies for using transportation as an instrument of economic development, while also accommodating to the region's persistent expansion and while maintaining and enhancing the quality of life there.

The Center distributes reports on its research in working papers, monographs, and in reprints of published articles. It also publishes *Access*, a magazine presenting summaries of selected studies. For a list of publications in print, write to the address below.



**University of California  
Transportation Center**

108 Naval Architecture Building  
Berkeley, California 94720  
Tel: 510/643-7378  
FAX: 510/643-5456

The contents of this report reflect the views of the author who is responsible for the facts and accuracy of the data presented herein. The contents do not necessarily reflect the official views or policies of the State of California or the U.S. Department of Transportation. This report does not constitute a standard, specification, or regulation.

**Practicability of Screening International Checked Baggage  
for U.S. Airlines**

Geoffrey D. Gosling  
Mark M. Hansen

Institute of Transportation Studies  
University of California  
Berkeley, CA 94720-1720

*Working Paper*  
*July 1990*

UCTC No. 401

The University of California Transportation Center  
University of California at Berkeley



# TABLE OF CONTENTS

	Page
<b>Table of Contents</b>	ii
<b>Executive Summary</b>	iv
<b>1. Introduction</b>	1
Background	1
Operational Impacts of EDS Screening	2
Methodology	3
Limitations of Analysis	3
Structure of the Report	4
<b>2. Assessment of Systemwide Impacts</b>	6
Site Specific Factors	6
Total TNA System Requirements	7
TNA Cost Impact	11
TNA Schedule Impact	13
Low Volume Stations	16
<b>3. Scale of the Problem</b>	19
System Statistics	19
Case Study Airports	19
TNA Technology	21
Design Considerations for TNA Facilities	24
Parametric Analysis	26
<b>4. Situation at the Case Study Airports</b>	40
General Considerations	41
Statistical Profile of Case Study Airports	49
John F. Kennedy Airport, New York	51
Chicago O'Hare	64
Miami International Airport	72
Gatwick Airport, London	83
Frankfurt/Main Airport	86
Leonardo Da Vinci (Fiumicino) Airport, Rome	92

	Page
<b>5. Simulation Analysis</b>	95
Approach	95
Model Description	96
Application to Kennedy Airport	96
Input Data	96
Results	98
<b>6. EDS Screening Impacts at JFK</b>	107
Alternative Screening Scenarios	107
TNA Requirements	109
Facilities	113
Personnel	117
Total TNA Cost Impact	120
Operational Impacts	124
Service Quality	126
<b>7. Alternative Screening Strategies</b>	130
Improved EDS Technology	131
<b>8. Conclusions</b>	133
<b>Acknowledgements</b>	135
<b>References</b>	137

## EXECUTIVE SUMMARY

On September 5, 1989, the Federal Aviation Administration announced its intention to impose a major new security requirement on U.S. airlines. In accordance with an implementation timetable to be developed at a later date, airlines would be required to screen all checked baggage on all international flights with an FAA-approved explosive detection system (EDS).

Presently, there is only one approved technology -- thermal neutron analysis (TNA) -- that meets FAA's criteria for automated explosive detection systems.

Airlines concern about the practicality of deploying and using TNA machines in the widespread manner envisioned by the FAA led to a study of the issues involved by the Institute of Transportation Studies, University of California, Berkeley, the results of which are described in this report.

The study did not attempt to assess the TNA's effectiveness at detecting explosives in baggage. Rather, it focused on how well TNA devices fit into current airline/airport baggage handling systems, the effects TNA would have on those systems, and the tradeoffs involved in widespread, routine use of TNA technology.

### OPERATIONAL IMPACT

The study found that while it is technically feasible to meet FAA's EDS requirement with TNA machines, routine use of TNA screening for all U.S. airline international baggage would have a significant adverse impact on airline schedules and service. Full scale TNA screening could not be accommodated without rescheduling flights, or taking other measures that could put U.S. carriers at a competitive disadvantage.

Airlines would need more time to transfer baggage between domestic and international flights, and in most cases, would have to eliminate plane-to-plane baggage transfers. Instead, they would have to route all connecting baggage through their terminals, which would cause delays in baggage processing inside the terminals.

A requirement that airlines screen all international baggage with TNA equipment would mean adding between 15 and 30 minutes to minimum connecting times. This would make it difficult for airlines to schedule connecting flights at their international gateways with short layover times.

Of a sample of 105 connections studied, 14% would be invalidated if 15 minutes were added, and more than 30% would be invalidated if 30 minutes were added.

Passenger convenience would also be adversely affected by stricter enforcement of check-in times, and possibly earlier check-in requirements than at present.

In addition, systemwide deployment of TNA machines would be costly. Not only are the machines themselves expensive to buy (about \$1 million per unit), but in many

cases the airlines would have to reconfigure or rebuild terminal space to house the number of TNA units they would need. There also would be staff and maintenance costs.

## RESCHEDULING DIFFICULT

Changing flight schedules to accommodate the need for additional baggage handling time at the gateways would be extremely difficult because the changes would ripple throughout each airline's system. Slot controls and other restrictions at international destinations make it difficult and in some cases impossible to reschedule international departures, and domestic hub and spoke networks, with their closely spaced connecting flight complexes, make it difficult to reschedule flights feeding domestic passengers into the international gateways.

Increasing connecting time between arrivals of feeder flights and international departures also would increase total traveling time for connecting passengers and the number of passengers within the terminals of major international airports at peak times, many of which are already extremely crowded.

This, of course, would adversely affect originating passengers as well as connecting passengers.

## SIX AIRPORTS STUDIED

The study examined six U.S. and European airports, but focused primarily on Kennedy Airport in New York where a detailed assessment of the number of units and facilities needed to comply with the rule and the likely operational impacts at that airport was performed.

The other airports studied were Miami, Chicago, Frankfurt, London, and Rome, which were examined primarily to see if the experiences at Kennedy represented conditions elsewhere in the system and to identify location-specific factors that may have a significant bearing on the cost or practicality of complying with the FAA rule.

A parametric analysis was performed that explored the tradeoffs between the number of TNA units, airlines schedules, and baggage processing delays. This work was supplemented with a more detailed simulation analysis of passenger and baggage flows through the terminals of Kennedy's two biggest airlines at the peak of their 1989 operations.

The computer models developed in the course of the study should help the airlines, airports, the FAA, and other interested parties assess the practicality of future EDS systems and explore various tradeoffs.

## UNITS REQUIRED

Not unexpectedly, it was found that the number of TNA units required to comply with the FAA's rule depends on the throughput capacity of each TNA unit, on the way the units are deployed, and on whether machines are shared by different airlines. The number of bags a machine can process per hour depends on their sensitivity setting and the operating practices adopted by the airline to reduce the number of false alarms. Based on data collected for a prototype TNA machine in use at Kennedy, it appears the operational throughput of the device is considerably lower than previous FAA estimates.

**The study concluded that the number of machines required to screen all checked baggage on international flights at 1988 traffic levels ranges from 312 to 700 units, depending on how much operational disruption the airlines are willing to bear.**

This number of units translates into a one-time acquisition cost for the TNA machines of between \$280 million and \$630 million, and an annual recurring cost of between \$92 million and \$218 million. In addition, the airlines would need to construct facilities to house the TNAs and reconfigure baggage processing equipment at an estimated cost of between \$182 million and \$386 million systemwide.

In view of the above, **the study explored alternative screening strategies that would provide significant security benefits but require less equipment, fewer facilities, and have less of an impact on airline operations than routine screening of all international baggage.** The report also suggests some possible developments of EDS technology that could increase effective screening rates and would make widespread use of EDS more viable, from an operational standpoint.

## SUMMARY OF KEY FINDINGS

The case study field visits and the analysis described in this report have led to the following conclusions:

I. The current FAA plan to require TNA screening of all international checked baggage would require extensive changes to airline operations, such as:

- baggage handling procedures
- scheduling of connecting flights
- gate assignments

and would involve a major expenditure of resources, including:

- acquisition and installation of machines
- operational personnel
- new or reconfigured terminal facilities.

II. Given the operational throughput of current TNA equipment (which the study has determined may be substantially less than past FAA estimates), the airlines would

require between 300 and 700 units to comply with the rule at 1988 traffic levels. The higher estimate is about 40% above the FAA projection.

- III. There is not enough room at many of the existing terminal facilities at the airports visited during the study to accommodate the anticipated number of TNA units required, without relocating or substantially modifying facilities, such as gates, ticket counters, and baggage areas.
- IV. Practical constraints on terminal reconstruction are likely to require major changes to airline operations and could involve a substantial reduction in the quality of airline service, such as:
  - less convenient connections
  - increased layover time for connecting passengers
  - earlier check-in requirements for originating passengers
  - increased flight departure delays
  - an increase in bags missing flights.

**These impacts would make flying internationally on a U.S. carrier less convenient, particularly for the high-fare, time-sensitive traveller -- which could put U.S. carriers at a significant competitive disadvantage.**

- V. The impacts of EDS screening will obviously increase with future growth of international traffic, and the addition of new gateways and overseas stations. The high cost per passenger at low volume stations could discourage U.S. carriers from initiating or maintaining international service from those stations.
- VI. In view of the widespread distribution of the foregoing impacts, the implementation of more selective screening strategies would appear to be significantly more cost effective.

# 1. INTRODUCTION

This report analyzes the economic and operational impacts of widespread deployment of explosive detection systems by U.S. airlines at international airports. An assessment of the systemwide impacts is described in the following chapter. The study examined the practicability of deployment of thermal neutron analysis (TNA) machines, as proposed by the Federal Aviation Administration (FAA), by conducting a detailed case study of the necessary equipment and facilities and likely operational impacts at John F. Kennedy International Airport, New York (JFK), and through field visits to a number of other airports in the U.S. and Europe.

On the basis of these results a preliminary assessment was made of the likely total system impacts at all airports affected by the FAA rule.

## BACKGROUND

On September 5, 1989 the Federal Aviation Administration issued a final rule effective October 5, 1989 amending FAR Part 108 to authorize the FAA Administrator to require the use of explosive detection systems (EDS) to screen baggage in accordance with airline security programs.

### Previous Analysis

As required for any proposed rule, the FAA prepared a regulatory impact analysis during the summer of 1989. An initial regulatory analysis was published in June 1989 (FAA, 1989b), and then following a public comment period, a final regulatory impact analysis was published in August 1989 (FAA, 1989c).

The FAA analysis examined the costs and benefits of three alternative rules, including that subsequently adopted. The assessment of the benefits of the proposed rule is not relevant to the present study. The analysis of the expected costs of implementing the rule included the cost of acquiring, maintaining and operating the EDS machines, including personnel and rental of the space necessary to house the equipment.

The analysis was based on the use of thermal neutron analysis (TNA) technology, the only technology currently approved by the FAA as meeting the requirements of the rule. The assessment of the number of machines required was based on estimated 1989 annual international enplanements by U.S. carriers at all airports with certificated international service, adjusted to a peak hour flow using a percentage of average daily traffic based on the traffic volume. The number of machines required to serve the peak hour flow was then calculated assuming a throughput rate per machine.

No explicit consideration was given to the practicabilities of installing the machines in existing airport terminals, nor how the requirement to screen checked baggage would affect existing baggage handling procedures. The analysis estimated a total systemwide cost, but did not consider how airport or airline-specific factors would affect that cost.

A subsequent analysis was performed by the Nuclear Regulatory Commission (NRC) in connection with an application by the Federal Aviation Administration for a license to install TNA machines in public areas of airports (NRC, 1990). Although this environmental assessment was primarily concerned with nuclear materials safety (the TNA machine uses a radioactive source element), more detailed consideration was given to the practicabilities of installing the machines in airport terminals, and some hypothetical arrangements of facilities were developed.

Costs of deploying and operating TNA machines were estimated in order to perform a comparative analysis of alternative screening techniques, including hand searching all bags. This analysis generally followed the FAA cost assumptions, although some of the personnel costs were significantly higher than the FAA had assumed. The NRC also made no attempt to assess airline operational impacts, beyond installing and operating the machines.

## OPERATIONAL IMPACTS OF EDS SCREENING

In addition to the acquisition costs of screening equipment itself, the total operational impacts of the requirement to screen all international checked baggage include:

- Cost of constructing or modifying facilities.
- Operating costs of equipment and facilities.
- Airline and security personnel requirements.
- Flight delays and schedule modifications.
- Passenger waiting time and inconvenience.
- Competitive disadvantage of U.S. carriers.

Many of these impacts, such as the need to impose early check-in requirements on passengers, reduction in aircraft utilization due to scheduling considerations, and the possible loss of traffic to non-U.S. carriers, may be more important considerations than the cost of the screening equipment itself.

### Operational Considerations

The number of EDS machines required by a given traffic level at a particular airport cannot be uniquely determined, but depends on the way the machines are operated and the operational changes that can be accepted. As with any screening system, there is an inherent trade-off between the threat level that the system is attempting to detect, the probability of detection, and the false alarm rate. In addition, the particular EDS technology deployed will determine the first-pass throughput rate that can be achieved by a single machine.

Consideration must be given to how an alarm is handled. Options include an immediate hand search of the bag, a visual examination of the EDS image by a security



agent, or a second pass through the machine to attempt to resolve the alarm.

If the alarm cannot be resolved by the second pass or visual examination of the EDS image, the bag will generally have to be opened and hand searched. Normal practice would require passengers to be present during a hand search of their baggage, which may require them to be located and brought to the search facility.

For the purposes of the current study, analysis of EDS performance was based on the thermal neutron analysis (TNA) equipment, settings, and procedures currently in operation at JFK, and being installed at a number of other airports.

## METHODOLOGY

In order to estimate the number of EDS units needed, the airline staffing requirements and the impact on passenger check-in requirements, a parametric analysis was performed that explored the trade-offs between the EDS screening capacity, the scheduling of departing international and inbound connecting flights, and the delays to the flow of baggage through the terminal. This was supplemented by a more detailed simulation analysis of terminal passenger and baggage flow for 1989 peak month traffic levels for the two largest carriers at Kennedy Airport.

To supplement the analysis of the EDS screening requirements at JFK, field visits were made to four other airports in the U.S. and Europe to assess the extent to which the experience at JFK is representative of the conditions at those airports, and to identify any location-specific factors that may have a significant bearing on the costs or feasibility of performing EDS screening at those airports.

On the basis of the JFK case study and the results of these field visits, a preliminary assessment has been made of the likely total system impacts of screening international checked baggage at all airports affected by the new rule. In addition, a number of alternative screening strategies have been identified that would require less equipment and facilities, or impose less operational costs, than full screening of all baggage, and a preliminary assessment performed of the likely impacts of these alternative strategies on the total system requirements.

## LIMITATIONS OF ANALYSIS

The current study has attempted to provide a more detailed assessment than previous studies of the operational impacts of EDS screening. In order to do this within the time and budget constraints, the study has examined the situation at a few selected airports, and has used these findings to extrapolate to a systemwide perspective.

The conclusions are thus dependent on the extent to which the selected airports are indeed representative of the system as a whole. In particular, the study did not examine any small airports, although several carriers at the airports that were examined had relatively small traffic volumes.

As the study proceeded, it became clear that the FAA rules governing the way in which the EDS machines would be used would greatly influence the magnitude of the impacts. Unfortunately, these rules were not published at the time the analysis was performed.

Furthermore, it also became clear that the performance of the existing EDS technology is highly dependent on the level of the threat that it is desired to detect, and that there is presently no clear agreement on how this threat should be specified. Therefore assumptions had to be made, and the findings are conditioned on those assumptions.

In many cases, the analysis was able to examine a range of values. However, in a system as complex as a large international airport, the potential combinations of alternative operating scenarios, equipment performance, and traffic patterns did not permit exhaustive analysis. While it is believed that the combinations of factors examined provide a reasonable assessment of likely outcomes, the possibility exists that a more thorough analysis might uncover unexpected interactions that could give significantly more adverse results.

Finally, it should be noted that while the study team obtained extensive assistance from many of the airlines operating at the case study airports, which made available an unprecedented quantity of proprietary information, the detailed nature of the analysis that was performed meant that some of the data that was needed was simply not available at the level of detail requested. In these cases, values were assumed based on the information that was available and the authors' knowledge of the industry. Unfortunately, it is not always possible to clearly identify where and how this was done, while still protecting the confidentiality of the data that was received.

## STRUCTURE OF THE REPORT

The remaining chapters of this report document the principal findings of the study. An analysis of the total systemwide impacts of EDS screening is described in Chapter 2, based on the more detailed analysis discussed in subsequent chapters.

Chapter 3 discusses the scale of the problem to be faced by U.S. carriers in screening all international checked baggage. It reviews the number of airports affected and the range of traffic volumes at those airports, as well as describing in general terms the situation at the airports selected for the case study analysis. This chapter discusses the current state of EDS technology and design consideration for the facilities necessary to accommodate TNA machines under operational conditions. Finally it concludes with a parametric analysis of the number of TNA machines required to handle a given traffic volume, and the effect of varying operational factors on this number.

Chapter 4 presents a detailed case study analysis of six airports, three in the U.S. and three in Europe. It examines the current situation at each airport and discusses potential alternatives for performing TNA screening.

Chapter 5 describes a more in-depth analysis of the TNA requirements for two airlines at Kennedy International Airport, using a terminal simulation computer model. Based on the results of this analysis, an assessment of the total impacts of EDS screening on operations at Kennedy Airport is presented in Chapter 6.

Chapter 7 discusses some alternative screening strategies that might be adopted to reduce the systemwide impacts, while still meeting the objectives of the screening requirement. Finally, Chapter 8 summarizes the overall findings of the study, and presents the principal conclusions.

## 2. ASSESSMENT OF SYSTEMWIDE IMPACTS

This chapter estimates the systemwide impacts of the implementation of FAR 108.20. While it is far easier to describe these impacts than it is to quantify them, this chapter makes every attempt at the latter. In particular, three quantifications of impact are made. First and foremost, the number of units required for systemwide installation is estimated. Second, this unit requirement is translated into an estimate of cost of installation and operation. Third, the impact of TNA screening on airline connection schedules is estimated.

It would be desirable to go beyond these estimates and project a total cost for implementing FAR 108.20. Two factors preclude such an exercise. First, many of the impacts would be most difficult to monetize. TNA installation and usage will consume not only airline resources, but the time and energy of their customers as well. These customer impacts will, in turn, affect the airline in the form of reduced demand, declining market share, and lower yields. Basic research concerning the air transport demand and travelers valuation of different service attributes is required before these effects can be quantified.

Second, as will be stressed repeatedly, there is no "magic number" of required units or "one right way" to install them. Both of these involve tradeoffs between very unlike things -- queueing time versus capital outlay, or lost lobby space versus the inconvenience of calling passengers to the bag room. Hence, the key results of the analysis presented in this chapter are ranges of numbers, and not single values.

### SITE SPECIFIC FACTORS

Subsequent chapters will document the degree of airport-to-airport and terminal-to-terminal variation with respect to both the TNA unit requirements associated with FAR 108.20 and the expected costs and impacts of installing and operating the system. The factors that underlay this variation range from basic considerations such as international traffic levels to more subtle differences such as the propensity of passengers to arrive early for their flights.

In theory, a projection of systemwide impacts would take all of these factors into account. Unfortunately, this was not possible under the resource and time constraints of this project. Thus, we were forced to use a much more simple model in order to arrive at systemwide projections. The model makes use of two inputs from each airport under consideration, total 1988 international enplanements of U.S. flag carriers (we used 1988 because it is the latest year for which complete data were available) and the number of U.S. flag carriers serving each airport. Moreover, as elaborated below, we used flight schedule data for a sample of airports covering the entire range of enplanement levels observed among the international airports.

## TOTAL TNA SYSTEM REQUIREMENTS

Total TNA requirements estimates were generated by applying the deterministic spreadsheet model developed for the parametric analysis described in the next chapter and applying it to U.S. flag carrier international flight schedules for a sample of airports. The model was used to obtain the TNA processing capacity necessary to provide an "acceptable" level of service at each airport in the sample. Statistical relationships between these capacity requirements and the 1988 international enplanement levels at the airport were then obtained and applied to all 190 airports to estimate systemwide requirements.

The assumptions made in the analysis are summarized in Table 2-1. In this application, the distinction between connecting and originating passengers is not explicitly recognized. Rather, it is assumed that passenger bags -- whether from originating passengers or those connecting from feed flights -- have a certain arrival profile. This arrival profile is assumed to have a 90 minute spread with the first arrivals occurring 120 minutes before flight time. This represents a conservative assumption in that actual arrivals for a given flight would probably be spread over a somewhat longer period, resulting in a smaller amount of queueing delay.

The analysis proceeds by superimposing the arrival profiles for each flight in order to attain an overall cumulative arrival curve. The level of service of the system is measured by the maximum amount of time a bag is delayed in the TNA system queue. Two hypothetical service levels are assumed: no queueing delay and a maximum delay of 15 minutes. The higher level of service would be required when time constraints are severe, while the lower level is appropriate when there is some extra time. In practice, more detailed considerations involving the time of delays in relation to departing flight times would be required to determine whether a given delay is acceptable or not. For present purposes, however, the maximum delay approach is a reasonable means of approximating TNA process capacity requirements.

Figure 2-1 plots the required high and low level of service capacities against 1988 annual international enplanements for the airports in our sample. A reasonable correlation between capacity requirements and the 1988 enplanements is observed, as is a fairly consistent ratio between the high and low level of service capacities. On the other hand, it is apparent that other factors than the 1988 enplanement level influence these capacity requirements. The most important are the degree of peaking in the international flight schedule and changes in the level of operations between 1988 and August, 1989 -- the month for which the schedule data were obtained.

The pattern observed in Figure 2-1 is consistent with the common sense expectation that capacity requirements are linearly related to enplanement levels, and that the lines representing these relationships go through the origin. Accordingly, least squares estimates of the slopes of the lines relating 1988 enplanements to high and low level of service capacity needs were obtained.

The estimated slopes -- based on the a priori assumption that the intercepts are zero, and measuring enplanements in thousands and TNA capacity in bags per hour -- are 2.4 for high level of service and 1.7 for low level of service. In other words, to estimate

**Table 2-1**  
**Summary of Assumptions for Systemwide Requirements Analysis**

<u>Parameter</u>	<u>Value</u>
International Load Factor	0.70
Bags per International passenger	2
Time from Check-In to TNA System	15 min
Time from TNA System to Aircraft	15 min
Originating Passenger Arrival Profile: (time before flight departure)	
First Arrival	120 min
Last Arrival	30 min
Time of Maximum Arrivals	75 min

**Figure 2-1**  
**Estimated TNA Capacity Requirements**  
**Observations and Trend Lines**

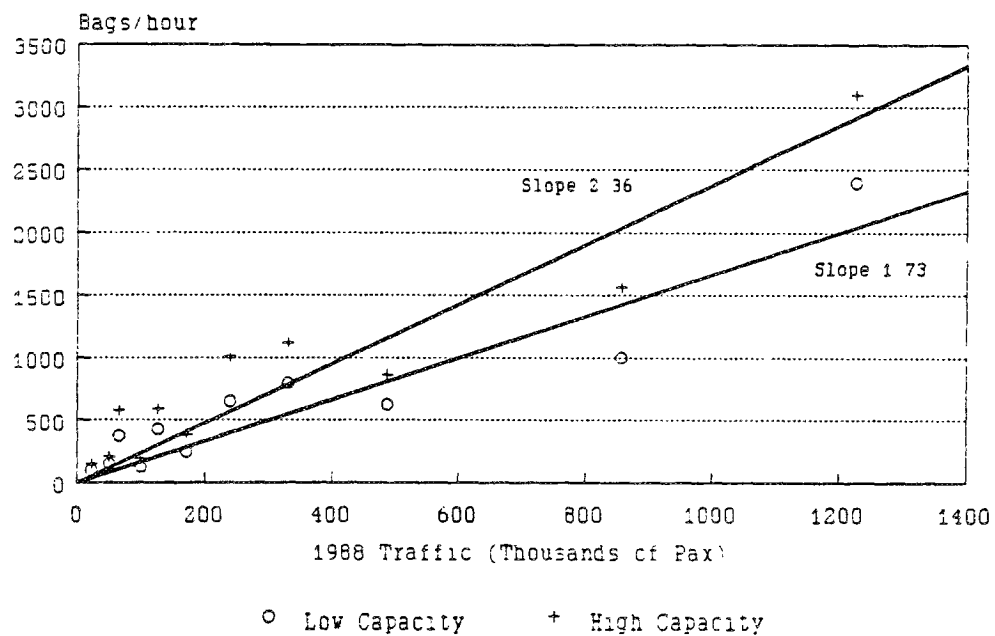

the hourly TNA capacity required to have no queueing delays at a given airport, multiply its annual international enplanements, measured in thousands, by 2.4.

The next step in estimating total system requirements is to apply the multipliers above to each airport out of which U.S. flag carriers conducted international operations in 1988. From this, high and low level of service capacity requirements are estimated for each airport.

The final step is to translate the capacity requirements at each airport into numbers of TNA units. In order to make this translation, two issues must be considered. First, one must define the capacity of an individual TNA unit. As discussed in Chapter 3, these capacities are expected to fall between 220 and 390 bags per hour.

The second factor concerns the impact of indivisibilities on TNA requirements. Because fractional TNA units are impossible, the quotient of the capacity required and the TNA unit capacity must be rounded up to the next whole number. Beyond this, additional units would be necessary if TNA processing systems are to be airline specific rather than shared. In general, every TNA processing system will be expected to have one underutilized unit as a consequence of the indivisibility problem. For example, if an airport has three separate TNA facilities, it can be expected to require two additional units over what would be required if there were one shared system.

In light of this, total requirements were estimated under two different assumptions concerning the degree of TNA unit sharing. Under the first assumption, each airport has just one TNA processing system that is used by tenant airlines who must conduct TNA screening. In the second scenario, each airline has its own TNA system at airports where more than one TNA unit is required, while the systems are assumed to be shared at airports requiring TNA processing capacity equivalent to less than one unit.

In summary, airport TNA requirements were estimated by (1) estimating the processing capacity required; (2) dividing the capacity required by the assumed capacity per unit and then rounding up; and (3) under the scenario involving airline-dedicated TNA processing systems, adding one unit for each U.S. flag airline operating at the airport, with the exception of the first.

The results of the analysis are summarized in Table 2-2. Eight different estimates, corresponding to each combination of high and low unit capacity, high and low level of service, and full and partial sharing of TNA processing systems, are presented. The overall range extends from 312 units to 700 units. The breadth of this range reflects the cumulative importance of the assumptions concerning TNA unit capacity, degree of sharing of TNA facilities, and level of service of the TNA system. More specifically, the estimates assuming a TNA processing capacity of 220 bags per hour are about 45-50 per cent higher than the estimates assuming the higher capacity of 390 bags per hour, the estimates based on partial sharing of TNA units are 30-35 per cent higher than those which assume full sharing, and the high level of service estimate exceed the low level of service ones by 20-25 per cent.

**Table 2-2**  
**Estimated Systemwide TNA Requirements**  
**1989 Traffic Levels**

---

<u>Level of Service</u>	<u>TNA Capacity</u>	<u>Shared Status</u>	<u>TNA Units Required</u>
High	390	Full	364
High	390	Partial	489
High	220	Full	536
High	220	Partial	700
Low	390	Full	312
Low	390	Partial	424
Low	220	Full	436
Low	220	Partial	574

---



It should be noted that 12 of the above systems are required at airports that enplaned less than 500 international passengers in 1988, while a further 13 are required at airports that enplaned less than 5,000 international passengers (or approximately one flight per week).

In comparison to the above results, the FAA estimated, for 1989 flight levels, a TNA unit requirement of 491. This falls within the range of estimates obtained here. The basis for these estimates is, however, somewhat different. FAA assumed a TNA capacity of 540 bags per hour, which disregarded reductions in throughput from false alarms and other factors that usually prevent the units from achieving such a high throughput. The FAA estimate also neglected the extra units required if TNA systems are to be airline specific.

On the other hand, the FAA appears to have overestimated the severity of international traffic peaking at many airports, and furthermore assumed that the TNA system must accommodate the peak hour demand with no queuing. The results of the current analysis imply a less severe demand on the system than that assumed by the FAA. These differences in capacity, share status, and demand assumptions tend to cancel one another, leaving substantial agreement with respect to the final results.

## TNA COST IMPACT

The estimates of TNA unit costs were based on a critical review of the FAA unit costs estimates, and were further informed by interviews during the field visits, and by the analysis of TNA facility and operating costs discussed in Chapter 6. Table 2-3 shows the FAA cost estimates given in the Regulatory Impact Assessment (FAA, 1989c) and documents the adjustments made to them for this study.

The FAA assumed that TNA acquisition and maintenance costs would reduce over time. However, the 1990 unit costs were used for consistency with traffic volume estimates. Space rental is replaced with a estimate for one-time facility modification and expansion costs, based on the results of the cost analysis in Chapter 6. The range of construction costs reflect the higher costs of lobby space compared to operational space. The costs for modification to baggage handling equipment is likely to be highly site specific. In the case of lobby installations, no modifications may be necessary. However, in this case there may be additional labor costs for moving screened baggage to the check-in counters, and any savings from avoiding baggage system modifications will be offset by the higher costs of lobby space required. Thus baggage handling costs have been based on an assumed bag room installation. Facility maintenance costs were based on the analysis in Chapter 6, with no specific allowance for baggage handling equipment.

As noted in Chapter 6, it is simplistic to estimate labor costs on a per unit basis, as different units will be used more or less intensively, and certain economies of scale exist for multi-unit installations. Labor cost estimates are significantly higher than FAA estimates due to the higher staffing levels assumed, as discussed in Chapter 6. The labor costs at each airport were adjusted for the assumed number of weekly shifts, based on a

**Table 2-3**  
**Estimated TNA Unit Costs**

Cost Item	Cost Type	FAA Estimate (\$ thousands)		Revised Estimate (\$ thousands)	
		<u>1990</u>	<u>1992+</u>	<u>per unit</u>	<u>per facility</u>
TNA Unit Cost	One-Time	750	500	750	---
Xenix Unit Cost	One-Time	150	75	150	---
TNA Maint.	Annual	26.2	26.2	26.2	---
Xenix Maint.	Annual	15	7.5	15	---
Space Rental	Annual	19	19	---	---
Labor	Annual	140	140	511 <sup>a</sup>	140 <sup>a</sup>
Space Maint.	Annual	---	---	18-22.5	---
Construction	One-Time	---	---	180-375	---
Baggage Handling Equip.	One-Time	---	---	240	320
<b>Total</b>	<b>One-Time</b>	<b>900</b>	<b>575</b>	<b>1275-1320</b>	<b>320</b>
	<b>Annual</b>	<b>200</b>	<b>193</b>	<b>570-575</b>	<b>140</b>

NOTE: a) Assuming 14 shifts per week

relationship between annual traffic and schedule peaking that was estimated by examining the schedule at a selection of airports of varying traffic levels.

Folding these estimates together with those of the TNA unit requirements generated systemwide estimates for the total cost of acquiring and operating the TNA systems necessary to fulfill FAR 108.20. Applying the unit costs estimates to the maximum and minimum unit requirements obtained above, resulted in a one-time acquisition cost between \$463 and \$1,016 million, and an annual recurring cost between \$92 and \$218 million.

The cost of acquiring and installing the TNA/Xenix machines accounts for between \$280 and \$630 million of the one-time cost, while the cost of facility construction and modification, including baggage handling systems is estimated to account for between \$180 and \$390 million.

### TNA SCHEDULE IMPACT

In addition to the costs of installing and operating the TNA units, FAR 108.20 will affect the ability of airlines to schedule connecting flights with short layover times. The TNA screening requirement will at best add some irreducible amount of processing time to that currently required to move connecting bags between inbound and outbound flights. In most cases, this additional processing time will include the extra time required for through-terminal as opposed to tail-to-tail bag routing. In some cases, additional delay will be incurred as a result of queueing. These additional time requirements may affect the viability of current flight schedules, particularly those connections with short layovers.

To quantify the impact of extra connecting bag processing time on current schedules, the following procedure was used. A random sample of connecting service listings was drawn from the August, 1989 Official Airline Guide Worldwide Edition. The listings were screened so that each met the following criteria:

- *The service is from a U.S. point to a point outside the U.S.*

On-line connecting services to the U.S. would require screening at the origination point.

Inter-line connecting services to the U.S. would require screening at the connecting point, but layovers in these circumstances are usually sufficient to accommodate the screening.

- *The service is offered by U.S. flag airlines.*
- *The connection involves only one change of flights.*

Services that involve more than one change are relatively unpopular.

The services involving one change are more likely to actually attract passengers.

- The connection point is within the U.S.

If the connecting point is outside the U.S., screening would have to occur upline.

For each sample listing that met the above criteria, the scheduled layover time was noted. In addition, the appropriate "minimum connecting time" was obtained. This is the shortest layover time of a connecting service for which airlines will normally accept reservations. As such, it can be interpreted as the shortest amount of time that would normally be required to get passengers and their bags from their inbound to their outbound flight. The minimum connecting times published in the Official Airline Guide vary with the airport, the airlines, and the type of service (international versus domestic).

The impact of TNA processing as the connecting point is assessed by adding to the minimum connecting times currently in effect. It was estimated that, at best, TNA processing would require an additional 15 minutes, while a less optimistic estimate would be an increase of 30 minutes. The schedule impact is therefore assessed by determining whether the actual layovers for the sample of connecting services exceed the minimum connecting times by more than 15 or more than 30 minutes.

The results of the analysis are summarized in Table 2-4. Of the 105 connections in the sample, 14 per cent would become invalid as a consequence of adding 15 minutes to the existing minimum connecting time, 31 per cent would be invalidated if 30 minutes were added, and 41 and 46 per cent would be invalidated by 45 and 60 minute processing times, respectively. In general, schedules at interior gateways -- those which also serve as major domestic hubs -- would be most strongly affected unless the extra TNA processing time could be kept to under 30 minutes (which would be unlikely because at these points are most dependent on tail-to-tail transfer to keep connecting times low). It is therefore apparent that existing schedules would have to be substantially overhauled in order to accommodate TNA processing at the connecting point.

Furthermore, it is probable that these results understate the actual schedule impact for several reasons:

- Passengers prefer shorter layovers.

The services affected are therefore precisely the same ones that are presently most attractive.

- Minimum connecting times may not be realistic for large numbers of flights.

Airlines generally have an additional time cushion above the minimum connecting time for their international connections. One reason for this may be that it is not feasible to operate connecting banks where all layover times are close to the minimum.

Thus, extra processing time at the connecting point may require other schedule adjustments beyond those connections that are directly affected.

**Table 2-4**  
**Impact of TNA Screening on International Connect Service**

<u>Gateway Category</u>	<u>No. of Obs</u>	<u>Percent of Connections Invalidated if TNA Screening Requires Over:</u>			
		<u>15 min</u>	<u>30 min</u>	<u>45 min</u>	<u>60 min</u>
Coastal	85	15	28	34	39
Interior	20	10	45	70	75
<b>TOTAL</b>	<b>105</b>	<b>14</b>	<b>31</b>	<b>41</b>	<b>46</b>

- A larger proportion of connecting services involving interior hubs such as Chicago, Detroit, and St. Louis would be invalidated by increased processing times.

These interior hubs are expected to experience the most rapid growth in international services over the next decade.

- The ability of U.S. flag carriers to translate their exclusive access to the U.S. domestic market into high quality international connecting service is one of their primary sources of comparative advantage over international carriers.

TNA processing at the connecting point would erode this advantage.

- As noted earlier, many airlines do not have much flexibility to reschedule their services.

Slot controls and other restrictions at international destinations make it difficult, and in some cases impossible, to reschedule international flights.

Rescheduling of domestic feed flights may be hampered in situations where airlines are offering closely spaced connecting complexes.

In many situations, it will therefore not be possible to re-establish a connection by slightly "tweaking" the schedule. Rather, international passengers will simply be put on an earlier connecting flight, resulting in a very substantial increase in layover time.

In light of the above, the impact of requiring TNA processing of connecting bags appears to be considerable. Unfortunately, it is not possible to place a dollar figure on this impact. This would require additional research concerning the sensitivity of passengers to layover times and the ability of airlines to adjust their schedules.

## LOW VOLUME STATIONS

An important consideration in the systemwide impact assessment is the situation at low volume stations. As noted above, 25 of the stations enplaning international passengers in 1988 had an average of less than 100 passengers per week. The cost of installing and operating TNA machines at such stations would be prohibitive if covered only by those international passengers using the station. A requirement to use EDS machines at such stations could discourage U.S. carriers from initiating or maintaining international service from those stations. This might open low volume gateways in the U.S. to foreign flag carriers that would not face these costs.

## SUMMARY

- There is no "magic number" of required units or "one right way" to install them.
  - ▶ Both involve tradeoffs between very unlike things, queueing time vs. capital outlay, or lost lobby space vs. inconvenience of calling passengers to bag rooms.
  - ▶ Hence, projections consist of ranges of numbers, not single values.
- Projections are based on a model making use of two inputs for each airport under consideration.
  - ▶ 1988 international enplanements of U.S. flag carriers.
  - ▶ Number of U.S. flag carriers serving each airport.
  - ▶ Model derived from an analysis of flight schedule data for a sample of airports covering the range of implementing levels.
- TNA requirements are estimated by:
  - ▶ Estimating the processing capacity required; and
  - ▶ dividing the capacity required by the assumed capacity per unit and rounding up fractional units.
  - ▶ Where airlines do not share TNA systems, a minimum of one system per airline will be required for each U.S. flag carrier operating at the airport.
- Analysis of TNA equipment requirements reflects:
  - ▶ The overall range of TNA requirements extends from 312 units to 700 units, based upon 1988 traffic levels.
  - ▶ Estimates assuming TNA processing of 220 bags per hour are about 45%-50% higher than estimates assuming the higher capacity of 390 bags per hour.
  - ▶ High level service (reduced queueing time) estimates of TNA unit requirements exceed low level service estimates by 20%-25%.
- Cost impacts are based upon estimates of about \$1.3 million per unit for acquisition and installation and annual operating costs as high as \$600K or more per unit.
  - ▶ One-time acquisition costs of \$463 to \$1,016 million.
  - ▶ Annual recurring costs of \$92 to \$218 million
  - ▶ While highly site specific, systemwide terminal construction costs

and baggage processing equipment reconfiguration would appear to cost between \$180 and \$390 million.

■ *TNA screening requirements will affect the ability of airlines to schedule connecting flights with short layover times -- precisely the service most attractive to passengers.*

- ▶ Some irreducible processing time will be added to that currently required to move connecting bags between inbound and outbound flights.
- ▶ This time will be needed for through-terminal processing instead of current aircraft tail-to-tail bag handling and to accommodate queueing.
- ▶ At best an additional 15 minutes would be required for processing connecting baggage. A less optimistic estimate would be 30 minutes.
- ▶ Both estimates probably understate the impact on connecting schedules.
- ▶ Extra processing time at connecting points may have a cascading effect requiring other schedule adjustments.
- ▶ A larger proportion of connecting services would be invalidated at interior hubs -- which are expected to experience the most rapid growth in international services.

■ *Competitive disadvantages for U.S. flag carriers:*

- ▶ TNA screening at connecting points would erode the advantage U.S. carriers have over their foreign competitors to translate exclusive access to U.S. domestic markets into high quality international service.
- ▶ In many situations, "tweaking" of schedules would not re-establish connections. Rather, international passengers would simply be put on earlier flights, negating the short layover service attractive to passengers and resulting in substantially increased layover times.
- ▶ Airports which can only support international service at something less than daily flight operations, may lose U.S. flag carrier service due to the added cost of TNA equipment.



### 3. SCALE OF THE PROBLEM

#### SYSTEM STATISTICS

In 1988, U.S. flag airlines enplaned 38 million international passengers at 190 airports around the world, hereafter referred to as international airports. Of these, 41 were located in the United States, 61 elsewhere in the western hemisphere, 47 in Europe, 5 in the Middle East and Africa, and 36 in Asia and Oceania.

A breakdown of enplanements in these different regions is shown in Table 3-1. It indicates that among those airports where international passengers were enplaned, traffic levels were substantially higher at U.S. points than at those overseas. Nonetheless, Table 3-1 reinforces the obvious point that international air transport, the foremost example of a "far flung" enterprise, requires regulatory policies that take due consideration of its global nature.

Despite the large number of international airports, the majority of international enplanements are actually fairly concentrated. Table 3-2 shows that 46 per cent of international enplanements take place at the top 10 international airports, just over half at the top 20, and over 95 per cent at the top half. Conversely, many of the international airports have extraordinarily low numbers of international enplanements. Defining 100 passengers per day, 300 days per year, as the threshold for what could be termed regular service, over 36 per cent of the 190 airports fall below that threshold.

The United States airline industry is relatively competitive, resulting in a large number of cases in which a given station is served by more than one airline. In general, the number of airlines is correlated with the number of enplanements, although there are clearly exceptions to this rule. However, the busier airports also have larger numbers of international enplanements per carrier, despite the fact that more airlines operate at them.

#### CASE STUDY AIRPORTS

Six case study airports, John F. Kennedy, Miami (New York), Chicago O'Hare, London Gatwick, Frankfurt, and Leonardo De Vinci (Rome), were chosen by the Air Transport Association for more detailed analysis. These airports collectively enplaned 9.8 million U.S. flag international passengers in 1988, roughly 25 per cent of the total for all airports. As this suggests, the case study airports are larger than the average, ranking first, third, fourth, ninth, 27th, and 39th among the 190. The mean U.S. flag international enplanements for these airports was 1.6 million, as compared to a mean for the 190 airports of 205,000. Nonetheless, they represent a wide range of enplanement levels, with the largest (JFK) 16 times larger than the smallest (Leonardo De Vinci).

**Table 3-1**  
**International Airports & Enplanements of U.S. Flag Carriers**

---

<u>Region</u>	<u>Airports</u>	<u>Thousands of Enplanements</u>
USA	41	14,193
Europe	47	9,441
Asia/Oceania	36	5,624
Canada	7	3,226
Mexico/Central America	22	2,972
Caribbean	21	2,579
South America	11	489
Middle East/Africa	5	402
<b>TOTAL</b>	<b>190</b>	<b>38,296</b>

---

**Table 3-2**  
**Concentration of International Enplanements**

---

<u>N</u>	<u>Percentage of Total International Enplanements From Top N Airports</u>
1	11
5	32
10	46
20	52
50	84
95	95

---

One benefit of the size of these airports is the large number of airlines operating at them. An average of five U.S. flag airlines enplaned international passengers at the case study airports, as compared with an average of two for all international airports. Nonetheless, the international enplanements per U.S. flag airline were over three times greater for the case study airports. Thus, while focussing on larger airports offers the benefit of allowing a greater number of individual airline station operations to be considered, it also skews the size of these operations to above average.

## TNA TECHNOLOGY

Although the FAA has claimed a throughput for the currently approved TNA equipment of 600 bags per hour, there is reason to doubt that this is currently attainable on a sustained basis. Discussions with the manufacturer of the equipment have suggested that 540 bags per hour may be a more realistic figure, and this figure was in fact used by the FAA in the Regulatory Impact Assessment (FAA, 1986).

It should be noted that these figures refer to the use of the machine in automatic detection mode. If a bag causes an alarm, it is diverted from the belt by a mechanical arm as it emerges from the machine. Under automatic detection mode, there is not enough time for the operator to view the EDS image before the next bag enters the machine, and the image is lost.

Furthermore, analysis of two days of operational data from Kennedy Airport yields an average throughput rate for operation in automatic detection mode much lower than 540 bags per hour. Of a total of 92 minutes during which the machine was continually screening bags, a rate of 9 bags/minute (540 bags/hour) was only observed for one minute. The observed distribution of bags processed in successive minute intervals is shown in Figure 3-1.

The variability in processing rate appears to be more a result of the baggage feed process than inherent capabilities of the machine. At JFK, baggage is brought to the existing TNA machine by cart and loaded by hand onto a single belt feeding the machine. Thus the throughput of the machine is obviously limited by the rate at which bags are loaded onto the belt.

The design of the machine is such that each bag is carried on a belt sequentially through three sets of radiation absorbing doors at each end. Technical specifications published by the equipment manufacturer give the speed of the belt as 30 feet/minute. Thus a throughput rate of 10 bags/minute would correspond to an average bag spacing of 36 inches.

However, the separation of the three sets of doors generally precludes such a spacing, since for most bags it would require all three sets of doors to be open at once. Because of the design of the doors, the minimum separation between successive bags depends on the height of the leading bag. Thus the minimum spacing between bags depends on both the height and length of the bag. For a typical bag (15in x 22in x 9in) the minimum spacing would be around 60 inches if the bag was run through the machine

**Figure 3-1**  
**Distribution of TNA Throughput Rates**

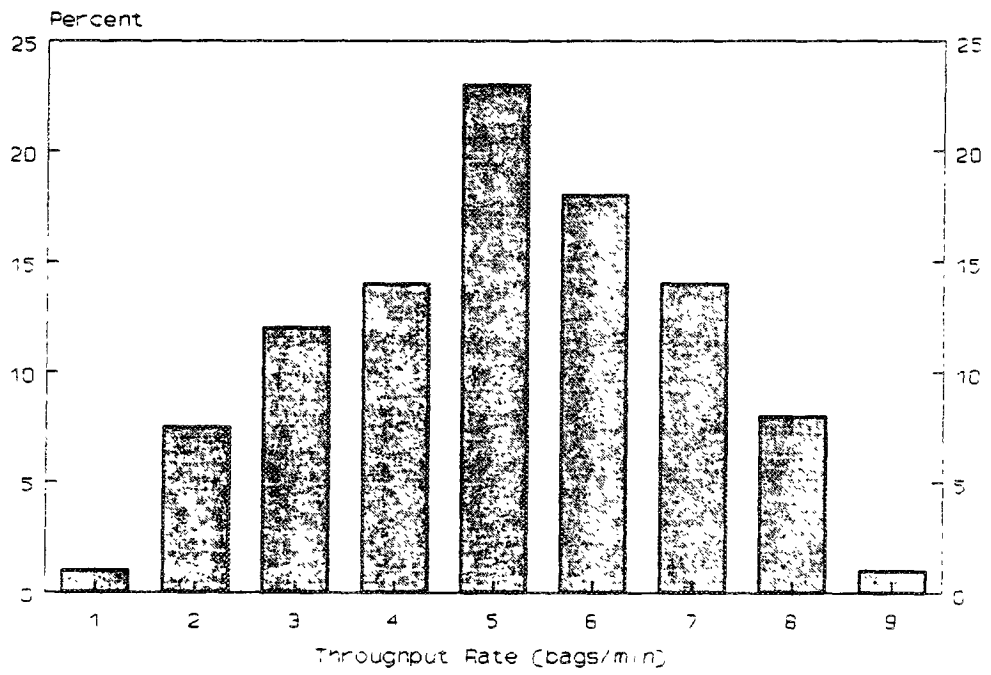

lengthwise and 52 inches if the bag was run through the machine sideways. These spacings correspond to throughput rates of about 6 bags/minute and 7 bags/minute respectively. Thus it can be seen that the maximum TNA throughput rate depends not only on the distribution of baggage dimensions, but also on the effort made by operating personnel to align the bags on the feed belt.

If an alarm is encountered on the first pass at Kennedy, the bag is screened a second time. This is a slower process, since allowance must be made for examining the TNA enhanced x-ray image if the alarm recurs.

Adjusting for the percentage of false alarms on both the first and second pass, the operational sustained throughput rate of a single TNA machine based on the performance experienced at Kennedy appears to be between about 220 and 390 bags per hour. The lower rate corresponds to the observed throughput rate in automatic detection mode, while 390 bags per hour corresponds to a throughput rate of 540 bags per hour in automatic detection mode.

Elimination of the second pass screening would increase the throughput rate, but at the cost of a higher alarm rate and correspondingly greater resources required for visual inspection of the TNA image and hand search of bags with unresolved alarms.

Based on the above, the false alarm rate emerges as an important variable. It is sensitive to the settings of the machine, which in turn depend on the amount of explosives that it is desired to be able to detect (termed the threat level), as well as the probability that a given amount will be detected. As with any screening system, there are tradeoffs between the threat level, the probability of detection, and the false alarm rate.

While the foregoing analysis has been based on the experience to date at Kennedy, doubts have been raised by the President's Commission on Aviation Security and Terrorism that the current EDS specification of the threat level is adequate (President's Commission, 1990). A reduction in the threat level to the amount of explosive believed to have destroyed Pan Am flight 103 over Lockerbie, Scotland in December 1988 could still be detected by adjusting the settings of the machine, but this would lead to a significantly higher false alarm rate, far in excess of the rate currently permitted by the FAA specifications (President's Commission, 1990). This in turn would reduce the effective throughput.

Another important consideration is the weight of the TNA machine. With its x-ray unit it weighs over 28,000 lbs. Structural considerations could present significant restrictions on the location of machines in existing terminal facilities. The scope of the current study did not allow this aspect to be explored in any detail at the case study airports, but this would need to be given careful consideration in planning specific installations.

At one proposed TNA installation (Washington Dulles Airport) the machine location has been chosen to place it over a floor beam. At another (London Gatwick Airport) a spreader plate has been designed to distribute the load.

## DESIGN CONSIDERATIONS FOR TNA FACILITIES

Operational experience with TNA equipment to date has been limited to a single machine at Kennedy International Airport, in intermittent use. The machine is located in an air-conditioned industrial-type building about 40 by 18 feet in size (750 square feet), located on the ramp, adjacent to the terminal building. The machine has only been screening interline bags, which are brought to the machine on baggage trolleys and unloaded by hand onto a feed belt into the TNA building. After screening, the cleared bags are transferred by belt into the outbound bag system. If it is decided to hand search a bag, the passenger is located and brought to the building to be present while the bag is opened.

While this situation may be similar to the type of TNA facilities required at smaller stations, more complex facilities with several TNA machines will be required at those stations handling significant volumes of international traffic. In addition to the space required for the TNA machines themselves, arrangements will be necessary to feed bags to the various machines.

For significant volumes of bags, manual handling will not be practical, and it may be assumed that bags will arrive at the TNA facility on a belt. A sorting mechanism will be needed to route the bags onto the feed belts for individual machines. Consideration must also be given to arrangements to store bags during periods when the inflow of bags exceeds the TNA processing rate. If a TNA machine can process about 400 bags per hour, a 15 minute queue would require approximately 200 to 300 feet of belt, depending on the spacing of the bags on the belt.

If alarmed bags are to be rescreened, this could be done by diverting the bags to a return belt that either reenters them into the feed belt for the TNA machines, or feeds them to another machine that is dedicated to rescreening alarmed bags. In the former case, it will be necessary to communicate to the TNA machine if a bag is being rescreened, so it can be handled appropriately. The latter arrangement has the advantage that delays in rescreening do not hold up processing of unscreened bags.

Arrangements will also be required to perform hand searches of alarmed bags that the TNA operators are unable to resolve by viewing the display. The extent of these facilities will depend on the rate of unresolved alarms, which in turn will depend both on the threat level that the machine is set to detect, and the training of the operators.

The experience to date with the TNA machine at Kennedy International Airport has been that this rate is very low, less than one bag per thousand (0.73 bags/thousand over a 173 day period, during which 52,000 bags were screened). However, the volume of bags handled has been such that the operators have been under no time pressure to take a decision. The unresolved alarm rate can be expected to increase if the threat level is reduced from that used at Kennedy, if the operators are under pressure to make relatively quick assessments, or if less well trained operators are employed.

If these searches are to be conducted at the TNA facility, secure access will need to be provided to permit passengers to be brought to the facility. A possible layout for a typical facility, housing six TNA machines, is shown in Figure 3-2.

Figure 3-2  
Possible TNA Facility Layout

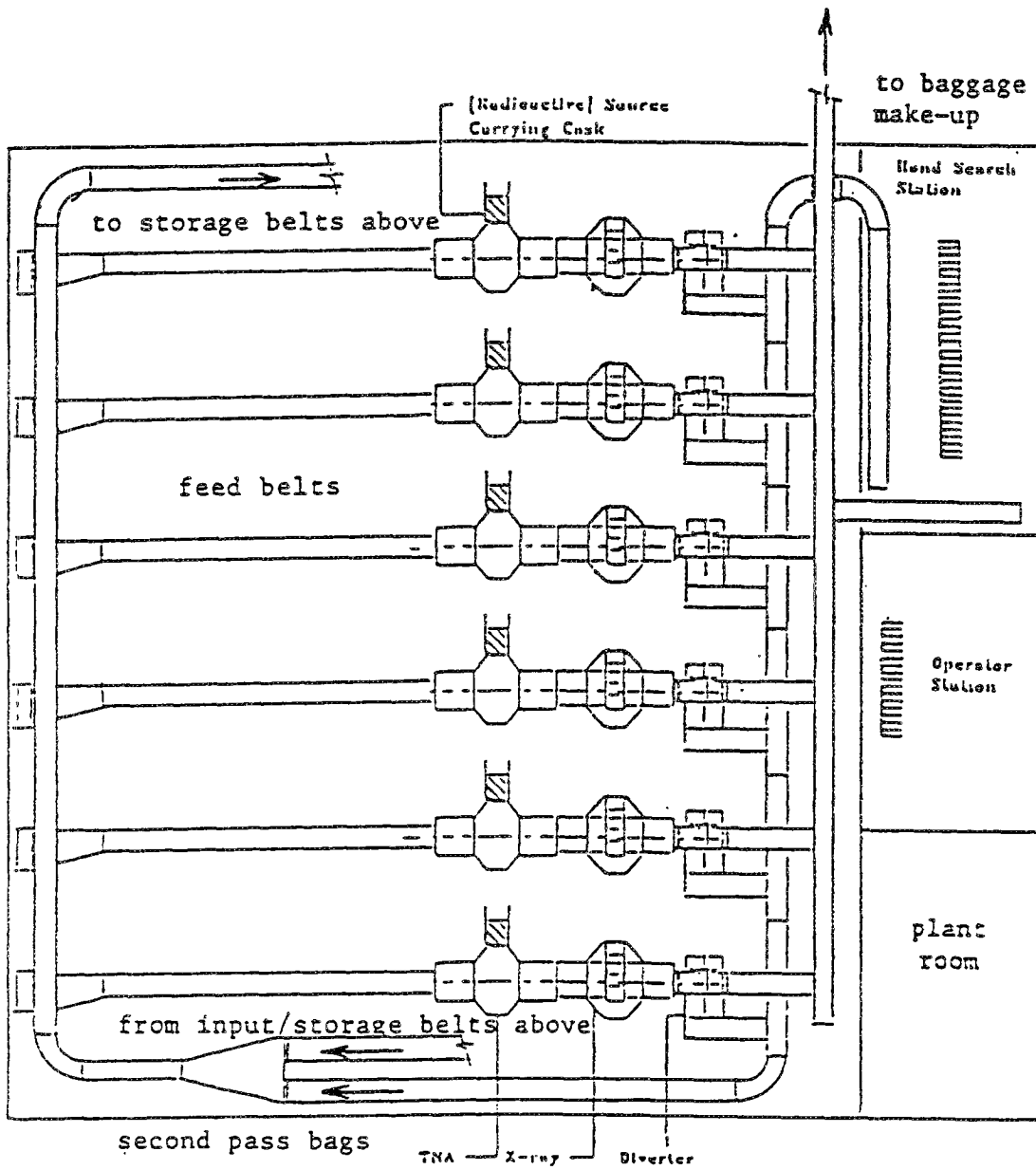

SOURCE: ITS

## PARAMETRIC ANALYSIS

Previous sections have summarized the characteristics of TNA technology and of the set of airports where, under the FAA Rule 108.20, it will be applied. We now turn to the question of how TNA system characteristics and airport traffic characteristics combine to determine system performance.

As has already been stressed, system performance is multi-dimensional. The most important dimension, the degree of security that the system provides, is not within the terms of reference of this study, and will not be considered further here. Among the other dimensions of performance, it is useful to identify three.

First are the direct costs associated with installation and operation of the systems. In general, these will increase with the TNA capacity provided.

Second are the schedule modifications made to accommodate the process. Increases in the minimum connecting times, spreading of scheduling peaks, and more stringent requirements (or enforcement of existing requirements) concerning arrival times of international passengers are among the modifications that may be undertaken.

The third dimension of performance concerns the effect of the systems on the flow of baggage through the terminal. Of particular interest here is the amount of time spent by bags waiting to be processed, the size of the queues that result, and the incidence of bags missing flights as a consequence of TNA processing delays.

The deployment of TNA units under FAR 108.20 will not result in uniquely determined performance impacts along any of these three dimensions. Rather, the new requirements impose a set of tradeoffs among the impacts. At a high direct cost (perhaps high enough to cover rebuilding an entire terminal!), one could ensure that a given schedule could be accommodated with a complete absence of queues. Queues could also be avoided with a far smaller number of machines, but with schedule adjustments that would curtail or eliminate peaks. Or, a relatively few machines could be used without schedule adjustments at the expense of long bag queues and extensive flight delays (or the planes could leave at their appointed times, but leaving many bags behind).

Clearly, none the above possibilities is very attractive. More promising approaches entail more balanced tradeoffs, or performance compromises, along the various dimensions. In order to define such approaches more precisely, it is necessary to understand more clearly the tradeoffs involved. This is the central purpose of the parametric analysis.

To carry out the analysis, a deterministic queueing model<sup>1</sup> of airport passenger and baggage handling was developed, using a computer spreadsheet. The model is designed to take a small number of operating parameters and use them to predict queueing characteristics and therefore system performance. Sensitivity testing is used to determine the performance impacts of varying different parameters. By this means, a wide range of

---

<sup>1</sup>A deterministic queueing model describes the behavior of a system in which neither demand nor processing rates are subject to stochastic (random) variation. In the present application, it is assumed that stochastic variation is insignificant enough for the deterministic approach to be realistic.



issues can be explored, including:

- TNA handling capacity requirements.
- The influence of traffic composition (connecting vs originating).
- The influence of scheduling variables (such as the degree of peaking and the time interval between feed flight arrivals and international departures).
- The influence of originating passenger arrival times.

In addition to addressing these specific issues, the parametric analysis serves an additional role. The simplicity of the model makes it possible to understand qualitatively why certain results are being obtained. This qualitative understanding can result in a better position to intelligently define and interpret the results of the more complex simulation model discussed in Chapter 5.

### Structure of the Model

The basic concepts used in deterministic queueing analysis are depicted in Figure 3-3. The "Cumulative Arrivals" curve plots the total number of items (bags) that have arrived at a server queue (TNA system) as a function of time. The "Cumulative Departures" curve represents the total number of bags the server has commenced to process as a function of time.

Cumulative departures can never be greater than cumulative arrivals, because an item must arrive before it can be processed. The vertical difference between the cumulative arrival and departure curves represents the number of bags that have arrived at the server but have yet to be processed -- the queue length. The horizontal difference between the two curves represents the time interval between a given bag's arrival and its departure from the queue -- the queueing delay.

The TNA system has a fixed capacity, determined primarily by the number of units. The capacity of the system is the maximum sustainable rate at which it can process bags. In the queueing diagram shown in Figure 3-3, the capacity is represented as the maximum slope of the departure curve. It is obvious that if this slope increases, the amount of queueing -- measured either by queue lengths or waiting times -- will diminish. Likewise, queueing can be reduced by altering the arrival curve so that arrivals occur more gradually. Thus the queueing diagram encompassed all three of the dimensions noted above: cost, through the maximum steepness of the departure curve; schedule, through the shape of the arrival curve; and queueing, through the differences between the arrival and departure curves.

The general flow of the queueing model is depicted in Figure 3-4. The arrival curve is composed of two parts, one representing the arrival of originating passengers' baggage, and the other for bags of connecting passengers. The originating arrival curve is determined by the international flight departure schedule, as well as an assumed passenger arrival time profile defined in terms of the time before scheduled departure. The connecting arrival curve is based on the scheduled arrival times of flights feeding the

**Figure 3-3  
Queueing Diagram**

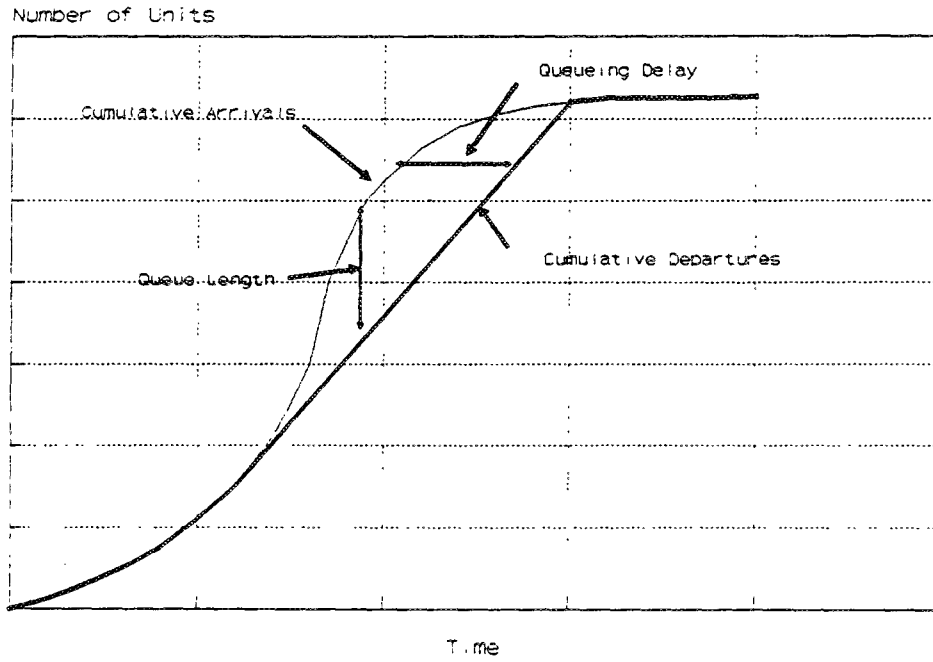

**Figure 3-4  
Queueing Model Flow**

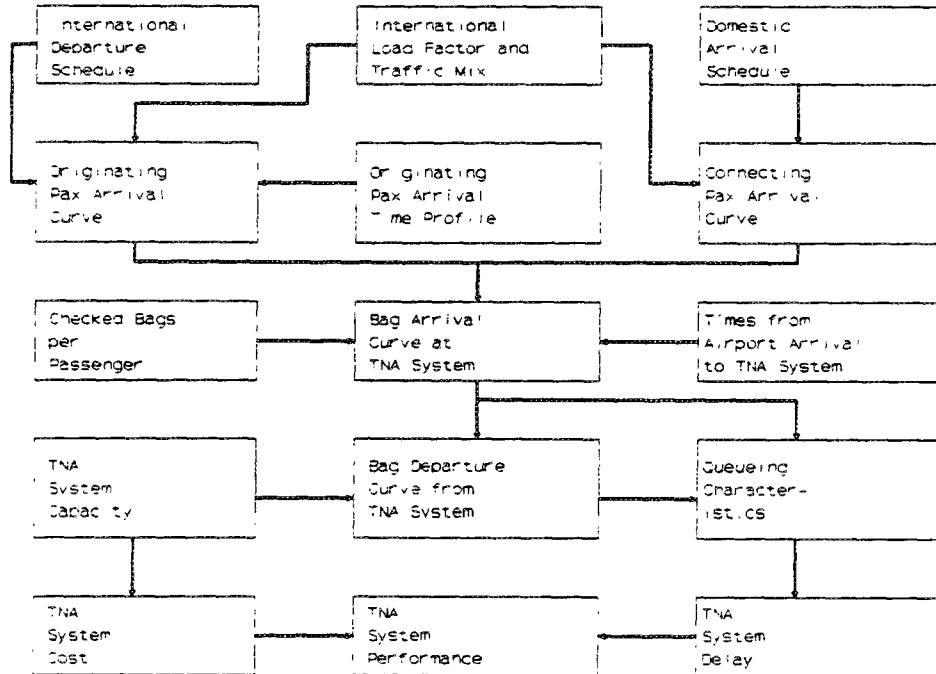

international flights.

The departure curve is defined by the total capacity of the TNA system. The capacity is a function of the processing rate of individual units, the number of such units, the incidence of false alarms, and other factors. This analysis does not specifically model the underlying relationships that determine overall system capacity. As discussed above, a single unit has been assumed to provide an effective capacity of between 220 and 390 bags per hour.

The analysis used a 15 minute interval as the basic unit of time. Arrival and departure curves were evaluated at the end of each interval. Model inputs, including flight schedules and passenger arrival profiles, are also defined on this basis.

Although the analysis could be performed by simply introducing actual or hypothetical flight schedules, it is more convenient to characterize these schedules parametrically. The parametrization found to work the best was to specify, for a given set of flights:

- The schedule time interval of the first arrival or departure;
- The scheduled time interval of the last arrival or departure;
- The time interval when the number of scheduled arriving (or departing) seats is at a maximum.

These parameters define a triangular distribution of arrivals or departures, which, when combined with the total number of arriving or departing seats, determines the total number of seats arriving or departing during any interval. (See Figure 3-5). A triangular distribution, defined in terms of the amount of time before departure, was also assumed for the passenger arrival profile.

Table 3-3 summarizes the model runs that serve as the basis for the parametric analysis. Two sets of runs were made. The first assumed that international passenger traffic is composed of 50 per cent originating and 50 per cent connecting passengers. The second set of runs assumed that the traffic is 100 per cent originating. Schedule parameters were based on TWA's JFK afternoon bank of European departures. Other parameters -- load factors, bags per passenger, bag processing times, etc. -- were set at reasonable values based on prevailing conditions in the industry and discussions with airline station staff.

Figure 3-6 shows the relationships between capacity and queuing that were obtained. Two queuing measures were considered. The first is the maximum queue length: the largest number of bags that must be somehow stored while waiting to be processed. The second measure is the maximum critical delay. This is the longest time a bag will spend in the queue during the period beginning at the time when bags must leave the TNA unit for the first departing flight. After this time queuing delays may cause bags to miss the outbound flights.

When the system has capacity approximating that of a single unit, the degree of queuing is clearly intolerable under the assumed schedule. Bags would be waiting as

**Table 3-3**  
**Summary of Model Runs**

**A. Parameters Fixed for All Runs**

<u>Parameter</u>	<u>Value</u>
Total International Seats	4110
International Load Factor	0.70
Bags per International Passenger	2
Time from Check-In to TNA System	15 min
Time from TNA System to Aircraft	15 min

**B. Parameters for Runs with 50 Per Cent Originating Passengers**

<u>Parameter</u>	<u>Value</u>
Total Feed Flight Seats	5548
Feed Flight Load Factor	0.65
Proportion of Feed Flight Passengers Connecting to International Flights	0.40
Time from Flight Arrival to TNA System	30 min
Feed Flight Arrival Profile	
First Arrival Time	<b>1500</b> 1430 1400 1430 1400
Last Arrival Time	<b>1830</b> 1800 1730 1800 1800
Time of Maximum Arrivals	<b>1645</b> 1615 1545 1630 1615
International Flight Departure Profile	
First Departure Time	1815 1815 1815
Last Departure Time	<b>2030</b> 2100 2130
Time of Maximum Departures	<b>1830</b> 1845 1900
Originating Passenger Arrival Profile (mins before departure)	
First Arrival	120 150 180
Last Arrival	<b>30</b> 60 90
Time of Maximum Arrivals	<b>75</b> 105 135
TNA System Capacity (bags/hr)	400 800 1200 <b>1600</b> 2000 2400

**C. Parameters for Runs with 100 Per Cent Originating Passengers**

<u>Parameter</u>	<u>Value</u>
International Flight Departure Profile	
First Departure	<b>1815</b> 1815 1815
Last Departure	<b>2030</b> 2100 2130
Time of Maximum Departures	<b>1830</b> 1845 1900
Originating Passenger Arrival Profile (mins before departure)	
First Arrival	<b>200</b> 230 300
Last Arrival	<b>30</b> 100 130
Time of Maximum Arrivals	<b>115</b> 146 215
Capacity (bags/hr)	400 800 1200 <b>1600</b> 2000 2400 2800

**Note: Boldfaced Values are Defaults Used when Other Parameters are Varied**

**Figure 3-5  
Triangularized Arrival Process**

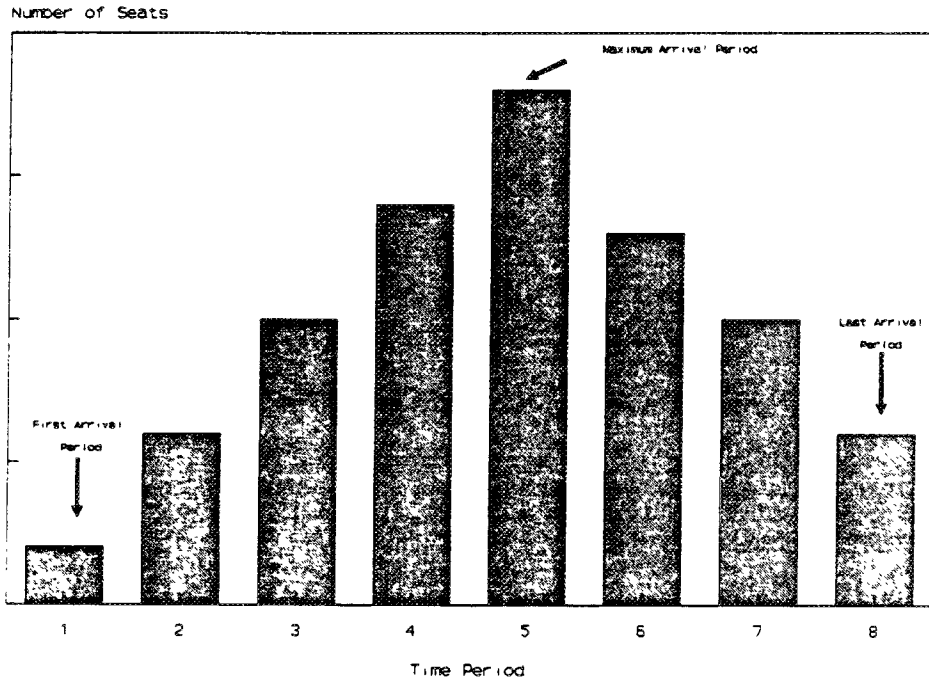

**Figure 3-6  
Maximum Queue Lengths and Queuing Delays**

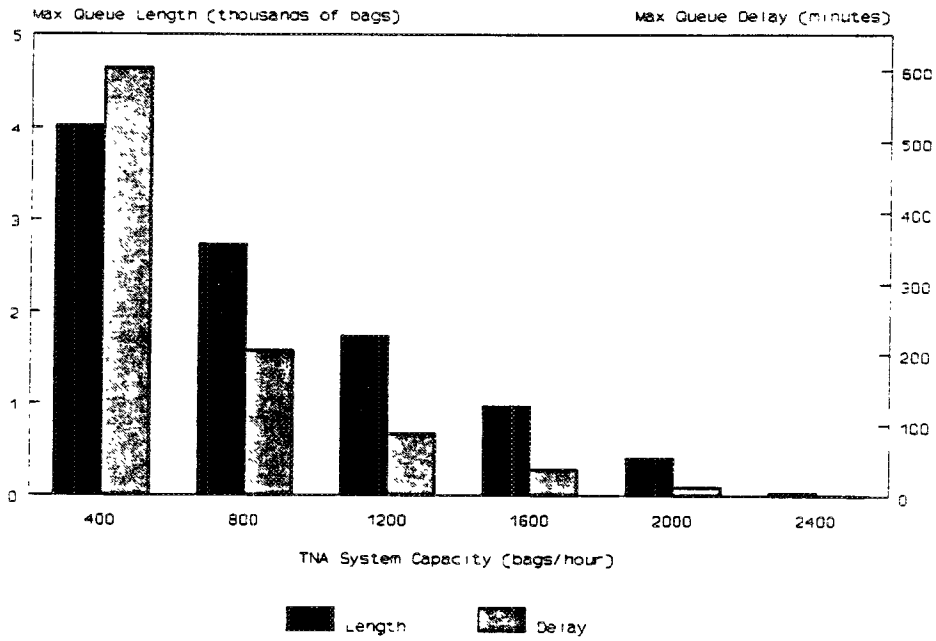

many as 10 hours for processing. Furthermore, the maximum queue of 4000 bags would require approximately 2.7 miles of belt, or 8000 square feet of floor area, for storage.

A processing capacity greater than 2000 bags per hour -- between 5 and 10 units depending upon the unit capacity assumptions made -- is required to limit queueing to reasonable levels. Determination of how much greater the actual capacity should be depends upon further tradeoff analysis. If layovers are so short no queueing delay can be tolerated, a capacity as high as 2500 bags per hour may be needed, while a lower figure may be reasonable if there is some slack in the schedule.

The above analysis assumes that the status quo is maintained for all aspects of the current schedule. We now turn to the question of how adjustments to the schedule could reduce capacity requirements. In approaching this analysis, we assume a TNA processing capacity of 1600 bags per hour. Under the baseline schedule at this capacity, queueing is a significant problem, involving a 36 minute maximum queueing delay.

The first schedule adjustment considered involves altering the arrival time profile of originating passengers. In the capacity analysis, it was assumed that passengers began arriving 2 hours before the scheduled departure time and the last passenger arrived 30 minutes beforehand, with the maximum rate of arrivals occurring midway between these two time periods. Figure 3-7 shows that earlier arrivals tend to exacerbate the queueing problem slightly, as originating passenger arrivals from the peak of the outbound flights coincide more closely with those from the peak of the feed flights. This could be avoided if the arrival times were made even earlier, but such a measure might not be feasible from a marketing standpoint. Thus, within the range considered here<sup>2</sup>, adjustments to the arrival times of originating passengers does not appear to be a promising means of reducing the degree of queueing.

The next schedule adjustment considered was to increase the time separation between the arriving and departing flights. This could be accomplished either by making the arriving flights earlier or the departing flights later, but slot limitations and other considerations suggest that adjusting arrival times might be easier. In either case, the greater time separation allows more time for the screening process for connecting bags before the first international departure.

The results are shown in Figure 3-8. A 30 minute increase in time separation decreases the maximum critical delay from 36 to 26 minutes, while a 1 hour increase yields a 20 minute reduction in maximum critical delay. Furthermore, these schedule adjustments decrease the processing capacity required to eliminate all queueing. In the case of the 1 hour adjustment, the reduction is about 400 bags per hour -- roughly equivalent to one TNA unit.

A second form of possible flight schedule adjustment involves spreading arrivals and departures over longer time periods. The approach was analyzed for both the arriving and departing flights, as they have different peaking characteristics. For incoming flights, the

---

<sup>2</sup>If originating passenger arrivals could be made to occur before connecting flight arrivals, there would certainly be a reduction of critical queueing delay.

**Figure 3-7**  
**Impact of Earlier Arrivals of Originating Passengers**  
**On Maximum Queue Lengths and TNA Capacity Required for Zero Queuing**

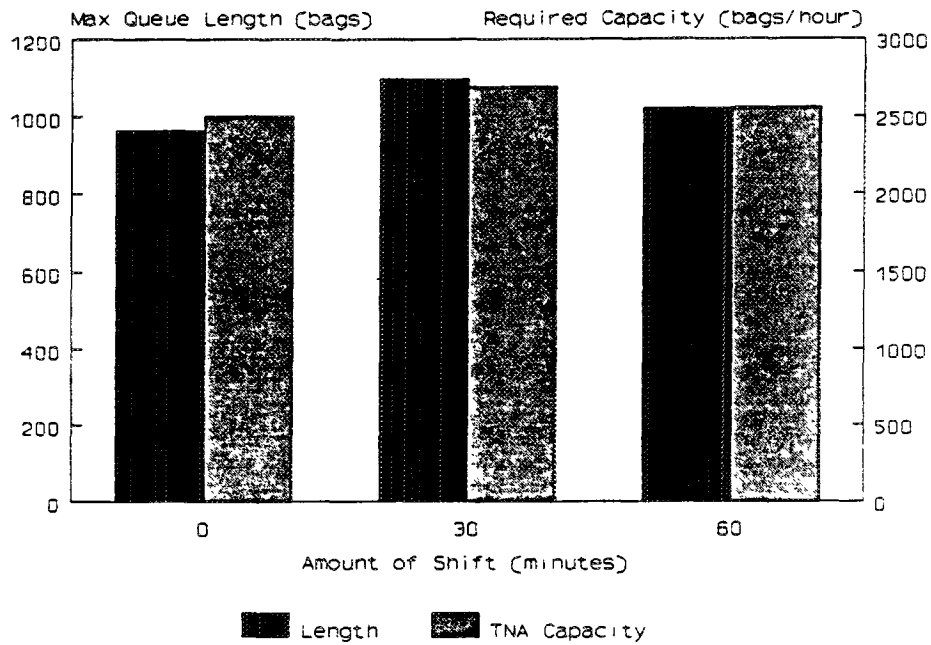

**Figure 3-8**  
**Impact of Increased Separation Between Flight Arrivals and Departures**  
**On Maximum Queue Lengths and TNA Capacity Required**

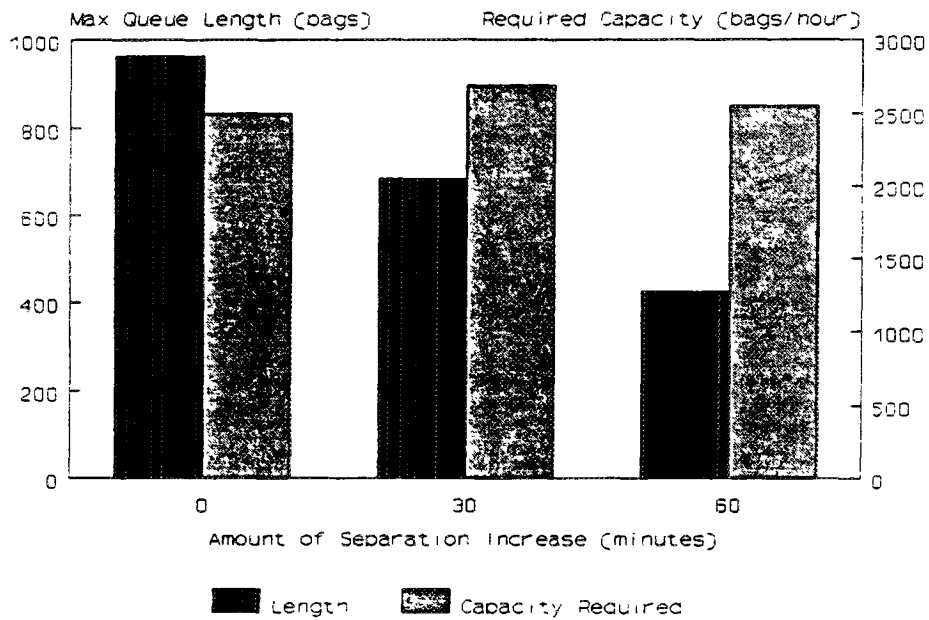

first arrivals occur around 1500 hours, the peak arrival time is 1645, and arrivals cease at around 1930. To spread out this schedule, first arrivals and peak arrival times were pushed forward in 30 minute and 15 minute increments respectively, while leaving the time when arrivals cease unchanged. As shown in Figure 3-9, this reduced the maximum critical delay by 8 minutes for the first adjustment and 6.5 minutes for the second, with the required capacity to eliminate queueing reduced by 150 and 120 bags per hour for the first and second adjustments respectively.

For outbound flights, the current schedule has departures beginning at 1815, peaking at 1830, and ending at 2030. The peak was spread by pushing the peak period back in 15 minute increments, and the end period back in 30 minute increments. As shown in Figure 3-10 maximum critical delays are reduced by about 9 minutes for each adjustment, while the required capacity to eliminate queueing reduced by 230 and 200 bags per hour for the first and second adjustments respectively. The slightly greater benefit attained from spreading of the departure peak derives from its initial asymmetry, which increased the amount of reduction in peak period activity resulting from the spreading process.

The above analysis was based on a scenario in which the passenger mix is half connecting and half originating. An additional analysis was carried out for 100 per cent originating passengers, assuming the same overall international flight load factor and outbound flight schedule. This is obviously not realistic, as TWA does hub traffic over JFK, but it provides a basis for understanding how traffic composition affects TNA system performance.

Figure 3-11 plots the maximum queue delay against TNA System capacity for both 50 per cent and 100 per cent originating traffic. The latter has more queueing for a given TNA processing rate. To attain zero queueing under the 100 per cent originating traffic scenario, a TNA capacity of 3100 bags per hour would be required, while a capacity of at least 2400 bags per hour would be necessary to keep queueing within reasonable bounds.

The strategy of requiring early passenger check-in is more promising under the no-hub scenario. Although the amount of queueing is not changed, the impact of the queueing on missed flights is reduced. For example, a processing rate of 1600 bags per hour yields a maximum waiting time of one hour. This is clearly unacceptable as passengers are arriving as little as 30 minutes before departure time, but may be tolerable if passengers arrive 90 minutes beforehand (this would leave 30 minutes for getting the bag to the TNA and from the TNA to the aircraft).

One consequence of early check-in not considered above is the possibility that the passenger arrival peak could be compressed. In other words, instead of merely translating a given arrival profile backwards in time, a requirement for early check-in could cause the later passengers to arrive earlier without changing the arrival times of the earlier passengers.

As Figure 3-12 demonstrates, the impact of this is to increase the overall amount of queueing, but nonetheless to reduce the incidence of missed flights. At the limit, when all passengers for a given flight arrive in a 15 minute interval ending two hours before



**Figure 3-9**  
**Impact of Arrival Peak Spreading**  
**On Maximum Queue Delays and TNA Capacity for Zero Queueing**

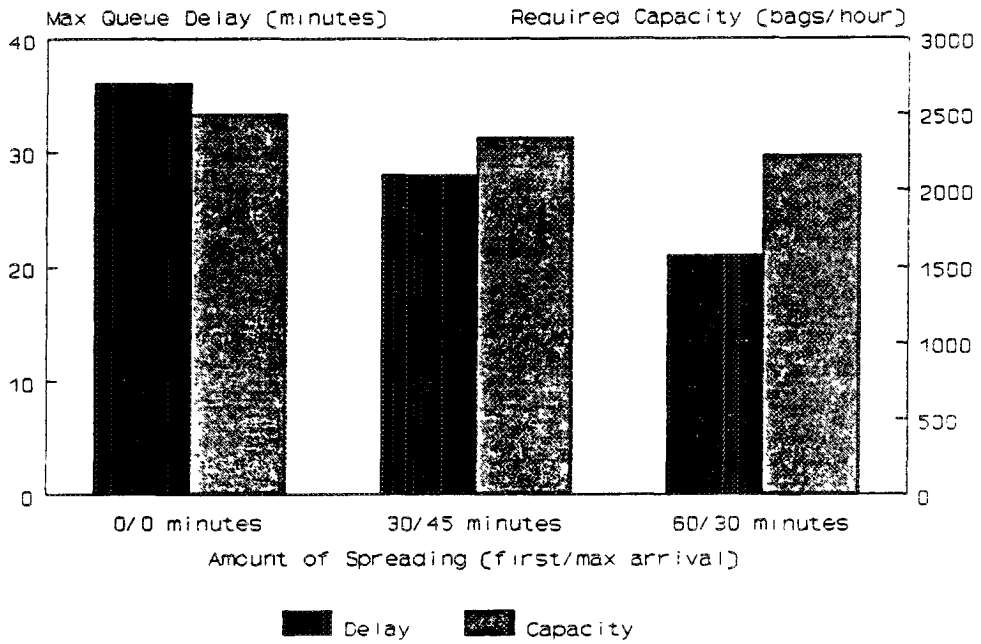

**Figure 3-10**  
**Impact of Departure Peak Spreading**  
**On Maximum Queue Delays and TNA Capacity for Zero Queueing**

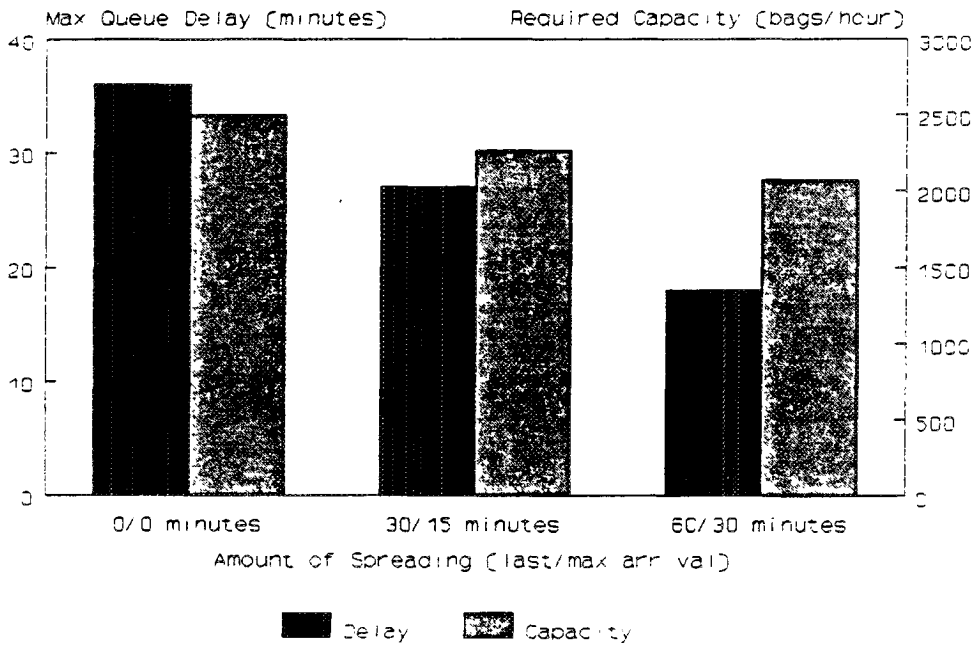

**Figure 3-11**  
**Impact of TNA System Capacity On Maximum Queue Delay**  
**by Per Cent of Originating Passengers**

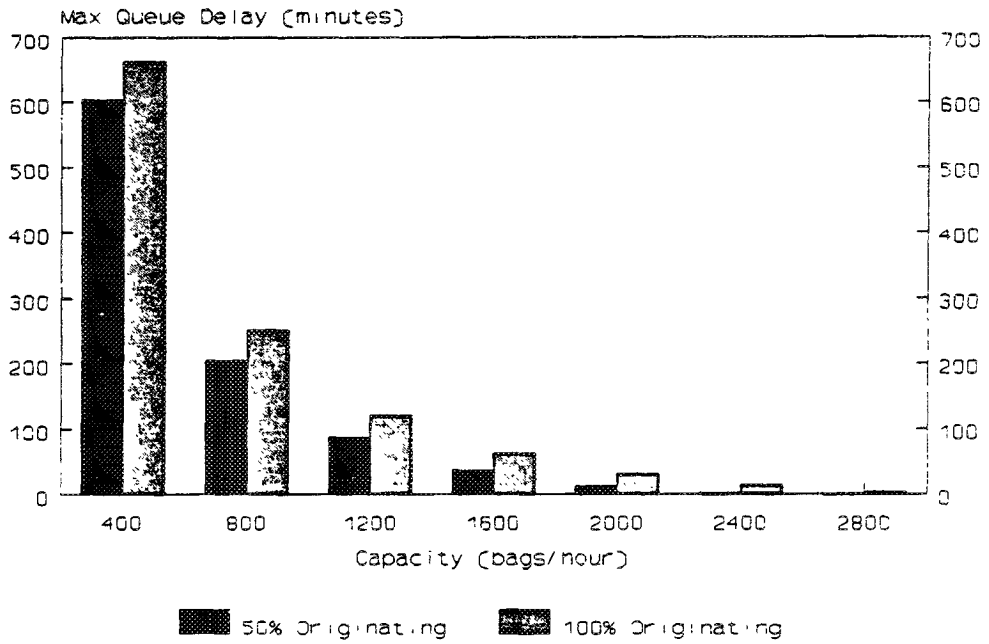

**Figure 3-12**  
**Impact of Arrival Period Compression**  
**On Total Available Processing Time and Maximum Queue Delays**

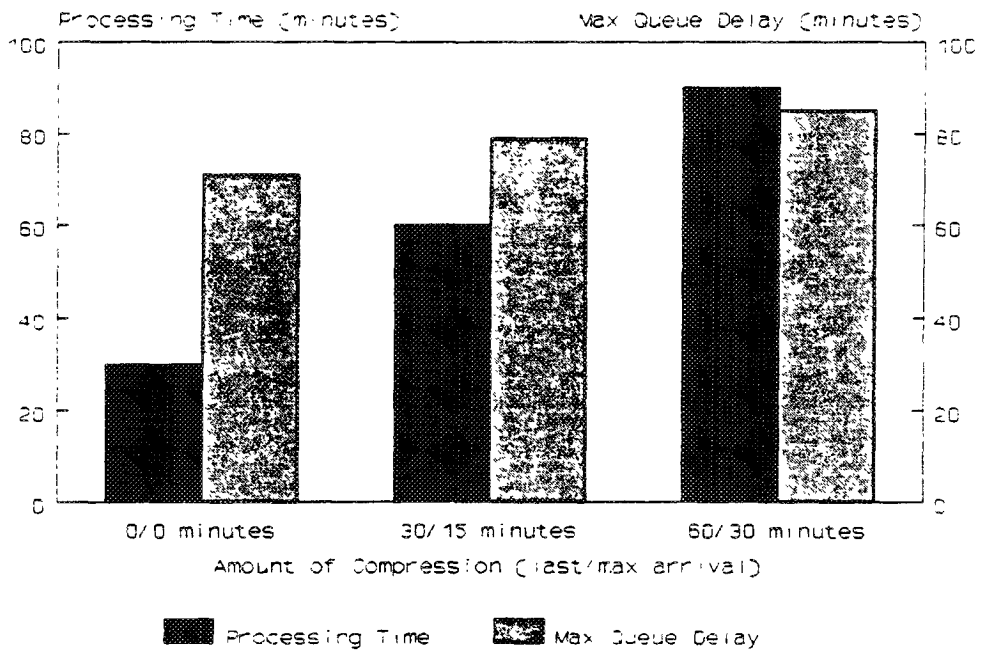

flight time, the waiting time (still assuming the 1600 bag per hour system capacity) is increased by 14 minutes. However, all bags would now make their flights, even allowing for 30 minutes of non-TNA processing time. On the other hand, a compressed arrival period would increase the amount of queueing and therefore the storage space necessary to accommodate bags waiting to be processed.

Spreading the departure peak is also effective in reducing queueing in the no-hub scenario, as shown in Figure 3-13. Maximum delay is reduced from 50 minutes to 28 minutes when the length of the departure period is increased from 3 hours to 4 hours and the peak period is shifted from 15 minutes to 60 minutes after the departures commence. The magnitude of this effect is roughly the same as in the case of the 50 per cent connecting traffic scenario.

In conclusion, the parametric analysis has demonstrated the following relationships:

- A TNA capacity of 2500 to 3000 bags per hour is necessary to eliminate queueing for the case examined.  
Queue delays are reduced below 15 minutes with capacities of 2000 to 2400 bags per hour.
- The 100 per cent originating passenger mix results in capacity requirements at the higher end on this range, while the 50/50 originating-connecting mix yields the lower requirements.
- Shifting the passenger arrival time profile to allow more time before departures for originating passengers appears to slightly increase the amount of queueing in the case of 50 per cent connecting traffic due to the overlap with connecting traffic arrivals.

## SUMMARY

### Activity

- In 1988 U.S. flag carriers enplaned 39 million international passengers at 190 airports around the world.
  - ▶ 41 in the United States
  - ▶ 47 in Europe
  - ▶ 5 in the Middle East and Africa
  - ▶ 36 in Asia and Oceania
- Over 95% of 1988 international enplanements occurred at the top half of the 190 airports.
  - ▶ More than 50% at the top 20

**Figure 3-13**  
**Impact of Departure Peak Spreading**  
**On Maximum Queue Delays and Capacity Required for Zero Queueing**

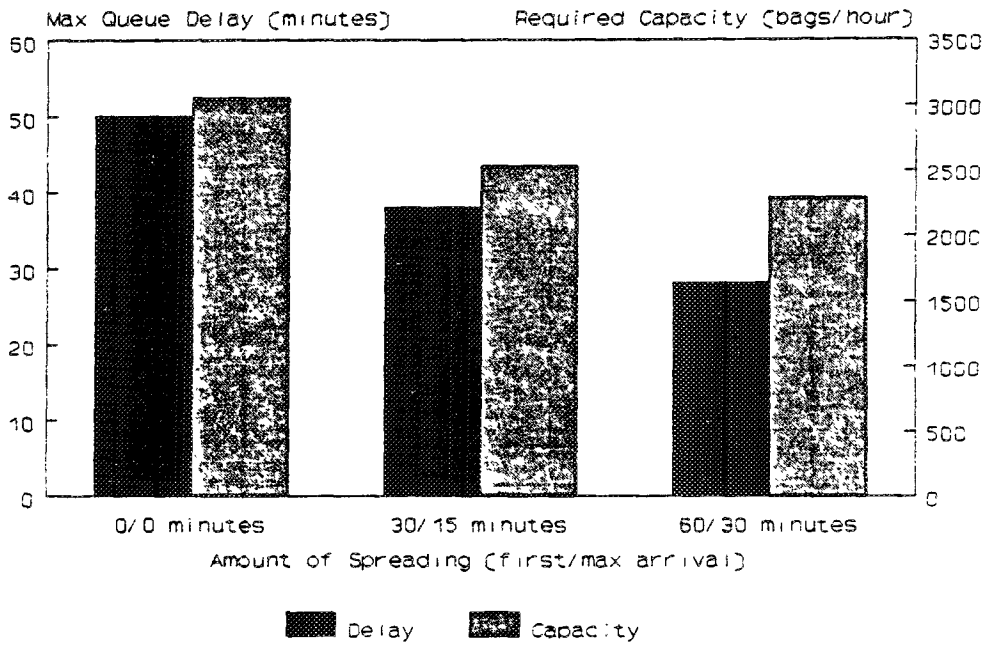

- ▶ More than 46% at the top 10
- At the six case study airports U.S. flag carriers enplaned 9.8 million international passengers in 1988.
  - ▶ Roughly 25% of the total

#### TNA Technology

- Observed TNA throughput in the automatic detection mode was significantly less than 540 bags per hour figure used by the FAA.
- Additional processing required for false alarms may reduce average throughput to between 220-390 bags per hour.
- Reduction in the explosives threat level amount will lead to significantly higher false alarm rates.

#### Design Considerations

- Experience to date limited to single installation (JFK).
- 750 sq. ft. of air-conditioned space required for each machine.
- Each TNA/Xenix machine weighs 28,000 lbs.
- At a throughput rate of 400 bags per hour, a 15-minute queue would require 200-300 feet of conveyor belt.
- Design of facilities should provide storage for periods when baggage inflow exceeds throughput rate.
- Secure facilities needed for conduct of hand searches.

#### Parametric Analysis

- TWA would require a TNA capacity of 2,500-3,000 bags per hour to avoid queueing at JFK airport.
- Throughput rate of 2,000-2,400 bags per hour would keep queues under 15 minutes.
- Spread of flight departure peaks would be slightly more effective than spread of arrival peaks to reduce delays.
- In the case of 50% originating and 50% connecting passengers, an hour spread in the departure peak would reduce maximum queueing delays by about 18 minutes.
- In the case of 100% originating passengers, an hour spread in the departure peak would reduce maximum queueing delays by about 22 minutes.

## 4. SITUATION AT THE CASE STUDY AIRPORTS

Many of the issues and problems associated with the introduction of TNA screening are inherently site-specific. Airports are one of the least standardized transport facilities. Their designs have been influenced by functional and aesthetic considerations that vary from place to place and designer to designer. In addition to these differences in physical layout, there is considerable diversity in patterns of use and operation. Lastly, approaches to airport planning and management reflect the vast differences among nations with regard to economic organization, decision making style, and political and social values.

Almost all airports do share a common feature: they were designed and built before the time when airport security issues, in particular screening of checked baggage, were an issue of major concern. The possibilities for introducing such screening procedures into an existing airport is thus largely a matter of chance. In some airports -- the "lucky" ones -- TNA screening equipment can fit into existing physical facilities and baggage screening procedures can be introduced into the current processing streams quite easily, while in others these changes will entail substantial costs and disruptions.

The impacts of TNA screening cannot, therefore, be accurately assessed without detailed consideration of existing facilities and processing procedures at the airports where it will be introduced. Time and resource limitations precluded such a treatment for all potentially affected airports. Instead, six airports -- including three in the United States and three in Europe -- were selected. Site visits were made to five of these airports. These visits included extensive conversations with airline station and airport managers, inspections of possible locations for TNA screening, and observation of passenger and baggage handling operations. The sixth airport was studied "at a distance" through phone conversations and inspection of detailed drawings and other documentation.

This chapter summarizes the results of these studies. It begins with an overview of the baggage handling process of the general possibilities for and problems associated with the introduction of TNA screening into that process. The situation at each of the six airports is then discussed. Finally, results of the case studies are synthesized to arrive at some generalizations concerning the problems with and prospects for the implementation of the FAA's EDS screening requirements.

To assess the implications of requiring EDS screening of checked baggage, it is necessary to have a general understanding of how checked bags are currently processed at different airports around the world. Although procedures vary somewhat, they are on the whole fairly uniform. The following description is based on Robuste (1988).

In the vast majority of cases, passengers are responsible for getting their bags to the airport. The major exception, off-airport terminals, has been widely advocated but little implemented. Passenger and checked bags separate at the time when the passenger checks in, or, in the case of curbside check-in, just before the passenger enters the terminal. For reasons of security, curbside check-in of international baggage is not generally permitted. The airline agent checking in the passenger weighs and tags the bag and enters it into the baggage handling system, typically by placing it on a belt leading to

the bag room.

In the bag room, bags are sorted by outbound flight. Sorting procedures vary. The simplest approach involves transporting the bags to a carousel or a recirculating conveyor belt, from which loaders pull off bags going to specific flights. In automated systems, bags are given machine readable tags which are scanned to determine their destination, or an operator enters their destination into a computer system which keeps track of their position on the belt. They are then diverted at the appropriate point by means of some mechanical device to storage belts, often termed "laterals". In either case, the sorting activity creates groups of bags destined for the same outbound flight.

The next step in the baggage handling process is to get the bags from the bag room to the aircraft. This involves loading containers or carts which are then pulled out to the aircraft. Containers are then loaded directly into the aircraft cargo hold, while if carts are used individual bags must be handled once more.

Connecting passengers' bags arrive at the airport on inbound aircraft. The bags are unloaded and either sent to the bag room or directly to the outbound aircraft. In the latter case, sorting is done on the ramp. In some cases, this is facilitated by having bags on the inbound aircraft sorted by the flight to which they are connecting. Sorting on the ramp may also occur in two stages: a cart may be loaded with bags destined for a set of flights whose assigned gates are in a certain area, with the driver stopping at each outbound aircraft to identify and unload the bags bound for it.

## GENERAL CONSIDERATIONS

There are, in general, six points within the check-in and outbound baggage handling process where TNA screening could be performed:

1. At curbside
2. In the check-in lobby, before check-in
3. In the terminal, after check-in
4. In, or adjacent to, the outbound bag room
5. At a remote location on the ramp
6. At the departure gate.

A seventh alternative, really a special case of the first three, would be to construct a dedicated international check-in facility at a new location on the airport, with appropriate provisions for TNA screening. This may be a significant alternative in cases where existing terminal facilities are being expanded or remodelled (given the time frame of the proposed implementation of the TNA screening requirements). By designing new terminal facilities with appropriate space and provisions for TNA (or other EDS) screening, many of the difficulties of performing the screening in existing facilities may be avoided.

The various considerations, advantages, and disadvantages of the different scenarios are discussed below.

### **Curbside**

At present, the FAA does not permit international baggage to be checked at curbside for security reasons. If all international bags were subject to EDS screening, this restriction might be lifted. International passengers might proceed to TNA units at the curbside where staff (possibly skycaps, but more likely passenger service agents) would examine their ticket, place a baggage tag on each bag, and run them through the TNA machine. If the bags are cleared they would enter the baggage handling system. If not, the passenger would be directed to take the bag to a security station for the bag to be hand searched.

Since the passenger has not yet checked in, if some difficulty is encountered on check-in (such as an overbooked flight), the airline is then faced with the problem of retrieving the bags from the system. (Of course, this is also true for domestic curbside check-in, but the consequences of the baggage proceeding to the destination without the passenger are more serious for international flights). This scenario also would make it difficult to select particular passengers for hand search of baggage, unless some form of profiling is conducted during baggage check, which would make the process extremely cumbersome.

Ideally, curbside screening would involve dedicated check-in points which would only be used for international bags. This would create difficulties at airports where international and domestic passengers use the same entrances. Signage and other means would have to be used to prevent domestic passengers from attempting to use these points. Conversely, international passengers would have to be informed of the need to check their bags at curbside. Inevitably, some international passengers would carry their bags to the check-in area, only to be told that the bags must be taken back to the entrance.

At most airports, the curbside area is extremely congested at peak periods and provision of sufficient space for TNA machines is likely to be difficult, without significant relocation of curbside roadways. The departure curb is often the upper level of a two level structure, presenting possible structural concerns due to the weight of the TNA machine. Finally, protecting the TNA machine from adverse temperature or humidity is likely to be difficult in a curbside area, unless a special enclosure is constructed. It may be possible in some situations to locate the machine itself within the terminal building, such as on a plant level between the departure and arrival levels, and feed it by a belt from the curb. However, this would require a return belt for rejected baggage.

### **Before Check-in**

If space is available in the check-in lobby, it may be possible to have passengers pass their bags through a TNA machine before proceeding to check-in. The advantage of this arrangement is that the passenger is present in case a bag has to be hand searched



due to a TNA alarm. If passenger profiling interviews are conducted, these can be performed before the TNA screening and selected bags marked for hand search, whether or not there is a TNA alarm.

If the machine is located near the check-in counter, it may be possible for the TNA operator to adjust the throughput of the machine to ensure that relatively few passengers are queueing between the machine and the check-in desks. This practice is currently employed for pre-check-in X-ray screening at some airports. Security agents can keep those passengers under surveillance to ensure they do not place anything in the bags after they have been screened. However, during busy periods this may be difficult.

Thus it may be necessary to either secure the bags in some way, such as banding them, or to have airline personnel (or contractors) transport the bags from the TNA machine to the check-in desks. This would also avoid the problem of expecting passengers to carry heavy bags without skycap assistance. Another solution might be to have special trolleys with hoods that prevent passenger access to baggage (at least without being very conspicuous), although these might be very cumbersome, especially in crowded conditions. For short distances it may be sufficient to accumulate the bags at the TNA machine until a check-in desk is free and allow the passenger to transport the bags directly to the desk.

At many airports, separate check-in stations for different fare classes are used in order to provide a shorter wait for the first class and business class passengers. It would be difficult to maintain this separation without having separate TNA processing stations as well. In many cases, this would necessitate acquisition of more units than would otherwise be required.

Check-in lobbies are frequently used for circulation space, as well as queueing for the check-in desks and seating (particularly for wellwishers waiting while passengers check in). Thus, even where the lobbies are fairly wide, there may not be sufficient space for a TNA machine without restricting circulation or causing passenger queues to back up out the door. Special concern must be given to crowding levels in situations where the lobby is accessed by escalators, lest passengers on the escalators find the crowds prevent them getting off and moving clear as fast as the escalator is delivering them. Also, in multilevel terminals, the check-in lobbies are almost always on the upper level, requiring attention to the structural adequacy of the floor to support the weight of the TNA machine.

Location of the TNA machine within the check-in lobby must also give consideration to providing a protected area for the operators to work, and keeping the public a safe distance from the machine, particularly if a mechanical diverter is used to separate cleared bags from alarmed ones. In some localities, radiation exposure rules may also require the public to be kept a specified distance from the machine.

The throughput of the machine in this situation is likely to be reduced by both the rate at which passengers are ready to place their bags on the feed belt, and by the rate at which bags can be removed after screening, especially if some have to be separated for hand searching.

Adequate space should be provided for accumulated baggage after screening and before it can be moved to the check-in desks. There should also be a balance between the capacity of the TNA machine, the number of check-in positions served, and the number of profiling podiums (if required). Consideration should also be given for access to a suitable hand-search area.

### After Check-in

Performing the screening immediately after the passenger has checked in, and is still at the check-in desk, has a number of advantages. The passenger is still readily available, in case a hand search is required. The baggage can be selected for hand search based on automatic profiling within the reservation system as well as any questions asked before or during check-in. The passenger has no access to the TNA equipment itself and no further contact with those bags that are cleared by the TNA screening. Finally, the space immediately behind the check-in desks are often occupied by airline administrative functions, which it may be possible to relocate without too much disruption to the rest of the terminal operation.

If additional space is required, the height of the check-in lobbies is usually such that it may be possible to relocate the airline administrative offices or other functions on a mezzanine level above the TNA equipment. As in the case of locating the TNA machine in the ticketing lobby, consideration needs to be given to the structural adequacy of the floor in multilevel terminals. Procedures to ensure that passengers do not leave the check-in area until their bags have been cleared will also be necessary. Various check-in procedures could be adopted such as:

1. After placing the baggage tags on each checked bag, the agent would then release them to a lateral belt that would move them to a TNA machine. Once the bag has been cleared by the TNA operator it would enter the automatic baggage handling system and the agent would be notified via a message on the departure control system console and would issue the passenger boarding pass.

If a bag does not clear the TNA screening, or if the passenger is identified as requiring baggage to be hand searched, the boarding pass would be handed to a security agent, who would escort the passenger to a hand-search area beyond the TNA machine. This system would require the owner of each bag entering the TNA machine to be determined, as well as communication links from the TNA machine and software modifications to the departure control system. Bag owners could be identified by placing a machine-readable tag on the bag or more simply by keeping track of its position on the belt.

2. After checking each passenger in and placing baggage tags on each piece of checked baggage, the counter agent would place a three-part security tag on each bag, remove one part and place it on the

boarding pass (or envelope) and release the bags to a feed belt to the TNA machine as before. The boarding pass would then be placed on a small document belt that would transport it to a security agent by the exit belt from the TNA machine, and the passenger would be directed to an adjacent counter to pick up the boarding pass. If the bag is cleared by the TNA machine, the agent would remove the second part of the security tag, affix it to the boarding pass, and return it to the passenger when all bags have been cleared. If a bag is not cleared, then the passenger would be directed to a hand-search area before receiving the boarding pass.

These two systems each have their disadvantages. The first would require the passenger to wait at the check-in position until the bags have passed through the TNA machine. This would slow down the check-in process, although it may be possible for an agent to begin processing the next air party while the previous party is waiting for their boarding passes to clear.

The second system involves an agent removing security tags as the bags exit the TNA machine and matching them with boarding passes. This could easily slow down the throughput of the TNA machine. There would also be the difficulty of keeping track of the tags and boarding pass if a passenger had more than one bag, some of which cleared and some did not.

Juxtaposing the TNA process with passenger check-in -- either at curbside, immediately before check-in, or immediately after check-in -- has one clear disadvantage. Passengers connecting from other flights do not typically go through these processes. Connecting passengers' bags are usually checked through to their final destination, and thus never enter the check-in area of the airport where the connection is made. In order to co-locate the check-in and TNA screening processes, it would therefore be necessary to take appropriate measures to enable screening of connecting bags. Options would include:

- Screen all bags at the originating airport.

This has several advantages. Schedule impacts would be kept to a minimum, as no additional processing would be required at the connecting airport. The procedure is also consistent with how the majority of airlines currently perform security screening of checked bags.

On the other hand, the costs of this approach could be prohibitive because of the large number of airports -- many of which have a very small number of international passengers -- where TNA installation would be required.

- Have separate TNA screening facilities in the bag room or ramp for connecting bags.

This would require fewer TNA units than the first alternative, and is also fairly compatible with current operations. There would be some

added costs from having separate facilities.

Additionally, tail-to-tail transfer of connecting bags, the procedure found to be most efficient when connecting complexes are scheduled tightly, would be precluded.

■ Eliminate through checking of bags onto international flights.

Passengers connecting to international flights would be forced to claim their bags at the connecting airport and then re-check them onto the international flight.

This would be the most economical with respect to TNA acquisition, but would also have the most serious impact on service quality. Some flight rescheduling might be required to allow sufficient layover times for this kind of processing.

■ A mixed strategy combining the first and third of the above alternatives.

Bags would be screened at the originating point whenever international passenger traffic was sufficient to make this economic. Passengers originating at other points would re-check their bags at the gateway.

It is difficult to conjecture what proportion of international connecting passengers would fall into these categories, since it depends not only on the traffic pattern of each airline, but also on the way TNA machines are deployed at upline stations.

### Outbound Bag Room

This alternative generally provides the last opportunity to perform TNA screening without significantly altering the existing baggage handling procedures and facilities. After the baggage has been sorted by flight (or separated into domestic and international streams), it is routed to the input feed to the TNA machines. After being screened it is then routed to the make-up laterals or racetracks for loading onto carts or containers.

If the bag clears the screening, no further action is necessary. If the bag generates a TNA alarm that cannot be resolved by the operator, then two options exist. Either the passenger must be located and brought to the TNA screening area for a hand-search of the bag, or the bag must be marked in some way and sent to another, more appropriate, location, where the hand search can be performed. The most suitable such location is the departure gate, since that is where the passenger will ultimately come anyway (unless he or she has decided not to take the flight for whatever reason) and the bag will be conveniently close to the aircraft for loading once cleared. Since it may take some time to locate the passenger and complete the search, having both the passenger and bag at the gate may avoid having to delay the departure. It should also reduce any concerns of other members of the air party that the passenger may not make the flight.

Since it is obviously desirable to complete any such hand search of baggage before the passengers in question have boarded the aircraft, this implies that alarmed or selected bags should be at the gate before boarding commences (or at least that the gate agents are notified of passengers who will be required to be present for a hand search). This may impose an earlier close-out of checked baggage than is currently used.

It is obviously not essential that the TNA equipment be physically located in the bag room itself, as long as it is sufficiently close that the movement of baggage between the bag room and the TNA facility can be easily accomplished. Given the congested conditions in most outbound bag rooms, and the restrictions on available space due to the conveyor belts and other baggage handling machinery, a nearby location on the ramp is more likely to be feasible. This will typically require the construction of a suitable structure to house the TNA equipment and provide the necessary environmental control. Indeed, since bag rooms usually have minimal heating and no air conditioning (and large doors), it would probably be necessary to provide an air conditioned enclosure anyway, even if the TNA machines were inside the bag room.

If the TNA screening facility is directly linked to the baggage handling system, then some provision needs to be made to store surge loads when the inflow rate of bags exceeds the throughput capacity of the TNA facilities. For a station handling several wide-body departures around the same time, this could amount to several hundred bags. One possible arrangement would be to have a continuously recirculating storage belt with diverters to switch flow to or from the storage belt.

### **Remote Ramp Location**

Constructing a separate facility for the TNA equipment at a location on the ramp (or elsewhere on the airport) away from the existing bag rooms avoids the problem of finding sufficient space in existing terminal facilities and would allow the TNA facility to be adequately sized to meet future demand levels. Although this alternative offers the most flexibility, it suffers from two major disadvantages.

The first is that the baggage would have to be transported out to the TNA facility for screening and then back to the outbound bag room, unless the facility also included its own baggage make-up facilities. This would not only take additional time, requiring earlier flight close-out, but depending on the location, might also require constructing elevated or underground baggage belts to cross service roads or ramp movement areas.

The second is the difficulty of bringing passengers to the facility for hand searching baggage. While it would be possible to tag such baggage and have it searched at the gate, this would require a separate trip (or possibly several) to the gate and then delaying loading the last container until all bags have been searched.

### **Departure Gates**

Performing the TNA screening at the departure gates may overcome some of the problems of a remote ramp location, but at the price of requiring both TNA equipment and baggage make-up facilities at every gate used for international departures. After

check-in, all bags would be routed to the departure gate, where they would be screened and cleared bags loaded into carts or containers. Alarmed bags would be set aside and the gate agents notified to locate the appropriate passengers when they appear at the gate, and bring them to a hand search area adjacent to the TNA facility.

In order not to delay the flight departure, this approach would require all passengers to report to the gate in sufficient time to allow the hand search to be performed if necessary. It would also be necessary to construct the relevant facilities at the ramp level in the gate area.

Since ramp level space at most existing gates is already fully utilized, it would generally be necessary to relocate existing facilities or construct new facilities on the ramp itself. This may well require moving the aircraft parking positions to create sufficient space between the aircraft and the terminal building or adjacent gate positions. Aircraft parking positions are already tightly constrained at many existing terminals with limited clearance between adjacent gates or from ramp throughways.

### Site Specific Considerations

The foregoing discussion highlights the importance of terminal-specific characteristics in determining appropriate locations for TNA screening facilities, as well as the impact of installation on existing operations. Furthermore, additional site specific factors not covered in the above discussion are expected to be important at specific facilities. Consequently, the airport site visits were made with a twofold objective: first, to observe how the general factors outlined in the above discussion affect the feasibility of TNA installation at specific sites, and second, to investigate other more site specific factors.

The following generic factors were explored during the on-site studies:

■ Space availability.

Each TNA/Xenix unit requires, at minimum, a footprint roughly 40 feet by 20 feet. Additional room may be required to store bags queued for screening.

Furthermore, the units must be protected from extreme temperatures and humidity levels, and require considerable structural support. Lastly, the screening activity must not significantly interfere with other terminal activities.

■ Traffic characteristics.

The cost and feasibility of TNA screening is strongly influenced by the volume, temporal pattern, and composition of passenger traffic. These variables determine the total TNA capacity required, and the relative convenience of different screening locations.

Capacity requirements determine space requirements, which together with space availability constitute the single most important determinant

of installation cost. In cases where the traffic level is very low, there is the additional issue of having few passengers over which to spread the costs of a given unit.

■ Baggage flow characteristics.

All international checked bags will have to be routed through one or more locations where the TNA screening takes place. The implications of this requirement depend on current baggage flows.

In the ideal case, all international checked bags would currently flow past some point which is a suitable location for the TNA system. In actuality, there may be multiple streams of bags whose paths may never intersect until they reach the outbound flight, or which currently meet at a point unsuitable for a TNA system. In such situations, multiple screening locations or rerouting of current baggage streams may be required.

Another important aspect of baggage flow involves segregation between international and domestic bags. If both types of bags are normally intermingled until final sorting, it may be necessary to segregate the flow into separate international and domestic streams.

■ Commonality of facilities.

Airports vary widely with respect to the extent to which airlines share common passenger and baggage handling facilities. In general, it is expected that the TNA screening activity will follow existing precedent with regard to whether separate or common facilities, or a mixture of both, are used.

This will affect total TNA requirements, with consolidation of TNA screening tending to reduce total capacity requirements. On the other hand, use of common facilities may pose an obstacle when these are shared either with domestic airlines or foreign flag carriers not subject to the TNA screening requirement.

## STATISTICAL PROFILE OF CASE STUDY AIRPORTS

Table 4-1 summarizes the operations of U.S. flag international carriers at the six case study airports during 1989. International enplanement levels varied widely. Three stations -- Pan Am at Kennedy and Frankfurt, and TWA at Kennedy -- boarded over one million passengers. At the other extreme, many carriers boarded under 100,000. Some of these involved services either begun or discontinued during the course of the year. These cases are readily identified by their peak quarter ratios approaching or exceeding 0.5, implying that more than half their traffic occurred during a single quarter.

**Table 4-1**  
**Traffic Characteristics at Case Study Airports**

<u>Airport</u>	<u>Airline</u>	<u>Pax (000)</u> <u>Total</u>	<u>Peak Qtr.</u> <u>Ratio</u>	<u>Daily</u> <u>Flights</u>	<u>Daily</u> <u>Seats</u>	<u>Peak Hr.</u> <u>Seats</u>	<u>Peak</u> <u>Hour</u>
JFK	AA	695	.28	12	2805	520	10
	EA	85	1.00				
	NW	100	.32	1	405	405	11
	PA	1135	.32	27	7386	1475	18
	TW	1213	.32	17	6011	1803	20
	TO	89	.30				
	UA	86	.27	1	405	405	11
	total	3871	.30				
ORD	AA	64	.49	18	3327	740	16
	NW	85	.28	1	405	405	12
	PA	14	.53	8	1446	417	15
	TW	67	.33				
	total	230	.49				
MLA	AA	202	.39	7	1376	558	12,20
	CO	127	.36	7	751	538	19
	DL	(1)	1.00				
	EA	615	.37	41	6484	1722	17
	PA	906	.28	21	4166	1759	17
	TO	44	.49				
	total	1895	.27				
LGW	AA	101	.33	2	568	284	10,13
	CO	319	.33	3	1084	689	11
	DL	155	.33	3	693	231	11,13
	NW	159	.34	2	810	405	10,13
	PI	30	.42	1	197	197	12
	TW	110	.35	3	993	699	13
	US	21	.56				
	total	895	.32				
FRA	AA	152	.29	3	765	568	10
	DL	174	.30	4	924	462	11
	NW	93	.41	2	568	284	12,14
	PA	1115	.29	31	6407	1802	12
	TW	24	.32	9	1586	520	10
	total	1778	.30				
FCO	TW	660	.36	2	602	405	10,11
	PA	108	.31	1	405	405	11,12
	total	269	.34				



Neglecting these exceptional cases, peak quarter ratios range from below 0.3 to almost 0.4 (note that the smallest possible ratio is 0.25). American and Continental at Miami, and TWA at Rome, are among the more strongly peaked operations. Pan Am's Miami station and United's Kennedy operation are among the least peaked. Somewhat surprisingly, there is no strong correlation between the amount of seasonal peaking and the size of the operation. As a general rule, however, seasonal peaking for a given airport tends to be less severe than for the individual airlines at the airport. This is particularly true in airports whose carriers are undergoing substantial realignment, such as Miami.

Table 4-1 also provides summary schedule information for those airline stations which board more than 30,000 international passengers in 1989. International flights per day (on the busiest day of the week), vary from 1 to 41, and daily seats from 197 to 7400. The range of peak hour seats is somewhat narrower, again with a lower limit of 197 but with a maximum of 1803. This is far less than the peak period activity levels that occur at major domestic hub operations. Unlike the seasonal peaking phenomenon, daily peaking is related to the level of operation. At the limit, carriers with just one daily flight will have peak hour departures equal to their total activity. The larger stations have at most a third of their international seats leaving during their peak hour.

## **JOHN F. KENNEDY AIRPORT, NEW YORK**

Kennedy Airport (JFK) currently receives international service from six U.S. flag airlines. These airlines together with Eastern, which discontinued service in March 1989, enplaned 4.1 million international passengers in 1988 and 3.9 million in 1989. In terms of both number of carriers and traffic volume it is the premier international gateway in the United States. It is therefore appropriate that JFK be the object of the most detailed analysis concerning the impact of TNA screening, the results of which are presented in subsequent chapters. The discussion here will be on a more general level, and is intended to support comparisons between JFK and the other case study airports.

JFK has service to international destinations throughout the world. The different airlines have distinct regions of specialization. Pan Am and American focus on the North Atlantic and Caribbean routes, with the latter also offering service to Canada. TWA's international non-stop destinations are all in Europe. Northwest and United connect New York to North Asia with non-stop flights to Tokyo, with United also offering Canadian service.

Figure 4-1 shows the layout of the central terminal area at JFK, a classic example of the unit terminal airport design concept. Each of the major airlines operates its own terminal facility on land leased from the Port Authority of New York and New Jersey. All terminal functions -- concessions, passenger and baggage processing, and federal inspection services -- are therefore specific to each carrier. In 1987, the Port Authority adopted a plan to build a central facility to serve as a transport hub connecting the airport with the region and the different terminals with each other. This plan, which would have created new possibilities for TNA screening, has recently been indefinitely postponed, and its implications will not be considered further here.



In total, the parametric analysis described in the previous chapter suggests that U.S. airlines would require 30 to 40 TNA units to screen 100 per cent of their international checked baggage. In the light of the unit terminal concept, it is clear that separate facilities will be required in most cases. The impacts of this requirement on individual airlines are discussed below.

## TWA

TWA operates both a domestic and an international terminal on the east side of the airport. Thus, one stream of checked bags requiring screening would originate from the international terminal check-in area, while the other would emanate from feed flights arriving at the domestic terminal. As it would be infeasible to route the connecting bags through the international check-in area, the main options are to have just one screening facility, located in the vicinity of the international bag room, or to have a second, dedicated to originating traffic, near the check-in area.

There are two possibilities for lobby installation. First, units could be installed between the entrance lobby and the international counter area on the east side of the terminal as shown in Figure 4-2. One unit could be installed in this area without displacing existing facilities, while two units would be possible if 10 of the 39 counter positions were eliminated. It is unlikely that two units would provide adequate TNA processing capacity. Furthermore, this location would constrain pedestrian flow and reduce queueing space. For these reasons, it is unlikely to be feasible.

The second possible lobby installation site is behind the international check-in counter, as shown in Figure 4-2. This area is currently occupied by an employee cafeteria, employee lockers, a kitchen and food storage facilities. The amount of space available appears adequate to house the six units that would be the maximum required for originating baggage screening. The cost and operational implications of relocating the current occupants of this space would, however, be extremely high. Possible locations include the adjacent parking area or above the baggage make-up building behind the terminal.

The most promising location for the screening is on the ramp near the baggage break-down belts. This alternative was chosen for the demonstration unit, which is located on the ramp just outside the terminal adjacent to the input and coding positions for the baggage system as shown in Figure 4-3. This general area could house a maximum of five units.

This location is desirable because of its proximity to the conveyor system. However, installation of the necessary number of units, while possible from a space availability standpoint, would seriously affect current patterns of baggage cart movement. Also consideration would have to be given to passenger access for hand searching baggage, although this might be achieved by a stairway from the adjacent passenger walkway.

Unlike many other terminal operations surveyed in this study, the need to route connecting bags into the terminal would not in and of itself have a tremendous impact on TWA's operation, as most connecting bags are already routed in this manner. Although



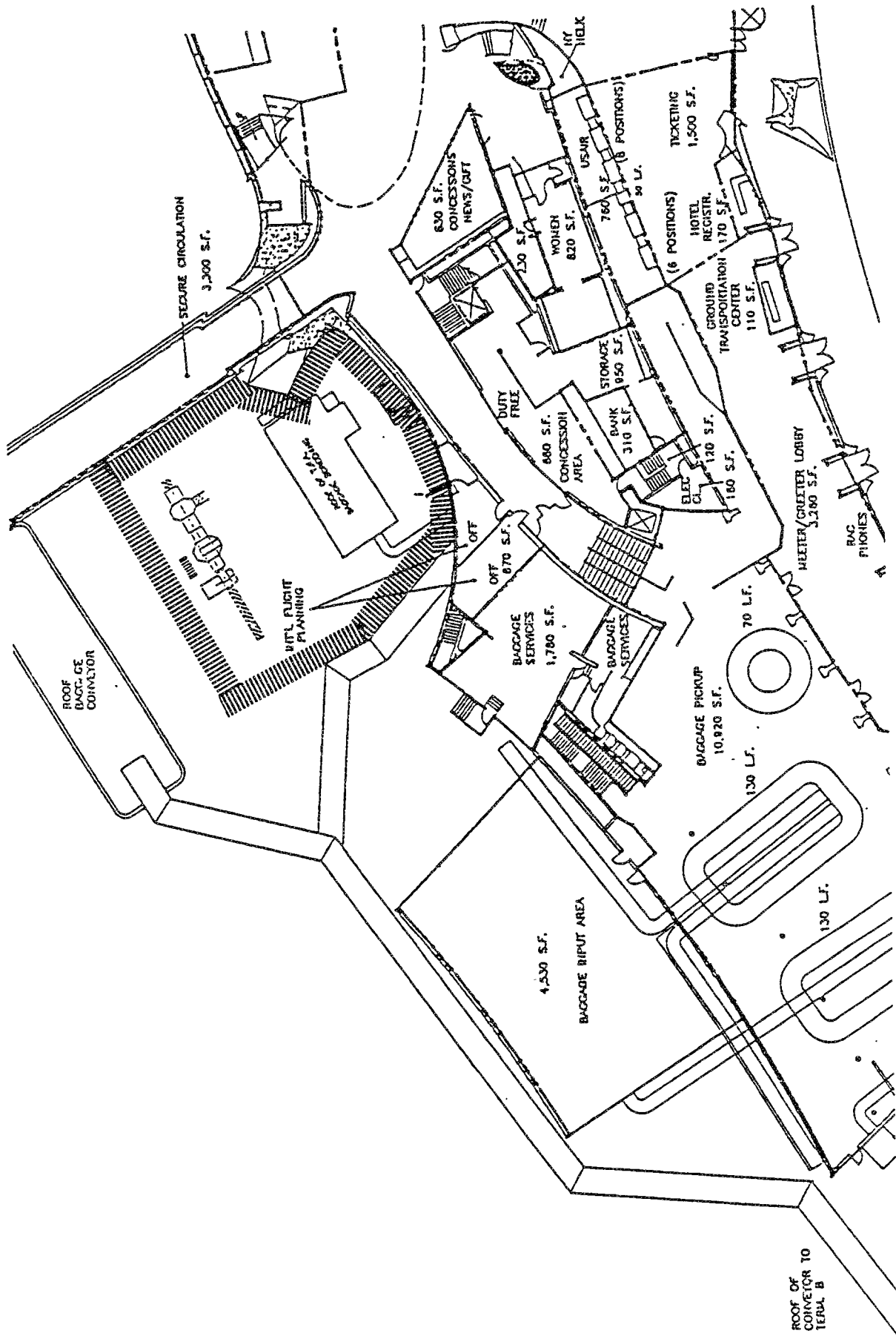

Figure 4-3  
Possible TNA Location on Ramp Near TWA Baggage Input Area

on occasion baggage is transferred directly from plane to plane, this is the exception rather than the rule for TWA.

An alternative location is near the baggage make-up area on the east side of the international terminal as shown in Figure 4-4. This location has ample space, although it is currently used for parking equipment. It could be easily linked by belt to the baggage make-up room. This could expedite the handling of connecting bags, which are the most time sensitive given TWA's traffic pattern. Bags could be screened after passing through the baggage coding station and before being routed to the make-up lateral. This location also could have access from an adjacent passenger walkway.

### **Pan Am**

Pan Am's World Port is JFK's largest terminal, and the airline's most important station. It consists of two terminals. Terminal A is a triangular structure located at the southwest corner of the airport. Terminal B, located to the north of terminal A, is used for domestic flights.

Pan Am's lobby area is very poorly suited to TNA screening, since as currently configured originating passengers can check their bags at 12 different locations and both domestic and international passengers can use any counter. It would clearly be impractical to conduct screening at each of these locations, and, short of a complete terminal reconfiguration, it would be necessary to restrict some locations to international passengers and some to domestic. The impact of this on operations could be quite serious, and would need careful study.

Thus screening in the vicinity of the bag room appears to be Pan Am's most practical alternative. The bag room is located at ramp level, above the baggage claim area and below the check-in area. The bag room itself has adequate space for the required 12-14 units, but installation would be extremely costly because it would necessitate drastic changes to the conveyor belts used for the automated baggage sorting system.

A more promising alternative would be a ramp location to the south of the baggage handling area. This area is just outside an area currently used for mail and cargo handling. The installation of TNA units in this location would interfere with traffic flow in and out of the mail and cargo handling area. Thus, it may be desirable to relocate this area to the south and make the TNA area immediately adjacent to the baggage handling area. About half of the space of the current mail/cargo handling area would be required to install the number of units estimated to be necessary.

Routing connecting bags through the bag room will create a bigger problem for Pan Am than it would for TWA. Plane to plane transfer is used when connecting times are under one hour. Although Pan Am does not schedule many layover times below this threshold, schedule delays make connecting times under one hour common in practice. Station personnel estimate that sending connecting bags through the bag room will add as much as 30 minutes to their total processing time.

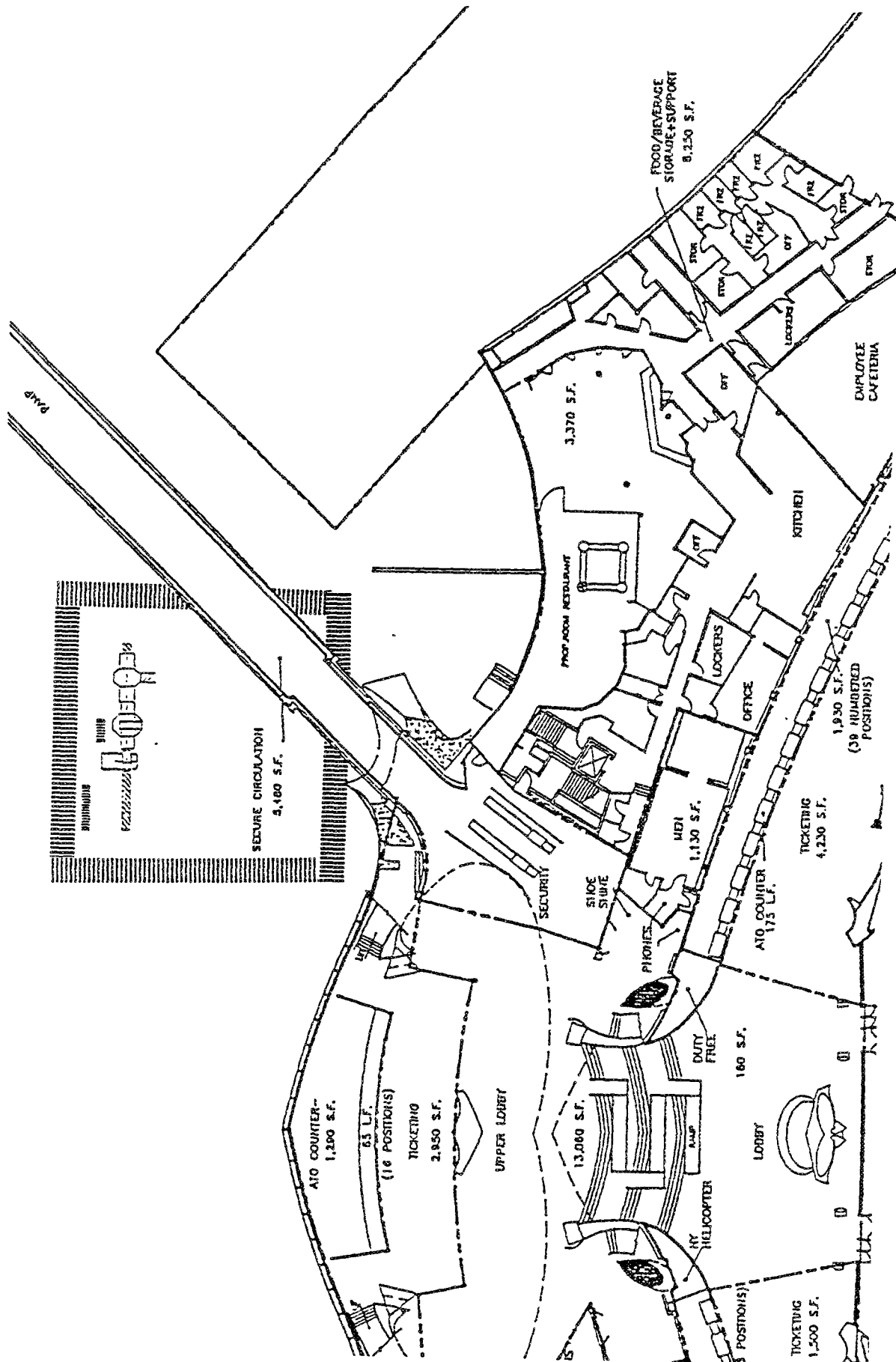

Figure 4-4  
Possible TNA Location Near TWA Make-up Area

## United

The present United Air Lines Terminal, which is shared with Northwest, is located in the northwest corner of the JFK terminal area. However, it is about to move into the southeast side of the British Airways (BA) terminal, located at the northeast corner. This discussion is based on the new location.

There appears to be adequate space in the United side of the BA lobby for the installation of one unit. A possible TNA position in the lobby is shown in Figure 4-5, between the domestic and international check-in counters. International passengers would be queued so that they would go past the mouth of the unit, where they would hand their bags to security personnel. The screened bags would be moved by conveyor to the area of the international counters, where passengers could retrieve them for check-in.

This location would involve sacrificing some combination of domestic check-in queue and circulation area. An alternative location is behind the domestic check-in counters, as shown in Figure 4-5. As presently planned, this area will be occupied by commissary and storage space, the check-in supervisor's office, a smoking room, and other facilities. A TNA unit would occupy about two thirds of this space, probably intruding into the corridor behind. Connecting the unit to the international baggage belt would also be difficult. In light of this, and the availability of space for lobby installation, the former is probably to be preferred.

Location adjacent to the outbound bag room would also be feasible for United. Space could possibly be made available in the operations area, as shown in Figure 4-6, depending on the planned use of the area. Alternatively, it would be possible to place the unit on the ramp in front of the bag room, between gates 7 and 8, as shown in Figure 4-6.

It appears that the lobby location is the preferred alternative for United's JFK terminal. It is anticipated that most of United's international traffic will consist of originating passengers. The bag room is two stories beneath the gate areas, making access for passengers difficult in the event of an unresolved alarm. A bag room location would therefore suffer from a greater than usual disadvantage with respect to originating bag handling, without much offsetting benefit deriving from the more expeditious handling of connecting bags.

## Northwest

Northwest Airlines occupies the east side of the present United terminal, at the northwest corner of the airport. It operates one flight a day between New York and Tokyo.

Northwest's bag room is located in close proximity to and at the same level as its lobby. The tradeoffs between lobby and bag room location are therefore less serious for Northwest than they are for many of the other airlines. Connecting bags could be processed through a lobby system, or originating bags could be screened in the bag room, without great difficulty.



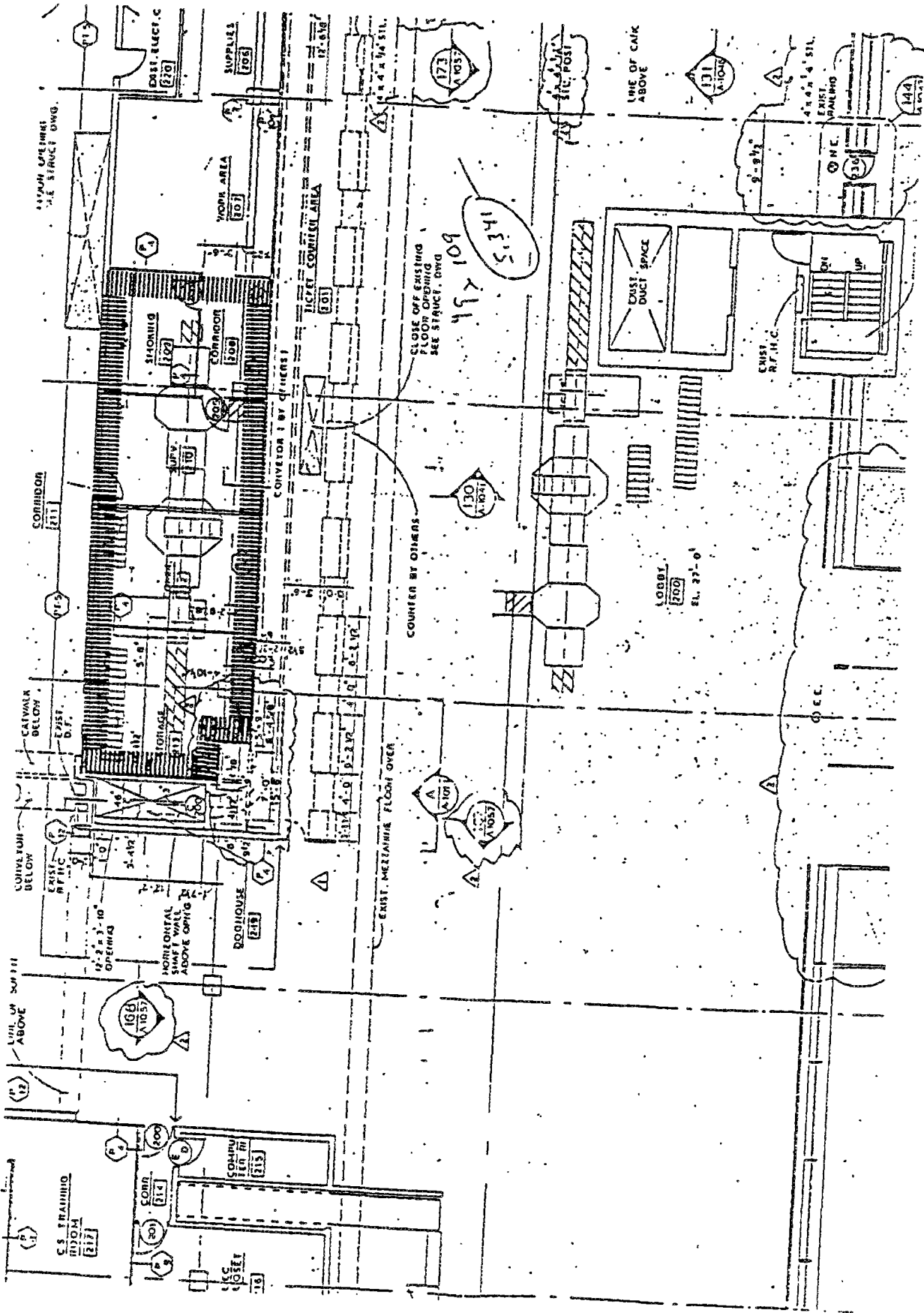

Figure 4-5  
Possible TNA Locations in United Lobby

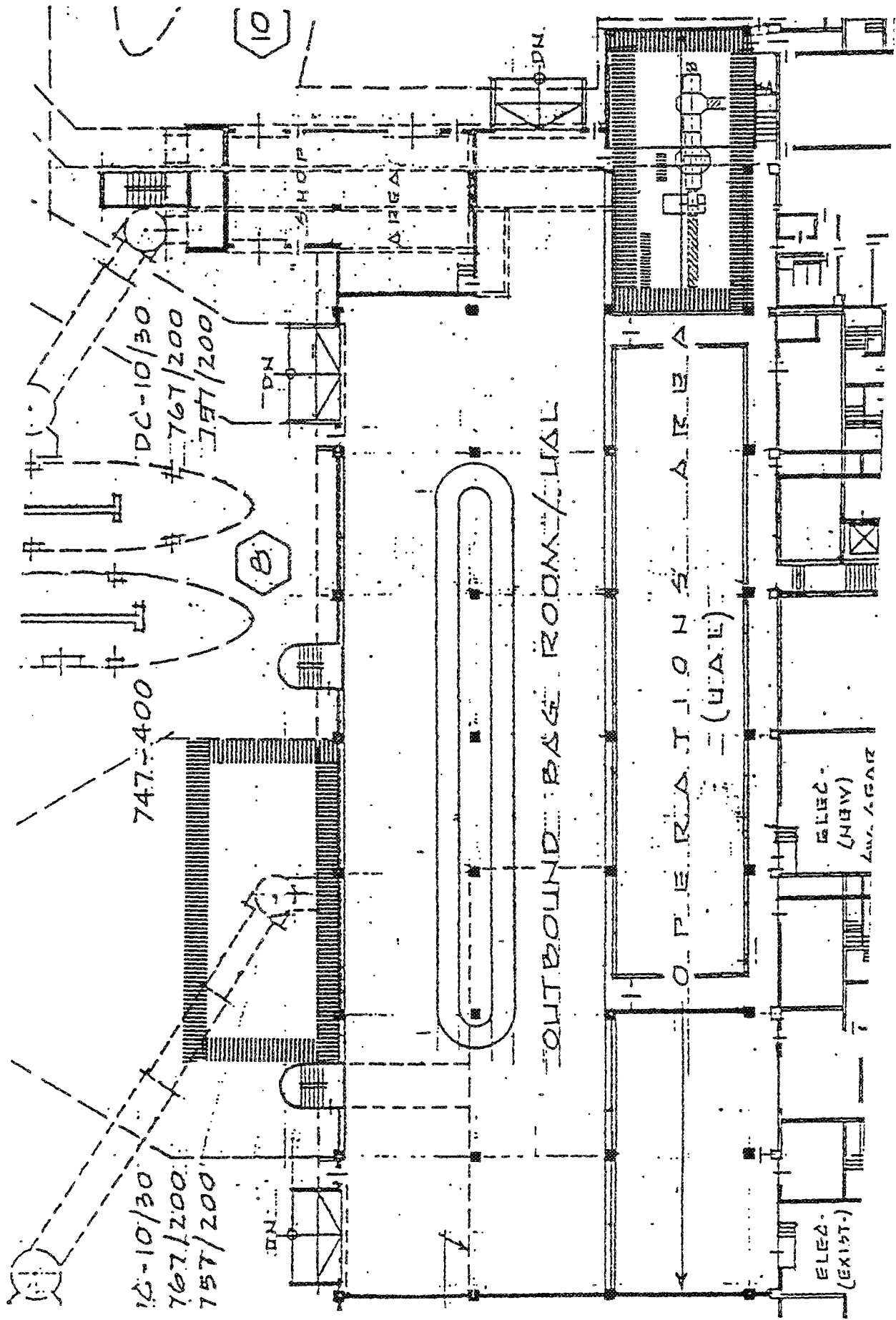

Figure 4-6  
Possible TNA Locations Adjacent to United Bag Room

Lobby installation may be feasible at Northwest. One possible location is just inside the west vestibule, as shown in Figure 4-7. The system would extend behind the ticket counter. Once screened, the bags could be placed on the existing conveyor belt. This would eliminate four of Northwest's 14 check-in positions.

Another lobby location worthy of consideration is between the two vestibules, parallel to the ticket counter. In this case, no check-in positions would be lost, but about half the total queueing and circulation area would be eliminated. Also, the transport of screened bags from the TNA unit to the check-in counter would have to be arranged.

A second possible location is in the bag room. The belt leading to the racetrack device runs along the east wall. The TNA unit could be positioned next to where the existing belt enters the bag room, as shown in Figure 4-8, and a diverter used to route international bags through it. Alternatively, a second belt could be built on top of the first, to provide a direct feed to the TNA unit. This would reduce the difficulty of ensuring that the appropriate bags are screened. Screened bags could be routed by return belt, to merge with the existing belt before it feeds the racetrack device.

Because Northwest operates only one international flight per day, the possibility of sharing a TNA system warrants some consideration. Northwest's current neighbor is United, which is planning to move to the British Airways terminal as noted above. It appears likely that the vacated space will be occupied by American, which may find it convenient to share TNA units, as the Northwest and American international traffic peaks do not coincide.

### American

American Airlines occupies its own terminal, on the north side of the airport. The international check-in area is on the west end of the terminal building, adjacent to the entrance to the west pier, which includes gates for the airline's international flights.

Based on American's 1988 international traffic characteristics, it appears the airline would require between three and five TNA units. About 40 per cent of its passengers are connecting either on-line or interline, making some combination of lobby and bag room TNA facilities desirable.

Space in the international check-in area will, however, be hard to come by. It appears that the screening area would have to be located across from the entrance to the west pier. This would interfere with pedestrian traffic and could cause confusion regarding which bags require screening. Thus, lobby installation under the current terminal configuration would be very difficult. American is, however, in the process of renovating its terminal area. Plans for the renovation were unavailable, so it is not possible to determine whether this may create new opportunities for TNA installation.

Space in the bag room appears to be adequate for up to five TNA units. If this would interfere with bag room traffic, adjacent space on the ramp could be used. Either approach would require substantial modifications to American's baggage handling system.

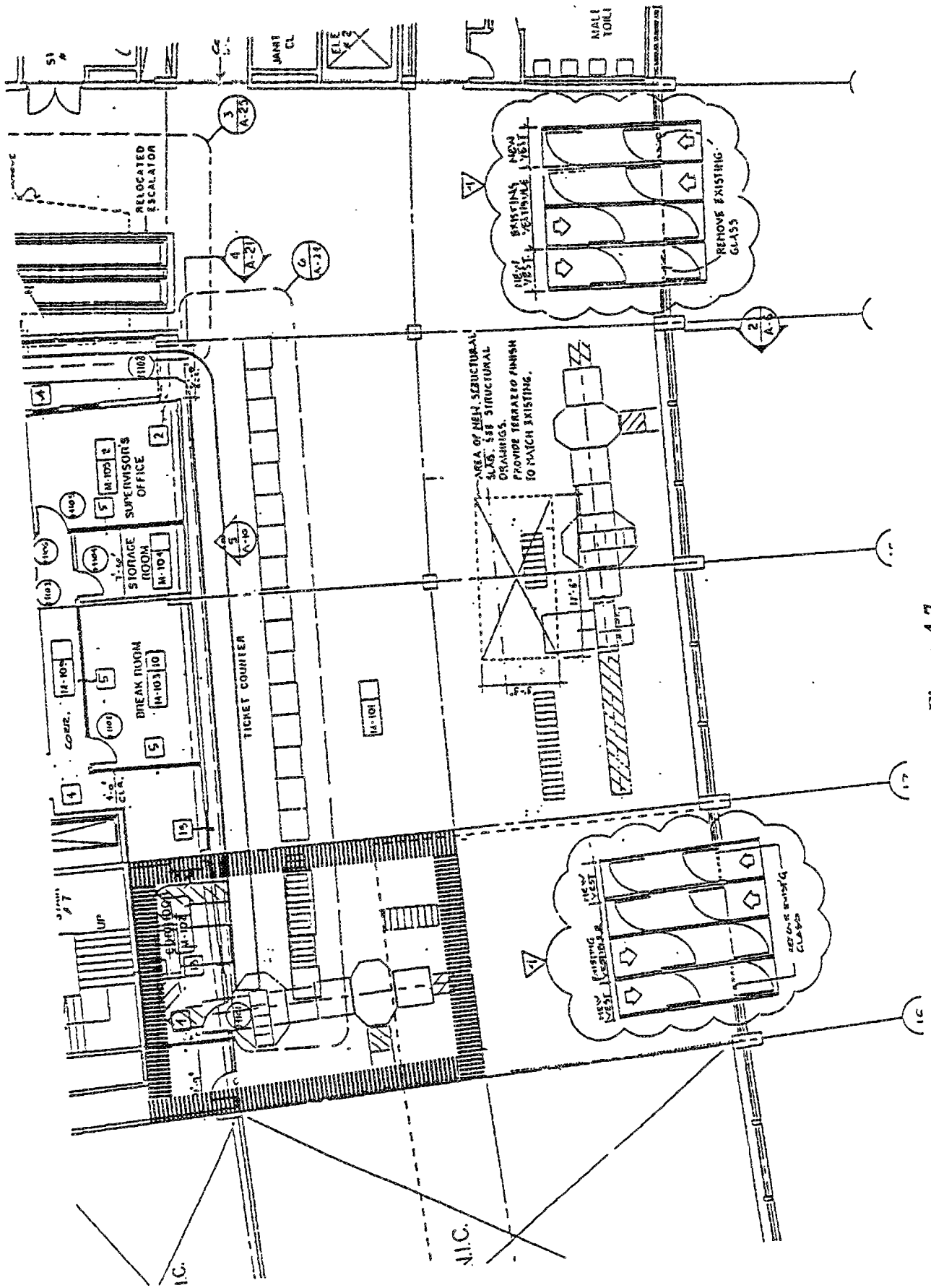

Figure 4-7  
Possible TNA Locations  
Northwest Lobby



## Eastern

The Eastern terminal, located on the west side of JFK airport, has been virtually unused since March 1989, when Eastern suspended service. The terminal building has an unusually large lobby area, which would probably be the most suitable location for TNA screening activity. Prior to suspending service, Eastern conducted x-ray screening of international checked baggage in the lobby area.

There appears to be adequate space in the bag room for TNA screening as well. Few of Eastern's passengers were connecting from other points, however, so there is little need for bag room screening. This may become more important if the new occupant has a different traffic mix.

## CHICAGO O'HARE

Long one of the nation's leading domestic airports, O'Hare has until recently handled relatively little international traffic. In 1989, U.S. airlines at O'Hare enplaned 0.4 million international passengers, only about 10 per cent of JFK's U.S. flag international traffic and ranking the airport 27th in this traffic category. The terminal layout at O'Hare is shown in Figure 4-9.

Five U.S. airlines offered international flights out of Chicago in 1989. American, the leading carrier, offered 18 daily flights, primarily to Canada and Mexico, but with as many as four daily European flights as well. United offered eight daily international flights: seven to Canada and one to Mexico City. The other three airlines, TWA, Pan Am, and Northwest, each featured one daily international departure out of Chicago, to London, Frankfurt, and Tokyo respectively. The TWA and Pan Am services have since been abandoned. The discussion presented here therefore focusses on United, American, and Northwest.

The analysis in Chapter 3 suggests that O'Hare would require between four and six TNA units at 1989 traffic levels. However, these requirements can be expected to increase rapidly. This summer, for example, United is initiating European services, American is increasing its European schedule, and both airlines are vying for a new Tokyo route. However, the following discussion focusses on the status quo, rather than trying to anticipate consequences of future service and schedule changes.

## United

United Airline's terminal occupies concourses B and C on the west side of O'Hare. Concourse B is on the access road, while concourse C is a remote terminal connected to concourse B by an underground moving walkway. The bag room is located underground between the two concourses. Unlike most other airlines consulted, United has given significant consideration to where TNA units would be located. In the case of O'Hare, at least a tentative decision to locate units in both the lobby and the bag room has been reached. The lobby installation would be in the front of the flow-thru check-in positions at the north end of Terminal B used for international passengers. Presently, two x-ray

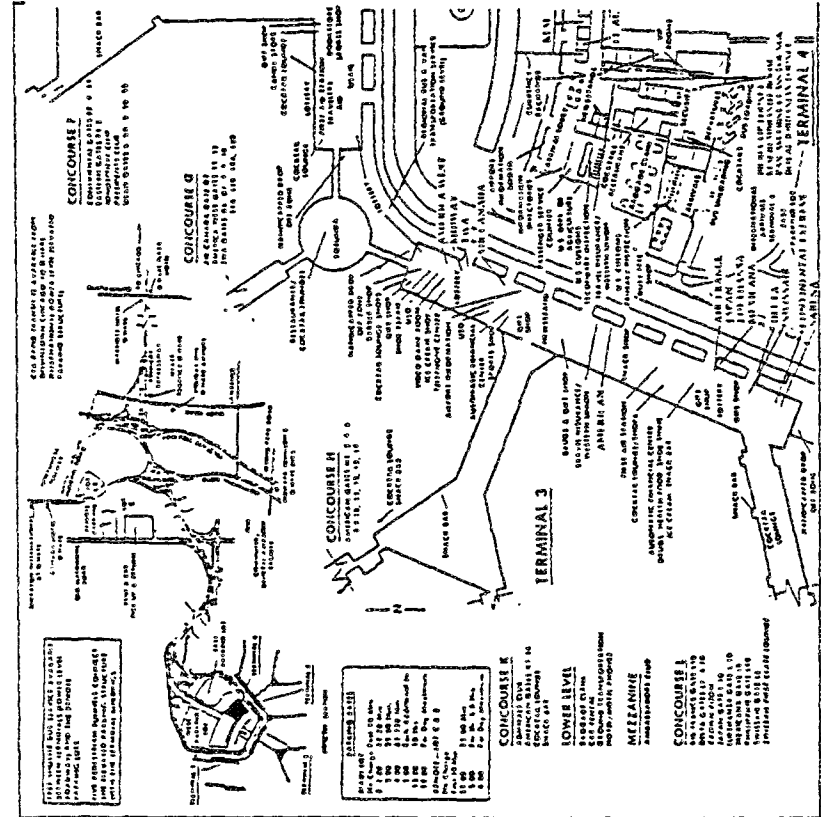
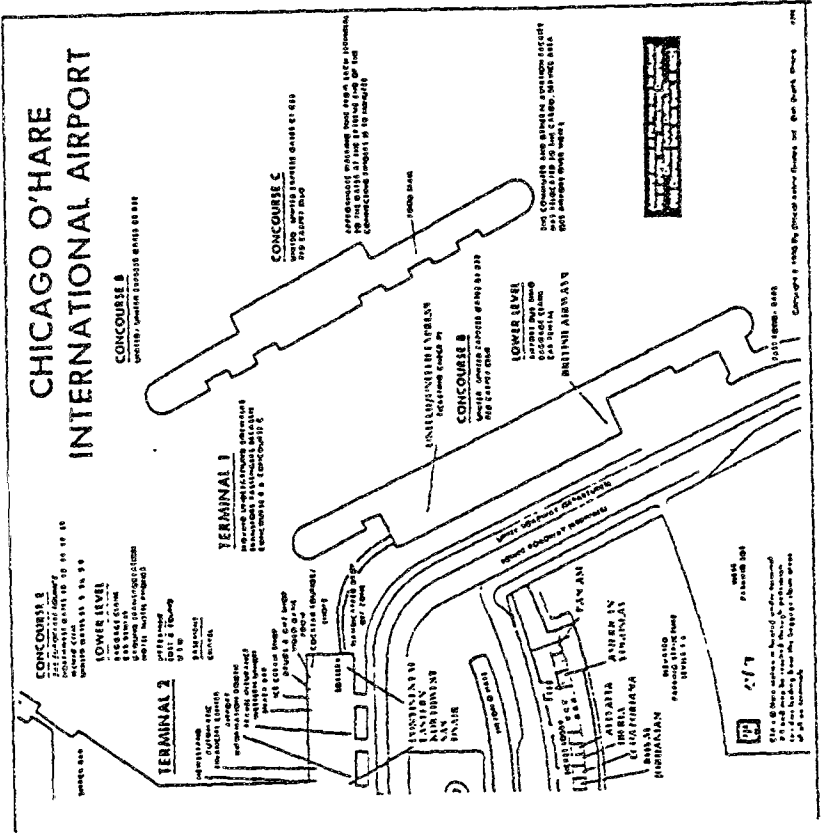

Reprinted with special permission from the March-May, 1990 Official Airline Guides Travel Planner Hotel & Motel RedBook North American Edition. All rights reserved.

Figure 4-9 Chicago O'Hare International Airport Terminal Layout

machines are located in this area, with one of them dedicated to first class passengers. A similar number of TNA units would be required, unless it was decided to stop segregating passengers by class for purposes of TNA screening.

Despite the airline's expressed intentions, fitting the TNA units into the lobby will prove very difficult. The 45-foot width between front wall and the check-in positions precludes perpendicular placement. It is, however, possible that one machine oriented parallel to the lobby might be squeezed in. From a space management viewpoint, the most suitable location would be just inside the entrance to the south of the international check-in positions as shown in Figure 4-10. This location may not be structurally adequate, however. Most other locations in this general vicinity would greatly reduce the queuing area available for international passengers. Two machines in this area would almost certainly be out of the question.

No other lobby locations appear appropriate. The flow-thru design appears to make post-check-in screening impossible. Although curbside check-in positions exist, the midwest climate strongly discourages any approach that could result in the formation of queues out of doors.

The possibilities for bag room location, shown in Figure 4-11, are somewhat more promising. The location deemed most appropriate by station personnel is at the east end, an area currently used to park utility vehicles. This area could accommodate at least one and at most two units, depending on the vehicle circulation patterns in the bag room. A second possible location is the southeast corner of the bag room, in the vicinity of the east encoding station. This area is considerably larger than the previous one mentioned, but it also has extensive baggage cart traffic which may present difficulties.

However suitable these locations, TNA screening would have a severe impact on United's baggage transfer operations at O'Hare, for two reasons. First, connecting bags are normally transferred directly from one plane to another. Thus, as was the case in Miami, the requirement to route bags connecting to international flights through the bag room would result in extra processing time which could endanger the integrity of some connections.

Second, United uses a highly sophisticated (and proprietary) technique for accomplishing the interplane transfer expeditiously. Use of this technique would be complicated by the introduction of another class of bag which have to be given special treatment. This could require as much as one more runner per incoming flight. Assuming a runner works 250 days per year, and can make 6-7 runs per day, and that half of United's incoming flights may carry international connecting passengers, between 30 and 40 more runners would have to be hired, at an annual cost approaching \$1 million.

### American

American occupies Terminal 3, on the east side of O'Hare. Its gates are along two concourses, H and K, that together with the corridor connecting them to the terminal form a Y shape. American's international operations use the outer gates of concourse K.



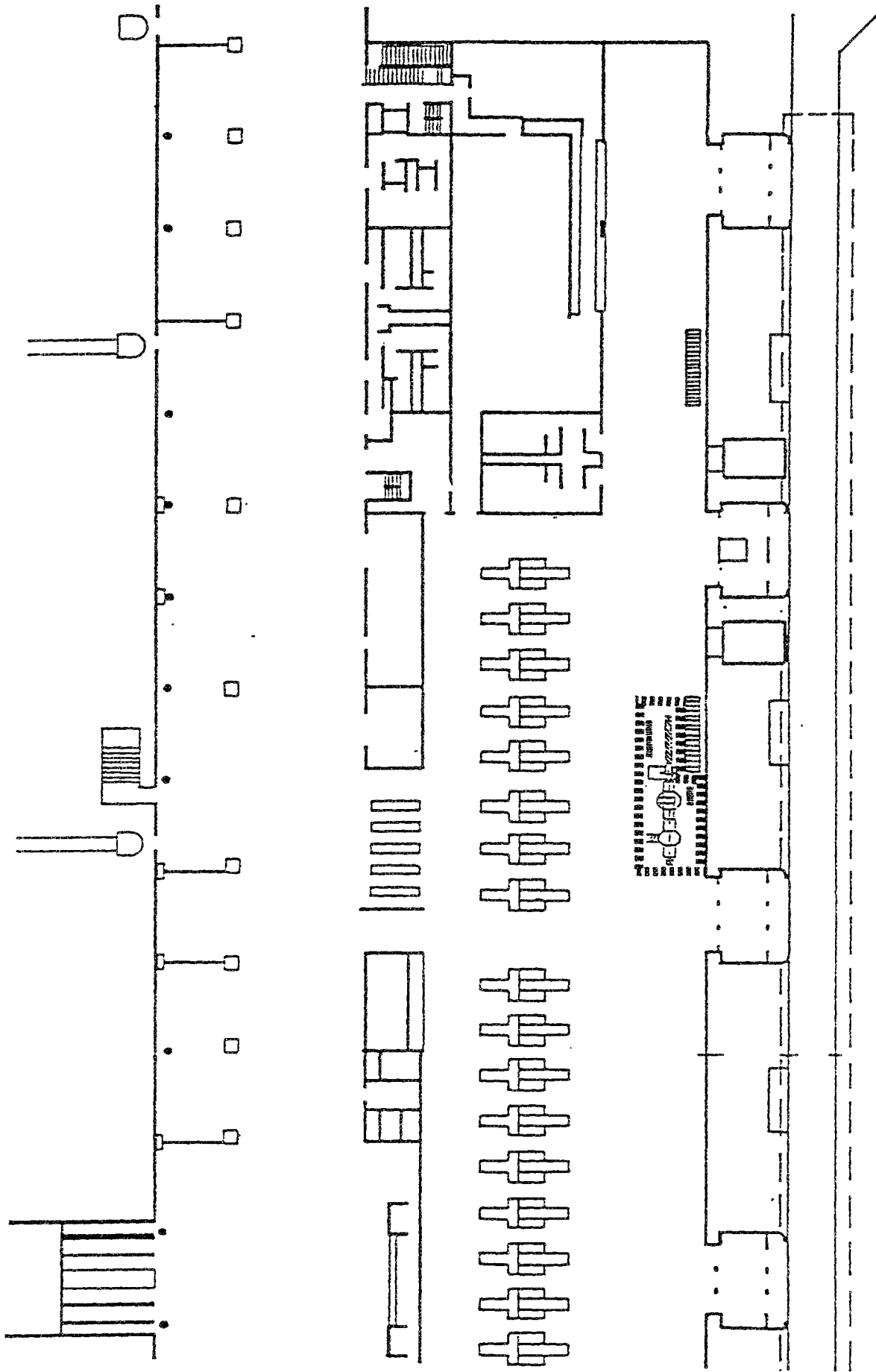

Figure 4-10  
Possible TNA Locations  
United Lobby

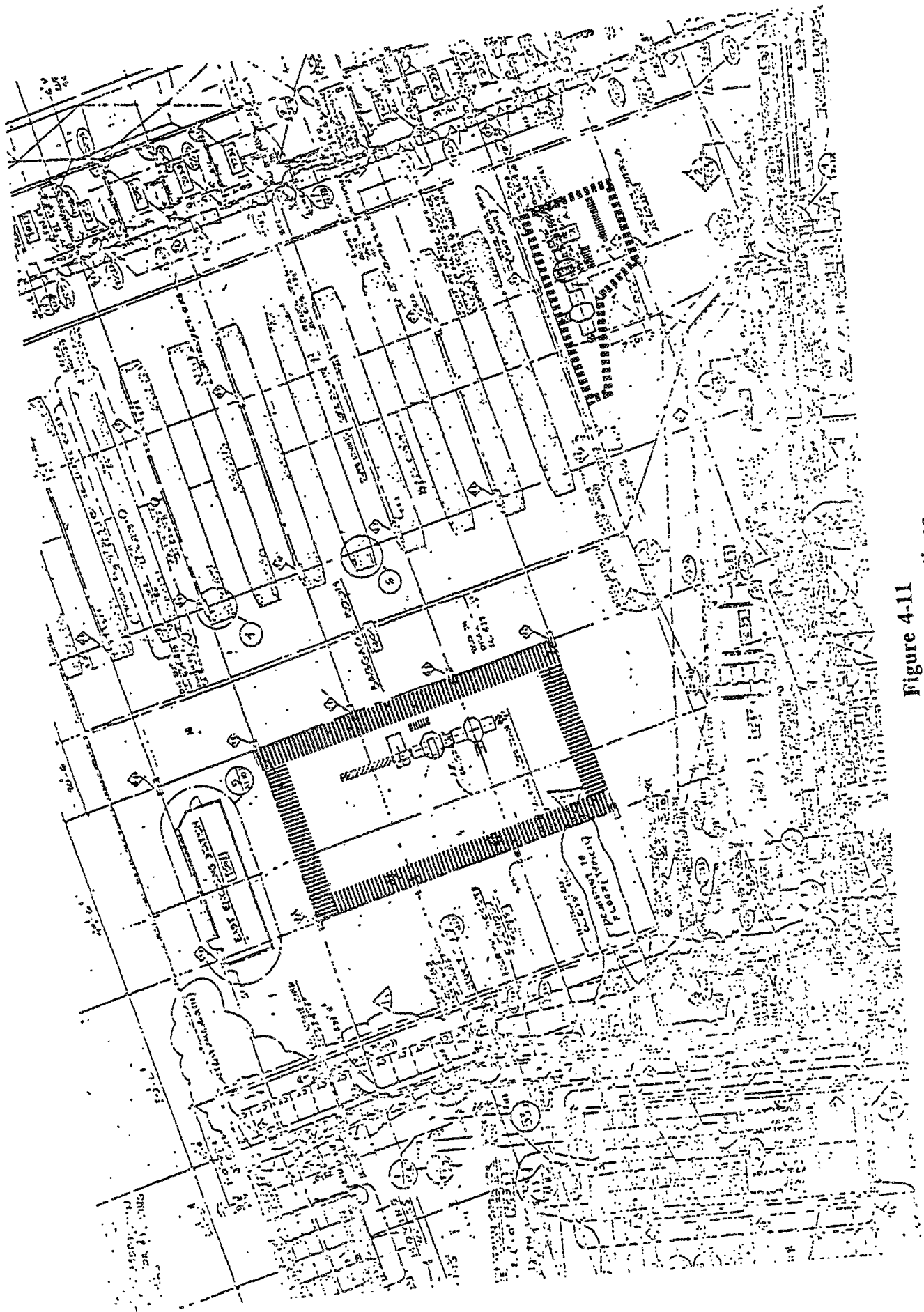

Figure 4-11  
Possible TNA Locations  
United Baggage Room

Lobby installation would pose many of the same problems for American as it would for United. The geometry of the terminal buildings are roughly the same, except that American uses the more traditional counter arrangement instead of flow-thru stations. One important difference is the larger number of escalators in Terminal 3, which virtually precludes installation in front of the ticket counters. Such an approach is further discouraged by the perception on the part of station personnel that the airport authority, which controls all space in front of the ticket counter, would not approve. (Although United is in a similar predicament, its staff seem to expect more cooperation from the airport authority.)

On the other hand, there is some possibility for installation behind the ticket counter as shown in Figure 4-12. This would require extensive renovation, as the area behind the counter currently houses restrooms, storage facilities, concessions, and a USO club, some or all of which would have to be moved for the installation to occur. Another possible way of using this space -- one which has been given some consideration as a long term plan already -- would be to move the ticket counters back into it, thereby freeing lobby space for a TNA installation. Either of these approaches is possible only in the long run. In the short run, lobby installation is essentially impossible for American.

This suggests that American would be forced to install its TNA facilities in the vicinity of the bag room. Three possible locations were identified. One would be to take out several of the baggage piers and replace them with a screening area. At the present time, four out of American's 40 piers are not in use. This area could accommodate at least two and perhaps three TNA units. American would be reluctant to do this because of its long term growth plans, but at current activity levels it would be feasible.

Two other possible bag room area locations are the transfer bag receiving area and the interline bag area. The transfer bag area, which consists of approximately a dozen belts leading into the baggage sorting system, is where bags arriving too early for plane-to-plane transfer are sent. The area was designed on the assumption that all of American's transfer bags would go through the bag room. Consequently, there is extra capacity, presently which is used mainly at night for processing mail. It appears feasible to locate the TNA units in this area. The difficulty would be to pull out the international bags, which would be intermingled with the domestic bags at this point.

The other possible point is where the interline transfer bags are x-rayed. This is also where bags whose bar code cannot be deciphered are routed. The scenario involving this location would be to send all international bags here (the system can be programmed to do this fairly easily). After screening, the bags would be placed on a belt (which would have to be built) leading back to the main sortation system.

Space for TNA processing would also be available on the ramp to the east of the walkway leading out to the concourses, near gate K-2, as shown in Figure 4-12. This area has been occupied by contractors' trailers for the last several years, but these will be removed soon. This location is directly above the bag room. Thus, it might be possible to build a feed from the end of the TNA unit into the sortation system. A second feed could send originating bags from the bag room up to this area. Further structural analysis

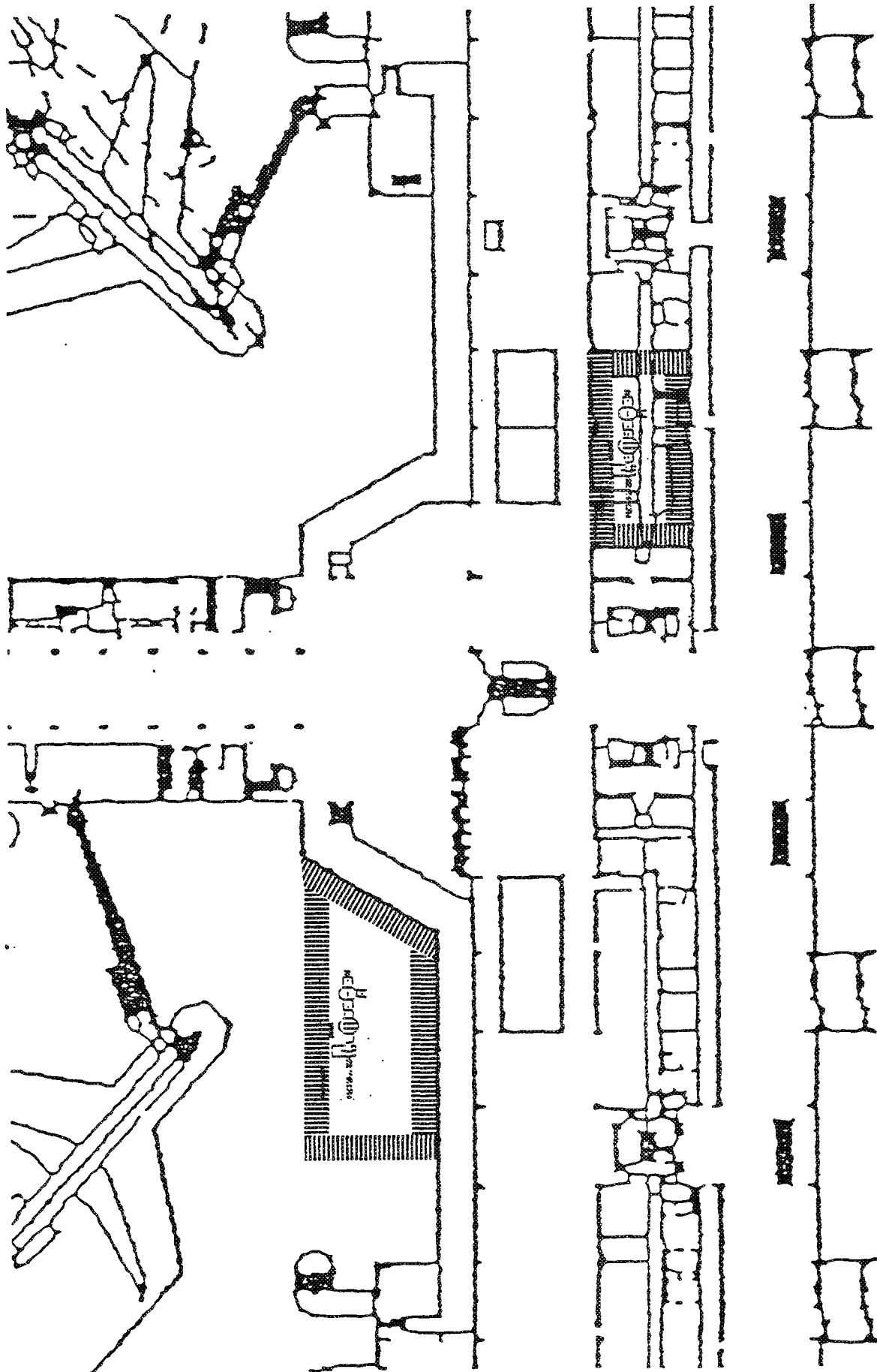

Figure 4-12  
Possible TNA Locations  
American Airlines

would be required to assess whether this is a feasible alternative.

Whatever the implementation method, American, like United, will have difficulty maintaining its current layover times. Neither of the two possibilities for adjusting the schedule are very attractive. If incoming flights arrive sooner, this would affect American's entire ten-bank-a-day schedule. The other approach -- making the flights to Europe leave a bit later -- could prove very difficult in light of the tight slot controls at European airports. Either measure would increase layover time for international connecting passengers, thus hurting American competitively.

### Northwest

Northwest currently offers one flight per day between Chicago and Tokyo. The airline occupies part of Terminal 2, with its gates located on concourse E. Its lobby area, similar to American's, is not suitable for lobby installation as a result of lack of space and the control of the existing space outside the ticket counter by the airport authority. The airline controls the space behind the ticket counter, but because this area has been renovated recently, conversion of this space to a screening area would involve writing off several million dollars of investment.

One feasible TNA screening location for Northwest would be in the bag room. Space is available in this area, although climate control would be required to moderate the 0-100 degree temperatures that occur there. A second possibility, which would be ideal from a space utilization standpoint and is technically feasible because of Northwest's one-flight-per-day schedule, would be a mobile unit which could be used once a day for the Tokyo flight and otherwise parked in a remote location where space is less valuable.

However well suited the location, Northwest is faced with the problem of having to make a sizable investment in order to accommodate just one daily flight. One alternative would be to share facilities with United, whose terminal is just west of Northwest's. The viability of this arrangement depends upon the degree of competition between the two airlines. At present, competitive pressures are unlikely to be important, as the two airlines' international services out of Chicago are to different regions of the world. This situation would change dramatically, however, if United were awarded the Chicago-Tokyo route for which it has applied.

If a mobile unit were used, the prospect for sharing the unit with other airlines with low levels of international activity would exist. At present, there are no potential partners other than United and American, each of whom would presumably have their own TNA facilities, but there is some possibility that such a partner would emerge in the future. Additionally, a foreign flag airline which, while not required to conduct screening, desires to do so for marketing reasons, may wish to share a TNA unit.

## MIAMI INTERNATIONAL AIRPORT

Miami International Airport is one of the busiest international gateways in the United States. With strong local ties as well as good proximity to the Caribbean and Latin America, it is the primary gateway to these regions. Services to Canada, Mexico, and Europe are also offered. In 1989, 1.9 million international passengers were enplaned by U.S. flag carriers at Miami, making it the second busiest international gateway in the United States. The terminal layout is shown in Figure 4-13.

In an arrangement somewhat unusual for a U.S. airport, the Dade County Airport Authority maintains firm control over the facility. Airlines rent, but do not lease, space. In the last couple of years, there have been substantial reassignments of facilities and reconstruction as a consequence of traffic growth, as well as changing circumstances of individual carriers. Of the latter, the most notable have been the Eastern machinists' strike, which has resulted in a drastic curtailment of the airline's hub operation at Miami, and American's rapid build-up. From the first to the fourth quarters of 1989, Eastern's international enplanements dropped by about 66,000 (29%), while American's increased by about 69,000, or almost 900%.

The passenger terminal consists of a horseshoe shaped lobby area out of which seven concourses radiate. The main terminal has three levels. The lower level is used primarily for baggage handling, while the ground level includes ticketing, check-in, and concession areas. The upper level houses offices and the passenger customs area. A commuter terminal is located on the airport's southern boundary, while a major cargo facility is located across the airfield from the passenger terminal and connected to it via an underground roadway.

As shown in Table 4-1, American, Eastern, Pan Am, and Continental were the primary international operators in 1989. Pan Am, the largest U.S. flag international carrier at Miami, offers extensive Caribbean service to the Bahamas, Barbados, Haiti, and the West Indies, as well as service to destinations in South and Central America, Mexico, and Europe. Eastern, the second largest international carrier, flew to destinations throughout the Caribbean (including the Bahamas, Virgin Islands, and Haiti), South America (Lima, Bogota, Buenos Aires), Central America (Panama, Guatemala), and also to Canada. American specializes in the Caribbean market, with service to Jamaica, the Virgin Islands, and Haiti (its flights to Puerto Rico are considered to be domestic services). Continental serves the Bahamas, Mexico, and Europe. Finally, Northwest has the smallest international operation, consisting of a single flight per day to the Grand Cayman Islands.

On the basis of the analysis in Chapter 3, between 14 and 28 TNA units would be required for Miami if each airline were to handle its own TNA processing. The expected impacts of these requirements on each airline are discussed in the following sections.

### Pan Am

Pan Am's gates are located along concourse F, and its ticket counters are located on both sides of the entrance to that concourse, extending all the way to the entrance for concourse E. The airline is in the process of a major overhaul of its terminal facilities in

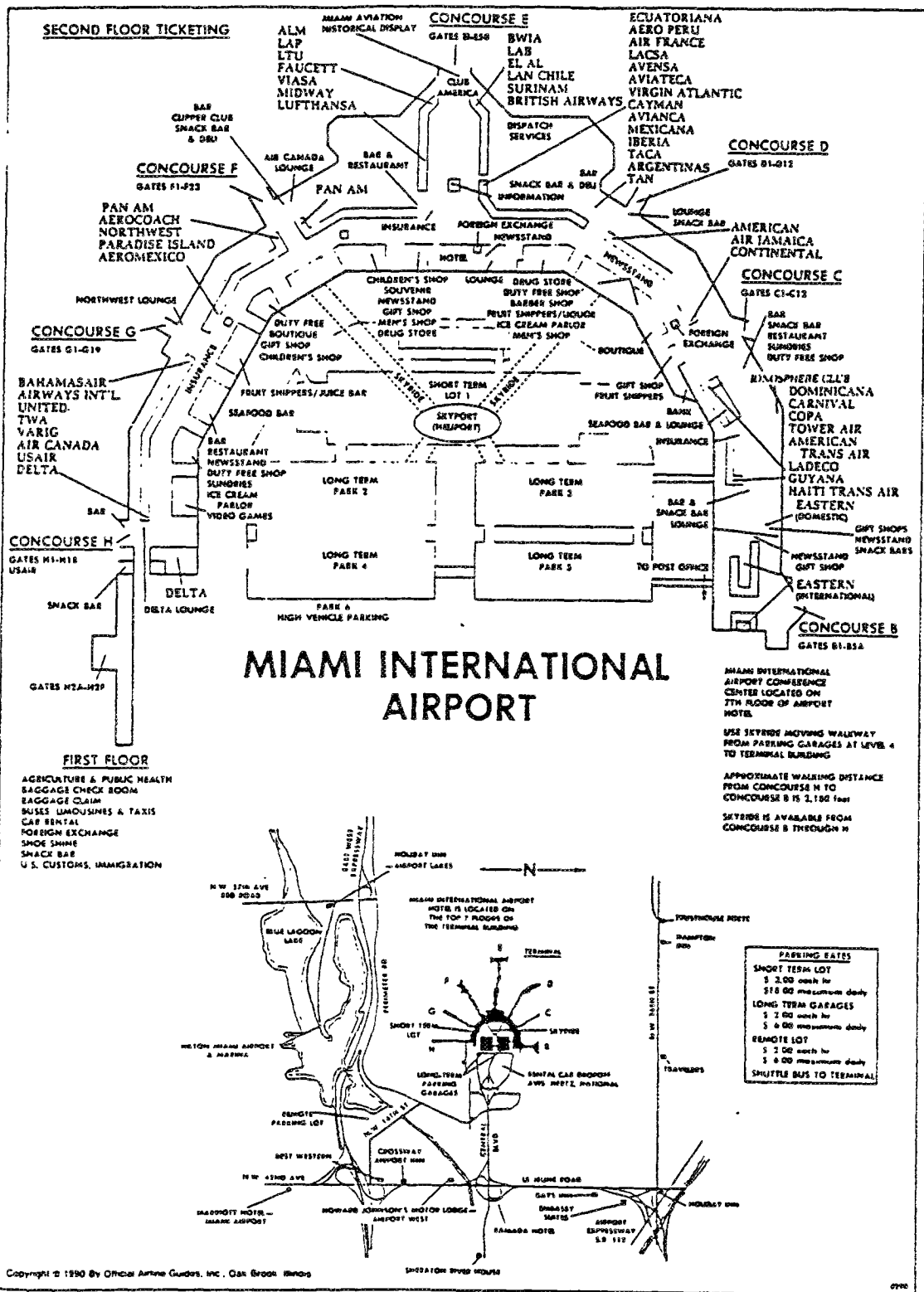

Reprinted with special permission from the March-May, 1990 Official Airline Guides Travel Planner Hotel & Motel RedBook North American Edition. All rights reserved.

Figure 4-13  
Miami International Airport Terminal Layout  
Departure Level

Miami. Based on the terms of reference for the study, the discussion will focus on its current terminal configuration.

Pan Am would have several options for locating TNA systems in the lobby or check-in area. All of these options, which are shown in Figure 4-14, would require changes to its current operation, and most would entail some structural renovation.

The width of the lobby, from the concession area at the front of the terminal to Pan Am's check-in counter, is 60 feet. Thus it would be possible to locate TNA units in the lobby area in front of the counter. This would require some relocation of seating areas and increase pedestrian traffic congestion. Up to three units could be placed in front of the ticket counter between concourse E and concourse F, which is where international passengers are handled. Such an arrangement could restrict the area for passenger check-in queues, but this would not appear to be a serious problem.

A second possible approach to lobby installation would be to place the units at either end of the international check-in counter. One unit could be installed at either end, using an approach similar to that proposed for the demonstration unit at Washington Dulles. This would consume approximately one sixth of this counter, and require some relocation of the areas behind it, which include Pan Am administrative offices. This option would also reduce passenger flow capacity along the main concourse somewhat, but less than the previous alternative. The main difficulty with this approach is that two units would probably not be adequate for Pan Am's traffic levels. To use additional units in these locations would result in excessive loss of counter length and office space.

The third possible lobby position would be behind the Pan Am ticket counter adjacent to concourse F as shown in Figure 4-14. This area, which could accommodate at least three machines, houses Pan Am administrative offices and crew facilities, which would have to be relocated or downsized. It would also be necessary to acquire some space currently used for an Air Canada lounge. This alternative would probably have the greatest initial cost, but would also have the least effect on how passenger services are currently delivered.

About 30 per cent of Pan Am's passengers are connecting from upline points. With a minimum connecting time for domestic to international flights of 30 minutes, baggage transfer times must be kept to a minimum. Thus, some bag room installation would be necessary. Pan Am's existing bag room, located between concourses E and F on the lower level, appears to have adequate space for the installation of the required capacity. Even with bag room installation, however, connecting bag processing would have to be substantially altered, because at the present time all bags with connecting times of less than one hour are transferred directly between aircraft. Station personnel estimate that tail-to-tail transfer can be accomplished in as little as 15 minutes, as compared with the 45 minutes required when a bag is routed through the bag room.

### **Eastern**

Eastern's terminal facilities are located at the north end of the terminal, near concourse B. As is widely known, the airline is having financial difficulties, and is in the



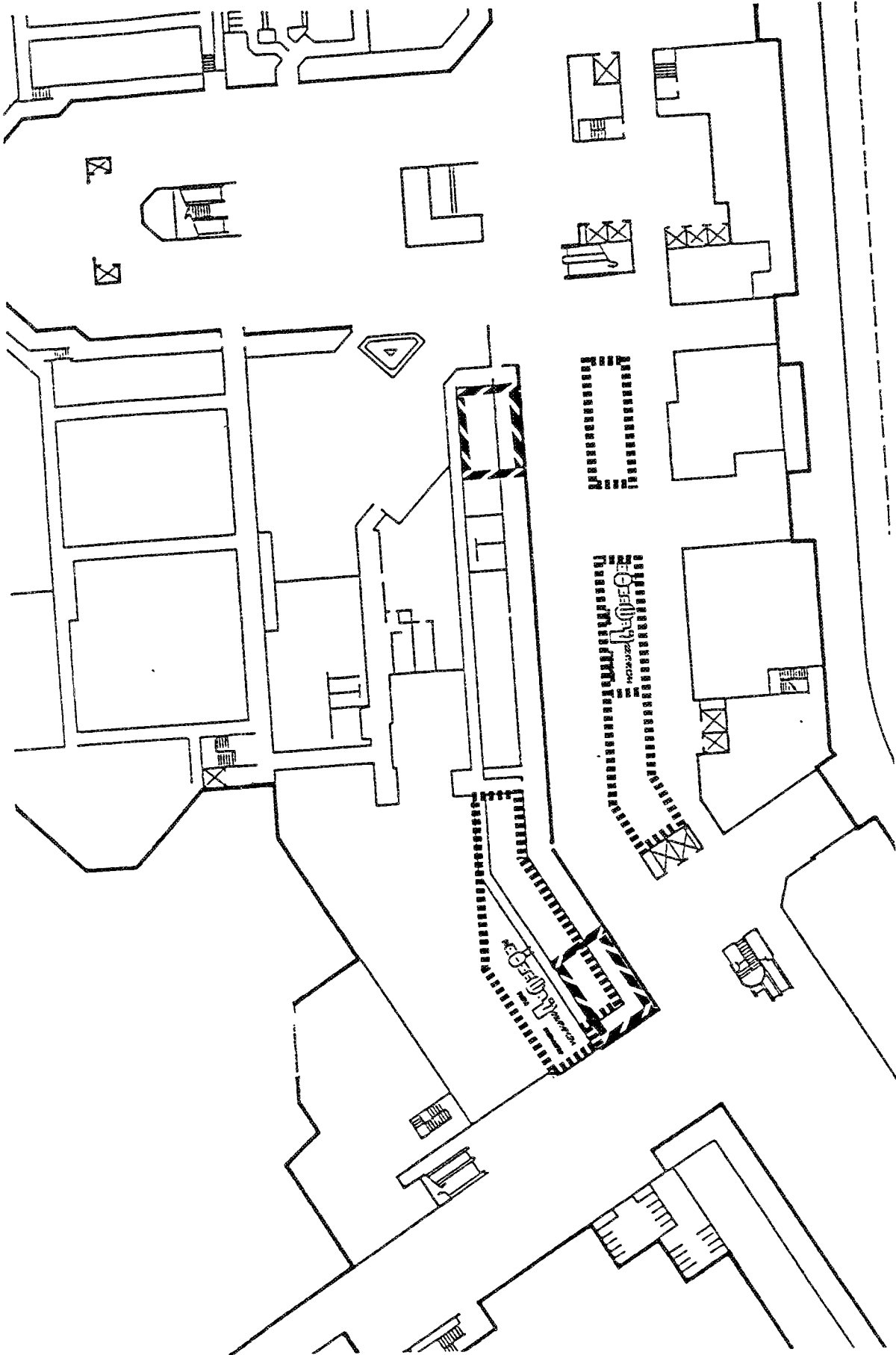

Figure 4-14  
Possible TNA Locations  
Pan Am Lobby Area

process of selling its Latin American routes to American. This would drastically reduce its international activity at Miami. As with Pan Am, these eventualities are not considered for the purposes of this analysis.

At peak 1989 activity levels (i.e. before the strike), it is estimated that Eastern would have required about 7 units. Although actual numbers were not made available, connecting passengers were described as a "fairly important source of international traffic." Thus, like Pan Am, the logical approach for TNA installation for Eastern would involve units in the lobby for originating passengers and in the bag room for connecting traffic.

Lobby installation appears to be quite feasible for Eastern. It has two pod-shaped check-in counters, as shown in Figure 4-15. The area on the south side of the pods (adjacent to the entrance) could accommodate units oriented parallel to the counter, while either a parallel or a perpendicular orientation is feasible on the north side. These positions would reduce passenger flow capacity, but at this location such a reduction would not have a major impact. An additional possibility would be to enlarge the two pods and install TNA equipment inside the pods.

Eastern's bag room also appears to have adequate space for installation of the required TNA capacity. An area that is currently used to x-ray interline connecting international bags could be used for TNA screening instead, as shown in Figure 4-16. As Eastern's bag room is open to the ramp, an enclosure would have to be built for this purpose. Also, the need to route all connecting bags through the bag room would increase processing time, and therefore minimum connecting times.

### American

American uses concourse D, with its ticket counter located between concourses C and D. As with the other carriers discussed so far, it is presently in a state of flux, having expanded rapidly in the past several months, and with even greater growth anticipated from the acquisition of Eastern's international routes.

American's current facilities are very poorly suited for lobby installation of TNA units. It is located on a portion of the main concourse that is already obstructed by a newsstand and other facilities. Its international counter area faces the airside of the terminal, with less than 40 feet between the counter and the wall. Installation perpendicular to the counter would therefore be impossible. Installation parallel to the counter could be feasible, but would require a reduction of the concession area behind the counter (see Figure 4-17).

The foregoing, as well as the relatively small amount of TNA capacity that can be provided in the lobby, suggests a bag room installation for American. The bag room, which has been sized in anticipation of future expansion, has ample room for the installation of the 2-3 TNA units required to serve current traffic levels. This availability will clearly be squeezed in the future, as traffic grows and bag room activity increases.

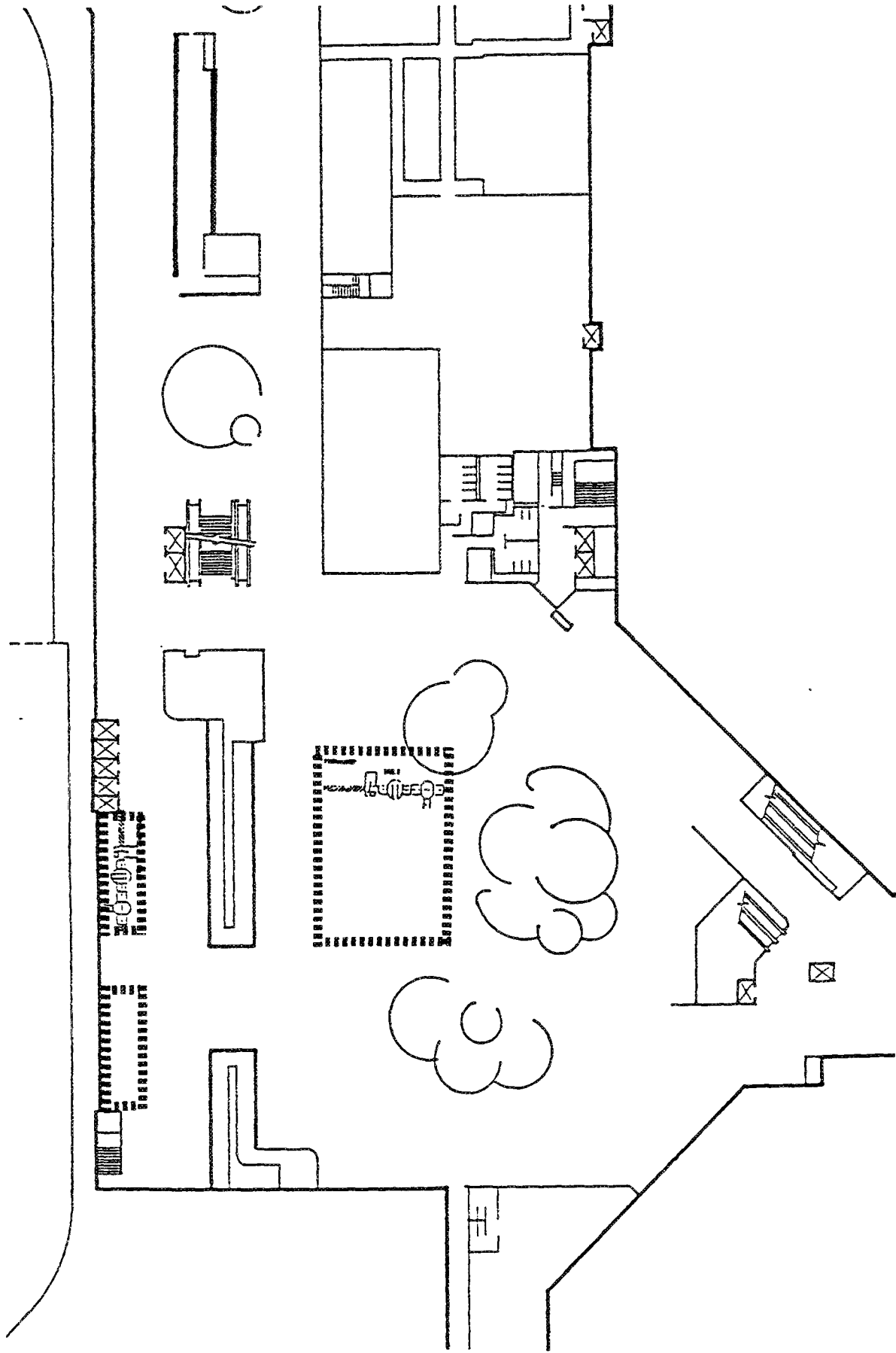

Figure 4-15  
Possible TNA Locations  
Eastern Lobby Area

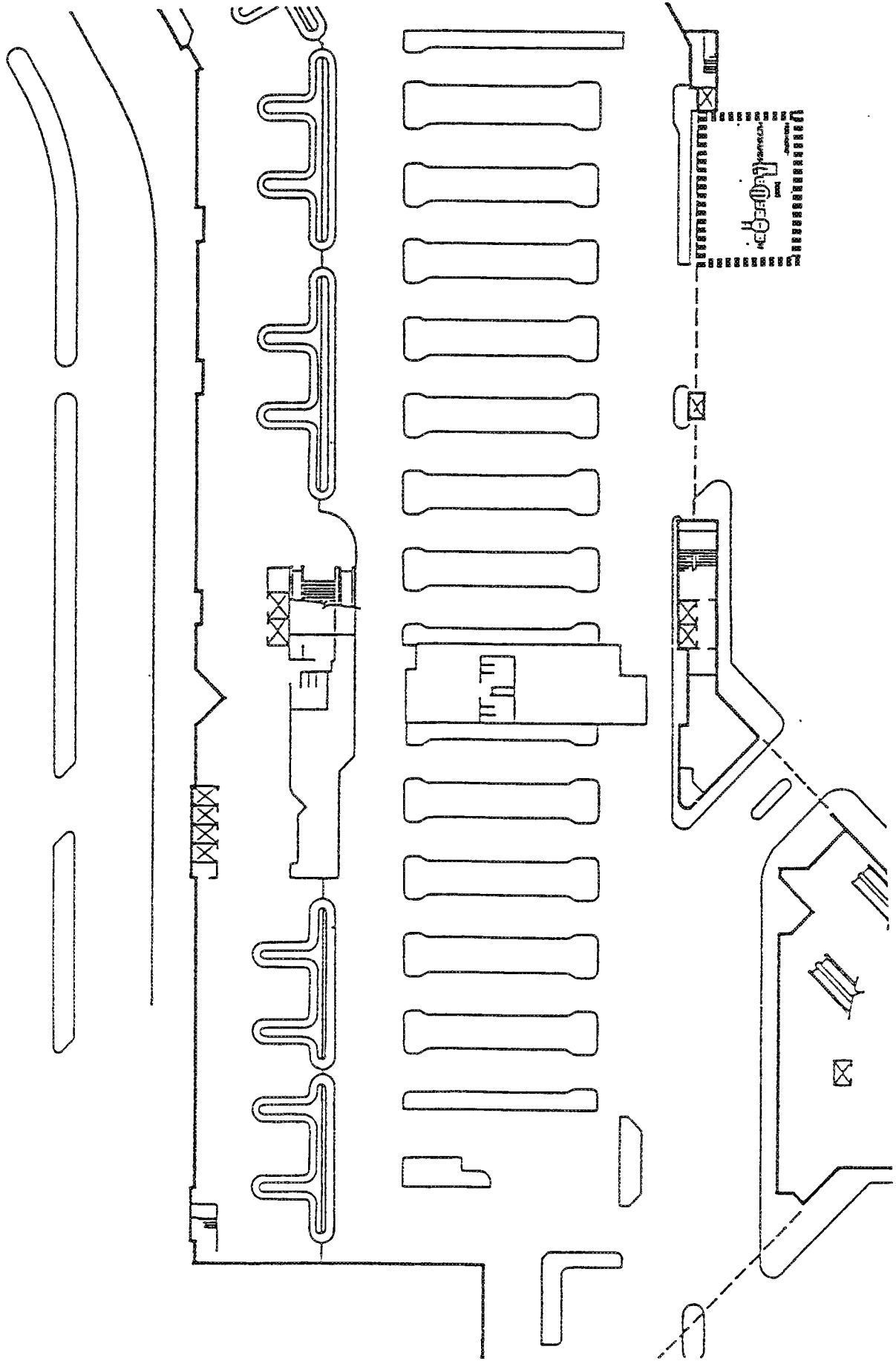

Figure 4-16  
Possible TNA Locations  
Eastern Bag Room

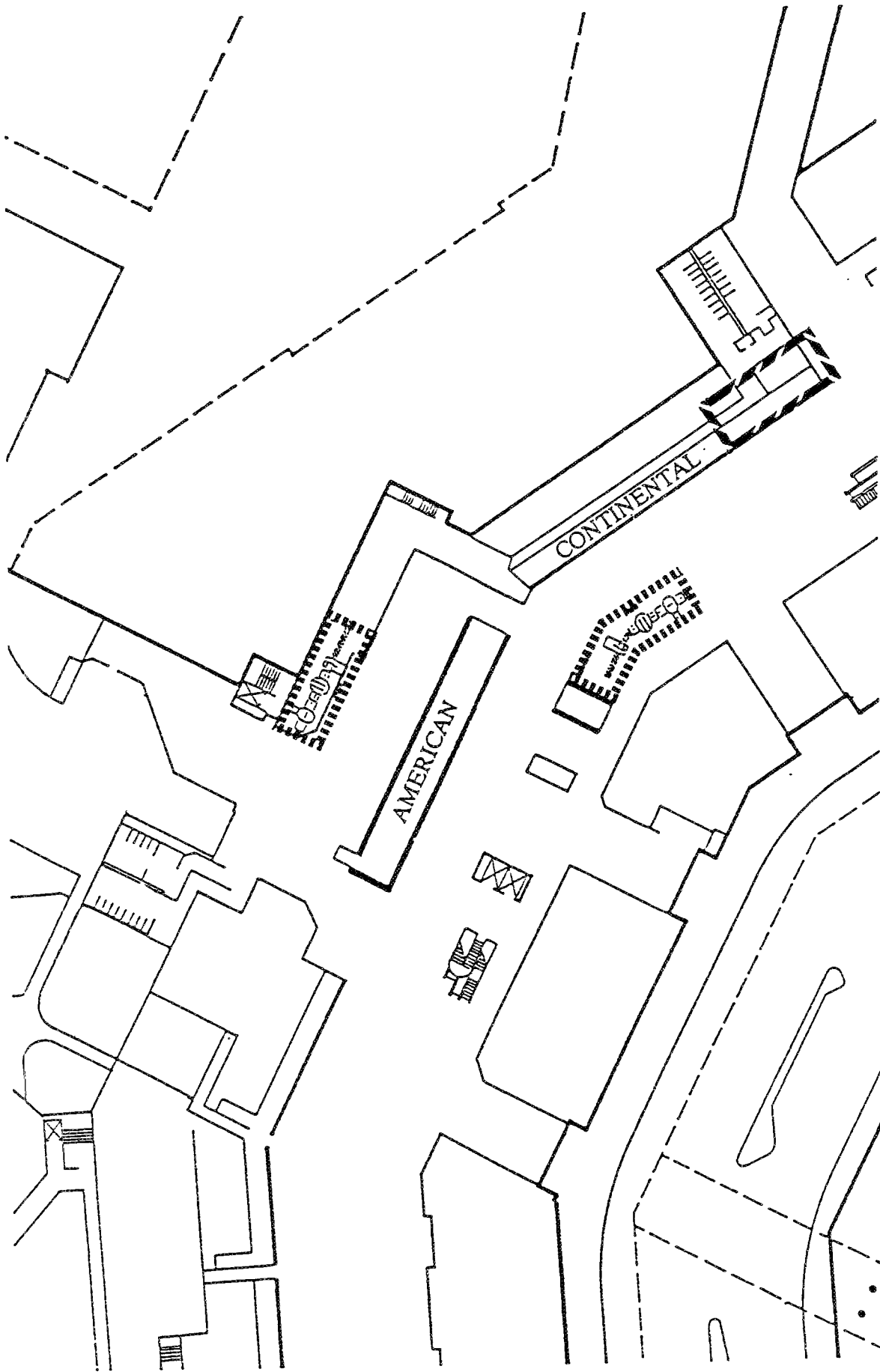

Figure 4-17  
Possible TNA Lobby Installations  
American and Continental

## **Continental**

Continental operates out of concourse C in Miami, with its counter space extending from the entrance of concourse C toward concourse D. One unit would probably be sufficient for its TNA capacity needs, and could be located in the lobby in front of the ticket counter at the concourse D end as shown in Figure 4-17. Another possibility is installation at the concourse C end of the counter. This would eliminate operational space behind the counter and adversely impact pedestrian flow, however, without offering any clear advantages over the former alternative.

Continental's traffic levels probably do not justify a separate bag room installation. Thus, it would be necessary to bring unscreened connecting bags to the lobby. This procedure, while cumbersome, would be feasible in light of the relatively small numbers of connecting passengers served by Continental.

## **Other Airlines**

Both Northwest and Tower Air offer international service out of Miami. Both have traffic levels well below what could be handled by a single unit, and would probably opt for a sharing arrangement if this could be arranged. If the other airlines installed their own systems, it might be feasible to relocate one of these airlines so that they could share the same system. Tower, could, for example, be moved from its current position near concourse C to a location beside Northwest near concourse G as shown in Figure 4-18. A unit could then be installed perpendicular to the ticket counter at the entrance to concourse G. The major problem with this approach is the fact that 50 per cent of Northwest's traffic is connecting, and these bags would have to be diverted to the lobby for screening.

## **The Possibility of Common Facilities**

In view of the active role taken by the Dade County Airport Authority in the day-to-day operation of the airport, the possibility of developing a common facility for all TNA screening merits some consideration. This would reduce the number of units somewhat because fewer "fractional" machines would be required. It would particularly benefit the smaller operators for whom the cost of TNA acquisition could be prohibitive. Finally, the common facility approach would simplify the process of airline relocation within the airport, which seems to occur quite often at Miami.

Several locations for the common facility were identified. These include an area east of concourse H currently used for the check-in of cruise traffic transported to the airport by motorcoach; the area currently used for the In-transit Baggage Facility (where bags connecting between international flights can be screened without having to go through customs), located on the lower level between concourses D and E (as shown in Figure 4-19); the cargo area across the airfield from the passenger terminal; and the curbside check-in facilities located near several airport entrances.

All of these possibilities, save for the last, have the clear disadvantage of locating the screening activity far from most passengers. This would be extremely cumbersome in

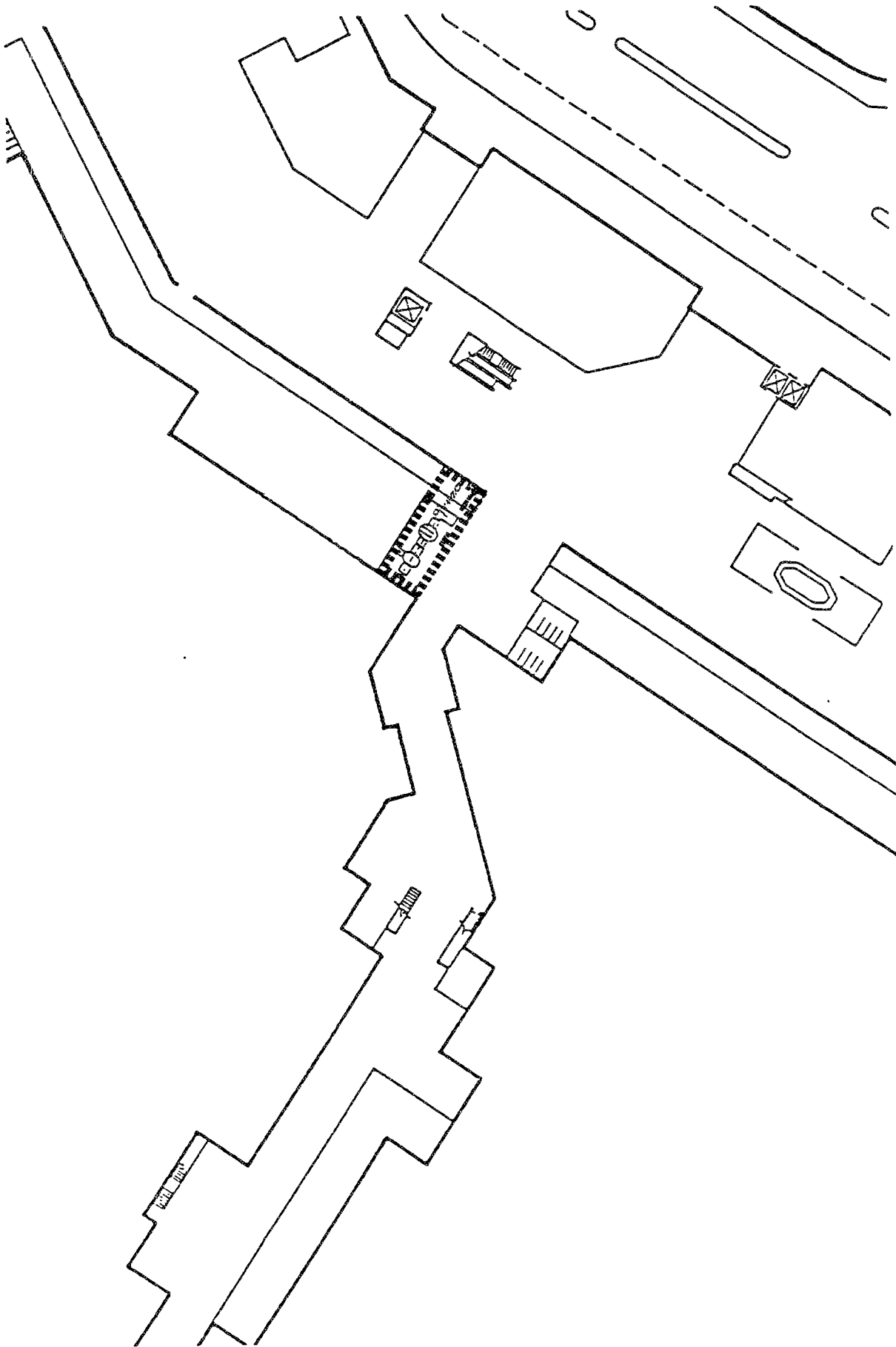
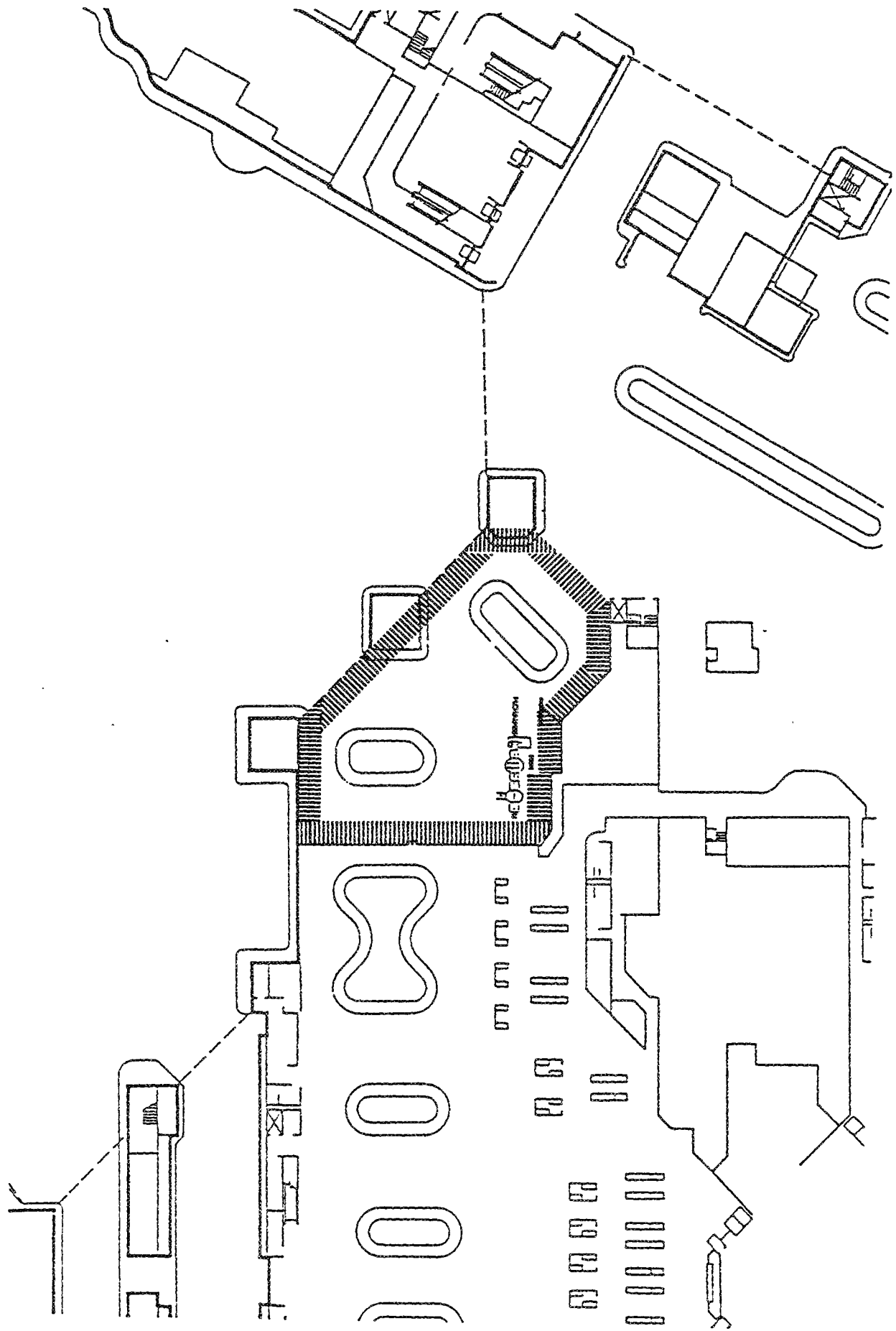

Figure 4-18  
Possible Common TNA Locations  
Tower and Northwest



**Figure 4-19**  
**Possible TNA Locations**  
**In-Transit Baggage Facility**



the event of an unresolved alarm. In addition bags would have to be transported for considerable distances. It therefore appears that these ideas would not be very attractive to the larger carriers. A common facility at one of these locations whose sole purpose was to serve airlines with very small operations (who could all be located near the facility) might, however, serve a useful purpose.

The possibility of curbside check-in remains an intriguing one for Miami. The fact that curbside check-in facilities are already in place would greatly facilitate the adoption of this approach. On the other hand, conversations with station staff indicated that the curbside is already extremely congested at times, and it is likely that the screening activity would exacerbate this problem. Perhaps the curbside approach, like the others, is most promising when limited to screening for smaller operators.

## **GATWICK AIRPORT, LONDON**

Gatwick Airport is London's second largest airport, handling both intra-European and transatlantic flights. Due to congestion at Heathrow Airport, all new carriers serving London must operate at Gatwick (or other, smaller airports). Gatwick is currently served by six U.S. carriers: American, Continental, Delta, Northwest, TWA, and USAir, and is about to have a TNA machine installed as a cooperative experiment between the FAA and the UK Department of Transport. The airport has two terminal buildings, linked by an automated people mover. All the U.S. carriers operate from the older South Terminal, located adjacent to a British Rail station that provides frequent, fast train connections to London's Victoria Station. The general configuration of the South Terminal is shown in Figure 4-20.

All passenger and baggage handling is done by one of three handling companies at the airport. At present the check-in desks for the U.S. carriers are scattered throughout the departure hall in the South Terminal. Security agents located in front of the check-in desks ask passengers profiling questions that are used to select passengers for hand search of baggage. In addition, a further two percent are selected randomly, to satisfy both FAA and the U.K. Civil Aviation Authority requirements. Selected passengers and baggage are taken to a screening area at the end of the departure hall, operated by the airport authority. After check-in, the bags move on belts to an outbound bag room at the ramp level below the departure hall, where they are x-rayed.

Space is extremely limited in the departure hall, with the area between the check-in desks on either side of each of three aisles frequently filled at busy periods with passengers waiting to check in. The experimental TNA machine will be installed in the area currently used to hand search selected baggage.

### **TNA Screening Alternatives**

There appear to be two options to install sufficient TNA machines to handle peak summer traffic: on an extension of the departure hall constructed over the tracks of the adjacent British Rail station, or in a new structure on the ramp adjacent to the outbound bag room. Both alternatives would require the airport authority to plan and undertake the

# LONDON-GATWICK AIRPORT

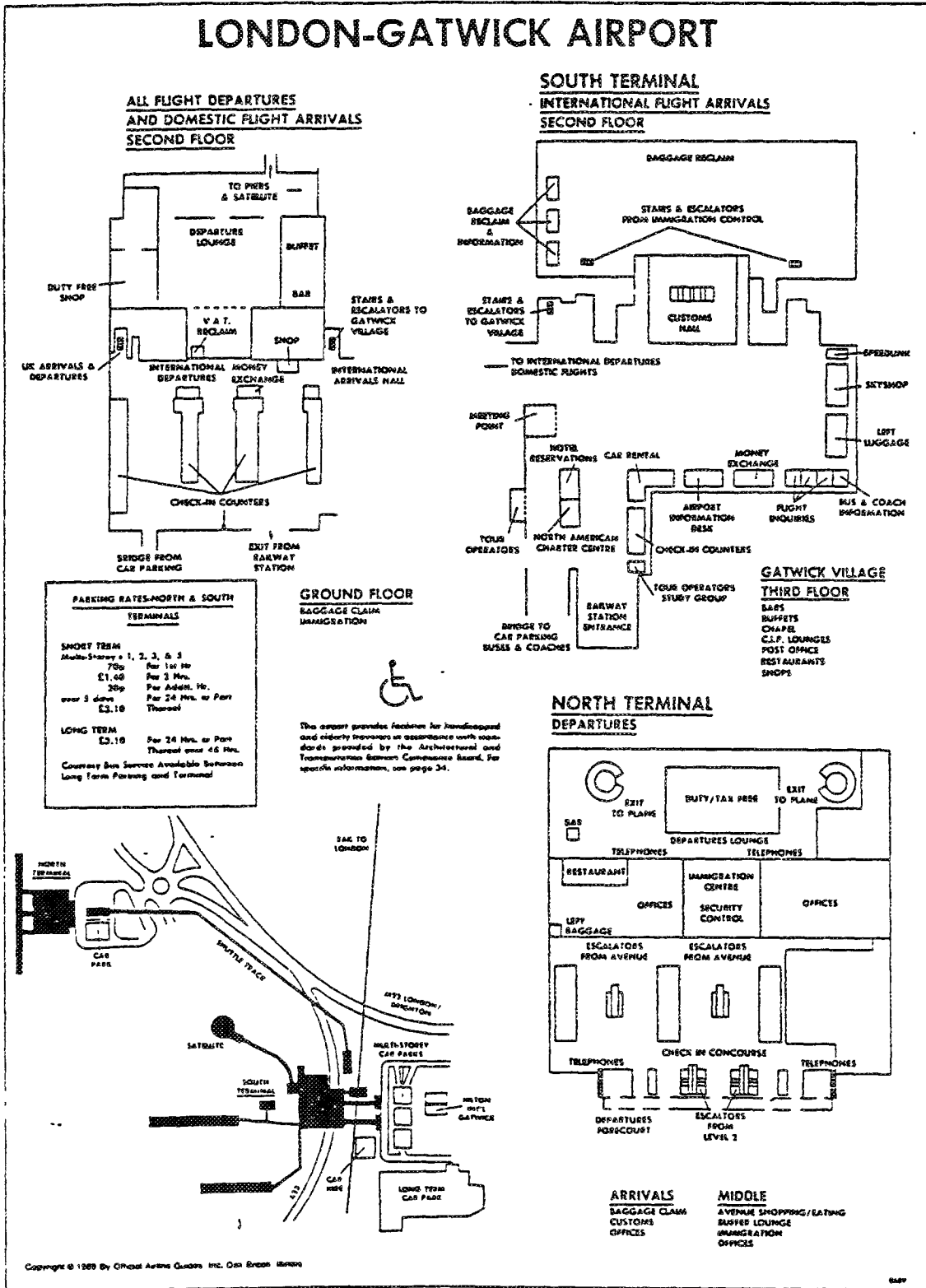

Reprinted with special permission from the Oct.-Dec., 1989 Official Airline Guides Travel Planner Hotel & Motel RedBook European Edition. All rights reserved.

Figure 4-20  
Gatwick Airport Terminal Layout

necessary construction, and the first option would also require the agreement of British Rail to allow the use of the air rights over the station.

The high proportion of passengers arriving at Gatwick by train, combined with the configuration of the terminal, restricts the number of feasible alternatives. Passengers from the British Rail station enter the South Terminal check-in hall directly, via a pedestrian bridge from the station, completely by-passing the terminal curb. Passengers parking in the parking structure can also cross over the railway station and directly enter the check-in hall by two other pedestrian bridges, by-passing the curbside. Thus curbside screening would not be a viable option. With the U.S. carriers distributed through the check-in hall as at present, it would be impossible to locate sufficient machines in the aisles between the check-in desks without completely disrupting access to the desks of other carriers.

However, if the U.S. carriers were grouped in the end aisle, it might prove possible to construct a TNA screening facility in an extension of the terminal on a deck over the tracks of the rail station in the area of one of the existing bridges. Originating passengers on U.S. carriers entering the check-in hall at other points could be directed to this facility, while passengers on other carriers using the bridge could by-pass the TNA screening facility. Apart from the construction cost itself, there would also be the question of any payment required by British Rail for the use of the air rights over the station. Consideration must also be given to how the bags would be transported from the TNA machines to the check-in desks, without allowing passenger access.

Space in the outbound bag room is highly constrained and there is no room to install even one TNA machine. The area on the ramp in front of the outbound bag room is currently used for equipment parking, principally containers and dollies. If these could be relocated, this area might be used for a TNA screening facility. However, airline station personnel indicated that equipment parking space was very scarce.

One possibility might be to construct a TNA screening facility above the equipment parking area at the level of the check-in hall. This would have two advantages. First, the baggage belts could run out to the TNA facility at the same level, over the service roadway running along the facade of the terminal and then back into the outbound bag room at the ceiling level, to connect to the existing feeds to the baggage sorting systems. Second, it would be possible to provide secure access to the TNA facility from the check-in hall for passengers whose bags need to be hand searched.

Finally, it might be possible to construct a TNA screening facility at a remote location somewhere on the ramp area. No potential locations were identified during the visit, and determining suitable locations would require detailed discussions with the airport authority. This option would also experience the difficulties of baggage transport and handling alarmed bags noted in the foregoing general discussion on alternative screening scenarios. For these reasons this alternative was not pursued further in this study.

## FRANKFURT/MAIN AIRPORT

Frankfurt/Main Airport (FRA) is West Germany's largest international airport, and serves as a major hub for Lufthansa and is the most important European gateway after London Heathrow. Seven U.S. carriers currently serve Frankfurt from the U.S.: American, Delta, Hawaiian, Northwest, Pan Am, TWA, and USAir, with Pan Am and TWA transatlantic flights connecting to flights on their European network. Pan Am also operates the intra-German service between Frankfurt and Berlin. In addition, United Air Lines is about to commence service from Chicago.

The airport currently consists of a single passenger terminal with three piers, although a second terminal is under construction to the east of the current terminal. The terminal has separate levels for departures and arrivals, with a commercial concourse below the arrival level. A train station below the commercial concourse serves both the Federal German main line rail service and a regional commuter rail system (S-bahn) that provides frequent train service to the center of Frankfurt. There is a passenger check-in facility on the concourse above the rail station, where Lufthansa and a number of other carriers, including Pan Am, have counters. The general layout of the departure level is shown in Figure 4-21.

Each airline provides its own passenger handling personnel, although all baggage handling is performed by the airport authority. The airport has a sophisticated automatic baggage sorting and transfer system that moves each bag from the check-in desks directly to the departure gate. Arriving flights are assigned to gates by the airport authority and baggage containers are made up at the gate. Airlines do not know which gate they will be assigned until shortly before each flight arrives.

Passenger profiling is performed prior to check-in and selected baggage is hand searched on the spot. The largest U.S. carriers are located in central check-in islands in the main international departure hall, and these provide an area behind the check-in desks where baggage can be searched. The more recent U.S. carriers are located at desks along the side of the hall, and hand searching must be conducted at unused adjacent desk positions or on tables in the departure hall itself. A mobile x-ray unit is moved from gate to gate to screen bags before they are loaded into the containers or aircraft.

### TNA Screening Alternatives

The existing terminal concourse layout and centralized baggage handling system at Frankfurt constrains potential TNA screening alternatives. The congestion on the concourse during busy periods and the current distributed location of the U.S. carrier check-in positions would make screening baggage before check-in extremely problematic. Apart from the difficulty of preventing passenger access to baggage while it is transferred from the screening to check-in, the location of sufficient machines on the concourse would completely obstruct circulation, and this would certainly be opposed by the airport authority. It was not possible within the limits of the study to determine if the concourse floor could support the weight of the TNA machines without additional strengthening.

# FRANKFURT INTERNATIONAL AIRPORT

**ZONE 2**  
 AIR FRANCE  
 AIR MALTA  
 AUSTRIAN  
 AVIANCA  
 BRITISH AIRWAYS  
 CYPRIUS  
 EGYPTAIR  
 KLM  
 MIDDLE EAST  
 PAN AMERICAN  
 SAS  
 SAUDI ARABIAN  
 SINGAPORE  
 SWISSAIR  
 THAI AIRWAYS INTL.

**ZONE 3**  
 AIR CANADA  
 ALITALIA  
 DELTA  
 IBERIA  
 JAPAN AIR LINES  
 LUFTHANSA  
 OLYMPIC  
 PAKISTAN  
 QANTAS  
 ROYAL JORDANIAN  
 SOUTH AFRICAN  
 TAP AIR PORTUGAL  
 TURK HAVA YOLLARI  
 VARIG

**ZONE 1**  
 AEROLINEAS  
 ARGENTINAS  
 AIR INDIA  
 AIRLANKA  
 CANADIAN AIRLINES  
 INTL.  
 ETHIOPIAN  
 GARUDA  
 IRAN AIR  
 LAP  
 MALAYSIAN  
 PHILIPPINE  
 RFG  
 SINGAPORE  
 TWA  
 VIASA  
 YEMENIA  
 CHARTER FLIGHTS

**ZONE 4**  
 AER LINGUS  
 AEROFLOT  
 AIR ALGERIE  
 BALKAN-BULGARIAN  
 CAAC  
 CZECHOSLOVAK  
 FINNAIR  
 IRAQI  
 JAMAHIRIYA  
 LIBYAN ARAB  
 KENYA  
 KUWAIT  
 LOT  
 LUFTHANSA  
 LUXAIR  
 MALEV-HUNGARIAN  
 ROYAL AIR MAROC  
 SOMALI  
 TAROM  
 TUNIS AIR  
 TYROLEAN  
 VIASA  
 CHARTER FLIGHTS

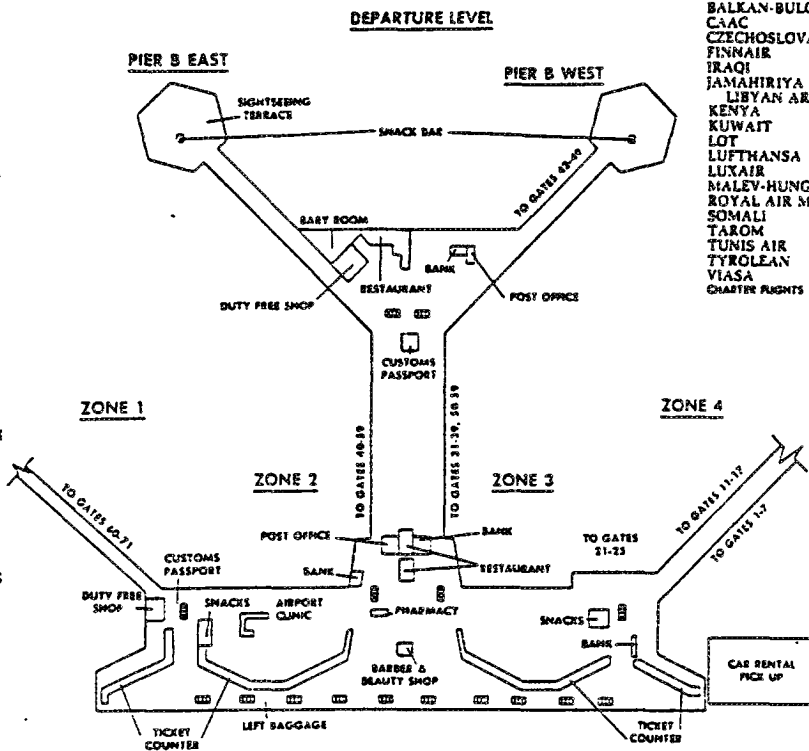

This airport provides facilities for handicapped and elderly persons in accordance with standards provided by the Architectural and Transportation Barriers Compliance Board. For specific information, see page 24.

**LOWER LEVEL**

NON-FOOD MARKET  
 PARKING GARAGE  
 RAILROAD STATION (TO FRANKFURT, MAINZ, & WIESBADEN)  
 RESTAURANTS  
 SHOPS  
 SUPERMARKET

**ARRIVAL LEVEL**

(GROUND FLOOR)  
 BAGGAGE CLAIM  
 BANK  
 BUS STATION  
 CAR RENTAL COUNTERS  
 CUSTOMS  
 INFORMATION BOOTH  
 LOST BAGGAGE  
 AIRWAY TICKETS  
 RESTAURANTS  
 SHOPS  
 TRAVEL OFFICE  
 USO LOUNGE

PARKING RATES	
DM 1.00	Rest hr.
DM 2.00	per additional hr. up to 12 hrs.
DM 16.00	per day up to 7 days
DM 3.00	each additional day

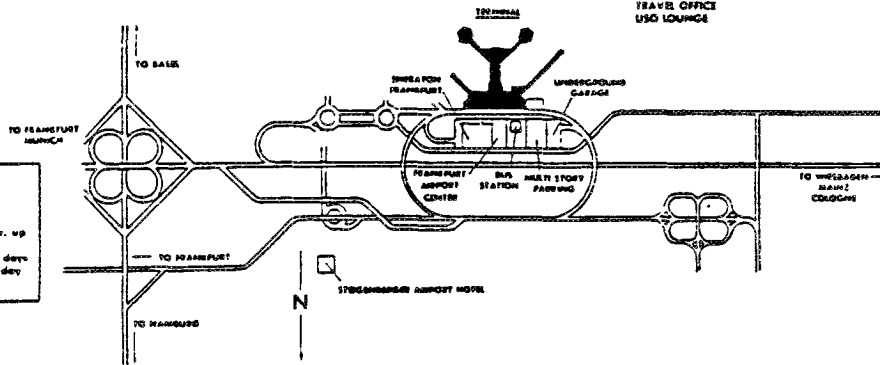

Copyright © 1989 By Official Airline Guides, Inc. Oak Brook, Illinois

Reprinted with special permission from the Oct.-Dec., 1989 Official Airline Guides Travel Planner Hotel & Motel RedBook European Edition. All rights reserved.

Figure 4-21  
 Frankfurt Airport Terminal Layout  
 Departure Level

Screening originating bags after check-in appears more feasible. Currently Pan Am, TWA, and Delta occupy parts of two large island check-in desk complexes in Terminal B. The layout of each island is shown in Figure 4-22, and provides 49 check-in desk positions on the two sides and 21 ticket counter positions at the two ends. Each pair of desks feeds a lift mechanism that enters the bag into the automated baggage handling system. A short belt moves the bag to the lift, which lowers it to a mechanical area below the island where it is placed in a tub and fed into the system. By grouping the U.S. carriers in one or more of the check-in islands and modifying the baggage system input machinery to permit the bags to be screened after being checked in and before entering the automated baggage handling system, it may be possible to locate a sufficient number of TNA machines within the islands to handle originating traffic.

It would not be practical to bring connecting baggage into the departure concourse and use the same system. Thus connecting baggage requiring screening would have to be screened at some point in the baggage handling system between flights. If originating bags are being screened at the departure gate, then connecting bags could simply be handled in the same way.

If originating bags are screened before entering the baggage distribution system, then the number of connecting bags may not justify a machine at each gate and it may be more efficient to route connecting bags to a specific location within the baggage distribution system where they would be screened and re-entered into the system for distribution to the gate.

This could significantly increase the time required for connecting baggage to move between flights. If the TNA machine could be located adjacent to the baggage input point to interline connecting baggage, then interline bags connecting to U.S. carrier flights might be separated before input and placed directly onto feed belts to the TNA facility. After screening, those bags requiring hand search would be tagged and then all the bags placed in tubs and entered into the baggage distribution system. At the departure gate, the tagged bags would be separated and the relevant passengers called down for a hand search.

Since on-line connecting baggage by definition would be arriving on a U.S. carrier, it would in general have already been screened at the upline station. The two exceptions would be if screening was not yet implemented at all stations, but was required for all bags departing Frankfurt, and for those bags moving on intra-German flights that might not be covered by the rule. These could be handled the same way as interline connecting baggage. However, this may take too long for airlines trying to maintain a tight hub schedule of connecting flights. If TNA screening is done at the departure gate, then on-line connecting baggage could be moved directly plane-to-plane, as at present.

If a central TNA screening facility is provided, then the bags could be moved directly to the facility and a way provided to expedite their transport to the departure gate. Even so, additional time would be required at the departure gate to allow for any hand searching required. At present, only Pan Am and TWA have on-line connecting flights. However, with U.S. carriers seeking to expand their European markets, either by developing onward route extensions or through interline (or even code-sharing) agreements

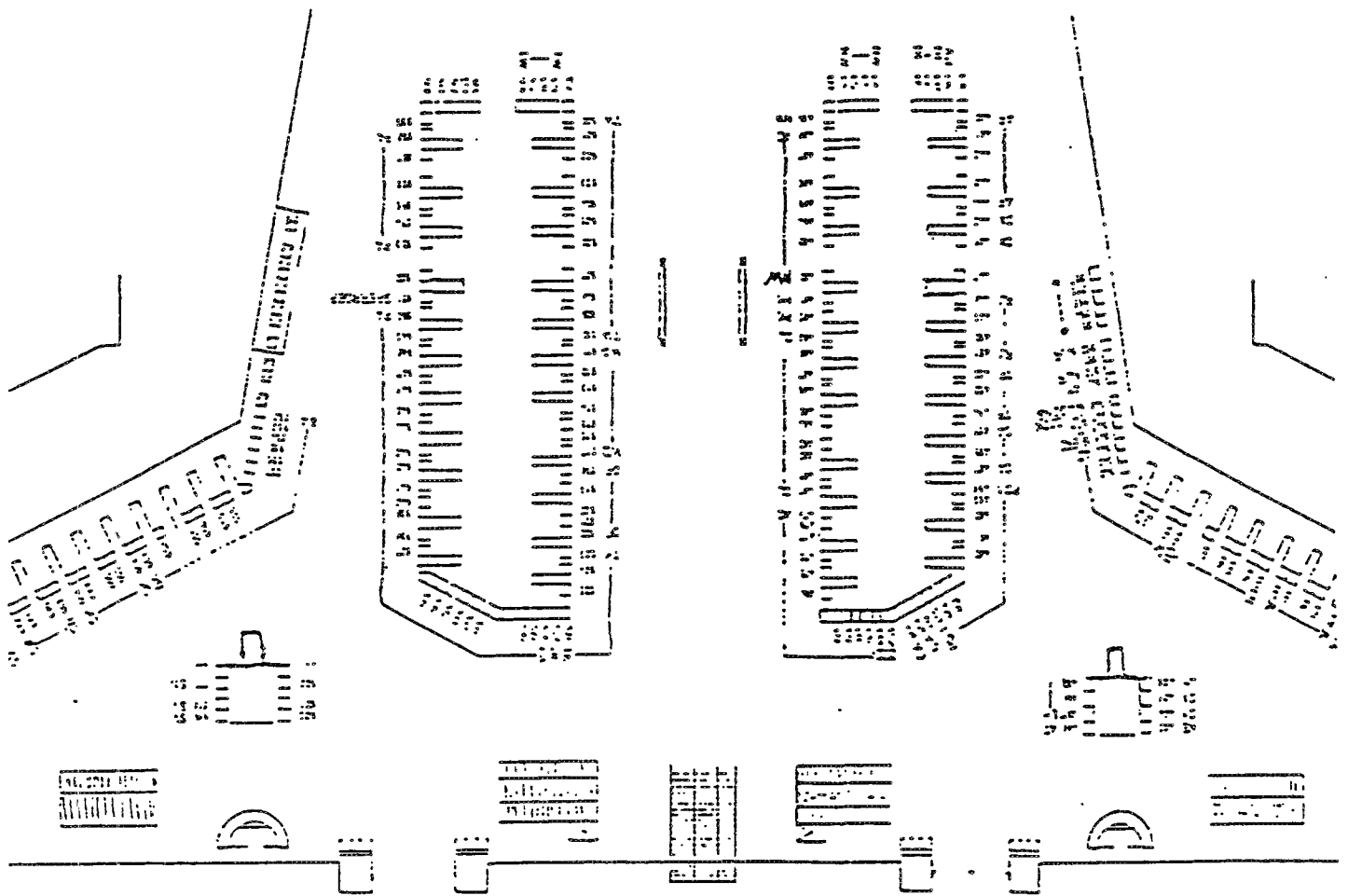

Figure 4-22  
Island Counter Configuration

with European carriers, the proportion of tightly scheduled connecting traffic is likely to increase. Ignoring any queueing at the TNA facility due to other flights, and assuming that the on-line connecting bags are the first off the arriving flight, an estimate of the minimum connect time for bags on a non-containerized aircraft is given by Table 4-2.

Baggage for originating passengers could also be screened at the departure gate or at a centralized location, either within the terminal building or on the ramp. The baggage distribution system could be used to transport bags to a centralized TNA facility and thence to the gate. However, this would increase the minimum close-out time required to ensure a checked bag can reach the gate before flight departure (currently around 30 minutes).

There is very limited ramp space at the departure gates. The gate rooms contain the baggage delivery machine and have an enclosed area between the baggage track and the doors about 6 feet deep and 20 feet wide. This is currently occupied by a mobile x-ray unit when the gate is in use by a U.S. carrier. It would not be possible to locate a TNA unit within this space and still have access to the baggage delivery station.

Thus if TNA units are to be located at departure gates it would be necessary to place them in a shelter on the ramp, which would either have to be located clear of the drive units for the existing boarding bridges, or the boarding bridges would have to be replaced by fixed units. Both arrangements would occupy space currently used to position ramp equipment, which would have to be relocated. Even if screening commences as soon as the aircraft arrives (and the gate is occupied by the carrier), it is likely that two TNA machines would be required to handle the peak load for a B-747. A somewhat smaller facility would be required for those flights that only need one TNA machine.

Even if the airport authority was willing to dedicate specific gates to the U.S. carriers, and permit the necessary ramp construction and modification, it may well insist on preserving the flexibility of being able to accommodate a B-747 at any of these gates. This could be accommodated through the use of mobile TNA units.

Performing screening at one or more centralized facilities has the advantages of not requiring major modification of gate positions, preserving the existing flexibility in gate use, and having the increased peak throughput capacity that comes from grouping machines together. It was not possible in the course of the field visit to identify a location within the terminal building where such a facility could be constructed. It is extremely unlikely, given the generally constrained facilities, that an area of sufficient space is currently unused.

However, if the airport authority is willing to cooperate, it may be possible to rearrange existing facilities, moving less critical functions out of the terminal building or consolidating less intensively used space. Even so, significant construction is likely to be required to remodel facilities, and the modification of the baggage distribution system to connect to the new TNA screening facility is likely to prove quite expensive, depending on the location.

Thus it may be both more practical and less expensive to construct a new building, or an extension of an existing building, either adjacent to the terminal building or in a



**Table 4-2**  
**Minimum Connect Times**

---

position equipment	2.0
unload bags to cart(s) @20 bags/min	0.05n
move cart(s) to TNA facility	5.0
screen bags @ 390 bags/hour	0.15n
move cart(s) to departure gate	5.0
identify and locate passengers	2.0
hand search r% @ 2 min/bag	<u>0.02rn</u> 14+(0.2+0.02r)n

For a hand search rate of 5% and 50 bags, this would thus require about 30 minutes before the last container could be loaded and passengers boarded. If the hand search rate is increased to 10% and the search time to 4 minutes per bag (e.g. if the security agents were also searching other bags and only one search position was available), then the minimum time would increase to about 45 minutes. Allowing 30 minutes to board the aircraft and secure the doors for departure, this would give minimum connecting times of 60 minutes and 75 minutes respectively.

---

remote location on the ramp. While a remote location may be less disruptive of existing ramp activities, additional time will be required to move baggage to and from the facility. It will also be impractical to bring passengers to the facility for hand searching baggage, although this may be difficult even with a facility adjacent to the terminal building. Therefore it is assumed that any hand searching would be done at the gate.

## LEONARDO DA VINCI (FIUMICINO) AIRPORT, ROME

Leonardo Da Vinci airport is currently served by Pan Am and TWA. Like all international carriers, they operate out of the international terminal on the west side of the airport.

The international terminal has two levels, with departures on the upper level. Island check-in counters are aligned parallel to the passenger flow. Presently, international flights are operated from gates located along the facade of the terminal and piers that extend on either side of the terminal.

The airport master plan calls for extensive changes to the terminal, including the construction of a satellite terminal on the west end of the terminal for foreign flag carriers, connected by a people-mover to the main terminal. A schematic of the terminal in its present configuration is shown in Figure 4-23.

Due to scheduling difficulties, it was not possible to visit the airport in the course of the study, as had originally been intended, and the information in this section has been assembled from published materials and written responses by the local station personnel.

Information from TWA, but not Pan Am, was supplied. TWA currently screens checked bags at a remote facility, using x-ray. Checked bags first go via conveyor belt to a carousel at the ramp level, where they are loaded onto carts and taken to the screening area. The carts are then reloaded and taken to the aircraft for loading. The time required for the process is between 10 and 25 minutes.

On-line connecting bags already have been screened at their originating station and are transferred aircraft-to-aircraft. TWA does extensive interlining with Olympic. Bags connecting from Olympic flights are also screened at the remote security area. Screening connecting bags takes between 20 and 35 minutes.

We were unable to learn what procedure is followed in cases where there is a suspicious bag. Presumably, passengers are taken to the secure area to resolve the situation. Otherwise, the purpose of the remote location would be defeated.

The most natural way to introduce TNA screening at Leonardo Da Vinci would be to replace the current x-ray screening procedure with one involving the TNA units. This may require expansion of the screening area, and perhaps some additional climate control.

The remote location suggests that such expansion can be accomplished with little disruption to current activities. TWA's current operation is already substantially encumbered by baggage security procedures, and it is unlikely that TNA screening would make the system much worse.

# ROME LEONARDO da VINCI (FIUMICINO) AIRPORT

## INTERNATIONAL ARRIVALS

### FIRST FLOOR - GROUND FLOOR

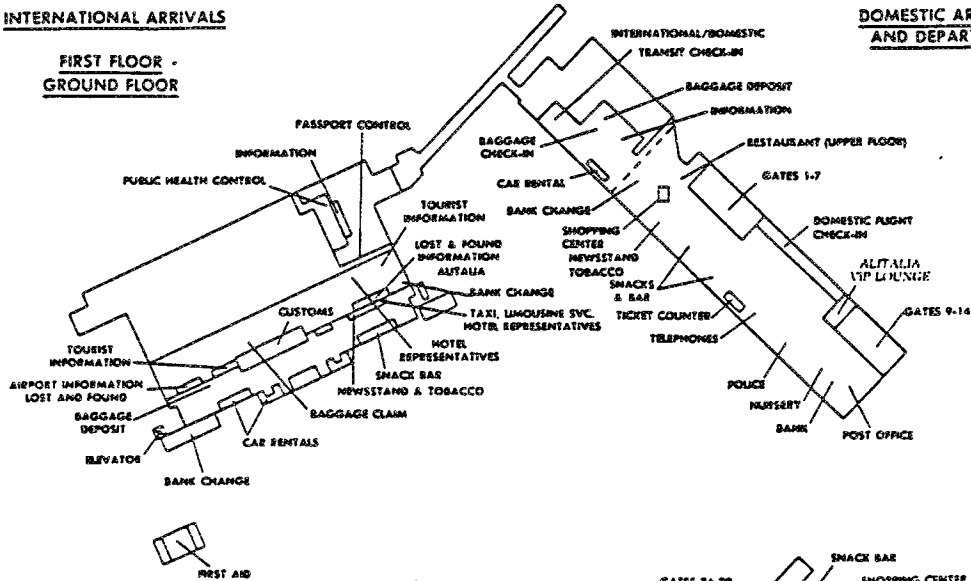

## INTERNATIONAL DEPARTURES

### SECOND FLOOR

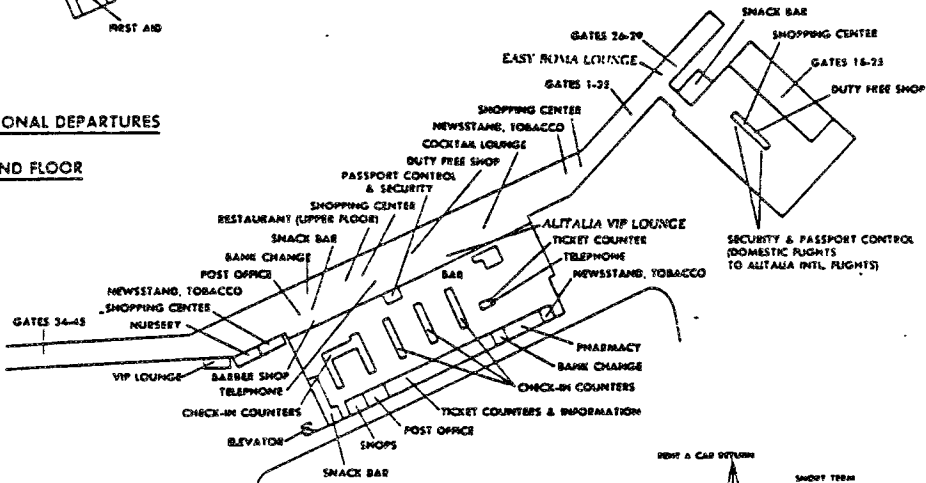

### THIRD FLOOR RESTAURANT



The airport provides facilities for handicapped and elderly travelers in accordance with standards provided by the Architectural and Transportation Barriers Compliance Board. For specific information, see page 34.

Copyright © 1989 By Official Airline Guides, Inc. Oak Brook, Illinois

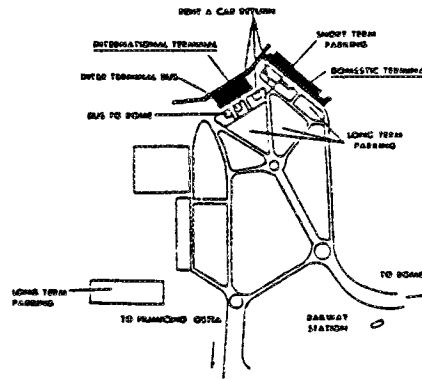

Reprinted with special permission from the Oct.-Dec., 1989 Official Airline Guides Travel Planner Hotel & Motel RedBook European Edition. All rights reserved.

Figure 4-23  
Leonardo Da Vinci Airport, Rome  
Terminal Layout

## SUMMARY

- Considerations with respect to the introduction of TNA screening are inherently site specific.
- Airports are one of the least standardized transport facilities.
- Almost all airports were built before security became a major concern.
- In addition to differences in physical layout of airports, there is considerable diversity in patterns of use and operation.
- In the absence of construction of a dedicated international check-in facility with appropriate provisions for TNA screening, there are six points in the checked baggage process where TNA screening could be performed.
  - ▶ At curbside
  - ▶ In the lobby before check-in
  - ▶ In the terminal after check-in
  - ▶ In or adjacent to the outbound bag room
  - ▶ At a remote location on the ramp
  - ▶ At the departure gate.
- Most airline stations at the case study airports visited could only accommodate the number of TNA units required by extensive relocation of existing functions or by incurring significantly increased congestion in public or operational areas.
- Airlines with connecting hub operations, such as American and United at Chicago, would be most heavily affected by baggage screening requirements because of the need to reroute connecting baggage.
- Several other obstacles to the installation and use of TNA screening facilities were found in the airport visits.
  - ▶ lack of airline control of possible screening areas
  - ▶ multiple entry points into baggage handling system
  - ▶ low traffic volumes
  - ▶ Frequent relocations of airline tenants
  - ▶ Centralized baggage handling facility serving both U.S. flag and foreign flag airlines.

## 5. SIMULATION ANALYSIS

In order to analyze the influence of flight schedule peaking and traffic variability on the number of TNA machines required, a computer simulation model of the screening process was developed that models the flow of baggage through the screening system, based on an input flight schedule.

The simulation generates measures of performance of the system, such as the proportion of bags missing their flight or the departure delay required to allow all the baggage to make the flight. The model permits such factors as the throughput of the screening devices or the amount and type of baggage on a flight to be varied to study the effect on the system.

### APPROACH

The model simulates the movement of each bag through the baggage system over the course of a specified period, typically a day. The inflow of bags to the system is determined by a specified flight schedule.

Bags are generated by arriving flights and by passengers checking in. For each outbound international flight, the number of passengers originating at the station and the number of passengers connecting from each inbound arriving flight must be specified. A variable number of bags is generated for each passenger, based on a specified distribution of bags per passenger.

The timing of arriving flights is determined from the schedule, with a variable allowance for arrival delays computed from a delay distribution. The connecting bags enter the system a specified time after an inbound flight actually arrives.

The originating passengers are generated at varying times before their scheduled flight departure, based on a specified distribution of check-in times. Passenger check-in is modelled as a multi-channel queueing system, with a defined number of agents and a specified service time distribution. After each passenger check-in is completed, the bags for that passenger enter the system.

The time required for the bags to move through the baggage handling system to the TNA screening facility is defined, together with the TNA screening rate. The TNA screening process is modelled as a single channel queueing system, with a constant service rate. After bags are screened, they move through the baggage handling system and appear at the outbound bag room for baggage make-up after a specified time.

The model keeps track of the number of bags for each flight that appear at baggage make-up after two specified times before scheduled flight departure. The first corresponds to the flight close-out time and the second corresponds to the latest time a bag could still make the flight, if it was given priority handling (such as being put on a cart and taken directly to the aircraft). It also keeps track of the length of the queue of bags at the TNA

screening facility, at specified reporting intervals, and the number of bags screened during each interval.

## MODEL DESCRIPTION

The flow of events in the model is shown in Figure 5-1. The model is written in the SIMSCRIPT language, with each stage in the system represented as a separate process. The current version of the model requires three input files:

- a. a problem description file, specifying the values of the variables in the model, such as the number of TNA machines and check-in agents, and distributions of bags per passenger and check-in times;
- b. the schedule of arriving and departing flights;
- c. a matrix showing the passengers connecting between each arriving and departing flight, together with the number of originating and interline passengers for each departure.

The separation of input data into the three files allows the same problem to be run for varying flight schedules, or differing passenger loads.

## APPLICATION TO KENNEDY AIRPORT

The model was applied to study the peak month operations for the two U.S. carriers with the largest volume of international traffic at Kennedy International Airport: TWA and Pan Am. Traffic and schedule data were obtained from each carrier for their peak month in 1989.

Although the model could be applied to reflect different locations and configurations of TNA facilities, the difference in baggage movement times between different potential locations is not large in relation to other factors in the model, and the representation of the TNA screening process would not distinguish between one group of machines at a single location and several smaller groups at different locations.

Therefore the analysis was performed for each carrier assuming a single, central TNA facility. In the case of TWA, this was assumed to be located on the ramp at the site of the existing TNA facility. In the case of Pan Am, it was assumed to be located in the outbound bag room, adjacent to Gate 7. It is recognized that constructing a facility of the size required at these locations would displace other activities.

## INPUT DATA

Apart from the traffic and schedule data, the results of the model depend on the TNA processing rate, and the assumptions regarding the delays to arriving flights, and the passenger check-in time distribution and number of check-in agents available. The model

**Figure 5-1  
Simulation Model Flowchart**

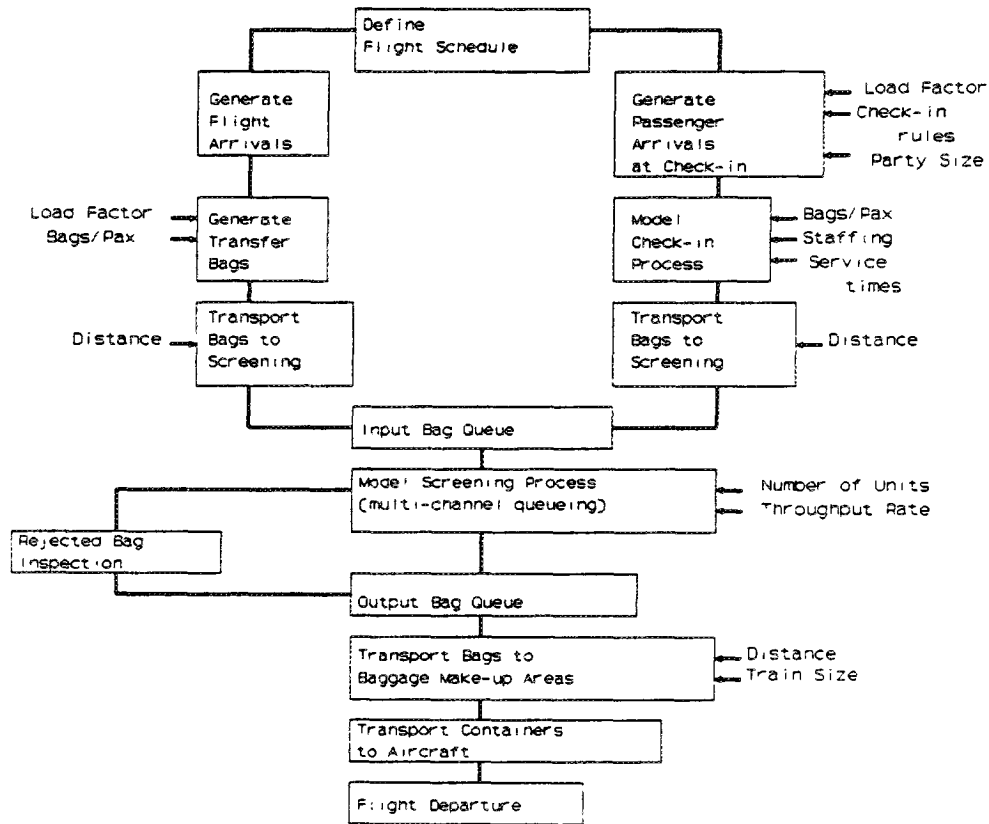

was run with varying TNA processing rates, to examine the influence of the number of machines and their throughput on the performance of the system.

An analysis was performed of the differences between the actual and scheduled arrival times of TWA and Pan Am flights during the respective peak months, using data provided by the airlines. On the basis of this analysis, a standard delay distribution was developed, as shown in Figure 5-2. This distribution is expressed in terms of the mean and standard deviation of the delay experienced by flights scheduled to arrive at a given time of day.

The actual values for a representative selection of flights, together with the relationships assumed for the model, are shown in Figures 5-3 and 5-4. It was assumed that the stochastic component of the delays (the variability about the mean) were independent for successive flights.

Data were obtained from both airlines on distribution of passenger check-in times before flight departure, and a consolidated distribution defined for the tests, as shown in Figure 5-5. The number of agents available at TWA was determined from the number of TWA counter positions in the international terminal, assuming all positions are staffed at peak times.

In the case of Pan Am, determining the number of agents is a little more complex, because any passenger can check in at any counter, and thus both international and domestic passengers are served by the same agents. Based on the traffic data and the passenger check-in distributions, the number of originating international passengers was determined in 15 minute intervals though the day, and the Pan Am counter staffing standards were applied to determine the number of agents required to handle international traffic alone.

Baggage movement times were determined from terminal layout drawings and assumed baggage belt speeds.

## RESULTS

Simulation runs were performed for a range of TNA processing rates, as well as varying passenger loads and earlier passenger check-in times. A typical pattern of aircraft arrival times is shown in Figure 5-6, and the distribution of the simulated arrival delays is shown in Figure 5-7. The exact delays varied from run to run, due to the stochastic component of the simulation.

This variation of flight arrival times resulted in different numbers of bags missing the flight close-out and departure times for each run. Each case was run ten times, with different random number seeds, and the resulting number of bags missing departure times were averaged. It was found that ten runs were sufficient to cause these averages to converge to consistent values.

The distribution of aircraft arrival delays generated by the simulation appears to conform to the pattern of observed data for Kennedy Airport. Approximately 50% of the



**Figure 5-2**  
**Standard Delay Distribution**

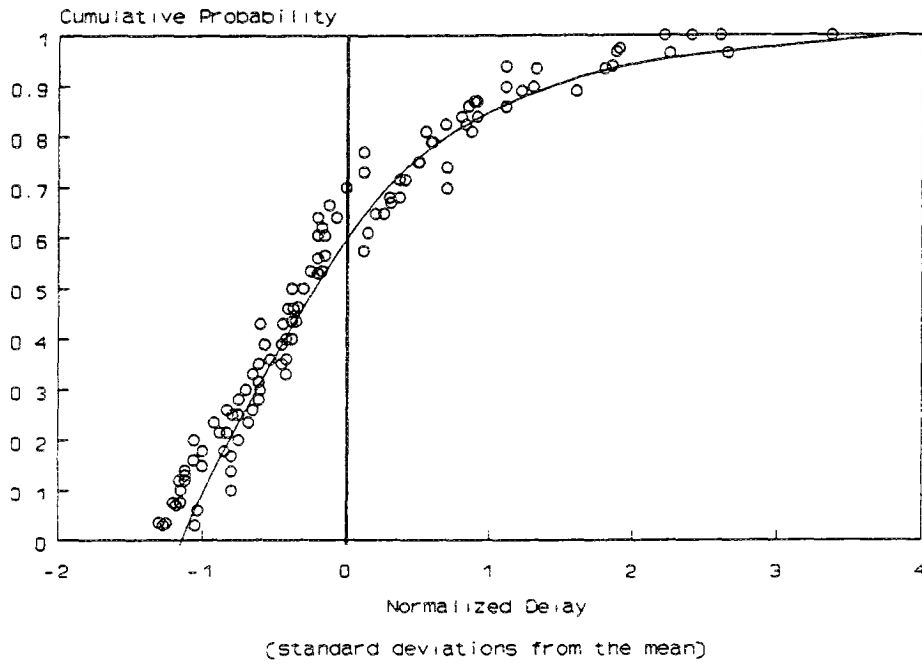

**Figure 5-3**  
**JFK Arrival Delay Pattern**  
**July 1989**

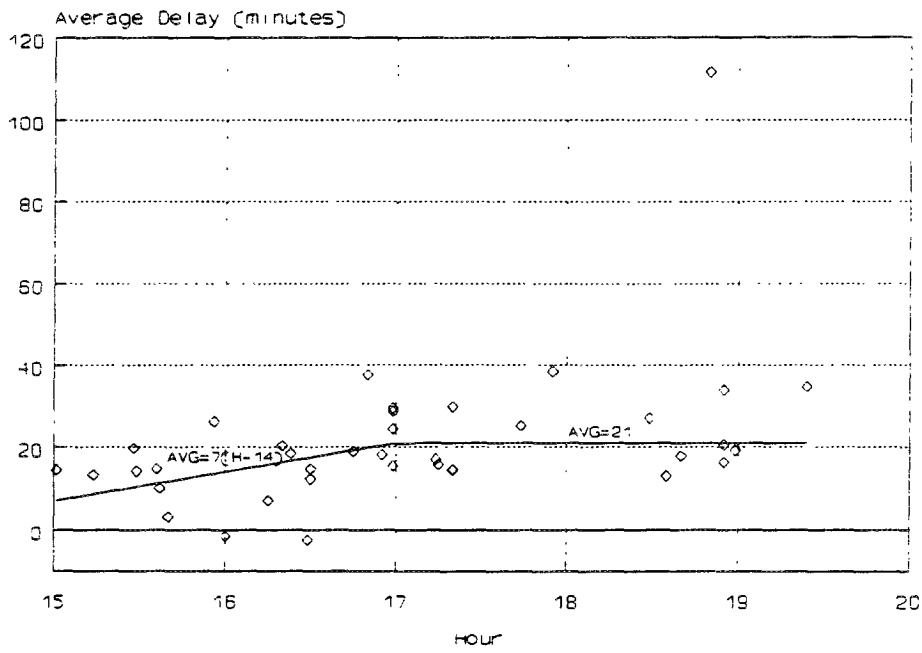

**Figure 5-4**  
**JFK Arrival Delay Variability**  
 July 1989

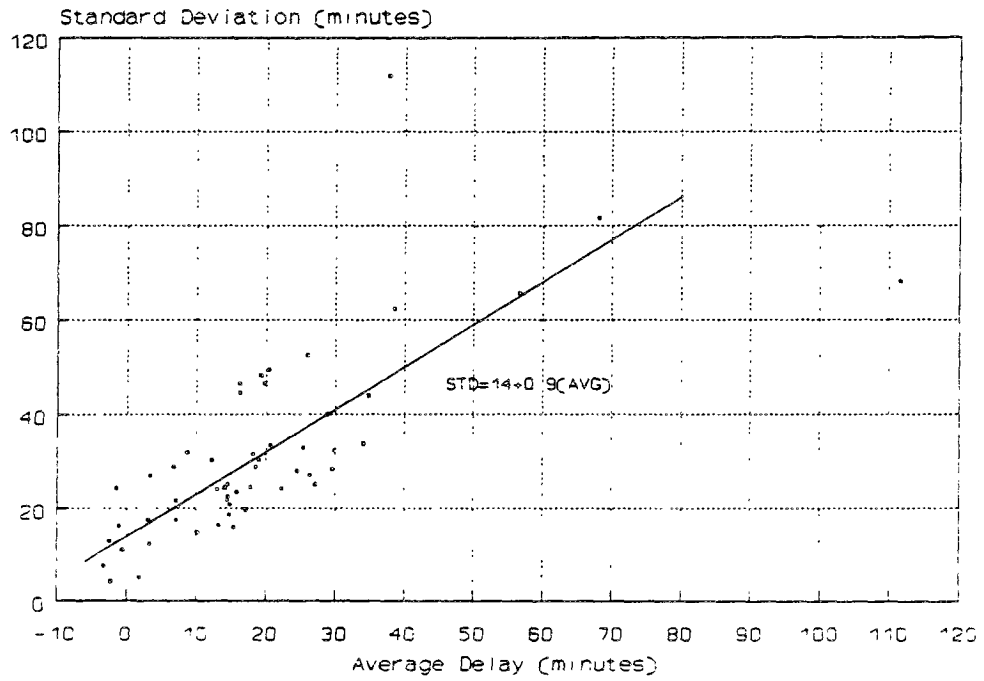

**Figure 5-5**  
**Distribution of Passenger Check-in Times**

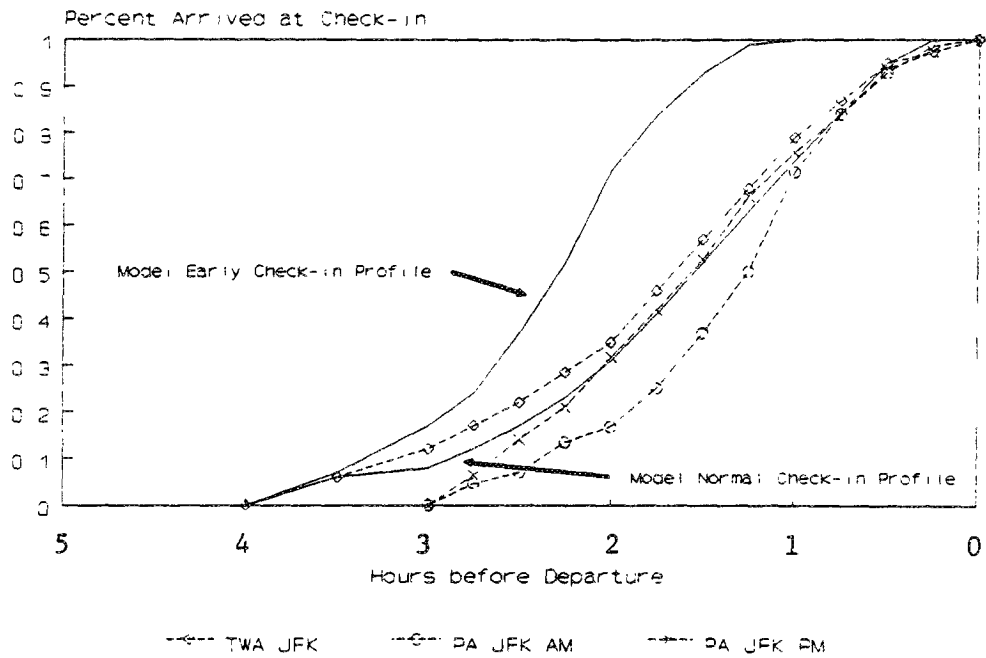

**Figure 5-6**  
**Pattern of Simulated Flight Arrival Times**  
**Typical Run**

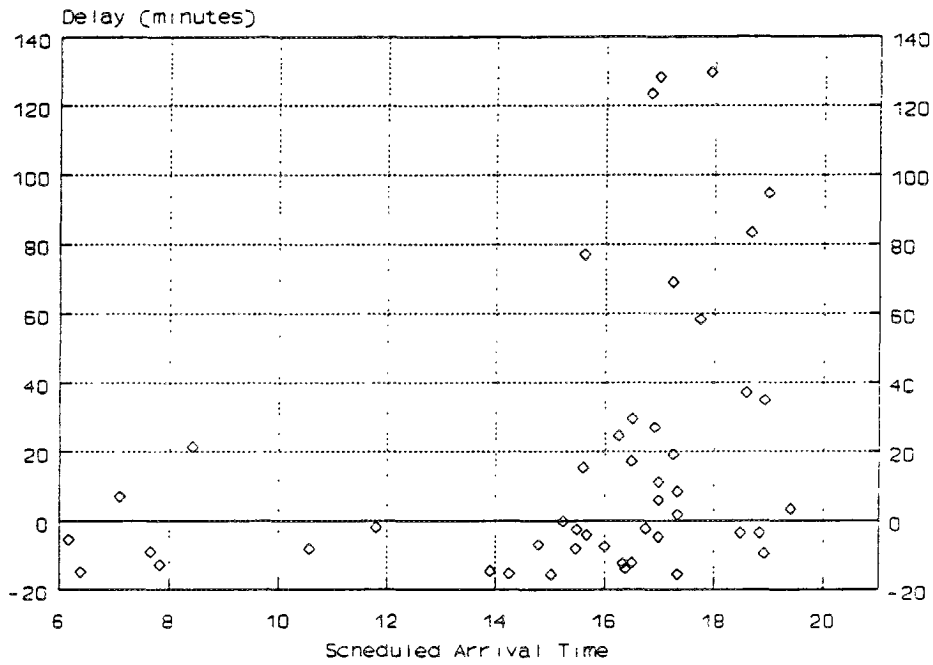

**Figure 5-7**  
**Cumulative Distribution of Arrival Flight Delays**  
**Typical Simulation Run**

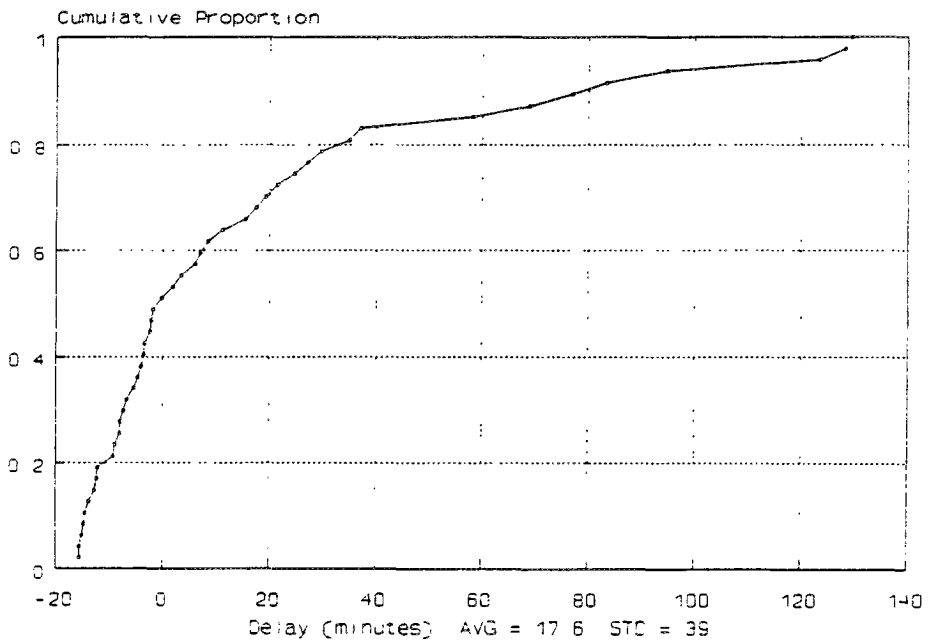

flights arrived up to 15 minutes early. A further 30% or so of the flights arrived within 30 minutes of schedule. The remaining flights incurred delays fairly evenly distributed between 30 minutes and a little over two hours. Passengers on these flights could be expected to have difficulty making some connections, even in the absence of TNA processing delays.

The variation in the TNA processing rate and bag queue for a typical run is shown in Figure 5-8. It can be seen that the TNA facility capacity is saturated for about four hours during the afternoon, during which time the queue of bags reaches a maximum of a little over 1,000.

At the processing capacity of 1560 bags per hour, this would impose a maximum delay of about 40 minutes on each bag, in addition to the time to move the bag to and from the facility. As the processing rate is increased, so the both duration of the saturated period and bag queueing delays are reduced.

### **TWA Simulation**

The impact of varying the TNA processing rate on the percent of bags missing either the baggage close-out time or the flight departure time is shown in Figure 5-9, for a traffic volume and flight schedule corresponding to the average daily conditions during the peak month for TWA. The simulations were also run with a modified passenger check-in time distribution, corresponding to a minimum check-in time of one hour before flight departure. This significantly reduced the percentage of bags missing both the close-out and departure times, as shown in Figure 5-9.

The results of the simulation also allow the impact of delaying flight departures on the percentage of late bags to be assessed. There are a number of strategies that could be adopted to determine which flights to delay and by how much, but the least overall delay will be incurred by progressively increasing the delay of that flight that results in the largest reduction in late bags per additional minute of delay. The effect of this strategy on a the results of a typical simulation run is shown in Figure 5-10.

The effect of varying traffic volume on the percentage of bags missing the close-out and departure time was simulated by increasing and reducing the traffic volumes on each flight by 20%. Examination of passenger loads during the peak month showed that a traffic volume 20% above average corresponds roughly to the fifth busiest day of the month, while a volume 20% below average corresponds roughly to the third least busy day of the month, and also the average day of the year. The change in late bags for a given TNA processing rate is shown in Figure 5-11.

### **Pan Am Simulation**

Similar results were obtained for Pan Am, as shown in Figure 5-12. Although the number of flights and volume of bags is higher than for TWA, the percentage of bags missing baggage close-out is similar, for the same TNA processing rate, while the percentage of bags missing the flight departure time is somewhat less.

**Figure 5-8**  
**TNA Throughput and Queue**  
**Typical Simulation Run**

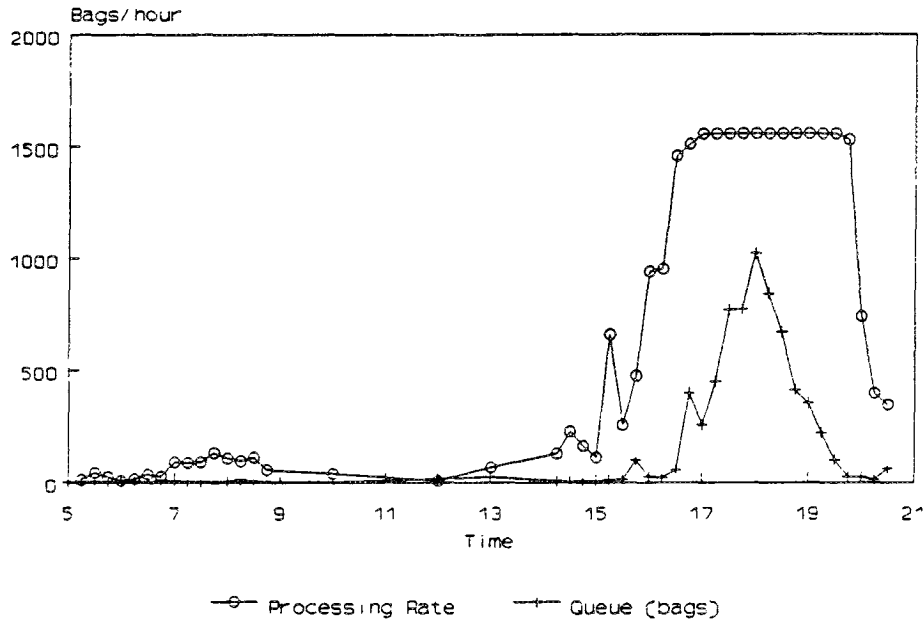

**Figure 5-9**  
**Bags Missing Departure/Close-out**  
**TWA Simulation**  
**Traffic Volume - 7800 bags/day**

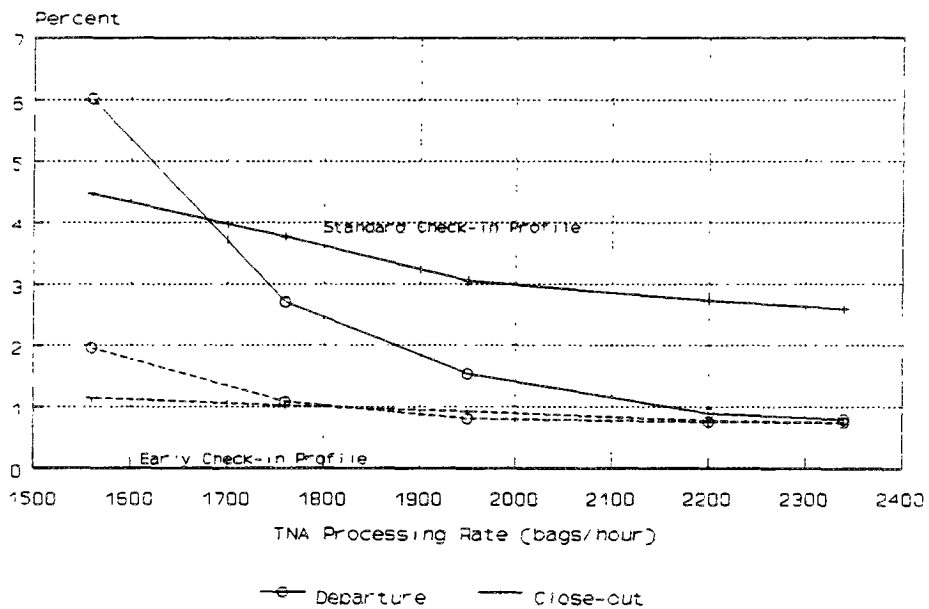

**Figure 5-10**  
**Reduction in Late Bags**  
**Typical Simulation Run**

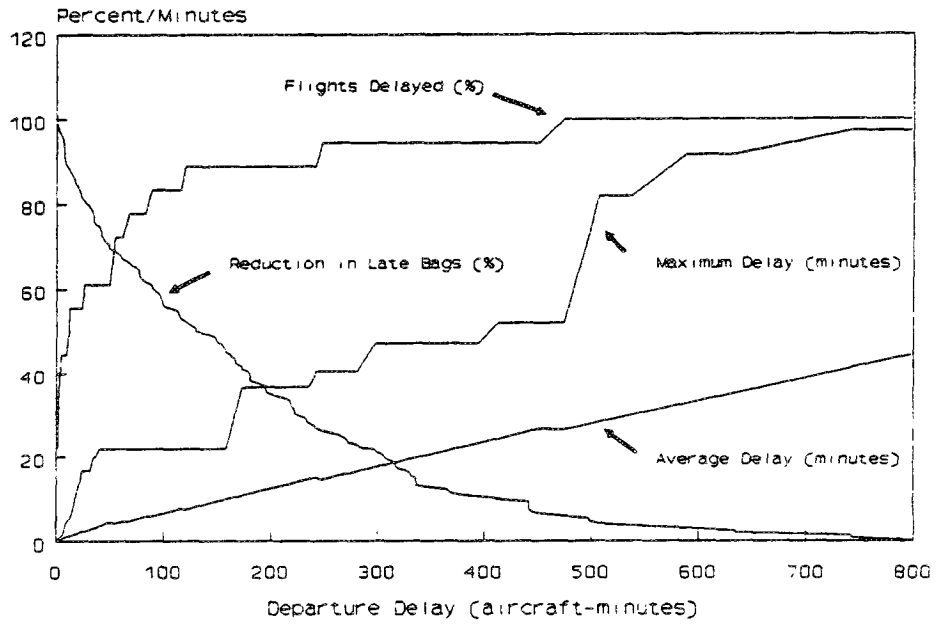

**Figure 5-11**  
**Bags Missing Departure/Close-out**  
**TWA Simulation**  
**TNA Processing Rate - 1950 bags/hour**

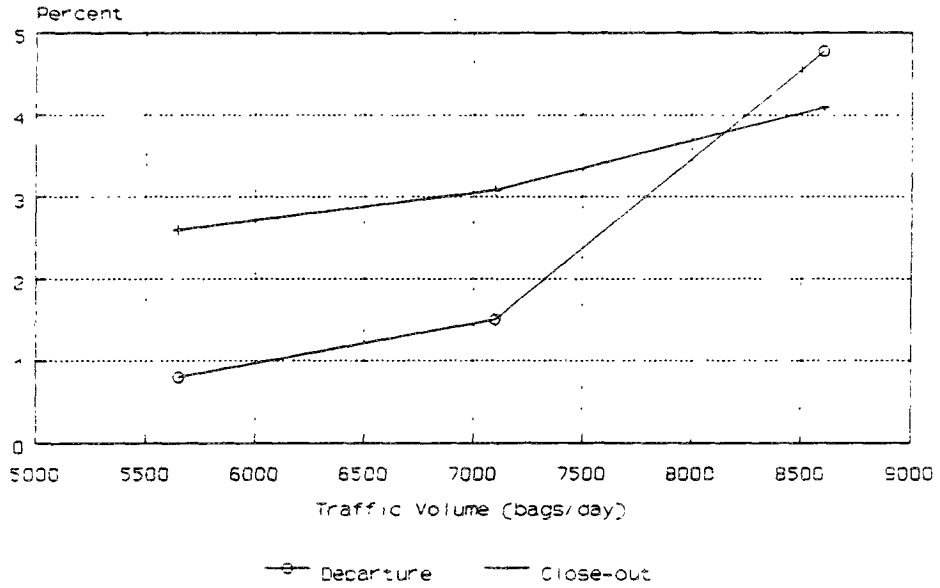

**Figure 5-12**  
**Bags Missing Departure/Close-out**  
**Pan Am Simulation**  
**Traffic Volume - 9750 bags/day**

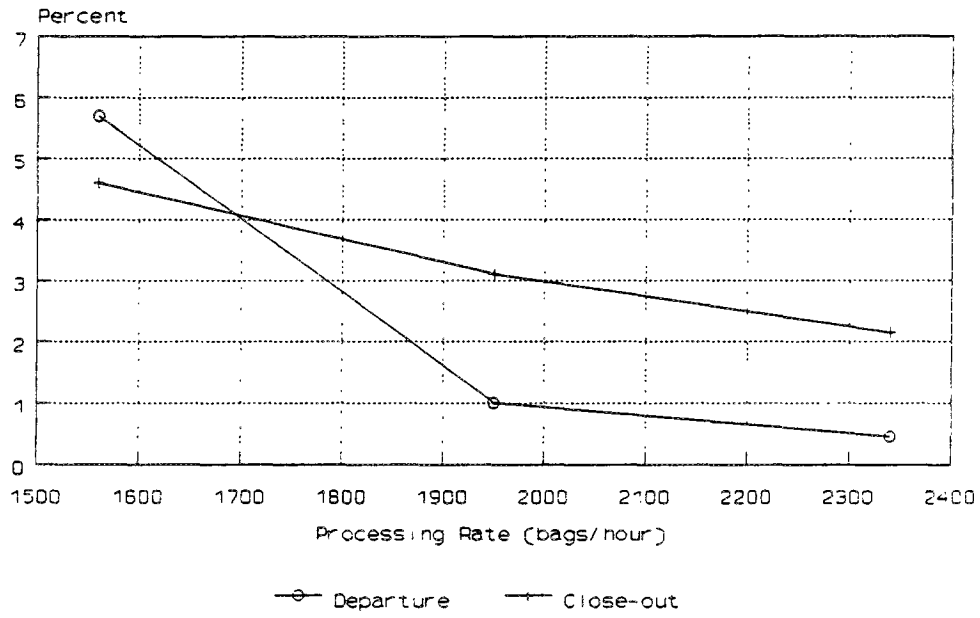

This appears to be due primarily to the differences in flight scheduling, with TWA having more arrivals during the critical period at the start of the departure flight bank. However, it should be noted that this result could arise in part from the assumptions that were made about the pattern of connecting traffic.

Analysis of the impact of delaying flight departures on the percentage of late bags showed similar results to TWA.

## SUMMARY

- A computer simulation model of the screening process was developed which models the flow of baggage through the screening system, based on input flight schedules, and generates measures of system performance.
  - ▶ The model can analyze the influence of flight schedule peaking and traffic variability on the number of TNA machines required.
  - ▶ TNA baggage throughput rates and amounts of baggage can be varied to study effects on the system.
- Application of the model to TWA at Kennedy Airport at a processing capacity of 1,560 bags per hour showed saturation of TNA facility capacity for about four hours during the afternoon and queueing of over 1,000 bags.
- This situation would impose a maximum delay of about 40 minutes on each bag in addition to the time to move the bag to and from the facility.
- As the processing rate is increased, so both the duration of the saturated period and bag queueing delays are reduced.
- The number of bags missing the flight departure time in this situation due to TNA screening delays can be reduced by about 95% if flight departures are delayed by an average of about 25 minutes.
  - ▶ Worst case delays could exceed one hour.



## 6. EDS SCREENING IMPACTS AT JFK

The results of the simulation analysis described in the previous chapter were used to make an assessment of the likely impacts of performing EDS screening of all checked baggage at Kennedy International Airport. As discussed in Chapter 1, these impacts include not only the provision and operation of the EDS equipment itself, but a wide range of other impacts affecting both airline operations and passenger service.

### ALTERNATIVE SCREENING SCENARIOS

Although the results of the simulation analysis are expressed in terms of EDS throughput rates, and thus are applicable to a broad range of potential technologies, the TNA equipment currently being installed in selected airports around the world is at present the only EDS equipment approved by the FAA, and thus forms a natural baseline for evaluation.

This section discusses the number of such machines that might be required at JFK to handle all international checked baggage. If other equipment with different performance characteristics is approved in the future, these results can be fairly easily adjusted to reflect the differences in performance.

As noted earlier in this report, the operational throughput of the TNA machines is dependent on a broad range of factors, including the threat level setting, desired probability of detection, procedures for handling alarms, and operator training. Many of these factors are policy variables, and will depend on FAA regulations in force at the time, and the manner of their implementation by each airline. For the purposes of the current analysis, three different performance scenarios have been assumed:

1. An average throughput rate of 220 bags per hour per machine, with a requirement to hand search one bag per thousand.

This corresponds approximately to the observed average operational performance of the TNA machine used by TWA at Kennedy Airport, and assumes that the alarm rate would be reduced by two-pass screening.

2. An average throughput rate of 390 bags per hour per machine, with a requirement to hand search 3 bags per thousand.

This corresponds to a two-pass screening process, with a first pass throughput of 540 bags per hour and a 5 percent false positive rate.

The hand search rate reflects a lower rate of operator-resolved alarms than has been experienced to date at Kennedy, to allow for the higher pressure of continuous operation and less skilled operators.

3. An average throughput rate of 600 bags per hour per machine, with a hand search rate of 5 bags per thousand.

This corresponds to a single pass screening at the highest rate claimed for the technology, with an initial 5 percent false positive rate and the operators able to resolve 90% of the alarms.

These three scenarios correspond to a reducing number of machines, but a higher requirement for hand searching bags generating unresolved alarms.

In addition to variation in the performance of the TNA machines, the location of the machines is likely to influence the magnitude of the total impacts. As discussed in Chapter 4, the three most practical alternatives at Kennedy Airport for screening the bags of originating passengers are to locate the machines:

1. in the lobby area, before check-in;
2. behind the check-in desks, as part of the check-in process;
3. in the outbound bag room or adjacent ramp area.

In the first two cases, the most practical location for machines for screening connecting bags would be the bag room or ramp area.

While in principal the number of machines should not be greatly affected by the alternative selected, since the same volume of bags has to be processed, in practice several constraints would tend to increase the number of machines required in the first two alternatives, including:

- a. the need to limit the length of queues in front of lobby machines, to maintain circulation;
- b. the need to be able to keep up with passenger check-in rates for counter installations;
- c. machine indivisibility, and the need to place machines in several locations, either due to space constraints or terminal configuration.

Since the time constraints of the current study only permitted simulation analysis of the third of the above location alternatives, this has been used as the basis for the impact assessment. For the reasons given, this is likely to give the lowest number of machines, although it may also be the least attractive from considerations of passenger convenience. However, in view of the cost of the machines and the difficulty of finding suitable locations in the public areas of the terminals, it is probably the alternative that most airlines at Kennedy would select.

## TNA REQUIREMENTS

The number of machines required by each airline will depend on the peak traffic that must be handled. It is not likely that an airline would size its facility to handle the very worst case traffic load, but some lower level. The peak hour of the average day of the peak month (ADPM) is widely accepted in terminal planning as an appropriate design criterion (Hart, 1985).

However, in the case of TNA screening, consideration must be given to the interaction between arrivals in one hour and departures in another, as well as passengers who may check in several hours before their flight. Since the simulation analysis considered the entire day, the ADPM traffic level has been adopted as the design criterion to size facilities.

As the previous analysis has shown, the number of TNA machines required is dependent on the operational disruption that an airline is willing to accept, in terms of either departure delays or bags missing their flight. For the purposes of this assessment, the number of TNA machines required is determined for two conditions:

1. **High service scenario** - the number of bags that miss their flight baggage close-out time above those that would in the absence of TNA screening is no more than one per thousand;
2. **Low service scenario** - twice as many bags miss their flight baggage close-out time as would in the absence of TNA screening.

It should be noted that a bag missing its flight departure time does not necessarily mean that it is left behind. The flight departure might be (and often is) delayed, either for late bags or other reasons.

### Present Traffic Levels

The average daily international outbound traffic volume during the peak month in 1989 for each of the U.S. carriers at Kennedy is shown in Table 6-1. Assuming that the TNA capacity is sized to handle the average day peak month (ADPM) traffic, the number of TNA machines required under the various screening scenarios are shown in Table 6-2.

### Future Traffic Levels

Obviously, traffic growth will increase the number of TNA machines required. Recent trends in international enplanements by the U.S. carriers at JFK are shown in Figure 6-1, together with international enplanements by foreign flag carriers and domestic enplanements. The 1995 and 2000 traffic levels projected for JFK in the latest FAA Terminal Area Forecasts (FAA, 1989a) are shown in Table 6-3.

Projecting recent trends in airline market share to 1995 results in the projected range of traffic levels for each carrier shown in Table 6-4. In general, these projections are bounded on the one hand by an airline maintaining its current share and on the other by an extrapolation of the recent trend in its market share. In the case of United Air Lines, some judgement was applied, since the airline has only just begun to offer service

**Table 6-1**  
**Peak Month Outbound International Traffic at JFK**

---

Airline	----- Enplaned Passengers -----		
	1989	Peak Month	ADPM <sup>a</sup>
American	694,500	66,700 <sup>b</sup>	2,150
Northwest	100,300	16,900	545
Pan Am	1,679,900	190,500	6,145
TWA	1,212,500	124,300	4,010
United	86,400	8,200 <sup>b</sup>	265
Other <sup>c</sup>	96,900	10,300 <sup>b</sup>	330

---

Note: a) Average Day Peak Month  
b) Estimated  
c) Eastern (discontinued service 3/89); Tower Air

---

**Table 6-2**  
**Number of TNA Machines Required**  
**1989 Traffic Levels**

---

Airline	----- Processing Scenario -----		
	220 bags/hr	390 bags/hr	600 bags/hr
American	4 - 5	2 - 3	2
Northwest	1 - 2	1	1
Pan Am	9 - 11	5 - 6	3 - 4
TWA	8 - 11	5 - 6	3 - 4
United	1	1	1
Other	1	1	1
Total	24 - 31	15 - 18	11 - 13

---

**Figure 6-1**  
**Trends in Traffic at Kennedy Airport**

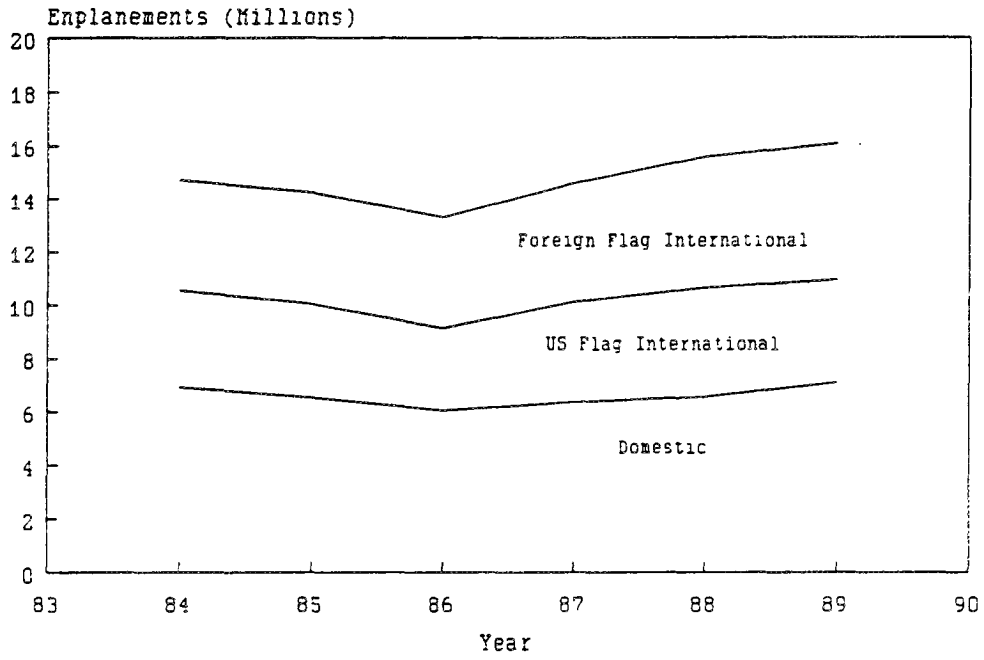

**Table 6-3**  
**Projected Growth in Traffic at JFK**

Year	Air Carrier Enplanements	- International Enplanements -	
		U.S. Carrier	Foreign Flag
1989	15,487,000	3,871,000	4,528,000
1995	18,836,000	5,368,000	7,064,000
2000	21,531,000	6,545,000	8,957,000

**Table 6-4**  
**Projected U.S. Carrier International Enplanements**  
**1995**

Airline	----- Enplaned Passengers -----	
	Annual (000)	ADPM
American	800 - 1,300	2,500 - 4,000
Northwest	100 - 150	500 - 800
Pan Am	2,000 - 2,800	7,300 - 10,200
TWA	1,200 - 1,700	4,000 - 5,600
United	500 - 800	1,500 - 2,500
Other	100 - 150	350 - 500

to Europe.

On the basis of these projected peak month traffic levels, the number of TNA machines required under the various screening scenarios are shown in Table 6-5.

## FACILITIES

The cost to construct and operate the facilities necessary to support a given number of TNA machines will depend both on the floor area required, and the location within the terminal building. In addition, consideration should be given to any necessary modifications to the baggage handling system to transfer bags to and from the TNA machines.

The FAA regulatory impact assessment (FAA, 1989b,c) assumed that each machine would require 750 sq. feet, which could be provided at an annualized cost of \$25 per sq. foot. This area corresponds to the structure housing the TNA machine being used by TWA at Kennedy Airport, and includes no formal provision for hand searching baggage at the facility or unloading or queueing baggage waiting to be screened.

An analysis was performed of the areas designated to accommodate the TNA machines that the FAA is in the process of installing at Washington Dulles and London Gatwick airports, as shown in Figures 6-2 and 6-3, as well as the hypothetical facility discussed earlier (Figure 3-2). The results of this analysis are summarized in Table 6-6, and suggest that a more reasonable assessment might be 1800 sq. feet per machine for installation in bag rooms or similar locations, and 1500 sq. feet per machine for lobby installation, where no provision need be made for baggage handling equipment.

However, it should be noted that additional space may be required in lobby installations for passenger queueing and hand search of alarmed bags, depending on the throughput of the machines and the rate of hand search required.

The cost to construct, maintain, and operate terminal space is likely to be highly site specific, and will depend on the architectural quality of the finished space. Lobby space will generally be more expensive than operational space (such as bag rooms). While it may be possible to locate TNA machines in currently underutilized space, and thus appear to incur fairly low costs, this space would eventually be required for other uses, and thus its true long run cost is the marginal cost of expanding the terminal building by the amount of space in question.

An analysis was performed of the reported costs of recent terminal expansion projects in the U.S. and overseas. Construction of an outbound bag room at Kennedy Airport appeared to cost around \$106 per sq. foot for about 6,000 sq. feet of unfinished space. Reported costs for new terminal buildings at Newark, Phoenix, and Raleigh-Durham gave a range between \$190 and \$290 per sq. foot. American Airlines was recently quoted as having invested \$1.25 billion in recent terminal expansion projects, that provided an additional 244 gates and 2.9 million sq. feet of terminal space (Aviation Daily, 5/8/90), or an average of \$430 per sq. foot.

**Table 6-5**  
**Number of TNA Machines Required**  
**1995 Traffic Levels**

---

Airline	Processing Scenario		
	220 bags/hr	390 bags/hr	600 bags/hr
<b>HIGH SERVICE SCENARIO</b>			
American	7 - 10	4 - 6	3 - 4
Northwest	2	1 - 2	1
Pan Am	13 - 18	8 - 10	5 - 7
TWA	11 - 15	6 - 8	4 - 6
United	4 - 7	3 - 4	2 - 3
Other	1 - 2	1	1
<b>Total</b>	<b>44 - 65</b>	<b>25 - 37</b>	<b>16 - 24</b>
<b>LOW SERVICE SCENARIO</b>			
American	5 - 8	3 - 5	2 - 3
Northwest	1 - 2	1	1
Pan Am	10 - 14	6 - 8	4 - 5
TWA	8 - 11	5 - 6	3 - 4
United	3 - 5	2 - 3	2
Other	1	1	1
<b>Total</b>	<b>33 - 49</b>	<b>19 - 28</b>	<b>12 - 18</b>

---

Note: Columns do not sum to totals, due to low values for one carrier offsetting high values for another.



Figure 6-2  
Proposed TNA Arrangement at Washington Dulles Airport

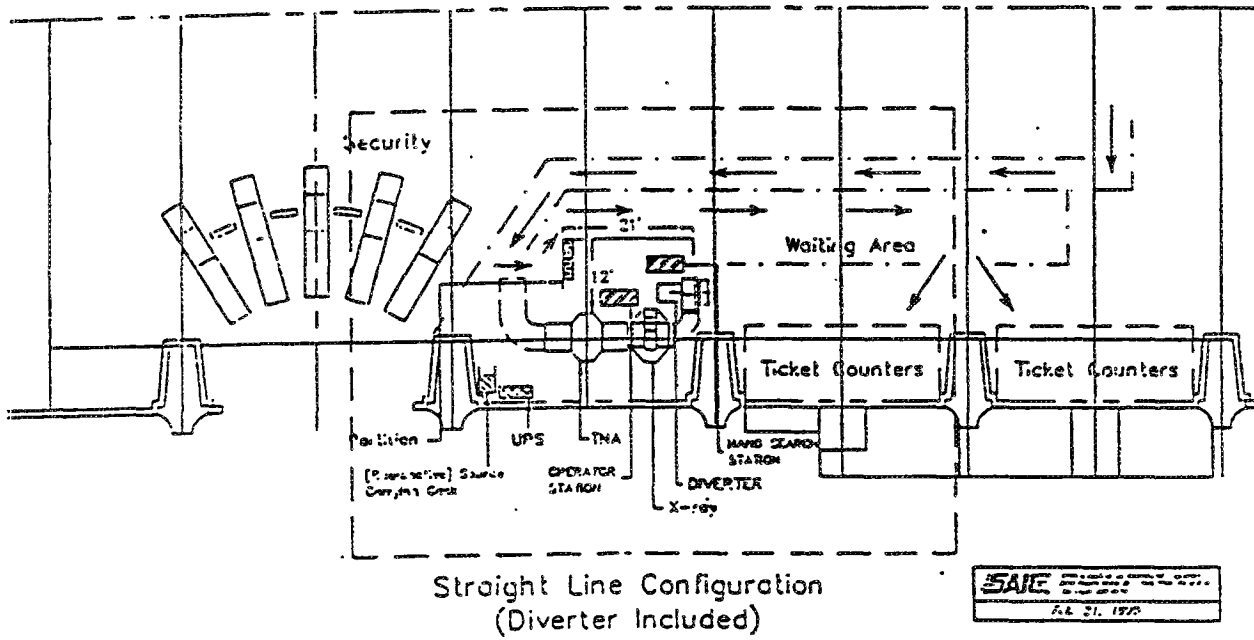
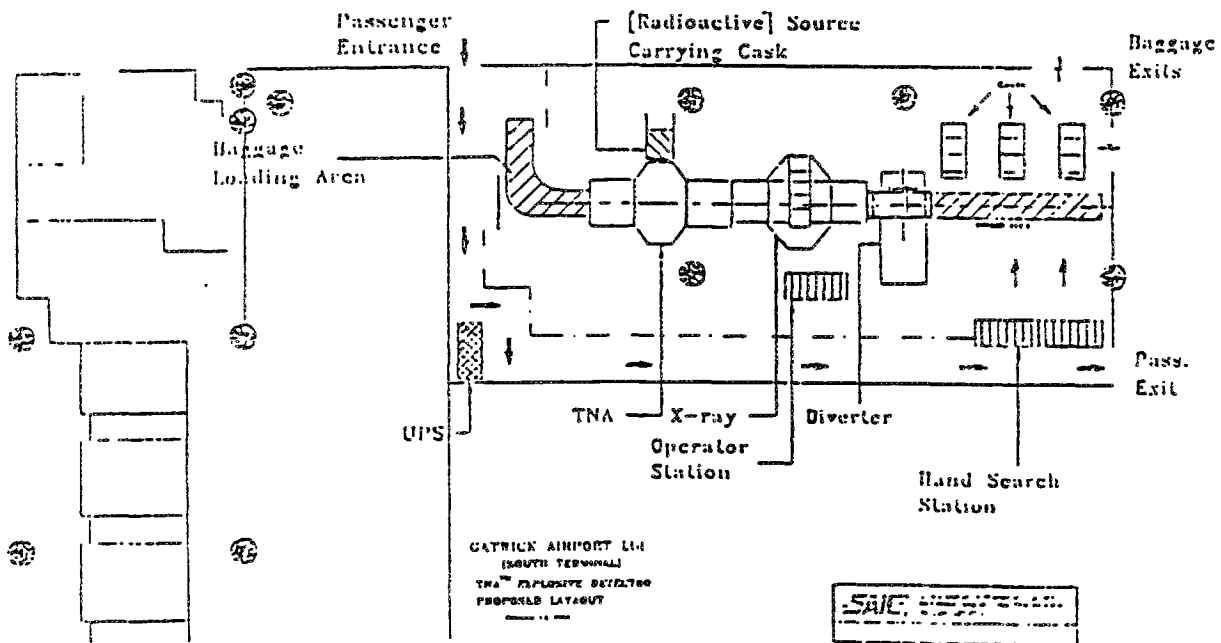

Figure 6-3  
Proposed TNA Arrangement at London Gatwick Airport



**Table 6-6**  
**TNA Space Requirements**

Facility	Number of Machines	Location	Unit Area (sq ft/machine)
Kennedy Airport	1	Ramp	760
Dulles Airport	1	Lobby	1,390
Gatwick Airport	1	Lobby	1,630
Proposed Arrangement <sup>a</sup>	6	Operations Area	1,830

Note: a) See Figure 3-2

However, these costs are greatly influenced by the extent of ramp or other facilities (such as baggage handling systems or parking structures) that are included in the totals, as well as regional variations in construction costs. On the basis of these data, it appears reasonable to assume an average construction cost of \$100 per sq. foot for unfinished operational space and \$250 per sq. foot for finished lobby space.

The cost of baggage handling equipment will depend on the complexity of the installation, and the extent of any structural modifications involved. A recent installation at Kennedy Airport, consisting of about 320 feet of belt and a racetrack sorting device 68 feet long by 20 feet wide cost \$0.5m. If the sorting device accounted for 50% of the cost, installation of the belt cost about \$800 per foot. This figure has been used to estimate the cost of feed and storage belts.

The principal facility operating costs are cleaning, heating and air conditioning, which are likely to vary considerably with local wage rates and the climate zone of the airport. In many situations, these costs will be combined into the terminal space rental rate paid to the airport authority. Recent data from the Metropolitan Oakland International Airport, a medium sized California airport, gave an annual maintenance and operating cost of about \$22 per sq. foot of usable floor space. These data appear to be consistent with earlier data from other airports (Gosling, 1979), after adjusting for inflation.

Janitorial services comprise a large part of terminal operating costs, and are strongly influenced by the flight schedule, which affects the staffing levels on different shifts. Cleaning costs for operational space will be lower than for public areas, while TNA facilities will not incur some categories of cost, such as maintenance of escalators or cleaning restrooms. Heating and air conditioning costs are likely to be higher for New York than for more temperate climates.

On balance, an annual maintenance and operating cost of \$10 per sq. foot for operational space and \$15 per sq. foot for public areas appears reasonable.

## PERSONNEL

The principal personnel requirements for TNA screening are the TNA operators and security agents required to hand search baggage. In its regulatory impact assessment, the FAA assumed that each TNA machine would require two operators for an eight hour shift, and that airport requirements system-wide would average two shifts per day, over a five-day week (i.e. 10 shifts per week per machine).

The salary cost per operator was assumed to be \$30,000 per year, including benefits and overhead. In addition, it was assumed that each operator would require eight weeks of training at a cost of \$5,000, and that personnel turnover would average 25% per year.

In practice, shift staffing requirements are likely to vary with the number of machines. Operators of x-ray baggage scanning machines are typically rotated to other duties every 20 minutes to maintain alertness, and sufficient staff must be available to

cover breaks or job absence. Supervisors cannot be expected to also perform routine duties on a regular basis.

With the current TNA technology, at least one operator appears to be required at all times to align the bags feeding into the machine, although one operator may be able to handle two machines at once, if they are adjacent. The number of operators required to monitor the image screens will depend on the alarm rate and the screening procedure. If the image is examined at the first alarm, then one operator will be required at all times for each machine.

However, if the first pass screening is done in automatic mode, and alarmed bags are rescreened on a separate machine (or by stopping the first pass flow on one of the machines and using it), then fewer operators will be required. Assuming that one machine is required to handle rescreened bags from two machines operating in automatic mode, then a team of three operators could conceivably handle up to three machines.

In practice, workload considerations, as well as allowance for job absences, might require a normal complement of four operators per team. Allowing for a shift supervisor, the number of operators per shift would be as shown in Table 6-7.

The traffic pattern of international departures at Kennedy is quite peaked, and full screening capacity would only be required for a period in the late afternoon. Based on typical simulation analysis runs, the effect of the variation of the TNA screening rates on the number of machines required at different times of day is shown in Figure 6-4. Full processing capacity is only required for one shift per day, and one or two TNA machines appear adequate to handle the morning departures. The impact of this on the number of staff required to cover the 14 shifts per week is shown in Table 6-7.

The figure of \$30,000 per operator per year appears consistent with current wage levels for security personnel, depending on the allowance for benefits and overhead, but may be too low for TNA operators, given the nature of the job, particularly for New York. Operators need to be quite skilled, and may have to meet Nuclear Regulatory Commission licensing criteria for handling the Californium source element, as well as being willing to handle heavy bags.

The FAA estimate of the operator training cost appears to include only the trainee salary and overhead, unless it is assumed that trainees are on a reduced salary. It also appears to ignore any recurrent training requirements. The full cost of training will depend on the training requirements, and could include travel and accommodation if attendance at off-site facility is required. However, since neither the actual requirements nor the turnover rate are currently known, the FAA figure of \$1,250 per operator per year has been assumed for this analysis.

Based on the current rates paid to the TNA operators at Kennedy Airport, a cost of \$40,000 per operator per year has been assumed, including training costs. The above figures are somewhat lower than the personnel costs assumed in the NRC Environmental Assessment (NRC, 1990) of \$60,000 per year for an EDS operator, \$35,000 per year for an EDS assistant, \$40,000 per year for a security agent, and \$45,000 per year for a baggage handler.

**Table 6-7**  
**Operator Requirements per Shift**

Number of TNA Machines	Staff per Shift	Person-shifts per Week	Annual Personnel Cost (\$000)
1	4	56	448
2	4	56	448
3	5	63	504
4	7	77	616
5	8	84	672
6	9	91	728
7	11	105	840
8	13	119	952
9	14	126	1,008
10	15	133	1,064
11	17	147	1,176
12	18	154	1,232

**Figure 6-4**  
**TNA Processing Rate Required**  
**Typical Runs**

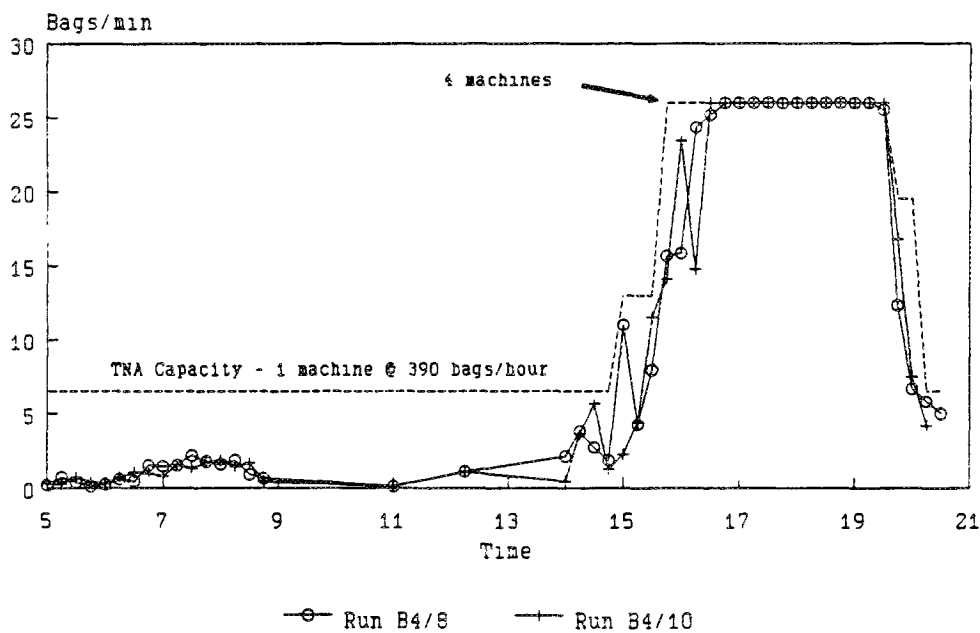

The NRC estimated that hand searching baggage would take an average of 2 minutes per bag and each hand search station would require 20 sq. feet. This does not appear to allow for any queueing of baggage waiting to be searched or space for passengers to be present. While the exact area will depend on the configuration of the facility, 50 sq. feet per station appears a more reasonable value.

The number of stations required per TNA machine will depend on both the throughput rate and the percent of bags that need to be searched. The number of TNA machines that can be served by a single station for the three processing scenarios is shown in Table 6-8. It can be seen that most installations would only require one search position.

However, the number of peak shift agents required would depend on the arrangements for notifying passengers whose bags must be searched, and escorting them to the search station if necessary. Consideration must also be given to coverage for breaks or rotation of duties to maintain alertness. It was therefore assumed that three agents would be required for the peak shift and two for the off-peak shift.

If the number of bags to be searched is significantly less than 30 bags/hour (the rate to keep one agent fully occupied), say 15 bags/hour or less, staffing levels could be reduced to two agents per shift. Assuming each agent works five shifts per week, and the off-peak shift only requires two agents, the annual personnel cost for hand searching baggage is shown in Table 6-9, based on an annual cost of \$40,000 per agent.

## TOTAL TNA COST IMPACT

Combining the foregoing estimates of the number of TNA machines required for 1989 traffic levels with the costs for facilities and personnel gave the estimates of total TNA installation and operating costs shown in Table 6-10. These estimates are based on the FAA projections for TNA/Xenix equipment, acquisition, installation, and maintenance, given in the regulatory impact assessment (FAA, 1989b,c), using 1990 cost levels. The total TNA installation costs lie in the range \$16 million to \$42 million, while the annual operating costs range between \$4.6 million and \$7.4 million.

It can be seen that the annual operating costs are a significant part of the total costs, and average out to between \$1 and \$2 per enplaned international passenger.

The projected total TNA installation and operating costs at 1995 traffic levels are shown in Table 6-11. These costs are based on the same unit costs for TNA/Xenix acquisition and maintenance as Table 6-10. While the FAA projected that these costs would drop after 1992, due to volume production and competitive procurement, their estimates of the amount of the reduction may be optimistic, and many of the units will need to be installed before 1992.

While the low end of the projected cost range at 1995 traffic levels is not significantly higher than for 1989 levels, the upper end of the installation cost-range is more than twice as high as at 1989 traffic levels, while that for the annual operating costs

**Table 6-8  
Hand Search Personnel Requirements**

Processing Scenario (bags/hour)	Hand Search Rate Per Machine (bags/hour)	Hand Search Capacity (machines/station)
220	0.22	136
390	1.17	25
600	3.00	10

**Table 6-9  
Annual Cost for Hand Search of Baggage**

Peak Shift Search Rate (bags/hour)	Peak Shift Agents	Agent-Shifts per Week	Annual Personnel Cost (\$)
15 or less	2	28	224,000
15-30	3	35	280,000
30-60	4	42	336,000
60-90	5	49	392,000

**Table 6-10**  
**TNA Installation and Operating Costs**  
**1989 Traffic Levels**

<u>Airline</u>	----- Processing Scenario -----					
	220 bags/hour		390 bags/hour		600 bags/hour	
	<u>low</u> <u>service</u>	<u>high</u> <u>service</u>	<u>low</u> <u>service</u>	<u>high</u> <u>service</u>	<u>low</u> <u>service</u>	<u>high</u> <u>service</u>
	ONE-TIME COSTS (in millions)					
American	5.4	6.8	2.8	4.1	2.8	2.8
Northwest	1.5	2.8	1.5	1.5	1.5	1.5
Pan Am	12.5	15.2	7.2	8.6	4.6	5.9
TWA	10.9	14.8	6.9	8.2	4.3	5.6
United	1.5	1.5	1.5	1.5	1.5	1.5
Other	1.3	1.3	1.3	1.3	1.3	1.3
Total	33.1	42.3	21.2	25.2	15.9	18.6
	ANNUAL COSTS (in thousands)					
American	1,070	1,210	790	930	790	790
Northwest	650	790	650	650	650	650
Pan Am	1,770	2,050	1,210	1,350	930	1,070
TWA	1,630	2,050	1,210	1,350	930	930
United	650	650	650	650	650	650
Other	655	655	655	655	655	655
Total	6,425	7,405	5,165	5,585	4,605	4,885



**Table 6-11**  
**TNA Installation and Operating Costs**  
**1995 Traffic Levels**

<b>HIGH SERVICE SCENARIO</b>			
<u>Airline</u>	Processing Scenario		
	<u>220 bags/hour</u>	<u>390 bags/hour</u>	<u>600 bags/hour</u>
ONE-TIME COSTS (in millions)			
American	9.4 - 13.4	5.4 - 8.1	4.1 - 5.4
Northwest	2.8 - 2.8	1.5 - 2.8	2.8
Pan Am	17.8 - 24.4	11.2 - 13.8	7.2 - 9.9
TWA	14.8 - 20.1	8.2 - 10.9	5.6 - 8.2
United	5.4 - 9.4	4.1 - 5.4	2.8 - 4.1
Other	1.3 - 2.6	1.3	1.3
<b>Total</b>	<b>59.2 - 86.8</b>	<b>34.1 - 49.9</b>	<b>22.2 - 32.8</b>
ANNUAL COSTS (in thousands)			
American	1,490 - 1,910	1,070 - 1,350	930 - 1,070
Northwest	790 - 790	650 - 790	650
Pan Am	2,330 - 3,030	1,630 - 1,910	1,266 - 1,546
TWA	2,050 - 2,610	1,350 - 1,630	1,070 - 1,406
United	1,070 - 1,490	930 - 1,070	790 - 930
Other	650 - 790	650	650
<b>Total</b>	<b>9,220 - 12,160</b>	<b>6,560 - 8,240</b>	<b>5,356 - 6,532</b>
<b>LOW SERVICE SCENARIO</b>			
<u>Airline</u>	Processing Scenario		
	<u>220 bags/hour</u>	<u>390 bags/hour</u>	<u>600 bags/hour</u>
ONE-TIME COSTS (in millions)			
American	6.8 - 10.7	4.1 - 6.8	2.8 - 4.1
Northwest	1.5 - 2.8	1.5	1.5
Pan Am	13.8 - 19.1	8.6 - 11.2	5.9 - 7.2
TWA	10.9 - 14.8	6.9 - 8.2	4.3 - 5.6
United	4.1 - 6.8	2.8 - 4.1	2.8
Other	1.3	1.3	1.3
<b>Total</b>	<b>44.6 - 65.8</b>	<b>26.2 - 38.0</b>	<b>16.9 - 24.8</b>
ANNUAL COSTS (in thousands)			
American	1,210 - 1,630	930 - 1,210	790 - 930
Northwest	650 - 790	650	650
Pan Am	1,910 - 2,470	1,350 - 1,630	1,070 - 1,266
TWA	1,630 - 2,050	1,210 - 1,350	930 - 1,070
United	930 - 1,210	790 - 930	790
Other	650	650	650
<b>Total</b>	<b>7,680 - 9,920</b>	<b>5,720 - 6,980</b>	<b>4,740 - 5,636</b>

is over 50% higher. The upper range of the TNA installation costs would be reduced, if the unit costs of the TNA equipment drop, as predicted by the FAA.

## OPERATIONAL IMPACTS

The principal operational impact of TNA screening is likely to be the increase in time required to transfer bags between inbound domestic and departing international flights in order to screen connecting baggage. This could be handled by leaving schedules unchanged and incurring late departures, or by rescheduling either departures or arrivals.

Changing departure schedules will require not only rescheduling arrival times at the destination, but also the return (or onward) departure from the destination airport. Slot restrictions at many European airports may make this very difficult to achieve.

Changing arrival flight schedules at Kennedy also poses slot availability questions. Perhaps equally important, it would affect the scheduling of the airline's entire U.S. network. In the case of the two largest international carriers, Pan Am and TWA, where the domestic routes are primarily spokes to the Kennedy hub, this may be acceptable. However, in the case of airlines such as American and United, which have large and tightly scheduled domestic networks, this could present significant difficulties.

Since the departure times of the domestic flights from Kennedy in the connection bank are constrained by the time required for arriving international passengers to clear immigration and customs, scheduling earlier domestic arrivals is likely to increase the layover time of the aircraft at Kennedy, reducing aircraft utilization.

If schedules are left unchanged, some bags will miss their connection (or departing flights will be delayed) due to late arriving flights even in the absence of TNA machines. The delays that would be required to ensure that no more bags miss their flight than would in the absence of TNA screening is obviously dependent on the number of TNA machines available. Based on the simulation analysis, the relationship between the percentage of late bags and average delay per aircraft is indicated in Figure 5-10. Using the block hour operating cost for the aircraft types in question, excluding fuel costs, the projected daily peak month cost of each minute of average daily delay is shown in Table 6-12 as a function of the reduction in number of late bags. While this may overestimate the maintenance component of a gate delay, it ignores the impact of reduced aircraft utilization on the investment cost, and of course the cost of the delay to the passengers themselves. Although estimates of these costs could be included, they are likely to be questionable, since it is not clear how small changes in departure delays would influence aircraft utilization, given time of day constraints on flight scheduling, nor how passengers might value small amounts of their time in the context of a long flight.

With the current passenger check-in profile, the percentage of late bags given by the simulation runs described in the previous chapter ranged from around 7.5% under the low service level scenario to around 3.5% under the high service scenario. To reduce the percentage of late bags to 3.5% under the low service level scenario would involve an average delay of about 8 minutes per departure, or a delay cost of around \$450,000 for

**Table 6-12**  
**Peak Month Departure Delay Costs**  
 1989 Traffic levels

<u>Airline</u>	<u>Weekly Departures</u>	<u>Average Delay Cost<sup>a</sup></u> (\$/hour)	<u>Daily Cost per Minute Average Delay</u> (\$)
American	35	1,575	131
Northwest	12 <sup>b</sup>	2,740	78
Pan Am	175	2,337	974
TWA	116	2,187	604
United	7 <sup>c</sup>	1,445	24
<b>Total</b>	<b>345</b>		<b>1,811</b>

NOTES: a) Block hour operating cost excluding fuel (1988 \$)  
 b) 3 departures via Seattle (change of equipment)  
 c) Via Seattle (change of equipment)

the peak month.

Extrapolation to an annual delay cost is complicated by the nonlinearity of the relationship between traffic volume and delay, and would have required more simulation runs than could be performed within the scope of the current analysis. However, if it is assumed that the annual cost is likely to lie between three and six times the peak month cost, this gives a range of \$1.5 million to \$3 million. Comparing these figures with difference in cost between the high and low service scenario suggests that the costs of the higher service level appear to be justified by the reduction in delay costs.

Further reduction in the number of bags missing their flights could be achieved by longer flight delays, but these bags would miss their flight departure times even without TNA screening, due to late arrival of connecting flights or passengers attempting to check in at the last minute.

Delays waiting for connecting baggage to be screened could be avoided entirely if connecting bags were screened at the originating station. Such bags could be appropriately marked, and could then be transferred between flights at Kennedy in the normal way. Based on the traffic pattern of Pan Am and TWA, about 70% of the connecting bags originate at airports that are themselves international gateways, and would thus eventually have TNA screening capability.

However, the cost of screening a few bags at the originating station may be quite high, if the departure occurs at a time when the TNA machine would not otherwise be in use and an additional shift of operators is required.

## SERVICE QUALITY

The operational changes that would be required to accommodate the TNA screening would have an adverse effect on the service quality offered by U.S. carriers. The extent of these impacts would obviously depend on the nature of the changes that the airlines decide to implement. There is also the potential problem that the TNA machines at the originating station may be under the control of another carrier.

The simulation analysis with the early check-in profile has suggested that requiring all passengers to check in at least one hour before flight departure could significantly reduce the number of TNA machines required to achieve a given level of delay. While passengers are technically required to check in for international flights two hours before departure already, in practice very few do.

Enforcement of earlier flight close-out would result in more passengers being denied boarding (or at least in having their bags travel on a later flight, if this becomes permitted for TNA screened bags). This may be of particular concern, since many of the last-minute passengers are likely to be the full-fare, business traveller. If foreign flag carriers are known to accept last minute passengers, while U.S. carriers do not, this may act as a serious competitive disadvantage, that not only diverts traffic to foreign flag airlines, but the higher yielding traffic at that.

Increasing the connection times between domestic arrivals and international departures will obviously increase the total travel time for connecting passengers, as well as increase the passenger load in the terminals. The higher levels of crowding will adversely affect the comfort of all passengers using the terminals.

Increased connection times may also create opportunities for domestic carriers without international routes from Kennedy to enter into arrangements to provide feed to foreign flag airlines. These flights could appear on reservation screens as leaving later and arriving earlier than a competing service entirely on a U.S. carrier, and may divert significant amounts of the international traffic to the foreign carrier or force the U.S. carrier to lower fares to retain market share.

Finally, the deployment of TNA screening would require some percentage of passengers to have their bags hand searched. The inconvenience of this will depend on the location of the TNA machines, with a lobby installation presenting the least impact. However, being paged and then escorted to a search area in the operations area of the terminal will be an unpleasant experience for many passengers.

There will also be the problem of passengers who do not hear the page and who appear at the gate a few minutes before flight departure, creating anxiety about whether they (or their bags) will make the flight. On the other hand, if the TNA screening reduces the amount of hand searching compared to existing procedures, this may be seen as an improvement in service quality.

## SUMMARY

- Based upon 1989 traffic levels, TNA screening at Kennedy Airport would require between 11 and 13 machines at a baggage throughput rate of 600 bags per hour per machine; between 15 and 18 at a rate of 390; and between 24 and 31 at the currently achieved rate of 220 bags per hour.
- At anticipated 1995 traffic levels, TNA equipment requirements would increase to between 12 and 24, between 19 and 37, and between 33 and 65, respectively, at the corresponding throughput rates.
- Contrary to the FAA space estimate of 750 sq. ft. per TNA unit, assessments of proposed TNA installations indicate that more reasonable estimates would be 1,800 sq. ft. for bag room or similar installations and 1,500 sq. ft. for lobby installations where baggage handling equipment would not be required.
- Terminal space costs for construction, maintenance, and operations will be highly site specific, with lobby space being more expensive than operational space.
  - ▶ Construction costs are estimated at \$100 per sq. ft. for unfinished operation space and \$250 per sq. ft. for finished lobby space.

- ▶ Annual maintenance and operating costs are estimated at \$10 per sq. ft. for operational space and \$15 per sq. ft. for public areas.
  - ▶ One-time costs for TNA installation at Kennedy Airport, including terminal reconstruction and baggage system modification, are estimated to lie between \$16 and \$24 million at 1989 traffic levels, depending on the TNA processing rate and the amount of operational disruption that the airlines are willing to tolerate.
  - ▶ These costs are projected to increase to between \$17 and \$87 million at 1995 traffic levels.
- Principal personnel requirements would be the TNA operators and security agents to conduct hand searches.
    - ▶ Operator costs are estimated at \$40,000 per operator, per year, including training costs.
    - ▶ Annual staffing and other operating costs at Kennedy Airport are estimated to lie between \$4.6 and \$7.4 million at 1989 traffic levels.
    - ▶ These costs are projected to increase to between \$4.7 and \$12.2 million per year at 1995 traffic levels.
- The principal operational impact would likely be the increase in time required to transfer connecting bags between inbound domestic and departing international flights in order to conduct TNA screening.
    - ▶ Schedule changes would be required to avoid bags missing connecting flights or delay of departing flights
    - ▶ These schedule changes would be constrained by slot restrictions at European airports and the highly interconnected nature of the domestic feed network.
    - ▶ With no schedule changes, peak month departure delays to wait for late bags could cost as much as \$450,000, depending on the TNA processing capacity provided.
- Delays to connecting baggage caused by TNA screening could be avoided if these bags were screened at originating stations.
    - ▶ Bags originating at U.S. gateways comprise about 70% of connecting bags at Kennedy Airport, based on the traffic pattern of Pan Am and TWA.
    - ▶ However, the costs of screening a few bags at originating stations could be quite high, if departures occur at times when

TNA machines would not otherwise be in use.

- The operational impacts of TNA screening would also have adverse effects on the quality of service offered by U.S. carriers.
  - ▶ U.S. airlines may find it necessary to require earlier passenger check-in.
  - ▶ There would be an increase in denied boardings due to late arrival of passengers, which could particularly affect business travelers.
  - ▶ There could be an increase in total passenger travel time, due to rescheduling connecting flights.
  - ▶ Higher levels of terminal crowding would adversely affecting the comfort of passengers.
  - ▶ Passengers could experience significant inconvenience from hand search of bags generating unresolved alarms if TNA screening is conducted after the bag is checked in.
- The operational and service impacts of TNA screening might divert passengers to foreign carriers, especially if they are known to accept last minute passengers, and place U.S. airlines at a competitive disadvantage.

## 7. ALTERNATIVE SCREENING STRATEGIES

In view of the significant scale of the costs and other impacts that would arise from subjecting all international checked baggage to EDS screening, the possibility of a more selective approach to the use of EDS technology deserves consideration. Instead of screening all bags, the number of EDS machines and the operational impacts could obviously be reduced by only screening a percentage of the bags. Existing profiling procedures could be maintained to select passengers for EDS screening. This could be supplemented by a small random percentage, as presently used at some airports for hand searching bags, if this was thought to act as a deterrent.

The percentage of bags on a given flight to be screened could be varied to reflect the assessment of different threats, and could of course be 100% for flights deemed to pose a significant risk.

The objective of selecting the percentage of bags to be screened on a given flight should be to balance the costs and impacts incurred against an assessment of the risks posed by not screening all bags. This assessment should take into account other security measures in effect, such as positive bag match or passenger profiles, as well as the origin and destination of the flight.

Since no EDS system can have a 100% probability of detection for any defined threat level, any given overall probability of detection can be achieved by increasing the probability of detection of a screened bag, while reducing the percentage of bags screened by a corresponding amount. This may have a number of advantages both from a deterrence perspective, as well as from an airline operational perspective.

For example, airlines might be permitted to waive screening requirements for a certain percentage of late bags on connecting flights at gateway hubs. Since a terrorist would have no way of knowing in advance which flights would be delayed, there would be no way to take advantage of this relaxation. However the advantages for airline operators could be significant.

In a variable percentage screening strategy, the percentage of bags selected for EDS screening could be based on such criteria as:

- a. Flight origin or destination;
- b. Passenger origin, destination or intermediate stops;
- c. Aircraft size.

In addition, the percentage could be temporarily increased (perhaps to 100%) in response to specific threats or intelligence about terrorist activities. Passengers are likely to be much more willing to tolerate disruption and delays due to screening requirements on an occasional basis if they can be explained as a temporary response to a specific situation.



## **IMPROVED EDS TECHNOLOGY**

Although not strictly an alternative screening strategy, there are a number of possible improvements to the current TNA technology that would significantly reduce the impact of EDS screening. It was not possible to determine the technical difficulty or likely cost of achieving these improvements within the scope of the current study. However, because of their potential to significantly reduce the magnitude of the inputs, they appear to deserve closer examination.

### **Low Volume Machines**

An extremely useful development would be an EDS machine designed for a much lower throughput rate than current TNA machines, but at significantly lower cost. Many low-volume stations do not need high throughput, and any EDS machine would have very low utilization. Such a machine could be used at domestic stations to screen originating baggage that will be transferred to an international flight downline.

It would also be very useful at gateway stations for supplementing the capacity of larger machines during peak times, without incurring the full cost of an additional high capacity machine. If it was not only slower and less expensive than current TNA technology, but also smaller and lighter, it would be even more useful.

While these requirements may be difficult to achieve with existing TNA technology, due to the inherent design of the machine and need for adequate shielding, it may be possible to meet them with an alternative technology, or even a modification of the TNA technology.

Reduction of the size of the TNA machine would greatly facilitate lobby installation. Ideally they would be small enough to incorporate into the check-in counter, even if this meant the counter positions might be larger than at present. Throughput in this situation would not be an issue, since the check-in process typically takes several minutes.

Such a machine might be sized for smaller bags than the current machines, provided at least one larger machine was available for oversize bags. This would also provide weight reduction, since the smaller chamber would require less shielding. Although it would be desirable for a counter installation machine to be significantly less expensive (since more will be required), this is less important than might at first appear, since the great majority of stations do not have the traffic volume to require the throughput of the current machines anyway. Thus the total number required would not increase inversely with the reduction in capacity.

### **Stored Image Processing**

The throughput rate of the current TNA machines during the second pass screening (or first pass if one-pass screening is used) is greatly reduced by the need to stop the belt if a bag generates an alarm, so that the combined TNA/x-ray image can be viewed by the operator. While this is being done, no more bags can be screened, even though most of them would not generate a further alarm.

If the image could be electronically stored in the event of an alarm, and recalled by the operator for subsequent viewing, the TNA machine could continue to process bags at its maximum rate in automatic mode. Bags generating alarms could be diverted to a secondary belt, while their images are successively screened by the operators.

If the average time for an operator to resolve an alarm (or decide to have a bag hand searched) is about 30 seconds, the number of operators required to keep up with a TNA machine running at  $r$  bags/hour and generating an alarm rate of  $a\%$  would be:

$$n = r \cdot a / 12,000$$

Thus an installation of up to four machines running at 540 bags/hour with an alarm rate of 5% would require only one operator. Even an alarm rate of 20% would only require one operator per machine.

## SUMMARY

- Selective or threat-oriented application of TNA screening of checked baggage would produce significant security benefits and reduce the severe operational, facility and economic problems associated with screening all international baggage.
- Various screening alternatives are available.
  - ▶ Random selection of passengers.
  - ▶ Variable percentages of passengers selected for screening based on aircraft size, flight origin or destination, or passenger itinerary.
  - ▶ Selection of passengers or flights based on a threat assessment or passenger profile.
  - ▶ Coordination with other screening techniques.
- Improved EDS technology could significantly reduce the impacts of screening checked baggage.
  - ▶ Machines designed to handle low volumes of bags at lower cost would greatly reduce the cost impact of screening bags at low volume stations.
  - ▶ Smaller machines would provide more options for lobby installation.
  - ▶ Stored image processing would allow much more efficient use of current TNA equipment.

## 8. CONCLUSIONS

The analysis of the Kennedy Airport case study and the results of the other field visits has shown that the installation of sufficient TNA machines to screen all checked baggage, while technically feasible, would require extensive changes to airline operations, such as baggage handling procedures, scheduling of connecting flights, and gate assignments, and would involve a major expenditure of resources, including acquisition and installation of machines, operating personnel, and baggage handling equipment and personnel. Furthermore, the FAA plan could involve a substantial reduction in the quality of airline service, such as less convenient connections, earlier passenger check-in, and an increase in bags missing flights.

The number of TNA machines required systemwide to screen all international checked baggage at all airports affected by the new rule was found, not unexpectedly, to be highly dependent on capacity of an individual machine, as well as the way in which the machines are deployed. However, it was also found that the number of bags per hour that a machine can process is by no means well understood, depending as it does on the settings of the machine as well as operating practices adopted to reduce the number of false alarms.

Based on data obtained from the operational use of a prototype TNA machine at Kennedy Airport, it appears that the operational throughput is considerably lower than previous FAA figures. The number of machines that would have been required systemwide to handle 1988 traffic levels was estimated to lie between 312 and 700, depending on the level of operational disruption that the airlines would be willing to accept and the extent to which their use is shared by different airlines. These requirements translate into a one-time acquisition cost between \$463 and \$1,016 million, and an annual recurring cost between \$92 and \$218 million.

These TNA requirements will obviously increase with future growth of international traffic, and the addition of new gateways and overseas stations.

While the estimated range of the number of TNA machines required agrees in broad terms with the estimate developed by the FAA in the regulatory impact assessment of the proposed rule, it should be noted that this is due in part to the effects of differing assumptions tending to offset each other. Under worst case assumptions, the number of machines required would be about 200 (or 40%) more than the FAA estimated. More detailed analysis of the sensitivity of the results to changes in the assumptions might reveal circumstances that would increase the number of machines required even further or exacerbate other impacts.

Even so, the number of machines required at larger airports will present a significant challenge to find suitable locations within the terminal. In many cases it appears that it will be necessary to construct special purpose facilities on the ramp area adjacent to the terminal, linked to the outbound baggage handling system. It was found that there is not enough room at many of the existing terminal facilities at the airports visited during the study to accommodate the anticipated number of TNA units required, without

relocating or substantially modifying facilities, such as gates, ticket counters, and baggage facilities.

The alternative to major terminal reconstruction would be significant changes to airline operations and passenger check-in requirements, such as:

- ▶ increased layover time for connecting passengers
- ▶ earlier check-in requirements for originating passengers
- ▶ increased flight departure delays.

These impacts would make flying internationally on a U.S. carrier less convenient, particularly for the high-fare, time-sensitive traveller -- which could put U.S. carriers at a significant competitive disadvantage.

The number of EDS machines required is highly dependent on a range of operational factors, including the throughput rate of the machine, the false alarm rate and the procedures for resolving alarms, the peaking of departures and the schedule of connecting flights, typical levels of air traffic delay, and the locations available to install the machines. While none of these factors are irrevocably fixed, changes may be costly or impact the perceived level of security. The analysis performed as part of this study suggest that there are significant trade-offs between the short-term EDS screening capacity and factors such as the proportion of bags that do not make a flight, or the amount of departure delay that can be incurred. Thus any assessment of the total requirements and impacts must be heavily conditioned on the operational assumptions used.

In view of the widespread distribution of the foregoing impacts, the implementation of more selective screening strategies would appear to be significantly more cost effective. Among the options available are varying the percentage of bags on a given flight that must be screened and selectively designating flights for screening. Improvements in EDS technology, such as smaller, less expensive machines or stored image processing, could significantly reduce costs and other impacts of screening checked baggage.

## ACKNOWLEDGEMENTS

This report documents research performed for and funded by the Air Transport Association of America (ATA). The study was conducted in cooperation with staff of the ATA, in particular Mr. Ronald Welding, Manager of Operations Standards, who organized and participated in the case study field trips, and provided many useful suggestions.

The study would not have been possible without the assistance of many individuals in the air transport industry, who gave unstinting amounts of time to conduct tours of their facilities, answer questions and provide detailed operational data. Valuable help was also provided by the staff of Science Applications International Corporation (SAIC), who made extensive data available on the operation of their thermal neutron analysis machines, and by staff of the various airports visited during the study. While it is not possible to mention everyone who assisted in some way in the study, particular appreciation is extended to the following:

Israel Bar-Nir	SAIC
Dennis Bidlnencik	Northwest Airlines, Chicago
Monika Borsy	American Airlines, New York
Frank Cattano	Pan Am
Richard Davis	United Air Lines, Chicago
Robert Diaz	Metro-Dade Aviation Department, Miami
Bruce Drum	Metro-Dade Aviation Department, Miami
Roland Garland	Pan Am, Miami
Maureen Garrity	Trans World Airlines, New York
Frank Gillespie	Pan Am
Al Graser	Port Authority of NY & NJ
Taty Konde	Pan Am, Miami
Nick Lancy	Pan Am, New York
Ray MacIntyre	Pan Am, Frankfurt
Lyle Malotky	Federal Aviation Administration
Gary Mohr	Trans World Airlines
Nick Morocco	United Air Lines, Chicago
Lucia Oswald	Trans World Airlines, Frankfurt
John Pagnotta	Pan Am, New York
Larry Philippon	Northwest Airlines, New York
Dominick Protomastro	SAIC
J.M. Rondabush	American Airlines, Chicago
Susan Rourke	Trans World Airlines
Patrick Shea	SAIC
Kieran Sheridan	Northwest Airlines, Miami
Michael Spencer	Trans World Airlines, Gatwick
Steve Stys	Pan Am
Edward Vallenti	United Air Lines
Robert Von Husen	Eastern Airlines, Miami
Tony Woodward	Pan Am

The authors wish to acknowledge the assistance of Professor Sadashiv Adiga, Anna Chen and John Cavalli of the Department of Industrial Engineering and Operations Research at the University of California at Berkeley, who helped structure and program the simulation model developed in the course of the study. The study also benefited from the efforts of Yonel Grant, John Liu and Joan Walker, who served as research assistants. Particular appreciation is extended to Ingo Bentrrott, who was largely responsible for the word processing and graphics contained in the report, and managed to remain continually cheerful while working long hours under difficult circumstances.

The contents of this report reflect the views of the authors, who are solely responsible for the facts and accuracy of the data presented herein.

## REFERENCES

- Gosling, Geoffrey D., An Economic Framework for the Planning of Airport Passenger Terminals, Ph.D. Dissertation, University of California, Berkeley, August 1979.
- Hart, Walter, The Airport Passenger Terminal, John Wiley & Sons, New York, 1989.
- President's Commission on Aviation Security and Terrorism, Report to the President, Washington, D.C., May 15, 1990.
- Robuste, Francesc, Analysis of Baggage Handling at Airports, Ph.D. Dissertation, University of California, Berkeley, 1988.
- Science Applications International Corporation, Detection of Explosives by Thermal Neutron Analysis (TNA), Santa Clara, California, undated.
- Science Applications International Corporation, Explosive Detection in Airports, Informational Brochure, Santa Clara, California, March 12, 1990.
- U.S. Federal Aviation Administration, Terminal Area Forecasts, Washington, D.C., April 1989.
- U.S. Federal Aviation Administration, Initial Regulatory Analysis, Initial Regulatory Flexibility Determination, and Trade Impact Assessment for NPRM - Explosives Detection Systems for Checked Baggage, Office of Aviation Policy and Plans, Washington, D.C., June 1989.
- U.S. Federal Aviation Administration, Final Regulatory Analysis, Final Regulatory Flexibility Determination, and Trade Impact Assessment for Final Rule - Explosives Detection Systems for Checked Baggage, Office of Aviation Policy and Plans, Washington, D.C., August 1989.
- U.S. Nuclear Regulatory Commission, Environmental Assessment for the Use of the Thermal Neutron Activation Explosive Detection System in Concourse Installations at U.S. Airports, Report NUREG-1396, Office of Nuclear Materials Safety and Safeguards, Washington, D.C., February 1990.