

UC Berkeley

Research Reports

Title

Platoon Collision Dynamics And Emergency Maneuvering III: Platoon Collision Models And Simulations

Permalink

<https://escholarship.org/uc/item/4kr4r8vm>

Authors

Tongue, Benson H.
Yang, Yean-tzong

Publication Date

1994

This paper has been mechanically scanned. Some errors may have been inadvertently introduced.

CALIFORNIA PATH PROGRAM
INSTITUTE OF TRANSPORTATION STUDIES
UNIVERSITY OF CALIFORNIA, BERKELEY

Platoon Collision Dynamics and Emergency Maneuvering III: Platoon Collision Models and Simulations

**Benson H. Tongue
Yean-Tzong Yang**

California PATH Research Paper

UCB-ITS-PRR-94-02

This work was performed as part of the California PATH Program of the University of California, in cooperation with the State of California Business, Transportation, and Housing Agency, Department of Transportation; and the United States Department Transportation, Federal Highway Administration.

The contents of this report reflect the views of the authors who are responsible for the facts and the accuracy of the data presented herein. The contents do not necessarily reflect the official views or policies of the State of California. This report does not constitute a standard, specification, or regulation.

February 1994

ISSN 1055-1425

Platoon Collision Dynamics and Emergency Maneuvering III:
Platoon Collision Models and Simulations

Benson H. Tongue
Yean-Tzong Yang

Department of Mechanical Engineering
University of California, Berkeley

February 1994

California PATH Research Report for MOU 22

Abstract

Platoon Collision Dynamics and Emergency Maneuvering III: Platoon Collision Models and Simulations

Benson H. Tongue and Yean-Tzong Yang

PATH Project

August 1992

A platoon collision model has been developed and used to examine the effect, under four different control algorithms, of non-nominal operating conditions. A new back-control concept has been introduced in an effort to mitigate collision severity and a bumper model has been included in the vehicle model so that accurate collision simulations could be made. Simulations were undertaken to investigate the effect of uncertainty in the system's response delay, the effect of the deceleration rate of the lead vehicle on the platoon's behavior, the influence of platoon size, and the importance of the control effort of the last car in the platoon. The occurrence of an internal collision and the collision wave generated by the control methods are also discussed. Based on the simulation results, it is concluded that the current platoon model can be successfully used for the analysis of the platoon collision dynamics. Future topics are discussed and are aimed at modifications to the control algorithm, development of a more tractable analytical model, and further investigations into platoon collision behavior.

Nomenclature

A	Maximum deceleration of the lead vehicle, m/s^2
a	Baseline maximum deceleration of the lead vehicle, $-1.5708 m/s^2$
Dt	Time duration for the deceleration operation of the lead vehicle, <i>sec</i>
maxp	Spacing control gain of the last vehicle
τ_c	Response delay using in formulating the control law, <i>sec</i>
τ_e	Response delay of the real system, <i>sec</i>

1 INTRODUCTION

The purpose of this report is to document the development of a platoon collision model which can be used to study platoon collision dynamics under emergency situations. Based on previous studies [1,2], the vehicle model within the platoon is implemented with two bumpers, which are developed to meet the realistic performance of a real bumper. Four control algorithms have been utilized to carry out the simulations.

In pursuit of an automated highway system, many researchers have centered their attention on the vehicle tracking problem [3-14], focusing either on longitudinal or lateral control. A basic assumption of these investigations has been that velocities vary slowly. This means that in general, only the nominal operations of the platoon have been studied. However, there is also a need to consider platoon dynamics in the face of non-nominal operations. These include both high rates of acceleration and/or deceleration in a platoon (often as a precursor to a collision), and also situations which substantially alter the nominal operational mode, such as entry and/or exit from a platoon (with the attendant changes in the aerodynamic forces). The purpose of this project is to examine the behavior of a nonlinear platoon during non-nominal operations, to examine the platoon's nonlinear responses, and to investigate ways to mitigate any adverse effects due to non-nominal behavior.

During the second year's work, a vehicle model, based on the first year's results [1], has been modified by implementing a bumper model. A concept of back control has been introduced and the controller based on this idea was compared to one having no knowledge of following vehicles' states. Two different cases were considered for each basic approach: inclusion or non-inclusion of lead vehicle information. Thus, a total of four platoons were examined. The effect of uncertainty in the system's response time, the effect of the platoon size, and the effect of the deceleration rate of the lead vehicle were investigated. The role of the last vehicle was considered for the back-control algorithms. The occurrence of a collision and the

propagation of the collision wave was also examined. It is shown that the present platoon models can be used successfully in studying internal platoon collision dynamics.

2 CURRENT WORK

2.1 Realistic Bumper Model [16, 17, 18]

Based on the 1980 requirements for bumpers in 8 km/hr (5 mph) barrier impacts, a realistic bumper model has been developed. The requirements limit the damage that may be sustained to be less than 9.5 mm ($3/8 in$) for dents and to be less than 19 mm ($3/4 in$) for permanent deformation. The characteristics of the bumper are shown in Figure 1. This bumper model considers both the bumper stiffness and the vehicular body stiffness. The value at point A in Figure 1 is the point at which body rigidity comes into play. The enclosed area indicates the total energy absorbed.

Figure 2 shows the variation of energy absorption capacity as a function of bumper stiffness for a fixed body stiffness. The closer the spring's stiffness is to the body stiffness, the higher the energy absorption. However, it is also true that, if the body stiffness is too close to the bumper stiffness, the impact will begin to strongly affect the passenger chamber, increasing the passenger discomfort level. Typically, a reasonable region for the bumper stiffness is one with bumper stiffness below 2 MPa .

2.2 Back Control Concept

A control concept that mimics to a degree the way in which drivers react to impending collisions has been developed and investigated. The basic idea is that some drivers look both ahead and behind and blend braking and throttle to keep their vehicle midway between the following and preceding cars when faced with an emergency situation. Based on this behav-

ior, a controller has been developed that weights the state of the following vehicle as well as the preceding one in emergency operations and ignores the state of the following vehicle when in nominal operation. One clear disadvantage to this approach is that it fully couples the system, producing a dynamical system that resembles a series of mass/spring elements. Although this potentially simplifies analytical analyses, it allows disturbances to propagate both forward and backward within the platoon. The advantage is that by positioning the vehicle midway between two others, one can presumably best avoid vehicle contacts.

To apply this concept, scheduled control gain surfaces have been implemented. Figure 3 illustrates the control gain surface as a function of the spacing errors. For emergency situations, a large control gain has been assigned. When a vehicle is exactly between two other vehicles, the back controller is inoperative. During nominal operations, the control gain only depends upon the forward spacing error. The same algorithm is also applied to the velocity and acceleration control gain surfaces. It should be noted that no attempt was made at this point to achieve optimality, beyond some basic gain modifications based on good judgement. Since developing an optimal formulation is quite time intensive, it was decided to first look at a reasonable design and decide if the basic approach had merit.

2.3 Platoon Models

Four platoon models have been simulated. Each platoon consisted of ten vehicles, excluding the lead car (whose dynamics are presumed to be known). The power systems were assumed to exhibit response delay and saturation for both throttle and braking systems. Bumper models were included in the front and the rear of the vehicles. Aerodynamical forces and rolling resistance were also included. No communication delay was assumed. Since controllers are integral to the platoon concept, a choice had to be made as to the specific controller to be utilized. It was decided to adopt Sheikholeslam and Desoer's controller [3,4] to serve as a basic for the simulations and provide a baseline comparison for the back controllers.

2.3.1 Platoon I: Desoer's Platoon without Lead Information

Figure 4 shows the SIMULAB block diagram of this platoon. The lead car has fully specified dynamics. The control algorithm of the following vehicles is described in Sheikholeslam and Desoer's paper [3]. Constant gains have been applied to the linear control law. Control efforts are computed from the differences between the car being controlled and the preceding vehicle.

2.3.2 Platoon II: Desoer's Platoon with Lead Information

All configurations are the same as those of Platoon I, except that lead vehicle information is available to all vehicles in the platoon. The control gains are the same as those in the Sheikholeslam and Desoer's report [4]. Platoon II is illustrated in Figure 5.

2.3.3 Platoon III: Back-Control Platoon without Lead Information

Figure 6 shows the configuration of Platoon III. As shown in the block diagram, state of the following vehicle are also included in calculating the control effort. Three control gain surfaces, one for the position error, one for the velocity error, and the other for the acceleration error, have been used to carry out the back-control concept.

2.3.4 Platoon IV: Back-Control Platoon with Lead Information

The only change from the Platoon III case is that lead information has now been included in the control law. No communication delay has been assumed for the data transmission. The SIMULAB block diagram for Platoon IV is shown in

Figure 7. Control gains for the state errors stay the same as those of Platoon III. The weighting gains on lead information are the same as Platoon II.

2.4 Simulations

Dynamics of the lead vehicle is assumed to be a half-sine-wave decelerating profile, which has amplitude a (the baseline value of a is -1.5708 m/s^2). Note that this represents a moderate braking rate and is chosen to see how the controllers compare under normal braking. It is assumed that the initial velocity for all vehicles is 26.8 m/s and the initial spacing is 1 meter .

2.4.1 Role of Response Delay

In Sheikhholeslam and Desoer's control algorithm [4], the engine response is assumed to be available for use by the controller ($\tau_c = \tau_e$). However, it is impossible to know the engine response delay exactly (τ_e) since some uncertainties always exist in the engine and transmission systems. Although some investigators [3, 4, 10] do ignore the response delay, it is expected that even relatively small uncertainties ($\tau_c - \tau_e$) in the power system can cause a noticeable change in the platoon dynamics.

Platoon I is chosen to demonstrate the effect of the response uncertainty on the platoon dynamics. Figure 8 illustrates the standard response of the Sheikhholeslam and Desoer's controller ($\tau_c = \tau_e$), which includes the response delay, $.2 \text{ sec}$, exactly. Figure 9 shows the dynamics of a platoon in which each vehicle has a $.25 \text{ sec}$ response delay (τ_e) and each controller expects the response delay (τ_c) to be $.2 \text{ sec}$. Figure 10 illustrates the dynamics of another platoon, one in which the vehicles have a $.5 \text{ sec}$ response delay (τ_e), but the controller expects the response delay to be $.2 \text{ sec}$ (τ_c).

It is obvious from these results that uncertainty in the response delay will degrade the platoon's behavior. The spacing error increases on both the positive and the negative side, with the negative side's deviations being the most pronounced. Saturation of the engine force occurs in these cases and causes the spacing error to grow. Due to the accumulation of the error effect, the rear vehicles in the platoon are affected more strongly than the front vehicles. Thus it is seen that an unmodelled error in the response delay can have a significant effect on the platoon dynamics and it is possible that such an uncertainty might cause the platoon to experience an internal collision, if the unmodelled error is significant enough.

2.4.2 Effect of the Platoon Size

A previously mentioned difficulty of the back controlled platoon is that it will be affected by the number of vehicles in a platoon since the control law takes into account the state errors of the following vehicle and thus allows a disturbance of the rear vehicles to propagate forward and affect the dynamics of the front vehicles. Since the control gains are computed by considering the state of both the preceding and the following vehicles, the dynamics of a specific vehicle will depend strongly on the platoon size. The disturbance wave will propagate forward if there exists an instant in which the rearward state errors are negative, which causes the back controller to consider the state of the following vehicle. This can be observed easily from the control gain surface, in which negative rear state errors cause the back controller to respond.

Simulations have been run with Platoons III and IV to illustrate the effects of the platoon size. A baseline deceleration rate with a 4-sec duration, Figure 11, has been used. The dynamics of Platoons I and II are used as references for

Platoons III and IV, respectively. Five platoon sizes, 10-car, 8-car, 6-car, 4-car, and 2-car platoons, are simulated.

Figure 12 shows the acceleration history of the first car in Platoon III. It can be seen that the maximum deceleration rates for these cases do not differ appreciably. However, the larger the platoon size is, the more time that is needed to achieve steady state. Moreover, the acceleration peaks occur later for a larger platoon. The greatest acceleration and deceleration of the first vehicle occurred for the 10-car platoon. Figure 13 illustrates the spacing error characteristics of Platoon III.

The rationale for examining a controller that doesn't include lead information is to simulate the case in which lead information is unavailable, either because of a failure of the lead vehicle's sensors or a failure in the communications link. Normally one would presume that such information is available and thus one would want to examine both cases - controllers with and without lead information. It can be shown that for the problem under consideration, lead information substantially improves the platoon's response.

It is expected that the effect of platoon size will be reduced when lead information is utilized. Figure 14 shows the acceleration of car 1 for different platoon sizes. The maximum deceleration values for all cases are close. The time to achieve steady state is less than for the previous cases (in which lead information was not considered) and maximum accelerations are also smaller. Figure 15 shows the spacing errors of car 1 for Platoon IV. It shows that the spacing errors of car 1 for Platoon IV are close to each other, and the peak values are less than those of Platoon III.

It is clear from the foregoing results that lead information plays an important role. Not only the magnitudes of the state errors but also the variations due to platoon size can be reduced by applying lead information.

2.4.3 Effect of Deceleration

Two deceleration profiles were used to demonstrate the effect of deceleration on the platoon responses. The same peak deceleration value for the lead vehicle was used while the duration of the deceleration was varied (one case lasting 1 sec and the other for 7 sec). All four controllers were used in the simulations and all involved a ten car platoon. The results are illustrated in Figures 16 to 23. Both acceleration and spacing error plots are shown. Figures 16 and 17 show the responses of Platoon I, Figures 18 and 19 involve Platoon II, Figures 20 and 21 involve Platoon III, and Figures 22 and 23 involve Platoon IV.

As expected, the more abrupt acceleration profile ($Dt = 1$ sec) is more difficult for the controllers to handle, leading to larger differences in peak acceleration levels between the first and last car when compared to those associated with a more gradual excitation profile ($Dt = 7$ sec). Also, the more abrupt input induces a larger time delay between the time that the first and last vehicle achieve their maximum deceleration and acceleration values. The same qualitative observation holds for the spacing errors (Figure 17). Although the peak deceleration level is greater for $Dt = 1$ sec than for $Dt = 7$ sec, the opposite condition holds in the case of the spacing errors ($Dt = 7$ sec causes a larger error than $Dt = 1$ sec).

The same sort of situation holds when lead information is added (Figures 18 and 19). Additionally, one can see that in this case the spacing errors show some interesting characteristics. Note that for either $Dt = 1$ second or 7 seconds, the

peak deceleration and acceleration for each vehicle have almost identical absolute values, unlike the cases when lead information is absent. Also, the magnitudes decrease monotonically along the platoon, quite a different characteristic than that exhibited by a controller without lead information (Figure 17). A more gentle input ($Dt = 7$) serves both to more evenly distribute the peak accelerative loads among the individual vehicles as well as to reduce the overall spacing error.

Figures 20 and 21 illustrate the acceleration and the spacing error dynamics of Platoon III for different deceleration durations. As can be seen, the back controller has caused the response profiles to become more irregular. For the case of $Dt = 1 \text{ sec}$, the first vehicle experiences the maximum deceleration level and the seventh vehicle has the smallest magnitude of the maximum deceleration. However, for the case of $Dt = 7 \text{ sec}$ the maximum deceleration value occurs for the last vehicle while the first vehicle has the smallest value of maximum deceleration. Nevertheless, the first vehicle is the most dangerous one in the platoon, (largest spacing error), as can be seen from Figure 21. The reason that the responses have become more complex is due to the control gain surface used by the back controller. By altering the time duration of the accelerations, one effectively alters the controller gains. This is conceptually similar to the case of wave disturbances in a continuous medium, in which the excitation rate causes a system property (such as the mass or stiffness) to change. Clearly, this will directly affect the wave propagation speed within the medium. Thus, depending upon the disturbance rate, the propagation of information within the platoon will be either retarded or increased in speed. Unlike the results for Platoon III (Figure 20), the vehicles with milder inputs ($Dt = 7 \text{ sec}$) have smaller values of maximum deceleration than those seeing more abrupt inputs ($Dt = 1 \text{ sec}$) (Figure 22).

As in the previous cases of Platoons I and II, the acceleration profile for Platoon IV will become more compact when lead information is included in the control law. As can be seen from Figure 23, the case of $Dt = 1$ second causes an increase in the spacing irregularity as compared with that of $Dt = 7$ seconds. This contrasts with the results for Platoon III, in which the largest spacing deviations were associated with the longer time duration acceleration input. However, it should be noted that this is only due to the behavior of car 1; all other vehicles followed the same trends seen in Figure 21. In addition, Figure 23 shows the spacing error profile of Platoon IV under different deceleration rates. Generally speaking, the maximum and minimum spacing errors decrease monotonically along the platoon. The inclusion of lead information markedly decreases the spacing error for all vehicles, which can be easily observed by comparing Figure 23 with Figure 21.

2.4.4 Role of the Last Vehicle in Back-control Platoon

As stated in Section 2.2, the back-control algorithm tries to keep the controlled vehicle midway between the preceding and the following vehicles. Although this would be advantageous if a collision was imminent, it also allows a disturbance wave to propagate back and forth since the controller considers the states of both the preceding and the following vehicles. This will induce internal oscillations which clearly will complicate the dynamics of the platoon. It is relatively obvious that the last vehicle, which considers only the state of the preceding vehicle, plays an important role with regard to absorbing or reflect the error wave. It essentially acts like the terminal constraint in an acoustic duct, with the capability of reflecting much, or little, disturbance back into the platoon. Thus, it seems reasonable that the performance of the platoon can be improved by adjusting the

control gains of the last vehicle. One might expect the optimum performance to involve several of the trailing vehicles, with the gain increasing as the end of the platoon is neared.

A baseline maximum deceleration with a 4-sec duration has been applied to Platoon III (consisting of 6 vehicles, excluding the lead car). Four trials are shown, in which the control gain of the spacing error for the last vehicle was changed. Case 1 used the nominal control gains used previously. Cases 2, 3, and 4 used spacing error gains equal to 3.0, 4.5, and 6.0 times the nominal value, respectively.

Figures 24 and 25 show a comparison between cases 1 and 2 for the acceleration and spacing errors. It is clear that the spacing error between adjacent vehicles has been reduced by at least 20 percent, although the acceleration profile does not change appreciably. Figures 26 and 27 compares cases 1 and 4. It is noted that the acceleration profile of case 4 is a bit more compact than that of case 1, and the spacing error between adjacent vehicles is reduced by 30 percent for the first vehicle and 80 percent for the last vehicle.

It seems that increasing the control gains will reduce the spacing error. However, there is a trade-off associated with such an operation. Figure 28 shows the absolute value of the maximum jerk for all vehicles within the platoon for these four cases. It is obvious that the maximum jerk, which is directly related to passenger comfort, has been increased for the first car and has been decreased for the rest by increasing the spacing error gains of the last vehicle. It also seems that there does not exist a spacing error gain that reduces the maximum jerk levels for all vehicles within the platoon.

2.4.5 Occurrence of a Collision

The occurrence of a collision depends upon the magnitude of the disturbance and the type of controller. Platoon I is used to illustrate the evolution of a collision. Platoons II, III, and IV are used to demonstrate the influence of the control algorithm on the collision dynamics. The function of the bumper and saturation of the engine force will easily be seen in these simulations. In these simulations, it is assumed that the bumper will return to its nominal shape after the collision is over. The time duration for the deceleration of the lead car is presumed to be 1 second. The nominal spacing between adjacent vehicles is 1 meter.

Figure 29 through Figure 36 are the simulation results for Platoon I. As observed from Figure 29, it can be seen that the first vehicle is close to a collision. (the spacing error is equal to -1 meter). Saturation of the engine force and the braking force occur when the acceleration profile flattens out (Figure 30). It is noted that the peak acceleration and deceleration grow monotonically along the platoon from the second vehicle onwards.

As the maximum deceleration of the lead vehicle is increased from 5.60 times to 5.74 times the baseline maximum deceleration value (i.e. $-1.5798m/s^2$), the first vehicle hits the lead one (a minor collision), which is shown in Figures 31 and 32. As the maximum deceleration of the lead increased to 5.80 times the lead one (Figures 33 and 34), the second vehicle deviates from its previously smooth trajectory (point C in Figure 33). This deviation will increase in magnitude as the magnitude of the deceleration is increased, causing vehicle two to be the next vehicle to experience a collision. This is interesting in that, prior to the first vehicle's impact, vehicle two had the smallest state deviation in the platoon while the last vehicle exhibited the largest. Thus one might have expected the last

vehicle to be the most likely to experience a collision. In addition, comparing Figure 32 with Figure 34, it is seen that the acceleration history of the first car has a sharp change (point B in Figure 34) during the collision. This indicates that for the case in Figure 32, a minor collision occurs, which involves only the bumper spring. However, in the case of Figure 34, the first car experiences a major collision, in which the bumper has been fully compressed and the vehicle's body stiffness comes into action.

Figures 35 and 36 illustrate the response of the platoon with a maximum deceleration of 6.10 times the baseline value. It can be observed that two collisions occur. The first vehicle hits the lead first, and, after 0.18 seconds, the second car hits the first one. During the second collision, it is easy to see the interaction between the bumpers from Figure 36, in which the second car is under a negative acceleration and the first car is under a positive acceleration at the same time.

Figures 37 and 38 show the dynamics of Platoon II under a maximum lead deceleration of 6.10 times the baseline one. Under such a lead car motion, Platoon I would experience two internal collisions. However, due to the inclusion of lead information to each vehicle within the platoon, Platoon II only experiences a single collision, (which occurs to the first vehicle). As for Platoon I, the second vehicle will be the next vehicle to experience a collision if the deceleration rate is increased. As discussed in the previous section, Platoon II will exhibit a compact acceleration profile prior to collision. After the collision, the individual vehicle's acceleration profiles become much more widely distributed (seen by comparing Figure 38 and Figure 18).

Figures 39 and 40 illustrate the response of Platoon III under a maximum lead deceleration of 5.60 times of the baseline one. All the minimum values of spacing

error history of individual vehicles are approaching -1 meter, implying that a series of collisions is likely for increased deceleration levels. Figures 41 and 42 show the dynamics of Platoon III under a maximum lead deceleration of 5.74 times of the baseline one. A large number of internal collisions can be observed from Figure 42. It is noted that all vehicles in the platoon are involved in such a group collision. The collisions are initiated by the first car, then the collision wave propagates backwards and causes a series of collisions of the following vehicles. All these collisions occur within 4 seconds. The last internal collision occurs between the third and the fourth vehicles.

Figure 43 through Figure 46 show the dynamic response of Platoon IV under a maximum lead deceleration of 5.74 and 6.10 times of the baseline one. As observed from Figure 43, two internal collisions exist in this case. First, the second vehicle hits the first one, and then the third vehicle hits the second one at a later time. The second collision is a minor one, as seen by inspecting Figure 44. It is interesting to note that, except for the first vehicle, the Platoon IV won't drive the vehicles to the positive spacing error side too much. It keeps the platoon more compact than the other platoon models, even though it does allow an internal collision. As the deceleration rate increased from 5.74 times nominal to 6.10 times nominal, the dynamics become far more complex. As seen in Figures 45 and 46, a series of collisions occurs within the platoon. Initially, the first car hits the lead. Then, the collision wave propagates backward, accumulates energy, and increases the magnitude of the collisions for the following vehicles, except for the last one. However, unlike the previous case, the collision wave does not propagate back. It is noticed that introducing lead information into the control

law makes the platoon operation more stable than that without the lead information. The feedforward property diminishes not only the possibility of internal collisions, but also the propagation of the collision wave.

Based on the above discussions, it seems that the responses of the back controlled platoon are always worse than those of the platoon which looks forward only. One reason for this is that Platoons I and II have used close to optimal control gains [3,4] while optimal gains for Platoons III and IV were not implemented, the initial interest simply being to see how a back controller might affect platoon operations. Furthermore, in all the present simulations, the disturbances resulted from the lead vehicle's motions. It is expected that Platoons I and II will react well to an emergency situation which occurs in the lead vehicle. However, the control algorithm which only considers the state of the preceding vehicle cannot react to a disturbance from a following vehicle. Even if the following vehicles are overtaking the preceding ones, the front vehicles of the platoon still assume a nominal operation, something the back controller will not do. Additional development aimed at producing optimal gains that damp out internal waves in the back controlled platoons and simulations involving disturbances other than ones from the lead car are necessary before one can state that one controller is clearly superior.

3 FUTURE WORK

3.1 Development of Nonlinear Analytical Approaches

In this aspect of the work, attention will be directed towards quantifying the degree of disturbance propagation within the platoon. The platoon will be modeled as a string of discrete, lumped, nonlinear dynamical systems. Based on the simulation results of the first

two years' work, the specifications of this analytical model will be decided which can then be used to examine the effect of parametric variations on the platoon's behavior.

3.2 Behavior of Platoon During Vehicle Exit/Entry

Entering and exiting a platoon cause the individual vehicle to be subjected to a large variation in forces. Outside of a platoon, an individual vehicle faces the full force of the surrounding air and consequently requires a large throttle angle (in order to maintain speed). Once in the platoon, the drafting effect will greatly reduce the drag on the vehicle, allowing much smaller throttle positions. Clearly, as the vehicle transitions from independent vehicle status into platoon member, the force on the vehicle will vary a great deal. It will be difficult for the controller to determine these forces with any accuracy and so it will have to treat the drag as a largely unknown external force. The degree to which the changing forces affect the platoon will obviously depend upon the speed at which the entry/exit takes place from the platoon. Part of the work in the third year will be to examine the effect of entry/exit and determine what the limiting speed is for which these maneuvers can be done safely.

3.3 Inclusion of a Gear Shifting Model

The present vehicle model assumes that the engine and braking forces change continuously and smoothly. However, gear shifting will cause some engine force irregularity. As a result, the vehicle will endure a sudden acceleration change, an additional disturbance to the platoon operation. The current model will be extended to encompass this effect.

4 CONCLUSIONS

It has been shown that the current simplified dynamical platoon model can be used successfully in the analysis of platoon collision dynamics. Based on the simulation results, it

is noted that the vehicle behavior within a platoon depends strongly upon the control algorithm. Moreover, some unmodelled uncertainties, for example, the response delay, will generate an unpredictable deviation from the nominal results. The platoon size, the deceleration rate of the lead vehicle, the unmodelled parameters, and the control algorithm are all factors that affect the safety of platoon operations. The occurrence of a collision and the propagation of the internal collision wave depends upon the control law as well. Qualitative results have been discussed on the topics above. Collision simulations will be continued and more quantitative analysis will be presented in the following year.

References

- [1] Tongue, B. H., Yang, Y. T., and White, M. T., "*Platoon Collision Dynamics and Emergency Maneuvering I: Reduced Order Modeling of a Platoon for Dynamical Analysis,*" PATH Research Report UCB-ITS-PRR-91-15, August 1991.
- [2] Tongue, B. H. and Yang, Y. T., "*Platoon Collision Dynamics and Emergency Maneuvering II: Platoon Simulations for Small Disturbances,*" PATH Research Report, November 1991.
- [3] Sheikholeslam, S. and Desoer, C. A., "*Longitudinal Control of a Platoon of Vehicles with no Communication of Lead Vehicle Information,*" Proceedings of the American Control Conference, Vol. 3, 1991, pp. 3102-3106.
- [4] Sheikholeslam, S. and Desoer, C. A., "*Longitudinal Control of a Platoon of Vehicles III: Nonlinear Model,*" PATH Research Report UCB-ITS-PRR-90-1, April 1990.

- [5] Tan, Han-Shue and Chin, Yuen-Kwok, "*Vehicle Traction Control: Variable-Structure Control Approach,*" Transactions of the ASME, Journal of Dynamic Systems, Measurement, and Control, Vol. 113, June 1991, pp. 223-230.
- [6] Chang, K. S., Li, W., Shaikhhahai, A., Assaderaghi, F., and Varaiya, P., "*A Ppreliminary Implementation For Vehicle Platoon Control System,*" Proceedings of the 1991 American Control Conference at Boston, pp. 3078-3083.
- [7] Hessburg, T., Peng, H., Tomizuka, M., Zhang, W. B., and Kamei, E., "*An Experimental Study on Lateral Control of a Vehicle,*" Proceedings of the 1991 American Control Conference at Boston, pp. 3084-3089.
- [8] Peng, H. and Tomizuka, M., "*Preview Control for Vehicle Lateral Guidance in Highway Automation,*" Proceedings of the 1991 American Control Conference at Boston, pp. 3090-3095.
- [9] Kehtarnavas, N. and Sohn, W., "*Steering Control of Autonomous Vehicles by Neural Networks,*" Proceedings of the 1991 American Control Conference at Boston, pp. 3096-3101.
- [10] Hedrick, J.K., McMahon, D., Narendran, V., and Swaroop, D., "*Longitudinal Vehicle Controller Design for IVHS Systems,*" Proceedings of the 1991 American Control Conference at Boston, pp. 3107-3112.
- [11] Hauksdottir, A. S. and Sigurdardottir, G., "*On the use of robust design methods in Vehicle Controller Design,*" Proceedings of the 1991 American Control Conference at Boston, pp. 3113-3118.
- [12] Niehaus, A. and Stengel, R. F., "*Rule-Based Guidance for Vehicle Highway Driving in the Presence of Uncertainty,*" Proceedings of the 1991 American Control Conference at Boston, pp. 3119-3124.

- [13] Tan, H. S. and Chin, Y. K., "*Vehicle Traction Control: Variable-Structure Control Approach*," ASME Journal of Dynamic Systems, Measurement, and Control, June 1991, Vol. 113, pp. 223-230.
- [14] Tsugawa, S., Murata, S., Yatabe, Teruo, and Hirose, T., "*Vehicle Following System Using Vehicle- To-vehicle Communication - Its Concept, Control Algorithm, and Communication System*," ASME Book No. 10271B, Advances in Flexible Automation and Robotics - Volume II.
- [15] Tsugawa, S. and Murata, S., "*Steering Control Algorithm For Autonomous Vehicle*," 1990 Japan-U.S.A. Symposium on Flexible Automation- A Pacific Rim Conference- ISCIE, Kyoto, Japan.
- [16] Sharp, M. L., Peters, R. M., and Weiss, R. B., "*Structural Design Considerations for Aluminum Bumper*," 1978 SAE Paper No. 770269.
- [17] Johnke, D., Fehrecke, H., and McLeod, D. G., "*Realization via Dynamic Testing with Glass-Fibre Reinforced Plastics - Interpretations for bumper System*," 1984 SAE Paper No. 830990.
- [18] Glance, P. M. and Daroczy, G., "*Computer-Aided Design, Analysis, and Testing of Automotive Bumpers*," 1989 SAE Paper No. 880462.

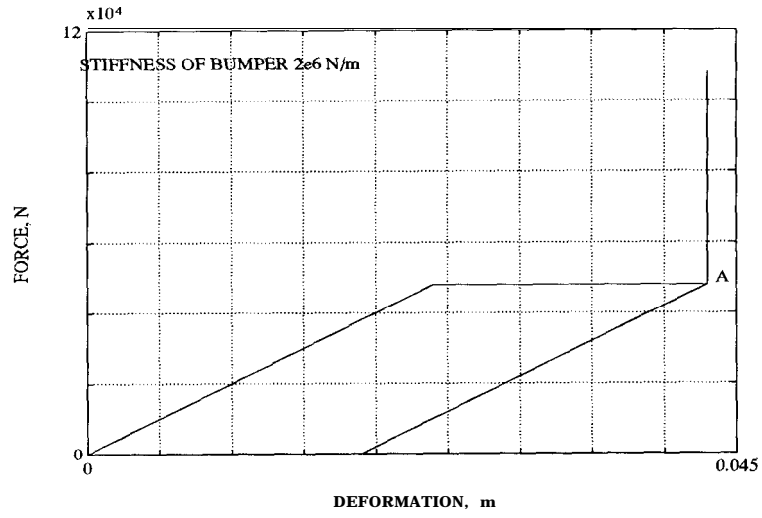

Figure 1: Characteristic of the Bumper Model

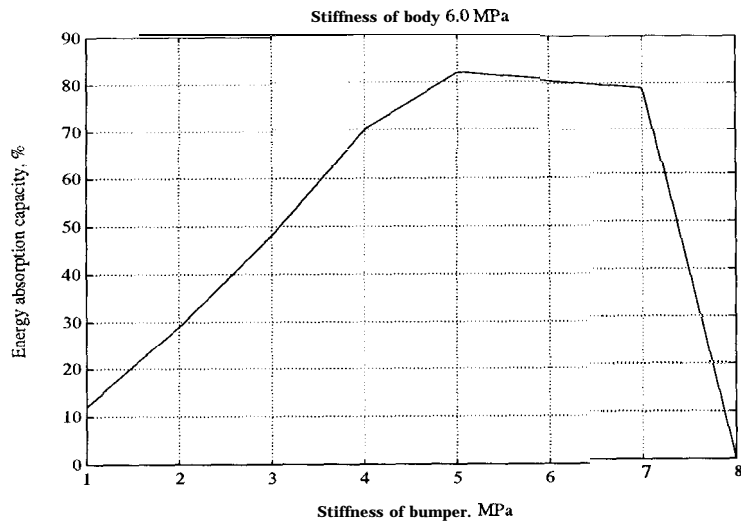

Figure 2: Energy Absorption Capacity of the Bumper Model¹

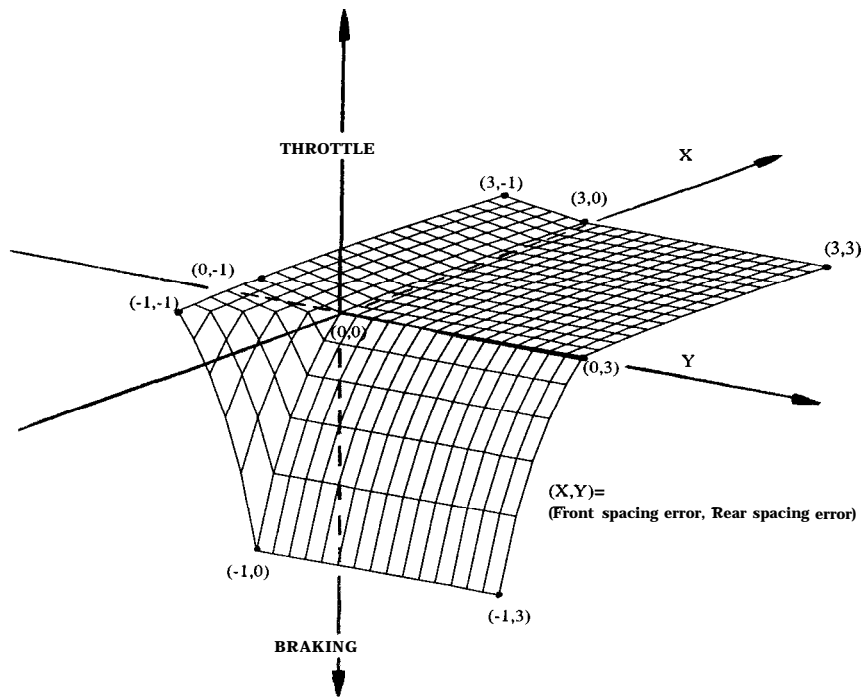

Figure 3: Control Gain Surface for Spacing Error

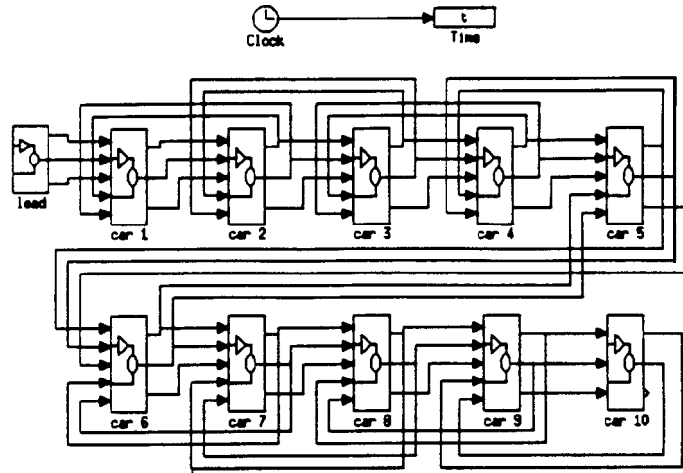

Figure 4: Platoon I

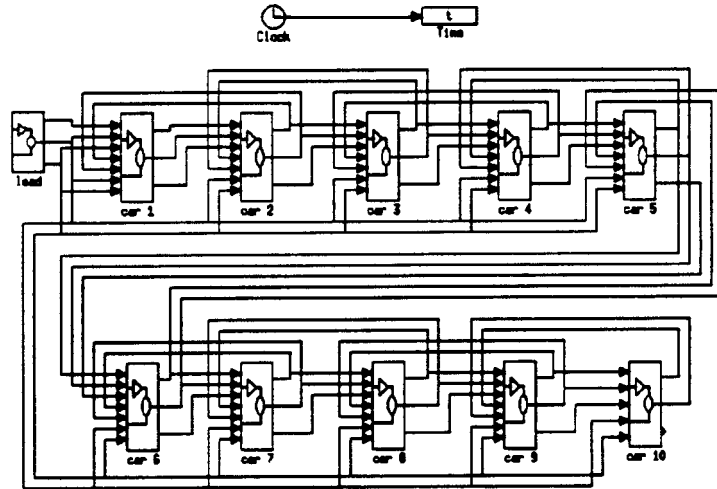

Figure 5: Platoon II

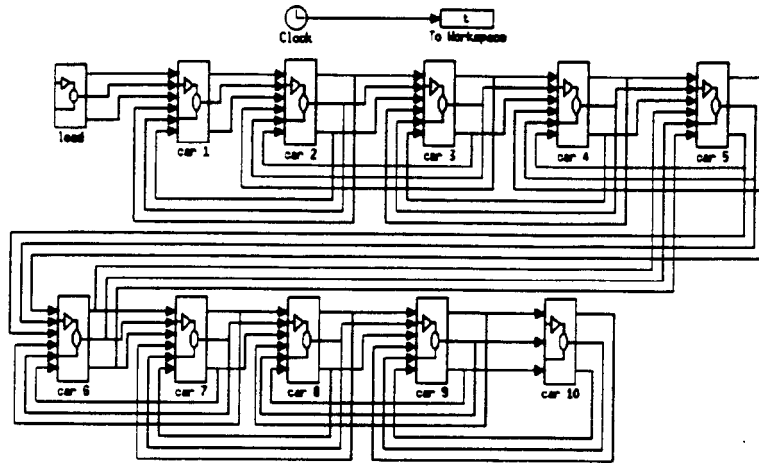

Figure 6: Platoon III

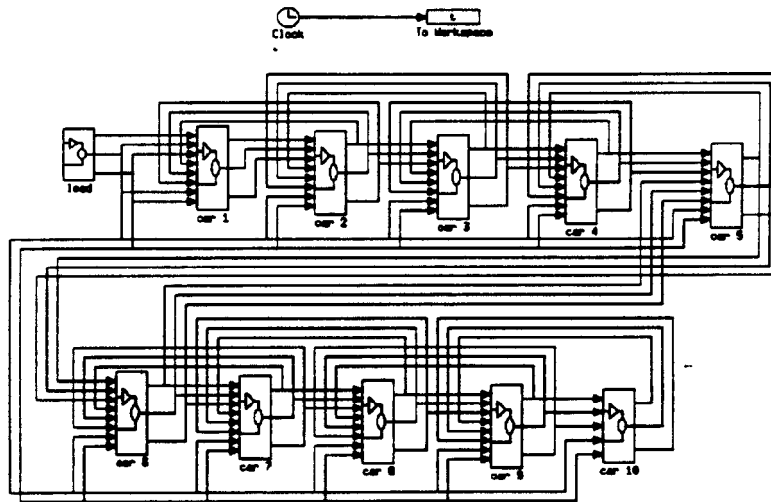

Figure 7: Platoon IV

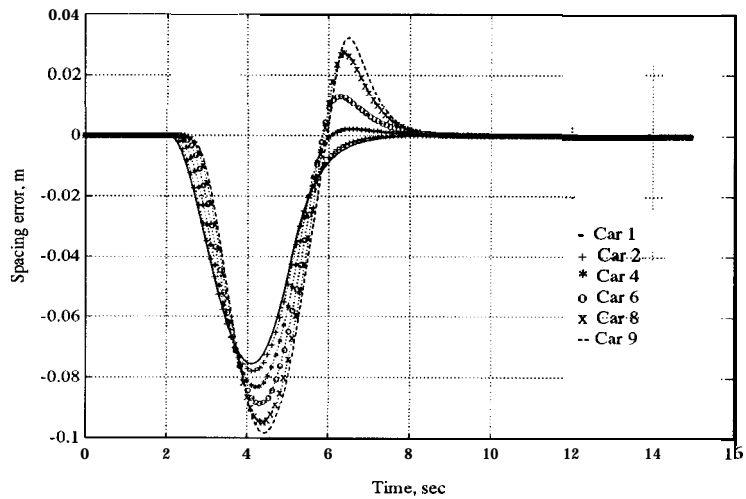

Figure 8: Spacing Error Profile of Platoon I for $\tau_c=0.2\text{sec}$ and $\tau_e=0.2\text{sec}$

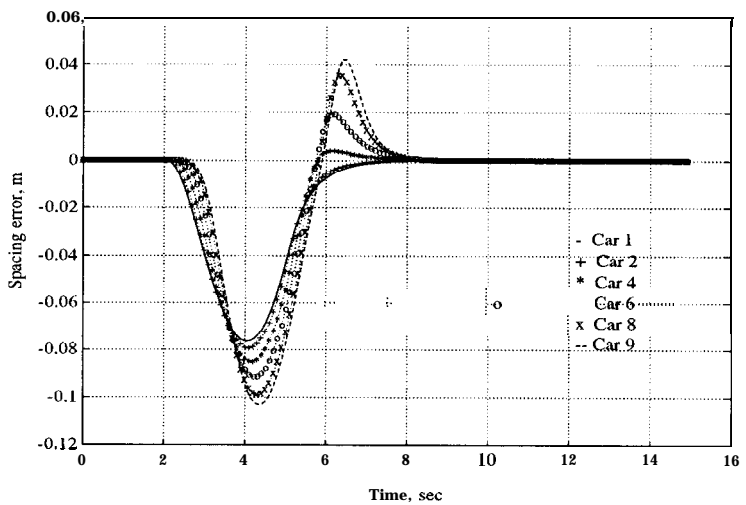

Figure 9: Spacing Error Profile of Platoon I for $\tau_c=0.2\text{sec}$ and $\tau_e=0.25\text{ sec}$

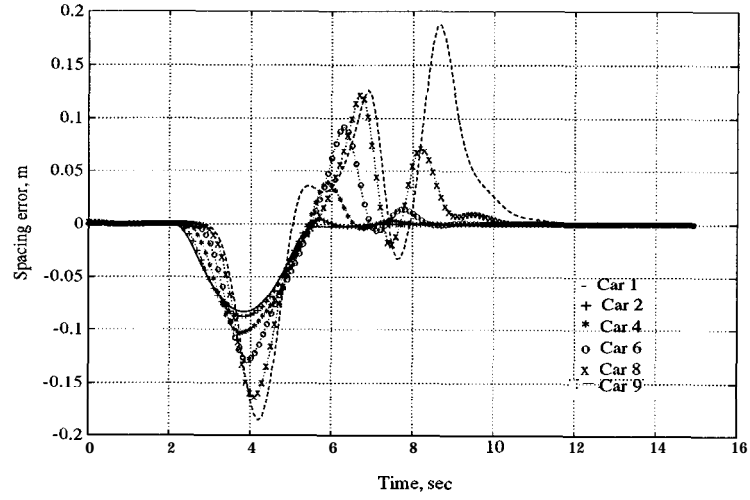

Figure 10: Spacing Error Profile of Platoon I for $\tau_c=0.2\text{sec}$ and $\tau_e=0.5\text{sec}$

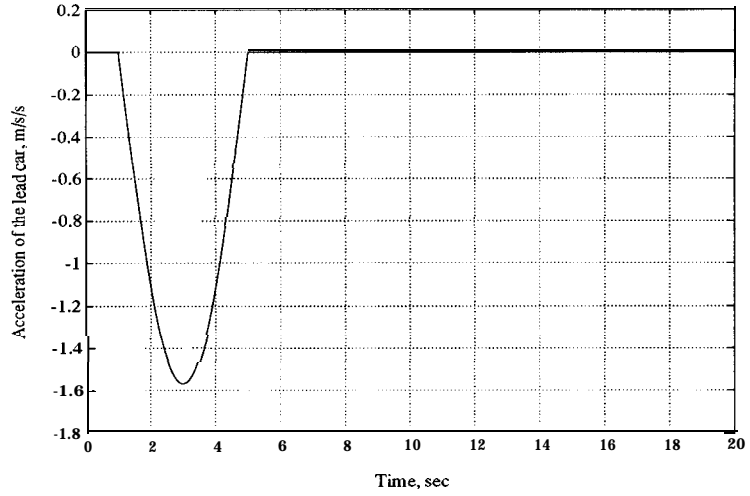

Figure 11: Standard Deceleration Profile of the Lead for a 4 sec Duration

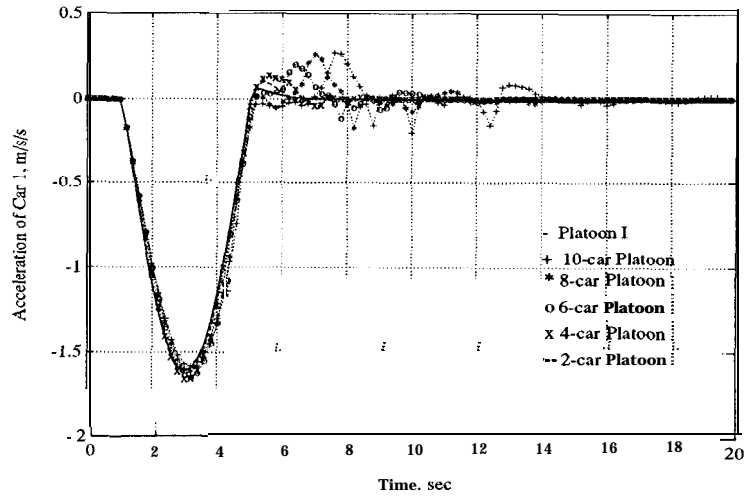

Figure 12: Acceleration Profile of Car 1 of Platoon III for Different Platoon Sizes

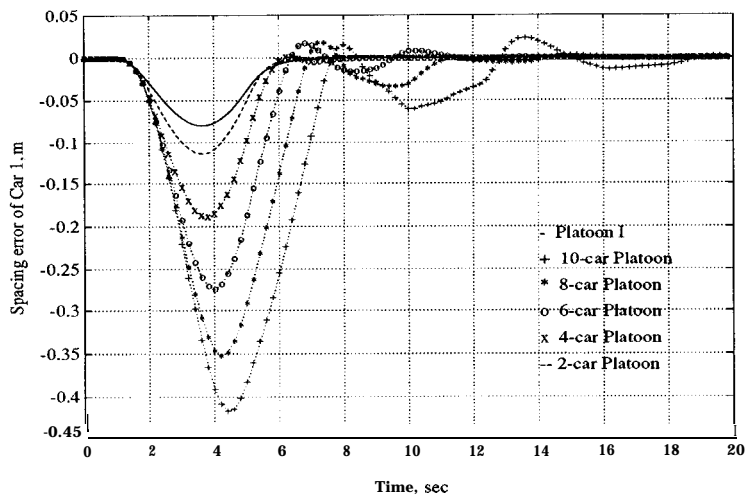

Figure 13: Spacing Error Profile of Car 1 of Platoon III for Different Platoon Sizes

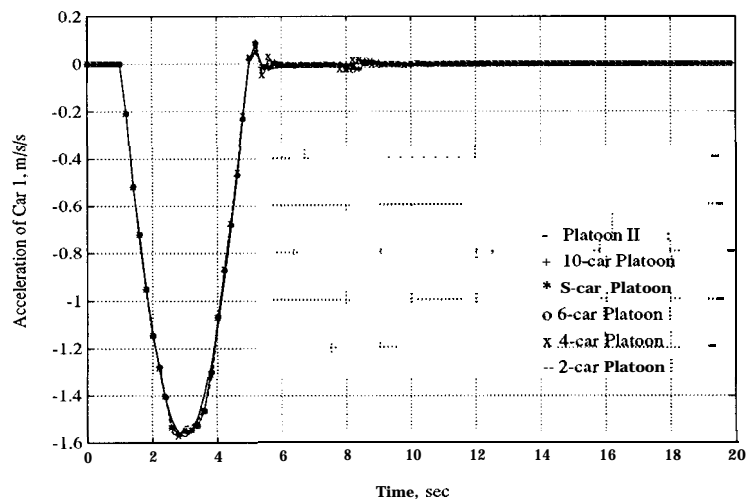

Figure 14: Acceleration Profile of Car 1 of Platoon IV for Different Platoon Sizes

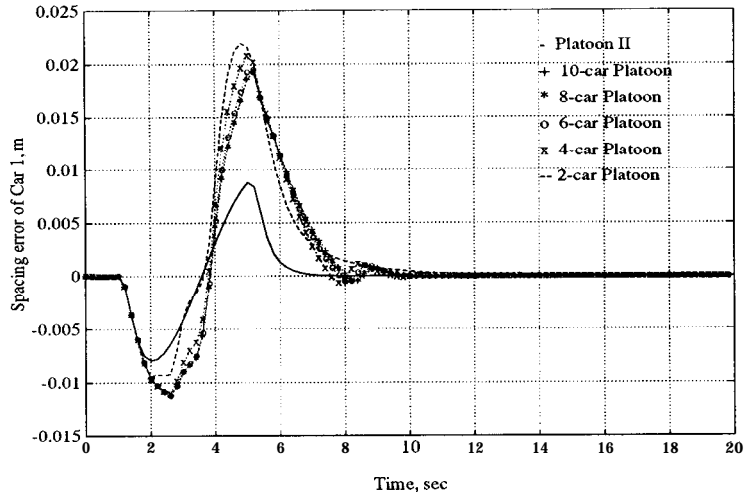

Figure 15: Spacing Error Profile of Car 1 of Platoon IV for Different Platoon Sizes

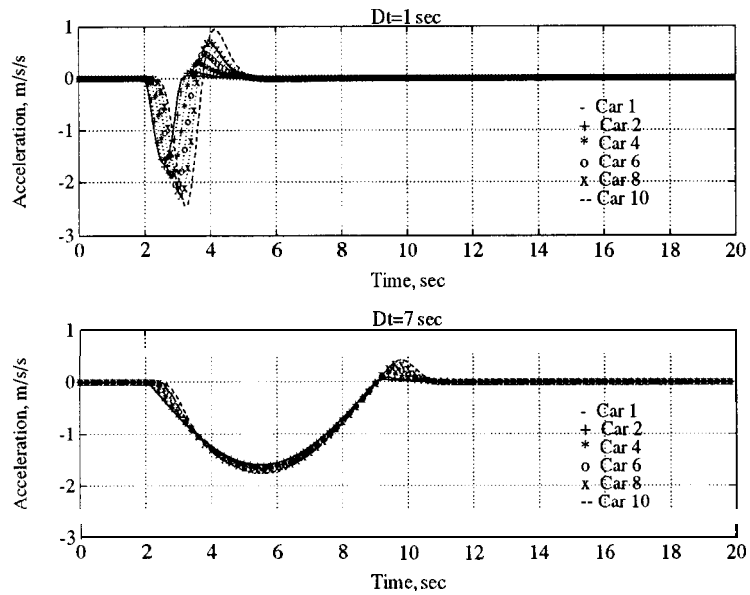

Figure 16: Comparison of the Acceleration Response of Platoon I for Different Deceleration Durations

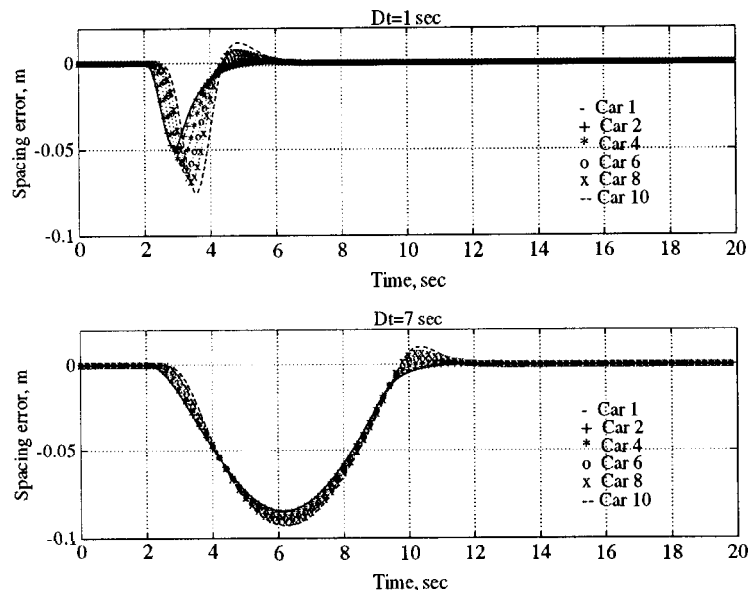

Figure 17: Comparison of the Spacing Error Response of Platoon I for Different Deceleration Durations

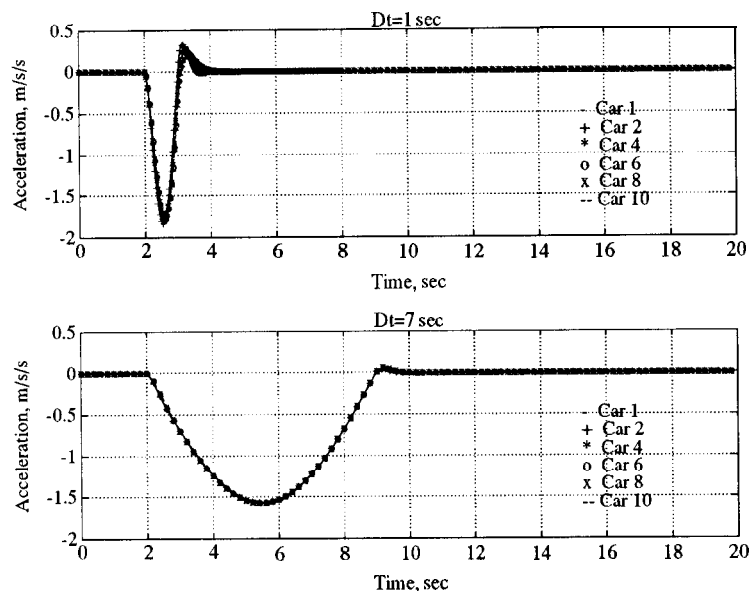

Figure 18: Comparison of the Acceleration Response of Platoon II for Different Deceleration Durations

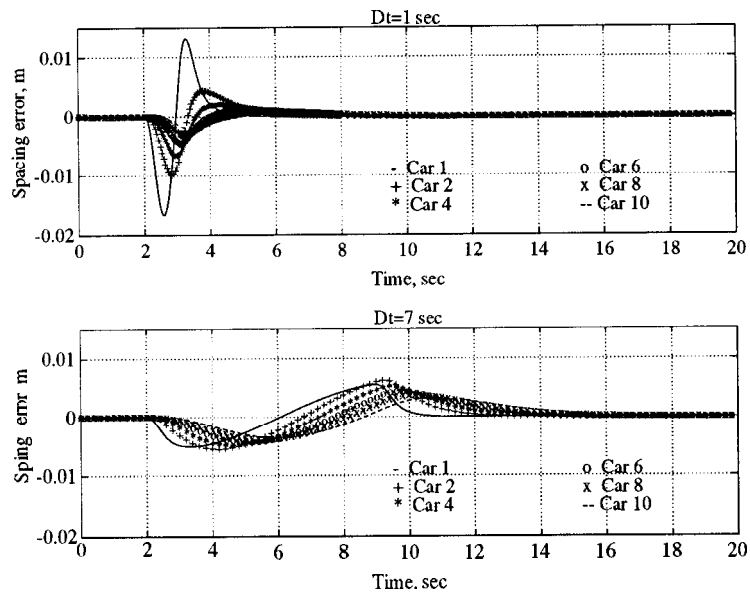

Figure 19: Comparison of the Spacing Error Response of Platoon II for Different Deceleration Durations

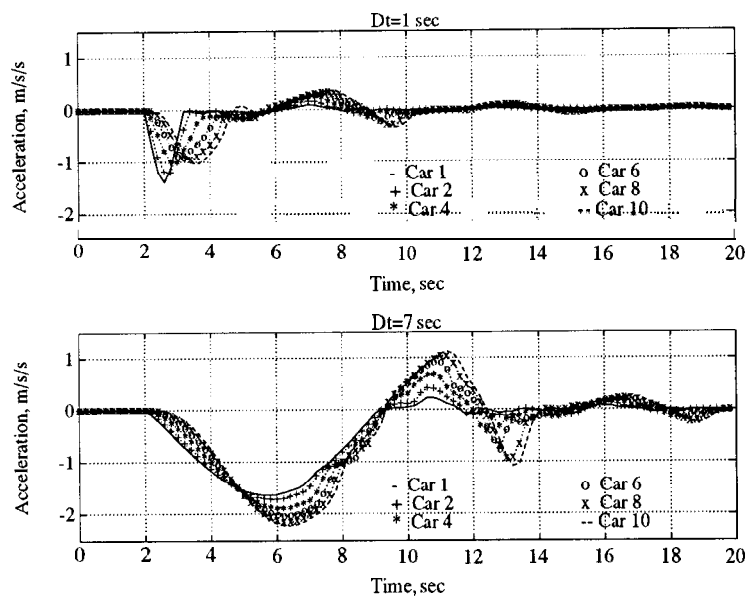

Figure 20: Comparison of the Acceleration Response of Platoon III for Different Deceleration Durations

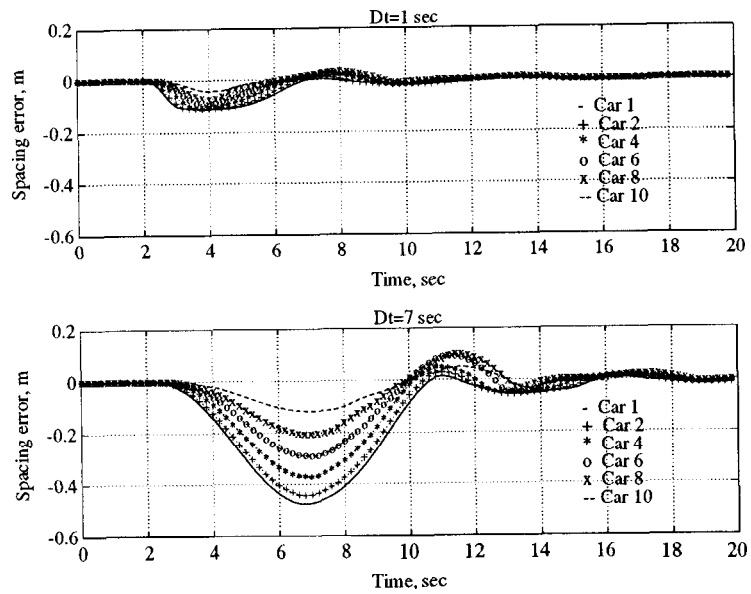

Figure 21: Comparison of the Spacing Error Response of Platoon III for Different Deceleration Durations

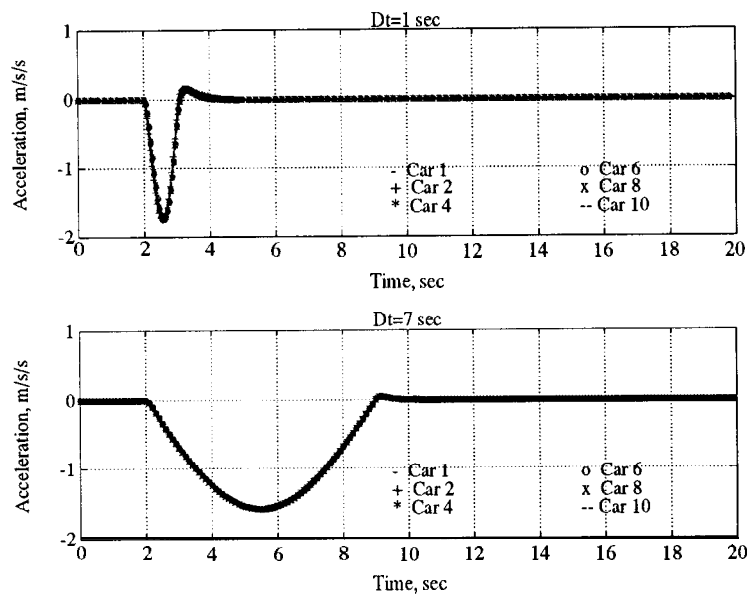

Figure 22: Comparison of the Acceleration Response of Platoon IV for Different Deceleration Durations

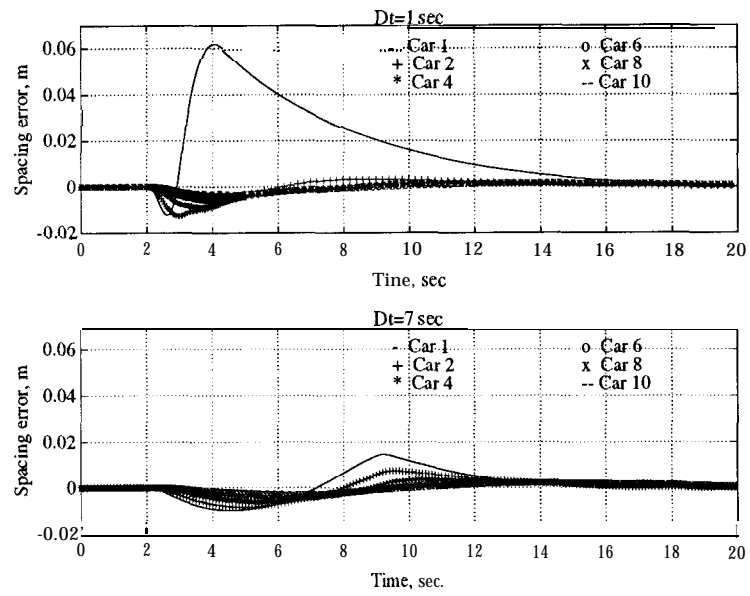

Figure 23: Comparison of the Spacing Error Response of Platoon IV for Different Deceleration Durations

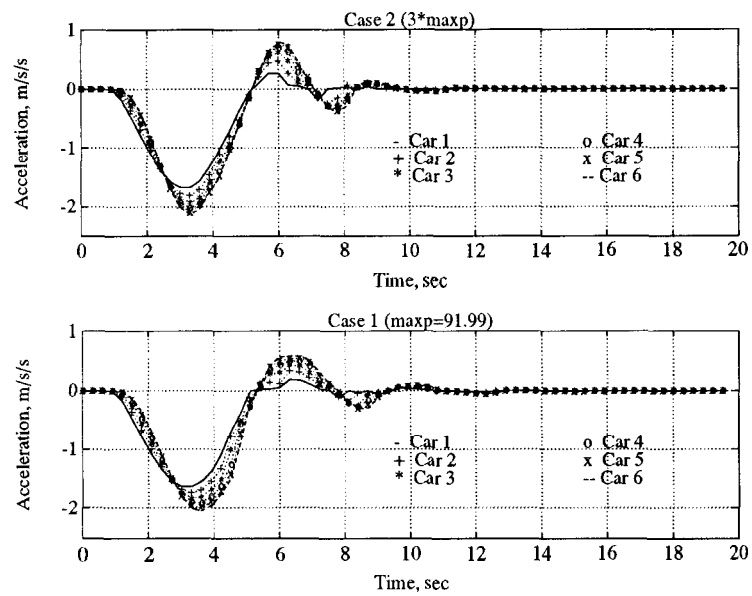

Figure 24: Comparison of the Acceleration Response of Platoon III for Different Spacing Control Gain of the Last Car ($\max p$)

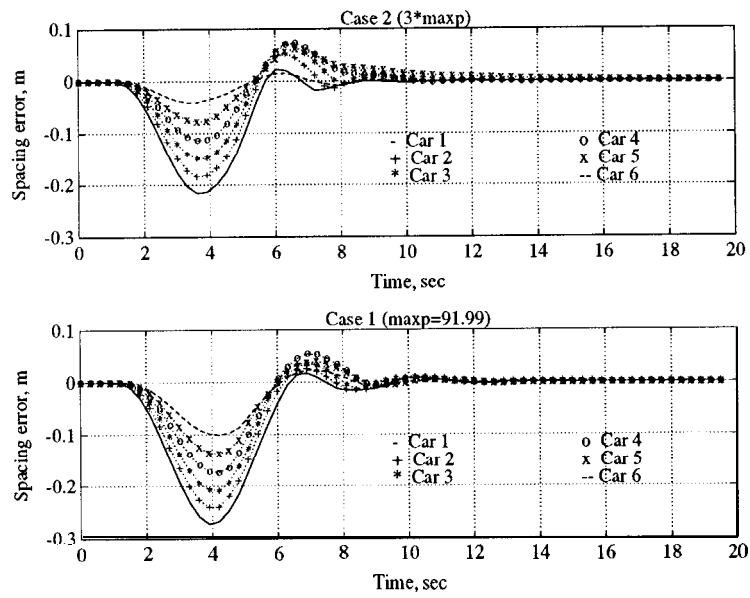

Figure 25: Comparison of the Spacing Error Response of Platoon III for Different Spacing Control Gain of the Last Car ($maxp$)

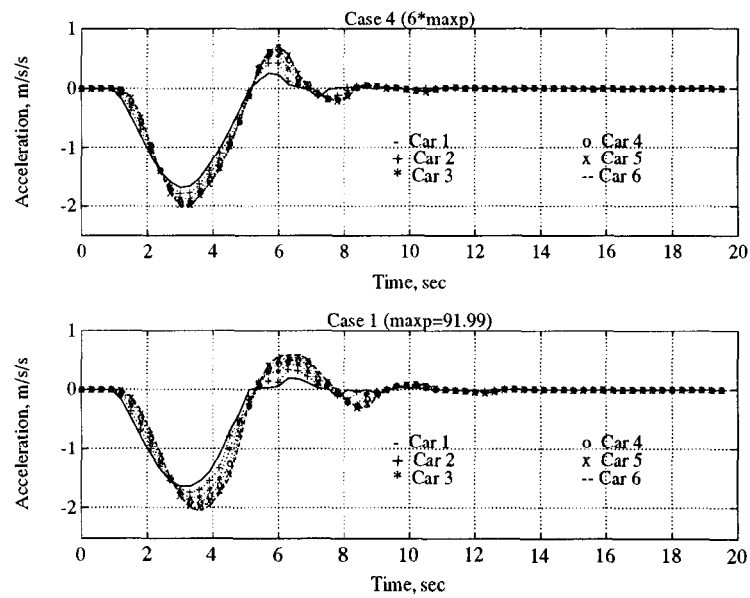

Figure 26: Comparison of the Acceleration Response of Platoon III for Different Spacing Control Gain of the Last Car (maxp)

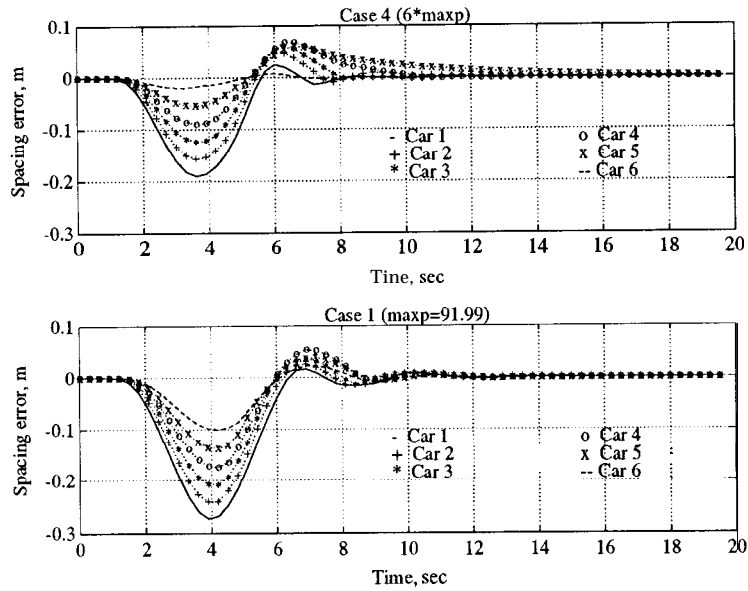

Figure 27: Comparison of the Spacing Error Response of Platoon III for Different Spacing Control Gain of the Last Car (maxp)

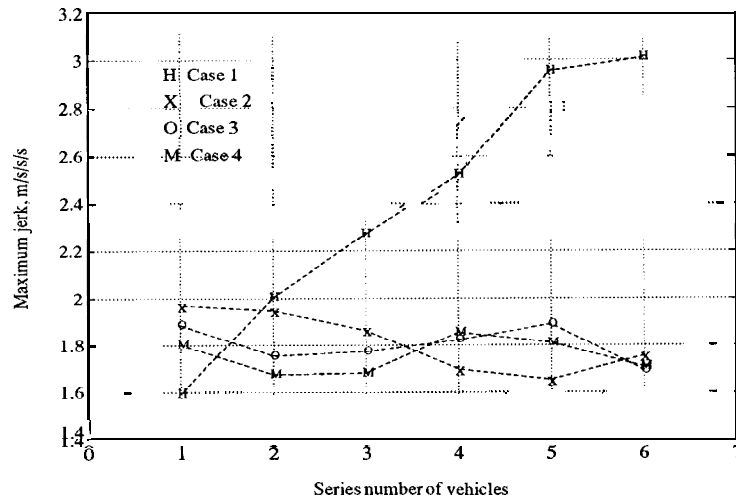

Figure 28: Maximum Jerk of Platoon III for Different Spacing Control Gain of the Last Car

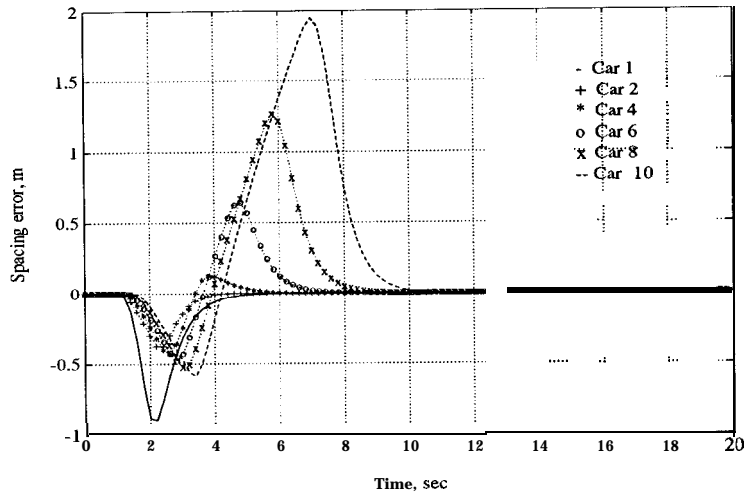

Figure 29: Platoon I: Spacing Error Profile for $Dt=1$ sec and $A=5.60a$

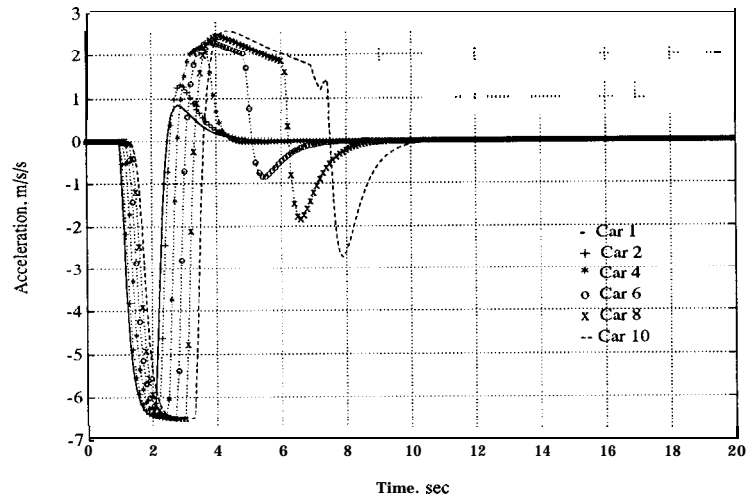

Figure 30: Platoon I: Acceleration Profile for $Dt=1$ sec and $A=5.60a$

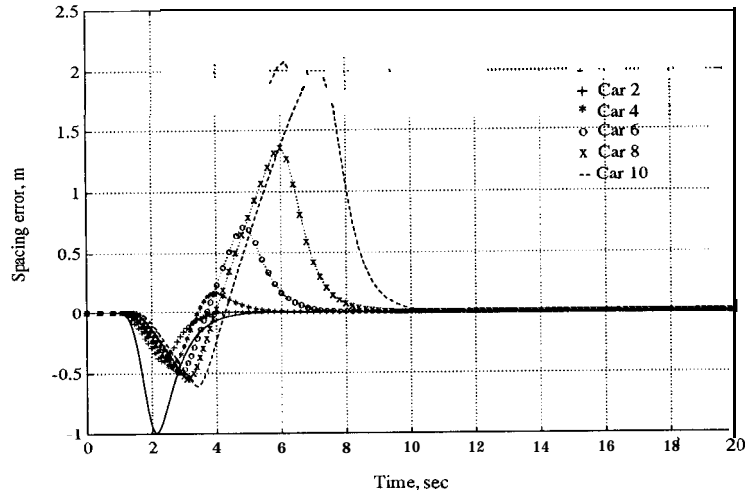

Figure 31: Platoon I: Spacing Error Profile for $Dt=1$ sec and $A=5.74a$

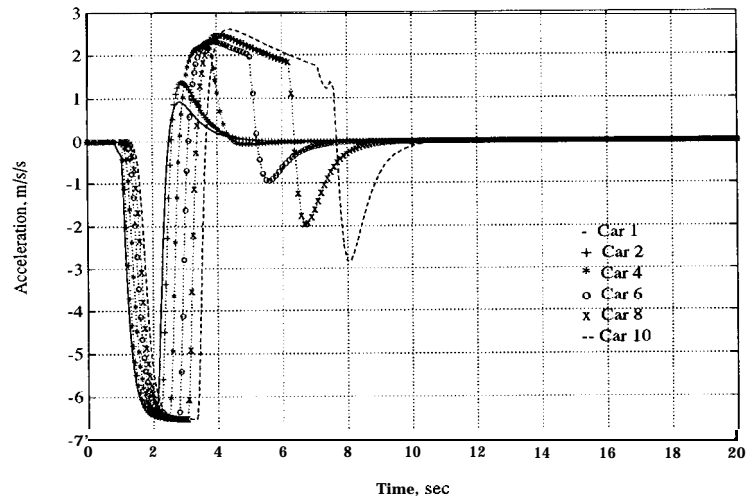

Figure 32: Platoon I: Acceleration Profile for $Dt=1$ sec and $A=5.74a$

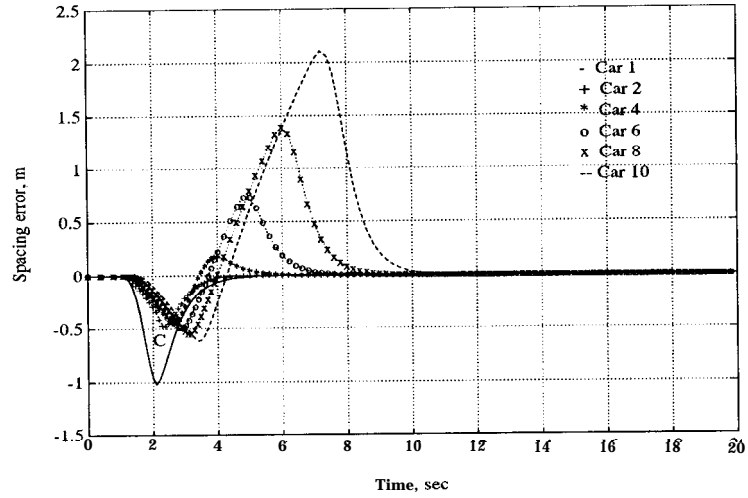

Figure 33: Platoon I: Spacing Error Profile for $Dt=1$ sec and $A=5.80a$

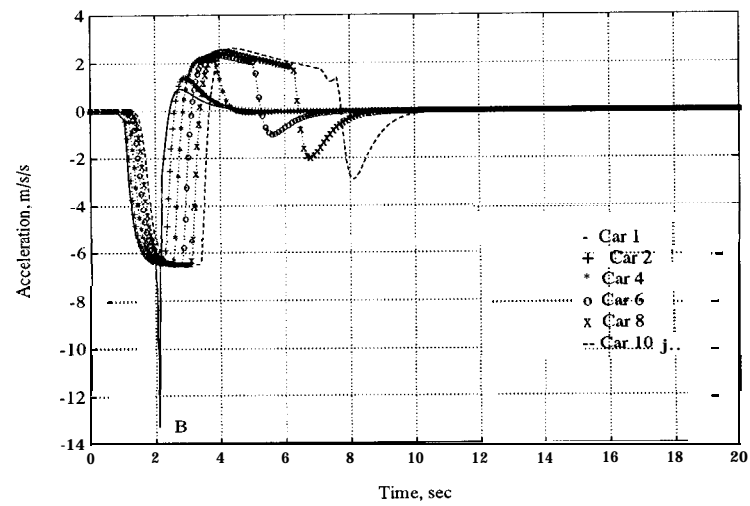

Figure 34: Platoon I: Acceleration Profile for $Dt=1$ sec and $A=5.80a$

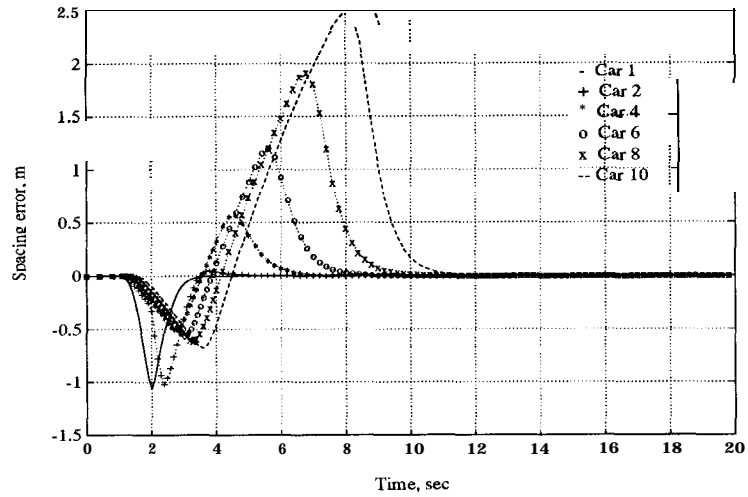

Figure 35: Platoon I: Spacing Error Profile for $Dt=1$ sec and $A=6.10a$

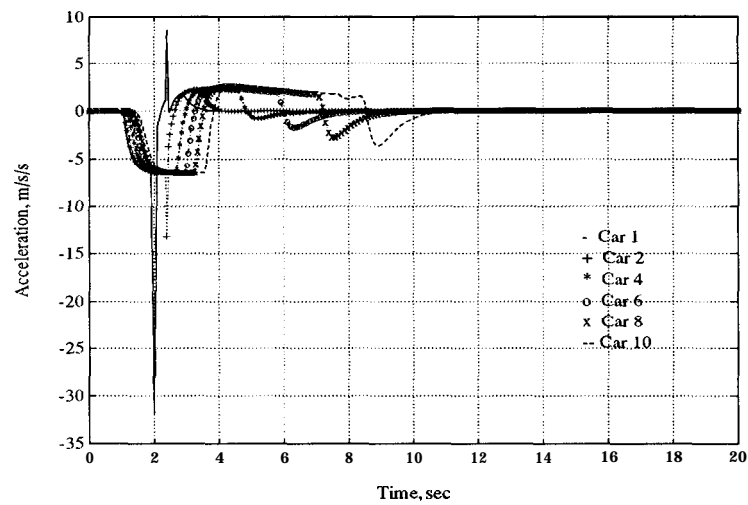

Figure 36: Platoon I: Acceleration Profile for $Dt=1$ sec and $A=6.10a$

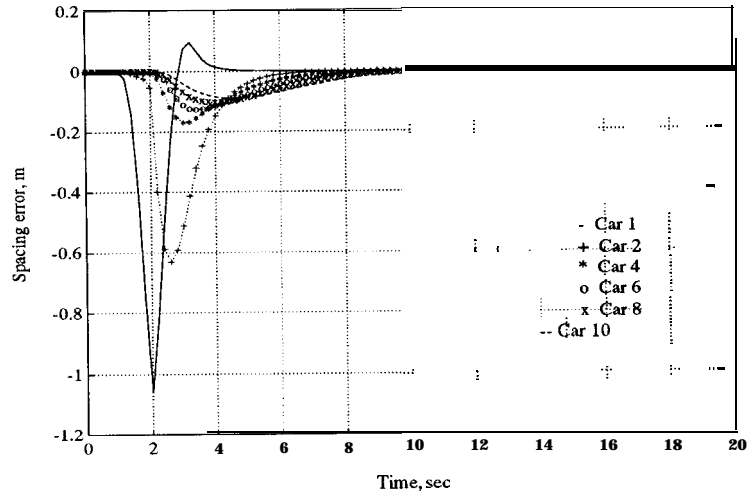

Figure 37: Platoon II: Spacing Error Profile for $Dt=1$ sec and $A=6.10a$

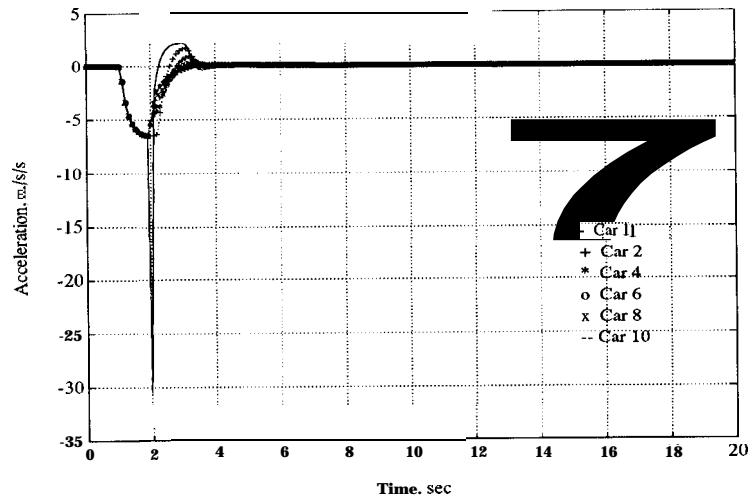

Figure 38: Platoon II: Acceleration Profile for $Dt=1$ sec and $A=6.10a$

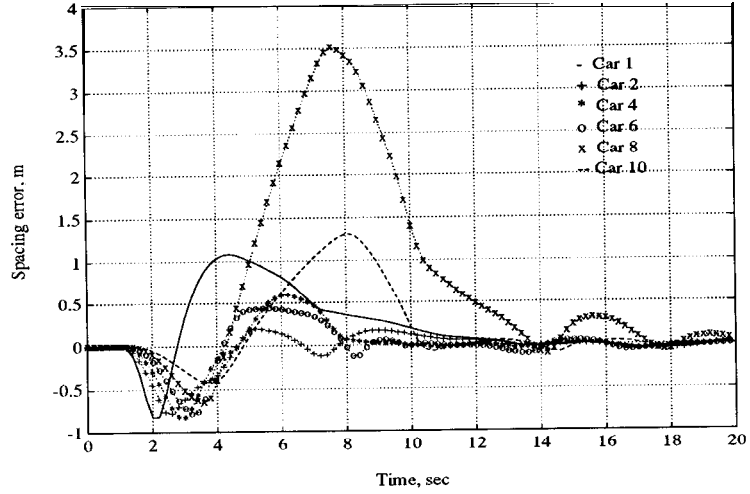

Figure 39: Platoon III: Spacing Error Profile for $Dt=1$ sec and $A=5.60a$

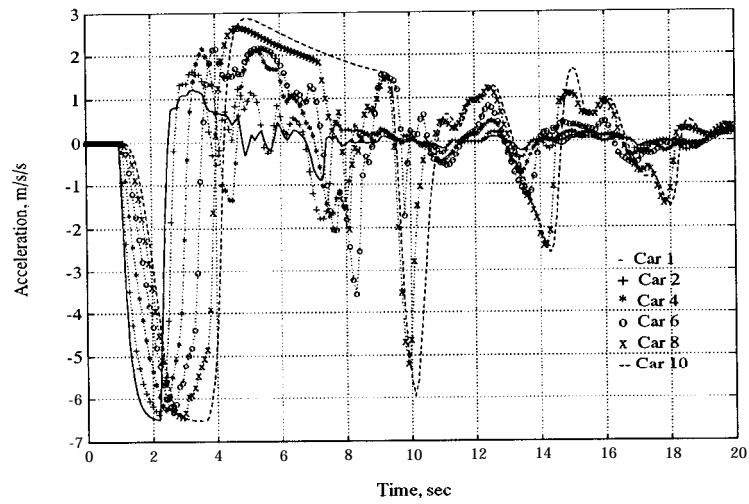

Figure 40: Platoon III: Acceleration Profile for $Dt=1$ sec and $A=5.60a$

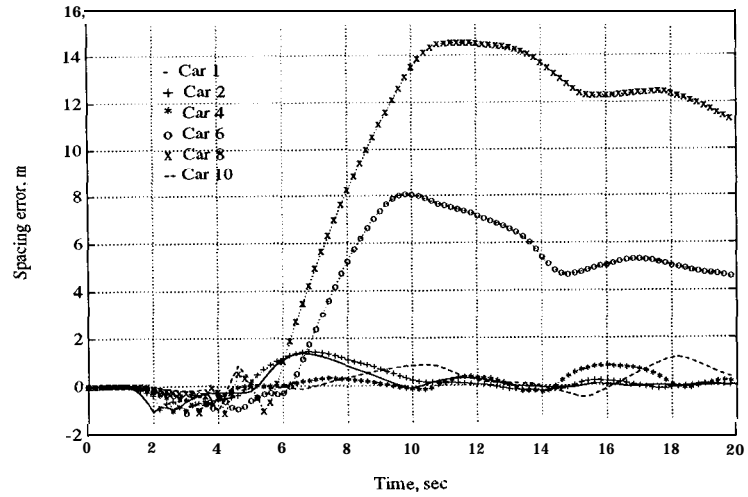

Figure 41: Platoon III: Spacing Error Profile for $Dt=1$ sec and $A=5.74a$

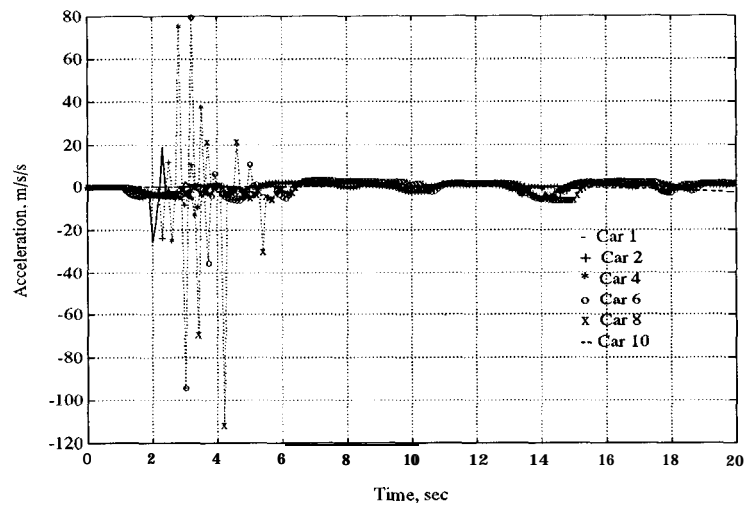

Figure 42: Platoon III: Acceleration Profile for $Dt=1$ sec and $A=5.74a$

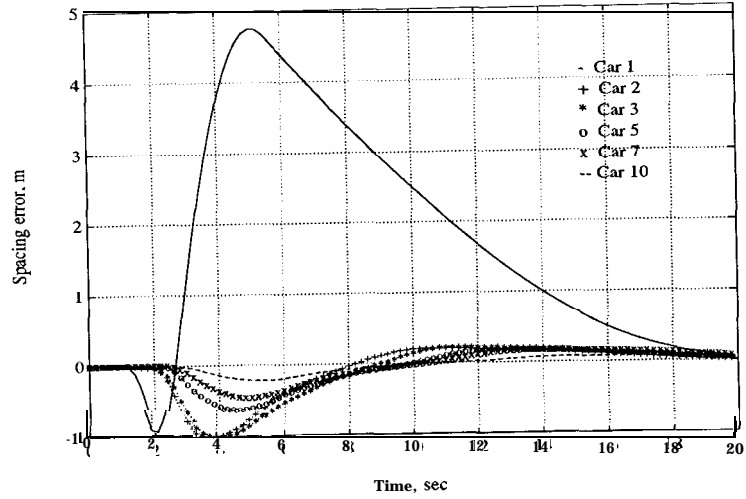

Figure 43: Platoon IV: Spacing Error Profile for $Dt=1\text{sec}$ and $A=5.74a$

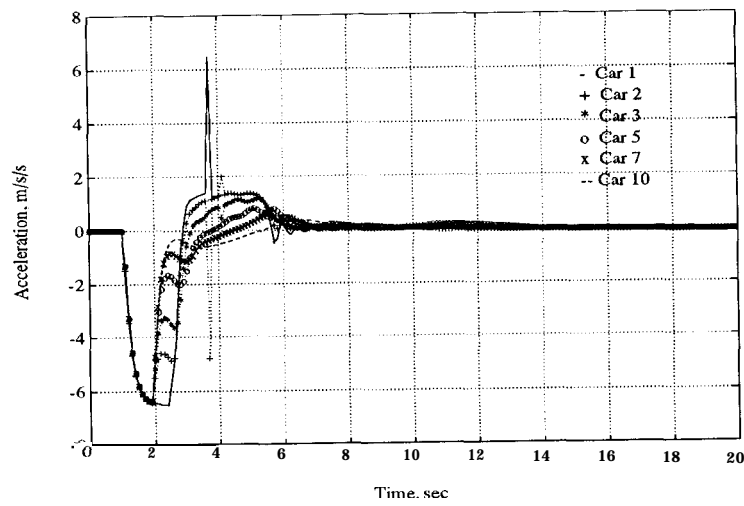

Figure 44: Platoon IV: Acceleration Profile for $Dt=1\text{sec}$ and $A=5.74a$

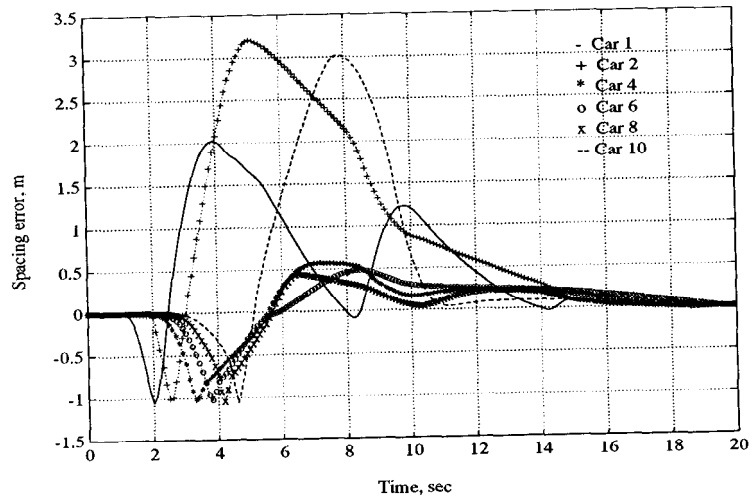

Figure 45: Platoon IV: Spacing Error Profile for $Dt=1$ sec and $A=6.10a$

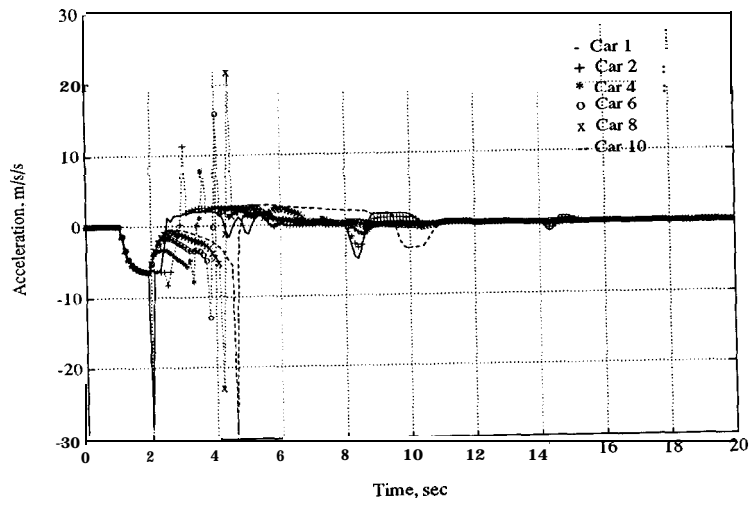

Figure 46: Platoon IV: Acceleration Profile for $Dt=1$ sec and $A=6.10a$