

## **UC Davis**

### **Recent Work**

#### **Title**

Optimum Performance of Direct Hydrogen Hybrid Fuel Cell Vehicles

#### **Permalink**

<https://escholarship.org/uc/item/5x31w1vd>

#### **Authors**

Zhao, Hengbing  
Burke, Andy

#### **Publication Date**

2009-06-01

Peer reviewed

*EVS24*  
*Stavanger, Norway, May 13 – 16, 2009*

# **Optimum Performance of Direct Hydrogen Hybrid Fuel Cell Vehicles**

Hengbing Zhao, Andrew F. Burke  
*Institute of Transportation Studies, UC Davis, CA 95616, hbzhao@ucdavis.edu*

---

## **Abstract**

Proton Exchange Membrane fuel cell (PEMFC) technology is one of the most attractive candidates for transportation applications due to its inherently high efficiency and high power density. However, the fuel cell system efficiency can suffer because of the need for forced air supply and water-cooling systems. Hence the operating strategy of the fuel cell system can have a significant impact on the fuel cell system efficiency and thus vehicle fuel economy. The key issues are how the fuel cell back pressure and air flow through the fuel cell are controlled. One approach is fixed back pressure control. The other is optimum varying back pressure control. In both cases, the air flow stoichiometry is optimized. In this paper, a dynamic forward-looking vehicle model with a dynamic fuel cell system model is employed. The effects of different fuel cell system operation modes and different power split strategies on fuel economy of fuel cell hybrid vehicles are simulated. The simulation results of light duty vehicles on various driving cycles indicate a significant improvement in fuel economy for optimum varying back pressure operation compared to high fixed back pressure operation. For various fuel cell system operation modes, the load leveling control can significantly improve fuel economy on some aggressive driving cycles such as US06. The vehicle with a small fuel cell system becomes more efficient during low speed or low power demand driving by avoiding low fuel cell output power region.

*Keywords: fuel cell system, hybrid fuel cell vehicle, optimization, dynamic, power assist, load leveling*

---

## **1 Introduction**

In recent decades, hydrogen Proton Exchange Membrane fuel cell (PEMFC) technology for use in vehicles has been extensively developed by major auto companies. One of the main reasons is that fuel cells can achieve high energy efficiency. However, the fuel cell system efficiency can suffer because of the need for forced air supply and water-cooling systems. Hence the operating strategy of the fuel cell system can have a

significant impact on the fuel cell system efficiency and thus vehicle fuel economy. Different fuel cell system operating modes to maximize system efficiency on driving cycles were investigated in the present study. Another important issue is the lifetime of the fuel cell stack. A fuel cell stack can achieve up to 10000 hours in stationary power applications. However, the lifetime in automotive applications is much shorter (less than 5000 hours) because of the dynamic operating conditions, such as rapidly varying power demand, in those

applications. These rapid changes in the operating conditions of the fuel cell stack can have a major impact on the lifetime of the fuel cell stack due to the mechanical and thermal stresses on the MEA and the stack accessory components. Hybridization of the vehicle power train is an effective approach to mitigate the stress on the fuel cell stack by shifting most of the dynamic power demand to a second power source such as batteries and/or ultracapacitors. Another advantage of hybridization of a fuel cell vehicle is to recover energy while decelerating through regenerative braking. In the hybrid configuration, the total power demand from the vehicle is satisfied by splitting the power between the fuel cell stack and the second power source, usually a battery pack. The power split strategy has a significant effect on the dynamics of the power demands of the fuel cell stack and the battery pack. The primary factors of interest for different power split strategies are impacts on the sizing of the power sources, durability of the fuel cell stack and battery, and vehicle fuel economy.

Much work has been done in the past to model fuel cell systems, optimize the operating conditions, and simulate fuel cell vehicles and different control strategies. Studies concerned with optimum operating conditions of the fuel cell system are discussed in [1]-[6]. The characteristics of low pressure and high pressure fuel cell systems are addressed with regard to the system efficiency and transient response in [3][7][8]. Lumped filling/emptying dynamic fuel cell models are presented in [9][10]. Various levels of vehicle hybridization and different power split control strategies are described in [11]-[23]. These studies have established a good foundation for understanding fuel cell systems and fuel cell vehicles.

In this study, a forward-looking hybrid fuel cell vehicle model with a dynamic fuel cell system operation was developed to simulate the performance of the fuel cell and vehicle in a realistic manner – taking into account transient behavior and control system characteristics. Fixed back pressure and optimum varying back pressure operation are considered in the simulation. In the vehicle hybridization, a nickel metal hydride (NiMH) battery is connected to the fuel cell bus through a DC/DC converter. A load leveling power split control strategy is implemented to simulate

the vehicle operation on several driving cycles to explore the potential of improving vehicle fuel economy and achieving near-constant power operation of the fuel cell.

Section 2 introduces the approach for optimizing the operating conditions of the fuel cell system and describes the dynamic fuel cell system model, the fuel cell vehicle drive train configuration, and power split strategies used in this paper. In Section 3 the optimum operating conditions of the fuel cell system and the simulation results for the fuel cell vehicle are presented. Finally, the conclusions are summarized in section 4.

## 2. Approach

To investigate how different fuel cell system operating modes affect the fuel cell system efficiency, a scalable fuel cell system optimization model [14] developed at ITS-UCDavis is employed to analyze both fixed back pressure operation and optimum varying back pressure operation. In both cases, the air flow stoichiometry is optimized to minimize the auxiliary power consumption and maximize the net output power of the fuel cell stack. Based on the optimal stoichiometry and back pressure, a lumped filling/emptying dynamic fuel cell system model is developed and integrated into a dynamic forward-looking fuel cell vehicle model to analyze the effect of the dynamic fuel cell system on the vehicle performance and fuel economy. Then power split strategies are introduced and evaluated using the vehicle model to investigate their effect on fuel economy and fuel cell dynamics.

### 2.1 The Fuel Cell System Optimization Model

The fuel cell stack delivers electricity at high efficiency. However, the operation of the on-board auxiliaries significantly affects the performance and efficiency of fuel cell system. These auxiliaries include reactant supply subsystems and water and thermal management subsystems. A scalable fuel cell system optimization model was developed to evaluate different air supply configurations and their tradeoffs and to search for the optimum operating conditions to maximize the net system power and system efficiency. The fuel cell system optimization model considered the flow field

channel design of the stack, sizing of the air supply system, the impact of the humidification and oxygen consumption on the pressure loss, maximum pressure drop on the stack, and different system operation modes. Since there is a correlation between the pressure drop across the stack, flow path numbers in the flow field plates, the back pressure and humid air flow, an iterative method is employed to find the optimal design and the optimum operating conditions for satisfying the maximum specified pressure drop. The optimization model interface is shown in Figure 1.

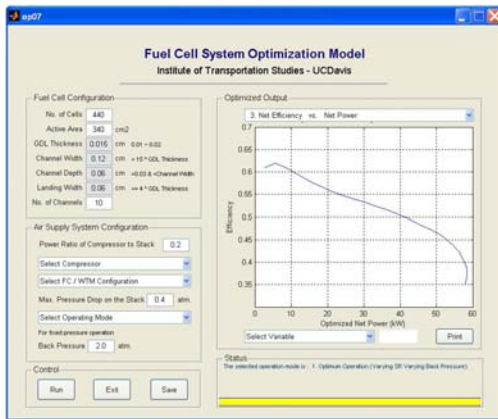

Figure 1 Fuel cell system optimization model

Temperature, relative humidity, operating pressure and the air mass flow are the four key external variables that have a major impact on the performance of the fuel cell stack. Assuming the stack temperature and the relative humidity are well controlled, the operating pressure and the air mass flow will determine the oxygen partial pressure at the cathode catalyst layer, which determines the resultant cathode overpotential for a given stack current. In the optimization model, the average pressure in the stack is used to calculate the effect of the water vapor on the mass flow rate. Thermal and water management for fuel cells are challenging issues in automotive applications. The losses (accessory loads) from the coolant pump, radiator fan and condenser are small compared to the loss from the air compression subsystem. Water and thermal management data from [2] are used and scaled according to the stack power. For open end hydrogen systems, a pump is usually employed to circulate the unused hydrogen. Compared to the power provided to air supply system and cooling system, the power consumption of the hydrogen

fuel supply system is small and is neglected in the model.

The optimization model varies the back pressure, air stoichiometry, and load current density to calculate the pressure loss across the stack and calculates for every triplet (current density,  $J$ , dry air mass flow,  $\dot{m}$  and back pressure,  $P_r$ ), the net output power of  $P_{net}(J, \dot{m}, P_r)$ . Then it scans among those which are within the safe operational region of the compressor, to find the one with  $\max(P_{net}(J, \dot{m}, P_r))$ .

$$P_{net}(J, \dot{m}_{optimal}, P_{r,optimal}) = \max[P_{net}(J, \dot{m}, P_r)] \quad (1)$$

In other words, the optimal mass flow  $\dot{m}_{optimal}$  and back pressure  $P_{r,optimal}$  will yield the maximum net power for a given  $J$  value.

## 2.2 Fuel Cell System Model

The transient behavior of the air supply system will affect the performance of the fuel cell system and thus vehicle due to the relatively slow response of the compressor, manifold filling/emptying, and the pressure control valve. To understand the dynamics of the fuel cell system and its effect on the vehicle performance, a model that accounts for the above dynamics was developed. The spatial variation of temperature, humidity, pressure, and flow rate etc. in the air system components is approximated or averaged. A lumped filling/emptying model approach similar to papers [9][10] is used. The variables to be controlled are the air mass flow and the stack back pressure. A twin screw compressor is employed to control the mass flow and a pressure valve is used to control the back pressure of the stack. Conventional feed forward and feedback control are employed to control the mass flow and back pressure around the optimum operating conditions which are generated from the fuel cell system optimization model. The pressure loss across the stack due to flow friction is included by using the Darcy-Weisbach law. The fuel cell stack model [1] derived from a basic diagnostic fuel cell model [24] was used to predict the stack voltage for various operating conditions such as stack current, temperature, back pressure, and mass flow.

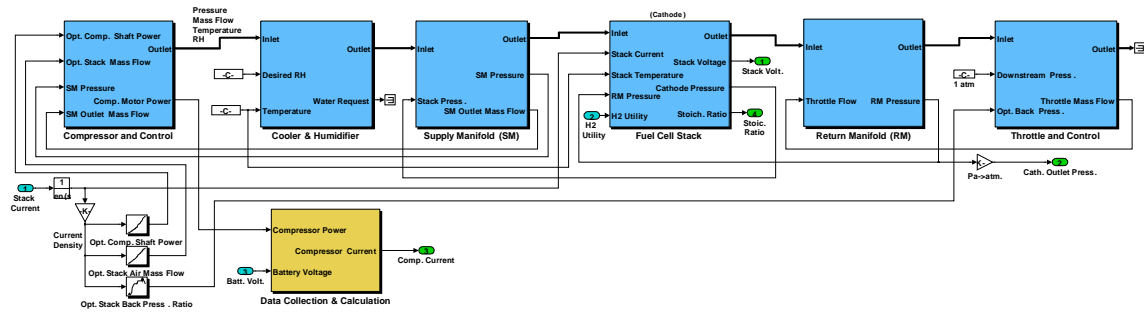

Figure 2 Diagram of the dynamic fuel cell system model (Air supply)

The dynamic air supply system model consists of the compressor and its control, supply manifold, cooler and humidifier, fuel cell stack, return manifold, and throttle and its control. To ensure that each of the components is realistically represented, the powertrain simulation model incorporates either fundamental equations, as in the fuel cell stack, or performance based maps, as for the compressor. The model was developed by using Matlab®/Simulink®, as shown in Figure 2. The inputs are the required current and the optimum operating conditions for the fuel cell system and the output is the stack voltage. The rotational speed of the compressor and the pressures in each stage of the air supply system are the state variables, which can be expressed by

Compressor dynamics:

$$J_{cp} \frac{dw_{cp}}{dt} = T_{em} - T_{cp} \quad (2)$$

Mass balance:

$$\frac{dm}{dt} = \dot{m}_{in} - \dot{m}_{out} \quad (3)$$

Energy equation:

$$\frac{dp}{dt} = \frac{R}{V} (\dot{m}_{in} T_{in} - \dot{m}_{out} T_{out}) \quad (4)$$

Humidifier:

$$\dot{m}_{humid\ air} = \dot{m}_{dry\ air} + \dot{m}_{vapor} \quad (5)$$

Nozzle equation:

$$\dot{m} = \begin{cases} \frac{C_D A_T p}{\sqrt{RT}} \gamma^{1/2} \left( \frac{2}{\gamma+1} \right)^{\frac{\gamma+1}{\gamma-1}} \text{ If } \frac{p_0}{p} \leq \left( \frac{2}{\gamma+1} \right)^{\frac{\gamma}{\gamma-1}} \\ \frac{C_D A_T p}{\sqrt{RT}} \left( \frac{p_0}{p} \right)^{\frac{1}{\gamma}} \left[ \frac{2\gamma}{\gamma-1} \left[ 1 - \left( \frac{p_0}{p} \right)^{\frac{\gamma-1}{\gamma}} \right] \right]^{1/2} \text{ others} \end{cases} \quad (6)$$

## 2.3 Vehicle Model and Power Split Control Strategy

The dynamic fuel cell system model was integrated into a forward-looking vehicle model. A fuel cell/battery hybrid vehicle consists of the fuel cell system and an electrical energy storage unit such as a battery pack and/or ultracapacitors. These components can be configured in different ways. The fuel cell stack voltage bus configuration is utilized in the vehicle model. The electrical energy storage unit - a NiMH battery- is connected to the fuel cell bus through a bidirectional DC/DC converter, as shown in Figure 3. The NiMH battery can recapture at least 50 percent of the kinetic energy of the vehicle through regenerative braking. The remaining energy is dissipated through mechanical braking. The advantage of this configuration is that the fuel cell provides energy directly to the traction motor electronics and only a fraction of energy passes through the DC/DC converter and is therefore subject to its efficiency loss.

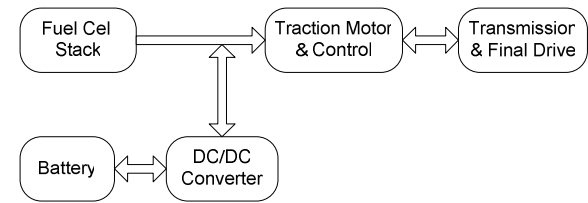

Figure 3 Schematic of the drive train configuration

In this study the vehicle speed, the battery state of charge (SOC), and the compressor speed and manifold pressure of the fuel cell system are the dynamic states. The dynamics of the DC/DC converter are assumed to be fast and ignored in the model. An efficiency map indexed by the power

and the voltage ratio is used to calculate the DC/DC converter loss.

A key issue for hybrid vehicles is the power split control strategy. Various types of power control strategies have been developed for hybrid electric vehicles with an internal combustion engine. Some of them are being applied to fuel cell battery hybrid vehicles [15]-[23]. This paper focuses on the power-assist and load leveling control strategies for comparison with the simple load following strategy (non-hybridized operation).

The power-assist strategy is a rules-based strategy, which splits the power/current demand of the traction motor based on the fuel cell voltage and the battery SOC. If the fuel cell voltage remains relatively high, it will provide most of the current to the motor. If the fuel cell voltage becomes low (less than about 200V) and the SOC of the battery is greater than 50%, the battery will provide a large fraction of the current demanded by the motor. The battery and fuel cell currents are given as

$$i_{bat} = f_{fc}(V_{fc}) \cdot f_{bat}(SOC) \cdot i_{motor} \quad (7)$$

$$i_{fc} = i_{motor} - i_{bat} \quad (8)$$

The  $f_{fc}$  and  $f_{bat}$  factors are shown in Figure 4. The battery will provide most of the current when  $f_{fc}$  is large (close to one). This strategy will favor operation of the fuel cell at high voltage and thus high efficiency when ever possible.

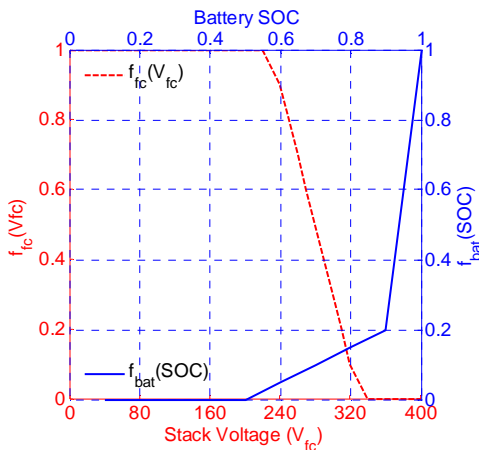

Figure 4 Power split factors for power assist control

In the load leveling control strategy, the fuel cell will provide relatively steady power and the battery

provides transient power. The fuel cell power command is calculated by averaging the power requested by the vehicle over a specified time period. In this paper, a 90-second simple moving average is used for smoothing the power requirement for the fuel cell system. The power from the battery at any time is simply

$$P_{bat} = P_{veh} - P_{av,90sec} \quad (9)$$

This strategy permits the fuel cell to operate within a relatively narrow high efficiency region. In addition, the load leveling control can make the fuel cell operate much like in a stationary state, which will improve the lifetime of the fuel cell, especially for a fuel cell operating at the optimum varying back pressure and stoichiometric modes. However, for this strategy a significant fraction of the power passes through the DC/DC converter for charging and discharging battery, which can introduce significant losses in the electronics.

The implementation of the control strategies for power split is schematized in Figure 5.

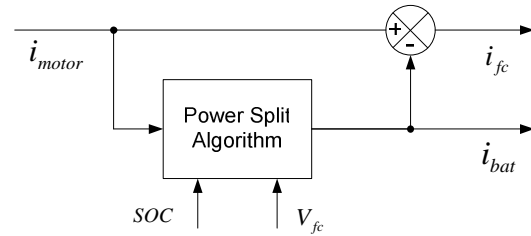

Figure 5 Schematic of power split control

In both control strategies, the battery SOC will be maintained within a narrow range, such that regenerative braking energy can be efficiently absorbed and power assist for transients provided, while ensuring battery life. The battery is charged to the pre-defined range of SOC by the fuel cell only when the battery SOC is below the minimum set point.

### 3 Simulation Results

This section presents and discusses the results of vehicle simulations for optimum fuel cell operation and hybridization of the powertrains. Results are given for the different power split strategies and for vehicles on U.S., European, and Japanese standardized driving cycles.

### 3.1 Optimum fuel cell operating conditions

It is of interest to compare fixed and varying back pressure operation of the fuel cell system. Hence the fuel cell system optimization model was run for optimum and fixed back pressure operation. The optimization was implemented for the optimum back pressure and fixed back pressures of 2.0, 1.5, and 1.1 atm. The characteristics of the fuel cell system are listed in Table 1. A plot of system efficiency vs. system net power is shown in Figure 6. The optimal air supply stoichiometry ratio and back pressure for different operating modes are shown in Figure 7 and Figure 8, respectively.

Table 1 Fuel cell stack and system parameters

No. of Cells	440	Width of Flow Path (mm)	1.2
Active Area (cm <sup>2</sup> )	510	Depth of Flow Path (mm)	0.6
No. of Flow Paths	15	Width of Landing Area (mm)	0.6
Thickness of GDL (mm)	0.15	Power Ratio of Twin Screw Compressor to Stack	0.2

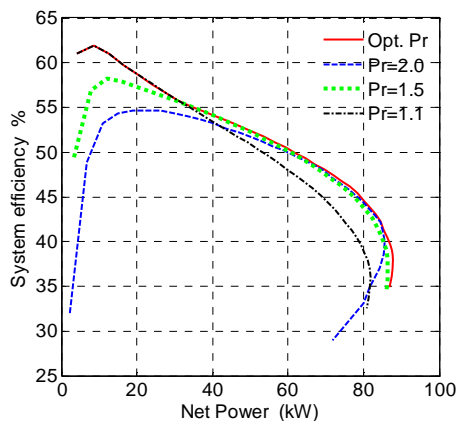

Figure 6 Optimized performance of the fuel cell system

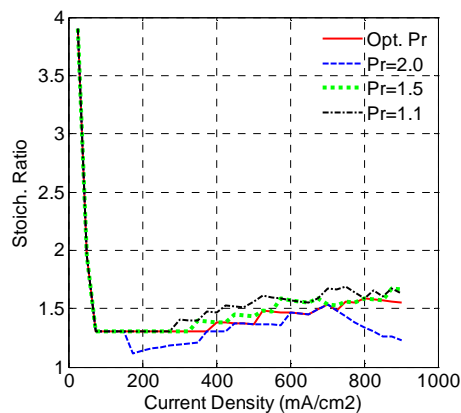

Figure 7 Optimized air stoichiometry ratio

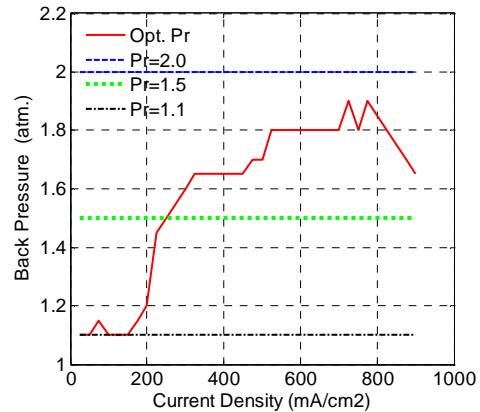

Figure 8 Optimized stack back pressure

The comparison of the optimized characteristics shows that optimal back pressure operation achieves the highest fuel cell system efficiency over the full load range and the low fixed back pressure operation achieves the same efficiency as the optimal back pressure operation in the partial load range. Since fuel cell vehicles operate most of time in the partial load range, the optimal varying back pressure operation and low fixed back pressure operation appear to be best suited for a fuel cell vehicle. However, low back pressure operation needs a large humidifier (for current fuel cell membrane technology), which limits its application in fuel cell vehicles. The optimum back pressure operation varies the back pressure and air supply stoichiometry ratio according to the change of the power demand. These rapid changes in the operating conditions of the fuel cell stack will have a significant impact on the lifetime of the fuel cell stack due to the mechanical and thermal stresses on the membrane electrolyte assembly (MEA) and the stack accessory components. This drawback of the optimal back pressure operation can be avoided through power split control strategies. The operating conditions for the optimum back pressure and fixed back pressure operation modes are applied to the dynamic fuel cell system model and used in the vehicle simulations discussed in the next section.

### 3.2 Simulation results for hybrid fuel cell vehicles

Simulations were performed for hybrid fuel cell vehicles with a dynamic fuel cell system operating in the optimal back pressure mode. Power assist

and load leveling control strategies are applied to the model to study the specific details, the advantages and disadvantages of each control strategy, and their impact on vehicle fuel economy. The characteristics of the vehicle, battery and the fuel cell system are listed in Table 2. The two control strategies were simulated over five FUDS cycles (60 km or 37.5 miles). The simulation results show that the vehicle can follow the drive profile without difficulty for both control strategies. The responses of the battery and the fuel cell for power assist and load leveling control strategies are shown in Figure 9 and Figure 10, respectively. Compared to power assist strategy, load leveling control mitigates the load fluctuations on the fuel cell, which causes less pressure changes within the cathode side of the stack and makes the fuel cell operate in a near stationary state. Therefore, load leveling control can improve the lifetime of the fuel cell. However, load leveling control results in rapid battery charge/discharge and significant SOC swings, which could have a significant impact on battery life.

Table 2 Vehicle simulation parameters (Case 1)

Vehicle and System Parameters	
Drag Coefficient	0.3
Frontal Area (m <sup>2</sup> )	2.2
Rolling Resistance	0.01
Vehicle Hotel Load (kW)	0.3
Vehicle Mass (kg)	1500.0
Electric Motor (kW)	75.0
Fuel Cell Stack and Auxiliaries	
Max. Net Power (kW)	87.6
Gross Power (kW)	106.2
Number of Cells	440
Cell Area (cm <sup>2</sup> )	510.0
Compressor (kW)	17.2
Battery (NiMH)	
Capacity (Ah)	9.0
Specific Energy (kWh)	3.0

Hybrid fuel cell vehicles utilizing power assist and load leveling control strategies have been simulated on various driving cycles - FUDS, US06, HIWAY, JP1015, ECE, and NEDC. The corrected gasoline equivalent miles per gallon have been calculated from the hydrogen consumption results. Figure 11 shows the fuel economies for fuel cell vehicles with the power assist and load leveling

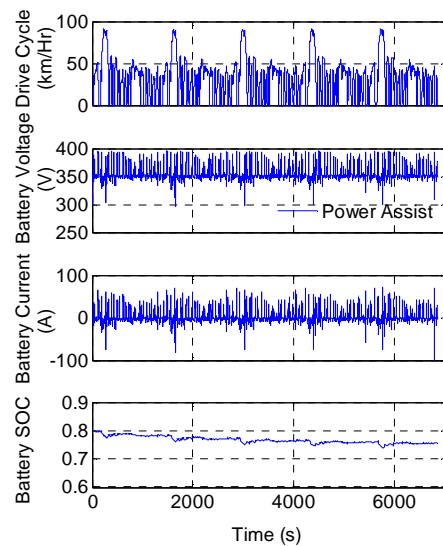

Power assist

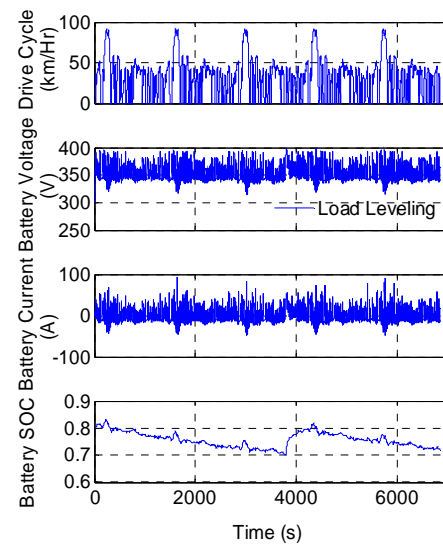

Load leveling

Figure 9 Fuel cell/battery responses on FUDS cycle

control strategies for the five driving cycles. As expected, optimal system operation and low back pressure operation achieve the highest fuel economy due to the higher fuel cell system efficiency. Therefore, fuel cell system efficiency is the dominant effect on vehicle fuel economy. Figure 12 shows the impact of the control strategy on fuel economy for various driving cycles in terms of the ratio of the fuel economies (mpg-load leveled/mpg-power assist). The driving cycle with



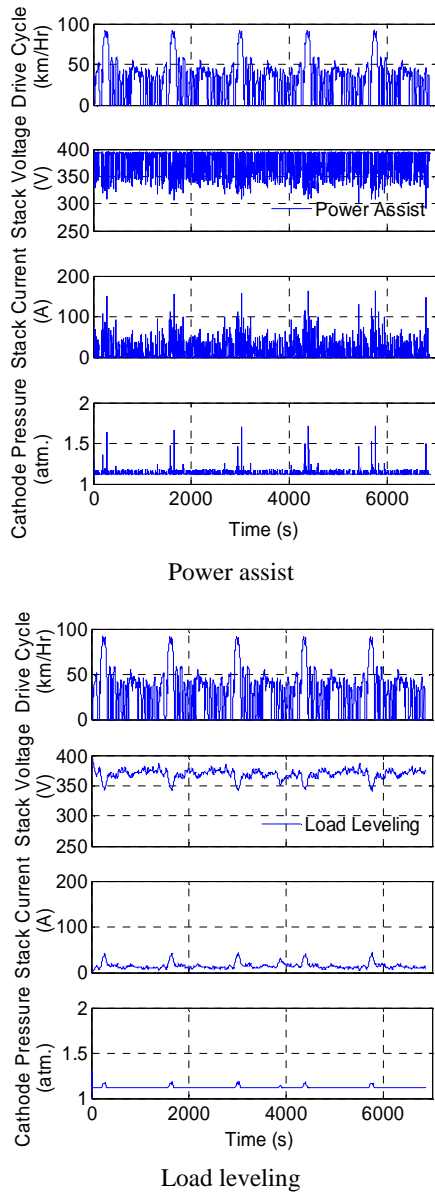
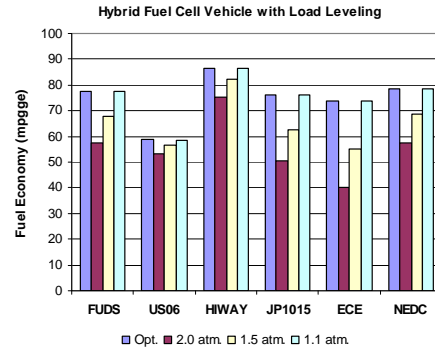
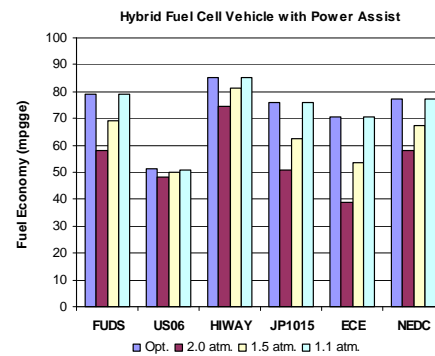

Figure 10 Fuel cell responses on FUDS cycle

high power demand (high speed and transient operations) such as US06 cycle appears to be best suited for load leveling control. The driving cycles with low power demand such as FUDS cycle are consequently the least effective for load leveling control. However, the fuel economy differences using the two control strategies are relatively small (less than 5% in most cases). The fuel cell system efficiency vs. stack power for power assist and load leveling control strategies on FUDS cycle are shown in Figure 13. The curve shows that load leveling control enables the fuel cell to operate



Load leveling



Power assist

Figure 11 Fuel economies for various driving cycles with load leveling and power assist control strategies (Case 1)

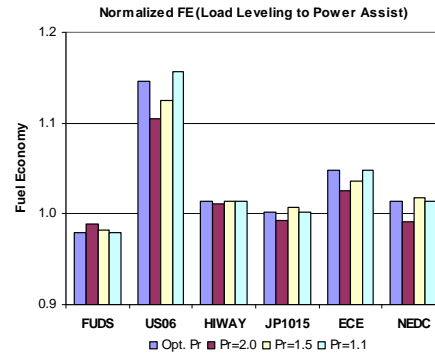

Figure 12: Control strategy impact on fuel economy for various driving cycles

within a narrow power range. Thus, load leveling control makes downsizing fuel cell system possible.

Since load leveling control makes downsizing the fuel cell system possible, simulations were also performed for the vehicle with a small fuel cell system and a small battery (Case 2) to study the impact of power system sizing on fuel economy. Table 3 gives the simulation parameter for Case 2.

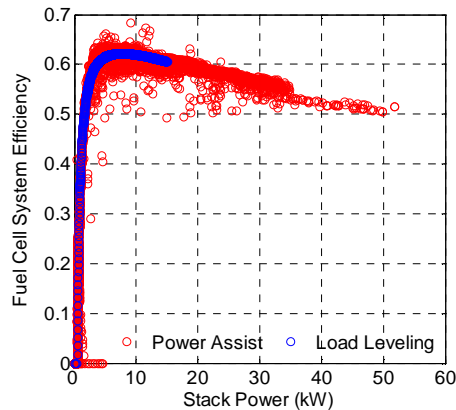

Figure 13: Fuel cell system efficiencies on FUDS cycle

Normalized fuel economy to Case 1 with the power assist and load leveling control strategies is shown Figure 14. The results indicates that for both control strategies the vehicle with smaller fuel cell system becomes more efficient during low speed or low power demand driving by avoiding low fuel cell output power region. The comparison of the fuel cell system efficiency on FUDS cycle for case 1 (large fuel cell system) and case 2 (small fuel cell system) is given in Figure 15. It can be seen that most of time the stack operates in the range 3 – 7 kW which is located in the high efficiency range of the small fuel cell system. Since fuel cell system efficiency has the dominant effect on vehicle fuel economy and the fuel cell system efficiency is significantly lower in the high or low fuel cell output power regions, the fuel cell system should be sized based on the average driving power, not the maximum power required for acceleration, in order to operate the fuel cell system in the high efficiency region. Comparing Figure 12 and Figure 14 shows that the effect of fuel cell system sizing on fuel economy is significantly greater than the selection of the control strategies used.

It is of interest to compare the fuel economies of the direct hydrogen fuel cell vehicle without energy storage (DHFC) and the hybrid fuel cell vehicle with leveling load control. The comparisons for several driving cycles for optimum varying back pressure operation with load leveling are given in Figure 16. The results show that hybridization of fuel cell vehicles can improve fuel economy 10-15% on most of driving cycles due primarily to recovering energy by regenerative braking. This increase is much smaller than for engine-hybrids for which the average engine efficiency is

Table 3 Vehicle simulation parameters (Case 2)

Vehicle and System Parameters	
Drag Coefficient	0.3
Frontal Area (m <sup>2</sup> )	2.2
Rolling Resistance	0.01
Vehicle Hotel Load (kW)	0.3
Vehicle Mass (kg)	1500.0
Electric Motor (kW)	50.0
Fuel Cell Stack and Auxiliaries	
Max. Net Power (kW)	58.4
Gross Power (kW)	70.8
Number of Cells	440
Cell Area (cm <sup>2</sup> )	340
Compressor (kW)	11.4
Battery (NiMH)	
Capacity (Ah)	6.0
Specific Energy (kWh)	2.0

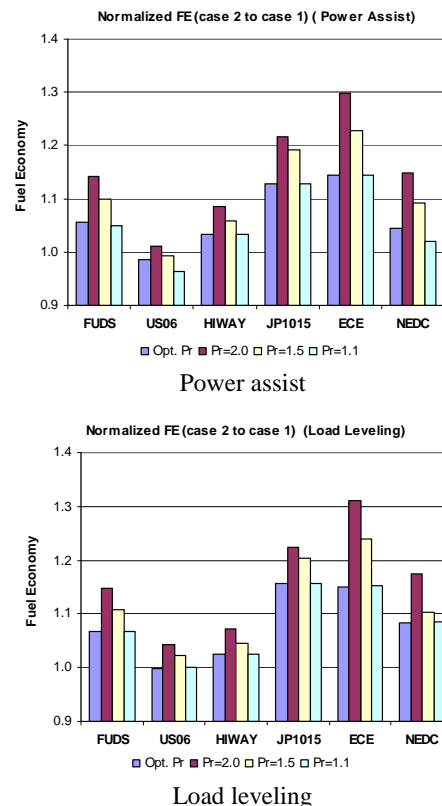

Figure 14: Fuel economies for various driving cycles with load leveling and power assist control strategies (Normalized fuel economy of Case 2 to Case 1)

significantly increased by hybridizing (by more than 50%). In the case of the fuel cell hybrid, the efficiency of the fuel cell system is not

significantly changed. As cited previously, the major advantages of hybridizing the fuel cell powertrain are a large reduction in power demand dynamics and its effect on stack lifetime and the possibility of downsizing the fuel cell without sacrificing vehicle performance. Both of these advantages have large economic impacts for commercializing fuel cell vehicles.

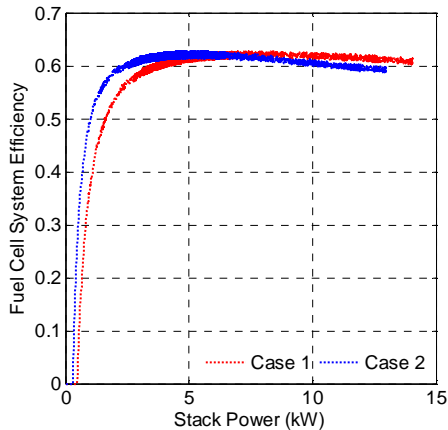

Figure 15: Comparison of fuel cell system efficiency on the FUDS cycle with load leveling control

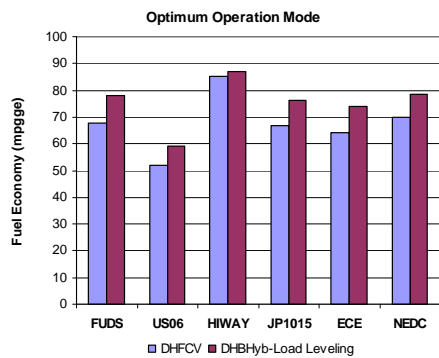

Figure 16 Comparison of fuel economy of the DHFC and hybrid fuel cell vehicle with load leveling control

## 4 Conclusions

Fuel cell/battery hybrid vehicles with various fuel cell system operating modes and control strategies have been simulated on various driving cycles. Vehicles with the fuel cell operating in the optimum back pressure operating mode achieve the best fuel economy and performance. Hybrid vehicles utilizing a load leveling control strategy have both high fuel economy, especially on aggressive driving cycles like the US06, and near

transient-free fuel cell operation which will improve stack lifetime. Load leveling control makes varying back pressure operation of fuel cell system feasible with a large fuel economy advantage over fixed high pressure operation. The study demonstrated that the fuel cell system efficiency is dominant in improving the fuel economy of hybrid fuel cell vehicles and properly downsizing the fuel cell system improves fuel economy for the driving cycles with lower power demand.

## Acknowledgements

The work presented in this paper was supported by the STEPS program and the PHEV Center of the Institute of Transportation Studies of the University of California, Davis. Please refer to <http://www.its.ucdavis.edu> for further details about the STEP program, the PHEV Center, sponsors, and previous reports/papers.

## References

- [1] D.J. Friedman etc., *PEM Fuel Cell System Optimization*, Proceedings of the 2<sup>nd</sup> International Symposium on Proton Conducting Membrane Fuel Cells II, Electrochemical Society, 1998, 407-423.
- [2] P. Badrinarayanan, etc., *Minimizing the Water and Thermal Management Parasitic Loads in Fuel Cell Vehicles*, International Journal of Transport Phenomena, vol.3 no.3 (2001), 213-229.
- [3] J.M. Cunningham, etc., *A Comparison of High Pressure and Low Pressure Operation of PEM Fuel Cell Systems*, SAE 2001, 2001-01-0538.
- [4] D.J. Friedman, *Maximizing Direct-Hydrogen Pem Fuel Cell Vehicle Efficiency-Is Hybridization Necessary?* SAE 1999, 1999-01-0530.
- [5] F. Barbir, etc., *Design and operational characteristics of automotive PEM fuel cell stacks*, SAE 2000, 2000-01-0011.
- [6] J. Cunningham, etc., *A Comparison of Energy Use for a Direct-Hydrogen Hybrid Versus a Direct-Hydrogen, Load-Following Fuel Cell Vehicle*, SAE 2003, 2003-01-0416.
- [7] S. Gelfi, etc., *Dynamics of Low-Pressure and High-Pressure Fuel Cell Air Supply System*, 2003 American Control Conference Denver, ACC2003, 2003.

- [8] S. Pischinger, etc., *Analysis of dynamic requirements for fuel cell systems for vehicle applications*, Journal of Power Sources, vol.154 no.2 (2006), 420-427.
- [9] J.T. Pukrushpan, etc., *Modeling and Control for PEM Fuel Cell Stack System*, Proceedings of the American Control Conference, 2002, 3117-3122.
- [10] C.J. Sjostedt, etc., *The Design of Modular Dynamical Fluid Simulation Systems*, OST, Stockholm Sweden, 2005.
- [11] J.T. Pukrushpan, etc., *Control of Fuel Cell Power Systems*, Springer, 2004.
- [12] K.-H. Hauer, etc., *The Hybridized Fuel Cell Vehicle Model of the University of California, Davis*, SAE 2001, 2001-01-0543.
- [13] R.M. Moore, etc., *A dynamic simulation tool for hydrogen fuel cell vehicles*, Journal of Power Sources, vol.141, no.2(2005), 272-285.
- [14] H. Zhao, etc., *Optimization of Fuel Cell System Operating Conditions for Fuel Cell Vehicles*, Journal of Power Sources, Vol.186, Iss.2 (2009), 408-416.
- [15] A. Schell, etc., *Modelling and control strategy development for fuel cell electric vehicles*, Annual Reviews in Control, Vol.29 no.1 (2005), 159-168.
- [16] P. Rodatz, etc., *Optimal power management of an experimental fuel cell/supercapacitor-powered hybrid vehicle*, Control Engineering Practice, Vol.13, Iss.1 (2005), 41-53.
- [17] V. Paladini, etc., *Super-capacitors fuel-cell hybrid electric vehicle optimization and control strategy development*, Energy conversion and management, Vol.48, no.11 (2007), 3001-3008.
- [18] P. Corbo, etc., *Experimental assessment of energy-management strategies in fuel-cell propulsion systems*, Journal of Power Sources, Vol.157, Iss.2 (2006), 799-808.
- [19] R.K. Ahluwalia, etc., *Fuel economy of hybrid fuel-cell vehicles*, Journal of Power Sources, 152(2005), 233-244.
- [20] M. Stevens, etc., *Fuel Cell Hybrid Control Strategy Development*, SAE, 2006-01-0214.
- [21] O. Sundstrom, etc., *Optimum battery size for fuel cell hybrid electric vehicle-Part I*, Journal of fuel cell science and technology, vol.4, no.2 (2007), 167-175.
- [22] P. Thounthong, etc., *Energy management of fuel cell/battery/supercapacitor hybrid power source for vehicle applications*, Journal of Power Sources, doi:10.1016/j.jpowsour.2008.12.120, 2009.

- [23] D. Wu, etc., *Performance Characterization and Comparison of Power Control Strategies for Fuel Cell Based Hybrid Electric Vehicles*, Vehicle Power and Propulsion Conference (2007), 55-61.
- [24] T.E. Springer, etc., Gottesfeld, *Modeling and Experimental Diagnostics in Polymer Electrolyte Fuel Cells*, Journal of Electrochemistry Society, 140(1993), 3513-352.

## Authors

Hengbing Zhao, Research Engineer in ITS-Davis. He received his Ph.D. at Zhejiang University in 1999. His research has involved many aspects of battery-powered electric vehicles, uninterruptible power sources, distributed power generation systems, fuel cell systems, and fuel cell vehicles. His particular interests are fuel cell system, fuel cell vehicle, hybrid drivetrain design and evaluation, and distributed power generation systems.



Andrew F. Burke, Research Engineer, ITS-Davis. Ph.D., 1967, Princeton University. Since 1974, Dr. Burke's research has involved many aspects of electric and hybrid vehicle design, analysis, and testing. He was a key contributor on the US Department of Energy Hybrid Test Vehicles (HTV) project while working at the General Electric Research and Development Center. He continued his work on electric vehicle technology, while Professor of Mechanical Engineering at Union College and later as a research manager with the Idaho National Engineering Laboratory (INEL). Dr. Burke joined the research faculty of the ITS-Davis in 1994. He directs the EV Power Systems Laboratory and performs research and teaches graduate courses on advanced electric driveline technologies, specializing in batteries, ultracapacitors, fuel cells and hybrid vehicle design. Dr. Burke has authored over 80 publications on electric and hybrid vehicle technology and applications of batteries and ultracapacitors for electric vehicles.

