

# UC Berkeley

## Research Reports

### Title

Integrating a Comprehensive Modal Emissions Model into ATMIS Transportation Modeling Frameworks

### Permalink

<https://escholarship.org/uc/item/6248p2dr>

### Authors

Barth, Matthew  
Malcom, Carrie  
Scora, George

### Publication Date

2001-08-01

CALIFORNIA PATH PROGRAM  
INSTITUTE OF TRANSPORTATION STUDIES  
UNIVERSITY OF CALIFORNIA, BERKELEY

# **Integrating a Comprehensive Modal Emissions Model into ATMIS Transportation Modeling Frameworks**

**Matthew Barth, Carrie Malcolm, George Scora**  
*University of California, Riverside*

**California PATH Research Report  
UCB-ITS-PRR-2001-19**

This work was performed as part of the California PATH Program of the University of California, in cooperation with the State of California Business, Transportation, and Housing Agency, Department of Transportation; and the United States Department of Transportation, Federal Highway Administration.

The contents of this report reflect the views of the authors who are responsible for the facts and the accuracy of the data presented herein. The contents do not necessarily reflect the official views or policies of the State of California. This report does not constitute a standard, specification, or regulation.

Report for MOU 381

August 2001

ISSN 1055-1425



## Summary

Intelligent Transportation Systems (ITS) have generated considerable enthusiasm in the transportation community as a potential means to improve roadway safety, reduce congestion, enhance the mobility of people and goods, and reduce energy consumption and vehicle emissions. In order to estimate these potential benefits, new and improved analytical techniques and simulation models are being developed for ITS. In terms of environmental effects, the University of California, Riverside, College of Engineering-Center for Environmental Research and Technology (CE-CERT) has developed a comprehensive modal emissions and energy consumption (CME/EC) model that can be directly used for ITS evaluation.

In this project, an examination was performed on the key interface issues between the detailed CME/EC model and other ITS simulation models and analytical techniques developed within the California PATH program. Methodologies for integrating various ITS transportation models/data sets with the CME/EC model were established. These integration issues are not trivial; many ITS simulation models and analytical techniques inherently have different levels of aggregation and detail (e.g., both in time and across various vehicle fleets).

Much of the work performed focused on integrating the CME/EC model with PARAMICS. PARAMICS is used throughout CALTRANS and the PATH program for various ITS studies. After successfully completing this integration, two case studies were carried out using this PARAMICS/CME-EC tool. The first case study examined the emissions impact of HOT lanes along the SR-91 corridor in Southern California. The other case study examined the emissions impact associated redesignating uphill lanes on I-60 near Riverside, California. By completing these case studies, the integrated transportation/emissions model was thoroughly debugged. These case studies can serve as examples as how to apply this new tool for creating microscale emission inventories.

In this report, background material is first provided on the Comprehensive Modal Emissions/Energy Consumption (CME/EC) model and ITS traffic simulation modeling efforts in the California PATH program. This is followed by a description of the integration methodology between CME/EC and PARAMICS. In the last part of the report, two separate case studies are described, where analyses with the integrated models were carried out.



# Contents

- SUMMARY ..... I**
- CONTENTS.....II**
- 1. INTRODUCTION.....1**
- 2. BACKGROUND .....3**
- 2.1. COMPREHENSIVE MODAL EMISSIONS/ENERGY CONSUMPTION MODEL3**
- 2.2. ATMIS MODELING WORK IN PATH PROGRAM .....11**
- 2.3. PARAMICS MICROSCOPIC TRAFFIC SIMULATOR .....15**
- 3. METHODOLOGY .....17**
- 3.1. EMISSION LOOKUP TABLES .....17**
- 3.2. POST-PROCESSING VEHICLE TRAJECTORIES .....19**
- 3.3. USING EMBEDDED EMISSIONS FUNCTIONS .....19**
- 3.4. VEHICLE FLEET COMPOSITION.....20**
- 4. CASE STUDIES.....25**
- 4.1. SR-91 HIGH OCCUPANCY TOLL (HOT) LANE EXPANSION PROJECT.....25**
  - 4.1.1. BACKGROUND .....25
  - 4.1.2. OVERALL STUDY METHODOLOGY.....26
  - 4.1.3. VEHICLE EMISSIONS METHODOLOGY .....27
  - 4.1.4. TRAFFIC AND EMISSIONS RESULTS.....30
- 4.2. I-215/SR-60 MORENO VALLEY FREEWAY EXPANSION PROJECT .....38**
  - 4.2.1. BACKGROUND .....38
  - 4.2.2. METHODOLOGY .....39
  - 4.2.3. RESULTS.....42
- 5. CONCLUSIONS AND FUTURE WORK.....45**
- 6. REFERENCES.....47**



# 1. Introduction

The general goals of Intelligent Transportation Systems (ITS) are to increase transportation system efficiency and capacity, enhance mobility, improve safety, reduce energy consumption and environmental costs, increase economic productivity, and create ITS markets [ITS America, 1995]. However, it is difficult to quantify the impact of ITS on emissions and energy consumption because tradeoffs exist between ITS-based changes in travel behavior, transportation system performance, and vehicle operation. For example, potential emissions and energy consumption reductions may come about from:

- improvements in traffic flow due to mitigation of recurrent and nonrecurrent congestion;
- the generation of shorter trips through route guidance;
- the elimination or delay of trips during poor traffic conditions; and
- reductions of wasted travel produced by navigational errors.

Potential increases in emissions and energy consumption may occur from:

- induced travel demand from significant improvements in the transportation system;
- increases of the number and length of trips due to faster travel times;
- shifts from HOV trips to SOV trips; and
- changes in land use patterns that increase trip distance.

The tradeoffs among these factors are difficult to quantify using standard models and analytical techniques. Much progress is being made in developing new travel demand, traffic simulation, and emission models. These newer models must be integrated together to better understand the impact of ITS on emissions and fuel consumption. Such an understanding will assist localities with the implementation of ITS strategies that are compatible with local air quality goals and mandates.

In this PATH project, an examination was performed on the key interface issues between a state-of-the-art vehicle modal emissions/energy model and ITS simulation models (as well as analytical techniques) developed within the PATH program. The vehicle emissions model is the result of a four-year National Cooperative Highway Research Program (NCHRP, project 25-11) carried out at the University of California, Riverside, College of Engineering-Center for Environmental Research and Technology (CE-CERT). Details on this model are provided in Section 2 of this report. In this PATH project, methodologies for integrating various ITS transportation models/data sets with the vehicle emissions/energy model were developed, with a particular focus on the PARAMICS traffic simulator used throughout CALTRANS and the PATH program. Because many ITS simulation models and analytical techniques inherently have different levels of aggregation and detail (e.g., both in time and across various vehicle fleets), these integration methods are not simple.



In this report, background material is first provided on the Comprehensive Modal Emissions/Energy Consumption (CME/EC) model and ITS traffic simulation models such as PARAMICS. This is followed by a description of the integration methodology between CME/EC and PARAMICS. In the last part of the report, two separate case studies are described, where analyses with the integrated models were carried out.

## 2. Background

### 2.1. COMPREHENSIVE MODAL EMISSIONS/ENERGY CONSUMPTION MODEL

In order to develop and evaluate transportation policy, agencies at the local, state, and federal levels currently rely on the mobile source emission-factor models MOBILE (developed by the US Environmental Protection Agency, [US EPA, 1997]) or EMFAC (developed by the California Air Resources Board [CARB, 1995]). Both MOBILE and EMFAC predict vehicle emissions based in part on average trip speeds and were built upon regression coefficients based on a large number of FTP (Federal Test Procedure, see [FTP, 1989]) bag emission measurements. Since these models are intended to predict emission inventories for large regional areas, they are not well suited for evaluating operational improvements that are more “microscopic” in nature, such as ramp metering, signal coordination, and many ITS strategies. What is needed in addition to these “regional-type” of mobile source models is an emissions model that considers at a more fundamental level the *modal* operation of a vehicle, i.e., emissions that are directly related to vehicle operating modes such as idle, steady-state cruise, various levels of acceleration/deceleration, etc.

In August 1995, the College of Engineering-Center for Environmental Research and Technology (CE-CERT) at the University of California, Riverside began a four-year research project to develop a comprehensive modal emissions and energy consumption model, sponsored by the National Cooperative Highway Research Program (NCHRP, Project 25-11). The overall objective of this research project was to develop and verify a modal emissions and fuel consumption model that accurately reflects Light-Duty Vehicle (LDV, i.e., cars and small trucks) emissions produced as a function of the vehicle’s operating mode. The model is comprehensive in the sense that it is able to predict emissions for a wide variety of LDVs in various states of condition (e.g., properly functioning, deteriorated, malfunctioning). Further background on modal emission modeling and this NCHRP project is given in [Barth et al., 1996, 1997, 1999].

This NCHRP research project was divided into four phases:

**Phase 1**—The first phase of work consisted of: 1) collecting data and literature from recent related studies; 2) analyzing these data and other emission models as a starting point for the new model design; 3) developing a new dynamometer emission testing protocol to be used for the vehicle testing phase of the project (described in detail in [Barth et al., 1997a]); 4) conducting preliminary testing on a representative sample of vehicles (approximately 30) with the developed dynamometer emission testing protocol. These data supplement existing data which were used for 5) the development of an interim working model (described in detail in [An et al., 1997]).

**Phase 2**—The objectives of Phase 2 were to collect emissions data (using the developed dynamometer testing procedure) from a larger representative sample of vehicles (approximately 320) and to iteratively refine the working model.

**Phase 3**—This phase of work consists of refining and validating the model. The objective of this phase was to demonstrate that the emissions model is responsive to the regulatory compliance needs of transportation and air quality agencies.

**Phase 4**—This phase of work consisted of 1) incorporating additional vehicle/technology categories in order to better estimate emission inventories into future years; 2) developing a graphical user interface (GUI) for the model, making it more user-friendly; and 3) holding a national workshop on the model, in order to help introduce the model to transportation/air quality model practitioners.

In Phase 1 of this project (and later in Phase 4), 26 different vehicle/technology categories (see Table 2.1) have been defined to serve as the basis for the model, as well as to guide the vehicle recruitment and testing performed in Phase 2 and 4. Because the eventual output of the model is emissions, the vehicle/technology categories and the sampling proportions of each were chosen based on a group's *emissions contribution*, as opposed to a group's actual population in the national fleet. Because of this, five distinct high-emitting vehicle/technology groups have been included. The other vehicle/technology categories have been chosen based on vehicle class (e.g., car or truck), emission control technology (e.g., no catalyst, 3-way catalyst, etc.), emission certification standard (e.g., Tier 0, Tier 1), power-to-weight ratio, and mileage.

Category #	Vehicle Technology Category
<b><i>Normal Emitting Cars</i></b>	
1	No Catalyst
2	2-way Catalyst
3	3-way Catalyst, Carbureted
4	3-way Catalyst, FI, >50K miles, low power/weight
5	3-way Catalyst, FI, >50K miles, high power/weight
6	3-way Catalyst, FI, <50K miles, low power/weight
7	3-way Catalyst, FI, <50K miles, high power/weight
8	Tier 1, >50K miles, low power/weight
9	Tier 1, >50K miles, high power/weight
10	Tier 1, <50K miles, low power/weight
11	Tier 1, <50K miles, high power/weight
24	Tier 1, >100K miles
<b><i>Normal Emitting Trucks</i></b>	
12	Pre-1979 (<=8500 GVW)
13	1979 to 1983 (<=8500 GVW)
14	1984 to 1987 (<=8500 GVW)
15	1988 to 1993, <=3750 LVW
16	1988 to 1993, >3750 LVW
17	Tier 1 LDT2/3 (3751-5750 LVW or Alt. LVW)
18	Tier 1 LDT4 (6001-8500 GVW, >5750 Alt. LVW)
25	Gasoline-powered, LDT (> 8500 GVW)
40	Diesel-powered, LDT (> 8500 GVW)
<b><i>High Emitting Vehicles</i></b>	
19	Runs lean
20	Runs rich
21	Misfire
22	Bad catalyst
23	Runs very rich

**Table 2.1.** Vehicle/Technology modeled categories. Note diesel vehicles start at category 40; “blank” categories are user programmable from category #60.

For testing, vehicles were recruited randomly within each vehicle/technology bin in this matrix. Each vehicle was tested using a comprehensive dynamometer testing procedure that consists of a standard FTP test, the high-speed US06 cycle (to be used in future supplemental FTP testing), and an in-house developed modal emission cycle. This modal emission cycle (MEC01) has been designed to include various levels of acceleration and deceleration, a set of constant speed cruises, speed-fluctuation driving, and constant power driving. Details of this dynamometer testing procedure are given in [Barth et al., 1997].

For each vehicle/technology category shown in Table 2.1, a different model “instance” or sub-model has been created using a parameterized physical approach (see [Barth et al., 1996]). For each sub-model, there are a number of vehicle parameters and operating variables that are considered. As shown in Figure 2.1, the generalized model for each category consists of six distinct modules that individually predict: 1) engine power; 2) engine speed; 3) air/fuel ratio; 4) fuel-use; 5) engine-out emissions; and 6) catalyst pass fraction. The vehicle parameters used in the model are divided into two groups: 1) parameters that are obtained from the public domain (or determined generically), and 2) parameters that need to be calibrated based on the second-by-second dynamometer emission measurements. Examples of the first group include vehicle mass, engine displacement, rated engine power and torque, etc. Examples of the second group include engine friction factor, enrichment threshold and strength, catalyst pass fraction, etc. This second group of parameters are determined based on an extensive calibration process, where a series of optimization procedures are applied to minimize the differences between the measured and modeled emissions over the test cycles. Details of the model structure are given in [An et al., 1997].

The modal emissions model has been designed so that it can interface with a wide variety of transportation models and/or transportation data sets in order to produce an emissions inventory. As shown in Figure 2.2, these transportation models/data vary in terms of their inherent temporal resolution. For example, at the lowest level, microscopic transportation models typically produce second-by-second vehicle trajectories (location, speed, acceleration). Driving cycles used for vehicle testing are also specified on a second-by-second basis (speed vs. time). In addition, there are other types of transportation models/data sets that aggregate with respect to time, producing traffic statistics such as average speed on a roadway facility type basis. Similar acceleration statistics may also be produced by these models. At the highest level, total vehicle volume and average speed over an entire regional network may be all that is provided.

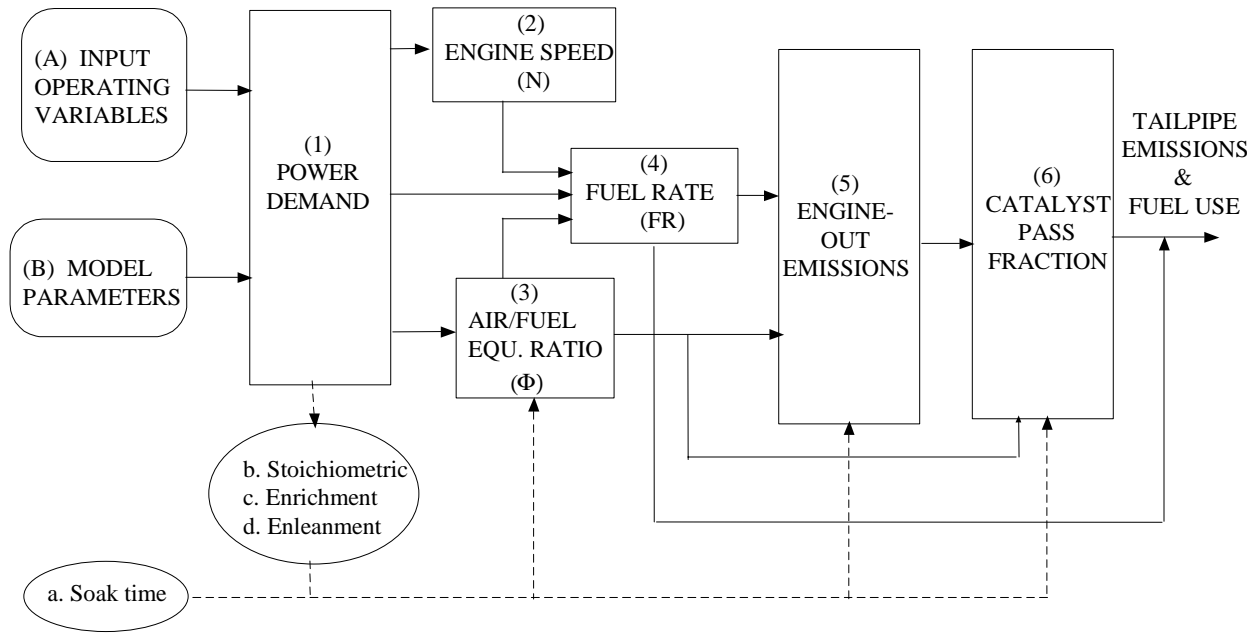

Figure 2.1. Modal Emissions Model structure.

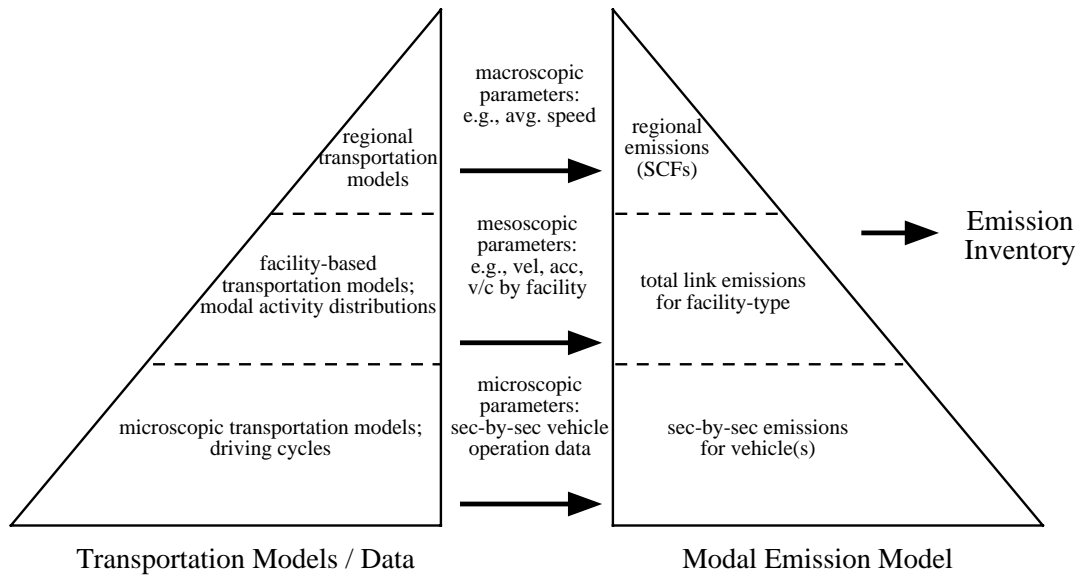

Figure 2.2. Transportation/Emission Model interface.

In order for the emission model to be closely integrated with different types of transportation models (with varying levels of temporal and vehicle resolution), it must be able to operate at various temporal resolutions. The model was developed in a bottom-up fashion, concentrating first at a high temporal resolution (i.e., on the order of a few seconds) and then aggregating upwards. As illustrated in Table 2.2, emissions can be predicted second-by-second, by vehicle operating mode, or aggregate emissions can be given for a specific driving cycle (i.e., velocity profile).

In addition to temporal aggregation, vehicle aggregation must also be considered. Given an appropriate parameter set, the model is capable of predicting emissions and fuel consumption for individual vehicles. However, our ultimate goal is the prediction of detailed emissions for an average *composite* vehicle within each vehicle/technology category. This composite vehicle approach is somewhat different from the approach used by traditional emission factor models. The compositing techniques used are based on developed stochastic distributions of the various model parameters. At the highest level of vehicle aggregation, the model outputs from each vehicle/technology category can be combined appropriately to represent emissions from the general vehicle population.

Temporal Aggregation:	<i>second-by-second</i> → <i>several seconds mode</i> → <i>driving cycle or scenario</i>
Vehicle Aggregation:	<i>specific vehicle</i> → <i>vehicle/technology category</i> → <i>general vehicle mix</i>

**Table 2.2.** Temporal and vehicle aggregation.

The CME/EC model currently exists in several different forms. During development, the model was carried out in a research environment, using MATLAB modeling/analysis tools [Mathworks, 2000]. In order to use the model outside the development environment, executable code was created from the finalized source code. For this executable code a command line user interface was initially developed. The command-line code was developed for both the PC environment (running from a DOS command line) and the UNIX environment (compiled for both SUN and SGI workstations). Running from the command line, the executable code reads in specific input files and produces specific output files, as described below.

The CME/EC executable code takes on two forms:

**Core Model**—the core executable code allows the user to obtain emission data for a single specified vehicle category and a given vehicle activity file. As illustrated in Figure 2.3, the core model uses two input files and outputs two emission files. One input file is used to control the parameters of the model, the other input is a second-by-second vehicle activity file. One resulting output file provides tailpipe emissions and fuel consumption on a second-by-second basis. The other output file is a vehicle summary file. The control input file specifies the vehicle category to be modeled and the soak time prior to the model run. Default parameters to the model can be overridden with specific entries in the control input file. The vehicle activity file consists of column-oriented data vectors. The minimum vectors that are required are time (in seconds) and vehicle velocity (in MPH or KPH depending on control file). Optional data vectors in the vehicle activity input file include acceleration (if directly measured and not derived from velocity differentiation), grade, and secondary load activity (such as AC use). The emissions

output file also consists of column-oriented data vectors, including time, velocity, HC, CO, NOx, and fuel use. Other second-by-second parameters (e.g., CO<sub>2</sub>, fuel/air ratio, etc.) can also be selected for output via the control file.

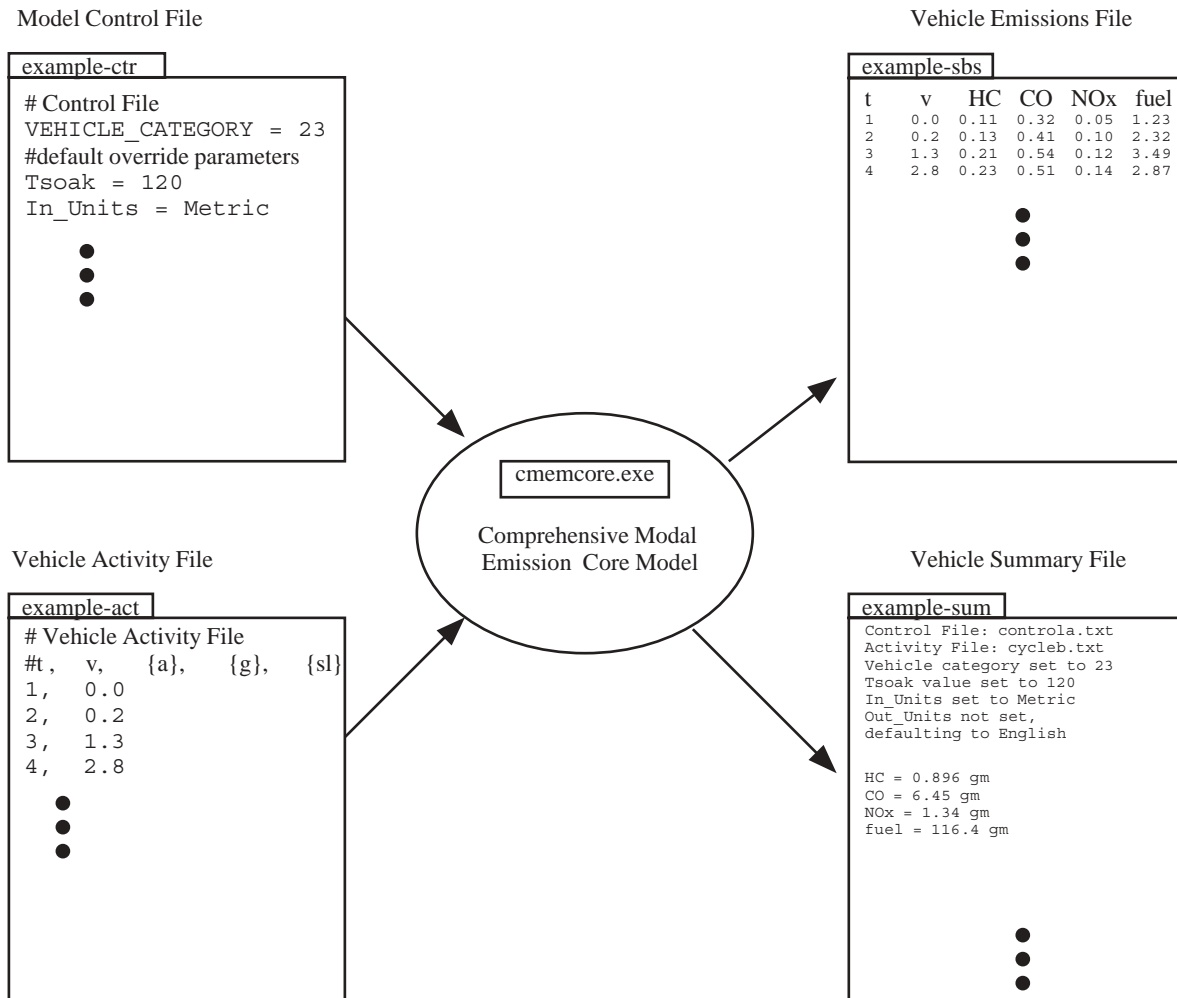

Figure 2.3. Core form of the modal emission model executable.

**Batch Model**—the batch executable code allows the user to obtain emission data for multiple vehicles (from a variety of categories) with different trajectories specified in the vehicle activity file. As illustrated in Figure 2.4, the batch model requires three input files: a parameter control file, a soak-time file, and a time-ordered vehicle activity file. Two output files are available: a second-by-second, time-ordered vehicle emissions file, and a vehicle integrated emissions file. The control file is similar to that described above, however it also includes a matrix correlating vehicle ID (*vehid* of the activity file) and the vehicle type (*vehtyp*). The control file also specifies whether a soak time file exists. An optional soak time file specifies how long each vehicle has been stopped prior to the model application. The vehicle activity file is similar to that described above, except it has an additional column vector specifying particular vehicles (*vehid*). Several transportation models output vehicle trajectories in this format. The second-by-second time-ordered vehicle emissions file is similar to that used in the core model, except again it has an

added column specifying vehicle ID. The vehicle integrated emissions file provides the integrated emission results of the velocity patterns for each vehicle.

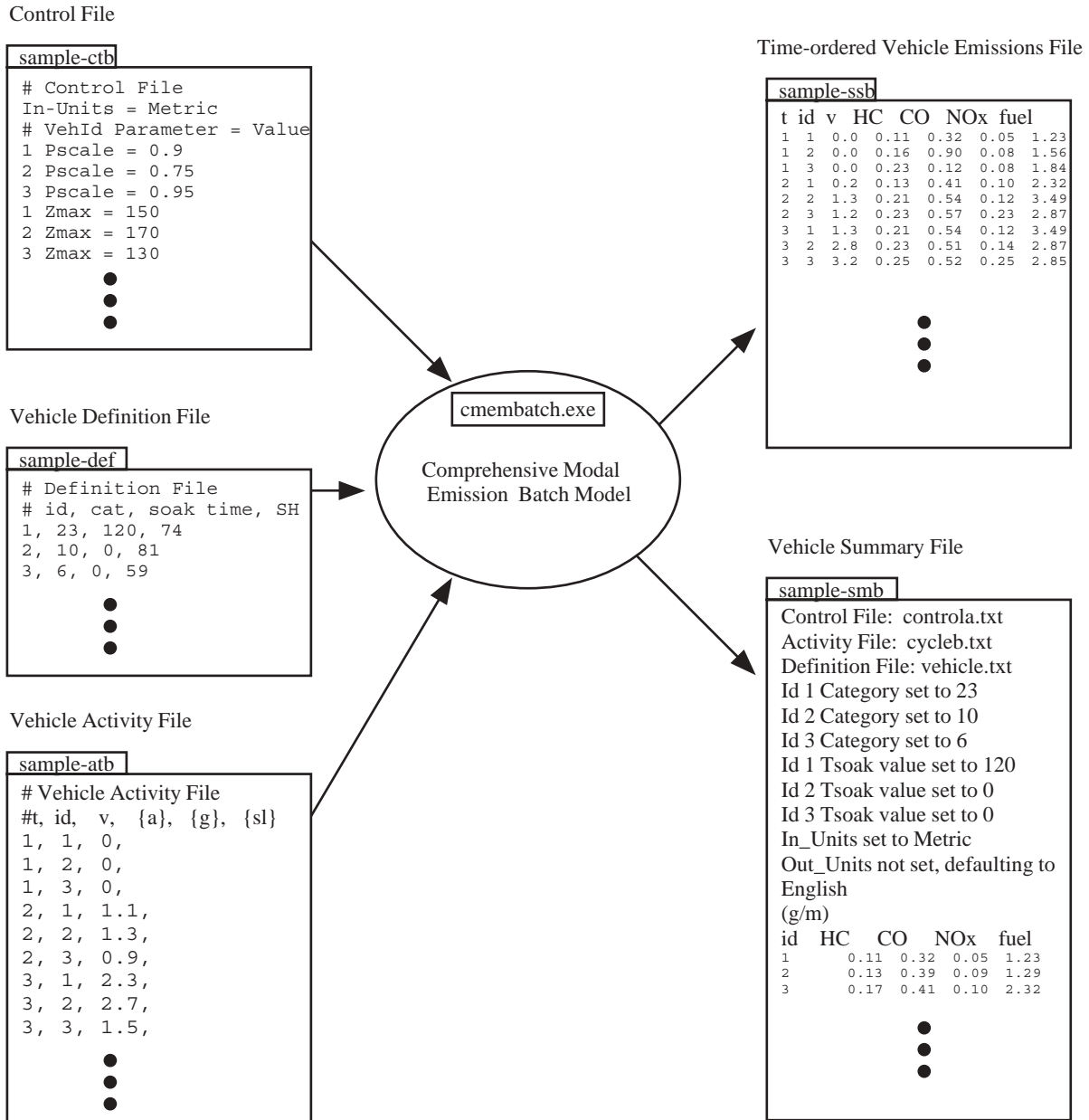

Figure 2.4. Batch form of the modal emission model executable.

In addition to the command line version of the code, a friendlier graphical user interface for the CME/EC model has been implemented in Microsoft ACCESS. ACCESS is a separate database management program sold by Microsoft, and is often bundled with Microsoft Office software. ACCESS runs on Windows 95, 98, and NT platforms. It is possible to cut, copy, and paste data from any Windows application to and from ACCESS. Because ACCESS is part of the Microsoft



Office software, it is also possible to link and embed various software objects between the Office suite of software.

ACCESS is a database management system that stores and retrieves data, presents information, and automates repetitive tasks. The user can also create various input forms and create reports. It is also possible to develop code in Visual Basic and embed the code within individual ACCESS databases. That is how the CME/EC model is implemented. An example of the GUI is shown in Figure 2.5. For more details on how to run the CME/EC model either through the command line interface or through the ACCESS graphical user interface, please refer to the user’s guide [Barth et al., 2000].

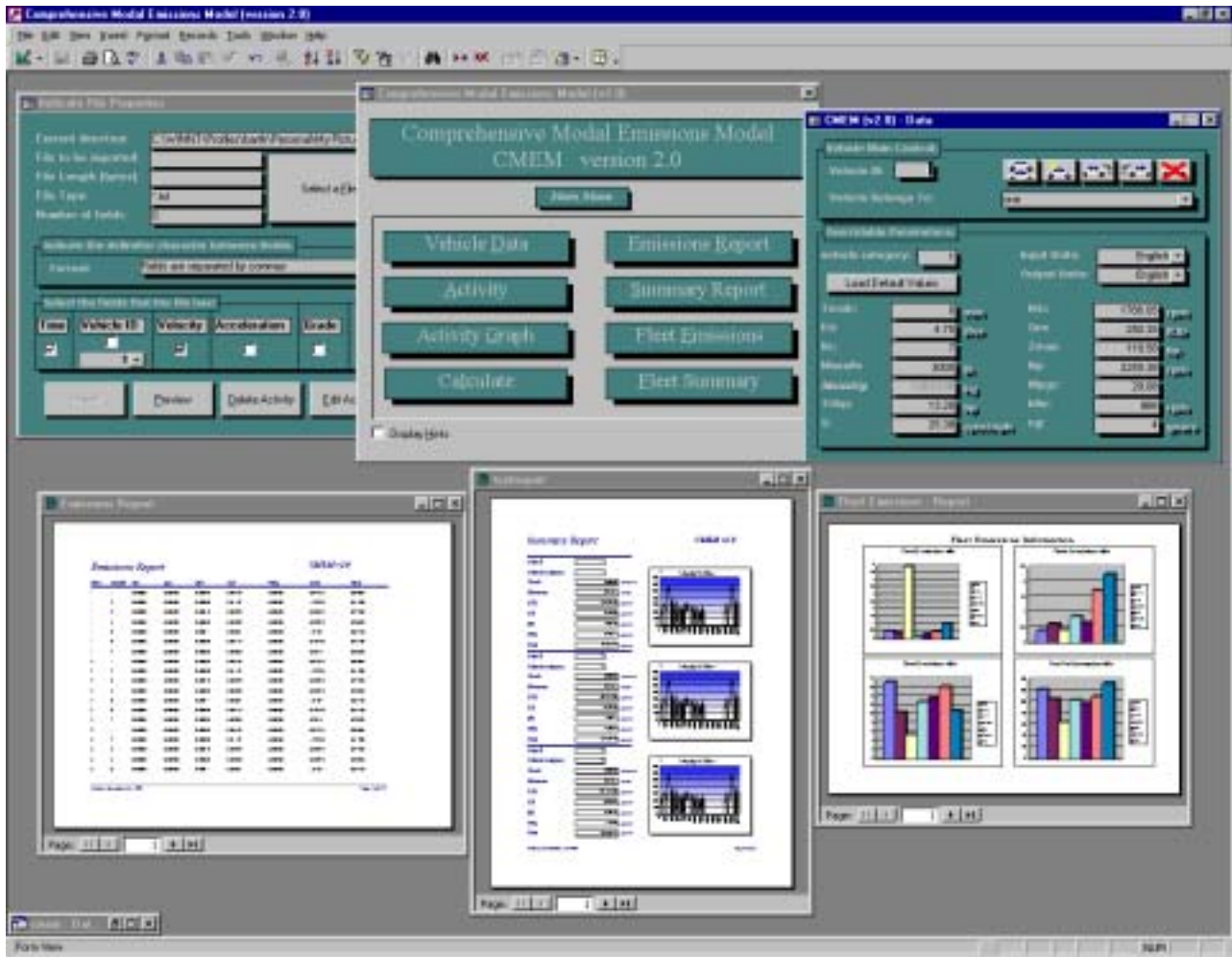

Figure 2.5. Microsoft ACCESS GUI form of the modal emission/energy consumption model.

## 2.2. ATMIS MODELING WORK IN PATH PROGRAM

In the early stages of this PATH project (early 1999), discussions were held with representatives from the three UC Institute of Transportation Studies (ITS) campuses involved with transportation modeling, with a focus on ATMIS. The purpose of this was to investigate how it would be best to integrate CE-CERT's CME/EC model with ATMIS transportation models being used in the PATH program. The results of this task are discussed below.

### *UC Davis Institute of Transportation Studies*

UC Davis began a project in 1996 to identify and prioritize environmentally beneficial intelligent transportation technologies<sup>1</sup>. The objectives of this project were to:

- 1) review previous qualitative and quantitative environmental assessments of ITS, including both field operational tests and modeling studies;
- 2) review the regulatory and policy contexts which encompass ITS;
- 3) develop a modeling framework suitable for assessing the short term environmental impacts of ITS;
- 4) identify those ITS technologies that have positive environmental effects; and
- 5) rank those technologies according to their energy and emission benefits.

The results of this project are given in [Shaheen et al., 1998] and [Young et al., 1999]. In terms of transportation modeling, an attempt was made to develop a model that would be capable of quantifying the short-term environmental impacts of ITS applications along a typical transportation corridor. For this study, a section of the SMART Corridor (Santa Monica Freeway (I-10) between I-405 and I-110) was chosen. The model used in this study was INTEGRATION (v2.0) developed at the Queen's University in Ontario Canada [Van Aerde, 1995]. INTEGRATION (v.2.0) is a microscopic traffic simulation and dynamic assignment model that traces movement of individual vehicles on freeways and arterials to a temporal resolution of one second. Incorporating a built-in traffic assignment algorithm, the model tracks the spatial and temporal activities of up to 500,000 vehicles operating on a sub-area with a maximum of 10,000 links. INTEGRATION's ability to combine arterial and freeway movements sets it apart from most conventional traffic simulation models<sup>2</sup>. At the time, INTEGRATION was slated to be one of the better transportation models for evaluating ITS. Currently INTEGRATION uses fuel consumption and emission rates that are calculated for two modes of operation: constant speed cruise (including idle), and velocity change (determined as a function of initial and final speed).

---

<sup>1</sup> MOUs 225 and 337, the Identification and Prioritization of Environmentally Beneficial Intelligent Transportation Technologies at UC Davis (P.I.s Daniel Sperling, Troy Young).

<sup>2</sup> The name INTEGRATION comes from the model's ability to combine movements on arterials and freeways.

Thus far, efforts have been made to calibrate the fuel consumption and emissions based on “reverse-engineering” drive cycle information inherent to the U.S. EPA’s MOBILE5a emissions model. Currently INTEGRATION is not very sensitive to a variety of levels of acceleration experienced by a vehicle during a specific trip. However, because it operates on a second-by-second basis, it would potentially match well with the comprehensive modal emissions / energy consumption model described previously.

Unfortunately, this modeling effort at UC Davis was coming to a close when our emissions model integration project began. Further, the modeling effort was not entirely successful since there were significant difficulties working with the SMART Corridor database. For these reasons, no further effort was made to integrate our CME/EC model with this particular UC Davis project.

Since that time, further discussions were made with Michael Zhang at UC Davis. He is currently working on a PATH project to develop and evaluate adaptive ramp metering strategies. Thus far, a conceptual evaluation of existing ramp metering algorithms has been carried out. Based on a set of evaluation criteria, six of these ramp-metering algorithms have been retained for further analysis, including simulations and field tests. The simulation will be carried out using the PARAMICS model (see Section 2.3). The ramp metering API (application programming interface) developed by UC Irvine will be used, providing a direct way to feedback into PARAMICS the results of an external adaptive ramp-metering algorithm. In the future, it should be possible to determine the energy and emission impacts of these ramp-metering algorithms, since the majority of the effort of our PATH project was to create an embedded emissions/energy API for use with PARAMICS. Details on this work are described in Section 3.

### ***UC Berkeley Institute of Transportation Studies and PATH***

In 1999, researchers at UC Berkeley’s Institute of Transportation Studies have developed an ATMIS transportation modeling environment and are now using the environment to assess the effectiveness of different ATMIS strategies<sup>3</sup>. In creating the ATMIS modeling environment, the researchers initially expanded on research with the TRAF-NETSIM model to enable it to simulate both the performance of traffic responding to real-time control systems and the actual real-time control environment. Interfaces have been developed between real-time control software and the microscopic traffic simulation modeling so that the entire control/operations environment can be simulated in microscopic detail.

Due to limitations with the TRAF-NETSIM model, the researchers have also looked at two other microscopic traffic simulators: WATSIM and INTEGRATION. INTEGRATION, as mentioned previously, has limited energy and emission algorithms. The researchers are using the microscopic models to simulate the Smart Corridor and are evaluating which model can best simulate existing traffic conditions and model ATMIS strategies.

Later, in April 2000, work began on a research effort whose objectives are to conduct experiments and develop expertise in the application of the PARAMICS model in the

---

<sup>3</sup> MOU 362, The Development of an ATMIS Transportation Modeling Environment and Assessment of the Effectiveness of ATMIS Strategies, being carried out at UC Berkeley (P.I. Alex Skabardonis).

investigations of freeway operational strategies<sup>4</sup>. This one-year initial research project focuses on the investigation of a portion of the southbound morning peak I-680 freeway facility, between I-580 in Pleasanton and SR-237 in San Jose. Particular attention is being given to model calibration and to the investigation of corridor improvements currently under consideration by CALTRANS. Joy Dahlgren is the principal investigator of this project, with Professor Adolf May and Alex Skabardonis from UC Berkeley serving as project advisors. Yonnel Gardes is the full time engineer on this project. In the first phase of the project, several simple networks were developed to provide the opportunity for conducting some initial experiments with the PARAMICS model. The intent was to apply the model to very simple situations in which the predicted model results could be compared with known accepted results or observed real-life data. Three test freeway networks were developed: the lane-drop, ramp merge, and weaving experiments. Most of the initial findings are reported and discussed in a PATH working paper released on September 20, 2000. This initial project phase provided not only a valuable learning experience on the model capabilities but also a basis for discussion with a number of partners including CALTRANS (headquarters support team and District 4), Quadstone (PARAMICS development and support company), Dowling Associates, and the UC Irvine research team.

More recently, the work has focused on gathering I-680 data under the form of freeway design features, traffic counts, tach runs, O/D matrices, and FREQ simulation outputs. As a first step, the network has been coded as a straight pipe, providing a basis for a first calibration exercise. It was found that the speed performances predicted by the model were very similar to the spot-speed travel time run data collected by CALTRANS. The current effort focuses on the refinement of the network coding to include precise geometric description, allowing the visual aspect of the simulation to be significantly improved. This process involves the use of a network AUTOCAD drawing provided by CALTRANS, and its importation into PARAMICS as an overlay. Once the model is calibrated, it is intended that it will be used for a number of investigations and corridor improvements currently under study by CALTRANS. These improvements include adding auxiliary lane(s), implementing HOV lanes, and implementing ramp metering strategies. In the ramp metering investigations, the API module developed by PATH researchers at UC Irvine and Davis will be tested.

Again, it should be possible to determine the energy and emission impacts of these corridor improvements, since the majority of the effort of our PATH project was to create an embedded emissions/energy API for use with PARAMICS.

### ***UC Irvine's TMC Testbed and associated Microscopic Traffic Simulator***

The California ATMIS Testbed Program was initiated in early 1991 and is considered an important element of California's strategy to develop and deploy new and innovative transportation technologies. With the real-world testbed, potential new technologies and strategies in the management of advanced transportation systems can be evaluated. The testbed provides: 1) an instrumented, multi-jurisdictional, multi-agency transportation operations environment linked to university laboratories for real-world development, testing and evaluation of near-term technologies and applications; 2) a meeting ground for practitioners and researchers

---

<sup>4</sup> Descriptions of this work have been taken from a PATH report entitled "Paramics-Related Work in California", compiled by Yonnel Gardes in December 2000.

to try new approaches to transportation system management; 3) a site for private industry to demonstrate and evaluate their prototype technologies under live traffic conditions; and 4) an ongoing testing ground for California and national ITS efforts. The system has been developed to interface with existing traffic surveillance and control components and provide a common integrated real-time traffic database for ATMIS research conducted within the testbed. The system design is built upon a wide-area communications network backbone linking the cities of Anaheim and Irvine Transportation Management Centers (TMCs) to the California Department of Transportation's District 12 TMC and with the ATMIS Research Laboratories at the UCI Institute of Transportation Studies and with the Cal Poly testbed Laboratory.

Also associated with the testbed is the state-of-the-art traffic simulator<sup>5</sup>. The simulator can be used as an off-line evaluation/design tool and as an on-line control/guidance tool. With the simulator, numerous ATMIS applications can and will be evaluated. Example ATMIS applications include traveler information and route guidance, surface street and freeway adaptive control, incident detection and management, and automated toll collection.

Currently, researchers at UC Irvine are using the PARAMICS microscopic traffic simulator [Quadstone, 2000]. Work with PARAMICS at UCI started in late 1996<sup>4</sup>. Early projects have included coding and calibrating the freeway network in Orange County, California. A PATH research report (UCB-ITS-PRR-99-12) published in April 1999 by Baher Abdulhai, Jiuh-Biing Sheu and Will Recker described this effort. A follow-up paper by Der-Horng Lee and Xu Yang presented the genetic algorithm approach developed for the calibration of PARAMICS with data collected from the Irvine ATMS testbed. More recently, work at UCI has mostly focused on developing Application Programming Interfaces (APIs) in order to override some of the PARAMICS default models or add complementary modules to the core model. UCI has become a worldwide leader of PARAMICS API development, together with the Social System Research Institute in Tokyo.

Quadstone Limited was commissioned to integrate the PARAMICS software into the ATMS testbed, to interface with existing traffic management and control models implemented by UCI. The introduction of PARAMICS provides UCI with the ability to undertake detailed wide-area congestion modeling on a large scale, to visualize the effects, and to collect a massive array of outputs for the statistical analysis of performance.

The APIs developed at UCI include CMS (changeable message signs) and Paradyn (an hybrid dynamic traffic assignment between PARAMICS and Dynasmart). These modules work as components in CARTESIUS, a software architecture providing cooperation among control agents. CARTESIUS also embeds the communication mechanism between PARAMICS and outside (such as knowledge-based Traffic Congestion Management) using CORBA. Current research under PATH involves the work by Henry Liu and Reinaldo Garcia. Henry Liu is focusing on the development of new PARAMICS APIs. He recently finished two PARAMICS plug-in components, one is the fully-actuated signal control (170 type controller) and the other is ramp-metering control with different metering rates for time of day. His current effort is to develop the API for the actuated signal coordination. He is also doing research on the

---

<sup>5</sup> MOU 359, Simulation of ITS at the UC Irvine Transportation Management Center Testbed using a Scalable Microscopic Traffic Simulator (P.I.s Baher Abdulhai, Will Recker).

intersection delay estimation, signal plan optimization, and travel time estimation, all through PARAMICS APIs. The first phase of these works should be completed by early 2001. Reinaldo Garcia is also involved in the continuing effort to expand the PARAMICS capabilities, making it a more complete tool to evaluate the expected net benefits of ATMIS applications. More specifically, his research will incorporate true dynamic OD estimation within PARAMICS, allowing for real-time data feeds to enable dynamic operational use.

### ***UC Riverside College of Engineering-Center for Environmental Research and Technology***

Based on this review of ATMIS modeling work in the PATH program, it was evident that many of the on-going efforts revolve around the traffic simulator PARAMICS. For this reason, it was determined that the majority of the effort of this UC Riverside CE-CERT PATH project should focus on developing a functional interface between PARAMICS and CE-CERT's CME/EC model. The methodology of this work is described in Section 3. Prior to describing the methodology, a brief description of PARAMICS is first provided.

### **2.3. PARAMICS MICROSCOPIC TRAFFIC SIMULATOR**

PARAMICS is a suite of high performance software tools for microscopic traffic simulation. Individual vehicles are modeled in fine detail for the duration of their entire trip, providing very accurate traffic flow, transit time and congestion information, as well as enabling the modeling of the interface between drivers and ITS. The PARAMICS software is portable and scalable, allowing a unified approach to traffic modeling across the whole spectrum of network sizes, from single junctions up to national networks. The parallel computing high-performance approach used in PARAMICS allows for faster than real-time simulation of networks of any size with no loss of detail. Key features of the PARAMICS model include direct interfaces to macroscopic data formats, sophisticated microscopic car-following and lane-change algorithms, integrated routing functionality, direct interfaces to point-count traffic data, batch model operation for statistical studies, a comprehensive visualization environment, and integrated simulation of ITS elements.

PARAMICS comes as a software suite of five modules<sup>4</sup>:

- ***Modeller***: the core simulation and visualization tool;
- ***Processor***: the simulation configuration tool and batch mode simulator;
- ***Analyser***: the post simulation statistics viewing tool;
- ***Programmer***: the API (Application Programming Interface); and
- ***Monitor***: the interface provided to users for following simulation status.

The **PARAMICS Modeller** is the modeling tool that provides the three fundamental operations of 1) model build; 2) traffic simulation (with 3-D visualization); and 3) statistical output available through a graphical user interface. Every aspect of the transportation network can potentially be investigated including mixed urban and freeway networks, advanced signal control, roundabouts, public transportation, car parking, incidents, truck or HOV lanes.

The **PARAMICS Programmer** allows users to customize some critical parts of the PARAMICS core models. Through the use of an Application Programming Interface or API, traffic modeling researchers can override PARAMICS default behavioral models (such as car following, gap acceptance, lane changing or route choice) to better reproduce local driver and vehicle characteristics, or implement their own complementary traffic control strategies (such as signal optimization, adaptive ramp metering, incident detection, etc.).

At present, PARAMICS uses simple look-up tables of exhaust pollution and fuel consumption as a function of vehicle type, speed, and acceleration. Currently, there are only default tables for a single vehicle type. In order to make this a more powerful model, data sets for a variety of vehicles must be provided.

### 3. Methodology

A microscopic transportation simulation model can be integrated with an instantaneous (i.e., modal) emissions model in (at least) three ways: 1) using emission lookup tables; 2) post-processing vehicle trajectories; or 3) using an embedded set of emission functions. These methods are described below.

#### 3.1. EMISSION LOOKUP TABLES

Many microscopic traffic simulation models already have the built-in ability to predict emissions and fuel consumption, given velocity/acceleration-indexed lookup tables of emissions and fuel. These lookup tables can be established from extensive vehicle testing (i.e., emissions can be measured for different values of speed and acceleration) or from other models, such as the CME/EC model. All the different combinations of velocity and acceleration are input into the model (or emissions measurement plan) and an emissions “mesh” is created as output. An example set of lookup tables is shown in Figure 3.1.

When inputting different sets of velocity and acceleration, the core modal emissions model also evaluates whether the input is outside the performance envelope of the vehicle. For example, if you ask a low-powered vehicle to undertake a hard acceleration at high speed, the vehicle will not be able to meet this performance demand. When vehicle operation inputs are beyond the performance envelope, emissions and fuel consumption are predicted for the maximum performance at the given speed. Once the lookup tables are established, they simply have to be properly formatted for input into a specific traffic simulator.

The lookup table-based emission model form is straightforward to implement, and the computational costs are very low. However there is a serious potential problem with this form of an emissions model. Using instantaneous lookup tables assumes that there is no time dependence in the emissions response to the vehicle operation. This assumption is not true for many vehicle types where vehicle operating history (i.e., the last several seconds of vehicle operation) can play a significant role in an instantaneous emissions value (e.g., the use of a timer to delay command enrichment, and oxygen storage in the catalytic converter). Further, there is no convenient way to introduce other load-producing effects on emissions such as road grade, or accessory use (e.g., air conditioning), other than introducing numerous other lookup tables, or perhaps a applying a set of corrections.



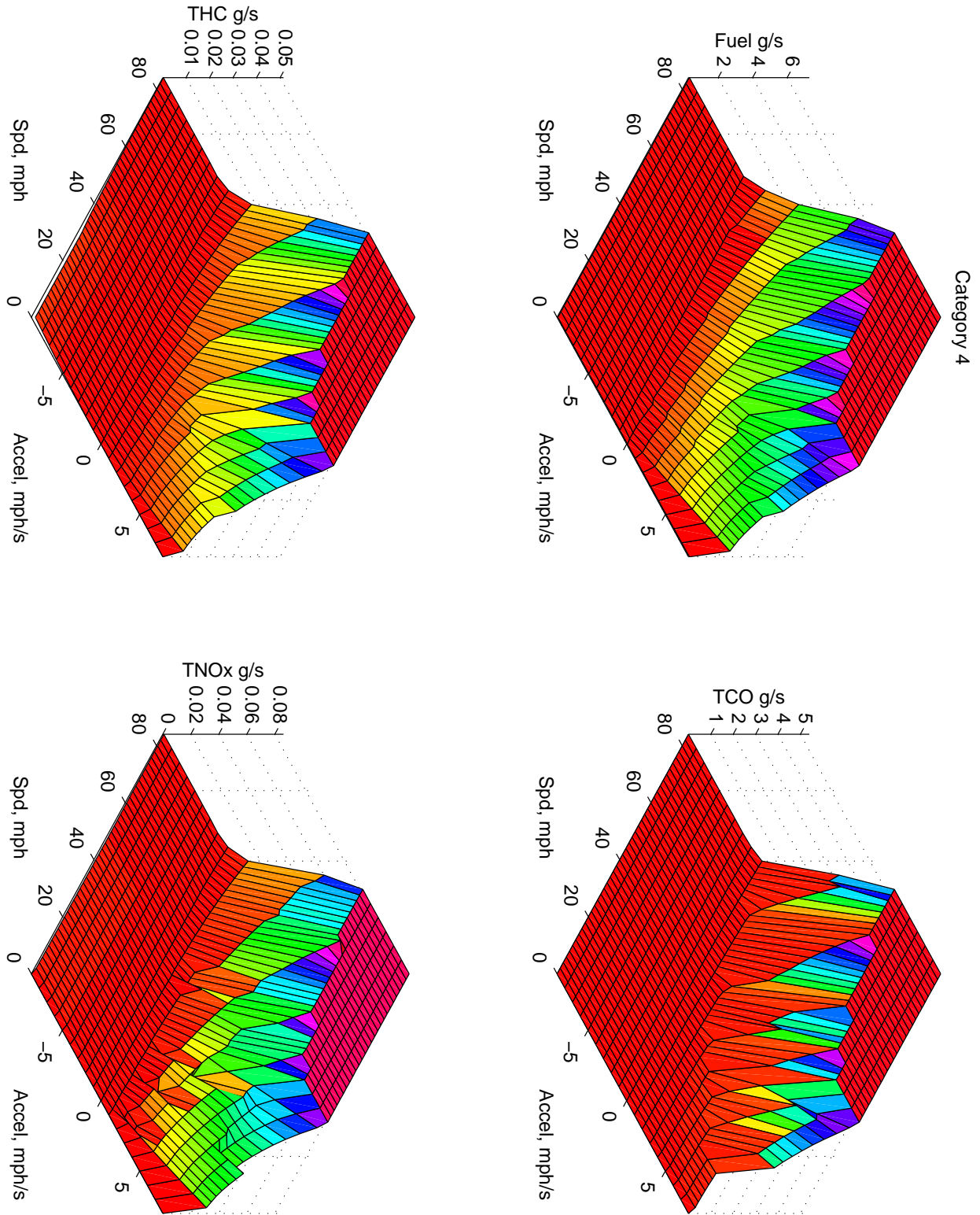

Figure 3.1. CME/EC category 4 velocity/acceleration-indexed fuel, CO, HC, and NOx emission lookup tables.

### 3.2. POST-PROCESSING VEHICLE TRAJECTORIES

It is possible to separate the transportation and emissions modeling problem into two separate steps. First, the transportation simulation model can be first configured and then executed for a particular scenario. As the model runs, it outputs second-by-second vehicle trajectory data for the entire simulation. The resulting dataset is stored as a file and subsequently used as input to an instantaneous (modal) emissions model. The instantaneous emissions model then runs, processes each vehicle trajectory, and then integrates emissions from all vehicles to produce a total emissions inventory.

As an example of the integration methodology, the latest Microsoft ACCESS version of the CME/EC model (developed as part of the NCHRP 25-11 project) was configured to read the processed trajectory output file of the U.S. Federal Highway Administration's CORSIM traffic simulator. As background, the FHWA developed a suite of microscopic models over the years, referred to as the TRAF models. These models are used to simulate second-by-second traffic operations for arterials (i.e., NETSIM) and for freeways (i.e., FRESIM). Later, elements of both these models were integrated to form a corridor simulation model (i.e., CORSIM). A traffic network can be input into CORSIM and various simulation runs can be carried out. The resulting vehicle trajectories can then be post-processed to determine the corresponding emissions.

This method does not have the history effect problem, as does the previous lookup table method. However, for any simulation that has a large number of vehicles and runs for many minutes, the resulting vehicle trajectory file is extremely large and cumbersome to handle. In many cases if there isn't sufficient files space, the CORSIM model locks-up past a certain volume of vehicle traffic.

### 3.3. USING EMBEDDED EMISSIONS FUNCTIONS

Some microscopic transportation simulation models have open architectures that allow a user to create different plug-in modules that can be used for a variety of functions (e.g., PARAMICS). In this case, the modal emissions model can be written as a specific function that is called within the transportation simulation model to estimate emissions in-situ. This method does not suffer from history effect problems when vehicle performance state information is stored. Further, there are no intermediate trajectory files to worry about, and the performance of the integrated model is quite satisfactory. This is essentially what has been for the PARAMICS traffic simulation software. As described earlier, PARAMICS has an open architecture for integrating plug-in modules for carrying out specific functions. This is carried out through application programming interfaces or APIs. Integrating CME/EC within PARAMICS was accomplished by creating an API through the use of the PARAMICS Programmer utility. The PARAMICS Programmer utility is a framework that allows the user to access many of PARAMICS' features and variables as the simulation takes place.

The CMEM/PARAMICS API was written in C and revolves around two elements: 1) control functions and 2) callback functions. Control functions are functions that PARAMICS uses as part of its standard simulation. These control functions allow the user to override or add additional code to the simulation run. Callback functions allow the user to retrieve specific information from the simulation such as vehicle and network attributes. On UNIX systems, the plug-in is compiled as a shared object file (.so) and a path directing the PARAMICS simulation

to the .so file is specified in the .plugin file. This allows PARAMICS to find and load the plug-in on opening.

The CME/EC API for PARAMICS calls the CME/EC function during the PARAMICS simulation in order to obtain calculated emission values for each vehicle at every second. This is done through the overloading of control functions, most notably the *vehicle\_link\_action*, which is where the CME/EC function call is located. This control function is called for every vehicle on every link at each time-step. During this function call, the current vehicle type, speed, acceleration and previous vehicle history are identified using callback functions and from previously stored values. This information is passed to the CME/EC function which calculates emissions for that vehicle type at that second and with that history. Updated vehicle history values are then stored for future events. Emission values are also stored at this point and can be cumulated and summarized at the end of the simulation or at given intervals during the simulation. Currently the CME/EC API summarizes link emissions at every 15 minutes of simulation.

### 3.4. VEHICLE FLEET COMPOSITION

One of the key challenges for all of these microscopic models is how to match the different vehicle types represented in the traffic simulation component with the vehicle types represented within the emissions component. Traffic simulation models typically have different vehicle types that are based on how they operate within a roadway network. In addition to the obvious divisions of vehicle types (i.e., motorcycles, passenger cars, buses, heavy-duty trucks), categories are often made based on vehicle performance (e.g., high-performance cars, low-performance cars) that can be closely related to traffic simulation parameters. For heavy-duty trucks, transportation models/datasets typically categorize their vehicles based on their configuration and number of axles. In all cases, a straightforward approach to handling the vehicle matching is to create an appropriate *mapping* between the vehicle types defined in the traffic simulation model, and the vehicle types defined in the emission model.

As described in Section 2.1, the CME/EC model currently has 26 different categories of light-duty vehicles. For these 26 categories, it is possible to obtain vehicle fleet population data and determine the appropriate CME/EC model category for each vehicle. A common vehicle database will typically come from a state's department of motor vehicles (DMV) or a national database such as that assembled by the R.L. Polk & Company. A DMV vehicle registration database contains information about each registered vehicle, and with that information, each vehicle can be categorized into the appropriate CME/EC model vehicle/technology group. A state's entire vehicle registration database can be used, but more commonly, *regional subsets* of the database are often applied. These regional subsets could be at the county level, city level, or even at the zip-code level.

A subset of a vehicle registration database can also be determined using license plate monitoring. If a set of license plate numbers are observed and recorded, the license plate numbers can be used as a filter set applied to the vehicle registration database. This is similar to creating a regional subset (by county, city, zip-code, etc.), however the license plate number is used as the filter field. Many states now use remote sensing equipment for monitoring instantaneous emissions of vehicles as they pass a particular spot on the road. With these emission

measurements, the license plate is typically imaged with a video camera and registered with the measurement database.

As an example of a methodology for going from a vehicle registration database to the CME/EC model vehicle/technology categories, a *categorization program* has been developed as part of NCHRP Project 25-11. The categorization process is illustrated in Figure 3.2. This categorization program uses certain fields from a vehicle registration database and classifies each individual vehicle. Several fields are extracted from the database, and a *decision tree* is used when categorizing each vehicle. In addition to the information provided from the vehicle registration database, additional information is necessary. For example, in order to classify a vehicle as either a high- or normal-emitter, high emitter probability distributions are necessary. For further details on this decision tree process, please refer to [Barth et al., 1999]. As an example, the categorization program was applied to the Riverside, California city limits and its larger encompassing area. The results of the program are given in Table 3.1. In this table, the percentage of the fleet are given for the 26 different categories for the year 1998.

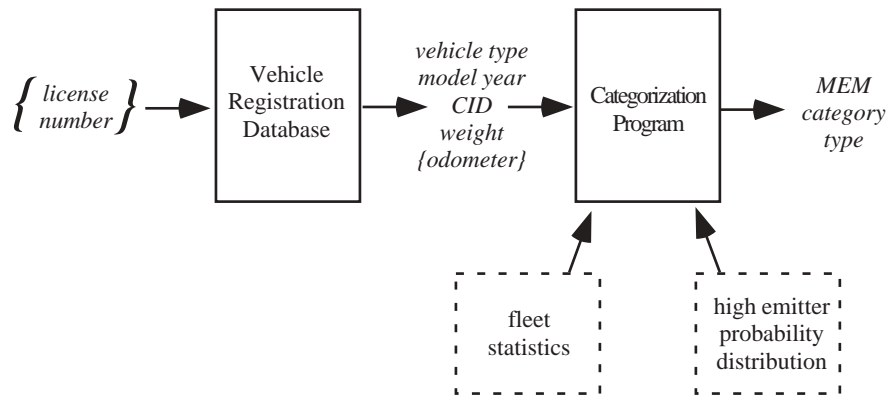

Figure 3.2. Registration Database to CME/EC model category type.

#	Vehicle Technology Category	Categorization Results (%)	
		Riverside proper	Riverside region
<i>Normal Emitting Cars</i>			
1	No Catalyst	5.18%	4.68%
2	2-way Catalyst	7.68%	7.41%
3	3-way Catalyst, Carbureted	5.12%	5.16%
4	3-way Catalyst, FI, >50K miles, low power/weight	10.51%	10.99%
5	3-way Catalyst, FI, >50K miles, high power/weight	14.16%	14.12%
6	3-way Catalyst, FI, <50K miles, low power/weight	1.08%	1.16%
7	3-way Catalyst, FI, <50K miles, high power/weight	1.68%	1.67%
8	Tier 1, >50K miles, low power/weight	1.45%	1.54%
9	Tier 1, >50K miles, high power/weight	2.67%	2.65%
10	Tier 1, <50K miles, low power/weight	1.30%	1.44%
11	Tier 1, <50K miles, high power/weight	2.68%	4.68%
24	Tier 1, >100K miles	0.09%	0.10%
<i>Normal Emitting Trucks</i>			
12	Pre-1979 (<=8500 GVW)	5.24%	4.96%
13	1979 to 1983 (<=8500 GVW)	2.01%	1.96%
14	1984 to 1987 (<=8500 GVW)	2.62%	2.60%
15	1988 to 1993, <=3750 LVW	3.87%	3.96%
16	1988 to 1993, >3750 LVW	3.64%	3.52%
17	Tier 1 LDT2/3 (3751-5750 LVW or Alt. LVW)	0.29%	0.30%
18	Tier 1 LDT4 (6001-8500 GVW, >5750 Alt. LVW)	0.43%	0.43%
25	Gasoline-powered, LDT (> 8500 GVW)	1.79%	1.86%
40	Diesel-powered, LDT (> 8500 GVW)	0.07%	0.06%
<i>High Emitting Vehicles</i>			
19	Runs lean	4.88%	4.90%
20	Runs rich	1.82%	1.83%
21	Misfire	10.45%	10.53%
22	Bad catalyst	7.40%	7.46%
23	Runs very rich	1.89%	1.91%

**Table 3.1.** Vehicle/Technology categorization results for the Riverside area in 1998.

Further fleet categorization results using this method are given for the case studies outlined in Section 4. It should be noted that alternative categorization methods also exist. For example, it is possible to use the fleet characteristics many states have already calculated for their region using the conventional regional emission inventory models MOBILE (US EPA, for the 49 states) and EMFAC (CARB, for California). In order to calculate these emission inventory estimates, vehicle fleet percentages and/or vehicle populations have to be determined for the region in question. These vehicle fleet percentages and/or vehicle populations have been calculated for the gross vehicle categories of the regional models. For MOBILE, these categories consist of light duty gas vehicle (LDGV), light duty diesel vehicle (LDDV), light-duty gasoline trucks (LDGT), light-duty diesel trucks (LDDT), and a variety of different heavy-duty truck categories.

Since the current version of CME/EC model only addresses light-duty vehicles, we are only concerned at this point with LDGVs, LDGTs, and LDDTs. For each of these categories, MOBILE also specifies the vehicle fleet fraction by model year.

For CARB’s MVEI model suite (i.e., EMFAC), the categories are very similar, with a bit more disaggregation for the light duty vehicle technologies. The categories include light duty automobiles (LDA) which are split into gasoline fueled with no catalytic converter (LDA-NOCAT), those with catalytic converter (LDA-CAT), and those that are diesel fueled (LDA-diesel). Similarly with light duty trucks (LDT), there are LDT-NOCAT, LDT-CAT, and LDT-diesel. CARB also has a wide range of medium- and heavy-duty truck categories, which are currently outside the scope of this project. Similar to MOBILE, CARB’s MVEI model also specifies the vehicle fleet fraction by model year.

Vehicle fleet percentages and vehicle populations have already been determined for many regions, therefore it makes sense to take advantage of this information in determining vehicle fleet percentages and/or populations for the CME/EC vehicle categories. For this reason, mappings have been created between CARB’s and EPA’s vehicle category types and CME/EC model’s vehicle categories. Using these mappings, states can take existing vehicle distributions based on the current CARB/EPA models and translate them for input into the CME/EC model. This mapping procedure is illustrated in Figure 3.3.

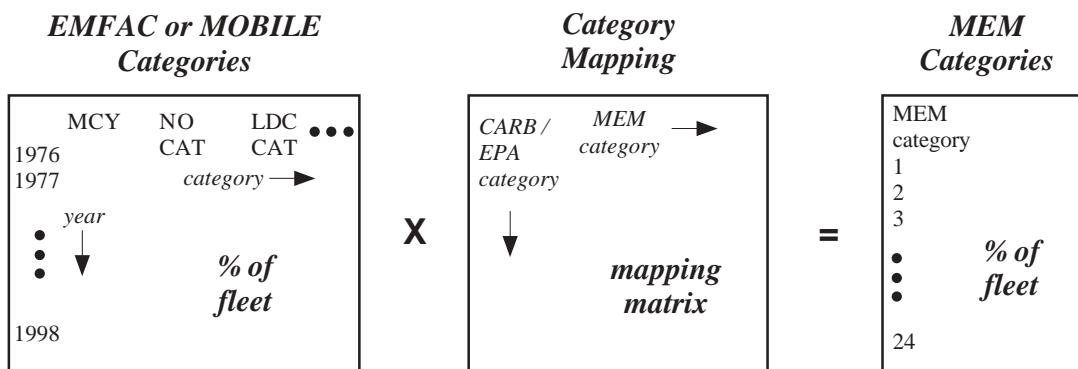

Figure 3.3. EMFAC/MOBILE to CME/EC category mapping procedure.

In this illustration, the gross vehicle categories of MOBILE or MVEI are given across the top of a matrix, while the model year index runs along the side. The category mapping simply gives the percentage distribution for each category/year bin that corresponds to the appropriate CME/EC model category. These mappings can be created using knowledge of what vehicle model years correspond to the different CME/EC model categories. For example, model year 1974 and older automobiles do not have catalytic converters, therefore all of these vehicles can be categorized into CME/EC model category 1 (CME/EC model category 12 for LDTs). Information that was used in creating the previously described decision trees is also used here in determining the weights of the mappings. Further details on these types of mappings are given in [Barth et al., 1999].

When using the integrated PARAMICS /CME/EC model, 26 different vehicle types should be defined within PARAMICS that correspond to the 26 categories of the CME/EC model. The fleet percentages of these categories can then be directly applied within PARAMICS to get the

proper vehicle fleet population generated within the simulation. In the case studies described in Section 4, the vehicle characteristics are assumed to be the same between all categories. That is, each of the 26 vehicle categories has the same performance characteristics. This is not true in real life, since some of the vehicle categories will have more powerful performance characteristics than other categories. Determining more appropriate vehicle performance characteristics for the 26 vehicle categories of the CME/EC model is an area of future research.

## 4. Case Studies

In an effort to exercise the integrated PARAMICS/CME/EC model, CE-CERT has carried out two case studies as part of a larger research program. These case studies are described below, with an emphasis on the emissions and fuel consumption modeling techniques.

### 4.1. SR-91 HIGH OCCUPANCY TOLL (HOT) LANE EXPANSION PROJECT<sup>6</sup>

#### 4.1.1. Background

The SR-91 is a critical interregional transportation corridor for travel within and between the four most populous counties in Southern California (see Figure 4.1). Because of this, traffic congestion has been occurring over lengthening peak periods of each day along many key segments of SR-91.

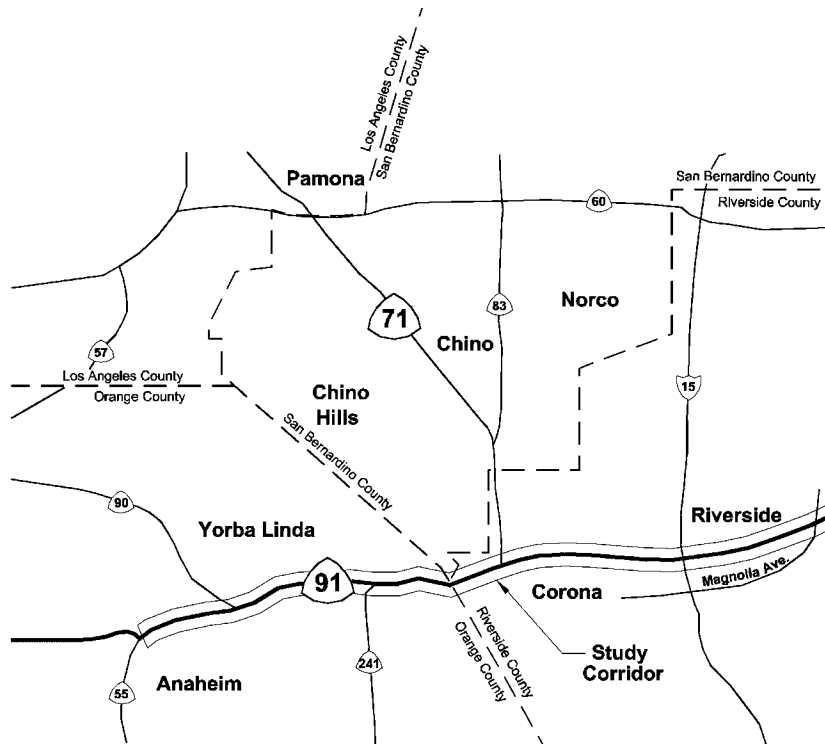

Figure 4.1. SR-91 study area.

In 1990, the opportunity to improve SR-91 and relieve congestion through the critically-constrained segment of SR-91 connecting Riverside County and Orange County, came in the form of a toll facility. The facility was to be privately financed, built and operated by the

<sup>6</sup> Descriptions of this work have been taken from the Draft Final Report of the project "SR-91 HOT Lane Extension and Intermediate Access Feasibility Study", submitted to the Southern California Association of Governments, January 2001.



California Private Transportation Company (CPTC). CPTC presently holds an exclusive 35-year franchise from the State of California (CALTRANS). The franchise agreement entitles CPTC to construct and operate one or more toll road facilities within the SR-91 corridor, extending from the Los Angeles/Orange County Line on the west to I-15 on the east. To date, CPTC has implemented one ten-mile toll lane project located entirely in Orange County, and extending from the Santa Ana River (SR-55) in Orange County on the west to the Riverside County line on the east.

The SR-91 Express Lanes opened in late December 1995. It is a toll facility that offers discounted toll rates to 3+ person carpools. The opening of the Express Lanes instantly improved traffic flow for users of the facility, and for general-purpose lane traffic that benefited from the diversion of vehicles into the Express Lanes improving the general purpose lane level of service one full level (from F<sub>4</sub> to F<sub>3</sub>). However, as growth and development have continued within the region served by SR-91, travel demand along SR-91 has continued to grow. Peak period congestion along SR-91 has extended easterly, through much of the City of Corona approaching I-15. The duration of congestion has also increased.

As a result, the Southern California Association of Governments (SCAG) initiated an SR-91 HOT lane extension and intermediate access feasibility study as part of its REACH (Reduce Emissions and Congestion on Highways) Program. A project development team was formed between SCAG, the CPTC, the Riverside County Transportation Commission (RCTC), CALTRANS, UCR's CE-CERT, and HDR Engineering (a consulting firm) to consider alternatives to address traffic congestion and resultant air quality impacts of the SR-91 corridor. The overall objective of the study is to evaluate the potential to extend the HOT lanes from their existing terminus at the Orange/Riverside County line, easterly to I-15 or beyond, to consider opportunities to provide intermediate access along the existing Express Lane facility, and to evaluate the potential air quality impacts of the extended HOT lane facility.

#### **4.1.2. Overall Study Methodology**

A number of steps were carried out as part of this study. As an initial step, potential strategies to improve the corridor were identified, including adding lane extensions and providing intermediate/additional access. A set of preliminary alternatives were then defined and subsequently screened. A set of more refined alternatives were then developed and evaluated in detail. Finally, a set of recommendations was produced. During these steps, a number of efforts were carried out to support the final recommendations. These efforts include:

***Travel Demand and Revenue Forecasting***—this process played an essential role in defining and evaluating project alternatives. After consultations with SCAG, RCTC, and OCTA (Orange County Transportation Authority), OCTAM (Orange County Traffic Analysis Model) was chosen to provide the travel demand component of the overall modeling effort.

***Telephone Survey***—in order to assess attitudes about carpool lanes and HOT lanes, and to explore the level of interest in the proposed extension of the HOT lanes, a telephone survey was conducted. Four hundred adults, 18 years of age or older who traveled most frequently on any portion of SR-91 between the I-15 interchange and the SR-55 interchange in the 30 days preceding the survey, were interviewed. The interviews were conducted between February 23 and March 5, 2000. The interview sample consisted of a “random digit dialing” sample

supplemented by a sample of current CPTC transponder owners. In order to assure sufficient sample sizes for analytical purposes, quotas were applied based on geography and transponder ownership. The interviews for the survey lasted 10 minutes and included 37 questions to obtain information and opinions on SR-91 travel, 91 Express Lanes, carpool lanes, HOT lanes, carpool lane conversion/HOT lane extension, and HOT lane access points.

**Financial Analysis**—the assessment of the financial viability of the various project alternatives was an important component of the study. The analysis consisted of evaluating whether the proposed alternatives would generate sufficient revenues to cover the cost of implementing them. Implementation costs consisted of right-of-way and construction expenditures, operating and maintenance costs, and financing costs. Revenue estimates were conservative to account for the uncertainties associated with forecasting future conditions.

**Air Quality Emissions Analysis**—one of the primary objectives of the study was to evaluate the effects of HOT lane operations on vehicle emissions and air quality. In coordination with the consultant team, CE-CERT looked at the vehicle emissions aspects of the various HOT lane alternatives including the existing configuration of the SR-91 study corridor with the 91 Express Lanes, and the various alternatives to extend the Express Lanes. CE-CERT carried out the vehicle emissions analysis using two modeling methodologies: 1) utilizing the conventional California Air Resources Board (CARB) EMFAC2000 emission factor model paired with predicted traffic volumes; and 2) utilizing the CME/EC model in conjunction with the PARAMICS traffic simulation tool. Both of these models were applied to the SR-91 corridor. Methodological details on the vehicle emissions analysis are given in the follow section, along with preliminary results of the air quality analysis.

#### 4.1.3. Vehicle Emissions Methodology

In order to carry out the integrated PARAMICS/CME-EC model simulations, different datasets were required and the model needed to be configured in specific ways. The overall diagram of the setup is shown in Figure 4.2. In this figure, the integrated transportation/emissions simulation model is shown in the middle. There are a number of inputs that are used by the model, specifically:

**Travel Demand Data**—these data are generated from the OCTAM travel demand model. Separate sets of travel demand data were generated for the different evaluation scenarios. The conversion of the travel demand model output to the appropriate input data format for PARAMICS was performed as follows. Future traffic volumes for the different scenarios to be evaluated were generated for different pricing schemes (see Chapter 3 of [SCAG, 2001]). These volumes were then entered into a demand matrix for PARAMICS. The traffic volumes generated did not vary greatly between the scenarios<sup>7</sup>. VMT was determined for three separate time periods (AM, midday, and PM) and direction then added together.

---

<sup>7</sup> in all future scenarios, traffic volumes were predicted at very high levels; i.e., volume to capacity ratios were between 0.8 and 1.1.

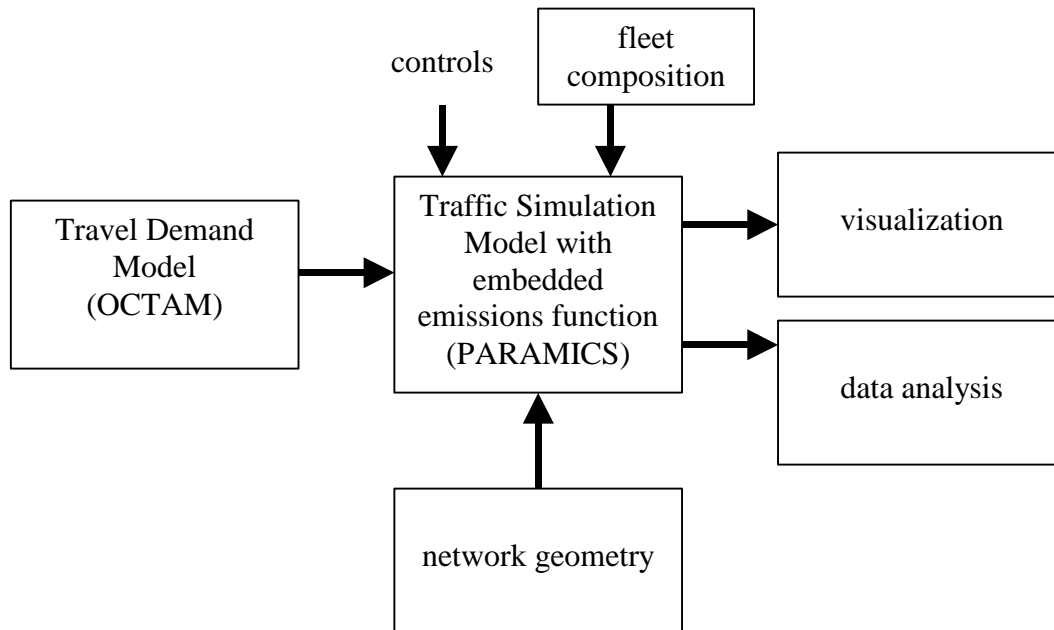

**Figure 4.2.** Transportation/Emission Model Block Diagram.

**Network Geometry**—the network geometry data had to be generated not only for the SR-91 baseline case, but also for three future proposed configurations. The process for generating the network geometry for the baseline case consisted of using data collected from an instrumented vehicle that could accurately measure vehicle position while traversing the corridor. Local area maps were also used during the network coding process. A generalized PARAMICS network was coded using nodes and links, where a node can be an on-ramp, off-ramp, bend in the freeway, or some other change in a link. A link is the section of freeway between two nodes. The SR-91 corridor under study was coded as close to reality as possible, including changes in grade. The total number of nodes and links were 14 and 13 respectively. Since HOV and HOT (network) behavior is similar, these lane types were modeled as one for this evaluation. The HOV and HOT lanes were modeled alongside the general-purpose lanes with connectors at the existing egress and ingress points along the corridor. By modeling restrictions into the HOV/HOT lanes, only HOV and HOT vehicles are allowed to enter into the lanes. For the future scenarios, the general-purpose lanes were not changed, therefore only changes to the HOV/HOT lanes had to be made. The different scenarios were modeled according to the overall study’s specifications (see Chapter 6 of [SCAG, 2001]).

**Fleet Composition Information**—a critical aspect for the emissions analysis was specifying the types of vehicles that operate on the SR-91 corridor. The corridor usage by origin zip code was determined through a major survey that was carried out as part of the study (see Chapter 4 of [SCAG, 2001]). By knowing the break down of zip codes in the study region, vehicle registration data were found by looking at DMV vehicle registration data for those specific zip codes. These data were used to form a vehicle fleet distribution that was applied to the CME/EC module for the study corridor. To characterize the HOT lanes, a random sample of the lane’s regular users’ license plates was obtained and modeled into CME/EC model categories. Table 4.1 lists the categories and the distribution for the general-purpose lanes and the HOT lanes. It is evident that the general-purpose lanes has a large number of non-catalyst vehicles; whereas, the

HOT lanes have almost double the amount of newer, Tier 1 vehicles than the general purpose lanes. Both have roughly the same amount of trucks and high emitting vehicles.

No	CMEM Category	General Purpose	HOT
1	No Catalyst	12.40	0.53
2	2-way Catalyst	4.81	0.64
3	3-way Catalyst, Carbureted	3.74	2.53
4	3-way Catalyst, FI, >50K miles, low power/weight	9.17	9.66
5	3-way Catalyst, FI, >50K miles, high power/weight	12.22	16.63
6	3-way Catalyst, FI, <50K miles, low power/weight	0.98	1.18
7	3-way Catalyst, FI, <50K miles, high power/weight	1.53	2.60
8	Tier 1, >50K miles, low power/weight	1.54	2.29
9	Tier 1, >50K miles, high power/weight	2.99	6.41
10	Tier 1, <50K miles, low power/weight	3.25	4.36
11	Tier 1, <50K miles, high power/weight	7.01	14.51
12	Pre-1979 (<=8500 GVW)	7.01	0.66
13	1979 to 1983 (<=8500 GVW)	1.59	0.61
14	1984 to 1987 (<=8500 GVW)	1.84	1.69
15	1988 to 1993, <=3750 LVW	3.07	4.46
16	1988 to 1993, >3750 LVW	2.90	6.39
17	Tier 1 LDT2/3 (3751-5750 LVW or Alt. LVW)	0.79	1.50
18	Tier 1 LDT4 (6001-8500 GVW, >5750 Alt. LVW)	0.80	2.50
19	Runs lean	3.80	3.58
20	Runs rich	1.45	1.60
21	Misfire	7.90	6.00
22	Bad catalyst	5.52	4.39
23	Runs very rich	1.38	0.73
24	Tier 1, >100K miles	0.10	0.17
25	Gasoline-powered, LDT (> 8500 GVW)	2.14	4.24
26	Diesel-powered, LDT (> 8500 GVW)	0.04	0.17
Total		100.00	100.00

**Table 4.1.** Vehicle fleet distribution for general purpose and HOT lanes.

**Model Controls**—various simulation model controls needed to be specified for the numerous scenario runs. Examples of these controls include maximum vehicle speeds, required output, etc.

Further, there are several outputs:

**Visualization**—a key part of the model runs was viewing the resulting traffic flow. This is important for performing cursory validation of the model.

**Traffic and Emissions Data**—the resulting traffic and emissions data were analyzed. These analyses are described in the next section.

As the integrated PARAMICS/CME-EC model was developed, there were a number of validation steps that took place. For example, an instrumented vehicle was driven on the study corridor to map the trends in peak and off-peak periods. Data were collected in the general purpose lanes, the HOT lanes, and the HOV lanes, during different periods of the day. Vehicle speed and location data were collected. Further, a visual evaluation was conducted to understand activity along the corridor. The speed and driving behavior of the instrumented vehicle were

matched as closely as possible to traffic without violating traffic rules, safety considerations, or interfering with other drivers. An example of the data collected is shown in Figure 4.3. In this figure, speed by freeway links are shown for the westbound AM period.

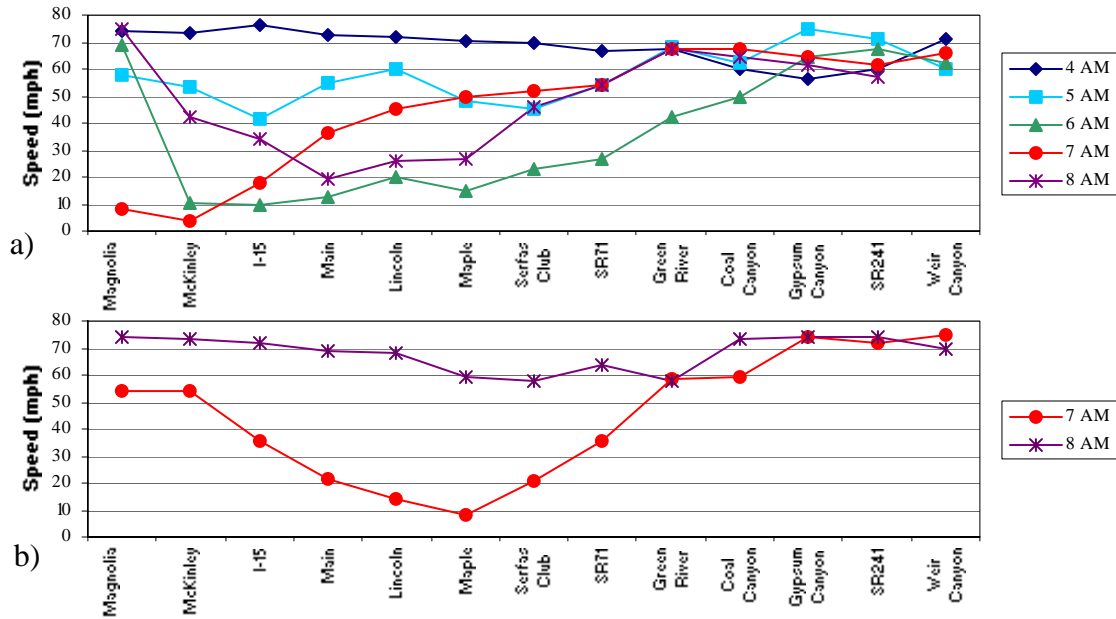

Figure 4.3. Westbound SR-91 speed by link for the AM hours for a) general purpose lanes and b) HOT/HOV lanes.

In addition to providing insight on the corridor’s traffic behavior, it was possible to use these data to validated the output of the model runs, for the existing baseline conditions. This is illustrated in Figure 4.4. It can be seen that the modeled AM westbound peak period closely resembles the observed data. The modeled eastbound midday is slower than the observed data through Corona and the eastbound modeled PM is slower through Anaheim Hills and faster through Corona.

#### 4.1.4. Traffic and Emissions Results

##### Traffic

The five scenarios modeled in PARAMICS were the existing configuration (EC), existing configurations with additional access at Fairmont (EC\*), 1B, 2B, and 2C. Each of these scenarios had slightly different network geometry and access points; refer to Chapter 6 of [SCAG 2001] for a more detailed description of these scenarios. The scenarios were compared by average speed. Modeled velocity data was averaged together for each scenario, time of day, direction and toll rate. Table 4.2 shows the data for pricing structure 1 (flat rate level-1) and Table 4.3 shows the data for pricing structure 2 (per mile rate level-1). The existing condition toll level is flat rate-1 therefore there is no data for per mile-1 rate level.

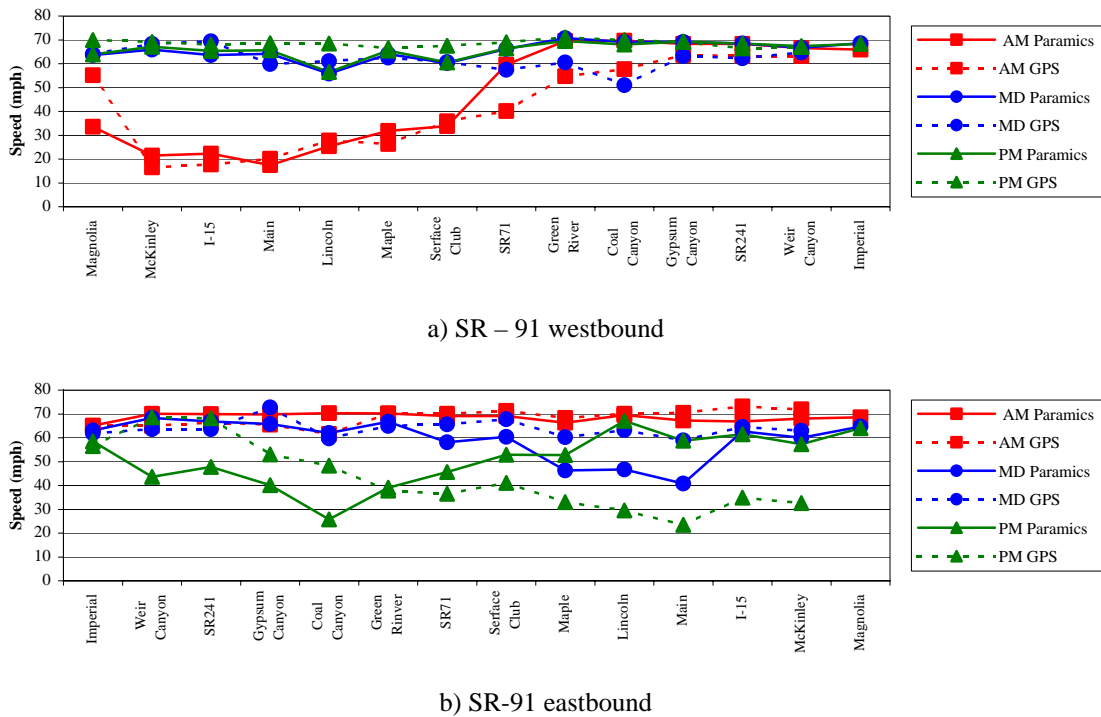

Figure 4.4. SR-91 (a) westbound and (b) eastbound comparison of PARAMICS output and collected GPS data for the AM, midday, and PM periods.

Flat Rate	General Purpose			HOT		
	AM	MD	PM	AM	MD	PM
WB	43.7	59.3	56.5	59.3	63.7	60.6
EC	42.6	58.3	57.9	58.4	63.0	60.9
EC*	39.9	54.5	60.5	68.4	70.0	70.4
1B	40.0	58.8	62.8	67.1	67.7	70.0
2C	43.4	55.3	58.4	67.5	69.3	70.3

Flat Rate	General Purpose			HOT		
	AM	MD	PM	AM	MD	PM
EB	67.5	43.3	36.4	69.5	60.7	64.8
EC	67.2	43.2	32.1	66.8	59.2	64.0
EC*	66.5	54.2	33.3	72.4	71.3	65.6
1B	67.0	46.1	30.2	68.8	70.1	63.5
2C	66.7	48.6	31.6	71.1	71.6	64.2

Table 4.2. Average speed by scenario for flat rate level 1 by time period for a) westbound and b) eastbound.

Per Mile	General Purpose			HOT		
	AM	MD	PM	AM	MD	PM
WB						
EC						
EC*						
1B	45.3	53.5	63.9	60.5	70.0	68.7
2B	40.7	58.6	64.8	66.7	69.2	70.9
2C	45.2	55.0	58.7	67.5	69.2	68.7

Per Mile	General Purpose			HOT		
	AM	MD	PM	AM	MD	PM
EB						
EC						
EC*						
1B	67.1	48.0	33.7	69.7	69.1	65.7
2B	66.9	43.3	32.6	69.7	71.1	59.4
2C	66.0	42.4	31.4	70.1	71.7	56.5

Table 4.3. Average speed by scenario for per mile rate level 1 by time period for a) westbound and b) eastbound.

The flat rate HOT lane velocities are at free flow conditions for all scenarios. Scenarios 1B and 2B have similar speed traces for the westbound am general-purpose lanes for flat rate-1, see Figure 4.5. Scenario 2C has higher speeds at the start of the study corridor through Green River. For the flat rate eastbound pm scenarios, see Figure 4.6, 2B and 2C exhibit similar speed traces, with 1B being slightly faster through Corona. The HOT lanes slow down at Main Street for

Scenarios 2B and 2C. This is most likely due to the high volume of vehicles exiting the toll lanes to the I-15. The per mile rate level data has similar average speeds for both westbound and eastbound directions, but have slightly different characteristics, see Figures 4.7 and 4.8.

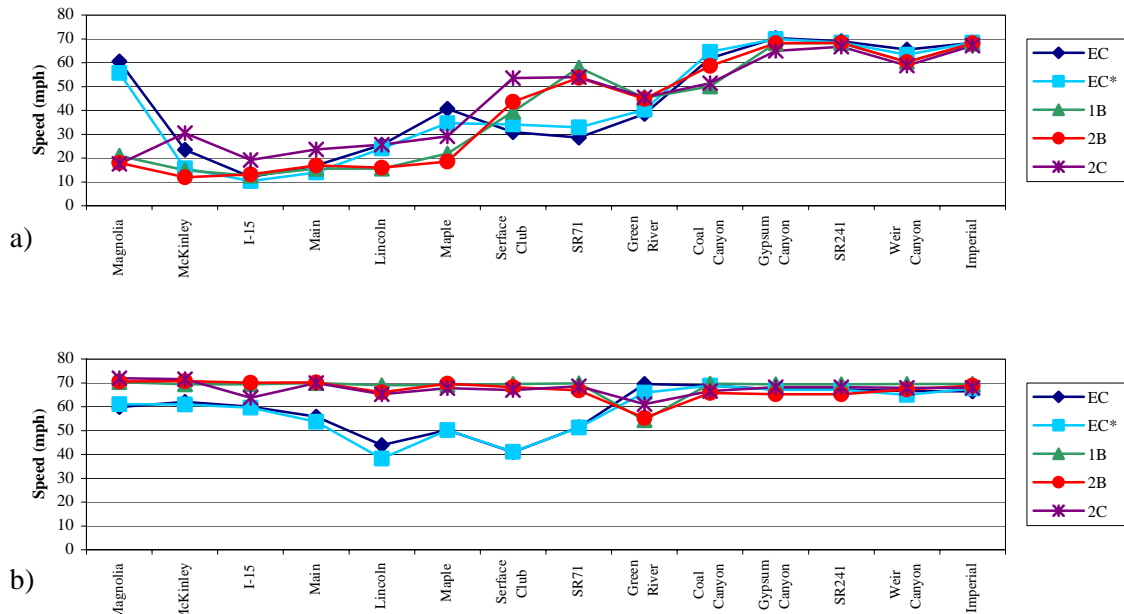

Figure 4.5. Speed trace for the westbound am SR-91 by scenario for flat rate level1 for a) general purpose lanes and b) HOT lanes.

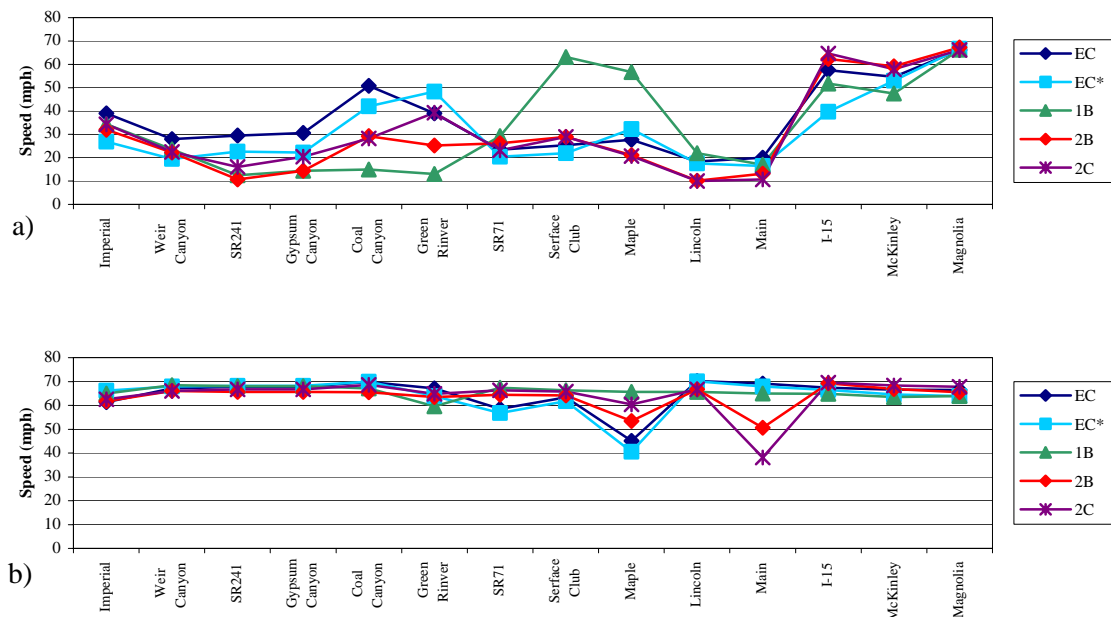

Figure 4.6. Speed trace for the eastbound pm SR-91 by scenario for flat rate level1 for a) general purpose lanes and b) HOT lanes.

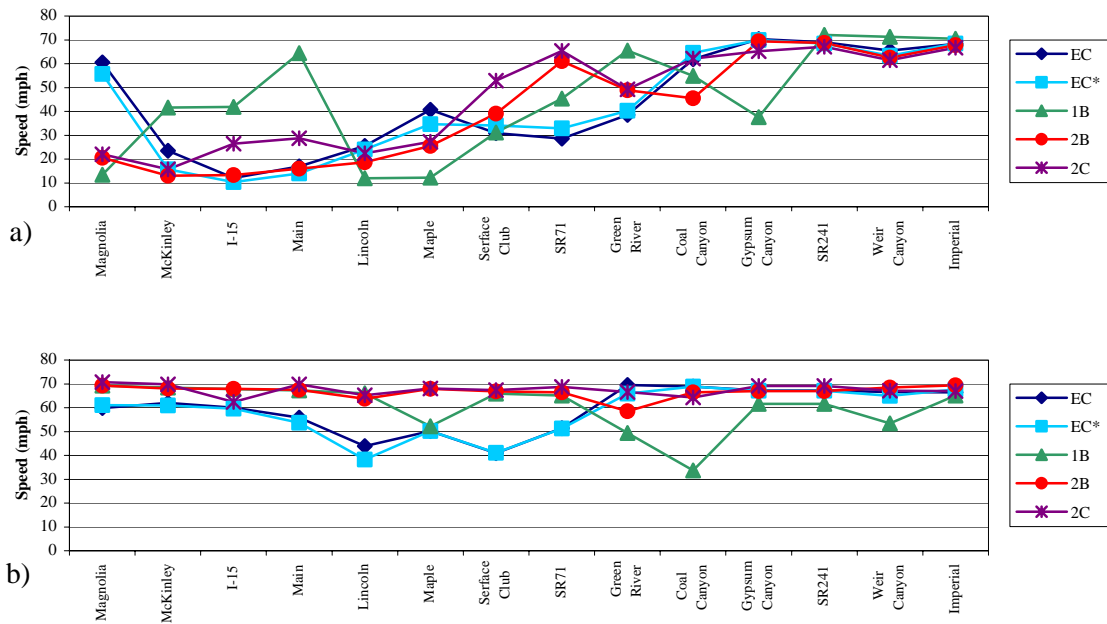

Figure 4.7. Speed trace for the westbound am SR-91 by scenario for per mile rate level1 for a) general purpose lanes and b) HOT lanes.



Figure 4.8. Speed trace for the eastbound pm SR-91 by scenario for per mile rate level1 for a) general purpose lanes and b) HOT lanes.

To get an idea of how the average speeds shown above relate to congestion, an average time delay was calculated. A set free flow time of 1000 seconds (set to 72mph) was divided by the average time it takes to travel the corridor. Tables 4.4 and 4.5 show the relative delay differences of the various scenarios. For example, it takes almost twice as long to travel the eastbound PM



SR-91 for the existing condition than it would under pure free flow conditions while there is virtually no time delay associated with the HOT lanes. As with the speed data, there are few differences between the modeled scenarios.

Flat Rate	General Purpose			HOT		
	AM	MD	PM	AM	MD	PM
WB						
EC	0.61	0.82	0.78	0.82	0.89	0.84
EC*	0.59	0.81	0.80	0.81	0.87	0.85
1B	0.55	0.76	0.84	0.95	0.97	0.98
2B	0.56	0.82	0.87	0.93	0.94	0.97
2C	0.60	0.77	0.81	0.94	0.96	0.98

Flat Rate	General Purpose			HOT		
	AM	MD	PM	AM	MD	PM
EB						
EC	0.94	0.60	0.51	0.96	0.84	0.90
EC*	0.93	0.60	0.45	0.93	0.82	0.89
1B	0.92	0.75	0.46	1.01	0.99	0.91
2B	0.93	0.64	0.42	0.96	0.97	0.88
2C	0.93	0.68	0.44	0.99	0.99	0.89

Table 4.4. Average time delay by scenario for flat rate level 1 by time period for a) westbound and b) eastbound.

Per Mile	General Purpose			HOT		
	AM	MD	PM	AM	MD	PM
WB						
EC						
EC*						
1B	0.63	0.74	0.89	0.84	0.97	0.95
2B	0.57	0.81	0.90	0.93	0.96	0.99
2C	0.63	0.76	0.82	0.94	0.96	0.95

Per Mile	General Purpose			HOT		
	AM	MD	PM	AM	MD	PM
EB						
EC						
EC*						
1B	0.93	0.67	0.47	0.97	0.96	0.91
2B	0.93	0.60	0.45	0.97	0.99	0.83
2C	0.92	0.59	0.44	0.97	1.00	0.78

Table 4.5. Average time delay by scenario for per mile rate level 1 by time period for a) westbound and b) eastbound.

The number of vehicles that were released onto the network in the PARAMICS simulation as well as the total vehicles in the time period by scenario for the peak periods of westbound AM and eastbound PM are shown in Tables 4.6 and 4.7. Release GP stands for the total number of vehicles released in the simulation for the general purpose lanes and release HOT is the total number of vehicles released in the HOT lanes. Only the peak periods were looked at because it was assumed that all of the demand would be released on non-peak directions. The tables show that over 85% of the AM demand does make it on the network and only over half of the PM demand are simulated. The tables also show the increased traffic on the HOT lanes for the scenarios over the existing condition with the exception of 1B for westbound AM peak period.

WBAM	EC	EC*	1B	2B	2C
Release GP	61418	60582	57881	53385	54780
Release HOT	8711	8630	7843	9028	11283
Total GP	67509	67132	62285	62541	61841
Total HOT	8946	8882	8085	10949	11950
% Released	91.73	91.05	93.40	84.93	89.53

EBPM	EC	EC*	1B	2B	2C
Release GP	77016	76269	72533	65815	67847
Release HOT	9722	9690	11631	15128	18112
Total GP	135515	135231	129133	119850	121781
Total HOT	15079	15175	15909	21796	26767
% Released	57.60	57.15	58.03	57.14	57.87

Table 4.6. Number of vehicles released onto the network and total peak demand for flat rate level 1 for a) westbound and b) eastbound.

WBAM	EC	EC*	1B	2B	2C	EBPM	EC	EC*	1B	2B	2C
Release GP			56422	52874	53809	Release GP			73231	65941	63318
Release HOT			8756	11070	13824	Release HOT			13018	17871	22010
Total GP			64510	61151	60600	Total GP			132005	122227	118116
Total HOT			9261	13206	14789	Total HOT			18112	26642	35484
% Released			88.35	86.00	89.71	% Released			57.45	56.30	55.55

**Table 4.7.** Number of vehicles released onto the network and total peak demand for per mile rate level 1 for a) westbound and b) eastbound.

The amount of time it would take for all of the peak demand to be released onto the network was calculated by determining the amount of vehicles that were released onto the network versus the total demand. Tables 4.8 and 4.9 show the total time the simulation would need to release all of the peak period demand.

Flat Rate	EC	EC*	1B	2B	2C	Flat Rate	EC	EC*	1B	2B	2C
WBAM	4.36	4.39	4.28	4.71	4.47	EBPM	10.42	10.50	10.34	10.50	10.37

**Table 4.8.** Total time (hours) by scenario to release all of the demand for flat rate level 1 for a) westbound and b) eastbound.

Per Mile	EC	EC*	1B	2B	2C	Per Mile	EC	EC*	1B	2B	2C
WBAM			4.53	4.65	4.46	EBPM			10.44	10.66	10.80

**Table 4.9.** Total time (hours) by scenario to release all of the demand for per mile rate level 1 for a) westbound and b) eastbound.

**Emissions**

The existing air quality of the study corridor was found by modeling the scenario and traffic volumes using the integrated PARAMICS/CME-EC model. The AM, midday and PM periods were combined to create a total per day (note: this only covers the hours from 5AM to 7PM), as given in Table 4.10.

1999	Emissions (tons)
CO2	1467
CO	57.08
HC	4.32
NOx	4.87

**Table 4.10.** Emissions (tons) for existing condition.

The five scenarios were modeled in PARAMICS with the CME/EC plug-in. The emissions outputs for each time period were summed together and the westbound and eastbound data were combined to form a total per day. As with the previous analysis, the “day” is from 5AM to 7PM since nighttime data was not available. The total emissions per day for flat rate level-1 pricing structure are in Table 4.11 and Table 4.12 for per mile rate level-1 pricing structure.

Flat Rate	EC	EC*	1B	2B	2C
CO2	1665.47	1679.52	1547.99	1578.81	1702.04
CO	66.73	67.16	64.94	65.86	69.29
HC	5.46	5.47	5.32	5.29	5.54
NOx	5.28	5.26	4.82	4.96	5.42

**Table 4.11.** Emissions (tons) per day by scenario for flat rate level-1.

Per Mile	EC	EC*	1B	2B	2C
CO2			1556.46	1605.95	1773.32
CO			64.43	64.59	69.96
HC			5.30	5.22	5.59
NOx			4.81	5.02	5.58

**Table 4.12.** Emissions (tons) per day by scenario for per mile rate level-1.

The emissions vary little between the different scenarios. Scenario 2C produces slightly more emissions than 1B or 2B. This is because scenario 2C lets a higher VMT through the corridor than the other two. The emissions difference between flat rate and per mile rate is small. An emissions reduction from the existing condition is achieved with scenarios 1B and 2B, though very small. The emissions results are also shown in Figure 4.9. The emissions results were normalized by VMT, see Figure 4.10.

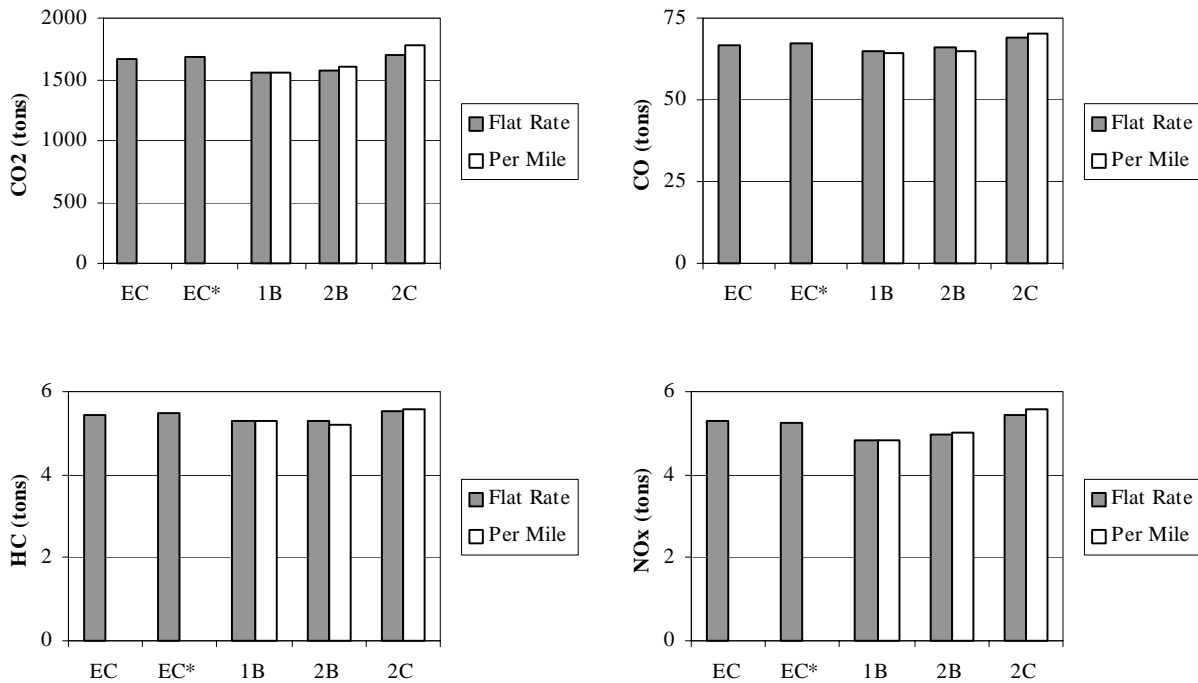

**Figure 4.9.** Emissions (tons) per day by scenario.

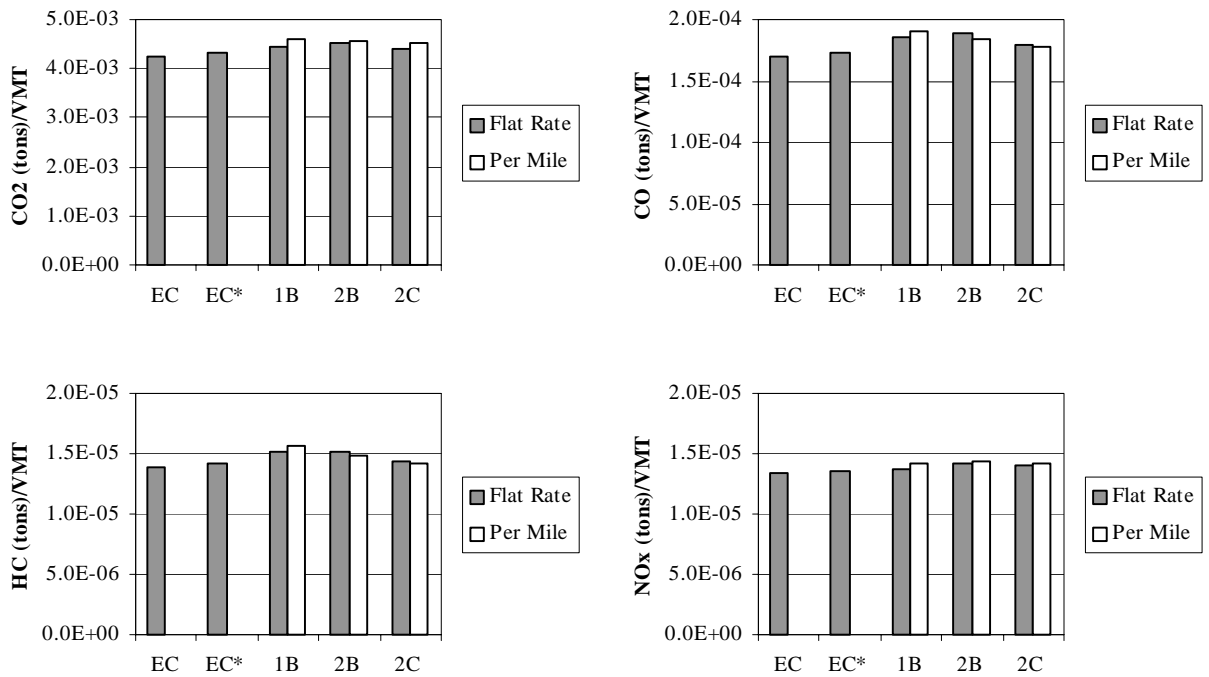

Figure 4.10. Normalized emissions (tons) per day by scenario.

By normalizing the emissions by VMT, all of the scenarios have higher emissions than the existing condition scenario. Overall, scenario 2C has lower emissions by VMT than scenario 1B or 2B. For the most part, per mile rate level 1 has higher emissions than flat rate level 1.

**Preliminary Conclusions for SR-91 Corridor Study**

There is little variance in the modeled emissions between the scenarios. An emissions reduction is achieved for scenarios 1B and 2B from the existing conditions but there is a slight increase with scenario 2C. Scenario 2C lets a higher VMT through the corridor than the other two. The emissions difference between flat rate and per mile rate is small.

The corridor is already beyond capacity. The additional toll lanes do improve the average speed through the HOT lanes and allows a greater number of vehicles to travel in the lanes while diverting some traffic from the general-purpose lanes. Scenario 1B for the westbound AM and scenarios 1B and 2C for the eastbound PM allow a greater portion of traffic trough the corridor than the existing conditions. The operational differences between the scenarios were small and almost undetectable by the model.

## 4.2. I-215/SR-60 MORENO VALLEY FREEWAY EXPANSION PROJECT

In a smaller scale project, an analysis was performed with the combined PARAMICS/CME-EC model for the I-215/SR-60 freeway section in Riverside county. A summary of that study is provided below.

### 4.2.1. Background

In recent years, a significant amount of population growth has occurred in Western Riverside County, particularly in the communities along State Route-60 (SR-60) and Interstate-215. Along with this population growth, came a concomitant increase of traffic along the I-215/SR-60 shared freeway section that extends from State Route 91 (SR-91) to where SR-60 and I-215 split just west of Moreno Valley, as shown in Figure 4.11. This section of freeway currently has three general purpose lanes in both directions and has a significant grade (approximately 3%), climbing nearly 760 feet over 5 miles from west to east. In response to the increase of traffic along the corridor, this section of freeway has recently been widened, however additional lanes have yet to be designated.

The primary objective of this case study was to estimate the relative traffic flow and emission benefits for different lane designation scenarios along the I-215/SR-60 shared section of the Moreno Valley Freeway. Three choices exist for a fourth lane in each direction: 1) add a High Occupancy Vehicle (HOV) lane; 2) add a truck climbing lane going uphill (eastbound); or 3) add another general purpose, mixed-flow lane.



Figure 4.11. Location of the Moreno Valley freeway.

### 4.2.2. Methodology

For this study, estimates of traffic flow and emission benefits were accomplished by modeling the corridor initially in CORSIM, followed by post-processing vehicle trajectories for determining emissions and fuel consumption. Later, the same analysis was carried using the PARAMICS traffic simulator with the embedded CME/EC plug-in module. Prior to carrying out the detailed modeling task, various input data sets were obtained. Both the current and proposed (i.e., future) geometries of the freeway were determined, including grade information measured by CE-CERT’s specialized instrumented vehicle. In addition, Vehicle Classification Counts (VCCs) were performed along the freeway section and connecting ramps. These VCCs also included vehicle occupancy estimates. The network geometry for the present conditions are shown in Figure 4.12a, whereas the planned future geometry is shown in Figures 4.12b and 4.12c.

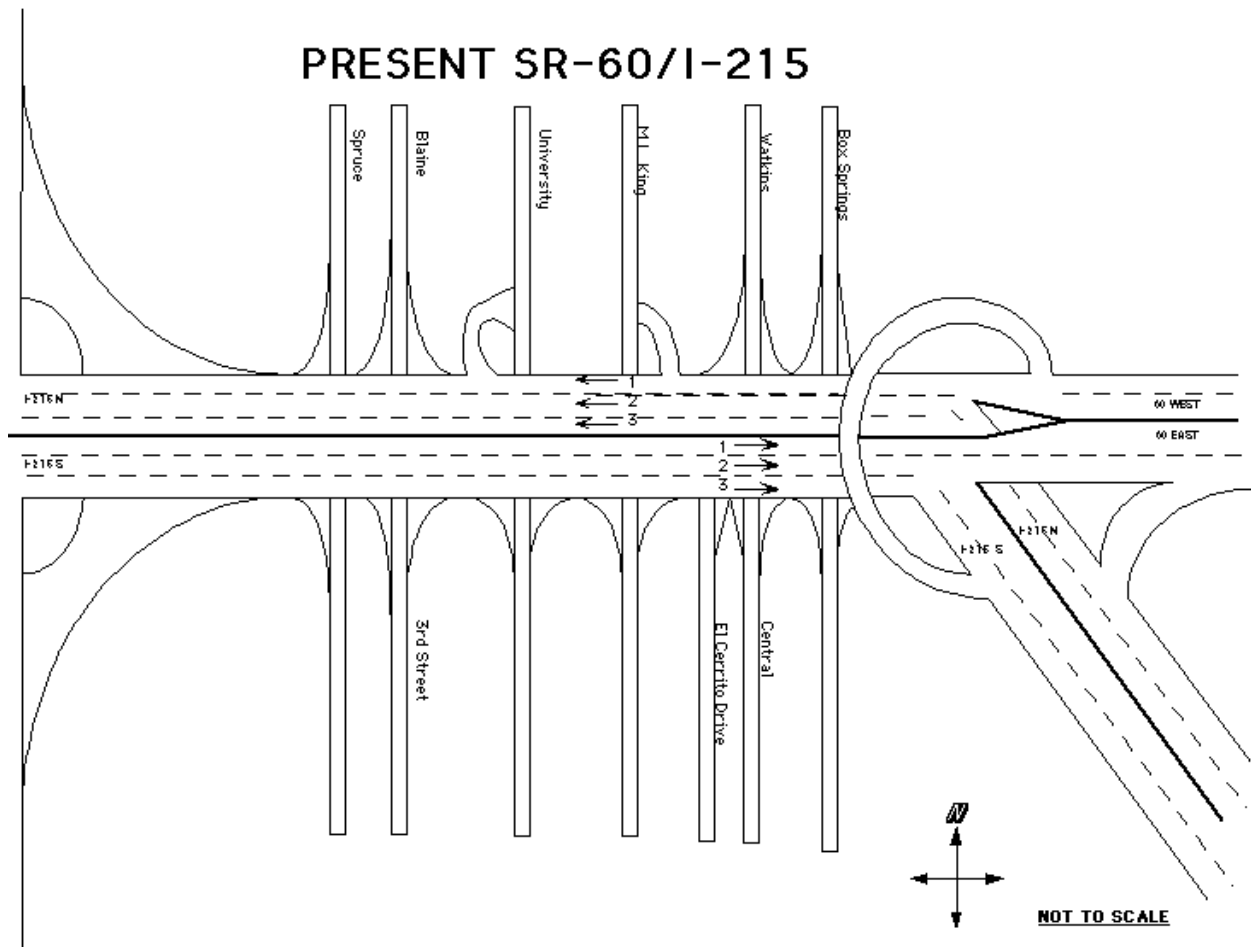

Figure 4.12a. Generalized representation of network geometry for the I-215/SR-60 facility.

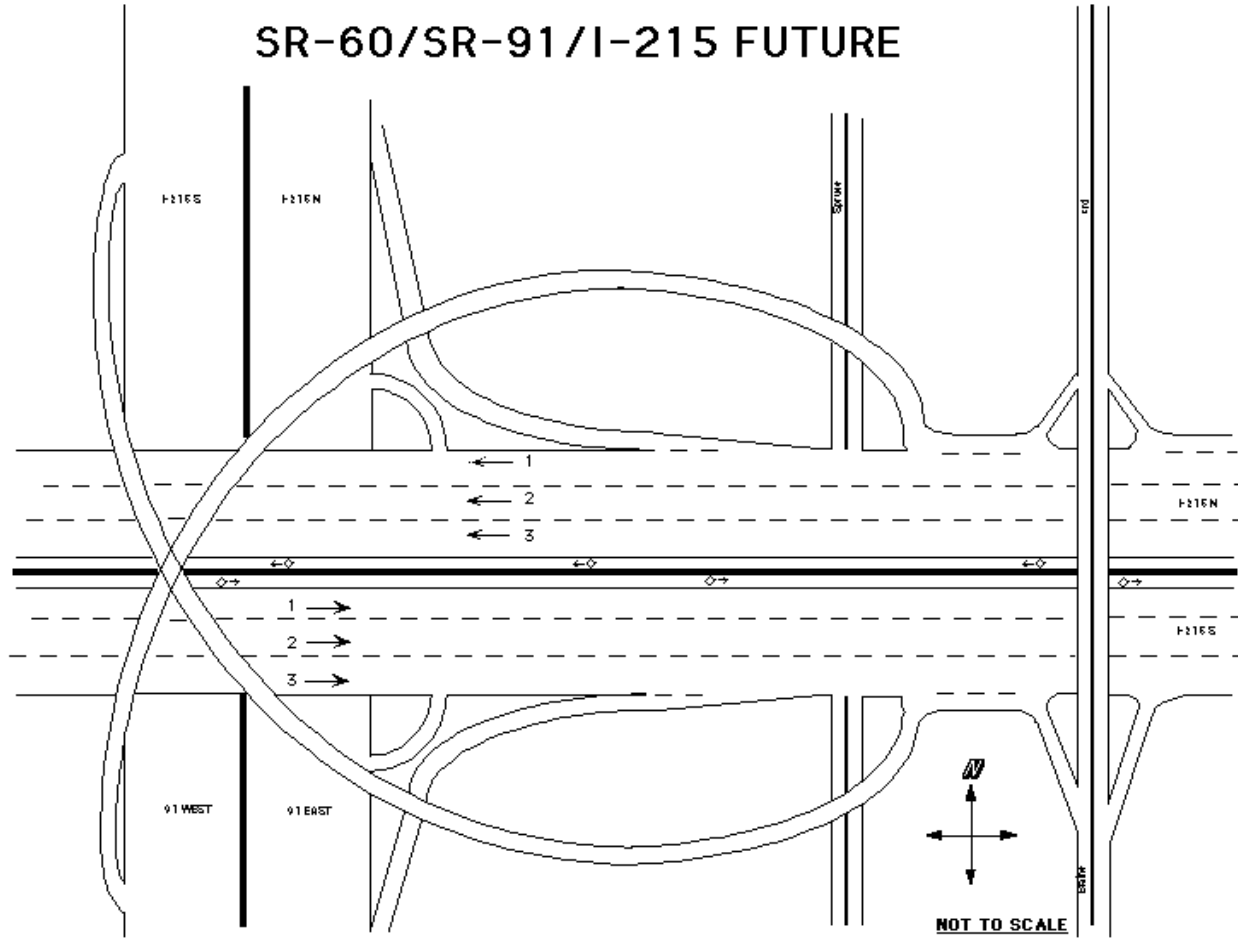

Figure 4.12b. SR-60/SR-91/I-215 proposed future geometry.

Using the modeling tools, various scenarios were evaluated. For both the east- and west-bound, a baseline case was first evaluated, reflecting current conditions on the freeway. Four lanes of mixed flow traffic (in each direction) were then evaluated for current and future traffic volumes. Next, using the additional lane(s) as an HOV lane was then analyzed. This was followed by an evaluation of an eastbound truck climbing lane scenario, where the rightmost lane is restricted to trucks and merging vehicles. Influences of network geometry changes due to new construction were evaluated.

Snapshots of the Paramics simulation of this corridor are shown in Figure 4.13a and 4.13b.

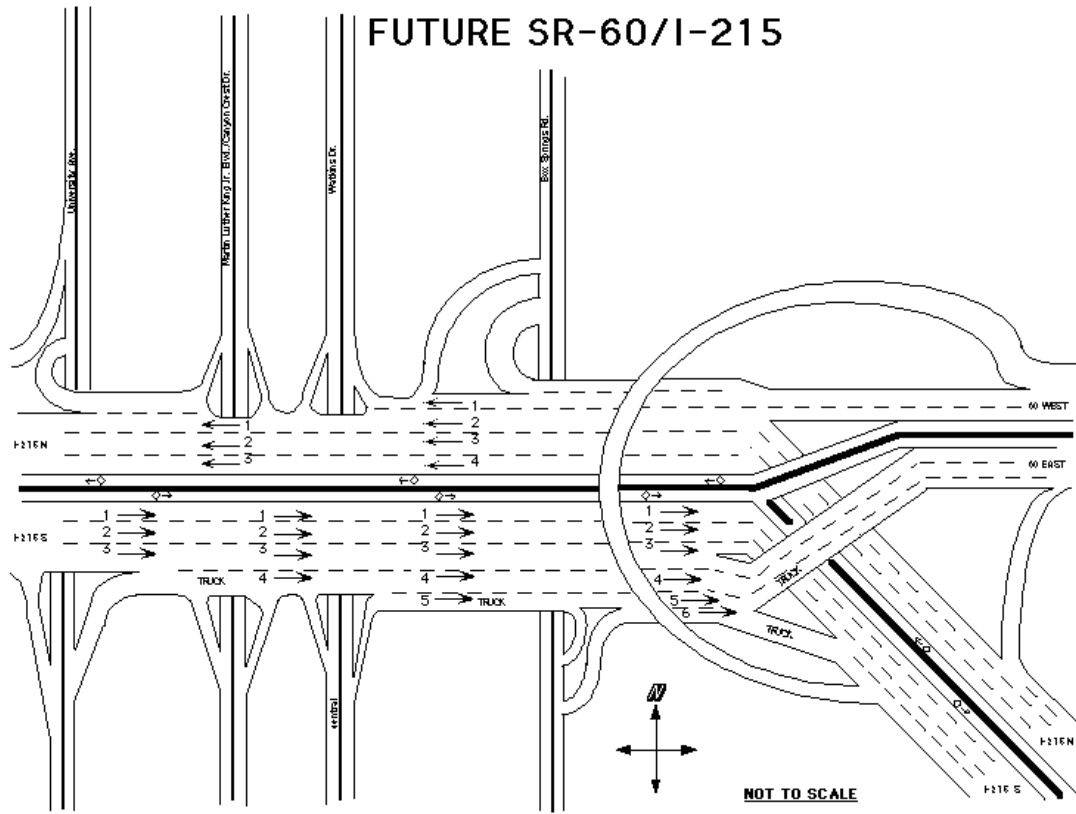

Figure 4.12c. SR-60/I-215 split proposed future geometry.

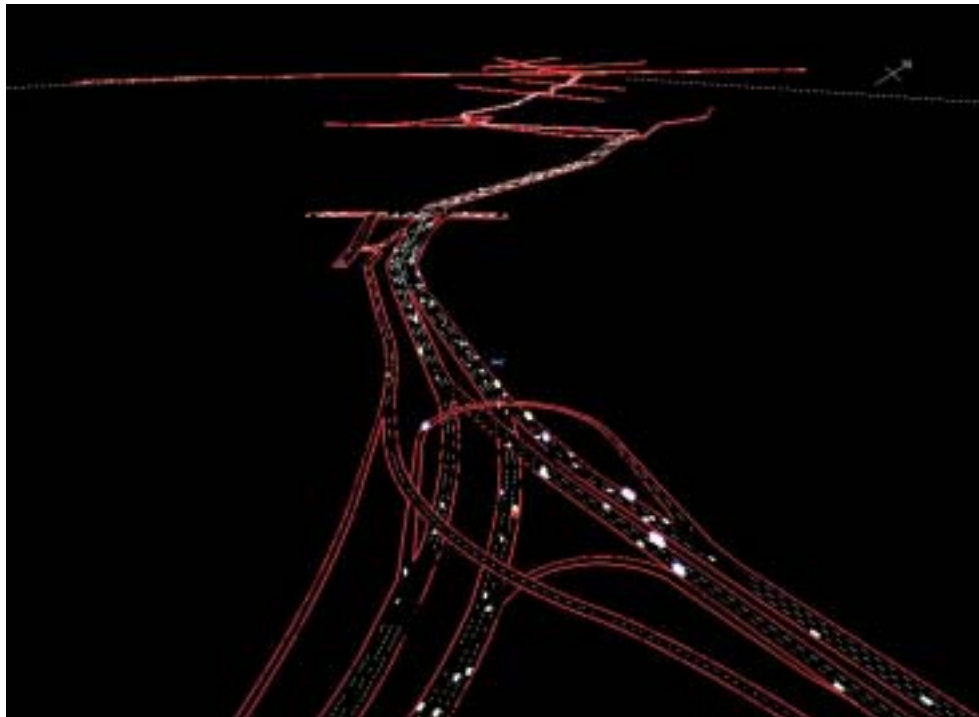
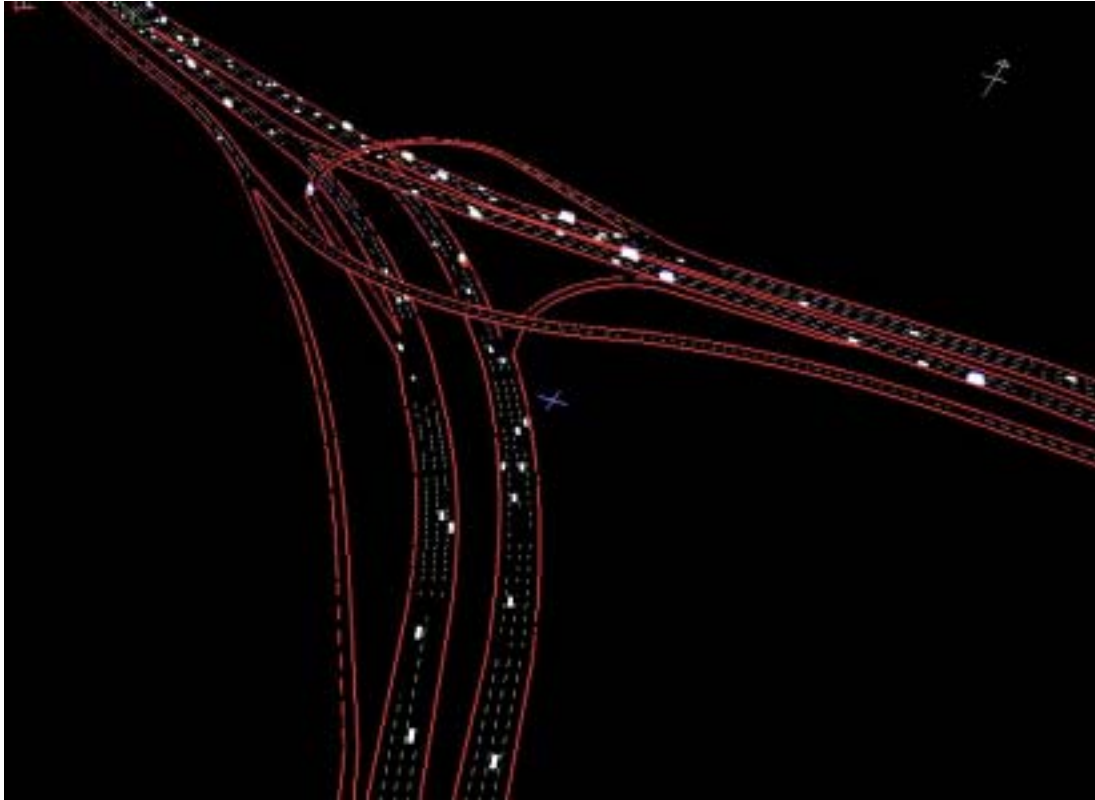

Figure 4.13a. Snapshot of Paramics simulation of the SR-60/I-215 Moreno Valley Freeway corridor. Foreground is SR-60/I-215 split in Moreno Valley, background is the corridor climbing the grade from SR-91.





**Figure 4.13b.** Snapshot of Paramics simulation of the SR-60/I-215 split in Moreno Valley.

### 4.2.3. Results

Using the modeling tools, it was found that road grade significantly affects vehicle speeds and emissions, especially for low performance and heavy vehicles. The truck climbing lane analysis performed as part of this study showed that significant decreases in congestion could be achieved through the addition of a truck lane for eastbound traffic (going uphill).

However, it was found that adding a mixed flow lane leads to the greatest improvements in congestion. The addition of a fourth mixed flow lane improves flow through the interchanges, mitigates congestion on the eastbound grade, and overall produces large increases in network capacity and speeds. Eastbound speeds for the 4-lane mixed flow were found to only drop 6 mph in response to volume increases, while westbound speeds dropped 4.5 mph.

Congestion reduction through addition of an HOV lane is greatly dependent upon usage and presence of dedicated HOV connectors. HOV scenarios proved effective at mitigating congestion when the majority of 2+ occupant vehicles had access to the HOV lane. Even when 2+ occupant volumes were simulated as one third of the total network flow, SR-60 to SR-60 HOV usage was only 8.1%. To achieve a SR-60 to SR-60 HOV lane usage of 12%, approximately 55% of the total network volume would have to be 2+ occupant vehicles. HOV usage could be improved by providing dedicated interchange connectors to the HOV users originating or destined to non SR-60 highways.

Considering present vehicle occupant volumes, an HOV facility along SR-60 without HOV dedicated connector ramps would not alleviate as much traffic as a truck lane or mixed flow lane. An eastbound HOV facility with a dedicated ramp at the SR-60/I-215 interchange for I-215 HOV traffic would relieve congestion similarly to a eastbound truck lane with a dedicated ramp at the SR-60/I-215 interchange for I-215 truck traffic. An HOV facility with dedicated HOV connector ramps at both interchanges would alleviate congestion close to the levels of an additional mixed flow lane. The overall network simulated traffic congestion is dominated by vehicle interactions at the interchanges and future congestion improvements are limited primarily by connector improvements.

The higher network volumes for eastbound and westbound mixed flow scenarios lead to an overall increase in emissions, however lower emissions on a vehicle-by-vehicle basis. Individual vehicle emissions were reduced primarily through lower speeds when traveling up the grade, which results in lower engine loads.

The westbound HOV scenarios were characteristically similar to the mixed flow lanes in regards to decreasing individual vehicle CO emissions at higher network volumes. Additionally, eastbound HOV scenarios displayed a consistent decrease in individual vehicle CO emissions as network volumes increased. Similarly, individual vehicle HC emissions have a decreasing trend with increased volumes on the eastbound HOV network. Variances in truck percentage can slightly influence HOV scenario HC emissions.

NO<sub>x</sub> appears to be the only tailpipe emission that is dominated by truck volumes on the network. Eastbound HOV scenarios displayed drastic fluctuations in total NO<sub>x</sub> emissions in response to changes in truck volumes. Higher truck volumes created elevated NO<sub>x</sub> emissions. Conversely, when passenger car volumes increased, NO<sub>x</sub> decreased.

Overall, when evaluating the influence of grade, CO emissions were approximately 25 times higher for eastbound flow in comparison with similar westbound scenarios. Grade effects the network in two ways: 1) as vehicles climb the hill, their engine load is higher, resulting in greater emissions and fuel consumption; 2) on the other hand, climbing a grade generally slows down the average speed of traffic, resulting in lower emissions. The interaction of these two characteristics leads to the majority of the emission trends evaluated in this study. Further analysis is on-going for this particular corridor.



## 5. Conclusions and Future Work

In this PATH project, we have examined the key interface issues between a state-of-the-art modal emissions/energy (CME-EC) model and ITS traffic simulation models developed within the PATH program. Based on an examination of all the modeling efforts in ATMIS, the key traffic simulator currently being used is PARAMICS. As a result, a good deal of effort has been spent in this project on integrating the CME-EC model with PARAMICS. This was not a trivial issue. An application programming interface (API) had to be developed and integrated within the PARAMICS environment. Further, issues with vehicle fleet mix were considered.

After the combined PARAMICS/CME-EC model was completed, it was successfully applied to two evaluation projects. Performing these types of detailed studies allowed us to find various bugs in the integrated model that were subsequently eliminated. By describing these case studies, other practitioners can learn to create microscale emission inventories using this integrated tool.

The CME/EC model will continue to be maintained for years to come. It is anticipated that the PARAMICS API version of the model will periodically be updated. In the current implementation, no relationships have been developed between the vehicle performance characteristics used in the traffic simulation and the vehicle characteristics of the emissions model. This is a key area of future research, i.e., developing a mapping between traffic simulation parameters (e.g., acceleration performance, power) and the categories developed within the emissions model.



## 6. References

An, F., M. Barth, M. Ross, and J. Norbeck. “The development of a comprehensive modal emissions model: operating under hot-stabilized conditions”. *Transportation Research Record*, No. 1587, pp. 52-62, Transportation Research Board, National Academy of Science. 8/97.

Barth, M., et al., “Modal Emissions Modeling: A Physical Approach”, *Transportation Research Record* No. 1520, pp. 81-88, Transportation Research Board, National Academy of Science, August 1996.

Barth, M., T. Younglove, T. Wenzel, G. Scora, F. An, M. Ross, and J. Norbeck. “Analysis of modal emissions from a diverse in-use vehicle fleet”. *Transportation Research Record*, No. 1587, pp. 73-84, Transportation Research Board, National Academy of Science, August 1997.

Barth, M., F. An, T. Younglove, C. Levine, G. Scora, M. Ross, and T. Wenzel. (1999) “The development of a comprehensive modal emissions model” Final report submitted to the National Cooperative Highway Research Program, December, 1999, 255 p.

Barth, M., F. An, T. Younglove, C. Levine, G. Scora, M. Ross, and T. Wenzel. (2000) “The comprehensive modal emissions model (CMEM) User’s Guide” Technical documented submitted to the National Cooperative Highway Research Program; also available at <http://www.cert.ucr.edu/cmем>.

CARB, “Methodology for Estimating Emissions from On-Road Motor Vehicles”, California Air Resources Board, Technical Support Division, 1995.

Federal Test Procedure. 40 Code of Federal Regulations, Parts 86-99, 1989.

ITS America and US DOT, *National Transportation Plan for Intelligent Transportation Systems*, 1st edition, 1995.

Mathworks, (2000) “MATLAB, the language of technical computing”, see <http://www.mathworks.com>.

Quadstone, “The Paramics Transportation Modeling Suite”, [html://www.paramics.com/](http://www.paramics.com/). 2000.

SCAG (2001). Southern California Association of Governments, “SR-91 HOT Lane Extension and Intermediate Access Feasibility Study”, draft final report, March 2001.

Shaheen, S., T. Young, D. Sperling, D. Jordan, and T. Horan (1998) “Identification and Prioritization of Environmentally Beneficial Intelligent Transportation Technologies. UC Davis ITS Research Report UCD-ITS-RR-98-1, Institute of Transportation Studies, University of California, Davis, February 1998.

Sierra Research, “Development of Speed Correction Cycles”, US EPA Document Number M6.SPD.001, June, 1997.

TRB, *Highway Capacity Manual - Special Report 209*, Transportation Research Board, National Academy of Science, 1994.

US EPA, “Progress Report on the Development of MOBILE”, *Proceedings of the Seventh CRC On-Road Vehicle Emissions Workshop*, San Diego, CA, April, 1997.

US EPA, “Support Document to the Proposed Regulations for Revisions to the Federal Test Procedure”, US EPA technical report, Office of Air and Radiation, 1995.

Van Aerde, M. (1995). INTEGRATION Release 2: User’s Guide – Volume 1, 2, and 3, Transportation Systems Research Group, Queen’s University, Kingston, Ontario, Canada.

Young, T., D. Sperling, and S. Shaheen (1999) “Identification and Prioritization of Environmentally Beneficial Intelligent Transportation Technologies: Modeling Effort”, California PATH Working Paper UCB-ITS-PWP-99-20, December, 1999.