

UC Davis

Recent Work

Title

A Low-Carbon Fuel Standard for California, Part 1: Technical Analysis

Permalink

<https://escholarship.org/uc/item/6j67z9w6>

Authors

Farrell, Alexander E.
Sperling, Dan

Publication Date

2007-05-01

Peer reviewed



Year 2007

UCD—ITS—RR—07—07

A Low-Carbon Fuel Standard for California

Part 1: Technical Analysis

August 1, 2007

Project Directors

Alexander E. Farrell, UC Berkeley
Daniel Sperling, UC Davis

Contributors

S.M. Arons, A.R. Brandt, M.A. Delucchi, A. Eggert, A.E. Farrell,
B.K. Haya, J. Hughes, B.M. Jenkins, A.D. Jones, D.M. Kammen,
S.R. Kaffka, C.R. Knittel, D.M. Lemoine, E.W. Martin, M.W. Melaina,
J.M. Ogden, R.J. Plevin, D. Sperling, B.T. Turner, R.B. Williams, C. Yang

TABLE OF CONTENTS

Executive Summary	8
1 Introduction	17
1.1 Goals	18
1.2 Strategies	21
1.3 Why sector-specific strategies for transportation	22
1.4 Definitions	24
1.5 Fuel carbon intensity after 2050	25
1.6 Structure of this report	27
1.7 References	27
2 Methods	29
2.1 Baseline	29
2.2 Scope of the standard.....	29
2.3 Measuring GHG intensity.....	31
2.4 Scope of the intensity metric	32
2.5 Baseline AFCI, 2020 target and compliance pathways	34
2.6 Compliance paths	37
2.7 Mid-GHG and low-GHG biofuels.....	39
2.8 Life cycle assessment	39
2.9 Summary of the WTW analysis.....	44
2.10 Scenario analysis with the VISION model.....	45
2.11 References	48
3 Fuel Characteristics	51
3.1 Fossil hydrocarbon fuels.....	51
3.2 Biofuels.....	58
3.3 Electricity	68
3.4 Hydrogen	70
3.5 Other environmental issues	72
3.6 References	72
4 Resources for Low-Carbon Fuels.....	77
4.1 Biomass resources for low-carbon fuels.....	77
4.2 Natural gas.....	101
4.3 Petroleum and fossil substitutes.....	102
4.4 Electricity	104
4.5 Hydrogen.....	107
4.6 References	113
5 Representative scenarios.....	117
5.1 Scenario definitions	118
5.2 Scenario infrastructure costs.....	120
5.3 Scenario assumptions	123
5.4 Scenario results.....	128
5.5 Low-GHG fuels in heavy-duty and off-road applications	174
5.6 Electrification of off-road diesel fuel applications	175
5.7 References	178

LIST OF TABLES

Table ES-1: Potential low-carbon fuel supplies (million gallons of gasoline equivalent per year).....	9
Table ES-2: Scenario results using the VISION-CA model	11
Table ES-3: Global Warming Impacts estimated by two LCA models, adjusted for energy at the wheel (g CO ₂ eq / MJ).....	13
Table 1-1: California transportation fuel GHG emissions in the baseline year, 2004	20
Table 1-2: California’s climate change policies and initiatives	22
Table 1-3: Effect of a \$25/MT CO ₂ e price on energy prices	23
Table 2-1: Baseline and 2020 target AFCI values	35
Table 2-2: Possible LCFS compliance schedules	38
Table 2-3: Global warming impacts estimated by two LCA models under various assumptions (gCO ₂ -e / MJ)	47
Table 3-1: Fuels considered in this section.....	51
Table 3-2: GHG emissions from fossil-based transportation fuels	54
Table 3-3: Gross System Power, 2005 (GWh)	68
Table 4-1: Estimates of current total annual residue biomass in California	78
Table 4-2: California starch and sugar crop yields, acres harvested, and ethanol potentials	84
Table 4-3: Starch and sugar crop land area requirements for in-state ethanol production goals (thousand acres)	84
Table 4-4: Oil seed crop requirements to meet in-state production goals for conventional biodiesel (thousand acres)	85
Table 4-5: California lignocellulosic ethanol potential.....	90
Table 4-6: Characteristics and potential energy of landfilled urban waste in California.....	95
Table 4-7: Theoretical ethanol yields of organic MSW components.....	96
Table 4-8: Estimates of annual ethanol or liquid hydrocarbon potential from lignocellulosic fraction of California landfill stream	97
Table 4-9: Estimated capital costs for enzymatic cellulose-ethanol process with on-site boiler and turbine/generator	98
Table 4-10: PG&E May 2006 residential electricity tariffs and equivalent gasoline prices for PHEVs .	105
Table 4-11: Near term hydrogen supply options for California.....	108
Table 4-12: Crude oil and hydrogen capacities for California refineries.....	109
Table 4-13: Industrial hydrogen facilities in California.....	110
Table 4-14: WESTCARB carbon capture and sequestration projects	112
Table 5-1: Light duty vehicle scenario names, descriptions and AFCI goals.....	119
Table 5-2: Representative GWI values used in LCFS scenarios	126
Table 5-3: Acronyms for scenario descriptions	126
Table 5-4: Fuel energy, GHG intensities, AFCI values & GHG emissions for the BAU Scenario.....	136
Table 5-5: Sales of new LDVs for the BAU Scenario.....	136
Table 5-6: Fuel energy, GHG intensities, AFCI values and GHG emissions for Scenario C5.....	141
Table 5-7: Sales of new LDVs for Scenario C5.....	141
Table 5-8: Fuel energy, GHG intensities, AFCI values and GHG emissions for Scenario D5	145
Table 5-9: Sales of new LDVs for Scenario D5	145
Table 5-10: Fuel energy, GHG intensities, AFCI values & GHG emissions for Scenario D10	147
Table 5-11: Sales of new LDVs for Scenario D10	147
Table 5-12: Fuel energy, GHG intensities, AFCI values and GHG emissions for Scenario F5	151
Table 5-13: Sales of new LDVs for Scenario F5	151
Table 5-14: Fuel energy, GHG intensities, AFCI values & GHG emissions for Scenario F10.....	153
Table 5-15: Sales of LDVs for Scenario F10.....	153
Table 5-16: Fuel energy, GHG intensities, AFCI values & GHG emissions for Scenario G5	159
Table 5-17: Sales of LDVs for Scenario G5	159

Table 5-18: Fuel energy, GHG intensities, APCI values & GHG emissions for Scenario G10	161
Table 5-19: Sales of LDVs for Scenario G10	161
Table 5-20: Fuel energy, GHG intensities, APCI values & GHG emissions for Scenario G15	163
Table 5-21: Sales of new LDVs for Scenario G15	163
Table 5-22: Fuel energy, GHG intensities, APCI values & GHG emissions for Scenario H5	169
Table 5-23: Sales of new LDVs for Scenario H5	169
Table 5-24: Fuel energy, GHG intensities, APCI values & GHG emissions for Scenario H10	171
Table 5-25: Sales of new LDVs for Scenario H10	171
Table 5-26: Fuel energy, GHG intensities, APCI values & GHG emissions for Scenario H15	173
Table 5-27: Sales of new LDVs for Scenario H15	173
Table 5-28: Populations of off-road electric vehicle technologies	176
Table 5-29: GHG reductions from off-road electric vehicle technologies.....	176
Table 5-30: GHG reductions from off-road electric vehicle technologies.....	177

LIST OF FIGURES

Figure 1-1: Historical and forecast GHG emissions, and Governor Schwarzenegger’s goals.....	19
Figure 1-2: GHG emissions by end-use sector, including electricity generation, 2002.....	19
Figure 1-3: Trajectories for light duty vehicle GHG emissions to 2050.....	26
Figure 2-1: Possible LCFS compliance schedules	38
Figure 2-2: Fuel life cycle analyses	40
Figure 3-1: Schematic of fossil transportation fuels production.....	53
Figure 3-2: Production costs and GHG emissions for fossil hydrocarbon fuels.....	56
Figure 3-3: Crude oil and U.S. gasoline prices	57
Figure 3-4: Biofuel production pathways	58
Figure 3-5: Fuel production cost estimates	67
Figure 3-6: Options for hydrogen production.....	70
Figure 3-7: Delivered H ₂ costs.....	72
Figure 4-1: Total annual residue biomass in California and estimated technically recoverable feedstock potential.....	79
Figure 4-2: Distribution of biomass resources in California.....	79
Figure 4-3: Estimated per-acre ethanol yields for various crop types.....	86
Figure 4-4: Impact of conversion efficiency on the feedstock cost contribution to cost of energy (COE) from biomass	93
Figure 4-5: Ethanol production costs from MSW with variable feedstock costs, 70 MGY design basis..	99
Figure 4-6: Projected waste disposal (million tons/year) and biomethane production (BCF/year) from landfills in California with constant per-capita disposal.....	100
Figure 4-7: The quantity of electricity beyond observed demand available at each price, as determined by the supply bids given to the California Power Exchange in 1999. Also, the number of PHEVs that would need to charge during the hour to use that much electricity with a charge rate of 1 kWh/hr (or a charger size of 1.2 kW).	107
Figure 5-1: Share of HEVs as a percent of new LDV sales, historical nationwide values and projections in the VISION-CA BAU scenario.....	128
Figure 5-2: Assumed share of VMT in electric drive as a function of PHEV electric range.....	128
Figure 5-3: Projected gasoline demand for VISION-CA and the CEC 2005 IEPR.....	130
Figure 5-4: LDV sales per person and total California population to 2020 (all scenarios)	132
Figure 5-5: New LDV sales for passenger cars, light trucks and total LDVs (all scenarios)	132
Figure 5-6: Fuel energy consumption in the BAU Scenario.....	134
Figure 5-7: Fuel energy consumption in the BAU Scenario (gasoline not shown)	134
Figure 5-8: New LDVs sold per year in the BAU Scenario	135
Figure 5-9: New LDVs sold per year in the BAU Scenario (gasoline ICE LDVs not shown).....	135
Figure 5-10: ACFI reductions for each assumption in Scenario C5	139
Figure 5-11: Fuel energy consumption in Scenario C5	140
Figure 5-12: New LDVs sold per year in Scenario C5	140
Figure 5-13: ACFI reductions for each assumption in Scenarios D5 and D10.....	143
Figure 5-14: Fuel energy consumption in Scenario D5	144
Figure 5-15: New LDVs sold per year in Scenario D5.....	144
Figure 5-16: Fuel energy consumption in Scenario D10	146
Figure 5-17: New LDVs sold per year in Scenario D10.....	146
Figure 5-18: ACFI reductions for each assumption in Scenarios F5 and F10	149
Figure 5-19: Fuel energy consumed in Scenario F5	150
Figure 5-20: New LDV sales per year in Scenario F5	150
Figure 5-21: Fuel energy consumption in Scenario F10.....	152
Figure 5-22: New LDVs sold per year in Scenario F10.....	152

Figure 5-23: AFCI reductions for each assumption in Scenarios G5, G10 and G15	156
Figure 5-24: Fuel energy consumption in Scenario G5	158
Figure 5-25: New LDVs sales per year in Scenario G5.....	158
Figure 5-26: Fuel energy consumption in Scenario G10	160
Figure 5-27: New LDVs sold per year in Scenario G10.....	160
Figure 5-28: Fuel energy consumption in Scenario G15	162
Figure 5-29: New LDVs sold per year in Scenario G15 (identical to Scenario G10).....	162
Figure 5-30: AFCI reductions for each assumption in Scenarios H5, H10 and H15	166
Figure 5-31: Fuel energy consumption in Scenario H5	168
Figure 5-32: New LDVs sold per year in Scenario H5.....	168
Figure 5-33: Fuel energy consumption in Scenario H10	170
Figure 5-34: New LDVs sold per year in Scenario H10.....	170
Figure 5-35: Fuel energy consumption in Scenario H15	172
Figure 5-36: New LDVs sold per year in Scenario H15.....	172

Acknowledgments

This research was supported by the Energy Foundation. The authors would like to thank the staffs of the California Air Resources Board, the California Energy Commission, the representatives of the many stakeholder organizations who participated in the study, and Stefan Unnasch. The view and opinions herein, as well as any remaining errors, are those of the authors alone and do not necessarily represent the views of the sponsor or any other organization or person.

Executive Summary

Executive Order S-1-07, the Low Carbon Fuel Standard (LCFS) (January 18, 2007), calls for a reduction of at least 10 percent in the carbon intensity of California's transportation fuels by 2020. It instructed the Secretary of the California Environmental Protection Agency to coordinate activities between the University of California, the California Energy Commission (CEC) and other state agencies to develop and propose a draft compliance schedule to meet the 2020 Target. This report is the first of two by the University of California in response. This first study assesses the low-carbon fuels options that might be used to meet the proposed standard, and presents a number of scenarios for mixes of fuels that might meet a 5, 10, and 15 percent standard. The second part of the study, to be released one month later, will examine key policy issues associated with the LCFS.

On the basis of a study of a wide range of vehicle fuel options, we find a 10 percent reduction in the carbon intensity of transportation fuels by 2020 to be an ambitious but attainable target. With some vehicle and fuel combinations, a reduction of 15 percent may be possible. All of the major low carbon fuel options to reduce GHG emissions from the transportation sector (*e.g.*, biofuel production and electric vehicles) have technical and economic uncertainties that need further research and evaluation. However, there is a wide variety of options, of which many show great potential to lower the global warming impact of transportation fuels. Many research and development efforts are already underway to bring these advanced technologies to market. The diversity of promising low-carbon fuel and vehicle options leads us to conclude that the California Air Resources Board should include the LCFS as an early action measure under AB 32 (Núñez/Pavley), the Global Warming Solutions Act.

Under the LCFS, fuel providers would be required to track the global warming intensity (GWI) of their products, measured on a per-unit-energy basis, and reduce this value over time. "Global warming intensity" is a measure of all of the mechanisms that affect global climate including not only greenhouse gases (GHGs) but also other processes (like land use changes that may result from biofuel production). The term "life cycle" refers to all of the activities included in the production, transport, storage and use of the fuel. The unit of measure for GWI used in this study is grams of carbon dioxide equivalent per megajoule of fuel delivered to the vehicle (gCO₂e/MJ) adjusted for inherent differences in the in-use energy efficiency of different fuels (*e.g.*, diesel, electricity and hydrogen). These definitions are important both because they are direct measurements of the objectives of the policy and because of their scientific clarity, making a successful policy more likely. For convenience, the term *carbon intensity* is used to refer to the total life cycle GWI per unit of delivered fuel energy.

Attaining both the AB 32 (Núñez/Pavley) legislative goal for 2020 and the climate stabilization goal for 2050 will be challenging, requiring significant changes in the transportation sector to achieve the required emission reductions. The magnitude of the 2050 goal, combined with the large size and complexity of California's transportation and energy systems, means that it is crucial to begin the process of technological innovation immediately and to build markets for low carbon fuels so that suppliers will have incentives to innovate, as well as to support research and development for work that is further away from commercialization.

This report addresses only the climate change impacts of fuels, and does not address other public health and environmental impacts, such as air quality, water use and quality, loss of habitat, soil erosion, and so forth. Many of these issues will become more important if biofuel

production and use expand, and they are critical to the long-term viability of all energy resources. Neither does this study consider energy efficiency, mass transit, city planning, and other ways to lower fuel consumption. These issues are obviously important and need consideration as the LCFS is developed. Separate policies to address these issues may also be needed. This part of the study does not examine these types of policies or how they might influence the scenarios we examine.

We find it possible to either manufacture a significant amount of low-carbon fuel within California or to import it from outside the state. Many of the low carbon fuels expected to be commercially available in large quantities within the 2020 time horizon are biofuels. Table ES-1 summarizes some of the analysis in Section 4 on the potential volumes of low-carbon biofuels available for use in California. Like many calculations in this study, these values are uncertain. California has or could have sufficient feedstocks to produce over a billion gallons of biofuels per year by 2020 in state, and perhaps even twice that amount. This amount can be compared to total projected light duty vehicle fuel consumption of 16.5 to 17 billion gallons in 2020, plus about 4 billion gallons of diesel fuel used by heavy duty vehicles. However, the facilities to produce these biofuels do not currently exist, some of the feedstocks listed in the table are not currently grown commercially, and many of the conversion processes are not yet commercially viable. Research and development projects are underway to investigate some of these new crops and new technologies; these efforts will eventually enhance the quantity and diversity of fuel options available.

Table ES-1: Potential low-carbon biofuel supplies (million gallons of gasoline equivalent per year)

In-state feedstocks for biofuel production	Potential volume⁶
California starch and sugar crops ¹	360 to 1,250
California cellulosic agricultural residues	188
California forest thinnings	660
California waste otherwise sent to landfills ²	355 to 366
Cellulosic energy crops on 1.5 million acres in California ³	400 to 900
California corn imports ⁴	130 to 300
Forecasted 2012 production capacity nationwide⁵	Potential volume
Nationwide low-GHG ethanol	288
Nationwide mid-GHG ethanol	776 to 969
Nationwide biodiesel	1,400
Nationwide renewable diesel	175

Notes:

¹ Low value is based on 2005 crop, high value based on maximum crops since 1950. Attaining the high value would require massive shifting of crops in California.

² Low value is for ethanol, higher value is for Fischer-Tropsch liquids. See Section 4.

³ Range based on low and high yields, see Section 4.

⁴ These values are preliminary. See Section 4.

⁵ Forecasts by USEPA. Mid-GHG ethanol and biodiesel values are estimated for fuels currently in commercial production, but using relatively low carbon intensity methods, such as corn ethanol in modern dry mills with low-carbon fuels for process energy (*e.g.*, natural gas as opposed to coal without carbon sequestration) and soy-based biodiesel. Low-GHG ethanol and renewable diesel values are estimated for fuels currently under development, such as cellulosic ethanol and Fischer-Tropsch diesel fuel from wood and other biomass. See Sections 2 and 4 for more complete information.

⁶ No total is given because not all feedstocks shown will be available simultaneously.

Large volumes of low-GHG ethanol are anticipated to become available elsewhere in the United States by 2012, as indicated from US EPA forecasts in Table ES-1. These EPA forecasts of potential production are based on facilities that have been selected for funding by the U.S. Department of Energy or are already in commercial production. Diversion of this fuel production to California may (at least initially) not decrease overall greenhouse gas emissions. It may represent only a rationalization (or “shuffling”) of existing production, not a change in the type of biofuel production nationwide. (The same phenomenon may occur with low-carbon fuels imported from other countries.) Such rationalization would lower the carbon intensity of California transportation fuels, but may increase the carbon intensity of fuels elsewhere in the United States (and the world in the case of international imports). However, this is a one-time phenomenon. Once existing low carbon biofuel production is rationalized so that it goes to California, further reductions in carbon intensity will require new investment and innovation. The LCFS will clearly induce technological innovation and investment in new technologies, but perhaps with some delay. As other states or regions adopt similar measures, the amount of rationalization that can occur will decline. These issues will be discussed further in Part 2 of this report.

To evaluate the technical feasibility of the proposed LCFS, we constructed and examined a dozen light duty vehicle and fuel scenarios, summarized in Table ES-2. This table indicates the name of each set of scenarios and the quantities of major low carbon fuels and vehicles introduced to achieve the specified carbon intensity reduction target, shown as an average fuel carbon intensity (AFCI) value. Each scenario is indicated with a letter for the scenario type and a number for the percent of carbon intensity reduction (e.g., H15 is in the last set of scenarios, and achieves a 15 percent carbon intensity reduction). This analysis, discussed in detail in Section 5, considers population and economic growth, fleet turnover rates, and the effects of AB 1493 (Pavley). Potential reductions in carbon intensity in heavy duty and off-road applications were considered separately. Emission reductions due to changes in oil production and refining are ignored, as is the potential use of offsets from other sectors or from geologic sequestration of CO₂. These simplifying assumptions were made to permit the scenario analysis to be completed with the time and resources available, and are not policy recommendations. The implications of these assumptions for public policy will be explored in Part 2 of the study.

Six of these scenarios were designed to meet or exceed a 10 percent carbon intensity reduction by 2020, including two that attain a 15 percent reduction. These scenarios all contain plausible combinations of technological innovation and investment in vehicle technologies and low-carbon fuel production and distribution infrastructure, although opinions may differ regarding how easy or difficult they will be to achieve.

This analysis suggests that a 5 percent reduction in carbon intensity is feasible with electric drive vehicles alone (Scenario C5). Electric drive vehicles comprise a tiny fraction of the light duty fleet today and significant technological innovation would be needed to gain large market penetration. Because vehicles last a long time, the fleet turns over relatively slowly, limiting the potential effect of changes in vehicle technology on near-term reductions in the GWI of fuels.

Table ES-2: Scenario results using the VISION-CA model

Volume of fuel sold in 2020 (billion gallons of gasoline equivalent, BGGE) and thousands of vehicles sold in 2020
 Top box for each scenario in the second column lists the fuel consumed in that scenario. The bottom box in the same scenario lists the vehicle types that must penetrate the market to achieve stated AFCI goals.

Scenario	Major Low-Carbon Fuels and Vehicles	Carbon Intensity Reductions (AFCI)					
		-5%		-10%		-15%	
Business as Usual (A)	<i>For year 2020:</i> Gasoline: 15.3 BGGE Diesel: 0.86 BGGE LDVs sold: 2.32 million	*		*		*	
Electric Drive (C5)	Hydrogen	0.183	1.1%	**		**	
	Electricity	0.131	0.8%				
	Plug-in hybrid vehicles	269	11.6%				
	Fuel cell vehicles	182	7.8%				
	Battery electric vehicles	40	1.7%				
Existing Vehicles and Advanced Biofuels (D5, D10)	Low-GHG Biofuel	0.608	3.6%	0.946	5.7%	**	
	Low-GHG FT Diesel	-	-	0.471	2.8%		
	Diesel vehicles	<i>BAU</i>	<i>BAU</i>	593	25.5%		
Evolving Biofuels and Advanced Batteries (F5, F10)	Mid-GHG Biofuel	0.979	5.9%	1.993	12.0%	**	
	Electricity	0.118	0.7%	0.118	0.7%		
	Mid-GHG Biodiesel	-	-	0.314	1.9%		
	Plug-in hybrid vehicles	188	8.1%	188	8.1%		
	Battery electric vehicles	35	1.5%	35	1.5%		
	Flex-fuel vehicles	<i>BAU</i>	<i>BAU</i>	915	39.4%		
	Diesel vehicles	<i>BAU</i>	<i>BAU</i>	593	25.5%		
Biofuel Intensive (G5, G10, G15)	Mid-GHG Biofuel	1.066	6.3%	1.038	6.2%	1.466	8.7%
	Mid-GHG Biodiesel	0.171	1.0%	0.314	1.9%	0.314	1.9%
	Low-GHG FT Diesel	-	-	-	-	0.471	2.8%
	Low-GHG Biofuel	-	-	-	-	0.733	4.4%
	Sub-zero GHG Biofuel	-	-	-	-	0.293	1.7%
	Flex-fuel vehicles	805	34.7%	805	34.7%	805	34.7%
	Diesel vehicles	<i>BAU</i>	<i>BAU</i>	593	25.5%	593	25.5%
Multiple Fuels & Vehicles (H5, H10, H15)	Low-GHG Biofuel	0.216	1.3%	0.410	2.4%	0.516	3.1%
	CNG	0.289	1.7%	0.289	1.7%	0.289	1.7%
	Electricity	<i>BAU</i>	<i>BAU</i>	<i>BAU</i>	<i>BAU</i>	0.097	0.6%
	Hydrogen	<i>BAU</i>	<i>BAU</i>	<i>BAU</i>	<i>BAU</i>	0.059	0.4%
	Low-GHG FT Diesel	-	-	0.314	1.9%	0.314	1.9%
	Sub-zero GHG Biofuel	-	-	-	-	0.645	3.9%
	CNG vehicles	107	4.6%	107	4.6%	107	4.6%
	Plug-in hybrid vehicles	171	7.4%	171	7.4%	171	7.4%
	Flex-fuel vehicles	<i>BAU</i>	<i>BAU</i>	806	34.7%	806	34.7%
	Diesel vehicles	<i>BAU</i>	<i>BAU</i>	593	25.5%	593	25.5%
	Battery electric vehicles	<i>BAU</i>	<i>BAU</i>	<i>BAU</i>	<i>BAU</i>	12	0.5%
	Fuel cell vehicles	<i>BAU</i>	<i>BAU</i>	<i>BAU</i>	<i>BAU</i>	45	1.9%

Notes: Percent values are percent of total fuel energy or total LDVs sold per year. *BAU* implies no new change from the Business as Usual scenario. Results are based on GREET 1.7 beta GWI values similar to those in Table ES-1 (Wang 2006 for DOE; Unnasch 2007 for CEC).

Changes in fuel type and composition can happen more quickly. Thus we include multiple scenarios that attain the 10 percent carbon intensity reduction target by 2020, and most of the reductions are due to fuel technology innovations. For instance, if low-GHG biofuels are commercialized as in Scenario D10, there may be no need for any change in vehicles in California and only modest changes to fuel delivery infrastructure. In this scenario, 1.4 billion gallons gasoline equivalents (BGGE) of “low-GHG” fuels (made from cellulosic feedstocks or from residues and wastes) will be needed by 2020, a volume that seems feasible based on the information in Table ES-1.

Even if no technological innovation in biofuel production occurs, it may be that biofuels could still be used to lower carbon intensity by up to 10 percent by 2020 (Scenario G10), although such a strategy has considerable uncertainty associated with it. Up to 1.3 BGGE of “mid-GHG” biofuels may be needed, or an approximate doubling of current consumption. More analysis is needed, however, to determine how such an expansion of biofuel production could be accomplished in an environmentally acceptable manner.

Scenarios F10, H10, and H15 assume technological innovation occurs broadly in vehicles and transportation fuels, and show that a mixture of low-carbon fuels can attain up to 15 percent emission reductions. In this case, innovation in biofuel production can help avoid the environmental uncertainty by switching away from crop-based biofuels. Nearly 2.0 BGGE of low-GHG fuels would be required to meet the 15 percent goal in scenario H15, a value that seems feasible by 2020 if advances in vehicle and biomass conversion and other fuel technologies become commercialized and expand in the next 5 years or so.

In addition to these reductions in carbon intensity in the light duty fleet, vehicles that use diesel fuel today (heavy duty on-road vehicles and a wide variety of off-road applications like forklifts and construction equipment) might use low-carbon fuels. Three strategies seem feasible, low-GHG diesel fuels, natural gas, and electrification. Assuming low-GHG diesel fuels are commercialized, they could be blended with regular diesel fuel up to 10% if they are biodiesel (FAME) or at higher levels if they are renewable diesel. However, large volumes of these fuels would be needed to meet the 10 percent target by 2020. For some applications, such as forklifts, electrification is a second strategy. Based on work conducted for the electric power industry, significant carbon intensity reductions could be achieved this way, possibly the equivalent of 1 to 2 percentage point reductions in the overall state average carbon intensity of diesel fuels.

There is considerable uncertainty associated with this analysis, and thus improvements in the data and tools used to measure GWI are an important part of successful implementation of the LCFS. *Life cycle assessment* (LCA) is used to measure the carbon intensity (and other impacts more generally) of transportation fuels, but there is no widely agreed upon LCA methodology for measuring all of the important global warming impacts of transportation fuels. In some cases, data about important effects are missing or uncertain (*e.g.*, carbon dioxide emissions due to land use conversion from natural systems to agriculture, and nitrous oxide emissions due to growing soybeans and other energy crops). However, life cycle assessment of vehicle fuels is a complex and evolving field of study, and there remain uncertainties and in key data and input assumptions. Table ES-3 contains GWI estimates for several possible transportation fuels using two models, GREET (Wang 2006 as modified for application in California for a study under AB1007 the CEC) and an unpublished version of LEM (Delucchi 2003). Neither LEM nor the California version of GREET have undergone rigorous peer review and their results are not directly comparable due to structural differences. These differences

illustrate the range of results possible using different reasonable approaches to analyzing the GWI of fuels.

Table ES-3: Global Warming Impacts estimated by two LCA models, adjusted for energy at the wheel (g CO₂ e / MJ)

Fuel	Fuel production pathway	GREET	LEM (CEF)
CA RFG	Marginal gallon produced in CA	92	85
Diesel	Ultra-low-sulfur diesel produced in CA	71	73
Propane	From petroleum	77	67
CNG	From North American natural gas (in spark ignition engines)	68	81
BTL	Fischer-Tropsch diesel from California biomass (poplar trees)	- 3	–
CTL	Fischer-Tropsch diesel from coal	167	–
Biodiesel	FAME biodiesel from Midwest soybeans	30	224
Ethanol	Midwest corn ethanol from a coal-fired dry-mill	114	–
Ethanol	Midwest corn ethanol from a natural gas-fired dry-mill	70	97
Ethanol	Midwest corn ethanol using stover as fuel in a dry-mill	47	–
Ethanol	California corn from a gas-fired dry-mill, wetcake coproduct	52	–
Ethanol	Cellulosic ethanol from California poplar trees	- 12	–
Ethanol	Cellulosic ethanol from Midwest prairie grass	7	–
Ethanol	Cellulosic ethanol from municipal solid waste	5	–
Electricity	CA average electricity	27	–
Electricity	Natural gas combined cycle and renewable generation	21	34
Hydrogen	Hydrogen from biomass, delivered by pipeline	22	–
Hydrogen	Hydrogen from steam-reformation of onsite natural gas	48	26

Sources: Unnasch et al (2007) for CEC and unpublished analysis based on Delucchi (2003). See Section 2.3

Notes: Net GWI using the GREET and LEM models are not strictly comparable due to differences in boundaries considered and other factors described in Section 2.4. “CA RFG” is California reformulated gasoline. “CNG” is compressed natural gas. “BTL” is biomass-to-liquids. “CTL” is coal-to-liquids. “FAME” is fatty acid methyl ester. “Stover” is an agricultural residue that can be used in limited quantities as an energy feedstock. “Wetcake” is a form of corn ethanol co-product that requires little energy to produce because it is not dried although care is needed to avoid additional air pollution emissions in handling. Not all of the fuel production pathways shown are commercialized and not all fuel production pathways are shown.

The GREET model is probably the best publicly available LCA model for fuel analysis, but its shortcomings in the handling of land use changes are well recognized (US EPA 2007). LEM is more comprehensive, including more extensive and detailed treatment of land use-related effects, though some of the analysis is fairly speculative. It tends to produce lower GWI values for gasoline and higher GWI values for alternatives than the GREET model, especially for soy-based biodiesel and corn-based ethanol. Advanced biofuels that use residues and wastes have not yet been evaluated with LEM. Because residue- and waste-based biofuels do not cause significant changes in land use, GREET and LEM results may be closer for these fuels.

As more research occurs and consensus develops around the correct approach to treating land-use change (and other climate-related and market-mediated effects) significantly different outcomes for biofuels may occur. If the broader approach embodied in LEM proves to be more representative of actual climate-related effects than the narrower framework used by GREET,

most biofuels made from row crops may have little or no benefit in reducing the carbon intensity of transportation fuels, and may actually increase emissions relative to gasoline. This study uses a modified version of the GREET model, produced by TIAX for the CEC under AB 1007, since this is the current basis for alternative fuel analysis by both the CEC and ARB and because it is publicly available and therefore provides a level of transparency (Unnasch et al. 2007).

These uncertainties do not prevent the implementation of an LCFS, but do necessitate a careful approach to regulation and to compliance and they should be addressed by a significant, robust, and continuing research effort. Because the greatest uncertainties are associated with the expansion of biofuel production from crops and the attendant land use changes, strategies that increase land requirements may have the least certain GWI reductions. Strategies less sensitive to these GWI reduction uncertainties are those that reduce fossil fuel inputs and other sources of GHG emissions in biofuel production (*e.g.*, by better management of fertilizers or using biomass energy for processing), and those that focus on biofuels made from residues and wastes. Strategies that do not use biomass as an energy source (*e.g.*, wind-generated electricity) probably have the least uncertainties in measuring GWI.

Further, LCA may not be the best tool to measure some relevant phenomena (*e.g.*, changes in energy and agricultural markets resulting from biofuel production). Therefore, improving the data and methods needed to measure the GWI of fuels is an important research priority for the successful implementation of the LCFS. A good place to start would be to conduct transparent, side-by-side comparisons of all relevant analyses to understand where they differ in structure, data, assumptions, and so forth (*e.g.*, see Farrell et al. 2006). Such comparisons will also be important to the design of sustainability standards to be used in assessing commercial production practices and fuel products.

Using data from public sources, the average fuel carbon intensity (AFCI) value for the baseline year and the 2020 target AFCI can be calculated. For simplicity, and to match the scenario analysis presented in Section 5, we assume that the LCFS will cover all transportation-related gasoline and diesel fuel, but not LPG, jet fuel, residual oil, or lubricants. We calculate this value to be 87.9 gCO_{2e}/MJ, which implies that the 2020 target of a 10% reduction is 79.1 gCO_{2e}/MJ. The ARB and CEC may need to update these estimates with more recent or more California-specific data.

Having established a baseline value for GHG content, one must specify target levels for successive years leading up to 2020, which together make up the compliance pathway referred to in the Executive Order. Two key issues are important here: rationalization and the overall shape of the curve.

Figure ES-1 illustrates some possible compliance pathways (see section 2.5 for more detail). The “Rationalized” curve reflects a future in which biofuel purchases are rearranged in such a way that existing low-carbon fuels are redirected to California initially, and high-carbon fuels are redirected away from California. This rationalization (or shuffling) may not have any effect on net GHG emissions to the atmosphere, at least initially. Such cost-minimizing behavior is unavoidable, though. Indeed, it is actually desirable because it quickly sends the appropriate signal to fuel markets that more innovation and investment in new technologies will be needed.

The “Two-Stage” compliance curves in Figure ES-1 allow the slowest tightening of the standard in the initial years. They are premised on the belief that industry will need more time to

develop low-carbon fuel technologies and invest in new infrastructure, and that more time should be allowed so that industry does not “lock-in” technologies with small or modest GHG benefits.

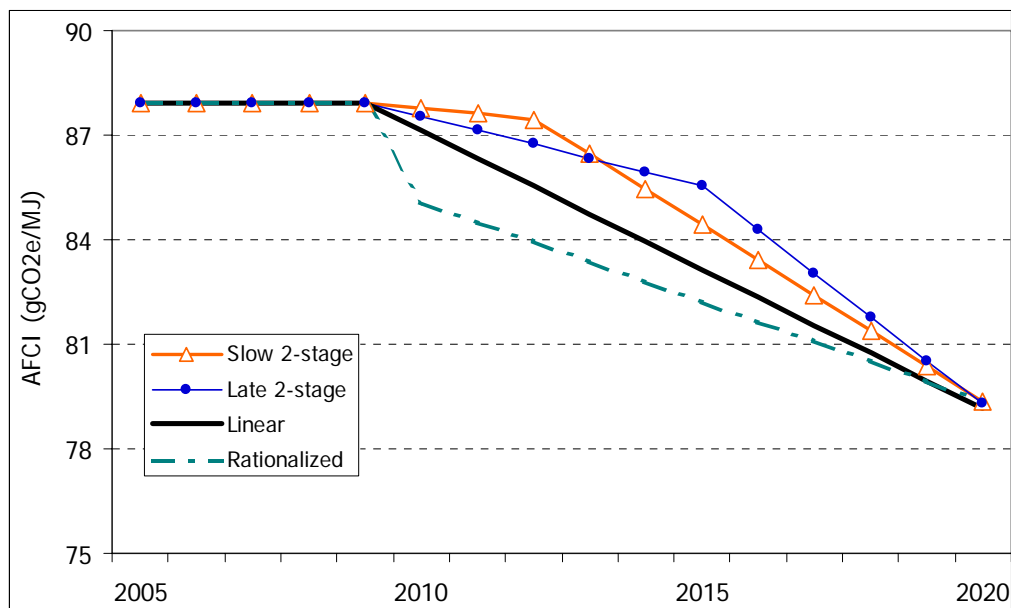

Figure ES-1: Possible LCFS compliance pathways

Taking all of the factors discussed above into consideration, we lean toward a compliance path with more aggressive reductions in the early years – something similar to the “Rationalized” curve in Figure ES-1. Such a compliance path would account for the large amount of initial shuffling, and would simply ratchet the compliance requirement down disproportionately in the first year. In the next few years, emission reductions would be much smaller (about -0.7% per year). The ARB and CEC may want to examine the potential for rationalization further before determining a compliance schedule.

In summary, a 10 percent Low Carbon Fuel Standard target seems plausible, though it requires innovation in fuel and/or vehicle technologies. Because innovation in the transportation sector is necessary to achieve long-term climate stabilization in any case, the fact that the LCFS will stimulate innovation in the near term is an advantage, not a problem. A 15 percent LCFS target may be possible if some of the low-carbon fuel technologies currently being developed are successful and the regulations are flexible enough to allow fuel suppliers and consumers to take advantage of them. Uncertainties exist in the measurement of the global warming intensity of transportation fuels, necessitating a careful approach to regulation and a robust research effort. Other environmental effects and other approaches to reducing global warming are also important and deserve study. The Air Resources Board should include the LCFS as an early action measure under AB 32 (Núñez/Pavley), the Global Warming Solutions Act.

References

Delucchi, M.A. 2003. A Lifecycle Emissions Model (LEM): Lifecycle Emissions from Transportation Fuels, Motor Vehicles, Transportation Modes, Electricity Use, Heating and Cooking Fuels, and Materials: University of California, Davis.

- Farrell, A.E., R.J. Plevin, B.T. Turner, A.D. Jones, M. O'Hare, and D.M. Kammen. 2006. Ethanol can contribute to energy and environmental goals. *Science* 311 (5760):506-508.
- Unnasch, S., J. Pont, M.Chan, and L. Waterland. 2007. Full Fuel Cycle Assessment Well To Wheels Energy Inputs, Emissions, And Water Impacts. Sacramento: California Energy Commission.
- US EPA. 2007. Regulatory Impact Analysis: Renewable Fuel Standard Program. Washington, DC: Assessment and Standards Division, Office of Transportation and Air Quality, U.S. Environmental Protection Agency.
- Wang, M.Q. *GREET 1.7 (beta) Spreadsheet Model*. Center for Transportation Research, Energy Systems Division, Argonne National Laboratory, January 2006 .

1 Introduction

Rising concentrations of greenhouse gases (GHGs) in the atmosphere have already caused perceptible changes in climate and will lead to further climate change in the future (Intergovernmental Panel on Climate Change 2007; Intergovernmental Panel on Climate Change 2001). The impact of climate change on California's water resources, agriculture, and sensitive coastal and forest ecosystems may be particularly significant (Roos 2003; Shaw for CEC 2002; Hayhoe et al. 2004). In turn, these impacts could have serious repercussions for the economy and public health, and for California's agricultural and recreation industries.

On June 1, 2005, recognizing and responding to dangers posed to California by climate change, Governor Schwarzenegger signed Executive Order # S-3-05 (Schwarzenegger 2005). The Executive Order established the following GHG emission reduction targets for California:

- by 2010, reduce GHG emissions to 2000 levels;
- by 2020, reduce GHG emissions to 1990 levels; and,
- by 2050, reduce GHG emissions to 80 percent below 1990 levels.

Climate scientists agree that avoiding significant risks of dangerous climate change will require stabilizing GHG emissions at levels far below today's emissions rate (Wagner and Sathaye 2006; Schafer 2000; Wigley, Richels, and Edmonds 1996). Governor Schwarzenegger's ambitious 2050 target for California is the sort of climate stabilization target needed to accomplish this task. Future research may show that more or less ambitious efforts are needed, but the 2050 climate stabilization target in Executive Order S-3-05 sets the framework for an appropriate public policy response to the risks posed by climate change.

The California Legislature passed AB 32 (Núñez/Pavley) the Global Warming Solutions Act on August 31, 2006 (AB 32: California Global Warming Solutions Act of 2006). This law enacted the 2020 goals, which require a reduction of approximately 25% below "business as usual" projections. It also charged the California Air Resources Board (ARB) with adopting regulations to control GHG emissions, starting no later than 2012. In addition, AB 32 (Núñez/Pavley) authorizes CARB to identify "discrete early action measures" that can be put into place by 2010. All rules and regulations must achieve maximum feasible and cost-effective GHG emission reductions. These goals are set in a long-term context of innovative energy and environmental analysis and policy in California (Bakker, Buckingham et al. 2003; Jones, Smith et al. 2005)

Governor Schwarzenegger issued a subsequent executive order (S-1-07) for the Low Carbon Fuel Standard (LCFS) on January 18, 2007, setting a statewide goal to reduce the carbon intensity of California's transportation fuels at least 10 percent by 2020, and ordering CARB to determine if the LCFS could be adopted as a discrete early action (Schwarzenegger 2007). Under the LCFS, fuel providers would be required to measure the impact of their products on global warming on a per-unit basis and reduce this impact. A unit of measure for this task might be pounds of carbon dioxide (CO₂) per gallon, or grams of CO₂ equivalent (to account for other effects besides CO₂) per megajoule (an energy unit). As discussed in this report, choosing an appropriate and manageable metric is a challenging task, but a feasible one (Bauen, Howes, and Franzosi 2006; Turner et al. 2007).

Reducing the carbon intensity of transportation fuels is a key element within a set of strategies to reduce total greenhouse gas emissions. Note that the quantity of greenhouse gases emitted from vehicles is equal to the carbon intensity of the fuel multiplied by the amount of fuel consumed; which depends, in turn, on the characteristics of vehicles and how much those vehicles are used.

The first step in meeting this goal was for the University of California to work with various state agencies to study the LCFS. Key among the state agencies are CARB; the California Energy Commission (CEC), which is supervising the development of the State Alternative Fuels Plan per AB 1007; and the California Public Utility Commission, which is implementing a GHG emissions cap in the electric power sector.

Preventing the negative effects of climate change will require global action. California's emissions are only a small share of the global total, though they are as large as all but a handful of entire nations. California is taking leadership in pursuing new policies and new technologies to mitigate climate change, including the LCFS. The intention is to provide an inspiration and model for the rest of the US and, in the case of the low carbon fuel standard, the rest of the world. The California LCFS is being designed to be consistent with fuel standards developed elsewhere and to serve as a model for those other efforts.

This report is the first of two parts of the study called for by Governor Schwarzenegger's Executive Order S-01-07. It evaluates multiple compliance pathways for an LCFS by developing a variety of potential future scenarios. The second part of the study will evaluate key policy issues associated with implementing the LCFS.

1.1 Goals

Figure 1-1 indicates the extent of the challenge. It presents recent trends in California's GHG emissions, a baseline forecast for 2010 and 2020, and the goals established by the Governor and Legislature. The 2020 and 2050 goals are similar to those adopted elsewhere, including internationally. They are roughly compatible with future emission pathways that are considered by climate scientists necessary to avoid dangerous climate change while still allowing for global economic growth and development (Wigley, Richels, and Edmonds 1996; Hayhoe et al. 2004; Baer et al. 2000; Intergovernmental Panel on Climate Change 2007).

Transportation currently accounts for over 40% of California's GHG emissions, the vast majority from motor vehicles (Bemis and Allen for CEC 2005 Figure 2 and Table A-4). Figure 1-2 compares the GHG emissions in California and the United States by end-use sector, including electricity generation as an end-use. Because transportation is such a large part of California's GHG emissions, significant changes in the transportation sector can help to meet the 2020 GHG reduction goal, and will be essential in meeting the 2050 climate stabilization goal.

The largest proportion of GHG emissions from the transportation sector are associated with gasoline, as shown in Table 1-1 (Bemis for CEC 2006). In 2004, gasoline accounted for 70% of total GHG emissions from the transport sector. Gasoline is almost entirely consumed in light duty vehicles. Diesel fuel, mostly used in trucks but also some off-road construction and agricultural equipment, accounts for another 17%. In this study we consider the use of these two

fuels by light duty vehicles, ignoring other fuel uses due to limits of time and analytical resources (specifically, the VISION model used in Section 5).

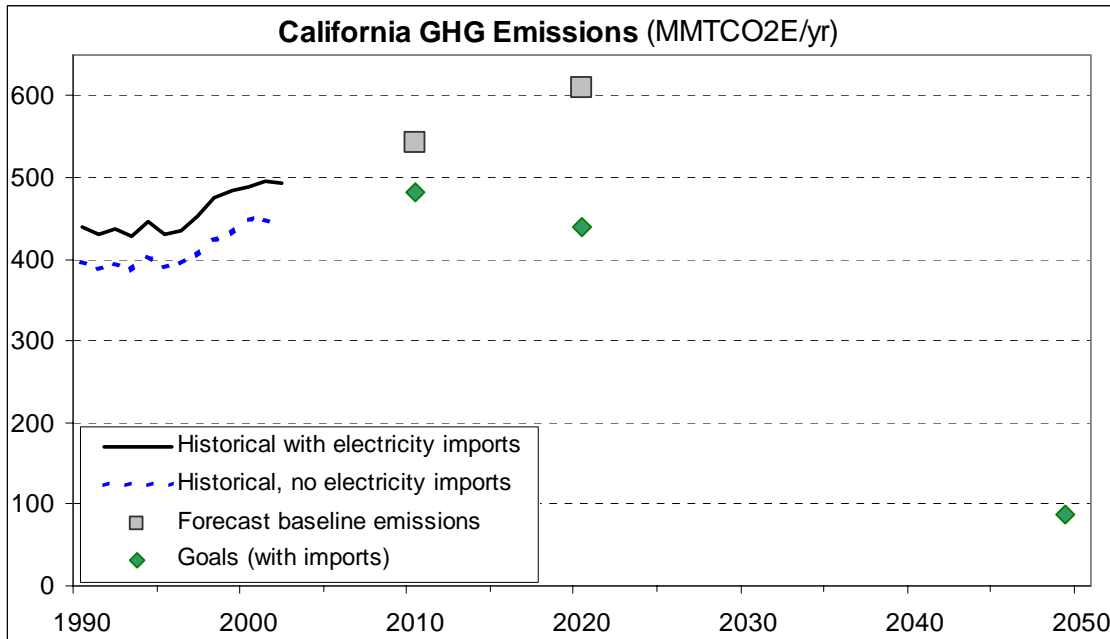

Figure 1-1: Historical and forecast GHG emissions, and Governor Schwarzenegger’s goals
 Source: Bemis and Allen, California Energy Commission (2005)

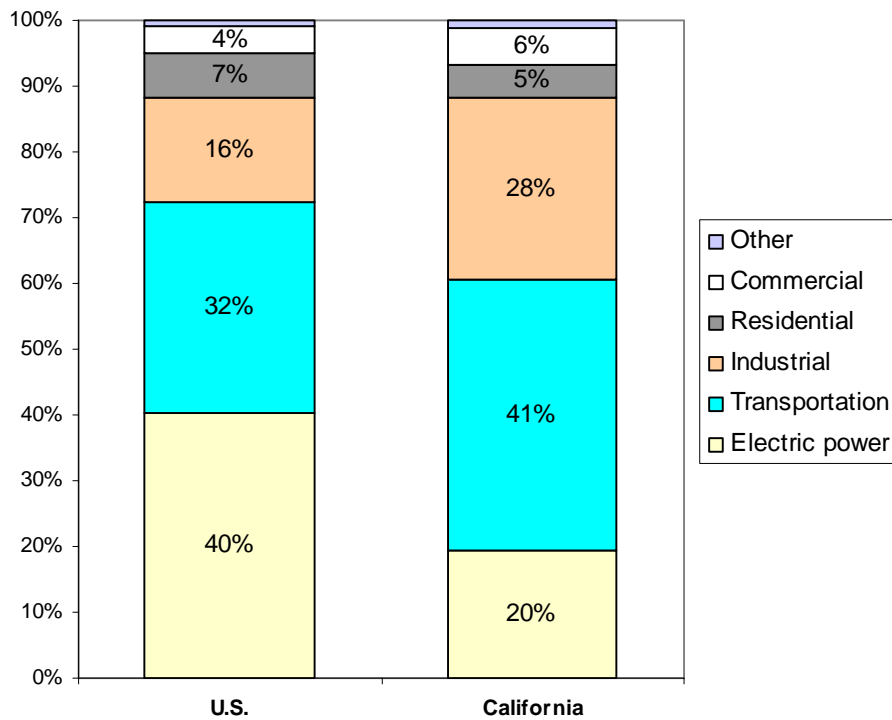

Figure 1-2: GHG emissions by end-use sector, including electricity generation, 2002
 Source: U.S. data from U.S. Environmental Protection Agency (2005); California data from Bemis and Allen, California Energy Commission (2005)

Table 1-1: California transportation fuel GHG emissions in the baseline year, 2004

Fuel	Emissions (MMTCO ₂ e)	Percent of total	Included in this study?
LPG	0.19	0.10%	No
Motor gasoline	131.92	70%	Yes. Scenarios in Section 5
Jet fuel	22.24	12%	No
Diesel	32.16	17%	Yes. Separate analysis in Section 5
Residual oil	0.61	0.33%	No
Lubricants	0.75	0.40%	No
TOTAL	187		

Source: CEC-600-2006-013-SF Table A-4 pg. 64. Motor gasoline includes ethanol.

Achieving the 2020 and 2050 goals will not be easy. A central element will be technological innovation, the process of inventing new products, bringing them to market, and enabling them to become widely used (Taylor, Rubin, and Nemet 2006). The 2020 target requires a reversal of historical trends, while the 2050 climate stabilization target calls for a profound change in energy supply and other parts of the economy. Because the 2020 goal is only slightly more than a decade away, and because energy technologies tend to be large, complex, and slow to change, California will need to rely not only on mature technologies that are already in the market but are under-used, but also technologies that can be commercialized within the next several years, along with a variety of non-technological solutions.

The more distant but far more ambitious 2050 climate stabilization goal requires a very different approach. The products (such as cars and fuels) needed to achieve the 2050 goal are not available today, so technological innovation is needed to get them. Attaining the 2050 climate stabilization goal therefore requires major innovations and investments in new technologies, as well as changes in behavior. Government action is appropriate and necessary to bring these changes about because climate change is a market externality and, like most environmental protection, a public good. Without government intervention, markets ignore externalities and provide less of public goods than socially and economically optimal. In addition, innovation designed to achieve public goods also requires government action (Arrow et al. 1995; Norberg-Bohm 1999)

Meeting the state's GHG emission reduction goals will affect many other key priorities, including economic growth, improved air quality, affordable energy prices, environmental justice, energy source diversification, environmental protection and others. AB 32 and Executive Orders S-3-05 and S-01-07 explicitly identify these related goals. The California Air Resources Board (CARB) is directed to maximize their achievement within climate policies. While the LCFS addresses only the GHG intensity of fuels, it is part of the State's larger efforts to reduce total GHG emissions. Thus, the LCFS must be considered in the context of changes in vehicle technology and usage.

The design of the Low Carbon Fuel Standard (LCFS) should therefore respond to the following goals:

1. Encourage investment and improvement in current and near-term technologies that will help meet the 2020 goal,

2. Stimulate innovation and development of new technologies that can dramatically lower GHG emissions at low costs and can start to be deployed by 2020 or soon thereafter, creating the conditions for meeting the later 2050 goal,
3. Contribute to attainment of related objectives as much as possible, including economic growth, air quality and other environmental protection goals, affordable energy prices, environmental justice, and diverse and reliable energy sources.

1.2 Strategies

The LCFS fits into a larger set of strategies being undertaken in California to reduce GHGs. It is necessary to understand this context in order to evaluate the LCFS. California's overall approach includes a research portfolio and sector-specific policies such as those listed in Table 1-2 below, and eventually will likely include multi-sectoral policies such as cap and trade and perhaps even carbon taxes. The research portfolio includes work supported by CARB and by CEC's Public Interest Energy Research (PIER) program (Franco et al. for CEC 2003). Sector-specific policies have been identified for electricity, manufacturing, transportation, and other activities (Climate Action Team 2006). Some of these are regulatory, such as energy efficiency standards for buildings and appliances; others may be market-based.

As indicated in Table 1-2, three broad strategies may be used to reduce GHG emissions from the transportation sector: vehicle technology, fuel-related GHG emissions, and amount of usage of vehicles and fuels. All three strategies will likely be necessary to achieve the state's 2020 goals, and almost definitely to achieve the 2050 goals.

The first set of strategies was addressed when California enacted AB 1493 (Pavley) in 2002. That law resulted in vehicle performance standards that require a 30 percent reduction in emissions from new light duty vehicles by 2016. The AB 1493 regulations are currently being contested in the courts by the automotive industry. Heavy duty vehicles have not yet been addressed.

This report addresses the second strategy, reduction of emissions from fuels. The LCFS, like the AB 1493 vehicle law, is a performance standard. It calls for a reduction in emissions per unit of fuel sold in the state. This report examines the different fuels that might be used to meet the standard. A subsequent Part 2 report elaborates upon the design of the LCFS.

The third strategy to reduce GHG emissions from transportation relates to usage, which addresses how much travel and goods movement are demanded, and how they are provided. Usage-related strategies include switching to lower-carbon modes of travel, managing land use to reduce the demand for travel, using less carbon-intense transport infrastructure, and providing new and better transportation services that would reduce demand for carbon-intense travel. Some examples of the latter include greater use of telecommunications, neighborhood vehicles, smart growth, car-sharing, smart paratransit services, and much more. This third set of strategies is part of California's Climate Action Plan (Climate Action Team 2006) and will be addressed in future deliberations.

Table 1-2: California's climate change policies and initiatives

<p>Overall goals</p> <ul style="list-style-type: none"> Executive Order S-3-05 (2005) Global Warming Solutions Act 2006 (AB 32 Núñez/Pavley) Energy Action Plan (CEC and CPUC) Bioenergy Action Plan (CARB, CEC, CPUC, and other agencies) <p>Energy research portfolio</p> <ul style="list-style-type: none"> California Air Resources Board Research Division California Energy Commission Public Interest Energy Research program <p>Buildings and appliances</p> <ul style="list-style-type: none"> Energy efficiency standards (<i>e.g.</i>, Title 24) <p>Electricity and other large sources</p> <ul style="list-style-type: none"> Carbon Adder (CPUC) Renewable portfolio standard for electricity (SB 107) GHG performance standard (CPUC and SB1368) GHG emissions cap (CPUC) Energy efficiency targets for utility companies (AB 2021) <p>Transportation</p> <ul style="list-style-type: none"> Vehicle GHG performance standard (AB 1493, CARB) Low Carbon Fuel Standard (Executive Order S-1-07, CARB, CEC, and others)* Alternative Fuels Plan (AB 1007, CEC) Reduce vehicle usage <p>Other policies</p>
--

* Only this policy is included in this report, even though a combined strategy that addresses vehicle performance and vehicle usage is needed to meet the climate stabilization targets.

It may be worth noting that other jurisdictions that are actively attempting to reduce GHG emissions and counteract global warming are adopting or considering similar sectoral strategies. In Europe, for instance, the multi-sectoral cap and trade system for large stationary sources is combined with sector-specific high taxes on transportation fuels, new and stringent fuel economy standards for vehicles, and requirements in some countries to use biofuels. One example is the United Kingdom's Renewable Transportation Fuel Obligation, which will require regulated companies to measure the global warming impact of their fuels. In addition, the European Commission has proposed to issue a low carbon fuel standard.

1.3 Why sector-specific strategies for transportation

The sectoral approach is important in part because it may better achieve all three goals of the LCFS (reduce emissions, encourage technological innovation, and promote related objectives) than would an economy-wide approach that addresses all emissions with a single policy, such as a cap-and-trade system. Some argue that transportation should be treated together with other sectors in these economy-wide approaches. According to economic principles, such economy-wide approaches are more efficient than narrower sectoral approaches at reducing emissions. But there are a wide variety of reasons why this would not be true in practice, and especially with respect to the transport sector. We believe the unique aspects of the transportation sector call for a unique approach, including the proposed LCFS.

The problem is, first, that multi-sectoral strategies that impose uniform carbon-based costs (such as carbon taxes) will have much less effect on GHG reductions in transportation than in other sectors. Such a strategy is likely to fail to induce sufficient technological innovation. Second, encompassing strategies such as a cap and trade program are not well suited to transportation. Transportation activities are very diffuse, and both fuel supply and fuel use is relatively insensitive to fuel price increases.

Compare, for instance, the electricity and transportation sectors. In electricity generation, multiple energy sources with very different GHG emissions compete. Some have very low emissions, such as renewable and nuclear power, while coal has very high emissions. Natural gas is intermediate. Thus, even relatively minor increases in cost can begin to affect the electric power sector in a profound way. A charge of \$25 per metric ton of CO₂, for instance, would have only a minor effect on the cost of nuclear and renewable power. But the same charge on coal-fired electricity would have a significant effect on its cost, increasing the retail price about 17 percent, as indicated in Table 1-3. That \$25 charge might make carbon capture and storage (CCS) economically attractive for many coal-fired power plants (Katzner 2007). Because of these cost and GHG differences among different electricity supply options, CO₂ prices over \$25 per tonne-CO₂ would induce an enormous amount of innovation and new investment in electricity supply. It would accelerate decarbonization of the electricity sector, and create the conditions for deep GHG reductions within that sector. However, this innovation and investment would not necessarily spread to the rest of the economy.

Table 1-3: Effect of a \$25/tonne CO₂e price on energy prices

Energy type	Price change and percentages of retail prices	
Electricity		
Nuclear and renewables	<\$0.1/MWh	<1%
Integrated coal gasification combined cycle with carbon capture and storage	\$02.5/MWh	2%
Natural gas combined cycle	\$12.5/MWh	11%
Pulverized coal	\$20/MWh	17%
Transportation		
Gasoline	\$0.21/gallon	8%
Heating		
Natural gas	\$1.27/million Btu	11%

Notes: Percentages are for retail prices in California including PG&E residential electricity \$0.1144/kWh, gasoline \$2.50/gallon, and PG&E residential gas \$1.14/therm. Electricity values calculated from (Pacca and Horvath 2002). Gasoline and Natural Gas values calculated from the Energy Information Agency's emission coefficients. See <http://www.eia.doe.gov/oiaf/1605/coefficients.html>

In contrast, a \$25 carbon charge would not generate a strong enough signal in the transportation sector, either to produce fuel switching or reductions in demand. Transportation does not have such low-GHG substitutes readily available. Petroleum-based fuels power almost all road vehicles. Petroleum is firmly entrenched. In addition, petroleum has much less carbon per unit of energy than coal. A charge of \$25 per tonne of CO₂ would therefore induce very little technological innovation in the transportation sector. As indicated in Table 1-3, such a cost translates to about an 8 percent increase in the price of gasoline. This price increase would at most attract a small amount of low-GHG biofuels, such as ethanol from Brazil.

The price signal associated with a \$25 per tonne of CO₂ would also be too small to induce significant reductions in transportation demand, either for passengers or freight. Consumers appear to be very insensitive to changes in gasoline prices, at least in the short term, with price elasticity of demand of less than -0.1 (*i.e.*, an increase in price of 10 percent would reduce consumption by less than 1 percent) (Hughes, Knittel, and Sperling 2006). And on the freight side, transportation costs are a small fraction of the cost of goods sold, so price increases of this size are unlikely to reduce consumer demand for goods. The experience with high fuel prices in Europe provides further evidence that 10%-20% increases in the cost of fuel would spur little innovation in the transportation sector. Europe's much higher fuel prices have led to the use of smaller and more efficient vehicles (including many diesel cars), but not the introduction of alternative fuels.

Another complicating factor is that transportation fuels involve severe coordination and investment problems between infrastructure and vehicles (Winebrake and Farrell 1997). Both experience and analysis suggest that transitions to new fuels are slow and difficult, in part because of the cost and difficulty of changing energy distribution infrastructure (McNutt and Rodgers 2004; Leiby and Rubin 2004). This effect partly explains why ethanol in the US and biodiesel in Europe have been more successful than other alternative fuels; both can be blended in gasoline (or diesel) and at low blends require no changes in vehicles or distribution infrastructure. Plug-in hybrid vehicles also require little in the way of new infrastructure except metering and possibly some new outlets in a few locations, but are more difficult because new vehicle technologies are needed (*e.g.*, less costly batteries and power electronics). Hydrogen is even more difficult because it requires both a new fuel distribution system and new vehicle technologies. Therefore, low-carbon fuels that leverage existing capital resources will tend to have a strong advantage, all else equal. Additional measures will likely be needed, beyond the LCFS, to reduce infrastructure and other barriers for promising low-carbon fuels.

1.4 Definitions

To develop the LCFS, we use the following metrics. First, the word “carbon” in the LCFS name, as generally used in this report, is shorthand for life cycle global warming impact. The term “life cycle” refers to all the activities of production and use of the fuel, including what happens at the farm (in the case of biofuels) and the refinery. The term “global warming impact” means all of the mechanisms that affect global climate including not only greenhouse gases, but also changes in water cycling, land cover and other effects that increase the radiative forcing of the atmosphere, most of which are associated only with biofuels because of their impact on land use. Throughout this report and in all public presentations of the LCFS, the fuels are analyzed and measured in terms of life cycle global warming impact. We will show that there is significant uncertainty in some of these effects, and even in how they are measured. Second, to compare different fuels and mixes of fuels to determine their net effect on the overall pool of transport fuels, we use the term “average fuel carbon intensity” (AFCI). Technically, the AFCI is defined as grams of CO₂-equivalent per megajoule of fuel, adjusted for the greater efficiency of vehicle drivetrains associated with particular fuels (*e.g.*, electricity and hydrogen), and adjusted to include the global warming effects of non-CO₂ gases and other effects. (These units and adjustments are explained in more detail in Section 2.4.) The AFCI can be interpreted as an

index of average GHG emissions associated with the use of transportation fuels. An LCFS target of 10% reduction is equivalent to saying the AFCI is reduced by 10%.

In 2005, we calculate the AFCI for the pool of gasoline fuels in California to be 87.9 gCO₂e/MJ. (The calculation of this value is explained in Section 2.4) The gasoline in this calculation includes 5.7% ethanol, and an average value for Midwest corn-ethanol production is assumed, using values developed for the CEC (Unnasch et al. 2007). We assume that this is the value to which any LCFS percentage reduction is applied (as opposed to using a forecasted value for 2010 or some other baseline future). Thus, the 2020 goal of a 10% reduction by 2020 implies an AFCI value of 82.9 by that date. In Section 5 of this report, six scenarios are presented that meet or exceed the 10% target for light duty vehicles, with additional discussion presented on how it could be met in heavy duty and off-road applications as well. These scenarios involve the use of biofuels produced with low global warming impacts, electric vehicles, and hydrogen vehicles. Options to reduce GHG emissions associated with the production or processing of fossil resources are not evaluated due to limitations of time, however, these options will be evaluated in Part 2 of this study.

1.5 Fuel carbon intensity after 2050

Large emission reductions will be needed to meet the 2050 climate stabilization target. Achieving these reductions will require substantial technological innovation, and substantial further reduction in the carbon content of transportation fuels.

Figure 1-3 illustrates two possible emissions trajectories to 2050. Both are based on a projection in which the total fuel consumption in California follows the dashed line labeled Reduced Fuel Consumption (RDF), with units of billion gallons of gasoline equivalent (BGGE) per year. This projection peaks and begins to decline in 2015 (due to AB 1493), and continues a steady decline to 6 BGGE by 2050. This Reduced Fuel Consumption projection could be achieved by a combination of a reduction in vehicle usage and increased efficiency of fuel consumption per mile driven. This reduced consumption projection is very aggressive; it represents a roughly 70 percent reduction below a projected BAU consumption of 20 BGGE by 2050.

The RFC projection has been calculated as the fuel consumption that would be required to meet half of the 2050 GHG stabilization target if there were no change in the carbon intensity of transportation fuels. This constant fuel carbon intensity is shown as a solid line labeled BAU AFCI, with a value of 12.2 kgCO₂eq./GGE from 1990 to 2050. The resulting GHG emissions, shown as the line with solid circles and labeled RFC GHG Emissions with BAU AFCI, are reduced to 73 MMT CO₂eq. by 2050. This is a 40 percent reduction below the estimated 1990 GHG emissions of 122 MMT CO₂eq., and is therefore half of the 2050 stabilization goal.

In order for the RFC projection to meet the 2050 stabilization goal, the average carbon intensity of transportation fuels must be reduced over time. The line with open triangles, labeled AFCI Required to Stabilize RFC, indicates the change in the average carbon intensity that would be necessary for total RFC GHG emissions to meet the 2050 reduction goal. The line with open squares, labeled GHG Emissions with Required AFCI, indicates the GHG emissions over time that meet the 80 percent reduction below 1990 levels by 2050. The carbon intensity required by

2050 is 4 kgCO₂eq./GGE. It should be noted that the AFCI required to stabilize the RFC projection includes the 2020 target for the LCFS, and then declines at a slightly faster rate between 2020 and 2050. This projection should be interpreted as a conservative rate of reduction in the average carbon intensity of fuels in which the 2050 stabilization target can be achieved, in part, with aggressive reductions in fuel consumption. If total future fuel consumption is higher than the RFC projection out to 2050, which very likely, a more aggressive reduction in the average carbon intensity will be required. For example, if the fuel consumption in 2050 is 20 BGGE, the average carbon intensity by 2050 would have to be 1.24 kgCO₂eq./GGE.

These trajectories were created with the VISION-CA model, the same model that was used to develop the scenarios in Section 5 of this report. This model estimates GHG emissions from light duty vehicles based on a number of pre-set inputs, and accounts for population growth, vehicle stock turnover, and other phenomena, including existing CA climate policy such as AB 1493.

These trajectories illustrate how the state’s 2050 climate stabilization goals can only be met in the transportation sector if there is a substantial reduction in both fuel consumption and the emissions per unit of fuel consumed, or carbon intensity, and that a balanced strategy addressing fuels, vehicles, and usage is necessary. They also illustrate the critical importance of technological innovation.

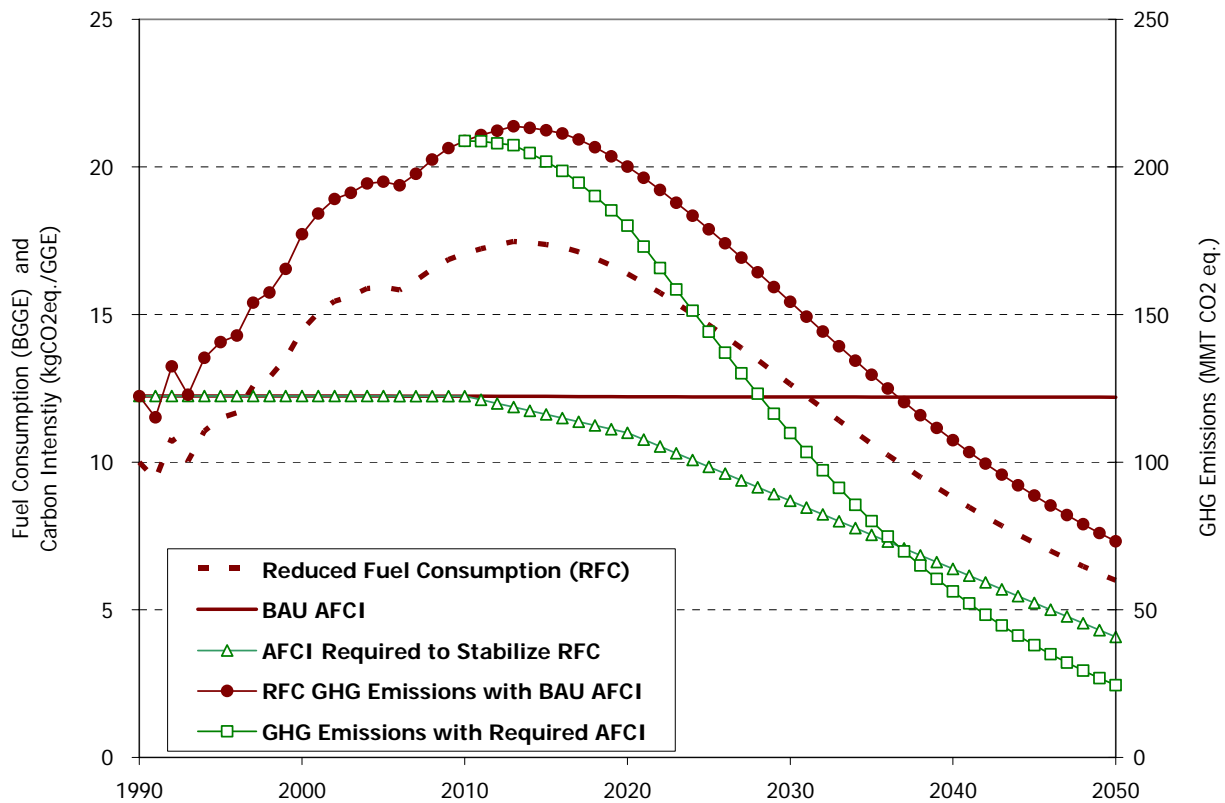

Figure 1-3: Trajectories for light duty vehicle GHG emissions to 2050
 BGGE=billion gallons of gasoline equivalent; GGE=gallons of gasoline equivalent; MMT=million metric tons

1.6 Structure of this report

This report focuses on technical aspects of regulating the carbon intensity of transportation fuels. Following this introduction, the second section presents short descriptions of the key methods used in this study, specifically the VISION model and the practice of life cycle assessment, especially as represented in the GREET model. The third section contains brief descriptions of some (but by no means all) of the fuels that might be used to comply with the LCFS. The fourth section discusses the potential for the production of these fuels in California. The fifth section may be among the most important because it presents the scenarios that were explored with the VISION model. The regulatory design and various policy issues of the LCFS will be addressed in a second report, referred to as Part 2.

1.7 References

- AB 32: *California Global Warming Solutions Act of 2006*. Núñez/Pavley 2004-6, AB 32.
- Arrow, Kenneth, Bert Bolin, Robert Costanza, Partha Dasgupta, Carl Folke, C.S. Holling, Bengt-Owe Jansson, Simon Levin, Karl-Goren Maler, Charels Perrins, and David Pimentel. 1995. Economic Growth, Carrying Capacity, and the Environment. *Science* 268:520-521.
- Bakker, S., R. Buckingham, et al. (2003) "Integrated Energy Policy Report." California Energy Commission, 47 <http://www.energy.ca.gov/energypolicy/>.
- Baer, Paul, John Harte, Barbara Haya, Antonia V. Herzog, John Holdren, Nathan E. Hultman, Daniel M. Kammen, Richard B. Norgaard, and Leigh Raymond. 2000. Equity and Greenhouse Gas Responsibility. *Science* 289:2287.
- Bauen, A., J. Howes, and M. Franzosi. 2006. A methodology and tool for calculating the carbon intensity of biofuels. London: E4tech, ECCM, Themba.
- Bemis, Gerry. 2006. Inventory of California Greenhouse Gas Emissions and Sinks: 1990 to 2004. Sacramento: California Energy Commission.
- Bemis, Gerry, and Jennifer Allen. 2005. Inventory of California Greenhouse Gas Emissions and Sinks: 1990 to 2002 Update. In *2005 Integrated Energy Policy Report*. Sacramento: California Energy Commission.
- Climate Action Team. 2006. Report to Governor Schwarzenegger and the Legislature, edited by 2005-06_GHG_STRATEGIES_FS.PDF. Sacramento: California Environmental Protection Agency.
- Franco, Guido, Robert Wilkinson, Alan H. Sanstad, Mark Wilson, and Edward Vine. 2003. Climate Change Research, Development, and Demonstration Plan. In *Public Interest Energy Research Program*. Sacramento: California Energy Commission.
- Hayhoe, K., D. Cayan, C. B. Field, P. C. Frumhoff, E. P. Maurer, N. L. Miller, S. C. Moser, S. H. Schneider, K. N. Cahill, E. E. Cleland, L. Dale, R. Drapek, R. M. Hanemann, L. S. Kalkstein, J. Lenihan, C. K. Lunch, R. P. Neilson, S. C. Sheridan, and J. H. Verville. 2004. Emissions pathways, climate change, and impacts on California. *Proceedings of the National Academy of Sciences of the United States of America* 101 (34):12422-12427.
- Hughes, J. E., C. R. Knittel, and D. Sperling. 2006. Evidence of a Shift in the Short-Run Price Elasticity of Gasoline Demand. In *Institute of Transportation Studies*. Davis: University of California.
- Intergovernmental Panel on Climate Change. 2001. *Third Assessment Report: The Scientific Basis*. New York: Cambridge University Press.

- . 2007. Climate Change 2007: Impacts, Adaptation, and Vulnerability. In *Fourth Assessment Report*
- Jones, M., M. Smith, et al. (2005) "Integrated Energy Policy Report." California Energy Commission, 208 <http://www.energy.ca.gov/energypolicy/>
- Katzer, James. 2007. *The Future of Coal*. Cambridge, MA: MIT.
- Leiby, Paul N., and Jonathan Rubin. 2004. Understanding the Transition to New Fuels and Vehicles. In *The Hydrogen Energy Transition*, edited by D. Sperling and J. S. Cannon. San Francisco: Elsevier.
- McNutt, B. and D. Rodgers. 2004. Lessons Learned from 15 Years of Alternative Fuel Experience. In *The Hydrogen Energy Transition*, edited by D. Sperling and J. S. Cannon. San Francisco: Elsevier.
- Norberg-Bohm, V. 1999. Stimulating 'green' technological innovation: An analysis of alternative policy mechanisms. *Policy Sciences* 32 (1):13-38.
- Pacca, S., and A. Horvath. 2002. Greenhouse gas emissions from building and operating electric power plants in the upper Colorado River Basin. *Environmental Science & Technology* 36 (14):3194-3200.
- Roos, Michael. 2003. The Effects of Global Climate Change on California Water Resources. In *Public Interest Energy Research Program - Research Development and Demonstration Plan*. Sacramento, CA: California Energy Commission.
- Schafer, A. 2000. Carbon dioxide emissions from world passenger transport - Reduction options. In *Energy Air Quality, and Fuels 2000*.
- Schwarzenegger, Arnold. 2007. Executive Order S-01-07: Low Carbon Fuel Standard. Sacramento, CA.
- Shaw, Rebecca. 2002. Ecological Impacts of a Changing Climate. In *PIER Environmental Area Report*. Sacramento: California Energy Commission.
- Taylor, M. R., E. S. Rubin, and G. F. Nemet. 2006. Technological Innovation and public policy. In *Managing Greenhouse Gas Emissions In California*, edited by M. Hanemann and A. E. Farrell. Berkeley: University of California.
- Turner, Brian T., Richard J. Plevin, Michael O'Hare, and Alexander E. Farrell. 2007. Creating Markets for Green Biofuels. In *Transportation Sustainability Research Center*. Berkeley: University of California.
- Unnasch, Stefan, Jennifer Pont, Michael Chan, and Larry Waterland. 2007. Full Fuel Cycle Assessment Well To Wheels Energy Inputs, Emissions, And Water Impacts. Sacramento: California Energy Commission.
- Wagner, F., and J. A. Sathaye. 2006. Sharing the burden of climate change stabilization: An energy sector perspective. *Energy Policy* 34 (15):2217-2231.
- Wigley, T. M. L., R. Richels, and J. A. Edmonds. 1996. Economic and environmental choices in the stabilization of atmospheric CO2 concentrations. *Nature* 379 (6562):240-243.
- Winebrake, James J., and Alex Farrell. 1997. The AFV Credit Program and Its Role in Future AFV Market Development. *Transportation Research D* 2 (2):125-132.

2 Methods

In analyzing the technical feasibility of the LCFS, several policy choices must be assumed. These choices will be further evaluated in Part 2 of the study.

2.1 Baseline

The baseline used in Part 1 is the most recent year for which adequate greenhouse gas (GHG) emission data exist for California. The most recent data is used so that the analysis most accurately reflects recent fuel production in California before any steps were taken to reduce carbon intensity. Before January 2007, there was little to no discussion of a potential LCFS and no steps had been taken to measure, let alone control the global warming impact of fuels. Therefore, the most recent year for which adequate data exist is the most appropriate baseline year. The most recent CEC data available are for 2004, so this year is chosen as the baseline for the following analysis (Bemis 2006). This source also contains data on fuel consumption.

In order to avoid contamination of ground water, ARB regulations required removal of a widely used gasoline additive, methyl-tertiary butyl ether (MTBE), from gasoline by 2004. MTBE was used to meet a requirement for gasoline to contain oxygen (and not just hydrogen and carbon). The petroleum industry responded beginning in 2002, replacing MTBE with ethanol. According to CEC data, approximately 12 percent of the gasoline pool was converted in 2002, 65 percent in 2003 and 98 percent in 2004 (Bemis 2006 p. 40).

Approximately 15.7 billion gallons of gasoline were consumed in the transportation sector in 2004 (Bemis 2006 Appendix B; California Board of Equalization 2007). This implies approximately 893 million gallons of ethanol were consumed that year in California, equivalent to 589 million gallons of gasoline in terms of energy content. Accounting for the denaturant and energy content, about 3.6% of the energy in California's gasoline came from ethanol in 2004.

The GWI of the ethanol used in California is not known, but a reasonable and straightforward assumption is that this ethanol was essentially the same as that used in the rest of the United States. In this study we assume that the "average Midwest ethanol" determined in the AB 1007 study under the authority of the CEC is representative of the average ethanol used in 2004 (Unnasch, Pont et al. 2007).¹

2.2 Scope of the standard

This section evaluates three questions about the scope of the LCFS: Which transportation fuels does the standard apply to? Should upstream emissions (those from fuel production, such as refinery emissions) be included? Should electricity be included?

¹ This estimate may understate the GWI by several g/MJ due to assumed energy efficiency improvements in the AB 1007 analysis, which is for 2012, not 2004. Further analysis should resolve this issue.

2.2.1 Which fuels

Executive Order S-1-07 refers to “California’s transportation fuels,” which a plain reading of the text suggests includes all types of fuels. However, it may not be practical for CARB to regulate every fuel type, or CARB may not have the statutory authority to do so. For instance, aircraft emissions are controlled by international agreements, not state regulation. The potential scope of regulation under the LCFS can be described by the following possibilities:

- Gasoline-powered vehicles
- Light duty vehicles
- On-road vehicles (light and heavy duty)
- On-road and off-road vehicles (including trains, construction equipment, forklifts, etc.)
- All transportation fuels

Currently, the first two categories are essentially the same, but automobile manufacturers are expected to introduce diesel passenger vehicles that comply with California’s air quality regulations, in part to comply with AB 1493. Many fuel retailers have installed diesel dispensing infrastructure in preparation for the deployment of such vehicles.

In Part 1 of this study, twelve light duty vehicle scenarios were generated and evaluated using a spreadsheet model, and a simpler method is used to evaluate GHG emissions from heavy-duty and off-road transportation applications (*e.g.*, forklifts). This choice was made for simplicity and to allow a relatively broad analysis of how the LCFS could be applied. In Part 2 of the study, policy issues associated with the implementation of the LCFS will be explored, including what the scope of the LCFS should be. The assumptions made in Part 1 are not endorsements of any particular regulatory choice.

2.2.2 Upstream emissions

Oil refineries produce numerous products simultaneously from each barrel of petroleum, including petrochemicals, asphalt, and various fuel products. It is difficult to attribute refinery process emissions to specific products. AB 32 (Núñez/Pavley) could cover all the emissions from refineries. For simplicity in Part 1 of this study, differences in oil production and refining emissions (*i.e.*, “upstream”) emissions are ignored. In Part 2 of the study, policy issues associated with the implementation of the LCFS will be explored, including the scope of the standard. The assumptions made in Part 1 are not endorsements of any particular regulatory choice.

2.2.3 Electricity

New battery electric vehicle (BEV) or plug-in hybrid electric vehicle (PHEV) technologies could bring about significant changes in transportation energy use by allowing electricity to power a large number of light duty vehicles. (There are a few BEVs in California already.) An appropriate approach to promoting BEVs and PHEVs and regulating their GHG emissions is necessary. In doing so, it is convenient to define “fuel electricity” as electricity used to power new electric transportation technologies and separate it from traditional applications such as heavy duty rail.

For simplicity and to enable a broad analysis of the LCFS, Part 1 of this study includes the electricity used to power on-road vehicles as part of the LCFS.

2.3 Measuring GHG intensity

Executive Order S-1-07 states “(t)hat a statewide goal be established to reduce the carbon intensity of California’s transportation fuels by at least 10 percent by 2020.” The terms of this regulation must be further defined. We interpret *carbon* more broadly to mean the life cycle global warming intensity (GWI) associated with a unit of energy consumed in a particular fuel-vehicle combination. The bounds of what is included in this life cycle emissions assessment and the methods for measuring these emissions are discussed in detail in Part 2 of this study. Section 2.4 discusses several possible ways of defining carbon *intensity*, recommending that intensity be measured per unit of energy *at the wheel* (or *motive energy*). The phrase “10 percent by 2020” refers to a baseline carbon intensity, which is discussed briefly in Section 2.1, and in more detail in Part 2 of this report. The scope of the phrase “California’s transportation fuels” is discussed briefly in Section 2.2, and in more detail in Part 2.

The distinction between an absolute target and an intensity target is perhaps the most fundamental characteristic of the LCFS. As an intensity target, the LCFS addresses GHG emissions as a ratio of total GHGs to some denominator, such as per miles driven, or per quantity of fuel consumed. An absolute target would require total GHG emissions from the transportation sector to fall below some fixed value, such as 120 MMTCE (million metric tons carbon equivalent), or “10 percent below 1990 values.” An absolute target would be independent of any future changes in annual VMT or fuel consumed. If VMT or fuel consumed were greater than anticipated in the target year, an absolute target would be more difficult to meet than originally expected. Alternatively, if VMT or fuel consumed were less than anticipated in the target year, an absolute target could be met more easily (see Box 1). In contrast, an intensity target accommodates these changes.

BOX 1: What if the LCFS were an absolute target instead of an intensity target?

Given BAU projections of increases in VMT of 1.76% per year in California between 2003 and 2025², California can expect an increase in VMT of approximately 25% between 2007 and 2020. Absent any change in average vehicle fuel efficiency, this increase in total driving would result in a 25% increase in fuel use. A 10% reduction in carbon intensity would result in an increase of 13% in *absolute* emissions³. Under the same assumptions, if the LCFS were defined as an *absolute* 10% emissions reduction, it would in effect require a reduction in carbon *intensity* of 31% by 2020⁴.

Examples of intensity values include “grams of carbon dioxide equivalent GHGs per vehicle mile traveled” (gCO₂-eq/mile), or “tons of carbon dioxide equivalent GHGs per million British thermal units of fuel energy” (tCO₂-eq/MMBtu fuel). A number of these intensity formulations were explored during our study. Our final recommendation, explained in more detail below, uses fuel energy adjusted for the efficiency of the vehicle drive train as a basis for calculating greenhouse gas intensity. We call this approach the *motive energy* basis.

² Kavalec, C., J. Page, and L. Stamets, Forecasts of California Transportation Energy Demand 2005-2025. 2005, California Energy Commission.

³ 125% * 90% = 113%

⁴ Assume current emissions are X tons. A 10% absolute reduction would cap emissions at 0.9 X. Given projected growth to 1.25X by 2020, a 31% $((1.25 - 0.90)/1.25)$ carbon intensity would be required.

2.4 Scope of the intensity metric

Life cycle analysis studies of transportation fuels typically refer to two parts of the total fuel cycle. The term “well-to-tank” (WTT) is used to discuss emissions specific to the fuel production, processing and transportation, and the term “tank-to-wheel” (TTW) is used to discuss emissions specific to the vehicle (see Figure 2-2). When discussing total life cycle emissions for a vehicle-fuel combination, the term “well-to-wheels” (WTW) is used.

A full WTW assessment would be the most comprehensive approach to tracking GHG emissions from the transportation sector (WTW life cycle analysis assessments also have the shortcomings discussed in section 2.2.). The life cycle intensity metric we recommend for the LCFS is a well-to-tank GHG emissions per unit of fuel energy with an adjustment reflecting the associated vehicle drive train efficiency. By adjusting for the drive train efficiency, the energy in the denominator is the *motive energy*—the amount of energy delivered to the wheels to power the vehicle associated with the fuel-vehicle combination. We discuss three main classes of emissions intensity metrics below in order to clarify the advantages of the motive energy-based intensity metric.

The three approaches considered are:

- At-the-pump/plug: Emissions are measured per MJ (or MMBtu) entering into the vehicle, at the tank for liquid fuels and at the battery for plug-in vehicles.
- Per-mile: Emissions are measured per mile driven.
- At-the-wheel (motive energy): Emissions are measured per MJ (or MMBtu) delivered to the wheel to move the vehicle.

The fundamental difference between these metrics is how they take into account vehicle fuel economy.

2.4.1 At-the-tank/plug metric

On one end of the spectrum, measuring emissions intensity at-the-tank/plug calculates emissions per the amount of energy contained in the fuel as it enters the vehicle. It does not take into account the differences in fuel economy of different vehicle types nor their use. While this metric is the easiest to calculate, it is the least accurate representation of the overall relative GHG characteristics of different fuels. For example, electricity is more carbon intensive than gasoline per MJ entering the vehicle (at-the-tank/plug), but significantly less carbon intensive per mile driven due to the higher inherent efficiency of electric drive trains. Diesel is another example of a fuel that is more carbon intensive than gasoline at the tank, but less carbon intensive if the higher efficiency of diesel engines is taken into account. While electricity and diesel are perhaps the most prominent examples, discrepancies exist for all fuels that are more or less efficiently converted to power in the vehicles that use them.

2.4.2 Per-mile metric

On the other end of the spectrum, the per-mile metric would take full account of the differences in fuel economy of vehicles running on different fuels. Assuming the same distance traveled, this metric most accurately represents the actual difference in emissions to the atmosphere resulting from the choice of fuel (and implied vehicle) holding everything else constant.

The disadvantage of this metric is that it requires significantly more data than the other two metrics and is therefore less transparent, less certain for the regulated entities, and more cumbersome to calculate. Data are needed on the fuel economy of the vehicles on California's roads. While DMV data provide information about the cars that are registered in California, determining the fuel economy of these vehicles is difficult⁵.

Another potential problem with a per-mile metric is that, without adjustments, the anticipated improvements in vehicle fuel economy such as from AB 1493 would artificially weaken the LCFS by decreasing each fuel provider's calculated intensity. AB 1493 is expected to result in an 18 percent reduction in greenhouse gas emissions from the light duty fleet in 2020¹. If this were indeed achieved, a per-mile LCFS standard would not require any reductions in emissions intensity beyond those achieved through these non-LCFS related fuel economy improvements. Creating a dynamic baseline that follows fuel economy improvements can prevent this. Regulated entities would be required to reduce fuel emissions by 10 percent beyond those improvements. Correcting for fuel economy improvements is possible with the data available, but involves a relatively complicated procedure and is therefore less transparent.

2.4.3 At-the-wheel (motive energy) metric

The at-the-wheel intensity metric sits between the at the plug/tank and per-mile options in the fuel cycle. The key advantages of this approach are simplicity, relative to the per-mile metric, and improved accuracy in estimating emissions, relative to the at-the tank/plug approach. This metric takes into account differences in engine and drive train efficiency, representing the efficiency with which the fuel is converted to motive power for a to-be-determined set of fuel/vehicle categories. However, it does not take into account other vehicle efficiency losses, such as those due to vehicle weight, air drag, rolling resistance and accessories, which are included in the per-mile metric.

Intensity using the motive energy metric is calculated per unit energy entering the tank or battery of the vehicle, adjusted for the drive chain efficiency in order to measure the amount of energy reaching the wheels to power the vehicle. Intuitively, the adjustment factors are determined by comparing the difference in fuel economy resulting from different drive trains in two otherwise identical vehicles. This metric is much more accurate than measuring carbon intensity at-the-tank/plug since an essential feature of a vehicle fuel is the efficiency of the technology associated with its conversion to power. Drive train efficiencies do not vary significantly among vehicles using the same drive train technology and therefore can be estimated for a relatively small number of vehicle/fuel categories. Another positive feature of this metric is that over time as technologies change, it easily accommodates updates to efficiency factors and the creation of new vehicle/fuel categories. As with the per-mile metric described above, a key consideration is whether the baseline vehicle efficiency will be a set value, or if it will dynamically follow improvements in vehicle engine and drive train efficiency within each fuel/vehicle category that could result from policies such as AB 1493. Allowing the baseline vehicle efficiency value to change over time (*e.g.*, as gasoline vehicle efficiencies improve) would make the LCFS more difficult to meet, as the vehicle efficiency values would not decrease as quickly over time relative to the baseline efficiency.

⁵ Two major uncertainties are the actual on-road fuel economy, which is a function of driver behavior and vehicle age, and differences in vehicle utilization (annual VMT) if for example, utilization declines with vehicle age.

The motive energy metric can avoid the cumbersome data requirements of accounting for the fuel economy of all vehicles on the California roads. The LCFS accounting framework can be greatly simplified by relying on imputed efficiency adjustments for particular fuels. These values would need to be updated periodically as vehicle drivetrain efficiencies improve over time. However, this leads to some level of inaccuracy in weighting the GHG emissions of different fuels. For example, if diesel engines are generally utilized in heavier vehicles or plug-in drive trains are preferentially used in lightweight or low-drag platforms, the additional differences in emissions resulting from other vehicle characteristics are not factored into the relative carbon intensities calculated with the at-the-wheel metric. There is a large potential for improvements in vehicle fuel economy beyond improvements in the engine and drive train efficiencies, such as through the use of very light materials and more aerodynamic frames. If such technologies become widely adopted for some types of vehicles more than others, the inaccuracies of the motive energy metric will increase. If these inaccuracies are deemed significant, it is also possible to track drivetrain efficiencies through the vehicle fleet using DMV data as new vehicles are introduced over time. This would reintroduce the data requirements and cumbersome accounting of the per-mile metric, but would preserve the intensity basis of the LCFS (*i.e.*, vehicle mass, aerodynamic drag, rolling resistance, and accessories would still be excluded. For a discussion of energy flows through vehicles, see (Ross 1997)).

2.4.4 Example regulatory approach

Below is an example of one equation that could be used to calculate carbon intensity using the motive energy metric. Under the LCFS system, each firm's average fuel carbon intensity (AFCI) must not exceed a set standard (\overline{LCFS}), such that $AFCI \leq \overline{LCFS}$. The \overline{LCFS} can be the same for all fuels, vary by fuel, or vary by firm. A firm's AFCI is calculated as the weighted average of each fuel's carbon intensity using one of the three metrics described above or a comparable scheme. A fuel's at-the-wheel carbon intensity equals the carbon intensity at the tank or plug (CI_i) measured in gCO_{2e}/MJ, divided by a unitless drivetrain efficiency adjustment factor (η_{i*}), which is the ratio of the vehicle's drivetrain efficiency (η_i) to that of a baseline drivetrain efficiency (η_*), where drivetrain efficiency is the percentage of energy input at the tank or plug that reaches the wheel. The CI includes a fuel's life cycle fuel carbon emissions per MJ delivered at the tank (or the plug) plus the emissions resulting from the combustion of the fuel. In the equation below, the adjusted CI value is weighted by the total amount of motive energy of each fuel (E_{im}), measured in MJ. E_{im} is calculated as the $E_{it} * \eta_i$, where E_{it} is the total amount of energy in MJ entering the vehicle at the tank or plug.

$$AFCI = \frac{\sum_i [CI_i / \eta_{i*}] E_{im}}{\sum_{i=1}^n E_{im}} \leq \overline{LCFS}$$

2.5 Baseline AFCI, 2020 target and compliance pathways

Using data from public sources, the AFCI value for the baseline year and the 2020 target AFCI can be calculated. For simplicity, and to match the scenario analysis presented in section 5, we assume that the LCFS will cover all transportation-related gasoline and diesel fuel, but not LPG,

jet fuel, residual oil, or lubricants. In Part 2 of the study, policy issues associated with the implementation of the LCFS will be explored, including what the scope of the LCFS should be. The assumptions made in Part 1 are not endorsements of any particular regulatory choice. To perform this calculation GHG emission and fuel composition data are used to estimate the weighted AFCI value in 2004, as shown in Table 2-1 below. This calculation is preliminary and may need to be updated or improved. Target AFCI values for 2020 are also shown.

Table 2-1: Baseline and 2020 target AFCI values

GHG emissions	(Bemis for CEC 2006)		MMTCO ₂ -e	Included?
	LPG		0.19	0.10% No
	Gasoline		130.92	70% Yes
	Jet fuel		22.24	12% No
	Diesel		32.16	17% Yes
	Residual oil		0.61	0.33% No
	Lubricants		0.75	0.40% No
	TOTAL		186.87	
Included total		163.08		
Fuel composition	(Bemis for CEC 2006)			
	Gasoline	Gasoline blendstock (including denaturant in fuel ethanol)		94.4%
		Pure (neat) ethanol in fuel ethanol		5.6%
	Diesel	Petroleum-based diesel		100%
Biodiesel and renewable diesel			0%	
AFCI values	(Unnasch, Chan et al. for CEC 2007)		gCO ₂ e/MJ	
	Gasoline blendstock		92.7	
	Pure (neat) Ethanol		75.9	
	Retail gasoline		92.0	
	Diesel		70.7	
Weighted AFCI			gCO ₂ e/MJ	
	Average for baseline year, 2004		87.9	
2020 AFCI targets			gCO ₂ e/MJ	
		-5%	83.5	
		-10%	79.1	
		-15%	74.7	

2.5.1 Targets and rate of progress

Having established a baseline value for GHG content, it remains to specify target levels for successive years.⁶ The central conceptual issue here is whether the standard should decline from the baseline in equal annual steps linearly, faster at the beginning and more slowly in later years, or slowly at the start and then more quickly.

A key factor to consider in designing a trajectory is the time required to develop new technologies and invest in new infrastructure. Most of the potentially regulated liquid fuel firms have suggested that their primary compliance strategy will likely be to blend biofuels, including

⁶ A single target to take effect only in 2020 would satisfy the literal mandate of the executive order but such an approach would at the least lose all the benefits of progressive reductions until that time and, in our view, ignore a legitimate state mandate for a consistent and explicit incentive program to help the industry innovate and adapt quickly. Businesses that invest in GHG-reducing practices need to be reassured that their competitors will face a cost structure that rewards this favored behavior.

ethanol. With this compliance strategy, it will take time to build more tanks, upgrade terminals, install E-85 pumps, etc. Note that recent changes to the ARB's air pollution regulations are likely to cause refiners to increase the ethanol content in California gasoline to 10 percent by volume, which would necessitate an increase in the capacity to make ethanol in California, or import it.

A second factor to consider is avoiding "lock-in" of near term capital intensive technologies with modest GHG improvements, and the inability to find markets for more advanced technologies that may offer greater long-term gains.

The third factor is the potential for rearranging biofuel purchasing so that existing low-carbon fuels are redirected to California, a practice called *shuffling* or *rationalization*. The former term is used to implicitly criticize the practice because it leads to compliance on paper without any change in net GHG emissions to the atmosphere. The latter term is used here in recognition of the fact that such cost-minimizing behavior is not avoidable and is in fact desirable because it begins to send the appropriate signal to fuel markets.

Bushnell *et al* argue that rationalization could become very large in the electricity sector as GHG regulations are enacted, in part because of pre-existing low-carbon electricity generation in the western grid and in part because compliance with of pre-existing renewable portfolio standard in California and other states (Bushnell, Peterman, and Wolfram 2007). Because of these factors, they find that no new innovation or investment is needed to meet a significant GHG emission reduction in electric power in California. Further, they find that existing technologies (specifically natural gas combined cycle, nuclear, and wind power plants) could allow California and other western states to return to 1990-level GHG emissions in the electric power sector by 2020, which would create little incentives to develop new technologies that might be needed to stabilize GHG concentrations in the atmosphere in the future.

In transportation fuels, pre-existing regulation and low-carbon technologies are probably less significant. The global warming intensity of fuels will be affected somewhat by the renewable fuel standard (RFS). However the RFS will cause the GWI of renewable fuels to go down only if market responses to this law coincidentally focus on low-GWI biofuels. Because the GWI of biofuels varies from very high (above gasoline) to potentially negative values, and the lowest-cost fuels have among the highest GWI values (corn ethanol processed in coal-burning facilities), this is extremely unlikely (Farrell 2006).

Section 3 of this study includes estimates of the amount of pre-existing low-GHG fuels in the United States (Table ES-1) and enough information to calculate approximately how much these resources might be able to contribute to LCFS compliance (Table ES-2). By 2012, production facilities that currently exist, are in construction, or have been funded by the U.S. Department of Energy as pilot projects are expected to be able to supply up to 299 million gallons of low-GHG ethanol and 175 million gallons of low-GHG renewable diesel in the United States each year (Anonymous 2007). If all of these fuels were sold in California instead of average ethanol, the statewide APCI would fall by about 4 percent or more. It is not clear, however, that all of the biofuels from these pilot plants could be readily shipped to California.

In addition, large volumes of mid-GHG ethanol and biodiesel are available in the United States, which could also be used in California, so rationalization could also come about simply by using Brazilian ethanol in California instead of any US-manufactured ethanol. However, doing so might require new transportation infrastructure to deliver Brazilian ethanol to California. Last year, the US imported approximately 400 million gallons of ethanol from Brazil, which may have very low GHG emissions (depending on how land use change is treated). Production capacity in Brazil is expanding in hopes of exporting more ethanol. However, the GWI of this fuel is not clear, as the most reliable studies analyze “best practices” rather than average production. Acknowledging this data gap in its rulemaking for the RFS, the US EPA estimated the GWI of average Brazilian ethanol to be halfway between cellulosic and corn-based ethanol (EPA 2007, p. 248). However, this doesn’t account for the climate effects of land use change, which is discussed in Section 2.7.4.

2.6 Compliance paths

Table 2-2 and Figure 2-1 illustrate four possible compliance paths. The first and simplest, Linear compliance, uses equal absolute reductions in state AFCI values to reach the target. This results in an annual decrease of 0.84 gCO₂e/MJ, which is a percentage reduction of 0.91% to 1.00% annually over the compliance period.

The Slow 2-stage compliance path has an initial reduction in AFCI that is only about 1/5 that of the linear reduction. This slow implementation is assumed to last only three years (2010-2012) so that the program review in 2014 has the opportunity to review at least one year of compliance (2013) during which a high rate of reduction in the state-wide AFCI value takes place. The rate of decline for the second stage is chosen to achieve approximately the same level as the linear reduction. The Late 2-stage simply uses half the linear rate of decline for the first half of the compliance period (actually 6 of 11 years) and the rate needed after that to catch up and achieve about the same reduction in AFCI as the simple linear reduction. Note that on both 2-stage compliance pathways that rationalization may account for most of the compliance activities through 2014 or later.

The Rationalized compliance pathway assumes that sufficient rationalization (or shuffling) is feasible in the first year to lower the AFCI by 2.3 percent and that it is appropriate to require all of this effect to occur in the first year so that the effect is limited to one year and no additional credits are created by rationalization. Once this effect is accounted for, a simple linear decrease in AFCI is imposed each year.

Taking all of the factors discussed above into consideration, the compliance pathway similar to the “Rationalization” pathway (dashed line) may be the best choice. It accounts for rationalization in the first year and then presents a relatively modest emission reduction (about –0.7% per year) for the next several years. The ARB and CEC may want to examine the potential for rationalization further before determining a compliance schedule.

Table 2-2: Possible LCFS compliance schedules

	Linear		Slow 2-stage (2013)		Late 2-stage (2016)		Rationalized	
	Change in AFCI value		Change in AFCI value		Change in AFCI value		Change in AFCI value	
	Annual		Stage 1	Stage 2	Stage 1	Stage 2	Initial	Annual
	-0.84		-0.17	-1.09	-0.42	-1.34	-2.30	-0.63
	AFCI	Change	AFCI	change	AFCI	change	AFCI	change
2004	87.9		87.9		87.9		87.9	
2005	87.9		87.9		87.9		87.9	
2006	87.9		87.9		87.9		87.9	
2007	87.9		87.9		87.9		87.9	
2008	87.9		87.9		87.9		87.9	
2009	87.9		87.9		87.9		87.9	
2010	87.1	-0.91%	87.5	-0.45%	87.5	-0.45%	85.1	-3.26%
2011	86.3	-0.92%	87.1	-0.46%	87.1	-0.46%	84.5	-0.67%
2012	85.5	-0.93%	86.7	-0.46%	86.7	-0.46%	83.9	-0.67%
2013	84.7	-0.93%	85.7	-1.15%	86.3	-0.46%	83.4	-0.68%
2014	83.9	-0.94%	84.7	-1.17%	85.9	-0.46%	82.8	-0.68%
2015	83.1	-0.95%	83.7	-1.18%	85.5	-0.47%	82.2	-0.69%
2016	82.3	-0.96%	82.7	-1.19%	84.3	-1.46%	81.6	-0.69%
2017	81.5	-0.97%	81.7	-1.21%	83.0	-1.48%	81.1	-0.70%
2018	80.7	-0.98%	80.7	-1.22%	81.8	-1.51%	80.5	-0.70%
2019	79.9	-0.99%	79.7	-1.24%	80.5	-1.53%	79.9	-0.71%
2020	79.1	-1.00%	78.7	-1.25%	79.3	-1.55%	79.4	-0.71%

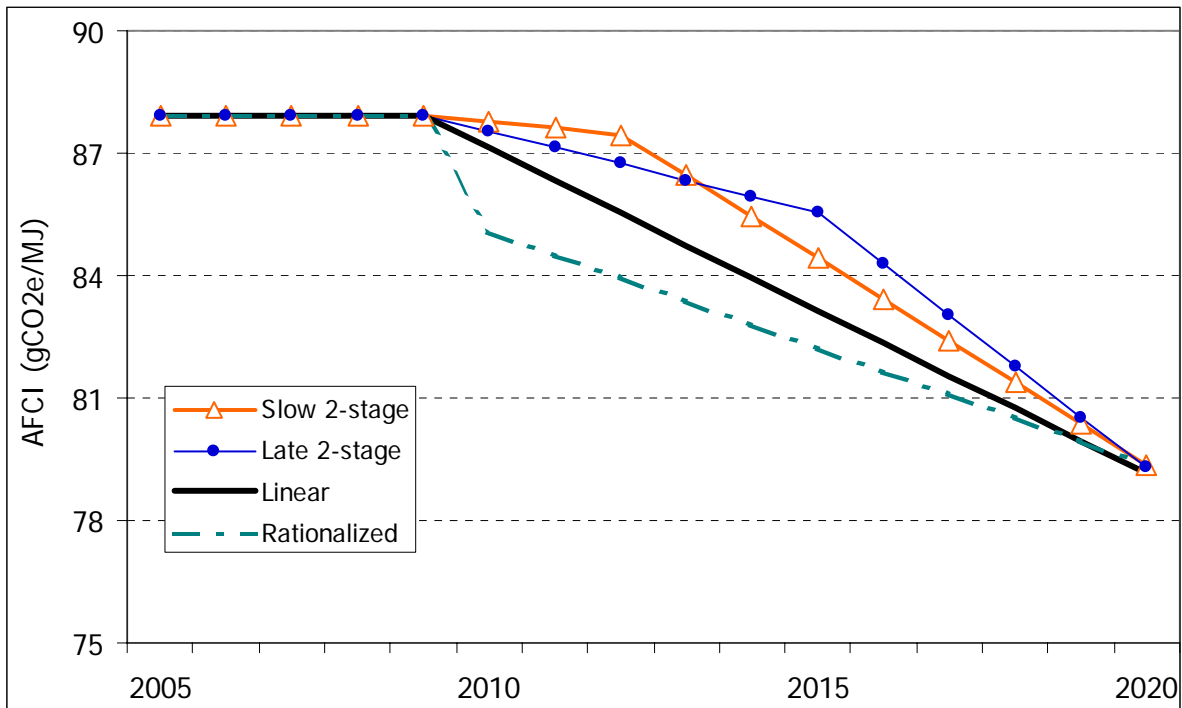

Figure 2-1: Possible LCFS compliance schedules

2.7 Mid-GHG and low-GHG biofuels

One of the key assumptions that must be made for each scenario is how the GWI of different fuels change over time. Possibly most important in this regard are biofuels, because there is great variety in possible biofuel production pathways and much current research, and because biofuels may require the fewest changes in vehicle and fuel infrastructure. We considered seven possible ways in which biofuels production could change from 2008 to 2020, including both improvements in ethanol production and the potential for other biofuels that could be produced with very low GHGs. From this analysis, we created two representative categories, “mid-GHG biofuels” and “low-GHG biofuels”.

In the scenarios in section 5, we assume that biofuels start out in 2010 with GWI values that are the average for current U.S. produced biofuels, per the AB1007 study developed by the CEC (Unnasch 2007). The production pathways are identified below.

When mid-GHG ethanol is specified, we assume that over time that ethanol production shifts to an equal mix of four production pathways that are in commercial operation today. All use corn in dry-mill plants, and include: a natural gas-fired plant (Et3), a natural gas-fired plant that sells wet distillers grains (Et4), a plant that uses biomass (stover) for energy (Et5), and a plant in California that uses natural gas and sells wet distillers grains (Et74). This results in an AFCI value for mid-GHG ethanol of 58 gCO₂e/MJ. We assume that mid-GHG diesel fuel is fatty acid methyl ester biodiesel made from Midwestern soybeans. This results in an AFCI value for mid-GHG biodiesel of 38 gCO₂e/MJ.

When low-GHG ethanol is specified, we assume that over time that ethanol production shifts to an equal mix of three cellulosic production pathways that are currently under development. These include ethanol made from California poplar (Et21), California switchgrass (Et23) and Midwestern prairie grass (Et24). This results in an AFCI value for mid-GHG ethanol of 4 gCO₂e/MJ. We assume that mid-GHG diesel is produced by a Fischer-Tropsch process from California poplar. This results in an AFCI value for mid-GHG biodiesel of -4 gCO₂e/MJ.

2.8 Life cycle assessment

The distinguishing feature of a “life cycle” environmental impact analysis is that it estimates environmental impacts associated with the entire life cycle of a particular product, as opposed to impacts from just consumer end use. For fuels, the life cycle includes the production of the fuel as well as its combustion. A life cycle comprises all of the physical and economic processes involved directly or indirectly in the “life” of the product, from the recovery of raw materials used to make pieces of the product to recycling of the product at the end of its life. A life cycle analysis (LCA) of emissions formally characterizes the inputs, outputs, and emissions for each stage of the life cycle, links the stages together, and aggregates the emission results over all of the linked stages.⁷

⁷ The LCA process described here is sometimes characterized as a “process” LCA because it involves detailed engineering analysis (Hendrickson, Lave, and Matthews 2006). A more aggregated approach uses emission factors and economic input-output models (Hendrickson et al. 1998), but this approach is not discussed in this study.

The basic building block in LCA is a set of energy and material inputs associated with a particular output of interest for a particular stage in a life cycle, with emission factors attached to some of the inputs. A life cycle is then a particular combination of I-O building blocks (or stages) linked together, where the output of one block (or stage) is one of the inputs to another stage, and the output of the last stage is the product or quantity of interest. An LCA aggregates the emissions attached to the inputs over all of the linked stages, to produce an estimate of total emissions per unit of final product output from the life cycle.

Consider, for example, the simplified depiction of the life cycle of gasoline shown in Figure 2-2: crude oil production and shipment, petroleum refining, and gasoline combustion. In the first stage, fuels and materials are input to the crude-oil recovery process, which results in an output of crude oil. This crude oil output is input to the next stage, petroleum refining. (The petroleum refining stage also has other energy and material inputs.)

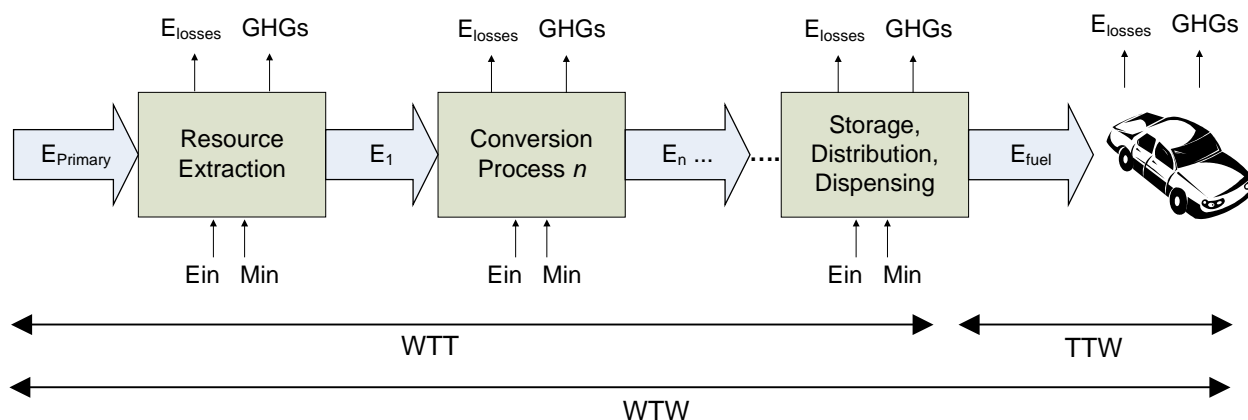

Figure 2-2: Fuel life cycle analyses

The output of the petroleum refining stage is a vehicle fuel, which is input to the last stage, end use. Each process requires energy and material inputs (E_{in} and M_{in}), and each process has energy losses due to conversion efficiencies (E_{losses}) and greenhouse gas emissions (GHGs). Adding up the emissions associated with all of the inputs for crude oil recovery, petroleum refining, and gasoline end use gives us a picture of the life cycle emissions impact of gasoline. Other types of gaseous emissions and wastes may also be generated from each process, but are not indicated in this figure.

2.8.1 LCA in the LCFS

The analysis of a transportation fuel life cycle—also known as a *fuel cycle*—is often reported in two distinct phases, as shown in Figure 2-2: the *well-to-tank* (WTT) phase includes resource extraction, feedstock production, fuel production, refining, blending, transportation and distribution, whereas the *tank-to-wheels* (TTW) phase includes refueling, consumption and evaporation. The complete fuel cycle analysis is also referred to as a *well-to-wheels* (WTW) analysis.

This separation into two phases allows a comparison of fuels independently from vehicle-related assumptions including efficiency, emissions controls, fleet turnover rates, and so on. In addition,

while there are many production pathways for producing some fuels (*e.g.*, ethanol), with distinct production phase GHG emissions, the resulting fuels behave identically in the use phase.

This LCFS study relies on the WTT assessment of transportation fuels produced by TIAX for the CEC as required under AB 1007 (Unnasch, Chan et al. 2007; Unnasch, Pont et al. 2007; Unnasch, Pont et al. 2007). The WTT analysis was based on a modified version of Argonne National Laboratory's *Greenhouse Gases, Regulated Emissions, and Energy Use in Transportation* (GREET) model with various assumptions modified for the California context. For consistency, and at the request of the ARB, the LCFS study has adopted the values for CO₂-equivalent emissions per megajoule for each fuel as per the report produced by TIAX for CEC.

2.8.2 Analytical issues in LCA

In general GREET follows widely accepted methods but significant uncertainties and omissions remain and current methods are not considered adequate by all experts (Delucchi 2004; Pennington, Potting et al. 2004; Rebitzer, Ekvall et al. 2004; International Standards Organization 2006). No single approach may be able to address all concerns. For instance, there is an important trade-off between detail and breadth, typically manifested in the choice between detailed engineering-type process-specific LCAs of limited extent and extensive economy-wide analyses of limited detail (for an example of the latter, see Matthews and Small 2001). It is not clear how to resolve this tradeoff, and a highly-detailed, economy-wide analysis may be impracticable.

The present generation of transportation fuel LCA models such as GREET produce global warming intensity (GWI) values for each fuel pathway, but these values must be understood as both incomplete and, in many cases, highly uncertain. The major areas of incompleteness and uncertainty include:

- Treatment of market-mediated effects (*e.g.*, co-products, changes in process emissions in response to changing production quantities)
- Land use change
- Climate impacts of emissions
- Inherent variability and limited quality in the data

This section discusses the limitations of the current generation of LCA methods. The subsequent section examines whether standard uncertainty analysis might be useful to address these problems, but finds that it cannot. Thus, research into improved LCA methods appears to be a key component of the effort to implement an LCFS and ultimately, to lower California's GHG emissions.

2.8.3 Market-mediated effects

All energy and environmental policies affect prices. Prices, in turn, affect consumption, and hence output, which then change emissions. In the real world, then, GHG emissions are a function of market forces, and in the case of fuels and agricultural products, these are global markets.

Many fuel production pathways result in multiple products, such as food, feed, or chemical coproducts. In an LCA focused on a single product, one includes all of the emissions from the entire joint production process (assuming that it is truly a non-separable joint production process), and then models what happens to production and hence emissions in the markets affected by the output of all of the “coproducts” (all joint products other than the product of interest). The best recent biofuel LCAs adopt the correct “displacement” or “system expansion” approach to estimating the consequences of joint production (Graboski 2002; Kim and Dale 2002). This approach assumes that each unit of coproduct manufactured along with the biofuel causes one unit to *not* be manufactured elsewhere, “displacing” that other production. The actual degree of displacement is the dynamic result of market interactions; a conceptually complete analysis therefore requires an economic model of the markets affected by coproducts. No fuel LCA study has integrated an economic analysis of this effect, and hence they all likely overestimate the “displacement credit.”

The same issue of joint production arises in petroleum refineries. A refinery turns crude oil into a broad slate of products, including numerous fuel products, petrochemicals, and asphalt. The attribution of energy inputs to each of these outputs is somewhat arbitrary, and will be unique to each refinery configuration and type of crude refined. Current generation LCA models, however, do not incorporate these effects.

2.8.4 Land use change

Among the most important market-mediated effects is land use change. An increase in the price of oil or a change in policy could result in expanded crop-based biofuel production, thereby displacing native ecosystems, existing agricultural production, or set-aside land. Changes in land use and vegetation can change physical parameters, such as albedo (reflectivity), evapotranspiration, and fluxes of sensible and latent heat, that directly affect the absorption and disposition of energy at the surface of the earth, and thereby affect local and regional temperatures (Marland, Pielke et al. 2003; Feddema, Oleson et al. 2005). The replacement of native vegetation with biofuel feedstocks and the subsequent cultivation of the biomass can also significantly change the amount of carbon stored in biomass and soils, and thereby significantly change the amount of CO₂ removed from or emitted to the atmosphere compared with the assumed baseline.

By producing biofuels on a given plot of land, the demand for the product of the alternative land use is no longer met and over time new production would be required to meet at least some of that demand (prices will presumably increase, reducing consumption to some degree). This “displaced production” could lead to GHG emissions or other environmental impacts elsewhere, such as soil erosion or deforestation. Current fuel life cycle models ignore (or treat too simply) changes in land use related biomass grown to make biofuels.

Of the existing LCA models, LEM has the most complex treatment of land use change. In this model the largest sources of cultivation and land-use emissions are: changes in soil carbon and biomass carbon due to cultivation; changes in soil and biomass carbon due to fertilization of off-site ecosystems by all nitrogen input; N₂O emissions from fertilizer use, crop-residues, and biological fixation; and NO_x emissions.

Although there is wide consensus that these effects may be important, there is no well-accepted method for calculating the magnitude of these effects. Because land use change is a market-mediated effect, it is not clear how to treat these effects in a fuel life cycle LCA.

2.8.5 Climate impacts of emissions

Most fuel life cycle studies consider only carbon dioxide (CO₂), methane (CH₄), and nitrous oxide (N₂O) emissions. These three greenhouse gases are referred to as “direct” GHGs, because they affect climate directly. However, indirect air pollutants, such as ozone and fine particles may also be important for climate change. Few life cycle GHG emissions models evaluate indirect effects, although LEM does so.

Not all LCA models treat emissions the same, even when they are included. For instance, GREET does not include N₂O emissions from atmospheric nitrogen fixed by soybeans, while LEM does, contributing to an almost order-of-magnitude greater estimate of GWI for soybean biodiesel.

Moreover, the black-carbon (BC) component of aerosols has a very strong global warming effect, and diesel engines are major sources of BC emissions. Some LCAs include BC; others do not. Stringent, health-based emissions standards for BC are now being implemented in the United States and Europe, but such standards do not exist (or are not enforced) in many other countries. This suggests that while BC emissions may become less important in some places in the future, they may be very significant elsewhere.

2.8.6 CO₂-equivalency factors

To aggregate the climate effects of emissions of different GHGs, a weighted sum of emissions is calculated by multiplying the mass of gases other than CO₂ by a factor that expresses their climate effects in terms of the amount of CO₂ that would have the same impact. Most fuel LCAs consider only three GHGs (CO₂, CH₄ and N₂O) and use the Global Warming Potentials (GWPs), developed by the IPCC, to convert non-CO₂ GHGs into CO₂ equivalents. The IPCC GWPs equate gases on the basis of their radiative forcing over a 100-year period, assuming an exponential decay of the gases (with multiple decay functions in the case of CO₂.)

CO₂-equivalency calculation in the LEM differs from the above in two general ways. First, LEM defines CEFs for additional pollutants CO, NMOCs, NO_x, SO₂, PM-BC, PM-OM, PM-dust, H₂. Second, LEM CEFs for CH₄ and N₂O are different from IPCC GWPs. In addition, the radiative forcing associated with each unit emitted of some GHGs depends on the atmospheric concentration of that particular gas. Therefore, the CO₂ equivalence changes over time. IPCC GWPs are treated as constants over different time horizons, whereas the LEM calculates CEFs as a function of concentration over time for a given target date. However, the choice of time horizon or target date is subjective, leading to a range of possible “correct” results.

2.8.7 Uncertain and variable data

A first-generation LCA model of climate impacts (*i.e.*, one excluding non-GHG climate impacts and market-mediated effects) can be represented roughly as the sum of the CO₂-equivalent emissions from a sequence of steps, with the emissions for each step calculated by multiplying the rate of use of some input by a GHG emissions factor associated with that input. Each emissions factor includes the life cycle GHG emissions for the related input. In practice, *all* of

the values entering into a life cycle GHG emissions calculation are uncertain. The emissions factors are generally more uncertain, as they usually represent some temporally- or spatially-varying natural process, or are the result of an earlier LCA. Unfortunately, in many cases there are so few real emissions data that we may only know emissions to within a factor of two. For example, nitrous oxide emissions from vehicles might contribute as little as 3% or as much as 10% of simple, first-order fuel cycle emissions.

Usage rates for process inputs can also be highly uncertain, particularly in assessments of average impacts, such as the average GWI of ethanol produced in the US, which averages across a heterogeneous mix of facilities that use a variety of fuels at differing efficiencies. In many cases, input usage rates are based on unaudited, self-reported values from a self-selected subset of companies engaged in a given practice. Statistically meaningful probability distributions cannot be derived from these data. In other cases, input usage rates are inferred from related statistics. For example, on-farm energy use is not tracked in USDA statistical surveys of crop production; rather energy use is estimated from expenditures on fuels, based on assumptions about average fuel prices. Exactly how this process biases the resulting estimates is not clear.

An often poorly characterized source of emissions is the change in carbon sequestration in biomass and soils as a result of changes in land use related to the establishment of biomass used as a feedstock for biofuels. Generic data on the carbon contents of soils and plants are available, but there can be much variation about these generic means from site to site. The uncertainty inherent in carbon-storage factors related to land use can change life cycle CO₂-equivalent emissions by several percentage points.

If the probability distributions for each of the usage rates and emissions factors and the correlations among them were well-defined, we could use standard statistical methods or Monte Carlo simulation to propagate uncertainty through the life cycle assessment model to understand the overall uncertainty of the result. However, in practice, many of the probability distributions are not known. What might be feasible, however, would be an investigation into the sensitivity of the LCA methods to uncertainty in various parameters in order to understand how to better understand the climate impacts of various transportation fuels. However, standard Monte Carlo techniques (and similar analyses) are unlikely to be useful at the current time.

2.8.8 Examples

In Box 2 below, we briefly compare three LCAs by examining how land-use changes are handled in each of them: the Life cycle Emissions Model (LEM) (Delucchi 2003); the CONCAWE study (Edwards, Larivé et al. 2006); and, finally, the GREET model (Wang 1999), which underlies the AB 1007 analysis performed for the CEC (Unnasch, Chan et al. 2007; Unnasch, Pont et al. 2007; Unnasch, Pont et al. 2007) and this study. There are two reasons why the changes in the carbon content of soil and biomass are large: 1) in general, native plants and undisturbed soils store a great deal of carbon, and 2) intensively cultivated agricultural lands typically have much less carbon than do undisturbed native lands.

2.9 Summary of the WTW analysis

Table 2-3 summarizes some of the relevant GWI calculations. Values in the GREET column are taken directly from a version of the AB 1007 analysis performed for the CEC provided by TIAX

in mid-April 2007. Adjustment values to account for inherent differences in converting fuel energy stored onboard the vehicle to motive power at the wheels are determined by dividing the weighted average fuel economies for conventional vehicles in VISION-CA by the weighted average fuel economies for diesel vehicles, electric vehicles, and hydrogen vehicles.⁸ This value is then used to determine the GWI values in the “GREET*” column, which can be interpreted as carbon intensity. The values labeled LEM are also adjusted for inherent conversion efficiencies and can be interpreted as carbon intensity. LEM results using CO₂ Equivalency Factors per Delucchi (2003) are labeled “CEF,” while those using Global Warming Potential factors from the IPCC (Intergovernmental Panel on Climate Change 2001) are labeled “GWP.”

Neither this version of the GREET model nor LEM have been peer reviewed so the reliability of these results is not clear. However, this comparison shows that significant differences in GWI can be obtained by using different LCA methods. Note that LEM tends to yield lower values for gasoline and LPG than GREET, but higher values for other fuel pathways. Some of the differences are very large. For instance, the LEM calculates a GWI for biodiesel over 7 times larger than the value found with GREET. These differences illustrate the uncertainty associated with current methods of calculating GWI and the need for more research in this area.

2.10 Scenario analysis with the VISION model

For this study, twelve light duty vehicle scenarios were generated and evaluated using a spreadsheet model for three target changes in AFCI, with reductions by 2020 of 5%, 10%, and 15%. We evaluated these scenarios with a modified version of the VISION model developed by Argonne National Laboratory, and incorporated GHG emission values from the GREET model developed by TIAX for the CEC under AB 1007. (The original Argonne VISION model is available at www.transportation.anl.gov/software/VISION/index.html.)

The VISION model has been developed by the U.S. Department of Energy to provide estimates of the potential energy use, oil use, and carbon emission impacts to 2050 of advanced light- and heavy-duty highway vehicle technologies and alternative fuels. Total carbon emissions for on-highway vehicles by year are also estimated. VISION is a spreadsheet model that uses vehicle survival and age-dependent usage characteristics to project total light- and heavy-vehicle stock, total vehicle miles of travel (VMT), and total energy use by technology and fuel type by year, given market penetration and vehicle energy efficiency assumptions developed exogenously. This model has been calibrated to represent the California vehicle fleet, and renamed as the VISION-CA model. The scenario analysis is discussed in detail in Section 5.

⁸ The corresponding onroad fuel economies are: 19.6 mpg for gasoline ICE, 25.1 mpg for diesel, 97.6 mpg for EVs, 40.9 mpg for FCVs. The EV and FCV mpg values represent mature vehicles introduced by 2020.

BOX 2: Comparing Three LCAs

LEM (Delucchi 2003) Although LEM has been under development for several years, it remains unfinished today, so some of the quantified impacts are best characterized as illustrative of rough magnitudes under certain sets of assumptions. It has not undergone any peer-review. However, LEM is more comprehensive than many other LCA models. It accounts for GHG emissions related to the cultivation of biomass feedstocks, including the impacts of land-use changes on the carbon cycle. Although it is not published, the author has continued to update this model and it may have the most recent and comprehensive data for land use.

CONCAWE Study (Edwards, Larivé et al. 2006) A consortium of European organizations⁹ released an update in 2006 of their 2003 life cycle fuel and powertrain analysis in the European context. The CONCAWE study does not include GHG emissions from land-use changes in its fuel cycle results, but does comment on the likely impacts of planting biofuel crops on grassland and forests: “We deliberately did not consider the expansion of arable area onto other land, notably pasture and forest...[however,] such change in land use would be likely to release large amounts of carbon from the soil, negating any benefit of the energy crops for decades to come” (Edwards, Larivé et al. 2006, p. 76). This comment on is based on off-line calculations in which they estimate the number of years it would take biofuels to “payback” the one-time carbon emissions from soil resulting from planting biofuel crops on grassland. On the basis of those calculations, the authors conclude that “planting biofuels crops on grazing lands would probably not pay off in GHG terms for decades” (Edwards, Larivé et al. 2006, WTT report, p. 30).

GREET (Wang 1999) The GREET model (version 1.7) has a limited accounting of the effects of land use change on the carbon cycle. In GREET, the calculation of CO₂ emissions related to land use change is dependent mainly on two factors: fractions of an acre of pasture land converted to cropland per acre of corn planted, and the change in CO₂ emissions resulting from converting pasture land to cropland. The cropland changes are from an economic simulation by USDA that is now outdated (Wang 2007). The first parameter, pasture land converted per acre of corn, is assumed to be about 0.5: “In other words, we assumed that increased planting makes up half of the import reduction and reduced consumer demand makes up the other half” (Wang 1999, p. 79; Wang 1999, p. 79)¹⁰. This assumption presumes a relatively elastic market for food products. The second parameter, the CO₂ emission rate from converting pasture to cropland is based on a 10-year old version of the LEM: “Delucchi (1998) estimated a CO₂-emission rate of 204,000 g/acre for cornfields converted from idle cropland or pasture land... Using the CO₂ emissions rate developed by Delucchi...we estimated a total CO₂ emission loading.” More recent estimates of the overall average CO₂ emission rate from converting temperate grasslands to croplands are more than an order of magnitude larger, over 3,000,0000 g/acre.

⁹ The organizations are: EUCAR, the European Council for Automotive R&D; CONCAWE, the oil companies’ European association for environment, health and safety in refining and distribution; and JRC/IES, the Institute for Environment and Sustainability of the EU Commission’s Joint Research Centre.

¹⁰ This assumption actually pertains only to land-use changes in countries that import grains from the U. S., but in the GREET documentation the land-use CO₂ emissions in grain-importing countries are 85% of the total estimated land-use CO₂ emissions.

Table 2-3: Global warming impacts estimated by two LCA models under various assumptions (gCO₂-e / MJ)

ID	Fuel	Fuel production pathway	GREET	LEF (CEF)	LEM (GWP)	Adjust.	GREET*	LEF* (CEF)	LEM* (GWP)
G1	CA RFG	Marginal gallon produced in CA	92	85	95	1	92	85	95
D2	Diesel	ULSD produced in CA	91	94	89	0.78	71	73	69
P1	LPG	From petroleum	78	67	75	1	78	67	75
C1	CNG	From North American Natural Gas	68	81		1	68	81	
F3	FT Diesel	Fischer-Tropsch diesel from CA poplar (BTL)	-4			0.78	-3	-	-
F4	FT Diesel	Fischer-Tropsch diesel from coal (CTL)	214			0.78	167	-	-
BD3	Biodiesel	FAME biodiesel from Midwest soybeans	38	288	60	0.78	30	224	-
Et1	Ethanol	Midwest average corn ethanol	76			1	76	-	-
Et2	Ethanol	Midwest corn ethanol from a coal-fired dry-mill	113			1	113	-	-
Et3	Ethanol	Midwest corn ethanol from a n. gas-fired dry-mill	70	97		1	70	97	-
Et5	Ethanol	Midwest corn ethanol from a stover-fired dry-mill	47			1	47	-	-
Et74	Ethanol	CA corn, NG-fired dry-mill, wetcake coproduct	52			1	52	-	-
Et21	Ethanol	Cellulosic ethanol from CA poplar	-10			1	-10	-	-
Et23	Ethanol	Cellulosic ethanol from CA switchgrass	15			1	15	-	-
Et24	Ethanol	Cellulosic ethanol from Midwest prairie grass	7			1	7	-	-
e54	Electricity	Electricity from biomass	15			0.20	3	-	-
e11	Electricity	CA average electricity	141			0.20	27	-	-
e1	Electricity	NG-CC electricity, assuming an RPS	108	175	166	0.20	20	34	32
H7	Hydrogen	Hydrogen from biomass, delivered by pipeline	47			0.48	21	-	-
H11	Hydrogen	Hydrogen from steam-reformation of onsite n. gas	102	56	62	0.48	47	26	29

GREET: Unnasch et al (2007) for CEC. GWI for Unnasch et al (2007) includes feedstock production and conversion, plus combustion carbon. Biotic carbon is sequestered (has a negative value) in biofuel production, and it then counted (has a positive value) in combustion. Production phase value includes GREET-calculated emissions or sequestration from land use change, which are limited in scope and based on outdated (1999) economic analysis, as discussed in section 2.4. The adjustment factor used to determine GREET* values accounts for inherent differences in energy efficiency per section 2.3.

LEM: Unpublished analysis by Delucchi that includes radiative forcing for a wide range of emissions and geophysical effects described in Delucchi (2003). CEF is CO₂ Equivalency Factor, GWP is Global Warming Potential. See section 2.4 for more information. The LEM model is still in development and has not been peer-reviewed. Some quantitative results are best characterized as illustrative of rough magnitudes under certain sets of assumptions.

Notes: Pathway ID refers to the identifier used in Unnasch et al (2007). “CA RFG” is California reformulated gasoline. “CNG” is compressed natural gas. “BTL” is biomass-to-liquids. “CTL” is coal-to-liquids. “FAME” is fatty acid methyl ester. “Stover” is an agricultural residue that can be used in limited quantities as an energy feedstock. “Wetcake” is a form of corn ethanol co-product that requires little energy to produce because it is not dried. Not all of the fuel production pathways shown are commercialized and not all fuel production pathways are shown. Efficiency adjustment factors are from the VISION-CA model.

2.11 References

- Bemis, G. (2006). Inventory of California Greenhouse Gas Emissions and Sinks: 1990 to 2004. Sacramento, California Energy Commission: 117.
- California Board of Equalization (2007). Net Taxable Gasoline Gallons. Sacramento: 1.
- Delucchi, M. A. (2003). A Lifecycle Emissions Model (LEM): Lifecycle Emissions from Transportation Fuels, Motor Vehicles, Transportation Modes, Electricity Use, Heating and Cooking Fuels, and Materials, University of California, Davis: 444.
- Delucchi, M. A. (2004). Conceptual and Methodological Issues in Lifecycle Analyses of Transportation Fuels. Institute of Transportation Studies. Davis, University of California: 25.
- Edwards, R., J.-F. Larivé, et al. (2006). Well-to-wheels Analysis of Future Automotive Fuels and Powertrains in the European Context: Well-to-Wheels Report, Version 2b, EUCAR, CONCAWE, and JRC/IES.
- Feddema, J. J., K. W. Oleson, et al. (2005). "The importance of land-cover change in simulating future climates." Science **310**(5754): 1674-1678.
- Graboski, M. (2002). Fossil Energy Use in the Manufacture of Corn Ethanol. St. Louis, National Corn Growers Association: 108.
- Hendrickson, C., A. Horvath, et al. (1998). "Economic input-output models for environmental life-cycle assessment." Environmental Science & Technology **32**(7): 184A-191A.
- Hendrickson, C. T., L. B. Lave, et al. (2006). Environmental Life Cycle Assessment of Goods and Services. Washington, RFF Press.
- Intergovernmental Panel on Climate Change (2001). Third Assessment Report: The Scientific Basis. New York, Cambridge University Press.
- International Standards Organization (2006). ISO 14040: Environmental management — Life cycle assessment — Principles and framework. Geneva, International Standards Organization.
- Kim, S. and B. Dale (2002). "Allocation procedure in ethanol production system from corn grain." International Journal of Life Cycle Assessment **7**(4): 237-243.
- Marland, G., R. A. Pielke, et al. (2003). "The climatic impacts of land surface change and carbon management, and the implications for climate-change mitigation policy." Climate Policy **3**(2): 149-157.
- Matthews, H. S. and M. J. Small (2001). "Extending the Boundaries of Life-Cycle Assessment Through Environmental Economic Input-Output Models." Journal of Industrial Ecology **4**: 7-10.
- Pennington, D. W., J. Potting, et al. (2004). "Life cycle assessment Part 2: Current impact assessment practice." Environment International **30**(5): 721-739.
- Rebitzer, G., T. Ekvall, et al. (2004). "Life cycle assessment Part 1: Framework, goal and scope definition, inventory analysis, and applications." Environment International **30**(5): 701-720.
- Ross, Marc. 1997. Fuel efficiency and the physics of automobiles. *Contemporary Physics* **38** (6):381-394. Available online at: http://sitemaker.umich.edu/mhross/files/fueleff_physicsautossanders.pdf
- Unnasch, S., M. Chan, et al. (2007). Full Fuel Cycle Assessment Tank To Wheels Energy Inputs, Emissions, And Water Impacts. Sacramento, California Energy Commission.
- Unnasch, S., J. Pont, et al. (2007). Full Fuel Cycle Assessment Well To Wheels Energy Inputs, Emissions, And Water Impacts. Sacramento, California Energy Commission.

Unnasch, S., J. Pont, et al. (2007). Full Fuel Cycle Assessment Well To Tank Energy Inputs, Emissions, And Water Impacts. Sacramento, California Energy Commission.

Wang, M. (2007). Land use change in GREET. (Pers. comm. with R.J. Plevin). R. J. Plevin.

Wang, M. Q. (1999). GREET 1.5 - Transportation Fuel Cycle Model - Volume 2: Appendices of Data and Results. Argonne, Ill, Argonne National Laboratory: 208.

Wang, M. Q. (1999). GREET 1.5 — Transportation Fuel-Cycle Model, Volume 1: Methodology, Development, Use, and Results, Center for Transportation Research, Energy Systems Division, Argonne National Laboratory.

This page is intentionally blank.

3 Fuel Characteristics

A variety of fuels could be considered to meet the Low Carbon Fuel Standard (LCFS) intensity targets. In Section 3 we briefly describe the characteristics of the fuels listed in Table 3-1. Fuel supply pathways are described and characterized with respect to fuel properties, feedstocks, fuel production processes, infrastructure issues and costs, for fossil hydrocarbon fuels, biofuels, electricity and hydrogen. To estimate greenhouse gas emissions associated with each fuel pathway, we have used the TIAX reports on well-to-tank and well-to-wheels emissions being developed for the California Energy Commission as part of AB 1007 (Unnasch et al. 2006; Unnasch 2007). These emissions results are summarized in Section 3.7. Not every possible fuel and not every possible fuel pathway could be considered in this study due to limitations of time and data. This does not imply any opinion about the likelihood of other fuels to be used in California to help meet the goals of the LCFS.

Table 3-1: Fuels considered in this section

Fuel	Primary Source(s)	Vehicles
Gasoline Diesel Liquefied Petroleum Gas (LPG)	Petroleum, natural gas, very heavy oil, coal, tar sands, oil shale	Internal combustion engine vehicles; hybrid vehicles; plug-in hybrid vehicles
Compressed Natural Gas(CNG) Liquefied Natural Gas (LNG)	Natural gas, biomass	
Dimethyl Ether (DME) Fischer-Tropsch (F-T) Blends	Natural gas, cellulosic materials, coal	
Ethanol	Cellulosic materials; starches and fermentable sugars	
Biodiesel (fatty acid esters) Renewable diesel (hydrocarbons)	Plant oils (soybean, palm oil, canola, mustard), algae,	
Biobutanol	Starch; Cellulosic materials	
Electricity	Fossil (w/carbon capture and storage), renewable, nuclear	
Hydrogen	Fossil (w/carbon capture and storage), renewable, nuclear	Fuel Cell Vehicles, Internal combustion engine vehicles; hybrid vehicles; plug-in hybrid vehicles

3.1 Fossil hydrocarbon fuels

Over 95% of U.S. transportation energy comes from petroleum products, and almost all the rest is natural gas used in both vehicles and pipelines, so greenhouse gas emissions associated with oil production, shipment, and refining are significant fractions of the greenhouse gases (GHGs) associated with transportation fuels, in addition to the combustion of the fuels themselves (Davis and Diegel 2006 Table 2.2). Transportation fuels like gasoline, diesel, and kerosene (*e.g.*, jet fuel) are manufactured from several distinct resources including conventional crude oil,

condensate (which is associated with natural gas production), extra heavy oil, tar sands, and even natural gas and coal (Brandt and Farrell 2006). The fuels are all standardized products, so the GHGs associated with their combustion is very uniform but the “upstream” (production and shipment) and refining emissions vary significantly among these resources.

Approximately 95% of conventional oil reserves are held by the national oil companies of countries like Saudi Arabia, Russia, Canada, Venezuela, Nigeria, Iran, Iraq, and so forth (Energy Information Administration 2006). (The actual size of these resources is hotly debated and may be smaller than claimed by some governments Mitchell, Thijssen, and Bentley 1995 ; Simmons 2005 ; O'Dell 2004.) Whatever their size, these resources are generally not available to private oil companies (*e.g.*, BP, ExxonMobil and Shell) which have thus begun to develop hard-to-access conventional oil (like deep offshore deposits) and lower-quality resources (like tar sands). Similarly, oil importing countries (like the United States and China) are concerned about the security of imports from some of these countries and have begun to consider supporting the production of domestic low-quality resources (*e.g.*, coal) into transportation fuels. This has led to the rise of production of substitutes for conventional petroleum (SCPs) which now account for about 3% of global petroleum production (Farrell and Brandt 2006). Understanding how these resources are produced is important to understanding the GHG emissions of transportation fuels.

Understanding conventional petroleum and fossil-SCPs

A schematic is presented below in Figure 3-1 showing the three major stages in fuel production and use, each of which has GHG emissions associated with it. Exploration for resources and their development are ignored because they have comparatively minor emissions. Emissions from end-use combustion are largely invariant because fuel specifications ensure that end-use fuels will be largely identical to conventional petroleum-derived fuels, regardless of their production process. Therefore, the major differences in GHG emissions for fossil-based fuels are in resource production and refining. However, it is not clear if the LCFS should include production and refining emissions. This issue will be explored in Part 2 of this study.

There are significant differences between conventional petroleum production and fossil-SCPs. Conventional petroleum production comprises many steps. A basic outline is provided by Hyne (Hyne 2001), while the *API Compendium of Greenhouse Gas Emissions Methodologies for the Oil and Gas Industry* (Shires and Loughran 2004), gives a very detailed overview of the industry.

Fossil-SCPs can be divided into two categories: low-quality petroleum products and synthetic liquid fuels. These categories differ in the properties of the fossil-fuel feedstock, but produce virtually identical end products. Table 3-2 contains estimates of the GHG emissions from each of these fuel production pathways available in the open literature (Brandt and Farrell 2006). These values are shown graphically in Figure 3-2.

Low-quality petroleum products are created from resources that are structurally similar to conventional hydrocarbons, but they have extreme physical or chemical properties that cause them to be unconventional. The most common of these sorts of hydrocarbons are the heavy oils of California, Venezuela, and Alberta Canada, as well as the tar sands of Alberta. These

resources consist of very heavy (dense), complex poly-condensed hydrocarbon molecules. Producing

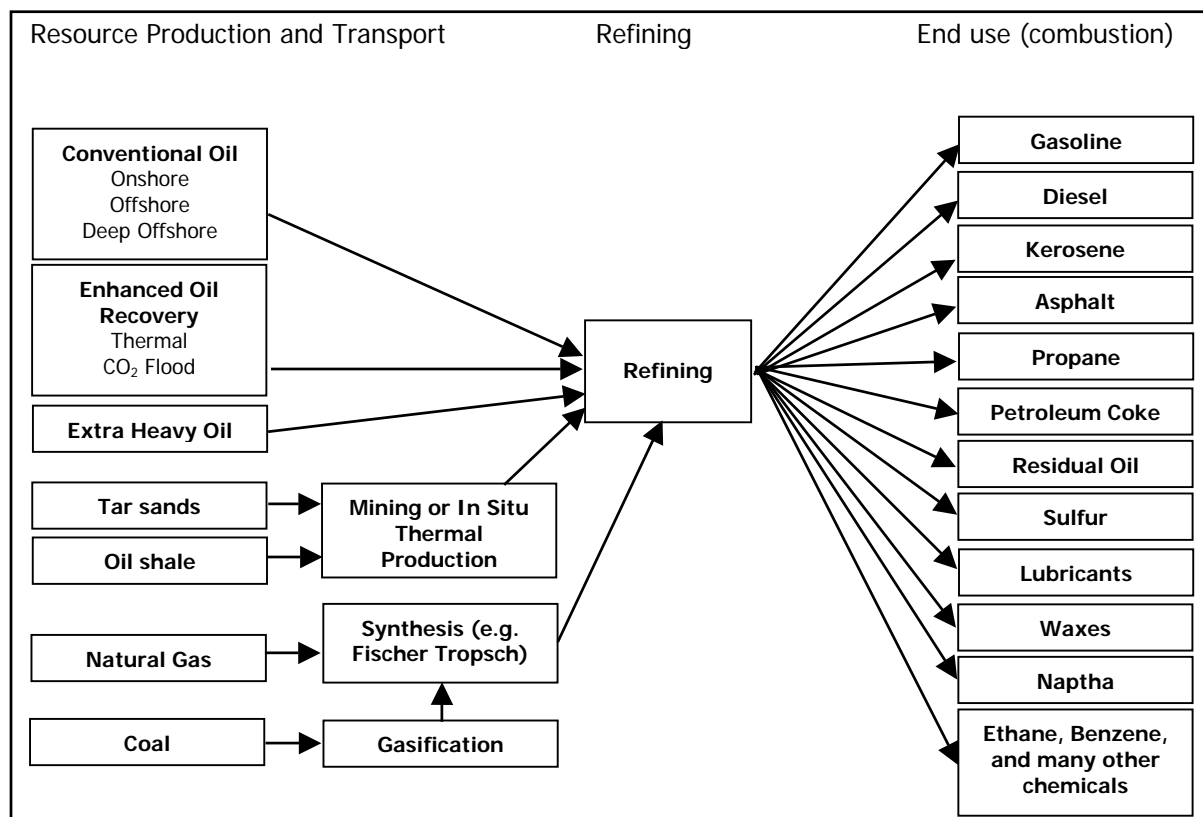

Figure 3-1: Schematic of fossil transportation fuels production

them emits additional GHGs because they are viscous and difficult to extract, and because they require additional refining in order to produce suitable finished fuels.

Synthetic liquid fuels are produced from fossil-fuel resources that cannot be reasonably classified as petroleum. The three fuels considered here are natural gas-based synthetic fuels (hereafter gas-to-liquids, GTLs, or GTL synfuels), coal-based synthetic fuels (hereafter coal-to-liquids, CTLs, or CTL synfuels), and oil shale-based synthetic crude oils. GTL and CTL processes produce synthetic diesel fuels and are described in a number of sources (Fleisch, Sills et al. 2002; Williams and Larson 2003; Brandt and Farrell 2006; Farrell and Brandt 2006). Oil shale production is much less commercially developed, and produces a synthetic crude oil that is refined into final fuels.

The cost of producing fossil hydrocarbons varies widely with the type of resource, and the price of petroleum varies with the specific properties of the oil (*e.g.*, sulfur content) and location. Average prices have varied significantly over the last 40 years. Figures 3-2 and 3-3 illustrate these ranges.

Table 3-2: GHG emissions from fossil-based transportation fuels
(gCeq/MJ of refined product)

	Conventional Oil Gasoline^a		Conventional Oil Diesel^a		Tar sands / extra heavy oil			
					low estimate		high estimate	
Upstream emissions	5.6	(22%)	4.4	(17%)	9.3 ^b	(31%)	15.8 ^c	(44%)
Combustion emissions	20.1	(78%)	21.1	(83%)	20.1	(69%)	20.1	(56%)
Total emissions	25.7	(100%)	25.5	(100%)	29.4	(100%)	35.9	(100%)
Normalized emissions	1.00		1.00		1.14		1.4	

	Enhanced oil recovery^d				Oil shale			
	low estimate		High estimate		low estimate		high estimate	
Upstream emissions	6.1 ^e	(23%)	10.6 ^e	(35%)	13	(39%)	50	(71%)
Combustion emissions	20.1	(77%)	20.1	(65%)	20.1	(61%)	20.1	(29%)
Total emissions	26.2	(100%)	30.7	(100%)	33 ^f	(100%)	70 ^{f,g}	(100%)
Normalized emissions	1.02		1.19		1.28		2.72	

	Gas-to-liquids^m				Coal-to-liquids^m			
	low estimate		high estimate		low estimate		high estimate	
Upstream emissions	7.1 ^h	(26%)	9.5 ^j	(32%)	20.7	(50%)	28.6	(59%)
Combustion emissions	20.2 ⁱ	(74%)	20.2 ⁱ	(68%)	21.1	(50%)	20.1	(41%)
Total emissions	27.3	(100%)	29.7	(100%)	41.8 ^k	(100%)	48.7 ^l	(100%)
Normalized emissions	1.07		1.16		1.64		1.89	

Notes:

- a – These figures are provided by the GREET model, which calculates upstream emissions from petroleum production, as well as 0.4gCeq./MJ emissions from natural gas leakages, 0.16 gC/MJ from natural gas flaring, and refining emissions that vary based on the product produced (Wang, Saricks et al. 1999 Volume 2, page 8).
- b – These emissions are reported by the Syncrude corporation (Syncrude Corporation 2004), which reports 5.03 gCeq./MJ upstream emissions per barrel of synthetic crude oil produced. To this, refining emissions are added. Wang reports the emissions from refining of gasoline and diesel to be 4.2 gCeq./MJ and 3.0 gCeq./MJ respectively (Wang, Saricks et al. 1999 Volume 2, page 8). The emissions from refining gasoline are used here. Estimates are also available from Suncor, another tar sands producer (Suncor 2003).
- c – The Canadian National Energy Board notes that the upstream emissions to produce a barrel of synthetic crude oil are reported at 11.54 gCeq./MJ, of which over half are methane emissions (National Energy Board 2004). Refining emissions are added to this as in note b.
- d – CCS through CO₂-induced-EOR is not included here. The amount of CCS capacity available through EOR projects is highly field-specific and still a matter of debate. Stevens *et al.* (Stevens, Kuuskraa et al. 2001) cite CO₂ injection ratios of 0.3 tonnes CO₂ per bbl of EOR output. However, much of this CO₂ is recycled in the production process, so all of it does not stay sequestered. A better figure is provided by Kovscek (2002), who notes that the volumetric density of carbon as CO₂ at typical reservoir conditions is about 1/4th that of oil (164 kgC/m³ vs. 686 kgC/m³ for oil). This suggests that approximately 5 g of carbon per MJ of oil produced through EOR can be stored in the same volume that the oil originally occupied (1/4th the C content of the produced oil).
- e – Green and Willhite (Green and Willhite 1998) cite numerous thermal enhanced oil recovery projects in California, Canada and Venezuela. If oil is used as the steam generating fuel, incremental emissions for thermal EOR range from between 0.34 gC/MJ and 7.2 gC/MJ of crude produced. If natural gas is used, emissions will

be approximately 25% lower, if coal is used, approximately 25% higher. These emissions are highly variable depending on the characteristics of the project. As a low-end estimate, a 0.5 gC/MJ penalty over conventional oil production is used, and as a non-extreme high-end estimate, a 5 gC/MJ penalty over conventional production is used.

- f – Emissions from oil shale are highly uncertain. These figures are from Sundquist and Miller (1980), and Sato and Enomoto (1997) corroborate the order of magnitude. To these emissions 4.2 gC/MJ are added for refining to gasoline (see note *b*). The low end of the range is for low-temperature retorting, and the high estimate is high because of emissions of CO₂ from decomposition of carbonate minerals contained in the shale, which occurs at high temperatures sometimes achieved in the retorting process (above 550 °C). Sato and Enomoto also see some inorganic carbon release at low temperatures in bench-scale experiments, meaning the low estimate of emissions may be too low.
- g – This figure is the high-end emissions estimate for high-grade oil shale resources. Sundquist also estimates emissions from low-grade oil shale resources, which are cited as 104 gC/MJ, or over 4 times the total emissions from conventional oil and approximately 16 times the upstream emissions(!)
- h – This datum calculated from Wang, Weber *et al.* (Wang, Weber et al. 2001), figure ES–1.4, page 10, using central estimates for Non-North American FT–diesel. Wang’s estimate of emissions from GTLs includes credits for co–produced electricity, which might not always occur. See further critiques of the GREET method in Greene (1999, pp. 28–29).
- i – Greene (Greene 1999) states that “On the basis of the energy equivalent of a gallon of petroleum–derived diesel fuel, GTL diesel should have about 4.4 percent less carbon.” Wang’s estimate of the carbon content of diesel (see note *a*) is decreased by 4.4%
- j – Greene (Greene 1999) cites two estimates of upstream emissions in tables 6 and 7. These upstream emissions are for 1995 GTL diesel.
- k – Datum from Marland (Marland 1983), for Sasol type F–T process, as cited in table 11. It should be noted that Williams and Larson (2003) cite lower emissions when credit for electricity co-production is given to the production of methanol or dimethyl-ether (DME).
- l – Datum from Williams and Larson (2003), from Bechtel/Amoco estimates, for direct coal liquefaction. Refining emissions were added from Wang (1999) as in note *b* above, because direct CTL produces a synthetic crude, not a synthetic fuel. There is uncertainty with the high-end emissions from CTL processes. For example, Marland (Marland 1983) describes the Mobil methanol-to-gasoline (MTG) process. MTG emissions are comparable to this estimate if all energy products produced are counted, but emissions per MJ of *gasoline delivered* are much higher (64.69 gC/MJ of gasoline).
- m – GTL and CTL processes are amenable to CCS, which would reduce emissions by about 90%. This potentiality is not included here but is discussed in detail by Williams and Larson (2003)

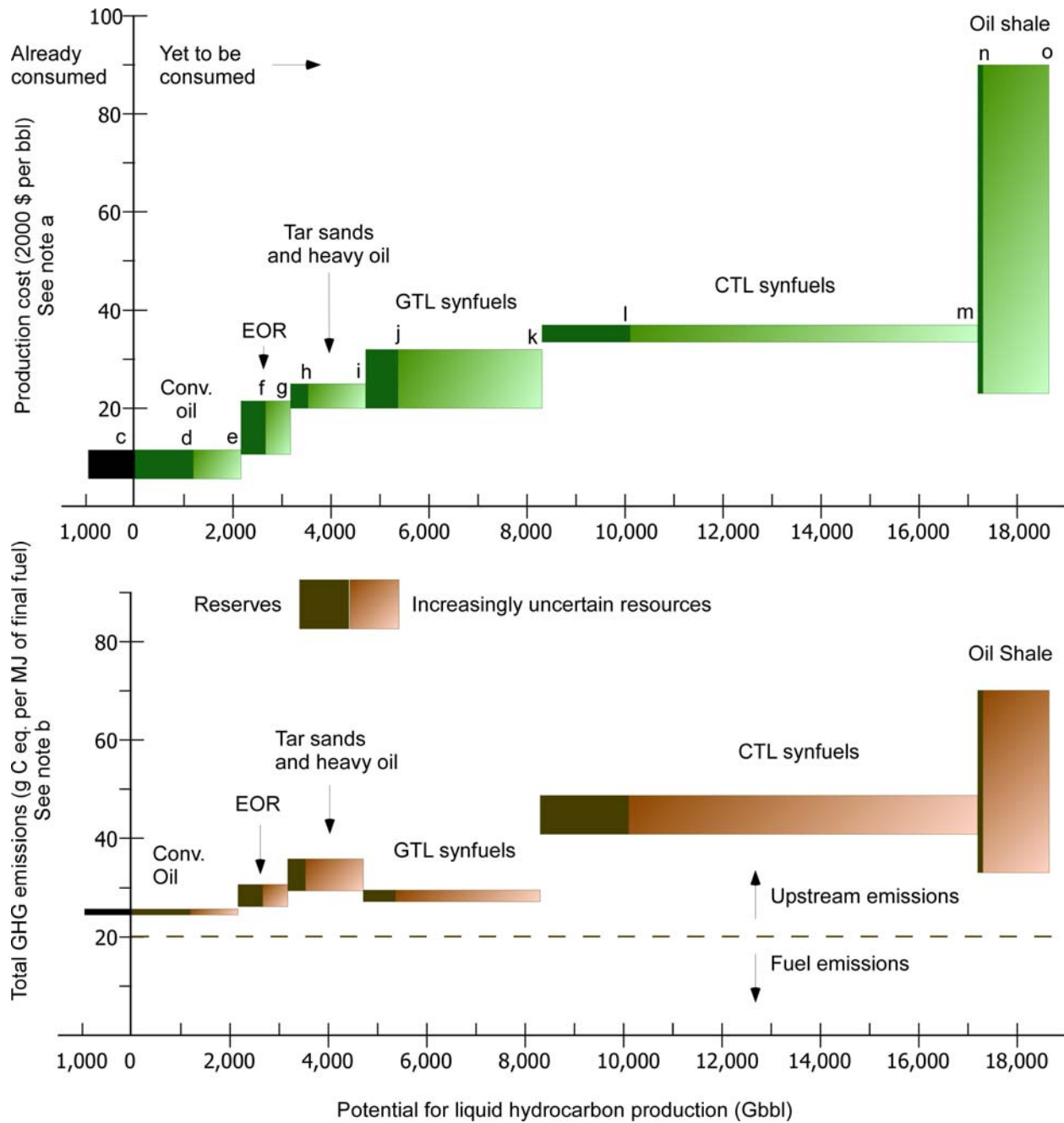

Figure 3-2: Production costs and GHG emissions for fossil hydrocarbon fuels

Source: Brandt and Farrell (2007)

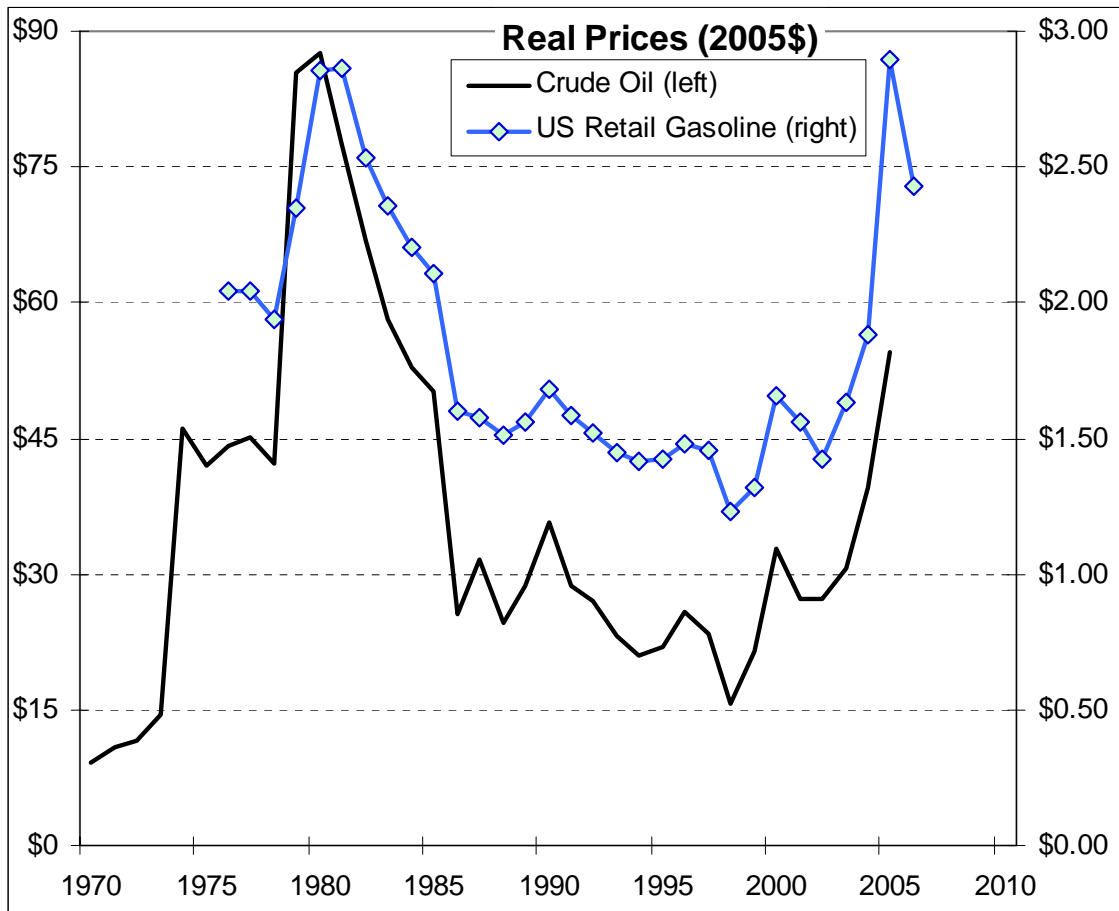

Figure 3-3: Crude oil and U.S. gasoline prices

Sources: British Petroleum (2006); Energy Information Administration (2007)

3.2 Biofuels

“Biofuels” are transportation fuels derived primarily from recently grown, as opposed to fossil, biological materials. Several types of fuel can be potentially produced from biomass; multiple processing strategies exist to convert biomass to these fuels; and a wide range of biomass feedstocks could be utilized for one or more of these processes and fuels. Each unique feedstock, conversion process, and fuel combination is referred to as a fuel “pathway.” Figure 3-4 provides an overview of several biofuel production pathways including animal feed and electricity coproducts.

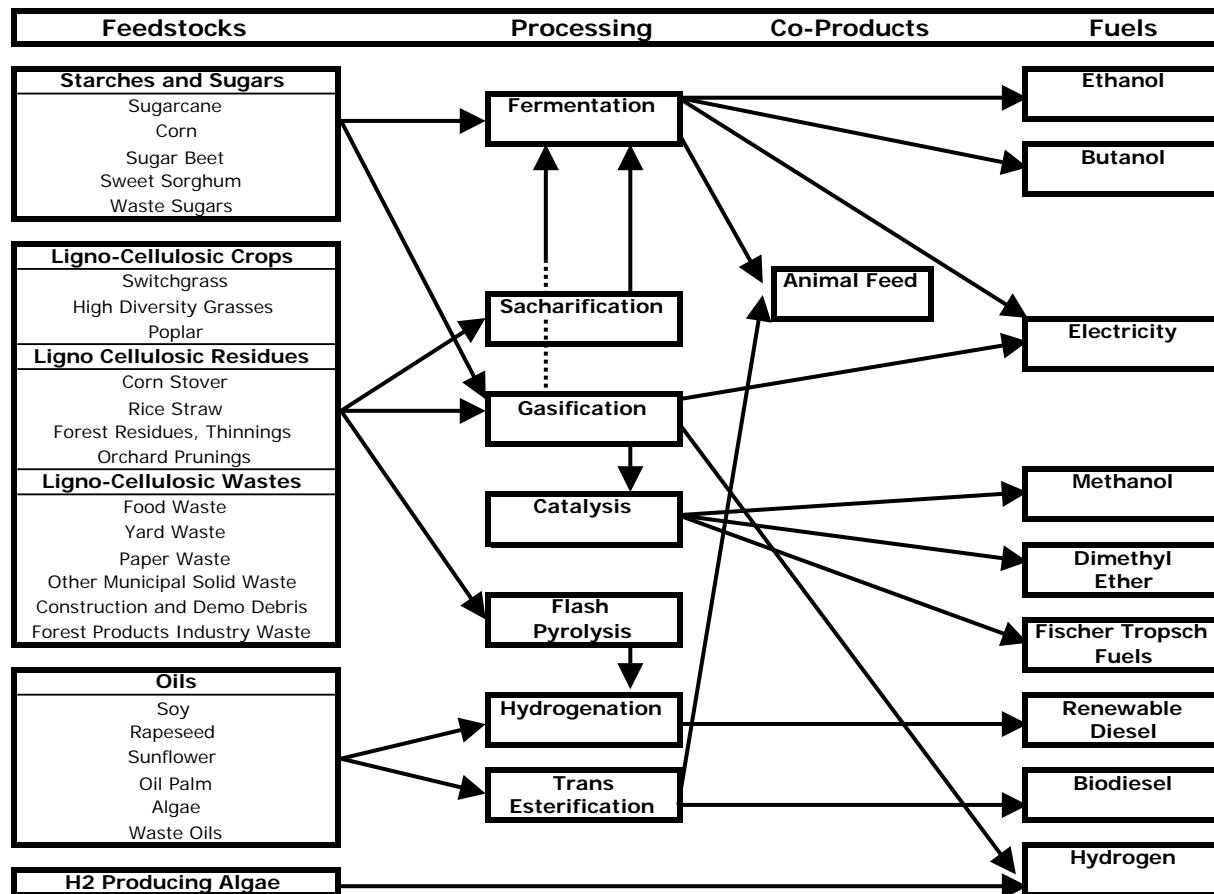

Figure 3-4: Biofuel production pathways

The net greenhouse gas emissions associated with a particular biofuel depends upon the entire fuel pathway, and can vary greatly even among pathways for which the final fuels produced are indistinguishable. In the following sections, we discuss the properties of biofuels as fuels, the various production pathways and their associated greenhouse gas emissions, infrastructure considerations, and cost drivers.

3.2.1 Biomass fuels and properties

The primary biofuels produced at a commercial scale today are ethanol from sugars and starches and transesterified biodiesel. Additional fuels in pilot- or small-scale applications include other alcohols (e.g., biobutanol and methanol; cellulosic ethanol), other diesel blendstocks (e.g.,

Fischer-Tropsch fuels, renewable diesel, and dimethyl ether), and gaseous biofuels (e.g. hydrogen and methane). In this section, we discuss the properties of biofuels, how this affects their use in vehicles, and the implications for infrastructure.

- **Ethanol**

Ethanol, $\text{CH}_3\text{CH}_2\text{OH}$, is an alcohol that can be substituted for gasoline in spark-ignition engines. Anhydrous ethanol is nearly dehydrated (<1% water) and mixed with a denaturant (typically 5% by volume gasoline) to prevent human consumption. Hydrous ethanol (an azeotrope of ethanol with 7% water) can be used in specially designed engines. Blends of anhydrous ethanol with gasoline are denoted by the letter “E” and the nominal percentage of ethanol, e.g., E85 indicates 85% anhydrous ethanol by volume. In fact, because of the presence of gasoline denaturant, the ethanol content is generally overstated by 5% (e.g., E85 actually contains roughly 81% ethanol), and in some cases the percentage may be even lower (ASTM standards allow for blends of E85 to contain as little as 72% ethanol in cold climates). In this report, this potential seasonal variation is ignored.

Ethanol can be (and indeed, currently is) blended at low percentages without any change in auto technology, while “flex-fuel” vehicles capable of burning high-ethanol blends require more corrosion-resistant materials throughout the fuel system and a system for sensing the percentage of alcohol in the fuel and adjusting the fuel injection appropriately. Ethanol-only vehicles are currently produced in Brazil and allow utilization of hydrous ethanol (saving de-watering energy in fuel production) and high-compression engines (benefiting from ethanol’s higher octane to achieve high engine thermal efficiencies).

Ethanol has high octane at 116 octane rating (compared to about 87 for regular gasoline) and high oxygen content, leading to its use as a blending component in conventional gasolines. It also has a 34% lower energy content per gallon, resulting in higher fuel consumption by volume per distance traveled in flexible-fuel vehicles.

The use of ethanol as a fuel may also incur some increased infrastructure costs because it is more corrosive to many materials than petroleum fuels, and it has a tendency to blend with water. For these reasons, ethanol is not transported in pipelines but in train and truck tankers, and splash blended with gasoline just prior to retail distribution. There is also concern about the volatility of ethanol in combination with gasoline – while the vapor pressure of ethanol is less than gasoline, the vapor pressure of low-level ethanol blends (10-20%) may be higher than gasoline.

Fuel ethanol is produced by fermentation of sugar (glucose) by yeast, a microorganism in the Fungi kingdom, just like ethanol for human consumption has been produced for millennia. Biomass feedstocks are the source of the sugar, and the simplest approach is to use sugar-producing plants, such as sugar cane, sugar beets, or sweet sorghum. Pressing these feedstocks to produce sugar requires relatively little capital and energy (compared to other methods), giving them an inherent advantage over other feedstocks. Roughly 40% of the fuel ethanol produced in the world today is made from sugar cane, almost all in Brazil. The dominant feedstock for fuel ethanol production is starch, in the form of corn kernels, wheat grains, and other agricultural products. Starch is a polymer (a long chain) of glucose that must be broken apart, so processing starch-based feedstocks requires more capital and energy relative to processing sugar-based feedstocks. For example, corn used for fuel ethanol production is ground into a fine powder,

mixed with water and enzymes, and then cooked to create fermentable sugars that are then fed to yeast. The third (and last) kind of biomass feedstock is called “cellulosic” and is made up of cellulose, hemicellulose, and lignin. Cellulose and hemicellulose are polymers of various sugars, so processing cellulosic material requires breaking it apart. Unfortunately, cellulosic material makes up the cell walls and is resistant to attack, so considerable capital and energy must be expended to do so. On the other hand, the costs and energy requirements to grow cellulosic material are far less than for sugar or starch, and this more than balances out the comparison. Considerable research is currently underway to improve the processing of cellulosic materials for use in ethanol production, including several pilot plants funded by the U.S. Department of Energy that will be constructed over the next several years.

- **Transesterified biodiesel**

Almost all biodiesel produced today is methyl ester, the result of reacting animal or vegetable esters with alcohol (methanol) in the presence of a catalyst, and then removing alcohol and glycerin co-product. The resulting biodiesel can be used in compression-ignition engines alone or in mixtures with petroleum diesel. Biodiesel blends are denoted with a “B” and the percentage by volume, but unlike ethanol these percentages are generally representative of actual content.

Transesterified biodiesel retains many unique characteristics from the feedstock oil from which it is derived. Thus soy biodiesel properties differ from canola biodiesel, which in turn varies from waste oil biodiesel. Biodiesel has a somewhat lower energy content than petrodiesel, however it has a higher lubricity and (usually) negligible sulfur content. Biodiesel generally has higher cetane rating than petrodiesel indicating improved autoignition properties, which is desirable for use in diesel engines.

Diesel engines theoretically do not require modifications to utilize biodiesel. However, natural variation in transesterified biodiesels can generate contaminants that increase fuel filters maintenance requirements and the higher gelling temperature of some biodiesels may require fuel system heating in cold climates.

- **Renewable diesel**

These products include hydrocarbons, such as alkanes, produced from biomass, that have chemical properties identical with those of fossil-derived diesel fuel. One way to do this is to hydrogenate animal fats, vegetable oils, or “bio-crude” derived from pyrolysis of biomass possibly at a refinery hydro-treater, perhaps in a specialized facility. These products can be blended easily and in large proportions with regular diesel fuel. A few forms of renewable diesel, such as the NexBTL process, are in active commercial development.

- **Fischer-Tropsch fuels**

FT fuels are produced from the reformation of synthesis gas, which is in turn produced from the gasification of many different solids. Biomass may be used as the feedstock in what is sometimes called “biomass-to-liquids” or BTL processes. The exact configuration of the gasification/FT synthesis process determines the proportion of diesel, gasoline, and electricity produced (Larsen et al 2005).

FT diesel has a more consistent chemistry than transesterified biodiesel, with energy density is closer to that of petrodiesel, very high cetane numbers, and virtually zero sulfur or aromatic hydrocarbons. Biomass FT diesel can be blended with non-compliant diesel fuels to meet California's fuel standards. FT fuels have low corrosivity and are not water-soluble. The yield of liquid fuels and electricity from FT processes is expected to be significantly higher than that from cellulosic ethanol conversion processes (Williams et al 2006).

Biomass Fischer-Tropsch technology is not yet commercialized, but offers the potential to use a relatively low-cost feedstock to produce very easy-to-use products that can be blended easily and in large proportions with conventional transportation fuels.

- **Dimethyl Ether**

Dimethyl Ether (DME), CH_3OCH_3 , is another fuel that can be derived from gasified biomass through a catalysis process different from Fischer-Tropsch. As a diesel blendstock it has a high cetane number (>55), but a low energy density. DME blending in conventional diesel can reduce sulfur, particulate, and NO_x emissions (Gray et al 2001). However, DME is more corrosive, flammable, and volatile than petroleum diesel. Using pure DME in vehicles requires pressurization to several atmospheres, similar to LPG.

- **Biobutanol**

A "second-generation" biomass fermentation product under active development, biobutanol is, like ethanol, also used with gasoline in spark-ignition engines but offers important advantages in its higher energy density and lower water contamination potential.

Butanol is less corrosive, water soluble, and evaporative than ethanol. Butanol can be shipped through existing fuel pipelines and mixed in more flexible proportions. And butanol has several key properties, including energy density and heat of vaporization, which are much closer to the properties of gasoline than in the case of ethanol. The production of butanol and incomplete combustion of butanol can lead to small amounts butyric acid, which has an extremely strong, unpleasant odor. The effects of using butanol in gasoline on air emissions are unknown.

- **Hydrogen pathways**

Hydrogen can be derived using a variety of biomass-based routes and other renewable pathways including solar and wind generated electricity, as well as nuclear power. Hydrogen can be used in fuel cell vehicles, with zero tailpipe emissions and high efficiency.

- **Biomethane**

Bio-methane is produced from the anaerobic digestion of biomass. The two common applications for this technology are landfills (yielding "landfill gas") and livestock-manure-biodigesters (biogas).

Biomethane has similar properties to natural gas, and like natural gas could potentially be used as a transportation fuel in compressed natural gas vehicles or reformed to hydrocarbon liquids using the Fischer-Tropsch process described above.

3.2.2 Biofuel feedstocks

The availability of feedstocks in California is discussed in Section 4. The feedstocks for biofuels can be divided into sugar and starch crops, ligno-cellulosic material, and oils.

- **Sugar and starch crops**

Sugar crops, including sugarcane, sugarbeets, and sweet sorghum, require relatively little processing to derive the simple sugar sucrose for fermentation to alcohol by yeasts. Starch crops such as corn, milo, or wheat require hydrolytic and enzymatic action to convert glucose and fructose to sucrose.

The greenhouse gas intensity of purpose-grown biofuel feedstocks is primarily a function of agricultural operation fuel use, release of GHGs associated with agricultural inputs such as fertilizer manufacture, and CO₂ emissions from soils and plants.¹¹ Crops that minimize extra operations and, especially, entail fewer chemical inputs per biofuel unit consequently have lower GHG emissions.

- **Ligno-cellulosic crops**

The cell walls of plants are composed mostly of lignin and cellulose. Cellulose is a polymer composed of starches that can be broken down into simpler components enzymatically through a process known as saccharification. Ligno-cellulosic crops, both herbaceous and woody plants, represent a potentially more widely available biofuel feedstock than sugar and starch crops. Both herbaceous and woody crops are perennial, and where they replace annual crops they are likely to increase soil organic carbon, creating a carbon sink¹². These crops may also have relatively low fertilizer and other input requirements, resulting in a relatively low GHG profile. Furthermore, because ligno-cellulosic conversion processes typically use the entire plant biomass either as direct feedstock or for process heat, the potential yields per land area are generally higher than for agricultural crops.

- **Ligno-cellulosic residues**

Residues may be collected as a by-product of the production of other crops, such as corn stover or rice or wheat straw, or they may be collected after processing of other crops, such as lumber mill, cotton gin, or vegetable processing residues. Residues, especially corn stover, are expected to be the first feedstocks for cellulosic biofuels to be utilized. Excessive residue removal can have important non-greenhouse gas environmental effects, such as erosion, and so should be closely limited to a sustainable level. At any level, residue removal is likely to marginally increase crop fertilizer needs and decrease soil organic carbon loads, resulting in some greenhouse gas costs. Residues collected at processing sites, such as vegetable processing and milling wastes, do not increase agricultural GHG emissions.

- **Municipal solid waste**

Municipal solid waste (MSW) destined for the landfill contains substantial ligno-cellulosic material that can be converted to biofuels. The organic fraction of MSW capable of serving as a biofuel feedstock (which does not include plastics or other energy-rich materials) constitutes 55% of all MSW destined for the landfill in California (Cascadia, 2004).

MSW, like industry residues, is already collected and concentrated, and so has a nearly-zero production “cost” and a low transportation cost.

¹¹ The release of dinitrogen oxide (N₂O) from applied nitrogen fertilizers and carbon dioxide from applied agricultural lime are two of the largest sources of chemical emissions.

¹² Though, if perennial biomass feedstocks replace native ecosystems, there generally will be a net carbon emission, not a net sequestration.

- **Oil seeds**

Oilseed crops, including soybeans, canola and mustard seeds, and sunflower seeds, are grown throughout the United States. Palm oil is grown in tropical Southeast Asia and has been linked to deforestation and the draining of peat bogs, both activities that result in large net GHG releases. Some varieties of algae are known to produce large amounts of fatty acids and have been proposed as biofuel feedstocks.

3.2.3 Biofuel production processes

- **Fermentation**

Alcohols are generally produced through fermentation. While fermentation of the simple sugars pressed from sugarcane, sweet sorghum, and sugar beets is straightforward, starch and cellulosic materials require increasingly complicated (and expensive) hydrolysis and saccharification processes before sugars are available to fermentation. Fermentation with different yeasts can produce either ethanol or butanol fuels.

Cellulosic material is often bound up with lignin in complex ways that must be broken before the cellulose is available for saccharification and fermentation. Thus ligno-cellulosic material must be pre-treated through one of several processes before enzymatic breakdown of cellulose can occur. Candidate pre-treatment processes include dilute-acid pretreatment and ammonia-fiber-explosion. The cost of pre-treatment is a major barrier to cellulosic alcohol production via the saccharification-fermentation pathway.

- **Transesterification**

The reaction of biomass oils with alcohol in the presence of a catalyst produces esters and glycerin. The esters have similar properties to diesel, and glycerin is valuable coproduct.

- **Gasification**

The partial combustion of biomass in an oxygen-limited environment can produce a CO- and H₂-rich gas called synthesis gas that can in turn be used in several processes to produce heat, electricity, and liquid fuels. Synthesis gas can be reformed using the Fischer-Tropsch process to hydrocarbons, primarily middle distillates for diesel production but also some gasoline components. Synthesis gas can also be fermented to ethanol, or refined to a pure hydrogen fuel product.

- **Flash pyrolysis**

Pyrolysis is the first stage of the gasification process that, when optimized by a short residence time and zero-oxygen environment, produces in addition to combustible synthesis gas a heavy liquid hydrocarbon called bio-oil. Bio-oil can be refined to gasoline- and diesel-like hydrocarbons.

- **Hydrothermal liquefaction**

Hydrothermal liquefaction uses high temperatures and pressure to combine water and biomass and convert both to an oily liquid that can then be separated to hydrocarbons and organic-rich water. The hydrocarbon components can then be added to standard petroleum feedstocks in refinery operations.

3.2.4 Greenhouse gases

Life cycle greenhouse gas emissions associated with biofuel production and use are the result of production emissions and the carbon released in combustion. Most, but not all, fuel-cycle carbon released from biomass was recently drawn from the atmosphere during photosynthesis by biomass feedstock, so most greenhouse gas emissions are generated from the production and use of inputs in the agricultural phase and external energy use in the conversion (biorefining) phase.

Estimating the GHG emissions of agriculture is notoriously difficult. Emissions from fossil fuel combustion in field operations and the embedded emissions of agricultural inputs is the simplest issue. More difficult is the estimation of GHG emissions from changes in soil organic carbon (SOC) and emissions of N₂O from soil interactions with nitrogen fertilizers and carbon emissions from agricultural lime.

The practices and inputs of individual farmers vary dramatically. Most of this variation, however, is captured by crop and region (Turner et al 2007). Moreover, the cost to track individual farmer practices through biorefineries may be prohibitively complex and expensive. Therefore this report recommends using average GHG emissions per feedstock and region. This is the approach used in the AB 1007 analysis conducted for the CEC.

- **Feedstock GHG emissions**

Crops that use higher levels of inputs, especially nitrogen fertilizer, per unit of biofuel yield generally have much higher GHG emissions. Crops associated with land conversion from high-carbon-storing land uses, such as palm oil's association with forest clearing and oxidation of peat soils in Southeast Asia, will have a high GHG value. Conversely, crops associated with conversion of intensively-managed annual croplands to perennial crops, such as planting deep-rooted perennial grasses on carbon-depleted row crop land, can result in net decreases in atmospheric carbon.

GHG emissions associated with feedstocks that are collected as a residue of another process are primarily based on the emissions from extra collection steps and any increase in input requirements to crop production resulting from a reduction in nutrients (or other services such as pest suppression) supplied by residues. Of course, the level of residue collection must also be set to maintain soil carbon content, or else changes in SOC must be accounted for in residue GHG intensity calculations.

- **Biofuel processing emissions**

Biofuel production typically requires both thermal and electrical energy. Ethanol producers today use a variety of fuel sources (*e.g.*, coal, natural gas, biomass) and energy conversion technologies (combustion, gasification, cogeneration) resulting in a range of environmental outcomes.

Typical dry-grind corn ethanol facilities burn fossil fuels such as coal or natural gas for heat and buy electricity from the grid. In response to higher natural gas prices, many U.S. dry-grind plants are using coal as a less costly alternative to natural gas. While many plants have been developed or redesigned to use coal, others are exploring innovative methods such as gasifying or combusting wood waste, distillers grains, and corn stover, or using advanced cogeneration units

(Nilles 2006). Others are locating near cattle feedlots to sell wet distillers grains, halving a typical plant's natural gas consumption by not drying the coproduced distillers grains.

Cellulosic fermentation, gasification, and pyrolysis biorefineries all derive their process energy from a portion of the biomass they process. Hence the CO₂ emissions from these processes are almost all "short-cycle" carbon and do not add to the overall emissions from these pathways.

As discussed above, in addition to emitting GHGs directly, biofuel production and use also *displaces* some GHG emissions because they substitute in fuel and other markets for products that have their own environmental effects. Technically, and in general, biofuel products may not merely *substitute* for other products, they also may effectively increase supply and thereby affect price and consumption. It is important to identify and quantify these effects.

For instance, corn-based ethanol produces a co-product of animal feed that may displace the production of other animal feeds and their associated GHG emissions. Similarly, but more directly, sugarcane ethanol, cellulosic ethanol, and gasification-based biofuel pathways may co-produce exportable heat and electricity that can displace alternative power production and the GHGs that would otherwise result. High net power production, such as in Brazilian sugarcane or California switchgrass scenarios above, can lead to a "net negative" GHG ratings.

3.2.5 Costs

The cost of biofuel production includes production plant capital and operating costs (energy inputs, labor) and feedstock costs (which include the costs of growing the biomass, harvesting costs, farm labor and land costs). For many biofuel pathways, revenues from coproducts such as animal feed or electricity is an important determinant of final product cost.

▪ Feedstock costs

The main components of feedstock cost for crop-based biofuels are land, chemicals and fertilizers, seeds, energy, labor, and equipment (see USDA farm cost of production data). Residues and wastes may have lower total costs because of low land, fertilizer, chemical, and seed costs, but costs for collection and transportation to the production plant may be high.

Land cost is primarily based on its opportunity cost – the per-acre returns to the farmer will be equal or greater than the returns that could be obtained from the next-best use of the land. Thus the lowest-cost feedstocks are sources that do not compete with existing crops – especially residues of existing crops, forestry residues, and food-industrial and urban wastes. The second-lowest cost feedstocks are those that displace relatively low-return land uses, such as range land, Conservation Reserve Program lands, or low-productivity field crops. Displacement of high-value crops would entail very high land cost.

Finally, price is determined by what biofuel producers are willing to pay for feedstocks. Feedstock demand is a derived function determined first by the price of the biofuel and then by the cost of processing. Thus, the greater potential per-acre biofuel production of cellulosic feedstocks does not automatically translate to a higher per-acre revenue because of the higher processing costs of cellulosic ethanol. Of course, the marginal cost of feedstock is dependent on the quantity demanded; small amounts are available at low (even negative) prices, while

increasing amounts demand increasing prices. ORNL has estimated that, nationally, a price of \$40/ton biomass is necessary to induce significant production.

Yield is the most powerful variable in determining feedstock cost. All else being equal, greater per-acre feedstock yields can decrease feedstock cost dramatically. It is potentially true that biomass crops, with sufficient research and development effort, could experience several fold yield improvements and attendant cost declines.

A large part of (prospective) cellulosic feedstock cost lies in the less-tangible issues of risk, logistics, contracting, processing, and storage. In the case of perennial crops, farmers must be assured of sufficient markets and prices over time (and/or compensated for their risk). One of the most significant hurdles to sufficient supply of new feedstocks is reducing this risk cost. Another major hurdle lies in contracting innovation. Farmers currently sell most crops on the spot market and a smaller proportion on future contracts of less than one year. But it is likely that for perennial crops, contracts of multiple years are required. Moreover, land tenure is likely to be an issue for developing perennial crops or harvest regimes. For instance, 60% of Iowa farmland is leased (Duffy 2006), most on year-to-year contracts. Longer-term rental agreements would need to be developed and to become commonplace to allow the cultivation of perennial crops.

- **Processing costs**

After feedstock, energy cost is the second cost for starch ethanol plants. While the trend in new plant construction has been toward natural gas energy sourcing, recent natural gas price volatility has engendered a resurgence in coal-fired facilities, though more creative solutions such as the use of biomass gasification systems or utilization of exhaust heat from existing thermal electric generating stations have also been employed. This trend is expected to continue into the future given the dynamics of the natural gas supply¹³, but a premium to low life cycle carbon ethanol brought about by the LCFS could be expected to encourage the latter energy solutions over coal.

In cellulosic ethanol production, process energy is obtained from the feedstock, but feedstock pre-treatment and enzyme costs are high. More speculative advanced technologies such as biomass-to-liquids technologies are characterized by high capital costs, which are in turn exacerbated by the high risk costs of these not-commercially-proven technologies.

As in feedstock production, yield of biofuel product per unit of feedstock is the greatest single determinant of product cost. Process efficiencies or feedstock quality improvements that create small increases in product yield can result in substantial aggregate cost savings.

- **Capital costs**

Capital costs for first-generation ethanol and biodiesel facilities have fallen significantly over the past two decades of development, and in the past year of strong industry growth. Costs per gallon of installed capacity in a 'standard' dry-grind corn ethanol refinery may now fall below \$1 per gallon (Gallagher et al 2003). Capital cost is particularly high for "next-generation" biofuels

¹³ North American natural gas demand is expected to increase at an annual rate of 1.1% over the next 25 years, and global demand at 3.4%, while North American supply increases at a rate of 0.4% (IEA 2006)

facilities, both because of the inherent complexity of the processes as well as high risk cost incurred by unproven technology.

▪ **Coproduct revenues**

For all biofuel technologies, revenues from coproducts of biofuel production are an important component of final product cost. Therefore the market characteristics of these coproducts affect biofuel prices. In the case of first-generation biofuels, the markets for animal feed (a coproduct of starch ethanol production) and of glycerin (a coproduct of transesterified biodiesel) have limited demand that may exert downward pressure on returns with increased supply. In contrast, the coproduct of many second-generation biofuels (and of contemporary sugarcane ethanol production) is electricity production for export to the common grid. The market for such electricity is much less limited, especially as such electricity is low-carbon, and so these coproducts may exert a more beneficial effect on biofuel cost over the long term.

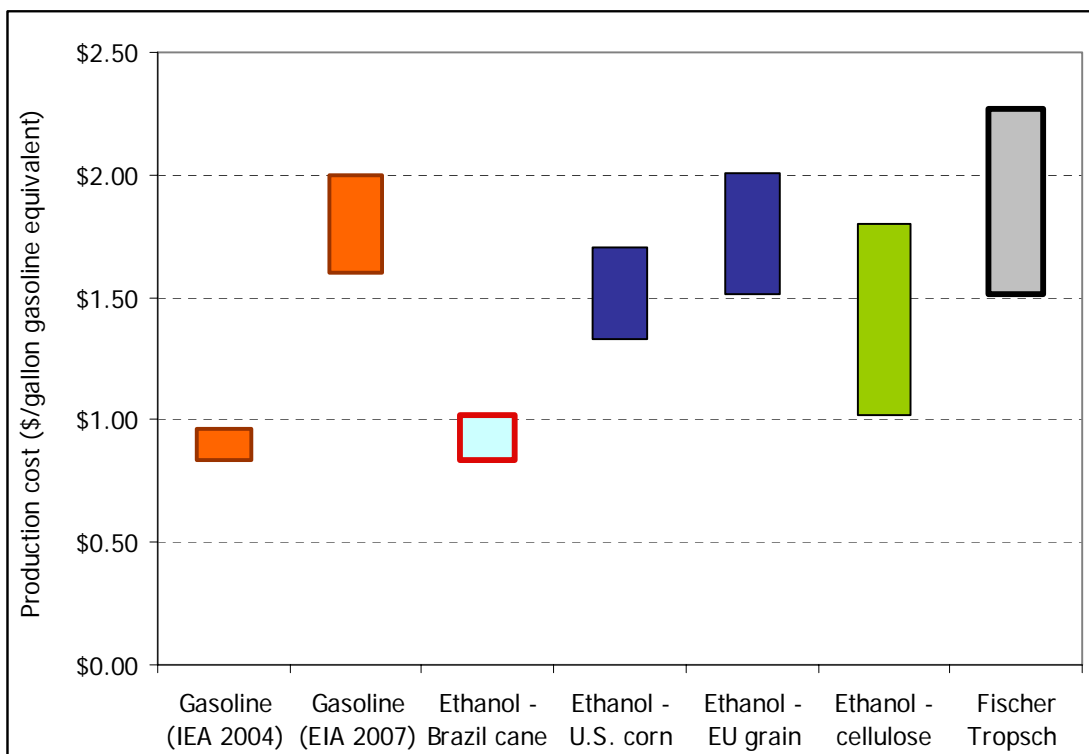

Figure 3-5: Fuel production cost estimates

Sources: Fulton, Howes et al. (2004) Figure 4.5; Energy Information Administration (2007) Figure 4

Figure 3-5 presents an estimate of the production costs for several biofuels in 2012, compared to two production prices for gasoline (Fulton, Howes et al. 2004 Figure 4.5; Energy Information Administration 2007 Figure 4). These estimates assume some technological innovation and thus are somewhat lower than current production costs may be, especially for cellulosic ethanol and Fischer Tropsch liquids. Note that only Brazilian cane-based ethanol has production costs comparable to 2004 estimated gasoline production costs, but all the biofuels shown in the figure have production costs similar to or lower than actual gasoline production costs seen in the United States over the last two years.

3.3 Electricity

Electricity is a ubiquitous energy carrier that is used for almost every imaginable purpose and application. Electricity is useful because it is flexible, efficient, and can be quite clean, but it has not been used widely for vehicle applications because of the technical and cost challenges associated with storing electricity on-board vehicles. As these challenges are addressed, electric vehicles can help the State achieve many of its policy goals, including reductions in greenhouse gas emissions, criteria air pollutants, and petroleum dependence. Unlike other alternative transportation fuels, electricity is already a widely used energy carrier and this section describes the current electricity supply system and implications for the use of electric vehicles.

The electric power system (“the grid”) produces and delivers electrical energy to customers in the residential, commercial and industrial sectors. Electricity is produced by power plants of different sizes and types, which can be fueled by a number of energy sources, such as coal, nuclear, natural gas, biomass, geothermal, wind, solar and hydropower. Demand for electricity varies on a daily and seasonal basis, so that all power plants do not need to operate continuously. Because excess electricity cannot be cheaply stored (unlike other fuels), generation and transmission of electricity is carefully managed to match the temporal pattern of demand. In California, there are nearly a thousand power plants that generate electricity using a variety of primary energy resources. Additionally, electric power is imported into the state from generators in the Northwest and Southwest states. Table 3-3 shows the breakdown of the electricity by fuel type, with additional detail about renewable electricity. Note this generation mix will change over time, and that even today it is not the generation mix that would actually provide fuel electricity for PHEVs and EVs.

Table 3-3: Gross System Power, 2005 (GWh)

Fuel Type	In-State	Imports	GSP	Share
Coal	28,129	13,090	41,219	14.3%
Large Hydro	34,500	12,484	46,984	16.3%
Natural Gas	96,088	30,163	126,251	43.8%
Nuclear	36,155	6,794	42,949	14.9%
Renewables	30,916	-	30,916	10.7%
Biomass	6,045		6,045	2.1%
Geothermal	14,379		14,379	5.0%
Small Hydro	5,386		5,386	1.9%
Solar	660		660	0.2%
Wind	4,446		4,446	1.5%
Total	225,788	62,531	288,245	100%

Source: CEC (2006)

Like many electricity systems, the electricity system in California has a great deal of underutilized capacity since the system capacity must be built for the peak demand times. In California, these peak demand times occur on summer afternoons. The annual minimum power demand can be less than 40% of the peak demand, the average demand is 60% of the peak demand, and there are several thousand hours of the year where demand is less than 50% of peak

demand. This means that the system could handle a great deal more demand without the need to upgrade capacity if the demand is appropriately timed. California relies much less on coal electricity than does much of the US (which is about 50% coal electricity), and SB1368 limits the amount of coal electricity that can be imported.

Nuclear and coal power plants are generally operated as must-run plants in that they are operated continuously except for maintenance and other outages. Other thermal plants like those operating on natural gas and biomass as well as large hydro are generally dispatchable -- they can be brought on-line when the additional generation is required and used to respond to changes in electricity demand. These are differentiated from intermittent renewables such as solar and wind whose generation is determined by natural patterns rather than a power plant operator.

Power plants are assumed to be dispatched based upon variable costs. Generators can be ordered from least to highest marginal costs and the marginal cost of the most expensive plant needed to meet an hour's demand determines that hour's market price for electricity. In California, because natural gas makes up the largest share of electricity generation and is relatively expensive on a variable cost perspective, it is typically the marginal form of generation.

The additional electricity demand with widespread use of EVs could contribute significantly to the total electricity use by the state. The total light-duty vehicle miles traveled VMT in 2005 (~265 billion miles) if all met by EVs would add more than 100,000 GWh or approximately 33% of the current statewide electricity demand. However, the timing of the electricity demand is more important than the total amount of electricity (Lemoine, Kammen et al. 2006). These additional electric demands could either ease the underutilization of power plants or exacerbate the problem depending on the time of day the vehicles are charged. This in turn affects electricity prices as well as average system emissions. It will be in the interest of utilities and the independent system operator (ISO) to ensure (or at least incentivize) that EVs are charged during off-peak periods to help raise average load factors and minimize the need for additional power plants and electricity imports.

Battery electric vehicles (BEVs) and plug-in hybrid electric vehicles (PHEVs) are two technologies that use electricity as a transportation fuel. PHEVs may overcome some of limitations of other alternatively fueled vehicles because their fuel flexibility overcomes the range limitations of EVs and relies on two currently existing and widespread infrastructures (for gasoline and electricity). BEVs operate only on electricity while PHEVs can operate in gasoline, all-electric, or 'blended' modes, which are characterized by which energy sources are used for propulsion and in general they are significantly more efficient than conventional vehicles. The electricity storage and "all-electric range" for PHEVs—the distance it can drive in electric mode—is determined by size of the batteries. PHEVs with all-electric ranges of 20 miles ("PHEV20") and 60 miles ("PHEV60") of both the compact car and SUV variety are discussed in this report. It may be that the first PHEVs adopted will have less all-electric range or will have their stored grid electricity fully "blended" into their hybrid electric mode, but electricity GHG emissions from these scenarios can be bounded by studying emissions from vehicles with greater all-electric ranges.

3.4 Hydrogen

In the past decade, hydrogen-fueled transportation has received significant attention from industry and policymakers, arising largely from its potential societal benefits. Like electricity, hydrogen can be used in vehicles with high efficiency and zero tailpipe emissions¹⁴. Hydrogen is one of the few long-term options for transportation that could reduce oil use and well to wheel emissions of both greenhouse gases and air pollutants to near zero (NRC 2004, IEA 2005).

3.4.1 Hydrogen supply pathways

Hydrogen can be produced from a range of primary sources including fossil fuels (natural gas, coal, oil) with carbon capture and sequestration, renewables (biomass, wind, solar), or nuclear energy (Figure 3-6).

Figure 3-6: Options for hydrogen production

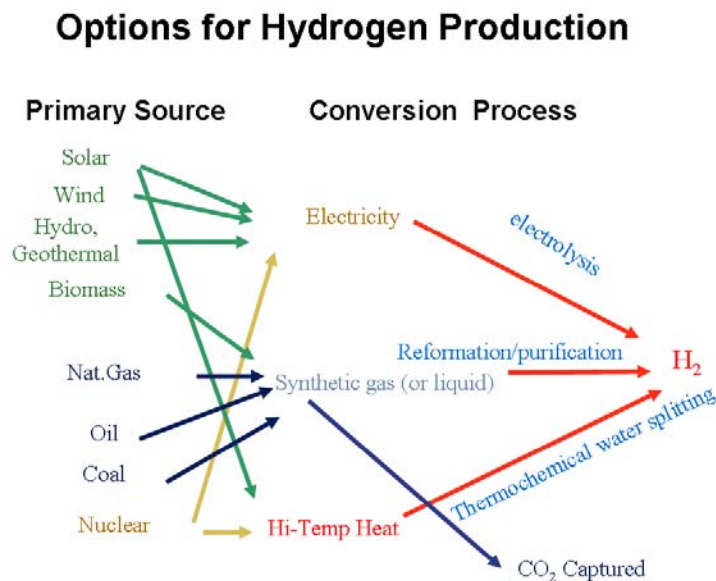

Large amounts of hydrogen are produced today for use in the oil refining and chemical industries, primarily from natural gas or other fossil sources.¹⁵ Syngas-based processes like steam methane reforming or coal gasification are well established, large-scale commercial methods for making hydrogen at relatively low costs of \$1-1.5/kg (1 kg of hydrogen has about the same energy content as 1 gallon of gasoline). Water electrolysis is a commercial technology that is used where low cost electricity is available, or at small scale where reforming is expensive. Any source of electricity could be used to power an electrolyzer, including

¹⁴ Fuel cell cars are about 2-2.5 times as efficient as a comparable gasoline internal combustion engine car, 30-50% more efficient than a gasoline hybrid, quiet and powerful. Hydrogen and fuel cells also offer the potential for innovation. Several auto companies are investigating fuel cells as a superior route to a viable electric car.

¹⁵ About 1-2% of primary energy worldwide goes to hydrogen production. Current US industrial hydrogen production could fuel about 30 million fuel cell cars, and accounts for about 5% of annual natural gas consumption..

intermittent renewable resources like wind or solar. Thermochemical water splitting, which utilizes high temperature heat from nuclear or solar sources to power a series of coupled chemical reactions to make hydrogen, is still in the research stage. There are many other processes that could be used to produce hydrogen that are undergoing basic research, but are far from commercialization.

For storage and transport to users, hydrogen is compressed to high pressure (1000-10,000 psi) or liquefied at very low temperature (-253 °C). Commercially available hydrogen storage technologies are energy intensive, requiring significant amounts of electricity, especially for liquefaction. Storing hydrogen is more costly than storing liquid fuels (although less costly than storing electricity in batteries). Developing new hydrogen storage methods is an active area of R&D.

Hydrogen can be produced “onsite” at refueling stations (via small scale steam reforming of natural gas or water electrolysis) or in a large central plant and delivered to users in compressed gas or liquid hydrogen trucks or via gas pipelines.

3.4.2 Delivered cost of hydrogen fuel

The delivered cost of hydrogen transportation fuel has been estimated in various studies (NRC, IEA, CONCAWE, Yang and Ogden). In Figure 3-7, we show results from the 2004 NRC Hydrogen Economy study, based on current (2004) and future (2020) technologies, used at large scale. The cost of production, delivery and refueling stations are indicated. Typical delivered hydrogen costs for large scale systems are in the \$2-4/kg range. There are a number of low carbon fossil and renewable routes that could compete with gasoline (shown as a red band), on a cents per mile basis. With scale economies, full utilization of the refueling station, and technical improvements, costs should reach the levels shown in Figure 3-7, once at least 5-10 percent of vehicles run on hydrogen.

It is important to note that these levels of vehicle use will not be reached for some time. (The most optimistic DOE scenarios indicate about 5% of US vehicles might run on hydrogen by 2025). Costs for hydrogen from the first hydrogen stations are likely to be significantly higher (California Hydrogen Highway Network Blueprint Plan 2005), because technology is still evolving, and early stations serving the first vehicles will tend to be smaller and underutilized (Weinert 2005). Strategies for coordinated introduction of hydrogen vehicles and build-up of hydrogen infrastructure in California are discussed further in Section 4.

Figure 3-7: Delivered H₂ costs

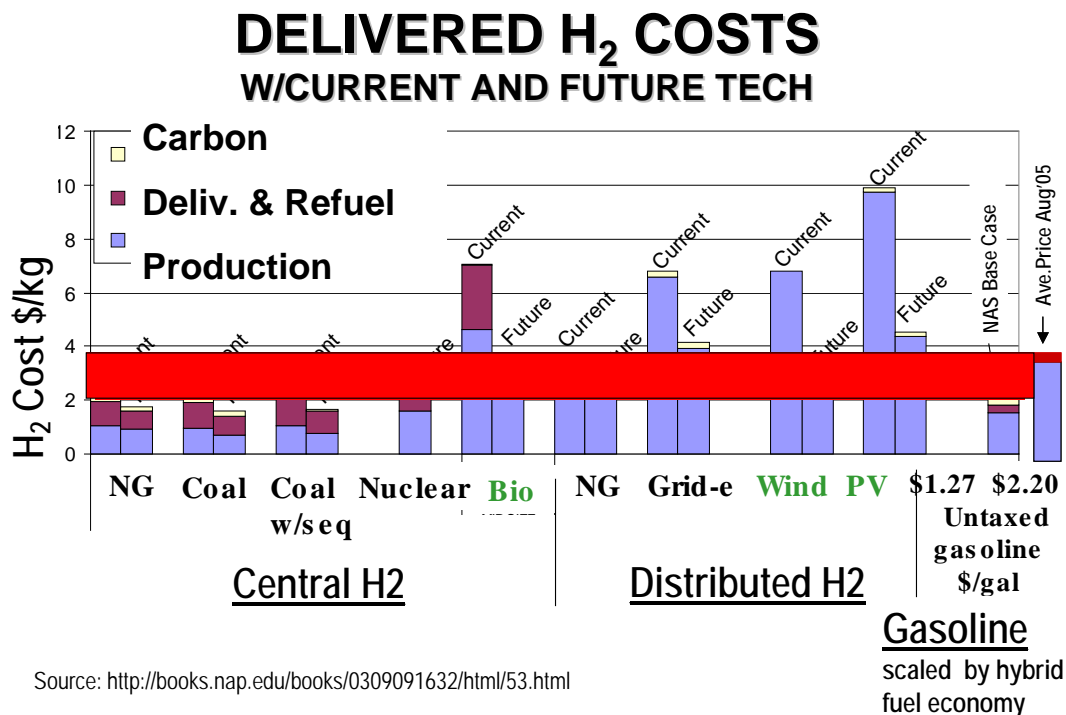

3.5 Other environmental issues

Transportation fuels have environmental impacts beyond greenhouse gas emissions. In evaluating the environmental performance of fuels, the range of concerns is potentially large and complex. This section is meant to be illustrative only, so a subset of issues that demonstrate the complexity of a more complete effort were chosen. They include:

- Land-use change
- Ground- and surface-water contamination
- Criteria and toxic combustion emissions
- Environmental impacts of perturbations to the complex nitrogen cycle
- Soil erosion and loss of soil nutrients
- Pesticides
- Water depletion
- Environmental impacts of electricity

3.6 References

(2003). "Emerging Risks in the 21st Century: An Agenda for Action." OECD Environment and Sustainable Development **2003**(4): I-290.

Bentley, R. W. (2002). "Oil forecasts, past and present." Energy Exploration & Exploitation **20-1**(6-1): 481-491.

- Brandt, A. R. and A. E. Farrell (2006). "Scraping the bottom of the barrel: CO2 emissions consequences of a transition to low-quality and synthetic petroleum resources." Climatic Change **Forthcoming**.
- Norman Brinkman, Michael Wang, Trudy Weber, Thomas Darlington, "Well-to-Wheels Analysis of Advanced Fuel/Vehicle Systems — A North American Study of Energy Use, Greenhouse Gas Emissions, and Criteria Pollutant Emissions," May 2005.
- British Petroleum (2006). BP Statistical Review Of World Energy. London, The British Petroleum Company, plc.
- California Energy Commission "Summer 2006 Electricity Supply and Demand Outlook." Final Staff Report. CEC 700-2006-005. April 2006.
- California Energy Commission Media Office. "Power Plant Fact Sheet" February, 23 2007.
- California Hydrogen Highway Network Blueprint Plan, 2005..
- http://www.cafcp.org/fuel-vehl_map.html
- CONCAWE, "Well-To-Wheels Analysis Of Future Automotive Fuels And Powertrains In The European Context," Well to Wheels report, Version 2c, March 2007.
- Davis, S. C. and S. W. Diegel (2006). Transportation Energy Data Book (25th Edition). Washington, DC, Office of Transportation Technologies, US Department of Energy: 280.
- Energy Information Administration (2006). International Energy Outlook. Washington, U.S. Department of Energy: 273.
- Energy Information Administration (2007). Petroleum Marketing Monthly Washington, U.S. Department of Energy.
- Farrell, A. E. and A. R. Brandt (2006). "Risks of the Oil Transition." Environmental Research Letters **1**(0104004): 6.
- Fleisch, T. H., R. A. Sills, et al. (2002). "Emergence of the Gas-To-Liquids Industry: A Review of Global GTL Developments." Journal of Natural Gas Chemistry **11**(1): 1-14.
- Fulton, L. M., T. Howes, et al. (2004). Biofuels For Transport. Paris, International Energy Agency.
- Green, D. W. and G. P. Willhite (1998). Enhanced Oil Recovery. Richardson, TX, Society of Petroleum Engineers.
- Greene, D. L. (1999). An Assessment of Energy and Environmental Issues Related to the Use of Gas-to-Liquid Fuels in Transportation. Oak Ridge Tennessee, Oak Ridge National Laboratory: 70.
- Hyne, N. J. (2001). Nontechnical Guide to Petroleum Geology, Exploration, Drilling and Production. Tulsa, PennWell.
- International Energy Agency, "Prospects for Hydrogen and Fuel Cells," Organization for Economic Cooperation and Development, Paris, France, 2005.
- Kovscek, A. R. (2002). "Screening criteria for CO2 storage in oil reservoirs." Petroleum Science and Technology **20**(7&8): 841-866.
- Kreutz, T., R. Williams, R. Socolow, P. Chiesa and G. Lozza (2002), "Analysis of Hydrogen and Electricity Production from Fossil Fuels with CO₂ Capture," *Proceedings of the 6th International Conference on Greenhouse gas Control technologies*, 30 Sept-4 October 2002, Kyoto, Japan.
- Lemoine, D., D. M. Kammen, et al. (2006). "Effects of PHEVs on Electricity and Gasoline Markets." **Under review**.

- Marland, G. (1983). "Carbon-Dioxide Emission Rates for Conventional and Synthetic Fuels." *Energy* **8**(12): 981-992.
- National Energy Board (2004). Canada's oil sands: opportunities and challenges to 2015. *Energy Market Assessment*, National Energy Board, Canada: 158.
- NRC, *The Hydrogen Economy: Opportunities, Costs, Barriers, and R&D Needs*. National Research Council - Board on Energy and Environmental Systems: Washington DC.(2004), p. 394.
- Nilles, D. (2006). Process Heat and Steam Alternatives Rising. *Ethanol Producer Magazine*. **June**.
- O'Dell, P. R. (2004). Why Carbon Fuels Will Dominate The 21st Century's Global Energy Economy. Brentwood, Multi-Science.
- Pacific Northwest Laboratory "Module 2: Permitting Hydrogen Motor Fuel Dispensing Facilities" PNNL-14518. *Office of Energy Efficiency and Renewable Energy*. December 14th, 2004.
- A. Rousseau and P. Sharer, "Comparing Apples to Apples: Well-to-Wheel Analysis of Current ICE and Fuel Cell Vehicle Technologies," Argonne National Laboratory, Report No. 2004-01-1015.
- Sato, S. and M. Enomoto (1997). "Development of new estimation method for CO₂ evolved from oil shale." *Fuel Processing Technology* **53**(1997): 41-47.
- Shires, T. M. and C. J. Loughran (2004). Compendium of Greenhouse Gas Emissions Methodologies for the Oil and Gas Industry. Washington, DC, American Petroleum Institute: 485.
- Simmons, M. R. (2005). Twilight In the Desert: The Coming Saudi Oil Shock and the World Economy. New York, John Wiley & Sons.
- Stevens, S. H., V. A. Kuuskraa, et al. (2001). "CO₂ injection and sequestration in depleted oil and gas fields and deep coal seams: worldwide potential and costs." *Environmental Geosciences* **8**(3): 200-209.
- Suncor (2003). Suncor energy Inc. 9th Annual Progress Report. Fort McMurray, Alberta, Canada, Suncor Energy inc.: 36.
- Sundquist, E. T. and G. A. Miller (1980). "Oil Shales and Carbon Dioxide." *Science* **208**(4445): 740-741.
- Syncrude Corporation (2004). An Action Plan for Reducing Greenhouse Gas Emissions: Action Plan and 2003 Progress Report. Fort McMurray, CA: 25.
- U.S. Department of Energy. "Alternative Fuels Data Center (Home Page)" *Office of Energy Efficiency and Renewable Energy*. <http://www.eere.energy.gov/afdc/> Accessed March 2007.
- U.S. Department of Energy. "Biodiesel: Handling and Use Guidelines." *Office of Energy Efficiency and Renewable Energy*. DOE/GO – 102006-2358, 3rd Edition, September 2006.
- U.S. Department of Energy. "Handbook for Storing, Dispensing and Handling E85." *Office of Energy Efficiency and Renewable Energy*. DOE/GO – 102006-2358, 3rd Ed., Sept. 2006.
- Wang, M., C. Saricks, et al. (1999). Effects of Fuel Ethanol Use on Fuel-Cycle Energy and Greenhouse Gas Emissions. Argonne, IL, Center for Transportation Research, Energy Systems Division, Argonne National Laboratory: 39.
- M. Wang, "Fuel Choices for Fuel Cell Vehicles: Well to Wheels Energy and Emissions Impacts," *Journal of Power Sources*. 112, (2002), p. 307-321.
- Michael Wang, Argonne National Laboratory, "Well-to-Wheels Analysis with the GREET Model," 2005 DOE Hydrogen Program Review, May 26, 2005

Wang, M., T. Weber, et al. (2001). Well-to-Wheel Energy Use and Greenhouse Gas Emissions of Advanced Fuel/Vehicle Systems - North American Analysis: Volume I, Executive Summary. Argonne, IL, Argonne National Laboratory: 47.

Jonathan Weinert, Masters' Thesis, University of California, Davis, January 2005.

Malcolm Weiss, John Heywood, Andreas Schaeffer, Vinod Natarajan, "Comparative Assessment of Fuel Cell Cars," MIT LFEE Report 2003-001-RP, February, 2003.

Williams, R. H. and E. D. Larson (2003). "A comparison of direct and indirect liquefaction technologies for making fluid fuels from coal." Energy and Sustainable Development **VII**(4): 103-129.

Yang, C., Ogden, J. "Determining the lowest costs hydrogen delivery mode" *International Journal of Hydrogen Energy*. Vol. 32. 2007. pp. 268 – 286.

Yacobucci, B. "Alternative Transportation Fuels and Vehicles: Energy, Environmental and Development Issues." *CRS Report for Congress*. Updated January 9th, 2004.

This page is intentionally blank.

4 Resources for Low-Carbon Fuels

4.1 Biomass resources for low-carbon fuels

Large amounts of biomass from both within and outside California are available to support increased production of alcohols, renewable gasolines and diesels, biogas, synthetic natural gas, hydrogen, electricity and other products in support of a low-carbon fuel standard. The full extent to which biomass resources can be managed for the production of energy and products remains speculative, however, due to uncertainties concerning the gross magnitude of the resource, the quantity that can be used on a sustainable basis, and the costs of producing, acquiring, and converting the large number of biomass feedstocks available and those that will emerge in the future.

To supplement biomass resources grown in the state, additional biomass beyond current imports could be used to expand biofuel production and renewable electricity generation. Corn grain is the principal imported feedstock that at present is being used to supplement in-state ethanol production, an operation building on existing use of grains and other commodities brought in as animal feeds. Rather than directly feeding the grain, distillers grains produced as a fermentation co-product with the alcohol are fed without substantial loss of nutritional value. Biomass is also imported in the form of food stuffs, packaging, and other materials that contribute to the urban waste stream. Biofuels and biofuel intermediates such as plant oils and other bio-oils imported from other states and nations might also contribute more to state supplies in the future. In implementing any LCFS, the state will need to address the sustainability of biomass and biofuel production practices associated with imports in addition to setting standards for in-state production.

The principal sources of biomass are agriculture and forestry. Biomass also makes up a major share of urban wastes such as municipal solid wastes. All three resource sectors provide biomass as residues of other operations and activities. Agriculture and forestry can both expand or shift production to dedicated or purpose-grown energy crops to increase supplies for biofuels and electricity generation.

The total or gross estimated California residue biomass resource as of 2005 amounts to 84 million dry tons (Gildart and Williams for CEC 2006) (Table 4-1, Figure 4-1), although there remains some uncertainty in this estimate. Biomass is a distributed resource with development opportunities across the entire state (Figure 4-2). The most concentrated sources are those associated with municipal waste collection and disposal (*e.g.*, landfilling), confined animal feeding operations (CAFO), food and agricultural processing, and forest products manufacturing.

The overall biofuel potential associated with the annual waste and residue biomass in California amounts to roughly 6 billion gallons per year of gasoline equivalent, but not all of the biomass produced in the state can or should be used for industrial purposes. For example, not all agricultural crop or forest management residue should be harvested where it is needed to maintain soil quality or for erosion control. Similarly, terrain limitations, environmental and ecosystem requirements, collection inefficiencies, and a number of other technical and social constraints limit the amount of biomass that can actually be used. For these reasons, amounts

that can technically be supplied to utilization activities are less than gross production (Figure 4-1). Expansion of bioenergy from residue biomass in the state supplemented by a modest growth in energy crop production might be producing on the order of 1 to 2 billion gallons ethanol equivalent per year within 15 years with double the current electricity generation (A roadmap for the development of biomass in California 2006). Major breakthroughs in biomass yields, production cost reductions, and energy and environmental policy changes might substantially influence these estimates. Additional economic constraints further limit development. The latter are site specific and require detailed analyses for any proposed project.

Table 4-1: Estimates of current total annual residue biomass in California

	Million dry tons per year (except as noted)
<i>Total Biomass</i>	<i>84.0</i>
<i>Total Agricultural</i>	<i>20.9</i>
Total Animal Manure	10.3
Total Cattle Manure	8.4
Milk Cow Manure	3.9
Total Orchard and Vine	2.5
Total Field and Seed	5.0
Total Vegetable	1.6
Total Food Processing	1.5
<i>Total Forestry</i>	<i>26.8</i>
Mill Residue	6.2
Forest Thinnings	7.7
Logging Slash	8.0
Chaparral	4.9
<i>Total Urban</i>	<i>36.3</i>
Biosolids Landfilled	0.1
Biosolids Diverted	0.7
Total MSW Biomass Landfilled	18.3
Total MSW Biomass Diverted	17.2
Methane in landfill gas	80 BCF/y ⁽¹⁾
Methane in biogas from waste-water treatment plants	10 BCF/y ⁽¹⁾

⁽¹⁾ billion cubic feet per year.

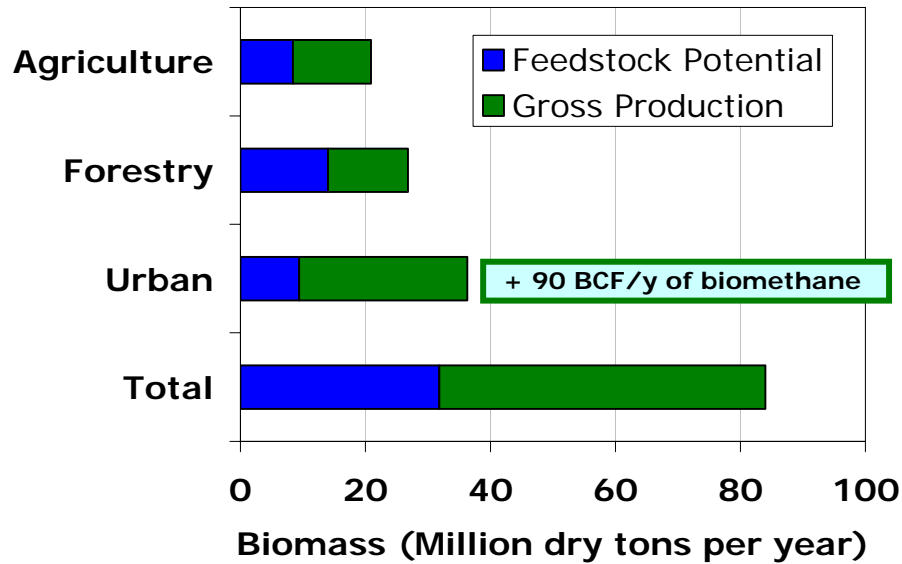

Figure 4-1: Total annual residue biomass in California and estimated technically recoverable feedstock potential

Source: Gildart and Williams for CEC (2006). BCF = billion cubic feet.

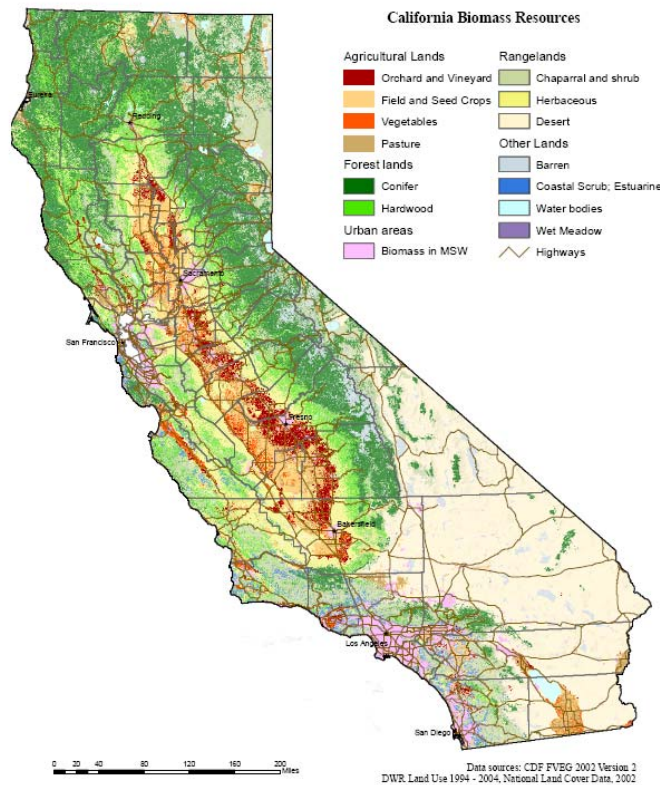

Figure 4-2: Distribution of biomass resources in California

Source: Gildart and Williams for CEC (2006)

Economies of scale for capital equipment, increasing feedstock acquisition costs as production capacities increase, and other effects create the potential for an optimal facility size (Jenkins 1997). Development of biofuel and other bioenergy systems may for this reason occur over a wide capacity range depending on type of facility, location, resource availability, transportation and other infrastructure, conversion process, regulatory conditions, product, and market. Available port facilities in addition to truck and rail access offer potential for increasing imports of biomass and biofuels from the Midwest and elsewhere in the US as well as from locations outside the US. Life cycle environmental and cost impacts need further assessment for these broader scale approaches for augmenting in-state supplies.

More than a billion tons of waste currently reside in landfills in the state, of which half or more is biomass that potentially could be mined for its resource value. Although landfills emit greenhouse gases in the form of uncontrolled methane, improved designs of landfill gas recovery systems have reduced total emissions and global warming impacts. Materials in landfills such as wood that do not fully decompose, or decompose only over highly extended periods of time (Micales and Skog 1997), represent a major stock of sequestered carbon. Attempts to mine the resource should recognize the greenhouse gas impacts associated with removal from landfill over the shorter term.

Nationally, biomass resources in agriculture and forestry amount to more than 1.3 billion dry tons, sufficient to meet roughly one-third of current transportation fuel demand in the US were they to be used entirely for this purpose (Perlack et al. 2005). By this estimate, forestlands contribute 368 million tons with agriculture responsible for another 1 billion tons including annual crop residues (428 million tons), perennial crops (377 million tons), grains (87 million tons), and animal manures, processing residues, and other feedstocks (106 million tons). Woods from forestry and biomass from annual and perennial crops are predominantly cellulosic feedstocks as contrasted with the grains and oil seeds supplying most of the existing US biofuel production capacity. In arriving at the national biomass resource estimate, a number of important assumptions were made relating to increased yields of grains, oilseeds, and residue biomass along with shifts to more sustainable cultivation practices. Inclusion of urban biomass resources and other future possibilities such as algae for lipids and carbohydrates increases the overall US biofuel feedstock potential. The extent to which this potential can be realized under sustainable practices remains somewhat speculative and a substantial research effort will be needed to support development on the scale envisioned.

Although the potential industrial biomass resource is large, the quantity of biofuel entering the California market under an LCFS will depend on the production practices employed in addition to other market effects. Ethanol is now the principal biofuel used in the state, and with a current in-state production capacity of only 71 million gallons per year (MGY), most of the 900 million gallons used are imported, with 90 percent coming from the Midwest (Integrated Energy Policy Report 2005). Processing energy for ethanol from corn comes principally from natural gas, but about 20% of capacity uses coal (EPA 2007). Without carbon capture and storage, net greenhouse gas emissions from coal-fired ethanol facilities exceed those from gasoline. In contrast, ethanol from facilities firing natural gas (78 percent of US capacity) yields reductions, if small, in greenhouse gas emissions compared with gasoline. In California, direct use of wet distillers grains as animal feeds further avoids emissions from dryers that are commonly utilized

in Midwest ethanol production. However, emissions of residual alcohols in the wet distillers grains during handling can contribute to volatile organic compound (VOC) emissions affecting local or regional air quality. Full system evaluations are critical to evaluating overall impacts associated with the various biofuel pathways.

Greater reductions in greenhouse gas emissions from grain fermentation come from the use of biomass in the form of grain crop residues, biogas from animal manures, landfill gas, and other sources to supply process energy. Beyond this, shifting from grain starch to sugar and cellulosic feedstocks can further reduce net greenhouse gas emissions from fermentation facilities. Sugar crops, such as sugar beets, sweet sorghum, and sugarcane have been investigated for ethanol production in California, and are receiving increasing attention as biofuel feedstocks for the US (Shaffer et al. 1992; Burnes et al. 2004). Sugarcane already serves as the primary feedstock for ethanol production in Brazil. Cellulosic feedstocks including annual and perennial grasses, algae, wood, cereal straws and other crop residues constitute a larger resource and avoid many of the agronomic and life cycle sustainability and food competition issues associated with grain production. Conversion of cellulosic biomass to alcohol, whether by biochemical, thermochemical, or integrated systems has yet to achieve commercial feasibility anywhere. Recent grant awards from the US Department of Energy in support of commercial scale (700 tons per day feedstock) biorefineries using a variety of approaches including enzyme hydrolysis, acid hydrolysis, and gasification with catalytic synthesis or syngas fermentation are intended to test commercial feasibility (USDOE 2007). Concentrated acid hydrolysis techniques for biomass fermentation that were employed commercially beginning prior to World War II (USDOE 2006), for example, need to show improved acid recovery and recycling in order to demonstrate environmental, technical, and economic feasibility. Similar technical and cost hurdles exist for other cellulosic biorefinery concepts, but potential greenhouse gas benefits are thought to be substantially better than for grain fermentation. Large greenhouse gas benefits are also thought to accrue to renewable diesel fuels from biomass, whether as lipid esters (biodiesel) or as Fischer-Tropsch and other liquids synthesized from syngas. Demonstration on the scale of the projects proposed will be required to prove these contentions.

Even with large greenhouse gas benefits, debate continues over other environmental impacts associated with large scale biofuel production and use, such as the potential for increased criteria and other pollutant emissions from ethanol and degradation of regional air quality with adverse health impacts (Archer and Jacobson 2003). Such concerns extend beyond ethanol and include electricity generation from biomass, for example. Concerns also exist over the agronomic sustainability of energy crop production techniques, especially where inputs of water and fertilizer are high to achieve high yields.

Water is likely to be a limiting resource for energy crop development in many areas. On more marginal lands with limited water, biomass yields might average 5 dry tons per acre per year or less. Much higher yields can be obtained under better conditions (Jenkins for CEC 2005). Water demands could be high if energy crop irrigation requirements are greater than for the crops displaced. California's high value specialty crop markets suggest that crop shifting to increase corn production, for example, may not occur on a large scale unless fuel prices increase substantially. Elsewhere in the US, water use by corn biorefineries has become limiting to capacity expansion (Keeney and Muller 2006).

The integration of biomass crop production into more conventional agriculture may assist in improving overall sustainability in some locations, however. In California, phytoremediation of soils through energy crop production could help sustain farming on the west-side of the San Joaquin Valley where restricted drainage has led to high water tables and increasing salinization with large tracts of land already retired from agriculture. Farming in the valley relies on irrigation using both imported water as well as groundwater. Drainage systems that were integral to plans for agricultural development through the state and federal water projects were never fully realized due to environmental and financial concerns. Discovery of wildfowl deformities and mortalities at the primary drain terminus at Kesterson reservoir in the early 1980s led to restrictions on drainage from farm lands. Growers and local water districts are now faced with identifying other drainage management options, including on-farm or regional management systems and land retirement. More than 100,000 acres have so far been retired due to shallow groundwater tables and salt buildup from inadequate drainage, and 1.5 million acres are considered drainage impaired. Dedicated biomass crops could be used to help remediate these lands and provide much needed economic relief to farmers and local communities. Such crops could serve as biological pumps, lowering groundwater tables and reducing waterlogging of the soil. The types of crops to plant, uses for the crops, supplemental irrigation requirements, and other impacts on the environmental quality of the valley, including air quality impacts, are the subjects of on-going research. The production of biomass crops in such areas might help overcome what has become a serious environmental and economic crisis for the state.

These sustainability issues have been generally recognized and have stimulated recommendations for state and federal actions defining standards and indices to certify sustainable practice and calling for state policies to ensure compliance with other environmental objectives (A roadmap for the development of biomass in California 2006; Turner et al. 2007; _____ 2007). Future performance standards and compliance mechanisms are likely to affect the amount of resource that will prove acceptable for use in biorefining and power generation.

Satisfying California's enormous appetite for transportation fuels is unlikely to occur through use of biomass alone. Under a high future gasoline and diesel demand scenario, in order to reduce state transportation greenhouse gas emissions to levels equal to the statewide targets under the Governor's Executive Order S-3-05 would require 11 billion gallons gasoline equivalent and 9 billion gallons diesel equivalent by 2050 (Jenkins 2007). To comply with targets (75% by 2050) for in-state biofuel production under the Governor's Executive Order S-06-06, California capacity would need to expand to a total of 15 billion gallons gasoline and diesel equivalent with a biomass feedstock requirement above 200 million tons per year. Even under a low gasoline and diesel demand scenario, total in-state production would need to exceed 11 billion gallons gasoline equivalent per year. While in-state capacity might be able to meet production targets through 2020 of roughly 2 billion gallons gasoline equivalent from biomass resources in California, the target for 2050 is clearly beyond any current biomass resource projections for the state. To meet these fuel levels will require biomass imports or the use of other alternative fuels along with increased transportation efficiency.

4.1.1 Energy crops and biomass in agricultural and forestry residues

Required land area for conventional starch and sugar ethanol feedstocks could reach from 1 to 7 million in-state acres depending on biofuel demand and combinations of crops. Land area required for oil seed crops for conventional biodiesel production could grow to more than 14 million acres by 2050 for a 20% renewable fuel standard (RFS) scenario. California currently harvests around 9 million acres of crop land. Competition for land will arise under high biofuel demands if conventional biofuel feedstocks only are proposed to meet in-state production targets such as described earlier. Utilization of lignocellulosic resources and continued research into improving sustainable yields and developing new products will be needed to satisfy long range targets. Ethanol from current in-state lignocellulosic resources could supply 2 – 3 billion gpy ethanol (1.3 – 2 billion gallons gasoline equivalent). The future production of high yielding species including energy grasses and algae could increase biofuel yields while reducing land area requirements. Improved yields arising from genetic improvement or modification of energy crops may similarly reduce land and production input requirements. Standards for sustainable production will be needed to ensure best practices and meet the objectives under the low-carbon fuel standard. Existing standards, such as those developed for some forestry management practices, can be adopted, but development of other new standards will be required as energy crop production and agricultural residue utilization increase (A roadmap for the development of biomass in California 2006).

4.1.2 In-state starch and sugar crops

California's diverse agricultural sector includes many starch and sugar crops that could be used for bioethanol feedstocks. Grown currently mostly for food and feed, existing California crops with the largest potential for conventional bioethanol production are rice, wheat, corn, barley, sorghum, and oat grain crops and sugar beets. These crops together accounted for more than 1.1 million acres harvested in 2005 or about 13% of all irrigated cropland in the state.

The potential ethanol production represented by the 2005 California harvest from these crops is about 360 million gallons (Table 4-2), or 240 million gallons gasoline equivalent (gge). With the exception of rice, these grain and sugar crops had been cultivated in much larger amounts at one time or another since 1950. In 1954, 1.9 million acres of barley was harvested and 1.3 million acres of wheat was harvested in 1981. However, maximum acreages were not necessarily concurrent due to crop rotations and crop shifting. Not all food crop production will be diverted to bioenergy, of course, but the magnitude of the resource needed to meet fuel demand is apparent. In some cases, the ability to shift grain and other crop production into energy markets will provide greater stability in farm prices.

4.1.3 California crop area requirements for ethanol production

If the current grain and sugar crops in the state were diverted from food and feed production to conventional ethanol production, they could meet the 2010 in-state goal for ethanol for an E10 or 10% RFS scenario (about 360 million gallons of ethanol potential from 1.1 million acres harvested).

To meet in-state production goals for ethanol using only corn from California would require between 0.8 and 3.1 million acres by 2020 and between 1.9 and 7.1 million acres by 2050 for E5.7 and E20 scenarios respectively (Table 4-3). The current irrigated crop land in the state totals only about 9 million acres at present.

For the same scenarios and goals, sugar beet acreage would be about half of that required for corn. In the case of an integrated biorefinery that utilizes corn grain as well as the lignocellulosic portions of the plant (*e.g.*, corn stover), required land area would be about 60% of that for an industry that utilizes only the grain fraction.

Table 4-2: California starch and sugar crop yields, acres harvested, and ethanol potentials

	Product Yield (tons/acre)	Ethanol Yield		Acres Harvested in 2005 (thousands)	Max. Acres Harvested post 1950		Ethanol Potential (million gallons)	
		(gallon/ton)	(gallon/acre)		Acres (thousands)	Year	2005 Crop	Historical Max. Crop
Rice	4.0	90	355	526	593	1981	187	211
Wheat	2.3	93.3	210	369	1345	1981	78	283
Corn	4.8	96.4	459	110	375	1984	51	172
Sugar beets	35.0	24.8	870	44	354	1964	38	305
Barley	1.4	58.3	84	60	1915	1954	5	161
Sorghum	2.4	96.4	230	10	424	1967	2.3	97
Oats	1.3	58	75	20	223	1957	1.5	17
Totals				1,139*	5,229*		360	1,250

*There are about 9 million irrigated acres in production in California. (Gildart and Williams for CEC 2006)

Sources : California crop yield and harvest data from NASS (Gildart and Williams for CEC 2006), Ethanol yields from Dale, B.E. (1991) (Dale 1991), and Shapouri et al., (2006) (Shapouri, Salassi, and Fairbanks 2006)

Table 4-3: Starch and sugar crop land area requirements for in-state ethanol production goals (thousand acres)

Year	Corn			Corn + Stover			Sugar Beet		
	E5.7	E10	E20	E5.7	E10	E20	E5.7	E10	E20
2010	398	709	1,468	231	411	851	211	375	776
2020	845	1,504	3,116	489	871	1,805	447	795	1,647
2050	1,919	3,416	7,076	1,112	1,979	4,100	1,015	1,806	3,742

4.1.4 California crop area requirements for conventional biodiesel production

Crop area requirements for conventional biodiesel production¹⁶ are substantially higher than those for conventional ethanol for any given volume of fuel because the yields of oil for biodiesel per acre from oilseed crops, at 40-120 gallons per acre, are substantially lower than the yield of ethanol per acre for starch and sugar crops. Oil crop acreage required to meet LCFS scenarios varies from about 0.1 to 1.3 million acres for the 2010 goal under the governor's executive order, between 0.3 and 3.4 million acres for the 2020 goal, and from 1.5 to 14.9 million acres by 2050 depending on blend-rates for B2 through B20 (Table 4-4). Biodiesel crop acreage is based on oil seed yield of 2000 pounds per acre per year, 40% oil content of seed, and about 94% oil extraction efficiency. This gives a biodiesel yield of about 100 gallons per acre.

¹⁶ Conventional biodiesel means a biofuel from transesterification of plant oils suitable for use in compression ignition (diesel) engines. Conventional ethanol production means bioethanol fermented from starch and sugar crops. Advanced biofuels will be produced from lignocellulosic components of plant material through thermochemical and biochemical processes.

Large-scale culture of algae could greatly expand oil production due to the high potential yields, estimated at a maximum of approximately 30 times those of conventional oil-seed crops like soybeans and canola (Sheehan et al. 1998). Future deployment of thermochemical conversion technologies using biomass-to-liquids (BTL) technologies such as gasification followed by Fischer-Tropsch synthesis, may allow the production of renewable diesel products from the wide range of lignocellulosic biomass resources available in the state (Tijmensen et al. 2002). These processes may have similar or higher per-ton energy and volume yields of renewable diesel compared with cellulosic ethanol yields of 70-100 gallons per ton.

Table 4-4: Oil seed crop requirements to meet in-state production goals for conventional biodiesel (thousand acres)

Year	B2	B5	B10	B20
2010	130	324	648	1,295
2020	343	857	1,713	3,427
2050	1,488	3,719	7,438	14,875

4.1.5 Energy crop types and potential biofuel yields

There are several types of potential energy crops that California farmers might produce profitably. These include cereals, oilseeds, sugar crops, forages or forage-type crops, and woody crops produced in plantations. Because of the state's long growing season, high-quality soils and potential available acreage, a wide array of biomass crops and strategies may prove feasible. Also as noted earlier, water will in some cases be a constraint but there are some areas where biomass production will be important in managing ground water regimes. These crops and strategies require systematic assessment based on available data, and research on plant genetics and plant improvement through biotechnology will be needed to improve candidate energy crops in order to take full advantage of their potential. Also needed are field trials for selected species and novel cultivars with significant potential but where little data are available for California conditions. Results should be integrated into simulation models to estimate the magnitude of correlated effects, the direction of change in cropping system properties, and greenhouse gas effects. (A roadmap for the development of biomass in California 2006)

Cereals

Cereals have several advantages for the production of ethanol and other fuels. Cereals are generally easy to grow, harvest, store and transport. Some are winter crops and can make efficient use of rainfall, and some are salt tolerant, so could be produced on lower quality land and/or with poorer quality water. The world's major, and many minor, cereals are currently produced in California. These include rice, wheat, barley, triticale, corn, and sorghum.

Corn grain Corn is the primary feedstock for ethanol in the United States, though most of this corn is grown in the "Corn Belt" of the Upper Midwest. Corn also grows well in California, with yields equal to or exceeding the most productive regions of the Corn Belt, and is widely grown in the state in association with dairy farms for silage, but also in the Delta and Sacramento Valley for grain. Yields are high in comparison to the Midwest with mostly rainfed production. However, achieving these yields requires substantially greater inputs, especially irrigation water.

Increased demand due to diversion of corn for ethanol may improve profitability. Some insecticides are used in corn production. The crop must be irrigated and is not salt tolerant. It is responsive to and requires N fertilizer or livestock manure for high yields.

Corn is currently grown on approximately 500,000 acres in California, though 400,000 acres of this is grown as silage for animal feed, and much of the corn grain is for human food and animal feed. Diverting all these 500,000 acres of current corn acreage to ethanol production could produce as much as 200 to 275 million gallons of ethanol with yields up to 5 tons of grain and 550 gallons of ethanol per acre per year (Figure 4-3). Producing ethanol from corn grain also generates distillers grains, a high-protein animal feed that can mitigate to some extent any loss of acreage presently dedicated to animal feed, but again, increasing biofuel production in the state will require careful attention to full system life cycle impacts.

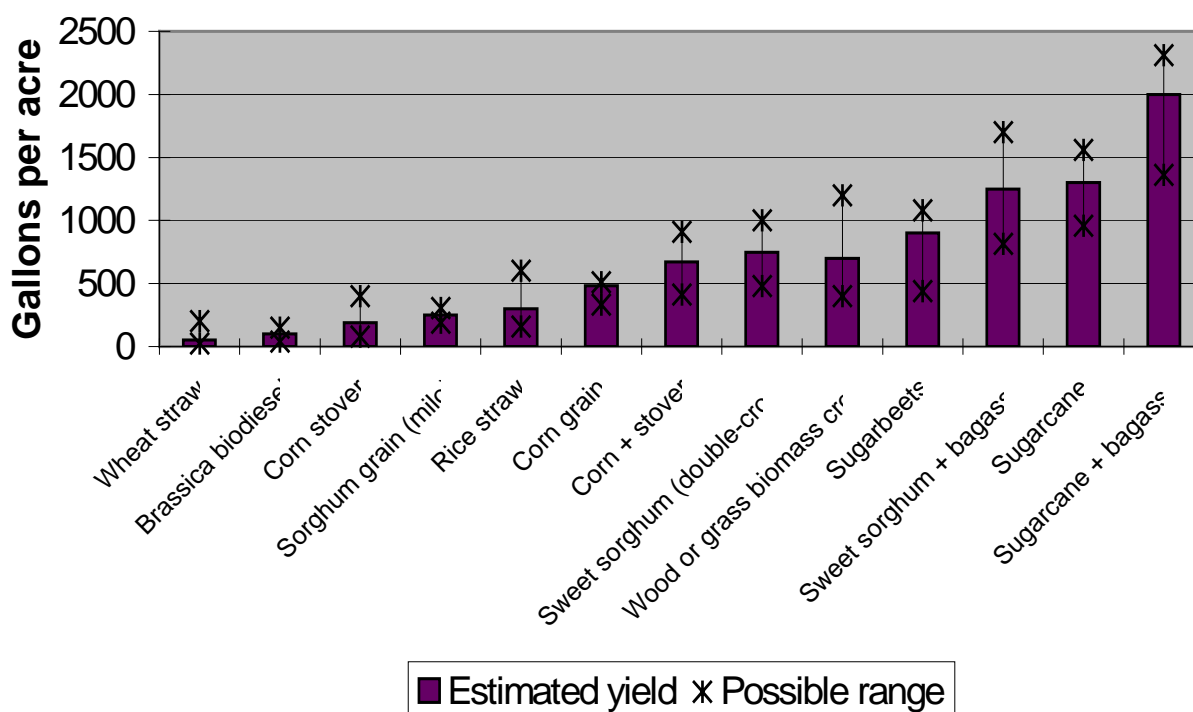

Figure 4-3: Estimated per-acre ethanol yields for various crop types

Brassica (canola) biodiesel yield shown for comparison.

Sorghum grain (milo) Sorghum is hardier than corn and can be grown with less water but still must be irrigated. It tends to be lower yielding, in part because it tends to be grown under less ideal conditions than corn.

Milo is the second-most utilized grain for ethanol production in the U.S. Sorghum grain yields nearly the same amount of ethanol per bushel of grain as corn, but yields almost half as much grain per acre. Fertilizer and pesticide requirements may be slightly less than corn, though the crop is also considerably more drought-resistant, meaning that under unexpected water shortages, crop failure is not as extreme as other crops. Like corn grain, milo can produce distillers grains useful for animal feed.

Wheat, barley and triticale are winter cereals. For the most part they are grown without irrigation in the Central Valley and elsewhere in the state, and several hundred thousand acres are in crop/fallow systems linked with livestock grazing. Diseases and pests are generally controlled through plant breeding, so they are low-input crops in general and very suitable for no-till production. It may be possible to modify these crops for energy purposes using molecular biotechnology and traditional plant-breeding once the needed characteristics are identified.

Sugar crops

Sugar cane trials have been carried out in the Imperial Valley in the last several years. Sugar cane grows well there and might be used for ethanol production, particularly in combination with sugar beets, as the two have different harvest periods. Sweet sorghum grows well in California but for economic reasons has not been widely produced.

Sweet sorghum Sweet sorghum is potentially a very promising biofuel feedstock. Sweet sorghum is a variety of the sorghum genus that concentrates simple sugars in its stalk that can be extracted through pressing and fermented directly, in a manner very similar to sugarcane. Sweet sorghum is also a short-season crop, with a roughly 120-day growing cycle. In California, this means that most lands can support two harvests of sweet sorghum cane from each annual planting.

At two crops of 15-20 tons of cane per acre, 500-700 gallons of ethanol per acre are possible. Like sugarcane, sweet sorghum also yields a fibrous residue, “bagasse,” that can be used for further energy production. While for the near future, and longer depending on the economics, bagasse will be used for electricity production as it is in sugarcane ethanol facilities in Brazil. However, these residues are also rich in cellulosic sugars that could be used for gasification or cellulosic fermentation. If the sweet sorghum bagasse were also utilized for cellulosic ethanol production, this could yield an additional 400-700 gallons of ethanol, although it can also be used for heat, steam, and power generation in a manner similar to most sugar cane mills.

Sugar beets Sugar beets represent a significant potential feedstock for conventional ethanol production in California. Sugar beets had been grown throughout the state on more than 200 thousand acres from the late 1950s until about 1990 (reaching 350 thousand acres in 1964 and again in 1971). Since 2000, about 45,000 to 50,000 acres of sugar beet have been farmed in the state, mostly in the Imperial and southern San Joaquin Valleys. Some of the highest commercial sugar beet yields in the world have been produced in California (Kaffka 2007). Production on 200,000 acres of sugar beets could support 170 million gpy of ethanol production.¹⁷ Sugar beet ethanol production also produces beet pulp, a useful animal feed. Annual dry matter yields of 18 to 25 tons per acre are possible.

Sugarcane Sugarcane is the most efficient feedstock for ethanol production currently utilized in the world, with Brazil producing a total amount of ethanol close to that produced by the United States at a fraction of the energy and environmental cost. Grown across the Gulf states of the southern US, sugarcane is primarily suited to more tropical regions, but one region of California,

¹⁷ Assumes sugarbeet yield of 35 ton/ac and ethanol yield of 24.8 gallons/ton.

the Imperial Valley, has been determined to be suitable for the crop and experimental plots have been grown for several years. These plots have shown remarkable yields of cane and sugar content, (Bazdarich and Sebesta 2001) potentially heralding ethanol yields of 1200 to 1400 gallons per acre. Water may prove limiting due to competition from the urban sector, although innovative strategies have been suggested to avoid water transfers out of the valley.

In addition, the residue of sugarcane ethanol, bagasse, can be used for further energy production. While this may likely be used for generating carbon-neutral electricity, it could also be used in cellulosic biofuel production, potentially generating an additional 400-700 gallons per acre.

However, because of the geographic limitations of suitable land for sugarcane in California, the total amount of biofuel that could be generated from this feedstock is also limited. Total Imperial Valley cropland covers roughly 500,000 acres, so an ambitious 20% crop shift to sugarcane could yield 140-200 million gallons of ethanol. The efficacy of such a shift remains to be examined.

Oilseeds

Safflower is the only significant oilseed in California. It is grown throughout the Central Valley, where it is very well-adapted. It is essentially disease- and pest-free. In the northern Central Valley on deeper soils it can be produced without irrigation. It produces an oleic fatty acid dominant oil (monounsaturated-18:1), which has excellent properties as feedstock for biodiesel. It is moderately salt tolerant and because it is deep-rooted it can be used in farming systems to reduce overall leaching losses to ground water. It is planted in spring and harvested in summer.

Canola is a mustard-family crop (a low eruric acid type of rapeseed) and is grown similarly to winter wheat. It can take advantage of winter rainfall but may need late spring irrigation. It is susceptible to some insect pests, particularly aphids. It also produces a high-quality oil and grows well in California. Molecular methods have successfully increased the salt tolerance of canola.

Residues from oilseed crops would be more limited than from cereals. Both canola and safflower can be produced in no-till systems in California.

Other novel oilseed crops may also develop as legitimate biomass sources. Flax is well adapted to the inter-mountain and coastal regions and was produced as a winter crop in the Imperial Valley at one time. Jojoba is a native desert shrub that produces seeds high in waxes and oils, but production is adequate only when produced under agricultural conditions. *Jatropha curcas*, a tree grown in India for oil, is also being studied for biodiesel production.

Forages

A large number of forages are grown in California. Alfalfa is the most common because of its value in the dairy industry, but grass hays are also widely produced. Perennial forages like switchgrass will grow but switchgrass has not yet been seriously evaluated as a biomass source here although work on this crop in California is now beginning. Switchgrass is currently

considered an invasive species for California but selected plot experiments have been approved to begin field trials. Bermuda grass and Jose tall wheat grass are two highly salt-tolerant forages that can be produced on poorer quality land using waste waters. Many other grass species, such as *Miscanthus*, might be suitable for energy crops but need evaluation over a range of California environments. Like switchgrass, other new crops introduced into California need also be considered in terms of their invasive potential.

Woody biofuel crops

In the past poplars and eucalyptus trees have been produced successfully on non-salt-affected soils for biomass in California. These and other sources of woody biomass such as short rotation willow and poplar deserve additional attention. Characteristics of woody as well as herbaceous crops grown under saline conditions are the subject of current research in the state.

Algae

Algae is produced at present primarily for high value protein and for its nutrient management capacity in waste-water treatment, but its potential as a bioenergy crop has been widely recognized. A number of species produce high oil yields, far exceeding yields from conventional oil seed crops. The biomass fraction can also be converted to ethanol and other biofuels. Harvesting remains a primary technical and economic hurdle, as do oil extraction and cell wall deconstruction for sugars production and alcohol fermentation. The large biofuel potential has renewed interest in algal systems and research is beginning to address large scale commercialization approaches.

4.1.6 California lignocellulosic ethanol potential

Lignocellulosic derived ethanol and other biofuels offer several advantages over ethanol produced from sugar or starch feedstocks. These include the potential for higher per acre ethanol yields and lower agronomic inputs for purpose-grown energy crops, improved product life cycle environmental performance, GHG balances and net-energy ratios, the potential to utilize marginal and retired or marginal lands which reduces competition with food crops, and the potential to utilize the diverse and large existing lignocellulosic biomass residue streams found in urban waste, forest thinnings, and agricultural residues. As the US will not be able to make enough biofuels (*e.g.*, bioethanol) from conventional starch and sugar feedstocks to substantially reduce petroleum imports or lower GHG emissions from the transportation sector, lignocellulosic routes to biofuels will be needed (Farrell et al. 2006; Perlack et al. 2005, Hill et al. 2006).

Existing lignocellulosic resources in California include forest operation and wood product residues, urban mixed paper, wood, and green wastes currently landfilled, and certain crop and agricultural residues. Technically recoverable amounts are estimated to be about 25 to 30 million dry tons per year (Figure 4-1). Energy crops, such as switchgrass,¹⁸ grown specifically for ethanol feedstock on 1.5 million acres of idle or marginal lands could add another 7 to 13 million dry tons per year. Potential ethanol production from cellulosic residues in California could be as

¹⁸ Switchgrass is used as an example and may not be the preferred crop for California. The best mix of energy crops that are agronomically and otherwise sustainable in California is the subject of on-going and proposed research.

much as 1.8 billion gallons.¹⁹ Energy crops could add another 600 million to 1.3 billion gallons of ethanol potential depending on crop and ethanol yield. Total ethanol production from in-state lignocellulosic feedstock material could approach between 2.4 and 3.1 billion gallons (between 1.6 and 2.1 billion gge or 10-13% of current gasoline use²⁰; see Table 4-5).²¹

Table 4-5: California lignocellulosic ethanol potential

Biomass Source	Potential Feedstock (million dry ton/yr)	Potential Ethanol	
		(million gallons/y)	(million gge/y)
Field and Seed	2.3	160	105
Orchard/Vine	1.8	125	83
Landfilled Mixed paper	4.0	320	213
Landfilled wood & greenwaste with ADC	2.7	216	144
Forest thinnings	14.2	990	660
Totals- Current California	24.9	1,814	1205
<i>1.5 Million Acres Dedicated Energy Crop</i>			
Low Yield (5 dry tons/acre, 80 gallons/ton)	7.5	600	400
High Yield (9 dry tons/acre, 100 gallons/ton)	13.5	1,350	900
State potentials with 1.5 M acres energy crop	Low Yield	32	2,414
	High Yield	38	3,164
		<i>Range</i>	1605
			2105

Source: Williams (2006)

4.1.7 Costs of biomass feedstock production and acquisition²²

Technical resource estimates discussed above do not specifically incorporate economic factors although biomass supply is cost sensitive. Forest biomass on steep terrains excluded from the technical resource estimates might, for example, be harvested at high cost as long as erosion control and other compensating measures deployed at great expense accomplished equal ecosystem or resource management objectives. There would be little economic merit to such activity for the purposes of biomass utilization.

The optimal use of biomass implies a system integration that accounts for production, handling, conversion, product marketing, and environmental management over the full life cycle. For this reason, the economic feasibility is feedstock-, product-, and site-dependent. Exclusive of

¹⁹ Assumes a conservative ethanol yield of 70 gallons per dry ton of field and seed crops, orchard and vine prunings and removals, forest and range thinnings. Assumes 80 gallons/BDT for landfilled paper and woody/green wastes considered to be available for utilization. Nearly 70% of the state estimate is due to the large potential for forest and rangeland thinnings. The estimate assumes no competition for the resource such as biopower, mulch, compost, etc.

²⁰ Current gasoline usage in the state is approaching 16 billion gallons. <http://www.boe.ca.gov/sptaxprog/spftrpts.htm>

²¹ Ethanol is not the only biofuel that can be made from lignocellulosic biomass. Butanol, mixed alcohols, Fischer-Tropsch liquids, and others can serve as gasoline and diesel fuel replacements.

²² This section abstracted from ref. (Jenkins 2005)

harvesting and downstream processing operations, production costs for agricultural and other biomass residues are typically allocated to the primary crop production system and not separately accounted. In contrast, dedicated crops grown for biomass assume full allocation of production costs, but may contribute other high value benefits, such as soil remediation, that can be used to offset high costs of production. Production costs for dedicated crops are quite variable and depend on species, production site, level of management, and resulting yield.

Biomass already collected at a potential site of use, such as certain food processing wastes, sawmill residues, and municipal wastes at transfer stations, material recovery facilities, and landfills may be available at little or no additional cost. Facilities using these feedstocks do not incur additional collection and transportation costs, although there are typically still expenses for handling, processing, and storage. Tipping fees are charged at most landfills and waste-to-energy facilities and are an important source of revenue. Continuing development of waste conversion processes could lead to greater resource competition and changes in tipping fees. Longer term supply contracting is an advantage for most facilities in securing financing and ensuring reliable operation.

Collection costs for agricultural crop residues depend on the type of crop, yields, harvesting equipment, labor, in-field drying and other processing, harvesting losses, and nutrient export, the latter representing the nutrients taken off the field in the biomass that otherwise would have been retained and reincorporated into the soil. If not returned in the form of ash, sludge, or compost, nutrients will need to be replaced for the cropping system to be sustainable. Animal manure collection and handling costs are low for dairies where anaerobic digesters are integrated into on-farm waste management operations, but high for pastured animals. In the latter case, manure collection is generally considered infeasible.

Transportation costs may limit the size of facilities using more distributed biomass resources such as crop residues, dedicated crops, forest thinnings, and logging slash. The combination of increasing feedstock delivery costs offset by generally declining capital, operating, and product-marketing costs as the facility size increases can lead to an optimum facility size. Where collection and other feedstock acquisition costs are low or offset by tipping fees, such as in the case of urban wood fuels separated from municipal waste, longer transport distances are economically feasible. Due to the low density of some forms of biomass, especially straw bales, truck payload is frequently limited by volume and trucks do not carry the full weight allowed. In order to increase payload, the biomass can be densified, such as by making pellets. The cost of densification must be offset by reduced transportation costs, and is generally justified only for long hauls. However, densification may have other advantages in material handling and conversion, so transportation may not be the only determining factor. Densification is not used currently in the fuel supply infrastructure for existing biomass power plants. Bulk densities of wood chips are sufficiently high that trucks mostly operate near their weight limits.

Most facilities using biomass require storage due to the seasonal feedstock production characteristics and to enhance reliability in the case of feedstock supply disruptions. Grains are commonly harvested during the summer and fall, whereas orchards are pruned in the winter and spring. Harvest windows may be quite short. Rice straw, for example, can typically be collected dry only during a six- to eight-week period during the fall and in the spring after the rains have

stopped, although in the latter case feedstock quality is substantially altered (Jenkins, Bakker, and Wei 1996; Bakker and Jenkins 2003).

Orchard removals that supply a large fraction of current agricultural fuel used by the state's biomass power sector occur throughout the year. The composition of MSW, including the fraction of green waste, fluctuates according to season, and much of food processing waste is highly seasonally dependent. Equipment access to forest lands can be limited by weather conditions both during winter and under extreme fire conditions during the summer. Wood and woody materials are mostly stored uncovered in piles or windrows. Herbaceous materials such as baled straw and forages generally require covered storage over winter to reduce losses. Storage under permanent cover, such as in metal barns, tends to be of lower overall cost due to reduced losses compared with tarps and other more temporary shelter (Huisman, Jenkins, and Summers 2002), but system selection is scale specific.

Impact of fuel cost on cost of energy

Feedstock-cost per unit of product output from a conversion facility depends on the conversion process efficiency. Fuel contributions to the product cost of energy (COE) depend on the efficiency of conversion (Figure 4-4). The impact of conversion efficiency on COE is a primary driver for research into advanced conversion systems. For conventional biomass fueled power plants operating at about 20% efficiency, each \$1 per dry ton increase in the cost of feedstock adds approximately \$0.001/kWh onto the cost of electricity generated. Advanced power stations such as integrated gasifier combined cycle (IGCC) systems should decrease this increment to about \$0.0006/kWh. For biofuel facilities, each \$1/dry ton increment in feedstock cost will add about \$0.125/MMBtu²³ to the product cost, which for an ethanol production facility will add between \$0.007 and 0.014/gallon to the cost of ethanol. Maintaining high conversion efficiency and low feedstock cost are critical to the economic success of bioenergy systems. Where feedstock is available at no cost, efficiency has no impact on the resulting product cost of energy due to feedstock.

Cumulative residue supply costs

Overall, about 30 million dry tons of in-state residue biomass might be obtained at average costs below about \$40/dry ton including short-haul transportation but excluding storage and processing. Beyond this value, costs begin to increase sharply. This does not mean that the either the existing biomass facilities or new facilities will be able to procure fuel at low cost. Each fuel type has an associated collection cost that can be allocated to the utilization activity. For any single facility, fuel cost might range from zero to \$40/dry ton or higher depending on the resource available.

²³ MMBtu = million British thermal units.

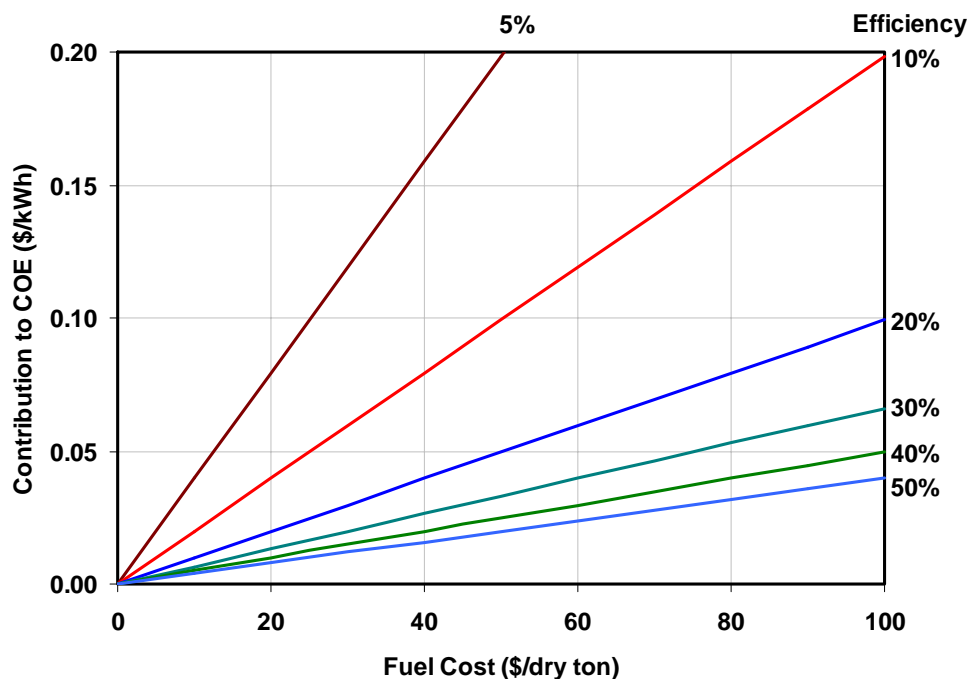

Figure 4-4: Impact of conversion efficiency on the feedstock cost contribution to cost of energy (COE) from biomass

Multiply \$/kWh by 293 to obtain \$/MMBtu.

Average fuel costs of \$22 to \$40/dry ton for the existing solid-fuel biomass direct combustion sector stem from an assortment of fuels ranging from sawmill and food processing residues to forest thinnings, although the latter may exceed \$50 to 60/dry ton delivered. Waste-to-energy facilities in the state charge disposal (tipping) fees in the amount of about \$35/ton for delivered feedstock, thereby offsetting other costs of operation.

Energy crop production costs

Cost estimates for energy and industrial crops in the US range between \$25 and \$105/dry ton, or \$1.60 – 5.80/ MMBtu (Klass 1998; Graham and Downing 1995; Wright 1936). These costs depend on the scale of production, the crop planted, management level, soil type, geographical region, and contributions of various governmental incentives and restrictions. An analysis for the southeastern US estimates costs for short rotation woody crops with yields of 2 to 5 dry tons per acre per year at \$29 – 46/dry ton on crop land, and \$44 – 63/dry ton on pasture land. Half of the cost is production cost exclusive of harvesting. For switchgrass (*Panicum virgatum*), with yields of 4.5 to 9 dry tons per acre per year, costs are \$27 – 63/dry ton, of which 40% is attributed to production prior to harvesting, although this fraction is sensitive to yield. Biomass production costs before harvesting are therefore in the range of \$15 to 32/dry ton and can range higher. A study of farm gate prices needed to increase biomass production in the US estimated that 2.4 million acres would be brought into production with prices at \$30-33/dry ton, and 6.5 million acres would be brought into production with prices at \$40-44/dry ton. Fossil energy

costs influence such conclusions, and recent escalation in petroleum and natural gas costs have increased costs of diesel fuel for field machinery and transportation, the cost of electricity from natural gas fired power stations, and the cost of energy for drying and other processing operations where employed.

Growth in ethanol demand has recently driven the price of corn from around \$2 to \$4/bushel, pushing the feedstock cost contribution to ethanol production from \$0.65 to \$1.30/gallon, exclusive of co-product credits in distillers grains. Increases in the cost of corn as feedstock for biofuel production also influence feed and food markets, raising the cost of production for commodities such as milk and other dairy products, meats, and cereals. Biodiesel production from virgin oilseeds similarly influences market prices of soybeans, safflower, canola and other oilseed commodities. With feedstock requirements for soydiesel of roughly 7.4 pounds crude, degummed oil per gallon of biodiesel and yields of 10.7 pounds of oil per bushel (60 pounds/bushel) of soybeans, feedstock costs represent 88% or more of total biodiesel production cost. Soybeans are not a preferred oil crop for California, but production cost fractions for other oilseeds are similar. Other environmental or agronomic benefits of production, such as land reclamation or remediation, can offset production costs.

Excise tax exemptions of \$0.054 per gallon of gasoline (\$0.014/L) blended with alcohol fuels were initially established by the Energy Security Act of 1979. The federal fuel tax exemption for ethanol under section 301 of the American Jobs Creation Act (AJCA) of 2004 replaces the previous tax incentive. AJCA allows blenders a federal tax exemption of \$0.51/gallon (\$0.135/L) of pure ethanol. Blending level is no longer relevant. Under the AJCA, biodiesel receives a federal excise tax credit of \$1.00/gallon (\$0.264/L) of “agri-diesel,” made from virgin oils and animal fats, and half that for non-agri-biodiesel (from waste oils).

4.1.8 Urban wastes and residues

Low-carbon renewable fuels can be made from municipal solid waste, landfill gas, waste mined from landfills, and biogas produced from sewage and waste-water treatment. Municipal solid waste (MSW) sent to the landfill constitutes a significant fraction of the total biomass potential within California and the largest resource in the urban category. As of 2003, the year of the most recent statewide municipal solid waste assessment, roughly 40 million tons of waste was sent to landfill. In 2005, about 42 million tons of MSW were disposed. If alternative daily cover (ADC) for landfill operations is included, the total 2005 disposal was 46.6 million tons (Table 4-6). About 70 percent of this waste stream is comprised of organic material including plastics. The biogenic portion of MSW, that is the amount that can be considered biomass and suitable for ethanol and other low-carbon fuel production, constitutes about 57 percent of waste and ADC sent to the landfill. This is nearly 27 million wet tons or about 18 million dry tons of biomass (Statewide Waste Characterization Study 2004).

The annual landfill flow of MSW organics is large in comparison to the quantities of agricultural and forest waste considered technically recoverable on a sustainable basis. Annual technically accessible forest residues and non-manure agricultural wastes are approximately 14.3 and 4.5 million dry tons, respectively. (Gildart and Williams for CEC 2006)

Reducing the flow of material to landfills with extraction of organic materials from MSW stands to offer significant environmental benefits. However, the industrial effort of obtaining this

material in acceptable purity is not trivial, and is perhaps the largest barrier to the utilization of organics otherwise destined to the landfill.

Table 4-6: Characteristics and potential energy of landfilled urban waste in California

Component	Landfilled ^a (Million tons)	% of Total	Moisture ^b (%wb)	Landfilled (Million tons dry)	HHV ^b (Btu/dry lb.)	Primary Energy by Component	
						(Quad) ^c	(million barrels oil equiv.) ^d
Paper/Cardboard	8.8	18.9	10	7.9	7,640	0.121	21
Food	6.1	13.2	70	1.8	6,020	0.022	4
C&D Lumber	4.0	8.7	12	3.5	8,310	0.059	10
Other Organics	1.8	4.0	4	1.8	3,810	0.014	2
Leaves and Grass	1.8	3.8	60	0.7	6,450	0.009	2
Prunings, branches and stumps	1.1	2.3	40	0.7	8,170	0.011	2
Green ADC	3.0	6.4	40	1.8	8,170	0.029	5
Biomass Total	26.7	57.3		18.3		0.27	47
Plastics and Textiles	5.9	12.6	3.3	5.7	12,340	0.140	25
Other C&D	5.0	10.8	-	5.0	-	-	-
Metal	3.2	6.9	-	3.2	-	-	-
Other Mixed and Mineralized	3.2	6.8	-	3.2	-	-	-
Glass	1.0	2.1	-	1.0	-	-	-
Other ADC	1.6	3.4	-	1.6	-	-	-
Totals	46.6	100.0		38		0.41	71

Source: (Williams 2006)

a) 2005 Disposal, 2003 Characterization: Waste stream composite data

(<http://www.ciwmb.ca.gov/Publications/default.asp?pubid=1097>) & 2005 Solid Waste Disposal and Diversion
(<http://www.ciwmb.ca.gov/lgcentral/Rates/Graphs/RateTable.htm>)

b) Adapted from (Tchobanoglous, Theisen, and Vigil 1993; Themelis, Kim, and Brady 2002).

c) 1 Quad = 10¹⁵ Btu. US primary energy use is about 100 Quads, World primary energy use is about 500 Quads.

d) Meant to indicate primary energy in MSW in terms of equivalent barrels of oil. This does not mean that MSW energy can be converted into liquid fuels with same yield and efficiencies as from crude oil.

Aside from the materials sorting and separation issue, post-recycled MSW has unique system advantages over agricultural and forest waste. It is one of the few biomass resources that are concentrated in locations of high energy demand and much of the collection and transportation infrastructure for the resource already exists. Sawmill residues and food processing wastes are similarly concentrated in locations of high energy demand, but not at the same scale as are municipal solid wastes.

Biofuels production from post recycled MSW has unique advantages with respect to full fuel life cycle impacts; 1) impacts due to resource and collection and transportation are allocated to waste disposal activities (these are existing activities that occur regardless of fuel production), and 2)

diversion of biodegradable material from landfill to fuels reduces life cycle impacts of the landfill (reduced methane emissions and leachate). These reduced landfill impacts should be credited to MSW derived biofuels.

As from other sources, potential biofuels that can be produced from biomass in MSW include ethanol, butanol, mixed alcohols, methanol, liquid hydrocarbons (*e.g.*, Fischer-Tropsch liquids), methane, and a number of others. Recent US DOE awards supporting six cellulosic biorefinery commercialization demonstrations include two projects that will use portions of the municipal waste stream for feedstocks, including one project planned for a landfill in Southern California (USDOE 2007).

The biomass fraction of the MSW landfill stream consists of 43 percent dry weight basis mixed paper and cardboard, 10 percent food waste, 19 percent construction and demolition lumber, with the remaining 28 percent consisting of green waste, “other organics”, and green ADC (Table 4-6). The materials within these categories are each associated with a theoretical ethanol yield based on their chemical composition.²⁴ Table 4-7 illustrates the known theoretical ethanol yields for the major categories of organic MSW. The actual or practical yield of a commercial cellulosic biorefinery is estimated to be between 60 to 90 percent of the theoretical yield.

Table 4-7: Theoretical ethanol yields of organic MSW components

Waste Component	Theoretical Yield (gallons/dry ton)
Paper	116
C&D Lumber	113
Leaves & Grass	92
Prunings, Trimmings	113
Branches & Stumps	113
Food Waste	92
Textiles	90

Source: USDOE (2007)

Potential ethanol as well as liquid hydrocarbons (Fischer-Tropsch or FT liquids) from the lignocellulosic portion of landfill disposal is estimated to be about 350 million gallons of gasoline equivalent (Table 4-8). The analysis assumes half of the mixed paper in the landfill stream and about 40% of the wood and green wastes can be economically recovered for fuel production. Ethanol yield and FT liquid yields are assumed to be 80 and 55 gallons per dry ton of feedstock respectively. Technical and economical recovery rates may be higher or lower than assumed here, but solid waste nonetheless represents a significant potential source of energy.

²⁴ The theoretical yield is the amount of ethanol that could be produced if 100% of the cellulose and hemicellulose in the feedstock could be hydrolyzed to sugars.

Table 4-8: Estimates of annual ethanol or liquid hydrocarbon potential from lignocellulosic fraction of California landfill stream

Ethanol Scenario	Gross Biomass (million dry tons)	Tech. Avail. Factor	Technical Annual amount (million dry tons)	Ethanol yield (gal/dry ton)	Potential Ethanol	
					(million gallons/y)	(million gallons gasoline equivalent)
Landfilled mixed paper/cardboard	7.9	0.5	4.0	80	320	213
Landfilled wood & green (+ ADC)	6.7	0.4	2.7	80	216	144
Totals					536	357
-Alternative Scenario -						
Conversion to Fischer-Tropsch Liquids (hydrocarbons)				FT Liquid yield (gal/dry ton)	(million gallons gasoline equivalent)	
Landfilled mixed paper/cardboard	7.9	0.5	4.0	55	220	
Landfilled wood & green (+ ADC)	6.7	0.4	2.7	55	149	
Total					369	

Classification of MSW feedstocks

Post-recycle MSW is a mixture that must be sorted or classified to remove inorganic and plastic material to access the biomass. Grinding or other processing of the separated biomass may be needed as well. The fuel production facility could be located at a material recovery facility (MRF) or at the landfill.

A lower bound for waste classification costs is \$25 per ton, which is a recently cited cost for processing pure green waste in San Jose, California (Diaz, Savage, and Golueke 2002). For a modern mechanized system, mixed waste MRFs are assumed to achieve processing costs of roughly \$30 per ton of MSW to extract the organic fraction. Most MRFs in California do not process raw MSW for the extraction of recyclables. Thus, this infrastructure would have to be expanded significantly.

Ethanol production cost estimates

The production cost varies and depends on the cost of the feedstock, capital costs, and operating expenses. Table 4-9 presents estimates of capital costs for a cellulosic biorefinery as a function of annual plant capacity. The cost values shown constitute a 0.7 scale factor representing a

significant economy of scale.²⁵ These capital costs assume mature technology after “industrial learning.”

Table 4-9: Estimated capital costs for enzymatic cellulose-ethanol process with on-site boiler and turbine/generator²⁶

Ethanol Plant Capacity Millions of Gallons per Year	Approximate cost 2005 \$/gallon capacity
15	6.22
20	5.87
40	4.58
60	4.22
80	3.70
100	3.52

To process all of California’s MSW-derived biomass, the state would require 25 cellulosic biorefineries each with a capacity of 50 million gallons per year depending on yield. Based on the schedule of capital costs stated above, a cellulosic biorefinery of this size would likely cost between \$200 and \$240 million depending on design specifications. Put in context, the average size of a starch (corn) biorefinery in the United States is currently 54 million gallons per year and the state of Iowa currently has 26 active biorefineries and another 18 planned (RFA 2007).

An analysis of a 70 MGY biorefinery using acid hydrolysis was conducted with capital cost projected at \$4/gallon-annual capacity and net feedstock cost of \$6.25/dry ton.²⁷ Total non-feedstock operating costs (labor, chemicals, utilities, maintenance) were estimated at \$0.33/gallon. The facility is assumed to be funded 100% with equity or venture financing (no grants or loans) with a required annual rate of return of 15%. Lignin is assumed burned for heat and power but no external power sales are generated. Combined state and federal taxes are 40%, general inflation is 2.1%/year. Economic life is assumed to be 20 years and 5 year modified accelerated cost recovery system (MACRS) depreciation is used. The base case cost of ethanol (required revenue) is \$1.14/gallon. Estimates range between \$0.70 to \$1.50 depending on feedstock costs and electricity credits (Figure 4-5).

Avoided Landfill Costs

The most recent survey conducted in 2000 by the California Integrated Waste Management Board found that the average tipping fee paid to a landfill in California was \$35.14 per ton (Solid

²⁵ A common way of expressing the economy is scale is $C = aMs$, where C is the cost, M is the size or scale of facility, a is a constant coefficient derived from a reference facility and s is the scale factor, $s = 0.7$ for the values shown in the table.

²⁶ Adapted from ref. (BBI 2001) Cited costs adjusted from \$1999 to \$2005. Also (Aden 2002)

²⁷ Assumes collection costs are borne by waste system and material arrives with a tipping fee of \$35/wet ton or about \$43.75/dry ton. Classification/sorting sizing costs are \$40/ ton (\$50/dry). Feedstock to the facility then is a net cost of \$6.25/dry ton.

Waste Tipping Fee Survey 2000). This fee has not changed much in the last seven years. The tipping fee to the landfill does not include transportation expenses. It is expected that for most waste, the difference in expense between shipping to a landfill versus shipping to a regional biorefinery would be small. Each raw ton processed at the MRF yields roughly 0.6 tons of organic waste. Therefore, roughly 1.7 tons of MSW would have to be processed to extract 1 ton of organic material. The economic benefit and thus the price of the organic MSW feedstock would be partially dependent on the value of other recyclables recovered from the processing system. Mixed-waste MRFs are typically designed to extract metals, glass, and plastics, as well as the relatively low value organics. The price of these other recovered materials would serve as an important input in determining the exact feedstock cost as well as the residual material that would be landfilled after processing. The total value of the material recovered from processing would significantly impact the degree to which avoided costs from landfilling are favorable or unfavorable.

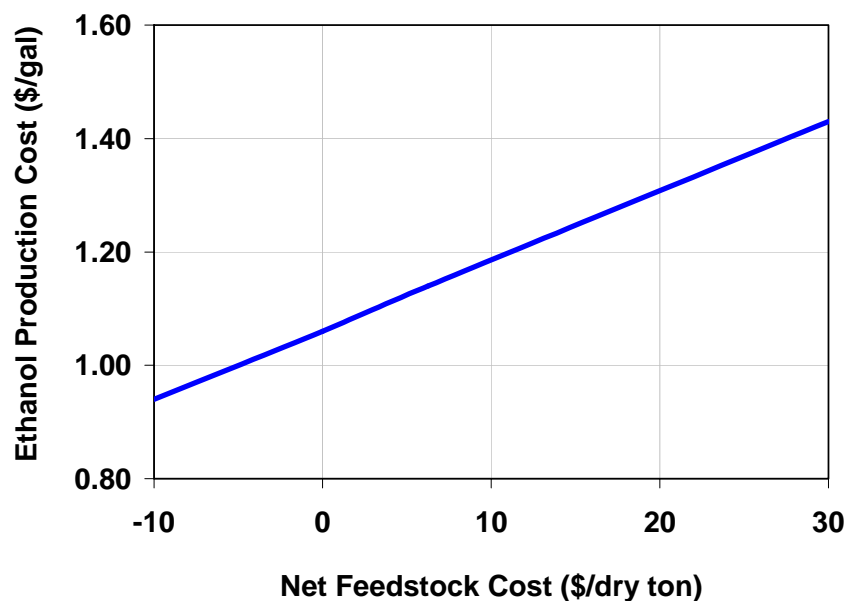

Figure 4-5: Ethanol production costs from MSW with variable feedstock costs, 70 MGY design basis

The economic profitability of an organic MSW feedstock conversion to ethanol is not assured. Many uncertain factors would determine what the minimum average price of ethanol would have to be over the economic life of the MRF and biorefinery for such a system to be economically justifiable. In addition, the conversion process utilized within the biorefinery will also impact the overall costs. When considering the capital expansions that would be required to sort raw MSW, the distribution costs, as well as costs associated with the variety of hydrolysis methods that could be used to pre-treat cellulosic feedstocks, it is possible that the price per gallon of ethanol required to cover the costs of a vertically integrated system would range from less than \$1.00 to above \$3.00 per gallon. Over the last two years, the price of ethanol nationwide has ranged well above \$2.00/gallon. However, the diversion of MSW to ethanol would result in substantial substitution of gasoline with biofuel as well as reductions in methane emissions from anaerobic decay in landfills. Given these anticipated benefits, even a small value on carbon reductions could make the economics of MSW to ethanol conversion favorable.

4.1.9 Biomethane

As noted earlier, California has approximately 1 billion tons of waste in-place in landfills. (Gildart and Williams for CEC 2006) Although this material might in the future be mined for its resource value, if left undisturbed it will continue to generate landfill gas. The gas produced from natural anaerobic decomposition of biomass in landfills contains methane, which is currently being used for power generation, mostly with reciprocating engines and microturbines. The gas is also used with fuel cells, as boiler fuel, and as vehicle fuel although much is still flared or vented without energy recovery. Active landfills must control landfill gas to restrict migration and reduce explosion risks to adjacent structures. Active control and flaring or utilization of the gas also reduces methane emissions, emitting carbon principally as CO₂ in a largely carbon neutral cycle rather than as the more potent greenhouse gas, methane. The total estimated statewide production of landfill methane is about 80 billion cubic feet per year (BCF/year), and if per-capita waste disposal rates remain constant as they have over the previous decade, landfill methane production might exceed 110 BCF/year by 2020 (Figure 4-6). Supplementing landfill methane is about 10 BCF/year of biomethane in sewage digester gas, which will also rise in volume with state population. Much of the latter is already used for onsite purposes including digester heating and power generation, although some is flared without energy recovery. Projects are also starting to upgrade biogas from animal manure digestion to make pipeline quality biomethane (PG&E 2007).

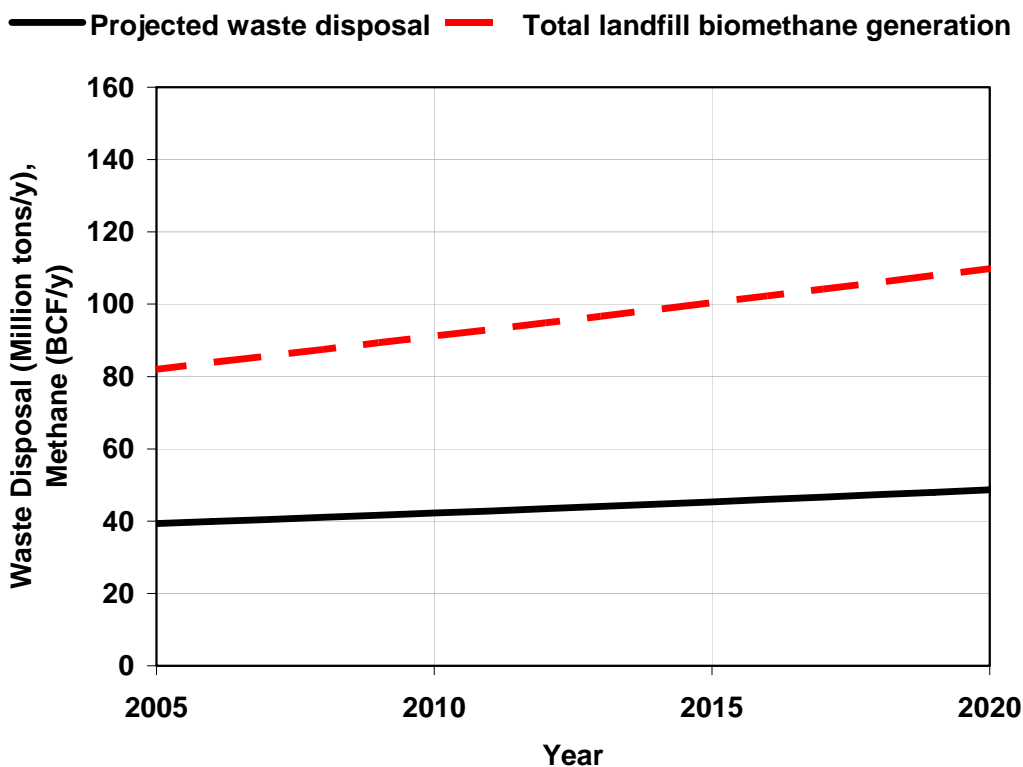

Figure 4-6: Projected waste disposal (million tons/year) and biomethane production (BCF/year) from landfills in California with constant per-capita disposal

Source: Gildart and Williams for CEC (2006)

The vehicle fuel potential in landfill and sewage digester biomethane is equivalent to between 300 to 400 million gallons of gasoline, whether as compressed or liquefied gas (*i.e.*, CNG or LNG) or converted to hydrogen (Kornbluth et al. 2006). Hydrogen enrichment through reforming a fraction of the biomethane can be used to reduce NO_x emissions from gas combustion. Upgrading techniques for landfill gas have improved so that landfill biomethane is again being considered along with digester gas and biogas from animal manure for pipeline distribution. In such case, biomethane could also be used for high efficiency electricity generation in natural gas combined cycle power stations or fuel cells, and to supplement CNG, LNG, or gas-to-liquids (GTL) production for vehicle propulsion. When blended with natural gas, the use of carbon capture and storage (CCS) in natural gas applications would result in net carbon reductions for the renewable methane component. Economic assessments of biomethane production and upgrading to hydrogen and other vehicle fuels are in progress.

Landfilling sequesters a portion of the carbon in biomass and other organic materials and as long as methane is controlled and not directly or otherwise vented to the atmosphere, may help reduce greenhouse gas emissions. Overall, however, the environmental impacts of landfilling will likely lead to increasing restrictions on the amount of organic material that can be disposed in this manner. More complete life cycle assessments (LCA) are beginning of waste management alternatives, and will provide better information for assessing contributions to the LCFS.

4.2 Natural gas

California natural gas production occurs as both associated gas production (gas that is co-produced along with produced oil) and non-associated gas production (gas produced from dedicated natural gas wells). Total production in California (including federal offshore areas) was 323 billion cubic feet, of which the majority (235 billion cubic feet) was associated gas production (CDC 2005). Production is geographically differentiated, with most dedicated natural gas production occurring in the northern San Joaquin valley (Zucca 2001). In-state estimated reserves totaled 3,100 billion cubic feet at the end of 2005, or about 10 years of production at current rates (CDC 2005).

Consumption in California in 2005 was significantly in excess of production. Total receipts for 2005 totaled 2161 billion cubic feet, meaning that in-state and federal offshore production met approximately 15% of state demand (CEC 2007). The remainder of the natural gas consumed in California originates in the southwest United States (44.5% of the remainder), Canada (26.6%), and the Rocky mountain region (28.8%) (CEC 2007).

California's natural gas production is in decline, most significantly due to declines in non-associated gas production. Non-associated gas production declined by 49% between 1991 and 2005 (CDC 2005). These declines are occurring simultaneously with stagnant United States natural gas production and with increased demand for natural gas in California and elsewhere for use in clean power generation (Maul for CEC 2004). These trends have caused many to suggest that the future price of natural gas is significantly uncertain.

4.3 Petroleum and fossil substitutes

4.3.1 California petroleum supply

In 2005, the California oil industry produced approximately 255 million barrels of oil (CDC 2005). Receipts of oil to refineries totaled 674 million barrels (CEC 2007), including in-state oil production (39%), oil from Alaska (20%), and oil from foreign sources (41%, of which 35% was imported from Saudi Arabia, 25% from Ecuador, 13% from Iraq, and 7% from Mexico) (Sheriden 2006).

The share of California production supplied by heavy oil has increased significantly over recent decades. Incremental production from thermal heavy oil recovery was 100.5 million barrels (incremental production is production above that which would have been produced without enhanced recovery operations) (CDC 2005). Heavy oil resources require additional energy inputs to production and additional refining energy inputs, increasing their GHG burden.

The stream of foreign crudes is of uncertain quality. Alaskan crude is of standardized quality, having undergone pretreatment in Alaska to form a standardized crude stream (ANS or Alaska North Slope crude) (Van Vactor 2000). The quality of imported foreign crude is collected by the Energy Information Administration (EIA) (Sheriden 2006). Understanding the quality of imported crudes will be important for constructing baseline emissions. Also, foreign crude streams present difficulties due to lack of verifiability and reporting of upstream operations, as well as presenting opportunity for shuffling, resulting in “leakage” of benefits from the LCFS.

California operations are likely better optimized and controlled than the global average. This is illustrated by the level of electrification, the use of cogeneration in steam production facilities, and the control of fugitive emissions. An LCFS that promotes leakage or increases the demand for imported crudes would likely have detrimental overall global impacts.

As described elsewhere, petroleum supplies are increasingly being supplemented by other fossil based substitutes including synthetic fuels in addition to lower quality crude oils. Lowering the carbon intensity of petroleum through switching of crude oil supplies may be market-constrained and offsets or means of decarbonizing petroleum and other fossil sources (such as by hydrogen production with CCS) will be needed for these to provide significant contributions toward meeting the LCFS.

4.3.2 California refineries

California refineries are unusual for a number of reasons. First, California Reformulated Gasoline (CaRFG) standards require the production of a high-quality final fuel. Secondly, refinery receipts in California contain a significant percentage of heavy oil, due to in-state heavy crude oil production which is related to the additional coking, hydrotreating, and hydrocracking capacity in California refineries as compared to the average US refinery (Worrell and Galitsky 2004). Also, gasoline production as a percentage of refinery outputs is higher in California than the national or regional average (Worrell and Galitsky 2004).

4.3.3 GHG impacts of low-quality oil production in California

Low-quality oil resources produce fuels with higher life cycle emissions than high-quality oil resources. The differences between fuels produced from heavy and conventional crudes are due

to two phenomena: 1) heavy oils are more difficult to produce, and 2) heavy oils require additional upgrading in refineries to produce the same fuel.

Heavy oil production results in increased emissions than conventional oil for two reasons: first, heavy oil is produced primarily using steam injection processes. In California, this steam is produced largely from natural gas, except for minor amounts produced from coal. If cogeneration is practiced, then the net carbon emissions will be less because of credits for electricity put onto the grid. Cogeneration is widely practiced in California thermal EOR projects, but not all steam is supplied through cogeneration projects, so there is the potential for producers to expand cogeneration in the face of an LCFS.²⁸

In addition to difficulties in production, heavy oils require additional refining due largely to the greater amount of carbon per unit mass of crude oil compared to the finished fuels. For this reason, carbon must be rejected from the crude oil in refining (through fluid catalytic cracking or coking), or hydrogen must be added. Correlations exist relating inputs of hydrogen for hydrocracking to crude qualities (Birky et al. 2001), as well as for coke production as a function of density of feed for FCC (Birky et al. 2001) and feed to coking units (Dhingra, Overly, and Davis 2001). The GHGs from these processes vary depending on the processes used, the various properties of the crude oil, and the configuration of the refinery. Complexity and verification issues are important here.

4.3.4 Existing inventory practices

Emissions can be estimated at the level of a rough approximation, such as in the IPCC *Good Practice Guidance and Uncertainty Management in National Greenhouse Gas Inventories* document, which exists to outline preferred and simplified techniques for nations performing GHG inventories. (IPCC 2000). Other methods exist from the EPA for guidance in state-level GHG inventories, such as the California GHG inventory performed by the CEC (ICF 1999; Bemis and Allen 2005). These simple methodologies rely heavily on aggregate “activity data”, which serve to characterize the scale of petroleum activity in a given state or nation (such as km of pipeline or the number of dedicated natural gas wells). These methodologies are too coarse for use by companies in meeting the documentation requirements of an LCFS, and therefore will not be discussed further.

Another approach to measuring GHGs is provided by the American Petroleum Institute (API), in their *Compendium of Greenhouse Gas Emissions Methodologies for the Oil and Gas Industry* (hereafter API Compendium) (Shires and Loughran 2004). The motivation of the document is to provide “consistent, standardized methodologies” for estimating GHG emissions from oil and gas fields.

The API Compendium is detailed, and includes procedures for estimating emissions from sources as detailed as fugitive emissions from oil stock tanks to and emergency natural gas blow-down procedures. The methods are designed to be implemented at the field or facility level. Tables 2-1 to 2-8 of the API Compendium outline processes that are included, including all

²⁸ A simple analysis was performed as follows: bbl of steam injected in 2005 into fields with TEOR [cite CDC-DOGGR p. 175-200] were compared to stated steam production rates for cogeneration facilities in those same fields [cite cdc-doggr 2005 p. 239-241]. The amounts of steam accounted for in cogeneration ranged between approximately 0.15 (South Belridge and Arroyo Grande) to over 1 (Kern Front).

stages from exploration to retailing. The methodologies in the API compendium would form a standardized basis with which fuel producers could record the emissions from their operations, and thus could serve as a method for companies to document claims for lower emissions.

Reducing GHG emissions

4.4 Electricity

Expansion in the use of electricity for vehicle propulsion can also reduce carbon intensity of transportation. Because electricity supply in California depends largely on low carbon sources, under almost any circumstance, the substitution of EVs and PHEVs for gasoline will result in reduced GHG emissions. Electricity will compete directly with biofuel production from biomass as markets develop for plug-in hybrid and other electric vehicles due to the potentially higher efficiencies and transport range and lower costs for some feedstocks. However, technology advances will likely be needed to reduce criteria air pollutant emissions, especially in oxides of nitrogen (NO_x) and allow improved siting in proximity to resource. Modeling efforts are underway to develop improved resource supply curves for biofuel facility assessment and siting. Electricity can also be used in making hydrogen by electrolysis such that wind, solar, geothermal, and other low carbon sources can be used to provide vehicle fuel in addition to direct use.

Significant expansion in the use of electricity for transportation as a low carbon alternative will place additional demands on renewable power providers to increase generating capacity and energy deliveries. As noted elsewhere, gross annual system electrical energy demand in the state exceeds 288 TWh. To satisfy requirements under California's existing renewable portfolio standard (RPS), the state's investor owned utilities will need to add between 1.5 and 6.3 TWh of renewable electricity by 2010 (Integrated energy policy report update 2006 2007). Although new contracts have been signed for up to 11.8 TWh, only 0.8 TWh (7%) have come on line. A number of barriers to meeting the RPS goals have been identified, and may prove similarly restrictive in providing low carbon electricity to the transportation sector. Among these are insufficient transmission access for renewable power projects, inadequate supplemental energy payments to promote needed financing, lack of transparency in utility bidding processes, reliance on contracted, rather than actual energy deliveries as a measure of progress toward the RPS, and limited progress in repowering aging wind facilities (Integrated energy policy report update 2006 2007). The latter is partly true for the biomass sector as well. The state has concluded that "without prompt attention...the state's ability to meet its RPS goals and secure the benefits of renewable energy for the state—particularly California's greenhouse gas emission reduction goals—continues to be threatened (Integrated energy policy report update 2006 2007)." Failure to meet renewable energy targets, including those that may arise from the LCFS, will not come as a result of inherent resource constraints as the state has abundant renewable resources (Integrated Energy Policy Report 2005). In the absence of substantial renewable capacity additions, demand for low-carbon electricity will place increasing emphasis on electricity from nuclear and natural gas sources, as well as other fossil sources with carbon capture and storage.

Under almost any scenario, plug-in hybrid electric vehicles (PHEVs) would be responsible for fewer greenhouse gases (GHGs) per mile driven when running in all-electric mode than when running in gasoline-fueled hybrid electric mode. But would Californians find it economical to

charge their PHEVs from the electric grid? Lemoine et al. (Lemoine, Kammen, and Farrell) find that the costs of all-electric operation are sensitive to the rate structure in place for PHEV charging (Table 4-10). Under the Pacific Gas & Electric Company's (PG&E's) standard residential tariff (E-1), PHEV owners would not buy gasoline unless it cost less than \$2.89 per gallon or they were using more than twice their baseline allowance and so paying more than \$0.22/kWh.²⁹ This standard rate structure would often make all-electric operation desirable.

PG&E does have an experimental time-of-use tariff (E-9) for electric vehicle (EV) owners. This rate structure differs according to time of year and hour of day. To discourage charging when supplies are tight, the summer peak hours have the highest rates, and they last from 2 p.m. to 9 p.m. on weekdays with a baseline rate of \$0.284/kWh. To encourage nighttime charging, the prices for summer off-peak hours are lower than normal with a baseline rate of 5.0¢/kWh. These off-peak hours occur during non-evening weekend hours and during the night and early morning on weekdays. The remaining summer hours have rates similar to the standard rates. If PHEV owners bought electricity according to this tariff, they would not save money by charging at peak hours unless gasoline cost more than \$3.73 per gallon. And they would want to charge their vehicles during off-peak hours as long as gasoline prices remained above \$1.96 per gallon or they were using more than twice their baseline allowance and so paying more than \$0.149/kWh. PG&E's experimental EV tariff would likely deter PHEV owners from charging during summer afternoon hours, but this effect depends upon the actual adoption of such a tariff by the vehicle owner, upon the specific peak hour rates, and upon the current prices of substitutable liquid fuels. Real-time electricity pricing may be less successful at shifting vehicle charging times since charging may be economical even during peak hours. On the other hand, real-time pricing would only encourage vehicles to charge up to the point at which electricity prices were equivalent to gasoline prices. Lemoine et al. use 1999 real-time price data from the California Power Exchange to show that millions of PHEVs could have economically charged during peak and off-peak hours with gasoline prices of \$2.00 per gallon or higher (Figure 4-7). While charging 1 million compact cars would probably not cause problems for the current electric grid, charging millions of vehicles could pose problems by raising the system peak and so requiring more generation capacity. Therefore, it may be desirable to use means such as special rate structures to shift charging to nighttime hours.

Low-GHG electricity is an appealing transportation fuel because California PHEV owners may actually save money by using it instead of liquid fuels. The California grid could economically and physically support several million PHEVs, especially if their owners use rate schedules that encourage them to charge during off-peak hours. If consumers purchase PHEVs, then it will often make financial sense for them to run their vehicles on electricity, which, if under a cap-and-trade scheme, could serve as a transportation fuel free of additional GHGs. It is possible that consumers would require a subsidy to purchase PHEVs if battery prices do not decline, but such a subsidy need not extend beyond the purchase decision into vehicle operation. The biggest barrier to using PHEVs to obtain low-GHG transportation will likely be in the initial purchase of PHEVs and not in their post-purchase operation.

Table 4-10: PG&E May 2006 residential electricity tariffs and equivalent gasoline prices for PHEVs

²⁹ All fuel price results are for compact car PHEVs. The results for SUV PHEVs are similar.

<i>Standard residential tariff</i>	Electricity rate (\$/kWh)	Equivalent gasoline price (\$/gal)
Baseline usage	\$0.11430	\$1.50
101%-130% of Baseline	\$0.12989	\$1.71
131%-200% of Baseline	\$0.21981	\$2.89
201%-300% of Baseline	\$0.30292	\$3.98
Over 300% of Baseline	\$0.34648	\$4.55

<i>EV summer tariff</i>	Peak		Off-Peak	
	Electricity rate (\$/kWh)	Equivalent gasoline price (\$/gal)	Electricity rate (\$/kWh)	Equivalent gasoline price (\$/gal)
Baseline usage	\$0.28368	\$3.73	\$0.04965	\$0.65
101%-130% of Baseline	\$0.28368	\$3.73	\$0.04965	\$0.65
131%-200% of Baseline	\$0.38323	\$5.04	\$0.14920	\$1.96
201%-300% of Baseline	\$0.47525	\$6.25	\$0.24122	\$3.17
Over 300% of Baseline	\$0.52348	\$6.88	\$0.28945	\$3.80

Notes: Electricity tariffs are from the Pacific Gas and Electric Company (2006).³⁰ Baseline allowances range from 8-19 kWh per day, depending upon climatic zone and time of year, and they may be even higher for households with electric heating. PHEV efficiency is 52.7 miles/gallon and 4.010 miles/kWh (EPRI, 2002). The gasoline prices yield the same cost per mile of PHEV operation as do the electricity rates. (from Lemoine et al. (forthcoming))

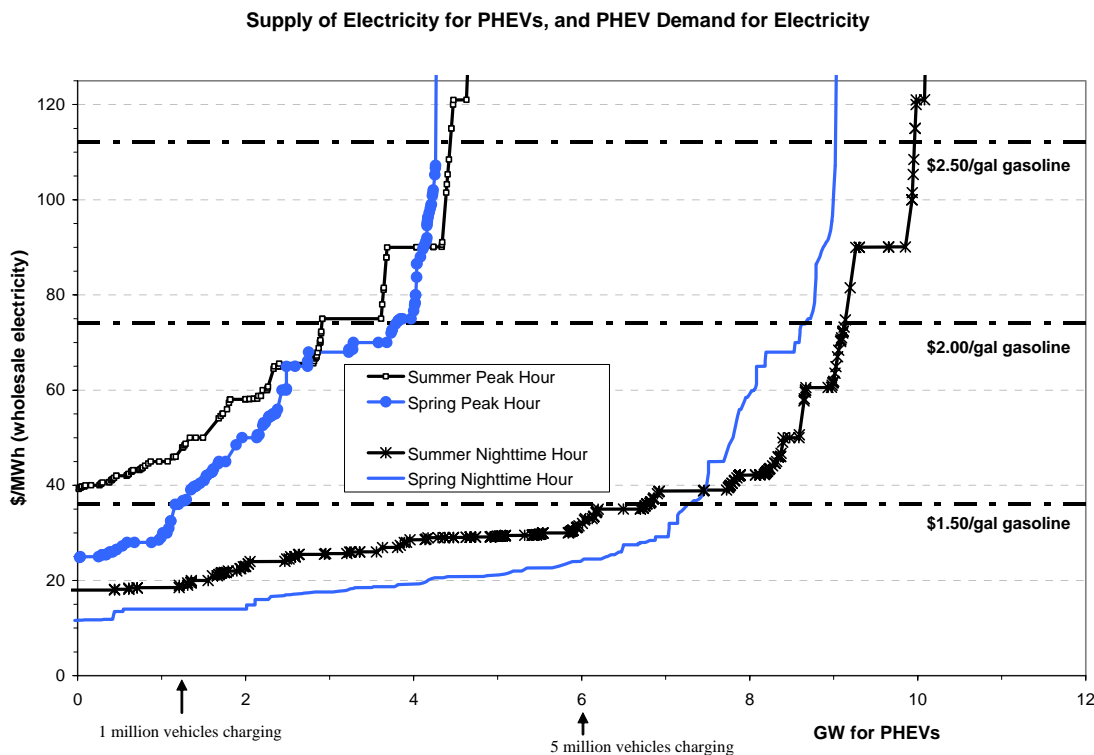

³⁰ Pacific Gas and Electric Company. 2006. "Schedule E-1—Residential Service" and "Schedule E-9— Experimental Residential Time-Of-Use Service for Low Emission Vehicle Customers." Effective May 1, 2006. Available at: <http://www.pge.com/tariffs/pdf/E-1.pdf> and <http://www.pge.com/tariffs/pdf/E-9.pdf>

Figure 4-7: The quantity of electricity beyond observed demand available at each price, as determined by the supply bids given to the California Power Exchange in 1999. Also, the number of PHEVs that would need to charge during the hour to use that much electricity with a charge rate of 1 kWh/hr (or a charger size of 1.2 kW).

The gasoline price lines provide the same cost per mile as the retail electricity rates that correspond to the marked wholesale prices. The gasoline price lines can be read as the PHEV demand for electricity with a given price of gasoline, assuming that gasoline and grid-supplied electricity are perfect substitutes and that consumers see real-time electricity prices with non-generation costs of \$0.07816/kWh (Pacific Gas and Electric Company, 2006). Households in the CAISO region own approximately 17 million vehicles (U.S. Department of Transportation, 2001; USDOE 2001).

4.5 Hydrogen

Hydrogen can be produced from a variety of primary sources including natural gas, coal, oil, biomass, wind, solar, and nuclear power. For this report, hydrogen supply options are considered that are commercial today or could be commercialized by 2020 (Table 4-11).

Table 4-11: Near term hydrogen supply options for California

Resource	H2 Production Technology	H2 Delivery method to station (for central plants)
Natural gas	Steam methane reformation (onsite)	n/a
	Steam methane reforming (central plant)	Liquid H2 truck Compressed gas truck H2 gas pipeline
Coal	Coal gasification with Carbon Capture and Sequestration (central plant)	Liquid H2 truck Compressed H2 gas truck H2 gas pipeline
Biomass (agricultural, forest and urban wastes, landfill gas, digester gas)	Biomass gasification (central plant) Reforming of biomethane	Liquid H2 truck Compressed H2 gas truck H2 gas pipeline
Electricity (from various electric generation resources)	Water electrolysis (onsite)	n/a

“Onsite” refers to hydrogen production at the refueling station.

To estimate how much hydrogen demand might develop in California by 2020, a range of scenarios is used as developed by the US Department of Energy for introduction of hydrogen vehicles in the Los Angeles and San Francisco areas (Gronich 2006). In the DOE scenarios, 200,000-800,000 hydrogen vehicles operate in these two California urban areas by 2020, using about 140-560 metric tons of hydrogen per day.

Hydrogen refueling stations: How many and how large?

To reach consumers, hydrogen is assumed to be provided at a network of stations. At present, 15 hydrogen refueling station demonstration projects are operating in California, with plans for an additional 24. The California Hydrogen Highway Network Blueprint Plan calls for a total of 50 stations by 2010 (including the 39 mentioned above), and as many as 250 in the longer term (CA H2H net Plan (Wang et al. 1998)).

If hydrogen vehicles and stations are introduced according to the USDOE scenarios, by 2020, hydrogen demand for vehicles would be about 95-340 metric tons per day in the LA area and 42-220 metric tons/day in SF. Assuming an average station size of 1.5 metric tons/day (Myers et al. 2003), this implies a total of 60-220 stations in LA and 30-140 stations in SF. More stations might be built along interstate highways connecting northern and southern California, and in other major cities such as San Diego and Sacramento. Some studies suggest that these relatively sparse urban networks may be adequate for consumer adoption (for example, with 200 stations in LA, the average driving time to a station is about 5 minutes)

One kilogram of hydrogen has about the same energy content as one gallon of gasoline. The average H2 fuel cell car uses 0.7 kg H2/day. However, hydrogen can be used perhaps 2-2.5 times as efficiently as a gasoline ICEV and 30-60% more efficiently than a gasoline hybrid. On a cost per mile basis, \$2/gallon gasoline is equivalent to about \$3/kg H2 (comparing H2 fuel cell vehicles to gasoline hybrids). Hydrogen costs were estimated using a model developed at UC Davis (Yang and Ogden 2007).

Existing Industrial Hydrogen Production in California

Significant quantities of hydrogen (about 3000 metric tons/day) are produced for industrial use in California today, primarily for oil refining (Table 4-12). This amount of hydrogen could fuel about 4 million fuel cell vehicles.) Over 90% of California's industrial hydrogen is produced via steam reforming of natural gas. It is likely that refinery hydrogen capacity will expand by at least 4% per year over the next 10 years, as gasoline demand grows and more hydrogen is needed for refining heavier crude oils with higher sulfur content. Studies at UC Davis indicate that excess refinery hydrogen production capacity during this expansion might be used to make fuel for tens of thousands of hydrogen cars. These preliminary results suggest that about 5% of total production capacity could be reliably available as fuel for hydrogen vehicles. Using 3% of each region's 2006 total refinery hydrogen production capacity, 57,000 hydrogen light-duty fuel-cell vehicles could be fueled in the LA Basin and 51,000 could be fueled in the SF Bay Area. Depending on the hydrogen demand, excess industrial hydrogen could play a role in starting a hydrogen based transportation system. Industrial H₂ capacity totals close to 400 MMscf/day or more than 900 metric tons per day (Table 4-13). The average cost of H₂ production via natural gas reformation in LA would be about \$1.7-2.0/kg (Yang and Ogden 2007). Distribution and dispensing through a network of 30-200 stations adds \$2-2.5/kg (Yang and Ogden 2007).

Table 4-12: Crude oil and hydrogen capacities for California refineries

Company Name	Location	Crude Oil Processing Capacity (Barrels per Day)	Hydrogen Production Capacity (MMscf/day)*
<i>LA Basin</i>		<i>1,028,200</i>	<i>664</i>
BP	Carson	247,000	105
ChevronTexaco	El Segundo	260,000	139
ExxonMobil	Torrance	149,500	159
ConocoPhillips	Wilmington	139,700	100.8
Shell Oil	Wilmington	100,000	110
Valero (Ultramar)	Wilmington	80,000	50
Paramount Petroleum	Long Beach	52,000	--
<i>San Francisco Bay Area</i>		<i>803,100</i>	<i>592</i>
ChevronTexaco	Richmond	225,000	155
Tesoro (Golden Eagle)	Martinez	161,000	105
Shell Oil	Martinez	157,600	101.3
Valero	Benicia	139,500	131.5
ConocoPhillips	Rodeo and Santa Maria	120,000	98.9
<i>Bakersfield</i>		<i>114,300</i>	<i>37</i>
Big West	Bakersfield	65,000	29.7
Kern Oil	Bakersfield	25,000	--
San Joaquin Refining	Bakersfield	24,300	7
<i>State Totals</i>		<i>1,945,600</i>	<i>1,292.2</i>

Source: Oil and Gas Journal (2005)

*1 MMscf = 1 million standard cubic feet = 2.3 metric tons of hydrogen (approx.)

Table 4-13: Industrial hydrogen facilities in California

Company/Location	H2 Production (MMScf/day)	Phase
Praxair Ontario	8.5	cry. liq.
Air Products		
Sacramento	2.3	cry. liq.
Carson	100	comp. gas
Martinez (2 units)	125	comp. gas
Wilmington (2 units)	160	comp. gas

Source: Ritchey S. (2007)

4.5.1 Hydrogen production from natural gas

Hydrogen can be made via small scale steam reforming of natural gas at the refueling station. This allows better matching of supply as demand grows, and eliminates the need for a distribution system. Results from cost modeling (Ogden) indicate that c. 2020 demand levels (1-5% of the fleet in LA and 3-12% in SF), the lowest cost hydrogen option in California is likely to be onsite steam reforming of natural gas. Hydrogen from onsite reformers costs \$3-3.5/kg depending on the total demand. Assuming that natural gas is reformed at 75% efficiency (higher heating value basis), the amount of natural gas needed for hydrogen production in 2020 compared to statewide natural gas demand, less than 1%. A recent study conducted by EEA for the USDOE (EEA 2007) indicated that peak natural gas demand for vehicles should not pose a problem for the NG infrastructure even at much higher levels of H2 demand.

4.5.2 Roles for renewable hydrogen

In the timeframe between now and 2020, the lowest cost renewable hydrogen pathway is likely to be gasification of biomass wastes. Studies indicate that hydrogen might be produced from low cost biomass wastes at costs of \$3.5/kg, which is roughly competitive with hydrogen from onsite steam reforming (Parker 2007). The total biomass waste resource, including landfill gas and sewage digester gas, could produce enough hydrogen for perhaps 9 million vehicles, or 25-30% of California's light duty fleet. Detailed studies of biomass hydrogen strategies in California are underway to develop a supply curve for biomass hydrogen.

4.5.3 Fossil-derived hydrogen with carbon capture and storage

Fossil hydrogen with carbon capture and storage (CCS) can be a low-cost route to low carbon hydrogen. At the highest demand levels anticipated in 2020, coal plants with CCS are just becoming competitive with onsite reforming. The total delivered H2 cost is about \$3-3.5/kg. It appears that 2020 would be the earliest time that hydrogen from coal with CCS might start to play a role in California.

In the nearer term, California is gaining experience with CCS technology. The West Coast Regional Carbon Sequestration Partnership (WESTCARB) is one of seven research partnerships in the US Department of Energy's program to characterize carbon sequestration potential and conduct testing at the pilot-scale. WESTCARB encompasses six western states (California, Arizona, Nevada, Oregon, Washington and Alaska) and one Canadian Province (British Columbia). The major goals include identifying major sources of CO₂ in the region, assessing status and cost of technologies for separating CO₂ from large point sources, determining the potential for geologic storage of CO₂, and analyzing the necessary infrastructure for transporting CO₂ from source to storage locations. A number of WESTCARB projects (Table 4-14) are assessing various aspects of carbon sources and sinks in the state of California (WESTCARB

2007). BP plans to gasify petcoke at its refinery in Carson, producing hydrogen to run a 500 MW gas turbine power plant, while capturing CO₂ to be used for enhanced oil recovery. This type of system might someday be used to co-produce hydrogen and electricity from fossil sources without introducing CO₂ into the atmosphere.

4.5.4 Co-production of hydrogen and electricity

Hydrogen and electricity can be co-produced from a variety of resources. Prospects for improving the economics of hydrogen via co-production are currently under investigation.

4.5.5 Summary

Hydrogen use before 2020 will be relatively small compared to overall energy use in California. Industrial hydrogen might play an early role. In the timeframe up to 2020, the lowest cost options will generally rely on natural gas (either through industrial hydrogen or onsite reforming), although there may be roles for biomass hydrogen where low cost wastes are available and a large enough demand is nearby. Coal-based hydrogen with CCS and pipeline distribution might begin to become competitive toward 2020, assuming the most optimistic DOE scenario unfolds.

Table 4-14: WESTCARB carbon capture and sequestration projects

Project Name	Storage Type*	Reservoir Type	Location	CO ₂ Source	Quantity of CO ₂ Injected/ Stored	Potential Storage Capacity
Rosetta-Calpine Saline Formation CO ₂ Storage Project	Geo	Saline Aquifer	Near Rio Vista, CA (northern Central Valley)	Commercial Vendor	2,000 tCO ₂	20 – 120 GtCO ₂
Rosetta-Calpine Gas Reservoir CO ₂ Storage Project	Geo	Depleted Gas Reservoir	Near Rio Vista, CA (northern Central Valley)	Commercial Vendor	2,000 tCO ₂	0.3 GtCO ₂
Northern Arizona Saline Formation (Salt River) CO ₂ Storage Project	Geo	Saline Aquifer	Near a coal-fired power plant in northeastern AZ	Commercial Vendor	2,000 tCO ₂	TBD
Kimberlina Saline Formation and Oil Field CO ₂ Storage Investigation	Geo	Depleted Oil Reservoir & Saline Aquifer	Kimberlina, CA (southern Central Valley)	Clean Energy Systems Power Plant	0 (reservoir assessment only)	TBD
Centralia Geologic Formation CO ₂ Storage Investigation	Geo	Deep Coal Seam & Saline Aquifer	Centralia, WA (Puget Sound basin)	Commercial Vendor	0 (reservoir assessment only)	2.8 GtCO ₂
Shasta County (CA) Terrestrial Sequestration Pilot	Ter	---	Shasta County, CA	---	---	3.2 GtCO ₂ (afforestation estimate for CA)
Lake County (OR) Terrestrial Sequestration Pilot	Ter	---	Lake County, OR	---	---	1.5 GtCO ₂ (afforestation estimate for OR)

Source: McCollum (2006)

*Geo = geological storage. Ter = terrestrial storage.

4.6 References

- Aden. 2002. Lignocellulosic Biomass to Ethanol Process Design and Economics Utilizing Co-Current Dilute Acid Prehydrolysis and Enzymatic Hydrolysis for Corn Stover: NREL/TP-510-32438.
- Bakker, R.R., and B. M. Jenkins. 2003. Feasibility of collecting naturally leached rice straw for thermal conversion. *Biomass and Bioenergy* 25:597-614.
- Bazdarich, M. and P.G. Sebesta, 2001, On the Economic Feasibility of Sugar Cane-to-Ethanol Operations in the Imperial Valley, UCR Forecasting Center, UC Riverside, and UC Desert Research and Extension Center, December.
- BBI. 2001. *Ethanol Plant Development Handbook*. 3rd ed: Great Lakes Regional Biomass Energy Program & Renewable Fuels Association.
- Bemis, Gerry, and Jennifer Allen. 2005. Inventory of California Greenhouse Gas Emissions and Sinks: 1990 to 2002 Update. In *Inventory of California Greenhouse Gas Emissions and Sinks*. Sacramento, CA: California Energy Commission.
- Burnes, E.I., N. Koehler, T. Koehler, and P. Sebesta. 2004. Ethanol in California: a feasibility framework. Great Valley Center, Modesto, California.
- CDC. 2005. 2005 Annual Report of the State Oil & Gas Supervisor. In *Annual Report of the State Oil & Gas Supervisor*. Sacramento, CA: California Department of Conservation: Division of Oil, Gas and Geothermal Resources.
- CEC. 2007. *California Natural Gas Receipts* California Energy Commission, 9/20/2006 2007 [cited March 26th 2007]. Available from http://www.energy.ca.gov/naturalgas/statistics/natural_gas_receipts.html.
- . 2007. *California Natural Gas Supply by Source*. California Energy Commission, 8/30/2006 2007 [cited March 26th 2007]. Available from http://www.energy.ca.gov/naturalgas/statistics/gas_supply_by_source.html.
- . 2007. *Oil and petroleum in California*. California Energy Commission 2007 [cited 3-6-07 2007]. Available from <http://www.energy.ca.gov/oil/index.html>.
- Dale, B.E. 1991. Ethanol production from cereal grains. In *Food Science and Technology*, edited by J. Lorenz and K. Kulp. New York: Marcel Dekker.
- Diaz, L., G. Savage, and C. Golueke, eds. 2002. *Composting of municipal solid waste*. Edited by G. Tchobanoglous and F. Kreith, *Handbook of Solid Waste Management*. New York: McGraw-Hill.
- EPA, US. 2007. Regulatory Impact Analysis: Renewable Fuel Standard Program.
- Farrell, A.E., R.J. Plevin, B.T. Turner, A.D. Jones, M. O'Hare, and D.M. Kammen. 2006. Ethanol can contribute to energy and environmental goals. *Science* 311 (5760):506-508.
- Gary, James H., and Glenn E. Handwerk. 2001. *Petroleum Refining: Technology and Economics*. 4th ed. New York: Marcel Dekker inc.
- Gildart, M. C., and R. B. Williams. 2006. An assessment of biomass resources in California. Sacramento, California: California Biomass Collaborative/California Energy Commission/Contract 500-01-016.
- Graham, R.L., and M.E. Downing. 1995. Potential supply and cost of biomass from energy crops in the TVA region. Oak Ridge, TN: Oak Ridge National Laboratory/ORNL-6858.

- Gronich, S. 2006. "Hydrogen & FCV Implementation Scenarios, 2010 – 2025," presented at the USDOE Hydrogen Transition Analysis Workshop, Washington, DC, August 9-10, 2006.
http://www1.eere.energy.gov/hydrogenandfuelcells/analysis/scenario_analysis_mtg.html
- Hill, J., Nelson, E., Tilman, D., Polasky, S., and Tiffany, D. 2006. "Environmental, economic, and energetic costs and benefits of biodiesel and ethanol biofuels." *PNAS*, 103(30), 11206-11210.
- Huisman, W., B. M. Jenkins, and M.D. Summers. 2002. Cost evaluation of bale storage systems for rice straw. In *Bioenergy 2002*. Madison, WI: Omnipress International.
- ICF. 1999. EIIP Volume 8, Chapter 3: Methods for Estimating Methane Emissions from Natural Gas and Oil Systems. In *Emissions Inventory Improvement Program Documentation*. Washington DC: Emissions Inventory Improvement Program.
- Integrated Energy Policy Report. 2005. Sacramento, California: California Energy Commission/CEC-100-2005-007CMF.
- Integrated energy policy report update 2006. 2007. Sacramento, CA: California Energy Commission CEC-100-2006-001-CMF.
- IPCC. 2000. Good Practice Guidance and Uncertainty Management in National Greenhouse Gas Inventories. Montreal: Intergovernmental Panel on Climate Change, National Greenhouse Gas Inventories Programme.
- Jacobson, M.Z. 2007. Effects of ethanol (E85) versus gasoline vehicles on cancer and mortality in the United States. *Environmental Science and Technology* Web 04/18/2007.
- Jenkins, B. M. 1997. A comment on the optimal sizing of a biomass utilization facility under constant and variable cost scaling. *Biomass and Bioenergy* 13 (1/2):1-9.
- . 2005. Biomass in California: challenges, opportunities, and potentials for sustainable management and development. Sacramento, CA: California Biomass Collaborative/California Energy Commission/CEC-500-2005-160.
- . 2007. More than just hot air: actions to achieve California's biofuel goals. In *BioCycle West Coast Conference*. San Diego, California.
- Jenkins, B. M., R.R. Bakker, and J.B. Wei. 1996. On the properties of washed straw. *Biomass and Bioenergy* 10 (4):177-200.
- Kaffka, S. 2007 [cited. Available from <http://sugarbeet.ucdavis.edu/sbchap.html>].
- Keeney, D., and M. Muller. 2006. Water use by ethanol plants: potential challenges. Institute for Agriculture and Trade Policy, Minneapolis, Minnesota.
- Klass, D.L. 1998. *Biomass for renewable energy, fuels, and chemicals*. San Diego, CA: Academic Press.
- Kornbluth, K., P. Erickson, R. B. Williams, and Z. McCafferty. 2006. The role of hydrogen in landfill gas utilization. Sacramento, CA: California Integrated Waste Management Board.
- Leiby, Paul. 1993. A Methodology for Assessing the Market Benefits of Alternative Motor Fuels: the Alternative Fuels Trade Model. Oak Ridge, TN: Oak Ridge National Laboratory.
- Lemoine, D., D.M. Kammen, and A.E. Farrell. Effects of Plug-In Hybrid Electric Vehicles in California Energy Markets (forthcoming).
- Maples, Robert E. 2000. *Petroleum refinery process economics*. 2nd ed. Tulsa, Oklahoma: PennWell Publishers.
- Maul, David. 2004. *California's Natural Gas Context*. Sacramento, CA: California Energy Commission. Presentation.

- McCollum, D.L. and J.M. Ogden. 2006. Techno-Economic Models for Carbon Dioxide Compression, Transport, and Storage & Correlations for Estimating Carbon Dioxide Density and Viscosity. Institute of Transportation Studies, University of California, Davis, Research Report UCD-ITS-RR-06-14
- Micales, J.A., and K.E. Skog. 1997. The decomposition of forest products in landfills. *International biodeterioration and biodegradation* 39 (2-3):145-158.
- Nicholas, M.A. and J.M. Ogden. 2007. Detailed Analysis of Urban Station Siting for California Hydrogen Highway Network. *Transportation Research Record* 2006 (1983), 129 - 139
- Nicholas, M.A., S.L. Handy, D. Sperling. 2004. Using Geographic Information Systems to Evaluate Siting and Networks of Hydrogen Stations. *Transportation Research Record* (1880), 126 - 134
- Oil and Gas Journal. 2005. Oil & Gas Journal Data Book 2005 (PennWell Publishers).
- Parker, N.C. 2007. Optimizing the Design of Biomass Hydrogen Supply Chains Using Real-World Spatial Distributions: A Case Study Using California Rice Straw. Institute of Transportation Studies, University of California, Davis, Research Report UCD-ITS-RR-07-04
- Perlack, R.D., L.L. Wright, A.F. Turhollow, R.L. Graham, B.J. Stokes, and D.C. Erbach. 2005. Biomass as Feedstock for a Bioenergy and Bioproducts Industry: The Technical Feasibility of a Billion-Ton Annual Supply. Oak Ridge, TN: Oak Ridge National Laboratory/TM-2005/66.
- PG&E. 2007 [cited. Available from http://www.pge.com/news/news_releases/q1_2007/070320a.html.
- Ritchey, S. 2007. graduate student, Transportation Technology and Policy program, UC Davis, private communications.
- A roadmap for the development of biomass in California. 2006. edited by B. M. Jenkins. Sacramento, California: California Biomass Collaborative/California Energy Commission/CEC-500-2006-095-D.
- Shaffer, S.D., B.M. Jenkins, D.L. Brink, M.M. Merriman, B. Mouser, M.L. Campbell, C. Frate, and J. Schmierer. 1992. Agronomic and economic potential of sweet sorghum and kenaf: preliminary results of the California industrial crops program.
- Shapouri, H., M. Salassi, and J.N. Fairbanks. 2006. The economic feasibility of ethanol production from sugar in the United States: USDA.
- Sheehan, J., T. Dunahay, H. Benemann, and P. Roessler. 1998. A look back at the U.S. Department of Energy's aquatic species program--biodiesel from algae: NREL/TP-580-24190.
- Sheriden, Margaret. 2006. California Crude Oil Production and Imports. In *Staff Paper*. Sacramento, CA: California Energy Commission.
- Shires, Theresa M., and Christopher J. Loughran. 2004. Compendium of Greenhouse Gas Emissions Methodologies for the Oil and Gas Industry. Washington, D.C.: American Petroleum Institute.
- Solid Waste Tipping Fee Survey 2000. 2000. Sacramento, CA: California Integrated Waste Management Board
- Statewide Waste Characterization Study. 2004. Sacramento, CA: Cascadia Consulting Group/California Integrated Waste Management Board.
- Tchobanoglous, G., H. Theisen, and S. Vigil. 1993. *Integrated solid waste management*. New York: McGraw-Hill.
- Themelis, N.J., Y.H. Kim, and M.H. Brady. 2002. Energy recovery from New York City municipal solid wastes. *Waste Management & Research* 20 (3):223-233.

- Tijmensen, M., A. Faaij, C. Hamelinck, and M. van Hardeveld. 2002. Exploration of the possibilities for production of Fischer Tropsch liquids and power via biomass gasification. *Biomass and Bioenergy* 23:129-152.
- Turner, B.T., R.J. Plevin, M. O'Hare, and A.E. Farrell. 2007. Creating markets for green biofuels: measuring and improving environmental performance: UCB-ITS-TSRC-RR-2007-1, UC Berkeley Transportation Sustainability Research Center, April.
- USDOE. 2001. National Household Travel Survey.
- . 2006 [cited. Available from http://www1.eere.energy.gov/biomass/concentrated_acid.html].
- . 2007 [cited. Available from <http://www.energy.gov/news/4827.htm>].
- . *Ethanol yield calculator* 2007 [cited. Available from http://www1.eere.energy.gov/biomass/ethanol_yield_calculator.html].
- Van Vactor, Samuel A. 2000. Pricing Royalty Crude Oil: Economic Insight, inc.
- Williams, R. B. 2006. Biomass in Solid Waste in California: Utilization and Policy. Davis, CA: California Biomass Collaborative/CEC PIER Contract 500-01-016.
- . 2006. Central Valley and California Lignocellulosic Ethanol Potential: Summary Analysis. Davis, CA: California Biomass Collaborative.
- Worrell, Ernst, and Christina Galitsky. 2004. Profile of the petroleum refining industry in California. In *California Industries of the Future Program*. Berkeley, CA: Energy Analysis Department, Lawrence Berkeley National Laboratory.
- Wright, L.L., M. Walsh, M.E., et al. 2000. Biomass feedstock research and development for multiple products in the United States. In *First World Conference and Exhibition on Biomass for Energy and Industry*. Sevilla, Spain.
- Yang, C., and J.M. Ogden, 2007. Determining the lowest-cost hydrogen delivery mode, *International Journal of Hydrogen Energy*, 32(2): 268-286.
- Zucca, Alfred J. 2001. Oil, Gas and Geothermal Fields in California. Sacramento, CA: California Department of Conservation, Division of Oil, Gas, and Geothermal Resources.

5 Representative Scenarios

The Low Carbon Fuel Standard (LCFS) articulated in Executive Order S-01-07 allows for flexibility on the part of regulated entities in reducing the carbon intensity of transportation fuels (Schwarzenegger 2007). Twelve light duty vehicle scenarios have been constructed in an attempt to represent a broad range of future outcomes that could result from this flexible regulatory approach. The primary information provided by the scenarios is the set of assumptions needed in each one to achieve a specific reduction in average fuel carbon intensity (AFCI, a measure of fuel carbon intensity discussed in Section 2.3). This allows the reader to judge for themselves how realistic each scenario is, and thus the technical feasibility of the LCFS. Due to limitations of time and resources, this study does not address all possible issues, and it does not address cost effectiveness. This study considers the LCFS as part of an overall strategy to reduce global warming, so it focuses on fuels and the adoption of alternative fuel vehicles. It does not address two other key issues in transportation, vehicle design (including energy efficiency) and vehicle usage (or, travel demand). These other strategies are essential, especially increasing energy efficiency in vehicle use, but are not the subject of the LCFS.

The scenarios below are not predictions of future events. The application of long-term forecasting methods in energy studies has a remarkably poor track record, and the present analysis is not an extension of this tradition (Shlyakhter et al. 1994; Huntington 1994; Craig, Gadgil, and Koomey 2002, Smil 2003 Chapter 3). In contrast to analyses that result in predictive claims, the goal of these scenarios is to broaden the reader's perspective on the variety of technological trends that could be consistent with the LCFS. Future analyses employing predictive models of change to evaluate the LCFS can certainly add to the debate and policy process concerning the future of alternative fuels in California. The set of scenarios presented here is intended to illustrate a variety of possible futures, and the changes needed to attain these futures, rather than a narrow range of probable outcomes.

To the greatest extent possible, these scenarios ignore details of regulatory design, which is left to Part 2 of this study. However, this is not entirely possible. For example, in some scenarios electric vehicles (e.g. plug-in hybrid electric vehicles) are included and the GHG emissions associated with their use are assumed to be included in the calculation of the AFCI for the entire state but how this is accomplished by regulation is unstated and ignored. This is another reason that the scenarios in Part 1 are only illustrative; different policy choices could change the types of assumptions required to meet the AFCI goals of each scenario. The potential implications of such policy choices are explored more fully in Part 2 of this study.

One of the scenarios is a *Business as Usual* (BAU) scenario, and is used as a reference for the carbon intensity or AFCI reductions in the other scenarios. The remaining eleven scenarios include different combinations of fuel and vehicle technologies, and each results in a significant reduction in carbon intensity. Some scenarios fall short of the 10% carbon intensity reduction goal called for the Executive Order, others meet the goal, and a few exceed the goal. The reason for providing all three types of scenarios is to offer a more complete view of the feasibility of the 10% reduction goal. The underlying scenario assumptions about technological innovation and rates of commercialization are not exhaustive, but they are representative of some of the major trends that could occur in response to the LCFS.

These scenarios have been constructed using a modified version of the VISION model, originally developed by Argonne National Laboratory to analyze nationwide trends in transportation energy, petroleum consumption and GHG emission trends (Mintz, Tompkins, and Camp 1994; Singh, Vyas, and Steiner 2003). The model is free and available online.³¹ The version of the VISION model used for the present analysis has been modified to represent the California light duty vehicle fleet, and is referred to as the VISION-CA model. The VISION-CA model has been calibrated using California specific inputs, many of which have been provided by staff at CARB and CEC. However, the model continues to be refined, and some parameters will likely be modified in the future as additional data is incorporated. The results presented here should therefore be interpreted as preliminary.

The first part of this section (5.1) provides context for the scenario analysis. The second part (5.2) provides a brief overview of infrastructure cost issues related to the scenarios presented. The third part (5.3) describes general input assumptions for the VISION-CA model. The fourth part (5.4) contains the specific assumptions and results for each scenario. The last part of this section (5.5) contains the results of a simple approach to estimating potential carbon intensity reductions by heavy duty and off-road vehicles that currently use diesel fuel. The use of bio/renewable diesel and electricity are the two approaches examined.

5.1 Scenario definitions

A total of 12 scenarios have been constructed, each defined by a combination of assumptions about fuel and vehicle technologies, and each meeting specified APCI targets, as shown in Table 5-1. The first scenario is the *Business as Usual* (BAU) scenario, and contains today's mix of vehicles and fuel usage, assuming no significant changes before 2020. The other scenarios all assume that the LCFS applies to light duty vehicles only and is either attained (10% reduction by 2020), partially attained (5% reduction by 2020) or exceeded (15% reduction by 2020).

Possible options for including heavy duty vehicles will be explored in Part 2 of this study.

All of the scenarios represent non-trivial departures from today's fuel mix and vehicle fleet because significant reductions in GHGs from the transportation sector will require change, not slight modifications to the status quo. For this reason, no scenario that is simply a marginal change in the status quo is presented. However, some of these scenarios would be virtually indistinguishable from the status quo in terms of what fuels most consumers would be using. In these cases, the change is in how these fuels are produced.

The first non-BAU scenario (C5), named *Electric Drive*, includes a great deal of innovation in vehicle technology. The scenario assumes that electric drive technologies (batteries, fuel cells and power electronics) improve significantly and become widely used within the next decade. In addition to battery electric vehicles (EVs) and plug-in hybrid electric vehicles (PHEVs), hydrogen fuel cell vehicles (FCVs) are also included. The variety of potential designs and usage patterns in this scenario is very large. (For instance, the amount of grid electricity that PHEV

³¹ <http://www.transportation.anl.gov/software/VISION/index.html>

owners will actually consume is unknown, as is the electrical capacity of such hypothetical vehicles.) To date, only very limited numbers of EVs are in use in California and only a handful of PHEVs have been converted by aftermarket firms (other than the original manufacturers). Prices for these vehicles are so far quite high, but PHEVs built by auto makers should be less expensive due to economies of scope and scale. Note that the 10% reduction goal is not considered: achieving a 5% reduction in the AFCI by 2020 by relying only on electric drive vehicles requires very aggressive assumptions about vehicle commercialization rates. Nonetheless, BEV, PHEV and FCV technologies are likely to be more mature within the 2010-2020 timeframe, and it is helpful to understand what such a scenario might look like.

Table 5-1: Light duty vehicle scenario names, descriptions and AFCI goals

Scenario name	Fuel Innovations	Vehicle Innovations	AFCI Goals		
			-5%	-10%	-15%
Baseline	Current technologies	Gasoline ICE dominates Increased diesel, HEVs	A*		
Electric Drive	Electric charging & H2 refueling	Significant innovation in PHEV, EV and FCV technologies	C5	**	**
Existing Vehicles with Advanced Biofuels	Significant biofuel innovation. Low-GHG biofuels (5.7% vol.) Low-GHG FT diesel blends	None required	D5	D10	**
Evolving Biofuels and Advanced Batteries	No fuel innovation. Mid-GHG biofuels (10% vol.) Mid-GHG biodiesel blends	Advances in PHEV, EV and FCV technologies	F5	F10	**
Biofuel Intensive	No fuel innovation. Mid-GHG biofuels (10%, 85%) Mid-GHG biodiesel blends Low-GHG fuels for G15	None required	G5	G10	G15
Multiple Fuels & Vehicles	Low-GHG biofuels (10%, /85%) Low-GHG FT diesel blends Electric charging & H2 refueling	Advances in PHEV, EV and FCV technologies	H5	H10	H15
Heavy Duty Compliance	(to be determined)	(to be determined)			

NOTES:

* No AFCI goal applies; ** Not considered

No "B" or "E" scenarios are used to avoid confusion with biodiesel and ethanol blends.

In the "No fuel innovation" scenarios, investment is needed to increase the use of current technologies, but no new technologies are assumed. Biofuel scenarios that assume energy crop production for mid-GHG ethanol (F and G scenarios) have large uncertainties due to feedstock production. See Section 2.4.

The next two scenarios (D5, D10), named *Existing Vehicles and Advanced Biofuels*, include two types of advanced biofuels for light duty vehicles, low-GHG biofuel blends with gasoline and low-GHG FT diesel blends. These scenarios minimize the changes to the fuel delivery infrastructure, including the equipment to ship biofuels into and within the state and at retail stations. In particular, these scenarios avoid the use of E-85. The discussion of these scenarios shows that they are quite limiting, attaining a 10% AFCI reduction by 2020 requires some biofuels with performance better than the low-GHG fuels defined in Table 2-3, so-called "carbon-negative" biofuels (Tilman, Hill, and Lehman 2006). Unfortunately, these are controversial and it is not clear that such fuels are technically feasible. An alternative, discussed in the last assumption of scenario D10, is to increase the fraction of biofuel blended with gasoline.

The third set of scenarios (F5, F10), named *Evolving Biofuels and Advanced Batteries*, assumes that significant vehicle innovations make PHEVs, EVs, and FCVs commercially viable (though to a lesser extent than in the *Electric Drive* scenario), and mostly modest innovations in biofuels occur. Thus, a sufficient combination of mid- and low-GHG biofuels (as blends with gasoline and diesel) and advances in electric drive vehicles achieves the 10% reduction goal. The uncertainties in the global warming impacts of biodiesel (specifically N₂O emissions from growing soybeans and black carbon from diesel emissions) are not considered here. (See Section 2.5.) If future research shows that these impacts are large and cannot be mitigated, then all of the low-GHG diesel will have to be FT or similar renewable diesel. Relatively little infrastructure is assumed to be needed for the PHEVs. However, new infrastructure is needed to support EVs and FCVs in this scenario. In addition, this scenario assumes that the use of E-85 by flex fuel vehicles (FFVs) increases, which would require new fuel distribution infrastructure; in particular it would require retail stations to offer E-85. An example of a tradeoff between lower-GHG intensity biofuels and increased blending fraction is discussed in the last assumption of the F10 scenario.

The scenarios named *Biofuel Intensive* (G5, G10, G15) are designed to explore potential outcomes that require as little fuel and vehicle innovation as possible, and instead rely mostly on large volumes of mid-GHG biofuels in both low blends (10% by vol. in gasoline and 10% bio/renewable diesel) and high blends (85% vol. in gasoline). Increased numbers of currently-available vehicles are also assumed, minimizing the need for vehicle innovation. New investment in biofuel distribution is needed in this scenario. As is the case for the F scenarios, the uncertainties in the global warming impacts of biodiesel (specifically N₂O emissions from growing soybeans and black carbon from diesel emissions) are not considered here. (See section 2.5.) If future research shows that these impacts are large and cannot be mitigated, then all the low-GHG diesel will have to be FT or similar renewable diesel. One possibly unrealistic aspect of the G5 and G10 scenarios is they assume the success of a biofuel-based compliance strategy with no significant advances in low-GHG biofuels. In reality, regulated firms committed to a biofuel strategy would likely take actions to stimulate innovation, including research and development, investments, and strategic partnerships and contractual relationships with low-GHG ethanol suppliers, most likely driving down the GHG emissions of advanced biofuels. The G15 scenario assumes that such actions are successful, and increased volumes of low-GHG biofuels result in a 15% reduction in AFCI.

In the last set of scenarios (H5, H10, H15), named *Multiple Fuels and Vehicles*, a combination of different fuel and vehicle types are combined to comply with the LCFS. Each of these scenarios includes a significant degree of innovation in both fuels (low-GHG biofuel and diesel fuels) and vehicles (PHEVs, EVs and FCVs). With a greater number of carbon intensity reduction options included, this set of scenarios culminates in a 15% AFCI reduction scenario.

5.2 Scenario infrastructure costs

The scenarios presented here are not based upon an analysis of vehicle or infrastructure costs. Each scenario is characterized by some combination of vehicle and fuel cost reductions due to technology innovation, as indicated in Table 5-1. These cost reductions are assumed to be the

driving force behind the trends portrayed in each scenario. A more thorough analysis of the costs involved in meeting the LCFS goal of a 10% reduction in carbon intensity by 2020 should be a major focus of future research. However, we anticipate significant controversy over estimates of future costs for the range of technologies capable of contributing to carbon intensity reductions. Developing consistent and reasonable cost projections will require a thorough and detail cost analysis of a wide range of vehicle and fuel cost components. Moreover, this analysis must include cost dynamics, such as learning by doing, economies of scale, and ideally the influence of policies such as the LCFS. Most challenging, perhaps, is realistic modeling of the interaction with existing energy infrastructures and competition among alternative fuels for market share, energy resources and capital. Though complex and dynamic alternative fuel vehicle models have been developed (for example, see Leiby et al, 2006, Struben and Sterman, 2006, and Cucinelli et al. 2005), we are not aware of an alternative fuel and vehicle cost model that represents cost dynamics with the degree of detail, scope, consistency and objectivity needed to evaluate the various options available for complying with the LCFS in California.

In reviewing the scenarios described below, it is helpful to keep in mind the major cost elements involved in expanding alternative fuel infrastructures. In addition to production facilities, a range of infrastructure elements must be established to expand the availability and quantity of different alternative fuels. Some of the issues related to these non-production infrastructure costs are outlined below for ethanol, biodiesel, electricity, natural gas and hydrogen.

I. Ethanol

- a. Main issues pertain to the unique transportation requirements of ethanol. Ethanol is not produced or distributed in volumes that current justify dedicated pipeline transportation. Pipeline transportation of ethanol is also technically difficult. It cannot be done combined with gasoline because of ethanol's propensity to absorb water. For similar reasons, it also cannot be batched in pipelines that are also used to transport other fuels. Pipeline distribution of ethanol has only been performed on small scales over short distances in the Midwest.
- b. Most ethanol is imported to the state of California by rail (95%). It is brought to rail transfer points where it is then distributed to the refineries by truck. The remaining 5% of ethanol is imported by barge or marine tanker from the Caribbean and Brazil. Transportation capacity may prove to be a major bottleneck for increased ethanol imports. This includes increasing the capacity of rail importation from the Midwest and marine capacity at ports. Marine capacity will be competing with non-fuel goods as well as any increase in demand for other international fuels shipped by tanker.
- c. Additional storage tanks would be required to handle increased imports.
- d. Additional mixing equipment may be needed for different fuel blends.
- e. Dedicated E85 pumps would be required at a sufficient number of refueling stations to provide adequate refueling availability for scenarios with significant consumption of E85 by FFVs.

II. Biodiesel

- a. Biodiesel has less complicated infrastructure issues than ethanol with regard to integration with existing infrastructure elements. Up to blends of 20% (B20), biodiesel requires no alterations in vehicles or in distribution infrastructure. In most respects, B20 can be handled like regular diesel. At blends greater than 20%, biodiesel requires protection against storage in cold weather. In addition, higher concentrations of biodiesel lead to greater rates of material corrosion within vehicle and distribution infrastructure. Trucks distributing pure biodiesel need to have tanks lined with materials that are resistant to biodiesel corrosion.

III. Electricity

- a. There are two primary concerns with respect to existing infrastructure being able to satisfy electricity demand by vehicles: 1) the time of day vehicle vehicles are recharged, and 2) the total quantity of electricity consumed by vehicles. Annual consumption of electricity in California is approaching 280,000 GWh, and annual peak demand was most recently about 56,000 MW in the summer of 2006. Time of day recharging may be a concern for the infrastructure required to handle peak demand, including both peak production capacity and peak transmission capacity. Efforts to influence time of day charging (e.g., through prices) may be key to managing the effect of electric vehicles on peak demand and the types of generation required to supply electricity for vehicles.
- b. The peak generation capacity of the state in the summer of 2006 was between 64,000 and 65,000 MW. The state electrical reserves are defined as the difference between the peak generation capacity and the peak demand. The reserve margin is a percentage defined by this difference divided by the peak generation capacity. By 2016, the state will need to procure 24,000 MW of additional capacity if it is to maintain a reserve margin of 15 to 17%. This forecast includes planned retirements of existing production facilities.
- c. Residential charging may be sufficient for a large number of early adopters of plug-in electric vehicles (PHEVs or BEVs). However, customers living in high density housing may not have access to convenient residential recharging, and some commuters may benefit from (or require) recharging their vehicles at work. Therefore, to achieve larger market penetration, dedicated recharging stations at non-residential locations will eventually be required.

IV. Natural Gas

- a. California currently consumes about 6,000 million standard cubic feet of natural gas per day (MMScf). The state produces 890 MMScf, and the remainder is imported, mainly from the Rockies, Canada, and the Southwest. Importation of natural gas originating from Mexico (by way of Arizona) is expected in coming years. There are two types of capacity that are of concern with respect to natural gas. One is the state delivery capacity, which is the maximum flow of gas that the state could receive from interstate pipelines. Including the anticipated increase in flow of gas from Baja California, this capacity is projected to be between 9,000 to 10,000 MMScf. The other capacity of importance is receiving capacity. This constitutes the amount of natural gas that the state

can receive, which is a function the capacity of major pipelines within the state to transport gas from border points to utilities as well as the state's storage capacity. This capacity is currently less than the delivery capacity. As of 2004, receiving capacity of the state was 7,970 MMScf. Both capacities have expanded on the order of 25% since the beginning of the decade in response to the energy crisis. Based on the most recent assessments by the California Energy Commission, the state has adequate capacity to handle projected increases in demand over the course of the next decade. This does not include any demands that would come from the use of natural gas in transportation.

V. Hydrogen

- a. Transportation and storage costs can be a significant fraction of the total cost of hydrogen, even in a fully developed and high-volume hydrogen infrastructure. The least cost hydrogen delivery pathways can be estimated across a range of volumes and distances, and tend to be higher for the dispersed delivery and low volumes associated with early infrastructure development (Yang and Ogden, 2006). Gaseous delivery by tank truck is viable for low volumes and short distances, while liquid truck delivery is the least cost option for low volumes and longer distances. Pipeline delivery is the least cost delivery option across a broad range of high volumes and most delivery distances.
- b. Retail hydrogen stations can require significant capital investment, mostly due to handling and storage equipment. Early stations may also include onsite production, such as from steam methane reformer or electrolysis units.
- c. The California Hydrogen Highways program (<http://www.hydrogenhighway.ca.gov>) supports expansion of California's hydrogen infrastructure. There are currently 24 hydrogen refueling stations in California, and 13 more in the planning or development stage. Eight new hydrogen stations were opened in 2006. The hydrogen Blueprint Plan suggests that by 2010, some 50-100 stations may support 2000 hydrogen vehicles.
- d. During the early decades of introducing dedicated hydrogen vehicles, a sufficient number of retail stations will be required to provide adequate refueling availability. These early stations will likely to incur high costs due to underutilization as the fleet of hydrogen vehicles increases over time.

5.3 Scenario assumptions

Each scenario is composed of a series of assumptions, with each assumption moving the scenario closer to a predefined AFCI reduction goal. The AFCI goals for each scenario are indicated in Table 5-1. Scenarios within a particular set (C, D, F, G or H) are developed by building upon the assumptions made in previous scenarios within that set. For example, scenario G15 begins with all of the assumptions used to construct both scenarios G5 and G10, and additional assumptions are then made to attain the 15 percent AFCI reduction that defines scenario G15. In a small number of instances successive assumptions undo or modify previous assumptions. These cases are clearly noted when they occur.

There are two general types of assumptions: 1) fuel characteristic assumptions, and 2) fuel quantity assumptions. Fuel characteristic assumptions typically concern the GWI of fuels that

play an important role in that scenario. Fuel quantity assumptions concern rates of change in the volumes of fuels sold over time. In many cases, fuel quantity assumptions are equivalent to vehicle adoption assumptions, and they may be described in the text in terms of fuel volumes or energy (e.g., gallons of gasoline equivalent energy), the number of vehicles sold per year, or the total stock of vehicle on the road consuming a particular fuel. Regardless of the descriptions in the text, numerical values for each of these results are presented for each scenario.

Each assumption has been determined to provide a fraction of a scenario's overall AFCI reduction. To a large extent, outputs of the VISION-CA model rely on adjustments made to exogenous variables, such as vehicle adoption rates or fuel GHG intensities. Any significant change in a key variable will typically result in a change in the AFCI value for a given scenario. However, some variables operate in tandem or in succession, such as the introduction of flex-fuel vehicles (FFVs) and a subsequent increase in the percentage of VMT driven by those vehicles on an alternative fuel. Only changes in both variables will result in significant AFCI reductions. Therefore, while each scenario is defined as meeting a particular AFCI reduction goal, the sequence with which different assumptions are introduced to build each scenario will sometimes influence the degree to which that particular assumption, or set of assumptions, moves the scenario toward the AFCI goal.

5.3.1 GWI scenario assumptions

The GHG intensity, or Global Warming Index (GWI), of different fuels is a critical parameter in each scenario. In order to simplify the discussion of scenarios, a number of representative fuel types with specified GWI values have been identified. This is particularly useful for biofuels and biofuel blends, which can have a wide range of GWI values. Table 5-2 indicates the GWI for key fuels used in the scenarios. A number of composite values for ethanol (shown with the generic title "biofuel") and bio-based and FT diesel fuels are indicated, and are based upon the discussion in section 2.5. The electricity value represents the typical average carbon intensity of electricity used to recharge vehicle batteries in California in 2005, and is reduced by 0.25% per year to approximate the influence of policies to reduce GHG emissions from electricity in California. The values shown are intended to be representative of the average GWI of each vehicle fuel as used in California.

Given the range of GWI values for distinct ethanol pathways, it is impossible to predict the actual evolution of ethanol GWI over time. Moreover, ethanol may not be the sole biofuel blended with gasoline within the 2020 timeframe. Therefore, we use the following three "biofuel" reference values in the scenarios:

1. *Average 2004 Biofuel.* Based on the average corn ethanol (a volume weighted average of wet-mill and dry-mill systems), produced in the Midwest and shipped to California. This is pathway *Et1* in the AB 1007 study performed for the CEC (Unnasch, Pont, Chan et al. 2007).
2. *Mid-GWI Biofuel.* A simple average of four pathways: (i) Midwest corn ethanol from a natural gas-fired dry-mill (pathway *Et3*), (ii) Midwest corn from NG-fired dry-mills delivering wet cake as a coproduct (pathway *Et4*), (iii) Midwest corn ethanol using stover as fuel in a dry-mill (pathway *Et5*), and (iv) California corn ethanol produced in a natural gas-fired dry-mill, delivering wet cake as a coproduct (pathway *Et74*).

3. *Low-GWI Biofuel*. A simple average of three cellulosic ethanol pathways based on (i) California poplar (pathway *Et21*), (ii) California switchgrass (pathway *Et23*), and (iii) Midwest prairie grass (pathway *Et24*).

GWIs for mid-GWI biodiesel and low-GWI FT diesel are also intended to be representative. The mid-GWI biodiesel value is based upon earlier TIAX estimates for California biodiesel, and is somewhat higher than the 31 gCO₂eq./MJ for FAME biodiesel from Midwest soybeans. The low-GWI FT diesel value is more than a three-fold decrease below the mid-GWI value for biodiesel, but is still much higher than the net negative GWI for FT diesel from CA poplar. The uncertainties in the global warming impacts of biodiesel (specifically N₂O emissions from growing soybeans and black carbon from diesel emissions) are not considered here. (See Section 2.5.) If future research shows that these impacts are large and cannot be mitigated, then all of the low-GHG diesel will have to be FT or similar renewable diesel.

Table 5-2 also indicates typical efficiency adjustment factors for each fuel, with diesel, electricity and hydrogen having the only non-unity adjustments. The resulting Average Fuel Carbon Index values specific to each fuel (i.e., not weighted and averaged across a mix of fuels) are also indicated. Gasoline is shown with an AFCI value of unity, and each of the other AFCI values have been normalized by the GWI value shown for gasoline. The efficiency adjustment factors for electricity and hydrogen are typical of new EVs and FCVs in the year 2020, while the diesel efficiency value is for current new LDVs and is reduced over time as diesel technology improves in the VISION-CA model (reaching 0.61 by 2020). These values are the ratio of the vehicle drivetrain efficiency to the 2005 baseline drivetrain efficiency.³² The higher fuel carbon intensities of electricity and hydrogen, once adjusted for by the efficiency adjustment factor, result in a lower fuel-specific AFCI than most of the other fuels.

In addition to these reference GWI values for fuels, a number of acronyms are used to describe fuels, vehicles and units. These are indicated in Table 5-3. Note that the VISION-CA model includes some fuels that are not discussed in detail in this study, such as diesel hybrid electric vehicles (D HEVs). The lack of a significant analysis of these vehicles is due to limitations of time and does not imply any opinion about the likelihood of different vehicles becoming widely commercialized. This study focuses on fuels, and representative vehicles have been chosen to simplify the analysis, recognizing that in actuality a more diverse mix of vehicles may be more probable. This simplification does not fundamentally change the fuels chosen for each scenario.

³² In the VISION-CA model, vehicle fuel economy ratios are used as a proxy for vehicle drivetrain efficiencies, and the AFCI equation is weighted by projected VMT (see Section 2). This is consistent with the new vehicle fuel economy estimates used in the model, which are based upon comparisons of vehicles with equivalent performance (with the exception of BEVs).

Table 5-2: Representative GWI values used in LCFS scenarios

Fuel Type	GWI (g CO ₂ eq./MJ)	Efficiency Adjustment Factor	AFCI	Description / Notes
Gasoline (with E5.7)	92.8	1	1	93.5 gCO ₂ eq./MJ for gasoline, with 5.7% average ethanol (below)
Diesel	91.6	0.78	0.77	California ultra low sulfur diesel, pathway D2
Electricity	121	0.20	0.26	Average California grid, pathway E11 (reduced by 0.25%/year)
Hydrogen	108	0.48	0.56	Onsite natural gas steam methane reformation
Ave. 2004 Biofuel	76	1	0.82	Midwest average corn ethanol, pathway Et1
Mid-GWI Biofuel	58	1	0.63	Average of Et3, Et4, Et5, and Et74
Low-GWI Biofuel	4	1	0.04	Average of Et21, Et23, and Et24
Mid-GWI Biodiesel	41	1	0.44	Comparable to FAME biodiesel from Midwest soy, pathway BD3
Low-GWI FT Diesel	12	1	0.13	Between BD3 and Fischer-Tropsch Diesel from CA poplar, pathway F3

Note: See Section 2-5 for discussion of the pathways, which are from the AB 1007 study performed for the CEC (Unnasch, Pont, Chan et al. 2007). Note that the average GWI factors will change over time and, in the case of electricity, is not reflective of the emissions associated with electricity likely to be sold to EVs and PHEVs, because of time-of-day considerations.

Table 5-3: Acronyms for scenario descriptions

<u>Acronym</u>	<u>Fuel or Vehicle</u>	<u>Included in Analysis</u>
FT Diesel	Fisher-Tropsch diesel	Yes
CNG	Compressed natural gas	Yes
FCV	Fuel cell vehicle	Yes
D PHEV	Diesel plug-in hybrid electric vehicle	No
SI PHEV	Spark ignition plug-in hybrid electric vehicle (gasoline)	Yes
EV	Electric vehicle	Yes
FFV HEV	Flex fuel hybrid electric vehicle	No
E85 FFV	85% Ethanol capable flex-fuel vehicle	Yes
D HEV	Diesel hybrid electric vehicle	No
SI HEV	Spark ignition hybrid electric vehicle (gasoline)	Yes
Gasoline ICE	Gasoline internal combustion engine vehicle	Yes
<u>Other</u>		
GGE	Gallons of gasoline equivalent energy*	

* The units of GGE, gallons of gasoline equivalents, are determined using a HHV for gasoline of 125,000 Btu/gallon. The HHV for diesel fuel used is 139,000 Btu/gallon, and 84,600 Btu/gallon is used for ethanol. These are the heating values used originally in VISION model calculations.

5.3.2 Technology diffusion rates

The VISION-CA model employs exogenously defined technology diffusion rates for fuels and vehicles based upon a symmetric logistic function. Rates of adoption or diffusion are a function of the maximum market share achievable, a growth rate, and the initial market share. These

parameters are determined in relation to a specified reduction in the AFCI values for each scenario assumption. In an attempt to represent the long lead-in times for many new fuels and vehicles, this diffusion framework generally limits the rate at which vehicles and fuels are adopted over time. However, some of the adoption rates in the scenarios below are very aggressive, and exceed historic rates of diffusion of other new technologies in the transportation sector. The transportation sector has seen surprises in the past, such as the introduction of hybrid electric vehicles, the timing of which was not anticipated by many transportation experts (Vyas et al. 1997). We recognize that rates of technology diffusion (and therefore rates of technology innovation and cost reduction) are highly controversial, and that estimates will vary significantly among different types of stakeholders (Collantes 2007). As discussed above, the scenarios presented here are based upon the assumption that significant advances in technology innovation are the main driving factor underlying technology diffusion rates.

As an example of the diffusion rates used in the scenarios below, Figure 5-1 indicates the share of new LDVs sold as HEVs, including historic nationwide values and projected values in the VISION-CA Business as Usual (BAU) scenario (see below. Historic HEV shares are based upon LDV sales values reported by the Electric Drive Transportation Association and the National Automobile Dealers Association). These values can be compared to the absolute vehicle sales values discussion in the BAU scenario section.³³ Note that in this case, the nationwide values are used to represent HEV sales. In most other cases empirical data specific to California, taken from the EMFAC model, are used to calibrate fleet dynamics.

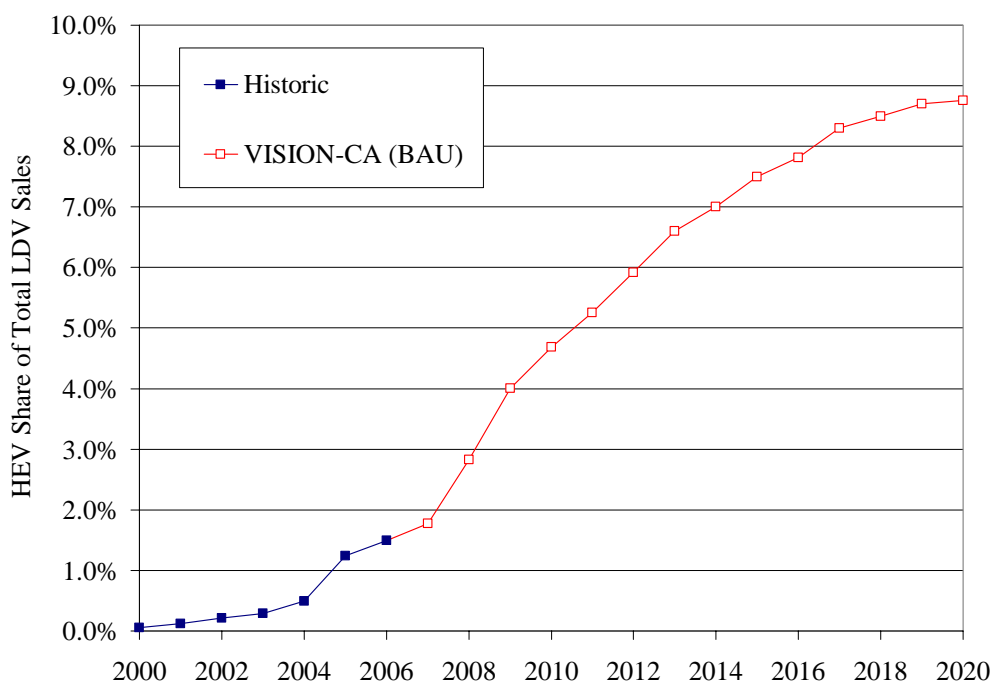

³³ The values shown in the graph have been smoothed slightly to remove irregularities resulting from the simultaneous introduction of other AFVs (FFVs and CNGVs) in the BAU scenario.

Figure 5-1: Share of HEVs as a percent of new LDV sales, historical nationwide values and projections in the VISION-CA BAU scenario

5.3.3 Plug-in hybrid vehicle VMT share

Significant uncertainty surrounds the future utilization of plug-in hybrid electric vehicles (PHEVs). Projections of future all-electric driving range are uncertain, and the fraction of total vehicle miles traveled (VMT) likely to be driven in electric drive mode, or mixed mode, are also uncertain. For the scenarios described below, default values from the original Argonne VISION model are employed to determine the fraction of VMT powered through electric drive for PHEVs with different all-electric drive ranges. This relationship is shown in Figure 5-2 below.

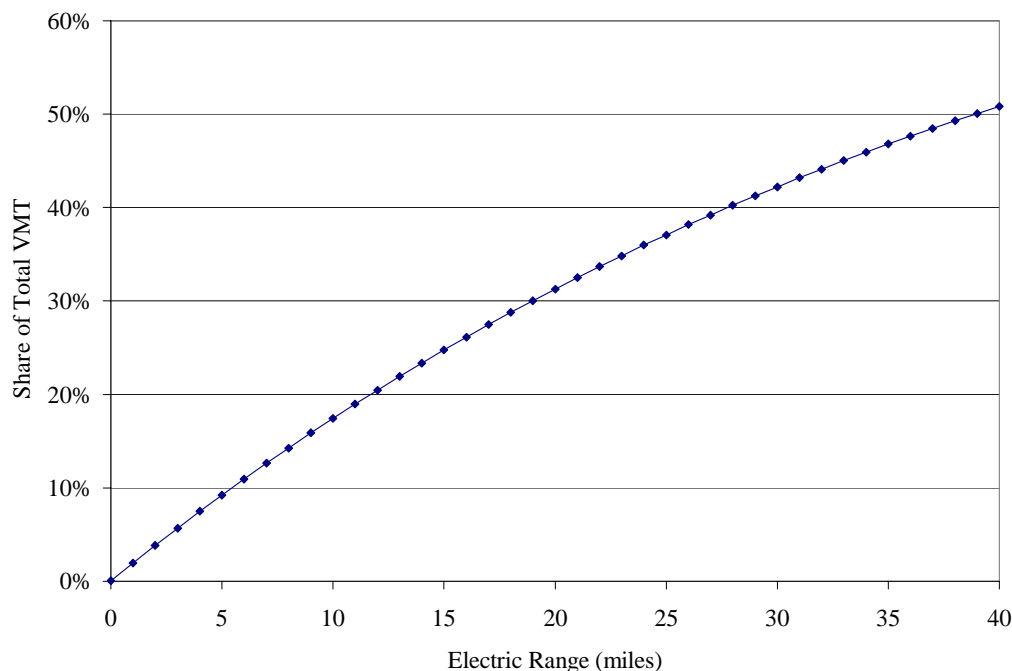

Figure 5-2: Assumed share of VMT in electric drive as a function of PHEV electric range

5.4 Scenario results

For each of the scenarios described above, VISION-CA was used to determine the effects of assumptions necessary to meet particular AFCI reduction goals. In the scenario descriptions below, assumptions are presented in bullet form in the order in which they are applied. The last assumption in each scenario achieves the associated AFCI goal for that scenario. With the exception of the BAU scenario, which is elaborated upon more than the other scenarios, results for each scenario are presented through:

1. A figure showing the AFCI reduction associated with each scenario assumption.
2. A figure showing the fuel energy consumed by year (in units of billions of GGEs)
3. A figure showing the number of new LDVs sold per year by vehicle type
4. A table indicating fuel energy (billions of GGEs), GHG intensity, AFCI values and total scenario GHG emissions (for the years 2005, 2010, 2015 and 2020).

5. A table indicating the number of new LDVs sold per year by vehicle type (for the years 2005, 2010, 2015 and 2020).

It is important to note that with the exception of Figure 5-3 and Figure 5-6, the fuel energy figures do not indicate gasoline energy consumption by year. The volume of gasoline consumed in each scenario in 2020 is shown numerically on each fuel energy figure, but gasoline itself is not indicated for the sake of scaling the vertical axis of each figure to better represent fuels introduced in smaller volumes. For example, compare the units on the vertical axis of Figure 5-6 and Figure 5-7 in the BAU section below. This scaling issue is resolved similarly for figures showing new LDV sales, where gasoline ICE LDV sales tend to be much higher than sales of any other LDV type in most scenarios. The number of gasoline ICE vehicles sold in 2020 is also indicated in each of these figures.

The Business as Usual Scenario (A)

The *Business as Usual* (BAU) scenario involves relatively minor changes to the future mix of alternative fuel vehicles and low carbon transportation fuels. With one major exception, projected trends in vehicle technology characteristics do not vary significantly from past trends. The major exception is an overall reduction in vehicle GHG tailpipe emissions achieved by complying with AB 1493 (Núñez/Pavley). The result of this assumption, combined with a modest increase in alternative fuel use, is that total gasoline consumption begins to level off around 2010 and begins to decline around 2015, as shown in Figure 5-3. This figure compares the gasoline demand projection from the VISION-CA model with: 1) a revised projection based on the CEC 2005 IEPR analysis that takes into account AB 1493, and 2) a linear projection of the gasoline consumption trend in California from 1950 to 2005, based on Board of Equalization data and labeled *100-Year BOE Trend*. The BAU Scenario, and therefore the VISION-CA model in general, has been calibrated to match this revised 2020 gasoline demand projection provided by the CEC. The VISION-CA gasoline demand projection varies only slightly from the CEC projection in the years between historic data (before 2007) and the 2020 projection. Major assumptions underlying the BAU scenario are discussed below.

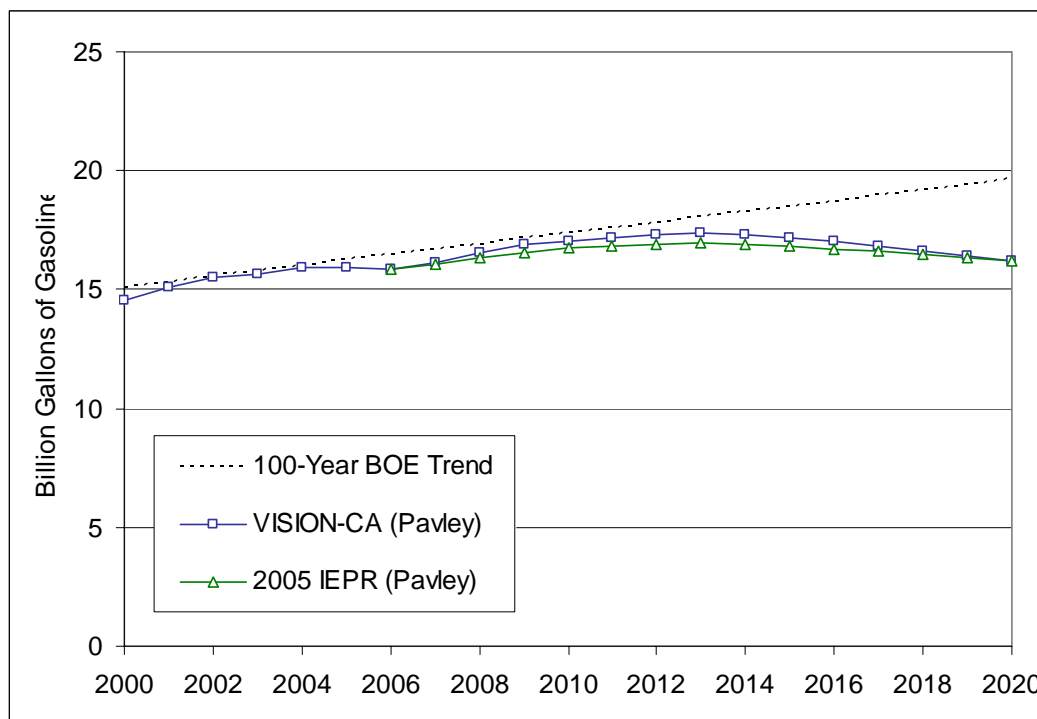

Figure 5-3: Projected gasoline demand for VISION-CA and the CEC 2005 IEPR

The number of new LDVs sold per year after 2005 is based upon trends in sales per person shown in Figure 5-4. Only a slight increase in sales per person is assumed between 2006 and 2020. New vehicle sales are therefore driven by growth in population, shown in the same figure increasing to 42.9 million persons by 2020. The historic trend in the share of LDVs between two LDV class categories, passenger cars and light trucks, is shown in Figure 5-5. The share of light duty truck sales is assumed to recover and match the share of passenger car sales by 2020. These vehicle sales assumptions are common to all scenarios.

Alternative fuels and vehicles in the BAU scenario

Other than a continued use of conventional gasoline ICE vehicles, three types of vehicles are sold in relatively large numbers in the BAU scenario: 1) spark ignition hybrid electric gasoline vehicles (SI HEVs), 2) diesel vehicles, and 3) E85 flex-fuel vehicles (FFVs). The rates at which these vehicles are introduced are shown in Figure 5-9 (which omits gasoline vehicle sales for the sake of increased resolution, see Figure 5-8). Small numbers of CNG vehicles, SI PHEVs, EVs and FCVs are also introduced in the BAU scenario. However, despite this change in the mix of new vehicles sold, the carbon intensity of transportation fuels required to support these vehicles does not change significantly. By definition, the gasoline and diesel fuels used by SI HEVs and diesel vehicles do not influence the AFCI, and the E85 FFVs only influence the AFCI to the degree that they are refueled with ethanol (provided that it is sufficiently low GHG ethanol). For the BAU scenario, it is assumed that FFVs drive 2% of VMT on E85 by 2010, and 5% of VMT on E85 by 2020, resulting in 52 million GGE of ethanol in 2020, which is less than 10% of the volume of ethanol blended with gasoline. Ethanol is assumed to include 10% mid-GHG ethanol in the BAU scenario by 2020, reducing the GHG intensity of gasoline by approximately 0.1% below the 2005 intensity.

Approximately 16 million gallons of biodiesel were consumed 2006, and additional production capacity is being installed in California. However, an attempt has not been made to estimate the portion of this biodiesel consumed by LDVs, and therefore it is not represented in the BAU scenario. Existing biodiesel consumption will be included in the BAU scenario when the VISION-CA model is expanded to include HD vehicles.

The non-gasoline fuel consumed in the BAU scenario is indicated in Figure 5-7. Note that ethanol blended with gasoline is the most significant non-gasoline fuel consumed until about 2015, when diesel fuel energy exceeds ethanol fuel energy on a GGE basis. Consumption of E85 is on a much lower level, and CNG fuel energy consumed reaches approximately 0.2 BGGE by 2020. In sum, these non-gasoline fuels comprise approximately 9% of total fuel energy in 2020 in the BAU scenario (see Table 5-4).

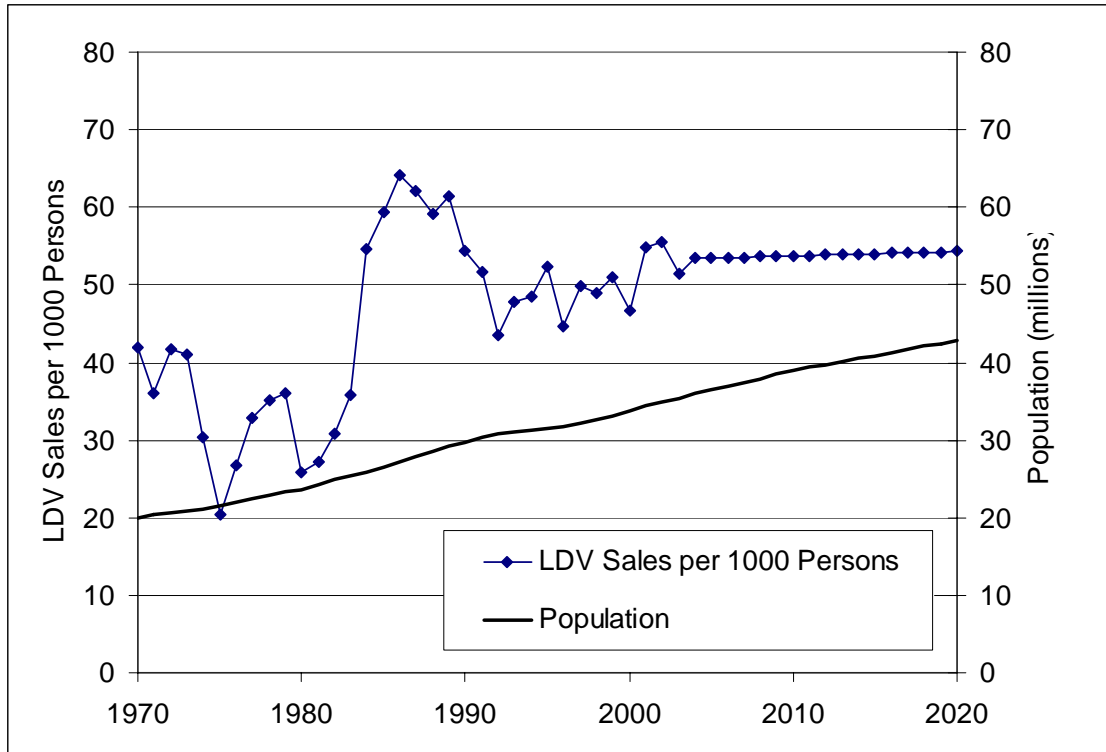

Figure 5-4: LDV sales per person and total California population to 2020 (all scenarios)

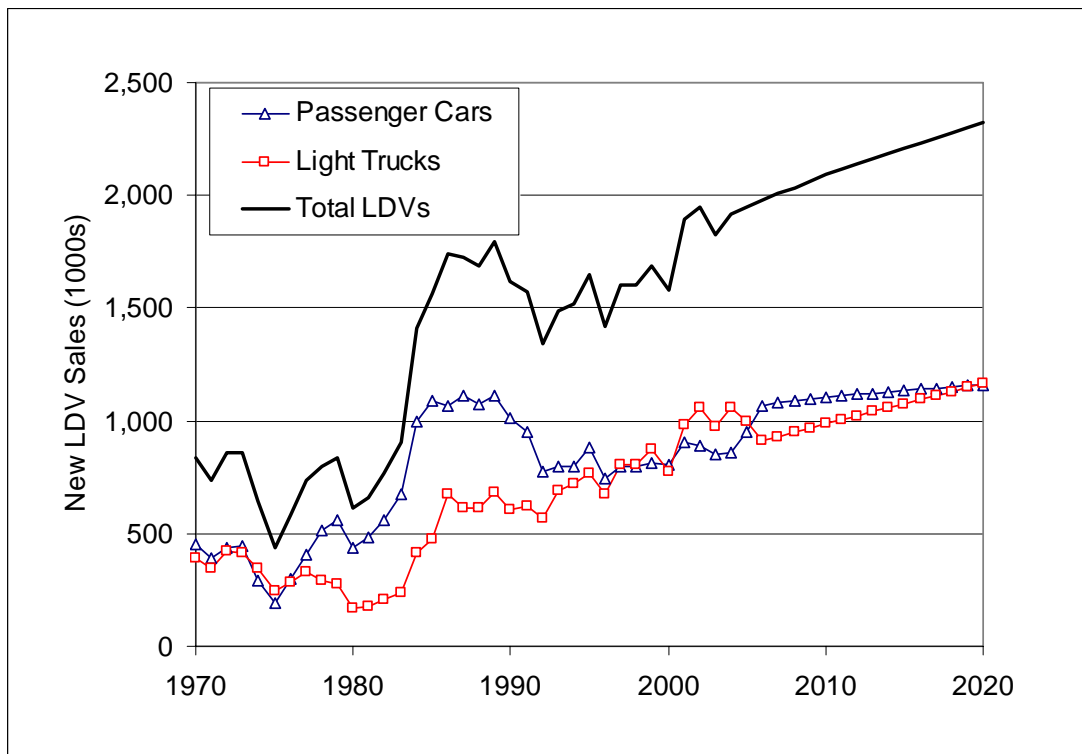

Figure 5-5: New LDV sales for passenger cars, light trucks and total LDVs (all scenarios)

BAU Scenario Results

The relatively small contribution of non-gasoline fuels to total LDV fuel consumption in the BAU scenario is made clear in Figure 5-6. Total fuel energy consumption in 2020 is 16.8 BGGE, and gasoline comprises 96% of this total. Diesel fuel, blended ethanol and CNG are the only significant non-gasoline fuels. The dominance of gasoline vehicles is also clear in Figure 5-6, which shows new LDV sales by type. Numerical values for fuel consumption are indicated in Table 5-4 and values for new LDVs sold per year are shown in Table 5-5. Table 5-4 also shows the carbon intensity of each fuel, the resulting AFCI value for the BAU scenario, the AFCI values associated with each fuel, and the total GHG emissions for the BAU scenario (205.6 MMT CO₂ eq. by 2020).

As indicated in Figure 5-3 and Figure 5-6, the gasoline demand projected in the BAU scenario tends to follow a strong growth trajectory until about 2012, and adheres more closely to the 100-year growth trend than the more moderate demand seen with high fuel prices in 2005 and 2006. More moderate growth rates in fuel consumption would lower the volumes of low-GHG fuels required to meet a particular GHG intensity target. If, for example, gasoline demand is 10% less in 2020 than projected here, the actual volumes of low-GHG fuels required to meet particular AFCI targets in each scenario would also be approximately 10% less. On the other hand, if gasoline demand reduction is not achieved through policies such as AB 1493 (Pavley), the volumes of alternative fuels required to meet AFCI goals would be higher than those projected here.

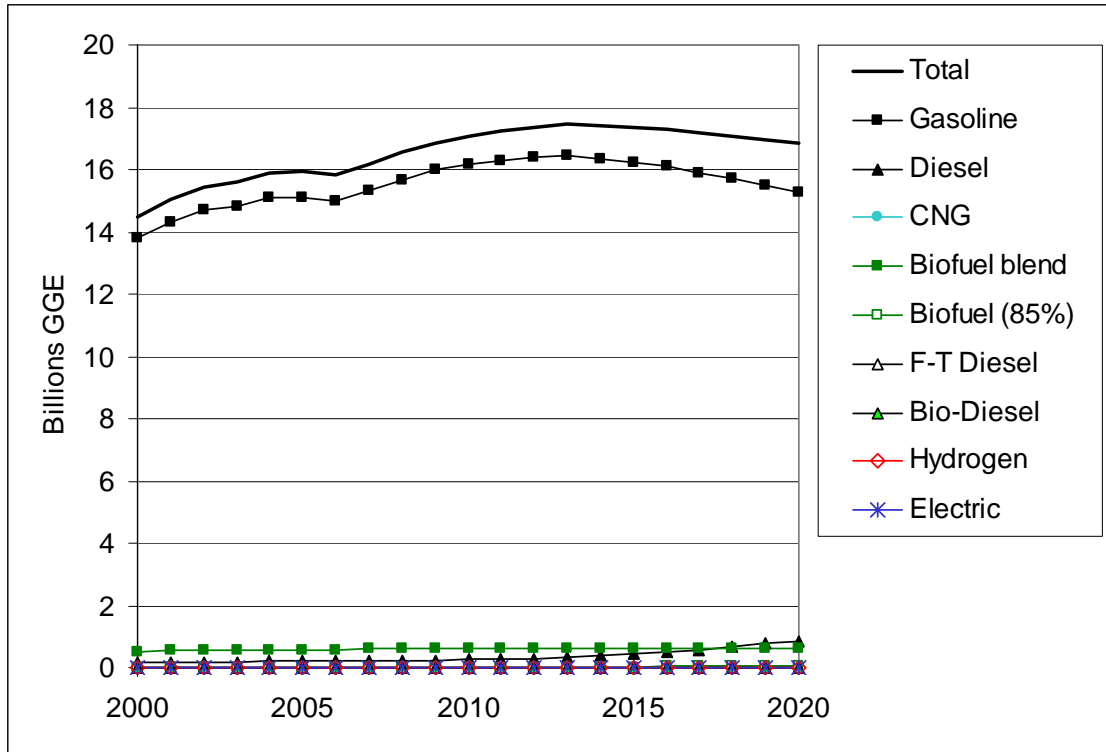

Figure 5-6: Fuel energy consumption in the BAU Scenario

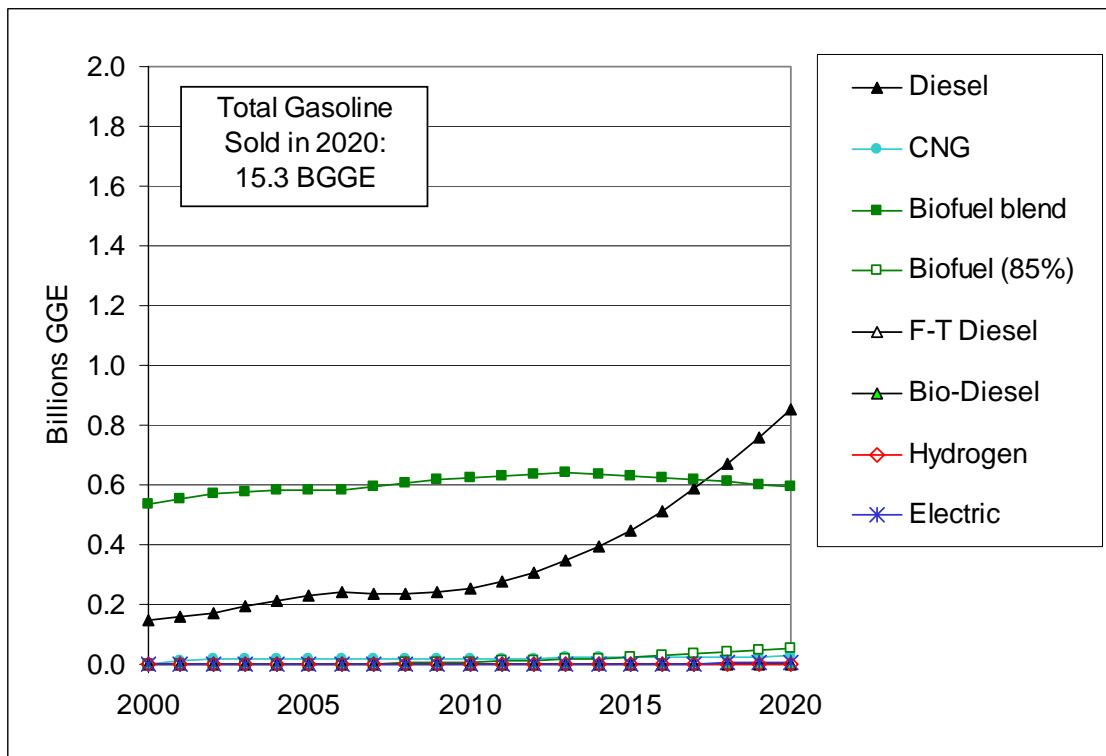

Figure 5-7: Fuel energy consumption in the BAU Scenario (gasoline not shown)

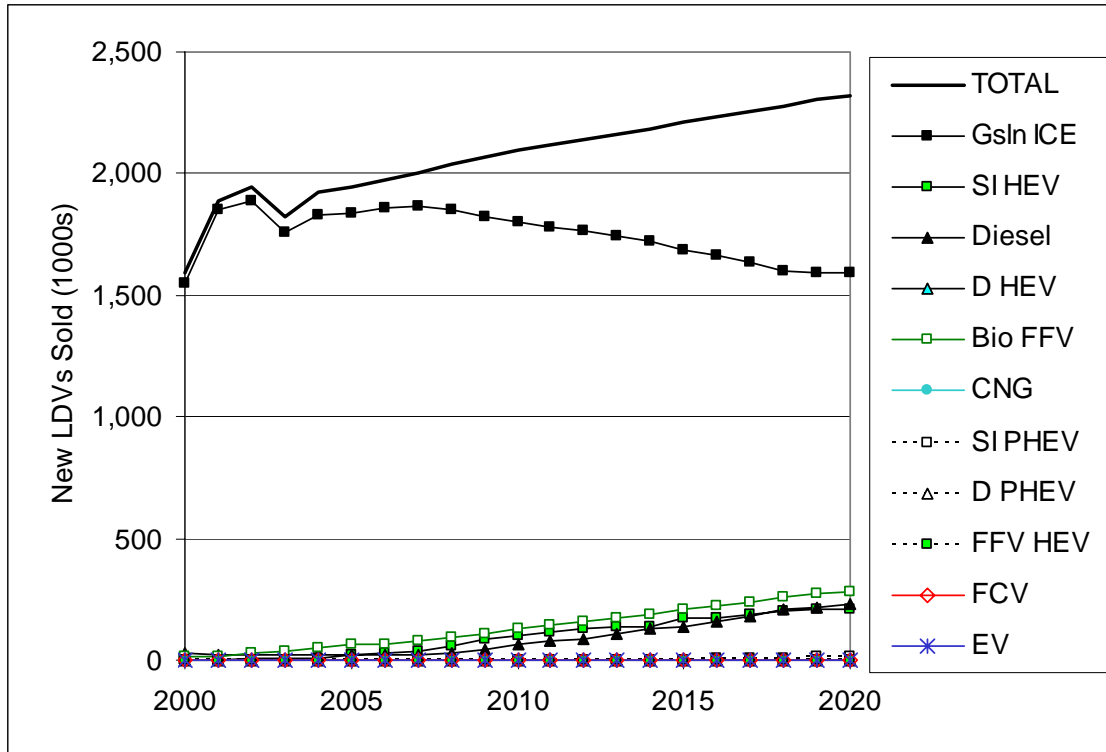

Figure 5-8: New LDVs sold per year in the BAU Scenario

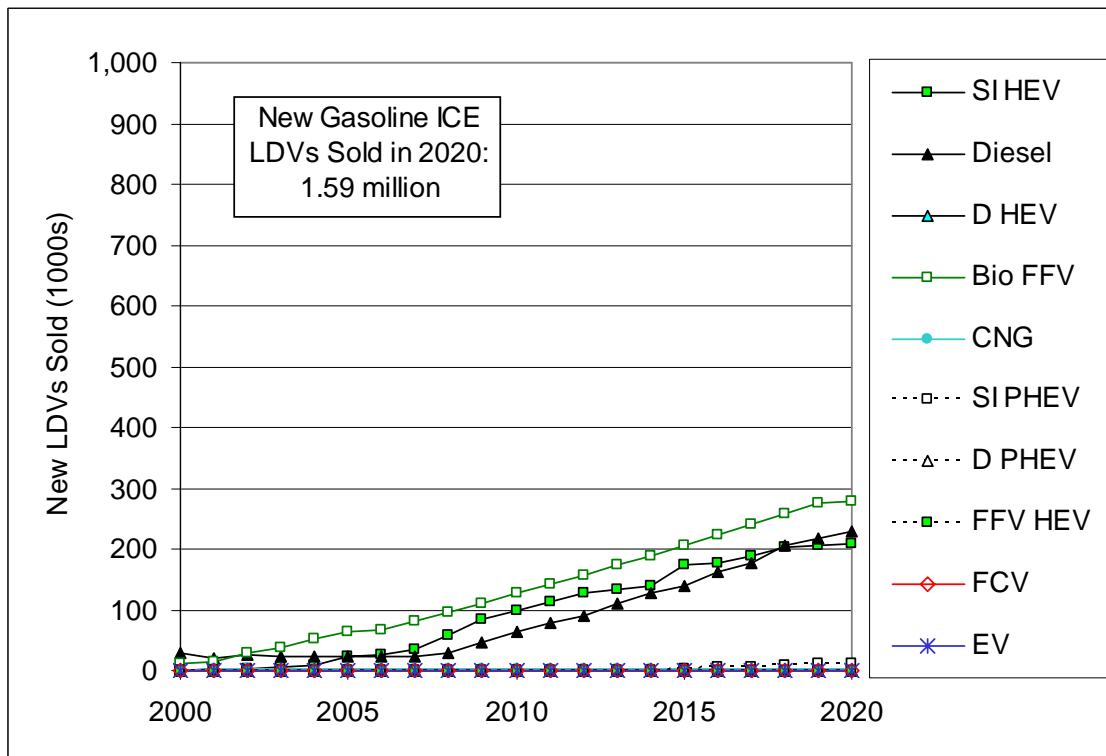

Figure 5-9: New LDVs sold per year in the BAU Scenario (gasoline ICE LDVs not shown)

Table 5-4: Fuel energy, GHG intensities, AFCI values & GHG emissions for the BAU Scenario

SCENARIO: Business as Usual				
	2005	2010	2015	2020
Fuel Energy Consumption by Type				
Total Fuel Energy LDVs (Billion GGE)	15.933	17.065	17.372	16.831
Gasoline	15.103	16.158	16.246	15.295
Diesel	0.230	0.255	0.448	0.855
CNG	0.015	0.018	0.023	0.027
F-T Diesel	0.000	0.000	0.000	0.000
Bio-Diesel	0.000	0.000	0.000	0.000
Methanol	0.000	0.000	0.000	0.000
Hydrogen	0.0000	0.0000	0.0001	0.0016
Electric	0.0001	0.0005	0.0011	0.0066
Ethanol (blended)	0.585	0.626	0.630	0.595
Ethanol (85% vol.)	0.000	0.008	0.024	0.052
Fuel GHG Intensities				
Average for all fuels (g CO2 eq/MJ)	92.8	92.8	92.7	92.6
Gasoline (with biofuel blend)	92.8	92.8	92.8	92.8
Diesel	91.6	91.6	91.6	91.6
CNG	68.1	68.1	68.1	68.1
Hydrogen	0.0	0.0	107.7	107.7
Electric	121.5	121.5	121.5	121.5
Ethanol (85% vol.)	0.0	76.0	75.0	74.1
AFCI Values				
Average for all fuels	1.000	0.999	0.993	0.981
Gasoline (with biofuel blend)	1.000	1.000	1.000	0.999
Diesel	0.764	0.740	0.677	0.649
CNG	0.701	0.688	0.677	0.666
Hydrogen	-	-	-	0.530
Electric	0.350	0.272	0.251	0.241
Ethanol (85% vol.)	1.000	0.997	0.995	0.992
Total GHG Emissions				
All LDVs (MMT CO2 eq.)	195.0	208.8	212.4	205.6

Table 5-5: Sales of new LDVs for the BAU Scenario

SCENARIO: Business as Usual				
	2005	2010	2015	2020
New Light Duty Vehicle Sales				
New LDV Sales (millions)	1.949	2.096	2.209	2.323
Gasoline ICE	1.837	1.804	1.684	1.591
Battery EVs	0.0	0.001	0.001	0.001
Ethanol ICE FFVs	0.064	0.126	0.206	0.279
Diesel	0.023	0.063	0.139	0.229
CNG	0.002	0.003	0.003	0.003
Gasoline SI HEV	0.022	0.099	0.174	0.208
E85 SI HEV	0.0	0.0	0.0	0.0
Diesel HEV	0.0	0.0	0.0	0.0
Gasoline SI PHEV	0.0	0.0	0.002	0.012
Diesel PHEV	0.0	0.0	0.0	0.0
Hydrogen FCV	0.0	0.0	0.0	0.001

This page is intentionally blank.

5.4.1 Electric Drive Scenario (C5)

In this scenario electric drivetrain technologies become more advanced and less expensive, and HEVs, EVs, PHEVs and FCVs all claim a significant share of new LDV sales by 2020. In order to achieve deep reductions in GHG intensity, the percent of renewable resources used in the production of electricity and hydrogen used in these vehicles is increased by approximately 30%.

The Electric Drive scenario consists of the introduction of three vehicle types: PHEVs, EVs, and FCVs. In addition, the carbon intensity of the electricity and hydrogen consumed by these vehicles is reduced to bring the AFCI value to 0.95. The vehicle introduction rates used in this scenario are very aggressive, and additional reductions below 0.95 are not considered. The introduction rates assumed exceed, for example, the commercialization rates discussed in the recently published review of the California ZEV mandate.³⁴ Though advances in batteries and other electric drivetrain technologies are assumed to improve the viability of EVs in this scenario, our EV introduction rates also assume the following: many sub-compact sized “city EVs” will be introduced, with top speeds of about 60 mph and limited driving ranges per charge (say 150 miles). In addition, each EV may be the equivalent of approximately 3 neighborhood EVs, which are driven less than conventional vehicles but are assumed to be sold in large volumes by 2020.

Given the aggressive introduction rates needed to attain an AFCI of 0.95, this scenario suggests that the introduction of electric drive vehicles alone would not be sufficient for the 10% 2020 LCFS goal, even if the vehicles are powered by very low carbon electricity and hydrogen. Figure 5-10 indicates the AFCI reduction resulting from each of the assumptions listed below. As indicated, these assumptions result in a very small AFCI reduction by 2015, suggesting a strong ramp-up in carbon intensity reductions near 2020. Fuel and vehicle results for the Electric Drive scenario are presented in Figure 5-11, Figure 5-12, Table 5-6, and Table 5-7.

Scenario C5 Assumptions

- **Assumption #1. Introduce PHEVs.**

The new LDV market share for PHEVs begins to increase exponentially in 2010. Approximately 270,000 PHEVs are sold per year by 2020. As shown in Figure 5-12, it is assumed that PHEVs are introduced at the expense of HEV market share (this substitution effect influences the total GHG emissions from the scenario, but not the carbon intensity).

- **Assumption #2. Increase number of EVs.**

The new LDV market share for EVs begins to increase significantly in 2010. By 2020, some 40,000 EVs are sold per year.

- **Assumption #3. Introduce FCVs.**

The new LDV market share for FCVs begins to increase exponentially in 2010. By 2020, some 180,000 fuel cell vehicles are sold per year.

³⁴ See Figure 3.1 in: http://www.arb.ca.gov/msprog/zevprog/zevreview/zev_review_staffreport.pdf

- **Assumption #4. Increase renewable energy fraction**

The electricity and hydrogen consumed by vehicles is composed of a greater fraction of renewable energy. For electricity, 10% is zero carbon by 2010, and 30% is zero carbon by 2020. For hydrogen, 10% is low carbon by 2010, and 30% is low carbon by 2020, where low carbon hydrogen has a GHG intensity of 7.3 gCO₂ eq/MJ (biomass derived, pipeline delivered).

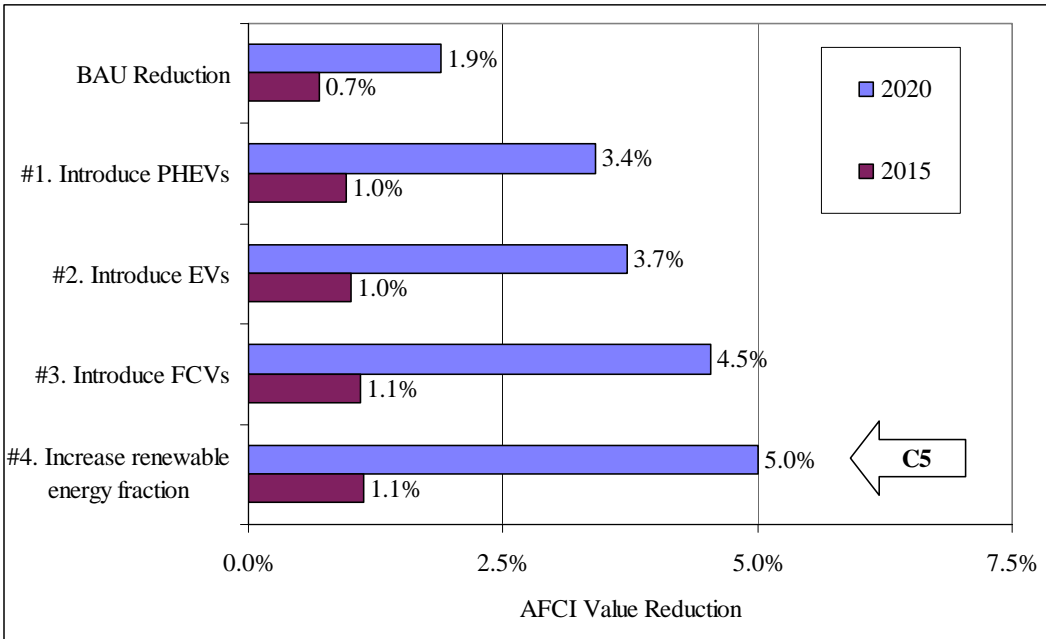

Figure 5-10: APCI reductions for each assumption in Scenario C5

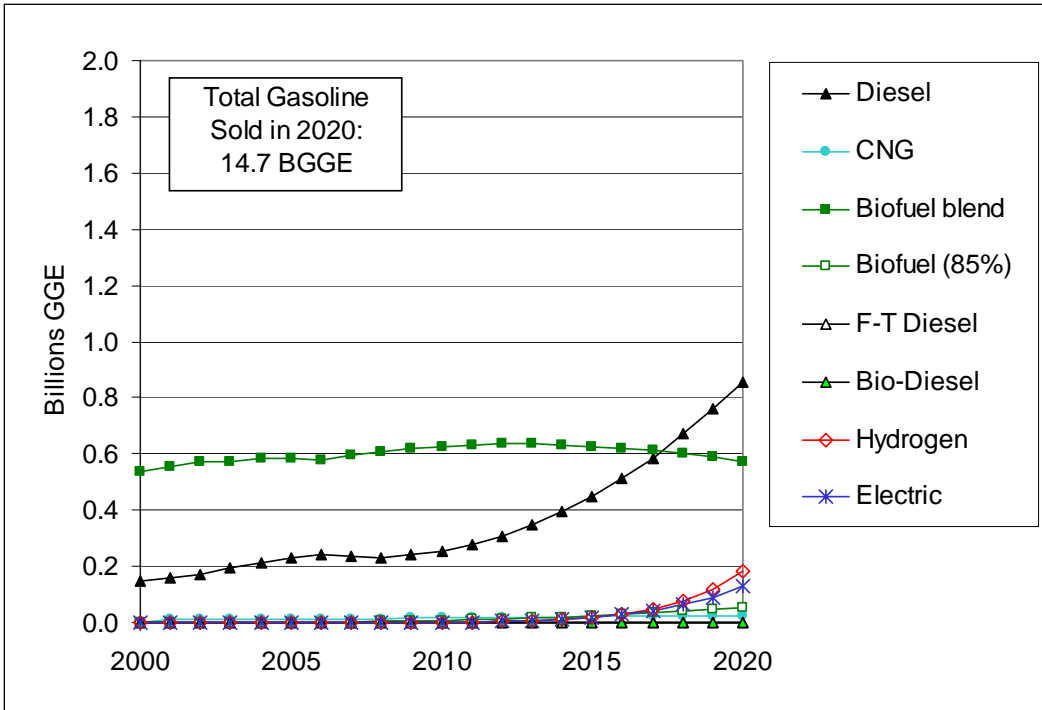

Figure 5-11: Fuel energy consumption in Scenario C5

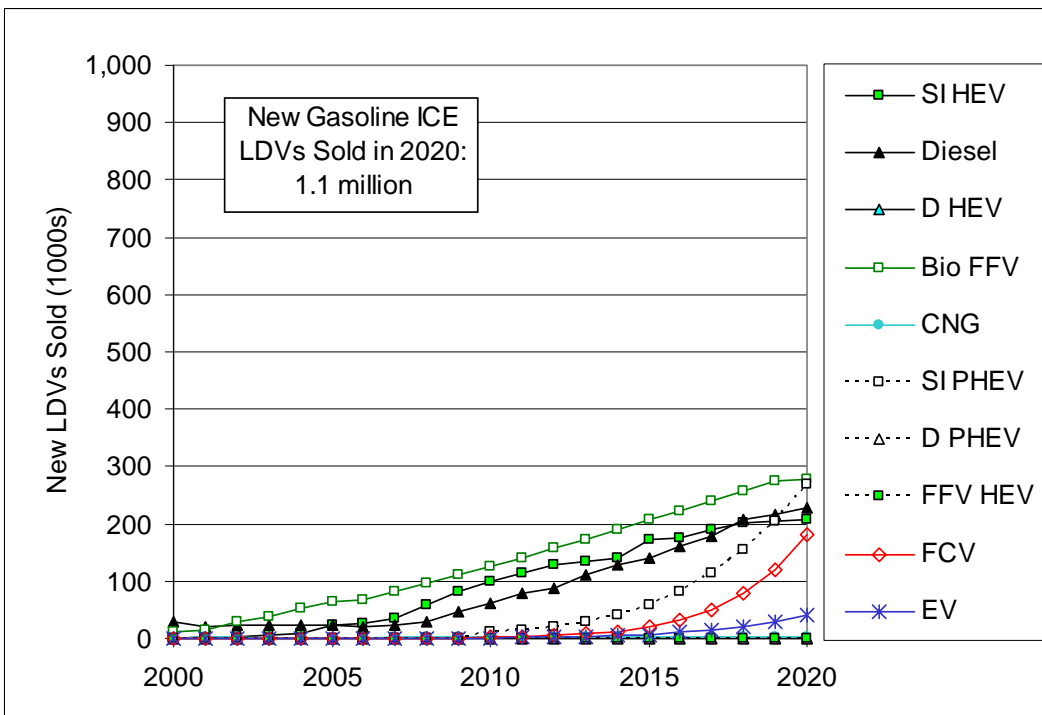

Figure 5-12: New LDVs sold per year in Scenario C5

Table 5-6: Fuel energy, GHG intensities, AFCI values and GHG emissions for Scenario C5

SCENARIO: Electric Drive (C5)				
	2005	2010	2015	2020
Fuel Energy Consumption by Type				
Total Fuel Energy LDVs (Billion GGE)	15.931	17.064	17.333	16.552
Gasoline	15.103	16.157	16.175	14.733
Diesel	0.230	0.255	0.448	0.855
CNG	0.013	0.016	0.021	0.026
F-T Diesel	0.000	0.000	0.000	0.000
Bio-Diesel	0.000	0.000	0.000	0.000
Methanol	0.000	0.000	0.000	0.000
Hydrogen	0.0000	0.0007	0.0186	0.1834
Electric	0.0001	0.0012	0.0187	0.1307
Ethanol (blended)	0.585	0.626	0.628	0.573
Ethanol (85% vol.)	0.000	0.008	0.024	0.052
Fuel GHG Intensities				
Average for all fuels (g CO2 eq/MJ)	92.8	92.8	92.7	92.4
Gasoline (with biofuel blend)	92.8	92.8	92.8	92.8
Diesel	91.6	91.6	91.6	91.6
CNG	68.1	68.1	68.1	68.1
Hydrogen	0.0	97.7	87.6	77.6
Electric	121.5	109.4	97.2	85.1
Ethanol (85% vol.)	0.0	76.0	75.0	74.1
AFCI Values				
Average for all fuels	1.00	1.00	0.99	0.95
Change from BAU (%)		0.0%	-0.5%	-3.2%
Gasoline (with biofuel blend)	1.00	1.00	1.00	1.00
Diesel	0.76	0.74	0.68	0.65
CNG	0.70	0.69	0.68	0.67
Hydrogen	-	-	0.48	0.43
Electric	0.35	0.24	0.20	0.17
Ethanol (85% vol.)	1.00	1.00	0.99	0.99
Total GHG Emissions				
All LDVs (MMT CO2 eq.)	195.0	208.8	212.0	201.7

Table 5-7: Sales of new LDVs for Scenario C5

SCENARIO: Electric Drive (C5)				
	2005	2010	2015	2020
New Light Duty Vehicle Sales				
New LDV Sales (millions)	1.949	2.096	2.209	2.323
Gasoline ICE	1.838	1.791	1.600	1.113
Change from BAU (%)		-0.7%	-5.0%	-30.0%
Battery EVs	0.0	0.001	0.007	0.040
Ethanol ICE FFVs	0.064	0.126	0.206	0.279
Diesel	0.023	0.063	0.139	0.229
CNG	0.001	0.003	0.003	0.003
Gasoline SI HEV	0.022	0.099	0.174	0.208
E85 SI HEV	0.0	0.0	0.0	0.0
Diesel HEV	0.0	0.0	0.0	0.0
Gasoline SI PHEV	0.0	0.010	0.059	0.269
Diesel PHEV	0.0	0.0	0.0	0.0
Hydrogen FCV	0.0	0.002	0.021	0.182

5.4.2 Existing Vehicles with Advanced Biofuels Scenarios (D5, D10)

In these scenarios, APCI reductions are attained by relying upon existing infrastructure to deliver two low-GHG blends: a biofuel blended with gasoline and an FT diesel blend. New production infrastructure and some delivery infrastructure would be required to support the introduction of these low-GHG biofuel blends. Significant advances in fuel production technology would occur in this scenario, but no significant vehicle technology innovations would be required. The number of diesel vehicles is increased, but the number of biofuel FFVs is the same as in the BAU scenario. The figures and tables following the list of assumptions below indicate the results for each of these scenarios.

Scenario D5 Assumptions

- **Assumption #1. Introduction of a low-GHG Biofuel (5.7% vol.)**
A low-GHG biofuel is introduced as a 5.7% blend in gasoline.³⁵ The fraction of the blend component composed of this new biofuel, as well as the fraction of E85 delivered to FFVs, increases to 10% by 2010 and 55% by 2020.
- **Assumption #2. Increase biofuel blend to 10% by vol.**
The biofuel blend in gasoline is increased to 7.5% by 2010 and 10% by 2020. The GHG intensity is the same as defined in assumption #1. Building on the GHG intensity reductions from Assumption #1, this assumption reduces the scenario APCI to the target value of 0.95.

Scenario D10 Assumptions

- **Assumption #3. Introduce low-GHG FT diesel**
A low-GHG FT diesel (12 gCO₂/MJ) is blended with diesel fuel at 5% by 2010 and 30% by 2020. The result is a 26% reduction in the carbon intensity of the blended diesel by 2020. This fuel is consumed by the same number of diesel vehicles on the road in the BAU scenario.
- **Assumption #4. Increase diesel fuel sales**
Diesel fuel sales increase significantly, with the total volume consumed in 2020 nearly doubling to 1.6 BGGE, and new LDV sales consisting of 26% diesel vehicles.
- **Assumption #5. Reduce biofuel blend GHG intensity (or increase blend volume)**
Assumption #4 brings the APCI value for scenario D10 to 0.918 by 2020. To achieve the additional reduction in GHG intensity required, the fraction of low-GHG biofuel is increased to 90% of the blend component for gasoline (and of the E85 delivered to FFVs) resulting in a gasoline GHG intensity of 87.9 gCO₂ eq./MJ. (Alternatively, the same APCI reduction could be achieved by increasing the blend of the low-GHG intensity biofuel to 15% by volume and maintaining the biofuel blend fraction defined in assumption #1.)

³⁵ The biofuel is assumed to have the same volumetric energy density as ethanol.

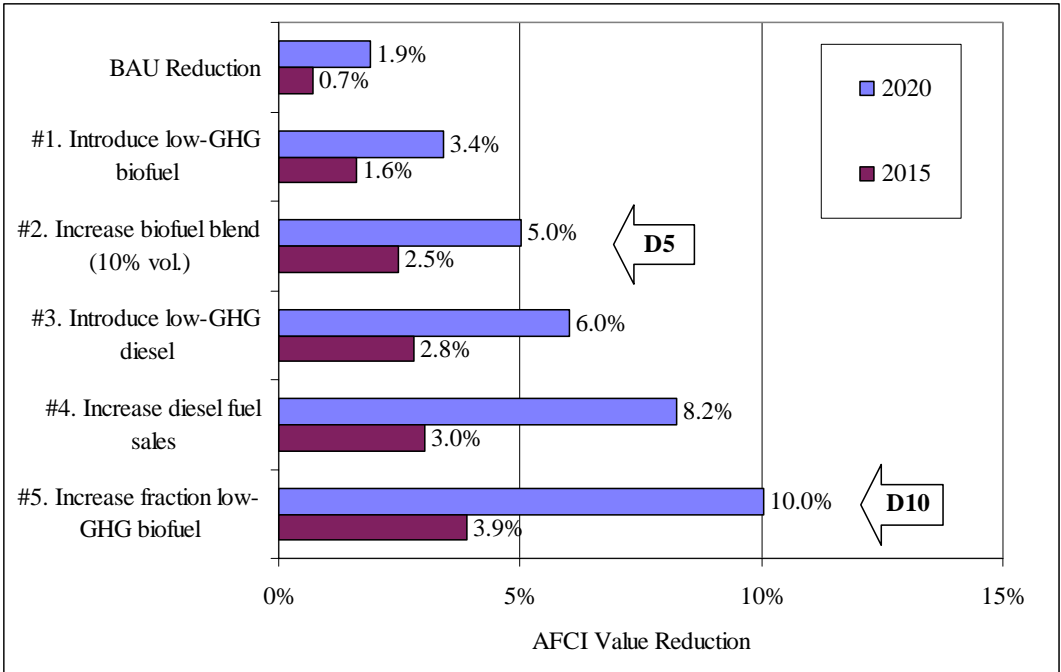

Figure 5-13: ACFI reductions for each assumption in Scenarios D5 and D10

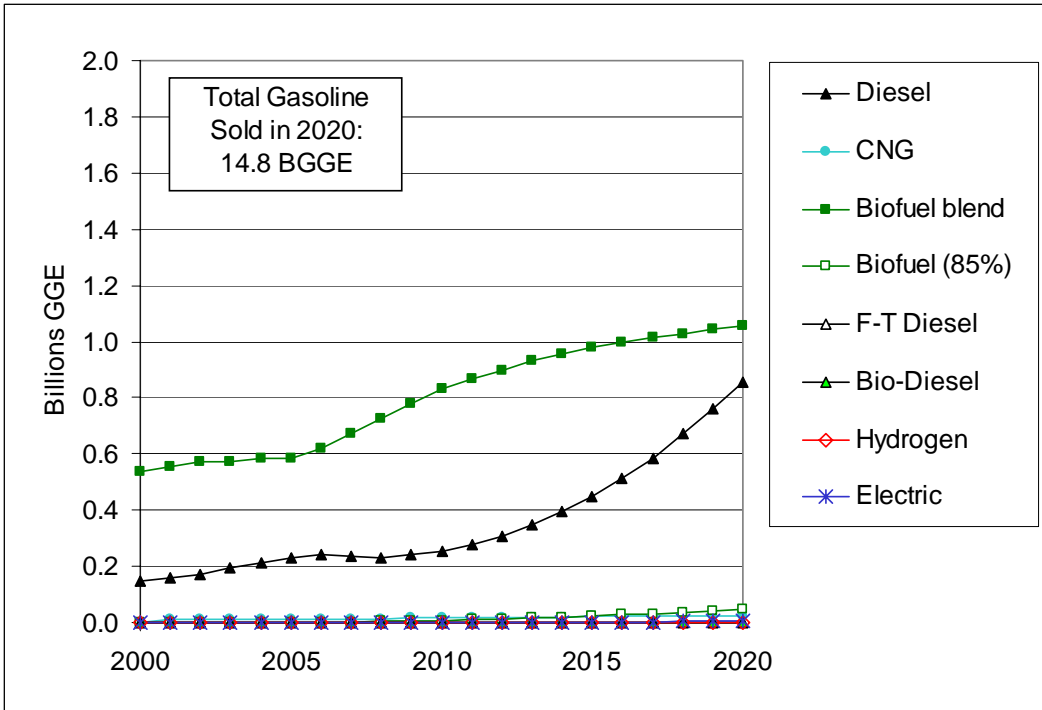

Figure 5-14: Fuel energy consumption in Scenario D5

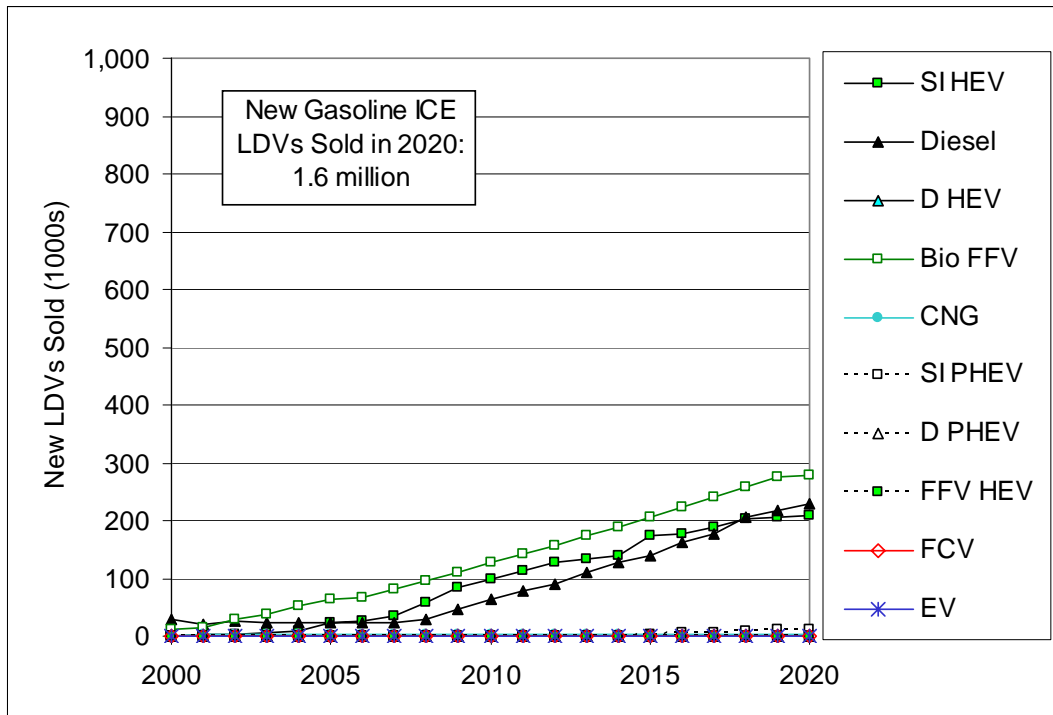

Figure 5-15: New LDVs sold per year in Scenario D5

Table 5-8: Fuel energy, GHG intensities, AFCI values and GHG emissions for Scenario D5

SCENARIO: Existing Infrastructure with Advanced Biofuels (D5)				
	2005	2010	2015	2020
Fuel Energy Consumption by Type				
Total Fuel Energy LDVs (Billion GGE)	15.931	17.065	17.372	16.831
Gasoline	15.103	15.958	15.901	14.835
Diesel	0.230	0.255	0.448	0.855
CNG	0.013	0.016	0.021	0.026
F-T Diesel	0.0	0.0	0.0	0.0
Bio-Diesel	0.0	0.0	0.0	0.0
Methanol	0.0	0.0	0.0	0.0
Hydrogen	0.0	0.0	0.0001	0.0016
Electric	0.0001	0.0005	0.0011	0.0066
Ethanol (blended)	0.585	0.829	0.977	1.057
Ethanol (85% vol.)	0.0	0.007	0.023	0.049
Fuel GHG Intensities				
Average for all fuels (g CO ₂ eq/MJ)	92.8	92.2	91.0	89.5
Gasoline (with biofuel blend)	92.8	92.3	91.1	89.6
Diesel	91.6	91.6	91.6	91.6
CNG	68.1	68.1	68.1	68.1
Hydrogen	0.0	0.0	107.7	107.7
Electric	121.5	121.5	121.5	121.5
Ethanol (85% vol.)	76.0	68.8	51.7	34.5
AFCI Values				
Average for all fuels	1.00	0.99	0.98	0.95
Change from BAU (%)		-0.6%	-1.8%	-3.2%
Gasoline (with biofuel blend)	1.00	0.99	0.98	0.96
Diesel	0.76	0.74	0.68	0.65
CNG	0.70	0.69	0.68	0.67
Hydrogen	-	-	-	0.53
Electric	0.35	0.27	0.25	0.24
Ethanol (85% vol.)	1.00	0.99	0.97	0.94
Total GHG Emissions				
All LDVs (MMT CO ₂ eq.)	195.0	207.6	208.5	198.7

Table 5-9: Sales of new LDVs for Scenario D5

SCENARIO: Existing Infrastructure with Advanced Biofuels (D5)				
	2005	2010	2015	2020
New Light Duty Vehicle Sales				
New LDV Sales (millions)	1.949	2.096	2.209	2.323
Gasoline ICE	1.838	1.804	1.684	1.591
Change from BAU (%)		0.0%	0.0%	0.0%
Battery EVs	0.0	0.001	0.001	0.001
Ethanol ICE FFVs	0.064	0.126	0.206	0.279
Diesel	0.023	0.063	0.139	0.229
CNG	0.001	0.003	0.003	0.003
Gasoline SI HEV	0.022	0.099	0.174	0.208
E85 SI HEV	0.0	0.0	0.0	0.0
Diesel HEV	0.0	0.0	0.0	0.0
Gasoline SI PHEV	0.0	0.0	0.002	0.012
Diesel PHEV	0.0	0.0	0.0	0.0
Hydrogen FCV	0.0	0.0	0.0	0.001

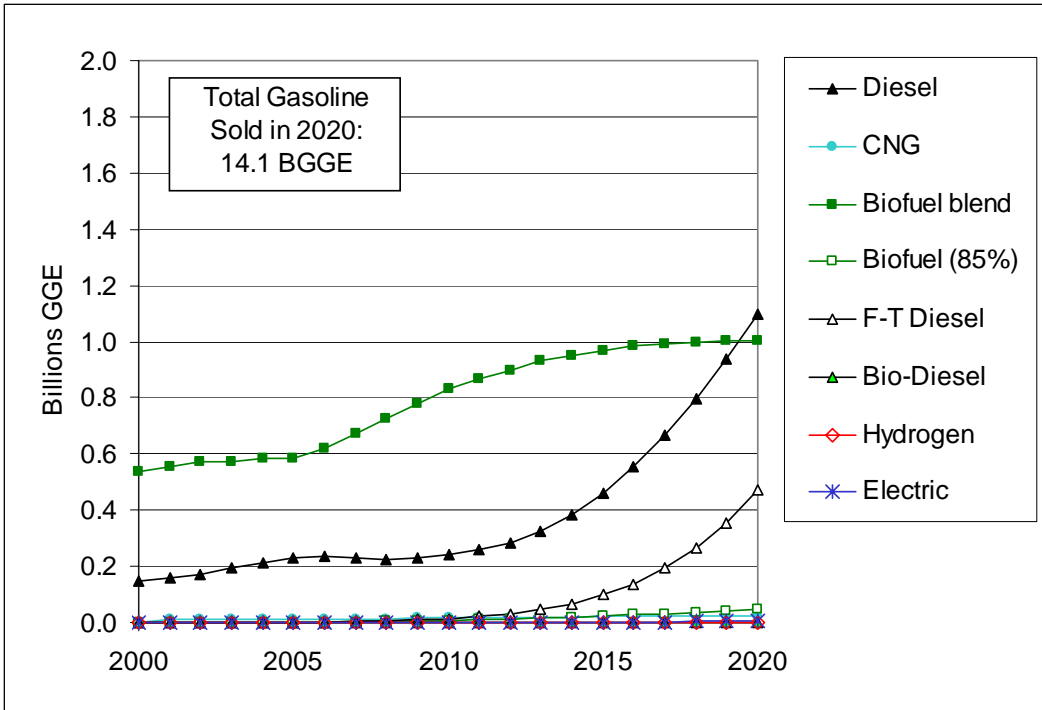

Figure 5-16: Fuel energy consumption in Scenario D10

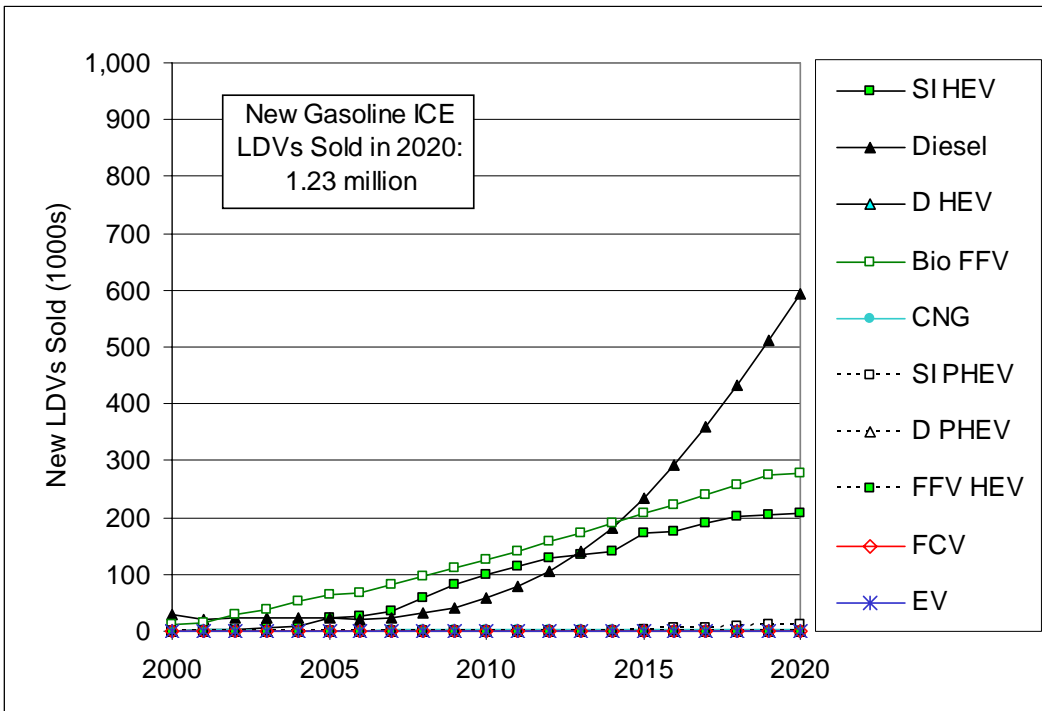

Figure 5-17: New LDVs sold per year in Scenario D10

Table 5-10: Fuel energy, GHG intensities, AFCI values & GHG emissions for Scenario D10

SCENARIO: Existing Infrastructure with Advanced Biofuels (D10)				
	2005	2010	2015	2020
Fuel Energy Consumption by Type				
Total Fuel Energy LDVs (Billion GGE)	15.931	17.066	17.353	16.715
Gasoline	15.103	15.959	15.782	14.060
Diesel	0.230	0.241	0.459	1.098
CNG	0.013	0.016	0.021	0.026
F-T Diesel	0.0	0.013	0.097	0.471
Bio-Diesel	0.0	0.0	0.0	0.0
Methanol	0.0	0.0	0.0	0.0
Hydrogen	0.0	0.0	0.0001	0.0016
Electric	0.0001	0.0005	0.0011	0.0066
Ethanol (blended)	0.585	0.829	0.970	1.002
Ethanol (85% vol.)	0.0	0.007	0.023	0.049
Fuel GHG Intensities				
Average for all fuels (g CO ₂ eq/MJ)	92.8	92.2	89.8	85.8
Gasoline (with biofuel blend)	92.8	92.3	90.3	87.9
Diesel	91.6	87.6	77.7	67.8
CNG	68.1	68.1	68.1	68.1
Hydrogen	0.0	0.0	107.7	107.7
Electric	121.5	121.5	121.5	121.5
Ethanol (85% vol.)	76.0	68.8	39.1	9.3
AFCI Values				
Average for all fuels	1.00	0.99	0.96	0.90
Change from BAU (%)		-0.7%	-3.2%	-8.3%
Gasoline (with biofuel blend)	1.00	0.99	0.97	0.95
Diesel	0.76	0.71	0.56	0.47
CNG	0.70	0.69	0.68	0.67
Hydrogen	-	-	-	0.53
Electric	0.35	0.27	0.25	0.24
Ethanol (85% vol.)	1.00	0.99	0.96	0.92
Total GHG Emissions				
All LDVs (MMT CO ₂ eq.)	195.0	207.5	205.6	189.0

Table 5-11: Sales of new LDVs for Scenario D10

SCENARIO: Existing Infrastructure with Advanced Biofuels (D10)				
	2005	2010	2015	2020
New Light Duty Vehicle Sales				
New LDV Sales (millions)	1.949	2.096	2.209	2.323
Gasoline ICE	1.838	1.809	1.590	1.226
Change from BAU (%)		0.3%	-5.6%	-22.9%
Battery EVs	0.0	0.001	0.001	0.001
Ethanol ICE FFVs	0.064	0.126	0.206	0.279
Diesel	0.023	0.058	0.233	0.593
CNG	0.001	0.003	0.003	0.003
Gasoline SI HEV	0.022	0.099	0.174	0.208
E85 SI HEV	0.0	0.0	0.0	0.0
Diesel HEV	0.0	0.0	0.0	0.0
Gasoline SI PHEV	0.0	0.0	0.002	0.012
Diesel PHEV	0.0	0.0	0.0	0.0
Hydrogen FCV	0.0	0.0	0.0	0.001

5.4.3 Evolving Biofuels and Advanced Battery Scenarios (F5, F10)

In these scenarios, existing delivery infrastructure is relied upon to provide mid-GHG (and some low-GHG) biofuel blends. Biofuel production technologies continue to evolve over time but are not radically different (in terms of GHG intensity) from processes in use today. Battery and electric drive technologies advance significantly, with PHEVs and BEVs being sold in relatively large volumes by 2020. The figures and tables following the list of assumptions below indicate the results for each of these scenarios.

Scenario F5 Assumptions

- **Assumption #1: Mid-GHG biofuel at 5.7% vol.**
A mid-GHG biofuel is introduced as a blend for gasoline, displacing today's average-GHG intensity ethanol over time. By 2010, 10% of the gasoline blend component is a mid-GHG intensity biofuel, and 90% is a mid-GHG biofuel by 2020.
- **Assumption #2: Increase biofuel blend to 10% vol.**
The quantity of biofuel blended with gasoline is increased to 10% by volume, maintaining the fraction of mid-GHG biofuel from assumption #1.
- **Assumption #3: Introduce PHEVs**
PHEVs are introduced and begin to consume electricity as a transportation fuel in 2010. By 2020, some 188,000 new LDVs sold per year are PHEVs.
- **Assumption #4: Increase EVs**
The number of EVs increases significantly toward the end of the time period, with approximately 35,000 being sold per year by 2020. This assumption brings the AFCI value for Scenario F5 to 0.95.

Scenario F10 Assumptions

- **Assumption #5: Increase FFV biofuel VMT to 50%**
The frequency of refueling existing FFVs with biofuel (e.g., ethanol) is increased such that half of all VMT are driven on an 85% vol. blend by 2020. This assumption relies upon the number of FFVs occurring under BAU conditions; only the volume of mid-GHG intensity biofuel provided changes.
- **Assumption #6: Introduce mid-GHG biodiesel**
A mid-GHG intensity biodiesel is blended with diesel fuel consumed by LDVs. By 2020, diesel consumed by LDVs is 20% mid-GHG intensity biodiesel.

- Assumption #7: Increase E85 sales to FFVs**
 In assumption #5, the fraction of VMT driven by FFVs on biofuel was increased to 50%. Now the number of FFVs sold is increased while maintaining this VMT fraction. The number of LDVs sold as FFVs increases to approximately 915,000 per year by 2020. This assumption is consistent with recent declarations by U.S. automakers of their capability to increase the percentage of ethanol-capable FFVs to half of all vehicles produced by 2012.³⁶
- Assumption #8: Increase sales of diesel fuel**
 Sales of diesel fuel are increased to roughly 1.6 BGGE by 2020, with 0.3 BGGE being mid-GHG biodiesel. (Alternatively, the same AFCI value could be achieved by increasing the gasoline biofuel blend to 21%, relying on the mid-GHG intensity in assumption #1.)

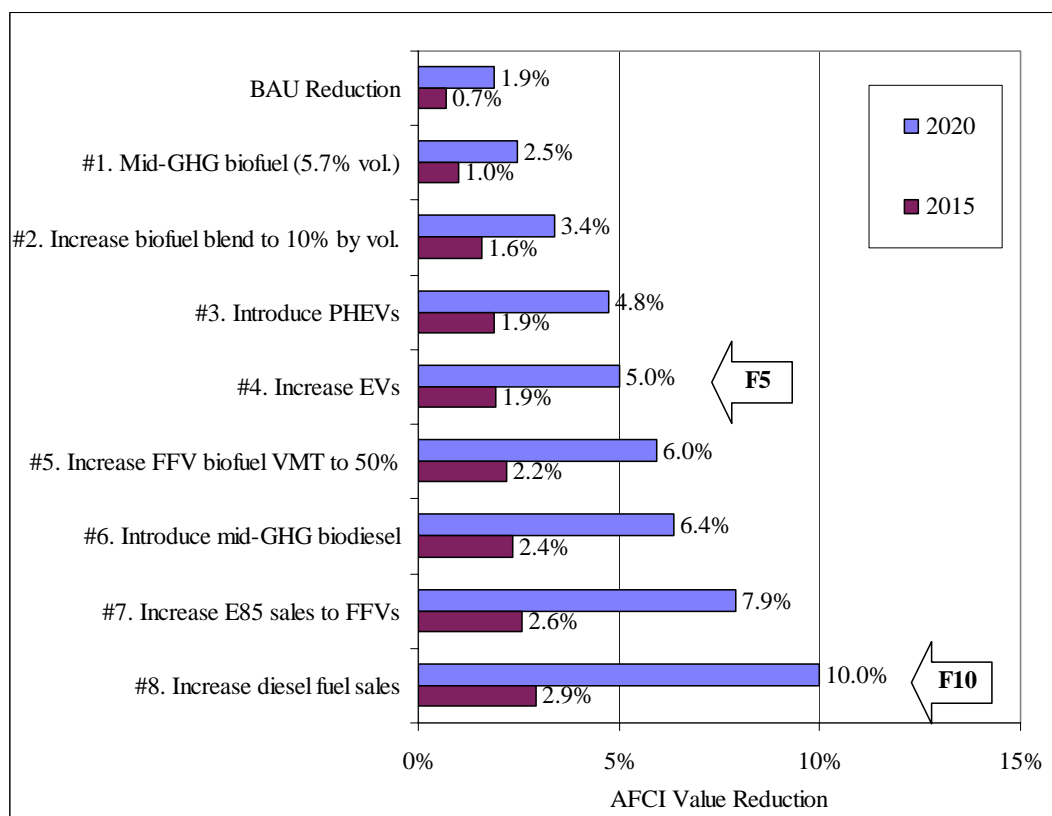

Figure 5-18: AFCI reductions for each assumption in Scenarios F5 and F10

³⁶ US Automakers Press Bush On Ethanol, AFP, March 26, 2007. http://www.energy-daily.com/reports/US_Automakers_Press_Bush_On_Ethanol_999.html

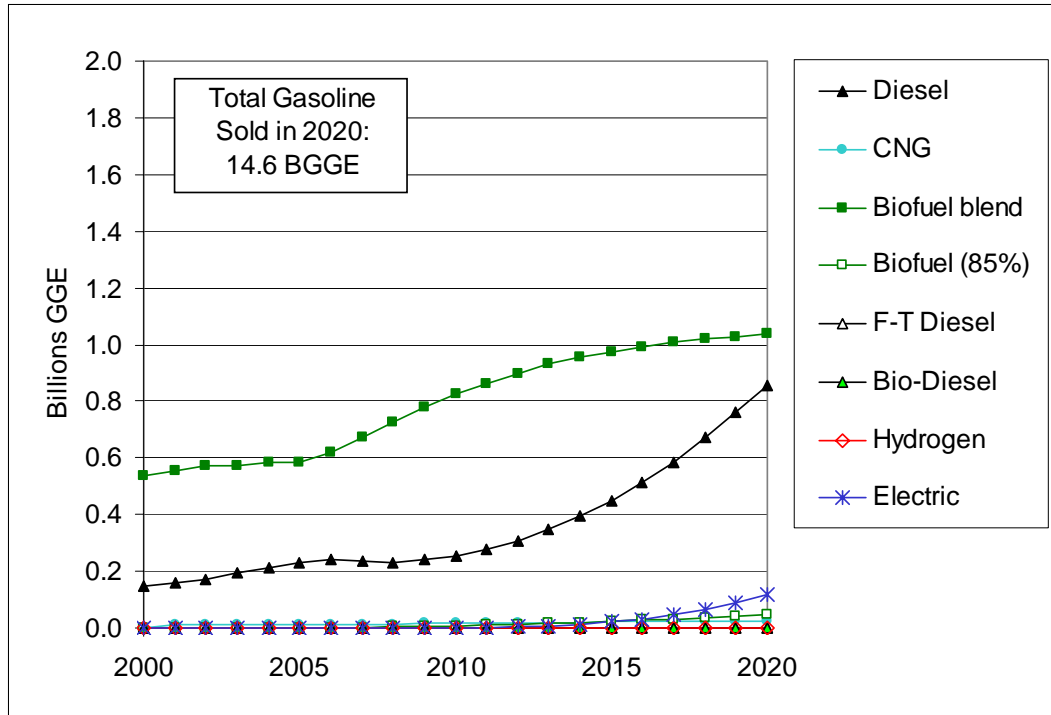

Figure 5-19: Fuel energy consumed in Scenario F5

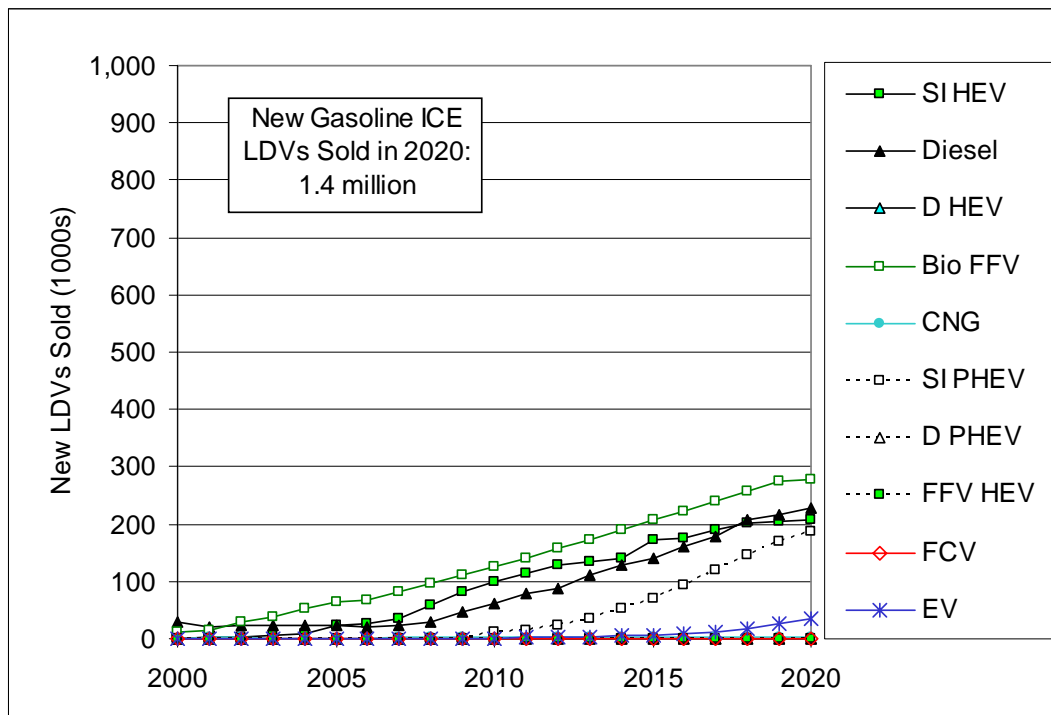

Figure 5-20: New LDV sales per year in Scenario F5

Table 5-12: Fuel energy, GHG intensities, AFCI values and GHG emissions for Scenario F5

SCENARIO: Evolving Biofuels and Advanced Batteries (F5)				
	2005	2010	2015	2020
Fuel Energy Consumption by Type				
Total Fuel Energy LDVs (Billion GGE)	15.931	17.064	17.340	16.664
Gasoline	15.103	15.956	15.852	14.575
Diesel	0.230	0.255	0.448	0.855
CNG	0.013	0.016	0.021	0.026
F-T Diesel	0.0	0.0	0.0	0.0
Bio-Diesel	0.0	0.0	0.0	0.0
Methanol	0.0	0.0	0.0	0.0
Hydrogen	0.0	0.0	0.0001	0.0016
Electric	0.0001	0.0012	0.0212	0.1182
Ethanol (blended)	0.585	0.829	0.974	1.039
Ethanol (85% vol.)	0.0	0.007	0.023	0.049
Fuel GHG Intensities				
Average for all fuels (g CO ₂ eq/MJ)	92.8	92.5	91.9	91.3
Gasoline (with biofuel blend)	92.8	92.5	91.9	91.2
Diesel	91.6	91.6	91.6	91.6
CNG	68.1	68.1	68.1	68.1
Hydrogen	0.0	0.0	107.7	107.7
Electric	121.5	121.5	121.5	121.5
Ethanol (85% vol.)	76.0	74.1	66.7	59.4
AFCI Values				
Average for all fuels	1.00	1.00	0.98	0.95
Change from BAU (%)		-0.3%	-1.2%	-3.2%
Gasoline (with biofuel blend)	1.00	1.00	0.99	0.98
Diesel	0.76	0.74	0.68	0.65
CNG	0.70	0.69	0.68	0.67
Hydrogen	-	-	-	0.53
Electric	0.35	0.27	0.25	0.24
Ethanol (85% vol.)	1.00	0.99	0.98	0.97
Total GHG Emissions				
All LDVs (MMT CO ₂ eq.)	195.0	208.2	210.2	200.7

Table 5-13: Sales of new LDVs for Scenario F5

SCENARIO: Evolving Biofuels and Advanced Batteries (F5)				
	2005	2010	2015	2020
New Light Duty Vehicle Sales				
New LDV Sales (millions)	1.949	2.096	2.209	2.323
Gasoline ICE	1.838	1.793	1.609	1.380
Change from BAU (%)		-0.6%	-4.4%	-13.3%
Battery EVs	0.0	0.001	0.007	0.035
Ethanol ICE FFVs	0.064	0.126	0.206	0.279
Diesel	0.023	0.063	0.139	0.229
CNG	0.001	0.003	0.003	0.003
Gasoline SI HEV	0.022	0.099	0.174	0.208
E85 SI HEV	0.0	0.0	0.0	0.0
Diesel HEV	0.0	0.0	0.0	0.0
Gasoline SI PHEV	0.0	0.0	0.071	0.188
Diesel PHEV	0.0	0.0	0.0	0.0
Hydrogen FCV	0.0	0.0	0.0	0.001

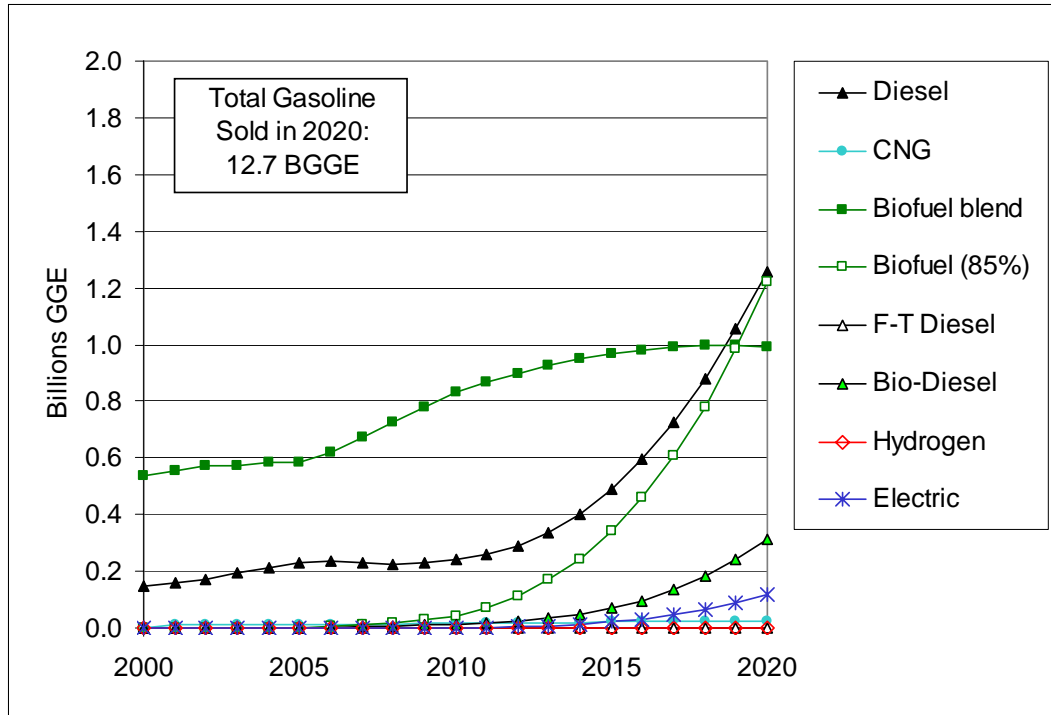

Figure 5-21: Fuel energy consumption in Scenario F10

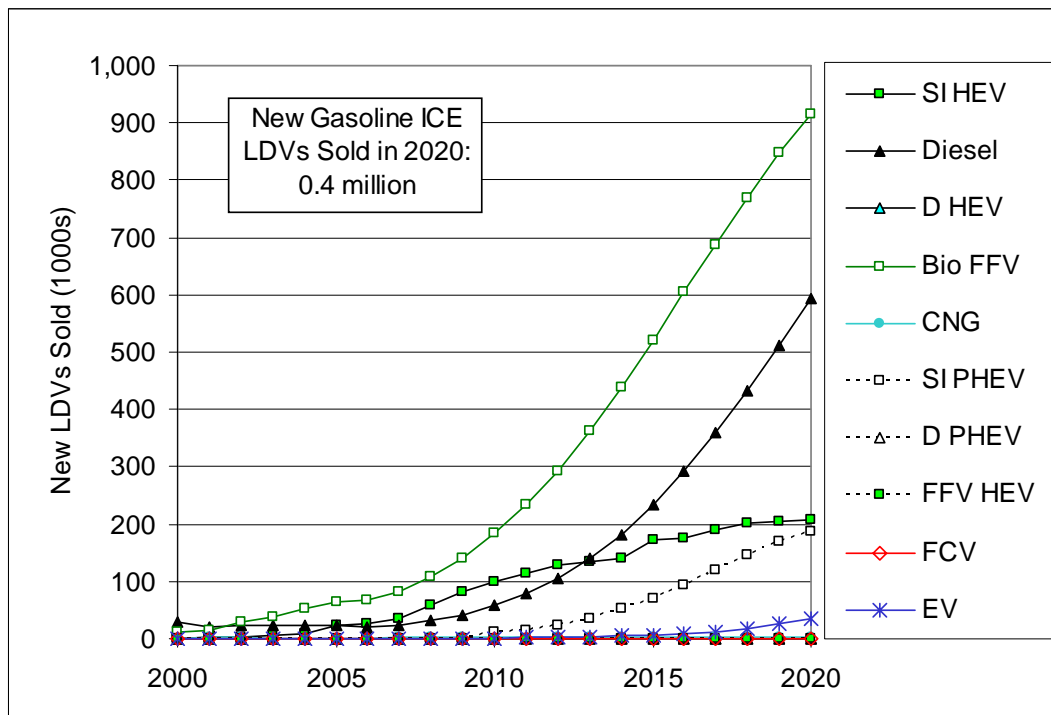

Figure 5-22: New LDVs sold per year in Scenario F10

Table 5-14: Fuel energy, GHG intensities, AFCI values & GHG emissions for Scenario F10

SCENARIO: Evolving Biofuels and Advanced Batteries (F10)				
	2005	2010	2015	2020
Fuel Energy Consumption by Type				
Total Fuel Energy LDVs (Billion GGE)	15.931	17.070	17.351	16.657
Gasoline	15.103	15.927	15.443	12.728
Diesel	0.230	0.241	0.487	1.255
CNG	0.013	0.016	0.021	0.026
F-T Diesel	0.0	0.0	0.0	0.0
Bio-Diesel	0.0	0.013	0.070	0.314
Methanol	0.0	0.0	0.0	0.0
Hydrogen	0.0	0.0	0.0001	0.0016
Electric	0.0001	0.0012	0.0212	0.1182
Ethanol (blended)	0.585	0.829	0.968	0.991
Ethanol (85% vol.)	0.0	0.042	0.339	1.223
Fuel GHG Intensities				
Average for all fuels (g CO ₂ eq/MJ)	92.8	92.4	91.2	88.0
Gasoline (with biofuel blend)	92.8	92.5	91.9	91.0
Diesel	91.6	89.1	85.3	81.5
CNG	68.1	68.1	68.1	68.1
Hydrogen	0.0	0.0	107.7	107.7
Electric	121.5	121.5	121.5	121.5
Ethanol (85% vol.)	76.0	74.1	66.7	59.4
AFCI Values				
Average for all fuels	1.00	1.00	0.97	0.90
Change from BAU (%)		-0.4%	-2.2%	-8.2%
Gasoline (with biofuel blend)	1.00	1.00	0.99	0.98
Diesel	0.76	0.72	0.61	0.57
CNG	0.70	0.69	0.68	0.67
Hydrogen	-	-	-	0.53
Electric	0.35	0.27	0.25	0.24
Ethanol (85% vol.)	1.00	0.98	0.93	0.86
Total GHG Emissions				
All LDVs (MMT CO ₂ eq.)	195.0	208.1	208.7	193.3

Table 5-15: Sales of LDVs for Scenario F10

SCENARIO: Evolving Biofuels and Advanced Batteries (F10)				
	2005	2010	2015	2020
New Light Duty Vehicle Sales				
New LDV Sales (millions)	1.949	2.096	2.209	2.323
Gasoline ICE	1.838	1.741	1.202	0.379
Change from BAU (%)		-3.5%	-28.6%	-76.2%
Battery EVs	0.0	0.001	0.007	0.035
Ethanol ICE FFVs	0.064	0.183	0.519	0.915
Diesel	0.023	0.058	0.233	0.593
CNG	0.001	0.003	0.003	0.003
Gasoline SI HEV	0.022	0.099	0.174	0.208
E85 SI HEV	0.0	0.0	0.0	0.0
Diesel HEV	0.0	0.0	0.0	0.0
Gasoline SI PHEV	0.0	0.0	0.071	0.188
Diesel PHEV	0.0	0.0	0.0	0.0
Hydrogen FCV	0.0	0.0	0.0	0.001

5.4.4 Biofuel Intensive Scenarios (G5, G10, G15)

In these scenarios a mid-GHG ethanol is introduced for both FFVs and as a blend in gasoline. The number of FFVs is increased and the frequency of refueling these vehicles with biofuels is increased. A low-GHG FT diesel fuel blend is introduced and the number of diesel vehicles sold per year increases.

The assumptions for Scenario G15 differ from the scenario description in the other G scenarios in that they bring online significant volumes of advanced low-GHG biofuels. Scenarios G5 and G10 achieved AFCI values of 0.95 and 0.9, respectively, by relying only on mid-GHG biofuels. Scenario G15 achieves an AFCI value of 0.85 by reducing the GHG intensity of the biofuel blend for gasoline and by introducing a low-GHG FT diesel blend.

Scenario G5 Assumptions

- **Assumption #1. Introduce mid-GHG Ethanol (5.7% vol.).**
A mid-GHG biofuel is introduced as a blend for gasoline, displacing today's average-GHG intensity ethanol over time. By 2010, 10% of the gasoline blend component is a mid-GHG intensity biofuel, and 50% is a mid-GHG biofuel by 2020.
- **Assumption #2. Increase biofuel blend to 10% by vol.**
The quantity of biofuel blended with gasoline is increased to 10% by volume, maintaining the fraction of mid-GHG biofuel from assumption #1
- **Assumption #3. Introduce mid-GHG biodiesel**
A mid-GHG intensity biodiesel is blended with diesel fuel consumed by LDVs. By 2020, diesel consumed by LDVs is 20% mid-GHG intensity biodiesel.
- **Assumption #4. Increase number of FFVs**
The number of FFVs sold is increased to approximately 800,000 per year by 2020. This assumption is consistent with recent declarations by U.S. automakers of their capability to increase the percentage of ethanol-capable FFVs to half of all vehicles produced by 2012 (see assumption #7 in Scenario F10).
- **Assumption #5. Increase FFV biofuel VMT to 50%**
The frequency of refueling existing FFVs with biofuel (e.g., ethanol) is increased such that 50% of all VMT are driven on an 85% vol. blend with the carbon intensity defined in assumption #1. This assumption brings the AFCI value for Scenario G5 to 0.95.

Scenario G10 Assumptions

- **Assumption #6. Introduce low-GHG biofuel**
In assumption #1, a mid-GHG biofuel was introduced for the biofuel blend component of gasoline. The present assumption is that 5% of this blend component is supplied as a low-GHG biofuel by 2010, and 25% by 2020.
- **Assumption #7. Introduce low-GHG FT diesel**
A low-GHG FT diesel blend is introduced in addition to the biodiesel blend from assumption

#3. The low-GHG FT diesel is blended at 2% by vol. in 2010 and 10% by vol. by 2020.

- **Assumption #8. Increase sales of diesel fuel**

The number of diesel vehicles sold per year increases exponentially beginning around 2010. By 2030, over 750,000 new LDVs sold per year are diesel vehicles. These vehicles operate on the diesel blend defined in assumptions #3 and #7.

Scenario G15 Assumptions

- **Assumption #9. Increase fraction of low-GHG FT diesel**

The fraction of diesel fuel provided as low-GHG FT diesel is increased to 30% by 2020.

- **Assumption #10. Introduce sub-zero biofuel.**

A sub-zero biofuel is introduced with a carbon intensity of -14 gCO₂eq./MJ, bringing the average biofuel carbon intensity to 40 gCO₂eq./MJ by 2020. Gasoline, with a 10% by volume biofuel blend, has a carbon intensity of 90 gCO₂eq./MJ. The E85 sold to FFVs has a carbon intensity of 71.8 gCO₂eq./MJ.

- **Assumption #11. Increase FFV biofuel VMT to 90%**

The frequency of refueling FFVs with the 85% by vol. biofuel blend is increased from 50% to 90%.. This assumption brings the AFCI value below 0.85 for Scenario G15 (Alternatively, the same AFCI reduction could be attained by increasing the biofuel blend component of gasoline to 19%).

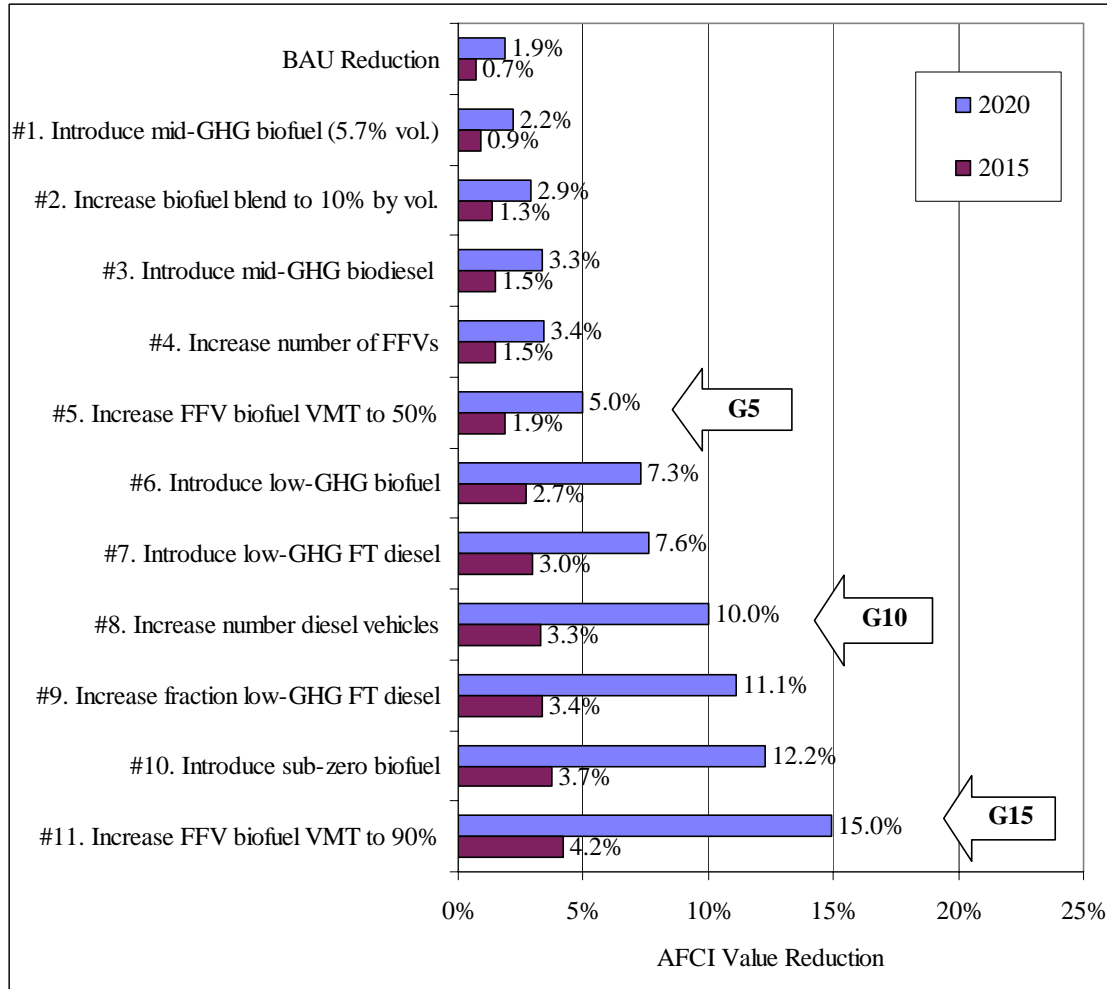

Figure 5-23: APCI reductions for each assumption in Scenarios G5, G10 and G15

This page is intentionally blank.

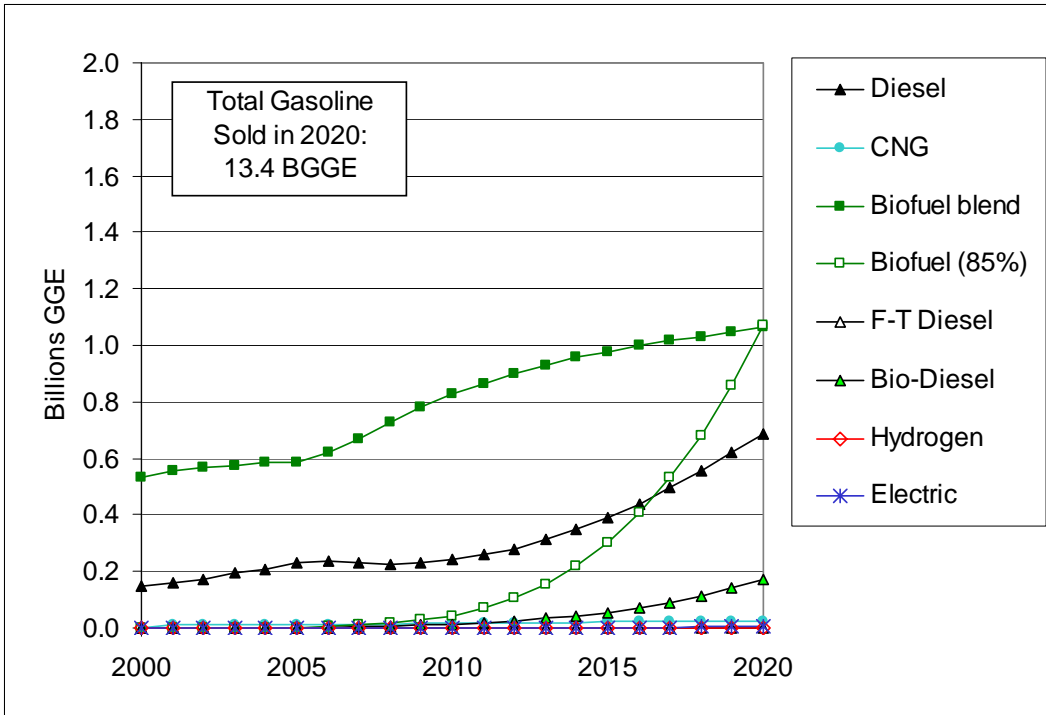

Figure 5-24: Fuel energy consumption in Scenario G5

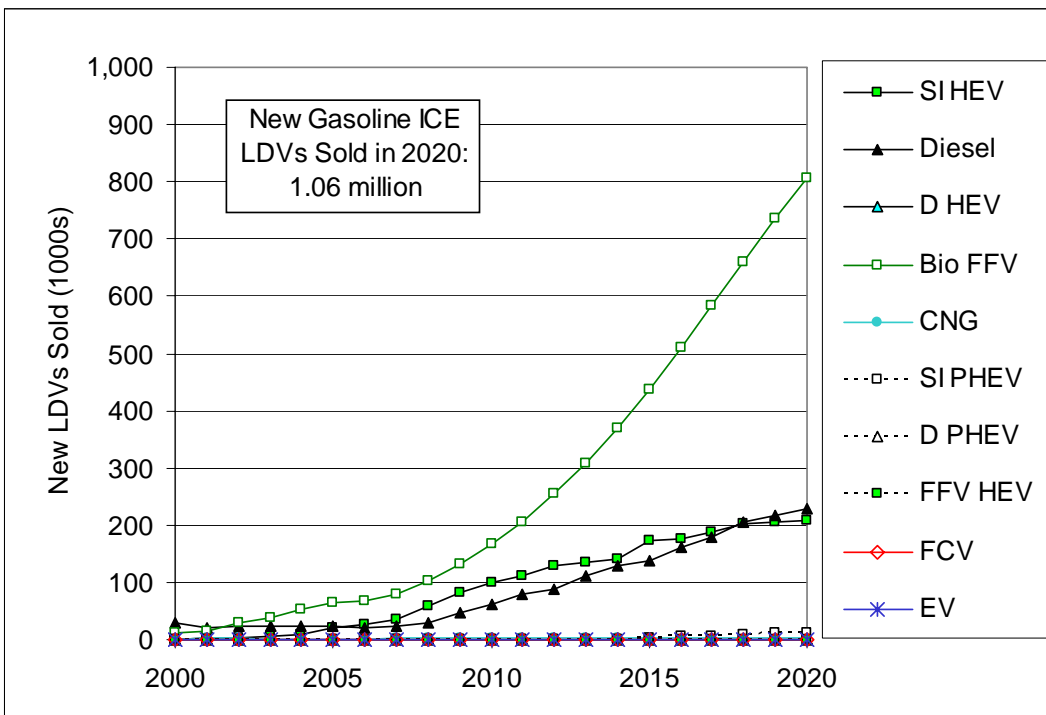

Figure 5-25: New LDVs sales per year in Scenario G5

Table 5-16: Fuel energy, GHG intensities, AFCI values & GHG emissions for Scenario G5

SCENARIO: Biofuel Intensive (G5)				
	2005	2010	2015	2020
Fuel Energy Consumption by Type				
Total Fuel Energy LDVs (Billion GGE)	15.931	17.069	17.394	16.920
Gasoline	15.103	15.928	15.642	13.899
Diesel	0.230	0.242	0.392	0.684
CNG	0.013	0.016	0.021	0.026
F-T Diesel	0.0	0.0	0.0	0.0
Bio-Diesel	0.0	0.013	0.056	0.171
Methanol	0.0	0.0	0.0	0.0
Hydrogen	0.0	0.0	0.0001	0.0016
Electric	0.0001	0.0005	0.0011	0.0066
Ethanol (blended)	0.585	0.829	0.978	1.063
Ethanol (85% vol.)	0.0	0.041	0.303	1.068
Fuel GHG Intensities				
Average for all fuels (g CO ₂ eq/MJ)	92.8	92.4	91.6	89.5
Gasoline (with biofuel blend)	92.8	92.5	92.1	91.6
Diesel	91.6	89.1	85.3	81.5
CNG	68.1	68.1	68.1	68.1
Hydrogen	0.0	0.0	107.7	107.7
Electric	121.5	121.5	121.5	121.5
Ethanol (85% vol.)	76.0	74.1	70.4	66.7
AFCI Values				
Average for all fuels	1.00	1.00	0.98	0.95
Change from BAU (%)		-0.4%	-1.2%	-3.2%
Gasoline (with biofuel blend)	1.00	1.00	0.99	0.99
Diesel	0.76	0.72	0.63	0.58
CNG	0.70	0.69	0.68	0.67
Hydrogen	-	-	-	0.53
Electric	0.35	0.27	0.25	0.24
Ethanol (85% vol.)	1.00	0.98	0.94	0.89
Total GHG Emissions				
All LDVs (MMT CO ₂ eq.)	195.0	208.1	210.0	199.7

Table 5-17: Sales of LDVs for Scenario G5

SCENARIO: Biofuel Intensive (G5)				
	2005	2010	2015	2020
New Light Duty Vehicle Sales				
New LDV Sales (millions)	1.949	2.096	2.209	2.323
Gasoline ICE	1.838	1.765	1.452	1.064
Change from BAU (%)		-2.2%	-13.8%	-33.1%
Battery EVs	0.0	0.001	0.001	0.001
Ethanol ICE FFVs	0.064	0.166	0.438	0.805
Diesel	0.023	0.063	0.139	0.229
CNG	0.001	0.003	0.003	0.003
Gasoline SI HEV	0.022	0.099	0.174	0.208
E85 SI HEV	0.0	0.0	0.0	0.0
Diesel HEV	0.0	0.0	0.0	0.0
Gasoline SI PHEV	0.0	0.0	0.002	0.012
Diesel PHEV	0.0	0.0	0.0	0.0
Hydrogen FCV	0.0	0.0	0.0	0.001

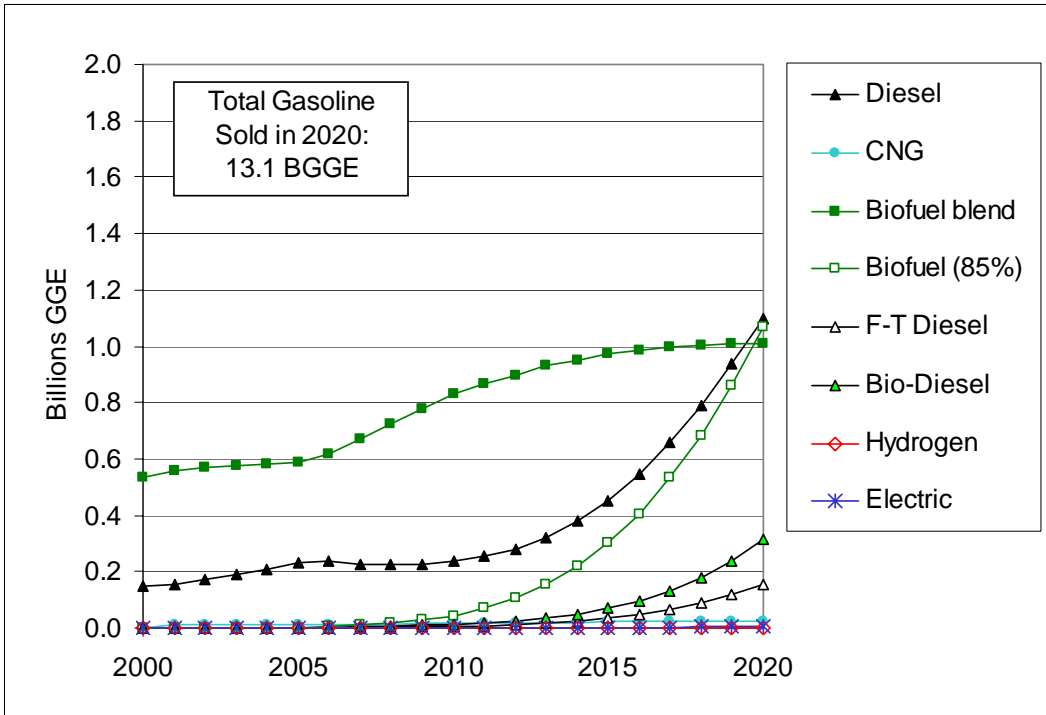

Figure 5-26: Fuel energy consumption in Scenario G10

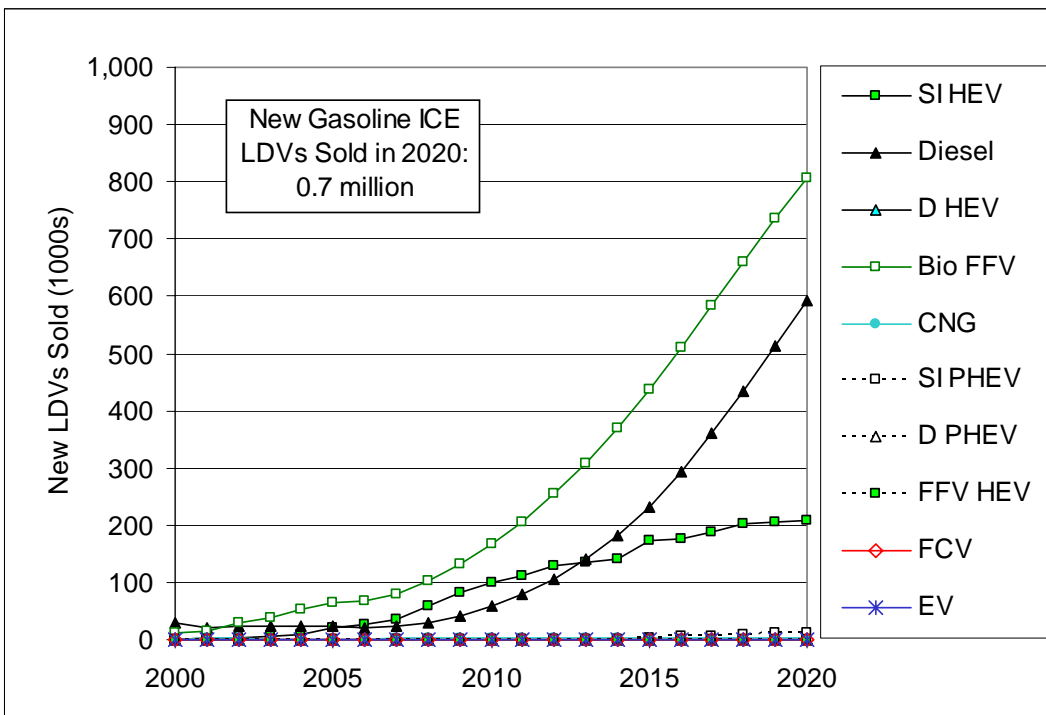

Figure 5-27: New LDVs sold per year in Scenario G10

Table 5-18: Fuel energy, GHG intensities, AFCI values & GHG emissions for Scenario G10

SCENARIO: Biofuel Intensive (G10)				
	2005	2010	2015	2020
Fuel Energy Consumption by Type				
Total Fuel Energy LDVs (Billion GGE)	15.931	17.070	17.376	16.804
Gasoline	15.103	15.929	15.523	13.124
Diesel	0.230	0.236	0.454	1.098
CNG	0.013	0.016	0.021	0.026
F-T Diesel	0.0	0.005	0.033	0.157
Bio-Diesel	0.0	0.013	0.070	0.314
Methanol	0.0	0.0	0.0	0.0
Hydrogen	0.0	0.0	0.0001	0.0016
Electric	0.0001	0.0005	0.0011	0.0066
Ethanol (blended)	0.585	0.829	0.971	1.008
Ethanol (85% vol.)	0.0	0.041	0.303	1.068
Fuel GHG Intensities				
Average for all fuels (g CO ₂ eq/MJ)	92.8	92.0	90.4	86.1
Gasoline (with biofuel blend)	92.8	92.2	91.4	90.3
Diesel	91.6	87.5	80.5	73.5
CNG	68.1	68.1	68.1	68.1
Hydrogen	0.0	0.0	107.7	107.7
Electric	121.5	121.5	121.5	121.5
Ethanol (85% vol.)	76.0	66.9	57.8	48.7
AFCI Values				
Average for all fuels	1.00	0.99	0.97	0.90
Change from BAU (%)		-0.8%	-2.6%	-8.2%
Gasoline (with biofuel blend)	1.00	0.99	0.98	0.98
Diesel	0.76	0.70	0.58	0.51
CNG	0.70	0.69	0.68	0.67
Hydrogen	-	-	-	0.53
Electric	0.35	0.27	0.25	0.24
Ethanol (85% vol.)	1.00	0.97	0.91	0.81
Total GHG Emissions				
All LDVs (MMT CO ₂ eq.)	195.0	207.2	207.2	190.8

Table 5-19: Sales of LDVs for Scenario G10

SCENARIO: Biofuel Intensive (G10)				
	2005	2010	2015	2020
New Light Duty Vehicle Sales				
New LDV Sales (millions)	1.949	2.096	2.209	2.323
Gasoline ICE	1.838	1.769	1.358	0.700
Change from BAU (%)		-1.9%	-19.4%	-56.0%
Battery EVs	0.0	0.001	0.001	0.001
Ethanol ICE FFVs	0.064	0.166	0.438	0.805
Diesel	0.023	0.058	0.233	0.593
CNG	0.001	0.003	0.003	0.003
Gasoline SI HEV	0.022	0.099	0.174	0.208
E85 SI HEV	0.0	0.0	0.0	0.0
Diesel HEV	0.0	0.0	0.0	0.0
Gasoline SI PHEV	0.0	0.0	0.002	0.012
Diesel PHEV	0.0	0.0	0.0	0.0
Hydrogen FCV	0.0	0.0	0.0	0.001

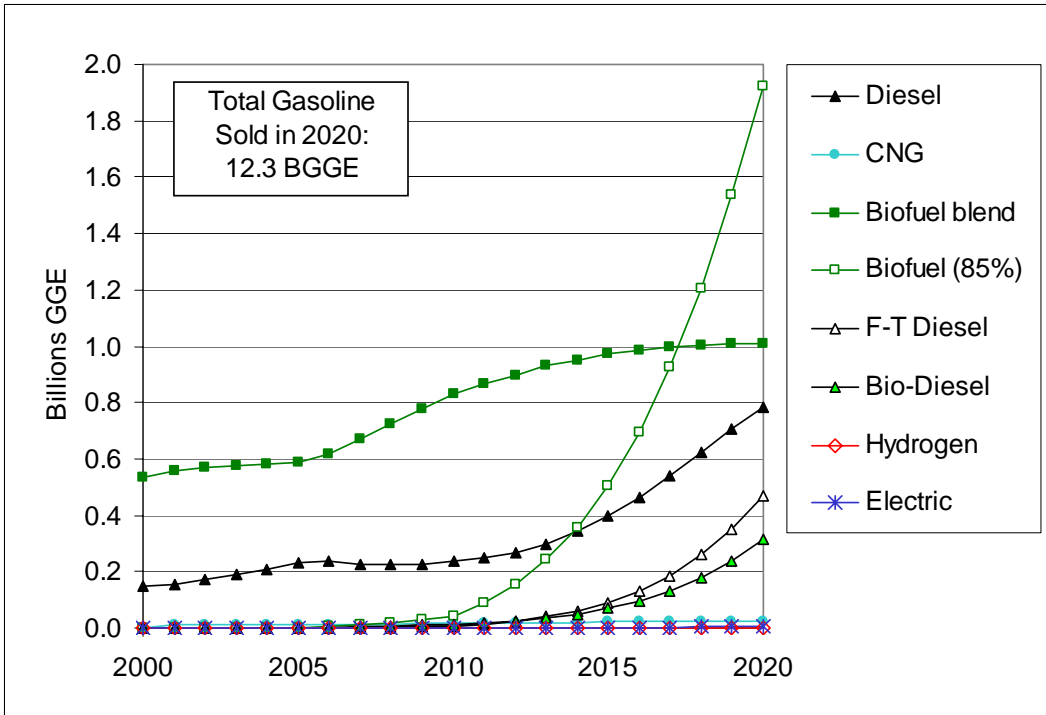

Figure 5-28: Fuel energy consumption in Scenario G15

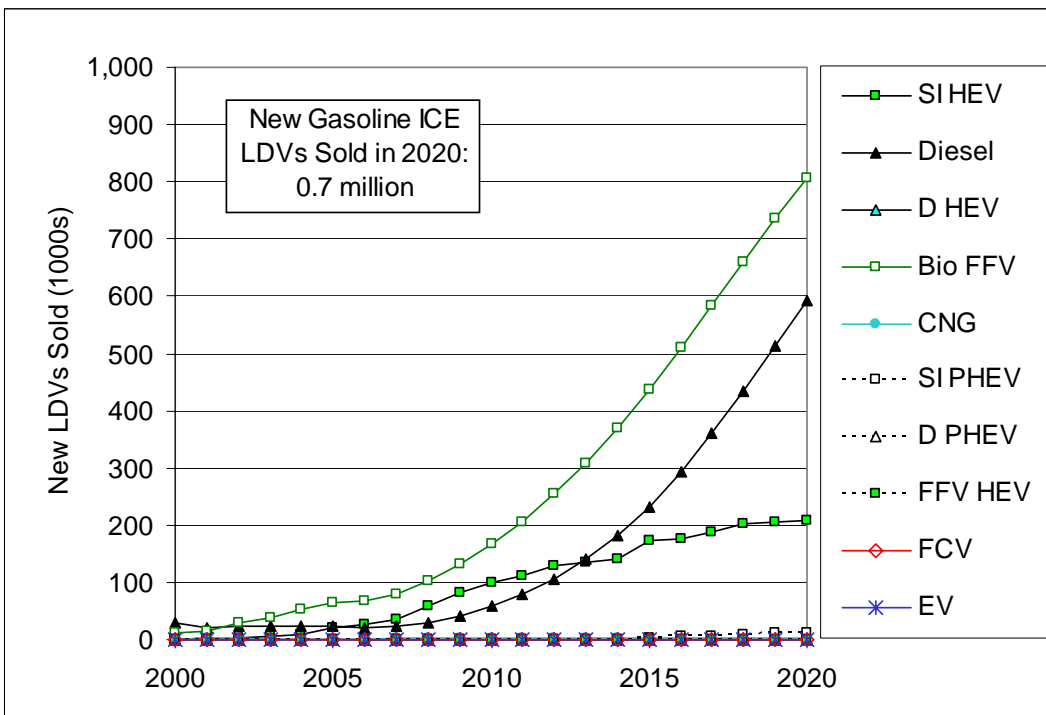

Figure 5-29: New LDVs sold per year in Scenario G15 (identical to Scenario G10)

Table 5-20: Fuel energy, GHG intensities, AFCI values & GHG emissions for Scenario G15

SCENARIO: Biofuel Intensive (G15)				
	2005	2010	2015	2020
Fuel Energy Consumption by Type				
Total Fuel Energy LDVs (Billion GGE)	15.931	17.070	17.376	16.804
Gasoline	15.103	15.929	15.320	12.270
Diesel	0.230	0.236	0.398	0.785
CNG	0.013	0.016	0.021	0.026
F-T Diesel	0.0	0.005	0.089	0.471
Bio-Diesel	0.0	0.013	0.070	0.314
Methanol	0.0	0.0	0.0	0.0
Hydrogen	0.0	0.0	0.0001	0.0016
Electric	0.0001	0.0005	0.0011	0.0066
Ethanol (blended)	0.585	0.829	0.971	1.008
Ethanol (85% vol.)	0.0	0.041	0.505	1.923
Fuel GHG Intensities				
Average for all fuels (g CO ₂ eq/MJ)	92.8	92.0	89.4	80.7
Gasoline (with biofuel blend)	92.8	92.2	91.1	89.4
Diesel	91.6	87.5	72.6	57.6
CNG	68.1	68.1	68.1	68.1
Hydrogen	0.0	0.0	107.7	107.7
Electric	121.5	121.5	121.5	121.5
Ethanol (85% vol.)	76.0	66.9	53.3	39.8
AFCI Values				
Average for all fuels	1.00	0.99	0.96	0.85
Change from BAU (%)		-0.8%	-3.7%	-13.4%
Gasoline (with biofuel blend)	1.00	0.99	0.98	0.97
Diesel	0.76	0.70	0.52	0.40
CNG	0.70	0.69	0.68	0.67
Hydrogen	-	-	-	0.53
Electric	0.35	0.27	0.25	0.24
Ethanol (85% vol.)	1.00	0.97	0.83	0.62
Total GHG Emissions				
All LDVs (MMT CO ₂ eq.)	195.0	207.2	204.8	178.9

Table 5-21: Sales of new LDVs for Scenario G15

SCENARIO: Biofuel Intensive (G15)				
	2005	2010	2015	2020
New Light Duty Vehicle Sales				
New LDV Sales (millions)	1.949	2.096	2.209	2.323
Gasoline ICE	1.838	1.769	1.358	0.700
Change from BAU (%)		-1.9%	-19.4%	-56.0%
Battery EVs	0.0	0.001	0.001	0.001
Ethanol ICE FFVs	0.064	0.166	0.438	0.805
Diesel	0.023	0.058	0.233	0.593
CNG	0.001	0.003	0.003	0.003
Gasoline SI HEV	0.022	0.099	0.174	0.208
E85 SI HEV	0.0	0.0	0.0	0.0
Diesel HEV	0.0	0.0	0.0	0.0
Gasoline SI PHEV	0.0	0.0	0.002	0.012
Diesel PHEV	0.0	0.0	0.0	0.0
Hydrogen FCV	0.0	0.0	0.0	0.001

5.4.5 Multiple Fuel and Vehicle Scenarios (H5, H10, H15)

These scenarios combine multiple fuels and vehicle technologies to meet a range of AFCI targets. Each scenario is constructed with assumptions similar to those used in previous scenarios, but combined in a unique sequence that begins with a low-GHG biofuel blend, introduces CNG and electric drive vehicles (at more modest rates than in the Electric Drive scenario), and attains final AFCI reductions by increasing volumes of low and sub-zero GHG biofuel and low-GHG FT diesel.

Scenario H5 Assumptions

- **Assumption #1. Introduction of a low-GHG Biofuel (5.7% vol.)**
A low-GHG biofuel is introduced as a 5.7% blend in gasoline. The fraction of the blend composed of this new biofuel increases to 10% by 2010 and 20% by 2020.
- **Assumption #2. Increase biofuel blend to 10% by vol.**
The biofuel blend in gasoline is increased to 7.5% by 2010 and 10% by 2020. The GHG intensity is the same as defined in assumption #1.
- **Assumption #3. Increase number of CNG vehicles**
The new LDV market share for CNG vehicles begins to increase rapidly after 2015. New CNG vehicles sales reach 94,000 by 2020.
- **Assumption #4. Introduce of PHEVs**
The new LDV market share for PHEVs begins to increase rapidly after 2010. By 2020, 172,000 PHEVs are sold per year. This assumption brings the AFCI to 0.95 for scenario H5.

Scenario H10 Assumptions

- **Assumption #5. Introduce low-GHG FT diesel**
A low-GHG FT diesel is blended with diesel fuel at 5% by 2010 and 20% by 2020. This fuel is consumed by the same number of diesel vehicles on the road in the BAU scenario.
- **Assumption #6. Increase biofuel sales to FFVs**
Now the number of FFVs increases to over 800,000 per year. This assumption is consistent with recent declarations by U.S. automakers of their capability to increase the percentage of ethanol-capable FFVs to half of all vehicles produced by 2012 (see assumption #7 in scenario F10).
- **Assumption #7. Increase FFV biofuel VMT to 50%**
The frequency of refueling existing FFVs with biofuel (e.g., ethanol) is increased such that half (50%) of all VMT are driven on an 85% vol. blend by 2020.
- **Assumption #8. Increase sales of diesel fuel**
The volume of diesel fuel sold is increased. The number of new diesel LDVs sold reaches approximately 600,000 per year by 2020, resulting in nearly a doubling of diesel fuel sales compared to the BAU scenario. This assumption brings the AFCI value to 0.90 for scenario H10.

Scenario H15 Assumptions

- **Assumption #9. Increase number of EVs**
The new LDV market share for EVs begins to increase modestly after 2015. Approximately 11,600 new EVs are sold per year by 2020.
- **Assumption #10. Introduce FCVs**
The new LDV market share for FCVs begins to increase rapidly after 2015. Approximately 45,200 new FCVs are sold per year by 2020.
- **Assumption #11. Increase FFV biofuel VMT to 75%**
The fraction of VMT for FFVs on the 85% by volume biofuel blend is increased from 50% to 75%.
- **Assumption #12. Introduce sub-zero biofuel**
A sub-zero biofuel is introduced with a carbon intensity of -14 gCO₂eq./MJ, bringing the average biofuel carbon intensity to 37.3 gCO₂eq./MJ by 2020. Gasoline, with a 10% by volume biofuel blend, has a carbon intensity of 89.7 gCO₂eq./MJ. The E85 sold to FFVs has a carbon intensity of 61.4 gCO₂eq./MJ. This assumption brings the AFCI value to 0.85 for scenario H15 (Alternatively, the same AFCI reduction from this assumption could be achieved by increasing the blend of biofuel in gasoline to 30% by volume).

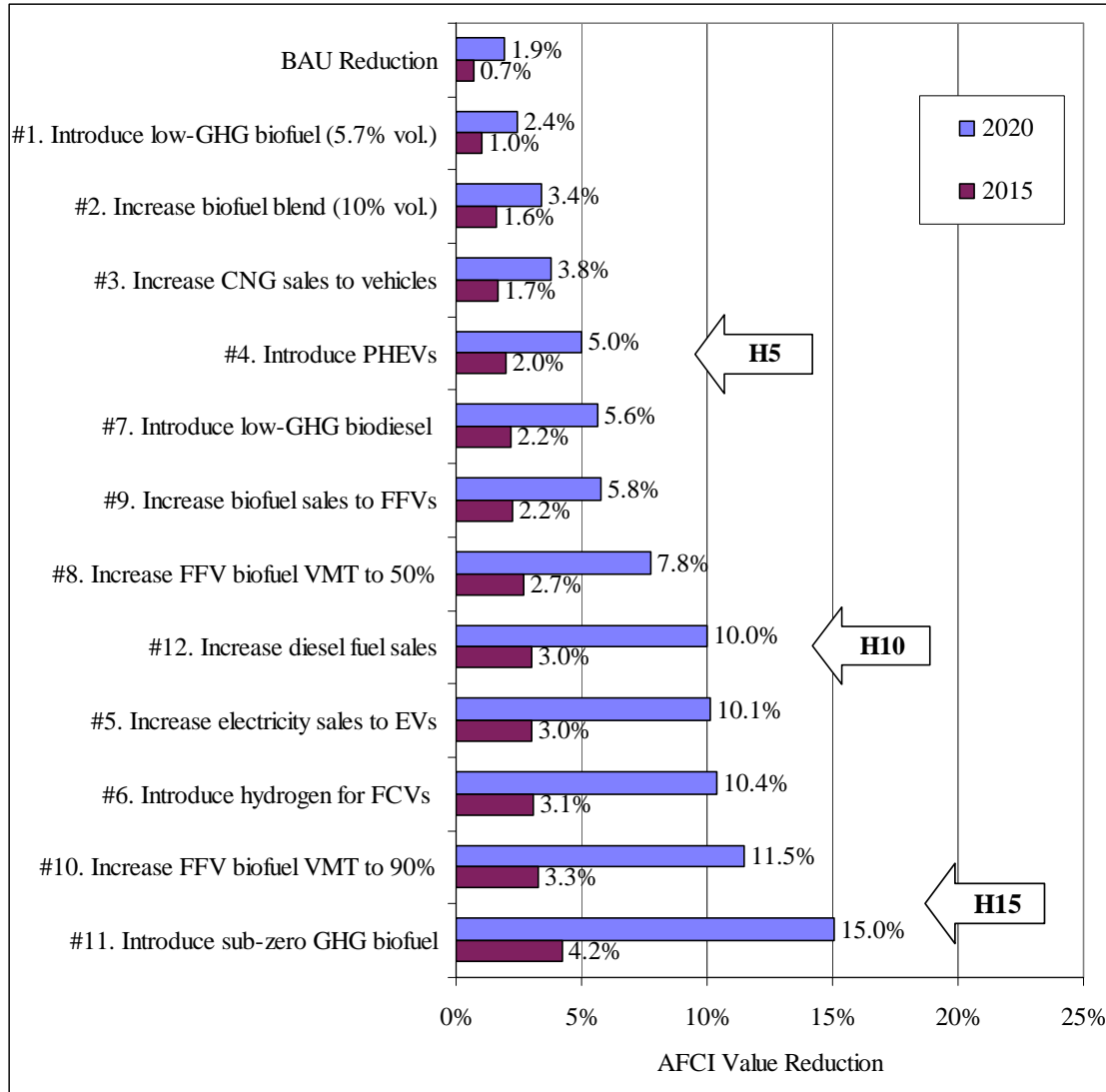

Figure 5-30: APCI reductions for each assumption in Scenarios H5, H10 and H15

This page is intentionally blank.

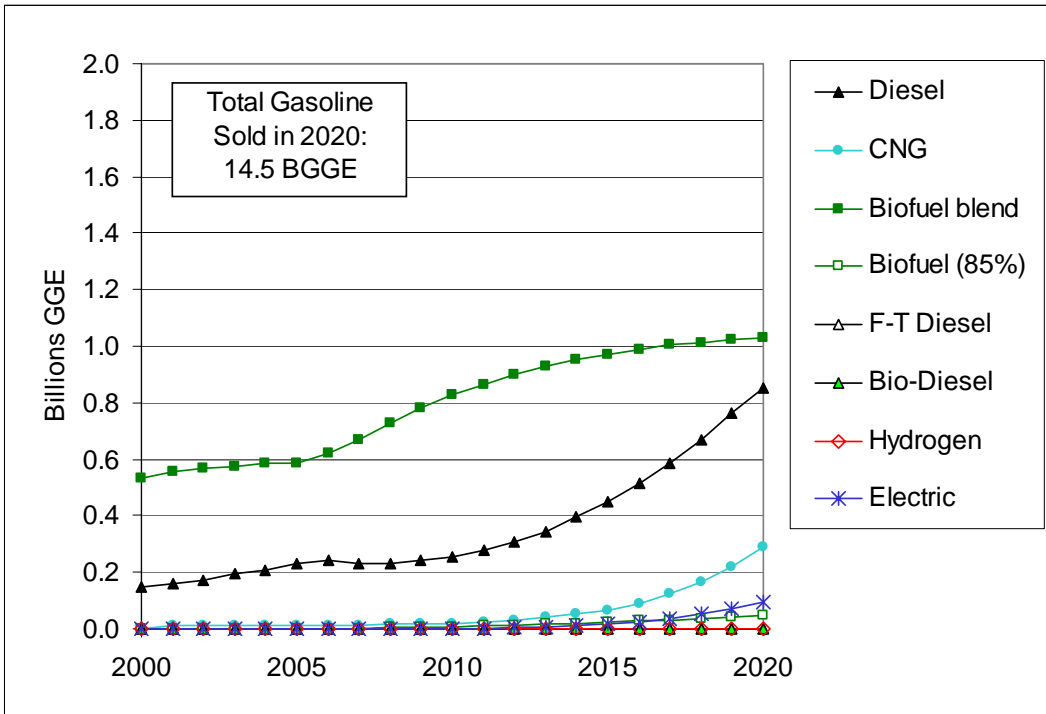

Figure 5-31: Fuel energy consumption in Scenario H5

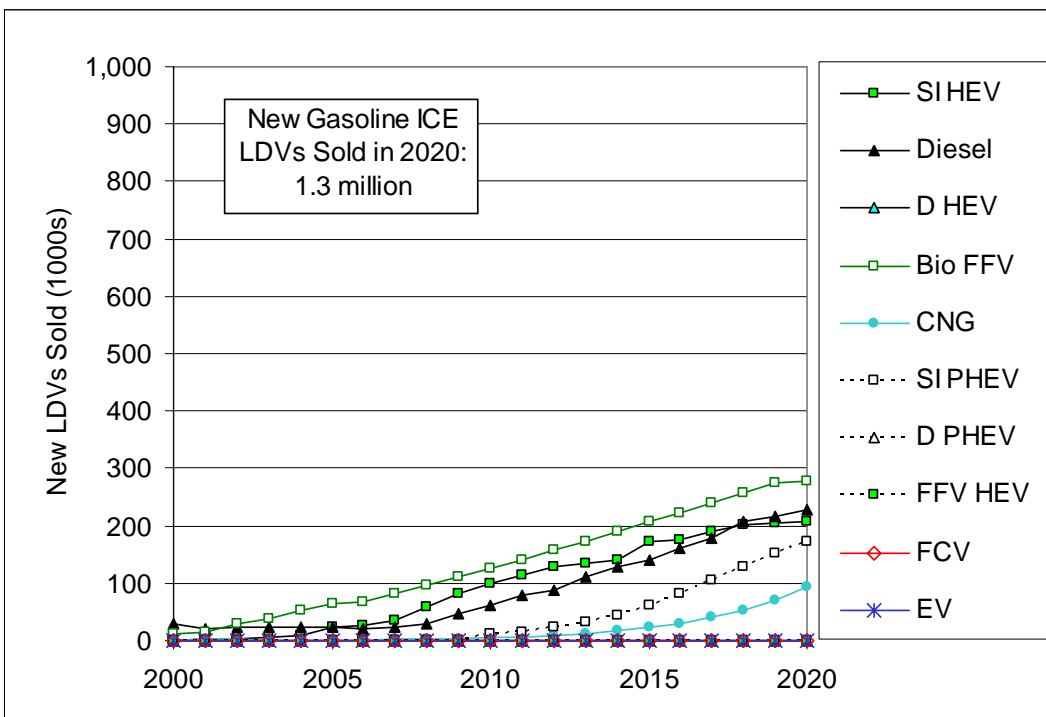

Figure 5-32: New LDVs sold per year in Scenario H5

Table 5-22: Fuel energy, GHG intensities, AFCI values & GHG emissions for Scenario H5

SCENARIO: Multiple Fuels and Vehicles (H5)				
	2005	2010	2015	2020
Fuel Energy Consumption by Type				
Total Fuel Energy LDVs (Billion GGE)	15.931	17.065	17.357	16.778
Gasoline	15.103	15.954	15.829	14.461
Diesel	0.230	0.255	0.448	0.855
CNG	0.013	0.019	0.068	0.289
F-T Diesel	0.0	0.0	0.0	0.0
Bio-Diesel	0.0	0.0	0.0	0.0
Methanol	0.0	0.0	0.0	0.0
Hydrogen	0.0	0.0	0.0001	0.0016
Electric	0.0001	0.0011	0.0172	0.0918
Ethanol (blended)	0.585	0.829	0.973	1.031
Ethanol (85% vol.)	0.0	0.007	0.023	0.049
Fuel GHG Intensities				
Average for all fuels (g CO2 eq/MJ)	92.8	92.4	91.8	90.9
Gasoline (with biofuel blend)	92.8	92.5	91.9	91.2
Diesel	91.6	91.6	91.6	91.6
CNG	68.1	68.1	68.1	68.1
Hydrogen	0.0	0.0	107.7	107.7
Electric	121.5	121.5	121.5	121.5
Ethanol (85% vol.)	76.0	72.4	66.1	59.7
AFCI Values				
Average for all fuels	1.00	1.00	0.98	0.95
Change from BAU (%)		-0.4%	-1.3%	-3.2%
Gasoline (with biofuel blend)	1.00	1.00	0.99	0.98
Diesel	0.76	0.74	0.68	0.65
CNG	0.70	0.68	0.67	0.66
Hydrogen	-	-	-	0.53
Electric	0.35	0.27	0.25	0.24
Ethanol (85% vol.)	1.00	0.99	0.98	0.97
Total GHG Emissions				
All LDVs (MMT CO2 eq.)	195.0	208.0	210.2	201.2

Table 5-23: Sales of new LDVs for Scenario H5

SCENARIO: Multiple Fuels and Vehicles (H5)				
	2005	2010	2015	2020
New Light Duty Vehicle Sales				
New LDV Sales (millions)	1.949	2.096	2.209	2.323
Gasoline ICE	1.838	1.791	1.602	1.327
Change from BAU (%)		-0.7%	-4.9%	-16.6%
Battery EVs	0.0	0.001	0.001	0.001
Ethanol ICE FFVs	0.064	0.126	0.206	0.279
Diesel	0.023	0.063	0.139	0.229
CNG	0.001	0.006	0.026	0.107
Gasoline SI HEV	0.022	0.099	0.174	0.208
E85 SI HEV	0.0	0.0	0.0	0.0
Diesel HEV	0.0	0.0	0.0	0.0
Gasoline SI PHEV	0.0	0.0	0.061	0.171
Diesel PHEV	0.0	0.0	0.0	0.0
Hydrogen FCV	0.0	0.0	0.0	0.001

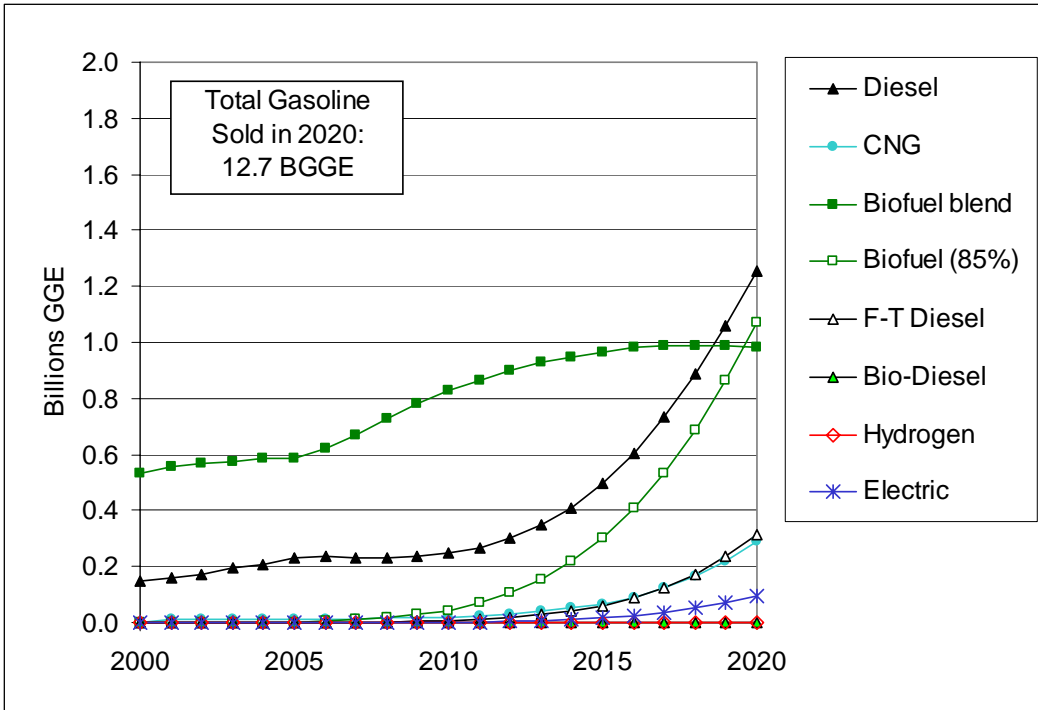

Figure 5-33: Fuel energy consumption in Scenario H10

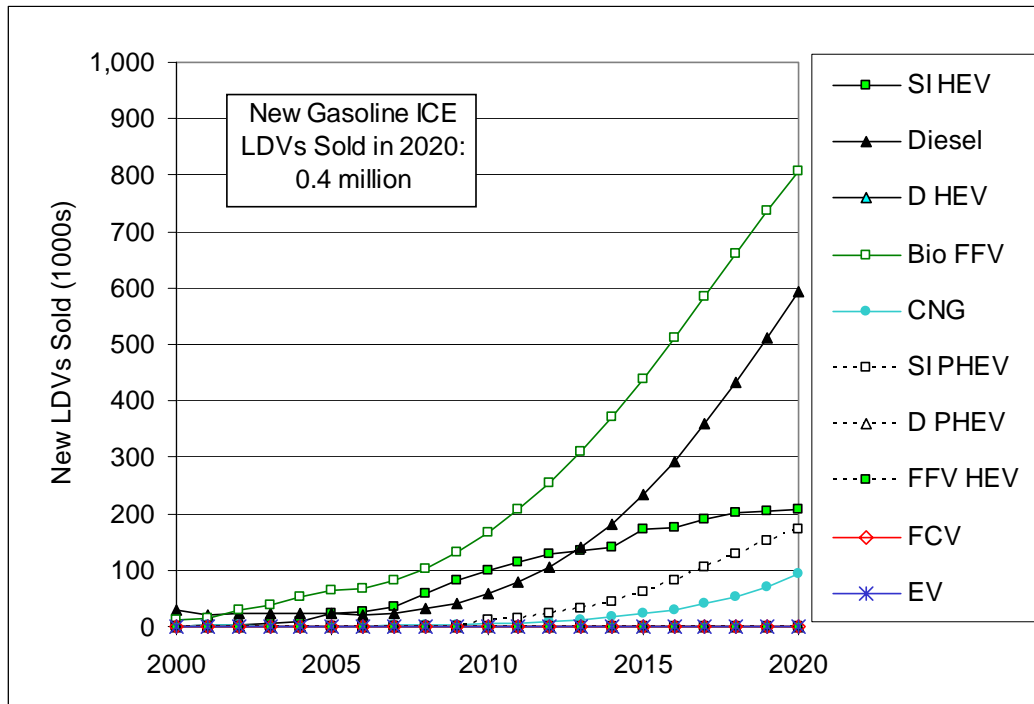

Figure 5-34: New LDVs sold per year in Scenario H10

Table 5-24: Fuel energy, GHG intensities, AFCI values & GHG emissions for Scenario H10

SCENARIO: Multiple Fuels and Vehicles (H10)				
	2005	2010	2015	2020
Fuel Energy Consumption by Type				
Total Fuel Energy LDVs (Billion GGE)	15.931	17.069	17.362	16.752
Gasoline	15.103	15.925	15.450	12.749
Diesel	0.230	0.249	0.496	1.255
CNG	0.013	0.019	0.068	0.289
F-T Diesel	0.0	0.005	0.061	0.314
Bio-Diesel	0.0	0.0	0.0	0.0
Methanol	0.0	0.0	0.0	0.0
Hydrogen	0.0	0.0	0.0001	0.0016
Electric	0.0001	0.0011	0.0172	0.0918
Ethanol (blended)	0.585	0.829	0.967	0.982
Ethanol (85% vol.)	0.0	0.041	0.303	1.070
Fuel GHG Intensities				
Average for all fuels (g CO ₂ eq/MJ)	92.8	92.2	90.9	87.4
Gasoline (with biofuel blend)	92.8	92.3	91.8	91.1
Diesel	91.6	90.0	82.9	75.7
CNG	68.1	68.1	68.1	68.1
Hydrogen	0.0	0.0	107.7	107.7
Electric	121.5	121.5	121.5	121.5
Ethanol (85% vol.)	76.0	68.8	64.3	59.7
AFCI Values				
Average for all fuels	1.00	0.99	0.97	0.90
Change from BAU (%)		-0.7%	-2.4%	-8.3%
Gasoline (with biofuel blend)	1.00	0.99	0.99	0.98
Diesel	0.76	0.72	0.59	0.53
CNG	0.70	0.68	0.67	0.66
Hydrogen	-	-	-	0.53
Electric	0.35	0.27	0.25	0.24
Ethanol (85% vol.)	1.00	0.98	0.92	0.86
Total GHG Emissions				
All LDVs (MMT CO ₂ eq.)	195.0	207.5	208.2	193.1

Table 5-25: Sales of new LDVs for Scenario H10

SCENARIO: Multiple Fuels and Vehicles (H10)				
	2005	2010	2015	2020
New Light Duty Vehicle Sales				
New LDV Sales (millions)	1.949	2.096	2.209	2.323
Gasoline ICE	1.838	1.756	1.275	0.435
Change from BAU (%)		-2.7%	-24.3%	-72.7%
Battery EVs	0.0	0.001	0.001	0.001
Ethanol ICE FFVs	0.064	0.166	0.439	0.806
Diesel	0.023	0.058	0.233	0.593
CNG	0.001	0.006	0.026	0.107
Gasoline SI HEV	0.022	0.099	0.174	0.208
E85 SI HEV	0.0	0.0	0.0	0.0
Diesel HEV	0.0	0.0	0.0	0.0
Gasoline SI PHEV	0.0	0.0	0.061	0.171
Diesel PHEV	0.0	0.0	0.0	0.0
Hydrogen FCV	0.0	0.0	0.0	0.001

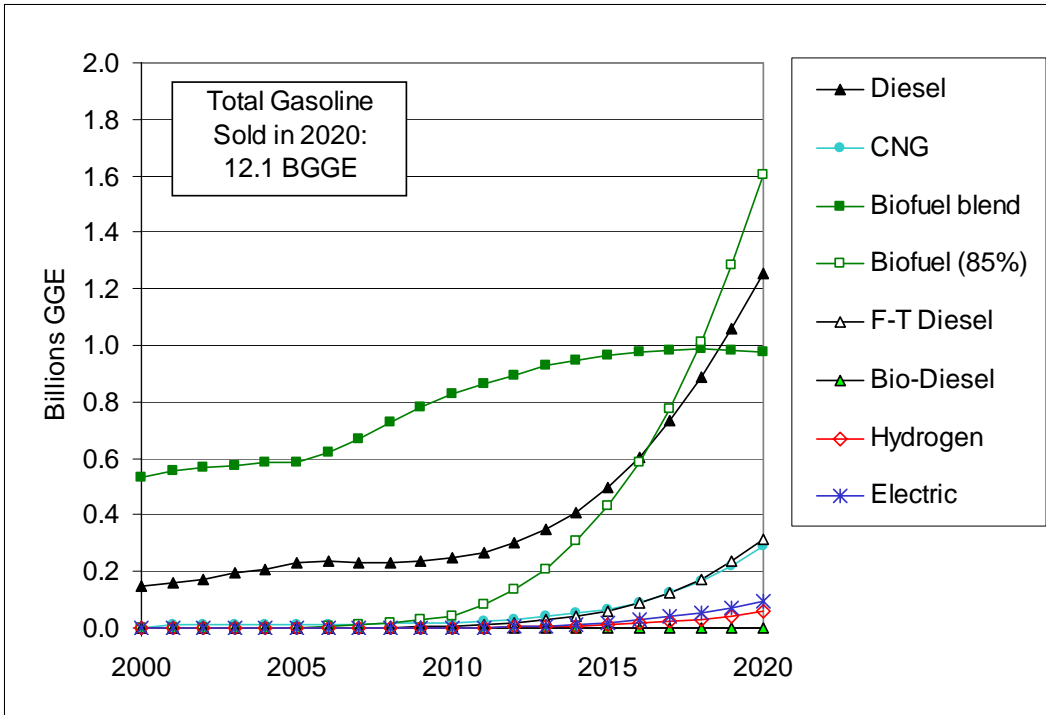

Figure 5-35: Fuel energy consumption in Scenario H15

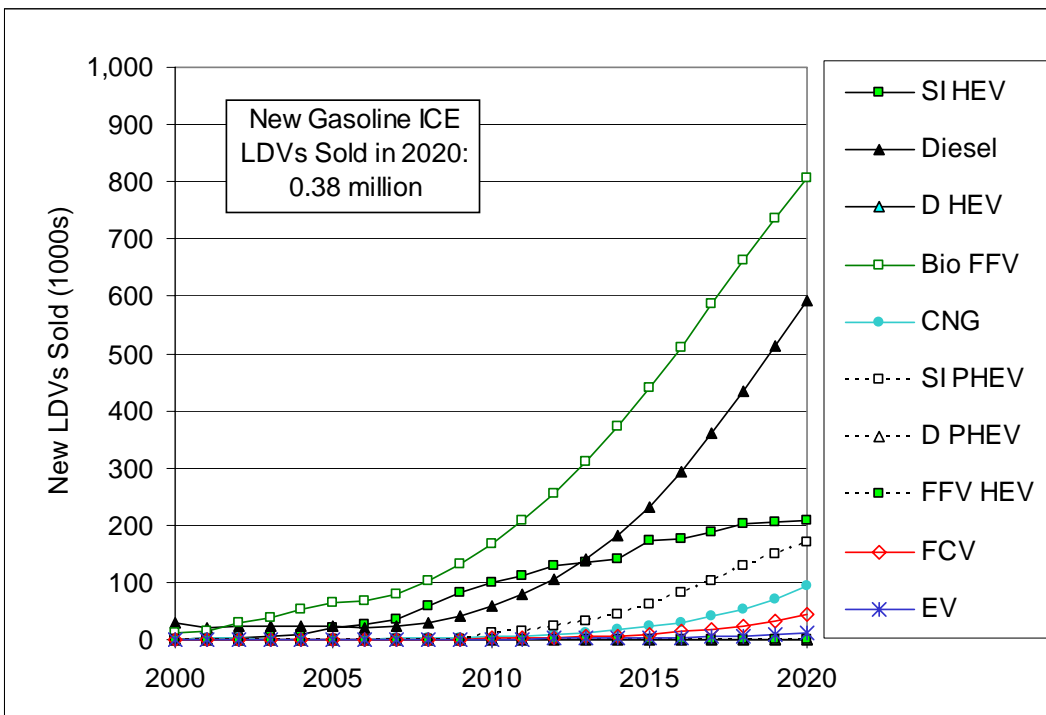

Figure 5-36: New LDVs sold per year in Scenario H15

Table 5-26: Fuel energy, GHG intensities, AFCI values & GHG emissions for Scenario H15

SCENARIO: Multiple Fuels and Vehicles (H15)				
	2005	2010	2015	2020
Fuel Energy Consumption by Type				
Total Fuel Energy LDVs (Billion GGE)	15.931	17.069	17.353	16.708
Gasoline	15.103	15.924	15.304	12.115
Diesel	0.230	0.249	0.496	1.255
CNG	0.013	0.019	0.068	0.289
F-T Diesel	0.0	0.005	0.061	0.314
Bio-Diesel	0.0	0.0	0.0	0.0
Methanol	0.0	0.0	0.0	0.0
Hydrogen	0.0	0.0	0.0110	0.0587
Electric	0.0001	0.0012	0.0181	0.0970
Ethanol (blended)	0.585	0.829	0.965	0.975
Ethanol (85% vol.)	0.0	0.041	0.430	1.605
Fuel GHG Intensities				
Average for all fuels (g CO ₂ eq/MJ)	92.8	92.3	90.0	82.9
Gasoline (with biofuel blend)	92.8	92.5	91.2	89.3
Diesel	91.6	90.0	82.9	75.7
CNG	68.1	68.1	68.1	68.1
Hydrogen	0.0	107.7	107.7	107.7
Electric	121.5	121.5	121.5	121.5
Ethanol (85% vol.)	76.0	72.4	54.8	37.3
AFCI Values				
Average for all fuels	1.00	0.99	0.96	0.85
Change from BAU (%)		-0.5%	-3.5%	-13.3%
Gasoline (with biofuel blend)	1.00	1.00	0.98	0.97
Diesel	0.76	0.72	0.59	0.53
CNG	0.70	0.68	0.67	0.66
Hydrogen	-	-	0.53	0.53
Electric	0.35	0.27	0.25	0.24
Ethanol (85% vol.)	1.00	0.98	0.86	0.66
Total GHG Emissions				
All LDVs (MMT CO ₂ eq.)	195.0	207.9	205.9	182.7

Table 5-27: Sales of new LDVs for Scenario H15

SCENARIO: Multiple Fuels and Vehicles (H15)				
	2005	2010	2015	2020
New Light Duty Vehicle Sales				
New LDV Sales (millions)	1.949	2.096	2.209	2.323
Gasoline ICE	1.838	1.753	1.263	0.380
Change from BAU (%)		-2.8%	-25.0%	-76.1%
Battery EVs	0.0	0.001	0.003	0.012
Ethanol ICE FFVs	0.064	0.166	0.439	0.806
Diesel	0.023	0.058	0.233	0.593
CNG	0.001	0.006	0.026	0.107
Gasoline SI HEV	0.022	0.099	0.174	0.208
E85 SI HEV	0.0	0.0	0.0	0.0
Diesel HEV	0.0	0.0	0.0	0.0
Gasoline SI PHEV	0.0	0.0	0.061	0.171
Diesel PHEV	0.0	0.0	0.0	0.0
Hydrogen FCV	0.0	0.0	0.0	0.045

5.5 Low-GHG fuels in heavy-duty and off-road applications

Diesel fuel (or distillate) consumption accounts for about 32 MMTCO₂e of GHG emissions, or about 17 percent of California's transportation GHG emissions. Due to limitations of time and resources, a detailed analysis of these uses was not conducted, although the VISION model includes some of them and they may be included in future analyses. This section presents a simpler analysis.

GHG emissions due to diesel fuel consumption are identified for three specific transportation uses in California's GHG inventory: onroad (28.6 MMTCO₂e), railroad (3.1 MMTCO₂e) and other (0.5 MMTCO₂e) (Bemis and Allen 2005).³⁷ Approximately 3.9 billion gallons of diesel fuel is consumed in California for these uses.

As discussed in Section 2, biodiesel and renewable diesel are potential low-carbon fuels, although there is significant uncertainty about soy-based biodiesel GHG emissions due to nitrous oxide emissions from soybean fields and emissions due to land use change (Delucchi 2003). On the other hand, renewable diesel produced from wastes or possibly from some biomass resources (e.g. poplar trees) may have very low or net negative GHG emissions, although these technologies are not yet commercialized and their environmental performance is also uncertain (Tilman, Hill, and Lehman 2006; Unnasch, Pont, Chan et al. 2007).

Both biodiesel (fatty acid methyl ester, or FAME) and biomass-derived Fischer-Tropsch diesel (BFTD, and referred to simply as low-GHG FT diesel earlier in this section) can be used by current diesel vehicles. The American Society of Testing and Materials has approved a standard for FAME at blends levels up to 20 percent by volume but some engine manufacturers caution about blends over 10 percent (National Biodiesel Board 2005). A third type of biomass-derived diesel fuel can be produced by the hydrogenation of animal or plant oils, possibly including both waste oils and crop-derived oils (Rantanen et al. 2005; Anonymous 2007). BFTD and hydrogenated oils are extremely similar to ordinary petroleum-derived diesel, being sulfur-free hydrocarbons. These fuels have energy densities and other properties very similar to those of ordinary diesel fuel so their introduction is likely to be relatively simple and require little in the way of infrastructure. However, these fuels are relatively new and there is little information about their global warming impact in the open literature, and none in the peer-reviewed literature (Gärtner et al. 2006). The AB 1007 analysis available for this study evaluated FAME biodiesel and BFTD (Unnasch, Pont, Chan et al. 2007).

The supply of biodiesel and BFTD may be limited, especially if the latter is made only from waste oils and greases. If biomass gasification is commercialized, however, significant quantities of renewable diesel may be available. If BFTD has the extremely low GHG emissions suggested by the AB1007 study conducted for the CEC (Unnasch, Pont, Chan et al. 2007) with GWI values close to zero (or below), the 2020 LCFS target could be met by blending 400 million gallons per year (or less). This would require technological innovation to achieve.

³⁷ Industrial sector usage of diesel fuel accounts for an additional 5.9 MMTCO₂e of GHG emissions, but these are ignored here because they are not transportation emissions.

Natural gas is also a heavy duty vehicle fuel, and can be is available in California as both a compressed and liquefied gas. There are over 125,000 natural gas vehicles in the United States today, and about 200 natural gas refueling stations in California. The carbon intensity of natural gas has is about 25 percent less than that of diesel fuel, although this advantage is diminished somewhat because natural gas engines tend to be less efficient than compression ignition engines using diesel fuel. Advances in natural gas engine technologies and increasingly stringent diesel engine emission requirements tend to reduce this gap. Thus, heavy duty vehicle use of natural gas may also help lower GHG emissions in the transportation sector.

5.6 Electrification of off-road diesel fuel applications

Off-road electric vehicles in California could contribute to state GHG reductions by 2020. These technologies can be applied in logistics (also known as freight handling and goods movement) as well as other applications such as small lawn and garden engines, which are numerous in California. A recent study categorized and estimated the number of these applications for 2002 and for several possible future circumstances (Greene et al. 2004). This report is not very transparent and many assumptions are not clear, but it appears to be a reasonable and fairly thorough evaluation.³⁸

Jackson (2005) evaluated two applications at ports: the use of shore power instead of ships' engines for electricity and heat (a practice called "cold ironing") and the use of electric-drive cranes instead of diesel-powered cranes. Two truck-related electric applications were also evaluated: electric truck refrigeration units (e-TRUs) instead of diesel-powered devices, and the supply of electricity at truck stops as a substitute for engine idling. Large off-road vehicles include airport ground service equipment, electric forklifts (class 1 and 2), and tow tractors/industrial tugs. Small off-road vehicles include small electric lawn and garden equipment, electric golf carts, electric sweepers/scrubbers, burnishers, electric forklifts (class 3), electric personnel and burden carriers, and turf trucks. Jackson (2005) does not consider light rail, high-speed rail, electric freight rail, electric trolley buses, electric boats, electric bikes, commercial walk-behind mowers, riding mowers, leaf-blowers or other applications.

Several scenarios are developed in Jackson (2005), and the most optimistic one is presented here as a bounding case. Their "Achievable" scenario projects "the impact of highly effective incentive and regulatory programs and [adds] that to the expected market population" (p. 4-1). Table 5-28 contains the populations of off-road electric vehicle technologies estimated in this scenario, as well as the penetration of electric technologies, which can be up to 100%.³⁹ These values are used to estimate the GHG emissions that are avoided by switching from diesel (or marine bunker fuel) to electricity, assuming 70% of electricity generated by natural-gas combined-cycle (NGCC) plants and 30% renewable energy in accordance with California's Renewable Portfolio Standard (RPS). These emission reductions are shown in Table 5-29.

³⁸ For example, the TIAX report does not define the scenarios it uses very well – specific assumptions about policies and trends are not mentioned. Similarly, "low" and "high" values are given for many results, but the report does not specify how these two values are calculated.

³⁹ Ports in California may implement electrification for air quality reasons, independent of global warming concerns, see, for instance [http:// www.portoflosangeles.org/environment air.htm](http://www.portoflosangeles.org/environment_air.htm)

Table 5-28: Populations of off-road electric vehicle technologies

Technology	Population in thousands ¹ (% Penetration)		
	2002	2020	
Ports	Cold ironing of ships	0	0.102
	Shore-side cranes	0	0.195
Truck-related	Electric truck refrigeration units (e-TRUs)	3.6	34.9
	Truck stop electrification	0.2 (1%)	30-40 (75%-100%)
Large off-road		41.7 (46%)	100-130 (75%-86%)
Small off-road	Lawn & garden	7,200	14,100
	Other	244 (81%)	414 (100%)

Source: (Greene et al. 2004)

¹ Population in 2002 is estimated by survey, while the population in 2020 is from the “Achievable” scenario, which contains the largest of several estimates presented for that year.

Table 5-29: GHG reductions from off-road electric vehicle technologies

Technology	MMTCO ₂ e per year		
	2002	2020	Additional ¹
Ports	Cold ironing of ships	0	0.09-0.5
	Shore-side cranes	0	* *
Truck-related	Electric truck refrigeration units (e-TRUs)	0.04	0.4
	Truck stop electrification	0	2.7-3.6 2.7-3.6
Large off-road ¹		1.8	4.3-5.6 2.5-3.8
Small off-road ²	Lawn & garden	0.3-0.9	0.6-1.7 0.3-0.8
	Other	2.9-4.1	4.8-6.8 1.9-2.7
	TOTAL	5.0-6.9	13-18.7 7.8-12

Source: (Greene et al. 2004). Values may not sum due to rounding. *Values are not clear in the source.

¹“Additional” emission reductions are those that may be feasible by 2020 beyond those in 2002 and thus may create credits for LCFS compliance. These values are upper limits based on the “Achievable” scenario in Jackson (2005).

Perhaps the most apparent omission is electric rail, which we do not include because electricity for trains is already part of current infrastructure, planning, and operations and it is already covered by AB 32. Including electrified rail in the LCFS thus seems like an unnecessary complication, and it may not encourage great amounts of innovation or investment because the value of any carbon credits may be small relative to the cost of rail extensions. It might help achieve some amount of reduced petroleum consumption, though rail extensions are more like land use planning than the sort of technological changes the LCFS is designed to address. Therefore, we recommend that electric rail be excluded from the LCFS and rail extensions be considered as part of a more holistic approach to land use and transportation planning. For these reasons we do not consider GHG emissions associated with electric rail in this study.

Two other scenarios are also defined in Jackson (2005). In the *Baseline* scenario growth in off-road EV technologies is estimated due solely to market growth in California, without any regulations and/or policies. In the *Expected* scenario, populations are estimated by “extrapolating the effects of natural market growth, incentive programs, and regulations on current market population trends” (p. 3-1). In Table 5-30, we present the number of additional emission

reductions beyond those in 2002, which range from 2 to 12 million tons of CO₂e per year. Achieving these emission reductions require little, if any technological innovation.

Depending on how off-road fuels are treated by the LCFS, some fraction of these emissions could be available to regulated entities for compliance purposes. Table 5-30 also shows the off-road emission reductions as a percentage of the GHG emissions from light duty vehicles in the baseline year 2004 (131 MMTCO₂e, see Table 1-1). These values make it possible to compare these emission reductions with the scenarios discussed earlier in Section 5. For instance, given the “Baseline” assumptions in Jackson (2005), emission reductions equivalent to a 1.5% reduction in the light duty vehicle AFCI value may be available, even if off-road vehicles are included in the LCFS requirement. If the “Achievable” assumptions in Jackson (2005) turn out to be true, emissions equivalent to a 4.6% reduction in the light duty vehicle AFCI may be possible. Of course, if heavy-duty vehicles and off-road applications are included in the LCFS, the AFCI percentage reductions will be smaller because the baseline is larger (163 MMTCO₂e, see Table 1-1).

Table 5-30: GHG reductions from off-road electric vehicle technologies

Jackson (2005) Scenario	Additional GHG emission reductions in 2020 ¹	Equivalent reduction in light duty vehicle AFCI ²
Baseline	2.0-3.8	up to 1.5%
Expected	3.5-6.4	1.1%-2.4%
Achievable	7.8-12	3%-4.6%

Source: (Greene et al. 2004).

¹“Additional” emission reductions are those that may be feasible by 2020 beyond those in 2002 and thus may create credits for LCFS compliance.

²These percentages represent half of the additional GHG emission reductions in the middle column expressed as a percentage of the light duty vehicle emissions in the baseline year, 131 million metric tons of CO₂e, as shown in Table 1-1.

The implications of this analysis seem clear: the electrification of off-road vehicle technologies may offer a significant opportunity to reduce the carbon intensity of transportation fuels. There is little uncertainty in the ability of the state to achieve these reductions because the use of biofuels is not required, nor are technological innovations needed. However, some additional costs associated with electrification may be incurred.

5.7 References

- Anonymous (2007). ConocoPhillips, Tysons Team on Project, Associated Press: 2.
- Bemis, G. (2006). Inventory of California Greenhouse Gas Emissions and Sinks: 1990 to 2004. Sacramento, California Energy Commission: 117.
- Craig, P., A. Gadgil, et al. (2002). "What can history teach us? A Retrospective Examination of Long-Term Energy Forecasts for the United States." *Annual Review of Energy and the Environment* **27**: 83-118.
- Collantes, Gustavo O. (2007.) Incorporating stakeholders' perspectives into models of new technology diffusion: The case of fuel-cell vehicles. *Technological Forecasting and Social Change* **74** (3):267-280.
- Cucinelli, N., E. Hesse, C. Pasch, R. Scotti and E. Wingfield, 2005. Evolutionary Pathways to Biofuels for Transport: A System Dynamics Approach. Masters Thesis, School of Natural Resources and Environment, University of Michigan, Ann Arbor, Michigan.
<http://www.erb.umich.edu/Research/Student-Research/BPFutureFuels.pdf>
- Delucchi, M. A. (2003). A Lifecycle Emissions Model (LEM): Lifecycle Emissions from Transportation Fuels, Motor Vehicles, Transportation Modes, Electricity Use, Heating and Cooking Fuels, and Materials, Institute of Transportation Studies, University of California, Davis.
- Gärtner, S. O., H. Helms, et al. (2006). An Assessment of Energy and Greenhouse Gases of NExBTL. Heidelberg, IFEU - Institute for Energy and Environmental Research: 25.
- Huntington, H. G. (1994). "Oil Price Forecasting in the 1980s - What Went Wrong." *Energy Journal* **15**(2): 1-22.
- Jackson, M., S. Fable, et al. (2005). Electric Transportation and Goods-Movement Technologies in California: Technical Brief. Sacramento, CA, California Electric Transportation Coalition: 49.
- Leiby, P.N., D.L. Greene, D. Bowman, and E. Tworek. (2006.) "Systems Analysis of the Hydrogen Transition with HyTrans", forthcoming, *Transportation Research Record*, National Research Council, Washington, DC.
- Mintz, M., M. Tompkins, et al. (1994). The IMPACTT Model: Structure and Technical Description, Argonne National Laboratory.
- National Biodiesel Board. (2005, Nov. 30, 2005). "Use of Biodiesel Blends above 20% Biodiesel." Retrieved April 28, 2007, from http://biodiesel.org/pdf_files/Biodiesel_Blends_Above%20_20_Final.pdf.
- Rantanen, L., R. Linnaila, et al. (2005). NExBTL - Biodiesel fuel of the second generation. Warrendale, PA, SAE International: 17.
- Schwarzenegger, A. (2007). Executive Order S-01-07: Low Carbon Fuel Standard. Sacramento, CA.
- Shlyakhter, A. I., D. M. Kammen, et al. (1994). "Quantifying the Credibility of Energy Projections from Trends in Past Data - the United-States Energy Sector." *Energy Policy* **22**(2): 119-130.
- Singh, M., A. Vyas, et al. (2003). VISION Model: Description of Model Used to Estimate the Impact of Highway Vehicle Technologies and Fuels on Energy use and Carbon Emissions to 2050. Argonne, IL, Argonne National Laboratory.
- Smil, V. (2003). *Energy at the Crossroads: Global Perspectives and Uncertainties*. Cambridge, MIT Press.

- Struben, J.R., J. Sterman, 2006. Transition Challenges for Alternative Fuel Vehicle and Transportation Systems. MIT Sloan Research Paper No. 4587-06.
http://papers.ssrn.com/sol3/papers.cfm?abstract_id=881800
- Tilman, D. A., J. Hill, et al. (2006). "Carbon-Negative Biofuels from Low-Input High-Diversity Grassland Biomass." *Science* **314**: 1598-1600.
- Unnasch, S., J. Pont, et al. (2007). Full Fuel Cycle Assessment Well To Wheels Energy Inputs, Emissions, And Water Impacts. Sacramento, California Energy Commission.
- Vyas, A.D., H.K. Ng, D.J. Santini, and J.L. Anderson. (2007.) Electric and Hybrid Electric Vehicles: A Technology Assessment Based on a Two-Stage Delphi Study. Center for Transportation Research, Energy Systems Division, Argonne National Laboratory. Argonne, IL. ANL/ESD-36.
- Yang, C., and J.M. Ogden, 2007. Determining the lowest-cost hydrogen delivery mode, *International Journal of Hydrogen Energy*, 32(2): 268-286.