

# Lawrence Berkeley National Laboratory

## Lawrence Berkeley National Laboratory

### **Title**

Studies in Photosynthesis with Isotopes

### **Permalink**

<https://escholarship.org/uc/item/6kp4c74n>

### **Authors**

Calvin, M.

Bassham, J.A.

### **Publication Date**

1952-07-08

UNIVERSITY OF CALIFORNIA

Radiation Laboratory

Contract No. 4705-eng-48

STUDIES IN PHOTOSYNTHESIS WITH ISOTOPES

M. Calvin and J. A. Bassham

July 8, 1952

Berkeley, California

## STUDIES IN PHOTOSYNTHESIS WITH ISOTOPES\*

M. Calvin and J. A. Bassham\*\*

Radiation Laboratory and Department of Chemistry  
 University of California  
 Berkeley, California

The net reaction of photosynthesis is usually written as

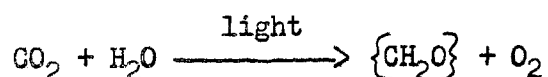

If we were to write under the arrow all the other elements essential to the various steps in the photosynthetic reaction, we would have to include phosphorus, nitrogen, sulfur and a number of metal ions. Of these, phosphorus is thought to enter into photosynthesis as a reactant in a number of the steps involved in the reduction of carbon dioxide to organic compounds. The present discussion will be confined to the use of isotopic oxygen, hydrogen, carbon and phosphorus.

Oxygen

In any investigation of the mechanism of photosynthesis, one of the first questions that one would want to answer is whether the oxygen evolved in photosynthesis comes instantaneously from the carbon dioxide, the water or both. These various possibilities are shown in the equations below.

---

(\*) The work described in this paper was sponsored by the U. S. Atomic Energy Commission.

(\*\*) Lt., USNR, Office of Naval Research Unit No. One, University of California, Berkeley. The opinions contained herein are the private ones of the writer and are not to be construed as official or reflecting the views of the Navy Department or the naval service at large.

---

Table I

ISOTOPIC RATIO IN OXYGEN EVOLVED IN PHOTOSYNTHESIS BY CHLORELLA<sup>a</sup>(AFTER RUBEN, RANDALL, KAMEN AND HYDE)<sup>5</sup>

Expt. No.	Substrate	Time between dissolving $\text{KHCO}_3 + \text{K}_2\text{CO}_3$ and start of $\text{O}_2$ collection, min.	Time at end of $\text{O}_2$ collection, min.	Per cent $\text{O}^{18}$ in		
				$\text{H}_2\text{O}$	$\text{HCO}_3^- + \text{CO}_3^-$	$\text{O}_2$
1	$\text{KHCO}_3$ , 0.09 M $\text{K}_2\text{CO}_3$ , 0.09 M	0		0.85	0.20	∞
		45	110	0.85	0.41b	0.84
		110	225	0.85	0.55b	0.85
		225	350	0.85	0.61	0.86
2	$\text{KHCO}_3$ , 0.14 M $\text{K}_2\text{CO}_3$ , 0.06 M	0		0.20		∞
		40	110	0.20	0.50	0.20
		110	185	0.20	0.40	0.20
3	$\text{KHCO}_3$ , 0.06 M $\text{K}_2\text{CO}_3$ , 0.14 M	0		0.20	0.68	∞
		10	50	0.20		0.21
		50	165	0.20	0.57	0.20

a The volume of evolved oxygen was large compared with the amount of atmospheric oxygen present at the beginning of the experiment.

b Calculated values.

the carbonate and bicarbonate. Therefore, only reaction (c) or (c'), in which the evolved oxygen originates in the water, can be correct.

There is another question regarding the photochemical evolution of oxygen during photosynthesis which can be answered by the use of isotopic oxygen. Warburg and co-workers, using the manometric method, followed the oxygen evolution by Chlorella while alternating short periods of illumination (down to one minute) with equally short periods of darkness.<sup>6</sup> Under these conditions, apparent quantum efficiencies approaching one molecule of oxygen evolved per quantum of light absorbed were observed. These workers proposed that in continuous photosynthesis, one molecule of oxygen is actually being produced for each quantum of light absorbed but 2/3 to 3/4 of this oxygen is re-absorbed in a light-enhanced back reaction so that the net observed efficiency is one molecule of oxygen evolved per four quanta absorbed.

This proposal presumes that there is a rapid equilibrium between the measured oxygen gas and the oxygen within the cell wall; otherwise, the slopes of the curves of oxygen evolved versus time during the one-minute intervals, upon which the conclusions are based, are meaningless.

If these proposals and assumptions are correct and if the gaseous oxygen in contact with the cell suspension is labeled with  $O^{18}$ , then the rate of entry of  $O^{18}$  into the water and into the organic compounds within the cell should be greatly enhanced in the light as compared with this rate in the dark.<sup>7</sup> Brown, Nier and Van Norman<sup>8</sup> have performed just such an experiment and found no light-enhanced increase in the rate of disappearance of  $O^{18}$  from the gas phase.

The above experiments provide information regarding the origin of the evolved oxygen but tell us little of the intermediates involved in the transformation of water to oxygen and hydrogen. Dorough and Calvin<sup>9</sup> have investigated the possible increase in  $O^{18}$  (in the form of epoxides) in xanthophyll pigments during photosynthesis. Chlorella were suspended in water containing 4%  $O^{18}$ -enriched oxygen. Bicarbonate was added to the suspension which was divided into two equal portions. One portion was allowed to photosynthesize in the light while the other portion was kept in the dark. Gas exchange was followed with a Warburg apparatus. After five hours the algae were centrifuged and killed. The xanthophylls were partially purified by extraction and chromatography, their oxygen was converted to CO and the latter was analyzed with a mass spectrograph. The results are shown in Table II

Table II<sup>9</sup>

## ISOTOPIC RATIO IN OXYGEN FOUND IN XANTHOPHYLL

FROM CHLORELLA EXPOSED TO  $H_2O^{18}$ 

(After Dorough and Calvin)

<u>Sample</u>	<u><math>O^{18}</math>, %</u>
1. Original $H_2O$	4.0
2. Water in equilibrium with algae: light run	3.01
3. Water in equilibrium with algae: dark run	3.06
4. CO sample from xanthophyll fraction of photosynthesized (5 hr.) algae (50% carotenoid)	0.245
5. CO sample from xanthophyll fraction of algae kept in the dark (40% carotenoid)	0.233
6. Normal $H_2O$	0.204

The investigators were limited by the fact that they had only 50 ml. of labeled water and the  $O^{18}$  concentration was only 4%. Isolation of the furan and epoxide carotenoids gave about 5 mg. of these compounds together with an equal amount of steroids. Further purification would have reduced the amount of material to a point where enough would not be left for mass spectrographic analysis. Therefore, the impure sample had to be used which resulted in an estimated tenfold dilution of the  $O^{18}$  so that the expected increase of  $O^{18}$  content of the carotenoids in the light would be at most 0.4% as compared with a normal content of 0.2%. The accuracy of the mass-spectrographic method is sufficient to allow one to say that the analyzed sample from the light exposed algae actually contained more  $O^{18}$  than that from the "dark" algae in this one experiment but no further conclusions are justified at present. The results do suggest that the experiment would be worth repeating with higher  $O^{18}$  enrichment of the water and a larger quantity of algae.

### Hydrogen

Another way in which one might study the decomposition of water during photosynthesis and perhaps the transfer of hydrogen to other molecules is found in the use of isotopic hydrogen. Two such isotopes are available: deuterium,  $H^2$ , a stable isotope; and tritium,  $H^3$ , an emitter of low energy  $\beta$  particles. Since these isotopes differ in mass from  $H^1$  by a factor of 2 and 3 respectively, there is a possibility for a much greater difference in the reaction and diffusion rates among these isotopes than would be expected among isotopes of higher atomic weight (such as  $O^{16}$  and  $O^{18}$  or  $P^{31}$  and  $P^{32}$ ).

In 1942 Norris, Ruben and Allen<sup>10</sup> studied the photosynthesis of Chlorella in water containing tritium. These workers found no incorporation

of tritium into chlorophyll during photosynthesis. In 1948, Calvin and Aronoff<sup>11</sup> performed similar experiments with deuterium but again the results were negative. Although these results may mean that chlorophyll does not serve as a reversible hydrogen donor, they could be explained in a number of other ways. For example, the chlorophyll hydrogen involved in photosynthesis might be an enolizable hydrogen which would exchange with water hydrogen thus giving the same result in the dark as in the light.

Another possibility is that the chlorophyll extracted from plants is the oxidized form of the redox couple involved in the photochemical hydrogen transfer so that no labeling would be observed even if the reduced form in the plant does become labeled. Since one reduced form of chlorophyll, 3,4-dihydrochlorophyll *a*, or bacteriochlorophyll<sup>12</sup> can be isolated from photosynthetic bacteria, it might be profitable to repeat the labeled hydrogen experiments with these organisms.

### Carbon

By far the greater part of the tracer studies of photosynthesis have been carried out with isotopic carbon. In 1939 Ruben and co-workers<sup>13</sup> reported the results of dark fixation of carbon dioxide labeled with C<sup>11</sup>. Evidence was found for the incorporation of carbon dioxide via carboxylation reactions. This type of carbon fixation is now known to be characteristic of the incorporation of carbon dioxide by certain reversible reactions of respiration which are quite similar for both photosynthetic and non-photosynthetic tissue. The short half-life of C<sup>14</sup> placed a severe limitation on the type of experiments that could be carried out with this isotope. The increased availability of C<sup>14</sup> after 1945 made possible more elaborate experiments.



In the early experiments with  $C^{14}$ , the dark fixation of radioactive carbon dioxide by algae was studied. It soon became apparent that the incorporation of carbon dioxide in the dark by algae was greatly dependent on the previous condition of light or dark, the uptake of carbon dioxide being twenty times as much in the dark immediately after illumination as in the dark without preillumination.<sup>14</sup>

The processes of photosynthesis are indicated schematically in Figure 1. The left half of this diagram represents the absorption of light by chlorophyll and the transfer of this energy, resulting in the photolysis of water and the formation of oxygen and hydrogen, the latter in the form of some unknown reducing agent which acts as either a hydrogen carrier or an electron donor. The overall reaction for this process may be written

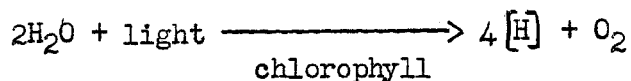

The right portion of the diagram represents the reduction of carbon dioxide to carbohydrate or other organic end products of photosynthesis through a number of unspecified intermediates. The net reaction for this process can be written

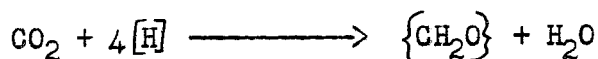

The separation of the process of photolysis of water from the reduction of carbon dioxide is based on several kinds of evidence including the result of studies of the origin of the evolved oxygen already discussed. Further evidence for this separation was found in the enhanced carbon dioxide dark fixation following pre-illumination. In order to show that the latter effect was similar to the reduction of carbon during photosynthesis, it was necessary to compare the intermediate products formed in the two cases and this in turn involves labeling, analysis and identification of compounds A, B, C,

etc. in Figure 1.<sup>15</sup> When this comparison was made, using the techniques that will be described later, the products formed were found to be quite similar for photosynthesis and preilluminated dark fixation and very different for non-preilluminated dark fixation.

It soon became clear that for the many experiments which would be required, it would be necessary to have available in the laboratory a constant source of plant material with properties which would vary as little as possible from time to time. For this purpose, the conditions of growth would have to be easily reproducible. These requirements are best satisfied by the unicellular algae, such as Chlorella and Scenedesmus. In our laboratory, these algae are grown in flasks mounted on a shaker and immersed in a thermostated bath and illuminated from below. The suspension of algae is withdrawn every other day, 10% of the volume being left in the flask as an inoculum to which fresh inorganic nutrient solution is added. The growing algae are aerated with carbon dioxide-enriched air. We have, in effect, continuous cultures which have been maintained for four months or more. The harvested algae are centrifuged, washed and resuspended in a flat illumination vessel, shown in Figure 2. A stream of carbon dioxide-enriched air is bubbled through the suspension during illumination until the algae reach a steady state of photosynthesis. At the start of a normal photosynthesis experiment, a suitable amount of C<sup>14</sup>-labeled sodium bicarbonate is injected into the suspension and photosynthesis is allowed to proceed for a predetermined number of seconds, after which the large stopcock at the bottom of the flask is opened and the algae run rapidly into boiling ethanol to stop enzymatic reactions.

In the case of preillumination experiments, the procedure is the same except that at the moment of injecting the radiocarbon, the suspension is placed in the dark.

If a study of carbon reduction as a function of time is being made (in either light or dark) aliquots of the suspension are allowed to run from the flask into the alcohol at measured time intervals. In some experiments, leaves of higher plants, such as soy bean or barley, are used, in which case a flat illumination vessel with a detachable face is used. At the start of the experiment, labeled carbon dioxide is admitted to the chamber and after the exposure the reaction is stopped by removing the face of the vessel and plunging the leaf into alcohol.

After the plants have been killed and extracted by 80% alcohol in water and then by 20% alcohol in water, the radioactivity incorporated into non-volatile compounds is determined by removing a small aliquot of the extracted material and mounting on an aluminum plate for counting with a Geiger-Muller counter. The insoluble material is resuspended and similarly counted. It was found that in short periods of photosynthesis nearly all the fixed radiocarbon is in the soluble extract as is seen in Figure 3.

The analysis of the radioactive compounds can then be carried out. Preliminary fractionation of the products of carbon dioxide fixation indicated a very complex pattern even in rather short periods of photosynthesis. Fortunately, a method which had been developed by Consden, Gordon and Martin<sup>16</sup> for the analysis of amino acids proved applicable to the analysis of the products of carbon dioxide fixation. This method, two-dimensional paper chromatography, was combined with radioautography to give a relatively simple and complete method of separating and detecting the  $C^{14}$ -labeled products. The extracts are combined and concentrated to a small volume. An aliquot of this material is then run onto a small area in the corner of a large square sheet of filter paper and dried with an air stream. The chromatogram

is then developed in the usual way<sup>17</sup> giving a two-dimensional distribution of all the extractable, soluble compounds from the plant except for those which were volatile or unstable under the conditions of analysis.

A sheet of X-ray film is then placed in contact with the chromatogram. The  $C^{14}$  in the labeled compounds emits beta particles which expose the film at the positions of the compounds. In this way we are able to locate precisely those compounds in which we are interested. A radioautograph of the carbon fixation products of sixty seconds photosynthesis by Chlorella is shown in Figure 4. This photographic film corresponds to a chromatogram on which the origin is near the lower right corner. The first solvent used to develop the chromatogram was phenol-water, running from right to left, and the second solvent was butanol-propionic acid-water, running from bottom to top.

After the analysis of the extract by paper chromatography and detection of the radioactive compounds by the radioautograph, the next major problem is the identification of these compounds.

The first step in identifying the compounds corresponding to darkened areas of the X-ray film ("spots") is to establish the position of a number of known compounds in the particular chromatographic system used. This is usually accomplished by chromatographing known unlabeled compounds on the paper chromatogram by means of suitable chemical spray tests. These chemical sprays (which are sometimes followed by heating of the paper or other development methods) cause a color to develop with the compound, thus allowing it to be seen. Usually, different classes of compounds require different spray tests. For example, amino acids are detected with ninhydrin spray,<sup>16</sup> phosphates with ammonium molybdate,<sup>18,19</sup> ketoses with naphthorecorcinol<sup>20</sup> and aldoses with aniline hydrogen phthalate.<sup>21</sup> Carboxylic acids

often can be located by means of a pH indicator spray.<sup>22</sup> Occasionally, when synthetically labeled radioactive compounds are available, they are chromatographed and detected by means of their radioactivity.

After the positions of a number of compounds have been determined in a given solvent system, a map is prepared of these positions.

The second step in identifying a new compound is to compare its chromatographic position with that of the compounds on the map. Such a comparison often provides an excellent clue as to the nature of the compound. Further identification depends on a number of observations in which the compound is eluted from the paper, treated chemically and the resulting material chromatographed a second time to determine whether or not the supposed chemical transformation has taken place in the radioactive compound.

For final identification, the unknown radioactive material is chromatographed together with an authentic sample of the suspected substance and complete coincidence of the radioactivity, as defined by the spot on the X-ray film, with the known material, as defined by some colored or otherwise visible product, is observed. This type of co-chromatogram, when carefully interpreted, provides an unequivocal identification since not only the positions of the radioactive and colored spots must coincide but the fine irregularities around the edge of the spot caused by the structure of the paper must exactly coincide also. The latter provide almost as unique an identification as a fingerprint.

Through the use of these methods of identification, a number of the early compounds formed during photosynthesis have been identified as shown in Figure 4. The radioactivity incorporated in a given compound can then

be measured by cutting out the area of paper containing that particular compound, as indicated by the spot on the X-ray film, eluting the compound from the paper and mounting on a plate for counting.

A faster but slightly less accurate method of determining radioactivity consists of counting the spot directly on the paper by placing a thin-window Geiger tube directly on the spot. The fraction of the total radioactivity of the spot registered by the counter in this case is about one third that obtained from a plate of the same material and is fairly constant for all  $C^{14}$ -labeled organic compounds.

When this was done, it was found that in very short times the radioactivity is incorporated in only a few compounds. The result of 10 seconds incorporation of  $C^{14}$ -labeled bicarbonate by Scenedesmus is shown in Figure 5. A considerable part of what is known about the path of carbon reduction during photosynthesis is indicated by this one chromatogram. First of all, it is seen that nearly all the radiocarbon is found in phosphorylated compounds. This is indicative of the important role phosphorus plays in carbon reduction in photosynthesis.

Secondly, over half the radioactivity is found in one compound--phosphoglyceric acid. At 5 seconds exposure, more than 80% of the radioactivity is found in PGA. If the percentage of total radioactivity found in PGA is given as a function of time of exposure, we find that in a series of experiments with different exposure times, this function approaches 100% at zero time. Thus, PGA appears to be the first product of carbon dioxide reduction that we can see by this method of analysis, under these conditions of photosynthesis.

If we look at the other compounds that are labeled in this short time, we find among them a triose phosphate, hexose monophosphates and hexose

diphosphates. These compounds suggest the formation of hexoses from phosphoglyceric acid via the well-known reversible reactions of glycolysis.

Finally we should note for later reference, the early appearance of pentose and heptose phosphates.

Having devised a means for following the incorporation of carbon dioxide into different compounds, it becomes equally important to find a way of observing the rate of labeling of individual carbon atoms of each compound. Thus, if phosphoglyceric acid is formed by a carboxylation reaction, we would hardly expect that the radiocarbon would be uniformly distributed among the three carbon atoms of this molecule after short exposures to labeled carbon dioxide. When a chemical degradation of glyceric acid, obtained from hydrolysis of phosphoglyceric acid, is carried out, nearly all the radiocarbon is found in the carboxyl position when the period of photosynthesis with radiocarbon has been only 5 seconds. After longer periods, more of the total radioactivity is found in the other two positions.

In Table III, several examples of these degradations are shown. From these results we find support for several proposals regarding the specific steps in carbon dioxide reduction.

It appears that PGA is formed by a carboxylation of a two carbon compound and that this carbon dioxide acceptor is labeled at an equal rate between the two positions. Furthermore, this rate is quite slow compared with the rate of the primary carboxylation which indicates that the two-carbon compound is not formed by a direct coupling and reduction of two molecules of carbon dioxide, especially in view of the fact that no large reservoirs of labeled two-carbon compounds have been found after short periods of photosynthesis with radiocarbon.<sup>23</sup> The possible relationship of glycolic acid to the two-carbon  $\text{CO}_2$  acceptor is indicated by the degradation data.

TABLE III

DISTRIBUTION OF RADIOCARBON IN COMPOUNDS  
LABELED DURING PHOTOSYNTHESIS

Compound	Conditions						
	Frillum 2 min. dark	4 sec. PS (Photosynthesis)	15 sec. PS	15 sec. PS	40 sec. PS	60 sec. PS	
Glyceric acid $\begin{array}{l} \text{COOH} \\   \\ \text{CHOH} \\   \\ \text{CH}_2\text{OH} \end{array}$	COOH	96.0	87.0	56	49		44
	CHOH	2.6	6.5	21	25		30
	CH <sub>2</sub> OH	1.7	6.8	23	26		25
Glycolic acid $\begin{array}{l} \text{COOH} \\   \\ \text{CH}_2\text{OH} \end{array}$	COOH		49.0	50 ± 5		47	
	CH <sub>2</sub> OH		52.0	50 ± 5		53	
Hexose (from sucrose) $\begin{array}{l} 1 \text{ C} \\   \\ 2 \text{ C} \\   \\ 3 \text{ C} \\   \\ 4 \text{ C} \\   \\ 5 \text{ C} \\   \\ 6 \text{ C} \end{array}$	1 C	-----	-----	-----	24		
	2 C	-----	-----	-----	25		
	3 C	-----	-----	-----			
	4 C	-----	-----	-----			
	5 C	-----	-----	-----	52		
	6 C	-----	-----	-----			



The agreement of the degradation for sucrose and for phosphoglyceric acid, provides further evidence for the formation of hexoses by the reversible reactions of glycolysis. If two molecules of PGA were reduced and condensed to hexose, we would expect carbons 3 and 4 of the hexose to correspond in labeling to the carboxyl of the PGA and carbons 1, 2, 5 and 6 of the hexose to correspond to the  $\alpha$  and  $\beta$  carbon atoms of PGA, as indeed they do.

These conclusions are summarized in Figure 6, in which the path of carbon from carbon dioxide to hexose is indicated.

There remains the problem of the regeneration of the two-carbon  $\text{CO}_2$  acceptor. The reasons for not believing it to be formed by direct coupling and reduction of carbon dioxide have been indicated. Moreover, in short exposures of the plant to radioactivity (30 sec. or less), it is possible to account for virtually all the carbon fixed (95% or more) in the form of soluble compounds which can be chromatographed and detected by radioautography. Since the  $\alpha$  and  $\beta$  carbon atoms of PGA (and hence of the 2-carbon  $\text{CO}_2$  acceptor) are appreciably labeled in these short times, this means that the  $\text{CO}_2$  acceptor is probably derived from some of the labeled compounds that are seen in these experiments.

In order to appraise this possibility, a more detailed study of the phosphates seen in Figure 4 is necessary. If one takes each of these compounds or groups of compounds and subjects it to a phosphatase enzyme and then chromatographs the resulting compounds, one obtains chromatograms of the phosphate-free compounds which often are more easily separated and identified than the original phosphates.

Figures 7, 8, 9 and 10 show such chromatograms. The hexose and heptose monophosphate areas from a chromatogram similar to that seen in Figure 4 have been treated with phosphatase and the resulting free sugars chromatographed.

When this is done for all the phosphate esters on the chromatogram, there are found, in addition to those compounds already mentioned, two sugars which do not have any known connection with the glycolysis scheme. These are sedoheptulose and ribulose, seven and five carbon ketoses respectively. Since each of these sugars, in the form of phosphates, becomes labeled in very short times, one is tempted to assign to them a role in the regeneration of 2-carbon compounds. One such scheme which has been proposed<sup>24</sup> is seen in Figure 11.

In this scheme, for each two molecules of the  $C_3$  compound (PGA), formed by carboxylations of two  $C_2$  compounds, one is used in hexose synthesis and one is further carboxylated to give a four carbon compound. This  $C_4$  compound is reduced and condensed with a  $C_3$  to give a  $C_7$  sugar which then splits to  $C_2$  and a  $C_5$  sugar. The latter splits to  $C_3$  and  $C_2$ , completing the cycle. The net reaction is the reduction of three carbon dioxide molecules to one half a hexose molecule for each turn of the cycle. The driving force which turns this cycle would be, of course, the reducing agent, formed by the photolysis of water, which reduces carboxylic acids to aldehydes and alcohols at appropriate points.

The missing link in this scheme is the lack of appearance of four carbon acids and sugars in experiments thus far. However, some malic and aspartic acids have been found labeled in fairly short times and while these acids are not believed to be intermediates,<sup>23</sup> they may well be indicators of actual intermediates. Perhaps the actual four carbon intermediates, if there are any, are present in such small concentrations that they are not seen even by the sensitive tracer method.

One experiment which indicates that this may be the case was a ten-second exposure of soy bean leaves to  $C^{14}O_2$ . The distribution of radiocarbon in the soluble compounds was as follows: PGA-32%, sedoheptulose monophosphate-24%, fructose monophosphate-18%, glucose monophosphate-6%, triose phosphate-8%,

pentose diphosphate and monophosphate-9%, phosphoenol pyruvic acid-3%. This result may indicate that the four carbon carboxylation product is so rapidly reduced and condensed with a three carbon compound that the compound which actually indicates this carboxylation is sedoheptulose monophosphate.

Other explanations of the early appearance of sedoheptulose are quite conceivable. One such possibility is that the four carbon fragment arises from splitting of hexose to a  $C_2$  fragment and a  $C_4$  fragment. In any event, further experiments in which constantly improving chromatographic methods are combined with more degradations and more accurate kinetic experiments, should help answer the question of the actual mechanism of carbon reduction in plants.

### Phosphorus

The importance of phosphorus in the processes of carbon reduction during photosynthesis is apparent from the foregoing discussion. While most of the tracer investigations of phosphorylated intermediates in carbon reduction employed  $C^{14}$ ,  $P^{32}$  has served as a valuable auxiliary tool for this purpose. In some experiments, both  $C^{14}$  and  $P^{32}$  were administered in the same experiment. The radioautographs of the chromatographed products of such an experiment are shown in Figures 12 and 13. In this case Scenedesmus were suspended in a solution containing radioactive phosphate for 20 hours and then were allowed to photosynthesize for five minutes with  $C^{14}$ -labeled bicarbonate before killing. Since the radiophosphorus emits a beta particle with a much higher energy than does radiocarbon, one can place two sheets of X-ray film on the developed chromatogram with the result that the film next to the paper will be exposed by the beta particles from both the phosphorus and carbon while the top film will be exposed by radiation from the phosphorus only, the carbon betas having been entirely absorbed by the first film. Then if one waits until a number of half

lives of  $P^{32}$  (14 days) have expired and places a fresh film on the chromatogram, a radioautograph of the carbon only is obtained. By superimposing the two films we can see at once which compounds have become labeled with both tracers and this in turn indicates which carbon compounds are phosphorylated.

If an experiment is carried out in which the plants are exposed to radiocarbon and radiophosphorus sufficiently long to saturate the soluble compounds in the plant with both tracers and if the usual chromatographic analysis is carried out, one can then count the carbon activity and phosphorus activity in a known compound, using suitable absorbers. By comparing this ratio ( $P^{32}/C^{14}$ ) with the known ratio of  $P^{31}/C^{12}$  for phosphoglyceric acid, Benson<sup>25</sup> was able to calculate the  $P^{31}/C^{12}$  ratio for other unknown compounds appearing on the chromatogram by measuring the  $P^{32}/C^{14}$  ratio for these compounds.

The use of tracer phosphorus is also applicable to phosphate compounds which are not labeled by carbon during photosynthesis. Several studies with radiophosphorus and photosynthetic organisms have been performed. In most cases, the fractionation of the products has been accomplished by means of extractions. Aronoff and Calvin<sup>26</sup> found no direct connection between gross formations of organic phosphorus compounds and photosynthesis or photochemical reductions when they exposed Chlorella to a solution of radiophosphate in the light and in the dark. Kamen,<sup>27</sup> and Simonis and Grube,<sup>28</sup> working with various organisms and conditions of exposure and extraction found some differences between the  $P^{32}$  content of certain fractions after exposure to tracer phosphorus in the light and that of these fractions in the dark.

Just as in the case of the studies with radiocarbon, a much more satisfactory method of studying the labeling of compounds with tracer phosphorus during photosynthesis in the light and in the dark is to be found in the use

of chromatography and radioautography as methods of analysis and detection. Such experiments are now underway in the Berkeley laboratory<sup>\*\*\*</sup> and only preliminary results can be reported at this time. In Figure 14 we see the radioautographs of the products of one-minute fixation by Scenedesmus of  $P^{32}$  in the dark and in the light. The intensities of the spots are not comparable in these experiments but the rapid conversion of inorganic to organic phosphate is worth noting. In the one-minute photosynthesis experiment, 70% of the soluble compounds is in the form of organic phosphates. In this experiment the algae were washed three times with distilled water before killing (requiring about 15 seconds) and then killed and extracted with 80% ethanol in water, 20% ethanol in water and water. The combined extracts contained 80% of the total fixed activity. It is hoped that through such experiments the path of phosphorus in photosynthesis may be traced.

---

(\*\*\*) Private communication from M. Goodman and D. Bradley.

---

## References

- (1) Bredig, G., Umschau, 18, 362 (1914).
- (2) Willstätter, R. and Stoll, A., "Untersuchungen über die Assimilation der Kohlensäure," Springer, Berlin, 1918, pp. 236-246 and 319, (1918).
- (3) Thunberg, T., Z. physik. Chem., 106, 305 (1923).
- (4) van Niel, C. B., Arch. Mikrobiol., 3, 1 (1931).
- (5) Ruben, S., Randall, M., Kamen, M. and Hyde, J. L., J. Am. Chem. Soc., 63, 877 (1941).
- (6) Burk, D. and Warburg, O., Naturwissenschaften, 24, 560, 37 (1950); Fed. Proc., 10, 1, part 1 (1951); Z. f. Naturf., 6B, 1, 12 (1951).
- (7) Calvin, M., Bassham, J. A., Benson, A. A. and Massini, P., Annual Rev. Phys. Chem., in press.
- (8) Brown, A. H., Nier, A. O. and Van Norman, R. W., Ann. Rev. Plant Physiol., 2, 89 (1951).
- (9) Dorough, G. D. and Calvin, M., J. Am. Chem. Soc., 73, 2362 (1951).
- (10) Norris, T. H., Ruben, S. and Allen, M. B., J. Am. Chem. Soc., 64, 3037 (1942).
- (11) Calvin, M. and Aronoff, S., UCRL-263 (1948).
- (12) Aronoff, S., Bot. Rev., 16, 525 (1950).
- (13) Ruben, S., Hassid, W. Z. and Kamen, M. D., J. Am. Chem. Soc., 61, 661 (1939); 62, 3443 (1940).
- (14) Benson, A. A., Calvin, M., Haas, V. A., Aronoff, S., Hall, A. G., Bassham, J. A., and Weigl, J. W., "Photosynthesis in Plants," Iowa State College Press, 381-401 (1949).
- (15) Calvin, M., The Harvey Lectures, Vol. 45, in press.
- (16) Conden, R., Gordon, A. H. and Martin, A. J. P., Biochem. J., 38, 224 (1944).
- (17) Benson, A. A., Bassham, J. A., Calvin, M., Goodale, T. C., Haas, V. A. and Stepka, W., J. Am. Chem. Soc., 72, 1710 (1950).
- (18) Hanes, C. S. and Isherwood, F. A., Nature, 164, 1107 (1949).
- (19) Axelrod, B. and Bandurski, R., J. Biol. Chem., 405, 193 (1951).
- (20) Partridge, S. M., Biochem. J., 42, 238 (1948).

- (21) Partridge, S. M., *Nature*, 164, 443 (1949).
- (22) Lugg, J. W. H. and Overell, B. T., *Australian J. of Sci. Res.*, 1, 98 (1948).
- (23) Benson, A. A., Calvin, M. and Bassham, J. A., *J. Biol. Chem.*, 185, 781 (1950).
- (24) Benson, A. A., Bassham, J. A., Calvin, M., Hall, A. G., Hirsch, H., Kawaguchi, S., Lynch, V. and Tolbert, N. E., *J. Biol. Chem.*, 196, 703 (1952).
- (25) Benson, A. A., UCRL-1412 (1951).
- (26) Aronoff, S. and Calvin, M., *Plant Physiol.*, 23, 351 (1948).
- (27) Kamen, M. D. and Spiegelman, S., "Symposia on Quantitative Biology," 13, p. 151-163 (1948).
- (28) Simonis, W. and Grube, K-H., *Z. f. Naturf.*, 7b, 3, 194 (1952).

## Captions to Figures

Figure 1 -

Figure 2 - Apparatus for exposing a suspension of algae to  $C^{14}O_2$  during photosynthesis. This experimental arrangement includes flat illumination vessel, fluorescent lights, gas circulating system and continuous recording system for measuring radioactivity of  $C^{14}O_2$ .

Figure 3 - Comparison of  $C^{14}$  incorporated into all plant constituents during photosynthesis with that incorporated into soluble compounds. The soluble compounds are those extracted by 80% ethanol in water and 20% ethanol in water.

Figure 4 - Radiogram of soluble compounds formed during 60 seconds photosynthesis with Chlorella. Cells killed at end of experiment by 80% ethanol in water at room temperature. Light intensity was 5,000 foot candles from each side of the illumination vessel.

Figure 5 - Radiogram of soluble compounds formed during 10 seconds photosynthesis with Scenedesmus. Other experimental conditions are the same as the experiment in Figure 4.

Figure 6 -

Figure 7 - Radiogram of sugars obtained by phosphatase hydrolysis of the "hexose monophosphate" area from a chromatogram of soluble compounds formed in 4 minutes photosynthesis with Scenedesmus.

Figure 8 - Co-chromatography of unlabeled authentic sugars with labeled sugars obtained by phosphatase hydrolysis of the "ribose phosphate" shown in Figure 4.

Figure 9 - Co-chromatography of unlabeled authentic sugars with labeled sugars obtained by phosphatase hydrolysis of the "ribulose phosphate" shown in Figure 4.



Figure 10 - Co-chromatography of unlabeled authentic sugars with labeled sugars obtained by phosphatase hydrolysis of the "dihydroxyacetone phosphate" shown in Figure 4.

Figure 11 -

Figure 12 -  $C^{14}$ -labeled compounds formed during 5 minutes photosynthesis with  $C^{14}$ -labeled bicarbonate with Scenedesmus which had been exposed to  $P^{32}$  for 20 hours. This radiogram was obtained by exposing X-ray film to the chromatogram after essentially all the  $P^{32}$  had decayed.

Figure 13 -  $P^{32}$ -labeled compounds found in the same experiment as that described in Figure 12. This radiogram was obtained by exposing a sheet of X-ray film to the same chromatogram as in Figure 12 shortly after the experiment was performed and using a sheet of exposed film to filter out the low-energy  $C^{14}$  beta particles.

Figure 14 - Radiogram of  $P^{32}$ -labeled compounds formed by 1 minute exposure of Scenedesmus to  $P^{32}$ -labeled phosphate in the light and in the dark. In each case, the Scenedesmus had been adapted to photosynthesis in the light previous to the experiment. The exposures in the two radiograms shown cannot be compared as to intensity, due to differences in experimental conditions and film exposure times.

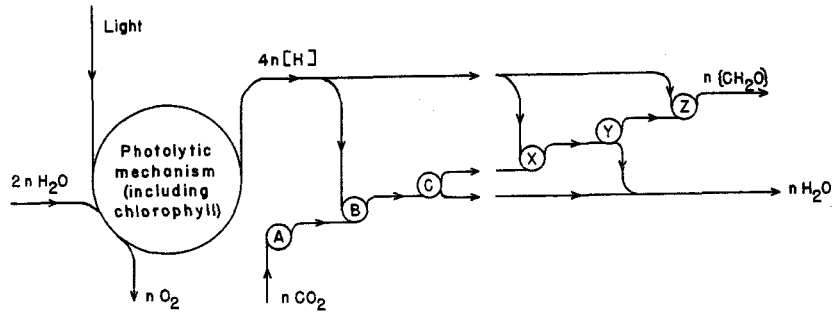

SCHEMATIC DIAGRAM OF PHOTOSYNTHESIS

Fig. 1

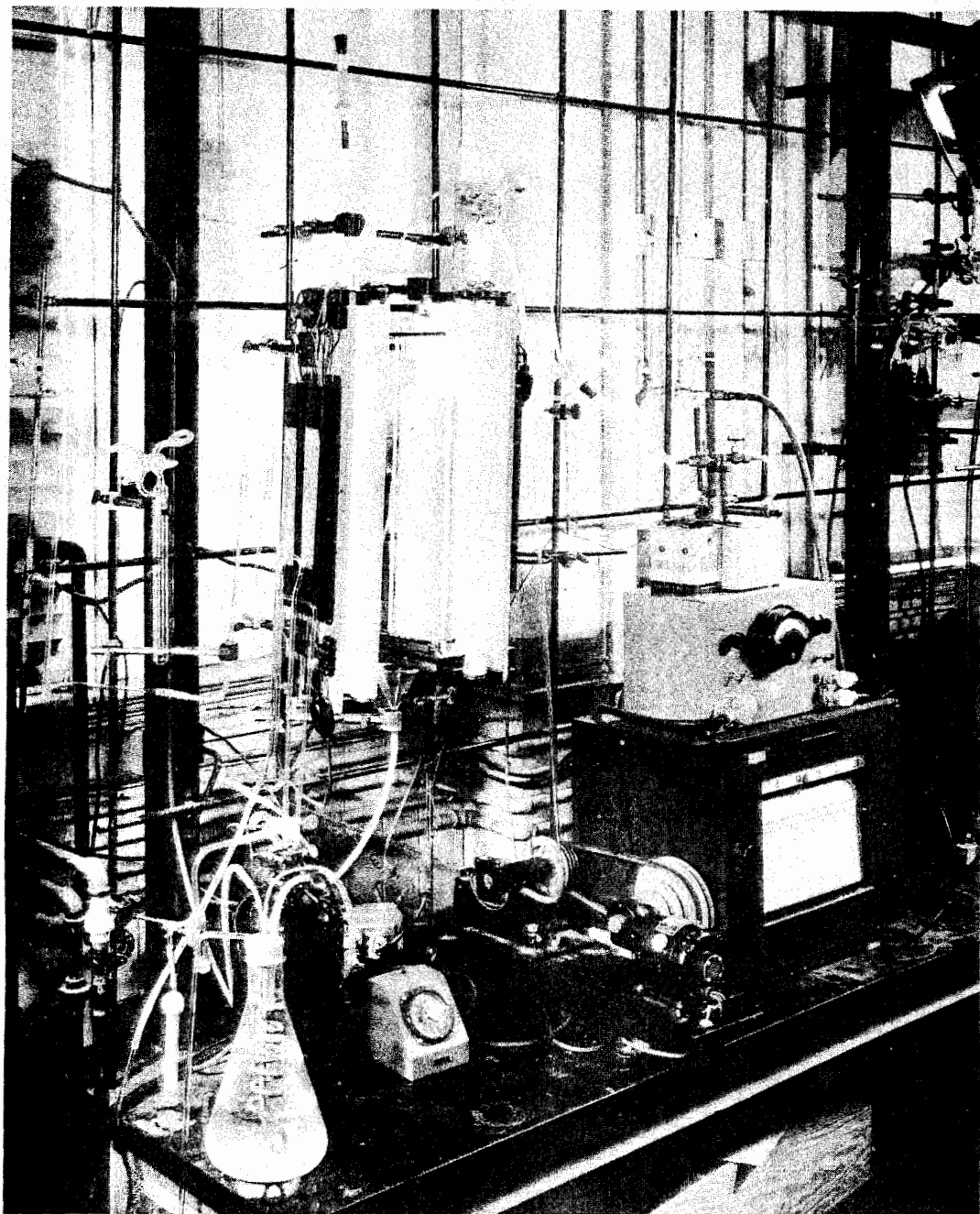

ZN356

Fig. 2

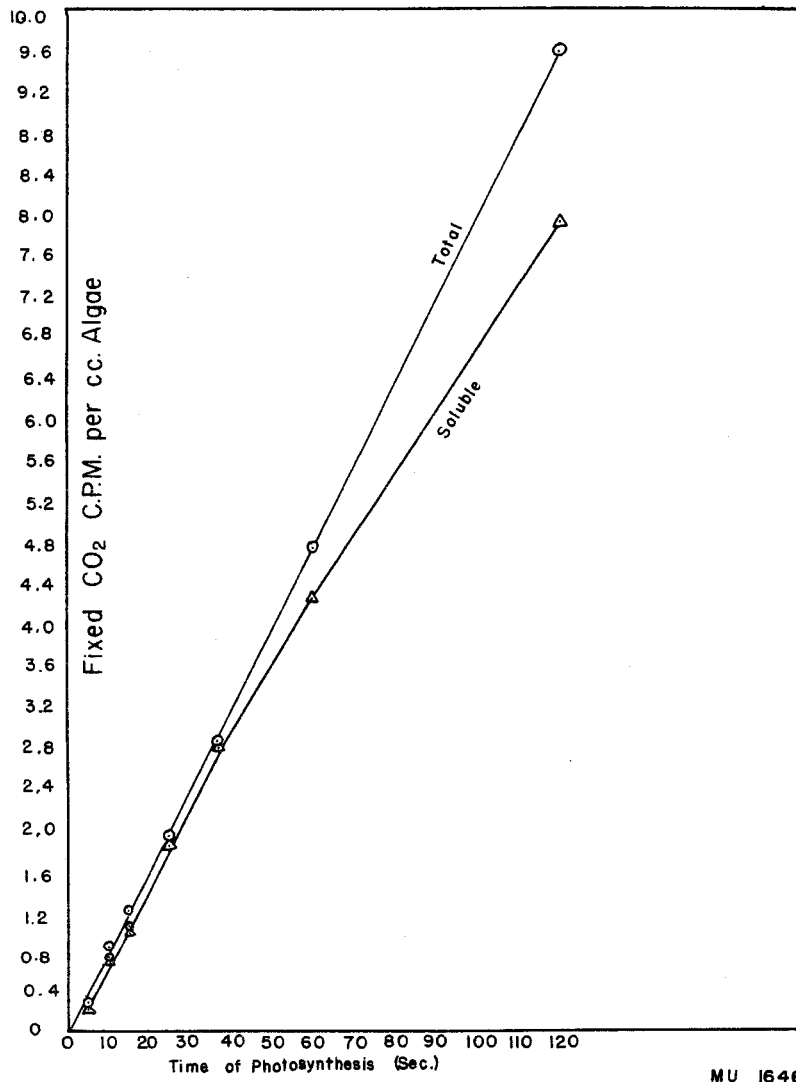

MU 1646

Fig. 3

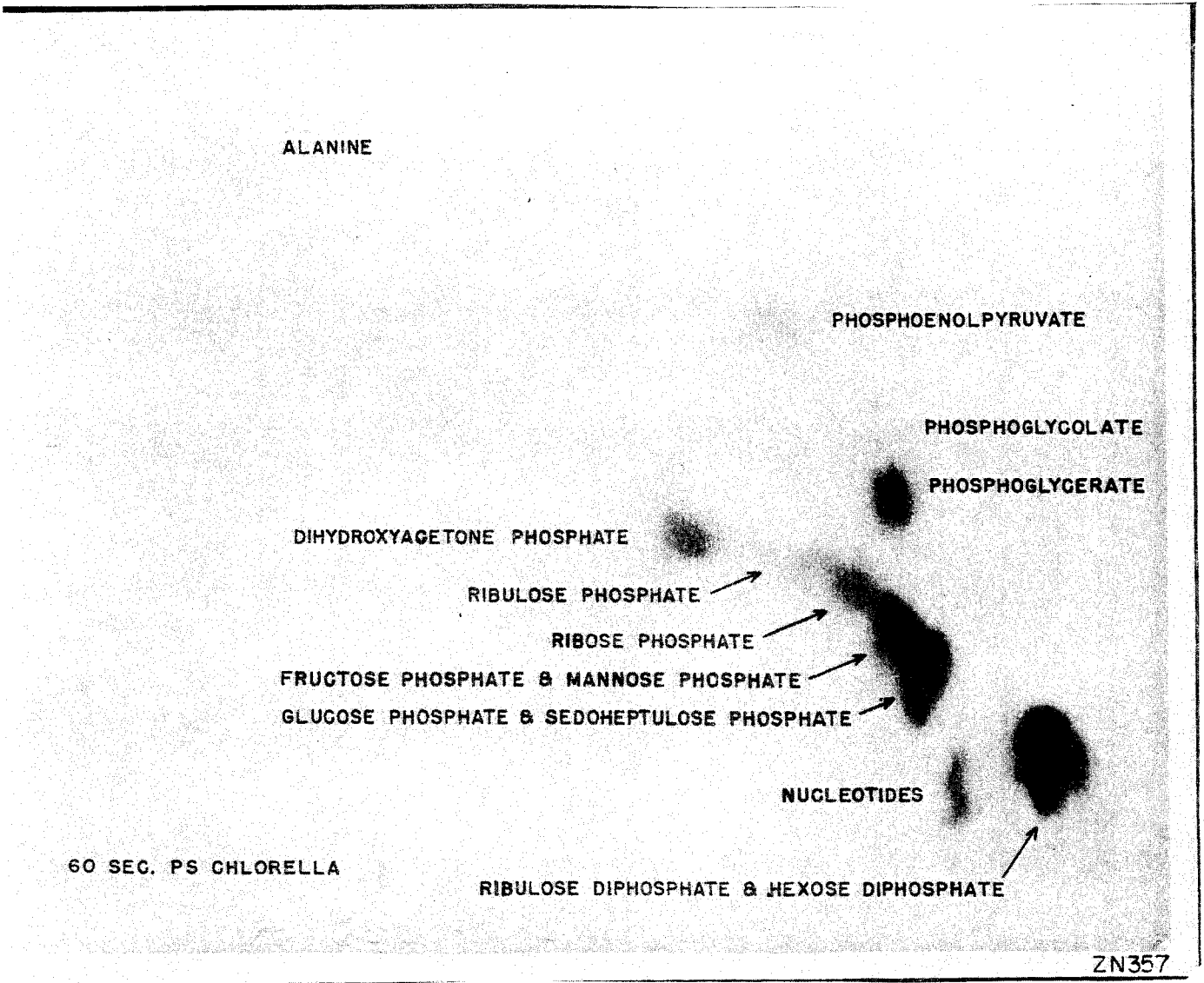

Fig. 4

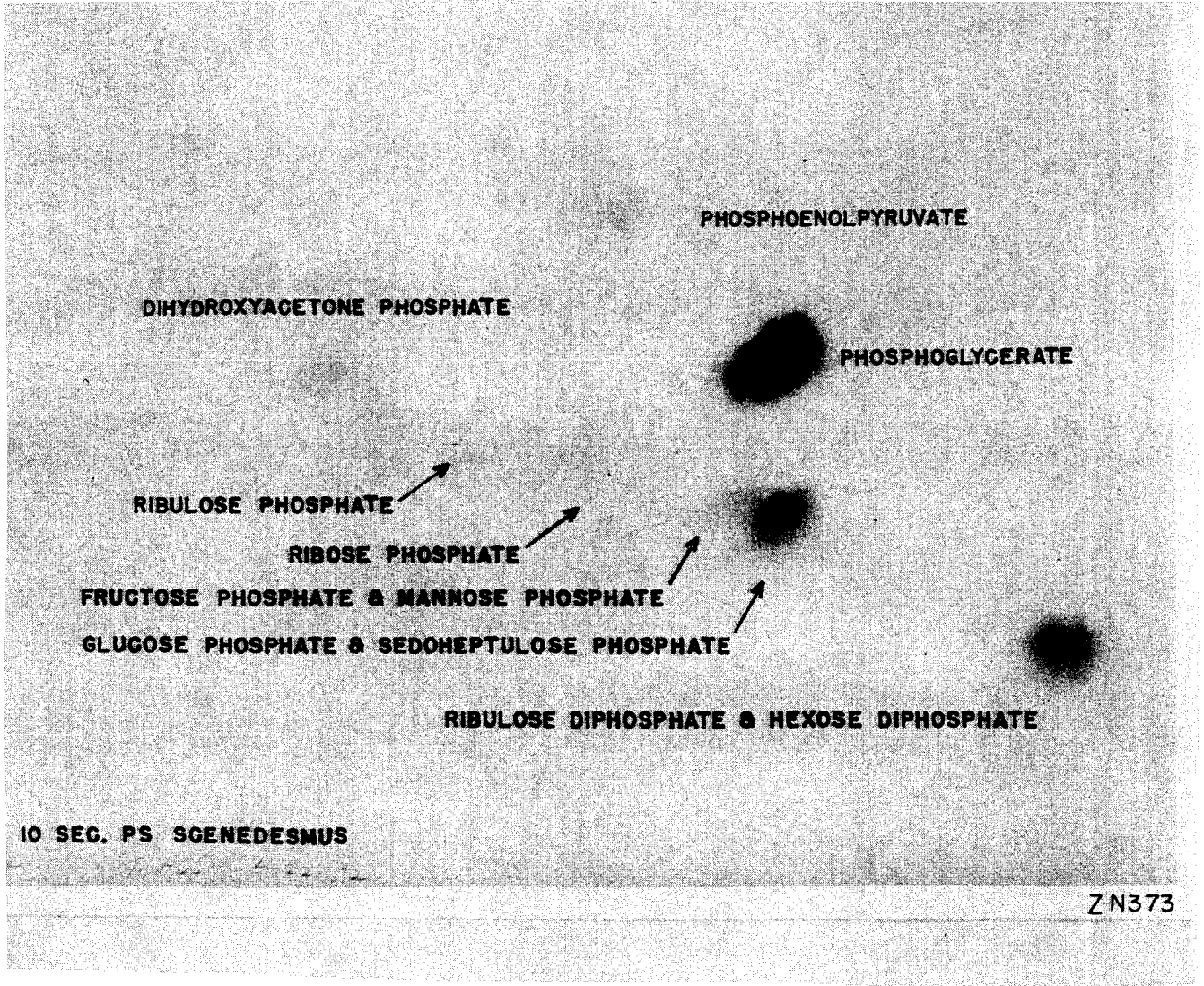

Fig. 5

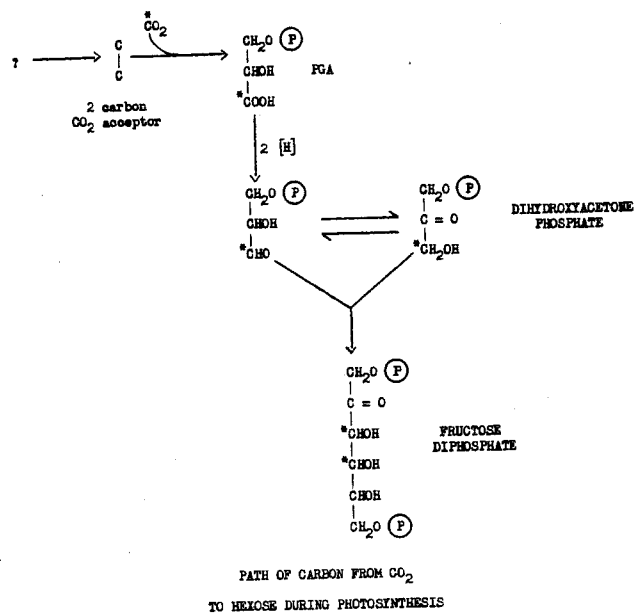

Fig. 6



Fig. 7



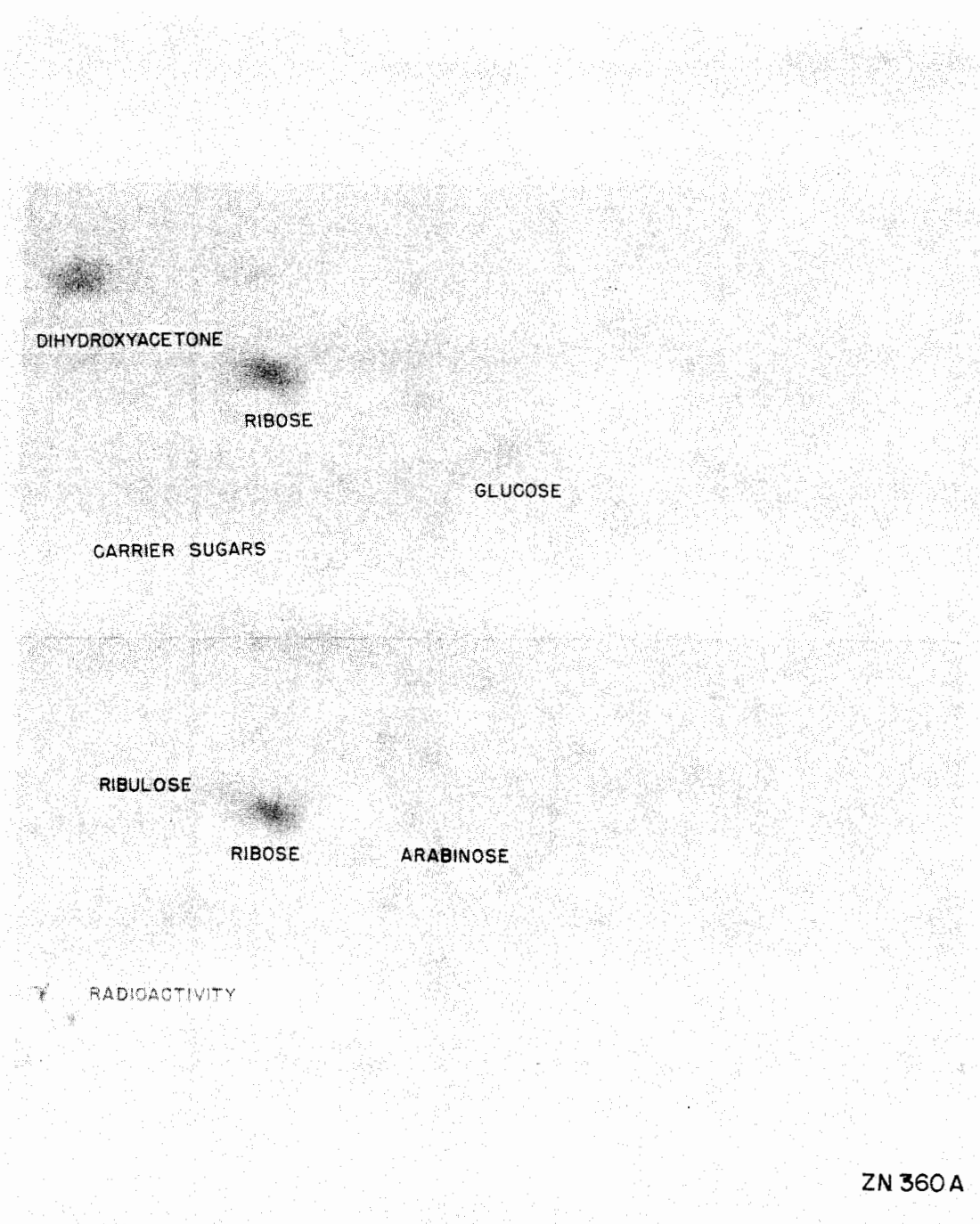

Fig. 8

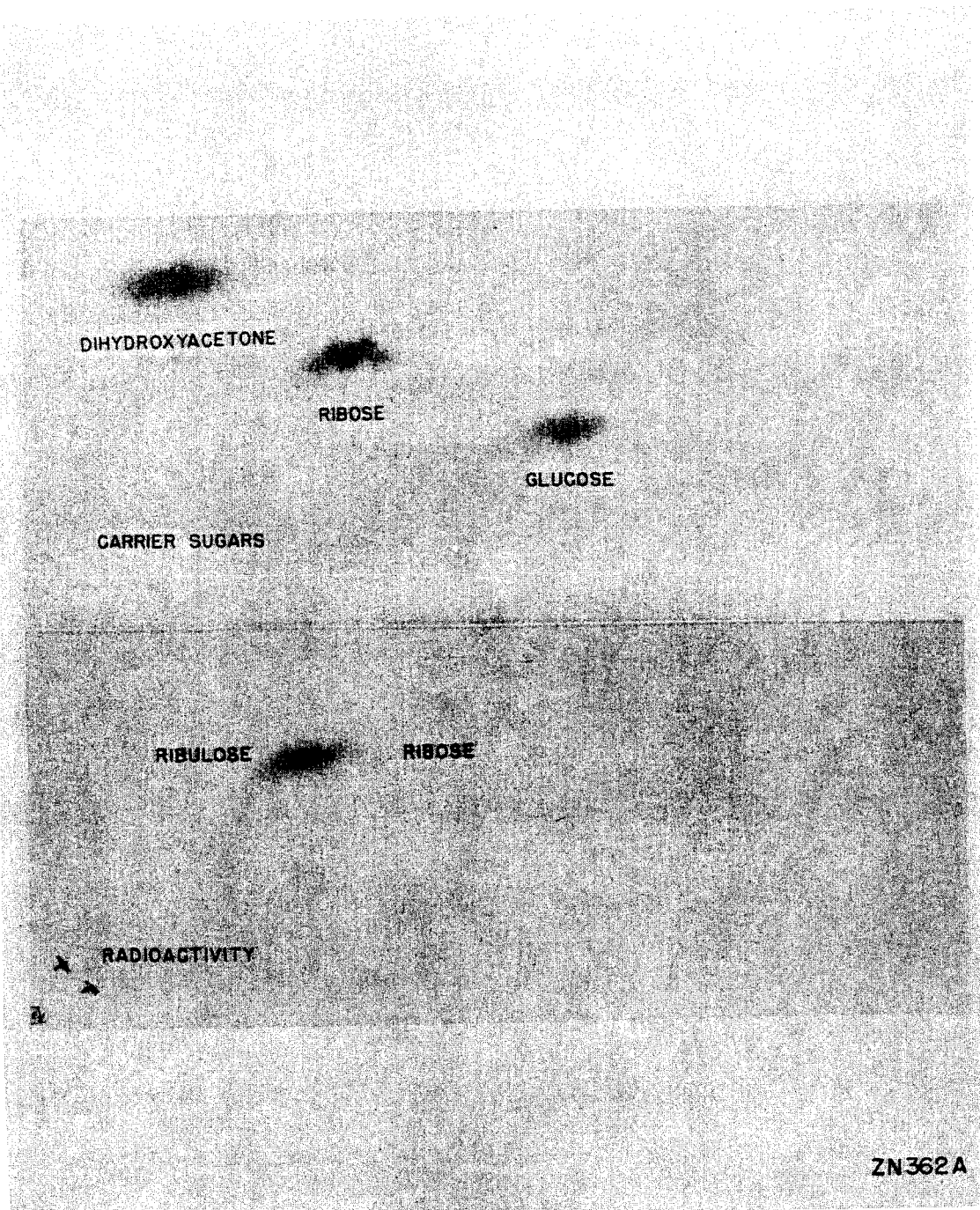

Fig. 9

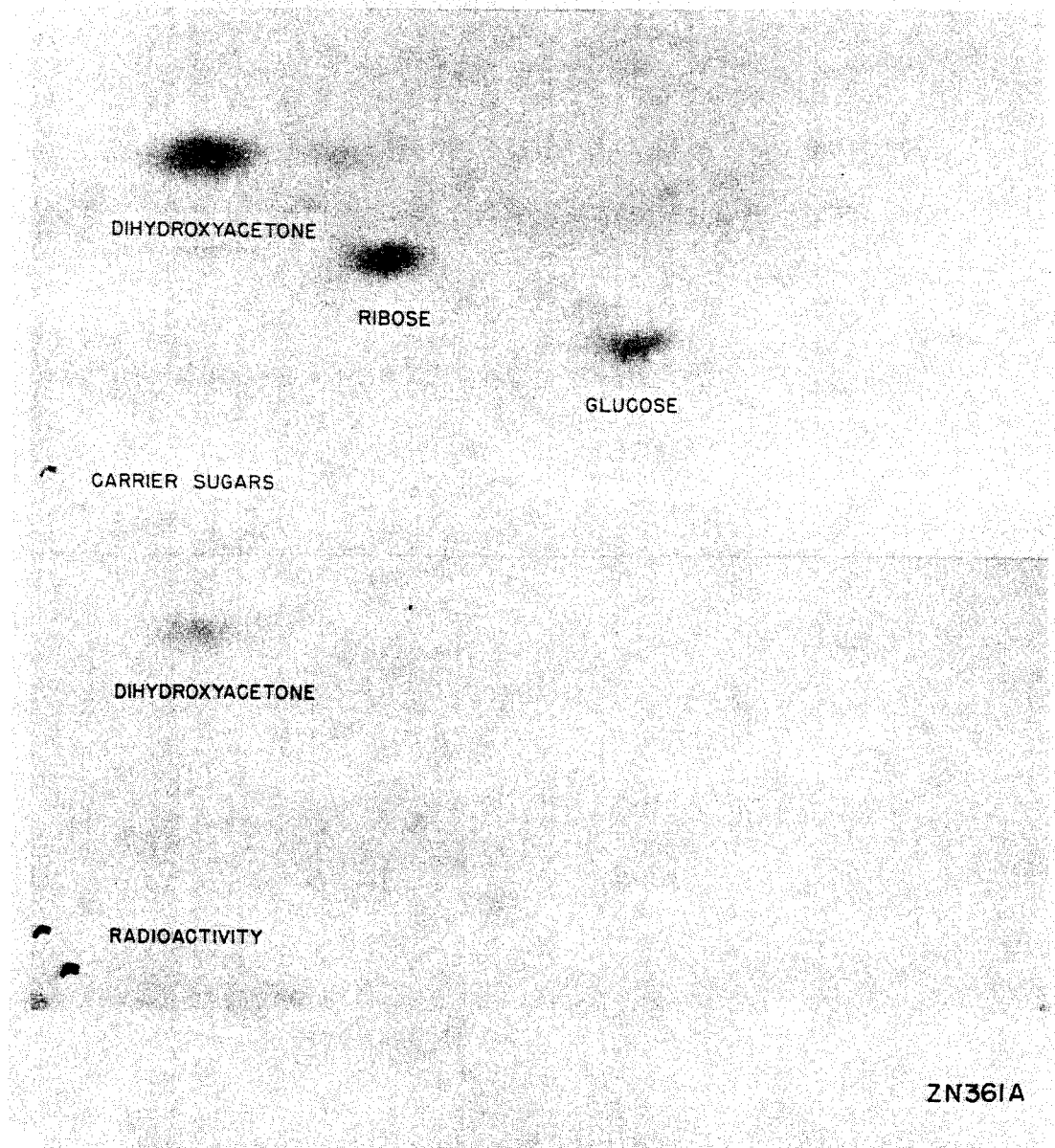
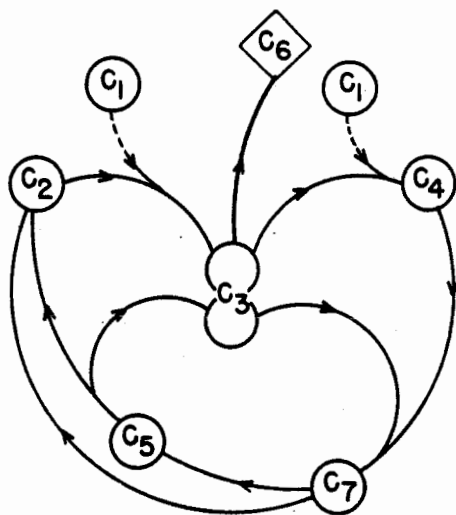

Fig. 10



PROPOSED CARBON CYCLE FOR REGENERATION  
OF TWO-CARBON CO<sub>2</sub> ACCEPTOR

Fig. 11

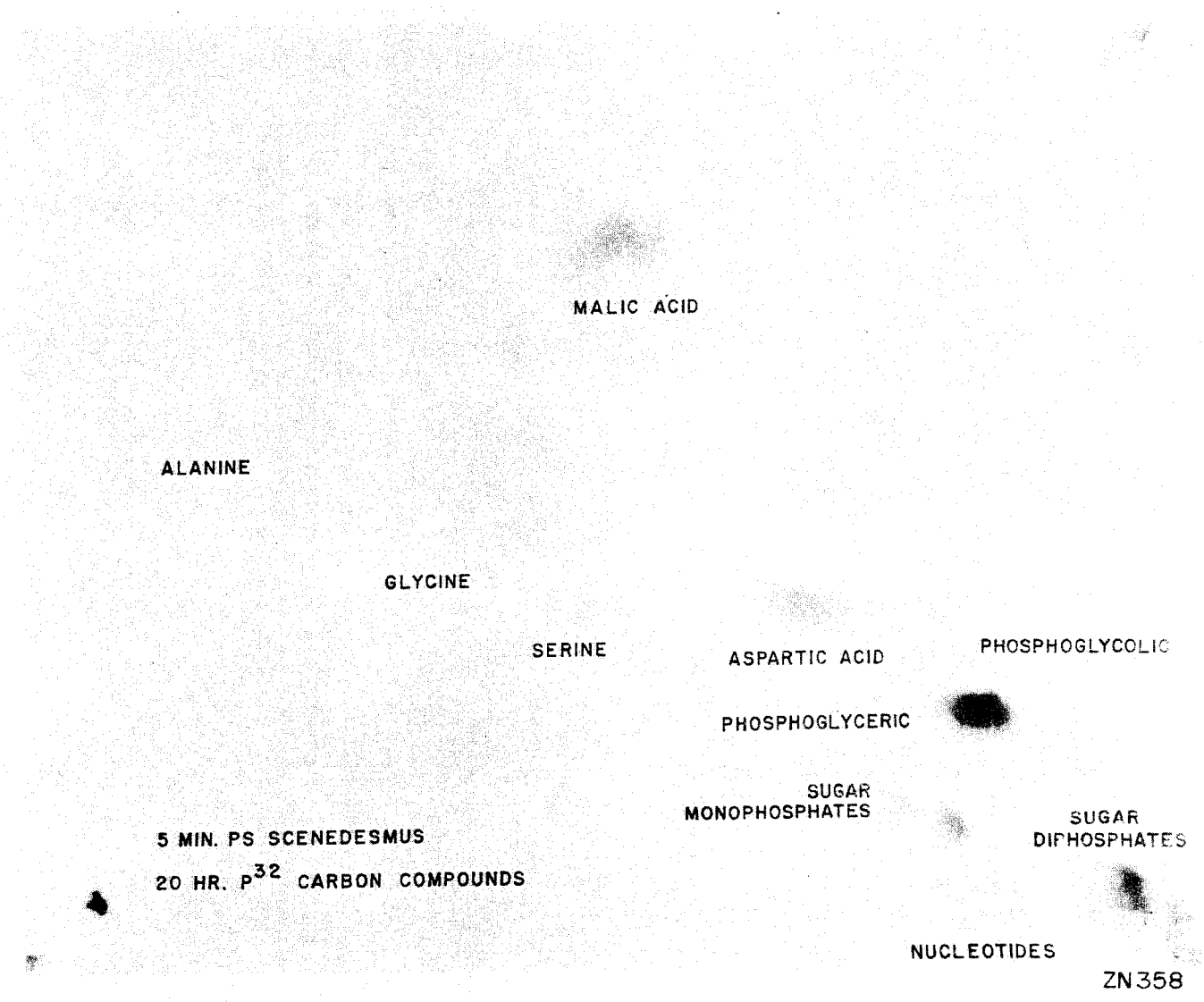

Fig. 12

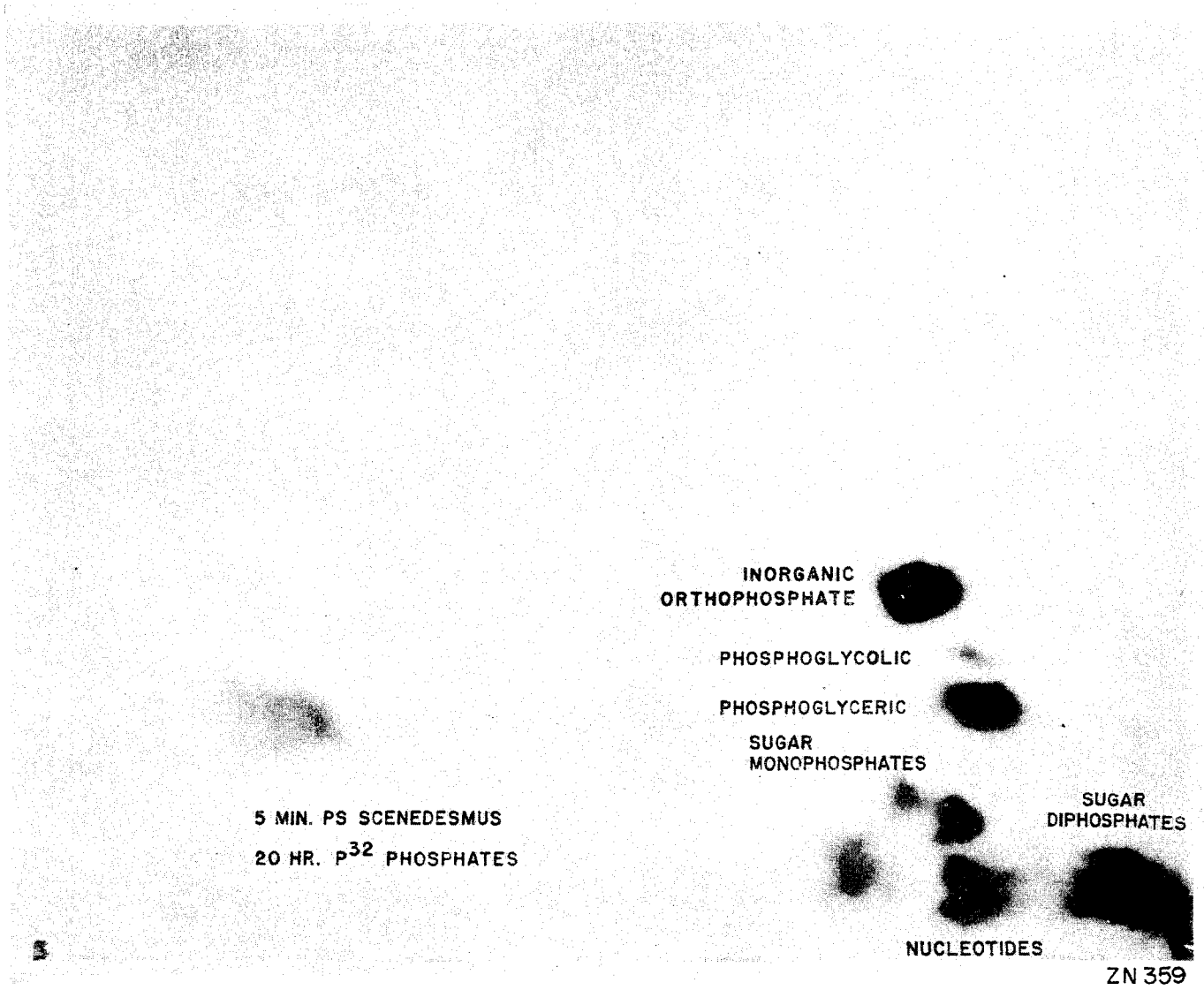
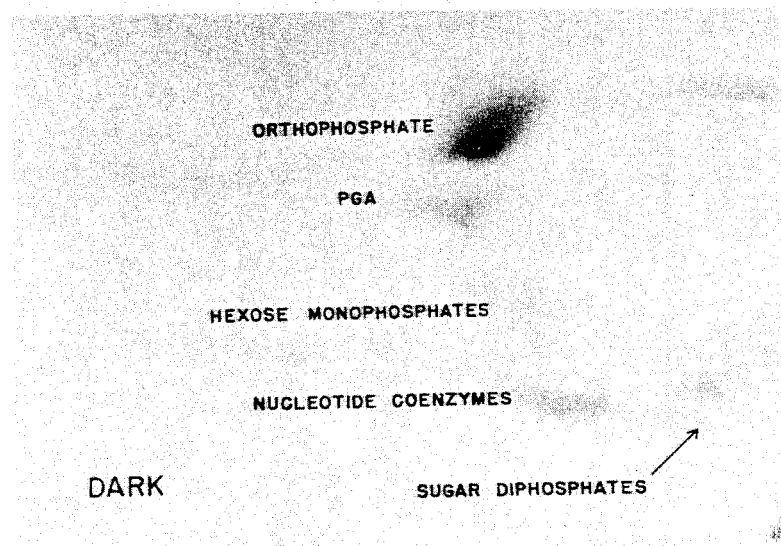
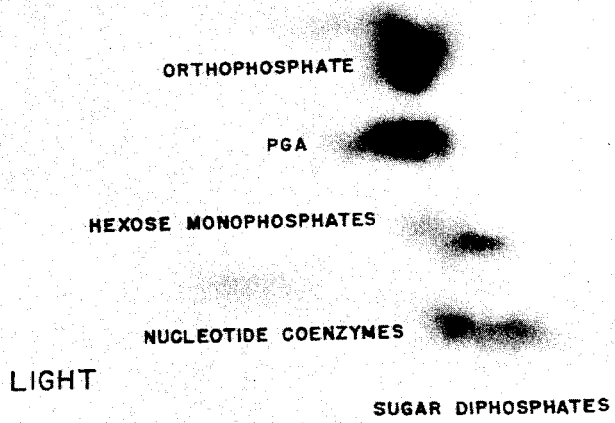

Fig. 13



ZN 363A

Fig. 14