

SYNTHESE

*An International Journal for Epistemology, Methodology
and Philosophy of Science*

Editor-in-Chief:

JAAKKO HINTIKKA

Academy of Finland and Stanford University

Review Editor:

DAGFINN FØLLESDAL

University of Oslo

Associate Editor:

RAIMO TUOMELA

University of Helsinki

Board of Consulting Editors:

DAVID M. ARMSTRONG, University of Sydney, Sydney, Australia

YEHOSHUA BAR-HILLEL, The Hebrew University, Jerusalem, Israel

ARTHUR W. BURKS, University of Michigan, Ann Arbor, Mich., U.S.A.

ROBERT S. COHEN, Boston University, Boston, Mass., U.S.A.

DONALD DAVIDSON, Rockefeller University and Princeton University,
U.S.A.

HANS FREUDENTHAL, University of Utrecht, Utrecht, The Netherlands

IAN HACKING, Peterhouse, Cambridge, England

BÉLA JUHOS, University of Vienna, Vienna, Austria

JERROLD J. KATZ, M.I.T., Cambridge, Mass., U.S.A.

IMRE LAKATOS, London School of Economics and Political Science,
London, England

G. NUCHELMANS, University of Leyden, Leyden, The Netherlands

WESLEY C. SALMON, Indiana University, Bloomington, Ind., U.S.A.

WOLFGANG STEGMÜLLER, University of Munich, W.-Germany

ERIK STENIUS, University of Helsinki, Helsinki, Finland

PATRICK SUPPES, Stanford University, Stanford, Calif., U.S.A.

KLEMENS SZANIAWSKI, University of Warsaw, Warsaw, Poland

LADISLAV TONDL, Academy of Sciences, Prague, Czechoslovakia

H. TÖRNEBOHM, Gothenburg University, Gothenburg, Sweden

MARX WARTOFSKY, Boston University, Boston, Mass., U.S.A.

Articles for publication and communications concerning them may be
sent to one of the following addresses:

PROF. JAAKKO HINTIKKA

Department of Philosophy

Stanford University

Stanford, California 94305, U.S.A.

DR. RAIMO TUOMELA

Porthania 3. C. 23

Hallituskatu 11-13

Helsinki 10, Finland

Books for review and communications concerning them should be sent to:

PROF. DAGFINN FØLLESDAL

Institute of Philosophy, University of Oslo, Blindern, Oslo 3, Norway

All Rights Reserved

Copyright © 1970 by D. Reidel Publishing Company, Dordrecht-Holland

Printed in The Netherlands by D. Reidel, Dordrecht

GEORGE LAKOFF

LINGUISTICS AND NATURAL LOGIC*

ABSTRACT. Evidence is presented to show that the role of a generative grammar of a natural language is not merely to generate the grammatical sentences of that language, but also to relate them to their logical forms. The notion of logical form is to be made sense of in terms of a 'natural logic', a logical form for natural language, whose goals are to express all concepts capable of being expressed in natural language, to characterize all the valid inferences that can be made in natural language, and to mesh with adequate linguistic descriptions of all natural languages. The latter requirement imposes empirical linguistic constraints on natural logic. A number of examples are discussed.

I. THE CORRESPONDENCE BETWEEN LOGICAL AND GRAMMATICAL STRUCTURE

For better or worse, most of the reasoning that is done in the world is done in natural language. And correspondingly, most uses of natural language involve reasoning of some sort. Thus it should not be too surprising to find that the logical structure that is necessary for natural language to be used as a tool for reasoning should correspond in some deep way to the grammatical structure of natural language. Take the following example.

- (1) The members of the royal family are visiting dignitaries.
- (2) Visiting dignitaries can be boring.
- (3) a. Therefore, the members of the royal family can be boring.
b. Therefore, what the members of the royal family are doing can be boring.

Example (1) is a classical case of a structurally ambiguous sentence. The phrase 'visiting dignitaries' can either be a noun phrase consisting of a head noun 'dignitaries' preceded by a modifier 'visiting', or it can be a verb phrase with the verb 'visit' and the object noun 'dignitaries'. The same structural ambiguity occurs in sentence (2). Corresponding to each of these grammatical analyses, we find a pattern of deduction. Thus if 'visiting' is assumed to be a modifier of the head noun 'dignitaries', then (3a) follows as a logical consequence. On the other hand, if 'visiting' is

taken to be a verb followed by a direct object, then (3b) follows as a logical consequence.

Whenever sentences of a form superficially similar to (1) and (2) can have only one of these grammatical analyses, then only one of the patterns of deduction appears. For example, consider the following case.

- (4) The members of the royal family are sniveling cowards.
- (5) Sniveling cowards can be boring.
- (6) a. Therefore, the members of the royal family can be boring.
b. *Therefore, what the members of the royal family are doing can be boring.

In (4) and (5) 'sniveling' can only be considered a modifier of 'cowards'; it cannot be considered a transitive verb. Correspondingly, from (4) and (5) one can conclude (6a), but (4) and (5) do not lead to the conclusion (6b).

- (7) The members of the royal family are smuggling brickbats.
- (8) Smuggling brickbats can be boring.
- (9) a. *Therefore, the members of the royal family can be boring.
b. Therefore, what the members of the royal family are doing can be boring.

In (7) and (8) the reverse is true. 'Smuggling' is only a transitive verb in (7) and not a modifier of 'brickbats'. Consequently, from (7) and (8), (9a) does not follow as a logical consequence, but (9b) does.

This is a trivial example of a case where there is a correspondence between grammatical structure and logical structure. It does, however, raise an interesting question. Is this an accidental case? Or is there some necessary connection between the grammatical structures of these sentences and the corresponding logical structures? Intuitively, one would guess that the connection was not accidental. If this is true, one would like such a fact to be represented in a theory of linguistic structure. Not all theories of linguistic structure guarantee that such a correspondence is not accidental. For example, the theory given in Chomsky's *Syntactic Structures* leaves open the question as to whether such correspondences are accidental. The reason is that, in that theory, the sentences of English are to be generated by rules that do not take into account the meaning of the sentences. Any rules relating English sentences to their logical

forms would be independent of the rules assigning those sentences grammatical structures, though the rules assigning logical form might or might not depend on the grammatical structures assigned by rules of grammar. To the extent to which a theory of grammar assigns grammatical form independently of meaning, to that extent that theory will be making the claim that any correspondence between grammatical form and logical form is accidental.

II. OVERLAPPING RULES

It is sometimes assumed, as it was in *Syntactic Structures*, that the rules that generate the grammatical sentences of English, separating them from the ungrammatical sentences and assigning them their grammatical structure, are distinct from the rules that relate English sentences to their corresponding logical forms. In the past several years, a considerable amount of evidence has been discovered which indicates that this is not true. In some cases, the rules which determine which sentences are grammatical or ungrammatical are identical to rules relating the surface form of an English sentence to its logical form. Consider the sentences of (1).

- (1) a. Sam smoked pot last night.
b. Last night, Sam smoked pot. (=a)

It is clear that (1a) is related to (1b) by a rule of grammar which moves an adverb to the front of the sentence. This much is uncontroversial. Let us call such a rule 'adverb-preposing'. In the simple case, adverb-preposing moves an adverb to the front of its own clause, as in (1b). However, there are cases where adverb-preposing moves the adverb to the front of a higher clause, as in (2) and (3).

- (2) a. I think Sam smoked pot last night.
b. Last night, I think Sam smoked pot. (=a)
- (3) a. It is possible that Sam will leave town tomorrow.
b. Tomorrow, it is possible that Sam will leave town.

However, there are cases where adverb-preposing may not move the adverb to the front of a higher clause, depending on what the verb or adjective in the higher clause is. When this restriction on adverb-

preposing is violated, the result can be an ungrammatical sentence.¹

- (4) a. I realize that Sam will leave town tomorrow.
 b. *Tomorrow, I realize that Sam will leave town. (\neq a)
- (5) a. It is mistaken that Sam smoked pot last night.
 b. *Last night, it is mistaken that Sam smoked pot. (\neq a)

'Realize' and 'mistaken' do not permit adverb-preposing from a lower clause in my speech. In (4b) and (5b), violation of this constraint on adverb-preposing leads to ungrammatical sentences. Thus, the rule of adverb-preposing, constrained as indicated, must be a rule of grammar, since it plays a role in distinguishing grammatical from ungrammatical sentences. Now consider examples (6) and (6').

- (6) a. I mentioned that Sam smoked pot last night.
 b. Last night, I mentioned that Sam smoked pot. (\neq a)
- (6') a. I mentioned that Sam will smoke pot tomorrow.
 b. *Tomorrow, I mentioned that Sam will smoke pot. (\neq a)

(6'b) shows that 'mention' is also a verb that does not permit adverb-preposing from a lower sentence. In (6b) on the other hand, we have a grammatical sentence which looks just like the sentence that would be formed by preposing the adverb 'last night' to the front of (6a). However, (6b) does not have the meaning of (6a). In (6b) 'last night' does not modify 'smoked', but rather 'mentioned'. The reason is obvious. 'Last night' in (6b) originates in the same clause as 'mentioned' and moves to the front of its own clause by adverb-preposing. On the other hand, 'tomorrow' in (6'b) cannot originate in the same clause as 'mentioned', since 'tomorrow' requires a future tense and 'mentioned' is in the past tense. Although 'tomorrow' can originate as a modifier of 'will smoke', it cannot move to the front of the higher clause, since adverb-preposing from a lower clause is blocked by 'mention'. The fact that 'mention' blocks adverb-preposing from a lower clause also accounts for the fact that (6b) cannot be understood as a paraphrase of (6a). Note however, that the same rule with the same constraint in the case of (6'b) yields an ungrammatical sentence, while in the case of (6b) it blocks a certain interpretation of a grammatical sentence. Here we have a case where the violation of a rule of grammar does not guarantee that the sentence generated will be ungrammatical. The violation only guarantees that the sentence will be

ungrammatical relative to a given reading. A sentence will be fully ungrammatical only if it is ungrammatical relative to all readings. This suggests that the role of rules of grammar is not simply to separate out the grammatical from the ungrammatical sentences of English, but also to pair surface forms of sentences with their corresponding meanings, or logical forms. Thus, rules like adverb-preposing appear to have two functions: to generate the grammatical sentences, filtering out the ungrammatical sentences, while at the same time relating the surface forms of sentences to their corresponding logical forms, while blocking any incorrect assignments of logical form to surface form.

This can be seen somewhat more clearly in the case of *if*-clauses. It is often assumed that sentences of the form

If S_1 , then S_2 ,

are to be translated into a logical form like

$$S_1 \supset S_2$$

or something of that sort, perhaps with a different connective. This view is mistaken. As Jerry Morgan has observed, *if*-clauses behave just like other adverbial clauses (e.g., *when*-clauses, *because*-clauses, etc.) with respect to low level syntax. In particular, *if*-clauses undergo the rule of adverb-preposing. Adverb-preposing derives (7b) from (7a).

- (7) a. Sam will smoke pot, if he can get it cheap.
 b. If he can get it cheap, *then* Sam will smoke pot. (=a)

Morgan (1970) has proposed that the 'then' of 'if-then' is inserted by transformation after the *if*-clause has been preposed. This view is substantiated by examples like (8) and (9).

- (8) a. I think Sam will smoke pot, if he can get it cheap.
 b. If he can get it cheap, *then* I think Sam will smoke pot.
 (=a)
- (9) a. It is possible that Sam will smoke pot, if he can get it cheap.
 b. If he can get it cheap, *then* it is possible that Sam will smoke pot. (=a)

In (8) and (9) adverb-preposing has moved the *if*-clause to the front of a higher clause. The *if*-clause in (8b) originates inside the object comple-

ment of 'think', as in (8a). Thus (8b) can be synonymous to (8a). Similarly, the *if*-clause in (9b) originates inside the sentential complement of 'possible' and so (9b) can be synonymous to (9a). Note, however, where the 'then' appears. In (8b) and (9b) 'then' appears in front of the higher clause. This corroborates Morgan's claim that 'then' is inserted after adverb-preposing.²

As we saw above, certain verbs and adjectives block the application of adverb-preposing from below. The examples we gave were 'realize', 'mistaken', and 'mention'. Examples (10) and (11) show that adverb-preposing blocks in the same cases with *if*-clauses.

- (10) a. I realize that Sam will smoke pot, if he can get it cheap.
 b. *If he can get it cheap, *then* I realize that Sam will smoke pot. (\neq a)
- (11) a. It is mistaken that Max smokes pot if he can get it cheap.
 b. *If he can get it cheap, *then* it is mistaken that Max smokes pot. (\neq a)

In (12) we have a case parallel to (6) above.

- (12) a. Max mentioned that Sam will resign if Sue is telling the truth.
 b. If Sue is telling the truth, *then* Max mentioned that Sam will resign.

The *if*-clause in (12b) is understood only as modifying 'mention' and not as modifying 'resign'.

It should be clear from these examples that sentences of the form

If S_1 , then S_2 .

are not necessarily to be translated as

$S_1 \supset S_2$.

If one permitted such a translation from surface form to logical form, then a sentence such as (9b), which has a logical form something like (13), would be given a logical form like (14).

- (13) $\Diamond(p \supset q)$
 (14) $p \supset (\Diamond q)$.

Classical logical fallacies are often results of such mistaken translations.

It should be clear from these remarks that the rule of adverb-preposing, which we have seen is a rule of grammar, plays a crucial role in relating surface forms to their logical forms. It follows that the rules determining which sentences are grammatical and which, ungrammatical are not distinct from the rules relating logical forms and surface forms. The rule of adverb-preposing is a rule which does both jobs.

Adverb-preposing is interesting in other respect as well. For example, it can be used to show that there are cases where material which is understood but does not appear overtly in the sentence, and which can only be determined from context, must appear in underlying grammatical structure and must be deleted by a rule of grammar. Consider the following case.

- (15) a. I'll slug him, if he makes one more crack like that.
 b. If he makes one more crack like that, I'll slug him.
 c. One more crack like that, and I'll slug him.

(15c) is understood in the same way as (15a) and (15b), that is, it is understood as an if-then construction. In (15c) 'he makes' is understood, though it does not appear overtly in the sentence. The question is whether 'he makes' in (15c) is to be deleted by a rule of grammar or to be supplied by a rule mapping surface form into logical form, which is not a rule of grammar. Further examples show that the missing material in such constructions is determinable only from context, that is, only from what is presupposed by the speaker. Consider, for example, (16).

- (16) a. One more beer, and I'll leave.
 b. If I drink one more beer then I'll leave.
 c. If you drink one more beer then I'll leave.
 d. If you pour one more beer down my back, then I'll leave.

and so on.

Sentence (16a) can be understood, depending upon the context, as any of (16b, c, d, etc.). Yet it can be shown that noun phrases such as 'one more beer' as in (16a) must be derived by deletion from full clauses. Consider examples (17), (18), (19) and (20).

- (17) a. It's possible that I'll slug him if he makes one more crack like that.

- b. If he makes one more crack like that, then it's possible that I'll slug him.
- c. One more crack like that, and it's possible that I'll slug him.
- (18) a. I think that I'll slug him if he makes one more crack like that.
- b. If he makes one more crack like that, then I think I'll slug him.
- c. One more crack like that and I think I'll slug him.
- (19) a. I realize that I'll slug him if he makes one more crack like that.
- b. *If he makes one more crack like that, then I realize that I'll slug him.
- c. *One more crack like that and I realize that I'll slug him.
- (20) a. It's mistaken that I'll slug him if he makes one more crack like that.
- b. *If he makes one more crack like that, then it's mistaken that I'll slug him.
- c. *One more crack like that and it's mistaken that I'll slug him.
- (21) a. I mentioned that I would slug him if he made one more crack like that.
- b. *If he made one more crack like that, then I mentioned that I would slug him.
- c. *One more crack like that and I mentioned that I would slug him.

It should be clear from such examples that constructions like (15c) are derived from preposed *if*-clauses, since they are paraphrases and obey the same grammatical constraints. It follows that noun phrases like 'one more crack' in (15c) are derived from full underlying clauses and that the 'and' in this construction is not an underlying 'and' but rather an underlying 'if-then'. (16a) is an instance of exactly the same construction. Moreover, it shows exactly the same constraints. Consider the examples of (22).

- (22) a. One more beer and I'll leave.
- b. One more beer and I think I'll leave.

- c. One more beer and it's possible that I'll leave.
- d. *One more beer and I'll realize that I'll leave.
- e. *One more beer and it's mistaken that I'll leave.
- f. *One more beer and I mentioned that I would leave.

These cases provide strong evidence that constructions such as (16a) must be derived from *if-then* clauses and that noun phrases such as 'one more beer' be derived from the full underlying *if*-clause. If there were no *if*-clause present in the syntactic derivation of sentences like (16a), then the facts of (22) would be inexplicable. Consequently, it follows that the understood matter in such sentences is recoverable only from context; it must be present in order to form a full clause at the time of adverb-preposing, and hence must be deleted by a rule of grammar. Thus rules of deletion in grammar must be sensitive to context, that is, to what is presupposed by the speaker. Let us now return to the facts of (1)-(14).

From a consideration of these facts we have reached conclusion 1.

CONCLUSION 1: The rules of grammar, which generate the grammatical sentences of English, filtering out the ungrammatical sentences, are not distinct from the rules relating the surface forms of English sentences to their corresponding logical forms.

The reason for this is that adverb-preposing must do both jobs at once. The only way conclusion 1 could be avoided would be to assume that there were two rules which did the same job as adverb-preposing and had exactly the same constraints and that one was a rule of grammar and the other a rule relating surface forms to logical forms. This would necessarily involve stating the same rule twice, and thus missing a significant generalization.

CONCLUSION 2: Conclusion 1 provides support for the theory of generative semantics, which claims that the rules of grammar are identical to the rules relating surface forms to their corresponding logical forms.

At present, the theory of generative semantics is the only theory of grammar that has been proposed that is consistent with conclusion 1.

It should be noted that both of the above conclusions depend upon a form of argumentation upon which just about all of the linguistics of the past decade and a half depends, namely, that if a given theory necessarily requires that the same rule be stated twice, then that theory is wrong. Not just inelegant, but empirically incorrect. It was on the basis of just

such an argument that the theory of classical phonemics was shown to be incorrect (see Halle, 1959 and Chomsky, 1964). If one agrees that classical phonemics has been shown to be wrong on the basis of such arguments, one must accept conclusions 1 and 2.

Of course, there may be some people who do not mind if a given theory necessarily forces one to state the same rule twice. Indeed, there may be individuals who actually prefer such theories. Such people will not accept arguments of the form given, and will thus not accept the usual counter-arguments to classical phonemics nor either of the conclusions reached above. Of course, in the absence of such arguments, it is not clear what sort of empirical evidence, if any, could possibly bear on the question of whether grammar is related to logic and if so, how. So far as I can see, there could be no such evidence. If so, then the question ceases to be an empirical one, and by refusing to accept such arguments, one is deciding a priori, by fiat, that there is no relation between grammar and logic. Anyone who wishes to claim that the question of whether grammar and logic are related is an empirical one has the burden of showing what sort of evidence and what sort of arguments could bear on the question. What is interesting about the form of argumentation which we have been using (and which is generally accepted in generative linguistics) is that it does permit empirical considerations to be brought to bear on the issue.

III. QUANTIFIERS

Consider sentences (1) through (4).

- (1) That archaeologist discovered nine tablets. (AMB)
- (2) All the boys carried the couch upstairs. (AMB)
- (3) Every boy carried the couch upstairs. (UNAMB)
- (4) That archaeologist discovered few tablets. (UNAMB)

(1) is ambiguous. It can mean either that the archaeologist discovered a group of nine tablets or that the number of tablets that he discovered altogether totalled nine, though they may not have been in a group. (2) has the same ambiguity. It can mean either that a group consisting of all the boys carried the couch upstairs or that each of the boys carried the couch upstairs. (3) and (4) do not have these ambiguities. (3) cannot

have the reading that a group consisting of every boy carried the couch upstairs. It can only mean that each boy carried the couch upstairs. Similarly, (4) cannot mean that the archaeologist found a group of tablets which didn't have many tablets in it. It can only mean that the total number of tablets that the archaeologist found was few. We will refer to these readings as the 'group-reading' and 'quantifier-reading' respectively.

Suppose now that we embed sentences like (1) and (2) inside the object of a verb like 'believe'. We would expect additional scope of quantification ambiguities. These show up in the quantifier-readings, but not in the group-readings. For example, consider (5) and (6).

- (5) Sam believed that that archaeologist discovered nine tablets.
- (6)
 - a. Sam believed that the number of tablets that that archaeologist discovered was nine.
 - b. Sam believed that that archaeologist discovered a group of nine tablets.
 - c. The number of tablets that Sam believes that that archaeologist discovered is nine.
 - d. Of a group of nine tablets, Sam believed that that archaeologist discovered them.

(5) is ambiguous in three ways. It can have the reading of (6a), where the scope of the quantifier is inside the scope of 'believe'. Or it can have the reading of (6c), where the scope of the quantifier is outside the scope of 'believe'. Or it can have the reading of (6b), the group-reading, where the group is understood as being inside the scope of 'believe'. However, it may not have the reading of (6d), where the group is understood as being outside the scope of 'believe'. The quantifier 'all' works the same way, as examples (7) and (8) show.

- (7) Sam believed that all the boys carried the table upstairs.
- (8)
 - a. Sam believed that the boys who (individually) carried the table upstairs included all the boys.
 - b. Sam believed that a group consisting of all the boys carried the table upstairs.
 - c. The boys who Sam believes carried that table upstairs includes all the boys.
 - d. Of a group consisting of all the boys, Sam believed that they (jointly) carried the table upstairs.

(7) may have the readings of (8a, b, and c), but not (d). I have no idea of how the group reading is to be represented formally. But whatever its formal representation is to be, the possibility of scope ambiguities, as is the norm with quantifiers, must be excluded.

Now let us consider some implications of the above facts. Let us begin with sentences like (9) and (10).

- (9) Everyone likes someone.
 (10) Someone is liked by everyone.

In my speech, though not in that of all speakers of English, (9) and (10) have different meanings.¹ (9) would have a logical form something like that of (11), while (10) would have to have a logical form something like that of (12).²

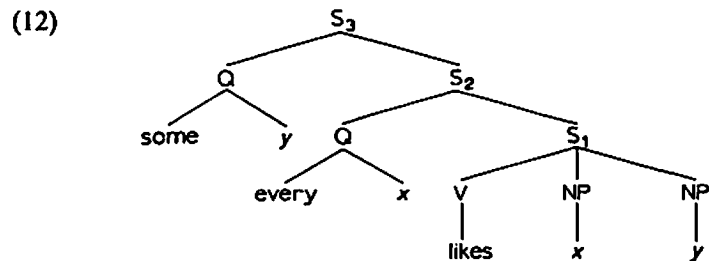
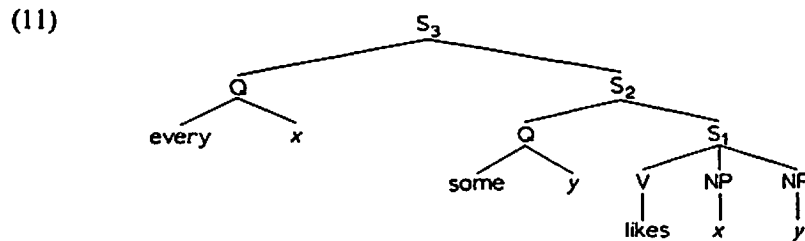

To relate the logical forms of the sentences and their corresponding surface forms, there would have to be a rule of quantifier-lowering, which in (11) would lower 'some' onto the NP with the index *y* and the 'every' onto the NP with the index *x*. The same rule would apply in (12). In my speech, though not in that of many other speakers, there is a constraint on possible pairs of logical forms and surface forms which says that when two quantifiers appear in the same surface clause, the leftmost quantifier must be the higher one in the logical form of the sentence. That constraint

accounts for the difference in meaning between (9) and (10) in my speech.

Any account of the relationship between the logical form and the surface form of sentences like (9) and (10) must include a rule essentially like quantifier-lowering (or, if one prefers, its inverse, which I will call 'quantifier-raising'). Quantifier-lowering (or quantifier-raising, if one prefers) will be a movement rule. That is, it will move a quantifier over a stretch of tree. Movement rules have been studied in great detail by John R. Ross (Ross, 1967). Ross discovered that movement rules (in particular, chopping rules, of which quantifier-lowering would be one) obeyed certain very general constraints. One of these constraints, known as the coördinate structure constraint, states that no movement rule may move an element into or out of one conjunct of a coördinate structure. For example, consider examples (13) through (15).

- (13) a. John and Bill are similar.
 b. John is similar to Bill.
 (14) a. *Who is John and similar?
 b. Who is John similar to?
 (15) a. *Bill, John and are similar.
 b. Bill, John is similar to.

In (13a) the subject is the coördinate NP 'John and Bill'. In (13b) there is no coördinate NP. Consider the NP in the position of 'Bill' in these examples. Suppose we try to question that NP. This is possible in (14b), where 'Bill' would not be part of a coördinate structure, but it is impossible in (14a), where one would be questioning an element of a coördinate structure. Or consider topicalization, as in (15). In (15b) 'Bill' can be moved to the front of the sentence, since it is not part of a coördinate structure, but in (15a), where 'Bill' would be part of a coördinate structure, it cannot be moved to the front of the sentence. Now let us return to the rule of quantifier-lowering and to the distinction between the group-reading and the quantifier-reading of 'nine' and 'all'. In cases of true quantification, where scope of quantification is involved, the rule of quantifier-lowering would apply, moving the quantifier down to the NP containing the appropriate variable. Thus, 'some' in (11) would move down to the NP containing the variable *y*. One would predict that, in such cases, Ross's coördinate structure constraint would apply. That is,

if the variable were contained in a coördinate NP, the rule of quantifier-lowering would be blocked. This, however, would only be the case for true quantifiers, and not for quantifiers with a group-reading, since the group-reading involves no scope of quantification, and hence no rule of quantifier-lowering. As one would guess, this is exactly what happens, as (16) and (17) show.

- (16) a. John and nine boys are similar. (UNAMB)
 b. John and all the girls are similar. (UNAMB)
 c. *John and every linguist are similar.
 d. *Few philosophers and John are similar.
- (17) a. John is similar to nine boys. (AMB)
 b. John is similar to all the boys. (AMB)
 c. John is similar to every linguist. (UNAMB)
 d. Few philosophers are similar to John. (UNAMB)

Compare (17a) with (16a). (17a) is ambiguous. It can mean either that nine boys share a single property with John or that there are nine boys who share some property or other with John. (16a) however only has the former reading. In (16a) the shared property must be the same, as in the group-reading of (17a). (16a) cannot have the reading that John shares different properties with each of the nine boys. The same is true of (16b) and (17b). This is predictable, since the true quantifier reading of (16a and b) is ruled out by the application of the coördinate structure constraint to the rule of quantifier-lowering, leaving only the group-reading for (16a and b). Since the quantifiers 'every' and 'few' do not have group-readings, but only quantifier readings, sentences (16c) and (16d) are ungrammatical, because in order to derive such sentences, the rule of quantifier-lowering would have to violate the coördinate structure constraint. Compare these with (17c and d) where there is no coördinate structure and where, correspondingly, the sentences are grammatical. The rule of quantifier-lowering not only obeys Ross's coördinate structure constraint, but also Ross's other constraints on movement transformations, as would be expected. For details, see G. Lakoff (1970).

Now let us consider what these facts show. First, they reveal the existence of a group-reading for quantifiers of certain sorts, the logical form of which is unknown. All we know about it is that it does not involve

scope of quantification. Secondly, we have seen that the rules relating sentences with true quantifiers to their corresponding logical forms must obey Ross's constraints on movement transformations. These are constraints on grammatical rules, such as question-formation and topicalization (see (14) and (15)). Thus, the rules relating the surface forms of sentences containing true quantifiers to their logical forms obey the same constraints as ordinary grammatical rules. This should not be surprising, since violations of the rule of quantifier-lowering lead to ungrammatical sentences, as in (16c) and (16d). Thus, quantifier-lowering seems to do double duty. It not only accounts for the difference between grammatical and ungrammatical sentences (compare (16c and d) with (17c and d)), but it also serves to relate the logical form of sentences to the corresponding surface forms. Note also that the same rule constrained in the same way will block the generation of the sentences in (16c) and (16d), but only block the corresponding readings for the sentences of (16a and b), it will not yield an ungrammaticality in the case of (16a and b), but only restrict the possibilities for what those sentences can mean. Here we have another case that shows that the rules of grammar, which separate grammatical from ungrammatical sentences, are not distinct from the rules which relate logical forms and surface forms. Consequently, we reach the same conclusions from these facts as we did from the facts considered in the previous section.

IV. PERFORMATIVE VERBS

In Sections II and III we saw that the rules of adverb-preposing and quantifier-lowering do double duty in that they serve both to distinguish the grammatical from the ungrammatical sentences of English and to relate the surface forms of sentences to their corresponding logical forms. They thus serve to confirm what has come to be called the theory of generative semantics.¹ Generative semantics claims that the underlying grammatical structure of a sentence is the logical form of that sentence, and consequently that the rules relating logical form to surface form are exactly the rules of grammar. If the theory of generative semantics is correct, then it follows that the study of the logical form of English sentences is indistinguishable from the study of grammar. This would mean that empirical linguistic considerations could affect decisions concerning how

the logical form of a sentence is to be represented. It would also mean that, on linguistic grounds, the logical forms of sentences are to be represented in terms of phrase structure trees. In this section, we will consider the question of how linguistic considerations can bear on the question of how the illocutionary force of a sentence is to be represented in logical form. In particular, we will consider some of the linguistic evidence which indicates that the illocutionary force of a sentence is to be represented in logical form by the presence of a performative verb, which may or may not appear overtly in the surface form of the sentence. This should not be too surprising in the case of imperatives or questions. It is clear that sentences like 'I order you to go home', in which there is an overt performative verb, namely 'order', enters into the same logical relations as a sentence like 'Go home' in which there is no overt performative verb in the surface form. Linguistic arguments in favor of such an analysis of imperatives can be found in R. Lakoff (1968). It should also not be too surprising that the logical form of questions should be represented in a similar way. On the other hand, it might be assumed that statements should be distinguished in their logical form from imperatives, questions, etc. by the absence of any such performative verb (or modal operator). However, there is considerable evidence to show that even statements should be represented in logical form by the presence of some performative verb with a meaning like 'say' or 'state'. Thus, it is claimed that the logical forms of imperatives, questions, and statements should be represented as in (A).²

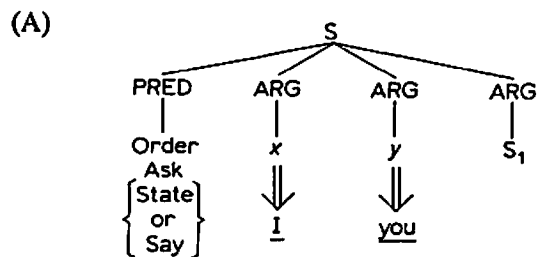

In (A), S_1 represents the propositional content of the command, question, or statement. Note that in statements it is the propositional content, not the entire sentence, that will be true or false. For example, if I say to you 'I state that I am innocent', and you reply 'That's false', you are

denying that I am innocent, not that I made the statement. That is, in sentences where there is an overt performative verb of saying or stating or asserting, the propositional content, which is true or false, is not given by the sentence as a whole, but rather by the object of that performative verb. In 'I state that I am innocent', the direct object contains the embedded sentence 'I am innocent', which is the propositional content. Thus, even in statements, it should not be surprising that the illocutionary force of the statement is to be represented in logical form by the presence of a performative verb.

In the analysis sketched in (A), the subject and indirect object of the performative verbs are represented in logical form by the indexical expressions x and y . Rules of grammar will mark the subject of the performative verb as being first person and the indirect object as being second person. Thus, logical forms need not contain any indication of first person or second person, as distinct from third person. If there are other instances of the indexical expressions x and y in S_1 , they will be marked as being first and second person respectively by the grammatical rule of person-agreement, which makes a NP agree in person with its antecedent. Thus all occurrences of first or second person pronouns will be either the subject or indirect object of a performative verb or will arise through the rule of person-agreement. The analysis given in (A) and the corresponding account of first and second person pronouns makes certain predictions. Since the structure given in (A) is exactly the same structure that one finds in the case of non-performative verbs of ordering, asking, and saying, it is predicted that rules of grammar involving ordinary verbs of these classes, which occur overtly in English sentences, may generalize to the cases of performative verbs, even when those verbs are not overtly present in the surface form of the sentence, as in simple orders, questions, and statements. Since the analysis of simple statements is likely to be the most controversial, let us begin by considering some of the grammatical evidence indicating that simple statements must contain a performative verb of saying in their logical forms. Consider sentences like (1)³.

(1) Egg creams, I like.

In (1), the object NP 'egg creams' has been moved to the front of the sentence by a rule of topicalization. Let us consider the general conditions under which this rule can apply. Consider (2) through (4).

- (2) John says that egg creams, he likes.
 (3) *The fact that egg creams, he likes bothers John.
 (4) *John dreamed that egg creams, he liked.

(2) shows that the rule must be able to occur inside the objects of verbs of saying. However, as (3) and (4) show, this rule does not generally apply inside complement constructions, either subject complements or object complements. It is limited to the objects of verbs of saying (actually, a somewhat larger class including verbs of saying). Without an analysis such as (A), one would have to state two environments in which the rule could apply, that is, one would have to say that the rule applies either in the objects of verbs of saying or in simple declarative sentences. Under the analysis given in (A), these two conditions for the application of the rule would be reduced to a single general condition, namely, that the rule applies in the objects of verbs of saying. This rule, as generalized, would then predict the ungrammaticality of (5a).

- (5) a. *Egg creams, I state that I like.
 b. Egg creams, I stated that I liked.

In (5a) the performative verb 'state' appears overtly. In the derivation of (5a), topicalization is not being applied inside the object of that verb of saying; instead the NP 'egg creams' is moved to the front of the sentence as a whole. In (5b), on the other hand, the performative verb of saying does not appear overtly. The verb 'stated', a non-performative, past-tense usage, appears instead. Since there is no overt performative verb of saying in (5b), the analysis of (A) requires that (5b), in logical form, be embedded inside the object of a performative verb of saying which is not overtly present in the sentence. That is, the logical form of (5b) would contain two occurrences of the verb 'state', as in 'I state to you that I stated that I liked egg creams'. Under this analysis, the NP 'egg creams' in (5b) would have been moved by topicalization to the front of the object of the understood performative verb. Without an analysis like that in (A), it would be impossible to state the general conditions under which topicalization applies or to explain the difference between (5a) and (5b).

Now consider sentence (6).⁴

- (6) Never have I seen such impudence.

(6) is derived from the structure underlying 'I have never seen such impudence', first by a rule moving 'never' to the front and then by the rule of auxiliary inversion, which moves 'have' to a position in front of 'I'. Since the inversion of the auxiliary is automatic when a negative adverb precedes, we will be concerned only with the conditions under which that adverb can be fronted, as it is in (6). Now consider (7) through (9).

- (7) John said that never had he seen such impudence.
 (8) *The fact that never had he seen such impudence bothered John.
 (9) *John dreamed that never had he seen such impudence.

As (7) shows, the rule may apply inside the objects of verbs of saying. As (8) and (9) show, the rule in general does not apply inside either subject or object complements. It applies in embedded sentences only in the objects of verbs of saying. Without an analysis of simple declaratives as given in (A), we would have to say that there was no single general condition under which the rule applied, but rather that it applied either in the objects of verbs of saying or in simple declarative sentences. Again, a generalization is being missed. With the analysis given in (A), we can state a single general condition, namely, that the rule applies only in the object of verbs of saying. This general principle now provides an explanation for the difference between (10a) and (10b).

- (10) a. *Never do I say to you that I have seen such impudence.
 b. Never did I say to you that I had seen such impudence.

Both sentences have first person subjects. The only difference between them is that in (a) the verb 'say' is in the present tense, which is marked by 'do', while in (b) the verb 'say' is in the past tense, which is marked by 'did'. In the present tense with a first person subject and a second person indirect object, the verb 'say' is used performatively. In the past tense, it is not being used performatively. Thus in (10a), a performative verb occurs overtly in the sentence, while in (10b) there is no overt performative verb. The analysis of (A) would claim that (10b) would be embedded in logical form inside the object of a performative verb of saying. Thus 'never' in (10b) is being moved to the front of an object of a verb of saying. Since a performative verb of saying appears overtly in (10a), the analysis of (A) would claim that (10a) is not embedded inside the object of some performative verb of saying which did not appear

overtly. Thus 'never' in (10a) would be moved to the front of the sentence as a whole, not to the front of the object of a verb of saying. (10a) would therefore be a violation of the general principle governing the fronting of such adverbs. Again, without an analysis such as (A), it would be impossible to state the general condition under which the rule applies and to provide an explanation for the difference between (10a) and (10b).

Now consider (11).

- (11) He did *so* eat the hot dog.

The emphatic morpheme 'so', with extra heavy stress, can occur in simple sentences, as (11) shows. In complex sentences, it may not always occur.

- (12) John said that he did *so* eat the hot dog.
 (13) *The fact that he did *so* eat the hot dog bothered John.
 (14) *John dreamed that he did *so* eat the hot dog.
 (15) *John thought that he did *so* eat the hot dog.

As (12) shows, the emphatic *so* may also occur in the objects of verbs of saying. However, as (13) through (15) show, emphatic *so*, in general, cannot occur inside sentential complements, either in subject or object position. It is restricted to complements which are objects of verbs of saying. Once more, without an analysis such as (A), one could not state a general condition for the occurrence of this morpheme. One would have to say that it occurred in two distinct environments, namely, in the objects of verbs of saying and in simple declarative sentences. However, with the analysis of (A), it is possible to state the single general condition that the emphatic morpheme *so* occurs inside the objects of verbs of saying. Thus we have seen that there are two movement rules and one condition on the occurrence of a morpheme which require, for their general statement, an analysis such as (A). In addition to the arguments given above, another variety of grammatical arguments can be given in support of the analysis of (A).

There are certain expressions which, when they appear in simple sentences, require the presence of a second person pronoun.⁵

- (16) Shove it up your (*my, *her, *their) ass.

However, when this expression is embedded inside the direct object of a verb that takes indirect object, the second person restriction no longer

holds. Instead, the pronoun must agree in number, person, and gender which the indirect object of the verb inside whose direct object the expression is embedded.^{5a}

- (17) John told *Sue* to shove it up *her* (*your, *my, *his) ass.

In (17), the pronoun 'her' must have as its antecedent the indirect object of 'tell', namely, 'Sue'. Without an analysis such as (A), there would have to be two distinct constraints on the occurrence of the pronoun in 'shove it up ____'s ass', namely, that in a simple sentence it must be second person, but when embedded it must agree in person, number, and gender with the indirect object of the next highest verb. However, under the analysis given in (A), two distinct conditions would no longer be required. Instead, the statement governing what happens in embedded sentences would suffice for both cases. The pronoun would only be required to agree with the indirect object of the next highest verb. In the case of the simple sentence, as in (16), the indirect object would always be second person. Exactly the same argument can be made for the construction 'Watch ____'s step'.

- (18) Watch your (*my, *his, *her) step.
 (19) John told *Sue* to watch *her* (*your, *my, *his) step.

There are many other constructions of this sort which can either be embedded or occur in a simple surface sentence. Each one of them provides grammatical evidence in favor of the analysis given in (A), since they all work like the cases given above.

There are also constructions, which, in unembedded sentences, require first person pronouns.

- (20) I'll (*you'll, *she'll, *he'll) be damned if I'll eat batwings on toast.

The construction '____'ll be damned if ...' in its nonliteral sense, is one of these, in non-reported speech. When such constructions are embedded, the constraint requiring first person pronouns disappears. In its place there appears a constraint which requires that the pronoun agree with the subject of the next highest verb in gender, number, and person. Once more, without an analysis such as (A), two separate conditions would be required. With an analysis like (A), only one condition would be required,

i.e., that the pronoun agree with the next subject of the next highest verb. In simple sentences, that will be the subject of the performative verb of saying, which will always be first person.

There are still other cases where a construction, when unembedded, requires either a first person or a second person pronoun.

- (22) It would be wise to wash yourself (myself, *himself, *themselves).

When constructions like 'It would be wise to wash ___self' are embedded, that constraint is lifted. Instead, the construction must have a pronoun which agrees in person, number, and gender with either the subject or the indirect object of the next highest verb.

- (23) John told Sue that it would be wise to wash herself (himself, *yourself, *myself).

Again, two separate principles would be required without (A), while with (A), a single general principle can be stated, namely that the pronoun must agree with either the subject or the indirect object of the next highest verb. Such cases provide extremely strong evidence in favor of an analysis like (A). Without (A), unnecessary duplication would be required in many rules. With (A), the general principles can be stated. Note, incidentally, that in each of the above cases the general principle did not involve a restriction on the occurrence of first or second person pronouns. Rather, the restriction on first and second person pronouns in unembedded sentences was *predicted* in each case from the behavior of the construction in embedded sentences.

Another class of arguments in favor of (A) involves adverbial expressions which modify the performative verbs which are understood, but which may not be present in the sentence as uttered.⁶ Consider (24) through (26).

- (24) Why is John leaving, since you know so much?
 (25) Since I'm tired, go home.
 (26) John has left, in case you haven't heard.

The adverbial clause 'Since you know so much' in (24) does not modify the verb 'leave'. The adverbial clause 'since I'm tired' in (25) does not modify the verb 'go'. And in (26) 'In case you haven't heard' does not

modify 'left'. Sentences (24) through (26) become much clearer when one considers their paraphrases, as in (27) through (29).

- (27) Since you know so much, I'm asking you why John is leaving.
 (28) Since I'm tired, I order you to go home.
 (29) In case you haven't heard, I'm telling you John has left.

In (27) through (29), the understood performative verbs of (24) through (26) have been supplied. In (27) 'since you know so much' obviously modifies 'ask'. It provides the reason why I am asking, which is exactly the same function that the phrase serves in (24). In (28) 'since I'm tired', obviously modifies 'order'. It provides the reason why I am giving the order, which is exactly what the corresponding expression does in (25). In (29), 'in case you haven't heard' modifies 'tell'. It gives the reason why I am telling you that information. This expression performs the same function in (26). Without an analysis like (A), there would be no way of specifying what the adverbial clauses in (24) through (26) modify. In fact, (24) would provide an extremely difficult problem. In (24) the adverbial clause is a reason adverbial, while the question being asked is a why-question. Simple sentences cannot contain both a why-question and a reason adverbial. Without an analysis like (A), one would be hard pressed even to explain why (24) should be grammatical at all.

Let us now turn to questions. (A) makes the claim that all direct questions are really indirect questions in logical form, that is, that sentences like 'Who left' have the same logical form as 'I ask you who left'. Certain facts about questions which were discovered by Leroy Baker tend to corroborate this view. Consider (30).

- (30) Who knows where John bought which books?

(30) is ambiguous. That is, it can be understood as asking for answers of two different sorts. In one sense, (30) can be asking for the addressee to supply a subject of 'know'. Under this reading, an appropriate answer would be 'Irving knows where John bought which books'. In the other reading (30) is asking for two pieces of information. That is, the speaker requires as an answer both a subject of 'know' and a specification of the books. Under such a reading, an appropriate answer to (30) would be 'Irving knows where John bought *Principia Mathematica* and Max knows

where John bought *Das Kapital*. Exactly the same ambiguity occurs in (31).

(31) Bill asked me who knew where John bought which books.

(31) allows one to see somewhat more clearly what is going on here. It appears that verbs like 'ask' and 'know', which take indirect questions, act like operators binding the items which they question.⁷ The reason for the ambiguity in (31) is that three items are being questioned, while there are only two verbs doing the binding. The third item may be bound by either of the verbs. Thus in (31), 'ask' binds 'who' and 'know' binds 'where'. 'Which books' may be bound either by 'ask' or by 'know'. Hence the ambiguity.⁸

(31) shows that verbs taking indirect questions bind the items that they question. But what of direct questions? (30) exhibits the same ambiguity as (31). Under analysis (A), this is not surprising, since under analysis (A), (30) would be embedded inside the object of a performative verb of asking. The performative verb would then act as a binder, binding 'who' on one reading and on the other reading binding both 'who' and 'which books'. Without an analysis like (A), there could be no non-ad hoc uniform analysis of binding in questions. In addition, both direct and indirect questions exhibit the movement of an interrogative pronoun to the front of some clause.

(32) Who did Sam say that Bill ordered Max to hit?

(33) Max asked Sue who Sam said Bill ordered Max to hit.

In (32), the pronoun is moved to the front of the sentence as a whole. In (33), the pronoun is moved only to the front of the clause which is the direct object of the verb of asking. Without an analysis like (A), one would have to state two distinct conditions for the application of that rule. With analysis (A), we can state only one condition, namely, that the interrogative pronoun is moved to the front of the clause which is the direct object of that verb of asking which binds that interrogative pronoun. Again, analysis (A) allows one to state a generalization that would otherwise be missed.

In this section we have provided a number of arguments, on linguistic grounds, that the underlying grammatical structure of imperatives, questions, and statements must be represented as in (A). All of these

arguments involved linguistic generalizations which could be stated if (A) was accepted, but which could not be stated otherwise. Under the generative semantics hypothesis, for which we provided arguments in Sections II and III, the underlying grammatical structure of each sentence would be identical with its logical form. Therefore the logical forms of imperatives, questions, and statements would have to look like (A) if all of these grammatical arguments are accepted.

The analysis of (A) not only permits the statement of grammatical generalizations, but it also permits one to simplify formal semantics. Consider, for example, the notion of an 'index' as given by Scott (1969). Scott assumed that indices would include among their coordinates specifications of the speaker, addressee, place, and time of the utterance, so that truth conditions could be stated for sentences such as 'Bring what you now have to me over here'. Under an analysis such as (A), the speaker and addressee coordinates could be eliminated from Scott's indices. Moreover, if (A) were expanded, as it should be, to include indications of the place and time of the utterance, then the place and time coordinates could be eliminated from Scott's indices.⁹ Truth conditions for such sentences could then be reduced to truth conditions for sentences with ordinary adverbs of place and time. Moreover, truth conditions for sentences such as 'I am innocent' and 'I state that I am innocent' could be generalized in terms of the notion 'propositional content', namely, S_1 in (A). Thus, (A) can be motivated from a logical as well as a grammatical point of view.

V. PRESUPPOSITIONS

Natural language is used for communication in a context, and every time a speaker uses a sentence of his language to perform a speech act – whether an assertion, question, promise, etc. – he is making certain assumptions about that context.¹ For example, suppose a speaker utters the sentence of (1a).

- (1) a. Sam realizes that Irv is a Martian.
b. $+R^+(S) \rightarrow +S$.

(1a) presuppose that Irv is a Martian. In general, the verb 'realize' presupposes the truth of its object complement. We will represent this as in (1b). In (1b) we let S stand for the object complement of 'realize', namely

'Irv is a Martian' in (1a).² R^+ stands for 'realize' and the superscripted plus indicates that positive form of S is to be presupposed under normal conditions. The arrow ' \rightarrow ' indicates the relation 'presupposes'.

When (1a) is negated, the complement of 'realize' is still presupposed, as (2a) shows.

- (2) a. Sam doesn't realize that Irv is a Martian.
b. $-R^+(S) \rightarrow +S$.

The minus sign in (2b) indicates that the sentence containing 'realize' is negated.

Certain grammatical constructions also involve presuppositions. Compare (3a) and (4a).

- (3) a. If Irv is a Martian, I'm leaving.
b. $+IF^{0,0}(S_1, S_2) \rightarrow 0S_1 \& 0S_2$.
(4) a. Since Irv is a Martian, I'm leaving.
b. $+SI^{+,0}(S_1, S_2) \rightarrow +S_1 \& 0S_2$.

The simple if-then construction, as in (3a), does not presuppose that either of the sentences it contains is true. This is indicated in (3b) by superscripting the two zeros to the right of IF. ' $0S_1$ ' indicates that neither S_1 nor its negative is presupposed. (4a), unlike (3a) does involve a presupposition. In (4a) the since-clause is presupposed to be true, though the other clause is not presupposed to be true, but rather asserted. As (5a) shows, the same presupposition relations hold when (4a) is negated.

- (5) a. It is not the case that, since Irv is a Martian, I'm leaving.
b. $-SI^{+,0}(S_1, S_2) \rightarrow +S_1 \& 0S_2$.

Let us now turn to cases where the negative of a given sentence is presupposed. As (6a) shows, the object complement of the verb 'pretend' is presupposed to be false.

- (6) a. Irv is pretending that he is sick.
b. $+P^-(S) \rightarrow -S$.

Counterfactual presuppositions will be represented by a superscripted minus, as in (6b). For many speakers, verbs requiring negative presuppositions, such as 'pretend', act quite differently under negation than verbs like 'realize' which require positive presuppositions. Consider (7a).

- (7) a. Irv is not pretending that he is sick.
b. $-P^-(S) \rightarrow 0S$ Dialect A
c. $-P^-(S) \rightarrow -S$ Dialect B.

For speakers of what I shall call Dialect A, (7a) makes no presupposition of either the truth or falsity of its complement. For speakers of Dialect B, (7a) presupposes the falsity of its complement. I happen to be a speaker of Dialect A. Incidentally, I am assuming that 'pretend' is unstressed in (7a). If it is stressed, the stress is understood contrastively and (7a) is normally taken in both dialects to either presuppose or assert the truth, not the falsity, of the complement of 'pretend'.

Counterfactual conditionals are not subject to such variation, so far as I have been able to determine.

- (8) a. If Irv were a Martian, I'd be running away from here.
b. $+IFC^{-,-}(S_1, S_2) \rightarrow -S_1 \& -S_2$.
(9) a. It is not the case that if Irv were a Martian, I'd be running away from here.
b. $-IFC^{-,-}(S_1, S_2) \rightarrow -S_1 \& -S_2$.

In a simple counterfactual conditional, as in (8a), the negative of both clauses is presupposed. Thus (8a) presupposes both that Irv is not a Martian and that I am not running away from here. The same presuppositions are made in (9a), where the counterfactual conditional is negated.

Verbs like 'realize' and 'pretend' are to be contrasted with verbs like 'ask' as in (10a) and (11a).

- (10) a. I asked whether Harry had left.
b. $+A^0(S) \rightarrow 0S$.
(11) a. I asked Harry to leave.
b. $+AT^0(S) \rightarrow 0S$.

In (10a) we have 'ask whether' and in (11a) we have 'ask to'. Both verbs act the same with respect to the presuppositions of their complements. Neither of them presupposes either the truth or the falsity of their complement. The same is true for their negations.

It is very often the case that a presupposed sentence presupposes still another sentence. Consider (12a).

- (12) a. Few men have stopped beating their wives.
 b. Some men have stopped beating their wives.
 c. Some men have beaten their wives.

(12a) presupposes (12b) and (12b), in turn, presupposes (12c). As it turns out, (12a) also presupposes (12c). Thus it would appear, at least in this case, that the presupposition relation is transitive. If S_1 presupposes S_2 , and S_2 presupposes S_3 , then S_1 presupposes S_3 . We will refer to (12b) as a 'first order presupposition' of (12a), and to (12c) as a 'second order presupposition' of (12a). As it turns out, first order presuppositions must be distinguished from second and higher presuppositions. The evidence for this comes from a set of odd constructions in English which I will refer to as 'qualifications'. Consider (13).

- (13) Few men have stopped beating their wives, if any at all have.

(13) consists of (12a), with the qualifying phrase 'if any at all have' tacked on. Though (12a) presupposes (12b), (13) does not presuppose (12b). In fact, the job of the qualifying phrase is to cancel the presupposition of (12b). Similarly, the sentence, 'Sam has stopped beating his wife' presupposes 'Sam has beaten his wife'. Yet in (14), the qualifying phrase has cancelled out this presupposition.

- (14) Sam has stopped beating his wife, if he has ever beaten her at all.

What is particularly interesting about qualifying phrases is that they can cancel out only first-order presuppositions, not second-order or higher-order presuppositions. Thus, given the sentence of (12a) we cannot tack on a qualifying phrase cancelling out a second-order presupposition (12c).

- (15) *?Few men have stopped beating their wives, if any have ever beaten them at all.

(15) is decidedly strange, if intelligible at all, while (13) and (14) are perfectly normal. Compare (15) to (16), where a first order presupposition is cancelled by the same qualifying phrase as in (15).

- (16) Few men have beaten their wives, if any have ever beaten them at all.

Some further examples of qualifying phrases are given in (17).

- (17) a. Few girls are coming, or maybe none at all are.
 b. If the FBI were tapping my phone, I'd be paranoid, but
 then { I am anyway.
 *they are anyway.
 c. If Irv weren't a Martian, I'd still be running away.
 d. If Irv still were a Martian, I'd be running away.

Note that in (17b) the negative presupposition associated with the second clause of a counterfactual condition can be cancelled by a qualifying phrase, but the presupposition corresponding to the first clause may not. In (17c) the word 'still' acts as a qualifying phrase for the second clause of the counterfactual conditional. Compare (17c) with (8a). In (8a), the simple counterfactual conditional, the negative of the second clause is presupposed. But in (17c) the positive of the second clause is presupposed, though the negative of the first clause is still presupposed. Note that 'still' used as a qualifying phrase cannot be inserted into the first clause of a counterfactual conditional, as (17d) shows. Though (17d) is grammatical, 'still' can be understood there only in its ordinary sense, and not as a qualifying phrase.^{2a}

We can define first-order presuppositions in terms of the concept 'immediately presupposes'. Thus, we will say that ' S_1 immediately presupposes S_2 , if and only if S_1 presupposes S_2 and there is no S_3 such that S_1 presupposes S_3 and S_3 presupposes S_2 '. This of course does not solve the deeper problem of how qualifying phrases are to be represented in logical form without contradictions arising. It only provides a way of restricting what the content of a qualifying clause can be.

In addition to qualifications, there is another construction discovered by Paul Neubauer and myself which differentiates first-order from second- and higher-order presuppositions. Consider (18).

- (18) a. Sam stopped beating his wife, and it is odd that he stopped beating his wife.
 b. Sam stopped beating his wife, and it is odd that he ever beat her at all.

In the second clauses of (18a and b), the speaker is making a comment about the first clause. In (18a) it is a comment about the entire first clause, while in (18b) it is a comment about the presupposition of the first clause.

However, if such comments are made about second-order presuppositions, they come out sounding like non-sequiturs.

- (19) a. Few men have stopped beating their wives, and it is odd that any at all have.
 b. *?Few men have stopped beating their wives, and it is odd that any ever beat them at all.

In (19a), the comment is about a first-order presupposition, while in (19b) it is about a second-order presupposition. The comment in (19b) is a non-sequitur. Or take another case.

- (20) a. John won't stop beating his wife until tomorrow, and it is odd that he will even stop then.
 b. *John won't stop beating his wife until tomorrow, and it is odd that he ever beat her at all.

(20b) contains a clear non-sequitur, where a comment is being made about a second-order presupposition.³

So far, we have seen that first-order presuppositions must be distinguished from second- and higher-order presuppositions, and we have seen, in the case of (12), that in certain cases the presupposition relation is transitive. Let us consider further cases of presuppositions of presuppositions to see whether the presupposition relation is transitive in general. Consider (21a).

- (21) a. Max realized that he was pretending that he was sick.
 b. $+R^+(P^-(S)) \rightarrow +P^-(S)$ (first order)
 c. $+P^-(S) \rightarrow A(-S)$ (second order)
 d. $+R^+(P^-(S)) \rightarrow A(-S)$ (by transitivity).

In (21a) we have 'pretend' inside the complement of 'realize'. Here the presupposition relation appears to be transitive. The first order presupposition of (21a) is that Max was pretending to be sick. That in turn presupposes that Max assumes he was not sick. And indeed (21a) presupposes that Max assumes he was not sick.

The situation is somewhat more complicated when 'realize' is embedded inside the object complement of 'pretend'. Consider (22a).

- (22) a. Sue pretended that her boss realized that she had an I.Q. of 180.

- b. $+P^-(R^+(S)) \rightarrow A(-R^+(S))$ (first order)
 c. $A^-(R^+(S)) \rightarrow A(+S)$ (second order)
 d. $+P^-(R^+(S)) \rightarrow A(+S)$ (by transitivity).

In my speech, (22a) presupposes that Sue had an I.Q. of 180, so the presupposition relation again appears to be transitive. However, there are some speakers who find it hard to make judgments about (22a) and some for whom transitivity seems to fail in such cases. Moreover, in my speech, transitivity fails when the subject of 'realize' is the same as the subject of 'pretend'.

- (23) a. Max pretended that he realized that he was sick.
 b. $+P^-(R^+(S)) \rightarrow A(-R^+(S))$ (first order)
 c. $A(-R^+(S)) \rightarrow A(+S)$ (second order)
 d. $+P^-(R^+(S)) \rightarrow A(OS)$ (transitivity fails).

In my speech, (23a) does not presuppose that Max assumed he was sick. Consequently, the presupposition relation is not always transitive for all speakers.

Let us now turn to counterfactual conditionals. In (24a) 'realize' is embedded in the if-clause of a counterfactual conditional.

- (24) a. If I had realized that Harry had survived, I'd have gone home.
 b. $+IFC^{-,-}(R^+(S_1), S_2) \rightarrow -R^+(S_1) \& -S_2$ (first order)
 c. $-R^+(S_1) \rightarrow +S_1$ (second order)
 d. $+IFC^{-,-}(R^+(S_1), S_2) \rightarrow +S_1$ (by transitivity).

(24a) presupposes the negative of both clauses, that is, that I didn't realize that Harry had survived and that I didn't go home. That I didn't realize that Harry survived presupposes, in turn, that Harry survived, as (24c) indicates. Since (24a) presupposes that Harry survived, it appears that transitivity holds when 'realize' is embedded in the if-clause of the counterfactual conditional.

The situation is somewhat more complex when 'realize' is embedded in the then-clause of a counterfactual conditional. If the complement of 'realize' is not identical with the content of the if-clause, then transitivity holds, otherwise it fails.

supposition is defined, at least as we have defined the presupposition relation. Thus (29c) is undefined. However, (29a) makes a positive presupposition, namely, that Sam was sick. Thus, given the way we have defined the lack of a presupposition, transitivity seems to fail for (29a). Suppose, however, that we redefine what is meant by the lack of a presupposition as meaning that either a positive or a negative presupposition is permitted, as in (30b).

- (30) a. I asked Sam whether he realized that he was sick.
 b. $A^{+V-}(R^+(S)) \rightarrow R^+(S) \vee -R^+(S)$ (first order)
 c. $+R^+(S) \rightarrow +S$ (second order)
 d. $-R^+(S) \rightarrow +S$ (second order)
 e. $A^{+V-}(R^+(S)) \rightarrow +S \vee +S (\equiv +S)$ (by distribution and transitivity).

If, in addition, we add an axiom of distribution saying that the presupposition of a disjunction entails the disjunction of the presuppositions, then transitivity holds for (30a).

- (31) Distribution
 $(S_1 \rightarrow (S_2 \vee S_3)) \supset ((S_1 \rightarrow S_2) \vee (S_1 \rightarrow S_3)).$

(30a) presupposes that either Sam realized that he was sick or that he didn't realize that he was sick. But both of those sentences presuppose that Sam was sick. Therefore, by distribution and transitivity, it follows that (30a) should presuppose that Sam was sick, which it does.

Distribution and transitivity also work in the case where 'pretend' is embedded inside 'ask whether'.⁶

- (32) a. I asked Sam whether he was pretending that he was sick.
 b. $AW^{+V-}(P^-(S)) \rightarrow +P^-(S) \vee -P^-(S)$ (first order)
 c. $+P^-(S) \rightarrow A(-S)$ (second order)
 d. $-P^-(S) \rightarrow (A(+S) \vee A(-S))$ (second order)
 e. $AW^{+V-}(P^-(S)) \rightarrow (A(+S) \vee A(-S))$ (by distribution and transitivity).

(32a) presupposes that either Sam pretended that he was sick or Sam didn't pretend that he was sick, as shown in (32b). 'Sam pretended that he was sick' presupposes that Sam assumed he was not sick, as given in

(32c), but 'Sam didn't pretend that he was sick' presupposes that he either assumed he was sick or assumed he wasn't sick, as shown in (32d). Therefore by distribution and transitivity, no particular presupposition is made.

Just as we saw above that there are cases where transitivity fails, so there are cases involving distribution where transitivity fails. Consider (33a), in Dialect A, which is the interesting dialect.

- (33) I asked Sam to pretend that he was sick.
 b. $AT^{+V-}(P^-(S)) \rightarrow (+P^-(S) \vee -P^-(S))$ (first order)
 c. $+P^-(S) \rightarrow A(-S)$ (second order)
 d. $-P^-(S) \rightarrow (A(+S) \vee A(-S))$ (second order)
 e. $AT^{+V-}(P^-(S)) \rightarrow A(-S)$ (transitivity fails).

In (33a) we have 'pretend' embedded inside 'ask to'. In Dialect A, 'ask to' works rather differently with respect to this phenomenon than 'ask whether'. 'Ask to' has the same first order presupposition as 'ask whether', namely that either Sam will pretend that he is sick or that Sam will not pretend that he is sick. This is shown in (33b). Given the principles of distribution and transitivity, one would expect that (33a) would have the same second-order presuppositions as (32a). These are indicated in (33c and d). Thus we would expect that (33a) would make no presupposition as to whether Sam assumed he was or was not sick. However (33a) presupposes that Sam assumed he was not sick, at least in Dialect A. Thus the principles of distribution and transitivity would appear not to fit in this case. Again, the principle at work here is mysterious.

Although we do not know how (33a) works, we can use the fact that it does work as indicated to account for an otherwise mysterious fact in Dialect A. Consider (34a).

- (34) a. Nixon refused to try to shut Agnew up.
 b. REFUSE (S).

(34a) entails (though does not presuppose) (35a).

- (35) a. Nixon didn't try to shut Agnew up.
 b. -S.

Thus, if someone refuses to do something which involves an act of the will and which he has control over, then it is entailed that he didn't do it.

In such situations, sentences of the form (34b) entail sentences of the form (35b). Now consider (36a) and (37a).

- (36) a. Nixon refused to pretend that he tried to shut Agnew up.
b. REFUSE ($P^-(S)$).
- (37) a. Nixon didn't pretend that he tried to shut Agnew up.
b. $-P^-(S)$.

(36a) entails (37a). (37a) has the form of (37b). As we have seen above, sentences of that form in Dialect A make no presupposition about the truth or falsity of their complements, as indicated in (38a).

- (38) a. $-P^-(S) \rightarrow (A(+S) \vee A(-S))$
b. Either Nixon assumed that he tried to shut Agnew up or that he didn't try to shut Agnew up.

Thus, we would expect sentences like (36a) not to presuppose or entail anything about the complement of 'pretend'. That is, we would expect (36a) to say nothing about whether Nixon assumed that he tried or did not try to shut Agnew up. However, (36a) does presuppose that Nixon assumed that he did not try to shut Agnew up, as indicated in (39)

- (39) REFUSE ($P^-(S)$) \rightarrow A(-S).

This would appear to be a mystery. However, as Robin Lakoff has pointed out (personal communication), (36a) presupposes that someone asked Nixon to pretend that he tried to shut Agnew up. In general, sentences with 'refuse' presuppose corresponding sentences with 'ask to', as indicated in (40a).

- (40) a. REFUSE ($P^-(S)$) \rightarrow AT($P^-(S)$)
b. AT ($P^-(S)$) \rightarrow A(-S).

As we saw above in (33a), when 'pretend' is embedded inside 'ask to', the negative of the complement of 'pretend' is presupposed, as indicated in (40b). Thus, if the principles of distribution and transitivity hold for 'refuse' and 'ask to', we can explain why (36a) presupposes that Nixon assumed that he did not try to shut Agnew up. Thus the problem of (36a) reduces to a previously unsolved problem. Note incidentally, that the question of whether distribution and transitivity hold for the pair of predicates 'refuse' and 'ask to' is separate from the question of whether those principles hold for the pair 'ask to' and 'pretend'. They seem to hold for the former pair, but they do not hold for the latter pair.

Most of the cases we've considered so far are examples where truth or falsity of some embedded sentence is presupposed. However, in (40a), this is not the case. What is presupposed is not the truth of the complement of 'refuse', but rather another sentence containing that complement. There are many such cases. For example, as Don Larkin (personal communication) observed, the verb 'agree' when it takes an infinitive complement, presupposes a request. Thus, 'Harry agreed to leave' presupposes that someone asked Harry to leave. Similarly, 'agree' with the complementizer 'that' presupposes a statement. 'Harry agreed that Marvin was a louse' presupposes that someone stated that Marvin was a louse. The difference between the verbs 'fear' and 'hope' lies in the fact that the former presupposes a sentence containing 'bad', while the latter presupposes a sentence containing 'good'. For example, 'Sam fears that Max will come' presupposes that Sam believes that it will be bad for someone for Max to come, while 'Sam hopes that Max will come' presupposes that Sam believes that it will be good for someone for Max to come.

A rather complicated but particularly interesting example of this sort involves the word 'even', which has been discussed in detail by Horn (1969).

- (41) a. Even John came.
b. John came. (assertion)
c. It was expected that John would not come. (presupposition)
d. Other people than John came. (presupposition)

(41a) asserts (41b). It presupposes (41c and d). What is particularly interesting is that while (41c), as expected, acts like a first-order presupposition of (41a), (41d) acts like a higher-order presupposition, even though it is not presupposed by (41c). We can tell this by testing possible negative-attitude comments and qualifying phrases. The presupposition of (41c) may be cancelled by a qualifying phrase, while that of (41d) may not.

- (42) a. Even John came, but then maybe it was to be expected.
b. *Even John came, $\left\{ \begin{array}{l} \text{but then maybe no one else did} \\ \text{if anyone else came.} \end{array} \right.$

In (42a) the qualifying phrase 'but then...' cancels the presupposition of (41c). But any attempt to cancel the presupposition of (41d) by a qualifying phrase yields an ungrammatical sentence, as in (42b). When 'even' is mixed with a verb like 'stop', which presupposes the truth of its complement, it is still the case that the presupposition of negative expectation associated with 'even' must be first-order, while the presupposition of 'stop' must be higher-order. Compare (43) and (44).

- (43) John has stopped beating his wife, if he ever beat her at all.
 (44) a. *Even John has stopped beating his wife, if he ever beat her at all.
 b. Even John has stopped beating his wife, but then maybe it was to be expected.

In (43), where there is no 'even', the qualifying phrase cancels the presupposition of the truth of the complement of 'stop'. However, if 'even' is added, as in (44a), then the same qualifying phrase cannot cancel the presupposition of the truth of the complement of 'stop'. Compare (44a) with (44b), where it is possible to cancel the presupposition of negative expectation associated with 'even'. Thus we have a case where a certain construction requires two presuppositions, one of which must be first-order, the other of which isn't second-order, but acts as if it were.

(41d) also acts like a second-order presupposition of (41a) with respect to the phenomenon of negative-attitude comments. Consider (45).

- (45) a. Even John came, and it was odd that he did.
 b. Even John came, and it was odd that it wasn't expected.
 c. *Even John came, and it was odd that anyone else did.

In (45a and b) we have comments on the assertion and first-order presupposition, as expected. But the comment of (45c) is ruled out, just as if it were a comment on a second-order presupposition.

It should be noted, incidentally, that not all first-order presuppositions can be qualified.

- (46) a. *Sam realized that Sue had gonorrhoea, if she ever did.
 b. *Irv regretted leaving home, if he ever left at all.

The general conditions under which first-order presuppositions can be qualified are not known at present, however, Horn (1970, and person

communication) has made an extremely insightful suggestion which works in a large number of cases. Compare (47) and (48).

- (47) a. Sixty per cent of the students are striking, if not more.
 b. *Sixty per cent of the students are striking, if not less.
 (48) a. *Only sixty percent of the students are striking, if not more.
 b. Only sixty percent of the students are striking, if not less.

Horn observes that in (47a) the qualifying phrase is making an assertion 'in the same direction' as the main assertion of the sentence. That is, the main assertion is a positive assertion giving a certain percentage. The qualifying phrase is in a sense 'still more positive', giving an even higher percentage. Thus, in some intuitive sense of the term, the qualifying phrase is making an assertion in the same direction as the main clause. Now consider (49), which accords with the analysis presented in Horn (1969).

- (49) a. Only sixty percent of the students are striking.
 b. No more than sixty percent of the students are striking. (assertion)
 c. Sixty percent of the students are striking. (presupposition)

Horn notes that (49b), the asserted part of (49a), is a negative statement. Thus, the qualifying phrase in (48b) would be going 'in the direction of' the assertion of the main clause, while the qualifying phrase in (48a) would not. Thus, Horn suggests that qualifying phrases cancelling out the presupposition of the main clause are permitted only if the assertion they make is 'in the same direction' as the assertion of the main clause, that is, toward greater universality, either in the positive or negative direction. Obviously, the notion 'in the same direction as' has not yet been made into a formal notion. Still, it is clear that there is something to it. If formalized, it would appear to account for such facts as the following, as Horn has observed.

- (50) a. Sam goes swimming sometimes, if not often.
 b. *Sam goes swimming often, if not sometimes.

In (50a), we have a positive statement, with a qualifying phrase going in the direction of greater universality. In (50b) we have a positive statement,

with a qualifying phrase going in the direction of less universality, and so the sentence is impermissible.

- (51) a. Sam seldom goes swimming, if he ever does.
 u. *Sam never goes swimming, if he seldom does.

In (51a) we have a negative statement in the main clause and a qualifying phrase in the direction of greater negative universality, namely, 'John seldom swims' versus 'John never swims'. In (51b), this is not the case, and the qualifying phrase is disallowed.

Horn's account of this phenomenon also provides an explanation for the difference between (52a) and (52b).

- (52) a. John doesn't beat his wife anymore, if he ever did.
 b. *John still beats his wife, if he ever did.

Both 'John doesn't beat his wife anymore' and 'John still beats his wife' have the first-order presupposition that John beat his wife at some point in the past. Thus, without Horn's hypothesis, one would guess that the same qualifying phrase could be used to cancel out both. But this fails in (52b). Horn's hypothesis, however, accounts for this. In (52a), the main clause is making a negative statement, namely, that at present John doesn't beat his wife. The qualifying phrase suggests that 'John doesn't beat his wife' may not only be true at present, but may have been true at all times in the past. Thus it is in the direction of greater (negative) universality. In (52b), however, the assertion is made that at present John does beat his wife, and thus the qualifying phrase does not constitute an extension of that assertion into the past, but rather suggests the contrary. Incidentally, Horn's hypothesis also appears to account for the sentences of (46), since the qualifying phrases there also seem not to go 'in the same direction as' the assertion.

It should be noted in addition that negative-attitude comments work differently than qualifications in cases like (46).

- (53) a. Sam realized that Sue had gonorrhea, and it is surprising that she did.
 b. Irv regretting leaving home, and it is strange that he ever left.

Thus, it would appear that negative-attitude comments allow all first-

order presuppositions, while qualifications are limited by Horn's hypothesis.

A particularly interesting phenomenon, observed by Morgan (1969), is that of embedded presuppositions. We can approach the problem by considering (54) and (55).

- (54) a. Nixon is pretending that everyone realizes that he is a homosexual.
 b. $P^-(R^+(S)) \rightarrow A(+S)$.
 (55) a. Nixon is pretending that he is a homosexual.
 b. $P^-(S) \rightarrow A(-S)$.

In (54a) it is presupposed that Nixon is a homosexual, as indicated in (54b). This should be clear from the discussion above. In (55a) it is presupposed that Nixon is not a homosexual, as is indicated in (55b). Now consider (56a).

- (56) a. Nixon is pretending that he is a homosexual and that everyone realizes it.
 b. $P^-(S \& R^+(S))$ (first order)
 c. $P^-(S) \& P^-(R^+(S))$ (by distribution over conjunction)
 d. $A(-S) \& A(+S)$ (conjunction of the presuppositions of c).

(56a) contains a conjunction inside the complement of 'pretend'. The conjunction is 'Nixon is a homosexual and everyone realizes that Nixon is a homosexual'. Since the presupposition of 'Nixon is pretending that he is a homosexual' is that he is not a homosexual, and since the presupposition of 'Nixon is pretending that everyone realizes that he is a homosexual' is that he is a homosexual, one would expect that (56) would have contradictory assumptions, as indicated in (56d). However, (56a) is not contradictory at all. What went wrong? Lest anyone think that the step from (56b) to (56c) was unjustified, note that (56a) has the same meaning as (57), which has the overt structure of (56c).

- (57) Nixon is pretending that he is a homosexual and he is pretending that everyone realizes it.

Morgan has suggested that the difficulty with (56a) lies in our assumptions that only sentences as a whole may presuppose other sentences.

Morgan suggests that embedded sentences may have presuppositions that entire sentences may not have. He notes that a verb like 'pretend' in essence defines a possible world (actually a class of worlds) such that the sentential complement of 'pretend' is true in that world. Morgan claims, correctly I think, that the way we understand (56a) is that 'Nixon is a homosexual' is true in the world of Nixon's pretense, but is presupposed to be false with respect to the world of the speaker. If Morgan is right, then we must distinguish between presuppositions of the entire sentence and presuppositions of embedded sentences. Unfortunately, we have no idea of how to represent embedded presuppositions at present in such a way that the relationship between presuppositions of embedded sentences and presuppositions of entire sentences can be stated naturally.^{7a}

The question now arises as to how presuppositions are to be represented in terms of logical form. There is a precedent for incorporating presuppositions into the logical form of the sentences that presuppose them. For example, Von Wright and others have employed what is called a 'dyadic modal logic', using formulas such as those in (58).

- (58) a. $L(p/q)$
b. $O(p/q)$.

(58a) is to be read ' p is necessary, given that q ', and (58b) is to be read ' p is obligatory, given that q '. So far as I can tell, the reading 'given that q ' is equivalent to 'presupposing q '. The notation in (58) is equivalent to representing the propositional and presuppositional content of a sentence by an ordered pair. This happens to be the approach I took in (G. Lakoff, in press). However, having an ordered pair of sentences is equivalent to having a relation between two sentences.⁸ In the above discussion, we have represented such relation by ' \rightarrow '. Let us consider how we can make sense of this in terms of a relationship between the surface form of a sentence and its logical form, assuming that that relationship is to be given by rules of grammar. Let S_1 and S_2 stand for the surface forms of two sentences, and let \mathcal{L}_1 and \mathcal{L}_2 stand for the underlying forms of the corresponding sentences. Suppose now that S_1 is a sentence whose main verb is 'realize'. For instance, suppose S_1 is 'Sam realizes that Harry is a fink' and S_2 is 'Harry is a fink'. Then we will say that the surface form S_1 can be related to the logical form \mathcal{L}_1 only if the relation ' \rightarrow ' holds between \mathcal{L}_1 and \mathcal{L}_2 , as indicated in (59) and (60).

$$(59) \quad \begin{array}{ccc} \mathcal{L}_1 & \rightarrow & \mathcal{L}_2 \\ \vdots & & \vdots \\ S_1 & & S_2 \end{array}$$

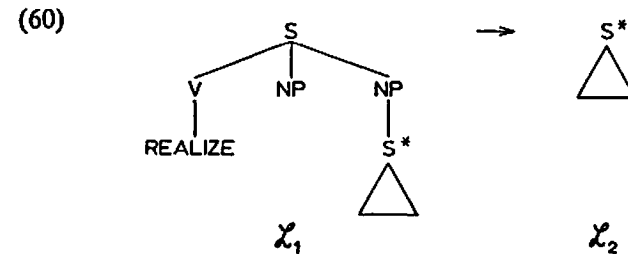

Thus the presupposition relation, as strictly defined, will hold only between logical forms of sentences and not between surface forms. We will, however, speak of the presupposition relation holding between two sentences, S_1 and S_2 , if the relation ' \rightarrow ' holds between their corresponding logical forms. In this formulation presuppositions need not be considered part of the logical forms of sentences. In the cases where rules of grammar interact with presuppositions, such rules will be stated as transderivational constraints.⁹

On the basis of the above discussion, we can draw the following conclusions.

CONCLUSION 1: An account of the logical form of a sentence must include an account of the presuppositions of that sentence. The question is left open as to whether presuppositions should best be represented as separate logical forms, related to the main assertion by ' \rightarrow ' or whether they should be incorporated into logical forms, as I believe they are in dyadic modal logic.

CONCLUSION 2: The presupposition relation is usually transitive, though transitivity fails in a number of cases. Thus, one cannot assume that there will be a simple, unrestricted axiom of transitivity for the relation ' \rightarrow '. Moreover, the restrictions on transitivity will differ from dialect to dialect, just as rules of grammar do.¹⁰

CONCLUSION 3: First-order presuppositions will have to be distinguished from higher-order presuppositions.

CONCLUSION 4: If Horn's hypothesis is correct, logical forms must be given in such a way that the notion 'in the same direction as' or 'in the

direction of greater (positive or negative) universality' can be stated formally for *all* relevant cases in natural language.

CONCLUSION 5: If Morgan's proposal is correct, logical forms must include some method of representing embedded presuppositions.

CONCLUSION 6: A method must be found for representing qualifications of first-order presuppositions without contradicting those presuppositions.¹¹

VI. BAKER'S CONJECTURE AND NATURAL LOGIC

So far we have been speaking about 'logical forms' of English sentences as though the term meant something. However, it makes sense to speak of the logical forms of sentences only with respect to some system of logic. And systems of logic are constructed with specific aims in mind – there are certain concepts one wants to be able to express, inferences one wants to be able to account for, mysteries one wants to explain or explain away, fallacies one wants to avoid, philosophical problems one wants to elucidate. Most of the attempts made in recent years to provide logics for given fragments of English have been motivated by a desire to shed light on philosophical problems that require that certain concepts (e.g., logical necessity, change in time, obligation, etc.) be expressed and inferences (e.g., what is logically necessary is true) be accounted for.¹

In this study we have set an additional goal. In Section I, we saw that there was some connection between grammar and reasoning, and we inquired as to whether it was accidental, and if not, just what the connection was. In Sections II and III, we saw that the connection was not accidental and we got an inkling as to what it was. We saw that the rules relating logical forms to the corresponding surface forms of English sentences must be identical to certain rules of English grammar, at least in the case of quantifiers and conditionals. These results were relative to another goal: that significant generalizations (especially linguistic ones) be expressed, that the same rule not be stated twice. From these results, and from a large number of other results not considered here,² we adopted the hypothesis known as 'generative semantics', which states that the rules of grammar are just the rules relating logical forms to surface forms of sentences. In Sections IV and V, we saw that such assumptions led to some rather interesting conclusions about logical form.

To recapitulate, we have made the following assumptions:

(i) We want to understand the relationship between grammar and reasoning.

(ii) We require that significant generalizations, especially linguistic ones, be stated.

(iii) On the basis of (i) and (ii), we have been led tentatively to the generative semantics hypothesis. We assume that hypothesis to see where it leads.

Given these aims, empirical linguistic considerations play a role in determining what the logical forms of sentences can be. Let us now consider certain other aims.

(iv) We want a logic in which all the concepts expressible in natural language can be expressed unambiguously, that is, in which all non-synonymous sentences (at least, all sentences with different truth conditions) have different logical forms.³

(v) We want a logic which is capable of accounting for all correct inferences made in natural language and which rules out incorrect ones. We will call any logic meeting the goals of (i)–(v) a 'natural logic'. As should be obvious, the construction of a full, nonfragmental natural logic is not an immediate practical goal. In fact, it may not even be a possible goal. Linguistic considerations alone, not to mention logical considerations, rule this out. For example, assumptions (ii) and (iii) require that a full, descriptively adequate grammar of English is required for there to be a natural logic. That is, all the relevant generalizations concerning the relation between logical forms and surface forms must be known. It would be ludicrous to think of this as a practical goal to be accomplished within the next several centuries, if it is possible at all. Serious grammatical studies are in their infancy. Moreover, the study of intensional logics has just gotten off the ground. So it should be clear that no one is about to successfully construct a full natural logic. The goals of (i)–(v) define a subject matter, and its viability depends not upon being able to construct full logics, but upon whether it leads to interesting results. The study of natural logic constitutes a program without an end in sight (like most programs) and the question to be asked is whether it is an interesting program.

If it makes sense to study a subject matter based on the assumptions of (i)–(v), one might expect that these assumptions might interact in some

empirically observable way. For example, if the rules of grammar are just those rules that relate logical forms and surface forms, and if it makes sense to speak of logical forms of sentences only in terms of some system of logic – with axioms, rules of inference, etc. – then it might be the case there might be an interaction between grammatical phenomena and logical phenomena. Perhaps there are grammatical constraints that are, for example, dependent upon one's choice of axioms. In fact, an example of such a phenomenon has been proposed by Baker (1969).

Baker considered cases like:

- (1) I would rather go.
- (2) *I wouldn't rather go.
- (3) I didn't meet anyone who wouldn't rather go.

He noted that 'affirmative polarity' items like *would rather*, which cannot occur when one negative is present, can occur in some cases when two negatives are present.^{3a} He first attempted to describe this phenomenon by saying that the item in question must be commanded by an even number of negatives. Faced with a number of counterexamples to this proposal, he observed that many of the double negation cases he had considered were logically equivalent to positive sentences, while none of the counterexamples were. He then conjectured that perhaps the distribution of affirmative polarity items like 'would rather' was determined by a principle involving logical equivalences. This conjecture, if true, would be a case of the above sort.

Let us begin by considering some apparent confirming instances of Baker's conjecture.

- (4) *I didn't meet the man who wouldn't rather go.
- (5) *I didn't meet anyone who claimed that he wouldn't rather go.
- (6) *I didn't claim that I met anyone who wouldn't rather go.
- (7) *I didn't claim that I wouldn't rather go.

Although (3) seems intuitively to be logically equivalent to a positive sentence, (4)–(7) seem not to be. Despite the occurrence of double negatives, *would rather* cannot occur in such cases. For example, in (6) the intervening complement construction with *claim* between the two negatives keeps the sentence from being logically equivalent to a positive sentence. Now compare (8a and b).

- (8) a. *I don't claim that I met anyone who wouldn't rather go.
- b. I don't think that I met anyone who wouldn't rather go.

The difference between (8a) and (8b) can be explained by the fact that *think* and not *claim* undergoes the rule of *not*-transportation, which moves a *not* from within the complement of *think* to the next highest clause. The existence of such a rule has been demonstrated beyond a reasonable doubt by R. Lakoff (1969).⁴ Thus, the occurrence of (8b) follows from the occurrence of (9).

- (9) I thought that I hadn't met anyone who wouldn't rather go.

If Baker's conjecture is correct, it provides still more confirming evidence for *not*-transportation. Note that it is exactly those verbs that take *not*-transportation that can occur in the position of *think* in (8b).

An especially interesting class of confirming instances arises in the case of modal equivalences. For example,

- (10) \sim NECESSARY (S) \equiv POSSIBLE \sim (S).

Baker's conjecture would predict that, just as one can get (11),

- (11) It is possible that I would rather go.

one should be able to get (12):

- (12) It is *not* necessarily true that I wouldn't rather go.

It is rather remarkable that this prediction is borne out. Compare (12) with (13), which is not logically equivalent to a positive sentence.⁵

- (13) *It is *not* probable that I wouldn't rather go.

This 'confirmation' of Baker's conjecture raises some questions in itself. If 'logical equivalences' are involved here, just what sort of logic are they associated with? Baker speaks only of the predicate calculus. The above examples seem to indicate that his conjecture would have to be extended to some system of modal logic, presumably quantified modal logic. Let us consider for a moment what this means. Suppose, like formalist logicians, we were to think of a logic as simply an arbitrary formal system, with operators chosen from an arbitrary vocabulary and logical equivalences defined in some arbitrary way. From this point of view, first-order

predicate calculus and quantified modal logic are simply two out of an infinite variety of possible logics. Why should the distribution of 'affirmative polarity' items like *would rather* depend on the translation of English sentences into any of these particular logics? After all, one could always construct some logic or other where any sentence containing two negatives was logically equivalent to a positive. Suppose, for example, we constructed a logic which contained a predicate SNURG. Suppose, in addition, that we defined the following logical equivalence:

$$(14) \quad \sim \text{PROBABLE} \sim (S) \equiv \text{SNURG} (S).$$

With respect to this arbitrary logic, (13) would be logically equivalent to a positive sentence. Should the fact that one can always construct such a logic be taken as showing that Baker's conjecture makes no sense? If there is always a logic in which any sentence with two negatives is logically equivalent to a positive sentence, then doesn't Baker's conjecture cease to be an empirical hypothesis?

I think that one would have to agree that Baker's conjecture does not make any sense if one conceives of logics as simply arbitrary formal systems. It is only with respect to natural logic that Baker's conjecture makes sense. In natural logic, the operators and atomic predicates would not be chosen from an arbitrary vocabulary, but would be limited to those that could occur in the logical forms of sentences of natural languages. That is, they would be limited in part on empirical linguistic grounds. Moreover, logical equivalence could not just be arbitrarily set down; rather they would be just those necessary to characterize the notion 'valid inference' for natural language arguments. Presumably, the predicate SNURG would not be a possible atomic predicate and (14) would not be a possible equivalence. From this point of view, the fact that Baker's conjecture holds, say, for the logical equivalence in (10), indicates that (10) is not an arbitrary logical equivalence like (14), but rather that it has an empirical basis in human reasoning.

Let us turn to some more complicated examples like those discussed in Baker's paper.⁶

- (15) It's *not* possible for Sam to convince Sheila that he wouldn't rather go.
 (16) It's *not* possible for Sam to make Sheila believe that he wouldn't rather go.

(17) ?*It's *not* possible for Sam to make Sheila claim that he wouldn't rather go.

(18) ?*It's *not* possible for Sam to make Sheila hope that he wouldn't rather go.

Clearly nothing from first-order predicate calculus tells us that (15) and (16) are logically equivalent to positive sentences, while (17) and (18) are not. Suppose we consider what might be required of natural logic for Baker's conjecture to account for (15)–(18). Let us start with a very rough approximation of what the relevant part of the logical structure of (15) might look like.

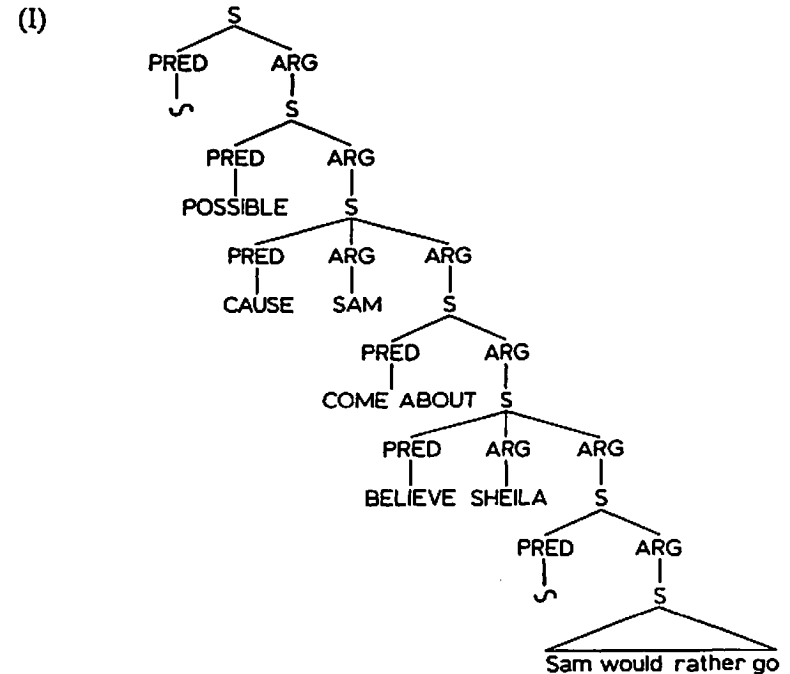

(I) makes use of the fact that *convince* in (15) means *cause to come to believe*. The PREDs in (I) are meant to be first approximations to atomic predicates that would occur in logical forms of natural language sentences; they are not meant to be words of English or predicates chosen from an arbitrary vocabulary.

lences like (24) and (25). The absence of such equivalences would keep the '~' from moving down into the clause below *claim* or *hope*, thus making it impossible for the two negatives to come to be in adjacent clauses and thereby ruling out the possibility that they could cancel out by the Law of Double Negation.^{6a}

Whether Baker's conjecture is right or wrong remains to be seen. But I think that this discussion has at least shown that it makes sense, even for very complicated cases like (15)–(18). I'm not sure how seriously one should take the supposed equivalences of (19)–(22). If considered, in detail, they would undoubtedly prove inadequate. Perhaps they could be fixed up, or perhaps an entirely different set of equivalences would do the job. However, (19)–(22) are at least plausible; they are not wild or far-fetched. Nor is it far-fetched to think that there are no natural logic equivalences like (24) and (25).

Baker's conjecture, given that it makes sense, raises questions of the utmost importance both for linguists and for logicians interested in human reasoning. For linguistics, its consequences are remarkable, since it claims that the *distribution of morphemes* (e.g., would rather) is determined not simply by which other elements and structures are present in the same sentence, or even in a transformational derivation of that sentence, but in addition by logical equivalences. As far as logic is concerned, Baker's conjecture would, if correct, show that natural logic is a field with real subject matter. At any rate, it would show that there was a relation between grammaticality and logical equivalence. Proposed equivalences for natural logic might be tested by constructing the appropriate sentences and seeing whether they were grammatical or not.

One apparent difficulty with the conjecture is that there are some cases where affirmative-polarity items are acceptable, but where there are no fairly obvious and reasonably plausible logical equivalences that can be invoked to yield a positive sentence. For example,

- (26) I wonder if there is anyone who wouldn't rather go home.
 (27) Is there anyone who wouldn't rather go home?
 (28) Anyone who wouldn't rather go home now is crazy.

(26) and (27) seem to be rhetorical questions and to presuppose a negative answer, which would contain two negatives of the appropriate sort. (28) seems to involve some sort of negative judgment, which again would

contain two negatives. Perhaps there is a constraint to the effect that the negative presupposition or judgment of such sentences must be logically equivalent to a positive. It is clear that the conjecture alone is insufficient and that there are other conditions involved.⁷ This does not invalidate the conjecture; it merely limits its scope of applicability. But even in such a limited form, the conjecture would lose none of its theoretical significance. If the distribution of morphemes is determined *even in part* by logical equivalences, then all of the consequences stated above still follow. There would have to be a natural logic, including some equivalences and excluding others.

VII. LEXICAL DECOMPOSITION VERSUS MEANING-POSTULATES

Lexical items are not undecomposable wholes with respect to the logical forms of the sentences that they appear in. We can see this clearly in a sentence like (1).

- (1) Sam has always loved his wife.

(1) is ambiguous. It can have the meaning of either (2a) or (2b).

- (2) a. Sam has always loved the person he is now married to.
 b. Sam has always loved whoever he was married to at that time.

Suppose that Sam has had several wives, and that he may or may not have loved his previous wives, though he has always loved the woman he is presently married to. (1) has the reading of (2a). On the other hand, suppose that Sam did not love his present wife before he married her, but that whenever he was married to a woman, he loved her at that time. Then (1) has the reading of (2b). (2a) and (2b) can be represented as (3a) and (3b), respectively, where t_0 is the time of the utterance and 'LOVE' is assumed (for the sake of discussion) to be a 3-place predicate where 'x loves y at time t'.

- (3) a. SAY (I, you, t_0 , ($\forall t$ (LOVE (Sam, Ix (WIFE (x, Sam, t_0)), t)))
 $t < t_0$
 b. SAY (I, you, t_0 , ($\forall t$ (LOVE (Sam, Ix (WIFE (x, Sam, t)), t)))
 $t < t_0$

Note that 'wife' must also be a 3-place predicate including a time-index.

In fact the only difference between (3a) and (3b) lies in what that time-index is. In (3a) it is t_0 , the time of the utterance, while in (3b) it is the variable t , which is bound by the universal quantifier of 'always'. Thus, the portion of the logical form corresponding to 'wife' in (1) must contain a time-index, though no reflex of this time-index appears overtly in (1). It follows that lexical items cannot be undecomposable with respect to the logical forms of the sentences that they appear in. The question therefore arises as to which lexical items are decomposable and what they are to be decomposed into.

In (Lakoff, 1965), it was proposed that certain verbs were decomposable not only with respect to the logical forms of the sentences they appeared in, but also with respect to the grammatical structures of those sentences. For example, it was proposed that sentences of the form (4a) were to be decomposed essentially into structures of the form (4b) and that the rules relating (4b) to (4a) were to be transformational rules of English grammar.

(4) a. x persuaded y to hit z .

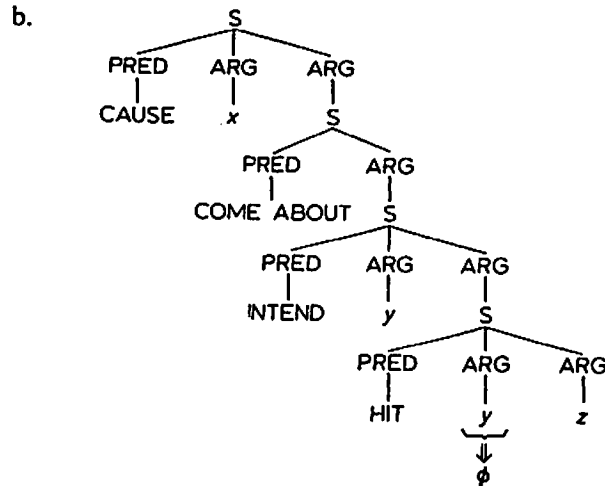

Including some refinements due to McCawley, the derivation of (4a) from (4b) would precede as follows. First, the rule of equi-NP-deletion would delete the second occurrence of y , as indicated in (4b). Then, the y which is the subject of 'INTEND' would undergo the rule of subject-raising, yielding (4c).

The rule of subject-raising is the rule that relates sentences like 'It is

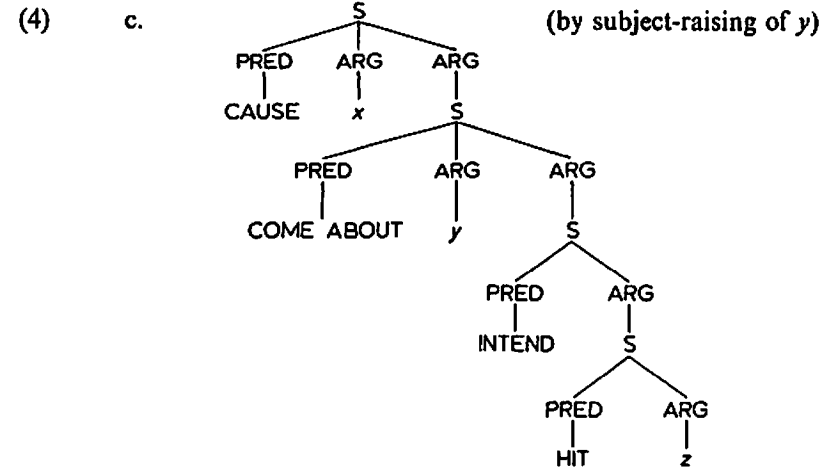

likely for John to go' and 'John is likely to go'. Then the rule of predicate-lifting would raise 'INTEND', yielding (4d).

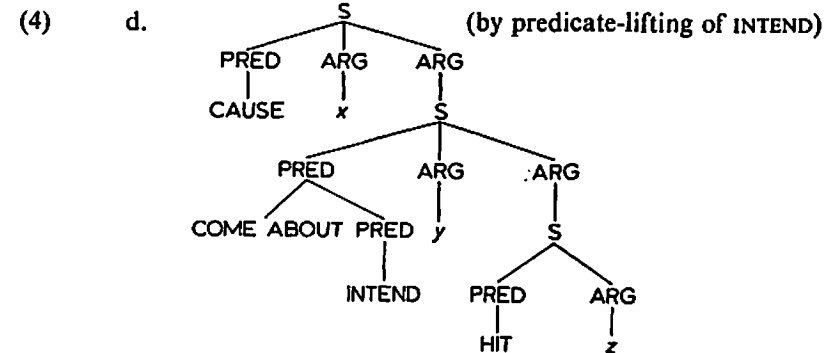

The rule of subject-raising again applied to y would yield (4e), and another application of predicate-lifting would yield (4f).

The lexical item *persuade* would substitute for the predicate CAUSE-COME ABOUT-INTEND. Aside from the rule of predicate-lifting, all of the rules used in this derivation and in similar derivations are needed anyway in English grammar. Moreover, structures like (4b) are also needed independently in English grammar. That is, there must be a verb 'cause' which is a two-place predicate, a verb 'come about' which is a one-place predicate, and a verb 'intend' which is a two-place predicate. Thus, we can reduce the structures of sentences containing 'persuade' to independ-

(4) e. (by subject-raising of *y*)

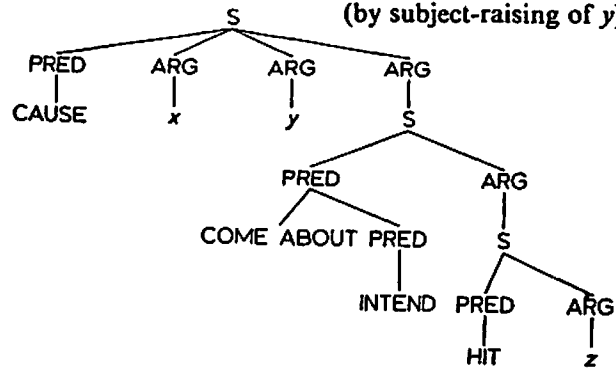

(4) f. (by predicate-lifting of COME ABOUT-INTEND)

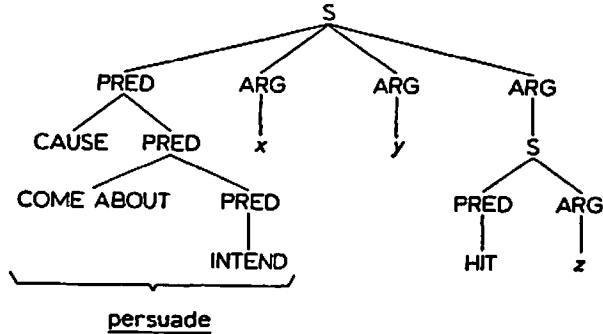

(5) a. *x* persuaded *y* that *y* hit *z*.

b.

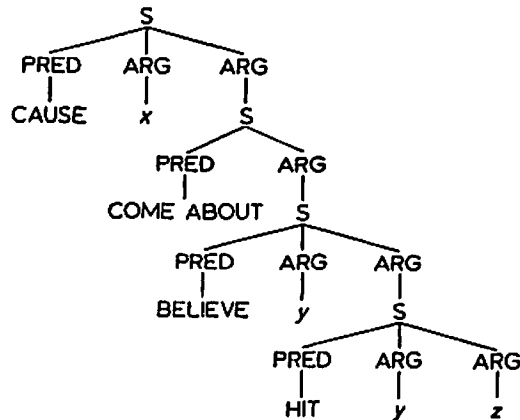

ently needed structures by, for the most part, independently needed rules.

So far, we have only considered 'persuade to', and not 'persuade that'. The former means 'cause to come to intend', while the latter means 'cause to come to believe'. Consequently, it was proposed that sentences like (5a) be derived by similar means from structures like (5b), where 'BELIEVE' appears instead of 'INTEND'.

Fillmore has added to analyses such as these considerations of presuppositions. For example, Fillmore observed that (6a),

(6) a. *x* accused *y* of stealing *z*.

asserts that *x* said that *y* was responsible for stealing *z* and presupposes that it was bad for *y* to steal *z*. We might represent such an analysis as in (6b).

(6) b.

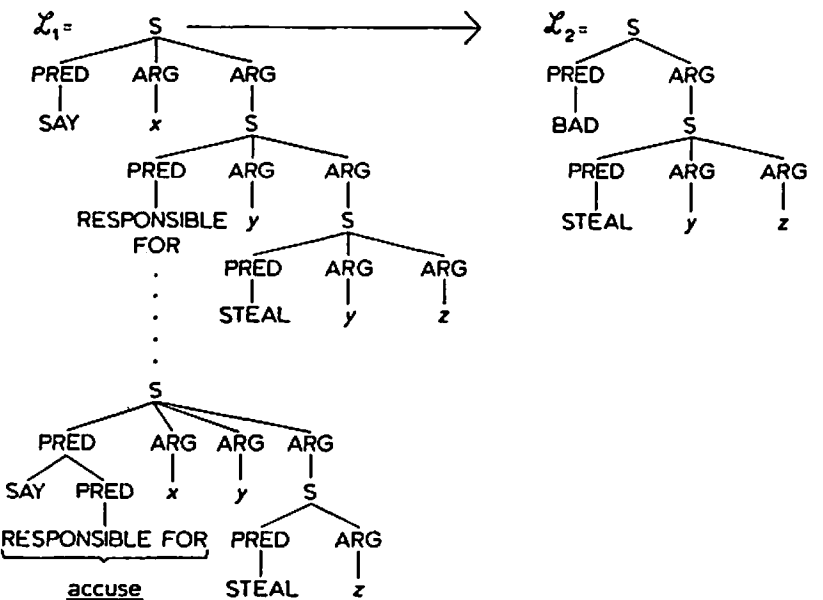

In (6b) the logical form \mathcal{L}_1 is related by the presupposition relation ' \rightarrow ' to \mathcal{L}_2 , and \mathcal{L}_1 is related by transformational rules of English grammar to the surface form of (6a). The lexical item 'accuse' is substituted in for the derived predicate 'SAY-RESPONSIBLE FOR' under the condition that the

corresponding logical form \mathcal{L}_1 presupposes \mathcal{L}_2 , where the encircled S's in \mathcal{L}_2 and \mathcal{L}_1 are identical.

Fillmore observed that the verbs 'accuse' and 'criticize' differ minimally in that what is part of the assertion of 'accuse' is the presupposition of 'criticize' and vice versa.

(7) a. x criticized y for stealing z .

That is, (7a) asserts that x said that it was bad for y to steal z and presupposes that y was responsible for stealing z . (7a) might be given the corresponding analysis of (7b).

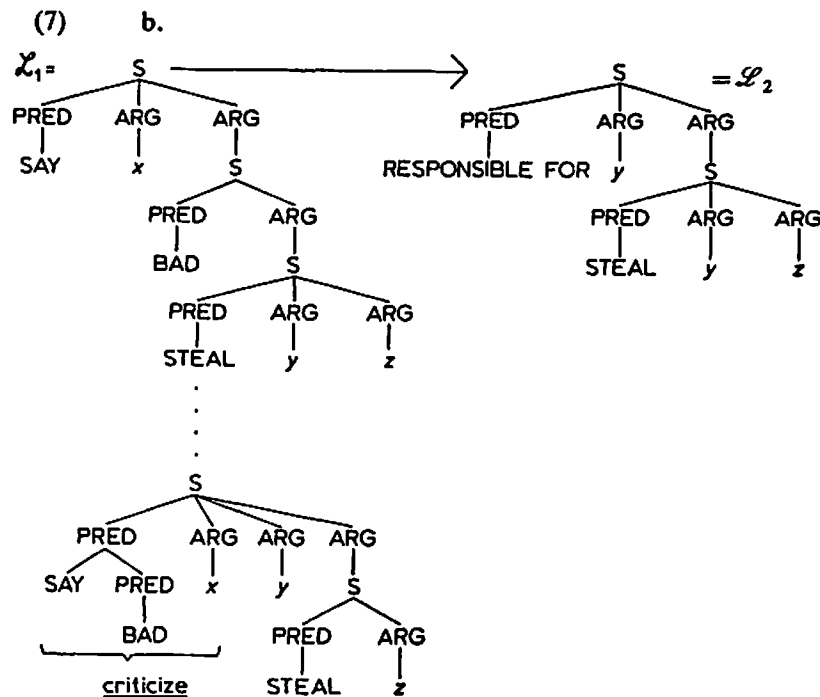

Similar analyses have been proposed by many others, including especially Binnick, Gruber, McCawley, and Postal.

Such proposals as the above make empirical claims as to the relationship between logical form and grammatical structure. These proposals seem especially appealing from the logical point of view, since they

obviate the necessity for stating certain axioms (and/or rules of inference) in natural logic to account for certain inferences. For example, from (5a), 'x persuaded y that y hit z', it follows that y came to believe that he hit z. Under an analysis such as (5b), no special axiom for 'persuade' is necessary. The independently needed axioms for 'CAUSE' will do the job. However, there is at least one other proposal under which this will also be true, which does not involve grammatical analyses like those given above. Before we consider this proposal, let us take up some preliminary considerations. Consider the question of whether the logical form of a sentence, as we have been considering that term, is a representation of the meaning of that sentence. Consider, for example, sentences of the form 'x requires y to do S_1 ' and 'x permits y to do S_1 '. Let us, for the sake of argument, consider these sentences as having the logical forms (8a) and (8b), respectively.

(8) a.

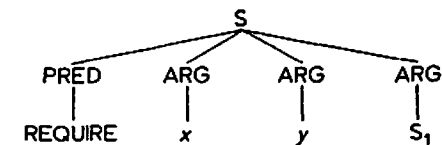

b.

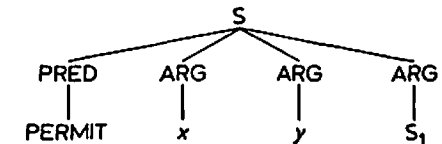

These logical forms differ only in the specification of the predicate. 'REQUIRE' and 'PERMIT' are to be understood not as words of English, but as symbols for certain atomic predicates. The symbols we have chosen happen to be English words in capital letters, but they could just as well have been a box and a diamond, or any other arbitrary symbols. Thus, in effect, both (8a) and (8b) have the same form, namely that of (8c),

(8) c.

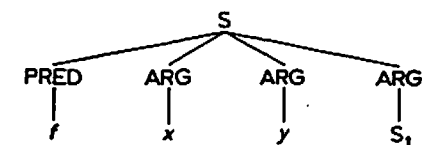

except that they contain different arbitrary symbols indicating atomic predicates.

Considering this, in what sense can we say that (8a) and (8b) reflect the different meanings of the sentences given above?

Note that (8a) and (8b) are not isolated cases. Any two sentences whose logical forms have the same geometry will raise the same questions. For example, consider sentences of the form 'It is certain that S_1 ' and 'It is possible that S_1 '. Let us assume that these sentences have logical forms like those of (9a) and (9b) respectively.

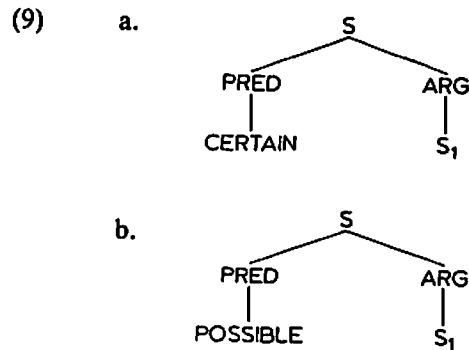

Both of these have basically the same form, namely that of (9c), except that they contain different arbitrary symbols indicating the atomic predicate of the sentence.

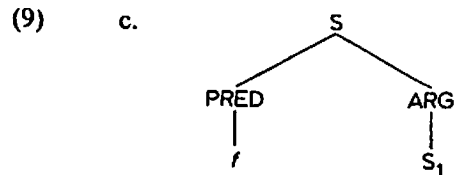

Again, how can we say that (9a) and (9b) represent different logical forms corresponding to different meanings?

It is clear that there is more to representing meanings than simply providing logical forms of sentences. In addition, we must provide certain axioms, or 'meaning-postulates', which indicate how certain atomic predicates are related to other atomic predicates. For example, we would want to include meaning-postulates like those in (10), but not like those in (11).

- (10) a. $\text{REQUIRE}(x, y, S_1) \supset \text{PERMIT}(x, y, S_1)$
 b. $\text{CERTAIN}(S_1) \supset \text{POSSIBLE}(S_1)$.
- (11) a. $*\text{PERMIT}(x, y, S_1) \supset \text{REQUIRE}(x, y, S_1)$
 b. $*\text{POSSIBLE}(S_1) \supset \text{CERTAIN}(S_1)$.

If something is required, then it is permitted, but not vice versa. And if something is certain, then it is possible, but not vice versa. Such axioms, or meaning postulates, together with the logical forms of the sentences and other appropriate logical apparatus will, hopefully, characterize a class of models in terms of which truth conditions for the sentences can be given. It is only in terms of such models that the logical forms of sentences can be said to represent meanings. Providing logical forms is only half of the job. At least as much work is involved in finding the right meaning-postulates, truth definitions, etc. Including analyses such as those in (4), (5), (6), and (7) as part of English grammar lessens the job of providing meaning-postulates. The question now arises as to whether there might not be a possible trade-off between the work done by rules of English grammar and the work done by meaning-postulates.

Suppose someone were to claim, for example, that the grammatical analyses of (4), (5), (6), and (7) were incorrect for English grammar, and that the paraphrase relations accounted for by such analyses could be done just as well by the use of meaning postulates. Instead of the grammatical analyses of (4) and (5), one might propose that 'persuade' in both cases be represented in logical form by atomic predicates (PERSUADE_1 and PERSUADE_2), and consequently that the verb 'persuade' was not decomposable in terms of English grammar. Instead, one might propose that the job done by the grammatical analyses of (4) and (5) could be done just as well or better by meaning-postulates like (12a) and (12b).

- (12) a. $\forall x, y, z (\text{PERSUADE}_1(x, y, z) \equiv \text{CAUSE}(x, (\text{COME ABOUT} (\text{BELIEVE}(y, z))))))$
 b. $\forall x, y, z (\text{PERSUADE}_2(x, y, z) \equiv \text{CAUSE}(x, (\text{COME ABOUT} (\text{INTEND}(y, z))))))$.

Similarly, one might say that the analyses given in (6) and (7) were not to be part of English grammar, but instead, that the work done by such analyses should be captured by meaning-postulates such as (13a) and (13b).

- (13) a. $\forall x, y, z(\text{ACCUSE}(x, y, z) \equiv \text{SAY}[x, (\text{RESPONSIBLE FOR}(y, z)/\text{BAD}(z))])$
 b. $\forall x, y, z(\text{CRITICIZE}(x, y, z) \equiv \text{SAY}[x, (\text{BAD}(z)/\text{RESPONSIBLE FOR}(y, z))])$.

In (13) the '/' represents the presupposition relation, as in dyadic modal logic.

The problem posed by such an alternative proposal is whether there is any empirical evidence favoring one proposal or the other. In other words, are there any empirical considerations which limit the role of meaning-postulates? It should be noted at the outset that there are certain immediate differences between these proposals. One of these is that rules of grammar may operate on structures containing either atomic predicates or lexical items with actual phonological shapes. Meaning-postulates on the other hand are defined only in terms of structures containing atomic predicates, variables, etc., but not lexical items with phonological shapes. (4f) thus differs in an important way from (12). In (4f), the complex predicate CAUSE – COME ABOUT – INTEND is represented by the phonological shape *persuade*. Similarly, the complex predicate CAUSE – COME ABOUT – BELIEVE is to be represented by the same phonological shape. In (12a) and (12b) however, we have atomic predicates PERSUADE₁ and PERSUADE₂. These are not to be confused with the single phonological form *persuade*. PERSUADE₁ and PERSUADE₂ are arbitrary symbols standing for atomic predicates; they are different symbols and have nothing whatever to do with each other. They are as different as '!' and '?'. Consequently, no regularities which can be stated only in terms of the phonological forms of lexical items can be stated by meaning-postulates, though it is possible that such regularities might be stated by rules of grammar. Another difference is that grammatical transformations are subject to certain constraints, such as Ross' constraints on movement transformations. There is no reason to believe that meaning-postulates should be subject to such constraints. Another difference is that under the meaning-postulate hypothesis there will be many more atomic predicates than under the lexical decomposition hypothesis. In fact, every lexical verb, will correspond to an atomic predicate. Since the stock of lexical verbs varies tremendously from language to language, the meaning-postulate hypothesis requires that the overwhelming proportion of meaning-

postulates will vary from language to language. Thus, there will not be a single natural logic for natural language in general, but rather a vastly different one for each different natural language.

Given such differences between the proposals, we can begin to consider what sorts of empirical evidence could confirm or disconfirm either of these proposals. Let us start with the observation that rules of grammar may describe regularities involving both atomic predicates and phonological forms, while meaning-postulates may state regularities involving atomic predicates but not phonological forms. Robert Binnick and Charles Fillmore, working independently, have noted certain regularities having to do with the lexical items 'come' and 'bring'. Consider (14).

- | | | |
|------|---|--|
| (14) | come | bring = CAUSE to <i>come</i> |
| | come about | bring about = CAUSE to <i>come</i> about |
| | come up (for discussion) | bring up = CAUSE to <i>come</i> up |
| | come to (awaken) | bring to = CAUSE to <i>come</i> to |
| | come together | bring together = CAUSE to <i>come</i> together |
| | come in (land, of an airplane) | bring in = CAUSE to <i>come</i> in |
| | come out (of a newspaper) | bring out = CAUSE to <i>come</i> out |
| | etc. | |
| | bring = CAUSE – to – <i>come</i> , where CAUSE is an atomic predicate and <i>come</i> is the phonological form corresponding to a lexical item. | |

The ordinary sense of 'come' is related to the ordinary sense of 'bring' by a predicate of direct causation, which, as in (14), we represent as CAUSE. In addition, there are many idiomatic expressions containing the phonological form *come*, whose corresponding causative has the phonological form *bring*. (14) contains an abbreviated list of such cases. Binnick (1969) lists many additional similar cases. There are also a number of cases in which the correspondence does not hold, for example, 'John came at me with an ax' does not have the corresponding '*Harry brought John at me with an ax'. There are several other cases where the correspondence fails. However, the overwhelming preponderance of such cases works as

in (14). There are enough of such cases to require that a rule be stated relating the cases with 'come' and the cases with 'bring' (though there will, of course, be exceptions to any such rule). In the lexical decomposition framework, the rule of predicate-lifting will create complex predicates such as 'CAUSE - come'. The regularity is that 'bring' substitutes for such a complex predicate.¹ Such an analysis is possible only under the lexical decomposition hypothesis. In the meaning-postulate hypothesis, no such regularity can be stated. The reason is that logical forms do not contain phonological shapes.² Thus the predicates 'BRING ABOUT', 'BRING UP', and 'BRING TO', will all be separate and distinct symbols for atomic predicates, having nothing whatever in common. Similarly 'COME ABOUT', 'COME UP', and 'COME TO', will also be symbols for atomic predicates having nothing whatever in common. Consequently, the regularity concerning their phonological shapes cannot be stated in terms of the meaning-postulate hypothesis. Hence, we have at least one case where a lexical decomposition of the sort we have discussed above is required on

- (15) a. LIQUEFY (x, y).
b.

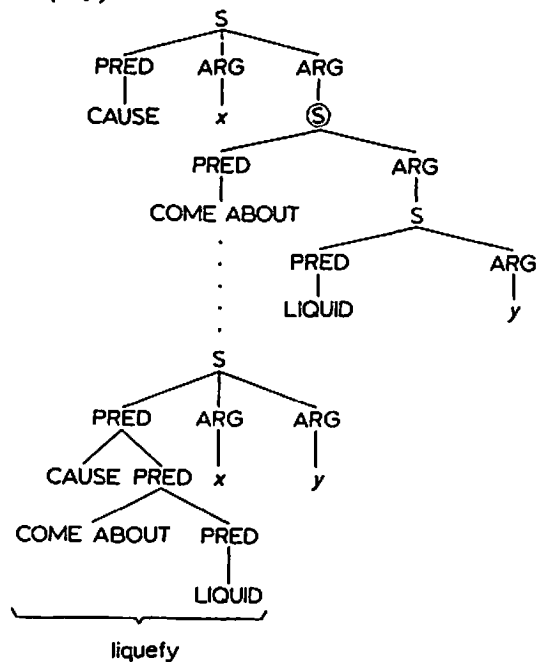

linguistic grounds. Otherwise a linguistic regularity would have to go unstated.

Another case providing confirmation of the lexical decomposition hypothesis is given in Lakoff (1968). Under the lexical decomposition hypothesis, sentences of the form (15a) receive an analysis like that in (15b). (15a) means that x caused y to liquefy, and 'y liquefied' means that y came to be liquid. If the transitive verb 'liquefy' is taken to be an atomic predicate in a logical form like (15a) then the intransitive sentence 'y liquefied' would not be represented as a subpart of (15a). However it would be represented as a sentence in (15b), as the encircled S in (15b) indicates.

Now consider (16a).

- (16) a. The metal liquefied, but it took me an hour to bring *it* about.
b. The chemist liquefied the metal in an hour, but it would have taken me a week to bring *it* about.

In (16a) the *it* takes as its antecedent the sentence 'the metal liquefied'. Now look at (16b). In (16b) the *it* is understood as taking as its antecedent not 'the chemist liquefied the metal', but, as before, 'the metal liquefied'. If the transitive verb 'liquefy' is represented in logical form as an atomic predicate, then there would be no antecedent for the 'it' in (16b). If, however, sentences with the transitive verb 'liquefy' are represented as in (15b), then the encircled S could serve as an antecedent for 'it' in (15b). For further arguments in favor of the lexical decomposition hypothesis on the basis of syntactic facts, see (Postal, 1970) and (Lakoff, in press).³

The fact that the meaning-postulate hypothesis provides for a great many more atomic predicates than the lexical decomposition hypothesis suggests another argument in favor of lexical decomposition. Consider sentences like (17a).

- (17) a. Sam kicked the door open.
b. Sam caused the door to come to be open, by kicking it.

(17a) essentially has the meaning of (17b). In (17b) 'kick' is used in its basic sense, that of striking with the foot. If (17a) is derived from a

grammatical structure like that suggested by (17b), then the same sense of 'kick' will appear in both sentences, and only one atomic predicate (or perhaps a complex one) will be required for 'kick'. However, if 'kick' in (17a) is taken to be undecomposable, as the meaning-postulate hypothesis would require, then one would need more than one atomic predicate corresponding to the verb 'kick'. The one needed for (17a) would be quite peculiar in that it would have to act as a sentential operator, that is, it would have to take a sentential complement as its object, as indicated in (18).

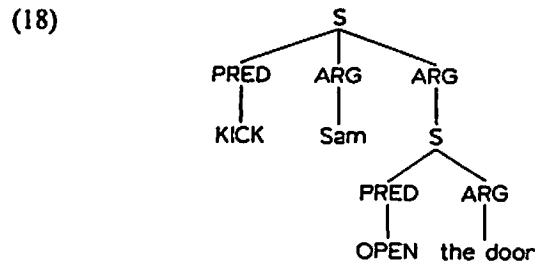

The same would be true of not only of 'kick', but also of verbs like 'scrub', 'beat', and many others.

- (19) a. Sam scrubbed the floor clean.
 b. Sam caused the floor to become clean, by scrubbing it.
- (20) a. Sam beat Harry into submission.
 b. Sam caused Harry to submit, by beating him.

(17a), (19a) and (20a) all show a regularity in their paraphrases. Sentences of the form (21a) have paraphrases of the form (21b).

- (21) a. Sam VERBEd *x* ADJ.
 b. Sam caused *x* to come to be ADJ, by VERB-ing *x*.

If sentences like (21a) are derived by grammatical transformation from structures underlying sentences of the form (21b), then verbs like 'kick', 'scrub', and 'beat', will not have to be represented as sentential operators in the *a* sentences, but can be given their simple senses, as in the *b* sentences. Only with the lexical decomposition hypothesis can we avoid the oddness of calling 'kick' in (17a) a sentential operator.

Moreover, since the relationship between sentences of the forms (21a

and b) is not regular, there is a further argument in favor of the lexical decomposition hypothesis. Under that hypothesis, the relationship between (21b) and (21a) will be given by transformational rules. Since grammatical rules can have lexical exceptions, such semi-productive relationships can be described by rules of grammar. However, the notion of a lexical exception makes no sense for meaning-postulates. There can be no semi-productive meaning-postulates.

Let us now consider the arguments from the point of view of constraints on transformational rules. According to the meaning-postulate hypothesis, the notion 'possible lexical item' is to be characterized in terms of possible meaning-postulates. Under the lexical decomposition hypothesis however, the notion 'possible lexical item' is to be characterized partially in terms of constraints on transformational rules. There is no reason to believe that constraints on transformational rules should be the same as constraints on meaning postulates. We know a good deal about constraints on transformational rules, and, so far as we can tell, they do in part determine the concept of a possible lexical item. Consider, for example, Ross's coordinate structure constraint. Ross's coordinate structure constraint, under the lexical decomposition hypothesis, makes certain predictions about possible lexical items. For example, it predicts that there cannot be a lexical item 'accusate' such that '*x* accused *y* that *S*₁' means that '*x* said that *S*₁ and that *y* was guilty'.

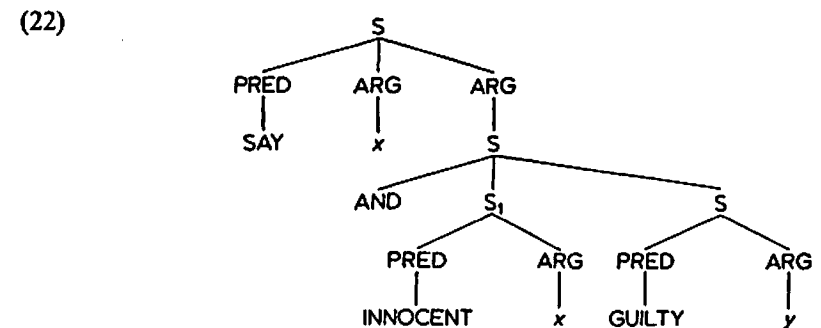

- (23) a. *x* accused *y* that *S*₁.
 b. *x* said that *S*₁ and that *y* was guilty.
- (24) a. *x* accused *y* that *x* was innocent.
 b. *x* said that *x* was innocent and that *y* was guilty.

Under the lexical decomposition hypothesis, this claim follows since the coordinate structure constraint will prevent 'GUILTY' in (22) from undergoing predicate-lifting up to 'SAY'. To my knowledge, there are no lexical items like 'accusate' in any language, and I think it is a fair guess to say that no natural language will ever turn up with one. This is a natural consequence of the lexical decomposition hypothesis. However, under the meaning-postulate hypothesis, it would be possible to have a meaning postulate like (25), which assigned such a meaning to 'accusate'.

- (25) $ACCUSATE(x, y, S_1) \equiv SAY(x, AND(INNOCENT(x)), GUILTY(y))$.

The only way to keep the meaning-postulate hypothesis from permitting such possible lexical items would be to impose something corresponding to Ross's coordinate structure constraint on meaning-postulates. Considerations of this sort also seem to lead to the correctness of the lexical decomposition hypothesis.

Referential opacity phenomena may also ultimately provide arguments in favor of the lexical decomposition hypothesis. For example, as Quine has pointed out, the verb 'look for' has an opaque object.

- (26) a. Oedipus is looking for his mother.
 b. Oedipus is looking for Jocasta.
 (27) a. Oedipus is trying to find his mother.
 b. Oedipus is trying to find Jocasta.

That is, sentences like (26a) are ambiguous, and may or may not mean the same thing as (26b), even granted that Jocasta is Oedipus's mother. Quine has attempted to explain this on the basis that (26a) is synonymous with (27a), where there is an embedded sentence, and which therefore, allows for an ambiguity in the scope of quantification. Any such explanation of opacity phenomena assumes the lexical decomposition hypothesis, that is, it assumes that 'look for' is not an atomic predicate in logical form. Though I currently believe that such an account is in the right direction, there are certain apparent difficulties. Consider (28) and (29).

- (28) a. Oedipus admires his mother.
 b. Oedipus admires Jocasta.

- (29) a. Oedipus hates his mother.
 b. Oedipus hates Jocasta.

(28a) can be true and (28b) false, even though I know that Jocasta is Oedipus's mother. The same is true of (29a) and (29b). Thus, both (28) and (29) display opacity phenomena, though it is not obvious that verbs like 'admire' and 'hate' can be paraphrased in terms of two independently needed atomic predicates. In other words, it is not clear that there are in natural language atomic predicates 'WURF' and 'GLIP' such that 'admire' means 'WURF-to-GLIP', and such that there are sentences like (30a and b) displaying the same difference in meaning as (28a and b).

- (30) a. Oedipus WURFS to GLIP his mother.
 b. Oedipus WURFS to GLIP Jocasta.

In an arbitrary system, one could always make up such predicates, but that is beside the point. The question here is an empirical one. Is there any evidence that such atomic predicates actually exist in the logical forms of sentences of a natural language? This does not necessarily mean that there must actually be in some language single lexical items directly corresponding to these predicates. However, it is required, at the very least, that such predicates appear elsewhere. For example, there might be a number of other verbs which can be decomposed in terms of one or the other of these predicates. And, presumably, there would be meaning-postulates relating these atomic predicates and others that we know to exist. However, at present, there is no reason to believe that atomic predicates 'WURF' and 'GLIP' exist in natural language. If they do not, then it might be difficult ultimately to use opacity evidence such as that given above to argue for the correctness of the lexical decomposition hypothesis. But more on this below.

I think it is clear that there are a range of cases where lexical decomposition is necessary. In addition, it is also clear that certain meaning-postulates are necessary, for example those in (10). The question is where to draw the line. The examples given above suggest certain guidelines. In the analyses offered above, certain atomic predicates kept recurring: CAUSE, COME ABOUT, SAY, GOOD, BAD, BELIEVE, INTEND, RESPONSIBLE FOR, etc. These are all sentential operators, that is, predicates that take sentential complements. It seems clear that we would want these, or predi-

cates like these, to function as atomic predicates in natural logic. Since these keep recurring in our analyses, it is quite possible that under the lexical decomposition hypothesis the list would end somewhere. That is, there would be only a finite number of atomic predicates in natural logic taking sentential complements. These would be universal, and so meaning-postulates would not vary from language to language. Moreover, verbs like 'kick' or 'scrub' in (17a) and (19a) would be ruled out as sentential operators, since they could be analyzed in terms of already existing sentential operators, as in (17b) and (19b). This seems to me to be an important claim. Kicking and scrubbing are two out of a potentially infinite number of human activities. Since the number of potential human activities and states is unlimited, natural logic will have to provide an open-ended number of atomic predicates corresponding to these states and activities. Hopefully, this can be limited to atomic predicates that do not take sentential complements. It is hard for me to visualize how one could construct a model for a logic with an unlimited number of sentential operators, and correspondingly an axiom system for such a logic. It seems to me that under the lexical decomposition hypothesis we have a fighting chance of limiting sentential operators to a finite number, fixed for all natural languages.

Moreover, it is possible that there may be empirical support for such a position coming from linguistics. Consider, for example, the possible derivational endings in natural languages. Certain languages have causative endings, others inchoative endings, others have endings meaning 'try', or 'want', etc. That is, to a certain extent, there is a correspondence between possible derivational endings and the finite number of sentential operators proposed under the version of the lexical decomposition hypothesis presented above. For example, there are languages with a causative derivational ending (let us use *-ga* for the sake of discussion) such that there would be a sentence of the form 'John open-*ga* the door', meaning 'John caused the door to open'; but to my knowledge there is no language containing a derivational ending *-ga* such that 'John open-*ga* the door' means 'John kicked the door open'. Under our hypothesis, this would follow from the fact that CAUSE is one of the finite number of sentential operators in natural logic, while KICK is not. Such a possible empirical confirmation of the above version of the lexical decomposition hypothesis certainly deserves further study.

One more thing: In Section VI we gave some examples of potential meaning postulates which, under Baker's conjecture, would not exist in natural logic. These were all cases where there was no dual for certain predicates, e.g., PROBABLE, CLAIM, and HOPE. At the same time, it was observed that three were lexical items corresponding to duals of other predicates, e.g., NECESSARY-POSSIBLE, etc. In order to make the claims of Chapter VI into an empirical hypothesis, we need to add at least one more constraint to the theory of lexical insertion. That is, we need to say that there are no lexical items of the structure of (31).

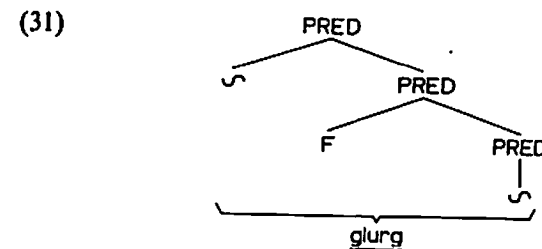

That is, there are no lexical items 'glurg' which mean 'not F not', for some atomic predicate F.⁴ That is, if there is a word for the dual of an atomic predicate, then that dual exists as an atomic predicate. Note that the converse is not required to be true. That is, natural logic may contain the dual of an atomic predicate, even though no existing natural language actually contains a word corresponding to that dual. However, the claim would be made that such a dual would be a possible lexical item in a possible natural language, if not an actual one. Facts like those given in Section VI might be used to determine whether or not such a dual existed, even though there were no actual word for it.

CONCLUSION I: There is more to meaning than logical form. Meaning-postulates, as well as other logical apparatus, are needed.

CONCLUSION II: There are empirical limits on the use of meaning-postulates. There are some cases where lexical decomposition is required on linguistic grounds.

HYPOTHESIS: Natural language employs a relatively small finite number of atomic predicates that take sentential complements (sentential operators). These do not vary from language to language. They are related to each other by meaning-postulates that do not vary from language to language.

VIII. MEANING-POSTULATES, POSSIBLE WORLDS,
AND PRONOMINAL REFERENCE

As we saw above, natural logic will require certain meaning-postulates and theorems and will rule out certain others, as indicated in (1) and (2).¹

- (1) a. CERTAIN(S) \supset POSSIBLE(S)
b. *POSSIBLE(S) \supset CERTAIN(S).
(2) a. REQUIRE(x, y, S) \supset PERMIT(x, y, S)
b. *PERMIT(x, y, S) \supset REQUIRE(x, y, S).

If something is certain, then it's possible, but not vice versa.^{1a} And if x requires y to do something, then x permits y to do it, but not vice versa. And as (3) shows, POSSIBLE and CERTAIN are duals, as are PERMIT and REQUIRE.

- (3) a. POSSIBLE(S) $\equiv \sim$ CERTAIN(\sim S)
b. PERMIT(x, y, S) $\equiv \sim$ REQUIRE(x, y, \sim S).

For any natural logic containing these concepts, truth conditions will be required. One way of providing truth conditions for such cases is to employ a model containing possible worlds and alternativeness relations holding between worlds. For each dual pair there will be one alternativeness relation. Let R_1 be the alternativeness relation corresponding to CERTAIN and POSSIBLE. Then we can define truth conditions for CERTAIN(S) and POSSIBLE(S) as in (4).

- (4) a. CERTAIN(S) is true in $w_0 \leftrightarrow (\forall w) (w_0 R_1 w \supset S \text{ is true in } w)$
b. POSSIBLE(S) is true in $w_0 \leftrightarrow (\exists w) (w_0 R_1 w \supset S \text{ is true in } w)$.

For cases like REQUIRE and PERMIT we will need an alternativeness relation for each different pair of subject and indirect object. For the sake of discussion, let us fix the subject and indirect object for REQUIRE and PERMIT and call the corresponding alternativeness relation R_2 .² Then we can state truth conditions as in (5).

- (5) a. REQUIRE(a, b, S) is true $\leftrightarrow (\forall w) (w_0 R_2 w \supset S \text{ is true in } w)$
b. PERMIT(a, b, S) is true $\leftrightarrow (\exists w) (w_0 R_2 w \supset S \text{ is true in } w)$.

Thus, a sentence of the form ' a requires b to do S ' is true just in case S is true in all worlds related to the actual world by R_2 . In this way, we can

assign truth conditions for the entire sentence based on the truth conditions for its parts. Moreover, the nature of the alternativeness relation (that is, whether it is transitive, reflexive, symmetric, or whatever) will depend upon what meaning-postulates there are for the corresponding operators. In other words, the meaning-postulates will determine which worlds are related to which other worlds.

A priori, one might think that such considerations would have nothing whatever to do with linguistics. But as it turns out, such matters are crucially important for the solution of certain very deep and difficult linguistic problems. Baker (1966) raised the problem of when a pronoun can refer back to an unspecified noun phrase. For example, he noted that while 'John wants to catch *a fish* and he wants to eat *it*' is grammatical, '*John wants to catch *a fish* and he will eat *it*' is not.^{2a} Karttunen (1968) suggested that some notion of 'discourse referent' would be necessary for such problems. Although he did not come close to solving the problem, he did point out a great number of interesting examples, upon which a good deal of the following is based. Consider (6).

- (6) a. It's certain that Sam will find *a girl* and possible that he will kiss *her*.
b. *It's possible that Sam will find *a girl* and certain that he will kiss *her*.³

In (6a), 'a girl' can be the antecedent of 'her', but not in (6b). If one compares (6) with (1), one finds a correspondence. Somehow, the grammaticality of (6a) corresponds to the valid meaning-postulate of (1a), while the ungrammaticality of (6b) corresponds to the invalid meaning-postulate of (1b). Looking at the possible world model, it becomes clear why. The truth conditions for 'It's certain that Sam will find a girl' say that that sentence is true just in case Sam finds a girl in every possible world related to by R_1 to w_0 , which we might take to be the actual world. If 'Sam finds a girl' is true in a world, then there must exist in that world a girl that Sam found. And because of the truth conditions for CERTAIN, that girl will exist in every world w related by R_1 to w_0 , the actual world. Now consider the truth conditions for 'It is possible that he will kiss her'. That will be true just in case 'he kisses her' is true in some possible world w related to w_0 by R_1 . Since we already know that there will be an appropriate girl in every world, w , we are guaranteed that a referent for 'her'

exists in each world w , and that in each world the pronoun will have an antecedent.

In (6b), however, this is not the case. The truth conditions for 'It's possible that Sam will find a girl' say that there will exist *some* world w related by R_1 to w_0 in which 'Sam finds a girl' is true. Thus, there will be some world in which such a girl exists, though it is not guaranteed that such a girl will exist in all worlds w related by R_1 to w_0 . Now if one considers the truth conditions for 'It is certain that he will kiss her' we see that in order for that to be true 'He kisses her' will have to be true in *all* worlds w related to w_0 by R_1 , and so a referent for 'her' will have to exist in all worlds w . Since the pronoun must have an antecedent, the referent of the antecedent must also exist in all w .

However, we have just seen that that is not the case. We cannot guarantee that the referent of the antecedent will be in all the worlds containing the referent for the pronoun. In just this case, the pronoun-antecedent relation is blocked, and ungrammaticality results. (7) is a similar case.

- (7) a. It is possible that Sam will kiss the girl that it is certain that he will find.
 b. *It is certain that Sam will kiss the girl that it is possible that he will find.

The general principle, I think, is clear.

- (8) The antecedent must have a referent in all the worlds in which the anaphoric noun phrase (or pronoun) has a referent.

(8) will work for cases like (6). (7) appears to be slightly different. However, if one recalls that restrictive relative clauses are always presupposed, then it becomes clear that the head noun phrase of the relative clause, 'the girl' in (7a) is acting as an anaphoric noun phrase. This can be seen clearly in (7'), where the phenomena of (6) and (7) are combined.⁴

- (7') a. It is certain that Sam will find a girl and it is possible that he will kiss the girl that it is certain that he will find.
 b. *It is possible that Sam will find a girl and it is certain Sam will kiss the girl that it is possible that he will find.

Given an appropriate analysis of relative clauses, principle (8) should do the job.

So far we have seen cases where possible pronoun-antecedent relations are determined by the meaning-postulates of (1). Let us now turn to the meaning-postulates of (2).

- (9) a. You are permitted to kiss the girl you are required to find.
 b. *You are required to kiss the girl you are permitted to find.
 (9') a. You are required to find a girl and permitted to kiss the girl you are required to find.
 b. *You are permitted to find a girl and you are required to kiss the girl you are permitted to find.
 (10) a. You are required to find *a girl* and permitted to kiss *her*.
 b. *You are permitted to find *a girl* and required to kiss *her*.⁵

These cases are parallel to the sentences cited above. Consider (10a). The truth definition for REQUIRE and PERMIT and the postulate of (2a) guarantee that the worlds in which the things you are required to do are true will be a subset of the set of worlds in which the set of things you are permitted to do are true, but not vice versa. Thus, in (10a) every world in which 'her' has a referent will also be a world in which 'a girl' has a referent, and therefore 'a girl' may be an antecedent for 'her' in (10a) by principle (8). This is not the case in (10b) however, because, given the truth definitions in (2), 'her' in (10b) may have reference in worlds related by R_2 to w_0 in which 'a girl' has no referent. Thus (10b) will violate condition (8). (9) and (9') work the same way.

Now consider (11).

- (11) a. CERTAIN(S) \supset S
 b. *POSSIBLE(S) \supset S
 c. (*REQUIRE(a, b, S)) \supset S.

It is not unreasonable to assume that (11a) will be a postulate of natural logic, while (11b) will not. (11c) will not be a postulate of natural logic, although for a fixed a and b , an assumption of this form may be made in certain instances by certain speakers. For example, a speaker may assume that b will do everything that a requires him to do. Now consider (12).

- (12) a. It is certain that Sam will find *a girl*, and he will kiss *her*.
 b. *It is possible that Sam will find *a girl* and he will kiss *her*.
 c. (*S) Sam is required to find *a girl* and he'll kiss *her*.

Given out truth definitions and principle (8), the grammaticality of (12a) will follow from the postulate of (11a). Correspondingly, the lack of grammaticality of (12b) will follow from the lack of validity of (11b). Whether or not (12c) will be considered grammatical, will depend on whether or not it is assumed that in this instance, Sam will do what he is required to do.

- (13) a. Sam will kiss the girl who it is certain that he'll find.
 b. *Sam will kiss the girl who it is possible that he'll find.
 c. (*)Sam will kiss the girl who he is required to find.

The facts of (13) follow accordingly.

So far, we have considered only postulates and theorems in which modal operators are not mixed. Now let us turn to cases in which they are mixed.

- (14) INTEND(x , S) \supset BELIEVE(x , (POSSIBLE(S))).

(14) appears to be a good candidate for a theorem, if not a postulate of natural logic. Let us assume that truth definitions for INTEND and BELIEVE are given as in (14'), using alternativeness relations R_1 and R_b respectively.⁶

- (14') a. INTEND(a , S) is true \leftrightarrow ($\forall w$) ($w_0 R_1 w \supset$ S is true in w)
 b. BELIEVE(a , S) is true \leftrightarrow ($\forall w$) ($w_0 R_b w \supset$ S is true in w).

Given (14), (14') and other obvious postulates involving INTEND and BELIEVE, principle (8) will then account for the grammaticality of the sentences in (15).

- (15) a. Sam intends to find *a girl* and he believes that it's possible that he'll kiss *her*.
 b. Sam believes that it's possible that he'll kiss the girl he intends to find.

Given the fact that (16) will be neither a postulate nor a theorem of natural logic,

- (16) *BELIEVE(x , POSSIBLE(S)) \supset INTEND(x , S)

it follows from principle (8) that sentences of (17) will be ungrammatical.

- (17) a. *Sam believes that it's possible that he'll find *a girl* and he intends to kiss *her*.

- b. *Sam intends to kiss the girl he believes it's possible that he'll find.

Incidentally, the effect of (14) can be captured by placing the following restriction on the alternativeness relations of R_1 , R_b , and R_1 :

- (18) ($\forall w$) [$w_0 R_1 w_2 \supset$ ($\exists w_1$) ($w_0 R_b w_1$ & $w_1 R_1 w_2$)].

Postulates like (14) give the meanings of certain concepts such as INTEND in terms of the meaning of other concepts such as BELIEVE and POSSIBLE. This raises certain interesting questions. For example, are there any modal concepts whose meaning is not defined in terms of other modal concepts. Let us call such concepts if they exist 'primitive concepts'.

- (19) F is a *primitive concept* if and only if natural logic contains no meaning-postulates of the form 'F(S) \supset ϕ ', where ϕ contains modal operators which are not identical to the dual of F.

In natural logic, it is an empirical question as to whether primitive concepts exist. Moreover, it is conceivable that there is a hierarchy of concepts, defined by (20).

- (20) F is *more primitive than* G if and only if there are meaning-postulates (or theorems) of the form 'G(S) \supset ϕ ', where ϕ contains F, but there are no meaning-postulates (nor theorems) of the form 'F(S) \supset ϕ ', where ϕ contains G.

A priori, we cannot tell whether natural logic will contain a hierarchy such as that defined by (20). Again, it is an empirical question. If natural logic contains primitive concepts and a concept hierarchy, what does this say about the nature of the human mind? Would such primitive concepts also be psychologically primitive in some significant sense? Would there be a corresponding psychological hierarchy in some significant sense of the term? One could also imagine that there might be linguistic correlates of such notions. For instance, would every natural language contain words or morphemes corresponding directly to the primitive concepts? Would it be the case in every natural language that if it contained a word for a concept at some point on the hierarchy it would contain words for all concepts higher on the hierarchy? It seems to me that these are questions worth investigating.

Another question raised by natural logic concerns the notion of a 'natural semantic class'. The truth conditions for modal operators taken together with the postulates and theorems which mention those operators may be considered as defining natural semantic classes containing those operators. Postulates or theorems of a certain form may impose certain linguistically significant semantic classifications. Correspondingly, truth conditions of a certain form may also impose linguistically significant semantic classifications.

- (21) a. $\Box(S_1 \supset S_2) \supset (\Box S_1 \supset \Box S_2)$
 b. $\Box S \supset S$
 c. $\Box S \supset \Diamond S$
 d. $\Box S \supset \Box \Box S$
 e. $\Box \Box S \supset \Box S$
 f. $S \supset \Box \Diamond S$
 g. $\Diamond S \supset \Box \Diamond S$.

- (22) a. $\Box S$ is true in $w_0 \leftrightarrow (\forall w) (w_0 R w \supset S$ is true in $w)$
 b. $\Diamond S$ is true in $w_0 \leftrightarrow (\exists w) (w_0 R w \supset S$ is true in $w)$.

(21) shows a number of the possible shapes of postulates and theorems. The box, \Box , represents an arbitrary modal operator and the diamond, \Diamond , represents its dual. Postulates or theorems of these forms will be true of various different modal operators. Moreover, various modal operators will have truth conditions of the form shown in (22), for different alternativeness relations R . Thus, as a first approximation, we can consider the definition of 'linguistically significant semantic class' as given in (23).

- (23) Two modal operators, \Box_1 , and \Box_2 , will be said to be in the same 'linguistically significant semantic class' if some postulate or theorem listed in (21) is true of both \Box_1 and \Box_2 , or if they have truth conditions of the same form.

(23) is just an approximation to this notion. For example, I have taken statements of the forms given in (21) as the only significant ones for defining linguistically significant semantic classes, though there is no question in my mind that the list given in (21) is incomplete or incorrect in certain respects. Moreover, I have only considered truth conditions of the form given in (22), though again I do not doubt that truth condi-

tions of other forms will be significant. Furthermore, (23) is an if-statement, not an if-and-only-if-statement. However, it may be the case that with the right list of postulates and theorems and with the right list of truth definition forms, (23) can be strengthened to be an if-and-only-if condition.

Let us take an example of how the truth conditions of (22) and the postulates and theorems of (21) can be said to impose a linguistically significant semantic classification. Consider (24) and (25).

- (24) a. Sam may leave.
 b. It is possible that Sam will leave.
 c. It is permitted for Sam to leave.
- (25) a. Sam may leave.
 b. It is possible for Sam to leave.
 c. It is required that Sam leave.

First consider (24). (24a) may have the meaning either of (24b) or (24c). That is, the lexical item 'may' can have the meaning of either 'possible' or 'permitted'. As (4b) and (5b) above show, POSSIBLE and PERMIT have truth conditions of the same form, namely, that of (22b). In addition, they share certain postulates and theorems of the same form. Consider (26).

- (26) a'. $(\Diamond S_1 \supset \Diamond S_2) \supset \Diamond(S_1 \supset S_2)$
 c. $\Box S \supset \Diamond S$
 e'. $\Diamond S \supset \Diamond \Diamond S$.

(26a') is deducible from the dual of (21a) above given (21c), (26c) is identical to (26c) above, and (26e') is the dual of (26e) above. Now consider (27) and (28), which seem to be valid.

- (27) a'. $(\text{POSSIBLE}(S_1) \supset \text{POSSIBLE}(S_2)) \supset \text{POSSIBLE}(S_1 \supset S_2)$
 c. $\text{CERTAIN}(S) \supset \text{POSSIBLE}(S)$
 e'. $\text{POSSIBLE}(S) \supset \text{POSSIBLE}(\text{POSSIBLE}(S))$
- (28) a'. $(\text{PERMIT}(a, b, S_1) \supset \text{PERMIT}(a, b, S_2)) \supset \text{PERMIT}(a, b, (S_1 \supset S_2))$
 c. $\text{REQUIRE}(a, b, S_1) \supset \text{PERMIT}(a, b, S_1)$
 e'. $\text{PERMIT}(a, b, S) \supset \text{PERMIT}(a, b, (\text{PERMIT}(a, b, S)))$.

(27) and (28) show that POSSIBLE and PERMIT share at least three postulates and theorems of the same form, namely, those of the forms given in (26). Robin Lakoff, observing these facts, raised the question of whether it was an accident that the two concepts of possibility and permission could be expressed by the same word 'may'. She suggested that it was no accident. One would like to be able to say that such cases are possible only if the concepts involved, in this case possibility and permission, are in the same linguistically significant semantic class. According to the definition of semantic classes given in (23), the concepts of permission and possibility would be in the intersection of at least four linguistically significant semantic classes. That is to say, their meanings have great deal in common. Thus, as R. Lakoff has suggested, a single lexical item may be used to represent two concepts only if those concepts are in the same semantic class. Moreover, one might add, the more of such classes two concepts are in, the more natural it is for the same lexical item to represent those concepts. Note that this makes a rather interesting claim. Namely, that there will be no natural language in which the same lexical item will represent the two concepts of permission and certainty, or the two concepts of requirement and possibility. That is, it is no accident that while (24b and c) above may be represented as the same sentences, (24a), (25b and c) above may not be represented as the same sentence, (25a).⁷

To consider another example, somewhat less formally, the logic of time and the logic of place will have a great deal in common. The logic of time will involve a linear dimension, while the logic of place will involve three linear dimensions. Notions such as 'later than' and 'farther from' will both be irreflexive, asymmetric and transitive. In both cases, there will be an axiom of density. Just as there will be a postulate saying that if S is always true, then S is sometimes true, there will be a postulate saying that if S is true everywhere, then S is true somewhere. And so on. The logic of time and the logic of place will have many postulates in common. Correspondingly, it is not surprising that the same grammatical constructions are very often used for both. Consider the prepositions 'at', 'within', 'up to', 'around', etc. These prepositions can be used to represent corresponding spacial and temporal concepts. By principle (23), this is to be expected, since such concepts will fall into natural classes due to the similarity of spacial and temporal postulates.

IX. MISCELLANEOUS TOPICS

A. Manner Adverbs

It has been proposed by Reichenbach and, more recently by Parsons, that adverbs of manner such as 'carefully' are operators that map a predicate into another predicate.

(1) Sam sliced the salami carefully.

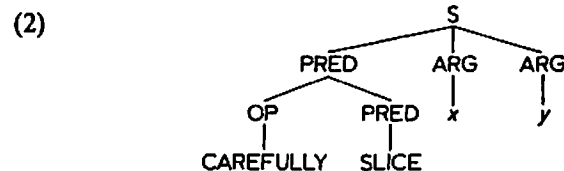

Thus (1) would, under such a scheme, be represented as (2). In Lakoff (1965) it was suggested that sentences like (1) are to be derived transformationally from structures like that underlying (3).

(3) Sam was careful in slicing the salami.

That is, it was claimed that 'carefully' was not an underlying adverb, but rather a transitive adjective, as in (3), or in other words, a two-place predicate relating an agent and an action. This might be represented roughly as in (4).

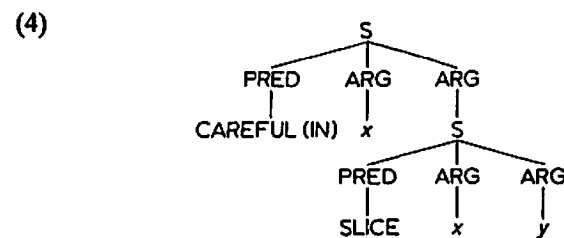

Thus we might ask whether the logical form of sentences like (1) should be more like (2) or like (4). What sort of empirical evidence bears upon an issue of this kind?

As we noted in Section IV, there is a difference in meaning between (5a) and (5b).

- (5) a. Every boy likes some girl.
 b. Some girl is liked by every boy.
- (6) a. $\forall x(\exists y(\text{LIKE}(x, y)))$
 b. $\exists y(\forall x(\text{LIKE}(x, y)))$.

(5a) has a logical form like (6a), while (5b) has a logical form like (6b). As we noted above, there is a regularity in these cases, at least in my speech. When two quantifiers are in the same surface structure clause, the leftmost one is understood as having wider scope. As it turns out, this principle is not simply limited to quantifiers, but also works with adverbs, and with adverbs mixed with quantifiers.¹ Consider, for example, the difference between (7a) and (7b).

- (7) a. Sam sliced all the bagels carefully.
 b. Sam carefully sliced all the bagels.

Here 'all' and 'carefully' appear in the same surface structure clause. As in (5), the leftmost of these elements is understood as having wider scope.² Thus, if we assume that sentences with 'carefully' such as (1) have a logical

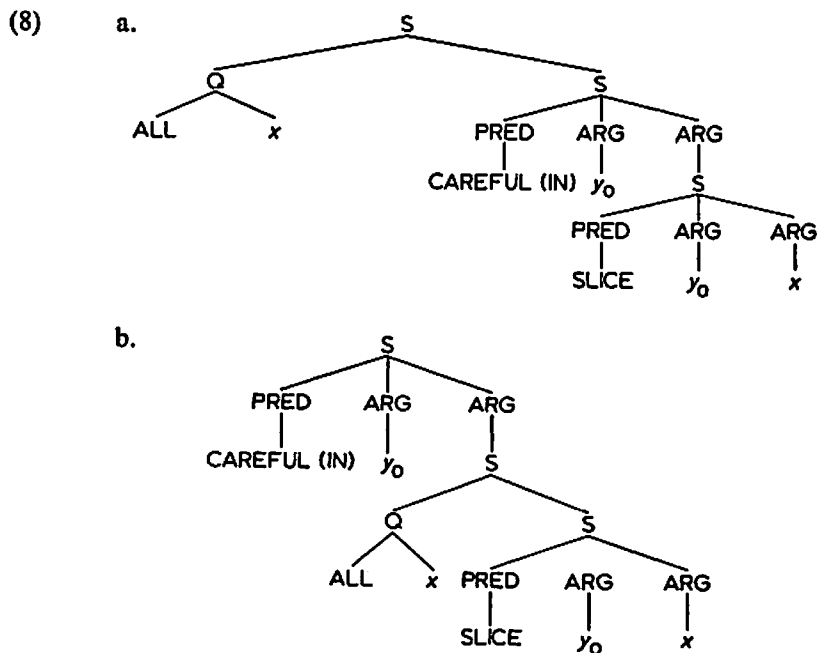

form such as (4) above, then we can state the difference between the logical forms of (7a) and (7b) as (8a) and (8b).

If, on the other hand, we assume that (1) has a logical form like (2), then there is no apparent way to provide a logical form which shows the distinction between (7a) and (7b). We conclude from this that manner adverbs such as 'carefully' are not to be represented in logical form as operators mapping predicates into predicates, but rather as sentential operators, that is, predicates taking sentential complements.

B. Absolutely

Consider the two occurrences of 'anyone' in (1a) and (1b).

- (1) a. Anyone can cook Peking duck.
 b. Sam didn't see anyone.

It is generally acknowledged that the "anyone" in (1a) is an instance of a universal quantifier, as in (2).

- (2) $\forall x(x \text{ can cook Peking duck})$.

Many linguists have assumed, on the other hand, that the 'anyone' in (1b) is a variant of 'someone', which occurs in certain contexts, for example, in the presence of the negative, as in (1b). However, Quine has suggested that both occurrences of 'anyone' are instances of universal quantifiers and that there is a constraint on 'anyone' to the effect that it always takes the widest scope it can. According to Quine's proposal, (1b) should be represented as (3a), whereas according to other proposals (1b) should be represented as (3b).

- (3) a. $\forall x(\sim(\text{Sam saw } x))$
 b. $\sim(\exists x(\text{Sam saw } x))$.

Since (3a) and (3b) are logically equivalent, it doesn't make much difference from the viewpoint of logic alone, and one could decide the matter arbitrarily. But if one were considering how such sentences were to be represented, not in terms of first-order predicate calculus, but in terms of a natural logic, which involves empirical linguistic considerations, the question would become an empirical one. Is there a right way and a wrong way to represent (1b)? In fact, would one want both universal and existential quantifiers as primitives in natural logic, or could

one get away with one of these, and if so, which one? Let us consider one sort of argument that might bear on such questions.

Quine has argued that treating (1b) as having the form of (3a) rather than (3b) would make for a uniform treatment of 'any'. However, there is some syntactic evidence which goes counter to Quine's proposal. This depends on certain properties of the word 'absolutely', which were first uncovered by Östen Dahl (1970) and investigated more thoroughly by Robin Lakoff. Consider (4). As (4a) shows, 'absolutely' can modify a universal quantifier. But 'absolutely' cannot modify an existential quantifier, as (4b) shows, though it can modify a negative existential, as (4c) shows.

- (4) a. Sam hates absolutely everyone.
 b. *Sam hates absolutely someone.
 c. Sam hates absolutely no one.

As Robin Lakoff has observed, application of this test to the sentences of (1) shows that 'absolutely' can modify 'anyone' in (1a), but not in (1b).

- (5) a. Absolutely anyone can cook Peking duck.
 b. *Sam didn't see absolutely anyone.

If it correct that 'absolutely' goes with universal but not existential quantifiers, that would indicate that (1b) should be given a logical form like (3b) with an existential quantifier, rather than one like (3a) with a universal quantifier. This conclusion is further substantiated by the fact that other occurrences of 'anyone', as in (6a and b), may not take 'absolutely'.

- (6) a. *Did absolutely anyone leave?
 b. *If absolutely anyone leaves, Sam will commit suicide.

The constraints on 'absolutely' have even more interesting consequences. Dahl noticed that they were not restricted to constraints on quantifiers, and pointed out cases like (7), (8), and (9).

- (7) a. That is absolutely necessary.
 b. *That is absolutely possible.
 (8) a. That is absolutely required.
 b. *That is absolutely permitted.
 (9) a. You absolutely must go.
 b. *You absolutely may go.

Dahl made the extremely interesting proposal that the facts of (7) through (9) followed from the constraints involving quantifiers, since in a possible world semantics, the *a* sentences would be statements about *all* alternative worlds, while the *b* sentences would be statements about *some* possible alternative worlds. 'Absolutely' would go with universal quantification over possible alternative worlds, but not with existential quantification. Under this fascinating proposal, facts about grammaticality of English sentences would follow from facts about the truth conditions for such sentences in a possible world semantics.

Unfortunately a damper, at least a tentative one, has been thrown on this alluring proposal by some further facts uncovered by Robin Lakoff. As (10) shows, the negatives of the above *b* sentences may also take 'absolutely'.

- (10) a. That is absolutely impossible.
 b. That is absolutely not permitted.
 c. You absolutely may not go.

This is entirely in line with what happens in quantification, as (4c) shows. However, there are a number of cases where 'absolutely' can occur and which seem essentially to be of the same sort as the above cases, but which involve neither universal quantifiers nor negative existentials, nor predicates that can be understood (at least not in any obvious way) in terms of a possible world semantics. Consider (11) through (13).

- (11) a. That is absolutely fascinating.
 b. *That is absolutely interesting.
 c. That is absolutely uninteresting.
 (12) a. I absolutely love snails.
 b. *I absolutely like snails.
 c. I absolutely loathe snails.
 (13) a. That's absolutely wonderful.
 b. *That's absolutely good.
 c. That's absolutely terrible.

Each of these cases seems to involve some sort of scale. In (11) it is a scale of interest running from the uninteresting through the relatively and very interesting up to the fascinating. 'Uninteresting' and 'fascinating' seem to represent end-points (or at least distant parts) of the scale. It is

these that can be modified by 'absolutely'. Similarly (12) and (13) seem to involve scales of fondness and goodness respectively. However, there seems to be no obvious way in which one can associate the *a* sentences with universal quantifiers, the *b* sentences with existentials, and the *c* sentences with negative existentials, though that is what would be required in order to reduce these cases to the quantifier cases. In the absence of such an analysis, R. Lakoff has suggested that the restrictions on 'absolutely' are to be understood in terms of such scales, and restricted so that they go with the extremes on such scales. She suggests moreover that quantifiers are really special cases of such scalar predicates, and that 'all' and 'none' can also be understood as end-points on a scale. What follows from this is that quantifiers must be cross-classified with predicates (that is, adjectives and verbs). This suggests that they are in the same category as adjectives and verbs, in other words, that quantifiers are predicates. This might be taken as more support for the claim to that effect, as made in Lakoff (1965), Carden (1968) and (1970), and McCawley (1970). On the other hand, it may be the case that predicates on these scales are not to be represented in logical form as atomic predicates, but are rather to be decomposed into quantifier expressions which range over a scale and an atomic predicate which defines the scale. If the latter analysis is correct, we would expect to find scope differences involving the understood quantifiers that range over such scales. However, there is no known evidence for such an analysis.¹

Incidentally, there are cases where a word may be understood either literally or figuratively, and the possibilities for the occurrence of 'absolutely' or 'absolute' will depend not on the occurrence of the word itself but on whether either of its meanings is understood as the end point on some scale. Consider for example (14) through (17).

- (14) a. Sam is an absolute elephant.
b. *Sam is an absolute wombat.
- (15) a. Sadie is running an absolute whorehouse.
b. *Sadie is running an absolute apartment house.
- (16) a. Moe is an absolute bastard.
b. *Moe is an absolute illegitimate child.

'Elephant' can be taken in its literal sense, in which case (14a) is meaningless. It would be absurd to assert (14a) of an elephant named Sam. (14a)

said of a person named Sam, means that he is enormous. That is because we have come to associate elephants with what is, from the point of view of our culture, their most outstanding property, their size. (14b) is strange, because it cannot be taken literally and because, in our culture (or at least in my subculture), wombats are not viewed as having any special defining property. In a culture where, say, wombats represented the quintessence of smelliness, (14b) would be perfectly fine. Thus our ability to understand sentences like those in (14) depend in part on our cultural assumptions. (15) and (16) are similar cases. (15a) is not understood literally. It is not the sort of thing you would say of a madame. It might be the sort of thing you would say figuratively if Sadie had a number of promiscuous daughters. (15b) is strange because in our culture there is no way of understanding it figuratively, though perhaps those with different cultural assumptions or wilder imaginations may find (15b) perfectly fine. (16) works in the same way.

C. Presuppositions and Propositional Functions

An *n*-place propositional function is a function mapping a sequence of *n* individuals into a proposition. In some instances two or more of the individuals may be coreferential. (1) and (2) below are two common ways of representing propositional functions.

- (1) $f(x, y, x)$.
(2) $f(\underbrace{\quad, \quad, \quad})$.

Propositions may be formed from (1) and (2)¹ either by substituting individual constants for the variables in (1) or the slots in (2), or by binding the variables or the slots by quantifiers. In (1), coreference is indicated by the use of the same variable letter, *x*. This indicates that the first and third places refer to the same individual. In the notation used in (2), this is indicated by drawing a line between the first and third places. It should be noted that, although the '*f*' in (1) and (2) may be an atomic predicate, it need not be. For example, (1) or (2) may be a representation of an extremely complex sentence, as in (3).

- (3) x 's sister thought that the man who kicked *y* was disturbed by the fact that *x* was rich.

In terms of tree structures, we will consider (1) to be an abbreviation for

any complex sentence containing three arguments, the first and third of which are coreferential, as indicated in (4).

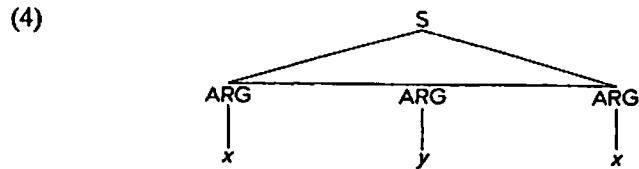

It should be noted that the indication of coreference, whether a specification of identical variable letters or a line between the slots, is considered an integral part of a propositional function. Thus, (5) through (9) below all represent different propositional functions.

- (5) $f(x, y, z)$ $f(\underline{\quad}, \underline{\quad}, \underline{\quad})$
 (6) $f(x, x, z)$ $f(\underline{\quad}, \underline{\quad}, \underline{\quad})$
 (7) $f(x, y, y)$ $f(\underline{\quad}, \underline{\quad}, \underline{\quad})$
 (8) $f(x, y, x)$ $f(\underline{\quad}, \underline{\quad}, \underline{\quad})$
 (9) $f(x, x, x)$ $f(\underline{\quad}, \underline{\quad}, \underline{\quad})$

Let us now consider some facts concerning the word 'before'. Consider (10).

- (10) a. Before Sue punched anyone, she was miserable.
 b. Before Sue punches anyone, she'll get drunk.

(10a) presupposes that Sue punched someone, and (10b) presupposes that Sue will punch someone. In sentences of this sort, the content of the before-clause is presupposed, as in (11a).

- (11) a. $\text{BEFORE}(S_1, S_2) \rightarrow S_1$
 b. $S_1 = (\exists x) (\text{PUNCH}(\text{Sue}, x))$.

Note that in (10a and b), S_1 is understood as being a sentence containing an existential quantifier binding a propositional function.

Under somewhat different conditions, which aren't completely understood, before-constructions presuppose the negative of the content of the before-clause. Consider (12).

- (12) a. Before Sue punched anyone, she left the party.
 b. Before Sue punches anyone, she'll fall asleep.

(12a) presupposes that Sue didn't punch anyone and (12b) presupposes that she won't punch anyone. We can represent this as in (13a).

- (13) a. $\text{BEFORE}(S_1, S_2) \rightarrow \sim S_1$ (under certain conditions)
 b. $S_1 = (\exists x) (\text{PUNCH}(\text{Sue}, x))$.

Again, S_1 is understood as containing an existential quantifier binding a propositional function. Note that (11a) and (13a) both involve identity conditions. The S_1 which is the first argument of BEFORE must be identical to the S_1 which is presupposed in (11) and whose negation is presupposed in (13a).

Now let us turn to (14) and (15).

- (14) a. *Before Sue punched *anyone*, *he* got her to leave the party.
 b. *Before Sue punches *anyone*, *he*'ll make sure she falls asleep.
 (15) a. *Before Sue punched *anyone*, Max tried to convince *him* to leave.
 b. *Before Sue punches *anyone*, I'll try to convince *him* to leave.

In each of these sentences there is an occurrence of 'anyone' in the before-clause and a pronoun 'he' in the other clause. In each case, 'he' cannot have 'anyone' as its antecedent. There are various possible explanations of this. In (14a) it is assumed that Sue didn't punch anyone and therefore there would be no individual for 'he' to refer to. However, such an explanation will not account for the facts of (15), since in (15) it is presupposed that Sue did (or will) punch someone. This leaves us two possible explanations for the ill-formedness of (15). These depend on what logical forms one attempts to provide for the sentences of (15). We can, for example, assume that there is some sort of quantifier outside of BEFORE binding two occurrences of a variable, one in each clause, as in (16a).

- (16) a. $(Qx) (\text{BEFORE}(f(x), g(x)))$
 b. * $\text{BEFORE}((\exists x) f(x), g(x))$.

On the other hand, we can assume, as in (15b), that there is an existential quantifier inside the first clause binding a variable inside that clause, and that there is another occurrence of that variable inside the second clause. Unfortunately, in such constructions as (16b), the quantifier in the first

clause cannot bind the variable in the second clause. Thus, if such an analysis is necessary, we have an explanation for why the sentences of (15) are ungrammatical. However, one can always retreat to an analysis like (16a). As it turns out, (16a) also offers us an explanation for the ungrammaticality of (15). Recall that both sentences of (15) must presuppose the content of the before-clause, as in (11a) above. This would give us a presupposition-relation as given in (17a).

- (17) a. $[(Qx) \text{ BEFORE } (f(x), g(x))] \rightarrow (\exists x) f(x)$
 b. $[(Q _) \text{ BEFORE } (f(_), g(_))] \rightarrow (\exists _) f(_)$
 c. $\text{BEFORE } (f(_), g(_))$
 d. $f(_)$.

(17a) is equivalent to (17b), using the slot-and-line notation for propositional functions instead of the identical-variable-letter notation. However, (17b) cannot be a schema of the form (11a). Note that the expression in the square brackets of (17b) contains the propositional function of (17c), in which two slots are joined by a line. If that line, the indication of coreference, is an integral part of the propositional function, then the expression of (17d) is not a proper subpart of (17c). That is, if we call (17d) S_1 , then S_1 does not occur as a proper subpart of (17c). Consequently (17b) cannot be an instance of (11a), or any similar statement. The reason is that there can be no identity statement between anything on the right side of the arrow in (17b) and anything on the left side of the arrow. One propositional function, say that of (17d), cannot be identical to part of another propositional function, say that of (17c). Thus, assuming that the line connecting the slots, the indication of coreference, is an integral part of a propositional function, we have an explanation for the ungrammaticality of the sentences of (15). Under no possible analysis can 'him' in (15) be bound by the quantifier corresponding to 'any' in (15). Thus analyses like (16a) are ruled out, as well as analyses like (16b).

So far, everything works pretty much as it should. The assumption that the indication of coreference is an integral part of a propositional function and that (17d) is not a proper subpart of (17c) has paid dividends.

Unfortunately, the market is about to collapse. Consider (18).

- (18) Before Sue punches *anyone*, she tries to get *him* to leave.

'Any' in (18) might well be said to be understood as a universal quantifier. Thus (18) might be given the form of (19).

- (19) $(\forall x) \text{ BEFORE } (f(x), g(x)).$

Now, (18) presupposes that Sue punches people. Thus we should have an instance of (11a). The presupposition relation of (18) is given in (20).

- (20) a. $[(\forall x) \text{ BEFORE } (f(x), g(x))] \rightarrow (\exists x) (fx)$
 b. $[(\forall _) \text{ BEFORE } (f(_), g(_))] \rightarrow (\exists _) f(_)$.

Unfortunately, neither (20a) nor (20b) can be an instance of (11a). (20a) and (20b) are of the same form as (17a and b) above. As we saw, under the assumption that the indication of coreference, the line between the slots, is an integral part of a propositional function, there cannot be any identity condition between the expression on the right of the arrow in (20b) or any of the propositional function it contains and any part of the expression on the left. Thus it is impossible for (20a) to be an instance of (11a), or any similar statement. In fact, it would be impossible to account for the presupposition relation in (18) generally, since any general account must contain an identity condition between a proposition or a propositional function in the expression on the left side of the arrow and a proposition or propositional function in the expression on the right side of the arrow – if it is true that (17d) cannot be a proper subpart of (17c). Thus, given our assumptions, we can neither account for the grammaticality of (18), nor can we state a general rule accounting for the presuppositions of before-constructions. Something is wrong. And what appears to be wrong is the assumption that the indication of coreference is an integral part of the structure of the propositional function. That is, we need to be able to say that (17d) is a proper subpart of (17c). This leaves us with two problems. Why is (15) ungrammatical but (18) grammatical? And how can we represent coreference in a propositional function in such a way that the indication of coreference is not a proper part of the structure of the propositional function?

Before concluding let us consider some further examples.

- (21) a. Whenever *someone* comes to the door, I let *him* in.
 b. $(\exists x) (x \text{ comes to the door}).$

(21a) presupposes (21b). How can 'him' in (21a) be found by the quanti-

fier corresponding to 'some', at the same time as there is an identity-condition between (21b) and the content of the whenever-clause of (21a)?

Now let us turn to an even more complex case.

- (22)
- a. Before Mary realizes that *someone* has broken into her room, *he*'ll have stolen her jewels.
 - b. Mary will realize that someone has broken into her room.
 - c. Someone has broken into her room.

(22a) presupposes (22b) which in turn presupposes (22c). In (22a) 'someone' is inside the complement of the factive verb 'realize' which is in turn inside a before-clause. However, the quantifier corresponding to 'some' seems to be binding a variable corresponding to 'he' in the second clause of (21a). How is this possible? Note, incidentally, that the quantifier corresponding to 'some' in (22a) cannot be outside of the before-clause, as in (19). Thus it would appear that we have a situation in (22a) like that of (16b), which is impossible, given our current notions about how the binding of variables works. (23) presents even more difficulties.

- (23)
- a. *Before Mary claims that *someone* has broken into her room, *he*'ll have stolen her jewels.
 - b. *Before Mary claims that *someone* has broken into her room, *she*'ll claim that *he* stole her jewels.
 - c. After Mary claims that *someone* has broken into her room, *she*'ll claim that *he* stole her jewels.

Note that with 'claim' instead of 'realize', (23a) is ungrammatical. One might guess that this would follow from the facts of Section VIII, since it is not guaranteed that 'he' will have an antecedent in the appropriate worlds. However, it is not that simple, as (23b and c) indicate. These sentences indicate that time relations are somehow involved. A further complication arises in (24).

- (24) Before Mary realizes that *someone* has broken into her room, *he* will have stolen her jewels and her mother will have reported *it* to the police.

(24) is a continuation of (22). Note the occurrence of 'it' in (24). 'It' is understood as 'someone has stolen her jewels' not as 'he has stolen her jewels' nor as 'the man who broke into the room has stolen her jewels'.

This would provide problems for the view that 'he' in (22a) is not the reflex of a variable bound by the quantifier corresponding to 'some' but rather the reduction of a definite description such as 'the man who broke into her room'. Here too, there would be difficulties in stating the identity-condition between the sentence that 'it' is understood as representing and the sentence which is the antecedent of 'it'. Under any analysis of the logical forms of sentences like (24), there will be difficulties.

D. Counterparts and Propositional Functions¹

The problem of identifying individuals across possible worlds is a particularly vexing one. I would like to add some further vexations. Consider sentence (1).

- (1) I dreamt that I was Brigitte Bardot and that I kissed me.

(1) is interesting in a number of ways. First, the sentence '*I kissed me' is ungrammatical in isolation, though it occurs embedded in (1). Secondly, it is usually the case that all first-person singular pronouns refer to the same individual, the speaker. However, the 'I' which is the subject of 'kiss' and the 'me' which is the object of 'kiss' refer to different individuals. Moreover, there is a difficulty in making an identification between the speaker in the world of the utterance and the referent of 'I' in the world of the dream. In the dream, Brigitte Bardot is a counterpart of the speaker. However, in some sense, the speaker is also his own counterpart. It appears that what one needs is not simply a single counterpart relation for identifying individuals across possible worlds, but two counterpart relations. That is, the individual must be distinguished from his body. In (1), the 'I' which is the subject of 'kiss' has the body-counterpart of Brigitte Bardot, but is the individual-counterpart of the speaker. 'Me', in (1), has the body-counterpart of the speaker. Thus it would appear as though we must distinguish individual-counterparts from body-counterparts.

(1) is also interesting from a purely grammatical point of view. Why should the subject of 'kiss' be 'I' rather than 'she'? Or why should the object of 'kiss' be 'me' rather than 'him'? In order to account for these facts, it would appear that the rule of person-agreement in English must state that any counterpart of the first-person is marked with the first-person morpheme, whether it is an individual-counterpart or a body-

counterpart. Thus it would appear that the rule of person-agreement in English must involve the notion of counterparts. Secondly, why do we get 'I kissed me' rather than 'I kissed myself'? Note that in the world of the dream, the referent of 'I' and the referent of 'me' are different individuals; they are not coreferential. Thus it would appear that the rule of reflexivization in English requires a coreferentiality relationship rather than a counterpart relationship. It is rather interesting that the notion 'counterpart', which was introduced to handle problems of trans-world identity in possible world models, should play a role in English grammar.

There are still further counterpart relations that must be distinguished. Consider (2).

(2) I dreamt that I was playing the piano.

(2) can be understood in one of two ways. In one reading, my dream consists of feeling myself seated at the piano, seeing the keyboard in front of me, feeling my fingers hitting the keys, etc. I am a participant in the dream. On the other reading, I see, as in a movie, someone who looks like me seated at a piano, playing. In this reading, I am an observer. These two readings have correlates in English grammar. Consider (3).

(3) a. I enjoyed playing the piano. (participant)
b. I enjoyed my playing the piano. (observer)

In (3a), the subject of 'play' has been deleted by the rule of equi-NP-deletion. In (3b) the subject of 'play' has not been deleted by the rule of equi-NP-deletion. (3a) and (3b) mean different things. They have readings corresponding to the two readings of (2) given above. In (3a), I enjoyed my participation in playing the piano, while in (3b) I enjoyed the fact that I did it. In (3a), the relationship between the subject of 'enjoy' and the subject of 'play' might be called a participant-counterpart relation, while in (3b) one has an observer-counterpart relation. In English, the rule of equi-NP-deletion only operates in a case of participant-counterpart relation. Thus we have another rule of English in which the notion 'counterpart' plays a crucial role. (4) is another example of this sort.

(4) a. I wanted to be president. (participant)
b. I wanted myself to be president. (observer)

In (4a), equi-NP-deletion has taken place and we get a participant-

reading, while in (4b) equi-NP-deletion has not taken place and we get an observer-reading. Note that (4a) can be true and (4b) false.

(5) I wanted to be president, but I didn't want myself to be president.

(5) is not contradictory. I may want to be president because I am power-hungry, while not wanting myself to be president because I am lazy and corrupt, and it would be bad for the country. Thus it seems clear that one must distinguish a participant-counterpart relation from an observer-counterpart relation.

The above considerations have important consequences for the concept of a propositional function. Consider (6).

(6) a. Everyone wants to be president.
b. Everyone wants himself to be president.

Without a distinction between participant-counterparts and observer-counterparts, one would normally expect to represent (6a) something like (7a) or (7b).

(7) a. $(\forall x)(x \text{ wants } (x \text{ be president}))$
b. $(\forall _)(_ \text{ wants } _ \text{ be president})$

However, that is also how one would have to represent (6b). But they mean different things, and one can be true while the other is false. Hence, they must have different logical forms. However, given the notion of a propositional function as indicating identity only through using either the same variable letter, or lines connecting slots, there is no way of differentiating (6a) from (6b) in logical form. Consequently, our present notion of what a propositional function is will be inadequate for natural logic, since in natural logic (6a) and (6b) must both be given logical forms and the difference between them represented systematically.

One more thing: Lewis' notion that the counterpart of an individual in another world is that individual who shares the most properties with, or is most like, the first individual. Thus the counterpart of me in another world would be the person in that world who is most like me, according to Lewis' suggestion, while your counterpart in another world would be the person who is most like you. However, it is clear from (8) below that this notion of 'counterpart' is inadequate.

(8) If I were you and you were me, I'd hate you.

E. Individual and Class Coreference¹

Plural NPs in English may indicate either aggregates of individuals or classes. Consider (1).

- (1) a. Former servicemen are neurotic.
b. Former servicemen are numerous.

In (1a) we have a plural NP indicating an aggregate of individuals. (1a) predicates 'is neurotic' of each individual former serviceman. In (1b), on the other hand, we have the same plural NP representing a class. 'Numerous' is predicated not of the individual former serviceman, but of the class of former servicemen. That is, (1b) says that the class of former servicemen is large.

Corresponding to each of the two ways in which we can understand plural NPs there are two ways in which we can understand plural pronouns referring back to those NPs. Consider (2).

- (2) a. I like *former servicemen*, but the fact that *they* are neurotic disturbs me.
b. I like *former servicemen*, but the fact that *they* are numerous disturbs me.

In (2a), 'they' is understood as representing an aggregate of individuals and, as in (1a) above, 'neurotic' is predicated of each of those individuals. In (2b), 'they' is understood as representing a class and 'numerous', as in (1b) above, is understood as predicating something of that class. Since there is presumably some sort of identity relation between a pronoun and its antecedent, one would suspect that, since the pronouns in (2a) and (2b) are understood in different ways, their antecedents would also be understood in different ways. But this does not seem to be true. In both (2a) and (2b), I am saying that I like individual servicemen, not the class of servicemen. The problem becomes clearer in (3).

- (3) Whenever you put *former servicemen* in a room, *they* start discussing the fact that *they* are numerous.

In (3) there are two occurrences of 'they'. The first occurrence of 'they' refers to the individual servicemen, while the second occurrence of 'they'

refers to the class of former servicemen. If pronouns bear some sort of identity relation to their antecedents, how can these two pronouns have the same antecedent? Perhaps one might guess that the pronouns were somehow or other grammatically identical, though they referred to different things. (4), however, shows that this is not the case.

- (4) a. Whenever you put *former servicemen* in a room, *they* start discussing *their* numerousness.
b. Whenever you put *former servicemen* in a room, *they* start discussing *their own* problems.
c. *Whenever you put *former servicemen* in a room, *they* start discussing *their own* numerousness.

(4a) is just like (3) except that 'numerous' has been nominalized. In (4b) we find that 'their' refers to the individuals, not to the class, and it may be followed by 'own', the possessive marker in English. However, in (4c) 'their' may not be followed by 'own'. The reason is that reflexive markers like 'own' can only occur where there are propositional functions with the same variable, as in (5a). The fact that 'own' cannot occur in (4c) shows that (4c) does not contain a propositional function like (5a), but rather one like (5b).

- (5) a. *x* starts discussing *x's* numerousness.
b. *x* starts discussing *y's* numerousness.

There must be different variables for the individuals and for the class. It should be noted that both sorts of pronouns may not only have as an antecedent a plural NP which is interpreted as an aggregate of individuals, but may also have as an antecedent a plural NP interpreted as a class.

- (6) a. Because *former servicemen* are numerous, *they* are neurotic.
b. *Former servicemen* used to be numerous, but now *their size* is diminishing.

The problem is, how can one represent plural NPs and plural pronouns in such a way as to distinguish reference to individuals from reference to classes as (4) above requires, while also indicating the appropriate way in which a plural pronoun is related to its antecedent. Clearly, identity of reference will not do the job.

F. *Definite Descriptions*

In recent years there has been an adverse reaction of a non-Strawsonian sort to Russell's theory of descriptions. Logicians such as Lambert, and more recently Van Fraassen, Kaplan, Montague, and Scott have claimed that the problem of nonreferring definite descriptions such as 'the present king of France' can be avoided without claiming that definite descriptions are not really terms, that is, without a Russellian analysis. Taking the description operator '*Ixfx*' as a primitive, they provide a truth definition for it such that '*Ixfx*' is undefined if there is no individual *a* in the domain of *x* such that '*fa*' is true. In short, they use truth definitions to circumvent Russell's problem.¹

There is no question that the cases of nonreferring definite descriptions brought up by Russell can be handled in this way. However, there are cases in English of definite descriptions that do refer which cannot be handled by considering the description operator as a primitive. Thus, it would appear that the technique described above cannot be extended to natural logic, since natural logic would have to deal with the following sentences.

- (1) *The man who doesn't expect it* will be elected.
- (2) The usual men were meeting in *the usual place*.

The problem in (1) is the pronoun *it* inside the definite description, which refers to something outside the definite description. If the description operator is not taken as a primitive, (1) might be described as in (3).

- (3) $(\exists!x)[(\sim [x \text{ expects } (x \text{ will be elected})]) \& (x \text{ will be elected})]$.

Under such an analysis, the *it* would arise though the deletion of '*x will be elected*' under a condition of identity with the other occurrence of that phrase, by normal rules of grammar. If, however, (1) is represented as in (4),

- (4) $[Ix(\sim [x \text{ expects } (x \text{ will be elected})])] \text{ will be elected,}$

the normal rule of pronominalization cannot operate, since there is no sentence-identity.

(2) presents a much worse problem, since it contains two occurrences

of the word 'usual', while the logical form of the sentence would contain only one.² Thus (2) might be represented as in (5).

- (5) $\exists x_1 \dots x_n \exists!y [(Usual(x_1 \dots x_n \text{ meet at } y)) \& (x_1 \dots x_n \text{ were meeting at } y)]$.

The difficulty here is that 'usual' is predicated of an expression containing both *y* and $x_1 \dots x_n$, and in addition there must be another expression containing both. So far as I can tell, there is no way to represent the logical form of (2) if one takes the definite description operator as primitive. And things get even worse if one considers sentences like (6).

- (6) The usual men want to meet at *the usual place*.

(6) shows a scope ambiguity. It can have the reading of either (7) or (8).

- (7) $\exists x_1 \dots x_n \exists!y ([Usual(x_1 \dots x_n \text{ meet at } y)] \& [x_1 \dots x_n \text{ want } (x_1 \dots x_n \text{ meet at } y)])$
- (8) $\exists x_1 \dots x_n \exists!y ([Usual(x_1 \dots x_n \text{ want } (x_1 \dots x_n \text{ meet at } y))] \& [x_1 \dots x_n \text{ want } (x_1 \dots x_n \text{ meet at } y)])$.

In (7), the men usually do meet at the given place, while in (8) they usually want to meet at the given place. So far as I can see, it is absolutely impossible to represent the ambiguity of (6) using a primitive definite description operator.

The following sentences should also give pause to anyone wishing to maintain that description operators are primitives.

- (9) John and Bill live in *the same house*.
- (10) John and Bill want to live in *the same house*. (ambiguous)
- (11) The usual boys made love to *the same girl in the usual place*. (ambiguous)
- (12) The usual boys believed that they made love to *the same girl in the usual place*. (multiply ambiguous).

Similar difficulties will, of course, arise with Bach-Peters sentences like (13).

- (13) *The boy who deserves it* will get *the prize he wants*.

Anyone who wishes to propose a theory of definite descriptions for natural logic will have to take sentences like these into account.

X. CONCLUDING REMARKS

Natural logic is by no means new. The study of logic began and developed as an attempt to understand the rules of human reasoning (which is characteristically done in natural language). The discovery and development of symbolic logic can be viewed in part as the discovery that the regularities involved in human reasoning cannot be stated in terms of the surface forms of sentences of natural languages. One needs instead special logical forms containing quantifiers, variables, etc. To check on the correctness of an argument each surface form of each natural language sentence must be associated with a corresponding logical form, and rules of logic apply to the logical forms, not the surface forms.

The development of logic has followed a pattern common to many fields. As formal techniques are developed for dealing with certain aspects of the field's subject matter, that subject matter tends to shrink until it encompasses only those aspects of the original subject matter that the techniques developed can cope with. The development of the predicate calculus had this effect. For many logicians, logic, the study of human reasoning, became the study of those aspects of human reasoning capable of being dealt with by the techniques of predicate calculus. This was both good and bad. It was good, very good, in that it led to remarkable developments in the foundations of mathematics and a very deep understanding of how logical systems work. Unfortunately, the concentration on the development of known techniques had the consequence that most of the original subject matter of logic was ignored, if not forgotten. The recent development of modal logic, I think, has taken a large step toward remedying this situation. Although most modal logicians have, quite rightly, concentrated their effort on refining and developing the techniques made available by Kripke and others, this has been accompanied by a good deal of effort toward applying those techniques to deal with a wider and wider range of natural language constructions: imperatives, questions, tenses, and so on. It seems to me that recent developments in modal logic, together with recent developments in linguistics, make the serious study of natural logic possible. Just as modal logic will enable us to study seriously the logic of a very large number of natural language concepts, so the techniques of generative grammar and, more recently, generative semantics, will enable us to study to a great extent the rules

relating logical forms to surface forms for sentences of natural languages. It seems clear that neither the techniques that have been developed in modal logic up to now, nor those of generative semantics, will be capable of doing their respective jobs in the long run. Just as there are natural language phenomena which are beyond the scope of intensional logic, so there are natural language phenomena which are beyond the scope of global grammatical rules. This, of course, does not mean that either modal logic or generative semantics should be abandoned. Rather they should be vigorously developed to find out how far they can be extended and precisely what their limitations are. However, I think it is most important, both for linguists and for logicians who are interested in the subject matter of natural logic, not to lose sight of the ultimate goal. This is especially important, since the short-term goals of linguists and modal logicians are bound to be in conflict. Take, for example, the goals discussed by Dana Scott in his 'Advice on Modal Logic'. Scott is interested in setting up foundations for a general quantified intensional logic. His goals are therefore different in many respects from the goals of natural logic. He has limited his aims to something he thinks can be done in the foreseeable future, and that excludes a wide range of phenomena that actually occur in natural language. He is not attempting to deal with presuppositional phenomena nor with non-intensional concepts. Nor does he seem interested in having his results mesh with the results of linguistics, as any natural logic must. For instance, one of Scott's principle aims is the elegance and the simplicity of the system of intensional logic he is developing. Since he feels that there are no known three-valued logics that are sufficiently elegant for his tastes, he advises modal logicians to ignore three-valued logics for the present. But natural logic involves presuppositions, and so will require a three-valued logic. Here is a short-term conflict. Moreover, if it were to turn out that Scott's concept of elegance were to lead to some result incompatible with stating some linguistic generalization, there is no doubt in my mind that he, as well as other logicians, would consider logical elegance as more important than linguistic generalizations.¹ I, of course, would disagree, but then I am a linguist.

I do not intend these remarks as being a criticism of Scott or of anyone else. I have chosen to discuss Scott's remarks partly because they are typical of the attitude of many good practicing logicians, and partly

because he happened to put them down on paper. So far as short-term goals are concerned, Scott's seem to me to be not unreasonable for someone in his position. Good logic will undoubtedly be served through the refinement and vigorous development of the present techniques of modal logic. However, if one is interested in natural logic and in its long-term goals, then there are courses other than Scott's that one can follow. One can attempt to extend logic to deal with presuppositions, and there are a number of able logicians involved in this enterprise. One can study the group-reading of quantifiers mentioned in Section II above. One can study the logic of scalar predicates such as *like-love*, *interesting-fascinating*, etc., and how they are related to the quantifiers *some-all*. (One measure of success for such an endeavor would be the ability to state a general rule governing the occurrence of the word 'absolutely'.) In addition to studies in the logic of time, one might attempt parallel studies in the logic of location and linear dimensions in general, e.g., weight, cost, etc. One might study the various counterpart relations: individual-counterparts, body-counterparts, participant-counterparts, and observer-counterparts. Are all of these different types really necessary? Do they overlap in any way? What properties do they have? Can one use the notion of counterpart to revise our current notion of propositional function so as to make it adequate for doing natural logic? In short, there are many new things that logicians might be doing if they are interested in the goals of natural logic.

Natural logic, taken together with linguistics, is the empirical study of the nature of human language and human reasoning. It can have right and wrong answers. For example, as we saw in Section IXA above, any treatment of manner adverbs as operators mapping predicates into predicates is simply wrong. It is wrong because in principle it cannot provide different logical forms for sentences that require them – on logical grounds (see Example (7) in IXA and Footnote 2 in that section). An analysis of logical form can be wrong because it does not account for the logical facts. But under the assumptions of natural logic, analyses of logical form can be inadequate for other reasons. If, for example, an analysis of the logical form of some sentence or class of sentences does not permit the statement of some significant linguistic generalization, then that analysis is inadequate on linguistic grounds. Take, for instance, the case of scalar predicates. As we saw above, the word 'absolutely' can

occur with words indicating extreme points of a scale (*fascinating*, *uninteresting*), but not some intermediate point on the scale (*interesting*). We saw that the same was true of quantifiers (*all* and *none* versus *some*), and that, in this sense, quantifiers seemed to act like scalar predicates. Although quantifiers have been very well studied, scalar predicates have not. There is at present no known analysis of the logical forms of both quantifiers and scalar predicates such that the similarities between them are brought out. Consequently, we cannot say for sure that we have an adequate analysis of the logical forms of quantifiers such as *all*, *some*, and *none*, in the absence of a corresponding analysis of the logical forms of scalar predicates. Further study may show either that the traditional analysis of quantifiers is essentially correct, or that it is partly correct, or that it is entirely wrong, depending on how the study of scalar predicates turns out. One of the criteria for the correctness of such analyses of logical form will be the extent to which the similarities between quantifiers and scalar predicates are brought out. Unless these similarities are made sufficiently explicit so that a general rule governing the occurrence of 'absolutely' can be stated, our analyses of these concepts must be considered inadequate on linguistic grounds. Under the assumptions of natural logic, logical analyses must be linguistically adequate and vice versa. Thus the criteria for adequacy in natural logic are rather stringent. Since the criteria for adequacy of both linguistics and logic must be met at once, the inherent interest of natural logic is so much the greater.

In recent years, much attention has been paid to the ontological claims made by logical systems. Since a natural logic will undoubtedly contain just about all of the things most commonly questioned in such discussions – quantifications over propositions, classes, non-existent individuals, etc. – we ought to consider what it would mean to adopt some particular natural logic as being 'correct'. Are we saying that the universe contains non-existent or hypothetical individuals? If natural logic requires, in part, a possible world semantics, would we be claiming that the universe contains possible worlds? Certainly not. Recall that natural logic is a theory, a theory about the logical structure of natural language sentences and the regularities governing the notion of a valid argument for reasoning in natural language. That is, it is a theory about the human mind, not a theory about the universe. If natural logic requires a possible world semantics, then that might mean that people conceive of things in terms

of possible worlds, not that the physical universe contains possible worlds. If natural logic requires quantification over propositions, then that means that people can conceive of propositions as entities, not that there are propositional entities floating around in the universe. If natural logic requires that space and time be independent dimensions, then it is claimed that people conceive of space and time as independent dimensions, not that space and time are independent dimensions (which we know they are not). If one wants a logic capable of dealing with the physical facts of a Einsteinian universe, then it seems pretty sure that one doesn't want a natural logic. This is not to say that the ontological commitments of a natural logic are irrelevant or uninteresting. Quite the contrary. Though a natural logic, if one could be constructed, would not make claims about the universe, it would make claims about the way human beings conceive of the universe. And in the gap between the way the universe is and the way people conceive of the universe, there is much philosophy.

University of Michigan

BIBLIOGRAPHY

- Lennart Åqvist, *A New Approach to the Logical Theory of Interrogatives, Part I: Analysis*, Uppsala 1965.
- Emmon Bach and Robert T. Harms (eds.), *Universals in Linguistic Theory*, Holt, Rinehart and Winston, New York 1968.
- C. Leroy Baker, 'Definiteness and Indefiniteness in English', University of Illinois master's thesis, 1966.
- C. Leroy Baker, *Indirect Questions in English*, University of Illinois doctoral dissertation, 1968.
- C. Leroy Baker, 'Double Negatives', *Linguistic Inquiry* (1970).
- C. Leroy Baker, 'Notes on the Description of English Questions: The Role of an Abstract Question Morpheme', 1970b, in *Foundations of Language*.
- Nuel Belnap, 'An Analysis of Questions', TM-1287/000/000, Systems Development Corporation, 1957.
- Robert Binnick, *Studies in the Derivation of Predicative Structures*, University of Chicago Dissertation, 1969.
- Guy Carden, 'English Quantifiers', Harvard master's thesis, 1968.
- Guy Carden, *Idiolect Variation and Logical Predicates in English*, Harvard doctoral dissertation, 1970a.
- Guy Carden, 'A Note on Conflicting Idiolects', *Linguistic Inquiry* (1970b).
- Brian Chellas, *The Logical Form of Imperatives*, Stanford doctoral dissertation, Perry Lane Press, 1969.
- Noam Chomsky, *Syntactic Structures*, Mouton, The Hague, 1957.
- Noam Chomsky, 'Current Issues in Linguistic Theory', in *The Structure of Language*

- (ed. by Jerry A. Fodor and Jerrold J. Katz), Prentice-Hall, Englewood Cliffs, N.J., 1964.
- Östen Dahl, 'Some Notes on Indefinites', *Language*, 1970.
- Donald Davidson, 'The Logical Form of Action Sentences' in *The Logic of Decision and Action* (ed. by Nicholas Rescher), University of Pittsburgh Press, Pittsburgh, Pennsylvania, 1966.
- Charles Fillmore, 'Verbs of Judging: An Exercise in Semantic Description', *Papers in Linguistics* (1969).
- Charles Fillmore, 'Types of Lexical Information' to appear in *Semantics: An Interdisciplinary Reader in Philosophy, Linguistics, Anthropology and Psychology* (ed. by Leon Jakobovits and Danny Steinberg), Cambridge University Press, Cambridge.
- Jerry A. Fodor and Jerrold J. Katz (eds.), *The Structure of Language*, Prentice-Hall, Englewood Cliffs, N.J., 1964.
- H. P. Grice, *The Logic of Conversation*, Berkeley mimeo, 1968.
- Morris Halle, *The Sound Pattern of Russian*, Mouton, The Hague 1959.
- Jaakko Hintikka, *Knowledge and Belief*, Cornell University Press, Ithaca, N.Y., 1962.
- Laurence Horn, 'A Presuppositional Analysis of "Only" and "Even"' in *Papers from the Fifth Regional Meeting of the Chicago Linguistic Society*, University of Chicago Press, Chicago, Ill., 1969.
- Laurence Horn, 'Ain't It Hard Anymore?' in *Papers from the Sixth Regional Meeting of the Chicago Linguistic Society*, University of Chicago Press, Chicago, Ill., 1969.
- Laurence Horn, *Studies in the Semantics of Negation*, U.C.L.A. doctoral dissertation, in preparation.
- G. E. Hughes and M. J. Cresswell, *An Introduction to Modal Logic*, Methuen, 1968.
- Richard Jeffrey, *Formal Logic*, McGraw-Hill, New York 1967.
- David Kaplan, 'Quantifying In', *Synthese* 19 (1968-69).
- Lauri Karttunen, 'Problems of Reference in Syntax', University of Texas mimeograph, 1969.
- Edward Keenan, *A Logical Base for English*, University of Pennsylvania doctoral dissertation, 1969.
- Edward L. Keenan, 'Names, Quantifiers, and a Solution to the Sloppy Identity Problem', University of Pennsylvania, Unpublished, 1970.
- Edward L. Keenan, 'Quantifier Structures in English', to appear in *Foundations of Language*.
- Saul Kripke, 'Semantical Considerations on Modal Logic', *Acta Philosophica Fennica* 16 (1963).
- George Lakoff, *On the Nature of Syntactic Irregularity*, Report NSF-16, Harvard University Computation Laboratory, 1965; reprinted as *Irregularity in Syntax*, Holt, Rinehart and Winston, New York 1970.
- George Lakoff, 'Some Verbs of Causation and Change' in Report NSF-20, 1968.
- George Lakoff, 'Presuppositions and Relative Grammaticality' in *Philosophical Linguistics, Series I* (ed. by William Todd), Great Expectations, Evanston, Ill., 1969.
- George Lakoff, 'Repartee', *Foundations of Language* (1970).
- George Lakoff, 'On Generative Semantics' in *Semantics: An Interdisciplinary Reader in Philosophy, Linguistics, Anthropology and Psychology* (ed. by Leon Jakobovits and Danny Steinberg), Cambridge University Press, Cambridge 1970.
- George Lakoff, *Generative Semantics*, Holt, Rinehart and Winston, New York, in preparation.
- George Lakoff, 'Some Thoughts on Transderivational Constraints', to appear.

- George Lakoff and Peter Railton, 'Some Types of Presupposition and Entailment in Natural Language', University of Michigan mimeo, 1970.
- Robin Lakoff, *Abstract Syntax and Latin Complementation*, M.I.T. Press, Cambridge, Mass., 1968.
- Robin Lakoff, 'A Syntactic Argument for *Not-Transportation*' in *Papers from the Fifth Regional Meeting of the Chicago Linguistic Society*, University of Chicago Press, Chicago, Ill., 1969.
- Karel Lambert, 'Notes on E!III: A Theory of Descriptions', *Philosophical Studies* (1962).
- Karel Lambert, *The Logical Way of Doing Things*, Yale University Press, New Haven, Conn., 1969.
- Ronald Langacker, 'An Analysis of Questions', U.C.S.D. mimeograph, 1969.
- E. J. Lemmon, 'Deontic Logic and the Logic of Imperatives', *Logique et analyse* 29 (1965).
- E. J. Lemmon and Dana Scott, *Intensional Logic* (preliminary draft of initial chapters by E. J. Lemmon), Stanford mimeograph, 1966.
- David Lewis, 'General Semantics' in this volume.
- David Lewis, 'Counterpart Theory and Quantified Modal Logic', *Journal of Philosophy* (1968).
- Gerald J. Massey, *Understanding Symbolic Logic*, Harper and Row, 1969.
- James D. McCawley, 'The Role of Semantics in a Grammar' in *Universals in Linguistic Theory* (ed. by Emmon Bach and Robert T. Harms), Holt, Rinehart and Winston, New York 1968.
- James D. McCawley, 'Lexical Insertion in a Transformational Grammar without Deep Structure' in *Papers from the Fourth Regional Meeting of the Chicago Linguistic Society*, University of Chicago Press, Chicago, Ill., 1968a.
- James D. McCawley, 'Meaning and the Description of Languages', *Kotoba no Uchii* 1968b.
- James D. McCawley, 'Semantic Representations', to appear in *Cognition: A Multiple View* (ed. by Paul Garvin), Spartan Books, New York. (a)
- James D. McCawley, 'A Programme for Logic', to appear. (b)
- Richard Montague, 'Pragmatics and Intensional Logic', U.C.L.A. mimeograph, 1967.
- Richard Montague, 'English as a Formal Language I', U.C.L.A. mimeograph, 1968.
- Jerry Morgan, 'On the Treatment of Presupposition in Transformational Grammar' in *Papers from the Fifth Regional Meeting of the Chicago Linguistic Society*, University of Chicago Press, Chicago, Ill., 1969.
- Jerry Morgan, 'On the Derivation of If-Clauses', University of Michigan mimeograph, 1970.
- Jerry Morgan, *Presuppositional Structure*, University of Chicago doctoral dissertation, in preparation.
- Terence D. Parsons, *A Semantics for English*, University of Illinois at Chicago Circle mimeograph, 1968.
- Paul Postal, 'The Surface Verb "Remind"', *Linguistic Inquiry* (1970).
- A. N. Prior, *Time and Modality*, Oxford University Press, Oxford 1957.
- A. N. Prior, *Past, Present, and Future*, Oxford 1967.
- A. N. Prior, *Time and Tense*, Oxford 1968.
- W. V. Quine, *Word and Object*, M.I.T. Press, Cambridge, Mass., 1960.
- W. V. Quine, *Ontological Relativity*, Columbia University Press, New York 1969.
- Hans Reichenbach, *Elements of Symbolic Logic*, Macmillan, New York 1947.
- Nicholas Rescher, *The Logic of Commands*, Dover, 1966.

- John R. Ross, *Constraints on Variables in Syntax*, M.I.T. doctoral dissertation, 1967.
- John R. Ross, 'On Declarative Sentences' in *Readings in English Transformational Grammar* (ed. by Roderick Jacobs and Peter S. Rosenbaum), Blaisdell, Boston, 1970.
- Dana Scott, 'The Logic of Tenses', Stanford mimeograph, December 1965.
- Dana Scott, 'An Outline for Quantified Intensional Logic', Stanford mimeograph, June 1967.
- Dana Scott, 'Advice on Modal Logic', Stanford ditto-graph, 1968a.
- Dana Scott, 'Formalizing Intensional Notions', Stanford mimeograph, 1968b.
- Robert Stalnaker, 'Pragmatics', in this volume.
- P. F. Strawson, *Introduction to Logical Theory*, Methuen, 1952.
- John Tinnon, 'A Minimal System of Modal Logic', in preparation.
- William Todd (ed.), *Philosophical Linguistics, Series I*, Great Expectations, Evanston, Ill., 1969.
- G. H. von Wright, *Logical Studies*, Routledge and Kegan Paul, London 1957.
- G. H. von Wright, *Norm and Action*, Routledge and Kegan Paul, London 1963.

REFERENCES

* This work was partially supported by grant GS-2939 from the National Science Foundation to The University of Michigan. This work is the result of lengthy and informative conversations with the following persons: Lee Bowie, Wallace Chafe, Charles Fillmore, Georgia Green, Gilbert Harman, Lawrence Horn, Robin Lakoff, James D. McCawley, Jerry Morgan, Paul Neubauer, Paul Postal, Peter Railton, John R. Ross, John Tinnon and Bas Van Fraassen. In addition, I have relied heavily on observations of C. Leroy Baker and Lauri Karttunen. They are in no way responsible for any mistakes I may have made.

Section II

¹ The conditions under which adverb-preposing is blocked vary somewhat from person to person. The assignment of asterisks in the following examples corresponds to the author's speech. Readers whose idiolects disagree with these examples can easily construct similar examples in their own speech. The argument in this section does not depend on the particular examples given being correct for all dialects, but only on the *existence* of examples of this sort for *some* dialects.

² It should be noted that adverb-preposing can optionally move the adverb to the front of its own clause as well as to the front of the higher clause.

- a. I think that, if he can get it cheap, *then* Sam will smoke pot.
- b. It is possible that, if he can get it cheap, *then* Sam will smoke pot.

The point here is that *then* is introduced following preposing, and that the placement of *then* depends on how far the *if*-clause has been preposed. It should be noted, incidentally that the *if*-clause may also be preposed to the front of a clause more than one sentence up the tree.

- c. If he can get it cheap, *then* I think it's possible that Sam will smoke pot.

These are just the cases where other adverbs can prepose:

- d. Tomorrow, I think it's possible that Sam will smoke pot.

Section III

¹ For a fuller account of dialect differences see (G. Lakoff, in press) and (Carden, 1970a, 1970b).

² In (G. Lakoff, 1965), (G. Lakoff, 1970), (G. Lakoff, in press), and (McCawley, to appear) it was argued that quantifiers are predicates, not simply operators of the usual sort. Though I still maintain such a position, I am leaving the issue aside here for the sake of avoiding controversy.

In (11) and (12), *V* is meant to indicate atomic predicates and *NP*, arguments. The tree structure reflects the bracketings of most normal logical notation.

Section IV

¹ For discussions of generative semantics, see (Lakoff, in press), (Lakoff, in preparation), (McCawley, 1968), and (Postal, 1970).

² I will consider hierarchical structures like (A) to be equivalent to expressions like: ORDER (*x*, *y*, *S*₁).

³ Sentences like (1) are not normal in standard English, and are restricted to certain dialects. These are most common in urban centers in which there are, or were, a large number of Yiddish speakers. Again, the facts given here are from the author's native dialect and the argument is based on the existence of a dialect in which such facts hold.

⁴ The next two arguments are due to John R. Ross.

⁵ The following three arguments are due to David Perlmutter, John R. Ross, and William Cantrell respectively.

⁶ Strictly speaking, the pronoun must be coreferential with the underlying subject of 'shove', which, in turn, must be coreferential with the next highest indirect object. Agreement in number, person, and gender follows automatically.

⁷ This argument is due to R. Lakoff.

⁷ See (Baker, 1970b) and (Langacker, 1969). Baker concludes that in addition to the indirect question verb, there is an operator that binds the items questioned. Langacker argues convincingly that it is the verbs that do the binding.

⁸ Since it is not at all clear what it means for a verb like 'ask' to *bind* an item being questioned, we would naturally prefer an analysis in which the binding function was assumed by a quantifier associated with 'ask'. Hopefully such an analysis would increase our understanding of the nature of questions. In fact, such analyses have been proposed. Baker (1970b) suggests that verbs taking indirect questions have a new operator, *Q*, embedded directly below them, the operator functioning only to do the binding. This is little more than giving a name to the problem; it provides us no new insight. Belnap, on the other hand, attempts to identify the logical form of a question with the logical form of its primary (first-order) presupposition. Thus, 'a knows who left' would have the logical form '($\exists x$) (KNOW (*a*, (LEFT *x*)))'. Åqvist and Hintikka also assume such logical forms for indirect questions. Unfortunately, this proposal is inadequate in a number of ways. First, there is a sense of 'a knows that someone left' which has that logical form and which is not synonymous with 'a knows who left'.

Secondly, that proposal does not explain why sentences like 'a believes who left' and 'a expected who left' should be impossible, since logical forms like '($\exists x$) (BELIEVE (*a*, LEFT *x*))' and '($\exists x$) (EXPECT (*a*, (LEFT *x*)))' are possible, and in fact occur as possible readings for 'a believed that someone left' and 'a expected someone to leave'. Thirdly, there is the observation by J. R. Ross (personal communication) that some indirect questions involve disjunctions, while other involve conjunctions.

- | | |
|-----|--|
| (1) | a. I want to know who left, Sam or Irving? |
| | b. *I want to know who left, Sam and Irving. |
| (2) | a. I don't know who left, Sam or Irving. |
| | b. *I don't know who left, Sam and Irving. |
| (3) | a. *I know who left, Sam or Irving. |
| | b. I know who left, Sam and Irving. |

When one doesn't know the answer, one gets disjunctions; when one does know the answer, one gets conjunctions. Why? Any serious account of indirect questions must explain this. Fourthly, the Belnap-Hintikka-Åqvist analysis fails to indicate that in 'a knows who left' the content of *a*'s knowledge is some identifying description or proper name for the individual who left (or the ability to point him out), not simply the fact that that individual left, which is all that their analysis specifies. I wish that I had something positive to contribute at this point, but unfortunately I am as much in the dark as to the real logical form of questions as everyone else seems to be at the moment.

⁹ This becomes clearer if one considers Lewis' treatment in *General Semantics* rather than Scott's. Lewis distinguishes between 'contextual coordinates' and an 'assignment coordinate'. The contextual coordinates are for such things as speaker, audience, time of utterance, and place of utterance. The assignment coordinate gives 'the values of any variables that may occur free in such expressions as 'x is tall' or 'son of y'.

The assignment coordinate will have to assign a value corresponding to the speaker for person variables, since the speaker would presumably be in the worlds in question. The same for the audience. If times are assigned to time variables by the assignment coordinate, presumably the time of the utterance will be included. And if places are assigned to place variables, one would assume that the place of the utterance would be given by the assignment coordinate. Given this, and the analysis given in (A), the contextual coordinates become superfluous, since the job that they would do in Lewis' system would be done automatically by the assignment coordinate together with the analysis in (A). Since (A) involves no new types of structure – the same predicates occur in nonperformative uses and have to be given anyway – we have a considerable gain. What we have done is to largely, if not entirely eliminate pragmatics, reducing it to garden variety semantics.

Section V

¹ The felicity conditions governing successful speech acts are special cases.

² This notation is introduced purely as a device to keep track of what is going on. It is not meant to have any theoretical significance. I take the term 'presupposition' as meaning what must be true in order for the sentence to be either true or false.

^{2a} Unfortunately, this account of qualifications is by no means adequate. A brief look at qualifications in the case of definite descriptions will verify this.

- (1) The present king of France must be bald, if there is one.
- (2) *The present king of France used to have dark, wavy hair, if there is one.
- (3) John's children, if he has any, will keep him up all night.
- (4) *John's children, if he has any, are keeping him up all night.
- (5) The present king of France, if there is one, is a pervert.
- (6) *The present king of France, if there is one, is goosing me.
- (7) The local FBI agent, if there is one, is tapping my phone.
- (8) *The local FBI agent, if there is one, is tapping me on the shoulder.

³ It should be noted that this holds only for 'negative-attitude' comments like those with 'odd', 'surprising', etc., but not for 'positive-attitude' comments such as 'expected', 'normal', etc. Positive-attitude comments may be made about an entire preceding clause, but not about any presuppositions of that clause, not even first-order ones.

- a. John stopped beating his wife, and it was to be expected that he would stop.
- b. *John stopped beating his wife, and it was to be expected that he would beat her.

^{3a} Van Fraassen has made an alternative suggestion in an attempt to handle such cases. He observes correctly that there is a distinction between

- (1) Irving doesn't realize that the earth is flat.
- and
- (2) It is not true that Irving realizes that the earth is flat.

(1) presupposes that the earth is flat, while (2) makes no such presupposition. Choice negation, as in (1), permits presupposition, while exclusion negation, as in (2), does not. He suggests that in cases like (26), where there is pronominalization, the exclusion negation (it is not true that *S*) be presupposed, while in cases like (25), where there is no pronominalization, the choice negation be presupposed. Under this proposal, counterfactual conditionals would pose no problem for a transitive presupposition relation.

There are two problems with Van Fraassen's proposal. First, there would be no fully general account of what is presupposed in counterfactuals. Secondly, it would not work generally. Take a verb like 'stop'.

- (3) It is not true that Sam stopped beating his wife.
- (3) still presupposes that Sam beat his wife. For some mysterious reason, 'stop' does not work like 'realize' after 'it is not true that' (at least in my speech). Given this fact, one would expect, given Van Fraassen's proposal, that (4) would be contradictory.
- (4) If Sam had been beating his wife, he'd have stopped.

The first clause presupposes that Sam has not been beating his wife. Under the Van Fraassen proposal, the second clause would presuppose that it is not true that Sam has stopped beating his wife, which in turn presupposes that he has been beating her. If presupposition is transitive, we would expect a contradiction, given this proposal. The fact that (4) is not contradictory indicates that this way out won't work.

⁴ I am considering here only the facts of Dialect A. However, transitivity also holds in Dialect B. For Dialect B, (27c and d) would read:

- c. $-P^-(S_1) \rightarrow A(-S_1)$ (second order)
- d. $+IFC^{-+} (P^-(S_1), S_2) \rightarrow A(-S_1)$ (by transitivity)

⁶ Transitivity holds in Dialect B, strangely enough. (28c) would read:

- c. $-P^-(S_2) \rightarrow A(-S_2)$

⁶ Again I have represented only Dialect A. Distribution and transitivity also hold in Dialect B. For Dialect B, (32d and e) would read:

- d. $-P^-(S) \rightarrow A(-S)$
- e. $AW^{+V^-} (P^-(S)) \rightarrow A(-S)$

⁷ Again, transitivity holds in Dialect B. For Dialect B, (33d and e) would read:

- d. $-P^-(S) \rightarrow A(-S)$
- e. $AT^{-+V^-} (P^-(S)) \rightarrow A(-S)$

^{7a} Since this was written, some ideas have been developed. See Lakoff and Railton, 1970.

⁸ There is, however, a possible argument in favor of having presuppositions be part of the logical form of a sentence. One might, for example, consider the restrictions on restricted quantifiers as being given by presuppositions. For example, 'all men are mortal' might be represented as:

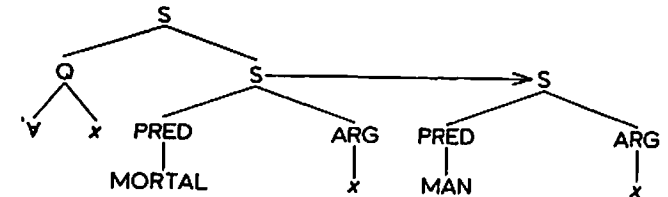

Such a representation would come in particularly handy for cases like:

- (i) John will stop cheating many of his friends.

(i) might be represented as (ii).

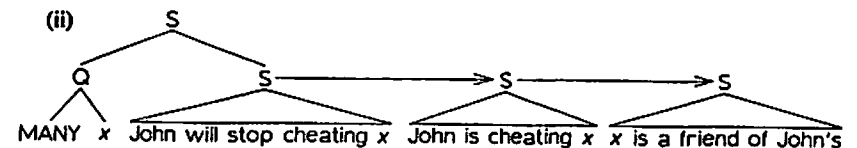

The point here is that the quantifier MANY binds the variable *x* in the presupposition, as well as in the assertion. This would also account for the fact that, although 'assassinate' presupposes that its object is an important political figure and is from Peoria, (iii) does not presuppose the existence of any important political figures from Peoria.

- (iii) John didn't assassinate anyone from Peoria.

(iii) might be represented as (iv).

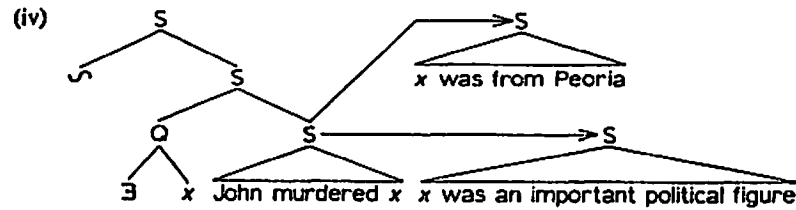

In (iv), as in (ii), the presupposition is within the scope of the quantifier. Under such an analysis, we would not be committed to the existence of any important political figures from Peoria.

Edward Keenan has supplied some clearer cases where the quantifier in the assertion binds a variable in the presupposition:

(v) Someone kicked his sister.

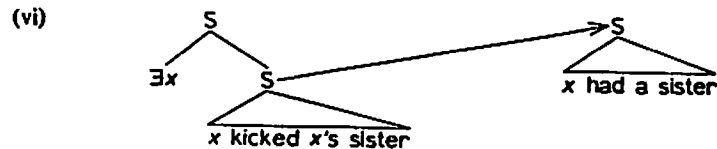

(vii) Someone was surprised by the fact that he flunked.

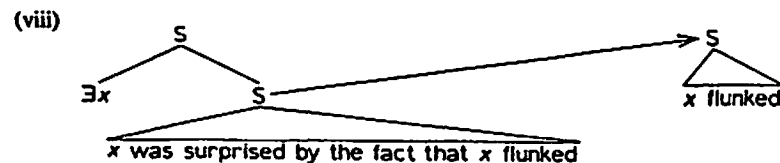

In (v), it is not simply presupposed that someone had a sister, but rather that the person who did the kicking did. In (viii), it is not merely presupposed that someone or other flunked, but rather that the person who was surprised flunked.

⁹ For a discussion of transderivational constraints, see (G. Lakoff, to appear).

¹⁰ We are assuming, then, that presupposition differs from entailment in two respects. Entailment is presumably always transitive, while presupposition is sometimes not transitive. And a sentence will be true or false only if its presuppositions are true.

¹¹ In the months since this paper was first submitted for publication, it has become clear to me that the treatment of presupposition in this section is woefully inadequate. At least three types of presupposition, each with different properties, have been lumped together under a single rubric. Because of this, a number of inadequate analyses are given in the above section. The problems discussed are, however, real enough, and to my knowledge, the failure to make the necessary distinctions has led to only one incorrect conclusion, namely, conclusion 2. A more adequate analysis reveals that transitivity of the presupposition relation is not what is involved in the cases under discussion, and the what appear as limitations of transitivity are really restrictions of a somewhat different sort. For a discussion of these issues, see Lakoff and Railton, 1970.

Section VI

¹ The following are a small number of the relevant works that have appeared in recent years: Åqvist, 1965; Belnap, 1957; Chellas, 1969; Davidson, 1966; Hintikka, 1962; Keenan, 1969 and 1970; Lemmon, 1965; Lemmon and Scott, 1966; Montague, 1967 and 1968; Parsons, 1968; Rescher, 1966; Scott (1965, 1967, 1968a, 1968b); Von Wright, 1957 and 1963. Hughes and Cresswell, 1968 is an excellent introduction to modern modal logic. Massey, 1969 covers some of the same ground, but is more elementary. Both are highly recommended.

² Some of the relevant works are: Bach and Harms, 1968; Baker, 1966, 1968, 1969, 1970, to appear; Binnick, 1969; Carden, 1968, 1970a, 1970b; Fillmore, 1969, in press; Horn, 1969, 1970, in preparation; Karttunen, 1969; Keenan, 1969, 1970, to appear; G. Lakoff, 1965, 1968, 1969, 1970, in press, in preparation; R. Lakoff, 1968, 1969; Langacker, 1969; McCawley, 1968, 1968a, 1968b, to appear a, to appear b; Morgan, 1969, 1970, in preparation; Postal, 1970; Ross, in press.

³ It should be noted that we are not assuming the converse, that sentences with the same truth conditions always have the same logical form. This will sometimes be true and sometimes not.

^{3a} Sentences like (2) are acceptable when they occur as denials. For example, if someone has just suggested that you would rather go, you might use (2) as an indignant reply. However, (2) could not be used where there has been no such prior suggestion, for example, at the beginning of a discourse. In what follows, we will restrict ourselves to such cases, i.e., where there has been no prior suggestion and, therefore, where sentences like (2) will be starred.

⁴ The point here is that sentences like

(i) I don't think John will leave until tomorrow.

can be understood as meaning

(ii) I think that John won't leave until tomorrow.

What R. Lakoff has shown is that the rule relating these sentences, moving the *not* up from the lower clause, must be a rule of grammar.

⁵ Harman (personal communication) has noted that *not*-transportation applied to (13) produces a grammatical sentence.

(i) It is not improbable that Sam would rather go.

Horn (personal communication) has observed that is regularly the case where *not*-transportation has applied.

(ii) a. *It is not likely that Sam wouldn't rather leave.

b. It is not unlikely that Sam would rather leave.

Sentences with *doubt*, in which a lower negative has been incorporated into the lexical item, works the same way.

(iii) I don't doubt that Sam would rather leave.

What these cases have in common is that negative associated with 'would rather' is incorporated into a lexical item. Thus it appears that the constraint on 'would rather' must not only take the logical form of the sentence into account, but must, in addition, take the surface grammatical form of the sentence into account.

⁶ I have found that there is some dialect variation in the following examples which would indicate that, at least for some speakers, there are further complicating grammatical factors at work here. The examples given here are from my own speech, though I have found that a goodly number of other speakers agree with my judgments in these cases. In any event, the dialect variation is irrelevant to the argument at hand, since it is an existence argument. That is, if there exists a dialect where these phenomena hold, rules must be given for that dialect. The question is whether those rules involve natural logic equivalences.

^{6a} It has been suggested to me that LEAVE OPEN is a possible candidate for BLIK in (24). I disagree. Just because one does not claim S, one need not be leaving open the possibility that $\sim S$. One may fail to claim something, for example, because one thinks it is obviously true, or because to do so would be impolite, even though everyone knows it is the case. To my knowledge, there is still no candidate for BLIK.

⁷ In the face of such difficult cases as

- (i) *You shouldn't make Sue believe that I wouldn't rather go.

which should be equivalent to a positive according to (19)–(22), Baker and Horn have proposed an alternate conjecture that a sentence of the form

- (ii) BELIEVE (x, WOULD RATHER (S))

be deducible from the sentence in question. ('x' would be identical to the subject of the next-highest verb of saying or thinking above 'would rather'). This, of course, requires deducibility in some system of logic, presumably a natural logic. Moreover, even under this conjecture, one would have to assume the equivalences of (19)–(22) and rule out (24)–(25). Baker's revised conjecture appears in (Baker, 1970a).

Section VII

¹ At the 1970 La Jolla Conference on English syntax, David Perlmutter provided a further argument in favor of this proposal. Take sentences of the form:

- (1) _____ came to _____'s senses.

The two occurrences of _____ must be coreferential:

- (2) I came to my senses.
 (3) Sam came to his senses.
 (4) *Sam came to my senses.
 (5) *I came to his senses.

We might account for this by principle I:

- (1) The idiom 'come to _____'s senses' requires that the pronoun filling the blank be coreferential with the subject of 'come'.

Now consider the idiom:

- (6) _____ brought _____ to _____'s senses.

Here a pronoun filling the third blank must be coreferential to the noun phrase filling the second blank.

- (7) I brought Sam to his senses.
 (8) *I brought Sam to my senses.

If (6) is considered a separate idiom from (1), we would need principle II.

- (II) The idiom 'bring _____ to _____'s senses' requires that the pronoun filling the last blank be coreferential to the object of 'bring'.

However, if we accept the Binnick-Fillmore proposal, (6) will not be a separate idiom but will be analysed into (9).

- (9) _____ CAUSE (_____ come to _____'s senses).

In this way, (6) is reduced to (1), and we have no need for principle II. Instead, principle I will suffice for both cases. In this case, lexical decomposition permits one to state a true linguistic generalization, which could not be otherwise stated.

³ The matter of which phonological shapes correspond to which atomic or molecular predicates is highly language-specific. Only in the case of borrowings, or closely related languages, or in a rare accident will the same atomic or molecular predicate have the same phonological shape. One of the points of postulating logical forms is to provide a *language-independent* characterization of meanings and meaning-relations. Presumably, the concepts characterized by atomic predicates are language-independent, and of the more primitive ones, many will be universal; those that are not will be culture-specific, rather than language specific. (It should be recalled that the question of whether a language has a word for a concept is distinct from the question of whether the members of a culture share the concept itself).

³ The distribution of adverbials provides more evidence in favor of lexical decomposition.

- (1) Nixon had persuaded the nation, until he invaded Cambodia, that he was serious about ending the war.
 (2) Nixon nearly persuaded Harry that he was serious about ending the war.

'Persuade' in (1) means 'CAUSE TO COME TO BELIEVE' (see (5b) above). The *until*-clause in (1) modifies BELIEVE, not CAUSE TO COME TO BELIEVE. (1) means only that the nation believed that Nixon was serious about ending the war until he invaded Cambodia, not that he repeatedly persuaded them until that time. Similarly, (2) can mean that Nixon brought it about that Harry nearly believed that he was serious about ending the war. If adverbial modification is to be represented in logical form, then 'persuade' must be decomposable in some fashion such as (5b) above.

⁴ It should be noted that this is not an ad hoc constraint, imposed just to make things work out. Such a constraint would follow from independently needed constraints on possible lexical items. For discussion of such constraints, see Horn, in preparation.

Section VIII

¹ (1a) will be a theorem rather than a postulate, if the postulate

CERTAIN (S) \Rightarrow S

is accepted.

^{1a} In saying that if something is certain, then it is possible, I am speaking only of

logical relations, not of what it is appropriate to say in a given situation where I know that something is certain. For example, suppose that I am testifying as a trial and I know that it is certain that Collins was the killer, then it would be misleading for me to say that it is possible that Collins is the killer, even though that proposition is consistent with what I know. Grice has, I believe, given an essentially correct account of what is going on in this example. According to his Cooperative Principle (Grice, 1968), it is assumed in conversation that one gives all of the relevant information. In the above case, we are in violation of this principle (or at least, of one of its maxims). According to Grice's account, if I say that S is possible, then it is conversationally implicated (Grice's term) on the assumption that I am obeying the cooperative principle, that S is not certain. As Grice observes, conversational implicatures are quite distinct from logical relations between propositions such as implication. In the examples below, I am concerned only the logical relations, not with conversational implicatures.

² We are here evading the problems involved in working out the details, in this matter as well as in others, because they are irrelevant to the point being made in this section.

^{2a} In all of the examples to follow, I will be discussing only what Baker calls the 'nonspecific' reading of 'a fish', 'a girl', etc. In this reading, one can qualify 'a fish' by 'some fish or other', not by 'the one we were just talking about'.

³ (6b) can be made grammatical by adding 'if he finds one', since then the certainty will be relative to those worlds in which Sam finds a girl. On the other hand, the addition of 'regardless' or 'in any event' will reinforce the ungrammaticality of (6b), as would be expected.

⁴ The noun phrase 'The girl that it is certain that he will find' presupposes 'It is certain that he will find a girl'. Since preceding conjoined sentences act like presuppositions, (7) reduces to (7'), which reduces to (6).

⁵ As in (6b), (10b) becomes grammatical if 'if you find one' is added, but remains ungrammatical if 'in any event' or 'regardless' is added. See footnote 3 above.

⁶ As is well-known, *believe* is non-intensional in the sense that the intension of the whole is not a function of the intension of its parts, since one may not believe distant logical consequences of one's conscious beliefs. Thus, strictly speaking, one should not be able to use a possible world semantics for *believe*. However, if principle (8) is correct then a possible world semantics will be necessary due to the facts of (15) and (17) below. My feeling is that we should extend the normal concept of a possible world semantics to handle *believe* to permit impossible worlds. Instead of a world being equivalent to a maximal consistent set of sentences, certain types of inconsistency might be permitted, and the set of sentences limited to a nonmaximal set. For a system in which this is done, see Tinnon, in preparation.

Inconsistent beliefs pose problems, but no more so for *believe* than for, say, *order*, a generally tamer modal operator. Inconsistent beliefs, such as (i) are paralleled by impossible orders such as (ii).

- (i) Sam believes that he'll find a round square.
- (ii) I order you to find a round square.

If *order* is to have a semantics along the lines given in (Chellas, 1969), where, corresponding to each order, there is a set of 'possible' worlds in which the order is carried out, this cannot be the null set in cases like (ii), since the following sentences have different meanings and, so require different truth conditions.

- (iii) I order you to find a round square, sell it, and give me the profits.
- (iv) I order you to find a round square, sell it, and give the profits to charity.

Both orders are impossible to carry out, but they are different orders. It should be noted incidentally that the same problem arises in the case of definite descriptions. Does (v) denote a 'possible individual'?

- (v) The man who found a round square.

Do (vi) and (vii) denote different possible individuals?

- (vi) The man who found a round square, sold it, and kept the profits.
- (vii) The man who found a round square, sold it, and gave the profits to charity.

It seems to me that it might make sense to speak of the man in (vi) as being selfish and of the man in (vii) as being charitable, if such men could exist. Be this as it may, the problem of inconsistent beliefs is no worse than problems encountered elsewhere.

⁷ With respect to the claim that *may* could never be a lexical representation for atomic predicates POSSIBLE and REQUIRE, Guy Carden has brought to my attention the following citation in the OED:

Law. In the interpretation of statutes, *may* = *shall* or *must*. 1728.

'For *may* in the Case of a public Officer is tantamount to *shall*'. 1728.

Carden also cites cases where a master says to a servant 'You may go', which can be a command, not a simple granting of permission. The issue raised is whether such cases constitute evidence against the claim that *may* can never be a lexical representation for atomic predicates POSSIBLE and REQUIRE. I think the answer is no. The above cases seem to me to arise from certain culture-specific conversational laws. In many cultures, including many British and American subcultures, politeness and civility require that persons with the power to give orders 'soften' them whenever possible. When a school-teacher says 'It would be nice if you opened the window, Johnny', she is giving a softened order, not just making a statement about one of the things that would be nice. But this does not mean that the logical form of 'it would be nice if S' is 'ORDER (I, you, S)'. It simply means that certain cultures have conversational laws, whereby a statement as to what would give the speaker pleasure is to be construed in certain situations as a request or command to do what is necessary to bring that about. Similarly, certain cultures have conversational laws whereby the granting of permission under certain circumstances is to be construed as a command. When a master says 'you may go' to his servant, he is giving an order without literally giving an order, and such 'restraint' is taken to indicate civility and deference to one's servants. After all, 'You may go' is the order of a genteel master, not of a barbarian. In such cultures, it would be appropriate for a servant to reply 'Thank you, sir' to 'You may go', though not to 'Get out of here'. In the former case, he would be recognizing the master's deference to him, while in the latter case he would either be making a sardonic remark or showing masochism. It is interesting that the case cited by the OED involves 'a public Officer', that is, a constable, sheriff, etc. The above quotation actually puts in writing the content of the implicature. It specifies that when a constable says 'You may stand aside', that is to be taken as an order, punishable by law if you violate it. It should be clear that the cases cited by Carden involve culture-specific conversational implicatures, and so are irrelevant to the claim made above.

Section IX-A

¹ For a fuller discussion see (Lakoff, in press).

² Thus there are different inferences that can be drawn from (7a) and (7b). For instance, it does not follow from (7b) that Sam sliced any bagel carefully. He may have done a careless job on all to them. This is not true of (7a). Consequently, (7b) is compatible with

- a. Sam sliced some of the bagels carelessly.

while (7a) is not compatible with (a).

Section IX-B

¹ It should be noted that 'fascinating' and 'interesting' also act like universal and existential quantifiers with respect to Horn's hypothesis that qualifying expressions must go in the direction of greater universality.

Compare

- (i) a. Some students are striking, if not all.
b. *All students are striking, if not some.
- (ii) a. That claim is interesting, if not fascinating.
b. *That claim is fascinating, if not interesting.

Section IX-C

¹ For a discussion of propositional functions of the form (2), see (Jeffrey, 1967, p. 130ff).

Section IX-D

¹ I am assuming here the concept of 'counterpart' as discussed in (Lewis, 1968).

Section IX-E

¹ These facts were discovered by McCawley and myself.

Section IX-F

¹ This technique is discussed at length in David Kaplan's 'What is Russell's Theory of Definite Descriptions?' UCLA mimeo, 1967. A technique of this sort was discussed earlier in Lambert, 1962.

² Such sentences were first brought to my attention by Donald Forman.

Section X

¹ Actually, Scott's notion of logical elegance in some cases is reminiscent of the linguist's notion of a significant generalization. For example, Scott (1967) defines a general binding operator, \mathcal{S} (for quantifiers and description operators), and a general equivalence predicate, e (for \leftrightarrow and \Rightarrow), so that he can state a single general axiom for substitution of identicals that will apply to both terms and formulas.