

UC Berkeley

Research Reports

Title

Longitudinal Control Of A Platoon Of Vehicles. III, Nonlinear Model

Permalink

<https://escholarship.org/uc/item/0dx8t12z>

Authors

Sheikholeslam, Shahab
Desoer, Charles A.

Publication Date

1990

Program on Advanced Technology for the Highway
INSTITUTE OF TRANSPORTATION STUDIES
UNIVERSITY OF CALIFORNIA AT BERKELEY

Longitudinal Control of a Platoon of Vehicles; III: Nonlinear Model

Shahab Sheikholeslam
Charles A. Desoer

UCB-ITS-PRR-90-1

The contents of this report reflect the views of the authors who are responsible for the facts and accuracy of the data presented. The contents do not necessarily reflect the official views or policies of the State of California or the Federal Highway Administration. This report does not constitute a standard, specification, or regulation.

April 1990

This paper has been mechanically scanned. Some errors may have been inadvertently introduced.

Abstract This paper presents a systematic analysis of a longitudinal control law for a platoon of *non-identical* vehicles using a non-linear model for the vehicle dynamics. The basic idea is to take full advantage of recent advances in communication and measurement and use these advances in the longitudinal control of a platoon of vehicles: in particular, we assume that for $i=1,2,\dots$ vehicle i knows at all times v_l and a_l (the velocity and acceleration of the lead vehicle) in addition to the distance between vehicle i and the preceding vehicle, $i-1$. A control law is developed and is tested on a simulation of a platoon of 16 vehicles where the lead vehicle increases its velocity at a rate of $3\text{ m}\cdot\text{sec}^{-2}$; it is shown that the distance between successive vehicles does not change by more than 0.12 m in spite of variations in the masses of the vehicles (from the nominal), of communication delay and of noise in measurements.

1 Introduction

Even though much effort has been spent on various control laws for longitudinal control of a platoon of vehicles [Hauk.1,Hobe.2,Rous.1,Shla.2,Sheik.1], this paper presents a systematic analysis of the longitudinal control for a platoon of *non-identical* vehicles using a *non-linear* model to represent the vehicle dynamics.

The basic concept of this study is: using exact linearization methods [Isid.1,Sast.1] to linearize and normalize the input-output behavior of each vehicle in the platoon; taking full advantage of recent advances in communication and measurement[Wal.1] and using these advances in longitudinal control of a platoon of vehicles.

To examine the behavior of a platoon of vehicles as a result of a change in the lead vehicle's velocity, simulations for platoons consisting of 16 non-identical vehicles were run. For the nominal case, these simulation results show that through the appropriate choice of coefficients in the control law for each vehicle in the platoon the deviations in vehicle spacings from their respective steady-state values do not get magnified from the front to the end of the platoon. An important feature of the design is that such deviations do not exhibit oscillatory time-behavior and their time-variations are well within passengers' comfort limits[Hobe.1].

2 Platoon Configuration

Figure 1 shows the assumed platoon configuration for a platoon of 4 vehicles. The platoon is assumed to move from left to right in a straight line. The position of the i -th vehicle's rear bumper with respect to a fixed reference point 0 on the roadside is denoted by x_i . The position of the lead vehicle's rear bumper with respect to the same fixed reference point 0 is denoted by x_l . Each vehicle is assigned a slot of length L along the road. As shown, Δ_i is the deviation of the i -th vehicle position from its assigned position. The subscript i is used because Δ_i is measured by the sensors located in the i -th vehicle.

Given the platoon configuration in Figure 1, elementary geometry shows that: for $i = 2,3,\dots$

$$A_i(t) := x_{i-1}(t) - x_i(t) - L \tag{2.1}$$

The corresponding kinematic equation for the lead vehicle and the first vehicle are as follows:

$$A_1(t) := x_l(t) - x_1(t) - L \tag{2.2}$$

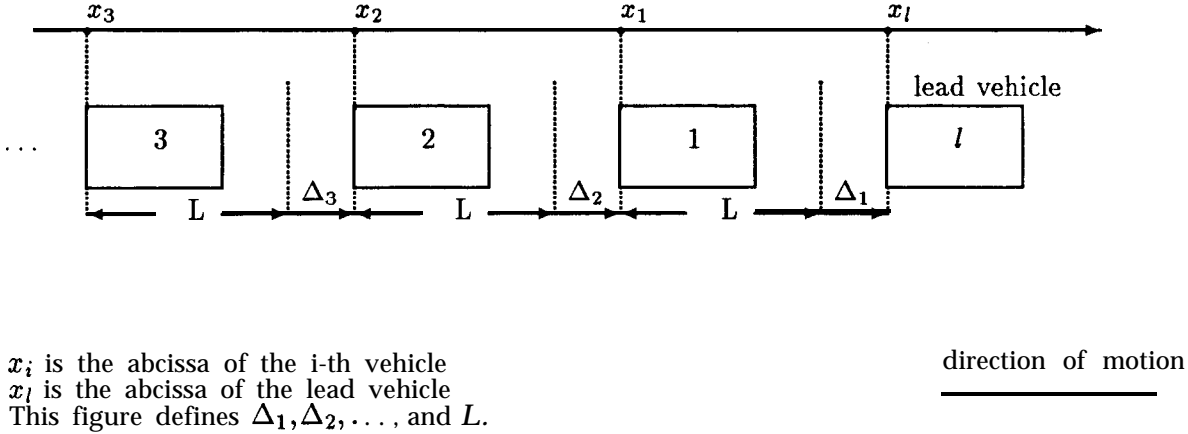

Figure 1: Platoon of 4 vehicles

Measurements We assume that Δ_i is measured in vehicle i and, together with its first and second derivatives, is used in the i -th vehicle's control law. We assume that for each vehicle in the platoon the lead vehicle's velocity (v_l) and acceleration (a_l) are known. (This requires a communication link from lead vehicle to each vehicle of the platoon.)

3 Vehicle Model

Figure 2 shows the vehicle model of the i -th vehicle in the platoon; the block $(m_i g \sin \theta)$ specifies the component of the i -th vehicle's weight parallel to the road surface, where m_i denotes the i -th vehicle's mass, g denotes the acceleration of gravity, and θ denotes the angle between the road surface and a horizontal plane (θ positive corresponds to uphill travel); the block $(\frac{\rho A_i C_{di}}{2} (\dot{x}_i + V_{wind})^2 \text{sgn}(\dot{x}_i + V_{wind}))$ specifies the force due to the air resistance, where ρ denotes the specific mass of air, A_i denotes the cross-sectional area of the i -th vehicle, C_{di} denotes the i -th vehicle's drag coefficient, and V_{wind} denotes the velocity of the wind gust; the constant d_{mi} denotes the mechanical drag of the i -th vehicle; the block $(\dot{\xi}_i = -\frac{\xi_i}{\tau_i(\dot{x}_i)} + \frac{u_i}{m_i \tau_i(\dot{x}_i)})$ models the i -th vehicle's engine dynamics, where $\tau_i(\dot{x}_i)$ denotes the i -th vehicle's engine time-constant when the i -th vehicle is traveling with a speed equal to \dot{x}_i ; u_i denotes the throttle input to the i -th vehicle's engine; $F_i = m_i \xi_i$ denotes the force produced by the i -th vehicle's engine.

The summing node at the bottom of Figure 2 represents Newton's second law for the i -th vehicle, namely

$$F_i - m_i g \sin \theta - \frac{\rho A_i C_{di}}{2} (\dot{x}_i + V_{wind})^2 \text{sgn}(\dot{x}_i + V_{wind}) - d_{mi} = m_i \ddot{x}_i \quad (3.1)$$

Simplified model In this preliminary study we assume that the road surface is horizontal ($\theta = 0$) and there is no wind gust ($V_{wind} = 0$). Figure 3 shows the simplified vehicle model of the i -th vehicle in the platoon: K_{di} denotes $\frac{\rho A_i C_{di}}{2}$; since the vehicles are assumed to travel in the same direction at all times, $\text{sgn}(\dot{x}_i) = 1$ for $i = 1, 2, \dots$. Consequently, the dynamics of the simplified model are described by two nonlinear differential equations, namely,

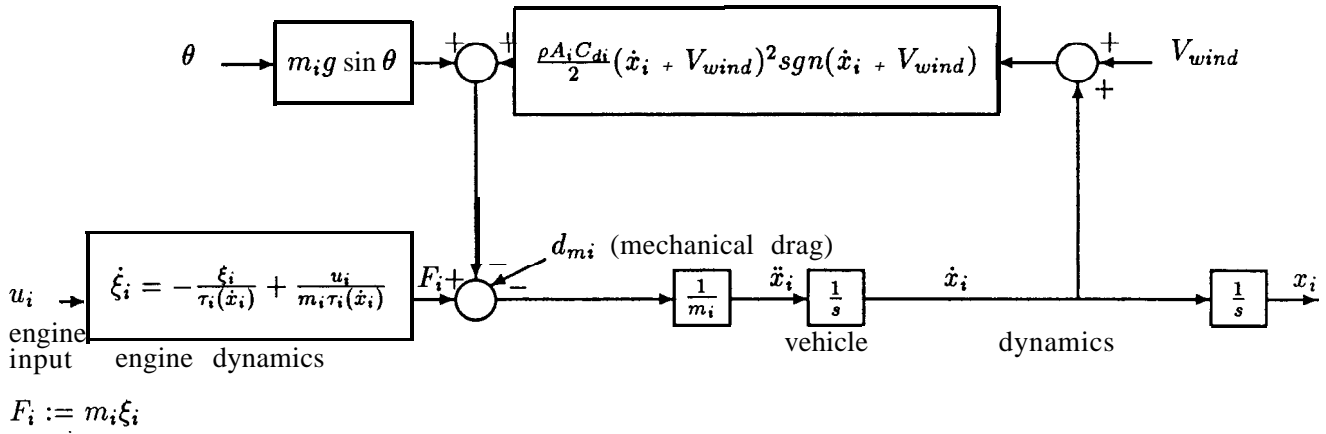

Figure 2: Vehicle model of the i -th vehicle in the platoon

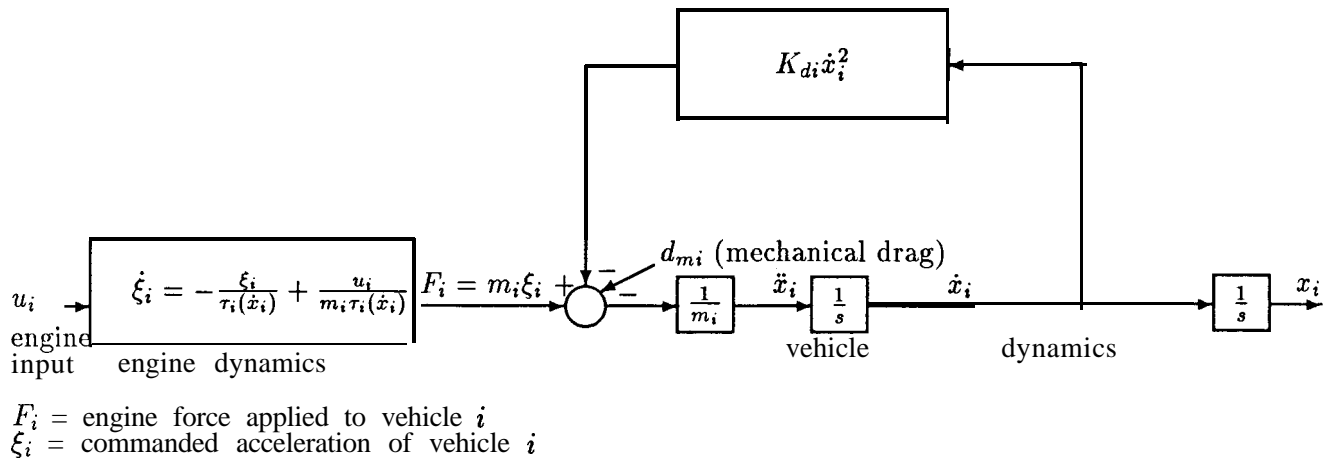

Figure 3: Simplified model of the i -th vehicle in the platoon

$$m_i \ddot{x}_i = m_i \xi_i - K_{di} \dot{x}_i^2 - d_{mi} \quad (3.2)$$

$$\dot{\xi}_i = -\frac{\xi_i}{\tau_i(\dot{x}_i)} + \frac{u_i}{m_i \tau_i(\dot{x}_i)} \quad (3.3)$$

4 Exact Linearization of Vehicle Dynamics

In the following section we will use exact linearization methods [Isid.1,sec.4.2,pp.156-159Sast.11] to linearize the input-output behavior of each vehicle in the platoon. A formal derivation of the following results is included in the appendix at the end of this paper.

Analysis In the following we consider exclusively the simplified model (3.2) and (3.3). From (3.2) we obtain

$$\xi_i = \ddot{x}_i + \frac{K_{di}}{m_i} \dot{x}_i^2 + \frac{d_{mi}}{m_i} \quad (4.1)$$

Substituting the expression for ξ_i from (4.1) in (3.3) gives

$$\dot{\xi}_i = -\frac{1}{\tau_i(\dot{x}_i)} \left[\ddot{x}_i + \frac{K_{di}}{m_i} \dot{x}_i^2 + \frac{d_{mi}}{m_i} \right] + \frac{u_i}{m_i \tau_i(\dot{x}_i)} \quad (4.2)$$

Differentiating both sides of (3.2) with respect to time and substituting the expression for $\dot{\xi}_i$ from (4.2) we get

$$\ddot{\xi}_i = -2 \frac{K_{di}}{m_i} \dot{x}_i \ddot{x}_i - \frac{1}{\tau_i(\dot{x}_i)} \left[\ddot{x}_i + \frac{K_{di}}{m_i} \dot{x}_i^2 + \frac{d_{mi}}{m_i} \right] + \frac{u_i}{m_i \tau_i(\dot{x}_i)} \quad (4.3)$$

Linearizing state feedback The expression in (4.3) is of the form

$$\ddot{\xi}_i = b(\dot{x}_i, \ddot{x}_i) + a(\dot{x}_i) u_i \quad (4.4)$$

where

$$b(\dot{x}_i, \ddot{x}_i) := -2 \frac{K_{di}}{m_i} \dot{x}_i \ddot{x}_i - \frac{1}{\tau_i(\dot{x}_i)} \left(\ddot{x}_i + \frac{K_{di}}{m_i} \dot{x}_i^2 + \frac{d_{mi}}{m_i} \right) \quad (4.5)$$

and

$$a(\dot{x}_i) := \frac{1}{m_i \tau_i(\dot{x}_i)} \quad (4.6)$$

To linearize the i -th vehicle's nonlinear dynamics, we create an exogeneous input c_i which is related to the i -th vehicle throttle input, u_i , by the following equation

$$u_i = \frac{1}{a(\dot{x}_i)} [c_i - b(\dot{x}_i, \ddot{x}_i)] \quad (4.7)$$

This equation describes a nonlinear state feedback applied to the i -th vehicle's dynamics (4.4) and it is illustrated by Figure 4.

Substituting (4.7) into (4.4) gives a system of linear differential equations representing the dynamics of the i -th vehicle after linearization by state feedback, namely, for $i=1,2,\dots$

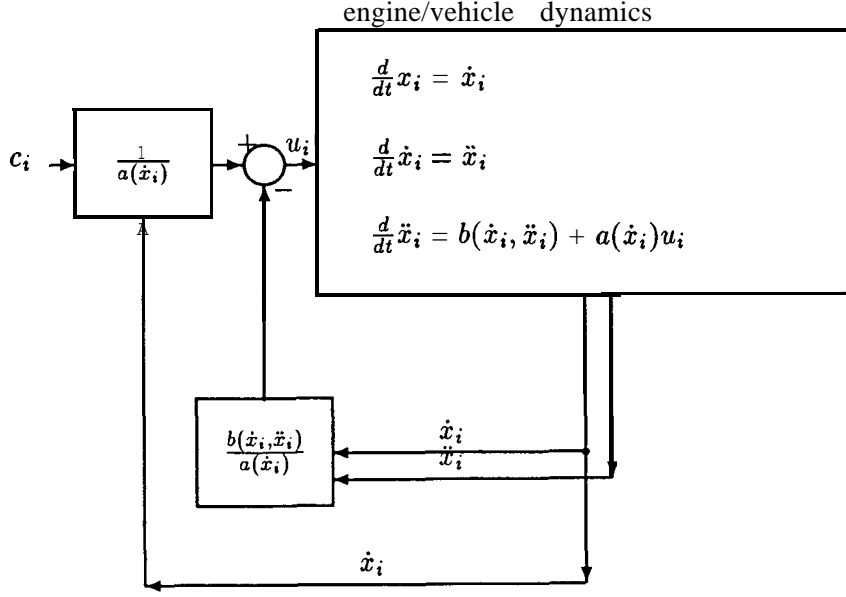

Figure 4: Block diagram showing the linearizing state feedback for the i -th vehicle in the platoon; it is based on equations (4.4) to (4.6) and the linearizing state feedback (4.7). The result is the set of equations (4.8)-(4.10).

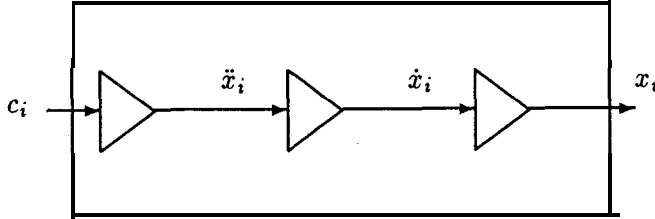

Figure 5: Input/Output point of view of the i -th vehicle's linearized model.

$$\frac{d}{dt}x_i = \dot{x}_i \quad (4.8)$$

$$\frac{d}{dt}\dot{x}_i = \ddot{x}_i \quad (4.9)$$

$$\frac{d}{dt}\ddot{x}_i = c_i \quad (4.10)$$

These equations are illustrated by Figure 5: note the new input c_i .

Remark The nonlinear state feedback law (4.7) has achieved two objectives:

1. It linearized the i -th vehicle dynamics;
2. It resulted in dynamics that are independent of m_i, d_{mi}, K_{di} , and $\tau_i(\dot{x}_i)$; i.e., the resulting dynamics of the vehicles are independent of their particular characteristics.

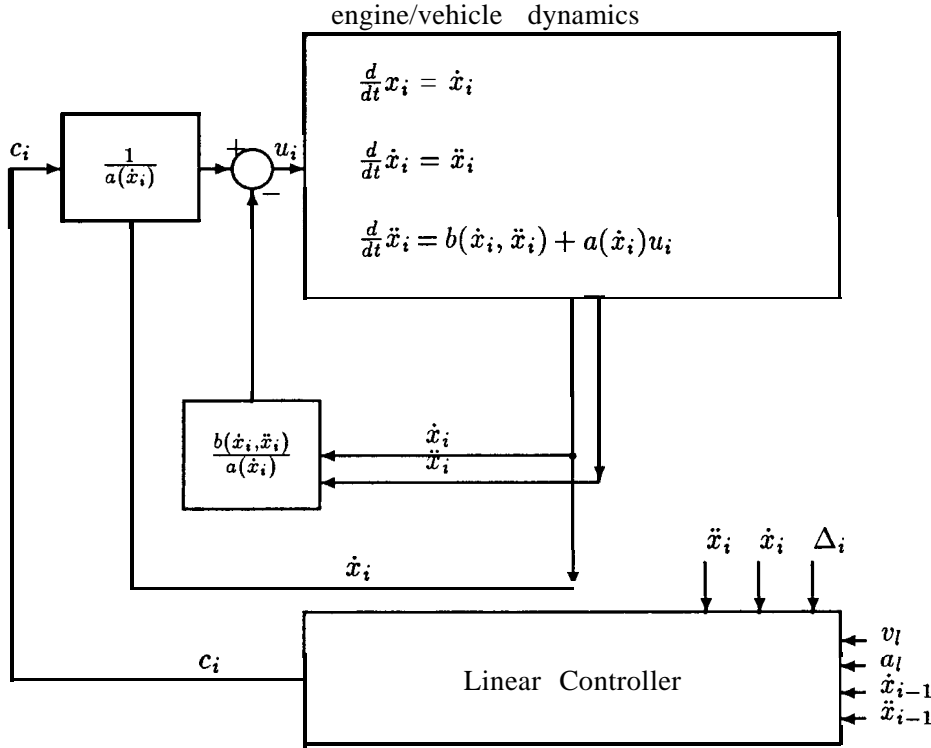

Figure 6: Linearized model of the i -th vehicle with control input $c_i, i=1, 2, \dots$

Implementation Issues To compute the linearizing state feedback (4.7), we need to be able to compute the values of the functions $b(\cdot, \cdot)$ and $a(\cdot)$. From (4.5) and (4.6) we note that computation of $b(\cdot, \cdot)$ and $a(\cdot)$ requires sensors to measure the velocity of the i -th vehicle (\dot{x}_i) and the acceleration of the i -th vehicle (\ddot{x}_i). In addition, we need to be able to accurately estimate mass of the i -th vehicle (m_i) and i -th vehicle's mechanical drag (d_{mi}). The vehicle's manufacturer will provide the data regarding engine time constant (the function $\tau_i(\cdot)$), and the vehicle's aerodynamic characteristics ($K_{di} := \frac{\rho A_i C_{di}}{2}$).

5 Platoon Dynamics

In the sequel we will use the linearized vehicle model given in (4.8)-(4.10) for analyzing the platoon dynamics.

5.1 Proposed control law

Figure 6 shows the linearized model of the i -th vehicle with control input c_i . We propose the following linear control law for longitudinal control of vehicles: for the first linearized vehicle model the control law is

$$c_1 := c_{p1}\Delta_1(t) + c_{v1}\dot{\Delta}_1(t) + c_{a1}\ddot{\Delta}_1(t) + k_{v1} [v_l(t) - v_l(0-)] + k_{a1}a_l(t) \quad (5.1)$$

where $v_l(0-)$ denotes the steady-state value of the lead vehicle's velocity (v_l); for linearized vehicle models $2, 3, \dots$ the control law is

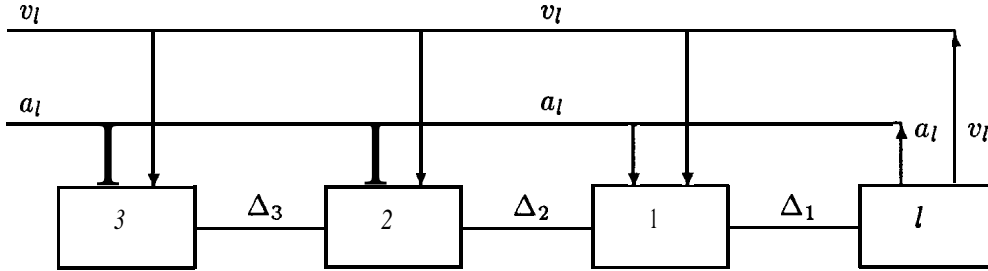

Figure 7: Platoon Configuration under the proposed control law for a platoon of 4 vehicles

$$c_i := c_p \Delta_i(t) + c_v \dot{\Delta}_i(t) + c_a \ddot{\Delta}_i(t) + k_v [v_l(t) - v_i(t)] + k_a [a_l(t) - a_i(t)] \quad (5.2)$$

where c_{p1} , c_{v1} , c_{a1} , k_{v1} , k_{a1} , c_p , c_v , c_a and k_a are design constants. Note that the control law for the first vehicle differs from the control law for all the other vehicles in the two rightmost terms in (5.1). This is due to the fact that for the first vehicle $v_l - v_1 = \dot{\Delta}_1$ and $a_l - a_1 = \ddot{\Delta}_1$ which are already a part of the first vehicle's control law; whereas, for vehicle i ($i = 2, 3, \dots$) $v_l - v_i = \dot{\Delta}_1 + \dots + \dot{\Delta}_i$ and $a_l - a_i = \ddot{\Delta}_1 + \dots + \ddot{\Delta}_i$.

Comparison of our control law (5.2) for the i -th vehicle with the control laws in the literature shows that using the lead vehicle's acceleration (a_l) in the i -th vehicle's control law is the new addition to the i -th vehicle's control laws considered in the literature. Shladover had used lead vehicle's velocity (v_l) [Shla.1] and $\ddot{\Delta}_i$ [Shla.2] in the i -th vehicle's control law.

5.2 Implementation Issues

Figure 7 shows the platoon configuration under the proposed control law for a platoon of 4 vehicles: the lead vehicle's velocity (v_l) and acceleration (a_l) are transmitted to all the vehicles within the platoon. In addition, sensors on each vehicle, say i , measure the deviation of the i -th vehicle from its assigned position, namely Δ_i . Computation of the first and the second order time derivatives of the i -th vehicle's deviation from its assigned position, namely $\dot{\Delta}_i$ and $\ddot{\Delta}_i$, can be done in two different ways:

1. Communication of the $(i-1)$ -st vehicle's velocity (\dot{x}_{i-1}) and acceleration (\ddot{x}_{i-1}) to the i -th vehicle. Obtaining the i -th vehicle's velocity (\dot{x}_i) and acceleration (\ddot{x}_i) from the sensors on the i -th vehicle, then the computer in this vehicle estimates $\dot{\Delta}_i$ ($:= \dot{x}_{i-1} - \dot{x}_i$) and $\ddot{\Delta}_i$ ($:= \ddot{x}_{i-1} - \ddot{x}_i$) for use in the i -th vehicle's control law.
2. Direct estimation of $\dot{\Delta}_i$ and $\ddot{\Delta}_i$ using the measured values for Δ_i .

The communication of the position, velocity, and acceleration information is unidirectional: from the lead vehicle to each vehicle in the platoon. Communication speed and processing of the measured data should be fast compared to the time constants of the vehicle dynamics. Preliminary studies in [Wal.1] suggest that such a requirement is feasible with the present communication and data processing technology.

5.3 First vehicle dynamics

Initial Conditions Throughout the study of the platoon dynamics we assume the following: for all $t < 0$, the platoon is in steady-state; for $t < 0$, $\dot{x}_i(t) = \dot{x}_l(t) = v_0$, $\Delta_i(t) = h_i(t) = \ddot{\Delta}_i(t) = 0$. Let w_l denote the increment of velocity of the lead vehicle from its steady-state value (v_0). Thus $w_l(t) := w_l(t) - v_0$.

The linear control law (5.1) applied to the linearized model results in the differential equation (5.4) relating Δ_1 to w_l .

Differentiating both sides of (2.2) three times with respect to the time variable and using the expression for \ddot{x}_1 from Figure 5 we obtain

$$\ddot{\Delta}_1(t) = \ddot{x}_l(t) - c_1(t) \quad (5.3)$$

Substituting (5.1) in (5.3) we obtain

$$\ddot{\Delta}_1(t) = \ddot{x}_l(t) - [c_{p1}\Delta_1(t) + c_{v1}\dot{\Delta}_1(t) + c_{a1}\ddot{\Delta}_1(t) + k_{v1}w_l(t) + k_{a1}a_l(t)] \quad (5.4)$$

Taking Laplace transforms we obtain

$$\begin{aligned} \{s^3 + c_{a1}s^2 + c_{v1}s + c_{p1}\} \hat{\Delta}_1(s) \\ = \{s^2 - k_{a1}s - k_v\} \hat{w}_l(s) \end{aligned} \quad (5.5)$$

where we use the symbol “ $\hat{\cdot}$ ” to distinguish Laplace transforms from the corresponding time-domain functions.

Thus:

$$\hat{h}_{\Delta_1 w_l}(s) = \frac{s^2 - k_{a1}s - k_{v1}}{s^3 + c_{a1}s^2 + c_{v1}s + c_{p1}} \quad (5.6)$$

Equ. (5.6) is the first basic design equation. From (5.6), we note that we can independently select all the zeros and all the poles of $\hat{h}_{\Delta_1 w_l}$ by choosing the design parameters $c_{a1}, c_{v1}, c_{p1}, k_{a1}$, and k_{v1} . It is crucial to note that **the selection of zeros and poles are independent of one another**.

5.4 Second vehicle dynamics

The linear control law (5.2) applied to the linearized model results in the differential equation (5.8) relating Δ_2 to Δ_1 and w_l .

From Figure 5 we obtain

$$\ddot{\Delta}_2(t) = c_1(t) - c_2(t) \quad (5.7)$$

Substituting in (5.7) the control laws for the first and the second vehicles, namely (5.1) and (5.2), we obtain

$$\begin{aligned}
\ddot{\Delta}_2(t) &= (c_{p1}\Delta_1(t) + c_{v1}\dot{\Delta}_1(t) + c_{a1}\ddot{\Delta}_1(t) + k_{v1}w_l(t) + k_{a1}a_l(t)) \\
&\quad - (c_p\Delta_2(t) + c_v\dot{\Delta}_2(t) + c_a\ddot{\Delta}_2(t)) \\
&\quad - (k_v[v_l(t) - v_2(t)] + k_a[a_l(t) - a_2(t)])
\end{aligned} \tag{5.3}$$

Taking Laplace transforms we obtain

$$\begin{aligned}
&\{s^3 + (c_a + k_a)s^2 + (c_v + k_v)s + c_p\} \hat{\Delta}_2(s) \\
&= \{c_{a1} - k_a\}s^2 + (c_{v1} - k_v)s + c_{p1} \} \hat{\Delta}_1(s) \\
&\quad + \{k_{a1}s + k_{v1}\} \hat{w}_l(s)
\end{aligned} \tag{5.9}$$

Thus:

$$\hat{h}_{\Delta_2\Delta_1}(s) = \frac{(c_{a1} - k_a)s^2 + (c_{v1} - k_v)s + c_{p1}}{s^3 + (c_a + k_a)s^2 + (c_v + k_v)s + c_p} \tag{5.10}$$

From (5.9), we note that in addition to the transfer function from Δ_1 to Δ_2 there is a transfer function from w_l to Δ_2 ; it differs from $\hat{h}_{\Delta_2\Delta_1}$ by its numerator which is $k_{a1}s + k_{v1}$.

5.5 i -th vehicle dynamics ($i = 3, 4, \dots$)

The linear control law (5.2) applied to the linearized model results in the differential equation (5.12) relating Δ_i to Δ_{i-1} .

From Figure 5 we obtain

$$\ddot{\Delta}_i(t) = c_{i-1}(t) - c_i(t) \tag{5.11}$$

Substituting the expressions for the proposed linear control laws for the $(i-1)$ -st and the i -th vehicles from (5.2) in (5.11) we obtain

$$\begin{aligned}
\ddot{\Delta}_i(t) &= c_p\Delta_{i-1}(t) + c_v\dot{\Delta}_{i-1}(t) + c_a\ddot{\Delta}_{i-1}(t) \\
&\quad + k_v[v_l(t) - v_{i-1}(t)] + k_a[a_l(t) - a_{i-1}(t)] \\
&\quad - c_p\Delta_i(t) - c_v\dot{\Delta}_i(t) - c_a\ddot{\Delta}_i(t) \\
&\quad - k_v[v_l(t) - v_i(t)] - k_a[a_l(t) - a_i(t)]
\end{aligned} \tag{5.12}$$

Taking Laplace transforms we obtain

$$\begin{aligned}
&\{s^3 + (c_a + k_a)s^2 + (c_v + k_v)s + c_p\} \hat{\Delta}_i(s) \\
&= \{c_a s^2 + c_v s + c\} \hat{\Delta}_{i-1}(s)
\end{aligned} \tag{5.13}$$

From (5.13), we obtain for $i = 3, 4, \dots$

$$\hat{g}(s) := \hat{h}_{\Delta_i\Delta_{i-1}}(s) = \frac{c_a s^2 + c_v s + c_p}{s^3 + (c_a + k_a)s^2 + (c_v + k_v)s + c_p} \tag{5.14}$$

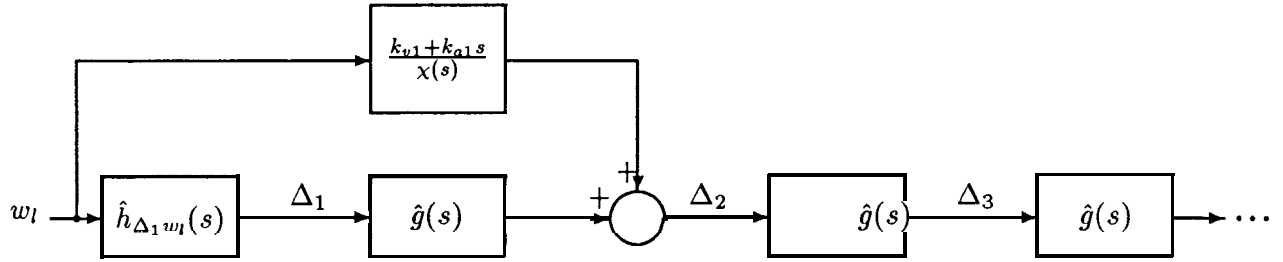

Figure 8: Block diagram for a platoon of linearized vehicle models

Let

$$x(s) := s^3 + (c_a + k_a)s^2 + (c_v + k_v)s + c_p \quad (5.15)$$

Equ. (5.14) is the second basic design equation. From (5.14), we note that we can select independently the poles of $\hat{g}(s)$ (bychoosing the appropriate design parameters $(c_a + k_a)$, $(c_v + k_v)$, and c_p) and the zeros of $\hat{g}(s)$ (bychoosing the appropriate c_a and c_v).

Furthermore, let us set $c_{a1} = c_a + k_a$, $c_{v1} = c_v + k_v$, and $c_{p1} = c_p$; then Equ.(5.6) shows that $\hat{h}_{\Delta_1 w_l}(s)$ has the same poles as $\hat{g}(s)$, and Equ.(5.10) shows that $\hat{h}_{\Delta_2 \Delta_1}(s)$ has the same poles as $\hat{g}(s)$; in other words, with these choices $\hat{g}(s)$, $\hat{h}_{\Delta_1 w_l}(s)$, and $\hat{h}_{\Delta_2 \Delta_1}(s)$ have $\chi(s)$ as denominator polynomial.

5.6 Design considerations

We use the block diagram in Figure 8 for analyzing the platoon. Some consideration of Figure 8 suggests the main design objectives for the longitudinal control law: from (5.5), (5.9), and (5.13), we have for $i = 2, 3, \dots$

$$\hat{h}_{\Delta_i w_l} = (\hat{g}(s))^{i-2} \left[\hat{h}_{\Delta_1 w_l}(s) \hat{g}(s) + \frac{k_{v1} + k_{a1}s}{\chi(s)} \right] \quad (5.16)$$

1. Since the perturbations in Δ_i due to changes (w_l) in the lead vehicle's velocity from its steady-state value should not get magnified from one vehicle to the next as one goes down the platoon, we require that $|\hat{g}(j\omega)| < 1$ for all $\omega > 0$ and $\omega \mapsto |\hat{g}(j\omega)|$ to be a strictly decreasing function of ω for $\omega > 0$.
2. Since the inverse Laplace transform of $[\hat{g}(s)]^2$ is the convolution of the impulse response of $\hat{g}(s)$ with itself (i.e., $g * g(t)$), to avoid oscillatory behavior down the platoon it is desirable to have $g(t) > 0$ for all t .

The design parameters have been chosen to satisfy these two requirements.

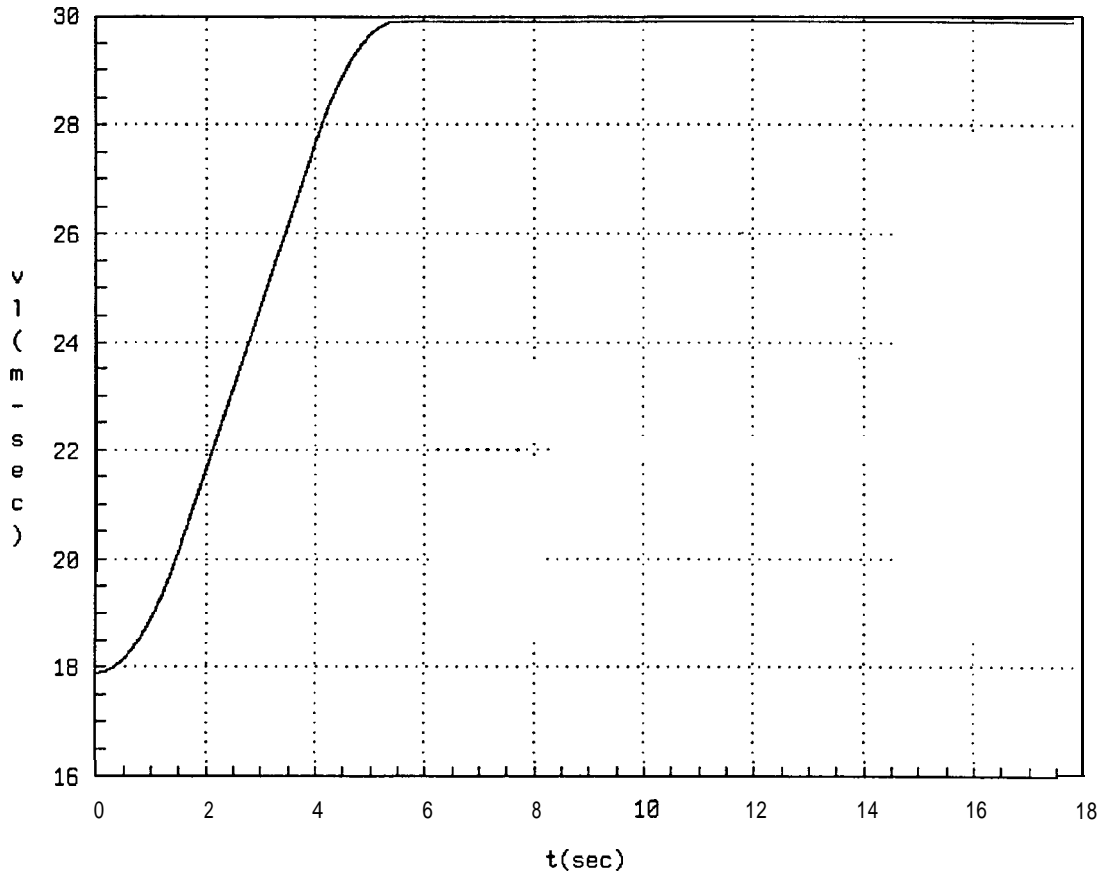

Figure 9: Lead vehicle's velocity profile (v_l)

6 Simulation Results

To examine the behavior of a platoon of non-identical vehicles under the above control laws, simulations for platoons consisting of 3 different types of vehicles were run using the System Build software package within MATRIXx. We ran simulations for platoons of 4 and 16 vehicles. In all the simulations conducted, all the vehicles were assumed to be initially traveling at the steady-state velocity of $v_0 = 17.9 \text{ m}\cdot\text{sec}^{-1}$ (i.e., 40 m.p.h.). Beginning at time $t = 0 \text{ sec}$, the lead vehicle's velocity was increased from its steady-state value of $17.9 \text{ m}\cdot\text{sec}^{-1}$ until it reached its final value of $29.9 \text{ m}\cdot\text{sec}^{-1}$ (i.e., 67 m.p.h.).

Figure 9 shows the lead vehicle's velocity as a function of time: the curve $v_l(t)$ corresponds to a maximum jerk of $2.0 \text{ m}\cdot\text{sec}^{-3}$ and peak acceleration of $3.0 \text{ m}\cdot\text{sec}^{-2}$ (i.e., roughly $0.3g$).

Simulations were run on a platoon of vehicles assuming different types of physical uncertainties

- Nominal system. Having exact knowledge of all the relevant parameters for applying exact linearization method (4.5)-(4.7) for all of the vehicles within the platoon; assuming no communication delays in transmitting the lead vehicle's velocity (v_l) and acceleration (a_l); assuming no communication delays in using A; in the i -th vehicle's control law (5.1)-(5.2) for $\ast = 1, 2, \dots$, assuming no noise in the measurement of A; for $i = 1, 2, \dots$
- Perturbed system without push button. Allowing perturbations in the i -th vehicle's mass (m_i) due to passengers' mass and luggage. The value of the mass parameter used for applying exact linearization method (4.5)-(4.7) is the vehicle's curb mass. All the assumptions regarding communication delays and measurement noise are identical to the nominal system. Note that

for vehicles with larger perturbations in vehicle's mass, one could use a push button device by which the driver punches in the number of vehicle occupants; but this is not assumed here.

- Perturbed system without push button, including communication delays. Allowing perturbations in the i -th vehicle's mass (m_i) due to passengers' mass and luggage. We assume there are no push button devices. The value of the mass parameter used for applying exact linearization method (4.5)-(4.7) is the vehicle's curb mass. We assume a constant communication delay in transmitting the lead vehicle's velocity (v_l) and acceleration (a_l) between any two successive vehicles following the lead vehicle; a constant communication delay in using A_i , $\dot{\Delta}_i$, and $\ddot{\Delta}_i$ in the i -th vehicle's control law (5.1)-(5.2) for $i = 1, 2, \dots$; and no noise in the measurement of A_i for $i = 1, 2, \dots$.
- Perturbed system without push button, including communication delays and noisy measurement. Allowing perturbations in the i -th vehicle's mass (m_i) due to passengers' mass and luggage. We assume there are no push button devices. The value of the mass parameter used for applying exact linearization method (4.5)-(4.7) is the vehicle's curb mass. We assume a constant communication delay in transmitting the lead vehicle's velocity (v_l) and acceleration (a_l) between any two successive vehicles following the lead vehicle; a constant communication delay in using Δ_i , $\dot{\Delta}_i$, and $\ddot{\Delta}_i$ in the i -th vehicle's control law (5.1)-(5.2) for $i = 1, 2, \dots$; and additive Gaussian noise in the measurement of Δ_i for $i = 1, 2, \dots$.

The following types of vehicles with their relevant parameters were used in the simulations

- Daihatsu Charade CLS- curb mass= 2015 *lbs.* (i.e., 916 *kg*); cross-sectional area (A)= 1.9 m^2 ; drag coefficient (C_d)= 0.35 (i.e., $K_d = 0.44 \text{ kg}\cdot m^{-1}$); engine time constant (τ)= 0.2 sec.
- Buick Regal Custom- curb mass= 3220 *lbs.* (i.e., 1464 *kg*); cross-sectional area (A)= 2.2 m^2 ; drag coefficient (C_d)= 0.35 (i.e., $K_d = 0.49 \text{ kg}\cdot m^{-1}$); engine time constant (τ)= 0.25 sec.
- BMW 750iL- curb mass= 4235 *lbs.* (i.e., 1925 *kg*); cross-sectional area (A)= 2.25 m^2 ; drag Coefficient (C_d)= 0.35 (i.e., $K_d = 0.51 \text{ kg}\cdot m^{-1}$); engine time constant (τ)= 0.2 sec.

The order in which the above vehicles followed the lead vehicle was as follows: Daihatsu Charade CLS followed by Buick Regal Custom followed by BMW 750iL followed by Daihatsu Charade CLS and so on.

The number of passengers in each vehicle and their respective weights were as follows:

- Daihatsu Charade CLS- 3 passengers each weighing 200 *lbs.*
- Buick Regal Custom- 2 passengers each weighing 140 *Zbs.*
- BMW 750iL- 4 passengers with the following weights (in *lbs.*): 100, 100, 200, 130.

The following values were chosen for the relevant parameters in the simulation:

$$c_{a1} = 15, c_{v1} = 74, c_{p1} = 120, k_{a1} = -3.03, k_{v1} = -0.05$$

$$c_a = 5, c_v = 49, c_p = 120, k_a = 10, k_v = 25$$

Using the above values for the parameters, we obtain

$$\hat{h}_{\Delta_1 w_l}(s) = \frac{(s + 3.01)(s + 0.017)}{(s + 4)(s + 5)(s + 6)}$$

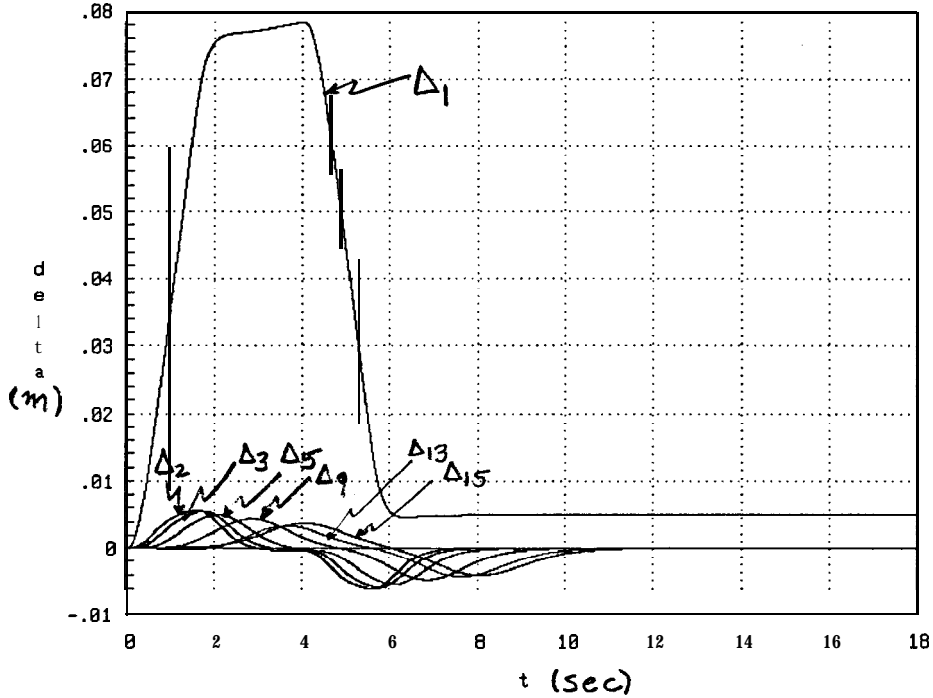

Figure 10: $\Delta_1, \Delta_2, \Delta_3, \Delta_5, \Delta_9, \Delta_{13},$ and Δ_{15} vs. t : nominal system

$$\hat{h}_{\Delta_2 w_l}(s) = \frac{s(1.97s^3 + 18.65s^2 + 43.75s - 1.25)}{[(s + 4)(s + 5)(s + 6)]^2}$$

$$\hat{g}(s) = \frac{5(s + 4.9)^2}{(s + 4)(s + 5)(s + 6)}$$

6.1 Nominal system

Figure 10 shows the deviations of the first, second, third, fifth, ninth, thirteenth, and fifteenth vehicles from their pre-assigned positions due to the lead vehicle's velocity profile shown in Figure 9.

Figure 11 shows the lead, first, second, third, fifth, ninth, thirteenth, and fifteenth vehicle's acceleration profiles due to the lead vehicle's velocity profile shown in Figure 9 for the nominal system.

Simulation results show that the deviations of the vehicles from their pre-assigned positions do not exceed 0.08 **m** (i.e., less than 4 inches) and decrease to values which are less than 1 **cm**. The acceleration profiles of the vehicles in the platoon are within the range of acceptable comfort limits and are almost identical to the lead vehicle's acceleration (a).

6.2 Perturbed system without push button

Figure 12 shows the deviations of the first, second, third, fifth, ninth, thirteenth, and fifteenth vehicles from their pre-assigned positions due to the lead vehicle's velocity profile shown in Figure 9

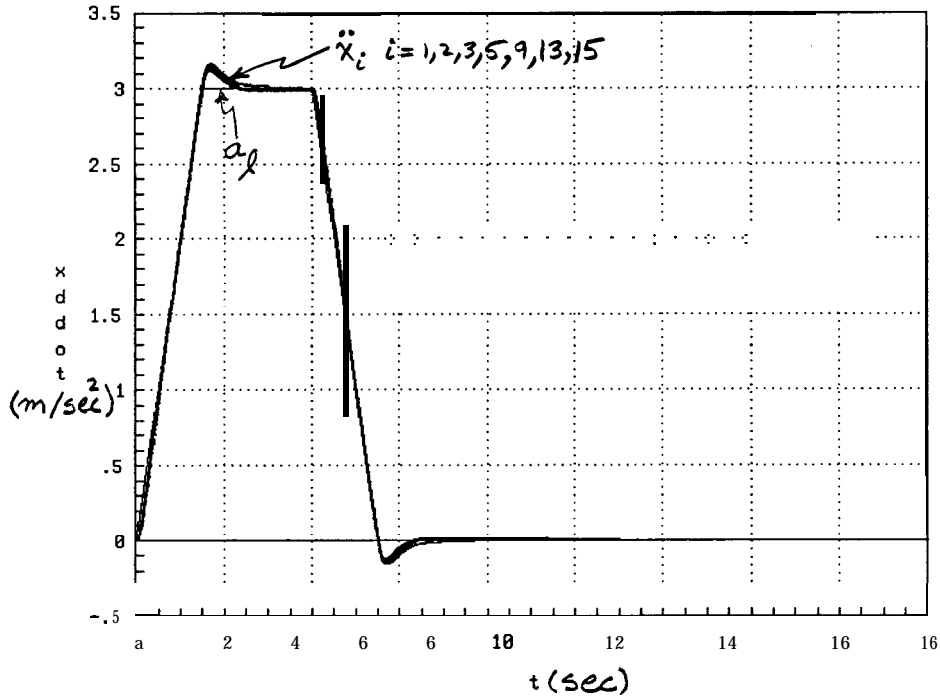

Figure 11: $a_l, \ddot{x}_1, \ddot{x}_2, \ddot{x}_3, \ddot{x}_5, \ddot{x}_9, \ddot{x}_{13},$ and \ddot{x}_{15} vs. t : nominal system

for the perturbed system without a push button device.

Note that the perturbations in the mass parameter range from 8% to 23%.

Figure 13 shows the lead, first, second, third, fifth, ninth, thirteenth, and fifteenth vehicle's acceleration profiles due to the lead vehicle's velocity profile shown in Figure 9 for the perturbed system without a push button device.

Simulation results show that the deviations of the vehicles from their pre-assigned positions do not exceed 0.11 m (i.e., 4 inches) and decrease to values which are less than 1 cm. Such deviations do not exhibit any oscillatory behavior. The acceleration profiles of the vehicles in the platoon are within the range of acceptable comfort limits and are almost identical to the lead vehicle's acceleration (a_l).

6.3 Perturbed system without push button, including communication delays

For the perturbed system without a push button device, including communication delays we chose the delay in communicating the lead vehicle's velocity (v_l) and acceleration (a_l) to the first vehicle in the platoon to be 20 msec; we chose the delay in communicating the lead vehicle's velocity (v_l) and acceleration (a_l) between any two successive vehicles in the platoon to be 6 msec; we chose the communication delay in using $A, \dot{A},$ and \ddot{A} to be 6 msec.

Figure 14 shows the deviations of the first, second, third, fifth, ninth, thirteenth, and fifteenth vehicles from their pre-assigned positions due to the lead vehicle's velocity profile shown in Figure 9 for the perturbed system without a push button device, including communication delays.

Note that the perturbations in the mass parameter range from 8% to 23%.

Figure 15 shows the lead, first, second, third, fifth, ninth, thirteenth, and fifteenth vehicle's

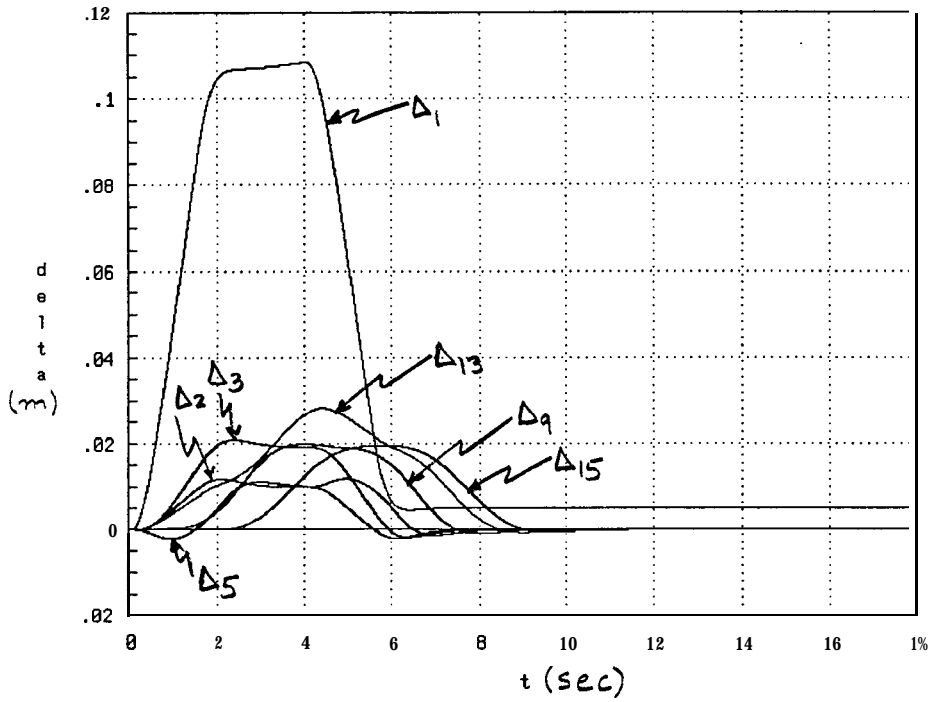

Figure 12: $\Delta_1, \Delta_2, \Delta_3, \Delta_5, \Delta_9, \Delta_{13}$, and Δ_{15} vs. t : perturbed system, not using push button

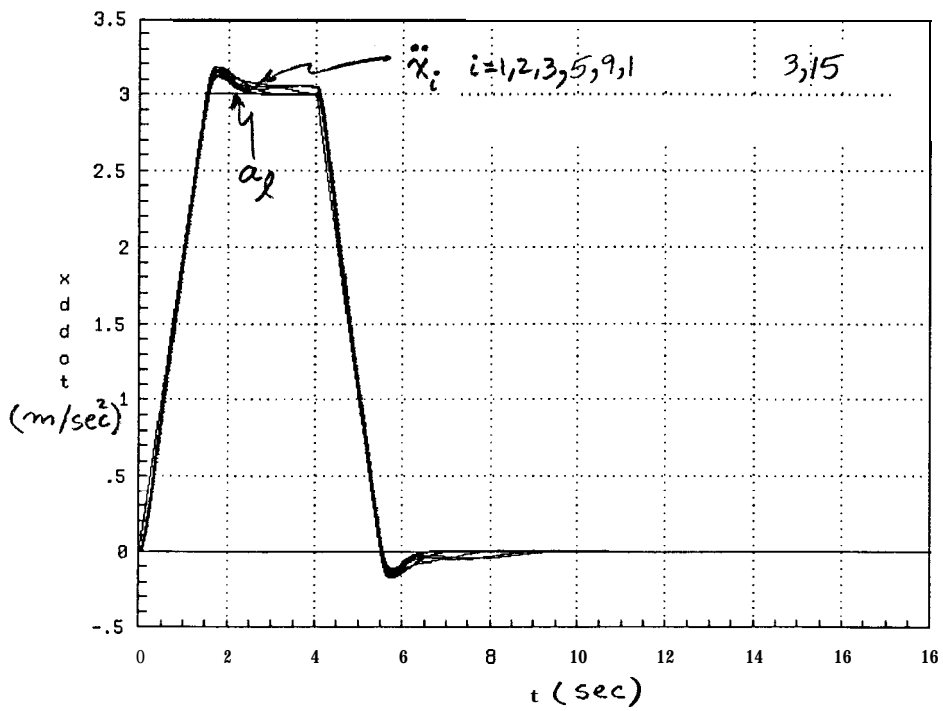

Figure 13: $a_1, \ddot{x}_1, \ddot{x}_2, \ddot{x}_3, \ddot{x}_5, \ddot{x}_9, \ddot{x}_{13}$, and \ddot{x}_{15} vs. t : perturbed system, not using push button

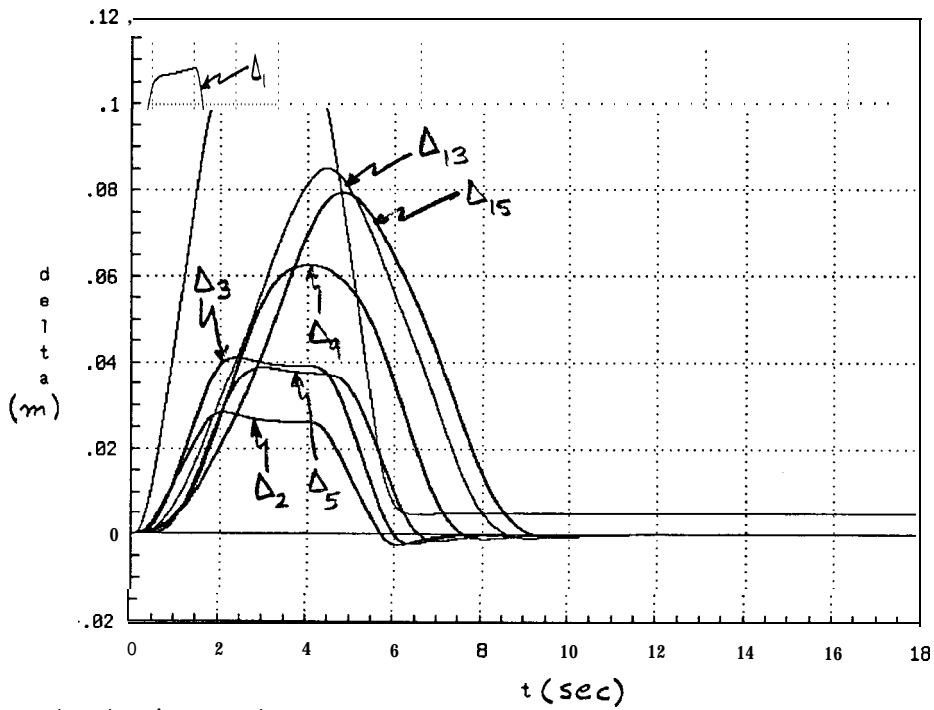

Figure 14: $\Delta_1, \Delta_2, \Delta_3, \Delta_4, \Delta_5, \Delta_9, \Delta_{13},$ and Δ_{15} vs. t : perturbed system with communication delay in transmitting lead vehicle's velocity (v_l), acceleration (a_l), and successive vehicle deviations ($A, \dot{\Delta},$ and $\ddot{\Delta}$); not using push button

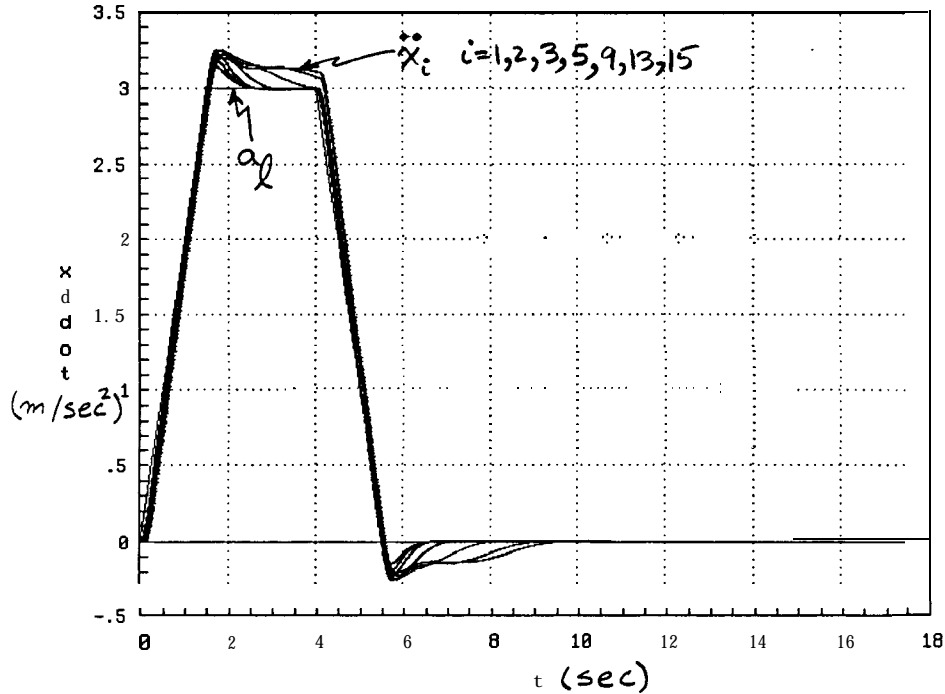

Figure 15: $a_l, \ddot{x}_1, \ddot{x}_2, \ddot{x}_3, \ddot{x}_5, \ddot{x}_9, \ddot{x}_{13},$ and \ddot{x}_{15} vs. t : perturbed system with communication delay in transmitting lead vehicle's velocity (v_l), acceleration (a_l), and successive vehicle deviations (A, A, and A); not using push button

acceleration profiles due to the lead vehicle's velocity profile shown in Figure 9 for the perturbed system without a push button device, including communication delays.

Simulation results show that the deviations of the vehicles from their pre-assigned positions do not exceed 0.11 m (i.e., 4 inches) and decrease to values which are less than 1 cm, but are noticeably worse than in the case without communication delays. The acceleration profiles of the vehicles in the platoon are within the range of acceptable comfort limits and are almost identical to the lead vehicle's acceleration (a_l).

6.4 Perturbed system without push button, including communication delays and measurement noise

For the perturbed system without a push button device, including communication delays and measurement noise we chose the delay in communicating the lead vehicle's velocity (v_l) and acceleration (a_l) to the first vehicle in the platoon to be 20 msec; we chose the delay in communicating the lead vehicle's velocity (v_l) and acceleration (a_l) between any two successive vehicles in the platoon to be 6 msec; we chose the communication delay in using A, A, and $\ddot{\Delta}$ to be 6 msec; The value of A; used in the i -th vehicle's control law (5.1)- (5.2) was the sum of the actual measured value of A; delayed by 6 msec and some Gaussian noise with zero mean and standard deviation (σ) of 0.05 m.

Figure 16 shows the deviations of the first, second, third, fifth, ninth, thirteenth, and fifteenth vehicles from their pre-assigned positions due to the lead vehicle's velocity profile shown in Fig-

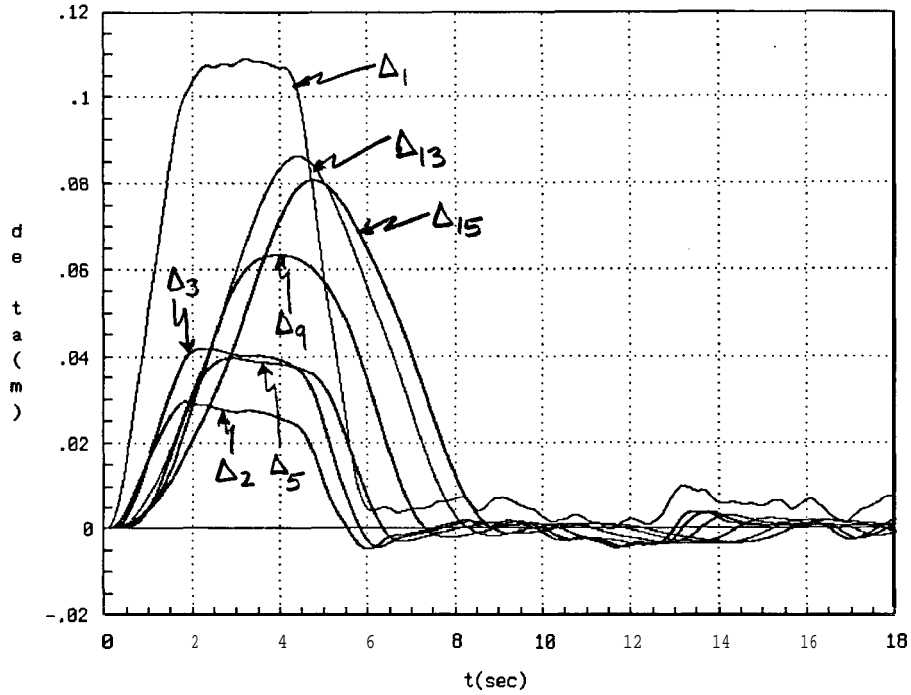

Figure 16: $\Delta_1, \Delta_2, \Delta_3, \Delta_5, \Delta_9, \Delta_{13},$ and Δ_{15} vs. t : perturbed system with noisy measurement of A and communication delay in transmitting lead vehicle's velocity (v_l), acceleration (a_l), and successive vehicle deviations ($A, \hat{\Delta},$ and A); not using push button

Figure 9 for the perturbed system without a push button device, including communication delays and measurement noise.

Note that the perturbations in the mass parameter range from 8% to 23%.

Figure 17 shows the lead, first, second, third, fifth, ninth, thirteenth, and fifteenth vehicle's acceleration profiles due to the lead vehicle's velocity profile shown in Figure 9 for the perturbed system without a push button device, including communication delays and measurement noise.

Simulation results show that the deviations of the vehicles from their pre-assigned positions do not exceed 0.11 m (i.e., 4 inches) and decrease to values which are less than 1 cm. The acceleration profiles of the vehicles in the platoon are within the range of acceptable comfort limits and are almost identical to the lead vehicle's acceleration (a_l). Note that the non-smooth variations in A and \ddot{x} are a result of injecting uncorrelated samples of noise at intervals of 3 msec whereas the linear controller's time constant is on the order of $\frac{1}{6} \text{ sec}$; thus, the system does not have enough time to react smoothly to such fast varying inputs.

7 Conclusion

We have shown that for the nominal case through the appropriate choice of design parameters, deviations in the successive vehicle spacings do not get magnified from the front to the back of a platoon of non-identical vehicles as a result of lead vehicle's acceleration from its initial steady-state velocity (v_n) to its final steady-state velocity; however, such deviations are noticeably worse

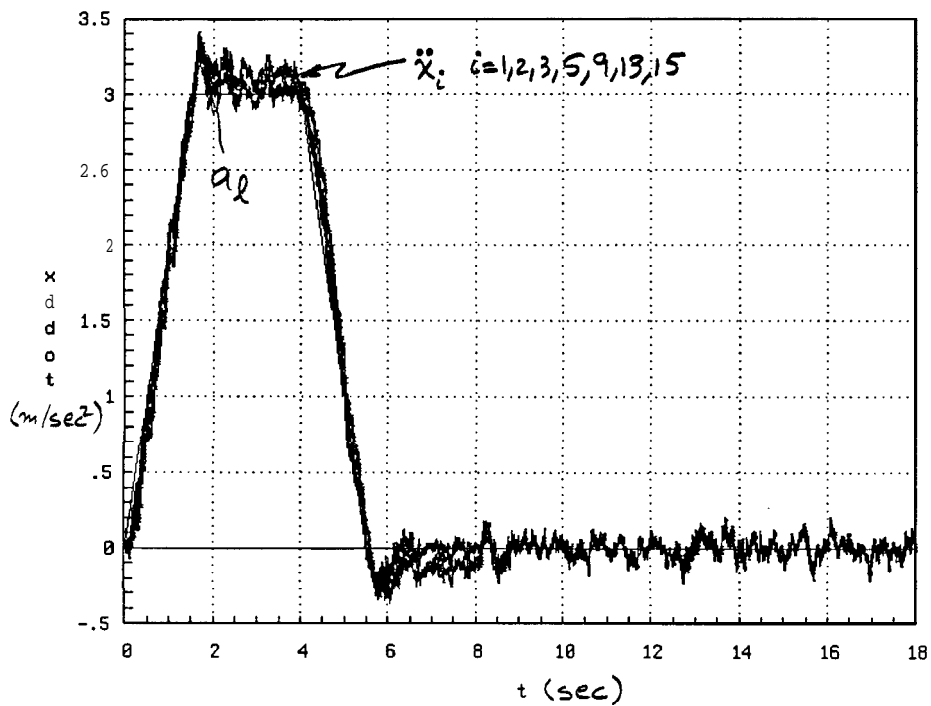

Figure 17: $a_l, \ddot{x}_1, \ddot{x}_2, \ddot{x}_3, \ddot{x}_5, \ddot{x}_9, \ddot{x}_{13},$ and \ddot{x}_{15} vs. t : perturbed system with noisy measurement of A and communication delay in transmitting lead vehicle's velocity (v_l), acceleration (a_l), and successive vehicle deviations ($\Delta, \dot{\Delta},$ and $\ddot{\Delta}$); not using push button

with delays in communication. Furthermore, for the nominal case, the deviations in the successive vehicle spacings do not exhibit any oscillatory time-behavior.

Simulation results show that the exact linearization method used performs well in the presence of perturbations in the vehicle's mass (from 8% to 23%), including communication delays and measurement noise; the magnitude of the successive vehicle spacings is well within 5 inches for a platoon of 16 vehicles and the acceleration profiles of the vehicles in the platoon are within the range of acceptable comfort limits.

8 Appendix

Notation In the sequel we will adopt the following notations:

$\vec{x}_i := (x_i, \dot{x}_i, \xi_i)^T$ for $i = 1, 2, \dots$, where v^T denotes the transpose of the vector v .

Let $f : R^n \rightarrow R^n$ and $h : R^n \rightarrow R$ be infinitely differentiable functions. We will denote the Lie derivative of $h(\cdot)$ along the vector field specified by $f(\cdot)$ by $L_f h(\cdot)$ where:

$$L_f h : R^n \rightarrow R$$

$$L_f h : x \mapsto \frac{\partial h}{\partial x}(x) f(x)$$

We will use $L_f^k h(\cdot)$ ($k = 2, 3, \dots$) to denote the following function:

$$L_f^k h : R^n \rightarrow R$$

$$L_f^k h : x \mapsto \frac{\partial L_f^{k-1} h}{\partial x}(x) f(x)$$

Analysis In the following we consider exclusively the simplified model (3.2) and (3.3). Noting the summing node and the engine dynamics block in figure 3, we write the engine/vehicle dynamics of the i -th vehicle as follows:

$$\dot{\vec{x}}_i = f(\vec{x}_i) + g(\vec{x}_i)u_i \quad (8.1)$$

where, from (3.2) and (3.3)

$$f(\vec{x}_i) := f(x_i, \dot{x}_i, \xi_i) = \left(\dot{x}_i, -\frac{K_{di}}{m_i} \dot{x}_i^2 + \xi_i - \frac{d_{mi}}{m_i}, -\frac{\xi_i}{\tau_i(\dot{x}_i)} \right)^T \quad (8.2)$$

$$g(\vec{x}_i) := g(x_i, \dot{x}_i, \xi_i) = \left(0, 0, \frac{1}{m_i \tau_i(\dot{x}_i)} \right)^T \quad (8.3)$$

To apply the exact linearization method, we choose as output the variable x_i ; that is, the output variable x_i is given in terms of the state $\vec{x}_i := (x_i, \dot{x}_i, \xi_i)^T$ by the function $h(\cdot)$; following the tradition, we label this chosen output y_i

$$y_i := h(\vec{x}_i) \quad (8.4)$$

where

$$h(\vec{x}_i) := h(x_i, \dot{x}_i, \xi_i) = x_i \quad (13.5)$$

Successively differentiating both sides of (8.4) with respect to the time variable and using (8.1), (8.2), (8.3), and (8.5) we obtain

$$\dot{y}_i = L_f h(\bar{x}_i) = \dot{x}_i \quad (8.6)$$

$$\dot{y}_i = L_f^2 h(\bar{x}_i) = -\frac{K_{di}}{m_i} \dot{x}_i^2 + \xi_i - \frac{d_{mi}}{m_i} \quad (8.7)$$

$$\ddot{y}_i = L_f^3 h(\bar{x}_i) + L_g L_f^2 h(\bar{x}_i) u_i \quad (8.8)$$

where

$$\begin{aligned} L_f^3 h(\bar{x}_i) &= \frac{\partial L_f^2 h}{\partial x}(\bar{x}_i) f(\bar{x}_i) \\ &= -2\frac{K_{di}}{m_i} \dot{x}_i \left(-\frac{K_{di}}{m_i} \dot{x}_i^2 + \xi_i - \frac{d_{mi}}{m_i}\right) - \frac{1}{\tau_i(\dot{x}_i)} \xi_i \end{aligned} \quad (8.9)$$

and

$$\begin{aligned} L_g L_f^2 h(\bar{x}_i) &= \frac{\partial L_f^2 h}{\partial x}(\bar{x}_i) g(\bar{x}_i) \\ &= \frac{1}{m_i \tau_i(\dot{x}_i)} \end{aligned} \quad (8.10)$$

Let Ψ_i denote the following transformation of coordinates for the i -th vehicle's state $\bar{x}_i := (x_i, \dot{x}_i, \xi_i)^T$:

$$\begin{aligned} \Psi_i : R^3 &\rightarrow R^3 \\ \Psi_i : (x_i, \dot{x}_i, \xi_i)^T &\mapsto (\xi_{1i}, \xi_{2i}, \xi_{3i})^T \end{aligned}$$

where

$$\xi_{1i} := x_i \quad (8.11)$$

$$\xi_{2i} := \dot{x}_i \quad (8.12)$$

$$\xi_{3i} := -\frac{K_{di}}{m_i} \dot{x}_i^2 + \xi_i - \frac{d_{mi}}{m_i} \quad (8.13)$$

By inspection Ψ_i is a bijection (i.e., one-to-one and onto) from R^3 onto R^3 . **Let $D\Psi_i$ denote** the Jacobian of the transformation Ψ_i given by (8.11), (8.12), and (8.13), then note that $\det[D\Psi_i(\bar{x}_i)] \equiv 1$ for all \bar{x}_i in R^3 .

Linearizing state feedback Using the coordinates ξ_{1i} , ξ_{2i} , and ξ_{3i} , we rewrite the equations (8.6), (8.7), and (8.8) of the simplified model as follows:

$$\dot{\xi}_{1i} = \xi_{2i} \quad (8.14)$$

$$\dot{\xi}_{2i} = \xi_{3i} \quad (8.15)$$

$$\dot{\xi}_{3i} = b(\xi_{1i}, \xi_{2i}, \xi_{3i}) + a(\xi_{1i}, \xi_{2i}, \xi_{3i}) u_i \quad (8.16)$$

where

$$b(\xi_{1i}, \xi_{2i}, \xi_{3i}) := -2\frac{K_{di}}{m_i} \xi_{2i} \xi_{3i} - \frac{1}{\tau_i(\xi_{2i})} (\xi_{3i} + \frac{K_{di}}{m_i} \xi_{2i}^2 + \frac{d_{mi}}{m_i}) \quad (8.17)$$

and

$$a(\xi_{1i}, \xi_{2i}, \xi_{3i}) := \frac{1}{m_i \tau_i(\xi_{2i})} \quad (8.18)$$

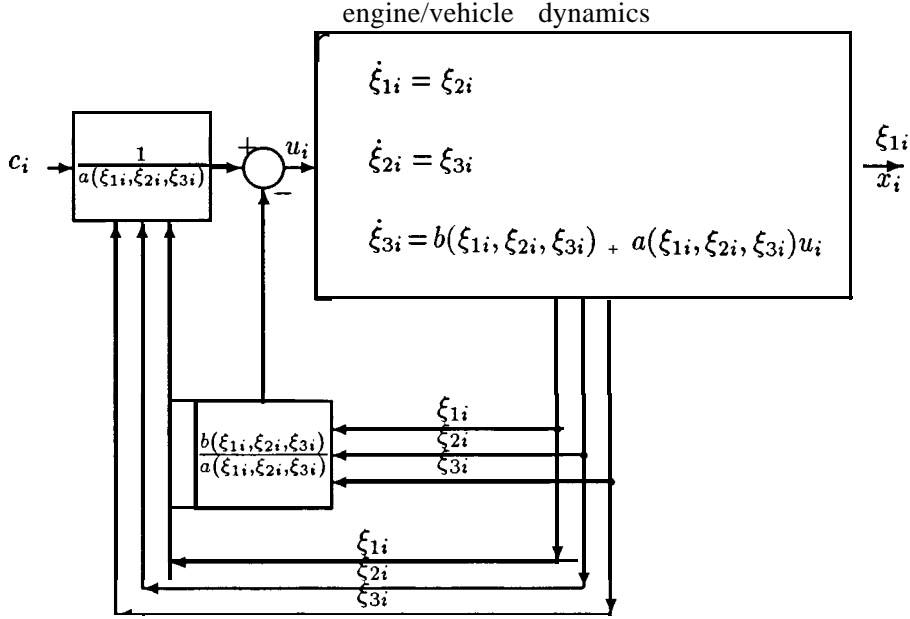

Figure 18: Block diagram showing the linearizing state feedback for the i -th vehicle in the platoon; it is based on equations (8.14) to (8.18) and the linearizing state feedback (8.19). The result is the set of equations (8.20)-(8.22).

Equations (8.14), (8.15) and (8.16) describe the i -th vehicle's dynamics. To linearize these nonlinear dynamics, we create an exogenous input c_i which is related to the i -th vehicle throttle input, u_i , by the following equation

$$u_i = \frac{1}{a(\xi_{1i}, \xi_{2i}, \xi_{3i})} [c_i - b(\xi_{1i}, \xi_{2i}, \xi_{3i})] \quad (8.19)$$

This equation describes a nonlinear state feedback applied to the system (8.14)-(8.16) and it is illustrated by Figure 18.

Substituting (8.19) into (8.16) gives a system of linear differential equations representing the dynamics of the i -th vehicle after linearization by state feedback, namely,

$$\dot{\xi}_{1i} = \xi_{2i} \quad (8.20)$$

$$\dot{\xi}_{2i} = \xi_{3i} \quad (8.21)$$

$$\dot{\xi}_{3i} = c_i \quad (8.22)$$

These equations are illustrated by Figure 19: note the new input c_i .

Remark The nonlinear state feedback law (8.19) has achieved two objectives:

1. It linearized the i -th vehicle dynamics.
2. It resulted in dynamics that are independent of m_i , d_i , K_{di} , and $\tau_i(\dot{x}_i)$; i.e., the resulting dynamics of the vehicles are independent of their particular characteristics.

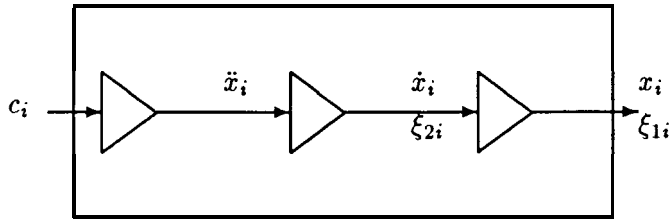

Figure 19: Input/Output point of view of the i -th vehicle's linearized model: here we note that $\xi_{1i} = x_i$ and $\xi_{2i} = \dot{x}_i$.

9 References

- [Hauk.1] Hauksdottir, A.S., Fenton, R.E. "On vehicle Longitudinal Controller Design," *1988 IEEE Workshop on Automotive Applications of Electronics*, 1988, pp.77-83.
- [Hobe.1] Hoberock, L.L., "A Survey of Longitudinal Acceleration Comfort Studies in Ground Transportation Vehicles," *Journal of Dynamic Systems, Measurement and Control*, vol.99, June 1977, pp.7684.
- [Hobe.2] Hoberock, L.L., Rouse, R.J., Jr., "Emergency Control of Vehicle Platoons: System Operation and Platoon Leader Control," *Journal of Dynamic Systems, Measurement and Control*, vol.98, No.3, Sept.1976, pp.245-251.
- [Isid.1] Isidori, A., *Nonlinear Control Systems*, 2nd. ed., Springer-Verlag 1989.
- [Rous.1] Rouse, R.J., Jr., Hoberock, L.L. "Emergency Control of Vehicle Platoons: Control of Following-Law Vehicles," *Journal of Dynamic Systems, Measurement and Control*, vol.98, No.3, Sept.1976, pp.239-244.
- [Sast.1] Sastry, S.S., Isidori, A. "Adaptive Control of Linearizable Systems," *IEEE Trans. on Auto. Cont.*, ~01.34, No.11, Nov.1989, pp.1123-1131.
- [Sheik.1] Sheikh, S., Desoer, C.A., "Longitudinal Control of a Platoon of Vehicles 1: Linear Model," *PATH Research Report UCB-ITS-PRR-SS-3 and UCB/ERL Memorandum MS9/106*, August 1989.
- [Shla.1] Shladover, S.E., "Operation of automated guideway transit vehicles in dynamically reconfigured trains and platoons," *Automated Guideway Transit Technology Program*, UMTA-MA-OG-00855-79-1, April 1979.
- [Shla.2] Shladover, S.E., "Longitudinal Control of Automotive Vehicles in Close-Formation Platoons," Preprint for Joint Symposium on Advanced Automotive Technologies 1989 ASME Winter Annual Meeting, Dec.1989.
- [Wal.1] Walrand, J.C., Private Communication at UC Berkeley, EECS Dept., Mar.-Aug.1989.