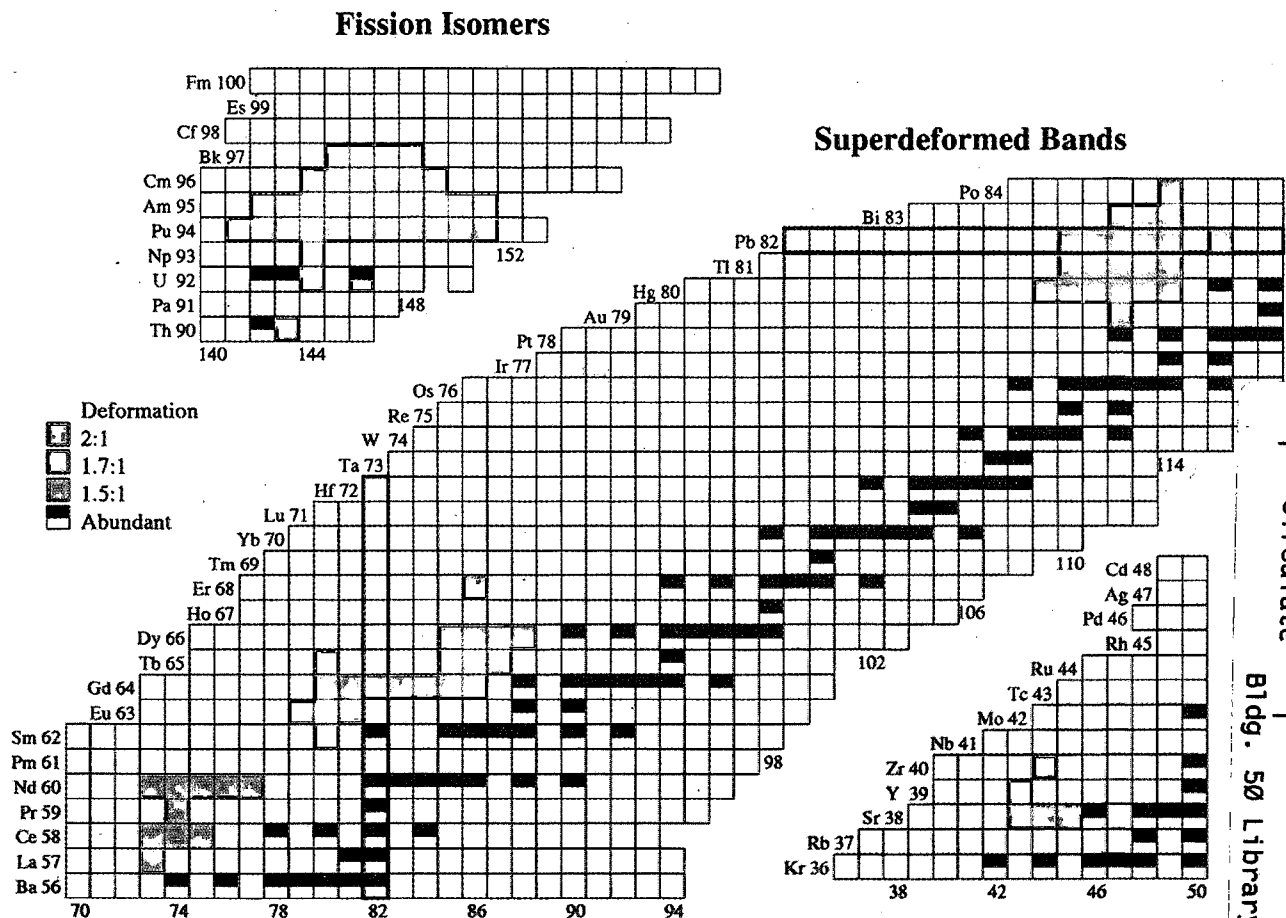

Table of Superdeformed Nuclear Bands and Fission Isomers

by Balraj Singh,
Richard B. Firestone,
and S. Y. Frank Chu



REFERENCE COPY |
 Does Not |
 Circulate |
 Bldg. 50 Library. |
 Copy 1 |
 LBL-38004

DISCLAIMER

This document was prepared as an account of work sponsored by the United States Government. While this document is believed to contain correct information, neither the United States Government nor any agency thereof, nor the Regents of the University of California, nor any of their employees, makes any warranty, express or implied, or assumes any legal responsibility for the accuracy, completeness, or usefulness of any information, apparatus, product, or process disclosed, or represents that its use would not infringe privately owned rights. Reference herein to any specific commercial product, process, or service by its trade name, trademark, manufacturer, or otherwise, does not necessarily constitute or imply its endorsement, recommendation, or favoring by the United States Government or any agency thereof, or the Regents of the University of California. The views and opinions of authors expressed herein do not necessarily state or reflect those of the United States Government or any agency thereof or the Regents of the University of California.

Table of Superdeformed Nuclear Bands and Fission Isomers

Second Edition

by Balraj Singh^{†‡}, Richard B. Firestone[†] and S.Y. Frank Chu[†]

May, 1996

[†]Lawrence Berkeley National Laboratory, Berkeley CA, 94720 (rbf@lbl.gov)

[‡]McMaster University, Hamilton, Ontario CANADA (Balraj@.McMaster.ca)

This work was supported by the Director, Office of Energy Research, Office of High-Energy and Nuclear Physics, Nuclear Physics Division of the U.S. Department of Energy under contract DE-AC03-76SF00098, subcontract LBNL no. 4573810; and by the Natural Sciences and Engineering Research Council (NSERC) of Canada.

INDEX

Introduction	3	¹⁹² Hg	101
Table I: Summary of Superdeformed Bands	7	¹⁹³ Hg	103
Table II: Summary of Fission Isomers	11	¹⁹⁴ Hg	107
Plots of the Dynamic Moment of Inertia	12	¹⁹¹ Tl	110
Table of Superdeformed Nuclear Bands	20	¹⁹² Tl	111
⁸¹ Sr	20	¹⁹³ Tl	113
⁸² Sr	22	¹⁹⁴ Tl	115
⁸³ Sr	24	¹⁹⁵ Tl	118
⁸² Y	25	¹⁹² Pb	120
⁸⁴ Zr	26	¹⁹³ Pb	121
¹³⁰ La	27	¹⁹⁴ Pb	123
¹³¹ Ce	28	¹⁹⁵ Pb	125
¹³² Ce	30	¹⁹⁶ Pb	127
¹³³ Ce	32	¹⁹⁸ Pb	129
¹³³ Pr	35	¹⁹⁵ Bi	131
¹³³ Nd	38	¹⁹⁶ Bi	132
¹³⁴ Nd	41	¹⁹⁷ Bi	133
¹³⁵ Nd	42	¹⁹⁸ Po	134
¹³⁶ Nd	44	Table of Fission Isomers	135
¹³⁷ Nd	46	²³³ Th	135
¹⁴² Sm	47	^{236,238} U	137
¹⁴² Eu	49	²³⁷ Np	140
¹⁴³ Eu	50	²³⁵⁻²⁴⁵ Pu	141
¹⁴⁴ Eu	52	²³⁷⁻²⁴⁶ Am	148
¹⁴⁴ Gd	53	²⁴⁰⁻²⁴⁵ Cm	153
¹⁴⁵ Gd	54	²⁴²⁻²⁴⁵ Bk	155
¹⁴⁶ Gd	56	References for Fission Isomers	156
¹⁴⁷ Gd	58	References for Superdeformed Nuclear Bands (Theoretical)	174
¹⁴⁸ Gd	60	References for Superdeformed Nuclear Bands (Ex- perimental)	190
¹⁴⁹ Gd	64		
¹⁵⁰ Gd	69		
¹⁴⁵ Tb	73		
¹⁵⁰ Tb	74		
¹⁵¹ Tb	76		
¹⁵² Tb	81		
¹⁵¹ Dy	82		
¹⁵² Dy	84		
¹⁵³ Dy	88		
¹⁵⁴ Dy	91		
¹⁵⁴ Er	93		
¹⁹¹ Au	94		
¹⁸⁹ Hg	95		
¹⁹⁰ Hg	96		
¹⁹¹ Hg	98		

Introduction

A minimum in the second potential well of deformed nuclei was predicted by Strutinsky⁽¹⁾, and the associated shell gaps are illustrated in the harmonic oscillator potential shell energy surface calculations shown in figure 1^(2,3). A strong superdeformed minimum in ¹⁵²Dy was predicted for $\beta_2 \sim 0.65$ ^(4,5,6). Subsequently, a discrete set of γ -ray transitions in ¹⁵²Dy was observed⁽⁷⁾ and assigned to the predicted superdeformed band. Extensive research at several laboratories has since focused on searching for other mass regions of large deformation⁽⁸⁻¹²⁾. A new generation of γ -ray detector arrays (Gammasphere, Eurogam, and GASP) is already producing a wealth of information about the mechanisms for feeding and deexciting superdeformed bands. These bands have been found in four distinct regions near $A=80$, 130, 150, and 190. This research extends upon previous work in the actinide region near $A=240$ where fission (shape) isomers were identified and also associated with the second potential well⁽¹³⁾. A third strong hyperdeformed minimum at $\beta_2 \sim 0.9$ is also indicated in figure 1 and has recently been tentatively reported in ¹⁵³Dy^{14,15}. Hyperdeformed bands reported in ¹⁴⁷Gd¹⁶ were not confirmed at the Gammasphere Dedication Conference at Berkeley in December, 1995. Quadrupole moment measurements for selected cases in each mass region are consistent with assigning the bands to excitations in the second local minimum.

As part of our commitment to maintain nuclear structure data as current as possible in the Evaluated Nuclear Structure Data File (ENSDF)⁽¹⁷⁾ and the *Table of Isotopes*⁽¹⁸⁾, we have been updating the information on superdeformed and hyperdeformed nuclear bands. As of February, 1996, we have compiled data for 161 superdeformed bands and 47 fission isomers identified in 93 nuclides for this publication. This is an increase of 75 superdeformed bands and 20 new nuclides since the first edition in 1994¹⁹. Partial data for superdeformed bands and fission isomers are shown in the band drawings.

For each nuclide there is a complete level table listing both normal (taken from the ENSDF file) and superdeformed band assignments; level energy, spin, parity, half-life, magnetic moments, decay branchings; and the energies, final levels, relative intensities, multipolarities, and mixing ratios for transitions deexciting each level. Mass excess, decay energies, and proton and neutron separation energies are also provided from the evaluation of Audi and Wapstra⁽²⁰⁾.

For superdeformed and hyperdeformed bands we provide the following quantities.

Level energies: For SD bands, since the absolute level energies, except in a few cases, are not yet known, only relative values are given. In the drawings the SD bands are shown with a common baseline for convenient display of multiple bands in a nucleus.

Level half-lives: Measured values are quoted in the tables only.

Level spins: The spin value is generally given only for the first member of the SD band. This value is typically suggested by the authors and has some uncertainty ($\sim 1-2 \hbar$) associated with it. Since linking to normal states is mostly unobserved, except for assignments in ^{133,135,137}Nd, ¹⁹⁴Hg, and ¹⁹⁴Pb, there is no direct confirmation of these spins. The cascading transitions are all assumed as E2 which is consistent with angular correlation data and short level half-lives in several cases. The parities are not generally shown because of insufficient evidence at this time.

γ -ray energies: The energies are adopted from the most complete set of data for each band. We have not averaged values because uncertainties are not usually available. Typical energy uncertainties range from 0.1-0.3 keV for intense transitions to 1 keV for weaker γ -rays.

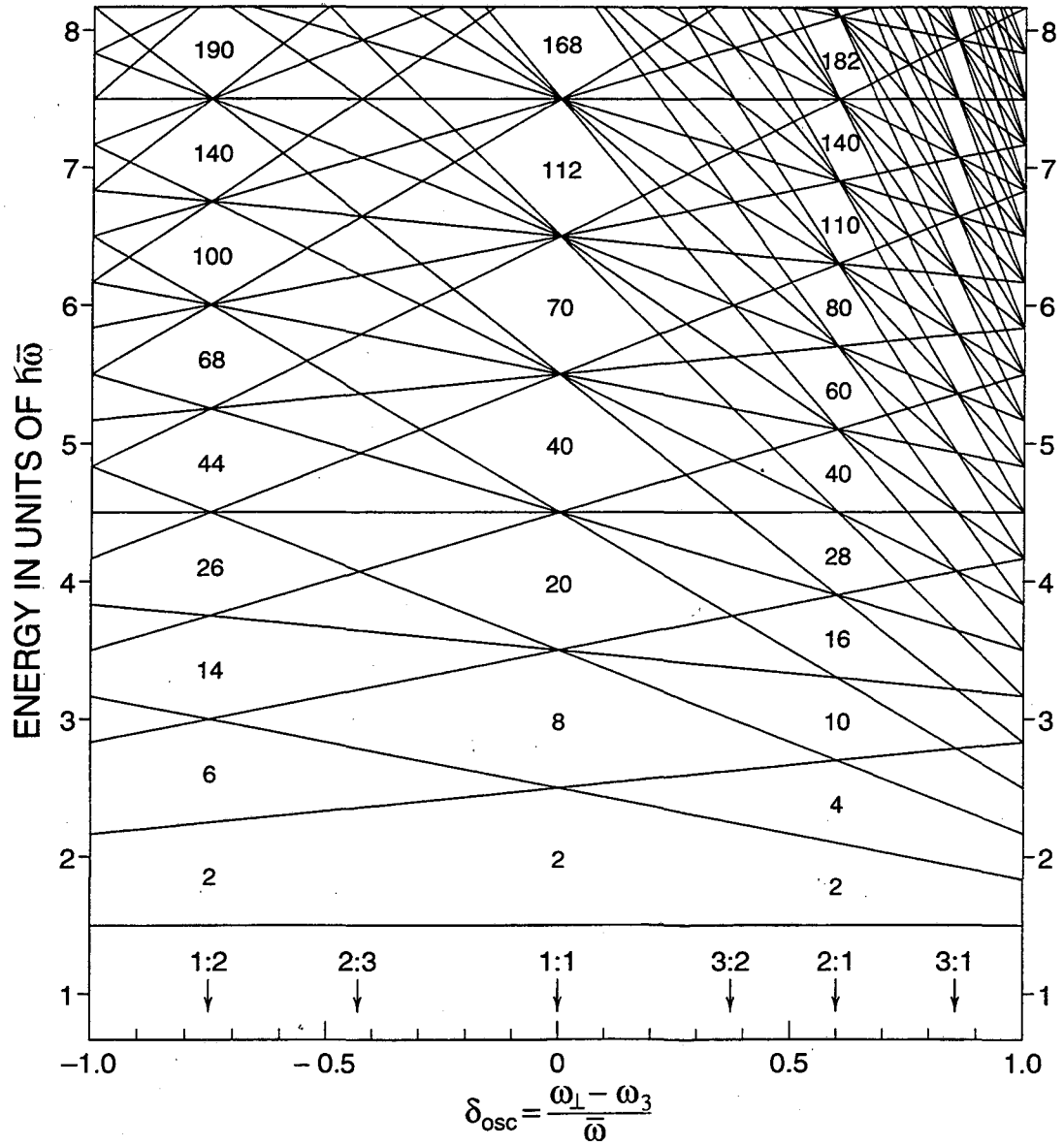

Figure 1. Single-particle level energies calculated for an axially symmetric harmonic oscillator (from reference 2).

γ -ray intensities: The values given are total relative intensities normalized to ~ 1.0 for the most intense transition in a superdeformed band or, for multiple bands, to the most intense transition in the superdeformed band. These values are typically read off of the intensity figures in the papers. Correction for internal conversion is assumed to have been applied by the authors. When more than one measurement exists, the most complete set of intensities has been chosen. Absolute intensities can be obtained by multiplying the relative intensities by the %-feeding in Table I.

Moments: Transition Quadrupole moments for SD states are deduced from Doppler broadening of γ -rays. The SD quadrupole moment is typically an average value for the band corresponding to the intrinsic (transition) moment. For fission isomers the quadrupole moments are also intrinsic. The values appear in the summary tables only.

The following calculated quantities^(21,22) are provided (E_γ in MeV):

Rotational frequency:

$$\hbar\omega(J) = \frac{E_\gamma((J+2) \rightarrow J) + (E_\gamma(J \rightarrow (J-2)))}{4} \text{ MeV}$$

Kinetic moment of inertia[†]:

$$I^{(1)}(J) = \frac{4J}{E_\gamma((J+2) \rightarrow J) + E_\gamma(J \rightarrow (J-2))} \hbar^2 \text{ MeV}^{-1}$$

Dynamic moment of inertia:

$$I^{(2)}(J) = \frac{4}{E_\gamma((J+2) \rightarrow J) - E_\gamma(J \rightarrow (J-2))} \hbar^2 \text{ MeV}^{-1}$$

The dynamic moments of inertia have been plotted as a function of rotational frequency at the beginning of the data section, and their values are also tabulated in the data tables.

We have not attempted to label bands according to particle or intruder configurations or according to their isospectral behavior. The reader is referred to the original papers for information about reactions populating these bands and fission isomers. References with keyword abstracts have been provided from the Nuclear Structure Reference (NSR) file⁽²³⁾. They are divided into three sections for fission isomers, superdeformed band theory, and superdeformed band experimental. The theoretical references before 1986 were not completely scanned for superdeformation.

The literature up to March 31, 1996 has been consulted for this compilation. More up-to-date information is available on the World Wide Web at the internet address <http://isotopes.lbl.gov/isotopes/hspin.html>.

We express our gratitude to the many nuclear data evaluators for creating the ENSDF file, to the staff at the National Nuclear Data Center at Brookhaven National Laboratory for maintaining ENSDF, and to Dr. Murray Martin for providing a thorough review of this work. Many useful suggestions were provided by members of the high-spin physics groups at Lawrence Berkeley National Laboratory, McMaster University, and Oak Ridge National Laboratory, and numerous other researchers in the field. This work was supported by the Director, Office of Energy Research, Office of High-Energy and Nuclear Physics, Nuclear Physics Division of the U.S. Department of Energy under contract DE-AC03-76SF00098, subcontract LBNL no. 4573810; and by the Natural Sciences and Engineering Research Council (NSERC) of Canada.

[†]Approximate since spins are uncertain.

References:

1. V.M. Strutinski, Nucl. Physics **A95**, 420 (1967); *ibid* **A122**, 1 (1968).
2. A. Bohr and B.R. Mottelson, Nuclear Structure, Vol. II, p. 591, New York, Benjamin (1975).
3. J.R. Nix, Ann. Rev. of Nucl. Sci. 22, 65 (1972).
4. T. Bengtsson *et al*, Phys. Scr. 24, 200(1981).
5. K. Neergard *et al*, Nucl. Phys. **A262**, 61 (1976).
6. G. Andersson *et al*, Nucl. Phys. **A268**, 205 (1976).
7. P.J. Twin *et al*, Phys. Rev. Lett. 57, 811 (1986).
8. J.F. Sharpey-Schafer and J. Simpson, Prog. Part. Nucl. Phys. 21, 293 (1988).
9. P.J. Nolan and P.J. Twin, Ann. Rev. Nucl. Part. Sci. 38, 533 (1988).
10. R.V.F. Janssens and T.L. Khoo, Ann. Rev. Nucl. part. Sci. 41, 321 (1991).
11. J.F. Sharpey-Schafer, Progr. Part. Nucl. Phys. 28, 187 (1992).
12. X.-L. Han and C.-L. Wu, At. Data and Nucl. Data Tables 52, 43 (1992).
13. S.M. Polikanov *et al*, Soviet Phys. JETP 15, 1016 (1962).
14. A. Galindo-Uribarri, H.R. Andrews, G.C. Ball, T.E. Drake, V.P. Janzen, J.A. Kuehner, S.M. Mullins, L. Persson, D. Prevost, D.C. Radford, J.C. Waddington, D. Ward, and R. Wyss, *Phys. Rev. Lett.* **71**, 231 (1993).
15. G. Viesti, M. Lunardon, D. Bazzacco, R. Burch, D. Fabris, S. Lunardi, N.H. Medina, G. Nebbia, C. Rossi-Alvarez, G. de Angelis, M. De Poli, E. Fioretto, G. Prete, J. Rico, P. Spolaore, G. Vedovato, A. Brondi, G. La Rana, R. Moro, and E. Vardaci, *Phys. Rev.* **C51**, 2385 (1995).
16. D.R. La Fosse, D.G. Sarantites, C. Baktash, P.-F. Hua, B. Cederwall, P. Fallon, C.J. Gross, H.-Q. Jin, M. Korolija, I.Y. Lee, A.O. Macchiavelli, M.R. Maier, W. Rathbun, D.W. Stracener, and T.R. Werner, *Phys. Rev. Lett.* **74**, 5186 (1995).
17. Evaluated Nuclear Structure Data File (ENSDF), maintained at the National Nuclear Data Center, Brookhaven National Laboratory, Upton, NY.
18. R.B. Firestone, V.S. Shirley, J. Zipkin, and S.Y.F. Chu, 8th edition of the *Table of Isotopes*, New York, John Wiley & Sons, Inc. (1996).
19. R.B. Firestone and B. Singh, *Table of Superdeformed Nuclear Bands and Fission Isomers*, LBL-35916 (1994).
20. G. Audi and A.H. Wapstra, Nucl. Phys. **A565**, 1 (1993).
21. A. Bohr and B.R. Mottelson, Phys. Scr. 24, 71 (1981).
22. F.S. Stephens, Phys. Scr. T5, 5 (1983).
23. Nuclear Structure Reference file (NSR), scanned by S. Ramavataram, maintained at the National Nuclear Data Center, Brookhaven National Laboratory, Upton, NY.

Table I
Summary of Superdeformed Bands

Nuclide	Band	E_{γ} -range (N _{γ})	J^{π} -range	~%-feeding	Q_0^a	Principal References ^b
⁸¹ Sr	SD-1	1214-2748 (12)	(J)-(J+24)	1.5		95Cr56
	SD-2	1773-2537 (6)	(J)-(J+12)	1.0		95Cr56
	SD-3	1881-2845 (7)	(J)-(J+14)	0.6		95Cr56
	SD-4	1938-2541 (5)	(J)-(J+10)	0.6		95Cr56
⁸² Sr	SD-1	1432-2736 (9)	(19)-(37)	1.0-1.5		95Sm08
	SD-2	1537-2603 (8)	(20)-(36)	0.5-1.0		95Sm08
⁸³ Sr	SD-1	1307-2646 (10)	(41/2)-(81/2)	1.4 5		95Ba26,95La21
⁸² Y	SD-1	1455-2755 (9)	(20)-(38)	1.5 5		95DaAA
⁸⁴ Zr	SD-1	1526-2761 (9)	(21)-(39)	4	5.2 10	95Ji08
¹³⁰ La	SD-1	762-1412 (9)	(16)-(34)	10		89Go13
¹³¹ Ce	SD-1	592-1732 (16)	(29/2)-(93/2)	5	5.5 5	88Lu01,90He12,93Mu09,93Pa02
	SD-2,3	846-1633 (12)	(J)-(J+24)			94NoAA
¹³² Ce	SD-1	807-2199 (19)	(18)-(56)	5.5	7.4 9	87Ki02,90Di01,95Ha28,95Sa21
	SD-2	794-1687 (13)	(J)-(J+26)	1.0		95Sa21
	SD-3	947-1725 (12)	(J)-(J+24)	1.0		95Sa21
¹³³ Ce	SD-1	748-1927 (17)	(43/2)-(111/2)	3.0	7.4 7	95Ha34,95Ha28
	SD-2	720-1912 (17)	(37/2)-(105/2)	1.5	7.5 8	95Ha34,95Ha28
	SD-3	957-1764 (15)	(45/2)-(105/2)	0.6		95Ha34
¹³¹ Pr	SD-1 ^c	411-892 (8)	(11/2 ⁺)-(43/2 ⁺)		5.5 8	94Ga31
	SD-2 ^c	378-738 (6)	(9/2 ⁺)-(33/2 ⁺)			94Ga31
¹³³ Pr	SD-1	840-1489 (10)	(53/2)-(93/2)	1		95Wi13
	SD-2	800-1530 (11)	(51/2)-(95/2)	1		95Wi13
	SD-3	784-1736 (13)	(53/2)-(105/2)	0.5		95Wi13
	SD-4	821-1656 (12)	(55/2)-(103/2)	0.2		95Wi13
¹³³ Nd	SD-1 ^d	345-1631 (18)	(17/2 ⁺)-(89/2 ⁺)	20	7.0 7 ,e	87Wa18,92Mu09,93Ba20,94Ba25,95Fo12,95Me08
¹³⁴ Nd	SD-1	664-1450 (12)	(J)-(J+24)	1.5		87Be32,87Wa18,94Pe16
	SD-2	821-1345 (9)	(J)-(J+18)	0.5		94Pe16
¹³⁵ Nd	SD-1 ^d	545-1692 (17)	(25/2 ⁺)-(93/2 ⁺)	10	7.4 ^f 10	87Be57,90Di01,93Pa02,93Wi09,95De40
¹³⁶ Nd	SD-1	716-1815 (16)	(16)-(48)	2		87Be32,95Cl02
	SD-2	888-1438 (9)	(J)-(J+18)	0.4		95Cl02
¹³⁷ Nd	SD-1 ^d	635-1431 (14)	(29/2 ⁺)-(85/2 ⁺)	13	4.0 5	87Wa18,92Mu09,95Lu09
¹⁴² Sm	SD-1	678-1783 (19)	(25)-(63)	0.5 1		93Ha03,95Ha29
	SD-2	725-1588 (16)	(J)-(J+32)	0.09 2		95Ha29
¹⁴² Eu	SD-1	700-1548 (15)	(27,29)-(57,59)	1.2 2		95Mu11
¹⁴³ Eu	SD-1	484-1743 (22)	(37/2)-(125/2)	1.1	13.0 15	91Mu11,93At01,95Fo02,95Mu11
¹⁴⁴ Eu	SD-1 ^g			0.1		93Mu16,94MuAA
	SD-2 ^g					94MuAA
	SD-3 ^g					94MuAA
¹⁴⁴ Gd	SD-1	846-1418 (14)	(J)-(J+28)	0.2		94Lu03
¹⁴⁵ Gd	SD-1	723-1576 (17)	(J)-(J+34)	1.1		95Rz03
	SD-2	793-1510 (16)	(J)-(J+32)	0.6		95Rz03
	*SD-3	920-1432 (10)	(J)-(J+20)	0.6		95Rz03
¹⁴⁶ Gd	SD-1	826-1554 (15)	(33)-(63)	0.65 19	12 2	90He14,93Ha19,95Sc31
	SD-2	806-1582 (15)	(32)-(62)	0.39 12	8 2	91Rz01,92StZU,93Ha19,95Sc31
	SD-3(?)	959-1369 (9)	(j)-(J+18)	0.08		95Sc31
¹⁴⁷ Gd	SD-1	697-1516 (17)	(55/2)-(123/2)	0.87 19		91Zu01,93Ha19
	SD-2	731-1559 (16)	(61/2)-(125/2)	0.57 15		91Zu01,93Ha19
	SD-3 ^g					94ViAA

Table I (continued)
Summary of Superdeformed Bands

Nuclide	Band	E_{γ} -range (N_{γ})	J^{π} -range	~%-feeding	Q_0^a	Principal References ^b
¹⁴⁸ Gd	SD-1	700-1700 (19)	(29)-(67)	1.6 1	14.6 2	88De10,93Ha19,95DeZZ,96DeAA
	SD-2	742-1546 (17)	(30)-(64)	0.7 2	14.8 3	93Ha19,95DeZZ,96DeAA
	SD-3	830-1472 (16)	(J)-(J+32)	0.4 2	17.8 13	95DeZZ,96DeAA
	SD-4	850-1537 (14)	(J)-(J+28)	0.5 2		95DeZZ,96DeAA
	SD-5	854-1562 (16)	(J)-(J+32)	0.5 1		95DeZZ,96DeAA
	SD-6	802-1540 (15)	(J)-(J+30)	0.4 1		95DeZZ,96DeAA
¹⁴⁹ Gd	SD-1	618-1730 (22)	(51/2)-(139/2)	1.8	15.0 2	88Ha02,90Ha31,93FI03,93FI07,95SaZZ
	SD-2	859-1620 (18)	(63/2)-(135/2)	0.45	15.6 3	88Ha02,90Ha31,93FI03,95SaZZ
	SD-3	650-1647 (20)	(57/2)-(137/2)	0.22	15.2 5	88Ha02,90Ha31,93FI03,95SaZZ
	SD-4	726-1575 (19)	(63/2)-(139/2)	0.25	17.5 6	93FI03,95FI01,95SaZZ
	SD-5	756-1595 (16)	(63/2)-(127/2)	0.14		93FI03,94De33,95FI01
	SD-6	688-1686 (19)	(57/2)-(133/2)	0.14		93FI03,94De33,95FI01
¹⁵⁰ Gd	SD-1	815-1494 (16)	(32)-(64)	1.0	17 3	89Fa02,90By01,91Fa07,94Fa13
	SD-2	728-1584 (19)	(29 ⁻)-(67 ⁻)	0.5		90By01,93Be37,94Fa13
	SD-3	617-1567 (19)	(24 ⁻)-(62 ⁻)	0.45		93Be37,94Fa13
	SD-4	688-1600 (18)	(27 ⁻)-(63 ⁻)	0.4		93Be37,94Fa13
	SD-5	910-1545 (16)	(34)-(66)	0.4		93Be37,94Fa13
¹⁴⁵ Tb	SD-1	627-1387 (14)	(J)-(J+28)	1		94Mu16
¹⁵⁰ Tb	SD-1	597-1600 (20)	(24)-(64)	1.0		89De10,90Ha31,95Fa09
	SD-2	663-1453 (16)	(J)-(J+32)	0.25		95Fa09
	SD-3	877-1494 (14)	(J)-(J+28)	0.10		95Fa09
¹⁵¹ Tb	SD-1	726-1535 (18)	(57/2)-(129/2)	1.0		90By01,92Mu10,93Be29,93Cu06,94De33,95Kh06
	SD-2	602-1495 (20)	(49/2)-(129/2)	0.50 5		90By01,92Mu10,93Be29,93Cu06,94De33,95Kh06
	SD-3	682-1505 (18)	(55/2)-(127/2)	0.35 5		94De33,95Kh06
	SD-4	769-1485 (16)	(63/2)-(127/2)	0.06 2		94De33,95Kh06
	SD-5	709-1501 (16)	(J)-(J+32)	0.10 2		94De33,95Kh06
	SD-6	739-1474 (15)	(J)-(J+30)	0.09 2		94De33,95Kh06
	SD-7	758-1489 (15)	(J)-(J+30)	0.11 2		94De33,95Kh06
	SD-8	785-1356 (12)	(J)-(J+24)	0.07 3		94De33,95Kh06
¹⁵² Tb	SD-1	823-1446 (14)	(J)-(J+28)			94De33
	SD-2	801-1367 (13)	(J)-(J+26)			94De33
¹⁵¹ Dy	SD-1	527-1542 (21)	(43/2)-(127/2)	1.0		88Ra19,92Mu10,95Ni06
	SD-2	633-1493 (19)	(J)-(J+38)	0.39 7		95Ni06
	SD-3	729-1450 (16)	(J)-(J+32)	0.30 5		95Ni06
	SD-4	712-1425 (16)	(J)-(J+32)	0.20 7		95Ni06
	SD-5	959-1366 (9)	(J)-(J+18)	0.13 4		95Ni06
¹⁵² Dy	SD-1	602-1546 (21)	(24 ⁺)-(66 ⁺)	1.47 7	17.5 2	86Tw01,91Be12,94Da20,95SaZZ
	SD-2	826-1477 (16)	(34)-(66)	0.11 2		94Da20
	SD-3	793-1605 (16)	(36)-(68)	0.12 2		94Da20
	SD-4	670-1376 (15)	(27 ⁻)-(57 ⁻)	0.059 15		94Da20
	SD-5	642-1304 (14)	(26 ⁻)-(54 ⁻)	0.059 15		94Da20
	SD-6	762-1434 (16)	(32 ⁻)-(64 ⁻)	0.074 15		94Da20
¹⁵³ Dy	SD-1	721-1500 (18)	(63/2)-(135/2)	1.46 22		89Jo04,95Ce03
	SD-2	679-1485 (18)	(59/2)-(131/2)	0.77 16		89Jo04,95Ce03
	SD-3	702-1460 (17)	(61/2)-(129/2)	0.57 12		89Jo04,95Ce03
	SD-4	723-1428 (16)	(59/2)-(123/2)	0.50 14		95Ce03
	SD-5	743-1452 (16)	(65/2)-(129/2)	0.47 13		95Ce03
	HD-1(?) ^{gh}					93Ga10,95Vi02
¹⁵⁴ Dy	SD-1	702-1504 (17)	(J)-(J+34)	0.6 2		95Ni03
¹⁵⁴ Er	SD-1	695-1302 (13)	(26)-(52)	0.4		95Be36
¹⁹¹ Au	SD-1	230-678 (13)	(19/2)-(71/2)	0.15		93Vo04
¹⁸⁹ Hg	SD-1	366-708 (10)	(29/2)-(69/2)	0.5		91Dr04,92Be18

Table I (continued)
Summary of Superdeformed Bands

Nuclide	Band	E_γ -range (N_γ)	J^π -range	~%-feeding	Q_0^a	Principal References ^b
¹⁹⁰ Hg	SD-1	317-802 (15)	(12)- (42)	0.8	18.3	91Dr04,93Ca23,94Cr08,95Cr02
	SD-2	511-707 (7)	(25)- (39)	0.2		94Cr08,95Cr02
¹⁹¹ Hg	SD-1	311-789 (14)	(31/2)- (87/2)	2	18.3	89Mo08,95Ca15,95So17
	SD-2	252-797 (16)	(21/2)- (85/2)	1	~18	90Ca18,95Ca15,95So17
	SD-3	272-801 (16)	(23/2)- (87/2)	0.8		90Ca18,95Ca15,95So17
	SD-4	281-789 (14)	(25/2)- (81/2)	<0.2		95Ca15
¹⁹² Hg	SD-1	214-889 (20)	(8)- (48)	2.0	18.6 ¹⁴	90Mo16,92La07,93Ha20 94Ga07,94W06,95Fa03
	SD-2	241-819 (18)	(10)- (46)	0.2	19.5 ¹⁵	95Fa03,95Ko17
	SD-3	333-681 (11)	(J)- (J+22)	0.1		95Fa03
¹⁹³ Hg	SD-1	233-881 (20)	(19/2 ⁻)- (99/2 ⁻)	1.6 ³	i	90Cu05,90He09,93Fa07,93Jo09,94Jo10
	SD-2 ⁱ	254-876 (19)	(21/2 ⁻)- (97/2 ⁻)	2.1 ⁱ³	i	90Cu05,90He09,93Fa07,93Jo09,94Jo10
	SD-3	234-861 (19)	(19/2 ⁺)- (95/2 ⁺)	0.9 ³		90Cu05,93Jo09,94Jo10
	SD-4 ^j	254-876 (19)	(21/2 ⁺)- (97/2 ⁺)	2.1 ^{j3}		90Cu05,93Jo09,94Jo10
	SD-5	291-861 (16)	(27/2 ⁻)- (95/2 ⁻)	1.1 ³		90Cu05,93Jo09,94Jo10
	SD-6	241-858 (17)	(21/2 ⁻)- (89/2 ⁻)	0.6		93Jo09,94Jo10
¹⁹⁴ Hg	SD-1 ^d	212-904(21)	(8 ⁺)- (50 ⁺)	7.0	17.2 ²⁰	90Be11,90Ri05,96KhAA
	SD-2	201-868 (20)	(8)- (48)	2.0	17.6 ³⁰	90Be11,90Ri05,94Ce04,94Hu05
	SD-3	263-884 (19)	(11)- (49)			90Be11,90Ri05,94Ce04
¹⁹¹ Tl	SD-1	318-656 (10)	(J)- (J+20)	0.4		92PiZR,92YuZY,94Pi01
	SD-2	378-666 (9)	(J)- (J+18)	0.4		92PiZR,92YuZY,94Pi01
¹⁹² Tl	SD-1	358-629 (8)	(J)- (J+16)	0.9		92Li21
	SD-2	378-637 (8)	(J)- (J+16)	0.5		92Li21
	SD-3	376-641 (8)	(J)- (J+16)	1.1		92Li21
	SD-4	357-619 (8)	(J)- (J+16)	0.7		92Li21
	SD-5	381-642 (8)	(J)- (J+16)	0.5		92Li21
	SD-6	407-634 (7)	(J)- (J+14)	0.3		92Li21
¹⁹³ Tl	SD-1	227-782(17)	(19/2 ⁺)- (83/2 ⁺)	0.5	k	90Fe07,96BoAA
	SD-2	207-783(16)	(17/2 ⁺)- (85/2 ⁺)	0.5	k	90Fe07,96BoAA
	SD-3	188-734(16)	(J)- (J+32)			96WiAA
	SD-4	251-747(14)	(J)- (J+28)			96WiAA
	SD-5	231-718(14)	(J)- (J+28)			96WiAA
¹⁹⁴ Tl	SD-1	268-704(13)	(12)- (38)	1.5		91Az03
	SD-2	209-686(14)	(9)- (37)	1.0		91Az03
	SD-3	241-718(14)	(10,11)- (38,39)	0.9		91Az03
	SD-4	220-703(14)	(9,10)- (37,38)	0.6		91Az03
	SD-5	188-628(13)	(8,9)- (34,35)	0.6		91Az03
	SD-6	207-613(12)	(9,10)- (33,34)	0.8		91Az03
¹⁹⁵ Tl	SD-1	146-777(18)	(11/2 ⁺)- (83/2 ⁺)	0.5	i	91Az04,94Du16
	SD-2	168-778(18)	(13/2 ⁺)- (85/2 ⁺)	0.25	i	91Az04,94Du16
¹⁹² Pb	SD-1	216-640(12)	(8,9)- (32,33)	0.35		91He11,93Pi01,94He15,95As04,95Du07
¹⁹³ Pb	SD-1	277-633(10)	(27/2)- (67/2)	0.5		95Hu01
	SD-2	191-528(9)	(17/2)- (53/2)	0.3		95Hu01
	SD-3	292-600(9)	(25/2)- (61/2)	0.25		95Hu01
	SD-4	314-610(9)	(27/2)- (63/2)	0.25		95Hu01
	SD-5	213-527(9)	(17/2)- (53/2)	0.2		95Hu01
	SD-6	233-579(10)	(19/2)- (59/2)	0.2		95Hu01
¹⁹⁴ Pb	SD-1 ^d	170-740(16)	(6 ⁺)- (38 ⁺)	1.0 ¹	20.6 ¹³	90Br10,90Hu10,93Ha20,93Wi02 94Kr18,95De26,95Ga10,96BrAA
	SD-2	241-544(9)	(J)- (J+18)	0.05		94Hu10
	SD-3(?) ^m	261-563(9)	(J)- (J+18)	0.06		94Hu10

Table I (continued)
Summary of Superdeformed Bands

Nuclide	Band	E_γ -range (N _{γ})	J ^{π} -range	~%-feeding	Q_0^a	Principal References ^b
¹⁹⁵ Pb	SD-1	182-689 (14)	(15/2)-(71/2)	0.25		95Fa11
	SD-2	163-689 (14)	(13/2)-(69/2)	0.25		95Fa11
	SD-3	198-684 (14)	(15/2)-(71/2)	0.25		95Fa11
	SD-4	214-632 (12)	(17/2)-(65/2)	0.1		95Fa11
¹⁹⁶ Pb	SD-1	170-752 (16)	(6)-(38)	1.5	18.3 ³⁰	90Br10,91Wa14,93Da04,93Mo19,94Cl02,95VaAA
	SD-2(?) ^m	204-665 (13)	(8)-(34)	0.5		95VaAA
	SD-3(?) ^m	227-680 (13)	(9)-(35)	0.5		95VaAA
¹⁹⁸ Pb	SD-1(?) ^m	305-853(15)	(12)-(42)	<0.5		91Wa14,94Cl02
¹⁹⁵ Bi	SD-1	262-495(7)	(J)-(J+14)	0.7		96CIAA
¹⁹⁶ Bi	SD-1	166-653(13)	(13/2)-(65/2)	<2		96CIAA
¹⁹⁷ Bi	SD-1(?) ^m	187-545(10)	(15/2)-(55/2)	<0.6		95Cl01,96CIAA
¹⁹⁸ Po	SD-1	176-543(10)	(6)-(26)	<0.3		96McAA
²³⁶ U	SD-1	20-101 (4)	(0 ⁺)-(8 ⁺)		32 ⁵	78Gu02,80Me15,89Ma57,90Ma59
²³⁸ U	SD-1	20 (1)	(0 ⁺)-(2 ⁺)		29 ³	69La14,79U101,82Go02,92St05
²³⁹ Pu	SD-1	24-32 (2)	(5/2 ⁺)-(9/2 ⁺)		36 ⁴	70Po01,77Ha01,79Ba02
²⁴⁰ Pu	SD-1	20-126 (5)	(0 ⁺)-(10 ⁺)			71Br39,72Sp06,73Be10,86De04

Footnotes

^a Transition or intrinsic quadrupole moment in eb obtained from lifetime (DSAM or RDM) data.

^b See *References for Superdeformed Bands (Experimental)* following the data tables.

^c This band, identified as a highly deformed band, is not listed in the tables and figures. The decay pattern and transition energies are not typical of those for superdeformed bands.

^d Linking transitions from this band to normal states have been reported. The superdeformed structure starts at the 2027 keV, (17/2⁺) level in ¹³³Nd; 3324 keV, (25/2⁺) level in ¹³⁵Nd; 4885 keV, (29/2⁺) level in ¹³⁷Nd; 6417 keV, (8⁺) level in ¹⁹⁴Hg; and 4712 keV, (8⁺) level in ¹⁹⁴Pb.

^e g-factor=0.31 8 at (41/2⁺)(95Me08).

^f $Q_0=1.44$ eb for the first member of the SD-1 band (93Wi09).

^g Discrete γ -ray data are not yet available for this band.

^h Hyperdeformed band. The isotopic identification (¹⁵³Dy or ¹⁵²Dy) and band assignment is considered tentative.

ⁱ $g_k(\text{intrinsic})=0.6111$ for $Q_0=19.2$ eb (93Jo09).

^j Unresolved bands.

^k $g_k(\text{intrinsic})=1.4617$ for $Q_0=19.2$ eb (96BoAA)

^l $g_k(\text{intrinsic})=1.44$ for $Q_0=19.2$ eb (94Du16).

^m Tentative assignment

Table II
Summary of Fission (Shape) Isomers

Nuclide	E(Isomer) ^a	J ^π	t _{1/2}	%IT ^b	Q ₀	Selected references
²³³ Th	1850 250		1-100 ns			94Ob02
²³⁶ U	2750 10 ^{cd}	(0+)	120 ns 2	87 6	32 5	78Gu02,80Me15,89Ma57,90Ma59,94ReAA
²³⁸ U	2557.6 5 ^{cd} 2557.6+y	0+	298 ns 18 >1 ns	-95	29 3	69La14,79UI01,82Go02,92St05 89Ha40
²³⁷ Np	2800 400		45 ns 5	e		73Wo03,77Mi09
²³⁵ Pu	3000 200		25 ns 5			69Me11,70Bu02,78SoZP,89SoZZ
²³⁶ Pu	~3000 4000 200	(0+)	37 ps 4 34 ns 8		37 ⁺¹⁴ ₋₈	74MeYP,77Me08 69La14,71Br39
²³⁷ Pu	2600 200 2900 250		85 ns 15 1.1 μs 1	f		69La14,79Gu03,82Ra04 70Po01,73Va16,79Gu03
²³⁸ Pu	~2400 ~3500	(0+)	0.6 ns 2 6.0 ns 15			73Li01,74MeYP 70Bu02,71Br39,73Na35,92DeZZ
²³⁹ Pu	3100 200 ^c ~3300 ^d	(5/2+) (9/2-)	7.5 μs 10 2.6 ⁺⁴⁰ ₋₁₂ ns		36 4	70Po01,77Ha01,79Ba02 77GoZH,80Gu20
²⁴⁰ Pu	~2800 ^c	(0+)	3.7 ns 3			71Br39,72Sp06,73Be10,86De04,94PaAA
²⁴¹ Pu	~2200 ~2300		21 μs 3 32 ns 5			70Po01,70Ga10,73Be05 69La14,81Gu04
²⁴² Pu	~2200 2200+y		3.5 ns 6 28 ns			74Me10,75Me28 69La14,70Po01
²⁴³ Pu	1700 300		45 ns 15			69La14,70Vi05,80Bj02
²⁴⁴ Pu	x		0.40 ns 10			74MoYC
²⁴⁵ Pu	2000 400		90 ns 30			71Au06,80Bj02
²³⁷ Am	2400 200		5 ns 2			70Po01,71Br39,73Br38
²³⁸ Am	~2500		35 μs 10			67Bo23,72Br35
²³⁹ Am	2500 200	(7/2+)	163 ns 12	g		69La14,72Br35,73Fl03,85Ra28
²⁴⁰ Am	3000 200		0.94 ms 4		32.7 ^h 20	71Br39,79Be46,85Jo04
²⁴¹ Am	~2200		1.0 μs 3			69La14,72Br35,73Be04,93Ku16
²⁴² Am	2200 80		14.0 ms 10			62Po09,63Pe27,85Ku18,92Ba67
²⁴³ Am	2300 200		5.5 μs 5			70Po01,72Wo07,87Gu03
²⁴⁴ Am	2800 400 2800+y		0.90 ms 15 ~6.5 μs			68Bj04,69Bo25,72Wo07 69SIZZ
²⁴⁵ Am	2400 400		0.64 μs 6			72Wo07,73Br38,80Bj02
²⁴⁶ Am	~2000		73 μs 10			72Wo07,83Po14
²⁴⁰ Cm	~2000 ~3000		10 ps 3 55 ns 12			76SI01 76SI01,78UI01
²⁴¹ Cm	~2300		15.3 ns 10			69Me11,71Br39,72Vy07
²⁴² Cm	1900 200 ~2800		40 ps 15 0.18 μs 7			75Me28,76SI01 71Re11,71Br39,73Br38
²⁴³ Cm	1900 300		42 ns 6			69MeZX,71Re11,80Bj02
²⁴⁴ Cm	~2200 ~3500		<5 ps >100 ns			69Me11,71Re11,80Bj02,80Me15 69Me11,80Me15,89Ha40
²⁴⁵ Cm	2100 300		13.2 ns 18			71Br39,72Wo07,80Bj02
²⁴² Bk	x x+y		9.5 ns 20 0.60 μs 10			72Wo07 72Wo07
²⁴³ Bk	~2200 ⁱ (?)		5 ns (?)			72Ga42,72Vy07
²⁴⁴ Bk	x		0.82 μs 6			72Ga42,72Wo07
²⁴⁵ Bk	~1560		2 ns 1			71Re11,72Ga42,72We09

^a Systematics of fission isomers suggest x=1600-2600; y<1000

^b %SF(²³⁶U isomer)=13 6, %SF(²³⁸U isomer)~5. For all other isomers, only SF decay has been observed.

^c Rotational band built on these states are shown in the figures.

^d Deexcitation to normal states is shown in the figures.

^e Some evidence for isomeric decay has been reported.

^f g-factor=-0.45 3

^g g-factor=0.74 5

^h Q₀=29.0 13 (85Jo04)

ⁱ Questionable existence

Plots of Dynamic Moments of Inertia

The dynamic moments of inertia ($I^{(2)}$) are plotted for all bands as a function of rotational frequency ($\hbar\omega$). Experimental uncertainties, calculated assuming the γ -ray energy uncertainties can be added in quadrature, are shown when available. The values of $I^{(1)}$, $I^{(2)}$, and $\hbar\omega$ are tabulated with the data.

Region I: A=81- 84

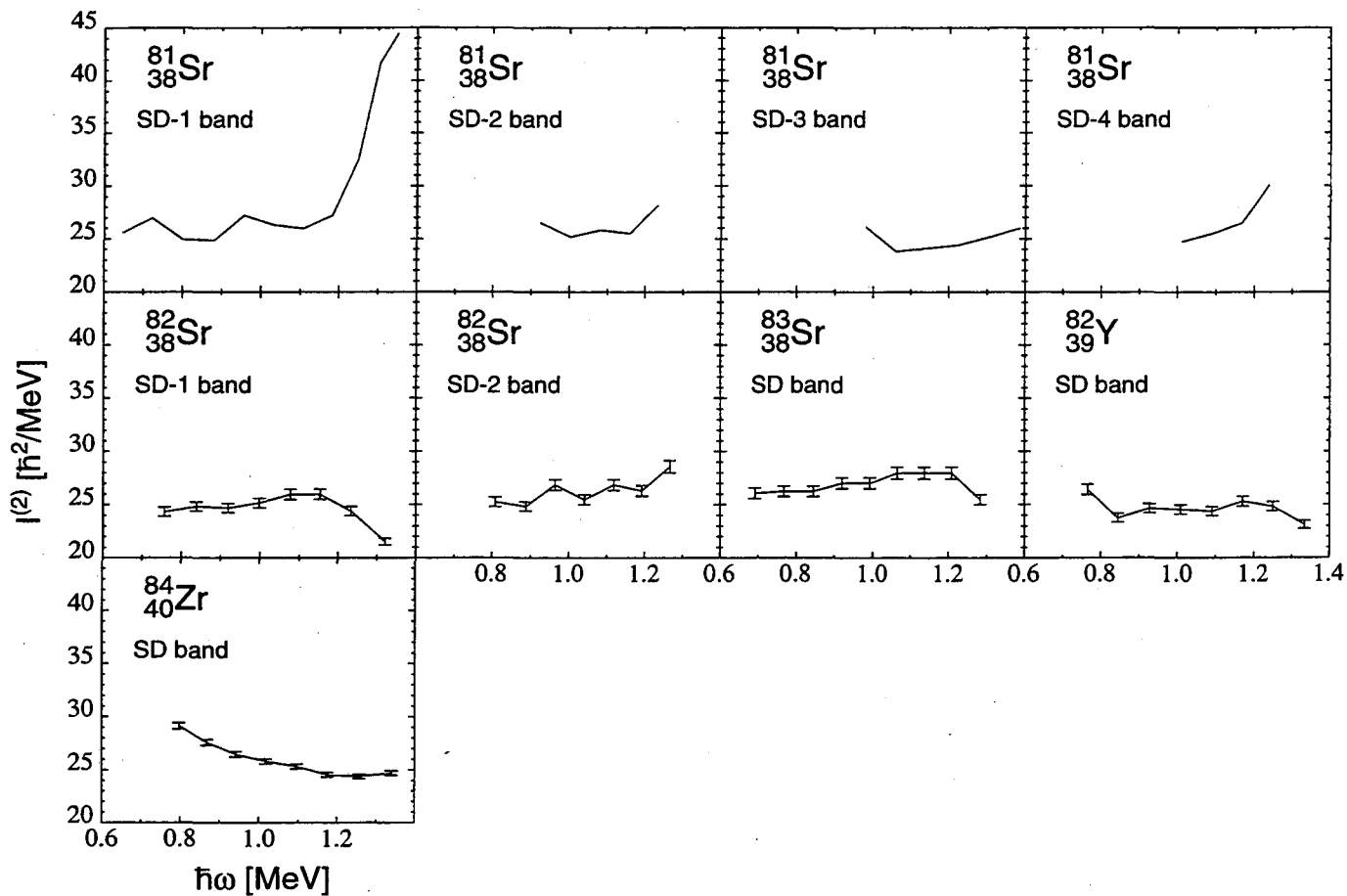

Region II: A=130 -137

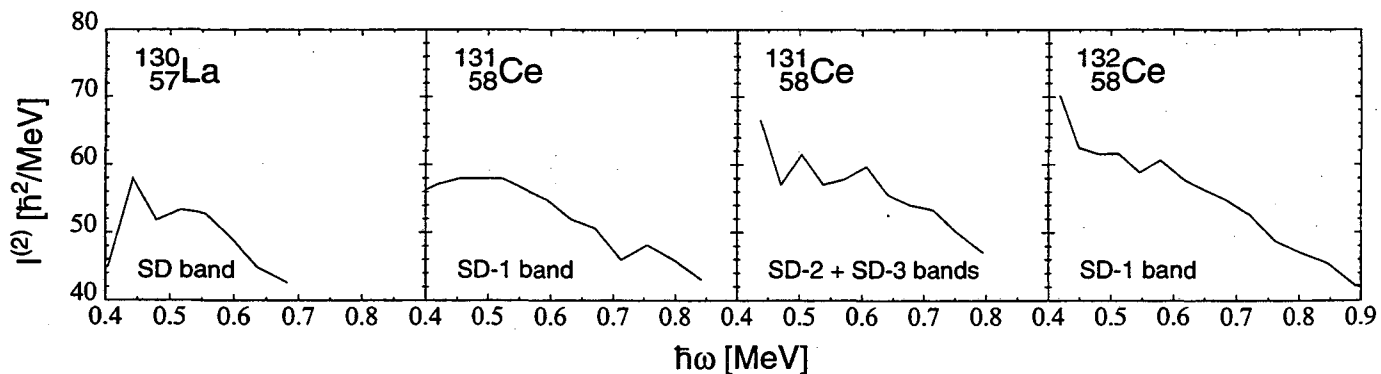

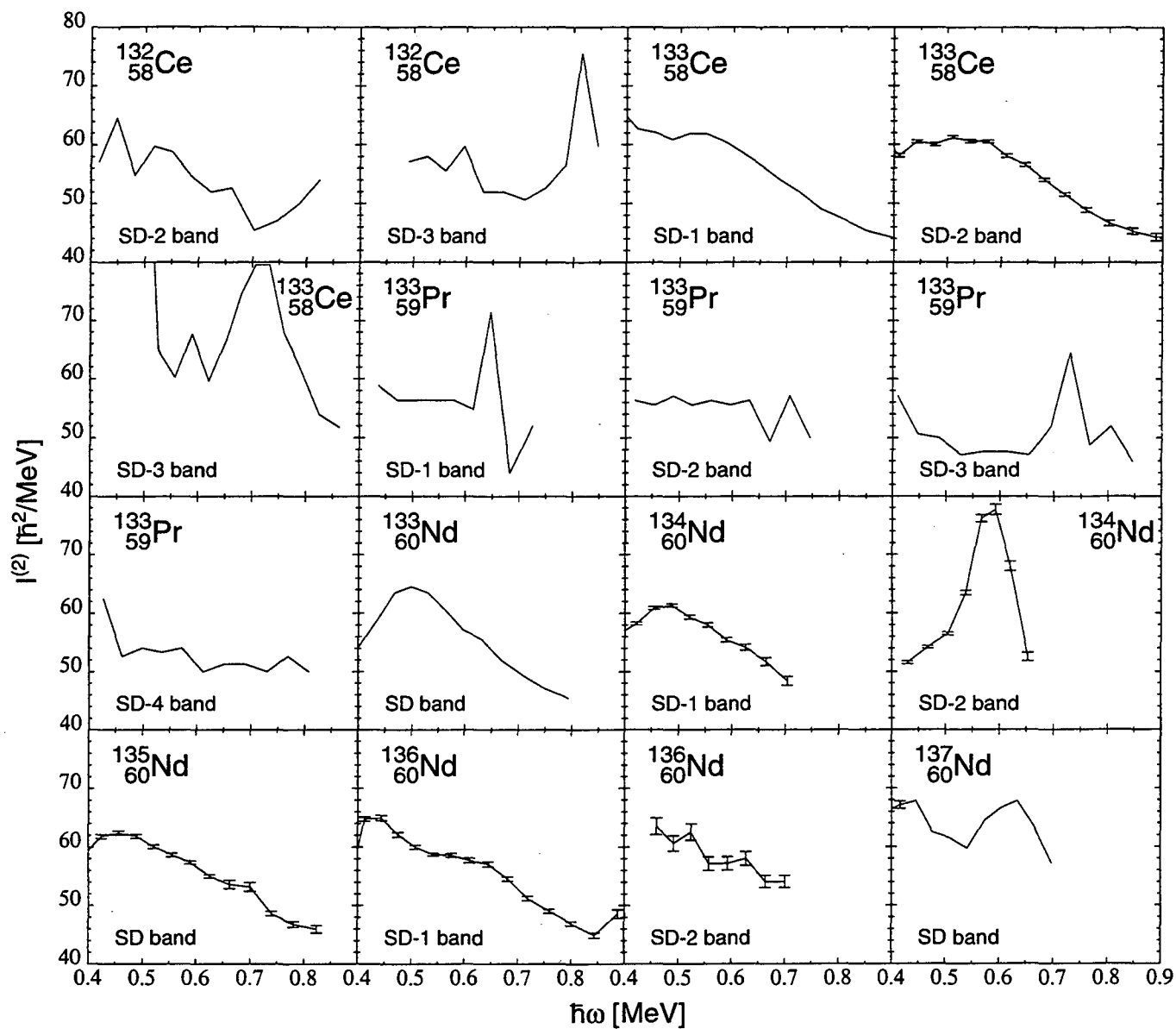

Region III: A=142 -154

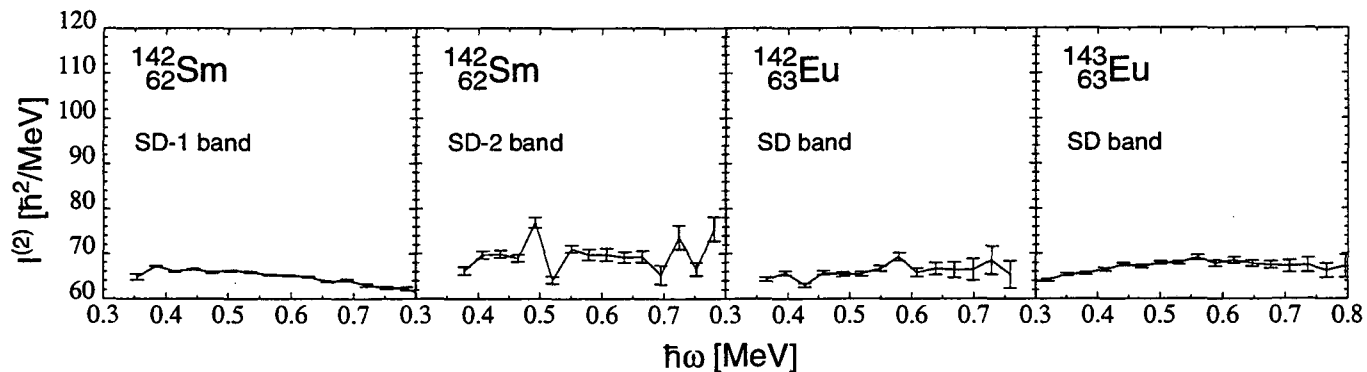

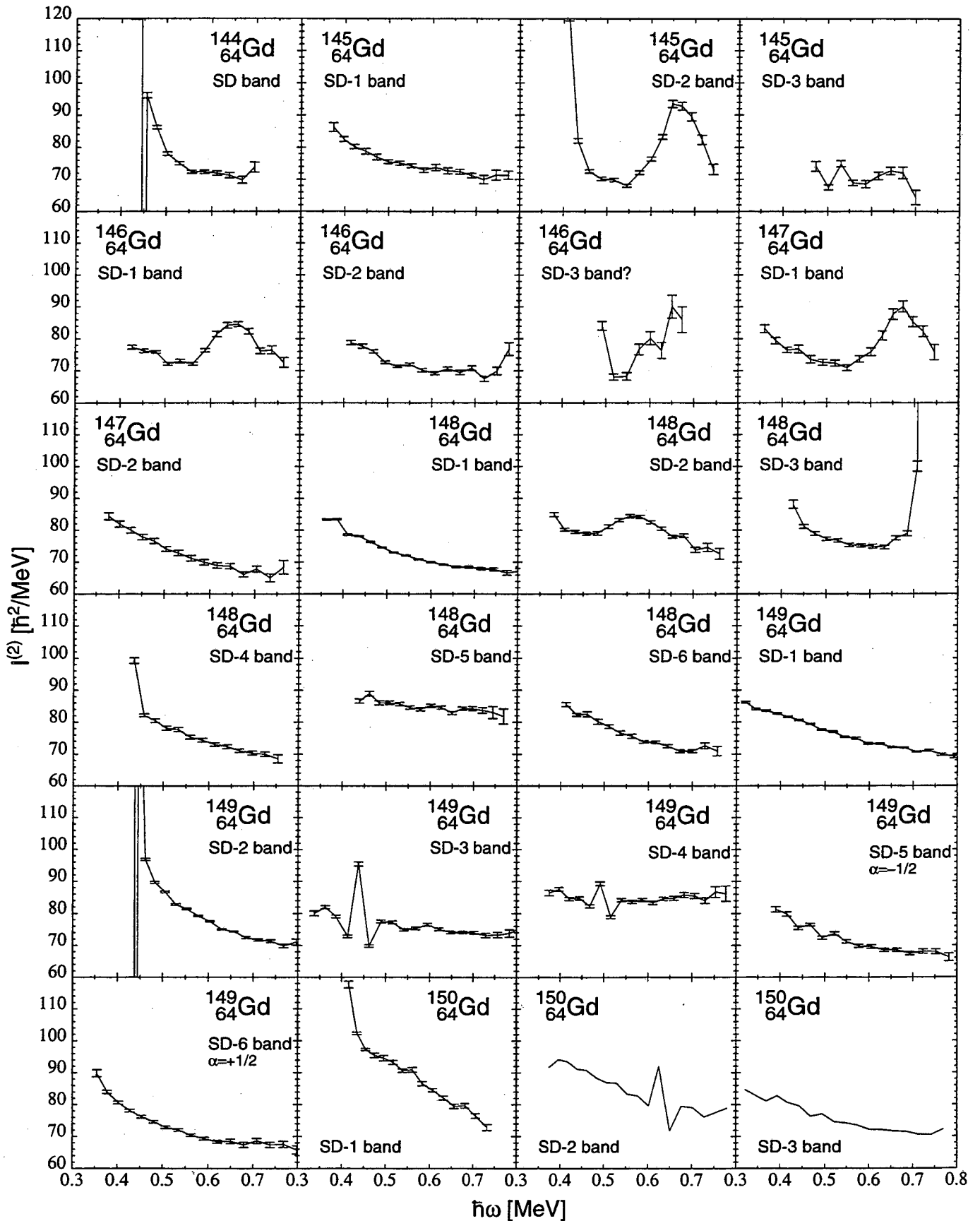

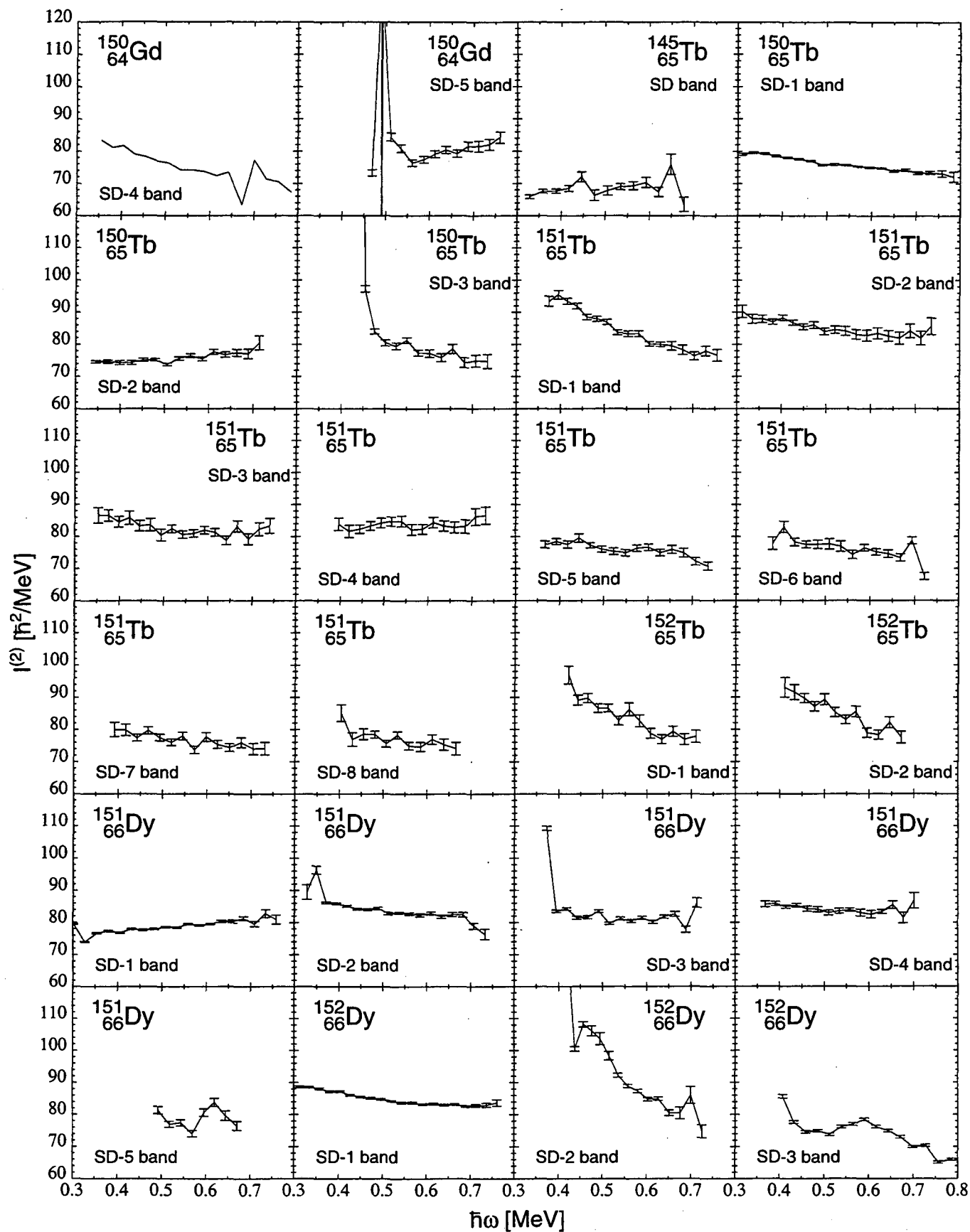

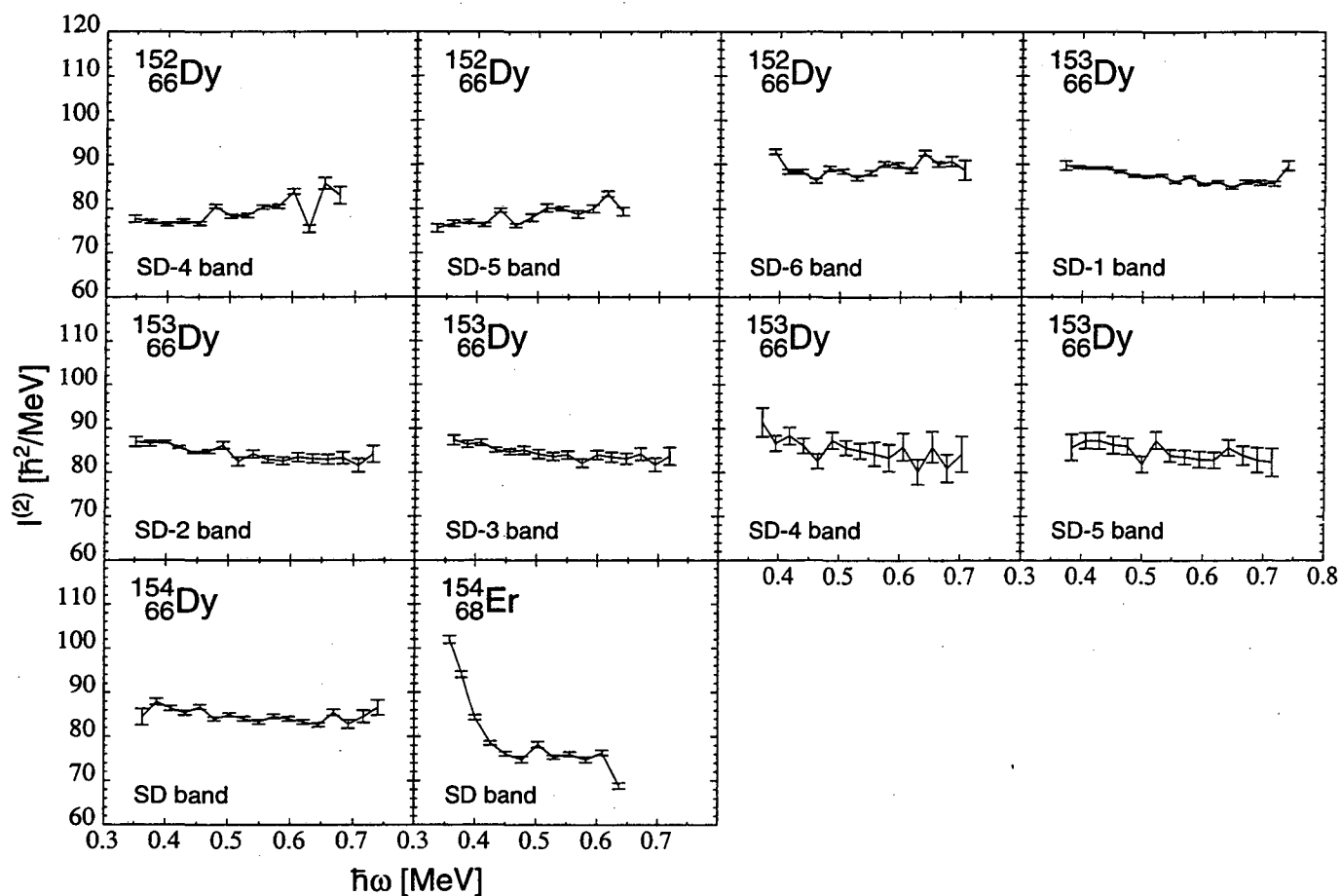

Region IV: A=189 -198

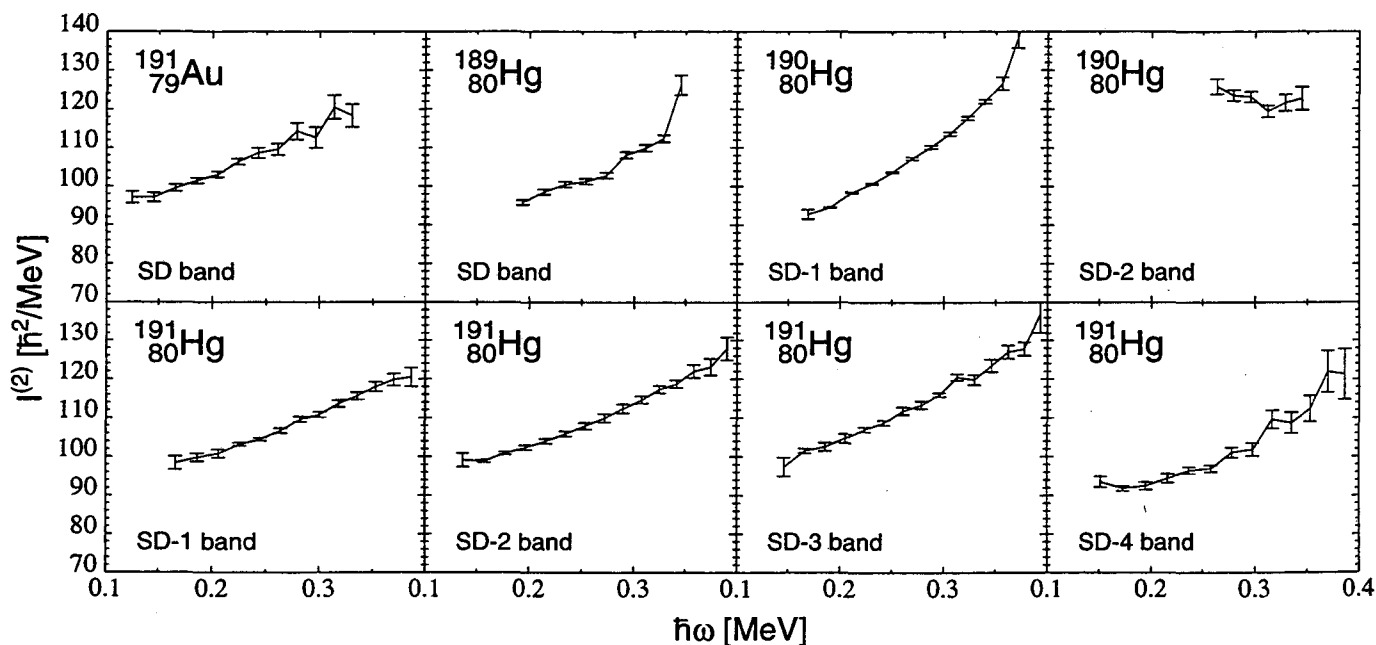

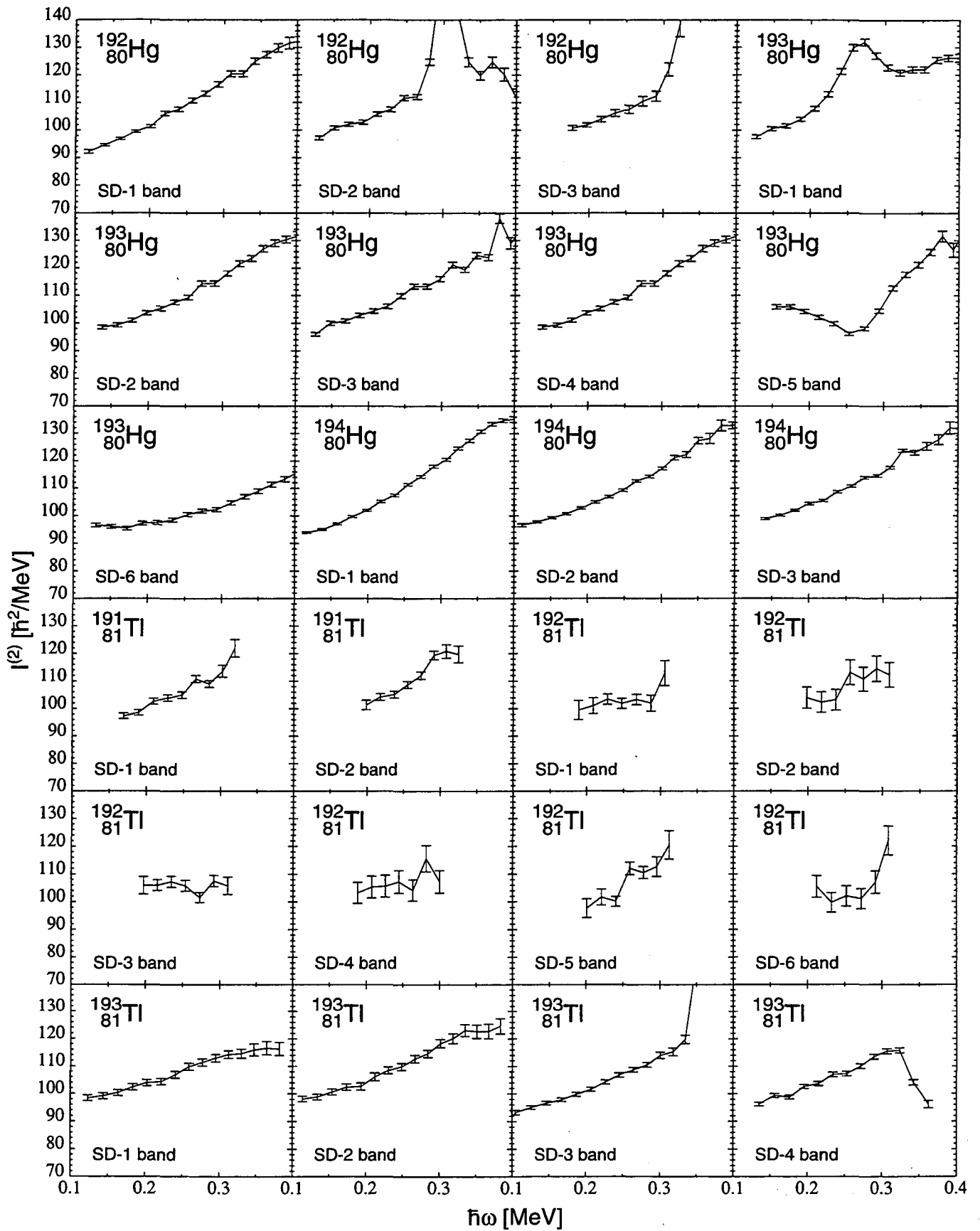

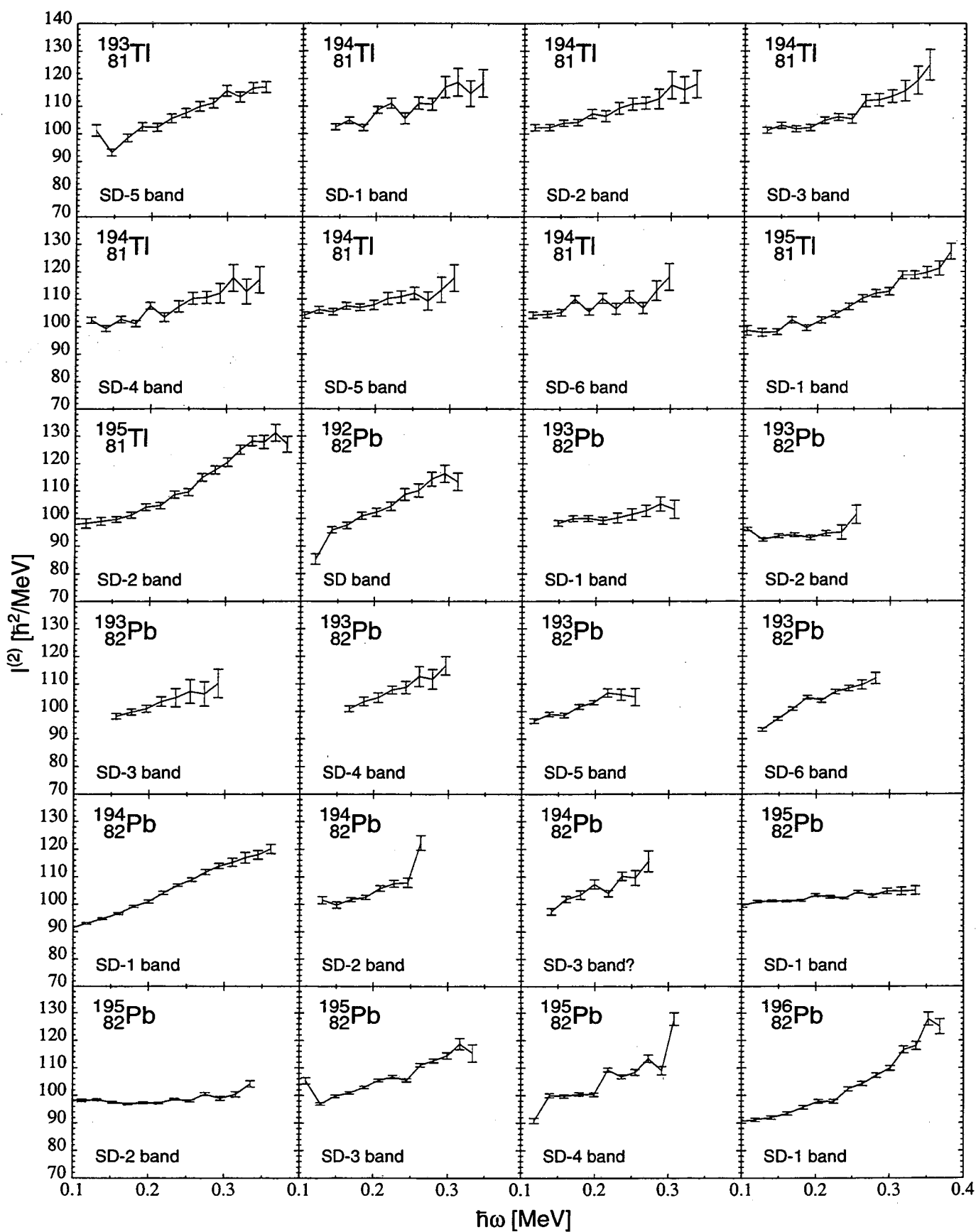

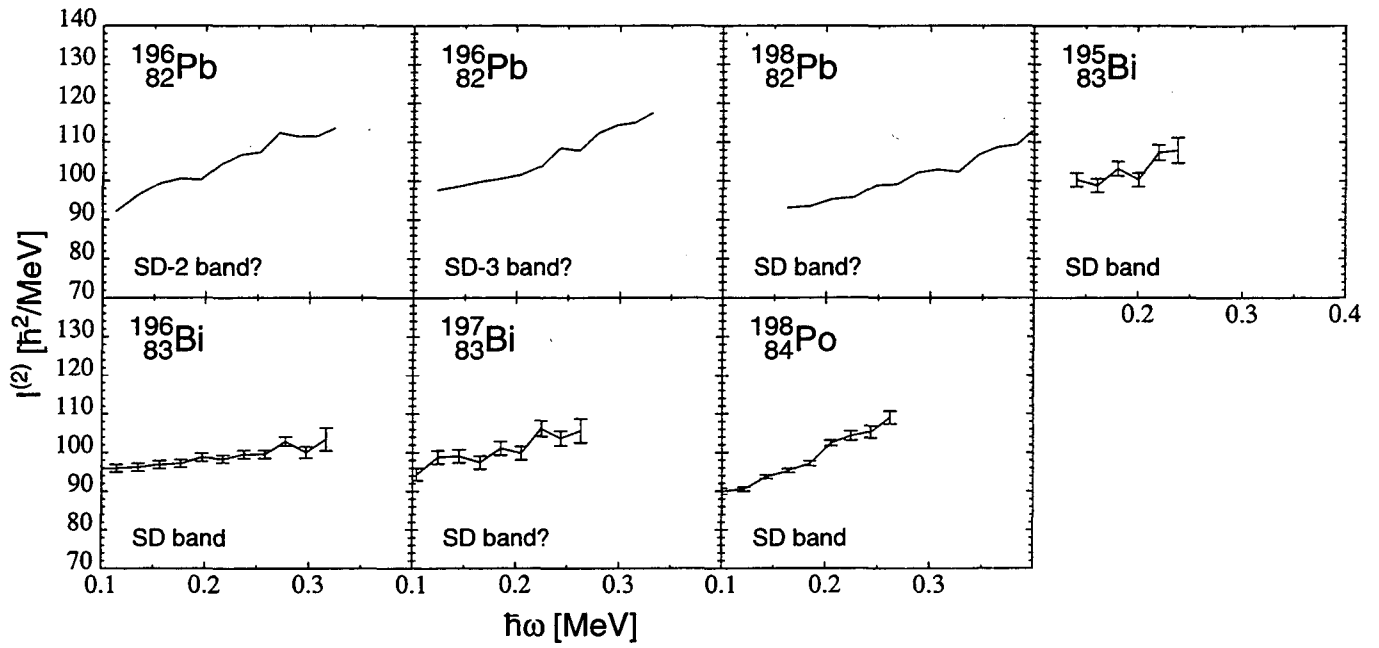

Region V: $A > 200$

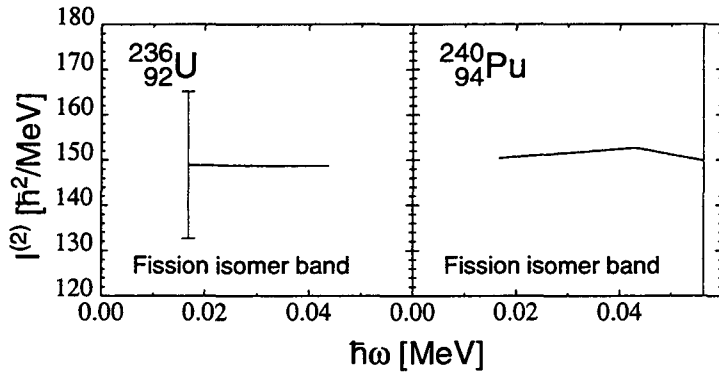

81
38Sr

Δ : -71524 8 S_n : 9293 11 S_p : 6643 10 Q_{EC} : 3932 10

Nuclear Bands

- A 1/2[301]
- B 5/2[303]
- C ν_{g_2}
- D 1/2[431]?
- E SD-1 band (95Ch56)
- F SD-2 band (95Ch56)
- G SD-3 band (95Ch56)
- H SD-4 band (95Ch56)

Levels and γ -ray branchings:

- A 0, 1/2⁻, 22.34 m, %EC+% β^+ =100, μ =+0.5440 4
- B 79.23 4, (5/2)⁻, 0.39 5 μ s γ_{79} 79.23 4 (\dagger_{γ} 100) E2
- C 89.05 7, (7/2)⁺, 6.4 5 μ s γ_{79} 9.82 8 (\dagger_{γ} 100) (E1)
- D 119.76 4, (1/2)⁻, 24 4 ns γ_0 119.76 4 (\dagger_{γ} 100) (E1)
- C 132.2 4, (9/2)⁺, <9 ns γ_{89} 43.2 4 (\dagger_{γ} 100) M1+E2: δ =-0.08 3
- A 155.21 10, (3/2)⁻, 74 20 ps γ_0 155.20 10 (\dagger_{γ} 100) (M1+E2): δ =+0.1 1
- 203.39 5, (5/2)⁺, 1.1 3 ns γ_{89} 114.34 4 (\dagger_{γ} 10.3 3) γ_{79} 124.16 3 (\dagger_{γ} 100.0 8) (E1)
- D 220.82 7, (3/2)⁻, 0.63 20 ns γ_{120} 101.05 5 (\dagger_{γ} 80.8) M1+E2: δ =-0.5 2 3
- γ_0 221.0 4 (\dagger_{γ} 100 7) (E1)
- 294.9 4, (3/2)⁻ γ_0 294.9 4 (\dagger_{γ} 100) M1
- D 336.22 9, (5/2)⁻, 0.16 5 ns γ_{221} 115.39 6 (\dagger_{γ} 100 13) (M1+E2): δ =-0.2 1
- γ_{120} 216.7 4 (\dagger_{γ} 200 20) (E2)
- B 366.6 3, (7/2)⁻, 53 15 ps γ_{89} 277.5 4 (\dagger_{γ} 56 6) (E1) γ_{79} 287.3 4 (\dagger_{γ} 100 5) M1+E2: δ =+2.2 8
- A 379.26 22, (5/2)⁻, 12 6 ps γ_{155} 224.3 4 (\dagger_{γ} 94.4 14) M1+E2: δ =+0.13 8
- γ_{79} 300.0 4 (\dagger_{γ} 20) γ_0 379.4 4 (\dagger_{γ} 100 20) E2
- 535.8 6, (5/2)⁻ γ_{295} 240.9 4 (\dagger_{γ} 100) (D)
- D 558.1 3, (7/2)⁻, 17 17 ps γ_{336} 221.9 4 (\dagger_{γ} 14.5 30) γ_{221} 337.4 4 (\dagger_{γ} 100 9) E2
- 611.75 12, (7/2)⁺, <7 ns γ_{203} 408.36 11 (\dagger_{γ} 100)
- A 632.6 3, (7/2)⁻ γ_{379} 253.5 4 (\dagger_{γ} 32 9) M1 γ_{155} 477.0 4 (\dagger_{γ} 100 15)
- B 706.9 4, (9/2)⁻ γ_{79} 627.7 4 (\dagger_{γ} 100) E2
- D 796.7 6, (9/2)⁺ γ_{558} 239 (\dagger_{γ} 17 3) D γ_{336} 460.3 4 (\dagger_{γ} 100 9) (Q)
- C 810.7 6, (11/2)⁺, 2.8 9 ps γ_{132} 678.6 4 (\dagger_{γ} 100) M1+E2: δ =-0.41 2 8
- C 904.6 5, (13/2)⁺, 4.6 13 ps γ_{132} 772.3 3 (\dagger_{γ} 100) E2
- A 999.9 4, (9/2)⁻ γ_{633} 367.2 4 (\dagger_{γ} <14) γ_{379} 620.8 4 (\dagger_{γ} 100 22) (Q)
- B 1055.7 5, (11/2)⁻ γ_{707} 349 (\dagger_{γ} <0.2) (M1) γ_{367} 689.1 4 (\dagger_{γ} 100 5) E2
- D 1109.1 5, (11/2)⁺ γ_{797} 312 (\dagger_{γ} <0.4) D γ_{558} 551.1 4 (\dagger_{γ} 100 7) (E2)
- A 1332.6 5, (11/2)⁻ γ_{633} 700.0 4 (\dagger_{γ} 100)
- D 1470.7 6, (13/2)⁺, >0.76 ps γ_{797} 674.0 4 (\dagger_{γ} 100) (E2)
- B 1505.5 6, (13/2)⁻ γ_{707} 798.6 4 (\dagger_{γ} 100) (E2)
- C 1739.8 6, (15/2)⁺ γ_{905} 835.0 4 (\dagger_{γ} 100) M1+E2 γ_{811} 929.3 4 (\dagger_{γ} 40)
- A 1804.1 6, (13/2)⁻ γ_{1000} 804.2 4 (\dagger_{γ} 100)
- D 1862.1 6, (15/2)⁺, 0.62 14 ps γ_{1109} 753.0 4 (\dagger_{γ} 100) E2
- C 1865.4 6, (17/2)⁺, 1.0 3 ps γ_{905} 960.7 3 (\dagger_{γ} 100) E2
- B 1911.0 6, (15/2)⁻, >1.2 ps γ_{1056} 855.3 4 (\dagger_{γ} 100) (E2)
- A 2212.6 7, (15/2)⁻ γ_{1333} 880.0 4 (\dagger_{γ} 100)
- D 2326.0 7, (17/2)⁺, 0.30 8 ps γ_{1471} 855.3 4 (\dagger_{γ} 100) E2
- B 2447.5 7, (17/2)⁻, 0.60 21 ps γ_{1506} 942.0 4 (\dagger_{γ} 100) E2
- A 2739.1 12, (17/2)⁻ γ_{1804} 935 (\dagger_{γ} 100)
- D 2791.1 12, (19/2)⁺, 0.14 4 ps γ_{1862} 929 (\dagger_{γ} 100) E2
- B 2906.6 12, (19/2)⁻, 0.36 10 ps γ_{1911} 995.6 (\dagger_{γ} 100) E2
- C 2962.7 7, (21/2)⁺, 0.22 5 ps γ_{1865} 1097.4 3 (\dagger_{γ} 100) E2
- A 3144.6 12, (19/2)⁻ γ_{2213} 932 (\dagger_{γ} 100)
- D 3331.0 12, (21/2)⁺, 0.17 5 ps γ_{2326} 1005 (\dagger_{γ} 100) E2
- 3406.7 9, (21/2)⁺ γ_{2963} 444(?) γ_{1865} 1541 (E2)
- B 3494.9 12, (21/2)⁻, 0.38 14 ps γ_{2448} 1047.4 (\dagger_{γ} 100)
- 3714.0 9, (23/2)⁺, 0.40 16 ps γ_{3407} 307 (\dagger_{γ} 25 6) (M1) γ_{2963} 751.1 (\dagger_{γ} 100 21) (M1+E2): δ =0.3 1

- D 3886.1 16, (23/2)⁺, 0.13 4 ps γ_{2791} 1095 (\dagger_{γ} 100) E2
- B 3980.4 16, (23/2)⁻, <0.55 ps γ_{2907} 1073.8 (\dagger_{γ} 100) E2
- C 4107.2 8, (25/2)⁺, 0.17 4 ps γ_{3714} 393 (\dagger_{γ} 10.6 28) (M1) γ_{2963} 1144.6 5 (\dagger_{γ} 100 14) E2
- D 4475.0 16, (25/2)⁺, 0.09 3 ps γ_{3331} 1144 (\dagger_{γ} 100) E2
- B 4550.9 16(?), (25/2)⁻, <0.55 ps γ_{3495} 1056(?) (\dagger_{γ} 100)
- 4753.1 10, (27/2)⁺, 0.20 4 ps γ_{4107} 646 (\dagger_{γ} 100 25) (M1+E2): δ =-0.1 1
- γ_{3714} 1039 (\dagger_{γ} 63 12) E2
- D 5080.2 19, (27/2)⁺, <0.21 ps γ_{3886} 1194 (\dagger_{γ} 100) E2
- B 5134.4 19, (27/2)⁻ γ_{3980} 1154 (\dagger_{γ} 100)
- C 5242.2 11, (29/2)⁺, <0.35 ps γ_{4753} 489 (\dagger_{γ} 100 40) (M1) γ_{4107} 1135 (\dagger_{γ} <27)
- D 5753.0 19, (29/2)⁺, <0.07 ps γ_{4475} 1278 (\dagger_{γ} 100)
- B 5762.9 19, (29/2)⁻ γ_{4551} 1212(?) (\dagger_{γ} 100)
- 5999.1 14, (31/2)⁺, <0.28 ps γ_{4753} 1246 (\dagger_{γ} 100) E2
- D 6368.2 21, (31/2)⁺ γ_{5080} 1288 (\dagger_{γ} 100)
- B 6389.4 21, (31/2)⁻ γ_{5134} 1255(?) (\dagger_{γ} 100)
- D 7127.0 22, (33/2)⁺ γ_{5753} 1374(?) (\dagger_{γ} 100)
- E x, J
- E 1214+x, J+2 γ_x 1214 (\dagger_{γ} 0.65 10) $I^{(2)}$ =25.6, $\eta\omega$ =0.646
- E 2584+x, J+4 γ_{1214+x} 1370 (\dagger_{γ} 0.95 10) $I^{(2)}$ =27.0, $\eta\omega$ =0.722
- E 4102+x, J+6 γ_{2584+x} 1518 (\dagger_{γ} 1.25 15) $I^{(2)}$ =25.0, $\eta\omega$ =0.799
- E 5780+x, J+8 γ_{4102+x} 1678 (\dagger_{γ} 1.10 10) $I^{(2)}$ =24.8, $\eta\omega$ =0.879
- E 7619+x, J+10 γ_{5780+x} 1839 (\dagger_{γ} 1.45 15) $I^{(2)}$ =27.2, $\eta\omega$ =0.956
- E 9605+x, J+12 γ_{7619+x} 1986 (\dagger_{γ} 1.50 15) $I^{(2)}$ =26.3, $\eta\omega$ =1.031
- E 11743+x, J+14 γ_{9605+x} 2138 (\dagger_{γ} 1.70 15) $I^{(2)}$ =26.0, $\eta\omega$ =1.108
- E 14035+x, J+16 $\gamma_{11743+x}$ 2292 (\dagger_{γ} 1.60 15) $I^{(2)}$ =27.2, $\eta\omega$ =1.183
- E 16474+x, J+18 $\gamma_{14035+x}$ 2439 (\dagger_{γ} 1.15 15) $I^{(2)}$ =32.5, $\eta\omega$ =1.250
- E 19036+x, J+20 $\gamma_{16474+x}$ 2562 (\dagger_{γ} 0.80 10) $I^{(2)}$ =41.7, $\eta\omega$ =1.305
- E 21694+x, J+22 $\gamma_{19036+x}$ 2658 (\dagger_{γ} 0.20 10) $I^{(2)}$ =44.4, $\eta\omega$ =1.352
- E 24442+x(?), J+24 $\gamma_{21694+x}$ 2748(?) (\dagger_{γ} 0.10 5)
- F y, J
- F 1773+y, J+2 γ_y 1773 (\dagger_{γ} 0.95 15) $I^{(2)}$ =26.5, $\eta\omega$ =0.924
- F 3697+y, J+4 γ_{1773+y} 1924 (\dagger_{γ} 0.90 15) $I^{(2)}$ =25.2, $\eta\omega$ =1.002
- F 5780+y, J+6 γ_{3697+y} 2083 (\dagger_{γ} 1.20 20) $I^{(2)}$ =25.8, $\eta\omega$ =1.080
- F 8018+y, J+8 γ_{5780+y} 2238 (\dagger_{γ} 0.80 20) $I^{(2)}$ =25.5, $\eta\omega$ =1.158
- F 10413+y, J+10 γ_{8018+y} 2395 (\dagger_{γ} 0.75 20) $I^{(2)}$ =28.2, $\eta\omega$ =1.233
- F 12950+y, J+12 $\gamma_{10413+y}$ 2537 (\dagger_{γ} 0.45 20)
- G z, J
- G 1881+z, J+2 γ_z 1881 (\dagger_{γ} 0.60 20) $I^{(2)}$ =26.1, $\eta\omega$ =0.979
- G 3915+z, J+4 γ_{1881+z} 2034 (\dagger_{γ} 0.80 20) $I^{(2)}$ =23.8, $\eta\omega$ =1.059
- G 6117+z, J+6 γ_{3915+z} 2202 (\dagger_{γ} 0.50 15) $I^{(2)}$ =24.1, $\eta\omega$ =1.142
- G 8485+z, J+8 γ_{6117+z} 2368 (\dagger_{γ} 0.50 15) $I^{(2)}$ =24.4, $\eta\omega$ =1.225
- G 11017+z, J+10 γ_{8485+z} 2532 (\dagger_{γ} 0.45 15) $I^{(2)}$ =25.2, $\eta\omega$ =1.306
- G 13708+z, J+12 $\gamma_{11017+z}$ 2691 (\dagger_{γ} 0.20 10) $I^{(2)}$ =26.0, $\eta\omega$ =1.384
- G 16553+z(?), J+14 $\gamma_{13708+z}$ 2845(?)
- H u, J
- H 1938+u, J+2 γ_0 1938 (\dagger_{γ} 0.50 20) $I^{(2)}$ =24.7, $\eta\omega$ =1.010
- H 4038+u, J+4 γ_{1938+u} 2100 (\dagger_{γ} 0.70 20) $I^{(2)}$ =25.5, $\eta\omega$ =1.089
- H 6295+u, J+6 γ_{4038+u} 2257 (\dagger_{γ} 0.55 20) $I^{(2)}$ =26.5, $\eta\omega$ =1.166
- H 8703+u, J+8 γ_{6295+u} 2408 (\dagger_{γ} 0.95 25) $I^{(2)}$ =30.1, $\eta\omega$ =1.237
- H 11244+u, J+10 γ_{8703+u} 2541 (\dagger_{γ} 0.55 20)

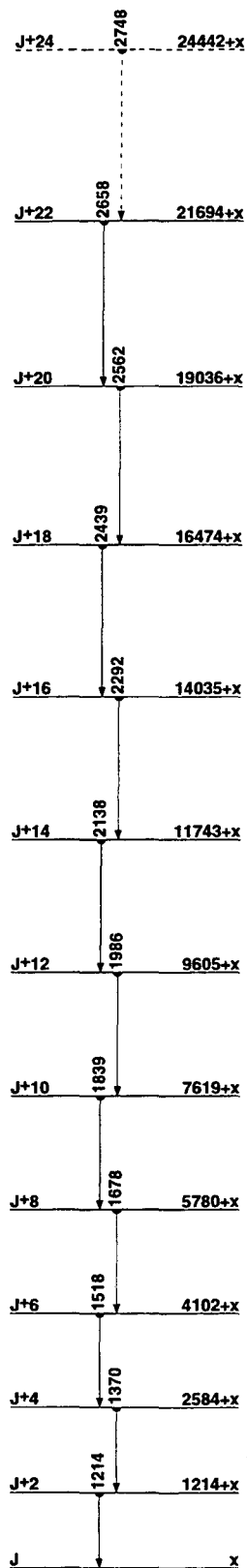

SD-1 band (95Ch56)

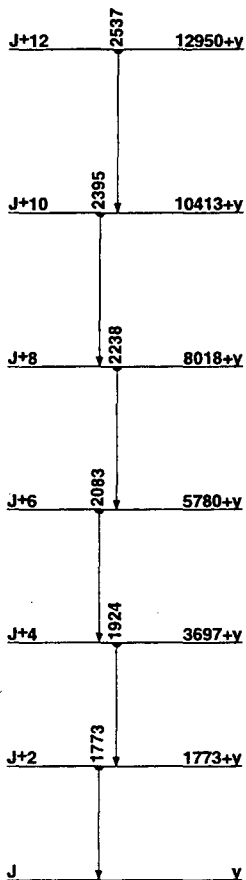

SD-2 band (95Ch56)

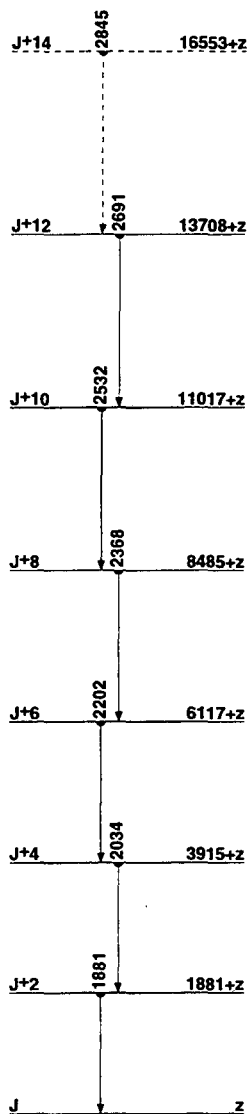

SD-3 band (95Ch56)

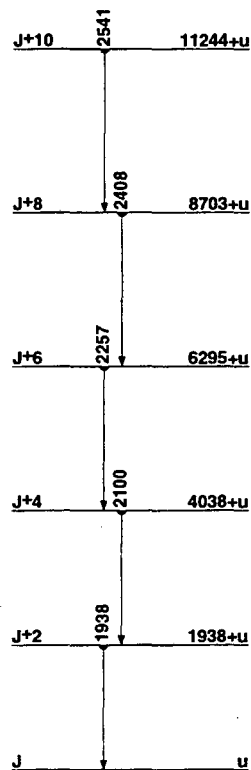

SD-4 band (95Ch56)

82
38Sr

Δ : -76007 6 S_n : 12554 9 S_p : 7840 8 Q_{Ec} : 180 9

Nuclear Bands

- A Band Structure
- B Band Structure
- C GS band
- D Band Structure
- E Yrast band
- F Yrare band
- G Band Structure
- H Band Structure
- I Band Structure
- J SD-1 band (95Sm08)
- K SD-2 band (95Sm08)

Levels and γ -ray branchings:

- C 0, 0⁺, 25.55 15 d, %EC=100
 C 573.57 6, 2⁺, 8.9 4 ps γ_{574} 573.66 7 (t₁₀₀) E2
 B 1175.71 6, 2⁺, 7.5 24 ps γ_{574} 602.14 7 (t₁₀₀ 7) M1(+E2): $\delta=+1.2$ 14
 γ_0 1175.58 8 (t_{10.4} 8)
 1310.93 12, 0⁺, <3.5 ns γ_{574} 737.35 10 (t₁₀₀)
 C 1328.56 9, 4⁺, 1.0 2 ps γ_{574} 754.9 1 (t₁₀₀) E2
 A 1688.99 10, 3⁺ γ_{1329} 359.9 3 (t₉ 3) γ_{1176} 512.9 2 (t₈₀ 12) γ_{574} 1115.8 2 (t₁₀₀ 15)
 1865 5, 2⁺
 B 1996.02 9, 4⁺, 1.3 4 ps γ_{1329} 667.53 10 (t₆₀ 9) M1(+E2): $\delta=+0.3$ 7
 γ_{1176} 820.25 10 (t₁₀₀ 12) E2 γ_{574} 1422.4 3 (t₅ 2)
 2195 5, 2⁺
 C 2229.43 10, 6⁺, 0.37⁺¹⁵ ps γ_{1329} 900.84 10 (t₁₀₀) E2
 E 2401.86 9, 3⁻ γ_{1689} 712.4 1 (t₁₀₀ 8) γ_{574} 1828.4 1 (t₂₉ 8)
 A 2525.83 11, 5⁺ γ_{1996} 529.8 2 (t₁₃ 4) γ_{1689} 837.1 1 (t₁₀₀ 22)
 γ_{1329} 1197.1 2 (t₂₁ 6)
 2665 5, 0⁺
 E 2817.38 10, 5⁻, 3.0 6 ps γ_{2402} 415.17 10 (t₁₃ 15) γ_{1329} 1489.00 10 (t₁₀₀ 13) E1
 I 2824.42 11, 4⁻ γ_{2402} 422.6 3 (t₇ 2) γ_{1996} 828.4 2 (t₁₆ 4)
 γ_{1689} 1135.52 10 (t₁₀₀ 13) E1(+M2): $\delta=+0.03$ 5 γ_{1329} 1494.9 3 (t₅ 2)
 B 2836.23 11, 6⁺, 0.6 4 ps γ_{2229} 606.65 10 (t₅₀ 3) M1(+E2): $\delta=+0.2$ 3
 γ_{1996} 840.24 10 (t₁₀₀ 8) E2
 2885 5, (2⁺)
 2920 5
 H 3006.94 11, 4⁻ γ_{2402} 605.1 1 (t₆₀ 20) γ_{1996} 1010.7 2 (t₂₀ 10)
 γ_{1689} 1318.3 3 (t₁₀₀ 20) γ_{1329} 1677.6 4 (t₄₀ 10)
 F 3073.29 13, (5⁻) γ_{2817} 255.4 3 (t₇ 7) γ_{2229} 843.6 2 (t₆₄ 14)
 γ_{1996} 1077.4 2 (t₁₀₀ 21)
 I 3086.26 10, 6⁻ γ_{2824} 261.83 10 (t₁₀₀ 9) γ_{2817} 269.02 10 (t₇₈ 9)
 γ_{2526} 560.8 2 (t₂₂ 4)
 G 3142.31 21, (5⁻) γ_{1329} 1812.8 4 (t₁₀₀)
 C 3242.74 12, 8⁺, 0.24⁻¹⁰ ps γ_{2229} 7013.36 10 (t₄₀₀) E2
 H 3339.60 11, 6⁻ γ_{3073} 266.2 2 (t₄ 1) γ_{3007} 332.5 2 (t₈ 2) γ_{2817} 522.1 1 (t₁₀₀ 12) γ_{2526} 813.9 1 (t₁₆ 3) γ_{2229} 1110.3 2 (t₁₆ 3)
 A 3476.98 15, 7⁺ γ_{2526} 951.15 10 (t₁₀₀)
 3510.81 16, (7⁻) γ_{2817} 694.04 10 (?) (t₁₀₀ 7) E2 γ_{2229} 1281.1 2 (t_{4.6} 8)
 E 3525.76 11, 7⁻ γ_{3086} 439.88 10 (t₈ 2) γ_{3073} 451.9 3 (t₄ 1) γ_{2817} 707.9 2 (t₇ 2) γ_{2229} 1296.19 10 (t₁₀₀ 12) D+Q: $\delta=+0.5$ 5
 F 3565.76 12, 7⁻ γ_{3086} 479.3 2 (t₁₇ 6) γ_{3073} 492.7 4 (t₁ 1) γ_{2817} 748.3 2 (t₁₄ 1) γ_{2229} 1336.5 2 (t₁₀₀ 13)
 G 3607.95 12, 7⁻ γ_{3142} 465.4 2 (t₃₀ 8) γ_{3086} 521.5 2 (t₁₀₀ 14)
 γ_{3073} 534.6 2 (t₃₅ 8) γ_{2836} 771.8 2 (t₆₈ 68) γ_{2817} 790.6 2 (t₃₂ 8)
 γ_{2229} 1378.6 2 (t₇₃ 19)
 B 3622.73 12, 8⁺, 0.7 4 ps γ_{3243} 379.96 10 (t₈ 8 9) γ_{2836} 786.36 10 (t₁₀₀ 7) E2 γ_{2229} 1393.5 1 (t₁₈ 6)
 D 3685.99 15, (8⁺) γ_{3243} 443.28 10 (t₁₀₀ 15) γ_{2229} 1456.2 3 (t₃₆ 11)
 H 4033.52 14, 8⁻ γ_{3526} 507.9 3 (t₈ 2) γ_{3340} 693.9 1 (t₁₀₀ 22)
 I 4142.62 13, 8⁻ γ_{3608} 534.7 2 (t₂₆ 8) γ_{3566} 577.0 2 (t₃₁ 8) γ_{3526} 617.1 4

- (t₈ 3) γ_{3086} 1056.3 1 (t₁₀₀ 23) E2
 4248.3 10 γ_{3243} 1005.6 (t₁₀₀)
 C 4350.22 15, 10⁺, 0.14⁻¹⁶ ps γ_{3243} 1107.47 10 (t₁₀₀) (E2)
 E 4366.82 13, 9⁻ γ_{3608} 758.8 1 (t₉₅ 8) γ_{3566} 801.11 10 (E2) γ_{3526} 841.3 3 (t₁₀₀ 10)
 4386.88 15, (9⁻) γ_{3511} 876.0 1 (t₁₀₀ 18) (E2) γ_{3243} 1144.20 10 (t₈₈ 7)
 B 4423.78 13, (10⁺), 0.9 2 ps γ_{3623} 801.11 10 (t₁₀₀ 12) (E2)
 γ_{3243} 1180.98 10 (t₁₆ 2)
 F 4472.84 13, 9⁻ γ_{3566} 907.0 1 (t₆₂ 8) γ_{3526} 947.2 2 (t₄₄ 4) γ_{3243} 1230.3 2 (t₁₀₀ 8)
 A 4492.5 4, 9⁺ γ_{3477} 1015.5 3 (t₁₀₀)
 D 4637.26 17, (10⁺) γ_{4424} 213.5 3 (t₁₀ 3) γ_{4350} 287.0 2 (t₃₈ 7)
 γ_{3686} 951.2 2 (t₁₀₀ 10) γ_{3243} 1394.7 3 (t₇ 2 10)
 H 4909.42 17, 10⁺, 0.36⁻¹¹ ps γ_{4034} 875.9 1 (t₁₀₀) E2
 I 5237.4 4, 10⁻ γ_{4143} 1094.8 3 (t₁₀₀)
 E 5308.15 16, 11⁻ γ_{4367} 941.32 10 (t₁₀₀) E2
 5333.7 15 γ_{4248} 1085.4 (t₁₀₀)
 5392.31 18 (?) γ_{4367} 1005.4 3 10 (t₁₀₀)
 B 5427.05 17, 12⁺, 0.33⁻¹¹ ps γ_{4424} 1003.26 10 (t₁₀₀) E2
 5468.8 10 γ_{4424} 1045 1 (t₁₀₀)
 F 5479.04 25, (11⁻) γ_{4473} 1006.2 3 (t₁₀₀ 7) γ_{4350} 1128.8 3 (t₆₂ 4)
 C 5568.9 4, 12⁺, 0.06 6 ps γ_{4350} 1218.7 3 (t₁₀₀)
 D 5738.2 5, (12⁺) γ_{4637} 1100.9 4 (t₁₀₀)
 H 5913.9 4, 12⁻, 0.27⁻¹¹ ps γ_{4909} 1004.5 3 (t₁₀₀) E2
 E 6367.2 3, 13⁻ γ_{5308} 1059.0 2 (t₁₀₀) E2
 6450.1 11 γ_{5427} 1023 1 (t₁₀₀)
 B 6543.6 4, 14⁺, 0.25⁻¹¹ ps γ_{5427} 1116.5 3 (t₁₀₀) E2
 6556.4 18 γ_{5334} 1222.6 (t₁₀₀)
 F 6564.8 4, (13⁻) γ_{5479} 1085.7 3 (t₁₀₀)
 C 6936.9 5, (14⁺), 0.04⁻⁵ ps γ_{5569} 1368.0 3 (t₁₀₀)
 H 7066.5 5, 14⁻, 0.08⁻⁵ ps γ_{5914} 1152.6 3 (t₁₀₀) E2
 7534.6 11 γ_{6544} 991 1 (t₁₀₀)
 E 7545.5 4, 15⁻, 0.12 5 ps γ_{6367} 1178.3 3 (t₁₀₀) E2
 F 7788.2 5, (15⁻) γ_{6565} 1223.4 3 (t₁₀₀)
 B 7812.0 6, 16⁺, 0.09⁻⁵ ps γ_{6544} 1268.4 4 (t₁₀₀) E2
 7936.0 20 γ_{6556} 1379.6 (t₁₀₀)
 H 8377.7 6, 16⁻, 0.14 6 ps γ_{7067} 1311.1 4 (t₁₀₀) E2
 C 8434.6 6, (16⁺), <0.18 ps γ_{6937} 1497.6 3 (t₁₀₀) E2
 E 8842.0 7, 17⁻, 0.08 6 ps γ_{7546} 1296.5 5 (t₁₀₀) E2
 F 9167.4 7, (17⁻) γ_{7788} 1379.2 4 (t₁₀₀)
 B 9237.7 7, 18⁺, 0.05⁻⁴ ps γ_{7812} 1425.7 4 (t₁₀₀)
 9478.0 23 γ_{7836} 1542 (t₁₀₀)
 H 9842.7 12, (18⁻), <0.19 ps γ_{8378} 1465 1 (t₁₀₀)
 10061.5 12, (18⁺) γ_{8435} 1626.9 (t₁₀₀)
 E 10258.8 8, (19⁻), 0.08⁻⁶ ps γ_{8842} 1416.8 5 (t₁₀₀)
 F 10709.4 12, (19⁻) γ_{9167} 1542 1 (t₁₀₀)
 B 10872.3 9, (20⁺), <0.21 ps γ_{9238} 1634.6 5 (t₁₀₀)
 H 11379.7 16, (20⁻) γ_{9843} 1537 1 (t₁₀₀)
 E 11798.4 10, (21⁻), <0.06 ps γ_{10259} 1539.6 5 (t₁₀₀)
 11837.5 16, (20⁺) γ_{10062} 1776 (t₁₀₀)
 12758.7 13, (22⁺) γ_{10872} 1886.4 (t₁₀₀)
 H 13005.7 19, (22⁻) γ_{11380} 1626 1 (t₁₀₀)
 E 13489.4 14, (23⁻) γ_{11798} 1691 1 (t₁₀₀)
 14832.7 21 (?), (24) γ_{13006} 1827 (t₁₀₀)
 14910.8 17, (24⁺) γ_{12759} 2152 (t₁₀₀)
 15409.5 17, (25) γ_{13489} 1920 (t₁₀₀)
 17246.8 20 (?), (26⁻) γ_{14911} 2336 (t₁₀₀)
 17616.5 20, (27) γ_{15410} 2207 (t₁₀₀)
 J x, J=(19)
 J 1432+x, J+2 γ_x 1432 2 (t₀ 60 7) I⁽¹⁾=27.7, I⁽²⁾=24.4, $\hbar\omega=0.757$
 J 3028+x, J+4 γ_{1432+x} 1596 2 (t₀ 65 7) I⁽¹⁾=27.4, I⁽²⁾=24.8, $\hbar\omega=0.838$
 J 4785+x, J+6 γ_{3028+x} 1757 2 (t₀ 83 7) I⁽¹⁾=27.2, I⁽²⁾=24.7, $\hbar\omega=0.919$

- J 6704+x, J+8 γ_{4785+x} 19192 (\dagger_{γ} 1.00 7) $I^{(1)}=27.0, I^{(2)}=25.2, \eta\omega=0.999$
- J 8782+x, J+10 γ_{6704+x} 20782 (\dagger_{γ} 1.00 7) $I^{(1)}=26.9, I^{(2)}=26.0, \eta\omega=1.078$
- J 11014+x, J+12 γ_{8782+x} 22322 (\dagger_{γ} 1.00 7) $I^{(1)}=26.9, I^{(2)}=26.0, \eta\omega=1.154$
- J 13400+x, J+14 $\gamma_{11014+x}$ 23862 (\dagger_{γ} 0.80 7) $I^{(1)}=26.7, I^{(2)}=24.4, \eta\omega=1.234$
- J 15950+x, J+16 $\gamma_{13400+x}$ 25502 (\dagger_{γ} 0.50 7) $I^{(1)}=26.5, I^{(2)}=21.5, \eta\omega=1.322$
- J 18686+x (?), J+18 $\gamma_{15950+x}$ 2736(?) (\dagger_{γ} 0.25 5)
- K y, J=(20)
- K 1537+y, J+2 γ_{1537+y} 15372 (\dagger_{γ} 0.70 5) $I^{(1)}=27.2, I^{(2)}=25.3, \eta\omega=0.808$
- K 3232+y, J+4 γ_{1537+y} 16952 (\dagger_{γ} 0.85 5) $I^{(1)}=27.0, I^{(2)}=24.8, \eta\omega=0.888$
- K 5088+y, J+6 γ_{3232+y} 18562 (\dagger_{γ} 1.00 10) $I^{(1)}=26.9, I^{(2)}=26.8, \eta\omega=0.965$
- K 7093+y, J+8 γ_{5088+y} 20052 (\dagger_{γ} 0.95 5) $I^{(1)}=26.9, I^{(2)}=25.5, \eta\omega=1.042$
- K 9255+y, J+10 γ_{7093+y} 21622 (\dagger_{γ} 0.92 5) $I^{(1)}=26.8, I^{(2)}=26.8, \eta\omega=1.118$
- K 11566+y, J+12 γ_{9255+y} 23112 (\dagger_{γ} 0.80 5) $I^{(1)}=26.8, I^{(2)}=26.3, \eta\omega=1.194$
- K 14029+y, J+14 $\gamma_{11566+y}$ 24632 (\dagger_{γ} 0.30 5) $I^{(1)}=26.8, I^{(2)}=28.6, \eta\omega=1.266$
- K 16632+y (?), J+16 $\gamma_{14029+y}$ 2603(?) (\dagger_{γ} 0.25 5)

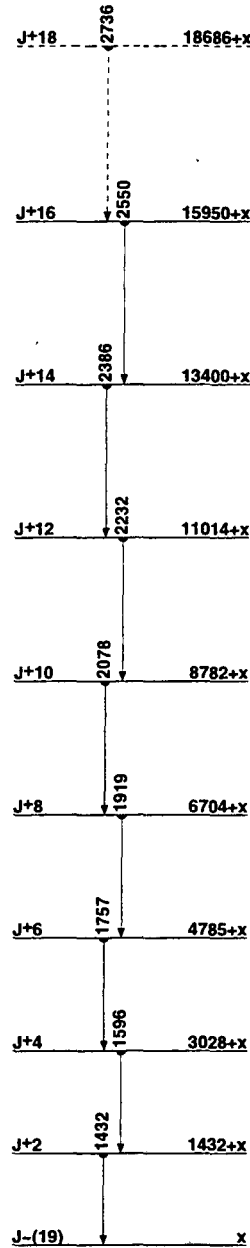

SD-1 band
(95Sm08)

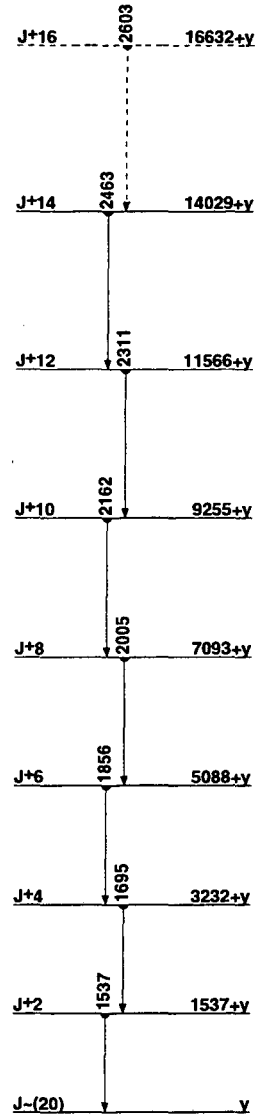

SD-2 band
(95Sm08)

⁸²₃₈Sr

83
38Sr

Δ : -76795.9 S_n : 8860.10 S_p : 7897.11 Q_{EC} : 2276.6

Nuclear Bands

A SD band (95Ba26,95La21)

Levels and γ -ray branchings:

- 0, $7/2^+$, 32.413 h, %EC+% β^+ =100, μ =-0.82983, Q =+0.82350
- 35.476, $(9/2)^+$, <15 ns γ_0 35.5010 (\dagger ,100) M1
- 259.159, $1/2^-$, 4.9512 s, %IT=100, μ =+0.5821 γ_0 259.1010 (\dagger ,100) E3
- 489.928 γ_0 489.9020 (\dagger ,100.022) γ_{35} 454.4020 (\dagger ,43.311)
- 545.43 γ_0 545.43 (\dagger ,100)
- 650.8115, $(3/2,5/2^-)$ γ_{259} 391.6020 (\dagger ,100)
- 681.1123, $(3/2^-,5/2^-)$ γ_{259} 421.83 (\dagger ,100)
- 717.539, $(7/2,9/2,11/2^*)$ γ_0 717.6020 (\dagger ,36.515) γ_{35} 682.1010 (\dagger ,100.5)
- γ_{490} 227.5020 (\dagger ,9.110)
- 753.7216, $(3/2^-)$ γ_{259} 494.5020 (\dagger ,100)
- 790.8317 γ_0 790.8020 (\dagger ,100)
- 800.4010, $(7/2,11/2)^+$, 3.725 ps γ_0 800.4010 (\dagger ,1006) E2 γ_{35} 764.96 (\dagger ,8010)
- 846.33, $(5/2^-,7/2,9/2^-)$ γ_{651} 195.44 (\dagger ,100)
- 894.1611, $(11/2)^+$, 1.66 ps γ_0 893.94 (\dagger ,3.58) (E2) γ_{35} 858.7010 (\dagger ,1004) M1+E2: δ =0.8313
- 910.510, $(13/2)^+$, 3.52 ps γ_{35} 875.0 (\dagger ,100) E2
- 951.779, $(5/2^+,7/2^-)$ γ_0 951.8010 (\dagger ,100.5) γ_{35} 916.55 (\dagger ,4.210)
- γ_{681} 270.53 (\dagger ,3.95) γ_{718} 234.43 (\dagger ,3.26)
- 962.798, $(7/2,9/2,11/2^*)$ γ_0 962.8010 (\dagger ,614) γ_{35} 927.3010 (\dagger ,100.5)
- γ_{718} 245.34 (\dagger ,7.222)
- 1092.83 γ_0 1092.46 (\dagger ,100.30) γ_{490} 603.03 (\dagger ,100.20)
- 1098.0612, $(7/2,9/2,11/2^*)$ γ_0 1097.28 (\dagger ,80.40) γ_{35} 1062.6010 (\dagger ,100.33)
- 1140.7125, $(7/2,9/2^-)$ γ_{651} 489.9020 (\dagger ,100)
- 1233.4011, $(7/2,9/2,11/2^*)$ γ_0 1233.36 (\dagger ,5.110) γ_{35} 1197.9020 (\dagger ,29.726) γ_{490} 743.5010 (\dagger ,100.5)
- 1239.1919, $(7/2,9/2,11/2^*)$ γ_0 1239.2020 (\dagger ,1004) γ_{35} 1203.65 (\dagger ,12.122)
- 1365.93, $(7/2,9/2,11/2^*)$ γ_0 1366.46 (\dagger ,3410) γ_{490} 875.83 (\dagger ,10017)
- 1371.987, $(7/2^*)$ γ_{1233} 138.84 (\dagger ,1.62) γ_{963} 409.34 (\dagger ,1.12) γ_{952} 420.33 (\dagger ,29.220) γ_{846} 525.64 (\dagger ,1.23) γ_{781} 581.13 (\dagger ,2.33) γ_{754} 618.22 (\dagger ,9.77) γ_{718} 654.52 (\dagger ,3.13) γ_{651} 721.22 (\dagger ,16.87) γ_{545} 927 (\dagger ,16.08) γ_{490} 882.11 (\dagger ,100.025) γ_{35} 1336.51 (\dagger ,49.020) γ_0 1371.91 (\dagger ,16.08)
- 1434.1219, $(7/2,9/2,11/2^*)$ γ_0 1434.2020 (\dagger ,1009) γ_{490} 943.65 (\dagger ,268)
- 1498.8315, $(7/2,9/2)$ γ_0 1498.8020 (\dagger ,938) γ_{35} 1463.43 (\dagger ,10012)
- γ_{952} 547.13 (\dagger ,6212)
- 1574.010, $(9/2)^+$ γ_{894} 679.8 (\dagger ,100) M1+E2: δ =+1.18
- 1604.85, $(7/2,9/2,11/2^*)$ γ_0 1604.68 (\dagger ,7220) γ_{490} 1115.05 (\dagger ,10030)
- 1745.48, $(7/2,9/2,11/2^*)$ γ_0 1745.39 (\dagger ,10029) γ_{35} 1710.015 (\dagger ,5628)
- 1752.64, $(7/2,9/2,11/2^*)$ γ_0 1752.64 (\dagger ,10016) γ_{35} 1717.08 (\dagger ,227)
- 1856.413, $(15/2)^+$ γ_{911} 945.97 (\dagger ,100) M1+E2: δ =+0.96
- 1882.5023, $(7/2,9/2)$ γ_0 1882.28 (\dagger ,3214) γ_{35} 1846.85 (\dagger ,5514)
- γ_{490} 1392.43 (\dagger ,1009) γ_{952} 931.55 (\dagger ,6818)
- 1915.43, $(7/2,9/2^-)$ γ_0 1915.74 (\dagger ,10012) γ_{35} 1879.87 (\dagger ,4810)
- γ_{651} 1264.34 (\dagger ,366)
- 1964.15, $(7/2,9/2,11/2^*)$ γ_0 1964.56 (\dagger ,10016) γ_{35} 19282 (\dagger ,3216)
- γ_{490} 1473.86 (\dagger ,8716)
- 1987.615, $(17/2)^+$, 0.72 ps γ_{911} 1077.1 (\dagger ,100) E2
- 2017.06, $(7/2,9/2,11/2^*)$ γ_0 2016.96 (\dagger ,10016) γ_{490} 1527.210 (\dagger ,3410)
- 2074.08, $(7/2,9/2,11/2^*)$ γ_0 2073.612 (\dagger ,10040) γ_{490} 1584.310 (\dagger ,7033)
- 2089.78, $(7/2,9/2,11/2^*)$ γ_0 2089.810 (\dagger ,6332) γ_{35} 2054.112 (\dagger ,10032)
- 2107.510, $(13/2)^+$ γ_{894} 1213.3 (\dagger ,100) M1
- 2373.26, $(7/2,9/2,11/2^*)$ γ_{1372} 1001.26 (\dagger ,100)
- 2905.23, $(7/2^-,9/2^+,11/2^*)$ γ_0 2905.39 (\dagger ,10012) γ_{35} 2869.615 (\dagger ,206)
- γ_{718} 2187.010 (\dagger ,156) γ_{800} 2104.98 (\dagger ,295) γ_{894} 2011.15 (\dagger ,569)

- γ_{963} 1942.310 (\dagger ,134) γ_{1372} 1532.210 (\dagger ,94) γ_{1499} 1407.110 (\dagger ,154)
- 2943.98, $(7/2^-,9/2^+,11/2^*)$ γ_0 2944.010 (\dagger ,10012) γ_{35} 29092 (\dagger ,168)
- γ_{894} 2049.015 (\dagger ,178)
- 3117.018, $(21/2)^+$, <0.7 ps γ_{1988} 1129.4 (\dagger ,100) E2
- 3644.920, $(23/2)^+$, 8.74 ps γ_{3117} 527.9 (\dagger ,100) M1+E2: δ =0.144
- A x, J=(41/2)
- A 1307+x2, J+2 γ_x 1307.2 $I^{(1)}$ =32.5, $I^{(2)}$ =26.1, $\eta\omega$ =0.692
- A 2767+x3, J+4 γ_{1307+x} 1460.2 $I^{(1)}$ =31.9, $I^{(2)}$ =26.3, $\eta\omega$ =0.768
- A 4379+x4, J+6 γ_{2767+x} 1612.2 $I^{(1)}$ =31.4, $I^{(2)}$ =26.3, $\eta\omega$ =0.844
- A 6143+x4, J+8 γ_{4379+x} 1764.2 $I^{(1)}$ =31.0, $I^{(2)}$ =27.0, $\eta\omega$ =0.919
- A 8055+x5, J+10 γ_{6143+x} 1912.2 $I^{(1)}$ =30.7, $I^{(2)}$ =27.0, $\eta\omega$ =0.993
- A 10115+x5, J+12 γ_{8055+x} 2060.2 $I^{(1)}$ =30.5, $I^{(2)}$ =28.0, $\eta\omega$ =1.066
- A 12318+x6, J+14 $\gamma_{10115+x}$ 2203.2 $I^{(1)}$ =30.3, $I^{(2)}$ =28.0, $\eta\omega$ =1.137
- A 14664+x6, J+16 $\gamma_{12318+x}$ 2346.2 $I^{(1)}$ =30.2, $I^{(2)}$ =28.0, $\eta\omega$ =1.209
- A 17153+x6, J+18 $\gamma_{14664+x}$ 2489.2 $I^{(1)}$ =30.0, $I^{(2)}$ =25.5, $\eta\omega$ =1.284
- A 19799+x7(?), J+20 $\gamma_{17153+x}$ 2646.2(?)

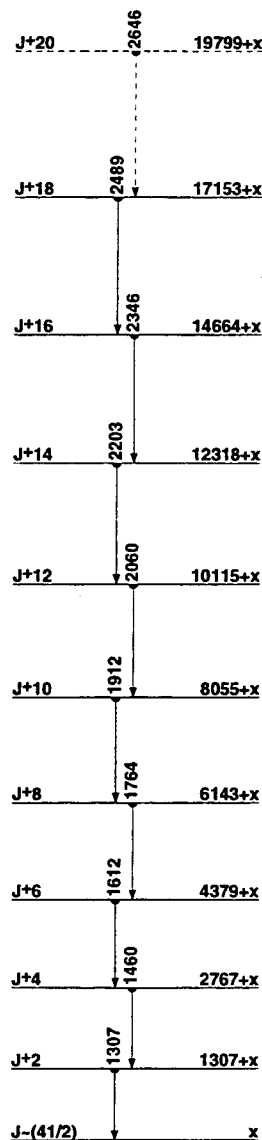

SD band
(95Ba26,95La21)

83
38Sr

82Y
39

Δ : -68190 100 S_n : 10250 120 S_p : 3960 100 Q_{EC} : 7820 100

Nuclear Bands

- A $\pi g_{9/2} \nu g_{9/2} \alpha=1$
- B $\pi g_{9/2} \nu g_{9/2} \alpha=0$
- C $\alpha=1$
- D $\alpha=0$
- E Band Structure
- F Band Structure
- G SD band (95Da30)

Levels and γ -ray branchings:

- 0, 1⁺, 9.53 s, %EC+% β^+ =100
- 142.34 7, 2⁺ γ_{142} 142.31 (†,100) D
- 250.19 9, 2⁺ γ_{142} 107.92 (†,294) γ_{250} 250.21 (†,100 7) D
- 313.69 8, 3⁺ γ_{250} 63.73 (†,46 18) γ_{142} 171.41 (†,100 4) D γ_{313} 313.71 (†,86 6) Q
- 337.00 10, 3⁺ γ_{142} 194.61 (†,100 4) D γ_{337} 337.12 (†,49 6) Q
- 401.10 9, 4⁺, 11.128 ns γ_{337} 64.33 (†,31 17) γ_{314} 87.51 (†,100 4) γ_{142} 258.71 (†,=7)
- D 402.64 13, 4⁻, 268.25 ns γ_{337} 65.72 (†,100 9) γ_{314} 88.92 (†,75 6)
- E 405.79 24, 4⁻, 35.421 ns γ_{337} 68.23 (†,100)
- E 473.89 16, (5⁻) γ_{406} 67.53 (†,100)
- B 507.52 12, 6⁺, 147.7 ns γ_{401} 106.41 (†,100) E2
- C 511.90 14, 5⁻ γ_{403} 109.21 (†,100)
- E 586.65 15, (6⁻) γ_{512} 74.22 (†,100 7) γ_{474} 112.42 (†,43 7)
- 594.71 14, (6⁺) γ_{401} 193.71 (†,100)
- D 677.98 14, 6⁻ γ_{587} 91.11 (†,8 1) γ_{512} 166.22 (†,81 9) γ_{508} 170.72 (†,100 13) γ_{474} 204.11 (†,63 9) γ_{403} 275.41 (†,56 9) (Q)
- A 718.87 14, 7⁺ γ_{508} 211.31 (†,100) D
- B 751.50 14, 8⁺ γ_{719} 32.63 (†,18 5) γ_{508} 243.91 (†,100) Q
- F 818.26 19, (6⁻) γ_{578} 140.02 (†,57 12) γ_{512} 306.62 (†,45 14) γ_{474} 344.53 (†,100 18)
- C 957.00 14, 7⁻ γ_{719} 238.12 (†,16 2) γ_{578} 279.02 (†,28 4) (D) γ_{587} 370.32 (†,33 3) γ_{512} 445.11 (†,100 6) Q γ_{508} 449.62 (†,34 3)
- A 1146.95 16, 9⁺ γ_{752} 395.51 (†,100 1) D γ_{719} 428.02 (†,3.1 5)
- E 1163.43 20, (7⁻) γ_{587} 576.82 (†,100 20) γ_{512} 651.52 (†,100 20)
- D 1272.27 16, 8⁻ γ_{957} 315.32 (†,9.0 5) γ_{578} 594.31 (†,100 2) Q
- 1284.12 17, (8⁻) γ_{752} 532.32 (†,35 3) γ_{719} 565.22 (†,100 2) γ_{595} 690.84 (†,9 3) γ_{508} 776.73 (†,98 5)
- F 1506.8 4, (8⁻) γ_{818} 688.53 (†,100)
- 1557.20 25, (9⁺) γ_{1284} 273.12 (†,13 8) γ_{719} 838.25 (†,100 8)
- B 1589.74 16, 10⁺ γ_{1147} 442.62 (†,11 2) D γ_{752} 838.21 (†,100 1) Q
- C 1687.79 17, 9⁻ γ_{957} 730.81 (†,100 2) Q γ_{752} 936.23 (†,17.6 3)
- A 1960.07 17, 11⁺, 0.42 10 ps γ_{1590} 370.21 (†,97 1) D γ_{1147} 813.21 (†,100 2) (E2)
- E 1963.7 4, (9⁻) γ_{1163} 800.33
- D 2061.57 18, 10⁻ γ_{1272} 789.31 (†,100 2) Q γ_{1147} 914.53 (†,17 2)
- F 2379.1 6, (10⁻) γ_{1507} 872.34 (†,100)
- C 2602.20 20, 11⁻, 0.31 5 ps γ_{1688} 914.41 (†,100) E2
- B 2651.21 19, 12⁺, 0.284 35 ps γ_{1960} 691.19 (†,21 1) D γ_{1590} 1061.51 (†,100 2) E2
- A 2970.9 3, 13⁺, 0.236 28 ps γ_{2651} 320.34 (†,53 10) M1 γ_{1960} 1010.53 (†,100 13) E2
- D 3026.2 4, 12⁻ γ_{2062} 964.63 (†,100) Q
- C 3675.00 22, 13⁻, 0.166 21 ps γ_{2602} 1072.81 (†,100) (E2)
- B 3904.02 22, 14⁺ γ_{2651} 1252.81 (†,100) Q
- A 4142.7 3, 15⁺, 0.132 14 ps γ_{2871} 1171.81 (†,100) E2
- D 4150.2 4, 14⁻ γ_{3026} 1124.01 (†,100) Q
- C 4886.0 4, 15⁻, <0.26 ps γ_{9575} 1211.03 (†,100) (E2)
- B 5250.0 3, 16⁺ γ_{3904} 1346.02 (†,100) Q
- D 5414.6 5, 16⁻ γ_{4150} 1264.42 (†,100) Q

- A 5456.3 5, 17⁺, 0.083 14 ps γ_{4143} 1313.63 (†,100) E2
- C 6222.7 5(?), (17⁻) γ_{4886} 1336.73(?) (†,100) (Q)
- B 6672.1 5, 18⁺ γ_{5250} 1422.14 (†,100) (Q)
- D 6777.4 5, (18⁻) γ_{5415} 1362.82 (†,100)
- A 6914.5 6, 19⁺, <0.21 ps γ_{5456} 1458.23 (†,100) (E2)
- C 7591.2 10(?), (19⁻) γ_{6223} 1368.58(?) (†,100)
- D 8187.7 6, (20⁻) γ_{6777} 1410.34 (†,100)
- B 8194.2 6, 20⁺ γ_{6672} 1522.03 (†,100) (Q)
- A 8515.9 6, 21⁺ γ_{6915} 1601.32 (†,100) (Q)
- D 9680.0 10, (22⁻) γ_{8188} 1492.38 (†,100)
- B 9861.0 7, 22⁺ γ_{8194} 1666.84 (†,100) (Q)
- A 10267.3 7, (23⁺) γ_{8516} 1751.44 (†,100)
- B 11712.8 11, (24⁺) γ_{9861} 1851.88 (†,100)
- A 12219.4 8, (25⁺) γ_{10267} 1952.14 (†,100)
- B 13785.5 12, (26⁺) γ_{11713} 2072.74 (†,100)
- A 14416.2 12, (27⁺) γ_{12219} 2196.88 (†,100)
- G x, J=(20)
- G 1455+x, J+2 γ_x 1455.2 (†,0.40 7) $I^{(1)}=28.7, I^{(2)}=26.5, \hbar\omega=0.765$
- G 3061+x, J+4 γ_{1455+x} 1606.2 (†,0.65 8) $I^{(1)}=28.4, I^{(2)}=23.8, \hbar\omega=0.845$
- G 4835+x, J+6 γ_{3061+x} 1774.2 (†,1.0 1) $I^{(1)}=28.0, I^{(2)}=24.7, \hbar\omega=0.928$
- G 6771+x, J+8 γ_{4835+x} 1936.2 (†,1.0 1) $I^{(1)}=27.8, I^{(2)}=24.5, \hbar\omega=1.009$
- G 8870+x, J+10 γ_{6771+x} 2099.2 (†,1.0 1) $I^{(1)}=27.5, I^{(2)}=24.4, \hbar\omega=1.090$
- G 11133+x, J+12 γ_{8870+x} 2263.2 (†,1.0 1) $I^{(1)}=27.3, I^{(2)}=25.3, \hbar\omega=1.171$
- G 13554+x, J+14 $\gamma_{11133+x}$ 2421.2 (†,0.65 8) $I^{(1)}=27.2, I^{(2)}=24.8, \hbar\omega=1.251$
- G 16136+x, J+16 $\gamma_{13554+x}$ 2582.2 (†,0.35 5) $I^{(1)}=27.0, I^{(2)}=23.1, \hbar\omega=1.334$
- G 18891+x(?), J+18 $\gamma_{16136+x}$ 2755.2(?) (†,0.13 5)

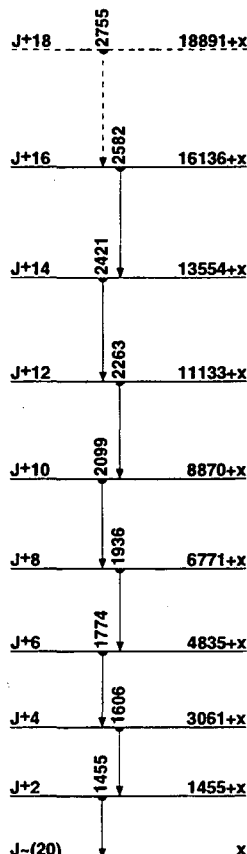

SD band
(95Da30)
82Y
39

84
40Zr

Δ : (-71500) S_n : (13100) S_p : (6500) Q_{EC} : (2700)

Nuclear Bands

- A GS band
- B Band Structure
- C Band Structure
- D Band Structure
- E SD band (95Ji08)

Levels and γ -ray branchings:

- A 0, 0⁺, 25.98 m, %EC+% β^+ =100
- A 540.05, (2⁺), 14.18 ps $\gamma_{540.05}$ (†,100) (E2)
- B 1119.1, (2⁺) γ_{540} 579.1 (M1+E2); $\delta=-0.031$ γ_0 1119.1
- A 1263.0, (4⁺), 2.84 ps γ_{540} 723.05 (†,100) (E2)
1514.2 γ_{1263} 251.2 (†,100)
- B 1575.2, (4⁺) γ_{1119} 456.1 (†,179) (E2) γ_{540} 1035.2 (†,1009) (E2)
1676.3 γ_{1263} 414.0 (†,100) (E2)
1842.2 γ_{1575} 267.0 (†,100)
- A 2136.2, (6⁺), 1.83 ps γ_{1263} 873.2 (†,100) (E2)
- B 2335.6, (6⁺) γ_{1575} 760.4 (E2) γ_{1263} 1072.0(?)
- C 2825.0, (5⁻), 10.935 ps γ_{1263} 1562.0 (†,100) (E1+M2); $\delta=+0.054$
2890.2 γ_{2136} 754.0 (†,100)
- A 3088.2, (8⁺), 1.43 ps γ_{2136} 952.0 (†,100)
- B 3202.8, (8⁺) γ_{2336} 867.2 (†,100) (E2)
- D 3313.3, (6⁻) γ_{2825} 488.3 (†,100) (M1+E2); $\delta=+0.062$
- C 3493.2, (7⁻), 5.421 ps γ_{2825} 668.2 (†,5017) (E2) γ_{2136} 1357.0 (†,100.33)
(E1+M2); $\delta=-0.061$
- D 4036.3, (8⁻) γ_{3493} 543.1 γ_{3313} 723.0
- A 4067.4, (10⁺), 1.02 ps γ_{3088} 979.2 (†,100) (E2)
- B 4138.9, (10⁺) γ_{3203} 936.1 (†,100) (E2)
- C 4378.3, (9⁻) γ_{3493} 885.1 (†,100) (E2)
- D 4868.4, (10⁻) γ_{4036} 832.1 (†,100) (E2)
- A 5134.5, (12⁺), 0.6214 ps γ_{4067} 1067.1 (†,100) (E2)
- B 5149.7, (12⁺) γ_{4138} 1010.8 (†,100)
- C 5315.8, (11⁻) γ_{4378} 937.5 (†,100)
- D 5784.0, (12⁻) γ_{4868} 915.6 (†,100)
- A 6300.3, (14⁺), 0.353 ps γ_{5135} 1165.8 (†,100)
- C 6322.0, (13⁻) γ_{5316} 1006.2 (†,100)
- D 6795.0, (14⁻) γ_{5784} 1011.0 (†,100)
- C 7409.3, (15⁻) γ_{6322} 1087.3 (†,100)
- A 7496.5, (16⁺), 0.12514 ps γ_{6300} 1196.2 (†,100)
- D 7928.1, (16⁻) γ_{6795} 1133.0 (†,100)
- C 8606.2, (17⁻) γ_{7409} 1196.8 (†,100)
- A 8741.7, (18⁺), 0.1117 ps γ_{7497} 1245.1 (†,100)
- D 9191.5, (18⁻) γ_{7928} 1263.4 (†,100)
- C 9866.3, (19⁻) γ_{8606} 1260.1 (†,100)
- A 10174.6, (20⁺), 0.0217 ps γ_{8742} 1432.9 (†,100)
- D 10592.1, (20⁻) γ_{9192} 1400.6 (†,100)
- C 11193.3, (21⁻) γ_{9866} 1327.0 (†,100)
- A 11815.5, (22⁺), 0.0147 ps γ_{10175} 1640.9 (†,100)
- A 13657.2, (24⁺), <0.007 ps γ_{11816} 1841.7 (†,100)
- A 15642.7, (26⁺) γ_{13657} 1985.5 (†,100)
- A 17801, (28⁺) γ_{15643} 2158 (†,100)
- A 20095, (30⁺) γ_{17801} 2294 (†,100)
- A 22580(?), (32⁺) γ_{20095} 2485(?) (†,100)
- A 25241(?), (34⁺) γ_{22580} 2661(?) (†,100)
- E x, J=(21)
- E 1526+x, J+2 γ_x 15261 (†,0.555) $I^{(1)}=28.8, I^{(2)}=29.2, \eta\omega=0.797$
- E 3189+x, J+4 γ_{1526+x} 16631 (†,1.005) $I^{(1)}=28.8, I^{(2)}=27.6, \eta\omega=0.868$
- E 4997+x, J+6 γ_{3189+x} 18081 (†,1.005) $I^{(1)}=28.7, I^{(2)}=26.5, \eta\omega=0.942$
- E 6956+x, J+8 γ_{4997+x} 19591 (†,1.005) $I^{(1)}=28.5, I^{(2)}=25.8, \eta\omega=1.018$
- E 9070+x, J+10 γ_{6956+x} 21141 (†,1.005) $I^{(1)}=28.3, I^{(2)}=25.3, \eta\omega=1.097$

- E 11342+x, J+12 γ_{9070+x} 22721 (†,0.905) $I^{(1)}=28.0, I^{(2)}=24.5, \eta\omega=1.177$
- E 13777+x, J+14 $\gamma_{11342+x}$ 24351 (†,0.51) $I^{(1)}=27.8, I^{(2)}=24.4, \eta\omega=1.259$
- E 16376+x, J+16 $\gamma_{13777+x}$ 25991 (†,0.31) $I^{(1)}=27.6, I^{(2)}=24.7, \eta\omega=1.340$
- E 19137+x(?), J+18 $\gamma_{16376+x}$ 27611(?) (†,0.065)

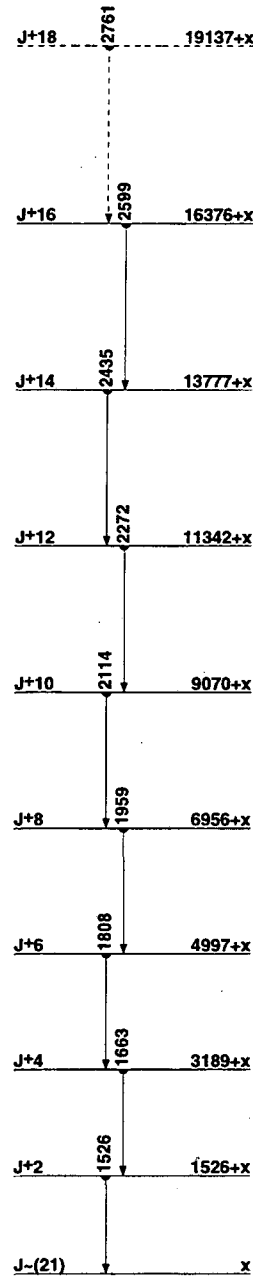

SD band
(95Ji08)
84
40Zr

130
57La

Δ : (-81670) S_n : (8400) S_p : (3890) Q_{EC} : (5600) Q_α : (250)

Nuclear Bands

A SD band (89Go13)

Levels and γ -ray branchings:

0, 3⁽⁺⁾, 8.7 i m, %EC+% β^+ =100

130.85(?), (1⁺) γ_0 130.85 (t_{1/2} 100)

0+x
5.1+x 5, (4)
45.1+x 8

88.4+x 7, (3⁻)

113.9+x 4, (5) γ_{0+x} 113.95 (t_{1/2} 100)

150.3+x 7, (5) γ_{45+x} 105.25 (t_{1/2} 100)

160.3+x 5, (4)

160.4+x 6, (4⁻) γ_{88+x} 72.03 (t_{1/2} 100.3) γ_{114+x} 46.4 10 (t_{1/2} <16)

279.1+x 6, (5⁻) $\gamma_{160.4+x}$ 118.73 (t_{1/2} 100.06) (M1) γ_{88+x} 190.75 (t_{1/2} 2.69)

385.4+x 4, (6⁺) γ_{278+x} 106.45 (t_{1/2} 7.26) $\gamma_{160.3+x}$ 225.13 (t_{1/2} 27.3 13) Q

γ_{150+x} 235.15 (t_{1/2} >55) D γ_{114+x} 271.53 (t_{1/2} 100.4) D γ_{5+x} 380.33

(t_{1/2} 40.1 18) Q γ_{0+x} 385.45 (t_{1/2} 13.1 9)

456.3+x 6, (6⁻) γ_{278+x} 177.23 (t_{1/2} 100.0 14) (M1) $\gamma_{160.4+x}$ 295.93 (t_{1/2} 16.7 5)

(E2)

522.9+x 5, (7⁺) γ_{85+x} 137.53 (t_{1/2} 100) (M1)

677.5+x 6, (7⁻) γ_{456+x} 221.23 (t_{1/2} 100.0 17) (M1) γ_{278+x} 398.43 (t_{1/2} 48.9 15)

(E2)

802.3+x 6, (8⁺) γ_{523+x} 279.43 (t_{1/2} 100.4) (M1) γ_{385+x} 416.9 10 (t_{1/2} <1.1)

947.0+x 6, (8⁻) γ_{678+x} 269.55 (t_{1/2} 88.4) (M1) γ_{456+x} 490.73 (t_{1/2} 100.3) (E2)

1048.6+x 6, (9⁺) γ_{802+x} 246.33 (t_{1/2} 100.0 23) (M1) γ_{523+x} 525.73

(t_{1/2} 49.3 22) (E2)

1250.2+x 7, (9⁻) γ_{947+x} 303.23 (t_{1/2} 59.6 15) (M1) γ_{678+x} 572.73 (t_{1/2} 100.3)

(E2)

1422.8+x 6, (10⁺) γ_{1049+x} 374.35 (t_{1/2} 100.3) γ_{802+x} 620.63 (t_{1/2} 40.3) (E2)

1597.3+x 7, (10⁻) γ_{1250+x} 347.15 (t_{1/2} 39.2) γ_{947+x} 650.33 (t_{1/2} 100.2) (E2)

1748.5+x 6, (11⁺) γ_{1423+x} 325.73 (t_{1/2} 47.7 20) (M1) γ_{1049+x} 700.03

(t_{1/2} 100.5) (E2)

1970.1+x 7, (11⁻) γ_{1597+x} 372.85 (t_{1/2} 40.2) γ_{1250+x} 719.93 (t_{1/2} 100.2) (E2)

2194.1+x 6, (12⁺) γ_{1749+x} 445.65 (t_{1/2} 100.6) γ_{1423+x} 771.33 (t_{1/2} 74.6) (E2)

2384.4+x 7, (12⁻) γ_{1970+x} 414.35 (t_{1/2} 15.1 18) (M1) γ_{1597+x} 787.13

(t_{1/2} 100.4) (E2)

2586.7+x 6, (13⁺) γ_{2194+x} 392.63 (t_{1/2} 37.3 19) (M1) γ_{1749+x} 838.23

(t_{1/2} 100.5) (E2)

2818.2+x 7, (14⁻) γ_{2384+x} 433.85 (t_{1/2} 10.6 16) (M1) γ_{1970+x} 848.13

(t_{1/2} 100.4) (E2)

3096.2+x 7, (14⁺) γ_{2587+x} 509.55 (t_{1/2} 81.6) γ_{2194+x} 902.15 (t_{1/2} 100.6)

3289.6+x 7, (14⁻) γ_{2818+x} 471.35 (t_{1/2} 17.3) (M1) γ_{2384+x} 905.15 (t_{1/2} 100.3)

3541.6+x 7, (15⁺) γ_{3096+x} 445.45 (t_{1/2} 24.4) γ_{2587+x} 954.95 (t_{1/2} 100.4)

3771.4+x 8, (15⁻) γ_{3290+x} 481.85 (M1) γ_{2818+x} 953.1 10

4105.1+x 7, (16⁺) γ_{3542+x} 563.55 (t_{1/2} 49.6) (M1) γ_{3096+x} 1008.95 (t_{1/2} 100.6)

(E2)

4271.6+x 8, (16⁻) γ_{3771+x} 500.2 10 (t_{1/2} 28.7) γ_{3290+x} 982.05 (t_{1/2} 100.7) (E2)

4589.7+x 8, (17⁺) γ_{4105+x} 484.67 (t_{1/2} 20.5) γ_{3542+x} 1048.15 (t_{1/2} 100.7) (E2)

4720.3+x 8, (17⁻) γ_{4272+x} 448.65 (t_{1/2} 71.9) (M1) γ_{3771+x} 948.87 (t_{1/2} 100.9)

5185.0+x 9, (18⁺) γ_{4720+x} 464.85 (t_{1/2} 100.5) (M1) γ_{4272+x} 913.47 (t_{1/2} 93.5)

(E2)

5185.2+x 8, (18⁺) γ_{4590+x} 595.67 (t_{1/2} 33.9) (M1) γ_{4105+x} 1080.27 (t_{1/2} 100.11)

(E2)

5644.6+x 8, (19⁻) $\gamma_{5185.0+x}$ 459.45 (t_{1/2} 69.6) (M1) γ_{4720+x} 924.25 (t_{1/2} 100.6)

(E2)

5696.8+x 10, (19⁺) $\gamma_{5185.0+x}$ 511.7 10 (t_{1/2} 30.10) γ_{4590+x} 1107.1 (t_{1/2} 100.10)

(E2)

6156.9+x 8, (20⁻) γ_{5645+x} 512.45 (t_{1/2} 55.6) (M1) $\gamma_{5185.0+x}$ 971.85 (t_{1/2} 100.6)

(E2)

6658.2+x 10, (21⁻) γ_{6157+x} 501.5 10 (t_{1/2} 31.5) γ_{5645+x} 1013.47 (t_{1/2} 100.5)

(E2)

6818.8+x 18, (21⁺) γ_{5697+x} 1122.0 14 (t_{1/2} 100) (E2)

7203.3+x 11, (22⁻) γ_{6658+x} 545.0 10 γ_{6157+x} 1046.5 10 (E2)

7759.0+x 12, (23⁻) γ_{7203+x} 555.8 10 (t_{1/2} 11.6) γ_{6658+x} 1100.8 10 (t_{1/2} 100.6)

(E2)

7949.8+x 23, (23⁺) γ_{6819+x} 1131.0 14 (t_{1/2} 100) (E2)

8282.7+x 13, (24⁻) γ_{7759+x} 523.7 10 (t_{1/2} 11.6) (M1) γ_{7203+x} 1079.5 10

(t_{1/2} 100.6) (E2)

0+y, (7)

86.9+y 8, (9)

358.8+y 5, (9) γ_{0+y} 358.85 (t_{1/2} 100) Q

489.7+y 6, (10) γ_{359+y} 130.93 (t_{1/2} 100.7) D γ_{87+y} 402.85 (t_{1/2} 57.5)

732.6+y 7, (11) γ_{490+y} 242.93 (t_{1/2} 100) (M1)

1046.6+y 8, (12) γ_{733+y} 314.03 (t_{1/2} 100) (M1)

1418.2+y 8, (13) γ_{1047+y} 371.63 (t_{1/2} 100) (M1)

1841.2+y 9, (14) γ_{1418+y} 423.03 (t_{1/2} 100) (M1)

2305.6+y 9, (15) γ_{1841+y} 464.43 (t_{1/2} 100) (M1)

2807.9+y 10, (16) γ_{2306+y} 502.35 (t_{1/2} 100.9) (M1) γ_{1841+y} 966.77 (t_{1/2} 18.2)

(E2)

3340.0+y 11, (17) γ_{2808+y} 532.15 (t_{1/2} 100.10) (M1) γ_{2306+y} 1034.4 12

(t_{1/2} 31.5) (E2)

3889.5+y 11, (18) γ_{3340+y} 549.55 (t_{1/2} 100.13) (M1) γ_{2808+y} 1081.6 12

(t_{1/2} 52.7) (E2)

4462.0+y 12, (19) γ_{3890+y} 572.55 (t_{1/2} 100.13) (M1) γ_{3340+y} 1122.0 12

(t_{1/2} 33.5) (E2)

5054.8+y 14, (20) γ_{4462+y} 592.8 10 (t_{1/2} 100.25) (M1) γ_{3890+y} 1165.3 12

(t_{1/2} 83.25) (E2)

5638.0+y 17, (21) γ_{5055+y} 583.2 10 (t_{1/2} 100) (M1)

A z, J=(16)

A 762.4+z, J+2 γ_2 762.4 (t_{1/2} 0.35) I⁽¹⁾=44.6, I⁽²⁾=44.9, $\eta\omega=0.403$

A 1613.9+z, J+4 γ_{762+z} 851.5 (t_{1/2} 0.80) I⁽¹⁾=45.1, I⁽²⁾=58.0, $\eta\omega=0.443$

A 2534.4+z, J+6 γ_{1614+z} 920.5 (t_{1/2} 1.00) I⁽¹⁾=45.9, I⁽²⁾=51.8, $\eta\omega=0.480$

A 3532.1+z, J+8 γ_{2534+z} 997.7 (t_{1/2} 1.00) I⁽¹⁾=46.4, I⁽²⁾=53.4, $\eta\omega=0.518$

A 4604.7+z, J+10 γ_{3532+z} 1072.6 (t_{1/2} 1.00) I⁽¹⁾=46.8, I⁽²⁾=52.8, $\eta\omega=0.555$

A 5753.0+z, J+12 γ_{4605+z} 1148.3 (t_{1/2} 0.75) I⁽¹⁾=47.1, I⁽²⁾=49.3, $\eta\omega=0.594$

A 6982.4+z, J+14 γ_{5753+z} 1229.4 (t_{1/2} 0.65) I⁽¹⁾=47.1, I⁽²⁾=44.8, $\eta\omega=0.637$

A 8301.0+z, J+16 γ_{6982+z} 1318.6 (t_{1/2} 0.50) I⁽¹⁾=46.9, I⁽²⁾=42.6, $\eta\omega=0.683$

A 9713.4+z, J+18 γ_{8301+z} 1412.4 (t_{1/2} 0.40)

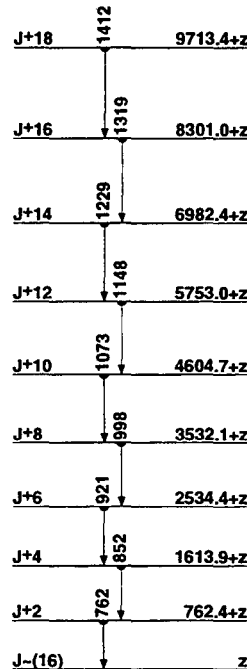

SD band
(89Go13)
130
57La

131
58Ce

Δ : -79700 400 S_n : (8300) S_p : (5300) Q_{EC} : 4000 400 Q_α : 700 400

Nuclear Bands

- A $\nu_{h,11/2}$
- B $\nu_{g,7/2}$
- C $\nu_{g,7/2} \pi_{h,11/2}^2$
- D $\nu_{h,11/2} \pi_{h,11/2} \pi_{g,7/2}$
- E $\nu_{h,11/2} \pi_{h,11/2}^2$
- F SD-1 band (94NoAA,88Lu01)(87Be32,93Pa02)
- G SD-2 + SD-3 bands (94NoAA)

Levels and γ -ray branchings:

- B 0, (7/2⁺), 10.23 m, %EC+% β^+ =100
0+x, (1/2⁺), 5.0 10 m, %EC+% β^+ =100
72.82+x 4, (3/2⁺) γ_{0+x} 72.826 (t_{1/2} 100)
- A 162.00 9, (9/2⁻), 70.5 ns γ_0 161.91 (t_{1/2} 100) (E1)
- B 257.31 19, (9/2⁺) γ_0 257.22 (t_{1/2} 100) (M1,E2)
266.16+x 5 γ_{73+x} 193.366 (t_{1/2} 5.65) γ_{0+x} 266.137 (t_{1/2} 100)
279.54+x 5 γ_{73+x} 206.726 (t_{1/2} 56.4) γ_{0+x} 279.557 (t_{1/2} 100 10)
285.40+x 5 γ_{73+x} 212.557 (t_{1/2} 56.4) γ_{0+x} 285.397 (t_{1/2} 100 10)
- A 300.24 13, (11/2⁻) γ_{162} 138.21 (t_{1/2} 100) (M1,E2)
324.33+x 6 γ_{73+x} 251.477 (t_{1/2} 40.326) γ_{0+x} 324.358 (t_{1/2} 100 9)
364.81+x 6 γ_{285+x} 79.36 10 (t_{1/2} 14.4) γ_{73+x} 292.047 (t_{1/2} 100 10) γ_{0+x} 364.72 (t_{1/2} 7.420)
384.70 11 γ_{162} 222.63 10 (t_{1/2} 100 9) γ_0 385.02 (t_{1/2} 45.14)
407.82+x 9 γ_{280+x} 128.22 (t_{1/2} 5.321) γ_{73+x} 334.95 10 (t_{1/2} 100 11)
440.57 10 γ_{162} 278.53 16 (t_{1/2} 18.7) γ_0 440.60 12 (t_{1/2} 100 10)
- B 542.70 24, (11/2⁺) γ_{257} 285.22 (t_{1/2} 100 20) γ_0 543.55 (t_{1/2} 91.9) (E2)
581.73+x 15 γ_{286+x} 315.52 (t_{1/2} 100 11) γ_{0+x} 581.82 (t_{1/2} 80.18)
585.02+x 11 γ_{280+x} 305.42 10 (t_{1/2} 100)
588.94 15 γ_{162} 426.94 12 (t_{1/2} 100)
599.93 22 γ_{300} 299.63 (t_{1/2} 95.40) γ_{162} 438.05 (t_{1/2} 100)
- A 636.85 25, (13/2⁻) γ_{300} 336.43 (t_{1/2} 100 7) (M1,E2) γ_{162} 475.34 (t_{1/2} 27.4) (E2)
785.26+x 8 γ_{408+x} 377.25 17 (t_{1/2} 21.6) γ_{365+x} 420.45 15 (t_{1/2} 100 15)
 γ_{73+x} 712.46 12 (t_{1/2} 51.5) γ_{0+x} 785.42 (t_{1/2} 37.5)
- A 809.8 3, (15/2⁻) γ_{637} 173.02 (t_{1/2} 14.3) (M1,E2) γ_{300} 509.45 (t_{1/2} 100 17)
865.59+x 12 γ_{585+x} 280.42 16 (t_{1/2} 100 40) γ_{280+x} 586.15 13 (t_{1/2} 72.14)
- B 866.2 4, (13/2⁺) γ_{543} 323.43 (t_{1/2} 18.4) (M1,E2) γ_{257} 609.46 (t_{1/2} 100 18) (E2)
884.17 20 γ_{600} 284.22 (t_{1/2} 100 40) γ_{385} 499.52 (t_{1/2} 95.20)
947.42 22 γ_{257} 690.6 (t_{1/2} 100) γ_{162} 785.42 (t_{1/2} 550.67)
1054.63+x 8 γ_{408+x} 646.5 (t_{1/2} 17) γ_{285+x} 769.21 10 (t_{1/2} 92.8)
 γ_{280+x} 775.12 10 (t_{1/2} 100 8)
- 1176.4 5, (15/2⁻) γ_{810} 367 γ_{637} 539.55 (t_{1/2} 100) (M1,E2)
- B 1212.0 5, (15/2⁺) γ_{866} 345.94 (t_{1/2} 8.3) γ_{543} 669.17 (t_{1/2} 100 8) (E2)
1213.43+x 11 γ_{785+x} 428.15 8 (t_{1/2} 100 14) γ_{365+x} 848.72 (t_{1/2} 17.4)
- A 1295.1 4, (17/2⁻) γ_{810} 485.54 (t_{1/2} 84.11) (M1,E2) γ_{637} 657.86 (t_{1/2} 100 17) (E2)
1408.9 11
- A 1451.7 6, (19/2⁻) γ_{1295} 156 γ_{810} 641.76 (t_{1/2} 100) (E2)
- B 1590.9 6, (17/2⁺) γ_{1212} 379 γ_{866} 724.87 (t_{1/2} 100) (E2)
1695.7 7, (17/2⁻) γ_{1176} 519.35 (t_{1/2} 100) (M1,E2)
1805.3 7, (19/2⁻) γ_{1295} 510(?) γ_{1176} 629 γ_{810} 996
- B 1976.3 7, (19/2⁺) γ_{1591} 385(?) γ_{1212} 764.37 (t_{1/2} 100) (E2)
1994.26+x 15 γ_{1055+x} 940.2 (t_{1/2} 23) γ_{324+x} 1669.72 (t_{1/2} 71.10)
 γ_{73+x} 1921.83 (t_{1/2} 100 16) γ_{0+x} 1994.33 (t_{1/2} 71.16)
- A 2067.3 7, (21/2⁻) γ_{1452} 615 γ_{1295} 773
- A 2202.0 8, (23/2⁻) γ_{2067} 135 γ_{1452} 749.97 (t_{1/2} 100) (E2)
2286.7 11 γ_{1409} 878
2313.3 10(?), (19/2⁻) γ_{1696} 617.56(?) (t_{1/2} 100) (M1,E2)
- D 2352.1 8, (19/2⁺) γ_{1409} 943 γ_{1212} 1140
- B 2386.8 8, (21/2⁺) γ_{1976} 411 γ_{1591} 795.68 (t_{1/2} 100) (E2)
- D 2505.4 8, (21/2⁺) γ_{2352} 153 γ_{2287} 219 γ_{1976} 529 γ_{1591} 915
- 2563.7 8, (23/2⁻) γ_{2067} 496 γ_{1805} 759 γ_{1452} 1112

- D 2685.2 8, (23/2⁺) γ_{2505} 180 γ_{2387} 298 γ_{2352} 333 γ_{1976} 709
- C 2761.3 9, (23/2⁺) γ_{2387} 375 γ_{1976} 784.67 (t_{1/2} 100) (E2)
- D 2909.3 10, (25/2⁺) γ_{2685} 224 γ_{2505} 404
- A 2912.3 9, (25/2⁻) γ_{2202} 710 γ_{2067} 845
- A 3028.7 10, (27/2⁻) γ_{2202} 826.68 (t_{1/2} 100) (E2)
- C 3035.6 10, (25/2⁺) γ_{2761} 274 γ_{2387} 649
- E 3069.3 11, (25/2⁻) γ_{2912} 157
- D 3198.3 11, (27/2⁺) γ_{2909} 289 γ_{2685} 513
- C 3272.1 11, (27/2⁺) γ_{3036} 236 γ_{2761} 511
- E 3287.4 9, (27/2⁻) γ_{3069} 218 γ_{3029} 258(?) γ_{2912} 375 γ_{2564} 724 γ_{2202} 1086(?)
- D 3522.3 12, (29/2⁺) γ_{3198} 324 γ_{2909} 613
- C 3539.3 12, (29/2⁺) γ_{3272} 267 γ_{3036} 504
- E 3543.9 11, (29/2⁻) γ_{3287} 257 γ_{3069} 475(?) γ_{3029} 515
- E 3817.7 11, (31/2⁻) γ_{3544} 274 γ_{3287} 530 γ_{3029} 789
- C 3840.2 13, (31/2⁺) γ_{3539} 301 γ_{3272} 568
- D 3893.3 13, (31/2⁺) γ_{3522} 371 γ_{3198} 695
- A 3920.7 14, (31/2⁻) γ_{3029} 892
- E 4152.8 12, (33/2⁻) γ_{3818} 335 γ_{3544} 609
- C 4177.4 14, (33/2⁺) γ_{3840} 337 γ_{3539} 638
- D 4313.3 13, (33/2⁺) γ_{3893} 420 γ_{3522} 791
- E 4510.7 13, (35/2⁻) γ_{4153} 358 γ_{3818} 693
- C 4549.0 14, (35/2⁺) γ_{4177} 371 γ_{3840} 709
- D 4745.3 14, (35/2⁺) γ_{4313} 432 γ_{3893} 852
- A 4842.7 17, (35/2⁻) γ_{3921} 922
- E 4908.9 13, (37/2⁻) γ_{4511} 398 γ_{4153} 756
- C 4954.9 15, (37/2⁺) γ_{4549} 405 γ_{4177} 778
- D 5244.3 17, (37/2⁺) γ_{4313} 931
- E 5341.4 14, (39/2⁻) γ_{4909} 432 γ_{4511} 831
- C 5389.5 16, (39/2⁺) γ_{4955} 434 γ_{4549} 841
- D 5714.3 18, (39/2⁺) γ_{4745} 969
- E 5796.6 15, (41/2⁻) γ_{5341} 455 γ_{4909} 888
- A 5804.7 20, (39/2⁻) γ_{4843} 962
- C 5859.7 17, (41/2⁺) γ_{5390} 470 γ_{4955} 905
- E 6292.5 16, (43/2⁻) γ_{5797} 496 γ_{5341} 951
- C 6351.6 19, (43/2⁺) γ_{5866} 491(?) γ_{5390} 962
- D 6742.3 20, (43/2⁺) γ_{5714} 1028
- E 6808.6 18, (45/2⁻) γ_{6293} 515(?) γ_{5797} 1012
- C 6879.7 19, (45/2⁺) γ_{6352} 529(?) γ_{5866} 1020
- E 7354.5 19, (47/2⁻) γ_{6809} 547(?) γ_{6293} 1062
- C 7421.6 21, (47/2⁺) γ_{6352} 1070
- D 7801.3 23, (47/2⁺) γ_{6742} 1059
- E 7931.6 21, (49/2⁻) γ_{6809} 1123
- C 8008.7 22, (49/2⁺) γ_{6880} 1129
- C 8576.4 23(?), (51/2⁺) γ_{7422} 1155(?)
- F $\gamma, J=(29/2)$
- F 592+y, J+2 γ_{592} (t_{1/2} 0.5 s) I⁽¹⁾=52.6, I⁽²⁾=57.1, $\eta\omega=0.314$
- F 1254+y, J+4 γ_{592+y} 662 (t_{1/2} 1.0 s) I⁽¹⁾=53.0, I⁽²⁾=56.3, $\eta\omega=0.349$
- F 1987+y, J+6 γ_{1254+y} 733 (t_{1/2} 1.1 s) I⁽¹⁾=53.3, I⁽²⁾=55.6, $\eta\omega=0.385$
- F 2792+y, J+8 γ_{1987+y} 805 (t_{1/2} 0.9 s) I⁽¹⁾=53.6, I⁽²⁾=57.1, $\eta\omega=0.420$
- F 3667+y, J+10 γ_{2792+y} 875 (t_{1/2} 1.0 s) I⁽¹⁾=53.9, I⁽²⁾=58.0, $\eta\omega=0.455$
- F 4611+y, J+12 γ_{3667+y} 944 (t_{1/2} 1.1 s) I⁽¹⁾=54.2, I⁽²⁾=58.0, $\eta\omega=0.489$
- F 5624+y, J+14 γ_{4611+y} 1013 (t_{1/2} 1.0 s) I⁽¹⁾=54.4, I⁽²⁾=58.0, $\eta\omega=0.524$
- F 6706+y, J+16 γ_{5624+y} 1082 (t_{1/2} 0.8 s) I⁽¹⁾=54.6, I⁽²⁾=56.3, $\eta\omega=0.559$
- F 7859+y, J+18 γ_{6706+y} 1153 (t_{1/2} 0.6 s) I⁽¹⁾=54.6, I⁽²⁾=54.8, $\eta\omega=0.595$
- F 9085+y, J+20 γ_{7859+y} 1226 (t_{1/2} 0.5 s) I⁽¹⁾=54.6, I⁽²⁾=51.9, $\eta\omega=0.632$
- F 10388+y, J+22 γ_{9085+y} 1303 (t_{1/2} 0.5 s) I⁽¹⁾=54.4, I⁽²⁾=50.6, $\eta\omega=0.671$
- F 11770+y, J+24 $\gamma_{10388+y}$ 1382 (t_{1/2} 0.3 s) I⁽¹⁾=54.0, I⁽²⁾=46.0, $\eta\omega=0.713$
- F 13239+y, J+26 $\gamma_{11770+y}$ 1469 (t_{1/2} 0.4 s) I⁽¹⁾=53.6, I⁽²⁾=48.2, $\eta\omega=0.755$

- F 14791+y, J+28 $\gamma_{13239+y}$ 1552 $I^{(1)}=53.3, I^{(2)}=46.0, \hbar\omega=0.798$
- F 16430+y, J+30 $\gamma_{14791+y}$ 1639 $I^{(1)}=52.8, I^{(2)}=43.0, \hbar\omega=0.843$
- F 18162+y, J+32 $\gamma_{16430+y}$ 1732
- G z, J
- G 846+z, J+2 γ_z 846 $I^{(2)}=66.7, \hbar\omega=0.438$
- G 1752+z, J+4 γ_{846+z} 906 $I^{(2)}=57.1, \hbar\omega=0.471$
- G 2728+z, J+6 γ_{1752+z} 976 $I^{(2)}=61.5, \hbar\omega=0.504$
- G 3769+z, J+8 γ_{2728+z} 1041 $I^{(2)}=57.1, \hbar\omega=0.538$
- G 4880+z, J+10 γ_{3769+z} 1111 $I^{(2)}=58.0, \hbar\omega=0.573$
- G 6060+z, J+12 γ_{4880+z} 1180 $I^{(2)}=59.7, \hbar\omega=0.607$
- G 7307+z, J+14 γ_{6060+z} 1247 $I^{(2)}=55.6, \hbar\omega=0.642$
- G 8626+z, J+16 γ_{7307+z} 1319 $I^{(2)}=54.1, \hbar\omega=0.678$
- G 10019+z, J+18 γ_{8626+z} 1393 $I^{(2)}=53.3, \hbar\omega=0.715$
- G 11487+z, J+20 $\gamma_{10019+z}$ 1468 $I^{(2)}=50.0, \hbar\omega=0.754$
- G 13035+z, J+22 $\gamma_{11487+z}$ 1548 $I^{(2)}=47.1, \hbar\omega=0.795$
- G 14668+z, J+24 $\gamma_{13035+z}$ 1633

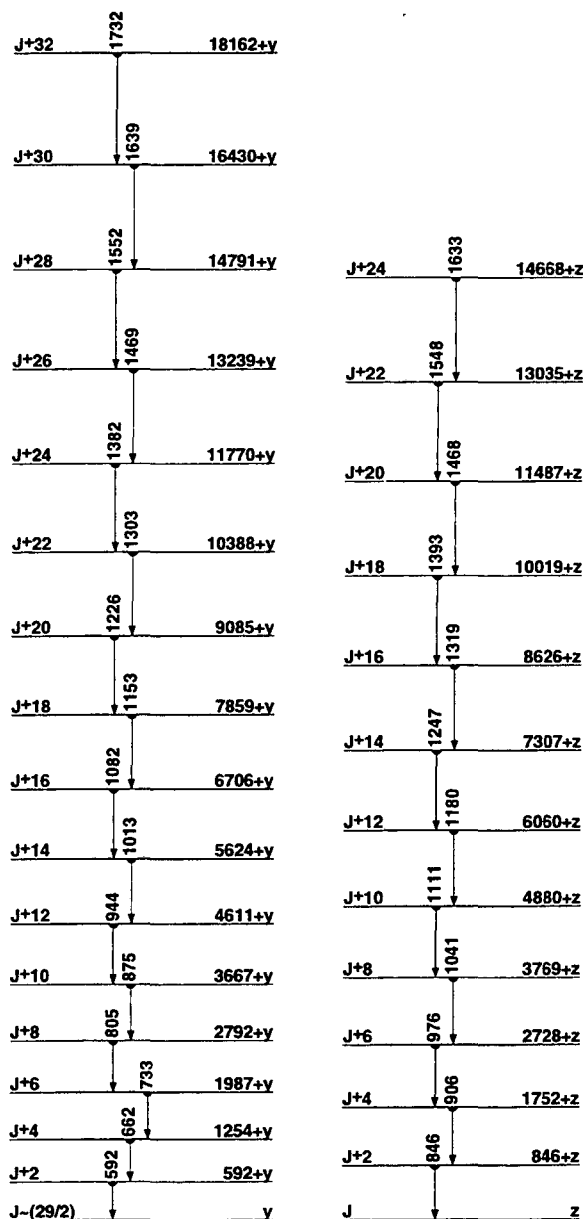

SD-1 band
(94NoAA, 88Lu01)
(87Be32, 93Pa02) ¹³¹₅₈Ce

SD-2 + SD-3 bands
(94NoAA)

¹³²Ce
₅₈Ce

Δ: (-82450) S_n: (10800) S_p: (6000) Q_{EC}: (1290) Q_α: (540)

Nuclear Bands

- A SD-1 band (95Sa21,95Ha28,87Ki02)
- B SD-2 band (95Sa21)
- C SD-3 band (95Sa21)

Levels and γ-ray branchings:

- 0, 0⁺, 3.51 11 h, %EC+%β⁺=100
- 325.54 16, 2⁺, 41.3 ps γ_{325.52} (†_γ100) E2
- 822.36 16, (2⁺) γ₃₂₆ 496.92 (†_γ100 12) γ₀ 822.42 (†_γ69 7)
- 859.13 24, 4⁺, 3.77 ps γ₃₂₆ 533.13 (†_γ100) E2
- 1199.66 20, (3⁺) γ₈₅₉ 340.55 (†_γ<3.5) γ₈₂₂ 377.22 (†_γ25 6) γ₃₂₆ 874.22 (†_γ100 10)
- 1383.94 23, (4⁺) γ₈₅₉ 524.62 (†_γ74 22) γ₈₂₂ 561.82 (†_γ100 22)
- 1497.56 24 γ₈₂₂ 675.22 (†_γ100 13) γ₃₂₆ 1172.06 (†_γ16 8)
- 1542.8 6, 6⁺, 0.74 ps γ₈₅₉ 683.75 (†_γ100) E2
- 1656.2 5, (5⁺) γ₁₂₀₀ 456.54 (†_γ100)
- 1734.56 25 γ₈₂₂ 912.22 (†_γ100 30) γ₃₂₆ 1409.08 (†_γ44 15)
- 1893.0 (?) γ₁₂₀₀ 692.7 γ₈₅₉ = 1034 γ₈₂₂ = 1071
- 2330.7 8, 8⁺, 0.72 ps γ₁₅₄₃ 787.95 (†_γ100) E2
- 2340.8, (8⁻,9⁻), 13 1 ms γ₁₅₄₃ 798 (†_γ100)
- 2507.6 6 γ₁₄₉₈ 1010.09 (†_γ100 19) γ₁₂₀₀ 1308.06 (†_γ58 12)
- 3158.5 11, 10⁺, 0.83 21 ps γ₂₃₃₁ 827.79 (†_γ100) E2
- 3309.6, 10⁺ γ₃₁₅₉ 151 (†_γ17) γ₂₃₃₁ 979 (†_γ100)
- 3670.7 12, 12⁺, 7.7 4 ps γ₃₃₁₀ 361 (†_γ32) E2 γ₃₁₅₉ 512.26 (†_γ100) E2
- 4240.4 13, 14⁺, 1.73 7 ps γ₃₆₇₁ 569.76 (†_γ100) E2
- 4939.0 15, 16⁺, 0.43 4 ps γ₄₂₄₀ 698.67 (†_γ100) E2
- 5762.4 18, 18⁺, 0.32 2 ps γ₄₉₃₉ 823.49 (†_γ100) E2
- 6701, 20⁺ γ₅₇₆₂ 939 (†_γ100) (E2)
- 7732, 22⁺ γ₆₇₀₁ 1031 (†_γ100) (E2)
- 8845, 24⁺ γ₇₇₃₂ 1113 (†_γ100) (E2)
- 10032, 26⁺ γ₈₈₄₅ 1187 (†_γ100) (E2)
- 11272, 28⁺ γ₁₀₀₃₂ 1240 (†_γ100) (E2)

A x, J=(18)

- A 807+x, J+2, 59 20 fs γ_x 807 (†_γ0.63 5) I⁽¹⁾=47.9, I⁽²⁾=70.2, ηω=0.418
- A 1671+x, J+4, 62 14 fs γ_{807+x} 864 (†_γ0.88 7) I⁽¹⁾=49.1, I⁽²⁾=62.5, ηω=0.448
- A 2599+x, J+6, 28 12 fs γ_{1671+x} 928 (†_γ1.00 10) I⁽¹⁾=50.0, I⁽²⁾=61.5, ηω=0.480
- A 3592+x, J+8, <17 fs γ_{2599+x} 993 (†_γ1.05 10) I⁽¹⁾=50.7, I⁽²⁾=61.5, ηω=0.513
- A 4650+x, J+10, <21 fs γ_{3592+x} 1058 (†_γ0.95 10) I⁽¹⁾=51.3, I⁽²⁾=58.8, ηω=0.546
- A 5776+x, J+12, 14 7 fs γ_{4650+x} 1126 (†_γ0.86 7) I⁽¹⁾=51.8, I⁽²⁾=60.6, ηω=0.580
- A 6968+x, J+14, 10 8 fs γ_{5776+x} 1192 (†_γ0.94 7) I⁽¹⁾=52.2, I⁽²⁾=58.0, ηω=0.613
- A 8229+x, J+16, <14 fs γ_{6968+x} 1261 (†_γ0.76 7) I⁽¹⁾=52.4, I⁽²⁾=56.3, ηω=0.648
- A 9561+x, J+18, <7 fs γ_{8229+x} 1332 (†_γ0.65 5) I⁽¹⁾=52.6, I⁽²⁾=54.8, ηω=0.684
- A 10966+x, J+20, <10 fs γ_{9561+x} 1405 (†_γ0.55 5) I⁽¹⁾=52.7, I⁽²⁾=52.6, ηω=0.722
- A 12447+x, J+22, <10 fs γ_{10966+x} 1481 (†_γ0.40 4) I⁽¹⁾=52.6, I⁽²⁾=48.8, ηω=0.761
- A 14010+x, J+24, <24 fs γ_{12447+x} 1563 (†_γ0.35 3) I⁽¹⁾=52.3, I⁽²⁾=47.1, ηω=0.803
- A 15658+x, J+26, <7 fs γ_{14010+x} 1648 (†_γ0.26 3) I⁽¹⁾=52.0, I⁽²⁾=45.5, ηω=0.846
- A 17394+x, J+28 γ_{15658+x} 1736 (†_γ0.18 3) I⁽¹⁾=51.6, I⁽²⁾=42.1, ηω=0.892
- A 19225+x, J+30 γ_{17394+x} 1831 (†_γ0.25 10) I⁽¹⁾=51.1, I⁽²⁾=42.6, ηω=0.939
- A 21150+x, J+32 γ_{19225+x} 1925 I⁽¹⁾=50.6, I⁽²⁾=40.0, ηω=0.988
- A 23175+x, J+34 γ_{21150+x} 2025 I⁽¹⁾=50.2, I⁽²⁾=44.4, ηω=1.035
- A 25290+x, J+36 γ_{23175+x} 2115 I⁽¹⁾=50.1, I⁽²⁾=47.6, ηω=1.078

- A 27489+x, J+38 γ_{25290+x} 2199
- B y, J
- B 794+y, J+2 γ_y 794 (†_γ0.15 3) I⁽²⁾=57.1, ηω=0.415
- B 1658+y, J+4 γ_{794+y} 864 (†_γ0.18 3) I⁽²⁾=64.5, ηω=0.448
- B 2584+y, J+6 γ_{1658+y} 926 (†_γ0.22 3) I⁽²⁾=54.8, ηω=0.481
- B 3583+y, J+8 γ_{2584+y} 999 (†_γ0.20 3) I⁽²⁾=59.7, ηω=0.516
- B 4649+y, J+10 γ_{3583+y} 1066 (†_γ0.18 3) I⁽²⁾=58.8, ηω=0.550
- B 5783+y, J+12 γ_{4649+y} 1134 (†_γ0.20 3) I⁽²⁾=54.8, ηω=0.585
- B 6990+y, J+14 γ_{5783+y} 1207 (†_γ0.18 3) I⁽²⁾=51.9, ηω=0.623
- B 8274+y, J+16 γ_{6990+y} 1284 (†_γ0.19 3) I⁽²⁾=52.6, ηω=0.661
- B 9634+y, J+18 γ_{8274+y} 1360 (†_γ0.16 3) I⁽²⁾=45.5, ηω=0.702
- B 11082+y, J+20 γ_{9634+y} 1448 (†_γ0.17 3) I⁽²⁾=47.1, ηω=0.745
- B 12615+y, J+22 γ_{11082+y} 1533 (†_γ0.17 3) I⁽²⁾=50.0, ηω=0.787
- B 14228+y, J+24 γ_{12615+y} 1613 (†_γ0.14 3) I⁽²⁾=54.1, ηω=0.825
- B 15915+y, J+26 γ_{14228+y} 1687 (†_γ0.05 3)
- C z, J
- C 947+z, J+2 γ_z 947 (†_γ0.20 3) I⁽²⁾=57.1, ηω=0.491
- C 1964+z, J+4 γ_{947+z} 1017 (†_γ0.25 3) I⁽²⁾=58.0, ηω=0.526
- C 3050+z, J+6 γ_{1964+z} 1086 (†_γ0.21 3) I⁽²⁾=55.6, ηω=0.561
- C 4208+z, J+8 γ_{3050+z} 1158 (†_γ0.23 3) I⁽²⁾=59.7, ηω=0.596
- C 5433+z, J+10 γ_{4208+z} 1225 (†_γ0.17 3) I⁽²⁾=51.9, ηω=0.632
- C 6735+z, J+12 γ_{5433+z} 1302 (†_γ0.20 3) I⁽²⁾=51.9, ηω=0.670
- C 8114+z, J+14 γ_{6735+z} 1379 (†_γ0.19 3) I⁽²⁾=50.6, ηω=0.709
- C 9572+z, J+16 γ_{8114+z} 1458 (†_γ0.14 3) I⁽²⁾=52.6, ηω=0.748
- C 11106+z, J+18 γ_{9572+z} 1534 (†_γ0.16 3) I⁽²⁾=56.3, ηω=0.785
- C 12711+z, J+20 γ_{11106+z} 1605 (†_γ0.10 3) I⁽²⁾=75.5, ηω=0.816
- C 14369+z, J+22 γ_{12711+z} 1658 (†_γ0.10 3) I⁽²⁾=59.7, ηω=0.846
- C 16094+z, J+24 γ_{14369+z} 1725 (†_γ0.06 3)

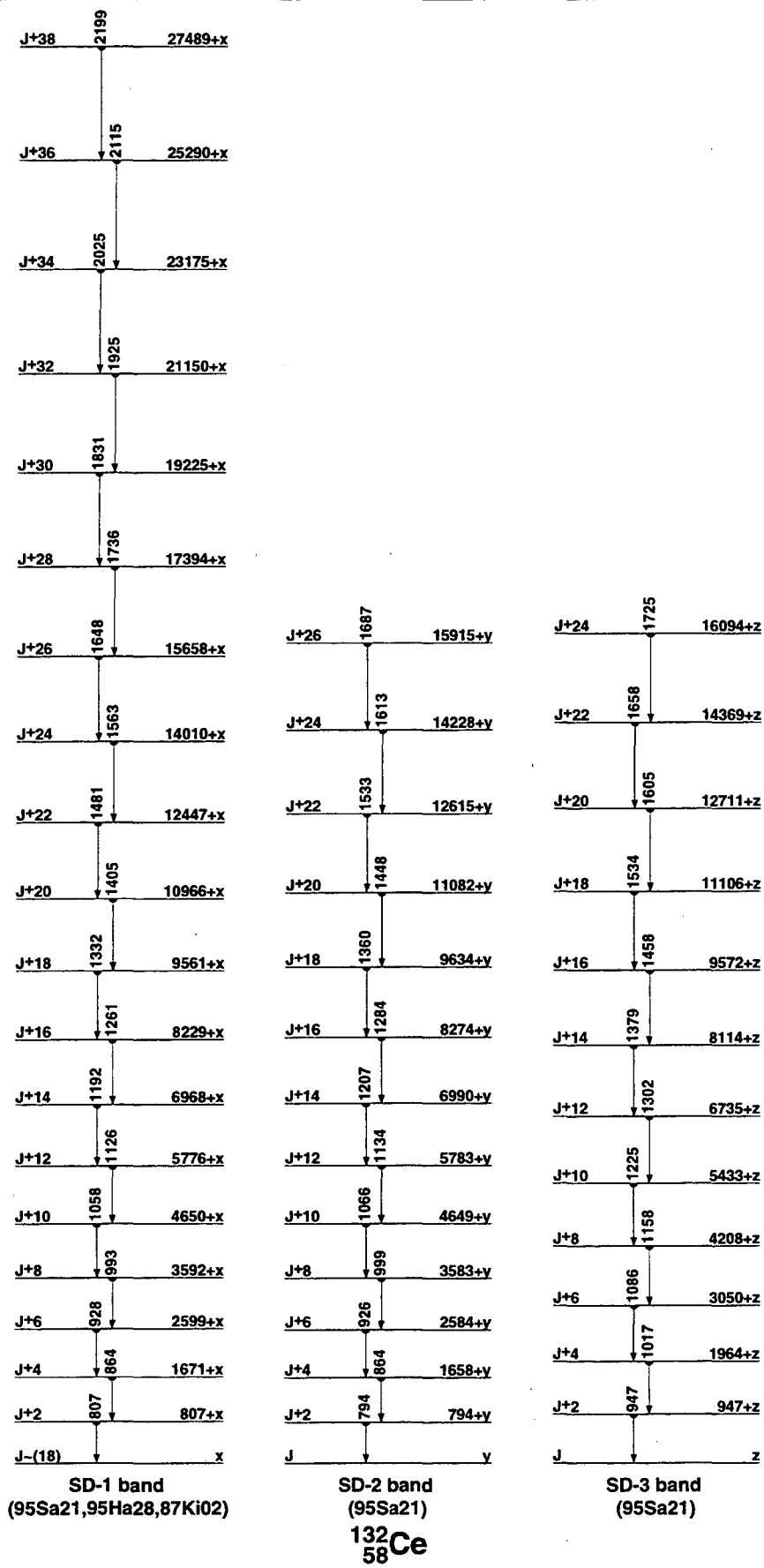

¹³³₅₈Ce

Δ: (-82390) S_n: (8000) S_p: (5950) Q_{EC}: (2900) Q_α: (250)

Nuclear Bands

- A 1/2[400]
- B vh_{11/2}^{πh}_{11/2}^{πg}_{7/2}
- C ΔJ=1 band
- D ΔJ=1 band
- E vi_{13/2}^{πh}_{11/2}⁺²
- F 11/2[514]
- G vh_{11/2}^{πh}_{11/2}⁺²
- H SD-1 band (95Ha34,95Ha28)
- I SD-2 band (95Ha34,95Ha28)
- J SD-3 band (95Ha34)

Levels and γ-ray branchings:

- A 0, 1/2⁺, 97.4 m, %EC+%β⁺=100
- F 37.18, 9/2⁻, 4.94 h, %EC+%β⁺=100
- A 134.20, 3/2⁺ γ₀ 134.32 (†,100) M1
- F 207.17, 11/2⁻ γ₃₇ 170.02 (†,100)
- 241.99, 5/2⁺ γ₁₃₄ 107.72 (†,0.95) γ₀ 241.92 (†,100) E2
- 315.69, 10, (3/2)⁺ γ₂₄₂ 73.62 (†,2.0) M1 γ₁₃₄ 181.32 (†,4.24) M1
γ₀ 315.62 (†,100) M1
- A 317.99, 5/2⁺ γ₂₄₂ 76.02 (†,11.4) γ₁₃₄ 183.82 (†,100) M1 γ₀ 318.02 (†,77.7)
- 465.18, 10, (1/2)⁺ γ₃₁₈ 147.22 (†,3.23) γ₃₁₆ 149.62 (†,10.3) γ₂₄₂ 223.22 (†,8.7) E2 γ₁₃₄ 330.92 (†,82) M1 γ₀ 465.22 (†,100) M1(+E2)
- 496.75, 11, 1/2⁺, 3/2⁺, 5/2⁺ γ₃₁₈ 178.82 (†,5.17) γ₂₄₂ 254.82 (†,5.97) γ₁₃₄ 362.52 (†,100) M1 γ₀ 496.42 (†,54.5)
- A 570.54, 7/2⁺ γ₃₁₈ 253.05 (†,90) γ₁₃₄ 436.15 (†,100)
- F 591.87, 13/2⁻ γ₂₀₇ 384.72 (†,100) (M1+E2) γ₃₇ 554.96 (†,37.4) E2
- 621.18, 10, (3/2,5/2)⁻ γ₄₈₇ 124.42 (†,2.513) γ₃₁₈ 303.02 (†,100) E1
γ₂₄₂ 379.32 (†,29.3) γ₁₃₄ 487.12 (†,26.3) γ₀ 621.42 (†,16.3)
- 656.64, 12, (1/2⁺, 3/2, 5/2⁺) γ₃₁₆ 340.92 (†,44.6) γ₂₄₂ 414.52 (†,56.6) γ₁₃₄ 522.62 (†,100) γ₀ 656.72 (†,72.6)
- 779.33, 10, (1/2⁺, 3/2, 5/2⁺) γ₆₂₁ 158.42 (†,5.19) γ₄₆₅ 314.22 (†,38.3) γ₃₁₈ 461.22 (†,21.2) γ₃₁₆ 463.42 (†,8.5) γ₂₄₂ 537.32 (†,52.5) M1(+E2) γ₁₃₄ 645.22 (†,100) (E2) γ₀ 779.42 (†,22.2)
- 787.62, 17 γ₄₈₇ 290.62 (†,71) γ₁₃₄ 653.72 (†,100)
- A 815.65, (9/2⁺) γ₅₇₁ 246 γ₃₁₈ 497.45 (†,100)
- F 826.87, 15/2⁻ γ₅₉₂ 234.95 (†,24.9) (M1+E2) γ₂₀₇ 619.72 (†,100) E2
- 834.80, 15, (1/2, 3/2, 5/2⁺) γ₁₃₄ 700.52 (†,96) γ₀ 834.92 (†,100)
- 902.68, 23(?) γ₆₂₁ 281.52 (†,100)
- 1005.56, 13, (1/2⁺, 3/2, 5/2⁺) γ₃₁₈ 687.82 (†,38) γ₃₁₆ 689.72 (†,100) γ₀ 1005.52 (†,33.2)
- 1116.18, 23(?) γ₆₂₁ 495.02 (†,100)
- 1200.07, 15/2⁻ γ₅₉₂ 608.55 (†,100) (M1+E2)
- A 1201.05, (11/2⁺) γ₈₁₆ 385 γ₅₇₁ 630.55 (†,100)
- 1335.18, 23 γ₆₂₁ 714.02 (†,100)
- F 1343.27, 17/2⁻ γ₆₂₇ 516.75 (†,98) (M1+E2) γ₅₉₂ 751.37 (†,100) E2
- A 1445.06, 13/2⁺ γ₁₂₀₀ 246 γ₈₁₆ 629.45 (†,100)
- 1521.01, 22(?) γ₁₃₄ 1386.82 (†,100)
- 1573.35, 23 γ₄₈₇ 1076.62 (†,100)
- F 1589.67, 19/2⁻ γ₁₃₄₃ 246.55 (†,100) (M1+E2) γ₆₂₇ 762.72 (†,41.4) E2
- 1881.30, 16 γ₂₄₂ 1639.32 (†,100) γ₁₃₄ 1747.12 (†,80.2)
- B 1897.27, 15/2⁺ γ₁₂₀₀ 697.05 (†,36) γ₅₉₂ 1305.45 (†,100)
- A 1932.16, (15/2⁺) γ₁₂₀₁ 731.05 (†,100)
- B 2096.27, 17/2⁺ γ₁₈₃₂ 164.05 (†,7) γ₁₈₉₇ 198.85 (†,39.4) γ₁₄₄₅ 651.55 γ₁₂₀₀ 896.45 (†,17.2) γ₆₂₇ 1269.35 (†,100) E1
- F 2199.08, 21/2⁻ γ₁₅₉₀ 609.55 (†,100) γ₁₃₄₃ 856.05 (†,99)
- B 2296.87, 19/2⁺ γ₂₀₉₆ 200.73 (†,100) (M1+E2) γ₁₈₉₇ 399.45 (†,3.6) γ₁₃₄₃ 954.05 (†,41.4) E1
- C 2415.57, (19/2) γ₂₀₉₆ 319.65 (†,34) γ₁₈₉₇ 518.65 (†,34) γ₁₃₄₃ 1071.65 (†,100)
- B 2456.37, 21/2⁺ γ₂₂₉₇ 159.52 (†,100) D+Q γ₂₀₉₆ 360.05 (†,3)

- F 2485.58, 23/2⁻ γ₂₁₉₉ 287.05 (†,6) γ₁₅₉₀ 896.05 (†,100)
- 2501.5, 11(?) γ₂₀₉₆ 405(?)
- C 2621.08, (21/2) γ₂₄₁₆ 205.55 (†,100) γ₁₅₉₀ 1031.55 (†,20)
- B 2645.87, 23/2⁺ γ₂₄₅₆ 189.52 (†,100) D+Q γ₂₂₈₇ 349.05 (†,3)
- G 2679.08, 23/2⁻ γ₁₅₉₀ 1089.05 (†,100) E2
- D 2743.68, (21/2) γ₂₂₉₇ 446(?) γ₁₅₉₀ 1154.05 (†,100)
- C 2844.69, (23/2) γ₂₆₂₁ 223.65 (†,100)
- B 2880.87, (25/2)⁺ γ₂₆₄₆ 235.02 (†,100) (M1+E2) γ₂₄₅₆ 424.55 (†,4.27)
- D 2959.28, (23/2) γ₂₇₄₄ 215.55 (†,100) γ₂₄₅₆ 503.05 (†,52.5)
- C 3128.11, (25/2) γ₂₈₄₅ 283.55 (†,100)
- F 3128.98, (25/2)⁺ γ₂₄₈₆ 643 γ₂₁₉₉ 930.05 (†,100)
- B 3175.48, 27/2⁺ γ₂₈₈₁ 294.63 (†,100) (M1+E2) γ₂₆₄₆ 529.55 (†,12.1)
- G 3235.513, (23/2)⁻ γ₂₄₈₆ 750
- D 3235.68, (25/2) γ₂₉₅₈ 276.55 (†,100)
- E 3332.69, (25/2)⁺ γ₂₅₀₂ 831.15 (†,53.5) γ₂₄₈₆ 847.15 (†,100) E1
- G 3375.68, 25/2⁻ γ_{3235.5} 140.02 (†,55.5) γ₃₁₂₈ 246 γ₂₄₈₆ 890.55 (†,36) γ₂₁₉₉ 1176.52 (†,100) E2
- F 3432.78, (27/2)⁻ γ₃₁₂₉ 304.05 (†,8) γ₂₄₈₆ 946.95 (†,100)
- C 3433.812, (27/2) γ₃₁₂₈ 305.75 (†,100)
- G 3530.48, 27/2⁻ γ₃₃₇₆ 154.75 (†,100) γ₂₆₇₉ 851.05 (†,9.6) γ₂₄₈₆ 1045.45 (†,40.4) E2
- B 3532.88, 29/2⁺ γ₃₁₇₅ 357.55 (†,100) γ₂₈₈₁ 652.05 (†,17)
- D 3571.19, (27/2) γ_{3235.5} 335.55 (†,100)
- E 3755.711, (29/2)⁺ γ₃₃₃₃ 423.15 (†,100)
- G 3770.99, 29/2⁻ γ₃₅₃₀ 240.65 (†,100) γ₃₄₃₃ 338.05 (†,6)
- C 3779.210, (29/2) γ₃₄₃₃ 346.55 (†,100)
- B 3917.49, 31/2⁺ γ₃₅₃₃ 384.55 (†,100) γ₃₁₇₅ 742.05 (†,21.2)
- D 3971.214, (29/2) γ₃₅₇₁ 400.1
- G 4065.89, 31/2⁻ γ₃₇₇₁ 294.95 (†,100) γ₃₅₃₀ 535.55 (†,10.7)
- C 4211.211, (31/2) γ₃₇₇₈ 432.05 (†,100)
- E 4245.112, (33/2)⁺ γ₃₇₅₆ 489.45 (†,100)
- B 4375.09, 33/2⁺ γ₃₉₁₇ 457.95 γ₃₅₃₃ 842.45 (†,100)
- F 4403.710, (31/2)⁺ γ₃₄₃₃ 971.05 (†,100)
- G 4407.99, 33/2⁻ γ₄₀₆₆ 342.05 (†,100) γ₃₇₇₁ 636.95 (†,19.7)
- G 4799.19, 35/2⁻ γ₄₄₀₈ 391.15 (†,100) γ₄₀₆₆ 733.55 (†,44.4)
- B 4831.19, 35/2⁺ γ₄₃₇₅ 456.55 (†,100) γ₃₉₁₇ 913.35 (†,13.5)
- E 4888.113, (37/2)⁺ γ₄₂₄₅ 643.05 (†,100)
- G 5214.810, 37/2⁻ γ₄₇₉₈ 415.65 (†,100) γ₄₄₀₈ 806.85 (†,43.4)
- B 5365.013, (37/2)⁺ γ₄₃₇₅ 990
- E 5655.614, (41/2)⁺ γ₄₈₈₈ 767.55 (†,100)
- G 5669.410, 39/2⁻ γ₅₂₁₅ 454.45 (†,100) γ₄₇₉₈ 870.55 (†,47.5)
- E 6543.615, (45/2)⁺ γ₅₆₅₆ 888.05 (†,100)
- E 7536.616, (49/2)⁺ γ₆₅₄₄ 993.05 (†,100)
- H x, J=(43/2)
- H 748.3+x, J+2 γ_x 748.3 (†,0.68) I⁽¹⁾=60.4, I⁽²⁾=65.8, η=0.389
- H 1557.4+x, J+4 γ_{748+x} 809.1 (†,0.95) I⁽¹⁾=60.6, I⁽²⁾=62.7, η=0.420
- H 2430.3+x, J+6 γ_{1557+x} 872.9 (†,1.00) I⁽¹⁾=60.8, I⁽²⁾=62.1, η=0.453
- H 3367.6+x, J+8 γ_{2430+x} 937.3 (†,0.85) I⁽¹⁾=60.8, I⁽²⁾=60.9, η=0.485
- H 4370.6+x, J+10 γ_{3368+x} 1003.0 (†,0.90) I⁽¹⁾=60.9, I⁽²⁾=61.9, η=0.518
- H 5438.2+x, J+12 γ_{4371+x} 1067.6 (†,0.80) I⁽¹⁾=60.9, I⁽²⁾=61.8, η=0.550
- H 6570.5+x, J+14 γ_{5438+x} 1132.3 (†,0.75) I⁽¹⁾=60.9, I⁽²⁾=60.5, η=0.583
- H 7768.9+x, J+16 γ_{6571+x} 1198.4 (†,0.60) I⁽¹⁾=60.9, I⁽²⁾=58.7, η=0.616
- H 9035.5+x, J+18 γ_{7768+x} 1266.6 (†,0.47) I⁽¹⁾=60.7, I⁽²⁾=56.5, η=0.651
- H 10372.9+x, J+20 γ_{9036+x} 1337.4 (†,0.33) I⁽¹⁾=60.4, I⁽²⁾=54.1, η=0.687
- H 11784.3+x, J+22 γ_{10373+x} 1411.4 (†,0.28) I⁽¹⁾=60.0, I⁽²⁾=51.9, η=0.725
- H 13272.8+x, J+24 γ_{11784+x} 1488.5 (†,0.25) I⁽¹⁾=59.5, I⁽²⁾=49.0, η=0.765
- H 14842.9+x, J+26 γ_{13273+x} 1570.1 (†,0.18) I⁽¹⁾=58.9, I⁽²⁾=47.3, η=0.806
- H 16497.6+x, J+28 γ_{14843+x} 1654.7 (†,0.10) I⁽¹⁾=58.3, I⁽²⁾=45.3, η=0.849
- H 18240.6+x, J+30 γ_{16498+x} 1743.0 I⁽¹⁾=57.6, I⁽²⁾=44.2, η=0.894
- H 20074.0+x, J+32 γ_{18241+x} 1833.4 I⁽¹⁾=56.9, I⁽²⁾=42.7, η=0.940
- H 22001.0+x(?) , J+34 γ_{20074+x} 1927(?)

- I y, J=(37/2)
- I 720.3+y, J+2 $\gamma_{720.3}$ 720.32 (\dagger 0.05 1) I⁽¹⁾=54.5, I⁽²⁾=61.4, $\hbar\omega$ =0.376
 - I 1505.7+y, J+4 γ_{720+y} 785.43 (\dagger 0.15 3) I⁽¹⁾=54.9, I⁽²⁾=58.1, $\hbar\omega$ =0.410
 - I 2359.9+y, J+6 γ_{1506+y} 854.22 (\dagger 0.52 8) I⁽¹⁾=55.2, I⁽²⁾=60.5, $\hbar\omega$ =0.444
 - I 3280.2+y, J+8 γ_{2360+y} 920.32 (\dagger 0.52 8) I⁽¹⁾=55.6, I⁽²⁾=60.1, $\hbar\omega$ =0.477
 - I 4267.1+y, J+10 γ_{3280+y} 986.92 (\dagger 0.52 8) I⁽¹⁾=55.9, I⁽²⁾=61.3, $\hbar\omega$ =0.510
 - I 5319.3+y, J+12 γ_{4267+y} 1052.22 (\dagger 0.52 8) I⁽¹⁾=56.2, I⁽²⁾=60.6, $\hbar\omega$ =0.543
 - I 6437.5+y, J+14 γ_{5319+y} 1118.22 (\dagger 0.52 8) I⁽¹⁾=56.5, I⁽²⁾=60.5, $\hbar\omega$ =0.576
 - I 7621.8+y, J+16 γ_{6438+y} 1184.32 (\dagger 0.38 7) I⁽¹⁾=56.6, I⁽²⁾=58.1, $\hbar\omega$ =0.609
 - I 8875.0+y, J+18 γ_{7622+y} 1253.23 (\dagger 0.31 5) I⁽¹⁾=56.7, I⁽²⁾=56.6, $\hbar\omega$ =0.644
 - I 10198.9+y, J+20 γ_{8875+y} 1323.92 (\dagger 0.24 4) I⁽¹⁾=56.6, I⁽²⁾=54.1, $\hbar\omega$ =0.680
 - I 11596.8+y, J+22 $\gamma_{10199+y}$ 1397.93 (\dagger 0.20 3) I⁽¹⁾=56.4, I⁽²⁾=51.5, $\hbar\omega$ =0.718
 - I 13072.3+y, J+24 $\gamma_{11597+y}$ 1475.53 (\dagger 0.15 3) I⁽¹⁾=56.1, I⁽²⁾=48.9, $\hbar\omega$ =0.758
 - I 14629.6+y, J+26 $\gamma_{13072+y}$ 1557.36 (\dagger 0.14 2) I⁽¹⁾=55.6, I⁽²⁾=46.7, $\hbar\omega$ =0.800
 - I 16272.6+y, J+28 $\gamma_{14630+y}$ 1643.06 (\dagger 0.07 1) I⁽¹⁾=55.1, I⁽²⁾=45.3, $\hbar\omega$ =0.844
 - I 18003.9+y, J+30 $\gamma_{16273+y}$ 1731.38 I⁽¹⁾=54.6, I⁽²⁾=44.3, $\hbar\omega$ =0.888
 - I 19825.5+y, J+32 $\gamma_{18004+y}$ 1821.610 I⁽¹⁾=54.1, I⁽²⁾=44.2, $\hbar\omega$ =0.933
 - I 21737.5+y (?), J+34 $\gamma_{19826+y}$ 1912(?)
- J z, J=(45/2)
- J 956.9+z, J+2 γ_z 956.9 (\dagger 0.09 2) I⁽¹⁾=50.4, I⁽²⁾=137.9, $\hbar\omega$ =0.486
 - J 1942.8+z, J+4 γ_{957+z} 985.9 (\dagger 0.22 4) I⁽¹⁾=52.8, I⁽²⁾=115.6, $\hbar\omega$ =0.502
 - J 2963.3+z, J+6 γ_{1943+z} 1020.5 (\dagger 0.21 4) I⁽¹⁾=54.2, I⁽²⁾=64.9, $\hbar\omega$ =0.526
 - J 4045.4+z, J+8 γ_{2963+z} 1082.1 (\dagger 0.23 4) I⁽¹⁾=54.7, I⁽²⁾=60.2, $\hbar\omega$ =0.558
 - J 5193.9+z, J+10 γ_{4045+z} 1148.5 (\dagger 0.21 4) I⁽¹⁾=55.2, I⁽²⁾=67.7, $\hbar\omega$ =0.589
 - J 6401.5+z, J+12 γ_{5194+z} 1207.6 (\dagger 0.21 4) I⁽¹⁾=55.6, I⁽²⁾=59.6, $\hbar\omega$ =0.621
 - J 7676.2+z, J+14 γ_{6402+z} 1274.7 (\dagger 0.21 4) I⁽¹⁾=56.0, I⁽²⁾=66.7, $\hbar\omega$ =0.652
 - J 9010.9+z, J+16 γ_{7676+z} 1334.7 (\dagger 0.21 4) I⁽¹⁾=56.6, I⁽²⁾=74.6, $\hbar\omega$ =0.681
 - J 10399.2+z, J+18 γ_{9011+z} 1388.3 (\dagger 0.15 2) I⁽¹⁾=57.3, I⁽²⁾=79.5, $\hbar\omega$ =0.707
 - J 11837.8+z, J+20 $\gamma_{10399+z}$ 1438.6 (\dagger 0.14 2) I⁽¹⁾=58.1, I⁽²⁾=79.5, $\hbar\omega$ =0.732
 - J 13326.7+z, J+22 $\gamma_{11838+z}$ 1488.9 (\dagger 0.14 2) I⁽¹⁾=58.6, I⁽²⁾=67.9, $\hbar\omega$ =0.759
 - J 14874.5+z, J+24 $\gamma_{13327+z}$ 1547.8 (\dagger 0.11 2) I⁽¹⁾=58.9, I⁽²⁾=61.7, $\hbar\omega$ =0.790
 - J 16487.1+z, J+26 $\gamma_{14875+z}$ 1612.6 (\dagger 0.07 1) I⁽¹⁾=58.8, I⁽²⁾=54.0, $\hbar\omega$ =0.825
 - J 18173.8+z, J+28 $\gamma_{16487+z}$ 1686.7 I⁽¹⁾=58.5, I⁽²⁾=51.7, $\hbar\omega$ =0.863
 - J 19937.8+z (?), J+30 $\gamma_{18174+z}$ 1764(?)

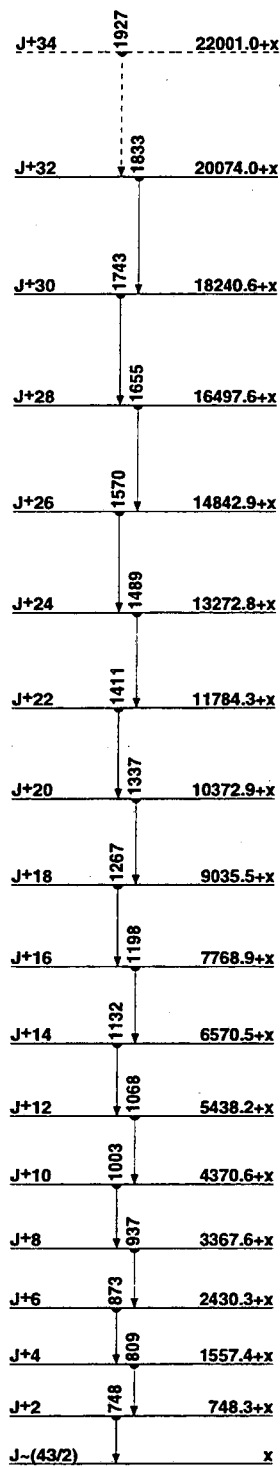

SD-1 band
(95Ha34, 95Ha28)

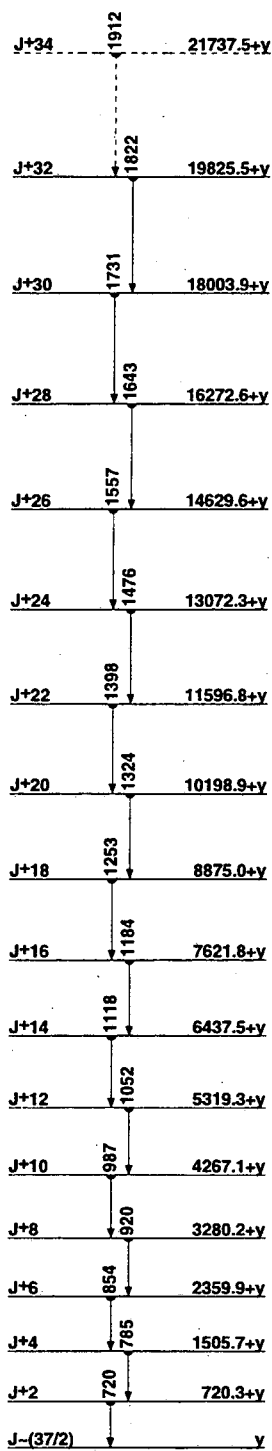

SD-2 band
(95Ha34, 95Ha28)

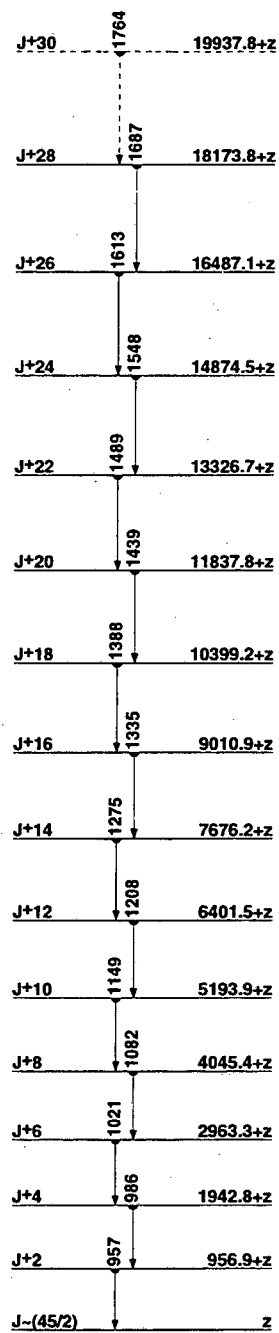

SD-3 band
(95Ha34)

¹³³₅₈Ce

¹³³Pr
⁵⁹Pr

Δ: (-78060) S_n: (10800) S_p: (2900) Q_{EC}: (4300) Q_α: (860)

Nuclear Bands

- A α=1/2, 7/2[413]
- B α=-1/2, 7/2[413]
- C πh_{11/2}
- D ΔJ=1 band
- E ΔJ=1 band
- F ΔJ=1 band
- G SD-1 band (95Wi13)
- H SD-2 band (95Wi13)
- I SD-3 band (95Wi13)
- J SD-4 band (95Wi13)

Levels and γ-ray branchings:

- 0, (3/2⁺), 6.53 m, %EC+%β⁺=100
- A 61.69 7, (5/2⁺) γ₀61.71 (†, 100 13) M1
- 166.71 6, (3/2⁺, 5/2⁺, 7/2⁺) γ₆₂105.12 (†, 100 16) M1+E2: δ=0.62 γ₀166.71 (†, 112)
- C 192.05 14, (1/2⁻), >1 μs γ₆₂130.42 (†, 100 18) E3
- B 225.87 8, (7/2⁺) γ₁₆₇59.13(?) (†, 1.74) γ₆₂164.21 (†, 100)
- M1(+E2): δ<0.35 γ₀225.93 (†, 19 4)
- 295.63 10, (7/2⁻) γ₁₉₂103.62 (†, 100 20) E2 γ₆₂233.91 (†, 100 20) E1
- 402.79 10, (1/2⁺, 3/2⁺, 5/2⁺) γ₆₂341.03 (†, 3 1) γ₀402.81 (†, 100) M1
- 428.61 8, (3/2⁺, 5/2⁺, 7/2⁺) γ₂₂₆202.71 (†, 7 1) γ₁₆₇261.92 (†, 16 3)
- γ₆₂367.02 (†, 100 14) M1(+E2) γ₀428.64 (†, 45 6)
- A 475.81 10, (9/2⁺) γ₂₂₆250.02 (†, 45 7) M1(+E2) γ₆₂414.32 (†, 100 10)
- 488.29 10, (3/2⁺, 5/2⁺, 7/2⁺) γ₂₂₆262.52 (†, 39 8) γ₁₆₇321.23 (†, 10 2)
- γ₆₂426.64 (†, 100 15) γ₀488.32 (†, 47 9)
- C 502.35 21, (15/2⁻) γ₁₉₂310.32 (†, 100) E2
- 551.39 14 γ₂₉₆255.72 (†, 29 4) γ₁₉₂359.14 (†, 100 14)
- 586.32 11, γ₁₆₇419.61 (†, 100 10) M1+E2 γ₆₂524.73 (†, 62 12)
- γ₀586.44 (†, 34 17)
- 619.09 9, (5/2⁺, 7/2⁺, 9/2⁺) γ₄₇₆143.24 (†, 8 2) γ₄₂₉190.52 (†, 15 3)
- γ₂₂₆393.32 (†, 63 13) M1(+E2) γ₁₆₇452.41 (†, 100 13) E2(+M1)
- γ₆₂557.43 (†, 35 53)
- 639.06 11 γ₁₆₇472.13 (†, 38 14) γ₆₂577.41 (†, 100 19) γ₀639.14 (†, 52 14)
- 656.44 γ₂₉₆360.83 (†, 100 10)
- 679.20 19 γ₂₉₆383.52 (†, 100 20)
- B 702.47 10, (11/2⁺) γ₄₇₆226.63 (†, 26 5) γ₂₂₆476.61 (†, 100 13) E2(+M1)
- 744.01 8 γ₁₆₇577.41 (†, 38 12) γ₆₂682.32 (†, 36 6) γ₀743.91 (†, 100 10)
- 753.08 10 γ₄₈₈264.82 (†, 18 3) γ₂₂₆527.22 (†, 65 13) γ₁₆₇586.33 (†, 16 3)
- γ₆₂691.42 (†, 37 7) γ₀753.12 (†, 100 17)
- 791.0 3, (13/2⁻) γ₅₀₂289.310 (†, 37 12) γ₁₉₂598.93 (†, 100 12)
- 859.7 4 γ₂₉₆564.73 (†, 100 33)
- 862.96 11 γ₄₈₈374.43 (†, 20 5) γ₄₇₆387.42 (†, 24 5) γ₂₂₆637.11 (†, 100 20) γ₁₆₇696.13 (†, 56 11) γ₆₂801.03 (†, 76 14)
- 872.17 12 γ₄₈₈383.94 (†, 39 7) γ₄₇₆396.32 (†, 72 14) γ₄₂₉443.94 (†, 18 4) γ₂₂₆646.33 (†, 72 14) γ₆₂810.55 (†, 61 10) γ₀872.22 (†, 100 20)
- 898.82 17 γ₇₄₄154.64 (†, 26 8) γ₄₀₃496.14 (†, 8 8) γ₁₆₇732.13 (†, 18 8)
- γ₆₂836.94 (†, 26 11) γ₀899.24 (†, 100 11)
- 903.61 14 γ₄₇₆428.15 (†, 97 22) γ₄₂₉475.02 (†, 63 16) γ₂₂₆677.84 (†, 100 16) γ₁₆₇736.73 (†, 78 19) γ₆₂841.94 (†, 53 16) γ₀903.74 (†, 44 16)
- 910.97 18 γ₆₇₉231.72 (†, 27 8) γ₅₅₁359.44 (†, 100 20) γ₂₉₆615.26 (†, 86 18)
- 916.53 22 γ₅₅₁365.12 (†, 100 25) γ₁₉₂724.64 (†, 70 35)
- 938.3 8 γ₅₀₂436
- 939.2 4 γ₁₆₇772.54 (†, 65 18) γ₆₂877.65 (†, 100 21)
- 977.3 3 γ₁₆₇810.55 (†, 43 11) γ₀977.33 (†, 100 20)
- 984.44 11 γ₄₈₈496.34 (†, 35 7) γ₄₇₆508.64 (†, 100 36) γ₄₂₉555.72 (†, 27 5) γ₂₂₆758.34 (†, 18 5) γ₁₆₇818.13 (†, 38 7) γ₆₂922.82 (†, 66 13)
- 1001.58 21 γ₅₅₁450.32(?) (†, 100 20) γ₄₇₆525.73 (†, 51 11) γ₄₂₉572.94

- (†, 48 10) γ₆₂939.94 (†, 52 0)
- 1027.29 12 γ₄₇₆551.52 (†, 63 13) γ₄₂₉598.71 (†, 100 15)
- 1041.99 22 γ₄₀₃639.22 (†, 100 40)
- C 1053.9 3, (9/2⁻) γ₅₀₂551.63 (†, 100 9) E2
- 1055.67 10 γ₇₀₂353.32 (†, 14 3) γ₆₁₉436.42 (†, 36 6) γ₄₇₆580.04 (†, 36 6) γ₄₂₉627.11 (†, 100 10) γ₂₂₆829.73 (†, 15 5) γ₁₆₇888.92 (†, 49 10) γ₆₂993.56 (†, 27 6)
- 1058.42 15 γ₆₁₉439.02(?) (†, 43 7) γ₄₈₈569.94(?) (†, 90 18)
- γ₄₂₉629.64(?) (†, 57 12) γ₂₂₆832.55 (†, 45 10) γ₁₆₇891.82 (†, 100 18)
- A 1081.43 22, (13/2⁺) γ₄₇₆605.62 (†, 100 17)
- 1129.9 γ₅₅₁578.4 (†, 71 36) γ₁₆₇963.4 (†, 100 36)
- 1167.12 14 γ₁₆₇1000.32 (†, 86 16) γ₆₂1105.42 (†, 100 19)
- 1171.92 24, (15/2⁻) γ₇₈₁381.02 (†, 100 14) γ₅₀₂669.52 (†, 43 14) γ₁₉₂980
- 1188.4 4 γ₆₁₉569.34 (†, 64 21) γ₄₇₆712.58 (†, 100 43)
- 1220.4 5 γ₄₈₈732.14 (†, 1.25)
- 1231.52 25 γ₄₂₉802.84 (†, 74 18) γ₆₂1169.93 (†, 100 21)
- 1255.88 10 γ₇₆₃502.813 (†, 100 20) γ₄₂₉826.83 (†, 95 25)
- 1265.0 3 γ₅₀₂762.72 (†, 100 8)
- 1284.14 γ₄₇₆808.35 (†, 100 24) γ₄₂₉855.54 (†, 59 17)
- 1295.7 5 γ₄₇₆819.94 (†, 100 22)
- 1297.3 3 γ₇₅₃544.23 (†, 100 19) γ₇₀₂594.85 (†, 71 16)
- 1308.5 3 γ₂₂₆1082.63 (†, 100 29)
- 1312.7 4 γ₄₇₆836.93 (†, 100 29)
- 1325.49 15 γ₇₅₃572.32 (†, 53 13) γ₄₈₈837.23 (†, 91 22) γ₄₇₆850.16 (†, 100 19) γ₀1325.73 (†, 91 19)
- B 1325.60 21, (15/2⁺) γ₇₀₂623.12 (†, 100 12) E2
- 1366.5 4 γ₄₂₉937.94 (†, 100 33)
- 1428.2 3 γ₂₂₆1202.33 (†, 100 23)
- 1431.3 4 γ₄₂₉1002.74 (†, 100 23)
- 1648.3 4 γ₁₁₇₂476.33 (†, 100 10) γ₁₀₅₈584(?) γ₉₃₈710
- 1656.76 20 γ₈₆₃793.76 (†, 77 23) γ₇₀₂954.59 (†, 23 13) γ₅₅₁1105.42 (†, 77 23) γ₄₂₉1228.04 (†, 100 23)
- 1671.1 5 γ₁₂₆₅406 γ₁₁₇₂499 γ₁₀₅₄617 γ₅₀₂1169
- 1706.05 16 γ₁₀₅₈647.73 (†, 41 10) γ₈₈₄721.34 (†, 35 7) γ₈₇₂833.85 (†, 100 21) γ₇₀₂1004.17 (†, 15 5) γ₄₂₉1277.49 (†, 24 6) γ₂₉₆1410.42 (†, 51 10) γ₁₉₂1514.14 (†, 41 10)
- 1723.07 11 γ₁₀₅₈664.72 (†, 36 2) γ₁₀₅₆667.42 (†, 100 20) γ₉₈₈738.72 (†, 63 95) γ₇₆₃969.83 (†, 19 5) γ₅₅₁1171.62 (†, 20 5) γ₄₂₉1294.52 (†, 89 19) γ₂₂₆1497.24 (†, 39 8)
- C 1762.9 3, (3/2⁻) γ₁₀₅₄709.02 (†, 100 10) E2
- 1785.27 12 γ₁₁₅₇617.84 (†, 37 8) γ₁₀₂₇758.34 (†, 31 9) γ₁₀₀₂783.45 (†, 68 12) γ₈₈₄801.03 (†, 100 18) γ₇₀₂1082.62 (†, 45 9) γ₆₁₉1166.52 (†, 75 15) γ₅₅₁1233.89 (†, 14 6) γ₄₂₉1356.43 (†, 31 8) γ₂₂₆1559.42 (†, 89 18) γ₆₂1723.25 (†, 66 15)
- A 1788.7 5, (17/2⁺) γ₁₀₈₁707.24 (†, 100 25)
- 1796.58 18 γ₁₁₆₇629.42 (†, 61 13) γ₁₀₅₆740.82(?) (†, 61 14) γ₈₇₂924.63 (†, 75 14) γ₄₂₉1368.14(?) (†, 34 9) γ₂₂₆1570.64 (†, 100 21)
- 1828.4 4(?) γ₁₀₀₂826.84 (†, 100 19)
- 1950.1 11 γ₁₀₅₄896(?)
- B 1992.7 3, (19/2⁺) γ₁₃₂₅667.33 (†, 100 14) γ₁₀₅₄938.54
- 2033.2 4 γ₁₂₆₅768.22 (†, 100 10)
- B 2045.6 3, (19/2⁺) γ₁₃₂₆719.93 (†, 100 17) γ₁₀₅₄992
- 2118.32 14 γ₁₀₅₆1062.64 (†, 59 11) γ₉₁₁1207.22 (†, 12 5) γ₇₀₂1416.05 (†, 16 7) γ₄₇₆1642.52 (†, 100 19) γ₄₂₉1689.82 (†, 63 12) γ₂₂₆1892.57 (†, 23 8)
- 2179.9 5 γ₁₀₅₈1121.54 (†, 100 25)
- D 2203.4 4, (23/2⁻) γ₂₀₃₃170.23 γ₁₆₄₈555.03 (†, 100 9) γ₁₀₅₄1149.67 (†, 36 9)
- 2331.2 6 γ₁₉₅₀400(?) γ₁₇₆₃568 γ₁₆₇₁660 γ₁₀₅₄1277
- D 2352.6 4 γ₂₂₀₃149.22 (†, 100 7)
- A 2356.5 5, (21/2⁺) γ₁₇₈₉567.3 (†, 50 12) γ₁₀₅₄1303.05 (†, 100 12)
- B 2445.3 3, (23/2⁺) γ₂₀₄₆399.72 (†, 40 10) γ₁₉₉₃452.44 (†, 70 10)
- γ₁₇₆₃682.53 (†, 100 10)
- 2473.4 11(?) γ₂₀₃₃440(?)
- 2554.7 8 γ₁₆₇2388.08 (†, 100 42)
- C 2575.5 4, (27/2⁻) γ₁₇₆₃812.62 (†, 100 12) E2
- D 2598.5 5 γ₂₃₅₃245.93 (†, 100 8)

2674.8 γ_{1789} 885.8	G 11967+y, J+21 $\gamma_{10478+y}$ 1489 (†, 0.20 s)
B 2692.3.8 γ_{2203} 489(?) γ_{1763} 929(?)	H 12755+y, J+22 $\gamma_{11225+y}$ 1530 (†, 0.23 s)
A 2744.9.5, (25/2 ⁺) γ_{2357} 388.42 (†, 100.10) γ_{1763} 981.8.5 (†, 25.6)	I z, J=(53/2)
D 2925.5.6 γ_{2596} 327.0.3 (†, 100.20)	I 784+z, J+2 γ_z 784 (†, 0.35 s) I ⁽¹⁾ =69.6, I ⁽²⁾ =57.1, $\hbar\omega=0.410$
B 2933.4.4, (27/2 ⁺) γ_{2445} 488.1.3 (†, 100.14) E2	I 1638+z, J+4 γ_{784+z} 854 (†, 0.50 s) I ⁽¹⁾ =68.3, I ⁽²⁾ =50.6, $\hbar\omega=0.447$
3078.8.8 γ_{2576} 504 γ_{2331} 747	I 2571+z, J+6 γ_{1638+z} 933 (†, 0.50 s) I ⁽¹⁾ =66.8, I ⁽²⁾ =50.0, $\hbar\omega=0.487$
A 3274.7.6, (29/2 ⁺) γ_{2745} 529.8.3 (†, 100.13) E2	I 3584+z, J+8 γ_{2571+z} 1013 (†, 0.55 s) I ⁽¹⁾ =65.4, I ⁽²⁾ =47.1, $\hbar\omega=0.528$
D 3320.2.6 γ_{2826} 394.7.2 (†, 100.33)	I 4682+z, J+10 γ_{3584+z} 1098 (†, 0.50 s) I ⁽¹⁾ =64.0, I ⁽²⁾ =47.6, $\hbar\omega=0.570$
E 3371.1.7 γ_{2353} 1019.1 (†, 100)	I 5864+z, J+12 γ_{4682+z} 1182 (†, 0.45 s) I ⁽¹⁾ =62.9, I ⁽²⁾ =47.6, $\hbar\omega=0.612$
C 3439.6.9, (31/2 ⁻) γ_{2576} 864 (†, 100.9)	I 7130+z, J+14 γ_{5864+z} 1266 (†, 0.52 s) I ⁽¹⁾ =61.9, I ⁽²⁾ =47.1, $\hbar\omega=0.654$
E 3536.4.7 γ_{3371} 165.4.3 (†, 100.14) γ_{2599} 937.8.5	I 8481+z, J+16 γ_{7130+z} 1351 (†, 0.40 s) I ⁽¹⁾ =61.2, I ⁽²⁾ =51.9, $\hbar\omega=0.695$
B 3565.0.5, (31/2 ⁺) γ_{2833} 631.6.3 (†, 100.8) E2	I 9909+z, J+18 γ_{8481+z} 1428 (†, 0.37 s) I ⁽¹⁾ =61.0, I ⁽²⁾ =64.5, $\hbar\omega=0.729$
D 3768.0.12 γ_{3320} 447.8 (†, 100)	I 11399+z, J+20 γ_{9909+z} 1490 (†, 0.30 s) I ⁽¹⁾ =60.7, I ⁽²⁾ =48.8, $\hbar\omega=0.765$
E 3787.6.7 γ_{3536} 251.2.2 (†, 100.20)	I 12971+z, J+22 $\gamma_{11399+z}$ 1572 (†, 0.28 s) I ⁽¹⁾ =60.2, I ⁽²⁾ =51.9, $\hbar\omega=0.805$
3820.7.10 γ_{3440} 381 γ_{3078} 742	I 14620+z, J+24 $\gamma_{12971+z}$ 1649 (†, 0.23 s) I ⁽¹⁾ =59.7, I ⁽²⁾ =46.0, $\hbar\omega=0.846$
A 3973.0.6, (33/2 ⁺) γ_{3275} 698.3.2 (†, 100.14)	I 16356+z, J+26 $\gamma_{14620+z}$ 1736 (†, 0.13 s)
E 4124.4.7 γ_{3788} 336.8.2 (†, 100.33)	J u, J=(55/2)
4264.6.16(?) γ_{3768} 496.4.10(?)	J 821+u, J+2 γ_0 821 (†, 0.17 s) I ⁽¹⁾ =69.2, I ⁽²⁾ =62.5, $\hbar\omega=0.426$
C 4305.6.14, (35/2 ⁻) γ_{3440} 866 (†, 100.9)	J 1706+u, J+4 γ_{821+u} 885 (†, 0.20 s) I ⁽¹⁾ =68.3, I ⁽²⁾ =52.6, $\hbar\omega=0.462$
B 4352.1.7, (35/2 ⁺) γ_{3565} 787.1.4 (†, 100.25)	J 2667+u, J+6 γ_{1706+u} 961 (†, 0.20 s) I ⁽¹⁾ =67.1, I ⁽²⁾ =54.1, $\hbar\omega=0.499$
E 4533.7.8 γ_{4124} 409.3.2	J 3702+u, J+8 γ_{2667+u} 1035 (†, 0.22 s) I ⁽¹⁾ =66.2, I ⁽²⁾ =53.3, $\hbar\omega=0.536$
A 4805.6.6, (37/2 ⁺) γ_{3973} 832.6.2	J 4812+u, J+10 γ_{3702+u} 1110 (†, 0.22 s) I ⁽¹⁾ =65.4, I ⁽²⁾ =54.1, $\hbar\omega=0.573$
E 5005.4.8 γ_{4534} 471.7.3 (†, 100)	J 5996+u, J+12 γ_{4812+u} 1184 (†, 0.20 s) I ⁽¹⁾ =64.5, I ⁽²⁾ =50.0, $\hbar\omega=0.612$
C 5173.6.17, (39/2 ⁻) γ_{4306} 868 (†, 100.9)	J 7260+u, J+14 γ_{5996+u} 1264 (†, 0.20 s) I ⁽¹⁾ =63.7, I ⁽²⁾ =51.3, $\hbar\omega=0.651$
B 5260.7.9, (39/2 ⁺) γ_{4352} 908.6.5	J 8602+u, J+16 γ_{7260+u} 1342 (†, 0.20 s) I ⁽¹⁾ =63.0, I ⁽²⁾ =51.3, $\hbar\omega=0.691$
A 5744.8.7, (41/2 ⁺) γ_{4806} 939.2.3	J 10022+u, J+18 γ_{8602+u} 1420 (†, 0.13 s) I ⁽¹⁾ =62.3, I ⁽²⁾ =50.0, $\hbar\omega=0.730$
C 6095.4.17, (43/2 ⁻) γ_{5174} 921.8.2 (†, 100)	J 11522+u, J+20 $\gamma_{10022+u}$ 1500 (†, 0.13 s) I ⁽¹⁾ =61.8, I ⁽²⁾ =52.6, $\hbar\omega=0.769$
B 6264.7.13, (43/2 ⁺) γ_{5261} 1004.1 (†, 100)	J 13098+u, J+22 $\gamma_{11522+u}$ 1576 (†, 0.11 s) I ⁽¹⁾ =61.3, I ⁽²⁾ =50.0, $\hbar\omega=0.808$
A 6765.0.9, (45/2 ⁺) γ_{5745} 1020.2.5	J 14754+u, J+24 $\gamma_{13098+u}$ 1656 (†, 0.08 s)
C 7086.1.18(?) γ_{6095} 990.5.4(?)	
B 7280.9.17(?) γ_{6265} 1016.1(?)	
F x	
F 196.1+x.8 γ_x 196.1.8	
F 440.1+x.9 γ_{196+x} 244.0.3 (†, 100.17)	
F 736.7+x.10 γ_{440+x} 296.6.4 (†, 100.25)	
F 1087.6+x.10 γ_{737+x} 350.9.3 (†, 100.25)	
F 1491.3+x.11 γ_{1088+x} 403.7.3 (†, 100.50)	
F 1945.7+x.12 γ_{1491+x} 454.4.5 (†, 100.50)	
F 2444.1+x.15(?) γ_{1946+x} 498.4.10(?)	
H y, J=(51/2)	
G 390+y, J+1 γ_y 390(?)	
H 800+y, J+2 γ_{390+y} 410 γ_y 800 (†, 0.15.10) I ⁽¹⁾ =65.8, I ⁽²⁾ =56.3, $\hbar\omega=0.418$	
G 1230+y, J+3 γ_{800+y} 430 (†, 0.15.3) γ_{390+y} 840 (†, 0.75.5) I ⁽¹⁾ =6.9, I ⁽²⁾ =58.8, $\hbar\omega=0.437$	
H 1671+y, J+4 γ_{1230+y} 441 (†, 0.16.5) γ_{800+y} 871 (†, 0.95.5) I ⁽¹⁾ =65.0, I ⁽²⁾ =55.6, $\hbar\omega=0.454$	
G 2138+y, J+5 γ_{1671+y} 467 γ_{1230+y} 908 (†, 0.88.5) I ⁽¹⁾ =10.6, I ⁽²⁾ =56.3, $\hbar\omega=0.472$	
H 2617+y, J+6 γ_{2138+y} 476 (†, 0.19.4) γ_{1671+y} 943 (†, 1.00.5) I ⁽¹⁾ =64.4, I ⁽²⁾ =57.1, $\hbar\omega=0.489$	
G 3117+y, J+7 γ_{2617+y} 1013 (†, 0.95.5) I ⁽¹⁾ =13.8, I ⁽²⁾ =56.3, $\hbar\omega=0.507$	
H 3627+y, J+8 γ_{3117+y} 1050 (†, 0.90.5) I ⁽¹⁾ =16.6, I ⁽²⁾ =56.3, $\hbar\omega=0.543$	
G 4167+y, J+9 γ_{3627+y} 1085 (†, 0.85.5) I ⁽¹⁾ =63.4, I ⁽²⁾ =56.3, $\hbar\omega=0.560$	
H 4712+y, J+10 γ_{4167+y} 1121 (†, 0.80.5) I ⁽¹⁾ =19.0, I ⁽²⁾ =56.3, $\hbar\omega=0.578$	
G 5288+y, J+11 γ_{4712+y} 1156 (†, 0.80.5) I ⁽¹⁾ =62.9, I ⁽²⁾ =55.6, $\hbar\omega=0.596$	
H 5868+y, J+12 γ_{5288+y} 1192 (†, 0.75.5) I ⁽¹⁾ =21.2, I ⁽²⁾ =54.8, $\hbar\omega=0.614$	
G 6480+y, J+13 γ_{5868+y} 1228 (†, 0.65.5) I ⁽¹⁾ =62.5, I ⁽²⁾ =56.3, $\hbar\omega=0.632$	
H 7096+y, J+14 γ_{6480+y} 1265 (†, 0.55.5) I ⁽¹⁾ =23.2, I ⁽²⁾ =71.4, $\hbar\omega=0.647$	
G 7745+y, J+15 γ_{7096+y} 1299 I ⁽¹⁾ =62.0, I ⁽²⁾ =49.4, $\hbar\omega=0.670$	
H 8395+y, J+16 γ_{7745+y} 1321 (†, 0.40.5) I ⁽¹⁾ =24.9, I ⁽²⁾ =44.0, $\hbar\omega=0.683$	
G 9066+y, J+17 γ_{8395+y} 1380 (†, 0.34.5) I ⁽¹⁾ =61.5, I ⁽²⁾ =57.1, $\hbar\omega=0.708$	
H 9775+y, J+18 γ_{9066+y} 1412 (†, 0.25.5) I ⁽¹⁾ =26.2, I ⁽²⁾ =51.9, $\hbar\omega=0.725$	
G 10478+y, J+19 γ_{9775+y} 1450 (†, 0.18.5) I ⁽¹⁾ =61.1, I ⁽²⁾ =50.0, $\hbar\omega=0.745$	

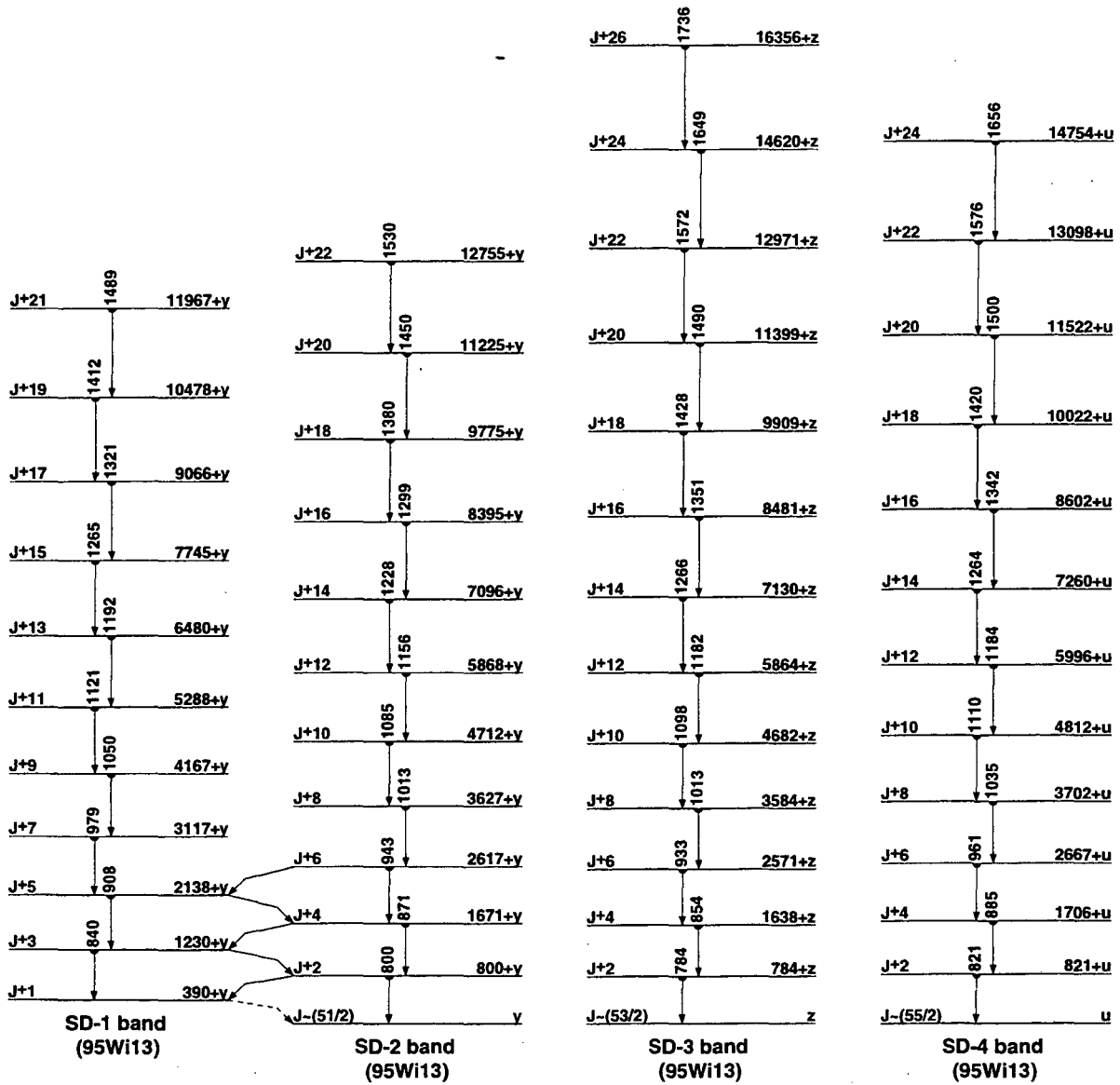

¹³³₆₀Nd $\Delta: (-72500)$ $S_n: (8900)$ $S_p: (4400)$ $Q_{EC}: (5600)$ $Q_\alpha: (1400)$ **Nuclear Bands**

- A 7/2+ GS band: $\alpha = -1/2, 7/2[404]$
 B $\alpha = 1/2, 7/2[404]$
 C $\alpha = -1/2, 9/2[514]$
 D $\alpha = 1/2, 9/2[514]$
 E 1/2[530]
 F 1/2[541]
 G SD band (94Ba25,93Ba20)(93Pa02,87Wa18)
 H $\alpha = -1/2, 1/2[400]$
 I $\alpha = 1/2, 1/2[400]$
 J $\alpha = -1/2, 5/2[402]$
 K $\alpha = 1/2, 5/2[402]$
 L Band Structure
 M Band Structure

Levels and γ -ray branchings:

- A 0, (7/2⁺), 70 10 s, %EC+ β^+ =100
 H 127.97 11, (1/2⁺), = 70 s γ_0 127.96 (†,100 50) M3
 I 173.06 9, (3/2⁺) γ_{128} 45.11 (†,100 12) M1(+E2): $\delta < 0.41$
 C 176.10 10, (9/2⁻), = 300 ns γ_0 176.11 (†,100 10) E1
 B 245.49 10, (9/2⁺) γ_0 245.51 (†,100 13) E2
 K 291.38 8, (5/2⁺) γ_{173} 118.31 (†,36 5) M1(+E2): $\delta < 0.36$ γ_0 291.41 (†,100 9) M1
 D 338.87 22, (11/2⁻) γ_{176} 162.82 (†,100 28) M1+E2
 345.23 9, γ_{291} 54.02 (†,2 3.6) γ_0 345.21 (†,100 11) E2
 E 353.64 12, (3/2⁻), = 50 ns γ_{291} 62.33 (†,2 4.8) γ_{173} 180.61 (†,100) E1
 H 397.93 11, (5/2⁺) γ_{173} 224.91 (†,100 15) M1 γ_{128} 270.04 (†,92 17) E2
 399.81 19, (1/2,3/2⁺) γ_{128} 271.94 (†,100 20) M1
 442.51 14, (7/2,9/2,11/2⁻) γ_{176} 266.41 (†,100 12) M1+E2
 444.67 14 γ_{173} 271.44 (†,84 20) γ_{128} 316.71 (†,100 24)
 472.15 11, (3/2,5/2,7/2⁺) γ_{291} 180.85 (†,19 4) E2 γ_{173} 299.11 (†,100 13) E2 γ_0 472.22 (†,42 8)
 J 483.52 11, (7/2⁺) γ_{291} 192.11 (†,100 14) E2 γ_0 483.52 (†,55 6)
 I 491.90 19, (7/2⁺) γ_{291} 200.54 (†,100 27) E2 γ_{173} 318.84 (†,55 27) γ_0 491.93 (†,40 5)
 E 492.32 21, (7/2⁻) γ_{354} 138.72 (†,100 10) E2
 A 519.4 6, (11/2⁺) γ_{245} 274 γ_0 519
 F 523.84 16, (5/2⁻) γ_{354} 170.21 (†,100 11) E2
 554.99 13, (1/2⁺,3/2,5/2⁺) γ_{398} 157.22 (†,6 6 11) γ_{173} 381.91 (†,100 22) M1+E2 γ_{128} 427.04 (†,78 17)
 585.44 γ_{176} 409.44 (†,100 31)
 587.14 γ_{173} 414.04 (†,100 24)
 628.34 γ_{339} 289.65 (†,30 4) γ_{176} 452.14 (†,100 20)
 C 646.6 7, (13/2⁻) γ_{339} 307.7 (†,91 18) M1+E2 γ_{176} 470.8 (†,100 11) E2
 660.30 21 γ_{445} 215.66 (†,68 9) γ_{173} 487.22 (†,100 30) γ_{128} 532.76 (†,8 2)
 674.61 16 γ_{400} 274.76 (†,21 3) γ_{345} 329.42 (†,100 10) γ_{245} 429.14 (†,100 20) γ_{128} 546.64 (†,50 20) γ_0 674.64 (†,83 8)
 K 687.7 6, (9/2⁺) γ_{484} 204 γ_{291} 396 γ_{245} 443
 738.84 22 γ_{398} 340.92 (†,100 33) γ_{173} 565.87 (†,83 33)
 F 758.8 11, (9/2⁻) γ_{524} 235
 787.83 14 γ_{398} 389.92 (†,100 9) γ_{345} 442.52 (†,80 9) γ_{173} 614.84 (†,91 23) γ_0 788.03 (†,73 9)
 806.45 20 γ_{472} 334.53 (†,64 6) γ_{445} 361.74 (†,50 13) γ_{400} 406.54 (†,50 13) γ_{398} 408.44 (†,75 25) γ_{291} 514.98 (†,100 25)
 E 808.2 9, (11/2⁻) $\gamma_{492,3}$ 316
 H 825.0 7, (9/2⁺) $\gamma_{491,9}$ 332 γ_{398} 428
 B 826.5 7, (13/2⁺) γ_{519} 307 γ_{245} 581
 D 836.9 7, (15/2⁻) γ_{647} 190.3 (†,19 4) M1+E2 γ_{339} 498.0 (†,100) E2
 837.5 5 γ_{445} 392.84 (†,100)
 879.37 17 $\gamma_{491,9}$ 387.54 (†,30 15) γ_{291} 588.06 (†,30 15) γ_{245} 633.92 (†,56 6) γ_{173} 706.34 (†,30 15) γ_0 879.25 (†,100 11)
 J 912.7 7, (11/2⁺) γ_{688} 225 γ_{484} 429
 932.2 6 γ_{345} 587.06 (†,100 25)
 937.09 17 γ_{400} 537.33 (†,11 5) γ_{398} 539.14 (†,14 6) γ_{345} 591.9 8 (†,25 4) γ_{291} 645.72 (†,100 27)
 I 963.3 8, (11/2⁺) $\gamma_{491,9}$ 471
 979.8 7 γ_{354} 626.26 (†,100 33)
 985.91 16 γ_{400} 586.16 (†,9 4) γ_{398} 588.16 (†,35 4) γ_{354} 632.43 (†,22 9) γ_{173} 812.92 (†,100 17) γ_{128} 857.82 (†,37 4)
 999.2 5 γ_{585} 413.94 (†,42 12) γ_{443} 556.46 (†,100 50)
 1007.0 5 γ_{585} 421.62 (†,100 12)
 1013.67 14 $\gamma_{491,9}$ 521.54 (†,16 2) γ_{484} 529.93 (†,15 2) γ_{354} 660.12 (†,31 3) γ_{291} 722.24 (†,75 17) γ_{128} 885.72 (†,100 8) γ_0 1013.74 (†,19 4)
 F 1116.8 15, (13/2⁻) γ_{759} 358
 1120.21 23 γ_{484} 636.55 (†,22 11) γ_{400} 720.54 (†,29 16) γ_{398} 722.34 (†,44 22) γ_{291} 828.87 (†,100 11) γ_{245} 874.75 (†,67 22)
 K 1130.7 9, (13/2⁺) γ_{913} 218 γ_{688} 443
 A 1150.6 8, (15/2⁺) γ_{827} 324 γ_{519} 631
 1154.5 3 γ_{291} 863.14 (†,56 15) γ_0 1154.54 (†,100 19)
 1183.1 6 γ_{354} 829.55 (†,100 20)
 1195.6 5 γ_{354} 842.04 (†,100 20)
 1206.0 7 $\gamma_{492,3}$ 713.76 (†,100 12)
 1209.1 4 γ_{354} 855.53 (†,100 40)
 1230.1 5 γ_{354} 876.55 (†,100 24) γ_{245} 984.58 (†,26 26)
 C 1271.4 9, (17/2⁻) γ_{838} 434 γ_{647} 625
 E 1280.0 9, (15/2⁻) γ_{808} 472
 1280.4 7 γ_{354} 926.86 (†,100 17)
 H 1359.6 8, (13/2⁺) γ_{963} 396 γ_{825} 535
 J 1364.7 10, (15/2⁺) γ_{1131} 234 γ_{913} 452
 D 1460.6 10, (19/2⁻) γ_{127} 189 γ_{837} 624.0 E2
 B 1491.6 9, (17/2⁺) γ_{1151} 341 γ_{827} 665
 I 1540.5 9, (15/2⁺) γ_{963} 577
 1595.8 4 γ_{555} 1041.19 (†,24 24) γ_{345} 1251.05 (†,82 11) γ_0 1595.25 (†,100 16)
 F 1598.8 18, (17/2⁻) γ_{1117} 482
 K 1622.7 11, (17/2⁺) γ_{1365} 258 γ_{1131} 492
 1770.5 5 γ_{345} 1425.35 (†,100 21)
 A 1798.7 10, (19/2⁺) γ_{1492} 307 γ_{1151} 648
 1834.3 8 γ_{345} 1489.18 (†,100 69)
 E 1871.2 11, (19/2⁻) $\gamma_{1280,0}$ 591
 1886.5 4 γ_{354} 1532.74 (†,100 28) γ_{345} 1541.66 (†,52 31)
 J 1934.7 12, (19/2⁺) γ_{1623} 312 γ_{1365} 570
 H 1962.5 9, (17/2⁺) γ_{1541} 422 γ_{1360} 603
 2005.0 4 γ_{354} 1651.43 (†,100 22)
 C 2010.5 11, (21/2⁻) γ_{1461} 550 γ_{1271} 739
 G 2026.6 7, (17/2⁺) γ_{1541} 486 (†,12 3) γ_{1360} 667 (†,100 15) $\gamma_{1280,0}$ 747 (†,30 5) γ_{837} 1190 (†,22 6)
 2043.4 4 γ_{354} 1689.83 (†,100)
 B 2088.8 10, (21/2⁺) γ_{1799} 290 γ_{1492} 597
 I 2159.5 13, (19/2⁺) γ_{1541} 619
 F 2185.8 20, (21/2⁻) γ_{1599} 587
 D 2199.5 12, (23/2⁻) γ_{2011} 189 γ_{1461} 739
 K 2311.7 13, (21/2⁺) γ_{1935} 377 γ_{1623} 689
 G 2371.3 9, (21/2⁺), 4.9 15 ps γ_{2027} 345 (†,100 7) $I^{(1)} = 53.4, I^{(2)} = 41.7, \hbar\omega = 0.197$ γ_{1963} 409 (†,75 7) γ_{1871} 500 (†,14 3)
 A 2383.7 11, (23/2⁺) γ_{2089} 295 γ_{1799} 585
 2451.2 3 γ_{400} 2051.55 (†,75 25) γ_{398} 2053.05 (†,100 25) γ_{291} 2160.05 (†,50 25)
 E 2538.2 15, (23/2⁻) γ_{1871} 667
 H 2553.6 10, (21/2⁺) γ_{2027} 527 γ_{1963} 591
 J 2674.7 14, (23/2⁺) γ_{2312} 363 γ_{1935} 740
 B 2692.8 11, (25/2⁺) γ_{2384} 309 γ_{2089} 604
 I 2764.5 17, (23/2⁺) γ_{2160} 605

G 2812.0 10, (25/2 ⁺), 2.17 ps γ_{2371} 441 ($t_{1/2}$ 100 s) (E) $I^{(1)}=52.4, I^{(2)}=54.8, \eta\omega=0.239$ γ_{2089} 723 ($t_{1/2}$ 5 s)	H 5210.6 23, (37/2 ⁺) γ_{4469} 742
C 2813.5 13, (25/2 ⁻) γ_{2200} 614 γ_{2011} 803	A 5278.8 18, (39/2 ⁺) γ_{4458} 821
F 2848.8 23, (25/2 ⁻) γ_{2186} 663	G 5376.0 19, (41/2 ⁺), $\mu=6.4$ 16 γ_{4614} 762 ($t_{1/2}$ 75) $I^{(1)}=51.3, I^{(2)}=54.1, \eta\omega=0.400$
M 3019.5 15 γ_{2011} 1009	I 5668.3, (39/2 ⁺) γ_{4878} 790
A 3019.7 11, (27/2 ⁺) γ_{2693} 327 γ_{2384} 636	B 5711.8 19, (41/2 ⁺) γ_{4860} 852
D 3027.5 13, (27/2 ⁻) γ_{2814} 214 γ_{2200} 828	B 5897.3, (41/2 ⁻) γ_{5056} 841
L 3030.5 15 γ_{2011} 1020	L 5956.5 25 γ_{4934} 1023
K 3089.7 16, (25/2 ⁺) γ_{2312} 778	H 5968.6 25, (41/2 ⁺) γ_{5211} 758
H 3128.6 14, (25/2 ⁺) γ_{2554} 575	E 6052.3, (43/2 ⁻) γ_{5167} 885
M 3019+x	A 6157.8 20, (43/2 ⁺) γ_{5279} 879
E 3205.2 18, (27/2 ⁻) γ_{2538} 667	G 6212.0 22, (45/2 ⁺) γ_{5376} 836 $I^{(1)}=51.7, I^{(2)}=58.8, \eta\omega=0.435$
G 3326.1 11, (29/2 ⁺), <1.25 ps $\gamma_{3019.5}$ 307 ($t_{1/2}$ 8 s) γ_{2812} 514 ($t_{1/2}$ 100 s) (E) $I^{(1)}=51.9, I^{(2)}=44.4, \eta\omega=0.279$ γ_{2693} 633 ($t_{1/2}$ 38 s)	B 6618.8 22, (45/2 ⁺) γ_{5712} 907
B 3364.8 11, (29/2 ⁺) $\gamma_{3019.5}$ 345 γ_{2812} 553 γ_{2693} 672	F 6817.4, (45/2 ⁻) γ_{5897} 920
L 3401.5 18 γ_{3031} 371	E 7039.3, (47/2 ⁻) γ_{6052} 987
I 3418.5 20, (27/2 ⁺) γ_{2765} 654	A 7094.8 23, (47/2 ⁺) γ_{6158} 937
F 3550.8 25, (29/2 ⁻) γ_{2849} 702	G 7116.0 24, (49/2 ⁺) γ_{6212} 904 $I^{(1)}=52.4, I^{(2)}=63.5, \eta\omega=0.468$
C 3568.5 14 γ_{3028} 541 γ_{2814} 755	B 7586.8 24, (49/2 ⁺) γ_{6619} 968
M 3511.0+x 10 γ_{3019+x} 492	F 7823.4, (49/2 ⁻) γ_{6817} 1006
A 3714.8 13, (31/2 ⁺) γ_{3365} 350 $\gamma_{3019.5}$ 695	G 8083.3, (53/2 ⁺) γ_{7116} 967 $I^{(1)}=53.1, I^{(2)}=64.5, \eta\omega=0.499$
H 3764.6 18, (29/2 ⁺) γ_{3129} 636	A 8096.8 25, (51/2 ⁺) γ_{7095} 1002
E 3770.2 20, (31/2 ⁻) γ_{3205} 565	E 8116.3, (51/2 ⁻) γ_{7039} 1077
D 3909.5 17, (31/2 ⁻) γ_{3028} 882	B 8623.3, (53/2 ⁺) γ_{7587} 1036
G 3930.0 13, (33/2 ⁺) γ_{3365} 565 ($t_{1/2}$ 8 s) γ_{3326} 604 ($t_{1/2}$ 100 s) $I^{(1)}=51.2, I^{(2)}=50.0, \eta\omega=0.322$	F 8911.4, (53/2 ⁻) γ_{7823} 1088
L 4000.5 21 γ_{3402} 599	G 9112.3, (57/2 ⁺), <0.03 ps γ_{8083} 1029 $I^{(1)}=53.7, I^{(2)}=63.5, \eta\omega=0.530$
B 4076.8 13, (33/2 ⁺) γ_{3715} 362 γ_{3365} 712	A 9169.3, (55/2 ⁺) γ_{8097} 1072
I 4123.5 22, (31/2 ⁺) γ_{3419} 705	E 9275.4, (55/2 ⁻) γ_{8116} 1159
F 4281.3, (33/2 ⁻) γ_{3551} 730	B 9730.3, (57/2 ⁺) γ_{8623} 1107
M 4219.0+x 15 γ_{3511+x} 708	F 10093.4, (57/2 ⁻) γ_{8911} 1182
E 4407.2 23, (35/2 ⁻) γ_{3770} 637	G 10204.3, (61/2 ⁺), <0.03 ps γ_{9112} 1092 $I^{(1)}=54.2, I^{(2)}=60.6, \eta\omega=0.563$
A 4457.8 14, (35/2 ⁺) γ_{4077} 381 γ_{3715} 743	A 10316.3, (59/2 ⁺) γ_{9169} 1147
H 4468.6 20, (33/2 ⁺) γ_{3765} 704	E 10513.4, (59/2 ⁻) γ_{9275} 1238
G 4614.0 16, (37/2 ⁺) γ_{3930} 684 ($t_{1/2}$ 100) $I^{(1)}=51.2, I^{(2)}=51.3, \eta\omega=0.362$	B 10914.3, (61/2 ⁺) γ_{9730} 1184
D 4684.5 20 γ_{3910} 775	G 11362.3, (65/2 ⁺), <0.03 ps γ_{10204} 1158 $I^{(1)}=54.5, I^{(2)}=57.1, \eta\omega=0.597$
L 4787.5 23 γ_{4001} 787	A 11541.3, (63/2 ⁺) γ_{10316} 1225
B 4859.8 17, (37/2 ⁺) γ_{4077} 783	B 12180.4, (65/2 ⁺) γ_{10914} 1266
I 4877.5 24, (35/2 ⁺) γ_{4124} 754	G 12590.4, (69/2 ⁺), <0.03 ps γ_{11362} 1228 $I^{(1)}=54.6, I^{(2)}=55.6, \eta\omega=0.632$
L 4933.5 23 γ_{4001} 933	A 12841.4, (67/2 ⁺) γ_{11541} 1300
F 5056.3, (37/2 ⁻) γ_{4281} 775	G 13890.4, (73/2 ⁺), <0.03 ps γ_{12590} 1300 $I^{(1)}=54.5, I^{(2)}=51.9, \eta\omega=0.669$
E 5167.2 25, (39/2 ⁻) γ_{4407} 760	G 15267.4, (77/2 ⁺), <0.03 ps γ_{13890} 1377 $I^{(1)}=54.3, I^{(2)}=49.4, \eta\omega=0.709$
M 5089.0+x 18 γ_{4219+x} 870	G 16725.4, (81/2 ⁺), <0.03 ps γ_{15267} 1458 $I^{(1)}=54.0, I^{(2)}=47.1, \eta\omega=0.750$
	G 18268.4, (85/2 ⁺), <0.03 ps γ_{16725} 1543 $I^{(1)}=53.6, I^{(2)}=45.5, \eta\omega=0.793$
	G 19899.4, (89/2 ⁺), <0.03 ps γ_{18268} 1631

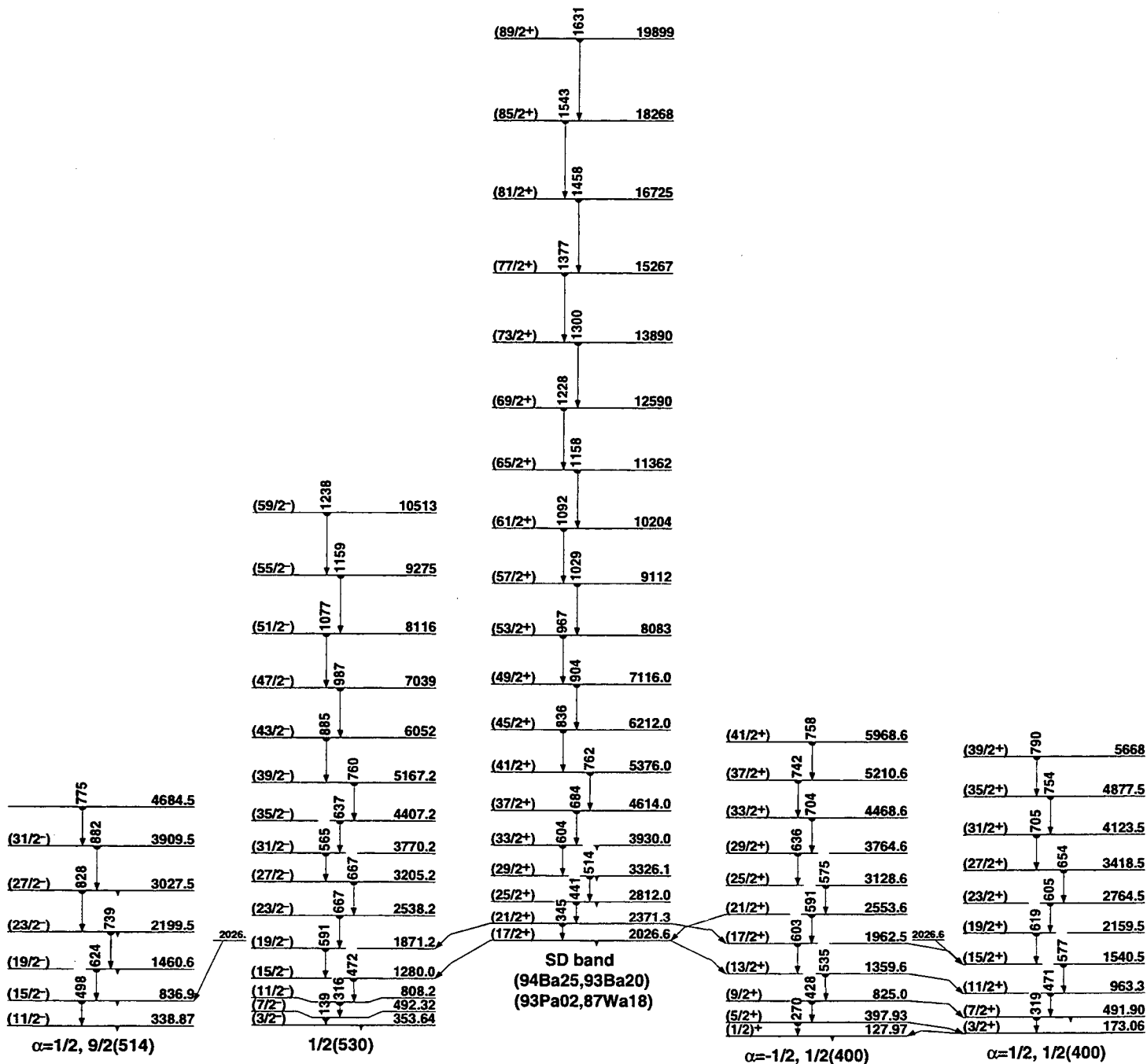

¹³⁴Nd
₆₀Nd

Δ : (-75760) S_n : (11400) S_p : (5000) Q_{EC} : 2770 150 Q_α : (1300)

Nuclear Bands

- A Band Structure
- B Band Structure
- C GS band
- D γ band
- E Band Structure
- F SD-1 band (94Pe16)
- G SD-2 band (94Pe16)

Levels and γ -ray branchings:

- C 0, 0⁺, 8.5 15 m, %EC+% β^+ =100
- C 294.30 16, 2⁺, 64 4 ps, $\mu=+1.23$ 36 γ_0 294.22 (\dagger ,100) E2
- D 753.73 16, (2⁺) γ_{294} 459.32 (\dagger ,90 10) γ_0 753.82 (\dagger ,100 10)
- C 788.97 21, 4⁺, <3.5 ps γ_{294} 494.72 (\dagger ,100) E2
- D 1089.02 21, (3⁺) γ_{754} 335.33 (\dagger ,24 5) γ_{294} 794.72 (\dagger ,100 8)
- D 1313.01 21, (4⁺) γ_{789} 523.82 (\dagger ,52 10) γ_{754} 559.22 (\dagger ,100 15)
- 1383.8 4 γ_{789} 594.74 (\dagger ,60 26) γ_0 1384.05 (\dagger ,100 30)
- C 1420.10 25, 6⁺, <9 ps γ_{789} 631.32 (\dagger ,100) E2
- 1605.0 3 γ_{1089} 516.03 (\dagger ,100 14) γ_{754} 851.33 (\dagger ,34 7)
- 1669.3 6 γ_{294} 1375.05 (\dagger ,100)
- 1670.9 5 γ_{789} 881.94 (\dagger ,100)
- D 1697.6 4, (5⁺) γ_{1089} 608.63 (\dagger ,100)
- D 1910.6 3, (6⁺) γ_{1420} 491 1 (\dagger ,<20) γ_{1313} 597.32 (\dagger ,100 10)
- B 1956.2 3, (5⁺) γ_{789} 1167.32 (\dagger ,100) (E1)
- 2036.4 5 γ_{789} 1247.44 (\dagger ,100)
- C 2126.5 3, 8⁺ γ_{1420} 706.42 (\dagger ,100) E2
- 2231.6 6 γ_{789} 1442.6 5 (\dagger ,100)
- 2293.1 4, (8⁺), 410 30 μ s, %IT=100 γ_{2127} 166.5 3 (\dagger ,100 7) E1 γ_{1420} 874 (\dagger ,7 2)
- B 2340.6 3, (7⁺) γ_{1856} 384.6 2 (\dagger ,34 5) (E2) γ_{1420} 920.4 2 (\dagger ,100 2) (E1)
- A 2412.5 3, (6⁺) γ_{1420} 992.4 2 (\dagger ,100)
- D 2467.2 3, (8⁺) γ_{1811} 556.3 2 (\dagger ,100 7) γ_{1420} 1047.3 2 (\dagger ,95 9)
- A 2728.5 3, (8⁺) γ_{2413} 316.0 2 (\dagger ,33 5) (E2) γ_{2341} 387.9 2 (\dagger ,100 11) D
- C 2816.9 4, 10⁺, 9.0 14 ps, $\mu=0$ γ_{2127} 690.4 2 (\dagger ,100) E2
- B 2840.7 4, (9⁺) γ_{2341} 500.1 2 (\dagger ,100) (E2)
- D 3052.0 3, (10⁺) γ_{2467} 584.7 2 (\dagger ,100 7) γ_{2127} 925.6 2 (\dagger ,100 10) (E2)
- A 3200.2 4, (10⁺) γ_{2729} 471.7 2 (\dagger ,100) (E2)
- E 3436.5 4, (12⁺) γ_{3052} 384.6 2 (\dagger ,83 4) (E2) γ_{2817} 619.5 2 (\dagger ,100 6)
- B 3453.0 4, (11⁺) γ_{2841} 612.3 2 (\dagger ,100) (E2)
- C 3483.0 4, 12⁺ γ_{2817} 666.0 2 (\dagger ,100) E2
- A 3863.0 5, (12⁺) γ_{3200} 662.8 2 (\dagger ,100) (E2)
- E 4028.2 4, (14⁺) γ_{3483} 545 γ_{3437} 591.7 2 (\dagger ,100) (E2)
- B 4175.4 5, (13⁺) γ_{3453} 722.4 2 (\dagger ,100) (E2)
- C 4183.7 5, 14⁺ γ_{3483} 700.7 2 (\dagger ,100) E2
- A 4607.5 5, (14⁺) γ_{3863} 744.5 2 (\dagger ,100) (E2)
- E 4776.7 5, (16⁺) γ_{4028} 748.5 2 (\dagger ,100) (E2)
- C 4942.7 5, 16⁺ γ_{4184} 759.0 2 (\dagger ,100) E2
- B 4947.9 5, (15⁺) γ_{4175} 772.5 2 (\dagger ,100) (E2)
- A 5345.9 5, (16⁺) γ_{4608} 738.4 2 (\dagger ,100) (E2)
- E 5629.7 11, (18⁺) γ_{4777} 853 1 (\dagger ,100) (E2)
- B 5711.0 6, (17⁺) γ_{4948} 763.1 2 (\dagger ,100)
- C 5777.7 11, 18⁺ γ_{4943} 835 1 (\dagger ,100) E2
- A 6082.5 6, (18⁺) γ_{5346} 736.6 2 (\dagger ,100)
- B 6488.0 12, (19⁺) γ_{5711} 777 (\dagger ,100)
- E 6531.7 15, (20⁺) γ_{5630} 902 (\dagger ,100)
- C 6710.7 15, 20⁺ γ_{5778} 933 (\dagger ,100) E2
- A 6891.5 12, (20⁺) γ_{6083} 809 (\dagger ,100)
- B 7358.0 15, (21⁺) γ_{6488} 870 (\dagger ,100)
- E 7467.7 18, (22⁺) γ_{6532} 936 (\dagger ,100)
- C 7744.7 18, (22⁺) γ_{6711} 1034 (\dagger ,100)

- A 7804.5 16, (22⁺) γ_{6892} 913 (\dagger ,100)
- B 8328.0 18, (23⁺) γ_{7358} 970 (\dagger ,100)
- E 8453.7 21, (24⁺) γ_{7468} 986 (\dagger ,100)
- A 8812.5 19, (24⁺) γ_{7805} 1008 (\dagger ,100)
- C 8869.7 21, (24⁺) γ_{7745} 1125 (\dagger ,100)
- B 9371.1 21, (25⁺) γ_{8328} 1043 (\dagger ,100)
- E 9501.7 23, (26⁺) γ_{8454} 1048 (\dagger ,100)
- C 10079.7 23, (26⁺) γ_{8870} 1210 (\dagger ,100)
- E 10616.7 25, (28⁺) γ_{9502} 1115 (\dagger ,100)
- E 11787 3, (30⁺) γ_{10617} 1170 (\dagger ,100)
- F x, J
- F 663.9+x, J+2 γ_x 663.9 5 (\dagger ,<0.20) $I^{(2)}=54.9$, $\eta\omega=0.350$
- F 1400.6+x, J+4 γ_{664+x} 736.7 3 (\dagger ,0.41 11) $I^{(2)}=56.3$, $\eta\omega=0.386$
- F 2208.4+x, J+6 γ_{1401+x} 807.8 2 (\dagger ,0.77 4) $I^{(2)}=58.2$, $\eta\omega=0.421$
- F 3084.9+x, J+8 γ_{2208+x} 876.5 2 (\dagger ,1.07 4) $I^{(2)}=60.9$, $\eta\omega=0.455$
- F 4027.1+x, J+10 γ_{3085+x} 942.2 2 (\dagger ,1.00) $I^{(2)}=61.3$, $\eta\omega=0.487$
- F 5034.5+x, J+12 γ_{4027+x} 1007.4 2 (\dagger ,1.02 4) $I^{(2)}=59.3$, $\eta\omega=0.521$
- F 6109.3+x, J+14 γ_{5035+x} 1074.8 3 (\dagger ,0.71 5) $I^{(2)}=58.0$, $\eta\omega=0.555$
- F 7253.1+x, J+16 γ_{6109+x} 1143.8 3 (\dagger ,0.49 5) $I^{(2)}=55.4$, $\eta\omega=0.590$
- F 8469.1+x, J+18 γ_{7253+x} 1216.0 4 (\dagger ,0.47 6) $I^{(2)}=54.1$, $\eta\omega=0.626$
- F 9759.0+x, J+20 γ_{8469+x} 1289.9 6 (\dagger ,0.37 5) $I^{(2)}=51.7$, $\eta\omega=0.664$
- F 11126.3+x, J+22 γ_{9759+x} 1367.3 8 (\dagger ,0.26 7) $I^{(2)}=48.4$, $\eta\omega=0.704$
- F 12576.3+x, J+24 $\gamma_{11126+x}$ 1450 1 (\dagger ,<0.16)
- G y, J
- G 820.9+y, J+2 γ_y 820.9 3 (\dagger ,0.59 6) $I^{(2)}=51.5$, $\eta\omega=0.430$
- G 1719.4+y, J+4 γ_{821+y} 898.5 2 (\dagger ,1.00) $I^{(2)}=54.2$, $\eta\omega=0.468$
- G 2691.7+y, J+6 γ_{1719+y} 972.3 2 (\dagger ,0.93 5) $I^{(2)}=56.5$, $\eta\omega=0.504$
- G 3734.8+y, J+8 γ_{2692+y} 1043.1 2 (\dagger ,0.85 5) $I^{(2)}=63.5$, $\eta\omega=0.537$
- G 4840.9+y, J+10 γ_{3735+y} 1106.1 3 (\dagger ,0.80 6) $I^{(2)}=76.2$, $\eta\omega=0.566$
- G 5999.5+y, J+12 γ_{4841+y} 1158.6 3 (\dagger ,0.67 6) $I^{(2)}=77.7$, $\eta\omega=0.592$
- G 7209.6+y, J+14 γ_{6000+y} 1210.1 5 (\dagger ,0.47 8) $I^{(2)}=68.0$, $\eta\omega=0.620$
- G 8478.5+y, J+16 γ_{7210+y} 1268.9 5 (\dagger ,0.41 8) $I^{(2)}=52.5$, $\eta\omega=0.653$
- G 9823.6+y, J+18 γ_{8479+y} 1345.1 9 (\dagger ,0.26 7)

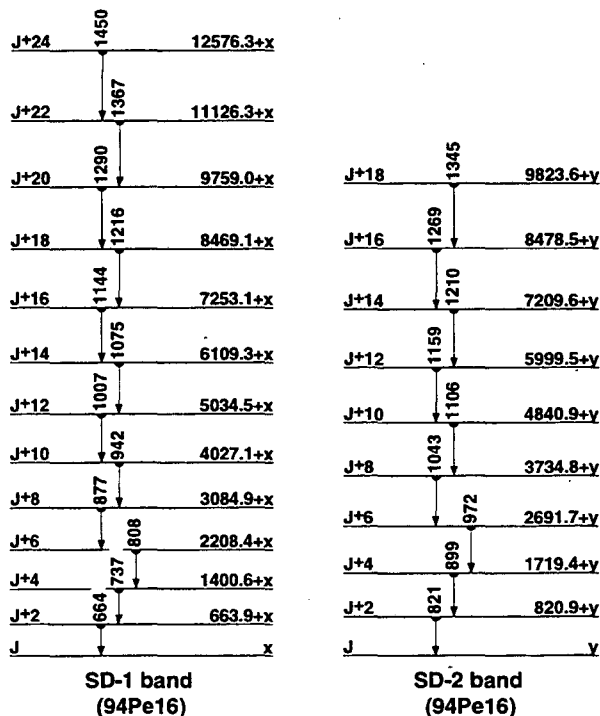

¹³⁴Nd
₆₀Nd

¹³⁵Nd
⁶⁰Nd

Δ : (-76160) S_n : (8500) S_p : (4900) Q_{EC} : (4750) Q_α : (1100)

Nuclear Bands

- A 9/2[514] $\alpha=+1/2$ (87Pi05)
- B 9/2[514] $\alpha=-1/2$ (87Pi05)
- C $\Delta J=1$ band
- D SD band (87Be57,87Wa18,95De40)

Levels and γ -ray branchings:

- A 0, 9/2⁽⁻⁾, 12.46 m, %EC+% β^+ =100
65.02, (1/2⁺), 5.55 m, %EC+% β^+ =100
193.73, (3/2⁺) γ_{65} 128.82 (†,100)
- B 198.75 13, (11/2⁺) γ_0 198.82 14 (†,100) D+Q: $\delta=-0.227$
273.03, (3/2,5/2) γ_{65} 208.12 (†,100)
328.13, (1/2⁺) γ_{194} 135.55 (†,41) γ_{65} 262.92 (†,10030)
347.13, (1/2,3/2,5/2) γ_{65} 282.12 (†,100)
371.12, (5/2⁺) γ_{273} 98.12 (†,236) γ_{194} 177.43 (†,173) γ_{65} 306.22 (†,10014)
463.73(?), (5/2⁺) γ_{328} 135.55 (†,41) γ_{273} 190.65 (†,=5) γ_{194} 270.02 (†,10035) γ_{65} 398.72 (†,8822)
493.22, (7/2,9/2,11/2) γ_0 493.22 (†,100)
- A 560.49 14, (13/2⁻) γ_{199} 361.88 15 (†,1001) D+Q: $\delta=-0.96$ γ_0 560.35 20 (†,611) (Q)
565.03 γ_{199} 366.22 25 γ_0 564.23(?)
588.14, (3/2⁺,5/2⁺) γ_{194} 394.23 (†,10050) γ_{65} 523.33 (†,9030)
602.94, (3/2⁺,5/2⁺) γ_{194} 409.22 (†,100)
663.87(?) γ_{199} 465.06(?) (†,100)
671.73 γ_{347} 324.62 (†,10030) γ_{273} 398.72 (†,=20)
713.02, (7/2⁺) γ_{493} 219.93 (†,2010) γ_{464} 249.33 (†,3710) γ_{371} 341.92 (†,6717) γ_{273} 439.94 (†,2310) γ_{199} 514.0 γ_0 713.02 (†,10017)
717.05 γ_{199} 518.34 (†,100)
744.34 γ_{273} 471.23 (†,100)
- B 792.92, (15/2⁻) γ_{560} 232.61 20 (†,252) D+Q: $\delta=-0.137$ γ_{199} 594.00 25 (†,1002) (Q)
826.210(?) γ_{199} 627.5
1109.85(?) γ_{199} 911.04(?) (†,100)
1176.82 γ_{713} 463.82 (†,1008) γ_{199} 978.22 (†,638) γ_0 1176.73 (†,528)
1181.87(?) γ_{664} 518.04 20 (†,100)
1215.02 γ_{199} 1016.22 (†,100)
- A 1269.42, (17/2⁻) γ_{793} 476.70 25 (†,758) D(+Q): $\delta=-0.0911$ γ_{560} 708.80 25 (†,1008) Q
1357.75 γ_{713} 644.8 γ_{199} 1159.05
1463.65(?) γ_{793} 670.74(?) (†,100)
1469.35(?) γ_{793} 676.44(?) (†,100)
- B 1520.03, (19/2⁻) γ_{1269} 250.55 (†,111) D+Q: $\delta=-0.198$ γ_{793} 727.00 25 (†,1001) Q
1776.47, (15/2⁺)
- C 1954.04, (17/2⁺) γ_{1776} 1781 γ_{793} 1161.125 (†,1002)
- A 2105.33, (21/2⁻) γ_{1520} 585.38 25 (†,389) D(+Q): $\delta=0.006$ γ_{1269} 836.00 25 (†,10024) (Q)
2122.66(?) γ_{1520} 602.65(?) (†,100)
- C 2157.84, (19/2⁺) γ_{1954} 203.85 25 (†,9511) γ_{1776} 3811 γ_{1269} 888.43 (†,10013)
2209.88(?), (17/2) γ_{1269} 9401(?)
2259.46, (17/2) γ_{1776} 4831(?) γ_{1520} 7391(?) γ_{793} 14661(?)
- C 2350.04, (21/2⁺) γ_{2158} 192.24 20 (†,1003) D(+Q): $\delta=-0.033$ γ_{1954} 3961
- B 2375.43, (23/2⁻) γ_{2105} 270.55 (†,=5) γ_{1520} 855.20 25 (†,1001) (Q)
2496.24(?) γ_{2375} 120.76 20(?) (†,100)
2533.18, (23/2) γ_{1520} 10131(?)
- C 2557.54, (23/2⁺) γ_{2350} 207.45 25 (†,10014) γ_{2158} 4001
2703.44, (21/2⁺) γ_{1520} 1183.74 (†,100) (D)
2775.15, (21/2⁺) γ_{2259} 5151(?) γ_{2210} 5651(?) γ_{2158} 6181 (†,10020) (D)
2795.15, (21/2) γ_{1520} 12751(?)
- C 2800.74, (25/2⁺) γ_{2558} 243.20 20 (†,10017) D+Q: $\delta=-0.064$ γ_{2350} 4501(?)
- A 2940.34, (25/2⁻) γ_{2496} 444.24(?) (†,181) γ_{2375} 564.79 20 (†,7712)

- D(+Q): $\delta=-0.027$ γ_{2105} 835.24 (†,10013) (Q)
- C 3101.85, (27/2⁺) γ_{2801} 301.13 20 (†,100) (D)
- B 3110.34, (27/2⁻) γ_{2940} 170.05 20 (†,1006) D(+Q): $\delta=+0.014$ γ_{2375} 734.64 (†,1711) (Q)
- D 3324.14, (25/2⁺), 1.76 ps γ_{2801} 523.54 (†,0.062) γ_{2795} 529.04 (†,0.102) (Q) γ_{2775} 548.94 (†,0.143) (Q) γ_{2703} 621.04 (†,0.133) (Q) γ_{2558} 766.54 (†,0.102) (D) γ_{2375} 9491 (†,0.122) (D)
3340.25, (25/2) γ_{2533} 8071(?) γ_{2375} 964.64 (†,10029) (D)
3345.95(?) γ_{3110} 235.63(?) (†,100)
- A 3358.24, (29/2⁻) γ_{3110} 247.74 25 (†,10014) D+Q: $\delta=-0.084$ γ_{2840} 418.05 (†,214)
- C 3470.95, (29/2⁺) γ_{3102} 369.12 25 (†,100) D+Q: $\delta=-0.166$
- B 3649.55, (31/2⁻) γ_{3358} 291.34 20 (†,1001) D+Q: $\delta=-0.124$ γ_{3110} 539.53 (†,133)
- C 3860.85, (31/2⁺) γ_{3471} 389.93 25 (†,6715) D+Q: $\delta=+0.113$ γ_{3102} 759.03 (†,1004) (Q)
- D 3869.44, (29/2⁺), 1.04 ps γ_{3340} 529.04 (†,0.102) (Q) γ_{3324} 545.40 25 (†,0.778) Q $I^{(1)}=50.6$, $I^{(2)}=70.8$, $\hbar\omega=0.287$
- A 4007.75, (33/2⁻) γ_{3650} 358.22 25 (†,10014) D(+Q): $\delta=-0.0213$ γ_{3358} 649.23 (†,238)
- B 4414.06, (35/2⁻) γ_{4008} 406.55 (†,10019) D+Q: $\delta=-0.2515$ γ_{3650} 764.95 (†,4624)
4416.75 γ_{4008} 408.55 (†,10031) γ_{3650} 767.43 (†,764)
- D 4471.35, (33/2⁺), 0.44 $^{+26}_{-8}$ ps γ_{3865} 601.90 25 (†,1.00) Q $I^{(1)}=51.7$, $I^{(2)}=54.1$, $\hbar\omega=0.319$
- A 4852.36, (37/2⁻) γ_{4414} 438.65 (†,10033) D+Q: $\delta=-0.2615$ γ_{4008} 844.24 (†,8140)
- D 5147.26, (37/2⁺), 0.21 $^{+14}_{-6}$ ps γ_{4471} 675.90 25 (†,0.808) $I^{(1)}=52.0$, $I^{(2)}=55.2$, $\hbar\omega=0.356$
- B 5330.46(?), (39/2⁻) γ_{4852} 478.05(?) (†,10076) γ_{4414} 916.54(?) (†,8265)
- D 5895.56, (41/2⁻), <0.15 ps γ_{5147} 748.30 25 (†,0.758) $I^{(1)}=52.4$, $I^{(2)}=58.5$, $\hbar\omega=0.391$
- D 6712.27, (45/2⁺) γ_{5896} 816.70 25 (†,0.657) $I^{(1)}=53.0$, $I^{(2)}=61.8$, $\hbar\omega=0.425$
- D 7593.67, (49/2⁺) γ_{6712} 881.40 25 (†,0.667) $I^{(1)}=53.6$, $I^{(2)}=62.4$, $\hbar\omega=0.457$
- D 8539.18, (53/2⁺) γ_{7594} 945.50 25 (†,0.557) $I^{(1)}=54.2$, $I^{(2)}=61.8$, $\hbar\omega=0.489$
- D 9549.38, (57/2⁺) γ_{8539} 1010.20 25 (†,0.426) $I^{(1)}=54.6$, $I^{(2)}=60.1$, $\hbar\omega=0.522$
- D 10626.19, (61/2⁺) γ_{9549} 1076.80 25 (†,0.336) $I^{(1)}=54.9$, $I^{(2)}=58.7$, $\hbar\omega=0.555$
- D 11771.19, (65/2⁺) γ_{10626} 1145.00 25 (†,0.256) $I^{(1)}=55.1$, $I^{(2)}=57.4$, $\hbar\omega=0.590$
- D 12985.89, (69/2⁺) γ_{11771} 1214.70 25 (†,0.165) $I^{(1)}=55.2$, $I^{(2)}=55.0$, $\hbar\omega=0.626$
- D 14273.210, (73/2⁺) γ_{12986} 1287.40 25 (†,0.094) $I^{(1)}=55.1$, $I^{(2)}=53.6$, $\hbar\omega=0.662$
- D 15635.215, (77/2⁺) γ_{14273} 13621 (†, <0.1) $I^{(1)}=55.0$, $I^{(2)}=53.2$, $\hbar\omega=0.700$
- D 17072.515, (81/2⁺) γ_{15635} 1437.24 $I^{(1)}=54.8$, $I^{(2)}=48.6$, $\hbar\omega=0.739$
- D 18592.015, (85/2⁺) γ_{17073} 1519.55 $I^{(1)}=54.4$, $I^{(2)}=46.8$, $\hbar\omega=0.781$
- D 20197.020, (89/2⁺) γ_{18592} 1605.07 $I^{(1)}=54.0$, $I^{(2)}=46.0$, $\hbar\omega=0.824$
- D 21889.020, (93/2⁺) γ_{20197} 1692.010

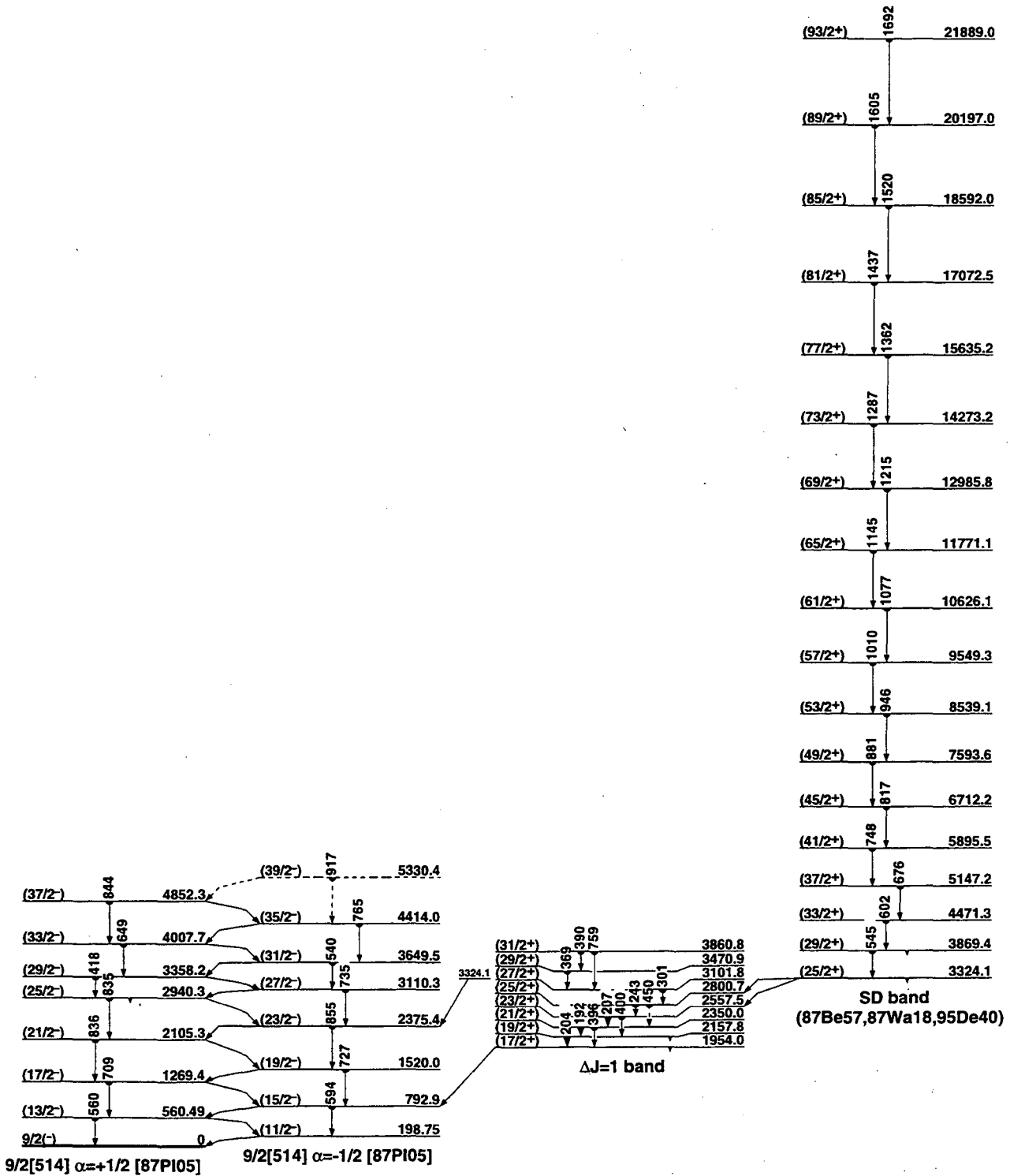

¹³⁵₆₀Nd

¹³⁶Nd
60

Δ : -79160 60 S_n: (11070) S_p: 5540 160 Q_{EC}: 2211 25 Q_α: (860)

Nuclear Bands

- A GS band
- B γ band?
- C πh_{11/2}πg_{7/2}, α=-1
- D πh_{11/2}πg_{7/2}, α=1
- E Aligned vh_{11/2}²
- F Aligned πh_{11/2}²
- G vh_{11/2}vg_{7/2}? α=-1, γ=-60°
- H α=-1?
- I vh_{11/2}vg_{7/2}? α=0, γ=-60°
- J Band Structure
- K SD-1 band (95Cl02,87Be32)
- L SD-2 band (95Cl02)

Levels and γ-ray branchings:

- A 0, 0⁺, 50.65 33 m, %EC+%β⁺=100
- A 373.6 3, 2⁺ γ₀ 373.8 2 (†_γ 100) E2
- B 862.51 16, 2⁺ γ₃₇₄ 488.7 2 (†_γ 98 10) E2+M1 γ₀ 862.5 2 (†_γ 100 10) E2
- A 976.3 4, 4⁺, <8 ps γ₃₇₄ 602.7 2 (†_γ 100) E2
- B 1231.04 18, (3⁺) γ₉₇₆ 254.7 2 (†_γ =2) γ₈₆₃ 368.7 2 (†_γ 27 3) γ₃₇₄ 857.2 2 (†_γ 100 10) E2+M1
- B 1541.77 20, (4⁺) γ₉₇₆ 565.2 2 (†_γ 33 4) γ₈₆₃ 679.2 2 (†_γ 100 10)
- A 1746.8 5, 6⁺, <14 ps γ₉₇₆ 770.3 2 (†_γ 100) E2
- 1775.6 3 γ₃₇₄ 1401.8 2 (†_γ 100)
- 1817.83 21 γ₁₂₃₁ 586.9 2 (†_γ 100 10) γ₈₆₃ 955.2 2 (†_γ 100 10)
- 1926.03 24 γ₁₂₃₁ 695.0 2 (†_γ 100)
- C 2035.9 5, 5(†) γ₉₇₆ 1059.4 2 (†_γ 100) D
- B 2045.9 5, (5⁺) γ₁₅₄₂ 503.7 2 (†_γ 4.3 4) γ₁₂₃₁ 814.7 2 (†_γ 100 10) Q
- γ₉₇₆ 1069.1 2 (†_γ 16.1 16)
- 2181.2 3 γ₉₇₆ 1204.7 2 (†_γ 100)
- 2227.93 24, (3,4,5) γ₂₀₃₆ 192.4 2 (†_γ 74 8) γ₉₇₆ 1251.3 2 (†_γ 100 10)
- 2346.22 25 γ₂₀₄₆ 300.6 2 (†_γ 100 10) γ₁₉₂₆ 420.2 2 (†_γ 31 3)
- 2416.7 3 γ₂₀₄₆ 371.1 2 (†_γ 100)
- C 2439.9 5, 7(†), 21 7 ps γ₂₀₃₆ 404.5 2 (†_γ 29.4 10) E2 γ₁₇₄₇ 693.1 2 (†_γ 100.0 14)
- D 2483.9 5, 6(†) γ₂₀₄₆ 438.1 4 (†_γ 59 9) γ₂₀₃₆ 448.0 5 (†_γ 77 9) D γ₁₇₄₇ 737.1 5 (†_γ 100 18) D
- 2522.9 3 γ₈₆₃ 1660.4 2 (†_γ 100)
- A 2632.7 7, 8⁺, <7 ps γ₁₇₄₇ 886.1 3 (†_γ 100) E2
- D 2757.8 5, 8(†) γ₂₄₈₄ 273.9 3 (†_γ 66 4) Q γ₂₄₄₀ 317.9 3 (†_γ 100 4) D
- C 2941.1 5, 9(†), 6 2 ps γ₂₄₄₀ 501.2 3 (†_γ 100) E2
- D 3244.4 6, (10⁺) γ₂₉₄₁ 303.3 3 (†_γ 31 3) D γ₂₇₅₈ 486.5 3 (†_γ 100 4) Q
- E 3278.7 6, 10⁺ γ₂₆₃₃ 645.8 3 (†_γ 100) Q
- F 3296.5 6, 10⁺, 51 6 ps, μ=+11.7 39 γ₂₉₄₁ 355.4 3 (†_γ 35.9 9) γ₂₆₃₃ 663.5 3 (†_γ 100.0 21) E2
- A 3552.6 6, 10⁺ γ₂₆₃₃ 919.7 3 (†_γ 100) Q
- C 3602.3 6, 11(†) γ₂₉₄₁ 661.2 3 (†_γ 100) Q
- F 3686.5 6, 12⁺, 19 3 ps, μ=+14.0 46 γ₃₂₉₇ 390.1 3 (†_γ 100) E2
- G 3768.2 7, (9⁺) γ₂₆₃₃ 1135.1 5 (†_γ 100) D
- E 3997.3 7, (12⁺) γ₃₂₇₆ 718.6 3 (†_γ 100) Q
- D 4016.8 8, (12⁺) γ₃₂₄₄ 772.4 5 (†_γ 100)
- G 4320.0 6, (11⁺) γ₃₇₆₈ 551.8 3 (†_γ 29 3) Q γ₃₅₅₃ 767.5 3 (†_γ 100 3) D
- F 4347.5 6, 14⁺, <4 ps γ₃₆₈₇ 661.0 3 (†_γ 100) E2
- C 4426.6 6, (13⁺) γ₃₆₀₂ 824.3 3 (†_γ 4.7 3) Q
- H 4455.7 7, (12) γ₃₆₈₇ 769.2 5 (†_γ 1 5.7 9)
- E 4849.1 8, (14⁺) γ₃₉₉₇ 851.8 3 (†_γ 100) Q
- J 4855.9 7, (13) γ₃₆₈₇ 1169.3 5 (†_γ 100) D
- I 5022.5 7, (12⁺) γ₄₃₂₀ 702.5 3 (†_γ 100) D
- D 5022.7 8, (14⁺) γ₄₀₁₇ 1005.9 3 (†_γ 100) Q
- G 5032.0 7, (13⁺) γ₄₃₂₀ 711.9 5 (†_γ 100) Q
- H 5132.7 8, (14) γ₄₄₅₆ 677.0 5 (†_γ 7 4 12) Q γ₄₃₄₈ 785.2 5 (†_γ 100 6) D

- F 5192.2 7, (16⁺) γ₄₃₄₈ 844.7 3 (†_γ 100) Q
- C 5415.8 7, (15⁺) γ₄₄₂₇ 989.1 3 (†_γ 1.9 3) Q
- J 5570.2 7, (15) γ₄₈₅₆ 714.3 3 (†_γ 93 22) Q γ₄₃₄₈ 1222.7 4 (†_γ 100 36) D
- I 5695.6 7, (14⁺) γ₅₀₃₂ 663.3 5 (†_γ 72 21) γ_{5022.5} 673.1 3 (†_γ 100 7) Q
- E 5844.1 8, (16⁺) γ₄₈₄₉ 994.9 3 (†_γ 100) Q
- G 5876.0 9(?), (15⁺) γ₅₀₃₂ 844.0 5(?)
- H 5942.2 9, (16) γ₅₁₃₃ 809.5 5 (†_γ 100)
- D 6040.4 9, (16⁺) γ_{5022.7} 1017.7 3 (†_γ 100) Q
- F 6191.7 7, (18⁺) γ₅₁₉₂ 999.5 3 (†_γ 100) Q
- C 6360.6 7, (17⁺) γ₅₄₁₆ 944.8 3 (†_γ 84 8) Q γ₅₁₉₂ 1168.4 3 (†_γ 100 8) D
- J 6472.1 9(?), (17) γ₅₅₇₀ 901.9 5(?)
- I 6522.7 8, (16⁺) γ₅₆₉₆ 827.1 3 (†_γ 100)
- D 6675.9 9, (18⁺) γ₆₀₄₀ 635.5 3 (†_γ 100)
- E 6756.3 9, (18⁺) γ₅₈₄₄ 912.2 3 (†_γ 100) Q
- G 6771.0 14(?), (17⁺) γ₅₈₇₆ 895 1(?)
- H 6930.8 10, (18) γ₅₉₄₂ 988.6 5 (†_γ 100) Q
- C 7142.1 8, (19⁺) γ₆₃₆₁ 781.5 4 (†_γ 100) Q
- F 7238.1 9, (20⁺) γ₆₁₉₂ 1046.4 5 (†_γ 100) Q
- I 7374.4 9(?), (18⁺) γ₆₅₂₃ 851.7 3(?)
- J 7497.1 14(?), (19) γ₆₄₇₂ 1025 1(?)
- D 7533.4 10, (20⁺) γ₆₆₇₆ 857.5 4 (†_γ 100)
- H 8025.8 14(?), (20) γ₆₉₃₁ 1095 1(?)
- C 8050.1 9, (21⁺) γ₇₁₄₂ 908.0 5 (†_γ 100) Q
- F 8329.1 14(?), (22⁺) γ₇₂₃₈ 1091 1(?)
- D 8566.4 14(?), (22⁺) γ₇₅₃₃ 1033 1(?)
- C 9072.7 11(?), (23⁺) γ₈₀₅₀ 1022.6 5(?)
- D 9728.4 18(?), (24⁺) γ₈₅₆₆ 1162 1(?)
- C 10175.7 15(?), (25⁺) γ₉₀₇₃ 1103 1(?)
- K x, J=(16)
- K 716.5+x, J+2 γ_x 716.5 2 (†_γ 0.4 1) I⁽¹⁾=47.6, I⁽²⁾=51.0, ηω=0.378
- K 1511.4+x, J+4 γ_{717+x} 794.9 2 (†_γ 1.0 1) I⁽¹⁾=48.4, I⁽²⁾=64.7, ηω=0.413
- K 2368.1+x, J+6 γ_{1511+x} 856.7 3 (†_γ 1.1 1) I⁽¹⁾=49.6, I⁽²⁾=64.9, ηω=0.444
- K 3286.4+x, J+8 γ_{2368+x} 918.3 3 (†_γ 1.0 1) I⁽¹⁾=50.5, I⁽²⁾=62.1, ηω=0.475
- K 4269.1+x, J+10 γ_{3286+x} 982.7 3 (†_γ 0.9 1) I⁽¹⁾=51.2, I⁽²⁾=60.0, ηω=0.508
- K 5318.5+x, J+12 γ_{4269+x} 1049.4 2 (†_γ 0.8 1) I⁽¹⁾=51.7, I⁽²⁾=58.7, ηω=0.542
- K 6436.0+x, J+14 γ_{5319+x} 1117.5 2 (†_γ 0.7 1) I⁽¹⁾=52.1, I⁽²⁾=58.6, ηω=0.576
- K 7621.8+x, J+16 γ_{6436+x} 1185.8 3 (†_γ 0.6 1) I⁽¹⁾=52.4, I⁽²⁾=57.7, ηω=0.610
- K 8876.9+x, J+18 γ_{7622+x} 1255.1 4 (†_γ 0.5 1) I⁽¹⁾=52.7, I⁽²⁾=57.1, ηω=0.645
- K 10202.1+x, J+20 γ_{8877+x} 1325.2 3 (†_γ 0.4 1) I⁽¹⁾=52.9, I⁽²⁾=54.6, ηω=0.681
- K 11600.6+x, J+22 γ_{10202+x} 1398.5 4 (†_γ 0.3 1) I⁽¹⁾=52.9, I⁽²⁾=51.2, ηω=0.719
- K 13077.2+x, J+24 γ_{11601+x} 1476.6 4 (†_γ 0.2 1) I⁽¹⁾=52.7, I⁽²⁾=49.0, ηω=0.759
- K 14635.4+x, J+26 γ_{13077+x} 1558.2 4 I⁽¹⁾=52.5, I⁽²⁾=46.9, ηω=0.800
- K 16278.9+x, J+28 γ_{14635+x} 1643.5 5 I⁽¹⁾=52.1, I⁽²⁾=44.9, ηω=0.844
- K 18011.5+x, J+30 γ_{16278+x} 1732.6 7 I⁽¹⁾=51.9, I⁽²⁾=48.5, ηω=0.887
- K 19826.5+x(?), J+32 γ_{18012+x} 1815 1(?)
- L y, J
- L 888+y, J+2 γ_y 888 1 I⁽²⁾=63.5, ηω=0.460
- L 1839+y, J+4 γ_{888+y} 951 1 I⁽²⁾=60.6, ηω=0.492
- L 2856+y, J+6 γ_{1839+y} 1017 1 I⁽²⁾=62.5, ηω=0.524
- L 3937+y, J+8 γ_{2856+y} 1081 1 I⁽²⁾=57.1, ηω=0.558
- L 5088+y, J+10 γ_{3937+y} 1151 1 I⁽²⁾=57.1, ηω=0.593
- L 6309+y, J+12 γ_{5088+y} 1221 1 I⁽²⁾=58.0, ηω=0.628
- L 7599+y, J+14 γ_{6309+y} 1290 1 I⁽²⁾=54.1, ηω=0.664
- L 8963+y, J+16 γ_{7599+y} 1364 1 I⁽²⁾=54.1, ηω=0.700
- L 10401+y, J+18 γ_{8963+y} 1438 1

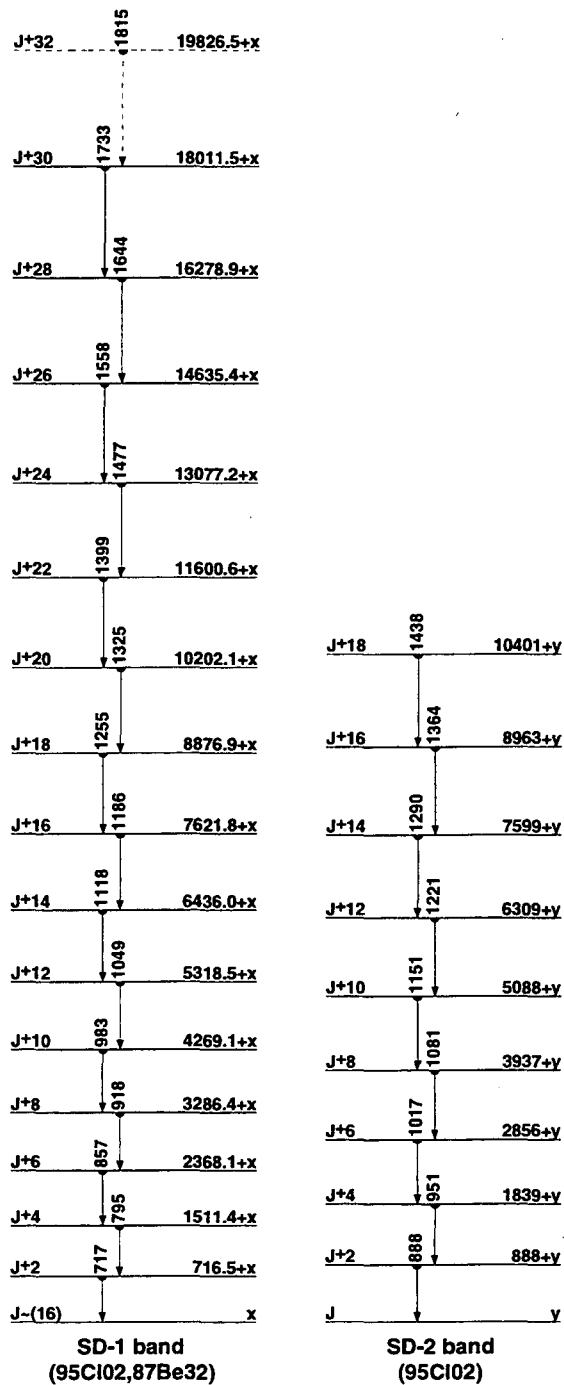

¹³⁶₆₀Nd

¹³⁷Nd
⁶⁰Nd

Δ : -79510 70 S_n : 8430 60 S_p : 5430 60 Q_{EC} : 3690 50 Q_{α} : (450)

Nuclear Bands

- A Band Structure
- B Band Structure
- C SD band (87Wa18,92Mu09)

Levels and γ -ray branchings:

- 0, 1/2⁺, 38.5 15 m, %EC+% β ⁺=100
- 108.6 2, 3/2⁺ γ_{108} 108.6 2 ($t_{1/2}$ 100) M1
- 268.7 3, (3/2)⁺ γ_{109} 160.5 4 ($t_{1/2}$ 19.4 4) M1,E2 γ_{268} 268.7 3 ($t_{1/2}$ 100.0 8) M1,E2
- 286.0 2, 5/2⁺ γ_{109} 177.5 2 ($t_{1/2}$ 100.0 3) M1(+E2) γ_{286} 286.0 2 ($t_{1/2}$ 39.9 2) E2
- A 519.6 5, 11/2⁻, 1.60 15 s, %IT=100 γ_{286} 233.6 3 ($t_{1/2}$ 100) E3
- 614.9 6, 7/2⁺ γ_{286} 328.5 5 ($t_{1/2}$ 4.7 1) M1,E2 γ_{109} 506.0 10 ($t_{1/2}$ 100 25)
- 797.8 6 γ_{286} 512.0 10(?) γ_{269} 529.2 4 ($t_{1/2}$ 100)
- 834.5 6, (7/2)⁺ γ_{286} 548.8 3 ($t_{1/2}$ 100 2) γ_{269} 565.6 3 ($t_{1/2}$ <66)
- 851.5 6, (7/2)⁺ γ_{286} 565.6 3 ($t_{1/2}$ <395) γ_{109} 743.3 4 ($t_{1/2}$ 100 6)
- 976.8 6, 9/2⁻ γ_{520} 457.3 5 ($t_{1/2}$ 100 2) γ_{286} 690.8 3 ($t_{1/2}$ 69 2) M2
- A 1100.0 10, 13/2⁻ γ_{520} 581 1 ($t_{1/2}$ 100) M1+E2
- A 1188.6 6, (15/2⁻) γ_{520} 669.0 3 ($t_{1/2}$ 100) Q
- 1374.5 7, (7/2,5/2⁻) γ_{977} 397.7 3 ($t_{1/2}$ 100 3) γ_{615} 759.5 5 ($t_{1/2}$ 91 3)
- 1510.6 8, (11/2⁻) γ_{1100} 410.6 5 ($t_{1/2}$ 100 2) M1,E2 γ_{977} 533.8 4 ($t_{1/2}$ <75)
- γ_{852} 658.6 3 ($t_{1/2}$ 7.5 5)
- A 1682.0 14, (15/2⁻) γ_{1189} 493.5 (?) ($t_{1/2}$ 10 1) γ_{1100} 582 1 ($t_{1/2}$ 100 8) M1+E2
- 1707.1 8, (9/2,11/2) γ_{615} 1092.2 5 ($t_{1/2}$ 100)
- 1788.5 (?) γ_{1375} 414.0 5 ($t_{1/2}$ 100) M1,E2
- A 1894.4 14, (17/2⁻) γ_{1189} 705.6 3 ($t_{1/2}$ 100 3) M1+E2 γ_{1100} 794 1 ($t_{1/2}$ 26 4) Q
- 1899.5 8, 9/2⁻, 11/2⁺ γ_{1707} 192.9 4 ($t_{1/2}$ 8.3 5) γ_{1511} 389.2 3 ($t_{1/2}$ 43.5 5) M1,E2
- γ_{1375} 525.1 4 ($t_{1/2}$ 20.7 5 2) γ_{1100} 798.6 5 ($t_{1/2}$ 7.3 5) γ_{977} 923.0 5 ($t_{1/2}$ 35.2 10)
- γ_{852} 1047.6 5 ($t_{1/2}$ 10.4 5) γ_{835} 1064.7 5 ($t_{1/2}$ 14.5 5) γ_{615} 1284.7 5 ($t_{1/2}$ 100 2)
- 1976.5 15, (19/2⁻) γ_{1682} 295.0 3 ($t_{1/2}$ 86 4) Q γ_{1189} 788 1 ($t_{1/2}$ 100 15) Q
- 1987.7 9, (9/2,11/2) γ_{1789} 199.0 5 γ_{788} 1189.9 5 ($t_{1/2}$ 100 3)
- 2072, (19/2⁻) γ_{1189} 883
- B 2222.5 16, (19/2⁺) γ_{1894} 328.1 3 ($t_{1/2}$ 100) D
- 2370.2 10, γ_{1900} 470.7 3 ($t_{1/2}$ 100 1) M1,E2 γ_{1375} 994.7 5 ($t_{1/2}$ 11.5 10)
- 2433.3 10 γ_{1900} 533.8 4 ($t_{1/2}$ 100)
- B 2629.1 17, (23/2⁺) γ_{2223} 406.7 3 ($t_{1/2}$ 100) Q
- 2722.5 10 γ_{2370} 352.3 3 ($t_{1/2}$ 100 3) M1,E2 γ_{1888} 735.0 5 ($t_{1/2}$ 27 1)
- γ_{1900} 821.7 5 ($t_{1/2}$ 60 3)
- 2803.9 10 γ_{2433} 370.6 3 ($t_{1/2}$ 100 1) M1,E2 γ_{2370} 434.0 3 ($t_{1/2}$ 22.9 12)
- γ_{1511} 1293.5 5 ($t_{1/2}$ 36 1)
- 2818.8 17, (21/2⁻) γ_{1894} 924.5 ($t_{1/2}$ 100)
- 3081, (23/2⁻) γ_{2072} 1009
- B 3555, (27/2⁺) γ_{2629} 924.5 1 ($t_{1/2}$ 100) Q
- B 4043, (25/2⁺) γ_{2629} 1412 1 ($t_{1/2}$ 100)
- C 4885, J=(29/2⁺) γ_{4043} 842.6 5 ($t_{1/2}$ 0.03 2) γ_{3555} 1330.4 5 ($t_{1/2}$ 0.06 2)
- B 4925, (29/2⁺) γ_{3555} 1370.0 5 ($t_{1/2}$ 100)
- B 4939, (29/2⁺) γ_{3555} 1383.9 5 ($t_{1/2}$ 100)
- C 5520, J+2 γ_{4839} 581.2 4 ($t_{1/2}$ 0.05 3) γ_{4925} 595.1 4 ($t_{1/2}$ 0.05 2) γ_{4885} 634.7 3 ($t_{1/2}$ 0.54 2) Q $I^{(1)}=50.3$, $I^{(2)}=91.3$, $\eta\omega=0.328$

- C 6199, J+4 γ_{5520} 678.5 3 ($t_{1/2}$ 1.09 4) Q $I^{(1)}=52.1$, $I^{(2)}=63.4$, $\eta\omega=0.355$
- C 6941, J+6 γ_{6199} 741.6 3 ($t_{1/2}$ 1.00) Q $I^{(1)}=53.1$, $I^{(2)}=65.8$, $\eta\omega=0.386$
- C 7744, J+8 γ_{6941} 802.4 4 ($t_{1/2}$ 0.99 4) Q $I^{(1)}=54.1$, $I^{(2)}=67.1$, $\eta\omega=0.416$
- C 8606, J+10 γ_{7744} 862 ($t_{1/2}$ 1.00 10) $I^{(1)}=55.0$, $I^{(2)}=67.8$, $\eta\omega=0.446$
- C 9527, J+12 γ_{606} 921 ($t_{1/2}$ 0.90 10) $I^{(1)}=55.6$, $I^{(2)}=62.5$, $\eta\omega=0.476$
- C 10512, J+14 γ_{9527} 985 ($t_{1/2}$ 0.75 8) $I^{(1)}=56.0$, $I^{(2)}=61.5$, $\eta\omega=0.509$
- C 11562, J+16 γ_{10512} 1050 ($t_{1/2}$ 0.63 8) $I^{(1)}=56.3$, $I^{(2)}=59.7$, $\eta\omega=0.542$
- C 12679, J+18 γ_{11562} 1117 ($t_{1/2}$ 0.45 5) $I^{(1)}=56.6$, $I^{(2)}=64.5$, $\eta\omega=0.574$
- C 13858, J+20 γ_{12679} 1179 ($t_{1/2}$ 0.37 5) $I^{(1)}=57.1$, $I^{(2)}=66.7$, $\eta\omega=0.604$
- C 15097, J+22 γ_{13858} 1239 ($t_{1/2}$ 0.25 5) $I^{(1)}=57.5$, $I^{(2)}=67.8$, $\eta\omega=0.634$
- C 16395, J+24 γ_{15097} 1298 ($t_{1/2}$ 0.20 5) $I^{(1)}=57.9$, $I^{(2)}=63.5$, $\eta\omega=0.665$
- C 17756, J+26 γ_{16395} 1361 ($t_{1/2}$ 0.15 5) $I^{(1)}=58.0$, $I^{(2)}=57.1$, $\eta\omega=0.698$
- C 19187, J+28 γ_{17756} 1431 ($t_{1/2}$ 0.10 3)

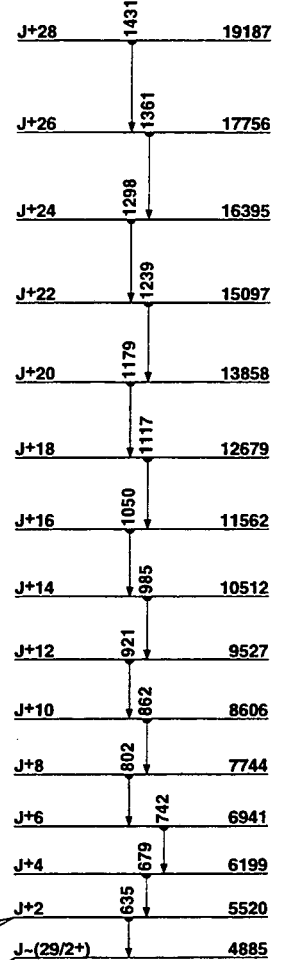

SD band (87Wa18,92Mu09)

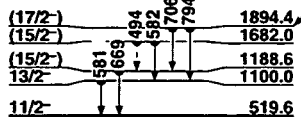

¹³⁷Nd
⁶⁰Nd

¹⁴²Sm
₆₂Sm

Δ: -78987 15 S_n: 11115 19 S_p: 5790 30 Q_{EC}: 2100 50 Q_α: (620)

Nuclear Bands

A SD-1 band (95Ha29,93Ha03)

B SD-2 band (95Ha29)

Levels and γ-ray branchings:

0.0, 0⁺, 72.49 5 m, %EC+%β⁺=100
 768.0 2, 2⁺ γ₀ 768.0 2 (†_γ100) E2
 1450.2 8, (0⁺) γ₇₆₈ 682.2 7 (†_γ100)
 1572 6
 1657.7 3, (2⁺) γ₇₆₈ 889.6 3 (†_γ100 9) γ₀ 1658.1 5 (†_γ98 23)
 1784.1 3, 3⁻ γ₇₆₈ 1016.1 2 (†_γ100) (E1)
 1791.2 3, 4⁺ γ₇₆₈ 1023.3 2 (†_γ100) E2
 2055.4 4, 2⁺ γ₇₆₈ 1287.4 3 (†_γ100 9) γ₀ 2055.5 10 (†_γ37 5)
 2173.2 5, 0⁺ γ₇₆₈ 1405.2 4 (†_γ100)
 2280 3, 0⁺
 2347.7 3, 5⁻ γ₁₇₉₁ 556.6 2 (†_γ100 3) E1 γ₁₇₈₄ 563.7 2 (†_γ9.6 5) E2, (M1)
 2371.8 4, 7⁻, 170.2 ns, μ=+0.06, Q=+1.12 27 γ₂₃₄₈ 24.1 3 (†_γ95.0) E2
 γ₁₇₉₁ 580.7 4 (?) (†_γ95=0.5)
 2415.9 1, (4) γ₁₇₈₄ 631.8
 2420.0 3, 6⁺, <2 ns γ₁₇₉₁ 628.7 2 (†_γ100)
 2497 2
 2582 2, 4⁺
 2656 2
 2747 6, (2⁺)
 2867 1, 4⁺
 2911.8 4, 7⁻ γ₂₄₂₀ 491.8 γ₂₃₇₂ 540.0 21 (†_γ00) M1
 2955 2, 4⁺
 3002.9 1, (6⁺) γ₁₇₉₁ 1211.7 (†_γ100)
 3007 5
 3052 3
 3112.9 4, 8⁻ γ₂₉₁₂ 200.9 5 (†_γ65 12) E2, M1 γ₂₃₇₂ 741.2 2 (†_γ100 12)
 3118 4
 3182 1
 3219.8 5 (?) γ₂₃₇₂ 848.0 3 (†_γ100)
 3245 4
 3326.1 4, 8⁺ γ₂₄₂₀ 906.4 3 (†_γ86 21) γ₂₃₇₂ 954.3 2 (†_γ100 14)
 3386.6 5, 9⁻ γ₃₁₁₃ 273.8 5 (†_γ100 17) E2, M1 γ₂₉₁₂ 474.4 5 (†_γ63 8)
 3570.8 4 γ₂₄₂₀ 1151.0 3 (†_γ90 18) γ₂₃₇₂ 1198.8 3 (†_γ100 26)
 3639.7 1, 11⁻ γ₃₃₈₇ 253.1 (†_γ100)
 3661.9 7, 10⁺, 480 60 ns γ₃₃₈₇ 275.1 γ₃₃₂₆ 336.0 γ₂₃₇₂ 1290.3
 3713.7 4 γ₂₃₇₂ 1341.9 2 (†_γ100)
 3798.6 4 γ₂₉₁₂ 886.7 2 (†_γ88 9) γ₂₃₇₂ 1426.8 3 (†_γ100 19)
 3825.7 8, 10⁺ γ₃₆₆₂ 163.9 γ₃₃₈₇ 438.9 (†_γ100)
 3974.4 8, 10⁻ γ₃₃₈₇ 587.7 γ₃₁₁₃ 861.6
 4072.1 4, (7⁻) γ₂₄₂₀ 1652.1 3 (†_γ35 7) γ₂₃₇₂ 1700.1 3 (†_γ100 8)
 γ₂₃₄₈ 1724.5 4 (†_γ14 5)
 4210.4 5 γ₂₃₇₂ 1838.6 3 (†_γ100 11)
 4293.8 9, 11⁻ γ₃₉₇₄ 319.4 γ₃₃₈₇ 907.2
 4309.1 4, (7⁻) γ₃₃₂₆ 982.0 5 (†_γ47 10) γ₂₄₂₀ 1889.0 4 (†_γ29 6)
 γ₂₃₇₂ 1937.6 3 (†_γ100 12)
 4371.6 1, 11⁻ γ₃₉₇₄ 397.1 γ₃₃₈₇ 985
 4541.3 1, 11⁺ γ₃₈₂₆ 715.6
 4546.7 1, 13⁻, 2.6 6 ns γ₄₃₇₂ 175.1 γ₄₂₈₄ 252.9
 4630.3 4 γ₂₃₇₂ 2258.4 2 (†_γ100 9)
 4745.7 1, 12⁺ γ₃₈₂₆ 920.0 (†_γ100)
 4970.1, (11⁺) γ₃₆₆₂ 1308.4
 5048.1, 12 γ₄₉₇₀ 78.1 γ₄₇₄₆ 302.5 γ₄₅₄₁ 506.7
 5133.5, 13 γ₅₀₄₈ 85.5 γ₄₇₄₆ 387.7
 5223.9, 14 γ₅₁₃₄ 90.5 γ₄₅₄₁ 677.1
 5417.7, 15 γ₅₂₂₄ 193.8 (†_γ100)
 5763.6, 16 γ₅₄₁₈ 345.7 (†_γ100)
 5802.9, 16 γ₅₄₁₈ 385.2
 6089.8 γ₅₈₀₃ 286.9

A x, J=(25)
 A 677.6+x, J+2 γ_x 677.6 6 (?) (†_γ0.30 17) I⁽¹⁾=76.2, I⁽²⁾=64.8, ηω=0.354
 A 1416.9+x, J+4 γ_{678+x} 739.3 1 (†_γ0.84 19) I⁽¹⁾=75.4, I⁽²⁾=67.2, ηω=0.385
 A 2215.7+x, J+6 γ_{1417+x} 798.8 1 (†_γ0.85 5) I⁽¹⁾=74.8, I⁽²⁾=66.1, ηω=0.415
 A 3075.0+x, J+8 γ_{2216+x} 859.3 1 (†_γ1.09 6) I⁽¹⁾=74.2, I⁽²⁾=66.6, ηω=0.445
 A 3994.4+x, J+10 γ_{3075+x} 919.4 1 (†_γ1.02 9) I⁽¹⁾=73.7, I⁽²⁾=65.9, ηω=0.475
 A 4974.5+x, J+12 γ_{3994+x} 980.1 1 (†_γ0.95 5) I⁽¹⁾=73.2, I⁽²⁾=66.2, ηω=0.505
 A 6015.0+x, J+14 γ_{4975+x} 1040.5 1 (†_γ1.11 6) I⁽¹⁾=72.8, I⁽²⁾=65.9, ηω=0.535
 A 7116.2+x, J+16 γ_{6015+x} 1101.2 1 (†_γ0.93 5) I⁽¹⁾=72.5, I⁽²⁾=65.4, ηω=0.566
 A 8278.6+x, J+18 γ_{7116+x} 1162.4 1 (†_γ0.94 5) I⁽¹⁾=72.1, I⁽²⁾=65.1, ηω=0.597
 A 9502.4+x, J+20 γ_{8279+x} 1223.8 1 (†_γ1.06 6) I⁽¹⁾=71.7, I⁽²⁾=64.8, ηω=0.627
 A 10787.9+x, J+22 γ_{9502+x} 1285.5 1 (†_γ0.82 5) I⁽¹⁾=71.4, I⁽²⁾=63.8,
 ηω=0.658
 A 12136.1+x, J+24 γ_{10788+x} 1348.2 1 (†_γ0.66 4) I⁽¹⁾=71.0, I⁽²⁾=64.1,
 ηω=0.690
 A 13546.7+x, J+26 γ_{12136+x} 1410.6 2 (†_γ0.58 4) I⁽¹⁾=70.7, I⁽²⁾=63.0,
 ηω=0.721
 A 15020.8+x, J+28 γ_{13547+x} 1474.1 2 (†_γ0.52 4) I⁽¹⁾=70.4, I⁽²⁾=62.4,
 ηω=0.753
 A 16559.0+x, J+30 γ_{15021+x} 1538.2 2 (†_γ0.31 3) I⁽¹⁾=70.0, I⁽²⁾=62.2,
 ηω=0.785
 A 18161.5+x, J+32 γ_{16559+x} 1602.5 3 (†_γ0.21 3) I⁽¹⁾=69.7, I⁽²⁾=60.2,
 ηω=0.818
 A 19830.4+x, J+34 γ_{18162+x} 1668.9 5 (†_γ0.12 2) I⁽¹⁾=69.4, I⁽²⁾=63.4,
 ηω=0.850
 A 21562.4+x, J+36 γ_{19830+x} 1732.0 9 (?) (†_γ0.06 2) I⁽¹⁾=69.4, I⁽²⁾=78.6,
 ηω=0.879
 A 23345.3+x, J+38 γ_{21562+x} 1782.9 14 (?) (†_γ0.04 2)
 B γ, J
 B 725.5+y, J+2 γ_y 725.5 6 (?) (†_γ0.08 3) I⁽²⁾=66.2, ηω=0.378
 B 1511.4+y, J+4 γ_{726+y} 785.9 5 (†_γ0.18 3) I⁽²⁾=69.7, ηω=0.407
 B 2354.7+y, J+6 γ_{1511+y} 843.3 5 (†_γ0.19 3) I⁽²⁾=69.9, ηω=0.436
 B 3255.2+y, J+8 γ_{2355+y} 900.5 4 (†_γ0.16 3) I⁽²⁾=69.0, ηω=0.465
 B 4213.7+y, J+10 γ_{3255+y} 958.5 5 (†_γ0.17 3) I⁽²⁾=76.9, ηω=0.492
 B 5224.2+y, J+12 γ_{4214+y} 1010.5 6 (†_γ0.16 3) I⁽²⁾=64.1, ηω=0.521
 B 6297.1+y, J+14 γ_{5224+y} 1072.9 5 (†_γ0.18 3) I⁽²⁾=71.0, ηω=0.551
 B 7426.3+y, J+16 γ_{6297+y} 1129.2 4 (†_γ0.25 6) I⁽²⁾=69.8, ηω=0.579
 B 8612.8+y, J+18 γ_{7426+y} 1186.5 9 (†_γ0.16 3) I⁽²⁾=69.8, ηω=0.608
 B 9856.6+y, J+20 γ_{8613+y} 1243.8 7 (†_γ0.13 3) I⁽²⁾=69.2, ηω=0.636
 B 11158.2+y, J+22 γ_{9857+y} 1301.6 7 (†_γ0.12 3) I⁽²⁾=69.3, ηω=0.665
 B 12517.5+y, J+24 γ_{11158+y} 1359.3 8 (†_γ0.08 3) I⁽²⁾=65.3, ηω=0.695
 B 13938.1+y, J+26 γ_{12518+y} 1420.6 18 (†_γ0.07 5) I⁽²⁾=73.7, ηω=0.724
 B 15413.0+y, J+28 γ_{13938+y} 1474.9 7 (†_γ0.08 2) I⁽²⁾=66.6, ηω=0.752
 B 16948.0+y, J+30 γ_{15413+y} 1535.0 11 (†_γ0.06 2) I⁽²⁾=75.5, ηω=0.781
 B 18536.0+y (?) , J+32 γ_{16948+y} 1588.0 15 (?) (†_γ0.04 2)

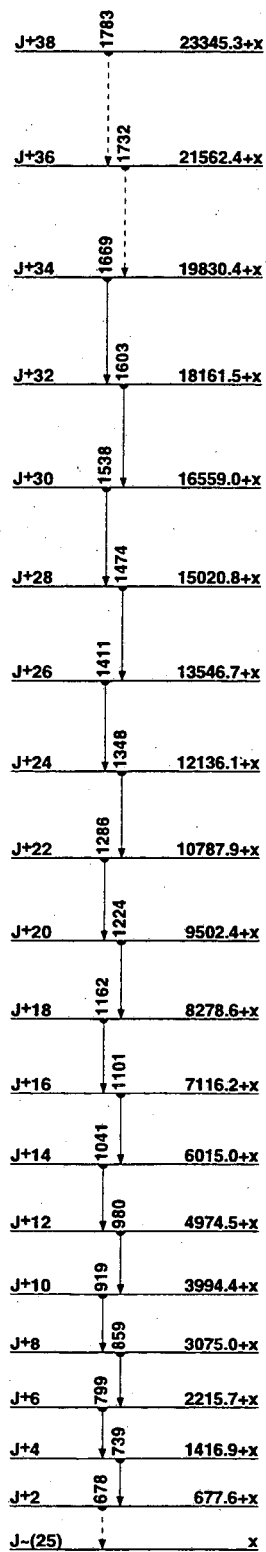

SD-1 band
(95Ha29,93Ha03)

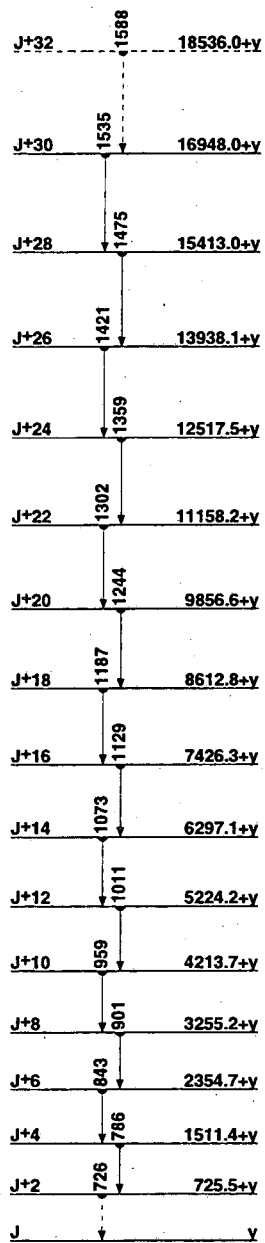

SD-2 band
(95Ha29)

¹⁴²₆₂Sm

¹⁴²₆₃Eu

Δ : -71630 100 S_n : 9300 140 S_p : 2970 100 Q_{EC} : 7360 90 Q_α : (1100)

Nuclear Bands

A SD band (95Mu11)

Levels and γ -ray branchings:

- 0, 1⁺, 2.4 2 s, %EC+% β^+ =100, μ =+1.536 19, Q =+0.12 5
- 178.75 6(?), (2)⁻ γ_0 178.90 5 (\dagger ,100) E1
- 280.29 5, 1⁺, 2⁺ γ_{178} 101.42 (\dagger , 2.5 4) γ_0 280.33 5 (\dagger ,100 2) E2+M1
- 284.44 4, 0⁺, 1⁺, 2⁺ γ_0 284.44 5 (\dagger ,100) M1
- 496.66 7 γ_{284} 212.22 6 (\dagger ,100) γ_{280} 216 1
- 503.04 5, 1⁺, 2⁺, 3⁺ γ_{280} 222.80 5 (\dagger ,100 4) M1+E2 γ_0 503.0 1 (\dagger , 44 11)
- 526.25 5, ⁺ γ_{284} 241.72 (\dagger , 2.9 7) M1 γ_{178} 347.64 7 (\dagger , 7.5 12) γ_0 526.19 5 (\dagger ,100 3) E2
- 550.6 2, ⁺ γ_0 550.62 (\dagger ,100) E2
- 585.72 7 γ_{178} 406.98 6 (\dagger ,100 8) γ_0 585.71 14 (\dagger , 98 13)
- 591.35 5 γ_{284} 306.93 5 (\dagger , 73 5) γ_0 591.30 6 (\dagger ,100 7)
- 614.49 5 γ_{284} 329.92 (\dagger , 50 21) γ_{280} 334.02 (\dagger , 12 9) γ_0 614.51 5 (\dagger ,100 6) E2
- 619.75 5 γ_{284} 336 1 γ_0 619.74 5 (\dagger ,100)
- 631.71 1 γ_{526} 105 1 γ_{487} 136 1 γ_0 631.70 8 (\dagger ,100)
- 660.83 8 γ_{178} 482.0 1 (\dagger , 61 9) γ_0 660.9 1 (\dagger ,100 13)
- 705.0 2 γ_0 704.92 (\dagger ,100)
- 731.9 2 γ_{503} 228.7 3 (\dagger , 80 70) γ_{284} 447.5 3 (\dagger ,100 20)
- 751.0 2 γ_{503} 247.82 (\dagger , 67) γ_{284} 466.62 γ_{280} 470.7 3 γ_{178} 572.14 (\dagger ,100)
- 935.7 1 γ_{732} 203.8 3 (\dagger , 19 4) γ_{284} 651.3 1 (\dagger , 66 9) γ_0 935.6 1 (\dagger ,100 12)
- 1210.2 3 γ_{836} 274.3 4 γ_{614} 595.9 3 (\dagger ,100)
- 1412.8 1 γ_{551} 861.8 2 (\dagger , 2.4 17) γ_{526} 886.3 2 (\dagger , 13 6) γ_{503} 910.0 1 (\dagger , 11 2) γ_{280} 1132.2 3 (\dagger , 8 2) γ_{178} 1233.9 1 (\dagger , 68 4) γ_0 1412.4 2 (\dagger ,100 7)
- 1437.8 1 γ_{614} 823 1 γ_{586} 852.5 4 (\dagger , 3.4 8) γ_{526} 912.0 2 (\dagger , 7.6 16) γ_{284} 1153.1 1 (\dagger , 5.6 14) γ_{178} 1259.60 5 (\dagger ,100 4) γ_0 1438.4 2 (\dagger , 30 10)
- 1481 1 γ_{178} 1302 1 (\dagger ,100)
- 1486 1 γ_{178} 1307 1 (\dagger ,100)
- 1778.95 8 γ_{705} 1073.6 4 γ_{520} 1158 1 γ_{531} 1187.5 3 (\dagger , 8 3) γ_{503} 1275.4 2 (\dagger , 32 3) γ_{284} 1495.0 2 (\dagger , 27 7) γ_{178} 1599.7 2 (\dagger , 38 2) γ_0 1779.1 1 (\dagger ,100 10)
- 2160.0 4 γ_{178} 1981.2 4 (\dagger ,100)
- 0+x, 8⁻, 1.22 2 m, %EC+% β^+ =100, μ =+2.978 11, Q =+1.41 6
- 282+x, 8⁺, 6.2 4 ns γ_{0+x} 282 (\dagger ,100) E1
- 292+x, 9⁺ γ_{282+x} 10 γ_{0+x} 292
- 376+x, 10⁺ γ_{282+x} 84 (\dagger ,100) M1,E2
- 795+x, 11⁺ γ_{376+x} 419 (\dagger ,100)
- 1098+x, 12⁺ γ_{795+x} 303 γ_{376+x} 722
- 1397+x, (12⁺) γ_{795+x} 602 γ_{376+x} 1021
- 1667+x, 13⁺ γ_{1098+x} 569 (\dagger ,100)
- 1857+x, (14⁺) γ_{1397+x} 460 (\dagger ,100)
- 2044+x γ_{795+x} 1249 (\dagger ,100)
- 2129+x, 14⁺ γ_{1667+x} 462 γ_{1098+x} 1031
- 2287+x γ_{2129+x} 158
- 2389+x, (16⁺) γ_{1857+x} 532 (\dagger ,100)
- 2441+x γ_{2044+x} 397 γ_{1098+x} 1343
- 2483+x γ_{2044+x} 439 γ_{1098+x} 1385
- 2541+x γ_{2287+x} 254 (\dagger ,100)
- 2609+x γ_{2483+x} 126 γ_{2441+x} 168 γ_{1667+x} 942
- 2749+x γ_{2609+x} 140 γ_{2287+x} 462
- 2933+x γ_{2749+x} 184 (\dagger ,100)
- 3054+x γ_{2541+x} 513 (\dagger ,100)
- 3200+x, (18⁺) γ_{2389+x} 811 (\dagger ,100)
- 3327+x γ_{2833+x} 394 (\dagger ,100)
- 3431+x γ_{3054+x} 377 (\dagger ,100)
- 3545+x γ_{3327+x} 218 (\dagger ,100)
- 3716+x γ_{3431+x} 285 (\dagger ,100)
- 3971+x γ_{3545+x} 425 (\dagger ,100)
- 4107+x, (20⁺) γ_{3200+x} 907 (\dagger ,100)

4927+x, (22⁺) γ_{4107+x} 820 (\dagger ,100)

A γ , J=(27,29)

- A 699.7+y, J+2 γ_0 699.7 3 $I^{(1)}$ =79.4, $I^{(2)}$ =64.3, $\hbar\omega$ =0.365
- A 1461.6+y, J+4 γ_{700+y} 761.9 3 $I^{(1)}$ =78.2, $I^{(2)}$ =65.7, $\hbar\omega$ =0.396
- A 2284.4+y, J+6 γ_{1462+y} 822.8 3 $I^{(1)}$ =77.2, $I^{(2)}$ =63.0, $\hbar\omega$ =0.427
- A 3170.7+y, J+8 γ_{2284+y} 886.3 3 $I^{(1)}$ =76.4, $I^{(2)}$ =65.8, $\hbar\omega$ =0.458
- A 4117.8+y, J+10 γ_{3171+y} 947.1 3 $I^{(1)}$ =75.7, $I^{(2)}$ =65.4, $\hbar\omega$ =0.489
- A 5126.1+y, J+12 γ_{4118+y} 1008.3 3 $I^{(1)}$ =75.1, $I^{(2)}$ =65.5, $\hbar\omega$ =0.519
- A 6195.5+y, J+14 γ_{5126+y} 1069.4 3 $I^{(1)}$ =74.6, $I^{(2)}$ =66.7, $\hbar\omega$ =0.550
- A 7324.9+y, J+16 γ_{6196+y} 1129.4 4 $I^{(1)}$ =74.2, $I^{(2)}$ =69.3, $\hbar\omega$ =0.579
- A 8512.0+y, J+18 γ_{7325+y} 1187.1 6 $I^{(1)}$ =73.9, $I^{(2)}$ =65.8, $\hbar\omega$ =0.609
- A 9759.9+y, J+20 γ_{8512+y} 1247.9 6 $I^{(1)}$ =73.6, $I^{(2)}$ =66.7, $\hbar\omega$ =0.639
- A 11067.8+y, J+22 γ_{9760+y} 1307.9 10 $I^{(1)}$ =73.2, $I^{(2)}$ =66.3, $\hbar\omega$ =0.669
- A 12436.0+y, J+24 $\gamma_{11068+y}$ 1368.2 12 $I^{(1)}$ =72.9, $I^{(2)}$ =66.4, $\hbar\omega$ =0.699
- A 13864.4+y, J+26 $\gamma_{12436+y}$ 1428.4 18 $I^{(1)}$ =72.7, $I^{(2)}$ =68.5, $\hbar\omega$ =0.729
- A 15351.2+y, J+28 $\gamma_{13864+y}$ 1486.8 20 $I^{(1)}$ =72.5, $I^{(2)}$ =65.4, $\hbar\omega$ =0.759
- A 16899.2+y (?), J+30 $\gamma_{15351+y}$ 1548 (?)

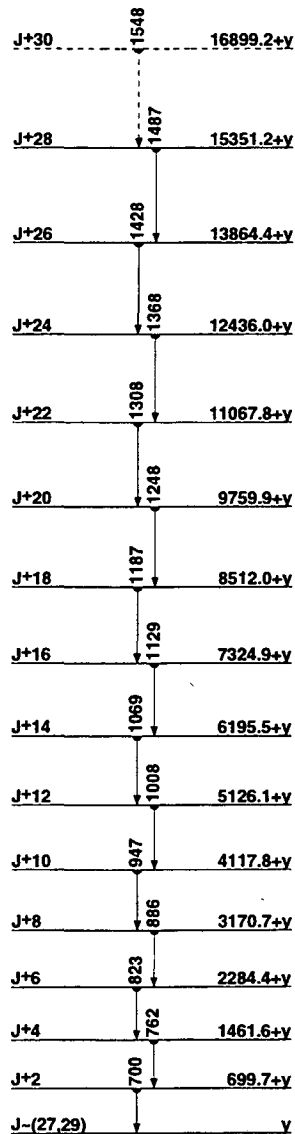

SD band
(95Mu11)
¹⁴²₆₃Eu

143
63Eu

Δ : -74360 40 S_n : 10800 100 S_p : 2660 40 Q_{EC} : 5170 40 Q_α : 740 60

Nuclear Bands

A SD band (93At01,91Mu08)

Levels and γ -ray branchings:

- 0, 5/2⁺, 2.63 s m, %EC+% β *=100
- 258.82 3, (3/2)⁺ γ_{258} 258.81 3 (†,100) (M1)
- 271.93 3, 7/2⁺ γ_{271} 271.94 3 (†,100) M1
- 389.51 4, 11/2⁻, 50.0 s μ s γ_{272} 117.57 5 (†,100 8) M2 γ_{389} 389.47 5 (†,53 4) E3
- 463.61 5, (1/2)⁺ γ_{259} 204.77 5 (†,100 7) M1,E2 γ_{463} 463.71 (†,51 4)
- 804.1 3 γ_{464} 340.5 3 (†,100)
- 812.90 10, (1/2,3/2)⁺ γ_{259} 554.1 3 (†,14 7) γ_{812} 812.9 1 (†,100 10)
- 906.94 6, 9/2⁺ γ_{906} 906.96 6 (†,100) E2
- 977.48 4, (9/2)⁻ γ_{390} 588.00 3 (†,100) M1+E2
- 1057.42 6, 11/2⁺ γ_{272} 785.56 6 (†,100) E2
- 1057.66 5, 13/2⁻ γ_{390} 668.10 3 (†,100) M1+E2: $\delta = -0.75^{+23}_{-73}$
- 1088.31 11 γ_{390} 698.8 1 (†,100)
- 1188.42 5, 11/2⁻ γ_{1057} 131.1 1 (†,3.5 6) γ_{977} 210.9 1 (†,10 1) M1 γ_{390} 798.89 6 (†,100 7) E2+M1
- 1213.94 10, 11/2⁻ γ_{390} 824.43 9 (†,100) E2+(M1)
- 1256.88 6, 11/2⁺ γ_{272} 984.93 5 (†,100) E2
- 1306.10 6, 15/2⁻ γ_{1058} 248.4 1 (†,67 9) D γ_{390} 916.53 5 (†,100 17) E2
- 1331.24 11, 11/2⁺ γ_{272} 1059.3 1 (†,100) Q
- 1405.58 21 γ_{977} 428.1 2 (†,100)
- 1497.74 20 γ_{907} 590.8 2 (†,100 50) γ_{272} 1225.8 5 (†,75 25)
- 1543.0 4 (?), (1/2,3/2)⁺ γ_{259} 1284.2 4 (†,100)
- 1565.24 21 γ_{272} 1293.3 2 (†,100)
- 1602.62 7 γ_{1057} 545.3 1 (†,50 7) γ_{977} 625.23 8 (†,100 7) γ_{390} 1213.1 3 (†,47 7)
- 1676.50 8 γ_{272} 1404.56 7 (†,100)
- 1723.6 4 (?), (1/2,3/2)⁺ γ_{259} 1464.8 4 (†,100)
- 1754.23 8 γ_{1257} 497.3 1 (†,70 10) γ_{977} 776.8 1 (†,100 10) M1
- 1761.74 21 γ_{272} 1489.8 2 (†,100)
- 1892.45 8, (15/2)⁻ γ_{1058} 834.3 1 (†,47 4) γ_{390} 1503.4 1 (†,100 7)
- 1903.62 15 γ_{1058} 845.5 2 (†,46 15) γ_{977} 926.6 2 (†,100 14)
- 1908.08 10, (15/2)⁻ γ_{1306} 601.7 2 (†,100 9) γ_{1058} 850.5 1 (†,24 4)
- 1970.6 3 γ_{977} 993.1 3 (†,100)
- 2018.72 5, (9/2)⁻ γ_{1188} 830.1 1 (†,18 2) γ_{977} 1041.35 5 (†,100 8) γ_{390} 1629.3 1 (†,64 6) γ_{272} 1746.4 1 (†,25 3)
- 2065.07 6, (9/2)⁻ γ_{977} 1087.3 1 (†,29 6) γ_{907} 1158.2 1 (†,21 3) γ_{390} 1675.9 3 (†,18 3) γ_{272} 1793.21 7 (†,100 6)
- 2092.15 7 γ_{390} 1702.5 1 (†,36 3) γ_{272} 1820.27 7 (†,100 8)
- 2116.83 10, 17/2⁻ γ_{1908} 208.5 γ_{1306} 810.4 2 γ_{1058} 1059.3 1 Q
- 2121.26 11, (15/2)⁺ γ_{1058} 1063.6 1 (†,100) Q
- 2196.69 5, (11/2)⁻ γ_{1892} 304.2 2 (†,13 1) M1+E2 γ_{1603} 594.3 1 (†,7.6 7) γ_{1306} 890.52 9 (†,43 4) γ_{1188} 1008.28 5 (†,18 2) M1 γ_{1058} 1138.9 1 (†,11 1) γ_{977} 1219.21 7 (†,54 4) γ_{390} 1807.14 7 (†,100 3) Q+D
- 2209.3 3 γ_{977} 1231.8 3 (†,100)
- 2254.33 12 γ_{1057} 1196.9 1 (†,100 8) γ_{977} 1276.9 5 (†,28 9)
- 2275.58 10 γ_{1188} 1087.3 1 (†,100 20) γ_{977} 1297.6 2 (†,42 7) γ_{390} 1886.0 2 (†,90 10)
- 2318.4 9, (19/2)⁻ γ_{1306} 1012.4 (†,100)
- 2329.58 20, (17/2)⁻ γ_{1058} 1271.9 2 (†,100) Q
- 2331.89 21 γ_{977} 1354.4 2 (†,100)
- 2351.12 10 γ_{1188} 1162.8 2 (†,100 8) γ_{977} 1373.6 1 (†,69 8)
- 2357.84 14 γ_{1214} 1143.9 1 (†,100)
- 2378.31 12, 19/2⁻ γ_{1306} 1072.2 1 (†,100) E2
- 2417.6 6 γ_{1088} 1329.3 5 (†,100)
- 2457.46 11, 17/2⁻ γ_{1908} 550.5 γ_{1306} 1151.3 1 M1+E2: $\delta = -4.16^{+43}_{-54}$
- 2474.1 10, 21/2^(*), 5.8 15 ns γ_{2318} 155.7 (†,100) (E1)
- 2559.46 22, 19/2⁻ γ_{2457} 101.6 3 (†,22 1) M1(+E2): $\delta = +0.09^{14}$ γ_{2330} 229.6 γ_{2117} 443.0 3 (†,100 4) D(+Q): $\delta = +0.00 5$

- 2600.63 12 γ_{1214} 1386.69 7 (†,100)
- 2610.8 5 γ_{977} 1633.3 6 (†,33 17) γ_{272} 2338.9 8 (†,100 33)
- 2612.1 8, 21/2^(*) γ_{2474} 138.1 γ_{2378} 233.4
- 2630.4 6, 21/2⁻ γ_{2559} 70.4 M1 γ_{2378} 251.6 γ_{2117} 514.9
- 2812.0 9, 23/2⁻ γ_{2630} 181.9 M1 γ_{2612} 199.5
- 3112.2 4, 21/2 γ_{2559} 552.7 3 (†,100) D(+Q): $\delta = -0.13^{+10}_{-11}$
- 3294.3 5, (23/2) γ_{3112} 182.1 3 (†,100) (D)
- 3343.8 12, 25/2 γ_{2812} 531.8 (†,100)
- 3364.6 10, 25/2 γ_{2812} 552.7 3 (†,100) D(+Q): $\delta = -0.13^{+10}_{-11}$
- 3470.0 6 (?), (25/2) γ_{3284} 175.7 3 (†,100)
- 3629.3 12 (?), (27/2) γ_{3470} 159.3 (†,100) D
- 3749.4 12, 27/2 γ_{3365} 384.8 γ_{3344} 405.6
- 4319.0 12, 29/2 γ_{3749} 569.5 γ_{3365} 954.4 γ_{3344} 975.1
- 4494.6 16 (?), 31/2 γ_{4319} 175.6 (†,100) D(+Q): $\delta = -0.02^{10}$
- 4653.9 16, 33/2 γ_{4485} 159.3 3 (†,100) D(+Q): $\delta = +0.00^{+9}_{-9}$
- 4947.3 19, 35/2 γ_{4654} 293.4 (†,100)
- A x, J=(37/2)
- A 483.7+x, J+2 γ_x 483.7 4 (†,0.29 3) $I^{(1)}=79.6, I^{(2)}=63.7, \eta\omega=0.258$
- A 1030.2+x, J+4 γ_{484+x} 546.5 4 (†,0.71 4) $I^{(1)}=77.9, I^{(2)}=63.7, \eta\omega=0.289$
- A 1639.5+x, J+6 γ_{1030+x} 609.3 2 (†,1.01 7) $I^{(1)}=76.5, I^{(2)}=64.1, \eta\omega=0.320$
- A 2311.5+x, J+8 γ_{1640+x} 671.7 2 (†,0.88 6) $I^{(1)}=75.5, I^{(2)}=65.4, \eta\omega=0.351$
- A 3044.1+x, J+10 γ_{2312+x} 732.9 2 (†,1.00 7) $I^{(1)}=74.7, I^{(2)}=65.6, \eta\omega=0.382$
- A 3838.0+x, J+12 γ_{3044+x} 793.9 2 (†,0.95 6) $I^{(1)}=74.0, I^{(2)}=66.4, \eta\omega=0.412$
- A 4692.1+x, J+14 γ_{3838+x} 854.1 2 (†,1.02 6) $I^{(1)}=73.6, I^{(2)}=67.6, \eta\omega=0.442$
- A 5605.4+x, J+16 γ_{4692+x} 913.3 2 (†,0.98 8) $I^{(1)}=73.2, I^{(2)}=67.1, \eta\omega=0.472$
- A 6578.3+x, J+18 γ_{5605+x} 972.9 2 (†,1.04 8) $I^{(1)}=72.8, I^{(2)}=67.9, \eta\omega=0.501$
- A 7610.1+x, J+20 γ_{6578+x} 1031.8 2 (†,1.03 7) $I^{(1)}=72.6, I^{(2)}=67.9, \eta\omega=0.531$
- A 8700.8+x, J+22 γ_{7610+x} 1090.7 2 (†,0.95 6) $I^{(1)}=72.3, I^{(2)}=69.1, \eta\omega=0.560$
- A 9849.4+x, J+24 γ_{8701+x} 1148.6 4 (†,0.75 11) $I^{(1)}=72.2, I^{(2)}=67.8, \eta\omega=0.589$
- A 11057.0+x, J+26 γ_{9849+x} 1207.6 4 (†,0.65 10) $I^{(1)}=72.0, I^{(2)}=68.5, \eta\omega=0.618$
- A 12323.0+x, J+28 $\gamma_{11057+x}$ 1266.0 4 (†,0.58 11) $I^{(1)}=71.8, I^{(2)}=67.8, \eta\omega=0.648$
- A 13648.0+x, J+30 $\gamma_{12323+x}$ 1325.0 4 (†,0.50 10) $I^{(1)}=71.6, I^{(2)}=67.5, \eta\omega=0.677$
- A 15032.3+x, J+32 $\gamma_{13648+x}$ 1384.3 6 (†,0.29 9) $I^{(1)}=71.4, I^{(2)}=67.2, \eta\omega=0.707$
- A 16476.1+x, J+34 $\gamma_{15032+x}$ 1443.8 10 (†,0.20 10) $I^{(1)}=71.3, I^{(2)}=67.5, \eta\omega=0.737$
- A 17979.2+x, J+36 $\gamma_{16476+x}$ 1503.1 10 (†,0.12 7) $I^{(1)}=71.1, I^{(2)}=66.2, \eta\omega=0.767$
- A 19542.7+x, J+38 $\gamma_{17979+x}$ 1563.5 10 (†,0.09 6) $I^{(1)}=70.9, I^{(2)}=67.2, \eta\omega=0.797$
- A 21165.7+x, J+40 $\gamma_{19543+x}$ 1623 2 $I^{(1)}=70.8, I^{(2)}=65.6, \eta\omega=0.827$
- A 22849.7+x, J+42 $\gamma_{21166+x}$ 1684 2 $I^{(1)}=70.6, I^{(2)}=67.8, \eta\omega=0.857$
- A 24592.7+x, J+44 $\gamma_{22850+x}$ 1743 2

J+44	1743	24592.7+x
J+42	1684	22849.7+x
J+40	1623	21165.7+x
J+38	1564	19542.7+x
J+36	1503	17979.2+x
J+34	1444	16476.1+x
J+32	1384	15032.3+x
J+30	1325	13648.0+x
J+28	1266	12323.0+x
J+26	1208	11057.0+x
J+24	1149	9849.4+x
J+22	1091	8700.8+x
J+20	1032	7610.1+x
J+18	973	6578.3+x
J+16	913	5605.4+x
J+14	854	4692.1+x
J+12	794	3838.0+x
J+10	733	3044.1+x
J+8	672	2311.5+x
J+6	609	1639.5+x
J+4	547	1030.2+x
J+2	484	483.7+x
J-(37/2)		x

SD band
(93At01,91Mu08)

¹⁴³₆₃Eu

144
63Eu

Δ : -75647 21 S_n : 9360 40 S_p : 3409 21 Q_{EC} : 6329 21 Q_α : 320 50

Nuclear Bands

- A SD-1 band (94MuAA,93Mu16)
- B SD-2 band (94MuAA)
- C SD-3 band (94MuAA)

Levels and γ -ray branchings:

0, 1⁺, 10.2 1 s, %EC+% β ⁺=100, μ =1.893 13, Q=0.10 3

333.1 4, (2)⁺ γ_{333} 333.3 2 (t_y100) M1

347.4 4, (3)⁺ γ_{333} 13.8 γ_{347} 347.1 2 (t_y100) E2

580.6 4, (4)⁺ γ_{347} 233.3 2 (t_y100.5) M1 γ_{333} 247.5 5 (t_y7.5 35) M1,E2

604.4 7, (3)⁺ γ_{347} 257.3 (t_y37.0) γ_{333} 271.1 (t_y100) M1,(E2)

621.5 5, (2,3)⁺ γ_{347} 274.4 (t_y51.2) γ_{333} 288.2 (t_y13.0) $\gamma_{621.5}$ (t_y100) E2,(M1)

629.6 5, (2)⁻ γ_{347} 282.4 (t_y4.3) M1 $\gamma_{629.5}$ (t_y100) E1

762.9 4, (5)⁺ γ_{581} 182.4 2 (t_y100 18) M1,E2 γ_{347} 415.3 3 (t_y68 27) E2

784.0 7, (2)⁺ γ_{581} 203.6 (t_y4.2) M1 γ_{333} 450.7 (t_y100) M1,E2

887.7 4, (5)⁻ γ_{763} 124.8 2 (t_y2.9 6) γ_{581} 307.0 2 (t_y100.5) E1

894.7 9, (4)⁺ γ_{604} 290.2 (t_y100) M1,E2 γ_{581} 314.1 (t_y46.4)

908.0 6 γ_{347} 560.8 (t_y48.4) $\gamma_{907.9}$ (t_y100)

926.3 5, (6)⁻, 28 2 ns γ_{888} 38.7 3 (t_y100 63) (M1+E2) γ_{763} 163.1 5 (t_y38 25)

974.8 5 γ_{622} 353.3 γ_{333} 641.5 (t_y100) $\gamma_{974.8}$ (t_y42.3)

1048.8 11, (4)⁻ γ_{926} 122.5 (t_y100)

1074.1 8 γ_{333} 740.9 (t_y100)

1120.4 6, (7)⁻ γ_{926} 194.1 4 (t_y100) M1

1127.9 7, (8)⁻, 1.0 1 μ s γ_{1120} 7.5 (t_y64 21) γ_{926} 201.6 5 (t_y100) E2

1145.6 6 γ_{784} 361.6 (t_y13.8) γ_{604} 541.2 (t_y55.2) γ_{333} 812.3 (t_y100) $\gamma_{1145.6}$ (t_y89.7)

1194.4 6, (6,7)⁻ γ_{926} 268.1 3 (t_y100) M1,E2

1201.4 6 γ_{622} 579.9 (t_y21.2) γ_{333} 868.1 (t_y100) $\gamma_{1201.4}$ (t_y20)

1293.5 5 γ_{908} 385.6 γ_{630} 664.0 (t_y35.3) γ_{333} 960.2 $\gamma_{1293.5}$ (t_y45.3)

1304.2 8 γ_{347} 956.9 (t_y100)

1338.2 7, (9)⁻, 5.0 5 ns γ_{1128} 210.3 3 (t_y100) M1

1402.3 7 γ_{347} 1055.1 (t_y100)

1559.8 7 γ_{333} 1226.6 (t_y100) $\gamma_{1559.9}$ (t_y53.7)

1669.5 7, (9)⁺ γ_{1338} 331.3 2 (t_y70 8) γ_{1128} 541.7 4 (t_y100 25) E1

1804.7 12 γ_{1201} 603.3 (t_y100)

1930.4 8 γ_{630} 1300.7 (t_y71.4) γ_{347} 1583.1 (t_y100)

2161.5 9, (10)⁺ γ_{1670} 492.0 5 (t_y100) M1

2362.1 7 γ_{347} 2015.0 (t_y19.0) γ_{333} 2028.8 (t_y9.2) $\gamma_{2362.1}$ (t_y100)

2432.6 4 γ_{1560} 872.7 (t_y3.3) γ_{1402} 1030.4 (t_y0.84) γ_{1304} 1128.6 (t_y6.6) γ_{1294} 1139.1 (t_y4.3) γ_{1201} 1231.2 (t_y14.8) γ_{1146} 1287.0 (t_y5.4) γ_{1074} 1358.4 (t_y1.7) γ_{975} 1457.8 (t_y10.6) γ_{908} 1524.7 (t_y3.6) γ_{630} 1803.1 (t_y12.5) $\gamma_{2432.6}$ (t_y100)

2692.7 7, (1)⁺ γ_{975} 1717.9 (t_y19.6) γ_{622} 2071.2 (t_y35.3) $\gamma_{2692.7}$ (t_y100)

2709.6 8 γ_{622} 2088.1 (t_y47.2) $\gamma_{2709.6}$ (t_y100)

2804.6 5, (1)⁺ γ_{1402} 1402.4 (t_y14.8) γ_{1284} 1511.1 (t_y13.8) γ_{975} 1829.8 (t_y27.6) γ_{622} 2183.1 (t_y26.2) γ_{347} 2457.5 (t_y11.4) γ_{333} 2471.3 (t_y100) $\gamma_{2804.6}$ (t_y7.6)

2827.9 7 γ_{630} 2198.4 (t_y100) γ_{333} 2494.6 (t_y85.1) $\gamma_{2827.9}$ (t_y61.7)

- A x, J
- B y, J
- C z, J

J _____ x	J _____ y	J _____ z
SD-1 band	SD-2 band	SD-3 band
(94MuAA,93Mu16)	(94MuAA)	(94MuAA)

144
63Eu

¹⁴⁴₆₄Gd

Δ :(-71910) S_n:(11600) S_p:(4840) Q_{EC}:(3740) Q_α:(1000)

Nuclear Bands

A SD band (94Lu03)

Levels and γ -ray branchings:

0, 0⁺, 4.5 1 m, %EC+% β *=100

743.0, 2⁺ γ_0 743.0 (†,100) E2

1702.3, (3⁻) γ_{743} 959.36 (†,100) (E1+M2); δ =+0.12 5

1744.6, (4⁺) γ_{743} 1001.6 (†,100)

1876.4, (2⁺) γ_{743} 1133.4 (†,75) γ_0 1876.4 (†,100)

1886.8, (0⁺) γ_{743} 1143.9 (†,100)

2223.5, (2⁺) γ_{743} 1483.5 (†,100) γ_0 2226.5 (†,80)

2302.7, (5⁻) γ_{1745} 558.0 (†,100) E1 γ_{1702} 600.3 (†,59.7)

2330.5, (4⁻) γ_{1702} 628.0 (†,100)

2354.3, (6⁺) γ_{1745} 609.7(?) (†,100)

2442.5, (5⁻) γ_{2303} 139.7 (†,42.9) γ_{1745} 697.9 (†,100)

2462.1, (0⁺, 1⁺, 2⁺) γ_{743} 1719.1 (†,100)

2471.9, (7⁻), 13.2 ns γ_{2303} 169.1 (†,100) E2

2787.0, (7⁻) γ_{2472} 315.0 (†,100) M1

2788.0 γ_{2303} 485.3 (†,100)

2862.0, (6⁺) γ_{1745} 1117.4 (†,100)

2912.7 γ_{2443} 470.2 (†,100)

3016.9, (5⁻, 6⁻, 7⁻) γ_{2443} 573.5(?) (†,40) γ_{2303} 712.8 (†,100)

3018, (8⁻) γ_{2787} 231.5 (†,67) M1 γ_{2472} 546.4 (†,100) M1+E2

3244, (8⁻) γ_{3018} 226.1 (†,100)

3346, (9⁻) γ_{3244} 101.7 (†,7.6) γ_{3018} 327.8 (†,100) M1

3433, (10⁺), 145.30 ns, μ =12.76 14, Q=1.46 6 γ_{3346} 87.3 (†,100) E1

γ_{3018} 415.3 (†,18.9) M2

3697, (10⁺) γ_{3433} 263.8 γ_{3346} 351.3

3910, (10⁻) γ_{3346} 564.3 γ_{3018} 892.0

4144, (11⁺) γ_{3433} 711.4 (†,100)

4267, (11⁻) γ_{3346} 921.3 (†,100)

4451, (12⁺) γ_{3433} 1017.8 (†,100)

4756, (12⁺) γ_{4144} 611.5 (†,100)

5133, (13⁺) γ_{4756} 377.8 γ_{4144} 989.3

5179, (12) γ_{4451} 711.4 (†,100)

5369, (14) γ_{5133} 235.9 (†,100)

5497, (13) γ_{4451} 1046 (†,100)

5626, (14) γ_{5497} 129.1 γ_{5133} 492.2

5722, (15) γ_{5369} 352.9 (†,100)

5834, (15) γ_{5626} 208.5 (†,100)

A x, J

A 846.3+x, J+2 γ_x 846.37 (†,0.36 10) I⁽²⁾=122.7, $\hbar\omega$ =0.431

A 1725.2+x, J+4 γ_{846+x} 878.94 (†,0.64 12) I⁽²⁾=175.4, $\hbar\omega$ =0.445

A 2626.9+x, J+6 γ_{1725+x} 901.72 (†,0.89 13) I⁽²⁾=400.0, $\hbar\omega$ =0.448

A 3518.6+x, J+8 γ_{2627+x} 891.73 (†,0.99 14) I⁽²⁾=96.2, $\hbar\omega$ =0.456

A 4451.9+x, J+10 γ_{3519+x} 933.32 (†,1.00) I⁽²⁾=86.2, $\hbar\omega$ =0.478

A 5431.6+x, J+12 γ_{4452+x} 979.72 (†,0.93 12) I⁽²⁾=78.0, $\hbar\omega$ =0.503

A 6462.6+x, J+14 γ_{5432+x} 1031.03 (†,0.95 12) I⁽²⁾=75.0, $\hbar\omega$ =0.529

A 7546.9+x, J+16 γ_{6463+x} 1084.32 (†,1.00 12) I⁽²⁾=72.3, $\hbar\omega$ =0.556

A 8686.5+x, J+18 γ_{7547+x} 1139.63 (†,0.97 11) I⁽²⁾=72.3, $\hbar\omega$ =0.584

A 9881.4+x, J+20 γ_{8687+x} 1194.93 (†,0.72 10) I⁽²⁾=71.9, $\hbar\omega$ =0.611

A 11131.9+x, J+22 γ_{9881+x} 1250.54 (†,0.79 10) I⁽²⁾=71.3, $\hbar\omega$ =0.639

A 12438.5+x, J+24 $\gamma_{11132+x}$ 1306.65 (†,0.69 11) I⁽²⁾=69.8, $\hbar\omega$ =0.668

A 13802.4+x, J+26 $\gamma_{12439+x}$ 1363.97 (†,0.52 10) I⁽²⁾=73.8, $\hbar\omega$ =0.695

A 15220.5+x, J+28 $\gamma_{13802+x}$ 1418.19 (†,0.34 12)

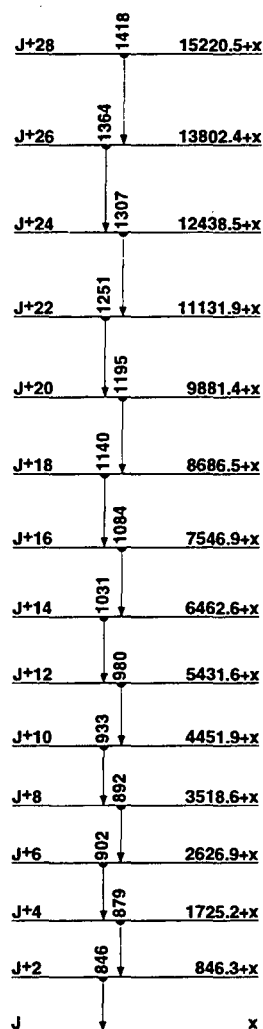

SD band
(94Lu03)

¹⁴⁴₆₄Gd

145
64 Gd

Δ : -72950.40 S_n : (9110) S_p : 4590.40 Q_{EC} : 5050.40 Q_α : 570.40

Nuclear Bands

- A SD-1 band (95Rz03)
- B SD-2 band (95Rz03)
- C SD-3 band (95Rz03)

Levels and γ -ray branchings:

0, 1/2⁺, 23.04 m, %EC+% β ⁺=100
 27.3 1, 3/2⁺, 11.53 ns γ_{27} 27.3 1 (†₁₀₀) M1+E2: δ =0.092
 748.7 1, 11/2⁻, 853 s, %IT=94.35, %EC+% β ⁺=5.75 γ_{27} 721.8 1 (†₁₀₀) M4
 1015.1, 5/2⁺ γ_{27} 987.8 (†₁₀₀ 6) M1+E2: δ =+0.205 γ_{1015} 1015.1 (†_{9.431}) E2
 1272.9, 7/2⁻ γ_{1015} 257.8 (†₁₀₀ 5) E1 γ_{748} 524.1 (†₃₀ 2) E2
 1415.3, 7/2⁺, <0.3 ns γ_{27} 1388.0 (†₁₀₀) E2
 1498.0, 5/2⁺ γ_{1273} 225.1 (†₁₀ 4) D γ_{27} 1471.0 (†₁₀₀ 10) M1+E2
 1524.7, 5/2⁻, 7/2⁻ γ_{1415} 109.5 (†₈ 4) γ_{1015} 509.8 (†₁₀₀ 40) E1
 1666.3, 7/2⁽⁻⁾ γ_{1525} 141.6 (†₂₃ 9) γ_{1498} 168.3 (†₁₀₀ 18) D γ_{1273} 393.9 (†₄₅ 9) D+Q γ_{1015} 651.7 (†₄₅ 23)
 1683.9, 9/2⁻ γ_{1415} 268.6 (†₆₃ 13) E1 γ_{748} 935.1 (†₁₀₀ 10) M1+E2
 1809.9, 9/2⁻ γ_{1273} 537.0 (†₁₀₀) M1+E2: δ =+0.82
 2181.8, (9/2⁻), <0.3 ns γ_{1810} 371.9 (†₁₅ 3) γ_{1273} 908.9 (†₇₆ 8) γ_{748} 1432.5 (†₁₀₀ 9)
 2195.6, 11/2⁻ γ_{748} 1446.8 (†₁₀₀) M1+E2
 2200.1, 13/2⁺, 20.4 16 ns γ_{1273} 927.2 (†₁₀₀ 8) E3 γ_{748} 1451.3 (†₅₆ 4) E1+M2+E3
 2258.5, 11/2⁻ γ_{1810} 448.6 (†₄₀ 7) M1+E2: δ =+0.31 γ_{1273} 985.6 (†₁₀₀ 7) E2
 2301.6, 13/2⁺ γ_{748} 1552.8 (†₁₀₀) E1
 2382.3, (9/2⁻) γ_{2182} 200.6 (†₅₁ 5) γ_{1810} 572.4 (†₁₀₀ 14) D+Q γ_{1684} 698.0 (†₃₉ 4) γ_{1273} 1109.4 (†₁₀₀ 14)
 2411.4, 15/2⁺ γ_{2302} 109.8 (†₁₀₀) M1+E2
 2411.8 γ_{2200} 211.7 (†₁₀₀) M1(+E2)
 2432.4, 17/2⁺, 0.37 15 ns γ_{2411} 20.7 (†₆₂ 3) [M1+E2]: δ <0.7 γ_{748} 1683.6 (†₁₀₀ 8) E3
 2442.7, 13/2⁻ γ_{2196} 247.1 (†₁₀₀) M1(+E2): δ =+0.11
 2472.4 γ_{2302} 170.8 (†₁₀₀)
 2784.1, (11/2⁺, 13/2⁺) γ_{2443} 341.4 (†₁₇ 6) γ_{748} 2035.3 (†₁₀₀ 9)
 2823.2, 15/2⁺ γ_{2200} 623.1 (†₁₀₀) M1+E2: δ =+0.83
 2872.6 γ_{1810} 1062.7 (†₁₀₀)
 2886.0 γ_{2411} 474.6 (†₁₀₀) E1
 2974.8 γ_{2784} 190.7 (†₁₀₀ 20) M1(+E2) γ_{2443} 532.1 (†₃₂ 8) M1(+E2) γ_{2411} 563.4 (†₃₂ 8) M1(+E2)
 2987.3 γ_{2443} 544.6 (†₁₀₀) M1
 3176.2 γ_{2975} 201.4 (†₁₀₀ 30) D γ_{2896} 290.2 (†₈₀ 20) M1(+E2)
 3195.1 γ_{2975} 220.3 (†₁₀₀ 43) D γ_{2896} 309.1 (†₅₇ 29)
 3207.3, 17/2⁺ γ_{2432} 775.5 (†₁₉ 10) γ_{2411} 795.9 (†₁₀₀ 6) M1+E2: δ =-0.134
 3285.1 γ_{3207} 77.8 (†₁₀₀)
 3354.2 γ_{2975} 379.4 (†₁₀₀)
 3357.1, 19/2⁺ γ_{3207} 149.8 (†₃₀ 3) D γ_{2432} 924.7 (†₁₀₀ 6) M1
 3458.4, 21/2⁺ γ_{3357} 101.3 (†₁₀₀ 20) D γ_{2432} 1026 (†₄₀ 20) E2
 3469.6 γ_{3357} 112.5 (†₁₀₀)
 3511.7 γ_{3176} 335.5 (†₁₀₀)
 3573.6 γ_{3458} 115.2 (†₁₀₀)
 3585 (?) γ_{3207} 378.3 (†₁₀₀)
 3603 (?), (19/2) γ_{3207} 395.7 (†₁₀₀) D

A x, J

A 723.2+x, J+2 γ_x 723.27 (†_{0.41} 5) I⁽²⁾=86.2, η ω =0.373
 A 1492.8+x, J+4 γ_{723+x} 769.63 (†_{1.00} 12) I⁽²⁾=82.5, η ω =0.397
 A 2310.9+x, J+6 γ_{1493+x} 818.13 (†_{0.85} 10) I⁽²⁾=80.2, η ω =0.422
 A 3178.9+x, J+8 γ_{2311+x} 868.03 (†_{0.85} 10) I⁽²⁾=78.7, η ω =0.447
 A 4097.7+x, J+10 γ_{3178+x} 918.85 (†_{1.02} 12) I⁽²⁾=76.9, η ω =0.472
 A 5068.5+x, J+12 γ_{4098+x} 970.83 (†_{0.94} 11) I⁽²⁾=75.5, η ω =0.499

A 6092.3+x, J+14 γ_{5068+x} 1023.83 (†_{1.12} 14) I⁽²⁾=75.0, η ω =0.525
 A 7169.4+x, J+16 γ_{6092+x} 1077.13 (†_{1.02} 11) I⁽²⁾=74.2, η ω =0.552
 A 8300.4+x, J+18 γ_{7169+x} 1131.03 (†_{0.84} 10) I⁽²⁾=72.9, η ω =0.579
 A 9486.3+x, J+20 γ_{8300+x} 1185.94 (†_{0.94} 11) I⁽²⁾=73.7, η ω =0.607
 A 10726.5+x, J+22 γ_{9486+x} 1240.26 (†_{0.75} 8) I⁽²⁾=72.6, η ω =0.634
 A 12021.8+x, J+24 $\gamma_{10727+x}$ 1295.34 (†_{0.63} 8) I⁽²⁾=72.3, η ω =0.661
 A 13372.4+x, J+26 $\gamma_{12022+x}$ 1350.64 (†_{0.58} 8) I⁽²⁾=71.2, η ω =0.689
 A 14779.2+x, J+28 $\gamma_{13372+x}$ 1406.84 (†_{0.38} 6) I⁽²⁾=69.9, η ω =0.718
 A 16243.2+x, J+30 $\gamma_{14779+x}$ 1464.01 (†_{0.30} 10) I⁽²⁾=71.3, η ω =0.746
 A 17763.3+x, J+32 $\gamma_{16243+x}$ 1520.17 (†_{0.28} 5) I⁽²⁾=71.3, η ω =0.774
 A 19339.5+x, J+34 $\gamma_{17763+x}$ 1576.27 (†_{0.25} 5)
B y, J
 B 792.7+y (?), J+2 γ_y 792.711 (?) (†_{0.21} 7) I⁽²⁾=228.6, η ω =0.401
 B 1602.9+y, J+4 γ_{793+y} 810.23 (†_{0.44} 6) I⁽²⁾=120.8, η ω =0.413
 B 2462.2+y, J+6 γ_{1603+y} 843.33 (†_{0.48} 7) I⁽²⁾=82.0, η ω =0.434
 B 3338.3+y, J+8 γ_{2446+y} 892.13 (†_{0.46} 6) I⁽²⁾=72.5, η ω =0.460
 B 4285.6+y, J+10 γ_{3338+y} 947.33 (†_{0.47} 6) I⁽²⁾=70.2, η ω =0.488
 B 5289.9+y, J+12 γ_{4286+y} 1004.33 (†_{0.60} 8) I⁽²⁾=69.8, η ω =0.516
 B 6351.5+y, J+14 γ_{5290+y} 1061.63 (†_{0.50} 7) I⁽²⁾=68.0, η ω =0.545
 B 7471.9+y, J+16 γ_{6352+y} 1120.43 (†_{0.54} 7) I⁽²⁾=72.1, η ω =0.574
 B 8647.8+y, J+18 γ_{7472+y} 1175.93 (†_{0.48} 7) I⁽²⁾=76.3, η ω =0.601
 B 9876.1+y, J+20 γ_{8648+y} 1228.33 (†_{0.43} 6) I⁽²⁾=83.2, η ω =0.626
 B 11152.5+y, J+22 γ_{9876+y} 1276.43 (†_{0.33} 5) I⁽²⁾=93.5, η ω =0.649
 B 12471.7+y, J+24 $\gamma_{11153+y}$ 1319.24 (†_{0.36} 6) I⁽²⁾=92.8, η ω =0.670
 B 13834.0+y, J+26 $\gamma_{12472+y}$ 1362.34 (†_{0.37} 6) I⁽²⁾=89.5, η ω =0.692
 B 15241.0+y, J+28 $\gamma_{13834+y}$ 1407.05 (†_{0.24} 5) I⁽²⁾=82.3, η ω =0.716
 B 16696.6+y, J+30 $\gamma_{15241+y}$ 1455.67 (†_{0.26} 5) I⁽²⁾=73.1, η ω =0.741
 B 18206.9+y, J+32 $\gamma_{16697+y}$ 1510.31 (†_{0.18} 4)
C z, J
 C 919.7+z, J+2 γ_z 919.710 (†_{0.06} 2) I⁽²⁾=74.1, η ω =0.473
 C 1893.4+z, J+4 γ_{920+z} 973.75 (†_{0.12} 3) I⁽²⁾=67.5, η ω =0.502
 C 2926.4+z, J+6 γ_{1893+z} 1033.05 (†_{0.15} 3) I⁽²⁾=74.9, η ω =0.530
 C 4012.8+z, J+8 γ_{2926+z} 1086.45 (†_{0.13} 3) I⁽²⁾=68.8, η ω =0.558
 C 5157.3+z, J+10 γ_{4013+z} 1144.55 (†_{0.14} 3) I⁽²⁾=68.5, η ω =0.587
 C 6360.2+z, J+12 γ_{5157+z} 1202.98 (†_{0.13} 5) I⁽²⁾=71.0, η ω =0.616
 C 7619.4+z, J+14 γ_{6360+z} 1259.25 (†_{0.13} 3) I⁽²⁾=72.6, η ω =0.643
 C 8933.7+z, J+16 γ_{7619+z} 1314.37 (†_{0.10} 3) I⁽²⁾=71.9, η ω =0.671
 C 10303.6+z, J+18 γ_{8934+z} 1369.912 (†_{0.09} 4) I⁽²⁾=64.3, η ω =0.700
 C 11735.7+z, J+20 $\gamma_{10304+z}$ 1432.118 (†_{0.08} 3)

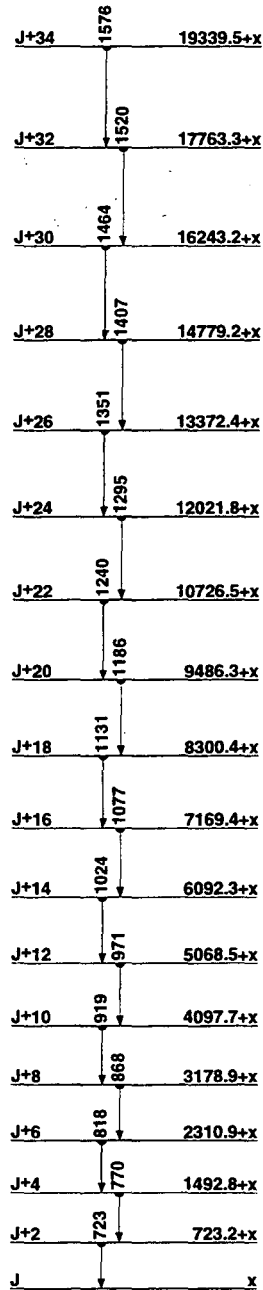

SD-1 band
(95Rz03)

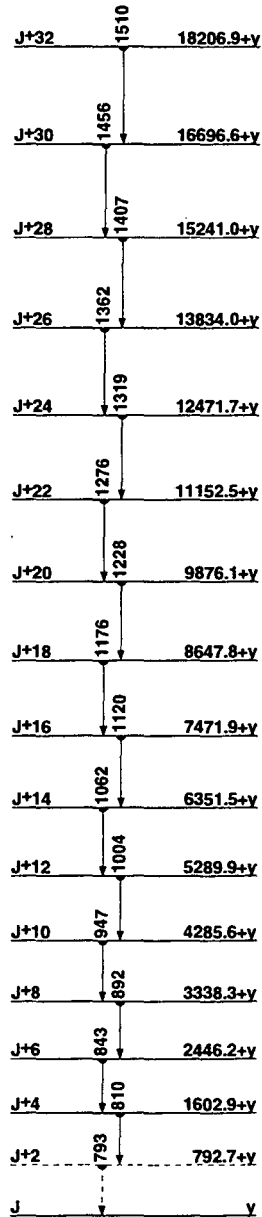

SD-2 band
(95Rz03)

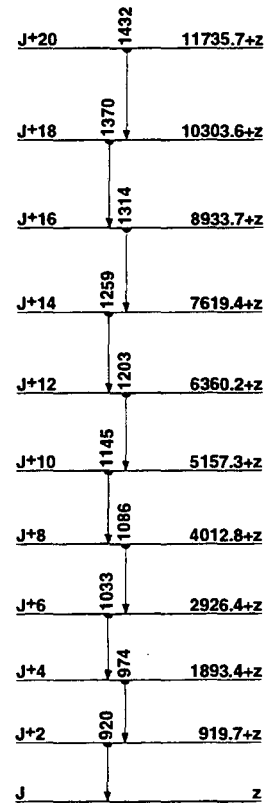

SD-3 band
(95Rz03)

¹⁴⁵₆₄Gd

¹⁴⁶Gd
⁶⁴Gd

Δ : -76097.5 S_n: 11220.40 S_p: 5385.5 Q_{EC}: 1030.8 Q_α: 465.16

Nuclear Bands

- A SD-1 band (95Sc31,90He14,93Ha19)
- B SD-2 band (95Sc31,91Rz01,93Ha19)
- C SD-3 band? (95Sc31)

Levels and γ-ray branchings:

0, 0⁺, 48.27 10 d, %EC=100
 1579.4 1, 3⁻, 1.06 12 ns γ₀ 1579.4 (†_γ100) E3
 1971.9 3, 2⁺, <1 ps γ₀ 1972.0 3 (†_γ100) E2
 2165.0 3, 0⁺, 375 40 ps γ₁₉₇₂ 193.0 5 (†_γ=23) γ₀ 2165.0 3 (†_γ100 17) E0
 2611.5 2, 4⁺ γ₁₉₇₂ 638 1 (†_γ=1.7) γ₁₅₇₉ 1032.1 1 (†_γ100 10) E1
 2658.0 2, 5⁻ γ₁₅₇₉ 1078.6 1 (†_γ100) E2
 2967.6 3, 4⁺, (2⁺) γ₁₅₇₉ 1388.2 2 (†_γ100) E1
 2982.0 3, 7⁻, 7.2 4 ns γ₂₆₅₈ 324.0 1 (†_γ100) E2
 2986 1 γ₀ 2986 1 (†_γ100)
 2996.6 4, 4⁻ γ₁₅₇₉ 1417.2 3 (†_γ100)
 3020 2, 0⁺ γ₀ 3020 2 (†_γ100) E0
 3031.2 3, 3⁺ γ₁₉₇₂ 1059.3 2 (†_γ100 30) M1 γ₁₅₇₉ 1451.7 3 (†_γ50 20)
 3098.2, 6⁻ γ₂₉₈₂ 116.7 γ₂₆₅₈ 440.9 1 M1
 3182.5 3, 8⁻ γ₂₉₈₂ 200.5 1 (†_γ100) M1+E2: δ=0.101
 3231 5
 3287.2, (3,5)⁺ γ₂₆₁₂ 675.7 2 (†_γ100) M1
 3290.2, 7⁻ γ₂₉₈₂ 308.2 2 (†_γ100) M1+E2
 3293.5 3, 8⁻, <300 ps γ₃₁₈₃ 111.1 1 (†_γ32 4) M1 γ₂₉₈₂ 311.4 2 (†_γ100 9)
 M1+E2: δ=0.160
 3312.8 5, 5⁽⁻⁾ γ₂₆₅₈ 654.8 4 (†_γ100 29) (M1) γ₂₆₁₂ 701.6 5 (†_γ=8.8)
 3354 5
 3378 5
 3384.0 5, 6⁻ γ₃₀₉₈ 285.2 2 (†_γ24 6) M1 γ₂₉₈₂ 402.0 2 (†_γ29 12)
 γ₂₆₅₈ 726.7 2 (†_γ100 12) M1
 3389 1, (3) γ₁₉₇₂ 1417 1 (†_γ100)
 3411.9 5, 4⁽⁺⁾ γ₂₉₉₇ 415.2 3 (†_γ100 33) (E1) γ₂₆₁₂ 800.6 5 (†_γ67)
 3416 1, 4 γ₁₅₇₉ 1837 (†_γ1100) D
 3422.7 5, (4) γ₁₅₇₉ 1843.3 5 (†_γ100) D
 3428.1 5, 9⁻, <300 ps γ₃₂₉₄ 134.6 1 (†_γ100 6) M1+E2: δ=0.071
 γ₃₁₈₃ 245.6 2 (†_γ7.5 25) M1+E2: δ=0.904 γ₂₉₈₂ 446.1 2 (†_γ7.5 25) E2
 3436.3 5, (3) γ₁₉₇₂ 1464.3 3 (†_γ100) D
 3442 5
 3456 1, (5⁻) γ₁₅₇₉ 1877 1 (†_γ100) Q
 3456.9, 6⁺ γ₂₆₅₈ 798.9 3 (†_γ100) E1
 3460 1, (5⁻) γ₁₅₇₉ 1881 1 (†_γ100) Q
 3463 1, (4) γ₁₅₇₉ 1884 1 (†_γ100) D
 3484.9 5, 6⁺ γ₂₆₅₈ 826.9 2 (†_γ100) E1
 3485 2, 0⁺ γ₀ 3485 2 (†_γ100) E0
 3639 2, 0⁺ γ₀ 3639 2 (†_γ100) E0
 3660.2 5, 6⁺ γ₂₆₅₈ 1002.2 4 (†_γ100) E1
 3779.0 5, 8⁺ γ₂₉₈₂ 797.0 3 (†_γ100) E1
 3783.7 5, (5,6)⁺ γ₂₆₁₂ 1172.2 5 (†_γ100) M1,E2
 3854.2 5, 7⁻ γ₃₁₈₃ 671.7 3 (†_γ63 13) M1 γ₃₀₉₈ 755.0 5 (†_γ=63) D
 γ₂₉₈₂ 872.2 3 (†_γ100 38) M1
 3864.4 4, 10⁺, <300 ps γ₃₄₂₈ 436.3 1 (†_γ100) E1
 3948
 4107.1 5, 8⁺ γ₃₁₈₃ 924.6 3 (†_γ100 33) E1 γ₂₉₈₂ 1125.7 3 (†_γ100 33) D
 4248.3 6, (9,10⁻)
 4330
 4501.3 6, 10⁻ γ₃₄₂₈ 1073.6 3 (†_γ100) D+Q
 4534, 0⁺
 4540.7, 10⁽⁺⁾ γ₃₄₂₈ 1112.6 3 (†_γ100) D
 4666.5 5, 11, 12⁺ γ₃₈₆₄ 802.1 4 (†_γ100)
 4700
 4719.1, 4⁻ γ₃₄₂₃ 1296.7 γ₂₆₅₈ 2060.9 γ₁₅₇₉ 3139.8
 4740 30

4828.3, (5⁻) γ₂₉₉₇ 1831.9
 5000
 5094.8, (11⁺) γ₄₅₀₁ 592.8 (†_γ43) D γ₃₈₆₄ 1229.9 (†_γ100) D
 5276.9, (11⁺) γ₄₅₀₁ 775 γ₃₈₆₄ 1412.5 3
 5350.9, (12⁺) γ₃₈₆₄ 1486.0 Q
 5447.5, (12⁺) γ₄₆₅₇ 781.1 γ₃₈₆₄ 1582.9
 5791.9, (13⁺) γ₅₄₄₈ 343.5 I⁽¹⁾=111.2, I⁽²⁾=-18.2, ηω=0.117 γ₅₃₅₁ 441.1
 (†_γ73) D γ₅₂₇₇ 514.0 γ₅₀₈₅ 697.0 (†_γ100) Q
 5894.4, (14⁺) γ₅₇₉₂ 102.5 D+Q γ₅₄₄₈ 446.5 γ₅₃₅₁ 543.7
 5996.2, (14⁺) γ₅₃₅₁ 645.3
 6120.3, (15⁺) γ₅₉₉₆ 124 I⁽¹⁾=149.0, I⁽²⁾=25.8, ηω=0.101 γ₅₈₉₄ 225.9 D+Q
 γ₅₇₉₂ 328
 6399.1, (16⁺) γ₆₁₂₀ 278.8 D I⁽¹⁾=166.1, I⁽²⁾=-27.0, ηω=0.102 γ₅₉₉₆ 402
 γ₅₈₉₄ 504.5 Q
 6470 30
 7034.3, (16⁺) γ₆₁₂₀ 914.0 D
 7164.9, (17⁺) γ₇₀₃₄ 130.6 I⁽¹⁾=69.8, I⁽²⁾=4.8, ηω=0.272 γ₆₃₉₉ 765.8 D
 γ₆₁₂₀ 1046 γ₅₉₉₆ 1166
 7513.6 γ₇₀₃₄ 479.3(?) γ₆₃₉₉ 1114.5
 7740 γ₇₅₁₄ 226
 8030.3, (18), 1.5 6 ns γ₇₇₄₀ 291 γ₇₅₁₄ 517(?) γ₇₁₆₅ 865.4 D
 8916.0, (20,19), 4.3 3 ns γ₈₀₃₀ 885.7
 A x, J=(33)
 A 826.3+x, J+2 γ_x 826.3 3 (†_γ0.61 5) I⁽¹⁾=82.1, I⁽²⁾=77.4, ηω=0.426
 A 1704.3+x, J+4 γ_{826+x} 878.0 3 (†_γ0.71 8) I⁽¹⁾=81.8, I⁽²⁾=76.2, ηω=0.452
 A 2634.8+x, J+6 γ_{1704+x} 930.5 2 (†_γ0.84 7) I⁽¹⁾=81.5, I⁽²⁾=75.9, ηω=0.478
 A 3618.0+x, J+8 γ_{2635+x} 983.2 2 (†_γ0.91 5) I⁽¹⁾=81.1, I⁽²⁾=72.2, ηω=0.505
 A 4656.6+x, J+10 γ_{3618+x} 1038.6 3 (†_γ1.00 6) I⁽¹⁾=80.7, I⁽²⁾=73.0, ηω=0.533
 A 5750.0+x, J+12 γ_{4657+x} 1093.4 3 (†_γ0.92 5) I⁽¹⁾=80.3, I⁽²⁾=72.2, ηω=0.561
 A 6898.8+x, J+14 γ_{5750+x} 1148.8 2 (†_γ0.81 5) I⁽¹⁾=80.0, I⁽²⁾=76.3, ηω=0.587
 A 8100.0+x, J+16 γ_{6899+x} 1201.2 3 (†_γ0.60 4) I⁽¹⁾=80.0, I⁽²⁾=81.5, ηω=0.613
 A 9350.3+x, J+18 γ_{8100+x} 1250.3 4 (†_γ0.52 4) I⁽¹⁾=80.1, I⁽²⁾=84.2, ηω=0.637
 A 10648.1+x, J+20 γ_{9350+x} 1297.8 3 (†_γ0.51 5) I⁽¹⁾=80.2, I⁽²⁾=84.6,
 ηω=0.661
 A 11993.2+x, J+22 γ_{10648+x} 1345.1 3 (†_γ0.47 5) I⁽¹⁾=80.3, I⁽²⁾=82.3,
 ηω=0.685
 A 13386.9+x, J+24 γ_{11993+x} 1393.7 4 (†_γ0.37 6) I⁽¹⁾=80.3, I⁽²⁾=76.2,
 ηω=0.710
 A 14833.1+x, J+26 γ_{13387+x} 1446.2 5 (†_γ0.23 4) I⁽¹⁾=80.1, I⁽²⁾=76.5,
 ηω=0.736
 A 16331.6+x, J+28 γ_{14833+x} 1498.5 7 (†_γ0.24 5) I⁽¹⁾=79.9, I⁽²⁾=72.6,
 ηω=0.763
 A 17885.2+x, J+30 γ_{16332+x} 1553.6 9 (†_γ0.16 5)
 B y, J=(32)
 B 806.2+y, J+2 γ_y 806.2 3 (†_γ0.51 5) I⁽¹⁾=81.8, I⁽²⁾=78.7, ηω=0.416
 B 1663.2+y, J+4 γ_{806+y} 857.0 3 (†_γ0.68 6) I⁽¹⁾=81.6, I⁽²⁾=77.7, ηω=0.441
 B 2571.7+y, J+6 γ_{1663+y} 908.5 3 (†_γ0.89 9) I⁽¹⁾=81.3, I⁽²⁾=76.0, ηω=0.467
 B 3532.8+y, J+8 γ_{2572+y} 961.1 2 (†_γ1.00 7) I⁽¹⁾=80.9, I⁽²⁾=72.6, ηω=0.494
 B 4549.0+y, J+10 γ_{3533+y} 1016.2 2 (†_γ0.91 7) I⁽¹⁾=80.4, I⁽²⁾=71.4, ηω=0.522
 B 5621.2+y, J+12 γ_{4549+y} 1072.2 2 (†_γ0.78 8) I⁽¹⁾=80.0, I⁽²⁾=71.9, ηω=0.550
 B 6749.0+y, J+14 γ_{5621+y} 1127.8 3 (†_γ0.77 7) I⁽¹⁾=79.6, I⁽²⁾=70.2, ηω=0.578
 B 7933.8+y, J+16 γ_{6749+y} 1184.8 3 (†_γ0.73 8) I⁽¹⁾=79.1, I⁽²⁾=69.2, ηω=0.607
 B 9176.4+y, J+18 γ_{7934+y} 1242.6 3 (†_γ0.73 7) I⁽¹⁾=78.7, I⁽²⁾=70.5, ηω=0.635
 B 10475.7+y, J+20 γ_{9176+y} 1299.3 4 (†_γ0.60 7) I⁽¹⁾=78.3, I⁽²⁾=69.4,
 ηω=0.664
 B 11832.6+y, J+22 γ_{10476+y} 1356.9 4 (†_γ0.55 6) I⁽¹⁾=78.0, I⁽²⁾=70.8,
 ηω=0.693
 B 13246.0+y, J+24 γ_{11833+y} 1413.4 4 (†_γ0.37 5) I⁽¹⁾=77.6, I⁽²⁾=67.5,
 ηω=0.722
 B 14718.7+y, J+26 γ_{13246+y} 1472.7 6 (†_γ0.20 4) I⁽¹⁾=77.3, I⁽²⁾=69.9,
 ηω=0.751
 B 16248.6+y, J+28 γ_{14719+y} 1529.9 8 (†_γ0.13 3) I⁽¹⁾=77.1, I⁽²⁾=76.8,
 ηω=0.778
 B 17830.6+y, J+30 γ_{16249+y} 1582.0 11 (†_γ0.12 4)

- C z(?), J
- C 958.5+z(?), J+2 $\gamma_{958.55}$ ($\dagger_{\gamma} 1.00$ 16) $I^{(1)}=42.8, I^{(2)}=84.0, \eta\omega=0.491$
- C 1964.6+z(?), J+4 γ_{959+z} 1006.16 ($\dagger_{\gamma} 0.84$ 14) $I^{(1)}=44.4, I^{(2)}=68.0, \eta\omega=0.518$
- C 3029.5+z(?), J+6 γ_{1965+z} 1064.96 ($\dagger_{\gamma} 0.94$ 16) $I^{(1)}=45.7, I^{(2)}=68.3, \eta\omega=0.547$
- C 4153.0+z(?), J+8 γ_{3030+z} 1123.58 ($\dagger_{\gamma} 0.73$ 16) $I^{(1)}=47.0, I^{(2)}=76.6, \eta\omega=0.575$
- C 5328.7+z(?), J+10 γ_{4153+z} 1175.78 ($\dagger_{\gamma} 0.69$ 16) $I^{(1)}=48.3, I^{(2)}=80.2, \eta\omega=0.600$
- C 6554.3+z(?), J+12 γ_{5329+z} 1225.610 ($\dagger_{\gamma} 0.64$ 18) $I^{(1)}=49.5, I^{(2)}=76.3, \eta\omega=0.626$
- C 7832.3+z(?), J+14 γ_{6554+z} 1278.014 ($\dagger_{\gamma} 0.49$ 17) $I^{(1)}=50.8, I^{(2)}=90.1, \eta\omega=0.650$
- C 9154.7+z(?), J+16 γ_{7832+z} 1322.411 ($\dagger_{\gamma} 0.59$ 17) $I^{(1)}=52.0, I^{(2)}=86.0, \eta\omega=0.673$
- C 10523.6+z(?), J+18 γ_{9155+z} 1368.919 ($\dagger_{\gamma} 0.30$ 17)

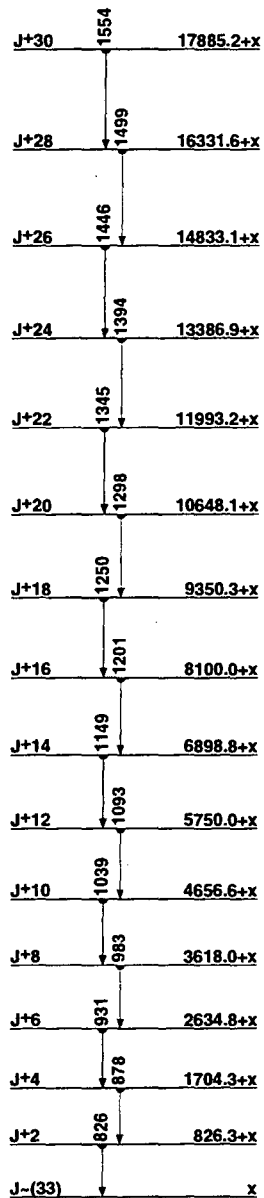

SD-1 band
(95Sc31,90He14,93Ha19)

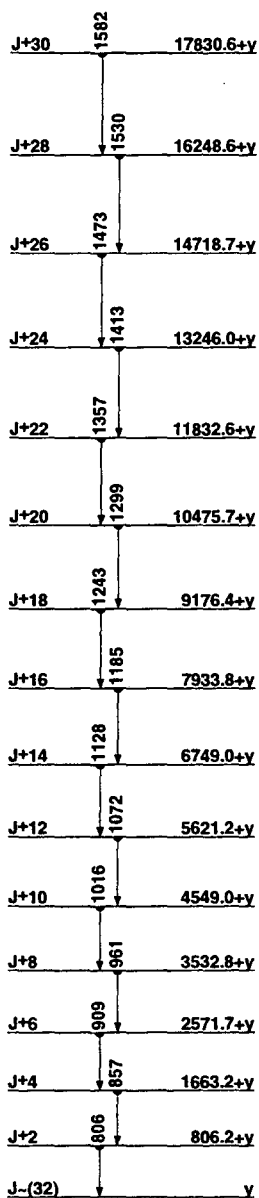

SD-2 band
(95Sc31,91RZ01,93Ha19)

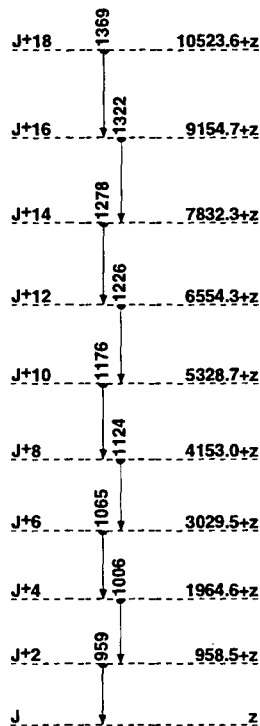

SD-3 band?
(95Sc31)

¹⁴⁶₆₄Gd

147
64 Gd

Δ : -75367 4 S_n : 7341 4 S_p : 5529 7 Q_{EC} : 2188 3 Q_α : 1735.220

Nuclear Bands

- A $\nu_{7/2}^+(^{146}\text{Gd } 3^-)$
- B SD-1 band (91Zu01,93Ha19)
- C SD-2 band (91Zu01,93Ha19)
- D SD-3 band (94ViAA)

Levels and γ -ray branchings:

- 0, 7/2⁻, 38.06 12 h, %EC+% β^+ =100, μ =1.02 9
- 997.1 1, 13/2⁺, 21.4 11 ns, μ =+0.487 20, Q =-0.73 7 $\gamma_{0997.11}$ (†,100) E3
- 1152.4 1, 3/2⁻, <0.2 ns $\gamma_{1152.41}$ (†,100) E2
- 1292.31 14, (1/2)⁺, <0.2 ns γ_{1152} 139.9 1 (†,100 θ) E1
- 1397.01 10, 9/2⁻, 0.35 21 ps $\gamma_{1397.01}$ (†,100 θ) M1+E2
- 1412.01 18, 3/2⁺, <0.2 ns γ_{1292} 119.7 1 (†,100 11) M1
- 1509.2 10 γ_{1292} 273.5 (†,100 23)
- A 1628.3 4, 7/2⁺, 0.42 21 ps $\gamma_{1628.34}$ (†,100 37) E1
- A 1643.0 3, 9/2⁺ $\gamma_{1643.03}$ (†,100 10) E1
- A 1699.36 24, 3/2⁺ γ_{1292} 407.0 3 (†,50 14) M1+E2 γ_{1152} 547.0 3 (†,100 18) E1
- A 1701.60 23, 11/2⁺ γ_{997} 704.5 2 (†,100 9) M1
- A 1759.2 11, (1/2)⁺ γ_{1412} 347.2 10 (†,100 37) M1
- 1797.1 4, 9/2⁻, 0.14 7 ps $\gamma_{1797.14}$ (†,100 11) M1+E2
- 1846.8 10, (1/2)⁻ γ_{1412} 434.8 γ_{1292} 554.7 γ_{1152} 694.4 10 (†,100 60) M1
- 1944.1, 11/2⁻ γ_{997} 947 (†,20) $\gamma_{1944.1}$ (†,100) E2
- 2028.9 10, 15/2^(*) γ_{1759} 253.6^(?) (†,402.5 θ) γ_{997} 1031.8 (†,100 10) (M1+E2)
- 2078.4 $\gamma_{2078.4}$ (†,100)
- 2385.9 3, (13/2)⁻ γ_{1759} 609.6 (†,100 10) γ_{997} 1388.8 (†,59 7) E1
- 2438.91 23, (15/2)⁻ γ_{997} 1441.8 2 (†,100 10) E1
- 2488.22 14, 17/2⁺ γ_{2029} 459.2^(?) (†, <2.41) γ_{1628} 894.3 (†,10.7 14) γ_{997} 1491.0 (†,100 7) E2
- 2489.8 4 γ_{1702} 788.2 3 (†,100 14)
- 2572.27 16, 19/2⁻, 0.37 8 ns γ_{2488} 84.0 1 (†,85 12) γ_{997} 1575.2 3 (†,100 19) E3
- 2625.9 10 γ_{997} 1628.8 10 (†,100 38)
- 2736.0 5 γ_{2386} 350.1 4 (†,100 40)
- 2760.47 17, 21/2⁺, 4.5 2 ns, μ =+7.6 12 γ_{2572} 188.0 2 (†,25 3) γ_{2488} 272.3 1 (†,100 θ) E2
- 2763.81 17, (19/2)⁺ γ_{2488} 275.6 1 (†,100 11) M1
- 2941.6 5 γ_{2488} 453.4 4 (†,100 38)
- 2942.7 3 γ_{2764} 178.9 4 (†,48 14) γ_{2760} 182.2 3 (†,100 14)
- 2960.3 10 γ_{2488} 472.1 10 (†,100 67)
- 2971.5, 9/2⁻, 11/2⁻ γ_{1944} 1027.7 (†,50) γ_{1397} 1574.2 (†,17) $\gamma_{2971.5}$ (†,100)
- 3005.6, 9/2⁻, 11/2⁻ γ_{1397} 1608.0 (†,100) $\gamma_{3005.6}$ (†,100)
- 3038.32 20, 23/2⁺ γ_{2760} 277.9 2 (†,100 15) M1+E2
- 3082.5 5 γ_{2764} 318.7 4 (†,100 30)
- 3170.0 5 γ_{2760} 409.5 4 (†,100 38)
- 3185.8, 23/2⁺ γ_{2760} 425.6 3 (†,100 28) M1(+E2)
- 3204.8, 9/2⁻, 11/2⁻ γ_{1944} 1260.0 (†,50) γ_{1797} 1407.0 (†,25) γ_{1397} 1809.0 (†,38) $\gamma_{3204.8}$ (†,100)
- 3227.9 5 γ_{2764} 464.1 4 (†,100 43)
- 3322.7, 9/2⁻, 11/2⁻ $\gamma_{3322.7}$ (†,100)
- 3360.1 5 γ_{3038} 321.8 4 (†,100 38)
- 3399.08 19, 25/2⁺ γ_{3038} 360.8 1 (†,100) M1+E2: δ =0.18 γ_{2760} 638.6 1 (†,10)
- 3581.97 21, 27/2⁻, 26.8 7 ns, μ =+11.34 23, Q =-1.26 8 γ_{3399} 182.9 1 (†,100 20) E1 γ_{3038} 543.7 1 (†,16) γ_{2760} 821.3 2 (†,5.5)
- 3691.94 21, 25/2⁻ γ_{3582} 110.0 1 M1 γ_{3186} 505.3 2 γ_{3038} 653.6 1 (†,=100)
- 3872.9, 13/2⁻, 11/2⁻ γ_{997} 2875.7 (†,100)
- 4006.94 23, 27/2⁻ γ_{3582} 424.8 2 (†,100)
- 4070.32 22, 27/2⁻ γ_{3692} 378.4 2 (†,100) M1 γ_{3399} 671.3 2 (†,20)

- 4230.00 22, 29/2⁻ γ_{4070} 159.7 1 (†,100) M1 γ_{4007} 223.0 1 (†,29)
- 4450.96 22, 29/2⁻ γ_{4007} 444.1 2 (†,68) E2 γ_{3582} 869.0 1 (†,100) M1
- 4617.92 22, 29/2⁺ γ_{3582} 1035.9 1 (†,100) E1
- 4844.08 22, 31/2⁻ γ_{445} 393.1 2 (†,61) γ_{4230} 614.0 2 (†,100) E2 γ_{3582} 1262.0 2 (†,60)
- 4948.76 23, 31/2⁺ γ_{4618} 330.8 1 (†,100) M1 γ_{4451} 498.1 2 (†,14)
- 4971.93 22, 31/2⁻ γ_{3582} 1390.0 1 (†,100) E2
- 5265.10 22, 31/2⁻ γ_{4844} 421.0 1 (†,49) M1(+E2) γ_{4451} 814.1 1 (†,34) M1,(E2) γ_{3582} 1683.2 2 (†,100) E2
- 5382.32 22, 33/2⁻ γ_{5265} 117.2 1 (†,100) M1 γ_{4972} 410.6 2 (†,13) γ_{4949} 433.8 3 (†,=9) γ_{4844} 538.1 2 (†,27) γ_{4230} 1152.3 1 (†,50) E2
- 5557.1 4, 35/2⁺ γ_{4949} 608.4 3 (†,100) E2
- 5583.05 25, 35/2⁻ γ_{5382} 200.7 2 (†,100) M1 γ_{4972} 611.1 2 (†,23) E2
- 5923.2 3, 37/2⁻ γ_{5583} 340.1 1 (†,100) M1
- 6236.1 3, (35/2⁺) γ_{4949} 1287.3 2 (†,100)
- 6471.4 3, 39/2⁻ γ_{5923} 548.2 1 (†,100) M1+E2
- 6541.4 5^(?), (37/2⁺) γ_{5557} 984.3 3 (†,100) (M1+E2)
- 6621.4 3, 39/2⁺ γ_{6541} 80.3^(?) D γ_{5923} 698.2 1 (†,100) E1 γ_{5557} 1064.4 3 (†,67) E2
- 6826.5^(?) γ_{6236} 590.8 1^(?) (†,100) (E2)
- 6906.7 3, 41/2⁺ γ_{6621} 285.4 2 (†,95) M1+E2 γ_{6471} 435.3 2 (†,100) (E1) γ_{5923} 984 1 (†,19)
- 7035.4 3, 41/2⁺ γ_{6827} 208.3 4 (†,=20) γ_{6621} 414.0 1 (†,100) M1+E2
- 7389.3 4, 45/2⁺ γ_{7035} 353.5 3 (†,45) γ_{6907} 482.5 3 (†,=100) E2
- 7665.4^(?), (39/2,41/2) γ_{5923} 1743 1^(?) (†,100)
- 7825.4 4^(?) γ_{5923} 1902 1^(?) (†,100)
- 7873.8 4, 41/2⁻ γ_{7665} 208.6 4^(?) (†,63) γ_{7035} 838.7 5 (†,59) E1 γ_{6621} 1253 1^(?) (†,14) γ_{5923} 1951 1 (†,100) Q
- 7963.9 4^(?) γ_{6907} 1057.3 2 (†,100) E1
- 7993.9 4, 43/2⁻ γ_{7874} 120.1 1 (†,100) M1 γ_{7825} 168.5 2 (†,22) γ_{7389} 604.5 1 (†,13) γ_{7035} 959 (E1) γ_{6907} 1087.5 3 (†,11)
- 8153.6 4^(?), (47/2)⁺ γ_{7389} 764.4 2 (†,100) M1
- 8333.4 4, 45/2⁺ γ_{7994} 339.0 3 (†,100) E1 γ_{7964} 369.5 2 (†,12) E1
- 8587.8 4, (49/2)⁺, 510 20 ns, μ =+10.9 2, Q =-3.24 18 γ_{8333} 254.4 1 (†,100) E2 γ_{8154} 434.5 3 (†,6) γ_{7994} 594.3^(?) (†,4) (E3)
- 9241, (51/2) γ_{8588} 653.0 (†,100) D(+Q): δ =+0.09 θ
- 9507.0, (51/2⁺), <1 ps γ_{8588} 919.1 (†,100) M1+E2: δ =+0.65 \pm 1⁶
- 9691.2, (53/2⁺), 3.1 7 ps γ_{8588} 1103.4 (†,100) E2
- 9879.8, (53/2⁺), = 76 ps γ_{9691} 188.5 (†,100) (E1) γ_{9507} 372.7 (†,60) E1(+M2): δ =-0.05 4 γ_{9241} 638.8 γ_{8588} 1291.9 (†,7) E3+M2
- 10271.6, (55/2⁺) γ_{9691} 580.4
- 10487.6, (55/2⁺) γ_{9691} 796.3 (†,100) M1+E2: δ =+0.29 4 γ_{9241} 1246.9
- 10688.7, (57/2⁺), 10 3 ps γ_{9880} 808.9 (†,100) E2
- 10747.2, (57/2⁺) γ_{10488} 259.6 (†,33) M1 γ_{9691} 1056.1 (†,100) E2
- 10993.3, (59/2⁺), 0.80 5 ns γ_{10747} 246.2 (†,27) E1 γ_{10689} 304.5 (†,100) M1+E2: δ =+0.27 4 γ_{10272} 721
- 11232.2, (61/2⁺), 17 3 ps γ_{10993} 238.9 (†,100) M1 γ_{10689} 543.6 (†,14) E2
- 11850.7, (65/2⁺) γ_{11232} 618.6 (†,100) E2
- 11930.3, (61/2) γ_{10993} 936.8 (†,100) D(+Q): δ =-0.07 6
- 12208.6, (65/2⁺), = 1.4 ps γ_{11232} 976.4 (†,100) E2
- 12548.7, (65/2) γ_{11930} 618.3 (†,100) E2
- 13104.7, (67/2,69/2) γ_{12209} 896.1 (†,100) E2
- 13265.1, (67/2) γ_{12549} 716.3 (†,36) γ_{11851} 1414.5 (†,100) D
- 13416, 67/2 γ_{12209} 1208.0 (†,100) D
- 13446, (69/2,71/2) γ_{13105} 341.3
- 13446.5, (69/2) γ_{13265} 181.3 (†,100) γ_{12549} 897.9 (†,100) E2
- 14433.2, (71/2) γ_{13446} 986.7 (†,100) M1+E2: δ =+0.55 6
- 14793^(?)
- 15174.8, (73/2) γ_{14433} 741.6 (†,100) D
- 15390, (73/2) γ_{15175} 215.5 (†,50) D+Q: δ =+0.34 \pm 1⁴ γ_{14793} 597.4 (†,100)
- 15691, (75/2) γ_{15390} 300.3 (†,100) D
- 16777 γ_{15691} 1086 (†,100)
- 16937, (79/2) γ_{15691} 1246 (†,100)

- B x, J=(55/2)
 B 696.9+x, J+2 γ_{697+x} 696.95 (\dagger 0.23 10) I⁽¹⁾=81.8, I⁽²⁾=83.2, $\eta\omega=0.360$
 B 1441.9+x, J+4 γ_{697+x} 745.05 (\dagger 0.77 10) I⁽¹⁾=81.8, I⁽²⁾=79.4, $\eta\omega=0.385$
 B 2237.3+x, J+6 γ_{1442+x} 795.44 (\dagger 0.90 10) I⁽¹⁾=81.6, I⁽²⁾=76.5, $\eta\omega=0.411$
 B 3085.0+x, J+8 γ_{2237+x} 847.74 (\dagger 0.93 8) I⁽¹⁾=81.3, I⁽²⁾=76.8, $\eta\omega=0.437$
 B 3984.8+x, J+10 γ_{3085+x} 899.87 (\dagger 1.06 8) I⁽¹⁾=80.9, I⁽²⁾=73.5, $\eta\omega=0.464$
 B 4939.0+x, J+12 γ_{3985+x} 954.25 (\dagger 1.05 10) I⁽¹⁾=80.5, I⁽²⁾=72.6, $\eta\omega=0.497$
 B 5948.3+x, J+14 γ_{4939+x} 1009.35 (\dagger 1.05 10) I⁽¹⁾=80.0, I⁽²⁾=72.3, $\eta\omega=0.518$
 B 7012.9+x, J+16 γ_{5948+x} 1064.65 (\dagger 0.89 10) I⁽¹⁾=79.6, I⁽²⁾=70.9, $\eta\omega=0.546$
 B 8133.9+x, J+18 γ_{7013+x} 1121.05 (\dagger 1.01 10) I⁽¹⁾=79.3, I⁽²⁾=73.7, $\eta\omega=0.574$
 B 9309.2+x, J+20 γ_{8134+x} 1175.35 (\dagger 1.03 10) I⁽¹⁾=79.1, I⁽²⁾=75.9, $\eta\omega=0.601$
 B 10537.2+x, J+22 γ_{9309+x} 1228.07 (\dagger 0.73 7) I⁽¹⁾=79.0, I⁽²⁾=81.0, $\eta\omega=0.626$
 B 11814.6+x, J+24 $\gamma_{10537+x}$ 1277.45 (\dagger 0.79 8) I⁽¹⁾=79.2, I⁽²⁾=87.7, $\eta\omega=0.650$
 B 13137.6+x, J+26 $\gamma_{11815+x}$ 1323.07 (\dagger 0.70 7) I⁽¹⁾=79.5, I⁽²⁾=90.1, $\eta\omega=0.673$
 B 14505.0+x, J+28 $\gamma_{13138+x}$ 1367.45 (\dagger 0.49 8) I⁽¹⁾=79.8, I⁽²⁾=85.3, $\eta\omega=0.695$
 B 15919.3+x, J+30 $\gamma_{14505+x}$ 1414.37 (\dagger 0.41 8) I⁽¹⁾=79.9, I⁽²⁾=82.3, $\eta\omega=0.719$
 B 17382.2+x, J+32 $\gamma_{15919+x}$ 1462.97 (\dagger 0.38 8) I⁽¹⁾=79.9, I⁽²⁾=75.8, $\eta\omega=0.745$
 B 18897.9+x, J+34 $\gamma_{17382+x}$ 1515.715 (\dagger 0.20 10)
 C y, J=(61/2)
 C 731.2+y, J+2 $\gamma_{731.2}$ 731.25 (\dagger 0.40 15) I⁽¹⁾=86.1, I⁽²⁾=84.4, $\eta\omega=0.377$
 C 1509.8+y, J+4 γ_{731+y} 778.64 (\dagger 0.52 15) I⁽¹⁾=85.9, I⁽²⁾=82.0, $\eta\omega=0.402$
 C 2337.2+y, J+6 γ_{1510+y} 827.44 (\dagger 0.92 15) I⁽¹⁾=85.6, I⁽²⁾=80.0, $\eta\omega=0.426$
 C 3214.6+y, J+8 γ_{2337+y} 877.44 (\dagger 1.21 20) I⁽¹⁾=85.3, I⁽²⁾=77.8, $\eta\omega=0.452$
 C 4143.4+y, J+10 γ_{3215+y} 928.84 (\dagger 0.87 15) I⁽¹⁾=84.8, I⁽²⁾=76.6, $\eta\omega=0.477$
 C 5124.4+y, J+12 γ_{4143+y} 981.04 (\dagger 0.79 15) I⁽¹⁾=84.3, I⁽²⁾=74.1, $\eta\omega=0.504$
 C 6159.4+y, J+14 γ_{5124+y} 1035.04 (\dagger 1.18 20) I⁽¹⁾=83.8, I⁽²⁾=72.9, $\eta\omega=0.531$
 C 7249.3+y, J+16 γ_{6159+y} 1089.95 (\dagger 1.01 20) I⁽¹⁾=83.2, I⁽²⁾=71.2, $\eta\omega=0.559$
 C 8395.4+y, J+18 γ_{7249+y} 1146.15 (\dagger 1.02 20) I⁽¹⁾=82.6, I⁽²⁾=69.9, $\eta\omega=0.587$
 C 9598.7+y, J+20 γ_{8395+y} 1203.35 (\dagger 0.80 15) I⁽¹⁾=82.0, I⁽²⁾=69.0, $\eta\omega=0.616$
 C 10860.0+y, J+22 γ_{9598+y} 1261.35 (\dagger 0.84 15) I⁽¹⁾=81.4, I⁽²⁾=68.7, $\eta\omega=0.645$
 C 12179.5+y, J+24 $\gamma_{10860+y}$ 1319.55 (\dagger 0.79 17) I⁽¹⁾=80.8, I⁽²⁾=66.1, $\eta\omega=0.675$
 C 13559.5+y, J+26 $\gamma_{12180+y}$ 1380.05 (\dagger 0.54 20) I⁽¹⁾=80.2, I⁽²⁾=67.8, $\eta\omega=0.705$
 C 14998.5+y, J+28 $\gamma_{13560+y}$ 1439.06 (\dagger 0.31 20) I⁽¹⁾=79.6, I⁽²⁾=65.0, $\eta\omega=0.735$
 C 16499.0+y, J+30 $\gamma_{14998+y}$ 1500.5 10 (\dagger 0.38 20) I⁽¹⁾=79.1, I⁽²⁾=68.4, $\eta\omega=0.765$
 C 18058.0+y, J+32 $\gamma_{16499+y}$ 1559.0 15 (\dagger 0.17 10)
 D z

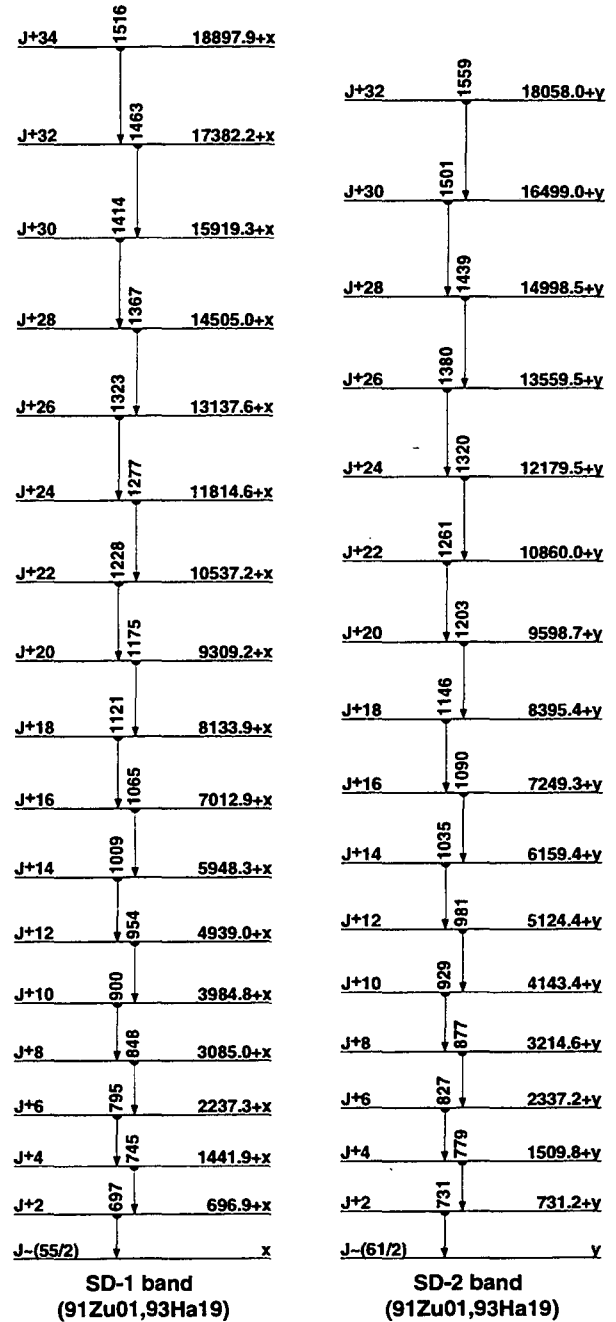

¹⁴⁷₆₄Gd

¹⁴⁸Gd
64

Δ : -76279.3 S_n: 8983.8 I₄ S_p: 6014.3 Q_α: 3271.213

Nuclear Bands

- A SD-1 band (96DeAA,95DeZZ)(93Ha19,88De10)
- B SD-2 band (96DeAA,95DeZZ,93Ha19)
- C SD-3 band (95DeZZ,96DeAA)
- D SD-4 band (95DeZZ,96DeAA)
- E SD-5 band (95DeZZ,96DeAA)
- F SD-6 band (95DeZZ,96DeAA)

Levels and γ -ray branchings:

0, 0⁺, 74.6 30 y, % α =100
 784.430 16, 2⁺ γ_{0} 784.430 16 (t_{1/2} 100) E2
 1273.479 20, 3⁻ γ_{784} 489.049 12 (t_{1/2} 100) E1
 1416.377 23, 4⁺ γ_{1273} 142.878 14 (t_{1/2} 2.90 13) E1 γ_{784} 631.947 17 (t_{1/2} 100.0 19) E2
 1811.0, 6⁺ γ_{1416} 394.6 (t_{1/2} 100) E2
 1834.58 5, ⁺ γ_{784} 1050.154 (t_{1/2} 100) E2, M1
 1863.42 5, 2⁺ γ_{1273} 589.97 (t_{1/2} 5.2 3) γ_{784} 1079.025 25 (t_{1/2} 100.0 19) E2+M1: δ =4.6 13 γ_{0} 1863.391 38 (t_{1/2} 49.3 10)
 1912.95 10, 4⁻ γ_{1273} 639.477 (t_{1/2} 100) M1
 2082.04 15, 5⁻ γ_{1913} 169.2 γ_{1811} 270.9 (t_{1/2} 38) E1 γ_{1416} 665.6 (t_{1/2} <39) γ_{1273} 808.567 (t_{1/2} 100) E2
 2188.65 20, 2⁺ γ_{1273} 915.30 12 (t_{1/2} 14) γ_{784} 1404.224 35 (t_{1/2} 100) E2, M1 γ_{0} 2188.657 (t_{1/2} 80)
 2233.59 6, 3⁻ γ_{1273} 960.097 (t_{1/2} <100) E2, M1 γ_{784} 1449.164 (t_{1/2} 85)
 2310.88 7, 2⁺ γ_{784} 1526.457 (t_{1/2} 55) γ_{0} 2311.037 (t_{1/2} 100)
 2424.09 15, ⁺ γ_{1416} 1007.729 (t_{1/2} <100) γ_{784} 1639.66 22 (t_{1/2} 65) M1, E2
 2503.86 15, ⁻ γ_{1273} 1230.18 5 (t_{1/2} 56) E2, M1 γ_{784} 1719.63 20 (t_{1/2} 100)
 2506.4 5, 3⁻ γ_{1416} 1089.411 28 (t_{1/2} 100) E1 γ_{784} 1722.47 28 (t_{1/2} 15.3)
 2522.0 3, 4⁺ γ_{1416} 1105.65 11 (t_{1/2} 100) M1, E2 γ_{1273} 1248.2 8 (t_{1/2} 33) γ_{784} 1737.9 6 (t_{1/2} 27)
 2563.8 3, 7⁻ γ_{2082} 481.65 10 (t_{1/2} 100) E2 γ_{1811} 752.8 2 (t_{1/2} 23.3) E1
 2615.0 8, 2⁺ γ_{1273} 1342.2 6 (t_{1/2} 9.2) γ_{784} 1830.14 4 (t_{1/2} 100) γ_{0} 2614.3 6 (t_{1/2} 38)
 2632.8 2, 5⁻ γ_{784} 1848.3 6 8 (t_{1/2} 100)
 2693.3 2, 8⁺ γ_{2564} 129.5 2 (t_{1/2} 2.7 4) γ_{1811} 882.3 E2
 2694.6, 9⁻, 16.5 3 ns, μ =-0.162 18, Q=-1.01 5 γ_{2564} 130.8 E2 γ_{1811} 883.6 E3
 2700.3 2, (2⁺) γ_{1273} 1426.49 8 (t_{1/2} 44) γ_{784} 1915.54 19 (t_{1/2} 63) γ_{0} 2700.57 20 (t_{1/2} 100)
 2763 3, 4⁺
 2872.9 4 γ_{1913} 960.097 (t_{1/2} <100) γ_{1273} 1599.39 6 (t_{1/2} 100) γ_{784} 2089 1 (t_{1/2} 41)
 2886.3 2 γ_{2504} 382.0 8 (t_{1/2} 24) γ_{1416} 1470.1 8 (t_{1/2} 20) γ_{784} 2101.87 10 (t_{1/2} 100)
 2915.3 3 γ_{1913} 1002.48 9 (t_{1/2} 28) γ_{1273} 1641.98 21 (t_{1/2} 37) γ_{784} 2131.14 11 (t_{1/2} 100)
 2936.3, 7⁻ γ_{1811} 1125.3 (t_{1/2} 100)
 3029.3, 8⁻ γ_{2695} 334.7 (t_{1/2} 100) M1 γ_{2564} 465.6 (t_{1/2} 58) M1
 3065 γ_{1835} 1230
 3076.1 4 γ_{1273} 1802.62 24 (t_{1/2} 100)
 3089.5 4 γ_{2082} 1007.72 9 (t_{1/2} <100) (E2, M1) γ_{1273} 1816.06 9 (t_{1/2} 68) γ_{0} 3090.5 15 (t_{1/2} 25)
 3130.9 2 γ_{784} 2345.1 8 (t_{1/2} 63) γ_{0} 3130.89 16 (t_{1/2} 100)
 3152.1, 8⁻ γ_{3028} 122.9 D+Q γ_{2695} 457.6 γ_{2564} 588.3
 3295.0 2 γ_{784} 2510.56 15 (t_{1/2} 100) γ_{0} 3295.5 10 (t_{1/2} 33)
 3310.0 (?), 8⁻ γ_{2836} 373.7 (t_{1/2} 100)
 3366.8, 9⁻ γ_{3310} 57 γ_{3152} 214.7 γ_{3028} 337.2 γ_{2836} 430.5 (t_{1/2} 100) γ_{2693} 673.8 (t_{1/2} 78) γ_{2564} 803.2
 3574.9 4 γ_{1273} 2301.44 21 (t_{1/2} 100) γ_{0} 3574.6 10 (t_{1/2} 90)
 3701.3, 11⁻ γ_{2695} 1006.7 (t_{1/2} 100) E2
 3757.9, 10⁺ γ_{2695} 1063.3 (t_{1/2} 100)
 3822, 10⁺ γ_{3758} 63 γ_{2693} 1128 γ_{2633} 1129

3917.4, 10⁻ γ_{3367} 550.3 γ_{3152} 765.3 γ_{3028} 888.3
 3980.1, 12⁺ γ_{3758} 221.6 γ_{3701} 278.8 E1 γ_{2695} 1285.4
 4050.8 15 γ_{1416} 2634.6 10 (t_{1/2} 39) γ_{1273} 2777.5 10 (t_{1/2} 19) γ_{784} 3266.4 10 (t_{1/2} 100)
 4068.7 15 γ_{1913} 2155.33 25 (t_{1/2} 100) γ_{1273} 2794.6 10 (t_{1/2} 51) γ_{0} 4066.8 10 (t_{1/2} 43)
 4121.2, 11⁻ γ_{3701} 420.1 γ_{3367} 754.2
 4429.4, 12⁻ γ_{4121} 308.2 γ_{3880} 449.1 γ_{3917} 511 γ_{3701} 728.3
 4499.8, 12⁺ γ_{3880} 519.7 (t_{1/2} 100) γ_{3822} 678 γ_{3758} 742.1 (t_{1/2} 100) γ_{3701} 799
 4542.3 4 γ_{1416} 3125.44 29 (t_{1/2} 47) γ_{1273} 3269.22 30 (t_{1/2} 100)
 4550.6, 13⁻ γ_{4428} 121.2 γ_{4121} 429.4 γ_{3880} 570
 4905.5, 14⁻ γ_{4551} 354.9
 5025.1, 14⁺ γ_{4551} 475 γ_{4500} 525.3 γ_{3880} 1045.1
 5116.9, 15⁻ γ_{4906} 211.4 (t_{1/2} 100) γ_{4551} 566.3 (t_{1/2} 100)
 5167.4, 14⁺ γ_{3980} 1187.3 (t_{1/2} 100)
 5354.7, 16⁺ γ_{5117} 237.9 (t_{1/2} 14) γ_{5025} 329.6 (t_{1/2} 100)
 5437.7, 16⁻ γ_{5117} 320.8 γ_{4906} 532
 5578 γ_{5167} 411
 5689, 17 γ_{5355} 334
 5800 γ_{5578} 222
 5831.8, 18⁺ γ_{5689} 142 γ_{5355} 476.8
 5882, 17 γ_{5438} 444
 5933, 17 γ_{5800} 133 γ_{5438} 495 γ_{5355} 578 γ_{5117} 816
 6268, 18 γ_{5832} 436
 6381, 18 γ_{5833} 448 γ_{5882} 499 γ_{5832} 549
 6545, 18⁻ γ_{5833} 612 γ_{5689} 855
 6574, 19⁺ γ_{6381} 193 γ_{6268} 306 γ_{5832} 742
 6640, 19⁻ γ_{5832} 808
 6834, 20⁻, \approx 2 ns γ_{6640} 194 γ_{6574} 259 γ_{6545} 289 γ_{5832} 1002
 7051, 19⁺ γ_{6381} 670 γ_{5832} 1219
 7110, 20⁺ γ_{5832} 1278
 7155, 21⁻ γ_{6834} 321 γ_{6640} 516
 7273, 20⁺ γ_{7051} 223 γ_{6574} 699
 7333 γ_{6574} 759
 7530, 21⁺ γ_{7333} 197 γ_{7273} 257 γ_{7110} 420 γ_{7051} 479
 7790, 22⁺ γ_{7530} 260 γ_{7110} 680
 8003, 22⁻ γ_{7155} 849 γ_{6834} 1170
 8241, 22⁻ γ_{6834} 1408
 8304, 23⁻ γ_{7155} 1149
 8308, 23⁺ γ_{7790} 518
 8363, 23⁻ γ_{7790} 574 γ_{7155} 1208
 8453, 23⁻ γ_{6304} 151 γ_{6241} 213 γ_{6003} 451 γ_{7790} 664
 8608, 23 γ_{7790} 818
 8637, 24⁻ γ_{8453} 184 γ_{8308} 330 γ_{8003} 634
 8831, 24 γ_{8608} 223 γ_{8453} 377 γ_{8363} 468 γ_{8308} 523
 8986, 25⁻ γ_{8831} 155 γ_{8637} 348 γ_{8363} 623
 9241, 25⁻ γ_{8637} 604
 9258 γ_{8637} 620 γ_{8363} 895
 9652, 26⁻ γ_{8986} 666
 9755, 26⁻ γ_{9241} 514 γ_{8986} 771
 9933, 26 γ_{8831} 1102
 9956 γ_{9241} 714
 10045, 25⁻ γ_{9258} 788 γ_{8363} 1682 γ_{8304} 1742
 10060, 27 γ_{9755} 305
 10317, 27 γ_{10045} 272 γ_{9956} 361 γ_{9755} 560 γ_{9652} 665 γ_{8986} 1331
 10472, 27 γ_{9755} 717
 10694, 27⁻ γ_{9652} 1042
 10757, 28 γ_{10060} 697
 10867, 28 γ_{10060} 807
 11157, 28 γ_{10694} 464 γ_{10472} 684 γ_{10317} 840
 11183, 29 γ_{10060} 1123
 11455, 29 γ_{11183} 271 γ_{11157} 298

11478 γ_{10317} 1160	$\eta\omega=0.835$	A 22448.5+x, J+38 $\gamma_{20748+x}$ 1700.36 ($\dagger_{0.073}$)
11546, 29 γ_{10684} 852 γ_{10317} 1228	B $\gamma, J=(30)$	B 741.8+y, J+2 γ_{γ} 741.83 ($I^{(1)}=83.6, I^{(2)}=84.9, \eta\omega=0.383$)
11585, 30 γ_{11455} 130	B 1530.7+y, J+4 γ_{742+y} 788.92 ($\dagger_{0.4610}$) ($I^{(1)}=83.6, I^{(2)}=80.2, \eta\omega=0.407$)	B 2369.5+y, J+6 γ_{1531+y} 838.82 ($\dagger_{0.889}$) ($I^{(1)}=83.3, I^{(2)}=79.5, \eta\omega=0.432$)
11725, 30 γ_{11183} 542 γ_{10867} 858 γ_{10757} 697	B 3258.6+y, J+8 γ_{2370+y} 889.12 ($\dagger_{0.899}$) ($I^{(1)}=83.1, I^{(2)}=78.9, \eta\omega=0.457$)	B 4198.4+y, J+10 γ_{3258+y} 939.82 ($\dagger_{0.9315}$) ($I^{(1)}=82.9, I^{(2)}=79.1, \eta\omega=0.483$)
12011 γ_{11455} 556	B 5188.8+y, J+12 γ_{4198+y} 990.43 ($\dagger_{1.0011}$) ($I^{(1)}=82.8, I^{(2)}=81.1, \eta\omega=0.508$)	B 6228.5+y, J+14 γ_{5188+y} 1039.72 ($\dagger_{0.9520}$) ($I^{(1)}=82.7, I^{(2)}=83.2, \eta\omega=0.532$)
12061, 30 γ_{11183} 878	B 7316.3+y, J+16 γ_{6228+y} 1087.82 ($\dagger_{1.0315}$) ($I^{(1)}=82.8, I^{(2)}=84.4, \eta\omega=0.556$)	B 8451.5+y, J+18 γ_{7316+y} 1135.22 ($\dagger_{0.9410}$) ($I^{(1)}=82.8, I^{(2)}=84.2, \eta\omega=0.579$)
12139, 31 γ_{12061} 74 γ_{11725} 411 γ_{11585} 554 γ_{11546} 593 γ_{11478} 661	B 9634.2+y, J+20 γ_{8452+y} 1182.72 ($\dagger_{0.828}$) ($I^{(1)}=82.9, I^{(2)}=82.5, \eta\omega=0.603$)	B 10865.4+y, J+22 γ_{9634+y} 1231.22 ($\dagger_{0.798}$) ($I^{(1)}=82.8, I^{(2)}=80.5, \eta\omega=0.628$)
12283, 30 γ_{11455} 880 γ_{11157} 1126	B 12146.3+y, J+24 $\gamma_{10865+y}$ 1280.92 ($\dagger_{0.778}$) ($I^{(1)}=82.7, I^{(2)}=78.0, \eta\omega=0.653$)	B 13478.5+y, J+26 $\gamma_{12146+y}$ 1332.22 ($\dagger_{0.627}$) ($I^{(1)}=82.5, I^{(2)}=78.3, \eta\omega=0.679$)
12380, 31 γ_{11455} 925	B 14861.8+y, J+28 $\gamma_{13478+y}$ 1383.33 ($\dagger_{0.566}$) ($I^{(1)}=82.2, I^{(2)}=73.8, \eta\omega=0.705$)	B 16299.3+y, J+30 $\gamma_{14862+y}$ 1437.55 ($\dagger_{0.445}$) ($I^{(1)}=82.0, I^{(2)}=74.6, \eta\omega=0.732$)
12527, 32 γ_{12283} 244 γ_{12139} 391 γ_{11585} 943	B 17790.4+y, J+32 $\gamma_{16299+y}$ 1491.18 ($\dagger_{0.274}$) ($I^{(1)}=81.7, I^{(2)}=72.6, \eta\omega=0.759$)	B 19336.6+y, J+34 $\gamma_{17790+y}$ 1546.210 ($\dagger_{0.234}$)
12681, 31 γ_{11585} 1096	C z, J	C 830.3+z, J+2 γ_z 830.36 ($\dagger_{0.235}$) ($I^{(2)}=88.1, \eta\omega=0.426$)
13037, 33 γ_{12681} 361 γ_{12527} 510 γ_{12380} 657	C 1706.0+z, J+4 γ_{830+z} 875.73 ($\dagger_{0.426}$) ($I^{(2)}=81.1, \eta\omega=0.450$)	C 2631.0+z, J+6 γ_{1706+z} 925.02 ($\dagger_{0.437}$) ($I^{(2)}=78.9, \eta\omega=0.475$)
13123, 33 γ_{12139} 987	C 3606.7+z, J+8 γ_{2631+z} 975.73 ($\dagger_{0.627}$) ($I^{(2)}=77.2, \eta\omega=0.501$)	C 4634.2+z, J+10 γ_{3607+z} 1027.52 ($\dagger_{0.638}$) ($I^{(2)}=76.8, \eta\omega=0.527$)
13146, 32 γ_{12681} 462 γ_{12380} 766 γ_{12139} 1009	C 4634.2+z, J+10 γ_{3607+z} 1027.52 ($\dagger_{0.638}$) ($I^{(2)}=76.8, \eta\omega=0.527$)	C 5713.8+z, J+12 γ_{4634+z} 1079.63 ($\dagger_{0.9511}$) ($I^{(2)}=75.3, \eta\omega=0.553$)
13242, 32 γ_{12681} 561	C 6846.5+z, J+14 γ_{5714+z} 1132.72 ($\dagger_{1.0012}$) ($I^{(2)}=75.2, \eta\omega=0.580$)	C 8032.4+z, J+16 γ_{6847+z} 1185.93 ($\dagger_{0.9330}$) ($I^{(2)}=74.9, \eta\omega=0.606$)
13352, 34 γ_{12527} 825	C 8032.4+z, J+16 γ_{6847+z} 1185.93 ($\dagger_{0.9330}$) ($I^{(2)}=74.6, \eta\omega=0.633$)	C 9271.7+z, J+18 γ_{8032+z} 1239.33 ($\dagger_{0.7215}$) ($I^{(2)}=74.6, \eta\omega=0.659$)
13734, 34 γ_{181} 492 γ_{13242} 492 γ_{13146} 588 γ_{13037} 697	C 10564.6+z, J+20 γ_{9272+z} 1292.93 ($\dagger_{0.9520}$) ($I^{(2)}=77.5, \eta\omega=0.659$)	C 11909.1+z, J+22 $\gamma_{10565+z}$ 1344.53 ($\dagger_{0.7118}$) ($I^{(2)}=78.9, \eta\omega=0.685$)
13868, 35, ≈ 2 ns γ_{13734} 134 γ_{12527} 1340	C 13304.3+z, J+24 $\gamma_{11909+z}$ 1395.24 ($\dagger_{0.6415}$) ($I^{(2)}=100.0, \eta\omega=0.708$)	C 13304.3+z, J+24 $\gamma_{11909+z}$ 1395.24 ($\dagger_{0.6415}$) ($I^{(2)}=100.0, \eta\omega=0.708$)
13886 γ_{13037} 849	C 14739.5+z, J+26 $\gamma_{13304+z}$ 1435.25 ($\dagger_{0.468}$) ($I^{(2)}=540.5, \eta\omega=0.719$)	C 16182.1+z, J+28 $\gamma_{14740+z}$ 1442.610 ($\dagger_{0.4012}$) ($I^{(2)}=784.3, \eta\omega=0.723$)
14009, 34 γ_{13037} 972	C 17629.8+z, J+30 $\gamma_{16182+z}$ 1447.76 ($\dagger_{0.189}$) ($I^{(2)}=164.6, \eta\omega=0.730$)	C 19101.8+z, J+32 $\gamma_{17630+z}$ 1472.010 ($\dagger_{0.228}$)
14144, 35 γ_{13037} 1107	D u, J	D 849.7+u, J+2 γ_0 849.73 ($I^{(2)}=99.3, \eta\omega=0.435$)
14827, 37 γ_{13868} 959	D 1739.7+u, J+4 γ_{850+u} 890.02 ($\dagger_{0.6215}$) ($I^{(2)}=82.1, \eta\omega=0.457$)	D 2678.4+u, J+6 γ_{1740+u} 938.72 ($\dagger_{0.6012}$) ($I^{(2)}=80.5, \eta\omega=0.482$)
14923, 36 γ_{14144} 779 γ_{13886} 1036 γ_{13868} 1056	D 3666.8+u, J+8 γ_{2678+u} 988.43 ($\dagger_{0.6410}$) ($I^{(2)}=78.1, \eta\omega=0.507$)	D 4706.4+u, J+10 γ_{3667+u} 1039.63 ($\dagger_{0.6810}$) ($I^{(2)}=77.7, \eta\omega=0.533$)
15122, 38 γ_{14827} 295	D 5797.5+u, J+12 γ_{4706+u} 1091.13 ($\dagger_{0.9215}$) ($I^{(2)}=75.3, \eta\omega=0.559$)	D 6941.7+u, J+14 γ_{5798+u} 1144.23 ($\dagger_{1.0520}$) ($I^{(2)}=74.3, \eta\omega=0.586$)
15164, 38 γ_{14827} 337	D 8139.7+u, J+16 γ_{6942+u} 1198.03 ($\dagger_{1.0015}$) ($I^{(2)}=73.0, \eta\omega=0.613$)	D 9392.5+u, J+18 γ_{8140+u} 1252.83 ($\dagger_{1.0213}$) ($I^{(2)}=72.3, \eta\omega=0.640$)
15726 γ_{14923} 803	D 10700.6+u, J+20 γ_{8383+u} 1308.13 ($\dagger_{0.8815}$) ($I^{(2)}=71.0, \eta\omega=0.668$)	D 12065.0+u, J+22 $\gamma_{10701+u}$ 1364.43 ($\dagger_{0.9018}$) ($I^{(2)}=70.3, \eta\omega=0.696$)
16076 γ_{15726} 350	D 13486.3+u, J+24 $\gamma_{12065+u}$ 1421.34 ($\dagger_{0.8210}$) ($I^{(2)}=69.9, \eta\omega=0.725$)	D 14964.8+u, J+26 $\gamma_{13486+u}$ 1478.54 ($\dagger_{0.579}$) ($I^{(2)}=68.5, \eta\omega=0.754$)
16111, 38 γ_{14923} 1188	D 14964.8+u, J+26 $\gamma_{13486+u}$ 1478.54 ($\dagger_{0.579}$) ($I^{(2)}=68.5, \eta\omega=0.754$)	D 16501.7+u, J+28 $\gamma_{14965+u}$ 1536.910 ($\dagger_{0.3010}$)
16203, 40 γ_{15164} 1039	E v, J	E 853.7+v, J+2 γ_0 853.73 ($\dagger_{0.456}$) ($I^{(2)}=86.6, \eta\omega=0.438$)
16256, 40 γ_{15164} 1092		
16406, 40 γ_{16111} 295		
16472, 39 γ_{15164} 1308		
17240 γ_{16406} 834		
17318 γ_{16472} 846		
17370, 42 γ_{16406} 964		
18481, 44 γ_{17370} 1111		
19148 γ_{18481} 667		
A x, J=(29)		
A 699.9+x, J+2 γ_{γ} 699.91 ($\dagger_{0.5415}$) ($I^{(1)}=85.6, I^{(2)}=83.3, \eta\omega=0.362$)		
A 1447.8+x, J+4 γ_{700+x} 747.91 ($\dagger_{0.879}$) ($I^{(1)}=85.5, I^{(2)}=83.5, \eta\omega=0.386$)		
A 2243.6+x, J+6 γ_{1448+x} 795.81 ($\dagger_{0.998}$) ($I^{(1)}=85.2, I^{(2)}=78.6, \eta\omega=0.411$)		
A 3090.3+x, J+8 γ_{2244+x} 846.71 ($\dagger_{0.978}$) ($I^{(1)}=84.8, I^{(2)}=78.1, \eta\omega=0.436$)		
A 3988.2+x, J+10 γ_{3090+x} 897.91 ($\dagger_{1.008}$) ($I^{(1)}=84.4, I^{(2)}=76.3, \eta\omega=0.462$)		
A 4938.5+x, J+12 γ_{3988+x} 950.31 ($\dagger_{0.978}$) ($I^{(1)}=83.9, I^{(2)}=74.6, \eta\omega=0.489$)		
A 5942.4+x, J+14 γ_{4939+x} 1003.91 ($\dagger_{1.0010}$) ($I^{(1)}=83.4, I^{(2)}=73.0, \eta\omega=0.516$)		
A 7001.1+x, J+16 γ_{5942+x} 1058.71 ($\dagger_{0.989}$) ($I^{(1)}=82.8, I^{(2)}=72.1, \eta\omega=0.543$)		
A 8115.3+x, J+18 γ_{7001+x} 1114.21 ($\dagger_{0.9910}$) ($I^{(1)}=82.3, I^{(2)}=70.9, \eta\omega=0.571$)		
A 9285.9+x, J+20 γ_{8115+x} 1170.61 ($\dagger_{1.0015}$) ($I^{(1)}=81.7, I^{(2)}=69.9, \eta\omega=0.600$)		
A 10513.7+x, J+22 γ_{9286+x} 1227.81 ($\dagger_{0.847}$) ($I^{(1)}=81.2, I^{(2)}=69.2, \eta\omega=0.628$)		
A 11799.3+x, J+24 $\gamma_{10514+x}$ 1285.61 ($\dagger_{0.718}$) ($I^{(1)}=80.6, I^{(2)}=68.5, \eta\omega=0.657$)		
A 13143.3+x, J+26 $\gamma_{11799+x}$ 1344.02 ($\dagger_{0.667}$) ($I^{(1)}=80.1, I^{(2)}=68.4, \eta\omega=0.687$)		
A 14545.8+x, J+28 $\gamma_{13143+x}$ 1402.52 ($\dagger_{0.556}$) ($I^{(1)}=79.6, I^{(2)}=67.9, \eta\omega=0.716$)		
A 16007.2+x, J+30 $\gamma_{14546+x}$ 1461.42 ($\dagger_{0.487}$) ($I^{(1)}=79.1, I^{(2)}=67.7, \eta\omega=0.745$)		
A 17527.7+x, J+32 $\gamma_{16007+x}$ 1520.53 ($\dagger_{0.345}$) ($I^{(1)}=78.7, I^{(2)}=66.7, \eta\omega=0.775$)		
A 19108.2+x, J+34 $\gamma_{17528+x}$ 1580.56 ($\dagger_{0.193}$) ($I^{(1)}=78.2, I^{(2)}=67.2, \eta\omega=0.805$)		
A 20748.2+x, J+36 $\gamma_{19108+x}$ 1640.010 ($\dagger_{0.155}$) ($I^{(1)}=77.8, I^{(2)}=66.3,$		

- E 1753.6+v, J+4 γ_{854+v} 899.92 (\dagger , 0.83 9) $I^{(2)}=88.9, \hbar\omega=0.461$
- E 2698.5+v, J+6 γ_{1754+v} 944.93 (\dagger , 0.85 10) $I^{(2)}=86.0, \hbar\omega=0.484$
- E 3689.9+v, J+8 γ_{2698+v} 991.42 (\dagger , 0.86 10) $I^{(2)}=86.0, \hbar\omega=0.507$
- E 4727.8+v, J+10 γ_{3690+v} 1037.92 (\dagger , 0.85 20) $I^{(2)}=85.7, \hbar\omega=0.531$
- E 5812.4+v, J+12 γ_{4728+v} 1084.62 (\dagger , 1.00 15) $I^{(2)}=84.6, \hbar\omega=0.554$
- E 6944.3+v, J+14 γ_{5812+v} 1131.92 (\dagger , 1.00 13) $I^{(2)}=84.0, \hbar\omega=0.578$
- E 8123.8+v, J+16 γ_{6944+v} 1179.52 (\dagger , 0.90 10) $I^{(2)}=85.1, \hbar\omega=0.602$
- E 9350.3+v, J+18 γ_{8124+v} 1226.52 (\dagger , 0.80 10) $I^{(2)}=84.6, \hbar\omega=0.625$
- E 10624.1+v, J+20 γ_{9350+v} 1273.82 (\dagger , 0.80 10) $I^{(2)}=82.8, \hbar\omega=0.649$
- E 11946.2+v, J+22 $\gamma_{10624+v}$ 1322.12 (\dagger , 0.52 8) $I^{(2)}=84.2, \hbar\omega=0.673$
- E 13315.8+v, J+24 $\gamma_{11946+v}$ 1369.62 (\dagger , 0.50 10) $I^{(2)}=84.2, \hbar\omega=0.697$
- E 14732.9+v, J+26 $\gamma_{13316+v}$ 1417.13 (\dagger , 0.44 7) $I^{(2)}=83.7, \hbar\omega=0.721$
- E 16197.8+v, J+28 $\gamma_{14733+v}$ 1464.94 (\dagger , 0.31 5) $I^{(2)}=83.0, \hbar\omega=0.744$
- E 17710.9+v, J+30 $\gamma_{16198+v}$ 1513.10 (\dagger , 0.26 4) $I^{(2)}=81.8, \hbar\omega=0.769$
- E 19272.9+v, J+32 $\gamma_{17711+v}$ 1562.1 (\dagger , 0.20 6)
- F w, J
- F 802.2+w, J+2 γ_0 802.23 $I^{(2)}=85.5, \hbar\omega=0.413$
- F 1651.2+w, J+4 γ_{802+w} 849.02 $I^{(2)}=82.3, \hbar\omega=0.437$
- F 2548.8+w, J+6 γ_{1651+w} 897.62 (\dagger , 0.91 12) $I^{(2)}=82.5, \hbar\omega=0.461$
- F 3494.9+w, J+8 γ_{2549+w} 946.14 (\dagger , 1.00 12) $I^{(2)}=80.2, \hbar\omega=0.486$
- F 4490.9+w, J+10 γ_{3495+w} 996.03 (\dagger , 1.00 22) $I^{(2)}=78.6, \hbar\omega=0.511$
- F 5537.8+w, J+12 γ_{4491+w} 1046.92 (\dagger , 1.00 10) $I^{(2)}=76.6, \hbar\omega=0.537$
- F 6636.9+w, J+14 γ_{5538+w} 1099.14 (\dagger , 0.95 18) $I^{(2)}=75.6, \hbar\omega=0.563$
- F 7788.9+w, J+16 γ_{6637+w} 1152.02 (\dagger , 0.97 10) $I^{(2)}=73.8, \hbar\omega=0.590$
- F 8995.1+w, J+18 γ_{7789+w} 1206.22 (\dagger , 1.00 15) $I^{(2)}=73.7, \hbar\omega=0.617$
- F 10255.6+w, J+20 γ_{8995+w} 1260.52 (\dagger , 1.00 19) $I^{(2)}=72.5, \hbar\omega=0.644$
- F 11571.3+w, J+22 $\gamma_{10256+w}$ 1315.73 (\dagger , 0.96 10) $I^{(2)}=70.9, \hbar\omega=0.672$
- F 12943.4+w, J+24 $\gamma_{11571+w}$ 1372.12 (\dagger , 0.78 9) $I^{(2)}=70.9, \hbar\omega=0.700$
- F 14371.9+w, J+26 $\gamma_{12943+w}$ 1428.53 (\dagger , 0.77 10) $I^{(2)}=72.6, \hbar\omega=0.728$
- F 15855.5+w, J+28 $\gamma_{14372+w}$ 1483.66 (\dagger , 0.70 15) $I^{(2)}=70.9, \hbar\omega=0.756$
- F 17395.5+w, J+30 $\gamma_{15856+w}$ 1540.1 (\dagger , 0.63 15)

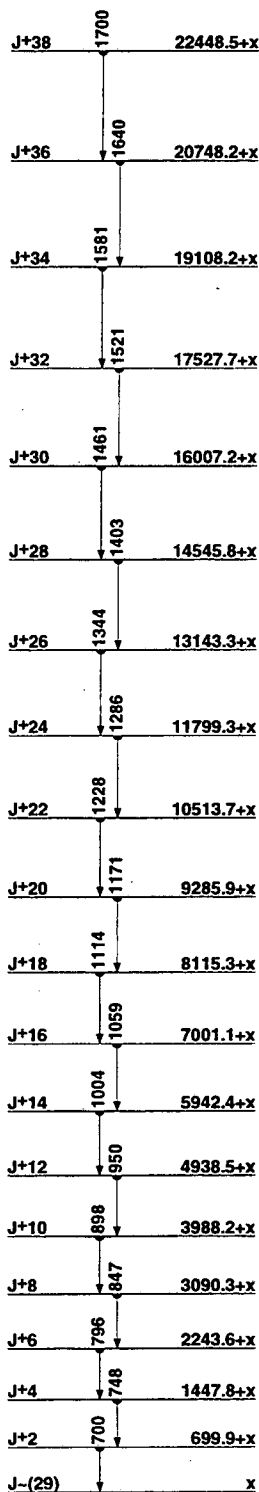

SD-1 band
(96DeAA,95DeZZ)
(93Ha19,88De10)

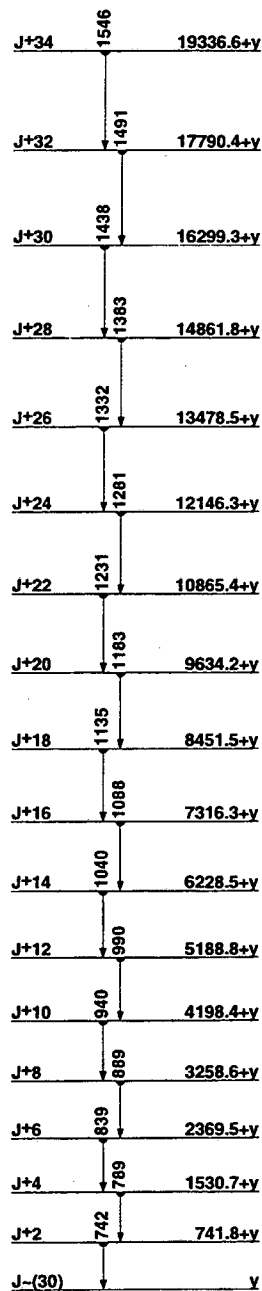

SD-2 band
(96DeAA,95DeZZ,93Ha19)

¹⁴⁸₆₄Gd

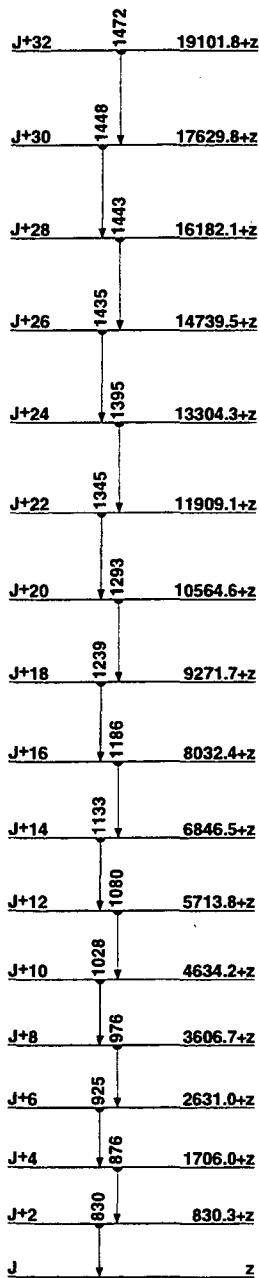

SD-3 band
(95DeZZ, 96DeAA)

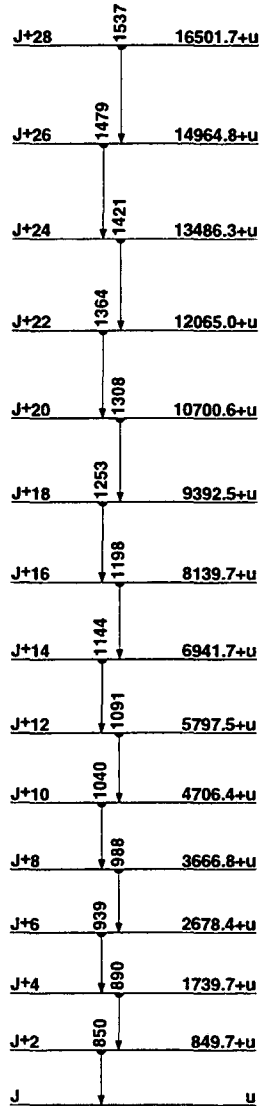

SD-4 band
(95DeZZ, 96DeAA)

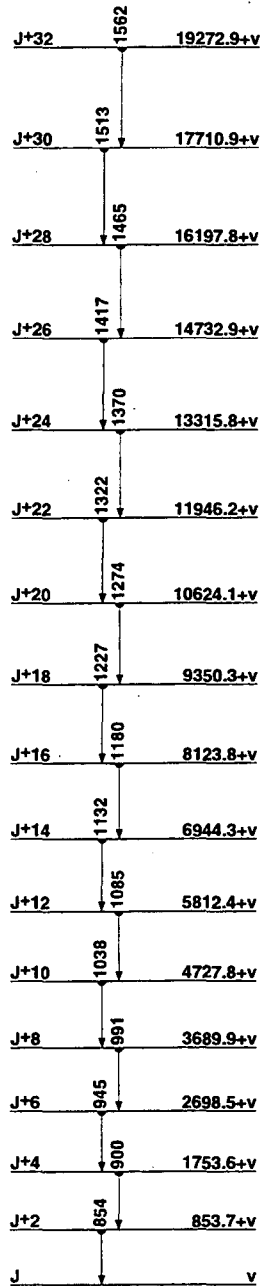

SD-5 band
(95DeZZ, 96DeAA)

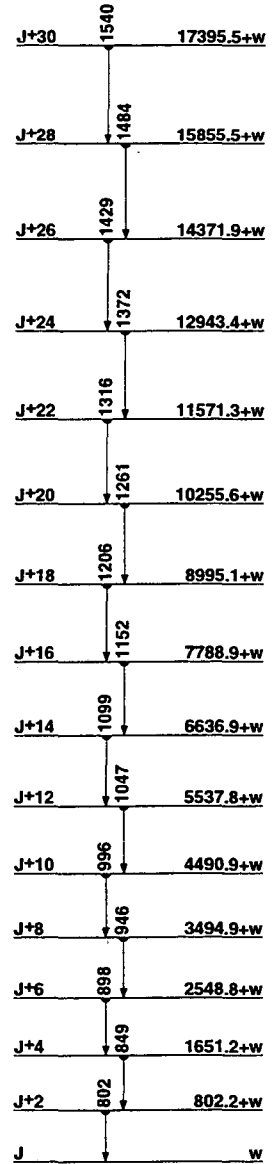

SD-6 band
(95DeZZ, 96DeAA)

¹⁴⁸₆₄Gd

¹⁴⁹Gd
⁶⁴Gd Δ : -751355 S_n : 69273 S_p : 618518 Q_{EC} : 13196 Q_α : 31013**Nuclear Bands**

- A SD-1 band (95FI01,93FI03,90Ha31,88Ha02)
 B SD-2 band (95FI01,93FI03,90Ha31,88Ha02)
 C SD-3 band (95FI01,93FI03,90Ha31,88Ha02)
 D SD-4 band (95FI01,93FI03)
 E SD-5 band $\alpha=-1/2$ (95FI01,93FI03,94De33)
 F SD-6 band $\alpha=+1/2$ (95FI01,93FI03,94De33)
 G $\nu_{7/2}^3$ (81Pi09)
 H $\nu_{9/2} \nu_{7/2}^2$ (81Pi09)
 I $\nu_{7/2}^3 + ^{148}\text{Gd}(3)$ (81Pi09)
 J Band Structure
 K Band Structure
 L Band Structure
 M Band Structure
 N Band Structure

Levels and γ -ray branchings:

- G 0, $7/2^-$, 9.28 10 d, %EC+% β^+ =100, % α = 4.3×10^{-4} 10, $\mu=0.88$ 4
 G 164.988 15, $5/2^-$, 1.71 ns, $\mu=-0.90$ 23 γ_0 164.982 (\dagger 100)
 M1+E2: $\delta=-0.93$ 2
 G 352.235 15, $3/2^-$, 0.43 s ns γ_{165} 187.222 (\dagger 14.62) M1+E2: $\delta=+0.5$ \dagger 2
 γ_0 352.242 (\dagger 100.3) E2
 G 775.20 8, $11/2^-$ γ_0 775.21 (\dagger 100) E2
 H 795.82 8, $9/2^-$ γ_{165} 630.53(?) (\dagger 15) γ_0 795.91 (\dagger 100.5)
 M1+E2: $\delta=+0.19$ 1
 817.10 2, $3/2^-$ γ_{352} 464.852 (\dagger 34.85) M1(+E2): $\delta=-0.10$ 14 γ_{165} 652.122
 (\dagger 100 1) M1+E2: $\delta=-0.57$ 5 γ_0 817.12 (\dagger 71.4 11) E2
 I 873.35 9, $11/2^+$, 1.66 ns γ_{796} 77.61 (\dagger 100 1) E1 γ_{775} 98.11 (\dagger 45 1) E1
 γ_0 873.12(?) (\dagger 4.2 2)
 I 955.81 11, (13/2)⁺ γ_{873} 82.32 (\dagger 43 1) M1 γ_{775} 180.51 (\dagger 100 1) E1
 1026.84 2, $3/2^+$ γ_{352} 674.616 (\dagger 9.12) E1 γ_{165} 861.862 (\dagger 100 1)
 E1(+M2): $\delta=-0.05$ 6
 1085.2 3, (5/2⁻, 7/2, 9/2⁻) γ_{796} 289.33 (\dagger 100 25) γ_{165} 920.5 (\dagger 38 12)
 γ_0 1085.5 (\dagger 75 38)
 1124.89 3, $1/2^+$, $3/2^+$, $5/2^+$ γ_{1027} 98.12 (\dagger 9.3 11) M1 γ_{817} 307.797
 (\dagger 16.5 11) γ_{352} 772.653 (\dagger 100 2) E1
 1144.09 5, $3/2^+$, $5/2^+$ γ_{1027} 117.2 (\dagger 4.2) γ_{352} 791.8 (\dagger 12.5) γ_{165} 979.096
 (\dagger 100 5) E1 γ_0 1144.09 (\dagger 59 5)
 1167.11 6, (3/2⁺) γ_{165} 1002.1 (\dagger 58 4) γ_0 1167.107 (\dagger 100 5) (M2)
 1205.67 2, (1/2⁻) γ_{817} 388.572 (\dagger 100.0 7) M1+E2: $\delta=-0.21$ 9
 γ_{352} 953.431 (\dagger 84.1 12) E2+M1: $\delta=-8$ \dagger 23 γ_{165} 1040.654 (\dagger 7.9 2) (E2)
 γ_0 1205.6(?) (\dagger <0.1)
 1348.73 9, $1/2^-$, $3/2, 5/2^-$ γ_{1027} 321.9 (\dagger 14 7) γ_{352} 996.51 (\dagger 100 7)
 γ_{165} 1183.72 (\dagger 57 14)
 1402.90 7, (5/2⁻) γ_{1085} 317.4 (\dagger 14 4) γ_{796} 606.7 (\dagger 4 2) γ_0 1402.919
 (\dagger 100 6)
 G 1483.80 11, (15/2⁻) γ_{956} 527.81 (\dagger 44 2) E1 γ_{775} 708.71 (\dagger 100 1) E2
 1487.60 7, $1/2^+$, $3/2, 5/2^-$ γ_{817} 670.4 (\dagger 5.2 15) γ_{352} 1135.31 (\dagger 100 3)
 M1(+E2): $\delta<0.7$ γ_{165} 1322.71 (\dagger 7.5 7)
 1544.13 5, (3/2⁻, 5/2⁻) γ_{352} 1191.898 (\dagger 100 7) γ_{165} 1379.11 (\dagger 100 5)
 γ_0 1544.12 (\dagger 21 5)
 1557.38 6, $1/2^-$, $3/2, 5/2^-$ γ_{1165} 390.3 (\dagger 29 7) γ_{1144} 413.31 (\dagger 31 2)
 γ_{1125} 432.52 (\dagger 18 4) γ_{817} 740.21 (\dagger 100 4) γ_{352} 1205.208 (\dagger 95 9)
 γ_{165} 1392.33 (\dagger 13 4)
 1597.29 11, $1/2, 3/2, 5/2^-$ γ_{1125} 472.41 (\dagger 100 15) γ_{817} 780.2 (\dagger 9 2)
 γ_{352} 1245.1 (\dagger 11 4)
 H 1609.05 13, (13/2⁻) γ_{796} 813.22 (\dagger 100 1) (E2) γ_{775} 834.02 (\dagger 99 3)
 D(+Q)
 1614.05 6, $3/2^+$ γ_{1167} 446.76 (\dagger 2.8 19) γ_{1144} 469.9 (\dagger 0.9 6) γ_{1027} 587.2
 (\dagger 5.7 19) γ_{817} 796.9 (\dagger 1.9 9) γ_{352} 1261.72 (\dagger 12 2) γ_{165} 1449.108
 (\dagger 100 4) E1
 1655.19 6, (3/2)⁺ γ_{1403} 252.31 (\dagger 11 2) γ_{1206} 449.6 (\dagger 7.7 22)
 γ_{1167} 488.12 (\dagger 11 2) γ_{1027} 628.42 (\dagger 9.9 22) γ_{817} 838.12 (\dagger 9 1)
 γ_{352} 1302.928 (\dagger 100 3) E1 γ_{165} 1490.32 (\dagger 22 3)
 I 1739.72, (17/2)⁺ γ_{956} 784.12 (\dagger 100) E2
 1750.61 9, $1/2^-$, $3/2, 5/2^-$ γ_{1403} 347.7 (\dagger 79 10) γ_{1125} 625.73 (\dagger 10 5)
 γ_{1027} 723.8 (\dagger 63 10) γ_{352} 1398.33 (\dagger 32 10) γ_{165} 1585.61 (\dagger 100 5)
 γ_0 1751.04(?) (\dagger 21 11)
 1751.12(?) γ_{873} 877.82(?) (\dagger 100)
 1772.83 5, $1/2^-$, $3/2^-$ γ_{1125} 648.01 (\dagger 100 9) γ_{1027} 746.01 (\dagger 49 3)
 γ_{817} 955.715 (\dagger 77 4) (E1) γ_{352} 1420.61 (\dagger 14 1) γ_0 1772.8(?) (\dagger 3 3)
 1844.31 7, $1/2^-$, $3/2, 5/2^-$ γ_{1167} 677.21 (\dagger 100 10) γ_{1027} 817.5 (\dagger 35 10)
 γ_{817} 1027.22 (\dagger 10 5) γ_{352} 1492.23 (\dagger 60 10) γ_{165} 1679.31 (\dagger 90 10)
 1992.49 4, $3/2^-$ γ_{1773} 219.7 (\dagger 0.3 16) γ_{1614} 378.51 (\dagger 3.8 5) γ_{1544} 448.5
 (\dagger 1.4 3) γ_{1206} 786.81 (\dagger 4.1 3) γ_{1167} 825.4 (\dagger 1.9 5) γ_{1027} 965.635
 (\dagger 16.2 8) γ_{817} 1175.4 (\dagger 100 4) M1 γ_{352} 1640.266 (\dagger 97.3 3)
 E2(+M1): $\delta>1$ γ_{165} 1827.5 (\dagger 33.5 2) M1(+E2): $\delta<1$ γ_0 1992.5(?)
 (\dagger 0.5 5)
 1999.53(?) (15/2⁺) γ_{1609} 390.52 (\dagger 100) E1
 2058.01 13, (17/2⁻) γ_{1609} 448.92 (\dagger 19 2) (E2) γ_{1484} 574.21 (\dagger 100 1) M1
 2088.47 9, $1/2^-$, $3/2, 5/2^-$ γ_{1403} 685.6 (\dagger 31 11) γ_{1144} 944.42 (\dagger 71 28)
 γ_{1125} 963.6 (\dagger 57 28) γ_{1027} 1061.61 (\dagger 100 14) γ_{352} 1736.32 (\dagger 93 13)
 γ_{165} 1923.4 (\dagger 16 9)
 2126.6 6, $1/2, 3/2, 5/2^-$ γ_{1403} 723.7 (\dagger 100 25) γ_{1125} 1001.7(?) (\dagger <37)
 γ_{352} 1774.4 (\dagger 75 25)
 2158.36 4, (3/2)⁺ γ_{1614} 544.3 (\dagger 1.1 4) γ_{1544} 614.21 (\dagger 7.3 8) γ_{1484} 670.8
 (\dagger 3.5 8) γ_{1206} 952.71 (\dagger 6.9 8) γ_{1125} 1033.4 (\dagger 10.8 19) (M1)
 γ_{1167} 1131.657 (\dagger 34.2 11) (M1) γ_{817} 1341.196 (\dagger 100 4) E1
 γ_{352} 1806.01 (\dagger 19.2 11) γ_{165} 1993.3 (\dagger 2 3 8)
 2199.90 11, $1/2^-$, $3/2, 5/2^-$ γ_{1403} 797.0 (\dagger 11 5) γ_{1206} 994.3 (\dagger 21 5)
 γ_{1167} 1032.8 (\dagger 53 16) γ_{1144} 1055.8 (\dagger 74 21) γ_{1125} 1075.01 (\dagger 42 5)
 γ_{352} 1847.7 (\dagger 47 5) γ_{165} 2034.8 (\dagger 100 16)
 H 2231.6 2, (17/2⁻) γ_{1609} 622.72 (\dagger 93 4) (E2) γ_{1484} 747.62 (\dagger 100 4)
 2261.54 9, $1/2^-$, $3/2$ γ_{1488} 774.0 (\dagger 7 4) γ_{1403} 858.6 (\dagger 32 8)
 γ_{1167} 1094.33 (\dagger 12 4) γ_{1144} 1117.5 (\dagger 4.8 8) γ_{1125} 1136.6 (\dagger 12 8)
 γ_{1027} 1234.72 (\dagger 30 5) γ_{817} 1444.4 (\dagger 36 8) γ_{352} 1909.31 (\dagger 100 8)
 γ_{165} 2096.5 (\dagger 16 4) γ_0 2261.5(?) (\dagger 12 12)
 2300.72 6, $1/2^-$, $3/2$ γ_{1614} 686.668 (\dagger 48 4) γ_{1125} 1175.8 (\dagger 46 7)
 γ_{1027} 1273.9 (\dagger 3.5 17) γ_{817} 1483.61 (\dagger 59 7) γ_{352} 1948.51 (\dagger 100 4)
 γ_{165} 2135.72 (\dagger 26 4)
 2314.1 7, $1/2^-$, $3/2, 5/2^-$ γ_{817} 1497.0 (\dagger 100 25) γ_{165} 2149.1 (\dagger 75 25)
 2383.4 2, (19/2⁻) γ_{2058} 325.22 (\dagger 67 1) (M1+E2): $\delta=-0.09$ 5 γ_{1740} 643.72
 (\dagger 100 2) E1 γ_{1484} 899.52 (\dagger 77 2) Q
 I 2401.1 2, (21/2)⁺ γ_{1740} 661.41 (\dagger 100) E2
 2482.75 19, $1/2, 3/2, 5/2^-$ γ_{1206} 1277.0 (\dagger 29 14) γ_{1144} 1338.6 (\dagger 36 14)
 γ_{1125} 1357.8 (\dagger 9 6) γ_{352} 2130.52 (\dagger 100 14)
 2503.7 2, $1/2^-$, $3/2, 5/2^-$ γ_{352} 2151.5 (\dagger 22 11) γ_{165} 2338.72 (\dagger 100 22)
 2514.6 3(?) $\gamma_{1751.1}$ 763.42(?) (\dagger 100)
 H 2523.9 2, (21/2⁻) γ_{2232} 292.32 (\dagger 19 2) (E2) γ_{2058} 465.92 (\dagger 100 1) E2
 2570.1 3, $1/2, 3/2, 5/2^-$ γ_{1206} 1363.8 (\dagger 35 9) γ_{1167} 1402.4 (\dagger 12 6)
 γ_{1027} 1543.43 (\dagger 100 25)
 2590.06 10, $1/2, 3/2$ γ_{1544} 1045.9 (\dagger 24 12) γ_{1488} 1102.5 (\dagger 18 6)
 γ_{1403} 1187.1 (\dagger 29 18) γ_{1206} 1384.4 (\dagger 12 6) γ_{1125} 1465.1 (\dagger 7 4)
 γ_{1027} 1563.2 (\dagger 8 5) γ_{817} 1772.9 (\dagger 35 12) γ_{352} 2237.81 (\dagger 100 12)
 2599.31 9, $1/2^-$, $3/2$ γ_{1544} 1055.1 (\dagger 12 4) γ_{1488} 1111.7 (\dagger 6 9)
 γ_{1125} 1474.3 (\dagger 8 4) γ_{1027} 1572.4 (\dagger 6 3) γ_{817} 1782.21 (\dagger 100 8)
 γ_{352} 2247.02 (\dagger 68 8) γ_{165} 2434.54 (\dagger 20 4)
 2613.2 5, $1/2^-$, $3/2$ γ_{1992} 620.7 (\dagger 50 12) γ_{1125} 1488.3 (\dagger 44 12)
 γ_{1027} 1586.4 (\dagger 25 6) γ_{352} 2261.0 (\dagger 100 12) γ_{165} 2448.2 (\dagger 81 12)
 2683.42 9, $1/2, 3/2$ γ_{1614} 1069.6 (\dagger 14 5) γ_{1544} 1139.5 (\dagger 19 5)
 γ_{1206} 1477.72 (\dagger 38 10) γ_{1144} 1539.64 (\dagger 29 10) γ_{1125} 1558.51
 (\dagger 52 10) γ_{1027} 1656.8 (\dagger 100 10)
 2702.9 4, $1/2^-$, $3/2, 5/2^-$ γ_{1206} 1497.6 (\dagger 36 14) γ_{1144} 1556.2 (\dagger 60 20)
 γ_{165} 2538.34 (\dagger 100 40)
 2757.21 9, $1/2, 3/2$ γ_{1488} 1269.7 (\dagger 5 3) γ_{1125} 1632.3 (\dagger 9 3) γ_{1027} 1730.4
 (\dagger 7) γ_{817} 1940.11 (\dagger 100 9) γ_{352} 2404.92 (\dagger 31 6)
 2768.0 4, $1/2, 3/2, 5/2^-$ γ_{1144} 1623.8 (\dagger 67 30) γ_{352} 2415.84 (\dagger 100 33)

2808.6 5, 1/2, 3/2 γ_{1488} 1320.9 (\dagger 26 12) γ_{1167} 1641.3 (\dagger 32 16) γ_{817} 1991.8 (\dagger 80 40) γ_{352} 2456.2 (\dagger 100 20)	3340.6 6, 1/2, 3/2 γ_{1206} 2135.0 (\dagger 67 33) γ_{1144} 2196.5 (\dagger 100 33) γ_{817} 2523.5 (\dagger 90 33)
2824.97 8, 1/2, 3/2 γ_{1544} 1280.8 (\dagger 11 1) γ_{1488} 1337.5 (\dagger 3 1) γ_{1403} 1422.1 (\dagger 6 2) γ_{1027} 1798.2 (\dagger 18 2) γ_{817} 2007.9 (\dagger 100 3) E2(+M1): $\delta > 2$ γ_{352} 2472.7 (\dagger 13 2)	3365.2 2, 1/2(-), 3/2 γ_{1488} 1877.7 (\dagger 8 4) γ_{1144} 2221.1 (\dagger 4.0 24) γ_{817} 2548.1 (\dagger 12 4) γ_{165} 3200.2 (\dagger 100 8)
2830.6 10, 1/2, 3/2, 5/2 γ_{352} 2478.3 (\dagger 100)	3384.7 10, 1/2, 3/2 γ_{352} 3032.4 (\dagger 100)
2856.4 4 γ_{2401} 455.33 (\dagger 100)	3387.0 2, (27/2 ⁺), 6.05 ns γ_{3228} 159.6 (\dagger 100 5) E2 γ_{2524} 863.0 4 (\dagger 16 1) (E3)
2861.8 5, 1/2(-), 3/2 γ_{1206} 1656.2 (\dagger 40 20) γ_{1167} 1694.7 (\dagger 60 40) γ_{1027} 1835.0 (\dagger 50 16) γ_{817} 2044.7 (\dagger 34 16) γ_{165} 2696.8 (\dagger 100 40)	3403.4 5, 1/2(-), 3/2 γ_{1544} 1859.3 (\dagger 100 33) γ_{1488} 1915.8 (\dagger 100 33) γ_{817} 2586.3 (\dagger 100 33) γ_{352} 3051.2 (\dagger 60 25) γ_{165} 3238.4 (\dagger 50 17)
2913.08 10, 1/2, 3/2 γ_{1544} 1368.9 (\dagger 15 3) γ_{1488} 1425.63 (\dagger 21 6) γ_{1206} 1707.53 (\dagger 9 3) γ_{1125} 1788.1 (\dagger 9 3) γ_{352} 2560.8 (\dagger 100 6)	3418.8 5, 1/2(-), 3/2 γ_{1488} 1931.0 (\dagger 55 27) γ_{1206} 2212.9 (\dagger 100 32) γ_{352} 3066.3 (\dagger 73 32) γ_{165} 3254.5 (\dagger 68 32)
2918.2 7, 1/2(-), 3/2 γ_{1403} 1515.3 (\dagger 100 50) γ_{165} 2753.2 (\dagger 60 20)	3431.4 4, 1/2(-), 3/2 γ_{352} 3078.9 (\dagger 100 33) γ_{165} 3266.4 4 (\dagger 53 13)
2922.7 3, 1/2, 3/2 γ_{1167} 1755.6 (\dagger 23 20) γ_{1027} 1895.9 (\dagger 7 4) γ_{817} 2105.63 (\dagger 100 20)	3442.8 6, 1/2, 3/2 γ_{1125} 2317.9 (\dagger 100 37) γ_{817} 2625.7 (\dagger 53 26) γ_{352} 3090.6 (\dagger 42 21)
2961.5 6, 1/2(-), 3/2 γ_{1206} 1755.8 (\dagger 77 30) γ_{165} 2796.5 (\dagger 100 33) $\gamma_{2961.4}$ (?) (\dagger <100)	3466.8 6, 1/2(-), 3/2 γ_{1027} 2440.0 (\dagger 58 33) γ_{817} 2649.7 (\dagger 83 42) γ_{165} 3301.8 (\dagger 100 50)
2977.7 2, 1/2(-), 3/2 γ_{1403} 1574.8 (\dagger 86 28) γ_{1167} 1810.62 (\dagger 100 14) γ_{1125} 1852.8 (\dagger 28 14) γ_{1027} 1950.9 (\dagger 23 11) γ_{817} 2160.6 (\dagger 33 13) γ_{165} 2812.7 (\dagger 57 14)	3473.2 3, 1/2(-), 3/2 γ_{1027} 2446.4 (\dagger 14 8) γ_{817} 2656.1 (\dagger 20 3) γ_{165} 3308.23 (\dagger 100 22)
2999.64 7, 1/2(-), 3/2 γ_{1655} 1344.5 (\dagger 4.2 2) γ_{1597} 1402.4 (\dagger 1.9 10) γ_{1488} 1512.12 (\dagger 19 4) γ_{1348} 1651.0 (\dagger 1.6 10) γ_{1206} 1794.1 (\dagger 3.5 16) γ_{1144} 1855.6 (\dagger 6 4) γ_{1125} 1874.6 (\dagger 63 4) γ_{1027} 1972.92 (\dagger 38 4) γ_{817} 2182.6 (\dagger 100 6) γ_{352} 2647.6 (\dagger 48 2) γ_{165} 2834.7 (\dagger 6 2)	3486.2 5, 1/2, 3/2 γ_{1167} 2319.0 (\dagger 59 1) γ_{352} 3133.95 (\dagger 100 1) 3499.6 7, 1/2(-), 3/2 γ_{352} 3147.0 (\dagger 90 40) γ_{165} 3335.0 (\dagger 100 30)
3003.4 5, 1/2(-), 3/2 γ_{1206} 1797.8 (\dagger 25 13) γ_{1125} 1878.5 (\dagger 100 25) γ_{1027} 1976.6 (\dagger 38 25) γ_{817} 2186.3 (\dagger 38 25) γ_{165} 2838.4 (\dagger 38 25)	3516.2 4, 1/2, 3/2 γ_{352} 3163.94 (\dagger 100)
3021.05 18, 1/2(-), 3/2 γ_{1655} 1366.0 (\dagger 13 7) γ_{1144} 1877.1 (\dagger 20 13) γ_{1125} 1896.3 (\dagger 17 6) γ_{1027} 1994.4 (\dagger 20 7) γ_{817} 2204.1 (\dagger 20 7) γ_{352} 2669.1 (\dagger 100 13) γ_{165} 2856.02 (\dagger 60 13)	3535.1 4, 1/2(-), 3/2 γ_{1027} 2508.3 (\dagger 18 10) γ_{817} 2718.0 (\dagger 18 10) γ_{352} 3182.84 (\dagger 100 25) γ_{165} 3370.1 (\dagger 20 10)
3057.0 4, 1/2(-), 3/2 γ_{165} 2892.0 4 (\dagger 100)	3543.9 4, 1/2(-), 3/2 γ_{165} 3378.9 4 (\dagger 100)
3070.8 7, 1/2(-), 3/2 γ_{817} 2253.7 (\dagger 100 27) γ_{165} 2905.8 (\dagger 66 24)	3611.4 2, (25/2 ⁻) γ_{3228} 383.73 (\dagger 12 1) D γ_{2524} 1087.6 (\dagger 100 1) E2
3079.8 3, 1/2, 3/2 γ_{1167} 1912.73 (\dagger 100)	3631.9 3, (27/2 ⁻), 0.7 ns γ_{3511} 21 γ_{3387} 245.02 (\dagger 42 1) D $\gamma_{3284.3}$ 337.72 (\dagger 55 1) D γ_{3134} 497.33 (\dagger 100 2) (E2)
3084.4 3, (23/2 ⁺) γ_{2401} 683.32 (\dagger 100)	3765.2 4, (29/2) γ_{3387} 378.23 (\dagger 100)
3099.76 10, 1/2(-), 3/2 γ_{1027} 2073.0 (\dagger 7 2) γ_{817} 2282.6 (\dagger 100 7) γ_{165} 2935.13 (\dagger 26 5)	J 4054.3 4, (29/2 ⁻) γ_{3632} 422.53 (\dagger 100) D
3124.07 10, 1/2, 3/2 γ_{1206} 1918.4 (\dagger 8 4) γ_{1027} 2097.1 (\dagger 27 7) γ_{352} 2771.8 (\dagger 100 13) γ_{165} 2959.0 (?) (\dagger <20)	4323.7 3, (29/2 ⁻) γ_{3611} 712.32 (\dagger 100) (E2)
3134.4 2, (23/2 ⁻) γ_{2401} 733.43 (\dagger 51 1) D γ_{2385} 750.82 (\dagger 100 1) (E2)	4340.0 4, (31/2 ⁻) γ_{4054} 285.63 (\dagger 22 1) D γ_{3632} 708.03 (\dagger 100 3) (E2)
3149.4 6, 1/2, 3/2 γ_{1206} 1943.7 (\dagger 12 8) γ_{1125} 2024.4 (\dagger 32 18) γ_{352} 2797.1 (\dagger 100 20)	4342.7 4, (29/2 ⁺) γ_{3387} 955.63 (\dagger 100)
3175.59 15, 1/2(-), 3/2 γ_{1403} 1772.7 (\dagger 20 10) γ_{1348} 1826.9 (\dagger 10 4) γ_{1206} 1970.0 (\dagger 40 10) γ_{1167} 2008.5 (\dagger 30 20) γ_{1125} 2050.74 (\dagger 50 20) γ_{1027} 2148.8 (\dagger 40 10) γ_{817} 2358.5 (\dagger 8 5) γ_{352} 2823.32 (\dagger 90 20) γ_{165} 3010.63 (\dagger 100 20)	4571.8 5 γ_{4324} 248.13 (?) (\dagger 100)
3201.4 4, 1/2(-), 3/2 γ_{1544} 1657.3 (\dagger 48 18) γ_{1403} 1798.5 (\dagger 60 40) γ_{1167} 2034.3 (\dagger 100 60) γ_{1125} 2076.4 (\dagger 80 20) γ_{817} 2384.3 (\dagger 32 12) γ_{352} 2849.2 (\dagger 36 14) γ_{165} 3036.45 (\dagger 60 20)	K 4719.3 4, (33/2 ⁺) γ_{4343} 376.63 (\dagger 5.7 4) (E2) γ_{4340} 379.43 (\dagger 100 1) D
3206.43 23, 1/2(-), 3/2 γ_{1614} 1592.4 (\dagger 100 40) γ_{1544} 1662.3 (\dagger 40 20) γ_{1488} 1718.9 (\dagger 20 12) γ_{1403} 1803.5 (\dagger 34 18) γ_{1206} 2000.8 (\dagger 40 20) γ_{1144} 2062.3 (\dagger 22 14) γ_{1027} 2179.6 (\dagger 100 20) γ_{817} 2389.33 (\dagger 100 20) γ_{352} 2854.2 (\dagger 60 20) γ_{165} 3041.4 (\dagger 40 20)	J 4801.4 4, (33/2 ⁻) γ_{4340} 461.03 (\dagger 10 1) γ_{4054} 747.43 (\dagger 100 3) (E2)
3227.5 2, (23/2 ⁺) γ_{2524} 703.62 (\dagger 100 2) E1 γ_{2401} 826.43 (\dagger 15 2)	5052.2 4, (35/2 ⁻) γ_{4801} 250.83 (\dagger 18 1) γ_{4340} 712.33 (\dagger 100 1) (E2)
3231.2 3, 1/2(-), 3/2 γ_{817} 2414.0 (\dagger 11 7) γ_{352} 2878.93 (\dagger 100 28) γ_{165} 3066.1 (\dagger 13 7)	J 5300.3 4, (37/2 ⁻) γ_{5052} 248.03 (\dagger 69 1) D γ_{4801} 498.83 (\dagger 100 3) (E2)
3258.4 6, 1/2, 3/2 γ_{1027} 2231.5 (\dagger 100 25) γ_{817} 2441.3 (\dagger 63 29) γ_{352} 2906.1 (\dagger 58 29)	K 5462.5 4, (37/2 ⁺) γ_{5052} 410.53 (\dagger 22 1) D γ_{4719} 743.23 (\dagger 100 1) (E2)
3272.9 6, 1/2, 3/2 γ_{1027} 2246.1 (\dagger 47 23) γ_{817} 2455.8 (\dagger 100 33) γ_{352} 2920.7 (\dagger 33 20)	J 5633.5 5, (41/2 ⁻) γ_{5300} 333.23 (\dagger 100) (E2)
3294.2 3, 1/2, 3/2 γ_{352} 2942.6 (\dagger 100)	5738.5 5, (39/2 ⁻) γ_{5634} 105 (\dagger 10) γ_{5300} 438.43 (\dagger 100) (M1+E2): $\delta = +0.162$ γ_{5052} 667 (\dagger 52)
3294.3 2, (25/2 ⁺) γ_{2401} 893.2 (\dagger 100 5) Q	K 6098.8 5, (41/2 ⁺) γ_{5739} 359.63 (\dagger 28.9 2) D γ_{5463} 636.63 (\dagger 100 2) (E2)
3313.62 16, 1/2(-), 3/2(-) γ_{1614} 1699.5 (\dagger 3 1) γ_{1544} 1769.4 (\dagger 2 1) γ_{1488} 1826.0 (\dagger 10 2) γ_{1206} 2108.23 (\dagger 10 2) γ_{1125} 2188.6 (\dagger 3 1) γ_{817} 2496.4 (\dagger 12 2) γ_{352} 2961.3 (\dagger 100 4) (M1, E2) γ_{165} 3148.5 (\dagger 1.7 6)	6264.8 5, (41/2, 43/2, 45/2 ⁻) γ_{5634} 631.33 (\dagger 100) 6299.8 (?) γ_{5634} 667 (?) (\dagger 100)
3319.0 4, 1/2(-), 3/2 γ_{1403} 1916.1 (\dagger 100 50) γ_{352} 2966.8 (\dagger 55 18) γ_{165} 3154.05 (\dagger 68 18)	K 6470.2 5, (45/2 ⁺) γ_{6265} 205.43 (\dagger 4.9 5) γ_{6099} 371.43 (\dagger 100 1) (E2) 6504 (?) γ_{6265} 240 (?) (\dagger 100)
	L 6656.4 6, (49/2 ⁺), 2.8 ns γ_{6470} 186.23 (\dagger 100) (E2) 6786.5 (?) γ_{6470} 317 (?) (\dagger 100) 7071.7 (?) γ_{6656} 416 (?) (\dagger 100)
	L 7821.5 6, (53/2 ⁺) γ_{6656} 1165.33 (\dagger 100) (Q)
	7824.4 7, (51/2 ⁻) γ_{6656} 1168.03 (\dagger 100) D
	7996.6 7, (53/2 ⁻) γ_{7824} 172.23 (\dagger 100) (M1)
	8217.6 7, (53/2 ⁺) γ_{6656} 1560.93 (\dagger 100) (Q)
	8433.3 7, (55/2) γ_{8218} 215.43 (\dagger 13 1) γ_{7822} 611.83 (\dagger 100 1)
	L 8557.0 7, (57/2 ⁺) γ_{8433} 123.33 (\dagger 31 1) γ_{7822} 735.83 (\dagger 100 1) (E2)
	M 8940.3 7, (57/2 ⁻) γ_{8433} 507.13 (\dagger 8.2 2) γ_{7997} 943.83 (\dagger 100 1) (Q)
	9273.0 7, (57/2 ⁻) γ_{7997} 1276.43 (\dagger 100) (Q)
	9325.8 7, (59/2) γ_{8557} 768.73 (\dagger 100)
	N 9437.9 7, (59/2) γ_{9273} 164.93 (\dagger 25 1) γ_{8557} 881.13 (\dagger 100 2)
	M 9501.6 7, (61/2 ⁻) γ_{8326} 175.63 (\dagger 12.5 2) γ_{8940} 561.43 (\dagger 100 1) (E2)
	N 10361.9 7, (63/2) γ_{9502} 860.13 (\dagger 45 1) γ_{9438} 924.03 (\dagger 100 4) (Q)
	10510.0 7, (63/2) γ_{9502} 1008.33 (\dagger 100)
	M 10601.8 7, (65/2 ⁻) γ_{9502} 1100.53 (\dagger 100) (Q)

10850.5 7, (63/2) γ_{9502} 1348.73 (\dagger ,100)	B 9880.6+y, J+20 γ_{8700+y} 1180.91 (\dagger ,1.02 14) $I^{(1)}=85.4$, $I^{(2)}=77.5$, $\eta\omega=0.603$
N 10930.3 7, (65/2 ⁻) γ_{10362} 568.33 (\dagger ,100 4) γ_{9502} 1428.73 (\dagger ,81 4) (Q)	B 11113.1+y, J+22 γ_{9881+y} 1232.51 (\dagger ,0.58 10) $I^{(1)}=85.0$, $I^{(2)}=75.0$, $\eta\omega=0.630$
11011.5 7, (65/2) γ_{10851} 160.73 (\dagger ,48 2) γ_{10510} 501.43 (\dagger ,100 4)	B 12398.9+y, J+24 $\gamma_{11113+y}$ 1285.81 (\dagger ,0.66 10) $I^{(1)}=84.6$, $I^{(2)}=74.3$, $\eta\omega=0.656$
N 11199.7 7, (67/2) γ_{10830} 269.33 (\dagger ,18 1) γ_{10602} 598.13 (\dagger ,100 1)	B 13738.5+y, J+26 $\gamma_{12399+y}$ 1339.61 (\dagger ,0.56 10) $I^{(1)}=84.1$, $I^{(2)}=72.5$, $\eta\omega=0.684$
γ_{10362} 838.03 (\dagger ,50 2) (E2)	B 15133.3+y, J+28 $\gamma_{13739+y}$ 1394.82 (\dagger ,0.52 10) $I^{(1)}=83.6$, $I^{(2)}=71.7$, $\eta\omega=0.711$
11711.7 7, (67/2) γ_{10602} 1109.93 (\dagger ,100)	B 16583.9+y, J+30 $\gamma_{15133+y}$ 1450.62 (\dagger ,0.42 8) $I^{(1)}=83.2$, $I^{(2)}=71.3$, $\eta\omega=0.739$
12268.3 8, (67/2) γ_{11200} 1068.63 (\dagger ,100)	B 18090.6+y, J+32 $\gamma_{16584+y}$ 1506.73 (\dagger ,0.26 6) $I^{(1)}=82.7$, $I^{(2)}=69.8$, $\eta\omega=0.768$
12383.7 7, (69/2) γ_{11712} 672.13 (\dagger ,100 5) γ_{11200} 1183.93 (\dagger ,78 8)	B 19654.6+y, J+34 $\gamma_{18091+y}$ 1564.03 $I^{(1)}=82.3$, $I^{(2)}=71.0$, $\eta\omega=0.796$
γ_{11012} 1372.03 (\dagger ,55 8) (Q)	B 21274.9+y, J+36 $\gamma_{19655+y}$ 1620.37
12469.0 8, (69/2 ⁻) γ_{10602} 1867.13 (\dagger ,100) (Q)	C z, J=(57/2)
12580.6 8, (71/2) γ_{11712} 868.93 (\dagger ,100) (Q)	C 649.8+z, J+2 γ_z 649.8 4 $I^{(1)}=90.4$, $I^{(2)}=80.0$, $\eta\omega=0.337$
12751.9 8, (71/2) γ_{11200} 1552.43 (\dagger ,100) (Q)	C 1349.6+z, J+4 γ_{650+z} 699.82 $I^{(1)}=89.8$, $I^{(2)}=82.0$, $\eta\omega=0.362$
12967.1 7, (71/2) γ_{12752} 215.43 (\dagger ,39 7) γ_{12384} 583.13 (\dagger ,100 6)	C 2098.2+z, J+6 γ_{1350+z} 748.62 $I^{(1)}=89.2$, $I^{(2)}=79.1$, $\eta\omega=0.387$
γ_{12268} 698.93 (\dagger ,90 4) (E2) γ_{11200} 1767.43 (\dagger ,59 4) (Q)	C 2897.4+z, J+8 γ_{2098+z} 799.22 $I^{(1)}=88.3$, $I^{(2)}=72.9$, $\eta\omega=0.413$
13189.1 8, (75/2) γ_{12581} 608.63 (\dagger ,100) (E2)	C 3751.5+z, J+10 γ_{2897+z} 854.12 $I^{(1)}=88.0$, $I^{(2)}=95.5$, $\eta\omega=0.438$
13278.6 8, (73/2) γ_{12967} 311.43 (\dagger ,100)	C 4647.5+z, J+12 γ_{3752+z} 896.02 (\dagger ,0.64 16) $I^{(1)}=87.6$, $I^{(2)}=69.8$, $\eta\omega=0.462$
13567.2 8, (75/2) γ_{13278} 288.63 (\dagger ,100)	C 5600.8+z, J+14 γ_{4648+z} 953.32 $I^{(1)}=86.8$, $I^{(2)}=77.5$, $\eta\omega=0.490$
14108.6 8, (77/2) γ_{13567} 541.43 (\dagger ,100 4) γ_{13189} 919.53 (\dagger ,74 4)	C 6605.7+z, J+16 γ_{5601+z} 1004.92 (\dagger ,0.64 16) $I^{(1)}=86.3$, $I^{(2)}=77.2$, $\eta\omega=0.515$
15163.3 9, (81/2) γ_{14109} 1054.73 (\dagger ,100) (Q)	C 7662.4+z, J+18 γ_{6606+z} 1056.72 (\dagger ,0.64 16) $I^{(1)}=85.8$, $I^{(2)}=74.9$, $\eta\omega=0.542$
15997.4 9, (85/2) γ_{15163} 834.13(?) (\dagger ,100)	C 8772.5+z, J+20 γ_{7662+z} 1110.12 (\dagger ,0.80 16) $I^{(1)}=85.3$, $I^{(2)}=75.3$, $\eta\omega=0.568$
A x, J=(51/2)	C 9935.7+z, J+22 γ_{8773+z} 1163.22 (\dagger ,0.96 16) $I^{(1)}=84.9$, $I^{(2)}=76.5$, $\eta\omega=0.595$
A 617.8+x, J+2 γ_x 617.81 (\dagger ,0.16 3) $I^{(1)}=85.8$, $I^{(2)}=86.2$, $\eta\omega=0.321$	C 11151.2+z, J+24 γ_{9936+z} 1215.52 (\dagger ,0.96 16) $I^{(1)}=84.5$, $I^{(2)}=75.0$, $\eta\omega=0.621$
A 1282.0+x, J+4 γ_{618+x} 664.21 (\dagger ,0.68 7) $I^{(1)}=85.8$, $I^{(2)}=84.0$, $\eta\omega=0.344$	C 12420.0+z, J+26 $\gamma_{11151+z}$ 1268.82 (\dagger ,0.96 16) $I^{(1)}=84.1$, $I^{(2)}=74.1$, $\eta\omega=0.648$
A 1993.8+x, J+6 γ_{1282+x} 711.81 $I^{(1)}=85.6$, $I^{(2)}=83.5$, $\eta\omega=0.368$	C 13742.8+z, J+28 $\gamma_{12420+z}$ 1322.82 (\dagger ,1.20 24) $I^{(1)}=83.7$, $I^{(2)}=74.1$, $\eta\omega=0.675$
A 2753.5+x, J+8 γ_{1994+x} 759.71 (\dagger ,0.88 9) $I^{(1)}=85.5$, $I^{(2)}=82.6$, $\eta\omega=0.392$	C 15119.6+z, J+30 $\gamma_{13743+z}$ 1376.82 (\dagger ,1.12 24) $I^{(1)}=83.3$, $I^{(2)}=73.9$, $\eta\omega=0.702$
A 3561.6+x, J+10 γ_{2754+x} 808.11 (\dagger ,0.96 10) $I^{(1)}=85.3$, $I^{(2)}=81.6$, $\eta\omega=0.416$	C 16550.5+z, J+32 $\gamma_{15120+z}$ 1430.93 (\dagger ,0.56 16) $I^{(1)}=83.0$, $I^{(2)}=73.1$, $\eta\omega=0.729$
A 4418.7+x, J+12 γ_{3562+x} 857.11 (\dagger ,1.00) $I^{(1)}=85.0$, $I^{(2)}=80.6$, $\eta\omega=0.441$	C 18036.1+z, J+34 $\gamma_{16551+z}$ 1485.64 (\dagger ,0.56 16) $I^{(1)}=82.6$, $I^{(2)}=73.3$, $\eta\omega=0.756$
A 5325.4+x, J+14 γ_{4419+x} 906.71 (\dagger ,1.05 10) $I^{(1)}=84.8$, $I^{(2)}=79.4$, $\eta\omega=0.466$	C 19576.3+z, J+36 $\gamma_{18036+z}$ 1540.25 $I^{(1)}=82.3$, $I^{(2)}=73.8$, $\eta\omega=0.784$
A 6282.5+x, J+16 γ_{5325+x} 957.11 (\dagger ,0.98 10) $I^{(1)}=84.4$, $I^{(2)}=77.5$, $\eta\omega=0.491$	C 21170.7+z, J+38 $\gamma_{19576+z}$ 1594.47 $I^{(1)}=82.1$, $I^{(2)}=75.5$, $\eta\omega=0.810$
A 7291.2+x, J+18 γ_{6283+x} 1008.71 (\dagger ,0.95 10) $I^{(1)}=84.1$, $I^{(2)}=76.9$, $\eta\omega=0.517$	C 22818.1+z, J+40 $\gamma_{21171+z}$ 1647.49
A 8351.9+x, J+20 γ_{7291+x} 1060.71 (\dagger ,0.90 9) $I^{(1)}=83.7$, $I^{(2)}=75.3$, $\eta\omega=0.544$	D u, J=(63/2)
A 9465.7+x, J+22 γ_{8352+x} 1113.81 (\dagger ,0.83 8) $I^{(1)}=83.3$, $I^{(2)}=74.9$, $\eta\omega=0.570$	D 725.6+u, J+2 γ_0 725.6 4 $I^{(1)}=89.5$, $I^{(2)}=86.4$, $\eta\omega=0.374$
A 10632.9+x, J+24 γ_{9466+x} 1167.22 $I^{(1)}=82.9$, $I^{(2)}=73.3$, $\eta\omega=0.597$	D 1497.5+u, J+4 γ_{726+u} 771.92 $I^{(1)}=89.3$, $I^{(2)}=87.5$, $\eta\omega=0.397$
A 11854.7+x, J+26 $\gamma_{10633+x}$ 1221.81 (\dagger ,0.80 8) $I^{(1)}=82.5$, $I^{(2)}=73.1$, $\eta\omega=0.625$	D 2315.1+u, J+6 γ_{1498+u} 817.62 $I^{(1)}=89.2$, $I^{(2)}=84.6$, $\eta\omega=0.421$
A 13131.2+x, J+28 $\gamma_{11855+x}$ 1276.51 (\dagger ,0.72 7) $I^{(1)}=82.0$, $I^{(2)}=72.1$, $\eta\omega=0.652$	D 3180.0+u, J+8 γ_{2315+u} 864.92 $I^{(1)}=88.9$, $I^{(2)}=84.7$, $\eta\omega=0.444$
A 14463.2+x, J+30 $\gamma_{13131+x}$ 1332.01 (\dagger ,0.60 6) $I^{(1)}=81.6$, $I^{(2)}=71.9$, $\eta\omega=0.680$	D 4092.1+u, J+10 γ_{3180+u} 912.12 $I^{(1)}=88.6$, $I^{(2)}=82.3$, $\eta\omega=0.468$
A 15850.8+x, J+32 $\gamma_{14463+x}$ 1387.61 (\dagger ,0.51 5) $I^{(1)}=81.2$, $I^{(2)}=70.7$, $\eta\omega=0.708$	D 5052.8+u, J+12 γ_{4092+u} 960.72 $I^{(1)}=88.5$, $I^{(2)}=89.3$, $\eta\omega=0.492$
A 17295.0+x, J+34 $\gamma_{15851+x}$ 1444.21 (\dagger ,0.38 5) $I^{(1)}=80.8$, $I^{(2)}=71.0$, $\eta\omega=0.736$	D 6058.3+u, J+14 γ_{5053+u} 1005.52 $I^{(1)}=88.3$, $I^{(2)}=78.9$, $\eta\omega=0.515$
A 18795.5+x, J+36 $\gamma_{17295+x}$ 1500.52 (\dagger ,0.28 4) $I^{(1)}=80.4$, $I^{(2)}=69.8$, $\eta\omega=0.765$	D 7114.5+u, J+16 γ_{6058+u} 1056.22 $I^{(1)}=88.0$, $I^{(2)}=84.2$, $\eta\omega=0.540$
A 20353.3+x, J+38 $\gamma_{18796+x}$ 1557.82 (\dagger ,0.19 3) $I^{(1)}=80.0$, $I^{(2)}=69.1$, $\eta\omega=0.793$	D 8218.2+u, J+18 γ_{7115+u} 1103.72 $I^{(1)}=87.8$, $I^{(2)}=83.7$, $\eta\omega=0.564$
A 21969.0+x, J+40 $\gamma_{20353+x}$ 1615.73 (\dagger ,0.10 2) $I^{(1)}=79.7$, $I^{(2)}=70.9$, $\eta\omega=0.822$	D 9369.7+u, J+20 γ_{8218+u} 1151.52 $I^{(1)}=87.6$, $I^{(2)}=84.2$, $\eta\omega=0.588$
A 23641.1+x, J+42 $\gamma_{21969+x}$ 1672.14 (\dagger ,0.06 2) $I^{(1)}=79.4$, $I^{(2)}=69.2$, $\eta\omega=0.851$	D 10568.7+u, J+22 γ_{9370+u} 1199.02 $I^{(1)}=87.5$, $I^{(2)}=83.3$, $\eta\omega=0.612$
A 25371.0+x, J+44 $\gamma_{23641+x}$ 1729.98 (\dagger ,0.03 1)	D 11815.7+u, J+24 $\gamma_{10569+u}$ 1247.02 (\dagger ,1.00 5) $I^{(1)}=87.4$, $I^{(2)}=84.6$, $\eta\omega=0.635$
B y, J=(63/2)	D 13110.0+u, J+26 $\gamma_{11816+u}$ 1294.32 (\dagger ,0.87 5) $I^{(1)}=87.3$, $I^{(2)}=84.7$, $\eta\omega=0.659$
B 858.5+y, J+2 γ_y 858.53 $I^{(1)}=76.7$, $I^{(2)}=134.7$, $\eta\omega=0.437$	D 14451.5+u, J+28 $\gamma_{13110+u}$ 1341.53 (\dagger ,0.72 5) $I^{(1)}=87.2$, $I^{(2)}=85.8$, $\eta\omega=0.682$
B 1746.7+y, J+4 γ_{859+y} 888.22 $I^{(1)}=80.4$, $I^{(2)}=396.0$, $\eta\omega=0.442$	D 15839.6+u, J+30 $\gamma_{14452+u}$ 1388.13 (\dagger ,0.62 5) $I^{(1)}=87.1$, $I^{(2)}=85.5$, $\eta\omega=0.706$
B 2624.8+y, J+6 γ_{1747+y} 878.12 (\dagger ,0.40 6) $I^{(1)}=84.3$, $I^{(2)}=174.7$, $\eta\omega=0.445$	D 17274.5+u, J+32 $\gamma_{15840+u}$ 1434.93 (\dagger ,0.42 5) $I^{(1)}=87.1$, $I^{(2)}=84.0$, $\eta\omega=0.729$
B 3525.8+y, J+8 γ_{2625+y} 901.01 (\dagger ,0.44 6) $I^{(1)}=85.7$, $I^{(2)}=96.9$, $\eta\omega=0.461$	
B 4468.1+y, J+10 γ_{3526+y} 942.31 $I^{(1)}=86.0$, $I^{(2)}=89.7$, $\eta\omega=0.482$	
B 5455.0+y, J+12 γ_{4468+y} 986.91 $I^{(1)}=86.1$, $I^{(2)}=86.8$, $\eta\omega=0.505$	
B 6488.0+y, J+14 γ_{5455+y} 1033.01 (\dagger ,0.86 12) $I^{(1)}=86.1$, $I^{(2)}=82.8$, $\eta\omega=0.529$	
B 7569.3+y, J+16 γ_{6488+y} 1081.31 $I^{(1)}=85.9$, $I^{(2)}=81.5$, $\eta\omega=0.553$	
B 8699.7+y, J+18 γ_{7569+y} 1130.41 (\dagger ,1.00 14) $I^{(1)}=85.7$, $I^{(2)}=79.2$, $\eta\omega=0.578$	

- D 18757.0+u, J+34 $\gamma_{17275+u}$ 1482.54 (\dagger , 0.22 5) $I^{(1)}=87.0, I^{(2)}=86.8, \eta\omega=0.753$
- D 20285.6+u, J+36 $\gamma_{18757+u}$ 1528.68 (\dagger , 0.12 5) $I^{(1)}=87.0, I^{(2)}=86.2, \eta\omega=0.776$
- D 21860.6+u, J+38 $\gamma_{20286+u}$ 1575.0 10
- E v, J=(63/2)
- E 755.7+v, J+2 γ_0 755.74 $I^{(1)}=85.9, I^{(2)}=81.3, \eta\omega=0.390$
- E 1560.6+v, J+4 γ_{756+v} 804.93 $I^{(1)}=85.5, I^{(2)}=79.8, \eta\omega=0.415$
- E 2415.6+v, J+6 γ_{1561+v} 855.03 $I^{(1)}=85.1, I^{(2)}=75.5, \eta\omega=0.441$
- E 3323.6+v, J+8 γ_{2416+v} 908.02 $I^{(1)}=84.6, I^{(2)}=76.5, \eta\omega=0.467$
- E 4283.9+v, J+10 γ_{3324+v} 960.32 $I^{(1)}=84.0, I^{(2)}=72.3, \eta\omega=0.494$
- E 5299.5+v, J+12 γ_{4284+v} 1015.63 $I^{(1)}=83.4, I^{(2)}=73.7, \eta\omega=0.521$
- E 6369.4+v, J+14 γ_{5300+v} 1069.93 $I^{(1)}=82.9, I^{(2)}=71.2, \eta\omega=0.549$
- E 7495.5+v, J+16 γ_{6369+v} 1126.13 $I^{(1)}=82.3, I^{(2)}=69.8, \eta\omega=0.577$
- E 8678.9+v, J+18 γ_{7496+v} 1183.43 $I^{(1)}=81.7, I^{(2)}=69.6, \eta\omega=0.606$
- E 9919.8+v, J+20 γ_{8679+v} 1240.93 $I^{(1)}=81.1, I^{(2)}=68.5, \eta\omega=0.635$
- E 11219.1+v, J+22 γ_{9920+v} 1299.33 $I^{(1)}=80.5, I^{(2)}=68.5, \eta\omega=0.664$
- E 12576.8+v, J+24 $\gamma_{11219+v}$ 1357.73 $I^{(1)}=80.0, I^{(2)}=67.5, \eta\omega=0.694$
- E 13993.8+v, J+26 $\gamma_{12577+v}$ 1417.04 $I^{(1)}=79.5, I^{(2)}=68.0, \eta\omega=0.723$
- E 15469.6+v, J+28 $\gamma_{13994+v}$ 1475.84 $I^{(1)}=79.1, I^{(2)}=68.0, \eta\omega=0.753$
- E 17004.2+v, J+30 $\gamma_{15470+v}$ 1534.65 $I^{(1)}=78.6, I^{(2)}=66.2, \eta\omega=0.782$
- E 18599.2+v, J+32 $\gamma_{17004+v}$ 1595.0 10
- F w, J=(57/2)
- F 688.1+w, J+2 γ_0 688.15 $I^{(1)}=85.9, I^{(2)}=89.9, \eta\omega=0.355$
- F 1420.7+w, J+4 γ_{688+w} 732.62 $I^{(1)}=85.9, I^{(2)}=84.0, \eta\omega=0.378$
- F 2200.9+w, J+6 γ_{1421+w} 780.22 $I^{(1)}=85.7, I^{(2)}=80.6, \eta\omega=0.402$
- F 3030.7+w, J+8 γ_{2201+w} 829.82 $I^{(1)}=85.3, I^{(2)}=78.1, \eta\omega=0.428$
- F 3911.7+w, J+10 γ_{3031+w} 881.02 $I^{(1)}=84.9, I^{(2)}=76.2, \eta\omega=0.454$
- F 4845.2+w, J+12 γ_{3912+w} 933.52 $I^{(1)}=84.3, I^{(2)}=74.6, \eta\omega=0.480$
- F 5832.3+w, J+14 γ_{4845+w} 987.12 $I^{(1)}=83.8, I^{(2)}=72.9, \eta\omega=0.507$
- F 6874.3+w, J+16 γ_{5832+w} 1042.02 $I^{(1)}=83.2, I^{(2)}=72.1, \eta\omega=0.535$
- F 7971.8+w, J+18 γ_{6874+w} 1097.52 $I^{(1)}=82.6, I^{(2)}=70.4, \eta\omega=0.563$
- F 9126.1+w, J+20 γ_{7972+w} 1154.32 $I^{(1)}=82.0, I^{(2)}=69.3, \eta\omega=0.592$
- F 10338.1+w, J+22 γ_{9126+w} 1212.03 $I^{(1)}=81.4, I^{(2)}=68.4, \eta\omega=0.621$
- F 11608.6+w, J+24 $\gamma_{10338+w}$ 1270.53 $I^{(1)}=80.8, I^{(2)}=68.5, \eta\omega=0.650$
- F 12937.5+w, J+26 $\gamma_{11609+w}$ 1328.95 $I^{(1)}=80.2, I^{(2)}=67.3, \eta\omega=0.679$
- F 14325.8+w, J+28 $\gamma_{12938+w}$ 1388.35 $I^{(1)}=79.7, I^{(2)}=68.6, \eta\omega=0.709$
- F 15772.4+w, J+30 $\gamma_{14326+w}$ 1446.64 $I^{(1)}=79.3, I^{(2)}=67.3, \eta\omega=0.738$
- F 17278.4+w, J+32 $\gamma_{15772+w}$ 1506.06 $I^{(1)}=78.8, I^{(2)}=67.6, \eta\omega=0.768$
- F 18843.6+w, J+34 $\gamma_{17278+w}$ 1565.26 $I^{(1)}=78.3, I^{(2)}=65.8, \eta\omega=0.798$
- F 20469.6+w, J+36 $\gamma_{18844+w}$ 1626.0 10 $I^{(1)}=77.9, I^{(2)}=66.7, \eta\omega=0.828$
- F 22155.6+w, J+38 $\gamma_{20470+w}$ 1686.0 10

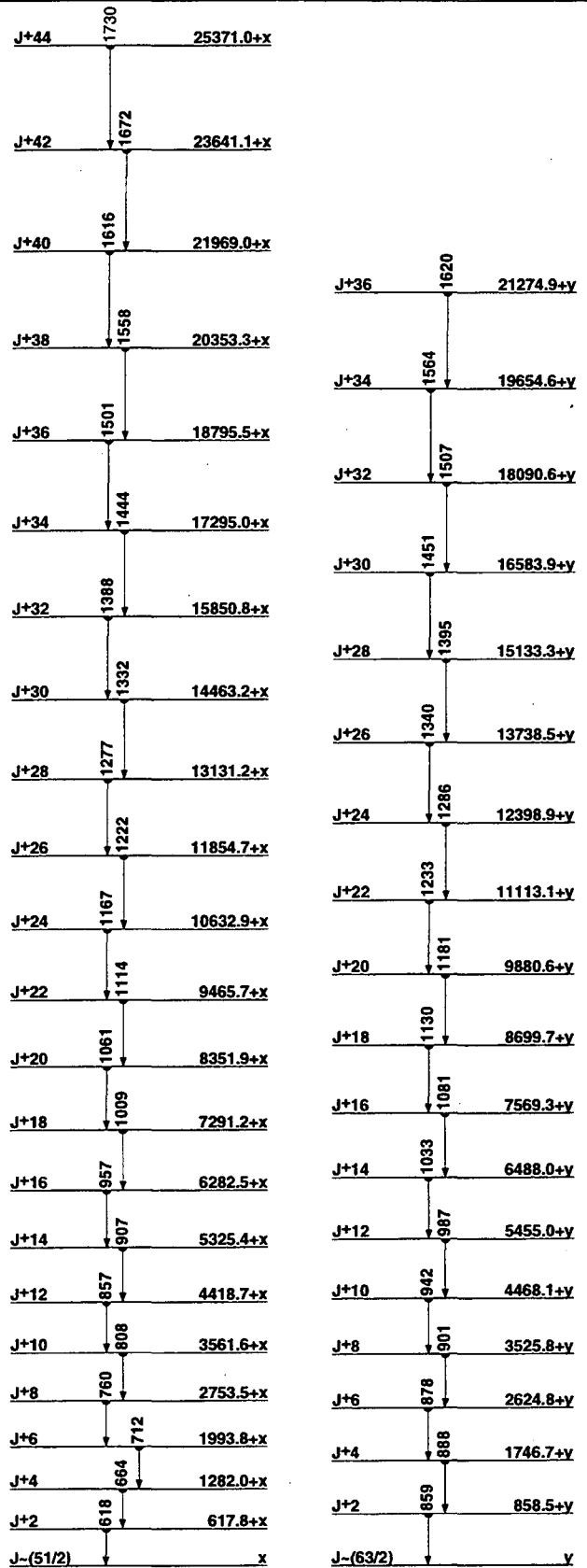

SD-1 band (95F101,93F103,90Ha31,88Ha02) SD-2 band (95F101,93F103,90Ha31,88Ha02)

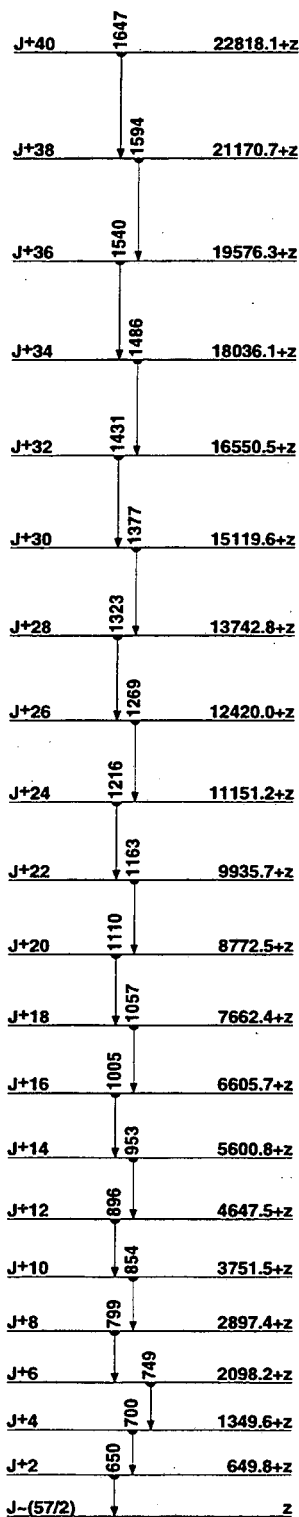

SD-3 band
(95FI01,93FI03,90Ha31,88Ha02)

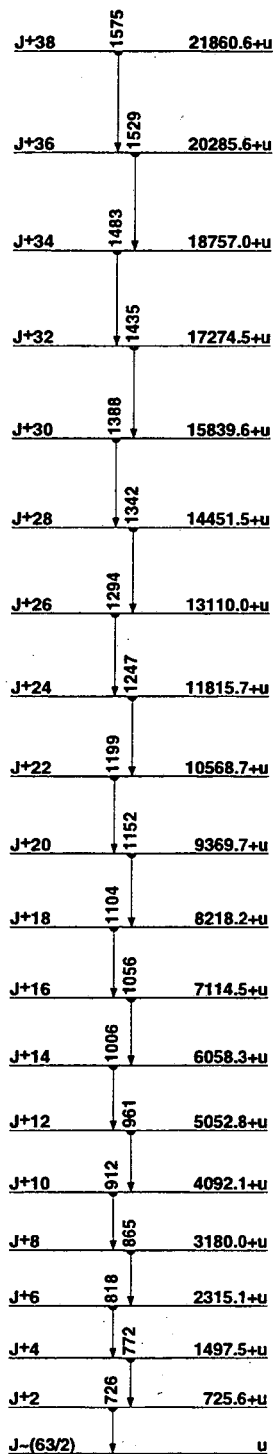

SD-4 band
(95FI01,93FI03)

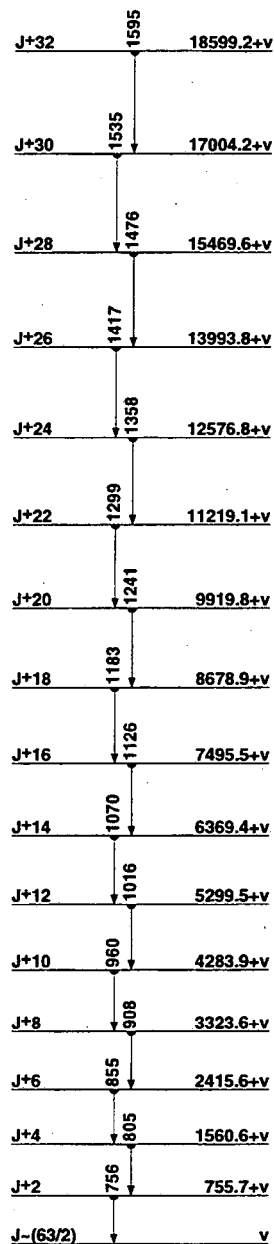

SD-5 band $\alpha=-1/2$
(95FI01,93FI03,94De33)

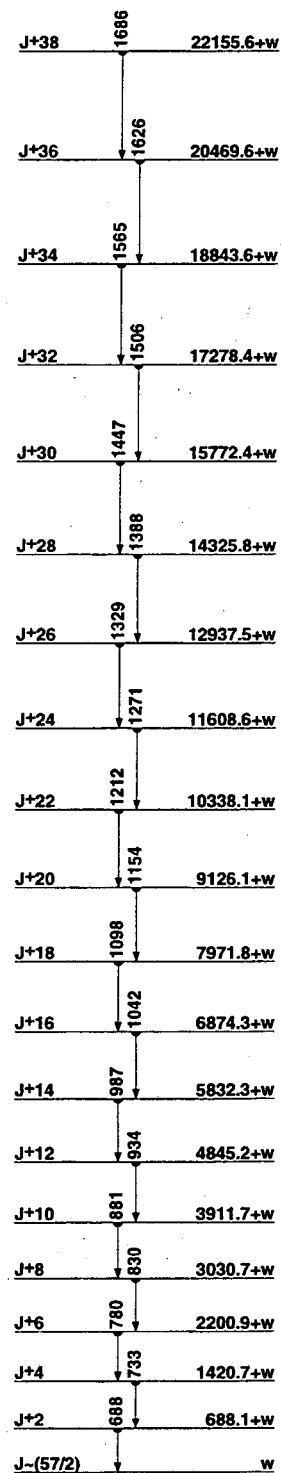

SD-6 band $\alpha=+1/2$
(95FI01,93FI03,94De33)

¹⁵⁰₆₄Gd

Δ: -757717 S_n: 87087 S_p: 66068 Q_α: 28096

Nuclear Bands

- A ΔJ=2 band
- B ΔJ=2 band
- C ΔJ=2 band
- D SD-1 band (89Fa02,91Fa07)
- E SD-2 band (93Be37)
- F SD-3 band (93Be37)
- G SD-4 band (93Be37)
- H SD-5 band (94Fa13,93Be37)
- I ΔJ=2 band

Levels and γ-ray branchings:

- B 0, 0⁺, 1.79×10⁶ eV, %α=100
- B 638.045 14, 2⁺ γ₆₃₈ 638.050 16 (†,100) E2
- A 1134.297 17, 3⁻ γ₆₃₈ 496.242 15 (†,100) E1
- 1207.135 20, 0⁺ γ₆₃₈ 569.083 15 (†,100.5) E2+M1 γ₀ 1207.22 (†₀1.04 15) E0
- B 1288.42 3, 4⁺ γ₁₁₃₄ 154.076 (†,1.84) γ₆₃₈ 650.36 (†,100) E2
- 1430.467 18, (2⁺) γ₆₃₈ 792.385 20 (†,100) E2 γ₀ 1430.464 (†,56.4) (E2)
- 1518.362 21, 2⁺ γ₁₁₃₄ 394.064 (†,13.2) γ₆₃₈ 880.273 (†,100.5) M1(+E2+E0) γ₀ 1518.34 (†,92.7) E2
- 1592.428 24, 1 γ₁₂₀₇ 385.35 (†,2.198) γ₆₃₈ 954.464 (†,61.3) E1 γ₀ 1592.514 (†,100.0 19) M1
- 1699.912 25, 5⁻ γ₁₂₈₈ 411.490 15 (†,77.4) M1 γ₁₁₃₄ 565.642 (†,100) E1 γ₆₃₈ 1061.52 10 (†,15.3)
- 1814.13 6, 3⁻ γ₁₂₈₈ 525.70 20 (†,35.21) γ₆₃₈ 1176.08 6 (†,100.6) E1
- B 1936.31 16, 6⁺ γ₁₇₀₀ 235.93 (†,=3) γ₁₂₈₈ 648.43 (†,100.26) E2
- 1947.36 3, 2⁺, 3⁺, 4⁻ γ₁₁₃₄ 813.06 2 (†,100) (E2)
- 1955.371 22, 2⁺ γ₁₅₁₈ 436.980 25 (†,66.3) M1+E2: δ=1.24 γ₁₄₃₀ 524.90 20 (†,38.46) (M1) γ₁₂₀₇ 748.23 (†,33.85) γ₁₁₃₄ 821.067 20 (†,100.6) E1 γ₆₃₈ 1317.50 6 (†,29.7 16) γ₀ 1955.32 (†,7.2 16)
- 1969.99 11 γ₁₅₉₂ 377.82 15 (†,83.25) γ₁₅₁₈ 450 (†,5) γ₁₄₃₀ 539.26 15 (†,50.25) γ₆₃₈ 1332.34 (†,100.40)
- 1987.93 3, 2⁺, 3⁺, 4⁻ γ₁₄₃₀ 557.45 3 (†,36.5 16) E2 γ₁₂₈₈ 699.47 (†,22.22) γ₆₃₈ 1349.83 (†,100) E2
- 2080.61 9, (2,3,4)⁺ γ₁₅₁₈ 560 (†,17.5) γ₁₄₃₀ 650.33 0 (†,75) (E2) γ₁₂₈₈ 792.38 (†,75) (E2) γ₁₁₃₄ 945.72 (†,30.8) γ₆₃₈ 1442.71 (†, <100)
- 2083.96 3, 2⁺, 3⁻ γ₁₅₉₂ 491.57 5 (†,2.3 23) γ₁₅₁₈ 565.71 (†,13.08) γ₁₁₃₄ 949.90 5 (†,100.5) (M1) γ₆₃₈ 1446.11 (†,51.5)
- 2091.623 25, 2⁺ γ₁₅₁₈ 573.30 (†,9.444) M1 γ₁₄₃₀ 661.18 4 (†,1.481) γ₁₂₈₈ 803 (†,0.9259) γ₁₂₀₇ 884.45 5 (†,5.7 4) γ₁₁₃₄ 957.33 4 (†,19.6 12) E1 γ₆₃₈ 1453.55 4 (†,100.6) (M1) γ₀ 2091.56 10 (†,48.0 24)
- B 2115.75 9, 6⁺ γ₁₉₃₆ 179.43 (?) (†,=1.3) E2 γ₁₇₀₀ 415.32 (†,25 11) E1 γ₁₂₈₈ 827.48 10 (†,100 14) E2
- 2157.57 γ₁₁₃₄ 1023 (†,4) γ₆₃₈ 1519.6 (†,100)
- 2179.912 21, 2⁺ γ₁₉₅₅ 224.41 (†,3.9 12) γ₁₅₉₂ 587 (†,2.809) γ₁₅₁₈ 661.55 4 (†,4.494) γ₁₄₃₀ 749.43 2 (†,3.933) γ₁₁₃₄ 1045.60 3 (†,100.5) E1 γ₆₃₈ 1541.94 6 (†,39.66 23) γ₀ 2179.92 (†,33.1 17)
- 2209.54 3, 2⁺, 3⁻ γ₁₄₃₀ 779.09 4 (†,47.5) γ₁₁₃₄ 1075.25 3 (†,100.5) M1 γ₆₃₈ 1571.26 12 (†,21.4)
- A 2211.11 14, 7⁻ γ₂₁₁₆ 95.52 (†,2.0 4) γ₁₉₃₆ 274.9 3 (†,8.3) E1 γ₁₇₀₀ 511 (†,100 16) E2
- 2262.21 4 γ₁₅₁₈ 743.86 6 (†,20.83) γ₁₄₃₀ 831.73 7 (†,14.58) γ₁₁₃₄ 1127.71 (†,65.5) γ₆₃₈ 1624.20 6 (†,100.7)
- 2306.2 4, (5⁻, 6⁺) γ₂₂₁₁ =95 γ₁₇₀₀ 606.8 5 (†,100 10) γ₁₂₈₈ 1017.2 5 (†,14.2)
- 2326.283 17 γ₁₉₈₈ 338.36 5 (†,36.6) γ₁₇₀₀ 626.47 10 (†,24.6) γ₁₅₁₈ 807.71 15 (†,20.4) γ₁₄₃₀ 895.86 5 (†,48.4) γ₁₂₈₈ 1037.9 3 (†,14.6) γ₆₃₈ 1688.23 1 (†,100 10)
- 2364.91 5, 1, 2⁺ γ₁₅₉₂ 772.52 8 (†,17.2 19) γ₁₅₁₈ 846.5 2 (†,3.1 19) γ₁₂₀₇ 1157.76 8 (†,16.0 13) γ₁₁₃₄ 1231 (†,1.840) γ₆₃₈ 1726.85 15 (†,23.9 25) γ₀ 2364.93 10 (†,100.5)
- 2392.06 17, (7⁺) γ₂₂₁₁ 180.9 3 γ₂₁₁₆ 276 γ₁₉₃₆ 455.7 2 M1

- 2408.53 5, 2⁺ γ₂₀₈₁ 328 1 (†,6.4) γ₁₄₃₀ 977.78 8 (†,20.5 24) γ₁₂₈₈ 1120.15 (†,16.8) γ₁₁₃₄ 1274.51 10 (†,45.4) γ₆₃₈ 1770.45 6 (†,100.5)
- 2416.7 5(?) γ₆₃₈ 1778.6 5 (†,100)
- 2426.20 3, 1, 2⁺ γ₁₅₁₈ 908.1 3 (†,1.9 12) γ₁₄₃₀ 995.38 10 (†,10.4 19) γ₁₁₃₄ 1291.66 3 (†,85.5) γ₆₃₈ 1788.91 5 (†,100.5) γ₀ 2425.98 10 (†,63.3)
- 2434.34 9 γ₁₅₁₈ 916.1 3 (†,19.7) γ₁₄₃₀ 1003.82 (†,9.375) γ₆₃₈ 1796.29 10 (†,100 10)
- 2521.56 7, (2⁺, 3, 4⁺) γ₁₉₄₇ 574.1 5 (†,15.79) γ₁₅₁₈ 1003.22 (†,26.32) γ₁₄₃₀ 1091.0 1 (†,47.37) γ₁₂₈₈ 1233.22 (†,53.8) γ₁₁₃₄ 1387.2 (†,21 14) γ₆₃₈ 1883.6 1 (†,100.8)
- B 2554.14 12, 8⁺ γ₂₃₉₂ 162.0 2 (†,14.4) M1 γ₂₂₁₁ 343.07 10 (†,59 19) E1 γ₂₁₁₆ 438.37 10 (†,100.45) E2
- 2558.51 20, 1, 2⁺ γ₁₂₀₇ 1351.2 (†,16.67) γ₀ 2558.49 20 (†,100 10)
- 2564.96 13, (1⁻, 2⁺, 3⁻) γ₁₅₉₂ 972.7 2 (†,27.14) γ₁₄₃₀ 1134 (†,90.91) γ₁₁₃₄ 1430.50 4 (†,90.90) (E2) γ₆₃₈ 1926.6 2 (†,100 14) γ₀ 2565.4 3 (†,50 14)
- 2593.9 7 γ₁₂₀₇ 1387.3 (†,50 70) γ₁₁₃₄ 1459 (†,100)
- 2627.99 6(?) γ₁₅₉₂ 1035.8 3 (†,30 13) γ₁₁₃₄ 1493.67 8 (†,100 13) γ₆₃₈ 1989.6 8 (†,48.22)
- 2654.39 7 γ₁₉₈₈ 666.49 8 (†,6.7 21) γ₁₉₅₅ 699.0 3 (†,12.75) γ₁₄₃₀ 1223.8 5 (†,5.4 21) γ₆₃₈ 2016.30 10 (†,100.5)
- 2678.45 13, 1, 2⁺ γ₁₈₁₄ 864.4 1 (†,7.273) γ₁₄₃₀ 1247.9 2 (†,16.4) γ₆₃₈ 2040.4 2 (†,100.8) γ₀ 2678.6 3 (†,40.6)
- 2686.84 4, 1⁻, 2, 3⁻ γ₂₃₆₅ 322.0 1 (†,16.4) γ₂₀₈₄ 602.78 6 (†,39.4) γ₁₉₄₇ 739.6 3 (†,7.5) γ₁₇₀₀ 987.3 3 (†,7.4) γ₁₅₉₂ 1094.41 5 (†,52.46) γ₁₅₁₈ 1168.6 6 (†,100.7) γ₁₄₃₀ 1256.4 (†,13.5) γ₁₁₃₄ 1544.1 5 (†,28 14) γ₆₃₈ 1552.3 5 (†,21 10)
- 2754.58 6, 2⁺, 3, 4⁺ γ₂₂₆₂ 492.3 5 (†,15.62) γ₁₂₈₈ 1466.1 3 (†,5.8) γ₁₁₃₄ 1620.30 10 (†,33.5) γ₆₃₈ 2116.8 2 (†,100.5) γ₀ 2754.6 8 (†,25.8)
- 2767.3 6(?), (8⁺) γ₁₉₃₆ 831.0 5 (†,100)
- 2786.49 5, 1⁻, 2⁺ γ₁₉₅₅ 831.18 7 (†,4.294) γ₁₉₄₇ 839.2 2 (†,4.3 13) γ₁₅₉₂ 1193.9 1 (†,8.0 19) γ₁₅₁₈ 1267 (†,4.294) γ₁₄₃₀ 1356.0 10 (†,15.3 19) γ₁₁₃₄ 1652.26 (†,13.5 19) γ₆₃₈ 2148.4 10 (†,100.5)
- A 2816.1 4, 9⁻ γ₂₂₁₁ 605.0 3 (†,100) E2
- 2827.81 7 γ₂₀₈₄ 743.8 6 (†,100) γ₁₉₅₅ 874
- 2845.41 5, 1, 2⁺ γ₂₀₈₂ 753.8 3 (†,1.6 11) γ₁₅₁₈ 1326.7 2 (†,7.1 17) γ₁₄₃₀ 1414.95 6 (†,27.5 17) γ₁₂₀₇ 1638.0 6 10 (†,14.3 22) γ₆₃₈ 2207.58 10 (†,100.5) γ₀ 2845.65 2 5 (†,19.3)
- 2857.7 6 γ₂₆₈₇ 146.2 5 (†,15.2) γ₂₃₀₆ 550.9 5 (†,100 10)
- 2868.27 10 γ₁₂₈₈ 1579.9 2 10 (†,100 20) γ₁₁₃₄ 1733.7 2 (†,88 16)
- 2906.0 5(?), 8⁺ γ₂₁₁₆ 789.9 4 (?) (†,100) E2
- 2956.20 5 γ₂₂₁₀ 746 (†,12.70) γ₂₀₈₂ 864.5 5 (†,12.70) γ₂₀₈₄ 871.9 2 (†,10.4) γ₁₉₈₈ 968.3 5 (†,32.8) γ₁₉₅₅ 1001.0 2 (†,27.7) γ₁₉₄₇ 1008.1 3 (†,19.7) γ₁₅₉₂ 1365.3 3 (†,16.5) γ₁₄₃₀ 1525.70 5 (†,98.5) γ₁₁₃₄ 1822.2 5 (†,16.7) γ₆₃₈ 2318.1 4 10 (†,100.5)
- 2984.95 11, 1, 2⁺ γ₁₉₈₈ 997.8 2 4 (†,19.6) γ₁₅₉₂ 1392.4 4 (†,17.6) γ₁₅₁₈ 1466.6 3 (†,10.7) γ₁₄₃₀ 1554.4 4 (†,38.9) γ₁₂₈₈ 1596 (†,8.333) γ₁₂₀₇ 1778.8 (†,27.78) γ₆₃₈ 2346.9 2 (†,38.5) γ₀ 2984.90 15 (†,100.6)
- 3024.7 3 γ₁₄₃₀ 1596 (†,100) γ₀ 3024.5 3 (†,100 17)
- 3035.6 4 5, 1⁻, 2⁺ γ₂₂₁₀ 826.3 4 15 (†,7.1 11) γ₂₀₈₄ 952 (†,30.30) γ₁₅₉₂ 1443.3 1 (†,40.40) γ₁₅₁₈ 1517.4 (†,10.10) γ₁₄₃₀ 1605.4 4 11 (†,22.3) γ₁₂₈₈ 1747.3 (†,30.30) γ₁₁₃₄ 1901.7 4 10 (†,97.5) γ₆₃₈ 2397.0 4 10 (†,100.5) γ₀ 3034.8 6 15 (†,53.3)
- 3042.61 2 4 γ₁₁₃₄ 1908.6 4 (†,50 19) γ₀ 3042.4 3 (†,100.9)
- 3083.76 17(?) γ₁₉₅₅ 1130.4 7 (†,20 14) γ₁₄₃₀ 1652.6 (†,20 10) γ₁₂₀₇ 1876.6 4 (†,20 10) γ₁₁₃₄ 1949.3 2 (†,100 10) γ₆₃₈ 2446.1 10 (†,50 17)
- 3118.75 8 γ₁₅₁₈ 1600.10 15 (†,78 13) γ₁₄₃₀ 1688.27 10 (†,70 22) γ₁₂₈₈ 1830.7 5 (†,39 18) γ₁₁₃₄ 1984.9 2 (†,100 18)
- 3134.1 3 6 γ₁₅₉₂ 1541.9 4 6 (†,27 16) γ₁₅₁₈ 1615.37 10 (†,58 12) γ₁₄₃₀ 1702.5 3 (†,31 12) γ₆₃₈ 2494.7 8 (†,100 20) γ₀ 3133.6 2 (†,58.8)
- 3176.8 5 γ₂₅₅₄ 622.7 5 (†,100)
- 3177.73 17 γ₂₀₈₄ 1094.1 9 5 (†,10.13) γ₁₅₉₂ 1585.1 9 14 (†,9.4) γ₁₅₁₈ 1659.9 (†,14.4) γ₁₄₃₀ 1747.8 (†,12.66) γ₁₁₃₄ 2043.7 10 (†,14.9) γ₆₃₈ 2539.6 4 5 10 (†,100.5)

- 3220.34, 10⁻ γ_{2816} 404.33 (\dagger ,100) M1+E2
 3251.55 γ_{1592} 1660.0 (\dagger ,100 19) γ_{638} 2614.3 10 (\dagger ,80 40) γ_0 3250.86 (\dagger ,38 13)
 3269.32 11(?) γ_{2180} 1089.41 (\dagger ,100)
 B 3288.24, 10⁺ γ_{2554} 734.03 (\dagger ,100) E2
 3298.34 22 γ_{1947} 1351.7 (\dagger ,41.67) γ_{1288} 2006.05 (\dagger ,42 17) γ_{638} 2661.20 25 (\dagger ,100 13)
 3329.33 16 γ_{1592} 1737.26 (\dagger ,17 10) γ_{1518} 1811.93 (\dagger ,24 8) γ_{1134} 2194.62 (\dagger ,100 8) γ_{638} 2691.05 (\dagger ,44 8)
 3344.68 6, (2⁻) γ_{2409} 935.42 (\dagger ,7 4) γ_{2092} 1253.01 (\dagger ,22 4) γ_{2084} 1260.52 (\dagger ,10 5) γ_{1955} 1389.64 (\dagger ,29 7) γ_{1814} 1530.53 (\dagger ,12 5) γ_{1700} 1645.52 (\dagger ,22 5) γ_{1592} 1752.12 (\dagger ,32 5) γ_{1518} 1826.25 (\dagger ,24 9) γ_{1430} 1914.32 (\dagger ,100 11) γ_{1288} 2056.32 (\dagger ,20 5) γ_{1134} 2210 (\dagger ,33.90) γ_{638} 2706.86 15 (\dagger ,88 5) γ_0 3344.35 (\dagger ,13.6 17)
 A 3366.44, 11⁻ γ_{3288} =78(?) γ_{3220} 146.23 γ_{2816} 550.33
 3375.72 14 γ_{2326} 1049.34 (\dagger ,16 10) γ_{1134} 2241.42 15 (\dagger ,53 7) γ_{638} 2737.85 (\dagger ,100 19) γ_0 3375.57 (\dagger ,14 5)
 3378.11 11 γ_{1814} 1563.96 10 (\dagger ,50 7) γ_{1430} 1947 (\dagger ,16.67) γ_{638} 2740.34 (\dagger ,100 17)
 3389.25 γ_{638} 2751.0 10 (\dagger ,60 50) γ_0 3389.25 (\dagger ,100 13)
 3461.75, 2⁺ γ_{1518} 1943 (\dagger ,4) γ_{1288} 2173.45 (\dagger ,100 30)
 3510.72 17, (1⁻,2⁺) γ_{1592} 1918 (\dagger ,17.95) γ_{1134} 2376.62 (\dagger ,85 8) γ_{638} 2872.23 (\dagger ,100 13)
 3522.46 γ_0 3522.46 (\dagger ,100)
 3631.43 γ_{1430} 2201.48 (\dagger ,100 40) γ_{1134} 2498 (\dagger ,28.57) γ_{638} 2993.23 (\dagger ,71 15)
 3657.35 19(?) 2⁺ γ_{1888} 1668.83 (\dagger ,56 17) γ_{1207} 2450.2 10 (\dagger ,44 23) γ_0 3657.74 25 (\dagger ,100 6)
 3712.40 22 γ_{2081} 1631.72 (\dagger ,100 40) γ_{1134} 2579.58 (\dagger ,90 40)
 3726.63 15 γ_{2210} 1518.24 (\dagger ,85.11) γ_{1430} 2296.98 (\dagger ,6 5) γ_{1134} 2592.25 15 (\dagger ,100 7)
 3772.03 19 γ_{1134} 2636.85 (\dagger ,50 30) γ_{638} 3134.12 (\dagger ,100)
 3828.44(?), (1,2⁺) γ_{1207} 2621.85 (\dagger ,100 40) γ_0 3828.04 (\dagger ,33 7)
 3840.04 17 γ_{1888} 1852.2 (\dagger ,16.39) γ_{1430} 2409.36 20 (\dagger ,100 5) γ_{638} 3202.43 (\dagger ,20 4)
 3963.64 23 γ_{1592} 2372 (\dagger ,27.78) γ_{1430} 2532.53 (\dagger ,100 30) γ_{1134} 2828.56 (\dagger ,33 17) γ_{638} 3327.75 (\dagger ,67 6)
 4021.24(?), (1,2⁺) γ_{638} 3383.65 (\dagger ,100 50) γ_0 4020.84 (\dagger ,0.71 7)
 C 4105.4 10, 12⁺ γ_{3288} 817 (\dagger ,100) E2
 4111.07 25(?), 1⁻, 2⁺ γ_{1288} 2822.76 (\dagger ,27 14) γ_{1134} 2975.96 (\dagger ,40 14) γ_0 4111.23 (\dagger ,100 14)
 A 4131.15, 13⁻ γ_{3366} 764.72 (\dagger ,100) E2
 4143.83(?), (1⁻,2⁺) γ_{1134} 3008.93 (\dagger ,100 17) γ_0 4145.45 (\dagger ,67 9)
 4151.04 γ_{638} 3512.17 (\dagger ,100 40) γ_0 4151.35 (\dagger ,40 9)
 4164.04, 2⁺ γ_{1288} 2876.66 (\dagger ,100 23) γ_{638} 3525.78 (\dagger ,23 9) γ_0 4163.35 (\dagger ,13.6 23)
 4178.65 γ_{1207} 2971.7 10 (\dagger ,100 70) γ_0 4178.55 (\dagger ,80 17)
 4186.95, (12⁻) γ_{3220} 966.63 (\dagger ,100) E2
 4206.93, (1,2⁺) γ_{638} 3570.66 (\dagger ,52 8) γ_0 4206.43 (\dagger ,100 6)
 4235.26(?), (1⁻,2⁺) γ_0 4235.16 (\dagger ,100)
 4246.23(?), (1,2⁺) γ_{638} 3609.48 (\dagger ,43 11) γ_0 4246.03 (\dagger ,100 6)
 4258.03, (1⁻,2⁺) γ_{1134} 3124.03 (\dagger ,100 14) γ_0 4256.56 (\dagger ,14 4)
 4264.63, 2⁺ γ_0 4264.53 (\dagger ,100)
 4283.1 10(?), (1,2⁺) γ_0 4283.0 10 (\dagger ,100)
 4289.43(?), (1,2⁺) γ_0 4289.33 (\dagger ,100)
 4296.7 10 γ_0 4296.6 10 (\dagger ,100)
 4303.23 γ_{1207} 3096.13 (\dagger ,100 11) γ_0 4302.48 (\dagger ,7 3)
 4314.03, 1,2⁺ γ_{638} 3675.35 (\dagger ,100 23) γ_0 4314.23 (\dagger ,70 6)
 4322.03, 2⁺ γ_{638} 3684.34 (\dagger ,65 11) γ_0 4321.64 (\dagger ,100 6)
 4343.94, (1,2⁺) γ_{1430} 2913.74 (\dagger ,100 20) γ_0 4343.36 (\dagger ,10 3)
 4378.66(?), (1⁻,2⁺) γ_0 4378.56 (\dagger ,100)
 4405.33, (1,2⁺) γ_{638} 3768.4 10 (\dagger ,70 40) γ_0 4405.13 (\dagger ,100 6)
 4435.26 γ_{638} 3797.47 (\dagger ,100 40) γ_0 4434.4 10 (\dagger ,19 10)
 4445.93, 1,2⁺ γ_{1207} 3239.25 (\dagger ,61 7) γ_0 4445.73 (\dagger ,100 5)
 4462.38 γ_0 4462.28 (\dagger ,100)
 4492.87 γ_{638} 3854.58 (\dagger ,100 50) γ_0 4493.3 15 (\dagger ,12 9)
 4499.88 γ_0 4499.78 (\dagger ,100)
 4522.86(?) γ_{638} 3884.76 (\dagger ,100)
 4529.44(?), (1,2⁺) γ_{1592} 2935.64 (\dagger ,100 20) γ_0 4531.55 (\dagger ,9.0 20)
 4545.66 γ_{638} 3907.56 (\dagger ,100)
 4557.2 10 γ_0 4557.1 10 (\dagger ,100)
 4563.3 10 γ_0 4563.2 10 (\dagger ,100)
 C 4739.6 11, 14⁺ γ_{4105} 634 (\dagger ,100)
 4744.93 γ_{1592} 3152.43 (\dagger ,100 15) γ_{1430} 3314.56 (\dagger ,29 8)
 A 4834.9 10, 15⁻ γ_{4131} 704 (\dagger ,100)
 C 5428.8 11, 16⁺ γ_{4835} 594 γ_{4740} 689
 A 5450.9 13, 17⁻ γ_{4835} 616 (\dagger ,100)
 5632.8 14, 17⁺ γ_{5429} 204 (\dagger ,100)
 B 5764.8 13, 18⁺ γ_{5633} 132 γ_{5451} 314 D γ_{5429} 336
 6311.8 16, (19⁻) γ_{5765} 547 (\dagger ,100)
 B 6450.8 16, (20⁺) γ_{5765} 686 (\dagger ,100)
 I 6495.8 19, (21⁻) γ_{6312} 184 (\dagger ,100)
 I 7275.8 22, (23⁻) γ_{6496} 780 (\dagger ,100)
 I 7929.8 24, (25⁻) γ_{7276} 654 (\dagger ,100)
 I 8325.3, (27⁻) γ_{7930} 395 (\dagger ,100)
 9410.3(?), (28⁺) γ_{8325} 1085 (\dagger ,100)
 9497.3, (29⁻) γ_{8325} 1172 (\dagger ,100)
 9582.3, (29⁺) γ_{6410} 172 (\dagger ,100)
 9851.3, (30⁺) γ_{9582} 269 γ_{9497} 354
 10532.3, (31⁺) γ_{9582} 950 (\dagger ,100)
 11231.4, (33⁺) γ_{10532} 699 (\dagger ,100)
 12185.4, (34⁺) γ_{11231} 954 (\dagger ,100)
 12678.4, (36⁺,34⁺) γ_{12185} 493 (\dagger ,100)
 D x, J=(32)
 D 814.9+x, J+2 γ_x 814.93 (\dagger ,0.82 9) $I^{(1)}=81.7$, $I^{(2)}=117.6$, $\hbar\omega=0.416$
 D 1663.8+x, J+4 γ_{815+x} 848.9 1 (\dagger ,1.03 8) $I^{(1)}=82.9$, $I^{(2)}=102.3$, $\hbar\omega=0.434$
 D 2551.8+x, J+6 γ_{1664+x} 888.0 1 (\dagger ,0.91 9) $I^{(1)}=83.6$, $I^{(2)}=97.3$, $\hbar\omega=0.454$
 D 3480.9+x, J+8 γ_{2552+x} 929.1 1 (\dagger ,1.03 10) $I^{(1)}=84.2$, $I^{(2)}=95.5$, $\hbar\omega=0.475$
 D 4451.9+x, J+10 γ_{3481+x} 971.0 3 (\dagger ,0.93 9) $I^{(1)}=84.7$, $I^{(2)}=94.6$, $\hbar\omega=0.496$
 D 5465.2+x, J+12 γ_{4452+x} 1013.32 (\dagger ,1.06 7) $I^{(1)}=85.0$, $I^{(2)}=93.2$, $\hbar\omega=0.517$
 D 6521.4+x, J+14 γ_{5465+x} 1056.22 (\dagger ,1.10 6) $I^{(1)}=85.3$, $I^{(2)}=90.7$, $\hbar\omega=0.539$
 D 7621.7+x, J+16 γ_{6521+x} 1100.32 (\dagger ,0.92 12) $I^{(1)}=85.5$, $I^{(2)}=90.9$, $\hbar\omega=0.561$
 D 8766.0+x, J+18 γ_{7622+x} 1144.33 (\dagger ,1.00 9) $I^{(1)}=85.7$, $I^{(2)}=86.6$, $\hbar\omega=0.584$
 D 9956.5+x, J+20 γ_{8766+x} 1190.52 (\dagger ,0.98 6) $I^{(1)}=85.7$, $I^{(2)}=84.6$, $\hbar\omega=0.607$
 D 11194.3+x, J+22 γ_{9957+x} 1237.82 (\dagger ,0.82 8) $I^{(1)}=85.6$, $I^{(2)}=82.1$, $\hbar\omega=0.631$
 D 12480.8+x, J+24 $\gamma_{11194+x}$ 1286.53 (\dagger ,0.56 7) $I^{(1)}=85.4$, $I^{(2)}=79.5$, $\hbar\omega=0.656$
 D 13817.6+x, J+26 $\gamma_{12481+x}$ 1336.83 (\dagger ,0.52 6) $I^{(1)}=85.2$, $I^{(2)}=79.7$, $\hbar\omega=0.681$
 D 15204.6+x, J+28 $\gamma_{13818+x}$ 1387.03 (\dagger ,0.35 6) $I^{(1)}=84.9$, $I^{(2)}=76.5$, $\hbar\omega=0.707$
 D 16643.9+x, J+30 $\gamma_{15205+x}$ 1439.34 (\dagger ,0.21 4) $I^{(1)}=84.5$, $I^{(2)}=72.9$, $\hbar\omega=0.733$
 D 18138.1+x, J+32 $\gamma_{16644+x}$ 1494.26 (\dagger ,0.10 8)
 E y, (29⁻)
 E 727.9+y, (31⁻) γ_y 727.9 $I^{(1)}=82.7$, $I^{(2)}=91.7$, $\hbar\omega=0.375$
 E 1499.4+y, (33⁻) γ_{728+y} 771.5 (\dagger ,0.34 10) $I^{(1)}=83.3$, $I^{(2)}=94.1$, $\hbar\omega=0.396$
 E 2313.4+y, (35⁻) γ_{1499+y} 814.0 (\dagger ,0.69 15) $I^{(1)}=83.8$, $I^{(2)}=93.5$, $\hbar\omega=0.418$
 E 3170.2+y, (37⁻) γ_{2313+y} 856.8 (\dagger ,0.84 10) $I^{(1)}=84.2$, $I^{(2)}=91.1$, $\hbar\omega=0.439$
 E 4070.9+y, (39⁻) γ_{3170+y} 900.7 (\dagger ,0.99 20) $I^{(1)}=84.5$, $I^{(2)}=90.7$, $\hbar\omega=0.461$
 E 5015.7+y, (41⁻) γ_{4071+y} 944.8 (\dagger ,0.96 20) $I^{(1)}=84.8$, $I^{(2)}=88.3$, $\hbar\omega=0.484$
 E 6005.8+y, (43⁻) γ_{5016+y} 990.1 (\dagger ,0.82 10) $I^{(1)}=84.9$, $I^{(2)}=87.0$, $\hbar\omega=0.507$
 E 7041.9+y, (45⁻) γ_{6006+y} 1036.1 (\dagger ,0.75 15) $I^{(1)}=85.0$, $I^{(2)}=86.8$, $\hbar\omega=0.530$
 E 8124.1+y, (47⁻) γ_{7042+y} 1082.2 (\dagger ,0.88 20) $I^{(1)}=85.0$, $I^{(2)}=83.3$, $\hbar\omega=0.553$

E 9254.3+y, (49 ⁻)	γ_{8124+y} 1130.2 (\dagger 0.82 10) $I^{(1)}=84.9$, $I^{(2)}=82.8$, $\eta\omega=0.577$	H v, J=(34)
E 10432.8+y, (51 ⁻)	γ_{9254+y} 1178.5 (\dagger 0.97 20) $I^{(1)}=84.7$, $I^{(2)}=79.7$, $\eta\omega=0.602$	H 909.9+v, J+2
E 11661.5+y, (53 ⁻)	$\gamma_{10433+y}$ 1228.7 (\dagger 0.97 20) $I^{(1)}=84.8$, $I^{(2)}=92.0$, $\eta\omega=0.625$	$\gamma_{909.95}$ (\dagger 0.50 10) $I^{(1)}=81.2$, $I^{(2)}=76.3$, $\eta\omega=0.468$
E 12933.7+y, (55 ⁻)	$\gamma_{11662+y}$ 1272.2 (\dagger 0.54 10) $I^{(1)}=84.6$, $I^{(2)}=71.8$, $\eta\omega=0.650$	H 1874.4+v, J+4
E 14261.6+y, (57 ⁻)	$\gamma_{12934+y}$ 1327.9 (\dagger 0.11 10) $I^{(1)}=84.3$, $I^{(2)}=79.5$, $\eta\omega=0.677$	γ_{810+v} 964.55 (\dagger 0.63 10) $I^{(1)}=77.6$, $I^{(2)}=133.3$, $\eta\omega=0.490$
E 15639.8+y, (59 ⁻)	$\gamma_{14262+y}$ 1378.2 $I^{(1)}=84.1$, $I^{(2)}=79.1$, $\eta\omega=0.702$	H 2868.9+v, J+6
E 17068.6+y, (61 ⁻)	$\gamma_{15640+y}$ 1428.8 $I^{(1)}=83.8$, $I^{(2)}=76.2$, $\eta\omega=0.728$	γ_{1874+v} 994.55 (\dagger 0.50 10) $I^{(1)}=81.5$, $I^{(2)}=148.7$, $\eta\omega=0.491$
E 18549.9+y, (63 ⁻)	$\gamma_{17069+y}$ 1481.3 $I^{(1)}=83.6$, $I^{(2)}=77.5$, $\eta\omega=0.754$	H 3836.5+v, J+8
E 20082.8+y, (65 ⁻)	$\gamma_{18550+y}$ 1532.9 $I^{(1)}=83.4$, $I^{(2)}=78.9$, $\eta\omega=0.779$	γ_{2869+v} 967.65 (\dagger 0.68 10) $I^{(1)}=85.4$, $I^{(2)}=129.0$, $\eta\omega=0.492$
E 21666.4+y, (67 ⁻)	$\gamma_{20083+y}$ 1583.6	H 4835.1+v, J+10
F z, (24 ⁻)		γ_{3837+v} 998.65 (\dagger 0.84 10) $I^{(1)}=86.1$, $I^{(2)}=84.4$, $\eta\omega=0.511$
F 617.1+z, (26 ⁻)	γ_z 617.1 (\dagger 0.55) $I^{(1)}=81.2$, $I^{(2)}=84.7$, $\eta\omega=0.320$	H 5881.1+v, J+12
F 1281.4+z, (28 ⁻)	γ_{617+z} 664.3 (\dagger 0.75) $I^{(1)}=81.3$, $I^{(2)}=83.0$, $\eta\omega=0.344$	γ_{4835+v} 1046.05 (\dagger 1.00 5) $I^{(1)}=85.9$, $I^{(2)}=80.8$, $\eta\omega=0.535$
F 1993.9+z, (30 ⁻)	γ_{1281+z} 712.5 (\dagger 0.9) $I^{(1)}=81.4$, $I^{(2)}=81.1$, $\eta\omega=0.369$	H 6976.6+v, J+14
F 2755.7+z, (32 ⁻)	γ_{1994+z} 761.8 (\dagger 1.0) $I^{(1)}=81.4$, $I^{(2)}=82.8$, $\eta\omega=0.393$	γ_{5881+v} 1095.55 (\dagger 0.93 5) $I^{(1)}=85.6$, $I^{(2)}=76.3$, $\eta\omega=0.561$
F 3565.8+z, (34 ⁻)	γ_{2756+z} 810.1 (\dagger 1.1) $I^{(1)}=81.4$, $I^{(2)}=80.6$, $\eta\omega=0.417$	H 8124.5+v, J+16
F 4425.5+z, (36 ⁻)	γ_{3566+z} 859.7 (\dagger 1.0) $I^{(1)}=81.4$, $I^{(2)}=79.7$, $\eta\omega=0.442$	γ_{6977+v} 1147.95 (\dagger 0.93 5) $I^{(1)}=85.2$, $I^{(2)}=77.4$, $\eta\omega=0.587$
F 5335.4+z, (38 ⁻)	γ_{4426+z} 909.9 (\dagger 1.1) $I^{(1)}=81.2$, $I^{(2)}=76.3$, $\eta\omega=0.468$	H 9324.1+v, J+18
F 6297.7+z, (40 ⁻)	γ_{5335+z} 962.3 (\dagger 0.9) $I^{(1)}=81.0$, $I^{(2)}=77.1$, $\eta\omega=0.494$	γ_{8125+v} 1199.65 (\dagger 1.08 5) $I^{(1)}=84.9$, $I^{(2)}=79.1$, $\eta\omega=0.612$
F 7311.9+z, (42 ⁻)	γ_{6298+z} 1014.2 (\dagger 1.0) $I^{(1)}=80.7$, $I^{(2)}=74.6$, $\eta\omega=0.521$	H 10574.3+v, J+20
F 8379.7+z, (44 ⁻)	γ_{7312+z} 1067.8 (\dagger 0.9) $I^{(1)}=80.4$, $I^{(2)}=74.2$, $\eta\omega=0.547$	γ_{9324+v} 1250.25 (\dagger 1.00 5) $I^{(1)}=84.7$, $I^{(2)}=80.3$, $\eta\omega=0.638$
F 9501.4+z, (46 ⁻)	γ_{8380+z} 1121.7 $I^{(1)}=80.1$, $I^{(2)}=73.5$, $\eta\omega=0.574$	H 11874.3+v, J+22
F 10677.5+z, (48 ⁻)	γ_{9501+z} 1176.1 $I^{(1)}=79.7$, $I^{(2)}=72.2$, $\eta\omega=0.602$	$\gamma_{10574+v}$ 1300.05 (\dagger 0.89 7) $I^{(1)}=84.5$, $I^{(2)}=79.2$, $\eta\omega=0.663$
F 11909.0+z, (50 ⁻)	$\gamma_{10678+z}$ 1231.5 $I^{(1)}=79.4$, $I^{(2)}=72.1$, $\eta\omega=0.630$	H 13224.8+v, J+24
F 13196.0+z, (52 ⁻)	$\gamma_{11909+z}$ 1287.0 $I^{(1)}=79.1$, $I^{(2)}=71.7$, $\eta\omega=0.657$	$\gamma_{11874+v}$ 1350.55 (\dagger 0.87 5) $I^{(1)}=84.4$, $I^{(2)}=81.5$, $\eta\omega=0.688$
F 14538.8+z, (54 ⁻)	$\gamma_{13196+z}$ 1342.8 $I^{(1)}=78.8$, $I^{(2)}=71.6$, $\eta\omega=0.685$	H 14624.4+v, J+26
F 15937.5+z, (56 ⁻)	$\gamma_{14539+z}$ 1398.7 $I^{(1)}=78.5$, $I^{(2)}=70.7$, $\eta\omega=0.713$	$\gamma_{13225+v}$ 1399.67 (\dagger 0.58 5) $I^{(1)}=84.3$, $I^{(2)}=81.5$, $\eta\omega=0.712$
F 17392.8+z, (58 ⁻)	$\gamma_{15938+z}$ 1455.3 $I^{(1)}=78.2$, $I^{(2)}=70.5$, $\eta\omega=0.742$	H 16073.1+v, J+28
F 18904.8+z, (60 ⁻)	$\gamma_{17393+z}$ 1512.0 $I^{(1)}=77.9$, $I^{(2)}=72.3$, $\eta\omega=0.770$	$\gamma_{14624+v}$ 1448.77 (\dagger 0.50 7) $I^{(1)}=84.2$, $I^{(2)}=82.0$, $\eta\omega=0.737$
F 20472.1+z, (62 ⁻)	$\gamma_{18905+z}$ 1567.3	H 17570.6+v, J+30
G u, (27 ⁻)		$\gamma_{16073+v}$ 1497.57 (\dagger 0.20 9) $I^{(1)}=84.1$, $I^{(2)}=84.2$, $\eta\omega=0.761$
G 688.3+u, (29 ⁻)	γ_0 688.3 $I^{(1)}=81.4$, $I^{(2)}=83.3$, $\eta\omega=0.356$	H 19115.6+v, J+32
G 1424.6+u, (31 ⁻)	γ_{688+u} 736.3 $I^{(1)}=81.5$, $I^{(2)}=81.1$, $\eta\omega=0.380$	$\gamma_{17571+v}$ 1545.07 (\dagger 0.08 6)
G 2210.2+u, (33 ⁻)	γ_{1425+u} 785.6 $I^{(1)}=81.5$, $I^{(2)}=81.6$, $\eta\omega=0.405$	
G 3044.8+u, (35 ⁻)	γ_{2210+u} 834.6 $I^{(1)}=81.4$, $I^{(2)}=79.1$, $\eta\omega=0.430$	
G 3930.0+u, (37 ⁻)	γ_{3045+u} 885.2 $I^{(1)}=81.3$, $I^{(2)}=78.3$, $\eta\omega=0.455$	
G 4866.3+u, (39 ⁻)	γ_{3930+u} 936.3 $I^{(1)}=81.1$, $I^{(2)}=76.9$, $\eta\omega=0.481$	
G 5854.6+u, (41 ⁻)	γ_{4866+u} 988.3 $I^{(1)}=80.8$, $I^{(2)}=76.3$, $\eta\omega=0.507$	
G 6895.3+u, (43 ⁻)	γ_{5855+u} 1040.7 $I^{(1)}=80.6$, $I^{(2)}=74.2$, $\eta\omega=0.534$	
G 7989.9+u, (45 ⁻)	γ_{6895+u} 1094.6 $I^{(1)}=80.2$, $I^{(2)}=74.2$, $\eta\omega=0.561$	
G 9138.4+u, (47 ⁻)	γ_{7990+u} 1148.5 $I^{(1)}=80.0$, $I^{(2)}=73.7$, $\eta\omega=0.588$	
G 10341.2+u, (49 ⁻)	γ_{9138+u} 1202.8 $I^{(1)}=79.6$, $I^{(2)}=72.3$, $\eta\omega=0.615$	
G 11599.3+u, (51 ⁻)	$\gamma_{10341+u}$ 1258.1 $I^{(1)}=79.4$, $I^{(2)}=73.4$, $\eta\omega=0.643$	
G 12911.9+u, (53 ⁻)	$\gamma_{11599+u}$ 1312.6 $I^{(1)}=78.9$, $I^{(2)}=63.4$, $\eta\omega=0.672$	
G 14287.6+u, (55 ⁻)	$\gamma_{12912+u}$ 1375.7 $I^{(1)}=78.5$, $I^{(2)}=77.2$, $\eta\omega=0.701$	
G 15715.1+u, (57 ⁻)	$\gamma_{14288+u}$ 1427.5 $I^{(1)}=78.3$, $I^{(2)}=71.4$, $\eta\omega=0.728$	
G 17198.6+u, (59 ⁻)	$\gamma_{15715+u}$ 1483.5 $I^{(1)}=78.1$, $I^{(2)}=70.5$, $\eta\omega=0.756$	
G 18738.8+u, (61 ⁻)	$\gamma_{17199+u}$ 1540.2 $I^{(1)}=77.7$, $I^{(2)}=67.3$, $\eta\omega=0.785$	
G 20338.4+u, (63 ⁻)	$\gamma_{18739+u}$ 1599.6	

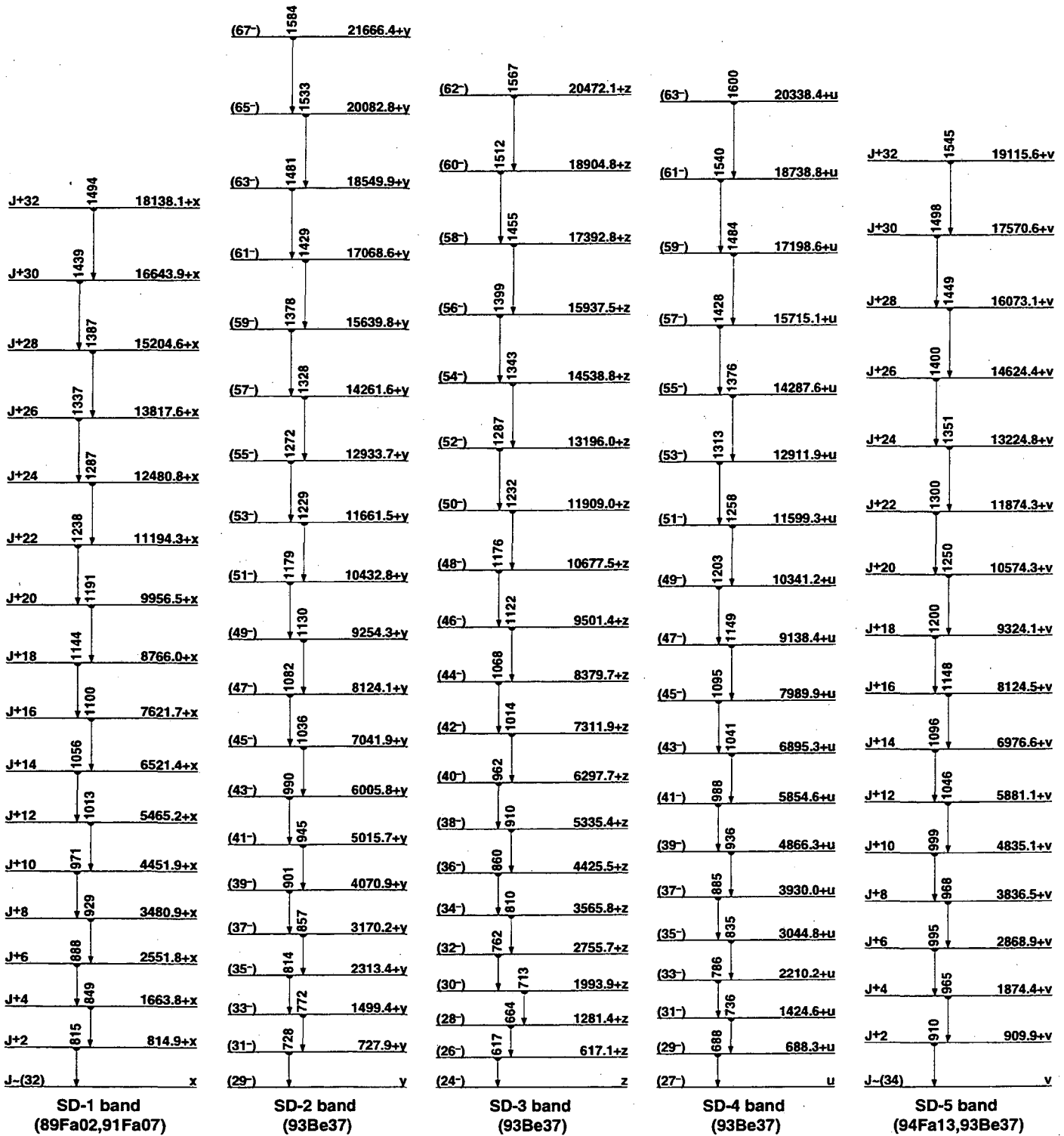

¹⁵⁰₆₄Gd

¹⁴⁵Tb
₆₅Tb

Δ : -66440 130 S_n : (11500) S_p : (1820) Q_{EC} : 6510 120 Q_α : 1530 160

Nuclear Bands

A SD band (94Mu16)

Levels and γ -ray branchings:

(0), (1/2⁺)

0+x, (11/2⁻), 29.5 10 s, %EC+% β^+ =100

578.2+x(?), (9/2⁻) γ_{0+x} 578.23 (†,100)

639.6+x(?), (13/2⁻) γ_{0+x} 639.63 (†,100)

804.3+x(?), (9/2⁻,11/2⁻) γ_{0+x} 804.33 (†,100)

A y, J

A 627.1+y, J+2 $\gamma_{627.14}$ $I^{(2)}=65.9$, $\hbar\omega=0.329$

A 1314.9+y, J+4 γ_{627+y} 687.84 $I^{(2)}=67.6$, $\hbar\omega=0.359$

A 2061.9+y, J+6 γ_{1315+y} 747.03 $I^{(2)}=67.7$, $\hbar\omega=0.388$

A 2868.0+y, J+8 γ_{2062+y} 806.15 $I^{(2)}=68.5$, $\hbar\omega=0.418$

A 3732.5+y, J+10 γ_{2868+y} 864.56 $I^{(2)}=72.1$, $\hbar\omega=0.446$

A 4652.5+y, J+12 γ_{3733+y} 920.1 $I^{(2)}=66.3$, $\hbar\omega=0.475$

A 5632.8+y, J+14 γ_{4653+y} 980.311 $I^{(2)}=67.8$, $\hbar\omega=0.505$

A 6672.1+y, J+16 γ_{5633+y} 1039.36 $I^{(2)}=69.0$, $\hbar\omega=0.534$

A 7769.4+y, J+18 γ_{6672+y} 1097.35 $I^{(2)}=69.3$, $\hbar\omega=0.563$

A 8924.4+y, J+20 γ_{7769+y} 1155.09 $I^{(2)}=70.3$, $\hbar\omega=0.592$

A 10136.3+y, J+22 γ_{8924+y} 1211.99 $I^{(2)}=67.3$, $\hbar\omega=0.621$

A 11407.6+y, J+24 $\gamma_{10136+y}$ 1271.39 $I^{(2)}=75.9$, $\hbar\omega=0.649$

A 12731.6+y, J+26 $\gamma_{11408+y}$ 1324.2 $I^{(2)}=63.5$, $\hbar\omega=0.678$

A 14118.6+y, J+28 $\gamma_{12732+y}$ 1387.1

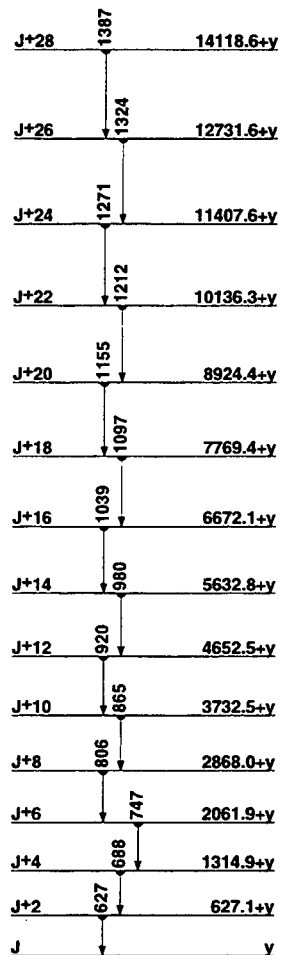

SD band
(94Mu16)
¹⁴⁵Tb
₆₅Tb

150Tb
65Tb

Δ : -71115 S_n : 7688 S_p : 3269 Q_{EC} : 4656 $9 Q_\alpha$: 3587 5

Nuclear Bands

- A SD-1 band (89D ϵ 10,95Fa09)
- B SD-2 band (95Fa09)
- C SD-3 band (95Fa09)

Levels and γ -ray branchings:

0, (2⁻), 3.48 h, %EC+% β^+ =100, % α <0.05
 397.2.3, (1⁺) γ_0 397.23 (?) (†,100) E1
 474.51, 9⁺, 5.82 m, %EC+% β^+ =100
 1067.95 25, 10⁺ γ_{474} 594.03 (†,100.0)
 1232.79 24, 11⁺ γ_{474} 758.83 (†,100.0)
 1306.55 25, 10⁻ γ_{474} 832.53 (†,100.0)
 1348.40 24, 11⁻, 0.396 ns γ_{1307} 41.83 (†,0.000) γ_{1233} 115.73 (†,29.3)
 γ_{1068} 280.53 (†,100.10)
 1586.5.4, 12⁻ γ_{1348} 238.13 (†,100.0)
 1910.4.4, 13⁺ γ_{1233} 677.53 (†,100.0)
 2114.0.4, 13⁻ γ_{1348} 765.73 (†,100.0)
 2404.9.4, 14⁻ γ_{2114} 290.93 (†,56.7) γ_{1587} 818.53 (†,100.13)
 2413.0.4, 14⁺ γ_{1910} 502.63 (†,100.0)
 2641.7.4, 16⁺ γ_{2413} 228.73 (†,100.0)
 2741.4.4, 15⁻ γ_{2114} 627.43 (†,100.0)
 2757.6.4, (15⁺) γ_{1910} 847.13 (†,100.0)
 3017.9.4, 16⁻ γ_{2758} 260.23 (†,2.17) γ_{2741} 276.53 (†,100.10) γ_{2642} 376.03
 (†,3.47) γ_{2405} 613.03 (†,37.5)
 3373.6.5, 18⁻ γ_{3018} 355.63 (†,100.10) γ_{2642} 732.13 (†,1.46)
 3684.5.5, 19⁻ γ_{3374} 310.93 (†,100.0)
 3898.2.5, 20⁻ γ_{3685} 213.73 (†,96.9) γ_{3374} 524.63 (†,100.9)
 3933.2.5, 19⁺ γ_{3374} 559.63 (†,100.0)
 4324.0.5, 20⁺ γ_{3933} 390.73 (†,100.12) γ_{3685} 639.43 (†,62.8)
 4818.2.5, 21⁺ γ_{4324} 494.13 (†,100.10) γ_{3898} 920.13 (†,85.8)
 4894.6.6, 22⁺ γ_{4818} 761 (†,0.000)
 4972.7.5, 21⁻ γ_{3898} 1074.53 (†,30.10) γ_{3685} 1288.23 (†,100.10)
 5238.9.5, 22⁻ γ_{4973} 266.23 (†,100.10) γ_{3898} 1340.73 (†,100.20)
 5448.8.6, 22⁺ γ_{4895} 554.13 (†,90.10) γ_{4818} 630.73 (†,100.10)
 5667.5.6, (22⁻) γ_{4818} 849.33 (†,100.0)
 5725.8.6, 23⁺ γ_{5668} 581 (†,0.000) γ_{5449} 277.13 (†,79.15) γ_{5238} 486.93
 (†,86.8) γ_{4895} 831.23 (†,93.22) γ_{4818} 907.53 (†,100.8)
 5842.5.6, 23⁻ γ_{5726} 116.63 (†,31.8) γ_{4895} 947.93 (†,100.10)
 5975.7.6, (24⁺) γ_{4895} 1081.03 (†,100.0)
 6010.9.6, 24⁺ γ_{5843} 168.43 (†,17.0.19) γ_{5726} 285.33 (†,100.12)
 γ_{4895} 1116.13 (†,44.4)
 6044.1.6, 25⁺ γ_{6011} 331 (†,0.000) γ_{5976} 681 (†,0.000) γ_{5726} 318.43
 (†,100.10)
 6382.5.7, 26⁺ γ_{6044} 338.33 (†,100.0)
 6509.0.7, (27⁺) γ_{6044} 465.13 (†,100.0)
 6571.4.7, 27⁺ γ_{6509} 62.53 (†,0.000) γ_{6383} 188.83 (†,100.9) γ_{6044} 527.23
 (†,56.6)
 7067.9.7, 28⁻ γ_{6571} 496.53 (†,100.0)
 8168.2.8, 30⁻ γ_{7068} 1100.53 (†,100.0)
 8266.1.8, (29⁺) γ_{7068} 1198.33 (†,100.0)
 8335.0.8, (29⁻) γ_{7068} 1266.93 (†,100.0)
 8496.9.8, (30) γ_{8266} 230.83 (†,100.0)
 8514.9.8, (30⁻) γ_{8335} 180.13 (†,100.0)
 8519.9.13 γ_{7068} 1452.1 (†,100.0)
 8540.5.8 γ_{7068} 1472.63 (†,100.0)
 8808.2.8, 31⁺ γ_{8497} 311.43 (†,33.33) γ_{8168} 640.03 (†,100.40)
 8901.2.13, 32 γ_{8168} 733.1 (†,100.0)
 8957.6.8, 32⁻ γ_{8808} 149.53 (†,15.4) γ_{8168} 789.53 (†,100.12)
 9013.4.8, (31) γ_{8335} 678.13 (†,100.50) γ_{8168} 846.1 (†,100.50)
 9188.2.13 γ_{8168} 1020.1 (†,100.0)

9327.2.13, (33) γ_{8901} 426.03 (†,100.0)
 9403.5.8 γ_{8808} 595.33 (†,100.0)
 9556.6.8, (32⁻) γ_{8515} 1041.93 (†,100.0)
 9914.3.8, (33⁻) γ_{8958} 956.73 (†,100.0)
 9921.4.8, (33⁺) γ_{8958} 963.83 (†,100.0)
 10006.9.13 γ_{8497} 1510.1 (†,100.0)
 10046.6.8, (33) γ_{9013} 1032.83 (†,100.0)
 10170.2.17 γ_{9327} 843.1 (†,100.0)
 10321.6.13 γ_{8958} 1364.1 (†,100.0)
 10906.2.9, (35⁻) γ_{9914} 991.93 (†,100.0)
 11072.4.13 γ_{9921} 1151.1 (†,100.0)
 11160.0.8, (34⁻) γ_{10047} 1113.13 (†,100.50) γ_{9921} 1238.73 (†,25.00)
 γ_{9914} 1245.83 (†,50.00) γ_{9557} 1603.63 (†,45.13)
 11567.7.9, (36⁻) γ_{11160} 407.73 (†,100.0)
 12596.5.9, (38⁻) γ_{11568} 1028.83 (†,100.0)
 13378.5.14, (39⁺) γ_{12597} 782.1 (†,100.0)

A x, J=(24)

A 596.8+x, J+2 γ_x 596.82 (†,0.265) $I^{(1)}$ =83.6, $I^{(2)}$ =79.1, η ω =0.311
 A 1244.2+x, J+4 γ_{597+x} 647.41 (†,0.573) $I^{(1)}$ =83.3, $I^{(2)}$ =79.5, η ω =0.336
 A 1941.9+x, J+6 γ_{1244+x} 697.71 (†,1.022) $I^{(1)}$ =83.0, $I^{(2)}$ =79.2, η ω =0.361
 A 2690.1+x, J+8 γ_{1942+x} 748.21 (†,1.042) $I^{(1)}$ =82.7, $I^{(2)}$ =78.4, η ω =0.387
 A 3489.3+x, J+10 γ_{2690+x} 799.21 (†,1.022) $I^{(1)}$ =82.4, $I^{(2)}$ =78.0, η ω =0.412
 A 4339.8+x, J+12 γ_{3489+x} 850.51 (†,0.893) $I^{(1)}$ =82.2, $I^{(2)}$ =77.5, η ω =0.438
 A 5241.9+x, J+14 γ_{4340+x} 902.11 (†,1.012) $I^{(1)}$ =81.9, $I^{(2)}$ =76.9, η ω =0.464
 A 6196.0+x, J+16 γ_{5242+x} 954.11 (†,0.992) $I^{(1)}$ =81.6, $I^{(2)}$ =75.8, η ω =0.490
 A 7202.9+x, J+18 γ_{6196+x} 1006.91 (†,0.982) $I^{(1)}$ =81.3, $I^{(2)}$ =75.9, η ω =0.517
 A 8262.5+x, J+20 γ_{7203+x} 1059.61 (†,0.962) $I^{(1)}$ =81.0, $I^{(2)}$ =75.8, η ω =0.543
 A 9374.9+x, J+22 γ_{8263+x} 1112.41 (†,0.902) $I^{(1)}$ =80.8, $I^{(2)}$ =75.3, η ω =0.569
 A 10540.4+x, J+24 γ_{9375+x} 1165.51 (†,0.882) $I^{(1)}$ =80.5, $I^{(2)}$ =75.0,
 η ω =0.596
 A 11759.2+x, J+26 $\gamma_{10540+x}$ 1218.81 (†,0.902) $I^{(1)}$ =80.3, $I^{(2)}$ =74.8,
 η ω =0.623
 A 13031.5+x, J+28 $\gamma_{11759+x}$ 1272.31 (†,0.672) $I^{(1)}$ =80.0, $I^{(2)}$ =73.9,
 η ω =0.650
 A 14357.9+x, J+30 $\gamma_{13032+x}$ 1326.42 (†,0.482) $I^{(1)}$ =79.8, $I^{(2)}$ =74.2,
 η ω =0.677
 A 15738.2+x, J+32 $\gamma_{14358+x}$ 1380.32 (†,0.382) $I^{(1)}$ =79.6, $I^{(2)}$ =73.3,
 η ω =0.704
 A 17173.1+x, J+34 $\gamma_{15738+x}$ 1434.92 (†,0.242) $I^{(1)}$ =79.3, $I^{(2)}$ =73.4,
 η ω =0.731
 A 18662.5+x, J+36 $\gamma_{17173+x}$ 1489.43 (†,0.173) $I^{(1)}$ =79.1, $I^{(2)}$ =73.1,
 η ω =0.758
 A 20206.6+x, J+38 $\gamma_{18663+x}$ 1544.17 (†,0.102) $I^{(1)}$ =78.9, $I^{(2)}$ =72.1,
 η ω =0.786
 A 21806.2+x, J+40 $\gamma_{20207+x}$ 1599.610 (†,0.053)

B y, J

B 662.5+y, J+2 γ_y 662.52 (†,0.646) $I^{(2)}$ =74.6, η ω =0.345
 B 1378.6+y, J+4 γ_{663+y} 716.12 (†,0.885) $I^{(2)}$ =74.6, η ω =0.371
 B 2148.3+y, J+6 γ_{1378+y} 769.73 (†,1.106) $I^{(2)}$ =74.3, η ω =0.398
 B 2971.8+y, J+8 γ_{2148+y} 823.53 (†,1.155) $I^{(2)}$ =74.3, η ω =0.425
 B 3849.1+y, J+10 γ_{2972+y} 877.33 (†,0.935) $I^{(2)}$ =75.2, η ω =0.452
 B 4779.6+y, J+12 γ_{3849+y} 930.52 (†,0.825) $I^{(2)}$ =75.2, η ω =0.479
 B 5763.3+y, J+14 γ_{4780+y} 983.72 (†,0.975) $I^{(2)}$ =73.8, η ω =0.505
 B 6801.2+y, J+16 γ_{5763+y} 1037.92 (†,0.915) $I^{(2)}$ =75.6, η ω =0.532
 B 7892.0+y, J+18 γ_{6801+y} 1090.83 (†,0.955) $I^{(2)}$ =76.5, η ω =0.558
 B 9035.1+y, J+20 γ_{7892+y} 1143.13 (†,0.644) $I^{(2)}$ =75.5, η ω =0.585
 B 10231.2+y, J+22 γ_{9035+y} 1196.13 (†,0.705) $I^{(2)}$ =77.7, η ω =0.611
 B 11478.8+y, J+24 $\gamma_{10231+y}$ 1247.64 (†,0.474) $I^{(2)}$ =76.8, η ω =0.637
 B 12778.5+y, J+26 $\gamma_{11478+y}$ 1299.74 (†,0.584) $I^{(2)}$ =77.4, η ω =0.663
 B 14129.9+y, J+28 $\gamma_{12778+y}$ 1351.46 (†,0.524) $I^{(2)}$ =77.1, η ω =0.689
 B 15533.2+y, J+30 $\gamma_{14130+y}$ 1403.38 (†,0.313) $I^{(2)}$ =80.5, η ω =0.714
 B 16986.2+y, J+32 $\gamma_{15533+y}$ 1453.011 (†,0.175)

C z, J

- C 877.0+z, J+2 $\gamma_{z, 877.04}$ ($\dagger, 0.686$) $I^{(2)}=354.0, \eta\omega=0.441$
- C 1765.3+z, J+4 $\gamma_{877+z, 888.33}$ ($\dagger, 0.786$) $I^{(2)}=97.3, \eta\omega=0.454$
- C 2694.7+z, J+6 $\gamma_{1765+z, 929.43}$ ($\dagger, 1.087$) $I^{(2)}=84.0, \eta\omega=0.477$
- C 3671.7+z, J+8 $\gamma_{2695+z, 977.03}$ ($\dagger, 0.8810$) $I^{(2)}=80.5, \eta\omega=0.501$
- C 4698.4+z, J+10 $\gamma_{3672+z, 1026.75}$ ($\dagger, 1.0110$) $I^{(2)}=79.5, \eta\omega=0.526$
- C 5775.4+z, J+12 $\gamma_{4698+z, 1077.04}$ ($\dagger, 1.089$) $I^{(2)}=81.3, \eta\omega=0.551$
- C 6901.6+z, J+14 $\gamma_{5775+z, 1126.23}$ ($\dagger, 0.918$) $I^{(2)}=77.4, \eta\omega=0.576$
- C 8079.5+z, J+16 $\gamma_{6902+z, 1177.95}$ ($\dagger, 0.828$) $I^{(2)}=77.2, \eta\omega=0.602$
- C 9309.2+z, J+18 $\gamma_{8080+z, 1229.76}$ ($\dagger, 1.0310$) $I^{(2)}=75.9, \eta\omega=0.628$
- C 10591.6+z, J+20 $\gamma_{9309+z, 1282.46}$ ($\dagger, 0.8010$) $I^{(2)}=78.6, \eta\omega=0.654$
- C 11924.9+z, J+22 $\gamma_{10592+z, 1333.37}$ ($\dagger, 0.656$) $I^{(2)}=74.3, \eta\omega=0.680$
- C 13312.0+z, J+24 $\gamma_{11925+z, 1387.19}$ ($\dagger, 0.325$) $I^{(2)}=74.9, \eta\omega=0.707$
- C 14752.5+z, J+26 $\gamma_{13312+z, 1440.510}$ ($\dagger, 0.208$) $I^{(2)}=74.8, \eta\omega=0.734$
- C 16246.5+z (?), J+28 $\gamma_{14753+z, 1494.012(?)}$ ($\dagger, 0.105$)

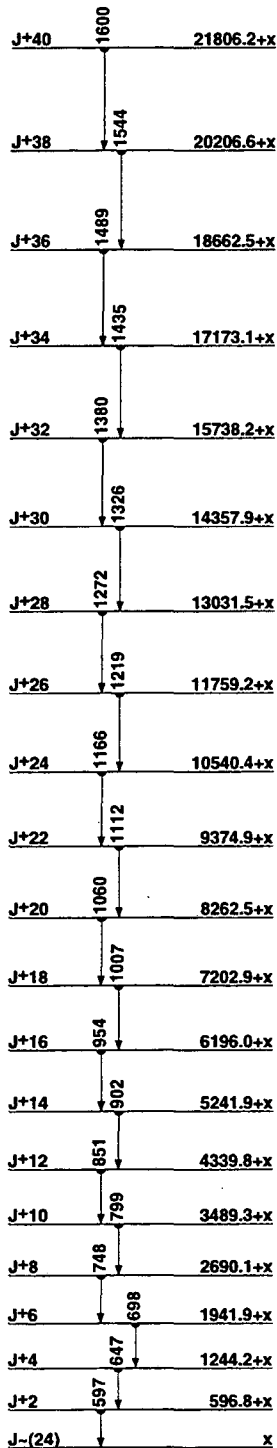

SD-1 band
(89De10, 95Fa09)

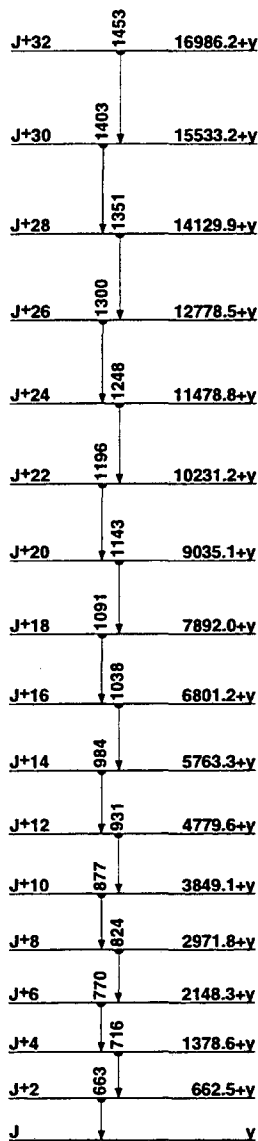

SD-2 band
(95Fa09)

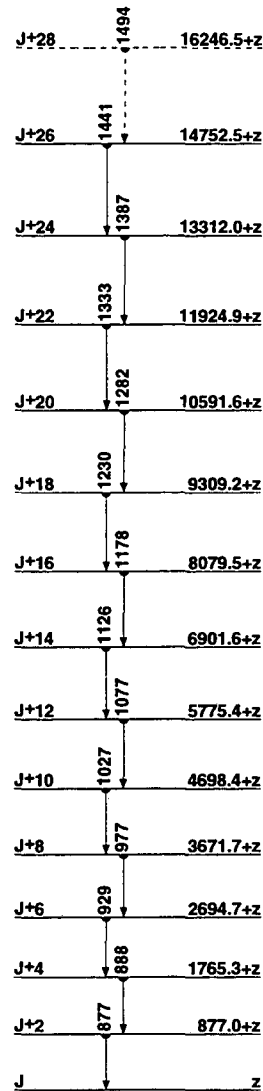

SD-3 band
(95Fa09)

151Tb
65Tb Δ : -71633 5 S_n : 8590 9 S_p : 3151 7 Q_{EC} : 2565 4 Q_α : 3496 4

Nuclear Bands

- A $\pi h_{11/2} + (^{150}\text{Gd})0^+$
 B $\pi h_{11/2} + (^{150}\text{Gd})3^-$
 C SD-1 band (89Fa02,93Cu06,95Kh06)
 D SD-2 band (90By01,93Cu06,95Kh06)
 E SD-3 band (95Kh06)
 F SD-4 band (95Kh06)
 G SD-5 band (94De33)
 H SD-6 band (94De33)
 I SD-7 band (94De33)
 J SD-8 band (94De33)

Levels and γ -ray branchings:

- 0, 1/2⁽⁺⁾, 17.609 1 h, %EC+% β^+ =100, % α =9.5 $\times 10^{-3}$ 15
 22.922 20, 3/2⁽⁺⁾, 4.05 7 ns $\gamma_{0,22.922}$ (†,100) M1+E2: δ =0.031 4
 72.39 3, (5/2⁻), 0.92 3 ns $\gamma_{23,72.393}$ (†,100 1) M1+E2: δ =0.06 2
 $\gamma_{0,72.50}$ 10 (†,0.5 1) (E2)
- A 99.54 6, (11/2⁻), 25 3 s, %IT=93.8 4, %EC+% β^+ =6.2 4 $\gamma_{72,99.546}$ 10 E3
 248.79 3, (5/2⁺, 7/2⁺), <0.26 ns $\gamma_{72,248.793}$ (†,100 2) M1+E2: δ =0.51 17
 $\gamma_{23,226.33}$ (†,2.3 5) M1, E2
 276.42 4 $\gamma_{72,276.424}$ (†,100)
 485.64 5, (7/2⁻) $\gamma_{100,485.645}$ 386.10 2 (†,100 2) E2 $\gamma_{72,413.2713}$ (†,2.1 2)
 548.85 5, (3/2⁺, 5/2⁺, 7/2⁺) $\gamma_{276,548.855}$ 272.43 23 (†,4.0 10) $\gamma_{249,300.00}$ 16
 (†,2.9 4) $\gamma_{72,476.56}$ 10 (†,100 2) M1
 583.98 6, (5/2⁻) $\gamma_{276,583.986}$ 307.48 8 (†,36 3) $\gamma_{23,561.00}$ 10 (†,78 6) $\gamma_{0,583.91}$
 (†,100 5)
- 646.02 5, (9/2⁻) $\gamma_{486,646.025}$ 160.40 2 (†,7.2 2) $\gamma_{100,546.31}$ 10 (†,100 2) M1
 686.70 7 $\gamma_{72,614.30}$ 10 (†,61 4) $\gamma_{23,663.67}$ 10 (†,100 5)
- A 703.8 1, (15/2⁻) $\gamma_{100,703.81}$ 604.3 1 (†,100) (E2)
 711.93 5 $\gamma_{549,711.935}$ 163.04 4 (†,7.2 1 7) $\gamma_{249,463.20}$ 10 (†,95 2) M1(+E2): δ <0.82
 $\gamma_{72,639.50}$ 10 (†,54 4) $\gamma_{23,689.17}$ 10 (†,100 2) $\gamma_{0,712.00}$ 20 (†,<47)
 841.11 9 $\gamma_{549,841.119}$ 292.16 10 (†,42 4) $\gamma_{72,768.90}$ 20 (†,100 5) $\gamma_{23,818.63}$
 (†,40 8)
 856.81 7 $\gamma_{486,856.817}$ 371.07 5 (†,35.0 20) $\gamma_{276,580.43}$ (†,9.4 24) $\gamma_{72,784.56}$
 (†,4.7 16) $\gamma_{23,933.92}$ (†,100 5)
 886.43 7 $\gamma_{549,886.437}$ 337.80 10 (†,48 4) $\gamma_{72,814.10}$ 10 (†,100 9)
 887.5 1, (13/2⁻) $\gamma_{704,887.51}$ 183.9 2 (†,7.0 7) $\gamma_{100,788.02}$ (†,100 5) (M1+E2)
 917.78 7, (5/2⁺, 7/2⁺) $\gamma_{687,917.787}$ 230.90 13 (†,12.9 15) $\gamma_{584,333.17}$ 26 (†,4.7 11)
 $\gamma_{486,432.16}$ 10 (†,100 3) M1 $\gamma_{276,642.26}$ (†,4.7 15) $\gamma_{72,845.46}$ 10
 (†,49.8 24)
 949.07 6 $\gamma_{646,949.076}$ 303.00 5 (†,75.4 24) $\gamma_{549,400.67}$ 16 (†,16.4 24)
 $\gamma_{249,700.32}$ 10 (†,100 4) $\gamma_{23,926.05}$ (†,26 3)
- 1082.61 6, (7/2⁻) $\gamma_{646,1082.616}$ 436.86 10 (†,25.0 14) M1 $\gamma_{549,533.66}$ 18 (†,9.4 14)
 $\gamma_{486,596.77}$ 10 (†,51.4 20) $\gamma_{72,1010.43}$ (†,100 3)
- B 1096.6 1, (15/2⁺) $\gamma_{883,1096.61}$ 209.1 1 (†,58 3) $\gamma_{704,392.81}$ (†,100 5) E1
 1119.38 8 $\gamma_{549,1119.388}$ 570.70 10 (†,79.6 25) $\gamma_{249,870.36}$ 10 (†,100 6)
 $\gamma_{100,1020.43}$ (†,60 3)
 1202.10 11 $\gamma_{857,1202.101}$ 345.13 16 (†,10.3 19) $\gamma_{646,556.40}$ 23 (†,13.3 23)
 $\gamma_{549,653.20}$ 20 (†,27.0 23) $\gamma_{72,1129.83}$ (†,100 4)
 1241.21 10, (7/2⁻, 9/2⁻) $\gamma_{486,1241.211}$ 755.57 10 (†,100 4) $\gamma_{249,992.37}$ 22 (†,10.7 17)
 $\gamma_{100,1141.83}$ (†,99 7)
 1319.4 3 $\gamma_{249,1319.43}$ 1070.6 3 (†,100)
- A 1319.7 1, (19/2⁻) $\gamma_{704,1319.71}$ 615.8 1 (†,100) E2
 1433.86 8 $\gamma_{918,1433.868}$ 515.95 (†,13 8) $\gamma_{646,788.07}$ 10 (†,95 6) $\gamma_{584,849.60}$ 10
 (†,100 7) $\gamma_{249,1185.63}$ (†,51 7) $\gamma_{100,1334.33}$ (†,49 4)
 1526.9 4 $\gamma_{704,1526.94}$ 823.2 3 (†,100)
 1582.29 12 $\gamma_{646,1582.291}$ 936.27 10 (†,100)
 1611.09 12 $\gamma_{1083,1611.091}$ 528.40 16 (†,12.3 26) $\gamma_{549,1062.53}$ (†,51 5)
 $\gamma_{249,1361.93}$ (†,12.3 18) $\gamma_{72,1538.13}$ (†,100 3) $\gamma_{0,1611.03}$ (†,7.9 26)
 1629.66 8 $\gamma_{949,1629.668}$ 680.41 10 (†,46.8 21) $\gamma_{918,712.00}$ 20 (†,58 3)
 $\gamma_{646,983.73}$ 10 (†,100) $\gamma_{486,1144.13}$ (†,20 5) $\gamma_{249,1381.23}$ (†,18.1 21)
 $\gamma_{100,1530.23}$ (†,40.1 17)
 1663.18 11 $\gamma_{918,1663.181}$ 745.40 10 (†,45.6 23) $\gamma_{549,1114.33}$ (†,100 4)
- B 1693.6 1, (19/2⁺) $\gamma_{1087,1693.61}$ 597.0 2 (†,100) (E2)
- 1724.46 15, (5/2⁻) $\gamma_{886,1724.461}$ 837.9 5 (†,4.4 15) $\gamma_{549,1175.53}$ (†,21.9 15)
 $\gamma_{249,1475.73}$ (†,46.8 19) $\gamma_{72,1652.13}$ (†,31.4 9) $\gamma_{23,1701.63}$ (†,100 3)
 1741.78 8 $\gamma_{949,1741.788}$ 793.08 10 (†,29.1 25) $\gamma_{857,884.62}$ 10 (†,37 3) $\gamma_{712,1029.43}$
 (†,21.2 25) $\gamma_{646,1096.13}$ (†,100 3) $\gamma_{486,1256.13}$ (†,62 3) $\gamma_{249,1493.33}$
 (†,15.8 25) $\gamma_{23,1718.45}$ (†,7 3)
 1773.74 10 $\gamma_{918,1773.741}$ 855.84 10 (†,87 5) $\gamma_{857,917.00}$ 10 (†,58 6) $\gamma_{841,932.51}$
 (†,19 4) $\gamma_{584,1190.63}$ (†,28 4) $\gamma_{486,1288.23}$ (†,53 3) $\gamma_{249,1525.13}$
 (†,100 4)
- 1841.63 11 $\gamma_{949,1841.631}$ 891.92 20 (†,27.0 23) $\gamma_{841,1000.43}$ (†,5.7 17)
 $\gamma_{712,1129.83}$ (†,88 3) $\gamma_{646,1196.83}$ (†,36.3 23) $\gamma_{486,1355.53}$
 (†,12.6 13) $\gamma_{249,1593.13}$ (†,100 3) $\gamma_{72,1769.73}$ (†,12.0 6)
- A 2002.2 1, (23/2⁻) $\gamma_{1320,2002.21}$ 682.5 1 (†,100) E2
 2045.8 2, (21/2⁺) $\gamma_{1694,2045.82}$ 352.6 3 (†,28 9) $\gamma_{1319,726.02}$ (†,100 14)
 2120.5 2, (23/2⁻) $\gamma_{1319,2120.52}$ 800.3 4 (†,100)
 2180.7 2, (25/2⁻) $\gamma_{2121,2180.72}$ 59.7 $\gamma_{2002,178.51}$ (†,100 7) M1, E2
- B 2220.0 1, (23/2⁺) $\gamma_{1694,2220.01}$ 526.5 1 (†,100) (E2)
 2375.4 1, (27/2⁻) $\gamma_{2181,2375.41}$ 194.8 1 (†,100) M1, E2
 2468.8 1, (25/2⁺) $\gamma_{2220,2468.81}$ 248.8 1 (†,100 5) (M1, E2) $\gamma_{2181,288.44}$ (†,9 4)
 $\gamma_{2121,348.14}$ (†,7.9 18) $\gamma_{2046,423.54}$ (†,13 4) $\gamma_{2002,466.02}$ (†,3.9 7)
- B 2782.7 1, (27/2⁺) $\gamma_{2468,2782.71}$ 313.9 3(?) (†,7.5) $\gamma_{2220,562.71}$ (†,100 2) E2
 2847.4 1, (29/2⁺) $\gamma_{2783,2847.41}$ 64.8 3 (†,25) (M1) $\gamma_{2468,378.61}$ (†,100 5)
 $\gamma_{2375,472.22}$ (†,56 6)
 3108.4 4(?) $\gamma_{2783,3108.44}$ 325.7 3(?) (†,100)
 3115.8 2, (31/2⁺) $\gamma_{2847,3115.82}$ 268.4 1 (†,100) M1, E2
 3128.8 2, (31/2⁻) $\gamma_{2375,3128.82}$ 753.4 2 (†,100)
 3159.2 3(?), (29/2⁻) $\gamma_{2181,3159.23}$ 978.5 3(?) (†,100)
 3196.6 3, (31/2⁺) $\gamma_{2847,3196.63}$ 348.6 4 (†,100)
 3274.1 2, (33/2⁺) $\gamma_{3197,3274.12}$ 77.5 $\gamma_{3129,146.04}$ (†,1.34 14) $\gamma_{3116,158.31}$
 (†,100 5)
 3287.8 3(?) $\gamma_{2847,3287.83}$ 440.4 3(?) (†,100)
 3808.5 2, (35/2⁻) $\gamma_{3129,3808.52}$ 679.7 1 (†,100)
 3900.8 2, (35/2⁺) $\gamma_{3116,3900.82}$ 784.9 2 (†,100)
 4148.2 2, (37/2⁺) $\gamma_{3901,4148.22}$ 247.4 1 (†,16 2) $\gamma_{3809,339.84}$ (†,1.8 2)
 $\gamma_{3274,874.01}$ (†,100 5)
 4565.0 2, (39/2⁺) $\gamma_{3901,4565.02}$ 664.1 1 (†,100)
 4765.6 3, (39/2⁻) $\gamma_{3809,4765.63}$ 957.0 4 (†,100)
 4774.1 2, (41/2⁺) $\gamma_{4565,4774.12}$ 209.0 2 (†,40 2) $\gamma_{4148,626.01}$ (†,100 5)
 4840.4 2, (39/2⁻) $\gamma_{3809,4840.42}$ 1031.7 2 (†,100)
 5034.3 3, (41/2⁻) $\gamma_{4148,5034.33}$ 886.0 4 (†,100)
 5162.6 2, (45/2⁺) $\gamma_{4774,5162.62}$ 388.5 1 (†,100)
 5363.8 3 $\gamma_{4766,5363.83}$ 598.2 4 (†,100)
 5467.3 2, (43/2⁻) $\gamma_{4840,5467.32}$ 627.0 2 (†,100)
 5475.0 2, (43/2⁺) $\gamma_{5034,5475.02}$ 440.5 4 (†,16 2) $\gamma_{4840,634.04}$ (†,16 8)
 $\gamma_{4774,701.12}$ (†,100 10)
 5656.6 4 $\gamma_{4766,5656.64}$ 891.0 4 (†,100)
 5819.0 2, (45/2⁻) $\gamma_{6475,5819.02}$ 343.9 4 (†,100 33) $\gamma_{5467,351.54}$ (†,33 16)
 5924.9 2, (45/2⁺) $\gamma_{5467,5924.92}$ 457.5 3 (†,100 10) $\gamma_{5364,561.04}$ (†,13 2)
 5985.6 2, (47/2⁻) $\gamma_{5819,5985.62}$ 166.6 4 (†,11 6) $\gamma_{5475,510.54}$ (†,18 10)
 $\gamma_{5163,822.72}$ (†,100 10)
 6165.6 2, (49/2⁻) $\gamma_{5925,6165.62}$ 240.7 3 (†,100 24) $\gamma_{5819,346.44}$ (†,35 23)
 6170.2 3, (49/2⁺) $\gamma_{5925,6170.23}$ 245.3 4 (†,100 10) $\gamma_{5819,351.14}$ (†,100 50)
 6485.2 2, (49/2⁺) $\gamma_{5163,6485.22}$ 1322.6 1 (†,100)
 6594.3 2, (51/2⁻) $\gamma_{6170,6594.32}$ 423.9 4 (†,8 2) $\gamma_{6166,428.72}$ (†,100 10)
 6674.1 3(?), (49/2⁻) $\gamma_{5819,6674.13}$ 855.1 4(?) (†,100)
 6880.4 2, (51/2⁻) $\gamma_{6674,6880.42}$ 206.3 4 (†,4 1) $\gamma_{5986,894.81}$ (†,100 10)
 7248.5 2, (53/2⁻) $\gamma_{6880,7248.52}$ 368.2 1 (†,100 10) $\gamma_{6594,654.64}$ (†,24 3)
 7264.8 2, (53/2⁺) $\gamma_{6594,7264.82}$ 670.8 4 (†,0.9 1) $\gamma_{6485,779.61}$ (†,100 5)
 7296.2 2, (53/2⁻) $\gamma_{6880,7296.22}$ 416.3 4 (†,100 38) $\gamma_{6594,700.74}$ (†,100 13)
 7304.5 2, (53/2⁺) $\gamma_{6594,7304.52}$ 710.4 4 (†,3.8 4) $\gamma_{6485,819.11}$ (†,100 5)
 7619.1 3, (55/2⁺) $\gamma_{7296,7619.13}$ 322.3 4 (†,100)
 7676.8 2, (55/2⁻) $\gamma_{7249,7676.82}$ 428.2 4 (†,100)
 7764.9 3, (57/2⁻) $\gamma_{7619,7764.93}$ 145.1 4 (†,100)

7882.9.2, (57/2⁻) γ_{7765} 117.24 (†, 4.2.4) γ_{7677} 205.92 (†, 100.10)
 γ_{7249} 634.62 (†, 42.14)
 7901.8.2, (57/2⁺) γ_{7616} 282.84 (†, 1.2.6) γ_{7305} 597.21 (†, 4.4.6)
 γ_{7265} 637.11 (†, 100.2) γ_{7249} 653.24 (†, 2.1.12)
 8283.2.2, (61/2⁺) γ_{7802} 381.41 (†, 100.2) γ_{7883} 400.54 (†, 3.2.11)
 8336.2.2, (59/2⁻) γ_{7677} 659.72 (†, 100)
 8802.8.2, (61/2⁻) γ_{8336} 466.82 (†, 100.10) γ_{7883} 919.94 (†, 28.3)
 9035.2.3, (63/2) γ_{8283} 752.14 (†, 100)
 9123.8.2, (63/2⁻) γ_{8803} 321.22 (†, 100.10) γ_{8283} 840.34 (†, 53.12)
 9379.7.2, (65/2⁺) γ_{8124} 256.24 (†, 2.6.3) γ_{8283} 1096.51 (†, 100.5)
 9406.5.2, (65/2) γ_{8283} 1123.22 (†, 100)
 9445.6.3, (63/2) γ_{8283} 1162.44 (†, 100)
 9490.3.2, (65/2⁺) γ_{9124} 366.94 (†, 33.3) γ_{9035} 455.34 (†, 43.4)
 γ_{8283} 1207.02 (†, 100.5)
 9530.5.3, (63/2⁻) γ_{8283} 1247.34 (†, 100)
 9708.9.2, (67/2) γ_{9407} 302.52 (†, 100)
 9733.8.2, (65/2⁺) γ_{9446} 288.24 (†, 78.33) γ_{8283} 1450.64 (†, 100.33)
 9750.7.2, (67/2⁻) γ_{9531} 220.24 (†, 1.9.2) γ_{9490} 260.32 (†, 11.7)
 γ_{9380} 371.01 (†, 100.5)
 10032.4.2, (67/2⁺) γ_{9734} 298.62 (†, 75.39) γ_{9380} 652.72 (†, 100.10)
 10296.9.4, (71/2) γ_{9708} 588.04 (†, 100)
 10350.6.2, (69/2⁺) γ_{10032} 318.22 (†, 100.33) γ_{9380} 970.92 (†, 100.10)
 10620.5.4 γ_{9380} 1240.84 (†, 100)
 10772.5.4, (71/2) γ_{9708} 1063.64 (†, 100)
 10792.1.2, (71/2⁻) γ_{10351} 441.34 (†, 3.4.4) γ_{9751} 1041.51 (†, 100.5)
 10997.9.3, (69/2⁻) γ_{9751} 1247.04 (†, 100)
 11200.7.4, (71/2) γ_{9751} 1450.04 (†, 100)
 11202.0.4 γ_{10351} 851.44 (†, 100)
 11275.0.3, (71/2⁻) γ_{10998} 276.94 (†, 100.10) γ_{10351} 924.34 (†, 86.9)
 γ_{9751} 1523.94 (†, 29.7)
 11426.0.4, (73/2⁺) γ_{10351} 1075.44 (†, 100)
 11593.2.2, (73/2) γ_{11275} 317.64 (†, 30.15) γ_{10792} 801.42 (†, 100.10)
 11726.5.2, (75/2⁻) γ_{11593} 134.34 (†, 1.2.1) γ_{10792} 934.22 (†, 100.10)
 11756.7.5 γ_{11426} 330.74 (†, 100)
 11760.8.5 γ_{10773} 988.34 (†, 100)
 11830.1.4, (73/2) γ_{10792} 1038.04 (†, 100)
 11957.0.3, (75/2⁻) γ_{10792} 1164.82 (†, 100)
 12704.2.3, (75/2⁻) γ_{10792} 1912.02 (†, 100)
 12720.1.3, (79/2⁻) γ_{11857} 763.04 (†, 21.2) γ_{11727} 993.62 (†, 100.10)
 12754.3.4, (79/2⁻) γ_{11727} 1027.84 (†, 100)
 13019.6.4, (79/2⁻) γ_{11727} 1293.14 (†, 100)
 13249.5.5 γ_{11830} 1419.34 (†, 100)
 13460.9.4, (81/2) γ_{12754} 706.64 (†, 60.20) γ_{12720} 740.84 (†, 100.20)
 13522.9.4 γ_{12704} 818.74 (†, 100)
 13524.7.4 γ_{11727} 1798.24 (†, 100)
 13791.4.4, (83/2⁻) γ_{13020} 771.84 (†, 14.2) γ_{12720} 1071.34 (†, 100.14)
 13850.6.4, (79/2⁻) γ_{12704} 1146.44 (†, 100)
 14539.1.5 γ_{13791} 747.74 (†, 100)
 14900.6.5 γ_{13851} 1050.04 (†, 100)
 15317.1.5 γ_{13851} 1466.54 (†, 100)
 15343.6.5 γ_{13851} 1493.04 (†, 100)
 15641.4.5, (87/2⁻) γ_{13791} 1850.04 (†, 100)
 16589.2.6, (91/2⁻) γ_{15641} 947.84 (†, 100)
 C x, J=(57/2)
 C 726.5+x, J+2 γ_x 726.55 I⁽¹⁾=81.6, I⁽²⁾=93.5, $\eta\omega=0.374$
 C 1495.8+x, J+4 γ_{727+x} 769.35 (†, 0.30.2) I⁽¹⁾=82.3, I⁽²⁾=95.5, $\eta\omega=0.395$
 C 2307.0+x, J+6 γ_{1496+x} 811.23 (†, 0.61.3) I⁽¹⁾=82.9, I⁽²⁾=93.5, $\eta\omega=0.416$
 C 3161.0+x, J+8 γ_{2307+x} 854.03 (†, 1.04.5) I⁽¹⁾=83.4, I⁽²⁾=92.0, $\eta\omega=0.438$
 C 4058.5+x, J+10 γ_{3161+x} 897.53 (†, 0.97.5) I⁽¹⁾=83.7, I⁽²⁾=88.5, $\eta\omega=0.460$
 C 5001.2+x, J+12 γ_{4058+x} 942.73 (†, 1.00.5) I⁽¹⁾=83.9, I⁽²⁾=87.9, $\eta\omega=0.483$
 C 5989.4+x, J+14 γ_{5001+x} 988.23 (†, 0.97.5) I⁽¹⁾=84.1, I⁽²⁾=87.0, $\eta\omega=0.506$
 C 7023.6+x, J+16 γ_{5989+x} 1034.23 (†, 1.02.6) I⁽¹⁾=84.1, I⁽²⁾=83.7, $\eta\omega=0.529$
 C 8105.6+x, J+18 γ_{7024+x} 1082.03 (†, 1.03.5) I⁽¹⁾=84.1, I⁽²⁾=83.3, $\eta\omega=0.553$

C 9235.6+x, J+20 γ_{8106+x} 1130.04 (†, 1.07.6) I⁽¹⁾=84.1, I⁽²⁾=83.3, $\eta\omega=0.577$
 C 10413.6+x, J+22 γ_{9236+x} 1178.03 (†, 0.96.5) I⁽¹⁾=84.0, I⁽²⁾=80.2, $\eta\omega=0.601$
 C 11641.5+x, J+24 $\gamma_{10414+x}$ 1227.93 (†, 0.94.5) I⁽¹⁾=83.8, I⁽²⁾=80.0, $\eta\omega=0.626$
 C 12919.4+x, J+26 $\gamma_{11642+x}$ 1277.93 (†, 0.78.4) I⁽¹⁾=83.6, I⁽²⁾=79.5, $\eta\omega=0.652$
 C 14247.6+x, J+28 $\gamma_{12919+x}$ 1328.28 (†, 0.63.4) I⁽¹⁾=83.5, I⁽²⁾=78.3, $\eta\omega=0.677$
 C 15626.9+x, J+30 $\gamma_{14248+x}$ 1379.35 (†, 0.48.4) I⁽¹⁾=83.2, I⁽²⁾=76.3, $\eta\omega=0.703$
 C 17058.6+x, J+32 $\gamma_{15627+x}$ 1431.77 (†, 0.25.2) I⁽¹⁾=83.0, I⁽²⁾=78.0, $\eta\omega=0.729$
 C 18541.6+x, J+34 $\gamma_{17059+x}$ 1483.07 (†, 0.16.2) I⁽¹⁾=82.8, I⁽²⁾=76.6, $\eta\omega=0.755$
 C 20076.8+x, J+36 $\gamma_{18542+x}$ 1535.210 (†, 0.050.15)
 D y, J=(49/2)
 D 602.1+y, J+2 γ_y 602.18 (†, 0.22.7) I⁽¹⁾=84.9, I⁽²⁾=90.3, $\eta\omega=0.312$
 D 1248.5+y, J+4 γ_{602+y} 646.45 (†, 0.39.8) I⁽¹⁾=85.2, I⁽²⁾=87.9, $\eta\omega=0.335$
 D 1940.4+y, J+6 γ_{1249+y} 691.95 (†, 1.04.15) I⁽¹⁾=85.4, I⁽²⁾=87.9, $\eta\omega=0.357$
 D 2677.8+y, J+8 γ_{1940+y} 737.43 (†, 1.04.15) I⁽¹⁾=85.5, I⁽²⁾=87.0, $\eta\omega=0.380$
 D 3461.2+y, J+10 γ_{2678+y} 783.43 (†, 1.12.15) I⁽¹⁾=85.6, I⁽²⁾=88.3, $\eta\omega=0.403$
 D 4289.9+y, J+12 γ_{3461+y} 828.73 (†, 0.91.13) I⁽¹⁾=85.7, I⁽²⁾=86.8, $\eta\omega=0.426$
 D 5164.7+y, J+14 γ_{4290+y} 874.83 (†, 1.08.13) I⁽¹⁾=85.7, I⁽²⁾=85.5, $\eta\omega=0.449$
 D 6086.3+y, J+16 γ_{5165+y} 921.64 (†, 0.96.12) I⁽¹⁾=85.7, I⁽²⁾=86.0, $\eta\omega=0.472$
 D 7054.4+y, J+18 γ_{6086+y} 968.14 (†, 1.00.13) I⁽¹⁾=85.7, I⁽²⁾=84.0, $\eta\omega=0.496$
 D 8070.1+y, J+20 γ_{7054+y} 1015.74 (†, 0.98.12) I⁽¹⁾=85.6, I⁽²⁾=84.6, $\eta\omega=0.520$
 D 9133.1+y, J+22 γ_{8070+y} 1063.05 (†, 0.97.13) I⁽¹⁾=85.6, I⁽²⁾=84.2, $\eta\omega=0.543$
 D 10243.6+y, J+24 γ_{9133+y} 1110.56 (†, 1.00.14) I⁽¹⁾=85.5, I⁽²⁾=83.2, $\eta\omega=0.567$
 D 11402.2+y, J+26 $\gamma_{10244+y}$ 1158.66 (†, 0.91.13) I⁽¹⁾=85.4, I⁽²⁾=82.8, $\eta\omega=0.591$
 D 12609.1+y, J+28 $\gamma_{11402+y}$ 1206.98 (†, 1.02.17) I⁽¹⁾=85.3, I⁽²⁾=83.5, $\eta\omega=0.615$
 D 13863.9+y, J+30 $\gamma_{12609+y}$ 1254.86 (†, 0.77.10) I⁽¹⁾=85.2, I⁽²⁾=82.6, $\eta\omega=0.639$
 D 15167.1+y, J+32 $\gamma_{13864+y}$ 1303.28 (†, 0.62.13) I⁽¹⁾=85.1, I⁽²⁾=82.0, $\eta\omega=0.664$
 D 16519.1+y, J+34 $\gamma_{15167+y}$ 1352.08 (†, 0.48.7) I⁽¹⁾=85.0, I⁽²⁾=84.2, $\eta\omega=0.688$
 D 17918.6+y, J+36 $\gamma_{16519+y}$ 1399.59 (†, 0.34.6) I⁽¹⁾=85.0, I⁽²⁾=82.0, $\eta\omega=0.712$
 D 19366.9+y, J+38 $\gamma_{17919+y}$ 1448.39 (†, 0.21.4) I⁽¹⁾=84.9, I⁽²⁾=85.7, $\eta\omega=0.736$
 D 20861.9+y, J+40 $\gamma_{19367+y}$ 1495.011 (†, 0.13.4)
 E z, J=(55/2)
 E 681.5+z, J+2 γ_z 681.510 (†, 0.31.10) I⁽¹⁾=83.7, I⁽²⁾=86.6, $\eta\omega=0.352$
 E 1409.2+z, J+4 γ_{682+z} 727.78 (†, 0.65.6) I⁽¹⁾=83.9, I⁽²⁾=86.6, $\eta\omega=0.375$
 E 2183.1+z, J+6 γ_{1409+z} 773.95 (†, 0.99.8) I⁽¹⁾=84.0, I⁽²⁾=84.6, $\eta\omega=0.399$
 E 3004.3+z, J+8 γ_{2183+z} 821.28 (†, 0.92.18) I⁽¹⁾=84.1, I⁽²⁾=85.8, $\eta\omega=0.422$
 E 3872.1+z, J+10 γ_{3004+z} 867.88 (†, 1.08.14) I⁽¹⁾=84.1, I⁽²⁾=83.3, $\eta\omega=0.446$
 E 4787.9+z, J+12 γ_{3872+z} 915.85 (†, 0.99.11) I⁽¹⁾=84.1, I⁽²⁾=83.7, $\eta\omega=0.470$
 E 5751.5+z, J+14 γ_{4788+z} 963.610 (†, 0.86.10) I⁽¹⁾=84.0, I⁽²⁾=80.5, $\eta\omega=0.494$
 E 6764.8+z, J+16 γ_{5752+z} 1013.35 (†, 1.08.13) I⁽¹⁾=83.9, I⁽²⁾=82.5, $\eta\omega=0.519$
 E 7826.6+z, J+18 γ_{6765+z} 1061.85 (†, 0.95.12) I⁽¹⁾=83.7, I⁽²⁾=80.6, $\eta\omega=0.543$
 E 8938.0+z, J+20 γ_{7827+z} 1111.45 (†, 1.04.12) I⁽¹⁾=83.6, I⁽²⁾=81.0, $\eta\omega=0.568$
 E 10098.8+z, J+22 γ_{8938+z} 1160.85 (†, 0.99.12) I⁽¹⁾=83.5, I⁽²⁾=82.0, $\eta\omega=0.593$
 E 11308.4+z, J+24 $\gamma_{10099+z}$ 1209.65 (†, 1.06.11) I⁽¹⁾=83.5, I⁽²⁾=81.3, $\eta\omega=0.617$
 E 12567.2+z, J+26 $\gamma_{11308+z}$ 1258.85 (†, 0.94.11) I⁽¹⁾=83.3, I⁽²⁾=78.7, $\eta\omega=0.642$
 E 13876.8+z, J+28 $\gamma_{12567+z}$ 1309.67 (†, 0.65.8) I⁽¹⁾=83.2, I⁽²⁾=83.2,

$\eta\omega=0.667$					
E 15234.5+z, J+30	$\gamma_{13877+z}$	1357.77 ($\dagger_{\gamma}0.527$)	$I^{(1)}=83.2, I^{(2)}=79.2,$		
		$\eta\omega=0.691$			
E 16642.7+z, J+32	$\gamma_{15235+z}$	1408.28 ($\dagger_{\gamma}0.486$)	$I^{(1)}=83.1, I^{(2)}=82.3,$		
		$\eta\omega=0.716$			
E 18099.5+z, J+34	$\gamma_{16843+z}$	1456.89 ($\dagger_{\gamma}0.325$)	$I^{(1)}=83.1, I^{(2)}=83.3,$		
		$\eta\omega=0.740$			
E 19604.3+z, J+36	$\gamma_{18100+z}$	1504.810 ($\dagger_{\gamma}0.157$)			
F u, J=(63/2)					
F 768.6+u, J+2	$\gamma_0768.65$	$I^{(1)}=84.5, I^{(2)}=83.9,$	$\eta\omega=0.396$		
F 1584.9+u, J+4	γ_{769+u}	816.310 ($\dagger_{\gamma}0.418$)	$I^{(1)}=84.4, I^{(2)}=81.6,$	$\eta\omega=0.420$	
F 2450.2+u, J+6	γ_{1585+u}	865.36 ($\dagger_{\gamma}0.6112$)	$I^{(1)}=84.3, I^{(2)}=82.3,$	$\eta\omega=0.445$	
F 3364.1+u, J+8	γ_{2450+u}	913.95 ($\dagger_{\gamma}0.8810$)	$I^{(1)}=84.2, I^{(2)}=83.3,$	$\eta\omega=0.469$	
F 4326.0+u, J+10	γ_{3364+u}	961.96 ($\dagger_{\gamma}0.9512$)	$I^{(1)}=84.2, I^{(2)}=84.2,$	$\eta\omega=0.493$	
F 5335.4+u, J+12	γ_{4326+u}	1009.46 ($\dagger_{\gamma}1.0413$)	$I^{(1)}=84.2, I^{(2)}=84.7,$		
		$\eta\omega=0.517$			
F 6392.0+u, J+14	γ_{5335+u}	1056.65 ($\dagger_{\gamma}0.999$)	$I^{(1)}=84.2, I^{(2)}=84.7,$	$\eta\omega=0.540$	
F 7495.8+u, J+16	γ_{6392+u}	1103.88 ($\dagger_{\gamma}1.0111$)	$I^{(1)}=84.2, I^{(2)}=82.1,$		
		$\eta\omega=0.564$			
F 8648.3+u, J+18	γ_{7496+u}	1152.56 ($\dagger_{\gamma}0.8313$)	$I^{(1)}=84.1, I^{(2)}=82.3,$		
		$\eta\omega=0.588$			
F 9849.4+u, J+20	γ_{8648+u}	1201.17 ($\dagger_{\gamma}1.1212$)	$I^{(1)}=84.1, I^{(2)}=84.4,$		
		$\eta\omega=0.612$			
F 11097.9+u, J+22	γ_{9849+u}	1248.56 ($\dagger_{\gamma}1.1014$)	$I^{(1)}=84.1, I^{(2)}=83.3,$		
		$\eta\omega=0.636$			
F 12394.4+u, J+24	$\gamma_{11098+u}$	1296.57 ($\dagger_{\gamma}1.0812$)	$I^{(1)}=84.0, I^{(2)}=82.8,$		
		$\eta\omega=0.660$			
F 13739.2+u, J+26	$\gamma_{12394+u}$	1344.87 ($\dagger_{\gamma}0.7713$)	$I^{(1)}=84.0, I^{(2)}=83.2,$		
		$\eta\omega=0.684$			
F 15132.1+u, J+28	$\gamma_{13739+u}$	1392.910 ($\dagger_{\gamma}0.707$)	$I^{(1)}=84.0, I^{(2)}=86.2,$		
		$\eta\omega=0.708$			
F 16571.4+u, J+30	$\gamma_{15132+u}$	1439.310 ($\dagger_{\gamma}0.426$)	$I^{(1)}=84.1, I^{(2)}=86.6,$		
		$\eta\omega=0.731$			
F 18056.9+u, J+32	$\gamma_{16571+u}$	1485.510			
G v, J=(53/2)					
G 709.3+v, J+2	$\gamma_0709.35$	$I^{(1)}=77.5, I^{(2)}=77.5,$	$\eta\omega=0.368$		
G 1470.2+v, J+4	γ_{709+v}	760.95 $I^{(1)}=77.6, I^{(2)}=78.4,$	$\eta\omega=0.393$		
G 2282.1+v, J+6	γ_{1470+v}	811.93 $I^{(1)}=77.6, I^{(2)}=77.5,$	$\eta\omega=0.419$		
G 3145.6+v, J+8	γ_{2282+v}	863.57 $I^{(1)}=77.6, I^{(2)}=79.5,$	$\eta\omega=0.444$		
G 4059.8+v, J+10	γ_{3146+v}	913.84 $I^{(1)}=77.7, I^{(2)}=77.2,$	$\eta\omega=0.470$		
G 5025.0+v, J+12	γ_{4060+v}	965.64 $I^{(1)}=77.6, I^{(2)}=76.0,$	$\eta\omega=0.496$		
G 6043.2+v, J+14	γ_{5025+v}	1018.25 $I^{(1)}=77.5, I^{(2)}=75.3,$	$\eta\omega=0.522$		
G 7114.5+v, J+16	γ_{6043+v}	1071.35 $I^{(1)}=77.4, I^{(2)}=74.9,$	$\eta\omega=0.549$		
G 8239.2+v, J+18	γ_{7115+v}	1124.75 $I^{(1)}=77.3, I^{(2)}=76.3,$	$\eta\omega=0.575$		
G 9416.3+v, J+20	γ_{8239+v}	1177.15 $I^{(1)}=77.3, I^{(2)}=76.6,$	$\eta\omega=0.602$		
G 10645.6+v, J+22	γ_{9416+v}	1229.35 $I^{(1)}=77.2, I^{(2)}=74.9,$	$\eta\omega=0.628$		
G 11928.3+v, J+24	$\gamma_{10646+v}$	1282.75 $I^{(1)}=77.2, I^{(2)}=75.9,$	$\eta\omega=0.655$		
G 13263.7+v, J+26	$\gamma_{11928+v}$	1335.47 $I^{(1)}=77.1, I^{(2)}=74.9,$	$\eta\omega=0.681$		
G 14652.5+v, J+28	$\gamma_{13264+v}$	1388.87 $I^{(1)}=77.0, I^{(2)}=72.2,$	$\eta\omega=0.708$		
G 16096.7+v, J+30	$\gamma_{14653+v}$	1444.26 $I^{(1)}=76.7, I^{(2)}=70.8,$	$\eta\omega=0.736$		
G 17597.4+v, J+32	$\gamma_{16097+v}$	1500.78			
H w, J=(55/2)					
H 739+w, J+2	γ_0739	$I^{(1)}=77.2, I^{(2)}=77.8,$	$\eta\omega=0.382$		
H 1529.4+w, J+4	γ_{739+w}	790.48 $I^{(1)}=77.3, I^{(2)}=83.0,$	$\eta\omega=0.407$		
H 2368.0+w, J+6	γ_{1529+w}	838.66 $I^{(1)}=77.5, I^{(2)}=78.3,$	$\eta\omega=0.432$		
H 3257.7+w, J+8	γ_{2368+w}	889.75 $I^{(1)}=77.6, I^{(2)}=77.5,$	$\eta\omega=0.458$		
H 4199.0+w, J+10	γ_{3258+w}	941.35 $I^{(1)}=77.6, I^{(2)}=77.5,$	$\eta\omega=0.484$		
H 5191.9+w, J+12	γ_{4199+w}	992.97 $I^{(1)}=77.6, I^{(2)}=77.7,$	$\eta\omega=0.509$		
H 6236.3+w, J+14	γ_{5192+w}	1044.48 $I^{(1)}=77.5, I^{(2)}=76.9,$	$\eta\omega=0.535$		
H 7332.7+w, J+16	γ_{6236+w}	1096.48 $I^{(1)}=77.5, I^{(2)}=74.3,$	$\eta\omega=0.562$		
H 8482.9+w, J+18	γ_{7333+w}	1150.25 $I^{(1)}=77.4, I^{(2)}=76.5,$	$\eta\omega=0.588$		
H 9685.4+w, J+20	γ_{8483+w}	1202.55 $I^{(1)}=77.3, I^{(2)}=75.2,$	$\eta\omega=0.615$		
H 10941.1+w, J+22	γ_{9685+w}	1255.75 $I^{(1)}=77.2, I^{(2)}=74.6,$	$\eta\omega=0.641$		
H 12250.4+w, J+24	$\gamma_{10941+w}$	1309.37 $I^{(1)}=77.1, I^{(2)}=73.4,$	$\eta\omega=0.668$		
H 13614.2+w, J+26	$\gamma_{12250+w}$	1363.85 $I^{(1)}=77.0, I^{(2)}=78.7,$	$\eta\omega=0.695$		
H 15028.8+w, J+28	$\gamma_{13614+w}$	1414.65 $I^{(1)}=76.9, I^{(2)}=67.6,$	$\eta\omega=0.722$		
H 16502.6+w, J+30	$\gamma_{15029+w}$	1473.88			
I r, J=(55/2)					
I 758+r, J+2	γ_0758	$I^{(1)}=75.4, I^{(2)}=80.0,$	$\eta\omega=0.392$		
I 1566+r, J+4	γ_{758+r}	808.1 $I^{(1)}=75.6, I^{(2)}=79.8,$	$\eta\omega=0.417$		
I 2424.1+r, J+6	γ_{1566+r}	858.15 $I^{(1)}=75.8, I^{(2)}=77.4,$	$\eta\omega=0.442$		
I 3333.9+r, J+8	γ_{2424+r}	909.85 $I^{(1)}=75.9, I^{(2)}=79.7,$	$\eta\omega=0.467$		
I 4293.9+r, J+10	γ_{3334+r}	960.05 $I^{(1)}=76.1, I^{(2)}=77.5,$	$\eta\omega=0.493$		
I 5305.5+r, J+12	γ_{4294+r}	1011.65 $I^{(1)}=76.1, I^{(2)}=76.0,$	$\eta\omega=0.519$		
I 6369.7+r, J+14	γ_{5306+r}	1064.25 $I^{(1)}=76.2, I^{(2)}=78.0,$	$\eta\omega=0.545$		
I 7485.2+r, J+16	γ_{6370+r}	1115.56 $I^{(1)}=76.1, I^{(2)}=73.7,$	$\eta\omega=0.571$		
I 8655.0+r, J+18	γ_{7485+r}	1169.86 $I^{(1)}=76.1, I^{(2)}=77.7,$	$\eta\omega=0.598$		
I 9876.3+r, J+20	γ_{8655+r}	1221.37 $I^{(1)}=76.1, I^{(2)}=75.3,$	$\eta\omega=0.624$		
I 11150.7+r, J+22	γ_{9876+r}	1274.45 $I^{(1)}=76.1, I^{(2)}=74.3,$	$\eta\omega=0.651$		
I 12478.9+r, J+24	$\gamma_{11151+r}$	1328.27 $I^{(1)}=76.0, I^{(2)}=75.9,$	$\eta\omega=0.677$		
I 13859.8+r, J+26	$\gamma_{12479+r}$	1380.98 $I^{(1)}=76.0, I^{(2)}=73.9,$	$\eta\omega=0.704$		
I 15294.8+r, J+28	$\gamma_{13860+r}$	1435.1 $I^{(1)}=75.9, I^{(2)}=74.1,$	$\eta\omega=0.731$		
I 16783.8+r, J+30	$\gamma_{15295+r}$	1489.1			
J s, J=(57/2)					
J 785+s, J+2	γ_0785	$I^{(1)}=75.4, I^{(2)}=85.1,$	$\eta\omega=0.404$		
J 1617+s, J+4	γ_{785+s}	832.1 $I^{(1)}=75.8, I^{(2)}=76.9,$	$\eta\omega=0.429$		
J 2501+s, J+6	γ_{1617+s}	884.1 $I^{(1)}=75.9, I^{(2)}=78.6,$	$\eta\omega=0.455$		
J 3435.9+s, J+8	γ_{2501+s}	934.95 $I^{(1)}=76.0, I^{(2)}=78.4,$	$\eta\omega=0.480$		
J 4421.8+s, J+10	γ_{3436+s}	985.95 $I^{(1)}=76.1, I^{(2)}=75.6,$	$\eta\omega=0.506$		
J 5460.6+s, J+12	γ_{4422+s}	1038.85 $I^{(1)}=76.1, I^{(2)}=78.3,$	$\eta\omega=0.532$		
J 6550.5+s, J+14	γ_{5461+s}	1089.95 $I^{(1)}=76.1, I^{(2)}=74.9,$	$\eta\omega=0.558$		
J 7693.8+s, J+16	γ_{6551+s}	1143.37 $I^{(1)}=76.1, I^{(2)}=74.6,$	$\eta\omega=0.585$		
J 8890.7+s, J+18	γ_{7694+s}	1196.97 $I^{(1)}=76.0, I^{(2)}=76.9,$	$\eta\omega=0.611$		
J 10139.6+s, J+20	γ_{8891+s}	1248.97 $I^{(1)}=76.1, I^{(2)}=75.3,$	$\eta\omega=0.638$		
J 11441.6+s, J+22	$\gamma_{10140+s}$	1302.1 $I^{(1)}=76.0, I^{(2)}=74.1,$	$\eta\omega=0.664$		
J 12797.6+s, J+24	$\gamma_{11442+s}$	1356.1			

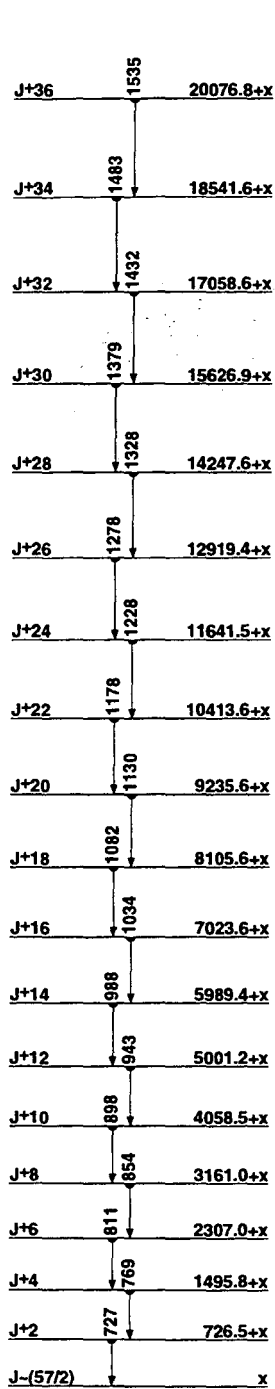

SD-1 band
(89Fa02,93Cu06,95Kh06)

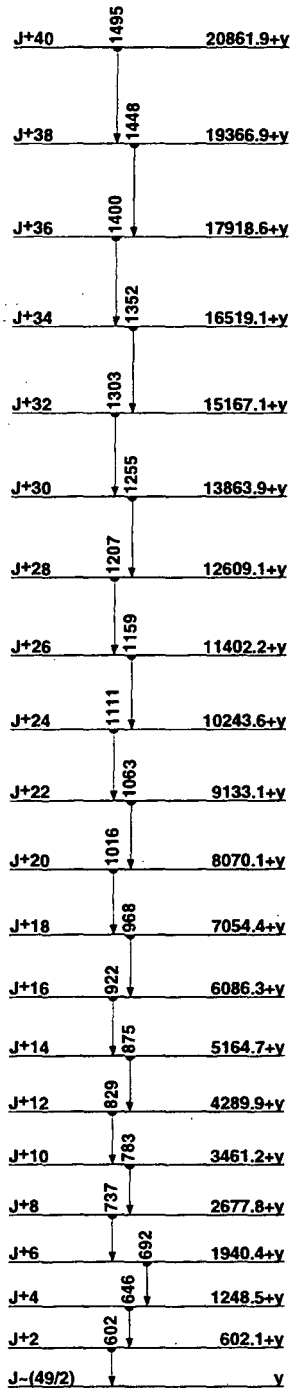

SD-2 band
(90BY01,93Cu06,95Kh06)

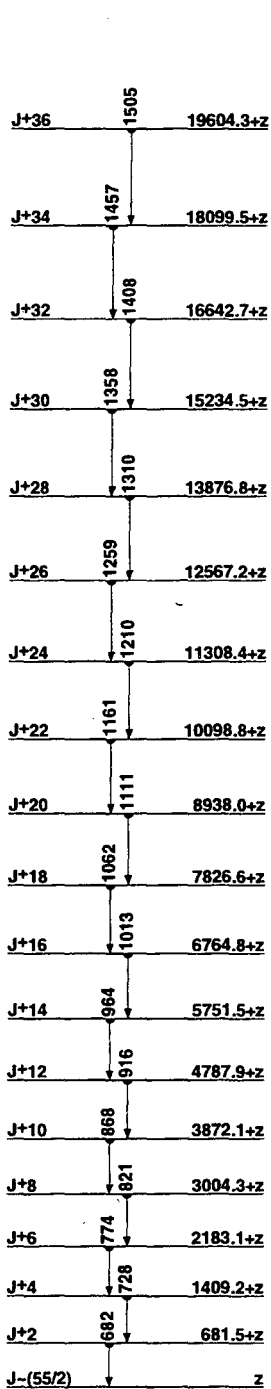

SD-3 band
(95Kh06)

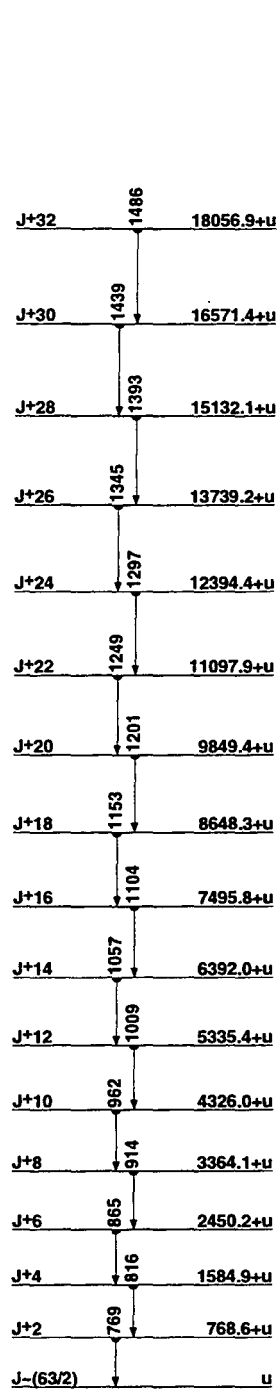

SD-4 band
(95Kh06)

¹⁵¹Tb
65

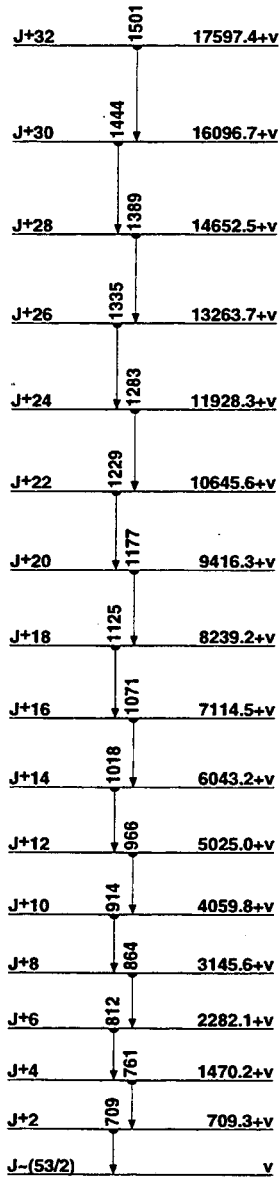

SD-5 band
(94De33)

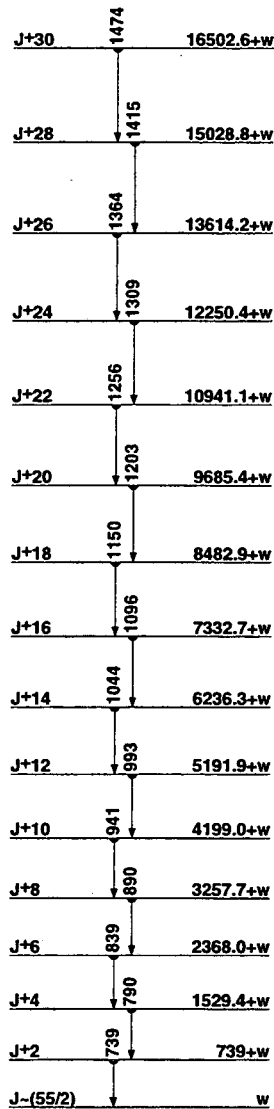

SD-6 band
(94De33)

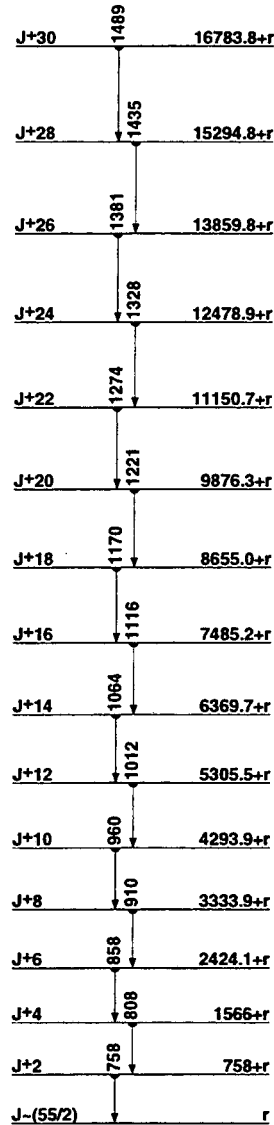

SD-7 band
(94De33)

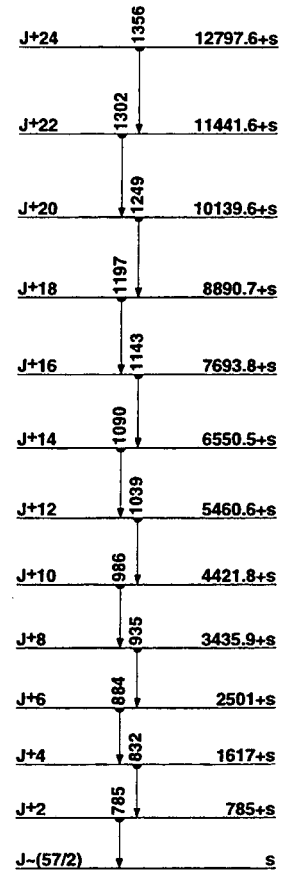

SD-8 band
(94De33)

¹⁵¹₆₅Tb

152Tb
65Tb

Δ : -70730 40 S_n : 7160 40 S_p : 3820 40 Q_{EC} : 3990 40 Q_α : 3090 40

Nuclear Bands

- A $\pi h_{11/2} \nu_{13/2}$
- B $\pi h_{11/2} \nu_{9/2}$
- C $\pi h_{11/2} \nu_{7/2}$
- D SD-1 band (94De33)
- E SD-2 band (94De33)

Levels and γ -ray branchings:

- 0, 2⁻, 17.5 h, $\mu = -0.58$ 2, $Q = +0.5$ 16, %EC+% β^+ =100, % α <7 $\times 10^{-7}$
 235.39 9, 3⁻ $\gamma_{0235.41}$ ($t_{1/2}$ 100) M1
 256.93 13, 1⁺, 0.39 ns $\gamma_{0256.93}$ 13 ($t_{1/2}$ 100) E1
 277.19 10, 3⁻ $\gamma_{0277.21}$ ($t_{1/2}$ 100) M1
 283.29 5, 4⁻ $\gamma_{277} 6.10$ $\gamma_{235} 48.02$ ($t_{1/2}$ 1.97 15) (M1) $\gamma_{0283.295}$ ($t_{1/2}$ 100.0) E2
 342.15 16, 5⁻, 0.96 μ s $\gamma_{283} 58.92$ ($t_{1/2}$ 100 6) (M1) $\gamma_{277} 65.03$ ($t_{1/2}$ 2.7 2) $\gamma_{235} 106.63$ ($t_{1/2}$ 3.7 2)
 501.74 19, 8⁺, 4.2 m, %IT=78.8 %, %EC+% β^+ =21.2 % $\gamma_{342} 159.59$ 10 ($t_{1/2}$ 100) E3
 C 600.3, 9⁺ $\gamma_{502} 98.55$ ($t_{1/2}$ 100) D(+Q): $\delta = -0.05$ 10
 B 806.1, 10⁺ $\gamma_{600} 205.74$ ($t_{1/2}$ 100) D(+Q): $\delta = +0.01$ 5 $\gamma_{502} 304.33$ ($t_{1/2}$ 13) E2
 A 1212.4, 9(-) $\gamma_{600} 612.1$ ($t_{1/2}$ 41) D+Q $\gamma_{502} 710.7$ ($t_{1/2}$ 100) D
 C 1230.1, 11⁺ $\gamma_{600} 629.8$ ($t_{1/2}$ 100) E2
 A 1237.7, 11(-), 4.2 ns $\gamma_{1212} 25.3$ ($t_{1/2}$ 25) $\gamma_{806} 431.66$ ($t_{1/2}$ 100) (E1+M2): $\delta = +0.15$ 5
 B 1349.2, 12⁺ $\gamma_{806} 543.1$ ($t_{1/2}$ 100) E2
 A 1370.2, 12(-) $\gamma_{1238} 132.44$ ($t_{1/2}$ 100) D(+Q): $\delta = +0.05$ 3
 A 1712.1, 13(-) $\gamma_{1238} 474.37$ ($t_{1/2}$ 100) E2
 B 1887.7, 14⁺ $\gamma_{1349} 538.5$ ($t_{1/2}$ 100) E2
 C 1887.8, (13⁺) $\gamma_{1230} 657.7$ ($t_{1/2}$ 100)
 A 1920.3, 14(-) $\gamma_{1712} 208.11$ ($t_{1/2}$ 72) D(+Q): $\delta = +0.01$ 5 $\gamma_{1370} 550.1$ ($t_{1/2}$ 100) E2
 A 2269.3, 15(-) $\gamma_{1712} 557.3$ ($t_{1/2}$ 100) E2
 A 2499.4, 16(-) $\gamma_{2269} 229.93$ ($t_{1/2}$ 58) D(+Q): $\delta = +0.06$ 6 $\gamma_{1920} 579.3$ ($t_{1/2}$ 100) E2
 2660.6 (?), (16⁻) $\gamma_{2269} 391.5$ ($t_{1/2}$ 100) $\gamma_{1920} 740.1$ ($t_{1/2}$ 85) E2
 B 2688.6, 16⁺ $\gamma_{1887.7} 800.9$ ($t_{1/2}$ 100) E2
 A 2889.4, 17(-) $\gamma_{2269} 620.0$ ($t_{1/2}$ 100) E2
 A 3126.7, 18(-) $\gamma_{2889} 237.1$ ($t_{1/2}$ 43) $\gamma_{2499} 627.4$ ($t_{1/2}$ 100) E2
 3218.3 (?) $\gamma_{2889} 328.8$ ($t_{1/2}$ 100) D
 A 3596.2, 19(-) $\gamma_{2889} 706.7$ ($t_{1/2}$ 100) E2
 A 3845.3, 20(-) $\gamma_{3127} 718.6$ ($t_{1/2}$ 100) E2
 A 4350.2, 21(-) $\gamma_{3596} 754.0$ ($t_{1/2}$ 100) E2
 D x, J=(31)
 D 823+x 1, J+2 $\gamma_{823} 1$ $I^{(1)}=78.2$, $I^{(2)}=96.9$, $\eta\omega=0.422$
 D 1687.3+x 12, J+4 $\gamma_{823+x} 864.36$ $I^{(1)}=78.9$, $I^{(2)}=89.1$, $\eta\omega=0.443$
 D 2596.5+x 13, J+6 $\gamma_{1687+x} 909.25$ $I^{(1)}=79.4$, $I^{(2)}=89.7$, $\eta\omega=0.466$
 D 3550.3+x 14, J+8 $\gamma_{2597+x} 953.85$ $I^{(1)}=79.8$, $I^{(2)}=86.6$, $\eta\omega=0.488$
 D 4550.3+x 15, J+10 $\gamma_{3550+x} 1000.05$ $I^{(1)}=80.1$, $I^{(2)}=86.6$, $\eta\omega=0.512$
 D 5596.5+x 15, J+12 $\gamma_{4550+x} 1046.24$ $I^{(1)}=80.3$, $I^{(2)}=82.6$, $\eta\omega=0.535$
 D 6691.1+x 17, J+14 $\gamma_{5597+x} 1094.67$ $I^{(1)}=80.5$, $I^{(2)}=86.2$, $\eta\omega=0.559$
 D 7832.1+x 18, J+16 $\gamma_{6691+x} 1141.08$ $I^{(1)}=80.7$, $I^{(2)}=82.6$, $\eta\omega=0.583$
 D 9021.5+x 20, J+18 $\gamma_{7832+x} 1189.47$ $I^{(1)}=80.7$, $I^{(2)}=78.7$, $\eta\omega=0.607$
 D 10261.7+x 21, J+20 $\gamma_{9022+x} 1240.27$ $I^{(1)}=80.6$, $I^{(2)}=76.9$, $\eta\omega=0.633$
 D 11553.9+x 22, J+22 $\gamma_{10262+x} 1292.26$ $I^{(1)}=80.5$, $I^{(2)}=79.4$, $\eta\omega=0.659$
 D 12896.5+x 23, J+24 $\gamma_{11554+x} 1342.68$ $I^{(1)}=80.4$, $I^{(2)}=76.9$, $\eta\omega=0.684$
 D 14291.1+x 25, J+26 $\gamma_{12897+x} 1394.68$ $I^{(1)}=80.3$, $I^{(2)}=77.8$, $\eta\omega=0.710$
 D 15737.1+x 30, J+28 $\gamma_{14291+x} 1446$ 1
 E y, J=(30)
 E 801+y 1, J+2 $\gamma_{801} 1$ $I^{(1)}=77.8$, $I^{(2)}=93.0$, $\eta\omega=0.411$
 E 1645+y 1, J+4 $\gamma_{801+y} 844$ 1 $I^{(1)}=78.5$, $I^{(2)}=91.5$, $\eta\omega=0.433$

- E 2532.7+y 15, J+6 $\gamma_{1645+y} 887.75$ $I^{(1)}=79.1$, $I^{(2)}=89.7$, $\eta\omega=0.455$
 E 3465.0+y 16, J+8 $\gamma_{2533+y} 932.35$ $I^{(1)}=79.6$, $I^{(2)}=87.1$, $\eta\omega=0.478$
 E 4443.2+y 17, J+10 $\gamma_{3465+y} 978.26$ $I^{(1)}=80.0$, $I^{(2)}=89.3$, $\eta\omega=0.500$
 E 5466.2+y 18, J+12 $\gamma_{4443+y} 1023.06$ $I^{(1)}=80.3$, $I^{(2)}=85.3$, $\eta\omega=0.523$
 E 6536.1+y 19, J+14 $\gamma_{5466+y} 1069.95$ $I^{(1)}=80.4$, $I^{(2)}=83.0$, $\eta\omega=0.547$
 E 7654.2+y 20, J+16 $\gamma_{6536+y} 1118.16$ $I^{(1)}=80.6$, $I^{(2)}=85.5$, $\eta\omega=0.571$
 E 8819.1+y 21, J+18 $\gamma_{7654+y} 1164.97$ $I^{(1)}=80.7$, $I^{(2)}=78.9$, $\eta\omega=0.595$
 E 10034.7+y 22, J+20 $\gamma_{8819+y} 1215.66$ $I^{(1)}=80.6$, $I^{(2)}=78.3$, $\eta\omega=0.621$
 E 11301.4+y 23, J+22 $\gamma_{10035+y} 1266.77$ $I^{(1)}=80.6$, $I^{(2)}=82.1$, $\eta\omega=0.646$
 E 12616.8+y 24, J+24 $\gamma_{11301+y} 1315.47$ $I^{(1)}=80.5$, $I^{(2)}=77.5$, $\eta\omega=0.671$
 E 13984.8+y 30, J+26 $\gamma_{12617+y} 1367$ 1

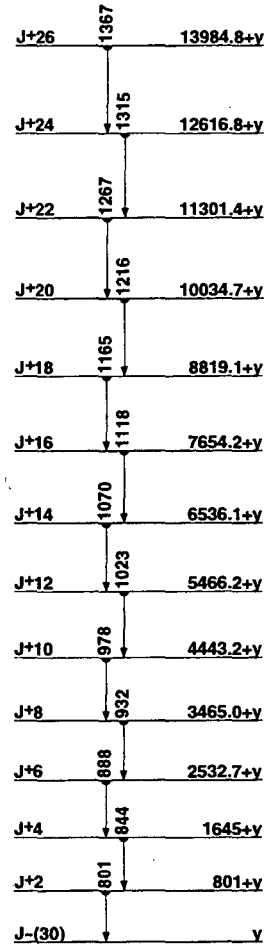
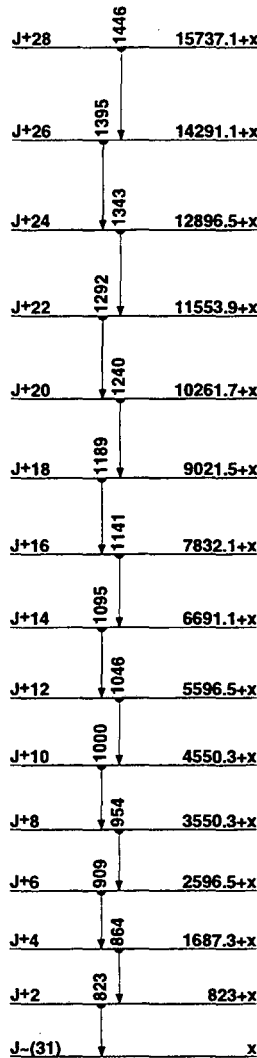

152Tb
65Tb

151
66 Dy

Δ : -68762 4 S_n : 7513 5 S_p : 4936 8 Q_{EC} : 2871 5 Q_α : 4180 3

Nuclear Bands

- A SD-1 band (88Ra19,95Ni06)
 B SD-2 band (95Ni06)
 C SD-3 band (95Ni06)
 D SD-4 band (95Ni06)
 E SD-5 band (95Ni06)

Levels and γ -ray branchings:

0, 7/2⁽⁻⁾, 17.9 3 m, % α =5.6 4, %EC+% β^+ =94.4 4, μ =-0.945 7, Q =-0.30 5
 527.38 9, (9/2⁻) γ_0 527.4 1 (\dagger , 100) D
 775.57 11, (11/2⁻) γ_0 775.53 15 (\dagger , 100) E2
 968.61 13, (13/2⁻) γ_{776} 193.0 1 (\dagger , 100) D
 984.75 22 γ_{776} 209.5 2 (\dagger , 100)
 1334.5 3 γ_{985} 350.8 8 (\dagger , 22 13) γ_{989} 366.0 3 (\dagger , 100 13) γ_{776} 559.4 5
 (\dagger , 50 13)
 1348.7 1, (13/2⁻) γ_{776} 573.2 5 (\dagger , 7.5 15) (D) γ_{527} 821.32 5 (\dagger , 100 2) E2
 1511.16 12, (15/2⁻) γ_{969} 542.5 1 (\dagger , 10 3) (D) γ_{776} 735.59 5 (\dagger , 100 3) E2
 1549.52 19 γ_{969} 580.5 10 (\dagger , =14) γ_{527} 1021.5 5 (\dagger , 36 8) γ_0 1549.7 2
 (\dagger , 100 7)
 1733.7 (?), (17/2⁻) γ_{969} 765.3 3 (?) (\dagger , 100) E2
 1856.6 3 (?) γ_{985} 871.0 10 (\dagger , =71) γ_{776} 1081.4 3 (\dagger , 100 11)
 1918.58 11, (17/2⁻) γ_{1511} 407.4 1 (\dagger , 43.2 13) (D) γ_{1349} 569.88 5 (\dagger , 100 2)
 E2
 1961.3 6 γ_{776} 1185.7 10 (\dagger , =77) γ_{527} 1434.3 6 (\dagger , 100 31)
 2263.02 11, (21/2⁻) γ_{1919} 344.44 4 (\dagger , 100) E2
 2402.0 (?), (21/2⁻) γ_{1734} 668.3 3 (?) (\dagger , 100) E2
 2554.3 3 (?) γ_{776} 1779.1 3 (\dagger , 100 9) γ_{527} 2026.9 5 (\dagger , 41 3)
 2582.9 5 (?) γ_{776} 1807.7 6 (\dagger , 55 18) γ_{527} 2055.7 8 (\dagger , 100 36)
 2866.1 4 (?) γ_{985} 1881.4 3 (\dagger , 100 11) γ_{776} 2090.4 11 (\dagger , 21 11)
 2911.66 12, (25/2⁻) γ_{2263} 648.64 5 (\dagger , 100) E2
 2958.6 10, (27/2⁻), 1.3 6 ns γ_{2912} 46.9 (\dagger , 100) M1
 3078.2 (?), (25/2⁻) γ_{2402} 675.7 3 (?) (\dagger , 100) E2
 3428.5 11, (29/2⁻) γ_{2959} 469.91 12 (\dagger , 100) D
 3733.9 11, (31/2⁻) γ_{3429} 305.3 γ_{2959} 775.38 15 E2
 4306.3 11, (33/2⁻) γ_{3734} 572.5 5 (\dagger , 100 14) (D) γ_{3429} 877.79 16 (\dagger , 43 13)
 (E2)
 4387.3 11, (35/2⁻) γ_{3734} 653.37 6 (\dagger , 100) E2
 4741.5 11, (37/2⁻) γ_{4387} 354.28 7 (\dagger , 100 2) D γ_{4306} 435.16 13 (\dagger , 22.9 21)
 E2
 4903.8 11, (41/2⁻), 5.9 7 ns γ_{4742} 162.32 5 (\dagger , 100) E2
 5742.9 11, (43/2⁻) γ_{4904} 839.02 10 (\dagger , 100) E1
 6007.2 11, (47/2⁻) γ_{5743} 264.29 8 (\dagger , 100) E2
 6032.2 15, (49/2⁻), 11.9 8 ns γ_{6007} 25.0 (\dagger , 100) D, E2
 7037.5 15, (51/2⁻), 1.2 6 ps γ_{6032} 1005.3 3 (\dagger , 100) E1
 7219.5 15, (53/2⁻), 13.7 6 ps γ_{7038} 182.07 9 (\dagger , 100) D
 8177.8 15, (55/2⁻), 4.5 15 ps γ_{7220} 958.2 3 (\dagger , 100) M1
 8302.7 15, (57/2⁻), 20.8 12 ps γ_{8178} 124.8 3 (\dagger , 14 2) D γ_{7220} 1083.2 3
 (\dagger , 100 10) E2
 8680.3 15, (59/2⁻), 2.0 3 ps γ_{8303} 377.7 3 (\dagger , 100) M1
 8891.7 15, (61/2⁻), 19.8 20 ps γ_{8680} 211.5 3 (\dagger , 99 10) D γ_{8303} 589.0 3
 (\dagger , 100 10) E2
 9813.4 18 (?) γ_{8680} 1133 1 (?)
 10029.8 16, (63/2⁻), <2 ps γ_{8892} 1138.1 3 (\dagger , 100) (D)
 10131.3 18 (?) γ_{8680} 1451 1 (\dagger , 100)
 10279.1 21 (?) γ_{10131} 148 1 (\dagger , 100)
 10320.7 18 (?), <2 ps γ_{10030} 291 1 (\dagger , 100) (D)
 10562.6 19 (?), <2 ps γ_{10321} 242 1 γ_{10030} 533 1 (?) γ_{9813} 749 1 (D)
 10749.9 22 (?) γ_{10279} 471 1
 11143.5 21 (?) γ_{10279} 864 1 (?) γ_{10131} 1012 1
 11840.7 22 (?) γ_{11144} 697 1 γ_{10750} 1091 1
 A x, J=(43/2)
 A 527.3+x (?), J+2 γ_x 527.3 1 (?) (\dagger , 0.21 15) $I^{(1)}$ =85.1, $I^{(2)}$ =79.8, $\hbar\omega$ =0.276
 A 1104.7+x, J+4 γ_{527+x} 577.4 1 (\dagger , 0.62 5) $I^{(1)}$ =84.6, $I^{(2)}$ =79.5, $\hbar\omega$ =0.301
 A 1732.4+x, J+6 γ_{1105+x} 627.7 1 (\dagger , 0.78 10) $I^{(1)}$ =84.0, $I^{(2)}$ =73.9, $\hbar\omega$ =0.327

A 2414.2+x, J+8 γ_{1732+x} 681.8 1 (\dagger , 0.81 7) $I^{(1)}$ =83.3, $I^{(2)}$ =76.6, $\hbar\omega$ =0.354
 A 3148.2+x, J+10 γ_{2414+x} 734.0 1 (\dagger , 0.90 10) $I^{(1)}$ =82.9, $I^{(2)}$ =77.4, $\hbar\omega$ =0.380
 A 3933.9+x, J+12 γ_{3148+x} 785.7 1 (\dagger , 0.91 10) $I^{(1)}$ =82.5, $I^{(2)}$ =76.8, $\hbar\omega$ =0.406
 A 4771.7+x, J+14 γ_{3934+x} 837.8 1 (\dagger , 1.00 10) $I^{(1)}$ =82.2, $I^{(2)}$ =78.0, $\hbar\omega$ =0.432
 A 5660.8+x, J+16 γ_{4772+x} 889.1 1 (\dagger , 0.93 10) $I^{(1)}$ =82.0, $I^{(2)}$ =77.7, $\hbar\omega$ =0.457
 A 6601.4+x, J+18 γ_{5661+x} 940.6 1 (\dagger , 1.03 10) $I^{(1)}$ =81.8, $I^{(2)}$ =78.0, $\hbar\omega$ =0.483
 A 7593.3+x, J+20 γ_{6601+x} 991.9 1 (\dagger , 1.07 15) $I^{(1)}$ =81.6, $I^{(2)}$ =78.6, $\hbar\omega$ =0.509
 A 8636.1+x, J+22 γ_{7593+x} 1042.8 1 (\dagger , 1.02 10) $I^{(1)}$ =81.4, $I^{(2)}$ =78.4,
 $\hbar\omega$ =0.534
 A 9729.9+x, J+24 γ_{8636+x} 1093.8 1 (\dagger , 1.00 10) $I^{(1)}$ =81.3, $I^{(2)}$ =79.5,
 $\hbar\omega$ =0.559
 A 10874.0+x, J+26 γ_{9730+x} 1144.1 1 (\dagger , 0.69 7) $I^{(1)}$ =81.2, $I^{(2)}$ =79.1,
 $\hbar\omega$ =0.585
 A 12068.7+x, J+28 $\gamma_{10874+x}$ 1194.7 1 (\dagger , 0.59 7) $I^{(1)}$ =81.2, $I^{(2)}$ =79.5,
 $\hbar\omega$ =0.610
 A 13313.7+x, J+30 $\gamma_{12069+x}$ 1245.0 1 (\dagger , 0.57 10) $I^{(1)}$ =81.1, $I^{(2)}$ =80.3,
 $\hbar\omega$ =0.635
 A 14608.5+x, J+32 $\gamma_{13314+x}$ 1294.8 2 (\dagger , 0.48 7) $I^{(1)}$ =81.1, $I^{(2)}$ =80.3,
 $\hbar\omega$ =0.660
 A 15953.1+x, J+34 $\gamma_{14609+x}$ 1344.6 2 (\dagger , 0.34 7) $I^{(1)}$ =81.1, $I^{(2)}$ =81.3,
 $\hbar\omega$ =0.685
 A 17346.9+x, J+36 $\gamma_{15953+x}$ 1393.8 3 (\dagger , 0.38 7) $I^{(1)}$ =81.0, $I^{(2)}$ =79.5,
 $\hbar\omega$ =0.709
 A 18791.0+x, J+38 $\gamma_{17347+x}$ 1444.1 4 (\dagger , 0.22 5) $I^{(1)}$ =81.0, $I^{(2)}$ =82.8,
 $\hbar\omega$ =0.734
 A 20283.4+x, J+40 $\gamma_{18791+x}$ 1492.4 6 (\dagger , 0.09 5) $I^{(1)}$ =81.1, $I^{(2)}$ =81.0,
 $\hbar\omega$ =0.759
 A 21825.2+x, J+42 $\gamma_{20283+x}$ 1541.8 6
 B y, J
 B 633.0+y, J+2 γ_y 633.0 10 $I^{(2)}$ =89.5, $\hbar\omega$ =0.328
 B 1310.7+y, J+4 γ_{633+y} 677.7 5 (\dagger , 0.35 8) $I^{(2)}$ =96.4, $\hbar\omega$ =0.349
 B 2029.9+y, J+6 γ_{1311+y} 719.2 1 (\dagger , 0.67 10) $I^{(2)}$ =86.2, $\hbar\omega$ =0.371
 B 2795.5+y, J+8 γ_{2030+y} 765.6 1 (\dagger , 0.95 13) $I^{(2)}$ =85.8, $\hbar\omega$ =0.394
 B 3607.7+y, J+10 γ_{2796+y} 812.2 1 (\dagger , 0.92 13) $I^{(2)}$ =85.1, $\hbar\omega$ =0.418
 B 4466.9+y, J+12 γ_{3608+y} 859.2 1 (\dagger , 0.94 14) $I^{(2)}$ =84.2, $\hbar\omega$ =0.441
 B 5373.6+y, J+14 γ_{4467+y} 906.7 1 (\dagger , 1.0 10) $I^{(2)}$ =84.0, $\hbar\omega$ =0.465
 B 6327.9+y, J+16 γ_{5374+y} 954.3 1 (\dagger , 1.00 8) $I^{(2)}$ =84.4, $\hbar\omega$ =0.489
 B 7329.6+y, J+18 γ_{6328+y} 1001.7 2 (\dagger , 1.00 12) $I^{(2)}$ =82.8, $\hbar\omega$ =0.513
 B 8379.6+y, J+20 γ_{7330+y} 1050.0 1 (\dagger , 1.02 19) $I^{(2)}$ =83.0, $\hbar\omega$ =0.537
 B 9477.8+y, J+22 γ_{8380+y} 1098.2 1 (\dagger , 0.95 8) $I^{(2)}$ =82.6, $\hbar\omega$ =0.561
 B 10624.4+y, J+24 γ_{9478+y} 1146.6 2 (\dagger , 0.74 7) $I^{(2)}$ =82.3, $\hbar\omega$ =0.585
 B 11819.6+y, J+26 $\gamma_{10624+y}$ 1195.2 2 (\dagger , 0.67 7) $I^{(2)}$ =82.8, $\hbar\omega$ =0.610
 B 13063.1+y, J+28 $\gamma_{11820+y}$ 1243.5 2 (\dagger , 0.54 7) $I^{(2)}$ =81.8, $\hbar\omega$ =0.634
 B 14355.5+y, J+30 $\gamma_{13063+y}$ 1292.4 2 (\dagger , 0.45 8) $I^{(2)}$ =82.5, $\hbar\omega$ =0.658
 B 15696.4+y, J+32 $\gamma_{14356+y}$ 1340.9 3 (\dagger , 0.35 8) $I^{(2)}$ =82.5, $\hbar\omega$ =0.683
 B 17085.8+y, J+34 $\gamma_{15696+y}$ 1389.4 3 (\dagger , 0.18 6) $I^{(2)}$ =78.9, $\hbar\omega$ =0.707
 B 18525.9+y, J+36 $\gamma_{17086+y}$ 1440.1 5 (\dagger , 0.18 6) $I^{(2)}$ =76.3, $\hbar\omega$ =0.733
 B 20018.4+y, J+38 $\gamma_{18526+y}$ 1492.5 10
 C z, J
 C 728.5+z, J+2 γ_z 728.5 1 $I^{(2)}$ =109.3, $\hbar\omega$ =0.373
 C 1493.6+z, J+4 γ_{729+z} 765.1 2 $I^{(2)}$ =83.5, $\hbar\omega$ =0.395
 C 2306.6+z, J+6 γ_{1494+z} 813.0 1 $I^{(2)}$ =84.2, $\hbar\omega$ =0.418
 C 3167.1+z, J+8 γ_{2307+z} 860.5 2 $I^{(2)}$ =81.5, $\hbar\omega$ =0.443
 C 4076.7+z, J+10 γ_{3167+z} 909.6 2 $I^{(2)}$ =81.6, $\hbar\omega$ =0.467
 C 5035.3+z, J+12 γ_{4077+z} 958.6 2 $I^{(2)}$ =83.5, $\hbar\omega$ =0.491
 C 6041.8+z, J+14 γ_{5035+z} 1006.5 1 $I^{(2)}$ =79.7, $\hbar\omega$ =0.516
 C 7098.5+z, J+16 γ_{6042+z} 1056.7 2 $I^{(2)}$ =81.1, $\hbar\omega$ =0.541
 C 8204.5+z, J+18 γ_{7099+z} 1106.0 2 $I^{(2)}$ =80.5, $\hbar\omega$ =0.565
 C 9360.2+z, J+20 γ_{8205+z} 1155.7 2 $I^{(2)}$ =81.5, $\hbar\omega$ =0.590
 C 10565.0+z, J+22 γ_{9360+z} 1204.8 2 $I^{(2)}$ =80.2, $\hbar\omega$ =0.615
 C 11819.7+z, J+24 $\gamma_{10565+z}$ 1254.7 2 $I^{(2)}$ =81.8, $\hbar\omega$ =0.640
 C 13123.3+z, J+26 $\gamma_{11820+z}$ 1303.6 2 $I^{(2)}$ =82.6, $\hbar\omega$ =0.664
 C 14475.3+z, J+28 $\gamma_{13123+z}$ 1352.0 4 $I^{(2)}$ =77.8, $\hbar\omega$ =0.689

C 15878.7+z, J+30 $\gamma_{14475+z}$ 1403.45 $I^{(2)}=86.2, \eta\omega=0.713$
 C 17328.5+z, J+32 $\gamma_{15879+z}$ 1449.86
 D u, J
 D 712.0+u, J+2 γ_0 712.04 (\dagger , 0.41 10) $I^{(2)}=85.7, \eta\omega=0.368$
 D 1470.7+u, J+4 γ_{712+u} 758.73 (\dagger , 0.92 15) $I^{(2)}=85.8, \eta\omega=0.391$
 D 2276.0+u, J+6 γ_{1471+u} 805.32 (\dagger , 0.96 15) $I^{(2)}=84.9, \eta\omega=0.414$
 D 3128.4+u, J+8 γ_{2276+u} 852.42 (\dagger , 1.00 20) $I^{(2)}=85.3, \eta\omega=0.438$
 D 4027.7+u, J+10 γ_{3128+u} 899.32 (\dagger , 0.84 20) $I^{(2)}=84.2, \eta\omega=0.462$
 D 4974.5+u, J+12 γ_{4028+u} 946.84 (\dagger , 1.00 19) $I^{(2)}=84.0, \eta\omega=0.485$

D 5968.9+u, J+14 γ_{4975+u} 994.42 (\dagger , 1.08 22) $I^{(2)}=83.0, \eta\omega=0.509$
 D 7011.5+u, J+16 γ_{5969+u} 1042.64 (\dagger , 1.00 18) $I^{(2)}=83.5, \eta\omega=0.533$
 D 8102.0+u, J+18 γ_{7012+u} 1090.52 (\dagger , 0.98 18) $I^{(2)}=83.9, \eta\omega=0.557$
 D 9240.2+u, J+20 γ_{8102+u} 1138.22 (\dagger , 0.68 12) $I^{(2)}=83.0, \eta\omega=0.581$
 D 10426.6+u, J+22 γ_{9240+u} 1186.46 (\dagger , 0.48 10) $I^{(2)}=82.5, \eta\omega=0.605$
 D 11661.5+u, J+24 $\gamma_{10427+u}$ 1234.93 (\dagger , 0.41 15) $I^{(2)}=83.3, \eta\omega=0.629$
 D 12944.4+u, J+26 $\gamma_{11662+u}$ 1282.92 (\dagger , 0.35 12) $I^{(2)}=85.5, \eta\omega=0.653$
 D 14274.1+u, J+28 $\gamma_{12944+u}$ 1329.76 (\dagger , 0.16 8) $I^{(2)}=81.5, \eta\omega=0.677$
 D 15652.9+u, J+30 $\gamma_{14274+u}$ 1378.88 (\dagger , 0.17 8) $I^{(2)}=86.8, \eta\omega=0.701$
 D 17077.8+u, J+32 $\gamma_{15653+u}$ 1424.9 10
 E v, J
 E 959.3+v, J+2 γ_0 959.35 $I^{(2)}=81.5, \eta\omega=0.492$
 E 1967.7+v, J+4 γ_{959+v} 1008.45 $I^{(2)}=77.1, \eta\omega=0.517$
 E 3028.0+v, J+6 γ_{1968+v} 1060.34 $I^{(2)}=77.5, \eta\omega=0.543$
 E 4139.9+v, J+8 γ_{3028+v} 1111.95 $I^{(2)}=74.1, \eta\omega=0.569$
 E 5305.8+v, J+10 γ_{4140+v} 1165.95 $I^{(2)}=80.6, \eta\omega=0.595$
 E 6521.3+v, J+12 γ_{5306+v} 1215.55 $I^{(2)}=83.9, \eta\omega=0.620$
 E 7784.5+v, J+14 γ_{6521+v} 1263.25 $I^{(2)}=79.7, \eta\omega=0.644$
 E 9097.9+v, J+16 γ_{7785+v} 1313.48 $I^{(2)}=76.5, \eta\omega=0.670$
 E 10463.6+v, J+18 γ_{9098+v} 1365.75

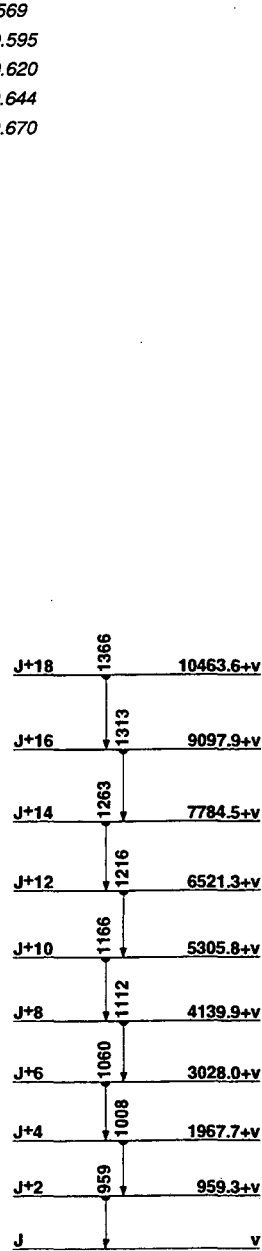
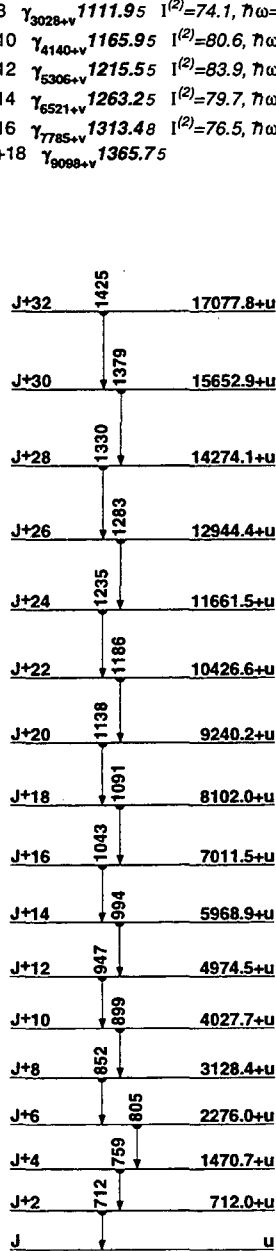
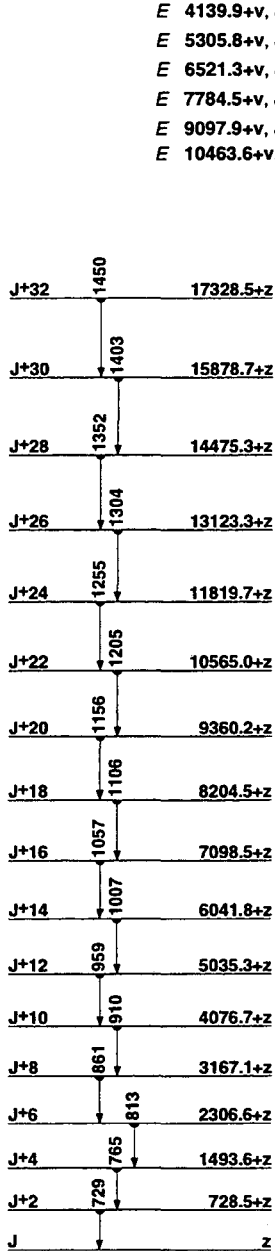
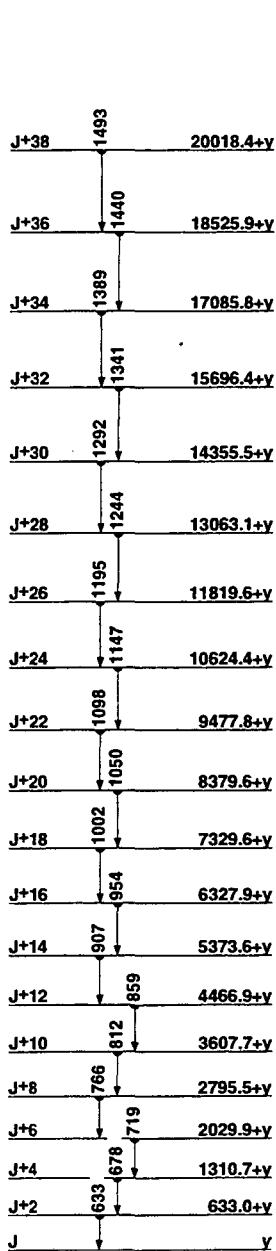
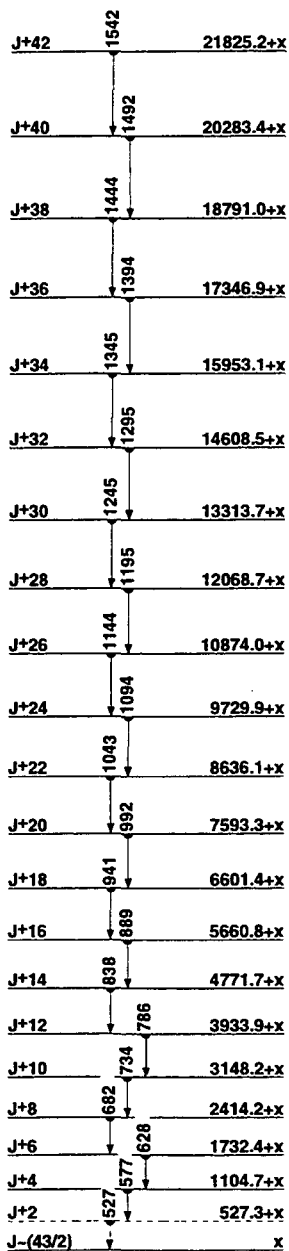

SD-1 band (88Ra19,95Ni06)

SD-2 band (95Ni06)

SD-3 band (95Ni06)

SD-4 band (95Ni06)

SD-5 band (95Ni06)

152Dy
66

Δ : -701286 S_n : 94375 S_p : 57836 Q_{EC} : 60040 Q_α : 37274

Nuclear Bands

- A GS band
- B Band Structure
- C SD-1 band (86Tw01,91Be12,94Da20)
- D SD-2 band (94Da20)
- E SD-3 band (94Da20)
- F SD-4 band (94Da20)
- G SD-5 band (94Da20)
- H SD-6 band (94Da20)

Levels and γ -ray branchings:

- A 0, 0⁺, 2.382 h, $\% \alpha = 0.1007$, $\% EC + \% \beta^+ = 99.9007$
- A 613.845, 2⁺, 10.5 ps γ_0 613.845 (†,100) E2
1227.74 14, 3⁻ γ_{614} 613.63 (†,100)
- A 1261.18 8, 4⁺, 10.616 ps γ_{614} 647.356 (†,100) E2
1313.7 3, 2⁺ γ_{614} 700.05 (†,100) (E2) γ_0 1313.75 (†,43)
1448.2 10, (2⁺) γ_0 1448.2 (†,100) (E2)
1452.8 7, 1⁺, 2⁺ γ_{614} 839.1 (†,100) E2 γ_0 1452.6 (†,32)
1697.9 10, 1⁻ γ_0 1697.9 (†,100) E1
1750.64 17, 4⁺ γ_{1314} 437.05 (†,5) γ_{1261} 489.55 (†,100) M1 γ_{614} 1136.85 (†,41)
1781.87 10, 5⁻ γ_{1261} 520.677 (†,100 16) E1 γ_{1228} 554.09 11 (†,54 14) E2
1840.6 5, 1⁻, 2⁻, 3⁻ γ_{614} 1226.8 (†,100) E1
- A 1944.57 10, 6⁺, 5.121 ps γ_{1782} 162.62 17 (†,0.7 3) γ_{1261} 683.46 8 (†,100) E2
2070.98 12, 6⁺ γ_{1945} 126.28 19 (†,11 3) M1 γ_{1751} 320.35 14 (†,58 3) E2
 γ_{1261} 809.74 17 (†,100 16) E2
2296.55 13, 7⁺ γ_{2071} 225.52 17 (†,63 4) M1 γ_{1945} 352.23 17 (†,100 6) (M1)
2342.62 11, 7⁻ γ_{1945} 398.03 7 (†,100 9) E1 γ_{1782} 560.69 9 (†,72 9) E2
2437.37 12, 8⁺, 10.3 ps γ_{2297} 140.83 10 (†,2.5 3) M1 γ_{2071} 366.31 14 (†,3.4 4) E2 γ_{1945} 492.82 8 (†,100 5) E2
- B 2703.13 12, 8⁺ γ_{2437} 265.63 (†,4.7 19) M1 γ_{2343} 360.53 (†,2.8 9)
 γ_{2287} 406.76 17 (†,5.7 19) (M1) γ_{1945} 758.60 8 (†,100 6) E2
2726.7 6, (8⁻) γ_{2343} 384.15 (†,100) M1
2906.05 12, 9⁻ γ_{2703} 203.01 9 (†,13 3) γ_{2437} 468.53 (†,30 10)
 γ_{2343} 563.34 9 (†,100 10) E2
2930.1 6, (7⁻) γ_{2071} 859.15 (†,100) E1
3149.7 6, 8⁻ γ_{2297} 853.15 (†,100) E1
3160.60 16, 11⁻, 3.9 ns γ_{2906} 254.43 14 (†,100) E2
3173.32 15, 10⁺ γ_{2437} 735.95 10 (†,100) E2
3173.4 4, (10⁻) γ_{2906} 267.33 (†,100) (M1)
3183.77 15, 10⁺ γ_{2906} 278.03 (†,79 22) γ_{2437} 746.44 11 (†,100 14) E2
3226.9 7, 8⁻ γ_{2297} 930.36 (†,100) E1
3243.9 4, (9⁺) γ_{2297} 947.33 (†,100) E2
- B 3395.9 4, 10⁺ γ_{2703} 692.8 3 (†,100) E2
=3500 (?), 1⁻, 2⁻, 3⁻
3535.0 6, 8⁻, 9⁻ γ_{2437} 1097.6 5 (†,100) E1
3820.27 16, 12⁺ γ_{3184} 636.59 12 (†,97) E2 $\gamma_{3173.3}$ 646.8 (†,100)
 γ_{3161} 659.58 13 (†,49)
3969.25 18, 13⁻ γ_{3161} 808.66 12 (†,100) E2
3992.1 8, 13⁻ γ_{3161} 831.3 (†,100)
4015.8 6, 8⁺ γ_{2297} 1719.2 5 (†,100) M1
- B 4029.8 11, 12⁺ γ_{3396} 633.9 (†,100) E2
4430.31 18, 14⁺ γ_{3969} 461.12 γ_{3820} 610.03 9 E2
- B 4652.1 15, 14⁺ γ_{4030} 622.3 (†,100) E2
4652.3 11, (15⁻) γ_{3969} 683
4734.66 20, (15⁻) γ_{3992} 742.4 γ_{3969} 765.38 15
4804.98 19, 13⁺, 14⁺ γ_{4430} 374.4 γ_{3820} 984.72 13
5034.87 19, 15⁺ γ_{4805} 229.90 17 γ_{4735} 300.18 15 γ_{4430} 604.57 9 M1
5088.2 3, 17⁺, 60.4 ns γ_{5035} 53.32 (†,100) E2

- 5179.3 15, (17⁻) $\gamma_{4652.1}$ 527
- B 5198.6 18, 16⁺ $\gamma_{4652.1}$ 546.5 (†,100) E2
5341.7 3, 18⁺ γ_{5088} 253.57 8 (†,100) M1
- B 5764.4 21, 18⁺ γ_{5199} 565.8 (†,100) E2
5867.0 3, 19⁻ γ_{5342} 525.27 10 (†,100) E1
6051.6 6, (20⁺) γ_{5342} 709.9 5 (†,100) Q
6111.5 4, (20⁺) γ_{5342} 769.65 21 (†,100) E2
6129.4 3, 21⁻, 9.5 7 ns γ_{5867} 262.44 8 (†,100) E2
6171.6 4 γ_{5867} 304.65 21 (†,100)
6225.4 5, (20) γ_{5867} 358.4 3 (†,100) (D)
- B 6373.4 23, 20⁺ γ_{5764} 609 (†,100) E2
6537.0 11 γ_{5867} 670 (†,100)
6737.1 4, (22⁺) γ_{6129} 609.0 10 (†,=36) γ_{6112} 625.46 24 (†,100) E2
- B 7054.5 25, 22⁺ γ_{6373} 681 (†,100) E2
7120.1 4, 23⁻ γ_{6737} 382 γ_{6129} 990.75 12 (†,100) E2
7227.1 10, (24⁺) γ_{6737} 490 (†,100) E2
7661.3 4, 25⁻ γ_{7120} 541.18 12 (†,100) E2
7710.1 10, (24⁺) γ_{7227} 483 (†,36 18) γ_{6737} 973 (†,100 36)
- B 7808 3, 24⁺ γ_{7055} 754 (†,100) E2
7881.9 4, 27⁻, 1.6 2 ns γ_{7861} 220.61 11 (†,100) E2
8185.9 11 γ_{7882} 304 (†,100)
8337.9 11 γ_{7882} 456 (†,100)
- B 8633 3, 26⁺ γ_{7808} 825 (†,100) E2
8848.9 4, 28⁺, 24.8 ps γ_{7882} 966.94 13 (†,100) E1
8945.4 9 γ_{7882} 1063 (†,100)
8996.3 4, 29⁺, 35.10 ps γ_{8849} 147.44 9 (†,100) M1
9398.7 5, 30⁺, 7.1 ps γ_{8996} 402.34 13 (†,100) M1
- B 9528 3, 28⁺ γ_{8633} 895 (†,100) E2
9835.8 9 γ_{8945} 890 (†,100)
10012.4 7 γ_{8399} 613 γ_{8996} 1016
10110.3 5, 31⁺ γ_{10012} 97 γ_{9835} 274 γ_{8399} 711.50 21 (†,72) M1
 γ_{8996} 1114.13 19 (†,100) E2
10257.5 8 γ_{8399} 858.6 (†,100)
- B 10490 4, 30⁺ γ_{9528} 962 (†,100) E2
10541.3 5, 32⁺, 6.2 6 ps γ_{10110} 431.07 19 (M1) γ_{8399} 1142
10674.3 11 γ_{10541} 133 (†,100)
10795.3 5, 33⁺, 15.5 ps γ_{10541} 254.23 D γ_{10110} 684.90 21 E2
10961.2 7 γ_{10258} 703 γ_{10110} 851
11209.2 7 γ_{10961} 248 γ_{10541} 668.06 γ_{10258} 952
11395.6 10 γ_{10795} 600
11443.0 9 γ_{10541} 901
- B 11518 4, 32⁺ γ_{10490} 1028 (†,100) E2
11574.8 5, 34⁺ γ_{11443} 131 γ_{10961} 613 γ_{10795} 779.60 21 E1
11602.3 8 γ_{10541} 1061 γ_{10258} 1345
11793.2 10 γ_{11602} 191
11859.2 8 γ_{11602} 257 γ_{10795} 1064
11963.4 6, 35⁺, 1.2 4 ps γ_{11575} 388.60 21 M1 γ_{11443} 520
12179.2 8 γ_{11859} 320 γ_{11793} 386 γ_{11209} 970
12325.3 8, 36⁻ γ_{11963} 362 D γ_{11575} 750
12429.0 9 γ_{11396} 1033 γ_{11209} 1220
- B 12611 4, 34⁺ γ_{11518} 1093 (†,100) E2
12717.2 9 γ_{12429} 288 γ_{12179} 538 γ_{11963} 754
12946.4 12 γ_{12429} 518 (?) γ_{11963} 983
13049.1 10 γ_{11963} 1086 (†,100)
13117.4 13 γ_{12325} 792 (†,100)
13253.7 14 γ_{11396} 1858 (†,100)
13396.9 9 γ_{13049} 348 γ_{12325} 1071 γ_{12179} 1218
13493.4 13 γ_{12325} 1168 (†,100)
13517.4 13 γ_{12325} 1192 (†,100)
13687.3 13 γ_{12325} 1362 (†,100)
13722.2 13 γ_{12717} 1005 (†,100)
- B 13770 4, 36⁺ γ_{12611} 1159 (†,100) E2
14485.2 17 γ_{13722} 763 (†,100)

- 14663.4 17 γ_{1368} 976 (\dagger , 100)
 14742.2 17 γ_{1372} 1020 (\dagger , 100)
 B 14992.4, 38⁺ γ_{13770} 1222 (\dagger , 100) E2
 B 16275.4, 40⁺ γ_{14982} 1283 (\dagger , 100) E2
 16397.2 20 γ_{14485} 1912 (\dagger , 100)
 17539.2 22 γ_{16387} 1142 (\dagger , 100)
 B 17616.4, 42⁺ γ_{16275} 1341 (\dagger , 100)
 B 19015.5, 44⁺ γ_{17616} 1399 (\dagger , 100)
 B 20469.5, 46⁺ γ_{19015} 1454 (\dagger , 100)
 C x, (24⁺)
 C 602.4+x 1, (26⁺) γ_x 602.4 1 (\dagger , 0.17 3) E2 $I^{(1)}=83.2$, $I^{(2)}=88.7$, $\hbar\omega=0.312$
 C 1249.9+x 1, (28⁺) γ_{602+x} 647.5 1 (\dagger , 0.51 7) E2 $I^{(1)}=83.6$, $I^{(2)}=88.5$,
 $\hbar\omega=0.335$
 C 1942.6+x 2, (30⁺), 30 fs γ_{1250+x} 692.7 1 (\dagger , 1.01 10) E2 $I^{(1)}=83.9$, $I^{(2)}=88.1$,
 $\hbar\omega=0.358$
 C 2680.7+x 2, (32⁺), 22 fs γ_{1943+x} 738.1 1 (\dagger , 0.93 11) E2 $I^{(1)}=84.1$, $I^{(2)}=87.1$,
 $\hbar\omega=0.381$
 C 3464.7+x 2, (34⁺), 16 fs γ_{2681+x} 784.0 1 (\dagger , 0.96 11) E2 $I^{(1)}=84.3$, $I^{(2)}=87.1$,
 $\hbar\omega=0.403$
 C 4294.6+x 2, (36⁺), 12 fs γ_{3465+x} 829.9 1 (\dagger , 1.01 8) E2 $I^{(1)}=84.4$, $I^{(2)}=86.0$,
 $\hbar\omega=0.427$
 C 5171.0+x 3, (38⁺), 9.3 fs γ_{4295+x} 876.4 1 (\dagger , 1.08 11) E2 $I^{(1)}=84.5$,
 $I^{(2)}=85.5$, $\hbar\omega=0.450$
 C 6094.2+x 3, (40⁺), 7.1 fs γ_{5171+x} 923.2 1 (\dagger , 1.04 10) E2 $I^{(1)}=84.5$,
 $I^{(2)}=85.1$, $\hbar\omega=0.473$
 C 7064.4+x 3, (42⁺), 5.5 fs γ_{6094+x} 970.2 1 (\dagger , 1.00 11) E2 $I^{(1)}=84.5$,
 $I^{(2)}=84.7$, $\hbar\omega=0.497$
 C 8081.8+x 3, (44⁺), 4.4 fs γ_{7064+x} 1017.4 1 (\dagger , 0.98 12) E2 $I^{(1)}=84.5$,
 $I^{(2)}=84.2$, $\hbar\omega=0.521$
 C 9146.7+x 3, (46⁺), 3.5 fs γ_{8082+x} 1064.9 1 (\dagger , 0.98 8) E2 $I^{(1)}=84.5$,
 $I^{(2)}=83.7$, $\hbar\omega=0.544$
 C 10259.4+x 3, (48⁺), 2.8 fs γ_{9147+x} 1112.7 1 (\dagger , 0.90 10) E2 $I^{(1)}=84.5$,
 $I^{(2)}=83.7$, $\hbar\omega=0.568$
 C 11419.9+x 4, (50⁺), 2.3 fs $\gamma_{10259+x}$ 1160.5 1 (\dagger , 0.87 6) E2 $I^{(1)}=84.4$,
 $I^{(2)}=83.2$, $\hbar\omega=0.592$
 C 12628.5+x 4, (52⁺), 1.8 fs $\gamma_{11420+x}$ 1208.6 1 (\dagger , 0.89 12) E2 $I^{(1)}=84.4$,
 $I^{(2)}=83.3$, $\hbar\omega=0.616$
 C 13885.1+x 4, (54⁺), 1.5 fs $\gamma_{12628+x}$ 1256.6 1 (\dagger , 0.75 10) E2 $I^{(1)}=84.3$,
 $I^{(2)}=83.0$, $\hbar\omega=0.640$
 C 15189.9+x 4, (56⁺), 1.2 fs $\gamma_{13885+x}$ 1304.8 1 (\dagger , 0.62 7) E2 $I^{(1)}=84.3$,
 $I^{(2)}=83.2$, $\hbar\omega=0.664$
 C 16542.8+x 4, (58⁺), 1.0 fs $\gamma_{15190+x}$ 1352.9 1 (\dagger , 0.49 8) E2 $I^{(1)}=84.2$,
 $I^{(2)}=82.6$, $\hbar\omega=0.689$
 C 17944.1+x 4, (60⁺), 0.90 fs $\gamma_{16543+x}$ 1401.3 1 (\dagger , 0.30 7) E2 $I^{(1)}=84.2$,
 $I^{(2)}=82.8$, $\hbar\omega=0.713$
 C 19393.7+x 5, (62⁺), 0.69 fs $\gamma_{17944+x}$ 1449.6 2 (\dagger , 0.16 6) E2 $I^{(1)}=84.1$,
 $I^{(2)}=83.0$, $\hbar\omega=0.737$
 C 20891.5+x 6, (64⁺) $\gamma_{19394+x}$ 1497.8 3 $I^{(1)}=84.1$, $I^{(2)}=83.7$, $\hbar\omega=0.761$
 C 22437.1+x 7, (66⁺) $\gamma_{20892+x}$ 1545.6 5
 D y, (34)
 D 825.9+y 10, (36) γ 825.9 10 $I^{(1)}=85.6$, $I^{(2)}=135.6$, $\hbar\omega=0.420$
 D 1681.3+y 10, (38) γ_{826+y} 855.4 2 $I^{(1)}=86.8$, $I^{(2)}=100.5$, $\hbar\omega=0.438$
 D 2576.5+y 10, (40) γ_{1681+y} 895.2 2 $I^{(1)}=87.6$, $I^{(2)}=108.1$, $\hbar\omega=0.457$
 D 3508.7+y 11, (42) γ_{2577+y} 932.2 2 $I^{(1)}=88.3$, $I^{(2)}=106.1$, $\hbar\omega=0.476$
 D 4478.6+y 12, (44) γ_{3508+y} 969.9 5 $I^{(1)}=89.0$, $I^{(2)}=103.6$, $\hbar\omega=0.495$
 D 5487.1+y 13, (46) γ_{4479+y} 1008.5 5 $I^{(1)}=89.4$, $I^{(2)}=98.3$, $\hbar\omega=0.514$
 D 6536.3+y 13, (48) γ_{5487+y} 1049.2 2 $I^{(1)}=89.6$, $I^{(2)}=92.2$, $\hbar\omega=0.535$
 D 7628.9+y 13, (50) γ_{6536+y} 1092.6 2 $I^{(1)}=89.7$, $I^{(2)}=88.9$, $\hbar\omega=0.558$
 D 8766.5+y 13, (52) γ_{7629+y} 1137.6 2 $I^{(1)}=89.6$, $I^{(2)}=87.3$, $\hbar\omega=0.580$
 D 9949.9+y 13, (54) γ_{8767+y} 1183.4 2 $I^{(1)}=89.5$, $I^{(2)}=84.7$, $\hbar\omega=0.603$
 D 11180.5+y 13, (56) γ_{9950+y} 1230.6 2 $I^{(1)}=89.3$, $I^{(2)}=84.9$, $\hbar\omega=0.627$
 D 12458.2+y 14, (58) $\gamma_{11181+y}$ 1277.7 2 $I^{(1)}=89.1$, $I^{(2)}=80.5$, $\hbar\omega=0.651$
 D 13785.6+y 15, (60) $\gamma_{12458+y}$ 1327.4 5 $I^{(1)}=88.7$, $I^{(2)}=80.5$, $\hbar\omega=0.676$
 D 15162.7+y 18, (62) $\gamma_{13786+y}$ 1377.1 10 $I^{(1)}=88.5$, $I^{(2)}=86.0$, $\hbar\omega=0.700$
 D 16586.3+y 20, (64) $\gamma_{15163+y}$ 1423.6 10 $I^{(1)}=88.3$, $I^{(2)}=74.8$, $\hbar\omega=0.725$
 D 18063.4+y 23, (66) $\gamma_{16586+y}$ 1477.1 10
 E z, (36)
 E 793.0+z 2, (38) γ 793.0 2 $I^{(1)}=93.1$, $I^{(2)}=85.7$, $\hbar\omega=0.408$
 E 1632.7+z 3, (40) γ_{793+z} 839.7 2 $I^{(1)}=92.4$, $I^{(2)}=77.7$, $\hbar\omega=0.433$
 E 2523.9+z 3, (42) γ_{1633+z} 891.2 2 $I^{(1)}=91.5$, $I^{(2)}=74.6$, $\hbar\omega=0.459$
 E 3468.7+z 4, (44) γ_{2524+z} 944.8 2 $I^{(1)}=90.6$, $I^{(2)}=74.9$, $\hbar\omega=0.486$
 E 4466.9+z 4, (46) γ_{3469+z} 998.2 2 $I^{(1)}=89.7$, $I^{(2)}=73.8$, $\hbar\omega=0.513$
 E 5519.3+z 5, (48) γ_{4467+z} 1052.4 2 $I^{(1)}=89.0$, $I^{(2)}=76.2$, $\hbar\omega=0.539$
 E 6624.2+z 5, (50) γ_{5519+z} 1104.9 2 $I^{(1)}=88.4$, $I^{(2)}=76.9$, $\hbar\omega=0.565$
 E 7781.1+z 6, (52) γ_{6624+z} 1156.9 2 $I^{(1)}=88.0$, $I^{(2)}=78.4$, $\hbar\omega=0.591$
 E 8989.0+z 6, (54) γ_{7781+z} 1207.9 2 $I^{(1)}=87.5$, $I^{(2)}=76.2$, $\hbar\omega=0.617$
 E 10249.4+z 6, (56) γ_{8989+z} 1260.4 2 $I^{(1)}=87.0$, $I^{(2)}=74.9$, $\hbar\omega=0.644$
 E 11563.2+z 7, (58) $\gamma_{10249+z}$ 1313.8 2 $I^{(1)}=86.5$, $I^{(2)}=73.0$, $\hbar\omega=0.671$
 E 12931.8+z 7, (60) $\gamma_{11563+z}$ 1368.6 2 $I^{(1)}=85.9$, $I^{(2)}=69.9$, $\hbar\omega=0.699$
 E 14357.6+z 7, (62) $\gamma_{12932+z}$ 1425.8 2 $I^{(1)}=85.3$, $I^{(2)}=70.3$, $\hbar\omega=0.727$
 E 15840.3+z 7, (64) $\gamma_{14358+z}$ 1482.7 2 $I^{(1)}=84.6$, $I^{(2)}=65.1$, $\hbar\omega=0.757$
 E 17384.4+z 8, (66) $\gamma_{15840+z}$ 1544.1 2 $I^{(1)}=83.8$, $I^{(2)}=66.0$, $\hbar\omega=0.787$
 E 18989.1+z 8, (68) $\gamma_{17384+z}$ 1604.7 2
 F u, (27⁺)
 F 669.6+u 5, (29⁺) γ_0 669.6 5 $I^{(1)}=83.4$, $I^{(2)}=77.8$, $\hbar\omega=0.348$
 F 1390.6+u 5, (31⁺) γ_{670+u} 721.0 2 $I^{(1)}=83.0$, $I^{(2)}=77.2$, $\hbar\omega=0.373$
 F 2163.4+u 6, (33⁺) γ_{1391+u} 772.8 2 $I^{(1)}=82.6$, $I^{(2)}=76.6$, $\hbar\omega=0.399$
 F 2988.4+u 6, (35⁺) γ_{2163+u} 825.0 2 $I^{(1)}=82.3$, $I^{(2)}=77.2$, $\hbar\omega=0.425$
 F 3865.2+u 6, (37⁺) γ_{2988+u} 876.8 2 $I^{(1)}=82.0$, $I^{(2)}=76.6$, $\hbar\omega=0.451$
 F 4794.2+u 7, (39⁺) γ_{3865+u} 929.0 2 $I^{(1)}=81.8$, $I^{(2)}=80.5$, $\hbar\omega=0.477$
 F 5772.9+u 7, (41⁺) γ_{4794+u} 978.7 2 $I^{(1)}=81.7$, $I^{(2)}=78.3$, $\hbar\omega=0.502$
 F 6802.7+u 7, (43⁺) γ_{5773+u} 1029.8 2 $I^{(1)}=81.5$, $I^{(2)}=78.4$, $\hbar\omega=0.528$
 F 7883.5+u 8, (45⁺) γ_{6803+u} 1080.8 2 $I^{(1)}=81.4$, $I^{(2)}=80.3$, $\hbar\omega=0.553$
 F 9014.1+u 8, (47⁺) γ_{7884+u} 1130.6 2 $I^{(1)}=81.4$, $I^{(2)}=80.5$, $\hbar\omega=0.578$
 F 10194.4+u 8, (49⁺) γ_{9014+u} 1180.3 2 $I^{(1)}=81.4$, $I^{(2)}=83.9$, $\hbar\omega=0.602$
 F 11422.4+u 9, (51⁺) $\gamma_{10194+u}$ 1228.0 3 $I^{(1)}=81.3$, $I^{(2)}=75.5$, $\hbar\omega=0.627$
 F 12703.4+u 10, (53⁺) $\gamma_{11422+u}$ 1281.0 5 $I^{(1)}=81.3$, $I^{(2)}=85.7$, $\hbar\omega=0.652$
 F 14031.1+u 11, (55⁺) $\gamma_{12703+u}$ 1327.7 5 $I^{(1)}=81.4$, $I^{(2)}=83.0$, $\hbar\omega=0.676$
 F 15407.0+u 15, (57⁺) $\gamma_{14031+u}$ 1375.9 10
 G v, (26⁺)
 G 642.1+v 5, (28⁺) γ_0 642.1 5 $I^{(1)}=83.8$, $I^{(2)}=75.8$, $\hbar\omega=0.334$
 G 1337.0+v 6, (30⁺) γ_{642+v} 694.9 4 $I^{(1)}=83.2$, $I^{(2)}=76.8$, $\hbar\omega=0.360$
 G 2084.0+v 7, (32⁺) γ_{1337+v} 747.0 2 $I^{(1)}=82.8$, $I^{(2)}=77.2$, $\hbar\omega=0.386$
 G 2882.8+v 7, (34⁺) γ_{2084+v} 798.8 2 $I^{(1)}=82.4$, $I^{(2)}=76.5$, $\hbar\omega=0.412$
 G 3733.9+v 7, (36⁺) γ_{2883+v} 851.1 2 $I^{(1)}=82.2$, $I^{(2)}=79.7$, $\hbar\omega=0.438$
 G 4635.2+v 8, (38⁺) γ_{3734+v} 901.3 2 $I^{(1)}=81.9$, $I^{(2)}=76.2$, $\hbar\omega=0.464$
 G 5589.0+v 8, (40⁺) γ_{4635+v} 953.8 2 $I^{(1)}=81.7$, $I^{(2)}=78.0$, $\hbar\omega=0.490$
 G 6594.1+v 9, (42⁺) γ_{5589+v} 1005.1 5 $I^{(1)}=81.5$, $I^{(2)}=80.2$, $\hbar\omega=0.515$
 G 7649.1+v 9, (44⁺) γ_{6594+v} 1055.0 2 $I^{(1)}=81.5$, $I^{(2)}=80.0$, $\hbar\omega=0.540$
 G 8754.1+v 10, (46⁺) γ_{7649+v} 1105.0 2 $I^{(1)}=81.4$, $I^{(2)}=78.7$, $\hbar\omega=0.565$
 G 9909.9+v 11, (48⁺) γ_{8754+v} 1155.8 5 $I^{(1)}=81.3$, $I^{(2)}=80.0$, $\hbar\omega=0.590$
 G 11115.7+v 11, (50⁺) γ_{9910+v} 1205.8 2 $I^{(1)}=81.3$, $I^{(2)}=83.3$, $\hbar\omega=0.615$
 G 12369.5+v 11, (52⁺) $\gamma_{11116+v}$ 1253.8 3 $I^{(1)}=81.3$, $I^{(2)}=79.4$, $\hbar\omega=0.639$
 G 13673.7+v 13, (54⁺) $\gamma_{12370+v}$ 1304.2 5
 H w, (32⁺)
 H 761.5+w 2, (34⁺) γ_0 761.5 2 $I^{(1)}=86.8$, $I^{(2)}=93.0$, $\hbar\omega=0.392$
 H 1566.0+w 3, (36⁺) γ_{762+w} 804.5 2 $I^{(1)}=87.1$, $I^{(2)}=88.5$, $\hbar\omega=0.414$
 H 2415.7+w 3, (38⁺) γ_{1566+w} 849.7 2 $I^{(1)}=87.1$, $I^{(2)}=88.5$, $\hbar\omega=0.436$
 H 3310.6+w 4, (40⁺) γ_{2416+w} 894.9 2 $I^{(1)}=87.1$, $I^{(2)}=86.4$, $\hbar\omega=0.459$
 H 4251.8+w 4, (42⁺) γ_{3311+w} 941.2 2 $I^{(1)}=87.2$, $I^{(2)}=89.1$, $\hbar\omega=0.482$
 H 5237.9+w 5, (44⁺) γ_{4252+w} 986.1 2 $I^{(1)}=87.2$, $I^{(2)}=88.5$, $\hbar\omega=0.504$
 H 6269.2+w 5, (46⁺) γ_{5238+w} 1031.3 2 $I^{(1)}=87.3$, $I^{(2)}=87.0$, $\hbar\omega=0.527$

H 7346.5+w 6, (48⁻) γ_{6269+w} 1077.32 $I^{(1)}=87.3, I^{(2)}=88.1, \eta\omega=0.550$
 H 8469.2+w 6, (50⁻) γ_{7347+w} 1122.72 $I^{(1)}=87.3, I^{(2)}=90.1, \eta\omega=0.572$
 H 9636.3+w 6, (52⁻) γ_{8469+w} 1167.12 $I^{(1)}=87.4, I^{(2)}=89.9, \eta\omega=0.595$
 H 10847.9+w 7, (54⁻) γ_{9636+w} 1211.62 $I^{(1)}=87.5, I^{(2)}=88.7, \eta\omega=0.617$
 H 12104.6+w 7, (56⁻) $\gamma_{10848+w}$ 1256.72 $I^{(1)}=87.6, I^{(2)}=92.6, \eta\omega=0.639$
 H 13404.5+w 7, (58⁻) $\gamma_{12105+w}$ 1299.92 $I^{(1)}=87.7, I^{(2)}=90.1, \eta\omega=0.661$
 H 14748.8+w 7, (60⁻) $\gamma_{13405+w}$ 1344.32 $I^{(1)}=87.8, I^{(2)}=90.7, \eta\omega=0.683$
 H 16137.2+w 9, (62⁻) $\gamma_{14749+w}$ 1388.45 $I^{(1)}=87.9, I^{(2)}=88.7, \eta\omega=0.705$
 H 17570.7+w 13, (64⁻) $\gamma_{16137+w}$ 1433.510

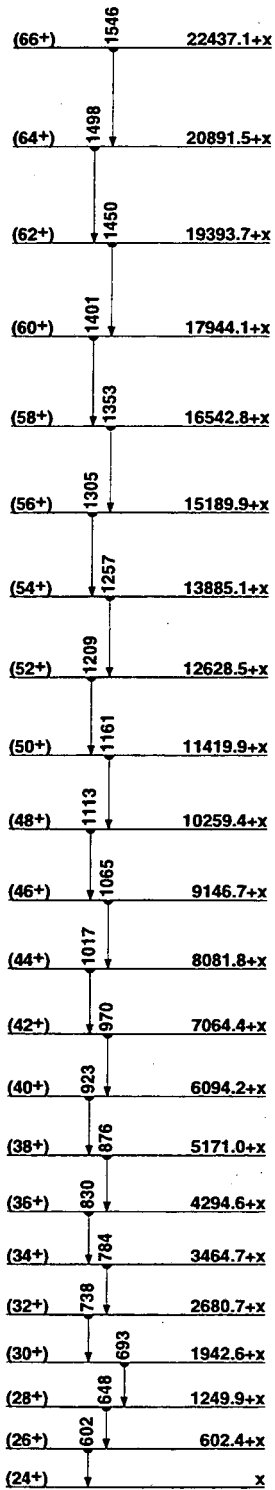

SD-1 band
(86Tw01,91Be12,94Da20)

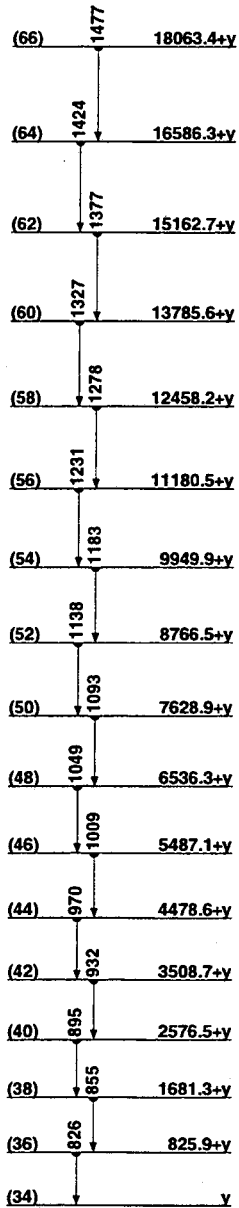

SD-2 band
(94Da20)

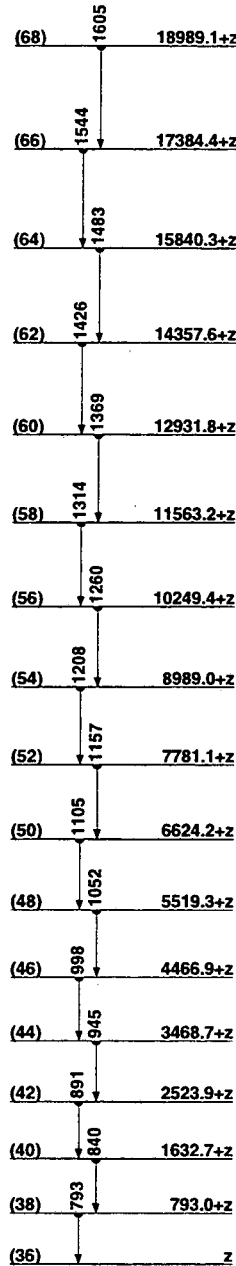

SD-3 band
(94Da20)

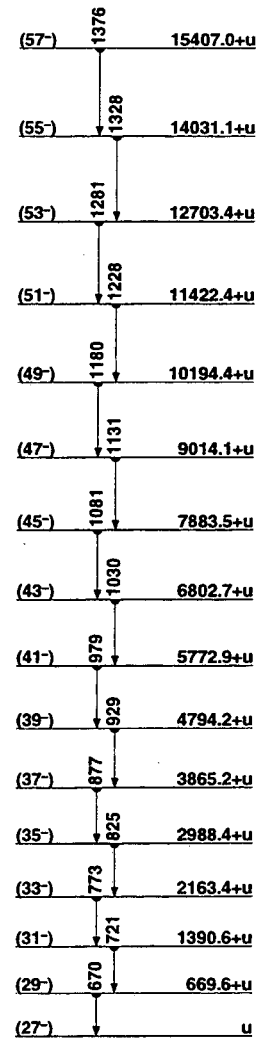

SD-4 band
(94Da20)

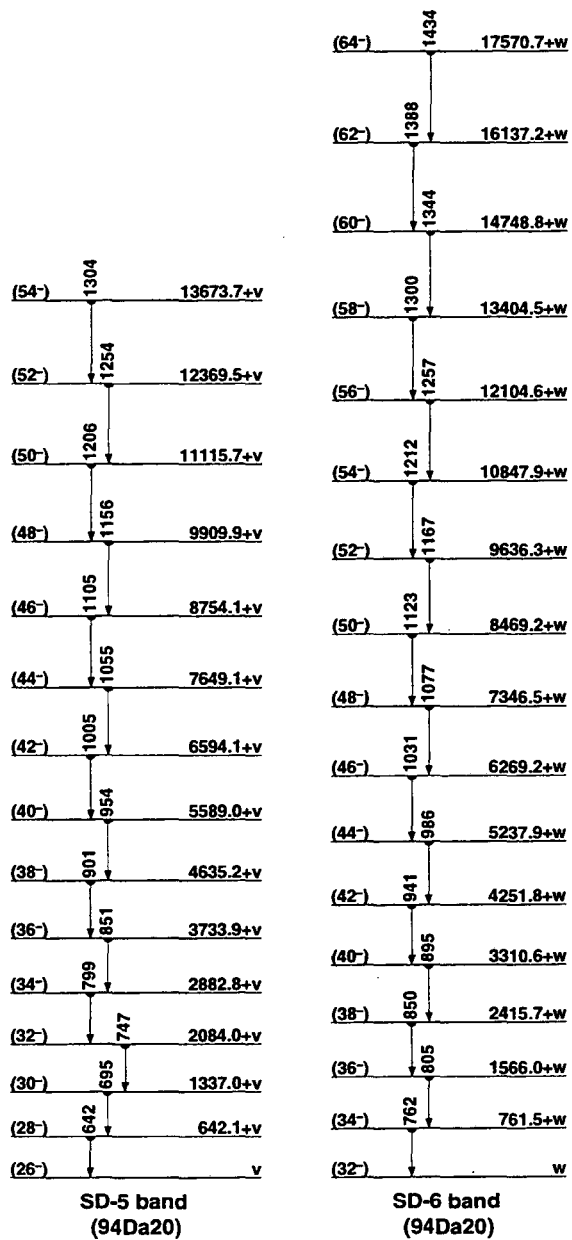

¹⁵²₆₆Dy

153Dy
66 Δ : -69151 5 S_n : 7095 6 S_p : 5710 40 Q_{EC} : 2170.6 19 Q_α : 3559 4

Nuclear Bands

- A $\nu_{h,11/2}$
 B $\nu_{h,9/2}$
 C Band Structure
 D $\nu_{i,13/2}$
 E SD-1 band (89Jo04,95Ce03)
 F SD-2 band (89Jo04,95Ce03)
 G SD-3 band (89Jo04,95Ce03)
 H SD-4 band (95Ce03)
 I SD-5 band (95Ce03)
 J HD band? (93Ga10,95Vi02)

Levels and γ -ray branchings:

0, 7/2⁽⁻⁾, 6.4 1 h, $\mu = -0.782 6$, $Q = -0.02 5$, $\% \alpha = 0.0094 14$,
 $\% EC + \% \beta^+ = 99.9906 14$

108.7 1, (3/2⁻), 1.35 10 ns γ_0 108.72 (†,100) E2

270.6 1, (3/2⁻, 5/2⁻, 7/2⁻), <0.25 ns γ_{109} 161.52 (†,100 5) M1+E2
 γ_0 270.62 (†,100 5) E2

B 295.8 1, (9/2⁻) γ_0 295.81 (†,100) M1

365.9 2 γ_{271} 95.23 (†,3.3) γ_0 365.92 (†,100 17)

500.9, (-), <0.2 ns γ_{271} 230.21 (†,100 7) M1 γ_{109} 391.72 (†,22.5)

565.8 γ_{109} 456.82 (†,100 50) γ_0 565.52 (†,60 20)

577.0 3 γ_{109} 468.22 (†,88 13) γ_0 577.03 (†,100 19)

637.0 2, 11/2⁽⁻⁾ γ_{296} 341.0 γ_0 637.02 E2

688.5 2 γ_{296} 392.54 (†,9 4) γ_{109} 579.73 (†,22 9) γ_0 688.52 (†,100 7)

D 712.4, (13/2⁺) γ_{637} 75.6 (†,100) E1

830.0 4 γ_{712} 117.33 (†,40 20) γ_{689} 141.83 (†,100 30) γ_{637} 192.82

(†,60 20) γ_{577} 253.82 (†,50 10) γ_{109} 721.05 (†,20 10)

B 837.1, (13/2⁻) γ_{296} 541.24 (†,100) (E2)

1040.6, (11/2⁺) γ_{712} 328.1 γ_{637} 403.7

A 1067.8, (11/2⁻) γ_{296} 771.9 10 (†,100)

1092.0 5 γ_{689} 404.13 (†,50 25) γ_0 1091.85 (†,100 25)

D 1160.2, (17/2⁻), 11.6 12 ps γ_{712} 447.8 (†,100) E2

1189.7 6 γ_{637} 552.05 (†,100 50) γ_{296} 893.95 (†,75 25) γ_0 1189.98
 (†,100 50)

1272.8, (13/2, 15/2⁻) γ_{712} 560.43 (†,48 9) γ_{637} 636.0 (†,100 24)

1276.9 6, (9/2⁻) γ_{366} 910.44 (†,28 4) γ_{109} 1167.65 (†,32 4) γ_0 1276.54
 (†,100 8)

1304.1 γ_{637} 467.12 (†,36) γ_{712} 591.62 (†,100 27)

A 1321.2, (13/2⁻) γ_{1068} 253.1 (†,100)

1381.2 6 γ_{689} 693.05 (†,8 3) γ_{566} 815.55 (†,16 5) γ_{296} 1085.84 (†,100 8)
 γ_0 1381.06 (†,50 8)

B 1454.6, (17/2⁻) γ_{637} 617.55 (†,100) (E2)

1501.4 5 γ_{689} 812.15 (†,17 6) γ_{637} 864.05 (†,33 11) γ_{577} 924.04
 (†,100 17)

1521.6

1581.0 7 γ_{712} 868.65 (†,29 7) γ_{689} 893.95 (†,21 7) γ_{577} 1004.14
 (†,29 14) γ_{566} 1015.44 (†,100 14) γ_{296} 1284.88 (†,7 7)

A 1584.2, (15/2⁻) γ_{1321} 262.4 γ_{1068} 515

C 1601, (17/2⁻) γ_{1273} 328.1 γ_{1160} 440.7 γ_{1041} 560.4

D 1648.4, (21/2⁺), 7.1 6 ps γ_{1160} 488.2 (†,100) E2

1753.6

1822.6 γ_{1455} 366.7 (†,64 14) (E1) γ_{1304} 518.5 (†,100 21) γ_{1160} 662.45
 (†,36 7)

A 1861.4, (17/2⁻) γ_{1584} 277.55 γ_{1321} 540.1

1892 (?) γ_{1160} 731.8 10 (†,100)

1953.0

C 2042, (21/2⁻) γ_{1648} 393.7 γ_{1601} 441.3

A 2151.6, (19/2⁻) γ_{1861} 290.14 γ_{1584} 568.0

D 2180.7, (25/2⁺), 2.1 4 ps γ_{1648} 532.31 (†,100) E2

2194.8

2231 (?) γ_{1455} 776 (†,100)

2285.2 γ_{1892} 393.25 (†,33 11) γ_{1823} 462.44 (†,100 11) E2

A 2453.3, (21/2⁻) γ_{2152} 301.75 γ_{1861} 592

C 2523.2, (25/2⁻) γ_{2181} 342.1 γ_{2042} 480.8

2686.4 γ_{2285} 401.23 (†,100) (E2)

2746.4

D 2762.2, (29/2⁺) γ_{2181} 581.6 (†,100) E2

A 2763.0, (23/2⁻) γ_{2453} 309.7 γ_{2152} 612

C 3075.0, (29/2⁻) γ_{2523} 551.8 (†,100)

A 3079.5, (25/2⁻) γ_{2763} 316.5 γ_{2453} 626

3170 γ_{2523} 646.6 (†,100)

D 3389.1, (33/2⁺) γ_{2762} 627.2 (†,100) E2

3415.6

C 3744, (33/2⁻) γ_{3075} 668.9 (†,100)

3829 γ_{3389} 439.5 γ_{3170} 659.6

D 4063.1, (37/2⁺) γ_{3389} 674.0 4 (†,100) (E2)

4134 (?)

C 4461, (37/2⁻) γ_{3744} 717.6 (†,100)

4487 γ_{4063} 423.4 γ_{3829} 657.9

D 4783, (41/2⁺) γ_{4063} 719.0 (†,100)

5141 γ_{4783} 358.4 γ_{4487} 654.0 γ_{4461} 679.8

5207 γ_{4487} 720.3 (†,100)

C 5245, (41/2⁻) γ_{4487} 757.6 γ_{4461} 783.4

5378 γ_{5245} 133.3 M1 γ_{5207} 170.3 γ_{5141} 236.6

5591, 2.3 ns γ_{5378} 213.9 (†,100)

5761 γ_{5591} 169.3 (†,100)

6228 γ_{5591} 636.3 (†,100)

6718 γ_{5761} 957.7 (†,100)

7000 γ_{6718} 281.5 (†,100)

7065 γ_{6228} 837.4 (†,100)

7934 γ_{7065} 869.3 (†,100)

8030 γ_{7000} 1029.9 (†,100)

8452 γ_{7934} 518.0 (†,100)

8638 γ_{8030} 608.1 (†,100)

E x, J=(63/2)

E 721.4+x 5, J+2 γ_x 721.45 $I^{(1)}=90.1$, $I^{(2)}=89.9$, $\hbar\omega=0.372$

E 1487.3+x 6, J+4 γ_{721+x} 765.9 1 $I^{(1)}=90.1$, $I^{(2)}=89.5$, $\hbar\omega=0.394$

E 2297.9+x 6, J+6 γ_{1487+x} 810.6 1 (†,1.06 9) $I^{(1)}=90.0$, $I^{(2)}=89.3$, $\hbar\omega=0.417$

E 3153.3+x 6, J+8 γ_{2298+x} 855.4 1 (†,1.09 12) $I^{(1)}=90.0$, $I^{(2)}=89.3$, $\hbar\omega=0.439$

E 4053.5+x 6, J+10 γ_{3153+x} 900.2 1 (†,0.79 8) $I^{(1)}=89.9$, $I^{(2)}=88.5$, $\hbar\omega=0.461$

E 4998.9+x 6, J+12 γ_{4054+x} 945.4 1 (†,1.00 6) $I^{(1)}=89.9$, $I^{(2)}=87.5$, $\hbar\omega=0.484$

E 5990.0+x 6, J+14 γ_{4999+x} 991.1 1 (†,0.88 12) $I^{(1)}=89.7$, $I^{(2)}=87.3$,
 $\hbar\omega=0.507$

E 7026.9+x 6, J+16 γ_{5990+x} 1036.9 1 (†,1.09 6) $I^{(1)}=89.6$, $I^{(2)}=87.5$,
 $\hbar\omega=0.530$

E 8109.5+x 6, J+18 γ_{7027+x} 1082.6 1 (†,1.18 12) $I^{(1)}=89.5$, $I^{(2)}=86.0$,
 $\hbar\omega=0.553$

E 9238.6+x 6, J+20 γ_{8110+x} 1129.1 1 (†,1.03 12) $I^{(1)}=89.4$, $I^{(2)}=87.1$,
 $\hbar\omega=0.576$

E 10413.6+x 6, J+22 γ_{9239+x} 1175.0 1 (†,0.94 8) $I^{(1)}=89.3$, $I^{(2)}=85.5$,
 $\hbar\omega=0.599$

E 11635.4+x 6, J+24 $\gamma_{10414+x}$ 1221.8 1 (†,0.88 6) $I^{(1)}=89.2$, $I^{(2)}=86.0$,
 $\hbar\omega=0.623$

E 12903.7+x 6, J+26 $\gamma_{11635+x}$ 1268.3 1 (†,0.79 21) $I^{(1)}=89.0$, $I^{(2)}=84.7$,
 $\hbar\omega=0.646$

E 14219.2+x 7, J+28 $\gamma_{12904+x}$ 1315.5 1 (†,0.79 9) $I^{(1)}=88.9$, $I^{(2)}=86.0$,
 $\hbar\omega=0.669$

E 15581.2+x 7, J+30 $\gamma_{14219+x}$ 1362.0 2 (†,0.39 11) $I^{(1)}=88.8$, $I^{(2)}=85.8$,
 $\hbar\omega=0.693$

E 16989.8+x 7, J+32 $\gamma_{15581+x}$ 1408.6 2 (†,0.58 15) $I^{(1)}=88.7$, $I^{(2)}=85.7$,
 $\hbar\omega=0.716$

E 18445.1+x 7, J+34 $\gamma_{16990+x}$ 1455.3 2 $I^{(1)}=88.7$, $I^{(2)}=89.7$, $\hbar\omega=0.739$

E 19945.0+x 9, J+36 $\gamma_{18445+x}$ 1499.9 5

F y, J=(59/2)

F 678.6+y 5, J+2 γ_y 678.65 $I^{(1)}=89.8$, $I^{(2)}=87.1$, $\hbar\omega=0.351$

F 1403.1+y 6, J+4 γ_{678+y} 724.5 3 $I^{(1)}=89.6$, $I^{(2)}=86.8$, $\hbar\omega=0.374$

F 2173.7+y 6, J+6 γ_{1403+y} 770.6 1 $I^{(1)}=89.5$, $I^{(2)}=87.1$, $\hbar\omega=0.397$

F 2990.2+y 6, J+8 γ_{2174+y} 816.5 1 $I^{(1)}=89.3$, $I^{(2)}=85.8$, $\hbar\omega=0.420$

F 3853.3+y 6, J+10 γ_{2990+y} 863.1 1 (†,0.76 18) $I^{(1)}=89.1$, $I^{(2)}=84.6$

$\eta\omega=0.443$
 F 4763.7+y 6, J+12 γ_{3853+y} 910.41 ($\dagger_{\gamma}0.7921$) $I^{(1)}=88.9, I^{(2)}=84.7$,
 $\eta\omega=0.467$
 F 5721.3+y 6, J+14 γ_{4764+y} 957.62 ($I^{(1)}=88.7, I^{(2)}=86.2, \eta\omega=0.490$)
 F 6725.3+y 8, J+16 γ_{5721+y} 1004.04 ($I^{(1)}=88.5, I^{(2)}=82.5, \eta\omega=0.514$)
 F 7777.8+y 9, J+18 γ_{6725+y} 1052.54 ($\dagger_{\gamma}0.6114$) $I^{(1)}=88.3, I^{(2)}=84.2$,
 $\eta\omega=0.538$
 F 8877.8+y 9, J+20 γ_{7778+y} 1100.03 ($\dagger_{\gamma}0.6114$) $I^{(1)}=88.1, I^{(2)}=83.0$,
 $\eta\omega=0.562$
 F 10026.0+y 10, J+22 γ_{8878+y} 1148.23 ($\dagger_{\gamma}0.8518$) $I^{(1)}=87.9, I^{(2)}=82.6$,
 $\eta\omega=0.586$
 F 11222.6+y 10, J+24 $\gamma_{10026+y}$ 1196.64 ($\dagger_{\gamma}0.826$) $I^{(1)}=87.7, I^{(2)}=83.5$,
 $\eta\omega=0.610$
 F 12467.1+y 11, J+26 $\gamma_{11223+y}$ 1244.54 ($\dagger_{\gamma}0.9412$) $I^{(1)}=87.5, I^{(2)}=83.2$,
 $\eta\omega=0.634$
 F 13759.7+y 12, J+28 $\gamma_{12467+y}$ 1292.64 ($\dagger_{\gamma}0.9412$) $I^{(1)}=87.3, I^{(2)}=83.0$,
 $\eta\omega=0.658$
 F 15100.5+y 13, J+30 $\gamma_{13760+y}$ 1340.85 ($\dagger_{\gamma}0.3912$) $I^{(1)}=87.2, I^{(2)}=83.3$,
 $\eta\omega=0.682$
 F 16489.3+y 14, J+32 $\gamma_{15101+y}$ 1388.86 ($\dagger_{\gamma}0.559$) $I^{(1)}=87.0, I^{(2)}=81.6$,
 $\eta\omega=0.707$
 F 17927.1+y 16, J+34 $\gamma_{16489+y}$ 1437.87 ($I^{(1)}=86.9, I^{(2)}=84.2, \eta\omega=0.731$)
 F 19412.4+y 18, J+36 $\gamma_{17927+y}$ 1485.38
 G z, J=(61/2)
 G 702.0+z 5, J+2 γ_z 702.05 ($I^{(1)}=89.7, I^{(2)}=87.5, \eta\omega=0.362$)
 G 1449.7+z 6, J+4 γ_{702+z} 747.73 ($I^{(1)}=89.5, I^{(2)}=86.6, \eta\omega=0.385$)
 G 2243.6+z 7, J+6 γ_{1450+z} 793.93 ($I^{(1)}=89.4, I^{(2)}=87.0, \eta\omega=0.408$)
 G 3083.5+z 7, J+8 γ_{2244+z} 839.92 ($I^{(1)}=89.2, I^{(2)}=85.3, \eta\omega=0.432$)
 G 3970.3+z 7, J+10 γ_{3084+z} 886.82 ($\dagger_{\gamma}0.369$) $I^{(1)}=89.0, I^{(2)}=84.7, \eta\omega=0.455$
 G 4904.3+z 8, J+12 γ_{3970+z} 934.03 ($\dagger_{\gamma}0.4514$) $I^{(1)}=88.8, I^{(2)}=85.1, \eta\omega=0.479$
 G 5885.3+z 9, J+14 γ_{4904+z} 981.04 ($\dagger_{\gamma}0.456$) $I^{(1)}=88.6, I^{(2)}=84.2, \eta\omega=0.502$
 G 6913.8+z 10, J+16 γ_{5885+z} 1028.54 ($\dagger_{\gamma}0.459$) $I^{(1)}=88.4, I^{(2)}=83.7$,
 $\eta\omega=0.526$
 G 7990.1+z 10, J+18 γ_{6914+z} 1076.33 ($\dagger_{\gamma}0.559$) $I^{(1)}=88.2, I^{(2)}=84.0$,
 $\eta\omega=0.550$
 G 9114.0+z 11, J+20 γ_{7990+z} 1123.94 ($\dagger_{\gamma}0.559$) $I^{(1)}=88.0, I^{(2)}=82.1$,
 $\eta\omega=0.574$
 G 10286.6+z 12, J+22 γ_{9114+z} 1172.64 ($\dagger_{\gamma}0.399$) $I^{(1)}=87.8, I^{(2)}=84.0$,
 $\eta\omega=0.598$
 G 11506.8+z 12, J+24 $\gamma_{10287+z}$ 1220.24 ($\dagger_{\gamma}0.2417$) $I^{(1)}=87.6, I^{(2)}=83.5$,
 $\eta\omega=0.622$
 G 12774.9+z 13, J+26 $\gamma_{11507+z}$ 1268.15 ($\dagger_{\gamma}0.219$) $I^{(1)}=87.5, I^{(2)}=83.2$,
 $\eta\omega=0.646$
 G 14091.1+z 14, J+28 $\gamma_{12775+z}$ 1316.25 ($\dagger_{\gamma}0.6417$) $I^{(1)}=87.3, I^{(2)}=84.2$,
 $\eta\omega=0.670$
 G 15454.8+z 15, J+30 $\gamma_{14091+z}$ 1363.76 ($\dagger_{\gamma}0.276$) $I^{(1)}=87.2, I^{(2)}=81.8$,
 $\eta\omega=0.694$
 G 16867.4+z 17, J+32 $\gamma_{15455+z}$ 1412.67 ($\dagger_{\gamma}0.369$) $I^{(1)}=87.0, I^{(2)}=83.7$,
 $\eta\omega=0.718$
 G 18327.8+z 19, J+34 $\gamma_{16867+z}$ 1460.49

H u, J=(59/2)
 H 723.4+u 15, J+2 γ_0 723.415 ($I^{(1)}=84.5, I^{(2)}=91.5, \eta\omega=0.373$)
 H 1490.5+u 16, J+4 γ_{723+u} 767.15 ($I^{(1)}=84.8, I^{(2)}=86.8, \eta\omega=0.395$)
 H 2303.7+u 18, J+6 γ_{1491+u} 813.28 ($I^{(1)}=84.9, I^{(2)}=88.5, \eta\omega=0.418$)
 H 3162.1+u 19, J+8 γ_{2304+u} 858.46 ($I^{(1)}=85.1, I^{(2)}=86.2, \eta\omega=0.441$)
 H 4066.9+u 20, J+10 γ_{3162+u} 904.87 ($I^{(1)}=85.0, I^{(2)}=82.6, \eta\omega=0.465$)
 H 5020.1+u 21, J+12 γ_{4067+u} 953.27 ($I^{(1)}=85.0, I^{(2)}=87.3, \eta\omega=0.488$)
 H 6019.1+u 22, J+14 γ_{5020+u} 999.07 ($I^{(1)}=85.1, I^{(2)}=85.7, \eta\omega=0.511$)
 H 7064.8+u 23, J+16 γ_{6019+u} 1045.76 ($I^{(1)}=85.1, I^{(2)}=84.9, \eta\omega=0.535$)
 H 8157.6+u 24, J+18 γ_{7065+u} 1092.88 ($I^{(1)}=85.1, I^{(2)}=84.2, \eta\omega=0.558$)
 H 9298+u 3, J+20 γ_{8158+u} 1140.313 ($I^{(1)}=85.0, I^{(2)}=83.3, \eta\omega=0.582$)
 H 10486+u 3, J+22 γ_{9298+u} 1188.312 ($I^{(1)}=85.0, I^{(2)}=85.8, \eta\omega=0.606$)
 H 11721+u 3, J+24 $\gamma_{10486+u}$ 1234.912 ($I^{(1)}=84.9, I^{(2)}=80.2, \eta\omega=0.630$)
 H 13006+u 3, J+26 $\gamma_{11721+u}$ 1284.813 ($I^{(1)}=84.9, I^{(2)}=85.8, \eta\omega=0.654$)
 H 14337+u 4, J+28 $\gamma_{13006+u}$ 1331.414 ($I^{(1)}=84.8, I^{(2)}=81.0, \eta\omega=0.678$)
 H 15718+u 4, J+30 $\gamma_{14337+u}$ 1380.813 ($I^{(1)}=84.7, I^{(2)}=84.2, \eta\omega=0.702$)
 H 17146+u 4, J+32 $\gamma_{15718+u}$ 1428.319
 I v, J=(65/2)
 I 743.2+v 15, J+2 γ_0 743.215 ($I^{(1)}=90.0, I^{(2)}=85.8, \eta\omega=0.383$)
 I 1533.0+v 16, J+4 γ_{743+v} 789.86 ($I^{(1)}=89.8, I^{(2)}=87.3, \eta\omega=0.406$)
 I 2368.6+v 18, J+6 γ_{1533+v} 835.67 ($I^{(1)}=89.7, I^{(2)}=87.3, \eta\omega=0.429$)
 I 3250.0+v 19, J+8 γ_{2369+v} 881.47 ($I^{(1)}=89.5, I^{(2)}=86.4, \eta\omega=0.452$)
 I 4177.7+v 21, J+10 γ_{3250+v} 927.78 ($I^{(1)}=89.4, I^{(2)}=86.0, \eta\omega=0.475$)
 I 5151.9+v 21, J+12 γ_{4178+v} 974.26 ($I^{(1)}=89.1, I^{(2)}=82.0, \eta\omega=0.499$)
 I 6174.9+v 23, J+14 γ_{5152+v} 1023.09 ($I^{(1)}=88.9, I^{(2)}=87.3, \eta\omega=0.523$)
 I 7243.7+v 24, J+16 γ_{6175+v} 1068.85 ($I^{(1)}=88.8, I^{(2)}=83.9, \eta\omega=0.546$)
 I 8360.2+v 24, J+18 γ_{7244+v} 1116.56 ($I^{(1)}=88.6, I^{(2)}=83.5, \eta\omega=0.570$)
 I 9524.6+v 25, J+20 γ_{8360+v} 1164.47 ($I^{(1)}=88.3, I^{(2)}=83.0, \eta\omega=0.594$)
 I 10737+v 3, J+22 γ_{9525+v} 1212.68 ($I^{(1)}=88.1, I^{(2)}=82.8, \eta\omega=0.618$)
 I 11998+v 3, J+24 $\gamma_{10737+v}$ 1260.97 ($I^{(1)}=88.0, I^{(2)}=85.7, \eta\omega=0.642$)
 I 13306+v 3, J+26 $\gamma_{11998+v}$ 1307.67 ($I^{(1)}=87.9, I^{(2)}=83.9, \eta\omega=0.666$)
 I 14661+v 3, J+28 $\gamma_{13306+v}$ 1355.310 ($I^{(1)}=87.7, I^{(2)}=82.8, \eta\omega=0.690$)
 I 16065+v 3, J+30 $\gamma_{14661+v}$ 1403.613 ($I^{(1)}=87.5, I^{(2)}=82.3, \eta\omega=0.714$)
 I 17517+v 3, J+32 $\gamma_{16065+v}$ 1452.214
 J w

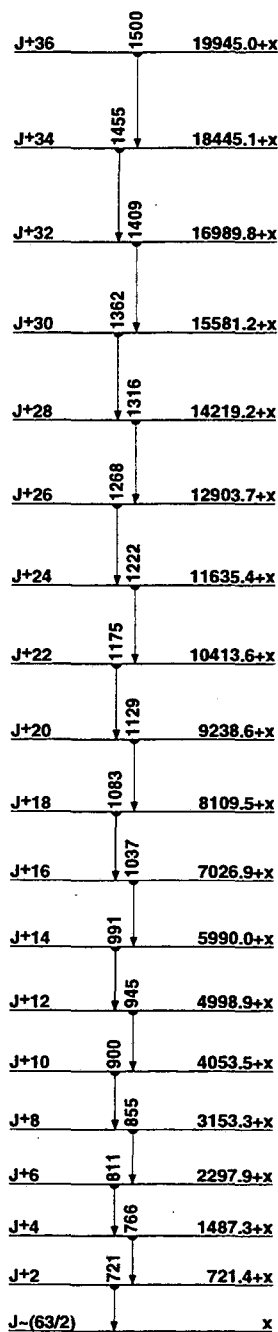

SD-1 band
(89Jo04,95Ce03)

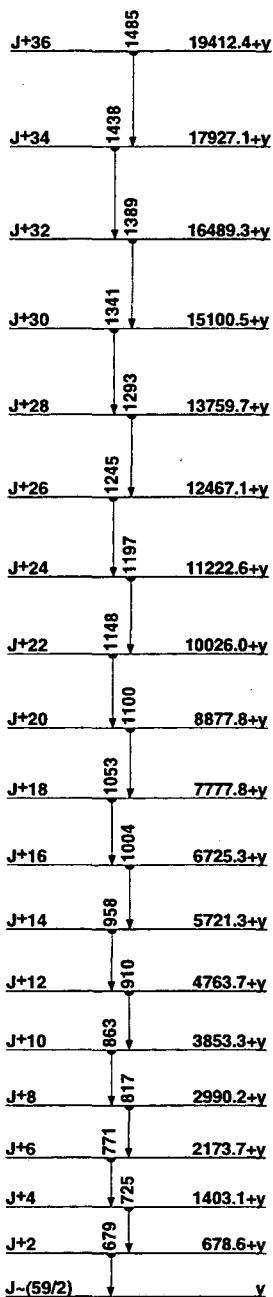

SD-2 band
(89Jo04,95Ce03)

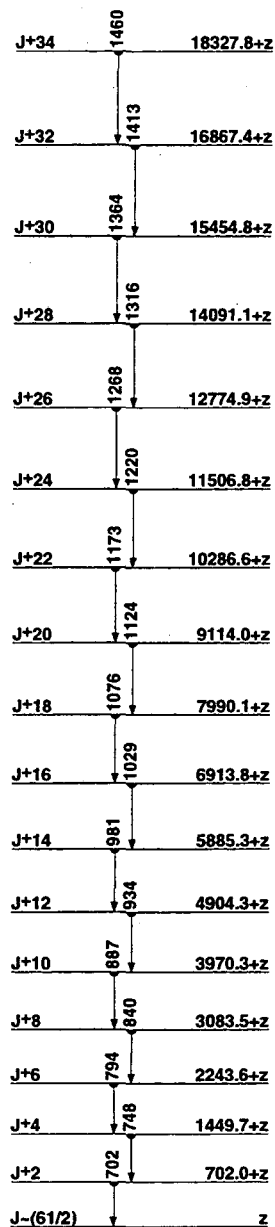

SD-3 band
(89Jo04,95Ce03)

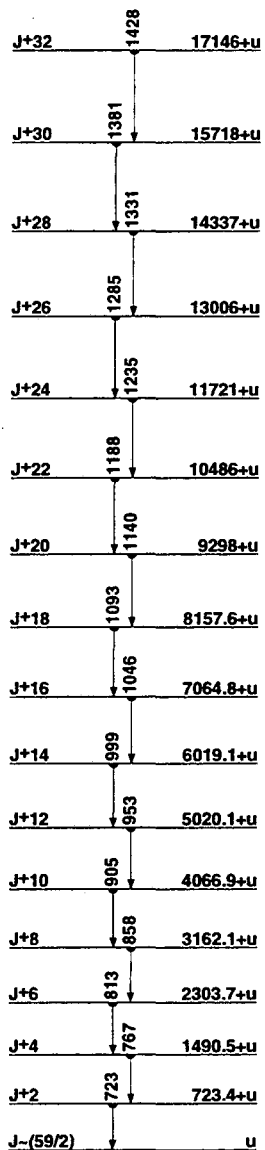

SD-4 band
(95Ce03)

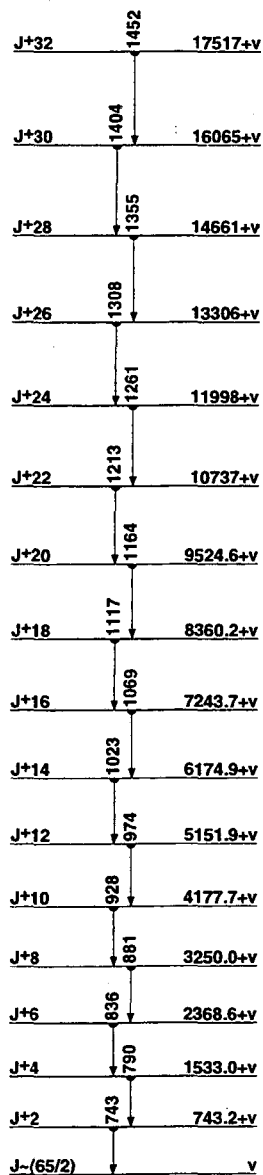

SD-5 band
(95Ce03)

¹⁵³₆₆Dy

**154
66 Dy**

Δ : -70400 g S_n : 93209 S_p : 63679 Q_α : 29475

Nuclear Bands

- A GS band
- B β band
- C γ band
- D Band Structure
- E Octupole band
- F Band Structure
- G Band Structure
- H Band Structure
- I SD band (95Ni03)

Levels and γ -ray branchings:

- A 0, 0⁺, 3.0x10⁵ 15 y, % α =100
- A 334.58 8, 2⁺, 27.520 ps γ_0 334.61 (t_{1/2} 100) E2
- B 660.82 12, 0⁺ γ_{335} 326.23 (t_{1/2} 100 16) γ_0 660.82 (t_{1/2} 9.55) E0
- A 747.04 12, 4⁺, 6.95 ps γ_{335} 412.41 (t_{1/2} 100) E2
- B 905.19 12, 2⁺ γ_{661} 244.24 (t_{1/2} 3.8 11) γ_{335} 570.2 (t_{1/2} 100.5) E0+E2, M1
 γ_0 905.22 (t_{1/2} 19.7 18)
- C 1027.11 12, 2⁺ γ_{661} 366.23 (t_{1/2} 18.7 24) γ_{335} 692.52 (t_{1/2} 90.6) M1
 γ_0 1027.12 (t_{1/2} 100.6)
- D 1058.08 18, 0⁺ γ_{905} 152.73 (t_{1/2} 100 17) γ_{661} 397.32 (t_{1/2} 244 15) E0
 γ_{335} 723.65 (t_{1/2} 34 17) γ_0 1058.46 (t_{1/2} 5.8 17) E0
- E 1208.02 12, 3⁻ γ_{747} 460.93 (t_{1/2} 7.4 7) γ_{335} 873.41 (t_{1/2} 100 7) E1
- A 1224.08 16, 6⁺, 2.4 4 ps γ_{747} 477.11 (t_{1/2} 100) E2
- B 1251.86 18, 4⁺ γ_{905} 346.63 (t_{1/2} 6.7 7) E2 γ_{747} 504.93 (t_{1/2} 100 10) E0+E2, M1
- C 1334.31 17, 3⁺ γ_{905} 429.14 (t_{1/2} 14.3) γ_{747} 587.43 (t_{1/2} 24.3 26) γ_{335} 999.72 (t_{1/2} 100.6)
- D 1390.30 15, 2⁺ γ_{1208} 182.04 (t_{1/2} 52 10) γ_{1027} 363.44 (t_{1/2} 29 14) γ_{905} 485.33 (t_{1/2} 45 7) E0+E2, M1 γ_{747} 642.84 (t_{1/2} 37 17) γ_{661} 729.73 (t_{1/2} 100.8)
 γ_{335} 1055.83 (t_{1/2} 78 10) E0+E2, M1 γ_0 1390.04 (t_{1/2} 40.9)
- E 1420.39 20, 1⁻ γ_{905} 515.24 (t_{1/2} 20.8) γ_{335} 1085.93 (t_{1/2} 80.7) γ_0 1420.33 (t_{1/2} 100 10)
- C 1442.67 23, 4⁺ γ_{1027} 415.84 (t_{1/2} 37.9) γ_{747} 695.53 (t_{1/2} 100.9) M1(+E2)
 γ_{335} 1108.04 (t_{1/2} 62 16)
- F 1507.65 15, 2⁺ γ_{1027} 480.04 (t_{1/2} 12.5) γ_{905} 602.94 (t_{1/2} 17.5) γ_{661} 846.63 (t_{1/2} 53.5) γ_{335} 1173.22 (t_{1/2} 100.9) γ_0 1507.64 (t_{1/2} 42.9)
- E 1546.0 4, 5⁻ γ_{747} 799.03 (t_{1/2} 100)
- G 1635.19 22, 2⁻ γ_{335} 1300.62 (t_{1/2} 100)
- B 1658.76 17, 6⁺ γ_{1252} 406.91 (t_{1/2} 100.7) E2 γ_{1224} 434.72 (t_{1/2} 13.4 15) E2+E0(+M1)
- C 1739.98 19, 5⁺ γ_{1334} 405.84 (t_{1/2} 58.9) γ_{1224} 515.63 (t_{1/2} 38.6) γ_{747} 992.93 (t_{1/2} 100.9)
- A 1747.82 17, 8⁺, 1.5 3 ps γ_{1224} 523.81 (t_{1/2} 100) E2
- F 1781.9 4, (3⁺) γ_{1027} 755.15 (t_{1/2} 100.20) γ_{335} 1447.14 (t_{1/2} 91.20)
- G 1819.1 3, (4⁻) γ_{1208} 610.65 (t_{1/2} 30.14) γ_{747} 1072.23 (t_{1/2} 100 13)
1832.9 4 γ_{335} 1498.33 (t_{1/2} 100)
1844.9 4 γ_{335} 1510.33 (t_{1/2} 100)
1877.2 4 γ_{335} 1542.75 (t_{1/2} 100 13) γ_0 1877.16 (t_{1/2} 52 13)
- C 1885.5 3, (6⁺) γ_{1224} 661.53 (t_{1/2} 100.26) M1, E2 γ_{747} 1138.53 (t_{1/2} 53 11)
- G 1903.8 3, (3⁻) γ_{1334} 569.1 (t_{1/2} 100.5) γ_{1027} 876.63 (t_{1/2} 5.4 8) γ_{747} 1156.84 (t_{1/2} 4.3 21)
1958.3 5 γ_{335} 1623.75 (t_{1/2} 100)
- E 1964.7 3, 7⁻ γ_{1224} 740.62 (t_{1/2} 100)
1991.1 4 γ_{335} 1656.53 (t_{1/2} 100)
2148.4 5 γ_{335} 1813.85 (t_{1/2} 100)
- B 2163.4 3, 8⁺ γ_{1659} 504.74 (t_{1/2} 100)
2168.7 4 γ_{335} 1834.14 (t_{1/2} 100)
2178.2 3 γ_{747} 1431.03 (t_{1/2} 100 19) γ_{335} 1843.85 (t_{1/2} 90 19)
- C 2183.45 24, 7⁺ γ_{1740} 443.32 (t_{1/2} 100.7) E2 γ_{1224} 959.13 (t_{1/2} 47.5)
 γ_{335} 1849.34 (t_{1/2} 100 13)
2192.4 4, (7, 8) γ_{1224} 968.33 (t_{1/2} 100)
2249.6 5 γ_{747} 1502.54 (t_{1/2} 100)
2271.92 25 γ_{1027} 1244.63 (t_{1/2} 55 14) γ_{661} 1611.25 (t_{1/2} 51 21) γ_{335} 1937.85

- (t_{1/2} 100 21)
- A 2304.3, 10⁺, 1.1 3 ps γ_{1748} 556.9 (t_{1/2} 100) E2
2344.9 6 γ_{335} 2010.36 (t_{1/2} 100)
- E 2421.2, 9⁻ γ_{1865} 456.9 γ_{1748} 673.84 D
2472.87 17, 7⁺ γ_{2182} 280.4 (t_{1/2} 7.4 11) γ_{2183} 289.42 (t_{1/2} 27.5 21) E0+M1, E2
 γ_{2163} 309.52 (t_{1/2} 21.7 16) M1 γ_{1885} 587.33 (t_{1/2} 6.9 11) γ_{1748} 725.11 (t_{1/2} 70.4) M1+E2 γ_{1740} 732.82 (t_{1/2} 17.5 16) γ_{1659} 814.11 (t_{1/2} 79.5) M1+E2
 γ_{1224} 1248.82 (t_{1/2} 100.5) M1
2493.3 γ_{1991} 434
- B 2758.4 11, (10⁺) γ_{2163} 596.08
- E 2882.3, 11⁻, 4.5 3 ps γ_{2421} 461.1 (t_{1/2} 44.3) E2 γ_{2304} 577.9 (t_{1/2} 100.4) D
- A 2892.6, 12⁺, 0.94 19 ps γ_{2304} 588.5 E2
2900.7, 12⁺ γ_{2304} 596.4
- E 3390.5, 13⁻, 1.7 ps γ_{2893} 497.9 (t_{1/2} 31.2) D γ_{2882} 508.1 (t_{1/2} 100.3) E2
- A 3508.6, 14⁺, 0.55 10 ps γ_{2893} 616.1 E2
- H 3679.4, 14⁺ γ_{2893} 786.8
- E 3982.6, 15⁺, 3.0 ps γ_{3509} 474.0 D γ_{3391} 592.0 E2
- H 4090.4, 16⁺, 1.3 5 ps γ_{3679} 411.0 γ_{3509} 581.8 E2
- A 4172.7, 16⁺ γ_{3679} 493.3(?) γ_{3509} 664.1 E2
- H 4636.9, 18⁺, 0.76 17 ps γ_{4090} 546.5 E2
- E 4642.5, 17⁻, 1.3₆⁺¹⁰ ps γ_{3983} 659.8 E2
- A 4868.6, 18⁺ γ_{4173} 695.9 γ_{4090} 778(?)
- H 5249.0, 20⁺, 0.62 9 ps γ_{4637} 612.2 E2
- E 5339.0, 19⁻ γ_{4643} 696.4 E2
- A 5589.9, 20⁺ γ_{4869} 721.3
- H 5934.2, 22⁺, 0.38 ps γ_{5249} 685.2 E2
- E 6035.8, 21⁻ γ_{5339} 696.7 E2
6181.9, 21⁻ γ_{5339} 842.9
- A 6349.9, 22⁺ γ_{5590} 760.0
- H 6690.0, 24⁺, 0.2 ps γ_{6834} 755.8 E2
- E 6754.5, 23⁻ γ_{6036} 718.7 E2
6805.4, 23⁻ γ_{6182} 623.4 γ_{6036} 769.5 γ_{5834} 871.3
- A 7160.7, 24⁺ γ_{6350} 810.8
7374.8, 24⁺ γ_{6690} 684.8
- H 7513.0, 26⁺, 0.2₂⁺⁴ ps γ_{6690} 823.0 E2
- E 7519.7, 25⁻ γ_{6755} 765.2 E2
7772 γ_{6805} 967
- A 8027.5, 26⁺ γ_{7161} 866.8
8138.3, 26⁺ γ_{7513} 625.6 γ_{7375} 763.2
8281.5, (27⁻) γ_{7772} 508.4(?) γ_{7520} 761.8
- E 8335.9, 27⁻ γ_{7520} 816.2 E2
- H 8400.3, 28⁺, 0.15 ps γ_{7513} 887.3 E2
- A 8723.4, 28⁺ γ_{8028} 695.9
8797.9
8916.1, 28⁺ γ_{8400} 516.0 γ_{8138} 777.6
9188.9, 29⁻ γ_{8336} 853.3 (E2) γ_{8282} 907.1
- E 9218.1, 29⁻ γ_{6336} 882.2 E2
- H 9349.6, 30⁺ γ_{8400} 949.3 E2
9566.6, 30⁺ γ_{8916} 650.5 γ_{8798} 768.7
9646.4, (30⁺) γ_{8723} 923.0
- A 9668.1, 30⁺ γ_{8723} 944.7
9693.9, 30⁺ γ_{8916} 777.8
10108.0, 31⁻ γ_{9218} 890.2 γ_{9189} 918.8
- E 10156.5, 31⁻ γ_{9218} 938.4 E2
10227.0, (31⁻) γ_{9218} 1008.9
10307.9
10358.4, 32⁺ γ_{9350} 1008.8 E2
- H 10384.0, 32⁺ γ_{9567} 817.1 (t_{1/2} =26) γ_{9350} 1034.6 (t_{1/2} 100.4) E2
- A 10446.0, 32⁺ γ_{9668} 777.9
10566.5, 32⁺ γ_{9634} 872.6
10628.9 γ_{9646} 982.5

11082.5, 33⁻ γ_{10308} 774.6 γ_{10157} 926.0 γ_{10108} 974.5 E2
H 11119.8, 34⁺ γ_{10384} 735.8 E2 γ_{10358} 761.5
E 11148.1, (33⁻) γ_{10157} 991.6 E2
A 11318.7, 34⁺ γ_{10629} 690.0(?) γ_{10567} 751.9 γ_{10446} 872.8 γ_{10384} 934.8
 γ_{10358} 960.2
11605(?), 34(?) γ_{11083} 523(?)
11829.8, 35⁻ γ_{11605} 224(?) (D) γ_{11083} 747.3 (E2)
11916.4, 35 γ_{11083} 833.9
H 11924.6, 36⁺ γ_{11319} 605.8 γ_{11120} 805.0 E2
E 12063.8, (35) γ_{11830} 234 (D)
12064, 36(?) γ_{11148} 915.7
A 12213.0, 36⁺ γ_{11319} 894.3
12408.9, 36⁺ γ_{11925} 483.8 γ_{11319} 1090.3 γ_{11120} 1289.5
12540.7, 37 $\gamma_{12063.8}$ 476 γ_{11830} 710.9 E2
12773.5, (37,38) γ_{11925} 848.9
12813, 38(?) γ_{12541} 272 (D)
13056.6(?) γ_{12213} 843.6(?)
H 13256.6, 38⁺, 0.84 ps γ_{12409} 847.8 γ_{11925} 1332.0 E2
13311.5, 39⁻ γ_{12813} 498 γ_{12541} 770.8 E2
13402.9, (39) γ_{12541} 862.2
13877, (40) γ_{12813} 1063.8
14012.3, 41⁻ γ_{13312} 700.8
H 14134.4, 40⁺, 0.83 ps γ_{13257} 877.8 E2
14467.8 γ_{13257} 1211.2
14728.2, (42,43) γ_{14012} 715.9
H 14884.7, 42⁺, 1.14 ps γ_{14134} 750.3 E2
15944.7(?) γ_{14468} 1476.9(?)
H 16010.5, 44⁺, 0.166 ps γ_{14885} 1125.8 E2
16357 γ_{14885} 1472
H 17321.6, 46⁺, 0.084 ps γ_{16011} 1311.1
H 18620.4, 48⁺, <0.11 ps γ_{17322} 1298.8
18733(?) γ_{17322} 1411(?)
I x, J
I 701.7+x, J+2 $\gamma_{701.7}$ 1.70 (\dagger 0.20 5) $I^{(2)}=84.6$, $\hbar\omega=0.363$
I 1450.7+x, J+4 γ_{702+x} 749.03 (\dagger 0.30 5) $I^{(2)}=88.1$, $\hbar\omega=0.386$
I 2245.1+x, J+6 γ_{1451+x} 794.42 (\dagger 0.67 8) $I^{(2)}=86.6$, $\hbar\omega=0.409$
I 3085.7+x, J+8 γ_{2245+x} 840.62 (\dagger 0.95 15) $I^{(2)}=85.5$, $\hbar\omega=0.432$
I 3973.1+x, J+10 γ_{3085+x} 887.42 (\dagger 1.10 20) $I^{(2)}=86.8$, $\hbar\omega=0.455$
I 4906.6+x, J+12 γ_{3973+x} 933.52 (\dagger 1.02 15) $I^{(2)}=84.0$, $\hbar\omega=0.479$
I 5887.7+x, J+14 γ_{4907+x} 981.11 (\dagger 1.00 15) $I^{(2)}=84.9$, $\hbar\omega=0.502$
I 6915.9+x, J+16 γ_{5888+x} 1028.22 (\dagger 1.07 15) $I^{(2)}=84.0$, $\hbar\omega=0.526$
I 7991.7+x, J+18 γ_{6916+x} 1075.82 (\dagger 1.10 12) $I^{(2)}=83.3$, $\hbar\omega=0.550$
I 9115.5+x, J+20 γ_{7992+x} 1123.82 (\dagger 1.05 17) $I^{(2)}=84.6$, $\hbar\omega=0.574$
I 10286.6+x, J+22 γ_{9116+x} 1171.12 (\dagger 0.90 10) $I^{(2)}=84.0$, $\hbar\omega=0.597$
I 11505.3+x, J+24 $\gamma_{10287+x}$ 1218.72 (\dagger 0.65 8) $I^{(2)}=83.3$, $\hbar\omega=0.621$
I 12772.0+x, J+26 $\gamma_{11505+x}$ 1266.72 (\dagger 0.45 7) $I^{(2)}=82.6$, $\hbar\omega=0.645$
I 14087.1+x, J+28 $\gamma_{12772+x}$ 1315.12 (\dagger 0.40 10) $I^{(2)}=85.5$, $\hbar\omega=0.669$
I 15449.0+x, J+30 $\gamma_{14087+x}$ 1361.93 (\dagger 0.30 7) $I^{(2)}=82.8$, $\hbar\omega=0.693$
I 16859.2+x, J+32 $\gamma_{15449+x}$ 1410.25 (\dagger 0.25 5) $I^{(2)}=84.6$, $\hbar\omega=0.717$
I 18316.7+x, J+34 $\gamma_{16859+x}$ 1457.56 (\dagger 0.17 7) $I^{(2)}=86.6$, $\hbar\omega=0.740$
I 19820.4+x, J+36 $\gamma_{18317+x}$ 1503.77

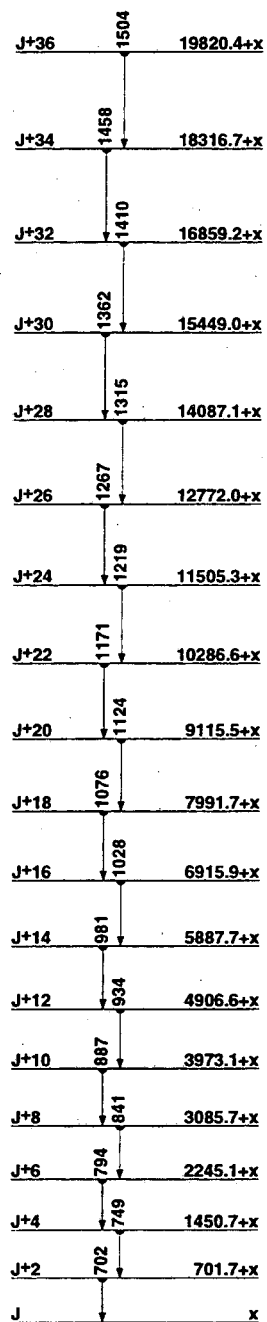

SD band
(95Ni03)
154Dy
66

154Er
68

Δ : -62617 6 S_n : 10229 12 S_p : 4883 8 Q_{EC} : 2032 10 Q_α : 4280 3

Nuclear Bands

- A Band Structure
- B Band Structure
- C SD band (95Be36)

Levels and γ -ray branchings:

- A 0, 0⁺, 3.73 9 m, $\% \alpha = 0.47$ 13, $\% EC + \% \beta^+ = 99.53$ 13
- A 560.0, 2⁺ $\gamma_{560.0}$ (†,100) E2
- A 1162.3, 4⁺ γ_{560} 601.3 (†,100) E2
- A 1786.6⁺ γ_{1162} 625 (†,100) E2
- B 1896.5⁻ γ_{1162} 735 (†,100) D
- A 2328.8⁺ γ_{1786} 542.0 (†,100) E2
- B 2461.7⁻ γ_{1896} 565.0 (†,16) γ_{1786} 674.5 (†,100) D
- 2582.8⁺ γ_{2328} 253.8 (†,33) D γ_{1786} 795.9 (†,100) E2
- B 3014.9⁻ γ_{2582} 432.2 (†,100) γ_{2461} 553.8 (†,85) γ_{2328} 686.3 (†,65)
- A 3016.10⁺ γ_{2328} 687.8 (†,100)
- B 3025.11⁻, 39 4 ns, $\mu = +0.169$ 13 γ_{3016} 9 γ_{3014} 11
- A 3655.12⁺ γ_{3016} 638.5 (†,100) E2
- B 3830.13⁻ γ_{3025} 805.0 (†,100) E2
- A 4274.14⁺ γ_{3655} 619.5 (†,100) E2
- B 4499.15⁻ γ_{3830} 668.8 (†,100) E2
- 4531. (15⁻) γ_{4274} 256.8 (†,100) D
- A 4678.16⁺ γ_{4531} 146.7 (†,33) D γ_{4274} 403.5 (†,100) E2
- B 5006.17⁻ γ_{4499} 506.9 (†,100) E2
- A 5328.18⁺ γ_{4678} 650.8 (†,100) E2
- B 5462.19⁻ γ_{5328} 134.1 (†,1.8) D γ_{5006} 455.6 (†,100) E2
- A 6063.20⁺ γ_{5328} 735 (†,100) E2
- 6087. (20⁻) γ_{5462} 625 (†,100) D
- B 6289.21⁻ γ_{6087} 202.2 (†,69) M1+E2 γ_{5462} 827.5 (†,100) E2
- 6575. (21⁻) γ_{5462} 1113.7 (†,100) E2
- A 6745.22⁺ γ_{6063} 682.0 (†,100) D
- B 7015.23⁻ γ_{6745} 270.7 (†,2.1) D γ_{6575} 441.0 (†,5) E2 γ_{6289} 726.7 (†,100) E2
- B 7334.25⁻ γ_{7015} 318.3 (†,100) E2
- 8009. (26⁻) γ_{7334} 675.5 (†,100) M1+E2
- B 8106.27⁻ γ_{8009} 97.0 (†,27) D γ_{7334} 772.6 (†,100) E2
- 8310. (26⁺) γ_{7334} 976.3 (†,100) D
- 8658. (27⁺) γ_{8310} 347.4 (†,88) D γ_{8009} 647.8 (†,100) D
- 8669. (28⁺) γ_{8310} 359.0 (†,2) γ_{8106} 562.9 (†,100) E1
- 9294. (29⁺) γ_{8669} 625 (†,100) D
- B 9475.29⁻ γ_{8106} 1368.8 (†,100) E2
- 9480. (29⁺) γ_{8669} 811.4 (†,100) D
- 9589. (30⁺) γ_{9480} 108.5 (†,12) D γ_{9475} 113.8 (†,2) γ_{9294} 294.5 (†,100) M1+E2 γ_{8669} 919.7 (†,90) E2
- 9843. (30⁺) γ_{9480} 362.7 (†,100)
- B 10108.31⁻ γ_{9843} 265.0 (†,42) D γ_{9589} 518.8 (†,38) D γ_{9475} 632.8 (†,100) E2
- 10150. (32⁺) γ_{9843} 307.1 (†,14) E2 γ_{9589} 561.1 (†,100) E2
- B 10429.33⁻ γ_{10150} 279.2 (†,100) D γ_{10108} 321.3 (†,24) E2
- 11354. (34) γ_{10429} 924.5 (†,100) D
- 11504 (?), (35) γ_{11354} 150.0 (†,100) D
- 11621. (34⁺) γ_{10429} 1192.3 (†,100) D γ_{10150} 1471 (†,30)
- 11660. (34⁺) γ_{10429} 1231.5 (†,100) D
- 11889. (35) γ_{11621} 267.6 (†,100) D
- 11897. (36⁺) γ_{11660} 236.2 (†,11) E2 γ_{11621} 275.2 (†,5) γ_{11504} 393.6 (†,100) M1+E2
- 13209. (37) γ_{11897} 1313.0 (†,100) D
- 13500. (38) γ_{11897} 1603.5 (†,100) E2
- 13950 (?), (40) γ_{13500} 450.1 (†,100)
- 14000. (38) γ_{13500} 500.0 (†,100) D γ_{11897} 2103.5 (†,38) E2

- 14269. (39) γ_{14000} 268.7 (†,100.5) D
- 14382. (39) γ_{13209} 1172.5 (†,100) E2
- 14676. (39) γ_{13209} 1466.3 (†,100) E2
- 14921. (41) γ_{14269} 652.5 (†,100) E2
- 16030. (42) γ_{14921} 1108.5 (†,100) D

C x, J=(26)

- C 695.1+x, J+2 γ_x 695.0625(?) (†,0.21 5) $I^{(1)}=78.4, I^{(2)}=102.0, \hbar\omega=0.357$
- C 1429.3+x, J+4 γ_{695+x} 734.2623 (†,1.00 8) $I^{(1)}=79.4, I^{(2)}=94.2, \hbar\omega=0.378$
- C 2206.1+x, J+6 γ_{1429+x} 776.7322 (†,0.98 8) $I^{(1)}=80.0, I^{(2)}=84.5, \hbar\omega=0.400$
- C 3030.1+x, J+8 γ_{2206+x} 824.0921 (†,0.96 9) $I^{(1)}=80.0, I^{(2)}=78.6, \hbar\omega=0.425$
- C 3905.1+x, J+10 γ_{3030+x} 874.9523 (†,0.68 7) $I^{(1)}=79.9, I^{(2)}=76.1, \hbar\omega=0.451$
- C 4832.6+x, J+12 γ_{3905+x} 927.5126 (†,0.76 7) $I^{(1)}=79.6, I^{(2)}=74.8, \hbar\omega=0.477$
- C 5813.6+x, J+14 γ_{4833+x} 981.04 (†,0.73 7) $I^{(1)}=79.5, I^{(2)}=78.2, \hbar\omega=0.503$
- C 6845.7+x, J+16 γ_{5814+x} 1032.1420 (†,0.71 9) $I^{(1)}=79.3, I^{(2)}=75.3, \hbar\omega=0.529$
- C 7931.0+x, J+18 γ_{6846+x} 1085.2422 (†,0.71 8) $I^{(1)}=79.2, I^{(2)}=76.0, \hbar\omega=0.556$
- C 9068.9+x, J+20 γ_{7931+x} 1137.93 (†,0.63 7) $I^{(1)}=79.0, I^{(2)}=74.8, \hbar\omega=0.582$
- C 10260.3+x, J+22 γ_{9069+x} 1191.43 (†,0.63 7) $I^{(1)}=78.8, I^{(2)}=76.3, \hbar\omega=0.609$
- C 11504.1+x, J+24 $\gamma_{10260+x}$ 1243.83 (†,0.41 7) $I^{(1)}=78.6, I^{(2)}=68.8, \hbar\omega=0.636$
- C 12806.0+x, J+26 $\gamma_{11504+x}$ 1301.95 (†,0.37 6)

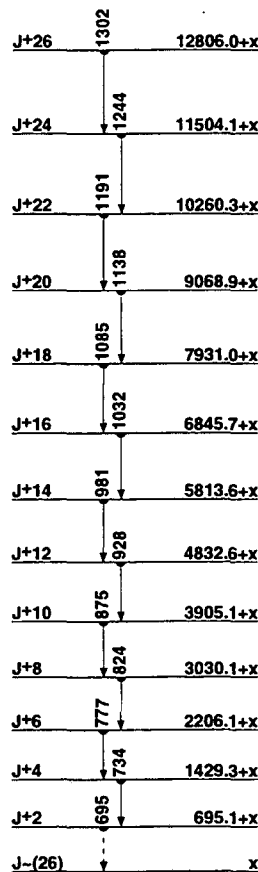

SD band
(95Be36)
154Er
68

¹⁹¹₇₉Au

Δ : -33860 50 S_n : 9050 50 S_p : 3820 50 Q_{EC} : 1830 50 Q_α : 3430 50

Nuclear Bands

- A Favored $\pi h_{11/2}$ band
- B Unfavored $\pi h_{11/2}$ band
- C Favored $\pi h_{9/2}$ band
- D Unfavored $\pi h_{9/2}$ band
- E SD band (93Vo04)

Levels and γ -ray branchings:

0, 3/2⁺, 3.18 s h, %EC+% β^+ =100, μ =+0.137 1, Q =-1.3 1

11.6 3, (1/2⁺), 15.5 s ns γ_0 11.2 (†,100)

207.9 3, (3/2⁺) γ_{12} 196.3 2 (†,100) M1

252.5 2, (5/2⁺) γ_{12} 240.9 2 (†,23.3 19) E2 γ_0 252.5 2 (†,100 9) M1+E2: δ =-0.9 3

A 266.2 5, (11/2⁻), 0.92 11 s, %IT=100, μ =6.6 6 γ_{253} 13.7 6 (†,100) (E3)

331.4 5(?), (5/2⁺) γ_0 331.4 5 (†,100)

490.9 6, (7/2⁻) γ_{266} 224.7 2 (†,100) E2

521.3 5, (5/2⁺) γ_{253} 268.8 5 γ_0 521.3 5 (†,100 13) E2

C 540.3 8, (9/2⁻), 10.2 ns γ_{266} 274.2 5 (†,100) M1+E2: δ =-0.096 15

662.5 5, (7/2⁺) γ_{253} 410.0 5 (†,100 20) M1 γ_{208} 454.6 5 γ_0 662.5 5 (†,41 10)

A 686.3 7, (15/2⁻) γ_{266} 420.1 4 (†,100) E2

788.6 5, (9/2⁺) γ_{521} 267.3 5 γ_{253} 536.1 5 (†,100 11) (E2)

844.8 6, (13/2⁻) γ_{686} 158.5 5 γ_{266} 578.6 3 (†,100 10) M1+E2: δ =0.34 5

876.7 7, (9/2⁻) γ_{491} 385.8 5 γ_{266} 610.6 5 (†,100) M1+E2

D 897.3 8, (11/2⁻) γ_{540} 356.9 4 (†,100) M1+E2: δ =-0.25 4

C 911.4 7, (13/2⁻) γ_{540} 371.1 3 (†,100 11) E2 γ_{266} 645.2 5 (†,14 4)

1066 1(?), (3/2⁻) γ_{491} 575 1 (†,100)

1132 1, (11/2⁺) γ_{789} 343.3 6 (†,100) M1

1268.5 7, (11/2⁻) γ_{911} 356.9 4 (†,286) M1+E2 γ_{877} 391.8 6 γ_{491} 777.6 5 (†,100 26) γ_{266} 1002.4 5 (†,91 23)

1341.3 6 γ_{789} 552.8 6 (†,74 15) γ_{663} 678.8 6 (†,100 18) γ_{521} 820.0 6 (†,55 13)

D 1352 1, (15/2⁻) γ_{911} 440.5 7 (†,100) M1+E2

1356 1 γ_{845} 511 1 (†,100)

B 1376.2 8, (17/2⁻) γ_{686} 689.9 5 (†,100 26) M1+E2 γ_{266} 1110.0 6 (†,82 21)

1394 1 γ_{845} 549 1 (†,100)

A 1412 1, (19/2⁻) γ_{686} 725 1 (†,100) E2

C 1431 1, (17/2⁻) γ_{911} 519 1 (†,100) E2

1460 1, (13/2⁺) γ_{789} 671 1 (†,100)

1482 1 γ_{845} 637 1 (†,100)

1550 1 γ_{686} 664 1 (†,100)

1630 1 γ_{911} 718.2 6 (†,100 15) γ_{897} 732.4 7 (†,17 4)

1991 1, <0.3 ns γ_{1412} 579.4 7 (†,100)

2024 1 γ_{686} 1338 1 (†,100)

C 2032.2, 21/2⁻ γ_{1431} 601 1 (†,100)

2041 1 γ_{686} 1355 1 (†,100)

2130 1 γ_{845} 1285 1 (†,100 26) γ_{266} 1863.5 7 (†,32 9)

2159 2, 0.96 10 ns γ_{1991} 168 1 (†,100)

2175 1 γ_{845} 1329.7 6 (†,100 25) γ_{686} 1488.2 6 (†,25 6) γ_{266} 1908.3 6 (†,55 14)

A 2187 1, (23/2⁻) γ_{1412} 775.3 7 (†,100) E2

2199 2 γ_{1991} 208 1 (†,100)

2219 1 γ_{686} 1533 1 (†,100)

2235 1 γ_{686} 1549 1 (†,100)

2348 1 γ_{845} 1504 1 (†,100)

2423 2, <0.2 ns γ_{2159} 264 1 (†,100)

A 2447 2, (27/2⁻), 0.89 9 ns, μ <20.25 γ_{2187} 260 1 (†,100) E2

2490 1, >400 ns γ_{2423} 67 1 (†,100) (E2)

A 2503 1, (31/2⁻), 6.1 5 ns γ_{2447} 56 1 (†,100) (E2)

2748 γ_{2447} 301 1 (†,100)

B 2804 1, (33/2⁻), <0.4 ns γ_{2503} 301 1 (†,100)

3147 1 γ_{2748} 399 1 (†,100)

A 3203 1, (35/2⁻), <0.3 ns γ_{2804} 399 1 (†,100)

3822 1 γ_{3147} 674 1 (†,100)

E x, J=(19/2)

E 229.5+x, J+2 γ_x 229.5 5 (†,0.45 15) $I^{(1)}$ =92.0, $I^{(2)}$ =97.3, $\eta\omega$ =0.125

E 500.1+x, J+4 γ_{230+x} 270.6 4 (†,0.62 20) $I^{(1)}$ =92.7, $I^{(2)}$ =97.3, $\eta\omega$ =0.146

E 811.8+x, J+6 γ_{500+x} 311.7 3 (†,0.87 15) $I^{(1)}$ =93.4, $I^{(2)}$ =99.8, $\eta\omega$ =0.166

E 1163.6+x, J+8 γ_{812+x} 351.8 2 (†,1.04 15) $I^{(1)}$ =94.2, $I^{(2)}$ =101.5, $\eta\omega$ =0.186

E 1554.8+x, J+10 γ_{1164+x} 391.2 2 (†,1.00 15) $I^{(1)}$ =95.0, $I^{(2)}$ =103.1, $\eta\omega$ =0.205

E 1984.8+x, J+12 γ_{1555+x} 430.0 2 $I^{(1)}$ =95.8, $I^{(2)}$ =106.4, $\eta\omega$ =0.224

E 2452.4+x, J+14 γ_{1985+x} 467.6 2 (†,0.86 15) $I^{(1)}$ =96.7, $I^{(2)}$ =108.7, $\eta\omega$ =0.243

E 2956.8+x, J+16 γ_{2452+x} 504.4 4 (†,0.83 20) $I^{(1)}$ =97.6, $I^{(2)}$ =109.6, $\eta\omega$ =0.261

E 3497.7+x, J+18 γ_{2957+x} 540.9 3 (†,0.69 15) $I^{(1)}$ =98.5, $I^{(2)}$ =114.3, $\eta\omega$ =0.279

E 4073.6+x, J+20 γ_{3498+x} 575.9 6 (†,0.52 15) $I^{(1)}$ =99.4, $I^{(2)}$ =112.7, $\eta\omega$ =0.297

E 4685.0+x, J+22 γ_{4074+x} 611.4 6 (†,0.66 20) $I^{(1)}$ =100.3, $I^{(2)}$ =120.5, $\eta\omega$ =0.314

E 5329.6+x, J+24 γ_{4685+x} 644.6 6 (†,0.53 15) $I^{(1)}$ =101.3, $I^{(2)}$ =118.3, $\eta\omega$ =0.331

E 6008.0+x, J+26 γ_{5330+x} 678.4 6 (†,0.54 15)

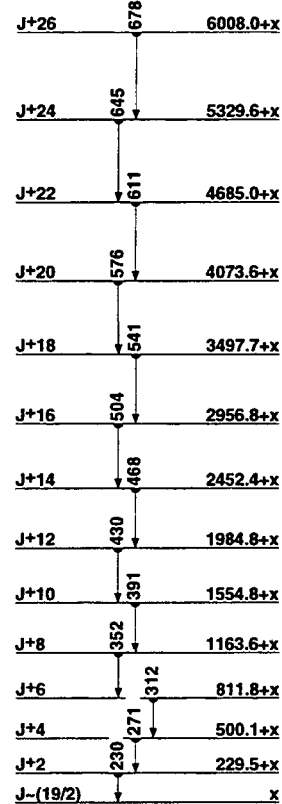

SD band
(93Vo04)
¹⁹¹₇₉Au

¹⁸⁹Hg
₈₀Hg

Δ : (-29700) S_n : (7500) S_p : (4500) Q_{EC} : (3950) Q_{α} : (4500)

Nuclear Bands

A SD band (92Be18,91Dr04)

Levels and γ -ray branchings:

0, 3/2⁻, 7.61 m, %EC+% β ⁺=100, % α <0.00003, μ =-0.60868, Q =-0.7635

64.35, (5/2)⁻, 0.404 ns $\gamma_{64.35}$ (\dagger_{γ} 100) M1+E2: δ =0.01

0+x, 13/2⁺, 8.61 m, %EC+% β ⁺=100, % α <0.00003, μ =-1.0586,

Q =-0.6626

403.00+x 19, 17/2⁺ $\gamma_{403.02}$ (\dagger_{γ} 100) E2

473.8+x 4, (15/2)⁺ $\gamma_{473.85}$ (\dagger_{γ} 100) M1+E2: δ =0.117

1029.8+x 3, 21/2⁺ $\gamma_{1029.82}$ (\dagger_{γ} 100) E2

1110.1+x 4, (19/2)⁺ $\gamma_{1110.1}$ (\dagger_{γ} 100 10) E2 $\gamma_{1110.1}$ (\dagger_{γ} 70 20) M1+E2: δ =0.5215

1690.8+x 4, (21/2)⁻ $\gamma_{1690.8}$ (\dagger_{γ} 100 11) E1 $\gamma_{1690.8}$ (\dagger_{γ} 48 7) E1

1762.8+x 3, 25/2⁺ $\gamma_{1762.8}$ (\dagger_{γ} 100) E2

1916.7+x 5, (25/2)⁻ $\gamma_{1916.7}$ (\dagger_{γ} 100) E2

1976.1+x 5, (23/2)⁻ $\gamma_{1976.1}$ (\dagger_{γ} 100) (E1)

2220.4+x 5, (27/2)⁻ $\gamma_{2220.4}$ (\dagger_{γ} 75 25) $\gamma_{2220.4}$ (\dagger_{γ} 100 12) (E1)

2252.6+x 6, (29/2)⁻ $\gamma_{2252.6}$ (\dagger_{γ} 100) E2

2434.9+x 7, (29/2)⁻ $\gamma_{2434.9}$ (\dagger_{γ} 100) (E2)

2476.9+x 4, 29/2⁺ $\gamma_{2476.9}$ (\dagger_{γ} 100) E2

2615.5+x 5, 29/2⁺ $\gamma_{2615.5}$ (\dagger_{γ} 100) E2

2674.3+x 5, 33/2⁺ $\gamma_{2674.3}$ (\dagger_{γ} <1) E2 $\gamma_{2674.3}$ (\dagger_{γ} 100 14) E2

2686.0+x 6, (31/2)⁻ $\gamma_{2686.0}$ (\dagger_{γ} 100) (E2)

2820.7+x 7, (33/2)⁻ $\gamma_{2820.7}$ (\dagger_{γ} 100) (E2)

3123.7+x (?), $\gamma_{3123.7}$ (\dagger_{γ} 100)

3139.7+x 9, (33/2)⁻ $\gamma_{3139.7}$ (\dagger_{γ} 100)

3153.5+x 7, 37/2⁺ $\gamma_{3153.5}$ (\dagger_{γ} 100) E2

3343.8+x 8, (35/2)⁻ $\gamma_{3343.8}$ (\dagger_{γ} 100) E2

3540.2+x 9, (37/2)⁻ $\gamma_{3540.2}$ (\dagger_{γ} 100)

3793.1+x 9 (?), $\gamma_{3793.1}$ (\dagger_{γ} 100)

3875.2+x 8, (41/2)⁺ $\gamma_{3875.2}$ (\dagger_{γ} 100)

4378.3+x 10 (?), (41/2)⁻ $\gamma_{4378.3}$ (\dagger_{γ} 100)

4741.4+x 10 (?), (45/2)⁺ $\gamma_{4741.4}$ (\dagger_{γ} 100)

A y, J=(29/2)

A 366.4+y, J+2 $\gamma_{366.4}$ (\dagger_{γ} 1.00 10) $I^{(1)}$ =85.2, $I^{(2)}$ =95.9, $\hbar\omega$ =0.194

A 774.5+y, J+4 $\gamma_{774.5}$ (\dagger_{γ} 1.00 15) $I^{(1)}$ =86.4, $I^{(2)}$ =98.5, $\hbar\omega$ =0.214

A 1223.2+y, J+6 $\gamma_{1223.2}$ (\dagger_{γ} 0.86 19) $I^{(1)}$ =87.5, $I^{(2)}$ =100.5, $\hbar\omega$ =0.234

A 1711.7+y, J+8 $\gamma_{1711.7}$ (\dagger_{γ} 0.89 16) $I^{(1)}$ =88.5, $I^{(2)}$ =101.3, $\hbar\omega$ =0.254

A 2239.7+y, J+10 $\gamma_{2239.7}$ (\dagger_{γ} 0.62 11) $I^{(1)}$ =89.5, $I^{(2)}$ =102.8, $\hbar\omega$ =0.274

A 2806.6+y, J+12 $\gamma_{2806.6}$ (\dagger_{γ} 0.58 11) $I^{(1)}$ =90.5, $I^{(2)}$ =108.1, $\hbar\omega$ =0.293

A 3410.5+y, J+14 $\gamma_{3410.5}$ (\dagger_{γ} 0.53 14) $I^{(1)}$ =91.6, $I^{(2)}$ =109.9, $\hbar\omega$ =0.311

A 4050.8+y, J+16 $\gamma_{4050.8}$ (\dagger_{γ} 0.58 11) $I^{(1)}$ =92.7, $I^{(2)}$ =112.4, $\hbar\omega$ =0.329

A 4726.7+y, J+18 $\gamma_{4726.7}$ (\dagger_{γ} 0.51 11) $I^{(1)}$ =94.0, $I^{(2)}$ =126.2, $\hbar\omega$ =0.346

A 5434.3+y (?), J+20 $\gamma_{5434.3}$ (?)

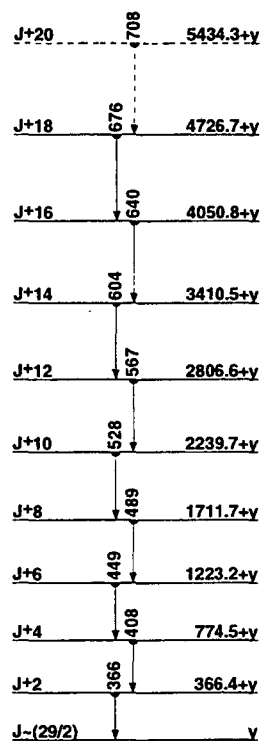

SD band
(92Be18,91Dr04)
¹⁸⁹Hg
₈₀Hg

190Hg
80Hg

Δ :(-31410) S_n :(9800) S_p :(5060) Q_{EC} :(1470) Q_{α} :(3960)

Nuclear Bands

- A GS band, $\alpha=0$ (86Hu02)
- B band, $\alpha=0$ (86Hu02)
- C band, $\alpha=0$ (86Hu02)
- D band, $\alpha=1$ (86Hu02)
- E band, $\alpha=1$ (86Hu02)
- F band, $\alpha=0$ (86Hu02)
- G band, $\alpha=0$ (86Hu02)
- H Intruder band
- I SD-1 band (91Dr04,95Cr02)
- J SD-2 band (95Cr02)

Levels and γ -ray branchings:

- A 0, 0⁺, 20.0 s m, %EC+% β^+ =100, % α <5 \times 10⁻⁵
- A 416.4 2, 2⁺ γ_{416} 416.42 (t_{1/2} 100) E2
- A 1041.8 2, 4⁺ γ_{416} 625.42 (t_{1/2} 100) E2
- 1099.9 2, 2⁺ γ_{416} 683.52 (t_{1/2} 100 10) E2+M1: $\delta=2.0$ s¹⁰ γ_0 1099.92 (t_{1/2} 62 6) E2
- H 1279.4 3, 0⁺ γ_{416} 863.02 (t_{1/2} 100) γ_0 1279 (t_{1/2} 3.2) E0
- 1558.8 2, (2⁺) γ_{1100} 458.73 (t_{1/2} 26 3) γ_{1042} 515.4 12(?) (t_{1/2} 39 16) γ_{416} 1142.53 (t_{1/2} 100 4) E2(+M1): $\delta>2$ γ_0 1558.93 (t_{1/2} 26 3)
- H 1571.1 3, 2⁺ γ_{1278} 292.02(?) (t_{1/2} 4 3) γ_{1042} 529.02 (t_{1/2} 26 10) γ_{416} 1155.02 (t_{1/2} 100 9) E0+M1+E2 γ_0 1571.02(?) (t_{1/2} 30 17)
- 1657.0 2, (3⁺) γ_{1100} 557.02 (t_{1/2} 100 10) E2(+M1): $\delta>3$ γ_{1042} 615.43 (t_{1/2} 67 7) E2+M1: $\delta=1.4$ 3 γ_{416} 1240.73 (t_{1/2} 21 2) (E2)
- A 1772.9 2, 6⁺ γ_{1042} 731.12 (t_{1/2} 100) E2
- D 1881.4 2, 5⁻ γ_{1042} 839.72 (t_{1/2} 100) E1
- H 1975.2 3, 4⁺ γ_{1571} 404.02 (t_{1/2} 23 7) γ_{1042} 933.02 (t_{1/2} 39 12) E0+M1+E2 γ_{416} 1559.02 (t_{1/2} 100 7)
- 2072.8 2, (4,5,6)⁺ γ_{1042} 1031.02 (t_{1/2} 100) M1+E2: $\delta=0.9$ 3
- D 2078.2 2, 7⁻ γ_{1881} 196.82 (t_{1/2} 29 3) E2 γ_{1773} 305.32 (t_{1/2} 100 10) E1
- 2200.9 2(?), (5⁺) γ_{1657} 543.92(?) E2
- 2251.7 2, (6,7)⁻ γ_{1881} 370.32 (t_{1/2} 100 10) E2(+M1): $\delta>7$ γ_{1773} 478.33 (t_{1/2} 27 3)
- F 2318.4 3, (8)⁻ γ_{2078} 240.22 (t_{1/2} 100 10) M1+E2: $\delta=1.5$ s³
- 2318.7 2, (4⁻,5,6⁺) γ_{2078} 240.2(?) γ_{1881} 437.63 (t_{1/2} 70 7) γ_{1042} 1276.73 (t_{1/2} 100 10)
- D 2335.3 2, (9⁻) γ_{2078} 257.12 (t_{1/2} 100) (E2)
- 2391.9 4(?), (5 to 9) γ_{2078} 313.73
- 2424.7 4(?), (5 to 9) γ_{2078} 346.53
- B 2464.9 3, (8)⁺ γ_{1773} 692.02 (t_{1/2} 100) E2
- H 2510.0 3, 6⁺ γ_{1975} 535.02 (t_{1/2} 100 8) γ_{1773} 737.02 (t_{1/2} 45 15) E0+M1+E2 γ_{1042} 1468.02 (t_{1/2} 51 4)
- 2572.9 3, (4 to 8)⁺ γ_{1773} 800.02 (t_{1/2} 100) E2
- B 2596.9 3, (10⁺) γ_{2465} 132.03 (t_{1/2} 100 10) E2 γ_{2335} 261.53 (t_{1/2} 6 2) D
- B 2620.8 6, (12⁺), 23 ns, g=-0.21 2, Q=1.17 14 γ_{2597} 23.9
- F 2724.0 3, (10⁻) γ_{2335} 388.63 (t_{1/2} 53 16) γ_{2318} 405.33 (t_{1/2} 100 10) Q
- D 2865.3 4, (11⁻) γ_{2335} 530.03 (t_{1/2} 100) Q
- 2930.9 4(?), (10⁺) γ_{2465} 466.03 (Q)
- B 3040.7 6, (14⁺) γ_{2621} 419.92 (t_{1/2} 100) Q
- F 3357.9 4, (12⁻) γ_{2724} 633.93 (t_{1/2} 100) Q
- D 3548.5 5, (13⁻) γ_{2865} 683.23 (t_{1/2} 100) Q
- 3611.3 5(?), (12⁺) γ_{2831} 680.43
- B 3703.4 6, (16⁺) γ_{3041} 662.72 (t_{1/2} 100) Q
- G 3979.5 5, (14⁻) γ_{3358} 621.63 (t_{1/2} 100) (Q)
- E 4087.1 6, (15⁻) γ_{3549} 538.63 (t_{1/2} 100) Q
- G 4242.8 6, (16⁻) γ_{3980} 263.43 (t_{1/2} 100 10) Q γ_{3703} 539.43 (t_{1/2} 24 7)
- E 4326.1 7, (17⁻) γ_{4087} 239.03 (t_{1/2} 100)
- B 4492.4 7, (18⁺) γ_{3703} 789.03 (t_{1/2} 100) Q
- G 4551.5 7, (18⁻) γ_{4243} 308.73 (t_{1/2} 100) Q
- E 4709.3 7, (19⁻) γ_{4326} 383.23 (t_{1/2} 100) Q

- G 5105.6 7, (20⁻) γ_{4552} 554.13 (t_{1/2} 100) Q
- C 5228.7 8, (20⁺) γ_{4492} 736.33 (t_{1/2} 100) Q
- E 5334.3 13, (21⁻) γ_{4709} 625.1 (t_{1/2} 100)
- B 5351.6 8, (20⁺) γ_{4492} 659.23 (t_{1/2} 100)
- C 5794.7 8, (22⁺) γ_{5229} 566.03 (t_{1/2} 100)
- E 6142.2 13, (23⁻) γ_{5334} 807.83 (t_{1/2} 100) Q
- 6335.1 9, (24⁺) γ_{5795} 540.43 (t_{1/2} 100)
- C 6576.1 9, (24⁺) γ_{5795} 781.43 (t_{1/2} 100)
- I x, J=(12)
- I 316.9+x, J+2 γ_x 316.94 (E2) I⁽¹⁾=82.7, I⁽²⁾=92.8, $\eta\omega=0.169$
- I 676.9+x, J+4 γ_{317+x} 360 (t_{1/2} 0.63 s) (E2) I⁽¹⁾=84.0, I⁽²⁾=94.5, $\eta\omega=0.191$
- I 1079.2+x, J+6 γ_{677+x} 402.344 (t_{1/2} 1.08 s) (E2) I⁽¹⁾=85.2, I⁽²⁾=98.4, $\eta\omega=0.211$
- I 1522.2+x, J+8 γ_{1079+x} 442.986 (t_{1/2} 0.91 s) (E2) I⁽¹⁾=86.4, I⁽²⁾=100.7, $\eta\omega=0.231$
- I 2004.9+x, J+10 γ_{1522+x} 482.716 (t_{1/2} 0.95 s) (E2) I⁽¹⁾=87.6, I⁽²⁾=103.7, $\eta\omega=0.251$
- I 2526.2+x, J+12 γ_{2005+x} 521.306 (t_{1/2} 0.92 12) (E2) I⁽¹⁾=88.9, I⁽²⁾=107.2, $\eta\omega=0.270$
- I 3084.8+x, J+14 γ_{2526+x} 558.61 (t_{1/2} 0.76 7) (E2) I⁽¹⁾=90.2, I⁽²⁾=110.2, $\eta\omega=0.288$
- J 3437.1+x, J+13 γ_{2526+x} 910.94 (E1)
- I 3679.7+x, J+16 γ_{3085+x} 594.91 (t_{1/2} 0.55 s) (E2) I⁽¹⁾=91.4, I⁽²⁾=113.6, $\eta\omega=0.306$
- J 3948.5+x, J+15 γ_{3437+x} 511.44 (I⁽¹⁾=56.9, I⁽²⁾=125.8, $\eta\omega=0.264$ γ_{3085+x} 864.1 (E1)
- I 4309.8+x, J+18 γ_{3680+x} 630.11 (t_{1/2} 0.46 s) (E2) I⁽¹⁾=92.7, I⁽²⁾=117.6, $\eta\omega=0.324$
- J 4491.7+x, J+17 γ_{3949+x} 543.23 (I⁽¹⁾=60.8, I⁽²⁾=123.5, $\eta\omega=0.280$ γ_{3680+x} 812.1 (E1)
- I 4973.9+x, J+20 γ_{4310+x} 664.11 (t_{1/2} 0.34 5) (E2) I⁽¹⁾=94.0, I⁽²⁾=122.0, $\eta\omega=0.340$
- J 5067.3+x, J+19 γ_{4492+x} 575.62 (I⁽¹⁾=64.2, I⁽²⁾=123.1, $\eta\omega=0.296$ γ_{4310+x} 757(?)
- I 5670.8+x, J+22 γ_{4974+x} 696.91 (t_{1/2} 0.24 4) (I⁽¹⁾=95.4, I⁽²⁾=126.6, $\eta\omega=0.356$
- J 5675.4+x, J+21 γ_{5067+x} 608.13 (I⁽¹⁾=67.2, I⁽²⁾=119.4, $\eta\omega=0.312$
- J 6317.0+x, J+23 γ_{5675+x} 641.63 (I⁽¹⁾=69.9, I⁽²⁾=121.6, $\eta\omega=0.329$
- I 6399.3+x, J+24 γ_{5671+x} 728.54 (t_{1/2} 0.21 6) (E2) I⁽¹⁾=96.9, I⁽²⁾=138.4, $\eta\omega=0.371$
- J 6991.5+x, J+25 γ_{6317+x} 674.55 (I⁽¹⁾=72.4, I⁽²⁾=122.7, $\eta\omega=0.345$
- I 7156.7+x, J+26 γ_{6399+x} 757.44 (t_{1/2} 0.15) (I⁽¹⁾=98.6, I⁽²⁾=153.3, $\eta\omega=0.385$
- J 7698.6+x, J+27 γ_{6992+x} 707.16
- I 7940.2+x, J+28 γ_{7157+x} 783.56 (t_{1/2} 0.12) (I⁽¹⁾=100.9, I⁽²⁾=218.6, $\eta\omega=0.396$
- I 8742.0+x, J+30 γ_{7940+x} 801.88(?) (t_{1/2} 0.05)

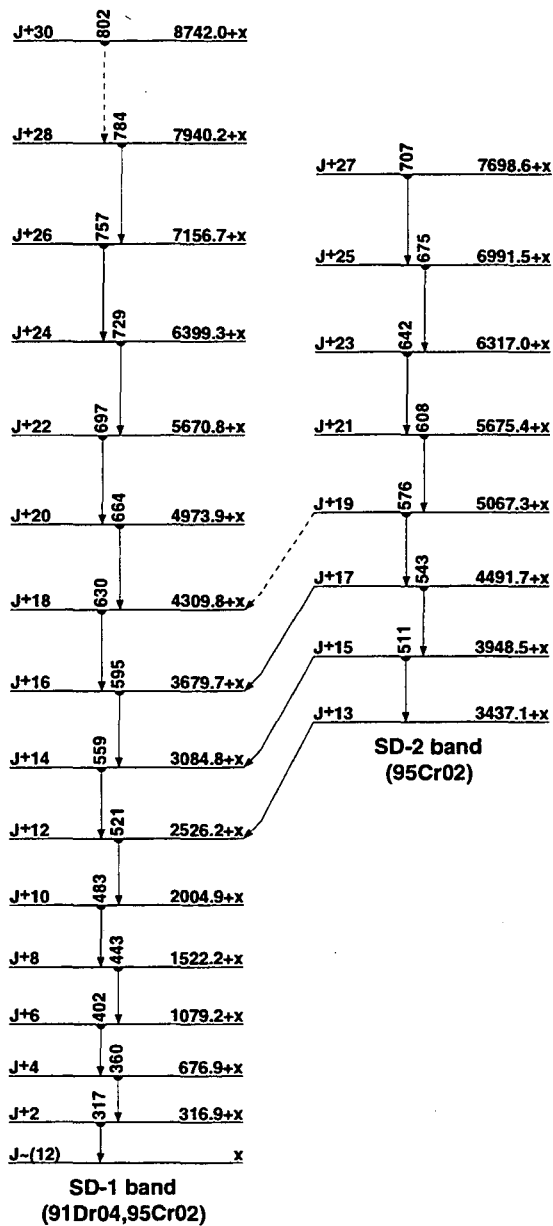

¹⁹⁰₈₀Hg

¹⁹¹Hg
₈₀

Δ : -30680 S_n : (7340) S_p : 5090 Q_{EC} : 3180 Q_α : (3500)

Nuclear Bands

- A $\alpha=1/2, \nu_{13/2}$
- B $\alpha=-1/2$
- C $\alpha=1/2$, Aligned band
- D $\alpha=1/2$
- E $\alpha=1/2$
- F $\alpha=-1/2$
- G $\alpha=-1/2$
- H $\alpha=1/2$
- I $\alpha=1/2$
- J $\alpha=1/2$
- K Band Structure
- L SD-1 band (89Mo08,95Ca15)
- M SD-2 band (90Ca18,95Ca15)
- N SD-3 band (90Ca18,95Ca15)
- O SD-4 band (95Ca15)

Levels and γ -ray branchings:

- 0, (3/2⁻), 49.10 m, %EC+% β^+ =100, $\mu=-0.618$ μ_N , $Q=-0.80$ 25
- A 0+x, (13/2⁺, 50.8 15 m, %EC+% β^+ =100, $\mu=-1.068$ 5, $Q=+0.64$ 25
- 51.6 2, (5/2⁻), 0.42 4 ns γ_0 51.6 2 (\dagger , 100) M1+E2: $\delta=0.7$
- 103.7 3, (1/2⁻) γ_0 103.7 3 (\dagger , 100) M1+E2
- 216.0+x 2, (9/2⁺) γ_{0+x} 216.0 2 (\dagger , 100) E2
- 265.0+x 2, (11/2⁺) γ_{216+x} 49.1 2 E2 γ_{0+x} 265.0 2 (\dagger , 100 5)
- M1+E2: $\delta=1.9$ μ_N
- 336.3 2, (5/2⁻) γ_{52} 284.7 2 (\dagger , 10.0 10) M1 γ_0 336.3 2 (\dagger , 100 6)
- M1+E2: $\delta=1.6$ μ_N
- 375.5 3, (3/2⁻) γ_{104} 271.8 4 (\dagger , 4.1 24) γ_{52} 323.9 4 (\dagger , 12 6) γ_0 375.5 3 (\dagger , 100 18) M1
- 377.9 3, (7/2⁻) γ_{336} 41.6 3 γ_{52} 326.3 2 (\dagger , 100 5) M1+E2: $\delta=1.0$ 2 γ_0 377.9 2 (\dagger , 13 7)
- A 390.5+x 2, (17/2⁺) γ_{0+x} 390.4 2 (\dagger , 100) (E2)
- 430.4 3, (1/2⁻, 3/2⁻, 5/2⁻) γ_{52} 378.8 3 (\dagger , =345) γ_0 430.4 3 (\dagger , 100 14)
- M1+E2: $\delta=0.8$ μ_N
- 534.7+x 4 γ_{216+x} 318.7 4 (\dagger , 100)
- B 535.3+x 2, (15/2⁺) γ_{0+x} 535.4 2 (\dagger , 100) (M1+E2): $\delta=0.14$ 4
- 563.5 3, (7/2⁻) γ_{336} 227.2 3 (\dagger , 5.1 24) γ_{52} 511.9 3 γ_0 563.5 3 (\dagger , 100 5) E2
- 588.6+x 4, (7/2⁺) γ_{265+x} 323.6 4 (\dagger , 13 7) γ_{216+x} 372.7 3 (\dagger , 100 10)
- M1+E2: $\delta=1.8$ μ_N
- 632.3 3, (9/2⁻) γ_{378} 254.4 3 (\dagger , 7 3) γ_{52} 580.7 3 (\dagger , 100 5) E2
- 659.1 4, (9/2⁻) γ_{378} 281.2 3 (\dagger , 7 7 8) M1+E2: $\delta=0.8$ 5 γ_{336} 322.7 4 (\dagger , 27 14)
- γ_{52} 607.5 3 (\dagger , 100 10) E2
- 691.8 3 γ_{430} 261.4 3 (\dagger , 10.1 25) γ_{336} 355.5 3 (\dagger , 8 3) γ_{52} 640.2 3 (\dagger , 100 10) γ_0 691.8 3 (\dagger , 31 8)
- 742.7+x 3, (13/2⁺) $\gamma_{535.3+x}$ 277.5 3 (\dagger , 10 4) γ_{265+x} 477.6 3 (\dagger , 90 10)
- γ_{216+x} 526.7 3 (\dagger , 11 3) γ_{0+x} 742.7 3 (\dagger , 100 10) (M1+E2): $\delta>1.6$
- 761.1+x 3, (11/2⁺) γ_{589+x} 172.4 4 (\dagger , 12 7) γ_{265+x} 496.0 3 (\dagger , 100 11)
- M1(+E2) γ_{216+x} 545.1 3 (\dagger , 40 20) (M1+E2): $\delta>1.6$ γ_{0+x} 761.1 3 (\dagger , 52 11)
- 880.3 9 γ_{52} 828.7 9 (\dagger , 100)
- 900.0+x 4, (11/2, 13/2)⁺ γ_{265+x} 635.0 4 (\dagger , 37 7) γ_{216+x} 684.1 4 (\dagger , 100 10)
- E2 γ_{0+x} 900.0 4 (\dagger , 71 10) M1+E2
- 911.3 4 γ_{430} 480.8 4 (\dagger , 100 77) γ_{378} 533.4 4 (\dagger , 96 23) γ_{376} 535.7 5 (\dagger , =200) γ_{336} 574.9 4 (\dagger , <80)
- 952.1 4, (9/2⁻) γ_{430} 521.7 4 (\dagger , 29 14) γ_{336} 615.8 4 (\dagger , 100 12) (E2)
- 997.1 3, (5/2⁻, 7/2⁻, 9/2⁻) γ_{430} 566.7 4 (\dagger , 82 15) γ_{378} 619.2 3 (\dagger , 100 12)
- M1+E2: $\delta=0.9$ μ_N γ_{336} 660.8 3 (\dagger , 92 10)
- 1016.3 4, (11/2⁻) γ_{632} 383.9 4 (\dagger , 14 4) γ_{378} 638.4 4 (\dagger , 100 21)
- A 1019.3+x 2, (21/2⁺) γ_{391+x} 628.7 2 (\dagger , 100) (E2)
- 1024 1 γ_{336} 687 1 (\dagger , 100)
- 1081.0 5 γ_{336} 744.7 5 (\dagger , 100 17) γ_0 1081.0 5 (\dagger , 70 13)
- 1088+x 1 γ_{216+x} 871.8 9 (\dagger , 100)
- 1105.7+x 7 γ_{589+x} 517.1 6 (\dagger , 100)
- 1107.2 4, (7/2⁻, 9/2⁻, 11/2⁻) γ_{632} 474.9 4 (\dagger , 19 10) M1+E2: $\delta>0.4$
- γ_{378} 729.3 4 (\dagger , 100 11) γ_{52} 1055.6 4 (\dagger , 61 7)

- 1130.8+x 8, (7/2, 9/2, 11/2)⁺ γ_{265+x} 865.6 9 (\dagger , 37 17) γ_{216+x} 914.9 7 (\dagger , 100 17) M1+E2
- 1133.3+x 6 γ_{265+x} 868.2 5 (\dagger , 32 16) γ_{216+x} 917.3 5 (\dagger , 100 16)
- γ_{0+x} 1133.3 5 (\dagger , 35 18)
- 1146.5 5 γ_{632} 514.2 5 (\dagger , 100 18) γ_{564} 583.0 5 (\dagger , 77 38)
- B 1171.8+x 2, (19/2⁺) $\gamma_{535.3+x}$ 636.6 2 (\dagger , 82 18) (E2) γ_{391+x} 781.3 2 (\dagger , 100 15) (M1+E2): $\delta=0.14$ 4
- 1178.3 8 γ_{52} 1126.7 8 (\dagger , 100)
- 1193.2 5 γ_{682} 501.4 5 (\dagger , 56 10) M1(+E2) γ_{378} 815.3 5 (\dagger , 100 21)
- 1199 1 γ_{52} 1148 1 (\dagger , 100)
- 1208+x 1 γ_{216+x} 992 1 (\dagger , 100)
- 1212.4 7 γ_{378} 834.5 7 (\dagger , 100) (E2)
- 1257+x 1 γ_{265+x} 992 1 (\dagger , 100)
- 1317.6 9, (5/2⁻, 7/2⁻, 9/2⁻) γ_{564} 754.1 8 (\dagger , 100) M1+E2: $\delta>1.2$
- 1319+x 1 γ_{216+x} 1102.6 9 (\dagger , 100 21) γ_{0+x} 1318.6 9 (\dagger , 75 25)
- 1320 1, (13/2⁻) γ_{632} 687 1 (\dagger , 100)
- 1434+x 1 γ_{216+x} 1218.2 9 (\dagger , 100)
- 1470.8 9 γ_{378} 1092.9 9 (\dagger , 100)
- 1539 1 γ_{378} 1161 1 (\dagger , 100)
- H 1637.9+x 2, (21/2⁻) γ_{1172+x} 466.2 2 (\dagger , 100 15) (E1) γ_{1019+x} 618.5 2 (\dagger , 33 4) (E1)
- 1688+x 1 γ_{216+x} 1472 1 (\dagger , 100)
- A 1769.5+x 3, (25/2⁺) γ_{1019+x} 750.1 7 (\dagger , 100) (E2)
- H 1804.6+x 3, (25/2⁻), 0.72 7 ns γ_{1638+x} 166.7 7 (\dagger , 100) (E2)
- 1844 1 γ_{336} 1508 1 (\dagger , 100)
- F 1861.8+x 3, (23/2⁻) γ_{1638+x} 223.9 6 (\dagger , 12 2) (M1) γ_{1019+x} 842.5 6 (\dagger , 100 16) (E1)
- F 2064.8+x 3, (27/2⁻) γ_{1862+x} 202.8 7 (\dagger , 100 7) (E2) γ_{1805+x} 260.0 7 (\dagger , 25 4) (M1) γ_{1770+x} 295.2 7 (\dagger , 49 9) (E1)
- H 2123.6+x 4, (29/2⁻) γ_{1805+x} 319.0 2 (\dagger , 100) (E2)
- 2286+x 2 γ_{216+x} 2070 2 (\dagger , 100)
- 2299+x 2 γ_{265+x} 2034.5 15 (\dagger , 100)
- 2303+x 1 γ_{216+x} 2087 1 (\dagger , 100)
- 2307+x 1 γ_{216+x} 2091.5 11 (\dagger , 100)
- 2310+x 1 γ_{265+x} 2045 1 (\dagger , 100)
- 2315+x 1 γ_{216+x} 2099 1 (\dagger , 100)
- 2328.9+x 8 γ_{743+x} 1586.3 7 (\dagger , 43 9) γ_{216+x} 2113.0 7 (\dagger , 45 9) γ_{0+x} 2328.9 7 (\dagger , 100 10)
- 2335+x 2 γ_{265+x} 2070 2 (\dagger , 100)
- 2340+x 1 γ_{265+x} 2075 1 (\dagger , 100)
- 2352+x 1 γ_{265+x} 2087 1 (\dagger , 100)
- 2357+x 1 γ_{743+x} 1613.9 9 γ_{216+x} 2140.6 9
- 2358.8+x 8 γ_{743+x} 1616.1 7 (\dagger , 100 10) γ_{0+x} 2358.7 7 (\dagger , 81 14)
- 2361.6+x 8 γ_{743+x} 1618.9 7 (\dagger , 46 9) γ_{0+x} 2361.6 7 (\dagger , 100 10)
- 2406+x 2 γ_{265+x} 2141 2 (\dagger , 100)
- 2409+x 2 γ_{216+x} 2193 2 (\dagger , 100)
- 2412.4 15 γ_{378} 2034.5 15 (\dagger , 100)
- 2423 1 γ_{378} 2045 1 (\dagger , 100)
- C 2431.6+x 4, (29/2⁺) γ_{1770+x} 662.1 2 (\dagger , 100) (E2)
- 2440.2 9 γ_{952} 1488.1 8 (\dagger , 100)
- 2442 2 γ_{336} 2105 2 (\dagger , 100)
- 2443 1 γ_{378} 2065 1 (\dagger , 100)
- 2460 1 γ_{1016} 1443.5 9 (\dagger , 100)
- 2475+x 1 γ_{1019+x} 1459 1 (\dagger , 100)
- 2476 1 γ_{632} 1844 1 (\dagger , 100)
- 2477 1 γ_{378} 2099 1 (\dagger , 100)
- 2543 1 γ_{564} 1980 1 (\dagger , 100)
- F 2545.0+x 4, (31/2⁻) γ_{2065+x} 479.7 9 (\dagger , 100) (E2)
- A 2588.9+x 4, (29/2⁺) γ_{1770+x} 819.4 8 (\dagger , 100) (E2)
- 2594.9+x 4, (29/2⁻) γ_{1805+x} 790.3 3 (\dagger , 100) (E2)
- C 2598.6+x 4, (33/2⁺), 0.92 6 ns γ_{2432+x} 167.0 7 (\dagger , 100) (E2)
- K 2643.5+x 5, (33/2⁻) γ_{2124+x} 519.9 3 (\dagger , 100) (E2)
- H 2690.4+x 4, (33/2⁻) γ_{2124+x} 566.8 2 (\dagger , 100) (E2)
- D 2935.5+x 4, (29/2⁺) γ_{1770+x} 1166.0 3 (\dagger , 100)
- C 3078.5+x 4, (37/2⁺) γ_{2598+x} 479.2 2 (\dagger , 100) (E2)

3117.5+x5, (33/2*)	γ_{2589+x} 528.63 (\dagger_{100}) (E2)	D 7077.4+x8, (57/2*)	γ_{6231+x} 846.63 (\dagger_{100}) (E2)
D 3167.0+x4, (33/2*)	γ_{2836+x} 231.63 (\dagger_{165}) (E2) γ_{2599+x} 568.47 ($\dagger_{100.26}$) (M1+E2) γ_{2589+x} 578.18 (\dagger_{389}) (E2)	7227.0+x7, (57/2*)	γ_{6937+x} 290.53 (\dagger_{100}) (M1)
F 3222.2+x5, (35/2*)	γ_{2545+x} 677.1 (\dagger_{100}) (E2)	7527.8+x7, (59/2)	γ_{7227+x} 300.83 (\dagger_{100}) D
3252.8+x4, (33/2*)	γ_{2595+x} 658.03 ($\dagger_{100.39}$) γ_{2124+x} 1129.33 ($\dagger_{22.17}$)	G 7670.7+x8	γ_{6679+x} 992.53 (\dagger_{100})
H 3428.9+x4, (37/2*)	γ_{2690+x} 738.52 (\dagger_{100}) (E2)	7689.9+x7, (59/2)	γ_{7227+x} 462.93 (\dagger_{100}) D
D 3487.7+x5, (37/2*)	γ_{3167+x} 320.68 ($\dagger_{71.14}$) (E2) γ_{3079+x} 409.38 ($\dagger_{100.20}$) (M1+E2)	7697.0+x8	γ_{6679+x} 1018.83 (\dagger_{100})
K 3518.9+x6, (37/2*)	γ_{2644+x} 875.43 (\dagger_{100}) (E2)	7987.4+x7, (61/2)	γ_{7528+x} 459.63 ($\dagger_{100.64}$) D γ_{7227+x} 760.43 ($\dagger_{50.27}$)
3728.1+x5, (35/2)	γ_{2690+x} 1037.73 (\dagger_{100})	8351.8+x7, (63/2)	γ_{7987+x} 364.43 ($\dagger_{100.79}$) γ_{7690+x} 661.93 ($\dagger_{75.17}$)
C 3792.7+x5, (41/2*)	γ_{3079+x} 714.1 (\dagger_{100}) (E2)		γ_{7528+x} 824.3 ($\dagger_{75.29}$) Q
3946.8+x4, (37/2*)	γ_{3253+x} 694.03 ($\dagger_{100.21}$) γ_{2690+x} 1256.43 ($\dagger_{42.33}$) (E2)	8668.9+x8	γ_{8352+x} 317.13 (\dagger_{100})
G 3957.2+x5, (39/2*)	γ_{3222+x} 735.1 (\dagger_{100}) (E2)	L u, J=(31/2)	
F 3969.0+x5, (39/2*)	γ_{3222+x} 746.83 (\dagger_{100}) (E2)	L 310.9+u7, J+2	γ_0 310.97 ($\dagger_{0.142}$) $I^{(1)}=105.7, I^{(2)}=98.5, \eta\omega=0.166$
D 3988.6+x5, (41/2*)	γ_{3488+x} 501.1 (\dagger_{100}) (E2)	L 662.4+u7, J+4	γ_{311+u} 351.51 ($\dagger_{0.835}$) $I^{(1)}=105.0, I^{(2)}=99.8, \eta\omega=0.186$
J 4140.9+x5, (41/2*)	γ_{3429+x} 712.03 (\dagger_{100}) (E2)	L 1054.0+u8, J+6	γ_{662+u} 391.64 ($\dagger_{1.009}$) $I^{(1)}=104.5, I^{(2)}=100.8, \eta\omega=0.206$
I 4217.7+x5, (41/2*)	γ_{3429+x} 787.1 (\dagger_{100}) (E2)	L 1485.3+u8, J+8	γ_{1054+u} 431.31 ($\dagger_{0.984}$) $I^{(1)}=104.3, I^{(2)}=103.1, \eta\omega=0.225$
K 4276.1+x6, (41/2*)	γ_{3519+x} 757.23 (\dagger_{100}) (E2)	L 1955.4+u8, J+10	γ_{1485+u} 470.11 ($\dagger_{1.024}$) $I^{(1)}=104.2, I^{(2)}=104.4, \eta\omega=0.245$
G 4357.4+x5, (43/2*)	γ_{3957+x} 400.1 (\dagger_{100}) (E2)	L 2463.8+u8, J+12	γ_{1955+u} 508.41 ($\dagger_{0.976}$) $I^{(1)}=104.3, I^{(2)}=106.7, \eta\omega=0.264$
4382.6+x5, (41/2*)	γ_{3429+x} 953.73 (\dagger_{100}) (E2)	L 3009.7+u9, J+14	γ_{2464+u} 545.92 ($\dagger_{0.885}$) $I^{(1)}=104.6, I^{(2)}=109.6, \eta\omega=0.282$
E 4492.0+x5, (41/2*)	γ_{3488+x} 1004.33 ($\dagger_{62.15}$) γ_{3079+x} 1413.53 ($\dagger_{100.23}$) (E2)	L 3592.1+u9, J+16	γ_{3010+u} 582.41 ($\dagger_{0.774}$) $I^{(1)}=104.9, I^{(2)}=110.8, \eta\omega=0.300$
4529.8+x4, (39/2)	γ_{3728+x} 801.73 ($\dagger_{53.13}$) γ_{3429+x} 1100.93 ($\dagger_{100.27}$) D	L 4210.6+u9, J+18	γ_{3592+u} 618.52 ($\dagger_{0.7310}$) $I^{(1)}=105.3, I^{(2)}=113.6, \eta\omega=0.318$
4587.1+x4, (41/2*)	γ_{4530+x} 57.33 γ_{3957+x} 629.93 ($\dagger_{90.20}$) (M1) γ_{3947+x} 640.33 ($\dagger_{80.17}$) (E2) γ_{3429+x} 1158.23 ($\dagger_{100.7}$) (E2)	L 4864.3+u9, J+20	γ_{4211+u} 653.72 ($\dagger_{0.615}$) $I^{(1)}=105.8, I^{(2)}=115.6, \eta\omega=0.335$
C 4632.3+x5, (45/2*)	γ_{3793+x} 840.1 (\dagger_{100}) (E2)	L 5552.6+u9, J+22	γ_{4864+u} 688.32 ($\dagger_{0.535}$) $I^{(1)}=106.3, I^{(2)}=118.0, \eta\omega=0.353$
4653.7+x6, (43/2)	γ_{4383+x} 271.13 (\dagger_{100}) D	L 6274.8+u10, J+24	γ_{5553+u} 722.23 ($\dagger_{0.345}$) $I^{(1)}=106.9, I^{(2)}=119.8, \eta\omega=0.369$
D 4667.4+x5, (45/2*)	γ_{3989+x} 678.83 (\dagger_{100}) (E2)	L 7030.4+u10, J+26	γ_{6275+u} 755.63 ($\dagger_{0.174}$) $I^{(1)}=107.5, I^{(2)}=120.5, \eta\omega=0.386$
E 4850.9+x5, (45/2*)	γ_{4492+x} 358.93 ($\dagger_{100.21}$) (E2) γ_{3989+x} 862.33 (\dagger_{254}) (E2)	L 7819.2+u12, J+28	γ_{7030+u} 788.86 ($\dagger_{0.092}$)
4855.9+x5, (43/2*)	γ_{4587+x} 268.83 (\dagger_{100}) (M1)	M v, J=(21/2)	
4894.9+x6, (45/2*)	γ_{4654+x} 241.23 ($\dagger_{40.20}$) D γ_{4383+x} 512.33 ($\dagger_{100.20}$) (E2)	M 252.4+v7, J+2	γ_0 252.47 $I^{(1)}=91.7, I^{(2)}=99.3, \eta\omega=0.136$
4903.5+x6, (45/2)	γ_{4654+x} 249.83 ($\dagger_{38.13}$) D γ_{4383+x} 520.93 ($\dagger_{100.25}$)	M 545.1+v7, J+4	γ_{252+v} 292.71 ($\dagger_{0.437}$) $I^{(1)}=92.7, I^{(2)}=99.0, \eta\omega=0.156$
I 4957.7+x11	γ_{4218+x} 740.1 (\dagger_{100})	M 878.2+v7, J+6	γ_{545+v} 333.11 ($\dagger_{0.7610}$) $I^{(1)}=93.5, I^{(2)}=101.0, \eta\omega=0.176$
G 5006.5+x6, (47/2*)	γ_{4357+x} 649.13 (\dagger_{100}) (E2)	M 1251.0+v7, J+8	γ_{878+v} 372.71 ($\dagger_{1.0714}$) $I^{(1)}=94.3, I^{(2)}=102.3, \eta\omega=0.196$
J 5027.8+x6, (45/2*)	γ_{4141+x} 886.93 (\dagger_{100}) (E2)	M 1662.8+v8, J+10	γ_{1251+v} 411.82 ($\dagger_{0.8719}$) $I^{(1)}=95.1, I^{(2)}=103.9, \eta\omega=0.216$
K 5072+x3, (45/2*)	γ_{4276+x} 796.3 (\dagger_{100}) (E2)	M 2113.1+v8, J+12	γ_{1663+v} 450.31 ($\dagger_{0.9713}$) $I^{(1)}=95.9, I^{(2)}=105.8, \eta\omega=0.235$
5128.2+x6, (47/2)	γ_{4895+x} 233.33 (\dagger_{100}) D	M 2601.2+v8, J+14	γ_{2113+v} 488.12 ($\dagger_{0.8313}$) $I^{(1)}=96.7, I^{(2)}=107.8, \eta\omega=0.253$
5142.5+x5, (45/2*)	γ_{4856+x} 286.63 (\dagger_{100}) (M1) γ_{4587+x} 555.43 ($\dagger_{86.5}$) (E2)	M 3126.4+v8, J+16	γ_{2601+v} 525.22 ($\dagger_{0.5716}$) $I^{(1)}=97.5, I^{(2)}=109.9, \eta\omega=0.272$
5296.1+x5, (47/2*)	γ_{4856+x} 440.23 (\dagger_{100}) (E2)	M 3688.0+v8, J+18	γ_{3126+v} 561.63 ($\dagger_{0.6510}$) $I^{(1)}=98.4, I^{(2)}=112.4, \eta\omega=0.290$
D 5427.3+x6, (49/2*)	γ_{4667+x} 759.93 (\dagger_{100}) (E2)	M 4285.2+v17, J+20	γ_{3688+v} 597.22 ($\dagger_{0.9714}$) $I^{(1)}=99.2, I^{(2)}=114.6, \eta\omega=0.307$
5506.6+x5, (47/2)	γ_{5296+x} 210.53 ($\dagger_{41.10}$) (M1) γ_{5143+x} 364.13 ($\dagger_{100.15}$) (M1) γ_{4856+x} 650.73 ($\dagger_{78.7}$) (E2)	M 4917.3+v17, J+22	γ_{4285+v} 632.12 ($\dagger_{0.5510}$) $I^{(1)}=100.1, I^{(2)}=117.3, \eta\omega=0.325$
E 5534.0+x5, (49/2*)	γ_{4851+x} 683.13 ($\dagger_{100.24}$) (E2) γ_{4667+x} 866.63 (\dagger_{214}) γ_{4632+x} 901.73 ($\dagger_{19.3}$) (E2)	M 5583.5+v17, J+24	γ_{4917+v} 666.22 ($\dagger_{0.536}$) $I^{(1)}=101.0, I^{(2)}=118.7, \eta\omega=0.342$
C 5553.4+x6, (49/2*)	γ_{4632+x} 921.13 (\dagger_{100}) (E2)	M 6283.4+v18, J+26	γ_{5584+v} 699.92 ($\dagger_{0.408}$) $I^{(1)}=101.9, I^{(2)}=122.0, \eta\omega=0.358$
5653.8+x6, (49/2*)	γ_{5507+x} 147.23 (\dagger_{100}) (M1)	M 7016.1+v18, J+28	γ_{6283+v} 732.74 $I^{(1)}=102.8, I^{(2)}=123.1, \eta\omega=0.374$
G 5795.7+x7, (51/2*)	γ_{5507+x} 789.23 (\dagger_{100}) (E2)	M 7781.3+v18, J+30	γ_{7016+v} 765.24 $I^{(1)}=103.7, I^{(2)}=127.8, \eta\omega=0.390$
I 5802.8+x12	γ_{4958+x} 845.13 (\dagger_{100})	M 8577.8+v19, J+32	γ_{7781+v} 796.56
J 6025.4+x7	γ_{5028+x} 997.63 (\dagger_{100})	N w, J=(23/2)	
6085.3+x6, (51/2*)	γ_{5654+x} 431.53 ($\dagger_{81.13}$) (M1) γ_{5507+x} 578.73 ($\dagger_{100.32}$) (E2)	N 272.0+w10, J+2	γ_0 272.0 $I^{(1)}=92.3, I^{(2)}=97.3, \eta\omega=0.146$
D 6230.8+x7, (53/2*)	γ_{5427+x} 803.53 (\dagger_{100}) (E2)	N 585.1+w10, J+4	γ_{272+w} 313.12 ($\dagger_{0.9516}$) $I^{(1)}=93.1, I^{(2)}=101.5, \eta\omega=0.166$
E 6333.7+x6, (53/2*)	γ_{5534+x} 799.73 (\dagger_{100}) (E2)	N 937.7+w10, J+6	γ_{585+w} 352.51 ($\dagger_{0.9616}$) $I^{(1)}=94.1, I^{(2)}=102.6, \eta\omega=0.186$
6459.6+x6, (53/2)	γ_{6085+x} 374.33 ($\dagger_{67.20}$) D γ_{5654+x} 805.83 ($\dagger_{100.47}$) Q		
C 6520.7+x7, (53/2*)	γ_{5553+x} 967.33 (\dagger_{100}) (E2)		
G 6678.2+x8, (55/2*)	γ_{5796+x} 882.53 (\dagger_{100}) (E2)		
6936.5+x6, (55/2*)	γ_{6460+x} 476.93 ($\dagger_{29.8}$) D γ_{6085+x} 851.23 ($\dagger_{100.6}$) (E2)		

- N 1329.2+w 11, J+8 γ_{938+w} 391.54 (\dagger_{γ} 1.44 19) I⁽¹⁾=95.0, I⁽²⁾=104.7, $\eta\omega=0.205$
- N 1758.9+w 11, J+10 γ_{1329+w} 429.71 I⁽¹⁾=95.9, I⁽²⁾=107.0, $\eta\omega=0.224$
- N 2226.0+w 11, J+12 γ_{1758+w} 467.12 (\dagger_{γ} 1.07 19) I⁽¹⁾=96.8, I⁽²⁾=108.7, $\eta\omega=0.243$
- N 2729.9+w 11, J+14 γ_{2226+w} 503.91 (\dagger_{γ} 0.78 14) I⁽¹⁾=97.7, I⁽²⁾=111.7, $\eta\omega=0.261$
- N 3269.6+w 12, J+16 γ_{2730+w} 539.73 (\dagger_{γ} 0.70 10) I⁽¹⁾=98.7, I⁽²⁾=113.3, $\eta\omega=0.279$
- N 3844.6+w 12, J+18 γ_{3270+w} 575.01 (\dagger_{γ} 0.71 12) I⁽¹⁾=99.6, I⁽²⁾=115.9, $\eta\omega=0.296$
- N 4454.1+w 12, J+20 γ_{3845+w} 609.51 (\dagger_{γ} 0.64 8) I⁽¹⁾=100.6, I⁽²⁾=120.5, $\eta\omega=0.313$
- N 5096.8+w 12, J+22 γ_{4454+w} 642.72 (\dagger_{γ} 0.50 5) I⁽¹⁾=101.6, I⁽²⁾=119.8, $\eta\omega=0.330$
- N 5772.9+w 12, J+24 γ_{5097+w} 676.13 (\dagger_{γ} 0.40 5) I⁽¹⁾=102.6, I⁽²⁾=123.5, $\eta\omega=0.346$
- N 6481.4+w 13, J+26 γ_{5773+w} 708.53 (\dagger_{γ} 0.33 6) I⁽¹⁾=103.6, I⁽²⁾=127.0, $\eta\omega=0.362$
- N 7221.4+w 13, J+28 γ_{6481+w} 740.03 I⁽¹⁾=104.5, I⁽²⁾=127.8, $\eta\omega=0.378$
- N 7992.7+w 13, J+30 γ_{7221+w} 771.33 I⁽¹⁾=105.6, I⁽²⁾=137.0, $\eta\omega=0.393$
- N 8793.2+w 17, J+32 γ_{7993+w} 800.510(?)

- O 2, J=(25/2)
- O 280.9+z 6, J+2 γ_z 280.96 (\dagger_{γ} 0.22 5) I⁽¹⁾=95.9, I⁽²⁾=93.7, $\eta\omega=0.151$
- O 604.5+z 6, J+4 γ_{281+z} 323.62 (\dagger_{γ} 0.58 9) I⁽¹⁾=95.6, I⁽²⁾=92.0, $\eta\omega=0.173$
- O 971.6+z 7, J+6 γ_{605+z} 367.12 (\dagger_{γ} 0.80 12) I⁽¹⁾=95.2, I⁽²⁾=92.6, $\eta\omega=0.194$
- O 1381.9+z 8, J+8 γ_{972+z} 410.34 (\dagger_{γ} 0.96 17) I⁽¹⁾=95.0, I⁽²⁾=94.6, $\eta\omega=0.216$
- O 1834.5+z 8, J+10 γ_{1382+z} 452.63 (\dagger_{γ} 1.04 15) I⁽¹⁾=95.1, I⁽²⁾=96.4, $\eta\omega=0.237$
- O 2328.6+z 9, J+12 γ_{1835+z} 494.12 (\dagger_{γ} 0.79 12) I⁽¹⁾=95.2, I⁽²⁾=96.9, $\eta\omega=0.257$
- O 2864.0+z 9, J+14 γ_{2329+z} 535.43 (\dagger_{γ} 0.71 15) I⁽¹⁾=95.5, I⁽²⁾=101.0, $\eta\omega=0.278$
- O 3439.0+z 10, J+16 γ_{2864+z} 575.04 (\dagger_{γ} 0.73 15) I⁽¹⁾=99.6, I⁽²⁾=115.9, $\eta\omega=0.296$
- O 4053.3+z 11, J+18 γ_{3439+z} 614.35 (\dagger_{γ} 0.58 11) I⁽¹⁾=96.4, I⁽²⁾=109.6, $\eta\omega=0.316$
- O 4704.1+z 13, J+20 γ_{4053+z} 650.86 (\dagger_{γ} 0.50 12) I⁽¹⁾=97.1, I⁽²⁾=108.7, $\eta\omega=0.335$
- O 5391.7+z 14, J+22 γ_{4704+z} 687.67 (\dagger_{γ} 0.46 11) I⁽¹⁾=97.8, I⁽²⁾=112.4, $\eta\omega=0.353$
- O 6114.9+z 16, J+24 γ_{5392+z} 723.28 (\dagger_{γ} 0.41 9) I⁽¹⁾=98.7, I⁽²⁾=122.0, $\eta\omega=0.370$
- O 6870.9+z 20, J+26 γ_{6115+z} 756.012 (\dagger_{γ} 0.32 8) I⁽¹⁾=99.7, I⁽²⁾=121.2, $\eta\omega=0.386$
- O 7659.9+z 24, J+28 γ_{6871+z} 789.013 (\dagger_{γ} 0.19 5)

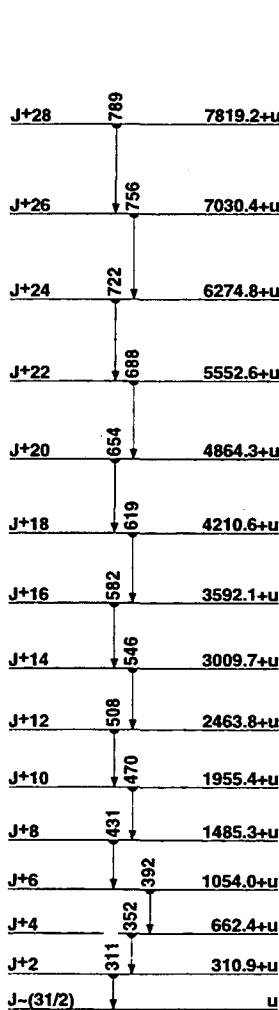

SD-1 band
(89Mo08,95Ca15)

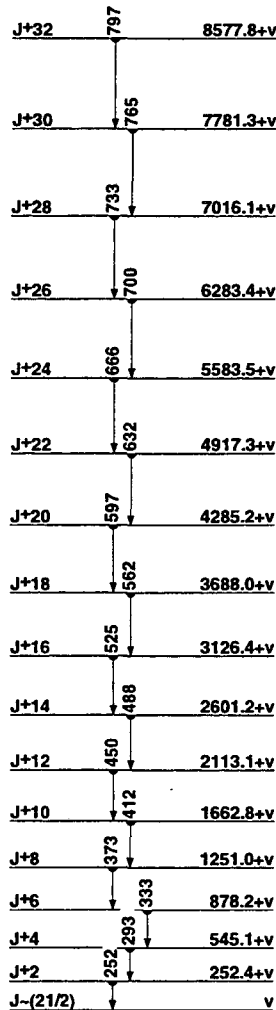

SD-2 band
(90Ca18,95Ca15)

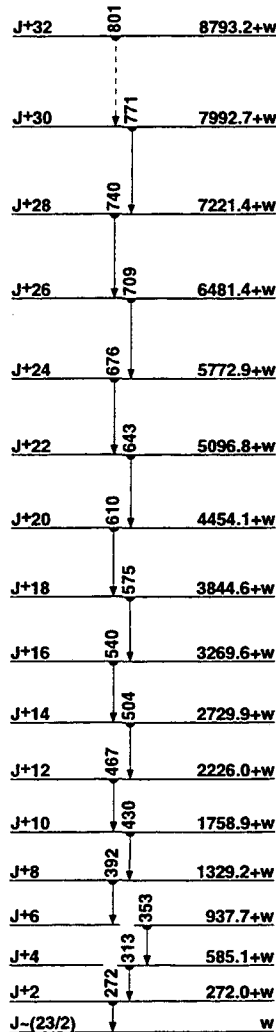

SD-3 band
(90Ca18,95Ca15)

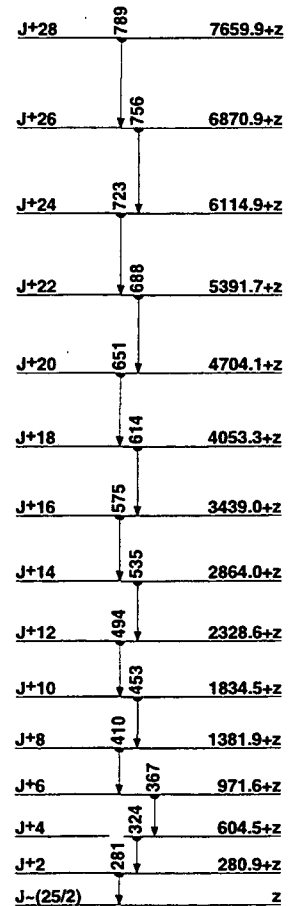

SD-4 band
(95Ca15)

¹⁹²Hg
80

Δ: (-32100) S_n: (9500) S_p: (5500) Q_{EC}: (700) Q_α: (3300)

Nuclear Bands

- A GS band, α=0
- B α=1
- C α=0
- D α=0
- E Band Structure
- F α=0
- G α=1
- H α=0
- I SD-1 band (92La07,94Ga07,95Fa03)
- J SD-2 band (95Fa03,95Ko17)
- K SD-3 band (95Fa03)

Levels and γ-ray branchings:

- A 0, 0⁺, 4.8520 h, %EC=100
- A 422.8 1, 2⁺ γ₀ 422.8 1 (†, 100) E2
- A 1057.6 2, 4⁺ γ₄₂₃ 634.8 1 (†, 100) E2
- 1113.6 2, 2⁺ γ₄₂₃ 690.8 1 (†, 100 6) M1+E2: δ=1.7⁺⁵ γ₀ 1113.0 (†, 24.3 12) E2
- 1535.6 2, 3⁺ γ₁₀₅₈ 477.6 3 (†, 12.3 14) M1+(E2): δ=0.5 5 γ₄₂₃ 1113.0 2 (†, 100 5) M1
- 1733.0 2, (4)⁺ γ₁₁₃₄ 619.4 2 (†, 84.4) E2 γ₁₀₅₈ 675.4 1 (†, 100 6)
- M1+E2: δ=0.7⁺²
- A 1803.1 2, 6⁺ γ₁₀₅₈ 745.5 1 (†, 100) E2
- 1831.6 2, (3,4) γ₁₁₁₄ 717.9 3 (†, 100.0 14) γ₁₀₅₈ 774.1 2 (†, 74.5)
- B 1843.9 2, (5)⁻ γ₁₀₅₈ 786.3 1 (†, 100) E1
- 1844.6 3, (3,4) γ₄₂₃ 1421.8 2 (†, 100)
- 1908.6 3, 1, 2⁺ γ₄₂₃ 1486.1 4 (†, 76 8) γ₀ 1908.4 3 (†, 100 7)
- B 1977.1 2, (7)⁻, 1.04 6 ns γ₁₈₄₄ 133.1 1 (†, 42.5 16) E2 γ₁₈₀₃ 174.0 1 (†, 100 4) E1
- 2056.3 3, (1, 2⁺) γ₄₂₃ 1633.5 2 (†, 100 7) γ₀ 2056.0 6 (?) (†, <56)
- 2081.7 3, (1, 2⁺) γ₄₂₃ 1658.9 2 (†, 100 8) γ₀ 2081.9 6 (?) (†, 3.5 13)
- 2187.0 3, (6)⁻ γ₁₈₄₄ 343.1 2 (†, 35 13) M1 γ₁₈₀₃ 383.9 2 (†, 100 13) E1
- C 2216.3 3, (8)⁻, 0.92 5 ns γ₁₉₇₇ 239.2 2 (†, 100) M1+E2: δ=1.2 6
- B 2223.9 3, (9)⁻ γ₁₉₇₇ 246.8 2 (†, 100) E2
- 2276.9 3, 1, 2⁺ γ₄₂₃ 1854.0 4 (†, 100 9) γ₀ 2277.0 6 (†, 57 9)
- 2284.7 4 γ₁₁₁₄ 1171.1 4 (†, 100)
- 2300.8 3, (6, 7, 8)⁻ γ₁₉₇₇ 323.7 2 (†, 100) M1+E2: δ=0.74 17
- D 2447.2 3, (8)⁺ γ₁₈₀₃ 644.1 2 (†, 100) E2
- D 2507.3 3, (10)⁺, 3.6 5 ns γ₂₄₄₇ 60.1 3 (†, ≈2.2) E2 γ₂₂₂₄ 283.4 2 (†, 100 20) E1
- 2534.6 4 (?) γ₁₅₃₆ 999.0 3 (?) (†, 100)
- D 2535.6 3, (12)⁺, 11.1 5 ns γ₂₅₀₇ 28.4 3 (†, 100) E2
- C 2632.7 3, (10)⁻ γ₂₂₂₄ 408.8 2 (†, 38) γ₂₂₁₆ 416.5 2 (†, 100) E2
- 2657 (?) γ₁₈₀₃ 854 (?) (†, 100)
- B 2756.8 3, (11)⁻ γ₂₂₂₄ 532.9 2 (†, 100) E2
- D 2951.8 3, (14)⁺ γ₂₅₃₆ 416.3 2 (†, 100) E2
- E 3047.0 3, (12)⁺ γ₂₅₃₆ 511.3 3 γ₂₅₀₇ 539.7 3 E2
- C 3261.9 3, (12)⁻ γ₂₇₅₇ 505.2 3 (†, 3.8) γ₂₆₃₃ 629.2 2 (†, 100) E2
- B 3449.7 3, (13)⁻ γ₂₇₅₇ 692.9 2 (†, 100) E2
- D 3608.7 4, (16)⁺ γ₂₉₅₂ 656.8 2 (†, 100) E2
- E 3669.9 4, (14)⁺ γ₃₀₄₇ 622.7 3 (†, 100) E2 γ₂₉₅₂ 718.4 3 (†, 63)
- 3725.7 4, (14)⁺ γ₃₀₄₇ 678.7 3 (†, 100) E2
- F 3894.9 3, (14)⁻ γ₃₄₅₀ 445.2 3 (†, 3.8) γ₃₂₆₂ 633.0 2 (†, 100) E2
- G 4010.5 3, (15)⁻ γ₃₄₅₀ 560.9 2 (†, 100) E2 γ₂₉₅₂ 1058.7 3 (†, 24)
- F 4090.0 3, (16)⁻, 0.39 4 ns γ₃₈₉₅ 195.0 2 (†, 100) E2
- E 4130.7 4, (16)⁺ γ₃₇₂₆ 405.0 3 (†, 26) E2 γ₃₆₇₀ 460.9 3 (†, 100) E2
- γ₃₆₀₉ 521.9 3 (†, 30)
- G 4216.9 4, (17)⁻ γ₄₀₉₀ 126.9 3 (†, 33) γ₄₀₁₁ 206.5 3 (†, 100) E2
- F 4387.7 4, (18)⁻ γ₄₀₉₀ 297.7 3 (†, 100) E2
- D 4389.5 4, (18)⁺ γ₃₆₀₉ 780.8 2 (†, 100) E2
- G 4588.4 4, (19)⁻ γ₄₃₈₈ 200.7 3 (†, 8.2) γ₄₂₁₇ 371.5 2 (†, 100) E2

- E 4741.7 4, (18)⁺ γ₄₁₃₁ 611.0 2 (†, 100) (E2)
- F 4950.5 5, (20)⁻ γ₄₃₈₈ 562.8 3 (†, 100) E2
- H 5130.8 5, (20)⁺ γ₄₃₉₀ 741.3 2 (†, 100) E2
- G 5216.0 4, (21)⁻ γ₄₅₈₈ 627.6 2 (†, 100) (E2)
- D 5271.7 5, (20)⁺ γ₄₃₉₀ 882.2 3 (†, 100)
- E 5316.5 5, (20)⁺ γ₄₇₄₂ 574.8 3 (†, 100) E2
- F 5655.2 6, (22)⁻ γ₄₈₅₁ 704.7 3 (†, 100) E2
- H 5700.7 5, (22)⁺ γ₅₁₃₁ 569.9 2 (†, 100) E2
- E 5787.9 6, (22)⁺ γ₅₃₁₇ 471.4 3 (†, 100) (E2)
- G 6012.2 5, (23)⁻ γ₅₂₁₆ 796.2 3 (†, 100) E2
- H 6428.2 6, (24)⁺ γ₅₇₀₁ 727.5 3 (†, 100) E2
- F 6437.5 7, (24)⁻ γ₅₆₅₅ 782.3 3 (†, 100)
- G 6855.0 6 (?), (25)⁻ γ₆₀₁₂ 842.8 3 (?) (†, 100)
- I x, J=(8)
- I 214.4+x, J+2, <77 ps γ_x 214.4 3 (†, 0.08 2) (E2) I⁽¹⁾=84.7, I⁽²⁾=92.2, ηω=0.118
- I 472.2+x, J+4, 3.7 7 ps γ_{214+x} 257.8 1 (†, 0.88 5) (E2) I⁽¹⁾=86.0, I⁽²⁾=94.6, ηω=0.139
- I 772.3+x, J+6, 1.74 19 ps γ_{472+x} 300.1 1 (†, 1.01 5) (E2) I⁽¹⁾=87.3, I⁽²⁾=96.9, ηω=0.160
- I 1113.7+x, J+8, 0.84⁺¹⁷₋₂₆ ps γ_{772+x} 341.4 1 (†, 1.07 6) (E2) I⁽¹⁾=88.5, I⁽²⁾=99.5, ηω=0.181
- I 1495.3+x, J+10, 0.48⁺²⁷₋₁₆ ps γ_{1114+x} 381.6 1 (†, 1.04 5) (E2) I⁽¹⁾=89.7, I⁽²⁾=101.3, ηω=0.201
- I 1916.4+x, J+12 γ_{1495+x} 421.1 2 (E2) I⁽¹⁾=90.9, I⁽²⁾=106.1, ηω=0.220
- I 2375.2+x, J+14, 0.18⁺³₋₅ ps γ_{1916+x} 458.8 2 (†, 1.08 6) (E2) I⁽¹⁾=92.2, I⁽²⁾=107.5, ηω=0.239
- I 2871.2+x, J+16, 0.137⁺¹⁵₋₂₅ ps γ_{2375+x} 496.0 2 (†, 0.94 6) (E2) I⁽¹⁾=93.4, I⁽²⁾=110.8, ηω=0.257
- I 3403.3+x, J+18, 0.093⁺⁹₋₁₆ ps γ_{2871+x} 532.1 2 (†, 0.88 5) (E2) I⁽¹⁾=94.6, I⁽²⁾=113.3, ηω=0.275
- I 3970.7+x, J+20, 0.068⁺⁸₋₁₃ ps γ_{3403+x} 567.4 2 (†, 0.69 4) (E2) I⁽¹⁾=95.8, I⁽²⁾=116.6, ηω=0.292
- I 4572.4+x, J+22, 0.062 8 ps γ_{3971+x} 601.7 2 (†, 0.71 4) (E2) I⁽¹⁾=97.0, I⁽²⁾=120.5, ηω=0.309
- I 5207.3+x, J+24, 0.050⁺⁸₋₁₅ ps γ_{4572+x} 634.9 2 (E2) I⁽¹⁾=98.2, I⁽²⁾=120.5, ηω=0.326
- I 5875.4+x, J+26, 0.031⁺⁷₋₁₀ ps γ_{5207+x} 668.1 2 (†, 0.55 5) (E2) I⁽¹⁾=99.4, I⁽²⁾=125.0, ηω=0.342
- I 6575.5+x, J+28, 0.032⁺⁷₋₁₀ ps γ_{5875+x} 700.1 2 (†, 0.49 6) (E2) I⁽¹⁾=100.6, I⁽²⁾=127.4, ηω=0.358
- I 7307.0+x, J+30, 0.021⁺⁸₋₂₁ ps γ_{6576+x} 731.5 2 (†, 0.42 6) (E2) I⁽¹⁾=101.8, I⁽²⁾=129.9, ηω=0.373
- I 8069.3+x, J+32, 0.019⁺⁹₋₁₉ ps γ_{7307+x} 762.3 3 (†, 0.31 5) (E2) I⁽¹⁾=102.9, I⁽²⁾=131.6, ηω=0.389
- I 8862.0+x, J+34 γ_{8069+x} 792.7 4 (†, 0.29 4) (E2) I⁽¹⁾=104.0, I⁽²⁾=132.5, ηω=0.404
- I 9684.9+x, J+36 γ_{8862+x} 822.9 4 (†, 0.06 2) (E2) I⁽¹⁾=105.0, I⁽²⁾=132.5, ηω=0.419
- I 10538.0+x, J+38 γ_{9685+x} 853.1 5 (†, 0.03 1) I⁽¹⁾=105.6, I⁽²⁾=112.4, ηω=0.435
- I 11426.7+x (?), J+40 γ_{10538+x} 888.7 7 (?) (†, <0.05)
- J y, J=(10)
- J 241.2+y, J+2 γ_y 241.2 I⁽¹⁾=91.7, I⁽²⁾=97.1, ηω=0.131
- J 523.6+y, J+4 γ_{241+y} 282.4 2 (†, 0.71 8) I⁽¹⁾=92.6, I⁽²⁾=100.8, ηω=0.151
- J 845.7+y, J+6 γ_{524+y} 322.1 2 (†, 1.03 8) I⁽¹⁾=93.6, I⁽²⁾=102.0, ηω=0.171
- J 1207.0+y, J+8 γ_{846+y} 361.3 2 (†, 1.00 7) I⁽¹⁾=94.6, I⁽²⁾=102.8, ηω=0.190
- J 1607.2+y, J+10 γ_{1207+y} 400.2 2 (†, 0.99 6) I⁽¹⁾=95.4, I⁽²⁾=105.8, ηω=0.210
- J 2045.2+y, J+12 γ_{1607+y} 438.0 2 (†, 0.96 6) I⁽¹⁾=96.4, I⁽²⁾=107.5, ηω=0.228
- J 2520.4+y, J+14, 0.14 4 ps γ_{2045+y} 475.2 2 (†, 0.97 7) I⁽¹⁾=97.3, I⁽²⁾=111.7, ηω=0.247
- J 3031.4+y, J+16, 0.15⁺⁵₋₃ ps γ_{2520+y} 511.0 2 (†, 1.08 7) I⁽¹⁾=98.3, I⁽²⁾=112.0, ηω=0.264

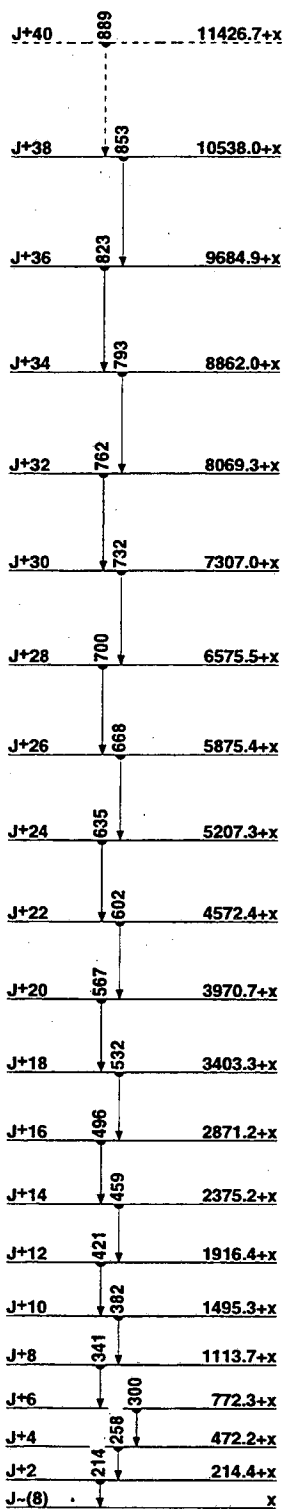

SD-1 band
(92La07,94Ga07,95Fa03)

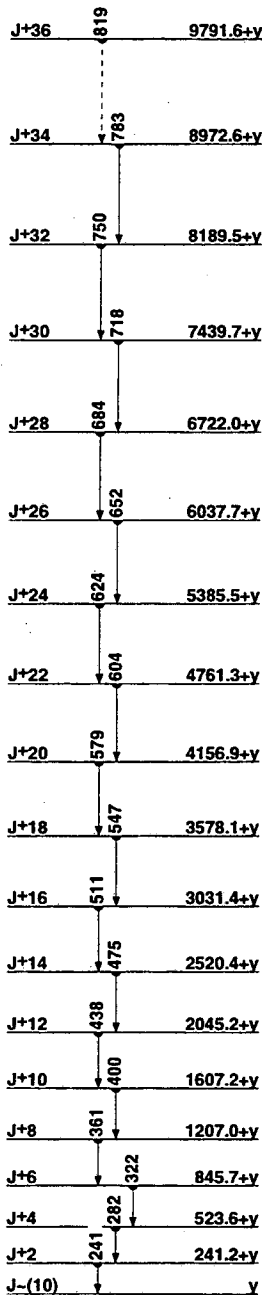

SD-2 band
(95Fa03,95Ko17)

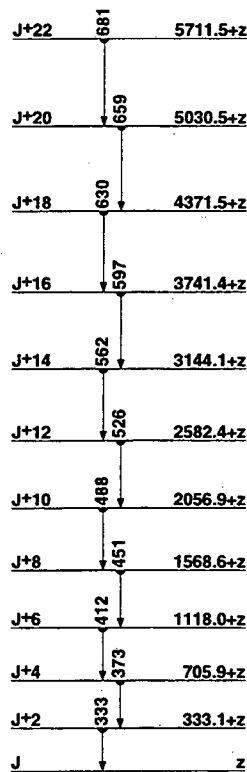

SD-3 band
(95Fa03)

- J 3578.1+y, J+18, 0.100 14 ps γ_{3031+y} 546.72 (\dagger_{γ} 1.036) $I^{(1)}=99.5$, $I^{(2)}=124.6$, $\hbar\omega=0.281$
- J 4156.9+y, J+20, 0.064 8 ps γ_{3578+y} 578.82 (\dagger_{γ} 0.917) $I^{(1)}=101.4$, $I^{(2)}=156.2$, $\hbar\omega=0.296$
- J 4761.3+y, J+22, 0.052 $\frac{9}{5}$ ps γ_{4157+y} 604.42 (\dagger_{γ} 0.827) $I^{(1)}=104.2$, $I^{(2)}=202.0$, $\hbar\omega=0.307$
- J 5385.5+y, J+24, 0.044 6 ps γ_{4761+y} 624.23 (\dagger_{γ} 0.558) $I^{(1)}=106.5$, $I^{(2)}=142.9$, $\hbar\omega=0.319$
- J 6037.7+y, J+26 γ_{5386+y} 652.23 (\dagger_{γ} 0.658) $I^{(1)}=107.7$, $I^{(2)}=124.6$, $\hbar\omega=0.334$
- J 6722.0+y, J+28 γ_{6038+y} 684.33 (\dagger_{γ} 0.508) $I^{(1)}=108.4$, $I^{(2)}=119.8$, $\hbar\omega=0.350$
- J 7439.7+y, J+30 γ_{6722+y} 717.73 (\dagger_{γ} 0.307) $I^{(1)}=109.0$, $I^{(2)}=124.6$, $\hbar\omega=0.367$
- J 8189.5+y, J+32 γ_{7440+y} 749.84 (\dagger_{γ} 0.194) $I^{(1)}=109.6$, $I^{(2)}=120.1$, $\hbar\omega=0.383$
- J 8972.6+y, J+34 γ_{8190+y} 783.15 (\dagger_{γ} 0.123) $I^{(1)}=109.9$, $I^{(2)}=111.4$, $\hbar\omega=0.401$
- J 9791.6+y, J+36 γ_{8973+y} 8191(?)
- K z, J
- K 333.1+z, J+2 γ_z 333.13 (\dagger_{γ} 0.667) $I^{(2)}=100.8$, $\hbar\omega=0.176$
- K 705.9+z, J+4 γ_{333+z} 372.82 (\dagger_{γ} 1.138) $I^{(2)}=101.8$, $\hbar\omega=0.196$
- K 1118.0+z, J+6 γ_{706+z} 412.12 (\dagger_{γ} 0.909) $I^{(2)}=103.9$, $\hbar\omega=0.216$
- K 1568.6+z, J+8 γ_{1118+z} 450.63 (\dagger_{γ} 0.958) $I^{(2)}=106.1$, $\hbar\omega=0.235$
- K 2056.9+z, J+10 γ_{1569+z} 488.33 (\dagger_{γ} 0.978) $I^{(2)}=107.5$, $\hbar\omega=0.253$
- K 2582.4+z, J+12 γ_{2057+z} 525.54 (\dagger_{γ} 0.808) $I^{(2)}=110.5$, $\hbar\omega=0.272$
- K 3144.1+z, J+14 γ_{2582+z} 561.74 (\dagger_{γ} 0.447) $I^{(2)}=112.4$, $\hbar\omega=0.290$
- K 3741.4+z, J+16 γ_{3144+z} 597.34 (\dagger_{γ} 0.507) $I^{(2)}=122.0$, $\hbar\omega=0.307$
- K 4371.5+z, J+18 γ_{3741+z} 630.15 $I^{(2)}=138.4$, $\hbar\omega=0.322$
- K 5030.5+z, J+20 γ_{4372+z} 659.08 (\dagger_{γ} 0.204) $I^{(2)}=181.8$, $\hbar\omega=0.335$
- K 5711.5+z, J+22 γ_{5031+z} 681.015 (\dagger_{γ} 0.156)

¹⁹³Hg
80

Δ : -31071 19 S_n : (7100) S_p : 5581 25 Q_{EC} : 2340 17 Q_α : 2989 22

Nuclear Bands

- A Favored band $\nu_{13/2}$
- B Unfavored band $\nu_{13/2}$
- C Band Structure
- D Band Structure
- E SD-1 band (94Jo10,93Jo09,90Cu05)
- F SD-2 band (94Jo10,93Jo09,90Cu05)
- G SD-3 band (94Jo10,93Jo09,90Cu05)
- H SD-4 band (94Jo10,93Jo09,90Cu05)
- I SD-5 band (94Jo10,93Jo09,90Cu05)
- J SD-6 band (94Jo10)

Levels and γ -ray branchings:

- 0, 3/2⁻, 3.80 15 h, %EC+% β^+ =100, μ =-0.62757 18, Q =-0.72 38
- 39.51 3, 5/2⁻, 0.63 3 ns γ_0 39.51 3 (\dagger ,100) M1
- 49.96 10, (1/2⁻) γ_0 49.96 15 (\dagger ,100)
- A 140.76 5, 13/2⁺, 11.8 2 h, %EC+% β^+ =92.9 9, %IT=7.1 9, μ =-1.0584297 26, Q =+0.916 97 γ_{40} 101.25 4 (\dagger ,100) M4
- 207.74 20, (7/2⁻) γ_0 207.74 20 (\dagger ,100) (E2)
- 324.36 7, (3/2⁻) γ_{60} 274.39 14 (\dagger ,13.5 13) (M1+E2): δ =1.8 γ_{40} 284.89 13 (\dagger ,21.6 10) (M1+E2): δ =0.5 γ_0 324.37 10 (\dagger ,100) (M1+E2): δ =0.4 γ_0 344.00 9, (3/2⁻) γ_{60} 294.08 25 (\dagger ,10.3 12) (M1+E2): δ =0.2 γ_0 343.99 10 (\dagger ,100 4) (M1+E2): δ =1.7 γ_{60} 374.62 9, (3/2⁻, 5/2⁻) γ_{324} 49.5 11 (\dagger ,<40) (M1+E2): δ =0.37 γ_{40} 335.11 10 (\dagger ,100 4) (M1+E2): δ =0.32 γ_0 374.58 22 (\dagger ,29 3) (E2)
- A 522.9 2, (17/2⁺) γ_{141} 382.1 2 (\dagger ,100) (E2)
- B 747.1 3, (15/2⁺) γ_{141} 606.4 3 (\dagger ,100) (M1+E2)
- 752.6 3, (3/2⁻, 5/2⁻) γ_{40} 713.0 4 (\dagger ,52 6) (M1+E2): δ =3.2 γ_0 752.5 4 (\dagger ,100 15) (M1)
- 1026.6 3, (13/2⁺, 15/2⁺) γ_{141} 885.8 3 (\dagger ,100)
- A 1145.4 3, (21/2⁺) γ_{523} 622.6 2 (\dagger ,100) (E2)
- B 1380.6 2, (19/2⁺) γ_{747} 633.4 3 (\dagger ,70) (E2) γ_{523} 857.6 2 (\dagger ,100) (M1+E2)
- 1523.3 3, (1⁻) γ_{753} 770.4 4 (\dagger ,100 6) (M1+E2): δ =0.9 γ_{40} 1484.1 7 (\dagger ,26 8) γ_0 1523.4 4 (\dagger ,62 15)
- 1523.4 3, (17/2⁺, 19/2⁺) γ_{1027} 496.9 3 (\dagger ,33) (E2) γ_{523} 1000.5 3 (\dagger ,100) (M1+E2)
- 1580.1 3 γ_{375} 1205.4 3 (\dagger ,23 3) γ_{324} 1256.0 3 (\dagger ,23 4) γ_{40} 1539.4 10 (\dagger ,20 4) γ_0 1579.3 10 (\dagger ,100 22)
- C 1756.0 3, (21/2⁻) $\gamma_{1523.3}$ 232.3 3 (\dagger ,<53) γ_{1381} 375.3 2 (\dagger ,100) (E1) γ_{1145} 610.4 4
- A 1884.2 3, (25/2⁺) γ_{1145} 738.7 2 (\dagger ,100) (E2)
- C 1886.5 3, (25/2⁻), 1.58 6 ns γ_{1756} 130.5 2 (\dagger ,100) (E2)
- D 1890.8 3, (23/2⁻) γ_{1756} 134.5 3 (\dagger ,18) γ_{1145} 745.5 2 (\dagger ,100) (E1)
- D 2095.9 3, (27/2⁻) γ_{1891} 205.0 2 (\dagger ,100) (E2) γ_{1887} 209.6 4 (\dagger ,7.5)
- C 2189.2 3, (29/2⁻) γ_{2096} 93.0 5 γ_{1887} 302.7 2 (E2)
- A 2502.1 4, (29/2⁺) γ_{1884} 617.8 2 (\dagger ,100) (E2)
- D 2583.6 4, (31/2⁻) γ_{2096} 487.6 2 (\dagger ,100) (E2)
- 2641.6 4, (29/2⁺) γ_{1884} 757.4 3 (\dagger ,100) (E2)
- A 2695.5 4, (33/2⁺), 573 30 ps γ_{2502} 193.4 2 (\dagger ,100) (E2)
- C 2762.2 4, (33/2⁻) γ_{2189} 573.0 2 (\dagger ,100) (E2)
- A 3176.1 4, (37/2⁺) γ_{2696} 480.6 2 (\dagger ,100) (E2)
- 3195.9 6, (33/2⁺) γ_{2642} 554.3 4 (\dagger ,100) (E2)
- D 3223.2 4, (35/2⁻) γ_{2584} 639.6 2 (\dagger ,100) (E2)
- 3260.0 4, (33/2⁺) γ_{2696} 564.5 4 γ_{2502} 757.8 3 (E2)
- C 3497.3 4, (37/2⁻) γ_{2762} 735.1 3 (\dagger ,100) (E2)
- 3570.0 5, (37/2⁺) γ_{3260} 309.9 3 (\dagger ,70) (E2) γ_{3176} 393.9 3 (\dagger ,100) (M1+E2)
- A 3880.4 5, (41/2⁺) γ_{3176} 704.3 3 (\dagger ,100) (E2)
- D 3883.4 5, (39/2⁻) γ_{3223} 660.1 3 (\dagger ,100) (E2)
- 4120.4 6, (41/2⁺) γ_{3570} 550.4 3 (\dagger ,100) (E2)
- C 4150.6 5, (41/2⁻) γ_{3497} 653.3 2 (\dagger ,100) (E2)
- 4197.7 6 γ_{3223} 974.5 4 (\dagger ,100)

- D 4396.2 6, (43/2⁻) γ_{3883} 512.8 4 (\dagger ,100)
- 4412.1 6 γ_{3497} 914.8 4 (\dagger ,100)
- C 4673.8 6, (45/2⁻) γ_{4151} 523.2 3 (\dagger ,100) (E2)
- A 4688.1 6, (45/2⁺) γ_{3880} 807.7 3 (\dagger ,100) (E2)
- D 5047.3 7, (47/2⁻) γ_{4396} 651.1 3 (\dagger ,100) (E2)
- C 5546.9 7, (49/2⁻) γ_{4674} 873.1 4 (\dagger ,100)
- A 5556.9 7, (49/2⁺) γ_{4688} 868.8 4 (\dagger ,100) (E2)
- D 5898.3 8, (51/2⁻) γ_{5047} 851.0 4 (\dagger ,100)
- E x, J=(19/2⁻)
- F 112.1+x, J+1
- E 233.2+x, J+2 γ_{112+x} 121.15 γ_x 233.2 2 (\dagger ,0.37 3) $I^{(1)}$ =90.7, $I^{(2)}$ =97.6, $\hbar\omega$ =0.127
- F 366.1+x, J+3 γ_{233+x} 132.2 5 γ_{112+x} 254.0 2 (\dagger ,0.12 5) $I^{(1)}$ =21.9, $I^{(2)}$ =98.5, $\hbar\omega$ =0.137
- E 507.4+x, J+4 γ_{366+x} 141.6 5 γ_{233+x} 274.2 2 (\dagger ,0.48 3) $I^{(1)}$ =91.8, $I^{(2)}$ =100.5, $\hbar\omega$ =0.147
- F 660.7+x, J+5 γ_{507+x} 152.9 5 γ_{366+x} 294.6 2 (\dagger ,0.38 8) $I^{(1)}$ =31.8, $I^{(2)}$ =99.3, $\hbar\omega$ =0.157
- E 821.4+x, J+6 γ_{661+x} 160.7 5 γ_{507+x} 314.0 2 (\dagger ,0.75 5) $I^{(1)}$ =92.9, $I^{(2)}$ =101.5, $\hbar\omega$ =0.167
- F 995.6+x, J+7 γ_{821+x} 173.7 5 γ_{661+x} 334.9 2 (\dagger ,0.61 9) $I^{(1)}$ =39.5, $I^{(2)}$ =101.0, $\hbar\omega$ =0.177
- E 1174.8+x, J+8 γ_{996+x} 179.3 5 γ_{821+x} 353.4 2 (\dagger ,0.90 5) $I^{(1)}$ =93.9, $I^{(2)}$ =103.9, $\hbar\omega$ =0.186
- F 1370.1+x, J+9 γ_{996+x} 374.5 2 (\dagger ,0.73 18) $I^{(1)}$ =45.7, $I^{(2)}$ =103.6, $\hbar\omega$ =0.197
- E 1566.7+x, J+10 γ_{1370+x} 196.9 5 γ_{1175+x} 391.9 2 (\dagger ,0.96 5) $I^{(1)}$ =95.0, $I^{(2)}$ =107.8, $\hbar\omega$ =0.205
- F 1783.2+x, J+11 γ_{1370+x} 413.1 2 (\dagger ,1.00 12) $I^{(1)}$ =50.9, $I^{(2)}$ =105.3, $\hbar\omega$ =0.216
- E 1995.7+x, J+12 γ_{1783+x} 212.3 5 γ_{1567+x} 429.0 2 (\dagger ,1.00 5) $I^{(1)}$ =96.3, $I^{(2)}$ =113.0, $\hbar\omega$ =0.223
- F 2234.3+x, J+13 γ_{1783+x} 451.1 2 $I^{(1)}$ =55.4, $I^{(2)}$ =107.5, $\hbar\omega$ =0.235
- E 2460.1+x, J+14 γ_{2234+x} 226.4 5 γ_{1996+x} 464.4 2 (\dagger ,0.98 3) $I^{(1)}$ =97.7, $I^{(2)}$ =121.2, $\hbar\omega$ =0.240
- F 2722.6+x, J+15 γ_{2234+x} 488.3 2 (\dagger ,0.96 18) $I^{(1)}$ =59.2, $I^{(2)}$ =109.3, $\hbar\omega$ =0.253
- E 2957.5+x, J+16 γ_{2460+x} 497.4 2 (\dagger ,1.00 3) $I^{(1)}$ =99.5, $I^{(2)}$ =129.9, $\hbar\omega$ =0.256
- F 3247.5+x, J+17 γ_{2723+x} 524.9 2 (\dagger ,0.98 20) $I^{(1)}$ =62.7, $I^{(2)}$ =114.3, $\hbar\omega$ =0.271
- E 3485.7+x, J+18 γ_{2958+x} 528.2 2 (\dagger ,1.11 10) $I^{(1)}$ =101.2, $I^{(2)}$ =132.0, $\hbar\omega$ =0.272
- F 3807.4+x, J+19 γ_{3248+x} 559.9 2 (\dagger ,1.08 10) $I^{(1)}$ =65.8, $I^{(2)}$ =114.3, $\hbar\omega$ =0.289
- E 4044.2+x, J+20 γ_{3486+x} 558.5 2 (\dagger ,0.94 14) $I^{(1)}$ =102.7, $I^{(2)}$ =127.0, $\hbar\omega$ =0.287
- F 4402.3+x, J+21 γ_{3807+x} 594.9 2 $I^{(1)}$ =68.6, $I^{(2)}$ =118.0, $\hbar\omega$ =0.306
- E 4634.2+x, J+22 γ_{4044+x} 590.0 2 (\dagger ,0.73 20) $I^{(1)}$ =103.9, $I^{(2)}$ =122.7, $\hbar\omega$ =0.303
- F 5031.1+x, J+23 γ_{4402+x} 628.8 2 (\dagger ,0.85 8) $I^{(1)}$ =71.3, $I^{(2)}$ =121.6, $\hbar\omega$ =0.323
- E 5256.8+x, J+24 γ_{4634+x} 622.6 2 $I^{(1)}$ =104.8, $I^{(2)}$ =120.8, $\hbar\omega$ =0.320
- F 5692.8+x, J+25 γ_{5031+x} 661.7 2 (\dagger ,0.52 12) $I^{(1)}$ =73.8, $I^{(2)}$ =123.5, $\hbar\omega$ =0.339
- E 5912.5+x, J+26 γ_{5257+x} 655.7 2 (\dagger ,0.40 16) $I^{(1)}$ =105.6, $I^{(2)}$ =122.0, $\hbar\omega$ =0.336
- F 6386.9+x, J+27 γ_{5693+x} 694.1 2 (\dagger ,0.56 15) $I^{(1)}$ =76.1, $I^{(2)}$ =127.0, $\hbar\omega$ =0.355
- E 6601.0+x, J+28 γ_{5913+x} 688.5 2 (\dagger ,0.18 10) $I^{(1)}$ =106.4, $I^{(2)}$ =122.0, $\hbar\omega$ =0.352
- F 7112.5+x, J+29 γ_{6387+x} 725.6 2 (\dagger ,0.45 19) $I^{(1)}$ =78.3, $I^{(2)}$ =129.0, $\hbar\omega$ =0.371
- E 7322.3+x, J+30 γ_{6601+x} 721.3 2 (\dagger ,0.39 10) $I^{(1)}$ =107.2, $I^{(2)}$ =125.4, $\hbar\omega$ =0.369
- F 7869.1+x, J+31 γ_{7113+x} 756.6 2 (\dagger ,0.38 10) $I^{(1)}$ =80.3, $I^{(2)}$ =130.3, $\hbar\omega$ =0.386
- E 8075.5+x, J+32 γ_{7322+x} 753.2 2 (\dagger ,0.55 16) $I^{(1)}$ =107.9, $I^{(2)}$ =126.2, $\hbar\omega$ =0.385

F 8656.4+x, J+33	γ_{7869+x}	787.32	$I^{(1)}=82.2, I^{(2)}=131.6, \eta\omega=0.401$
E 8860.4+x, J+34	γ_{8076+x}	784.92	$I^{(1)}=108.6, I^{(2)}=126.2, \eta\omega=0.400$
F 9474.1+x, J+35	γ_{8656+x}	817.73	$I^{(1)}=94.1, I^{(2)}=134.2, \eta\omega=0.416$
E 9677.0+x, J+36	γ_{8860+x}	816.63	$I^{(1)}=109.3, I^{(2)}=128.2, \eta\omega=0.416$
F 10321.6+x, J+37	γ_{9474+x}	847.54	$I^{(1)}=85.9, I^{(2)}=139.9, \eta\omega=0.431$
E 10524.8+x, J+38	γ_{9677+x}	847.84	$I^{(1)}=109.9, I^{(2)}=120.8, \eta\omega=0.432$
F 11197.7+x, J+39	$\gamma_{10322+x}$	876.15	
E 11405.7+x, J+40	$\gamma_{10525+x}$	880.95	
G y, J=(19/2 ⁺)			
H 111.1+y, J+1			
G 233.5+y, J+2	γ_{111+y}	122.65	$\gamma_{233.52} (\dagger_{0.213}) I^{(1)}=90.4, I^{(2)}=95.9, \eta\omega=0.127$
H 365.1+y, J+3	γ_{234+y}	132.25	$\gamma_{111+y} 254.02 (\dagger_{0.125}) I^{(1)}=21.9, I^{(2)}=98.5, \eta\omega=0.137$
G 508.7+y, J+4	γ_{365+y}	142.75	$\gamma_{234+y} 275.22 (\dagger_{0.305}) I^{(1)}=91.5, I^{(2)}=100.0, \eta\omega=0.148$
H 659.7+y, J+5	γ_{509+y}	152.95	$\gamma_{365+y} 294.62 (\dagger_{0.388}) I^{(1)}=31.8, I^{(2)}=99.3, \eta\omega=0.157$
G 823.9+y, J+6	γ_{660+y}	162.55	$\gamma_{509+y} 315.22 (\dagger_{0.535}) I^{(1)}=92.5, I^{(2)}=100.8, \eta\omega=0.168$
H 994.6+y, J+7	γ_{824+y}	173.75	$\gamma_{660+y} 334.92 (\dagger_{0.619}) I^{(1)}=39.5, I^{(2)}=101.0, \eta\omega=0.177$
G 1178.8+y, J+8	γ_{985+y}	182.65	$\gamma_{824+y} 354.92 (\dagger_{0.785}) I^{(1)}=93.5, I^{(2)}=102.8, \eta\omega=0.187$
H 1369.1+y, J+9	γ_{1179+y}	192.35	$\gamma_{985+y} 374.52 (\dagger_{0.7316}) I^{(1)}=45.7, I^{(2)}=103.6, \eta\omega=0.197$
G 1572.6+y, J+10	γ_{1369+y}	201.95	$\gamma_{1179+y} 393.82 (\dagger_{0.955}) I^{(1)}=94.4, I^{(2)}=104.4, \eta\omega=0.206$
H 1782.2+y, J+11	γ_{1573+y}	212.95	$\gamma_{1369+y} 413.12 (\dagger_{1.0012}) I^{(1)}=50.9, I^{(2)}=105.3, \eta\omega=0.216$
G 2004.7+y, J+12	γ_{1782+y}	220.55	$\gamma_{1573+y} 432.12 (\dagger_{1.028}) I^{(1)}=95.4, I^{(2)}=106.1, \eta\omega=0.225$
H 2233.3+y, J+13	γ_{1782+y}	451.12	$I^{(1)}=55.4, I^{(2)}=107.5, \eta\omega=0.235$
G 2474.5+y, J+14	γ_{2005+y}	469.82	$(\dagger_{1.008}) I^{(1)}=96.3, I^{(2)}=109.9, \eta\omega=0.244$
H 2721.6+y, J+15	γ_{2233+y}	488.32	$(\dagger_{0.9618}) I^{(1)}=59.2, I^{(2)}=109.3, \eta\omega=0.253$
G 2980.7+y, J+16	γ_{2475+y}	506.22	$(\dagger_{1.0014}) I^{(1)}=97.4, I^{(2)}=113.3, \eta\omega=0.262$
H 3246.5+y, J+17	γ_{2722+y}	524.92	$(\dagger_{0.9820}) I^{(1)}=62.7, I^{(2)}=114.3, \eta\omega=0.271$
G 3522.2+y, J+18	γ_{2981+y}	541.52	$(\dagger_{0.8232}) I^{(1)}=98.4, I^{(2)}=113.3, \eta\omega=0.280$
H 3806.4+y, J+19	γ_{3247+y}	559.92	$(\dagger_{1.0810}) I^{(1)}=65.8, I^{(2)}=114.3, \eta\omega=0.289$
G 4099.0+y, J+20	γ_{3522+y}	576.82	$(\dagger_{0.6324}) I^{(1)}=99.3, I^{(2)}=115.9, \eta\omega=0.297$
H 4401.3+y, J+21	γ_{3806+y}	594.92	$I^{(1)}=68.6, I^{(2)}=118.0, \eta\omega=0.306$
G 4710.3+y, J+22	γ_{4099+y}	611.32	$(\dagger_{0.4328}) I^{(1)}=100.4, I^{(2)}=121.2, \eta\omega=0.314$
H 5030.1+y, J+23	γ_{4401+y}	628.82	$(\dagger_{0.858}) I^{(1)}=71.3, I^{(2)}=121.6, \eta\omega=0.323$
G 5354.6+y, J+24	γ_{4710+y}	644.32	$I^{(1)}=101.4, I^{(2)}=119.4, \eta\omega=0.331$
H 5691.8+y, J+25	γ_{5030+y}	661.72	$(\dagger_{0.5212}) I^{(1)}=73.8, I^{(2)}=123.5, \eta\omega=0.339$
G 6032.4+y, J+26	γ_{5355+y}	677.82	$I^{(1)}=102.3, I^{(2)}=124.6, \eta\omega=0.347$
H 6385.9+y, J+27	γ_{5692+y}	694.12	$(\dagger_{0.5615}) I^{(1)}=76.1, I^{(2)}=127.0, \eta\omega=0.355$
G 6742.3+y, J+28	γ_{6032+y}	709.92	$I^{(1)}=103.3, I^{(2)}=123.8, \eta\omega=0.363$
H 7111.5+y, J+29	γ_{6386+y}	725.62	$(\dagger_{0.4519}) I^{(1)}=78.3, I^{(2)}=129.0, \eta\omega=0.371$
G 7484.5+y, J+30	γ_{6742+y}	742.22	$I^{(1)}=104.4, I^{(2)}=137.9, \eta\omega=0.378$
H 7868.1+y, J+31	γ_{7112+y}	756.62	$(\dagger_{0.3810}) I^{(1)}=80.3, I^{(2)}=130.3, \eta\omega=0.386$
G 8255.7+y, J+32	γ_{7485+y}	771.23	$I^{(1)}=105.5, I^{(2)}=129.0, \eta\omega=0.393$
H 8655.4+y, J+33	γ_{7868+y}	787.32	$I^{(1)}=82.2, I^{(2)}=131.6, \eta\omega=0.401$
G 9057.9+y, J+34	γ_{8256+y}	802.24	$I^{(1)}=106.5, I^{(2)}=133.8, \eta\omega=0.409$
H 9473.1+y, J+35	γ_{8655+y}	817.73	$I^{(1)}=84.1, I^{(2)}=134.2, \eta\omega=0.416$
G 9890.0+y, J+36	γ_{9058+y}	832.15	$I^{(1)}=107.5, I^{(2)}=140.8, \eta\omega=0.423$
H 10320.6+y, J+37	γ_{9473+y}	847.54	$I^{(1)}=85.9, I^{(2)}=139.9, \eta\omega=0.431$
G 10750.5+y, J+38	γ_{9890+y}	860.55	
H 11196.7+y, J+39	$\gamma_{10321+y}$	876.15	
I z, J=(27/2 ⁻)			
I 291.0+z, J+2	$\gamma_{291.02}$	($\dagger_{0.174}$)	$I^{(1)}=100.0, I^{(2)}=105.8, \eta\omega=0.155$
I 619.8+z, J+4	γ_{291+z}	328.82	($\dagger_{0.724}$) $I^{(1)}=100.7, I^{(2)}=105.8, \eta\omega=0.174$
I 986.4+z, J+6	γ_{620+z}	366.62	($\dagger_{0.875}$) $I^{(1)}=101.1, I^{(2)}=104.2, \eta\omega=0.193$
I 1391.4+z, J+8	γ_{986+z}	405.02	($\dagger_{0.986}$) $I^{(1)}=101.3, I^{(2)}=102.0, \eta\omega=0.212$
I 1835.6+z, J+10	γ_{1391+z}	444.22	($\dagger_{1.007}$) $I^{(1)}=101.2, I^{(2)}=99.8, \eta\omega=0.232$
I 2319.9+z, J+12	γ_{1836+z}	484.32	($\dagger_{1.005}$) $I^{(1)}=101.0, I^{(2)}=96.2, \eta\omega=0.253$
I 2845.8+z, J+14	γ_{2320+z}	525.92	($\dagger_{0.987}$) $I^{(1)}=100.7, I^{(2)}=98.0, \eta\omega=0.273$
I 3412.5+z, J+16	γ_{2846+z}	566.72	($\dagger_{0.988}$) $I^{(1)}=100.7, I^{(2)}=104.4, \eta\omega=0.293$
I 4017.5+z, J+18	γ_{3413+z}	605.02	$I^{(1)}=101.2, I^{(2)}=112.7, \eta\omega=0.311$
I 4658.0+z, J+20	γ_{4018+z}	640.52	($\dagger_{0.827}$) $I^{(1)}=101.9, I^{(2)}=117.6, \eta\omega=0.329$
I 5332.5+z, J+22	γ_{4658+z}	674.52	($\dagger_{0.807}$) $I^{(1)}=102.7, I^{(2)}=121.2, \eta\omega=0.346$
I 6040.0+z, J+24	γ_{5333+z}	707.52	($\dagger_{0.727}$) $I^{(1)}=103.7, I^{(2)}=125.8, \eta\omega=0.362$
I 6779.3+z, J+26	γ_{6040+z}	739.32	($\dagger_{0.617}$) $I^{(1)}=104.7, I^{(2)}=131.6, \eta\omega=0.377$
I 7549.0+z, J+28	γ_{6779+z}	769.74	($\dagger_{0.464}$) $I^{(1)}=105.7, I^{(2)}=126.6, \eta\omega=0.393$
I 8350.3+z, J+30	γ_{7549+z}	801.35	($\dagger_{0.363}$) $I^{(1)}=106.6, I^{(2)}=133.3, \eta\omega=0.408$
I 9181.6+z, J+32	γ_{8350+z}	831.35	($\dagger_{0.214}$) $I^{(1)}=107.5, I^{(2)}=134.7, \eta\omega=0.423$
I 10042.6+z(?), J+34	γ_{9182+z}	861(?)	($\dagger_{0.153}$)
J u, J=(21/2 ⁻)			
J 240.5+u, J+2	$\gamma_{240.52}$	($\dagger_{0.585}$)	$I^{(1)}=95.7, I^{(2)}=96.6, \eta\omega=0.131$
J 522.4+u, J+4	γ_{241+u}	281.92	($\dagger_{0.805}$) $I^{(1)}=95.8, I^{(2)}=96.2, \eta\omega=0.151$
J 845.9+u, J+6	γ_{522+u}	323.52	($\dagger_{0.905}$) $I^{(1)}=95.8, I^{(2)}=95.5, \eta\omega=0.172$
J 1211.3+u, J+8	γ_{846+u}	365.42	($\dagger_{1.005}$) $I^{(1)}=95.9, I^{(2)}=97.3, \eta\omega=0.193$
J 1617.8+u, J+10	γ_{1211+u}	406.52	($\dagger_{1.005}$) $I^{(1)}=96.0, I^{(2)}=97.6, \eta\omega=0.213$
J 2065.3+u, J+12	γ_{1618+u}	447.52	($\dagger_{0.985}$) $I^{(1)}=96.2, I^{(2)}=98.5, \eta\omega=0.234$
J 2553.4+u, J+14	γ_{2065+u}	488.12	($\dagger_{0.955}$) $I^{(1)}=96.5, I^{(2)}=100.5, \eta\omega=0.254$
J 3081.3+u, J+16	γ_{2553+u}	527.92	($\dagger_{1.056}$) $I^{(1)}=96.8, I^{(2)}=101.8, \eta\omega=0.274$
J 3648.5+u, J+18	γ_{3081+u}	567.22	($\dagger_{1.006}$) $I^{(1)}=97.1, I^{(2)}=102.3, \eta\omega=0.293$
J 4254.8+u, J+20	γ_{3648+u}	606.32	$I^{(1)}=97.5, I^{(2)}=104.7, \eta\omega=0.313$
J 4899.3+u, J+22	γ_{4255+u}	644.52	($\dagger_{0.9010}$) $I^{(1)}=98.0, I^{(2)}=107.0, \eta\omega=0.332$
J 5581.2+u, J+24	γ_{4899+u}	681.92	($\dagger_{0.706}$) $I^{(1)}=98.5, I^{(2)}=109.0, \eta\omega=0.350$
J 6299.8+u, J+26	γ_{5581+u}	718.62	($\dagger_{0.606}$) $I^{(1)}=99.1, I^{(2)}=111.4, \eta\omega=0.368$
J 7054.3+u, J+28	γ_{6300+u}	754.52	$I^{(1)}=99.7, I^{(2)}=113.3, \eta\omega=0.386$
J 7844.1+u, J+30	γ_{7054+u}	789.82	($\dagger_{0.425}$) $I^{(1)}=100.4, I^{(2)}=115.9, \eta\omega=0.404$
J 8668.4+u, J+32	γ_{7844+u}	824.33	($\dagger_{0.265}$) $I^{(1)}=101.1, I^{(2)}=119.0, \eta\omega=0.421$
J 9526.3+u, J+34	γ_{8668+u}	857.95	($\dagger_{0.245}$)

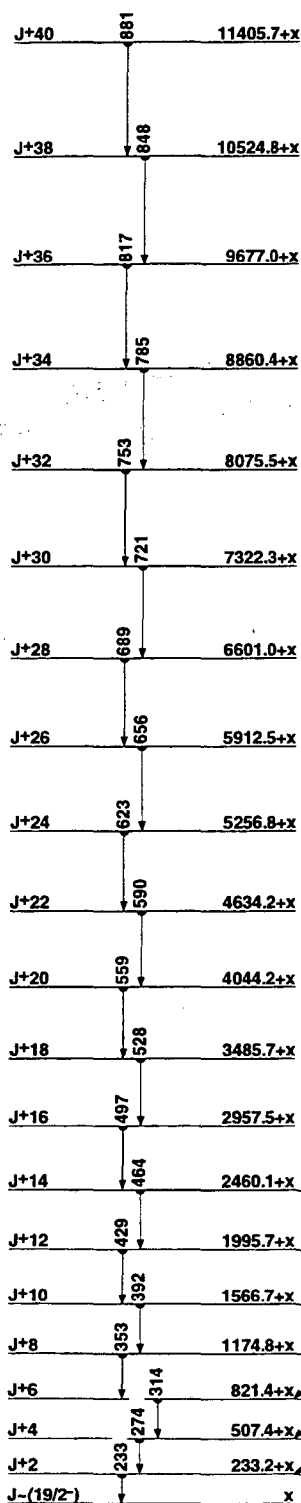

SD-1 band
(94Jo10,93Jo09,90Cu05)

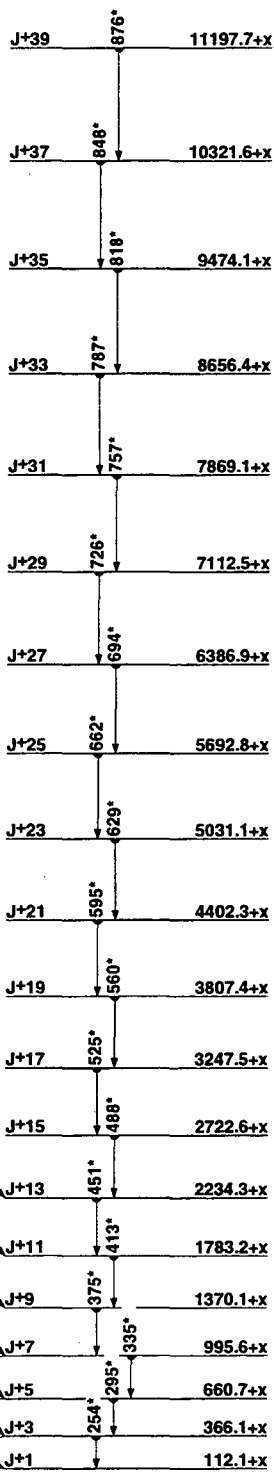

SD-2 band
(94Jo10,93Jo09,90Cu05)

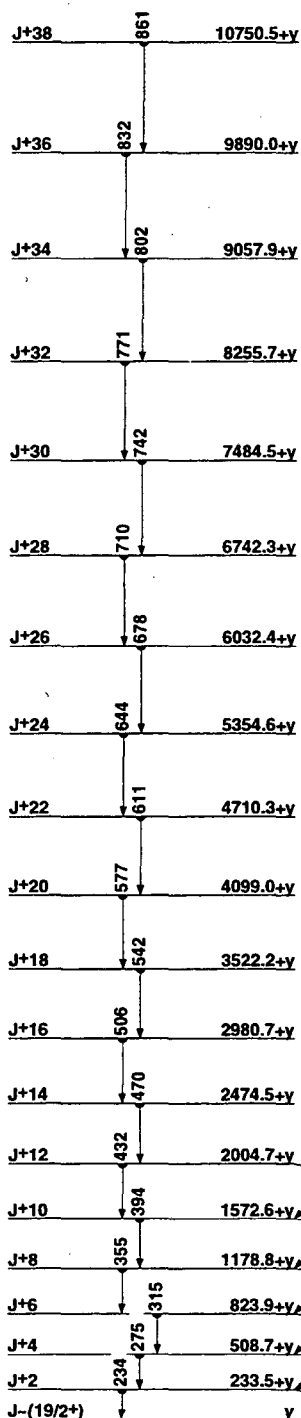

SD-3 band
(94Jo10,93Jo09,90Cu05)

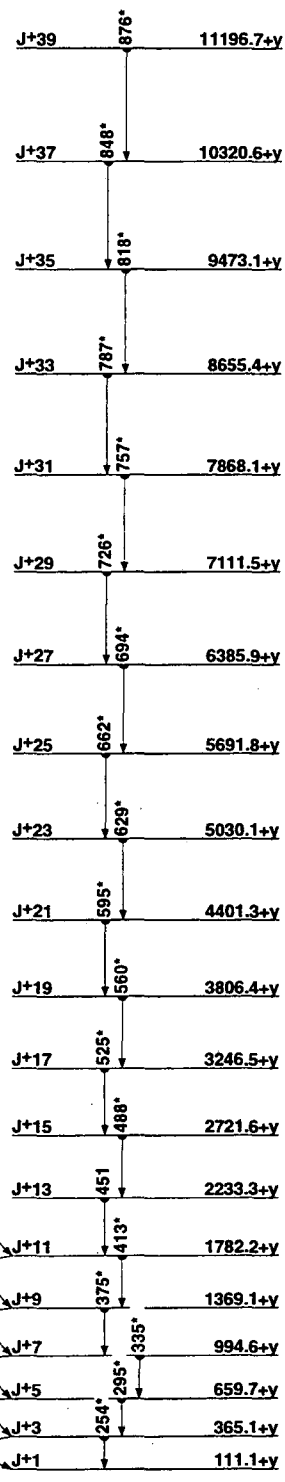

SD-4 band
(94Jo10,93Jo09,90Cu05)

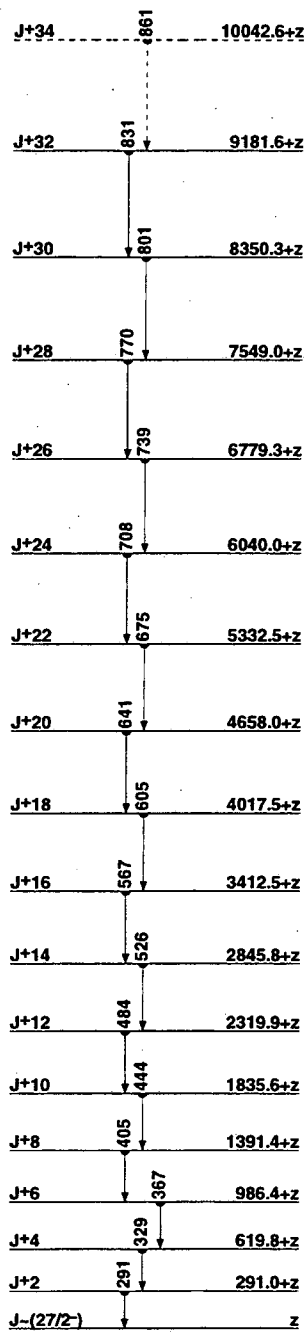

SD-5 band
(94Jo10,93Jo09,90Cu05)

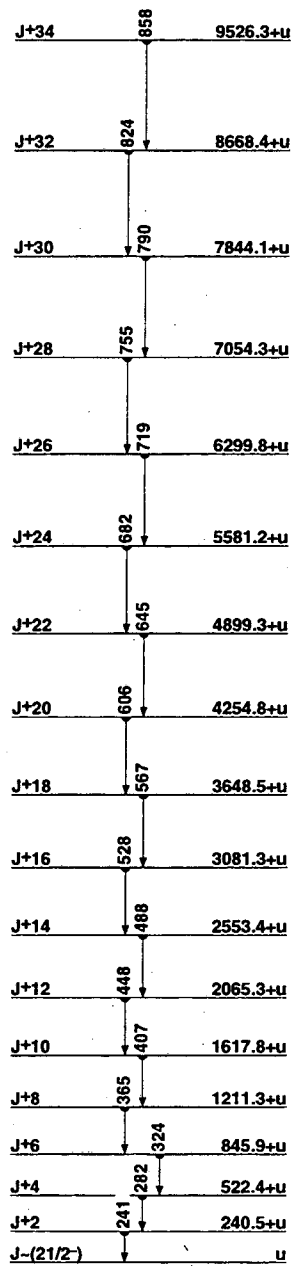

SD-6 band
(94Jo10)

¹⁹³₈₀Hg

¹⁹⁴Hg
₈₀Hg

Δ : -32247 23 S_n : 9250 30 S_p : 6125 25 Q_{EC} : 40 20 Q_α : 2653 24

Nuclear Bands

- A GS band
- B α =1: AE
- C SD-1 band (94Ce04,90Ri05,90Be11)
- D SD-2 band (94Ce04,90Ri05,90Be11)
- E SD-3 band (94Ce04,90Ri05,90Be11)
- F α =0: AB
- G α =0: ABCD
- H α =0: ABCDab
- I α =1: ABCE
- J α =0: AF
- K α =0: ABCF
- L α =0: ABEF
- M $\nu_{1,3/2}^{-2} \nu_{1,1/2}^{-2}$

Levels and γ -ray branchings:

- A 0, 0⁺, 520 32 y, %EC=100
- A 428.0 2, 2⁺ $\gamma_{428} 428.0 2$ (\dagger_{100}) E2
- A 1064.5 3, 4⁺ $\gamma_{428} 636.5 2$ (\dagger_{100}) E2
1073.2 3, (2)⁺ $\gamma_{428} 645.20 25$ ($\dagger_{100 25}$) E2(+M1): $\delta > 1$ $\gamma_{1073} 1073.3 5$ ($\dagger_{33 12}$)
1468.5 4, (3)⁺ $\gamma_{1073} 395.5 5$ ($\dagger_{40 8}$) M1(+E2): $\delta < 1$ $\gamma_{1065} 403.9 7$ ($\dagger_{48 10}$)
M1(+E2): $\delta < 1$ $\gamma_{428} 1040.3 5$ ($\dagger_{100 30}$)
- A 1799.4 3, 6⁺ $\gamma_{1065} 734.9 2$ (\dagger_{100}) E2
- B 1813.4 3, 5⁻, <0.15 ns $\gamma_{1065} 748.9 2$ (\dagger_{100}) E1
- B 1910.4 3, 7⁻, 3.75 11 ns $\gamma_{1813} 96.95 8$ ($\dagger_{100 10}$) E2 $\gamma_{1799} 110.98 8$ ($\dagger_{78 8}$)
- J 2138.3 4, 8⁻, 0.91 3 ns $\gamma_{1910} 227.9 2$ (\dagger_{100}) E2+M1: $\delta = 1.2 \pm 0.6$
- B 2143.5 4, 9⁻, 0.29 5 ns $\gamma_{1910} 233.0 2$ (\dagger_{100}) E2
- 2165.8 4, (6)⁻ $\gamma_{1910} 255.4 1$ ($\dagger_{100 17}$) M1(+E2): $\delta < 1$ $\gamma_{1813} 352.20 25$ ($\dagger_{18 3}$) M1+E2: $\delta = 1.0 5$
2179.9 4, (5,6)⁻ $\gamma_{1813} 366.5 2$ ($\dagger_{100 17}$) M1(+E2): $\delta < 1$ $\gamma_{1799} 380.5 3$ ($\dagger_{78 13}$)
2259.9 8(?), (4,5,6)⁻ $\gamma_{1813} 446.5 7$ (\dagger_{100}) M1(+E2): $\delta < 1$
2264.6 4, (6)⁻ $\gamma_{2166} 98.9 1$ ($\dagger_{12 5}$) $\gamma_{1813} 451.0 7$ ($\dagger_{100 23}$)
M1+E2: $\delta = 1.0 5$
- F 2364.3 4, (8)⁺ $\gamma_{1799} 565.0 2$ (\dagger_{100})
2374.7 4, (6,7,8)⁻ $\gamma_{2166} 208.90 18$ ($\dagger_{100 25}$) E2 $\gamma_{1910} 464.5 7$ ($\dagger_{38 13}$)
M1(+E2): $\delta < 1$
- F 2423.8 4, (10)⁺, 2.9 5 ns $\gamma_{2364} 59.5 2$ ($\dagger_{1.5 2}$) E2 $\gamma_{2144} 280.2 2$ ($\dagger_{100 5}$) (E1)
2463.8 4, 6⁻ $\gamma_{2180} 284.0 2$ ($\dagger_{27 5}$) M1(+E2): $\delta < 1$ $\gamma_{2166} 298.1 2$ ($\dagger_{30 3}$)
E2(+M1): $\delta > 1.5$ $\gamma_{1910} 553.2 3$ ($\dagger_{67 17}$) M1 $\gamma_{1813} 650.3 3$ ($\dagger_{100 22}$)
M1+E2: $\delta = 1.0 5$ $\gamma_{1799} 664.2 7$ ($\dagger_{17 5}$)
- F 2475.8 5, (12)⁺, 8.1 5 ns, g=0.24 4 $\gamma_{2424} 52.0 4$ (\dagger_{100}) E2
- J 2562.0 4, (10)⁻ $\gamma_{2144} 418.5 3$ ($\dagger_{28 6}$) $\gamma_{2138} 423.8 2$ ($\dagger_{100 6}$)
- B 2688.1 4, (11)⁻ $\gamma_{2144} 544.6 2$ (\dagger_{100})
- F 2888.8 5, (14)⁺ $\gamma_{2476} 412.9 2$ (\dagger_{100})
- J 3173.2 5, (12)⁻ $\gamma_{2688} 485.0 4$ ($\dagger_{30 3}$) $\gamma_{2562} 611.2 4$ ($\dagger_{100 6}$)
- B 3394.2 5, (13)⁻ $\gamma_{2688} 706.2 2$ (\dagger_{100})
- F 3531.8 5, (16)⁺ $\gamma_{2889} 643.0 2$ (\dagger_{100})
- K 3747.9 5, (14)⁻ $\gamma_{3394} 353.6 4$ ($\dagger_{2.6 13}$) $\gamma_{3173} 574.7 2$ ($\dagger_{100 9}$)
- 3820.1 6, (15)⁻ $\gamma_{2889} 931.4 4$ (\dagger_{100})
- I 3879.4 5, (15)⁻ $\gamma_{3394} 485.2 4$ (\dagger_{100})
- K 3984.2 5, (16)⁻, <0.50 ns $\gamma_{3748} 236.3 4$ (\dagger_{100})
- M 4004.6 8(?), (14,15) $\gamma_{2889} 1116.0 4$ (?) (\dagger_{100})
- L 4015.3 5, (14)⁻ $\gamma_{3748} 267.3 4$ ($\dagger_{100 50}$) $\gamma_{3394} 621.3 4$ $\gamma_{2889} 1126.5 4$ ($\dagger_{67 34}$)
- I 4114.9 5, (17)⁻ $\gamma_{3984} 130.8 4$ $\gamma_{3875} 235.5 4$ ($\dagger_{<540}$) $\gamma_{3532} 583.1 4$ ($\dagger_{100 20}$)
- F 4275.4 6, (18)⁺ $\gamma_{3532} 743.6 2$ (\dagger_{100})
- K 4290.1 6, (18)⁻ $\gamma_{3984} 305.9 2$ (\dagger_{100})

- L 4317.8 6, (16)⁺ $\gamma_{4015} 302.5 4$ $\gamma_{3984} 333.6 4$ (?) (\dagger_{100})
4491.4 7, (17)⁻ $\gamma_{3820} 671.3 4$ (\dagger_{100})
- I 4498.1 6, (19)⁻ $\gamma_{4290} 208.0 4$ ($\dagger_{100 20}$) $\gamma_{4115} 383.2 4$ ($\dagger_{<320}$)
- M 4521.1 6, (16,17)⁻ $\gamma_{4005} 516.2 4$ (?) $\gamma_{3820} 701.0 4$ ($\dagger_{40 15}$) $\gamma_{3532} 989.2 4$ ($\dagger_{100 40}$)
- L 4797.7 6, (18)⁺ $\gamma_{4318} 480.0 4$ (\dagger_{100}) $\gamma_{4290} 507.5 4$
- K 4896.9 7, (20)⁻ $\gamma_{4290} 606.8 4$ (\dagger_{100})
- G 4985.8 6, (20)⁺ $\gamma_{4275} 710.4 2$ (\dagger_{100})
- M 5103.5 7, (18,19)⁻ $\gamma_{4521} 582.4 4$ ($\dagger_{12 3}$) $\gamma_{4481} 612.1 4$ ($\dagger_{100 6}$)
 $\gamma_{4275} 828.3 2$ (?) ($\dagger_{1.8 9}$)
- I 5163.9 7, (21)⁻ $\gamma_{4498} 665.8 3$ (\dagger_{100})
- F 5266.1 7, (20)⁺ $\gamma_{4275} 990.7 4$ (\dagger_{100})
- L 5522.9 7, (20)⁺ $\gamma_{4798} 725.2 4$ (\dagger_{100})
- G 5578.6 7, (22)⁺ $\gamma_{4986} 592.8 3$ (\dagger_{100})
- M 5610.2 7, (20,21)⁻ $\gamma_{5104} 506.7 3$ (\dagger_{100}) $\gamma_{4986} 624.4 4$ (?)
- K 5700.5 8, (22)⁻ $\gamma_{4897} 803.6 3$ (\dagger_{100})
- I 6049.7 8, (23)⁻ $\gamma_{5164} 885.8 4$ (\dagger_{100})
- M 6120.5 9, (22,23)⁻ $\gamma_{5610} 510.3 4$ $\gamma_{5578} 541.6 4$ (?) (\dagger_{100})
6256.8 8 $\gamma_{5578} 678.2 4$ (\dagger_{100})
- L 6349.5 8(?), (22)⁺ $\gamma_{5523} 826.6 4$ (\dagger_{100})
- G 6411.2 7, (24)⁺ $\gamma_{5578} 832.6 3$ (\dagger_{100})
- C 6416.9 (?), (8)⁺
- C 6628.6 5, (10)⁺ $\gamma_{6417} 211.7$ (?) ($\dagger_{0.03}$) $I^{(1)}=85.8$, $I^{(2)}=93.9$, $\eta\omega=0.116$
 $\gamma_{2144} 4485.3 5$ ($\dagger_{0.015}$) D
- K 6645.7 9, (24)⁻ $\gamma_{5701} 945.2 4$ (\dagger_{100})
- H 6676.5 10(?), (22)⁺ $\gamma_{5523} 1152.0 4$ (?) (\dagger_{100})
- M 6815.5 9, (24,25)⁻ $\gamma_{6121} 695.0 3$ (\dagger_{100})
- H 6834.5 9, (24)⁺ $\gamma_{6677} 158.0 4$ ($\dagger_{57 29}$) $\gamma_{6121} 713.9 4$ ($\dagger_{100 40}$)
- C 6883.2 5, (12)⁺ $\gamma_{6628} 254.3 1$ ($\dagger_{0.56 3}$) $I^{(1)}=87.2$, $I^{(2)}=95.0$, $\eta\omega=0.138$
 $\gamma_{3394} 3489.3 5$ ($\dagger_{0.014}$) D $\gamma_{3173} 3709.6$ (?) ($\dagger_{0.007}$) D $\gamma_{2688} 4195.2 5$ ($\dagger_{0.012}$) D
- I 6941.4 9, (25)⁻ $\gamma_{6050} 891.7 4$ (\dagger_{100})
- H 6989.6 8, (26)⁻ $\gamma_{6835} 155.1 4$ ($\dagger_{71 30}$) $\gamma_{6411} 578.4 4$ ($\dagger_{100 41}$)
- C 7179.6 5, (14)⁺ $\gamma_{6883} 296.4 1$ ($\dagger_{1.04 5}$) $I^{(1)}=88.3$, $I^{(2)}=97.1$, $\eta\omega=0.158$
- H 7304.3 9, (28)⁺ $\gamma_{6990} 314.7 4$ (\dagger_{100})
- C 7517.2 5, (16)⁺ $\gamma_{7180} 337.6 1$ ($\dagger_{1.04 4}$) $I^{(1)}=89.5$, $I^{(2)}=99.8$, $\eta\omega=0.179$
- I 7767.9 10(?), (27)⁻ $\gamma_{6941} 826.6 4$ (?) (\dagger_{100})
- H 7784.6 10, (30)⁺ $\gamma_{7304} 480.3 4$ (\dagger_{100})
- C 7894.5 5, (18)⁺ $\gamma_{7517} 377.7 1$ ($\dagger_{1.04 4}$) $I^{(1)}=90.6$, $I^{(2)}=102.0$, $\eta\omega=0.199$
- C 8311.8 5, (20)⁺ $\gamma_{7895} 416.9 1$ ($\dagger_{1.00 5}$) $I^{(1)}=91.8$, $I^{(2)}=105.3$, $\eta\omega=0.218$
- C 8766.7 5, (22)⁺, 0.27 6 ps $\gamma_{8312} 454.9 1$ ($\dagger_{1.09 5}$) $I^{(1)}=92.9$, $I^{(2)}=107.5$, $\eta\omega=0.237$
- C 9258.8, (24)⁺, 0.166 22 ps $\gamma_{8767} 492.1 1$ ($\dagger_{1.00 5}$) $I^{(1)}=94.1$, $I^{(2)}=111.4$, $\eta\omega=0.255$
- C 9786.8, (26)⁺, 0.120 25 ps $\gamma_{9258} 528.0 1$ ($\dagger_{1.01 5}$) $I^{(1)}=95.3$, $I^{(2)}=114.3$, $\eta\omega=0.273$
- C 10349.8, (28)⁺, 0.114 39 ps $\gamma_{9787} 563.0 1$ ($\dagger_{0.97 4}$) $I^{(1)}=96.6$, $I^{(2)}=118.0$, $\eta\omega=0.290$
- C 10946.7, (30)⁺, 0.078 17 ps $\gamma_{10350} 596.9 1$ ($\dagger_{0.84 4}$) $I^{(1)}=97.8$, $I^{(2)}=120.5$, $\eta\omega=0.307$
- C 11576.8, (32)⁺, 0.060 21 ps $\gamma_{10947} 630.1 1$ ($\dagger_{0.85 5}$) $I^{(1)}=99.0$, $I^{(2)}=124.6$, $\eta\omega=0.323$
- C 12239.0, (34)⁺, 0.042 13 ps $\gamma_{11577} 662.2 1$ ($\dagger_{0.76 4}$) $I^{(1)}=100.3$, $I^{(2)}=127.4$, $\eta\omega=0.339$
- C 12932.6, (36)⁺, 0.026 11 ps $\gamma_{12239} 693.6 1$ ($\dagger_{0.65 4}$) $I^{(1)}=101.6$, $I^{(2)}=130.7$, $\eta\omega=0.354$
- C 13656.8, (38)⁺ $\gamma_{12933} 724.2 1$ ($\dagger_{0.51 3}$) $I^{(1)}=102.8$, $I^{(2)}=133.3$, $\eta\omega=0.370$
- C 14411.0, (40)⁺ $\gamma_{13657} 754.2 1$ ($\dagger_{0.38 3}$) $I^{(1)}=104.0$, $I^{(2)}=134.7$, $\eta\omega=0.385$
- C 15194.9, (42)⁺ $\gamma_{14411} 783.9 1$ ($\dagger_{0.41 3}$) $I^{(1)}=105.2$, $I^{(2)}=135.1$, $\eta\omega=0.399$
- C 16008.4, (44)⁺ $\gamma_{15195} 813.5 2$ ($\dagger_{0.34 3}$) $I^{(1)}=106.3$, $I^{(2)}=136.5$, $\eta\omega=0.414$
- C 16851.2, (46)⁺ $\gamma_{16008} 842.8 3$ ($\dagger_{0.15 5}$) $I^{(1)}=107.3$, $I^{(2)}=134.2$, $\eta\omega=0.429$
- C 17723.8, (48)⁺ $\gamma_{16851} 872.6 5$ ($\dagger_{<0.1}$) $I^{(1)}=108.1$, $I^{(2)}=129.4$, $\eta\omega=0.444$
- C 18627.3, (50)⁺ $\gamma_{17724} 903.5 8$ ($\dagger_{<0.1}$)

D y, J=(8)	E z, J=(11)
D 201.2+y, J+2 $\gamma_{201.2}$ 201.22 (\dagger 0.49 4) I ⁽¹⁾ =90.1, I ⁽²⁾ =96.6, $\hbar\omega$ =0.111	E 262.6+z, J+2 $\gamma_{262.6}$ 262.61 (\dagger 1.00 14) I ⁽¹⁾ =91.9, I ⁽²⁾ =99.0, $\hbar\omega$ =0.141
D 443.8+y, J+4 γ_{201+y} 242.61 (\dagger 1.01 5) I ⁽¹⁾ =91.2, I ⁽²⁾ =97.8, $\hbar\omega$ =0.132	E 565.6+z, J+4 γ_{263+z} 303.01 (\dagger 1.00 16) I ⁽¹⁾ =92.9, I ⁽²⁾ =100.3, $\hbar\omega$ =0.161
D 727.3+y, J+6 γ_{444+y} 283.51 (\dagger 1.11 10) I ⁽¹⁾ =92.2, I ⁽²⁾ =99.3, $\hbar\omega$ =0.152	E 908.5+z, J+6 γ_{566+z} 342.91 (\dagger 1.07 16) I ⁽¹⁾ =93.8, I ⁽²⁾ =102.0, $\hbar\omega$ =0.181
D 1051.1+y, J+8 γ_{727+y} 323.81 (\dagger 1.25 10) I ⁽¹⁾ =93.1, I ⁽²⁾ =100.8, $\hbar\omega$ =0.172	E 1290.6+z, J+8 γ_{908+z} 382.11 (\dagger 1.05 37) I ⁽¹⁾ =94.7, I ⁽²⁾ =104.4, $\hbar\omega$ =0.201
D 1414.6+y, J+10 γ_{1051+y} 363.51 (\dagger 1.08 14) I ⁽¹⁾ =94.0, I ⁽²⁾ =102.8, $\hbar\omega$ =0.191	E 1711.0+z, J+10 γ_{1291+z} 420.41 (\dagger 1.11 16) I ⁽¹⁾ =95.6, I ⁽²⁾ =105.5, $\hbar\omega$ =0.220
D 1817.0+y, J+12 γ_{1415+y} 402.41 (\dagger 1.10 17) I ⁽¹⁾ =94.9, I ⁽²⁾ =105.0, $\hbar\omega$ =0.211	E 2169.3+z, J+12 γ_{1711+z} 458.31 (\dagger 0.87 16) I ⁽¹⁾ =96.5, I ⁽²⁾ =108.7, $\hbar\omega$ =0.238
D 2257.5+y, J+14, 0.27 9 ps γ_{1817+y} 440.51 (\dagger 0.97 10) I ⁽¹⁾ =95.8, I ⁽²⁾ =107.0, $\hbar\omega$ =0.230	E 2664.4+z, J+14 γ_{2169+z} 495.11 (\dagger 1.02 12) I ⁽¹⁾ =97.4, I ⁽²⁾ =110.8, $\hbar\omega$ =0.257
D 2735.4+y, J+16, 0.20 5 ps γ_{2258+y} 477.91 (\dagger 0.96 14) I ⁽¹⁾ =96.7, I ⁽²⁾ =109.3, $\hbar\omega$ =0.248	E 3195.6+z, J+16 γ_{2664+z} 531.21 (\dagger 0.93 14) I ⁽¹⁾ =98.4, I ⁽²⁾ =114.0, $\hbar\omega$ =0.274
D 3249.9+y, J+18, 0.13 5 ps γ_{2735+y} 514.51 (\dagger 1.02 13) I ⁽¹⁾ =97.7, I ⁽²⁾ =112.7, $\hbar\omega$ =0.266	E 3761.9+z, J+18 γ_{3196+z} 566.31 (\dagger 1.16 14) I ⁽¹⁾ =99.4, I ⁽²⁾ =114.6, $\hbar\omega$ =0.292
D 3799.9+y, J+20, 0.100 33 ps γ_{3250+y} 550.01 (\dagger 0.98 11) I ⁽¹⁾ =98.7, I ⁽²⁾ =114.3, $\hbar\omega$ =0.284	E 4363.1+z, J+20 γ_{3762+z} 601.21 (\dagger 0.81 10) I ⁽¹⁾ =100.3, I ⁽²⁾ =117.6, $\hbar\omega$ =0.309
D 4384.9+y, J+22, 0.089 19 ps γ_{3800+y} 585.01 (\dagger 0.96 14) I ⁽¹⁾ =99.7, I ⁽²⁾ =117.3, $\hbar\omega$ =0.301	E 4998.3+z, J+22 γ_{4363+z} 635.21 (\dagger 0.93 23) I ⁽¹⁾ =101.3, I ⁽²⁾ =123.8, $\hbar\omega$ =0.326
D 5004.0+y, J+24, 0.065 28 ps γ_{4385+y} 619.11 (\dagger 0.82 14) I ⁽¹⁾ =100.7, I ⁽²⁾ =121.2, $\hbar\omega$ =0.318	E 5665.8+z, J+24 γ_{4998+z} 667.51 (\dagger 0.77 16) I ⁽¹⁾ =102.4, I ⁽²⁾ =123.1, $\hbar\omega$ =0.342
D 5656.1+y, J+26 γ_{5004+y} 652.12 (\dagger 0.74 23) I ⁽¹⁾ =101.7, I ⁽²⁾ =122.3, $\hbar\omega$ =0.334	E 6365.8+z, J+26 γ_{5666+z} 700.02 (\dagger 0.66 16) I ⁽¹⁾ =103.4, I ⁽²⁾ =125.4, $\hbar\omega$ =0.358
D 6340.9+y, J+28 γ_{5656+y} 684.82 (\dagger 0.65 7) I ⁽¹⁾ =102.8, I ⁽²⁾ =127.4, $\hbar\omega$ =0.350	E 7097.7+z, J+28 γ_{6366+z} 731.93 (\dagger 0.50 13) I ⁽¹⁾ =104.3, I ⁽²⁾ =127.8, $\hbar\omega$ =0.374
D 7057.1+y, J+30 γ_{6341+y} 716.22 (\dagger 0.46 10) I ⁽¹⁾ =103.9, I ⁽²⁾ =128.2, $\hbar\omega$ =0.366	E 7860.9+z, J+30 γ_{7098+z} 763.23 I ⁽¹⁾ =105.4, I ⁽²⁾ =132.0, $\hbar\omega$ =0.389
D 7804.5+y, J+32 γ_{7057+y} 747.44 (\dagger 0.63 12) I ⁽¹⁾ =104.9, I ⁽²⁾ =132.9, $\hbar\omega$ =0.381	E 8654.4+z, J+32 γ_{7861+z} 793.54 I ⁽¹⁾ =106.3, I ⁽²⁾ =131.6, $\hbar\omega$ =0.404
D 8582.0+y, J+34 γ_{7805+y} 777.52 (\dagger 0.20) I ⁽¹⁾ =106.0, I ⁽²⁾ =132.9, $\hbar\omega$ =0.396	E 9478.3+z, J+34 γ_{8654+z} 823.94 (\dagger <0.1) I ⁽¹⁾ =107.3, I ⁽²⁾ =135.1, $\hbar\omega$ =0.419
D 9389.6+y, J+36 γ_{8582+y} 807.62 (\dagger 0.35 12) I ⁽¹⁾ =107.0, I ⁽²⁾ =134.2, $\hbar\omega$ =0.411	E 10331.8+z, J+36 γ_{9478+z} 853.52 I ⁽¹⁾ =108.2, I ⁽²⁾ =130.3, $\hbar\omega$ =0.434
D 10227.0+y, J+38 γ_{9390+y} 837.44 (\dagger <0.1) I ⁽¹⁾ =107.9, I ⁽²⁾ =130.3, $\hbar\omega$ =0.426	E 11216.0+z (?), J+38 $\gamma_{10332+z}$ 884.210 (?) (\dagger <0.1)
D 11095.1+y (?), J+40 $\gamma_{10227+y}$ 868.112 (?) (\dagger <0.1)	

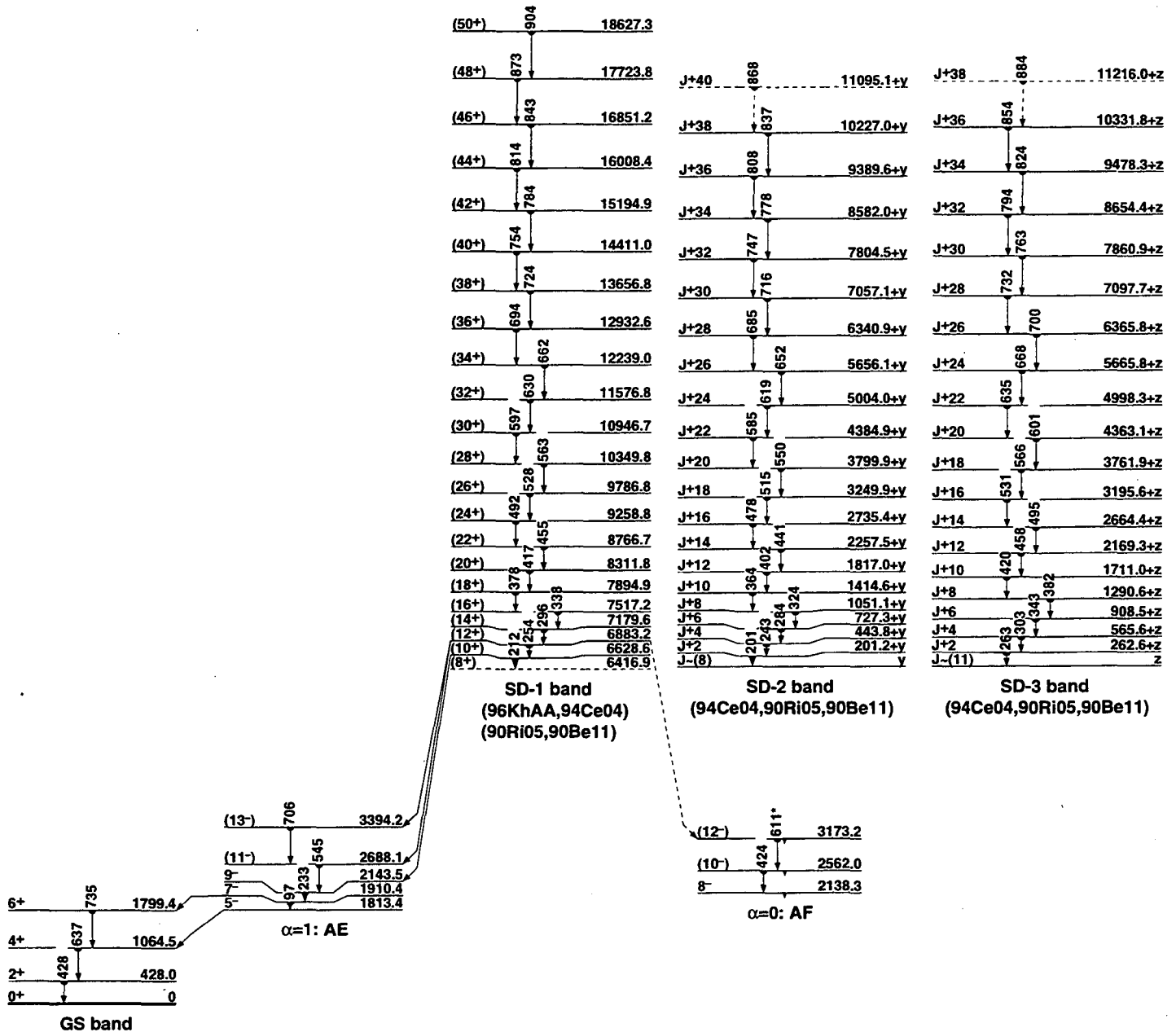

¹⁹⁴₈₀Hg

191
81Ti

Δ :(-26190) S_n :(9900) S_p :(2100) Q_{EC} :(4490) Q_α :(4400)

Nuclear Bands

- A Band Structure
- B 9/2[505]
- C Band Structure
- D 13/2[606]
- E Band Structure
- F Band Structure
- G Band Structure
- H SD-1 band (94Pi01)
- I SD-2 band (94Pi01)

Levels and γ -ray branchings:

- 0, (1/2⁺), $\mu=1.5884$
- B 299.7, 9/2⁻, 5.22 16 m, %EC+% β^+ =100, $\mu=+3.903448$, $Q=-2.202$
- A 341.22, (3/2⁺) γ_0 341.22 ($\dagger_{\gamma 100}$)
- B 686.12, (11/2⁻) γ_{299} 387.12 ($\dagger_{\gamma 100}$)
- A 745.37(?), (5/2⁺) γ_{341} 404.0(?) ($\dagger_{\gamma 100}$)
- C 859.62, (7/2⁻) γ_{299} 560.62 ($\dagger_{\gamma 100}$)
- B 1011.22, (13/2⁻) γ_{686} 325.02 ($\dagger_{\gamma 592}$) γ_{299} 712.22 ($\dagger_{\gamma 100 \ 7}$)
- C 1172.82, (9/2⁻) γ_{860} 313.02 ($\dagger_{\gamma 354}$) γ_{299} 873.92 ($\dagger_{\gamma 100 \ 4}$)
- A 1216.67(?), (7/2⁺) γ_{745} 471.32 ($\dagger_{\gamma 67 \ 34}$) γ_{341} 875.5 ($\dagger_{\gamma 100 \ 7}$)
- D 1299.82, (13/2⁺) γ_{1011} 288.1 γ_{686} 613.52 ($\dagger_{\gamma 100}$)
- 1392.12, (13/2⁻) γ_{686} 705.72 ($\dagger_{\gamma 100 \ 13}$) γ_{299} 1093.32 ($\dagger_{\gamma 94 \ 13}$)
- 1438.9(?), (15/2⁻) γ_{1011} 427.3(?) γ_{686} 752.8(?)
- 1704.7(?), (15/2⁺) γ_{1300} 404.6(?) ($\dagger_{\gamma 100}$)
- 1760.2(?), (17/2⁻) γ_{1439} 321.3(?) γ_{1011} 748.8(?)
- 1929.3, (17/2⁻) γ_{1439} 490.4 γ_{1011} 918.5
- 2010.7, (17/2⁺) γ_{1705} 306.0 γ_{1439} 571.6 γ_{1300} 710.9
- G 2077.5, (17/2⁺) γ_{1705} 372.4 γ_{1300} 777.4
- 2183.7, (19/2⁺) γ_{2078} 106.6 γ_{2011} 173.0 γ_{1760} 422.9
- 2231.8(?), (19/2⁻) γ_{1760} 471.6(?) γ_{1439} 792.8(?)
- 2321.0, (21/2⁺) γ_{2184} 137.3
- E 2329.2, (21/2⁺) γ_{2184} 145.5
- 2387.1, (19/2⁻) γ_{1929} 457.8 γ_{1439} 948.3
- F 2407.5, (19/2⁻) γ_{2232} 175.9 γ_{2184} 225.4(?) γ_{1760} 647.3
- G 2431.9, (19/2⁺) γ_{2184} 248.2 γ_{2078} 354.4
- 2486.3, (21/2⁺) γ_{2321} 165.5 γ_{2184} 303.4
- 2600.3(?), (21/2⁻) γ_{2408} 193.0 γ_{2387} 212.8 γ_{2232} 368(?) γ_{1760} 839(?)
- F 2622.1, (21/2⁻) γ_{2408} 214.6
- E 2642.0, (23/2⁺) γ_{2329} 312.8 γ_{2321} 321.0 γ_{2184} 458.6
- 2676.1, (23/2⁺) γ_{2486} 189.6 γ_{2432} 244.2 γ_{2408} 269.2(?)
- G 2738.5, (21/2⁺) γ_{2486} 252.0 γ_{2432} 306.6
- B 2852.0, (23/2⁻) γ_{2600} 251.5
- F 2861.5, (23/2⁻) γ_{2622} 239.4
- G 2882.7, (23/2⁺) γ_{2739} 144.2 γ_{2600} 282.8(?)
- 2955.6, (25/2⁺) γ_{2676} 279.5
- E 2968.7, (25/2⁺) γ_{2642} 326.7 γ_{2329} 639.6
- 3018(?), (23/2⁻) γ_{2600} 418(?) γ_{2232} 786(?)
- B 3077.3, (25/2⁻) γ_{2852} 225.3 γ_{2600} 476.8
- F 3093.5, (25/2⁻) γ_{2862} 232.0
- G 3131.1, (25/2⁺) γ_{2883} 248.4
- 3323.4, (27/2⁺) γ_{3131} 192.5 γ_{2956} 367.8
- E 3343.7, (27/2⁺) γ_{2969} 375.0 γ_{2642} 702.0
- B 3446.4, (27/2⁻) γ_{3077} 369.1 γ_{2852} 594.6
- 3595.4, (29/2⁺) γ_{3323} 272.0
- E 3674.3, (29/2⁺) γ_{3344} 330.6 γ_{2969} 706.2
- B 3763.0, (29/2⁻) γ_{3446} 316.6 γ_{3077} 685.8
- E 3963.4, (31/2⁺) γ_{3674} 289.1 γ_{3344} 620.0
- E 4123.0, (33/2⁺) γ_{3963} 159.6 γ_{3674} 449.0
- B 4194.7, (31/2⁻) γ_{3763} 431.7 γ_{3446} 748.6

- E 4323.9, (35/2⁺) γ_{4123} 200.9
- E 4513.1, (37/2⁺) γ_{4324} 189.2 γ_{4123} 390.4
- B 4566.4, (33/2⁻) γ_{4195} 371.7 γ_{3763} 803.2
- E 4792.6, (39/2⁺) γ_{4513} 279.5
- B 5030.4, (35/2⁻) γ_{4566} 464.0 γ_{4195} 836.5
- E 5075.5, (41/2⁺) γ_{4793} 282.5 γ_{4513} 564.1
- B 5425.9, (37/2⁻) γ_{5030} 395.5 γ_{4566} 859.9
- E 5430.0, (43/2⁺) γ_{5076} 354.5
- E 5793.0, (45/2⁺) γ_{5430} 363.0
- H x, J
- H 317.9+x, J+2 γ_x 317.93(?) $I^{(2)}=97.6, \hbar\omega=0.169$
- H 676.8+x, J+4 γ_{318+x} 358.93 ($\dagger_{\gamma 0.71 \ 25}$) $I^{(2)}=98.8, \hbar\omega=0.190$
- H 1076.2+x, J+6 γ_{677+x} 399.43 ($\dagger_{\gamma 0.79 \ 25}$) (E2) $I^{(2)}=102.8, \hbar\omega=0.209$
- H 1514.5+x, J+8 γ_{1076+x} 438.33 ($\dagger_{\gamma 0.64 \ 17}$) (E2) $I^{(2)}=103.9, \hbar\omega=0.229$
- H 1991.3+x, J+10 γ_{1515+x} 476.83 ($\dagger_{\gamma 0.57 \ 20}$) (E2) $I^{(2)}=105.0, \hbar\omega=0.248$
- H 2506.2+x, J+12 γ_{1991+x} 514.93 ($\dagger_{\gamma 0.50 \ 17}$) $I^{(2)}=110.8, \hbar\omega=0.266$
- H 3057.2+x, J+14 γ_{2506+x} 551.03 ($\dagger_{\gamma 0.39 \ 10}$) (E2) $I^{(2)}=109.0, \hbar\omega=0.285$
- H 3644.9+x, J+16 γ_{3057+x} 587.73 ($\dagger_{\gamma 0.25 \ 10}$) (E2) $I^{(2)}=113.6, \hbar\omega=0.303$
- H 4267.8+x, J+18 γ_{3645+x} 622.96 ($\dagger_{\gamma 0.18 \ 10}$) $I^{(2)}=122.0, \hbar\omega=0.320$
- H 4923.5+x, J+20 γ_{4268+x} 655.76 ($\dagger_{\gamma 0.13 \ 5}$)
- I y, J
- I 377.8+y, J+2 γ_y 377.86(?) ($\dagger_{\gamma 0.40 \ 12}$) $I^{(2)}=101.5, \hbar\omega=0.199$
- I 795.0+y, J+4 γ_{378+y} 417.23 ($\dagger_{\gamma 0.86 \ 25}$) (E2) $I^{(2)}=104.4, \hbar\omega=0.218$
- I 1250.5+y, J+6 γ_{795+y} 455.53 ($\dagger_{\gamma 0.80 \ 23}$) (E2) $I^{(2)}=105.3, \hbar\omega=0.237$
- I 1744.0+y, J+8 γ_{1251+y} 493.53 ($\dagger_{\gamma 0.71 \ 20}$) (E2) $I^{(2)}=108.7, \hbar\omega=0.256$
- I 2274.3+y, J+10 γ_{1744+y} 530.33 ($\dagger_{\gamma 0.67 \ 18}$) (E2) $I^{(2)}=112.0, \hbar\omega=0.274$
- I 2840.3+y, J+12 γ_{2274+y} 566.03 ($\dagger_{\gamma 0.54 \ 15}$) (E2) $I^{(2)}=119.4, \hbar\omega=0.291$
- I 3439.8+y, J+14 γ_{2840+y} 599.53 ($\dagger_{\gamma 0.54 \ 15}$) $I^{(2)}=120.8, \hbar\omega=0.308$
- I 4072.4+y, J+16 γ_{3440+y} 632.66 ($\dagger_{\gamma 0.27 \ 10}$) $I^{(2)}=119.8, \hbar\omega=0.325$
- I 4738.4+y(?) , J+18 γ_{4072+y} 666(?) ($\dagger_{\gamma 0.17 \ 8}$)

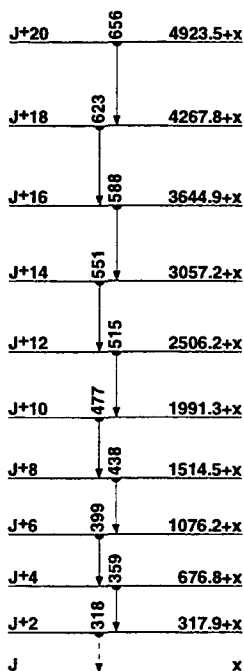

SD-1 band
(94Pi01)

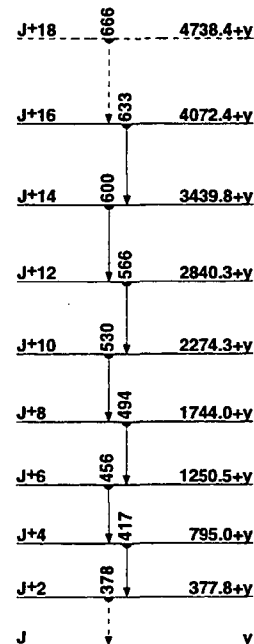

SD-2 band
(94Pi01)

191
81Ti

192
81 Tl

Δ : (-25900) S_n : (7800) S_p : (2600) Q_{EC} : (6120) Q_{α} : (4200)

Nuclear Bands

- A SD-1 band (92Li21)
- B SD-2 band (92Li21)
- C SD-3 band (92Li21)
- D SD-4 band (92Li21)
- E SD-5 band (92Li21)
- F SD-6 band (92Li21)

Levels and γ -ray branchings:

- 0+x, (2⁻), 9.64 m, %EC+% β^+ =100, $\mu=+0.2003$, $Q=-0.33711$
- 0+y, (7⁺), 10.82 m, %EC+% β^+ =100, $\mu=+0.518036$, $Q=+0.47720$
- 167.5+x 1, (1⁻) γ_{0+x} 167.51 (t_y100) M1(+E2): $\delta=0.7^{+3}$
- 250.6+y 2, (8⁻), 2965 ns, $\mu=+1.65640$, $Q=0.447$ γ_{0+y} 250.62 (t_y100) E1
- 250.6+z 2(?)
- 333.6+z 3 γ_{251+z} 331 (t_y100) (M1+E2)
- 371.0+x 2, (1⁻) γ_{0+x} 371.02 (t_y100) M1(+E2): $\delta=0.6^{+5}$
- 414.0+x 3, (1⁻, 2⁻) γ_{0+x} 414.13 (t_y100) M1
- 609.6+z 3 γ_{334+z} 275.82 (t_y100 15) (M1+E2) γ_{251+z} 359.02(?) (t_y203)
- 775.7+x 2, (0⁻, 1⁻) γ_{371+x} 404.53 (t_y17.124) γ_{168+x} 608.21 (t_y100 8)
- M1+E2: $\delta=1.6^{+5}$
- 871.6+z 3 γ_{610+z} 261.82 (t_y100 15) (M1+E2) γ_{334+z} 538.22 (t_y467) (E2)
- 1195.5+x 2, (1⁺) γ_{414+x} 781.63 (t_y182) γ_{0+y} 1195.42 (t_y100 6) E1
- 1267.9+z 3 γ_{872+z} 396.42 (t_y100 15) (M1+E2) γ_{610+z} 658.32 (t_y71 11)
- (E2)
- 1576.6+z 3 γ_{1268+z} 308.72 (t_y376) (M1+E2) γ_{872+z} 705.02 (t_y100 15)
- (E2)
- 2034.8+z 4 γ_{1577+z} 458.22 (M1+E2) γ_{1268+z} 767.6(?)
- 2255.7+z 4(?) γ_{2035+z} 220.92(?) (t_y100) (M1+E2)

A r, J

- A 357.8+r, J+2 γ_0 357.810 I⁽²⁾=99.5, $\hbar\omega=0.189$
- A 755.8+r, J+4 γ_{358+r} 398.010 I⁽²⁾=101.0, $\hbar\omega=0.209$
- A 1193.4+r, J+6 γ_{756+r} 437.65 I⁽²⁾=103.4, $\hbar\omega=0.228$
- A 1669.7+r, J+8 γ_{1193+r} 476.35 I⁽²⁾=101.8, $\hbar\omega=0.248$
- A 2185.3+r, J+10 γ_{1670+r} 515.65 I⁽²⁾=103.1, $\hbar\omega=0.268$
- A 2739.7+r, J+12 γ_{2185+r} 554.45 I⁽²⁾=101.8, $\hbar\omega=0.287$
- A 3333.4+r, J+14 γ_{2740+r} 593.710 I⁽²⁾=112.7, $\hbar\omega=0.306$
- A 3962.6+r, J+16 γ_{3333+r} 629.210

B s, J

- B 378+s, J+2 γ_0 378.1(?) I⁽²⁾=103.9, $\hbar\omega=0.199$
- B 794.5+s, J+4 γ_{378+s} 416.510 I⁽²⁾=102.3, $\hbar\omega=0.218$
- B 1250.1+s, J+6 γ_{795+s} 455.610 I⁽²⁾=103.1, $\hbar\omega=0.237$
- B 1744.5+s, J+8 γ_{1250+s} 494.410 I⁽²⁾=113.0, $\hbar\omega=0.256$
- B 2274.3+s, J+10 γ_{1745+s} 529.810 I⁽²⁾=110.5, $\hbar\omega=0.274$
- B 2840.3+s, J+12 γ_{2274+s} 566.010 I⁽²⁾=114.3, $\hbar\omega=0.292$
- B 3441.3+s, J+14 γ_{2840+s} 601.010 I⁽²⁾=112.0, $\hbar\omega=0.309$
- B 4078.0+s, J+16 γ_{3441+s} 636.710

C t, J

- C 375.7+t, J+2 γ_0 375.710 I⁽²⁾=106.1, $\hbar\omega=0.197$
- C 789.1+t, J+4 γ_{376+t} 413.45 I⁽²⁾=106.1, $\hbar\omega=0.216$
- C 1240.2+t, J+6 γ_{789+t} 451.15 I⁽²⁾=107.2, $\hbar\omega=0.235$
- C 1728.6+t, J+8 γ_{1240+t} 488.45 I⁽²⁾=105.8, $\hbar\omega=0.254$
- C 2254.8+t, J+10 γ_{1728+t} 526.25 I⁽²⁾=101.5, $\hbar\omega=0.273$
- C 2820.4+t, J+12 γ_{2255+t} 565.65 I⁽²⁾=107.5, $\hbar\omega=0.292$
- C 3423.2+t, J+14 γ_{2820+t} 602.85 I⁽²⁾=105.8, $\hbar\omega=0.311$
- C 4063.8+t, J+16 γ_{3423+t} 640.610

D u, J

- D 357+u, J+2 γ_0 357.1(?) I⁽²⁾=103.4, $\hbar\omega=0.188$
- D 752.7+u, J+4 γ_{357+u} 395.710 I⁽²⁾=105.5, $\hbar\omega=0.207$
- D 1186.3+u, J+6 γ_{753+u} 433.610 I⁽²⁾=105.8, $\hbar\omega=0.226$
- D 1657.7+u, J+8 γ_{1186+u} 471.410 I⁽²⁾=107.2, $\hbar\omega=0.245$
- D 2166.4+u, J+10 γ_{1658+u} 508.710 I⁽²⁾=104.2, $\hbar\omega=0.264$
- D 2713.5+u, J+12 γ_{2166+u} 547.110 I⁽²⁾=115.6, $\hbar\omega=0.282$
- D 3295.2+u, J+14 γ_{2714+u} 581.710 I⁽²⁾=107.2, $\hbar\omega=0.300$
- D 3914.2+u, J+16 γ_{3295+u} 619.1(?)

E v, J

- E 381.2+v, J+2 γ_0 381.210 I⁽²⁾=97.8, $\hbar\omega=0.201$
- E 803.3+v, J+4 γ_{381+v} 422.110 I⁽²⁾=101.8, $\hbar\omega=0.221$
- E 1264.7+v, J+6 γ_{803+v} 461.45 I⁽²⁾=100.3, $\hbar\omega=0.241$
- E 1766.0+v, J+8 γ_{1265+v} 501.35 I⁽²⁾=112.0, $\hbar\omega=0.260$
- E 2303.0+v, J+10 γ_{1766+v} 537.05 I⁽²⁾=110.5, $\hbar\omega=0.278$
- E 2876.2+v, J+12 γ_{2303+v} 573.25 I⁽²⁾=112.7, $\hbar\omega=0.295$
- E 3484.9+v, J+14 γ_{2876+v} 608.710 I⁽²⁾=120.5, $\hbar\omega=0.313$
- E 4126.8+v, J+16 γ_{3485+v} 641.910

F w, J

- F 406.5+w, J+2 γ_0 406.510 I⁽²⁾=105.5, $\hbar\omega=0.213$
- F 850.9+w, J+4 γ_{407+w} 444.410 I⁽²⁾=99.8, $\hbar\omega=0.232$
- F 1335.4+w, J+6 γ_{851+w} 484.510 I⁽²⁾=102.0, $\hbar\omega=0.252$
- F 1859.1+w, J+8 γ_{1335+w} 523.710 I⁽²⁾=101.0, $\hbar\omega=0.272$
- F 2422.4+w, J+10 γ_{1859+w} 563.310 I⁽²⁾=107.0, $\hbar\omega=0.291$
- F 3023.1+w, J+12 γ_{2422+w} 600.710 I⁽²⁾=122.0, $\hbar\omega=0.309$
- F 3656.6+w, J+14 γ_{3023+w} 633.510

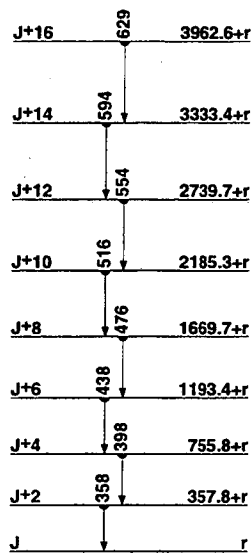

SD-1 band
(92Li21)

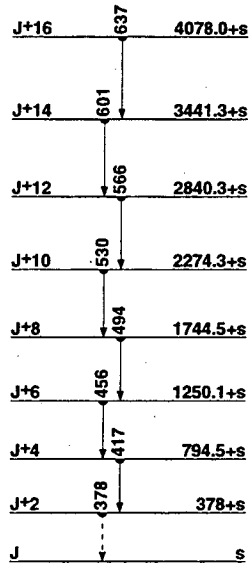

SD-2 band
(92Li21)

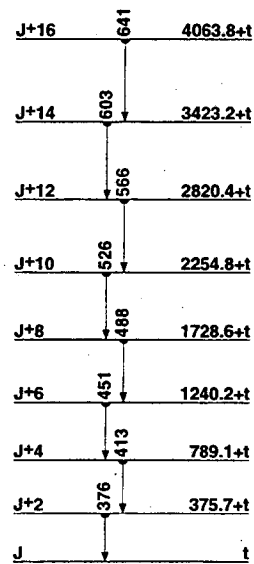

SD-3 band
(92Li21)

¹⁹²₈₁Tl

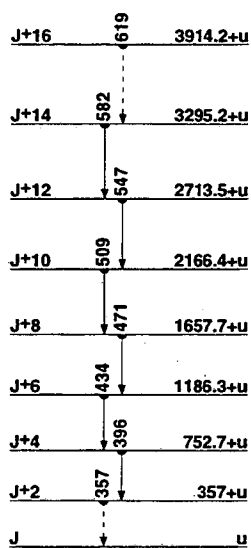

SD-4 band
(92Li21)

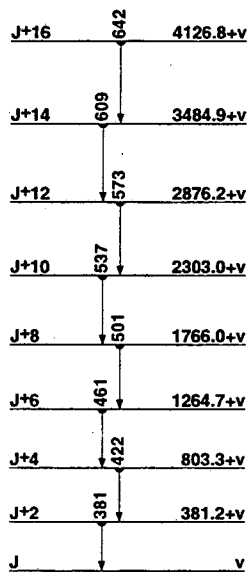

SD-5 band
(92Li21)

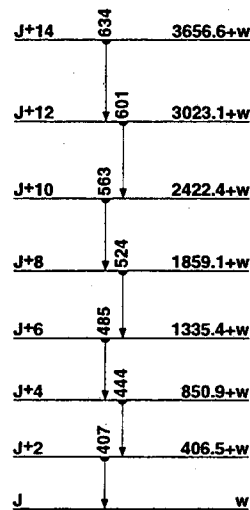

SD-6 band
(92Li21)

¹⁹²₈₁Tl

193
81 Tl

Δ : (-27430) S_n : (9600) S_p : (2700) Q_{EC} : (3640) Q_α : (3800)

Nuclear Bands

- A 9/2[505]
- B 13/2[606]?
- C SD-1 band (90Fe07,96BoAA)
- D SD-2 band (90Fe07,96BoAA)
- E SD-3 band (96BoAA,96WiAA)
- F SD-4 band (96BoAA,96WiAA)
- G SD-5 band (96BoAA,96WiAA)

Levels and γ -ray branchings:

- 0, 1/2(⁺), 21.6 8 m, %EC+% β^+ =100, μ =+1.5912 22
365.2, 3/2(⁺) $\gamma_{365.2}$ (\dagger_{100}) M1+E2: δ =1.6⁻⁵
- A 365.2+x, (9/2⁻), 2.11 15 m, %IT=75, %EC+% β^+ =25, μ =+3.9482 39,
 Q_α =-2.20 2 γ <13
- A 757.4+x, (11/2⁻) $\gamma_{365.2}$ 392.2 (\dagger_{100}) (M1+E2): δ =0.8⁻⁴
1037.7+x $\gamma_{365.2}$ 672.5 (\dagger_{100})
- A 1081.5+x, (13/2⁻) $\gamma_{757.4}$ 324.0 ($\dagger_{63.6}$) $\gamma_{365.2}$ 716.4 ($\dagger_{100.7}$) (E2)
1163.9+x $\gamma_{757.4}$ 406.4 (\dagger_{100})
1350.4+x $\gamma_{1082.2}$ 268.9 (\dagger_{100})
1423.6+x $\gamma_{757.4}$ 666.2 (\dagger_{100})
- B 1493.3+x, (13/2⁺) $\gamma_{757.4}$ 735.8 (\dagger_{100}) E1+M2: δ =0.18 7
- A 1512.6+x, (15/2⁻) $\gamma_{1082.2}$ 431.3 ($\dagger_{53.4}$) (M1+E2): δ =0.3 3 $\gamma_{757.4}$ 755.1
($\dagger_{100.11}$) (E2)
1552.7+x([?]) $\gamma_{1350.4}$ 202.33([?]) (\dagger_{100})
1558.3+x $\gamma_{1350.4}$ 207.9 (\dagger_{100})
- A 1833.4+x, (17/2⁻) $\gamma_{1513.3}$ 320.9 3 ($\dagger_{39.5}$) (M1) $\gamma_{1082.2}$ 751.7 ($\dagger_{100.13}$)
(E2)
1870.9+x $\gamma_{757.4}$ 1113.5 (\dagger_{100})
- B 1899.6+x([?]), (15/2⁺) $\gamma_{1493.3}$ 406.4([?]) (\dagger_{100})
1960.0+x $\gamma_{1493.3}$ 466.8 (\dagger_{100})
- B 2025.5+x([?]), (17/2⁺) $\gamma_{1900.4}$ 125.9([?]) (\dagger_{100})
- B 2492.3+x([?]), (19/2⁺) $\gamma_{2026.2}$ 466.8([?]) (\dagger_{100})
- B 2653.9+x([?]), (21/2⁺) $\gamma_{2492.2}$ 161.6([?]) (\dagger_{100})
- D y, J=(17/2⁺)
- C 98.4+y, J+1
- D 206.6+y, J+2 $\gamma_{98.4}$ 108.0 3 $\gamma_{206.6}$ 3 (\dagger_{100}) $I^{(1)}$ =92.5, $I^{(2)}$ =98.3, η ω =0.113
- C 325.6+y, J+3 $\gamma_{207.4}$ 118.9 3 $\gamma_{98.4}$ 227.3 3 ($\dagger_{0.98.10}$) $I^{(1)}$ =24.2, $I^{(2)}$ =98.5,
 η ω =0.124
- D 454.0+y, J+4 $\gamma_{326.6}$ 128.3 3 $\gamma_{207.4}$ 247.3 3 ($\dagger_{0.39.6}$) $I^{(1)}$ =93.5, $I^{(2)}$ =99.0,
 η ω =0.134
- C 593.4+y, J+5 $\gamma_{454.0}$ 139.2 3 (M1) $\gamma_{326.6}$ 267.9 3 ($\dagger_{1.13.23}$) $I^{(1)}$ =34.7,
 $I^{(2)}$ =99.3, η ω =0.144
- D 741.6+y, J+6 $\gamma_{593.4}$ 148.2 3 (M1) $\gamma_{454.0}$ 287.7 3 ($\dagger_{0.45.5}$) $I^{(1)}$ =94.3,
 $I^{(2)}$ =100.8, η ω =0.154
- C 901.6+y, J+7 $\gamma_{742.2}$ 160.1 3 (M1) $\gamma_{593.4}$ 308.2 3 ($\dagger_{0.86.9}$) $I^{(1)}$ =42.7,
 $I^{(2)}$ =100.5, η ω =0.164
- D 1069.0+y, J+8 $\gamma_{902.2}$ 167.4 3 (M1) $\gamma_{742.2}$ 327.4 3 ($\dagger_{0.53.5}$) $I^{(1)}$ =95.1,
 $I^{(2)}$ =102.6, η ω =0.173
- C 1249.6+y, J+9 $\gamma_{1069.0}$ 180.6 3 (M1) $\gamma_{902.2}$ 348.0 3 ($\dagger_{1.01.11}$) $I^{(1)}$ =49.0,
 $I^{(2)}$ =102.6, η ω =0.184
- D 1435.3+y, J+10 $\gamma_{1250.4}$ 185.8 3 (M1) $\gamma_{1069.0}$ 366.4 3 ($\dagger_{1.15.23}$) $I^{(1)}$ =95.9,
 $I^{(2)}$ =102.8, η ω =0.193
- C 1636.7+y, J+11 $\gamma_{1435.3}$ 201.4 3 (M1) $\gamma_{1250.4}$ 387.0 3 ($\dagger_{1.4.4}$) $I^{(1)}$ =54.2,
 $I^{(2)}$ =104.2, η ω =0.203
- D 1840.4+y, J+12 $\gamma_{1637.2}$ 203.5 3 $\gamma_{1435.3}$ 405.3 4 ($\dagger_{0.93.19}$) $I^{(1)}$ =96.7,
 $I^{(2)}$ =106.4, η ω =0.212
- C 2062.0+y, J+13 $\gamma_{1840.4}$ 221.5 3 $\gamma_{1637.2}$ 425.4 3 ($\dagger_{1.22.12}$) $I^{(1)}$ =58.5,
 $I^{(2)}$ =104.4, η ω =0.222
- D 2283.3+y, J+14 $\gamma_{1840.4}$ 442.9 3 $I^{(1)}$ =97.6, $I^{(2)}$ =108.7, η ω =0.231
- C 2525.7+y, J+15 $\gamma_{2062.0}$ 463.7 3 ($\dagger_{1.60.16}$) $I^{(1)}$ =62.2, $I^{(2)}$ =107.0,
 η ω =0.241
- D 2763.0+y, J+16 $\gamma_{2283.3}$ 479.7 3 ($\dagger_{0.72.17}$) $I^{(1)}$ =98.4, $I^{(2)}$ =109.9,
 η ω =0.249
- C 3026.8+y, J+17 $\gamma_{2526.6}$ 501.1 3 $I^{(1)}$ =65.5, $I^{(2)}$ =109.9, η ω =0.260

- D 3279.1+y, J+18 $\gamma_{2763.0}$ 516.1 3 ($\dagger_{1.11.17}$) $I^{(1)}$ =99.3, $I^{(2)}$ =112.7,
 η ω =0.267
- C 3564.3+y, J+19 $\gamma_{3027.4}$ 537.5 3 ($\dagger_{1.30.14}$) $I^{(1)}$ =68.4, $I^{(2)}$ =111.4,
 η ω =0.278
- D 3830.8+y, J+20 $\gamma_{3279.1}$ 551.6 3 ($\dagger_{1.00.14}$) $I^{(1)}$ =100.2, $I^{(2)}$ =114.6,
 η ω =0.285
- C 4137.7+y, J+21 $\gamma_{3564.3}$ 573.4 3 ($\dagger_{1.00.10}$) $I^{(1)}$ =71.1, $I^{(2)}$ =113.0,
 η ω =0.296
- D 4417.3+y, J+22 $\gamma_{3831.1}$ 586.5 3 ($\dagger_{0.84.17}$) $I^{(1)}$ =101.1, $I^{(2)}$ =118.3,
 η ω =0.302
- C 4746.5+y, J+23 $\gamma_{4138.1}$ 608.8 3 ($\dagger_{0.96.10}$) $I^{(1)}$ =73.4, $I^{(2)}$ =114.3,
 η ω =0.313
- D 5037.6+y, J+24 $\gamma_{4417.3}$ 620.3 3 ($\dagger_{0.81.13}$) $I^{(1)}$ =102.0, $I^{(2)}$ =120.1,
 η ω =0.318
- C 5390.3+y, J+25 $\gamma_{4747.7}$ 643.8 3 ($\dagger_{1.09.22}$) $I^{(1)}$ =75.6, $I^{(2)}$ =114.6,
 η ω =0.331
- D 5691.2+y, J+26 $\gamma_{5038.1}$ 653.6 4 ($\dagger_{0.42.11}$) $I^{(1)}$ =103.0, $I^{(2)}$ =123.1,
 η ω =0.335
- C 6069.0+y, J+27 $\gamma_{5390.3}$ 678.7 4 ($\dagger_{0.75.14}$) $I^{(1)}$ =77.6, $I^{(2)}$ =115.9,
 η ω =0.348
- D 6377.3+y, J+28 $\gamma_{5691.2}$ 686.1 4 ($\dagger_{0.46.11}$) $I^{(1)}$ =103.9, $I^{(2)}$ =122.7,
 η ω =0.351
- C 6782.2+y, J+29 $\gamma_{6069.0}$ 713.2 5 $I^{(1)}$ =79.4, $I^{(2)}$ =116.6, η ω =0.365
- D 7096.0+y, J+30 $\gamma_{6377.7}$ 718.7 5 $I^{(1)}$ =104.8, $I^{(2)}$ =122.7, η ω =0.368
- C 7529.7+y, J+31 $\gamma_{6782.2}$ 747.5 5 $I^{(1)}$ =81.1, $I^{(2)}$ =116.3, η ω =0.382
- D 7847.3+y, J+32 $\gamma_{7096.0}$ 751.3 5 $I^{(1)}$ =105.6, $I^{(2)}$ =124.6, η ω =0.384
- C 8311.6+y, J+33 $\gamma_{7530.7}$ 781.9 5
- D 8630.7+y, J+34 $\gamma_{7847.7}$ 783.4 5
- E z, J
- E 187.7+z, J+2 γ_z 187.7 3 $I^{(2)}$ =93.2, η ω =0.105
- E 418.3+z, J+4 $\gamma_{188.2}$ 230.6 2 $I^{(2)}$ =95.0, η ω =0.126
- E 691.0+z, J+6 $\gamma_{418.2}$ 272.7 2 $I^{(2)}$ =96.6, η ω =0.147
- E 1005.1+z, J+8 $\gamma_{691.0}$ 314.1 2 $I^{(2)}$ =97.8, η ω =0.167
- E 1360.1+z, J+10 $\gamma_{1005.1}$ 355.0 2 $I^{(2)}$ =99.8, η ω =0.188
- E 1755.2+z, J+12 $\gamma_{1360.1}$ 395.1 2 $I^{(2)}$ =101.5, η ω =0.207
- E 2189.7+z, J+14 $\gamma_{1755.2}$ 434.5 2 $I^{(2)}$ =104.2, η ω =0.227
- E 2662.6+z, J+16 $\gamma_{2190.4}$ 472.9 2 $I^{(2)}$ =106.7, η ω =0.246
- E 3173.0+z, J+18 $\gamma_{2663.4}$ 510.4 2 $I^{(2)}$ =108.7, η ω =0.264
- E 3720.2+z, J+20 $\gamma_{3173.0}$ 547.2 2 $I^{(2)}$ =110.5, η ω =0.283
- E 4303.6+z, J+22 $\gamma_{3720.2}$ 583.4 2 $I^{(2)}$ =114.0, η ω =0.300
- E 4922.1+z, J+24 $\gamma_{4304.4}$ 618.5 3 $I^{(2)}$ =115.3, η ω =0.318
- E 5575.3+z, J+26 $\gamma_{4922.1}$ 653.2 3 $I^{(2)}$ =119.8, η ω =0.335
- E 6261.9+z, J+28 $\gamma_{5575.3}$ 686.6 3 $I^{(2)}$ =148.1, η ω =0.350
- E 6975.5+z, J+30 $\gamma_{6262.2}$ 713.6 4 $I^{(2)}$ =201.0, η ω =0.362
- E 7709.0+z, J+32 $\gamma_{6976.2}$ 733.5 10
- F u, J
- F 250.6+u, J+2 γ_u 250.6 2 $I^{(2)}$ =96.2, η ω =0.136
- F 542.8+u, J+4 $\gamma_{251.4}$ 292.2 2 $I^{(2)}$ =99.3, η ω =0.156
- F 875.3+u, J+6 $\gamma_{543.1}$ 332.5 2 $I^{(2)}$ =98.8, η ω =0.176
- F 1248.3+u, J+8 $\gamma_{875.3}$ 373.0 2 $I^{(2)}$ =102.6, η ω =0.196
- F 1660.3+u, J+10 $\gamma_{1248.3}$ 412.0 2 $I^{(2)}$ =103.6, η ω =0.216
- F 2110.9+u, J+12 $\gamma_{1660.3}$ 450.6 2 $I^{(2)}$ =107.0, η ω =0.235
- F 2598.9+u, J+14 $\gamma_{2111.1}$ 488.0 2 $I^{(2)}$ =107.2, η ω =0.253
- F 3124.2+u, J+16 $\gamma_{2599.4}$ 525.3 2 $I^{(2)}$ =109.9, η ω =0.272
- F 3685.9+u, J+18 $\gamma_{3124.4}$ 561.7 2 $I^{(2)}$ =113.3, η ω =0.290
- F 4282.9+u, J+20 $\gamma_{3686.4}$ 597.0 2 $I^{(2)}$ =115.3, η ω =0.307
- F 4914.6+u, J+22 $\gamma_{4283.4}$ 631.7 2 $I^{(2)}$ =115.6, η ω =0.324
- F 5580.9+u, J+24 $\gamma_{4915.4}$ 666.3 2 $I^{(2)}$ =103.9, η ω =0.343
- F 6285.7+u, J+26 $\gamma_{5581.4}$ 704.8 3 $I^{(2)}$ =95.9, η ω =0.363
- F 7032.2+u, J+28 $\gamma_{6286.4}$ 746.5 5

- G v, J
- G 231.0+v, J+2 $\gamma_{231.0}^{(2)}$ $I^{(2)}=101.3, \hbar\omega=0.125$
- G 501.5+v, J+4 $\gamma_{231.5}^{(2)}$ $I^{(2)}=93.2, \hbar\omega=0.146$
- G 814.9+v, J+6 $\gamma_{502.5}^{(2)}$ $I^{(2)}=98.5, \hbar\omega=0.167$
- G 1168.9+v, J+8 $\gamma_{815.9}^{(2)}$ $I^{(2)}=102.6, \hbar\omega=0.187$
- G 1561.9+v, J+10 $\gamma_{1168.9}^{(2)}$ $I^{(2)}=102.3, \hbar\omega=0.206$
- G 1994.0+v, J+12 $\gamma_{1562.0}^{(2)}$ $I^{(2)}=105.5, \hbar\omega=0.226$
- G 2464.0+v, J+14 $\gamma_{1994.0}^{(2)}$ $I^{(2)}=107.5, \hbar\omega=0.244$
- G 2971.2+v, J+16 $\gamma_{2464.0}^{(2)}$ $I^{(2)}=109.9, \hbar\omega=0.263$
- G 3514.8+v, J+18 $\gamma_{2971.2}^{(2)}$ $I^{(2)}=111.1, \hbar\omega=0.281$
- G 4094.4+v, J+20 $\gamma_{3515.2}^{(2)}$ $I^{(2)}=115.6, \hbar\omega=0.298$
- G 4708.6+v, J+22 $\gamma_{4094.4}^{(2)}$ $I^{(2)}=113.3, \hbar\omega=0.316$
- G 5358.1+v, J+24 $\gamma_{4708.6}^{(2)}$ $I^{(2)}=116.6, \hbar\omega=0.333$
- G 6041.9+v, J+26 $\gamma_{5358.1}^{(2)}$ $I^{(2)}=117.0, \hbar\omega=0.350$
- G 6759.9+v, J+28 $\gamma_{6042.2}^{(2)}$ $I^{(2)}=117.0, \hbar\omega=0.350$

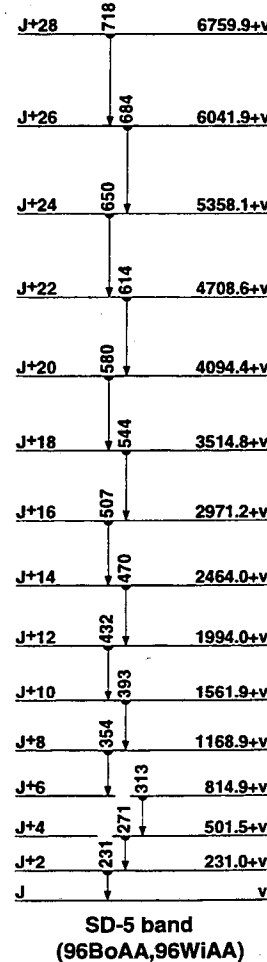
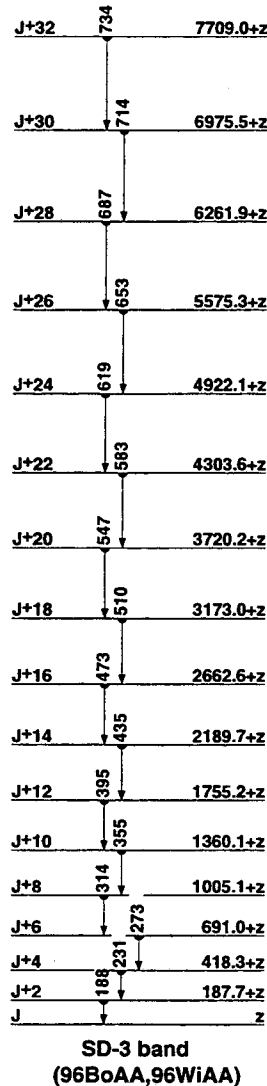
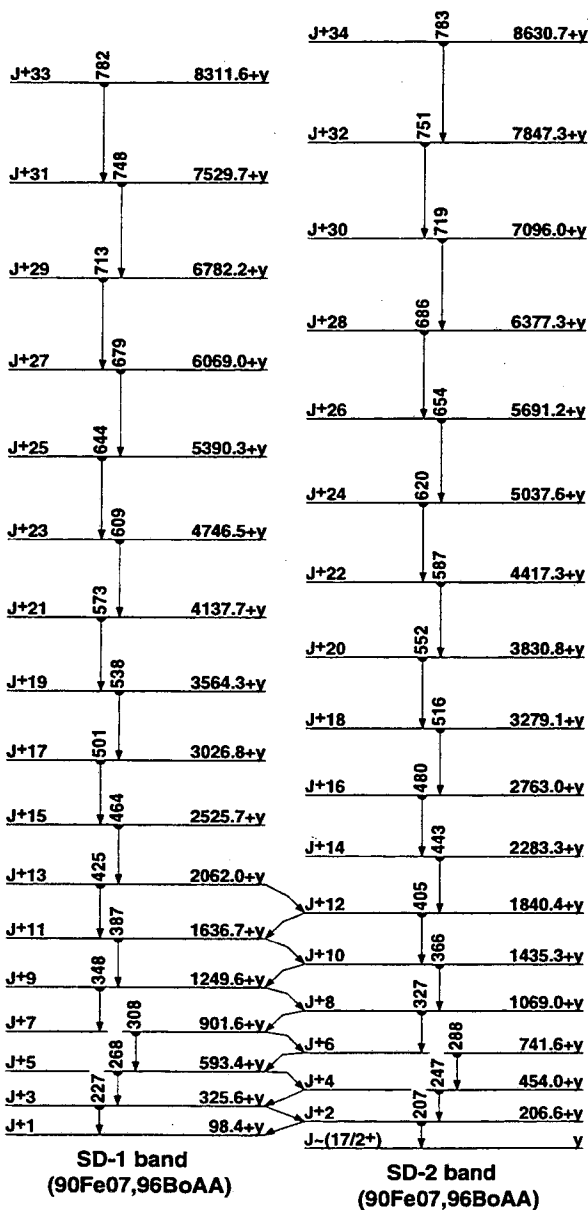

¹⁹³₈₁Tl

194
81 Tl

Δ : (-26970) S_n : (7610) S_p : (3180) Q_{EC} : (5280) Q_α : (3490)

Nuclear Bands

- A $\pi h_{9/2}^{-} \nu_{13/2}^{-}$
- B SD-1 band (91Az03)
- C SD-2 band (91Az03)
- D SD-3 band (91Az03)
- E SD-4 band (91Az03)
- F SD-5 band (91Az03)
- G SD-6 band (91Az03)

Levels and γ -ray branchings:

0, 2⁻, 33.0 s m, %EC+% β^+ =100, % α <1 $\times 10^{-7}$, μ =0.14 1
 192.14 4, (0)⁻ $\gamma_{0192.025}$ (†,100) E2
 203.83 3, 1⁻ $\gamma_{203.826}$ (†,100) M1(+E2); δ <0.3
 225.01 4, (2)⁻ $\gamma_{225.008}$ (†,100) M1(+E2); δ <0.3
 270.50 3, (3)⁻ $\gamma_{225} 45.5$ 10 (†,=0.23) $\gamma_{204} 66.7$ 10 (†,=0.14) $\gamma_{0270.524}$ (†,100.5) M1(+E2); δ <0.25⁻
 0⁺s, (7⁺), 32.8 s m, %EC+% β^+ =100, μ =0.540 5, Q =0.62
 367.76 4, 1⁻ $\gamma_{225} 142.94$ 10 (†,3.4 4) $\gamma_{204} 163.90$ 10 (†,5.14 12)
 M1(+E2); δ =1 $\gamma_{192} 175.68$ 12 (†,4.2 2) M1 $\gamma_{0367.80}$ 10 (†,100 8)
 M1(+E2); δ <0.1
 459.92 4, (2)⁻ $\gamma_{368} 92.22$ (†,2.3 3) $\gamma_{271} 189.44$ 5 (†,50 7) M1(+E2); δ <0.1
 $\gamma_{192} 267.92$ 10(?) (†,9.1 2) $\gamma_{0460.05}$ 10 (†,100 2) M1+E2; δ <0.9 2
 521.52 3, 1⁻ $\gamma_{368} 153.82$ (†,6.0 6) (M1) $\gamma_{225} 296.40$ 6 (†,11.9 3) (M1)
 $\gamma_{204} 317.70$ 5 (†,14.2 3) M1(+E2); δ <0.5 $\gamma_{192} 329.48$ 5 (†,3.9 4)
 M1(+E2); δ <0.5 $\gamma_{0521.55}$ 5 (†,100 2) M1(+E2); δ <0.3
 589.16 4, (2)⁻ $\gamma_{271} 318.69$ 5 (†,100 2) M1(+E2); δ <0.4 $\gamma_{204} 385.33$ 3
 (†,43 4) $\gamma_{0589.12}$ (†,59 2) M1(+E2); δ <0.3
 A 292.8+s, (8⁻) $\gamma_{048} 292.82$ (†,100)
 A 292.8+t, (8⁻,9⁻,10⁻)
 A 389.1+t, (9⁻,10⁻,11⁻) $\gamma_{293+t} 96.32$ (†,100)
 752.94 6, (1⁻) $\gamma_{460} 292.98$ 6(?) (†,56) $\gamma_{225} 527.72$ (†,5.1 8) $\gamma_{204} 549.0$ 1
 (†,53 1) (M1,E2) $\gamma_{0752.82}$ (†,100 4)
 785.78 5, (1)⁻ $\gamma_{368} 417.92$ 6 (†,12.1 2) M1(+E2); δ <0.3 $\gamma_{225} 560.69$ 10
 (†,7.2 15) $\gamma_{204} 581.82$ 10 (†,100 3) M1(+E2); δ <0.4 $\gamma_{0785.54}$ 10
 (†,2.1 12)
 833.28 4, (1)⁻ $\gamma_{522} 311.84$ 5 (†,37 3) M1+E2; δ =1.0 3 $\gamma_{460} 373.39$ 4
 (†,43 3) M1(+E2); δ <0.5 $\gamma_{368} 465.82$ (†,21 2) (M1) $\gamma_{204} 629.9$ 3
 (†,100 11) (M1) $\gamma_{192} 640.55$ 8 (†,90 13) $\gamma_{0833.43}$ (†,24 8)
 979.01 11, (1⁻,2⁻) $\gamma_{522} 457.52$ (†,59 15) $\gamma_{368} 611.03$ (†,39 4) $\gamma_{225} 754.42$
 (†,100 11) $\gamma_{204} 774.93$ (†,26 1) (M1) $\gamma_{192} 786.7$ 1(?) (†,22 11)
 998.43 8, 1⁻ $\gamma_{271} 244.93$ 10 (†,9.8 6) $\gamma_{368} 630.83$ (†,=10) $\gamma_{225} 773.46$ 20
 (†,20.2 6) M1(+E2); δ <0.7 $\gamma_{204} 794.85$ 7 (†,54 5) (M1,E2) $\gamma_{0998.47}$ 10
 (†,100 8) M1(+E2); δ <0.7
 1010.52 5, (1)⁻ $\gamma_{753} 257.95$ 10 (†,23 2) $\gamma_{522} 489.02$ (†,25 1) $\gamma_{460} 550.63$
 (†,18 1) $\gamma_{368} 642.79$ 8 (†,80 9) (M1) $\gamma_{225} 785.54$ 10 (†,29 18)
 $\gamma_{204} 806.52$ 7 (†,91 3) $\gamma_{192} 818.02$ (†,77 3) M1 $\gamma_{01010.54}$ 10 (†,100 5)
 A 667.0+t, (10⁻,11⁻,12⁻) $\gamma_{389+t} 277.92$ (†,100 6) $\gamma_{293+t} 373.5$ (?) (†,8 4)
 1152.01 7, (1)⁻ $\gamma_{368} 784.24$ (†,25 12) $\gamma_{225} 926.97$ 9 (†,100 21)
 M1(+E2); δ <0.7 $\gamma_{01152.04}$ 9 (†,38 1)
 1178.81 8, (1)⁻ $\gamma_{786} 392.63$ 10 (†,27 4) E2(+M1); δ >3 $\gamma_{271} 811.49$ 10
 (†,72 3) (M1,E2) $\gamma_{01178.62}$ (†,100 4)
 1187.56 7, (0,1)⁻ $\gamma_{998} 189.04$ (†,=5) $\gamma_{522} 666.05$ 8 (†,74 1)
 M1(+E2); δ <0.4 $\gamma_{368} 819.50$ 20 (†,100 2) $\gamma_{225} 962.64$ 12 (†,49 1) (E2)
 A 911.7+t, (11⁻,12⁻,13⁻) $\gamma_{667+t} 244.72$ (†,100 11) $\gamma_{389+t} 522.72$ (†,54 9)
 1272.20 8, (0⁻,1⁻,2⁻) $\gamma_{878} 292.98$ 6(?) (†,210) $\gamma_{833} 438.83$ 10 (†,54 3)
 $\gamma_{204} 1068.47$ 10 (†,100 9) (M1)
 1519.34 6, 1⁺ $\gamma_{878} 540.52$ (†,2.61 8) $\gamma_{833} 685.93$ 10 (†,3.80 7)
 $\gamma_{460} 1059.38$ 10 (†,23.6 4) E1 $\gamma_{225} 1294.42$ (†,11.6 4) E1 $\gamma_{204} 1315.62$
 (†,3.4 4) $\gamma_{01519.45}$ 13 (†,100 8)
 1553.10 13, (0,1) $\gamma_{368} 1185.35$ 15 (†,92 5) $\gamma_{204} 1349.25$ 20 (†,100 4)
 1602.8 2, (0⁻,1,2⁻) $\gamma_{01602.82}$ (†,100)
 1639.07 7, (1)⁻ $\gamma_{1011} 628.13$ (?) (†,21 4) $\gamma_{786} 852.94$ 10 (†,59 2)
 E2(+M1); δ >2 $\gamma_{368} 1271.98$ 25 (†,100 2) $\gamma_{225} 1414.35$ (†,30 6)

$\gamma_{01639.29}$ 10 (†,68 2)
 A 1314.9+t, (12⁻,13⁻,14⁻) $\gamma_{912+t} 403.22$ (†,100 10) $\gamma_{667+t} 648.52$ (†,43 7)
 1707.61 9, (1)⁻ $\gamma_{589} 1118.44$ 10 (†,100 13) M1,E2 $\gamma_{368} 1339.62$ (†,54 18)
 $\gamma_{225} 1482.92$ (†,62 5) $\gamma_{192} 1515$ 1 (†,=13)
 1722.97 17, (0⁻,1) $\gamma_{522} 1200.93$ (†,31 4) $\gamma_{01723.22}$ (†,100 20)
 1753.13 15, (0,1) $\gamma_{522} 1231.52$ (†,53 3) $\gamma_{204} 1549.42$ (†,100 4)
 1810.46 12, (1) $\gamma_{225} 1585.32$ (†,26 1) $\gamma_{192} 1618.52$ (†,35 1) $\gamma_{01810.42}$
 (†,100 2)
 1858.8 10, (0,1,2⁻) $\gamma_{1639} 220.05$ 12(?) (†,160 16) $\gamma_{204} 1655$ 1 (†,100 20)
 A 1598.2+t, (13⁻,14⁻,15⁻) $\gamma_{1315+t} 283.32$ (†,60 7) $\gamma_{912+t} 686.72$ (†,100 10)
 2192.7 3, (1,2⁻) $\gamma_{1639} 553.32$ (?) (†,172 10) $\gamma_{522} 1671$ 1 (†,42 22)
 $\gamma_{192} 2000.63$ (†,100 7)
 2343.4 5, (0⁻,1) $\gamma_{02343.45}$ (†,100)
 A 2056.8+t, (14⁻,15⁻,16⁻) $\gamma_{1598+t} 458.62$ (†,100 11) $\gamma_{1315+t} 741.92$ (†,46 7)
 A 2346.2+t, (15⁻,16⁻,17⁻) $\gamma_{2057+t} 289.42$ (†,100 11) $\gamma_{1598+t} 748.6$ (?)
 B u, J=(12)
 B 268.0+u, J+2 $\gamma_{0268.03}$ I⁽¹⁾=97.4, I⁽²⁾=102.6, $\hbar\omega$ =0.144
 B 575.0+u, J+4 $\gamma_{268+u} 307.03$ I⁽¹⁾=98.1, I⁽²⁾=105.0, $\hbar\omega$ =0.163
 B 920.1+u, J+6 $\gamma_{575+u} 345.13$ I⁽¹⁾=98.7, I⁽²⁾=102.3, $\hbar\omega$ =0.182
 B 1304.3+u, J+8 $\gamma_{920+u} 384.23$ I⁽¹⁾=99.4, I⁽²⁾=108.7, $\hbar\omega$ =0.201
 B 1725.3+u, J+10 $\gamma_{1304+u} 421.03$ I⁽¹⁾=100.2, I⁽²⁾=111.1, $\hbar\omega$ =0.220
 B 2182.3+u, J+12 $\gamma_{1725+u} 457.05$ I⁽¹⁾=100.9, I⁽²⁾=105.5, $\hbar\omega$ =0.238
 B 2677.2+u, J+14 $\gamma_{2182+u} 494.95$ I⁽¹⁾=101.4, I⁽²⁾=111.1, $\hbar\omega$ =0.256
 B 3208.1+u, J+16 $\gamma_{2677+u} 530.95$ I⁽¹⁾=102.0, I⁽²⁾=110.8, $\hbar\omega$ =0.274
 B 3775.1+u, J+18 $\gamma_{3208+u} 567.05$ I⁽¹⁾=102.7, I⁽²⁾=117.0, $\hbar\omega$ =0.292
 B 4376.3+u, J+20 $\gamma_{3775+u} 601.2$ 10 I⁽¹⁾=103.6, I⁽²⁾=118.7, $\hbar\omega$ =0.309
 B 5011.2+u, J+22 $\gamma_{4376+u} 634.9$ 10 I⁽¹⁾=104.2, I⁽²⁾=114.6, $\hbar\omega$ =0.326
 B 5681.0+u, J+24 $\gamma_{5011+u} 669.8$ 10 I⁽¹⁾=104.8, I⁽²⁾=118.3, $\hbar\omega$ =0.343
 B 6384.6+u, J+26 $\gamma_{5681+u} 703.6$ 10
 C v, J=(9)
 C 209.3+v, J+2 $\gamma_{0209.33}$ I⁽¹⁾=96.1, I⁽²⁾=102.3, $\hbar\omega$ =0.114
 C 457.7+v, J+4 $\gamma_{209+v} 248.43$ I⁽¹⁾=97.0, I⁽²⁾=102.3, $\hbar\omega$ =0.134
 C 745.2+v, J+6 $\gamma_{458+v} 287.53$ I⁽¹⁾=97.8, I⁽²⁾=103.9, $\hbar\omega$ =0.153
 C 1071.2+v, J+8 $\gamma_{745+v} 326.03$ I⁽¹⁾=98.5, I⁽²⁾=104.2, $\hbar\omega$ =0.173
 C 1435.6+v, J+10 $\gamma_{1071+v} 364.43$ I⁽¹⁾=99.2, I⁽²⁾=107.2, $\hbar\omega$ =0.192
 C 1837.3+v, J+12 $\gamma_{1436+v} 401.75$ I⁽¹⁾=99.9, I⁽²⁾=106.4, $\hbar\omega$ =0.210
 C 2276.6+v, J+14 $\gamma_{1837+v} 439.35$ I⁽¹⁾=100.5, I⁽²⁾=109.3, $\hbar\omega$ =0.229
 C 2752.5+v, J+16 $\gamma_{2277+v} 475.95$ I⁽¹⁾=101.2, I⁽²⁾=110.8, $\hbar\omega$ =0.247
 C 3264.5+v, J+18 $\gamma_{2753+v} 512.05$ I⁽¹⁾=101.9, I⁽²⁾=111.1, $\hbar\omega$ =0.265
 C 3812.5+v, J+20 $\gamma_{3265+v} 548.05$ I⁽¹⁾=102.5, I⁽²⁾=112.7, $\hbar\omega$ =0.283
 C 4396.0+v, J+22 $\gamma_{3813+v} 583.5$ 10 I⁽¹⁾=103.2, I⁽²⁾=117.6, $\hbar\omega$ =0.300
 C 5013.5+v, J+24 $\gamma_{4396+v} 617.5$ 10 I⁽¹⁾=104.0, I⁽²⁾=115.9, $\hbar\omega$ =0.317
 C 5665.5+v, J+26 $\gamma_{5014+v} 652.0$ 10 I⁽¹⁾=104.6, I⁽²⁾=118.0, $\hbar\omega$ =0.334
 C 6351.4+v, J+28 $\gamma_{5666+v} 685.9$ 10
 D w, J=(10,11)
 D 240.5+w, J+2 $\gamma_{0240.53}$ I⁽¹⁾=92.2, I⁽²⁾=101.3, $\hbar\omega$ =0.130
 D 520.5+w, J+4 $\gamma_{241+w} 280.03$ I⁽¹⁾=93.5, I⁽²⁾=103.1, $\hbar\omega$ =0.150
 D 839.3+w, J+6 $\gamma_{521+w} 318.83$ I⁽¹⁾=94.5, I⁽²⁾=101.8, $\hbar\omega$ =0.169
 D 1197.4+w, J+8 $\gamma_{839+w} 358.13$ I⁽¹⁾=95.3, I⁽²⁾=102.3, $\hbar\omega$ =0.189
 D 1594.6+w, J+10 $\gamma_{1197+w} 397.23$ I⁽¹⁾=96.1, I⁽²⁾=105.0, $\hbar\omega$ =0.208
 D 2029.9+w, J+12 $\gamma_{1595+w} 435.33$ I⁽¹⁾=96.9, I⁽²⁾=106.1, $\hbar\omega$ =0.227
 D 2502.9+w, J+14 $\gamma_{2030+w} 473.03$ I⁽¹⁾=97.6, I⁽²⁾=105.5, $\hbar\omega$ =0.246
 D 3013.8+w, J+16 $\gamma_{2503+w} 510.95$ I⁽¹⁾=98.3, I⁽²⁾=112.0, $\hbar\omega$ =0.264
 D 3560.4+w, J+18 $\gamma_{3014+w} 546.65$ I⁽¹⁾=99.2, I⁽²⁾=112.4, $\hbar\omega$ =0.282
 D 4142.6+w, J+20 $\gamma_{3560+w} 582.25$ I⁽¹⁾=100.0, I⁽²⁾=113.6, $\hbar\omega$ =0.300
 D 4760.0+w, J+22 $\gamma_{4143+w} 617.45$ I⁽¹⁾=100.8, I⁽²⁾=115.6, $\hbar\omega$ =0.317
 D 5412.0+w, J+24 $\gamma_{4760+w} 652.0$ 10 I⁽¹⁾=104.6, I⁽²⁾=118.0, $\hbar\omega$ =0.334
 D 6097.5+w, J+26 $\gamma_{5412+w} 685.5$ 10 I⁽¹⁾=102.6, I⁽²⁾=125.0, $\hbar\omega$ =0.351
 D 6815.0+w(?) , J+28 $\gamma_{6098+w} 717.5$ 10(?)
 E x, J=(9,10)
 E 220.3+x, J+2 $\gamma_{220.33}$ I⁽¹⁾=91.7, I⁽²⁾=102.3, $\hbar\omega$ =0.120

E 479.7+x, J+4	γ_{220+x}	259.43	$I^{(1)}=93.0, I^{(2)}=99.3, \eta\omega=0.140$	F 2109.7+y, J+14	γ_{1696+y}	413.75	$I^{(1)}=101.9, I^{(2)}=110.2, \eta\omega=0.216$
E 779.4+x, J+6	γ_{480+x}	299.73	$I^{(1)}=94.0, I^{(2)}=102.6, \eta\omega=0.160$	F 2559.7+y, J+16	γ_{2110+y}	450.05	$I^{(1)}=102.6, I^{(2)}=110.8, \eta\omega=0.234$
E 1118.1+x, J+8	γ_{779+x}	338.73	$I^{(1)}=94.8, I^{(2)}=101.0, \eta\omega=0.179$	F 3045.8+y, J+18	γ_{2560+y}	486.15	$I^{(1)}=103.2, I^{(2)}=112.0, \eta\omega=0.252$
E 1496.8+x, J+10	γ_{1118+x}	378.33	$I^{(1)}=95.7, I^{(2)}=107.5, \eta\omega=0.198$	F 3567.6+y, J+20	γ_{3046+y}	521.85	$I^{(1)}=103.7, I^{(2)}=109.3, \eta\omega=0.270$
E 1912.3+x, J+12	γ_{1497+x}	415.53	$I^{(1)}=96.6, I^{(2)}=103.4, \eta\omega=0.217$	F 4126.0+y, J+22	γ_{3568+y}	558.410	$I^{(1)}=104.2, I^{(2)}=113.3, \eta\omega=0.288$
E 2366.5+x, J+14	γ_{1912+x}	454.25	$I^{(1)}=97.3, I^{(2)}=107.2, \eta\omega=0.236$	F 4719.7+y, J+24	γ_{4126+y}	593.710	$I^{(1)}=104.8, I^{(2)}=117.6, \eta\omega=0.305$
E 2858.0+x, J+16	γ_{2367+x}	491.55	$I^{(1)}=98.1, I^{(2)}=110.2, \eta\omega=0.255$	F 5347.4+y(?)	γ_{4720+y}	627.710(?)	
E 3385.8+x, J+18	γ_{2858+x}	527.85	$I^{(1)}=98.9, I^{(2)}=110.5, \eta\omega=0.273$	G z, J=(9,10)			
E 3949.8+x, J+20	γ_{3386+x}	564.05	$I^{(1)}=99.7, I^{(2)}=112.0, \eta\omega=0.291$	G 207.0+z, J+2	$\gamma_{207.0}$	207.03	$I^{(1)}=97.3, I^{(2)}=104.2, \eta\omega=0.113$
E 4549.5+x(?), J+22	γ_{3950+x}	599.710(?)	$I^{(1)}=100.5, I^{(2)}=117.6, \eta\omega=0.308$	G 452.4+z, J+4	γ_{207+z}	245.43	$I^{(1)}=98.3, I^{(2)}=104.4, \eta\omega=0.132$
E 5183.2+x(?), J+24	γ_{4550+x}	633.710(?)	$I^{(1)}=101.3, I^{(2)}=112.7, \eta\omega=0.326$	G 736.1+z, J+6	γ_{452+z}	283.73	$I^{(1)}=99.1, I^{(2)}=105.0, \eta\omega=0.151$
E 5852.4+x(?), J+26	γ_{5183+x}	669.210(?)	$I^{(1)}=102.0, I^{(2)}=117.0, \eta\omega=0.343$	G 1057.9+z, J+8	γ_{736+z}	321.83	$I^{(1)}=100.0, I^{(2)}=109.9, \eta\omega=0.170$
E 6555.8+x(?), J+28	γ_{5852+x}	703.410(?)		G 1416.1+z, J+10	γ_{1058+z}	358.23	$I^{(1)}=100.7, I^{(2)}=105.3, \eta\omega=0.189$
F y, J=(8,9)				G 1812.3+z, J+12	γ_{1416+z}	396.23	$I^{(1)}=101.4, I^{(2)}=110.2, \eta\omega=0.207$
F 187.9+y, J+2	γ_y	187.93	$I^{(1)}=96.6, I^{(2)}=104.2, \eta\omega=0.104$	G 2244.8+z, J+14	γ_{1812+z}	432.55	$I^{(1)}=101.9, I^{(2)}=106.4, \eta\omega=0.226$
F 414.2+y, J+4	γ_{188+y}	226.33	$I^{(1)}=97.9, I^{(2)}=106.1, \eta\omega=0.123$	G 2714.9+z, J+16	γ_{2245+z}	470.15	$I^{(1)}=102.4, I^{(2)}=110.8, \eta\omega=0.244$
F 678.2+y, J+6	γ_{414+y}	264.03	$I^{(1)}=98.9, I^{(2)}=105.3, \eta\omega=0.142$	G 3221.1+z, J+18	γ_{2715+z}	506.25	$I^{(1)}=102.9, I^{(2)}=106.7, \eta\omega=0.262$
F 980.2+y, J+8	γ_{678+y}	302.03	$I^{(1)}=99.8, I^{(2)}=107.5, \eta\omega=0.160$	G 3764.8+z, J+20	γ_{3221+z}	543.75	$I^{(1)}=103.3, I^{(2)}=113.0, \eta\omega=0.281$
F 1319.4+y, J+10	γ_{980+y}	339.23	$I^{(1)}=100.6, I^{(2)}=107.0, \eta\omega=0.179$	G 4343.9+z, J+22	γ_{3765+z}	579.110	$I^{(1)}=104.0, I^{(2)}=118.0, \eta\omega=0.298$
F 1696.0+y, J+12	γ_{1319+y}	376.63	$I^{(1)}=101.2, I^{(2)}=107.8, \eta\omega=0.198$	G 4956.9+z, J+24	γ_{4344+z}	613.010	

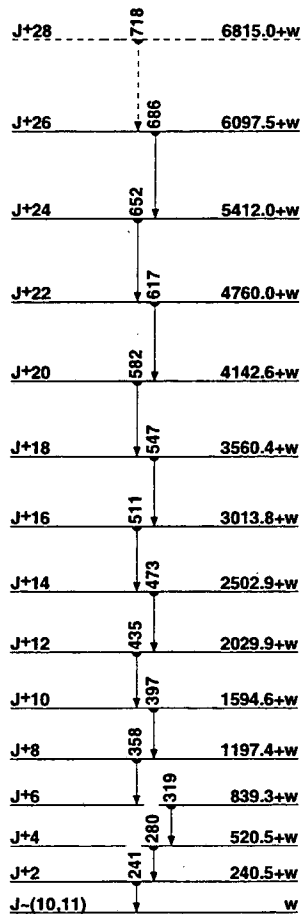
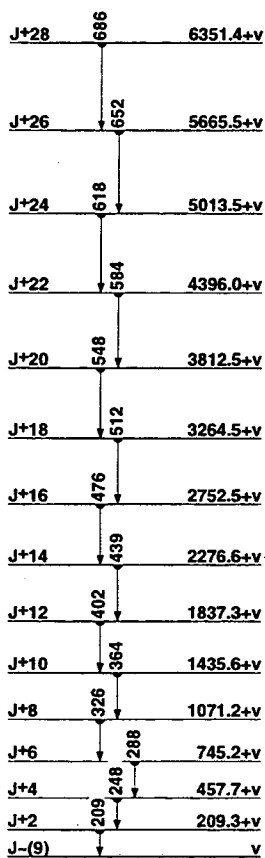
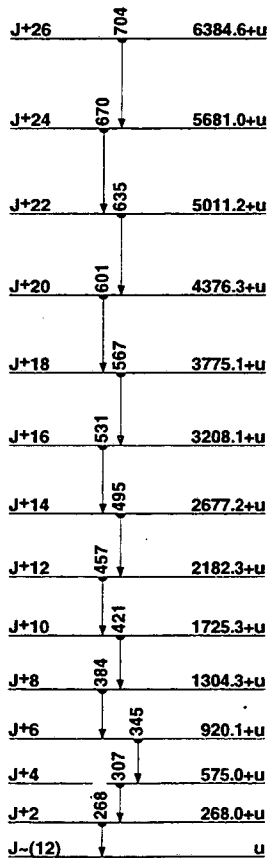

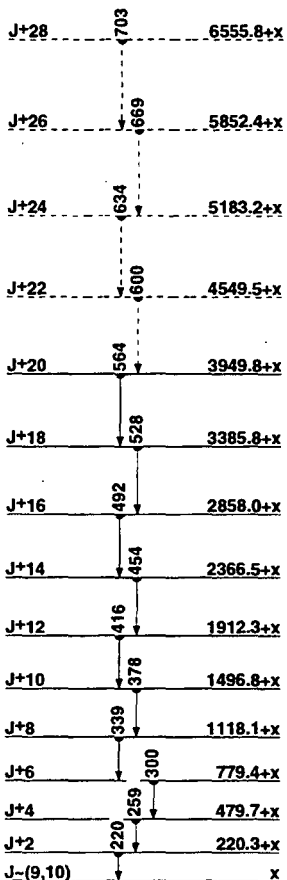

SD-4 band
(91Az03)

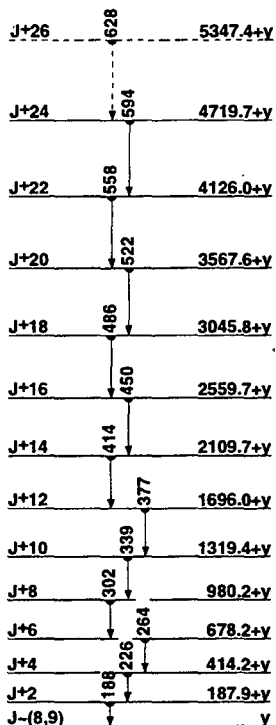

SD-5 band
(91Az03)

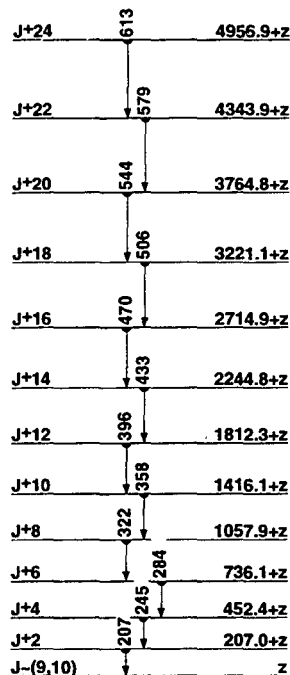

SD-6 band
(91Az03)

¹⁹⁴₈₁Tl

195
81Tl

Δ : (-28270) S_n : (9380) S_p : (3320) Q_{EC} : (2800) Q_α : (3160)

Nuclear Bands

- A Band Structure
- B Band Structure
- C SD-1 band (94Du16,91Az04)
- D SD-2 band (94Du16,91Az04)

Levels and γ -ray branchings:

- 0, 1/2⁺, 1.165 h, %EC+% β^+ =100, μ =+1.58 4
383.66 12, 3/2⁺ γ_{1924} **663.13** (\dagger_{100} 11) E2
 A **482.63** 17, 9/2⁺, 3.6 4 s, %IT=100 γ_{384} **98.97** 12 (\dagger_{100} 10) E3
777.55 17, (5/2⁺) γ_{384} **393.73** (\dagger_{100} 0.89) γ_{1924} **777.62** ($\dagger_{71.1}$ 89)
811.16 γ_{384} **427.45** (\dagger_{100})
 A **876.69** 19, 11/2⁻ γ_{483} **394.21** 12 (\dagger_{100} 10) M1(+E2): $\delta=0.42$ 13
1079.78 γ_{384} **696.08** (\dagger_{100})
1173.79 20, 9/2⁻, 11/2⁻ γ_{483} **691.17** 15 (\dagger_{100} 10) M1
 A **1190.12** 19, 13/2⁻ γ_{877} **313.22** 12 (\dagger_{50} 3) M1+E2: $\delta=0.38$ 10 γ_{483} **707.67** 15
 (\dagger_{100} 6) E2
1267.03, (1/2⁺, 3/2⁺, 5/2⁺) γ_{384} **883.13** (\dagger_{100}) (E2)
1285.34 γ_{778} **507.83** (\dagger_{100})
1360.95 22, 11/2⁻ γ_{483} **878.40** 16 (\dagger_{100} 10) M1(+E2)
1378 (?) γ_{384} **994.38** (?) (\dagger_{100})
1410.68 20, 11/2⁻, 13/2⁻ γ_{1174} **236.60** 23 ($\dagger_{1.12}$ 11) M1 γ_{877} **534.11** 14
 ($\dagger_{\approx 44.9}$) M1 γ_{483} **928.02** 16 (\dagger_{100} 15) (E2)
1434.77 γ_{384} **1051.08** (\dagger_{100})
1484.04 21, 13/2⁻ γ_{1190} **294.25** (\dagger_{65} 48) γ_{877} **607.64** 15 (\dagger_{100} 11)
 M1+E2: $\delta=0.66$ 19 γ_{483} **1000.92** 18 ($\dagger_{16.6}$ 14)
1612.79, (3/2⁺, 5/2⁺, 7/2⁺) γ_{1267} **346.05** (?) (\dagger_{18} 12) γ_{778} **835.28**
 (\dagger_{100} 15) M1
1616.42 21, 9/2⁻, 11/2⁻, 13/2⁻ γ_{1174} **442.74** 14 (\dagger_{100} 10) M1 γ_{877} **739.47** 23
 (\dagger_{47} 8) γ_{483} **1133.73** 21 ($\dagger_{98.9}$ 11)
 A **1618.74** 20, 15/2⁻ γ_{1190} **428.44** 13 (\dagger_{100} 6) M1+E2: $\delta=0.34$ 6
 γ_{877} **742.19** 15 (\dagger_{93} 6) E2
1648.65 γ_{778} **871.05** (\dagger_{100})
1687.97 γ_{1435} **253.25** (\dagger_{29} 12) γ_{384} **1304.28** (\dagger_{100} 15)
1725.26 23, (13/2⁺) γ_{877} **848.66** 16 (\dagger_{100} 25) E1(+M2) γ_{483} **1242.24** 32
 ($\dagger_{11.3}$ 25)
1843.7 10 γ_{384} **1461.18** (\dagger_{100})
1844.84 γ_{1649} **196.15** (\dagger_{73} 14) γ_{1267} **578.05** (\dagger_{36} 18) γ_{778} **1067.08**
 (\dagger_{100} 18)
1924.46 22, 17/2⁻ γ_{1619} **305.67** 15 (\dagger_{58} 6) M1+E2: $\delta=0.11$ 13
 γ_{1190} **734.43** 15 (\dagger_{100} 25) E2
1944.61 21, 13/2⁻ γ_{1619} **325.85** 14 ($\dagger_{10.6}$ 13) M1+E2 γ_{1411} **534.1**
 ($\dagger_{\approx 8.39}$) γ_{1190} **754.73** 32 (\dagger_{13} 3) M1 γ_{877} **1067.88** 17 (\dagger_{100} 6)
 M1(+E2)
1991.47 22, 11/2⁻, 13/2⁻ γ_{1361} **630.58** 14 (\dagger_{100} 8) M1(+E2) γ_{1190} **801.26** 17
 (\dagger_{62} 6) M1
 A **2011.53**, 17/2⁻ γ_{1619} **392.85** (\dagger_{100} 47) (M1+E2): $\delta=0.42$ 13 γ_{1190} **821.33**
 (\dagger_{82} 47) E2
2023.53, 11/2⁻, 13/2⁻, 15/2⁻ γ_{1484} **539.50** 15 (\dagger_{100} 10) M1 γ_{1435} **549.05** (?)
 (\dagger_{65} 59)
2033.75 (?) γ_{1190} **843.25** (\dagger_{100})
 B **2037.13**, 15/2⁺ γ_{1619} **418.53** (\dagger_{20} 3) (E1) γ_{1484} **552.93** (\dagger_{24} 4) (E1)
 γ_{1190} **847.15** (\dagger_{100} 35) (E1) γ_{877} **1161.65** (?)
2115.15 (?) γ_{1484} **630.58** 14 (\dagger_{100} 8)
2145.13, (11/2, 13/2, 15/2)⁺ γ_{1725} **419.81** 16 (\dagger_{100} 10) M1
 B **2212.94**, 17/2⁺ γ_{2037} **175.73** (\dagger_{100} 10) M1+E2: $\delta=0.13$ 5
2361.94, (11/2, 13/2, 15/2) γ_{1484} **877.93** ($\dagger_{2.1}$ 7)
2367.95 (?) γ_{1619} **748.85** (\dagger_{100})
 A **2470.13**, 19/2⁻ γ_{2012} **458.73** (\dagger_{100} 13) M1+E2: $\delta=0.75$ 15 γ_{1924} **545.73**
 (\dagger_{21} 5) M1+E2: $\delta=0.57$ 16 γ_{1619} **851.33** (\dagger_{17} 8) E2
 B **2529.64**, 19/2⁺ γ_{2213} **316.83** (\dagger_{100} 12) M1+E2: $\delta=0.21$ 4 γ_{2037} **492.63**
 (\dagger_{16} 5) E2
2581.55 (?) γ_{2115} **466.45** (\dagger_{32} 14) γ_{1190} **1391.05** (\dagger_{100} 32)

- A **2587.43**, 21/2⁻ γ_{2470} **117.35** (\dagger_{26} 9) (M1+E2) γ_{2012} **575.83** (\dagger_{42} 6) E2
 γ_{1924} **663.13** (\dagger_{100} 11) E2
 B **2840.75**, 21/2⁺ γ_{2530} **311.45** (\dagger_{100} 31) M1+E2: $\delta=0.23$ 5 γ_{2213} **627.73**
 (\dagger_{50} 8) E2
 A **2861.14**, 23/2⁻ γ_{2587} **273.73** (\dagger_{100} 10) M1(+E2): $\delta<0.14$
 A **3059.84**, 25/2⁻ γ_{2861} **198.83** (\dagger_{100} 25) (M1+E2) γ_{2587} **472.33** (\dagger_{64} 21)
 E2
 A **3157.15**, 27/2⁽⁻⁾ γ_{3060} **97.33** (\dagger_{100}) (M1+E2)
 B **3201.95**, 23/2⁺ γ_{2841} **361.13** (\dagger_{69} 8) M1+E2: $\delta=0.23$ 4 γ_{2530} **672.35**
 ($\dagger_{<100}$) E2
 B **3513.95**, 25/2⁺ γ_{3202} **312.35** (\dagger_{70} 22) M1+E2: $\delta=0.27$ 6 γ_{2841} **673.25**
 ($\dagger_{<100}$) (E2)
 B **3729.65**, 27/2⁺ γ_{3514} **215.83** (\dagger_{100} 10) M1(+E2): $\delta<0.14$ γ_{3202} **527.63**
 (\dagger_{60} 12) E2
 B **3885.36**, 29/2⁽⁺⁾ γ_{3730} **155.73** (\dagger_{100}) (M1+E2)
 B **4002.88**, 31/2⁽⁺⁾ γ_{3885} **117.55** (\dagger_{100}) (M1+E2)
 B **4174.89**, 33/2⁽⁺⁾ γ_{4003} **172.03** (\dagger_{100}) (M1+E2)
 B **4393.39**, 35/2⁽⁺⁾ γ_{4175} **218.53** (\dagger_{100}) (M1+E2)
 C x, J=(11/2⁺)
 D **67.8+x**, J+1
 C **146.2+x**, J+2 γ_x **146.25** $I^{(1)}=89.7$, $I^{(2)}=95.2$, $\eta\omega=0.084$
 D **235.3+x**, J+3 γ_{68+x} **167.55** $I^{(1)}=31.9$, $I^{(2)}=97.8$, $\eta\omega=0.094$
 C **334.4+x**, J+4 γ_{235+x} **99.05** γ_{146+x} **188.25** $I^{(1)}=91.1$, $I^{(2)}=98.5$, $\eta\omega=0.104$
 D **443.6+x**, J+5 γ_{334+x} **109.05** γ_{235+x} **208.45** $I^{(1)}=43.7$, $I^{(2)}=98.3$, $\eta\omega=0.114$
 C **563.2+x**, J+6 γ_{444+x} **119.55** γ_{334+x} **228.85** $I^{(1)}=92.3$, $I^{(2)}=97.8$, $\eta\omega=0.125$
 D **692.6+x**, J+7 γ_{563+x} **129.55** γ_{444+x} **249.15** $I^{(1)}=52.0$, $I^{(2)}=99.0$, $\eta\omega=0.135$
 C **832.9+x**, J+8 γ_{693+x} **140.55** γ_{563+x} **269.73** $I^{(1)}=93.1$, $I^{(2)}=98.0$, $\eta\omega=0.145$
 D **982.0+x**, J+9 γ_{833+x} **149.05** γ_{693+x} **289.53** $I^{(1)}=58.1$, $I^{(2)}=99.8$, $\eta\omega=0.155$
 C **1143.4+x**, J+10 γ_{982+x} **161.55** γ_{833+x} **310.53** $I^{(1)}=93.9$, $I^{(2)}=102.3$,
 $\eta\omega=0.165$
 D **1311.7+x**, J+11 γ_{1143+x} **168.05** γ_{982+x} **329.63** $I^{(1)}=63.0$, $I^{(2)}=101.3$,
 $\eta\omega=0.175$
 C **1492.9+x**, J+12 γ_{1312+x} **181.05** γ_{1143+x} **349.63** $I^{(1)}=94.7$, $I^{(2)}=99.5$,
 $\eta\omega=0.185$
 D **1680.8+x**, J+13 γ_{1312+x} **369.13** $I^{(1)}=67.0$, $I^{(2)}=104.2$, $\eta\omega=0.194$
 C **1882.7+x**, J+14 γ_{1493+x} **389.83** $I^{(1)}=95.3$, $I^{(2)}=102.3$, $\eta\omega=0.205$
 D **2088.3+x**, J+15 γ_{1681+x} **407.53** $I^{(1)}=70.3$, $I^{(2)}=104.7$, $\eta\omega=0.213$
 C **2311.6+x**, J+16 γ_{1883+x} **428.93** $I^{(1)}=96.0$, $I^{(2)}=104.4$, $\eta\omega=0.224$
 D **2534.0+x**, J+17 γ_{2088+x} **445.73** $I^{(1)}=73.3$, $I^{(2)}=108.7$, $\eta\omega=0.232$
 C **2778.8+x**, J+18 γ_{2312+x} **467.23** $I^{(1)}=96.7$, $I^{(2)}=107.2$, $\eta\omega=0.243$
 D **3016.5+x**, J+19 γ_{2534+x} **482.53** $I^{(1)}=75.9$, $I^{(2)}=109.6$, $\eta\omega=0.250$
 C **3283.3+x**, J+20 γ_{2778+x} **504.53** $I^{(1)}=97.6$, $I^{(2)}=110.2$, $\eta\omega=0.261$
 D **3535.5+x**, J+21 γ_{3017+x} **519.03** $I^{(1)}=78.3$, $I^{(2)}=114.9$, $\eta\omega=0.268$
 C **3824.1+x**, J+22 γ_{3283+x} **540.83** $I^{(1)}=98.5$, $I^{(2)}=112.0$, $\eta\omega=0.279$
 D **4089.3+x**, J+23 γ_{3536+x} **553.83** $I^{(1)}=80.6$, $I^{(2)}=117.6$, $\eta\omega=0.285$
 C **4400.6+x**, J+24 γ_{3824+x} **576.53** $I^{(1)}=99.3$, $I^{(2)}=112.7$, $\eta\omega=0.297$
 D **4677.1+x**, J+25 γ_{4089+x} **587.83** $I^{(1)}=82.7$, $I^{(2)}=120.5$, $\eta\omega=0.302$
 C **5012.6+x**, J+26 γ_{4401+x} **612.03** $I^{(1)}=100.2$, $I^{(2)}=118.7$, $\eta\omega=0.314$
 D **5298.1+x**, J+27 γ_{4677+x} **621.03** $I^{(1)}=84.8$, $I^{(2)}=125.0$, $\eta\omega=0.318$
 C **5658.4+x**, J+28 γ_{5013+x} **645.73** $I^{(1)}=101.1$, $I^{(2)}=118.7$, $\eta\omega=0.331$
 D **5951.1+x**, J+29 γ_{5298+x} **653.03** $I^{(1)}=86.7$, $I^{(2)}=128.2$, $\eta\omega=0.334$
 C **6337.8+x**, J+30 γ_{5658+x} **679.43** $I^{(1)}=102.0$, $I^{(2)}=119.8$, $\eta\omega=0.348$
 D **6635.3+x**, J+31 γ_{5951+x} **684.23** $I^{(1)}=88.6$, $I^{(2)}=127.8$, $\eta\omega=0.350$
 C **7050.6+x**, J+32 γ_{6338+x} **712.85** $I^{(1)}=102.8$, $I^{(2)}=121.2$, $\eta\omega=0.365$
 D **7350.8+x**, J+33 γ_{6635+x} **715.55** $I^{(1)}=90.3$, $I^{(2)}=131.1$, $\eta\omega=0.365$
 C **7796.4+x**, J+34 γ_{7051+x} **745.85** $I^{(1)}=103.7$, $I^{(2)}=127.4$, $\eta\omega=0.381$
 D **8096.8+x**, J+35 γ_{7351+x} **746.05** $I^{(1)}=91.9$, $I^{(2)}=127.0$, $\eta\omega=0.381$
 C **8573.6+x**, J+36 γ_{7796+x} **777.25**
 D **8874.3+x**, J+37 γ_{8097+x} **777.55**

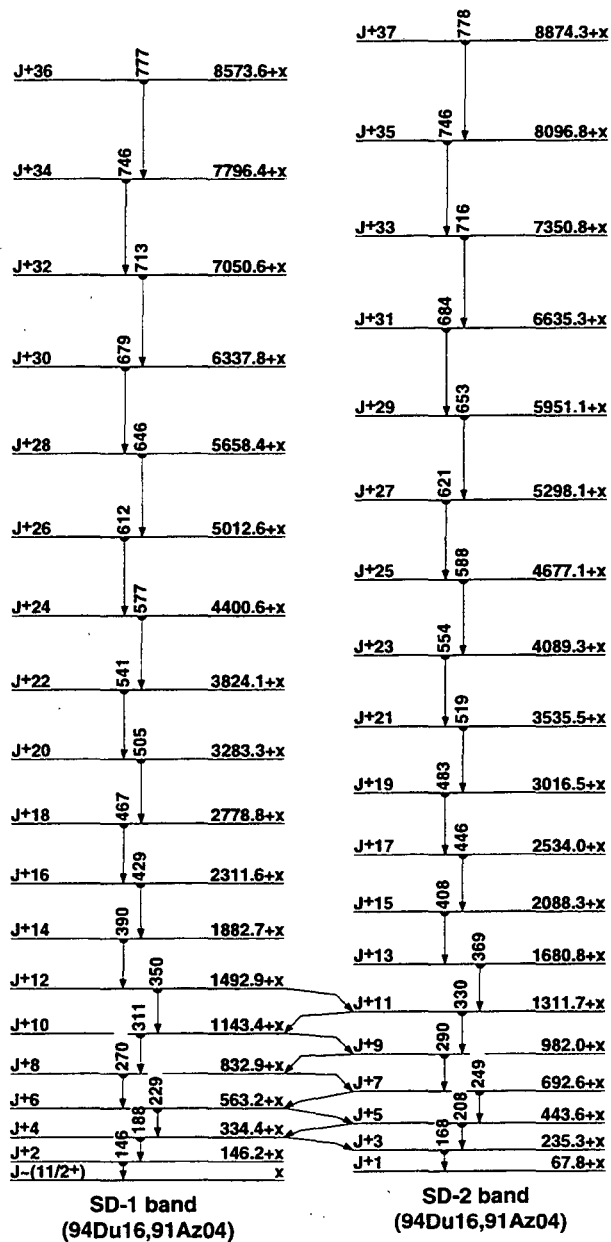

¹⁹²Pb
₈₂Pb

Δ : (-22580) S_n : (10300) S_p : (3700) Q_{EC} : (3400) Q_α : 5221.5

Nuclear Bands

- A GS band
- B Band Structure
- C SD band (91He11,94He15,95Du07,95As04)

Levels and γ -ray branchings:

- A 0, 0⁺, 3.5 ns, %EC+% β^+ =99.9943, % α =0.0057, 10
- B 768.84, 0⁺, 0.75 ns, γ_0 768.54 E0
- A 853.63, 2⁺, γ_0 853.82 (\dagger , 100) E2
- B 1237.93, (2⁺) γ_{854} 383.94 (\dagger , <10) γ_{769} 469.43 (\dagger , 4.3) γ_0 1237.73 (\dagger , 100.8)
- A 1355.54, 4⁺, γ_{854} 501.82 (\dagger , 100) E2
1430.24 γ_{854} 576.62 (\dagger , 100)
- 1544.13, 1, 2⁺, γ_{854} 690.72 (\dagger , 100.25) γ_{769} 775.02 (\dagger , 30.8)
- 1859.95, (5⁻) γ_{1356} 504.32 (\dagger , 100) E1
- A 1920.75, 6⁺, γ_{1356} 565.42 (\dagger , 100) E2
1983.36 γ_{1238} 745.43 (\dagger , 100)
- 2303.35, (7⁻) γ_{1921} 382.82 (\dagger , 100) E1(+M2)
- 2323.25, (7⁻) γ_{1921} 402.42 (\dagger , 13.5) γ_{1860} 463.42 (\dagger , 100.10) E2
- 2507.26, (8⁻) γ_{2323} 184.02 (\dagger , 100) M1+E2
- 2514.15, (9⁻) γ_{2323} 191.12 (\dagger , 100.14) E2 γ_{2303} 210.72 (\dagger , 17.8)
- A 2520.26, (8⁺) γ_{1921} 599.52 (\dagger , 100)
2562.36 γ_{1921} 641.62 (\dagger , 100)
- A 2581.28, (10⁺), 100 ns, γ_{2520} 61.05 (\dagger , =1.4) (E2) γ_{2514} 67.05 (\dagger , =100) E1
2622.45 γ_{1356} 1266.93 (\dagger , 97.9) γ_{854} 1768.94 (\dagger , 100.43)
- A \approx 2626, (12⁺), 1.10 ns, $\mu = -2.07624$ γ_{2581} 45.25 (\dagger , 100) (E2)
2789.15 γ_{2303} 486.12 (\dagger , 100.60) γ_{1860} 928.73 (\dagger , 93.33)
2894.07 γ_{2323} 570.83 (\dagger , 100)
3254.0, (11⁻) γ_{2514} 739.9
- C x, J=(8,9)
- C 215.6+x (?), J+2 γ_x 215.610 (?) $I^{(1)}=83.7$, $I^{(2)}=85.3$, $\hbar\omega=0.120$
- C 478.1+x, J+4 γ_{216+x} 262.53 (\dagger , 0.60 10) $I^{(1)}=84.7$, $I^{(2)}=95.9$, $\hbar\omega=0.142$
- C 782.3+x, J+6 γ_{478+x} 304.24 (\dagger , 0.85 15) $I^{(1)}=86.2$, $I^{(2)}=97.6$, $\hbar\omega=0.162$
- C 1127.5+x, J+8 γ_{782+x} 345.23 (\dagger , 0.80 15) $I^{(1)}=87.7$, $I^{(2)}=101.0$, $\hbar\omega=0.182$
- C 1512.3+x, J+10 γ_{1128+x} 384.84 (\dagger , 1.20 15) $I^{(1)}=89.0$, $I^{(2)}=102.3$, $\hbar\omega=0.202$
- C 1936.2+x, J+12 γ_{1512+x} 423.94 (\dagger , 1.00 20) $I^{(1)}=90.3$, $I^{(2)}=104.4$, $\hbar\omega=0.222$
- C 2398.4+x, J+14 γ_{1936+x} 462.24 (\dagger , 0.60 15) $I^{(1)}=91.6$, $I^{(2)}=108.7$, $\hbar\omega=0.240$
- C 2897.4+x, J+16 γ_{2398+x} 499.06 (\dagger , 0.70 30) $I^{(1)}=92.8$, $I^{(2)}=110.2$, $\hbar\omega=0.259$
- C 3432.7+x, J+18 γ_{2897+x} 535.35 (\dagger , 0.65 20) $I^{(1)}=94.1$, $I^{(2)}=114.3$, $\hbar\omega=0.276$
- C 4003.0+x, J+20 γ_{3433+x} 570.36 (\dagger , 0.50 25) $I^{(1)}=95.3$, $I^{(2)}=116.3$, $\hbar\omega=0.294$
- C 4607.7+x, J+22 γ_{4003+x} 604.77 $I^{(1)}=96.4$, $I^{(2)}=113.3$, $\hbar\omega=0.311$
- C 5247.7+x (?), J+24 γ_{4608+x} 640(?)

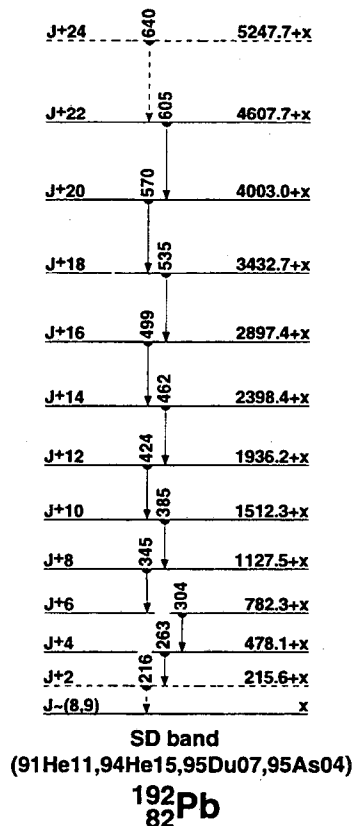

¹⁹³Pb
82

Δ : (-22280) S_n : (7800) S_p : (3600) Q_{EC} : (5150) Q_α : (5000)

Nuclear Bands

- A Band Structure
- B Band Structure
- C Band Structure
- D Band Structure
- E SD-1 band (95Hu01)
- F SD-2 band (95Hu01)
- G SD-3 band (95Hu01)
- H SD-4 band (95Hu01)
- I SD-5 band (95Hu01)
- J SD-6 band (95Hu01)

Levels:

- 0, (3/2⁻), ? , %EC+%β⁺=?
- A 0+x, (13/2⁻), 5.82 m
- A 881.57+x 19, (17/2⁺) γ_{0+x} 881.62 (†,100) E2
- B 1022.1+x 3, (15/2⁺) γ_{0+x} 1022.03 (†,100) E2
- A 1401.8+x 3, (21/2⁺) γ_{882+x} 520.22 (†,100) E2
- B 1550.2+x 3, (19/2⁺) γ_{1022+x} 528.04 (†,61 10) E2 γ_{882+x} 668.73 (†,100 10) E2+M1: δ=1.9⁺⁸₋₄
- C 1585.9+x 4, (21/2⁻), 22.2 ns γ_{1402+x} 184.13 (†,100) E1
- A 1994.9+x 4, (25/2⁺) γ_{1402+x} 593.14 (†,100) E2
- B 2141.4+x 4, (23/2⁺) γ_{1550+x} 591.24 (†,91 21) E2 γ_{1402+x} 739.63 (†,100 17) M1+E2: δ=0.70⁺¹⁷₋₁₅
- C 2141.9+x 5, (23/2⁻) γ_{1586+x} 556.14 (†,100) E2
- B 2214.0+x 4, (25/2⁺) γ_{2141+x} 72.65 (†,100) E2+M1: δ=0.21⁺⁴₋₂ γ_{1995+x} 219.13 (†,62 24) M1 γ_{1402+x} 812.24 (†,100 30) E2
- C 2322.3+x 5, (27/2⁻) γ_{2142+x} 180.44 (†,100) E2
- B 2426.9+x 5, (27/2⁺) γ_{2214+x} 212.93 (†,100) M1
- 2527.1+x 5, (29/2⁺) γ_{2322+x} 204.84 (†,28 14) E1+M2 γ_{1995+x} 532.23 (†,100 6) E2
- D 2585.1+x 6, (29/2⁻), 112 ns γ_{2427+x} 158.22 (†,100) E1
- 2612.6+x 7, (33/2⁺), 135⁺²⁵₋₁₅ ns γ_{2527+x} 85.55 (†,100) E2
- D 2966.8+x, (31/2) γ_{2585+x} 381.7 (†,100)
- D 3220.4+x, (33/2) γ_{2867+x} 253.6 (†,100)
- E y, J=(27/2)
- E 276.6+y 3, J+2 $\gamma_{276.6}$ (†,0.51 7) I⁽¹⁾=104.4, I⁽²⁾=98.3, ηω=0.148
- E 593.9+y 4, J+4 γ_{277+y} 317.33 (†,0.82 7) I⁽¹⁾=103.8, I⁽²⁾=100.0, ηω=0.169
- E 951.2+y 5, J+6 γ_{594+y} 357.33 (†,0.82 7) I⁽¹⁾=103.4, I⁽²⁾=100.0, ηω=0.189
- E 1348.5+y, J+8 γ_{951+y} 397.33 (†,0.84 7) I⁽¹⁾=103.0, I⁽²⁾=99.3, ηω=0.209
- E 1786.1+y, J+10 γ_{1349+y} 437.64 (†,0.82 7) I⁽¹⁾=102.7, I⁽²⁾=100.3, ηω=0.229
- E 2263.6+y, J+12 γ_{1786+y} 477.56 (†,0.75 7) I⁽¹⁾=102.6, I⁽²⁾=101.5, ηω=0.249
- E 2780.5+y, J+14 γ_{2264+y} 516.95 (†,1.00 10) I⁽¹⁾=102.5, I⁽²⁾=102.8, ηω=0.268
- E 3336.3+y, J+16 γ_{2781+y} 555.86 (†,0.93 7) I⁽¹⁾=102.6, I⁽²⁾=105.3, ηω=0.287
- E 3930.1+y, J+18 γ_{3336+y} 593.87 (†,0.60 7) I⁽¹⁾=102.7, I⁽²⁾=103.4, ηω=0.307
- E 4562.6+y, J+20 γ_{3930+y} 632.5 10 (†,0.22 7)
- F z, J=(17/2)
- F 190.54+z, J+2 γ_z 190.54 20 (†,0.40 7) I⁽¹⁾=99.4, I⁽²⁾=96.2, ηω=0.106
- F 422.68+z, J+4 γ_{191+z} 232.14 19 (†,0.61 9) I⁽¹⁾=98.5, I⁽²⁾=92.3, ηω=0.127
- F 698.14+z, J+6 γ_{423+z} 275.46 21 (†,1.00 10) I⁽¹⁾=97.7, I⁽²⁾=93.7, ηω=0.148
- F 1016.3+z, J+8 γ_{698+z} 318.15 23 (†,0.84 10) I⁽¹⁾=97.2, I⁽²⁾=94.0, ηω=0.170
- F 1377.0+z, J+10 γ_{1016+z} 360.69 23 (†,0.76 10) I⁽¹⁾=96.8, I⁽²⁾=93.0, ηω=0.191
- F 1780.7+z, J+12 γ_{1377+z} 403.73 (†,0.98 10) I⁽¹⁾=96.5, I⁽²⁾=94.6, ηω=0.212
- F 2226.7+z, J+14 γ_{1781+z} 446.03 (†,0.82 10) I⁽¹⁾=96.3, I⁽²⁾=95.0, ηω=0.234
- F 2714.8+z, J+16 γ_{2227+z} 488.1 11 (†,0.59 9) I⁽¹⁾=96.5, I⁽²⁾=101.5, ηω=0.254
- F 3242.3+z, J+18 γ_{2715+z} 527.57 (†,0.46 8)

- G u, J=(25/2)
- G 291.6+u, J+2 γ_0 291.63 (†,0.58 8) I⁽¹⁾=93.0, I⁽²⁾=98.3, ηω=0.156
- G 623.9+u, J+4 γ_{292+u} 332.33 (†,0.77 9) I⁽¹⁾=93.7, I⁽²⁾=99.8, ηω=0.176
- G 996.3+u, J+6 γ_{624+u} 372.43 (†,1.00 11) I⁽¹⁾=94.3, I⁽²⁾=101.0, ηω=0.196
- G 1408.3+u, J+8 γ_{996+u} 412.04 (†,0.95 11) I⁽¹⁾=95.1, I⁽²⁾=103.6, ηω=0.216
- G 1858.9+u, J+10 γ_{1408+u} 450.65 (†,0.79 10) I⁽¹⁾=95.8, I⁽²⁾=105.0, ηω=0.235
- G 2347.6+u, J+12 γ_{1859+u} 488.7 11 (†,0.94 11) I⁽¹⁾=96.6, I⁽²⁾=107.2, ηω=0.254
- G 2873.6+u, J+14 γ_{2348+u} 526.0 10 (†,0.88 11) I⁽¹⁾=97.3, I⁽²⁾=106.4, ηω=0.272
- G 3437.2+u, J+16 γ_{2874+u} 563.6 12 (†,0.74 10) I⁽¹⁾=98.0, I⁽²⁾=110.2, ηω=0.291
- G 4037.1+u, J+18 γ_{3437+u} 599.9 12 (†,0.40 8)
- H v, J=(27/2)
- H 313.8+v, J+2 γ_0 313.83 (†,0.42 8) I⁽¹⁾=92.9, I⁽²⁾=101.0, ηω=0.167
- H 667.2+v, J+4 γ_{314+v} 353.43 (†,0.71 10) I⁽¹⁾=93.9, I⁽²⁾=103.6, ηω=0.186
- H 1059.2+v, J+6 γ_{667+v} 392.05 (†,0.80 11) I⁽¹⁾=94.9, I⁽²⁾=105.0, ηω=0.206
- H 1489.3+v, J+8 γ_{1059+v} 430.14 (†,0.65 10) I⁽¹⁾=95.8, I⁽²⁾=107.8, ηω=0.224
- H 1956.5+v, J+10 γ_{1489+v} 467.23 (†,0.76 10) I⁽¹⁾=96.8, I⁽²⁾=108.7, ηω=0.243
- H 2460.5+v, J+12 γ_{1957+v} 504.07 (†,1.00 16) I⁽¹⁾=97.7, I⁽²⁾=112.7, ηω=0.261
- H 3000.0+v, J+14 γ_{2461+v} 539.59 (†,0.51 9) I⁽¹⁾=98.7, I⁽²⁾=111.7, ηω=0.279
- H 3575.3+v, J+16 γ_{3000+v} 575.37 (†,0.53 9) I⁽¹⁾=99.6, I⁽²⁾=116.6, ηω=0.296
- H 4184.9+v, J+18 γ_{3575+v} 609.67 (†,0.57 8)
- I w, J=(17/2)
- I 213.3+w, J+2 γ_0 213.33 (†,0.96 19) I⁽¹⁾=89.7, I⁽²⁾=96.6, ηω=0.117
- I 468.01+w, J+4 γ_{213+w} 254.71 23 (†,1.00 19) I⁽¹⁾=90.9, I⁽²⁾=99.0, ηω=0.137
- I 763.14+w, J+6 γ_{468+w} 295.13 21 (†,0.60 10) I⁽¹⁾=91.9, I⁽²⁾=98.6, ηω=0.158
- I 1098.8+w, J+8 γ_{763+w} 335.70 24 (†,0.45 10) I⁽¹⁾=92.9, I⁽²⁾=101.7, ηω=0.178
- I 1473.9+w, J+10 γ_{1099+w} 375.04 24 (†,0.90 18) I⁽¹⁾=93.8, I⁽²⁾=103.2, ηω=0.197
- I 1887.7+w, J+12 γ_{1474+w} 413.81 16 (†,0.90 18) I⁽¹⁾=94.8, I⁽²⁾=106.7, ηω=0.216
- I 2339.0+w, J+14 γ_{1888+w} 451.35 (†,0.87 18) I⁽¹⁾=95.7, I⁽²⁾=106.1, ηω=0.235
- I 2828.0+w, J+16 γ_{2339+w} 489.05 (†,0.69 16) I⁽¹⁾=96.5, I⁽²⁾=105.3, ηω=0.254
- I 3355.0+w, J+18 γ_{2828+w} 527.0 10 (†,0.30 19)
- J t, J=(19/2)
- J 232.86+t 19, J+2 γ_0 232.86 19 (†,0.26 6) I⁽¹⁾=90.5, I⁽²⁾=93.4, ηω=0.127
- J 508.56+t, J+4 γ_{233+t} 275.70 21 (†,0.39 6) I⁽¹⁾=91.1, I⁽²⁾=97.3, ηω=0.148
- J 825.35+t, J+6 γ_{509+t} 316.79 18 (†,0.40 6) I⁽¹⁾=92.1, I⁽²⁾=100.9, ηω=0.168
- J 1181.8+t, J+8 γ_{825+t} 356.42 13 (†,0.70 9) I⁽¹⁾=93.2, I⁽²⁾=105.1, ηω=0.188
- J 1576.3+t, J+10 γ_{1182+t} 394.48 19 (†,0.60 7) I⁽¹⁾=94.3, I⁽²⁾=104.0, ηω=0.207
- J 2009.2+t, J+12 γ_{1576+t} 432.94 19 (†,0.73 9) I⁽¹⁾=95.2, I⁽²⁾=107.2, ηω=0.226
- J 2479.5+t, J+14 γ_{2009+t} 470.27 21 (†,0.90 10) I⁽¹⁾=96.2, I⁽²⁾=108.5, ηω=0.244
- J 2986.6+t, J+16 γ_{2480+t} 507.13 25 (†,1.00 10) I⁽¹⁾=97.1, I⁽²⁾=109.7, ηω=0.263
- J 3530.2+t, J+18 γ_{2987+t} 543.6 5 (†,0.72 8) I⁽¹⁾=98.0, I⁽²⁾=112.0, ηω=0.281
- J 4109.5+t, J+20 γ_{3530+t} 579.34 (†,0.48 6)

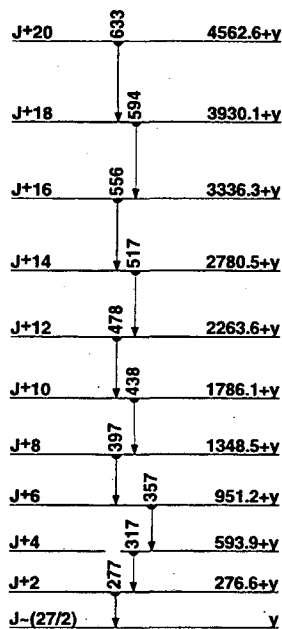

SD-1 band
(95Hu01)

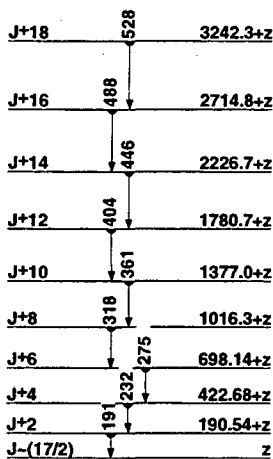

SD-2 band
(95Hu01)

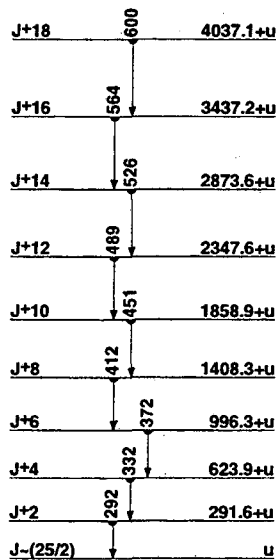

SD-3 band
(95Hu01)

¹⁹³₈₂Pb

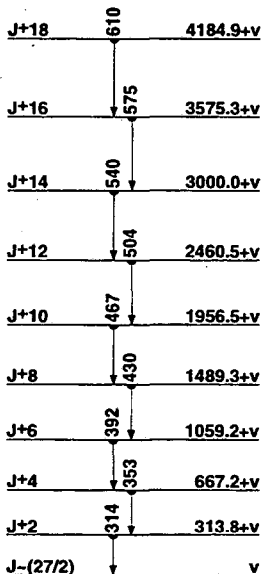

SD-4 band
(95Hu01)

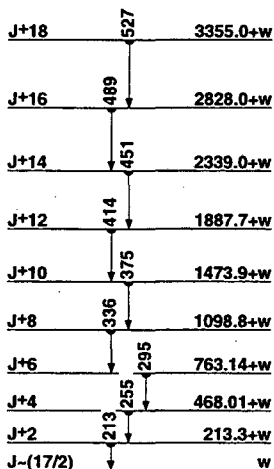

SD-5 band
(95Hu01)

¹⁹³₈₂Pb

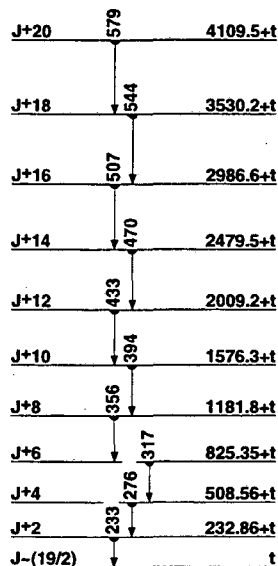

SD-6 band
(95Hu01)

194Pb
82Pb

Δ : (-24250) S_n : (10040) S_p : (4100) Q_{EC} : (2720) Q_α : 4738.20

Nuclear Bands

- A Oblate band
- B Oblate band
- C Oblate band
- D $\Delta J=1$ band (94Po08,93Me12)
- E $\Delta J=1$ band (94Po08)
- F $\Delta J=1$ band (94Po08,93Me12)
- G $\Delta J=1$ band (93Me12)
- H $\Delta J=1$ band (93Me12)
- I SD-1 band (96BrAA,95Ga10)(90Br10,90Hu10)
- J SD-2 band (94Hu10)
- K SD-3 band? (94Hu10)

Levels and γ -ray branchings:

- 0, 0⁺, 12.0 s m, %EC+% β^+ =100, % α =7.3 $\times 10^{-6}$ 29
- A 930.8 2, 0⁺ $\gamma_{930.64}$ E0
965.35 10, 2⁺ $\gamma_{965.41}$ (†,100) E2
- A 1308.44 13, (2⁺) γ_{965} 343.22 (†,165) (E0+M1+E2) γ_{931} 377.53 (†,63)
 $\gamma_{1308.32}$ (†,100 5) (E2)
- A 1540.43 13, 4⁺ γ_{1308} 231.92 (†,0.4 2) γ_{965} 575.11 (†,100 2) E2
1637.2 2, (≤ 4) γ_{965} 671.82 (†,100)
1738.9 2, (1,2⁺) γ_{965} 773.53 (†,100 50) γ_{931} 808.13 (†,20 15) $\gamma_{1738.93}$
(†,30 10)
1820.54 16, (5⁻), 1.1 2 ns γ_{1540} 280.11 (†,100) E1
2019.3 3, (≤ 4) γ_{1308} 710.92 (†,100)
- A 2135.7 3, (6⁺) γ_{1540} 595.43 (†,100) E2
2241.7 3, (7⁻) γ_{1821} 421.12 (†,100) E2
2407.7 3, (9⁻), 18 3 ns, $\mu=-0.63$ 36 γ_{2242} 166.01 (†,100) E2
2420.0 3, (8⁻) γ_{2242} 178.52 (†,100) (M1+E2); $\delta<0.7$
- B 2437.9 3, (8⁺), 17 4 ns γ_{2242} 196.12 (†,24 2) (E1) γ_{2136} 302.43 (†,100 4)
E2
2502.8 3, (8⁻) γ_{2242} 261.12 (†,100) (M1)
2581.4 3, (10⁺), 17.2 5 ns γ_{2408} 173.71 (†,100) E1
2628.6 4, (12⁻), 350 10 ns, $\mu=-2.004$ 24, $Q=0.49$ 3 γ_{2581} 47.03 (†,100)
2646.2 4, (11) γ_{2581} 64.83 (?) (†,100) D
2701.1 4 (?), (9) γ_{2242} 459.43 (†,100) (Q)
2799.9 4, (4 to 8) γ_{2136} 664.22 (†,100)
2914.5 4 (?), (9⁻) γ_{2242} 672.83 (†,100) (Q)
- B 2931.1 4, (9⁺) γ_{2438} 493.22 (†,100)
- C 2933.6 3, (11⁻), 124 10 ns γ_{2629} 305.01 (†,61 11) E1 γ_{2581} 352.21
(†,100 12) E1 γ_{2438} 496 (O)
3180.0 5 γ_{2646} 534
- H 3208.2 4, (10⁻) γ_{2420} 788.63 (†,100) (Q) γ_{2408} 800.0
- H 3272.1 5, (11⁻) γ_{2408} 863.7
- B 3282.6 5, (10⁺) γ_{2831} 351 γ_{2438} 844.5
- C 3475.9 3, (12⁻) γ_{2834} 542.21 (†,100) M1
3561.9 4, (14⁺) γ_{2629} 933.31 (†,100) E2
3610.0 4, (10⁺,11,12⁺) γ_{2646} 963 (?) γ_{2629} 982 γ_{2581} 1028
- H 3727.8 5, (12⁻) γ_{3272} 455.0 γ_{3208} 519.83 (†,100 9) (Q)
- B 3771.6 5, (11⁺) γ_{3283} 489 γ_{2931} 841
- C 3840.5 3, (13⁻) γ_{3476} 364.61 (†,100 4) M1 γ_{2934} 907.11 (†,85 2) E2
- H 3849.9 6, (13⁻) γ_{3272} 577.8
4003.7 4, (15⁻) γ_{3562} 441.81 (†,100) E1
- G 4136.9 4, (16⁺) γ_{3562} 575.01 (†,100) (Q)
- B 4236.3 4, (12⁺) γ_{3772} 465 γ_{3283} 953.0 γ_{2934} 1302.4
- H 4265.8 6, (14⁻) γ_{3850} 416.0 γ_{3728} 538.0
- G 4299.3 5 (?), (17⁺) γ_{4137} 162.43 (†,100) D
- E 4333.8 4, (12) γ_{4236} 98 γ_{3510} 723 γ_{3476} 858.5 γ_{3180} 1154 γ_{2934} 1400.1
 γ_{2646} 1688.1 γ_{2629} 1704.0
- C 4367.1 4, (14⁻) γ_{3841} 526.63 (†,100) D γ_{3476} 891
4376.3 4, (12,13,14⁺) γ_{4236} 139 γ_{3841} 537
4376.4 5, (16⁻) γ_{4004} 372.73 (†,100) M1

- H 4409.2 6, (15⁻) γ_{4266} 143.53 (†,100) γ_{3850} 559.2
- C 4450.3 3, (15⁻) γ_{3841} 609.71 (†,100) E2
4454.4 5 (?), (15) γ_{3562} 892.53 (†,100) D
4478.3 8, (15⁻) γ_{3850} 628.4
- G 4532.2 6, (18⁺) γ_{4298} 232.93 (†,100) D
4601.3 5, (17⁻) γ_{4004} 597.63 (†,100) (Q)
- E 4637.0 5, (13) $\gamma_{4376.3}$ 261 γ_{4334} 303.13 (†,100 3) D
- H 4693.5 7, (16⁻) γ_{4409} 284.33 (†,100) (D)
4702.6 6, (18⁻) $\gamma_{4376.4}$ 326.13 (†,100) (Q)
- I 4712.1 20, (6⁺)
4750.8 5 (?), (17) γ_{4137} 613.93 (†,100) D
4796.6 5, (18⁺) γ_{4137} 659.73 (†,100) E2
E 4800.1 6, (14) γ_{4637} 163.13 (†,100) D
- G 4820.4 7, (19⁺) γ_{4532} 288.23 (†,100) (D)
- I 4881.7 20, (8⁺) γ_{4712} 169.62 (†,0.57 7) $I^{(1)}=83.5$, $I^{(2)}=91.1$, $\hbar\omega=0.096$
 γ_{2136} 2746.2 (†,0.06 2)
- D 4965.7 4, (16⁻) γ_{4450} 515.41 (†,100) D
- H 5055.0 8, (17⁻) γ_{4694} 361.53 (†,100) (D)
5061.8 5 (?), (17⁻) γ_{4004} 1058.13 (†,100)
- D 5085.4 5, (17⁻) γ_{4966} 119.73 (†,100) (D)
5091.4 6, (17⁻) $\gamma_{4376.4}$ 715.03 (†,100) (D)
- I 5095.2 20, (10⁺), 6.0 22 ps γ_{4882} 213.51 (†,1.02 10) $I^{(1)}=85.1$, $I^{(2)}=93.0$
 $\hbar\omega=0.118$
5109.7 9, (17⁻) γ_{4478} 631.4
- G 5168.4 7, (20⁺) γ_{4820} 348.03 (†,100) D
- E 5197.4 6, (15) γ_{4800} 397.43 (†,100) D
- D 5230.5 6, (18⁻) γ_{5085} 145.13 (†,100) (D)
5258.8 6, (20⁺) γ_{4797} 462.23 (†,100)
5329.9 6, (18) γ_{4601} 728.63 (†,100) (D)
- I 5351.7 20, (12⁺), 2.4 $\times 10^{-14}$ ps γ_{5095} 256.51 (†,0.98 10) $I^{(1)}=86.5$, $I^{(2)}=94.8$
 $\hbar\omega=0.139$
- D 5427.6 7, (19⁻) γ_{5231} 197.13 (†,100) D
5465.2 5 (?), (17) γ_{4966} 499.53 (†,100) D
- G 5542.7 9, (21⁺) γ_{5168} 374.3
5551.7 6, (19⁻) γ_{5091} 460.43 (†,95 27) (Q) γ_{4703} 849.13 (†,100 7)
5553.1 6, (20⁺) γ_{4797} 756.53 (†,100 19) (Q)
- E 5573.9 6, (16) γ_{5197} 376.73 (†,100) D γ_{4800} 773.4
- I 5650.4 20, (14⁺), 1.8 $\times 10^{-10}$ ps γ_{5352} 298.71 (†,1.08 10) $I^{(1)}=87.7$, $I^{(2)}=96.6$
 $\hbar\omega=0.160$
- D 5687.9 7, (20⁻) γ_{5428} 260.33 (†,100) (D)
5732.4 6, (20⁻) γ_{4703} 1029.83 (†,100) (E2)
5735.9 6 (?), (18) γ_{5465} 270.73 (†,100) (D)
5930.5 7 (?), (20) γ_{5736} 194.63 (†,100) (Q)
- E 5937.5 7, (17) γ_{5574} 363.73 (†,100 7) (D) γ_{5197} 740.0
- G 5939.5 9, (22) γ_{5543} 396.83 (†,100) D
5983.1 7, (18) γ_{5574} 409.33 (†,100) (Q)
- I 5990.5 20, (16⁺) γ_{5650} 340.11 (†,0.95 10) $I^{(1)}=88.8$, $I^{(2)}=99.3$, $\hbar\omega=0.180$
- D 6024.5 8, (21⁻) γ_{5689} 336.63 (†,100) D
6139.2 7 (?), (21) γ_{5931} 208.73 (†,100) D
- F 6198.3 7 (?), (18) γ_{5938} 260.83 (†,100) (D)
6206.5 7, (21⁻) γ_{5552} 654.83 (†,100)
- F 6328.7 8 (?), (19) γ_{6198} 130.43 (†,100) (D)
6331.1 8 γ_{5983} 348.3 γ_{5574} 757 (?)
- I 6370.9 20, (18⁺), >0.5 ps γ_{5991} 380.41 (†,0.95 10) $I^{(1)}=90.0$, $I^{(2)}=101.0$
 $\hbar\omega=0.200$
6379.4 7, (22⁺) γ_{5553} 826.33 (†,100) (Q)
- D 6400.5 8, (22⁻) γ_{6025} 376.03 (†,100) D
- F 6465.7 9, (20) γ_{6329} 137.03 (†,100) D
- F 6677.9 9, (21) γ_{6466} 212.23 (†,100) D
- I 6790.9 20, (20⁺), 0.24 $\times 10^{-14}$ ps γ_{6371} 420.02 (†,0.96 10) $I^{(1)}=91.1$, $I^{(2)}=104.2$
 $\hbar\omega=0.220$
- D 6817.2 9, (23) γ_{6401} 416.73 (†,100) D
- F 6905.9 10, (22) γ_{6678} 228.03 (†,100) (Q)
- F 7173.8 10, (23) γ_{6906} 267.93 (†,100) (D)

D 7241.3 10, (24) γ_{6817} 424.1
 I 7249.3 20, (22⁺), 0.14⁺¹⁰ ps γ_{6791} 458.41 (\dagger , 0.85 10) I⁽¹⁾=92.2, I⁽²⁾=107.0, $\hbar\omega=0.239$
 F 7481.4 11, (24) γ_{7174} 307.83 (\dagger , 100) D
 I 7745.1 20, (24⁺), 0.13 5 ps γ_{7249} 495.81 (\dagger , 0.83 10) I⁽¹⁾=93.4, I⁽²⁾=109.0, $\hbar\omega=0.257$
 F 7842.3 11, (25) γ_{7481} 361.6 γ_{7174} 668(?)
 F 8235.7 11, (26) γ_{7842} 393.6 γ_{7481} 754(?)
 I 8277.6 20, (26⁺), 0.08 5 ps γ_{7745} 532.52 (\dagger , 0.65 10) I⁽¹⁾=94.5, I⁽²⁾=111.7, $\hbar\omega=0.275$
 I 8845.9 20, (28⁺), 0.07 2 ps γ_{8276} 568.32 (\dagger , 0.50 7) I⁽¹⁾=95.6, I⁽²⁾=114.0, $\hbar\omega=0.293$
 I 9449.3 20, (30⁺) γ_{8846} 603.42 (\dagger , 0.42 5) I⁽¹⁾=96.7, I⁽²⁾=115.3, $\hbar\omega=0.310$
 I 10087.4 22, (32⁺) γ_{9449} 638.14 (\dagger , 0.32 5) I⁽¹⁾=97.7, I⁽²⁾=117.0, $\hbar\omega=0.328$
 I 10759.7 22, (34⁺) γ_{10087} 672.34 (\dagger , 0.20 5) I⁽¹⁾=98.7, I⁽²⁾=118.0, $\hbar\omega=0.345$
 I 11465.9 22, (36⁺) γ_{10760} 706.22 (\dagger , 0.12 5) I⁽¹⁾=99.6, I⁽²⁾=120.1, $\hbar\omega=0.361$
 I 12205.4 22, (38⁺) γ_{11466} 739.54 (\dagger , 0.10 5)

J x, J
 J 241.2+x 3, J+2 $\gamma_{241.2}$ 241.23 (\dagger , 0.036 4) I⁽²⁾=101.5, $\hbar\omega=0.130$
 J 521.8+x 5, J+4 γ_{241+x} 280.64 (\dagger , 0.096 10) I⁽²⁾=99.8, $\hbar\omega=0.150$
 J 842.5+x 6, J+6 γ_{522+x} 320.72 (\dagger , 0.052 5) I⁽²⁾=101.8, $\hbar\omega=0.170$
 J 1202.5+x 8, J+8 γ_{843+x} 360.02 (\dagger , 0.060 6) I⁽²⁾=102.6, $\hbar\omega=0.190$
 J 1601.5+x 10, J+10 γ_{1203+x} 399.02 (\dagger , 0.071 7) I⁽²⁾=105.8, $\hbar\omega=0.209$
 J 2038.3+x 12, J+12 γ_{1602+x} 436.83 (\dagger , 0.064 7) I⁽²⁾=107.5, $\hbar\omega=0.228$
 J 2512.3+x 14, J+14 γ_{2038+x} 474.03 (\dagger , 0.072 8) I⁽²⁾=107.8, $\hbar\omega=0.246$
 J 3023.4+x 16, J+16 γ_{2512+x} 511.15 (\dagger , 0.051 6) I⁽²⁾=122.3, $\hbar\omega=0.264$
 J 3567.2+x 18, J+18 γ_{3023+x} 543.85 (\dagger , 0.031 4)
 K y(?), J
 K 260.9+y 4(?), J+2 $\gamma_{260.9}$ 260.94 (\dagger , 0.057 7) I⁽²⁾=97.3, $\hbar\omega=0.141$
 K 562.9+y 5(?), J+4 γ_{261+y} 302.03 (\dagger , 0.072 8) I⁽²⁾=101.8, $\hbar\omega=0.161$
 K 904.2+y 6(?), J+6 γ_{563+y} 341.33 (\dagger , 0.027 4) I⁽²⁾=103.4, $\hbar\omega=0.180$
 K 1284.2+y 8(?), J+8 γ_{904+y} 380.05 (\dagger , 0.046 6) I⁽²⁾=107.2, $\hbar\omega=0.199$
 K 1701.5+y 9(?), J+10 γ_{1284+y} 417.33 (\dagger , 0.048 6) I⁽²⁾=103.9, $\hbar\omega=0.218$
 K 2157.3+y 9(?), J+12 γ_{1702+y} 455.83 (\dagger , 0.063 8) I⁽²⁾=110.2, $\hbar\omega=0.237$
 K 2649.4+y 10(?), J+14 γ_{2157+y} 492.14 (\dagger , 0.082 10) I⁽²⁾=109.6, $\hbar\omega=0.255$
 K 3178.0+y 12(?), J+16 γ_{2649+y} 528.68 (\dagger , 0.044 6) I⁽²⁾=115.6, $\hbar\omega=0.273$
 K 3741.2+y 15(?), J+18 γ_{3178+y} 563.28 (\dagger , 0.069 9)

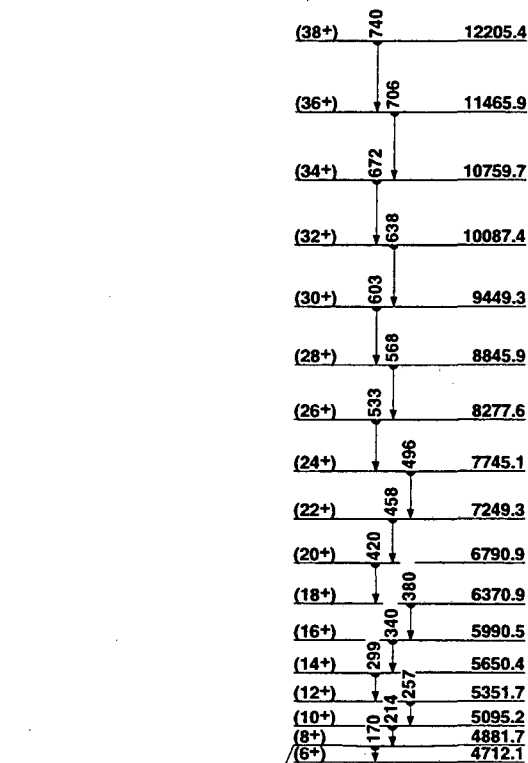

SD-1 band
 (96BrAA, 95Ga10)
 (90Br10, 90Hu10)

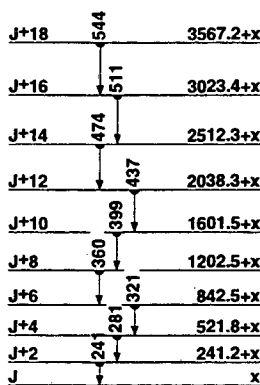

SD-2 band
 (94Hu10)

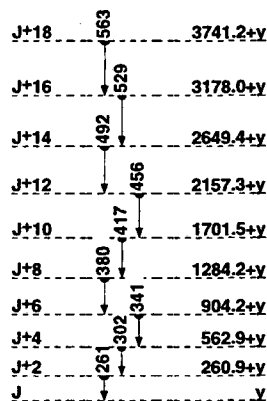

SD-3 band?
 (94Hu10)

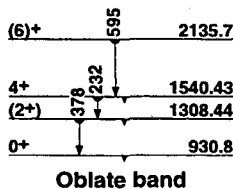

Oblate band

¹⁹⁵Pb
₈₂

Δ: (-23800) S_n: (7600) S_p: (4100) Q_{EC}: (4500) Q_α: (4500)

Nuclear Bands

- A SD-1 band (95Fa11)
- B SD-2 band (95Fa11)
- C SD-3 band (95Fa11)
- D SD-4 band (95Fa11)

Levels and γ-ray branchings:

0, 3/2⁻, = 15 m, %EC+%β⁺=100
 134.52 20, (5/2)⁻ γ₀ 134.43 (†, 100) M1(+E2)
 201 4, 13/2⁺, 15.0 12 m, %EC+%β⁺=100
 329.29 16, 1/2⁻, 3/2⁻, 5/2⁻ γ₀ 329.22 (†, 100) M1
 829.9 4, (7/2)⁻ γ₁₃₅ 695.43 (†, 100) M1
 966.94 20, (3/2, 5/2)⁻ γ₁₃₅ 831.77 (†, 100 7) M1(+E2) γ₀ 967.02 (†, 17.9 13) M1(+E2)
 978.9 7, (11/2)⁺ γ₂₀₁ 776.23 (†, 100) E2
 1009.86 24, (1/2 to 7/2)⁻ γ₁₃₅ 975.43 (†, 77 10) E2 γ₀ 1009.83 (†, 100 7) E2
 1010.8 7, (9/2)⁺ γ₂₀₁ 807.64 (†, 100) E2
 1093.1 8, 13/2⁺ γ₂₀₁ 890.04 (†, 100) E0+M1+E2
 1095.99 15, 3/2⁻, 5/2⁻, 7/2⁻ γ₃₂₉ 766.62 (†, 20.0 16) γ₁₃₅ 961.43 (†, 52.6 45) M1(+E2) γ₀ 1096.12 (†, 100 10) E2
 1120.3 5, 9/2⁻, (1/2 to 7/2)⁻ γ₁₃₅ 985.84 (†, 100) E2
 1172.6 7, 17/2⁺ γ₂₀₁ 969.62 (†, 100) E2
 1180.1 3, (1/2 to 7/2)⁻ γ₃₂₉ 850.82 (†, 9.9 8) M1
 1212.8 6, (1/2 to 7/2)⁻ γ₁₃₅ 1078.35 (†, 100) E2
 1308.1 3, (3/2, 5/2, 7/2)⁻ γ₁₃₅ 1173.62 (†, 100) M1
 1328.7 7, (9/2)⁺ γ₁₀₁₁ 317.75 (†, 1.5 10) E0+M1+E2 γ₈₃₀ 498.85 (†, 43.9 36) E1 γ₂₀₁ 1125.82 (†, 100 7) E2
 1379.8 7, (11/2)⁺ γ₁₀₉₃ 286.46 (†, 37.2 43) M1 γ₁₀₁₁ 368.93 (†, 100 7) M1(+E2) γ₈₇₉ 401.34 (†, 10.6 32) E0+M1+E2 γ₂₀₁ 1176.55 (†, 78.7 64) M1
 1391.5 7, (7/2)⁺ γ₁₀₁₁ 380.63 (†, 100 33) M1+E2 γ₈₇₉ 412.72 (†, 87 13) E2
 1428.5 3, (3/2, 5/2, 7/2)⁻ γ₁₃₅ 1294.02 (†, 100) M1, E2
 1444.1 7, (5/2 to 13/2)⁺ γ₁₀₁₁ 433.32 (†, 100) E2
 1566.9 8, (9/2, 11/2)⁺ γ₁₀₁₁ 556.24 (†, 64 13) M1+E2 γ₈₇₉ 587.66 (†, 100 11) M1+E2
 1645.0 7, (7/2 to 11/2)⁺ γ₁₀₁₁ 634.22 (†, 100) M1+E2
 1670.2 5, (3/2 to 11/2)⁻ γ₈₃₀ 840.33 (†, 100) E2
 1754.0 7, 21/2⁺ γ₁₁₇₃ 581.42 (†, 100) E2
 1759.1 7, 21/2⁻, 10.0 7 μs γ₁₇₅₄ 5.1 (†, 69 9) γ₁₁₇₃ 586.52 (†, 100 9) E3(+M2); δ=4.5⁺²⁶₋₁₀
 1780.0 6, (†) γ₁₀₉₆ 684.05 (†, 100) E2(+M1)
 1884.0 7, (23/2)⁻ γ₁₇₅₉ 125.01 (†, 100) (E2)+M1; δ<0.65
 2186.1 7, (23/2)⁻ γ₁₇₅₉ 427.02 (†, 100) M1
 2371.7 7, (25/2)⁺ γ₁₇₅₄ 617.72 (†, 100)
 2413.2 7, 27/2⁻, 2.3 7 ns γ₂₁₈₆ 227.11 (†, 59 10) E2 γ₁₈₈₄ 529.21 (†, 100 6) E2
 2815.0 7, 29/2⁺ γ₂₄₁₃ 401.81 (†, 100.4 14) E1 γ₂₃₇₂ 443.32 (†, 7.9 14)
 2901.8 8, 33/2⁺, 95 20 ns, g=-0.156 6 γ₂₈₁₅ 86.83 (†, 100) E2
 A x, J=(15/2)
 A 182.13+x, J+2 γ_x 182.13 21 (†, 0.30) I⁽¹⁾=94.0, I⁽²⁾=99.5, ηω=0.101
 A 404.46+x, J+4 γ_{182+x} 222.33 14 (†, 0.45) I⁽¹⁾=95.0, I⁽²⁾=100.9, ηω=0.121
 A 666.43+x, J+6 γ_{404+x} 261.97 10 (†, 0.78) I⁽¹⁾=95.8, I⁽²⁾=101.1, ηω=0.141
 A 967.95+x, J+8 γ_{666+x} 301.52 9 (†, 0.87) I⁽¹⁾=96.5, I⁽²⁾=101.1, ηω=0.161
 A 1309.04+x, J+10 γ_{968+x} 341.09 9 (†, 1.00) I⁽¹⁾=97.0, I⁽²⁾=101.4, ηω=0.180
 A 1689.58+x, J+12 γ_{1309+x} 380.54 10 (†, 0.90) I⁽¹⁾=97.5, I⁽²⁾=103.2, ηω=0.200
 A 2108.87+x, J+14 γ_{1689+x} 419.29 16 (†, 0.95) I⁽¹⁾=98.0, I⁽²⁾=102.6, ηω=0.219
 A 2567.13+x, J+16 γ_{2109+x} 458.26 9 (†, 0.84) I⁽¹⁾=98.4, I⁽²⁾=102.2, ηω=0.239

A 3064.51+x, J+18 γ_{2567+x} 497.38 9 (†, 0.86) I⁽¹⁾=98.7, I⁽²⁾=104.4, ηω=0.258
 A 3600.20+x, J+20 γ_{3065+x} 535.69 15 (†, 0.80) I⁽¹⁾=99.1, I⁽²⁾=103.0, ηω=0.278
 A 4174.72+x, J+22 γ_{3600+x} 574.52 18 (†, 0.50) I⁽¹⁾=99.4, I⁽²⁾=104.8, ηω=0.297
 A 4787.4+x, J+24 γ_{4175+x} 612.73 (†, 0.42) I⁽¹⁾=99.7, I⁽²⁾=104.7, ηω=0.316
 A 5438.3+x, J+26 γ_{4787+x} 650.94 (†, 0.35) I⁽¹⁾=100.0, I⁽²⁾=105.0, ηω=0.335
 A 6127+x(?), J+28 γ_{5438+x} 689(?) (†, 0.10)
 B y, J=(13/2)
 B 162.58+y, J+2 γ_y 162.58 18 (†, 0.50) I⁽¹⁾=92.9, I⁽²⁾=98.4, ηω=0.091
 B 365.80+y, J+4 γ_{163+y} 203.22 16 (†, 0.62) I⁽¹⁾=93.9, I⁽²⁾=98.1, ηω=0.112
 B 609.79+y, J+6 γ_{366+y} 243.99 11 (†, 0.90) I⁽¹⁾=94.6, I⁽²⁾=98.4, ηω=0.132
 B 894.42+y, J+8 γ_{610+y} 284.63 9 (†, 0.86) I⁽¹⁾=95.0, I⁽²⁾=97.5, ηω=0.153
 B 1220.06+y, J+10 γ_{894+y} 325.64 9 (†, 0.95) I⁽¹⁾=95.3, I⁽²⁾=96.9, ηω=0.173
 B 1586.97+y, J+12 γ_{1220+y} 366.91 10 (†, 0.85) I⁽¹⁾=95.5, I⁽²⁾=97.4, ηω=0.194
 B 1994.96+y, J+14 γ_{1587+y} 407.99 11 (†, 0.95) I⁽¹⁾=95.7, I⁽²⁾=97.2, ηω=0.214
 B 2444.10+y, J+16 γ_{1995+y} 449.14 9 (†, 0.80) I⁽¹⁾=95.9, I⁽²⁾=98.6, ηω=0.235
 B 2933.80+y, J+18 γ_{2444+y} 489.70 8 (†, 0.86) I⁽¹⁾=96.1, I⁽²⁾=98.0, ηω=0.255
 B 3464.31+y, J+20 γ_{2934+y} 530.51 13 (†, 1.00) I⁽¹⁾=96.3, I⁽²⁾=100.5, ηω=0.275
 B 4034.63+y, J+22 γ_{3464+y} 570.32 16 (†, 0.78) I⁽¹⁾=96.5, I⁽²⁾=98.9, ηω=0.295
 B 4645.38+y, J+24 γ_{4035+y} 610.75 23 (†, 0.56) I⁽¹⁾=96.7, I⁽²⁾=100.4, ηω=0.315
 B 5296.0+y, J+26 γ_{4645+y} 650.63 (†, 0.38) I⁽¹⁾=97.0, I⁽²⁾=104.2, ηω=0.335
 B 5985+y, J+28 γ_{5296+y} 689(?) (†, 0.10)
 C z, J=(15/2)
 C 198.2+z, J+2 γ_z 198.24 (†, 0.28) I⁽¹⁾=87.5, I⁽²⁾=105.3, ηω=0.109
 C 434.4+z, J+4 γ_{198+z} 236.19 14 (†, 0.70) I⁽¹⁾=89.6, I⁽²⁾=96.9, ηω=0.128
 C 711.9+z, J+6 γ_{434+z} 277.47 13 (†, 0.56) I⁽¹⁾=90.7, I⁽²⁾=99.7, ηω=0.149
 C 1029.5+z, J+8 γ_{712+z} 317.60 12 (†, 0.62) I⁽¹⁾=91.9, I⁽²⁾=101.0, ηω=0.169
 C 1386.7+z, J+10 γ_{1030+z} 357.22 11 (†, 0.85) I⁽¹⁾=92.9, I⁽²⁾=102.9, ηω=0.188
 C 1782.8+z, J+12 γ_{1387+z} 396.08 13 (†, 0.90) I⁽¹⁾=94.0, I⁽²⁾=105.4, ηω=0.208
 C 2216.8+z, J+14 γ_{1783+z} 434.02 13 (†, 0.80) I⁽¹⁾=95.0, I⁽²⁾=106.7, ηω=0.226
 C 2688.3+z, J+16 γ_{2217+z} 471.52 15 (†, 0.70) I⁽¹⁾=95.8, I⁽²⁾=105.4, ηω=0.245
 C 3197.8+z, J+18 γ_{2688+z} 509.46 14 (†, 0.70) I⁽¹⁾=96.7, I⁽²⁾=111.0, ηω=0.264
 C 3743.3+z, J+20 γ_{3188+z} 545.51 16 (†, 0.65) I⁽¹⁾=97.6, I⁽²⁾=112.6, ηω=0.282
 C 4324.3+z, J+22 γ_{3743+z} 581.04 17 (†, 1.00) I⁽¹⁾=98.6, I⁽²⁾=114.4, ηω=0.299
 C 4940.3+z, J+24 γ_{4324+z} 616.03 (†, 0.42) I⁽¹⁾=99.5, I⁽²⁾=118.7, ηω=0.316
 C 5590.0+z, J+26 γ_{4940+z} 649.75 (†, 0.30) I⁽¹⁾=100.4, I⁽²⁾=115.3, ηω=0.334
 C 6274.4+z, J+28 γ_{5590+z} 684.48 (†, 0.24)
 D u, J=(17/2)
 D 213.6+u, J+2 γ₀ 213.64 (†, 0.45) I⁽¹⁾=89.1, I⁽²⁾=90.8, ηω=0.118
 D 471.3+u, J+4 γ_{214+u} 257.66 23 (†, 0.60) I⁽¹⁾=90.0, I⁽²⁾=99.9, ηω=0.139
 D 769.0+u, J+6 γ_{471+u} 297.70 17 (†, 0.72) I⁽¹⁾=91.3, I⁽²⁾=99.7, ηω=0.159
 D 1106.8+u, J+8 γ_{769+u} 337.83 16 (†, 1.00) I⁽¹⁾=92.2, I⁽²⁾=100.4, ηω=0.179
 D 1484.5+u, J+10 γ_{1107+u} 377.68 17 (†, 0.90) I⁽¹⁾=93.1, I⁽²⁾=100.2, ηω=0.199
 D 1902.1+u, J+12 γ_{1485+u} 417.59 19 (†, 0.72) I⁽¹⁾=94.1, I⁽²⁾=109.2, ηω=0.218
 D 2356.3+u, J+14 γ_{1902+u} 454.21 14 (†, 0.80) I⁽¹⁾=95.1, I⁽²⁾=106.8, ηω=0.236
 D 2848.0+u, J+16 γ_{2356+u} 491.68 20 (†, 0.70) I⁽¹⁾=96.1, I⁽²⁾=108.3, ηω=0.255
 D 3376.6+u, J+18 γ_{2848+u} 528.63 (†, 0.80) I⁽¹⁾=97.0, I⁽²⁾=113.3, ηω=0.273
 D 3940.5+u, J+20 γ_{3377+u} 563.93 (†, 0.65) I⁽¹⁾=97.9, I⁽²⁾=109.0, ηω=0.291
 D 4541.1+u, J+22 γ_{3941+u} 600.64 (†, 0.45) I⁽¹⁾=99.0, I⁽²⁾=127.8, ηω=0.308
 D 5173.0+u, J+24 γ_{4541+u} 631.94 (†, 0.28)

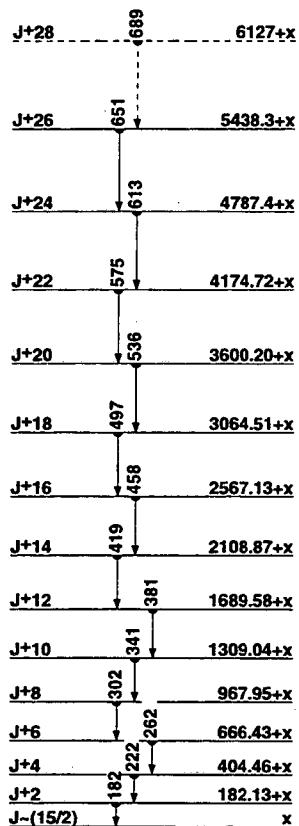

SD-1 band
(95Fa11)

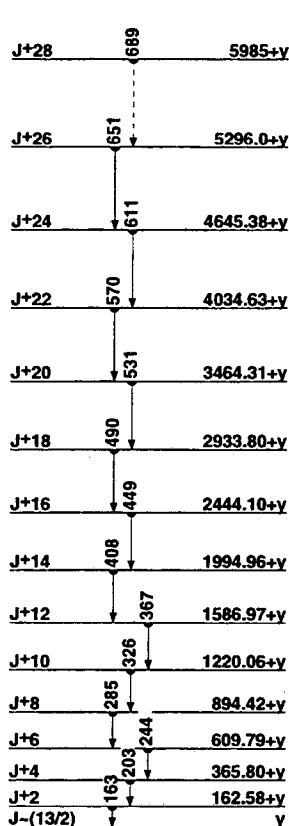

SD-2 band
(95Fa11)

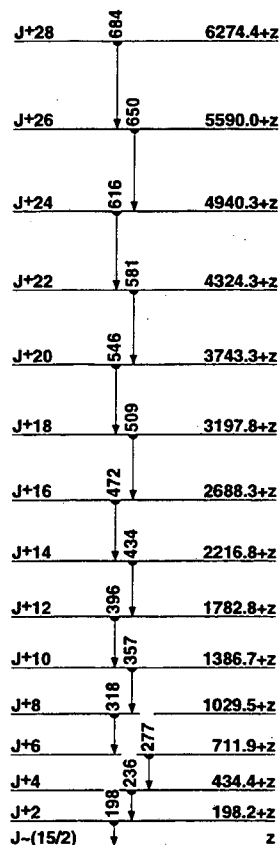

SD-3 band
(95Fa11)

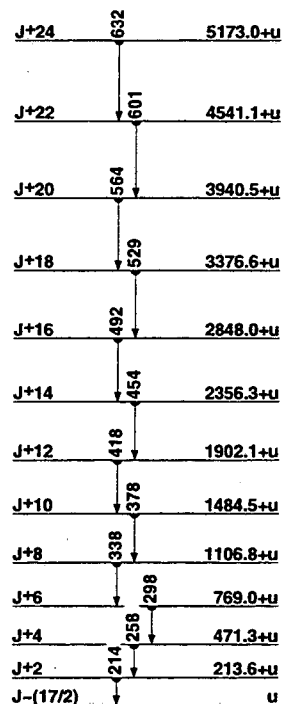

SD-4 band
(95Fa11)

¹⁹⁵Pb
⁸²

¹⁹⁶Pb
82Pb

Δ :(-25420) S_n :(9700) S_p :(4440) Q_{EC} :(2050) Q_α :(4200)

Nuclear Bands

- A $\Delta=2$ band
- B SD-1 band (95Va32,94Cl02,93Mo19,91Wa14,90Br10)
- C SD-2 band? (95Va32)
- D SD-3 band? (95Va32)

Levels and γ -ray branchings:

- 0, 0⁺, 373 m, %EC+% β ⁺=100, % α ≤3×10⁻⁵
- 1049.20 9, 2⁺, <100 ns γ_0 1049.219 (†,100) E2
- A 1142.86 17, 0⁺ γ_0 1142.73 (†,2.03) E0
- A 1449.87 13, 2⁺ γ_{1143} 306.93 (†,165) γ_{1049} 400.92 (†,915) E0+M1+E2
 γ_0 1449.73 (†,1009) E2
- 1697.85, 0⁺ γ_0 1697.85 (†,0.21) E0
- 1738.27 12, 4⁺, <1 μ s γ_{1450} 288.72 (†,1.34) γ_{1049} 689.009 (†,1004) E2
- 1797.51 14, 5⁺, 1338 ns, $\mu=0.490$ 15 γ_{1738} 59.239 (†,10023) E1
 γ_{1049} 748.43 (†,101) E3
- 1825.60 16, (3,4)⁺ γ_{1450} 375.52 (†,92) γ_{1049} 776.62 (†,1007) E2(+M1); $\delta=2.0$
- A 1861.76, (4⁺) γ_{1450} 411.85 (†,100)
- 1896.10 17, (2⁺) γ_{1143} 753.42 (†,5825) (E2) γ_{1049} 846.72 (†,1008) E2(+M1); $\delta=1.83$ γ_0 1896.35 (†,3817)
- 1991.61 22, 3⁻ γ_{1049} 942.42 (†,100) E1
- 2060.06 23, (1,2)⁺ γ_{1143} 916.83 (†,3325) γ_{1049} 1011.13 (†,10017) γ_0 2060.97 (†,178)
- 2124.41 22, (1,2,3) γ_{1450} 674.62 (†,10020) γ_{1049} 1075.04 (†,7050)
- 2169.44 16, 7⁻, <5 ns γ_{1798} 371.938 (†,100) E2
- 2203.27 24, (4⁺) γ_{1450} 753.42 (†,100) (E2)
- 2307.83 18, 9⁻, 533 μ s γ_{2169} 138.417 (†,100) E2
- 2333.9 3, (8⁻) γ_{2169} 164.52 (†,100)
- 2376.05 20, 6⁺ γ_{1826} 550.43 (†,126) γ_{1738} 637.82 (†,10018) E2
- A 2423.9 8, (6⁺) γ_{1862} 562.25 (†,100)
- 2470.77 23 γ_{1738} 732.52 (†,100)
- 2590.96 19, 8⁺ γ_{2308} 283.22 (†,638) γ_{2169} 421.51 (†,10013) E1
- A 2621.9 9, (8⁺), 5015 ns γ_{2424} 198.05 (†,100)
- 2645.12 19, 10⁺, <2 ns γ_{2308} 337.297 (†,100) E1
- 2692.8 6, 12⁺, 2713 ns, $\mu=-1.920$ 18, $Q=0.655$ γ_{2645} 47.75 (†,100) (E2)
- 3041.4 3, 4⁺ γ_{2376} 665.42 (†,100) E2
- 3087.25 25, (9,10)⁺ γ_{2591} 496.32 (†,100) M1(+E2); $\delta=0.89$
- 3190.5 6, 11⁻, 723 ns, $\mu=10.69$ γ_{2893} 497.72 (†,100) (E1) γ_{2645} 548.4(?)
- 3394.12 25, (9,10)⁺ γ_{3087} 306.93 (†,7525) (E2) γ_{2645} 749.02 (†,100)
- γ_{2591} 803.15 (†,5025)
- 3652.5 6, 14⁺ γ_{2683} 959.699 (†,100) E2
- 3737.9 7, (12,13)⁻ γ_{3191} 547.44 (†,100) (E2+M1)
- 4120.1 6, 15⁻ γ_{3653} 467.619 (†,100) E1
- 4217.2 6, 16⁺ γ_{3653} 564.71 (†,7.26) E2
- 4332.1 6, 16⁺ γ_{3653} 679.73 (†,100) E2
- 4478.0 6, 15⁻, 5.05 ns γ_{4120} 357.91 (†,100) M1+E2; $\delta=1.5$ \pm 0.2
- 4646.0 7, 16⁻ γ_{4120} 525.93 (†,100) M1+E2; $\delta=-0.4$ \pm 0.3
- 4675.0 7, () γ_{4478} 197.04 (†,100) (E2)
- 4722.3 6, 16⁻ γ_{4478} 244.31 10 (†,100) M1+E2; $\delta=0.3$ \pm 0.1
- 4962.4 6, (18⁺) γ_{4332} 630.43 (†,919) E2 γ_{4217} 745.22 (†,10018) E2
- 5491.5 7, (20⁺) γ_{4962} 529.13 (†,100) E2
- 5707.7, (19⁻) γ_{4962} 745.22(?) (†,100) E1
- B x, J=(6)
- B 171.4+x, J+2 γ_x 171.42 (†,0.205) $I^{(1)}=82.7$, $I^{(2)}=90.5$, $\eta\omega=0.097$
- B 387.0+x, J+4 γ_{171+x} 215.62 (†,0.605) (E2) $I^{(1)}=84.2$, $I^{(2)}=91.1$, $\eta\omega=0.119$
- B 646.5+x, J+6 γ_{387+x} 259.52 (†,0.905) (E2) $I^{(1)}=85.3$, $I^{(2)}=92.0$, $\eta\omega=0.141$
- B 949.5+x, J+8 γ_{647+x} 303.02 (†,0.955) (E2) $I^{(1)}=86.3$, $I^{(2)}=93.5$, $\eta\omega=0.162$
- B 1295.3+x, J+10 γ_{950+x} 345.82 (†,1.005) (E2) $I^{(1)}=87.3$, $I^{(2)}=95.7$, $\eta\omega=0.183$

- B 1682.9+x, J+12 γ_{1295+x} 387.62 (†,1.055) (E2) $I^{(1)}=88.2$, $I^{(2)}=97.8$, $\eta\omega=0.204$
- B 2111.4+x, J+14 γ_{1683+x} 428.52 (†,1.035) (E2) $I^{(1)}=89.1$, $I^{(2)}=97.8$, $\eta\omega=0.224$
- B 2580.8+x, J+16, 0.23 10 ps γ_{2111+x} 469.42 (†,1.005) (E2) $I^{(1)}=90.0$, $I^{(2)}=102.3$, $\eta\omega=0.244$
- B 3089.3+x, J+18, 0.12 \pm 0.3 ps γ_{2581+x} 508.52 (†,0.855) (E2) $I^{(1)}=91.0$, $I^{(2)}=104.2$, $\eta\omega=0.264$
- B 3636.2+x, J+20, 0.08 \pm 0.5 ps γ_{3089+x} 546.92 (†,1.005) (E2) $I^{(1)}=91.9$, $I^{(2)}=107.2$, $\eta\omega=0.283$
- B 4220.4+x, J+22 γ_{3636+x} 584.22 (†,0.755) (E2) $I^{(1)}=93.0$, $I^{(2)}=109.9$, $\eta\omega=0.301$
- B 4841.0+x, J+24 γ_{4220+x} 620.62 (†,0.655) (E2) $I^{(1)}=94.1$, $I^{(2)}=116.6$, $\eta\omega=0.319$
- B 5495.9+x, J+26 γ_{4841+x} 654.93 (†,0.655) $I^{(1)}=95.3$, $I^{(2)}=118.0$, $\eta\omega=0.336$
- B 6184.7+x, J+28 γ_{5496+x} 688.83 (†,0.555) $I^{(1)}=96.5$, $I^{(2)}=127.8$, $\eta\omega=0.352$
- B 6904.8+x, J+30 γ_{6185+x} 720.15 (†,0.355) $I^{(1)}=97.8$, $I^{(2)}=125.0$, $\eta\omega=0.368$
- B 7656.9+x, J+32 γ_{6905+x} 752.15 (†,0.205)
- C y, J=(8)
- C 204.5+y, J+2 γ_y 204.5 $I^{(1)}=88.4$, $I^{(2)}=92.2$, $\eta\omega=0.113$
- C 452.4+y, J+4 γ_{205+y} 247.9 $I^{(1)}=89.3$, $I^{(2)}=96.4$, $\eta\omega=0.134$
- C 741.8+y, J+6 γ_{452+y} 289.4 $I^{(1)}=90.5$, $I^{(2)}=99.3$, $\eta\omega=0.155$
- C 1071.5+y, J+8 γ_{742+y} 329.7 $I^{(1)}=91.5$, $I^{(2)}=100.5$, $\eta\omega=0.175$
- C 1441.0+y, J+10 γ_{1072+y} 369.5 $I^{(1)}=92.4$, $I^{(2)}=100.3$, $\eta\omega=0.195$
- C 1850.4+y, J+12 γ_{1441+y} 409.4 $I^{(1)}=93.3$, $I^{(2)}=104.2$, $\eta\omega=0.214$
- C 2298.2+y, J+14 γ_{1850+y} 447.8 $I^{(1)}=94.3$, $I^{(2)}=106.7$, $\eta\omega=0.233$
- C 2783.5+y, J+16 γ_{2298+y} 485.3 $I^{(1)}=95.2$, $I^{(2)}=107.2$, $\eta\omega=0.252$
- C 3306.1+y, J+18 γ_{2784+y} 522.6 $I^{(1)}=96.2$, $I^{(2)}=112.4$, $\eta\omega=0.270$
- C 3864.3+y, J+20 γ_{3306+y} 558.2 $I^{(1)}=97.2$, $I^{(2)}=111.4$, $\eta\omega=0.288$
- C 4458.4+y, J+22 γ_{3864+y} 594.1 $I^{(1)}=98.0$, $I^{(2)}=111.4$, $\eta\omega=0.306$
- C 5088.4+y, J+24 γ_{4458+y} 630.0 $I^{(1)}=98.8$, $I^{(2)}=113.6$, $\eta\omega=0.324$
- C 5753.6+y, J+26 γ_{5088+y} 665.2
- D z, J=(9)
- D 226.7+z, J+2 γ_z 226.7 $I^{(1)}=89.0$, $I^{(2)}=97.6$, $\eta\omega=0.124$
- D 494.4+z, J+4 γ_{227+z} 267.7 $I^{(1)}=90.3$, $I^{(2)}=98.5$, $\eta\omega=0.144$
- D 802.7+z, J+6 γ_{494+z} 308.3 $I^{(1)}=91.4$, $I^{(2)}=99.8$, $\eta\omega=0.164$
- D 1151.1+z, J+8 γ_{803+z} 348.4 $I^{(1)}=92.3$, $I^{(2)}=100.5$, $\eta\omega=0.184$
- D 1539.3+z, J+10 γ_{1151+z} 388.2 $I^{(1)}=93.2$, $I^{(2)}=101.5$, $\eta\omega=0.204$
- D 1966.9+z, J+12 γ_{1539+z} 427.6 $I^{(1)}=94.0$, $I^{(2)}=103.6$, $\eta\omega=0.223$
- D 2433.1+z, J+14 γ_{1967+z} 466.2 $I^{(1)}=94.9$, $I^{(2)}=108.4$, $\eta\omega=0.242$
- D 2936.2+z, J+16 γ_{2433+z} 503.1 $I^{(1)}=95.8$, $I^{(2)}=107.8$, $\eta\omega=0.261$
- D 3476.4+z, J+18 γ_{2936+z} 540.2 $I^{(1)}=96.8$, $I^{(2)}=112.4$, $\eta\omega=0.279$
- D 4052.2+z, J+20 γ_{3476+z} 575.8 $I^{(1)}=97.8$, $I^{(2)}=114.3$, $\eta\omega=0.297$
- D 4663.0+z, J+22 γ_{4052+z} 610.8 $I^{(1)}=98.7$, $I^{(2)}=114.9$, $\eta\omega=0.314$
- D 5308.6+z, J+24 γ_{4663+z} 645.6 $I^{(1)}=99.6$, $I^{(2)}=117.3$, $\eta\omega=0.331$
- D 5988.3+z, J+26 γ_{5308+z} 679.7

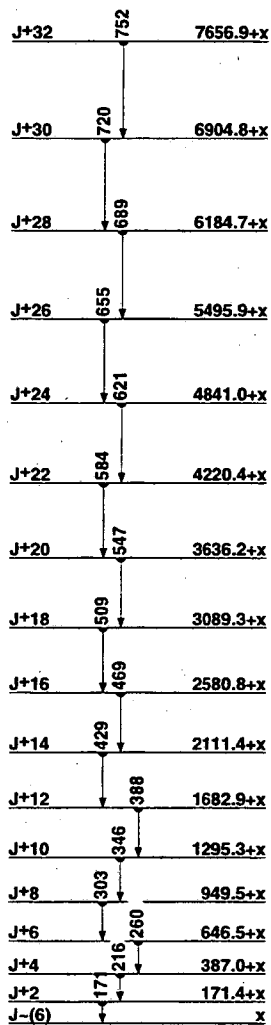

SD-1 band
(95Va32,94Cl02,93Mo19,91Wa14,90Br10)

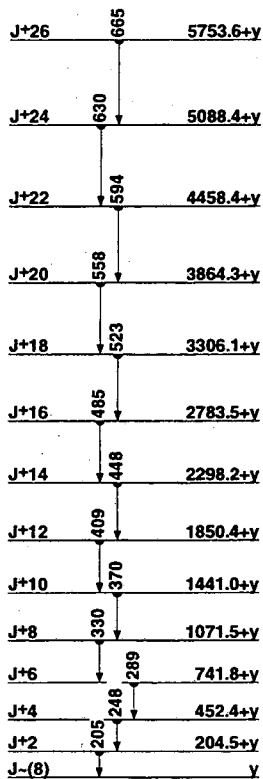

SD-2 band?
(95Va32)

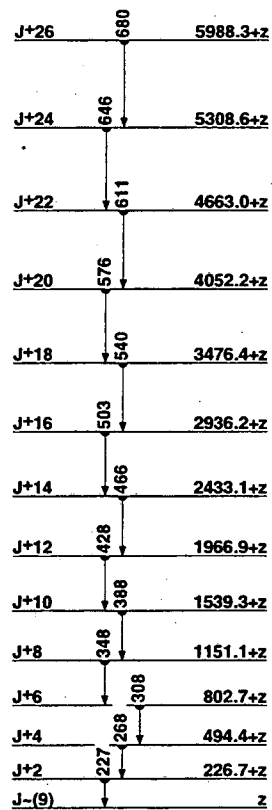

SD-3 band?
(95Va32)

¹⁹⁶Pb
⁸²Pb

198Pb
82Pb

Δ : (-26100) S_n : (9380) S_p : (5020) Q_{EC} : (1410) Q_{α} : (3720)

Nuclear Bands

- A GS band
- B $\Delta J=1$ band
- C $\Delta J=1$ band
- D $\Delta J=1$ band
- E $\Delta J=1$ band
- F $\Delta J=1$ band
- G Band Structure
- H Band Structure
- I Band Structure
- J SD band? (94Cl02,91Wa14)

Levels and γ -ray branchings:

- A 0, 0⁺, 2.40 10 h, %EC+% β ⁺=100
- A 1063.50 20, 2⁺ γ_0 1063.52 (†,100) E2
- 1392.1 10, (0⁺) γ_0 1392.1 (EO)
- A 1625.9 3, 4⁺ γ_{1064} 562.42 (†,100) E2
- 1734.7 10, (0⁺) γ_0 1734.7 (EO)
- 1823.5 4, (5⁻), 50.4 5 ns, $\mu=0.383$ γ_{1626} 197.62 (†,100) E1
- 1980.7 11, (4⁺) γ_{1064} 917.2 (†,100)
- 1996.4 11, (5⁻) γ_{1626} 370.5 (†,100)
- 2099.4 11, (4,5,6) γ_{1626} 473.5 (†,100)
- 2141.4 4, (7⁻), 4.19 10 μ s γ_{1824} 317.92 (†,100) E2
- 2190.7 11, (6⁻) γ_{1824} 367.2 (†,100)
- 2231.4 5, (9⁻), 137 10 ns γ_{2141} 90.02 (†,100) E2
- 2257.7 11, (6⁻) γ_{1824} 434.2 (†,100)
- 2568.7 15, (6⁺) γ_{1881} 588.0 (†,100)
- 2602.7 15 γ_{2191} 412 (†,100)
- A 2772.3 5, (10⁺) γ_{2231} 540.92 (†,100) E1
- A 2820.5 7, (12⁺), 212 4 ns γ_{2772} 48.25 (†,100) E2
- A 3749.6 8, (14⁺) γ_{2821} 929.12 (†,100) E2
- H 4190.2 8, (16⁺) γ_{3750} 440.62 (†,100) E2
- G 4379.6 8, (15⁻) γ_{3750} 630.02 (†,100) E1
- I 4701.5 8, (16⁺) γ_{4380} 321.92 (†,100) (E1) γ_{4190} 511.32 (†,47)
- 4773.0 8, (16⁻), 6.3 3 ns γ_{4702} 71.5(?) γ_{4380} 393.42 D
- 4841.8 8, (16⁺) γ_{4380} 462.22 (†,100) (E1)
- H 5070.5 8, 18⁺ γ_{4190} 880.33 (†,100) E2
- G 5140.3 8, (17⁻) γ_{4380} 760.72 (†,100) E2
- I 5649.2 8, (18⁺) γ_{4702} 947.72 (†,100) E2
- H 5700.5 9, (20⁺) γ_{5071} 630.02 (†,100)
- G 5837.8 8, (19⁻) γ_{5140} 697.52 (†,100) E2
- I 6466.2 8, (20⁻) γ_{5649} 817.02 (†,100) Q
- H 6499.0 9, (22⁺) γ_{5701} 798.52 (†,100) E2
- G 6499.1 9, (21⁻) γ_{5838} 661.32 (†,100) E2
- G 6978.1 9, (23⁻) $\gamma_{6499.1}$ 479.02 (†,100) (E2)
- t
- 455.8+t 3 γ_0 455.83 (†,100)
- 633.3+t 4 γ_{456+t} 177.52 (†,100) M1
- 662.6+t 4 γ_{456+t} 206.82 (†,100) M1
- 1082.2+t 4 γ_{663+t} 419.53 (†,76 9) M1 γ_{633+t} 449.02 (†,100 9) M1
- 1176.2+t 7 γ_{1082+t} 94.05 (†,100)
- 1293.1+t 7 γ_{1176+t} 116.92 (†,100) M1
- 1450.5+t 7 γ_{1293+t} 157.42 (†,100) M1
- 1604.2+t 9(?)
- 1839.6+t 9 γ_{1604+t} 235.42 (†,100)
- 1879.7+t 8 γ_{1451+t} 429.22 (†,100) M1
- 2137.8+t 8 γ_{1840+t} 298.22 (†,100) M1
- 2216.0+t 8 γ_{1880+t} 336.32 (†,100) M1
- 2444.0+t 8 γ_{2216+t} 228.02 (†,100 6) M1 γ_{2138+t} 306.22 (†,49 5) M1

- F v, (20⁺)
- F 206.80+v 20, (21⁺) γ_0 206.82 (†,100) M1
- F 444.9+v 3, (22⁺) γ_{207+v} 238.12 (†,100) M1
- F 725.1+v 4, (23⁺) γ_{445+v} 280.22 (†,100) M1
- F 1051.4+v 4, (24⁺), 0.40 10 ps γ_{725+v} 326.32 (†,100) M1
- F 1426.4+v 5, (25⁺), 0.23 5 ps γ_{1051+v} 375.02 (†,100) M1
- F 1848.3+v 5, (26⁺), 0.13 3 ps γ_{1426+v} 421.92 (†,100) M1
- F 2312.5+v 6, (27⁺), 0.053 14 ps γ_{1848+v} 464.22 (†,100) M1
- F 2818.7+v 6, (28⁺), 0.036 8 ps γ_{2313+v} 506.22 (†,100) M1
- F 3369.0+v 6, (29⁺) γ_{2819+v} 550.32 (†,100) M1
- F 3960.7+v 7, (30⁺) γ_{3369+v} 591.73 (†,100) M1
- E s, J
- E 220.80+s 20, J+1 γ_0 220.82 (†,100)
- E 461.2+s 3, J+2 γ_{221+s} 240.42 (†,100) M1
- E 716.0+s 4, J+3 γ_{461+s} 254.82 (†,100) M1
- E 997.7+s 4, J+4 γ_{716+s} 281.72 (†,100) M1
- E 1330.0+s 5, J+5 γ_{998+s} 332.32 (†,100) M1
- E 1718.0+s 5, J+6 γ_{1330+s} 388.02 (†,100) M1
- E 2110.0+s 6, J+7 γ_{1718+s} 392.02 (†,100) M1
- B w, (16,17,18)
- B 114.1+w 3, J+1 γ_0 114.13 (†,100)
- B 270.0+w 5, J+2 γ_{114+w} 155.93 (†,100) (M1)
- B 485.8+w 5, J+3 γ_{270+w} 215.82 (†,100) M1
- B 769.6+w 5, J+4 γ_{486+w} 283.82 (†,100) M1
- B 1113.9+w 6, J+5 γ_{770+w} 344.32 (†,100) M1
- B 1533.1+w 6, J+6 γ_{1114+w} 419.22 (†,100) (M1)
- B 2010.3+w 7, J+7 γ_{1533+w} 477.22 (†,100) M1 γ_{1114+w} 896(?)
- B 2495.1+w 7, J+8 γ_{2010+w} 484.82 (†,100) M1
- x, (12,13,14)
- 1258.71+x 20, J+1 γ_x 1258.72 (†,100) M1
- 1580.5+x 3, J+2 γ_{1259+x} 321.82 (†,100) M1
- 1813.6+x 4, J+3 γ_{1581+x} 233.62 (†,100) M1
- 2345.1+x 4, J+4 γ_{1814+x} 531.52 (†,35 5) M1 γ_{1581+x} 764.12 (†,100 5) E2
- 2610.2+x 4, J+5 γ_{2345+x} 264.62 (†,100 12) γ_{1814+x} 796.92 (†,27 8)
- 3152.5+x 4, J+6 γ_{2610+x} 542.72 (†,38 5) M1 γ_{2345+x} 807.12 (†,100 5) E2
- C z, (18⁻)
- C 113.90+z 20, (19⁻) γ_z 113.92 (†,100) (M1)
- C 269.9+z 3, (20⁻) γ_{114+z} 156.02 (†,100) M1
- C 485.2+z 4, (21⁻) γ_{270+z} 215.32 (†,100) M1
- C 763.9+z 4, (22⁻) γ_{485+z} 278.72 (†,100) (M1)
- C 1106.7+z 5, (23⁻), 0.79 14 ps γ_{764+z} 342.82 (†,100) M1
- C 1496.2+z 5, (24⁻), 0.50 7 ps γ_{1107+z} 389.52 (†,100) M1
- C 1919.3+z 6, (25⁻), 0.32 6 ps γ_{1496+z} 423.12 (†,100) M1
- C 2363.9+z 6, (26⁻), 0.18 3 ps γ_{1919+z} 444.62 (†,100) M1
- C 2835.6+z 6, (27⁻), 0.12 4 ps γ_{2364+z} 471.72 (†,100) M1
- C 3311.8+z 7, (28⁻), 0.17 4 ps γ_{2836+z} 476.22 (†,100) M1
- C 3840.8+z 8, (29⁻) γ_{3312+z} 529.05 (†,100)
- D y, J
- D 123.4+y 3, J+1 γ_y 123.43 (†,100)
- D 283.2+y 5, J+2 γ_{123+y} 159.83 (†,100) M1
- D 487.6+y 5, J+3 γ_{283+y} 204.42 (†,100) M1
- D 752.5+y 5, J+4 γ_{488+y} 264.92 (†,100) M1
- D 1090.3+y 6, J+5 γ_{753+y} 337.82 (†,100) M1
- D 1499.4+y 6, J+6 γ_{1090+y} 409.12 (†,100) M1
- D 1952.4+y 8, J+7 γ_{1499+y} 453.05 (†,100)
- D 2447.4+y 13(?), J+8 γ_{1952+y} 495 (†,100)

- J u, J=(12)
 J 304.6+u, J+2 γ_0 304.6 (\dagger 0.85 s) I⁽¹⁾=85.9, I⁽²⁾=93.0, $\hbar\omega$ =0.163
 J 652.2+u, J+4 γ_{305+u} 347.6 (\dagger 1.00 s) I⁽¹⁾=86.7, I⁽²⁾=93.5, $\hbar\omega$ =0.185
 J 1042.6+u, J+6 γ_{652+u} 390.4 (\dagger 0.90 s) I⁽¹⁾=87.5, I⁽²⁾=95.2, $\hbar\omega$ =0.206
 J 1475.0+u, J+8 γ_{1043+u} 432.4 (\dagger 0.85 s) I⁽¹⁾=88.2, I⁽²⁾=95.7, $\hbar\omega$ =0.227
 J 1949.2+u, J+10 γ_{1475+u} 474.2 (\dagger 1.00 s) I⁽¹⁾=89.0, I⁽²⁾=98.8, $\hbar\omega$ =0.247
 J 2463.9+u, J+12 γ_{1949+u} 514.7 (\dagger 1.15 s) I⁽¹⁾=89.7, I⁽²⁾=99.0, $\hbar\omega$ =0.267
 J 3019.0+u, J+14 γ_{2464+u} 555.1 (\dagger 0.95 s) I⁽¹⁾=90.5, I⁽²⁾=102.0, $\hbar\omega$ =0.287
 J 3613.3+u, J+16 γ_{3019+u} 594.3 (\dagger 1.00 s) I⁽¹⁾=91.2, I⁽²⁾=102.8, $\hbar\omega$ =0.307
 J 4246.5+u, J+18 γ_{3613+u} 633.2 (\dagger 0.75 s) I⁽¹⁾=91.9, I⁽²⁾=102.3, $\hbar\omega$ =0.326
 J 4918.8+u, J+20 γ_{4247+u} 672.3 (\dagger 0.75 s) I⁽¹⁾=92.6, I⁽²⁾=106.7, $\hbar\omega$ =0.346
 J 5628.6+u, J+22 γ_{4919+u} 709.8 (\dagger 0.70 s) I⁽¹⁾=93.4, I⁽²⁾=108.7, $\hbar\omega$ =0.364
 J 6375.2+u, J+24 γ_{5629+u} 746.6 (\dagger 0.60 s) I⁽¹⁾=94.1, I⁽²⁾=109.3, $\hbar\omega$ =0.382
 J 7158.4+u, J+26 γ_{6375+u} 783.2 (\dagger 0.25 s) I⁽¹⁾=94.9, I⁽²⁾=113.3, $\hbar\omega$ =0.400
 J 7976.9+u(?), J+28 γ_{7158+u} 818.5(?) I⁽¹⁾=95.7, I⁽²⁾=117.3, $\hbar\omega$ =0.418
 J 8829.5+u(?), J+30 γ_{7977+u} 852.6(?)

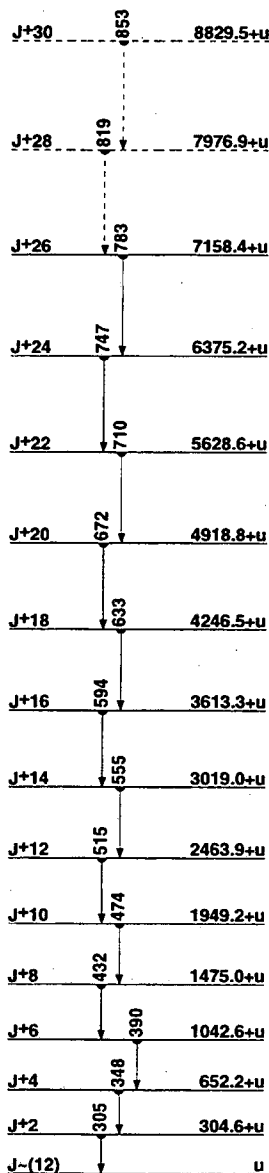

SD band?
(94Cl02,91Wa14)

¹⁹⁸₈₂Pb

¹⁹⁵Bi
83

Δ :(-17930) S_n :(9900) S_p :(1000) Q_{EC} :(5900) Q_α :5833.5

Nuclear Bands

A SD band (96CIAA)

Levels and γ -ray branchings:

- 0, (9/2⁻), 183.4 s, % α =0.032, %EC+% β^+ =99.972
- 401.7, (1/2⁺), 87.1 s, % α =33.17, %EC+% β^+ =67.17
- 887.9, (13/2⁺), 32.2 ns γ_0 887.9 (\dagger_{γ} 100) M2(+E3)
- 1232.2, (15/2⁻) γ_{888} 344.3 (\dagger_{γ} 100) (E1)
- 1623.9, (17/2⁺) γ_{1232} 391.7 (\dagger_{γ} 100) (E1)
- 2044.920, (21/2⁺) γ_{1624} 421.0 (\dagger_{γ} 100) (E2)
- 2196.2, (25/2⁺), 80.10 ns γ_{2045} 151.3 (\dagger_{γ} 100) (E2)
- 2311.4, (27/2⁺) γ_{2196} 115.2 (\dagger_{γ} 100) (M1)
- 2311.4+x(?), (29/2⁻), 750.50 ns

A y, J

- A 261.5+y, J+2 γ_y 261.55 (\dagger_{γ} 1.04 10) $I^{(2)}=100.3$, $\hbar\omega=0.141$
- A 562.9+y, J+4 γ_{262+y} 301.45 (\dagger_{γ} 0.93 10) $I^{(2)}=98.8$, $\hbar\omega=0.161$
- A 904.8+y, J+6 γ_{563+y} 341.95 (\dagger_{γ} 1.04 10) $I^{(2)}=103.1$, $\hbar\omega=0.181$
- A 1285.5+y, J+8 γ_{905+y} 380.75 (\dagger_{γ} 1.00 10) $I^{(2)}=100.3$, $\hbar\omega=0.200$
- A 1706.1+y, J+10 γ_{1286+y} 420.65 (\dagger_{γ} 0.96 10) $I^{(2)}=107.2$, $\hbar\omega=0.220$
- A 2164.0+y, J+12 γ_{1706+y} 457.95 (\dagger_{γ} 0.84 10) $I^{(2)}=107.8$, $\hbar\omega=0.238$
- A 2659.0+y, J+14 γ_{2164+y} 495.1 (\dagger_{γ} 0.338)

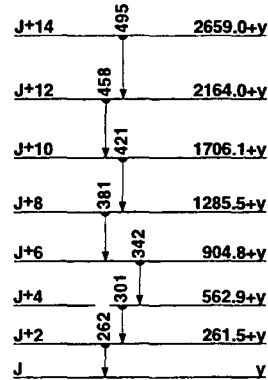

SD band
(96CIAA)
¹⁹⁵Bi
83

¹⁹⁶Bi
83

Δ : -18100 700 S_n : (8200) S_p : (1600) Q_{EC} : (7400) Q_α : (5460)

Nuclear Bands

A SD band (96CIAA)

Levels and γ -ray branchings:

- 0, (3⁺), 308 12 s, %EC+% β^+ =100, % α =0.00115 34
- 158.3 3, (6⁺) γ_{158} 158.33 (\dagger , 100) M3
- 167.4, (7⁺), 0.6 5 s γ_{158} 114 (\dagger , 100)
- 269.4, (10⁻), 240 3 s, %EC+% β^+ =74.2 25, %IT=25.8 25, % α =0.00038 10
- γ_{167} 102.020 (\dagger , 100) (E3)
- A x, J=(13/2)
- A 166.2+x, J+2 γ_x 166.23 (\dagger , 0.80 10) $I^{(1)}$ =90.9, $I^{(2)}$ =95.7, $\hbar\omega$ =0.094
- A 374.2+x, J+4 γ_{166+x} 208.03 (\dagger , 1.01 5) $I^{(1)}$ =91.8, $I^{(2)}$ =95.9, $\hbar\omega$ =0.114
- A 623.9+x, J+6 γ_{374+x} 249.73 (\dagger , 0.96 5) $I^{(1)}$ =92.4, $I^{(2)}$ =96.2, $\hbar\omega$ =0.135
- A 915.2+x, J+8 γ_{624+x} 291.33 (\dagger , 1.09 7) $I^{(1)}$ =93.0, $I^{(2)}$ =96.9, $\hbar\omega$ =0.156
- A 1247.8+x, J+10 γ_{915+x} 332.63 (\dagger , 0.91 5) $I^{(1)}$ =93.4, $I^{(2)}$ =97.1, $\hbar\omega$ =0.177
- A 1621.6+x, J+12 γ_{1248+x} 373.83 (\dagger , 1.03 5) $I^{(1)}$ =93.9, $I^{(2)}$ =98.8, $\hbar\omega$ =0.197
- A 2035.9+x, J+14 γ_{1622+x} 414.33 (\dagger , 0.85 5) $I^{(1)}$ =94.3, $I^{(2)}$ =98.3, $\hbar\omega$ =0.217
- A 2490.9+x, J+16 γ_{2036+x} 455.03 (\dagger , 0.89 5) $I^{(1)}$ =94.7, $I^{(2)}$ =99.5, $\hbar\omega$ =0.238
- A 2986.1+x, J+18 γ_{2491+x} 495.23 (\dagger , 0.81 5) $I^{(1)}$ =95.1, $I^{(2)}$ =99.5, $\hbar\omega$ =0.258
- A 3521.5+x, J+20 γ_{2986+x} 535.43 (\dagger , 0.70 5) $I^{(1)}$ =95.5, $I^{(2)}$ =102.8, $\hbar\omega$ =0.277
- A 4095.8+x, J+22 γ_{3522+x} 574.33 (\dagger , 0.46 5) $I^{(1)}$ =95.9, $I^{(2)}$ =100.0, $\hbar\omega$ =0.297
- A 4710.1+x, J+24 γ_{4096+x} 614.35 (\dagger , 0.42 5) $I^{(1)}$ =96.3, $I^{(2)}$ =103.4, $\hbar\omega$ =0.317
- A 5363.1+x, J+26 γ_{4710+x} 653.1 (\dagger , 0.19 5)

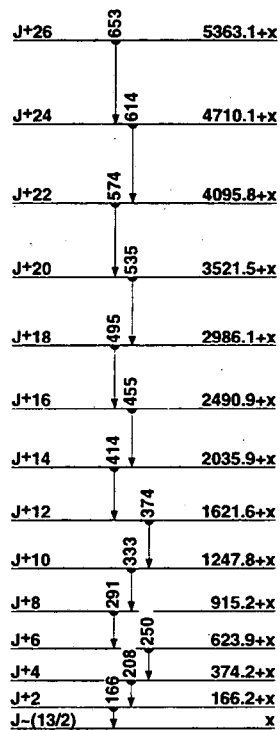

SD band
(96CIAA)
¹⁹⁶Bi
83

¹⁹⁷Bi
₈₃

Δ : -19620 160 S_n : 9600 700 S_p : (1490) Q_{EC} : (5180) Q_{α} : (5390)

Nuclear Bands

A SD band? (96CIAA)

Levels and γ -ray branchings:

- 0, (9/2⁻), 9.33 50 m, %EC+% β^+ =100, % α = 1×10^{-4} (syst)
- (500), (1/2⁺), 5.04 16 m, %EC+% β^+ =45 40, % α =55 40, %IT<0.3
- 1000.74 17, (13/2⁻) γ_0 1000.82 (\dagger_{γ} 100) (E2)
- 1009.20 20, (11/2⁻) γ_0 1009.22 (\dagger_{γ} 100) (M1+E2): $\delta=-0.38$ 14
- 1196.27 17, (13/2⁺) γ_{1009} 187.02 (\dagger_{γ} =100) (E1) γ_{1001} 195.62 (\dagger_{γ} 83 17) (E1) γ_0 1196.22 (\dagger_{γ} 53 6) (M2)
- 1601.0 3, (17/2⁺) γ_{1196} 404.72 (\dagger_{γ} 100) (E2)
- 1968.6 4, (21/2⁺) γ_{1601} 367.62 (\dagger_{γ} 100) (E2)
- 2065.5 4, (25/2⁺), 60 22 ns γ_{1969} 96.92 (\dagger_{γ} 100) (E2)
- 2129.3 4, (23/2⁻), 204 18 ns γ_{1969} 160.72 (\dagger_{γ} 100) (E1)
- 2360.4 5, (27/2⁺) γ_{2066} 294.92 (\dagger_{γ} 100) (E2)
- 2384.5 5, (25/2) γ_{2360} 20 20 γ_{2129} 255.22 (\dagger_{γ} 100) D
- 2360.4+x 5, (29/2⁻), 263 13 ns
- 2688.7 5, (27/2) γ_{2066} 623.22 (\dagger_{γ} 100) D
- 2846.0+x 5, (31/2⁻) γ_{2360+x} 485.62 (\dagger_{γ} 100) (M1+E2): $\delta=-0.33$ 18
- 2929.5 5, (31/2⁻), 209 30 ns γ_{2066} 864.02 (\dagger_{γ} 100) (E3)
- 3284.9+x 6, (33/2⁻) γ_{2846+x} 438.92 (\dagger_{γ} 100) (M1+E2): $\delta=-0.37$ 21
- 3558.3 7 γ_{2930} 628.8 5

A y, J=(15/2)

- A 186.7+y, J+2 γ_y 186.7 5 (\dagger_{γ} 0.66 7) $I^{(1)}=91.4$, $I^{(2)}=94.3$, $\hbar\omega=0.104$
- A 415.8+y, J+4 γ_{187+y} 229.1 5 (\dagger_{γ} 1.09 10) $I^{(1)}=92.2$, $I^{(2)}=98.8$, $\hbar\omega=0.125$
- A 685.4+y, J+6 γ_{416+y} 269.6 5 (\dagger_{γ} 1.03 10) $I^{(1)}=93.2$, $I^{(2)}=99.0$, $\hbar\omega=0.145$
- A 995.4+y, J+8 γ_{685+y} 310.0 5 (\dagger_{γ} 0.94 10) $I^{(1)}=93.8$, $I^{(2)}=97.3$, $\hbar\omega=0.165$
- A 1346.5+y, J+10 γ_{995+y} 351.1 5 (\dagger_{γ} 0.98 10) $I^{(1)}=94.4$, $I^{(2)}=101.0$, $\hbar\omega=0.185$
- A 1737.2+y, J+12 γ_{1347+y} 390.7 5 (\dagger_{γ} 0.97 10) $I^{(1)}=94.9$, $I^{(2)}=99.8$, $\hbar\omega=0.205$
- A 2168.0+y, J+14 γ_{1737+y} 430.8 5 (\dagger_{γ} 0.87 8) $I^{(1)}=95.6$, $I^{(2)}=106.1$, $\hbar\omega=0.225$
- A 2636.5+y, J+16 γ_{2168+y} 468.5 5 (\dagger_{γ} 0.46 8) $I^{(1)}=96.4$, $I^{(2)}=103.6$, $\hbar\omega=0.244$
- A 3143.6+y, J+18 γ_{2637+y} 507.1 5 (\dagger_{γ} 0.56 8) $I^{(1)}=96.9$, $I^{(2)}=105.5$, $\hbar\omega=0.263$
- A 3688.6+y(?), J+20 γ_{3144+y} 545 1(?)

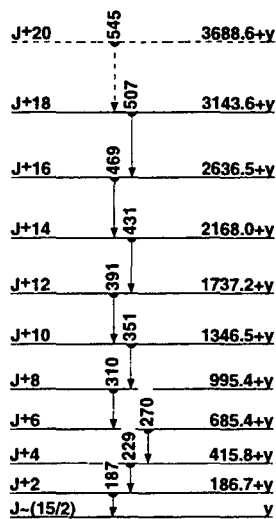

SD band?
(96CIAA)

¹⁹⁷Bi
₈₃

¹⁹⁸Po
₈₄Po

Δ : (-15510) S_n : (10140) S_p : (3180) Q_{EC} : (4030) Q_α : 6309.120

Nuclear Bands

- A GS band
- B Oblate band
- C SD band (96McAA)

Levels and γ -ray branchings:

- A 0, 0⁺, 1.763 m, % α =57.2, %EC+% β ⁺=43.2
- A 605.0 1, 2⁺ γ_{605} 605.01 († _{γ} 100) E2
- 816, 0⁺, <0.4 ns γ_{605} 211 († _{γ} 45.37) γ_{816} († _{γ} 100.37) E0
- B 1038.9 7, 2⁺ γ_{605} 434 γ_{1039}
- A 1158.51 14, 4⁺ γ_{605} 553.51 († _{γ} 100) E2
- B 1482.7 7, 4⁺ γ_{1159} 324 γ_{1039} 444
- A 1717.70 17, 6⁺ γ_{1159} 559.21 († _{γ} 100) E2
- 1808.61 17, 5⁻ γ_{1483} 326 γ_{1159} 650.11 († _{γ} 100.5) E1
- 1853.80 20, 8⁺, 29.2 ns γ_{1718} 136.12 († _{γ} 100) E2
- 1875.16 21, (6⁺) γ_{1159} 716.62 († _{γ} 100) E2
- 2114.50 18, 7⁻ γ_{1875} 239.32 († _{γ} 100) E1 γ_{1809} 305.91 († _{γ} 100.6) E2
- γ_{1718} 396.83 († _{γ} 22.11) E1
- 2324.92 19, 9⁻ γ_{2115} 210.41 († _{γ} 83.6) E2 γ_{1854} 471.11 († _{γ} 100.6) E1
- 2566.10 21, 11⁻, 200.20 ns γ_{2325} 241.22 († _{γ} 114) E2 γ_{1854} 712.31 († _{γ} 100.4) E3
- 2620.65 22, (8⁺) γ_{1854} 766.82 († _{γ} 44.11) (E2) γ_{1718} 903.02 († _{γ} 100.11) E2
- 2692.05 21, 10⁺ γ_{2566} 126.02 († _{γ} 100.13) E1 γ_{2325} 367.11 († _{γ} 71.8) E1
- γ_{1854} 838.32 († _{γ} 21.4) E2
- 2692.05+x 21, 12⁺, 0.755 ps γ_X
- 2888.52 22, 11⁻ γ_{2325} 563.61 († _{γ} 100) E2
- 3463.5, (13⁻) γ_{2889} 575.01 († _{γ} 100) (E2)

C y, J=(6)

- C 175.9+y, J+2 $\gamma_{175.9}$ 175.93 I⁽¹⁾=80.8, I⁽²⁾=89.9, $\hbar\omega$ =0.099
- C 396.3+y, J+4 γ_{176+y} 220.3720 († _{γ} 0.478) I⁽¹⁾=82.5, I⁽²⁾=90.5, $\hbar\omega$ =0.121
- C 660.9+y, J+6 γ_{396+y} 264.5915 († _{γ} 0.859) I⁽¹⁾=83.9, I⁽²⁾=93.7, $\hbar\omega$ =0.143
- C 968.2+y, J+8 γ_{661+y} 307.2915 († _{γ} 0.979) I⁽¹⁾=85.3, I⁽²⁾=95.2, $\hbar\omega$ =0.164
- C 1317.4+y, J+10 γ_{968+y} 349.2916 († _{γ} 1.0010) I⁽¹⁾=86.5, I⁽²⁾=97.2, $\hbar\omega$ =0.185
- C 1707.9+y, J+12 γ_{1317+y} 390.4620 († _{γ} 0.8910) I⁽¹⁾=87.8, I⁽²⁾=102.4, $\hbar\omega$ =0.205
- C 2137.4+y, J+14 γ_{1708+y} 429.5419 I⁽¹⁾=89.1, I⁽²⁾=104.3, $\hbar\omega$ =0.224
- C 2605.3+y, J+16 γ_{2137+y} 467.94 († _{γ} 0.8710) I⁽¹⁾=90.4, I⁽²⁾=105.3, $\hbar\omega$ =0.243
- C 3111.2+y, J+18 γ_{2605+y} 505.94 († _{γ} 0.8712) I⁽¹⁾=91.6, I⁽²⁾=109.0, $\hbar\omega$ =0.262
- C 3653.8+y, J+20 γ_{3111+y} 542.64 († _{γ} 0.409)

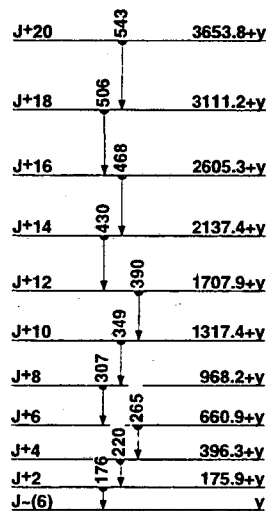

SD band
(96McAA)
¹⁹⁸Po
₈₄Po

233
90Th

Δ : 38727.921 S_n : 4786.3525 S_p : 7700 100 Q_{β^-} : 1245.2 14 Q_{α} : 3870 60
 σ_f : 1500 100 b, σ_f : 152 b

Nuclear Bands

- A 1/2[631]
- B 5/2[622]
- C 7/2[743]
- D 5/2[633]
- E 7/2[624]
- F 3/2[631]
- G 5/2[752]
- H 1/2[501]
- I 7/2[743]+2*
- J 5/2[622]+2*
- K 5/2[622]+0*
- L 1/2[631]+0*
- M Fission isomer

Levels and γ -ray branchings:

- A 0, 1/2⁺, 22.3 1 m, % β^- =100
- B 6.04 2, (5/2)⁺
- C 6.06 2, (7/2)⁻
- A 16.86 2, 3/2⁺
- B 50.38 2, (7/2)⁺ $\gamma_{6.0}$ 44.364 6 M1+E2: $\delta=0.23$ 9
- A 54.546 6, 5/2⁺ γ_{17} 37.697 8 (M1+E2) $\gamma_{6.0}$ 48.533 8 $\gamma_{6.0}$ 54.545 3 E2
- A 93.62 2, 7/2⁺ γ_{55} 39.091 7 γ_{17} 76.740 4 (E2)
- B 107.34 2, (9/2)⁺ γ_{50} 56.960 4 (M1)
- A 159.0 10, (9/2)⁺
- B 178 2, (11/2)⁺
- A 220 2, (11/2)⁺
- C 252.3 5, (15/2)⁻
- D 262.24 2, (5/2)⁺ γ_{50} 211.869 6 (\dagger , 17 3) M1 $\gamma_{6.0}$ 256.190 4 (\dagger , 100 12) M1
- E 279.40 2, (7/2)⁺ γ_{107} 172.072 13 (\dagger , 23 7) γ_{50} 229.017 7 (\dagger , 100 14) M1
- A 297, (13/2)⁺
- 309.5 20, (1/2, 3/2)
- E 326.0 10, (9/2)⁺
- F 335.928 3, 3/2⁺ γ_{55} 281.365 13 (\dagger , 20 3) M1 γ_{17} 319.067 3 (\dagger , 92.9 10) M1
 $\gamma_{6.0}$ 329.879 7 (\dagger , 26 3) M1 $\gamma_{6.0}$ 335.928 3 (\dagger , 100 11) M1
- 337.35 6, (5/2, 7/2)⁺ γ_{50} 286.2 4 (\dagger , 10 10) $\gamma_{6.0}$ 331.314 4 (\dagger , 100 11) M1
- F 371.17 2, (5/2)⁺ γ_{94} 277.549 10 (\dagger , 36 6) M1 γ_{55} 316.642 7 (\dagger , 100 10) M1
 γ_{50} 320.79 3 (\dagger , 13 3) M1 γ_{17} 354.313 4 (\dagger , 95 12) M1 $\gamma_{6.0}$ 365.113 15
(\dagger , 11.8 17) M1+E2: $\delta=1.3$ 5
- E 388.5 10, (11/2)⁺
- D 388.5 10, (9/2)⁺
- 405.8 20, 1/2, 3/2, 5/2⁺
- 410.0 15
- 413.8 20, (1/2, 3/2)
- F 421.15 2, (7/2)⁺ γ_{107} 313.814 17 γ_{94} 327.527 9 (\dagger , 100 11)
M1+E2: $\delta=0.65$ 35 γ_{55} 366.622 13 (\dagger , 53 8) M1
- 443 5(?)
- D 464 3, (11/2)⁺
- G 478.36 17, (5/2)⁻ $\gamma_{6.1}$ 472.300 5 M1
- F 480.9 10, (9/2)⁺
- 510(?)
- H 539.61 2, (1/2)⁻ γ_{17} 522.757 6 (\dagger , 100 11) E1 $\gamma_{6.0}$ 539.599 9 (\dagger , 64 7) E1
- I 572.70 3, (3/2)⁻ γ_{336} 236.81 3 (\dagger , 3.2 7) E1 $\gamma_{6.1}$ 566.630 7 (\dagger , 100 10) E2
- J 583.932 8, (1/2)⁺ $\gamma_{6.0}$ 577.888 6 (\dagger , 100 15) (E2) $\gamma_{6.0}$ 583.932 8 (\dagger , 57 6) M1
- H 586.135 9, 3/2⁻ γ_{55} 531.582 11 (\dagger , 97 11) (E1) γ_{17} 569.19 5 (\dagger , 24 4)
 $\gamma_{6.0}$ 586.140 7 (\dagger , 100 11) E1
- 599.29 6(?), (5/2)⁺ γ_{17} 582.44 7 (\dagger , 21 6) $\gamma_{6.1}$ 593.21 4 (\dagger , 100 11) (E2)
- J 611.476 12, (3/2)⁺ γ_{55} 556.931 19 (\dagger , 77 8) M1 γ_{50} 561.088 17 (\dagger , 64 7)
 $\gamma_{6.0}$ 605.442 13 (\dagger , 100 10)
- J 628.97 2, (5/2)⁺ γ_{107} 521.66 3 (\dagger , 37 14) (E2) γ_{94} 535.28 3 (\dagger , 34 6) E2
 γ_{55} 574.37 9 (\dagger , 32 5) M1 γ_{50} 578.607 17 (\dagger , 100 13) (E1) γ_{17} 612.10 3
(\dagger , 93 12) M1 $\gamma_{6.0}$ 622.95 6 (\dagger , 49 6) (E2)
- 632.8 20, 1/2, 3/2, 5/2⁺

- 645.5 20, 1/2, 3/2
- 681.846 19(?), (1/2)⁻ $\gamma_{6.0}$ 681.846 19 E1
- 682.11 3, (3/2)⁻ γ_{17} 665.252 17 (\dagger , 100 10) $\gamma_{6.1}$ 676.02 9 (\dagger , 4.9 14)
- 691.2 15
- 695.6 20, 1/2, 3/2, 5/2⁺
- K 711.19 18, (5/2)⁺ γ_{50} 660.49 13 (\dagger , 100 30) γ_{17} 694.40 7 (\dagger , 100 20)
 $\gamma_{6.0}$ 705.158 20 E0+M1(+E2) $\gamma_{6.0}$ 711.18 6 (\dagger , 90 18)
- L 713.72 2, 1/2⁺ γ_{17} 696.85 4 (\dagger , 73 11) $\gamma_{6.0}$ 713.719 16 (\dagger , 100 16) E0+M1
- L 721.84 5, 3/2⁺ γ_{540} 182.12 3 (\dagger , 20 7) γ_{94} 628.38 8 (\dagger , 47 6) (E2)
 γ_{17} 704.98 3 (\dagger , 100 15) E0+M1(+E2) $\gamma_{6.0}$ 721.95 6 (\dagger , 38 8)
M1+E2: $\delta=0.9$ 5
- 725.8 10
- 741.32 4, (3/2)⁻ γ_{540} 201.677 20 (\dagger , 46 11) M1+E2: $\delta=0.5$ 5 γ_{478} 263.02 3
(\dagger , 54 7) M1+E2: $\delta=0.5$ 5 γ_{371} 370.15 5 (\dagger , 31 5) $\gamma_{6.0}$ 735.30 4 (\dagger , 100 14)
 $\gamma_{6.0}$ 741.22 10 (\dagger , 100 14)
- 749.9 20, 1/2, 3/2
- K 753.98 5, (7/2)⁺ γ_{50} 703.61 4 (\dagger , 100 30) E0+M1(+E2) $\gamma_{6.1}$ 747.76 14
(\dagger , 58 24)
- 768.18 2, 1/2⁺, 3/2⁺ γ_{586} 182.12 γ_{336} 432.25 2 (\dagger , <69) M1+E2: $\delta=0.6$ 4
 γ_{17} 751.25 8 (\dagger , 100 19)
- L 769.60 2, 5/2⁺ γ_{55} 715.06 3 (\dagger , 100 17) E0+M1(+E2) γ_{17} 752.62 6 (\dagger , 47 8)
M1 $\gamma_{6.0}$ 769.83 9 (\dagger , 33 7)
- 783.64 8(?), (1/2⁺, 3/2⁺) γ_{371} 412.47 7 (\dagger , 25 4) $\gamma_{6.0}$ 777.71 13 (\dagger , 100 28)
- 796 3
- 803.41 6, (5/2)⁺ γ_{371} 432.250 γ_{262} 541.21 5 (\dagger , 18 4) γ_{17} 786.45 13
(\dagger , 25 7) M1 $\gamma_{6.0}$ 797.25 6 (\dagger , 100 20) (M1)
- 814.74 13, 3/2⁺ γ_{17} 798.08 8 (\dagger , 63 16) (M1) $\gamma_{6.0}$ 808.71 13 (\dagger , 92 13)
M1+E2 $\gamma_{6.0}$ 814.74 13 (\dagger , 100 14) M1+E2
- 830.5 20, (1/2, 3/2)
- 839.66 8, (3/2)⁻ $\gamma_{6.0}$ 833.63 7 (\dagger , 100 14) $\gamma_{6.0}$ 839.5 5 (\dagger , 15 3)
- 842.26 9, (1/2, 3/2)⁺ γ_{611} 230.784 6 (\dagger , 64 10) M1+E2: $\delta=1.1$ 5
 γ_{584} 258.335 16 (\dagger , 73 3) γ_{371} 471.28 9 (\dagger , 55 12) γ_{336} 506.25 5 (\dagger , 64 14)
 γ_{262} 579.99 3 (\dagger , 100 12) (E2) γ_{17} 825.37 14 (\dagger , 73 16) $\gamma_{6.0}$ 842.47 18
(\dagger , 41 13)
- 846 3
- 852.28 17, 1/2⁺, 3/2, 5/2⁺ γ_{262} 590.04 16 γ_{17} 835.05
- 861.54 11, 1/2⁺, 3/2⁺ γ_{584} 277.54 9 γ_{17} 844.55 12 (\dagger , 62 14) $\gamma_{6.0}$ 861.64 10
(\dagger , 100 18) M1
- 873.7 15, 1/2, 3/2, 5/2⁺
- 884.94 8, 1/2⁺, 3/2⁺, 5/2⁺ γ_{336} 548.95 13 (\dagger , 34 4) M1 γ_{55} 830.41 7
(\dagger , 100 15) (E2)
- 891.4 2, 1/2, 3/2
- 900 3
- 904.6 5, (1/2⁺, 3/2⁺)
- 918.0 10, (1/2⁻, 3/2⁻)
- 924.58 20, (3/2)⁻ γ_{640} 384.94 3 (\dagger , 25 6) M1+E2: $\delta=1.0$ 5 γ_{371} 553.39 3
(\dagger , 50 9) γ_{336} 588.72 12 (\dagger , 71 13) γ_{262} 661.88 6 (\dagger , 50 9) γ_{17} 907.42 13
(\dagger , 71 13) $\gamma_{6.0}$ 918.68 7 (\dagger , 100 15)
- 947.2 4, (3/2)⁻ γ_{262} 684.97 4 (\dagger , 77 10) $\gamma_{6.1}$ 940.53 12 (\dagger , 100 19) $\gamma_{6.0}$ 947.2 4
(\dagger , 25 4)
- 954 4
- 957.5 15(?), (5/2)⁺
- 968.1 2, (1/2, 3/2)⁺ γ_{336} 632.47 9 (\dagger , 22 6) M1 γ_{55} 913.63 10 (\dagger , 50 9)
 γ_{17} 951.4 4 (\dagger , 20 5) (M1) $\gamma_{6.0}$ 967.13 6 (\dagger , 100 18) M1(+E2)
- 973 4
- 984.2 8, (1/2⁺, 3/2⁺)
- 991 3
- 1013.1 3, 1/2⁻, 3/2⁻ γ_{586} 427.31 3 (\dagger , 11 2) (M1+E2) γ_{17} 996.1 3 (\dagger , 21 7)
 $\gamma_{6.0}$ 1012.97 11 (\dagger , 100 18) E1
- 1026 3
- 1031.6 2, 1/2⁻, 3/2⁻ γ_{17} 1014.85 11 (\dagger , 100 18) $\gamma_{6.0}$ 1031.1 4 (\dagger , 10 3)
- 1040.0 3, (1/2, 3/2)
- 1046 4
- 1051.5 5, (3/2)⁻ γ_{55} 996.15 γ_{17} 1034.27 7 (\dagger , 100 24) $\gamma_{6.0}$ 1052.11 19
(\dagger , 56 13)
- 1061.43 15, (1/2⁺, 3/2⁺) γ_{17} 1044.68 13 (\dagger , 100 19) $\gamma_{6.0}$ 1055.39 14
(\dagger , 100 19)

1074.0 6, (1/2⁻, 3/2⁻)
 1087.4 5(?), (1/2, 3/2)
 1101.7 7, (1/2⁺, 3/2⁺)
 1115.3 7, (1/2⁺, 3/2⁺)
 1132.11 9, (3/2)⁺ γ_{262} 869.87 8 (†_Y 100 17) M1+E2 γ_{50} 1081.44 (†_Y 31 8)
 $\gamma_{6,0}$ 1125.73 (†_Y 65 8)
 1151.72 22, (3/2, 5/2)⁺ γ_{371} 780.77 12 (†_Y 23 6) M1+E2 γ_{55} 1097.23
 (†_Y 41 6) γ_{50} 1101.15 10 (†_Y 100 16) $\gamma_{6,0}$ 1145.66 21 (†_Y 51 12) M1
 γ_0 1151.74 (†_Y 33 8)
 1164 4
 1171.2 10, 3/2⁻ γ_{55} 1117.73 (†_Y 69 23) γ_{17} 1154.34 (†_Y 50 8) $\gamma_{6,1}$ 1164.23
 (†_Y 100 12)
 1182.8 6, 1/2, 3/2, 5/2⁺
 1185.5 4, (3/2)⁺ γ_{336} 850.01 8 (†_Y 100 20) γ_{94} 1091.17 (†_Y 19 7) γ_0 1185.13
 (†_Y 87 13)
 1212.5 12(?), 1/2, 3/2, 5/2⁺
 1219 5
 1225.7 7, (1/2⁺, 3/2⁺)
 1238.2 6, 1/2, 3/2, 5/2⁺
 1256.7 6, 1/2⁻, 3/2⁻
 1259.4 5, 1/2, 3/2
 1262.8 6, 1/2, 3/2
 1276.8 5, 1/2, 3/2, 5/2⁺
 1282.9 6, 1/2, 3/2
 1293.4 4, 1/2⁻, 3/2⁻
 1304.8 6, (1/2⁺, 3/2⁺)
 1313.41 8, (3/2)⁻ γ_{478} 835.05 7 M1+E2
 1324.7 4, 1/2, 3/2, 5/2⁺
 1330.2 6, (1/2, 3/2)
 1338.1 6, 1/2⁻, 3/2⁻
 1344 5
 1350.7 2, (3/2)⁻ γ_{478} 872.34 15 M1
 1367 5
 1388.5 10, (1/2⁻, 3/2⁻)
 1395.2 4, 1/2, 3/2
 1402 5
 1408.4 3, 1/2, 3/2
 1422.6 4, 1/2, 3/2, 5/2⁺
 1430 4
 1445.5 10, 1/2, 3/2
 1459.7 6, 1/2, 3/2
 1479.1 4, 1/2⁻, 3/2⁻
 1491.0 4, 1/2, 3/2, 5/2⁺
 1498.1 4, 1/2, 3/2
 1509.9 4, 1/2, 3/2, 5/2⁺
 1517.4 7, 1/2, 3/2, 5/2⁺
 1525.1 4, 1/2, 3/2, 5/2⁺
 1532.7 8, (1/2, 3/2)
 1540.8 5, 1/2, 3/2, 5/2⁺
 1554.7 5, 1/2, 3/2, 5/2⁺
 1557.5 5, 1/2, 3/2, 5/2⁺
 1580.2 8, (1/2, 3/2)
 1589.8 10, 1/2⁻, 3/2⁻
 1601.3 5, 1/2, 3/2, 5/2⁺
 1612.3 5, 1/2, 3/2, 5/2⁺
 1638.0 3, 1/2, 3/2
 1653.6 5, 1/2, 3/2, 5/2⁺
 1658.7 4, 1/2, 3/2, 5/2⁺
 1668.3 5, (1/2⁺, 3/2⁺)
 1688.7 13, 1/2⁺, 3/2⁺, 5/2⁺
 1699.3 4, 1/2, 3/2
 1716.5 12, 1/2(°), 3/2(°)
 1727.7 7, 1/2, 3/2
 1730.6 7, 1/2, 3/2, 5/2⁺
 1736.7 7, 1/2, 3/2, 5/2⁺
 1741.2 9, 1/2, 3/2, 5/2⁺
 1776.4 8, 1/2, 3/2, 5/2⁺
 1796.8 5, 1/2, 3/2, 5/2⁺
 1805.6 5, 1/2, 3/2
 1816.0 5, 1/2, 3/2, 5/2⁺
 1842.0 11(?)

M 1850 250, <100 ns, %SF ≤ 100
 1859.7 9, 1/2, 3/2, 5/2⁺
 1862.5 7, 1/2, 3/2, 5/2⁺
 1894.9 7, 1/2, 3/2, 5/2⁺
 1905.4 4, 1/2, 3/2
 1935.4 5, 1/2, 3/2, 5/2⁺
 1944.4 7, 1/2⁻, 3/2⁻
 1948.0 6, 1/2, 3/2, 5/2⁺
 1961.4 5, 1/2, 3/2
 1964.2 6, 1/2, 3/2, 5/2⁺
 1970.7 10, 1/2, 3/2, 5/2⁺
 1979.0 5, 1/2, 3/2
 1991.0 7, 1/2, 3/2, 5/2⁺
 1995.9 7, 1/2, 3/2, 5/2⁺
 2002.1 5, 1/2, 3/2, 5/2⁺
 2014.7 7, 1/2, 3/2, 5/2⁺
 2026.4 7, 1/2, 3/2, 5/2⁺
 2041.5 6, 1/2, 3/2, 5/2⁺
 2046.6 6, 1/2, 3/2, 5/2⁺
 2053.5 4, 1/2, 3/2, 5/2⁺
 2066.3 5, 1/2, 3/2
 2069.6 9, 1/2, 3/2, 5/2⁺
 2073.9 4, 1/2, 3/2
 2083.1 5, 1/2, 3/2
 2097.2 6, 1/2, 3/2, 5/2⁺
 2114.5 5, 1/2, 3/2, 5/2⁺
 2126.8 4, 1/2, 3/2
 2132.9 4, 1/2, 3/2
 2145.1 5, 1/2, 3/2
 2150.1 7, 1/2, 3/2, 5/2⁺
 2156.2 5, 1/2, 3/2, 5/2⁺
 2176.3 6, 1/2, 3/2, 5/2⁺
 2179.6 7, 1/2, 3/2, 5/2⁺
 2189.4 4, 1/2, 3/2
 2195.3 6, 1/2, 3/2, 5/2⁺
 2228.1 6, 1/2, 3/2, 5/2⁺
 2234.4 6, 1/2, 3/2, 5/2⁺
 2240.9 6, 1/2, 3/2, 5/2⁺
 2244.0 7, 1/2, 3/2, 5/2⁺
 2261.5 6, 1/2, 3/2, 5/2⁺
 2282.6 6, 1/2, 3/2
 2300.6 6, 1/2, 3/2, 5/2⁺

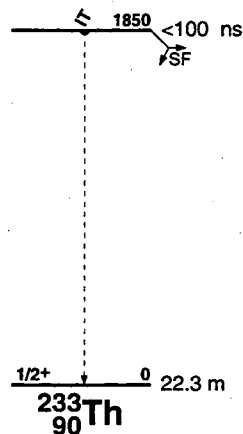

236
92U

Δ : 42439.820 S_n : 6544.85 S_p : 7170.50 Q_α : 4572.09
 σ_f : 0.07 b, σ_f^0 : 5.1121 b

Nuclear Bands

- A Band Structure
- B Band Structure
- C $\sqrt{7/2[743]}-\nu 1/2[631]$
- D $\sqrt{7/2[743]}+\nu 5/2[622]$
- E Band Structure
- F Band Structure
- G $\sqrt{7/2[743]}-\nu 5/2[622]$
- H $\sqrt{7/2[743]}+\nu 1/2[631]$
- I Band Structure
- J Fission isomer band

Levels and γ -ray branchings:

- A 0, 0⁺, 2.342 $\times 10^7$ 3y, % α =100, %SF=9.6 $\times 10^{-8}$ 6
- A 45.242 3, 2⁺, 234 6 ps γ_{100} 45.242 3 ($t_{1/2}$) E2
- A 149.476 15, 4⁺, 124 7 ps γ_{45} 104.234 6 ($t_{1/2}$) E2
- A 309.784 8, 6⁺, 58 3 ps γ_{149} 160.308 3 ($t_{1/2}$) E2
- A 522.24 5, 8⁺, 24 2 ps γ_{310} 212.46 5 ($t_{1/2}$) E2
- B 687.60 5, 1⁻, 3.78 9 ns γ_{449} 538.11 10 ($t_{1/2}$) E3 γ_{45} 642.35 9 ($t_{1/2}$) E1(+M2+E3) $\gamma_{687.59}$ 9 ($t_{1/2}$) E1
- B 744.15 8, 3⁻ γ_{688} 56.6 5 ($t_{1/2}$) (E2) γ_{149} 594.5 3 ($t_{1/2}$)
- A 782.3 5, 10⁺, 11.6 11 ps γ_{522} 260.1 5 ($t_{1/2}$) E2
- B 848.3 8, 5⁻ γ_{744} 104.1 10 ($t_{1/2}$) (E2)
- E 919.21 17, 0⁺ γ_{45} 874.1 2 ($t_{1/2}$) $\gamma_{918.93}$ (E0)
- F 957.99 17, (2⁺) γ_{45} 912.7 ($t_{1/2}$) (M1) $\gamma_{958.02}$ ($t_{1/2}$)
- E 960.3 3, (2⁺) γ_{149} 810.9 ($t_{1/2}$) γ_{45} 915.1 3 ($t_{1/2}$) (M1+E0) $\gamma_{959.9}$ ($t_{1/2}$)
- G 966.6 3 9, 1⁻ γ_{688} 279.0 1 ($t_{1/2}$) (M1,E2) γ_{45} 921.2 2 ($t_{1/2}$) E1 $\gamma_{966.92}$ ($t_{1/2}$) E1
- G 987.6 7 8, 2⁻ γ_{744} 243.6 2 ($t_{1/2}$) E2+M1: $\delta=1.6_{-6}^{+15}$ γ_{688} 300.0 1 ($t_{1/2}$) (E2) γ_{45} 942.4 2 ($t_{1/2}$) E1
- B 999.8 9, 7⁻ γ_{848} 151.5 5 ($t_{1/2}$) E2
- F 1001.5 3, (3⁺) γ_{744} 258.4 γ_{149} 852.2 ($t_{1/2}$) γ_{45} 956.2 3 ($t_{1/2}$)
- G 1035.6 7, (3⁺) γ_{149} 886.2 10 ($t_{1/2}$) γ_{45} 990.2 10 ($t_{1/2}$)
- E 1050.8 5 15, (4⁺) γ_{149} 901.2 5 17 γ_{45} 1006.0 3 ($t_{1/2}$)
- H 1052.8 9 19, (4⁻), 100 4 ns γ_{688} 6 5 1 ($t_{1/2}$) (E2) γ_{848} 204.6 10 ($t_{1/2}$) (E2) γ_{744} 308.0 6 ($t_{1/2}$) E2+M1: $\delta=1.4 7$ γ_{149} 903.5 2 ($t_{1/2}$) E1
- F 1058.6 1 20, (4⁺) γ_{149} 909.1 2 ($t_{1/2}$) (M1) γ_{45} 1014.1 ($t_{1/2}$)
- 1066.1 10, (3⁺, 4⁺)
- G 1070.0 10, (4⁻) γ_{149} 920.5 ($t_{1/2}$)
- A 1085.3 7, 12⁺, 5.3 8 ps γ_{782} 303.0 5 ($t_{1/2}$) E2
- 1093.8 10, (2⁺, 5⁺)
- H 1104.4 14, (5⁻)
- I 1110.6 7 8, (2⁻) γ_{744} 366.6 1 ($t_{1/2}$) γ_{688} 423.1 1 ($t_{1/2}$) γ_{45} 1065.0 2 ($t_{1/2}$)
- F 1126.9 6, (5⁺) γ_{149} 977.4 6 ($t_{1/2}$)
- 1147.0 10, (3⁺, 4⁺)
- I 1149.4 10, (3⁻) γ_{744} 405.2 ($t_{1/2}$)
- G 1164 3, (5⁻)
- H 1164 3, (6⁻)
- 1171.8 2
- B 1198.6 10, 9⁻ γ_{1000} 198.8 3 ($t_{1/2}$) E2
- 1221.4 10, (2⁺, 5⁺)
- H=1232, (7⁻)
- C 1232.2 10, (4⁻)
- 1249.3 10, 2⁺, 5⁺
- 1265.2 10, 3⁺, 4⁺
- 1271.0 9 8, (1⁻, 2, 3) γ_{744} 526.7 2 ($t_{1/2}$) γ_{45} 1225.9 1 ($t_{1/2}$)
- C 1282.2 10, (5⁻)
- H 1320 4, (8⁻)
- 1320.4 10, 2⁺, 5⁺
- 1329.0 10, 3⁺, 4⁺

- 1332.8 10, 3⁺, 4⁺
- C 1342.8 10, (6⁻)
- 1347.5 10, (3⁺, 4⁺)
- 1351.3 10, 3⁺, 4⁺
- 1381.3 10, 3⁺, 4⁺
- 1399.8 10, 2⁺, 5⁺
- C 1413.3 19, (7⁻)
- A 1426.3 9, 14⁺, 2.8 3 ps γ_{1085} 341.0 5 ($t_{1/2}$) E2
- B 1443.6 11, 11⁻ γ_{1189} 245.0 5 ($t_{1/2}$) E2
- D 1471.7 10, (6⁻)
- D 1541.8 13, (7⁻)
- 1572.2 6
- 1580 11 (?), (1, 2) γ_{1580} 11
- 1604.80 7, 1⁻, 2⁺ γ_{1271} 333.7 1 ($t_{1/2}$) γ_{688} 617.1 2 ($t_{1/2}$) γ_{744} 860.6 1 ($t_{1/2}$) γ_{688} 917.0 3 ($t_{1/2}$) γ_{45} 1559.6 1 ($t_{1/2}$) γ_{100} 1604.9 2 ($t_{1/2}$)
- D 1621.8 12, (8⁻)
- 1642.5 20
- 1662.3 7 8, 1, 2⁺ γ_{688} 674.5 2 ($t_{1/2}$) γ_{688} 975.0 2 ($t_{1/2}$) γ_{45} 1617.1 1 ($t_{1/2}$) γ_{100} 1662.4 2 ($t_{1/2}$)
- B 1732.6 15, 13⁻ γ_{1444} 289 1 ($t_{1/2}$) E2
- 1791.3 8, 1(1⁻) γ_{45} 1746.1 10 ($t_{1/2}$) (M1) γ_{100} 1791.3 10 ($t_{1/2}$) (M1)
- A 1800.9 10, 16⁺, 2.1 2 ps γ_{1426} 374.6 5 ($t_{1/2}$) E2
- 1807.8 7, 1, 2⁺ γ_{45} 1762.7 1 ($t_{1/2}$) γ_{100} 1807.8 1 ($t_{1/2}$)
- 1865.4 1 15, 1, 2⁺ γ_{688} 1177.7 2 ($t_{1/2}$) γ_{100} 1865.5 2 ($t_{1/2}$)
- 1896.9 7
- 1972.6 2 9, 1, 2⁺ γ_{45} 1927.0 2 ($t_{1/2}$) γ_{100} 1972.7 1 ($t_{1/2}$)
- 1979.1, 1⁻, 2⁻ γ_{744} 1234.9 1 ($t_{1/2}$) γ_{688} 1291.6 1 ($t_{1/2}$) γ_{45} 1934.1 2 ($t_{1/2}$)
- 1981.0 6 16, 1, 2⁺ γ_{1111} 870.4 2 ($t_{1/2}$) γ_{658} 1023.1 3 ($t_{1/2}$) γ_{100} 1981.0 3 ($t_{1/2}$)
- 2054.2 8, 1(1⁻) γ_{45} 2009.0 10 ($t_{1/2}$) (M1) γ_{100} 2054.2 10 ($t_{1/2}$) (M1)
- B 2060.6 18, 15⁻ γ_{1733} 328 1 ($t_{1/2}$) E2
- 2086.5 4 9, 1(1⁻) γ_{45} 2041.3 1 ($t_{1/2}$) (E1) γ_{100} 2086.5 2 ($t_{1/2}$) (E1)
- 2095.7 8, 1(1⁻) γ_{45} 2050.5 10 ($t_{1/2}$) (M1) γ_{100} 2095.7 10 ($t_{1/2}$) (M1)
- 2155.40 12, 0, 1, 2 γ_{1605} 550.6 1 ($t_{1/2}$)
- 2188.8 8, 1(1⁻) γ_{45} 2143.6 10 ($t_{1/2}$) (M1) γ_{100} 2188.8 10 ($t_{1/2}$) (M1)
- 2190 10, (1, 2⁺) γ_{100} 2190 30 ($t_{1/2}$)
- A 2203.9 12, 18⁺, 1.1 7 12 ps γ_{1801} 403.0 5 ($t_{1/2}$) E2
- 2226.9 3 (?), (2) γ_{45} 2181.6 3 ($t_{1/2}$)
- 2243.9 10, 1 γ_{100} 2243.9 10 ($t_{1/2}$)
- 2251.1 8, 1(1⁻) γ_{45} 2205.9 10 ($t_{1/2}$) γ_{100} 2251.1 10 ($t_{1/2}$)
- 2284.7 8, 1(1⁻) γ_{45} 2239.5 10 ($t_{1/2}$) (M1) γ_{100} 2284.7 10 ($t_{1/2}$) (M1)
- B 2426.6 21, 17⁻ γ_{2061} 366 1 ($t_{1/2}$) E2
- 2435.6 8, 1(1⁻) γ_{45} 2390.4 10 ($t_{1/2}$) (M1) γ_{100} 2435.6 10 ($t_{1/2}$) (M1)
- 2440.2 8, 1(1⁻) γ_{45} 2395.0 10 ($t_{1/2}$) (M1) γ_{100} 2440.2 10 ($t_{1/2}$) (M1)
- 2457.3 8, 1(1⁻) γ_{45} 2412.1 10 ($t_{1/2}$) (M1) γ_{100} 2457.3 10 ($t_{1/2}$) (M1)
- 2494.5 8, 1(1⁻) γ_{45} 2449.3 10 ($t_{1/2}$) (M1) γ_{100} 2494.5 10 ($t_{1/2}$) (M1)
- 2498.5 8, 1(1⁻) γ_{45} 2453.3 10 ($t_{1/2}$) (M1) γ_{100} 2498.5 10 ($t_{1/2}$) (M1)
- A 2631.7 13, 20⁺, 0.84 12 ps γ_{2204} 427.8 5 ($t_{1/2}$) E2
- 2699.0 8, 1(1⁻) γ_{45} 2653.8 10 ($t_{1/2}$) (M1) γ_{100} 2699.0 10 ($t_{1/2}$) (M1)
- 2712.1 8, 1(1⁻) γ_{45} 2666.9 10 ($t_{1/2}$) (E1) γ_{100} 2712.1 10 ($t_{1/2}$) (E1)
- J 2750 10, (0⁺), 120 2 ns, %SF=13 6, %IT=87 6, % α <10 γ_{2189} 560 10 ($t_{1/2}$)
- γ_{1580} 1170 10 ($t_{1/2}$) γ_{967} 1783 10 ($t_{1/2}$) γ_{688} 2062 10 ($t_{1/2}$)
- γ_{45} 2705 ($t_{1/2}$)
- 2756.2 8, 1(1⁻) γ_{45} 2711.0 10 ($t_{1/2}$) (M1) γ_{100} 2756.2 10 ($t_{1/2}$) (M1)
- J 2770 10, (2⁺) γ_{2750} 20.16 ($t_{1/2}$) $I^{(1)}$ =119.1, $I^{(2)}$ =149.0, $\eta\omega=0.017$
- J 2817 10, (4⁺) γ_{2770} 47.0 ($t_{1/2}$) (E2) $I^{(1)}$ =132.3, $I^{(2)}$ =148.7, $\eta\omega=0.030$
- 2823.3 8, 1(1⁻) γ_{45} 2778.1 10 ($t_{1/2}$) (M1) γ_{100} 2823.3 10 ($t_{1/2}$) (M1)
- B=2825, (19⁻) γ_{2427} 396 ($t_{1/2}$) (E2)
- 2838.3 8, 1(1⁻) γ_{45} 2793.1 10 ($t_{1/2}$) (M1) γ_{100} 2838.3 10 ($t_{1/2}$) (M1)
- 2877.8 8, 1(1⁻) γ_{45} 2832.6 10 ($t_{1/2}$) (E1) γ_{100} 2877.8 10 ($t_{1/2}$) (E1)
- J 2891 10, (6⁺) γ_{2817} 73.9 ($t_{1/2}$) (E2) $I^{(1)}$ =137.4, $I^{(2)}$ =148.7, $\eta\omega=0.044$

- 2924.0 8, (2) γ_{45} 2878.8 10 ($t_{1/2}$ 100) γ_{ν} 2924.0 10 ($t_{1/2}$ 60 17)
- 2969.0 8, 1(*) γ_{45} 2923.8 10 ($t_{1/2}$ 50 12) (M1) γ_0 2969.0 10 ($t_{1/2}$ 100) (M1)
- J 2992 10, (8*) γ_{2891} 100.8
- 3040 (?), (1*)
- A 3081.2 14, 22*, 0.65 15 ps γ_{2632} 449.25 ($t_{1/2}$ 100) E2
- 3143.8 8, 1(*) γ_{45} 3098.6 10 ($t_{1/2}$ 56 14) (M1) γ_0 3143.8 10 ($t_{1/2}$ 100) (M1)
- 3436 10(?), (0*) γ_{2750} 684.57 (E0)
- A 3550 2, (24*), 0.41 8 ps γ_{3081} 469 1 ($t_{1/2}$ 100) (E2)
- 3580 (?), (2*) γ_{2750} 830 not M1
- 3860 (?) γ_{3580} 280 γ_{3040} 830
- A 4039 2, (26*), 0.33 9 ps γ_{3550} 489 1 ($t_{1/2}$ 100) (E2)
- 4360 (?) γ_{3580} 780
- A 4549 2, (28*), 0.177 ps γ_{4039} 510 1 ($t_{1/2}$ 100) (E2)
- A \approx 5077, (30*) γ_{4549} =528 ($t_{1/2}$ 100) (E2)

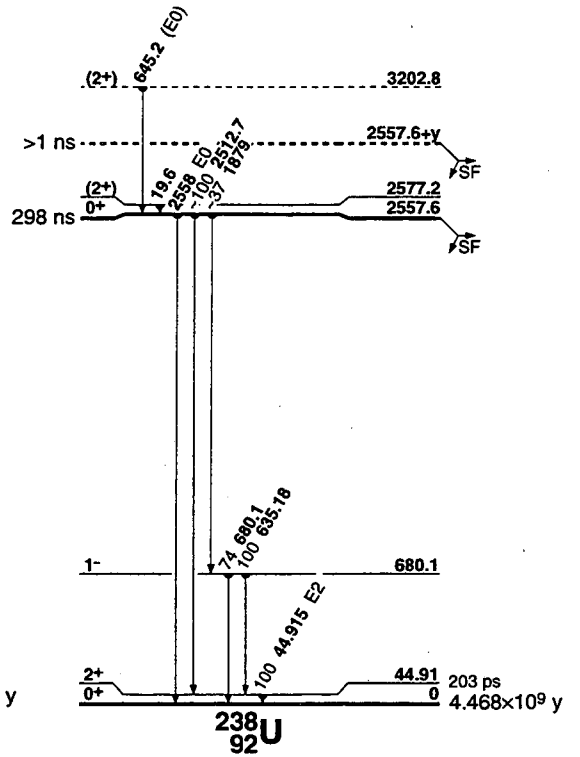
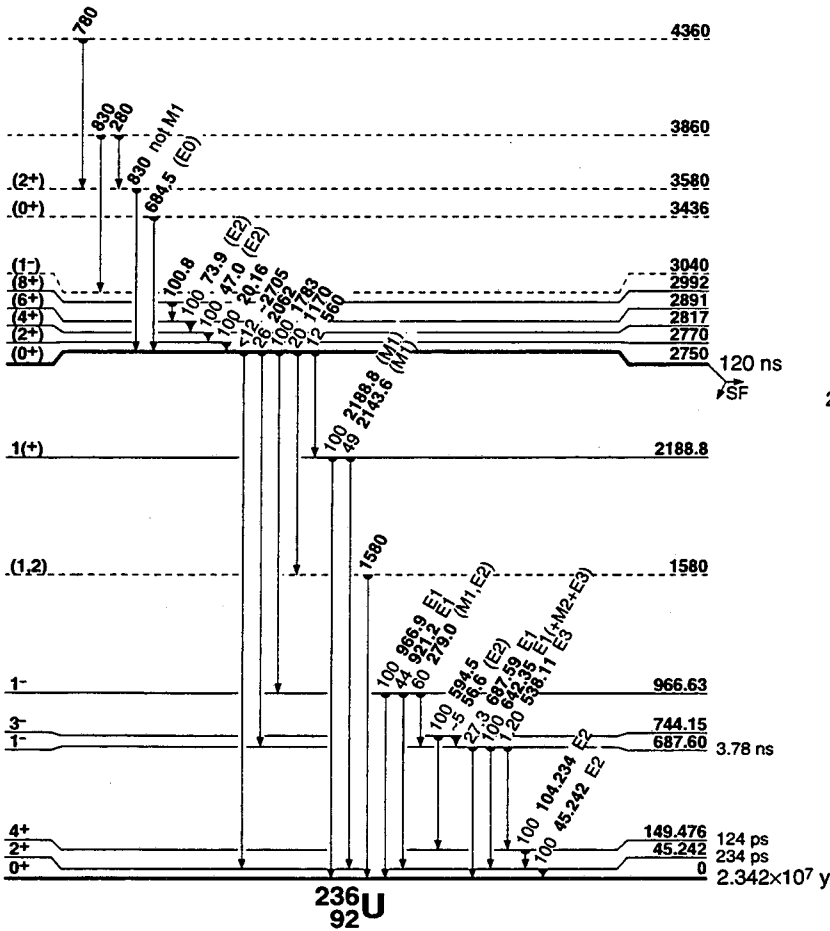

238U
92

%: 99.2745 60
 Δ : 47304.5 20 S_1 : 6152.0 14 S_2 : 7620 100 Q_α : 4270 3
 σ_α^0 : 2.680 19 b, σ_f : 0.004 mb, σ_{α} : 0.0013 6 mb

Nuclear Bands

- A GS band
- B Fission isomer band
- C Fission isomer
- D Octupole band
- E Band Structure
- F β band
- G γ band
- H Band Structure
- I Band Structure
- J v1/2[631]+v5/2[622]
- K Band Structure

Levels and γ -ray branchings:

- 0, 0⁺, 4.468x10⁹ 3 y, %SF=5.38x10⁻⁵ 11, % α =100, Q=13.9 20
- A 44.91 3, 2⁺, 203 7 ps $\gamma_{044.915 13}$ (†, 100) E2
 - A 148.41 5, 4⁺ $\gamma_{148.415 04}$ (†, 100)
 - A 307.21 10, 6⁺ $\gamma_{148.158.80 8}$ (†, 100)
 - A 518.3 3, 8⁺, 23 3 ps $\gamma_{307.211.2 3}$ (†, 100)
 - D 680.1 2, 1⁻ $\gamma_{45.635.18 3}$ (†, 100 2) $\gamma_{680.1 3}$ (†, 74 4)
 - D 731.9 2, 3⁻ $\gamma_{148.583.55 3}$ (†, 83 2) $\gamma_{45.686.99 3}$ (†, 100 2)
 - A 775.7 4, 10⁺, 9.0 9 ps $\gamma_{518.257.8 4}$ (†, 100)
 - D 826.7 5, 5⁻ $\gamma_{307.519.44 8}$ (†, 57 4) $\gamma_{148.678.4 6}$ (†, 100 6)
 - E 925.7 3, (0⁺) $\gamma_{45.880.8 2}$ (†, 100)
 - H 930.8 3, (1⁻) $\gamma_{680.251.3 10}$ (†, 11 3) $\gamma_{45.886.2 4}$ (†, 100 4) $\gamma_{0931.5 6}$ (†, 27 2)
 - H 950.2 4, (2⁻) $\gamma_{732.218.0 3}$ (†, 43 5) $\gamma_{680.270.1 4}$ (†, 37 6) $\gamma_{45.905.6 6}$ (†, 100 6)
 - D 966.3 5, 7⁻ $\gamma_{518.448.4 9}$ $\gamma_{307.659.1 2}$
 - E 967.3 3, 2⁺, 0.6 4 ps $\gamma_{732.234.5 10}$ (†, 16 2) $\gamma_{680.286.4 10}$ (†, 14 1) $\gamma_{148.818.4 4}$ (†, 100 5) $\gamma_{45.922.3 2}$ (†, 59 3) E2+M1+E0 $\gamma_{0967.3 2}$ (†, 18 1)
 - F 993 (?), (0⁺)
 - H 997.5 3, 3⁻ $\gamma_{827.171}$ (†, <1.5) $\gamma_{680.318.0 10}$ (†, 7.6 3) $\gamma_{148.849.1 4}$ (†, 100 3) $\gamma_{45.952.70 7}$ (†, 61 3)
 - F 1037.3 2, 2⁺, 0.67 15 ps $\gamma_{732.305.5 6}$ (†, 10.5 4) $\gamma_{680.357.7 4}$ (†, 9.0 4) $\gamma_{148.888.9 3}$ (†, 76.5 15) $\gamma_{45.993.0 10}$ (†, 73.8 15) E2+M1+E0 $\gamma_{01037.4 2}$ (†, 100 3)
 - E 1056.6 3, (4⁺) $\gamma_{307.749.3 3}$ (†, 100)
 - J 1059.5, (3⁺) $\gamma_{148.911.1}$ (†, 43) $\gamma_{45.1014.6}$ (†, 100)
 - G 1060.3 2, 2⁺, 0.66 5 ps $\gamma_{148.911.9 4}$ (†, 3.3 2) $\gamma_{45.1015.3 2}$ (†, 100 2) $\gamma_{01060.3 2}$ (†, 68.4 13)
 - A 1076.5 5, 12⁺, 4.2 6 ps $\gamma_{776.300.6 9}$ (†, 100)
 - G 1105.7, (3⁺) $\gamma_{148.957.33 6}$ (†, 100) $\gamma_{45.1060.98 3}$
 - I 1112.6 2, (1⁻) $\gamma_{680.432.5 3}$ $\gamma_{01112.7 3}$
 - F 1127.0 3, (4⁺) $\gamma_{827.300.6 10}$ (†, 57 48) $\gamma_{148.978.5 3}$ (†, <100)
 - I 1128.7 3, (2⁻) $\gamma_{931.198.6 3}$ (†, =12) $\gamma_{732.396.4 3}$ (†, 25.5 14) $\gamma_{680.448.3 4}$ (†, 100 4) $\gamma_{45.1084.0 4}$ (†, <80) $\gamma_{307.828.3 6}$ (†, 25 8) $\gamma_{45.1090.9 2}$ (†, 100 8)
 - D 1150.3 6, 9⁻ $\gamma_{776.374.8 4}$ $\gamma_{518.632.6 4}$
 - G 1168.0 2, (4⁺) $\gamma_{148.1019.61 8}$ (†, 100 7) $\gamma_{45.1123.1 2}$ (†, 40 4)
 - I 1170.4 3, 3⁻ $\gamma_{967.203.4 10}$ $\gamma_{680.490.3 2}$ $\gamma_{148.1021.1}$ $\gamma_{45.1123.1}$
 - 1224.2 3, (2⁻), 2.3 14 ps $\gamma_{1060.3.163.9 5}$ (†, 17.4 15) $\gamma_{950.274.0 10}$ (†, <11) $\gamma_{45.1179.4 2}$ (†, 93 4) $\gamma_{01223.7 4}$ (†, 100 4)
 - 1231
 - I 1232.6 5, (4⁺) $\gamma_{950.282.2 6}$ (†, 100 43) $\gamma_{827.405.8 10}$ (†, 57 28) $\gamma_{732.501.1}$ (†, 100 30) $\gamma_{148.1084.2}$
 - 1260.9 2 $\gamma_{1037.223.4 4}$ (†, 100 24) $\gamma_{148.1112.7 3}$ (†, <41) $\gamma_{45.1215.9 2}$ (†, 65 6) $\gamma_{01262.1}$ (†, 12 6)
 - F 1269.2 10, (6⁺) $\gamma_{307.962.0 10}$ (†, 100)
 - 1278.5 3, (1⁻, 2⁻) $\gamma_{732.547.0 3}$ (†, 80 20) $\gamma_{45.1233.8 3}$ (†, 80 20) $\gamma_{01278.8 2}$ (†, 100 10)
 - I 1285.8 3, (5⁻) $\gamma_{998.287.9 4}$ (†, <100) $\gamma_{307.978.5 3}$ (†, <63) $\gamma_{148.1138.0 10}$ (†, 27 9)
 - 1355.2 3, (1, 2⁻) $\gamma_{45.1310.5 4}$ (†, 100 20) $\gamma_{01354.5 10}$ (†, 60 20)

- 1375
- D 1378.4 6, 11⁻ $\gamma_{1150.228.1 4}$ $\gamma_{1077.302.3}$ $\gamma_{776.602.9 4}$
- I 1381.7 3, (6⁻) $\gamma_{827.555.3 5}$ (†, 71 28) $\gamma_{307.1074.4 2}$ (†, 100 14)
- 1413.3 2, (2⁺, 3⁻) $\gamma_{1113.300.6 10}$ $\gamma_{1060.3.352.3 1}$ (†, 100 8) $\gamma_{931.482.9 3}$ (†, 28 8) $\gamma_{148.1265.6 10}$ (†, 12 4) $\gamma_{45.1368.3 2}$
- A 1415.3 6, 14⁺, 2.6 2 ps $\gamma_{1077.338.8 4}$ (†, 100)
- K 1482.0 2, (0⁺) $\gamma_{1113.369.5 2}$ (†, 100 15) $\gamma_{1037.443.8 10}$ (†, 38 16) $\gamma_{931.552.5 10}$ (†, 38 16) $\gamma_{45.1437.1 2}$ (†, 100 15)
- 1516.5 2, (4⁺) $\gamma_{950.566.1 3}$ $\gamma_{307.1209.3 3}$ $\gamma_{148.1368.3 2}$ $\gamma_{45.1470.1}$
- K 1530.7 2, 2⁺ $\gamma_{1126.401.6 3}$ (†, 91 18) $\gamma_{732.798.9 2}$ (†, 100 10) $\gamma_{148.1381.8 5}$ (†, 36 9) $\gamma_{45.1485.1}$ (†, 18 9) $\gamma_{01531.6 10}$ (†, 18 9)
- 1594.9 2, (2⁺, 3, 4⁺) $\gamma_{827.768.3}$ $\gamma_{732.863.5 6}$ (†, <37) $\gamma_{148.1446.2 3}$ (†, 100 13) $\gamma_{45.1550.0 4}$ (†, 75 13)
- 1630
- K 1643.2 3, 4⁺ $\gamma_{1355.287.9 4}$ (†, <100) $\gamma_{827.816.6}$ $\gamma_{307.1336.2 3}$ (†, 54 9) $\gamma_{148.1495.1}$ (†, 36 12) $\gamma_{45.1598.2 4}$ (†, 46 13)
- D 1648.9 8, 13⁻ $\gamma_{1378.270.5 4}$ $\gamma_{1077.572.4 4}$
- 1665
- 1672.0 2 $\gamma_{1106.566.1 3}$ (†, <100) $\gamma_{148.1523.7 3}$ (†, 56 11) $\gamma_{45.1627.3 6}$ (†, 33 11)
- 1712
- 1761.2 4, (4⁺) $\gamma_{1224.536.8 4}$ (†, 46 18) $\gamma_{1136.625.2 2}$ (†, 100 20) $\gamma_{1106.655.1}$ (†, 46 18) $\gamma_{307.1454.1}$ (†, 27 9) $\gamma_{45.1716.7 6}$ (†, 36 9)
- 1774.7, (3⁻, 4, 5⁻) $\gamma_{1168.606.6 2}$ (†, 100 12) $\gamma_{1127.647.7 4}$ (†, 24 8) $\gamma_{966.808.4 1}$ (†, 56 8) $\gamma_{732.1043.1}$ (†, 4 4) $\gamma_{148.1627.3 6}$ (†, 12 3)
- A 1788.2 8, 16⁺, 1.66 7 ps $\gamma_{1415.372.9 4}$ (†, 100)
- K 1814.3 3, (6⁺) $\gamma_{1382.432.5 3}$ (†, <100) $\gamma_{518.1296.1}$ (†, 37 12) $\gamma_{307.1507.1 3}$ (†, 100 12)
- 1892.2 2, (4⁺, 5⁻) $\gamma_{1643.248.6 7}$ (†, 90 40) $\gamma_{732.1160.4 2}$ (†, 100 10) $\gamma_{307.1584.9 3}$ (†, 70 10)
- D 1958.6 8, 15⁻ $\gamma_{1649.309.9 4}$ $\gamma_{1415.543.7 4}$
- 1992.6 3, (3⁺) $\gamma_{1286.706.6 2}$ (†, 100 13) $\gamma_{1224.768.3 2}$ (†, <69) $\gamma_{1126.863.5 6}$ (†, <19) $\gamma_{1059.5.932.7 3}$ (†, 50 6) $\gamma_{148.1844.6 5}$ (†, 25 6)
- 2163.6 3 $\gamma_{732.1431.3 10}$ (†, 67 15) $\gamma_{307.1856.6 4}$ (†, 100 15) $\gamma_{148.2014.8 4}$ (†, 84 15)
- A 2190.7 13, 18⁺, 1.18 7 ps $\gamma_{1788.402.6 4}$ (†, 100)
- D 2305.9 10, 17⁻ $\gamma_{1959.347.5 4}$ $\gamma_{1788.518.3 4}$
- B 2557.6 5, 0⁺, 298 18 ns, %IT=95, %SF=5 $\gamma_{680.1879}$ (†, =37) $\gamma_{45.2512.7 5}$ (†, =100) $\gamma_{02558.2}$ (†, =0.8) E0
- B 2577.2, (2⁺) $\gamma_{2558.19.6}$
- C 2557.6+y (?), >1 ns, %SF \leq 100
- A 2618.7 16, 20⁺, 0.90 7 ps $\gamma_{2181.427.9 4}$ (†, 100)
- D 2687.2 14, 19⁻ $\gamma_{2306.382.7 4}$ $\gamma_{2181.498.3}$
- 2754, (1), $\Gamma=8.4 \times 10^{-5}$ eV $\gamma_{45.2709}$ (†, 20 10) γ_{02754} (†, 100)
- A 3067.2 20, 22⁺, 0.69 14 ps $\gamma_{2619.448.9 4}$ (†, 100)
- D 3104.2 14, 21⁻ $\gamma_{2687.415.1 10}$
- 3202.8 10 (?), (2⁺) $\gamma_{2558.645.2 9}$ (E0)
- 3253.4, 1⁻, $\Gamma=5.2 \times 10^{-4}$ 19 eV $\gamma_{1126.2125}$ (†, 44) $\gamma_{1037.2217}$ (†, 9) $\gamma_{998.2256}$ (†, 8) $\gamma_{967.2288}$ (†, 91) $\gamma_{950.2303}$ (†, 16) $\gamma_{931.2323}$ (†, 32) $\gamma_{926.2327}$ (†, 33) $\gamma_{732.2522}$ (†, 14) $\gamma_{680.2574}$ (†, 28) $\gamma_{45.3209}$ (†, 22) γ_{03253} (†, 100)
- A 3534.5 15, 24⁺, 0.51 4 ps $\gamma_{3067.467.1}$ (†, 100)
- D 3547.8 18, 23⁻ $\gamma_{3104.443.6 10}$
- 3809, (1, 2), $\Gamma>1.6 \times 10^{-3}$ eV $\gamma_{926.2882}$ (†, 55 22) $\gamma_{680.3128}$ (†, 28 22) $\gamma_{45.3764}$ (†, 96 14) γ_{03809} (†, 100)
- A 4017.3 18, 26⁺, 0.40 6 ps $\gamma_{3535.482.8 10}$ (†, 100)
- 4494, (1, 2), $\Gamma>4.7 \times 10^{-5}$ eV $\gamma_{45.4450}$ (†, 32 28) γ_{04495} (†, 100)
- A 4516.5 21, 28⁺, 0.37 9 ps $\gamma_{4017.499.3 10}$ (†, 100)
- 4592, (1, 2), $\Gamma>2.8 \times 10^{-4}$ eV $\gamma_{45.4546}$ (†, 190) γ_{04592} (†, 100)
- 4806.6, (1), $\Gamma=2.5 \times 10^{-4}$ 5 eV $\gamma_{967.3840}$ (†, 47 17) γ_{04807} (†, 100)
- A 5034.3 23, 30⁺ $\gamma_{4517.517.7 10}$
- 5206, (1, 2), $\Gamma>4.1 \times 10^{-4}$ eV $\gamma_{1059.5.4148}$ (†, 33 26) $\gamma_{45.5160}$ (†, 90 28) γ_{05206} (†, 100)

237
93Np

Δ : 44866.7 20 S_n : 6580 50 S_p : 4862.13 Q_α : 4959.1 12
 σ_f^0 : 1763 b, σ_f^p : 0.021524 b

Nuclear Bands

- A 5/2[642]
- B 5/2[523]
- C 1/2[530]
- D 1/2[400]
- E 3/2[521]
- F Band Structure
- G Fission isomer

Levels and γ -ray branchings:

- A 0.0, 5/2⁺, 2.144×10⁶ 7y, % α =100, %SF≤2×10⁻¹⁰, μ =+3.14 4, Q_α =+3.886 6
- A 33.1964 3, 7/2⁺, 54 24 ps γ_{60} 33.1964 3 M1+E2: δ =-0.13 3
- B 59.5412 1, 5/2⁻, 67 2 ns, μ =+1.68 3, Q_α =+3.85 4 γ_{33} 26.3448 2 (\dagger , 6.71 14)
E1 γ_0 59.5412 2 (\dagger , 100) E1
- A 75.92 4, 9/2⁺, ≈ 56 ps γ_{33} 42.73 5 (\dagger , 100 15) γ_0 75.82 (\dagger , =11)
- B 102.96 2, 7/2⁻, 80 40 ps γ_{76} 27.03 γ_{60} 43.423 10 (\dagger , 100 11)
M1+E2: δ =0.41 2 γ_{33} 69.76 3 (\dagger , 4.0 6) (E1) γ_0 102.98 2 (\dagger , 26.7 2) E1
- A 130.00 3, 11/2⁺ γ_{76} 54.0 γ_{33} 96.7
- B 158.51 2, 9/2⁻ γ_{103} 55.56 2 (\dagger , 89 9) M1+E2: δ =0.46 4 γ_{60} 98.97 2 (\dagger , 100 2)
E2 γ_{33} 125.30 2 (\dagger , 20.1 2)
- A 191.46 8, 13/2⁺ γ_{76} 115.5 1 (\dagger , 100)
- B 225.96 2, 11/2⁻ γ_{159} 67.45 5 (\dagger , 42 10) (M1+E2): δ =0.46 12 γ_{103} 123.01 2
(\dagger , 100 1) E2 γ_{76} 150.04 3 (\dagger , 7.40 15)
- C 267.54 2, 3/2⁻, 5.2 2 ns γ_{103} 164.61 2 (\dagger , 8.6 2) E2 γ_{60} 208.00 1 (\dagger , 100 1)
M1+E2: δ =+0.156 5 γ_{33} 234.40 4 (\dagger , 0.097 10) M2 γ_0 267.54 4
(\dagger , 3.36 10) E1+M2: δ =-0.490 15
- A 269.9 5, 15/2⁺ γ_{130} 139.9 (\dagger , 100)
- C 281.35 2, 1/2⁻ γ_{268} 13.81 2 (\dagger , 21.4 8) M1+E2: δ =0.0321 10 γ_{60} 221.80 4
(\dagger , 100 4) E2
- B 305.06 4, 13/2⁻ γ_{159} 146.55 3 (\dagger , 100 2) E2 γ_{130} 175.07 4 (\dagger , 3.9 3)
316.8 2(?) γ_0 316.8 2
- C 324.42 5, (7/2⁻) γ_{159} 165.81 6 (\dagger , 54.7 24) γ_{103} 221.46 3 (\dagger , 100 2)
 γ_{76} 249.00 15 (\dagger , 1.3) γ_{60} 264.89 6 (\dagger , 21.2 10) γ_{33} 291.30 20 (\dagger , 7.3 8)
- D 332.36 3, 1/2⁺, <1.0 ns γ_{281} 51.01 3 (\dagger , 93.4 16) E1 γ_{268} 64.83 2 (\dagger , 100 2)
E1 γ_0 332.36 4 (\dagger , 26.6 8) E2
- A 348.5 5, 17/2⁺ γ_{191} 157.0 (\dagger , 100)
- C 359.7 1, (5/2⁻) γ_{60} 300.13 6
- D 368.59 3, 5/2⁺ γ_{76} 292.77 6 (\dagger , 2.86 11) γ_{60} 309.1 3 (\dagger , 0.28) γ_{33} 335.38 3
(\dagger , 100 1) M1+E2: δ =-0.46 17 γ_0 368.59 4 (\dagger , 43.7 2) M1(+E2): δ <0.31
- D 370.93 3, 3/2⁺ γ_{332} 38.54 3 (M1+E2) γ_{33} 337.7 2 (\dagger , 8.3 5) (E2) γ_0 370.94 3
(\dagger , 100 1) M1+E2: δ =-0.43 \pm 21
- B 395.52 5, 15/2⁻ γ_{226} 169.56 3 (\dagger , 100 2) E2 γ_{191} 204.06 6 (\dagger , 1.68 11)
- C 434.12 16, (11/2⁻) γ_{324} 109.70 7 (\dagger , 74) γ_{305} 129.2 γ_{159} 275.77 8 (\dagger , 100 7)
 γ_{130} 304.21 20 (\dagger , 15 4) γ_{76} 358.25 20 (\dagger , 18 4)
- D 452.53 5, 9/2⁺ γ_{191} 260.80 15 (\dagger , 0.87 14) γ_{130} 322.52 3 (\dagger , 110 1)
(M1+E2): δ =0.6 γ_{76} 376.65 3 (\dagger , 100 1) (M1) γ_{33} 419.33 4 (\dagger , 20.8 5)
 γ_0 452.6 2 (\dagger , 1.74 18)
- A 454.4 10, 19/2⁺ γ_{270} 184.5
- D 459.69 4, 7/2⁺ γ_{324} 135.3 γ_{76} 383.81 3 (\dagger , 100 2) γ_{33} 426.47 4 (\dagger , 87.2 18)
 γ_0 459.68 10 (\dagger , 12.8 11)
- C 485.96 12, (9/2⁻) γ_{324} 161.54 10 (\dagger , 100) γ_{226} 260.80 15
- B 497.02 6, 17/2⁻ γ_{305} 191.96 4 (\dagger , 100)
- E 514.19 6, (3/2⁻) γ_{361} 154.27 20 (\dagger , 11.7) γ_{281} 232.81 5 (\dagger , 100 7)
 γ_{268} 246.73 10 (\dagger , 52 7) γ_{60} 454.66 8 (\dagger , 211 7) γ_0 514.0 5 (\dagger , 57 7)
- E 545.59 16, (5/2⁻) γ_{281} 264.89 6 γ_{268} 278.04 15 (\dagger , 38) γ_{33} 512.5 3
(\dagger , 100 20) γ_0 545.4 3 (\dagger , 64)
- A 547.0 10, 21/2⁺ γ_{349} 198.5
- E 590.28 15, (7/2⁻) γ_{268} 322.52 3 γ_{103} 487.3 3 (\dagger , 15.4) γ_0 590.28 15
(\dagger , 100 7)
- D 592.3 10, 13/2⁺ γ_{453} 139.44 8 (\dagger , 100 21) γ_{434} 159.26 20 (\dagger , 26 10)
 γ_{396} 197.0 2 (\dagger , 9.2) γ_{191} 401 3 (\dagger , 9.2) γ_{130} 463.22 20 (\dagger , 19)

- D 598.0 2, 11/2⁺ γ_{460} 138.5 γ_{191} 406.35 15 (\dagger , 50 8) γ_{130} 468.12 15 (\dagger , 100 8)
 γ_{76} 522.06 15 (\dagger , 31 11)
618 2
- E 646.1 2, (9/2⁻) γ_{159} 487.3 3 γ_{60} 586.59 20 (\dagger , 100)
666.2 2, (5/2⁺, 7/2⁻) γ_{268} 398.64 15 (\dagger , 160) γ_{76} 590.28 15 γ_{33} 632.93 15
(\dagger , 100) γ_0 666.5 3 (\dagger , 39)
- A 684.4 12, 23/2⁺ γ_{547} 137.6 γ_{454} 230.0
- E 709.3, (11/2⁻)
- F 721.95 5, 5/2⁻ γ_{268} 454.66 8 γ_{159} 563.05 30 (\dagger , 0.20) γ_{103} 619.01 2
(\dagger , 16.3 2) γ_{60} 662.40 2 (\dagger , 100 1) E0+M1+E2 γ_{33} 688.72 4 (\dagger , 8.9 2)
 γ_0 722.01 3 (\dagger , 53.8 3)
- F 756.00 10, 7/2⁻ γ_{159} 597.48 8 (\dagger , 19.7 8) γ_{103} 653.02 4 (\dagger , 100 3)
 γ_{76} 680.10 10 (\dagger , 8.3 5) γ_{60} 696.60 5 (\dagger , 14.2 5) γ_{33} 722.01 3 γ_0 755.90 5
(\dagger , 20.2 7)
758 6
770.57 5 γ_{324} 446.43 15 (\dagger , 6.1 2) γ_{33} 737.34 5 (\dagger , 100 3) γ_0 770.57 10
(\dagger , 59 3)
- A 787.1 12, 25/2⁺ γ_{547} 240.1
- F 800.00 10, 9/2⁻ γ_{226} 573.94 20 (\dagger , 18 3) γ_{159} 641.47 5 (\dagger , 100 5)
 γ_{130} 669.83 20 (\dagger , 5.4 17) γ_{103} 696.60 5 γ_{33} 767.00 10 (\dagger , 70.4 22)
805.8 2, (7/2⁺, 9/2⁺) γ_{130} 676.03 30 (\dagger , 24 5) γ_{76} 729.72 15 (\dagger , 50 6)
 γ_{33} 772.4 3 (\dagger , 100 6) γ_0 806.3 3 (\dagger , 11.7)
823 3
- F 853.36 20, 11/2⁻ γ_{324} 529.17 20 (\dagger , 82) γ_{226} 627.18 20 (\dagger , 100 31)
861.7 5, (5/2⁺, 7/2⁻) γ_{76} 786.00 15 (\dagger , 46) γ_{60} 801.94 20 (\dagger , 100) γ_{33} 828.5
(\dagger , 18 5) γ_0 862.7 5 (\dagger , 39 5)
906 2
914 4
920.9 5 γ_{60} 860.7 5 (\dagger , 37 12) γ_{33} 887.3 3 (\dagger , 100 23) γ_0 921.5 3 (\dagger , 86 19)
945.3 2, 11/2, 13/2, 0.71 4 μ s, %IT=100 γ_{305} 640.4 3 (\dagger , 33 7) γ_{270} 675.6 4
(\dagger , 5.4 11) γ_{226} 719.2 2 (\dagger , 41 9) γ_{191} 753.6 2 (\dagger , 48 10) γ_{159} 786.8 2
(\dagger , 45 9) γ_{130} 815.3 2 (\dagger , 100 20)
946 2
- A 959.6 15, 27/2⁺ γ_{787} 172.6 γ_{684} 275.1
961 3
963 2
984 2
1013 3
1020 3
1030 3
1040 4
1066 3
- A 1068.3 13, 29/2⁺ γ_{787} 281.2
1072 6
1112 4
- A 1278.8 14, 31/2⁺ γ_{1068} 210.5 γ_{960} 319
- A 1389.3 3/2⁺ γ_{1068} 321
- A 1639.3 5/2⁺ γ_{1389} 249.4 γ_{1279} 361
- A 1749.3 7/2⁺ γ_{1389} 360
- A 2041.3 9/2⁺ γ_{1749} 292.7 γ_{1639} 401.1
- A 2146.4 1/2⁺ γ_{1749} 396.9
- A 2480.4 3/2⁺ γ_{2146} 334.8 γ_{2041} 439.0
- A 2578.4 5/2⁺ γ_{2146} 431.9
- G 2800 400, 45 5 ns, %SF>0, %IT>0
- A 2955.4 7/2⁺ γ_{2578} 378.2 γ_{2480} 475.3
- A 3043.4 9/2⁺ γ_{2578} 465.5
- A 3464.5 1/2⁺ γ_{2955} 508.6
- A 3541.5 3/2⁺
- A 4004.5 5/2⁺ γ_{3464} 540.1
- A 4069.5 7/2⁺ γ_{3541} 527.5

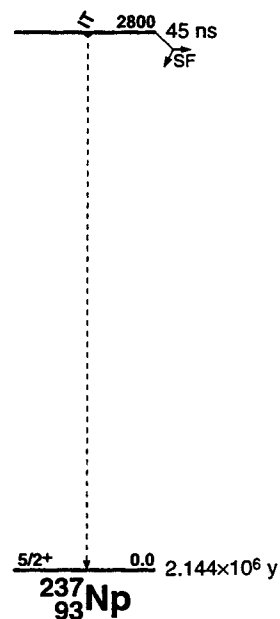

235
94Pu

Δ : (42200) S_n : (6210) S_p : (5040)
 Q_{EC} : (1170) Q_α : (6000)

Nuclear Bands

- A 5/2[633]
- B Fission isomer

Levels:

- A 0, (5/2⁺), 25.3 10 m, %EC=99.9973 5,
% α =0.0027 5
- B 3000 200, 25 5 ns, %SF \leq 100

236
94Pu

Δ : 42893 3 S_n : (7380) S_p : 5432.7 21 Q_α : 5867.07 8
 σ_f : 170.35 b

Nuclear Bands

- A Fission isomer

Levels and γ -ray branchings:

- 0, 0⁺, 2.858 8 y, % α =100, %SF=1.36 \times 10⁻⁷ 4
- 44.63 10, 2⁺ γ_0 44.63 10 (†, 100) E2
- 147.45 10, 4⁺ γ_{45} 102.82 2 (†, 100)
- 305.80 11, 6⁺ γ_{147} 158.35 2 (†, 100) E2
- 515.7 2, 8⁺ γ_{306} 209.9 2 (†, 100) E2
- 773.5 3, 10⁺ γ_{516} 257.8 2 (†, 100)
- 1074.3 4, 12⁺ γ_{774} 300.8 2 (†, 100)
- 1413.6 4, 14⁺ γ_{1074} 339.3 2 (†, 100)
- 1786.0 5, 16⁺ γ_{1414} 372.4 3 (†, 100)
- A =3000, (0⁺), 37 4 ps, %SF \leq 100
- A 4000 200, 34 8 ns, %SF \leq 100

237
94Pu

Δ : 45087.0 24 S_n : 5877.5 25 S_p : 5580 50
 Q_{EC} : 220.3 13 Q_α : 5750 3

σ_f : 2455 295 b

Nuclear Bands

- A 7/2[743]
- B 1/2[631]
- C 5/2[622]
- D 3/2[631]
- E 5/2[633]
- F 7/2[624]
- G 1/2[501]
- H Fission isomer
- I Band Structure
- J 1/2[631]+0⁺

Levels and γ -ray branchings:

- A 0, 7/2⁻, 45.2 1 d, % α =0.0042 4,
%EC=99.9958 4
- A 47.71 4, 9/2⁻ γ_0 47.71 4 M1+E2: δ =0.24 8
- A 106 5, 11/2⁻
- B 145.544 10, 1/2⁺, 0.18 2 s γ_0 145.544 10 E3
- B 155.45 2, 3/2⁺ γ_{146} 9.903 16 M1+E2: δ =0.07 2
- A 175 7, 13/2⁻
- B 201.18 2, 5/2⁺ γ_{155} 45.724 8 (†, 46 12)
M1+E2: δ =0.47 13 γ_{146} 55.638 11 (†, 100 16)
(E2)
- B 224.25 5, 7/2⁺ γ_{155} 68.8 1 (E2)
- A 257, 15/2⁻
- C 280.22 2, 5/2⁺ γ_{201} 79.05 2 (†, 0.42 7) (M1)
 γ_{155} 124.72 3 (†, 0.59 11) (M1) γ_0 280.23 2
(†, 100 5) E1

- B 304 4, 9/2⁺
- C 320.97 2, 7/2⁺ γ_{280} 40.748 6 (†, 2.0 4)
M1+E2: δ =0.19 3 γ_{48} 273.3 1 (†, 54 4)
 γ_0 321.0 1 (†, 100 8) E1
- D 370.40 4, 3/2⁺ γ_{155} 214.9 2 (†, 100 21) (M1)
 γ_{146} 224.86 4 (†, 100 21) (M1)
- C 371 5, 9/2⁺
- D 404.19 5, 5/2⁺ γ_{280} 123.8 3 (†, =7)
 γ_{224} 179.94 2 (†, 41 9) (M1(+E2)): δ =0.7 7
 γ_{201} 203.03 5 (†, 71 9) M1(+E2): δ =0.4 4
 γ_{155} 248.7 2 (†, 100 10) (M1(+E2)): δ =0.6 6
- E 407.83 6, 5/2⁺ γ_{280} 127.5 2 (†, 17 4)
 γ_{224} 183.7 2 (†, 30 8) M1(+E2): δ =0.7 7
 γ_{201} 206.7 1 (†, 52 7) M1(+E2): δ =0.3 3
 γ_{155} 252.2 2 (†, 43 12) M1(+E2): δ =0.6 6
 γ_0 407.8 1 (†, 100 8) (E1)
- E 438.41 10, 7/2⁺ γ_{280} 158.3 3 (†, 0.8 3)
 γ_{48} 390.7 1 (†, 6.6 5) E1 γ_0 438.4 1
(†, 100 5) E1
- D 453.2 2, 7/2⁺ γ_{224} 229.1 3 (†, 100 34)
 γ_{201} 252.2 2 (†, 100 34) γ_0 453.2 3
(†, 67 14)
- F 473.50 10, 7/2⁺ γ_{280} 193.4 3 (†, 2.1 7)
 γ_{48} 425.8 1 (†, 45 3) E1 γ_0 473.5 1
(†, 100 7) E1
- E 486, (9/2⁺)
- D 513, 9/2⁺
- G 545, (1/2⁻)
- G 582, (5/2⁻)
- G 591, (3/2⁻)
- 655
- I 655.3 2, (5/2⁻) γ_0 655.3 2 M1
- G 691, (7/2⁻)
- I 696.2 3, 7/2⁻ $\gamma_{655.3}$ 40.748 6 γ_{48} 648.5 3
(†, 100 16) M1 γ_0 696.2 3 (†, 77 16) M1
- 716
- 741
- 757
- 775
- J 800 2, 1/2⁺
- 809
- 840
- 851 5, 3/2⁺, 5/2⁺
- 852
- 884
- 908.9 2, 7/2⁺ γ_{474} 435.2 3 (†, 9.6 16) M1
 γ_{453} 455.8 3 (†, 3.5 8) M1 γ_{408} 501.2 3
(†, 10.8 16) M1 γ_{404} 504.8 3 (†, 7.3 16) M1
 γ_{48} 861.2 3 (†, 14.2 16) γ_0 908.8 2
(†, 100 6)
- 933
- 964
- 998 5
- 1000.6 3, 3/2⁺, 5/2⁺, 7/2⁺ γ_{280} 720.4 5 (†, 100 21)
 γ_0 1000.6 3 (†, 79 21)
- 1014
- 1025 3
- 1053
- 1104
- 1189
- 1216
- 1250
- 1264
- 1348
- 1383
- 1397
- 1463
- 1481
- 1534
- H 2600 200, 85 15 ns, %SF \leq 100
- H 2900 250, 1.1 1 μ s, %SF \leq 100

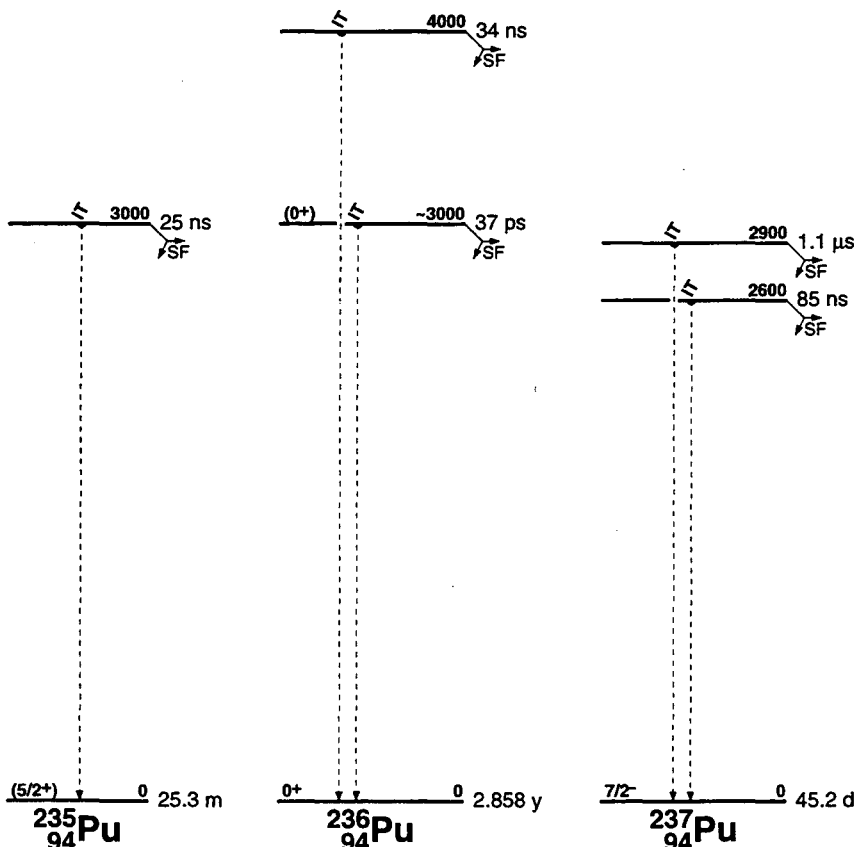

238Pu
94

Δ : 46157.820 S_n : 7000.515 S_p : 5997.87

Q_α : 5593.2019

σ_f^0 : 17.94 b, σ_f^0 : 5407 b

Nuclear Bands

- A GS band
- B Octupole band
- C β band
- D $\nu 7/2[743]-\nu 5/2[622]$
- E Band Structure
- F Band Structure
- G Band Structure
- H $\nu 7/2[743]+\nu 1/2[631]$
- I $\nu 7/2[743]-\nu 1/2[631]$
- J Fission isomer

Levels:

- 0, 0⁺, 87.73 y, $\% \alpha = 100$, $\% SF = 1.9 \times 10^{-7}$
- A 44.083, 2⁺, 177.5 ps $\gamma_{44} 44.083$ ($t_{1/2}$) E2
- A 145.964, 4⁺ $\gamma_{44} 101.903$ ($t_{1/2}$) E2
- A 303.407, 6⁺ $\gamma_{146} 157.425$ ($t_{1/2}$) E2
- A 513.42, 8⁺ $\gamma_{303} 210.02$ ($t_{1/2}$)
- B 605.186, 1⁻, 4.75 ps $\gamma_{44} 561.117$ ($t_{1/2}$) E1
- $\gamma_{44} 605.139$ ($t_{1/2}$) E1
- B 661.4310, 3⁻, 3.711 ps $\gamma_{146} 515.52$ ($t_{1/2}$)
- $\gamma_{44} 617.3611$ ($t_{1/2}$)
- B 763.23, (5⁻) $\gamma_{303} 459.8022$ $\gamma_{146} 617.3611$
- A 772.82, 10⁺ $\gamma_{513} 259.42$ ($t_{1/2}$)
- C 941.52, 0⁺ $\gamma_{605} 336.3815$ ($t_{1/2}$)
- $\gamma_{44} 897.3310$ ($t_{1/2}$) $\gamma_{605} 941.53$ ($t_{1/2}$) E0
- D 962.773, 1⁻, 6.212 ps $\gamma_{661} 301.43$ ($t_{1/2}$) E2
- $\gamma_{605} 357.627$ ($t_{1/2}$) M1+E2 $\gamma_{44} 918.694$ ($t_{1/2}$) E1
- $\gamma_{605} 962.773$ ($t_{1/2}$) E1
- 968.18(?), (2⁻) $\gamma_{44} 924$ ($t_{1/2}$)
- C 983.11, 2⁺, 0.53 ps $\gamma_{661} 321.7520$ ($t_{1/2}$)
- $\gamma_{605} 378.0513$ ($t_{1/2}$) $\gamma_{146} 837.1115$ ($t_{1/2}$)
- $\gamma_{44} 938.9510$ ($t_{1/2}$) E0+E2
- $\gamma_{605} 983.03$ ($t_{1/2}$)
- D 985.465, 2⁺ $\gamma_{661} 323.989$ ($t_{1/2}$) M1+E2
- $\gamma_{605} 380.2913$ ($t_{1/2}$) $\gamma_{44} 941.385$ ($t_{1/2}$)
- E 1028.552, 2⁺ $\gamma_{146} 882.633$ ($t_{1/2}$) E2
- $\gamma_{44} 984.452$ ($t_{1/2}$) E2 $\gamma_{605} 1028.542$ ($t_{1/2}$) E2
- E 1069.952, 3⁺ $\gamma_{146} 923.982$ ($t_{1/2}$) E2
- $\gamma_{44} 1025.872$ ($t_{1/2}$) E2
- A 1078.52, 12⁺ $\gamma_{773} 305.72$ ($t_{1/2}$)
- H 1082.577, (4⁻), 8.55 ns $\gamma_{968} 114.44$ ($t_{1/2}$)
- $\gamma_{763} 319.2911$ ($t_{1/2}$) M1+E2
- $\gamma_{661} 421.1411$ ($t_{1/2}$) $\gamma_{146} 936.616$ ($t_{1/2}$)
- E 1125.83, (4⁺) $\gamma_{146} 979.82$ ($t_{1/2}$)
- $\gamma_{44} 1081.73$ ($t_{1/2}$)
- 1134.4, (0⁺)
- 1174.44, (2⁺, 1) $\gamma_{44} 1130.25$ ($t_{1/2}$)
- $\gamma_{605} 1174.55$ ($t_{1/2}$)
- I 1202.6610, (3⁻) $\gamma_{1083} 119.91$ ($t_{1/2}$) (M1)
- $\gamma_{1070} 132.4911$ ($t_{1/2}$) $\gamma_{1029} 174.02$ ($t_{1/2}$)
- F 1228.73, 0⁺ $\gamma_{44} 1184.53$ ($t_{1/2}$) E2
- $\gamma_{605} 1228.73$ ($t_{1/2}$) E0
- 1252.2
- F 1264.23, 2⁺ $\gamma_{146} 1118.23$ $\gamma_{44} 1220.03$ E0+E2+M1
- 1310.33(?), (2⁺) $\gamma_{44} 1266.23$ ($t_{1/2}$) M1
- G 1426.63, 0⁺ $\gamma_{605} 821.54$ ($t_{1/2}$) E1

- $\gamma_{605} 1426.63$ ($t_{1/2}$) E0
- A 1427.23, 14⁺ $\gamma_{1079} 348.73$ ($t_{1/2}$)
- 1447.32, 1⁻ $\gamma_{605} 841.94$ ($t_{1/2}$) E0
- $\gamma_{44} 1403.23$ ($t_{1/2}$) E1 $\gamma_{605} 1447.33$ ($t_{1/2}$) E1
- G 1458.33, 2⁺ $\gamma_{44} 1414.03$ ($t_{1/2}$) $\gamma_{605} 1458.53$ ($t_{1/2}$)
- 1559.92, (1⁻) $\gamma_{985} 574.03$ ($t_{1/2}$) (E2+M1)
- $\gamma_{663} 597.03$ ($t_{1/2}$) $\gamma_{605} 954.73$ ($t_{1/2}$)
- $\gamma_{44} 1515.93$ ($t_{1/2}$) $\gamma_{605} 1560.03$ ($t_{1/2}$)
- 1596.43, (2⁺) $\gamma_{146} 1450.45$ ($t_{1/2}$)
- $\gamma_{44} 1552.23$ ($t_{1/2}$) $\gamma_{605} 1596.55$ ($t_{1/2}$)
- 1621.32, 1⁻ $\gamma_{963} 658.42$ ($t_{1/2}$) E0+E2+M1
- $\gamma_{942} 679.54$ ($t_{1/2}$) E1 $\gamma_{605} 1016.22$ ($t_{1/2}$) E0+E2+M1
- $\gamma_{44} 1577.33$ ($t_{1/2}$) E1 $\gamma_{605} 1621.44$ ($t_{1/2}$)
- 1636.42, 1⁻ $\gamma_{983} 653.35$ ($t_{1/2}$) $\gamma_{963} 673.42$ ($t_{1/2}$) E0
- $\gamma_{605} 1031.33$ ($t_{1/2}$) E0
- $\gamma_{44} 1592.53$ ($t_{1/2}$) $\gamma_{605} 1636.63$ ($t_{1/2}$) E1
- 1651.24, (1, 2⁻) $\gamma_{44} 1607.04$ ($t_{1/2}$)
- $\gamma_{605} 1651.45$ ($t_{1/2}$)
- 1726.43, (1, 2⁻) $\gamma_{44} 1682.23$ ($t_{1/2}$)
- $\gamma_{605} 1726.43$ ($t_{1/2}$)
- 1783.63, (1, 2⁻) $\gamma_{44} 1739.44$ ($t_{1/2}$)
- $\gamma_{605} 1783.64$ ($t_{1/2}$)
- A 1816.23, 16⁺ $\gamma_{1427.2} 389.03$ ($t_{1/2}$)
- 1898.33, 2⁻ $\gamma_{661} 1237.03$ ($t_{1/2}$) M1
- $\gamma_{605} 1293.23$ ($t_{1/2}$) M1
- A 2240.54, 18⁺ $\gamma_{1816} 424.34$ ($t_{1/2}$)
- J = 2400, 0.62 ns, $\% SF \leq 100$
- J = 3500, (0⁺), 6.015 ns, $\% SF \leq 100$

- $\gamma_{605} 209.7532$ ($t_{1/2}$)
- M1(+E2): $\delta = -0.004$ $\gamma_{57} 228.1831$ ($t_{1/2}$) M1(+E2): $\delta = +0.001$
- $\gamma_{605} 277.5991$ ($t_{1/2}$)
- M1+E2: $\delta = +0.1652$ $\gamma_{605} 285.4602$ ($t_{1/2}$) E2
- A 318.11, 13/2⁺ $\gamma_{164} 154.3510$ ($t_{1/2}$) E2
- C 330.1254, 7/2⁺ $\gamma_{285} 44.6652$ ($t_{1/2}$)
- M1+E2: $\delta = 0.203$ $\gamma_{164} 166.3692$ ($t_{1/2}$)
- M1 $\gamma_{76} 254.4183$ ($t_{1/2}$)
- M1+E2: $\delta = -0.15912$ $\gamma_{57} 272.8483$ ($t_{1/2}$)
- M1+E2: $\delta = +0.1659$ $\gamma_{605} 322.2643$ ($t_{1/2}$)
- A 358.11, 15/2⁺ $\gamma_{183} 165.418$ E2
- C 387.412, 9/2⁺ $\gamma_{330} 57.292$ ($t_{1/2}$)
- M1(+E2) $\gamma_{285} 101.952$ ($t_{1/2}$) E2
- $\gamma_{76} 311.702$ ($t_{1/2}$) (M1+E2)
- D 391.5863, 7/2⁻, 193.4 ns $\gamma_{330} 61.4612$ ($t_{1/2}$) E1
- $\gamma_{285} 106.1252$ ($t_{1/2}$) E1(+M2): $\delta = -0.0077$ $\gamma_{76} 315.8792$ ($t_{1/2}$) E1(+M2): $\delta = +0.0087$ $\gamma_{57} 334.3092$ ($t_{1/2}$) E1(+M2): $\delta = +0.0064$
- D 434.3, (9/2⁻)
- C 462.3, (11/2⁺)
- B 469.84, (1/2⁻) $\gamma_{8} 461.94$ ($t_{1/2}$)
- $\gamma_{605} 469.84$ ($t_{1/2}$)
- D 487.3, (11/2⁻)
- B 492.13, 3/2⁻ $\gamma_{57} 434.93$ ($t_{1/2}$)
- E1(+M2): $\delta = -0.0022$ $\gamma_{605} 484.33$ ($t_{1/2}$)
- $\gamma_{605} 492.13$ ($t_{1/2}$)
- B 505.52, (5/2⁻) $\gamma_{76} 429.82$ ($t_{1/2}$)
- $\gamma_{57} 448.22$ ($t_{1/2}$) $\gamma_{605} 497.82$ ($t_{1/2}$)
- E 511.83813, 7/2⁺ $\gamma_{387} 124.4348$ ($t_{1/2}$)
- M1(+E2): $\delta < 0.26$ $\gamma_{330} 181.7117$ ($t_{1/2}$)
- M1+E2: $\delta = -0.1507$ $\gamma_{285} 226.3788$ ($t_{1/2}$)
- M1+E2: $\delta = +0.1336$ $\gamma_{76} 436.13614$ ($t_{1/2}$)
- $\gamma_{57} 454.56512$ ($t_{1/2}$)
- $\gamma_{605} 503.97712$ ($t_{1/2}$)
- A 519.21, 17/2⁺ $\gamma_{318} 201.078$ ($t_{1/2}$) E2
- 538.3
- B 556.15, (7/2⁻) $\gamma_{164} 392.45$ ($t_{1/2}$)
- $\gamma_{57} 498.85$ ($t_{1/2}$)
- E 565, (9/2⁻)
- A 570.11, 19/2⁺ $\gamma_{358} 212.018$ ($t_{1/2}$) E2
- B 583.3, (9/2⁻)
- D 620, (15/2⁻)
- E 634, 11/2⁺
- B 659.3, (11/2⁻)
- 716
- 752.55, 1/2⁺, 3/2
- 756.5
- 763.3
- A 764.72, (21/2⁺) $\gamma_{519} 245.51$ (E2)
- 779.3
- 798.25, 1/2, 3/2
- 805.15, 1/2, 3/2
- 813.3
- 825.510, 1/2, 3/2
- A 826.92, (23/2⁺) $\gamma_{570} 256.81$ (E2)
- 854.2
- 888.05, 1/2, 3/2
- 900.2
- 915.3
- 933.310, 1/2, 3/2
- 948.3
- F 990, (3/2⁻)
- F 1017, (1/2⁻)
- 1027.2
- F 1038, (7/2⁻)
- A 1052.93, (25/2⁺) $\gamma_{765} 288.21$ ($t_{1/2}$) (E2)

239Pu
94

Δ : 48582.620 S_n : 5646.53 S_p : 6156.26

Q_α : 5244.5023

σ_f^0 : 748.120 b, σ_f^0 : 2693 b

Nuclear Bands

- A 1/2[631]
- B 1/2[631]+0⁺
- C 5/2[622]
- D 7/2[743]
- E 7/2[624]
- F 1/2[761]
- G 1/2[620]
- H 7/2[613]?
- I 3/2[622]?
- J 5/2[633] Fission isomer band
- K Fission isomer

Levels and γ -ray branchings:

- A 0, 1/2⁺, 24110.30 y, $\mu = +0.2034$, $\% \alpha = 100$, $\% SF = 3.1 \times 10^{-10}$
- A 7.8612, 3/2⁺, 36.3 ps, $Q = -2.3197$ $\gamma_{605} 7.8612$ ($t_{1/2}$) M1+E2: $\delta = 0.0552$
- A 57.2762, 5/2⁺, 101.5 ps, $Q = -3.34513$ $\gamma_{605} 49.4152$ ($t_{1/2}$) M1+E2: $\delta = 0.503$ $\gamma_{605} 57.2762$ ($t_{1/2}$) E2
- A 75.7063, 7/2⁺, 83.8 ps, $Q = -3.82626$ $\gamma_{57} 18.4302$ ($t_{1/2}$) $\gamma_{605} 67.8462$ ($t_{1/2}$) E2
- A 163.762, 9/2⁺, 73.4 ps $\gamma_{76} 88.052$ ($t_{1/2}$)
- M1+E2: $\delta = 0.5010$ $\gamma_{57} 106.482$ ($t_{1/2}$) E2
- A 192.8110, 11/2⁺ $\gamma_{76} 117.11$ ($t_{1/2}$) E2
- C 285.4602, 5/2⁺, 1.125 ns, $\mu = -1.2529$

1062.2
1099.5, 1/2, 3/2
F 1100, (5/2)
A 1126.6, (27/2)⁺ γ_{827} 299.72 (t₁₀₀) (E2)
F 1137, (11/2)
1174
G 1214, (1/2)⁺
G 1233, (3/2)⁺
H 1233, (9/2)⁺
G 1261, (5/2)⁺
I 1261, (3/2)⁺
I 1289, (5/2)⁺
G 1311, (7/2)⁺
I 1342, (7/2)⁺
G 1359, (9/2)⁺
A 1381.7, (29/2)⁺ γ_{1053} 328.83 (t₁₀₀)
1390
I 1409, (9/2)⁺
1437
1465
A 1466.6, (31/2)⁺ γ_{1127} 340.02 (t₁₀₀) (E2)
1488
A 1749.0, (33/2)⁺ γ_{1382} 367.34 (t₁₀₀) (E2)
A 1845.6, (35/2)⁺ γ_{1467} 379.04 (t₁₀₀) (E2)
A 2152.5, (37/2)⁺ γ_{1748} 403.54 (t₁₀₀) (E2)
A 2261.1, (39/2)⁺ γ_{1846} 415.54 (t₁₀₀) (E2)
A 2590.3, (41/2)⁺ γ_{2153} 437.84 (t₁₀₀) (E2)
A 2712.0, (43/2)⁺ γ_{2261} 450.94 (t₁₀₀) (E2)
A 3060.5, (45/2)⁺ γ_{2590} 470.24 (t₁₀₀) E2
J 3100.200, (5/2)⁺, 7.5 ns, %SF=100
J 3124.3, (7/2)⁺ γ_{3100+} 24.3 (t₁₀₀, 73.15)
J 3156.2, (9/2)⁺ γ_{3124} 31.9 (t₁₀₀, 55.10)
M1+E2: $\delta > 0.85$ γ_{3100+} 56.2 (t₁₀₀, 25.5) E2
A 3199.0, (47/2)⁺ γ_{2712} 487.04 (t₁₀₀) (E2)
K 3303, (9/2)⁺, 2.6⁺⁴⁰₋₁₂ ns, %SF=100 γ_{3156} 146.6
(t₁₀₀, 91.20) (E1) γ_{3124} 178.5 (t₁₀₀, 41.70)
(E1) γ_{3100+} 202.8 (t₁₀₀, 4.2)
A 3558.4, (49/2)⁺ γ_{3061} 497.94 (t₁₀₀) (E2)

240
94Pu

Δ : 50120.520 S_{α} : 6533.55 S_{β} : 6472.99
 Q_{α} : 5255.78¹⁵
 σ_{α} : 289.514 b, σ_{β} : 0.063 b

Nuclear Bands

- A Fission isomer band
- B GS band
- C Band Structure
- D Band Structure
- E Band Structure
- F v1/2[631]-v5/2[622]
- G Band Structure
- H Band Structure
- I Band Structure
- J π 5/2[642]+ π 5/2[523]
- K π 5/2[642]- π 5/2[523]
- L Band Structure

Levels and γ -ray branchings:

- B 0, 0⁺, 6564 ns, γ_{α} =100, %SF=5.7 \times 10⁻⁶ 2
- B 42.824, 8, 2⁺, 164.5 ps γ_{α} 42.8248 (t₁₀₀) E2
- B 141.690, 15, 4⁺ γ_{43} 98.86013 (t₁₀₀) E2
- B 294.319, 24, 6⁺ γ_{142} 152.63020 (t₁₀₀) E2
- B 497.52, 21, 8⁺ γ_{294} 203.22 (t₁₀₀)
- C 597.34, 4, 1⁻ γ_{43} 554.607 (t₁₀₀, 6) E1
 γ_{α} 597.407 (t₁₀₀, 6) E1
- C 648.85, 4, 3⁻ γ_{142} 507.2010 (t₁₀₀)

γ_{43} 606.107 (t₁₀₀, 5)
C 742.33, 4, 5⁻, <2 ns γ_{294} 448.016 (t₁₀₀, 3)
 γ_{142} 600.576 (t₁₀₀, 5)
B 747.8, 3, (10⁺) γ_{498} 250.32 (t₁₀₀)
D 860.71, 7, 0⁺ γ_{597} 263.377 (t₁₀₀, 2)
 γ_{43} 917.8910 (t₁₀₀) E2 γ_{α} 860.70 E0
D 900.32, 4, 2⁺ γ_{649} 251.477 (t₁₀₀, 3)
 γ_{597} 302.987 (t₁₀₀, 3) γ_{142} 758.618
(t₁₀₀, 3) E2 γ_{43} 857.4810 (t₁₀₀, 2)
 γ_{α} 900.3710 (t₁₀₀, 2)
E 938.06, (1) γ_{649} 289.2110 (t₁₀₀, 1.4)
 γ_{597} 340.7010 (t₁₀₀, 5.05) γ_{43} 895.3010
(t₁₀₀, 5) γ_{α} 938.0210 (t₁₀₀, 4)
E 958.85, (2) γ_{649} 309.999 (t₁₀₀, 4.3)
 γ_{597} 361.5510 (t₁₀₀, 3.5) γ_{43} 915.989
(t₁₀₀, 3)
D 992.2, (4⁺) γ_{742} 249.710 (t₁₀₀, 4.15)
 γ_{649} 343.710 (t₁₀₀, 10) γ_{294} =697.8
(t₁₀₀, 7.16)
E 1001.93, 10, (3⁺) γ_{43} 959.11 (t₁₀₀)
F 1030.53, (3)⁺, 1.3215 ns γ_{142} 888.805
(t₁₀₀, 3.45) E2 γ_{43} 987.766 (t₁₀₀, 2) E2
E 1037.52, (6⁺) γ_{742} 295.2010 (t₁₀₀, 3.24)
 γ_{649} 388.7010 (t₁₀₀, 6.65) γ_{142} 895.8010
(t₁₀₀, 5)
B 1041.8, (12⁺) γ_{748} 294.0020 (t₁₀₀)
F 1076.22, (4⁺) γ_{142} 934.5010 (t₁₀₀, 12)
 γ_{43} 1033.5020 (t₁₀₀, 4)
G 1089.45, 10, 0⁺ γ_{43} 1046.6210 (t₁₀₀)
E 1115.53, (6, 5⁻) γ_{649} 466.7010 (t₁₀₀, 4.5)
 γ_{294} 821.2010 (t₁₀₀, 4.5) γ_{142} 973.9010
(t₁₀₀, 5)
G 1131.95, 10, (2⁺) γ_{142} 989.2010 (t₁₀₀, 7)
 γ_{43} 1088.3020 (t₁₀₀, 39.4) γ_{α} 1131.0020
(t₁₀₀, 75.6)
H 1136.97, 13, (2⁺) γ_{43} 1094.2020 (t₁₀₀, 15)
 γ_{α} 1137.04 (t₁₀₀, 7)
E 1161.53, (6⁻) γ_{742} 419.2010 (t₁₀₀, 9.8)
 γ_{294} 867.2010 (t₁₀₀, 6)
H 1177.50, 10, (3⁺) γ_{1038} 139.9010
 γ_{1002} 175.4010 γ_{142} 1036.13 γ_{43} 1135.13
1180.4, (2⁺)
1199.2
1223.00, (2⁺) γ_{43} 1180.2020 (t₁₀₀, 8)
 γ_{α} 1223.0020 (t₁₀₀, 12)
H 1232.46, 10, (4⁺) γ_{294} 938.2010 (t₁₀₀, 17)
 γ_{142} 1090.5020 (t₁₀₀, 44.9) γ_{43} 1190.010
(t₁₀₀, 7.4)
I 1240.8, (2⁺) γ_{43} 1198.03 (t₁₀₀)
1262.0, (3⁺) γ_{142} 1120.34 (t₁₀₀, 31.3)
 γ_{43} 1219.23 (t₁₀₀, 6)
I 1282, (3⁻)
J 1308.74, (5, 5⁻), 165 ns γ_{1162} 147.2010
(t₁₀₀, 4.03) (M1+E2) γ_{1116} 193.3010
(t₁₀₀, 22.11) (M1+E2) γ_{1038} 271.3010
(t₁₀₀, 22.51) (M1+E2) γ_{1002} 306.8010
(t₁₀₀, 1.62) (M1+E2) γ_{742} 566.346 (t₁₀₀, 100.5)
(M1+E2) γ_{294} 1014.4010 (t₁₀₀, 83.22)
 γ_{142} 1167.1010 (t₁₀₀, 17.811)
1321.1010 (?) γ_{α} 1321.1010 (t₁₀₀)
1337.0, (3, 4) γ_{142} 1195.54 (t₁₀₀, 20)
 γ_{43} 1294.03 (t₁₀₀, 35.4)
B 1375.6, (14⁺) γ_{1042} 333.84 (t₁₀₀)
1379.4
1407.3

K 1410.75, 15, 0⁽⁻⁾ γ_{597} 813.4110 (t₁₀₀)
1413.0, (*)
K 1438.45, 8, 2⁽⁻⁾ γ_{649} 789.5910 (t₁₀₀, 17)
 γ_{597} 841.1110 (t₁₀₀, 83.9) γ_{α} 1438.5 (t₁₀₀, 0.6)
1488.17, (1) γ_{43} 1445.3010 (t₁₀₀, 3)
 γ_{α} 1488.2010 (t₁₀₀, 53.3)
L 1525.86, (0⁺) γ_{597} 928.5510 (t₁₀₀, 13)
 γ_{43} 1483.0010 (t₁₀₀, 18.3)
1539.67, (1⁻) γ_{958} 580.7020 (t₁₀₀, 0.5315)
 γ_{649} 890.6020 (t₁₀₀, 1.32) γ_{597} 942.3910
(t₁₀₀, 7.27) γ_{43} 1496.9010 (t₁₀₀, 2)
 γ_{α} 1539.629 (t₁₀₀, 63.215)
L 1558.87, (2⁺) γ_{649} 910.1010 (t₁₀₀, 14)
 γ_{597} 961.6210 (t₁₀₀, 93.5) γ_{142} 1417.2010
(t₁₀₀, 16.3) γ_{43} 1515.9010 (t₁₀₀, 11.4)
 γ_{α} 1558.8010 (t₁₀₀, 4.314)
1574
1580
1607.72, 15, (1⁻) γ_{1089} 518.23 (t₁₀₀, 11.4)
 γ_{649} 959.02 (t₁₀₀, 13.4) γ_{α} 1607.6020
(t₁₀₀, 9)
1626.77, 15, (1⁻) γ_{43} 1584.1020 (t₁₀₀, 12)
 γ_{α} 1626.6020 (t₁₀₀, 29.6)
1633.37, (1⁻) γ_{1137} 496.73 (t₁₀₀, 6.513)
 γ_{597} 1036.53 (t₁₀₀, 1.913) γ_{43} 1590.5010
(t₁₀₀, 63.3) γ_{α} 1633.3310 (t₁₀₀, 3)
1641.5
1675.2
1710.43, (2⁺) γ_{1137} 573.4020 (t₁₀₀, 28.7)
 γ_{649} 1061.6020 (t₁₀₀, 24) γ_{597} 1113.2020
(t₁₀₀, 62.2) γ_{142} 1568.6020 (t₁₀₀, 21.3)
 γ_{43} 1667.6010 (t₁₀₀, 66.10) γ_{α} 1711.010
(t₁₀₀, 7.4)
1752.3
1775.30, (1⁻) γ_{43} 1732.4020 (t₁₀₀, 67.34)
 γ_{α} 1775.3020 (t₁₀₀, 33)
1784.3
1796.34, 15, (1⁻) γ_{1321} 475.03 (t₁₀₀, 27)
 γ_{1223} 573.4020 (t₁₀₀, 73.18) γ_{958} 837.6020
(t₁₀₀, 73.27) γ_{α} 1796.23 (t₁₀₀, 27.9)
1808.00, (1⁻, 2⁺) γ_{649} 1159.2020 (t₁₀₀, 40.13)
 γ_{597} 1210.55 (t₁₀₀, 30) γ_{43} 1765.2020
(t₁₀₀, 47.7) γ_{α} 1807.94 (t₁₀₀, 13.7)
1861.3
1902.3
1917.8, (1⁻) γ_{43} 1874.93 (t₁₀₀, 8)
 γ_{α} 1918.010 (t₁₀₀, 7.3)
1954.50, 10, (2⁺) γ_{649} 1305.8020 (t₁₀₀, 26)
 γ_{597} 1357.2020 (t₁₀₀, 57.13) γ_{142} 1812.8010
(t₁₀₀, 22.9) γ_{43} 1911.43 (t₁₀₀, 61.4)
1996.40, (1⁻, 2⁺) γ_{597} 1398.55 (t₁₀₀, 40)
 γ_{43} 1953.6020 (t₁₀₀, 46.10) γ_{α} 1996.74
(t₁₀₀, 20.8)
2117.60, 20, γ_{43} 2074.8020 (t₁₀₀, 16)
 γ_{α} 2117.510 (t₁₀₀, 23.13)
2127.4, (*)
A =2800, (0⁺), 3.73 ns, %SF>0
A 2820.1, (2⁺) γ_{2800} 20.1 I⁽¹⁾=119.8, I⁽²⁾=150.4,
 η_{ω} =0.017
A 2866.8, (4⁺) γ_{2820} 46.7 (E2) I⁽¹⁾=133.6,
I⁽²⁾=151.5, η_{ω} =0.030
A 2939.9, (6⁺) γ_{2867} 73.1 (E2) I⁽¹⁾=139.2,
I⁽²⁾=152.7, η_{ω} =0.043
A 3039.2, (8⁺) γ_{2940} 99.3 (E2) I⁽¹⁾=142.0,
I⁽²⁾=149.8, η_{ω} =0.056
A 3165 (?), (10⁺) γ_{3039} =126

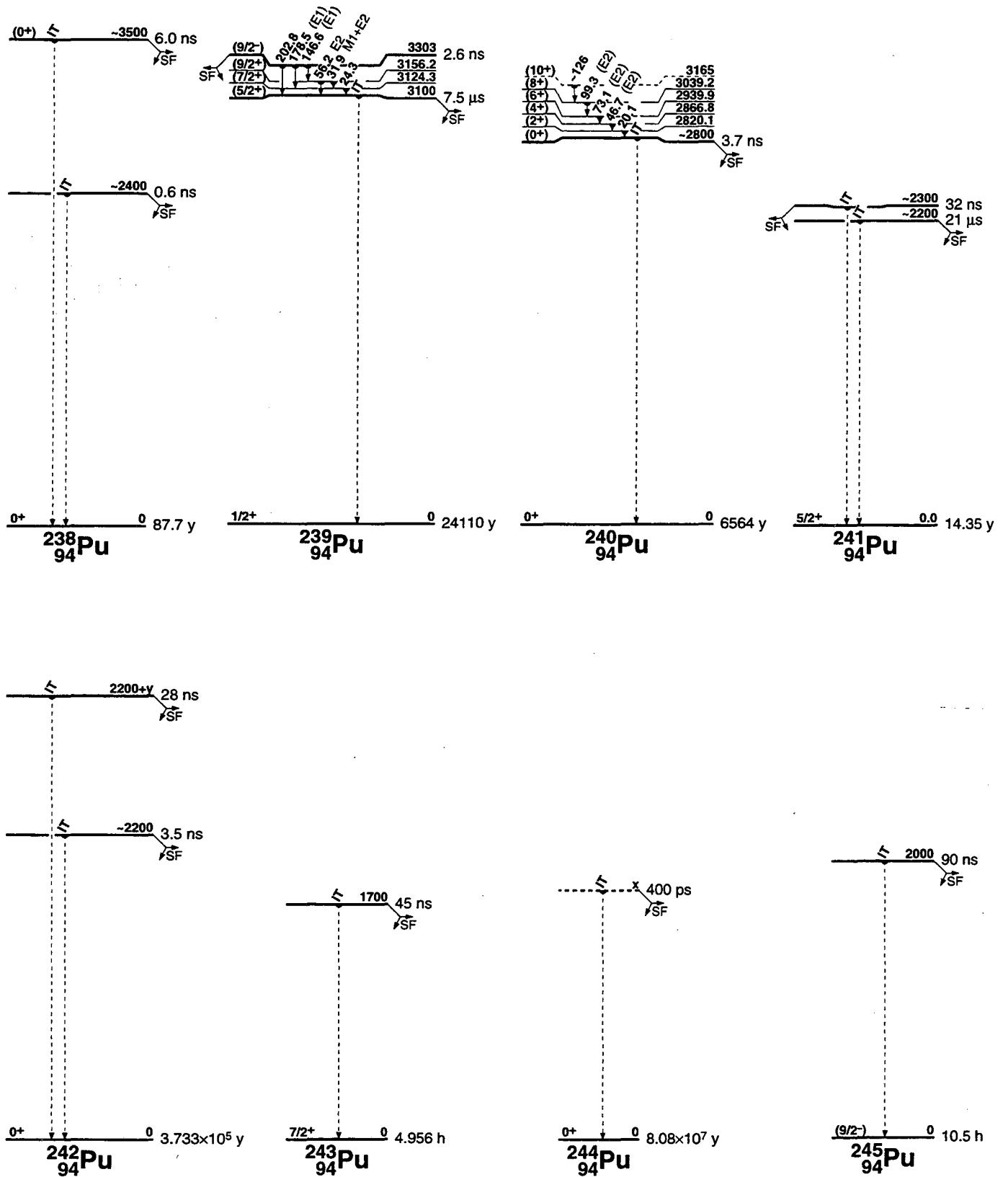

241Pu
94Pu

Δ : 52950.220 S_n : 5241.6019 S_p : 6659.15 Q_β^- : 20.8120 Q_α : 5140.15
 σ_p^0 : 1011.6 b, σ_f : 1011.6 b, σ_{abs}^0 : 1369.8 b, σ_f^+ : 358.5 b

Nuclear Bands

- A 5/2[622]
- B 1/2[631]
- C 7/2[624]
- D 7/2[743]
- E Fission isomer
- F 1/2[620]
- G 1/2[501]?
- H Band Structure

Levels and γ -ray branchings:

- A 0.0, 5/2⁺, 14.35 10 y, $\mu = -0.683$ 15, $Q = +5.6$ 20, $\% \beta^- = 99.998$,
 $\% \alpha = 2.45 \times 10^{-3}$ 2, $\% SF < 2.4 \times 10^{-14}$
- A 41.95 3, 7/2⁺ γ_{42} 41.95 3 (M1+E2)
- A 95.69 7, 9/2⁺ γ_{42} 53.74 6 (M1+E2)
- A 161.05 10, (11/2⁺) γ_{96} 65.36 6
- B 161.6 1, 1/2⁺, 0.88 5 μs γ_0 161.6 1
- B 170.9 8, (3/2⁺)
- C 174.94 4, 7/2⁺ γ_{96} 79.25 6 (\dagger , 1.58 9) γ_{42} 132.99 3 (\dagger , 29.2 15) γ_0 174.94 4
(\dagger , 100)
- B 223.1 20, (5/2⁺)
- C 231.76 8, 9/2⁺ γ_{175} 56.81 6 (\dagger , 18.7 10) (M1+E2); $\delta = 0.59$ 8 γ_{96} 136.06 6
(\dagger , 58 4) γ_{42} 189.82 6 (\dagger , 100 7)
- A 235 4, (13/2⁺)
- B 242.7, (7/2⁺)
- C 300.93 8, (11/2⁺) γ_{232} 69.17 6 (\dagger , 100 43) (M1+E2) γ_{161} 139.81 6 (\dagger , 86 29)
- B 335 2, 9/2⁺
- 337, (1/2, 3/2)
- C 368 4, (13/2⁺)
- = 376, (1/2, 3/2)
- = 384
- 404.4 2, (5/2⁺, 7/2) γ_{96} 308.8 2 (\dagger , 37 11) γ_{42} 362.4 1 (\dagger , 100 11) $\gamma_0 = 405$
- D 444 3, (11/2⁺)
- 473
- 495 10
- B 499 3, (13/2⁺)
- H 518.7 2, (5/2⁻) γ_{42} 476.6 2 (\dagger , 100 10) γ_0 518.8 1 (\dagger , = 400)
- H 561.0 3, (7/2⁻) γ_{42} 518.8 1 (\dagger , = 50) γ_0 561.1 2 (\dagger , 100 40)
- D 569 3, (15/2⁻)
- 620 10
- 645 9
- 681, (1/2, 3/2)
- F 755.2 10, (1/2⁺) γ_{171} 584.3 (\dagger , 5.6) γ_{162} 593.6 (\dagger , 100)
- F 769.7 7, (3/2⁺) γ_{171} 598.7 (\dagger , 39) γ_{162} 608.1 (\dagger , 100)
- 770 3
- 777 4
- 784.4 7, (1/2⁺, 3/2) γ_{171} 613.0 (\dagger , 40) γ_{162} 622.5 (\dagger , 60) γ_0 784.4 (\dagger , 100)
- 797 4, (1/2, 3/2)
- 800 2
- F 800.5, (5/2⁺)
- 808 3
- 834.6 2, 3/2, 5/2⁺ γ_0 834.6 2
- 841.8 9, 1/2⁺, 3/2 γ_{171} 671.3 (\dagger , 62.5) γ_{162} 680.6 (\dagger , 62.5) γ_0 841.0
(\dagger , 100)
- 844 3
- 850.3 10, 1/2, 3/2 γ_{171} 678.9 (\dagger , 40) γ_{162} 688.7 (\dagger , 100)
- 864 3
- 875(?)
- F 897 4, (9/2⁺)
- 918 3
- 929.7 2, (7/2⁺) γ_{96} 834.6 2 γ_0 929.7 2
- 936 3
- 942.4 10, 1/2, 3/2 γ_{171} 772.0 (\dagger , 30) γ_{162} 781.3 (\dagger , 100)
- 948 5
- G 965.2 8, (1/2⁻) γ_{171} 794.2 (\dagger , 100) γ_{162} 803.3 (\dagger , 86)
- 967 3

- 994.4 10, 1/2, 3/2, 5/2⁺
- 995 3
- G 1009 2, (3/2⁻ and 5/2⁻)
- 1016 3
- 1049, 1/2, 3/2
- 1063 3
- 1075 3
- 1090.5 8, (1/2, 3/2)
- 1091 3
- 1121 3
- 1173
- 1180 3
- 1196
- 1209 4
- 1219 4
- 1224.1, 1/2, 3/2, 5/2⁺
- 1242 4
- 1253.9, 1/2, 3/2, 5/2⁺
- 1258 4
- 1269.1, 1/2, 3/2, 5/2⁺
- 1277 4
- 1288 4
- 1297.0, 1/2, 3/2, 5/2⁺
- 1299 4
- 1309 4
- 1344 4
- 1356 4
- 1357.8, 1/2, 3/2, 5/2⁺
- 1381 4
- 1399 3
- 1441 5
- 1452 5
- 1474 3
- 1489 5
- 1546 5
- 1594 5
- 1759 3
- 1801 4
- 1826 4
- 1868.5, (15/2⁻)
- 1944 5
- 1991 4
- = 2045(?)
- 2199, 1/2, 3/2
- E = 2200, 21 3 μs , $\% SF = 100$
- E = 2300, 32 5 ns, $\% SF = 100$

242Pu
94Pu

Δ : 54712.120 S_n : 6309.47 S_p : 6830.70 Q_α : 4982.7 12
 σ_f^0 : 18.5 5 b, σ_f^+ : < 0.2 b

Nuclear Bands

- A GS band
- B Octupole band
- C γ band?
- D Band Structure
- E Band Structure
- F Fission isomer

Levels and γ -ray branchings:

- A 0, 0⁺, 3.733 $\times 10^5$ 12 y, $\% \alpha = 100$, $\% SF = 5.50 \times 10^{-4}$ 6
- A 44.54 2, 2⁺, 158 6 ps γ_0 44.54 2 (\dagger , 100) E2
- A 147.3 2, 4⁺ γ_{45} 102.8 2 (\dagger , 100) E2
- A 306.4 2, 6⁺ γ_{147} 159.0 1 (\dagger , 100) E2
- A 518.1 3, 8⁺ γ_{306} 211.7 4 (\dagger , 100) E2
- A 778.7 6, 10⁺ γ_{518} 260.5 6 (\dagger , 100) E2
- B 780.46 4, (1⁻) γ_{45} 735.93 7 (\dagger , 100) γ_0 780.44 5 (\dagger , 53)
- B 832.3 2, 3⁻ γ_{147} 685.0 1 γ_{45} 787.8 10
- B 927, (5⁻)
- E 956, (0⁺)
- E 992.5 2, (2⁺) γ_{45} 948.0 2 (\dagger , 100)
- D 1019.4, 3⁻ γ_{45} 974.9 (\dagger , 100)
- 1039.2 3, (1⁺, 2⁺) γ_0 1039.2 3

D 1064.0, (4⁻) γ_{147} 915.7 (†₁₀₀)
 A 1084.0 12, 12⁺ γ_{776} 305.88 (†₁₀₀)
 1092.1 2, (6⁺) γ_{306} 785.71 (†₁₀₀) γ_{147} 944.81 (†₆₃)
 C 1102.4, (2⁺)
 D 1122, (5⁻)
 1150.1, (2⁻) γ_{45} 1105.6 (†₁₀₀)
 1154.6 2, (3⁻) γ_{147} 1007.32 (†₄₅) γ_{45} 1110.02 (†₁₀₀)
 1181.6 2, (2⁺) γ_{147} 1034.22 (†₂₂) γ_{45} 1137.11 (†₁₀₀) γ_0 1181.62 (†₁₂)
 1357.2 2(?) γ_{1092} 265.11 (†₁₀₀)
 1401.0 1(?), (0, 1⁺) γ_{780} 620.61 (†₁₀₀)
 1427.96 25, (2⁻) γ_{780} 647.43 (†₁₀₀) γ_{45} 1383.64 (†₂₂)
 A 1431.3, 14⁺ γ_{1084} 347.310 (†₁₀₀)
 1517.65 7, (1⁻) γ_{45} 1473.11 (†₁₀₀) γ_0 1517.61 (†₅₃)
 1744.9
 A 1816.3 20, 16⁺ γ_{1431} 385.011 (†₁₀₀)
 1825.0 11, (4⁺, 5⁺) γ_{306} 1518.6 (†₁₀₀)
 1871.4 3 γ_{632} 1039.23 (†₉₆) γ_{45} 1826.93 (†₁₀₀)
 1874.1 1 γ_{780} 1093.51 (†₁₀₀) γ_0 1874.53 (†₂₂)
 1903.6 2 γ_{780} 1123.12 (†₄₅) γ_{45} 1859.23 (†₁₀₀)
 1949.8 2, (1, 2⁺) γ_{45} 1905.12 (†₃₇) γ_0 1949.92 (†₁₀₀)
 1969.9 2, (1, 2⁺) γ_{45} 1925.42 (†₄₃) γ_0 1969.92 (†₁₀₀)
 2091.2 γ_{1150} 941.1
 F ≈ 2200, 3.5 6 ns, %SF>0
 F 2200+y, 28 ns, %SF>0
 A 2235.6 23, 18⁺ γ_{1816} 419.312 (†₁₀₀)
 2246.0 4, (1, 2⁺) γ_{45} 2201.65 (†₁₀₀) γ_0 2246.05 (†₇₅)
 2331.3 1, (2⁺) γ_{1518} 813.61 (†₁₀₀) γ_{780} 1550.91 (†₂₈)
 2437.5
 A 2686 3, 20⁺ γ_{2236} 450.213 (†₁₀₀) E2
 A 3163 3, 22⁺ γ_{2686} 477.214 (†₁₀₀) E2
 A 3662 4, 24⁺ γ_{3163} 499.215 (†₁₀₀) E2
 A 4172 4, 26⁺ γ_{3662} 510.015 (†₁₀₀) E2

²⁴³₉₄Pu

Δ: 57749 3 S_n: 5034 3 S_p: 6950 200 Q_β: 582 3 Q_α: 4754 3
 σ_n: 87 10 b, σ_f: 196 16 b

Nuclear Bands

- A 7/2[624]
- B 5/2[622]
- C 1/2[631]
- D 9/2[734]
- E 1/2[620]
- F 7/2[613]
- G Band Structure
- H 1/2[761]
- I 3/2[622]
- J 1/2[501]
- K 3/2[631]
- L Fission isomer

Levels and γ-ray branchings:

- A 0, 7/2⁺, 4.956 3 h, %β⁻=100
- A 58.1 4, 9/2⁺
- A 124.6 10, 11/2⁺
- A 204.4 15, (13/2⁺)
- B 287.4 3, 5/2⁺ γ_{58} 229.32 (†_{1.84}) γ_0 287.43 (†_{100 14}) M1
- B 333.2 4, 7/2⁺ γ_{58} 275.12 (†_{100 19}) γ_0 333.010 (†_{64 28})
- C 383.6 4, (1/2⁺), 0.33 3 μs γ_{287} 96.22
- B ≈ 388 (?), (9/2⁺)
- C 392.0 5, (3/2⁺)
- D 402.6 3, 9/2⁻ γ_{125} 278.08 (†_{4.7 10}) γ_{58} 344.55 (†_{1.8}) γ_0 402.63 (†_{100 9}) E1
- C 446.8 4, (5/2⁺)
- C 450.1 15, (7/2⁺)

D 454 6, 11/2⁻
 B 466.7 15, (11/2⁺)
 B 536.6 15, (13/2⁺)
 C 564.5 15, (9/2⁺)
 D 595.3 15, (15/2⁻)
 E 625.6 4, (1/2⁺) γ_{392} 233.96 (†_{5.0 16}) γ_{384} 242.02 (†_{100 19})
 F 626.2, (9/2⁺)
 E 653.8 4, (3/2⁺) γ_{392} 261.73
 E 677.2 5, (5/2⁺) γ_{392} 284.43 (†_{100 40}) γ_{333} 343.9
 G 703.9 4, (3/2⁻) γ_{287} 416.52
 734.1 20
 E 741.8 15, (7/2⁺)
 H 790.7 4, (3/2⁻) γ_{447} 343.92 (†_{<158}) γ_{384} 407.13 (†_{100 12})
 809.5 3, (1/2⁺, 3/2⁻) γ_{384} 426.06 (†_{<29}) γ_{287} 522.13 (†_{<100})
 I 813.8 2, 3/2⁺ γ_{654} 159.213 (†_{27 11}) γ_{333} 480.63 (†_{31 4}) γ_{287} 526.23 (†_{100 11}) γ_0 813.82 (†_{96 10})
 H 834.4 15, (7/2⁻)
 I 845.4 4, (5/2⁻) γ_{287} 558.03 (†_{100 11}) γ_{58} 787.58 (†_{34 17}) γ_0 844.38 (†_{<26})
 H 873.7 10, (1/2⁻) γ_{654} 219.93
 884 3
 I 895.6 15, (7/2⁺)
 J 905.7 5, (1/2⁻) γ_{392} 513.63 (†_{100 12}) γ_{384} 522.13 (†_{<34})
 H 920.6 15, (11/2⁻)
 J 948.0 4, (3/2⁻) γ_{447} 501.23 (†_{59 7}) γ_{392} 555.75 (†_{51 17}) γ_{384} 564.74 (†_{100 11})
 I 954 2, (9/2⁺)
 K 981.0 4, (5/2⁺) γ_{447} 533.94 (†_{80 16}) γ_{392} 589.13 (†_{100 12}) γ_{333} 648.88 (†_{<48}) γ_{287} 693.57 (†_{32 12})
 1044 2
 K 1080 2, (9/2⁺)
 1114 3
 1130.1 4, (1/2⁺, 3/2⁻) γ_{704} 426.06 (†_{<38}) γ_{447} 683.44 (†_{<53}) γ_{392} 738.23 (†_{79 9}) γ_{384} 746.43 (†_{100 11})
 1145 3
 1176.5 3, 3/2⁺, 5/2⁺ γ_{791} 385.73 (†_{13.5 23}) $\gamma_{625.6}$ 551.75 (†_{6.7 18})
 γ_{447} 730.17 (†_{5.4 18}) γ_{333} 844.38 (†_{<9.9}) γ_{287} 889.16 (†_{100 14})
 γ_0 1176.55 (†_{52 11})
 1197 3
 1213 2 γ_{333} 879.810 (†_{75 35}) γ_{287} 925.310 (†_{100 50})
 1233 3
 1243 3
 1265 3
 1286 3
 1299 2
 1301.6 5, 1/2, 3/2 γ_{654} 648.88 (†_{<37}) $\gamma_{625.6}$ 676.03 (†_{100 10})
 γ_{384} 918.010 (†_{43 16})
 1324 2
 1354 2
 1359 3
 1367.8 6, 1/2, 3/2 γ_{704} 663.96 (†_{100 16}) γ_{654} 714.711 (†_{31 16})
 γ_{392} 976.012 (†_{84 42})
 1387.4 4, 3/2⁺ γ_{948} 439.43 (†_{93 14}) γ_{704} 683.44 (†_{<107}) γ_{333} 1053.810 (†_{100 38})
 1403 3
 1420.5 6, (3/2⁺) γ_{704} 716.95 (†_{61 13}) γ_{392} 1028.410 (†₃₉)
 γ_{333} 1087.18 (†_{100 52})
 1434.7 4, 1/2(+), 3/2 γ_{810} 625.22 (†_{100 11}) γ_{791} 644.24 (†_{38 9})
 γ_{677} 757.54 (†_{44 8}) γ_{654} 781.112 (†_{25 17}) γ_{392} 1042.15 (†_{73 11})
 1444 3
 1465 3
 1491.0 10, 1/2, 3/2
 1516.6 10, 3/2 γ_{677} 838.75
 L 1700 300, 45 15 ns, %SF=100

²⁴⁴₉₄Pu

Δ : 59799.5 S_n: 6021.4 S_p: 7409.10 Q_α: 4665.510
 σ_f : 1.71 b

Nuclear Bands

- A GS band
- B Fission isomer

Levels and γ -ray branchings:

- A 0, 0⁺, 8.08×10⁷ 10 y, %SF=0.1236, %α=99.8776
- A 46.2, 2⁺, 155.2 ps γ_0 46
- A 156.8 11, 4⁺ γ_{46} 110.82 (†_γ100)
- A 319.7 11, 6⁺ γ_{157} 162.91 (†_γ100)
- A 536.8 10, 8⁺ γ_{320} 217.11 (†_γ100)
- 708.4, (2⁺, 3⁻)
- A 803.3 12, 10⁺ γ_{537} 266.56
- 957.2, (3⁻)
- 1015.2, (2⁺)
- 1068.4
- 1108.2, (3⁻)
- A 1115.7 15, 12⁺ γ_{803} 312.48
- 1194.3, (5⁻)
- 1210.3
- 1217.8 11, (7, 8) γ_{537} 681.01 (†_γ100)
- 1353.4
- 1378.3
- 1434.3
- A 1469.4 18, 14⁺ γ_{1116} 353.710
- 1613.3, (3⁻)
- 1783.3
- 1805.3
- 1847.3
- A 1860.4 21, 16⁺ γ_{1469} 391.011
- 1896.3
- B x(?), 400 100 ps, %SF≤100
- A 2284.2 24, 18⁺ γ_{1860} 423.812
- A 2736.3, 20⁺ γ_{2284} 451.514
- A 3208.4(?), 22⁺ γ_{2736} 472.025
- A 3680.5(?), 24⁺ γ_{3208} 472.025
- A 4137.5(?), (26⁺) γ_{3680} 457.714

²⁴⁵₉₄Pu

Δ : 63097.14 S_n: 4773.13 Q_{β⁻}: 1205.15
 σ_f : 150.30 b

Nuclear Bands

- A 9/2[734]
- B 1/2[620]
- C 7/2[613]
- D 3/2[622]
- E 1/2[761]?
- F Fission isomer

Levels:

- A 0, (9/2⁻), 10.51 h, %β⁻=100
- A 217, (15/2⁻)
- 246.4
- B 306.3, (1/2⁺)
- C 325.2, (9/2⁺)
- B 355.3, (5/2⁺)
- B 423.5, (7/2⁺)
- B 459.5, (9/2⁺)
- D 575.4, (3/2⁺)
- D 613.4, (5/2⁺)
- E 637.4, (3/2⁻)
- D 660.3, (7/2⁺)
- E 675.3, (7/2⁻)
- D 723.3, (9/2⁺)
- 738.3
- 758.4
- 802.2
- 1071.3
- 1128.3
- 1279.3
- 1389.4
- F 2000 400, 90.30 ns, %SF≤100

237
95Am

Δ : 46820 S_n : (7430) S_p : (3370)
 Q_{EC} : (1730) Q_α : (6250)

Nuclear Bands

A Fission isomer

Levels:

0, 5/2⁻, 73.0 10 m, % α =0.025 3,
%EC=99.975 3

A 2400 200, 5.2 ns, %SF \leq 100

238
95Am

Δ : 48420 50 S_n : (6470) S_p : 3960 50
 Q_{EC} : 2260 50 Q_α : 6040 50

Nuclear Bands

A Fission isomer

Levels:

0, 1⁺, 98.2 m, % α =1.0 \times 10⁻⁴ 4, %EC+% β^+ >99.99
A =2500, 35 10 μ s, %SF \leq 100

239
95Am

Δ : 49386 3 S_n : 7100 50 S_p : 4061.3 20
 Q_{EC} : 802.9 20 Q_α : 5923.7 18

Nuclear Bands

A 5/2[523]

B 5/2[642]

C 3/2[521]

D Fission isomer

Levels and γ -ray branchings:

A 0, (5/2)⁻, 11.9 1 h, %EC=99.990 1,
% α =0.010 1

A 40.7 7, (7/2⁻)

A 94 6, (9/2⁻)

A 156 7, (11/2⁻)

B 187.1 5, (5/2⁺) γ_{41} 146.4 5 (\dagger_{120} 6) (E1)
 γ_0 187.1 5 (\dagger_{100} 25) (E1)

B 220 6, (7/2⁺)

B 260 6, (9/2⁺)

B 317 7, (11/2⁺)

B =370, (13/2⁺)

C 557 6, (3/2⁻)

C 586 6, (5/2⁻)

D 2500 200, (7/2⁺), 163 12 ns, %SF \leq 100,
 μ =(+)2.59 18

240
95Am

Δ : 51499 14 S_n : 5957 14 S_p : 4372 14
 Q_{EC} : 1379 14 Q_α : 5690 50

Nuclear Bands

A π 5/2[523]+v1/2[631]

B π 5/2[523]-v1/2[631]

C π 5/2[523]-v5/2[622]

D π 5/2[523]+v5/2[622]

E π 5/2[523]+v1/2[501]

F π 5/2[523]-v1/2[501]

G Fission isomer

Levels:

A 0, (3⁻), 50.8 3 h, %EC=100, % α =1.9 \times 10⁻⁴ 7

A 41, (4⁻)

B 53, (2⁻)

B 87, (3⁻)

A 96, (5⁻)

B 130, (4⁻)

A 158, (6⁻)

B 186, (5⁻)

213

A 233, (7⁻)

B 252, (6⁻)

281

A 316, (8⁻)

B 329, (7⁻)

C 346, (1⁻)

C 398, (3⁻)

D 398, (5⁻)

C 423, (2⁻)

D 458, (6⁻)

474

C 498, (4⁻)

C 498, (5⁻)

D 534, (7⁻)

551

C 616, (6⁻)

C 640, (7⁻)

660

757

777

809

819

845

856

877

898

917

932

956

E 973, (3⁺)

997

F 1016, (2⁺)

E 1016, (4⁺)

F 1052, (3⁺)

1066

1079

1194

1218

1235

1248

1305

1318

1335

1349

1372

1386

1407

1437

1495

1515

1545

G 3000 200, 0.94 4 ms, %SF \leq 100

241
95Am

Δ : 52929.4 20 S_n : 6641 14 S_p : 4480.1 3
 Q_α : 5637.81 12

σ_f^0 : 3.20 9 b, σ_f^0 (to 0): 533 13 b, σ_f^0 (to 48.6): 54 5 b

Nuclear Bands

A 5/2[523]

B 5/2[642]

C 3/2[521]

D 1/2[400]

E 1/2[530]

F 3/2[651]

G Fission isomer

Levels and γ -ray branchings:

A 0, 5/2⁻, 432.2 7 y, % α =100,
%SF=4.3 \times 10⁻¹⁰ 18, μ =+1.61 3, Q=4.34 6,
Q=+4.2 13

A 41.176 3, 7/2⁻ γ_0 41.176 3 (\dagger_{100})
M1+E2: δ =-0.48 5

A 93.65 10, 9/2⁻

A 158.0 15, 11/2⁻

B 205.883 10, 5/2⁺ γ_{41} 164.8 2 (\dagger_{16} 3)
 γ_0 205.879 13 (\dagger_{100} 6) E1

A 234.0 13, (13/2⁻)

B 235 1, (7/2⁺) γ_{41} 195 1 (\dagger_{100})

239 2(?)

B 272 2, (9/2⁺)

273 2(?)

B 320 2, (11/2⁺)

B 380 1, (13/2⁺)

459 (?)

C 471.810 9, 3/2⁻ γ_{206} 265.922 12 ($\dagger_{0.56}$ 6)
(E1) γ_{41} 430.634 20 ($\dagger_{5.7}$ 3) E2
 γ_0 471.805 20 (\dagger_{100} 5) M1+E2

495

C 504.448 9, 5/2⁻ γ_{472} 32.639 3 (\dagger_{17} 3)
M1+E2: δ =0.125 10 γ_{206} 298.57 5 ($\dagger_{6.4}$ 17)
 γ_{94} 410.8 1 ($\dagger_{7.0}$ 7) γ_{41} 463.273 20
(\dagger_{100} 7) M1+E2 γ_0 504.45 3 (\dagger_{48} 4)
(M1+E2)

543 (?)

C 549 1, 7/2⁻

D 623.10 4, (1/2⁺) γ_{472} 151.4 4 ($\dagger_{\approx 3}$)
 γ_{206} 417.2 4 (\dagger_{100} 7) (E2) γ_0 623.1 3
($\dagger_{1.8}$ 5)

E 636.861 10, 3/2⁻ γ_{504} 132.413 7 (\dagger_{100} 6)
M1+E2: δ =0.060 20 γ_{472} 165.049 8 (\dagger_{77} 6)
M1+E2: δ =0.22 3 γ_{206} 430 1 ($\dagger_{\approx 1.0}$)
 γ_{41} 595.8 3 ($\dagger_{0.38}$ 8) γ_0 636.88 3 (\dagger_{40} 3)
M1+E2: δ =0.57 20

E 652.089 10, (1/2⁺) γ_{637} 15.228 2 ($\dagger_{11.5}$ 7)
M1+E2: δ =0.032 7 γ_{623} 29.02 5 ($\dagger_{6.3}$ 13)
 γ_{504} 147.67 3 ($\dagger_{4.2}$ 17) γ_{472} 180.277 8
(\dagger_{100} 9) M1+E2 γ_0 652.1 4 ($\dagger_{8.3}$ 21)

D 653.23 4, (3/2⁺) γ_{206} 447.35 4 (\dagger_{80} 10)
(M1+E2): δ =0.36 38 γ_0 653.2 2 (\dagger_{100} 7)

F 670.24 8, (3/2⁺) γ_{206} 464.36 8 (\dagger_{15} 3)
(M1+E2): δ =1.5 37 γ_0 670.2 2 (\dagger_{100} 7)

C 682 3, (11/2⁻)

732 4 1106 4

822 4 1132 5

884 4 1136 3

952 1, 5/2⁻ 1163 3

982 2 1227 3

1020 4 1550 4, (5/2⁻)

1064 4 G =2200, 1.0 3 μ s, %SF=100

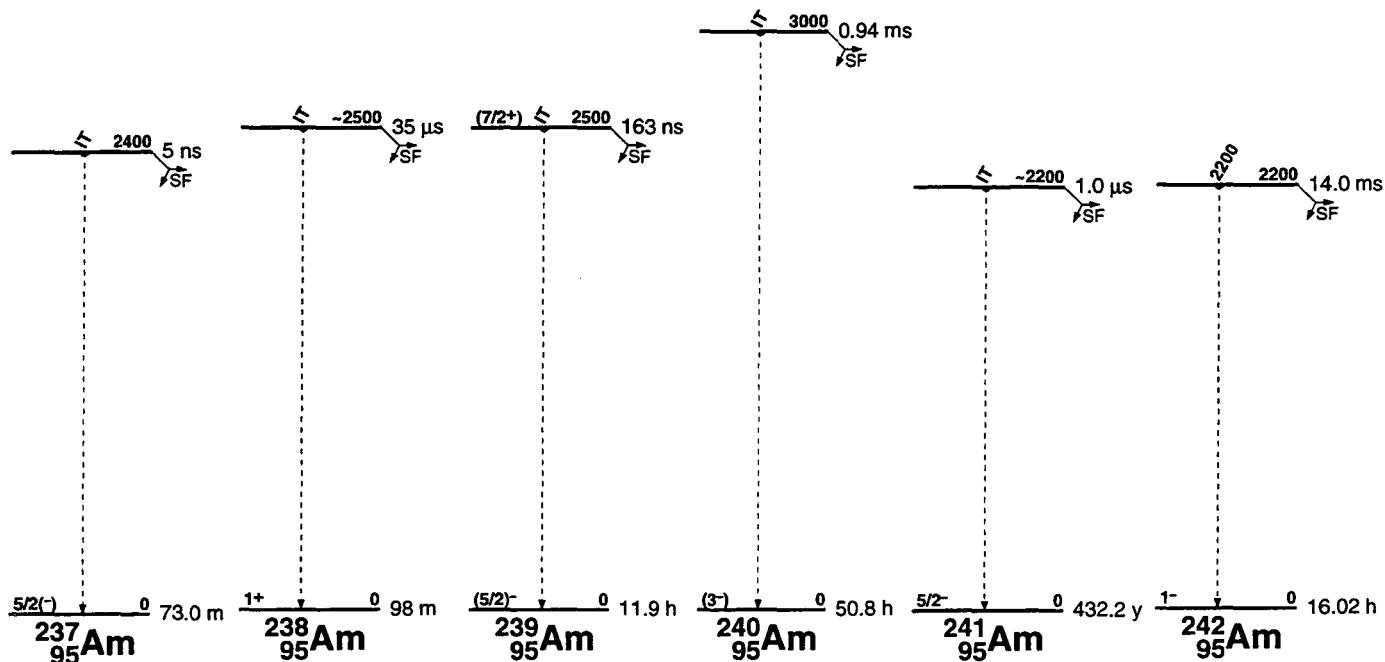

²⁴²₉₅Am

Δ : 55463.120 S_n : 5537.5710 S_p : 4776.0322
 Q_{β^-} : 664.87 Q_{EC} : 751.07 Q_{α} : 5588.3325
 σ_f (for 0): 2100200 b, σ_f (for 48.6): 2000600 b, σ_f (for 48.6): 6950280 b

Nuclear Bands

- A $\pi 5/2[523]-v 5/2[622]$
- B $\pi 5/2[523]+v 5/2[622]$
- C $\pi 5/2[523]+v 1/2[631]$
- D $\pi 5/2[523]-v 1/2[631]$
- E $\pi 5/2[523]+v 1/2[501]$
- F $\pi 5/2[523]-v 1/2[501]$
- G Fission isomer

Levels and γ -ray branchings:

- A 0, 1⁻, 16.022 h, $\mu=+0.3822$, $Q=-2.76$,
 $\% \beta^- = 82.73$, $\% EC = 17.33$
- A 44.1 (?), (0⁻) $\gamma_0 44.1$
- B 48.635, 5⁻, 1412 y, $\% \alpha = 0.45912$,
 $\% IT = 99.54112$, $\% SF = 1.5 \times 10^{-8}6$ $\gamma_0 48.635$
 E4
- A 52.9, (3⁻) $\gamma_0 52.9$
- A 75.8, (2⁻) $\gamma_0 75.8$
 99
- B 114, (6⁻)
- A 148, (5⁻)
- A 149.9, (4⁻) $\gamma_{53} 96.9$
 171
- B 190, (7⁻)
 197.6, (3⁻)
 230.5, (1⁺) $\gamma_{76} 154.7$ $\gamma_{44} 186.4$
- C 244.13, (3⁻)
- A 263, (6⁻)
- A 263, (7⁻)
 270.13, (2⁺)
 283.33, (3⁺)
- C 288.4, (4⁻)

- D 291.8, (2⁻) 1140
- 306.94, (3⁻) 1151
- D 326.06, (3⁻) 1162
- C 341.429, (5⁻) 1167
- 363.53, (2⁺) 1171
- D 370.23, (4⁻) 1187
- 377.0, (2⁺) 1192
- 400.24, (3⁺) 1199
- C 410.012, (6⁻) 1210
- 417.93, (2⁺) 1230
- D 428.74, (5⁻) 1243
- 463.7, (3⁺) 1263
- C 488, (7⁻) 1290
- D 500, (6⁻) 1300
- D 581, (7⁻) 1310
- 608 1325
- 626 1343
- 658 1362
- D 679, (8⁻) 1380
- 697 1406
- D 792(?), (9⁻) 1417
- 821 1443
- 833 1455
- 846 1467
- 873, (2⁻) 1482
- 899, (3⁻) 1507
- 915 1519
- 936 1562
- 951
- E 975, (3⁺)
- 995
- F 1011, (2⁺)
- E 1031, (4⁺)
- F 1051, (3⁺)
- E 1065, (5⁺)
- 1077
- 1088
- F 1098, (4⁺)
- 1118

G 220080, 14.010 ms, $\% SF \leq 100$ $\gamma_0 220080(?)$

243
95Am

Δ : 57167.4 22 S_n : 6367.0 11 S_p : 4833.6 12 Q_α : 5438.1 9
 α_T^0 : 75.1 18 b, σ_T^0 : 0.198 4 b, σ_T^0 (to 0): 3.8 4 b

Nuclear Bands

- A 5/2[523]
- B 5/2[642]
- C 3/2[521]
- D 7/2[633]
- E Fission isomer

Levels and γ -ray branchings:

- A 0, 5/2⁻, 7370 40 y, $\mu=1.53$ z, $Q=+4.30$ z, $\% \alpha=100$, $\% SF=3.7 \times 10^{-9}$ 2
- A 42.2 3, 7/2⁻, ≈ 40 ps γ_0 42.2 5 M1+E2: $\delta=0.29$
- B 84.0 2, 5/2⁺, 2.34 7 ns, $\mu=+2.74$ 14, $Q=4.20$ 3 γ_{42} 41.8 2 (\dagger , 3.3 3) γ_0 84.0 2 (\dagger , 100) E1
- A 96.4 4, 9/2⁻ γ_{42} 54 1 (\dagger , <100) γ_0 96.4 4 (\dagger , 60 10) (E2)
- B 109.2 2, 7/2⁺ γ_{42} 67 1 (\dagger , 100 50) γ_0 109.2 2 (\dagger , 70 7)
- B 143.5 5, (9/2⁺) γ_{109} \approx 34 γ_{42} 101.3
- A 162.3 10, 11/2⁻
- B 189.3 7, (11/2⁺)
- A 238 1, 13/2⁻
- B 244 2, (13/2⁺)
- C 266 2, (3/2⁻) γ_0 265 10 (M1+E2)
- C 300 2, (5/2⁻)
- C 345 1, (7/2⁻)
- 383 2
- 407.1 5(?) γ_0 407.1 5(?)
- 423 5
- 445 3
- D 465.7 3, 7/2⁺ γ_{144} 322.2 3 (\dagger , 5.0 5) γ_{109} 356.4 3 (\dagger , 24 2) (M1+E2): $\delta=0.4$ 4
 γ_{84} 381.7 3 (\dagger , 100 9) M1 γ_{42} 423.2(?) γ_0 465.7 5 (\dagger , <0.04)
- C 466 5, (11/2⁻)
- D 532.5 4, (9/2⁺) γ_{189} 343.2 5 (\dagger , \approx 11) γ_{144} 388.9 3 (\dagger , 38 6) γ_{109} 423.2 3 (\dagger , 100 12) γ_{84} 448.7 5 (\dagger , \approx 1.9)
- 586 5
- D 704 2, (13/2⁺)
- 724 4
- 933 4
- 977 3
- 1053 3
- 1123 3
- 1174 3
- 1222 3
- E 2300 200, 5.5 5 μ s, $\% SF \leq 100$

244
95Am

Δ : 59875.0 22 S_n : 5363.7 9 S_p : 5163 3 Q_β : 1428.1 9 Q_{EC} : 76 5 Q_α : 5130 15
 α_T^0 (for 0): 2300 300 b, σ_T^0 (for 70): 1600 300 b

Nuclear Bands

- A π 5/2[523]+v7/2[624]
- B π 5/2[642]-v7/2[624]
- C π 5/2[523]-v7/2[624]
- D π 3/2[521]-v7/2[624]
- E π 5/2[523]-v5/2[622]
- F π 1/2[400]-v7/2[624]
- G π 7/2[633]-v7/2[624]
- H π 5/2[642]-v1/2[631]?
- I π 5/2[523]-v9/2[734]
- J π 5/2[523]+v1/2[631]
- K π 5/2[523]-v1/2[631]
- L π 5/2[642]-v9/2[734]
- M π 3/2[651]-v7/2[624]
- N π 3/2[521]-v5/2[622]
- O Fission isomer

Levels and γ -ray branchings:

- A 0, (6⁻), 10.1 1 h, $\% \beta^- = 100$
- B 88.0 30, 1⁺, ≈ 26 m, $\% \beta^- = 99.9639$ 13, $\% EC = 0.0361$ 13
- B 100.3092 11, (2⁺)

- B 123.2811 11, (3⁺) γ_{100} 22.975 10 (\dagger , 100 20) M1 γ_{88} 35.31 3 (\dagger , 0.10 2) E2
- B 148.2831 16, (4⁺) γ_{123} 25.034 20 (\dagger , 100) M1
- C 175.6573 10, (1⁻) γ_{100} 75.3475 13 (\dagger , 67 10) E1+M2: $\delta=0.025$ 6
 γ_{88} 87.6553 15 (\dagger , 100 17) E1+M2: $\delta=0.020$ 6
- B 183.511 5, (5⁺) γ_{148} 35.23 3 (\dagger , 100) M1
- C 197.2947 11, (2⁻) γ_{176} 21.636 10 (\dagger , 49 10) M1 γ_{123} 74.0144 7 (\dagger , 100 14)
E1(+M2): $\delta=0.052$ 20 γ_{100} 96.985 1 10 (\dagger , 63 10) E1
- C 228.2990 12, (3⁻) γ_{197} 31.00 1 (\dagger , 30 6) M1 γ_{176} 52.64 1 (\dagger , 2.9 6) E2
 γ_{148} 80.0156 11 (\dagger , 41 7) E1(+M2): $\delta=0.123$ 25 γ_{123} 105.011 6 (\dagger , 3.3 14)
 γ_{100} 127.989 1 24 (\dagger , 100 8) E1(+M2): $\delta=0.12$ 5
- D 261.6962 11, (2⁻) γ_{228} 33.396 10 (\dagger , 8.5 16) M1 γ_{197} 64.4013 20 (\dagger , 60 9)
M1+E2: $\delta=0.015$ 10 γ_{176} 86.0376 10 (\dagger , 100 14) M1+E2: $\delta=0.3$ 2
 γ_{123} 138.4157 17 (\dagger , 22 4) γ_{100} 161.391 4 (\dagger , 6.4 16) γ_{88} 173.698 4 (\dagger , 68 11)
- C 272.2018 17, (4⁻) γ_{228} 43.904 10 (\dagger , 77 15) M1 γ_{197} 74.918 10 (\dagger , 29 5) E2
 γ_{123} 148.9208 19 (\dagger , 100 20) E1
- E 289.2119 12, (1⁻) γ_{197} 91.9252 13 (\dagger , 55 10) M1 γ_{176} 113.5625 12 (\dagger , 100 17) M1+E2: $\delta=0.3$ 2 γ_{100} 188.910 5 (\dagger , 35 5) E1 γ_{88} 201.219 4 (\dagger , 20 4) E1
- D 296.6583 26, (3⁻) γ_{262} 34.975 15 (\dagger , 100) E2
- C 322.7506 24, (5⁻) γ_{272} 50.550 10 (\dagger , 54 12) M1 γ_{228} 94.454 4 (\dagger , 31 7)
 γ_{148} 174.466 5 (\dagger , 100 17)
- E 335.575 4, (0⁻) γ_{289} 46.375 20 (\dagger , 100) M1
- E 342.6498 13, (3⁻) γ_{289} 53.43 1 (\dagger , 14 3) E2 γ_{272} 70.4522 24 (\dagger , 8.9 36) M1
 γ_{262} 81.3663 10 (\dagger , 29 5) M1 γ_{228} 114.3510 17 (\dagger , 100 15) M1
 γ_{197} 145.356 4 (\dagger , 26 4) M1 γ_{148} 194.363 8 (\dagger , 28 7) γ_{123} 219.365 13 (\dagger , 25 10)
- D 343.658 3, (4⁻) γ_{228} 115.362 4 (\dagger , 70 14) M1 γ_{123} 220.380 5 (\dagger , 100 20) E1
- F 348.4047 16, (3⁺) γ_{148} 200.117 3 (\dagger , 17 4) M1+E2: $\delta=1.1$ 3 γ_{123} 225.120 5 (\dagger , 60 11) M1+E2: $\delta=0.76$ 20 γ_{100} 248.097 5 (\dagger , 100 17) M1+E2: $\delta=0.66$ 22
 γ_{88} 260.39 4 (\dagger , 2.0 7)
- E 361.8376 20, (2⁻) γ_{289} 72.6184 12 (\dagger , 100) M1
367.6 10(?)
- G 377.0566 22, (0⁺) γ_{176} 201.393 9 (\dagger , 11 4) γ_{88} 289.0570 22 (\dagger , 100 25) M1
- F 390.028 7, (4⁺) γ_{348} 41.63 2 (\dagger , 24 12) M1 γ_{184} 206.559 20 (\dagger , 100 25)
 γ_{148} 241.721 13 (\dagger , 30 10) (M1) γ_{123} 266.732 4 (\dagger , 91 14) (M1)
- D 398.743 4, (5⁻) γ_{272} 126.541 5 (\dagger , 43 13) γ_{148} 250.43 5 (\dagger , 100 25)
- G 414.6889 14, (2⁺) γ_{148} 266.37 3 (\dagger , 1.5 5) γ_{123} 291.4059 19 (\dagger , 73 18) M1
 γ_{100} 314.382 3 (\dagger , 100 17) M1 γ_{88} 326.6902 22 (\dagger , 37 7) M1
- H 418.957 2, (2⁺) γ_{297} 122.299 3 (\dagger , 22 4) E1 γ_{100} 318.6478 24 (\dagger , 100 20) M1
 γ_{88} 330.9556 23 (\dagger , 84 14) M1
- I 420.1309 14, (2⁺) γ_{262} 158.4352 10 (\dagger , 7.1 10) E1 γ_{228} 191.829 4 (\dagger , 1.0 2)
 γ_{197} 222.834 3 (\dagger , 28 5) E1 γ_{176} 244.471 3 (\dagger , 100 20) E1(+M2): $\delta=0.10$ 3
 γ_{123} 296.848 3 (\dagger , 29 5) M1 γ_{100} 319.821 3 (\dagger , 5.8 19) M1+E2: $\delta=1.5$ 5
 γ_{88} 332.134 3 (\dagger , 5.1 9) M1
- J 421.2035 16, (3⁻) γ_{348} 72.7992 7 (\dagger , 100 17) E1(+M2): $\delta=0.04$ 2
 γ_{262} 159.506 10 (\dagger , 6.5 13) γ_{228} 192.907 4 (\dagger , 5.4 11) γ_{123} 297.920 6 (\dagger , 5.3 16) γ_{100} 320.887 4 (\dagger , 6.5 22)
431.0 3
- E 435.036 3, (4⁻) γ_{323} 112.285 3 (\dagger , 80 19) M1 γ_{272} 162.819 6 (\dagger , <130)
 γ_{228} 206.718 18 (\dagger , 100 19) γ_{184} 251.509 13 (\dagger , 54 12) γ_{148} 286.74 3 (\dagger , <54)
- E 437.310 3, (5⁻) γ_{343} 94.666 5 (\dagger , 54 13) γ_{323} 114.557 3 (\dagger , 100 17)
 γ_{272} 165.110 6 (\dagger , 61 15)
- I 444.381 3, (3⁺) γ_{228} 216.087 5 (\dagger , 80 16) γ_{148} 296.103 5 (\dagger , 100 18) M1
 γ_{123} 321.098 9 (\dagger , 23 6) γ_{100} 344.054 9 (\dagger , 86 40) M1
- G 454.002 3, (1⁺) γ_{420} 33.888 10 (\dagger , 6.8 12) M1 γ_{100} 353.693 4 (\dagger , 54 10) M1
 γ_{88} 365.9998 24 (\dagger , 100 17) M1
- H 456.8632 23, (4⁺) γ_{148} 308.5818 21 (\dagger , 100 15) M1 γ_{123} 333.585 3 (\dagger , 33 6) M1
- J 466.263 5, (4⁻) γ_{421} 45.074 10 (\dagger , 100 30) M1 γ_{297} 169.597 7 (\dagger , <80) M1
 γ_{272} 194.079 13 (\dagger , 24 6)
- 478.0960 18, (2⁺) γ_{419} 59.139 10 (\dagger , 8 2) M1 γ_{123} 354.8132 24 (\dagger , 80 20) M1
 γ_{100} 377.790 3 (\dagger , 100 20) M1 γ_{88} 390.100 3 (\dagger , 24 5)

I 478.349126, (4)⁺ $\gamma_{272} 206.147_{10}$ (†,378) $\gamma_{228} 250.0444$ (†,10020) $\gamma_{148} 330.0677$ (†,174) $\gamma_{123} 355.0684$ (†,9020) M1 $\gamma_{100} 378.0517$ (†, <33)

K 484.791120, (2)⁻ $\gamma_{348} 136.3836_{15}$ (†,10016) E1 $\gamma_{197} 287.5004_{19}$ (†,8515) M1 $\gamma_{176} 309.1387$ (†,4.08)

G 495.3943, (4)⁺ $\gamma_{184} 311.899_{11}$ (†,113) $\gamma_{148} 347.1103$ (†,9223) M1 $\gamma_{123} 372.1133$ (†,10020) M1

G 514.142322, (3)⁺ $\gamma_{148} 365.8593$ (†,10024) M1 $\gamma_{123} 390.8584$ (†,6413) M1 $\gamma_{100} 413.8364$ (†,248) (M1)

I 516.2678, (5)⁺ $\gamma_{323} 193.5226$ (†,10020) $\gamma_{272} 244.115$ (†, <51) $\gamma_{184} 332.738_{13}$ (†,4912) $\gamma_{148} 367.934$ (†,4020)

L 516.823013, (2)⁻ $\gamma_{420} 96.6925_{19}$ (†,2.45) $\gamma_{262} 255.1276$ (†,5711) M1 $\gamma_{228} 288.5229_{19}$ (†,267) M1 $\gamma_{197} 319.5279_{21}$ (†,7013) M1 $\gamma_{176} 341.1649_{22}$ (†,10020) M1 $\gamma_{123} 393.549_{14}$ (†,0.84) $\gamma_{100} 416.5204$ (†,5.012) $\gamma_{88} 428.8255$ (†,143)

K 524.251624, (3)⁻ $\gamma_{348} 175.8408$ (†,4.214) $\gamma_{272} 252.0523$ (†,10016) M1(+E2): $\delta=0.43$ $\gamma_{228} 295.9533$ (†,194)

L 535.755817, (3)⁻ $\gamma_{444} 91.3695$ (†,1.54) (E1) $\gamma_{420} 115.6262_{20}$ (†,3.26) $\gamma_{419} 116.8017$ (†,0.72) $\gamma_{297} 239.092$ (†,3.68) $\gamma_{272} 263.5544$ (†,5010) M1 $\gamma_{262} 274.0543$ (†,3.59) $\gamma_{228} 307.4552$ (†,10015) M1 $\gamma_{197} 338.4603$ (†,5910) M1 $\gamma_{100} 435.4507$ (†,134)

L 561.559426, (4)⁻ $\gamma_{444} 117.1853$ (†,8.016) $\gamma_{399} 162.8196$ (†, <11) $\gamma_{323} 238.784_{12}$ (†,8016) M1 $\gamma_{272} 289.3540_{22}$ (†,5815) M1 $\gamma_{228} 333.2566$ (†,256) M1 $\gamma_{184} 378.0517$ (†, <17) $\gamma_{148} 413.2824$ (?) (†,10020) $\gamma_{123} 438.282_{13}$ (†,154)

K 578.8426, (4)⁻ $\gamma_{348} 230.497$ (†, <20) $\gamma_{343} 236.2036$ (†,10020) $\gamma_{323} 256.064$ (†, <36) $\gamma_{272} 306.646_{11}$ (†,3014) $\gamma_{123} 455.52422$ (†,8622)

584.0413, (2)⁻ $\gamma_{485} 99.2465$ (†,3.211) $\gamma_{362} 222.2059$ (†,9.321) M1 $\gamma_{289} 294.8242_{22}$ (†,10025) $\gamma_{197} 386.7463$ (†,399) $\gamma_{176} 408.3866$ (†,306) $\gamma_{123} 460.7332$ (†,9.321) $\gamma_{100} 483.708_{12}$ (†,6020) $\gamma_{88} 496.0296$ (†,9324)

608.43

G 610.8874, (5)⁺ $\gamma_{344} 267.2306$ (†,2810) $\gamma_{184} 427.3719$ (†,5015) (M1) $\gamma_{148} 462.6046$ (†,10025) M1

M 615.2434, (2)⁺ $\gamma_{524} 90.9923$ (?) (†,3.28) $\gamma_{100} 514.9254$ (†,3913) M1 $\gamma_{88} 527.2524$ (†,10025) M1

643.1145, (3)⁺ $\gamma_{419} 224.213$ (†,4.015) $\gamma_{184} 459.603_{15}$ (†,123) $\gamma_{148} 494.870_{15}$ (†,218) $\gamma_{123} 519.8317$ (†,10025) M1 $\gamma_{100} 542.8097$ (†,4016) (M1)

M 650.1874, (3)⁺ $\gamma_{485} 165.422_{16}$ (†,1.69) $\gamma_{262} 388.4816$ (†,123) $\gamma_{148} 501.893_{10}$ (†,146) $\gamma_{123} 526.9105$ (†,10025) M1 $\gamma_{100} 549.8805$ (†,6120) M1

670.7585, (2)⁺ $\gamma_{457} 213.95224$ (†,6.718) $\gamma_{420} 250.6155$ (†,518) M1 $\gamma_{419} 256.064$ (†, <12) $\gamma_{176} 495.121_{10}$ (†,299) $\gamma_{100} 570.4689$ (†,10030) (M1) $\gamma_{88} 582.743_{14}$ (†,114)

N 680.572623, (1)⁻ $\gamma_{517} 163.7435$ (†,266) M1 $\gamma_{420} 260.394$ (†, <9.6) $\gamma_{336} 345.0006$ (†, <13) $\gamma_{289} 391.3604$ (†,338) M1 $\gamma_{197} 483.2765$ (†,10024) M1 $\gamma_{176} 504.9154$ (†,10025) M1

M 696.8256, (4)⁺ $\gamma_{184} 513.348$ (†, <42) $\gamma_{148} 548.5609$ (†,10030) (M1) $\gamma_{123} 573.522_{17}$ (†,8028) (M1)

N 699.778821, (2)⁻ $\gamma_{536} 164.0203$ (†,143) M1(+E2): $\delta=1.1550$ $\gamma_{517} 182.9604$ (†,7.212) $\gamma_{289} 410.5618$ (†,287) $\gamma_{228} 471.4826$ (†,4615) M1 $\gamma_{176} 524.1204$ (†,10030) M1

N 731.1414, (3)⁻ $\gamma_{562} 169.5977$ (†, <17) $\gamma_{444} 286.743$ (†, <5.3) $\gamma_{435} 296.1035$ (†,6112) M1 $\gamma_{343} 388.4816$ (†,265) $\gamma_{272} 458.9335$ (†,5111) M1 $\gamma_{197} 533.8556$ (†,10025) M1

749

M 756.7056, (5)⁺ $\gamma_{611} 145.8166$ (†,205) $\gamma_{184} 573.187_{18}$ (†,7926) (M1) $\gamma_{148} 608.437_{15}$ (†,10030)

774.9146, (1)⁺ $\gamma_{336} 439.3477$ (†,5.416) $\gamma_{262} 513.348$ (†, <17) $\gamma_{100} 674.5967$ (†,7823) (M1) $\gamma_{88} 686.9227$ (†,10025) M1

N 779.9145, (4)⁻ $\gamma_{662} 218.332_{16}$ (†,328) $\gamma_{536} 244.115$ (†, <22) $\gamma_{421} 358.703$ (†,116) $\gamma_{390} 389.8735$ (†,7413) $\gamma_{344} 436.2697$ (†,7018) $\gamma_{272} 507.7317$ (†,10032) (M1)

780.1524, (2)⁻ $\gamma_{514} 266.025_{16}$ (†, <22) $\gamma_{478,1} 302.0696$ (†,124) $\gamma_{454} 326.165_{16}$ (†,7.520) $\gamma_{420} 360.053_{12}$ (†,6.520) $\gamma_{419} 361.1873$ (†,266) $\gamma_{289} 483.4925$ (†,10030) M1 $\gamma_{100} 679.866$ (†,4114) $\gamma_{88} 692.187$ (†,3817)

782.8755, (2)⁻ $\gamma_{579} 204.0528$ (†,8.512) $\gamma_{536} 247.1075$ (†,10025) (M1+E2): $\delta=1.7535$ $\gamma_{524} 258.703$ (†,3612) M1 $\gamma_{517} 266.025_{16}$ (†, <13) (M1) $\gamma_{435} 347.8366$ (†,93) $\gamma_{343} 440.233_{10}$ (†,7.921) $\gamma_{336} 447.2858$ (†,6.721) $\gamma_{228} 554.523$ (†,124) $\gamma_{123} 659.620_{13}$ (?) (†,4012)

795.0067, (4)⁻ $\gamma_{536} 259.164$ (†,1813) $\gamma_{517} 278.205_{16}$ (†,3010) $\gamma_{399} 396.2624$ (†,10025) M1 $\gamma_{344} 451.360_{11}$ (†,197) $\gamma_{323} 472.272_{13}$ (†,7550) $\gamma_{197} 597.663$ (†,3010) $\gamma_{184} 611.489_{10}$ (†, <92)

799.0065, (2)⁻ $\gamma_{454} 345.0006$ (†, <12.5) $\gamma_{289} 502.3587$ (†,7924) M1 $\gamma_{289} 509.775_{12}$ (†,2513) (M1) $\gamma_{197} 601.733$ (†,188) $\gamma_{123} 675.716_{19}$ (†,10033)

808.8004, (3)⁻ $\gamma_{650} 158.6167$ (†,168) $\gamma_{457} 351.9425$ (†,579) $\gamma_{435} 373.7606$ (†,10020) M1 $\gamma_{362} 446.944_{17}$ (†,237) $\gamma_{348} 460.3799$ (†,237) $\gamma_{289} 519.593_{13}$ (†,6722) $\gamma_{262} 547.163$ (†,178) $\gamma_{197} 611.489_{10}$ (†, <89)

825.5264, (2)⁻ $\gamma_{466} 359.2653$ (†,4313) $\gamma_{421} 404.3185$ (†,348) (M1) $\gamma_{336} 489.9525$ (†,7718) $\gamma_{289} 528.903$ (†,4618) $\gamma_{262} 563.884$ (†,10033) M1 $\gamma_{123} 702.185$ (†,4618)

832.23

840.6486, (2)⁺ $\gamma_{457} 383.7864$ (†,379) $\gamma_{444} 396.2624$ (†,10025) M1 $\gamma_{197} 643.435$ (†,6728) $\gamma_{176} 665.105$ (†,2812) $\gamma_{100} 740.413$ (†,10033) $\gamma_{88} 752.666$ (†,5120)

842.7544, (3)⁺ $\gamma_{584} 258.703$ (?) (†,7023) $\gamma_{457} 385.8964$ (†,4811) M1 $\gamma_{454} 388.735_{12}$ (†,116) $\gamma_{444} 398.371_{11}$ (†,136) $\gamma_{420} 422.6183$ (†,10017) M1 $\gamma_{419} 423.8116$ (†,6514) M1 $\gamma_{289} 553.613$ (?) (†,155)

859.1954, (3)⁺ $\gamma_{697} 162.3745$ (†,6.815) $\gamma_{643} 216.0875$ (†,306) $\gamma_{495} 363.8013$ (†,10033) (M1) $\gamma_{478,3} 380.836_{15}$ (†,114) $\gamma_{396} 469.1458$ (†,225) (M1) $\gamma_{362} 497.353$ (†,7.525) $\gamma_{123} 735.933$ (†,279) $\gamma_{100} 758.895$ (†,3612)

875.0595, (2)⁻ $\gamma_{783} 92.1813$ (†,7.320) $\gamma_{615} 259.883$ (†,166) $\gamma_{536} 339.3198$ (†,5.320) $\gamma_{420} 454.879_{24}$ (†,143) $\gamma_{415} 460.3799$ (†,195) $\gamma_{176} 699.444$ (†,3312) $\gamma_{148} 726.793_{23}$ (†,8727) $\gamma_{123} 751.804_{20}$ (†,10033) (M1) $\gamma_{100} 774.755$ (†,8729)

880.7864, (3)⁻ $\gamma_{778,9} 100.8723$ (†,104) M1 $\gamma_{650} 230.497$ (†, <9.0) $\gamma_{524} 356.5366$ (†,7513) $\gamma_{421} 459.603_{15}$ (†,317) $\gamma_{419} 461.819_{15}$ (†,4414) $\gamma_{262} 619.094$ (†,10030) $\gamma_{197} 683.495_{17}$ (†,8228) $\gamma_{88} 792.75_{13}$ (†,2711)

893.73
901.43
914.23
933.24
951.33
982
999.63
1015.89
1030.53
1046.15
1052.43
1063.25
1071.314(?)
1097
1125
1142
1151.33
1179
1203
1252
1281
1335
1357

○ 2800400, 0.9015 ms, %SF≤100
○ 2800+x, = 6.5 μs, %SF≤100

245
95Am

Δ : 618933 S_n : 60543 S_p : 51955 Q_{β^-} : 894.018 Q_{α} : 521070

Nuclear Bands

- A 5/2[642]
- B 5/2[523]
- C 7/2[633]
- D Band Structure
- E Fission isomer

Levels and γ -ray branchings:

- A 0, (5/2)⁺, 2.051 h, % β^- =100
- A 19.202, (7/2)⁺
- B 27.9320, (5/2)⁻ γ_0 281 (E1)
- A 47.072, (9/2)⁺
- B 70.4320, (7/2)⁻
- A 87.6510, (11/2)⁺
- B 124.5920, (9/2)⁻
- A 134.5120, (13/2)⁺
- B 190.8220, (11/2)⁻
- C 327.4288, 7/2⁺ γ_{47} 280.38513 (\dagger 5.18) (M1+E2): $\delta=0.7525$ γ_{28} 299.87 (\dagger 0.074) γ_{19} 308.2228 (\dagger 19.3) M1+E2: $\delta=0.6\text{--}0.6^{\pm}$ γ_0 327.4288 (\dagger 10015) M1+E2: $\delta=0.55$
- C 395.872, 9/2⁺ γ_{88} 308.222(?) γ_{47} 348.7829 (\dagger 305) γ_{19} 376.6763 (\dagger 100) (M1) γ_0 395.8720 (\dagger 31)
- C 475.523, 11/2⁺ γ_{135} 341.0020 (\dagger 194) γ_{88} 387.884 (\dagger 5514) γ_{47} 428.43822 (\dagger 100)
- C 563.13, (13/2)⁺ γ_{135} 428.438(?) γ_{88} 475.16
- D 887.4710, (7/2)⁺ γ_{476} 411.935 (\dagger 9.113) γ_{396} 491.5919 (\dagger 508) (E2) γ_{327} 560.135 (\dagger 100) (E2) γ_{125} 762.7320 (\dagger 13.118) γ_{88} 799.8720 (\dagger 295) γ_{70} 817.0420 (\dagger 163) γ_{47} 840.5620 (\dagger 244) γ_{28} 859.5320 (\dagger 9.414) γ_{19} 868.84 (\dagger 2.27) γ_0 887.14(?)
- 921.0120, (9/2)⁺, 11/2⁺ γ_{563} 357.9020 (\dagger 176) γ_{476} 445.3420 (\dagger 8218) γ_{396} 525.0820 (\dagger 7314) γ_{327} 593.76 (\dagger 95) γ_{181} 730.4020 (\dagger 5012) γ_{135} 786.5420 (\dagger 100) γ_{125} 796.3720 (\dagger 6821) γ_{88} 833.1420 (\dagger <141) γ_{47} 874.1620 (\dagger 3611) γ_{19} 901.98 (\dagger 148)

- D 957.532, (9/2)⁺ γ_{476} 481.910 (\dagger 0.5026) γ_{396} 560.13(?) γ_{327} 630.10214 (\dagger 100) M1+(E2) γ_{191} 766.5915 (\dagger 133) γ_{135} 824(?) (\dagger <1.3) γ_{125} 833.1420 (\dagger <19) γ_{88} 870.55 (\dagger 2.513) γ_{70} 887.1420 (\dagger 265) γ_{47} 910.4620 (\dagger 518) γ_{19} 938.42 (\dagger 378) γ_0 957.5920 (\dagger 366)
- 987.515, (7/2⁺, 9/2⁺) γ_{476} 511.510 (\dagger 2.613) γ_{396} 591.63 (\dagger 133) γ_{327} 660.085 (\dagger 6412) γ_{70} 917.05 (\dagger 63) γ_{47} 941.010 (\dagger 1913) γ_{19} 968.57 (\dagger 2.613) γ_0 987.6020 (\dagger 100)
- 1024.2220, (7/2⁺, 9/2⁺) γ_{476} 549.26 (\dagger 128) γ_{396} 630.102(?) γ_{327} 696.84 (\dagger 3117) γ_{125} 899.310 (\dagger 128) γ_{70} 9532 (\dagger 64) γ_{47} 977.22 (\dagger <144) γ_{28} 996.03 (\dagger 7531) γ_{19} 1005.13 (\dagger 100)
- 1065.3020 γ_{396} 669.2820 (\dagger 337) γ_{327} 737.9620 (\dagger 216) γ_{135} 930.36 (\dagger 53) γ_{88} 977.2(?) γ_{47} 1018.3320 (\dagger 100)
- 1111.23 γ_{88} 1023.3220 (\dagger 100) γ_{70} 1040.212 (\dagger 1.37) γ_{28} 1083.95 (\dagger 6.318) γ_0 1111.95 (\dagger 103)
- 1185.65 γ_{135} 1051.38 (\dagger 104) γ_{88} 1097.97 (\dagger 3311) γ_{47} 1138.55 (\dagger 8318) γ_{19} 1166.35 (\dagger 100)
- E 2400400, 64060 ns, %SF \leq 100

246
95Am

Δ : 6498818 S_n : 497618 S_p : 539823 Q_{β^-} : 237618 Q_{α} : 5150200

Nuclear Bands

- A Fission isomer

Levels and γ -ray branchings:

- 0, (7⁻), 393 m, % β^- =100
- >0, 2(7⁻), 25.02 m, % β^- =100, %IT<0.01
- 16.233, (0⁺, 1⁻, 2⁻) $\gamma_{0,00}$ 16.233 (\dagger 100)
- 43.812, (1⁺), 4.33 ns γ_{16} 27.582 (\dagger 14.115) (E1) $\gamma_{0,00}$ 43.812 (\dagger 1005) (E1)
- 74.335
- 223.752, (1⁺) γ_{74} 149.423 (\dagger 0.2420) γ_{44} 179.942 (\dagger 41.320) (M1) $\gamma_{0,00}$ 223.752 (\dagger 1007) (E1)
- 232.763 γ_{74} 158.423 (\dagger 317) γ_{44} 189.004 (\dagger 427) γ_{16} 216.554 (\dagger 10016) γ_{16} 223.752 (\dagger 7111)
- 299.354, 0⁻, 1 γ_{233} 66.602 (\dagger 1007) γ_{224} 75.642 (\dagger 7110) γ_{44} 255.543 (\dagger 907) $\gamma_{0,00}$ 299.346 (\dagger 123)
- A =2000, 7310 μ s, %SF \leq 100

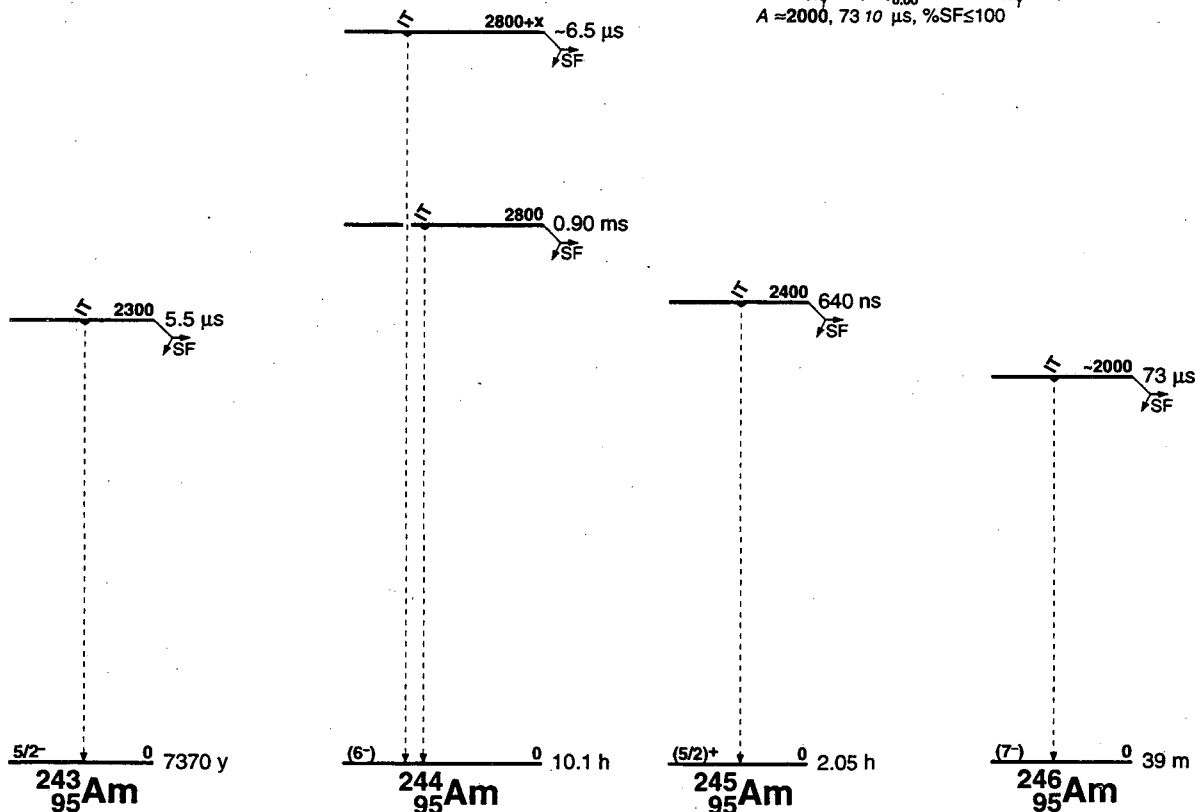

240 Cm

Δ : 51715.3 S_n: (7440) S_p: 4959.3
 Q_{EC}: 216.14 Q_α: 6397.26

Nuclear Bands

A Fission isomer

Levels:

- 0, 0⁺, 27.1 d, %α=99.5, %EC<0.5,
 %SF=3.9×10⁻⁶
- 38.5, 2⁺
- A ≈2000, 10.3 ps, %SF≤100
- A ≈3000, 55.12 ns, %SF=100

241 Cm

Δ : 53696.923 S_n: 6089.825 S_p: 5092.14
 Q_{EC}: 767.512 Q_α: 6185.06

Nuclear Bands

A Fission isomer

Levels:

- 0, 1/2⁺, 32.82 d, %α=1.01, %EC=99.01
- 0+x
- 53+x
- 103+x
- 157+x
- 255+x
- A ≈2300, 15.310 ns, %SF=100

242 Cm

Δ : 54798.320 S_n: 6969.914 S_p: 5420.07
 Q_α: 6215.568

σ_f: <5 b, σ_f⁰: 16.5 b

Nuclear Bands

A GS band
 B Fission isomer

Levels and γ-ray branchings:

- A 0, 0⁺, 162.82 d, %α=100, %SF=6.2×10⁻⁶
- A 42.131, 2⁺ γ₀ 42.131 E2
- A 138.4, 4⁺ γ₄₂ 96.3
- A 284.7, 6⁺ γ₁₃₈ 146.5
- B 1900.200, 40.15 ps, %SF≤100
- B ≈2800, 180.70 ns

243 Cm

Δ : 57176.322 S_n: 5693.310 S_p: 5575.812
 Q_{EC}: 8.914 Q_α: 6168.810

σ_{abs}: 747.23 b, σ_f⁰: 617.20 b, σ_f⁰: 130.10 b

Nuclear Bands

A 5/2[622]
 B 1/2[631]
 C 7/2[624]
 D 1/2[501]
 E Fission isomer

Levels and γ-ray branchings:

- A 0, 5/2⁺, 29.11 y, %α=99.713, %EC=0.293,
 %SF=5.3×10⁻⁹, μ=0.41
- A 42.2, 7/2⁺
- B 87.41, 1/2⁺, 1.083 μs γ₀ 87.41 (†,100) E2
- A 94.2, 9/2⁺
- B 94.2, (3/2⁺)
- C 128.4, (7/2⁺)
- 153.2
- 164.2
- C 187.9, (9/2⁺)
- 219.3

228.3

B 260.2, (9/2⁺)

530.3

D 729.2, (1/2⁻)

769.2

798.2

842.2

860.4(?)

892.2

904.3

930.4

973.2

1015.3

1023.2

1046.4

1136.2

1217.3

1222.4

1359.3

1367.4

E 1900.300, 42.6 ns, %SF≤100

244 Cm

Δ : 58447.020 S_n: 6800.711 S_p: 6009.410

Q_α: 5901.615

σ_f⁰: 1.0420 b, σ_f⁰: 15.212 b

Nuclear Bands

A GS band
 B Fission isomer

Levels and γ-ray branchings:

- A 0, 0⁺, 18.102 y, %SF=1.347×10⁻⁴, %α=100
- A 42.96510, 2⁺, 97.5 ps γ₀ 42.96510 (†,100) E2
- A 142.3484, 4⁺ γ₄₃ 99.3834 (†,100) E2
- A 296.21111, 6⁺ γ₁₄₂ 153.8632 (†,100) E2
- A 501.78712, 8⁺ γ₂₉₆ 205.5754 (†,100) E2
- 970.4, (2⁺,3⁺)
- 984.91515, 0⁺ γ₄₃ 941.952 γ₀ 984.91920 E0
- 1020.75922(?), (2⁺) γ₄₃ 977.802 (†,100) E0(+M1)
- 1038.6, (2⁺,3⁺)
- 1040.18111, 6⁺, 34.2 ms γ₅₀₂ 538.40016 (†,1.02) γ₂₉₆ 743.9715 (†,100.30) M1+E2: δ=-0.928 γ₁₄₂ 897.8487 (†,42.12) E2
- 1084.19912(?), (1,2⁺) γ₄₃ 1041.27822 (†,53.18) γ₀ 1084.18114 (†,100.30)
- 1105.90820(?), (1,2⁺) γ₄₃ 1062.95318 (†,100.30) (M1),(E1) γ₀ 1105.4319 (†,15.8)
- 1187.4, (2⁺,3⁺)
- B ≈2200(?), <5 ps, %SF=?
- B ≈3500, >100 ns, %SF≤100

245 Cm

Δ : 60999.3 S_n: 5519.819 S_p: 6165.521

Q_α: 5623.519

σ_f⁰: 369.17 b, σ_{abs}: 2514.60 b, σ_f⁰: 2145.58 b

Nuclear Bands

A 7/2[624]
 B 5/2[622]
 C 1/2[631]
 D 9/2[734]
 E Band Structure
 F 7/2[743]
 G 7/2[613]
 H 1/2[620]
 I 1/2[501]
 J Fission isomer

Levels and γ-ray branchings:

- A 0, 7/2⁺, 8500.100 y, μ=0.51, %α=100,
 %SF=6.1×10⁻⁷
- A 54.815, 9/2⁺, <0.10 ns γ₀ 54.815 M1+E2: δ=1.32
- A 121.604, 11/2⁺ γ₅₅ 66.802 (†,64.4) M1+E2: δ=0.8630 γ₀ 121.604 (†,100.10)
- A 197.420, 13/2⁺ γ₁₂₂ 75.820(?)
- B 252.802, 5/2⁺ γ₅₅ 198.01 (†,0.547) E2 γ₀ 252.802 (†,100.7) M1+E2: δ=0.163
- B 295.722, 7/2⁺ γ₂₅₃ 42.882 (†,17.510) γ₅₅ 240.862 (†,100.4) M1(+E2): δ<0.7 γ₀ 295.722 (†,65.3) M1+E2: δ=0.2222
- B 350.644, 9/2⁺ γ₂₉₆ 54.8 (†,20.15) γ₁₂₂ 229.5010 (†,100.5)
- C 355.9010, 1/2⁻, 0.292 μs γ₂₅₃ 103.11 E2
- C 361.44, (3/2⁻)
- D 388.185, 9/2⁻, 0.45020 ns γ₃₅₁ 37.543 (†,0.022411) γ₂₉₆ 92.512 (†,0.49416) γ₁₂₂ 266.622 (†,1.054) (E1) γ₅₅ 333.372 (†,21.16) E1 γ₀ 388.162 (†,100.3) E1
- B 416.605, 11/2⁺ γ₃₅₁ 65.962
- C 418.75, (5/2⁺)
- C 431.2, (7/2⁺)
- D 442.845, 11/2⁻ γ₃₈₈ 54.8 (†,56.13) M1+E2: δ=0.6817 γ₁₂₂ 321.243 (†,100.6)
- B 498.2, 13/2⁺
- D 509.02, 13/2⁻ γ₄₄₃ 65.96 γ₃₈₈ 120.8010
- C 532.2, (9/2⁺)
- 545.3
- C 555.5, (11/2⁺)
- 558.3
- D 588.3, (15/2⁻)
- B 598.3, (15/2⁺)
- E 633.6011, (3/2⁻) γ₃₆₁ 272.23 (†,0.5013) γ₂₅₃ 380.81 (†,100) E1 =638(?)
- F 643.656, (7/2⁻) γ₃₈₈ 255.453 (†,100.13) γ₂₅₃ 390.855 (†,67.8) γ₅₅ 589.0010 (†,9.215) γ₀ 643.23 (†,49.18) 660.5(?)
- E 661.520, 5/2⁻ γ₂₉₆ 365.81 (†,100) E1 γ₂₅₃ 408.71 (†,51.9)
- D 672.3, (17/2⁻)
- F 701.7211, (9/2⁻) γ₂₉₆ 406.0010 (†,100.8) γ₀ =700(?) (†,55)
- G 722.3, (7/2⁻)
- 735.3(?)
- H 740.92, (1/2⁺) γ₃₅₆ 385.01 (†,100) M1 γ₂₅₃ 488.22 (†,2.56)
- H 769.25, (3/2⁺) γ₄₁₉ 350.51 (†,100) M1 γ₃₆₁ 407.82 (†,37) (M1) 772.3
- F 773.4, (11/2⁻) I 956.2, (3/2⁻,5/2⁻) =972
- G 782.4, (9/2⁺)
- H 791.4, (5/2⁺) 980.5 995.5 =838 =1009 1017.4 1042.5 1050.5 1056.3 1083.3 1103.3 1259.5 1271.2 1473.3
- I 913.3, (1/2⁻) =936 942.3 J 2100.300, 13.218 ns, %SF≤100

NUCLEAR DATA SHEETS

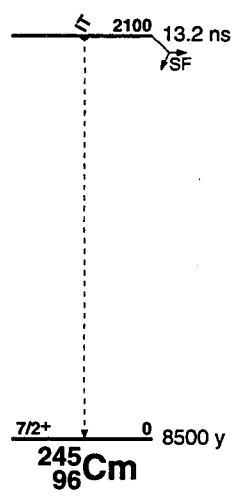
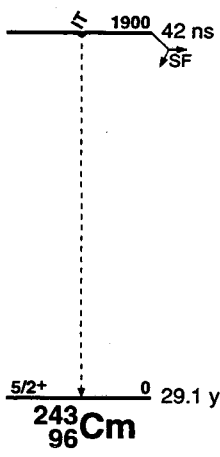
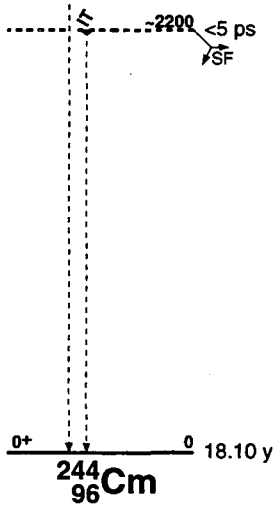
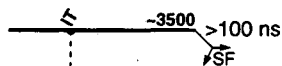
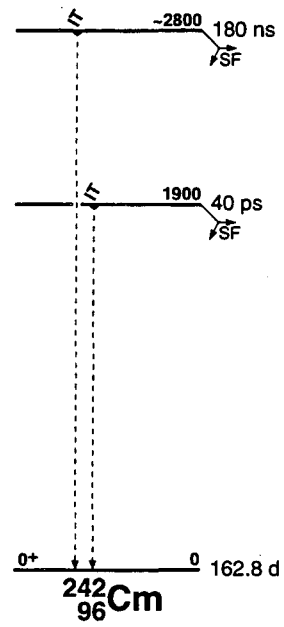
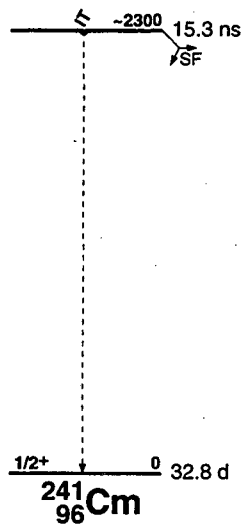
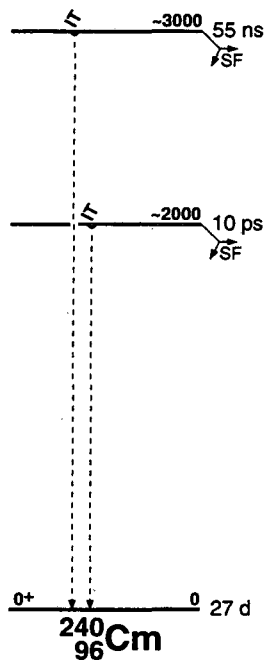

²⁴²₉₇Bk

Δ : (57800) S_n : (6400) S_p : (3190) Q_{EC} : (3000) Q_α : (6960)

Nuclear Bands

A Fission isomer

Levels:

0, 7.0 13 m, %EC+% β ⁺=100

\approx 330

A x, 9.5 20 ns, %SF>0

A y, 0.60 10 μ s, %SF>0

²⁴³₉₇Bk

Δ : 58685.5 S_n : (7190) S_p : 3403.5 Q_{EC} : 1508.5 Q_α : 6874.4

Nuclear Bands

A 7/2[633]

B Fission isomer

Levels:

0, (3/2⁻), 4.5 2 h, % α \approx 0.15, %EC=99.85

A 0+x, (7/2⁺)

A 49+x 4, (9/2⁺)

A 112+x 6, (11/2⁺)

B =2200 (?), 5 ns, %SF \leq 100

²⁴⁴₉₇Bk

Δ : 60700.50 S_n : 6050.50 S_p : 3760.50 Q_{EC} : 2260.50 Q_α : 6780.50

Nuclear Bands

A Fission isomer

Levels:

0, (1⁻), 4.35 15 h, % α =0.006 2, %EC=99.994 2

\approx 130

\approx 158

\approx 190

A x, 820 60 ns, %SF \leq 100

²⁴⁵₉₇Bk

Δ : 61808.8 25 S_n : 6970.50 S_p : 3927.2 15 Q_{EC} : 810.2 24 Q_α : 6454.5 15

Nuclear Bands

A 3/2[521]

B 7/2[633]

C Fission isomer

Levels:

A 0, 3/2⁻, 4.94 3 d, % α =0.12 1, %EC=99.88 1

B 0+x, 7/2⁺(*)

B 61+x 13, (9/2⁺)

C =1560, 2 1 ns, %SF=100

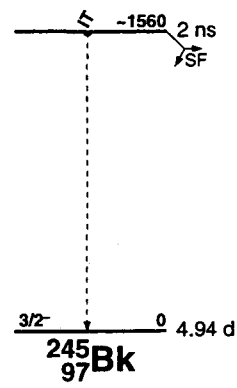
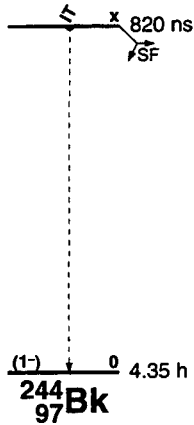
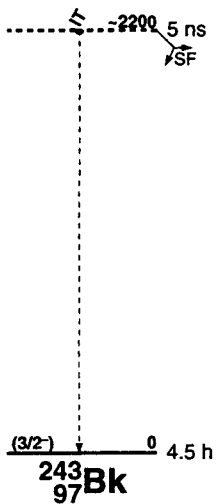
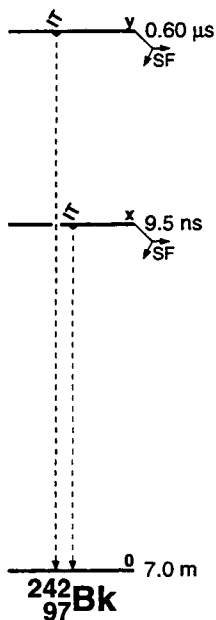

References for Fission Isomers

62Po09 Spontaneous Fission with an Anomalous Short Period. I.

S. M. Polikanov, V. A. Druin, V. A. Kamaukhov, V. L. Mikheev, A. A. Pleve, N. K. Skobelev, G. M. Ter-Akopyan, V. A. Fomichev, Zhur. Eksptl. i Teoret. Fiz. 42, 1464 (1962); Soviet Phys. JETP 15, 1016 (1962).

Nuclear Structure: Fission ^{242}Am ; measured not abstracted; deduced nuclear properties.

62Pe26 Spontaneous Fission with an Anomalous Short Period. II

V. P. Pereygin, S. P. Almazova, B. A. Gvozdev, Y. T. Chuburkov, Zhur. Eksptl. i Teoret. Fiz. 42, 1472 (1962); Soviet Phys. JETP 15, 1022 (1962).

63Fi08 Formation of a Spontaneously Fissioning Isomer in Reactions Involving α Particles and Deuterons

G. N. Flerov, S. M. Polikanov, K. A. Gavrilov, V. L. Mikheev, V. P. Pereygin, A. A. Pleve, Zh. Eksperim. i Teor. Fiz. 45, 1396 (1963); Soviet Phys. JETP 18, 964 (1964).

63Pe27 Half-Life of a Spontaneously Fissioning Isomer

V. G. Pereygin, S. P. Tretyakova, Zh. Eksperim. i Teor. Fiz. 45, 863 (1963); Soviet Phys. JETP 18, 592 (1964).

Nuclear Structure: Fission ^{238}U ; measured not abstracted; deduced nuclear properties.

65Fi04 The Excitation Function and the Isomeric Yield Ratio for the 14 msec Fissioning Isomer from Deuteron Irradiation of Plutonium

G. N. Flerov, A. A. Pleve, S. M. Polikanov, E. Ivanov, N. Martalogu, D. Poenaru, N. Vilcov, Rev. Roumaine Phys. 10, 217 (1965).

Nuclear Structure: ^{242}Am ; measured not abstracted; deduced nuclear properties.

65Le22 Decay of the Am^{242m} 14-msec Isomer

R. B. Leachman, B. H. Erkkila, Bull. Am. Phys. Soc. 10, No. 9, 1204, P12 (1965)

Nuclear Structure: ^{242}Am ; measured not abstracted; deduced nuclear properties.

65Li05 The Formation of a Spontaneously Fissioning Isomer in the Capture of Neutrons by Am

A. F. Linev, B. N. Markov, A. A. Pleve, S. M. Polikanov, Nucl. Phys. 63, 173 (1965).

Radioactivity: ^{242}Am ; measured $T_{1/2}$, SF. $^{243}\text{Am}(n, 2n)$, $E=14$ MeV; measured σ .

66Br23 A Study of Nuclear Isomers Which Decay by Spontaneous Fission

D. S. Brenner, L. Westgaard, S. Bjornholm, Nucl. Phys. 89, 267 (1966).

Radioactivity: ^{242}Am isomer [from $^{242}\text{Pu}(d,2n)$]; measured $T_{1/2}$ (SF), E(fragment)-spectrum. Enriched target. $^{242}\text{Pu}(d,2n)$, (d,F), $E = 12$ MeV; measured $\sigma(\text{F})(\text{delayed})/\sigma(\text{F})(\text{prompt})$. Enriched target. ^{232}Th , ^{235}U , ^{239}Pu , ^{241}Am , $^{243}\text{Am}(d, xn)(d,F)$, $E = 12$ MeV; $^{243}\text{Am}(p, xn)(p,F)$, $E = 13$ MeV; measured upper limits $\sigma(\text{F})(\text{delayed})/\sigma(\text{F})(\text{prompt})$. Enriched targets.

66Ma48 Structure of Spontaneously Fissionable Isomers

L. A. Malov, S. M. Polikanov, V. G. Solovov, Yadern. Fiz. 4, 528 (1966); Soviet J. Nucl. Phys. 4, 376 (1967).

67Bj03 Excitation Energy of the Spontaneously Fissioning Isomeric State in ^{240}Am

S. Bjornholm, J. Borggreen, L. Westgaard, V. A. Kamaukhov, Nucl. Phys. A95, 513 (1967).

Nuclear Reactions: $^{240}\text{Pu}(d,2n)$, $E = 12.1$ MeV; $^{240}\text{Pu}(p,n)$, $E = 10.3-11.3$ MeV; measured σ (delayed fission). $^{241}\text{Pu}(p,2n)$, $E = 9.6-13.6$ MeV; measured σ (delayed fission); deduced threshold. Enriched target. ^{240m}Am measured $T_{1/2}$ for spontaneous fission.

67Bo23 A New Spontaneously Fissioning Isomer: ^{238}Am

J. Borggreen, Y. P. Gangrsky, G. Sletten, S. Bjornholm, Phys. Letters 25B, 402 (1967).

Nuclear Structure: ^{238}Am ; measured not abstracted; deduced nuclear properties.

67Fi03 Excitation Energy of Spontaneously Fissioning Isomer ^{242m}Am

G. N. Flerov, A. A. Pleve, S. M. Polikanov, S. P. Tretyakova, N. Martalogu, D. Poenaru, M. Sezon, I. Vilcov, N. Vilcov, Nucl. Phys. A97, 444 (1967).

Nuclear Reactions: $^{243}\text{Am}(n,2nF)$, $E = 8-14.4$ MeV; measured $\sigma(E)$, n, F-delay. ^{242}Am deduced level, $T_{1/2}$. Enriched target.

67Fi08 A Study of the Spontaneously-Fissioning Isomer of ^{242}Am Through the $^{241}\text{Am}(n,\gamma)$ Reaction

G. N. Flerov, A. A. Pleve, S. M. Polikanov, S. P. Tretyakova, I. Boca, M. Sezon, I. Vilcov, N. Vilcov, Nucl. Phys. A102, 443 (1967).

Nuclear Reactions: Fission $^{241}\text{Am}(n,\gamma)$; $E=0-6.5$ MeV; measured $\sigma(E)$.

Radioactivity: Fission ^{244m}Am [from $^{243}\text{Am}(n,\gamma)$]; measured $T_{1/2}$ (SF).

67Ga04 Investigation of the Reaction $\text{U}^{238} + \text{B}^{11}$, Which Leads to the Spontaneously-Fissioning Isomer Am^{242}

Y. P. Gangrskii, B. N. Markov, S. M. Polikanov, G. Jungclaussen, Yadern. Fiz. 5, 22 (1967); Soviet J. Nucl. Phys. 5, 16 (1967).

Nuclear Structure: ^{242}Am ; measured not abstracted; deduced nuclear properties.

67Vi01 On the Spin Value of the 14-msec Spontaneously Fissioning Isomer of Am^{242}

N. Vilcov, Rev. Roumaine Phys. 12, 487 (1967).

Nuclear Structure: ^{242}Am ; measured not abstracted; deduced nuclear properties.

68Bj04 Investigation of (d,p) and (d,t) Reactions Leading to Spontaneously Fissile Isomeric States

S. Bjornholm, I. Borggreen, Y. P. Gangrskii, G. Sletten, Yadern. Fiz. 8, 459 (1968); Soviet J. Nucl. Phys. 8, 267 (1969).

Nuclear Reactions: 241 , $^{243}\text{Am}(d,p)$, (d,t), $E=9-13$ MeV; measured $\sigma(E)$; deduced isomeric ratio.

- 68Ca23** *Autocorrelation Effects in the Neutron Induced Fission Cross Section of ^{235}U*
M. G. Cao, E. Migneco, J. P. Theobald, Phys. Lett. 27B, 409 (1968).
Nuclear Reactions: Fission $^{235}\text{U}(n,F)$, $E=0.006\text{-}3$ keV; measured $\sigma(E)$. ^{236}U deduced resonance, autocorrelation, intermediate state, shape isomer. Reanalysis of data.
- 68Er01** *Energy of ^{242}Am and ^{242m}Am Fission Fragments*
B. H. Erkkila, R. B. Leachman, Nucl. Phys. A108, 689 (1968).
Radioactivity: Fission $^{242m}\text{Am}(SF)$ [from $^{242}\text{Pu}(d,2n)$]; measured $T_{1/2}$, $E(\text{fragment})$. ^{252}Cf measured $E(\text{fragment})$.
Nuclear Reactions: Fission $^{240}\text{Pu}(d,F)$, $E=7.6\text{-}14$ MeV; measured $\sigma(E)$; $E(\text{fragment})$) ^{230}Th , ^{233}U , $^{242}\text{Pu}(d, F)$, $E=14$ MeV; measured $\sigma(E(\text{fragment}))$.
- 68Mi14** *Resonance Grouping Structure in Neutron Induced Subthreshold Fission of ^{240}Pu*
E. Migneco, J. P. Theobald, Nucl. Phys. A112, 603 (1968).
Nuclear Reactions: $^{240}\text{Pu}(n,F)$, $E=0.2$ to 8 keV; measured $\sigma(nf)(E)$. ^{241}Pu resonances deduced F-width.
- 68WoZZ** *Short-Lived Spontaneous Fission Isomers*
K. L. Wolf, R. Vandenbosch, Bull. Am. Phys. Soc. 13, No. 11, 1407, CF4(1968).
Nuclear Reactions: $^{238}\text{U}(\alpha,2n)$, $E=21\text{-}42$ MeV; measured isomer ratio, $\sigma(E\alpha)$. ^{240}Pu deduced $T_{1/2}$, spontaneous fission.
- 69Bj02** *Intermediate States in Fission*
S. Bjornholm, V. M. Strutinsky, Nucl. Phys. A136, 1 (1969).
- 69Bo25** *Population of the Spontaneously Fissioning Isomer ^{244m}Am Through the (n,γ) Reaction*
I. Boca, N. Martalogu, M. Sezon, I. Vilcov, N. Vilcov, G. N. Flerov, A. A. Pleva, S. M. Polikanov, S. P. Tretyakova, Nucl. Phys. A134, 541 (1969).
Nuclear Reactions: $^{243}\text{Am}(n,\gamma)$, (n,F) , $E = 0.3\text{-}4$ MeV; measured $\sigma(E)$. ^{244}Am deduced $T_{1/2}$, spontaneous fission. Enriched target.
- 69Ei06** *Discussion on Papers SM 122/110 and SM 122/29*
A. J. Elwyn, A. T. G. Ferguson, 2nd Symp. Phys. Chem. of Fission, Vienna, Intern. At. Energy Agency, Vienna, p. 457 (1969).
- 69Ja01** *Fission Components in ^{242}Pu Resonances*
G. D. James, Nucl. Phys. A123, 24 (1969).
Nuclear Reactions: $^{242}\text{Pu}(n,F)$, $E=16$ eV-35 keV; measured $\sigma(E)$. ^{243}Pu deduced resonances, resonance parameters. Enriched target.
- 69JoZU**
A. B. Jorgensen, S. M. Polikanov, G. Sletten, Priv. Comm., quoted by 70PO01, unpublished (1969).
- 69Ka27** *Photofission of Even-Even Nuclei and Structure of the Fission Barrier*
S. P. Kapitza, N. S. Rabotnov, G. N. Smirenkin, A. S. Soldatov, L. N. Usachev, Y. M. Tsipenyuk, ZhETF Pisma v Redaktsiyu 9, 128 (1969); JETP Letters 9, 73 (1969).
Nuclear Reactions: ^{232}Th , ^{238}U , ^{240}U , $^{242}\text{Pu}(\gamma, F)$, $E < 5\text{-}8$ MeV; measured $\sigma(E;E(\text{fragment}),\theta(\text{fragment}))$. ^{232}Th , ^{238}U , ^{238}U , ^{240}U , ^{242}Pu deduced fission barrier structure.
- 69Kr12** *The Moment of Inertia of the Fission Isomer*
J. Krumlind, Phys. Letters 30B, 221 (1969).
Nuclear Structure: Fission ^{238}U , ^{242}Pu , ^{246}Cm , $^{250}\text{Cf}(SF)$; calculated moments of inertia. Cranking model.
- 69La14** *Spontaneously Fissioning Isomers in U, Np, Pu and Am Isotopes*
N. L. Lark, G. Sletten, J. Pedersen, S. Bjornholm, Nucl. Phys. A139, 481 (1969).
Radioactivity: Fission ^{236m}U , ^{239m}Np , ^{236m}Pu , ^{237m}Pu , ^{240m}Pu , ^{241m}Pu , ^{242m}Pu , ^{243m}Pu , ^{239m}Am , $^{241m}\text{Am}(SF)$; measured $T_{1/2}$.
Nuclear Reactions: ^{235}U , ^{239}U , $^{241}\text{Pu}(d,p)$, $^{240}\text{Pu}(d,X)$, $E=11\text{-}13$ MeV; measured σ delayed fission. $^{237}\text{Np}(p,2n)$, $E=9\text{-}14$ MeV; $^{240}\text{Pu}(p, 2n)$, $E=10\text{-}13$ MeV; $^{242}\text{Pu}(p,2n)$, $E=8.8\text{-}13$ MeV; measured σ delayed fission; deduced thresholds. ^{238}U , $^{237}\text{Np}(d,X)$, ^{239}Pu , $^{241}\text{Pu}(d, 2n)$, $E=13$ MeV; measured σ delayed fission. $^{237}\text{Np}(p, 2n)$, $E=13$ MeV; measured σ ground state. Enriched targets.
- 69Na20** *On the Detection of Spontaneously Fissioning Isomer States*
L. Nagy, T. Nagy, I. Vinnay, KFKI Közlem. 17, 165 (1969).
- 69Me11** *Fission Isomerism Induced by Helium Ions*
V. Metag, R. Repnow, P. Von Brentano, J. D. Fox, Z. Physik 226, 1 (1969).
Nuclear Reactions: ^{233}U , ^{235}U , ^{236}U , ^{238}U , ^{237}Np , $^{239}\text{Pu}(\alpha,2n)$, $E=26.1$ MeV; measured α . ^{235}U , ^{237}U , ^{238}U , ^{240}Pu , ^{239}Am , ^{241}Cm deduced $T_{1/2}$ (SF-isomer). $^{239}\text{Pu}(^3\text{He}, 2np)$, $E=30$ MeV; measured σ . ^{239}Am deduced $T_{1/2}$ (SF-isomer). $^{238}\text{U}(\alpha,n)$, $E=26$ MeV; measured σ . ^{239}Pu deduced $T_{1/2}$ (SF-isomer). $^{237}\text{Np}(^3\text{He},p)(^3\text{He},np)$, $(^3\text{He}, 2np)$, $E=26, 30$ MeV; measured σ . ^{237}Np , ^{238}Pu deduced $T_{1/2}$ (SF-isomer).
- 69MeZX** *Charged-Particle Studies of Isomeric Fission*
V. Metag, R. Repnow, P. von Brentano, J. D. Fox, Proc. Symp. Phys. Chem. Fission, 2nd, Vienna, Intern. At. En. Agency, p. 449 (1969).
- 69Ni13** *On the Nuclear Structure and Stability of Heavy and Superheavy Elements*
S. G. Nilsson, C. F. Tsang, A. Sobczewski, Z. Szymanski, S. Wycech, C. Gustafson, I. -L. Lamm, P. Moller, B. Nilsson, Nucl. Phys. A131, 1 (1969).
- 69SIZZ** *Discussion on Papers SM-122/110 and SM-122/29*
G. Sletten, S. M. Polikanov, Symp. Phys. Chem. Of Fission, 2nd, Vienna, Intern. At. Energy Agency, Vienna, p. 461 (1969).
Radioactivity: Fission ^{237m}Am , ^{239m}Am , ^{240m}Am , ^{241m}Cm , ^{243m}Cm , ^{244m}Am ; measured $T_{1/2}$.

69VaZX Spontaneous Fission Isomers with Very Short Half-Lives

R. Vandenbosch, K. L. Wolf, Proc. Symp. Phys. Chem. Fission, 2nd, Vienna, Intern. At. En. Agency, Vienna, p. 439 (1969).

Radioactivity: Fission 236 , 237 , 238 , 239 , ^{240}Pu (SF); measured $T_{1/2}$.

Nuclear Reactions: 236 , $^{238}\text{U}(\alpha, 3n)$, $^{238}\text{U}(\alpha, 2n)$, $E=21-42$ MeV; measured $\sigma(E)$; deduced isomer ratios.

69Vo18 Analysis of Neutron Fission of the Odd-Even Nuclei Pa^{231} , Np^{237} , and Am^{241}

P. E. Vorotnikov, Yadern. Fiz. 9, 538 (1969); Soviet J. Nucl. Phys. 9, 308 (1969).

Nuclear Reactions: ^{231}Pa , ^{237}Np , $^{241}\text{Am}(n, \gamma)$, (n, F) , $E=0-1$ MeV; calculated $\sigma(E)$. ^{232}Pa , ^{238}Np , ^{242}Am calculated level-width, fission barrier penetrability.

70AIZT On Vibrational Type Resonances in Fission

J. Almberger, S. Jagare, Ann. Rept., Research Inst. Phys., Stockholm, p. 217 (1970).

Nuclear Structure: Fission 239 , ^{242}Pu , ^{242}Am ; calculated fission branching ratios. Vibrational-type resonances.

70Be44 Search for a Long-Lived Spontaneous Fission Isomer of ^{241}Pu

C. E. Bemis, Jr., R. J. Silva, J. E. Bigelow, A. M. Friedman, Inorg. Nucl. Chem. Lett. 6, 747 (1970); ORNL-4581, p. 36 (1970).

Nuclear Reactions: $^{240}\text{Pu}(n, \gamma)$, $E=\text{thermal}$, > 1 MeV; $^{242}\text{Pu}(n, 2n)$, $E > 6.2$ MeV; $^{239}\text{U}(\alpha, n)$, $E=40$ MeV; measured σ . ^{241}Pu deduced no 0.3-yr SF-isomer.

70Bj02 Search for New Islands of Fission Isomerism

S. Bjornholm, J. Borggreen, E. K. Hyde, Nucl. Phys. A156, 561 (1970).

Nuclear Reactions: $^{197}\text{Au}(\text{HI}, X)$, $E=5-10$ MeV/nucleon for $\text{HI}=\text{B}^{11}$, C^{12} , N^{14} , O^{16} ; measured $\sigma(E)$ for SF-isomers. 200 , 201 , 202 , 203 , ^{204}Po , 201 , 202 , 203 , 204 , ^{205}At , 202 , 203 , 204 , 205 , 206 , ^{207}Rn , 202 , 203 , 204 , 205 , 206 , 207 , 208 , 209 , ^{210}Fr deduced no SF-isomer ($\sigma < 0.1$ μb) with $2\text{ns} < T_{1/2} < 2000\text{s}$.

70Br32 Fission of Odd-A Uranium and Plutonium Isotopes Excited by (d, p) , (t, d) , and (t, p) Reactions

H. C. Britt, J. D. Cramer, Phys. Rev. C2, 1758 (1970).

Nuclear Reactions: 234 , 236 , ^{238}U , $^{242}\text{Pu}(d, pF)$, 233 , ^{235}U , $^{239}\text{Pu}(t, pF)$, ^{236}U , 240 , $^{242}\text{Pu}(t, dF)$, $E=18$ MeV; measured $(p)(\text{fragment})(\theta)$, $(d)(\text{fragment})(\theta)$. 235 , 237 , ^{239}U , 241 , ^{243}Pu deduced fission probabilities.

70Bu02 Systematics of Plutonium Fission Isomers

S. C. Bumett, H. C. Britt, B. H. Erkkila, W. E. Stein, Phys. Lett. 31B, 523 (1970).

Radioactivity: Fission $^{233\text{m}}\text{Pu}$, $^{237\text{m}}\text{Pu}$, $^{238\text{m}}\text{Pu}$, $^{239\text{m}}\text{Pu}$, $^{240\text{m}}\text{Pu}$ (SF); measured $T_{1/2}$.

Nuclear Reactions: 233 , 235 , 236 , $^{238}\text{U}(\alpha, 2n)$, $E=20-28$ MeV; $^{234}\text{U}(\alpha, xn)$, $^{236}\text{U}(\alpha, n)$, $^{238}\text{U}(\alpha, n)$, $(\alpha, 3n)$, $E=20-29$ MeV; measured isomeric σ ratios(E); deduced thresholds for SF-isomer production.

70Da05 Production of Spontaneously Fissioning Isomers ^{242}Am and ^{244}Am by Slow Neutron Capture

B. Dalhsuren, G. N. Flerov, Y. P. Gangrsky, Y. A. Lazarev, B. N. Markov, Nguyen Cong Khanh, Nucl. Phys. A148, 492 (1970).

Nuclear Reactions: 241 , $^{243}\text{Am}(n, \gamma)$, (n, F) , $E=0.2-20$ eV; measured delayed, prompt fission σ ratios, $(n)(\text{fission fragment})\text{-delay}$. 242 , ^{244}Am [SF-isomers] deduced $T_{1/2}$.

70Ei03 Short-Lived Fission Isomers from Neutron Studies

A. J. Elwyn, A. T. G. Ferguson, Nucl. Phys. A148, 337 (1970).

Nuclear Reactions: 233 , 234 , 235 , ^{238}U , $^{239}\text{Pu}(n, \gamma)$, $E=0.55, 2.2$ MeV; measured σ for SF-isomer production; deduced isomeric σ ratios. 234 , 235 , 236 , ^{239}U , ^{240}Pu deduced SF-isomers, $T_{1/2}$.

70Ga04 Study of (γ, n) Reactions Leading to Formation of Spontaneously Fissioning Isomers of Am

Y. P. Gangrskii, B. N. Markov, Y. M. Tsipenyuk, Yad. Fiz. 11, 54 (1970); Sov. J. Nucl. Phys. 11, 30 (1970).

Nuclear Reactions: 241 , $^{243}\text{Am}(\gamma, n)$, $E < 9.5-13.5$ MeV; measured $\sigma(E)$ for producing SF-isomers. 240 , ^{242}Am deduced energy of SF isomeric state.

70Ga10 Investigation of the Properties of the Spontaneously Fissioning Isomer ^{241}Pu in the Reaction (γ, n)

Y. P. Gangrsky, B. N. Markov, Y. M. Tsipenyuk, Phys. Lett. 32B, 182 (1970).

Nuclear Reactions: $^{242}\text{Pu}(\gamma, nF)$, $E < 8-13$ MeV; measured $\sigma(E)$, $(\gamma)(\text{fragment})\text{-delay}$. ^{241}Pu deduced SF-isomer $T_{1/2}$.

70Ga34 Production of Spontaneously Fissioning Isomers of Uranium, Plutonium, and Americium in the Neutron Reactions

Y. P. Gangrsky, T. Nagy, I. Vinnay, I. Kovacs, JINR-P3-5528 (1970).

Nuclear Reactions: ^{232}Th , 235 , ^{238}U , ^{239}Pu , $^{243}\text{Am}(n, 2n)$, ^{238}U , ^{242}Pu , $^{243}\text{Am}(n, n')$, E not given; measured SF-isomer production σ .

70Ja16 Excitation Energies of Fissioning Shape Isomers

S. Jagare, Phys. Lett. 32B, 571 (1970).

Nuclear Reactions: 239 , 240 , 241 , $^{242}\text{Pu}(p, 2n)$, $E=10.9-13.5$ MeV; calculated σ for SF-isomer production. 238 , 239 , 240 , 241 , ^{242}Am calculated SF-isomer excitation energies.

70KrZT

Report: IN-1407 P151

Radioactivity: ^{241}Pu ; measured activity; deduced no SF-isomer.

70Ot02 Fragment Angular Distributions from Neutron-Induced Fission of ^{242}Pu

K. Otozai, J. W. Meadows, A. N. Behkami, J. R. Huizenga, Nucl. Phys. A144, 502 (1970).

Nuclear Reactions: Fission $^{242}\text{Pu}(n, F)$, $E_n=500, 620, 730, 990, 1230$ keV; measured $\sigma(E_n, \theta(\text{fragment}))$. ^{243}Pu deduced information on transition states.

70PaZU

Report: CEA-N-1339, D Paya, 7/12/71

Nuclear Reactions: Fission $^{237}\text{Np}(n,F)$, E not given; measured(fragment)(fragment)-coin, (fragment)(fragment)-delay. ^{238}Np deduced no SF-isomer.

70Po01 Spontaneously Fissioning Isomers in U, Pu, Am and Cm Isotopes

S. M. Polikanov, G. Sletten, Nucl. Phys. A151, 656 (1970).

Nuclear Reactions: $^{233}\text{U}(d,p)$, $^{238}\text{U}(d,pn)$, $^{237}\text{Np}(d,2n)$, 238 , $^{244}\text{Pu}(p,2n)$, 238 , $^{240}\text{Pu}(d,p)$, 239 , $^{241}\text{Pu}(d,pn)$, 241 , $^{243}\text{Am}(p,2n)$, 241 , $^{243}\text{Am}(d,2n)$, $^{243}\text{Am}(d,pn)$; $E=9-14.2$ MeV; measured $\sigma(E)$ delayed fission. $^{238}\text{Pu}(p,2n)$, $E=12.1-14.0$ MeV; measured $\sigma(E)$; deduced threshold. Enriched targets.

Radioactivity: Fission 237m , 239m , 240m , 241m , $^{243m}\text{Pu}(SF)$, 243m , $^{237m}\text{Am}(SF)$, 240m , 241m , 242m , $^{243m}\text{Cm}(SF)$, $^{234m}\text{U}(SF)$; measured $T_{1/2}$. 237m , 242m , $^{243m}\text{Pu}(SF)$; analyzed data, reevaluated $T_{1/2}$. ^{239}Np deduced misassignment of (SF) isomer. $^{238m}\text{U}(SF)$ deduced $T_{1/2}$.

70Re05 Evidence for a Direct Reaction Mechanism in the Production of Fission Isomers

R. Repnov, V. Metag, J. D. Fox, P. von Brentano, Nucl. Phys. A147, 183 (1970).

Nuclear Reactions: $^{235}\text{U}(d,p)$, $E=13-20$ MeV; measured σ delayed fission. Enriched target. $^{236}\text{U}(d,pn)$, $E=11-20$ MeV; measured σ delayed fission. Enriched target. $^{238}\text{U}(d,pn)$, $E=11-20$ MeV; measured σ delayed fission. Natural target. $^{233}\text{U}(d,X)$, $^{236}\text{U}(p,X)$, $E=14, 20$ MeV; E upper limits σ delayed fission. Enriched targets. $^{238}\text{U}(p,X)$, $E=14-20$ MeV; measured upper limits σ delayed fission. Natural target.

Radioactivity: Fission 236 , ^{238}U deduced $T_{1/2}$ (SF-isomer). 234 , ^{237}U deduced no SF-isomer.

70So06 Intermediate Structure Effects in the Fission of Some Actinide Nuclei

D. K. Sood, N. Sarma, Nucl. Phys. A151, 532 (1970).

Nuclear Reactions: Fission 233 , ^{235}U , 239 , 240 , ^{241}Pu , $^{242}\text{Am}(n,F)$, $E < 1$ MeV; measured nothing; analyzed $\sigma(E)$ data; deduced spacing of second minimum levels.

70Vi05 Izomeri Spontan Fisionabili Ai Nucleelor Transuraniene

N. Vilcov, Stud. Cercet. Fiz. 22, 795 (1970).

Radioactivity: Fission ^{236}U , ^{238}Np , 236 , 240 , 241 , 242 , ^{243}Pu , 239 , $^{241}\text{Am}(SF)$; measured $T_{1/2}$.

70Wo06 Spontaneous Fission Isomerism in Uranium Isotopes

K. L. Wolf, R. Vandenbosch, P. A. Russo, M. K. Mehta, C. R. Rudy, Phys. Rev. C1, 2096 (1970).

Radioactivity: Fission ^{236m}U , $^{238m}\text{U}(SF)$; measured $T_{1/2}$.

Nuclear Reactions: 236 , $^{238}\text{U}(d,X)$, (d,pn), $E=13-22$ MeV; measured $\sigma(E;Ep)$. 236 , ^{238}U deduced isomer ratios.

71Au06 Neutron-Induced Fission Cross Sections of ^{242}Pu and ^{244}Pu

G. F. Auchampaugh, J. A. Farrell, D. W. Bergen, Nucl. Phys. A171, 31 (1971).

Nuclear Reactions: Fission 242 , $^{244}\text{Pu}(n,F)$, $E=20$ eV-10 MeV; measured $\sigma(E)$. 243 , ^{244}Pu deduced level spacings, resonance parameters, second barrier widths.

71Ba30 Fission of U, Np, Pu and Am Isotopes Excited in the (d,p) Reaction

B. B. Back, J. P. Bondorf, G. A. Otroschenko, J. Pedersen, B. Rasmussen, Nucl. Phys. A165, 449 (1971).

Nuclear Reactions: Fission 233 , ^{235}U , ^{237}Np , 238 , 239 , ^{241}Pu , 241 , $^{243}\text{Am}(d,pF)$, $E=13.0$ MeV; measured $\sigma(Ep,E(\text{fragment}))$. 234 , ^{236}U , ^{238}Np , 239 , 240 , ^{242}Pu , 242 , ^{244}Am deduced fission probability, fission barrier heights, transparencies.

71Be12 Neutron-Induced Fission Cross Section of ^{242}Pu

D. W. Bergen, R. R. Fullwood, Nucl. Phys. A163, 577 (1971).

Nuclear Reactions: Fission $^{242}\text{Pu}(n,F)$, $E=50$ eV-5 keV, 0.1-3 MeV; measured $\sigma(E)$. ^{243}Pu deduced resonances, F-width, fission barrier.

71Be62 Production of the Spontaneously Fissioning U^{236} Isomer in Thermal Neutron Radiative Capture

A. G. Belov, Y. P. Gangrskii, B. Dalkhsuren, A. M. Kucher, Yad. Fiz. 14, 685 (1971); Sov. J. Nucl. Phys. 14, 385 (1972).

Nuclear Reactions: Fission $^{235}\text{U}(n,\gamma F)$, $E=\text{thermal}$; measured σ , (fragment)(ce)-delay. ^{236m}U deduced $T_{1/2}$.

71Bo61 Study of the ^{236m}U Isomeric Fission Through the $^{235}\text{U}(n,\gamma)$ Reaction in the Energy Range 0.25 - 4 MeV

I. Boca, M. Sezon, I. Vilcov, N. Vilcov, Rev. Roum. Phys. 16, 473 (1971).

Radioactivity: $^{236m}\text{U}(SF)$; measured $T_{1/2}$.

Nuclear Reactions: Fission $^{235}\text{U}(n,\gamma F)$, $E=0.25-4$ MeV; measured $\sigma(E)$ for $^{236m}\text{U}(SF)$ production.

71Br38 Population of Fission Isomers in ^{236}U by the (d,p) Reaction

H. C. Britt, B. H. Erkkila, Phys. Rev. C4, 1441 (1971).

Nuclear Reactions: Fission $^{235}\text{U}(d,pf)$, (d,p), $E=12$ MeV; measured σ ratios, $\sigma(Ep)$, (d)(fragment)-delay. ^{236m}U deduced $T_{1/2}$.

Radioactivity: Fission ^{236m}U ; measured $T_{1/2}$.

71Br39 Systematics of Spontaneously Fissioning Isomers

H. C. Britt, S. C. Burnett, B. H. Erkkila, J. E. Lynn, W. E. Stein, Phys. Rev. C4, 1444 (1971).

Radioactivity: Fission 235m , 237m , 238m , 239m , 240m , $^{241m}\text{Pu}(SF)$, 241m , 242m , 243m , 244m , $^{245m}\text{Cm}(SF)$, $^{236m}\text{U}(SF)$, 239m , 240m , 242m , 243m , $^{244m}\text{Am}(SF)$; measured $T_{1/2}$, $T_{1/2}$ lower limits.

- 71Ga19** *Excitation of the Spontaneously Fissioning Isomeric States of ^{239}Pu and ^{243}Am at Inelastic γ -Quantum Scattering*
 Y. P. Gangrsky, B. N. Markov, I. F. Kharisov, Y. M. Tsipenyuk, JINR-P15-5959 (1971).
Nuclear Reactions: ^{239}Pu , $^{243}\text{Am}(\gamma, \gamma)$, $E=7-11$ MeV; measured $\sigma(E; E\gamma)$, (γ) (fragment)-delay. ^{239}Pu , ^{243}Am deduced SF-isomer excitation. ^{239m}Pu deduced $T_{1/2}$.
- 71Ga35** *Spontaneously Fissioning Isomers of Uranium, Plutonium, and Americium from Neutron Reactions*
 Y. P. Gangrskii, T. Nad, I. Vinnai, I. Kovach, At. Energ. 31, 156 (1971); Sov. At. Energy 31, 874 (1972).
Nuclear Reactions: ^{232}Th , ^{235}U , ^{238}U , ^{239}Pu , $^{243}\text{Am}(n, 2n)$, $E=14.7$ MeV; ^{238}U , ^{242}Pu , $^{243}\text{Am}(n, n')$, $E=2-7$ MeV; measured σ (SF isomers). ^{231}Th , ^{234}U , ^{238}Pu deduced no SF-isomer yield. ^{238}U , ^{242}U , ^{242}U , ^{243}Am deduced SF isomer yield.
- 71Ga39** *Excitation of Spontaneously Fissioning Isomer States ^{239}Pu and ^{243}Am in Inelastic Scattering of γ Quanta*
 Y. P. Gangrskii, B. N. Markov, I. F. Kharisov, Y. M. Tsipenyuk, Pisma Zh. Eksp. Teor. Fiz. 14, 370 (1971); JETP Lett. (USSR) 14, 249 (1971).
Nuclear Reactions: Fission ^{239}Pu , $^{243}\text{Am}(\gamma, \gamma F)$, $E < 11$ MeV; measured (γ) (fragment)-delay. ^{239m}Pu deduced $T_{1/2}$. ^{239}Pu , ^{243}Am deduced isomer yields.
- 71MaZE**
 Thesis: , Univ Kansas, D E Maharry, DABBB 32B 5981, 5/5/72
Nuclear Reactions: $^{92}\text{Mo}(d, p\gamma)$, measured $\sigma(\text{Ep}, E\gamma)$. ^{93}Mo deduced levels.
Nuclear Structure: $A=230-256$; ^{236}U ; calculated fission barriers, shape isomer excitation energies, equilibrium deformations, total energy surfaces.
- 71Me03** *Correlation between Fission Isomer Half-Lives and Liquid-Drop Model Parameters*
 V. Metag, R. Repnow, P. von Brentano, Nucl. Phys. A165, 289 (1971).
- 71Mo11** *Analysis of the Fission and Capture Cross Sections of the Curium Isotopes*
 M. S. Moore, G. A. Keyworth, Phys. Rev. C3, 1656 (1971).
Nuclear Reactions: ^{244}Cm , ^{245}Cm , ^{246}Cm , ^{247}Cm , $^{248}\text{Cm}(n, F)$, ^{244}Cm , $^{246}\text{Cm}(n, \gamma)$, $E=20$ eV-3 MeV; measured $\sigma(E)$. ^{245}Cm , ^{246}Cm , ^{247}Cm , ^{248}Cm deduced resonances, level-width.
- 71Na26** *Investigations of the Radiative Capture of Fast Neutrons Producing the Spontaneously Decaying Isomers ^{242}Am and ^{244}Am*
 T. Nagy, A. G. Belov, Y. P. Gangrsky, B. N. Markov, I. V. Sizov, I. F. Harisov, Acta Phys. 30, 293 (1971).
Nuclear Reactions: ^{241}Am , $^{243}\text{Am}(n, \gamma)$, $E < 16$ MeV; measured σ ratios for ^{242}Am , ^{244}Am SF-isomer production.
- 71Pa33** *Fission Threshold Energies in the Actinide Region*
 H. C. Pauli, T. Ledergerber, Nucl. Phys. A175, 545 (1971).
Nuclear Structure: Fission ^{232}Th , ^{234}Th , ^{234}U , ^{236}U , ^{238}U , ^{240}U , ^{236}Pu , ^{238}Pu , ^{240}Pu , ^{242}Pu ; calculated liquid-drop barriers, first, second saddle point energies.
- 71Re11** *Fission Isomers in Cm and Bk Isotopes*
 R. Repnow, V. Metag, P. von Brentano, Z. Phys. 243, 418 (1971).
Radioactivity: Fission ^{245m}Bk , ^{242m}Cm , ^{241m}Cm , ^{243m}Am , ^{243m}Cm , ^{237m}Pu ; measured $T_{1/2}$. $^{243}\text{Am}(\alpha, 2n\gamma)$, $E=26$ MeV; $^{243}\text{Am}(p, 2n\gamma)$, $(p, 3n\gamma)$, $E=14, 20$ MeV; $^{243}\text{Am}(d, pn)$, $(d, 2n\gamma)$, $E=13-20$ MeV; $^{237}\text{Np}(d, 2n\gamma)$, $E=12-18$ MeV; measured delays, $\sigma(E)$.
- 71Ru03** *Spin Isomers of the Shape Isomer ^{237m}Pu*
 P. A. Russo, R. Vandenbosch, M. Mehta, J. R. Tesmer, K. L. Wolf, Phys. Rev. C3, 1595 (1971).
Radioactivity: Fission ^{237m}Pu (SF); measured $T_{1/2}$; deduced shape isomerism.
- 71Ta17** *Search for Bremsstrahlung-Induced Fission Isomers of ^{238}U and ^{239}Pu*
 B. Tamain, B. Pfeiffer, H. Wollnik, E. Konecny, Nucl. Phys. A173, 465 (1971).
Radioactivity: Fission ^{238}U , ^{239}Pu (SF); measured $T_{1/2}$.
Nuclear Reactions: Fission ^{238}U , $^{239}\text{Pu}(\gamma, F)$, $E < 53$ MeV; measured (γ) (fragment)-delay. ^{238}U , ^{239}Pu deduced fission isomers, $T_{1/2}$.
- 71Te07** *Spontaneously Fissioning Isomers in ^{237}Pu*
 J. K. Temperley, J. A. Morrissey, S. L. Bacharach, Nucl. Phys. A175, 433 (1971).
Radioactivity: Fission ^{237m}Pu (SF) [from $^{237}\text{Np}(d, 2n)$]; measured $T_{1/2}$, E (fragment). $^{237}\text{Np}(d, 2n)$, $E=8.5-14.5$ MeV; measured delayed, prompt fission σ ratios, (d) (fission-fragment)-delay; $E=13.0$ MeV, measured E (fragment).
- 72Bo48** *Search for Spontaneously Fissioning Isomers Produced with 600 MeV Protons*
 A. H. Boos, R. Brandt, D. Molzahn, D. M. Montgomery, J. Inorg. Nucl. Chem. 34, 3309 (1972).
Nuclear Reactions: U, Th, Bi, Pb(p, X), $E=600$ MeV; measured fission activities; deduced σ for SF-isomer production.
- 72Br04** *Investigation of γ -Ray Emission Preceding Isomeric Fission of ^{236}U*
 J. C. Browne, C. D. Bowman, Phys. Rev. Lett. 28, 617 (1972).
Nuclear Reactions: Fission $^{235}\text{U}(n, \gamma F)$, $E=1-100$ eV; measured (γ) (fragment)-delay; deduced limit on pre-fission γ -emission. ^{236}U deduced relative double barrier penetrabilities.

- 72Br35** *Excitation Functions for the Production of Fission Isomers in Various Am Isotopes*
H. C. Britt, B. H. Erkkila, B. B. Back, Phys. Rev. C6, 1090 (1972).
Radioactivity: Fission ^{239m}Am , ^{245m}Am ; measured $T_{1/2}$.
Nuclear Reactions: 238 , 240 , 242 , $^{244}\text{Pu}(p,2n)$, $(t,2n)$, $(t,3n)$, $E=10\text{-}16$ MeV; measured σ for SF-isomer production.
- 72Ga04** *Measurement of the Excitation Energy of the Spontaneously Fissioning Isomer $\text{Pu}^{238}(\gamma,n)$*
Y. P. Gangrskii, V. N. Maykov, I. F. Kharisov, Y. M. Tsipenyuk, Yad. Fiz. 16, 271 (1972); Sov. J. Nucl. Phys. 16, 151 (1973).
Nuclear Reactions: $^{240}\text{Pu}(\gamma,n)$, $E < 15$ MeV; measured $\sigma(E)$ for ^{238m}Pu (SF) production. ^{239m}Pu (SF) deduced excitation energy.
- 72Ga42** *Production of Spontaneously Fissioning Isomers with Nanosecond Lifetimes in α -Particle Reactions*
Y. P. Gangrskii, Nguen Kong Khan, D. D. Pulatov, At. Energ. 33, 829 (1972); Sov. At. Energy 33, 948 (1973).
Nuclear Reactions: 233 , 235 , ^{238}U , 239 , ^{242}Pu , 241 , $^{243}\text{Am}(\alpha,xn)$, $E=20\text{-}36$ MeV; measured $\sigma(E)$ for SF-isomers. 235 , 237 , ^{240}Pu , 241 , ^{243}Cm , 242 , 243 , 244 , ^{245}Bk deduced SF-isomers, $T_{1/2}$.
- 72Ho11** *Total Spontaneous and Isomer Fission Half-Lives of ^{234}U , ^{236}U and ^{240}Pu*
M. A. Hooshyar, F. B. Malik, Phys. Lett. 38B, 495 (1972).
Nuclear Structure: Fission 234 , ^{236}U , ^{240}Pu (SF); calculated total $T_{1/2}$, $T_{1/2}$ (SF), average fragment kinetic energies. Coupled-channel decay theory.
- 72Ho48** *A Coupled Channel Approach to the Isomer Fission State*
M. A. Hooshyar, F. B. Malik, Helv. Phys. Acta 45, 567 (1972).
- 72HoXQ** *Suche nach γ -Übergängen im Spaltungs-Isomer ^{236}U*
F. Horsch, E. Konecny, K. E. G. Lobner, H. J. Specht, Univ., Tech. Univ. Munchen, Jahresbericht 1972, p. 104 (1973).
Nuclear Reactions: $^{235}\text{U}(n,F\gamma)$; measured $E\gamma$, ^{236}U deduced isomer.
- 72Ka59** *Search for γ -Branch in the ^{236m}U Fission Isomer Decay*
E. Kashy, J. Hattula, J. Borggreen, V. Maarbjerg, Comment. Phys. -Math. 42, 266 (1972).
Radioactivity: ^{236m}U ; measured upper limit for γ -ray decay.
- 72Ko10** *Search for Conversion Electrons Populating the ^{236}U Fission Isomer*
E. Konecny, H. J. Specht, J. Weber, H. Weigmann, R. L. Ferguson, P. Osterman, M. Waldschmidt, G. Siegert, Nucl. Phys. A187, 426 (1972).
Nuclear Reactions: Fission $^{235}\text{U}(n,\gamma F)$, $E=\text{thermal}$; measured (fragment)(ce)-coin, -delay; deduced upper limit for isomeric/prompt fission ratio.
- 72Ku26** *Search for Fission Isomers in the Radium Region*
I. M. Kuks, V. I. Matvienko, Y. A. Nemilov, Y. A. Selitskii, V. B. Funsh-tein, Yad. Fiz. 16, 438 (1972); Sov. J. Nucl. Phys. 16, 244 (1973).
Nuclear Reactions: $^{226}\text{Ra}(d,X)$, $E=6.6, 11.3$ MeV; $^{226}\text{Ra}(n,X)$, $E=0.7\text{-}10, 14.5$ MeV; measured $\sigma(F)$. 224 , 225 , 226 , ^{227}Ra , 225 , 226 , ^{227}Ac deduced no SF-isomer.
- 72La05** *Fission Barriers and the Inclusion of Axial Asymmetry*
S. E. Larson, I. Ragnarsson, S. G. Nilsson, Phys. Lett. 38B, 269 (1972).
Nuclear Structure: Fission 186 , 188 , 190 , ^{192}W , ^{196}Pt , ^{196}Hg , 196 , ^{204}Pb , ^{242}Pu , ^{246}Cm , ^{252}Fm , $^{258}104$, superheavy; calculated potential energy surfaces vs deformation parameters, fission barriers. Modified oscillator model, axial symmetry.
- 72Ma11** *A Single-Particle Model Calculation of Total Energy Surfaces in Heavy Nuclei*
D. E. Maharry, J. P. Davidson, Nucl. Phys. A183, 371 (1972).
Nuclear Structure: Fission ^{236}U , 230 , ^{232}Th , 234 , 236 , ^{238}U , 246 , 248 , 250 , ^{252}Cf , 238 , 240 , 242 , ^{244}Am , 236 , 238 , 240 , 242 , ^{244}Pu , 240 , 242 , 244 , 246 , 248 , ^{250}Cm ; calculated total energy surfaces, fission barriers. Single-particle model.
- 72Mo27** *Odd-Multipole Shape Distortions and the Fission Barriers of Elements in the Region $84 < Z < 120$*
P. Moller, Nucl. Phys. A192, 529 (1972).
Nuclear Structure: Fission $Z=84\text{-}120$; ^{210}Po , ^{236}U , ^{256}Fm , ^{252}Fm ; calculated potential energy surfaces, fission barriers.
- 72NaYU**
Thesis: T Nagy, Dubna
Nuclear Reactions: 241 , $^{243}\text{Am}(n,\gamma)$, $E=0.8\text{-}16$ MeV; ^{235}U , $^{239}\text{Pu}(n,\gamma)$, $E=\text{th}$; ^{238}U , 238 , ^{242}Pu , $^{243}\text{Am}(n,n')$, $E=3\text{-}7$ MeV, 14.7 MeV; 240 , ^{242}Pu , $^{243}\text{Am}(n,2n)$, $E=14.7$ MeV; measured $\sigma(E)$ for SF isomers. ^{232}Th , 233 , 235 , ^{238}U , ^{237}Np , $^{239}\text{Pu}(n, 2n)$, $E=14.7$ MeV; measured no SF isomer.
- 72Pe01** *An Investigation of the Population of the Shape Isomer ^{236m}U Through the (d,p) Reaction*
J. Pedersen, B. Rasmussen, Nucl. Phys. A178, 449 (1972).
Nuclear Reactions: $^{235}\text{U}(d,pF)$, $E=11$ MeV; measured (p)(fragment)-delay. ^{236m}U deduced $T_{1/2}$, fission barrier parameters.
- 72PiZR** *Fission Isomer in Uranium-236*
J. V. Pilcher, F. D. Brooks, W. R. McMurray, INDC(SEC)-28/L, p. 249 (1972).
Radioactivity: Fission ^{236m}U (SF); measured $T_{1/2}$.
- 72Sp06** *Identification of a Rotational Band in the ^{240}Pu Fission Isomer*
H. J. Specht, J. Weber, E. Konecny, D. Heunemann, Phys. Lett. 41B, 43 (1972).
Radioactivity: Fission ^{240}Pu (SF) [from $^{238}\text{U}(\alpha,2n\gamma)$; $E=25$ MeV]; measured $I(\text{ce})$, (α) (fragment)-delay, $E(\text{ce})$. ^{240m}Pu deduced levels, rotational band structure.

- 72Va08** *Spontaneous-Fission-Isomer Excitation Energies from Threshold Measurements*
R. Vandenbosch, Phys. Rev. C5, 1428 (1972).
- 72Va44** *Searches for the Spontaneously Fissioning Isomer Pu^{240m} in the Thermal-Neutron Capture Reaction*
G. V. Valskii, O. M. Mrachkovskii, G. A. Petrov, Y. S. Pleva, Yad. Fiz. 16, 667 (1972); Sov. J. Nucl. Phys. 16, 374 (1973).
Nuclear Reactions: Fission ²³⁹Pu(n,F); E=thermal; measured σ production for ^{240m}Pu.
- 72Vi10** *^{237m}Pu(f) Double Fission Isomer Study Through the ²³⁷Np(d,2n) Reaction in the E = 9-12 MeV Energy Range*
N. Vilcov, G. Griffith, I. Vilcov, R. B. Leachman, Rev. Roum. Phys. 17, 1031 (1972).
Nuclear Reactions: ²³⁷Np(d,2n), E=9.1-12.1 MeV; measured $\sigma(E)$ ratio for two isomers. ²³⁷Pu deduced levels, T_{1/2}.
- 72Vy07** *Excitation Energies of the Spontaneously Fissile Isomers of Pu²⁴⁰, Cm²⁴¹, and Bk²⁴³ in Reactions with α -Particles*
I. Vylkov, N. Vylkov, Y. P. Gangrskii, M. Marinescu, A. A. Pleva, D. Poenaru, I. F. Kharisov, Yad. Fiz. 16, 454 (1972); Sov. J. Nucl. Phys. 16, 253 (1973).
Nuclear Reactions: ²³⁸U, ²³⁹Pu, ²⁴¹Am(α ,2n), E=20-26 MeV; measured σ for SF-isomer production. ²⁴⁰Pu, ²⁴¹Cm, ²⁴³Bk deduced SF isomer excitation energies.
- 72We09** *Evaluation of Fission Barrier Parameters from Near-Barrier Fission and Isomeric Half-Life Data*
H. Weigmann, J. P. Theobald, Nucl. Phys. A187, 305 (1972).
Nuclear Structure: Fission ²³⁴, ²³⁵, ²³⁶, ²³⁷, ²³⁸, ²³⁹U, ²³⁷, ²³⁸, ²³⁹, ²⁴⁰Np, ²³⁵, ²³⁶, ²³⁷, ²³⁸, ²³⁹, ²⁴⁰, ²⁴¹, ²⁴², ²⁴³, ²⁴⁴, ²⁴⁵Pu, ²³⁷, ²³⁸, ²³⁹, ²⁴⁰, ²⁴¹, ²⁴², ²⁴³, ²⁴⁴Am, ²⁴¹, ²⁴², ²⁴³, ²⁴⁴, ²⁴⁵Cm, ²⁴⁶, ²⁴⁷Cm, ²⁴⁴, ²⁴⁵, ²⁴⁶Bk; calculated fission barriers, T_{1/2}.
- 72Wo07** *Fissioning Isomers of Americium, Curium and Berkelium Isotopes*
K. L. Wolf, J. P. Unik, Phys. Lett. 38B, 405 (1972).
Radioactivity: Fission ^{240m}Am, ^{243m}Am, ^{245m}Am, ^{246m}Am, ^{244m}Am, ^{239m}Pu, ^{242m}Bk, ^{244m}Bk, ^{243m}Cm, ^{245m}Cm; measured T_{1/2}.
Nuclear Reactions: ²⁴², ²⁴⁴Pu, ²⁴¹, ²⁴³Am(α , xF), E=25-46 MeV; measured $\sigma(E)$ for SF-isomer production.
- 73AI08** *A New Two-Center Shell Model for Nuclear Fission*
K. Albrecht, Nucl. Phys. A207, 225 (1973).
Nuclear Structure: ²²⁶Ra, ²³²Th, ²³⁶, ²³⁸U, ²⁴⁰, ²⁴²Pu, ²⁴⁴Cm, ²⁴⁸, ²⁵²Cf, ²⁵²Fm; calculated deformation energies, isomer energies.
- 73Ba19** *Fission and Decay of Excited Nuclei*
V. S. Barashenkov, A. S. Iljinov, V. D. Toneev, F. G. Gereghi, Nucl. Phys. A206, 131 (1973).
Nuclear Structure: ¹⁴⁹Eu, ¹⁵⁷Ho, ¹⁷⁵Ta, ¹⁸⁶Os, ¹⁸⁷Os, ¹⁸⁸Os, ¹⁸⁵Ir, ¹⁸⁹Ir, ¹⁹¹Ir, ¹⁹⁴Hg, ¹⁹⁸Hg, ²¹⁰Po, ²¹¹Po, ²¹²Po, ²¹⁹At, ²²⁷Ra, ²³³U, ²³⁴U, ²³⁵U, ²³⁶U, ²³⁷U, ²³⁸U, ²³⁹U, ²³⁷Np, ²³⁸Np, ²⁴¹Am, ²⁴²Am, ²⁴⁴Am, ²⁴⁰Cm, ²⁴²Cm, ²⁴⁶Cm, ²⁵⁰Cm, ²⁴⁶Cf, ²⁴⁸Cf, ²⁵⁰Cf, ²⁵²Cf, ²⁵¹No, ²⁵²No, ²⁵³No, ²⁵⁴No, ²⁵⁵No, ²⁵⁶No, ²⁵⁷No, ²⁵⁹No; calculated fission barrier, level-width(n)/level-width(F).
- 73Be04** *Production of Spontaneously Fissioning Isomers in Th, U, Np, Pu and Am Isotopes in Reactions Induced by 14.7 MeV Neutrons*
A. G. Belov, Y. P. Gangrsky, B. Dalkhsuren, A. M. Kucher, T. Nagy, D. M. Nadkarni, Indian J. Phys. 47, 232 (1973).
Nuclear Reactions: ²³²Th, ²³⁵, ²³⁸U, ²³⁷Np, ²⁴⁰, ²⁴²Pu, ²⁴¹, ²⁴³Am(n,2n), ²³⁹Pu, ²⁴¹, ²⁴³Am(n,n'), E=14.7 MeV; measured production σ for SF isomers, nF(t). ^{239m}, ^{241m}Pu, ^{240m}, ^{241m}, ^{242m}, ^{243m}Am deduced T_{1/2}.
- 73Be05** *Search for α Emission in the Decay of Spontaneously Fissionable Isomers*
A. G. Belov, Y. P. Gangrskii, B. Dalkhsuren, A. M. Kucher, Nguen Kong Khan, Yad. Fiz. 17, 942 (1973); Sov. J. Nucl. Phys. 17, 493 (1974).
Radioactivity: Fission ^{240m}, ^{242m}Am, ^{241m}Pu(SF); measured E α , I α . Deduced no α -emission.
- 73Be10** *Search for γ -Rays Emitted in the Formation of a Fission Isomer*
D. Benson, Jr., C. M. Lederer, E. Cheifetz, Nucl. Phys. A201, 445 (1973).
Nuclear Reactions: ²³⁸U(α , γ F); measured $\alpha f(t)$, $\gamma f(t)$, E γ . ^{240m}Pu(SF); deduced limits on pre-fission γ -ray photons.
- 73Br04** *Fission Barriers Deduced from the Analysis of Fission Isomer Results*
H. C. Britt, M. Bolsterli, J. R. Nix, J. L. Norton, Phys. Rev. C7, 801 (1973).
- 73Br38** *Properties of Fission Isomers*
H. C. Britt, At. Data Nucl. Data Tables 12, 407 (1973).
- 73BrWU**
Report: USNDC-7 P106
Nuclear Reactions: ²⁴³Pu(n,F); measured $\sigma(E)$. ²⁴³Pu deduced fission isomer.
- 73FI03** *Excitation Functions for Spallation Products and Fission Isomers in ²³⁷Np(⁴He,xn)^{241-x}Am Reactions*
A. Fleury, F. H. Ruddy, M. N. Namboodiri, J. M. Alexander, Phys. Rev. C7, 1231 (1973).
Nuclear Reactions: ²³⁷Np(α ,2n), (α ,3n), (α ,4n), E=19-45 MeV; measured $\sigma(E)$, σ , isomer σ ratio. ^{238m}Am deduced T_{1/2}.

- 73HeYN** *Search for Conversion Electrons from the Decay of Excited States in the Secondary Minimum of ^{236}U*
R. Heffner, J. Pedersen, P. A. Russo, H. Swanson, RLO-1388-221, p. 123 (1973).
Radioactivity: ^{236}U ; measured I(ce).
- 73Kh06** *Angular Distribution of Fragments of Spontaneously Fissioning Isomers*
Fam Zui Khien, Yad. Fiz. 17, 489 (1973); Sov. J. Nucl. Phys. 17, 251 (1974).
Nuclear Reactions: $^{235}\text{U}(\alpha, n)$; calculated ^{236}Pu fission isomer angular distribution.
- 73Li01** *A Subnanosecond and a Nanosecond Fission Isomer in ^{238}Pu*
P. Limkilde, G. Sletten, Nucl. Phys. A199, 504 (1973).
Radioactivity: Fission ^{238m}Pu , ^{240m}Pu ; measured $T_{1/2}$.
Nuclear Reactions: $^{236}\text{U}(\alpha, 2n)$, $E=21.0-27.0$ MeV; measured $\sigma(1)(E)$, $\sigma(2)(E)$ delayed fission; deduced thresholds; $^{236}\text{U}(\alpha, F)$, $E=20.0-28.0$ MeV; measured $\sigma(E)$ prompt fission; $^{238}\text{U}(\alpha, 2n)$, E approx 25 MeV; measured σ delayed fission.
- 73Me23** *Neutron-Fission Competition Near Threshold; The Influence of Shells and Pairing on the Decay of the ^{241}Cm Compound Nucleus*
V. Metag, S. M. Lee, E. Liukkonen, G. Sletten, S. Bjornholm, A. S. Jensen, Nucl. Phys. A213, 397 (1973).
Nuclear Reactions: $^{239}\text{Pu}(\alpha, n)$, $E=19.9-23$ MeV; $^{239}\text{Pu}(\alpha, 2n)$, $E=19.9-27$ MeV; $^{241}\text{Am}(p, 2n)$, $E=8.2-16$ MeV; measured $\sigma(^{241}\text{Cm})$, $\sigma(^{240}\text{Cm})$, $\sigma(\text{fission})$. 241 , ^{242}Cm deduced n-width, F-width.
- 73Na03** *Excitation Functions for the Fission Isomers ^{240m}Pu and ^{239m}Pu from $^{238}\text{U}(^4\text{He}, xn)$ Reactions*
M. N. Namboodiri, F. H. Ruddy, J. M. Alexander, Phys. Rev. C7, 1222 (1973).
Nuclear Reactions: $^{238}\text{U}(\alpha, 2n)$, $(\alpha, 3n)$, $E < 28$ MeV; measured $\sigma(E)$, σ . ^{240m}Pu deduced $T_{1/2}$.
- 73Na35** *Neutronokkal Letrehozott, Izomer Allapotbol Spontan Hasado Magok Keletkezésere Vezeto Reakciok Vizsgálata*
T. Nagy, Magy. Fiz. Foly. 21, 555 (1973).
Radioactivity: Fission ^{238}U , 239 , 241 , ^{242}Pu , 242 , 243 , ^{244}Am , $^{236}\text{Np}(\text{SF})$; measured $T_{1/2}$. ^{238}Pu , 232 , 234 , ^{237}U , ^{231}Th measured $T_{1/2}$ limits.
Nuclear Reactions: 241 , $^{243}\text{Am}(n, \gamma)$, $E=0.8-16$ meV; 233 , 235 , ^{238}U , $^{239}\text{Pu}(n, \gamma)$, $E=\text{thermal}$; ^{238}U , 239 , ^{242}Pu , $^{243}\text{Am}(n, n')$, $E=3-7$, 14.7 MeV; ^{237}Np , 233 , 235 , ^{238}U , ^{232}Th , 239 , 240 , ^{242}Pu , $^{243}\text{Am}(n, 2n)$, $E=14.7$ MeV; measured $\sigma(E)$ for production of SF isomers.
- 73OZX**
Report: RCN-203 P169
Nuclear Reactions: $^{235}\text{U}(n, F)$, $E=1$ MeV; measured fission isomer yield.
- 73Po05** *Spontaneously Fissioning Isomer U^{236m} Excited by Capture of Thermal Neutrons*
L. A. Popeko, G. A. Petrov, E. F. Kochubei, T. K. Zvezdkina, Yad. Fiz. 17, 234 (1973); Sov. J. Nucl. Phys. 17, 120 (1974).
Nuclear Reactions: $^{235}\text{U}(n, F)$, $E=\text{thermal}$; measured (fragment)(ce, γ, X)-delay. ^{236m}U deduced yield.
- 73Po08** *Neutron Resonance Parameters of ^{242}Pu*
F. Poortmans, G. Rohr, J. P. Theobald, H. Weigmann, G. J. Vanpraet, Nucl. Phys. A207, 342 (1973).
Nuclear Reactions: $^{242}\text{Pu}(n, n)$, $^{242}\text{Pu}(n, \gamma)$, $E=20-1300$ eV; measured σ . ^{243}Pu resonances deduced resonance parameters n-width, γ -width. Enriched target.
- 73PoZA** *Fission Isomers, Eleven Years of Experimental Work*
D. N. Poenaru, IFA-CRD-54-1973 (1973).
Compilation: Fission 234m , 235m , 236m , $^{238m}\text{U}(\text{SF})$, $^{237m}\text{Np}(\text{SF})$, 235m , 236m , 237m , 238m , 239m , 240m , 241m , 242m , $^{243m}\text{Pu}(\text{SF})$, 237m , 238m , 239m , 240m , 241m , 242m , 243m , 245m , ^{246m}Am , 240m , 241m , 242m , 243m , ^{245m}Cm , 242m , 243m , 244m , ^{245m}Bk ; compiled experimental $T_{1/2}$.
- 73Sp04** *Statistical Theory of Isomer Ratios for Shape (Fission) Isomers in (n, γ) Reactions*
D. Sperber, Nuovo Cim. 13A, 373 (1973).
Nuclear Reactions: 233 , ^{235}U , ^{239}Pu , $^{241}\text{Am}(n, \gamma)$; calculated isomer ratios.
- 73Va16** *Relative Excitations of the ^{237}Pu Shape Isomers*
R. Vandenbosch, P. A. Russo, G. Sletten, M. Mehta, Phys. Rev. C8, 1080 (1973).
Radioactivity: Fission $^{237m}\text{Pu}(\text{SF})$, ^{237}Pu ; measured delayed yields. ^{237}Pu deduced levels, $J, \pi, T_{1/2}$.
- 73Va30** *Probability of Formation of Spontaneously Fissioning Isomer States Following Thermal Neutron Capture by U^{235} and Pu^{239}*
G. V. Valskii, O. M. Mrachkovskii, G. A. Petrov, Y. S. Pleva, Yad. Fiz. 18, 492 (1973); Sov. J. Nucl. Phys. 18, 253 (1974).
Nuclear Reactions: ^{235}U , $^{239}\text{Pu}(n, \gamma)$; measured $\sigma(\text{isomer})$.
- 73Wo03** *The Fissioning Isomer ^{237m}Np*
K. L. Wolf, J. P. Unik, Phys. Lett. 43B, 25 (1973).
Radioactivity: Fission $^{237m}\text{Np}(\text{SF})$; measured $T_{1/2}$, excitation energy.
- 73Ze05** *Search for a Spontaneously Fissioning Isomer Nucleus U^{236m} in the Reaction $U^{235}(n, \gamma)$*
Zen Chang Bom, A. Lajtai, A. A. Omelyanenko, T. T. Panteleev, S. M. Polikanov, Y. V. Ryabov, Tang San Khak, Yad. Fiz. 18, 34 (1973); Sov. J. Nucl. Phys. 18, 18 (1974).
Nuclear Reactions: $^{235}\text{U}(n, \gamma)$, E approx 60 keV; measured σ for SF isomer. ^{236}U deduced no SF isomer.

- 74Ba73** *Fission of Odd-A and Doubly Odd Actinide Nuclei Induced by Direct Reactions*
 B. B. Back, H. C. Britt, O. Hansen, B. Leroux, J. D. Garrett, Phys. Rev. C10, 1948 (1974).
Nuclear Reactions: $^{230, 232}\text{Th}(\text{He}, \alpha\text{F})$, $^{230, 232}\text{Th}$, $^{233, 234, 235, 236, 238}\text{U}$, $^{239, 240, 242}\text{Pu}$, $^{248}\text{Cm}(\text{He}, \text{dF})$, $E=24$ MeV; ^{230}Th , ^{231}Pa , ^{237}Np , $^{248}\text{Cm}(\text{d,pF})$, $E=15$ MeV; ^{243}Am , $^{239}\text{Pu}(\text{t}, \text{pF})$, $E=15$ MeV; $^{248}\text{Cm}(\text{t}, \alpha\text{F})$, $E=16$ MeV; measured fission probabilities. $^{229, 231}\text{Th}$, $^{231, 232, 233}\text{Pa}$, $^{234, 235, 236, 237, 238, 239}\text{Np}$, ^{241}Pu , $^{240, 241, 243, 245, 247}\text{Am}$, ^{249}Cm , ^{248}Bk deduced barrier heights.
- 74Ba28** *Fission of Doubly Even Actinide Nuclei Induced by Direct Reactions*
 B. B. Back, O. Hansen, H. C. Britt, J. D. Garrett, Phys. Rev. C9, 1924 (1974).
Nuclear Reactions: $^{230, 232}\text{Th}$, $^{234, 236, 238}\text{U}$, $^{238, 240, 242}\text{Pu}$, $^{248}\text{Cm}(\text{t,pF})$, $E=15$ MeV; $^{231}\text{Pa}(\text{t}, \alpha\text{F})$, $E=16$ MeV; ^{231}Pa , ^{237}Np , $^{243}\text{Am}(\text{He}, \text{dF})$, $E=24$ MeV; $^{233}\text{U}(\text{d,pF})$, $E=13$ MeV; $^{248}\text{Cm}(\text{p,p'F})$, $E=22.5$ MeV; measured $E(\text{fragment})$, $l(\text{fragment})$. $^{230, 232, 234}\text{Th}$, $^{232, 234, 236, 238, 240}\text{U}$, $^{238, 240, 242, 244}\text{Pu}$, $^{244, 248, 250}\text{Cm}$ deduced fission probability.
- 74Ba82** *Comparison of Fragment Kinetic Energies from Two ^{237}Pu Fission Isomers*
 S. L. Bacharach, P. S. Hoepfer, J. A. Morrissey, J. K. Temperley, Phys. Rev. C10, 2636 (1974).
Radioactivity: Fission $^{237\text{m}}\text{Pu}(\text{SF})$; measured $T_{1/2}$.
- 74Be52** *Attempted Coulomb Excitation of the Spontaneous-Fission Isomeric State in ^{239}Pu*
 C. E. Bemis, Jr., F. Plasil, R. L. Ferguson, E. E. Gross, A. Zucker, Phys. Rev. C10, 1590 (1974).
Nuclear Reactions: $^{239}\text{Pu}(^{20}\text{Ne}, ^{20}\text{Ne}')$, $E=100, 117$ MeV; measured fission fragments. $^{239\text{m}}\text{Pu}$ deduced upper limit on yield.
- 74BeYO**
 Report: ORNL-4937 P26
Nuclear Reactions: $^{239}\text{Pu}(^{20}\text{Ne}, ^{20}\text{Ne}')$, $E=100, 117$ MeV; measured $\sigma(\text{fragment mass}, \theta)$. ^{239}Pu deduced fission isomer.
- 74Bo02** *Search for a γ -Branch from Shape Isomers in ^{238}U and ^{238}Np*
 J. Borggreen, J. Hattula, E. Kashy, V. Maarbjer, Nucl. Phys. A218, 621 (1974).
Nuclear Reactions: $^{235}\text{U}(\text{d,p})$, $E=11$ MeV; $^{238}\text{U}(\text{p,n})$, $E=8$ MeV; measured $\sigma(\text{delayed } \gamma)$, $T_{1/2}=130$ ns, $2 \mu\text{s} < T_{1/2} < 20$ ms. $^{238\text{m}}\text{U}$, $^{238\text{m}}\text{Np}$ deduced limits on σ for delayed γ from shape isomer.
- 74Br05** *Investigation of the γ Decay of Subthreshold-Fission Resonances of ^{242}Pu to a Fission Isomeric State*
 J. C. Browne, C. D. Bowman, Phys. Rev. C9, 1177 (1974).
Nuclear Reactions: $^{242}\text{Pu}(\text{n}, \text{F}\gamma)$, $E=400\text{-}3000$ eV; measured $\sigma(E)$, $\gamma(t)$. ^{243}Pu resonance deduced γ -branching.
- 74BrYE**
 Conference proceedings: Rochester(Phys. Chem of Fission), Vol2 P493
Nuclear Reactions: $^{242}\text{Pu}(\text{n}, \text{F})$, $E=\text{subthreshold}$; measured $E\gamma$. ^{243}Pu deduced no fission isomer.
- 74Ga41** *Investigation of Photoneuclear Reactions Leading to Spontaneously Fissioning Isomers*
 Y. P. Gangrsky, B. N. Markov, Y. M. Tsypenyuk, Fortschr. Phys. 22, 199 (1974).
Nuclear Reactions: ^{239}Pu , $^{243}\text{Am}(\gamma, \gamma)$, $^{240, 242}\text{Pu}$, $^{241, 243}\text{Am}(\gamma, \text{n})$, $E=7\text{-}16$ MeV; measured $\sigma(E)$ for the production of spontaneously fissioning isomers; deduced barrier parameters.
- 74GaZD** *Delayed Fission Fragment Angular Distributions in Some Alpha-Particle-Induced Reactions*
 D. Galeriu, M. Marinescu, D. Poenaru, I. Vilcov, N. Vilcov, Y. P. Gangrsky, P. Z. Hien, N. C. Khan, Proc. Symp. Phys. Chem. Fission, 3rd, Rochester, N. Y. (1973), Int. At. En. Agency, Vienna, Vol. 1, p. 297 (1974).
Nuclear Reactions: $^{235, 238}\text{U}$, ^{239}Pu , $^{241}\text{Am}(\alpha, 2\text{n})$, ^{235}U , $^{242}\text{Pu}(\alpha, 3\text{n})$, $E=26\text{-}33$ MeV; measured $\sigma(\text{fragment mass}, \theta)$, $\text{fragment}(t)$. $^{236\text{m}}, ^{237\text{m}}, ^{240\text{m}}\text{Pu}$, $^{241\text{m}}, ^{243\text{m}}\text{Cm}$ deduced anisotropies.
- 74HeZE** *Experimental Study of the Deformation of the Fission Isomer in ^{236}U*
 R. H. Heffner, Thesis, Univ. Washington (1973); Diss. Abstr. Int. B35, 435 (1974).
Radioactivity: Fission $^{236\text{m}}\text{U}(\text{SF})$; measured $\gamma\text{ce}(t)$; deduced $T_{1/2}$, β .
- 74LoZN** *Gamma-Ray Transitions Preceding Isomeric Fission in ^{236}U*
 K. E. G. Lobner, D. Harrach, E. Konecny, N. Nenoff, H. J. Specht, J. Weber, Contrib. Int. Symp. Neutron Capture Gamma Ray Spectroscopy and Related Topics, 2nd, Petten, p. 409 (1974).
Nuclear Reactions: $^{235}\text{U}(\text{n}, \text{F})$; measured $(\text{fragment})\gamma(t)$. ^{236}U deduced transitions.
- 74Me10** *Detection of Fission Isomers with Half-Lives in the Picosecond Range by the Recoil-Distance Technique*
 V. Metag, E. Liukkonen, G. Sletten, O. Glomset, S. Bjornholm, Nucl. Instrum. Methods 114, 445 (1974).
Nuclear Reactions: $^{237}\text{Np}(\text{p}, \text{F})$, $^{242}\text{Pu}(\text{d}, \text{pnF})$; measured recoil distance. ^{242}Pu level deduced $T_{1/2}$.
- 74MeYP** *Half-Life Systematics of Fission Isomers in Even-Even Pu Isotopes*
 V. Metag, E. Liukkonen, O. Glomset, A. Bergman, Proc. Symp. Phys. Chem. Fission, 3rd, Rochester, N. Y. (1973), Int. At. En. Agency, Vienna, Vol. 1, p. 317 (1974).
Nuclear Reactions: $^{238, 240, 242, 244}\text{Pu}(\text{d}, \text{pn})$, $^{237}\text{Np}(\text{p}, 2\text{n})$, $^{234}\text{U}(\alpha, 2\text{n})$; measured delayed fission. $^{236, 238, 242, 244}\text{Pu}$ deduced fission isomers, $T_{1/2}$.
- 74MoYC** *Calculation of Fission Barriers*
 P. Moller, J. R. Nix, Proc. Symp. Phys. Chem. Fission, 3rd, Rochester, N. Y. (1973), Int. At. En. Agency, Vienna, Vol. 1, p. 103 (1974).
Nuclear Structure: $^{244, 248, 252, 256, 260}\text{No}$, $^{240, 244, 248, 252, 256}\text{Cf}$, $^{236, 240, 244, 248, 252}\text{Pu}$, $^{232, 236, 240, 244, 248}\text{Th}$; calculated fission barriers. $A=242$; calculated single particle energies.

74SpZS *Fragment Anisotropy in Isomeric Fission*

H. J. Specht, E. Konecny, J. Weber, C. Kozuharov, Proc. Symp. Phys. and Chem. Fission, Rochester, N. Y., 3rd, (1973), IAEA, Vienna, Vol. I, p. 285 (1974).

Nuclear Reactions: ^{235}U , ^{236}U , $^{239}\text{Pu}(\alpha, 2n)$, $E=25$ MeV; measured σ (fragment mass, θ), fragment(t). 237m , ^{238m}Pu , ^{241m}Cm deduced anisotropies, J.

74WoZW *Measurements on the Fissioning Isomer ^{238m}U with the (n, n') and (d, pn) Reactions*

K. L. Wolf, J. W. Meadows, Bull. Am. Phys. Soc. 19, No. 4, 595, KH1 (1974)

Nuclear Reactions: Fission $^{238}\text{U}(n, n'F)$, (d, pnF) ; measured $\sigma(E; E(\text{fragment}), t)$. ^{238m}U deduced $T_{1/2}$.

75Ch09 *Investigation of Delayed Fission in ^{236}U*

J. Christiansen, G. Hempel, H. Ingwersen, W. Klinger, G. Schatz, W. Witthuhn, Nucl. Phys. A239, 253 (1975).

Nuclear Reactions: $^{235}\text{U}(d, pF)$, $E=11$ MeV; measured prompt, delayed fission. $^{236m}\text{U}(\text{SF})$ deduced $T_{1/2}$, isomeric to prompt fission ratio. $^{232}\text{Th}(d, F)$, $E=11$ MeV; measured prompt fission.

75Gr16 *Feasibility of Experimental Verification of the Shape-Isomerism Hypothesis in Heavy Nuclei*

D. P. Grechukhin, Yad. Fiz. 21, 956 (1975); Sov. J. Nucl. Phys. 21, 491 (1976).

Nuclear Structure: 242 , ^{242m}Am ; calculated isomeric shift.

75Ha09 *An Investigation of the Properties of Single-Particle-States in the Second Minimum of ^{237}Pu*

I. Hamamoto, W. Ogle, Nucl. Phys. A240, 54 (1975).

Nuclear Reactions: $^{235}\text{U}(\alpha, 2n)$, $E=22-25$ MeV; analyzed data. ^{237}Pu levels deduced g, J, π , K.

75Kh06 *Determination of the Spins of Spontaneously-Fissioning Isomers*

P. Z. Hien, Yad. Fiz. 22, 938 (1975); Sov. J. Nucl. Phys. 22, 489 (1976).

Radioactivity: Fission $^{241}\text{Cm}(\text{SF})$, 235 , 237 , $^{238}\text{Pu}(\text{SF})$; calculated spins of SF isomers.

75LoZT *Gamma-Ray Transitions Preceding Isomeric Fission in ^{236}U*

K. E. G. Lobner, D. Harrach, E. Konecny, N. Nenoff, H. J. Specht, J. Weber, Proc. Int. Symp. Neutron Capture Gamma Ray Spectroscopy and Related Topics, 2nd, Petten, The Netherlands (1974), K. Abrahams, F. Stecher-Rasmussen, P. Van Assche, Eds., Reactor Centrum Nederland, p. 665 (1975).

Nuclear Reactions: $^{235}\text{U}(n, \gamma)$, $E=\text{thermal}$; measured fragment $\gamma(t)$. ^{236}U deduced levels.

75Me28 *Systematics of Fission Isomer Half-lives*

V. Metag, Nukleonika 20, 789 (1975).

Nuclear Structure: 236 , 238 , 242 , ^{244}Pu , 242 , ^{244}Cm ; analyzed, reviewed fission isomer $T_{1/2}$. Systematics.

75Ru03 *Gamma Decay of the ^{238}U Shape Isomer*

P. A. Russo, J. Pedersen, R. Vandenbosch, Nucl. Phys. A240, 13 (1975).

Nuclear Reactions: $^{238}\text{U}(d, np\gamma)$, $E=13, 18$ MeV; $^{238}\text{U}(p, p'\gamma)$, $E=13$ MeV; measured $\sigma(E, \gamma, t)$. ^{238}U deduced levels, J, π , $T_{1/2}$, barrier parameters.

75Va21 *Formation of the Spontaneously Fissile Isomer ^{242m}Am in Thermal-Neutron Capture*

G. V. Valsky, V. L. Varentsov, G. A. Petrov, Y. S. Pleva, B. M. Aleksandrov, A. S. Krivokhatsky, Yad. Fiz. 22, 701 (1975); Sov. J. Nucl. Phys. 22, 363 (1976).

Nuclear Reactions: $^{241}\text{Am}(n, \gamma)$, $E=\text{thermal}$; measured σ for production of $^{242}\text{Am}(\text{SF})$ isomer. ^{242m}Am deduced $T_{1/2}$.

76An11 *The Shape Isomer in ^{236}U Populated by Thermal Neutron Capture*

V. Andersen, C. J. Christensen, J. Borggreen, Nucl. Phys. A269, 338 (1976).

Nuclear Reactions: $^{235}\text{U}(n, \gamma)$, $E=\text{th}$; measured ce X-coin, fragment delay; obtained isomeric/prompt fission ratio. ^{236m}U shape isomer deduced γ/F branching ratio.

76Be55 *Search for Conversion Electrons Emitted during the Decay of Spontaneously Fissile Isomers*

A. G. Belov, Y. P. Gangrskii, B. Dalkhsuren, M. B. Miller, Izv. Akad. Nauk SSSR, Ser. Fiz. 40, 1109 (1976); Bull. Acad. Sci. USSR, Phys. Ser. 40, No. 6, 10 (1976).

Nuclear Reactions: ^{238}U , 239 , ^{242}Pu , 241 , $^{243}\text{Am}(n, X)$, $E=14.7$ MeV; ^{238}U , 239 , ^{242}Pu , 241 , $^{243}\text{Am}(\gamma, X)$, $E=9, 15$ MeV; measured $E(\text{ce})$, $I(\text{ce})$. ^{238}U deduced γ -decay for SF isomer.

76BeZM *Search for the Conversion Electrons Emitted in the Decay of Spontaneously Fissioning Isomers*

A. G. Belov, Y. P. Gangrsky, B. Dalkhsuren, M. B. Miller, JINR-P6-9397 (1976).

Radioactivity: Fission ^{238}U , 239 , ^{241}Pu , 240 , 241 , 242 , $^{243}\text{Am}(\text{SF})$; measured ce spectra.

76Br38 *Search for Fissile Isomers in the $(n, 2n)$ Reaction*

J. S. Browne, R. E. Houve, At. Energ. 40, 491(1976); Sov. At. Energy 40, 587 (1976).

Nuclear Reactions: ^{238}U , 242 , $^{244}\text{Pu}(n, 2n)$, $E=14$ MeV; measured σ for production of SF isomers. ^{237}U , 241 , ^{243}Pu deduced no SF isomers.

76Ga11 *ΓnTf for Actinide Nuclei Using $(^3\text{He}, df)$ and $(^6\text{He}, tf)$ Reactions*

A. Gavron, H. C. Britt, E. Konecny, J. Weber, J. B. Wilhelmy, Phys. Rev. C13, 2374 (1976).

Nuclear Structure: 230 , 231 , 232 , ^{233}Pa , 231 , ^{232}U , 233 , 234 , 235 , 236 , 237 , 238 , ^{239}Np , 237 , ^{238}Pu , 239 , 240 , 241 , 242 , ^{243}Am , 241 , 242 , 243 , ^{244}Cm ; measured fission probability in ^3He induced reactions; deduced barrier heights, average ΓnTf .

Nuclear Reactions: 230 , ^{232}Th , ^{231}Pa , 234 , 236 , ^{238}U , ^{237}Np , 239 , ^{241}Pu , 241 , $^{243}\text{Am}(^3\text{He}, df)$, $(^6\text{He}, tf)$, ^{232}U , $^{242}\text{Pu}(^6\text{He}, df)$; $E=25$ MeV; measured fission spectra; deduced barrier heights, average neutron-, fission-widths. 230 , 231 , 232 , ^{233}Pa , 231 , ^{232}U , 233 , 234 , 235 , 236 , 237 , 238 , ^{239}Np , 237 , ^{238}Pu , 239 , 240 , 241 , 242 , ^{243}Am , 241 , 242 , 243 , ^{244}Cm deduced fission probability.

76Ga29 Study of the γ -Ray Spectra Emitted in Formation of the Spontaneously Fissile Isomer ^{238}U in the (n,γ) Reaction

Y. P. Gangrskii, A. Lajtai, B. N. Markov, *Yad. Fiz.* 24, 880 (1976); *Sov. J. Nucl. Phys.* 24, 460 (1976).

Nuclear Reactions: $^{235}\text{U}(n,\gamma)$, $E=\text{th}$; measured γ -spectrum from $^{238\text{m}}\text{U}(\text{SF})$, fragment γ -coin.

76Si01 Picosecond Fission Isomers in Even-Even Cm Isotopes

G. Sletten, V. Metag, E. Liukkonen, *Phys. Lett.* 60B, 153 (1976).

Radioactivity: Fission 240 , $^{242}\text{Cm}(\text{SF})$; measured $T_{1/2}$, $^{244}\text{Cm}(\text{SF})$; measured $T_{1/2}$ upper limit.

76We03 Mass and Kinetic Energy Measurements of Fragments from the Isomeric and Excited State Fission of ^{242}Am

J. Weber, B. R. Erdal, A. Gavron, J. B. Wilhelmy, *Phys. Rev.* C13, 189 (1976).

Radioactivity: Fission $^{242\text{m}}\text{Am}(\text{SF})$; measured $T_{1/2}$, $\sigma(E(\text{fragment mass}))$.

Nuclear Reactions: $^{241}\text{Am}(d,pF)$, $E=15$ MeV; measured $\sigma(E(\text{fragment mass}))$.

77ArZZ Excitation and Spontaneous Fission of $^{238\text{m}}\text{U}$ Isomer by Neutrons with 14 MeV Energy

R. Arlt, G. Muziol, D. Hoffman, *Proc. Conf. Neutron Physics, Kiev, Part 3*, p. 247 (1977).

Nuclear Reactions: $^{238}\text{U}(n,n')$, $E=14$ MeV; measured isomer excitation, $\sigma(\text{ratio})$.

Radioactivity: Fission $^{238\text{m}}\text{U}(\text{SF})$; measured $\sigma(\text{fragment})$ vs t .

77BoZO On the Spontaneous Fission of ^{238}U Isomer

A. P. Bordulya, S. N. Ezhov, *Proc. Conf. Neutron Physics, Kiev, Part 3*, p. 244 (1977).

Radioactivity: ^{238}Pa [from $^{238}\text{U}(n,p)$, $E=14.7$ MeV]; measured β -delayed γ -decay. ^{238}U deduced isomer fission probability.

77Bo09 The Rotational Band of the ^{236}U Shape Isomer

J. Borggreen, J. Pedersen, G. Sletten, R. Heffner, E. Swanson, *Nucl. Phys.* A279, 189 (1977).

Nuclear Reactions: $^{235}\text{U}(d,p)$, $E=12$ MeV; measured ce-delayed fission coin, pce-coin. $^{236\text{m}}\text{U}$ deduced rotational constant.

77Di09 Near Threshold Neutron-Fission Cross Section

M. Di Toro, G. Russo, *Nucl. Phys.* A284, 177 (1977).

Nuclear Structure: ^{235}U , ^{236}Np , ^{243}Pu ; calculated fission parameters. ^{238}Np ; calculated, predicted isomer.

77Ga09 $\Gamma n\gamma$ in Heavy Actinides

A. Gavron, H. C. Britt, P. D. Goldstone, R. Schoenmackers, J. Weber, J. B. Wilhelmy, *Phys. Rev.* C15, 2238 (1977).

Nuclear Reactions: ^{244}Pu , 245 , 246 , ^{248}Cm , 249 , $^{250}\text{Cf}({}^3\text{He},d)$, $({}^3\text{He},t)$, $E=8$, 11 MeV; measured fission probability of compound systems 244 , ^{245}Am , 245 , 246 , 247 , 248 , ^{249}Bk , 249 , 250 , ^{251}Es .

77Go03 Cross Section for Fission of ^{244}Pu by Fast Neutrons

B. M. Gokhberg, S. M. Dubrovina, V. A. Shigin, *Yad. Fiz.* 25, 21 (1977); *Sov. J. Nucl. Phys.* 25, 11 (1977).

Nuclear Reactions: $^{244}\text{Pu}(n,F)$, $E=\text{fast}$; measured $\sigma(E)$; deduced fission threshold. ^{245}Pu deduced fission barrier height.

77GoZH Transmissionresonanzen und Winkelverteilungen der prompten Spaltung in der $^{238}\text{Pu}(d,pf)$ Reaktion

U. Goerlach, D. Habs, M. Just, V. Metag, E. Mosler, B. Neumann, P. Paul, J. Schukraft, P. Singer, H. J. Specht, G. Ulfert, C. O. Wene, Max-Planck Institut fur Keimphysik (Heidelberg), *Jahresbericht 1976*, p. 49 (1977).

Nuclear Reactions: $^{238}\text{Pu}(d,p)$, $E=11$ MeV; measured fission yields; deduced transmission resonance. $^{238}\text{U}(\alpha,3n)$; measured $\gamma(\theta,H,t)$. $^{238\text{m}}\text{Pu}$ deduced g .

77GoYZ Messung der Energie- und Massenverteilung bei der Spaltung des $^{239\text{m}}\text{Pu}$ mit Hilfe des Magnetischen Ruckstossionenseparator

U. Goerlach, D. Habs, M. Just, V. Metag, E. Mosler, J. Pedersen, J. Schukraft, P. Singer, H. J. Specht, G. Ulfert, C. O. Wene, Max-Planck Institut fur Keimphysik (Heidelberg), *Jahresbericht 1977*, p. 51 (1977).

Radioactivity: Fission $^{239}\text{Pu}(\text{SF})$ [from $^{238}\text{U}(\alpha,3n)$]; measured fragment mass, kinetic energy distribution. Compared with neutron induced fission.

77Ha01 Quadrupole Moment of the $8\text{-}\mu\text{s}$ Fission Isomer in ^{239}Pu

D. Habs, V. Metag, H. J. Specht, G. Ulfert, *Phys. Rev. Lett.* 38, 387 (1977).

Nuclear Reactions: $^{238}\text{U}(\alpha,3n)$, $E=33$ MeV; measured charge distribution, activity by charge-plunger technique. ^{239}Pu fission isomer deduced quadrupole moment.

77KeZI Investigation of $(n,\gamma F)$ Reaction

J. Kecskemeti, Gy. Kluge, A. Lajtai, *INDC(SEC)-61/LN*, p. 44 (1977).

Nuclear Reactions: $^{235}\text{U}(n,F)$, $E=\text{th}$; measured $\gamma\gamma(t)$. $^{236\text{m}}\text{U}(\text{SF})$ deduced transitions.

77Me08 The Quadrupole Moment of the 40 ps Fission Isomer in ^{236}Pu

V. Metag, G. Sletten, *Nucl. Phys.* A282, 77 (1977).

Nuclear Reactions: $^{234}\text{U}(\alpha,2n)$, $E=25$ MeV; measured delayed fission fragment(θ). ^{236}Pu shape isomer deduced $T_{1/2}$, Q_0 .

77Mi09 Fission Isomer of $^{237\text{m}}\text{Np}$

E. Migneco, G. Russo, R. De Leo, A. Pantaleo, *Phys. Rev.* C16, 1919 (1977).

Nuclear Reactions: $^{238}\text{U}(n,2n)$, $E=9.75$, 11.6 , 12.5 MeV; measured delayed/prompt fission ratios. $^{237\text{m}}\text{Np}$ deduced partial $T_{1/2}$ for γ , fission, branching ratio.

77Ta05 ^{239}Pu Fission Isomer in the Reaction with 3-5 MeV Neutrons

E. Takekoshi, Y. Tsukihashi, *J. Phys. Soc. Jap.* 42, 1773 (1977).

Nuclear Reactions: $^{239}\text{Pu}(n,n')$, (n,F) , $E=3-5$ MeV; measured σ for isomer production/ σ prompt fission; deduced σ for isomer production/ σ ground state.

77VaYN Spontaneously Fissioning Isomers

R. Vandenbosch, *Ann. Rev. Nucl. Sci.* 27, 1 (1977).

Nuclear Structure: $^{236, 238}\text{U}$, ^{237}Np , $^{235, 237, 239, 241, 243}\text{Pu}$, $^{237, 238, 239, 240, 241, 242, 243, 244, 245}\text{Am}$, $^{240, 241, 242, 243, 245}\text{Cm}$, $^{252, 254, 255, 256}\text{Bk}$; compiled, reviewed isomer SF-decay $T_{1/2}$ data.

77VoZU Production of Fission Isomers in the Reaction $^{238}\text{U}(n, n')$

P. E. Vorotnikov, V. A. Vukolov, E. A. Kolytyn, Yu. D. Molchanov, G. A. Otroschenko, *Proc. Conf. Neutron Physics, Kiev, Part 3*, p. 239 (1977).

Nuclear Reactions: $^{238}\text{U}(n, n')$, $E=2.5-4.7$ MeV; measured fission isomer yield, $T_{1/2}$, reaction threshold.

78Ba47 Search for a γ -Decay of the ^{236}U Shape Isomer

H. Bartsch, W. Gunther, K. Huber, U. Kneissl, H. Krieger, H. J. Maier, *Nucl. Phys.* A306, 29 (1978).

Radioactivity: ^{236m}U shape isomer [from $^{238}\text{U}(\gamma, 2n)$, $E=45$ MeV bremsstrahlung]; measured E_γ , I_γ ; deduced Γ_γ/Γ_f .

78De07 Fission-Evaporation Competition in Pu Isotopes of Mass 235-239

H. Delagrang, A. Fleury, J. M. Alexander, *Phys. Rev.* C17, 1706 (1978).

Nuclear Reactions: $^{233, 234, 235}\text{U}(\alpha, xn)$, $X=1-4$, $E \leq 46$ MeV; measured fusion $\sigma(E)$.

78Fi05 Statistical-Model Analysis of Fission Isomer Production for $^{237, 238}\text{Pu}$ And ^{239}Am

A. Fleury, H. Delagrang, J. M. Alexander, *Phys. Rev.* C17, 1721 (1978).

Nuclear Reactions: $^{235, 233}\text{U}$, $^{237}\text{Np}(\alpha, 2n)$, $E=22-28$ MeV; calculated $\sigma(E)$, isomer production $\sigma(E)$. Statistical model analysis.

78Go10 Resonances in the Isomeric and Prompt Fission Probabilities of ^{240}Pu

U. Goerlach, D. Habs, M. Just, V. Metag, P. Paul, H. J. Specht, H. J. Maier, *Z. Phys.* A287, 171 (1978).

Nuclear Reactions: $^{239}\text{Pu}(d, p)$, $E=11$ MeV; measured proton-fragment time distributions, prompt, delayed fission σ ; deduced fission probability.

78Gu02 Population of the ^{236}U Shape Isomer in a Photonuclear Reaction

W. Gunther, K. Huber, U. Kneissl, H. Krieger, *Nucl. Phys.* A297, 254 (1978).

Nuclear Reactions: $^{238}\text{U}(\gamma, 2n)$, $E=45$ MeV bremsstrahlung; measured isomer/prompt yields; deduced σ for isomer production. ^{236m}U shape isomer deduced $T_{1/2}$, Γ_γ/Γ_f . Natural target.

78Po01 Properties of Fission Isomers

K. Pomorski, A. Sobczewski, *Acta Phys. Pol.* B9, 61 (1978).

Nuclear Structure: ^{226}Ra , $^{230, 232}\text{Th}$, $^{234, 236, 238}\text{U}$, $^{236, 238, 240, 242, 244}\text{Pu}$, $^{240, 242, 244, 246, 248, 250}\text{Cm}$; calculated fission isomer properties: moment of inertia, pairing energy gap, g. Nilsson potential.

78SoZP Production of ^{235m}U Fission Isomer and ^{234}Pu in the Reactions $\alpha + ^{233}\text{U}$ and $^3\text{He} + ^{234}\text{U}$

L. P. Somerville, M. J. Nurmi, A. Ghiorso, G. T. Seaborg, LBL-8151, p. 39 (1978).

Nuclear Reactions: $^{234}\text{U}(^3\text{He}, 2n)$, $E=21.5-31.4$ MeV; $^{238}\text{U}(\alpha, 2n)$, $E=36.1$ MeV; measured production $\sigma(E)$. ^{235m}U level deduced $T_{1/2}$. Mica spontaneous fission detector.

78U101 Lifetime Measurements of Nuclear Levels with the Charge Plunger Technique

G. Ulfert, D. Habs, V. Metag, H. J. Specht, *Nucl. Instrum. Methods* 148, 369 (1978).

Nuclear Reactions: $^{239}\text{Pu}(\alpha, 3n)$, $E=27, 33$ MeV; measured recoil distance. ^{240}Cm levels deduced $T_{1/2}$, Q.

79Ba02 Spectroscopy in the Second Minimum of the Potential Energy Surface of ^{239}Pu

H. Backe, L. Richter, D. Habs, V. Metag, J. Pedersen, P. Singer, H. J. Specht, *Phys. Rev. Lett.* 42, 490 (1979).

Radioactivity: ^{239m}Pu [from $^{238}\text{U}(\alpha, 3n)$, $E=33$ MeV]; measured $E(\text{ce})$, $I(\text{ce})$. ^{239}Pu deduced levels in second minimum, J, π, δ , rotational parameters. Nilsson assignments.

79Be33 Deep Subthreshold Photofission Yields Analysis

G. Bellia, A. Del Zoppo, E. Migneco, R. C. Bama, D. De Pasquale, *Phys. Rev.* C20, 1059 (1979).

Nuclear Reactions: ^{232}Th , $^{235, 236, 238}\text{U}(\gamma, f)$, $E=3.6, 4.1, 4.6, 5.1$ MeV (bremsstrahlung); measured σ . ^{232}Th deduced three-humped fission barrier. ^{232}Th , $^{235, 236, 238}\text{U}$ deduced energies, fission branching ratios for shape isomers. Double-humped fission barrier model.

79Be46 Optical Isomer Shift for the Spontaneous-Fission Isomer $^{240}\text{Am-m}$

C. E. Bemis, Jr., J. R. Beene, J. P. Young, S. D. Kramer, *Phys. Rev. Lett.* 43, 1854 (1979); Erratum *Phys. Rev. Lett.* 44, 500 (1980).

Radioactivity: ^{240m}Am ; measured $T_{1/2}$, optical isomer shift. ^{240m}Am , ^{240}Am deduced difference in rms radii.

Atomic Physics: $+240\text{Am}(\text{SF})$; measured optical isomer shift. 240m , ^{240}Am deduced difference in rms radii.

79Gr04 Excitation of a Spontaneously Fissile Isomer in Positron Annihilation In the K Shell of an Atom

D. P. Grechukhin, A. A. Soldatov, *Yad. Fiz.* 29, 296 (1979); *Sov. J. Nucl. Phys.* 29, 146 (1979).

Radioactivity: Fission $^{236, 238}\text{U}$; calculated $T_{1/2}$ (SF).

79Gu03 Photonuclear Yields of the ^{237}Pu Fission Isomers

W. Gunther, K. Huber, U. Kneissl, H. Krieger, H. J. Maier, *Phys. Rev.* C19, 433 (1979).

Nuclear Reactions: $^{239}\text{Pu}(\gamma, 2n)$, $E=45$ MeV bremsstrahlung; measured $T_{1/2}$, isomeric yield ratio. ^{237m}Pu levels deduced isomeric ratio, spin. Nilsson assignments.

79U01 *Quadrupole Moment of the 200-ns Fission Isomer in ^{237}U*

G. Ulfert, V. Metag, D. Habs, H. J. Specht, Phys. Rev. Lett. 42, 1596 (1979).

Nuclear Reactions: $^{238}\text{U}(\text{d,pn})$, $E=20$ MeV; measured yield of fission-isomeric recoil. $^{238\text{m}}\text{U}$ level deduced quadrupole moment.

79Va25 *On Gamma-Rays in the Population of the Spontaneously Fissioning Isomer in the Reaction $^{241}\text{Am}(n,\gamma)^{242\text{m}}\text{Am}$*

G. V. Valskii, V. L. Varentsov, G. A. Petrov, Y. S. Pleva, Y. A. Otchik, Pisma Zh. Eksp. Teor. Fiz. 29, 92 (1979); JETP Lett. 29, 84 (1979).

Nuclear Reactions: $^{241}\text{Am}(n,\gamma)$, $E=\text{thermal}$; measured $\gamma(t)$. ^{242}Am deduced transition, E(SF) isomer.

80Bj02 *The Double-Humped Fission Barrier*

S. Bjornholm, J. E. Lynn, Rev. Mod. Phys. 52, 725 (1980).

Nuclear Structure: $A=231-245$; analyzed resonance structure, fission data; deduced fission features. Double-humped fission barrier concept.

80Bu13 *Experimental Upper Limit for a γ Branch from the ^{235}U Shape Isomer*

P. A. Butler, R. Daniel, A. D. Irving, T. P. Morrison, P. J. Nolan, V. Metag, J. Phys. (London) G6, 1165 (1980).

Nuclear Reactions: $^{235}\text{U}(\text{d,p})$, $E=11$ MeV; measured $\sigma(E\gamma)$, $\gamma\text{p}(t)$. ^{235}U level deduced limit on $\Gamma\gamma/\Gamma\text{f}$.

80BuZL *Experimental Upper Limit for a γ -Branch from the ^{235}U Shape Isomer*

P. A. Butler, R. Daniels, A. D. Irving, T. P. Morrison, P. J. Nolan, V. Metag, R. Wadsworth, Univ. Liverpool, 1979-1980 Ann. Rept., p. 52 (1980)

Nuclear Reactions: $^{235}\text{U}(\text{d,p})$, $E=11$ MeV; measured $E\gamma$, $I\gamma$, $\gamma\text{p}(t)$. ^{235}U deduced shape isomer $\Gamma\gamma/\Gamma\text{f}$ upper limit.

80Gu20 *Systematics of Photonuclear Yields and Cross Sections for Plutonium and Uranium Fission Isomers*

W. Gunther, K. Huber, U. Kneissl, H. Krieger, H. Ries, H. Stroher, W. Wilke, H. J. Maier, Nucl. Phys. A350, 1 (1980).

Nuclear Reactions: Fission ^{240}Pu , $^{235}\text{U}(\gamma,\text{xn})$, $^{239}\text{Pu}(\gamma, 2\text{n})$, $^{242}\text{Pu}(\gamma,\text{n})$, $E=45$ MeV bremsstrahlung; measured $T_{1/2}$, isomeric to prompt yield ratios. ^{238}U , 237 , 239 , ^{241}Pu levels deduced $\sigma(\text{fission})$. Natural, enriched targets.

80Ku14 *A Simple Description of Dependence of Fission Barriers and of the Ratio $\Gamma(n)/\Gamma(\text{f})$ on the Nucleonic Composition for Transuranium Nuclei*

V. M. Kupriyanov, K. K. Istekov, B. I. Fursov, G. N. Smirenkin, Yad. Fiz. 32, 355 (1980); Sov. J. Nucl. Phys. 32, 184 (1980).

Nuclear Structure: 225 , 226 , 227 , ^{228}Ra , 226 , 227 , ^{228}Ac , 227 , 228 , 229 , 230 , 231 , 232 , ^{233}Th , 230 , 231 , 232 , ^{233}Pa , 231 , 232 , 233 , 234 , 235 , 236 , 237 , 238 , 239 , ^{240}U , 233 , 234 , 235 , 236 , 237 , 238 , 239 , 240 , 241 , 242 , 243 , 244 , ^{245}Pu , 239 , 240 , 241 , 242 , 243 , 244 , 245 , 246 , ^{247}Am , 241 , 242 , 243 , 244 , 245 , 246 , 247 , 248 , 249 , ^{250}Cm , 245 , 246 , 247 , 248 , 249 , ^{250}Bk , 250 , ^{253}Cf , 249 , 250 , ^{251}Es ; calculated $\langle \Gamma\text{n}/\Gamma\text{f} \rangle$, fission barrier height dependences on neutron number. Phenomenological model.

80Li15 *Spectroscopic Properties of 237 , ^{239}Pu Fission Isomers from Self-Consistent Calculations*

J. Libert, M. Meyer, P. Quentin, Phys. Lett. B95, 175 (1980).

Nuclear Structure: 237 , ^{239}Pu ; calculated levels, $B(\lambda)$, fission isomer spectroscopic properties. Rotor plus quasiparticle model, self-consistent single particle states.

80Me15 *Spectroscopic Properties of Fission Isomers*

V. Metag, D. Habs, H. J. Specht, Phys. Rep. 65, 1 (1980).

Nuclear Structure: $A=230-250$; compiled, reviewed fission isomers data; deduced superdeformed related features.

80Pa16 *Superprolate shape of the Spontaneous-Fission Isomer ^{240}Am*

L. Pauling, Phys. Rev. C22, 1585 (1980).

Nuclear Structure: ^{240}Am ; calculated deformation parameter. Cluster, polyspheron theory.

80Ti03 *Isomeric-to-Prompt Fission Ratios for the Uranium Fission Isomers $^{236\text{m}}\text{U}$ and $^{238\text{m}}\text{U}$*

R. Tischler, A. Kleinrahm, R. Kroth, C. Gunther, Phys. Rev. C22, 324 (1980).

Nuclear Reactions: $^{235}\text{U}(\text{d,pF})$, 236 , $^{238}\text{U}(\text{d,npF})$, $E=17-25$ MeV; measured delayed E(fission fragment). 236 , ^{238}U deduced isomeric to prompt fission ratio.

81Be48 *Study of the Fission Isomer $^{240\text{m}}\text{Am}(\text{S.F.})$ using Laser-Induced Nuclear Polarization*

J. R. Beene, C. E. Bemis, Jr., J. P. Young, S. D. Kramer, Hyperfine Interactions 9, 143 (1981).

Radioactivity: Fission $^{240\text{m}}\text{Am}(\text{SF})$ [from $^{239}\text{U}(\text{Li}, 5\text{n})$, $E=49$ MeV]; measured optical isomer shift; deduced quadrupole moment. Laser induced nuclear polarization, optical pumping.

81Ga25 *A Rotating Wheel System for the Detection of Spontaneously Fissioning Nuclides from Heavy Ion Reactions*

H. Gaggeler, W. Bruchle, J. V. Kratz, M. Schadel, K. Summerer, W. Weber, G. Wirth, G. Hermann, Nucl. Instrum. Methods 188, 367 (1981).

Radioactivity: Fission $^{252}\text{Cf}(\text{SF})$, $^{244}\text{Fm}(\text{SF})$ [from $^{207}\text{Pb}(\text{Ar}, 3\text{n})$, $E=199$ MeV]; $^{242\text{m}}\text{Am}(\text{SF})$ [from $^{238}\text{U}(\text{U}, \text{X})$, $E=7.6$ MeV/nucleon]; measured $T_{1/2}$. Rotating wheel technique, catcher foil, fission track detectors.

Nuclear Reactions: $^{238}\text{U}(\text{U}, \text{X})$, $E=7.6$ MeV/nucleon; $^{207}\text{Pb}(\text{Ar}, 3\text{n})$, $E=199$ MeV; measured production $\sigma(E)$ for ^{244}Fm , ^{242}Am . Rotating wheel technique, catcher foil, fission track detectors.

81Gu04 *Yield Ratio for the Two ^{241}Pu Fission Isomers in the $^{242}\text{Pu}(\gamma,\text{n})$ Reaction*

W. Gunther, K. Huber, U. Kneissl, H. Krieger, H. Ries, H. Stroher, W. Wilke, Nucl. Phys. A359, 397 (1981).

Nuclear Reactions: $^{242}\text{Pu}(\gamma,\text{n})$, $E=40-48$ MeV bremsstrahlung; measured $T_{1/2}$, isomeric to prompt yield ratio. ^{241}Pu levels deduced isomeric ratio, J. Enriched target.

81Me19 *New Results on the Spectroscopy and Dynamics of Fission*

V. Metag, Nucl. Phys. A354, 271c (1981).

Nuclear Structure: ^{236}U , ^{238}U , ^{236}Pu , ^{240}Am ; compiled, reviewed fission isomer, ground state quadrupole moment, deformation data. Other nuclei included in review.

81Re06 *Analysis of Fissionability Data at High Excitation Energies I. The Level Density Problem*

W. Reisdorf, Z. Phys. A300, 227 (1981).

Nuclear Structure: ^{208}Pb , ^{216}Th , ^{212}Rn ; calculated level density constant; ^{230}Pa , ^{231}U , ^{233}Pa , ^{234}U , ^{235}U , ^{236}U , ^{237}Np , ^{238}Pu , ^{239}Pu , ^{240}Am , ^{241}Am , ^{242}Cm , ^{243}Cm ; analyzed fission probabilities; deduced barrier parameters, shell correction effects. Balian-Bloch single particle level density, shell, pairing effect Ansatz.

Nuclear Reactions: Fission ^{232}Th , ^{237}Np , ^{236}U , ^{240}Pu (^3He , dF), E=25 MeV; calculated fission probability vs excitation energy. Balian-Bloch single particle level density, shell, pairing effect Ansatz.

81VaZQ *Experiments on the Transferrmium Element Production in Nuclear Reactions Induced by Mg Ions*

V. M. Vasko, G. G. Gulbekyan, S. P. Tretyakova, E. A. Cherepanov, JINR-P7-81-863 (1981).

Radioactivity: ^{242}Am (SF) [from ^{243}Am (^{26}Mg , X), E=110-140 MeV]; measured $T_{1/2}$.

Nuclear Reactions: ^{232}Th , ^{238}U , ^{243}Am (^{24}Mg , F), E=130 MeV; ^{232}Th , ^{238}U , ^{243}Am (^{26}Mg , F), E=110-140 MeV; measured fission production σ for $^{252}\text{102}$, $^{265}\text{107}$, $^{260}\text{104}$, $T_{1/2}$ (SF).

82Fo08 *Parameters of Fission Barriers for Compound Nuclei ^{245}Cm , ^{247}Cm and ^{249}Cm*

E. F. Fomushkin, G. F. Novoselov, Yu. I. Vinogradov, V. V. Gavrilov, Yad. Fiz. 36, 582 (1982).

Nuclear Reactions: ^{248}Cm (n,F), E=0.3-5.5 MeV; measured fission σ (E). 245 , 247 , ^{249}Cm deduced fission barrier parameters. Underground nuclear explosion impulse neutron source.

82Go02 *Lowest β -Vibrational Phonon in the Second Minima of ^{236}U*

U. Goerlach, D. Habs, V. Metag, B. Schwartz, H. J. Specht, H. Backe, Phys. Rev. Lett. 48, 1160 (1982).

Nuclear Reactions: Fission ^{235}U , ^{238}U (d,np), E=20 MeV; measured I(ce), ce(fragment)(t). 236 , ^{238}U deduced shape isomer decay characteristics, K/L ratio, transition multipolarity, vibrational band characteristics.

82Ma34 *Symmetry Considerations on the Fission Isomer Spectra*

G. Maino, A. Ventura, Lett. Nuovo Cim. 34, 533 (1982).

Nuclear Structure: ^{236}U , ^{238}U ; calculated levels, B(E2), band structure. Interacting boson model, SU_3 limit.

82Ra04 *Measurement of the g Factor of the ^{237}Pu Short-Lived Fission Isomer*

M. H. Rafailovich, E. Dafni, G. Schatz, S. Y. Zhu, K. Dybdal, S. Vajda, C. Alonso-Arias, G. D. Sprouse, Phys. Rev. Lett. 48, 982 (1982); Erratum Phys. Rev. Lett. 49, 244 (1982).

Nuclear Reactions: ^{235}U (α ,2n), E=25.2 MeV; measured γ (θ , H,T). ^{237}Pu deduced fission isomer g, Nilsson configuration.

83Dm04 *Yield of Fissionable Isomers from Reactions $^{234}\text{U}(n, n')$, $^{236}\text{U}(n, n')$, and $^{238}\text{U}(n, n')$*

S. V. Dmitriev, G. A. Otroshchenko, S. M. Solovyev, Yad. Fiz. 38, 1394 (1983).

Nuclear Reactions: 234 , 236 , $^{238}\text{U}(n, n')$, E=2.6-4.7 MeV; measured fission isomer production σ (E).

83Dr14 *The Decay of Uranium Shape Isomers Investigated by Photonuclear Reactions*

J. Drexler, R. Heil, K. Huber, U. Kneissl, G. Mank, R. Ratzek, H. Ries, H. Stroher, T. Weber, W. Wilke, Nucl. Phys. A411, 17 (1983).

Nuclear Reactions: $^{238}\text{U}(\gamma, \gamma)$, E=12 MeV bremsstrahlung; measured isomer $T_{1/2}$, isomeric to prompt yield ratio; deduced isomeric fission cross section. ^{238}U deduced isomer decay branching ratio. Natural target.

83Ka11 *Observation of an E0 Isomeric Transition from the ^{238}U Shape Isomer*

J. Kantele, W. Stoffl, L. E. Ussery, D. J. Decman, E. A. Henry, R. W. Hoff, L. G. Mann, G. L. Struble, Phys. Rev. Lett. 51, 91 (1983).

Radioactivity: ^{238m}U [from ^{238}U (d,pn), E=18 MeV]; measured I(ce); deduced shape isomer E0 transition, J, π , $T_{1/2}$ assignment consistency. Reevaluation of γ data, superconducting, solenoid type electron spectrometer.

83Po14 *Identification of ^{246}Pu , ^{247}Pu , ^{246m}Am , and ^{247}Am and Determination of Their Half-Lives*

Yu. S. Popov, P. A. Privalova, G. A. Timofeev, V. B. Mishenev, A. V. Mamelin, B. I. Levakov, V. M. Prokopen, Radiokhimiya 25, 482 (1983); Sov. Radiochemistry 25, 458 (1983).

Radioactivity: 246 , ^{247}Pu , ^{246m}Am , $^{247}\text{Am}(\beta)$ [from Pu neutron irradiation]; measured E_γ , I_γ , E(X-ray), I(X-ray); deduced $T_{1/2}$, ^{246}Pu burnout σ . Isotope identification by α -, β -, γ -spectroscopy techniques.

83Ra36 *g-Factor Measurements of Fission Isomers*

M. H. Rafailovich, E. Dafni, G. Schatz, S. Y. Zhu, K. Dybdal, S. Vajda, C. Alonso-Arias, S. Rolston, G. D. Sprouse, Hyperfine Interactions 15/16, 43 (1983).

Radioactivity: ^{239m}Am , ^{237}Pu (SF) [from ^{235}U , $^{237}\text{Np}(\alpha, 2n)$, E=25 MeV]; measured fission fragment anisotropy, isomer $T_{1/2}$, g.

Nuclear Reactions: ^{235}U , $^{237}\text{Np}(\alpha, 2n)$, E=25 MeV; measured γ (θ , H,t). ^{239m}Am , ^{237}Pu deduced fission isomer g, $T_{1/2}$.

83WeZT *Search for Alpha Particle Emission from the 14-ms ^{242m}Am Shape Isomer*

J. Weber, H. C. Britt, C. Fontenla, M. M. Fowler, Z. Fraenkel, A. Gavron, K. Rudolph, J. Van der Plicht, J. B. Wilhelmy, LA-9797-PR, p. 151 (1983); Isotope and Nucl. Chem. Div. Ann. Rept., 1981-1982, H. A. Lindberg Ed., Los Alamos Nat. Lab., p. 151 (1983).

Radioactivity: $^{242m}\text{Am}(\alpha)$ (SF) [from $^{242}\text{Pu}(t, 3n)$, E=17 MeV]; measured E_α , I_α ; deduced deexcitation shape dependence, $T_{1/2}$, long range α -particle to SF branching ratio.

83WeZU *Messungen zum α -Zerfall des Formisomers ^{242m}Am*

J. Weber, K. Rudolph, C. Ley, K. E. G. Lobner, S. J. Skorka, J. B. Wilhelmy, H. C. Britt, A. Gavron, Z. Fraenkel, Univ., Tech. Univ. Munich, Jahresbericht 1982, p. 16 (1983).

Radioactivity: $^{242}\text{Am}(\alpha)$ [from $^{242}\text{Pu}(t, 3n)$, (d,2n)]; measured E_α , I_α .

84Bo33 *Alpha Decay of Fission Isomers*

N. M. Borstnik, *ATOMKI Kozlem.* 26, 100 (1984).

Nuclear Structure: ^{242m}Am ; calculated α -decay characteristics. Vibrational degrees, α -particle motion dynamical coupling.

84Du03 *Theoretical Analysis of the Single-Particle States in the Secondary Minima of Fissioning Nuclei*

J. Dudek, W. Nazarewicz, A. Faessler, *Nucl. Phys.* A412, 61 (1984).

Nuclear Structure: 239m , ^{237m}Pu , ^{239m}Am , 231 , ^{233}Th ; calculated g, single particle resonances, deformations near fission second minima. Deformed Woods-Saxon potential.

84Ka10 *Reinvestigation of the Gamma Branch from the ^{238}U Shape Isomer*

J. Kantele, W. Stoffl, L. E. Ussery, D. J. Decman, E. A. Henry, R. J. Estep, R. W. Hoff, L. G. Mann, *Phys. Rev.* C29, 1693 (1984).

Nuclear Reactions: ICPND $^{238}\text{U}(d, np)$, $E=18.1$ MeV; measured E_γ , I_γ ; deduced (isomeric/ground state) σ . ^{238}U deduced shape isomer SF, conversion decay characteristics, levels.

Radioactivity: $^{238m}\text{U}(\text{SF})$, (IT) [from $^{238}\text{U}(d, np)$, $E=18.1$ MeV]; measured E_γ , I_γ ; deduced isomer decay process relative probabilities.

84Ku05 *Systematics of Neutron Cross Sections and Other Characteristics of Fission Probabilities of Transuranium Nuclei*

V. M. Kupriyanov, G. N. Smirenkin, B. I. Fursov, *Yad. Fiz.* 39, 281 (1984).

Nuclear Structure: 228 , 229 , 230 , 231 , 232 , 233 , 234 , 235 , 236 , 237 , 238 , 239 , 240 , 241 , ^{242}U , 230 , 231 , 232 , 233 , 234 , 235 , 236 , 237 , 238 , 239 , 240 , 241 , ^{242}Np , 234 , 235 , 236 , 237 , 238 , 239 , 240 , 241 , 242 , 243 , 244 , 245 , 246 , 247 , 248 , 249 , 250 , 251 , 252 , 253 , 254 , 255 , 256 , ^{257}Pu , 236 , 237 , 238 , 239 , 240 , 241 , 242 , 243 , 244 , 245 , 246 , 247 , 248 , 249 , 250 , 251 , 252 , 253 , 254 , 255 , 256 , ^{257}Am , 238 , 239 , 240 , 241 , 242 , 243 , 244 , 245 , 246 , 247 , 248 , 249 , 250 , 251 , 252 , 253 , 254 , 255 , 256 , ^{257}Cf , 244 , 245 , 246 , 247 , 248 , 249 , 250 , 251 , 252 , 253 , 254 , 255 , 256 , ^{257}Es , 250 , 251 , 252 , 253 , 254 , 255 , 256 , ^{257}Fm ; calculated fast neutron induced fission σ ; analyzed fission data systematics; deduced fission barrier heights, $(\Gamma(n)/\Gamma(F))$. Statistical approach, two-hump fission barrier model.

84Ma44 *α Decay of Fission Isomers*

N. Mankoc-Borstnik, *J. Phys. (London)* G10, 1371 (1984).

Radioactivity: $^{242}\text{Am}(\text{EC})$, (β^-) , (α) , $^{242m}\text{Am}(\text{SF})$, (α) ; calculated α -decay constant. First-order perturbation theory.

84Ni04 *On Connection between α Decay and Ternary Fission of Heavy Nuclei*

A. M. Nikitin, *Yad. Fiz.* 39, 380 (1984).

Nuclear Structure: ^{252}Cf , 233 , 234 , 235 , ^{236}U , 243 , ^{242m}Am ; analyzed ternary fission light fragment emission, α -decay characteristics systematics; deduced initial nucleus quasistationary α -particle state role.

84Oh09 *Systematic Analysis of Fission Cross Sections of Actinides by Means of Double-Humped Barrier Model*

T. Ohsawa, Y. Shigemitsu, M. Ohta, K. Kudo, *J. Nucl. Sci. Technol. (Tokyo)* 21, 887 (1984).

Nuclear Reactions: ^{231}Pa , 232 , 234 , 235 , 236 , ^{238}U , ^{237}Np , 238 , 239 , 240 , 241 , 242 , ^{244}Pu , 241 , 242 , ^{243}Am , 243 , 244 , 245 , 246 , 247 , ^{249}Cm , ^{249}Bk , $^{252}\text{Cf}(n, F)$, E 0.5-6 MeV; calculated $\sigma(E)$; deduced optical model parameters. ^{232}Pa , 233 , 235 , 236 , 237 , ^{238}U , ^{238}Np , 239 , 240 , 241 , 242 , 243 , ^{245}Pu , 242 , 243 , ^{244}Am , 244 , 245 , 246 , 247 , 248 , ^{249}Cm , ^{250}Bk , ^{253}Cf deduced fission barriers. Double-humped barrier model.

84Vo18 *Energy Dependence of Yield of Fission Isomers in the Reactions $^{241}\text{Am}(n, \gamma)$ and $^{243}\text{Am}(n, \gamma)$*

P. E. Vorotnikov, G. A. Otroshchenko, *Yad. Fiz.* 40, 1135 (1984).

Nuclear Reactions: 241 , $^{243}\text{Am}(n, \gamma)$, $E=0.2-1.3$ MeV; measured fission isomer, prompt fission product yield ratios.

85Ba20 *On Measurement of the Angular Momenta of Fission Isomer*

A. L. Barabanov, D. P. Grechukhin, *Yad. Fiz.* 41, 582 (1985).

Nuclear Reactions: $^{238}\text{U}(^7\text{Li}, 5n)$, $E=46.1$ MeV; analyzed data. ^{240m}Am deduced fission isomer J estimate. Residual orientation in laser radiation field.

85Be58 *Laser Optical Pumping in Nuclear Physics: Fission Isomers, Oriented Targets, and Hyperfine Pumping in Single-Electron Atoms*

C. E. Bemis, Jr., *Hyperfine Interactions* 24, 139 (1985).

Radioactivity: $^{240m}\text{Am}(\text{SF})$; measured optical isomer shift. Oriented targets, anisotropic fission decay from resonant laser optical pumping.

85Dr01 *The 'Isomeric Shelf' in the Deep Subbarrier Photofission of ^{238}U*

J. Drexler, R. D. Heil, K. Huber, U. Kneissl, G. Mank, R. Ratzek, H. Ries, T. Weber, W. Wilke, B. Fischer, H. Hollick, *Nucl. Phys.* A437, 253 (1985).

Nuclear Reactions: $^{238}\text{U}(\gamma, F)$, $E=3.9-4.3$ MeV bremsstrahlung; measured $T_{1/2}$, isomeric to prompt yield ratio. Depleted targets.

85Ig01 *Analysis of Cross Sections of U and Pu Isotope Fission Induced by Neutrons in the Range of the First 'Plateau'*

A. V. Ignatyuk, A. B. Klepatsky, V. M. Maslov, E. Sh. Sukhovitsky, *Yad. Fiz.* 42, 569 (1985).

Nuclear Reactions: 239 , 240 , 241 , 242 , 244 , ^{245}Pu , 234 , 235 , 236 , 237 , 238 , 239 , $^{240}\text{U}(n, F)$, $E=1-5.5$ MeV; analyzed fission $\sigma(E)$. 240 , 241 , 242 , 243 , 245 , ^{246}Pu , 235 , 236 , 237 , 238 , 239 , 240 , ^{241}U deduced fission barriers, transitional states statistical characteristics.

85Jo04 *^{241}Am and ^{243}Am Charge Distributions from Muonic X-Ray Spectroscopy and the Quadrupole Moment of the ^{240}Am Fission Isomer*

M. W. Johnson, E. B. Shera, M. V. Hoehn, R. A. Naumann, J. D. Zumbro, C. E. Bemis, Jr., *Phys. Lett.* 161B, 75 (1985).

Nuclear Reactions: 241 , $^{243}\text{Am}(\mu, X)$, E at rest; measured muonic E X-ray, I X-ray. 241 , ^{243}Am deduced intrinsic quadrupole moment, Barrett radii. ^{240}Am deduced fission isomer quadrupole moment. Optical isotope shift data input.

Atomic Physics: esic-Atoms 241 , $^{243}\text{Am}(\mu, X)$, E at rest; measured muonic X-rays.

85Ku18 *Excitation of Fission Isomer ^{242m}Am , $^{242}\text{Am}(f)$ by Electrons in the Energy Region 17.5-78 MeV*

V. L. Kuznetsov, L. E. Lazareva, V. G. Nedorezov, N. V. Nikitina, A. S. Sudov, *Yad. Fiz.* 42, 29 (1985).

Nuclear Reactions: $^{243}\text{Am}(e, n)$, (γ, n) , $E=17.5-78$ MeV; measured residual fission isomer production $\sigma(E)$; $^{243}\text{Am}(e, F)$, (γ, F) , $E=17.5-78$ MeV; measured fission $\sigma(E)$; deduced fission isomer production mechanism. Virtual photon theory.

- 85Ra28** *A g-Factor Measurement of the ^{239}Am Fission Isomer*
M. H. Rafailovich, S. Vajda, E. Dafni, G. Schatz, S. Rolston, S. Y. Zhu, G. D. Sprouse, Phys. Lett. 163B, 327 (1985).
Nuclear Reactions: $^{237}\text{Np}(\alpha, 2n)$, E=tandem; measured $\gamma(\theta, H, t)$. ^{239}Am deduced fission isomer g.
- 85Vo17** *Anisotropy of Fission of ^{242m}Am by Fast Neutrons*
P. E. Vorotnikov, B. M. Gokhberg, V. A. Shigin, E. F. Fomushkin, G. F. Novoselov, Yad. Fiz. 42, 1038 (1985); Sov. J. Nucl. Phys. 42, 656 (1985).
Radioactivity: $^{242m}\text{Am}(\text{SF})$; measured fission fragment decay $\sigma(\theta_n=0^\circ)/\sigma(\theta_n=90^\circ)$, anisotropy.
- 86B110** *Intermediate Structure in the Fission Cross Sections of the Even Curium Isotopes*
R. C. Block, D. R. Harris, H. T. Maguire, Jr., C. R. S. Stopa, R. E. Slovacek, J. W. T. Dabbs, R. J. Dougan, R. W. Hoff, R. W. Lougheed, Radiat. Eff. 92, 305 (1986).
Nuclear Reactions: $^{244}, ^{246}, ^{248}\text{Cm}(n, F)$, $E \leq 100$ keV; analyzed fission $\sigma(E)$; deduced structure. $^{245}, ^{247}, ^{249}\text{Cm}$ deduced barrier parameter differences.
- 86De04** *Excitation Function and Half-Life for the Fission Isomer ^{240m}Pu from the $^{238}\text{U}(\alpha, 2n)^{240m}\text{Pu}$ Reaction*
S. de Barros, S. D. de Magalhaes, H. Wolf, J. Barreto, J. Eichler, N. Lisbona, I. O. de Souza, D. M. Vianna, Z. Phys. A323, 101 (1986).
Radioactivity: $^{240m}\text{Pu}(\text{SF})$ [from $^{238}\text{U}(\alpha, 2n)$, $E=20.1-27.3$ MeV]; measured $T_{1/2}$.
Nuclear Reactions: ICPND $^{238}\text{U}(\alpha, 2n)$, $E=20.1-27.3$ MeV; measured residual fission isomer production $\sigma(E)$. ^{240m}Pu deduced delayed fission σ , isomeric σ ratio.
- 87Ah07** *Search for the Shape-Isomeric Gamma Decay in Muonic Uranium*
S. Ahmad, G. A. Beer, B. H. Olaniyi, A. Olin, S. N. Kaplan, A. Miresghii, J. A. Macdonald, O. Hausser, Can. J. Phys. 65, 753 (1987).
Nuclear Reactions: $^{236}, ^{238}, ^{235}\text{U}(\mu, \gamma)$, E at rest; measured E_γ , I_γ , E X-ray, I X-ray, $\gamma(t)$; deduced no shape isomer excitation evidence. $^{235}, ^{236}, ^{238}\text{U}$ deduced μ -capture $T_{1/2}$.
Atomic Physics: esic-Atoms $^{236}, ^{238}, ^{235}\text{U}(\mu, \gamma)$, E at rest; measured E_γ , I_γ , E X-ray, I X-ray, $\gamma(t)$.
- 87Gu03** *A New Macroscopic-Microscopic Description of the Double-Humped Fission Barriers*
S. K. Gupta, L. Satpathy, Z. Phys. A326, 221 (1987).
Nuclear Structure: ^{228}Ra , ^{228}Ac , ^{228}Th , ^{228}Pa , ^{234}U , ^{238}Np , ^{239}Pu , ^{241}Am , ^{243}Cm , ^{248}Bk , ^{250}Cf , ^{254}Es , ^{256}Fm , ^{256}Md , ^{257}No , ^{259}Lr , 261^{104} ; calculated binding energies; $Z=90-98$; calculated doubled-humped fission barriers, shell energies. New mass relation.
- 87ScZP** *On the γ -Decay of the Shape Isomer in ^{236}U*
J. Schirmer, D. Habs, D. Schwalm, H. J. Maier, GSI-87-1, p. 32 (1987).
Nuclear Reactions: $^{235}\text{U}(d, p)$, $E=11$ MeV; measured γ -spectra, $\gamma(t)$. ^{236}U deduced shape isomer decay characteristics.
- 88Ma43** *α -Decay Probability of Spontaneously Fissioning Isomer and Deformation Hindrance Factor*
V. E. Makarenko, V. G. Nosov, Yad. Fiz. 48, 73 (1988).
Radioactivity: $^{238m}\text{U}(\alpha)$; calculated α -decay probability; deduced deformation hindrance factor.
- 88Ma52** *Triple Fission of the Spontaneously Fissioning Isomer ^{238}U*
V. E. Makarenko, Yu. D. Molchanov, G. A. Otroshchenko, G. B. Yan'kov, Pisma Zh. Eksp. Teor. Fiz. 47, 489 (1988); JETP Lett. (USSR) 47, 573 (1988).
Radioactivity: $^{238m}\text{U}(\alpha)$, (SF) [from $^{238}\text{U}(n, n')$, $E=4.5$ MeV]; measured decay $T_{1/2}$, triple fission branching ratio.
Nuclear Reactions: $^{238}\text{U}(n, n')$, $E=4.5$ MeV; measured isomer production yield.
- 89Eg01** *Actinide Nuclei Fission Cross-Section Irregularities*
S. A. Egorov, V. A. Rubchenya, S. V. Khlebnikov, Nucl. Phys. A494, 75 (1989).
Nuclear Reactions: $^{227}\text{Ac}(n, F)$, E 2-16 MeV; $^{228}\text{Ra}(n, F)$, E 3-16 MeV; $^{244}\text{Cm}(n, F)$, E 1-3 MeV; $^{242}, ^{245}, ^{248}\text{Cm}(n, F)$, E 0.5-5 MeV; calculated fission $\sigma(E)$. $^{243}, ^{245}, ^{247}, ^{249}\text{Cm}$, $^{226}, ^{228}, ^{227}\text{Ra}$, $^{228}, ^{227}\text{Ac}$ deduced fission barrier parameters.
- 89Ha40** *Spectroscopy of the Second Minimum*
D. Habs, Nucl. Phys. A502, 105c (1989).
Nuclear Structure: A 150; analyzed high spin level systematics; deduced comparison with fission second minimum in actinide region.
- 89HoZP** *Second Minimum Spectroscopy Using Heavy Ion Transfer Reactions*
T. H. Hoare, P. A. Butler, G. D. Jones, R. J. Poynter, C. A. White, Daresbury Lab., 1988-1989 Ann. Rept., Appendix, p. 92 (1989).
Nuclear Reactions: $^{238}\text{U}(^{58}\text{Ni}, ^{60}\text{Ni})$, $E=325$ MeV; measured $\gamma\gamma$ -coin, $\gamma(t)$; deduced residue fission isomer σ .
- 89Ma54** *Ternary Fission of Neutron Induced Uranium Fissioning Isomers*
V. E. Makarenko, Yu. D. Molchanov, G. A. Otroshchenko, G. B. Yan'kov, Nucl. Phys. A502, 363c (1989).
Radioactivity: $^{236m}, ^{238m}\text{U}(\text{SF})$ [from $^{238}, ^{235}\text{U}(n, n')$, $E=4.5$ MeV]; measured $T_{1/2}$, fission fragment; deduced relative fission probabilities.
- 89Ma57** *Ternary Fission of Uranium Fissioning Isomers Excited by Neutrons*
V. E. Makarenko, Yu. D. Molchanov, G. A. Otroshchenko, G. B. Yan'kov, Yad. Fiz. 50, 928 (1989).
Radioactivity: $^{236m}, ^{238m}\text{U}(\text{SF})$ [from $^{238}, ^{235}\text{U}(n, n')$, $E=4.5$ MeV]; measured fission fragment spectra; deduced $T_{1/2}$, decay probability, fission mechanism.
- 89Ma64** *Spontaneous Fission Isomers α -Decay Hindrance Factor*
V. E. Makarenko, V. G. Nosov, Izv. Akad. Nauk SSSR, Ser. Fiz. 53, 933 (1989); Bull. Acad. Sci. USSR, Phys. Ser. 53, No. 5, 105 (1989).
Radioactivity: $^{238m}\text{U}(\text{SF})$; calculated α -decay hindrance factor.

89Sc30 γ Decay of the Superdeformed Shape Isomer in ^{236}U

J. Schirmer, J. Gerl, D. Habs, D. Schwalm, Phys. Rev. Lett. 63, 2196 (1989).

Nuclear Reactions: $^{235}\text{U}(\text{d,p})$, $E=11$ MeV; measured γ time spectra, missing energy vs delayed sum energy. ^{236}U deduced isomer, decay, superdeformation features, γ -decay to fission branching ratio.

89SoZZ Production of the Fission Isomer ^{235m}Pu and ^{234}Pu in the Reactions $\alpha + ^{232}\text{U}$ and $^3\text{He} + ^{234}\text{U}$

L. P. Somerville, M. J. Nurmi, A. Ghiorso, J. M. Nitschke, G. T. Seaborg, Bull. Am. Phys. Soc. 34, No. 1, 69, EG7 (1989)

Nuclear Reactions: ICPND $^{234}\text{U}(^3\text{He},2n)$, $(^3\text{He},3n)$, E not given; measured $\sigma(E)$. $^{233}\text{U}(\alpha,3n)$, $E=36$ MeV; measured $E(\alpha)$, $I(\alpha)$; deduced reaction σ , 235 , ^{234}Pu production.

90Bh02 Test of the Adequacy of Using Smoothly Joined Parabolic Segments to Parametrize the Multihumped Fission Barriers in Actinides

B. S. Bhandari, Phys. Rev. C42, 1443 (1990).

Nuclear Structure: 236 , ^{238}U , ^{237}Np , 235 , 237 , 238 , 239 , 240 , 241 , 242 , 243 , 244 , ^{245}Pu , 239 , 240 , 241 , 242 , 243 , 244 , ^{245}Am , 241 , 242 , 243 , 244 , ^{245}Cm ; calculated fission $T_{1/2}$; deduced fission barrier parametrization.

90HoZU Second Minimum Spectroscopy Using Heavy Ion Reactions

T. H. Hoare, P. A. Butler, N. Clarkson, G. D. Jones, C. A. White, R. J. Poynter, R. A. Cunningham, Daresbury Labs., 1989-1990 Ann. Rept., Appendix, p. 84 (1990).

Nuclear Reactions: ICPND $^{238}\text{U}(^{58}\text{Ni},^{60}\text{Ni})$, $E=325$ MeV; $^{238}\text{U}(^{62}\text{Ni},^{64}\text{Ni})$, $E=332$ MeV; measured fission isomer production σ upper limit.

90Ku17 Energy of Alpha Particles in Triple Fission of the Fissile Isomer Uranium-238

I. A. Kukushkin, V. E. Makarenko, Yu. D. Molchanov, G. A. Otroshchenko, G. B. Yankov, Pisma Zh. Eksp. Teor. Fiz. 51, 611 (1990); JETP Lett. (USSR) 51, 693 (1990).

Radioactivity: ^{238m}U [from $^{238}\text{U}(n,n')$, $E=4.5$ MeV]; measured fission fragment, α -spectra; deduced $T_{1/2}$; triple fission α -distribution features, branching ratio relative to SF-decay.

90Ma59 Method of Half-Life Determination

V. E. Makarenko, G. A. Otroshchenko, Yad. Fiz. 51, 1201 (1990); Sov. J. Nucl. Phys. 51, 765 (1990).

Radioactivity: 236m , ^{238m}U ; calculated $T_{1/2}$. Time spectrum processing method proposed.

91Ku23 Energies of Long-Range Particles in Ternary Fission of the ^{238}U Spontaneously Fissioning Isomer

I. A. Kukushkin, V. E. Makarenko, Yu. D. Molchanov, G. A. Otroshchenko, G. B. Yankov, Yad. Fiz. 54, 8 (1991); Sov. J. Nucl. Phys. 54, 4 (1991).

Nuclear Reactions: $^{238}\text{U}(n,n')$, $E=4.5$ MeV; measured (fragment)(fragment)-coin following SF-decay, ternary fission. ^{238m}U deduced $T_{1/2}$, fission branching ratio.

92Ba67 First Observation of a Resonance Ionization Signal on ^{242m}Am Fission Isomers

H. Backe, Th. Blonnigen, M. Dahlinger, U. Doppler, P. Graffe, D. Habs, M. Hies, Ch. Illgner, H. Kunz, W. Lauth, H. Schope, P. Schwamb, W. Theobald, R. Zahn, Hyperfine Interactions 74, 47 (1992).

Radioactivity: $^{242m}\text{Am}(\text{SF})$ [from $^{242}\text{Pu}(\text{d},2n)$, $E=12$ MeV]; measured resonance ionization followed by isomer fission decay. Buffer gas cell, two-step resonance ionization, excimer dye laser combination.

92Bh03 Systematics of the Deduced Fission Barriers for the Doubly Even Transactinium Nuclei

B. S. Bhandari, Y. B. Bendaraf, Phys. Rev. C45, 2803 (1992).

Nuclear Structure: 236 , 238 , 240 , 242 , ^{244}Pu , 240 , 242 , 244 , 246 , 248 , ^{250}Cm ; calculated isomer energies, $T_{1/2}$, SF-decay $T_{1/2}$, outer barrier heights. 230 , ^{232}Th , 230 , 232 , 234 , 236 , ^{238}U , 246 , 248 , 250 , 252 , 254 , ^{256}Cf , 242 , 244 , 246 , 248 , 250 , 252 , 254 , ^{256}Fm , 250 , 252 , 254 , 256 , 260 , ^{262}No , $^{250}\text{104}$, $^{252}\text{104}$, $^{254}\text{104}$, $^{256}\text{104}$, $^{258}\text{104}$, $^{260}\text{104}$; calculated SF-decay $T_{1/2}$, outer barrier height. Double humped fission barrier model. Other nuclei, other aspects discussed.

92BIZZ Search for Low Spin Superdeformed States by Transfer Reaction

J. Blons, D. Goutte, A. Lepretre, R. Lucas, V. Meot, D. Paya, X. H. Phan, G. Barreau, T. Doan, G. Pedemey, Contrib. Int. Conf. Nuclear Structure at High Angular Momentum, Ottawa, p. 57 (1992); AECL-10613 (1992)

Nuclear Reactions: $^{236}\text{U}(^{18}\text{O},^{16}\text{O})$, $E=9$ MeV/nucleon; $^{102}\text{Pt}(^{16}\text{O},^{14}\text{C})$, E not given; measured γ sum spectra, $\gamma(\text{particle})$ -coin. ^{194}Hg deduced superdeformed band population.

92Ch08 Limits on the Lifetime of the Shape Isomer of ^{238}U

C. R. Chinn, J. -F. Berger, D. Gogny, M. S. Weiss, Phys. Rev. C45, 1700 (1992).

Radioactivity: ^{238}U ; calculated fission isomer partial $T_{1/2}$. Constrained Hartree-Fock-Bogoliubov.

92DeZZ Population of the 0.5ns Fission Isomer and Excited States in ^{238}Pu by Heavy-Ion Induced 1n-Transfer

M. Devlin, D. Cline, K. G. Helmer, R. Ibbotson, C. Y. Wu, A. Cresswell, P. A. Butler, G. D. Jones, M. A. Stoyer, J. O. Rasmussen, Bull. Am. Phys. Soc. 37, No. 2, 870, A8 1 (1992)

Nuclear Reactions: $^{239}\text{Pu}(^{117}\text{Sn},^{118}\text{Sn})$, $E=630$ MeV; measured E_γ , I_γ , γ -multiplicity, particle spectra, (fragment)(fragment)-coin. ^{239}Pu deduced levels, J , π . ^{238}Pu deduced levels, J , π , fission isomer population.

92Er01 Quasi-Stationary State Population Probability of the Actinide Nuclei Second Well

D. O. Eremenko, S. Yu. Platonov, O. A. Yuminov, Bull. Rus. Acad. Sci. Phys. 56, 70 (1992).

Nuclear Structure: 239 , 238 , 236 , ^{235}Np , 240 , 238 , ^{237}Pu , 238 , ^{232}Pa ; calculated quasistationary states population probability under induced fission, second potential. Fluctuation dissipation dynamics.

92Ma34 α and γ Spectroscopy of Spontaneous-Fission Isomers

V. E. Makarenko, Yad. Fiz. 55, 1759 (1992); Sov. J. Nucl. Phys. 55, 973 (1992).

Nuclear Structure: ^{238}U , 239 , ^{241}Pu , 240 , 241 , 242 , ^{243}Am ; compiled, reviewed fission isomer decay by α -, γ - emission.

- 92So10** *Intrinsic Structures and Associated Rotational Bands in Deformed Even-Even Nuclei of the Actinide Region*
P. C. Sood, D. M. Headly, R. K. Sheline, At. Data Nucl. Data Tables 51, 273 (1992).
Nuclear Structure: $Z \geq 88$; $N \geq 134$; $^{230, 232, 234, 236, 238}\text{U}$, $^{220, 222, 224, 226, 228, 230, 232, 234}\text{Th}$, $^{218, 220, 222, 224, 226, 228, 230}\text{Ra}$; analyzed levels; deduced band structure, fission isomers superdeformation, hyperdeformation evidence.
- 92St05** *Fission and Gamma-Ray Decay of the ^{238}U Shape Isomer*
M. Steinmayer, K. E. G. Lobner, L. Corradi, U. Lenz, U. Quade, P. R. Pascholati, K. Rudolph, W. Schomburg, Z. Phys. A341, 145 (1992).
Radioactivity: ^{238m}U [from $^{238}\text{U}(\text{d}, \text{np})$, $E=18$ MeV]; measured $\gamma(\text{ce})$ -coin; deduced delayed fission $T_{1/2}$, ^{238}U deduced transitions.
- 93Ar03** *Fission of Heavy Hypernuclei Formed in Antiproton Annihilation*
T. A. Armstrong, J. P. Bocquet, G. Ericsson, T. Johansson, T. Krogulski, R. A. Lewis, F. Malek, M. Maurel, E. Monnard, J. Mougey, H. Nifenecker, J. Passaneau, P. Perrin, S. M. Polikanov, M. Rey-Campagnolle, C. Ristori, G. A. Smith, G. Tibell, Phys. Rev. C47, 1957 (1993).
Nuclear Reactions: $^{238}\text{U}(\bar{p}, X)$, E at 105 MeV/c; measured hypernuclei yield, fission (fragment)(fragment)-coin; deduced fission hypernuclei $T_{1/2}$.
- 93Ku16** *Yield of the Fissioning Isomer in the Reaction $^{241}\text{Am}(n, n')$*
I. A. Kukushkin, V. E. Makarenko, Yu. D. Molchanov, G. A. Otroschenko, Yad. Fiz. 56, No 9, 13 (1993); Phys. Atomic Nuclei 56, 1157 (1993).
Nuclear Reactions: $^{241}\text{Am}(n, n')$, (n, γ) , $E=4.5$ MeV; measured fission isomer yields; deduced reaction dependence.
Radioactivity: $^{242m, 241m}\text{Am}(\text{SF})$ [from $^{241}\text{Am}(n, n')$, (n, γ) , $E=4.5$ MeV]; measured fission fragment spectra. ^{241}Am deduced isomeric state fission probability, $T_{1/2}$.
- 93Ro07** *The Study of Prompt and Delayed Muon Induced Fission III. The Ratios of Prompt to Delayed Fission Yields*
Ch. Rosel, H. Hanscheid, J. Hartfiel, R. von Mutius, J. F. M. d'Achard van Enschut, P. David, H. Janszen, T. Johansson, J. Konijn, T. Krogulski, C. T. A. M. de Laat, H. Paganetti, C. Petitjean, S. M. Polikanov, H. W. Reist, F. Risse, L. A. Schaller, L. Schellenberg, W. Schrieder, A. K. Sinha, A. Taal, J. P. Theobald, G. Tibell, N. Trautmann, Z. Phys. A345, 89 (1993).
Nuclear Reactions: $^{233, 234, 235, 236, 238}\text{U}$, ^{237}Np , $^{242, 244}\text{Pu}(\mu^-, F)$, E not given; measured prompt to delayed fission yields ratios, absolute probabilities; deduced fission probabilities per muon capture.
- 94Kr06** *GCM Calculation of the E2 Decay Lifetimes of Shape Isomers*
S. J. Krieger, P. Bonche, H. Flocard, P. H. Heenen, M. S. Weiss, Nucl. Phys. A572, 384 (1994).
Nuclear Structure: $^{230, 232}\text{Th}$, ^{238}U ; calculated deformation energy vs mass quadrupole moment, first barrier, second minimum, absolute minimum quadrupole moment, charge quadrupole transition matrix element between superdeformed, ground bands, isomer E2 decay $T_{1/2}$. Hartree-Fock BCS calculations.
- 94Ob02** *Intermediate Structure and the Shape Isomer in ^{233}Th*
S. Oberstedt, J. P. Theobald, H. Weigmann, J. A. Wartena, C. Burkholz, Nucl. Phys. A578, 31 (1994).
Nuclear Reactions: $^{232}\text{Th}(n, \gamma)$, $E=0.05-4.2$ keV; measured $\gamma(t)$. ^{233}Th deduced shape isomer $T_{1/2}$ range, decay features, resonances admixture, coupling width.
- 94ReAA**
Gamma Spectroscopy of Superdeformed ^{236}U . Reiter et al., Annual Report GSI 94-1 (March 1994), p 75.
- 94PaAA**
Gamma Spectroscopy in the Second Minimum of ^{240}Pu . Pansegrau et al., Annual Report GSI 94-1 (March 1994), p 76.

References for Superdeformed Bands (Theoretical)

67SiAA

Shell Effects in Nuclear Masses and Deformation Energies. Strutinsky, Nucl. Phys. A95, 420 (1967).

70Ts01 *Shape Isomeric States in Heavy Nuclei*

C. F. Tsang, S. G. Nilsson, Nucl. Phys. A140, 275 (1970).

Nuclear Structure: A=174-256; calculated potential energy surface, two-peaked fission barriers, total potential energy, $T_{1/2}$.

74Co41 *Equilibrium Configurations of Rotating Charged or Gravitating Liquid Masses with Surface Tensor. II.*

S. Cohen, F. Plasil, W. J. Swiatecki, Ann. Phys. (New York) 82, 557 (1974).

Nuclear Reactions: $^{107}\text{Ag}(^{20}\text{Ne}, X)$, $E(\text{cm})=25\text{-}205$ MeV; calculated impact parameter. $^{85}\text{Rb}(^{20}\text{Ne}, X)$, $^{65}\text{Cu}(^{40}\text{Ar}, X)$, $^{48}\text{Ti}(^{18}\text{O}, X)$, $^{27}\text{Al}(^{16}\text{O}, X)$, $^{12}\text{C}(^{12}\text{C}, X)$, E not given; calculated fission barrier, neutron binding energy, excitation energy. ^{106}Ag , ^{66}Zn , ^{43}Sc , ^{24}Mg ; deduced possible superdeformation. Rotating liquid masses.

Nuclear Structure: A=1-300; calculated angular momentum where fission barrier would vanish. A=1-200; calculated fission barrier. Rotating liquid masses.

75Be35 *Yrast Bands and High-Spin Potential-Energy Surfaces*

R. Bengtsson, S. E. Larsson, G. Leander, P. Moller, S. G. Nilsson, S. Aberg, Z. Szymanski, Phys. Lett. 57B, 301 (1975).

Nuclear Structure: ^{146}Sm , ^{160}Yb ; calculated yrast bands, energy surfaces.

79Bi09 *Alpha Decay Amplification in Superdeformed Nuclei: An Important New Mechanism of Nuclear de-Excitation at High Angular Momenta*

M. Blann, Phys. Lett. 88B, 5 (1979).

Nuclear Reactions: $^{108}\text{Ag}(^{40}\text{Ar}, \alpha)$, $E=169\text{-}337$ MeV; calculated transmission coefficients for n, p, α . ^{149}Tb deduced decay probabilities for n, p, α , fission channels, evidence for superdeformation. Statistical model for deformed nuclei.

80Bi04 *Decay of Deformed and Superdeformed Nuclei Formed in Heavy Ion Reactions*

M. Blann, Phys. Rev. C21, 1770 (1980).

Nuclear Reactions: $^{109}\text{Ag}(^{40}\text{Ar}, X)$, $E=236$ MeV; $^{40}\text{Ca}(^{16}\text{O}, X)$, $E=214$ MeV; calculated transmission coefficients for spherical, deformed, superdeformed nuclei. ^{149}Tb , ^{56}Ni deduced fraction of α decay vs spin, α , n, p branching ratios, superdeformation effects. Rotating liquid drop model, Hauser-Feshbach calculation.

80RaAA

Nilsson-Strutinsky Model of Very High-Spin States. Ragnarsson et al., Nucl. Phys. A347, 287 (1980)

81Be41 *Some Properties of Superdeformed Nuclei*

T. Bengtsson, M. E. Faber, G. Leander, P. Moller, M. Ploszajczak, I. Ragnarsson, S. Aberg, Phys. Scr. 24, 200 (1981).

Nuclear Structure: ^{152}Dy ; calculated potential, shell energy surfaces; ^{90}Zr , ^{96}Ru ; calculated potential energy vs deformation; ^{96}Ru ; calculated liquid drop model energy. Anisotropic harmonic oscillator potential. A 150; deduced superdeformed properties. A 150; deduced superdeformed properties.

81Fa05 *Shell Structure in Superdeformed Light Nuclei (A < 40) at High Rotational Frequencies*

M. E. Faber, M. Ploszajczak, Phys. Scr. 24, 189 (1981).

Nuclear Structure: ^{24}Mg , ^{26}Al , ^{28}Si ; calculated deformation, superdeformation energy surfaces. Cranking Strutinsky model, Saxon-Woods potential.

82Ab01 *High-Spin Potential-Energy Surfaces*

S. Aberg, Phys. Scr. 25, 23 (1982).

Nuclear Structure: A=66-218; calculated high-spin potential energy surfaces. Cranked Nilsson-Strutinsky model.

85Be10 *Rotational Bands and Particle-Hole Excitations at Very High Spin*

T. Bengtsson, I. Ragnarsson, Nucl. Phys. A436, 14 (1985).

Nuclear Structure: ^{187}Au , ^{156}Yb ; calculated deformation energy surfaces. ^{118}Te ; calculated yrast state energies, transition energies vs J. ^{106}Pd ; calculated yrast band, shape trajectories. 158 , 160 , ^{165}Yb , ^{169}Hf , ^{171}Ta , ^{130}Ce ; calculated transition energy vs J, yrast levels, rotational band characteristics; deduced shape changes, shape coexistence, band crossings, band termination. Cranked Nilsson-Strutinsky framework.

85Du01 *Shape Evolution in the Transitional Gadolinium, Dysprosium, Erbium, and Ytterbium Nuclei*

J. Dudek, W. Nazarewicz, Phys. Rev. C31, 298 (1985).

Nuclear Structure: 144 , 146 , 148 , ^{150}Gd , 150 , 152 , 154 , ^{156}Dy , 152 , 154 , 156 , ^{158}Er , 154 , 156 , 158 , ^{160}Yb ; calculated levels; deduced shape evolution at high J. Cranking approximation, generalized Strutinsky method.

86ChZE *High Energy Dipole Bump in the Continuum as a Probe for Super-Deformation*

Y. S. Chen, C. Baktash, Proc. Intern. Nuclear Physics Conference, Harrogate, U. K., p. 49 (1986).

Nuclear Structure: ^{158}Yb ; calculated E2, M1 transition strength; deduced superdeformation features. Cranked shell model.

87Ch07 *Superdeformation in the Rare-Earth Region*

R. R. Chasman, Phys. Lett. 187B, 219 (1987).

Nuclear Structure: ^{132}Ce , ^{148}Pm , 141 , 142 , 147 , ^{148}Sm , 142 , 143 , 144 , 145 , 146 , 147 , 148 , ^{149}Eu , 144 , 147 , 148 , 149 , ^{150}Gd , 149 , 150 , 151 , ^{152}Tb , 151 , 152 , ^{153}Dy , ^{153}Ho ; calculated well depths, deformation, superdeformation parameters, excitation energies, proton, neutron unoccupied levels. Strutinsky method.

87Du02 *Shape Coexistence Effects and Superdeformation in ^{84}Zr*

J. Dudek, W. Nazarewicz, N. Rowley, Phys. Rev. C35, 1489 (1987).

Nuclear Structure: $^{78, 80, 82, 84, 86}\text{Zr}$; calculated total energy surfaces, Routhians. ^{84}Zr ; calculated levels, yrast scheme, band structure; deduced shape coexistences, superdeformation. Woods-Saxon potential, cranking, Hartree-Fock-Bogolyubov method, Strutinsky generalizations, particle number projection.

87Du04 *Abundance and Systematics of Nuclear Superdeformed States; Relation to the pseudospin and pseudo-SU(3) symmetries*

J. Dudek, W. Nazarewicz, Z. Szymanski, G. A. Leander, Phys. Rev. Lett. 59, 1405 (1987).

Nuclear Structure: $^{148, 152, 154}\text{Dy}$, $^{136, 144, 150}\text{Sm}$, $^{132, 134, 144}\text{Nd}$, $^{128, 132, 142}\text{Ce}$; calculated potential energy surfaces; deduced super elongation particle number dependence, superdeformation effects.

87He23 *Population and Decay of the Superdeformed Rotational Band of ^{152}Dy*

B. Herskind, B. Lauritzen, K. Schiffer, R. A. Broglia, F. Barranco, M. Gallardo, J. Dudek, E. Vigezzi, Phys. Rev. Lett. 59, 2416 (1987).

Nuclear Structure: ^{152}Dy ; calculated E1 transition probabilities, superdeformed yrast band.

87Na21 *Pairing Correlations in the Superdeformed Rotational Bands: The frequency-deformation scaling*

W. Nazarewicz, Z. Szymanski, J. Dudek, Phys. Lett. 196B, 404 (1987).

Nuclear Structure: ^{152}Dy ; calculated routhians vs deformation parameter, pairing correlation energy, associated dealignment in superdeformed states.

87Sh25 *Role of Static and Dynamic Pairing Correlations in the Superdeformed Band of ^{152}Dy*

Y. R. Shimizu, E. Vigezzi, R. A. Broglia, Phys. Lett. 198B, 33 (1987).

Nuclear Structure: ^{152}Dy ; calculated superdeformed configuration kinetic, dynamic moments of inertia, correlation energy; deduced pairing correlations role.

87St08 *Superdeformed States in Rotating ^{152}Dy*

V. M. Strutinsky, Z. Phys. A326, 261 (1987).

Nuclear Structure: ^{152}Dy ; analyzed level data; calculated deformation energy; deduced angular momentum minimum, stability against rotation criteria for superdeformation. Liquid drop, Nilsson models.

87Sw01 *Superdeformed Band in ^{152}Dy as Evidence for the Centrifugal Solidification of a Rotating Nucleus*

W. J. Swiatecki, Phys. Rev. Lett. 58, 1184 (1987).

Nuclear Structure: ^{152}Dy ; analyzed superdeformed rotational spectrum; deduced centrifugal solidification evidence. Macroscopic model.

88Be22 *The Role of High-N Orbits in Superdeformed States*

T. Bengtsson, I. Ragnarsson, S. Aberg, Phys. Lett. 208B, 39 (1988).

Nuclear Structure: ^{152}Dy , ^{149}Gd , ^{149}Eu , ^{146}Sm ; calculated superdeformed quadrupole moment, moment of inertia vs spin.

88Du13 *Pairing, Temperature, and Deformed-Shell Effects on the Properties of Superdeformed ^{152}Dy Nucleus*

J. Dudek, B. Herskind, W. Nazarewicz, Z. Szymanski, T. R. Werner, Phys. Rev. C38, 940 (1988).

Nuclear Structure: ^{152}Dy ; calculated barrier heights, potential energy surfaces, high spin behaviour, deformation, superdeformation properties. Strutinsky model.

88Du15 *Prediction of Hyperdeformed Nuclear States at Very High Spins*

J. Dudek, T. Werner, L. L. Riedinger, Phys. Lett. 211B, 252 (1988).

Nuclear Structure: ^{168}Yb ; calculated total energy surface; deduced high spin hyperdeformed states evidence. $^{166, 168, 170, 172, 174}\text{Yb}$; calculated total energy vs elongation.

88Du16 *Dependence of the First Saddle-Point Energy on Temperature and Spin in Superdeformed Rare-Earth Nuclei*

J. Dudek, T. Werner, L. L. Riedinger, Phys. Lett. 213B, 120 (1988).

Nuclear Structure: $^{146, 152, 156, 162}\text{Dy}$, $^{152, 154, 156, 158, 160, 162}\text{Er}$, $^{148, 150, 152, 154, 156, 158}\text{Gd}$, $^{146, 148, 150, 152, 154, 156}\text{Sm}$; calculated saddle point energy vs temperature, spin, superdeformation.

88FIZW *Microscopic Description of the Ground-State and High-Spin Properties of the Light Strontiums*

H. C. Flocard, Proc. Intern. Workshop Nucl. Struct. of the Zirconium Region, Bad Honnef, Germany, p. 143 (1988).

Nuclear Structure: $^{76, 78, 82, 84, 86, 88}\text{Sr}$; calculated deformation energy surfaces, rms radii. ^{88}Sr calculated superdeformed band level energies, deformation energy surfaces, rms radii, fission barriers. Constrained Hartree-Fock with Skyrme interactions.

88KiZQ *Moments of Inertia of Superdeformed Nuclei*

S. -I. Kinouchi, T. Kishimoto, Univ. Tsukuba, Tandem Accel. Center, Ann. Rept., 1987, p. 54 (1988); UTTAC-54 (1988).

Nuclear Structure: ^{152}Dy ; calculated superdeformed moments of inertia. Microscopic calculation with improved effective interactions.

88Sh37 *Superdeformation and Other Phases at Very High Spin*

J. F. Sharpey-Schafer, Nucl. Phys. A488, 127c (1988).

Nuclear Structure: $^{151, 152}\text{Dy}$, $^{149, 150}\text{Gd}$, ^{151}Tb , $^{159, 160}\text{Er}$; analyzed level systematics; deduced superdeformation role.

88Si18 *Nuclear Shapes and Phases at Very High Spin*

J. Simpson, Phys. Scr. T23, 37 (1988).

Nuclear Reactions: ^{114}Cd , $^{108}\text{Pd}(^{48}\text{Ca}, 4n)$, $E=205$ MeV; analyzed data. ^{152}Dy , ^{156}Er deduced levels, superdeformed band features.

Nuclear Structure: $^{133, 135, 137}\text{Nd}$, ^{131}Ce ; analyzed data; deduced superdeformed band features.

88TaZU *Intrinsic Structure of the Superdeformed Band in ^{132}Ce*

K. Tanabe, K. Sugawara-Tanabe, Proc. of the Conf. on High-Spin Nuclear Structure and Novel Nuclear Shapes, April 13-15, 1988, Argonne National Laboratory, Argonne, Illinois; ANL-PHY-88-2, p. 53 (1988).

Nuclear Structure: ^{132}Ce ; calculated levels, proton, neutron pairing gaps; deduced superdeformation parameters. Cranked HFB.

89Bo24 *Superdeformation and Shape Isomerism at Zero Spin*

P. Bonche, S. J. Krieger, P. Quentin, M. S. Weiss, J. Meyer, M. Meyer, N. Redon, H. Flocard, P. -H. Heenen, Nucl. Phys. A500, 308 (1989).

Nuclear Structure: ^{186, 196, 194, 192, 190, 188, 186, 202, 210}Os, ^{200, 198, 196, 194, 192, 190, 188, 186}Pt, ^{194, 202, 210, 218}Hg; calculated Hartree-Fock energies, energy surfaces. ^{192, 184, 196, 198, 200, 202, 204, 206, 208, 210, 212, 214, 216, 218}Hg; calculated secondary minima deformations. ^{194, 196, 198}Pt; calculated axial deformation energies. ^{66, 68}Ni, ^{190, 192}Pt, ^{206, 208, 210}Os, ^{194, 196, 214}Hg; deduced possible superdeformation effects. Microscopic Hartree-Fock plus BCS.

89ShZZ *Semi-Empirical Fits for Superdeformed Band Energies*

Y. Y. Sharon, R. A. Naumann, G. Loring, Bull. Am. Phys. Soc. 34, No. 4, 1169, D6 7 (1989)

Nuclear Structure: A=100-180; analyzed superdeformed band in 11 nuclei. Semi-empirical fits.

90Ab08 *Superdeformations - A Theoretical Overview*

S. Aberg, Nucl. Phys. A520, 35c (1990).

Nuclear Structure: A=66-218; compiled superdeformed state calculations, data analyses.

90AbAA

Nuclear Shapes in Mean Field Theory. Aberg et al., Ann. Rev. Nucl. Part. Sci. 40, 439 (1990).

90Be37 *Level Spin and Moments of Inertia in Superdeformed Nuclei Near A = 194*

J. A. Becker, N. Roy, E. A. Henry, S. W. Yates, A. Kuhnert, J. E. Draper, W. Korten, C. W. Beausang, M. A. Deleplanque, R. M. Diamond, F. S. Stephens, W. H. Kelly, F. Azaiez, J. A. Cizewski, M. J. Brinkman, Nucl. Phys. A520, 187c (1990).

Nuclear Structure: ^{190, 191, 192, 193, 194}Hg, ^{194, 196}Pb, ^{193, 194}Tl; analyzed data; deduced levels, J, superdeformed band parameters. Least-squares fit to rotational formulas.

90BeZK *Spin Determination in Superdeformed ¹⁹²Hg and ¹⁹⁴Hg*

J. A. Becker, N. Roy, E. A. Henry, S. W. Yates, J. E. Draper, C. W. Beausang, M. A. Deleplanque, R. M. Diamond, F. S. Stephens, W. Korten, J. A. Cizewski, M. J. Brinkman, Proc. Inter. Conf. Nuclear Structure of the Nineties, Oak Ridge, Tennessee, Vol. 1, p. 2 (1990).

Nuclear Structure: ^{192, 194}Hg; analyzed data; deduced superdeformed band exit spin.

90Bo40 *Quadrupole Collective Correlations and the Depopulation of the Superdeformed Bands in Mercury*

P. Bonche, J. Dobaczewski, H. Flocard, P. H. Heenen, S. J. Krieger, J. Meyer, M. S. Weiss, Nucl. Phys. A519, 509 (1990).

Nuclear Structure: ^{190, 192, 194, 196, 198}Hg; calculated deformation energy, wave functions, proton quadrupole moments, superdeformed band decay Γ . Self-consistent generator coordinate method, Hartree-Fock plus BCS wave functions.

90Ch24 *The Effects of Pairing on Superdeformed Rotational Bands Near A = 190*

R. R. Chasman, Phys. Lett. 242B, 317 (1990).

Nuclear Structure: ^{190, 191, 192, 193, 194}Hg, ^{193, 194}Tl; calculated superdeformed level second moments of inertia.

90ChZI *The Criterion for the Observation of the GDR Built on Superdeformed States*

Y. S. Chen, Proc. Inter. Conf. Nuclear Structure of the Nineties, Oak Ridge, Tennessee, Vol. 1, p. 200 (1990).

Nuclear Structure: ^{146, 148, 150, 152}Dy, ^{132, 134, 136}Nd, ^{80, 82, 84}Sr; calculated levels, $\sigma(\gamma, X)$; deduced superdeformed state based GDR excitation criterion. Linear response theory.

89Ch06 *Superdeformation Near A = 190*

R. R. Chasman, Phys. Lett. 219B, 227 (1989).

Nuclear Structure: ¹⁷⁸W, ^{191, 192, 193}Re, ^{178, 180, 192, 193, 194}Os, ^{191, 192, 193, 194, 195}Ir, ^{190, 191, 192, 193, 194, 195, 196}Pt, ^{190, 191, 192, 193, 194, 195, 196}Au, ^{187, 190, 191, 192, 193, 194, 195, 196}Hg, ¹⁸⁸Tl, ¹⁹¹At, ^{192, 203, 204}Rn, ¹⁹³Fr; calculated level energies; deduced superdeformation features. Cranked Strutinsky method.

89Ch41 *On the Formation of Superdeformed Nuclear States*

Y. Chen, Chin. J. Nucl. Phys. 11, No. 1, 53 (1989).

Nuclear Structure: ^{130, 131}Ce, ¹³¹Pr; calculated yrast configuration potential energy surfaces; deduced superdeformation features.

89Na07 *Shape Variations, Influence of Pairing and Alignment of Angular Momentum in Superdeformed Bands in the A = 150 Region*

W. Nazarewicz, R. Wyss, A. Johnson, Phys. Lett. 225B, 208 (1989).

Nuclear Structure: ¹⁵²Dy, ¹⁵⁰Gd, ¹⁵¹Tb; calculated levels, equilibrium deformations, dynamical moments of inertia. Deformation-self-consistent pairing average model and variants. ¹⁵²Dy, ¹⁵⁰Gd; deduced superdeformation character.

89Na17 *Structure of Superdeformed Bands in the A = 150 Mass Region*

W. Nazarewicz, R. Wyss, A. Johnson, Nucl. Phys. A503, 285 (1989).

Nuclear Structure: ^{144, 148, 150, 148, 146}Gd, ^{150, 152, 153}Dy, ^{150, 151}Tb, ¹⁵²Ho, ^{148, 143}Eu; calculated levels, rotational band moments of inertia, quadrupole moments. ^{143, 148}Eu, ^{144, 146, 148, 149}Gd, ^{150, 152, 153}Dy, ¹⁵³Ho, ¹⁵⁴Er; analyzed superdeformed moments of inertia. ¹⁴⁸Gd; analyzed superdeformed moments of inertia; deduced π . ¹⁵⁰Gd; analyzed superdeformed moments of inertia, quadrupole moments. ¹⁵⁰Tb; analyzed superdeformed moments of inertia; deduced configuration. ¹⁵¹Tb; analyzed superdeformed moments of inertia; deduced π and signature. ¹⁵¹Dy; analyzed superdeformed moments of inertia; deduced possible band crossings. Deformed shell model. Comparison with other data.

89Ok01 *Fission Stability of Superdeformed Nuclei*

J. Okolowicz, J. M. Irvine, J. Phys. (London) G15, 823 (1989).

Nuclear Structure: ¹⁴⁴Nd; calculated free energy vs mass quadrupole moment; deduced superdeformation shapes. Constrained Hartree-Fock.

89Sc02 *Lifetimes and Lineshapes in Superdeformed Bands*

K. Schiffer, B. Herskind, J. Gascon, Z. Phys. A332, 17 (1989).

Nuclear Structure: ¹⁵²Dy; calculated levels, $T_{1/2}$, $B(\lambda)$, $I(\gamma)$; deduced normal, superdeformed state mixing. Statistical model, Monte Carlo simulation.

90Do05 *The Superdeformed Isotope Chains in the Rare-Earth Region*

B. Dong, Y. Chen, X. Jin, Chin. J. Nucl. Phys. 12, No 1, 1 (1990).

Nuclear Structure: ^{144, 145, 146, 147, 148, 149, 150, 151, 152}Gd, ^{146, 148, 150, 152, 154}Dy; calculated total equipotential energy surfaces; deduced superdeformation features. Cranked Nilsson model.

90DoZY *A Model for the Decay of Superdeformed Bands*

T. Dossing, E. Vigezzi, Proc. Inter. Conf. Nuclear Structure of the Nineties, Oak Ridge, Tennessee, Vol. 1, p. 12 (1990).

Nuclear Structure: ¹⁵²Dy; calculated superdeformed band decay features.

90Dr08 *Spins in Superdeformed Bands in the Mass 190 Region*

J. E. Draper, F. S. Stephens, M. A. Deleplanque, W. Korten, R. M. Diamond, W. H. Kelly, F. Azaiez, A. O. Macchiavelli, C. W. Beausang, E. C. Rubel, J. A. Becker, N. Roy, E. A. Henry, M. J. Brinkman, A. Kuhnert, S. W. Yates, Phys. Rev. C42, R1791 (1990).

Nuclear Structure: ^{192, 194}Hf, ²³³U; analyzed superdeformed band structure; deduced level J. Pseudospin formalism.

90Du10 *Prediction of Octupole-Deformation Effects in Superdeformed Nuclei of A 150 and A 190 Mass Regions and Possible Interrelation with Pseudo-Spin Symmetry*

J. Dudek, T. R. Wemer, Z. Szymanski, Phys. Lett. 248B, 235 (1990).

Nuclear Structure: ¹⁴⁶Nd, ¹⁴⁸Sm, ¹⁵⁰Gd, ¹⁵²Dy, ¹⁵⁴Er, ¹⁵⁶Yb, ^{186, 188, 190, 192, 194, 196, 198, 200, 202}Hg; calculated potential energy vs deformation parameter; deduced pronounced octupole effects, superdeformed nuclei.

90Ge06 *On a Possible Supersymmetry in Superdeformed Bands*

A. Gelberg, P. von Brentano, R. F. Casten, J. Phys. (London) G16, L143 (1990).

Nuclear Structure: ¹⁵²Dy, ¹⁵¹Tb; analyzed level data; deduced supersymmetry role in superdeformation.

90Ho13 *Octupole Instability of Super- and Hyperdeformed Nuclei*

J. Holler, S. Aberg, Z. Phys. A336, 363 (1990).

Nuclear Structure: ¹⁵²Dy, ^{190, 194}Hg, ²⁰⁰Rn; calculated potential energy surfaces; deduced possible superdeformation, hyperdeformation. ¹⁴⁶Gd, ¹⁵²Dy, ^{194, 196}Hg, ¹⁹⁶Pb, ¹⁸⁸Po, ²⁰⁰Rn; calculated octupole softness; deduced possible superdeformation. Cranked Nilsson-Strutinsky model.

90Ja13 *Superdeformation in the Mercury Nuclei*

R. V. F. Janssens, M. P. Carpenter, M. W. Drigert, P. B. Fernandez, E. F. Moore, D. Ye, I. Ahmad, K. B. Beard, I. G. Bearden, Ph. Benet, P. J. Daly, U. Garg, Z. W. Grabowski, T. L. Khoo, W. Reviol, F. L. H. Wolfs, Nucl. Phys. A520, 75c (1990).

Nuclear Structure: ^{184, 196}Pb, ^{193, 194}Tl, ^{189, 190, 191, 192, 193, 194}Hg; compiled, analyzed superdeformed band data.

90Ko12 *A Relativistic Theory of Superdeformations in Rapidly Rotating Nuclei*

W. Koepf, P. Ring, Nucl. Phys. A511, 279 (1990).

Nuclear Structure: ¹⁵²Dy, ⁸⁰Sr; calculated superdeformed band structure, quadrupole moments. Cranked relativistic mean field theory.

90Kr10 *Coupling Schemes in Doubly Odd Nuclei and Identical Superdeformed Bands*

A. J. Kreiner, A. O. Macchiavelli, Phys. Rev. C42, R1822 (1990).

Nuclear Structure: ^{150, 148, 146, 147}Gd; analyzed band structure, superdeformation features. Coupling schemes from pseudospin symmetry.

90Mi13 *Octupole Vibrations Built on Superdeformed Rotational Bands*

S. Mizutori, Y. R. Shimizu, K. Matsuyanagi, Prog. Theor. Phys. (Kyoto) 83, 666 (1990).

Nuclear Structure: ¹⁵²Dy; calculated giant octupole resonance strength functions; deduced resonances built on superdeformed band states. Cranking model based RPA.

90Na08 *Natural-Parity States in Superdeformed Bands and Pseudo SU(3) Symmetry at Extreme Conditions*

W. Nazarewicz, P. J. Twin, P. Fallon, J. D. Garrett, Phys. Rev. Lett. 64, 1654 (1990).

Nuclear Structure: ¹⁵¹Tb, ¹⁵²Dy, ¹⁵⁰Gd; analyzed level schemes, superdeformed bands; deduced pseudo SU(3) symmetry features.

90Ra27 *Transition Energies in Superdeformed Bands. Dependence on Orbital and Deformation*

I. Ragnarsson, Nucl. Phys. A520, 67c (1990).

Nuclear Structure: ¹⁵²Dy; calculated superdeformed band transition energy differences; deduced orbital, deformation dependence.

90RaZW *Transition Energies in Superdeformed Bands - Dependence on Orbital and Deformation*

I. Ragnarsson, Proc. Inter. Conf. Nuclear Structure of the Nineties, Oak Ridge, Tennessee, Vol. 1, p. 32 (1990).

Nuclear Structure: ^{151, 152, 153}Dy; calculated superdeformed band transition energies. Pure single particle model.

90Sh05 *Effects of Pairing Correlations on Superdeformed Bands in the A 150 Region*

Y. R. Shimizu, E. Vigezzi, R. A. Broglia, Nucl. Phys. A509, 80 (1990).

Nuclear Structure: ^{150, 149, 148}Gd, ^{150, 151, 152}Tb, ^{151, 152, 153}Dy; calculated deformation, superdeformation band structure, moments of inertia. Pair correlations, different models.

90Sh07 *Inertias of Superdeformed Bands*

Y. R. Shimizu, E. Vigezzi, R. A. Broglia, Phys. Rev. C41, 1861 (1990).

Nuclear Structure: ^{149, 150}Gd, ¹⁵²Dy; calculated superdeformed moment of inertia. Self-consistent treatment of nuclear deformation, pairing correlations.

90Sh08 *Quantum Size Effects in Rapidly Rotating Nuclei*

Y. R. Shimizu, R. A. Broglia, Phys. Rev. C41, 1865 (1990).

Nuclear Structure: ¹⁶⁶Yb; calculated effective pairing gap. ¹⁵⁰Gd; calculated superdeformed band moments of inertia. RPA, strongly rotating nuclei.

- 90Sh21** *A Comparison of the RPA and Number Projection Approaches for Calculations of Pairing Fluctuations in Fast Rotating Nuclei*
Y. R. Shimizu, R. A. Broglia, Nucl. Phys. A515, 38 (1990).
Nuclear Structure: ^{166}Yb ; calculated correlation energy vs rotational frequency, pairing force strength. ^{150}Gd ; calculated superdeformed band two moments of inertia. RPA, number projection methods.
- 90ShZS** *Effects of Pairing Correlations on the Depopulation of Superdeformed Bands*
Y. R. Shimizu, E. Vigezzi, T. Dossing, R. A. Broglia, Proc. Inter. Conf. Nuclear Structure of the Nineties, Oak Ridge, Tennessee, Vol. 1, p. 184 (1990).
Nuclear Structure: $^{151}, ^{152}\text{Dy}$; calculated potential energy surfaces vs spin; deduced pairing correlations role in superdeformed band decay. Cranked HFB plus RPA.
- 90ShZT** *Effects of Particle Correlations on the Moment of Inertia of Superdeformed Bands*
Y. R. Shimizu, E. Vigezzi, R. A. Broglia, Proc. Inter. Conf. Nuclear Structure of the Nineties, Oak Ridge, Tennessee, Vol. 1, p. 182 (1990).
Nuclear Structure: $^{151}, ^{152}, ^{153}\text{Dy}$, $^{150}, ^{151}, ^{152}\text{Tb}$, $^{148}, ^{149}, ^{150}\text{Gd}$; calculated superdeformed band moments of inertia; deduced pairing correlations role. Cranked HFB plus RPA.
- 90St11** *Pseudospin Symmetry and Quantized Alignment in Nuclei*
F. S. Stephens, M. A. Deleplanque, J. E. Draper, R. M. Diamond, A. O. Macchiavelli, C. W. Beausang, W. Korten, W. H. Kelly, F. Azaiez, J. A. Becker, E. A. Henry, S. W. Yates, M. J. Brinkman, A. Kuhnert, J. A. Cizewski, Phys. Rev. Lett. 65, 301 (1990).
Nuclear Structure: $^{192}, ^{191}, ^{193}, ^{194}\text{Hg}$, ^{194}Ti , ^{194}Pb ; analyzed level, band data; deduced pseudospin symmetry, quantized alignment roles.
- 90St22** *Spin Alignment in Superdeformed Rotational Bands*
F. S. Stephens, Nucl. Phys. A520, 91c (1990).
Nuclear Structure: A=151-194; calculated incremental, total alignment for bands; deduced pairing vibrations role in superdeformation. Plausibility arguments.
- 90Su05** *The Nuclear Meissner Effect and Superdeformation in the Number-Projected Constrained-Cranked HFB Approach*
K. Sugawara-Tanabe, K. Tanabe, Phys. Lett. 238B, 15 (1990).
Nuclear Structure: ^{132}Ce ; calculated levels, superdeformed band structure. Self-consistent constrained-cranked HFB approach.
- 90SuZU** *Mottelson-Valatin Effect in the Number-Projected Constrained-Cranked HFB Solution and the Superdeformation*
K. Sugawara-Tanabe, K. Tanabe, Proc. Inter. Conf. Nuclear Structure of the Nineties, Oak Ridge, Tennessee, Vol. 1, p. 34 (1990).
Nuclear Structure: ^{132}Ce ; calculated levels, alignments; deduced superdeformed band structure. Constrained-cranked HFB, number projection.
- 90Ta29** *Microscopic Structure of the Superdeformed Rotational Band in ^{132}Ce*
K. Tanabe, K. Sugawara-Tanabe, Prog. Theor. Phys. (Kyoto) 83, 1148 (1990).
Nuclear Structure: ^{132}Ce ; calculated levels, average pairing gaps, g, intrinsic quadrupole moments; deduced superdeformed band structure. Self-consistent cranked HFB.
- 90TaZY** *Microscopic Structure of the Superdeformed Bands in A = 130 Region*
K. Tanabe, K. Sugawara-Tanabe, Proc. Inter. Conf. Nuclear Structure of the Nineties, Oak Ridge, Tennessee, Vol. 1, p. 36 (1990).
Nuclear Structure: ^{132}Ce , $^{136}, ^{134}\text{Nd}$; calculated levels, alignments; deduced superdeformed band structure. Angular momentum constrained HFB.
- 90Tw02** *Superdeformation - An Experimental Overview*
P. J. Twin, Nucl. Phys. A520, 17c (1990).
Compilation: A=152; compiled, reviewed data on superdeformation.
- 90Vi06** *A Model for the Decay Out of Superdeformed Bands*
E. Vigezzi, R. A. Broglia, T. Dossing, Nucl. Phys. A520, 179c (1990).
Nuclear Structure: $^{146}, ^{149}\text{Gd}$, $^{150}, ^{151}\text{Tb}$, $^{151}, ^{152}\text{Dy}$; analyzed rotational, superdeformed band decay features. Admixture considerations.
- 90Vi08** *The Decay Out of Superdeformed Rotational Bands*
E. Vigezzi, R. A. Broglia, T. Dossing, Phys. Lett. 249B, 163 (1990).
Nuclear Structure: $^{146}, ^{149}, ^{150}\text{Gd}$, $^{150}, ^{151}\text{Tb}$, $^{151}, ^{152}\text{Dy}$; analyzed superdeformed states decay data; deduced superdeformed, normal states barrier transmission coefficient. Statistical model.
- 90Za05** *Variable Volume Parameters for the Radii and Kinetic Energies of Superdeformed States*
L. Zamick, E. Moya de Guerra, J. Caballero, D. Berdichevsky, D. C. Zheng, Phys. Lett. 242B, 7 (1990).
Nuclear Structure: ^{40}Ca ; calculated level kinetic energy, radii differences, superdeformation. Hartree-Fock calculations, Skyrme interactions.
- 90Zh05** *Superdeformed Many-Particle - Many-Hole States in N = Z Nuclei: Beyond the 8p-8h state in ^{40}Ca*
D. C. Zheng, L. Zamick, D. Berdichevsky, Phys. Rev. C42, 1004 (1990).
Nuclear Structure: ^{40}Ca , ^{44}Ti , ^{48}Cr , ^{52}Fe , ^{56}Ni ; calculated multi-particle, multi-hole bands, shapes; deduced possible superdeformation. Fixed configuration, deformed Hartree-Fock.
- 91Am03** *Supersymmetric Quantum Mechanics and Superdeformed Nuclei*
R. D. Amado, R. Bijker, F. Cannata, J. P. Dedonder, Phys. Rev. Lett. 67, 2777 (1991).
Nuclear Structure: A=146-198; deduced supersymmetry role in superdeformation.

91Be48 *Very Elongated Nuclei Near A = 194*

J. A. Becker, E. A. Henry, S. W. Yates, T. F. Wang, A. Kuhnert, M. J. Brinkman, J. A. Cizewski, M. A. Deleplanque, R. M. Diamond, F. S. Stephens, F. Azaiez, W. Korten, J. E. Draper, Nucl. Instrum. Methods Phys. Res. B56/57, 500 (1991)

Nuclear Structure: A=194; 192 , ^{194}Hg ; compiled, reviewed data; deduced new superdeformation region.

91Bo07 *Cranked Hartree-Fock Study of the Yrast Line of ^{80}Sr*

P. Bonche, H. Flocard, P. -H. Heenen, Nucl. Phys. A523, 300 (1991).

Nuclear Structure: ^{80}Sr ; calculated levels, quadrupole moments, superdeformed bands. Cranked Hartree-Fock.

91Bo11 *Description of Superdeformed Bands by the Quantum Algebra SU(q)(2)*

D. Bonatsos, S. B. Drenska, P. P. Raychev, R. P. Roussev, Yu. F. Smirnov, J. Phys. (London) G17, L67 (1991).

Nuclear Structure: 134 , ^{136}Nd , ^{150}Gd , 162 , ^{152}Dy , 182 , ^{194}Hg , ^{174}Yb , ^{248}Cm ; analyzed level data; deduced superdeformed band features. Quantum SU(q)(2) algebra.

91Bo19 *Octupole Softness of Superdeformed ^{194}Pb*

P. Bonche, S. J. Krieger, M. S. Weiss, J. Dobaczewski, H. Flocard, P. -H. Heenen, Phys. Rev. Lett. 66, 876 (1991).

Nuclear Structure: ^{194}Pb ; analyzed data; deduced band structure, superdeformed softness features. Generator coordinate method, pairing projection.

91Ch01 *Giant Dipole Resonance Built on Superdeformed Rotational States*

Y. S. Chen, Phys. Rev. C43, 173 (1991).

Nuclear Structure: 146 , 148 , 150 , ^{152}Dy , 132 , 134 , ^{136}Nd , ^{80}Sr , ^{82}Sr , ^{84}Sr ; calculated superdeformed states based GDR, γ -anisotropy following decay. Linear response theory, superdeformed mean field, self-consistent approach.

Nuclear Reactions: ^{150}Dy , ^{134}Nd , $^{82}\text{Sr}(\gamma, X)$, $E \leq 20$ MeV; calculated total absorption $\sigma(E)$. Linear response theory, superdeformed mean field, self-consistent approach.

91Ch36 *Superdeformed and Hyperdeformed Banana Shaped Nuclides Near A = 190*

R. R. Chasman, Phys. Lett. 266B, 243 (1991).

Nuclear Structure: ^{190}Pt , 189 , 190 , 191 , ^{192}Au , 188 , 189 , 190 , 191 , 192 , 193 , 194 , ^{195}Hg , 189 , 190 , 191 , 192 , 193 , 194 , ^{195}Tl , 190 , 191 , 192 , ^{193}Pb , 193 , 194 , 195 , ^{196}Bi , ^{194}Po ; calculated level energy relative to prolate minimum, barrier heights, reflection symmetric shapes; deduced superdeformed, hyperdeformed minima, deformation features.

91Cu01 *Cullen et al. Reply:*

D. M. Cullen, M. A. Riley, A. Alderson, I. Ali, C. W. Beausang, T. Bengtsson, M. A. Bentley, P. Fallon, P. D. Forsyth, F. Hanna, S. M. Mullins, W. Nazarewicz, R. J. Poynter, P. H. Regan, J. W. Roberts, W. Satula, J. F. Sharpey-Schafer, J. Simpson, G. Sletten, P. J. Twin, R. Wadsworth, R. Wyss, Phys. Rev. Lett. 67, 1175 (1991).

Nuclear Structure: ^{193}Hg ; analyzed data; deduced superdeformed states features.

91Gu03 *Stability of the Superdeformed Z = 38 Shell Against Exotic Cluster Decays: Reinforcing and switching of shell gaps in nuclei*

R. K. Gupta, W. Scheid, W. Greiner, J. Phys. (London) G17, 1731 (1991).

Nuclear Structure: ^{78}Sr , ^{80}Zr ; calculated cluster-decay $T_{1/2}$; deduced superdeformed Z=38 stability against exotic decay. Cluster ^{16}O - ^{40}Ca nuclei.

91Ia02 *Physics of High-Spin States in the Interacting Boson Model*

F. Iachello, Nucl. Phys. A522, 83c (1991).

Nuclear Structure: ^{192}Hg ; analyzed data; deduced superdeformed band features. Other nuclei discussed. Interacting boson model.

91Ji05 *Symmetries of the Nuclear Average Field Hamiltonian and a Search for Possible Exotic Equilibrium Deformations in Superdeformed Nuclei*

X. Ji, J. Dudek, P. Romain, Phys. Lett. 271B, 281 (1991).

Nuclear Structure: Z=54-78; N=86-122; calculated proton, neutron shell energies vs deformation. ^{158}Hf ; calculated total energy surface vs deformations, superdeformed configurations. Nuclear average field hamiltonian.

91Ko18 *The Spin-Orbit Field in Superdeformed Nuclei: A relativistic investigation*

W. Koepf, P. Ring, Z. Phys. A339, 81 (1991).

Nuclear Structure: ^{208}Pb , ^{16}O ; calculated nucleon single particle levels. ^{152}Dy ; calculated potential parameters; analyzed superdeformation. Relativistic mean field theory.

91Me07 *Pairing Vibrations and Stability of Superdeformed States*

J. Meyer, P. Bonche, J. Dobaczewski, H. Flocard, P. H. Heenen, Nucl. Phys. A533, 307 (1991).

Nuclear Structure: ^{194}Hg ; calculated levels, quadrupole moments; deduced pairing vibrations role in superdeformed state stability.

91Mi07 *Octupole Vibrations with K = 1 and 2 in Superconducting, Superdeformed Nuclei*

S. Mizutori, Y. R. Shimizu, K. Matsuyanagi, Prog. Theor. Phys. (Kyoto) 85, 559 (1991).

Nuclear Structure: ^{192}Hg , ^{144}Gd ; calculated octupole strength functions, superdeformed nuclei. RPA.

91Ot02 *Interacting Boson Model for Superdeformation*

T. Otsuka, M. Honma, Phys. Lett. 268B, 305 (1991).

Nuclear Structure: ^{194}Hg ; calculated neutron, proton occupation probabilities, I_γ levels; deduced possible superdeformed β , γ bands features, boson charge, interaction strength. Super interacting boson model.

91Ra20 *Additivity in Superdeformed Bands*

I. Ragnarsson, Phys. Lett. 264B, 5 (1991).

Nuclear Structure: 146 , 147 , ^{148}Gd ; analyzed superdeformed bands transition energies; deduced stability, two-orbitals role.

91Sa12 *Structure of Superdeformed States in Au-Ra Nuclei*

W. Satula, S. Cwiok, W. Nazarewicz, R. Wyss, A. Johnson, Nucl. Phys. A529, 289 (1991).

Nuclear Structure: $^{180, 182, 184, 196}\text{Hg}$, $^{182, 184, 186, 198}\text{Pb}$, $^{184, 186, 188, 200, 202}\text{Po}$, $^{186, 200, 202, 204, 206}\text{Rn}$, $^{204, 206, 208, 210, 212}\text{Ra}$; calculated superdeformed state energies, equilibrium deformations, band head energies, barrier heights, potential energy surfaces. $^{189, 191, 193, 195, 197, 199, 201, 203, 205, 207, 209, 211, 213}\text{Tl}$, $^{187, 189, 191, 193, 195}\text{Au}$; calculated equilibrium deformations. Strutinsky shell correction method.

91Sc09 *The Population of the Superdeformed Continuum*

K. Schiffer, B. Herskind, Phys. Lett. 255B, 508 (1991).

Nuclear Structure: ^{152}Dy ; analyzed superdeformed level data; deduced continuum features.

91St05 *Stephens et al. Reply:*

F. S. Stephens, M. A. Deleplanque, W. Korten, R. M. Diamond, F. Azaiez, A. O. Macchiavelli, J. A. Becker, E. A. Henry, A. Kuhnert, J. E. Draper, J. A. Cizewski, M. J. Brinkman, Phys. Rev. Lett. 66, 1378 (1991).

Nuclear Structure: $^{192, 194}\text{Hg}$; analyzed superdeformed band data, spin assignments.

91Ta14 *Microscopic Properties of the Superdeformed Rotational States in Light Rare-Earth Nuclei ^{132}Ce and $^{134, 136}\text{Nd}$*

K. Tanabe, K. Sugawara-Tanabe, Phys. Lett. 259B, 12 (1991).

Nuclear Structure: ^{132}Ce , $^{134, 136}\text{Nd}$; calculated levels, g-factors, yrast sequence electric quadrupole moment, dynamical moments of inertia; deduced superdeformed to yrast transition. Particle number, angular momentum constrained HFB.

91Tw01 *Superdeformed Nuclei at High Spin*

P. J. Twin, Nucl. Phys. A522, 13c (1991).

Nuclear Structure: ^{152}Dy , ^{151}Tb , ^{150}Gd , ^{152}Eu ; analyzed data; deduced superdeformed band evidence. Other data reviewed.

91Wa24 *Comment on 'Landau-Zener Crossing in Superdeformed ^{193}Hg : Evidence for octupole correlations in superdeformed nuclei'*

P. M. Walker, Phys. Rev. Lett. 67, 1174 (1991).

Nuclear Structure: ^{193}Hg ; analyzed data; deduced octupole correlations role in superdeformed states.

91We12 *Superdeformation in the Quasicontinuum: Microscopic view of the excited superdeformed bands and the corresponding level densities*

T. R. Werner, J. Dudek, Phys. Rev. C44, R948 (1991).

Nuclear Structure: ^{152}Dy , ^{149}Gd ; calculated rotational, superdeformed bands. Microscopic approach, Woods-Saxon potential, extended Strutinsky method.

91Wu01 *Superdeformations and Fermion Dynamical Symmetries*

C. -L. Wu, Nucl. Phys. A522, 31c (1991).

Nuclear Structure: ^{150}Gd , ^{194}Hg ; calculated levels, band features, decay characteristics, superdeformation effects. Other nuclei discussed. Fermion dynamical symmetry model.

91Wu04 *Comment on 'Spin Alignment in Superdeformed Hg Nuclei'*

C. -L. Wu, D. H. Feng, M. W. Guidry, Phys. Rev. Lett. 66, 1377 (1991).

Nuclear Structure: $^{192, 194}\text{Hg}$; analyzed superdeformed band data; deduced spin alignment features.

91Wy01 *Integer Alignment and Strong Coupling Limit in Superdeformed Nuclei*

R. Wyss, S. Pilotte, Phys. Rev. C44, R602 (1991).

Nuclear Structure: $^{191, 192, 193, 194}\text{Hg}$; analyzed levels, superdeformed band spin, alignment data; deduced strong coupling limit role.

91Ze01 *Spin Determination and Quantized Alignment in the Superdeformed Bands in ^{152}Dy , ^{151}Tb , and ^{150}Gd*

J. Y. Zeng, J. Meng, C. S. Wu, E. G. Zhao, Z. Xing, X. Q. Chen, Phys. Rev. C44, R1745 (1991).

Nuclear Structure: ^{152}Dy , ^{151}Tb , ^{150}Gd ; analyzed data. ^{152}Dy deduced superdeformed band lowest level J. ^{152}Dy , ^{151}Tb , ^{150}Gd deduced superdeformed band quantized alignment.

91Zh23 *An Excited Superdeformed band of ^{80}Zr in Skyrme Hartree-Fock Calculations*

D. C. Zheng, L. Zamick, Phys. Lett. 266, 5 (1991).

Nuclear Structure: ^{80}Zr ; calculated levels; deduced superdeformed band features. Skyrme Hartree-Fock approach.

92Ba42 *Low-Spin Identical Bands in Neighboring Odd-A and Even-Even Nuclei: A possible challenge to mean-field theories*

C. Baktash, J. D. Garrett, D. F. Winchell, A. Smith, Phys. Rev. Lett. 69, 1500 (1992).

Nuclear Structure: $^{157, 161, 163}\text{Ho}$, $^{159, 161, 163, 167, 169}\text{Tm}$, $^{163, 165, 167, 169, 171, 173, 175, 177}\text{Lu}$, $^{171, 173, 175, 177, 179, 181}\text{Ta}$, $^{177, 181, 183, 185}\text{Re}$, $^{175, 177, 185}\text{Ir}$; analyzed band structure; deduced identical bands at deformations between normal, superdeformed values.

92Be25 *Level Spin for Superdeformed Nuclei Near $A = 194$*

J. A. Becker, E. A. Henry, A. Kuhnert, T. F. Wang, S. W. Yates, R. M. Diamond, F. S. Stephens, J. E. Draper, W. Korten, M. A. Deleplanque, A. O. Macchiavelli, F. Azaiez, W. H. Kelly, J. A. Cizewski, M. J. Brinkman, Phys. Rev. C46, 889 (1992).

Nuclear Structure: $^{189, 190, 191, 192, 193, 194}\text{Hg}$, $^{192, 194, 196, 198}\text{Pb}$, $^{193, 194, 195}\text{Tl}$; analyzed superdeformed band transition E_{γ} ; deduced J, π . Power series expansion approach.

92Ch20 *The Fermion Dynamic Symmetry Model and Superdeformation Near $A = 220$*

R. R. Chasman, Phys. Lett. 280B, 187 (1992).

Nuclear Structure: $^{222, 223, 224}\text{Fr}$, $^{222, 223, 224, 225}\text{Ra}$, $^{222, 223, 224, 225, 226}\text{Ac}$, $^{223, 224, 225, 226, 227}\text{Th}$, $^{223, 224, 225, 226, 227, 228}\text{Pa}$, $^{224, 225, 226, 227, 228, 229}\text{U}$; calculated well depths, quadrupole, hexadecapole deformation, level energies, static moments of inertia; deduced oblate superdeformed minima, prolate superdeformation features. Fermion dynamic symmetry model.

92Ch32 *Observation of Identical Bands in Superdeformed Nuclei with the Cranked Hartree-Fock Method*

B. -Q. Chen, P. -H. Heenen, P. Bonche, M. S. Weiss, H. Flocard, Phys. Rev. C46, R1582 (1992).

Nuclear Structure: 194 , 192 Hg, 194 Pb; calculated superdeformed band level energies, quadrupole moments, dynamical, rigid moments of inertia; deduced twinning characteristics. Cranked Hartree-Fock, Skyrme effective interaction.

92CiZZ *Identical Bands and Quantized Alignment in Superdeformed A = 194 Nuclei: Evidence for a new kind of rotor*

J. A. Cizewski, J. A. Becker, E. A. Henry, M. J. Brinkman, T. F. Wang, A. Kuhnert, F. S. Stephens, M. A. Deleplanque, R. M. Diamond, F. Azaiez, A. O. Macchiavelli, J. E. Draper, Contrib. Int. Conf. Nuclear Structure at High Angular Momentum, Ottawa, p. 68 (1992); AECL-10613 (1992)

Nuclear Structure: A=194; analyzed data; deduced superdeformed, identical band features. Spin-rotor framework.

92Ci06 *On the DSAM and Lifetime Measurements for Superdeformed States*

R. Clark, N. Rowley, J. Phys. (London) G18, 1515 (1992).

Nuclear Structure: 152 Dy, 153 Nd; analyzed DSA, $T_{1/2}$ data procedures; deduced improved results possibility with inverse reactions; calculated superdeformed bands quadrupole moments. Bateman equations equivalent formalism.

92Cs03 *On the Relation between Cluster and Superdeformed States of Light Nuclei*

J. Cseh, W. Scheid, J. Phys. (London) G18, 1419 (1992).

Nuclear Structure: 12 C, 16 O, 20 Ne, 24 Mg, 28 Si, 32 S, 36 Ar, 40 Ca, 44 Ti; analyzed levels; deduced superdeformed states clusterization features.

92DeZW *Microscopic Description of Superdeformed Bands in 190 , 192 , 194 Hg and 152 Dy*

J. P. Delaroche, M. Girod, J. F. Berger, J. Libert, Contrib. Int. Conf. Nuclear Structure at High Angular Momentum, Ottawa, p. 77 (1992); AECL-10613 (1992)

Nuclear Structure: 190 , 192 , 194 Hg, 152 Dy; calculated potential energy surfaces, inertia tensors; deduced band structure, superdeformed band characteristics. Constrained HFB, Gogny force.

92DuAA

Nuclear Superdeformations at High Spin. Dudek, Prog. Part. Nucl. Phys. 28, 131 (1992).

92Fa02 *The Influence of Pairing on the Properties of 'Identical' Superdeformed Bands in Hg Nuclei*

P. Fallon, W. Nazarewicz, M. A. Riley, R. Wyss, Phys. Lett. 276B, 427 (1992).

Nuclear Structure: 190 , 181 , 192 , 193 , 194 Hg; analyzed band structure data; deduced good reference for superdeformed bands, neutron pairing relative magnitude.

92FaZY *Differences in 'Identical' Superdeformed Bands*

P. Fallon, W. Nazarewicz, M. A. Riley, R. Wyss, Contrib. Int. Conf. Nuclear Structure at High Angular Momentum, Ottawa, p. 74 (1992); AECL-10613 (1992)

Nuclear Structure: 194 Hg; analyzed superdeformed band low spin state transition energies; deduced low spin deviations qualitative picture. Blocking arguments.

92Gi01 *Ab Initio Calculation of Superdeformed Bands in 192 Hg*

M. Girod, J. P. Delaroche, J. Libert, I. Deloncle, Phys. Rev. C45, R1420 (1992).

Nuclear Structure: 192 Hg; calculated levels, kinematic moment of inertia, $B(\lambda)$; deduced superdeformed bands. Griffin-Hill-Wheeler equation, Gaussian overlap approximation, constrained Hartree-Fock-Bogoliubov calculation based potential, tensor of inertia, Gogny's force.

92Ha32 *Magnetic Dipole Strength in Superdeformed Nuclei*

I. Hamamoto, W. Nazarewicz, Phys. Lett. 297B, 25 (1992).

Nuclear Structure: 162 Hg, 152 Dy; calculated $B(M1)$, superdeformed nuclei; deduced isovector GQR, scissors mode overlap.

92Ha35 *Nuclear Superdeformation Data Tables*

X. -L. Han, C. -L. Wu, At. Data Nucl. Data Tables 52, 43 (1992).

Compilation: A=130, 150, 190; compiled by for transitions in superdeformed bands.

92HaZT *Recent Results and Future Prospects Along the N = Z Line with Radioactive Nuclear Beams and RMS*

J. H. Hamilton, A. V. Ramayya, Contrib. 6th Intern. Conf. on Nuclei Far from Stability + 9th Intern. Conf. on Atomic Masses and Fundamental Constants, Bernkastel-Kues, Germany, PE10 (1992)

Nuclear Structure: 72 , 74 , 76 Kr; reviewed, analyzed data. 88 Ru; analyzed band structure; deduced low spin superdeformation. Nuclei along N=Z line.

92Kr07 *Super-Deformation and Shape Isomerism: Mapping the isthmus*

S. J. Krieger, P. Bonche, M. S. Weiss, J. Meyer, H. Flocard, P. -H. Heenen, Nucl. Phys. A542, 43 (1992).

Nuclear Structure: Z=108-152; calculated excitation energy, rigid moment of inertia. 190 , 192 , 194 , 196 , 198 , 200 , 202 , 204 , 206 , 210 , 212 , 214 , 216 , 218 , 220 , 222 , 224 , 226 , 228 , 230 Pb calculated rigid moment of inertia, quadrupole moment, superdeformed isomers; deduced shape isomerism isthmus superdeformation region. Microscopic Hartree-Fock-BCS formalism.

92Me01 *Superdeformed Single-Particle Orbitals in the A = 190 Region from Hartree-Fock Plus BCS Calculations*

M. Meyer, N. Redon, P. Quentin, J. Libert, Phys. Rev. C45, 233 (1992).

Nuclear Structure: 192 , 194 , 196 , 198 , 200 Pb, 194 , 192 , 190 Hg; calculated superdeformed nucleon state components, spectra; deduced particle number symmetry restoration role. Self-consistent axial Hartree-Fock plus BCS.

92Na03 *Dynamical Symmetries, Multiclustering, and Octupole Susceptibility in Superdeformed and Hyperdeformed Nuclei*

W. Nazarewicz, J. Dobaczewski, Phys. Rev. Lett. 68, 154 (1992).

Nuclear Structure: A=66-230; calculated minimum shell correction energy; deduced new superdeformation and hyperdeformation classification schemes.

92Na12 *Quadrupole Splitting of Octupole Vibrational States*

R. Nazmitdinov, S. Aberg, Phys. Lett. 289B, 238 (1992).

Nuclear Structure: A=150; calculated giant octupole, dipole, quadrupole resonance K-component splittings; deduced analytical RPA solutions at spherical, superdeformed, hyperdeformed shells.

92Na15 *Octupole Vibrations in the Harmonic-Oscillator-Potential Model with Axis Ratio Two to One*

T. Nakatsukasa, S. Mizutori, K. Matsuyanagi, Prog. Theor. Phys. (Kyoto) 87, 607 (1992).

Nuclear Structure: Z=80; N=80; calculated RPA octupole transition strength functions; deduced open shell superdeformed configurations octupole vibrations evidence. Harmonic oscillator potential model, axis ratio two to one, RPA solutions.

92NaZZ *Couplings between Octupole-Vibrational and Quasiparticle Modes of Excitation in Rotating, Superconducting, Superdeformed Nuclei*

T. Nakatsukasa, S. Mizutori, K. -I. Arita, Y. R. Shimizu, K. Matsuyanagi, Contrib. Int. Conf. Nuclear Structure at High Angular Momentum, Ottawa, p. 87 (1992); AECL-10613 (1992)

Nuclear Structure: ¹⁹³Hg; calculated intraband coupling effects, superdeformed states. Microscopic particle-vibration couplings.

92NaZS *New Vistas in Superdeformation*

W. Nazarewicz, Proc. Int. Conf. Nuclear Structure at High Angular Momentum, Ottawa, p. 32 (1992); AECL-10613 (1992)

Nuclear Structure: ¹⁷⁰, ¹⁸⁰, ¹⁹⁰, ²⁰⁰Hg; analyzed total potential energies. ¹⁶⁶, ¹⁶⁸, ¹⁷⁰, ¹⁷², ¹⁷⁴, ¹⁷⁶, ¹⁷⁸, ¹⁸⁰, ¹⁸², ¹⁸⁴, ¹⁸⁶, ¹⁸⁸, ¹⁹⁰, ¹⁹², ¹⁹⁴, ¹⁹⁶, ¹⁹⁸, ²⁰⁰Hg; analyzed shape-coexisting states energies; deduced superdeformation related features. Other nuclei discussed.

92Pa22 *On a Possible Origin of Identical Superdeformed and Normally Deformed Bands and Absence of Polarization in Interacting Boson-Fermion Model*

V. Paar, D. K. Sunko, D. Vretenar, J. Phys. (London) G18, L191 (1992).

92PaZW *Highly-Deformed Bands in the Mass 130 Region*

E. S. Paul, Proc. Int. Conf. Future Directions in Nuclear Physics with 4π Gamma Detection Systems of the New Generation, Strasbourg, France (1991), J. Dudek, B. Haas, Eds., American Institute of Physics, New York, p. 165 (1992).

Compilation: ¹³³, ¹³⁵, ¹³⁷Sm, ¹³⁸Gd, ¹⁴²Eu, ¹³³, ¹³⁴, ¹³⁵, ¹³⁶, ¹³⁷Nd, ¹³⁴Pr, ¹³¹, ¹³², ¹³³, ¹³⁶Ce, ¹³⁰La; compiled, reviewed superdeformed, intruder bands, T_{1/2} data; deduced dominant configuration.

92Ra06 *Hyperdeformed States in ³⁶Ar and ⁴⁸Cr in the Cranked Cluster Model*

W. D. M. Rae, A. C. Merchant, Phys. Lett. 279B, 207 (1992).

Nuclear Structure: ³⁶Ar, ⁴⁸Cr; calculated hyperdeformed states α-particle constituents, single particle density contours; deduced possible evidence from reaction data. Cranked cluster model.

92RaZV *Assignment of Nilsson Orbitals at Superdeformation - Identical Bands*

I. Ragnarsson, Proc. Int. Conf. Nuclear Structure at High Angular Momentum, Ottawa, p. 187 (1992); AECL-10613 (1992)

Nuclear Structure: ¹⁴⁶, ¹⁴⁷, ¹⁴⁸, ¹⁴⁹Gd; analyzed superdeformed bands data; deduced effective alignments direct imaging of Nilsson orbitals, other features.

92Se01

P. B. Semmes, I. Ragnarsson, S. Aberg, Phys. Rev. Lett. 68, 460 (1992).

Nuclear Structure: ¹⁹³, ¹⁹⁴Hg; calculated transition I_γ in superdeformed bands. ¹⁹³Hg deduced internal conversion dominated M1 cross talk evidence.

92Sh04 *Superfluid Tunneling in Superdeformed Nuclei*

Y. R. Shimizu, F. Barranco, R. A. Broglia, T. Dossing, E. Vigezzi, Phys. Lett. 274B, 253 (1992).

Nuclear Structure: ¹⁵²Dy; calculated potential energy vs adiabatic path. ¹⁴⁹, ¹⁵⁰Gd, ¹⁵⁰, ¹⁵¹Tb, ¹⁵¹, ¹⁵²Dy; calculated invariant adiabatic action vs angular momentum, superdeformed band decay related parameter. Superfluid tunneling model.

92ShZX *On the Mechanism of Decay Out of Superdeformed Bands*

Y. R. Shimizu, T. Dossing, E. Vigezzi, R. A. Broglia, Contrib. Int. Conf. Nuclear Structure at High Angular Momentum, Ottawa, p. 70 (1992); AECL-10613 (1992)

Nuclear Structure: A=150, 190; analyzed superdeformed decay characteristics; deduced possible mechanism plausibility.

92Sk01 *Octupole Correlations at Superdeformed Shape in the Hg-Pb Region - Including Nonaxial Components*

J. Skalski, Phys. Lett. 274B, 1 (1992).

Nuclear Structure: ¹⁹², ¹⁹⁴Hg, ¹⁹², ¹⁹⁴, ¹⁹⁶, ¹⁹⁸Pb; calculated routhian stiffness vs octupole deformation components; deduced octupole vibration frequencies at superdeformed minima.

92So10 *Intrinsic Structures and Associated Rotational Bands in Deformed Even-Even Nuclei of the Actinide Region*

P. C. Sood, D. M. Headly, R. K. Sheline, At. Data Nucl. Data Tables 51, 273 (1992).

Nuclear Structure: Z ≥ 88; N ≥ 134; ²³⁰, ²³², ²³⁴, ²³⁶, ²³⁸U, ²²⁰, ²²², ²²⁴, ²²⁶, ²²⁸, ²³⁰, ²³², ²³⁴Th, ²¹⁸, ²²⁰, ²²², ²²⁴, ²²⁶, ²²⁸, ²³⁰Ra; analyzed levels; deduced band structure, fission isomers superdeformation, hyperdeformation evidence.

92TaZX *The Anisotropy Coefficient of Gamma-Rays from Thermal High-Spin Giant-Dipole-Resonances*

K. Tanabe, K. Sugawara-Tanabe, Contrib. Int. Conf. Nuclear Structure at High Angular Momentum, Ottawa, p. 94 (1992); AECL-10613 (1992)

Nuclear Structure: ¹³²Ce; calculated γ-ray anisotropy coefficients, α(γ,X); deduced behavior for superdeformed states. Thermal RPA, GDR, high spin.

- 92TaZY** *The Thermal Energy-Weighted Sum Rule for Giant-Dipole-Resonances in Hot Nuclei*
K. Tanabe, K. Sugawara-Tanabe, Contrib. Int. Conf. Nuclear Structure at High Angular Momentum, Ottawa, p. 93 (1992); AECL-10613 (1992)
Nuclear Structure: ^{132}Ce ; calculated GDR resonance thermal energy-weighted sum rule; deduced $\gamma(\theta)$ asymmetry behavior for superdeformed band. Thermal RPA.
- 92Th01** *Nuclear Dissipation and the Feeding of Superdeformed Bands*
M. Thoennessen, J. R. Beene, Phys. Rev. C45, 873 (1992).
Nuclear Reactions: $^{159}\text{Tb}(^{16}\text{O},\text{X})$, $E=160$ MeV; calculated fusion, fission, evaporation residue σ vs spin, high energy γ -spectra; deduced dissipation role, enhanced superdeformed band feeding features. Statistical model.
- 92WaZW** *Topological Excitations and Identical Superdeformed Bands*
J. C. Waddington, R. K. Bhaduri, Contrib. Int. Conf. Nuclear Structure at High Angular Momentum, Ottawa, p. 80 (1992); AECL-10613 (1992)
Nuclear Structure: ^{192}Hg ; analyzed identical superdeformed band features; deduced vortices role. Topological excitations, ^{152}Dy core.
- 92Wu01** *Spin Determination and Calculation of Nuclear Superdeformed Bands in A 190 Region*
C. S. Wu, J. Y. Zeng, Z. Xing, X. Q. Chen, J. Meng, Phys. Rev. C45, 261 (1992).
Nuclear Structure: $^{190, 191, 192, 193, 194}\text{Hg}$, $^{193, 194}\text{Tl}$, $^{194, 196}\text{Pb}$; calculated superdeformed bands, transition energies. Two-parameter approach.
- 92Wu05** *Relation between the Kinematic and Dynamic Moments of Inertia in Superdeformed Nuclei*
C. S. Wu, L. Cheng, C. Z. Lin, J. Y. Zeng, Phys. Rev. C45, 2507 (1992).
Nuclear Structure: $^{164, 166}\text{Er}$, $^{168, 170, 172, 174, 176}\text{Yb}$, $^{170, 172, 174, 176, 178}\text{Hf}$, ^{238}U , ^{242}Pu , ^{248}Cm ; analyzed ground state bands data. $^{191, 192, 193, 194}\text{Hg}$, $^{193, 194}\text{Tl}$, $^{194, 196}\text{Pb}$, $^{151, 152}\text{Dy}$, ^{150}Tb , ^{150}Gd ; analyzed superdeformed band level data; deduced R-parameter remains independent of spin.
- 92Wu06** *Is There Objective Evidence for Quantized Spin Alignment in Superdeformed Nuclei (Question)*
C. -L. Wu, D. H. Feng, M. Guidry, Phys. Rev. C46, 1339 (1992).
Nuclear Structure: $^{192, 191, 193, 194}\text{Hg}$, ^{194}Pb , ^{194}Tl ; analyzed superdeformed band γ -transition energy analyses for spin determination; deduced quantized spin alignment related characteristics.
- 93Ar16** *Octupole Instability of the Closed-Shell Configurations in the Superdeformed Oscillator Potential*
K. -I. Arita, K. Matsuyanagi, Prog. Theor. Phys. (Kyoto) 89, 389 (1993).
Nuclear Structure: $A=40-160$; calculated shell structure energy vs particle number, octupole deformation parameter; deduced octupole instability, superdeformed shape connection. Closed shell configurations, axially-symmetric harmonic oscillator potential.
- 93Ab08** *Superdeformed Nuclei*
S. Aberg, Nucl. Phys. A557, 17c (1993).
Nuclear Structure: $^{146, 150}\text{Gd}$, ^{151}Tb , ^{152}Dy , $^{188, 190, 191, 192, 193, 194}\text{Hg}$; compiled, reviewed superdeformed band related data. ^{146}Gd deduced hyperdeformation evidence. Other nuclei included.
- 93Ba17** *On the Question of Spin Fitting and Quantized Alignment in Rotational Bands*
C. Baktash, W. Nazarewicz, R. Wyss, Nucl. Phys. A555, 375 (1993).
Nuclear Structure: $^{76, 78}\text{Kr}$; analyzed level energy rms deviation vs spin. ^{150}Gd , $^{151, 152}\text{Dy}$, ^{151}Tb , $^{192, 194}\text{Hg}$; analyzed superdeformed states data, level energy rms deviation vs spin. ^{180}Pt , ^{175}Ir , ^{175}Re , ^{177}Pt , ^{183}Os , ^{235}U , $^{172, 166}\text{Yb}$, ^{166}Lu , $^{174, 178}\text{Hf}$, $^{180, 182}\text{Os}$, ^{186}Hg ; calculated superdeformed, rotational bands. Harris expansion formula.
- 93Ba36** *High-Spin States and Superdeformation in the Proton-Neutron Interacting Boson Model*
A. F. Barfield, B. R. Barrett, Nucl. Phys. A557, 551c (1993).
Nuclear Structure: ^{192}Hg , ^{232}U ; calculated levels, moment of inertia for bands. ^{192}Hg deduced possible new superdeformed band candidate. Neutron-proton interacting boson model.
- 93Ch43** *Calculation of Nuclear Superdeformed Bands by Using the Particle-Rotor Model*
X. Q. Chen, Z. Xing, J. Phys. (London) G19, 1869 (1993).
Nuclear Structure: $^{193, 195}\text{Tl}$; calculated superdeformed bands kinematic, dynamic moments of inertia, $B(\lambda)$, dynamical quadrupole moments. Particle-rotor model.
- 93Ch47** *Configuration Interaction Effects in Rotational Bands of Superdeformed Nuclei*
R. R. Chasman, Phys. Lett. 319B, 41 (1993).
Nuclear Structure: ^{192}Hg ; calculated superdeformed band neutron, proton pairing, transition energies. Cranking Hamiltonian with pairing.
- 93Fi04** *Hartree-Fock and Hartree-Fock-Bogoliubov Calculations of Superdeformed Bands*
H. Flocard, B. Q. Chen, B. Gall, P. Bonche, J. Dobaczewski, P. H. Heenen, M. S. Weiss, Nucl. Phys. A557, 559c (1993).
Nuclear Structure: $^{192, 194}\text{Hg}$, ^{194}Pb ; calculated superdeformed bands quadrupole moments, dynamical, rigid body moments of inertia. Hartree-Fock, HFB calculations, limitations discussed.
- 93Gu08** *Some General Constraints on Identical Band Symmetries*
M. W. Guidry, M. R. Strayer, C. -L. Wu, D. H. Feng, Phys. Rev. C48, 1739 (1993).
Nuclear Structure: $^{192, 194, 196}\text{Hg}$, $^{234, 236, 238}\text{U}$, $^{238, 240, 242, 244}\text{Pu}$, $^{246, 248}\text{Cm}$, $^{248, 250}\text{Cf}$; analyzed band structure; deduced normal, superdeformed identical bands related features.
- 93Ho17** *E2 Contribution to the Decay Out of a Superdeformed Band*
M. Honma, T. Otsuka, Phys. Lett. 314B, 1 (1993).
Nuclear Structure: ^{199}Hg ; calculated superdeformed band $B(\lambda)$, I_γ ; deduced superdeformed band sudden termination reason. Nilsson+particle number conserving BCS model.

- 93Hu06** *Spin Determination of Superdeformed Bands, A - 190 and A - 150 Regions*
J. Hu, C. Zheng, Chin. J. Nucl. Phys. 15, No 1, 45 (1993).
Nuclear Structure: $^{190, 191, 192, 193, 194}\text{Hg}$, $^{193, 194}\text{Tl}$, $^{194, 196, 198}\text{Pb}$, $^{146, 147, 148, 149, 150}\text{Gd}$, $^{150, 151}\text{Tb}$, $^{151, 152, 153}\text{Dy}$; analyzed level spectra, E γ ; deduced superdeformed band states spin. Different methods.
- 93Kh06** *Feeding and Decay of Superdeformed States*
T. L. Khoo, T. Lauritsen, I. Ahmad, M. P. Carpenter, P. B. Fernandez, R. V. F. Janssens, E. F. Moore, F. L. H. Wolfs, Ph. Benet, P. J. Daly, K. B. Beard, U. Garg, D. Ye, M. W. Drigert, Nucl. Phys. A557, 83c (1993).
Nuclear Structure: ^{192}Hg ; analyzed superdeformed band feeding, decay data; deduced mechanisms.
- 93Ko41** *Identical Bands in Superdeformed Nuclei: A relativistic description*
J. Konig, P. Ring, Phys. Rev. Lett. 71, 3079 (1993).
Nuclear Structure: ^{152}Dy , ^{151}Tb ; calculated binding energy, mass quadrupole moment, static, rigid body moment of inertia, transitional energy differences for superdeformed band. Relativistic mean field theory, rotating frame.
- 93Li09** *Microscopic Description of Superdeformed Bands in $^{190, 192, 194}\text{Hg}$*
J. Libert, J. F. Berger, J. P. Delaroche, M. Girod, Nucl. Phys. A553, 523c (1993).
Nuclear Structure: $^{190, 192, 194}\text{Hg}$; calculated levels, normal, superdeformation bands. Microscopic model.
- 93Lu08** *On the Fits to the Superdeformed Bands*
W. Luo, Y. Chen, Chin. J. Nucl. Phys. 15, No 1, 50 (1993).
Nuclear Structure: $^{146, 147, 148, 149, 150}\text{Gd}$, $^{150, 151}\text{Tb}$, $^{151, 152, 153}\text{Dy}$; analyzed level spectra, E γ ; deduced superdeformed band states spin. Different methods.
- 93Mi10** *Octupole Correlations in Superdeformed High-Spin States*
S. Mizutori, T. Nakatsukasa, K. Arita, Y. R. Shimizu, K. Matsuyanagi, Nucl. Phys. A557, 125c (1993).
Nuclear Structure: $^{158, 156, 154, 152, 150, 148, 146, 144, 142}\text{Gd}$, $^{184, 186, 188, 190, 192, 194, 196, 198, 200}\text{Hg}$; calculated curvature against octupole deformation, stretched octupole strengths; deduced octupole instability, superdeformed shape relationship.
- 93Na16** *Effects of Octupole Vibrations on Quasiparticle Modes of Excitation in Superdeformed ^{192}Hg*
T. Nakatsukasa, S. Mizutori, K. Matsuyanagi, Prog. Theor. Phys. (Kyoto) 89, 847 (1993).
Nuclear Structure: ^{192}Hg ; calculated superdeformed states octupole transitions strength distribution. ^{193}Hg ; calculated superdeformed rotational bands. Cranked shell model, RPA based particle-vibration coupling.
- 93No04** *Superdeformation and High Spin States*
P. J. Nolan, Nucl. Phys. A553, 107c (1993).
Nuclear Structure: A=130-140; A 150; A 190; compiled, reviewed superdeformation, other data features.
- 93Pa05** *E0 Transitions and the Depopulation of SD Bands*
M. Palacz, Z. Sujkowski, J. Bacelar, A. Atac, B. Herskind, J. Nyberg, M. Piiparinen, G. de Angelis, S. Forbes, N. Gjørup, G. Hagemann, F. Ingebretsen, H. Jensen, D. Jerrestam, H. Kusakari, R. Lieder, G. M. Marti, S. Mullins, D. Santonocito, H. Schnare, G. Sletten, K. Strahle, M. Sugawara, P. O. Tjorn, A. Virtanen, R. Wadsworth, Acta Phys. Pol. B24, 399 (1993).
Nuclear Structure: ^{132}Ce , ^{142}Eu , ^{152}Dy , ^{192}Hg ; calculated transition probability vs excitation energy for superdeformed states. ^{142}Eu ; analyzed γ (K X-ray)-coin following superdeformed states decay.
- 93Pa10** *Shapes of Exotic Nuclei in the Mass A = 70 Region*
S. K. Patra, C. R. Prahara, Phys. Rev. C47, 2978 (1993).
Nuclear Structure: ^{64}Ge , ^{66}Se , ^{72}Kr , ^{76}Sr , ^{80}Zr ; calculated ground state deformation parameters. ^{76}Se ; calculated occupation probability vs neutron single particle energies for normal deformation, superdeformation. Deformed relativistic mean field theory.
- 93Pa25** *Shapes of N = Z Nuclei in the Mass A = 20-48 Region*
S. K. Patra, C. R. Prahara, Nucl. Phys. A565, 442 (1993).
Nuclear Structure: ^{20}Ne , ^{24}Mg , ^{28}Si , ^{32}S , ^{36}Ar , ^{40}Ca , ^{44}Ti , ^{46}Cr ; calculated binding energy, rms matter radius, quadrupole deformation parameter, hexadecupole moment. ^{20}Ne , ^{32}S , ^{36}Ar deduced hyperdeformed states. Axially symmetric deformed relativistic mean field theory.
- 93Pi03** *Model of Superfluid Liquid with Triplet Pairing, Cranking Model and Model of Variable Moment of Inertia in Superdeformed Bands in A 190 Region*
R. Piepenbring, K. V. Protasov, Z. Phys. A345, 7 (1993).
Nuclear Structure: $^{189, 190, 191, 193, 194}\text{Hg}$, $^{194, 196}\text{Pb}$, $^{193, 194}\text{Tl}$; calculated superdeformed band states transition energies; deduced spin assignments. Triplet pairing model.
- 93Pi13** *Superfluid Liquid Model with Triplet Pairing for Superdeformed Bands in A 130-150 Region*
R. Piepenbring, K. V. Protasov, Z. Phys. A347, 27 (1993).
Nuclear Structure: $^{151, 153, 152}\text{Dy}$, $^{131, 132}\text{Ce}$, $^{146, 147, 148, 149, 150}\text{Gd}$, $^{136, 137}\text{Nd}$, ^{130}La , ^{142}Sm , $^{150, 151}\text{Tb}$, ^{143}Eu ; calculated superdeformed band level energies, transition E γ . Superfluid liquid model, triplet pairing.
- 93Pr01** *Rotational Spectra of Nuclei: Equivalence of a superfluid liquid model, the cranking model and a model with a variable moment of inertia*
K. V. Protasov, R. Piepenbring, J. Phys. (London) G19, 597 (1993).
Nuclear Structure: ^{194}Tl ; calculated superdeformed band transition energies; deduced model equivalences. Superfluid liquid, cranking, variable moment of inertia models.
- 93Ra07** *Orbital and Spin Assignment of SD Bands in the Dy/ Gd Region - Identical Bands*
I. Ragnarsson, Nucl. Phys. A557, 167c (1993).
Nuclear Structure: $^{146, 147, 148, 149, 150}\text{Gd}$, ^{151}Tb , $^{151, 152, 153}\text{Dy}$; analyzed superdeformed band transition $I\gamma$, other data; deduced J, π assignments.

- 93Ro04** *Hyperdeformation in ^{152}Dy at Very High Spins*
G. Royer, F. Haddad, Phys. Rev. C47, 1302 (1993).
Nuclear Structure: ^{152}Dy ; calculated macroscopic, rotational energies, rigid moment of inertia, electric quadrupole moment vs deformation. ^{58}Ni ; calculated macroscopic, rotational energies vs deformation. ^{152}Dy deduced hyperdeformed states evidence. Rotational liquid drop model.
- 93Sh18** *Tunneling Probability for Decays Out of Superdeformed Bands*
Y. R. Shimizu, E. Vigezzi, T. Dossing, R. A. Broglia, Nucl. Phys. A557, 99c (1993).
Nuclear Structure: $^{151, 152}\text{Dy}$, ^{192}Hg ; ^{143}Eu , $^{145, 147, 148, 149, 150}\text{Gd}$, $^{150, 151}\text{Tb}$; analyzed data; deduced tunneling probability for decays out of superdeformed bands.
- 93Sk01** *Octupole Correlations in Superdeformed Mercury and Lead Nuclei: A generator-coordinate method analysis*
J. Skalski, P. -H. Heenen, P. Bonche, H. Flocard, J. Meyer, Nucl. Phys. A551, 109 (1993).
Nuclear Structure: ^{184}Pb , $^{184, 182}\text{Hg}$; calculated axial, nonaxial octupole level energies built on superdeformed states, $B(\lambda)$; deduced weak coupling. Generator coordinate method, self-consistent Hartree-Fock BCS basis.
- 93Su10** *The Angular Distribution of Gamma-Rays from Thermal High-Spin Giant-Dipole-Resonances on Superdeformed States*
K. Sugawara-Tanabe, K. Tanabe, Nucl. Phys. A559, 42 (1993).
Nuclear Structure: ^{132}Ce ; calculated levels, transition $\gamma(\theta)$, absorption $\sigma(E\gamma)$, thermal high spin GDR, superdeformed states. Microscopic approach, thermal RPA, thermal cranked HFB ensemble.
- 93Su14** *Quantization of Alignment and Different Parity Pair Levels with Omega = 1/2*
K. Sugawara-Tanabe, A. Arima, Nucl. Phys. A557, 157c (1993).
Nuclear Structure: ^{192}Hg , ^{152}Dy ; calculated l-s operator matrix element for parity doublet levels; deduced degeneracy features at superdeformation.
- 93Su23** *Parity Doublet Levels in Superdeformation*
K. Sugawara-Tanabe, A. Arima, Phys. Lett. 317B, 1 (1993).
Nuclear Structure: ^{192}Hg , ^{152}Dy ; calculated parity-doublet levels; deduced degeneracy features at Fermi surface in superdeformed shape.
- 93Wu06** *Nuclear Superdeformation and the Supershell Fermion Dynamical Symmetry Model*
C. -L. Wu, D. H. Feng, M. W. Guidry, Ann. Phys. (New York) 222, 187 (1993).
Nuclear Structure: $Z=60-110$; $N=60-150$; calculated regions favorable for superdeformation. Other aspects related to superdeformation discussed. Supershell fermion dynamical symmetry model.
- 93Zh21** *Comment on 'Evidence for Superdeformed Shape Isomeric States in ^{28}Si at Excitations Above 40 MeV Through Observations of Selective Particle Decays of $^{16}\text{O} + ^{12}\text{C}$ Resonances in ^9Be and Alpha Channels'*
J. Zhang, A. C. Merchant, W. D. M. Rae, Phys. Rev. C48, 2117 (1993).
Nuclear Reactions: $^{12}\text{C}(^{16}\text{O}, ^9\text{Be})$, $(^{16}\text{O}, \alpha)$, $E(\text{cm})=25.7-38.6$ MeV; analyzed previous data analyses. ^{28}Si deduced superdeformed shape isomeric states structure.
- 94Ab17** *Clustering Aspects of Nuclei with Octupole and Superdeformation*
S. Aberg, L. -O. Jonsson, Z. Phys. A349, 205 (1994).
Nuclear Structure: $A=4-149$; $N=20-140$; compiled, reviewed clustering aspects; deduced superdeformation, di-molecules, hyperdeformation related features.
- 94Ba07** *A $U(\text{qp})(u_2)$ Model for Rotational Bands of Nuclei*
R. Barbier, J. Meyer, M. Kibler, J. Phys. (London) G20, L13 (1994).
Nuclear Structure: $^{192, 194}\text{Hg}$, $^{192, 194, 196, 198}\text{Pb}$; calculated γ transition energies, rotating superdeformed nuclei. Two-parameter quantum algebra based rotational model.
- 95BaAA**
Identical Bands in Deformed and Superdeformed Nuclei. Baktash et al., Annu. Rev. Nucl. Part. Sci. 45, 485 (1995).
- 94Be20** *Large Amplitude Collective Motion*
G. F. Bertsch, Nucl. Phys. A574, 169c (1994).
Nuclear Structure: ^{124}Xe , ^{182}Os , ^{218}Ra , ^{143}Eu , ^{194}Hg ; compiled, reviewed data, collective motion analyses, superdeformation features in some cases; deduced hopping model suitability features.
- 94Bo24** *Microscopic Approach to Collective Motion*
P. Bonche, E. Chabanat, B. Q. Chen, J. Dobaczewski, H. Flocard, B. Gall, P. H. Heenen, J. Meyer, N. Tajima, M. S. Weiss, Nucl. Phys. A574, 185c (1994).
Nuclear Structure: ^{192}Hg , ^{194}Pb ; calculated superdeformed bands, energies, quadrupole moments, dynamical, rigid body moments of inertia, E_γ . $^{194, 196, 198, 200, 202, 204, 206, 208, 210, 212, 214, 216, 218, 220}\text{Pb}$; calculated proton, neutron rms radii. Microscopic approach, collective motion.
- 94Ch33** *Some Features of Superdeformed Bands Built Upon $j_{1/2, 3/2}$ Orbitals*
X. -Q. Chen, X. Zheng, J. Phys. (London) G20, 1041 (1994).
Nuclear Structure: ^{191}Hg ; calculated E_γ , kinematic, dynamic moments of inertia for superdeformed bands. Particle-rotor model.
- 94Ch52** *Configuration Assignment of Superdeformed Bands in Odd-A Hg Nuclei*
X. Chen, Z. Xing, Chin. J. Nucl. Phys. 16, No 2, 133 (1994).
Nuclear Structure: $^{193, 191, 189}\text{Hg}$; calculated superdeformed band $B(\lambda)$. Particle-rotor model.

94Ch60 *Analysis of Superdeformed Band of ^{193}Tl*

X. Chen, Z. Xing, Chin. J. Nucl. Phys. 16, No 1, 50 (1994).

Nuclear Structure: ^{193}Tl ; calculated superdeformed bands dynamic moment of inertia vs energy gap, triaxial deformation parameters. Particle-rotor model.

94Ch73 *Calculations of Superdeformed Bands in $(j15/2)$ -Model*

X. -Q. Chen, Z. Xing, Chin. J. Nucl. Phys. 16, No 3, 233 (1994).

Nuclear Structure: ^{191}Hg ; calculated superdeformed band transitions $E\gamma$, $B(\lambda)$, kinematic, dynamic moments of inertia. Particle-rotor model.

94Cw01 *Hyperdeformations and Clustering in the Actinide Nuclei*

S. Cwiok, W. Nazarewicz, J. X. Saladin, W. Plociennik, A. Johnson, Phys. Lett. 322B, 304 (1994).

Nuclear Structure: 220 , ^{222}Ra , ^{232}Th , ^{234}U ; calculated Woods-Saxon-Strutinsky total potential energy vs deformation parameters β_2 , β_3 ; deduced hyperdeformed minima features. Shell correction approach.

94Ga22 *Superdeformed Rotational Bands in the Mercury Region. A Cranked Skyrme-Hartree-Fock-Bogoliubov Study*

B. Gall, P. Bonche, J. Dobaczewski, H. Flocard, P. -H. Heenen, Z. Phys. A348, 183 (1994).

Nuclear Structure: 190 , 192 , ^{194}Hg , ^{194}Pb ; calculated superdeformed bands moment of inertia, proton, neutron pairing energies, charge quadrupole moments versus angular velocity. Cranked Skyrme-Hartree-Fock-Bogoliubov method.

94Gi05 *Self-Consistent Cranking Hartree-Fock-Bogoliubov Description of Superdeformed Rotational States in ^{194}Hg with the Gogny Force*

M. Girod, J. P. Delaroche, J. F. Berger, J. Libert, Phys. Lett. 325B, 1 (1994).

Nuclear Structure: ^{194}Hg ; calculated yrast superdeformed band dynamic moment of inertia. Self-consistent cranking HFB calculations, Gogny force.

94Ha13 *$K(\pi) = 1^+$ Pairing Interaction and Moments of Inertia of Superdeformed Rotational Bands in Atomic Nuclei*

I. Hamamoto, W. Nazarewicz, Phys. Rev. C49, 2489 (1994).

Nuclear Structure: ^{194}Hg ; calculated Migdal to cranking moment of inertia ratio; deduced $K(\pi)=1^+$ pairing role on moments of inertia frequency dependence at superdeformed shapes.

94Kr06 *GCM Calculation of the E2 Decay Lifetimes of Shape Isomers*

S. J. Krieger, P. Bonche, H. Flocard, P. H. Heenen, M. S. Weiss, Nucl. Phys. A572, 384 (1994).

Nuclear Structure: 230 , ^{232}Th , ^{238}U ; calculated deformation energy vs mass quadrupole moment, first barrier, second minimum, absolute minimum quadrupole moment, charge quadrupole transition matrix element between superdeformed, ground bands, isomer E2 decay $T_{1/2}$. Hartree-Fock BCS calculations.

94Me06 *Calculations of Particle Decay Widths of Hyper-Deformed Nuclei using Prolate Spheroidal Coordinates*

A. C. Merchant, W. D. M. Rae, Nucl. Phys. A571, 43 (1994).

Nuclear Structure: ^{24}Mg , ^{48}Cr ; calculated α -decay widths, hyperdeformed nuclei. Prolate spheroidal coordinates, coupled-channels calculations.

94Sa35 *The Lipkin-Nogami Formalism for the Cranked Mean Field*

W. Satula, R. Wyss, P. Magierski, Nucl. Phys. A578, 45 (1994).

Nuclear Structure: ^{152}Dy , ^{144}Gd , ^{184}Hg ; calculated moment of inertia, yrast superdeformed bands. Cranked mean field, Lipkin-Nogami formalism, lattice calculations.

94Sa41 *Coherence of Nucleonic Motion in Superdeformed Nuclei: Towards an understanding of identical bands*

W. Satula, R. Wyss, Phys. Rev. C50, 2888 (1994).

Nuclear Structure: 190 , 192 , 194 , ^{196}Hg , 192 , 194 , 196 , ^{198}Pb ; calculated superdeformed bands dynamical moments of inertia. Cranked Strutinsky-Lipkin-Nogami approach, self-consistent treatment of deformation, pairing effects.

94Sk02 *Octupole-Induced Dipole Moments of Very Deformed Nuclei*

J. Skalski, Phys. Rev. C49, 2011 (1994).

Nuclear Structure: ^{224}Ra , ^{192}Hg ; calculated dipole moments vs β_2 , β_3 deformation. 190 , 192 , ^{194}Hg , 192 , 194 , ^{196}Pb ; calculated intrinsic dipole moments at superdeformed shape vs β_3 deformation. Shell correction method.

94Tw01 *Extreme Deformations at High Spin*

P. J. Twin, Nucl. Phys. A574, 51c (1994).

Nuclear Structure: 151 , 152 , ^{153}Dy , 149 , ^{150}Gd , 151 , ^{150}Tb ; compiled, reviewed moment of inertia vs average rotational frequency, other features. Other nuclei, aspects included, extreme deformations at high spins.

94Tw02 *Superdeformed Nuclei*

P. J. Twin, Nuovo Cim. 107A, 1145 (1994).

Nuclear Structure: $A=150-189$; compiled, reviewed data on superdeformed levels, systematics.

94Xu03 *Cranking Bohr-Mottelson Hamiltonian Applied to Superdeformed Bands in A 190 Region*

F. Xu, J. Hu, Phys. Rev. C49, 1449 (1994).

Nuclear Structure: 189 , 191 , ^{192}Hg ; $A=160$; analyzed superdeformed bands data. Cranking Bohr-Mottelson Hamiltonian.

94Zh01 *Superdeformed and Hyperdeformed States in ^{56}Ni*

J. Zhang, A. C. Merchant, W. D. M. Rae, Phys. Rev. C49, 562 (1994).

Nuclear Structure: ^{56}Ni ; calculated superdeformed, hyperdeformed states features. Alpha-cluster model.

- 94Zh40** *Level Spin Assignment of Superdeformed Bands for A 190 Region*
C. Zhou, T. Liu, Chin. J. Nucl. Phys. 16, No 1, 85 (1994).
Nuclear Structure: $^{189, 190, 191, 192, 193, 194}\text{Hg}$, $^{193, 194, 195}\text{Ti}$, $^{192, 194, 196, 198}\text{Pb}$; analyzed superdeformed bands data; deduced J assignment in some cases.
- 95Ba10** *Decay of Superdeformed Structures Studied with GASP*
D. Bazzacco, Nucl. Phys. A583, 191c (1995).
Nuclear Structure: ^{132}Nd , ^{194}Pb ; analyzed high-spin level data, γ -branching ratios, $B(\lambda)$; deduced band mixing role in superdeformed bands decay. GASP array.
- 95Ca07** *Highly Deformed Nuclear Shapes: Recent results from experiment and theory*
M. P. Carpenter, R. V. F. Janssens, Nucl. Phys. A583, 183c (1995).
Nuclear Structure: $^{194, 192}\text{Hg}$; ^{152}Dy ; analyzed level data; deduced high-spin superdeformed, identical bands related features. Other nuclei included.
- 95Ci05** *Spin-Rotor Interpretation of Identical Bands and Quantized Alignment in Superdeformed A 190 Nuclei*
J. A. Cizewski, R. Bijker, J. A. Becker, M. J. Brinkman, E. A. Henry, F. S. Stephens, M. A. Deleplanque, R. M. Diamond, Phys. Rev. C52, 1307 (1995).
Nuclear Structure: $^{191, 192, 193, 194}\text{Hg}$, $^{193, 194}\text{Ti}$, ^{194}Pb ; analyzed identical bands, superdeformed nuclei; calculated level spectra, γ -transition energies. Pseudo-SU(3) symmetries, supersymmetries.
- 95Do22** *Time-Odd Components in the Mean Field of Rotating Superdeformed Nuclei*
J. Dobaczewski, J. Dudek, Phys. Rev. C52, 1827 (1995).
Nuclear Structure: ^{152}Dy , ^{151}Tb , ^{150}Gd ; calculated proton quadrupole moments, dynamical moment of inertia, yrast, superdeformed bands. Hartree-Fock cranking approach, rotation induced time-odd components in mean field.
- 95Do26** *Effects of Pair Correlations in Statistical γ -Decay Spectra*
T. Dossing, T. L. Khoo, T. Lauritsen, I. Ahmad, D. Blumenthal, M. P. Carpenter, B. Crowell, D. Gassmann, R. G. Henry, R. V. F. Janssens, D. Nisius, Phys. Rev. Lett. 75, 1276 (1995).
Nuclear Structure: $^{192, 194, 191}\text{Hg}$; analyzed superdeformed band statistical γ -decay data features; deduced pairing correlation energy related features. Other nuclei included.
- 95Ha30** *Neutron Skin of Nuclei Near the Neutron Drip Line*
I. Hamamoto, X. Z. Zhang, Phys. Rev. C52, R2326 (1995).
Nuclear Structure: ^{152}Dy ; analyzed Hartree-Fock minima density distribution at superdeformed shape. $A=152$; $A=178$; $A=208$; calculated one-neutron levels vs $N=78-110, 94-126, 118-142$ respectively; deduced neutron skin related features. Skyrme type deformed Hartree-Fock calculations.
- 95Ha36** *$\Delta I = 4$ Structure in Superdeformed Rotational Band - Deformation with $C(4v)$*
I. Hamamoto, B. Mottelson, Phys. Scr. T56, 27 (1995).
Nuclear Structure: $A=120$; $A=100$; $A=90$; analyzed yrast quartet splittings for $C(4v)$ Hamiltonian, other aspects, superdeformed bands; deduced $\Delta I=4$ structure related features, model parameters characteristics.
- 95He12** *Microscopic Study of Superdeformation in ^{193}Hg*
P. -H. Heenen, P. Bonche, H. Flocard, Nucl. Phys. A588, 490 (1995).
Nuclear Structure: ^{193}Hg ; calculated superdeformed bands dynamical moment of inertia. Cranked HFB method.
- 95Ku17** *1/N Expansion Formalism for High-Spin States*
S. Kuyucak, S. C. Li, Phys. Lett. 349B, 253 (1995).
Nuclear Structure: $^{190, 192, 194}\text{Hg}$; calculated dynamic moments of inertia; deduced normal, superdeformed nuclei high-spin states analysis implications.
- 95Lu15** *Microscopic Study of a C_2 -Symmetry Hypothesis in a - 150 Superdeformed Nuclei: Deformed Woods-Saxon mean field*
W. D. Luo, A. Bouguettoucha, J. Dobaczewski, J. Dudek, X. Li, Phys. Rev. C52, 2989 (1995).
Nuclear Structure: ^{149}Gd ; calculated equilibrium deformation, superdeformed bands total energies vs spin. ^{153}Dy ; calculated superdeformed bands total energies vs spin. Microscopic study of C_2 symmetry, deformed Wood-Saxon mean field.
- 95Ma01** *C_2 Symmetry Effects in Nuclear Rotational Motion*
A. O. Macchiavelli, B. Cederwall, R. M. Clark, M. A. Deleplanque, R. M. Diamond, P. Fallon, I. Y. Lee, F. S. Stephens, S. Asztalos, Phys. Rev. C51, R1 (1995).
Nuclear Structure: $A=149-238$; analyzed, reviewed $\Delta I=2$ staggering effects in E_γ of superdeformed band transitions. Multiple K-bands mixing approach.
- 95Ma38** *Generator-Coordinate Method Study of Hexadecapole Correlations in Superdeformed ^{194}Hg*
P. Magierski, P. -H. Heenen, W. Nazarewicz, Phys. Rev. C51, R2880 (1995).
Nuclear Structure: ^{194}Hg ; calculated potential energy curve, mass quadrupole moment vs $(Q_{44}(z))$ moment; deduced hexadecapole correlations role in superdeformed band, rotation effect. Skyrme-HFB method, zero-range density-dependent pairing interaction.
- 95Me07** *Quadrupole and Octupole Correlations in Normal, Superdeformed and Hyperdeformed States of ^{194}Pb*
J. Meyer, P. Bonche, M. S. Weiss, J. Dobaczewski, H. Flocard, P. -H. Heenen, Nucl. Phys. A588, 597 (1995).
Nuclear Structure: $^{192, 194, 196, 198, 200}\text{Pb}$; calculated superdeformed band population evolution, spectra, energy curves vs quadrupole moment, quadrupole, octupole correlations in normal, hyperdeformed bands as well. Generator coordinate method.

- 95Mi20** *Microscopic Structure of Octupole Correlations at High-Spin in Superdeformed Open-Shell Nuclei*
S. Mizutori, Y. R. Shimizu, K. Matsuyanagi, Phys. Scr. T56, 276 (1995).
Nuclear Structure: ^{146}Nd , ^{148}Sm , ^{150}Gd , ^{152}Dy , ^{154}Er ; calculated octupole strength function; deduced superdeformed bands octupole softness related features.
- 95Na03** *Octupole Correlations in Excited Bands of Superdeformed ^{152}Dy*
T. Nakatsukasa, K. Matsuyanagi, S. Mizutori, W. Nazarewicz, Phys. Lett. 343B, 19 (1995).
Nuclear Structure: ^{152}Dy ; calculated superdeformed band dynamical moments of inertia; deduced rotation, octupole vibration interplay features. Cranked shell model, RPA.
- 95Na13** *Multicustering and Physics of Exotic Nuclear Shapes*
W. Nazarewicz, S. Cwiok, J. Dobaczewski, J. X. Saladin, Acta Phys. Pol. B26, 189 (1995).
Nuclear Structure: ^{220}Rn , ^{224}Rn , ^{222}Ra , ^{226}Ra , ^{230}Ra , ^{224}Th , ^{228}Th , ^{232}Th , ^{228}U , ^{230}U , ^{234}U ; compiled, reviewed, analyzed potential energy surface predictions; deduced hyperdeformed minimum resemblance to di-nucleus. Multi-cluster model.
- 95Pa02** *C_4 Symmetry and Bifurcation in Superdeformed Bands*
I. M. Pavlichenkov, S. Flibotte, Phys. Rev. C51, R460 (1995).
Nuclear Structure: ^{148}Gd ; analyzed superdeformed band γ -transition data; deduced $\Delta I=2$ staggering effect explanation. Phenomenological $C(4v)$ bifurcation theory.
- 95Ro08** *On the Stability of Rotating Nuclei Against Fission Through Creviced Shapes*
G. Royer, F. Haddad, J. Phys. (London) G21, 339 (1995).
Nuclear Structure: ^{24}Mg , ^{72}Se , ^{132}Ce , ^{191}Hg ; calculated deformation rotational energy vs deformation, compact, crevice shaped path. $A=20-120$; calculated angular momentum, excitation energy, moment of inertia, mass quadrupole moment, hyperdeformed nuclei.
Nuclear Reactions: $^{100}\text{Mo}(^{55}\text{Mn}, X)$, $^{76}\text{Ge}(^{81}\text{Br}, X)$, $^{120}\text{Sn}(^{37}\text{Cl}, X)$, E not given; calculated deformation, rotational energies vs moment of inertia, angular momentum; deduced hyperdeformed states population related features.
- 95Se05** *Magnetic Dipole Transitions in Superdeformed Nuclei*
P. B. Semmes, I. Ragnarsson, S. Aberg, Phys. Lett. 345B, 185 (1995).
Nuclear Structure: ^{194}Hg , ^{194}Tl ; calculated superdeformed, rotational bands $B(\lambda)$. Particle plus rotor model.
- 95St17** *New Results from Gammasphere*
F. S. Stephens, Acta Phys. Pol. B26, 133 (1995).
Nuclear Structure: $Z=80-82$; $Z=64-66$; $Z=57-60$; compiled, reviewed superdeformed band transition pairs energy difference.
Nuclear Reactions: $^{176}\text{Yb}(^{46}\text{Ca}, X)$, $E=250$ MeV; measured production σ for Hf, Yb, Tm, Er isotopes, $\gamma\gamma$ -coin. ^{177}Yb , ^{178}Yb deduced levels, J, π . Deep inelastic collision, Gammasphere.
- 95Su04** *Resurrection of the L-S Coupling Scheme in Superdeformation*
K. Sugawara-Tanabe, A. Arima, N. Yoshida, Phys. Rev. C51, 1809 (1995).
Nuclear Structure: ^{152}Dy , ^{192}Hg ; calculated P-D levels (i.s.) operator eigenvalues near superdeformation, M1 transition rates; deduced real-spin mechanism capability to reproduce unique parity level. Comparison with pseudo-spin mechanisms.
- 95Su21**
Reference unavailable.
- 95Sz03** *On the Origin of Identical Bands in the Superdeformed States of Atomic Nuclei*
Z. Szymanski, Acta Phys. Pol. B26, 175 (1995).
Nuclear Structure: ^{152}Dy , ^{146}Gd , ^{147}Gd , ^{194}Tl , ^{192}Hg ; analyzed superdeformed band characteristics.
- 95Te03** *Superdeformed Rotational Bands with Density Dependent Pairing Interactions*
J. Terasaki, P. -H. Heenen, P. Bonche, J. Dobaczewski, H. Flocard, Nucl. Phys. A593, 1 (1995).
Nuclear Structure: ^{190}Hg , ^{192}Hg , ^{194}Hg , ^{194}Pb ; calculated superdeformed bands charge quadrupole moments, nucleon quasi particle routhians, dynamic moments of inertia. ^{150}Gd ; calculated dynamic moments of inertia.
- 95Tw01** *New Insights into Superdeformed Nuclei with EURO GAM*
P. J. Twin, Nucl. Phys. A583, 199c (1995).
Nuclear Structure: ^{151}Dy , ^{152}Dy , ^{153}Dy , ^{150}Tb , ^{151}Tb , ^{149}Gd , ^{150}Gd ; analyzed data; deduced $\Delta I=4$ staggering in superdeformed bands.
- 95Tw02** *Evidence for Shell Closure at Superdeformed Shape*
P. J. Twin, Phys. Scr. T56, 23 (1995).
Nuclear Structure: ^{151}Dy , ^{152}Dy , ^{153}Dy , ^{150}Tb , ^{151}Tb , ^{149}Gd , ^{150}Gd ; compiled, reviewed yrast superdeformed band dynamic moments of inertia, other data aspects; deduced particle-hole excitations role in superdeformed bands.
- 95We02** *Shape Coexistence Effects of Super- and Hyperdeformed Configurations in Rotating Nuclei II. Nuclei with $42 \leq Z \leq 56$ and $74 \leq Z \leq 92$*
T. R. Werner, J. Dudek, At. Data Nucl. Data Tables 59, 1 (1995).
Nuclear Structure: $Z=42-56$; $Z=74-92$; compiled, reviewed high-spin data; calculated total energies; deduced superdeformed, hyperdeformed configurations shape coexistence features. Macroscopic-microscopic approach.
- 95Wy02** *Blocking Effects at Super-Deformed Shape*
R. Wyss, W. Satula, Phys. Lett. 351B, 393 (1995).
Nuclear Structure: ^{191}Hg , ^{193}Hg , ^{194}Hg , ^{193}Tl , ^{194}Tl , ^{195}Tl , ^{196}Pb ; calculated dynamical moments of inertia, superdeformed bands; deduced blocking effect related features. Cranked Strutinsky pairing, deformations, self-consistent Lipkin-Nogami approach.

95Xu01 *Cranking Bohr-Mottelson Hamiltonian Applied to Superdeformed Bands in the A 150 Region*

F. Xu, J. Hu, Phys. Rev. C52, 431 (1995).

Nuclear Structure: ^{143}Eu , ^{152}Dy ; calculated superdeformed band states transition energies. $^{146, 147, 148, 149, 150}\text{Gd}$, $^{150, 151}\text{Tb}$, $^{151, 152, 153}\text{Dy}$; deduced superdeformed state spin assignments. Cranking Bohr-Mottelson Hamiltonian.

96DeAA

Rotational Inertia of Superdeformed Nuclei: Intruder Orbitals, Pairing, and Identical Bands. De France et al., Phys. Rev. C53, R1070 (1996).

96SuAA

Magnetic Dipole Transitions in Superdeformed Nuclei. Sugawara-Tanabe et al., Phys. Rev. C53, 195 (1996)

96WoAA

The Strength of Electric Monopole Transitions and the Decay out of Superdeformed Bands. Wood et al., Z. Phys. A353, 355 (1996).

References for Superdeformed Bands (Experimental)

82Sc07 Search for Collective Effects in Very High Spin States of ^{152}Dy

Y. Schutz, J. P. Vivien, F. A. Beck, T. Byrski, C. Gehringer, J. C. Merdinger, J. Dudek, W. Nazarewicz, Z. Szymanski, Phys. Rev. Lett. 48, 1534 (1982).

Nuclear Reactions: $^{123}\text{Sn}(^{32}\text{S},\text{xn})$, $E=160$ MeV; measured $\gamma(\theta)$ ratio, $\gamma\gamma(E)$. ^{152}Dy deduced high spin collective effects, superdeformed configuration parameters, moments of inertia. Rotating Woods-Saxon potential.

83Ku16 Suppression of Neutron Emission after Heavy-Ion Fusion: Is shape relaxation affected by a superdeformed minimum (question)

W. Kuhn, P. Chowdhury, R. V. F. Janssens, T. L. Khoo, F. Haas, J. Kasagi, R. M. Ronningen, Phys. Rev. Lett. 51, 1858 (1983).

Nuclear Reactions: $^{92}\text{Zr}(^{64}\text{Ni},\text{xn})$, $E=233$ MeV; measured neutron yield, $n\gamma$, $\gamma\gamma$ -coin, neutron multiplicity, $E\gamma$, $l\gamma$; deduced temperature vs entry state spin, two-neutron emission dominance. ^{150}Er deduced level density, possible superdeformation at high-spin.

84Ny01 Observation of Superdeformation in ^{152}Dy

B. M. Nyako, J. R. Cresswell, P. D. Forsyth, D. Howe, P. J. Nolan, M. A. Riley, J. F. Sharpey-Schafer, J. Simpson, N. J. Ward, P. J. Twin, Phys. Rev. Lett. 52, 507 (1984).

Nuclear Reactions: $^{106}\text{Pd}(^{46}\text{Ca},4\text{n})$, $E=205$ MeV; measured $\gamma\gamma$ -energy correlation. ^{152}Dy deduced dynamical moment of inertia, rotational behavior, deformation, superdeformation characteristics. Bismuth germanate, escape suppressed Ge detectors.

85Be40 Comparison of Cross Sections for C + O Reactions in the Second Regime of Complete Fusion

C. Beck, F. Haas, R. M. Freeman, B. Heusch, J. P. Coffin, G. Guillaume, F. Rami, P. Wagner, Nucl. Phys. A442, 320 (1985).

Nuclear Reactions: ICPND $^{12}\text{C}(^{16}\text{O},\text{X})$, $E=32-140$ MeV; $^{13}\text{C}(^{17}\text{O},\text{X})$, $E=54-140$ MeV; $^{12}\text{C}(^{16}\text{O},\text{X})$, $E=62-150$ MeV; $^{16}\text{O}(^{12}\text{C},\text{X})$, $E=46.5-112.5$ MeV; measured $\sigma(\text{fragment } \theta, E)$ for fragment $Z=3-14$, fusion $\sigma(E)$; deduced critical, grazing angular momenta. ^{28}Si deduced possible superdeformation. Statistical, complete fusion model predictions.

85Tw01 Collectivity of the Superdeformed Bands in ^{152}Dy

P. J. Twin, A. H. Nelson, B. M. Nyako, D. Howe, H. W. Cranmer-Gordon, D. Elenkov, P. D. Forsyth, J. K. Jabber, J. F. Sharpey-Schafer, J. Simpson, G. Sletten, Phys. Rev. Lett. 55, 1380 (1985).

Nuclear Reactions: $^{106}\text{Pd}(^{46}\text{Ca},4\text{n})$, $E=210$ MeV; measured $\gamma\gamma$ -energy correlation. ^{152}Dy deduced rotational band transition $T_{1/2}$, collectivity, superdeformed prolate shape.

86Tw01 Observation of Discrete-Line Superdeformed Band up to $60(\hbar)$ in ^{152}Dy

P. J. Twin, B. M. Nyako, A. H. Nelson, J. Simpson, M. A. Bentley, H. W. Cranmer-Gordon, P. D. Forsyth, D. Howe, A. R. Mokhtar, J. D. Morrison, J. F. Sharpey-Schafer, G. Sletten, Phys. Rev. Lett. 57, 811 (1986).

Nuclear Reactions: $^{106}\text{Pd}(^{46}\text{Ca},4\text{n})$, $E=205$ MeV; measured $E\gamma$, $l\gamma$, $\gamma\gamma$ -energy correlation, $\gamma\gamma$ -coin. ^{152}Dy deduced levels, J , π , γ -branching, yrast sequence, band structure, deformation, superdeformation characteristics.

86Vi05 Search for Superdeformation Effects in ^{144}Gd

J. P. Vivien, A. Nourredine, F. A. Beck, T. Byrski, C. Gehringer, B. Haas, J. C. Merdinger, D. C. Radford, Y. Schutz, J. Dudek, W. Nazarewicz, Phys. Rev. C33, 2007 (1986).

Nuclear Structure: ^{144}Gd ; calculated Routhians, superdeformed configuration temperature, pairing effects. Cranking model, Woods-Saxon fields.

Nuclear Reactions: $^{120}\text{Sn}(^{28}\text{Si},4\text{n})$, $E=125, 135, 145, 155$ MeV; measured γ -spectra, $\gamma(\theta)$, multiplicity distribution, anisotropy. ^{144}Gd level deduced isomer $T_{1/2}$, superdeformation effects.

87Be32 Superdeformed Bands in Nd Nuclei

E. M. Beck, R. J. McDonald, A. O. Macchiavelli, J. C. Bacelar, M. A. Deleplanque, R. M. Diamond, J. E. Draper, F. S. Stephens, Phys. Lett. 195B, 531 (1987).

Nuclear Reactions: $^{96}\text{Mo}(^{40}\text{Ar},4\text{n})$, $E=173$ MeV; $^{100}\text{Mo}(^{40}\text{Ar}, 4\text{n})$, $E=176$ MeV; measured $E\gamma$, $l\gamma$, $\gamma\gamma$ -energy correlations. $^{134}, ^{136}\text{Nd}$ deduced levels, J , π , superdeformed bands, dynamic moments of inertia.

87Be41 Intrinsic Quadrupole Moment of the Superdeformed Band in ^{152}Dy

M. A. Bentley, G. C. Ball, H. W. Cranmer-Gordon, P. D. Forsyth, D. Howe, A. R. Mokhtar, J. D. Morrison, J. F. Sharpey-Schafer, P. J. Twin, B. Fant, C. A. Kalfas, A. H. Nelson, J. Simpson, G. Sletten, Phys. Rev. Lett. 59, 2141 (1987).

Nuclear Reactions: $^{106}\text{Pd}(^{46}\text{Ca},4\text{n})$, $E=205$ MeV; measured $E\gamma$, $l\gamma$, DSA. ^{152}Dy deduced levels, J , effective $T_{1/2}$, band characteristics, superdeformed quadrupole moment, moment of inertia.

87Be57 Superdeformed Band in ^{135}Nd

E. M. Beck, F. S. Stephens, J. C. Bacelar, M. A. Deleplanque, R. M. Diamond, J. E. Draper, C. Duyar, R. J. McDonald, Phys. Rev. Lett. 58, 2182 (1987).

Nuclear Reactions: $^{100}\text{Mo}(^{40}\text{Ar},5\text{n})$, $E=173, 177$ MeV; measured $\gamma\gamma$ -coin. ^{135}Nd deduced levels, J , π , superdeformed band, moment of inertia.

87BeYB Superdeformed Bands in Nd Nuclei

E. M. Beck, R. J. McDonald, A. O. Macchiavelli, J. C. Bacelar, M. A. Deleplanque, R. M. Diamond, J. E. Draper, F. S. Stephens, Proc. Intern. Conf. Nuclear Structure Through Static and Dynamic Moments, Melbourne, Australia, Vol. 1, p. 48 (1987).

Nuclear Reactions: $^{96}\text{Mo}(^{40}\text{Ar},4\text{n})$, $E=173$ MeV; $^{100}\text{Mo}(^{40}\text{Ar}, \text{xn})$, $E=176$ MeV; measured γ -spectra. $^{134}, ^{135}, ^{136}\text{Nd}$ deduced levels, J , π , superdeformed bands.

87De17 Superdeformed Bands at High Spin in $Z = 66$ and 68 Isotopes

M. J. A. de Voigt, J. C. Bacelar, E. M. Beck, M. A. Deleplanque, R. M. Diamond, J. E. Draper, H. J. Riezebos, F. S. Stephens, Phys. Rev. Lett. 59, 270 (1987).

Nuclear Reactions: $^{114}, ^{116}\text{Cd}$, $^{118}, ^{120}\text{Sn}(^{40}\text{Ar}, \text{xn})$, $E=180$ MeV; measured $\gamma\gamma$ -coin, $\gamma\gamma$ -energy correlation spectra. $^{150}, ^{152}\text{Dy}$, $^{154}, ^{156}\text{Er}$ deduced superdeformed bands. Compton suppressed Ge detectors.

Radioactivity: $^{150}, ^{152}\text{Dy}$, $^{154}, ^{156}\text{Er}(\text{EC})$, (β^+); measured $\gamma\gamma$ -energy correlations, $\gamma\gamma$ -coin spectra. $^{150}, ^{152}\text{Dy}$, $^{154}, ^{156}\text{Er}$ deduced superdeformed bands. Compton suppressed Ge detectors.

87DeZT *The β^+ and EC Decay of ^{69}Se Possible Shape-Coexistence and Superdeformation Effects in ^{69}As*

Ph. Dessagne, Ch. Miehé, P. Baumann, A. Huck, J. M. Maison, G. Klotz, M. Ramdane, G. Walter, J. Dudek, Contrib. Proc. 5th Int. Conf. Nuclei Far from Stability, Rosseau Lake, Canada, K10 (1987).

Radioactivity: $^{69}\text{Se}(\beta^+)$, (EC) [from $^{40}\text{Ca}(^{32}\text{S}, n2p)$, $E=100$ MeV]; measured $\gamma\gamma$ -coin; deduced log ft. ^{69}As deduced levels, shape characteristics, γ -branching ratios, superdeformed band.

Nuclear Reactions: $^{40}\text{Ca}(^{32}\text{S}, n2p)$, $E=100$ MeV; measured $p(X\text{-ray})$, $\gamma\gamma$ -coin, $\sigma(\text{Ep})$.

87He16 *Observation of Superdeformation in the Doubly Closed-Shell Nucleus ^{146}Gd*

G. Hebbinghaus, T. Rzaca-Urban, C. Senff, R. M. Lieder, W. Gast, A. Kramer-Flecken, H. Schnare, W. Urban, G. de Angelis, P. Kleinheinz, W. Starzecki, J. Styczen, P. von Brentano, A. Dewald, J. Eberth, W. Lieberz, T. Mylaeus, A. v. d. Werth, H. Wolters, K. O. Zell, S. Heppner, H. Hubel, M. Murzel, H. Grawe, H. Kluge, Phys. Rev. Lett. 59, 2024 (1987).

Nuclear Reactions: $^{110}\text{Pd}(^{40}\text{Ar}, X)$, $E=180$ MeV; measured $\gamma\gamma$ -energy correlation, DSA. ^{146}Gd deduced levels, moment of inertia, deformation, superdeformation characteristics, quadrupole moment, stretched E2 transitions.

87He23 *Population and Decay of the Superdeformed Rotational Band of ^{152}Dy*

B. Herskind, B. Lauritzen, K. Schiffer, R. A. Broglia, F. Barranco, M. Gallardo, J. Dudek, E. Vigezzi, Phys. Rev. Lett. 59, 2416 (1987).

Nuclear Structure: ^{152}Dy ; calculated E1 transition probabilities, superdeformed yrast band.

87HeZJ *Observation of Superdeformation in ^{146}Gd*

G. Hebbinghaus, T. Rzaca-Urban, C. Senff, R. M. Lieder, W. Gast, A. Kramer-Flecken, H. Schnare, W. Urban, G. de Angelis, P. Kleinheinz, W. Starzecki, J. Styczen, P. von Brentano, J. Eberth, W. Lieberz, T. Mylaeus, A. von der Werth, H. Wolters, K. O. Zell, S. Heppner, H. Hubel, M. Murzel, H. Grawe, H. Kluge, Proc. Intern. Conf. Nuclear Structure Through Static and Dynamic Moments, Melbourne, Australia, Vol. 1, p. 3 (1987).

Nuclear Reactions: $^{110}\text{Pd}(^{40}\text{Ar}, 4n)$, $E=180$ MeV; measured γ energy correlations, DSA. ^{146}Gd deduced levels, $T_{1/2}$, superdeformed bands.

87Ki02 *Mean-Lifetime Measurements within the Superdeformed Second Minimum in ^{132}Ce*

A. J. Kirwan, G. C. Ball, P. J. Bishop, M. J. Godfrey, P. J. Nolan, D. J. Thornley, D. J. G. Love, A. H. Nelson, Phys. Rev. Lett. 58, 467 (1987).

Nuclear Reactions: $^{100}\text{Mo}(^{36}\text{S}, 4n)$, $E=150$ MeV; measured E_γ , I_γ , DSA. ^{132}Ce deduced levels, J, π , rotational band structure, $T_{1/2}$, deformation, superdeformation. Bismuth germanate detectors.

Radioactivity: $^{132}\text{Ce}(\text{EC})$ [from $^{100}\text{Mo}(^{36}\text{S}, 4n)$, $E=150$ MeV]; measured E_γ , I_γ , DSA. ^{132}Ce deduced levels, J, π , rotational band structure, $T_{1/2}$, deformation, superdeformation. Bismuth germanate detectors.

87Ma54 *Search for Entrance-Channel Effects in the Production of Superdeformed Nuclei*

A. O. Macchiavelli, M. A. Deleplanque, R. M. Diamond, R. J. McDonald, F. S. Stephens, J. E. Draper, Phys. Rev. C36, 2177 (1987).

Nuclear Reactions: $^{82}\text{Se}(^{74}\text{Ge}, 4n)$, $E=4.6$ MeV/nucleon; measured $\gamma\gamma$ -coin. ^{152}Dy deduced levels, superdeformed band excitation mechanism.

87Rz01 *Search for Superdeformation in ^{160}Os*

T. Rzaca-Urban, R. M. Lieder, W. Gast, W. Urban, J. Bacelar, J. D. Garrett, G. Sletten, R. Chapman, J. C. Lisle, J. N. Mo, Z. Phys. A328, 379 (1987).

Nuclear Reactions: $^{150}\text{Nd}(^{24}\text{S}, 4n)$, $E=158$ MeV; measured $\gamma\gamma$ -energy correlation spectra. ^{160}Os deduced levels, J, π , band structure, moments of inertia, superdeformation axis ratio.

87Sc01 *Search for Superdeformed Shapes in ^{144}Gd*

Y. Schutz, C. Baktash, I. Y. Lee, M. L. Halbert, D. C. Hensley, N. R. Johnson, M. Oshima, R. Ribas, J. C. Lisle, L. Adler, K. Honkanen, D. G. Sarantites, A. J. Larabee, J. X. Saladin, Phys. Rev. C35, 348 (1987).

Radioactivity: $^{144}\text{Gd}(\text{EC})$, (IT) [from $^{120}\text{Sn}(^{28}\text{Si}, 4n)$, $E=145$ MeV]; measured $\gamma\gamma$ -transition energy correlation; deduced moment of inertia, shape characteristics, no evidence for superdeformation. Germanium detectors.

87St15 *γ -Rays Draining the Superdeformed Band in ^{152}Dy*

J. Styczen, R. Menegazzo, W. Starzecki, P. Kleinheinz, Z. Phys. A327, 481 (1987).

Nuclear Reactions: $^{152}\text{Gd}(\alpha, 4n)$, $E=60$ MeV; measured E_γ , I_γ , $\gamma(\theta)$, $\gamma\gamma$ -coin. ^{152}Dy deduced levels, J, π , γ -branching, γ multipolarity, superdeformed band.

87Wa18 *The New Spectroscopy of Superdeformed States: Systematics in the light rare earths and unexpected feeding patterns*

R. Wadsworth, A. Kirwan, D. J. G. Love, Y. -X. Luo, J. -Q. Zhong, P. J. Nolan, P. J. Bishop, M. J. Godfrey, R. Hughes, A. N. James, I. Jenkins, S. M. Mullins, J. Simpson, D. J. Thornley, K. L. Ying, J. Phys. (London) G13, L207 (1987).

Nuclear Reactions: $^{104}\text{Pd}(^{32}\text{S}, 2n2p)$, ($^{32}\text{S}, n2p$), $E=152$ MeV; $^{104}\text{Ru}(^{34}\text{S}, 4n)$, ($^{34}\text{S}, 3n$), $E=155$ MeV; $^{104}\text{Ru}(^{36}\text{S}, 4n)$, ($^{36}\text{S}, 3n$), $E=150$ MeV; $^{104}\text{Ru}(^{34}\text{S}, 4np)$, $E=162$ MeV; $^{106}\text{Pd}(^{34}\text{S}, 4np)$, ($^{34}\text{S}, 4n$), $E=152$ MeV; $^{100}\text{Mo}(^{36}\text{S}, 4n)$, $E=150$ MeV; measured E_γ , I_γ , $\gamma\gamma$ -coin. ^{132}Ce , 133 , 134 , 135 , ^{137}Nd deduced transitions, feeding level J, π , dynamical moments of inertia, superdeformed bands.

88BaZP *Search for Superdeformed Bands in ^{82}Sr*

C. Baktash, G. Garcia-Bermudez, M. L. Halbert, D. C. Hensley, N. R. Johnson, I. Y. Lee, F. K. McGowan, M. A. Riley, A. Virtanen, V. Abenante, D. G. Sarantites, T. M. Semkow, H. C. Griffin, X. T. Liu, Bull. Am. Phys. Soc. 33, No. 8, 1574, BD7 (1988)

Nuclear Reactions: $^{82}\text{Cr}(^{34}\text{S}, 2n2p)$, $E=130$ MeV; measured not given. ^{82}Sr deduced levels, J, π , band structure, no strong evidence for superdeformation.

88BeZG *Lifetimes of the Superdeformed Band in ^{105}Pd*

C. W. Beausang, J. Burde, R. M. Diamond, M. A. Deleplanque, A. O. Macchiavelli, R. J. McDonald, F. S. Stephens, J. E. Draper, Bull. Am. Phys. Soc. 33, No. 8, 1584, CD3 (1988)

Nuclear Reactions: $^{64}\text{Ni}(^{40}\text{Ca}, X)$, $E=190$ MeV; measured γ -spectra. ^{105}Pd deduced superdeformed band, level $T_{1/2}$.

88Bu19 Unusual Rotational Behavior in ^{178}Os

J. Burde, A. O. Macchiavelli, M. A. Deleplanque, R. M. Diamond, F. S. Stephens, C. W. Beausang, R. J. McDonald, J. E. Draper, Phys. Rev. C38, 2470 (1988).

Nuclear Reactions: $^{154}\text{Sm}(^{28}\text{Si},5n)$, $E=150, 155$ MeV; measured $\gamma\gamma$ -coin. ^{178}Os deduced levels, J, π , $I\gamma$, band features.

88CuZY Noyaux en Rotation Rapide et Etats Extrêmes de la Matière Nucleaire: Etude des changements de formes dans les noyaux ^{151}Tb et ^{153}Dy

D. Curien, Thesis, Univ. Louis Pasteur de Strasbourg (1988); CRN/PN 88-17 (1988).

Nuclear Structure: $^{151}, ^{152}\text{Tb}$; analyzed data; deduced superdeformed band characteristics.

88De10 Superdeformed Band in ^{148}Gd : A test of shell effects in the mass-150 region

M. A. Deleplanque, C. Beausang, J. Burde, R. M. Diamond, J. E. Draper, C. Duyar, A. O. Macchiavelli, R. J. McDonald, F. S. Stephens, Phys. Rev. Lett. 60, 1626 (1988).

Nuclear Reactions: $^{104}\text{Ru}(^{48}\text{Ca},4n)$, $E=202, 215$ MeV; $^{124}\text{Sn}(^{28}\text{Si}, 5n)$, $E=157, 150$ MeV; measured γ -spectra, $\gamma\gamma$ -coin. ^{148}Gd deduced levels, J, π , band structure, deformation, superdeformation.

88DeZX Superdeformation in ^{150}Tb

M. A. Deleplanque, C. Beausang, J. Burde, R. M. Diamond, R. J. McDonald, F. S. Stephens, J. E. Draper, Bull. Am. Phys. Soc. 33, No. 8, 1585, CD9 (1988)

Radioactivity: ^{150}Tb ; measured γ -spectra; deduced superdeformation.

88DiZV Quadrupole Moment of Superdeformed Band in ^{135}Nd

R. M. Diamond, M. A. Deleplanque, R. J. McDonald, F. S. Stephens, A. O. Macchiavelli, J. Bacelar, J. Burde, J. L. Draper, C. Duyar, Proc. of the Conf. on High-Spin Nuclear Structure and Novel Nuclear Shapes, April 13-15, 1988, Argonne National Laboratory, Argonne, Illinois; ANL-PHY-88-2, p. 58 (1988).

Nuclear Reactions: $^{100}\text{Mo}(^{40}\text{Ar},5n)$, $E=175$ MeV; measured Doppler shifted $E(\gamma)$, $I(\gamma)$, DSA. ^{135}Nd deduced levels, J, π , band structure, dynamic moment of inertia, superdeformed band quadrupole moment.

88Dr01 Evidence for Superdeformation in ^{148}Gd

M. W. Drigert, R. V. F. Janssens, R. Holzmann, R. R. Chasman, I. Ahmad, J. Borggreen, P. J. Daly, B. K. Dichter, H. Emling, U. Garg, Z. W. Grabowski, T. L. Khoo, W. C. Ma, M. Piiparinen, M. Quader, D. C. Radford, W. Trzaska, Phys. Lett. 201B, 223 (1988).

Radioactivity: $^{148}\text{Gd}(\alpha)$ [from $^{116}\text{Cd}(^{36}\text{S},4n)$, $E=170$ MeV]; measured $E\gamma$, $I\gamma$, $\gamma\gamma$ -coin, energy correlations. ^{148}Gd deduced moment of inertia superdeformation. Compton suppressed Ge detectors. Cranked Strutinsky calculations.

Nuclear Structure: $^{146}, ^{147}, ^{148}, ^{150}, ^{151}, ^{152}, ^{153}, ^{154}, ^{155}, ^{156}\text{Er}$, $^{145}, ^{147}, ^{148}, ^{149}, ^{150}, ^{151}, ^{152}, ^{153}, ^{154}, ^{155}\text{Ho}$, $^{144}, ^{145}, ^{146}, ^{147}, ^{148}, ^{149}, ^{150}, ^{151}, ^{152}, ^{153}\text{Dy}$, $^{143}, ^{144}, ^{145}, ^{146}, ^{147}, ^{148}, ^{149}, ^{150}, ^{151}, ^{152}\text{Gd}$, $^{141}, ^{142}, ^{143}, ^{144}, ^{145}, ^{146}, ^{147}, ^{148}, ^{149}, ^{150}, ^{151}\text{Eu}$, $^{140}, ^{141}, ^{142}, ^{143}, ^{144}, ^{145}, ^{146}, ^{147}, ^{148}, ^{149}, ^{150}\text{Sm}$, $^{139}, ^{140}, ^{141}, ^{142}, ^{143}, ^{144}, ^{145}, ^{146}, ^{147}, ^{148}, ^{149}\text{Pm}$, $^{138}, ^{139}, ^{140}, ^{141}, ^{142}, ^{143}, ^{144}, ^{145}, ^{146}, ^{147}, ^{148}\text{Pr}$, $^{138}, ^{139}, ^{140}, ^{141}, ^{142}, ^{143}, ^{144}, ^{145}, ^{146}, ^{147}, ^{148}\text{Nd}$; calculated moments of inertia. ^{148}Gd deduced superdeformation evidence. Cranked Strutinsky model.

88FIZX Spins and Average Quadrupole Moment of the Superdeformed Band in ^{148}Gd and Evidence for a Superdeformed Band in ^{146}Gd

S. Flibotte, S. Pilotte, F. Banville, S. Coumoyer, J. Gascon, B. Haas, S. Monaro, N. Nadon, D. Prevost, P. Taras, D. Thibault, J. K. Johansson, D. Tucker, J. C. Waddington, H. R. Andrews, G. C. Ball, D. Horn, D. C. Radford, D. Ward, Proc. of the Conf. on High-Spin Nuclear Structure and Novel Nuclear Shapes, April 13-15, 1988, Argonne National Laboratory, Argonne, Illinois; ANL-PHY-88-2, p. 21 (1988).

Nuclear Reactions: $^{124}\text{Sn}(^{30}\text{Si},5n)$, $E=150$ MeV; $^{124}\text{Sn}(^{30}\text{Si}, 6n)$, $E=160$ MeV; $^{124}\text{Sn}(^{28}\text{Si},5n)$, $E=147$ MeV; measured $\gamma\gamma$ -coin, $\gamma\gamma(\theta)$. ^{148}Gd deduced levels, J, π , superdeformed band. ^{149}Gd deduced levels, J, π , superdeformed band, quadrupole moment.

88Ha02 Superdeformed Band up to Spin (127/2) in ^{149}Gd

B. Haas, P. Taras, S. Flibotte, F. Banville, J. Gascon, S. Coumoyer, S. Monaro, N. Nadon, D. Prevost, D. Thibault, J. K. Johansson, D. M. Tucker, J. C. Waddington, H. R. Andrews, G. C. Ball, D. Horn, D. C. Radford, D. Ward, C. St. Pierre, J. Dudek, Phys. Rev. Lett. 60, 503 (1988).

Nuclear Reactions: $^{124}\text{Sn}(^{30}\text{Si},5n)$, $E=150$ MeV; measured $E\gamma$, $I\gamma$, Doppler shift fraction. ^{149}Gd deduced levels, J, π , moment of inertia superdeformed band quadrupole moment.

88HeZO Superdeformation in ^{146}Gd und Gestaltskoexistenz in ^{186}Pt

G. Hebbinghaus, JUL-2208 (1988).

Nuclear Reactions: $^{102}\text{Ru}(^{48}\text{Ca},4n)$, $E=205$ MeV; measured $\gamma\gamma$ -coin, energy correlations, DSA. ^{146}Gd deduced levels, deformation, superdeformation features, static quadrupole moment. $^{186}\text{Os}(\alpha,6n)$, $E=70-90$ MeV; measured $\gamma\gamma$ -coin, energy correlation, $\gamma\gamma(\theta)$, oriented nuclei. ^{186}Pt deduced levels, $I(\gamma)$, J, π , deformation.

88HeZV Study of Superdeformed Shapes in ^{146}Gd

G. Hebbinghaus, T. Rzaca-Urban, C. Senff, G. de Angelis, E. M. Beck, P. von Brentano, J. Eberth, W. Gast, H. Grawe, S. Heppner, D. Howe, H. Hubel, P. Kleinheinz, H. Kluge, A. Kramer-Flecken, W. Lieberz, R. M. Lieder, M. Murzel, T. Mylaeus, B. Nyako, H. Schnare, W. Starzacki, J. Styczen, W. Urban, A. v. d. Werth, R. Wirowski, H. Wolters, K. O. Zell, JUL-Spez-422, p. 32 (1988).

Nuclear Reactions: $^{102}\text{Ru}(^{48}\text{Ca},x_n)$, $E=205$ MeV; measured γ -spectra, energy correlation. ^{146}Gd deduced superdeformed structures.

88JaZT A Superdeformed Band in ^{151}Dy

R. V. F. Janssens, G. -E. Rathke, M. W. Drigert, I. Ahmad, K. Beard, R. R. Chasman, U. Garg, M. Hass, T. L. Khoo, H. -J. Komer, W. C. Ma, S. Pilotte, P. Taras, F. L. H. Wolfs, Proc. of the Conf. on High-Spin Nuclear Structure and Novel Nuclear Shapes, April 13-15, 1988, Argonne National Laboratory, Argonne, Illinois; ANL-PHY-88-2, p. 31 (1988).

Nuclear Reactions: $^{122}\text{Sn}(^{34}\text{S},5n)$, $E=174.5$ MeV; measured γ -multiplicity, summed $\gamma\gamma$ -coin, $I(\gamma)$. ^{151}Dy deduced levels, J, π , rotational superdeformed band, dynamic moment of inertia.

88Ko17 Neutron-Emission Spectra and Superdeformation in Light Nuclei

J. J. Kolata, R. A. Kryger, P. A. DeYoung, F. W. Prosser, Phys. Rev. Lett. 61, 1178 (1988).

Nuclear Reactions: $^{12}\text{C}(^{18}\text{O},x_{np})$, $E=56$ MeV; measured np-coin. ^{28}Si deduced shape transitions, superdeformation.

88Lu01 *A Superdeformed Band in ^{131}Ce*

Y. -X. Luo, J. -Q. Zhong, D. J. G. Love, A. Kirwan, P. J. Bishop, M. J. Godfrey, I. Jenkins, P. J. Nolan, S. M. Mullins, R. Wadsworth, Z. Phys. A329, 125 (1988).

Nuclear Reactions: $^{100}\text{Mo}(^{36}\text{S},5n)$, $^{98}\text{Mo}(^{36}\text{S},3n)$, $E=155$ MeV; measured E_γ , I_γ , $\gamma\gamma$ -coin. ^{131}Ce deduced levels, rotational band, superdeformed band, moment of inertia.

88Ma38 *Superdeformation in 104 , ^{105}Pd*

A. O. Macchiavelli, J. Burde, R. M. Diamond, C. W. Beausang, M. A. Deleplanque, R. J. McDonald, F. S. Stephens, J. E. Draper, Phys. Rev. C38, 1088 (1988).

Nuclear Reactions: $^{64}\text{Ni}(^{48}\text{Ca},4n\alpha)$, $(^{48}\text{Ca},3n\alpha)$, $E=200$ MeV; measured $\gamma\gamma$ -coin, $\gamma\gamma(\theta)$, E_γ , I_γ . 104 , ^{105}Pd deduced levels, J , π , moments of inertia, superdeformation evidence.

88NoAA

Superdeformed Shapes at High Angular Momentum. Nolan and Twin, Ann. Rev. Nucl. Part. Sci. 38, 533 (1988).

88NoZY *Superdeformation in the $A = 130$ -140 Region*

P. J. Nolan, P. J. Bishop, Y. He, M. J. Godfrey, I. Jenkins, A. Kirwan, R. Wadsworth, R. Hughes, S. M. Mullins, D. J. G. Love, Y. -X. Luo, J. -Q. Zhong, J. Simpson, Proc. of the Conf. on High-Spin Nuclear Structure and Novel Nuclear Shapes, April 13-15, 1988, Argonne National Laboratory, Argonne, Illinois; ANL-PHY-88-2, p. 63 (1988).

Nuclear Reactions: $^{100}\text{Mo}(^{36}\text{S},4n)$, $E=150$ MeV; measured $E(\gamma)$, $I(\gamma)$, $\gamma\gamma\gamma$ -coin. $^{105}\text{Pd}(^{32}\text{S}, 2n2p)$, $E=152$ MeV; measured $\gamma\gamma$ -coin, DSA. $^{64}\text{Zn}(^{76}\text{Se}, n2p)$, $E=300$ MeV; measured γ -spectra. ^{132}Ce , ^{132}Nd , ^{137}Sm deduced levels, J , π , band structure, superdeformed bands.

88PiZW *Search for Superdeformed States in the Continuum of ^{149}Gd*

S. Pilotte, P. Taras, F. Banville, S. Flibotte, J. Gascon, B. Haas, H. R. Andrews, D. C. Radford, D. Ward, AECL-9758, p. 3-9 (1988).

Nuclear Reactions: $^{124}\text{Sn}(^{30}\text{Si},6n)$, $(^{30}\text{Si},4n)$, $(^{30}\text{Si}, 5n)$, $E=150$ MeV; measured γ -energy correlation; deduced residuals relative yields. ^{149}Gd deduced superdeformed states.

88Ra19 *A Superdeformed Band in ^{151}Dy*

G. -E. Rathke, R. V. F. Janssens, M. W. Drigert, I. Ahmad, K. Beard, R. R. Chasman, U. Garg, M. Hass, T. L. Khoo, H. -J. Komer, W. C. Ma, S. Pilotte, P. Taras, F. L. H. Wolfs, Phys. Lett. 209B, 177 (1988).

Nuclear Reactions: $^{122}\text{Sn}(^{34}\text{S},5n)$, $E=174.5$ MeV; measured $\gamma\gamma$ -coin, γ multiplicity, E_γ , I_γ . ^{151}Dy deduced levels, J , π , γ -branching, deformation, superdeformation features.

88RzZY *Search for Superdeformation in ^{146}Gd and ^{180}Os*

T. Rzaca-Urban, W. Gast, G. Hebbinghaus, A. Kramer-Flecken, R. M. Lieder, H. Schnare, C. Senff, M. Thoms, W. Urban, G. de Angelis, P. Kleinheinz, W. Starzecki, J. Styczen, P. von Brentano, A. Dewald, J. Eberth, W. Lieberz, T. Mylaeus, A. v. d. Werth, H. Wolters, K. O. Zell, S. Heppner, H. Hubel, M. Murzel, H. Grawe, H. Kluge, K. H. Maier, R. Chapman, J. C. Lisle, J. N. Mo, J. D. Garrett, G. Sletten, J. Bacelar, Proc. of the Conf. on High-Spin Nuclear Structure and Novel Nuclear Shapes, April 13-15, 1988, Argonne National Laboratory, Argonne, Illinois; ANL-PHY-88-2, p. 46 (1988).

Nuclear Reactions: $^{110}\text{Pd}(^{40}\text{Ar},4n)$, $E=180$ MeV; $^{150}\text{Nd}(^{34}\text{S}, 4n)$, $E=157$ MeV; $^{102}\text{Ru}(^{48}\text{Ca},4n)$, $E=205$ MeV; measured $\gamma\gamma(\theta)$, γ -energy correlation, $\gamma\gamma$ -coin. ^{146}Gd , ^{180}Os deduced levels, band structure, superdeformation evidence.

88RzZZ *Search of Superdeformation in ^{180}Os*

T. Rzaca-Urban, R. M. Lieder, W. Gast, W. Urban, J. Bacelar, J. D. Garrett, G. Sletten, R. Chapman, J. C. Lisle, J. N. Mo, JUL-Spez-442, p. 30 (1988).

Nuclear Reactions: $^{150}\text{Nd}(^{34}\text{S},4n)$, $E=158$ MeV; measured $\gamma\gamma$ -coin, energy correlation. ^{180}Os deduced superdeformation possibility.

88ShAA

Escape Suppressed Spectrometer Arrays: A Revolution in Gamma-Ray Spectroscopy. Sharpey-Schafer and Simpson, Prog. Part. Nucl. Phys. 21, 293 (1988)

88StZW *Some Results on γ -Rays Draining the Superdeformed Band in ^{152}Dy*

J. Styczen, H. Guven, W. Urban, G. Hebbinghaus, W. Gast, R. Mene-gazzo, P. Kleinheinz, JUL-Spez-442, p. 52 (1988).

Nuclear Reactions: $^{152}\text{Gd}(\alpha,4n)$, $E=60$ MeV; measured $\gamma\gamma$ -coin, $\gamma(\theta)$, oriented nuclei. ^{152}Dy deduced levels, J , π , γ -branching, superdeformed band.

88Ta20 *Feeding of Discrete-Line Superdeformed Bands at Very High Spin*

P. Taras, S. Flibotte, J. Gascon, B. Haas, S. Pilotte, D. C. Radford, D. Ward, H. R. Andrews, G. C. Ball, F. Banville, S. Courmoyer, D. Horn, J. K. Johansson, S. Monaro, N. Nadon, D. Prevost, C. Pruneau, D. Thibault, D. M. Tucker, J. C. Waddington, Phys. Rev. Lett. 61, 1348 (1988).

Nuclear Reactions: $^{124}\text{Sn}(^{30}\text{Si},4n)$, $(^{30}\text{Si},5n)$, $(^{30}\text{Si}, 6n)$, $(^{30}\text{Si},xn)$, $E=140$ -160 MeV; measured γ yields, γ sum spectra, multiplicities. ^{149}Gd deduced superdeformed band features.

88TwwZ *Superdeformation - Perspectives*

P. J. Twin, Proc. of the Conf. on High-Spin Nuclear Structure and Novel Nuclear Shapes, April 13-15, 1988, Argonne National Laboratory, Argonne, Illinois; ANL-PHY-88-2, p. 83 (1988).

Nuclear Reactions: $^{130}\text{Te}(^{26}\text{Mg},6n)$, $E=145$ MeV; $^{108}\text{Pd}(^{48}\text{Ca}, 4n)$, $E=205$ MeV; measured not given. ^{150}Gd , ^{152}Dy deduced band structure, superdeformation.

88WaZR *A Search for Discrete Line Superdeformed Bands in ^{126}Ba and ^{184}Pt*

J. C. Waddington, J. K. Johansson, D. Rajnauth, D. Tucker, H. R. Andrews, G. C. Ball, D. Hom, D. C. Radford, D. Ward, M. P. Carpenter, V. P. Janzen, L. L. Riedinger, F. Banville, J. Gascon, S. Monaro, N. Nadon, S. Pilotte, D. Prevost, P. Taras, D. Thibault, Proc. of the Conf. on High-Spin Nuclear Structure and Novel Nuclear Shapes, April 13-15, 1988, Argonne National Laboratory, Argonne, Illinois; ANL-PHY-88-2, p. 41 (1988).

Nuclear Reactions: $^{96}\text{Zr}(^{34}\text{S},4n)$, $E=155$ MeV; $^{160}\text{Gd}(^{29}\text{Si}, 5n)$, $E=151$ MeV; measured $\gamma\gamma$ -coin, γ -energy correlations. ^{126}Ba , ^{184}Pt deduced levels, J , π , band structure, possible superdeformation.

89AkZY *Search for Low-Spin Superdeformed States in ^{186}Hg*

Y. A. Akovali, E. A. Henry, J. A. Becker, J. Kormicki, C. R. Bingham, R. Meyer, H. K. Carter, W. Schmidt-Ott, I. C. Girit, Y. -S. Xu, H. Carmichael, ORNL-6508, p. 90 (1989).

Radioactivity: ^{186}Tl ; measured E_γ , I_γ , E_α , I_α , $\alpha\gamma$ -, $\gamma\gamma$ -coin, $\gamma(\theta)$. ^{186}Au , ^{186}Pt , ^{186}Ir , ^{186}Hg deduced transitions, possible superdeformation.

89AkZZ *Search for Low-Spin Superdeformed States in ^{186}Hg and ^{186}Hg*

Y. A. Akovali, H. K. Carter, W. D. Hamilton, I. C. Girit, J. Breitenbach, C. R. Bingham, W. Schmidt-Ott, R. L. Knight, J. M. Bauer, J. A. Becker, E. A. Henry, R. A. Meyer, N. Roy, J. Kormicki, Bull. Am. Phys. Soc. 34, No. 8, 1816, CC4 (1989)

Radioactivity: $^{186}\text{Tl}(\beta^+)$; measured not given. ^{186}Hg deduced levels, J , shape characteristics, possible superdeformation.

89AIZS *The De-Excitation of the Superdeformed Band in ^{152}Dy*

A. Alderson, P. J. Twin, M. A. Bentley, A. M. Bruce, P. Fallon, P. D. Forsyth, D. Howe, J. W. Roberts, J. F. Sharpey-Schafer, Daresbury Lab., 1988-1989 Ann. Rept., Appendix, p. 50 (1989).

Nuclear Reactions: $^{108}\text{Pd}(^{48}\text{Ca},4n)$, $E=197$ MeV; measured $\gamma\gamma$ -coin, energy correlations. ^{152}Dy deduced levels, J , π , superdeformed band.

89BaZC *Search for Superdeformed Bands in ^{82}Sr*

C. Baktash, M. A. Riley, G. Garcia-Bermudez, A. Virtanen, M. L. Halbert, V. Abenante, D. C. Hensley, D. G. Sarantites, N. R. Johnson, T. M. Semkow, I. Y. Lee, H. C. Griffin, F. K. McGowan, X. T. Liu, ORNL-6508, p. 75 (1989).

Nuclear Reactions: $^{52}\text{Cr}(^{34}\text{S},2n2p)$, $E=130$ MeV; measured $\gamma\gamma$ -coin. ^{82}Sr deduced levels, J , π , moments of inertia, band structure, possible superdeformation.

89BeYO *Lifetimes and Line-Shapes in the Superdeformed Band of ^{152}Dy*

M. A. Bentley, N. Rowley, K. Schiffer, P. D. Forsyth, H. W. Cranmer-Gordon, D. Howe, A. R. Mokhtar, J. D. Morrison, J. F. Sharpey-Schafer, P. J. Twin, Daresbury Lab., 1988-1989 Ann. Rept., Appendix, p. 55 (1989).

Nuclear Reactions: $^{108}\text{Pd}(^{48}\text{Ca},4n)$, $E=205$ MeV; analyzed data. ^{152}Dy deduced superdeformed band features.

89BeYP *The Population Mechanism of the Superdeformed Band in ^{152}Dy*

M. A. Bentley, A. Alderson, P. Fallon, P. D. Forsyth, J. D. Morrison, J. W. Roberts, J. F. Sharpey-Schafer, P. J. Twin, B. M. Nyako, C. A. Kafas, Daresbury Lab., 1988-1989 Ann. Rept., Appendix, p. 52 (1989).

Nuclear Reactions: $^{108}\text{Pd}(^{48}\text{Ca},4n)$, $E=195$ - 212 MeV; measured $\gamma\gamma$ -coin. ^{152}Dy deduced levels, J , π , superdeformed band, level population intensities. Comparison with other data.

89BeZD *Evidence for Superdeformation at $N=80$, $Z=64$*

Ph. Benet, P. J. Daly, I. Ahmad, P. Fernandez, T. Happ, R. V. F. Janssens, T. L. Khoo, E. F. Moore, F. L. H. Wolfs, M. W. Drigert, K. B. Beard, D. Ye, Bull. Am. Phys. Soc. 34, No. 8, 1824, DC2 (1989)

Nuclear Reactions: $^{98}\text{Mo}(^{50}\text{Ti},xn)$, $E=219$ MeV; measured $\gamma(\theta)$; deduced $N=80$, $Z=64$ superdeformation.

89De10 *Superdeformation in the Odd-Odd Nucleus ^{150}Tb : Experimental search for superdeformed configurations*

M. A. Deleplanque, C. W. Beausang, J. Burde, R. M. Diamond, F. S. Stephens, R. J. McDonald, J. E. Draper, Phys. Rev. C39, 1651 (1989).

Nuclear Reactions: $^{124}\text{Sn}(^{31}\text{P},X)$, $E=160$ MeV; measured $E(\gamma)$, $I(\gamma)$, $\gamma\gamma(\theta)$, $\gamma\gamma$ -coin. ^{150}Tb deduced levels, J , π , deformation, band structure, superdeformed band.

89Fa02 *Superdeformed Bands in ^{150}Gd and ^{151}Tb : Evidence for the influence of high- N intruder states at large deformations*

P. Fallon, P. Alderson, M. A. Bentley, A. M. Bruce, P. D. Forsyth, D. Howe, J. W. Roberts, J. F. Sharpey-Schafer, P. J. Twin, F. A. Beck, T. Byrski, D. Curien, C. Schuck, Phys. Lett. 218B, 137 (1989).

Nuclear Reactions: $^{130}\text{Te}(^{28}\text{Mg},6n)$, $E=145$ MeV; $^{130}\text{Te}(^{27}\text{Al}, 6n)$, $E=150$ MeV; measured $\gamma\gamma$ -coin, $\gamma(\theta)$. ^{150}Gd , ^{151}Tb deduced levels, J , π , superdeformed band structure, shapes, moments of inertia.

89Go13 *The Proton Structure of the Superdeformed Bands in the $N=73$ Isotones ^{130}La , ^{131}Ce and ^{132}Nd*

M. J. Godfrey, Y. He, I. Jenkins, A. Kirwan, P. J. Nolan, R. Wadsworth, S. M. Mullins, J. Phys. (London) G15, L163 (1989).

Nuclear Reactions: $^{51}\text{V}(^{82}\text{Se},3n)$, $E=290$ MeV; measured $\gamma\gamma$ -coin. ^{130}La deduced levels, superdeformed band structure, shape features, moments of inertia.

89GoZR *A Superdeformed Band in ^{130}La*

M. J. Godfrey, Y. He, I. Jenkins, A. Kirwan, P. J. Nolan, R. Wadsworth, S. M. Mullins, Daresbury Lab., 1988-1989 Ann. Rept., Appendix, p. 30 (1989).

Nuclear Reactions: $^{51}\text{V}(^{82}\text{Se},3n)$, $E=290$ MeV; measured $\gamma\gamma$ -coin. ^{130}La deduced levels, J , π , superdeformed band structure.

89HeYZ *Search for Low-Spin Superdeformed States in ^{184}Hg*

E. A. Henry, C. R. Bingham, Y. A. Akovali, W. D. Schmidt-Ott, J. A. Becker, R. A. Meyer, H. K. Carter, Y. S. Xu, J. Kormicki, H. V. Carmichael, ORNL-6508, p. 150 (1989).

Radioactivity: ^{184}Tl ; measured E_γ , I_γ , $\gamma\gamma$ -, $\alpha\gamma$ -coin, E_α , I_α . ^{184}Hg deduced levels, possible superdeformation.

89HeZI *Mean Lifetime Measurements in the Superdeformed Band in ^{131}Ce*

Y. He, M. J. Godfrey, I. Jenkins, P. J. Nolan, R. Wadsworth, S. M. Mullins, J. R. Hughes, Daresbury Lab., 1988-1989 Ann. Rept., Appendix, p. 32 (1989).

Nuclear Reactions: $^{100}\text{Mo}(^{36}\text{S},5n)$, $E=155$ MeV; measured centroid shifts. ^{131}Ce deduced levels, superdeformed quadrupole moment.

89HeZR *Discovery of a Discrete Superdeformed Band in ¹⁴⁶Gd*

G. Hebbinghaus, K. Strahle, T. Rzaca-Urban, D. Alber, D. Balabanski, E. M. Beck, P. von Brentano, W. Gast, J. Eberth, H. Hubel, H. Kluge, A. Kramer-Flecken, R. M. Lieder, H. Maier, W. Schmitz, M. Thoms, W. Urban, H. Wolters, K. O. Zell, JUL-Spez-499, p. 28 (1989).

Nuclear Structure: ¹⁴⁶Gd; analyzed data; deduced discrete superdeformed band in ¹⁴⁶Gd.

89Jo04 *Multiple Superdeformed Bands in ¹⁵³Dy*

J. K. Johansson, H. R. Andrews, T. Bengtsson, A. Djaafri, T. E. Drake, S. Flibotte, A. Galindo-Uribarri, D. Hom, V. P. Janzen, J. A. Kuehner, S. Monaro, N. Nadon, S. Pilotte, D. Prevost, D. C. Radford, I. Ragnars-son, P. Taras, A. Tehami, J. C. Waddington, D. Ward, S. Aberg, Phys. Rev. Lett. 63, 2200 (1989).

Nuclear Reactions: ¹²⁴Sn(³⁴S,5n), E not given; measured $\gamma\gamma$ -coin, sum spectra. ¹⁵³Dy deduced levels, J, π , moment of inertia, band structure, deformation, superdeformation features.

89KoZL *Superdeformation a Spin Nul dans ¹⁸⁹Pt*

A. Korichi, Ch. Bourgeois, N. Perrin, H. Sergolle, M. G. Porquet, F. Hannachi, G. Bastin, N. Redon, M. Meyer, R. Beraud, Ph. Quentin, H. Hubel, Univ. Paris, Inst. Phys. Nucl., 1989 Ann. Rept., p. E33 (1989).

Nuclear Reactions: ¹⁷⁸Yb(¹⁶O,5n), E=145 MeV; measured γ -spectra. ¹⁸⁹Pt deduced levels, J, π .

89LaZY *DSA of γ -Rays from the Highly Deformed Band in ¹³¹Ce*

A. Lampinen, R. Julin, A. Pakkanen, P. Ahonen, J. Hattula, S. Juutinen, and the ESSA-30 Collaboration, JYFL Ann. Rept., 1987-1988, p. 73 (1989).

Nuclear Reactions: ⁹⁸Mo(³⁶S,3n), E=143, 150 MeV; measured DSA. ¹³¹Ce deduced levels, J, π , band structure.

89LiZV *A Search for Superdeformation in ⁸⁶Zr*

C. J. Lister, P. Chowdhury, P. Ennis, B. Crowell, H. R. Andrews, D. Hom, D. C. Radford, D. Ward, S. Pilotte, J. C. Waddington, J. K. Johansson, AECL-9859, p. 3-5 (1989).

Nuclear Reactions: ⁶⁰Ni(³⁰Si,2n2p), E=135 MeV; measured γ -multiplicities. 8 π spectrometer; deduced possible superdeformation ef-fects.

89Ma32 *High-Spin Structures in ¹³⁷Sm: Role of the β -driving ν_{132} intruder in deformation enhancement*

R. Ma, C. W. Beausang, E. S. Paul, W. F. Piel, Jr., S. Shi, N. Xu, D. B. Fossan, J. Burde, M. A. Deleplanque, R. M. Diamond, A. O. Macchiavelli, F. S. Stephens, Phys. Rev. C40, 156 (1989).

Nuclear Reactions: ¹⁰⁴Pd(³⁷Cl,3np), E=170 MeV; measured E_{γ} , I_{γ} , $\gamma\gamma(\theta)$, $\gamma(t)$. ¹³⁷Sm deduced levels, J, π , band structures, B(λ) ratios. Cranked shell model, quasiparticle configurations.

89Mo08 *Observation of Superdeformation in ¹⁹¹Hg*

E. F. Moore, R. V. F. Janssens, R. R. Chasman, I. Ahmad, T. L. Khoo, F. L. H. Wolfs, D. Ye, K. B. Beard, U. Garg, M. W. Drigert, Ph. Benet, Z. W. Grabowski, J. A. Cizewski, Phys. Rev. Lett. 63, 360 (1989).

Nuclear Reactions: ¹⁶⁰Gd(³⁶S,5n), E=172 MeV; measured $\gamma\gamma$ -coin. ¹⁹¹Hg deduced superdeformed band structure, shape characteristics.

89MoZS *Feeding of the Superdeformed Band in ¹⁹¹Hg*

E. F. Moore, R. V. F. Janssens, D. Ye, M. P. Carpenter, P. Fernandez, I. Ahmad, K. B. Beard, Ph. Benet, R. R. Chasman, M. D. Drigert, T. L. Khoo, F. L. H. Wolfs, Bull. Am. Phys. Soc. 34, No. 8, 1816, CC5 (1989)

Nuclear Structure: ¹⁹¹Hg; measured not given; deduced superdeformed band feeding features.

89MoZX *Feeding of the Superdeformed Band in ¹⁵²Dy*

E. F. Moore, I. Ahmad, M. Hass, R. V. F. Janssens, T. L. Khoo, H. -J. Korner, W. C. Ma, G. -E. Rathke, F. L. H. Wolfs, U. Garg, D. Ye, K. Beard, Z. Grabowski, M. W. Drigert, Bull. Am. Phys. Soc. 34, No. 4, 1234, J8 6 (1989)

Nuclear Reactions: ¹²⁰Sn(³⁶S,4n), E=172 MeV; measured not given. ¹⁵²Dy deduced levels, band structure, deformation, superdeformation features.

89MuZR *Normal and Highly Deformed Rotational Bands in ¹⁵⁵Sm and ¹⁵³Nd*

S. M. Mullins, Thesis, Univ. York (1989).

Nuclear Reactions: ⁶⁴Zn(⁷⁴Se,n2p), E=290 MeV; ⁹²Mo(⁴⁶Ti, n2p), E=210 MeV; ¹⁰⁴Pd(³²S,n2p), E=152 MeV; measured $\gamma\gamma$ -coin, DSA. ¹⁵⁵Sm deduced levels, band structure, configuration. ¹⁵³Nd deduced levels, J, π , superdeformed band, quadrupole moment. Cranked shell model, total Routhian surface calculations.

89NyZX *Search for Superdeformation in ¹²⁹La*

B. M. Nyako, S. Andre, D. Bameoud, F. A. Beck, H. El-Samman, C. Foin, J. Genevey, A. Gizon, J. Gizon, M. Jozsa, J. C. Merdinger, L. Zolnai, ATOMKI 1988 Ann. Rept., p. 16 (1989).

Nuclear Reactions: ¹⁰⁰Mo(³⁴S,4np), E=165 MeV; measured $\gamma\gamma$ -coin. ¹²⁹La deduced levels, band structure, possible superdeformation.

89RaZX *Search for a Second Superdeformed Band in ¹³³Nd*

D. C. Radford, H. R. Andrews, B. Herskind, J. F. Sharpey-Schafer, S. Pilotte, S. Flibotte, D. Prevost, J. K. Johansson, J. C. Waddington, AECL-9859, p. 3-8 (1989).

Nuclear Reactions: ¹¹⁰Pd(²⁸Si,5n), E=151, 155 MeV; measured $\gamma\gamma$ -coin, γ -multiplicity, sum spectra. ¹³³Nd deduced levels, J, π , band structure, shape, no evidence for second superdeformed band.

89RoZS *Search for a Superdeformed Band in ¹⁹²Hg*

N. Roy, J. A. Becker, E. A. Henry, J. A. Cizewski, M. J. Brinkman, C. Beausang, M. A. Deleplanque, R. M. Diamond, F. S. Stephens, J. E. Draper, Bull. Am. Phys. Soc. 34, No. 8, 1816, CC7 (1989)

Nuclear Reactions: ¹⁷⁶Yb(²²Ne,6n), E=122 MeV; measured γ -spectra. ¹⁹²Hg deduced levels, superdeformed band structure, moment of inertia.

89Sc02 *Lifetimes and Lineshapes in Superdeformed Bands*

K. Schiffer, B. Herskind, J. Gascon, Z. Phys. A332, 17 (1989).

Nuclear Structure: ¹⁵²Dy; calculated levels, $T_{1/2}$, B(λ), I(γ); deduced normal, superdeformed state mixing. Statistical model, Monte Carlo simulation.

89Sc30 γ Decay of the Superdeformed Shape Isomer in ^{236}U

J. Schirmer, J. Gerl, D. Habs, D. Schwalm, Phys. Rev. Lett. 63, 2196 (1989).

Nuclear Reactions: $^{235}\text{U}(d,p)$, $E=11$ MeV; measured γ time spectra, missing energy vs delayed sum energy. ^{236}U deduced isomer, decay, superdeformation features, γ -decay to fission branching ratio.

89ScZS Search for Superdeformation in ^{180}Os

H. Schnare, T. Rzaca-Urban, D. Balabanski, W. Gast, G. Hebbinghaus, A. Kramer-Flecken, R. M. Lieder, W. Urban, K. H. Maier, G. Sletten, JUL-Spez-499, p. 41 (1989).

Nuclear Reactions: $^{150}\text{Nd}(^{34}\text{S},4n)$, $E=158$ MeV; measured E_γ , $\gamma\gamma$ -coin, γ -multiplicities, $\gamma\gamma$ -energy correlation. ^{180}Os deduced levels, band deformation, superdeformation features.

89Ta12 Additional Superdeformed States in the Continuum of ^{149}Gd

P. Taras, S. Flibotte, J. Gascon, B. Haas, S. Pilotte, D. C. Radford, D. Ward, H. R. Andrews, F. Banville, J. K. Johansson, J. C. Waddington, Phys. Lett. 222B, 357 (1989).

Nuclear Reactions: $^{124}\text{Sn}(^{30}\text{Si},5n)$, $E=150$ MeV; analyzed data. ^{149}Gd deduced levels, J, π , superdeformation.

89Wi19 High Spin States in ^{78}Kr : Approaching superdeformation in the $A = 80$ Region

D. F. Winchell, M. S. Kaplan, J. X. Saladin, H. Takai, J. J. Kolata, J. Dudek, Phys. Rev. C40, 2672 (1989).

Nuclear Reactions: $^{46}\text{Ti}(^{32}\text{S},n2p)$, $E=97$ MeV; measured $\gamma\gamma$ -coin. ^{78}Kr deduced levels, J, π , moment of inertia, possible superdeformation. Cranked HFB calculations.

Nuclear Structure: ^{78}Kr ; calculated Routhians, moments of inertia; deduced possible superdeformation. Cranked HFB.

89Zu01 Non-Yrast States in ^{152}Dy Around $22(h\text{-bar})$, the Region into which the Discrete Superdeformed Band Drains

K. Zuber, E. Bozek, F. A. Beck, P. Benet, T. Byrski, D. Curien, G. Duchene, C. Gehringer, B. Haas, A. Kreiner, J. C. Merdinger, P. Romain, J. P. Vivien, Z. Phys. A332, 231 (1989).

Nuclear Reactions: $^{124}\text{Sn}(^{32}\text{S},4n)$, $E=132$ MeV; measured $\gamma\gamma$ -coin. ^{152}Dy deduced levels, J, π , superdeformed band drainage.

90AaZZ Superdeformed Band in ^{146}Gd : First observation of band crossing

S. Aaberg, D. Alber, D. Balabanski, E. M. Beck, T. Bengtsson, P. von Brentano, J. Eberth, W. Gast, G. Hebbinghaus, H. Hubel, R. M. Lieder, K. H. Maier, E. Ott, I. Ragnarsson, T. Rzaca-Urban, W. Schmitz, H. Schnare, K. Strahle, J. Theuerkauf, W. Urban, H. Wolters, K. O. Zell, JUL-Spez-562, p. 55 (1990).

Nuclear Reactions: $^{110}\text{Pd}(^{40}\text{Ar},4n)$, $E=175$ MeV; measured E_γ , I_γ , $\gamma(t)$, $\gamma\gamma$ -correlation matrix. ^{146}Gd deduced levels, J, π , superdeformed band structure.

90AIZY Population of the Superdeformed Continuum in ^{152}Dy

A. Alderson, P. Fallon, P. D. Forsyth, D. Howe, J. W. Roberts, J. F. Sharpey-Schafer, P. J. Twin, M. A. Bentley, A. M. Bruce, Daresbury Labs., 1989-1990 Ann. Rept., Appendix, p. 49 (1990).

Nuclear Reactions: $^{108}\text{Pd}(^{48}\text{Ca},xn)$, $E=197$ MeV; measured $\gamma\gamma$ -coin. ^{152}Dy deduced superdeformed continuum features.

90AIZZ The Collectivity of the Superdeformed Band in ^{152}Dy at the Point of De-Excitation

A. Alderson, I. Ali, D. M. Cullen, P. Fallon, P. D. Forsyth, M. A. Riley, J. W. Roberts, J. F. Sharpey-Schafer, P. J. Twin, M. A. Bentley, A. M. Bruce, Daresbury Labs., 1989-1990 Ann. Rept., Appendix, p. 47 (1990).

Nuclear Reactions: $^{108}\text{Pd}(^{48}\text{Ca},xn)$, $E=197$ MeV; measured DSA, γ -multiplicity, transition fractional Doppler shifts. ^{152}Dy deduced superdeformed band quadrupole moment.

90Az03 Superdeformed Bands in ^{184}Tl

F. Azaiez, W. H. Kelly, W. Korten, M. A. Deleplanque, F. S. Stephens, R. M. Diamond, C. W. Beausang, J. A. Becker, E. A. Henry, J. E. Draper, M. J. Brinkman, S. W. Yates, A. Kuhnert, E. Rubel, Z. Phys. A336, 243 (1990).

Nuclear Reactions: $^{176}\text{Yb}(^{22}\text{Ne},5n)$, $(^{23}\text{Ne},4n)$, $(^{23}\text{Ne},6n)$, $E=116, 122$ MeV; $^{181}\text{Ta}(^{16}\text{O},6n)$, $(^{16}\text{O},5n)$, $(^{16}\text{O},4n)$, $E=95-104$ MeV; measured $\gamma\gamma$ -coin. ^{184}Tl deduced levels, J, π , superdeformed band structure.

90Az06 Superdeformed Bands in ^{184}Tl

F. Azaiez, W. H. Kelly, W. Korten, M. A. Deleplanque, F. S. Stephens, R. M. Diamond, C. W. Beausang, J. A. Becker, E. A. Henry, J. E. Draper, M. J. Brinkman, S. W. Yates, A. Kuhnert, E. Rubel, Nucl. Phys. A520, 121c (1990).

Nuclear Reactions: $^{176}\text{Yb}(^{23}\text{Ne},4n)$, $(^{23}\text{Ne},5n)$, $(^{23}\text{Ne},6n)$, $E=116, 122$ MeV; $^{181}\text{Ta}(^{16}\text{O},X)$, $E=95-104$ MeV; measured $\gamma\gamma$ -coin. ^{184}Tl deduced levels, superdeformed band structure.

90Be01 Observation of Superdeformation in ^{192}Hg

J. A. Becker, N. Roy, E. A. Henry, M. A. Deleplanque, C. W. Beausang, R. M. Diamond, J. E. Draper, F. S. Stephens, J. A. Cizewski, M. J. Brinkman, Phys. Rev. C41, R9 (1990).

Nuclear Reactions: $^{176}\text{Yb}(^{22}\text{Ne},6n)$, $E=122$ MeV; measured $\gamma\gamma$ -coin. ^{192}Hg deduced levels, J, π , superdeformed band structure. HERA detector array.

90Be11 Observation of Superdeformed Bands in ^{194}Hg

C. W. Beausang, E. A. Henry, J. A. Becker, N. Roy, S. W. Yates, M. A. Deleplanque, R. M. Diamond, F. S. Stephens, J. E. Draper, W. H. Kelly, J. Burde, R. J. McDonald, E. Rubel, M. J. Brinkman, J. A. Cizewski, Y. A. Akovali, Z. Phys. A335, 325 (1990).

Nuclear Reactions: $^{150}\text{Nd}(^{48}\text{Ca},4n)$, $(^{48}\text{Ca},5n)$, $E=195-210$ MeV; measured $\gamma\gamma$ -, $\gamma\gamma$ -coin. ^{194}Hg deduced levels, J, π , superdeformed band structure.

90Br10 Superdeformation in Lead Nuclei

M. J. Brinkman, A. Kuhnert, E. A. Henry, J. A. Becker, S. W. Yates, R. M. Diamond, M. A. Deleplanque, F. S. Stephens, W. Korten, F. Azaiez, W. H. Kelly, J. E. Draper, C. W. Beausang, E. Rubel, J. A. Cizewski, Z. Phys. A336, 115 (1990).

Nuclear Reactions: $^{176}\text{Yb}(^{24}\text{Mg},xn)$, $E=122-132$ MeV; measured $\gamma\gamma$ -coin. $^{194}, ^{196}\text{Pb}$ deduced levels, J, π , superdeformed band structure.

90BrZN Superdeformed Bands in ^{193}Hg

M. J. Brinkman, E. A. Henry, C. W. Beausang, J. A. Becker, N. Roy, S. W. Yates, R. M. Diamond, M. A. Deleplanque, F. S. Stephens, J. E. Draper, W. H. Kelly, R. J. McDonald, J. Burde, A. Kuhnert, W. Korten, E. Rubel, J. A. Cizewski, Y. A. Akovali, Proc. Inter. Conf. Nuclear Structure of the Nineties, Oak Ridge, Tennessee, Vol. 1, p. 5 (1990).

Nuclear Reactions: $^{176}\text{Yb}(^{22}\text{Ne},5n)$, $^{150}\text{Nd}(^{48}\text{Ca}, 5n)$, E not given; measured γ -spectra. ^{193}Hg deduced levels, J, π , superdeformed band structure.

90BrZQ Search for Superdeformed Bands in Lead

M. J. Brinkman, J. A. Cizewski, A. Kuhnert, E. A. Henry, J. A. Becker, S. W. Yates, R. M. Diamond, M. A. Deleplanque, F. S. Stephens, R. J. McDonald, W. Korten, F. Azaiez, W. H. Kelly, C. W. Beausang, J. E. Draper, E. Rubel, Bull. Am. Phys. Soc. 35, No. 6, 1398, H6 14 (1990).

Nuclear Reactions: $^{176}\text{Yb}(^{24}\text{Mg},xn)$, E=122, 127, 132 MeV; measured E_{γ} . 194 , ^{196}Pb deduced superdeformed band structure.

90BrZX Search for Superdeformed Bands in ^{193}Hg

M. J. Brinkman, J. A. Cizewski, E. A. Henry, J. A. Becker, N. Roy, S. W. Yates, A. Kuhnert, C. W. Beausang, R. M. Diamond, M. A. Deleplanque, F. S. Stephens, R. J. McDonald, J. Burde, W. Korten, J. E. Draper, E. Rubel, W. H. Kelly, Y. A. Akovali, Bull. Am. Phys. Soc. 35, No. 4, 1017, H6 11 (1990).

Nuclear Reactions: $^{176}\text{Yb}(^{22}\text{Ne},5n)$, $^{150}\text{Nd}(^{48}\text{Ca}, 5n)$, E not given; measured E_{γ} . ^{193}Hg deduced levels, J, π , superdeformed band structure.

90By01 Observation of Identical Superdeformed Bands in $N = 86$ Nuclei

T. Byrski, F. A. Beck, D. Curien, C. Schuck, P. Fallon, A. Alderson, I. Ali, M. A. Bentley, A. M. Bruce, P. D. Forsyth, D. Howe, J. W. Roberts, J. F. Sharpey-Schafer, G. Smith, P. J. Twin, Phys. Rev. Lett. 64, 1650 (1990).

Nuclear Reactions: $^{130}\text{Te}(^{28}\text{Mg},6n)$, E=145 MeV; $^{130}\text{Te}(^{27}\text{Al}, 6n)$, E=150 MeV; measured $\gamma\gamma$ -coin, sum spectra. ^{150}Gd , ^{151}Tb deduced levels, J, π , superdeformed band structure.

90Ca18 Excited Superdeformed Bands in ^{191}Hg

M. P. Carpenter, R. V. F. Janssens, E. F. Moore, I. Ahmad, P. B. Fernandez, T. L. Khoo, F. L. H. Wolfs, D. Ye, K. B. Beard, U. Garg, M. W. Drigert, Ph. Benet, R. Wyss, W. Satula, W. Nazarewicz, M. A. Riley, Phys. Lett. 240B, 44 (1990).

Nuclear Reactions: $^{160}\text{Gd}(^{36}\text{S},5n)$, E=167, 172 MeV; measured $\gamma\gamma$ -coin. ^{191}Hg deduced levels, J, π , superdeformed band structure.

90Ca37 Evidence of Time Delay in the Decay of the Superdeformed Bands of 191 , ^{192}Hg

M. P. Carpenter, D. Ye, R. V. F. Janssens, T. L. Khoo, I. Ahmad, K. B. Beard, Ph. Benet, J. A. Cizewski, M. W. Drigert, P. Fernandez, U. Garg, E. F. Moore, F. L. H. Wolfs, Nucl. Phys. A520, 133c (1990).

Nuclear Reactions: $^{160}\text{Gd}(^{36}\text{S},4n)$, $(^{36}\text{S},5n)$, E=167 MeV; measured $\gamma\gamma$ -coin. 191 , ^{192}Hg deduced levels, J, π , superdeformed band decay time delay.

90Cu05 Landau-Zener Crossing in Superdeformed ^{193}Hg : Evidence for octupole correlations in superdeformed nuclei

D. M. Cullen, M. A. Riley, A. Alderson, I. Ali, C. W. Beausang, T. Bengtsson, M. A. Bentley, P. Fallon, P. D. Forsyth, F. Hanna, S. M. Mullins, W. Nazarewicz, R. J. Poynter, P. H. Regan, J. W. Roberts, W. Satula, J. F. Sharpey-Schafer, J. Simpson, G. Sletten, P. J. Twin, R. Wadsworth, R. Wyss, Phys. Rev. Lett. 65, 1547 (1990).

Nuclear Reactions: $^{150}\text{Nd}(^{48}\text{Ca},5n)$, E=205, 213 MeV; measured E_{γ} , I_{γ} , $\gamma\gamma$ -coin. ^{193}Hg deduced levels, J, π , superdeformed band structure, shape features.

90Cu06 Evidence for Octupole Softness of the Superdeformed Shape from Band Interactions in 193 , ^{194}Hg

D. M. Cullen, M. A. Riley, A. Alderson, I. Ali, T. Bengtsson, M. A. Bentley, A. M. Bruce, P. Fallon, P. D. Forsyth, F. Hanna, S. M. Mullins, W. Nazarewicz, R. Poynter, P. Regan, J. W. Roberts, W. Satula, J. F. Sharpey-Schafer, J. Simpson, G. Sletten, P. J. Twin, R. Wadsworth, R. Wyss, Nucl. Phys. A520, 105c (1990).

Nuclear Reactions: $^{150}\text{Nd}(^{48}\text{Ca},4n)$, E=205 MeV; $^{150}\text{Nd}(^{48}\text{Ca}, 5n)$, E=213 MeV; measured $\gamma\gamma$ -coin. 193 , ^{194}Hg deduced levels, J, π , superdeformed band structure.

90Di01 Line Shape and Lifetimes in the ^{152}Nd Superdeformed Band

R. M. Diamond, C. W. Beausang, A. O. Macchiavelli, J. C. Bacelar, J. Burde, M. A. Deleplanque, J. E. Draper, C. Duyar, R. J. McDonald, F. S. Stephens, Phys. Rev. C41, R1327 (1990).

Nuclear Reactions: $^{100}\text{Mo}(^{40}\text{Ar},5n)$, E=175 MeV; measured $\gamma\gamma$ -coin, DSA. ^{152}Nd deduced levels, J, π , superdeformed band features, transition quadrupole moment.

90DrZZ Search for Superdeformation in ^{190}Hg

M. W. Drigert, I. Ahmad, M. P. Carpenter, P. Fernandez, R. V. F. Janssens, T. L. Khoo, E. F. Moore, F. L. H. Wolfs, D. Ye, K. Beard, U. Garg, Ph. Benet, Bull. Am. Phys. Soc. 35, No. 4, 1016, H6 8 (1990).

Nuclear Reactions: $^{160}\text{Gd}(^{34}\text{S},4n)$, E=159 MeV; measured γ -spectra. ^{190}Hg deduced levels, superdeformed band features.

90Fe07 Proton Excitations in the Superdeformed Well of ^{192}Tl

P. B. Fernandez, M. P. Carpenter, R. V. F. Janssens, I. Ahmad, E. F. Moore, T. L. Khoo, F. Scarlassara, I. G. Bearden, Ph. Benet, P. J. Daly, M. W. Drigert, U. Garg, W. Reviol, D. Ye, S. Pilotte, Nucl. Phys. A517, 386 (1990).

Nuclear Reactions: $^{160}\text{Gd}(^{37}\text{Cl},4n)$, E=167 MeV; measured E_{γ} , I_{γ} , $\gamma\gamma$ -coin. ^{192}Tl deduced levels, J, π , rotational, superdeformed bands characteristics. Enriched targets, Ge detectors, array of Compton suppressed spectrometers, 4π bismuth germanate array. Cranked Woods-Saxon calculations.

90GaZO The Role of Charged Particles in the Population of the ^{133}Nd Superdeformed Band

A. Galindo-Uribarri, T. K. Alexander, H. R. Andrews, G. C. Ball, T. E. Drake, S. Flibotte, J. S. Forster, V. P. Janzen, J. K. Johansson, S. Pilotte, D. Prevost, D. C. Radford, P. Taras, J. Waddington, D. Ward, G. Zwartz, Proc. Inter. Conf. Nuclear Structure of the Nineties, Oak Ridge, Tennessee, Vol. 1, p. 14 (1990).

Nuclear Reactions: $^{105}\text{Pd}(^{32}\text{S},X)$, E=155 MeV; measured (charged particle) γ -coin, $p\gamma\gamma$ -coin. ^{133}Nd deduced superdeformed band.

90Ha25 Feeding of the Superdeformed Yrast Band in ^{149}Gd

B. Haas, J. P. Vivien, S. K. Basu, F. A. Beck, Ph. Benet, T. Byrski, D. Curien, G. Duchene, C. Gehringer, H. Kluge, J. C. Merdinger, P. Romain, D. Santos, S. Flibotte, J. Gascon, P. Taras, E. Bozek, K. Zuber, Phys. Lett. 245B, 13 (1990).

Nuclear Reactions: $^{124}\text{Sn}(^{30}\text{Si},5n)$, $E=150-160$ MeV; measured γ -spectra. ^{149}Gd deduced superdeformed yrast band relative $I\gamma$.

90Ha31 Observation of Excited Proton and Neutron Configurations in the Superdeformed ^{149}Gd Nucleus

B. Haas, D. Ward, H. R. Andrews, G. C. Ball, T. E. Drake, S. Flibotte, A. Galindo-Uribarri, V. P. Janzen, J. K. Johansson, H. Kluge, J. Kuehner, A. Omar, S. Pilotte, D. Prevost, J. Rodriguez, D. C. Radford, P. Taras, J. P. Vivien, J. C. Waddington, S. Aberg, Phys. Rev. C42, R1817 (1990).

Nuclear Reactions: $^{124}\text{Sn}(^{30}\text{Si},5n)$, $E=155$ MeV; $^{124}\text{Sn}(^{31}\text{P}, 5n)$, $E=156$ MeV; measured γ -spectra, $\gamma\gamma$ -coin. ^{149}Gd deduced levels, J , π , superdeformed band structure.

90He09 Superdeformed Bands in ^{193}Hg and ^{194}Hg

E. A. Henry, M. J. Brinkman, C. W. Beausang, J. A. Becker, N. Roy, S. W. Yates, J. A. Cizewski, R. M. Diamond, M. A. Deleplanque, F. S. Stephens, J. E. Draper, W. H. Kelly, R. J. McDonald, J. Burde, A. Kuhnert, W. Korten, E. Rubel, Y. A. Akovali, Z. Phys. A335, 361 (1990).

Nuclear Reactions: $^{176}\text{Yb}(^{22}\text{Ne},5n)$, $(^{22}\text{Ne},6n)$, $E=116, 122$ MeV; $^{150}\text{Nd}(^{46}\text{Ca},5n)$, $(^{46}\text{Ca},4n)$, $E=195-210$ MeV; measured $\gamma\gamma$ -coin. $^{193}, ^{194}\text{Hg}$ deduced levels, J , π , superdeformed band structure.

90He12 Quadrupole Moment of the Superdeformed Band in ^{131}Ce

Y. He, M. J. Godfrey, I. Jenkins, A. J. Kirwan, P. J. Nolan, S. M. Mullins, R. Wadsworth, D. J. G. Love, J. Phys. (London) G16, 657 (1990).

Nuclear Reactions: $^{100}\text{Mo}(^{36}\text{S},5n)$, $E=155$ MeV; measured $\gamma\gamma$ -coin, DSA. ^{131}Ce deduced levels, J , π , mean $T_{1/2}$, β_2 , superdeformed intrinsic quadrupole moment, band structure.

90He14 Superdeformed Band in ^{146}Gd . First Observation of Band Crossing

G. Hebbinghaus, K. Strahle, T. Rzaca-Urban, D. Balabanski, W. Gast, R. M. Lieder, H. Schnare, W. Urban, H. Wolters, E. Ott, J. Theuerkauf, K. O. Zell, J. Eberth, P. von Brentano, D. Alber, K. H. Maier, W. Schmitz, E. M. Beck, H. Hubel, T. Bengtsson, I. Ragnarsson, S. Aberg, Phys. Lett. 240B, 311 (1990).

Nuclear Reactions: $^{110}\text{Pd}(^{40}\text{Ar},4n)$, $E=180$ MeV; measured γ -multiplicity, sum spectra, DSA. ^{146}Gd deduced levels, J , π , $T_{1/2}$, superdeformed band structure.

90He23 Properties of Superdeformed Bands in the $A = 194$ Region

E. A. Henry, J. A. Becker, M. J. Brinkman, A. Kuhnert, S. W. Yates, M. A. Deleplanque, R. M. Diamond, F. S. Stephens, C. W. Beausang, W. H. Kelly, W. Korten, F. Azaiez, J. E. Draper, E. Rubel, J. A. Cizewski, Y. A. Akovali, Nucl. Phys. A520, 115c (1990).

Nuclear Reactions: $^{150}\text{Nd}(^{46}\text{Ca},5n)$, $E=200, 205, 210$ MeV; $^{176}\text{Yb}(^{22}\text{Ne}, 5n)$, $E=110, 116, 122$ MeV; measured $\gamma\gamma\gamma$ -coin, relative $I\gamma$. ^{193}Hg deduced levels, superdeformed band structure.

90Hu10 Superdeformation in ^{194}Pb

H. Hubel, K. Theine, D. Mehta, W. Schmitz, P. Willsau, C. X. Yang, F. Hannachi, D. B. Fossan, H. Grawe, H. Kluge, K. H. Maier, Nucl. Phys. A520, 125c (1990).

Nuclear Reactions: $^{158}\text{Gd}(^{40}\text{Ar},4n)$, $E=178-188$ MeV; measured $\gamma\gamma$ -coin, $I\gamma$. ^{194}Pb deduced superdeformed band structure, moments of inertia vs rotational frequency.

90Kh06 Population of Superdeformed Bands, the Competition with Fission, and the Barrier between Normal and Superdeformed States

T. L. Khoo, R. V. F. Janssens, E. F. Moore, K. B. Beard, Ph. Benet, I. Ahmad, M. P. Carpenter, R. R. Chasman, P. J. Daly, M. W. Drigert, U. Garg, Z. W. Grabowski, F. L. H. Wolfs, D. Ye, Nucl. Phys. A520, 169c (1990).

Nuclear Reactions: $^{160}\text{Gd}(^{36}\text{S},4n)$, $E=154-172$ MeV; $^{120}\text{Sn}(^{36}\text{S}, 4n)$, $E=170$ MeV; measured $\gamma\gamma$ -coin, γ -multiplicity. ^{152}Dy , ^{192}Hg deduced superdeformed band level entry, feeding spin features.

90Li32 Band Crossing in the Superdeformed Band of ^{146}Gd

R. M. Lieder, Nucl. Phys. A520, 59c (1990).

Nuclear Reactions: $^{110}\text{Pd}(^{40}\text{Ar},4n)$, $E=175$ MeV; measured γ -multiplicity, DSA, $I\gamma$. ^{146}Gd deduced levels, superdeformed band structure, Nilsson assignments.

90Ma53 An i_{132} Intruder Band in ^{139}Gd

R. Ma, D. B. Fossan, E. S. Paul, N. Xu, R. J. Poynter, P. H. Regan, R. Wadsworth, Y. -J. He, I. Jenkins, M. S. Metcalfe, S. M. Mullins, P. J. Nolan, J. Phys. (London) G16, 1233 (1990).

Nuclear Reactions: $^{92}\text{Mo}(^{50}\text{Cr},n2p)$, $E=220$ MeV; measured $\gamma\gamma(\theta)$, oriented nuclei. ^{139}Gd deduced levels, J , π , band structure.

90MeZX The Search for Hyperdeformation in ^{163}Er

M. S. Metcalfe, P. Fallon, Y. He, I. Jenkins, C. Lowndes, P. J. Nolan, J. Simpson, Daresbury Labs., 1989-1990 Ann. Rept., Appendix, p. 55 (1990).

Nuclear Reactions: $^{82}\text{Se}(^{82}\text{Se},n)$, $E=290, 310$ MeV; measured cascade γ -multiplicity; deduced possible hyperdeformation.

90Mo16 Lifetime Measurements in the Superdeformed Band of ^{192}Hg

E. F. Moore, R. V. F. Janssens, I. Ahmad, M. P. Carpenter, P. B. Fernandez, T. L. Khoo, S. L. Ridley, F. L. H. Wolfs, D. Ye, K. B. Beard, U. Garg, M. W. Drigert, Ph. Benet, P. J. Daly, R. Wyss, W. Nazarewicz, Phys. Rev. Lett. 64, 3127 (1990).

Nuclear Reactions: $^{160}\text{Gd}(^{36}\text{S},4n)$, $E=159$ MeV; measured $\gamma\gamma$ -coin, DSA. ^{192}Hg deduced levels, $T_{1/2}$, $B(E2)$, transition quadrupole moment, J , π , superdeformed band structure.

90MoZS Population of Superdeformed States and Competition with Fission

E. F. Moore, R. V. F. Janssens, T. L. Khoo, I. Ahmad, M. P. Carpenter, R. R. Chasman, F. L. H. Wolfs, K. B. Beard, D. Ye, U. Garg, Ph. Benet, P. J. Daly, Z. W. Grabowski, M. W. Drigert, Bull. Am. Phys. Soc. 35, No. 8, 1657, BC 9 (1990)

Nuclear Reactions: $^{160}\text{Gd}(^{36}\text{S},4n)$, $E=154-172$ MeV; measured not given. ^{192}Hg deduced normal level, superdeformed states entry point comparison.

90MuZY A Superdeformed Band in ^{142}Eu

S. M. Mullins, P. Fallon, S. A. Forbes, Y. -J. He, M. S. Metcalfe, P. J. Nolan, E. S. Paul, P. H. Regan, R. Wadsworth, Daresbury Lab., 1989-1990 Ann. Rept., Appendix, p. 37 (1990).

Nuclear Reactions: $^{110}\text{Pd}(^{37}\text{Cl},5n)$, $E=160$ MeV; measured $\gamma\gamma$ -coin. ^{142}Eu deduced superdeformed band structure.

90Ri05 Multiple Superdeformed Bands in ^{194}Hg and Their Dynamical Moments of Inertia

M. A. Riley, D. M. Cullen, A. Alderson, I. Ali, P. Fallon, P. D. Forsyth, F. Hanna, S. M. Mullins, J. W. Roberts, J. F. Sharpey-Schafer, P. J. Twin, R. Poynter, R. Wadsworth, M. A. Bentley, A. M. Bruce, J. Simpson, G. Stetten, W. Nazarewicz, T. Bengtsson, R. Wyss, Nucl. Phys. A512, 178 (1990).

Nuclear Reactions: $^{150}\text{Nd}(^{48}\text{Ca},4n)$, $E=205$ MeV; measured E_γ , I_γ , $\gamma\gamma$ -coin. ^{194}Hg deduced levels, J , π , rotational, superdeformed band characteristics. Enriched targets, Ge detectors, array of anti-Compton spectrometers, 4π bismuth germanate ball. Cranked Woods-Saxon and Nilsson model calculations.

90Sc31 The Population of Superdeformed Bands in the $A = 150$ Region by Compound Reactions

K. Schiffer, B. Herskind, Nucl. Phys. A520, 521c (1990).

Nuclear Reactions: $^{124}\text{Sn}(^{30}\text{Si},4n)$, $^{120}\text{Sn}(^{26}\text{S}, 4n)$, E not given; $^{108}\text{Pd}(^{40}\text{Ca},4n)$, $E=185-205$ MeV; analyzed data; deduced superdeformed band population mechanism.

90St12 Spin Alignment in Superdeformed Hg Nuclei

F. S. Stephens, M. A. Deleplanque, J. E. Draper, R. M. Diamond, C. W. Beausang, W. Korten, W. H. Kelly, F. Azaiez, J. A. Becker, E. A. Henry, N. Roy, M. J. Brinkman, J. A. Cizewski, S. W. Yates, A. Kuhnert, Phys. Rev. Lett. 64, 2623 (1990).

Radioactivity: 192 , ^{194}Hg ; analyzed spectra; deduced superdeformed band spin alignment.

90Th01 Superdeformation in ^{194}Pb

K. Theine, F. Hannachi, P. Willsau, H. Hubel, D. Mehta, W. Schmitz, C. X. Yang, D. B. Fossan, H. Grawe, H. Kluge, K. H. Maier, Z. Phys. A336, 113 (1990).

Nuclear Reactions: $^{158}\text{Gd}(^{40}\text{Ar},4n)$, $E=180, 188$ MeV; measured $\gamma\gamma$ -coin. ^{194}Pb deduced levels, J , π , superdeformed band structure, dynamic moment of inertia.

90Tw02 Superdeformation - An Experimental Overview

P. J. Twin, Nucl. Phys. A520, 17c (1990).

Compilation: $A=152$; compiled, reviewed data on superdeformation.

90Wa24 Studies in Superdeformation at Chalk River

D. Ward, Nucl. Phys. A520, 139c (1990).

Nuclear Reactions: $^{124}\text{Sn}(^{30}\text{Si},5n)$, $E=155$ MeV; $^{124}\text{Sn}(^{31}\text{P}, 5n)$, $E=156$ MeV; $^{105}\text{Pd}(^{32}\text{S},2p)$, $(^{32}\text{S}, 2n)$, $E=155$ MeV; compiled $\gamma\gamma$ -coin data. ^{149}Gd , ^{150}Tb deduced band structure, deformation, superdeformation features. 8π spectrometer.

90Ye01 Superdeformed Band in ^{192}Hg

D. Ye, R. V. F. Janssens, M. P. Carpenter, E. F. Moore, R. R. Chasman, I. Ahmad, K. B. Beard, Ph. Benet, M. W. Drigert, P. B. Fernandez, U. Garg, T. L. Khoo, S. L. Ridley, F. L. H. Wolfs, Phys. Rev. C41, R13 (1990).

Nuclear Reactions: $^{160}\text{Gd}(^{36}\text{S},4n)$, $E=162$ MeV; measured $\gamma\gamma$ -coin. ^{192}Hg deduced levels, J , π , superdeformed band structure.

90Zu02 Superdeformed Bands in $^{147}\text{Gd}_{207}$ a Possible Test of the Existence of Octupole Correlations in Superdeformed Bands

K. Zuber, D. Balouka, F. A. Beck, Th. Byrski, D. Curien, G. Duchene, C. Gehringer, B. Haas, J. C. Meringer, P. Romain, D. Santos, J. Styczen, J. P. Vivien, J. Dudek, Z. Szymanski, T. Werner, Nucl. Phys. A520, 195c (1990).

Nuclear Reactions: $^{122}\text{Sn}(^{30}\text{Si},5n)$, $E=155$ MeV; measured E_γ , I_γ . ^{147}Gd deduced levels, superdeformed band structure.

91Az03 Six 'Identical' Superdeformed Bands in ^{194}Tl

F. Azaiez, W. H. Kelly, W. Korten, F. S. Stephens, M. A. Deleplanque, R. M. Diamond, A. O. Macchiavelli, J. E. Draper, E. C. Rubel, C. W. Beausang, J. Burde, J. A. Becker, E. A. Henry, S. W. Yates, M. J. Brinkman, A. Kuhnert, T. F. Wang, Phys. Rev. Lett. 66, 1030 (1991).

Nuclear Reactions: $^{181}\text{Ta}(^{18}\text{O},4n)$, $(^{18}\text{O},5n)$, $(^{18}\text{O}, 6n)$, $E=95, 100, 104$ MeV; measured $\gamma\gamma$ -coin. ^{194}Tl deduced levels, superdeformed bands.

91Az04 Superdeformed Bands in ^{195}Tl

F. Azaiez, W. H. Kelly, W. Korten, M. A. Deleplanque, F. S. Stephens, R. M. Diamond, J. E. Draper, A. O. Macchiavelli, E. Rubel, J. de Boer, M. Rohn, J. A. Becker, E. A. Henry, M. J. Brinkman, S. W. Yates, A. Kuhnert, T. F. Wang, Z. Phys. A338, 471 (1991).

Nuclear Reactions: $^{181}\text{Ta}(^{18}\text{O},xn)$, $E=95-104$ MeV; $^{186}\text{W}(^{15}\text{N}, 5n)$, $(^{15}\text{N},6n)$, $E=90, 95$ MeV; measured $\gamma\gamma$ -coin. ^{195}Tl deduced superdeformed bands.

91Be12 Gamma-Ray Spectroscopy of Superdeformed States in the Nucleus ^{152}Dy

M. A. Bentley, A. Alderson, G. C. Ball, H. W. Cranmer-Gordon, P. Fallon, B. Fant, P. D. Forsyth, B. Herskind, D. Howe, C. A. Kalfas, A. R. Mokhtar, J. D. Morrison, A. H. Nelson, B. M. Nyako, K. Schiffer, J. F. Sharpey-Schafer, J. Simpson, G. Stetten, P. J. Twin, J. Phys. (London) G17, 481 (1991).

Nuclear Reactions: $^{108}\text{Pd}(^{40}\text{Ca},4n)$, $E=205$ MeV; measured E_γ , I_γ , $\gamma\gamma$ -coin, $\gamma\gamma(\theta)$, DSA. ^{152}Dy deduced levels, J , π , superdeformed band, intrinsic T_{12} quadrupole moment. Microscopic structure, Nilsson, Woods-Saxon models comparison, Monte Carlo simulations.

91Be48 Very Elongated Nuclei Near $A = 194$

J. A. Becker, E. A. Henry, S. W. Yates, T. F. Wang, A. Kuhnert, M. J. Brinkman, J. A. Cizewski, M. A. Deleplanque, R. M. Diamond, F. S. Stephens, F. Azaiez, W. Korten, J. E. Draper, Nucl. Instrum. Methods Phys. Res. B56/57, 500 (1991)

Nuclear Structure: $A=194$; 192 , ^{194}Hg ; compiled, reviewed data; deduced new superdeformation region.

91BeZM *Entry Spin Distributions for Superdeformed and Normal States in ^{182}Hg*

Ph. Benet, T. L. Khoo, K. Beard, E. F. Moore, I. Ahmad, M. P. Carpenter, P. J. Daly, M. W. Drigert, P. B. Fernandez, U. Garg, Z. W. Grabowski, R. V. F. Janssens, S. L. Ridley, J. Winn, F. L. H. Wolfs, D. Ye, *Bull. Am. Phys. Soc.* 36, No. 4, 1387, M10 3 (1991)

Nuclear Reactions: $^{160}\text{Gd}(^{36}\text{S},4n)$, $E=154-172$ MeV; measured not given. ^{182}Hg deduced normal, superdeformed states spin distribution.

91BrZX *A Search for Superdeformed Oblate States in ^{24}Mg*

J. D. Brown, A. Martinez-Davalos, K. Ioannides, W. D. M. Rae, A. E. Smith, S. J. Bennett, M. Freer, B. R. Fulton, J. T. Murgatroyd, G. J. Gyapong, N. S. Jarvis, C. D. Jones, D. L. Watson, Daresbury Lab., 1990-1991 Ann. Rept., Appendix, p. 67 (1991).

Nuclear Reactions: $^{10}\text{B}(^{28}\text{Si},^{24}\text{Mg})$, E not given; measured (particle)(particle)-coin total energy spectra following ejectile breakup, search for superdeformation evidence.

91CuZY 192 , ^{193}Hg *Superdeformation Population with Light Ion Beams*

D. M. Cullen, M. A. Riley, I. Ali, C. W. Beausang, P. Fallon, P. D. Forsyth, F. Hanna, S. M. Mullins, J. F. Sharpey-Schafer, G. Smith, R. J. Poynter, R. Wadsworth, Daresbury Lab., 1990-1991 Ann. Rept., Appendix, p. 41 (1991).

Nuclear Reactions: $^{186}\text{W}(^{13}\text{C},6n)$, $E=92$ MeV; $^{186}\text{W}(^{13}\text{C}, 7n)$, $E=105$ MeV; measured $\gamma\gamma$ -energy correlations. $^{192}\text{Gd}(^{36}\text{S},4n)$, $E=162$ MeV; measured not given. 192 , ^{193}Hg deduced levels, J, π , superdeformed bands.

91Dr04 *Superdeformed Bands in 189 , ^{190}Hg*

M. W. Drigert, M. P. Carpenter, R. V. F. Janssens, E. F. Moore, I. Ahmad, P. B. Fernandez, T. L. Khoo, F. L. H. Wolfs, I. G. Bearden, Ph. Benet, P. J. Daly, U. Garg, W. Reviol, D. Ye, R. Wyss, *Nucl. Phys. A530*, 452 (1991).

Nuclear Reactions: $^{160}\text{Gd}(^{34}\text{S},xn)$, $E=159, 162$ MeV; measured $E_\gamma, I_\gamma, \gamma\gamma$ -coin, DSA. 189 , ^{190}Hg deduced levels, $J, \pi, T_{1/2}$, superdeformed band characteristics. Enriched targets, Ge detectors, array of anti-Compton spectrometers, 4π bismuth germanate ball. Cranked Woods-Saxon model calculations.

91Fa07 *The Collectivity and the De-Excitation of the Yrast Superdeformed Band in ^{150}Gd*

P. Fallon, A. Alderson, I. Ali, D. M. Cullen, P. D. Forsyth, M. A. Riley, J. W. Roberts, J. F. Sharpey-Schafer, P. J. Twin, M. A. Bentley, A. M. Bruce, *Phys. Lett.* 257B, 269 (1991).

Nuclear Reactions: $^{130}\text{Te}(^{26}\text{Mg},6n)$, $E=145$ MeV; measured $\gamma\gamma$ -coin spectra, DSA. ^{150}Gd deduced levels, J, π , deformation, superdeformation, band structure, quadrupole moment.

91FaZY *An Experiment to Search for Superdeformation in ^{186}Pb*

P. Fallon, C. W. Beausang, P. Butler, N. Clarkson, D. M. Cullen, F. Hanna, T. Hoare, S. M. Mullins, M. A. Riley, J. W. Roberts, G. Smith, R. Wadsworth, R. J. Poynter, M. A. Bentley, A. M. Bruce, J. Simpson, B. Cederwall, B. Fant, L. O. Norlin, Daresbury Lab., 1990-1991 Ann. Rept., Appendix, p. 45 (1991).

Nuclear Reactions: $^{164}\text{Dy}(^{36}\text{S},5n)$, $E=165$ MeV; measured $\gamma\gamma$ -energy correlation. ^{186}Pb deduced no superdeformation evidence.

91HaZY *Rotational Bands in the Odd-Odd ^{132}Pr Nucleus*

C. V. Hampton, A. Rios, R. M. Ronningen, W. A. Olivier, Wm. C. McHarris, *Bull. Am. Phys. Soc.* 36, No. 4, 1361, K10 6 (1991)

Nuclear Reactions: $^{100}\text{Mo}(^{37}\text{Cl},5n)$, $E=160$ MeV; measured $\gamma\gamma$ -coin spectra. ^{132}Pr deduced transitions, possible superdeformation.

91He11 *Observation of Superdeformed Band in ^{192}Pb*

E. A. Henry, A. Kuhnert, J. A. Becker, M. J. Brinkman, T. F. Wang, J. A. Cizewski, W. Korten, F. Azaiez, M. A. Deleplanque, R. M. Diamond, J. E. Draper, W. H. Kelly, A. O. Macchiavelli, F. S. Stephens, *Z. Phys.* A338, 469 (1991).

Nuclear Reactions: $^{173}\text{Yb}(^{24}\text{Mg},5n)$, $E=128, 132$ MeV; measured $\gamma\gamma$ -coin. ^{192}Pb deduced levels, J, π , superdeformed band dynamic moment of inertia.

91JaAA

Superdeformed Nuclei. Janssens and Khoo, *Ann. Rev. Nucl. Part. Sci.* 41, 321 (1991).

91KuZT *Superdeformed Band in ^{196}Pb*

A. Kuhnert, J. A. Becker, E. A. Henry, S. W. Yates, T. F. Wang, M. J. Brinkman, J. A. Cizewski, R. M. Diamond, M. A. Deleplanque, F. S. Stephens, C. W. Beausang, A. O. Macchiavelli, W. H. Kelly, W. Korten, F. Azaiez, J. E. Draper, E. Rubel, *Bull. Am. Phys. Soc.* 36, No. 4, 1388, M10 6 (1991)

Nuclear Reactions: $^{176}\text{Yb}(^{24}\text{Mg},4n)$, $(^{26}\text{Mg},6n)$, E not given; measured not given. ^{196}Pb deduced levels, superdeformed band structure.

91Ma09 *Search for the Discrete Non-Yrast States in ^{152}Dy Around 86 ns Isomer, the Region into which the γ -Rays Drain the Super-Deformed Band*

N. Mansour, *Appl. Radiat. Isot.* 42, 395 (1991).

Nuclear Reactions: $^{122}\text{Sn}(^{35}\text{Cl},4np)$, $E=167$ MeV; measured $E_\gamma, I_\gamma, \gamma\gamma$ -coin. ^{152}Dy deduced levels, J, π , superdeformed band structure.

91Mo11 *K X-Ray Yields Associated with the Superdeformed Band of ^{192}Hg*

E. F. Moore, R. V. F. Janssens, I. Ahmad, M. P. Carpenter, A. M. Baxter, M. E. Bleich, P. B. Fernandez, T. Lauritsen, T. L. Khoo, I. G. Bearden, Ph. Benet, P. J. Daly, U. Garg, W. Reviol, D. Ye, *Phys. Lett.* 258B, 284 (1991).

Nuclear Reactions: $^{160}\text{Gd}(^{36}\text{S},4n)$, $E=159$ MeV; measured γ -, X-ray spectra, $\gamma(X\text{-ray})$ -coin, X-ray yields. ^{192}Hg ; deduced no strong superdeformed band E0 decay.

91Mu08 *Superdeformation and Double Blocking in ^{142}Eu*

S. M. Mullins, R. A. Wyss, P. Fallon, T. Byrski, D. Curien, S. A. Forbes, Y. -J. He, M. S. Metcalfe, P. J. Nolan, E. S. Paul, R. J. Poynter, P. H. Regan, R. Wadsworth, *Phys. Rev. Lett.* 66, 1677 (1991).

Nuclear Reactions: $^{110}\text{Pd}(^{37}\text{Cl},5n)$, $E=160$ MeV; measured $\gamma\gamma$ -coin sum spectra. ^{142}Eu deduced levels, superdeformed band.

91Rz01 *Excited Superdeformed Band in ^{146}Gd*

T. Rzaca-Urban, K. Strahle, G. Hebbinghaus, D. Balabanski, W. Gast, R. M. Lieder, H. Schnare, W. Urban, P. von Brentano, A. Dewald, J. Eberth, E. Ott, J. Theuerkauf, H. Wolters, K. O. Zell, D. Alber, K. H. Maier, E. M. Beck, H. Hubel, W. Schmitz, Z. Phys. A339, 421 (1991).

Nuclear Reactions: $^{110}\text{Pd}(^{40}\text{Ar},4n)$, $E=175$ MeV; measured $\gamma\gamma$ -coin, summed spectra. ^{146}Gd deduced superdeformed band.

91RzZZ *Search for Superdeformation in ^{145}Gd*

T. Rzaca-Urban, R. M. Lieder, K. Strahle, D. Balabanski, W. Gast, A. Georgiev, H. Schnare, M. Binderberger, M. Eschenauer, S. Freund, E. Ott, J. Theuerkauf, H. Wolters, K. O. Zell, J. Eberth, P. von Brentano, K. H. Maier, H. Grawe, C. Bach, R. Schubart, KFA-IKP Ann. Rept., 1990, p. 23 (1991).

Nuclear Reactions: $^{110}\text{Pd}(^{40}\text{Ar},4n)$, $(^{40}\text{Ar},5n)$, $E=189, 200$ MeV; measured E_γ , I_γ , γ -multiplicity, DSA. $^{145}, ^{146}\text{Gd}$ deduced superdeformed bands.

91ThZY *Nuclear Dissipation and the Feeding of Superdeformed Bands*

M. Thoennessen, J. R. Beene, F. E. Bertrand, C. Baktash, M. L. Halbert, D. J. Horen, D. C. Hensley, R. L. Vamer, D. G. Sarantites, D. W. Stracener, W. Spang, Bull. Am. Phys. Soc. 36, No. 4, 1271, C11 9 (1991)

Nuclear Reactions: $^{159}\text{Tb}(^{16}\text{O},X)$, E not given; measured γ (fission fragment)-coin following fusion. ^{175}Ta deduced GDR decay features, feeding of superdeformed bands.

91Tw01 *Superdeformed Nuclei at High Spin*

P. J. Twin, Nucl. Phys. A522, 13c (1991).

Nuclear Structure: ^{152}Dy , ^{151}Tb , ^{150}Gd , ^{152}Eu ; analyzed data; deduced superdeformed band evidence. Other data reviewed.

91Wa14 *Superdeformation in $^{198}, ^{196}\text{Pb}$*

T. F. Wang, A. Kuhnert, J. A. Becker, E. A. Henry, S. W. Yates, M. J. Brinkman, J. A. Cizewski, F. A. Azaiez, M. A. Deleplanque, R. M. Diamond, J. E. Draper, W. H. Kelly, W. Korten, A. O. Macchiavelli, E. Rubel, F. S. Stephens, Phys. Rev. C43, R2465 (1991).

Nuclear Reactions: $^{154}\text{Sm}(^{48}\text{Ca},xn)$, $E=205$ MeV; $^{176}\text{Yb}(^{28}\text{Mg}, xn)$, $E=135$ MeV; measured $\gamma\gamma$ -coin. $^{198}, ^{196}\text{Pb}$ deduced levels, superdeformed band features. Other isotopes discussed.

91Wa24 *Comment on 'Landau-Zener Crossing in Superdeformed ^{192}Hg : Evidence for octupole correlations in superdeformed nuclei'*

P. M. Walker, Phys. Rev. Lett. 67, 1174 (1991).

Nuclear Structure: ^{192}Hg ; analyzed data; deduced octupole correlations role in superdeformed states.

91WaZV *A Superdeformed (SD) Band in ^{196}Pb*

T. F. Wang, J. A. Becker, E. A. Henry, A. Kuhnert, S. W. Yates, M. J. Brinkman, J. A. Cizewski, F. A. Azaiez, M. A. Deleplanque, R. M. Diamond, J. E. Draper, W. H. Kelly, W. Korten, A. O. Macchiavelli, E. Rubel, F. S. Stephens, Bull. Am. Phys. Soc. 36, No. 4, 1388, M10 8 (1991)

Nuclear Reactions: $^{148}\text{Sm}(^{48}\text{Ca},xn)$, $E=205$ MeV; measured not given. ^{196}Pb deduced superdeformed band.

91Zu01 *A Comparative Study of Superdeformation in $^{146}, ^{147}, ^{148}\text{Gd}$. Possible Manifestations of the Pseudo-SU₃ Symmetry, Octupole Shape Susceptibility and Superdeformed Deep-Hole Excitations*

K. Zuber, D. Balouka, F. A. Beck, Th. Byrski, D. Curien, G. De France, G. Duchene, C. Gehringer, B. Haas, J. C. Merdinger, P. Romain, D. Santos, J. Styczen, J. P. Vivien, J. Dudek, Z. Szymanski, T. R. Werner, Phys. Lett. 254B, 308 (1991).

Nuclear Reactions: $^{122}\text{Sn}(^{20}\text{Si},5n)$, $E=155$ MeV; measured E_γ , I_γ , sum spectra. ^{147}Gd deduced levels, J , π , superdeformed band features. Model comparison.

92AtZW *Observation of the Decay Out of the Superdeformed Band in ^{142}Eu*

A. Atac, M. Piiparinen, B. Herskind, J. Nyberg, G. Sletten, G. de Angelis, R. M. Clark, S. A. Forbes, N. Gjorup, G. B. Hagemann, F. Ingebretsen, H. J. Jensen, D. Jerrestam, H. Kusakari, R. M. Lieder, G. V. Mari, S. Mullins, P. J. Nolan, E. S. Paul, P. H. Regan, D. Santonocito, H. Schnare, K. Strahle, M. Sugawara, P. O. Tjom, A. Virtanen, R. Wadsworth, Priv. Comm. (1992).

Nuclear Reactions: $^{110}\text{Pd}(^{37}\text{Cl},4n)$, $E=160$ MeV; measured $\gamma\gamma$ -coin. ^{142}Eu deduced levels, J , π , γ -branching, superdeformed to normal band transitions.

92Be18 *Characterization of the Superdeformed Band in ^{199}Hg*

I. G. Bearden, R. V. F. Janssens, M. P. Carpenter, E. F. Moore, I. Ahmad, A. M. Baxter, Ph. Benet, P. J. Daly, M. W. Drigert, P. B. Fernandez, U. Garg, Z. W. Grabowski, T. L. Khoo, T. Lauritsen, W. Reviol, D. Ye, Z. Phys. A341, 491 (1992).

Nuclear Reactions: $^{160}\text{Gd}(^{34}\text{S},5n)$, $E=165$ MeV; measured $\gamma\gamma$ -coin. ^{199}Hg deduced superdeformed band, levels, J , π .

92BeZL *Higher Superdeformed Band Members in ^{190}Hg : Evidence for a band interaction (Question)*

I. G. Bearden, R. V. F. Janssens, M. P. Carpenter, I. Ahmad, P. J. Daly, M. W. Drigert, U. Garg, T. L. Khoo, T. Lauritsen, Y. Liang, W. Reviol, R. Wyss, Proc. Int. Conf. Nuclear Structure at High Angular Momentum, Ottawa, p. 10 (1992); AECL-10613 (1992)

Nuclear Reactions: $^{160}\text{Gd}(^{24}\text{S},4n)$, $E=159-165$ MeV; measured $\gamma\gamma$ -coin, γ -multiplicity. ^{190}Hg deduced superdeformed band, dynamic moment of inertia, band interaction evidence.

92BeZR *Entrance Channel Effects and the Superdeformed Band in ^{152}Dy*

C. W. Beausang, A. Alderson, I. Ali, M. A. Bentley, P. J. Dagnall, G. de France, P. Fallon, S. Flibotte, P. D. Forsyth, B. Haas, P. Romain, G. Smith, P. J. Twin, J. P. Vivien, Contrib. Int. Conf. Nuclear Structure at High Angular Momentum, Ottawa, p. 66 (1992); AECL-10613 (1992)

Nuclear Structure: ^{152}Dy ; analyzed superdeformed band data analyses; deduced accurate I_γ measurement need. Discussed test runs for reactions $^{120}\text{Sn}(^{36}\text{S},X)$, $^{74}\text{Ge}(^{32}\text{Se},X)$.

92BeZT *Feeding of the Superdeformed Band in ^{192}Hg : The mechanism and Constraints on the superdeformed band energies and well depth*

Ph. Benet, T. Lauritsen, T. L. Khoo, I. Ahmad, K. Beard, I. G. Bearden, M. P. Carpenter, P. Daly, M. W. Drigert, P. B. Fernandez, U. Garg, R. V. F. Janssens, Y. Liang, E. F. Moore, W. Reviol, D. Ye, Contrib. Int. Conf. Nuclear Structure at High Angular Momentum, Ottawa, p. 54 (1992); AECL-10613 (1992)

Nuclear Reactions: $^{160}\text{Gd}(^{26}\text{S},4n)$, $E=154, 167$ MeV; measured transition I_γ , quasicontinuum γ -spectra. ^{192}Hg deduced superdeformed band, feeding mechanism. Model comparison.

92BeZV Shape Coexistence to High Spin in ^{180}Hg

I. G. Bearden, M. P. Carpenter, A. M. Baxter, R. V. F. Janssens, I. Ahmad, Ph. Benet, P. J. Daly, M. W. Drigert, P. B. Fernandez, B. Fornal, U. Garg, Z. W. Grabowski, T. L. Khoo, R. M. Mayer, E. F. Moore, W. Reviol, D. Ye, Contrib. Int. Conf. Nuclear Structure at High Angular Momentum, Ottawa, p. 18 (1992); AECL-10613 (1992)

Nuclear Reactions: $^{156}\text{Gd}(^{36}\text{S},4n)$, $E=167$ MeV; measured $\gamma\gamma$ -coin. ^{180}Hg deduced levels, J, π , band structure, shape features, no superdeformation evidence.

92BIZZ Search for Low Spin Superdeformed States by Transfer Reaction

J. Blons, D. Goutte, A. Lepretre, R. Lucas, V. Meot, D. Paya, X. H. Phan, G. Barreau, T. Doan, G. Pedemey, Contrib. Int. Conf. Nuclear Structure at High Angular Momentum, Ottawa, p. 57 (1992); AECL-10613 (1992)

Nuclear Reactions: $^{226}\text{U}(^{18}\text{O},^{16}\text{O})$, $E=9$ MeV/nucleon; $^{192}\text{Pt}(^{16}\text{O},^{14}\text{C})$, E not given; measured γ sum spectra, $\gamma(\text{particle})$ -coin. ^{194}Hg deduced superdeformed band population.

92BrZY Shape Coexistence in ^{194}Pb

M. J. Brinkman, A. Kuhnert, M. A. Stoyer, J. A. Becker, E. A. Henry, T. F. Wang, J. A. Cizewski, R. M. Diamond, F. S. Stephens, M. A. Deleplanque, J. E. Draper, Contrib. Int. Conf. Nuclear Structure at High Angular Momentum, Ottawa, p. 71 (1992); AECL-10613 (1992)

Nuclear Reactions: $^{176}\text{Yb}(^{24}\text{Mg},6n)$, $E=132, 134$ MeV; $^{150}\text{Sm}(^{40}\text{Ca}, 4n)$, $E=205$ MeV; $^{124}\text{Sn}(^{72}\text{Ge},3n)$, $E=305$ MeV; analyzed data. ^{194}Pb deduced superdeformed, near-oblate collective states interplay.

92CiZZ Identical Bands and Quantized Alignment in Superdeformed $A = 194$ Nuclei: Evidence for a new kind of rotor

J. A. Cizewski, J. A. Becker, E. A. Henry, M. J. Brinkman, T. F. Wang, A. Kuhnert, F. S. Stephens, M. A. Deleplanque, R. M. Diamond, F. Azaiez, A. O. Macchiavelli, J. E. Draper, Contrib. Int. Conf. Nuclear Structure at High Angular Momentum, Ottawa, p. 68 (1992); AECL-10613 (1992)

Nuclear Structure: $A=194$; analyzed data; deduced superdeformed, identical band features. Spin-rotor framework.

92DeZV Search for Transitions Deexciting the Superdeformed Band in ^{192}Hg

M. A. Deleplanque, F. S. Stephens, R. M. Diamond, J. R. B. Oliveira, J. Burde, J. E. Draper, E. Rubel, C. Duyar, J. A. Becker, E. A. Henry, M. J. Brinkman, A. Kuhnert, T. F. Wang, M. A. Stoyer, Contrib. Int. Conf. Nuclear Structure at High Angular Momentum, Ottawa, p. 79 (1992); AECL-10613 (1992)

Nuclear Reactions: $^{176}\text{Yb}(^{22}\text{Ne},6n)$, $E=125, 130$ MeV; measured $\gamma\gamma$ -coin. ^{192}Hg deduced superdeformed band transition intensity features.

92FI02 Entrance-Channel Effects in the Population of Superdeformed Bands in 147 , ^{148}Gd

S. Flibotte, H. R. Andrews, T. E. Drake, A. Galindo-Uribarri, B. Haas, V. J. Janzen, D. Prevost, D. C. Radford, J. Rodriguez, P. Romain, J. P. Vivien, J. C. Waddington, D. Ward, G. Zwart, Phys. Rev. C45, R889 (1992).

Nuclear Reactions: $^{124}\text{Sn}(^{28}\text{Si},xn)$, $^{122}\text{Sn}(^{30}\text{Si}, xn)$, $E=155$ MeV; $^{76}\text{Ge}(^{76}\text{Ge},xn)$, $E=319$ MeV; measured E_γ , I_γ , $\gamma\gamma$ -coin. 147 , ^{148}Gd deduced superdeformed bands population intensity. Enriched targets, Compton-suppressed hyperpure Ge array.

92FI03 Multidimensional Analysis of High Resolution γ -Ray Data

S. Flibotte, U. J. Huttmeier, P. Bednarczyk, G. de France, B. Haas, P. Romain, Ch. Theisen, J. P. Vivien, J. Zen, Nucl. Instrum. Methods Phys. Res. A320, 325 (1992)

Nuclear Structure: ^{148}Gd ; analyzed superdeformed band γ -transition data; deduced transitions for use in Monte Carlo simulation. Multidimensional analysis, algorithm development.

92FoZX Lifetime Measurements on Superdeformed Bands in ^{132}Nd and ^{142}Eu

S. A. Forbes, S. M. Mullins, P. J. Nolan, E. S. Paul, R. M. Clarke, P. H. Regan, R. Wadsworth, A. Atac, G. B. Hagemann, B. Herskind, J. Nyberg, M. J. Piiparinen, A. Dewald, G. Boehm, R. Kruecken, Contrib. Int. Conf. Nuclear Structure at High Angular Momentum, Ottawa, p. 65 (1992); AECL-10613 (1992)

Nuclear Reactions: $^{110}\text{Pd}(^{27}\text{Cl},4n)$, $E=160$ MeV; measured $\gamma\gamma$ -coin, DSA. $^{106}\text{Pd}(^{32}\text{S},2n2p)$, $E=150$ MeV; measured $\gamma\gamma$ -coin. ^{142}Eu deduced superdeformed band states $T_{1,2}$ deformation. ^{132}Nd deduced superdeformed band states $T_{1,2}$.

92GaZX New Features in the Spectrum of ^{152}Dy : Evidence for hyperdeformation (Question)

A. Galindo-Uribarri, H. R. Andrews, G. C. Ball, T. E. Drake, G. Hackmann, V. P. Janzen, S. M. Mullins, L. Persson, D. C. Radford, J. C. Waddington, D. Ward, R. Wyss, Contrib. Int. Conf. Nuclear Structure at High Angular Momentum, Ottawa, p. 16 (1992); AECL-10613 (1992)

Nuclear Reactions: $^{120}\text{Sn}(^{37}\text{Cl},4np)$, E not given; measured $\gamma(\text{particle})$ -coin, proton gated E_γ - E_γ correlation. ^{152}Dy deduced superdeformed ridge, other ridges. Discussion of hyperdeformation evidence.

92Ha35 Nuclear Superdeformation Data Tables

X. -L. Han, C. -L. Wu, At. Data Nucl. Data Tables 52, 43 (1992).

Compilation: $A=130, 150, 190$; compiled by for transitions in superdeformed bands.

92HaZT Recent Results and Future Prospects Along the $N = Z$ Line with Radioactive Nuclear Beams and RMS

J. H. Hamilton, A. V. Ramayya, Contrib. 6th Intern. Conf. on Nuclei Far from Stability + 9th Intern. Conf. on Atomic Masses and Fundamental Constants, Bernkastel-Kues, Germany, PE10 (1992)

Nuclear Structure: $^{72, 74, 76}\text{Kr}$; reviewed, analyzed data. ^{88}Ru ; analyzed band structure; deduced low spin superdeformation. Nuclei along $N=Z$ line.

92HaZX A Superdeformed Rotational Band in ^{142}Sm

G. S. Hackman, A. Galindo-Uribarri, V. P. Janzen, S. M. Mullins, D. Prevost, D. C. Radford, J. C. Waddington, D. Ward, Contrib. Int. Conf. Nuclear Structure at High Angular Momentum, Ottawa, p. 81 (1992); AECL-10613 (1992)

Nuclear Reactions: $^{124}\text{Sn}(^{24}\text{Mg},6n)$, $E=145$ MeV; measured γ -multiplicity, total sum energy. ^{142}Sm deduced levels, J, π , dynamical moment of inertia, superdeformed rotational band.

92HaZY Study of the Superdeformed Band in ^{194}Pb with Eurogam

F. Hannachi, Contrib. Int. Conf. Nuclear Structure at High Angular Momentum, Ottawa, p. 67 (1992); AECL-10613 (1992)

Nuclear Reactions: $^{164, 162}\text{Dy}(^{32}\text{S},X)$, $(^{36}\text{S},X)$, $E=157-162$ MeV; measured $\gamma\gamma$ -coin, DSA. ^{194}Pb deduced superdeformed band states $T_{1,2}$ decay features.

92HeZM Superdeformation in the A = 190 Region: The lead nuclei

E. A. Henry, J. A. Becker, M. J. Brinkman, A. Kuhnert, M. A. Stoyer, T. F. Wang, S. W. Yates, F. A. Azaiez, C. W. Beausang, J. Burde, M. A. Deleplanque, R. M. Diamond, J. E. Draper, W. H. Kelly, W. Korten, A. O. Macchiavelli, J. Oliveira, E. Rubel, F. S. Stephens, J. A. Cizewski, Proc. Int. Conf. Nuclear Structure at High Angular Momentum, Ottawa, p. 15 (1992); AECL-10613 (1992)

Nuclear Reactions: $^{176}\text{Yb}(^{26}\text{Mg},6n)$, $E=138$ MeV; measured $\gamma\gamma$ -coin. ^{196}Pb deduced new levels in superdeformed band. $^{154}\text{Sm}(^{40}\text{Ca},X)$, $E=205, 210$ MeV; $^{176}\text{Yb}(^{24}\text{Mg}, xn)$, $E=129-134$ MeV; $^{176}\text{Yb}(^{26}\text{Mg},xn)$, $E=130, 135$ MeV; measured not given. $^{197}, ^{195}, ^{193}\text{Pb}$ deduced no superdeformed bands.

Nuclear Structure: $^{192}, ^{194}, ^{196}\text{Pb}$; analyzed superdeformed band data.

92KoZX New Results on the Superdeformed Band in ^{194}Pb

W. Korten, M. J. Piiparinen, A. Atac, R. A. Bark, B. Herskind, T. Ramsøy, G. Sletten, J. Gerl, H. Hubel, P. Willsau, B. Cederwall, L. O. Nordin, B. Fant, Contrib. Int. Conf. Nuclear Structure at High Angular Momentum, Ottawa, p. 58 (1992); AECL-10613 (1992)

Nuclear Reactions: $^{164}\text{Dy}(^{24}\text{S},4n)$, $E=160$ MeV; measured $\gamma\gamma$ -coin. ^{194}Pb deduced superdeformed band origin uncertainties.

92La07 Dynamic Moment of Inertia of the ^{192}Hg Superdeformed Band at High Rotational Frequencies

T. Lauritsen, R. V. F. Janssens, M. P. Carpenter, E. F. Moore, I. Ahmad, P. B. Fernandez, T. L. Khoo, J. A. Kuehner, D. Prevost, J. C. Waddington, U. Garg, W. Reviol, D. Ye, M. W. Drigert, Phys. Lett. 279B, 239 (1992).

Nuclear Reactions: $^{160}\text{Gd}(^{36}\text{S},4n)$, $E=154-167$ MeV; measured $\gamma\gamma$ -coin. ^{192}Hg deduced superdeformed states, relative I_y , increasing dynamic moment of inertia.

92La19 Feeding of Superdeformed Bands: The mechanism and constraints on band energies and the well depth

T. Lauritsen, Ph. Benet, T. L. Khoo, K. B. Beard, I. Ahmad, M. P. Carpenter, P. J. Daly, M. W. Drigert, U. Garg, P. B. Fernandez, R. V. F. Janssens, E. F. Moore, F. L. H. Wolfs, D. Ye, Phys. Rev. Lett. 69, 2479 (1992).

Nuclear Reactions: $^{160}\text{Gd}(^{36}\text{S},4n)$, $E=159$ MeV; measured $\gamma\gamma$ -coin. ^{192}Hg deduced superdeformed band feeding, entry distribution features.

92LaZS Search for Long-Lived Fissioning Isomers in Superdeformed High-Spin Nuclei Around ^{152}Dy and ^{190}Hg

Yu. A. Lazarev, Yu. Ts. Oganessian, I. V. Shirokovsky, S. P. Tretyakova, V. K. Utyonkov, Contrib. 6th Intern. Conf. on Nuclei Far from Stability + 9th Intern. Conf. on Atomic Masses and Fundamental Constants, Bernkastel-Kues, Germany, PE48 (1992)

Nuclear Reactions: $^{116}\text{Cd}(^{40}\text{Ar},X)$, $E=203$ MeV; measured not given; deduced no fragment delayed fission evidence, σ upper limit. ^{152}Dy deduced superdeformed rotational band population. $^{154}\text{Sm}(^{40}\text{Ar}, X)$, $E=219$ MeV; measured not given; deduced no fragment delayed fission evidence, σ upper limit.

92LaZT Calculations of the Decay of Superdeformed Bands and Search for the γ Rays Connecting Superdeformed and Normal States

T. Lauritsen, T. L. Khoo, E. F. Moore, I. Ahmad, M. P. Carpenter, P. Fernandez, R. V. F. Janssens, Y. Liang, M. Freer, A. Wuosmaa, P. Benet, I. Bearden, P. J. Daly, B. Fornal, D. Ye, U. Garg, M. W. Drigert, Contrib. Int. Conf. Nuclear Structure at High Angular Momentum, Ottawa, p. 53 (1992); AECL-10613 (1992)

Nuclear Structure: $A=150, 190$; analyzed superdeformed bands decay; deduced mixing into normal states role.

92LeZS Lifetimes of the Low Spin States in the Superdeformed Band of ^{192}Hg

I. Y. Lee, C. Baktash, D. Cullen, J. D. Garrett, N. R. Johnson, F. K. McGowan, D. F. Winchell, C. H. Yu, Proc. Int. Conf. Nuclear Structure at High Angular Momentum, Ottawa, p. 21 (1992); AECL-10613 (1992)

Nuclear Reactions: $^{160}\text{Gd}(^{36}\text{S},4n)$, $E=159$ MeV; measured $\gamma\gamma$ -coin, recoil distance. ^{192}Hg deduced superdeformed band levels $T_{1/2}$.

92Li21 Double Blocking in the Superdeformed ^{192}Tl Nucleus

Y. Liang, M. P. Carpenter, R. V. F. Janssens, I. Ahmad, R. G. Henry, T. L. Khoo, T. Lauritsen, F. Soramel, S. Pilotte, J. M. Lewis, L. L. Riedinger, C. -H. Yu, U. Garg, W. Reviol, I. G. Bearden, Phys. Rev. C46, R2136 (1992).

Nuclear Reactions: $^{160}\text{Gd}(^{37}\text{Cl},5n)$, $E=178, 181$ MeV; measured E_γ , I_γ , $\gamma\gamma(\theta)$. ^{192}Tl deduced levels, J , π , superdeformed band features, moments of inertia. Cranked shell model.

92LiZU

Y. Liang, M. P. Carpenter, R. V. F. Janssens, I. Ahmad, R. Henry, T. L. Khoo, T. Lauritsen, S. Pilotte, J. M. Lewis, L. L. Riedinger, C. -H. Yu, U. Garg, W. Reviol, I. G. Bearden, Contrib. Int. Conf. Nuclear Structure at High Angular Momentum, Ottawa, p. 56 (1992); AECL-10613 (1992)

Nuclear Reactions: $^{160}\text{Gd}(^{37}\text{Cl},5n)$, $E=187$ MeV; measured γ -spectra. ^{192}Tl deduced several superdeformed band pairs.

92Ma51 The Feeding of the Superdeformed Band in ^{148}Gd

N. Mansour, Appl. Radiat. Isot. 43, 1499 (1992).

Nuclear Reactions: $^{122}\text{Sn}(^{30}\text{Si},4n)$, $E=150-166$ MeV; measured E_γ , I_γ . ^{148}Gd deduced superdeformed band feeding.

92MaZP Search for Superdeformation in ^{190}Au

G. Marti, W. Gast, A. Georgiev, D. Kutchin, R. M. Lieder, K. Strahle, H. Maier, J. Heese, KFA-IKP Ann. Rept., 1991, p. 100 (1992).

Nuclear Reactions: $^{176}\text{Yb}(^{19}\text{F},4n)$, $(^{19}\text{F},5n)$, $(^{19}\text{F},6n)$, $E=107$ MeV; measured E_γ , $\gamma\gamma$ -energy correlation. ^{190}Au deduced weak ridge structure, superdeformation aspects.

92Mu09 Second Minimum Lifetime Measurements in ^{193}Nd and ^{197}Nd

S. M. Mullins, I. Jenkins, Y. -J. He, A. J. Kirwan, P. J. Nolan, J. R. Hughes, R. Wadsworth, R. A. Wyss, Phys. Rev. C45, 2683 (1992).

Nuclear Reactions: $^{105}\text{Pd}(^{32}\text{S},2n2p)$, $E=152$ MeV; $^{104}\text{Ru}(^{36}\text{S},3n)$, $E=145$ MeV; measured $\gamma\gamma$ -coin, DSA, centroid shifts. $^{193}, ^{197}\text{Nd}$ deduced levels, $T_{1/2}$, deformed band quadrupole moments. Total Routhian surface calculations.

92Mu10 *Study of Superdeformed Bands in Nuclei with A 150 by Heavy-Ion- γ Coincidences*

L. Muller, F. Soramel, E. Adamides, S. Beghini, L. Corradi, G. LoBianco, B. Million, N. Molho, H. Moreno, D. R. Napoli, G. F. Prete, F. Scarfassara, G. F. Segato, S. Signorelli, C. Signorini, P. Spolaore, A. M. Stefanini, Z. Phys. A341, 131 (1992).

Nuclear Reactions: ICPND $^{124}\text{Sn}(^{32}\text{S},5n)$, $(^{32}\text{S},4np)$, $(^{32}\text{S},6n)$, $(^{32}\text{S},5np)$, $(^{32}\text{S},7n)$, $(^{32}\text{S},6np)$, $(^{32}\text{S},5n2p)$, $(^{32}\text{S},7n2p)$, $(^{32}\text{S},5n\alpha)$, $E=160, 170$ MeV; measured γ (evaporation residue)-coin; deduced residue relative production σ . $^{152}, ^{151}\text{Dy}$, ^{151}Tb deduced superdeformed bands.

92PaZW *Highly-Deformed Bands in the Mass 130 Region*

E. S. Paul, Proc. Int. Conf. Future Directions in Nuclear Physics with 4 π Gamma Detection Systems of the New Generation, Strasbourg, France (1991), J. Dudek, B. Haas, Eds., American Institute of Physics, New York, p. 165 (1992).

Compilation: $^{133}, ^{135}, ^{137}\text{Sm}$, ^{139}Gd , ^{142}Eu , $^{133}, ^{134}, ^{135}, ^{136}, ^{137}\text{Nd}$, ^{134}Pr , $^{131}, ^{132}, ^{133}, ^{136}\text{Ce}$, ^{130}La ; compiled, reviewed superdeformed, intruder bands, $T_{1/2}$ data; deduced dominant configuration.

92PaZX *Intensity of K X-Rays in Coincidence with Superdeformed Band in ^{142}Eu*

M. Palacz, Z. Sujkowski, J. Bacelar, A. Atac, B. Herskind, J. Nyberg, M. Piiparinen, G. de Angelis, S. Forbes, N. Gjørup, G. Hagemann, F. Ingebretsen, H. Jensen, D. Jerrestam, H. Kusakari, R. Lieder, G. M. Marti, S. Mullins, D. Santonocito, H. Schnare, G. Sletten, K. Strahle, M. Sugawara, P. O. Tjøm, A. Virtanen, R. Wadsworth, KVI 1991 Ann. Rept., p. 31 (1992).

Nuclear Structure: $^{142}, ^{143}\text{Eu}$; analyzed data; deduced evidence for enhanced X-ray yields for coincidence with superdeformed band transitions.

92PiZR *Superdeformation in ^{191}Tl*

S. Pilotte, J. M. Lewis, L. L. Riedinger, C. -H. Yu, M. P. Carpenter, R. V. F. Janssens, T. L. Khoo, T. Lauritsen, Y. Liang, F. Soramel, I. G. Bearden, Proc. Int. Conf. Nuclear Structure at High Angular Momentum, Ottawa, p. 2 (1992); AECL-10613 (1992)

Nuclear Reactions: $^{189}\text{Tb}(^{36}\text{S},4n)$, $E=165$ MeV; measured E_{γ} , I_{γ} , $\gamma\gamma$ -coin. ^{191}Tl deduced levels, J, π , band structure, superdeformation. Enriched target, Compton-suppressed Ge detector array, BGO array. Cranked shell model.

92Re05 *Measurement of the Intrinsic Quadrupole Moments in the $v_{1/2}$ Bands of $^{135}, ^{137}\text{Sm}$*

P. H. Regan, R. Wadsworth, S. M. Mullins, J. Nyberg, A. Atac, S. A. Forbes, D. B. Fossan, Y. -J. He, J. R. Hughes, I. Jenkins, R. Ma, M. S. Metcalfe, P. J. Nolan, E. S. Paul, R. J. Poynter, D. Santonocito, A. Virtanen, N. Xu, J. Phys. (London) G18, 847 (1992).

Nuclear Reactions: $^{92}\text{Mo}(^{46}\text{Ti},n2p)$, $E=210$ MeV; $^{104}\text{Pd}(^{37}\text{Cl},3np)$, $E=168$ MeV; measured $\gamma\gamma$ -coin, DSA. ^{137}Sm deduced levels, J, π , $T_{1/2}$, deformation parameter β_2 , quadrupole moments, band structure. ^{135}Sm deduced levels, J, π , $T_{1/2}$, deformation parameter β_2 , quadrupole moments, band structure, superdeformation features.

92RzZZ *Excited Superdeformed Band in ^{146}Gd*

T. Rzaca-Urban, K. Strahle, G. Hebbinghaus, D. Balabanski, W. Gast, R. M. Lieder, H. Schnare, W. Urban, P. von Brentano, H. Wolters, K. O. Zell, D. Alber, K. H. Maier, E. M. Beck, H. Hubel, W. Schmitz, KFA-IKP Ann. Rept., 1991, p. 92 (1992).

Nuclear Reactions: $^{110}\text{Pd}(^{40}\text{Ar},4n)$, $E=175$ MeV; measured $\gamma\gamma$ -coin, sum spectra. ^{146}Gd deduced levels, J, π , excited superdeformed band.

92ShAA

see 92ShZR *.

92ShZR *Octupole Correlations, Spin Assignments and Identical Bands in ^{183}Hg*

J. F. Sharpey-Schafer, D. M. Cullen, M. A. Riley, A. Alderson, I. Ali, T. Bengtsson, M. A. Bentley, A. M. Bruce, P. Fallon, P. D. Forsyth, F. Hanna, S. M. Mullins, W. Nazarewicz, R. Poynter, P. Regan, J. W. Roberts, W. Satula, J. Simpson, G. Sletten, P. J. Twin, R. Wadsworth, R. Wyss, Proc. Int. Conf. Future Directions in Nuclear Physics with 4 π Gamma Detection Systems of the New Generation, Strasbourg, France (1991), J. Dudek, B. Haas, Eds., American Institute of Physics, New York, p. 64 (1992).

Nuclear Reactions: $^{150}\text{Nd}(^{48}\text{Ca},5n)$, $E=213$ MeV; measured E_{γ} , I_{γ} , $\gamma\gamma$ -coin, $\gamma\gamma(\theta)$. ^{183}Hg deduced levels, J, π , superdeformed band. Also discussed data on $^{181}, ^{184}\text{Hg}$.

92Sm01 *Entrance-Channel Effects in the Population of Superdeformed Bands*

G. Smith, B. Haas, A. Alderson, I. Ali, C. W. Beausang, M. A. Bentley, P. Dagnall, P. Fallon, G. de France, P. D. Forsyth, U. Huttmeier, P. Romain, D. Santos, P. J. Twin, J. P. Vivien, Phys. Rev. Lett. 68, 158 (1992).

Nuclear Reactions: $^{74}\text{Ge}(^{62}\text{Se},4n)$, $E=324-346$ MeV; $^{108}\text{Pd}(^{48}\text{Ca},4n)$, $E=205$ MeV; $^{120}\text{Sn}(^{36}\text{S},4n)$, $E=175$ MeV; measured $\gamma\gamma$ -coin. ^{152}Dy deduced superdeformed band population entrance channel effects.

92SoZZ *Entrance-Channel Dependence in the Population of the Superdeformed Bands in ^{191}Hg (Question)*

F. Soramel, T. L. Khoo, R. V. F. Janssens, I. Ahmad, M. P. Carpenter, T. Lauritsen, Y. Liang, B. Fornal, I. Bearden, Ph. Benet, P. J. Daly, Z. W. Grabowski, R. Maier, D. Ye, U. Garg, W. Reviol, M. W. Drigert, Contrib. Int. Conf. Nuclear Structure at High Angular Momentum, Ottawa, p. 52 (1992); AECL-10613 (1992)

Nuclear Reactions: $^{130}\text{Te}(^{64}\text{Ni},3n)$, $E=259$ MeV; $^{160}\text{Gd}(^{36}\text{S},5n)$, $E=169$ MeV; measured not given. ^{191}Hg deduced superdeformed band entrance channel dependence effects.

92StZQ *Search for Superdeformation in $^{144}, ^{145}\text{Gd}$*

K. Strahle, T. Rzaca-Urban, R. M. Lieder, S. Utzelmann, D. Balabanski, B. Bochev, W. Gast, A. Georgiev, D. Kutchin, G. Marti, H. Schnare, K. Spohr, M. Binderberger, M. Eschenauer, S. Freund, E. Ott, J. Theuerkauf, H. Wolters, K. O. Zell, J. Eberth, P. von Brentano, K. H. Maier, H. Grawe, C. Bach, J. Heese, H. Kluge, M. Schramm, R. Schubarth, KFA-IKP Ann. Rept., 1991, p. 90 (1992).

Nuclear Reactions: $^{110}\text{Pd}(^{40}\text{Ar},4n)$, $(^{40}\text{Ar},5n)$, $E=189$ MeV; $^{108}\text{Pd}(^{40}\text{Ar},3n)$, $(^{40}\text{Ar},4n)$, $E=200$ MeV; measured $\gamma\gamma$ -energy correlation, DSA. $^{144}, ^{145}\text{Gd}$ deduced evidence for superdeformed states.

92StZS *Superdeformation in ^{193}Pb (Question)*

M. A. Stoyer, E. A. Henry, J. A. Becker, M. J. Brinkman, A. Kuhnert, T. F. Wang, J. Burde, M. A. Deleplanque, R. M. Diamond, J. Draper, J. Oliveira, E. Rubel, F. Stephens, Contrib. Int. Conf. Nuclear Structure at High Angular Momentum, Ottawa, p. 72 (1992); AECL-10613 (1992)

Nuclear Reactions: $^{174}\text{Yb}(^{24}\text{Mg},5n)$, $(^{24}\text{Mg},4n)$, $(^{24}\text{Mg},6n)$, $E=129, 134$ MeV; measured relative σ , $\gamma\gamma$ -coin. ^{193}Pb deduced transitions, band structure, superdeformed band evidence.

92StZT Search for Population of Superdeformed States in ^{194}Pb using ^{194}Bi β^- Decay

M. A. Stoyer, E. A. Henry, J. A. Becker, R. W. Hoff, A. Kuhnert, T. F. Wang, J. Breitenbach, M. Jarrjo, J. L. Wood, Y. A. Akaoli, C. R. Bingham, M. Zhang, P. Joshi, H. K. Carter, J. Kormicki, P. Mantica, Contrib. Int. Conf. Nuclear Structure at High Angular Momentum, Ottawa, p. 69 (1992); AECL-10613 (1992)

Nuclear Structure: $^{194}\text{Bi}(\beta^-)$; measured E_γ , I_γ , $I(\text{ce})$, $\gamma\gamma$, $\gamma(\text{ce})$ -coin. ^{194}Pb deduced no evidence of superdeformed states. Analyzed actinide data. Deformed liquid drop model.

92StZU Quadrupole Moment of the Excited SD Band in ^{146}Gd

K. Strahle, T. Rzaca-Urban, G. Hebbinghaus, R. M. Lieder, D. Balabanski, W. Gast, H. Schnare, W. Urban, P. von Brentano, A. Dewald, J. Eberth, E. Ott, J. Theuerkauf, H. Wolters, K. O. Zell, D. Alber, K. H. Maier, E. M. Beck, H. Hubel, W. Schmitz, Contrib. Int. Conf. Nuclear Structure at High Angular Momentum, Ottawa, p. 64 (1992); AECL-10613 (1992)

Nuclear Structure: ^{146}Gd ; analyzed data; deduced excited superdeformed band quadrupole moment.

92StZV Search for Superdeformation in 144 , ^{145}Gd

K. Strahle, T. Rzaca-Urban, R. M. Lieder, S. Utzelmann, D. Balabanski, B. Bochev, W. Gast, A. Georgiev, D. Kutchin, G. Marti, H. Schnare, K. Spohr, M. Binderberger, M. Eschenauer, S. Freund, E. Ott, J. Theuerkauf, H. Wolters, K. O. Zell, J. Eberth, P. von Brentano, K. H. Maier, H. Grawe, C. Bach, J. Heese, H. Kluge, M. Schramm, R. Schubarth, Contrib. Int. Conf. Nuclear Structure at High Angular Momentum, Ottawa, p. 63 (1992); AECL-10613 (1992)

Nuclear Reactions: $^{110}\text{Pd}(^{40}\text{Ar}, \text{xn})$, $E=189$ MeV; $^{106}\text{Pd}(^{40}\text{Ar}, \text{xn})$, $E=182$ MeV; measured γ -spectra, sum coincidences. ^{145}Gd deduced superdeformed band.

92Vi03 Radiation Originating from Unresolved Superdeformed States in ^{149}Gd

J. P. Vivien, D. Balouka, B. Haas, H. R. Andrews, D. C. Radford, D. Ward, V. P. Janzen, D. Prevost, J. C. Waddington, S. Flibotte, S. Pilotte, P. Taras, A. Galindo-Uribarri, H. Kluge, S. Aberg, Phys. Lett. 278B, 407 (1992).

Nuclear Reactions: $^{124}\text{Sn}(^{30}\text{Si}, \text{xn})$, $E=155$ MeV; measured correlated $\gamma\gamma$ -coincidence matrix, I_γ . ^{149}Gd deduced unresolved superdeformed states.

92WaZW Topological Excitations and Identical Superdeformed Bands

J. C. Waddington, R. K. Bhaduri, Contrib. Int. Conf. Nuclear Structure at High Angular Momentum, Ottawa, p. 80 (1992); AECL-10613 (1992)

Nuclear Structure: ^{192}Hg ; analyzed identical superdeformed band features; deduced vortices role. Topological excitations, ^{152}Dy core.

92WaZX Feeding of the Yrast Superdeformed Band through the Superdeformed Continuum

J. C. Waddington, J. A. Kuehner, H. R. Andrews, D. Balouka, T. Drake, S. Flibotte, A. Galindo-Uribarri, B. Haas, V. P. Janzen, J. Kluge, S. M. Mullins, S. Pilotte, D. Prevost, D. C. Radford, J. P. Vivien, D. Ward, S. Aberg, Contrib. Int. Conf. Nuclear Structure at High Angular Momentum, Ottawa, p. 62 (1992); AECL-10613 (1992)

Nuclear Reactions: $^{124}\text{Sn}(^{30}\text{Si}, \text{xn})$, $E=155$ MeV; measured $\gamma\gamma$ -coin. ^{149}Gd deduced superdeformed continuum feeding of yrast superdeformed band.

92WiZS Lifetimes of Superdeformed States in ^{194}Pb

P. Willsau, H. Hubel, F. Azaiez, M. A. Deleplanque, R. M. Diamond, A. Macchiavelli, F. S. Stephens, H. Kluge, F. Hannachi, J. C. Bacelar, J. A. Becker, M. J. Brinkman, E. A. Henry, A. Kuhnert, T. F. Wang, J. A. Draper, E. Rubel, KVI 1991 Ann. Rept., p. 32 (1992).

Nuclear Reactions: $^{150}\text{Sm}(^{46}\text{Ca}, 4n)$, $E=205$ MeV; measured DSA, γ -spectra. ^{194}Pb deduced superdeformed state $T_{1/2}$, transition quadrupole moment.

92WiZU Lifetimes of Superdeformed States in ^{194}Pb

P. Willsau, H. Hubel, F. Azaiez, M. A. Deleplanque, R. M. Diamond, W. Korten, A. O. Macchiavelli, F. S. Stephens, H. Kluge, F. Hannachi, J. C. Bacelar, J. A. Becker, M. J. Brinkman, E. A. Henry, A. Kuhnert, T. F. Wang, J. A. Draper, E. Rubel, Contrib. Int. Conf. Nuclear Structure at High Angular Momentum, Ottawa, p. 82 (1992); AECL-10613 (1992)

Nuclear Reactions: $^{150}\text{Sm}(^{46}\text{Ca}, 4n)$, $E=205$ MeV; measured $\gamma\gamma$ -coin, DSA. ^{194}Pb deduced superdeformed states $T_{1/2}$.

92YuZY Observation of Superdeformation in ^{191}Tl

C. -H. Yu, S. Pilotte, J. M. Lewis, L. L. Riedinger, I. Bearden, M. P. Carpenter, R. V. F. Janssens, T. L. Khoo, Y. Liang, T. Lauritsen, F. Soramel, Bull. Am. Phys. Soc. 37, No. 2, 1029, Q7 4 (1992)

Nuclear Reactions: $^{159}\text{Tb}(^{36}\text{S}, 4n)$, $E=165$ MeV; measured γ -multiplicity. ^{191}Tl deduced superdeformation, band structure.

92ZwZZ Search for Superdeformed Nuclei in the $A = 190$ Region

G. Zwartz, H. Andrews, M. Cromaz, T. Drake, A. Galindo-Uribarri, F. Ingebretsen, V. Janzen, S. Mullins, L. Persson, T. Porcelli, D. Prevost, D. Radford, J. Waddington, D. Ward, Contrib. Int. Conf. Nuclear Structure at High Angular Momentum, Ottawa, p. 76 (1992); AECL-10613 (1992)

Nuclear Reactions: $^{176}\text{Yb}(^{19}\text{F}, \text{xn})$, $E=105, 110$ MeV; $^{184}\text{W}(^{19}\text{F}, \text{xn})$, $E=107$ MeV; measured $\gamma\gamma$ -coin. $^{186}\text{W}(^{18}\text{O}, \text{xn})$, $(^{18}\text{O}, \text{xn}\alpha)$, $E=105, 110$ MeV; measured $\gamma\alpha$ -, $\gamma\eta$ -coin. 190 , ^{189}Au , 195 , ^{196}Hg , 197 , ^{198}Pb deduced levels, J, π , no superdeformed band evidence.

93At01 Linking Transitions from the Superdeformed Band in ^{143}Eu

A. Atac, M. Piiparinen, B. Herskind, J. Nyberg, G. Sletten, G. de Angelis, S. Forbes, N. Gjorup, G. Hagemann, F. Ingebretsen, H. Jensen, D. Jerrestam, H. Kusakañ, R. M. Lieder, G. V. Marti, S. Mullins, D. Santonocito, H. Schnare, K. Strahle, M. Sugawara, P. O. Tjorn, A. Virtanen, R. Wadsworth, Phys. Rev. Lett. 70, 1069 (1993).

Nuclear Reactions: $^{110}\text{Pd}(^{37}\text{Cl}, 4n)$, $E=160$ MeV; measured $\gamma\gamma$ -, higher fold-coin, E_γ , I_γ . ^{143}Eu deduced levels, J, π , I_γ , normal deformed superdeformed states connection.

93At02 Superdeformed Band in the ^{143}Eu Nucleus: Study of the decay out

A. Atac, M. Piiparinen, B. Herskind, J. Nyberg, G. Sletten, G. de Angelis, S. Forbes, N. Gjorup, G. Hagemann, F. Ingebretsen, H. Jensen, D. Jerrestam, H. Kusakañ, R. Lieder, G. M. Marti, S. Mullins, D. Santonocito, H. Schnare, K. Strahle, M. Sugawara, P. O. Tjorn, A. Virtanen, R. Wadsworth, Acta Phys. Pol. B24, 395 (1993).

Nuclear Reactions: $^{110}\text{Pd}(^{37}\text{Cl}, 4n)$, $E=160$ MeV; measured $\gamma\gamma$ -coin sum spectra. ^{143}Eu deduced superdeformed band decay features.

93At03 *Observation of the Decay Out of the Superdeformed Band in ^{140}Eu*

A. Atac, M. Piiparinen, B. Herskind, J. Nyberg, G. Sletten, G. de Angelis, R. M. Clark, S. A. Forbes, N. Gjorup, G. B. Hagemann, F. Ingebretsen, H. J. Jensen, D. Jerrestam, H. Kusakari, R. M. Lieder, G. V. Marti, S. Mullins, P. J. Nolan, E. S. Paul, P. H. Regan, D. Santonocito, H. Schnare, K. Strahle, M. Sugawara, P. O. Tjom, A. Virtanen, R. Wadsworth, Nucl. Phys. A557, 109c (1993).

Nuclear Reactions: $^{110}\text{Pd}(^{37}\text{Cl},4n)$, $E=160$ MeV; measured $\gamma\gamma$ -coin, $E\gamma$, $I\gamma$. ^{140}Eu deduced levels, J , π , superdeformed band decay features.

93Ba20 *Linking Transitions between the Highly Deformed States and the Yrast States of Normal Deformation in ^{139}Nd*

D. Bazzacco, F. Brandolini, R. Burch, A. Buscemi, C. Cavedon, D. De Acuna, S. Lunardi, R. Menegazzo, P. Pavan, C. Rossi-Alvarez, M. Stierazza, R. Zanon, G. de Angelis, P. Bezzon, M. A. Cardona, M. De Poli, G. Maron, M. L. Mazza, D. Napoli, J. Rico, P. Spolaore, X. N. Tang, G. Vedovato, N. Blasi, I. Castiglioni, G. Falconi, G. LoBianco, P. G. Bizzeti, R. Wyss, Phys. Lett. 309B, 235 (1993).

Nuclear Reactions: $^{106}\text{Pd}(^{32}\text{S},2n2p)$, $E=155$ MeV; measured $\gamma\gamma$ -coin, $\gamma(\theta)$. ^{139}Nd deduced levels, J , π , moments of inertia, intra-band transition features, deformed intruder band.

93Be29 *The First Results from EUROAM: Superdeformed structures in ^{151}Tb*

F. A. Beck, Th. Byrski, D. Curien, G. Duchene, S. Flibotte, G. de France, B. Haas, B. Kharraja, J. C. Merdinger, C. Theisen, J. P. Vivien, J. C. Lisle, C. W. Beausang, P. Dagnall, P. Fallon, J. Simpson, P. Twin, F. Hannachi, C. Schuck, Z. Fulop, M. Jozsa, A. Kiss, B. M. Nyako, C. M. Petrache, Nucl. Phys. A557, 67c (1993).

Nuclear Reactions: $^{124}\text{Sn}(^{31}\text{P},4n)$, $E=145$ MeV; $^{130}\text{Te}(^{27}\text{Al}, 6n)$, $E=150$ MeV; measured $\gamma\gamma$ -coin. ^{151}Tb deduced superdeformed bands.

93Be37 *Degenerate Superdeformed States in ^{150}Gd*

C. W. Beausang, P. Fallon, S. Clarke, F. A. Beck, Th. Byrski, D. Curien, P. J. Dagnall, G. de France, G. Duchene, P. D. Forsyth, B. Haas, M. J. Joyce, A. O. Macchiavelli, E. S. Paul, J. F. Sharpey-Schafer, J. Simpson, P. J. Twin, J. P. Vivien, Phys. Rev. Lett. 71, 1800 (1993).

Nuclear Reactions: $^{130}\text{Te}(^{26}\text{Mg},6n)$, $E=149$ MeV; measured $\gamma\gamma\gamma$ -coin. ^{150}Gd deduced levels, J , π , superdeformed state degeneracy features.

93BeZJ *Detailed Band Structures in $A = 188-190$ Mercury Isotopes: Superdeformation and other high-spin excitations*

I. G. Bearden, Thesis, Purdue Univ. (1993).

Nuclear Reactions: $^{160}\text{Gd}(^{34}\text{S},5n)$, $(^{34}\text{S},4n)$, $(^{34}\text{S}, 6n)$, E not given; measured $E\gamma$, $I\gamma$, DCO ratios. 189 , ^{190}Hg deduced high-spin levels, J , π , superdeformed bands. ^{188}Hg deduced high-spin levels, band structure, J , π .

93Ca23 *New Results on Superdeformed Bands in Hg and Tl Nuclei*

M. P. Carpenter, R. V. F. Janssens, Y. Liang, I. G. Bearden, I. Ahmad, M. W. Drigert, U. Garg, R. G. Henry, J. M. Lewis, T. L. Khoo, T. Lauritsen, S. Pilotte, W. Reviol, L. L. Riedinger, F. Soramel, C. -H. Yu, Nucl. Phys. A557, 57c (1993).

Nuclear Reactions: $^{159}\text{Tb}(^{36}\text{S},4n)$, $E=165$ MeV; $^{160}\text{Gd}(^{37}\text{Cl}, 5n)$, $E=178$, 181 MeV; analyzed data. 191 , ^{192}Tl , ^{190}Hg deduced levels, J , π , superdeformed bands. Other data input.

93Cu02 *X-Ray Yields of Superdeformed States in ^{193}Hg*

D. M. Cullen, I. Y. Lee, C. Baktash, J. D. Garrett, N. R. Johnson, F. K. McGowan, D. F. Winchell, Phys. Rev. C47, 1298 (1993).

Nuclear Reactions: $^{150}\text{Nd}(^{48}\text{Ca},5n)$, $E=213$ MeV; measured $E\gamma$, $I\gamma$, X-ray spectra, $\gamma(X\text{-ray})$ -, $\gamma\gamma$ -coin. ^{193}Hg deduced superdeformed, normal deformed bands X-ray yields.

93Cu06 *Deexcitation from Superdeformed Bands in ^{151}Tb and Neighboring $A = 150$ Nuclei*

D. Curien, G. de France, C. W. Beausang, F. A. Beck, T. Byrski, S. Clark, P. Dagnall, G. Duchene, S. Flibotte, S. Forbes, P. D. Forsyth, B. Haas, M. A. Joyce, B. Kharraja, B. M. Nyako, C. Schuck, J. Simpson, C. Theisen, P. J. Twin, J. P. Vivien, L. Zolnai, Phys. Rev. Lett. 71, 2559 (1993).

Nuclear Reactions: $^{130}\text{Te}(^{27}\text{Al},6n)$, $E=154$ MeV; measured $E\gamma$, $I\gamma$, $\gamma\gamma\gamma$ -coin. ^{151}Tb deduced superdeformed band transition energies, relative $I\gamma$ decay mechanism features.

93Da04 *Coexistence of Collective Oblate and Superdeformed Prolate Shapes in ^{196}Pb*

P. J. Dagnall, C. W. Beausang, P. Fallon, P. D. Forsyth, E. S. Paul, J. F. Sharpey-Schafer, P. J. Twin, I. Ali, D. M. Cullen, M. J. Joyce, G. Smith, R. Wadsworth, R. M. Clark, P. H. Regan, A. Astier, M. Meyer, N. Redon, J. Phys. (London) G19, 465 (1993).

Nuclear Reactions: $^{184}\text{W}(^{16}\text{O},4n)$, $E=98$ MeV; $^{186}\text{W}(^{16}\text{O}, 6n)$, $E=120$ MeV; measured $\gamma\gamma$ -coin. ^{196}Pb deduced levels, J , π , collective oblate, superdeformed prolate band coexistence.

93De35 *RDDS Coincidence Lifetime Measurement for Two Superdeformed States in ^{192}Hg*

A. Dewald, R. Kruecken, P. Sala, J. Altmann, O. Stuch, P. von Brentano, D. Bazzacco, C. Rossi-Alvarez, G. de Angelis, J. Rico, G. Vedovato, G. Lo Bianco, J. Phys. (London) G19, L177 (1993).

Nuclear Reactions: $^{160}\text{Gd}(^{36}\text{S},4n)$, $E=168$ MeV; measured $E\gamma$, $\gamma\gamma$ -coin. ^{192}Hg deduced superdeformed states $T_{1/2}$, $B(\lambda)$, transition quadrupole moments. Recoil distance Doppler shift coincidence plunger, differential decay curve method, Ge detectors, anti-Compton shields, BGO ball, enriched target.

93Es01 *Evidence for Superdeformed Shape Isomeric States in ^{28}Si at Excitations Above 40 MeV Through Observations of Selective Particle Decays of $^{16}\text{O} + ^{12}\text{C}$ Resonances in ^8Be and Alpha Channels*

M. A. Eswaran, S. Kumar, E. T. Mirgule, D. R. Chakrabarty, V. M. Datar, N. L. Ragoowansi, U. K. Pal, Phys. Rev. C47, 1418 (1993).

Nuclear Reactions: $^{12}\text{C}(^{16}\text{O},^8\text{Be})$, $(^{16}\text{O},\alpha)$, $E(\text{cm})=25.7-38.6$ MeV; measured spectra, $\sigma(\theta)$ vs E . ^{28}Si deduced resonances, J , π , configuration, superdeformed isomeric states.

93Es03 *Reply to 'Comment on 'Evidence for Superdeformed Shape Isomeric States in ^{28}Si at Excitations Above 40 MeV Through Observations of Selective Particle Decays of $^{16}\text{O} + ^{12}\text{C}$ Resonances in ^8Be and Alpha Channels ''*

M. A. Eswaran, S. Kumar, Phys. Rev. C48, 2120 (1993).

Nuclear Reactions: $^{12}\text{C}(^{16}\text{O},^8\text{Be})$, $(^{16}\text{O},\alpha)$, $E(\text{cm})=25.7-38.6$ MeV; analyzed previous data analyses. ^{28}Si deduced superdeformed shape isomeric states structure.

93Fa07 Evidence for M1 Transitions between Superdeformed States in ^{192}Hg

P. Fallon, J. Burde, B. Cederwall, M. A. Deleplanque, R. M. Diamond, I. Y. Lee, J. R. B. Oliveira, F. S. Stephens, J. A. Becker, M. J. Brinkman, E. A. Henry, A. Kuhnert, M. A. Stoyer, J. E. Draper, C. Duyar, E. Rubel, Phys. Rev. Lett. 70, 2690 (1993).

Nuclear Reactions: $^{176}\text{Yb}(^{22}\text{Ne},5n)$, $E=116$ MeV; measured $\gamma\gamma$ -energy correlation, $\gamma\gamma$ -coin. ^{192}Hg deduced superdeformed bands two-way decay.

93Fi03 Multiparticle Excitations and Identical Bands in Superdeformed ^{149}Gd Nucleus

S. Flibotte, G. Hackman, Ch. Theisen, H. R. Andrews, G. C. Ball, C. W. Beausang, F. A. Beck, G. Belier, M. A. Bentley, T. Byrski, D. Curien, G. de France, D. Disdier, G. Duchene, P. Fallon, B. Haas, V. P. Janzen, P. M. Jones, B. Kharraja, J. A. Kuehner, J. C. Lisle, J. C. Merdinger, S. M. Mullins, E. S. Paul, D. Prevost, D. C. Radford, V. Rauch, J. F. Smith, J. Styczen, P. J. Twin, J. P. Vivien, J. C. Waddington, D. Ward, K. Zuber, Phys. Rev. Lett. 71, 688 (1993).

Nuclear Reactions: $^{124}\text{Sn}(^{30}\text{Si},5n)$, $E=158$ MeV; measured $\gamma\gamma$ -coin. ^{149}Gd deduced levels, J, π , superdeformed bands.

93Fi07 $\Delta I = 4$ Bifurcation in a Superdeformed Band: Evidence for a C_2 Symmetry

S. Flibotte, H. R. Andrews, G. C. Ball, C. W. Beausang, F. A. Beck, G. Belier, T. Byrski, D. Curien, P. J. Dagnall, G. de France, D. Disdier, G. Duchene, Ch. Finck, B. Haas, G. Hackman, D. S. Haslip, V. P. Janzen, B. Kharraja, J. C. Lisle, J. C. Merdinger, S. M. Mullins, W. Nazarewicz, D. C. Radford, V. Rauch, H. Savajols, J. Styczen, Ch. Theisen, P. J. Twin, J. P. Vivien, J. C. Waddington, D. Ward, K. Zuber, S. Aberg, Phys. Rev. Lett. 71, 4299 (1993).

Nuclear Reactions: $^{124}\text{Sn}(^{30}\text{Si},5n)$, $E=158$ MeV; measured $E_\gamma, I_\gamma, \gamma\gamma$ -coin. ^{149}Gd deduced yrast superdeformed band moment of inertia, evidence for fourfold rotational symmetry.

93Ga10 First Evidence for the Hyperdeformed Nuclear Shape at High Angular Momentum

A. Galindo-Uribarri, H. R. Andrews, G. C. Ball, T. E. Drake, V. P. Janzen, J. A. Kuehner, S. M. Mullins, L. Persson, D. Prevost, D. C. Radford, J. C. Waddington, D. Ward, R. Wyss, Phys. Rev. Lett. 71, 231 (1993).

Nuclear Reactions: $^{120}\text{Sn}(^{37}\text{Cl},xnp)$, $E=187$ MeV; measured $\gamma\gamma$, $\gamma\gamma(\text{particle})$ -coin. $^{152}, ^{153}\text{Dy}$ deduced levels, γ -multipolarity, band structure, moment of inertia, hyperdeformation evidence.

93Ha03 Superdeformed Band in ^{142}Sm

G. Hackman, S. M. Mullins, J. A. Kuehner, D. Prevost, J. C. Waddington, A. Galindo-Uribarri, V. P. Janzen, D. C. Radford, N. Schmeing, D. Ward, Phys. Rev. C47, R433 (1993).

Nuclear Reactions: $^{124}\text{Sn}(^{24}\text{Mg},xn)$, $E=145$ MeV; measured $\gamma\gamma$ -coin, E_γ, I_γ . ^{142}Sm deduced superdeformed rotational band, continuum, dynamic moment of inertia.

93Ha19 Studies of Superdeformation in the Gadolinium Nuclei

B. Haas, V. P. Janzen, D. Ward, H. R. Andrews, D. C. Radford, D. Prevost, J. A. Kuehner, A. Omar, J. C. Waddington, T. E. Drake, A. Galindo-Uribarri, G. Zwart, S. Flibotte, P. Taras, I. Ragnarsson, Nucl. Phys. A561, 251 (1993).

Nuclear Reactions: $^{120}, ^{122}, ^{124}\text{Sn}(^{28}\text{Si},xn)$, $(^{29}\text{Si},xn)$, $(^{30}\text{Si},xn)$, $E=155$ MeV; measured $E_\gamma, I_\gamma, \gamma\gamma$ -coin, DCO ratios. $^{145}, ^{146}, ^{147}, ^{148}, ^{149}\text{Gd}$ deduced, γ -multiplicities, J, π , levels, superdeformed bands. Compton-suppressed hyperpure Ge detector array, 4π -bismuth germanate ball. Cranked shell-model-Strutinsky calculations.

93Ha20 Study of the Superdeformed Band in ^{194}Pb and ^{192}Hg with EURO GAM

F. Hannachi, C. Schuck, G. Bastin, I. Deloncle, B. Gall, M. G. Porquet, A. G. Smith, F. Azaiez, C. Bourgeois, J. Duprat, A. Korichi, N. Perrin, N. Poffe, H. Sergolle, A. Astier, Y. Le Coz, M. Meyer, N. Redon, M. Bentley, J. Simpson, J. F. Sharpey-Schafer, M. J. Joyce, C. W. Beausang, P. Fallon, E. S. Paul, P. J. Dagnall, S. A. Forbes, S. Gale, P. M. Jones, R. Wadsworth, R. M. Clark, M. M. Leonard, D. Curien, G. De France, M. Carpenter, R. Henry, T. Lauritsen, P. Willsau, Nucl. Phys. A557, 75c (1993).

Nuclear Reactions: $^{162}\text{Dy}(^{36}\text{S},4n)$, $E=162$ MeV; measured $E_\gamma, I_\gamma, \gamma\gamma$ -coin, DSA. $^{160}\text{Gd}(^{36}\text{S}, 4n)$, $E=159$ MeV; measured $\gamma\gamma$ -coin. ^{194}Pb deduced decay out of superdeformed band.

93HaZZ

G. S. Hackman, Priv. Comm. (1993).

Nuclear Structure: ^{149}Gd ; measured not given; deduced superdeformed band.

93Je02 A ' Superdeformed ' Band in ^{102}Pd

D. Jerrestam, S. Mitarai, E. Ideguchi, B. Fogelberg, A. Gizon, J. Gizon, W. Klamra, Th. Lindblad, R. Bark, J. Nyberg, M. Piiparinen, G. Sletten, Nucl. Phys. A557, 411c (1993).

Nuclear Reactions: ICPND $^{76}\text{Ge}(^{34}\text{S},3n\alpha)$, $E=130-153$ MeV; measured γ yields, $\gamma\gamma$ -coin, $\gamma\gamma(\theta)$. ^{102}Pd deduced levels, J, π , superdeformed band, configurations.

93JoZY First Measurement of a g-Factor in a Superdeformed Nucleus: ^{193}Hg

M. J. Joyce, J. F. Sharpey-Schafer, P. J. Twin, C. W. Beausang, D. M. Cullen, M. A. Riley, R. M. Clark, P. J. Dagnall, I. Deloncle, J. Duprat, P. Fallon, P. D. Forsyth, N. Fotiades, S. J. Gale, B. Gall, F. Hannachi, S. Harissopoulos, K. Hauschild, P. M. Jones, C. A. Kalfas, A. Korichi, I. Le Coz, M. Meyer, E. S. Paul, M. G. Porquet, N. Redon, C. Schuck, J. Simpson, R. Vlastou, R. Wadsworth, Priv. Comm. (1993).

Nuclear Reactions: $^{150}\text{Nd}(^{48}\text{Ca},5n)$, $E=213$ MeV; measured $E_\gamma, \gamma\gamma$ -coin. ^{193}Hg deduced superdeformed bands transition γ -multipolarity, g-factors, γ -branching ratio, configurations. Cranked Woods-Saxon calculations.

93Jo09 First Measurement of Magnetic Properties in a Superdeformed Nucleus: ^{193}Hg

M. J. Joyce, J. F. Sharpey-Schafer, P. J. Twin, C. W. Beausang, D. M. Cullen, M. A. Riley, R. M. Clark, P. J. Dagnall, I. Deloncle, J. Duprat, P. Fallon, P. D. Forsyth, N. Fotiades, S. J. Gale, B. Gall, F. Hannachi, S. Harissopoulos, K. Hauschild, P. M. Jones, C. A. Kalfas, A. Korichi, Y. Le Coz, M. Meyer, E. S. Paul, M. G. Porquet, N. Redon, C. Schuck, J. Simpson, R. Vlastou, R. Wadsworth, Phys. Rev. Lett. 71, 2176 (1993).

Nuclear Reactions: $^{150}\text{Nd}(^{48}\text{Ca},5n)$, $E=213$ MeV; measured $\gamma\gamma$ -coin. ^{193}Hg deduced levels, $J, \pi, B(\lambda), M1/E2$ branching ratios, superdeformed bands linking, g factor. Strong coupling model.

93Ko08 On the Decay of the Superdeformed Band in ^{194}Pb

W. Korten, M. J. Piiparinen, A. Atac, R. A. Bark, B. Herskind, T. Ramsoy, G. Sletten, J. Gerl, H. Hubel, P. Willsau, B. Cederwall, L. O. Nordin, B. Fant, Z. Phys. A344, 475 (1993).

Nuclear Reactions: $^{164}\text{Dy}(^{34}\text{S},4n)$, $E=160$ MeV; measured $\gamma\gamma$ -coin. ^{194}Pb deduced levels, J, π , superdeformed band decay features.

93LiZV Investigation of Superdeformation in Doubly-Magic ^{146}Gd

R. M. Lieder, W. Gast, A. Georgiev, S. Utzelmann, T. Rzaca-Urban, P. von Brentano, A. Dewald, Chr. Schuhmacher, F. Linden, J. Lisle, W. Urban, F. Hannachi, Daresbury Lab., 1992-1993 Ann. Rept., Appendix, p. 23 (1993).

Nuclear Reactions: $^{102}\text{Ru}(^{48}\text{Ca},4n)$, $E=203$ MeV; measured not given. ^{146}Gd deduced superdeformed band levels.

93Lu02 First Results from Ga. Sp. Experiments

S. Lunardi, Acta Phys. Pol. B24, 31 (1993).

Nuclear Reactions: $^{105}\text{Pd}(^{32}\text{S},2n2p)$, $E=155$ MeV; measured $\gamma\gamma$ -coin. ^{133}Nd deduced levels, J, π , superdeformed band states decay features.

93Lu04 First Results from Ga. Sp. Experiments: The decay out of the superdeformed band in ^{133}Nd

S. Lunardi, and the Ga. Sp. Collaboration, Nucl. Phys. A557, 331c (1993).

Nuclear Reactions: $^{105}\text{Pd}(^{32}\text{S},2n2p)$, $E=155$ MeV; measured $\gamma\gamma$, $\gamma\gamma\gamma$ -coin. ^{133}Nd deduced levels, J, π , decay out of superdeformed band.

93Ma02 First Evidence for States in Hg Nuclei with Deformations between Normal and Super Deformation

W. C. Ma, J. H. Hamilton, A. V. Ramayya, L. Chaturvedi, J. K. Deng, W. B. Gao, Y. R. Jiang, J. Kormicki, X. W. Zhao, N. R. Johnson, J. D. Garrett, I. Y. Lee, C. Baktash, F. K. McGowan, W. Nazarewicz, R. Wyss, Phys. Rev. C47, R5 (1993).

Nuclear Reactions: $^{154}\text{Gd}(^{36}\text{S},4n)$, $E=159-175$ MeV; measured $\gamma\gamma$ -coin. ^{186}Hg deduced levels, J, π , $T_{1/2}$, deformation between normal and superdeformed, configuration, Iy, quadrupole moments.

93Mo19 Spectroscopy of the Superdeformed Band in ^{196}Pb

E. F. Moore, Y. Liang, R. V. F. Janssens, M. P. Carpenter, I. Ahmad, I. G. Bearden, P. J. Daly, M. W. Drigert, B. Fomal, U. Garg, Z. W. Grabowski, H. L. Harrington, R. G. Henry, T. L. Khoo, T. Lauritsen, R. H. Mayer, D. Nissius, W. Reviol, M. Sferazza, Phys. Rev. C48, 2261 (1993).

Nuclear Reactions: $^{170}\text{Er}(^{30}\text{Si},4n)$, $E=142-151$ MeV; measured $E\gamma$, Iy, $\gamma\gamma$ -coin, DSA. ^{196}Pb deduced superdeformed band transitions, intrinsic quadrupole moment, dynamic moment of inertia. Model comparison.

93Mu05 Perturbed Alignments within an i_{132} Neutron Intruder Band in ^{141}Gd

S. M. Mullins, A. Omar, L. Persson, D. Prevost, J. C. Waddington, H. R. Andrews, G. C. Ball, A. Galindo-Uribarri, V. P. Janzen, D. C. Radford, D. Ward, T. E. Drake, D. B. Fossan, D. LaFosse, P. Vaska, M. Waring, R. Wadsworth, Phys. Rev. C47, R2447 (1993).

Nuclear Reactions: $^{112}\text{Sn}(^{32}\text{S},n2p)$, $E=155$ MeV; $^{112}\text{Sn}(^{33}\text{S}, 2n2p)$, $E=170$ MeV; measured $\gamma\gamma$, $\gamma\gamma$ (charged particle)-coin. ^{141}Gd deduced levels, J, π , configuration, alignment features. Cranked shell model.

93Mu09 Population Effects in the Highly-Deformed Bands of ^{131}Ce and ^{135}Nd from ^{16}O , ^{16}O -Induced Reactions

S. M. Mullins, J. Nyberg, A. Maj, M. S. Metcalfe, P. J. Nolan, P. H. Regan, R. Wadsworth, R. A. Wyss, Phys. Lett. 312B, 272 (1993).

Nuclear Reactions: $^{117}\text{Sn}(^{16}\text{O},4n)$, $E=85$ MeV; measured $E\gamma$, Iy, $\gamma\gamma$ -coin, DSA. $^{122}\text{Te}(^{16}\text{O}, 3n)$, $E=85$ MeV; measured $E\gamma$, Iy, $\gamma\gamma$ -coin. ^{131}Ce , ^{135}Nd deduced levels, J, π , highly deformed band structure.

93Mu16 Superdeformation in ^{144}Eu

S. M. Mullins, G. Hackman, A. Galindo-Uribarri, D. C. Radford, J. C. Waddington, D. Ward, Z. Phys. A346, 327 (1993).

Nuclear Reactions: $^{122}\text{Sn}(^{27}\text{Al},5n)$, $E=142$ MeV; measured $\gamma\gamma$ -coin. ^{144}Eu deduced superdeformed band evidence.

93No04 Superdeformation and High Spin States

P. J. Nolan, Nucl. Phys. A553, 107c (1993).

Nuclear Structure: $A=130-140$; $A 150$; $A 190$; compiled, reviewed superdeformation, other data features.

93Pa02 Resolution of the Highly Deformed Band Assignment Anomaly in $^{134}\text{Nd}/^{131}\text{Ce}$

E. S. Paul, C. W. Beausang, R. M. Clark, R. A. Cunningham, P. Fallon, S. A. Forbes, C. J. Gross, F. Hannachi, A. N. James, A. Korichi, P. J. Nolan, J. Simpson, R. Wadsworth, J. N. Wilson, J. Phys. (London) G19, L23 (1993).

Nuclear Reactions: $^{104}\text{Ru}(^{32}\text{S},xn\text{p}\alpha)$, $E=155, 160$ MeV; measured $E\gamma$, Iy, $\gamma\gamma$, (recoil) γ -coin; deduced relative Iy for many exit channels. 133 , ^{135}Nd , ^{131}Ce deduced highly deformed bands.

93Pa05 $E0$ Transitions and the Depopulation of SD Bands

M. Palacz, Z. Sujkowski, J. Bacelar, A. Atac, B. Herskind, J. Nyberg, M. Piiparinen, G. de Angelis, S. Forbes, N. Gjorup, G. Hagemann, F. Ingebretsen, H. Jensen, D. Jerrestam, H. Kusakari, R. Lieder, G. M. Marti, S. Mullins, D. Santonocito, H. Schnare, G. Sletten, K. Strahle, M. Sugawara, P. O. Tjom, A. Virtanen, R. Wadsworth, Acta Phys. Pol. B24, 399 (1993).

Nuclear Structure: ^{132}Ce , ^{143}Eu , ^{152}Dy , ^{192}Hg ; calculated transition probability vs excitation energy for superdeformed states. ^{143}Eu ; analyzed $\gamma(K X\text{-ray})$ -coin following superdeformed states decay.

93PI01 Lack of Evidence for a Superdeformed Band in ^{192}Pb

A. J. M. Plompen, M. N. Harakeh, W. H. A. Hesselink, G. van't Hof, N. Kalantar-Nayestanaki, J. P. S. van Schagen, R. V. F. Janssens, I. Ahmad, I. G. Bearden, M. P. Carpenter, T. L. Khoo, T. Lauritsen, Y. Liang, U. Garg, W. Reviol, D. Ye, Phys. Rev. C47, 2378 (1993).

Nuclear Reactions: $^{173}\text{Yb}(^{24}\text{Mg},5n)$, $E=132$ MeV; measured $\gamma\gamma$ -coin, DSA. ^{192}Pb deduced no superdeformed band.

93Ra08 High-Spin Studies: Recent results from the 8π spectrometer

D. C. Radford, A. Galindo-Uribarri, G. Hackman, V. P. Janzen, and the 8π Collaboration, Nucl. Phys. A557, 311c (1993).

Nuclear Reactions: $^{54}\text{Fe}(^{58}\text{Ni},3p)$, $E=243$ MeV; $^{86}\text{Ru}(^{19}\text{F}, 2n2p)$, $E=90$ MeV; $^{92}\text{Mo}(^{23}\text{Na},2n2p)$, $E=120$ MeV; $^{94}\text{Mo}(^{23}\text{Na},2n2p)$, $E=117$ MeV; $^{96}\text{Zr}(^{23}\text{Na}, 5n)$, $E=102$ MeV; $^{96}\text{Zr}(^{23}\text{Na},4n)$, $E=102$ MeV; $^{108}\text{Pd}(^{11}\text{B},4n)$, $E=47$ MeV; $^{110}\text{Pd}(^{11}\text{B}, 4n)$, $E=45$ MeV; $^{116}\text{Cd}(^{7}\text{Li},4n)$, $E=39$ MeV; $^{54}\text{Fe}(^{58}\text{Ni},2\text{p}\alpha)$, $E=243$ MeV; $^{54}\text{Fe}(^{58}\text{Ni}, 4p)$, $E=243$ MeV; $^{94}\text{Mo}(^{19}\text{F},2np)$, $E=83$ MeV; $^{94}\text{Mo}(^{23}\text{Na},2n\text{p}\alpha)$, $E=117$ MeV; $^{76}\text{Ge}(^{37}\text{Cl}, 4n)$, $E=138$ MeV; $^{96}\text{Zr}(^{19}\text{F},5n)$, $E=95$ MeV; $^{96}\text{Zr}(^{19}\text{F},4n)$, $E=85$ MeV; $^{96}\text{Zr}(^{19}\text{F}, 4n)$, $E=70$ MeV; deduced band structure for Sb, Sn, In isotopes, A 100. ^{142}Sm deduced superdeformed band. Other data input. $^{120}\text{Sn}(^{27}\text{Cl},xnp)$, $E=187$ MeV; measured $\gamma\gamma$, $\gamma\gamma\gamma$ -coin. 152 , ^{153}Dy deduced hyperdeformation evidence. 8π γ -ray spectrometer.

93Ri02 *Highly Deformed Band in ^{136}Pm and the Anomalous Dynamical Moment of Inertia Behavior in the A 135 Superdeformed Region*

M. A. Riley, T. Petters, J. Shick, D. E. Archer, J. Doring, J. W. Holcomb, G. D. Johns, T. D. Johnson, O. N. Tekyi-Mensah, S. L. Tabor, P. C. Womble, V. A. Wood, C. Baktash, M. L. Halbert, D. C. Hensley, I. Y. Lee, R. J. Charity, D. G. Sarantites, L. L. Wittmer, J. Simpson, Phys. Rev. C47, R441 (1993).

Nuclear Reactions: $^{106}\text{Pd}(^{34}\text{S},\text{xpy}\alpha)$, $^{106}\text{Pd}(^{32}\text{S},\text{xpy}\alpha)$, $E=165$ MeV; measured $\gamma\text{-coin}$ sum spectra. ^{136}Pm deduced deformed rotational band, dynamical moment of inertia, superdeformation aspects. Other nuclei considered.

93SeZZ *A Search for a Superdeformed Band in ^{144}Gd*

A. T. Semple, C. W. Beausang, S. A. Forbes, P. J. Nolan, E. S. Paul, J. N. Wilson, R. M. Clark, K. Hauschild, I. M. Hibbert, R. Wadsworth, J. Simpson, A. Gizon, J. Gizon, D. Santos, Daresbury Lab., 1992-1993 Ann. Rept., Appendix, p. 22 (1993).

Nuclear Reactions: $^{118}\text{Sn}(^{32}\text{Si},4n)$, $E=155$ MeV; measured $\gamma\text{-coin}$. ^{144}Gd deduced no definite superdeformed band.

93St01 *Search for Population of Superdeformed States in ^{194}Pb Using ^{194}Bi β^+ Decay*

M. A. Stoyer, E. A. Henry, Y. A. Akovali, J. A. Becker, C. R. Bingham, J. Breitenbach, H. K. Carter, R. W. Hoff, M. Jarrico, P. Joshi, J. Kormicki, A. Kuhnert, P. F. Mantica, T. F. Wang, J. L. Wood, M. Zhang, Phys. Rev. C47, 76 (1993).

Radioactivity: $^{194}\text{Bi}(\beta^+)$, (EC) [from $\text{Re}(^{16}\text{O},\text{xn})$, $E=170$ MeV]; measured $E\gamma$, $I\gamma$, $\gamma\text{-}$, $\gamma(\text{ce})\text{-coin}$, $I(\text{ce})$. ^{194}Pb deduced levels, J , π upper limit for superdeformed states population.

93Vo04 *Superdeformation in ^{191}Au*

D. T. Vo, W. H. Kelly, F. K. Wahn, J. C. Hill, M. A. Deleplanque, R. M. Diamond, F. S. Stephens, J. R. B. Oliveira, J. Burde, A. O. Macchiavelli, J. deBoer, B. Cederwall, I. Y. Lee, P. Fallon, J. A. Becker, E. A. Henry, M. J. Brinkman, A. Kuhnert, M. A. Stoyer, J. R. Hughes, J. E. Draper, C. Duyar, E. Rubel, Phys. Rev. Lett. 71, 340 (1993).

Nuclear Reactions: $^{186}\text{W}(^{11}\text{B},7n)$, $(^{11}\text{B},6n)$, $(^{11}\text{B},5n)$, $E=84, 86$ MeV; $^{176}\text{Yb}(^{19}\text{F},\text{xn})$, $E=100, 105$ MeV; measured $\gamma\text{-coin}$. ^{191}Au deduced levels, J , π , superdeformed band, dynamic moments of inertia.

93Wi02 *Transition Quadrupole Moments of Superdeformed States in ^{194}Pb*

P. Willsau, H. Hubel, W. Korten, F. Azaiez, M. A. Deleplanque, R. M. Diamond, A. O. Macchiavelli, F. S. Stephens, H. Kluge, F. Hannachi, J. C. Bacelar, J. A. Becker, M. J. Brinkman, E. A. Henry, A. Kuhnert, T. F. Wang, J. A. Draper, E. Rubel, Z. Phys. A344, 351 (1993).

Nuclear Reactions: $^{150}\text{Sm}(^{48}\text{Ca},4n)$, $E=205$ MeV; measured $\gamma\text{-coin}$, DSA. ^{194}Pb levels deduced $T_{1/2}$, superdeformed states transition quadrupole moments.

93Wi09 *Lifetimes of the Decay from Superdeformed to Normal Deformed in ^{135}Nd*

P. Willsau, H. Hubel, R. M. Diamond, M. A. Deleplanque, A. O. Macchiavelli, J. R. Oliveira, F. S. Stephens, H. Kluge, J. A. Becker, E. A. Henry, A. Kuhnert, M. Stoyer, Phys. Rev. C48, R494 (1993).

Nuclear Reactions: $^{100}\text{Mo}(^{40}\text{Ar},5n)$, $E=175$ MeV; measured $\gamma\text{-coin}$, Doppler shift recoil distance. ^{135}Nd deduced superdeformed states $T_{1/2}$, transition probabilities, quadrupole moments.

93WiZX *Multiple, Excited Superdeformed Bands in ^{133}Pr*

J. N. Wilson, P. J. Nolan, E. S. Paul, A. T. Semple, C. W. Beausang, S. A. Forbes, R. Wadsworth, K. Hauschild, I. M. Hibbert, R. M. Clark, J. Gizon, A. Gizon, D. Santos, B. Nyako, J. Simpson, Daresbury Lab., 1992-1993 Ann. Rept., Appendix, p. 17 (1993).

Nuclear Reactions: $^{100}\text{Mo}(^{37}\text{Cl},4n)$, $E=155$ MeV; measured $\gamma\text{-coin}$. ^{133}Pr deduced levels, J , π , superdeformed band.

93WiZZ *Highly Deformed Bands in ^{132}Ce and ^{133}Pr*

J. N. Wilson, C. W. Beausang, S. A. Forbes, P. J. Nolan, E. S. Paul, A. T. Semple, A. Gizon, J. Gizon, D. Santos, B. M. Nyako, R. M. Clark, I. M. Hibbert, K. Hauschild, R. Wadsworth, J. Simpson, Bull. Am. Phys. Soc. 38, No. 2, 981, 16 9 (1993)

Nuclear Reactions: $^{100}\text{Mo}(^{36}\text{S},4n)$, $(^{37}\text{Cl},4n)$, E not given; measured $\gamma\text{-coin}$. ^{132}Ce , ^{133}Pr deduced levels, J , π , superdeformed bands.

93Zh21 *Comment on 'Evidence for Superdeformed Shape Isomeric States in ^{28}Si at Excitations Above 40 MeV Through Observations of Selective Particle Decays of $^{16}\text{O} + ^{12}\text{C}$ Resonances in ^{9}Be and Alpha Channels'*

J. Zhang, A. C. Merchant, W. D. M. Rae, Phys. Rev. C48, 2117 (1993).

Nuclear Reactions: $^{12}\text{C}(^{16}\text{O},^9\text{Be})$, $(^{16}\text{O},\alpha)$, $E(\text{cm})=25.7\text{-}38.6$ MeV; analyzed previous data analyses. ^{28}Si deduced superdeformed shape isomeric states structure.

94At01 *Superdeformation in ^{142}Eu*

A. Atac, S. Petzold, J. Nyberg, M. Piipariinen, C. Rossi Alvarez, G. de Angelis, D. de Acuna, R. A. Bark, D. Bazzacco, G. Lo Bianco, R. Burch, A. Buscemi, B. Herskind, S. Leoni, S. Lunardi, G. Maron, B. Million, D. Napoli, M. de Poli, J. Rico, G. Stetten, G. Vedovato, Z. Phys. A348, 251 (1994).

Nuclear Reactions: $^{110}\text{Pd}(^{37}\text{Cl},5n)$, $E=160$ MeV; measured $\gamma\text{-coin}$, $E\gamma$, $I\gamma$. ^{142}Eu deduced high-spin levels, J , π , superdeformed band, moment of inertia. Cranked shell model comparison.

94Ba25 *Complete Decay Out of the Superdeformed Band in ^{133}Nd*

D. Bazzacco, F. Brandolini, R. Burch, S. Lunardi, E. Maglione, N. H. Medina, P. Pavan, C. Rossi-Alvarez, G. de Angelis, D. De Acuna, M. De Poli, J. Rico, D. Bucurescu, C. Ur, Phys. Rev. C49, R2281 (1994).

Nuclear Reactions: $^{104}\text{Pd}(^{32}\text{S},n2p)$, $E=135$ MeV; measured $\gamma\text{-coin}$. ^{133}Nd deduced levels, J , π , superdeformed, normal band linking transitions, γ -branching ratios.

94Ce04 *New Features of Superdeformed Bands in ^{194}Hg*

B. Cederwall, R. V. F. Janssens, M. J. Brinkman, I. Y. Lee, I. Ahmad, J. A. Becker, M. P. Carpenter, B. Crowell, M. A. Deleplanque, R. M. Diamond, J. E. Draper, C. Duyar, P. Fallon, L. P. Farris, E. A. Henry, R. G. Henry, J. R. Hughes, T. L. Khoo, T. Lauritsen, A. O. Macchiavelli, E. Rubel, F. S. Stephens, M. A. Stoyer, W. Satula, I. Wiedenhoever, R. Wyss, Phys. Rev. Lett. 72, 3150 (1994).

Nuclear Reactions: $^{150}\text{Nd}(^{48}\text{Ca},4n)$, $E=206$ MeV; measured $\gamma\text{-coin}$. ^{194}Hg deduced levels, J , π , superdeformed band properties.

- 94Cl02 Superdeformation in the Pb Nuclei and the Evolution of the Dynamic Moments of Inertia**
R. M. Clark, R. Wadsworth, K. Hauschild, I. M. Hibbert, E. Dragulescu, C. W. Beausang, M. H. Bergstrom, S. Clarke, P. J. Dagnall, P. M. Jones, E. S. Paul, A. T. Semple, J. F. Sharpey-Schafer, J. Simpson, W. Satula, R. Wyss, Phys. Rev. C50, 1222 (1994).
Nuclear Structure: $^{186}\text{W}({}^{18}\text{O},\text{xn})$, $E=113$ MeV; measured E_{γ} , I_{γ} , $\gamma\gamma$ -coin. 184 , 196 , ^{198}Pb deduced superdeformed band features, dynamic moments of inertia. Comparison with cranked Woods-Saxon calculations. Enriched targets, hyperpure Ge detectors, BGO suppression shields.
- 94Cr06 Heavy Ion Transfer Studies using Detector Arrays**
A. J. Cresswell, P. A. Butler, D. Cline, R. A. Cunningham, M. Devlin, F. Hannachi, K. G. Helmer, R. Ibbotson, G. D. Jones, P. M. Jones, I. -Y. Lee, X. -T. Liu, J. O. Rasmussen, M. W. Simon, J. Simpson, J. F. Smith, M. A. Stoyer, C. -Y. Wu, Acta Phys. Pol. B25, 565 (1994).
Nuclear Reactions: ICPND $^{161}\text{Dy}({}^{61}\text{Ni}, {}^{62}\text{Ni})$, (${}^{61}\text{Ni}$, ${}^{60}\text{Ni}$), $E=270$ MeV; measured $\gamma\gamma$ -coin. 150 , ^{162}Dy deduced levels, band structure, configuration. $^{239}\text{Pu}({}^{117}\text{Sn}, {}^{118}\text{Sn})$, $E=630$ MeV; measured fragment spectra following residual isomer fission, $\gamma\gamma$ -coin; deduced superdeformed states population probability by transfer reaction.
- 94Cr08 Superdeformed Band with a Unique Decay Pattern: Possible evidence for octupole vibration in ^{190}Hg**
B. Crowell, R. V. F. Janssens, M. P. Carpenter, I. Ahmad, S. Harfenist, R. G. Henry, T. L. Khoo, T. Lauritsen, D. Nisius, A. N. Wilson, J. F. Sharpey-Schafer, J. Skalski, Phys. Lett. 333B, 320 (1994).
Nuclear Reactions: $^{160}\text{Gd}({}^{34}\text{S}, 4n)$, $E=163$ MeV; measured $\gamma\gamma$ -coin. ^{190}Hg deduced high-spin levels, J , π , superdeformed band transitions, dynamic moment of inertia, shape features.
- 94Da20 Excited Bands in the Doubly-Magic Superdeformed ^{152}Dy Nucleus: Evidence for the first $N = 7$ proton hyper-intruder orbital**
P. J. Dagnall, C. W. Beausang, P. J. Twin, M. A. Bentley, F. A. Beck, Th. Byrski, S. Clarke, D. Curien, G. Duchene, G. de France, P. D. Forsyth, B. Haas, J. C. Lisle, E. S. Paul, J. Simpson, J. Styczen, J. P. Vivien, J. N. Wilson, K. Zuber, Phys. Lett. 335B, 313 (1994).
Nuclear Reactions: $^{108}\text{Pd}({}^{48}\text{Ca}, 4n)$, $E=200$ MeV; measured $\gamma\gamma$ -coin, E_{γ} , I_{γ} . ^{152}Dy deduced high-spin levels, J , π , superdeformed bands, configurations.
- 94De24 Superdeformation in the Mass 150 Region: New results with the EURO-GAM array**
G. De France, Acta Phys. Pol. B25, 555 (1994).
Nuclear Reactions: $^{124}\text{Sn}({}^{30}\text{Si}, 5n)$, $E=158$ MeV; $^{130}\text{Te}({}^{27}\text{Al}, 6n)$, $E=154$ MeV; measured not given. ^{149}Gd , ^{151}Tb deduced superdeformed band features. Discussed other nuclei systematics, EURO-GAM facility.
- 94De33 Neutron Excitations Across the $N = 86$ Superdeformed Shell Gap**
G. de France, B. Haas, I. Ragnarsson, P. J. Twin, C. W. Beausang, F. A. Beck, T. Byrski, S. Clarke, D. Curien, P. J. Dagnall, G. Duchene, P. Fallon, S. Flibotte, S. Forbes, P. D. Forsyth, B. Kharraja, J. C. Lisle, J. C. Merdinger, C. M. Petrache, D. Prevost, J. F. Sharpey-Schafer, J. Simpson, J. P. Vivien, K. Zuber, Phys. Lett. 331B, 290 (1994).
Nuclear Structure: ^{149}Gd , 152 , ^{151}Tb , ^{152}Dy ; analyzed E_{γ} data; deduced superdeformed high-spin bands features.
- 94Du12 First Observation of a Superdeformed Nucleus Produced in an αxn Reaction Channel**
J. Duprat, B. J. P. Gall, M. G. Porquet, F. Hannachi, F. Azaiez, M. Aiche, G. Bastin, C. W. Beausang, R. Beraud, C. Bourgeois, R. M. Clark, I. Deloncle, R. Duffait, K. Hauschild, H. Hubel, M. J. Joyce, M. Kaci, A. Korichi, Y. Le Coz, M. Meyer, E. S. Paul, N. Perrin, N. Poffe, N. Redon, C. Schuck, H. Sergolle, J. F. Sharpey-Schafer, J. Simpson, A. G. Smith, R. Wadsworth, Z. Phys. A349, 5 (1994).
Nuclear Reactions: $^{184}\text{W}({}^{16}\text{O}, 4n\alpha)$, $E=113$ MeV; measured $\gamma\gamma$ -coin. ^{192}Hg deduced superdeformed high-spin band feeding, decay-out patterns.
- 94Du13 High Spin States in the Nucleus ^{150}Tb**
G. Duchene, C. M. Petrache, C. W. Beausang, F. A. Beck, T. Byrski, D. Curien, P. J. Dagnall, S. Flibotte, P. D. Forsyth, G. de France, B. Haas, B. Kharraja, J. C. Merdinger, D. Prevost, C. Schuck, C. Theisen, P. J. Twin, J. P. Vivien, Z. Phys. A350, 39 (1994).
Nuclear Reactions: $^{130}\text{Te}({}^{27}\text{Al}, 7n)$, $E=154$ MeV; measured $\gamma\gamma$ -coin. ^{150}Tb deduced high-spin levels, J , π , configurations, yrast superdeformed band decay features. Deformed independent particle model.
- 94Du16 M1 Transitions between Superdeformed States in ^{195}Tl : The fingerprint of the $i_{13/2}$ proton intruder orbital**
J. Duprat, F. Azaiez, C. Bourgeois, J. F. Sharpey-Schafer, M. G. Porquet, M. Aiche, C. W. Beausang, R. M. Clark, I. Deloncle, R. Duffait, B. Gall, S. J. Gale, F. Hannachi, I. Hibbert, M. J. Joyce, M. Kaci, W. H. Kelly, A. Korichi, Y. Le Coz, M. Meyer, N. Perrin, N. Poffe, N. Redon, H. Sergolle, C. Schuck, J. Simpson, R. Wadsworth, Phys. Lett. 341B, 6 (1994).
Nuclear Reactions: $^{198}\text{W}({}^{15}\text{N}, 6n)$, $E=105$ MeV; measured $\gamma\gamma$ -coin. ^{195}Tl deduced high-spin superdeformed band transitions, γ -branching, γ -multipolarity.
- 94Fa13 Pair Excitations and a Proton Band Crossing in Superdeformed ^{150}Gd**
P. Fallon, C. W. Beausang, S. Clarke, P. J. Twin, F. A. Beck, Th. Byrski, D. Curien, P. J. Dagnall, G. de France, G. Duchene, P. D. Forsyth, B. Haas, M. J. Joyce, A. O. Macchiavelli, E. S. Paul, J. F. Sharpey-Schafer, J. Simpson, J. P. Vivien, S. Aberg, W. Nazarewicz, Phys. Rev. Lett. 73, 782 (1994).
Nuclear Reactions: $^{130}\text{Te}({}^{26}\text{Mg}, 6n)$, $E=149$ MeV; measured $\gamma\gamma$ -coin. ^{150}Gd deduced superdeformed high-spin band, configuration, dynamic moments of inertia, relative I_{γ} .
- 94FiZZ Table of Superdeformed Nuclear Bands and Fission Isomers**
R. B. Firestone, B. Singh, LBL-35916 (1994).
Compilation: $A=130-245$; compiled, evaluated superdeformed bands, fission isomers data.
- 94Ga07 New Results on the Superdeformed Band in ^{192}Hg**
B. J. P. Gall, M. G. Porquet, F. Hannachi, A. Korichi, I. Ahmad, M. Aiche, F. Azaiez, G. Bastin, C. W. Beausang, R. Beraud, C. Bourgeois, M. P. Carpenter, R. M. Clark, I. Deloncle, R. Duffait, J. Duprat, K. Hauschild, R. Henry, R. V. F. Janssens, M. J. Joyce, T. L. Khoo, M. Kaci, T. Lauritsen, Y. Le Coz, M. Meyer, E. S. Paul, N. Perrin, N. Poffe, N. Redon, C. Schuck, H. Sergolle, J. F. Sharpey-Schafer, J. Simpson, A. G. Smith, R. Wadsworth, P. Willsau, Z. Phys. A347, 223 (1994).
Nuclear Reactions: $^{160}\text{Gd}({}^{36}\text{S}, 4n)$, $E=159$ MeV; measured $\gamma\gamma$ -coin. ^{192}Hg deduced superdeformed band dynamical moment of inertia features. Cranked HFB model comparison.

94Ga31 *Strongly Coupled Enhanced-Deformation Band in ^{131}Pr*

A. Galindo-Uribarri, D. Ward, T. Drake, G. Hackman, V. P. Janzen, S. M. Mullins, S. Pilotte, D. C. Radford, I. Ragnarsson, N. C. Schmeing, J. C. Waddington, Phys. Rev. C50, R2655 (1994).

Nuclear Reactions: $^{98}\text{Mo}(^{37}\text{Cl},4n)$, $E=155$ MeV; measured E_γ , $\gamma\gamma$ -coin, DSA. ^{131}Pr deduced high-spin levels, J, π , rotational band structure, enhanced deformation, superdeformation.

94HaAA

Shape Coexistence in ^{133}Ce at High Rotational Frequency. Hauschild et al., Proc. Conf. Large Gamma-Ray Detector Arrays, Berkeley, LBL-35687, vol. 1, p 7 (1994) (abstract).

94He15 *Comment on 'Lack of Evidence for a Superdeformed Band in ^{192}Pb '*

E. A. Henry, A. Kuhnert, J. A. Becker, M. J. Brinkman, T. F. Wang, J. A. Cizewski, W. Korten, F. Azaiez, M. A. Deleplanque, R. M. Diamond, J. E. Draper, W. H. Kelly, A. O. Macchiavelli, F. S. Stephens, Phys. Rev. C49, 2849 (1994).

Nuclear Reactions: $^{148}\text{Sm}(^{48}\text{Ca},4n)$, $E=205$ MeV; $^{173}\text{Yb}(^{24}\text{Mg}, 5n)$, $E=128, 132$ MeV; measured E_γ , γ . ^{192}Pb deduced superdeformed band.

94He30 *Spectrum of γ Rays Connecting Superdeformed and Normal States in ^{192}Hg*

R. G. Henry, T. Lauritsen, T. L. Khoo, I. Ahmad, M. P. Carpenter, B. Crowell, T. Dossing, R. V. F. Janssens, F. Hannachi, A. Korichi, C. Schuck, F. Azaiez, C. W. Beausang, R. Beraud, C. Bourgeois, R. M. Clark, I. Deloncle, J. Duprat, B. Gall, H. Hubel, M. J. Joyce, M. Kaci, Y. Lecoq, M. Meyer, E. S. Paul, N. Perrin, N. Poiffe, M. G. Porquet, N. Redon, H. Sergolle, J. F. Sharpey-Schafer, J. Simpson, A. G. Smith, R. Wadsworth, P. Willsau, Phys. Rev. Lett. 73, 777 (1994).

Nuclear Reactions: $^{160}\text{Gd}(^{36}\text{S},4n)$, $E=159$ MeV; measured $\gamma\gamma$ -coin. ^{192}Hg deduced superdeformed to normal high-spin states transition, band coupling features.

94Hu05 *Lifetime Measurement in Excited and Yrast Superdeformed Bands in ^{194}Hg*

J. R. Hughes, I. Ahmad, J. A. Becker, M. J. Brinkman, M. P. Carpenter, B. Cederwall, M. A. Deleplanque, R. M. Diamond, J. E. Draper, C. Duyar, P. Fallon, S. Harfenist, E. A. Henry, R. G. Henry, R. W. Hoff, R. V. F. Janssens, T. L. Khoo, T. Lauritsen, I. Y. Lee, E. Rubel, F. S. Stephens, M. A. Stoyer, Phys. Rev. Lett. 72, 824 (1994).

Nuclear Reactions: $^{150}\text{Nd}(^{48}\text{Ca},4n)$, $E=205$ MeV; measured $\gamma\gamma$ -coin, DSA. ^{194}Hg deduced superdeformed bands $T_{1/2}$, average transition quadrupole moments, $B(\lambda)$.

94Hu10 *Excitations in Doubly-Magic Superdeformed ^{194}Pb*

J. R. Hughes, J. A. Becker, M. J. Brinkman, L. P. Farris, E. A. Henry, R. W. Hoff, M. A. Stoyer, B. Cederwall, M. A. Deleplanque, R. M. Diamond, P. Fallon, I. Y. Lee, A. O. Macchiavelli, F. S. Stephens, J. A. Cizewski, L. A. Bernstein, W. Younes, H. -Q. Jin, J. E. Draper, C. Duyar, E. Rubel, W. H. Kelly, D. T. Vo, Phys. Rev. C50, R1265 (1994).

Nuclear Reactions: $^{174}\text{Yb}(^{26}\text{Mg},5n)$, $E=130$ MeV; measured E_γ , γ , $\gamma\gamma$ -coin. ^{194}Pb deduced excited superdeformed high-spin bands.

94Jo10 *The $N = 7$ Unfavoured Superdeformed Band in ^{193}Hg : Coriolis splitting and neutron shell structure at extreme deformation*

M. J. Joyce, J. F. Sharpey-Schafer, M. A. Riley, D. M. Cullen, F. Azaiez, C. W. Beausang, R. M. Clark, P. J. Dagnall, I. Deloncle, J. Duprat, P. Fallon, P. D. Forsyth, N. Fotiades, S. J. Gale, B. Gall, F. Hannachi, S. Harissopoulos, K. Hauschild, P. M. Jones, C. A. Kalfas, A. Korichi, Y. Le Coz, M. Meyer, E. S. Paul, M. G. Porquet, N. Redon, C. Schuck, J. Simpson, R. Vlastou, R. Wadsworth, W. Nazarewicz, Phys. Lett. 340B, 150 (1994).

Nuclear Reactions: $^{150}\text{Nd}(^{48}\text{Ca},5n)$, $E=213$ MeV; measured $\gamma\gamma$ -coin, E_γ , γ . ^{193}Hg deduced high-spin levels, J, π , superdeformed band.

94KhZZ *Etude de la Superdeformation dans les Isotopes 151 , ^{152}Tb a l'Aide du Multidetector EUROGRAM*

Ei. B. Kharraja, Thesis, Univ. Louis Pasteur de Strasbourg (1994); CRN 94-26 (1994).

Nuclear Structure: ^{151}Tb , ^{152}Dy ; analyzed $\gamma\gamma$ -coin data. ^{152}Dy deduced high-spin levels, J, π , band structure. ^{151}Tb deduced high-spin levels, J, π , superdeformed bands.

94Kr18 *Decay Out of Low Spin Superdeformed States in ^{194}Pb by Weak Mixing with Normal Deformed States*

R. Kruecken, A. Dewald, P. Sala, C. Meier, H. Tiesler, J. Altmann, K. O. Zell, P. von Brentano, D. Bazzacco, C. Rossi-Alvarez, R. Burch, R. Menegazzo, G. de Angelis, G. Maron, M. de Poli, Phys. Rev. Lett. 73, 3359 (1994).

Nuclear Reactions: $^{162}\text{Dy}(^{36}\text{S},4n)$, $E=168$ MeV; measured $\gamma\gamma$ -coin, recoil distance Doppler shift. ^{194}Pb deduced high-spin superdeformed states $T_{1/2}$, $B(\lambda)$, transition quadrupole moments.

94Le24 *Lifetimes of Low-Spin States in the Superdeformed Band of ^{192}Hg*

I. Y. Lee, C. Baktash, D. M. Cullen, J. D. Garrett, N. R. Johnson, F. K. McGowan, D. F. Winchell, C. H. Yu, Phys. Rev. C50, 2602 (1994).

Nuclear Reactions: $^{160}\text{Gd}(^{36}\text{S},4n)$, $E=159$ MeV; measured $\gamma\gamma$ -coin. ^{192}Hg deduced superdeformed high-spin states $T_{1/2}$. Recoil distance method.

94Lu03 *Proton Backbend in the Doubly-Magic Superdeformed Nucleus ^{144}Gd*

S. Lunardi, D. Bazzacco, C. Rossi-Alvarez, P. Pavan, G. de Angelis, D. De Acuna, M. De Poli, G. Maron, J. Rico, O. Stuch, D. Weil, S. Utzelmann, P. Hoernes, W. Satula, R. Wyss, Phys. Rev. Lett. 72, 1427 (1994).

Nuclear Reactions: $^{100}\text{Mo}(^{48}\text{Ti},4n)$, $E=221$ MeV; measured E_γ , γ , $\gamma\gamma$ -coin. ^{144}Gd deduced levels, J, π , superdeformed band dynamical moment of inertia. Cranked mean field calculations comparison.

94Mu16 *Proton Configurations and Pairing Correlations at the $N = 80$ Superdeformed Shell Closure: Study of ^{145}Tb*

S. M. Mullins, N. C. Schmeing, S. Filibotte, G. Hackman, J. L. Rodriguez, J. C. Waddington, L. Yao, H. R. Andrews, A. Galindo-Uribarri, V. P. Janzen, D. C. Radford, D. Ward, J. DeGraaf, T. E. Drake, S. Pilotte, E. S. Paul, Phys. Rev. C50, R2261 (1994).

Nuclear Reactions: $^{112}\text{Sn}(^{37}\text{Cl},2n2p)$, $E=187$ MeV; $^{118}\text{Sn}(^{31}\text{P}, 4n)$, $E=160$ MeV; measured $\gamma\gamma$ (charged particle)-, $\gamma\gamma$ -coin, E_γ , γ . ^{145}Tb deduced superdeformed rotational band, high-spin levels, J, π . Cranked Woods-Saxon-Strutinsky calculations. Hyperpure Ge detectors, BGO suppression shields, BGO total energy, multiplicity filter, CsI detectors coupled to photodiodes, enriched targets.

94MuAA

Studies of Superdeformation near N=80. Mullins et al., Proc. Conf. Large Gamma-Ray Detector Arrays, Berkeley, LBL-35687, vol. 2, p 24 (1994).

94NoAA

Identical Degenerate Bands in the Second Minimum in ^{191}Ce . Nolan et al., Proc. Conf. Large Gamma-Ray Detector Arrays, Berkeley, LBL-35687, vol. 2, p99 (1994).

94Pe16 Multiple-Highly Deformed Bands in the Nucleus ^{134}Nd

C. M. Petrache, S. Lunardi, D. Bazzacco, D. Bucurescu, G. de Angelis, C. Rossi-Alvarez, C. Ur, R. Wyss, Phys. Lett. 335B, 307 (1994).

Nuclear Reactions: $^{110}\text{Pd}(^{28}\text{Si},4n)$, E=130 MeV; measured $\gamma\gamma$ -coin. ^{134}Nd deduced levels, J, π , band structure.

94Pe17 Detailed Level Scheme of ^{151}Tb and the Feeding of the Normal-Deformed States by the Superdeformed Bands

C. M. Petrache, G. Duchene, B. Kharraja, C. W. Beausang, F. A. Beck, T. Byrski, D. Curien, P. Dagnall, S. Flibotte, P. D. Forsyth, G. de France, B. Haas, A. Kiss, J. C. Merdinger, D. Prevost, C. Schuck, C. Theisen, P. J. Twin, J. P. Vivien, Nucl. Phys. A579, 285 (1994).

Nuclear Reactions: $^{130}\text{Te}(^{27}\text{Al},6n)$, E=154 MeV; measured E_γ , I_γ , $\gamma\gamma$ -coin, $\gamma(\theta)$. ^{151}Tb deduced high-spin levels, J, π , configurations, band structure, deformations, decay out of superdeformed bands. Enriched targets, Compton-suppressed hyperpure Ge detector array EUROGAM. Deformed independent particle model calculations.

94Pi01 Superdeformed Bands in ^{191}Tl

S. Pilotte, C. -H. Yu, H. Q. Jin, J. M. Lewis, L. L. Riedinger, Y. Liang, R. V. F. Janssens, M. P. Carpenter, T. L. Khoo, T. Lauritsen, F. Soramel, I. G. Bearden, C. Baktash, J. D. Garrett, N. R. Johnson, I. Y. Lee, F. K. McGowan, Phys. Rev. C49, 718 (1994).

Nuclear Reactions: $^{159}\text{Tb}(^{36}\text{S},4n)$, E=165 MeV; measured E_γ , I_γ , $\gamma\gamma$ -coin. ^{191}Tl deduced superdeformed levels J, π , single particle configuration. Enriched target, Compton-suppressed Ge detector array. Cranked shell model.

94Pi02 Reply to 'Comment on 'Lack of Evidence for a Superdeformed Band in ^{192}Pb '

A. J. M. Plompen, M. N. Harakeh, W. H. A. Hesselink, G. van't Hof, N. Kalantar-Nayestanaki, J. P. S. van Schagen, R. V. F. Janssens, I. Ahmad, I. G. Bearden, M. P. Carpenter, T. L. Khoo, T. Lauritsen, Y. Liang, U. Garg, W. Reviol, D. Ye, Phys. Rev. C49, 2851 (1994).

Nuclear Structure: ^{192}Pb ; analyzed, reviewed existing data; deduced need for more definitive experiments to determine superdeformed band evidence.

94St12 Single Particle Motion at High Spins

F. S. Stephens, Nucl. Phys. A574, 11c (1994).

Nuclear Structure: ^{151}Tb , ^{152}Dy , ^{184}Pb , ^{192}Hg ; compiled, reviewed high spin data. Other nuclei, aspects included.

94Tw01 Extreme Deformations at High Spin

P. J. Twin, Nucl. Phys. A574, 51c (1994).

Nuclear Structure: 151 , 152 , ^{153}Dy , 149 , ^{150}Gd , 151 , ^{150}Tb ; compiled, reviewed moment of inertia vs average rotational frequency, other features. Other nuclei, aspects included, extreme deformations at high spins.

94Va15 Neutron $i_{13/2}$ Intruder Band in ^{139}Sm

P. Vaska, S. Bhattacharjee, D. B. Fossan, D. R. LaFosse, Y. Liang, H. Schnare, K. Starosta, M. P. Waring, I. Hibbert, R. Wadsworth, K. Hauschild, C. W. Beausang, S. Clarke, S. A. Forbes, P. J. Nolan, E. S. Paul, A. T. Semple, S. M. Mullins, H. Grawe, K. H. Maier, Phys. Rev. C50, 104 (1994).

Nuclear Reactions: $^{110}\text{Pd}(^{34}\text{S},5n)$, E=159 MeV; measured $\gamma\gamma$ -coin. ^{139}Sm deduced high-spin levels, J, π , deformation parameters.

Nuclear Structure: 139 , ^{137}Sm , 141 , ^{139}Gd ; analyzed data; deduced dynamic moment of inertia, deformation parameters. Total Routhian surface, cranked shell model calculations.

94Vi06 The Role of Nuclear Dynamics in the Population of Highly- and Super-Deformed Bands

G. Viesti, T. Negro, D. Bazzacco, R. Burch, G. de Angelis, M. De Poli, D. Fabris, E. Fioretto, S. Lunardi, G. Nebbia, G. Prete, J. Rico, C. Rossi-Alvarez, Nucl. Phys. A579, 225 (1994).

Nuclear Reactions: $^{105}\text{Pd}(^{22}\text{S},2n2p)$, E=150, 166 MeV; $^{77}\text{Se}(^{60}\text{Ni}, 2n2p)$, E=249 MeV; measured E_γ , I_γ , $\gamma\gamma$ -coin. ^{133}Nd deduced highly deformed high-spin band population reaction mechanism, channel effects role. Comparison to statistical and dynamical models. Enriched target, Ge detector array, multiplicity filter.

94ViAA

Neutron Excitations in ^{147}Gd Superdeformed Nucleus. Vivien et al., Proc. Conf. Large Gamma-Ray Detector Arrays, Berkeley, LBL-35687, vol. 1, p 15 (1994) (abstract).

94WaAA

Comparison of the Intrinsic Quadrupole Moments of the Yrast Superdeformed Bands in ^{131}Ce and ^{132}Ce . Ward et al., Proc. Conf. Large Gamma-Ray Detector Arrays, Berkeley, LBL-35687, vol. 1, p 4 (1994) (abstract).

94Wi06 Lifetimes of the Superdeformed Band in ^{192}Hg

P. Willsau, A. Korichi, F. Hannachi, H. Hubel, W. Korten, M. Neffgen, F. Azaiez, C. Bourgeois, J. Duprat, N. Perrin, N. Poffe, H. Sergolle, G. Bastin, I. Deloncle, B. Gall, M. Kaci, M. G. Porquet, C. Schuck, J. Simpson, R. Duffait, Y. Le Coz, M. Meyer, N. Redon, G. De France, A. G. Smith, C. W. Beausang, M. J. Joyce, E. S. Paul, J. F. Sharpey-Schafer, R. M. Clark, R. Wadsworth, I. Ahmad, M. P. Carpenter, R. G. Henry, R. V. F. Janssens, T. L. Khoo, T. Lauritsen, J. H. Hughes, H. J. Maier, Nucl. Phys. A574, 560 (1994).

Nuclear Reactions: $^{160}\text{Gd}(^{36}\text{S},4n)$, E=159 MeV; measured $\gamma\gamma$ -coin, Doppler shifts. ^{192}Hg deduced $T_{1/2}$ of high-spin superdeformed states, transition quadrupole moments. EUROGAM Ge detector spectrometer array.

95As04 Confirmation of the Superdeformed Band in ^{192}Pb

S. J. Asztalos, P. Fallon, R. M. Clark, J. A. Becker, L. A. Bernstein, B. Cederwall, M. A. Deleplanque, R. M. Diamond, L. P. Farris, E. A. Henry, W. H. Kelly, I. Y. Lee, A. O. Macchiavelli, F. S. Stephens, *Z. Phys.* A352, 239 (1995).

Nuclear Reactions: $^{173}\text{Yb}(^{24}\text{Mg},5n)$, $E=140$ MeV; measured $\gamma\gamma$ -coin. ^{192}Pb deduced high-spin levels, J, π , superdeformed band dynamic moment of inertia.

95Az01 M1 Transitions between Superdeformed States in $^{194}, ^{195}\text{Tl}$: The fingerprint of the $i_{13/2}$ proton intruder orbital

F. Azaiez, J. Duprat, J. F. Sharpey-Schafer, M. Aiche, G. Bastin, C. W. Beausang, C. Bourgeois, R. M. Clark, I. Deloncle, R. Duffait, S. J. Gale, B. Gall, F. Hannachi, I. Hibbert, M. J. Joyce, M. Kaci, W. H. Kelly, A. Korichi, Y. Le Coz, M. Meyer, N. Perrin, N. Poffe, M. G. Porquet, N. Redon, H. Sergolle, C. Schuck, J. Simpson, R. Wadsworth, *Phys. Scr.* T56, 35 (1995).

Nuclear Reactions: $^{186}\text{W}(^{15}\text{N},6n)$, $E=105$ MeV; $^{184}\text{W}(^{15}\text{N}, 5n)$, $E=96$ MeV; measured $\gamma\gamma$ -coin. $^{194}, ^{195}\text{Tl}$ deduced levels, J, π , M1 transition strengths between superdeformed bands, γ -multipolarity.

95Ba26 First Observation of a Superdeformed Band in the $N, Z = 40$ Mass Region

C. Baktash, D. M. Cullen, J. D. Garrett, C. J. Gross, N. R. Johnson, W. Nazarewicz, D. G. Sarantites, J. Simpson, T. R. Werner, *Phys. Rev. Lett.* 74, 1946 (1995).

Nuclear Reactions: $^{56}\text{Fe}(^{30}\text{Si},X)$, $E=128$ MeV; measured $\gamma\gamma$ -coin. ^{83}Sr deduced high-spin levels, J, π , rotational band, dynamical moment of inertia.

95Be20 Search for Linking Transitions between the Superdeformed and Normal Deformed States in ^{152}Dy

M. A. Bentley, C. W. Beausang, P. J. Twin, P. J. Dagnall, A. Atac, F. A. Beck, Th. Byrski, S. Clarke, D. M. Curien, G. Duchene, G. de France, P. D. Forsyth, B. Herskind, B. Haas, J. C. Lisle, B. M. Nyako, J. Nyberg, E. S. Paul, J. Simpson, J. Styczen, J. P. Vivien, K. Zuber, *J. Phys. (London)* G21, L21 (1995).

Nuclear Reactions: $^{106}\text{Pd}(^{40}\text{Ca},4n)$, $E=200$ MeV; measured $\gamma\gamma$ -coin, $E\gamma, I\gamma$. ^{152}Dy deduced superdeformed, normal deformed states linking transitions evidence.

95Be36 Superdeformation in ^{154}Er

L. A. Bernstein, J. R. Hughes, J. A. Becker, L. P. Farris, E. A. Henry, S. J. Asztalos, B. Cederwall, R. M. Clark, M. A. Deleplanque, R. M. Diamond, P. Fallon, I. Y. Lee, A. O. Macchiavelli, F. S. Stephens, J. A. Cizewski, W. Younes, *Phys. Rev.* C52, R1171 (1995).

Nuclear Reactions: $^{118}\text{Sn}(^{40}\text{Ar},4n)$, $E=185$ MeV; measured $\gamma\gamma$ -coin, $E\gamma, I\gamma(\theta)$. ^{154}Er deduced superdeformed band to high-spin states transitions.

95Ca15 Identification of the Unfavored $N = 7$ Superdeformed Band in ^{191}Hg

M. P. Carpenter, R. V. F. Janssens, B. Cederwall, B. Crowell, I. Ahmad, J. A. Becker, M. J. Brinkman, M. A. Deleplanque, R. M. Diamond, P. Fallon, L. P. Farris, U. Garg, D. Gassmann, E. A. Henry, R. G. Henry, J. R. Hughes, T. L. Khoo, T. Lauritsen, I. Y. Lee, A. O. Macchiavelli, E. F. Moore, D. Nisius, F. S. Stephens, *Phys. Rev.* C51, 2400 (1995).

Nuclear Reactions: $^{160}\text{Gd}(^{36}\text{S},5n)$, $E=172$ MeV; $^{174}\text{Yb}(^{28}\text{Ne}, 5n)$, $E=120$ MeV; measured $\gamma\gamma$ -coin, $E\gamma, I\gamma$. ^{191}Hg deduced high-spin levels, J, π , superdeformed bands dynamical moment of inertia. Cranked Woods-Saxon calculations.

95Ce03 Properties of Superdeformed Bands in ^{163}Dy

B. Cederwall, G. Hackman, A. Galindo-Uribarri, D. C. Radford, J. A. Becker, M. J. Brinkman, M. A. Deleplanque, R. M. Diamond, J. E. Draper, C. Duyar, P. Fallon, L. P. Farris, E. A. Henry, J. R. Hughes, I. Y. Lee, A. O. Macchiavelli, S. M. Mullins, E. Rubel, F. S. Stephens, M. A. Stoyer, J. C. Waddington, *Phys. Lett.* 346B, 244 (1995).

Nuclear Reactions: $^{110}\text{Pd}(^{48}\text{Ca},5n)$, $E=220$ MeV; measured $E\gamma, I\gamma, \gamma\gamma$ -coin. ^{163}Dy deduced high-spin levels, J, π , superdeformed band, dynamic moment of inertia.

95Ch56 Multiple Superdeformed Bands in ^{81}Sr

F. Cristancho, D. R. LaFosse, C. Baktash, D. F. Winchell, B. Cederwall, J. Doring, C. J. Gross, P. -F. Hua, H. -Q. Jin, M. Korolija, E. Landulfo, I. Y. Lee, A. O. Macchiavelli, M. R. Maier, W. Rathbun, J. X. Saladin, D. Sarantites, D. W. Stracener, S. L. Tabor, A. Vander Molen, T. R. Werner, *Phys. Lett.* 357B, 281 (1995).

Nuclear Reactions: $^{58}\text{Ni}(^{28}\text{Si},2p\alpha)$, $E=128$ MeV; measured $\gamma\gamma$ -coin. ^{81}Sr deduced high-spin levels, J, π , multiple superdeformed bands, moments of inertia. Cranked shell model.

95Cr56

See 95Ch56.

95Cl01 Superdeformation in the Bismuth Nuclei

R. M. Clark, S. Bouneau, F. Azaiez, S. Asztalos, J. A. Becker, B. Cederwall, M. A. Deleplanque, R. M. Diamond, J. Duprat, P. Fallon, L. P. Farris, E. A. Henry, J. R. Hughes, W. H. Kelly, I. Y. Lee, A. O. Macchiavelli, M. G. Porquet, J. F. Sharpey-Schafer, F. S. Stephens, M. A. Stoyer, D. T. Vo, A. N. Wilson, *Phys. Rev.* C51, R1052 (1995).

Nuclear Reactions: $^{183}\text{W}(^{19}\text{F},xn)$, $E=108$ MeV; measured $\gamma\gamma$ -coin. $^{196}, ^{197}\text{Bi}$ deduced tentative high-spin levels, J, π , evidence for superdeformation.

95Cl02 A Pair of Identical Superdeformed Bands in ^{136}Nd

R. M. Clark, M. A. Deleplanque, B. Cederwall, R. M. Diamond, P. Fallon, I. Y. Lee, A. O. Macchiavelli, F. S. Stephens, J. A. Becker, M. J. Brinkman, L. P. Farris, E. A. Henry, J. R. Hughes, M. A. Stoyer, J. E. Draper, C. Duyar, E. Rubel, H. Hubel, W. Korten, P. Willsau, *Phys. Lett.* 343B, 59 (1995).

Nuclear Reactions: $^{100}\text{Mo}(^{40}\text{Ar},4n)$, $E=176, 182$ MeV; measured $\gamma\gamma$ -coin. ^{136}Nd deduced high-spin levels, J, π , superdeformed bands.

95Cr02 Relative Spins and Excitation Energies of Superdeformed Bands in ^{190}Hg : Further evidence for octupole vibration

B. Crowell, M. P. Carpenter, R. V. F. Janssens, D. J. Blumenthal, J. Timar, A. N. Wilson, J. F. Sharpey-Schafer, T. Nakatsukasa, I. Ahmad, A. Astier, F. Azaiez, L. du Croux, B. J. P. Gall, F. Hannachi, T. L. Khoo, A. Korichi, T. Lauritsen, A. Lopez-Martens, M. Meyer, D. Nisius, E. S. Paul, M. G. Porquet, N. Redon, *Phys. Rev.* C51, R1599 (1995).

Nuclear Reactions: $^{160}\text{Gd}(^{34}\text{S},4n)$, $E = 158$ MeV; measured $E\gamma$, relative $E\gamma$, relative $I\gamma$, $\gamma\gamma$ -coin, DCO ratios. ^{190}Hg deduced high-spin levels, J, π , J^2 moments of inertia, $B(\lambda)$, relative excitation energy between two superdeformed bands. Comparison with RPA calculations.

95Da30 *The Observation of a Superdeformed Structure in ^{62}Y*

P. J. Dagnall, A. G. Smith, J. C. Lisle, D. H. Smalley, R. Chapman, C. Finck, B. Haas, M. Leddy, D. Prevost, N. Rowley, H. Savajols, Z. Phys. A353, 251 (1995).

Nuclear Reactions: $^{56}\text{Ni}(^{30}\text{Si},n\alpha)$, $E=134$ MeV; measured $\gamma\gamma$ -coin. ^{62}Y deduced high-spin states decay features, superdeformed structure evidence.

95De26 *Population of the Yrast Superdeformed Band in ^{194}Pb*

I. Deloncle, B. J. P. Gall, M. -G. Porquet, F. Hannachi, M. Aiche, M. Kaci, C. Schuck, A. G. Smith, F. Azaiez, C. Bourgeois, J. Duprat, D. Hojman, A. Korichi, H. Sergolle, N. Perrin, N. Poffe, A. Astier, R. Beraud, R. Duffait, Y. Le Coz, M. Meyer, N. Redon, I. Ali, C. W. Beausang, P. Dagnall, M. J. Joyce, E. S. Paul, J. F. Sharpey-Schafer, H. Timmers, J. Simpson, R. M. Clark, K. Hauschild, R. Wadsworth, B. Fant, H. Hubel, J. Phys. (London) G21, L35 (1995).

Nuclear Reactions: $^{184}\text{W}(^{16}\text{O},6n)$, $E=113, 117$ MeV; $^{184}\text{W}(^{17}\text{O}, 7n)$, $E=120$ MeV; $^{164}\text{Dy}(^{34}\text{S},4n)$, $E=157, 160$ MeV; $^{162}\text{Dy}(^{36}\text{S},4n)$, $E=162$ MeV; measured $\gamma\gamma$ -coin, γ . ^{194}Pb deduced yrast superdeformed band.

95De33 *New Features in Superdeformed Nuclei*

M. A. Deleplanque, Acta Phys. Pol. B26, 221 (1995).

Nuclear Reactions: $^{100}\text{Mo}(^{40}\text{Ar},X)$, $E=176, 182$ MeV; measured $\gamma\gamma\gamma$ -coin. ^{135}Nd deduced superdeformed band to normal states linking transitions features. Data on ^{194}Hg , ^{152}Dy discussed.

95De40 *Low-Spin Termination of the Superdeformed Band in ^{135}Nd*

M. A. Deleplanque, S. Frauendorf, R. M. Clark, R. M. Diamond, F. S. Stephens, J. A. Becker, M. J. Brinkman, B. Cederwall, P. Fallon, L. P. Farris, E. A. Henry, H. Hubel, J. R. Hughes, W. Korten, I. Y. Lee, A. O. Macchiavelli, M. A. Stoyer, P. Willsau, J. E. Draper, C. Duyar, E. Rubel, Phys. Rev. C52, R2302 (1995).

Nuclear Reactions: $^{100}\text{Mo}(^{40}\text{Ar},5n)$, $E=176-182$ MeV; measured $\gamma\gamma\gamma$ -coin, $E\gamma$, γ . ^{135}Nd deduced high-spin levels, J, π , superdeformed band decay, termination.

95De50 *Spectroscopy in the Second Potential Well of ^{151}Tb*

G. de France, Phys. Scr. T56, 39 (1995).

Nuclear Reactions: $^{130}\text{Te}(^{27}\text{Al},6n)$, $E=154$ MeV; measured $\gamma\gamma$ -coin. ^{151}Tb deduced levels, J, π , superdeformed bands.

95DeZZ *Excited Superdeformed Bands in ^{148}Gd : Band crossing and identical bands*

G. de France, D. Prevost, J. C. Lisle, H. R. Andrews, G. C. Ball, C. W. Beausang, F. A. Beck, Th. Byrski, D. Curien, G. Duchene, Ch. Finck, S. Flibotte, B. Gall, B. Haas, G. Hackman, V. Janzen, B. Kharraja, J. C. Merdinger, S. M. Mullins, S. Pilote, D. C. Radford, C. Rigollet, H. Savajols, O. Stezowski, Ch. Theisen, P. J. Twin, J. P. Vivien, J. C. Waddington, D. Ward, L. Wei, K. Zuber, J. Dobaczewski, J. Dudek, W. D. Luo, A. Bouguettoucha, W. Nazarewicz, Priv. Comm. (1995).

Nuclear Reactions: $^{124}\text{Sn}(^{30}\text{Si},6n)$, $E=162$ MeV; measured $\gamma\gamma$ -coin. ^{148}Gd deduced superdeformed band levels, J, π , configuration. Models comparison.

95Du07 *Configuration of the Existence of a Superdeformed Rotational Band in ^{192}Pb*

L. Ducroux, A. Astier, R. Beraud, R. Duffait, Y. Le Coz, M. Meyer, S. Perries, N. Redon, J. F. Sharpey-Schafer, A. N. Wilson, R. Collatz, I. Deloncle, F. Hannachi, M. Kaci, A. Lopez-Martens, M. G. Porquet, C. Schuck, F. Azaiez, S. Bouneau, C. Bourgeois, J. Duprat, A. Korichi, N. Perrin, N. Poffe, H. Sergolle, D. Goutte, R. Lucas, V. Meot, I. Hibbert, R. Wadsworth, F. Beck, D. Curien, G. De France, G. Duchene, B. Gall, B. Haas, J. P. Vivien, Z. Phys. A352, 13 (1995).

Nuclear Reactions: $^{168}\text{Er}(^{30}\text{Si},6n)$, $E=159$ MeV; measured $\gamma\gamma$ -coin. ^{192}Pb deduced superdeformed band.

95Fa03 *Quasiparticle Excitations in Superdeformed ^{162}Hg*

P. Fallon, T. Lauritsen, I. Ahmad, M. P. Carpenter, B. Cederwall, R. M. Clark, B. Crowell, M. A. Deleplanque, R. M. Diamond, B. Gall, F. Hannachi, R. G. Henry, R. V. F. Janssens, T. L. Khoo, A. Korichi, I. Y. Lee, A. O. Macchiavelli, C. Schuck, F. S. Stephens, Phys. Rev. C51, R1609 (1995).

Nuclear Reactions: $^{160}\text{Gd}(^{36}\text{S},4n)$, $E=159$ MeV; measured $\gamma\gamma$, $\gamma\gamma\gamma$ -coin. ^{192}Hg deduced high-spin levels, J, π , superdeformed bands, dynamic moment of inertia.

95Fa09 *Proton and Neutron Excitations in Superdeformed ^{150}Tb*

P. Fallon, C. W. Beausang, S. Asztalos, D. Nisius, R. V. F. Janssens, M. Bergstrom, M. Carpenter, B. Cederwall, S. Clarke, B. Crowell, M. A. Deleplanque, R. M. Diamond, R. G. Henry, T. L. Khoo, T. Lauritsen, I. Y. Lee, A. O. Macchiavelli, F. S. Stephens, P. J. Twin, Phys. Rev. C52, 93 (1995).

Nuclear Reactions: $^{124}\text{Sn}(^{21}\text{P},5n)$, $E=167$ MeV; measured $E\gamma$ - $E\gamma$ -coin. ^{150}Tb deduced levels, J, π , superdeformed bands.

95Fa11 *Neutron Blocking and Delayed Proton Pair Alignment in Superdeformed ^{185}Pb*

L. P. Farris, E. A. Henry, J. A. Becker, M. J. Brinkman, B. Cederwall, J. A. Cizewski, M. A. Deleplanque, R. M. Diamond, J. E. Draper, C. Duyar, P. Fallon, J. R. Hughes, W. H. Kelly, I. Y. Lee, A. O. Macchiavelli, E. C. Rubel, F. S. Stephens, M. A. Stoyer, D. T. Vo, Phys. Rev. C51, R2288 (1995).

Nuclear Reactions: $^{174}\text{Yb}(^{26}\text{Mg},5n)$, $E=130$ MeV; measured $\gamma\gamma$ -coin. ^{185}Pb deduced high-spin levels, J, π , superdeformed bands, transition energies, dynamic moment of inertia.

95Fi01 *Multi-Particle Excitations in the Superdeformed ^{148}Gd Nucleus*

S. Flibotte, G. Hackman, I. Ragnarsson, Ch. Theisen, H. R. Andrews, G. C. Ball, C. W. Beausang, F. A. Beck, G. Belier, M. A. Bentley, T. Byrski, D. Curien, G. de France, D. Disdier, G. Duchene, B. Haas, D. S. Haslip, V. P. Janzen, P. M. Jones, B. Kharraja, J. A. Kuehner, J. C. Lisle, J. C. Merdinger, S. M. Mullins, E. S. Paul, D. Prevost, D. C. Radford, V. Rauch, J. F. Smith, J. Styczen, P. J. Twin, J. P. Vivien, J. C. Waddington, D. Ward, K. Zuber, Nucl. Phys. A584, 373 (1995).

Nuclear Reactions: $^{124}\text{Sn}(^{30}\text{Si},5n)$, $E=158$ MeV; measured $E\gamma$, γ , $\gamma\gamma$ -coin. ^{148}Gd deduced high-spin levels, J, π , superdeformed bands. Compton-suppressed hyperpure Ge detector array. Nilsson-Strutinsky cranking model calculations.

- 95Fo02** *Determination of the Intrinsic Quadrupole Moment of the Superdeformed Band in ^{143}Eu*
S. A. Forbes, A. Atac, G. B. Hagemann, B. Herskind, S. M. Mullins, P. J. Nolan, J. Nyberg, M. J. Piiparinen, G. Sletten, R. Wadsworth, Nucl. Phys. A584, 149 (1995).
Nuclear Reactions: $^{110}\text{Pd}(^{37}\text{Cl},4n)$, $E=160$ MeV; measured E_γ , Doppler shifts. ^{143}Eu deduced high-spin level superdeformed band $T_{1/2}$, intrinsic quadrupole moment, β_2 .
- 95Fo12** *Measurement of the Mean Lifetimes of Low Spin States in the Superdeformed Band in ^{133}Nd*
S. A. Forbes, G. Bohm, R. M. Clark, A. Dewald, R. Krucken, S. M. Mullins, P. J. Nolan, P. H. Regan, R. Wadsworth, Z. Phys. A352, 15 (1995).
Nuclear Reactions: $^{105}\text{Pd}(^{32}\text{S},2n2p)$, $E=152$ MeV; measured $\gamma\gamma$ -coin, recoil distance method. ^{133}Nd deduced high-spin levels, J , π , $T_{1/2}$, superdeformed band, $B(\lambda)$, β_2 , intrinsic quadrupole moments. Total Routhian surface.
- 95Ga10** *The Yrast Superdeformed Band in ^{194}Pb . Differences with ^{192}Hg*
B. J. P. Gall, I. Deloncle, M. -G. Porquet, F. Hannachi, M. Aiche, F. Azaiez, G. Bastin, C. W. Beausang, R. Beraud, C. Bourgeois, R. M. Clark, R. Duffait, J. Duprat, K. Hauschild, H. Hubel, M. J. Joyce, M. Kaci, A. Korichi, Y. Le Coz, M. Meyer, E. S. Paul, N. Perrin, N. Poffe, N. Redon, C. Schuck, H. Sergolle, J. F. Sharpey-Schafer, J. Simpson, A. G. Smith, R. Wadsworth, Phys. Lett. 345B, 124 (1995).
Nuclear Reactions: $^{184}\text{W}(^{16}\text{O},6n)$, $E=113$ MeV; measured $\gamma\gamma$ -coin. ^{194}Pb deduced high-spin superdeformed band decay features, kinematical, dynamical moments of inertia. Comparison with ^{192}Hg .
- 95Ha28** *Lifetime Measurements within the Superdeformed Minimum of ^{133}Ce and ^{132}Ce*
K. Hauschild, R. Wadsworth, I. -Y. Lee, R. M. Clark, P. Fallon, D. B. Fossan, I. M. Hibbert, A. O. Macchiavelli, P. J. Nolan, H. Schnare, A. T. Semple, I. Thorslund, L. Walker, Phys. Rev. C52, R2281 (1995).
Nuclear Reactions: $^{116}\text{Cd}(^{22}\text{Ne},5n)$, $(^{22}\text{Ne},6n)$, $E=120$ MeV; measured $\gamma\gamma$ -coin, DSA, centroid shifts. ^{133}Ce high-spin states $T_{1/2}$, bands intrinsic quadrupole moments. ^{132}Ce deduced yrast superdeformed band $T_{1/2}$, intrinsic quadrupole moments.
- 95Ha29** *Excited Superdeformed Band in ^{142}Sm Identical to ^{146}Gd*
G. Hackman, R. Wadsworth, D. S. Haslip, R. M. Clark, J. Dobaczewski, J. Dudek, S. Flibotte, K. Hauschild, I. M. Hibbert, I. -Y. Lee, S. M. Mullins, A. O. Macchiavelli, S. Pilotte, A. T. Semple, I. Thorslund, J. Timar, P. Vaska, J. C. Waddington, L. Walker, Phys. Rev. C52, R2293 (1995).
Nuclear Reactions: $^{124}\text{Sn}(^{24}\text{Mg},2n)$, $E=145$ MeV; measured $\gamma\gamma$ -coin, E_γ , l_γ . ^{142}Sm deduced superdeformed band, l_γ , alignment. Hartree-Fock model comparison.
- 95Ha34** *Neutron Orbitals Above the $N = 74$ Shell Gap at Large Deformation: Spectroscopy in the superdeformed minimum of ^{132}Ce*
K. Hauschild, R. Wadsworth, R. M. Clark, P. Fallon, D. B. Fossan, I. M. Hibbert, A. O. Macchiavelli, P. J. Nolan, H. Schnare, A. T. Semple, I. Thorslund, L. Walker, W. Satula, R. Wyss, Phys. Lett. 353B, 438 (1995).
Nuclear Reactions: $^{116}\text{Cd}(^{22}\text{Ne},5n)$, $E=120$ MeV; measured $\gamma\gamma$ -coin. ^{132}Ce deduced high-spin levels, superdeformed bands, configuration, dynamic moments of inertia.
- 95He12** *Microscopic Study of Superdeformation in ^{193}Hg*
P. -H. Heenen, P. Bonche, H. Flocard, Nucl. Phys. A588, 490 (1995).
Nuclear Structure: ^{193}Hg ; calculated superdeformed bands dynamical moment of inertia. Cranked HFB method.
- 95Hu01** *Superdeformation in ^{193}Pb and the Effects of the $N = 7$ Intruder Orbital*
J. R. Hughes, J. A. Becker, L. A. Bernstein, M. J. Brinkman, L. P. Farris, E. A. Henry, R. W. Hoff, M. A. Stoyer, D. T. Vo, S. Asztalos, B. Cederwall, R. M. Clark, M. A. Deleplanque, R. M. Diamond, P. Fallon, I. Y. Lee, A. O. Macchiavelli, F. S. Stephens, Phys. Rev. C51, R447 (1995).
Nuclear Reactions: $^{174}\text{Yb}(^{24}\text{Mg},5n)$, $E=131$ MeV; measured E_γ , $l_\gamma(\theta)$. ^{193}Pb deduced superdeformed high-spin band structure.
- 95Ji08** *Identification and Quadrupole-Moment Measurement of a Superdeformed Band in ^{84}Zr*
H. -Q. Jin, C. Baktash, M. J. Brinkman, C. J. Gross, D. G. Sarantites, I. Y. Lee, B. Cederwall, F. Cristancho, J. Doring, F. E. Durham, P. -F. Hua, G. D. Johns, M. Korolija, D. R. LaFosse, E. Landulfo, A. O. Macchiavelli, W. Rathbun, J. X. Saladin, D. W. Stracener, S. L. Tabor, T. R. Werner, Phys. Rev. Lett. 75, 1471 (1995).
Nuclear Reactions: $^{58}\text{Ni}(^{28}\text{Si},n2p)$, $E=128$ MeV; $^{58}\text{Ni}(^{22}\text{S}, 2p\alpha)$, $E=135$ MeV; measured (charged particle) $\gamma\gamma$ -coin. ^{84}Zr deduced high-spin levels, J , π , superdeformed band transition quadrupole moment, deformation features.
- 95Kh06** *Unfavoured Signature Partner Superdeformed Bands Associated with Proton Excitations in ^{151}Tb*
B. Kharraja, T. Byrski, F. A. Beck, C. W. Beausang, M. A. Bentley, D. Curien, P. J. Dagnall, G. Duchene, S. Flibotte, G. de France, Zs. Fulop, B. Haas, A. Z. Kiss, J. C. Lisle, C. M. Petrache, Ch. Theisen, P. J. Twin, J. P. Vivien, K. Zuber, Phys. Lett. 341B, 268 (1995).
Nuclear Reactions: $^{130}\text{Te}(^{27}\text{Al},X)$, $E=154$ MeV; measured E_γ , multiplicities. ^{151}Tb deduced high-spin superdeformed bands, configurations. Self-consistent relativistic Hartree-Fock model comparison.
- 95Ko17** *Observation and Lifetime of the First Excited Superdeformed Band in ^{192}Hg*
A. Korichi, F. Hannachi, I. Deloncle, W. Korten, I. Ahmad, F. Azaiez, G. Bastin, C. W. Beausang, C. Bourgeois, M. P. Carpenter, R. M. Clark, R. Duffait, J. Duprat, B. J. P. Gall, R. G. Henry, H. Hubel, R. V. F. Janssens, M. Joyce, M. Kaci, T. L. Khoo, T. Lauritsen, Y. Le Coz, M. Meyer, E. S. Paul, N. Perrin, N. Poffe, M. G. Porquet, N. Redon, C. Schuck, H. Sergolle, J. F. Sharpey-Schafer, J. Simpson, A. G. Smith, R. Wadsworth, P. Willsau, Phys. Lett. 345B, 403 (1995).
Nuclear Reactions: $^{160}\text{Gd}(^{36}\text{S},4n)$, $E=159$ MeV; measured $\gamma\gamma$ -coin, DSA. ^{192}Hg deduced high-spin levels, J , π , superdeformed band two-quasineutron excitation, $T_{1/2}$, deformation features, $B(\lambda)$, transition quadrupole moments.
- 95La18** *Evidence for Hyperdeformation in ^{147}Gd*
D. R. LaFosse, D. G. Sarantites, C. Baktash, P. -F. Hua, B. Cederwall, P. Fallon, C. J. Gross, H. -Q. Jin, M. Korolija, I. Y. Lee, A. O. Macchiavelli, M. R. Maier, W. Rathbun, D. W. Stracener, T. R. Werner, Phys. Rev. Lett. 74, 5186 (1995).
Nuclear Reactions: $^{100}\text{Mo}(^{51}\text{V},X)$, $E=230$ MeV; measured $\gamma\gamma$ -coin. ^{147}Gd deduced levels, J , π , hyperdeformation.

95La21 *Characterization of the First Superdeformed Band in the A 80 Region*

D. R. LaFosse, P. -F. Hua, D. G. Sarantites, C. Baktash, Y. A. Akovali, M. Brinkman, B. Cederwall, F. Cristancho, J. Doring, C. J. Gross, H. -Q. Jin, M. Korolija, E. Landolfo, I. Y. Lee, A. O. Macchiavelli, M. R. Maier, W. Rathbun, J. X. Saladin, D. W. Stracener, S. L. Tabor, A. Vander Molen, T. R. Wemer, Phys. Lett. 354B, 34 (1995).

Nuclear Reactions: $^{86}\text{Ni}(^{29}\text{Si},\text{X})$, E=128 MeV; measured $\gamma\gamma$ -coin, energy correlations. ^{83}Sr deduced high-spin levels, J, π , superdeformed bands.

95Le31 *A Finite Number of Regular Rotational Bands in the Superdeformed Well of ^{143}Eu*

S. Leoni, B. Herskind, T. Dossing, K. Yoshida, M. Matsuo, A. Atac, G. B. Hagemann, F. Ingebrøtzen, H. J. Jensen, R. M. Lieder, G. V. Marti, N. Nica, J. Nyberg, M. Piiparinen, H. Schnare, G. Sletten, K. Strahle, M. Sugawara, P. O. Tjom, A. Virtanen, Phys. Lett. 353B, 179 (1995).

Nuclear Reactions: $^{110}\text{Pd}(^{97}\text{Cl},4n)$, E=160 MeV; measured (E γ -E γ)-coin, E γ , I γ . ^{143}Eu deduced superdeformed bands. Fluctuation analysis model.

95Li24 *Proton Band Crossing in the Superdeformed Nucleus ^{144}Gd*

R. M. Lieder, St. Utzelmann, W. Gast, A. Georgiev, Ph. Hoernes, S. Lunardi, D. Bazzacco, R. Menegazzo, C. Rossi-Alvarez, G. de Angelis, D. R. Napoli, M. De Poli, Acta Phys. Pol. B26, 249 (1995).

Nuclear Reactions: $^{100}\text{Mo}(^{48}\text{Ti},\text{X})$, E=215 MeV; measured $\gamma\gamma\gamma$ -coin. ^{144}Gd deduced superdeformed band proton crossing features.

95Lu03 *Proton Spectra in Coincidence with Super- and Hyper-Deformed Structures in ^{152}Dy*

M. Lunardon, G. Viesti, D. Bazzacco, R. Burch, D. Fabris, S. Lunardi, N. Medina, G. Nebbia, C. Rossi-Alvarez, G. de Angelis, M. De Poli, E. Fioretto, G. Prete, J. Rico, P. Spolaore, G. Vedovato, A. Brondi, G. La Rana, R. Moro, E. Vardaci, Nucl. Phys. A583, 215c (1995).

Nuclear Reactions: $^{120}\text{Sn}(^{27}\text{Cl},\text{X})$, E=187 MeV; measured $\gamma\gamma(p)$ -coin. ^{152}Dy deduced high-spin hyperdeformed structure.

95Lu09 *Decay Out of the Highly Deformed Bands in the Odd Nd Isotopes: The ^{137}Nd nucleus*

S. Lunardi, R. Venturelli, D. Bazzacco, C. M. Petrache, C. Rossi-Alvarez, G. de Angelis, G. Vedovato, D. Bucurescu, C. Ur, Phys. Rev. C52, R6 (1995).

Nuclear Reactions: $^{123}\text{Sb}(^{19}\text{F},5n)$, E=87 MeV; $^{110}\text{Pd}(^{30}\text{Si}, 3n)$, E=130 MeV; measured E γ , I γ , DCO ratios, $\gamma\gamma$ -coin. ^{137}Nd deduced levels, J, π , hyperdeformed band structure, high-spin features.

Nuclear Structure: 133 , 135 , ^{137}Nd ; analyzed hyperdeformed bands data. Total Routhian surfaces calculations.

95Me08 *Superdeformed Band g-Factor in ^{139}Nd*

N. H. Medina, F. Brandolini, D. Bazzacco, P. Pavan, C. Rossi-Alvarez, R. Burch, S. Lunardi, R. Menegazzo, M. De Poli, G. Maron, R. V. Ribas, M. Ionescu-Bujor, Nucl. Phys. A589, 106 (1995).

Nuclear Reactions: $^{104}\text{Pd}(^{32}\text{S},n2p)$, E=135 MeV; measured $\gamma\gamma(\theta, \text{H})$ in polarized Gd. ^{139}Nd deduced superdeformed band g-factor. Model comparison. Enriched multi-layered target.

95Mu11 *Strong Population of a Superdeformed Band in ^{142}Eu*

S. M. Mullins, S. Flibotte, G. Hackman, J. L. Rodriguez, J. C. Waddington, A. V. Afanasjev, I. Ragnarsson, H. R. Andrews, A. Galindo-Uribarri, V. P. Janzen, D. C. Radford, D. Ward, M. Cromaz, J. DeGraaf, T. E. Drake, S. Pilotte, Phys. Rev. C52, 99 (1995).

Nuclear Reactions: $^{120}\text{Sn}(^{27}\text{Al},5n)$, E=152 MeV; measured $\gamma\gamma$ -coin, E γ , I γ . ^{142}Eu deduced levels, J, π , superdeformed band.

95Ni03 *Superdeformed Band in ^{154}Dy*

D. Nisius, R. V. F. Janssens, T. L. Khoo, I. Ahmad, D. Blumenthal, M. P. Carpenter, B. Crowell, D. Gassmann, T. Lauritsen, W. C. Ma, J. H. Hamilton, A. V. Ramayya, P. Bhattacharyya, C. T. Zhang, P. J. Daly, Z. W. Grabowski, R. H. Mayer, Phys. Rev. C51, R1061 (1995).

Nuclear Reactions: $^{122}\text{Sn}(^{36}\text{S},4n)$, E=165 MeV; measured E γ , relative I γ , $\gamma\gamma$ -coin. ^{154}Dy deduced high-spin levels, J, π , superdeformation band transitions.

95Ni06 *evidence for the pseudospin coupling scheme*

D. Nisius, R. V. F. Janssens, P. Fallon, B. Crowell, I. Ahmad, C. W. Beausang, M. P. Carpenter, B. Cederwall, P. J. Daly, M. A. Deleplanque, R. M. Diamond, D. Gassmann, Z. W. Grabowski, R. G. Henry, T. L. Khoo, T. Lauritsen, I. Y. Lee, A. O. Macchiavelli, R. H. Mayer, F. S. Stephens, P. J. Twin, Phys. Lett. 346B, 15 (1995).

Nuclear Reactions: $^{122}\text{Sn}(^{34}\text{S},5n)$, E=175 MeV; measured E γ , I γ , $\gamma\gamma$ -coin. ^{151}Dy deduced levels, J, π , superdeformed band.

95Pe16 *Decay Out of Superdeformed Bands in Tb Isotopes*

C. M. Petrache, G. Duchene, C. W. Beausang, F. A. Beck, T. Byrski, D. Curien, P. J. Dagnall, S. Flibotte, P. D. Forsyth, G. de France, B. Haas, B. Kharraja, A. Kiss, J. C. Merdinger, D. Prevost, C. Schuck, C. Theisen, P. J. Twin, J. P. Vivien, Phys. Scr. T56, 299 (1995).

Nuclear Reactions: $^{130}\text{Te}(^{27}\text{Al},xn)$, E=154 MeV; measured E γ , I γ , $\gamma\gamma$ -coin. ^{152}Tb deduced high-spin levels, J, π . 150 , ^{151}Tb deduced high-spin levels, J, π , superdeformed band decay features.

95Ro15 *Decay-Out of the Highly-Deformed Bands in the A = 130-140 Mass Region*

C. Rossi-Alvarez, D. Bazzacco, S. Lunardi, N. Medina, R. Menegazzo, R. Venturelli, G. de Angelis, M. De Poli, D. R. Napoli, C. M. Petrache, D. Bucurescu, C. Ur, Acta Phys. Pol. B26, 237 (1995).

Nuclear Reactions: $^{110}\text{Pd}(^{30}\text{Si},3n)$, E=125 MeV; $^{104}\text{Pd}(^{37}\text{Cl}, 3np)$, E=172 MeV; $^{110}\text{Pd}(^{34}\text{S},5n)$, E=150, 165 MeV; $^{92}\text{Mo}(^{50}\text{Cr},n2p)$, E=220 MeV; measured $\gamma\gamma$ -coin. ^{137}Nd , 139 , ^{137}Sm , ^{139}Gd deduced high-spin levels, J, π , hyperdeformed band decay features.

95Rz03 *Double Band Crossing in the Superdeformed Nucleus ^{145}Gd*

T. Rzaca-Urban, R. M. Lieder, S. Utzelmann, W. Gast, A. Georgiev, H. M. Jager, D. Bazzacco, S. Lunardi, R. Menegazzo, C. Rossi-Alvarez, G. de Angelis, D. R. Napoli, G. Vedovato, R. Wyss, Phys. Lett. 356B, 456 (1995).

Nuclear Reactions: $^{114}\text{Cd}(^{36}\text{S},5n)$, E=182 MeV; measured $\gamma\gamma$ -coin, E γ , I γ . ^{145}Gd deduced levels, J, π , superdeformed bands.

95Sa21 *Observation of Excited Superdeformed Bands in ^{132}Ce and Evidence for Identical Bands in the Mass 130 Region*

D. Santos, J. Gizon, C. Foin, J. Genevey, A. Gizon, M. Jozsa, J. A. Pinston, C. W. Beausang, S. A. Forbes, P. J. Nolan, E. S. Paul, A. T. Semple, J. N. Wilson, R. M. Clark, K. Hauschild, R. Wadsworth, J. Simpson, B. M. Nyako, L. Zolnai, W. Klamra, N. El Ouad, J. Dudek, Phys. Rev. Lett. 74, 1708 (1995).

Nuclear Reactions: $^{100}\text{Mo}(^{36}\text{S},4n)$, $E=155$ MeV; measured $\gamma\gamma$ -coin. ^{132}Ce deduced high-spin levels, J, π , superdeformed bands, configuration.

95SaZZ *Lifetime Measurements of Superdeformed Bands in $^{148-149}\text{Gd}$ and ^{152}Dy : Evidence for structure-dependent elongations*

H. Savajols, A. Korichi, D. Ward, D. Applebe, G. C. Ball, C. Beausang, F. A. Beck, T. Byrski, D. Cuien, P. Dagnall, S. Erturk, G. de France, D. Disdier, G. Duchene, C. Finck, S. Flibotte, B. Gall, A. Galindo-Urbarri, B. Haas, G. Hackman, V. P. Janzen, B. Kharraja, J. C. Lisle, J. C. Merdinger, S. M. Mullins, S. Pilotte, D. Prevost, D. C. Radford, V. Rauch, C. Rigollet, D. Smalley, O. Stezowski, J. Styczen, Ch. Theisen, P. J. Twin, J. P. Vivien, J. C. Waddington, K. Zuber, I. Ragnarsson, Priv. Comm. (1995).

Nuclear Reactions: $^{124}\text{Sn}(^{30}\text{Si},6n)$, $(^{30}\text{Si},5n)$, $E=158$ MeV; $^{120}\text{Sn}(^{36}\text{S},4n)$, $E=170$ MeV; measured $\gamma\gamma$ -coin, DSA. 148 , ^{149}Gd , ^{152}Dy deduced superdeformed level $T_{1/2}$, quadrupole moment.

95Sc31 *Superdeformation in ^{146}Gd*

C. Schumacher, O. Stuch, T. Rzaca-Urban, P. von Brentano, A. Dewald, A. Georgiev, R. Lieder, F. Linden, J. Lisle, J. Theuerkauf, W. Urban, S. Utzelmann, D. Weisshaar, Phys. Rev. C52, 1302 (1995).

Nuclear Reactions: $^{102}\text{Ru}(^{48}\text{Ca},4n)$, $E=203$ MeV; measured E_γ , I_γ , $\gamma\gamma$ -coin. ^{146}Gd deduced superdeformed band levels, J, π , decay.

95Sc39 *Superdeformed Triaxial Bands in 163 , ^{165}Lu*

H. Schnack-Petersen, R. Bengtsson, R. A. Bark, P. Bosetti, A. Brockstedt, H. Carlsson, L. P. Ekstrom, G. B. Hagemann, B. Herskind, F. Ingebretsen, H. J. Jensen, S. Leoni, A. Nordlund, H. Ryde, P. O. Tjorn, C. X. Yang, Nucl. Phys. A594, 175 (1995).

Nuclear Reactions: $^{130}\text{Ba}(^{31}\text{P},4n)$, $E=155$ MeV; $^{150}\text{Sm}(^{19}\text{F}, 4n)$, $E=95$ MeV; measured E_γ , $\gamma\gamma$ -coin, I_γ . ^{163}Lu deduced high-spin levels, J, π , rotational, band, superdeformed structure. Enriched target, array of Compton suppressed Ge-detectors. Calculation of superdeformed highly triaxial local minima in configuration separated total energy surfaces.

95Sm08 *Observation of Superdeformation in ^{92}Sr*

A. G. Smith, P. J. Dagnall, J. C. Lisle, D. H. Smalley, T. R. Werner, R. Chapman, C. Finck, B. Haas, M. Leddy, W. Nazarewicz, D. Prevost, N. Rowley, H. Savajols, Phys. Lett. 355B, 32 (1995).

Nuclear Reactions: $^{58}\text{Ni}(^{30}\text{Si},2p\alpha)$, $(^{30}\text{Si},X)$, $E=134$ MeV; measured $\gamma\gamma$ -coin. ^{92}Sr deduced high-spin levels, superdeformed bands, configuration. Cranked Woods-Saxon calculations.

95So17 *Search for Entrance Channel Dependence in the Population of Superdeformed Bands in ^{191}Hg*

F. Soramel, T. L. Khoo, Ph. Benet, K. B. Beard, R. V. F. Janssens, I. Ahmad, I. Bearden, M. P. Carpenter, P. J. Daly, M. W. Drigert, B. Fornal, U. Garg, Z. Grabowski, T. Lauritsen, Y. Liang, R. Meyer, E. F. Moore, W. Reviol, D. Ye, Phys. Lett. 350B, 173 (1995).

Nuclear Reactions: $^{160}\text{Gd}(^{36}\text{S},5n)$, $E=169$ MeV; $^{130}\text{Te}(^{64}\text{Ni}, 3n)$, $E=257$ MeV; measured $\gamma\gamma$ -coin, E_γ , I_γ . ^{191}Hg deduced levels, J, π , superdeformed bands population entrance channel dependence.

95St17 *New Results from Gammasphere*

F. S. Stephens, Acta Phys. Pol. B26, 133 (1995).

Nuclear Structure: $Z=80-82$; $Z=64-66$; $Z=57-60$; compiled, reviewed superdeformed band transition pairs energy difference.

Nuclear Reactions: $^{176}\text{Yb}(^{48}\text{Ca},X)$, $E=250$ MeV; measured production σ for Hf, Yb, Tm, Er isotopes, $\gamma\gamma$ -coin. 177 , ^{178}Yb deduced levels, J, π . Deep inelastic collision, Gammasphere.

95Va32 *A Pair of Excited Superdeformed Bands in ^{198}Pb*

U. J. van Severen, W. Korten, H. Hubel, D. Bazzacco, G. LoBianco, N. H. Medina, C. Rossi Alvarez, S. Signorelli, K. Strahle, P. Willsau, Z. Phys. A353, 15 (1995).

Nuclear Reactions: $^{170}\text{Er}(^{30}\text{Si},4n)$, $E=143$ MeV; measured $\gamma\gamma$ -coin. ^{198}Pb deduced levels, J, π , excited superdeformed bands.

95Vi02 *Population of Hyperdeformed Structures in ^{152}Dy from Proton-Gamma Coincidence Experiments*

G. Viesti, M. Lunardon, D. Bazzacco, R. Burch, D. Fabris, S. Lunardi, N. H. Medina, G. Nebbia, C. Rossi-Alvarez, G. de Angelis, M. De Poli, E. Fioretto, G. Prete, J. Rico, P. Spolaore, G. Vedovato, A. Brondi, G. La Rana, R. Moro, E. Vardaci, Phys. Rev. C51, 2385 (1995).

Nuclear Reactions: $^{120}\text{Sn}(^{37}\text{Cl},xnp)$, $E=187$ MeV; measured E_γ , I_γ , γ -multiplicity, $p\gamma$ -coin, sum energy. ^{152}Dy deduced possible hyperdeformed shapes related ridge.

95Wi10 *Decay Patterns of Dysprosium Nuclei Produced in $^{92}\text{S} + ^{118}$, ^{124}Sn Fusion Reactions*

J. L. Wile, D. L. Coffing, E. T. Bauer, A. L. Michael, M. A. Doerner, S. P. Baldwin, B. M. Szabo, B. Lott, B. M. Quednau, J. Toke, W. U. Schroder, R. T. de Souza, Phys. Rev. C51, 1693 (1995).

Nuclear Reactions: 118 , $^{124}\text{Sn}(^{32}\text{S},X)$, $E=130-180$ MeV; measured neutron multiplicity distributions, α -, proton spectra, average multiplicities. 150 , ^{156}Dy deduced level density parameters, maximum effect of superdeformed trapping.

95Wi13 *Excited Superdeformed Bands in ^{133}Pr : Identification of the $g_{9/2}$ proton orbital*

J. N. Wilson, P. J. Nolan, C. W. Beausang, R. M. Clark, S. A. Forbes, A. Gizon, J. Gizon, K. Hauschild, I. M. Hibbert, E. S. Paul, D. Santos, A. T. Semple, J. Simpson, R. Wadsworth, Phys. Rev. Lett. 74, 1950 (1995).

Nuclear Reactions: $^{100}\text{Mo}(^{37}\text{Cl},4n)$, $E=155$ MeV; measured $\gamma\gamma$ -coin. ^{133}Pr deduced high-spin levels, J, π , superdeformed bands, configuration, dynamic moment of inertia, $B(\lambda)$.

96BoAA

The $i_{1/2}$ Proton Intruder Orbital in the Superdeformed ^{192}Tl Nucleus: Effective Magnetic Moment and Blocking of Proton Pairing. Bouneau et al., Phys. Rev. C53, R9 (1996).

96BrAA

Decay from a Superdeformed Band in ^{194}Pb . Brinkman et al., Phys. Rev. C53, R1461 (1996).

96CIAA

Superdeformation in Bismuth. Clark et al., Phys. Rev. C53, 117 (1996).

96DeAA

Spectroscopy in the Second Well of the ^{148}Gd Nucleus: Two Quasiparticle and Collective Excitations. De Angelis et al., Phys. Rev. C53, 679 (1996)

96KhAA

Excitation Energies and Spins of a Superdeformed Band in ^{194}Hg from One-step Discrete Decays to the Yrast Line. Khoo et al., Phys. Rev. Lett. 76, 1583 (1996).

96McAA

Superdeformation in ^{198}Po . McNabb et al., Phys. Rev. C53, R541 (1996).

96WiAA

Excited superdeformed bands in ^{182}Tl , Wison et al., Priv. comm. (March 7, 1996).



ERNEST ORLANDO LAWRENCE BERKELEY NATIONAL LABORATORY
TECHNICAL AND ELECTRONIC INFORMATION DEPARTMENT
UNIVERSITY OF CALIFORNIA | BERKELEY, CALIFORNIA 94720