

# UC Berkeley

## UC Berkeley Electronic Theses and Dissertations

### Title

Effective Daylighting: Evaluating Daylighting Performance in the San Francisco Federal Building from the Perspective of Building Occupants

### Permalink

<https://escholarship.org/uc/item/0vd3q8s2>

### Author

Konis, Kyle Stas

### Publication Date

2011

Peer reviewed|Thesis/dissertation

Effective Daylighting:  
Evaluating Daylighting Performance in the San Francisco Federal Building from the  
Perspective of Building Occupants

By

Kyle Stas Konis

A dissertation submitted in partial satisfaction of the

requirements for the degree of

Doctor of Philosophy

in

Architecture

in the

Graduate Division

of the

University of California, Berkeley

Committee in charge:

Professor Charles C. Benton, Chair

Professor Edward A. Arens

Professor Thomas D. Wickens

Fall 2011

Effective Daylighting: Evaluating Daylighting Performance in the San Francisco Federal Building from the Perspective of Building Occupants

© 2011

by Kyle Stas Konis

## Abstract

### Effective Daylighting: Evaluating Daylighting Performance in the San Francisco Federal Building from the Perspective of Building Occupants

by

Kyle Stas Konis

Doctor of Philosophy in Architecture

University of California, Berkeley

Professor Charles C. Benton, Chair

Commercial office buildings promoted as “sustainable,” “energy efficient,” “green,” or “high performance” often reference use of daylight as a key strategy for reducing energy consumption and enhancing indoor environmental quality. However, buildings are rarely studied in use to examine if the design intent of a sufficiently daylit and a visually comfortable work environment is achieved from the perspective of building occupants or how occupant use of shading devices may affect electrical lighting energy reduction from photocontrols. This dissertation develops a field-based approach to daylighting performance assessment that pairs repeated measures of occupant subjective response using a novel desktop polling station device with measurements of the physical environment acquired using High Dynamic Range (HDR) imaging and other environmental sensors with the objective of understanding the physical environmental conditions acceptable to occupants. The approach is demonstrated with a 6-month field study involving (N=44) occupants located in perimeter and core open-plan office spaces in the San Francisco Federal Building<sup>1</sup> (SFFB). Over 23,100 subjective assessments paired with physical measures were analyzed to develop models of visual discomfort and shade control and to examine the assumptions of existing daylighting performance indicators. The analysis found that existing daylight performance indicators overestimated the levels of daylight illuminance required by occupants to work comfortably without overhead ambient electrical lighting. Time-lapse observation of interior roller shades showed that existing shade control models overestimated the frequency of shade operation and underestimated the level of facade occlusion due to interior shades. Comparison of measured results to the daylighting objectives of the SFFB showed that available daylight enabled electrical lighting energy reduction in the perimeter zones but not in the open-plan core zones. The results extend existing knowledge regarding the amount of daylight illuminance acceptable for occupants to work comfortably without overhead electrical lighting and for the physical variables (and stimulus intensities) associated with visual discomfort and the operation of interior shading devices.

---

<sup>1</sup> 90, 7<sup>th</sup> Street, San Francisco, CA.

## Table of Contents

<b>1 Introduction</b>	<b>1</b>
1.1 The dual goals of daylighting : energy and IEQ	1
1.2 The challenge of defining and assessing daylighting performance	1
1.3 Provisions for daylighting in green building rating systems, standards and codes	3
1.4 The “transparent” facade as a strategy to maximize daylight and views	4
1.5 Problem statement	5
1.6 Research objectives	6
1.7 Broad research questions	7
1.8 Approach	9
1.9 Scope and limitations	11
1.10 Organization of the dissertation	14
<b>2 Overview of Performance Indicators</b>	<b>15</b>
2.1 Introduction	15
2.2 Electrical lighting energy reduction from photocontrols	18
2.2.1 Definition of performance and performance objectives	18
2.2.2 Methods of performance assessment in design	20
2.2.3 Methods of performance assessment in the field	21
2.2.4 Summary and questions	22
2.3 Daylight and Indoor Environmental Quality	24
2.3.1 Definition of performance and performance objectives	24
2.3.2 Established methods of performance assessment	24
2.3.3 Emerging methods of performance assessment	25
2.3.4 Summary and questions	27
2.4 Sufficient visual connection to the outdoors	29
2.4.1 Definition of performance and performance objectives	29
2.4.2 Criteria for window views in codes and standards	30
2.4.3 Methods of performance assessment	30
2.4.4 Summary and questions	34
2.5 Visual discomfort	34
2.5.1 Definition of visual comfort and performance objectives	34
2.5.2 Methods of performance assessment in design	35
2.5.3 Methods of performance assessment in the field	37
2.5.4 Summary and questions	39
2.6 Operation of interior shades	39
2.6.1 Overview	39
2.6.2 Field studies using external monitoring	40
2.6.3 Field studies using internal monitoring	41
2.6.4 Summary and questions	42
2.7 Conclusions	44

<b>3 The San Francisco Federal Building: A Review of Design Objectives, Environmental Control Strategies, Performance Criteria, and Existing Studies</b>	<b>45</b>
3.1 Introduction	45
3.2 Review of energy and IEQ objectives	46
3.2.1 The GSA portfolio, policy into practice	46
3.2.2 Design Excellence program	47
3.2.3 Energy efficiency performance objectives	47
3.2.4 IEQ performance objectives	48
3.3 Design strategies used to achieve energy and IEQ objectives	50
3.3.1 Building overview and design team	50
3.3.2 Daylighting and natural ventilation	51
3.3.3 Site description	52
3.3.4 Building massing and orientation	53
3.3.5 Plan and sectional organization	54
3.3.6 Facade solar exposures	56
3.3.7 Facade solar control strategies	57
3.3.7.1 SE facade exterior solar control	59
3.3.7.2 NW facade exterior solar control	62
3.4 Indicators, tools, and methods used to assess performance	64
3.4.1 Assessment of thermal comfort during design	64
3.4.2 Assessment of visual comfort and daylight sufficiency	68
3.4.3 Assessment of visual connection to the outdoors	71
3.4.4 Assessment of photocontrolled electrical lighting energy	72
3.4.5 Field assessment of thermal comfort prior to occupancy	73
3.4.6 Field assessment of visual comfort prior to occupancy	74
3.5 Facade retrofits completed after occupancy	77
3.6 Occupant subjective assessments of daylighting conditions after retrofits	80
3.7 Summary and questions	83
<b>4 Research Methods</b>	<b>85</b>
4.1 Introduction	85
4.2 Study variables	86
4.2.1 Dependent variables	87
4.2.1.1 Occupant control of roller shades and facade occlusion	87
4.2.1.2 Occupant “right now” subjective assessments	87
4.2.1.3 Electrical lighting power	90
4.2.2 Independent variables	91
4.2.2.1 Thermal comfort	91
4.2.2.2 Daylight sufficiency	91
4.3 Description of zones within the SFFB studied	92
4.4 Scheduling of test phases	94
4.5 Participants	96
4.5.1 Participant recruitment	96
4.5.2 Summary of participant descriptive information	97
4.6 Measures	99
4.6.1 Measures of electrical lighting power	99

4.6.2	Exterior measures .....	99
4.6.2.1	Exterior solar measures .....	99
4.6.2.2	Exterior temperature and relative humidity measures ..	100
4.6.3	Interior measures .....	101
4.6.3.1	Interior solar measures .....	101
4.6.3.2	Interior air temperature and relative humidity .....	102
4.6.3.3	Scene luminance .....	102
4.6.3.3.1	Calibration of HDR-enabled cameras .....	104
4.6.3.3.2	Point of view luminance measures .....	107
4.6.3.3.3	Processing of HDR image data .....	110
4.6.3.4	Interior roller shade operation .....	113
4.6.4	Desktop polling stations .....	116
4.6.4.1	Overview .....	117
4.6.4.2	Subjective measures .....	118
4.6.4.3	Physical measures .....	119
4.6.4.4	Prototype development .....	119
4.6.4.5	Operational reliability and user interface testing .....	120
4.6.5	Subjective questionnaire .....	122
4.6.6	Measurement protocol .....	122
4.6.7	Data processing .....	124
4.6.8	Data diagnostics and initial visual exploration of responses .....	125
4.6.8.1	NW perimeter zones .....	125
4.6.8.2	SE perimeter zones .....	129
4.6.8.3	Core zones .....	131
4.7	Summary .....	133
<b>5</b>	<b>Shade Positioning and Frequency of Operation .....</b>	<b>134</b>
5.1	Introduction .....	135
5.2	Overview and selection of shade control behavioral models .....	137
5.3	Northwest facade .....	139
5.3.1	Scope of monitoring .....	140
5.3.2	Observed facade solar exposures and model predictions .....	141
5.3.3	Observed northwest window occlusion .....	144
5.3.3.1	Phase 1 (NW sections without upper shades) .....	145
5.3.3.2	Phase 4 (NW sections without upper shades) .....	148
5.3.3.3	Phase 1 (NW sections with upper shades) .....	150
5.3.3.4	Phase 4 (NW sections with upper shades) .....	152
5.3.4	Summary for the NW facade .....	153
5.3.4.1	Frequency of shade operation .....	153
5.3.4.2	Predicted vs. observed levels of window occlusion .....	155
5.4	Southeast facade .....	157
5.4.1	Scope of monitoring .....	158
5.4.2	Observed facade solar exposures and model predictions .....	159
5.4.3	Southeast window occlusion results .....	162
5.4.3.1	Phase 2 (SE facade) .....	163
5.4.3.2	Phase 5 (SE facade) .....	165

5.4.4	Summary analysis .....	167
5.4.4.1	Frequency of shade operation .....	167
5.4.4.2	Predicted vs. observed levels of window occlusion .....	172
5.5	Summary of results .....	174
<b>6</b>	<b>Logistic Regression Models of Shade Control Behavior .....</b>	<b>177</b>
6.1	Introduction .....	177
6.2	Shade operation data .....	179
6.2.1	Selection of independent variables .....	179
6.2.2	Description of independent variables .....	182
6.2.3	Scaling of independent variables .....	184
6.2.4	Intercorrelation of independent variables .....	184
6.2.5	Binary classification of shade operations .....	185
6.3	Single-variable logistic models .....	185
6.3.1	Evaluation of single-variable logistic models .....	185
6.3.2	Ranking of single-variable logistic regression models .....	186
6.3.3	Selection of single-variable logistic models .....	188
6.4	Comparison of models to existing guidance .....	189
6.4.1	Average and maximum window luminance .....	189
6.4.2	Interior global vertical illuminance and irradiance .....	192
6.4.3	IESNA luminance contrast ratio limits and UGR .....	194
6.4.4	Horizontal illuminance .....	197
6.4.5	Logistic regression model operation thresholds .....	198
6.5	Summary and conclusions .....	199
<b>7</b>	<b>Logistic Regression Models of Visual Discomfort .....</b>	<b>201</b>
7.1	Introduction .....	201
7.2	Review of Polling Station Responses .....	202
7.2.1	Selection of independent variables .....	206
7.2.2	Description of independent variables .....	207
7.2.3	Scaling of independent variables .....	210
7.2.4	Intercorrelation of independent variables .....	210
7.2.5	Binary classification of subjective assessments .....	214
7.3	Single-variable logistic models .....	217
7.3.1	Evaluation of single-variable logistic models .....	217
7.3.2	Ranking of single-variable logistic regression models .....	217
7.3.3	Selection of single-variable logistic models .....	220
7.4	Comparison of models to existing indicators .....	222
7.4.1	Average and maximum window luminance .....	222
7.4.2	Interior global vertical illuminance and irradiance .....	226
7.4.3	Glare indices .....	228
7.4.4	IESNA luminance contrast ratio limits .....	230
7.4.5	Horizontal illuminance .....	232
7.4.6	Logistic regression model operation thresholds .....	232
7.5	Summary and conclusions .....	234



<b>8 Daylight Sufficiency Results</b> .....	<b>237</b>
8.1 Introduction .....	237
8.2 Summary of subjective assessments of AMOUNT of daylight .....	238
8.3 NW perimeter zones .....	242
8.4 SE perimeter zones .....	248
8.5 Core zones .....	252
8.6 Daylight autonomy .....	258
8.7 The daylight factor (DF) .....	257
8.8 Summary and conclusions .....	258
<b>9 Results and Analysis of Visual Connection to the Outdoors</b> .....	<b>261</b>
9.1 Introduction .....	261
9.2 Occupant assessment of LEED Daylight and View EQ credit intent .....	262
9.3 Occupant level of satisfaction with visual connection to the outdoors.....	264
9.3.1 Sources of dissatisfaction .....	265
9.4 Satisfaction with visual connection to the exterior and satisfaction with personal workspace and building overall .....	267
9.5 Shade position and subjective assessment of visual connection to the outdoors .....	269
9.6 Summary of results .....	275
<b>10 Results and analysis of electrical lighting energy consumption</b> .....	<b>277</b>
10.1 Introduction .....	277
10.2 Electrical lighting system .....	280
10.2.1 Lighting system design .....	280
10.2.2 Electrical lighting controls .....	282
10.2.2.1 Automated control of lighting zones .....	283
10.2.2.2 Occupant control of lighting zones.....	285
10.2.2.3 Occupant control of task lighting .....	286
10.3 Monitoring of electrical lighting power.....	288
10.3.1 The automated lighting control system .....	288
10.3.2 Scope of monitoring .....	288
10.4 Response of the electrical lighting system to available daylight.....	290
10.4.1. Are photocontrols working effectively to reduce electrical lighting power in response to daylight at the scale of an entire floor? .....	290
10.4.2 Are photocontrols working effectively to reduce electrical lighting power in response to daylight at the scale of individual perimeter zones?.....	291
10.4.3 Is lighting power reduced in response to daylight in open-plan core zones?.....	295
10.4.4 What is the contribution of the electrical ambient lighting system to workplane illuminance?.....	296
10.4.5 How efficient is the electrical lighting system in terms of workplane illuminance delivered per watt?.....	297

10.4.6	What is the contribution of electrical lighting to total illuminance at the workplane? .....	299
10.4.7	What is the electrical lighting energy consumption of the ambient lighting system? .....	303
10.5	Occupant assessment of daylight sufficiency .....	304
10.5.1	What fraction of energy was consumed when occupants perceived daylight levels to be sufficient to work comfortably without supplemental electrical ambient illuminance? .....	304
10.5.2	Comparison of SFFB photocontrolled lighting to idealized models .....	312
10.5.3	How much electrical lighting energy could theoretically be reduced if electrical lighting were controlled based on occupant perception of insufficient daylight?.....	316
10.6	Summary and conclusions .....	318
<b>11</b>	<b>Discussion of results .....</b>	<b>319</b>
11.1	Introduction .....	319
11.2	Lessons learned from the SFFB as a case study .....	321
11.2.1	High VLT glazing and large window-to-wall ratio (WWR) .....	322
11.2.2	Extended floor-to-ceiling height .....	324
11.2.3	Exterior solar control .....	326
11.2.3.1	NW facade exterior solar control .....	326
11.2.3.2	SE facade exterior solar control .....	329
11.2.4	Shallow floor plate depth and open-plan office layout .....	335
11.2.5	Photocontrolled overhead electrical ambient lighting .....	339
11.2.6	Summary of lessons learned .....	342
11.3	Lessons learned from examination of existing daylighting indicators .....	344
11.3.1	Shade positioning and frequency of operation .....	345
11.3.2	The balance of daylight transmission with visual comfort .....	348
<b>12</b>	<b>Conclusions .....</b>	<b>350</b>
12.1	Conclusions .....	350
12.2	Suggestions for future work .....	352
Appendix A:	Approval letter from the U.C. Berkeley Committee for Protection of Human Subjects (CPHS) .....	355
Appendix B:	Amended approval letter from the CPHS .....	356
Appendix C:	Illuminance logging equipment design .....	357
Appendix D:	Method of calibration for illuminance measurement equipment .....	359
Appendix E:	Polling station fabrication .....	362
Appendix F:	Integration of illuminance and temperature sensing with the Arduino microcontroller .....	363
Appendix G:	Method for subtracting the contribution of electrical ambient lighting from measures of horizontal workplane illuminance .....	365
Appendix H:	Instructions for study participants .....	366
Appendix I:	Web-based occupant survey .....	369
References	.....	383

## List of figures

Figure 1.1	Example “sustainable” buildings that incorporate large areas of high visible light transmittance glazing in the facade .....	4
Figure 1.2	The NW facade of the SFFB presented on the cover of three architectural publications that describe the building as a model of “high performance,” “integrated,” and “green” design .....	11
Figure 2.1	Environmental control functions performed by the building facade as conceptualized by Fitch (1999) .....	16
Figure 2.2	Environmental control functions related to the building facade investigated in this research .....	17
Figure 2.3	Recommended workplane illuminances for general offices in the U.S., UK, and the Soviet Union/Russia since 1930. From (Boyce, 2003) after Mills and Borg (1999) .....	19
Figure 2.4	Lighting energy savings performance metrics. From Deru, et al. (2005) .....	21
Figure 2.5	Energy performance assessment of occupied non-domestic buildings By analyzing end-use energy consumptions. From Field et al. (1997) ...	22
Figure 2.6	Daylight factor (DF), daylight autonomy (DA), and useful daylight illuminance (UDI) area plots for a generic building. From Nabil and Mardaljevic (2005) .....	25
Figure 2.7	Required vertical glazing for typical cellular office .....	32
Figure 2.8	Required vertical glazing for 30-foot deep open-plan office .....	32
Figure 2.9	Theoretical limit of depth from facade for typical 9-foot office ceiling height and fully glazed facade for workstation compliant with LEED View EQ credit 11-degree visual angle criteria.....	32
Figure 2.10	(Left) Interior view of an open plan office space looking out through shades lowered (75%). (Right) Similar view with shades retracted showing increased contrast .....	33

Figure 2.11	Image of experimental environment (left) created to determine the borderline between comfort and discomfort produced by a small glare source (luminance, size and position) and a uniformly illuminated background. From Guth (1949). Results (right) .....	35
Figure 2.12	(Left) Image of the shielded and unshielded illuminance sensors used to calculate the Daylight Glare Index (DGI) according to the IEA SHC Task 21 monitoring procedures. (Right) High dynamic range (HDR) image post-processed using RADIANCE to identify size, position, and luminance of glare sources above 500 cd/m <sup>2</sup> .....	38
Figure 3.1	Timeline locating field evaluation and facade retrofits of SFFB .....	46
Figure 3.2	(Left) exterior view of the SFFB (SE facade). (Right) exterior view showing NE facade .....	50
Figure 3.3	Aerial view of the SFFB from the south .....	52
Figure 3.4	(Left) wind tunnel study model. (Right) Direction and distribution of wind. From McConahey (2001).....	53
Figure 3.5	Generic SFFB tower section floor plan. From Haves et. al. (2004) .....	54
Figure 3.6	Generic section through SFFB tower showing interior cabin workspaces. From Haves et. al. (2004).....	55
Figure 3.7	Sunpath diagram for the SFFB field test site. Sun position is shown at sunrise on January 1 .....	56
Figure 3.8	Floor to ceiling high glazing with high visible light transmittance on SE facade photographed prior to installation of exterior perforated steel scrim. From McConahey (2005) .....	57
Figure 3.9	Exterior view of the SE exterior metal screen. Image shows select panels that are open .....	59
Figure 3.10	Interior view looking through SE facade at exterior metal screen. Image from PBS Design e2 podcast entitled: “Greening the Federal Government” .....	60
Figure 3.11	Generic section through the SE facade showing solar control layers implemented in the initial design prior to occupancy. ....	61
Figure 3.12	Exterior view of the NW facade exterior solar shading devices .....	62

Figure 3.13	Generic section through NW facade showing solar control layers implemented in the initial design prior to occupancy. ....	63
Figure 3.14	Acceptable operative temperature ranges for naturally conditioned spaces. From ASHRAE Standard 55, after Brager and de Dear (200) ....	65
Figure 3.15	Monthly mean ambient outdoor air temperatures for San Francisco and the 80% acceptability limits (max and min) for indoor operative temperature. From McConahey et al. (2002) .....	66
Figure 3.16	Predicted operative temperature for different ventilation strategies on 3 July. From Haves et al. (2004).....	67
Figure 3.17	6th floor southeast perimeter zone air temperatures on October 17-29, 2006. From Diamond et al. (2007) .....	74
Figure 3.18	South facade glare measurements, August 25, 2006. From Lee et al. (2006) .....	75
Figure 3.19	North facade glare measurements, August 25, 2006. From Lee et al. (2006). .....	76
Figure 3.20	Typical wall section through the southeast facade showing location and details for the solar control film and interior manually controlled roller shade retrofits .....	77
Figure 3.21	Generic cross section of the SE facade showing additional solar control layers of solar control film and interior roller shades added during the facade retrofits .....	78
Figure 3.22	Generic cross section of the NW facade showing additional solar control layer of interior roller shades added during the facade retrofits .....	79
Figure 3.23	Responses to the CBE survey for the tower-northwest group .....	80
Figure 3.24	Responses to the CBE survey for the tower-southeast group .....	81
Figure 3.25	Responses to the CBE survey for the tower-cabin group .....	81
Figure 3.26	Top topics of lighting dissatisfaction for the tower groups .....	82
Figure 4.1	Cross-section through the SFFB tower section showing the floors where participants were located.....	92
Figure 4.2	Overview of NW perimeter zone. Image taken after facade retrofits .....	93

Figure 4.3	Overview of SE perimeter zone. Image taken after facade retrofits .....	93
Figure 4.4	Overview of open-plan core zone. Image taken after facade retrofits .....	94
Figure 4.5	(Left) View from generic shaded NW viewpoint. (Right) Observed user modification to control direct sun in NW perimeter zone workstation. ....	95
Figure 4.6	Examples of depth of direct sun penetration on the SE facade during Phase 2.....	96
Figure 4.7	Location of exterior solar measures.....	99
Figure 4.8	Exterior illuminance and irradiance measurement and data logging device (left) and dual op-amp circuit (right) .....	100
Figure 4.9	Location of exterior rooftop temperature sensor .....	100
Figure 4.10	Vertical (unshaded) irradiance at glass (left) and vertical (shaded) irradiance and illuminance at 2” from interior face of roller shade fabric (right) .....	101
Figure 4.11	Hobo Temp./RH data logger attached to digital camera .....	102
Figure 4.12	Typical placement of digital camera on SE facade perimeter zone workstation partition (left) and isolated view of device showing method of attachment (right). ....	102
Figure 4.13	Example of exposure bracketing of low dynamic range (i.e. JPEG) images for compositing into a single HDR image .....	103
Figure 4.14	Example HDR image of the exterior glass fins viewed from the NW perimeter zone workspace .....	104
Figure 4.15	Shielded illuminance sensor (right) and “masked” region used to calculate the average window luminance for comparison to the shielded sensor .....	105
Figure 4.16	Comparison of measures of average window luminance from HDR image data to reference shielded illuminance sensor before and after HDR data were uniformly scaled by a calibration coefficient.....	106
Figure 4.17	Position of HDR camera equipment located in two vacant workstations on the SE facade. East-facing view (left) and south-facing view (right) .....	107

Figure 4.18	Generic viewpoint for east-facing workstation orientation (SE facade) showing luminance conditions recorded using HDR imaging with roller shades raised .....	108
Figure 4.19	Generic viewpoint for south-facing workstation orientation (SE facade) showing luminance conditions recorded using HDR imaging with roller shades raised.....	109
Figure 4.20	View of generic shaded facade view (SE view orientation). .....	109
Figure 4.21	Example view from participant workstation located in the core (view faces the NW facade).....	109
Figure 4.22	Example view from a core workspace showing the regions of the HDR image defined to calculate summary statistics (average, maximum) for each region at 5-minute intervals throughout the (6:00 – 20:00 PST) daily monitoring period .....	110
Figure 4.23	View from each of 12 of the cameras used to monitor the NW perimeter zone during Phase 1 .....	112
Figure 4.24	Visualization of time-lapse imaging from a viewpoint of one facade section showing one image per hour .....	113
Figure 4.25	Time-lapse movies of shade control were observed and changes to shade position logged in a spreadsheet format .....	113
Figure 4.26	The facade occlusion index developed to summarize position and frequency of operation of shading devices .....	114
Figure 4.27	Desktop polling station .....	117
Figure 4.28	Desktop polling station (left) and internal view of Arduino microcontroller and associated components (right) .....	118
Figure 4.29	Example data energy sequence: (left) IEQ question is displayed to the user on the screen, (center) user selects desired subjective response, (right) after user has selected response arcade button is pressed to record response and advance to next question .....	118
Figure 4.30	Calibration of thermistors in thermal bath at LBNL using a precision digital thermometer .....	119
Figure 4.31	Examples of early concept sketches (center) and physical prototypes (left and right) .....	120

Figure 4.32	Final assembly and inspection of polling stations (left) and operational reliability testing (right) .....	121
Figure 4.33	Polling station testing by volunteer in a daylit open-plan office located in the David Brower Center, Berkeley, CA .....	121
Figure 4.34	Delivery (left) and placement (right) of desktop polling stations.....	122
Figure 4.35	Occupant subjective assessment of daylight conditions (Q3, Q4) paired with physical measures of horizontal workplane illuminance ....	123
Figure 4.36	Diagram of sources of data used to create final data sets for analysis of shade control behavior .....	124
Figure 4.37	Diagram of sources of data used to create final data sets for analysis of occupant subjective assessments .....	125
Figure 4.38	Reporting frequency histograms for Phase 1 (NW perimeter zones) ....	126
Figure 4.39	Aggregate subjective assessments to polling station questions from all participants in Phase 1 (NW, Summer Solstice) .....	128
Figure 4.40	Aggregate subjective assessments to polling station questions from all participants in for Phase 4 (NW, Fall Equinox).....	128
Figure 4.41	Reporting frequency histograms for Phase 2 (SE perimeter zones) .....	129
Figure 4.42	Aggregate subjective assessments to polling station questions for Phase 2 .....	130
Figure 4.43	Aggregate subjective assessments to polling station questions for Phase 5 .....	130
Figure 4.44	Reporting frequency histograms for phase 3 (core zones) .....	131
Figure 4.45	Aggregate subjective assessments to polling station questions for Phase 3 .....	132
Figure 4.46	Aggregate subjective assessments to polling station questions for Phase 6 .....	132
Figure 5.1	Interior view from core workstations showing interior roller shades lowered and electrical ambient lighting on .....	134



Figure 5.2	Overview of NW facade workstations where interior roller shades were added to the row of vision windows only (left) and to the upper two rows of windows in addition to the vision windows (right) .....	139
Figure 5.3	Seasonal variation in global vertical irradiance incident on the NW facade of the SFFB .....	140
Figure 5.4	Seasonal variation in interior global vertical irradiance incident on workspaces adjacent to the NW facade (when interior shades are retracted) .....	141
Figure 5.5	Measured transmitted vertical irradiance incident on workspaces adjacent to the NW facade during Phase 1 (July 12 to 30, 2010) .....	142
Figure 5.6	Summary of facade occlusion for sections of the NW facade without interior roller shades installed on the upper two rows of windows for Phase 1 .....	145
Figure 5.7	Summary of responses to the (agree / disagree) survey question: “I keep the shades in my workspace LOWERED more often than I would prefer for the comfort of my coworkers” .....	146
Figure 5.8	Summary of responses to the (agree / disagree) survey question: “I keep the shades in my workspace RAISED more often than I would prefer for the comfort of my coworkers” .....	146
Figure 5.9	Summary of window occlusion for sections of the NW facade without interior roller shades installed on the upper two rows of windows for Phase 4 (October 18 to 29, 2010) .....	148
Figure 5.10	Summary of facade occlusion for sections of the NW facade with interior roller shades installed on the upper two rows of windows for Phase 1 (July 12 to 30, 2010).....	150
Figure 5.11	Summary of facade occlusion for sections of the NW facade with interior roller shades installed on the upper two rows of windows for Phase 4 (October 18 to 29, 2010) .....	152
Figure 5.12	Distribution of occupants by total number of shade operations observed (per person) during Phase 1 and Phase 4, comparing facade sections “with upper shades” to sections with shades on only the vision windows (i.e. “no upper shades”) .....	154
Figure 5.13	Comparison of levels of occlusion predicted to levels observed on NW facade for the subset of participants who participated in both Phase 1 and Phase 4 (N = 10) .....	155

Figure 5.14	Example perimeter workstation adjacent to the SE facade showing location of interior roller shades. Image taken on November 1st at 10:20 AM PST .....	157
Figure 5.15	Seasonal variation in global vertical irradiance incident on the SE facade of the SFFB .....	158
Figure 5.16	Daily variation in interior global vertical irradiance incident on workspaces adjacent to the SE facade (when interior shades are retracted) for Phase 2 and Phase 5 .....	159
Figure 5.17	Measured transmitted solar irradiance incident on workspaces adjacent to the SE facade during Phase 2 .....	160
Figure 5.18	Summary of SE facade occlusion for Phase 2 .....	163
Figure 5.19	Summary of SE facade occlusion for Phase 5 .....	165
Figure 5.20	Distribution of occupants (SE participants and adjacent occupied workspaces) by number of shade operations observed over 25 workdays during Phase 2 .....	167
Figure 5.21	Comparison of occlusion levels between the four shade operation behaviors identified .....	168
Figure 5.22	Comparison of observed level of window occlusion for “non-operator” group to levels predicted from model 4 and a modification to model ....	170
Figure 5.23	Comparison of observed level of window occlusion for “occasional operator” group to level predicted from a modification to model 4 using a 5-day trailing average of “near-worst-case” conditions .....	171
Figure 5.24	Comparison of daily average level of window occlusion predicted to levels achieved on SE facade during Phase 2 by the four different shade control behaviors identified .....	172
Figure 5.25	Comparison of daily average level of occlusion predicted to levels achieved on SE facade during Phase 5 by four different behavioral types .....	173
Figure 6.1	Occupant workstation adjacent to SE facade showing location of vision window shades and upper “daylight zone” window shades .....	177
Figure 6.2	Survey responses indicating reasons for lowering roller shades .....	179

Figure 6.3	Survey responses indicating reasons for raising roller shades.....	180
Figure 6.4	Logistic regression models for maximum window luminance.....	191
Figure 6.5	Logistic regression models for average window luminance.....	191
Figure 6.6	Logistic regression models for interior global vertical illuminance .....	193
Figure 6.7	Logistic regression models for interior global vertical irradiance .....	193
Figure 6.8	Logistic regression models of luminance ratio [window : 200 cd/m <sup>2</sup> task].....	196
Figure 6.9	Logistic regression models of the Unified Glare Rating (UGR) .....	196
Figure 6.10	Logistic regression models of daylight illuminance .....	197
Figure 7.1	Summary of occupant subjective responses to (Q6) for Phases 1, 2, 3 .....	203
Figure 7.2	Summary of occupant subjective responses to (Q6) for Phases 4, 5, 6 .....	203
Figure 7.3	Distribution of polling station responses to (Q6) by day (y-axis) and by hour (x-axis) for the SE perimeter zone group from August 2, to Sept. 3, 2010.....	205
Figure 7.4	Graphic representation of the three binary classifications used to define visual discomfort for logistic regression analysis .....	214
Figure 7.5	Logistic model of visual discomfort from windows (SMV model) from SE perimeter zone group .....	216
Figure 7.6	Logistic model of visual discomfort from windows (adding MV model) .....	216
Figure 7.7	Logistic model of visual discomfort from windows (adding V model).....	216
Figure 7.8	Maximum luminance of the upper two rows of windows ( $L_{\max UpWin}$ )....	223
Figure 7.9	Average luminance of the upper two rows of windows ( $L_{upWin}$ ).....	223
Figure 7.10	Maximum luminance of the lower (vision) window ( $L_{\max LwWin}$ ) .....	225
Figure 7.11	Average luminance of the lower (vision) window ( $L_{lwWin}$ ) .....	225

Figure 7.12	Interior global vertical irradiance ( $Irrad_{inVert}$ ) .....	227
Figure 7.13	The Unified Glare Rating (UGR) .....	229
Figure 7.14	Ratio of max. window luminance to a (200 cd/m <sup>2</sup> ) visual task ( $R_{CUPmax}$ ) .....	231
Figure 7.15	Ratio of average window luminance to a (200 cd/m <sup>2</sup> ) visual task ( $R_{CPU}$ ) .....	231
Figure 7.16	Maximum upper window luminance from the NW perimeter zone for an example day (7/19/2010) showing application of estimated discomfort thresholds ( $p = 0.2$ , $p = 0.5$ , $p = 0.75$ ) .....	234
Figure 8.1	Distribution of subjective responses to (Q3, satisfaction with daylight) for Phases 1,2,3 .....	240
Figure 8.2	Distribution of subjective responses to (Q4, preference for daylight change) for dissatisfied responses to (Q3) for Phases 1,2,3 .....	240
Figure 8.3	Distribution of subjective responses to (Q3) for Phases 4,5,6 .....	241
Figure 8.4	Distribution of subjective responses to (Q4) for dissatisfied responses to (Q3) for Phases 4,5,6.....	241
Figure 8.5	Distribution of binned responses to (Q3) in the NW perimeter zone workspaces for Phase 1 (July 12 – 29) .....	244
Figure 8.6	Distribution of binned responses to (Q3) in NW perimeter zone workspaces for Phase 4 (October 15 – 29) .....	244
Figure 8.7	Distribution of subjective responses to (Q3) for the NW perimeter zone by daylight illuminance for Phase 1 and Phase 4 combined .....	246
Figure 8.8	Distribution of subjective responses to (Q3) for the NW perimeter zone by subjective window discomfort rating (Q4) for Phase 1 and Phase 4 combined.....	246
Figure 8.9	Distribution of responses to (Q3) in SE perimeter zone workspaces for Phase 2 (Aug. 2 – Sept. 3).....	249
Figure 8.10	Distribution of responses to (Q3) in SE perimeter zone workspaces for Phase 5 (Nov. 8 - 19) .....	249
Figure 8.11	Distribution of subjective responses to (Q3) by daylight illuminance for Phase 2 and Phase 5 combined .....	250

Figure 8.12	Distribution of subjective responses to (Q3) by subjective window discomfort rating (Q4) for Phase 2 and Phase 5 combined .....	251
Figure 8.13	Distribution of responses to (Q3) in core workspaces for Phase 3 (October 4 - 15).....	253
Figure 8.14	Distribution of responses to (Q3) in core workspaces for Phase 6 (December 6 - 17) .....	253
Figure 8.15	Distribution of subjective responses to (Q3) by daylight illuminance for Phase 3 and Phase 6 combined.....	254
Figure 8.16	Distribution of subjective responses to (Q3) by subjective window discomfort rating (Q4) for Phase 3 and Phase 6 combined .....	255
Figure 9.1	Subjective responses to (Q1) .....	263
Figure 9.2	Subjective responses to (Q2) .....	263
Figure 9.3	Overall level of satisfaction with visual connection to the outdoors .....	264
Figure 9.4	Examples of personal modifications found to also restrict views to the outdoors (SE, SE, and NW facades respectively) .....	267
Figure 9.5	Overall level of satisfaction with the SFFB by overall level of satisfaction with visual connection to outdoors .....	268
Figure 9.6	Overall level of satisfaction with personal workspace by overall level of satisfaction with visual connection to outdoors .....	268
Figure 9.7	Distribution of responses to (Q5) during Phases 1, 2, and 3 .....	269
Figure 9.8	Distribution of responses to (Q5) during Phases 4, 5, and 6 .....	269
Figure 9.9	Satisfaction with position of shades on visual connection to outdoors (Q5) by occlusion level of vision windows for (N=30) perimeter zone participants.....	270
Figure 9.10	Box-and-whisker plot showing distributions of satisfied and dissatisfied responses by lower window occlusion level .....	271

Figure 9.11	View from core workspace to NW facade showing potential loss of view as a result of high contrast between windows and surrounding interior surfaces .....	273
Figure 9.12	The same image as in figure 9.11, with the exposure adjusted to illustrate that an unobstructed view content is present .....	273
Figure 9.13	The same image as in figure 9.11, with a false color luminance mapping showing the contrast between interior surfaces of low luminance and windows of comparably high luminance .....	274
Figure 10.1	Typical tower floor plan showing location of 4 perimeter photo-controlled lighting zones (NW = blue, SE = green) .....	280
Figure 10.2	Floor plan showing lighting zones for the 16th floor .....	281
Figure 10.3	Typical perimeter lighting zone on the NW (left) and SE (right) sides of the SFFB.....	281
Figure 10.4	Image of open-plan core lighting zone H located on the 16th floor .....	282
Figure 10.5	Location of wall controls and photosensor for typical perimeter zone...	283
Figure 10.6	Photosensors were mounted on a vertical wall surface at approximately 8-feet above the floor .....	283
Figure 10.7	Example daily lighting power profile for the NW perimeter zone (NW (b), 16 <sup>th</sup> floor) during Phase 1 (July 26, 2010) .....	284
Figure 10.8	Frequency of overhead electrical lighting control usage for NW, SE and core participants.....	285
Figure 10.9	Location of task lighting installed in workspace partitions on NW (left) and SE (right) perimeter zones .....	286
Figure 10.10	Frequency of task light usage for participants located in NW, SE and core zones. ....	287
Figure 10.11	Examples of supplemental task lighting added to SE workspaces where the facade was shaded by <i>ad-hoc</i> opaque devices .....	287
Figure 10.12	“Whole-floor” effective LPD for the overhead electrical lighting for one workweek (July 26 – 30, 2010) for the 16th floor .....	290
Figure 10.13	Daily variation in LPD for NW perimeter lighting zone B (16th floor) from July 12 to August 6, 2010.....	291

Figure 10.14	Daily variation in LPD for SE perimeter lighting zone D (15th floor) from August 2 to September 24, 2010 .....	292
Figure 10.15	Horizontal workplane illuminance from overhead electrical lighting measured at the polling station during the evening cleaning cycle when no daylight was present and task lighting was switched off .....	296
Figure 10.16	View of dust accumulation on fluorescent lamps and reflectors .....	298
Figure 10.17	View of SE perimeter lighting zone luminaires showing a single luminaire that has been cleaned of dust and re-lamped .....	298
Figure 10.18	Average electrical illuminance as a percentage of total illuminance measured at the polling station. NW perimeter zone, Phase 1 (N = 11) participants.....	300
Figure 10.19	NW perimeter zone, Phase 4 (N = 11) participants .....	300
Figure 10.20	SE perimeter zone, Phase 2 (N = 14) participants .....	301
Figure 10.21	SE perimeter zone, Phase 5 (N = 9) participants .....	301
Figure 10.22	Core zones, Phase 3 (N = 11) participants .....	302
Figure 10.23	Core zones, Phase 6 (N = 8) participants .....	302
Figure 10.24	Aggregate subjective responses to (Q7) from polling stations for Phases: 1, 2, 3 .....	305
Figure 10.25	Aggregate subjective responses to (Q7) from polling stations for “follow-up” Phases: 4, 5, 6 .....	305
Figure 10.26	Distribution of responses to (Q7) for NW perimeter zone (July 12 to 29) .....	308
Figure 10.27	Distribution of responses to (Q7) for NW perimeter zone (Oct. 18 to 29).....	308
Figure 10.28	Distribution of responses to (Q7) for SE perimeter zone (Aug. 2 - Sept. 3) .....	309
Figure 10.29	Distribution of responses to (Q7) for SE perimeter zone (Aug. 2 - Sept. 3) .....	309

Figure 10.30	Logistic model of (Q7): <i>perception of sufficient daylight to work comfortably without overhead electrical lighting</i> , as a function of workplane illuminance .....	311
Figure 10.31	LPD for NW perimeter zones during Phase 1 (July 12 – 29) .....	314
Figure 10.32	LPD for NW perimeter zones during Phase 4 (Oct. 18 – 29) .....	314
Figure 10.33	LPD for SE perimeter zones during Phase 2 (Aug. 2 – Sept. 3) .....	315
Figure 10.34	LPD for SE perimeter zones during Phase 5 (Nov. 8 – 19) .....	315
Figure 10.35	Daily (per person) perimeter zone electrical lighting energy Consumption. Measured vs. “idealized” models vs. T-24 (2005) baseline .....	316
Figure 11.1	Interior view of the SE perimeter zone prior to occupancy showing floor to ceiling high VLT glass window wall typical for both NW and SE facades .....	322
Figure 11.2	NW perimeter workspace (left) and NW perimeter zone (right) .....	324
Figure 11.3	Shades were lowered for upper zones of the NW facade when they were provided (8th floor). This figure is repeated from Chapter 5.....	325
Figure 11.4	Exterior vertical glass fins presented on the cover of the book High Performance Building (left) and an interior view of NW facade and perimeter zone (right) .....	326
Figure 11.5	HDR image of exterior glass fin showing peak luminances in excess of 22,500 cd/m <sup>2</sup> and average fin luminance in excess of 10,000 cd/m <sup>2</sup> .	327
Figure 11.6	Examples of interior workspace modifications to control direct sun and reduce window luminance observed in the NW perimeter zones ....	328
Figure 11.7	Architectural rendering showing anticipated daylighting conditions for the SE perimeter zone (left) and image of the SE perimeter zone under similar clear sky conditions (right) .....	329
Figure 11.8	Examples of personal workspace modifications made to block direct view of the solar disc .....	331
Figure 11.9	Generic viewpoint for east-facing workstation orientation (SE facade) showing unshaded (left) and shaded (right) luminance conditions recorded using HDR imaging .....	332



Figure 11.10	Diagram showing solar cut-off and view angles for a section of expanded metal screen. Image from Prof. Mathias Wambsganß of ip5 ingenieurpartnerschaft .....	333
Figure 11.11	Revitalisierung Haupthaus KfW, Frankfurt (Architekten Theiss and ip5 ingenieurpartnerschaft, 2003 - 2007) .....	334
Figure 11.12	Exterior view showing movable exterior solar control screen .....	334
Figure 11.13	Example of open-plan core zone investigated during the study .....	336
Figure 11.14	Left: Side view an example OLS (Lightlouver™) prior to being installed on the inward face of the daylight glazing at the Daylight Test Facility at Lawrence Berkeley National Laboratory .....	337
Figure 11.15	High dynamic range luminance map of test OLS condition (left) and reference venetian blind condition (right), acquired simultaneously on February 7, 2010 at 12:22 ST (clear sky conditions) with falsecolor tone mapping (yellow indicates luminance $\geq 2000$ cd/m <sup>2</sup> ) .....	338
Figure 11.16	Lightlouver™ OLS installed in National Renewable Energy Laboratory (NREL) Research Support Facility (RSF) .....	338
Figure 11.17	Whole-floor effective lighting power density (LPD) for one workweek (July 26 – 30, 2010) for the 16th floor. Average and minimum LPD are calculated from data recorded between 6AM – 7PM DST .....	340

## List of tables

Table 1.1	Existing daylighting performance indicators for shade operation and IEQ .....	4
Table 2.1	Subjective responses correlated to DGI in windowless and windowed laboratory setting. Windowless DGI correlation from (Hopkinson and Bradley, 1960), windows correlation from (Hopkinson, 1972) .....	37
Table 3.1	Example of results (for SFFB 16 <sup>th</sup> floor) submitted to the USGBC to demonstrate compliance with the LEED daylight and view credit criteria. Results compiled using the LEED Calculator 2.0. ....	70
Table 3.2	Summary of “daylit area” and “areas with views” for each floor of the SFFB. (From documentation submitted to the USGBC to demonstrate compliance with the LEED daylight and view credit criteria. Results compiled using the LEED <sup>TM</sup> Calculator 2.0) .....	71
Table 4.1	Dependent variables .....	86
Table 4.2	Independent variables .....	86
Table 4.3	Confounding factors .....	87
Table 4.4	Summary of study test phases .....	95
Table 4.5	Participant descriptive information.....	98
Table 5.1	Summary of shade control behavioral models investigated .....	138
Table 5.2	Summary of behavioral model predictions for shade operation during Phase 1 .....	143
Table 5.3	Summary of behavioral model predictions for shade operation during Phase 4 .....	143
Table 5.4	Summary of NW façade occlusion for Phase 1 .....	147
Table 5.5	Summary of NW facade occlusion for Phase 4 (no shades installed on upper windows) .....	149
Table 5.6	Summary of NW façade occlusion for Phase 1 (with shades installed on upper windows) .....	151

Table 5.7	Summary of NW facade occlusion for Phase 4 (with shades installed on upper windows) .....	152
Table 5.8	Summary of behavioral model predictions for shade operation during Phase 42 (SE facade).....	161
Table 5.9	Summary of behavioral model predictions for shade operation during Phase 5 (SE facade).....	161
Table 5.10	Summary of SE facade occlusion for Phase 2 .....	164
Table 5.11	Summary of SE facade occlusion for Phase 5 .....	166
Table 6.1	Descriptive statistics for vision window roller shade operations for both SE monitoring phases combined. ....	183
Table 6.2	Descriptive statistics for upper daylight zone roller shade operations for both SE monitoring phases combined.....	183
Table 6.3	Correlation among independent variables .....	184
Table 6.4	Ranking of logistic regression models of candidate variables .....	187
Table 6.5	Logistic regression models selected (vision window shades) .....	188
Table 6.6	Logistic regression models selected (upper daylight zone shades) .....	189
Table 6.7	Estimated threshold values at ( $p = 0.2$ ), ( $p = 0.5$ ) and ( $p = 0.95$ ) for physical environmental variables.....	198
Table 7.1	Descriptive statistics for NW perimeter zone independent variables associated with visual comfort votes from polling stations .....	208
Table 7.2	Descriptive statistics for SE perimeter zone independent variables associated with visual comfort votes from polling stations .....	209
Table 7.3	Descriptive statistics for core zone independent variables associated with visual comfort votes from polling stations .....	209
Table 7.4	Intercorrelation among independent variables for NW perimeter zones.....	211

Table 7.5	Intercorrelation among independent variables for SE perimeter zones .....	212
Table 7.6	Intercorrelation among independent variables for Core zones .....	213
Table 7.7	Ranking of logistic regression models of candidate predictor variables for visual discomfort (for all measures recorded in NW and SE perimeter zones) .....	218
Table 7.8	Ranking of logistic regression models of candidate predictor variables for visual discomfort for all measures recorded in core zones .....	219
Table 7.9	Logistic regression models (NW perimeter zones).....	221
Table 7.10	Logistic regression models (SE perimeter zones).....	221
Table 7.11	Logistic regression models (NW-facing core).....	221
Table 7.12	Logistic regression models (SE-facing core).....	222
Table 7.13	Estimated visual discomfort threshold values at (p = 0.2), (p = 0.5) and (p = 0.90) for luminance-based predictors (NW perimeter and NW-facing core groups) .....	233
Table 7.14	Estimated visual discomfort threshold values at (p = 0.2), (p = 0.5) and (p = 0.90) for luminance-based predictors (SE perimeter and SE-facing core groups) .....	233
Table 8.1	Summary of interior and exterior illuminance conditions (6:00 – 18:00 PST) .....	242
Table 8.2	Summary of interior and exterior illuminance conditions for SE perimeter zones.....	248
Table 8.3	Summary of interior and exterior illuminance conditions for Core zones.....	252
Table 8.4	DA performance for the NW perimeter, SE perimeter, and Core zones.....	256
Table 8.5	Hourly average daylight factor calculations for Core zones.....	257
Table 9.1	Summary of participants dissatisfied with visual connection to outdoors .....	265

Table 9.2	Reasons for dissatisfaction with visual connection to outdoors .....	265
Table 10.1	Scope of lighting zone monitoring.....	289
Table 10.2	Lighting power indicators for NW perimeter lighting zones.....	293
Table 10.3	Lighting power indicators for SE perimeter lighting zones.....	293
Table 10.4	Average lighting power for core lighting zones .....	295
Table 10.5	Efficiency for each zone type .....	297
Table 10.6	Average daily electrical lighting energy consumption by zone and (per person) .....	303
Table 10.7	Summary of logistic regression models of daylight sufficiency .....	310
Table 10.8	Perimeter zone electrical lighting energy consumption.....	317

## Acknowledgements

The possibility to conduct research in buildings in use requires the collaboration of a wide range of participants. I am grateful to Kevin Powell and David Leites of the U.S. General Services Administration (GSA) for their assistance with the planning and coordination of the field study as well as to the (N=44) individuals from the San Francisco Federal Building who agreed to participate in the study. Additionally, I am grateful to my supervisor at the Lawrence Berkeley National Laboratory (LBNL) Eleanor S. Lee for identifying the opportunity for this study and for her assistance and support as the study was planned and implemented. I feel privileged to have had the opportunity to meet and work with so many unique individuals in the Windows and Daylighting Group at LBNL. I would like to thank Dennis Dibartolomeo for his assistance with the polling station thermistor circuitry and calibration, Howdy Goudy for his time and guidance with milling the polling station enclosures, and Robert Clear for his guidance with the study design. I would also like to acknowledge that much of the measurement and analysis of glare implemented in this dissertation relies on the synthetic imaging system (Radiance), high dynamic range (HDR) image format, and associated analysis scripts developed by Greg Ward.

I would like to thank Jim Palm, Stephen F. Casey and the rest of the Enovity staff at the San Francisco Federal Building for their time and patience in escorting me as I tended my collection of instruments as well as for Jim's efforts in assisting with recovering data from the electrical lighting control system. I took inspiration from the quotation on his door: "Never Ever Ever Give Up." I do not know whom this quote is attributed to. A bit of research suggests a range from Charles Schulz (Peanuts) all the way to Thomas Edison and Winston Churchill. The words became relevant on a number of occasions during the field study, most notably during times of uncertainty. I was guided through these times with the help of my committee, colleagues, friends, and family. I would like to thank my committee, Professors Charles C. Benton, Edward Arens, and Thomas D. Wickens for their guidance and support of my dissertation work. I will always recall Professor Wickens' pantomime of a gorilla searching for a banana in a tree when I attempt to visualize statistical models with multiple degrees of freedom. I am indebted to Professor Benton for his patience and thoughtful suggestions during our meetings and to Professor Arens for his support and encouragement, as well as for providing me with my initial exposure to desktop polling stations. And, I am indebted to the entire Building Science Group for many insightful conversations, celebrations, tasty food, and restorative outings.

Finally, I would like to acknowledge support from my family and friends: thanks to my friends David and Bridget Lehrer and Paul Matthew for their insistence that I am done with my dissertation, to my parents, Peter and Jacque Konis for their support, to my brother Kjell, for his advice, and to my wife Sahar, for her life-long pursuit of risk taking.

## CHAPTER 1

### INTRODUCTION

#### **1.1 The dual goals of daylighting: energy reduction and enhanced Indoor Environmental Quality (IEQ)**

In commercial buildings, which account for roughly half of the energy used by all U.S. buildings, decisions related to fenestration directly affect the major categories of energy end use. Lighting represents the single largest electricity end use (39%)<sup>1</sup>, with the majority of use during daylight hours. Cooling loads represent another significant energy end use (14%), a third of which is due to electrical lighting and another one-third to solar heat gains through windows (Franconi and Huang 1996). Thus, facade strategies that control solar loads while transmitting sufficient daylight to minimize the need for electrical lighting have the potential to significantly improve energy performance compared to conventional commercial buildings.

In addition to energy, the introduction of daylight into interior environments has implications for Indoor Environmental Quality (IEQ). A growing body of research in the disciplines of photochemistry, photobiology, and human physiology demonstrates that exposure to daylight is important for health and well-being. For example, daylight is known to control the circadian rhythm of hormone secretions, with implications for sleep/wake states, alertness, mood and behavior (CIE, 2004). However, knowledge about what constitutes “healthy lighting” remains limited. Currently, there is no consensus for what the optimal daily light exposure might be, or when (in relation to the circadian rhythm) it should be timed (Veitch, 2004). Finally, research in the field of environmental psychology has demonstrated that window views are an important component of occupant health and well-being (Farley and Veitch, 2001). Therefore, in addition to daylight transmission, the provision of unobstructed visual connection to the outdoors, particularly to visual content that provides occupants with information, is an important component of IEQ.

#### **1.2 The challenge of defining and assessing daylighting *performance***

Although there is a growing consensus assigning importance to daylight and views in commercial buildings, there is less agreement for how electric lighting energy consumption, daylight sufficiency, visual comfort, and view performance objectives should be defined, measured, relatively valued, and how results should be interpreted to assess success or failure. As noted by Selkowitz (1998) on the challenge of defining “effective daylighting,” daylighting performance is often defined differently by different stakeholders in the design and use of the building. For example, a mechanical engineer may define performance in terms of electrical lighting energy reduction (Deru et. al.,

---

<sup>1</sup> CBECS, 2003, “Office” type.

2005). Alternatively, an architect may define performance in terms of the aesthetic qualities of daylight distribution in the space. The client may define performance based on whether or not the project complies with the requirements of green building certification criteria for daylight sufficiency and views. Finally, building occupants may judge the daylighting performance of the building based on their perception of daylight sufficiency, visual comfort, and available views. Thus, assessing daylighting performance encompasses a range of factors that, if considered in isolation, can lead to misleading conclusions. As an example, a design that “maximizes” daylight transmission to reduce electrical lighting energy consumption but results in visual discomfort for occupants may lead to constant use of interior shading devices as well as *ad hoc* modifications to the facade (or workstations), limiting both daylight availability and visual connection to the outdoors.

In this dissertation, assessing daylighting *performance* is based on the following rationale:

1. Post-occupancy modifications initiated by occupants, such as the positioning and frequency of use of interior shading devices, informal modifications to workspaces, or permanent retrofits to the facade have the potential to significantly reduce interior daylight availability and views to the outdoors. Therefore, daylighting performance assessment should include observation of buildings in use to account for temporary and permanent modifications to the original design.
2. A central objective of daylighting is to provide a sufficient level of interior daylight and visual connection to the outdoors without causing visual discomfort. Therefore, daylighting performance assessment should include subjective measures of visual discomfort, daylight sufficiency, and view.
3. The considerable potential for daylight to displace electrical lighting energy consumption, and thus serve the urgent need for energy reduction in buildings, requires that daylighting performance assessment consider electrical lighting energy outcomes.

Thus, the daylighting performance can be defined and investigated in consideration of three broad topics: post-occupancy modifications, occupant subjective assessment of IEQ, and electrical lighting energy consumption. In the scope of this research, investigation of post-occupancy modifications encompasses the positioning and frequency of use of interior shading devices, the informal modifications to the facade and personal workspace (e.g. cardboard over windows, use of umbrellas) and the retrofits to the facade completed by building management in response to occupant complaints (e.g. installation of solar control film). Subjective assessment of IEQ encompasses IEQ factors related to daylight transmission and solar control (e.g. daylight sufficiency, visual/thermal comfort, visual connection to the outdoors). Electrical lighting energy consumption is considered in regard to established reporting metrics as well as in regard to a novel metric of electrical lighting efficiency that incorporates occupant subjective assessment.



### **1.3 Provisions for daylighting in green building rating systems, standards and codes**

A number of provisions exist to encourage the use of daylight as a strategy for energy reduction and to enhance IEQ in green building rating systems, building energy standards and building energy codes. Prominent examples include the U.S. Green Building Council's (USGBC) Leadership in Energy and Environmental Design (LEED) green building rating system, the American Society of Heating and Refrigeration and Air-conditioning Engineers (ASHRAE) standards for the design of energy efficient buildings (ASHRAE 90.1 and 189.1), and the California energy code (Title 24, Section 6). These provisions predict daylight availability based on relatively simple calculations of effective aperture (a function of window area and visible light transmittance) with limited (or no) consideration for occupant visual comfort or the position of manually operated shading devices. During design, compliance with LEED daylighting criteria is determined by comparing calculated or simulating horizontal illuminance values to a threshold criterion. Similarly, compliance with energy codes and standards is determined by comparing simulated energy performance to a standard or code baseline building. These assumptions are problematic because they do not account for how buildings are operated or modified in use, for the level of occupant satisfaction with interior daylighting conditions (e.g. visual discomfort, solar overheating), or for how photocontrols perform under real operating conditions.

## 1.4 The “transparent” facade as a strategy to maximize daylight and views



**Figure 1.1** Example “sustainable” buildings that incorporate large areas of high visible light transmittance glazing in the facade. Each of these buildings has received a significant level of recognition through a green building certification program, design or energy efficiency awards, or significant levels of publicity on the basis of electrical lighting energy reduction and enhanced IEQ via daylighting.<sup>2</sup>

The desire to achieve green building certification as well as the preference of architects for glass facades has incentivized the construction of a significant number of office buildings in the U.S. with a large Window-to-Wall Ratio (WWR) and high Visible Light Transmittance (VLT) glazing, often referred to as “transparent” facades. A number of these buildings are recognized and promoted as successful prototypes for electrical lighting energy reduction and enhanced IEQ (EBN, 2010).

---

<sup>2</sup> From top left: 30 Hudson St., NJ; 4 Times Square, NY, NY; CDC Headquarters, Atlanta, GA; Genzyme Center, Cambridge, MA (LEED Platinum); Twelve West, Portland, OR (LEED Platinum); USGBC Headquarters, Washington, DC (LEED Platinum); U.S. EPA Region 8 HQ, Denver, CO (LEED Gold); NY Times Headquarters, NY, NY; San Francisco Federal Building, CA (LEED Silver), Deloitte Centre, Auckland, NZ (5 Star NZGBC), Hearst Tower NY, NY (LEED Gold), Terry Thomas Building Seattle, WA (LEED Gold).

However, the use of large areas of facade glazing is facing increasing criticism (NYT, 2009; Lstiburek, 2010; EBN, 2010) as the basis of reduced whole-building energy performance. In general, buildings with large areas of facade glazing consume more energy than buildings with more moderate levels of glazing. With a higher glazing fraction, solar heat gain and heat loss (in cold weather) are both greater (EBN, 2010). Therefore, energy “saved” through daylighting can be easily “lost” through diminished thermal performance.

Despite the downside risks for increased whole building energy consumption, commercial office building facades designed with a large WWR and high VLT glazing remain a common product of architecture firms. This is due, at least in part, to the assumption that making the facade as transparent as physically possible to visible light will have a direct relationship to the amount of interior daylight available, leading to greater levels of occupant satisfaction and visual connection to the outdoors. This approach is reinforced by the guidance provided in green building rating systems. For example, the LEED (2009) Daylight EQ credit “potential technologies and strategies” suggests that designers should “design the building to maximize interior daylighting.” However, because buildings are rarely studied in use, there is limited evidence to support the underpinning assumptions that anticipated levels of daylight availability and unobstructed views to the outdoors are achieved, installed photo controls reduce electrical lighting energy consumption, or occupants are satisfied with the resulting indoor environmental conditions.

## **1.5 Problem statement**

The use of daylight to reduce energy consumption and enhance Indoor Environmental Quality (IEQ) is one of the most common claims made for commercial office buildings promoted as “sustainable”, “energy efficient,” “green,” or “high performance.” Claims of successful daylighting are often founded on the use large areas of façade glazing, photo-controlled electrical lighting, or results from simulations performed prior to occupancy that demonstrate compliance with green building rating system criteria (e.g. USGBC LEED Daylight and View EQ credits) or electrical lighting energy reduction from photocontrols. However, buildings are rarely studied in use to determine if the design achieves the intent of creating a sufficiently daylit and a visually comfortable work environment from the perspective of building occupants or how occupant behavior affects the anticipated level of daylight availability and electrical lighting energy reduction. Casual observation of buildings in use often shows that interior shading devices are lowered by occupants limiting interior daylight availability and views. This is due, in large part, to visual discomfort and/or solar overheating, issues that could potentially be avoided if design decisions were informed by evidence from the post occupancy performance of existing daylit buildings.

Existing research assessing the post occupancy performance of daylit buildings typically focus on only one of several important sources of information: operation of interior shading devices by occupants, electrical lighting energy consumption, physical measures

of interior lighting conditions, or IEQ subjective survey data. Field-based methods rarely pair physical measures with subjective assessments or shade operation events. Where subjective assessments are paired with physical measures (HMG, 2005), results are reported to be highly variable because of the “opportunistic” methods used to collect the data, where variability is introduced by surveying occupants at different times of day, under varying sun and sky conditions, and facade shading devices in various configurations. The paucity of data describing the physical environmental conditions associated with visual discomfort and the operation of shading devices collected from buildings in use, limits architects and engineers in their ability to interpret quantitative results from simulation tools during design to differentiate the daylighting conditions acceptable to occupants from conditions that may cause visual discomfort and lead to the lowering of shading devices. Architects and engineers therefore rely on theoretical assumptions for the behavior and preferences of occupants, or recommendations from laboratory-based human factors studies that were conducted under controlled conditions that may not be directly applicable to daylit buildings in use. To provide architects and engineers with reliable guidance during design, it is important to examine how existing daylighting performance indicators (e.g. daylight autonomy, visual comfort, shade operation) and compliance criteria (e.g. LEED Daylight EQ credit) compare with occupant behavior and subjective assessment of IEQ in real office work environments. In identifying successful prototypes for daylit commercial office buildings, it is important to understand if design intent is achieved from a broad perspective, where achievements in electrical lighting energy reduction can be examined in relation to occupant visual comfort and satisfaction with interior daylight availability and visual connection to the outdoors.

## **1.6 Research objectives**

This research has three primary objectives. This first is to compare the daylighting performance of a prominent “high performance” office building in use to design intent with an emphasis on occupant visual comfort:

1. In a daylit office building designed for electrical lighting energy reduction and for earning the LEED Daylighting EQ credit, examine if perimeter and core zones within maintain acceptable levels of visual comfort.

Due to the lack of consensus regarding the physical measures, metrics and criteria appropriate for assessing visual comfort in the field, a second objective of this research is to:

2. Develop a field-based method capable of recording occupant subjective assessments of IEQ paired with physical environmental measures with minimal intervention to typical occupant behavioral patterns, workspace conditions, and work tasks.

Finally, to improve the design of future daylit office buildings, it is important to compare the outcomes predicted by existing daylighting indicators to a body of evidence collected from buildings in use.

3. Examine the applicability of existing shade control models and indicators of daylight sufficiency, visual comfort, and view used during design to predict the daylighting performance of office spaces. Where gaps are found in existing knowledge, develop predictive models that can be used to better predict shade control behavior or occupant satisfaction.

## 1.7 Broad research questions

This research addresses the daylighting performance of buildings in use from a broad perspective that includes understanding occupant behavior, characterizing occupants' subjective assessment of daylight sufficiency and visual discomfort, and measuring overhead electrical lighting energy consumption. The following broad research questions can be applied to any commercial office building where daylighting (via sidelighting) is implemented as a strategy to reduce overhead electrical lighting energy consumption and enhance IEQ. These questions were used to select the field test site and to organize a larger set of specific research questions addressed in the field study. The first question tests the assumptions of designers about the comfort conditions acceptable to building occupants by examining behavioral modifications to the building facade. As the frequent lowering of interior shading devices or permanent retrofits to the facade (e.g. solar control films) can significantly diminish the level of daylight transmission and views available, modifications to the facade provide an important "first order" indicator of daylighting performance.

1. In prominent daylit buildings in use, what modifications have been made to the building facade as indicators of occupant discomfort related to solar control and glare?
2. What is the relationship between the shade operation behavior predicted by existing behavioral models and the actual behavior observed? Can models based on field-data serve as more accurate predictors of shade operation?

In this research, "modifications" refer to the positioning and frequency of operation of available interior shading devices, retrofits to the building facades completed to address issues of occupant comfort, and informal (*ad hoc*) modifications made by occupants to reduce discomfort (e.g. cardboard applied over windows or added to workstations). Where interior shading devices are operated, this research seeks to identify the reasons for operation and measure the resulting indoor environmental conditions to increase existing knowledge for predicting occupant shade control. Although such study of facade modifications can improve knowledge of the physical levels of daylight illuminance achieved in buildings in use, these data do not describe if the modifications result in satisfactory levels of IEQ for building occupants. Therefore, the following questions

examine the influence of facade modifications on IEQ by comparing subjective assessments to design intent for daylight sufficiency, visual comfort and view:

3. In use, are occupants satisfied with visual comfort conditions over daily and seasonal changes in sun and sky conditions?
4. In use, (where interior shading devices may limit daylight transmission), are occupants satisfied with the level of daylight available? And, is daylight perceived to be sufficient to work comfortably without overhead electrical ambient lighting?
5. In use, (where interior shading devices may limit view), does the design result in a satisfactory level of visual connection to the outdoors?

Each of these questions addresses a common IEQ performance claim<sup>3</sup> made for daylit buildings. Although a number of quantitative indicators are available to measure and assess daylight sufficiency and visual discomfort in the field, there are limited data demonstrating how these indicators relate to occupant subjective assessments of buildings in use. This is due, at least in part, to the lack of field-based methods available to collect subjective feedback from occupants paired with simultaneous physical environmental measures. Therefore, a primary methodological objective of this research was to develop field-based methods to evaluate IEQ claims with occupant subjective data (collected without significant intervention into typical patterns of behavior and work tasks). The field-based methods developed for this research enabled the evaluation of existing indicators of successful daylighting performance through the following additional questions:

6. What is the relationship between the outcomes predicted by existing indicators of visual discomfort and occupant subjective assessment? Can discomfort models based on field-data serve as more accurate predictors of visual discomfort?
7. What is the relationship between the outcomes predicted by existing indicators of daylight sufficiency and occupant subjective assessments?
8. What is the relationship between the outcomes predicted by existing indicators of sufficient visual connection to the outdoors and occupant subjective assessments?

Finally, this research addresses daylighting performance from the perspective of electrical lighting energy consumption. Because electrical lighting energy savings are often referenced to an installed lighting power density considered necessary to provide acceptable workplane illuminance levels, this research examines occupant subjective

---

<sup>3</sup> It is important to note that buildings are rarely promoted on the basis of maintaining satisfactory levels of visual comfort. However, based on broader claims of “enhancing” IEQ via daylight transmission and views, visual comfort should be considered (and assessed) as an essential component of the stated objective.

assessment in relation to recommendations for workplane illuminance.

9. What is the relationship between workplane illuminance recommendations for offices (e.g. 300 – 500 lux) and occupants' subjective assessment of sufficient daylight to work comfortably without overhead electrical lighting (i.e. working only with optional task lighting)?
10. Are photocontrols working effectively to reduce electrical lighting power in response to the transient contributions of daylight? And, how does energy reduction in the perimeter zones compare to the core zones, and at the scale of an entire floor?

Answers to these broad questions can inform the design and operation of buildings that seek to use daylight as a strategy for electrical lighting energy reduction while maintaining satisfactory levels of visual comfort and visual connection to the outdoors. These broad research questions were used to define criteria for selection of a field test site and to identify a relevant set of daylighting performance indicators for examination in the field. Chapter 2 discusses the indicators selected for examination and identifies gaps in existing knowledge that can be addressed through human factors research in the field. Chapter 3 places these questions in context by reviewing the energy and IEQ performance objectives of the office building selected as the field test site, the indicators and tools used to predict performance during design and prior to occupancy, and existing knowledge from evidence of facade retrofits and previous studies of the building.

## **1.8 Approach**

The approach taken in this study is a longitudinal human factors field study involving groups of participants in perimeter and core zones within an individual building. There are other methods to conduct daylighting research with a human factors focus, each with varying advantages and disadvantages. For instance, laboratory studies theoretically allow a given effect (e.g. glare, daylight sufficiency) to be isolated by controlling all other sources of variation, enabling the researcher to explore correlations between a given environmental condition and an occupant response. However, given the limited availability of study participants, laboratory studies must be conducted over relative short periods of time (e.g. 4 hours) for any one session. This constraint limits the potential for studying how occupants respond and adapt to transient daylighting conditions as well as how (or if) occupants operate shading devices over an extended period of time (e.g. days or weeks) in response to changing exterior solar and weather conditions. In addition, given that the highly controlled laboratory environment is not where the participant performs his or her real office tasks, the behavior and preferences of the participant in the lab cannot be assumed to be directly applicable to a real office environment.

A field study was chosen to test building performance and the underlying assumptions of performance indicators under real work conditions. An addition reason was to add observational information about occupant behavior, both anticipated (e.g. shade

operation) and unanticipated (e.g. personal workspace modifications), as well as information related to modifications to the building envelope and to operation of the photocontrolled overhead electrical ambient lighting system. The site for the field study was selected based on the following criteria:

- Qualified (or could qualify) for LEED Daylight and View EQ credits
- Combination of open-plan perimeter zone and “core” workstations
- Daylight illumination is provided by side-lighting (rather than skylights)
- Large areas of high visible light transmittance glazing implemented as a strategy to enhance daylight transmission to workstations in core zone
- Photo-controlled electrical lighting system implemented as an energy strategy
- Explicit target set for electrical lighting energy reduction
- Facades designed to provide solar control of direct sun
- Recognized and promoted as a model of sustainable design
- Of interest to the architectural community

Based on the above criteria, several candidate buildings were considered for evaluation. These buildings included the EPA Region 8 headquarters in Denver, CO, the David Brower Center in Berkeley, CA, the Clif Bar headquarters in Berkeley, and 12-West in Portland, OR. The San Francisco Federal Building (SFFB) was selected as the site for the field study because it met the selection criteria as well as for additional practical reasons (e.g. close proximity to Berkeley enabled more frequent visits for site observations and to maintain monitoring equipment). The SFFB was additionally selected because of the significant level of recognition it has received on the basis of energy efficiency and enhanced IEQ. A detailed description of the SFFB and the goals and objectives underpinning its design are provided in Chapter 3. **Figure 1.1** shows the covers of three recent architectural publications that present the SFFB as a model of “high performance,” “integrated,” and “green” design respectively. In addition, the SFFB has received recognition for energy and IEQ through EPA Energy Star, California Public Utilities Savings By Design program, and LEED Silver certification.





**Figure 1.2** The NW facade of the SFFB presented on the cover of three architectural publications that describe the building as a model of “high performance,” “integrated,” and “green” design.

## 1.9 Scope and limitations

As defined in the introduction, daylighting performance assessment encompasses a range of outcomes related to occupant behavior, energy, and IEQ that, if considered in isolation could lead to misleading conclusions. Therefore, the scope of this research includes specific research questions related to each of these issues. In regard to energy performance, only the electrical lighting energy consumption of the overhead electrical ambient lighting system was measured. The study did not include measures of the energy consumption of installed or supplemental task lighting. Therefore, the measured energy outcomes are reported for the overhead ambient lighting system only. However, observations and survey questionnaire data were used to assess the frequency of task light usage. As noted in the introduction, daylighting as an energy strategy only contributes to energy reduction if the energy “saved” from photocontrols is not “lost” through a less thermally efficient building envelope. This study did not investigate the thermal performance of the glazed facade on whole-building energy use. Therefore, the electrical lighting energy results should not be extended to represent whole-building energy performance.

The scope of this study includes IEQ factors related to daylight transmission and solar control (e.g. daylight sufficiency, visual discomfort, and visual connection to the outdoors (i.e. view)). The study prioritizes investigation of measures and performance criteria for these factors that are included in consensus-based performance measurement protocols (e.g. ASHRAE PMP), and green building rating systems (e.g. LEED daylight and View EQ credits) recommended (or required) for assessing or certifying daylighting performance. **Table 1.1** presents each IEQ factor considered in this study along with the corresponding indicator used to predict or assess performance. In Chapter 4, a procedure is described for pairing occupant subjective assessment with physical measures for each factor to examine existing assumptions for gauging success or failure.

Monitoring the daylighting performance of the entire SFFB was not possible due to the size of the building (18 floors, ~2000 occupants) and practical limitations associated with the cost of monitoring equipment and participant recruitment. A representative space assessment was chosen as an alternate solution. In total, (N=44) individuals participated in the study. Participant selection and the spaces selected are described in Chapter 4.

**Table 1.1** Existing daylighting performance indicators for shade operation and IEQ

Prediction	Indicator	Measure	Threshold Criteria
<b>Shade operation</b>	Lightswitch-2002 behavioral algorithm (Reinhart and Voss, 2003)	Global vertical irradiance entering workspace	> 50 W/m <sup>2</sup> results in shade deployment, shade retracted on arrival (following day)
	Behavioral algorithm (Lee et. al., 1995)		> 95 W/m <sup>2</sup> results in shade deployment, shade retracted on following hour (if < 95W/m <sup>2</sup> )
	Single variable window shade control model (Inkarojrit, 2005)		50% probability of deployment at 13 W/m <sup>2</sup> , 95% at 100 W/m <sup>2</sup> (No prediction for retraction)
	LEED 2012 EQ 8.1	Presence of direct sun in workspace	Shades are deployed to prevent direct sun entering workspaces (Shades retracted if no dir sun)
<b>Sufficient daylight illuminance for occupant well-being</b>	Daylight autonomy (DA) (USGBC, 2012)	Global horizontal illuminance at the workplane	> 300 and < 2000 lux from daylight
	Continuous daylight autonomy (CDA) (Rogers, 2006)	Global horizontal illuminance at the workplane	> 300 and < 2000 lux from daylight, values < 300 lux are fractionally weighted
<b>Sufficient illumination for task visibility</b>	Minimum workplane illuminance for offices (IESNA, 2011)	Global horizontal illuminance at the workplane	300, 500 lux for computer-based and paper-based visual tasks respectively
<b>Visual connection to outdoors</b>	View IEQ credit (U.S.G.B.C., 2012)	Horizontal and vertical angle of direct line of sight	Maintain > 11 degrees (unobstructed) for both horizontal and vertical view angles
<b>Visual comfort</b>	DGI (Hopkinson, 1962), UGR (CIE, 1995), CGI (Eihorn, 1979)	Function of glare sources in the visual field	Variable, example: DGI ≤ 20 is considered "just acceptable"
	Luminance contrast ratio limits (IESNA, 2012)	Average luminance of surfaces in the visual field	Maintain [1:3:10] for [task:near:distant] surfaces
	Vertical illuminance (Velds, 2002)	Global vertical illuminance at the eye	20% dissatisfaction at 3700 lux, 50% dissatisfied at 6300 lux.

## 1.10 Organization of the dissertation

**Chapter 2** reviews the performance indicators defined in **table 1.1** in regard to performance objectives and methods of measurement and interpretation. Chapter 2 also provides a review of existing assumptions for occupant control of shading devices and discusses how these assumptions are presently implemented (or omitted) in existing methods of daylighting performance assessment.

**Chapter 3** presents an overview of the daylighting performance objectives of the SFFB, architectural design decisions related to daylighting (and their anticipated function) and reviews previous studies of the SFFB prior to occupancy and in use.

**Chapter 4** provides details on the methods and equipment used to conduct the research.

**Chapter 5** examines two common (and conflicting) hypotheses for occupant control of shading devices by comparing observations of shade positioning, frequency of operation, and overall levels of facade occlusion with assumptions from existing behavioral models.

**Chapter 6** examines the reasons for shade operation and pairs operations (e.g. “raise” and “lower” events) with physical measures to develop field-based predictive models of behavior.

**Chapter 7** and **Chapter 8** examine the effects of facade modifications on IEQ objectives of visual comfort and daylight sufficiency by analyzing repeated measures subjective assessments collected over daily and seasonal changes in sun and sky conditions. Subjective assessments paired with simultaneous physical measures are then analyzed to examine the applicability of existing performance indicators and to develop field-based logistic models of visual discomfort.

**Chapter 9** examines the effect of facade modifications on the IEQ objective of sufficient visual connection to the outdoors by comparing occupant subjective assessments with observations of interior shade positioning and additional *ad hoc* workspace modifications.

**Chapter 10** reports results from analysis of electrical lighting energy consumption and examines the contribution of electrical lighting in relation to available daylight and to subjective assessments.

**Chapter 11** discusses relationships between key findings from multiple topics and their implication for facade daylighting strategies as well as for the methods and indicators used to predict daylight availability, visual discomfort, and electrical lighting energy reduction during design.

**Chapter 12** suggests directions for future work and presents conclusions based on comparison of the performance of the SFFB in use to design intent, and for the application of daylighting performance indicators.

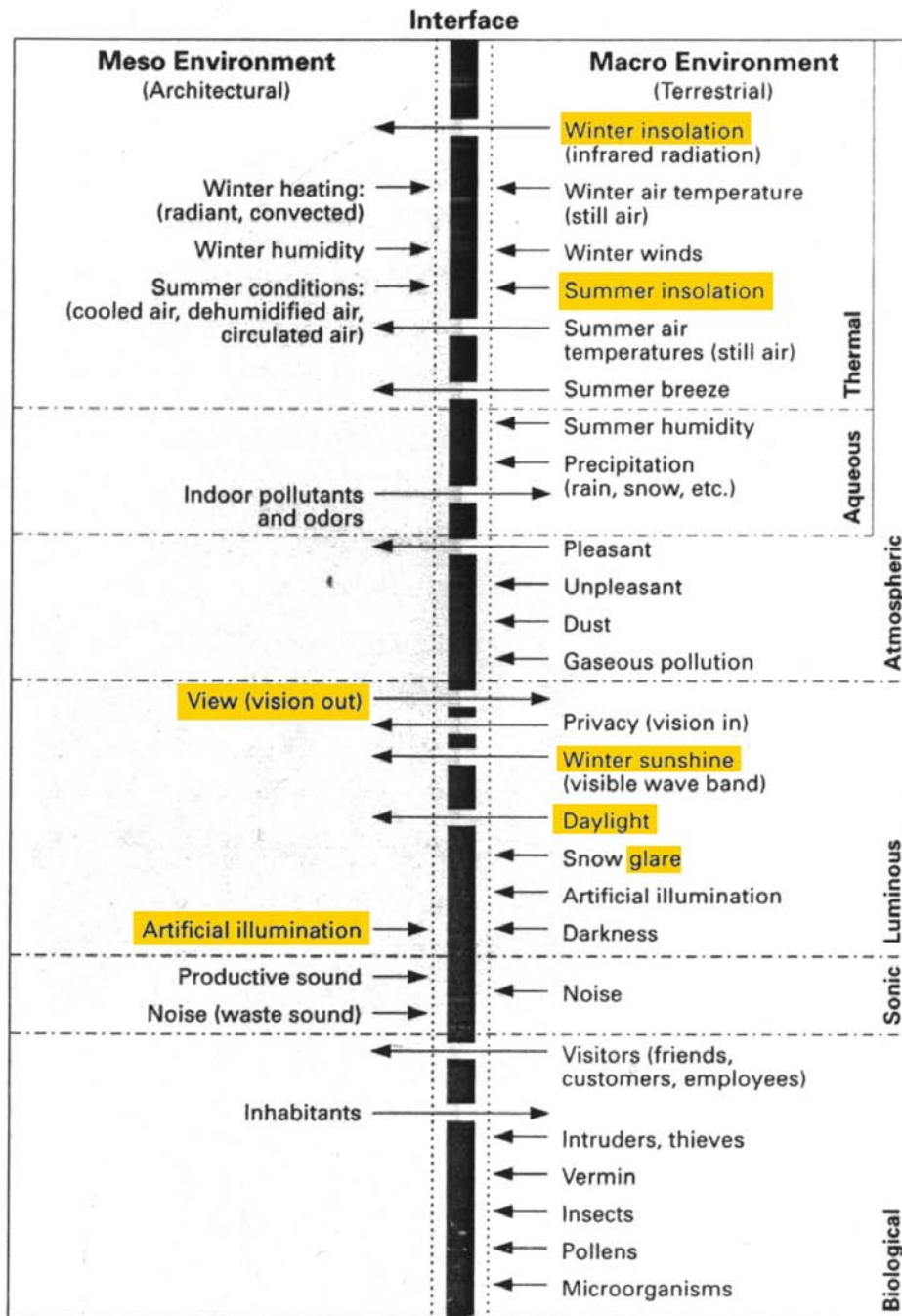
## CHAPTER 2

### OVERVIEW OF PERFORMANCE INDICATORS

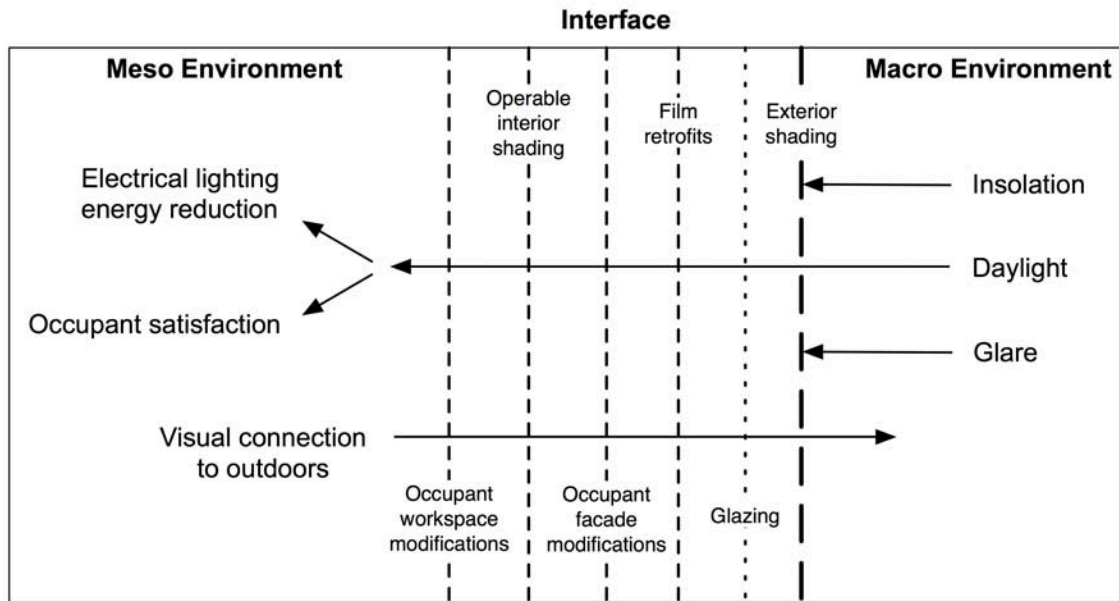
#### 2.1 Introduction

To evaluate buildings in use and to predict the performance of buildings during design, it is necessary to identify appropriate measures of performance, how such measures will be collected, and how results will be interpreted to determine the degree of success or failure. A number of indicators have been established for design teams to predict and assess the outcome of daylighting strategies, each with underlying assumptions for the preference and behavior of building occupants. One of the primary objectives of this study was to examine these assumptions in occupied open-plan office environments where participants performed real (i.e. not simulated) work tasks and where typical patterns of shade operation could be observed. Consequently, a primary methodological objective was to develop methods of collecting repeated subjective measures at each workspace with minimal disruption to participant work tasks and to collect shade operation data without intervening in the participant's chosen configuration of shading devices. The chapter discusses daylighting performance objectives of electrical lighting energy reduction using photocontrols, daylight sufficiency, view for connection to the outdoors, and visual comfort in regard to how each objective is defined, measured in the field (or predicted during design), and how measures are interpreted to assess success or failure. Additionally, this chapter provides a review of existing assumptions for occupant control of shading devices and discusses how these assumptions are presently implemented (or omitted) in existing methods of performance assessment. As a result of the broad scope of this subject, not all performance indicators can be discussed. Therefore, this chapter prioritizes those implemented in consensus-based green building rating systems (e.g. LEED, BREAM) and performance measurement protocols (e.g. ASHRAE PMP), on the basis that these indicators are anticipated to have the greatest influence on the design and evaluation of daylit office buildings. The chapter concludes with an assessment of gaps in existing knowledge that serve as the basis for the questions addressed by this research.

The daylighting performance objectives outlined above represent only several of the numerous environmental control functions performed by the building facade. As conceptualized in the diagram presented in **figure 2.1** (Fitch, 1999), the building facade ideally serves a wide range of functions as a “selective filter” between the natural macroenvironment and the constructed mesoenvironment.



**Figure 2.1** Environmental control functions performed by the building facade as conceptualized by Fitch (1999). The subset of functions examined within the scope of this research is highlighted in yellow.



**Figure 2.2** Environmental control functions related to the building facade investigated in this research.

**Figure 2.2** presents the environmental control functions investigated within the scope of this research. In **figure 2.2**, daylight is expanded from a single function to assess daylight transmission in terms of both levels sufficient for occupant satisfaction and for electrical lighting energy reduction. In addition, the depiction of the facade as an interface is expanded to encompass six distinct physical layers: exterior shading, facade glazing, solar control film, occupant facade modifications, operable interior shading, and occupant modifications to their workspace to address issues of solar control and glare. These additional layers are included to represent the potential effect of occupant behavior and facade retrofits (both temporary and permanent) on the performance of the environmental control functions identified in **figure 2.2**.

## 2.2 Electrical lighting energy reduction from photocontrols

### 2.2.1 Definition of performance and performance objectives

The transmission of daylight through windows (sidelighting) as a strategy for energy reduction is based on a simple concept: daylight is a renewable source of high efficacy<sup>1</sup> illuminance, which makes the daylighting of buildings an attractive energy strategy compared to the standard practice of electrically-powered, constant interior lighting. Because the quantity of energy *reduced* by daylighting, through photocontrols or occupant switching of electrical lighting, is often defined in relation to recommendations for standard electrical lighting practice (e.g. Illuminating Engineering Society of North America Lighting Handbook recommendations for office lighting), the energy required to achieve recommended task illuminance levels for electrical lighting often become the benchmark used to assess the performance of photocontrolled electrical lighting. As an example, in a procedure developed by the National Renewable Energy Laboratory (NREL) to measure indoor lighting energy performance (Deru et. al., 2005), daylighting is defined as:

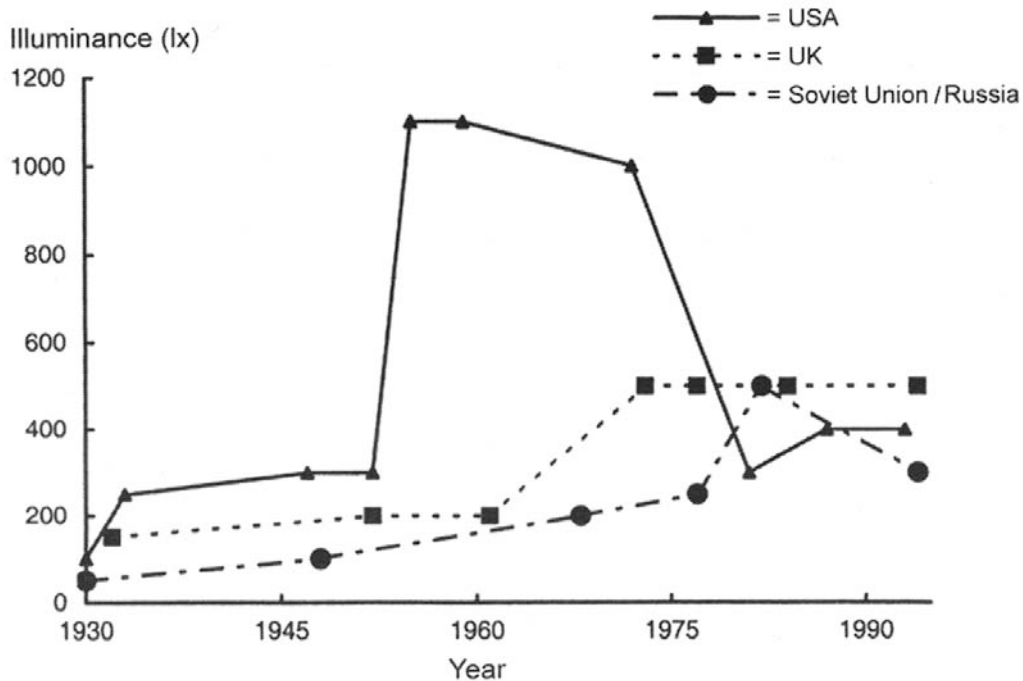
*Indoor illumination provided by natural light entering the space through some type of fenestration that results in a reduction of necessary electrical lighting for ambient, accent, emergency, or task lighting.*

In the NREL definition of daylighting, “necessary” refers to the standard workplane illuminance levels for commercial office buildings recommended by the IESNA Handbook (IESNA, 2000). Workplane illuminance refers to the amount of visible light measured at the workplane using a global illuminance meter. Performance is considered in terms of minimizing electrical lighting energy required to achieve recommended workplane illuminance levels. This definition is problematic for a number of reasons. The first is that current recommendations are based predominantly on an industry consensus rather than human factors data collected from daylit environments of buildings in use. The second is that it measures of horizontal illuminance record the amount of visible light incident on a horizontal surface, but not the luminance of the surface seen by a human observer. And, because the human visual system responds to patterns of surface luminance (most often seen on vertical rather than horizontal planes), horizontal illuminance is a relatively abstract measure. Third, in a review of 80 years of standards and recommendations for office lighting, Osterhaus (1993) demonstrates that industry consensus for office lighting has varied significantly over decades. A graphic depiction of the variability of office lighting recommendations over time and by regions of the world is presented in **figure 2.3** after Mills and Borg (1999). The persistence of horizontal illuminance recommendations and measures can be considered to result in large part from the ease with which these measures can be acquired in the field and through simulation.

---

<sup>1</sup> Daylight efficacies range from 80 lumens/W (low sun) to 150 lumens/W for blue sky. System efficacy for an electrical lighting system using high efficiency ballasts and florescent lighting providing 500lux at 10W/m<sup>2</sup> (LPD) is 50 lumens/W.





**Figure 2.3** Recommended workplane illuminances for general offices in the U.S., UK, and the Soviet Union/Russia since 1930. From Boyce (2003), after Mills and Borg (1999).

A second problem is that the recommended levels assume that the same level of illuminance should be applied homogeneously to all workspaces and maintained throughout all hours of the day that the building is occupied. Existing field studies demonstrate that the individual preferences of occupants for supplemental electrical illuminance are highly variable in daylit offices. In field studies conducted in daylit offices where occupants were able to incrementally adjust their electric lighting, results indicated a wide range in chosen workplane illuminances across occupants (Begemann et al. 1997; Escuyer and Fontoynt 2001), many of which were below the code recommendations, leading to a significant energy savings throughout the year (Moore et al., 2002). In addition, occupants did not try to maintain a constant light level at their desks (Halonen and Lehtovaara, 1995), and chosen levels depended on exterior weather conditions and time of year (Begemann et al. 1997) as well as the position of the occupant relative to the window (Laurentin et al. 2000).

Finally, a third problem with recommended workplane illuminances is the underlying assumption of the visual conditions required by office workers to perform their work comfortably and effectively. Where illuminance recommendations for office lighting have been developed from human factors data, the studies have historically been conducted in highly controlled laboratory settings and performance assessed in terms of simple visual acuity tasks that “simulate” real office work tasks. Examples of these tasks over time include: completing Landolt ring charts (Weston 1935, 1945), brightness discrimination of small disks (Blackwell, 1952), sorting screws of different sizes (Stenzel and Sommer, 1969), threading a needle (Smith, 1979), numerical verification of two

columns of numbers (Rea, 1981), reading speed (Bailey, 1993), and work speed for data entry tasks (Eklund et al., 2000). In each of these cases, performance is considered in terms of speed and accuracy rather than cognitive performance. As modern office work shifts from horizontal paper-based tasks to self-luminous vertical tasks (i.e. computer monitors), and worker performance is increasingly assessed based on cognitive tasks, the changing tasks and visual needs of office workers require critical assessment of the assumption that energy consumed to deliver recommended horizontal illuminance levels results in an actual service to building occupants.

### 2.2.2 Methods of performance assessment in design

Despite the issues described with the definition of daylighting presented in **section 2.2.1**, the modeling procedures for energy codes and standards operate on this definition to report the performance of photocontrolled electrical lighting. As an example, ASHRAE Standard 189.1 for the Design of High Performance Green Buildings (2009) establishes modeling requirements with assumptions for electrical lighting energy “reduction” that are based on comparison to a baseline building that has the maximum Lighting Power Density (LPD) allowed by ASHRAE Standard 90.1. For office space, the maximum allowed LPD allowed by ASHRAE Standard 90.1 is 1.0 W/ft<sup>2</sup>. Using industry standard fluorescent lighting, a LPD of 1.0 W/ft<sup>2</sup> corresponds to an illuminance of approximately 350 lux at the workplane. Therefore, the baseline building is assumed to require an ambient electrical lighting system that delivers 350 lux of illuminance. The energy performance of the proposed building (with photocontrols) is then considered relative to this baseline using **equation 2.1**:

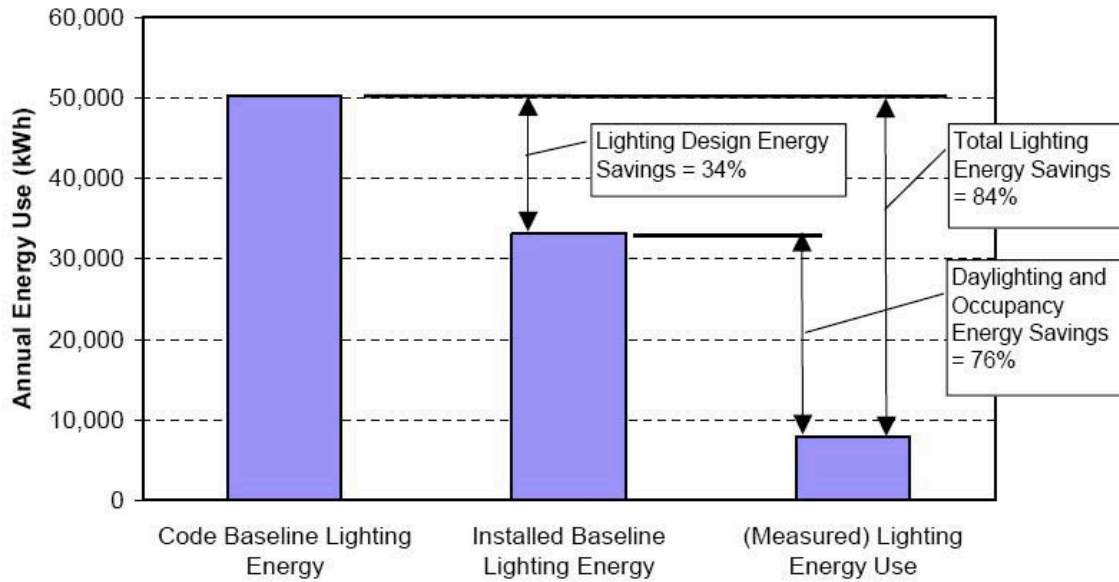
$$\text{Percent improvement} = 100 \times \frac{\text{Baseline performance} - \text{Proposed building performance}}{\text{Baseline building performance}}$$

**Equation 2.1** BSR/ASHRAE/USGBC/IESNA Standard 189.1 formula for calculating improvement in energy performance.

This assessment procedure is problematic for a number of reasons. The first is that, as discussed previously, there is limited evidence from the field that occupants require 350 lux of workplane illuminance throughout the entire office floor plate to work comfortably and effectively. The procedure is additionally problematic because it relies on the assumption of idealized performance of photocontrolled electrical lighting. Finally, the procedure is problematic because it does not include modeling criteria for the operation of shading devices. The potential for occupants to work comfortably with less than 350 lux as a workplane illuminance, the potential for non-ideal performance of photocontrols, and the potential for occupant operation of shading devices to limit daylight availability warrants the examination of these factors in buildings in use.

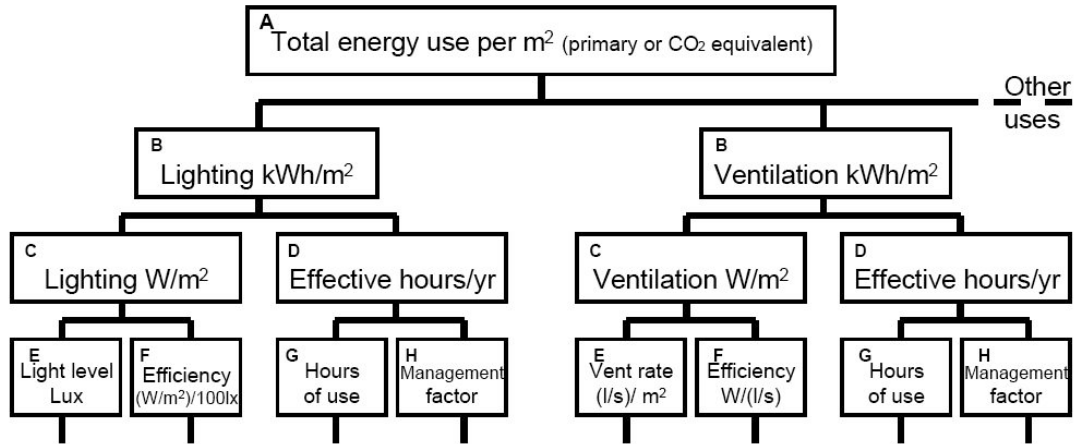
### 2.2.3 Methods of performance assessment in the field

In an effort to establish a consistent procedure to measure and report indoor lighting energy performance in real buildings, NREL defines lighting energy “savings” in terms of the percent difference between measured lighting energy consumption and code baseline lighting energy consumption (**figure 2.4**). This procedure effectively differentiates buildings in terms of total consumption, but does not include measures for the level of illuminance delivered to the workplane, or occupant subjective assessment (e.g. if the daylight available results in visual discomfort from glare).



**Figure 2.4** Lighting energy savings performance metrics. From (Deru, et al., 2005).

Field et al. (1997) presents a more detailed framework for examining lighting energy performance that accounts for additional factors of efficiency (e.g. illumination delivered to workplane, as well as the hours of use when electric lighting was on and the space was unoccupied (management factor)).



**Figure 2.5** Energy performance assessment of occupied non-domestic buildings by analyzing end-use energy consumptions. From (Field et al., 1997).

It is important to note that neither the procedure presented by Deru et al. (2005) nor Field et al. (1997) considers performance in terms of occupant subjective assessment. Therefore, although both procedures enable buildings to be differentiated based on aggregate energy consumption, neither can differentiate buildings that achieve energy reductions while maintaining comfortable visual conditions from those that do not. In addition, in the absence of procedures to visualize and report performance over time, neither can differentiate performance in regard to daily or seasonal changes in sun and sky conditions, both of which are likely to influence performance. In addition, without occupant subjective assessment, neither can identify where and when energy reductions are achieved at the expense of occupant discomfort, and neither can contribute to a body of evidence for the daylighting conditions (e.g. daylight sufficiency, visual comfort) acceptable to, or preferred by, building occupants.

Although the number of monitored daylit buildings is very limited, where field studies have compared electrical lighting energy achieved by photocontrols to design predictions, the results consistently demonstrate that the lighting systems in use consume more energy than anticipated during design (Floyd and Parker, 1995; Atif and Galasiu, 2003; Torcellini, 2003; HMG, 2005).

## 2.2.4 Summary and questions

Research and practice focused on daylighting as an energy strategy in office buildings in the past thirty years has failed to produce a significant number of built examples (Selkowitz, 1994; Atif, 1997; EBN, 2010). Existing research results that demonstrate significant electrical lighting energy reduction from daylighting are mostly derived from simulation, or measurements from test cells under controlled conditions and using theoretical (or no) assumptions for occupant preferences, visual comfort, and control of shading devices. In addition, electrical lighting energy “savings” achieved from

photocontrols are currently considered relative to electrical workplane illuminance recommendations (currently 300 – 500 lux for offices). These illuminance recommendations, and the assumption that a constant illuminance must be achieved homogeneously throughout the workspace, emerge from highly controlled laboratory settings where the source of light was from overhead ambient electrical lighting. Field data reporting the subjective assessments of occupants in transient daylight spaces supplemented with photocontrolled electrical ambient lighting is extremely limited. The changing tasks and visual needs of office workers require critical assessment of the assumption that energy consumed to deliver recommended horizontal illuminance levels results in a service to building occupants.

Therefore, this research seeks to examine occupant subjective assessment of the need for ambient electrical lighting to work comfortably in response to the transient contribution of daylight and photocontrolled electrical lighting to workplane illuminance. This research proposes the following questions:

Existing indicators of workplane illuminance for offices:

What is the relationship between workplane illuminance recommendations for offices (e.g. 300 – 500 lux) and occupant subjective assessment of sufficient daylight to work comfortably without overhead electrical lighting? (i.e. working only with optional task lighting).

Performance of photocontrols:

Are photocontrols working effectively to reduce electrical lighting power in response to available daylight at the scale of an entire floor?

Are photocontrols working effectively to reduce electrical lighting power in response to daylight at the scale of individual perimeter zones?

Is lighting power reduced in response to daylight in open-plan core zones?

Energy consumption:

How much energy is consumed per person per day by the electrical ambient lighting system?

What fraction of this energy is consumed when the level of daylight illuminance is perceived by occupants to be sufficient to work comfortably without electrical ambient lighting?

## **2.3 Daylight and Indoor Environmental Quality**

### **2.3.1 Definition of daylight sufficiency and performance objectives**

While daylight is often engaged as a means for interior illuminance it also plays a role for other qualitative aspects of occupant experience in buildings. Daylight sufficiency from the perspective of Indoor Environmental Quality (IEQ) is defined in regard to the human biological need for a circadian stimulus and for visual information enabling connection to the outdoors. A growing body of research in the disciplines of photochemistry, photobiology, and human physiology demonstrates that exposure to solar radiation (i.e. daylight), has a range of influences on human biology that are important for health and well-being. For example, daylight is known to control the circadian rhythm of hormone secretions, with implications for sleep/wake states, alertness, mood and behavior (CIE, 2004). Research has shown that disruption of the circadian system by shift work is associated with sleep-wake disorders, gastrointestinal pathology, and an increased risk of cardiovascular disease (Moore-Ede et al. 1997). Exposure of patients experiencing seasonal affective disorder (SAD) to a bright light source that simulates daylight in intensity and spectral quality has been shown to reduce symptoms of depression (Rosenthal, 1984). Subsequent studies have found that the effectiveness of light therapy depends not only on the intensity of light but also on the duration of exposure and the spectral quality of the light (Wirz-Justice, 1998, Graw et al., 1998). Research studying long-term occupants of in standard window zone offices during daytime working hours shows that people prefer a circadian cycle of light levels instead of a constant level of illuminance. However, knowledge about what constitutes “healthy lighting” remains limited. Currently, there is no consensus for what the optimal daily light exposure might be, or when (in relation to the circadian rhythm) it should be timed. (Veitch, 2004).

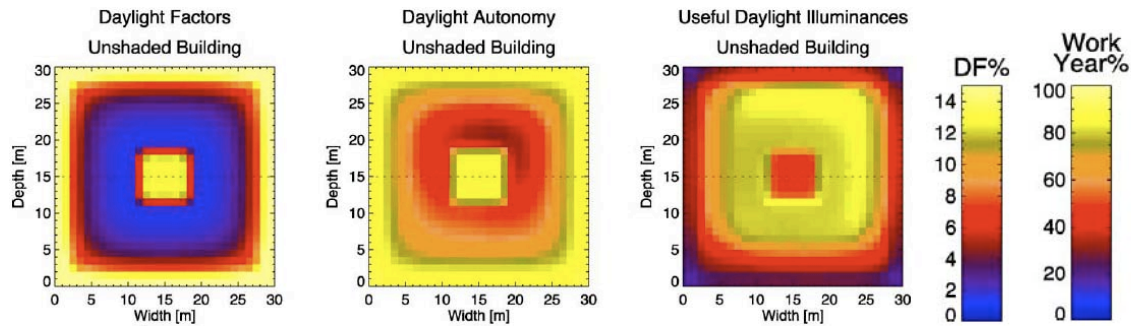
Despite the lack of consensus regarding the minimum or optimum daily daylight exposure for health and well-being, research provides a strong body of evidence indicating building occupants desire access to daylight (Heerwagen et al., 1986) and establishes that occupants who endorse beliefs about the effects of lighting on health tend to prefer natural daylight over electric light (Veitch et al., 1993). Therefore, creating the perception of “sufficient” daylight for building occupants is a central performance objective for daylit spaces and a common strategy to improve indoor environmental quality on the basis of occupant health and well-being.

### **2.3.2 Established methods of daylighting assessment**

The most common assessment of daylight sufficiency in an office space is made by measuring (or simulating) horizontal illuminance at the workplane. This measure emerged in parallel with the procedures used by the electrical lighting industry in the early 20<sup>th</sup> Century when typical office work involved visual acuity tasks performed on a horizontal workplane (Boyce, 2003). Historically, the daylight factor (DF) is the most widely applied metric used to assess daylight sufficiency based on this measure (Nabil and Mardaljevic, 2005). Use of the DF method is common because it is simple to

understand and relatively easy to measure, leading to its use in codes and standards in the UK and Europe and in previous<sup>2</sup> versions of the LEED rating system. The daylight factor is defined as the ratio of the internal illuminance at a point in a building to the unshaded, external horizontal illuminance under a CIE overcast sky, (Moon and Spencer, 1942) where an average DF of 2% across a given space is commonly considered to constitute sufficient daylight (Kwok, 2009; Lechner, USGBC, 2009; MEEB, 2011). In recent years, the DF approach has received increasing criticism as a result of several limitations. Because it is based on maintaining a minimum ratio of horizontal illuminance under overcast sky conditions, it is not sensitive to building orientation, geographical location, or daily/seasonal variations in sun and sky conditions. And because there is no consensus for an acceptable “upper limit” for the ratio, the DF approach has been criticized for incentivizing a “the more transmission the better” approach, where spaces that would have uncomfortable direct sun or glare can not be differentiated from those that would not. Therefore, several efforts have emerged proposing an alternative to the DF approach that claim to provide a more effective method of identifying spaces that are “sufficiently daylit” as well as differentiating between spaces that have comfortable and uncomfortable daylight illuminance levels.

### 2.3.3 Emerging methods of performance assessment



**Figure 2.6** Daylight factor (DF), daylight autonomy (DA), and useful daylight illuminance (UDI) area plots for a generic building. From Nabil and Mardaljevic (2005).

Broadly described as Climate Based Daylight Modeling (CBDM), a number of researchers have proposed an alternate method to the DF approach that relies on annualized simulation of workplane illuminance using local sun and sky conditions derived from standardized annual meteorological datasets (Mardaljevic et al. 2009). Several criteria have been proposed to differentiate performance based on the workplane illuminance metric and include *Daylight Autonomy* (DA) (Reinhart, 2002), *Useful Daylight Illuminance* (UDI) (Nabil and Mardaljevic 2005), and *Continuous Daylight Autonomy* (CDA) (Rogers, 2006). The most widely used criteria, *Daylight Autonomy* (DA), was originally defined by Reinhart (2002) as:

<sup>2</sup> Prior to LEED version 3, 2009.

*The percentage of occupied times of the year when a minimum work plane illuminance threshold of 500 lux can be maintained by daylight alone.*

The DA criterion was originally used by Reinhart (2002) to summarize the performance of a space to indicate the percent of the year (when occupied) that daylight is sufficient to eliminate the need for electrical lighting. The original DA criterion was expanded by Nabil and Mardaljevic (2005) in their metric UDI to include a “discomfort” threshold of 2000 lux, and reduced the minimum required daylight illuminance to 100 lux. The authors note that these limits were based on reports of occupant preferences and behavior in daylit offices with user-operated shading devices. Times of the year where the horizontal illuminance results in values outside these limits are then omitted from the annual summation of hours of “Useful” Daylight Illuminance to represent what they considered to be a more accurate representation of the daylight resource provided by a given design. Figure 2.6 presents an illustration of the DF, DA, and UDI results for a simplified building. Based on a concern that the binary threshold approach of the original DA criteria artificially differentiated between spaces that may not be perceived as different by the human visual system when adapted to a daylit environment (e.g. 400 lux vs. 600 lux illuminance), Rogers (2006) created the Continuous Daylight Autonomy metric (CDA), which assigns a fractional weighting to illuminance values below the established threshold in the annual summary of daylight availability.

The DA criteria are now used in the 2012 draft version of the LEED Daylight credit as the required criteria for the simulation compliance option:

*Demonstrate through computer simulations that at least 75% of all regularly occupied spaces (or 75% of instructional spaces for Schools projects) achieve a minimum DA value of 50%, based on an annual illuminance of 300 lux when blinds are operated to block direct sunlight.*

*Demonstrate that all regularly occupied spaces achieve a maximum DA value of 5%, based on an illuminance level of 2000 lux when blinds are operated to block direct sunlight.*

An important development exists in the implementation of the DA criteria by the LEED rating system. Namely, the illuminance threshold is reduced to 300 lux from 500 lux. Where the 500 lux criteria was initially specified by Reinhart (2002) because it is the most common illuminance setpoint for electrical lighting, the intent of the LEED Daylight credit is primarily focused on indoor environmental quality and emphasizes a connection to the outdoors rather than electrical lighting energy reduction. In versions prior to the draft version of LEED 2012, the intent of the Daylight credit was to:

*Provide for the building occupants a connection between indoor spaces and the outdoors through the introduction of daylight and views into the regularly occupied areas of the building.*



In the draft of the 2012 version of the LEED Daylight credit, the intent has been expanded to include language relating to the human biological need for a circadian stimulus:

*To provide building occupants with a connection between indoor spaces and the outdoors through the introduction of daylight and views into the regularly occupied areas of the building. To reduce the use of electrical lighting and give building occupants a circadian stimulus and a connection to the outdoors by admitting daylight into regularly occupied areas.*

Therefore, the threshold minimum of 300 lux, as well as the requirement that this threshold be exceeded for at least 50% of the year, serves as the criteria for identifying spaces that are sufficiently daylit and inversely, spaces that do not satisfy these criteria are considered insufficiently daylit. It is important to note that the U.S. Green Building Council does not specify why these criteria were chosen, or how they theoretically link these criteria with the stated intent for giving building occupants a circadian stimulus.

The daylight autonomy criteria and 300 lux minimum threshold have also been adopted by the Daylighting Metrics Sub-Committee (DMsC) created by the Illumination Engineering Society of North America. The basis for adoption in this case was the criteria enabled differentiation between annual simulations of different daylit spaces, as well as the fact that “a 300 lux threshold is also consistent with IES recommended minimum electric illuminance levels for many space types” (HMG, 2010). In consideration of the adoption of daylight autonomy criteria by the DMsC, as well as the Memorandum of Understanding between BREEAM, LEED, the UK Green Building Council and Green Star (Australia) signed on March 3, 2009 to harmonize the various rating systems, the daylight autonomy criteria represents the broadest available consensus for how daylight sufficiency should be defined and evaluated.

#### **2.3.4 Summary and questions**

Climate-based daylighting metrics (e.g. Daylight Autonomy, Useful Daylight Illuminance) have emerged as the consensus approach for predicting and promoting successful daylight practices. However, a number of gaps remain in existing knowledge for how indicators of success or failure based on quantitative measures of daylight illuminance relate to occupant perceptions of daylight sufficiency and potential visual discomfort. First, the criteria used to differentiate daylight illuminances acceptable to occupants from levels perceived to be insufficient or associated with visual discomfort are not supported with subjective responses to transient daylighting conditions in buildings in use. Second, the minimum daylight illuminance threshold criteria (e.g. 300 lux) is not sensitive to occupant perception, knowledge and expectations of daily and seasonal changes in sun and sky conditions, or location within the building (e.g. depth from the facade), all of which have been shown to influence occupant lighting preferences in the field (Begemann et al., 1997; Escuyer and Fontoynt, 2001; Halonen and Lehtovaara, 1995; Laurentin et al., 2000). Third, horizontal illuminance

recommendations are derived from lighting research focused on horizontal visual task performance. Given that the most common visual tasks in offices now involve viewing a vertical and self-illuminated screen, it may be possible that lower levels of daylight illuminance are acceptable for effective visual task performance. Finally, the criteria assume that interior shading devices will be fully deployed by occupants in the presence of direct sun and fully retracted when direct sun is not present. Deviations from this assumption in real buildings will result in significantly different quantities of illuminance, than those which form the basis for the daylight autonomy criteria. Therefore, prior to promoting successful daylight practices on the basis of compliance with daylighting metrics, it is important to develop a body of human factors data from buildings in use that demonstrates a relationship between the compliance or performance criteria and positive subjective assessments of daylighted environments. It is additionally important to examine the extent to which occupant operation of shading devices may limit daylight availability in buildings in use. To address these gaps, this research asks:

How do subjective assessments of daylight sufficiency compare to the outcomes predicted by quantitative indicators of daylight sufficiency (e.g. Daylight Autonomy, Useful Daylight Illuminance)?

Do subjective assessments of visual discomfort occur when daylight illuminances are below levels associated with visual discomfort (e.g. below 2000 lux)?

Do perceptions of daylight sufficiency vary by location in the building, or depth from the perimeter?

How does an occupant's frequency of operating interior shading devices compare to behavior assumed in the procedure for predicting Daylight Autonomy proposed for the LEED 2012 draft Daylighting EQ credit?

## 2.4 Sufficient visual connection to the outdoors

### 2.4.1 Definition of performance and performance objectives

Research in the field of environmental psychology supports the conventional wisdom that the provision of windows is an essential component of occupant performance, health, and well-being. In an effort to characterize these benefits (Collins, 1976) conducted a review of available literature and reported that windows serve a number of psychological functions, providing view, stimulation, and the perception of spaciousness in addition to sunlight and daylight which were both shown to be desired by building occupants. Collins additionally reported that the absence of windows in spaces could result in adverse reactions from occupants. Later research in windowless workspaces by Heerwagen and Orians (1986) showed that occupants frequently decorate a windowless office with posters of outdoor scenes as a means of creating a “surrogate” window. Studies have also shown that access to a window view can have a measurable relationship to changes in office worker performance. In a field-based investigation conducted in two large office buildings in California, the Heschong Mahone Group reported that better access to a window view was found to consistently predict better performance (HMG, 2003).

In addition to the availability of a view, the content of the view is shown to have an effect on psychological well-being. The most consistent finding is the preference for natural over built views (Veitch, 2001). Windows with natural views were found to enhance work and well-being in a number of ways including increasing job satisfaction, interest value of the job, perceptions of self-productivity, perceptions of physical working conditions, life satisfaction, and decreasing intention to quit and the recovery time of surgical patients (Farley and Veitch, 2001). The view of a natural scene through a window (either real or simulated) has also been proposed as a means of reliving stress (Clearwater and Cross, 1991; Kaplan, 1992; Ulrich, 1993). The content of the view can also affect the preference of occupants towards the size and shape of the window, with relatively smaller windows being acceptable for distant views and larger windows required for views of nearby objects (N’eman and Hopkinson, 1970).

The most widely acknowledged health outcome involves the contribution of window views to eye health. In modern office environments where workers spend increasing amounts of time viewing computer screens, ophthalmologists have stressed the importance of frequent changes in eye focus distance to give the eye muscles a chance to relax momentarily<sup>3</sup>. Because the focus distance required for ocular muscles to relax is significantly greater than the dimensions of most buildings, a window view of distant scenery provides an important alternative focus for the eyes.

Given the body of research on the importance of window view for occupant health and well-being, the provision of a satisfactory level of visual connection to the outdoors through window views is an important performance objective of the building facade. Where the provision of satisfactory views to the outdoors is an explicit objective, it is

---

<sup>3</sup> <http://www.mayoclinic.com/health/eyestrain/DS01084/DSECTION=treatments%2Dand%2Ddrugs>

important to examine buildings in use to assess the effect of occupant control of shading devices on the anticipated outcome. In addition, it is important to assess if the emerging criteria for defining satisfactory levels of visual connection to the outdoors (e.g. LEED View EQ credit compliance criteria) lead to satisfactory views for building occupants after building occupancy, when modifications to the façade in response to visual discomfort and solar control may limit available views.

#### **2.4.2 Criteria for window views in codes and standards**

First published in 1935, the German Standard on daylighting (DIN 5034) specifies minimum window sizes (based on room size) and requires that all workspaces be located within ten meters of a window. In addition, DIN 5034 makes explicit provisions for the clarity of the view: "For this reason it is necessary to provide windows with transparent, undistorted and neutrally colored glazing at the eye level of persons standing or sitting in a room." In the U.S. there are no similar requirements mandated by code, however the U.S. Green Building Council's LEED rating system provides a credit for designs that "achieve a direct line of sight between 90% of all regularly occupied spaces and a vision glazing" (US Green Building Council, 2009). The intent of the present LEED View credit is:

*To provide building occupants a connection to the outdoors through the introduction of daylight and views into the regularly occupied areas of the building.*

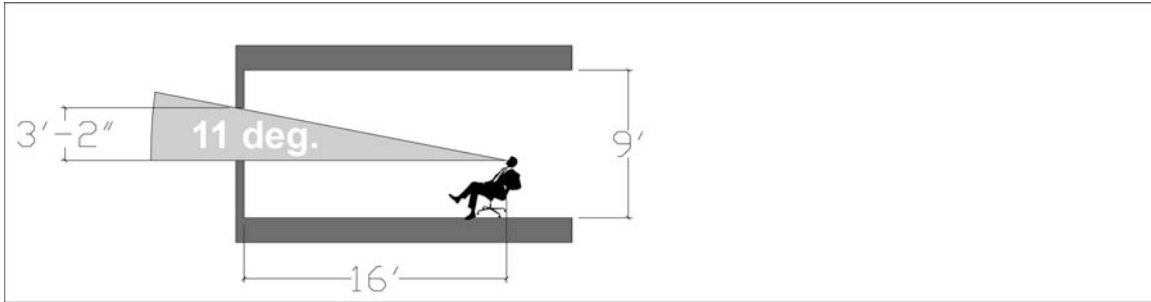
#### **2.4.3 Methods of performance assessment**

To determine if this intent is achieved for a given space in a building, the U.S. Green Building Council developed compliance criteria based on tabulation of regularly occupied spaces in the building that maintain a "direct line of sight" to the exterior. In LEED versions 2.2 and previous, the direct line of sight was considered as a line drawn at 42 inches above the floor from all occupied areas to the vision glazing. To reduce the ambiguity of this criterion (for example, spaces could comply even with an infinitesimally small view solid angle), the following version of LEED (version 3, 2009) added the requirement that the direct line of sight extend to vision glazing between 30 inches and 90 inches above the finished floor, effectively specifying minimum glazing geometry of 60 inches (vertically) for LEED View credit-compliant facades. However, in contrast to the DIN 5034 requirement that no workstation can exceed 10m from the facade, it is important to note that the current LEED version (2009) does not explicitly state a maximum distance for a workstation from the facade, enabling buildings to comply with the View credit with essentially any floor plate depth. Perhaps in response to this ambiguity, the draft 2012 version does not specify facade glazing minimum and maximum heights, but instead requires a minimum visual angle:

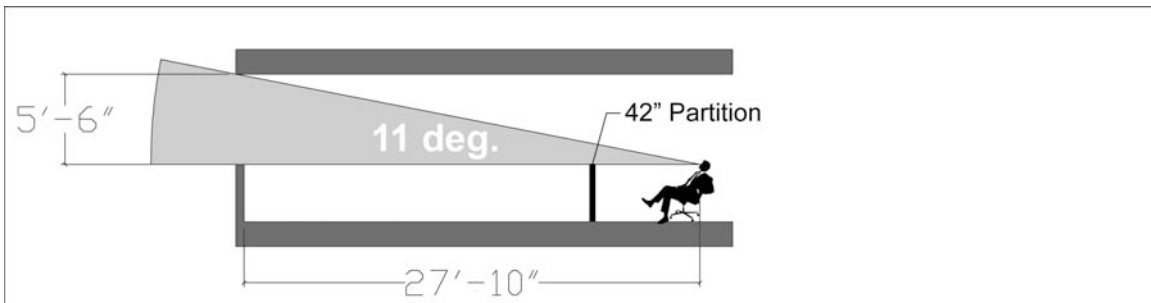
*In plan view, the area is within sight lines drawn from perimeter vision glazing to provide at least an 11 degree horizontal angle of view to the perimeter vision glazing.*

*In section view, the area is within sight lines drawn from perimeter vision glazing to provide at least an 11 degree vertical angle of view to the perimeter vision glazing.*

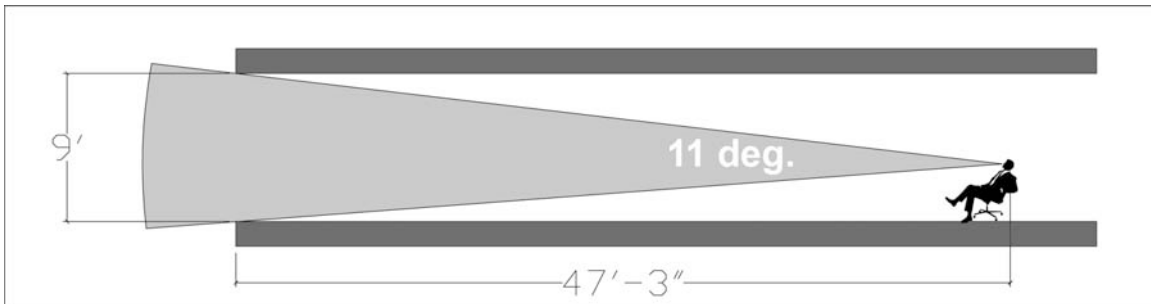
In addition, movable opaque full-height or partial-height partitions must be included in calculations and line-of-sight calculations. Therefore, assuming workstation partitions of 42 inches, the minimum visual angle effectively limits LEED View credit compliant floor area to a depth of 30 feet from the facade for a typical commercial office building ceiling height of 9 feet (because only 90% of the space has to comply with the requirement, the maximum compliant workstation depth of 27'-10" (**figure 2.8**) can be extended to 30 feet). **Figures 2.7 – 2.9**, illustrate the implications of minimum visual angle on the facade glazing in architectural section view. A typical cellular office of 20-foot depth (**figure 2.7**) can be considered to have a quality view if the window dimension is a minimum of 3'-2" vertically and 3'-2" horizontally. Therefore, additional glazed area beyond this relatively modest window size is only necessary for compliance if the office is deeper than 20 feet. For open-plan offices, the theoretical maximum depth from the facade is 52'-6" (if no partitions are considered) and 30'-2" if 42 inch partitions are considered (**figure 2.8**), translating to building floor plates of approximately 100 feet or 60 feet respectively.



**Figure 2.7** Required vertical glazing for typical cellular office.



**Figure 2.8** Required vertical glazing for 30-foot deep open-plan office.



**Figure 2.9** Theoretical limit of depth from facade for typical 9-foot office ceiling height and fully glazed facade for workstation compliant with LEED View EQ credit 11-degree visual angle criteria.

Given that the typical commercial building floor plate in the U.S. is significantly greater than 60 feet in depth as well as the trend away from cellular offices towards open-plan office space, the LEED View credit is likely to incentivize larger glazed areas of facade and greater ceiling heights as a means of achieving compliance in favor of locating occupant workstations near (e.g. within 20 feet) of the facade.

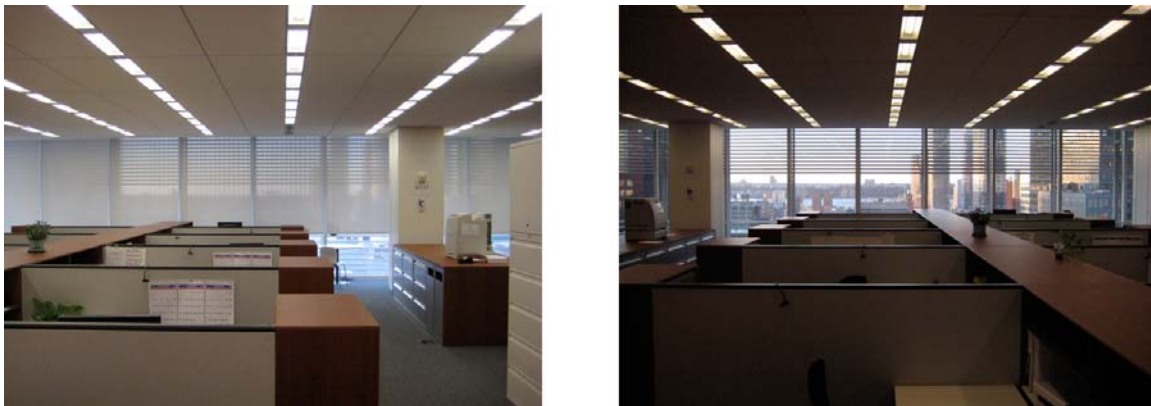
Although the LEED View credit states explicit requirements for direct-line-of-sight to vision glazing, the credit does not explicitly state how to interpret the use of shading devices that may negatively affect occupant's ability to discern important exterior visual information (despite the fact that the provision of shading devices for glare control is a

requirement of the Daylighting credit). The 2012 draft includes specific language describing necessary view content for compliance:

*The view from each area must include objects at least 50 feet outside the vision glazing, objects lit with daylight that are exposed to direct sunlight or display wind movement, and natural elements (e.g. sky, vegetation, water, people, animals, or other random movement).*

Considering the human visual system is capable of resolving objects that are partially occluded by other objects, the intent of the LEED EQ View credit can theoretically be achieved with shading devices deployed that preserve some “partial” view to the exterior. However, it can be inferred from the submittal requirements regarding obstructions in the field of view that the intent of the credit is that the vision glazing not occluded by “permanent” objects, even if a partial view remains:

*Fixed window treatments (e.g. ceramic frit patterns, wire meshes, bars, grill-work) in the field of view may compromise the quality of the view. The project team must submit photographs of the views from the interior spaces to demonstrate that such fixed treatments do not compromise the quality of view. (LEED, 2012).*



**Figure 2.10** (Left) Interior view of an open plan office space looking out through shades lowered (75%). (Right) Similar view with shades retracted showing increased contrast.

Consideration should also be given to the contrast between the view provided by the windows and surrounding elements. Figure 2.10 illustrates the change in contrast associated with a greater level of light transmittance through a window with interior shades retracted. Although the limited dynamic response of the camera that took these pictures exaggerates the change, the luminance of the exterior environment can be orders of magnitude greater than interior surfaces, creating a challenging environment for the visual adaptation and diminishing view as an amenity.

#### **2.4.4 Summary and questions**

The human visual system is capable of resolving scenes with limited visual information. The floor to ceiling glass window wall is a common strategy for providing sufficient visual connection to the outdoors in buildings promoted as “green.” Yet, fenestration of this type typically requires the use of interior shading devices. It is important to examine whether the diminished views available through shade fabric result in satisfactory visual connection between building occupants and outdoors. To test if provision of view is achieved in real buildings, the following research questions were asked:

How does the intent of the LEED Daylight and View EQ credits compare with occupant beliefs about the importance of sufficient daylight and views for feeling connected to the outdoors?

Overall, are occupants of the SFFB satisfied with their level of visual connection to the outdoors? If not, what are the causes of their dissatisfaction?

What is the relationship between overall level of satisfaction with the visual connection to the exterior and overall level of satisfaction with personal workspace and with the building overall?

What is the relationship between the position of the interior shading devices and “point-in-time” subjective assessments of visual connection to the outdoors?

### **2.5 Visual Comfort**

#### **2.5.1 Definition of visual comfort and performance objectives**

The balance of daylight transmission with the avoidance of visual discomfort is a central performance objective for effective daylighting. In most indoor environments, visual discomfort is produced from two sources: 1) excess non-uniformity (illuminance ratios) between visual tasks and 2) discomfort glare. Unlike disability glare: the disabling of the visual system to some extent by light scattering in the eye (Vos, 1984), there is no well-understood mechanism for the cause of discomfort glare, although fluctuation in pupil size (Fry and King, 1975) as well as distraction (Lynes, 1977) have been suggested. Discomfort glare is defined by the IEA SHC Task 21 as: a sensation of annoyance caused by high or non-uniform distributions of brightness in the field of view. The International Commission on Illumination (Commission Internationale de l’Eclairage, CIE) defines discomfort glare as: glare that causes discomfort without necessarily impairing the vision of objects (Vos, 2003).

Research focused on characterizing the conditions that produce visual discomfort began in the early 1900s and was published in the volumes of the Transactions of the Illuminating Engineering Society and the Journal of the Optical Society of America.



Research focused on developing an acceptable metric to gauge visual discomfort began in the 1950s concurrent with the wide-spread industrialization of fluorescent lighting technology in the U.S. and UK. The outcome is a variety of formulae used to calculate the glare sensation produced by an array of luminaries, and more recently from large area sources (e.g. windows).

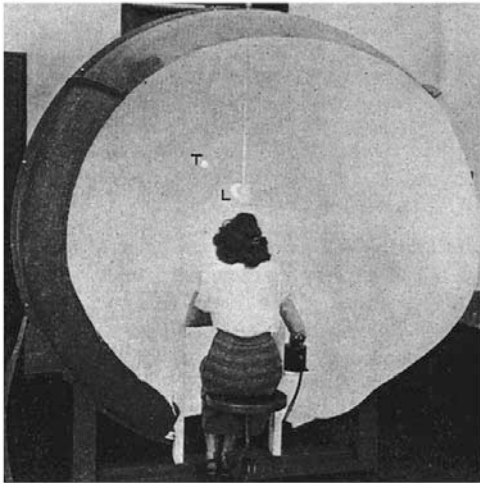


Figure 1. The experimental environment used throughout most of the present investigation was the illuminated white inner surface of an 80-inch sphere at the center of which the subject's eyes were located.

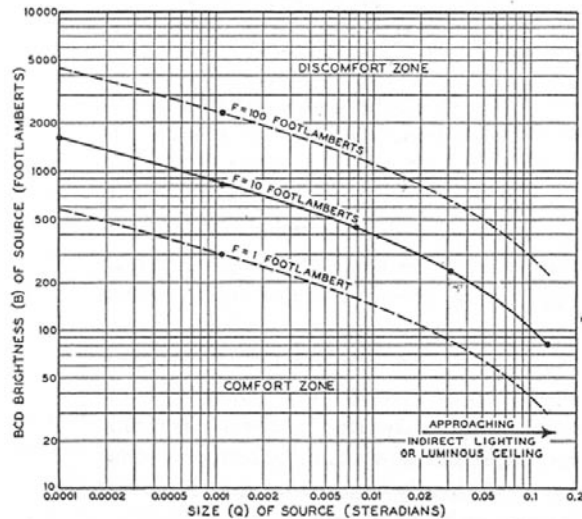


Figure 4. The relationship between BCD brightness  $B$  and size  $Q$  of sources located on the line of vision for three surrounding field brightnesses  $F$ .

**Figure 2.11** Image of experimental environment (left) created to determine the borderline between comfort and discomfort produced by a small glare source (luminance, size and position) and a uniformly illuminated background from Guth (1949). Results (right).

Initial studies, such as the one shown in **Figure 2.11** (Guth, 1949), required participants to sit in a fixed view position and view an experimental environment created in a windowless laboratory environment. Generally the experimental environment included a homogenous and uniformly illuminated “background” and a single static glare source that could have varied luminance, size, and position. Following a brief exposure to a combination of the above factors, participants would be asked to report their subjective assessment of their glare sensation in terms of whether glare was present or not, using constructs such as Guth’s comfort/discomfort borderline (BCD). In later studies, subjects reported using an incremental scale. An initial look at the test environments suggests that the goal of this early research was not to develop quality lighting but rather to determine the threshold for visual discomfort for patterns of luminaries.

## 2.5.2 Methods of performance assessment in design

Concurrent with the reemerging interest in the daylighting of buildings in the 1960s, a study was conducted by (Hopkinson and Bradley, 1960; IES 1962), to develop a metric to evaluate glare from large area sources (e.g. windows). The experimental setup consisted

of a large diffusing screen illuminated by closely packed fluorescent lamps, which provided a uniform luminance condition. The source size was varied from 10-3 sr to the whole field of view, and the source luminance was varied between 3.5 and 15,500 cd/m<sup>2</sup>. Subjects reported their subjective impressions of glare on a scale ranging from “just perceptible” to “just intolerable.” From these tests the Daylight Glare Index (DGI) was derived using correlations to the subjects’ subjective impressions.

$$DGI = 10 \log 0.478 \sum_{i=1}^n \frac{L_s^{1.6} \cdot \Omega^{0.8}}{L_b + 0.07 \cdot \omega^{0.5} \cdot L_s}$$

$L_s$  Source luminance (cd/m<sup>2</sup>)

$L_b$  Background luminance (cd/m<sup>2</sup>)

$\Omega$  Solid angular subtense of source modified for the effect of the observer in relation to the source (sr)

$\omega$  Solid angular subtense of source at the eye of the observer (sr)

**Equation 2.2** The daylight glare index (DGI).

The DGI can be applied during design to predict the level of visual discomfort from windows by providing values, either assumed or calculated, for the parameters identified above. The DGI is recommended by the International Energy Agency (IEA) Solar Heating and Cooling (SHC) Program Task 21 daylighting performance monitoring procedures (1999) as the appropriate metric for predicting visual discomfort in daylight spaces. However, a number of other glare metrics for use in evaluating visual discomfort from windows have been proposed based on human factors data collected in controlled laboratory experiments. These include: 1) the Unified Glare Rating (UGR) (CIE, 1995), recommended by the Commission Internationale de l’Eclairage and the ASHRAE Performance Measurement Protocols (PMP) for commercial buildings (ASHRAE, 2010), 2) the CIE Glare Index (CGI) (Einhorn, 1969, 1979), and 3) interior global vertical illuminance (Osterhaus, 1998). With the exception of global vertical illuminance, all of these metrics involve the same basic relationship between the four parameters of window luminance, solid angle subtended by the glare source, the angular displacement of the source from the observer’s line of sight, and the general field of luminance (i.e. “background” luminance). However, there is currently no agreed-upon method to accurately predict discomfort glare in daylight environments (Galasiu and Veitch, 2006). This is due, at least in part, to the differences in perception of glare from “artificial” sources (e.g. an electrical test apparatus) and glare from daylight. For example, in later studies (Hopkinson, 1972; Chauvel et. al., 1982; Boubekri et. al., 1992) involving real windows and daylight, results showed that the absolute level of response predicted by the DGI shifted when the source was from daylight. Glare from windows is judged to be less disturbing than that experienced in the original laboratory apparatus.

**Table 2.1** Subjective responses correlated to DGI in windowless and windowed laboratory setting. Windowless DGI correlation from (Hopkinson and Bradley, 1960), windows correlation from (Hopkinson, 1972).

<b>Glare criterion</b>	<b>DGI</b>	
	<b>Windowless</b>	<b>With Windows</b>
Just perceptible	10	16
Just acceptable	16	20
Just uncomfortable	22	24
Just intolerable	28	28

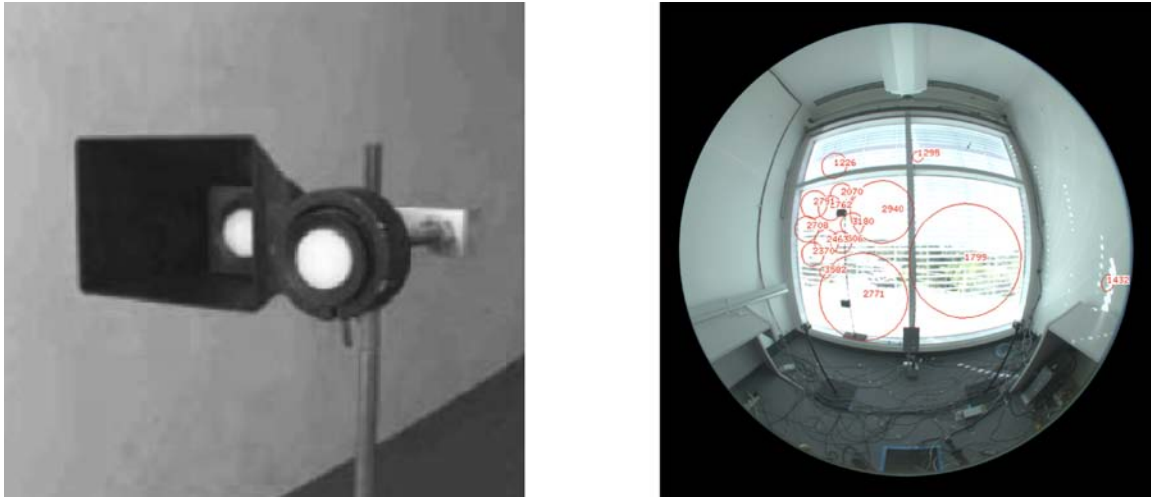
### 2.5.3 Methods of performance assessment in the field

In contrast to the relatively small, uniform, and stationary glare sources with constant brightness produced by electric lighting, the glare produced by windows varies in brightness, occurs in the horizontal field of view, is constantly changing in size and position, and is usually distributed non-uniformly across a large area (e.g. a window or facade). In addition, the relatively large solid angle (steradians) occupied by windows creates two problems with existing metrics: as outlined by Chauvel et al. (1982):

*The basic studies on discomfort glare by Luckiesh and Guth, and by Hopkinson examined the effects of source and background characteristics for relatively small sizes of sources and produced formulae which appeared to describe the relationships up to a size which subtended a solid angle on the eye in the region of 0.01 steradian. There appeared to be some evidence that as the source size increased above this value, the glare did not increase to the extent predicted. This seemed likely to be due to the effect of the glare source in occupying a large part of the visual field raising the adaptation level of the eye, thus reducing the visual response and the glare sensation and reducing the contrast effect. The other consequence of the source occupying a large part of the visual field is that different parts of its area have different weightings by the 'position factor', which evaluates the effect of a small glare source seen off the direct line of sight. It would be clearly inaccurate to use such a position factor which merely related to the position of the centroid of the large area.*

Visual comfort calculations for daylight spaces are inherently difficult to perform because they depend not only on the locations and brightnesses of light sources, but also on the apparent size of the light sources as seen from a particular viewpoint (Ward, 1998). This presents a difficult measurement problem to researchers using conventional instruments because the observer's entire field of view must be sampled in order to capture the luminance, position, and size of the glare source(s) produced by the sky conditions. In addition, due to the non-uniform lighting distributions common in daylight spaces, the boundary of the glare source is more difficult to define. In addition, recent research by Tuaycharoen and Tragenza (2007) indicates that the absolute tolerance of glare from

windows is related to the perceived visual content of the view through the window, where higher predicted DGI values will be tolerated for views rated positively.



**Figure 2.12** (Left) Image of the shielded and unshielded illuminance sensors used to calculate the Daylight Glare Index (DGI) according to the IEA SHC Task 21 monitoring procedures. (Right) High dynamic range (HDR) image post-processed using RADIANCE to identify size, position, and luminance of glare sources above  $500 \text{ cd/m}^2$ .

The method specified by IEA Task 21 (2000) to measure glare in daylit spaces defines the entire window area as a glare source and establishes the working luminance of the glare source as the average luminance across the surface of the window. This method enables the prediction of visual discomfort from large area glare sources using the DGI method described above. An example from the IEA Task 21 document showing the equipment for this method is provided in **figure 2.12** (left).

Vertical illuminance (measured near the facade) and average sky luminance (measured from the back of the room) have also been suggested as a means of monitoring visual discomfort (Velds, 2002). Although these measures were shown to correlate with visual discomfort under intermediate and overcast sky conditions they did not predict discomfort during clear or dynamic sky conditions or when blinds were partially or fully down. Velds speculates that this is a result of the inability of the instruments to accurately characterize the dynamic lighting conditions produced by these conditions.

High dynamic range images, which acquire scene luminance data at a wide area, “per-pixel” resolution, provide the ability to record the size, position and luminance of an arbitrary number of potential glare sources in the field of view (**figure 2.12**, right), potentially enabling greater accuracy in the detection of dynamic glare sources changing in regard to both position and boundary that are common in daylight spaces. However, the question remains how to relate physical measures of scene luminance with occupant subjective assessments of visual discomfort, where the desire for daylight transmission and views in real workspaces may influence the threshold for discomfort.

## 2.5.4 Summary and questions

Although the development of better methods and tools to predict visual discomfort in daylight spaces remains an active research topic (Wienold daylight glare probability: DGP, 2006), there is currently no agreed-upon method to accurately predict discomfort glare in daylight environments (Galasiu and Veitch, 2006). In addition, there are limited data from buildings in use describing the visual comfort responses of occupants related to predictions from glare metrics or more simplified measures of scene luminance (e.g. maximum window luminance, average window luminance). To address this gap in existing knowledge, the following questions were proposed in this study:

How do the results of existing methods and metrics recommended for measuring and assessing visual discomfort compare with subjective occupant responses? (e.g. glare indices, IESNA recommended luminance contrast ratio limits, vertical and horizontal illuminance).

Can predictive models based on variables of luminance or other interior physical measures be used to predict visual discomfort responses? If so, what variables best predict visual discomfort and with what level of accuracy? And, how does the probability of discomfort compare with the stimulus intensity of a given variable?

## 2.6 Operation of interior shades

### 2.6.1 Overview

Despite the intuitive understanding that occupant control of interior shading devices plays an important role in controlling glare, daylight transmission and view, shade operation is poorly represented in existing approaches to IEQ performance assessment. For example, both ASHRAE 189.1 and Title-24 fail to address the issue shade state and annual daylight metrics (e.g. DA implemented in LEED 2012) do not explicitly state how interior shading devices such as venetian blinds, roller shades, vertical louvers etc. (which can be retracted or in some cases configured to adjust transmittance) should be treated to generate consistent values. Few studies are available that describe the environmental and contextual conditions that cause occupants to control interior shading devices in real buildings. Initial studies were conducted using observation from the exterior and were directed toward characterizing the effect of occupant control of interior shading devices on interior daylight availability, and consequently potential for electrical lighting energy reduction. Therefore, early studies were concerned with questions such as: do occupants of office buildings use the shading devices according to predictable patterns? And, if so, are these patterns dependent on factors such as window orientation, time of day, sky condition, season, facade orientation, and workstation position? Later studies included measures of indoor environmental conditions and were concerned with identifying and describing the discomfort conditions associated with deployment of interior shading devices. The following presents a review of existing research regarding occupant control of interior shading devices.

## 2.6.2 Field Studies using external monitoring

In a study of six office buildings located in Maryland, USA, Rubin et al. (1978) used photography to examine if approximately 700 venetian blinds (purposely set by the researchers in either an open or a closed position after the occupants left for a weekend) had changed position after the subjects arrived back to work on the following Monday. The study was conducted over three 10-day periods in October, February and July, with each building facade photographed at least four times in the morning and in the afternoon before and after the change occurred. An occlusion index was developed to analyze resulting blind configurations based on the percentage of window coverage. Additionally, slat angles were described as either “open” or “closed” to report an indication of the available view remaining to the exterior. Based on the result that blind occlusion was higher on the southern facade (about 80%) than on the northern facade (about 50%), Rubin et al. hypothesized that occupants deploy shading devices to control direct sun and avoid overheating. And based on the result that the majority of blinds were set with the slats open rather than closed, Rubin hypothesized that a preference for a view out may moderate this objective. Rubin et al. also reported that occupants did not change the blind position daily, and their preference for a certain blind configuration seemed to be mostly based on perceptions formed over long periods of time ranging from weeks to months that had little to do with the sun position or the daily and seasonal climatic conditions.

Following on Rubin’s work, in a study of a 16-story office building in Ottawa, Canada, Rea (1984) used photography to examine the effects of (1) office window orientation, (2) time of day, (3) weather conditions, and the interactions between these variables, on blind positions set by the occupants of the building. Photographs were taken of the three building facades in the morning, at midday, and in the afternoon on a cloudy day in April and on a clear day in May. A total of 3,330 unique windows were photographed and an occlusion index was defined to describe the fraction of each window that was occluded. Although Rea found that both sky condition and facade orientation had a statistically significant effect of window occlusion, the overall effect was minimal. For example, the most significant variation was for the east facade, where the occlusion index changed from 39.3% occluded on the cloudy day, to 59.9% on the clear day. Overall, the windows for each facade were more shaded than unshaded on both days (clear, average occlusion = 63.3% and cloudy, average occlusion = 57.0%). In conclusion, Rea hypothesized that occupant preference for window blind position is based on long-term perceptions of solar radiation, and changes within a day are essentially ignored. However, Rea’s method of acquiring images of the facade, paired with the complexity of recovering each window’s blind position, did not enable him to test this hypothesis on an hourly or daily basis.

In a study of four high-rise office buildings located in Tokyo, Japan, Inoue et al. (1988) found that for direct solar radiation exceeding  $60 \text{ W/m}^2$  (falling on the occupants), the percentage of blind occlusion was directly proportional to the depth of the sunlight penetration into the room. The highest blind occlusion was observed when the sunlight penetration into the offices was over 2m, and when the solar radiation was above  $250 \text{ W/m}^2$ . The study involved monitoring over a thousand windows oriented in the east,

west, south-west and south-east directions during winter, summer and fall, as well as two questionnaires with responses from roughly 800 building occupants. Time-lapse photography of the facade exteriors was used to show that on clear sky days on the eastern facades, the blinds that were closed in the morning gradually opened in the afternoon, while the opposite occurred on the western facades. Additionally, results showed that blind operation varied with facade orientation and sky conditions (where blinds were not operated under overcast sky conditions). Notably, about 60% of the monitored blinds were not operated at all throughout the day (on average), which supports previous findings by Rubin et al. (1978) and Rea (1984).

In a four-year field study involving photographic surveys of 300 windows facing mostly south, south-east and south-west from five office buildings in the UK, Lindsay and Littlefair (1992) found a strong correlation between the magnitude of direct solar irradiance on the facade, sun position, and the frequency of venetian blind use. Operations were most frequent on south-facing facades, where the typical daily blind operating rate was similar to that reported by Inoue (35-40% on clear days). The researchers also report a large variation in the amount of blind usage by window, where some blinds were never adjusted, while others were used over 70% of the days studied. Although the researchers report that there was no conclusive evidence to suggest that blind operation was influenced more by either thermal or visual considerations, they speculate that the avoidance of glare is more likely the cause. However, their results include no physical data describing the glare conditions associated with blind operations.

In a study using video equipment to record the facades of three office buildings located in the UK, Foster and Oreszczyn (2001) examined the effects of facade orientation, sunshine, and electric lighting on blind usage in both summer and winter. In contrast to earlier work, results indicated no significant relationship between window orientation and the level of blind occlusion. The average occlusion for each facade was found to be approximately 40%, independent of orientation and time of year. The authors concluded that the way occupants used their blinds did not seem to be primarily affected by the solar availability.

### **2.6.3 Field studies using internal monitoring**

Reinhart and Voss (2001) monitored ten German south-west facing private and semi-private offices with no air-conditioning from March to December (N = 14 participants). Solar control for the offices was provided by an external two-component, photo-controlled exterior venetian blind system with a manual override option which, when used, disabled the automatic system for two hours. The blinds were automatically controlled to fully lower or retract when the global vertical illuminance on the facade was above or below 28,000 lux. When lowered, the slats of the bottom blinds were fully closed, while the slats of the top blinds were kept horizontal for daylight transmission. In total, 6,393 blind changes were recorded, of which, 1,413 were user-overrides of the automated system and 1,973 were operations initiated by occupants. Thus, approximately 47% of the automated blind adjustments were immediately overridden by

occupants, and there were an additional 1,973 events where occupant preferences were not met by the automation system. The researchers found that blinds were usually closed manually when the global vertical illuminance on the facade of the building exceeded 50,000 lux (450 W/m<sup>2</sup>), and retracted at 25,000 lux (225 W/m<sup>2</sup>). Results of user-override data showed that participants rarely used the manual override option to close the blinds when they were automatically retracted, 88% of the override operations changed the blinds from an automatically lowered state. Reinhart and Voss concluded that the occupants selected the position of their blinds consciously and consistently, and that individuals were more likely to accept the automatic opening rather than the closing of the blinds.

In a field study of blind operation conducted in two air-conditioned office buildings located in Berkeley, CA, conducted from the vernal equinox to winter solstice (N = 25 participants), Inkarojrit (2005) collected measures physical environmental conditions and subjective measures of participant's assessment of visual and thermal comfort sensations. Each participant was surveyed 1 to 4 times within one-day period (at approximately 2 hour intervals). The research protocol involved opening window blinds at building occupants' workstations at the beginning of the test. After a brief period of adaptation (5-10 minutes), participants were asked to rate their preference for window blind movement (want no change or want to close) on a web-based survey. Physical environmental data at the time of the survey were then matched with the window blind closing preference. Inkarojrit found that the probability of a window blind closing event increased with the magnitude of physical environmental factors increased. Results revealed that the most significant predictors were maximum window luminance, average window luminance, background luminance, and vertical solar irradiation at the window. Confounding factors included mean radiant temperature (MRT), direct solar penetration, and occupant's self-reported sensitivity to brightness. In contrast to previous studies that define glare criteria in terms of solar irradiation, by using high dynamic range imaging to record luminance conditions, Inkarojrit was able to identify glare in terms of window luminance. Because the human visual system responds to the luminance of the visual environment, window luminance is likely to be a more relevant predictor for visual discomfort than irradiance at the facade. The primary limitation of this study is that, similar to Rubin (1978) it describes the behavior of occupants in response to a research intervention (raising of shading devices in the morning) and may not represent the behavior of occupants under typical conditions (where shades must be raised and lowered exclusively by occupants).

#### **2.6.4 Summary and questions**

Existing research on occupant control of shading devices in office buildings reveals a general consensus for the hypothesis that shading devices are deployed by occupants to control glare, direct sun penetration and overheating. Frequency of operation and overall facade occlusion were typically found to be greater on facades with greater exposure to solar radiation (e.g. south), however the variation between facade orientations (e.g. north vs. south) was generally found to be relatively small. Field studies generally reported that occupants did not change the blind position daily, and their preference for a given



shade configuration seemed to be based on perceptions formed over periods of time ranging from weeks to months that had little to do with the sun position or the daily and seasonal climatic conditions. In contrast, studies where shades were manipulated by automated systems or researchers (Reinhart 2003, Inkarojrit 2005) revealed that occupants selected the position of their blinds consistently in response to the magnitude of indoor environmental conditions (Reinhart, 2003; Inkarojrit, 2005).

Due to the method (external observation) used in early studies of blind operation, the outcomes describe behavior without documenting interior conditions in terms of daylight sufficiency, view, or whether blind deployment resulted in (or improved) visual comfort. Nor do they relate observed behavior to the stimulus intensity of physical variables (e.g. solar radiation). Although general knowledge of blind positioning enables more accurate prediction of daylight availability in these buildings, it does not directly relate to electrical lighting energy reduction that may have been achieved via occupant switching behavior or photo-controls. Later studies that monitor the indoor environmental conditions associated with shade operations are focused on the comfort conditions of the perimeter zone adjacent to facade and focus primarily on visual and thermal comfort. Although these studies provide valuable knowledge, they do not describe the comfort conditions that may occur in the “core” zone away from the facade, where shade deployment for the comfort of perimeter occupants may result in insufficient daylight or loss of view at core workstations. Additionally, no studies report the effect of shade configuration on occupant subjective assessment of visual connection to the exterior. Finally, all of the existing studies of occupant control of interior shading devices are of buildings with venetian blinds installed at the window head and capable of covering the entire window. Given the emergence of a growing number of prominent “green” buildings that use interior roller shades on the basis of preserving view content when deployed, as well as the emergence of “subdivided” facades with a lower “view” zone and upper “daylight” zone, it is important to extend this research to include these characteristics. To address these gaps in existing knowledge, the following questions were proposed:

Are shading devices operated in response to the stimulus intensity of interior physical variables (e.g. transmitted global vertical irradiance, average or maximum window luminance?). If so, what variables best predict behavior and with what level of accuracy? And, are predictor variables different for control of upper “daylight zone” window shades than for control of lower “vision” window shades?

Can logistic models based on measures of interior physical variables be used to predict operation of interior roller shades? If so, how do such models compare to existing assumptions for the stimulus intensity associated with shade operation?

How does the positioning of roller shades and frequency of operation observed in the SFFB compare to the outcomes predicted by existing shade control behavioral models? Are upper “daylight zone” shades positioned and operated differently than lower “vision window” shades?

## 2.7 Conclusions

This chapter has covered daylighting performance objectives of electrical lighting energy reduction from photocontrols, daylight sufficiency and view for occupant perception of connection to the outdoors, and visual comfort in regard to how each objective is defined, measured in the field (or in simulation), and how measures are interpreted to assess success or failure. For each performance objective, gaps in existing knowledge were identified that form the basis for the specific research questions addressed in this study. These research questions are revisited and answered in Chapters 5 – 10, which present results from the study. In summary, three broad gaps in existing knowledge are identified: first, there is a lack of data from buildings in use examining the energy performance of photocontrolled electrical lighting that considers occupant assessment of the need for ambient electrical ambient lighting to supplement available daylight. Second, there is the lack of data from buildings in use relating predicted outcomes from performance indicators of daylight sufficiency and visual discomfort to occupant subjective assessments. Thirdly, the positioning and frequency of operation of interior shading devices in buildings in use is not well understood, nor are the effects of shading device deployment on view and daylight admission.. There are limited data from buildings in use describing the physical variables or stimulus intensities associated with shade operations, leading to assumptions for shade control behavior that are predominantly theoretical. And, no studies have included monitoring of facades that are subdivided into an upper “daylight” zone and lower “vision” zone, where shades could be controlled independently. Finally, field studies that examine daylighting performance often examine only one of three important daylighting performance indicators: occupant control of shading devices, electrical lighting energy reduced by photocontrols, or IEQ factors related to daylight sufficiency and visual discomfort. Therefore, a final gap in existing knowledge is the understanding that emerges from field studies relating energy outcomes to IEQ outcomes of daylight sufficiency, visual comfort and satisfactory views from the perspective of building occupants. In addition to electrical lighting energy outcomes in daylit buildings, occupant satisfaction with visual comfort, daylight sufficiency, and view are an important source of feedback to assess daylighting performance. This broad view forms the basis for the performance monitoring approach developed for this research and for the substantial number of research questions framed to assess performance.

## CHAPTER 3

### THE SAN FRANCISCO FEDERAL BUILDING: A REVIEW OF DESIGN OBJECTIVES, ENVIRONMENTAL CONTROL STRATEGIES, PERFORMANCE CRITERIA, AND EXISTING STUDIES

*As the largest consumer of energy in the U.S. economy, the Federal government can and should lead by example when it comes to creating innovative ways to reduce greenhouse gas emissions, increase energy efficiency, conserve water, reduce waste, and use environmentally-responsible products and technologies.*

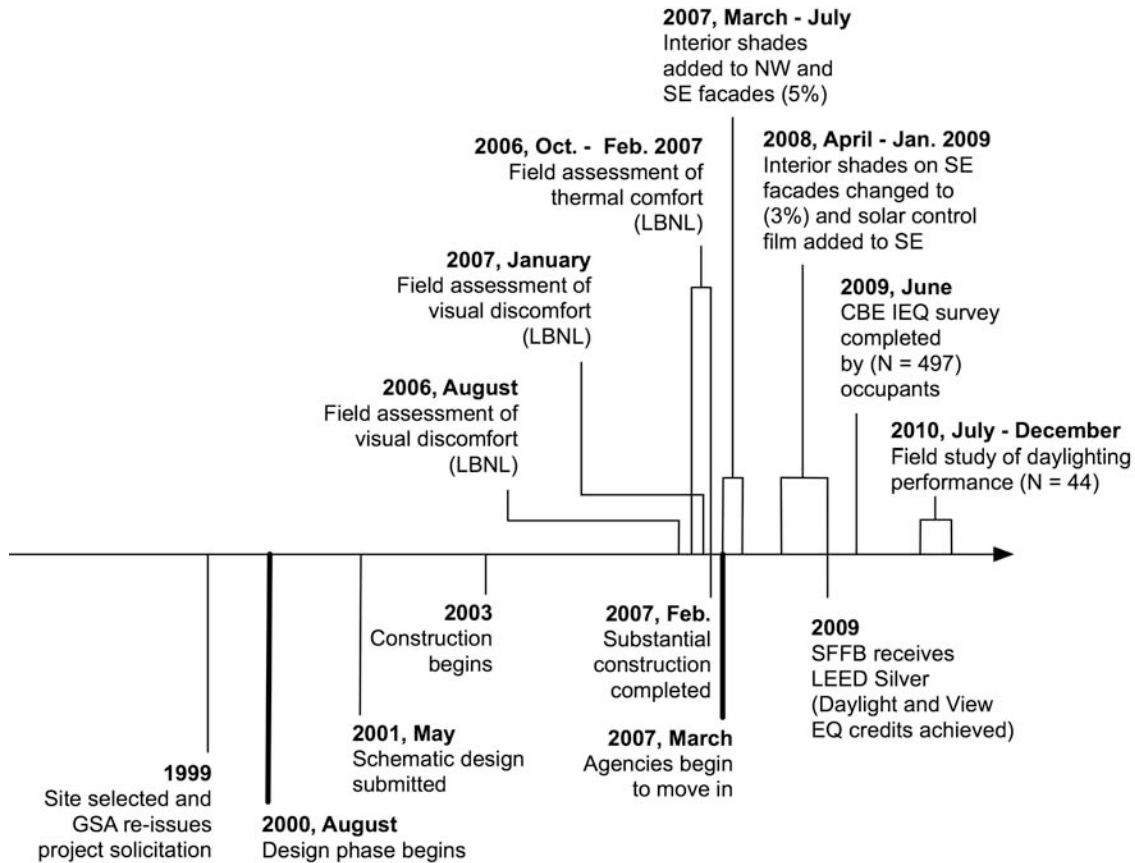
-President Barack Obama, October, 2009<sup>1</sup>

#### **3.1 Introduction**

This chapter progresses chronologically through the development of the San Francisco Federal Building (SFFB) as an early example of the General Services Administration (GSA)'s *Design Excellence* program. The chapter is divided into five sections. The first presents background on the energy and indoor environmental quality (IEQ) objectives of the SFFB. The second section reviews the design approach taken to achieve energy and IEQ objectives. The third section reviews indicators, tools, and methods used to assess energy and IEQ performance during SFFB design, for its LEED certification, and prior to building occupancy. The fourth section describes facade retrofits that were made to address issues of occupant discomfort. The fifth section reviews results from an IEQ survey questionnaire regarding daylighting performance conducted after the facade retrofits. The chapter concludes with specific questions, still unanswered after previous studies, that were used to guide this research. **Figure 3.1** provides a timeline locating this study in relation to existing studies of the building and facade retrofits.

---

<sup>1</sup> Executive Order 13514.



**Figure 3.1** Timeline locating field evaluation and facade retrofits of SFFB.

## 3.2 Review of energy and IEQ objectives

### 3.2.1 The GSA portfolio: policy into practice

The GSA is the largest developer and manager of real estate in the U.S. As the “landlord” for the Federal government, the GSA owns and leases over 354 million square feet of space in 8,600 buildings serving over 1.1 million occupants.<sup>2</sup> Approximately 300 million square feet consists of office space, a large portion of which was constructed in the 1960s and 1970s (Ivy, 2010). As a result of the lessons learned from the utility, maintenance, and replacement costs of these buildings, Federal efficiency mandates, and a pronounced end-user preference for work settings that are healthy and environmentally responsible (GSA PBS, 2009), a number of policies have been created in the past decade to improve the performance of the GSA real estate portfolio in regard to public opinion, resource efficiency, and indoor environmental quality. The construction of the San Francisco Federal building and subsequent post occupancy studies of the project represent an early example of GSA efforts to implement these policies.

<sup>2</sup> <http://www.gsa.gov/portal/content/104501> (accessed 9/21/11).

### **3.2.2 Design Excellence program**

Largely in response to negative employee and public opinion of existing Federal office buildings (Ivy, 2010) the GSA initiated the Design Excellence program in 1993. The program awards design commissions based on the result of a competitive private sector design and peer-review process. The primary goal of the program is to “produce facilities that reflect the dignity, enterprise, vigor, and stability of the Federal government, emphasizing designs that embody the finest contemporary architectural thought” (GSA). As the program has developed, its objectives have broadened to include GSA’s explicit commitment of “incorporating principles of sustainable design and energy efficiency into all of its building projects” (GSA). The San Francisco Federal Building (SFFB) was commissioned by the General Services Administration (GSA) in 1998 to serve as a model of the GSA’s Design Excellence program. Broadly understood, the project developed around three primary objectives: (1) energy efficiency, (2) enhanced indoor environmental quality, and (3) the creation of an urban landmark (McConahey et al., 2002; GSA, 2007).

### **3.2.3 Energy efficiency performance objectives**

The operation, maintenance, and construction of the GSA portfolio reflect the legitimacy of Federal claims of energy efficiency and sustainability. In recent years, the GSA has responded to increasingly rigorous Federal policy focused on more efficient use of electricity, natural gas, water, and sewage services, beginning with the *Federal Leadership in High Performance and Sustainable Buildings* memorandum of understanding (MOU) established in 2006. It charged Federal agencies with implementing building design and operation strategies that improved energy performance, but did not establish explicit efficiency targets. In January 2007, Executive Order 13423 established numerous federal energy and environmental management requirements, including a requirement that the entire GSA portfolio reduce metered energy use by 30 percent by 2015. In December 2007, the *Energy Independence and Security Act of 2007* established that new GSA buildings and major renovations must reduce fossil-fuel-generated energy consumption by 55 percent by 2010 (and by 100 percent by 2030). In October 2009, President Obama expanded the energy reduction and environmental requirements of (EO 13423) by making reductions of greenhouse gas emissions a priority of the Federal government, and by requiring agencies to develop sustainability plans focused on cost-effective projects and programs (EO 13514). And in February 2011, the *Better Buildings Initiative* was announced by the Obama administration, which aims to achieve a 20 percent improvement in energy efficiency by 2020 across the entire U.S. commercial building sector.

Although the design and initial construction of the SFFB commenced prior to the policy developments mandating energy reduction noted above, energy efficiency objectives are stated in a number of documents. The following statements regarding energy efficiency appeared in various SFFB project documents:

1. Reduce energy usage from existing energy standards by selecting systems that maximize energy conservation to the degree that such systems are commercially available with reliable track records (preliminary program and feasibility study, Kaplan McLaughlin Diaz, 1994).
2. Develop a design that is energy efficient in its total architecture (preliminary concept report, Morphosis, 2000).
3. Dramatically reduce energy consumption through the integration of architecture and sustainable engineering principles (final concept report, Smith Group and Morphosis, 2001).
4. Provide maximum energy efficiency throughout the facility (final value engineering report, 2001).
5. The design publications for the SFFB state a whole building energy use target of 30 percent below the California energy code (Title 24) requirement, in line with (EO 13423). Whole building energy use was modeled at 36.9 kBtu/GSF. The modeled energy use of the naturally ventilated portion of the Tower was 27.5 kBtu/GSF, and the Title-24 baseline modeled energy use was 55.8 kBtu/GSF (GSA, 2007).

### 3.2.4 IEQ performance objectives

Indoor environmental quality is recognized by the GSA to have a significant effect on worker productivity, health and well-being (GSA PBS, 2006). Through its *Sustainable Design Program*, the GSA uses the U.S. Green Building Council's *Leadership in Energy and Environmental Design* (LEED) Green Building Rating System as a tool for defining, assessing, and mandating IEQ criteria in its buildings.<sup>3</sup> The LEED rating system consists of a set of prerequisites as well as credits (points) which are earned by meeting specific requirements. Increasing point totals correspond to higher levels of sustainability and are the basis for *Certified*, *Silver*, *Gold* and *Platinum* certification. In 2003, GSA established a LEED *Silver* certification target for new construction and, in 2009, increased its minimum requirement for new construction and substantial renovation of Federally-owned facilities to LEED *Gold*. In 2009 the SFFB received its U.S. Green Building Council Leadership in Energy and Environmental Design (LEED) Silver certification for new construction (v 2.1). It received 34 out of a total of 69 points, and received both the LEED Daylight<sup>4</sup> and View environmental quality (EQ) credits. Although LEED compliance was not an original objective during the design of the SFFB, the preliminary program and feasibility study (Kaplan McLaughlin Diaz, 1994) established daylight, views, and visual privacy in general terms as design objectives: "Maximize daylight, access to views, as well as privacy for the tenants from outside view." However, no

---

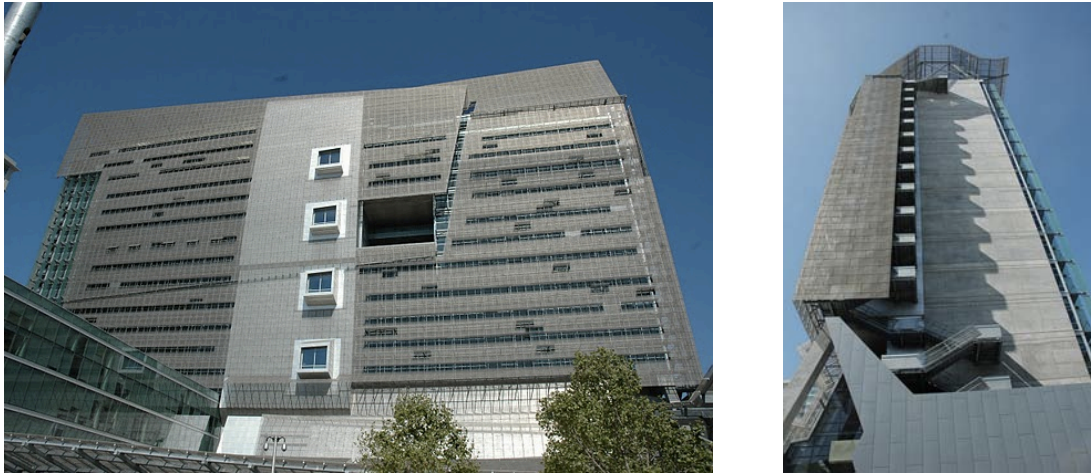
<sup>3</sup> <http://www.gsa.gov/portal/content/104462>

<sup>4</sup> The SFFB achieved an additional credit (8.2 Daylight and views) for demonstrating a minimum daylight factor of 2% in 90% of all occupied spaces using the compliance spreadsheet.

documentation was found for how progress towards this objective should be assessed during design, or after the building was occupied. The contrast between the level of emphasis on daylight as an IEQ objective and the lack of evidence demonstrating whether or not this objective was achieved serves as a central motivation for this dissertation.

### 3.3 Design strategies used to achieve energy and IEQ objectives

#### 3.3.1 Building overview and design team



**Figure 3.2** (Left) exterior view of the SFFB (SE facade). (Right) exterior view showing NE facade.<sup>5</sup>

The San Francisco Federal Building (**figure 3.2**) is a 605,000 GSF office building located in the Market District of San Francisco, with offices for the Department of Health and Human Services, Social Security Administration, Department of State, Department of Labor, and the Department of Agriculture.<sup>6</sup> The total building population is approximately 2000 people. The design team consisted of Morphosis (design consultant), Smith Group (Executive Architect), Hunt Construction Group (construction manager), and Brian Kangas Foulk (civil engineer). Ove Arup's Los Angeles office led the structural, mechanical, and electrical engineering from the schematic design stage onwards and lighting design was provided by Horton Lees Brogden Lighting Design, Inc. SmithGroup led the space planning effort and acted as the main liaison with the tenant agencies.

---

<sup>5</sup> Images from <http://architektur-fabrikation.blogspot.com/2009/11/san-francisco-federal-building.html>

<sup>6</sup> <http://www.morphopedia.com/projects/san-francisco-federal-building>



### 3.3.2 Daylighting and natural ventilation

Publications by McConahey et al. (2002) and Haves (2004) reveal the interest of the design team in applying natural ventilation and daylight to achieve energy and IEQ objectives. Based on San Francisco's temperate outdoor air temperatures (the monthly mean maximum temperature for September, which is the hottest month, is 75 deg. F), the possibility of a naturally ventilated building became an early consideration of the design team as an energy efficiency strategy. In addition to the potential to reduce or eliminate the need for mechanical air handling systems, the design team claimed that naturally ventilated buildings present additional benefits in terms of enhanced productivity and health, "the expected advantages of naturally ventilated buildings include increased worker productivity, lower turnover in the workforce, and fewer health issues, in contrast to the documented ventilation problems with sealed building envelopes" (McConahey et al., 2002).

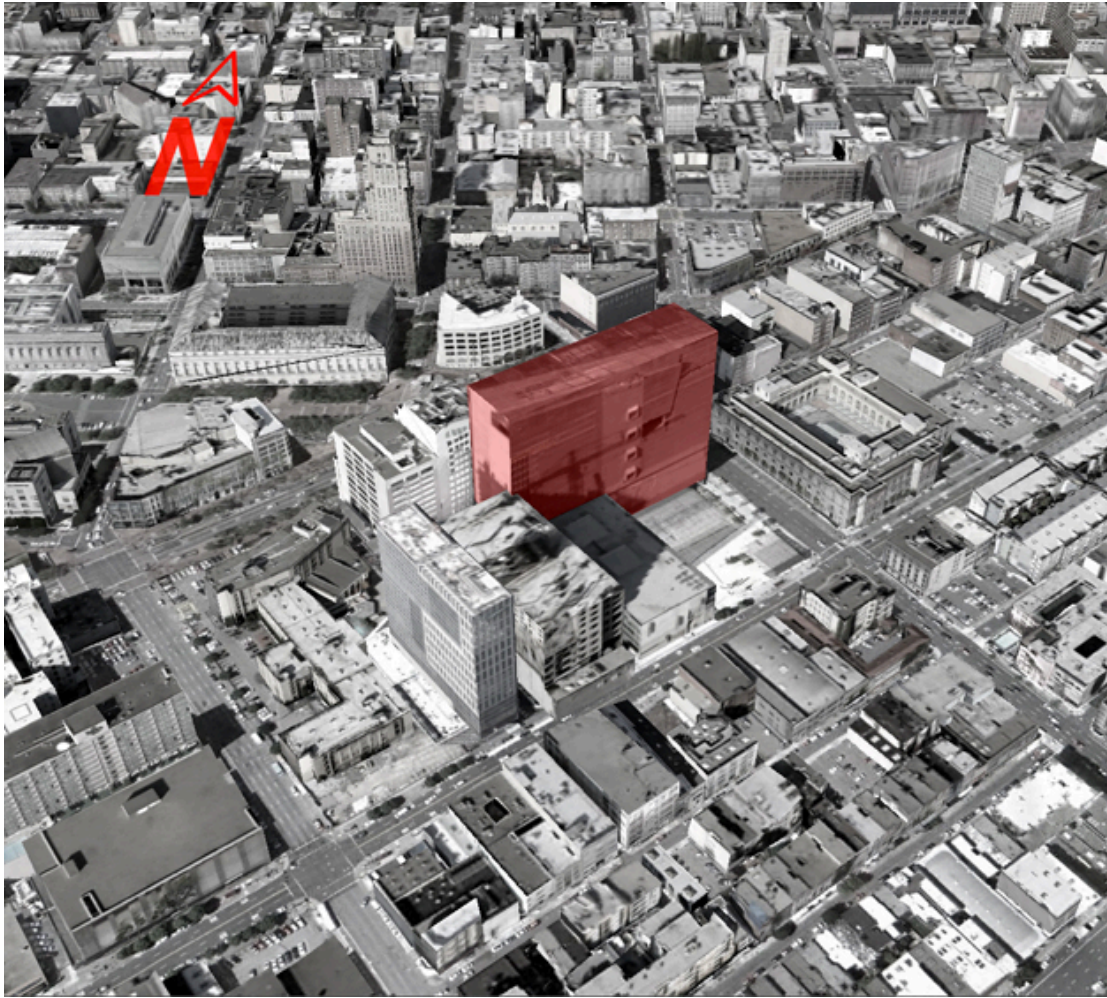
In response to the goal stated in the Program and Feasibility Study to "maximize daylight, access to views, as well as privacy for the tenants from the outside view" (Kaplan, McLaughlin, Diaz, 1994), the creation of "daylit interiors" was an additional consideration early in the design process with the objectives of enhanced productivity and health (McConahey et al., 2002). To develop concepts for a naturally ventilated building with "daylit" interiors, the design team worked in a self-described "environment of close collaboration" where emphasis was placed on the need for "multi-disciplinary" interaction (i.e. integrated design) (McConahey et al. 2002).

Organizing concepts for the SFFB from McConahey et. al. (2002)

1. The design of a building that offers dramatically reduced energy consumption through the integration of architecture and sustainable engineering principles.
2. The creation of office environments that influence the productivity and health of the working population through natural ventilation, operable windows, and daylit interiors.
3. The redefinition of the circulation and vertical movement paths in the building, using innovative elevators, three-story sky lobbies, and compelling stairways to promote walking throughout the building.

### 3.3.3 Site description

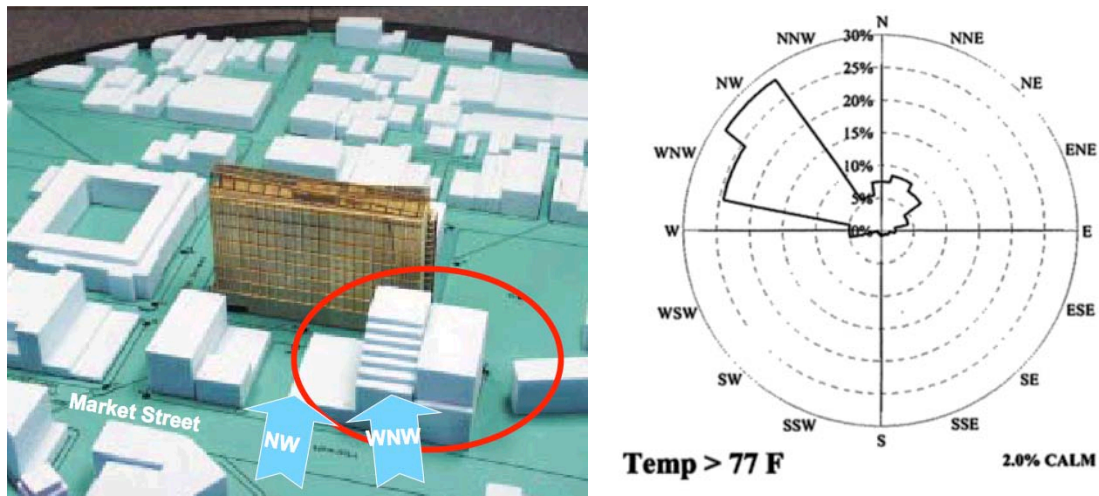
The SFFB is located in downtown San Francisco (latitude: 37.8 N, longitude: -122.4 W) among predominantly low-rise (3-5 story) buildings. As shown in **figure 3.3**, to the west of the SFFB are several taller buildings that overshadow lower portions of the SFFB for a period of the day.



**Figure 3.3** Aerial view of the SFFB from the south. SFFB is indicated in red.

### 3.3.4 Building massing and orientation

The building massing and orientation were determined to achieve the objective of a naturally ventilated tower section. The building massing consists of a slender, 18-story tower along the northwest edge of the site, with a 4-story annex building located perpendicular to the tower, along the western edge.



**Figure 3.4** (Left) wind tunnel study model. (Right) Direction and distribution of wind (blowing from). Data for daylight hours (6AM – 7PM) (1948 – 1999) obtained from San Francisco International Airport. From McConahey (2001).

Analysis of wind climate showed a strong prevailing wind condition from the west-northwest, leading to a decision to align the long axis of the tower section parallel to Market Street, which is oriented 45-degrees from true north (geodetic north) (McConahey, 2002) (**figure 3.4**).

### 3.3.5 Plan and sectional organization

*As a result of the tower's narrow profile and strategic integration of structural, mechanical and electrical systems, the building provides natural ventilation to 70% of the work area in lieu of air conditioning, and affords natural light and operable windows to 90% of the workstations.*

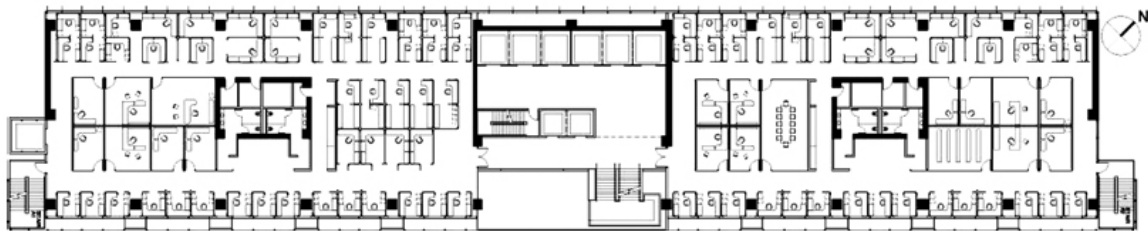
-Morphosis Architects<sup>7</sup>

*If you can build the tower floors narrow, they are 65' wide, you can have access to natural light for everyone.*

-Maria Ciprazo, supervisory architect, GSA Region 9<sup>8</sup>

*A third accomplishment is the Federal Building's high performance workplace in the upper tower. The narrow floor plates and the fact that the private offices are relegated to the interior mean that almost all have breathtaking views of the city or the bay.*

-GSA<sup>9</sup>



**Figure 3.5** Generic SFFB tower section floor plan. Each floor of the tower section measures 106.2 m (348 ft) long by 20.8m (68.24 ft) wide. From Haves et. al. (2004).

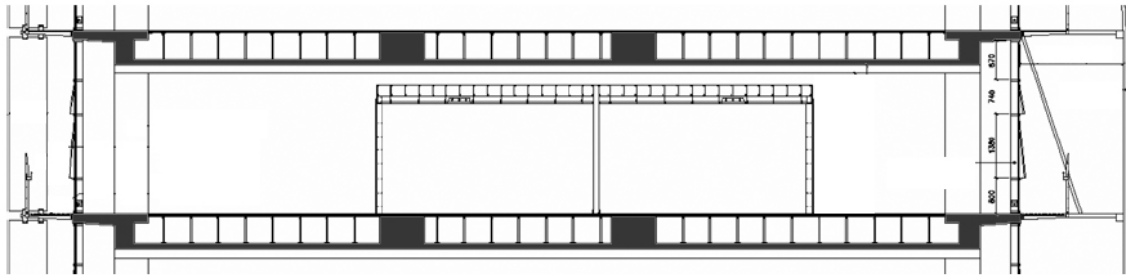
The objective of cross-ventilation in the tower section led to the decision to limit the floor plate depth to 20.8m (68.2 ft.) (**figure 3.5**), a dimension that is significantly less than conventional commercial office construction (McConahey et. al., 2002). In addition, the conventional commercial office layout of cellular offices along the perimeter and open-plan workspaces in the core was inverted to reduce the level of obstructions between the windows on both facades. This decision resulted in a floor plan layout with a single row of open-plan workspaces arrayed along the SE perimeter zone and two rows of open plan workspaces along the NW. Enclosed offices, open-plan offices, and miscellaneous program space (storage, kitchens, bathrooms etc.) are located in the central core areas. To further reduce obstructions, workstation partition panels perpendicular to the facade were limited to a height of 48 inches and panels parallel to the facade were limited to a height

<sup>7</sup> <http://morphopedia.com/projects/san-francisco-federal-building> (accessed 5/21/11).

<sup>8</sup> Building efficiency case study : San Francisco Federal Building (GSA). Video. Rocky Mountain Institute 2008.

<sup>9</sup> U.S. General Services Administration (2007). San Francisco Federal Building.

of 60 inches (1.5m). In addition to aiding ventilation, as indicated by the above quotations, the shallow floor plate was considered to have benefits for the energy and IEQ objectives of the design on the basis that nearly all workstations would have direct line of sight to the facade, and would generally be closer the façade than in conventional office buildings.



**Figure 3.6** Generic section through SFFB tower showing interior cabin workspaces. From Haves et. al. (2004).

The average floor-to-ceiling height of the SFFB of 13 feet (at the perimeter) is significantly greater than that of conventional commercial office construction (**figure 3.6**). The decision to extend the floor-to-ceiling height was based on the objective of achieving sufficient height above the interior cabin offices for cross-flow ventilation as well as to increase the level of daylight transmission to interior workspaces:

*With an average overall ceiling height in the tower of 13 feet, natural daylight will penetrate deep into work spaces.*

- Morphosis Architects<sup>11</sup>

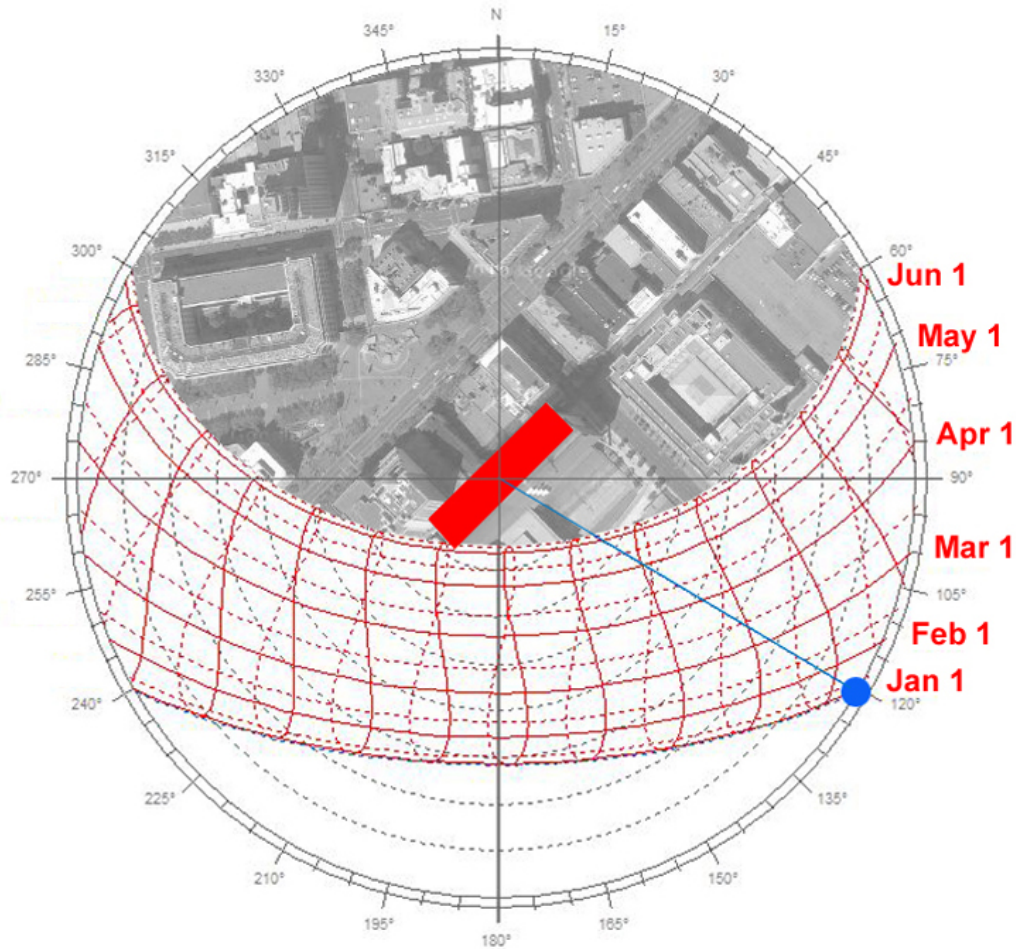
Although this Morphosis quotation does not explicitly reference any daylighting design guidance (i.e. “rules of thumb”) the assumption of a “daylight zone” which extends into the building a distance from 1.5 to 2.5 times the window head height is commonly stated in daylighting design guidance (O’Connor et. al., 1997; IESNA, 2000; Lechner, 2009; Grondzik, 2011; Marsh, 2011). Based on this assumption, increasing the window head height can be considered to increase the depth of daylight penetration.

---

<sup>11</sup> <http://morphopedia.com/projects/san-francisco-federal-building> (Accessed 10/08/2011)

### 3.3.6 Facade solar exposures

As a result of building massing and orientation, the tower section has two primary facades, one faces southeast (SE) with views to San Francisco Bay while the other faces northwest (NW) with views to Civic Center, UN Plaza and the city beyond. As shown in **figure 3.7**, The SE facade receives direct sun from sunrise to mid afternoon throughout the year and the NW facade receives direct sun towards the end of the day, with the number of hours of exposure increasing towards the summer solstice.



**Figure 3.7** Sunpath diagram for the SFFB field test site. Sun position is shown at sunrise on January 1.

### 3.3.7 Facade solar control strategies



**Figure 3.8** Floor to ceiling high glazing with high visible light transmittance on SE facade photographed prior to installation of exterior perforated steel scrim. From McConahey (2005).

**Figure 3.8** shows the SFFB under construction, as the floor-to-ceiling window wall glazing is being installed, but prior to addition of the exterior solar shading devices. Both NW and SE facades are glazed with a spectrally selective glazing assembly that enables 67% visible light transmittance while transmitting only 37% of solar heat gain. Therefore, the initial layer of solar control provided to the facade can be considered the spectrally-selective properties of the glazing. However, the addition of an exterior solar control layer for both facades was considered necessary for occupant comfort as well as for reducing internal cooling loads to a level that would allow elimination of mechanical cooling of the perimeter zones. The balance of solar control with daylighting objectives is discussed by McConahey et al. (2002) as one of the primary benefits of multi-disciplinary interaction:

*In fact, this multi-disciplinary type of intimate interaction is essential to the realization of a successful naturally ventilated building, as each discipline's design proposals have an impact on all the other disciplines in a cascading fashion. For instance, one decision about glazing that allows more light into the building might also simultaneously increase the solar gain to the point where the cooling from outside air alone will not be sufficient to keep indoor conditions comfortable. This would cause the mechanical engineer to introduce an air-*

*conditioning system, which would then add electrical load on the building. On this project, this conflict was identified early in the process, acknowledging that high solar gains through the glass of the southeast facade would not only be uncomfortable for the occupants but may serve to deplete the thermal mass of its charge during the morning hours through long-wave radiative exchange between the warmed low level surfaces and the nightcooled thermal mass above. Thus the exterior shade was introduced not only to provide solar protection but also to allow for a form-based visible architecture with a standard repeatable floorplan.* (McConahey et al. 2002).

The underlined section from the above quotation indicates that the addition of exterior solar control was due, in part, to consideration of occupant comfort. In this quotation, the use of the word “comfort” is general, but likely refers to thermal comfort rather than visual comfort.



### 3.3.7.1 SE facade exterior solar control



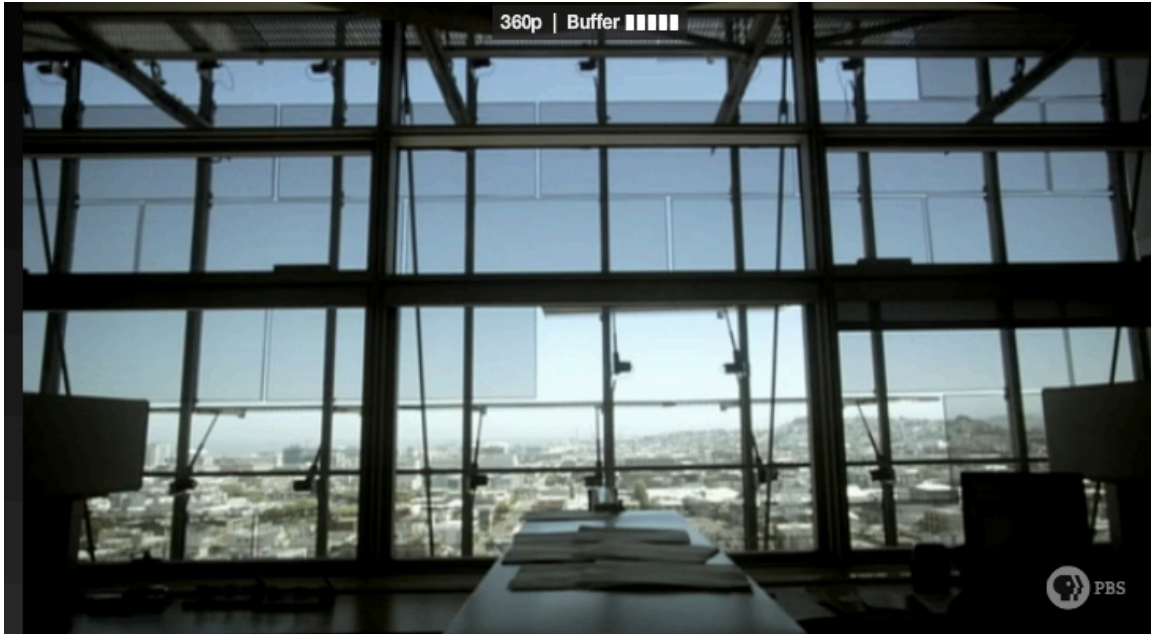
**Figure 3.9** Exterior view of the SE exterior metal screen. Image shows select panels that are open.<sup>12</sup>

The decision to provide additional solar control for the SE facade resulted in a “double layer” facade, where the outer layer consists of a screen of perforated metal panels (**figure 3.9**). The level of perforation results in an on-axis solar transmission of approximately 50%. In addition to the solar control function, the exterior metal screen was designed to absorb solar energy and then conduct the energy into the immediate airspace around it. This heated air was intended to rise alongside the building and help draw exhaust air out of the building through windows (PNNL, 2010). A subset of the metal screen panels are actuated mechanically with the intention of being automatically controlled by the Building Automation System (BAS). These panels are designed to tilt outward to reduce the level of obstruction for views to the outdoors. (**figure 3.10**).

**Figure 3.11** shows a generic cross section through the SE facade prior to facade retrofits illustrating the original solar control layers considered sufficient for occupant comfort.

---

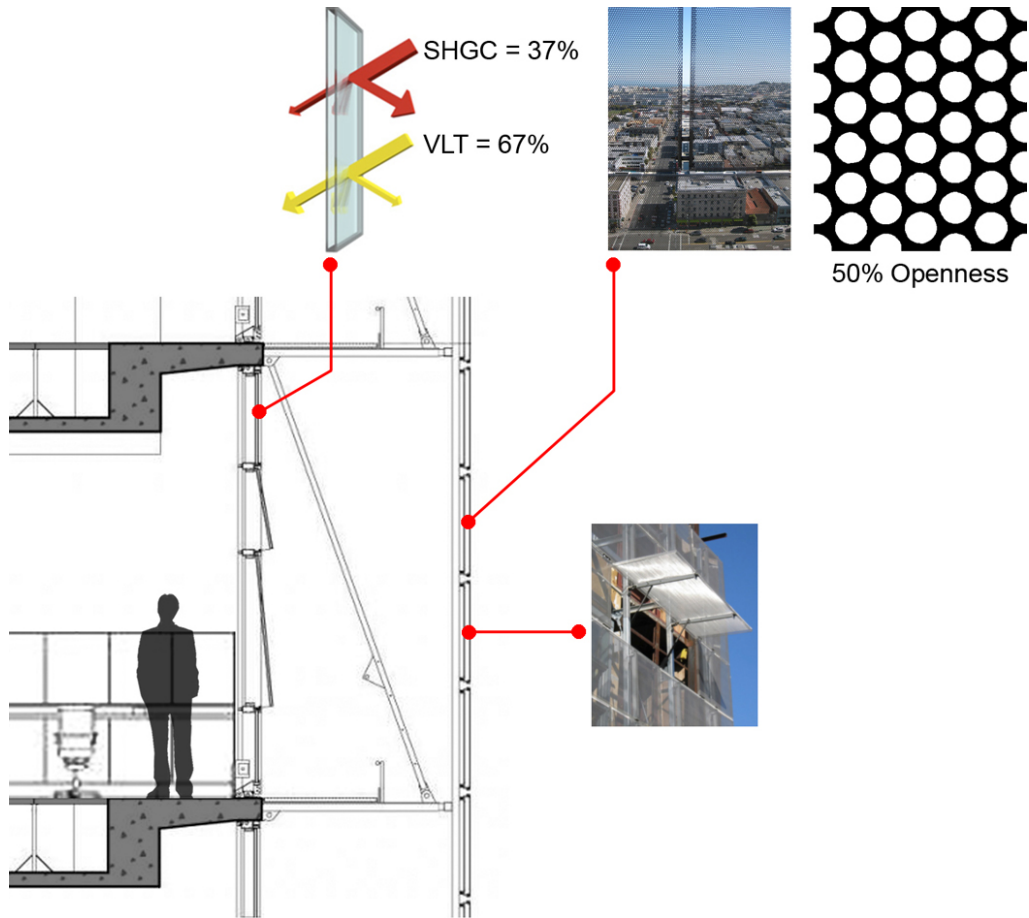
<sup>12</sup> Image from <http://architektur-fabrikation.blogspot.com/2009/11/san-francisco-federal-building.html> (accessed 8/30/11)



**Figure 3.10** Interior view looking through SE facade at exterior metal screen. Image shows select panels that are open. From PBS Design e2 podcast entitled “Greening the Federal Government.”<sup>13</sup>

---

<sup>13</sup> <http://www.youtube.com/watch?v=4WZnRk4cQ9Q> (accessed 10/10/2010)



**Figure 3.11** Generic section through the SE facade showing solar control layers implemented in the initial design prior to occupancy. Clockwise from right: exterior metal screen (shown with one panel tilted), screen detail and view through screen, spectrally selective glazing. Additional shading is provided inside the facade by (60 inch) and (48 inch) workspace partitions.

### 3.3.7.2 NW facade exterior solar control

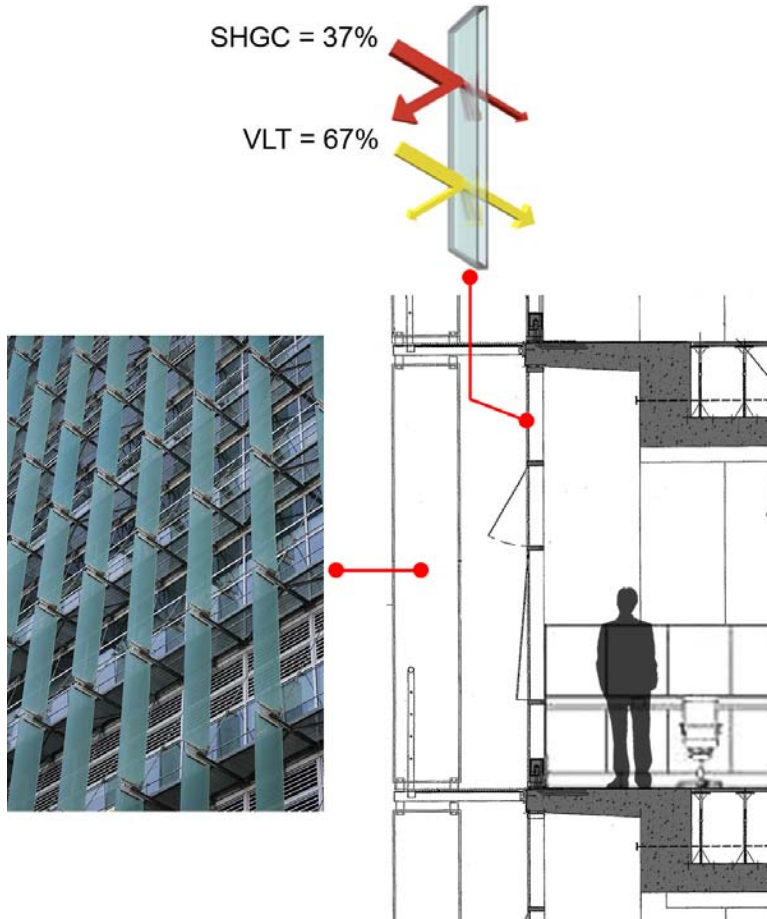


**Figure 3.12** Exterior view of the NW facade exterior solar shading devices.<sup>14</sup>

To control solar loads on the NW facade, the decision was made to create an exterior layer of translucent vertical fins (**figure 3.12**). The exterior fins are a sandwich composite of laminated glass and plastic. As described by (McConahey et al. 2002), the “...fins perpendicular to the northwest facade were introduced to intercept direct solar radiation during the afternoon hours when the sun would otherwise fall on the glazing simultaneous to the peak outdoor air temperatures.” **Figure 3.13** shows a generic cross section through the NW facade prior to facade retrofits showing original solar control layers considered acceptable for occupant comfort.

---

<sup>14</sup> Image obtained from <http://www.barbakoffdesign.com/1/post/2011/05/san-francisco-san-francisco-federal-building-detailing.html> (accessed 8/30/2011)



**Figure 3.13** Generic section through NW facade showing solar control layers implemented in the initial design prior to occupancy. Additional shading is provided by (60 inch) and (48 inch) workspace partitions.

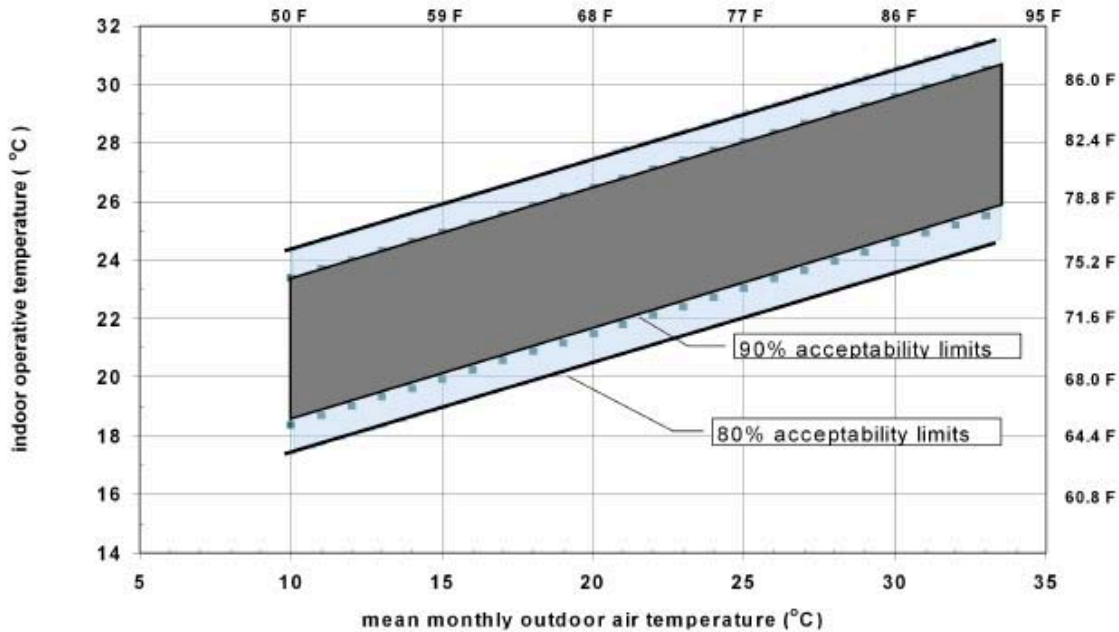
### **3.4 Indicators, tools and methods used during design**

Comparison between the consideration given to thermal comfort concerns during design and the consideration given to daylighting concerns highlights an important contrast in these two broad and overlapping aspects of indoor environmental quality. To examine the performance of the SFFB during design in regard to thermal comfort, the design team relied on an emerging consensus-based thermal comfort model and used established criteria for determining acceptable and unacceptable outcomes. From the initial design stage, the design team worked in collaboration with experts in both naturally ventilated buildings and energy modeling. During design, computer simulations of annualized performance were done for several facade design options using validated energy modeling software to balance energy objectives with provisions for occupant thermal comfort as well as reduction of cost and complexity. Following construction, the building was then evaluated by the same design professionals to examine if measured performance matched explicitly stated design intent.

In contrast, no documentation was found describing what information was used during design to establish criteria for the range of daylighting conditions considered comfortable, acceptable, or preferred for building occupants. Nor was information found describing the methods used to evaluate varying facade design options in regard to daylight sufficiency or visual comfort.

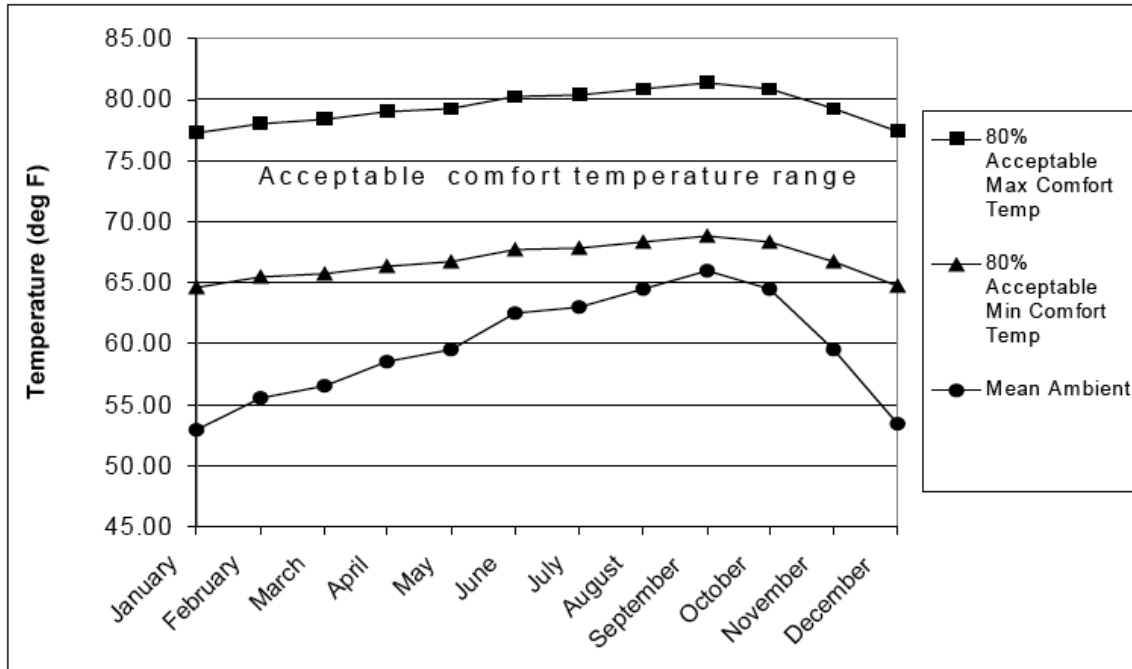
#### **3.4.1 Assessment of thermal comfort during design**

The need to address occupant comfort was identified early in the design stage (McConahey et al. 2002), and thermal comfort performance was assessed in partnership with research staff at Lawrence Berkeley National Laboratory using the energy simulation program EnergyPlus.



**Figure 3.14** Acceptable operative temperature ranges for naturally conditioned spaces. From ASHRAE Standard 55, after Brager and de Dear (2000).

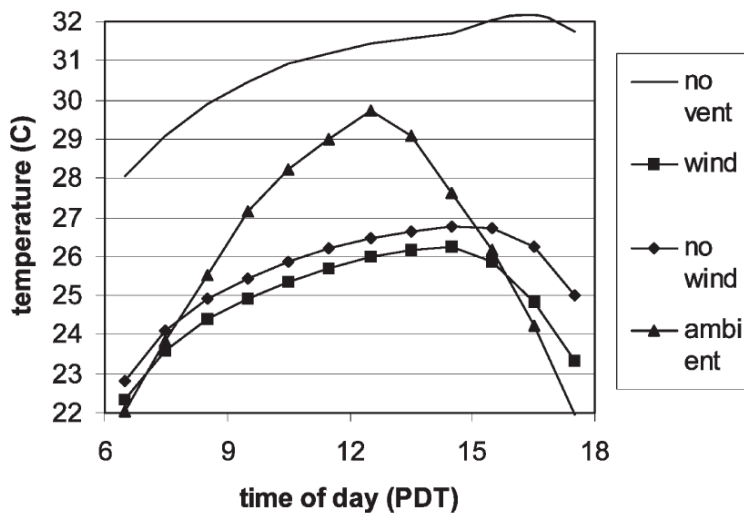
The comfort criteria for the SFFB were established using an extension to the ASHRAE Thermal Comfort Standard 55 (2004) based on the adaptive model for naturally ventilated buildings developed by Brager and de Dear (2000) (**figure 3.14**). While temperature setpoints in the air-conditioned areas of the SFFB were set at 75 in summer and 68 in winter, the work of Brager and de Dear suggested that occupants would accept a broader temperature range in the naturally ventilated portions of the building. Brager and de Dear's research findings come from an analysis of field data compiled from previous thermal comfort measurements conducted in 160 office buildings located on four continents and covering a broad spectrum of climate zones. The indoor operative temperatures (an average of dry bulb and mean radiant temperatures) for the SFFB were derived from the 80% acceptability limits of the adaptive model, which extend from a maximum of about 82 deg. F in the summer to a minimum of about 65 deg. F in the winter (**figure 3.14**). The adaptive model assumes that occupants will change their clothing and metabolic rates (within limits) in response to changing conditions in order to maintain comfort.



**Figure 3.15** Monthly mean ambient outdoor air temperatures for San Francisco and the 80% acceptability limits (max and min) for indoor operative temperature. From McConahey et al. (2002).

Based on the hypothesized “acceptable comfort temperature range” developed from the adaptive thermal comfort model (**figure 3.15**), the building energy simulation program EnergyPlus (which includes the multizone air-flow model COMIS) was used by research staff at LBNL to determine that the favorable wind climate in San Francisco produces sufficient cross-ventilation to maintain acceptable comfort.





**Figure 3.16** Predicted operative temperature for different ventilation strategies on 3 July. The various strategies that involve wind are indistinguishable from each other and are indicated by ‘wind’; the strategies that involve only buoyancy are also indistinguishable and are indicated by “no wind.” From Haves et al. (2004).

Haves et al. (2004) used operative temperature as an indicator to compare the performance of different natural ventilation strategies for space cooling. They concluded that in the San Francisco climate, wind-driven ventilation would provide sufficient nocturnal cooling to maintain comfortable conditions (**figure 3.16**) and that external chimneys do not provide significant additional ventilation at times when it would be beneficial. Additional simulation work was done by Carrilho de Graca et al. (2004) to evaluate a range of control strategies and their sensitivity to occupant behavior (e.g. operation / non-operation of windows). This work was performed to gain confidence in the effectiveness of the night cooling strategy during the warmest periods of the year. The simulation and analysis using EnergyPlus and the adaptive comfort model resulted in increased confidence in the performance of the passive cooling and natural ventilation systems, leading the consultants to gain a sufficient level of confidence in natural ventilation as a strategy for the SFFB. The process also identified potential sources of discomfort:

*Natural ventilation is able to produce a level of thermal comfort that is likely to be acceptable to the occupants for all but a modest number of hours in a typical year. (Haves et al. 2004).*

*The building faces a risk of overheating during a sequence of hot summer days, where using the stored thermal capacity (for night cooling) and increasing the natural ventilation rate during the day is inappropriate due to high ambient temperatures. (Haves et al. 2004).*

*On all but a few days, the nocturnal cooling of the building has to be limited in order to avoid uncomfortably cool conditions at the start of occupancy. The cooling*

*performance of the building is then limited by the available thermal capacity and the effectiveness of the solar control, particularly on the NW facade. (Haves et al. 2004).*

### **3.4.2 Assessment of visual comfort and daylight sufficiency**

In contrast to the performance indicators and tools referenced in the documentation of the thermal comfort analysis during the design phase, there are no documents describing what (if any) performance indicators were used to assess visual comfort during design, or how the design of adequately “daylit interiors” was determined. Although program documents (McConahey et. al., 2002) refer to the use of daylighting analysis, “with the improved penetration of daylight as confirmed by the lighting consultant’s daylighting analysis,” no record of the analysis was publically available. Conversations with research staff from LBNL familiar with the project suggest that daylight analysis by a consultant was removed from the scope of work (Diamond, 2010).

Below are a list of additional questions from a February 2007 effort to document design intent for the SFFB that illustrate the limited information available regarding design intent for lighting and daylighting (Diamond et al., 2007).

1. What were the assumptions about the expected daylighting levels in the tower?
2. What were the assumptions about the performance of the exterior scrim in controlling solar gain?
3. What are the algorithms for controlling the operable parts of the exterior scrim? Are there any that are manually controlled by occupants? If so, what were the assumptions about occupant use of those shades?
4. What were the internal lighting conditions predicted by the modeling with the use of the scrim? (e.g., light levels, glare reduction)

Documents published after the building was constructed reference the successful daylighting performance of the SFFB in terms of the LEED (v 2.1) *Daylight* credit compliance criteria: “achieve a minimum Daylight Factor of 2% (excluding all direct sunlight penetration) in 75% of all space occupied for critical visual tasks (USGBC, 2003). For example:

*(1) Illuminating interiors with natural light yields further sustainable design benefits. With an average floor-to-ceiling height in the tower of 13 feet, daylight reaches 85% of the workspaces. Powered lighting are used only when individuals are at their desks and are automatically dimmed or turned off when daylight is available. (GSA, 2007).*

(2) *As a result of the tower's narrow profile and strategic integration of structural, mechanical and electrical systems, the building provides natural ventilation to 70% of the work area in lieu of air conditioning, and affords natural light and operable windows to 90% of the workstations.* (Morphosis, 2007).

The indicator used to demonstrate that the intent of the LEED daylight credit (i.e. “provide for the building occupants a connection between indoor spaces and the outdoors through the introduction of daylight and views into the regularly occupied areas of the building”) is the daylight factor (DF). The DF is defined by Moon and Spencer (1942) as, “the ratio of the internal illuminance at a point in a building to the unshaded, external horizontal illuminance under a CIE overcast sky.” The DF is calculated in LEED v2.1 using an equation involving window and floor area, window geometry, visible light transmittance, and window height (**equation 3.1**).

Daylight Factor	=	$\frac{\text{Window Area [SF]}}{\text{Floor Area [SF]}}$	x	Window Geometry Factor	x	$\frac{\text{Actual Tvis}}{\text{Minimum Tvis}}$	x	Window Height Factor
--------------------	---	--	---	---------------------------	---	--	---	-------------------------

**Equation 3.1** Daylight credit compliance (option 1) from LEED v 2.1.

In **equation 3.1**, the terms *window geometry factor*, *minimum Tvis*, and *window height factor* are all obtained from a table of accepted window types published in the LEED 2.1 reference guide. Thus, for a given window type (e.g. sidelighting with daylight glazing), compliance is achieved primarily by varying the parameters for *window area* and *visible light transmittance* to produce a minimum DF of 2 percent. **Table 3.1** provides an example of how compliance was documented for one of the open-office floors of the SFFB tower section and shows that a daylight factor ranging from 2 to 2.3 percent is anticipated. And **table 3.2** presents the percentage of each floor considered to have sufficient daylight and views according to the LEED criteria. It is important to note that this calculation method does not address the effect of occupant control of shading devices on daylight factor predictions, nor does it include a discomfort indicator (e.g. a maximum allowable daylight factor) that might indicate when daylight transmission has exceeded an acceptable level for occupant comfort. To the contrary, there is explicit guidance to “design the building to maximize interior daylighting” in the LEED recommendations for potential technologies and strategies (USGBC, LEED Daylight credit v 2.1). Therefore, the daylight credit compliance method used by the SFFB design team (and associated recommendations) incentivizes a “the more the better” approach to daylight transmission with no explicit guidance for occupant behavior or the potential for producing glare discomfort.

**Table 3.1** Example of results (for SFFB 16<sup>th</sup> floor) submitted to the USGBC to demonstrate compliance with the LEED daylight and view credit criteria. Results compiled using the LEED Calculator 2.0.

16th Floor	Floor Area	Glazing Area	Window Geometry	Transmittance (T <sub>vis</sub> )		Window Height	Daylight Factor		Daylit Area	Views	
	[SM]	[SM]	Type	Factor	Actual	Min	Factor	Each	Room	[SM]	[SF]
1640	170.0	24.0	VISION	0.1	0.3	0.4	0.8	0.8%	2.0%	170.0	233.0
Open Office		32.0	DAYLIGHT	0.1	0.3	0.7	1.4	1.1%			
	63.0							0.0%			
1637	163.5	24.0	VISION	0.1	0.3	0.4	0.8	0.9%	2.1%	163.5	163.5
Open Office		32.0	DAYLIGHT	0.1	0.3	0.7	1.4	1.2%			
								0.0%			
1611	217.3	36.0	VISION	0.1	0.3	0.4	0.8	1.0%	2.3%	217.3	217.3
Open Office		48.0	DAYLIGHT	0.1	0.3	0.7	1.4	1.3%			
								0.0%			
1615	255.0	36.0	VISION	0.1	0.3	0.4	0.8	0.8%	2.0%	255.0	261.0
Open Office		48.0	DAYLIGHT	0.1	0.3	0.7	1.4	1.1%			
	6.0							0.0%			
1655	255.0	36.0	VISION	0.1	0.3	0.4	0.8	0.8%	2.0%	255.0	260.0
Open Office		48.0	DAYLIGHT	0.1	0.3	0.7	1.4	1.1%			
	5.0							0.0%			
1680	170.0	24.0	VISION	0.1	0.3	0.4	0.8	0.8%	2.0%	170.0	232.0
Open Office		32.0	DAYLIGHT	0.1	0.3	0.7	1.4	1.1%			
	62.0							0.0%			
1677	161.3	24.0	VISION	0.1	0.3	0.4	0.8	0.9%	2.1%	161.3	161.3
Open Office		32.0	DAYLIGHT	0.1	0.3	0.7	1.4	1.2%			
								0.0%			
1679	253.7	36.0	VISION	0.1	0.3	0.4	0.8	0.9%	2.0%	253.7	253.7
Open Office		48.0	DAYLIGHT	0.1	0.3	0.7	1.4	1.1%			
								0.0%			
<b>Total regularly occupied area 16th floor</b>		<b>1781.8</b>							<b>Total area with 2% daylighting</b>	<b>1645.8</b>	<b>1781.8</b>

**Table 3.2** Summary of “daylit area” and “areas with views” for each floor of the SFFB. (From documentation submitted to the USGBC to demonstrate compliance with the LEED daylight and view credit criteria. Results compiled using the LEED™ Calculator 2.0).

	Total Regularly Occupied Area	Total Area with 2% Daylighting Factor	Percentage of Daylit Area	Total Area with Access to Views	Percentage of Area with Views
	[SM]	[SM]		[SM]	
Basement	750.0	0.0	0%	0.0	0%
1st Floor	1995.7	1083.2	54%	1804.5	90%
2nd Floor	1173.4	800.0	68%	973.7	83%
3rd Floor	2018.3	955.2	47%	1677.5	83%
4th Floor	1956.7	1161.9	59%	1305.1	67%
5th Floor	718.0	576.1	80%	579.6	81%
6th Floor	1517.4	1457.4	96%	1517.4	100%
7th Floor	1529.2	1467.3	96%	1529.2	100%
8th Floor	1731.5	1533.0	89%	1575.1	91%
9th Floor	1569.5	1498.2	95%	1542.0	98%
10th Floor	1588.8	1519.3	96%	1588.8	100%
11th Floor	1376.6	1277.0	93%	1317.2	96%
12th Floor	1385.2	1318.1	95%	1385.2	100%
13th Floor	1387.5	1347.1	97%	1387.5	100%
14th Floor	1656.2	1553.5	94%	1611.2	97%
15th Floor	1661.6	1603.8	97%	1661.6	100%
16th Floor	1781.8	1645.8	92%	1781.8	100%
17th Floor	1521.0	1421.7	93%	1476.0	97%
18th Floor	1299.7	1296.7	100%	1299.7	100%
<b>Totals</b>	<b>28618.1</b>	<b>23515.3</b>	<b>82%</b>	<b>26013.1</b>	<b>91%</b>

<b>Percentage of Daylit Area</b>	<b>82%</b>
<b>Percentage of Area with Sufficient Views</b>	<b>91%</b>

### 3.4.3 Assessment of visual connection to the outdoors

“Maximize access to daylight and views” was one of the original objectives stated in the preliminary program and feasibility study (Kaplan McLaughlin Diaz, 1994). Following construction, the visual connection to the exterior environment is stated by the GSA as one of the central accomplishments of the SFFB tower, “a third accomplishment is the Federal Building’s high performance workplace in the upper tower. The narrow floor plates and the fact that the private offices are relegated to the interior mean that almost all have breathtaking views of the city or the bay.” (GSA, 2007). In the above statement, the narrow floor plate depth (68.2 ft) and the location of the open plan office workstations near the facade are given as indicators that occupants will have a satisfactory visual connection to the exterior. Visual connection to the exterior was demonstrated for the

final design using the simple method required for LEED v2.1 View credit compliance. This method requires that the design, “achieve direct line of sight to the outdoor environment via vision glazing between 2’6” and 7’6” above finish floor for building occupants in 90% of all regularly occupied areas.” In addition, the LEED reference guide recommends that the designers “design the space to maximize view opportunities.” **Table 3.2** shows that successful performance for the SFFB was achieved for all floors except the basement and the 4<sup>th</sup> floor. **Table 3.2** indicates that the tower section is anticipated to provide “views” for between 91 and 100 percent of occupants. It is important to note that the View credit is awarded without consideration for the permanent obstructions outside the vision glazing (e.g. the 50 percent perforated metal scrim or the translucent vertical glass louvers) or the potential for views to be occluded by operable shading devices. In addition, the “direct line of sight” criteria do not place a maximum limit on the distance of a compliant space from the facade.

#### **3.4.4 Assessment of photocontrolled electrical lighting energy**

In an interview conducted in the SFFB tower prior to occupancy, the project architect identified interior lighting as a significant electrical load and indicated that the use of daylight to offset electrical lighting energy consumption is a central objective of the design team’s energy strategy: “the estimates for lighting in office buildings, they range between 30 to 40 percent of the total energy use, so if we can absolutely obviate the need for them, and get rid of the heat gains that the lights may be putting into the space, we’ve gone a long, long way towards a sensible solution to the building” (Christ, 2006). To achieve this objective, photo-controlled electrical lighting was implemented in the final design for all overhead ambient lighting fixtures in the tower section, “there is a series of very inexpensive sensors that is going to be monitoring the daylight entering into the space, and when the lights are not required they will be dimmed down to zero” (Christ, 2006).

For participation in the California Savings by Design Incentive Program (SBD), an energy analysis was performed by ESS Engineering of San Francisco under contract with the Pacific Gas and Electric Company (PG&E). As a component of this analysis, the electrical lighting system proposed in the Final Concept Design of the SFFB was compared against a “GSA standard building.” For the purposes of this work, it was assumed that the GSA Standard Building is equivalent to the California Title 24 “Standard” in terms of overall efficiency levels for architectural, mechanical and lighting systems. The simulations assumed a task-ambient lighting design, which was the lighting design ultimately implemented in the SFFB tower sections. Task-ambient refers to designs in which a general uniform lighting system is supplemented with local task luminaires (Eley et al. 1993). Task ambient lighting design has the potential to consume less energy than conventional lighting designs because lower light levels can be specified for the general ambient lighting. This comparison was made to help facilitate the calculation of the PG&E SBD incentive, which is based on Title 24 (ESS, 2001). The report created by ESS focuses on demonstrating energy savings predicted from a number of energy conservation measures (ECMs) superior to the “GSA Standard,” which is

assumed to be equivalent to Title 24 “Standard” as described above. The EnergyPro v3.100 software program, which employs the DOE-2.1E calculation engine, was used to perform the analysis.

The contribution of photocontrolled lighting to energy “savings” was estimated by comparing the Lighting Power Density (LPD) of the standard building against the LPD estimated for the Final Concept Design, where the equivalent LPD was controlled by photocontrols. In the report, the high window-to-wall ratio and high VLT glazing were anticipated to enable a level of daylight transmission sufficient to “satisfy all or a significant portion of the lighting requirements in perimeter spaces during daylight hours.”

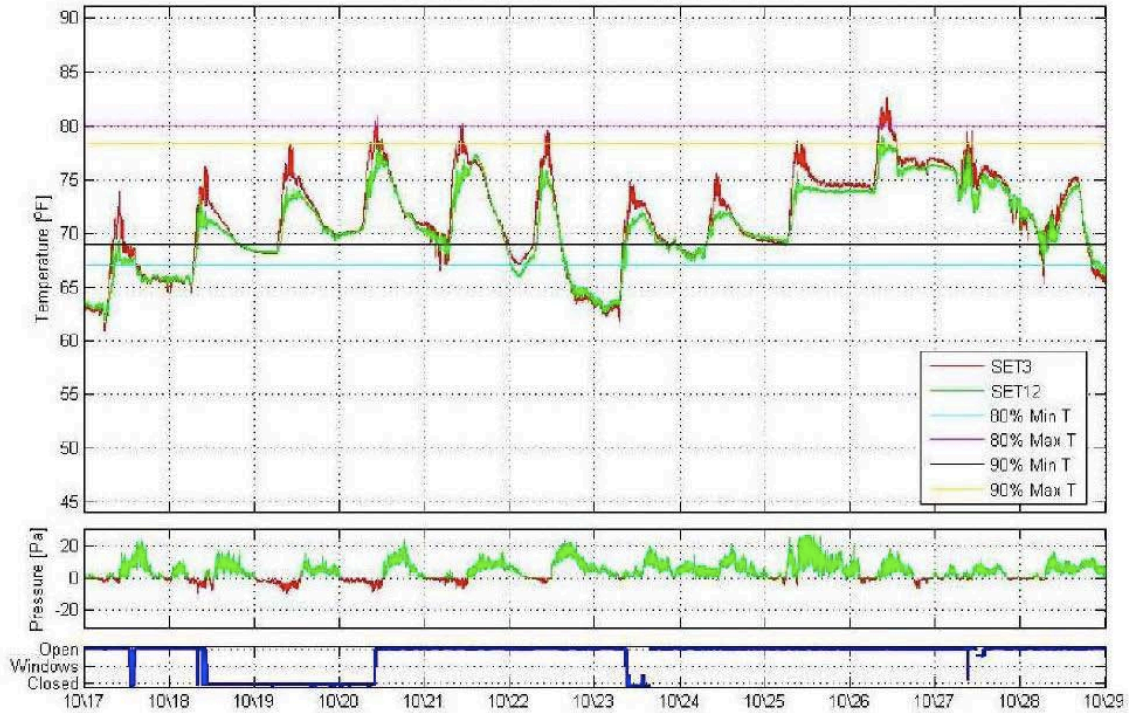
*This ECM calls for daylighting controls for lighting fixtures in areas that receive significant natural lighting. The design features a high window-to-wall ratio with high visible light transmittance glazing. With this design, natural lighting can be used to satisfy all or a significant portion of the lighting requirements in perimeter spaces during daylight hours. Fixtures with dimmable electronic ballasts controlled by photosensors will provide supplemental lighting to the spaces. Occupancy sensors are also included in this ECM.*

*The Standard lighting results in an LPD of 1.240 W/sq.ft. Implementing daylighting and occupancy sensor controls, together with the previous measure, (efficient task/ambient lighting system), will result in a reduction in overall effective LPD to 0.931 W/sq.ft (ESS, 2001).*

The simulation results showed that, compared to the base case, the photocontrolled lighting contributed to a 25% overall reduction in electrical lighting energy consumption annually.

### **3.4.5 Field assessment of thermal comfort prior to occupancy**

Prior to occupancy, LBNL staff instrumented the 6th floor of the tower, recorded measurements of air temperatures and air flows from mid-October 2006 through February 2007, and compared the results to the acceptable temperature range derived from the ASHRAE 2004 adaptive comfort model (**figure 3.17**).



**Figure 3.17** 6th floor southeast perimeter zone air temperatures on October 17-29, 2006. From Diamond et al. (2007).

The study found air drybulb temperatures along the southeast perimeter over a period of two weeks (**Figure 3.17**). The figure illustrates that for some mornings, the temperatures exceed the upper limit (80 deg. F) of the expected thermal comfort zone (i.e. below 80 deg. F, 80 percent of occupants are predicted to be satisfied with the thermal environment). Based on this field evaluation, the researchers concluded that the building is operating as expected, “the air temperatures in the tower are close to the expected values, with a rise in temperatures along the south facade in the morning.” In addition, LBNL analyzed the air flow and temperature measurements that were collected over a five-week period and found that the “measured air movement within the occupied space follows the paths identified during building modeling, with the exception of the flow in the interstitial space between the “lid” of enclosed offices and the bottom of the exposed slab.” This analysis also concluded the building is operating as expected in cooling mode, even with an observed rise in temperature on the south-facing facade during the morning. (Haves, Maile, Selkowitz, Diamond, and Linden, 2006). The LBNL report recommended that the GSA evaluate environmental conditions in the building during full occupancy as a “next step.”

### 3.4.6 Field assessment of visual comfort prior to occupancy

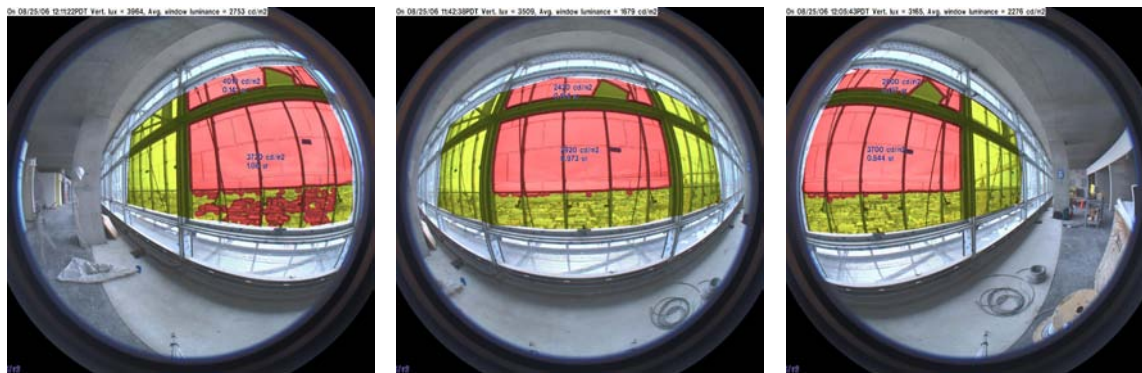
Prior to occupancy of the SFFB, research staff from LBNL conducted an assessment of the visual comfort conditions on the southeast and northwest facades using high dynamic range imaging to record luminance and a Licor photometer to record illuminance. The



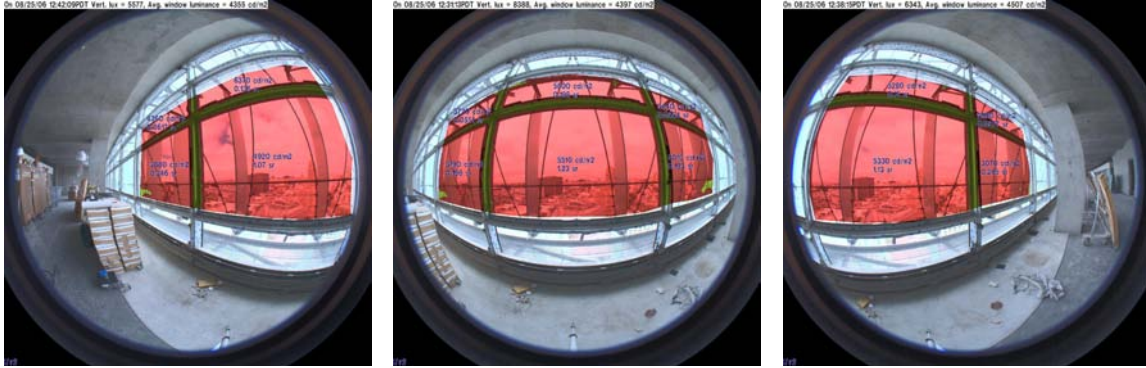
study was conducted under partly cloudy sky conditions on August 26, 2006 (on the 18<sup>th</sup> floor) and under clear sky conditions on January 12, 2007 (on the 16<sup>th</sup> floor). The industry guideline for office lighting (IESNA) recommendation for luminance contrast ration limits of (1:3:10) between primary task, near field, and far field surfaces was used as criteria to define a discomfort threshold limit of 2000 cd/m<sup>2</sup>. The discomfort limit of 2000 cd/m<sup>2</sup> is based on the assumption of a 200 cd/m<sup>2</sup> visual task and a 1:10 maximum acceptable luminance contrast, leading to 2000 cd/m<sup>2</sup>.

Under partly cloudy sky conditions (August 26, 2006), measured average window luminances on the north facade were reported at levels exceeding the discomfort threshold limit by a factor of two, (4000 cd/m<sup>2</sup>) and individual glare sources were reported at levels above (6000 cd/m<sup>2</sup>). Under clear sky conditions (January 7, 2007), average window luminances on the south exceeded (2000 cd/m<sup>2</sup>) and individual glare sources exceeded (4000 cd/m<sup>2</sup>) with the camera aimed so that it could not see the sun (**figure 3.18**).

Under clear sky conditions (January 7, 2007), measures of horizontal illuminance on work surfaces in direct sun on the southeast facade exceeded 10,000 lux, which is over 20 times the levels recommended by the IESNA. Measures of horizontal illuminance on work surfaces on the northwest that were not in direct sun were approximately 1000 lux. Measured work surface luminances exceeded 13,000 cd/m<sup>2</sup> and luminance ratios of a laptop screen versus its immediate surroundings reached 36:1, which far exceeds the IESNA recommended 3:1 ratio.



**Figure 3.18** South facade glare measurements, August 25, 2006. View from the first workstation closest to the window wall. Video display terminals (VDT) positioned at 45 deg diagonal from the window wall. Average luminance levels of outlined window (yellow) are 2753, 1679, and 2276 cd/m<sup>2</sup> (respectively from left to right). Glare sources indicated in pink, e.g., left photos shows two glare sources: the lower has an average luminance of 3720 cd/m<sup>2</sup> with a size of 1.06 sr and an upper glare source of 4010 cd/m<sup>2</sup> with size of 0.141 sr. From Lee et al. (2006).

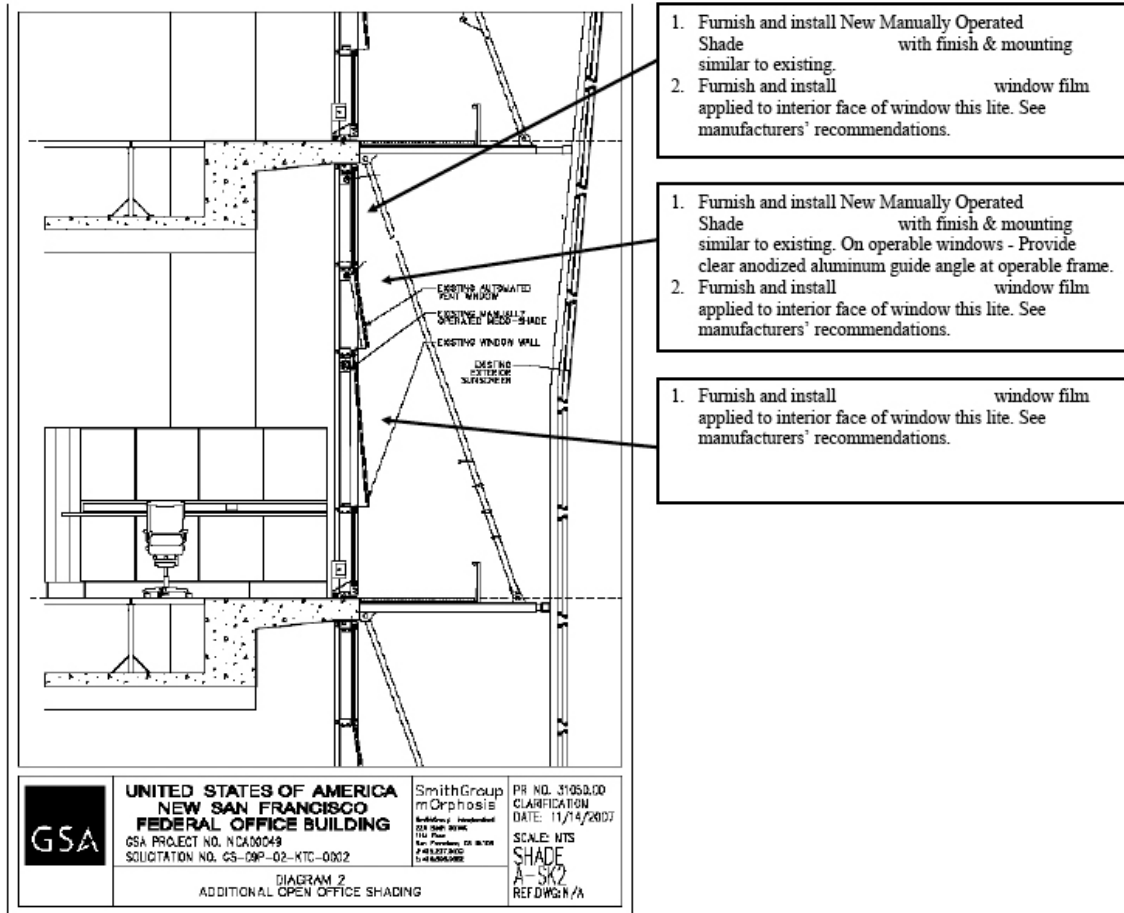


**Figure 3.19** North facade glare measures, August 25, 2006. Average window luminance was 4355, 4397, and 4507  $\text{cd}/\text{m}^2$ . Glare sources identified in left image: 2880  $\text{cd}/\text{m}^2$  at 0.246 st, 4920  $\text{cd}/\text{m}^2$  at 1.07 st, upper: 4350  $\text{cd}/\text{m}^2$  at 0.0617 st and 6370  $\text{cd}/\text{m}^2$  at 0.135 st. From Lee et al. (2006).

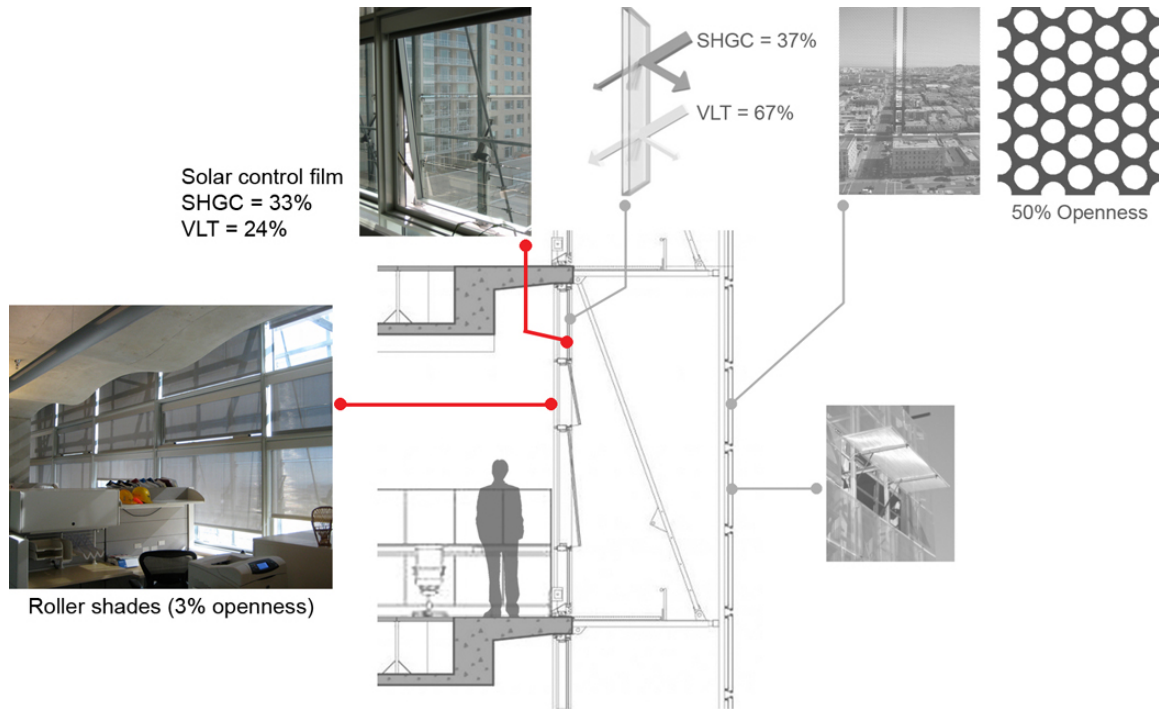
From their observations and analysis, the researchers concluded that occupants on the southeast facade were likely to experience loss of visibility and visual discomfort due to task shadowing, luminance contrasts, and direct view of the solar disc. And that discomfort glare on the northwest facade is likely to be more severe than on the south, due to the higher light transmittance of the northwest facade system (Lee et al., 2006). The researchers concluded that a solar control film would be insufficient to control glare discomfort from direct view of the solar disc, and recommended that the GSA consider installing blinds or shades to help control glare.

### 3.5 Facade retrofits completed after occupancy

Following initial occupancy of the building, three facade retrofits were installed to address issues related to glare and solar overheating. In response to complaints from occupants and recommendations from the LBNL field assessment of visual discomfort, the GSA coordinated an effort to retrofit the northwest and southeast facades with manually operated interior roller shades.



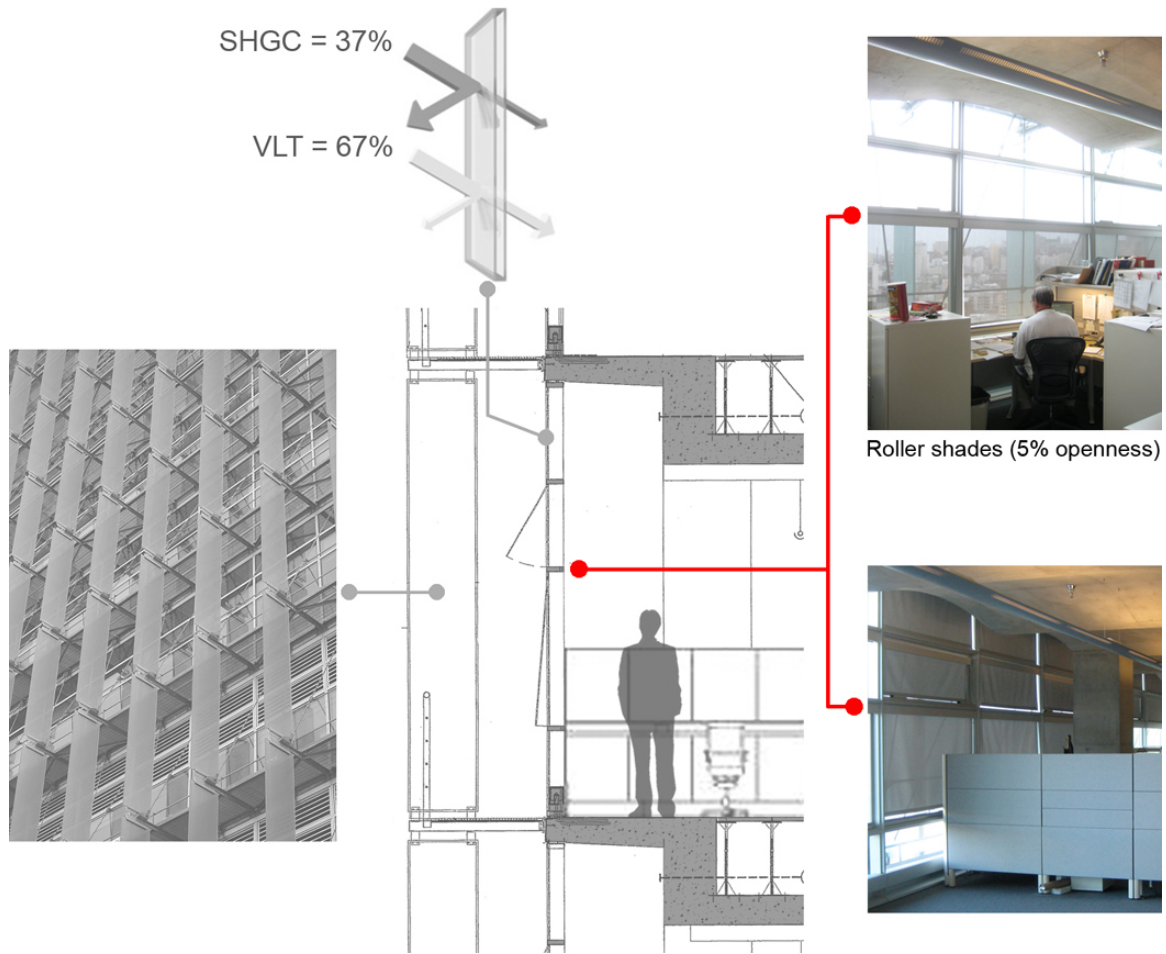
**Figure 3.20** Typical wall section through the southeast facade showing location and details for the solar control film and interior manually controlled roller shade retrofits. (Note: manufacturer details have been removed).



**Figure 3.21** Generic cross section of the SE facade showing additional solar control layers of solar control film and interior roller shades added during the facade retrofits.

From March 28, 2007 to July 13, 2007, interior roller shades ( color = grey, openness = 5%) were installed adjacent to the lower operable windows of both southeast and northwest facades. In response to complaints following the initial shading retrofit that the 5% openness fabric was not sufficient to control glare on the southeast facade<sup>17</sup>, from April 1, 2008 to January 15, 2009, the 5% openness roller shades on the southeast facade were replaced with 3% openness roller shades, and additional 3% openness roller shades were installed adjacent to the upper two sets of clerestory windows on the southeast facade as shown in **figure 3.22**. At the same time, the (0.67 VLT) glazing on the southeast facade was retrofit with a (0.24 VLT, 0.25 SHGC) solar control film, for a combined VLT of 0.16.

<sup>17</sup> From discussion with GSA staff, November 2009.



**Figure 3.22** Generic cross section of the NW facade showing additional solar control layer of interior roller shades added during the facade retrofits. Floor 8 was retrofit with shades for all windows above desk height. All other floors were retrofit with shades over only the vision windows.

The facade retrofits suggest a basic misunderstanding by the design team of the visual (and thermal) comfort conditions acceptable to occupants and indicate the inadequacy of the initial design assumption that the exterior shading would provide adequate solar control. In addition, the sequence of where additional shading was added to each facade (i.e. “vision” windows first, then upper “daylight zone” windows of the southeast facade only) indicates an initial assumption that shading would only be required to control direct sun striking occupants working in the perimeter. The subsequent modifications to the initial retrofit indicate that 5% openness fabric was insufficient to control direct sun and that the visual scene in occupants’ far field of view (e.g. brightness of upper clerestory windows) significantly affected the visual comfort of occupants working adjacent to the facade glazing.

### 3.6 Occupant subjective assessments of daylighting conditions after retrofits

In June 2009, following completion of the facade shading retrofits, the Center for the Built Environment (CBE) conducted an indoor environmental quality (IEQ) survey with survey invitations issued to over 1200 building occupants in the SFFB. When the survey closed in September 2009, there were 497 respondents. The CBE survey had 44 questions and additional targeted questions based on occupant responses. The questions covered the broad categories of thermal comfort, air quality, lighting, views, acoustic quality, communications, cleaning and maintenance, and overall satisfaction with the building. The survey results show that, following the facade retrofits, a large percentage of respondents remained dissatisfied with lighting (23%) and visual comfort (35%). To compare responses across different areas of the building, the survey asked for the general location of each respondent. The building locations defined in the survey are the tower-southeast (N = 121), tower-northwest (N = 228), tower-cabin (N = 37), tower-5th floor and below (N = 31), annex-perimeter (N = 33), and the annex-core (N = 34). When responses were compared across different zones of the building, the largest percentage of visual discomfort responses was reported by the tower-northwest group (41% dissatisfied, 21% “very dissatisfied” (figure 3.23). A large percentage of occupants from the tower-southeast zone (figure 3.24) was also dissatisfied with visual comfort (36%), and the tower-cabin zone had the lowest percentage of dissatisfaction (22%) among the tower groups (figure 3.25). Again, these responses reflect satisfaction after the retrofit installation of shading films and interior shades. The survey did not collect information regarding the position of user-controlled interior shades.

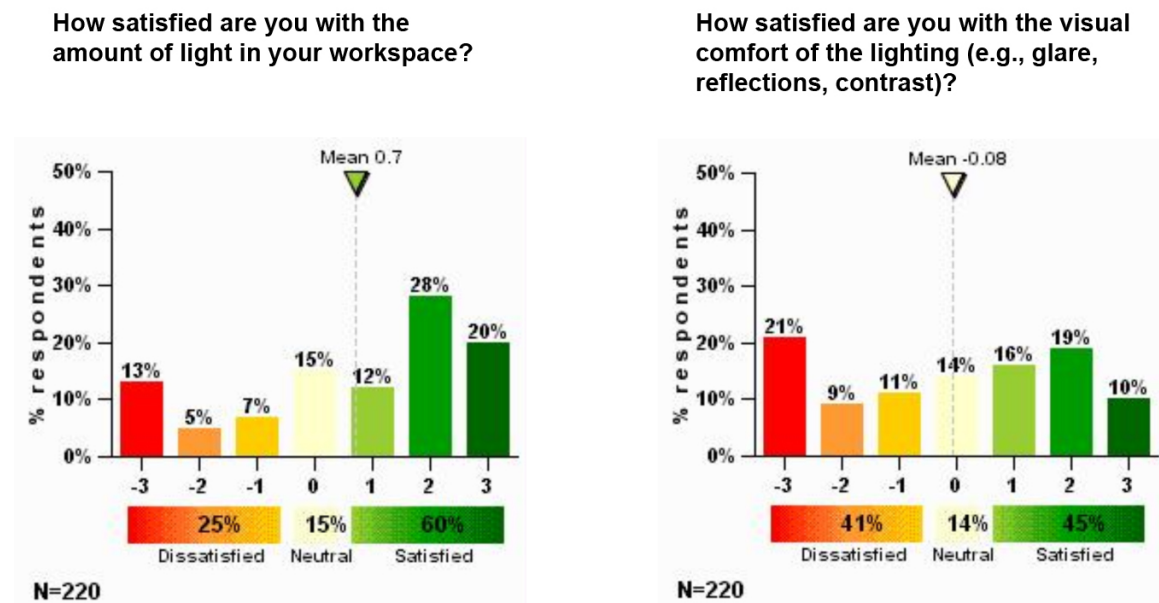
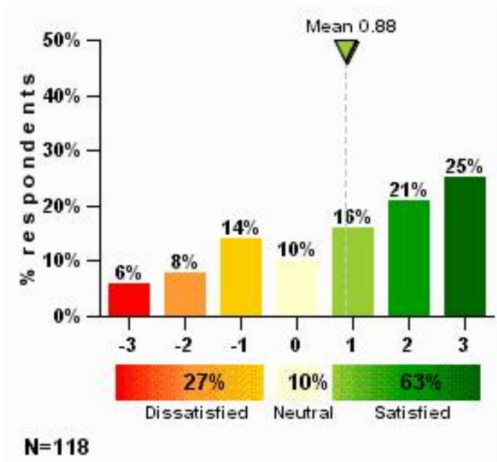


Figure 3.23 Responses to the CBE survey for the tower-northwest group (N = 220).

How satisfied are you with the amount of light in your workspace?



How satisfied are you with the visual comfort of the lighting (e.g., glare, reflections, contrast)?

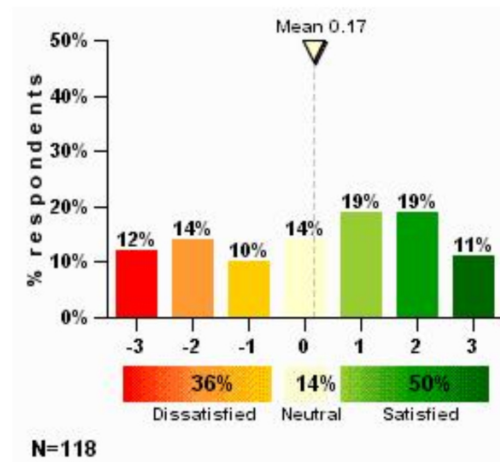
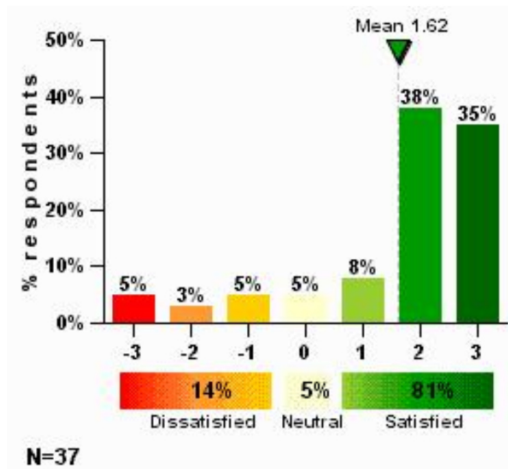


Figure 3.24 Responses to the CBE survey for the tower-southeast group (N = 118).

How satisfied are you with the amount of light in your workspace?



How satisfied are you with the visual comfort of the lighting (e.g., glare, reflections, contrast)?

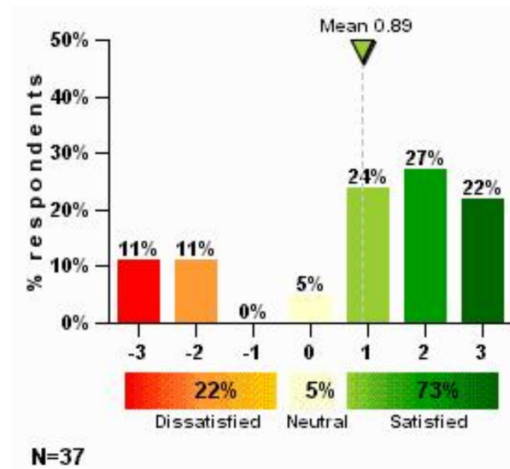
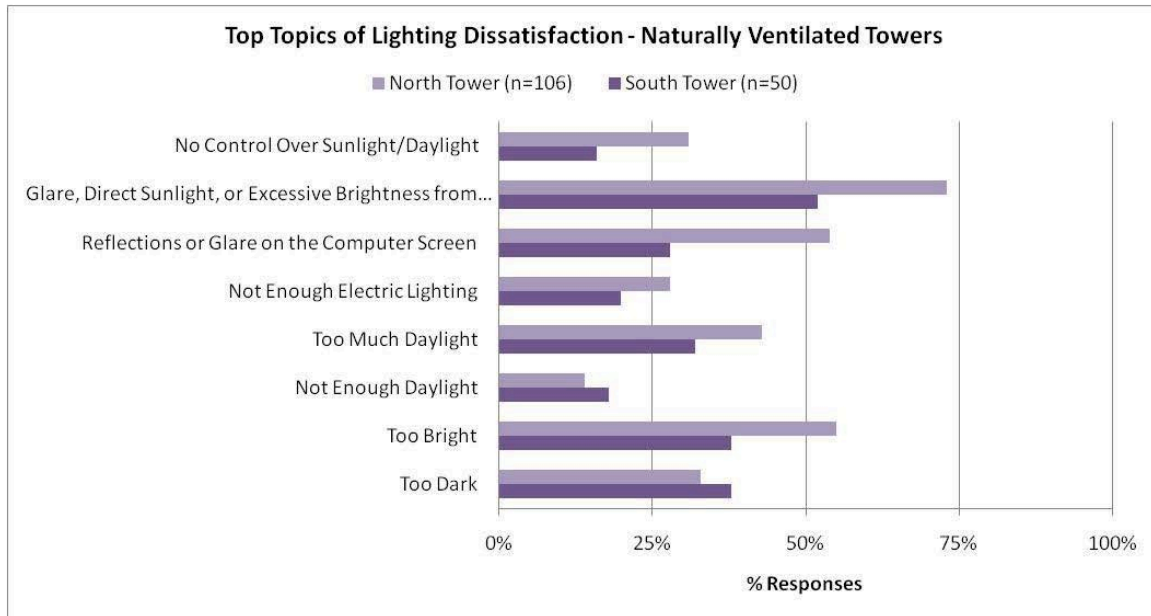


Figure 3.25 Responses to the CBE survey for the tower-cabin group (N = 37).

The survey asked occupants located in the tower who expressed dissatisfaction with lighting a targeted follow up question regarding the cause of their dissatisfaction. The most frequently reported source of dissatisfaction was “glare, direct sun, or excessive brightness from windows” followed by “reflections or glare on computer screen” and “too bright” (figure 3.26). And for most causes of lighting dissatisfaction in this follow up question, responses were more frequent for the northwest group than for the southeast group. These data support the predictions made by LBNL staff that visual discomfort conditions would be worse for the northwest perimeter zone. And overall, the results

indicate that the shading retrofits failed to create a satisfactory level of visual comfort for a large percentage of occupants<sup>19</sup>. However, the results do not explain how frequently discomfort conditions occur, or when they occur. In addition, because the subjective assessments were not paired with physical measures (such as those recorded prior to occupancy by LBNL), the results cannot be directly compared to physical measures of luminance or illuminance to better characterize the discomfort conditions.



**Figure 3.26** Top topics of lighting dissatisfaction for the tower groups.

<sup>19</sup> It is important to note that the northwest and southeast perimeter zone workstations characterize the majority of workspaces in the SFFB.



### 3.7 Summary and questions

This chapter establishes satisfactory levels of daylight transmission and views for occupants and the reduction of electrical lighting energy with photocontrols as important performance objectives of the SFFB. However, comparison between the consideration given to thermal comfort concerns and the consideration given to visual comfort concerns illustrates an important contrast in these two broad and overlapping aspects of indoor environmental quality. Thermal comfort performance was studied from the initial design phase with support from LBNL and UC Berkeley staff with expert knowledge in naturally-ventilated buildings and computer-based energy simulation. Established performance indicators (MRT, drybulb temp.), an emerging consensus-based thermal comfort model (ASHRAE 2004, Standard 55 Adaptive Model) developed from field data, and an established acceptability range (min. 80% of occupants satisfied) were used to evaluate the performance of a range of facade design options using sophisticated simulation tools (EnergyPlus, CFD analysis). This collaborative effort resulted in three scholarly publications documenting design intent, methods and simulated outcomes (McConahey et. al., 2002; Haves, 2004; Carrilho de Graca et al., 2004). The building was then studied prior to occupancy to assess if physical measures of dry-bulb temperature matched design expectations. Although the overall approach underestimated the thermal discomfort associated with direct solar gains, it serves as a model for how field-based measures of occupant comfort can inform design decision making and establish confidence among stakeholders for design strategies outside of conventional practice.

In contrast to the approach used to assess thermal comfort, no documentation was found describing what indicators were used during design to gain confidence that the design strategies under consideration would result in satisfactory levels of visual comfort for occupants. Although statements were found describing the function of the windows and interior surfaces to reduce glare and enable daylight transmission, the details of how these objectives are achieved are described in general and “optimistic” terms: “Ambient light, the general illumination in an office, comes from sunlight channeled through the windows and reflected off walls and ceilings to extend its reach with minimum glare and intensity” (Morphosis, 2011). The retrofits made to the facade to reduce visual discomfort demonstrate that the exterior solar control strategies implemented were insufficient to provide a visually comfortable environment for occupants. This outcome illustrates the importance of evaluating the potential for visual discomfort during the design process. However, to assess the potential for visual discomfort during design, design teams require validated indicators as well as criteria for how to interpret them in order to make design decisions. Given the limited amount data from buildings in use validating visual discomfort indicators, the first step is to establish a method where discomfort indicators can be validated against occupant subjective assessments in the field.

Given that occupant control of shading devices and the installation of glazing retrofits (e.g. solar control films) have the potential to significantly limit interior daylight availability and views, this research seeks to establish feedback for design teams

describing the performance of the SFFB in use relative to design intent of electrical lighting energy reduction from photocontrols, daylight sufficiency and view. Therefore, this study asks the additional question:

1. Following the facade retrofits, are the original design objectives of daylight sufficiency, visual connection to the exterior, and electrical lighting energy reduction from photocontrols achieved in use?

In addition, this research seeks to improve the tools available to collect human-factors data from buildings in use with an emphasis on describing the daylighting conditions acceptable to building occupants and the concept of establishing visual comfort models from field-based data. Following the facade retrofits, the CBE survey showed that significant percentage of survey respondents located on the NW and SE perimeter zones were dissatisfied with the visual comfort conditions in their workspace. Therefore, this research additionally asks:

2. What are the physical conditions associated with subjective assessments of visual discomfort? And, how frequently do they occur in the SFFB following the facade retrofits? What is the relationship between stimulus intensity and occupant subjective assessment of visual discomfort?

Answers to the first question are important to create a body of evidence for why the SFFB should (or should not) serve as a prototype of successful daylighting design. Answers to the second are important for improving the level of guidance available during design to predict the physical conditions and stimulus intensities associated with visual discomfort.

## CHAPTER 4

### RESEARCH METHODS

#### 4.1 Introduction

Existing field methods for assessing the performance of daylit buildings typically focus on only one of several important sources of information: observations of the positioning of shading devices by occupants, electrical lighting energy consumption, physical measures of interior lighting conditions, or IEQ subjective surveys. The primary methodological objective of this research was to pair subjective responses with physical measures of environmental variables to compare subjective outcomes with existing criteria for success or failure and to develop field-based models of visual discomfort and shade operation. Daylight and visual discomfort conditions in a daylit space are highly variable as a result of daily and seasonal changes in sun and sky conditions as well as the changing position of shading devices, therefore, a longitudinal repeated measures approach was taken to reduce the variability introduced by these factors. An additional methodological objective was to study occupant behavior and subjective assessment without significant intervention in the environmental conditions and patterns of behavior in real office work environments. The study applied two primary methods to meet these objectives. First, time-lapse imaging using a high dynamic range (HDR) image format was used to record occupant control of interior roller shades and measure interior luminances. Second, a novel desktop polling station device was developed to serve as an interface for occupants to record their subjective assessment of environmental conditions multiple times each day. The polling station's survey methods draw upon methods used in cross-sectional field studies that pair subjective response with physical measures but adapt them to a longitudinal, repeated-measures study design. A number of additional methods, including interviews, archival research, observations, exterior physical measures, a survey questionnaire, and monitoring of electrical lighting energy were also used to address the research objectives.

Prior to the start of the field study, several prototypes of the polling station were developed and tested for operational reliability and to refine the process of user interaction. Additionally, several visits were made to the SFFB to make site observations and meet with building management and prospective study participants. The visits helped to identify the core and perimeter zones used in the field study, appropriate placement of polling stations and equipment, and to refine and clarify the questions used to collect subjective data from building occupants.

This chapter begins by describing the study variables and the instruments used. The chapter then describes the study procedure and analysis techniques.

## 4.2 Study Variables

**Tables 4.1** and **4.2** describe the dependent and independent variables measured during the field study. The dependent variables represent performance outcomes of interest, namely: occupant control of shading devices, occupant subjective assessment of IEQ factors related to daylight transmission, and electrical lighting power. **Table 4.3** provides a list of the confounding factors used to group study participants, schedule monitoring phases during the field study, and as controls during data analysis.

**Table 4.1** Dependent variables

---

Occupant control of roller shades	<ol style="list-style-type: none"> <li>1. Roller shade lowering event</li> <li>2. Roller shade raising event</li> </ol>
Occupant "right now" subjective assessment	<ol style="list-style-type: none"> <li>1. Satisfaction with thermal comfort</li> <li>2. Thermal preference</li> <li>3. Level of satisfaction with amount of daylight</li> <li>4. Daylight preference</li> <li>5. Level of satisfaction with position of roller shades on view to outdoors</li> <li>6. Subjective assessment of visual discomfort from windows</li> <li>7. Subjective assessment of daylight sufficiency*</li> </ol>
Overall satisfaction with view	<ol style="list-style-type: none"> <li>1. Satisfaction level with visual connection to outdoors</li> </ol>
Electrical lighting	<ol style="list-style-type: none"> <li>1. Electrical lighting power (average over 15 minute intervals)</li> </ol>

**Table 4.2** Independent variables

---

Thermal comfort	<ol style="list-style-type: none"> <li>1. Indoor air temperature at the workspace</li> <li>2. Indoor globe temperature at the workspace</li> <li>3. Mean radiant temperature (MRT)</li> <li>4. Transmitted solar irradiance at the workstation</li> </ol>
Daylight sufficiency	<ol style="list-style-type: none"> <li>1. Global horizontal illuminance at the workplane</li> <li>2. Daylight factor (DF)</li> </ol>
Visual comfort	<ol style="list-style-type: none"> <li>1. Daylight glare indices (DGI, CGI, UGR)</li> <li>2. Vertical illuminance</li> <li>3. Average window luminance</li> <li>4. Maximum window luminance</li> <li>5. Ratio of average window luminance to background luminance</li> </ol>
Facade occlusion	<ol style="list-style-type: none"> <li>1. Occupant position of shading devices (facade occlusion index)</li> <li>2. USGBC LEED View EQ credit compliance criteria</li> </ol>
Exterior weather	<ol style="list-style-type: none"> <li>1. Global horizontal illuminance on roof</li> <li>2. Global vertical illuminance on NW and SE facades</li> <li>3. Exterior air temperature (measured at the roof)</li> </ol>

**Table 4.3** Confounding factors

---

1. Participant view direction (when viewing computer monitor)
2. Facade orientation
3. Facade exterior solar control elements (e.g. glass fins)
4. Facade retrofits (e.g. presence of roller shades, solar control film)
5. Contribution of electrical lighting to illuminance at the workplane
6. Participant depth from facade (e.g. core vs. perimeter zone)
7. Exterior sky conditions (clear, dynamic)
8. Seasonal changes in solar position

## **4.2.1 Dependent variables**

### **4.2.1.1 Occupant control of roller shades and facade occlusion**

To investigate the relationship between occupant shade control actions (e.g. raise and lower events) and physical environmental measures, occupant shade control actions were considered a dependent variable. In addition, because the lowering of shading devices has the potential to diminished views, the positioning of shading devices was considered as an independent variable in the relationship between the level of facade occlusion and overall level of occupant satisfaction with visual connection to the outdoors. The procedures used to record occupant shade control events as well as to summarize shade positioning over time are described in **Section 4.7.3.4**.

### **4.2.1.2 Occupant “right now” subjective assessment**

Occupant “right now” subjective assessments, gathered by the desktop polling station, were considered as dependent variables to investigate the relationship between occupant subjective assessment with existing quantitative indicators of successful performance. A description of the desktop polling station used to administer the repeated-measures “right now” surveys is provided in **Section 4.7.4**. Because existing research on occupant control of shading devices reports that shading devices are deployed to reduce thermal discomfort from direct sun, subjective assessment of thermal comfort was included to investigate the thermal sensation of participants in response to transmitted solar irradiance and an approximation of Mean Radiant Temperature (MRT). The polling station survey contained two questions addressing thermal comfort.

---

<b>(Q1) How satisfied are you with your level of THERMAL COMFORT right now?</b>						
Very dissatisfied	Moderately dissatisfied	Slightly dissatisfied	Neutral	Slightly satisfied	Moderately satisfied	Very satisfied
<b>(Q2) (If dissatisfied) Would you prefer to be COOLER or WARMER right now?</b>						
Prefer to be COOLER			Neutral (prefer no change)			Prefer to be WARMER

---

The (McIntyre, 1980) thermal preference scale (prefer cooler, no change, prefer warmer) was used for Q2.

There is no consensus-based rating scale for subjective assessment of daylight sufficiency. The polling station survey asked participants to assess daylight sufficiency using two separate approaches. Existing approaches to phrasing questions for subjective assessment of daylight sufficiency include the Center for the Build Environment (CBE) IEQ daylighting module (CBE, 2011) which uses the phrasing, “*How satisfied are you with the amount of daylight in your workspace?*” and uses a 7-point satisfaction rating scale. Another approach, used by (HMG, 2003), asks respondents to rate how often the lighting in their workspace was “just right,” “too bright,” “too dim,” “too glaring,” and “too dull” on a 7-point frequency scale from “never” to “always.” A branching question then asked respondents who were dissatisfied to choose from a number of potential sources of dissatisfaction that included “too much daylight,” and “not enough daylight.” Both approaches rely on the assumption that occupant satisfaction with daylight is related to the perceived magnitude of daylight in the workspace. To examine this assumption in a real daylit work environment, Q3 used the CBE language and rating scale. This decision was based, in part, on the fact that this question was used to examine satisfaction with daylight in the CBE survey of SFFB occupants conducted in 2009 (as described in Chapter 3, **section 3.6**).

---

<b>(Q3) How satisfied are you with the AMOUNT of DAYLIGHT in your workspace right now?</b>						
Very dissatisfied	Moderately dissatisfied	Slightly dissatisfied	Neutral	Slightly satisfied	Moderately satisfied	Very satisfied
<b>(Q4) (If dissatisfied) Would you prefer LESS or MORE daylight in your workspace right now?</b>						
Prefer LESS daylight			Neutral (prefer no change)			Prefer MORE daylight

---

This phrasing was also chosen because it can be used to examine the hypothesis used by the LEED Daylight EQ credit compliance criteria that workplane illuminance from daylight between 300 and 2000 lux will create satisfactory daylighting conditions for occupants. To investigate this hypothesis further, a branching question, adapted after (McIntyre, 1980) was included to examine the relationship between dissatisfied responses and preference for more and less daylight with physical measures of horizontal illuminance.

The second approach was to phrase the assessment of daylight sufficiency in terms of the need for electrical lighting rather than occupant satisfaction. Occupants were asked to consider if the overhead electrical lighting was necessary to work comfortably. This question is adapted from a survey module used by the Heschong Mahone Group in a research project focused on developing and validating climate-based daylighting metrics which collected subjective feedback from occupants in the field from a number of daylit buildings (HMG, 2010). The original question was presented in an agree/disagree form, and phrased as: “I can work happily in this room with ALL of the electric lights turned off (using only daylight).” In this study, the question was phrased:

---

<b>(Q7) Could you work COMFORTABLY with the overhead ELECTRICAL LIGHTING turned OFF right now?</b>		
No, there is not sufficient daylight	Neutral (don't know)	Yes, there is sufficient daylight

---

Because each occupant had access to a built-in task light, this question effectively asked participants if daylight was sufficient for them to work comfortably with daylight as the only source of ambient lighting. The source of electrical lighting referenced in this question was reviewed with study participants when polling stations were distributed to resolve confusion. It is important to note that this question is somewhat problematic in that occupants responded to the question while working with some contribution of electrical lighting to total workplane illuminance. Therefore, occupants were not assessing an environment where the ambient lighting was provided solely by daylight. However, as shown in Chapter 10, the contribution of electrical ambient lighting to total workplane illuminance in the perimeter zones was found to be relatively low compared to daylight (less than 5% for the majority of daylit hours).

Similar to daylight sufficiency, there is no agreed-upon procedure for subjective assessment of window view “performance” in buildings. Notably, no discussion of access to window views is included in the ASHRAE PMP (ASHRAE, 2010). And, the LEED View EQ credit assumes that occupant views to the exterior will be unobstructed by shading devices when compliance criteria is considered (USGBC, 2009). Subjective assessment of view requires the researcher to consider what aspects of window view are of interest. For example, a field study by the HMG considered the interest level, occlusion level (e.g. blind properties and position), and visual content of window views (HMG, 2003). In the study of the SFFB, the relationship between the window occlusion created by shading devices to occupant perception of access to views of the outdoors was of interest. Therefore, occupants were instructed that the “right now” survey question was asking them to rate their level of satisfaction with the current position of the shading devices on their ability to see clearly through the facade to the outdoors. Participants were instructed that this question was not asking them to rate the “quality” of what they saw outdoors (e.g. the quality of the Civic Center Plaza). The question was phrased as follows:

---

<b>(Q5) How satisfied are you with the position of the SHADES on your VIEW to the OUTDOORS right now?</b>						
Very dissatisfied	Moderately dissatisfied	Slightly dissatisfied	Neutral	Slightly satisfied	Moderately satisfied	Very satisfied

---

For the question regarding visual discomfort from windows (Q6), a modified version of the 7-point subjective scale (4-points rather than 7) was used rather than one of the multiple existing daylight glare subjective criteria (e.g. the Daylight Glare Index (DGI): “Imperceptible”, “Just perceptible,” “just acceptable,” just uncomfortable,” “just intolerable”). The basis for this decision is that existing glare criteria are notoriously ambiguous (e.g. what is the difference between “Just perceptible” and “just acceptable,” glare?). In addition, using the negative end of the same subjective scale as Q1, Q3, and Q5 enabled the survey to have greater intelligibility for participants.

---

<b>(Q6) Please rate your level of VISUAL DISCOMFORT from WINDOWS right now.</b>			
Very uncomfortable	Moderately uncomfortable	Slightly uncomfortable	No discomfort

---



### 4.2.1.3 Electrical lighting power

A basic assumption of photocontrolled lighting systems is that electrical lighting power will be minimized when available daylight exceeds the threshold set for minimum workplane illuminance. Therefore, electrical lighting power of photocontrolled lighting zones was considered a dependent variable and examined in relation to measures of horizontal daylight illuminance at the workplane. A description of the procedure for acquiring electrical lighting power data in the SFFB is provided in Chapter 10.

## 4.2.2 Independent variables

The following sections describe the physical measures acquired for comparison to occupant subjective assessments and control of shading devices. A description of the instruments used to collect these measures begins in **Section 4.7**.

### 4.2.2.1 Thermal comfort

The variables selected to assess thermal comfort are MRT and transmitted solar irradiance. MRT values were approximated from measures of globe and air temperature. Measures of globe temperature are described in **Section 4.7.4.3**. The simplified equation used in this study for deriving MRT under still air is:

$$MRT = T_{air} + [(T_{glo} - T_{air}) \cdot 2] \quad (4.1)$$

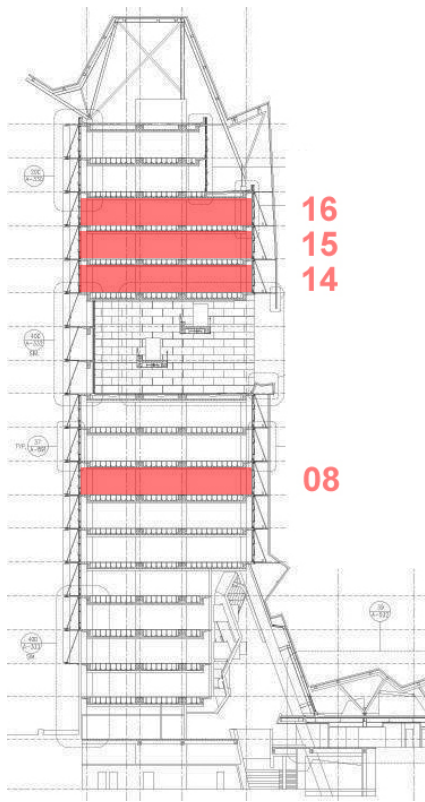
Although the SFFB is designed with operable windows at desk height, these windows were rarely observed in an open state, therefore the approximation of MRT using the simplified equation was considered acceptable. The strategy was also necessary due to the expense and difficulty of gathering accurate interior air velocity data. Transmitted solar irradiance was included because it has been commonly used in previous research to predict the lowering of shading devices by occupants to reduce thermal discomfort from solar overheating.

### 4.2.2.2 Daylight sufficiency

Daylight sufficiency was assessed using the measures specified by the daylight autonomy and daylight factor approaches. Both approaches specify measures of global horizontal illuminance at the workplane. This measure additionally allows existing recommendations for minimum workplane illuminance (e.g. 300, 500 lux) from the electrical lighting industry to be assessed against occupant subjective responses to (Q7). To calculate the daylight factor, global horizontal illuminance was measured on the roof of the SFFB.

### 4.3 Description of zones within the SFFB studied

The SFFB has an 18-story tower, four story annex, day care center, and cafeteria. As a result of the location of departments willing to participate in the study, the study was conducted on the upper floors (8, 11, 14-16) of the tower section as illustrated in **figure 4.1**. Each floor of the tower section measures 106.2 m (348 ft) long by 20.8m (68.24 ft) wide. Because depth-from-façade and facade orientation (e.g. NW vs. SE), were considered confounding variables in this study, study participants were organized by physical location on the floor plan into three groups: NW perimeter zone (**figure 4.2**), SE perimeter zone (**figure 4.3**), and core (**figure 4.4**). Because this study was conducted on the upper floors of the tower section, controlling for facade overshadowing by horizon obstructions was not required.



**Figure 4.1** Cross-section through the SFFB tower section showing the floors where participants were located. Although participants were located on 4 unique floors, the majority of participants were located on the 16<sup>th</sup> floor.



**Figure 4.2** Overview of NW perimeter zone. Image taken after facade retrofits.



**Figure 4.3** Overview of SE perimeter zone. Image taken after facade retrofits.



**Figure 4.4** Overview of open-plan core zone. Image taken after facade retrofits.

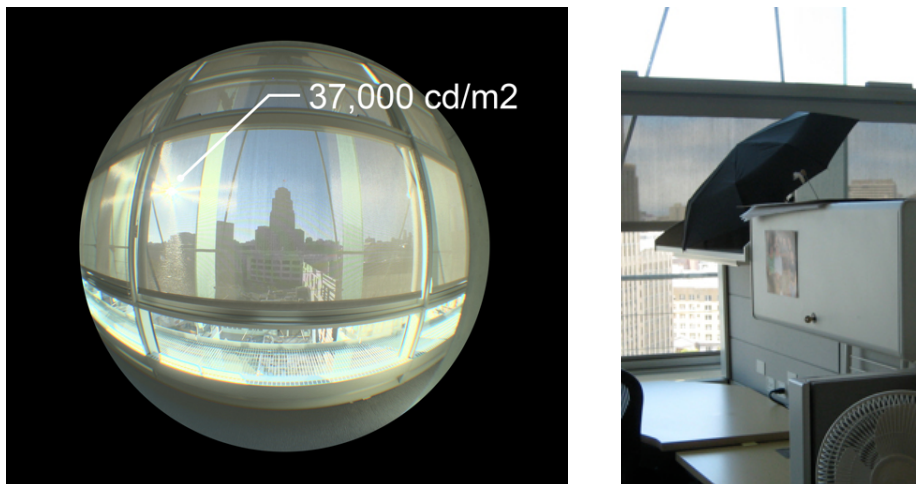
#### **4.4 Scheduling of test phases**

The monitoring approach was designed around short term (i.e. 2-3 week) monitoring of the SFFB strategically distributed across the year to allow inferences from short-term monitoring to inform an understanding of annual performance. Because seasonal changes in solar conditions were anticipated as a confounding factor in this study, the design of the study was initially structured to monitor each participant group (NW, SE, core) over two-week intervals near summer solstice, fall equinox, and winter solstice conditions. Because of the limited number of polling stations and HDR cameras (N=15) in relation to the number of participants who ultimately volunteered (N=44), the study proceeded by rotating measurement equipment from group to group (e.g. NW to SE to core) sequentially. As a result of a long delay in recruiting sufficient participants to create the first “core” group as well as an extension to the second monitoring phase in order to collect data during clear sky conditions, the initial objective of studying each group three times over a solstice-to-solstice interval had to be revised to two times. The decision to revise the structure to two monitoring phases per group was also driven by participant feedback suggesting that a number of participants would only be willing to participate in two monitoring phases. Therefore, scheduling for each group followed the monitoring phases presented in **table 4.4**.

**Table 4.4** Summary of study test phases

Phase	Location	N	Start Date	End Date	Wk.days	Period of year
1	NW Perim.	11	7/12/2010	7/29/2010	15	summer solstice
2	SE Perim.	14	8/2/2010	9/3/2010	25	fall equinox
3	Core	14	10/4/2010	10/15/2010	10	fall equinox
4	NW Perim.	11	10/18/2010	10/29/2010	10	fall equinox
5	SE Perim.	9	11/8/2010	11/19/2010	10	winter solstice
6	Core	8	12/6/2010	12/17/2010	10	winter solstice

As shown in **table 4.4**, the final scheduling of the monitoring phases achieved the objective of recording occupant subjective assessment for both (NW and SE) perimeter zone groups during near “worst case” solar control conditions (N indicates the number of participants in each phase). For the NW facade, solar analysis, observation of personal modifications, previous research (LBNL, 2007), and comments from building occupants indicated that “worst case” conditions occurred near the summer solstice when the NW facade received the most hours of direct sun. An example of these conditions is provided by **figure 4.5**. For the SE facade, similar sources indicated that “worst case” conditions would occur near the winter solstice, when the sun was at a relatively low altitude angle (**figure 4.6**, right). These periods of the year were of interest for the question of whether sufficient daylight transmission was achieved when the facade was required to provide solar control for the most extreme cases of direct sun. Similarly, near-equinox solar control conditions were monitored for both NW and SE facade groups. These conditions provided data to more confidently make inferences for occupant control of shading devices and subjective assessments during solar conditions more representative of the majority of the year. As a result of the delay in recruiting sufficient core participants, the core monitoring phases included fall equinox conditions and winter solstice conditions. These conditions provide data representing “typical” and “worst case” conditions in terms of daylight availability. Data for each phase are presented and discussed separately.



**Figure 4.5** (Left) View from generic shaded NW viewpoint. (Right) Observed user modification to control direct sun in NW perimeter zone workstation.



**Figure 4.6** Examples of depth of direct sun penetration on the SE facade during Phase 2 (left: September 2, 11:15 AM PST) and Phase 5 (right: November 9, 8:30 AM PST). Images are taken from areas of the SFFB that were unoccupied during the study.

## 4.5 Participants

The following two sections describe the process used to recruit study participants and summarize participant descriptive information.

### 4.5.1 Participant recruitment

Because this research involved collecting data from human subjects, prior to beginning the field study, the study objectives and procedure were submitted to, and reviewed by, the UC Berkeley Committee for the Protection of Human Subjects (CPHS). The recruitment phase of the study followed approval by the CPHS. A representative of the General Services Administration (GSA) facilitated the recruitment of participants. The GSA representative obtained initial approval for the researcher to contact potential participants by circulating a description of the study to department managers. The study description included a summary of the study procedures, rationale, duration, risks and benefits, data privacy, and the researcher's contact information for prospective participants' questions or concerns. If a department manager was willing to allow his/her staff to participate, the manager then circulated the study description to all staff members.

Prospective participants attended a 2-hour informational meeting where the study was explained by the researcher followed by a question and answer session. Willing participants were then asked to write their names and email addresses on a list at the end of the meeting. All prospective participants were informed that they could choose to stop participating at any point during the study. As a result of the approval process beginning at the department level, the majority of participants were from one department located on

the 15<sup>th</sup> and 16<sup>th</sup> floors. Several additional participants were recruited from the 8<sup>th</sup>, 11<sup>th</sup>, and 14<sup>th</sup> floors.

#### **4.5.2 Summary of participant descriptive information**

**Table 4.5** provides descriptive information on the study participants. Data were collected from 44 unique participants (38% male, 62% female) from the SFFB, with an approximately equal number of participants recruited from each zone (NW perimeter: N=12, SE perimeter: N=18, core: N=14). Forty-three percent (43%) of participants were between the ages of 30-40, (36%) were between the ages of 40 and 50, and the remainder were above 50 (21%). Participant workstations along the perimeter zones are oriented so that occupants face the facade at a 45-degree angle. Because the SFFB is oriented 45-degrees from north, north-facing or west-facing views result for participants on the NW perimeter zone, and east-facing and south-facing views for participants on the SE perimeter zone. Workstations located in the core generally face perpendicular to one of the facades, leading to NW-facing views or SE-facing views for core participants. In **table 4.5**, view directions labeled “away” indicate that the participant had oriented his or her view away (perpendicular) from the facade. This adjustment represents a behavioral modification to the original workplace layout.

**Table 4.5** Participant descriptive information

N	Workstation location	Depth from facade (feet)	View direction	Gender	Age	Shades installed on upper windows	Participated in test phases
1	NW perimeter	3	W	f	30-40	No	1 and 4
2	NW perimeter	3	W	m	30-40	No	1 and 4
3	NW perimeter	3	W	f	30-40	No	1 only
4	NW perimeter	3	W	f	30-40	No	1 and 4
5	NW perimeter	3	N	f	30-40	No	1 and 4
6	NW perimeter	3	N	m	40-50	No	1 and 4
7	NW perimeter	3	away	f	40-50	No	1 and 4
8	NW perimeter	3	away	f	30-40	No	1 and 4
9	NW perimeter	3	N	m	40-50	No	4 only
10	NW perimeter	3	W	f	30-40	Yes	1 and 4
11	NW perimeter	3	N	f	50-60	Yes	1 and 4
12	NW perimeter	3	W	m	40-50	Yes	1 and 4
13	SE perimeter	3	S	m	30-40	Yes	2 only
14	SE perimeter	3	E	f	40-50	Yes	2 and 5
15	SE perimeter	3	S	m	30-40	Yes	2 only
16	SE perimeter	3	E	f	50-60	Yes	2 only
17	SE perimeter	3	E	f	40-50	Yes	2 only
18	SE perimeter	3	S	m	30-40	Yes	2 only
19	SE perimeter	3	S	m	30-40	Yes	2 only
20	SE perimeter	3	E	m	40-50	Yes	2 only
21	SE perimeter	3	E	m	30-40	Yes	2 only
22	SE perimeter	3	E	f	40-50	Yes	2 and 5
23	SE perimeter	3	S	f	40-50	Yes	2 only
24	SE perimeter	3	E	f	50-60	Yes	2 and 5
25	SE perimeter	3	S	m	50-60	Yes	2 and 5
26	SE perimeter	3	S	f	40-50	Yes	2 and 5
27	SE perimeter	3	E	f	30-40	Yes	5 only
28	SE perimeter	3	E	f	40-50	Yes	5 only
29	SE perimeter	3	S	f	40-50	Yes	5 only
30	SE perimeter	8	E	f	50-60	Yes	5 only
31	Core	20	NW	f	30-40	Yes	3 and 6
32	Core	22	SE	f	40-50	Yes	3 and 6
33	Core	22	NW	m	40-50	No	3 and 6
34	Core	26	NW	f	30-40	No	3 only
35	Core	19	SE	f	40-50	Yes	3 and 6
36	Core	22	NW	f	50-60	No	3 and 6
37	Core	22	SE	m	40-50	Yes	3 only
38	Core	33	NW	f	30-40	No	3 and 6
39	Core	33	NW	f	30-40	No	3 and 6
40	Core	30	NW	m	50-60	No	3 and 6
41	Core	22	SE	f	30-40	Yes	3 only
42	Core	16	NW	m	30-40	No	3
43	Core	33	NW	f	40-50	No	3
44	Core	16	NW	m	40-50	No	3



## 4.6 Measures

### 4.6.1 Measures of electrical lighting power

Electrical lighting in the tower section of the SFFB consists of a combination of task and ambient lighting fixtures. The ambient lighting system consists of direct/indirect fluorescent pendant luminaires controlled by an automated lighting control system. The automated lighting control system is capable of reporting average electrical lighting power at a maximum resolution of 15-minute intervals for each lighting zone. Data can be aggregated to produce reports of average lighting power for multiple zones, or entire floors. Numerous issues emerged in collecting lighting power data from the automated lighting control system. These issues, as well as details for the photocontrolled ambient lighting system, are described in Chapter 10. As a general objective, lighting power data were desired from each zone occupied by participants during the study at the maximum sample rate (15 minute intervals). However, as a result of communication issues between the lighting zones and the automated lighting control system, data from at least one zone were not available at any given time (with the exception of a brief period), making the process of aggregating zones unreliable and limiting the analysis of lighting zones relevant to the study. A detailed description of monitoring of electrical lighting power is provided in Chapter 10.

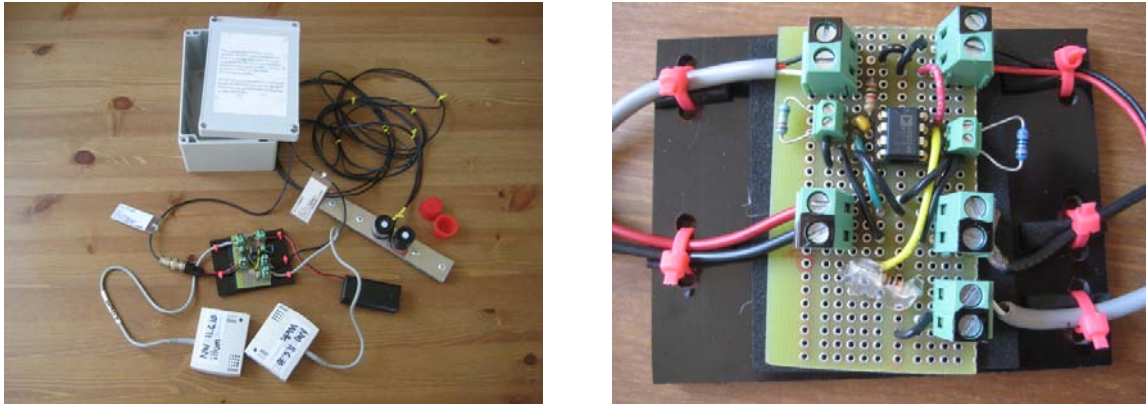
### 4.6.2 Exterior measures

#### 4.6.2.1 Exterior solar measures

Measures of exterior solar radiation were collected continuously throughout the study using purpose built data logging equipment attached to the building's unique exterior elements with custom mounts. Measures of global vertical illuminance and irradiance were acquired on the northwest and southeast facades and measures of global horizontal illuminance and irradiance were acquired immediately above the rooftop superstructure (**figure 4.7**). The acquisition interval for all exterior measures was 2 minutes.



**Figure 4.7** Location of exterior solar measures. Vertical illuminance/irradiance on northwest facade (left), rooftop horizontal illuminance/irradiance (center), and vertical illuminance/irradiance on the SE facade (right).



**Figure 4.8** Exterior illuminance and irradiance measurement and data logging device (left) and dual op-amp circuit (right).

All global illuminance measures were made using cosine-corrected LI-COR photometric sensors (type = LI-210, nominal accuracy = 3%). The LI-COR 210 measures illuminance as related to the *CIE Standard Observer* curve. All global irradiance measures were made using cosine-corrected LI-COR radiometric sensors (type = LI-200, nominal accuracy = 3%). Measures were logged using the (0-2.5 V) external input of a 12-bit HOBO U12 series temperature/RH (+ 2 external inputs) data logging device. For both LI-COR illuminance and irradiance sensors, current output is directly proportional to visible light or total solar radiation respectively. To amplify the signal output from the LI-COR sensors to a 0-2.5 V range, an op-amp circuit was built using an AD822 single-supply, rail-to-rail low power FET-input op amp (**figure 4.8**).

#### 4.6.2.2 Exterior temperature and relative humidity (RH) measures

Exterior air temperature and relative humidity were acquired throughout the study using a 12-bit HOBO U12 series temperature/RH data logger (**figure 4.9**). The data logger was attached to the rooftop superstructure in a shaded (and covered) location, which was isolated from direct contact with the steel structure using a foam pad. The acquisition interval for temperature and RH measures was 2 minutes.



**Figure 4.9** Location of exterior rooftop temperature sensor.

### 4.6.3 Interior measures

#### 4.6.3.1 Interior solar measures



**Figure 4.10** Vertical (unshaded) irradiance at glass (left) and vertical (shaded) irradiance and illuminance at 2” from interior face of roller shade fabric (right).

Interior global vertical irradiance at the inside surface of the facade was monitored with and without the interior shading system in place (**figure 4.10**). For the unshaded condition, the sensor was positioned horizontally adjacent to the interior face of glass. For the shaded condition, the sensor was located at a distance of 50.8mm (2”) horizontally from the interior face of the roller shade fabric. Vertical illuminance was also acquired at this position for the shaded condition. All sensors were positioned vertically at a generic “seated head height” of 1.27m (50”) from the floor. Interior solar measures were acquired continuously at 2-minute intervals.

#### 4.6.3.2 Interior air temperature and relative humidity



**Figure 4.11** Hobo Temp./RH data logger attached to digital camera.

Interior measures of air temperature and relative humidity (RH) were acquired using HOBO U-12 Temp./RH data loggers. A HOBO was mounted to the digital camera located at each participant's workstation. The HOBO was located at an approximate height of 42 inches from the floor (**figure 4.11**).

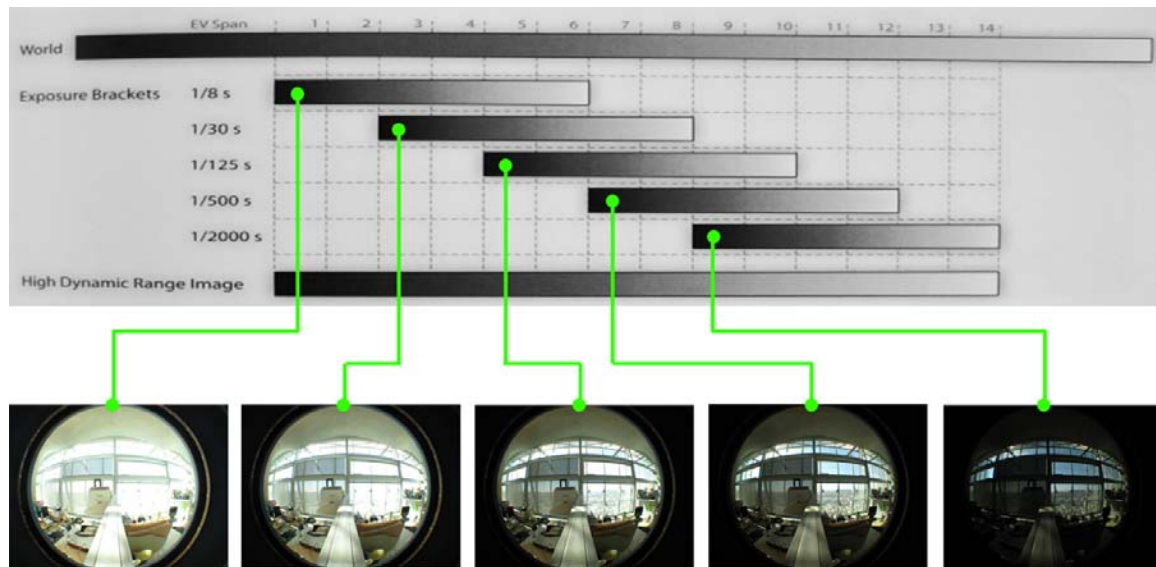
#### 4.6.3.3 Scene luminance



**Figure 4.12** Typical placement of digital camera on SE facade perimeter zone workstation partition (left) and isolated view of device showing method of attachment (right). The camera's center of view was aligned perpendicular to the facade.

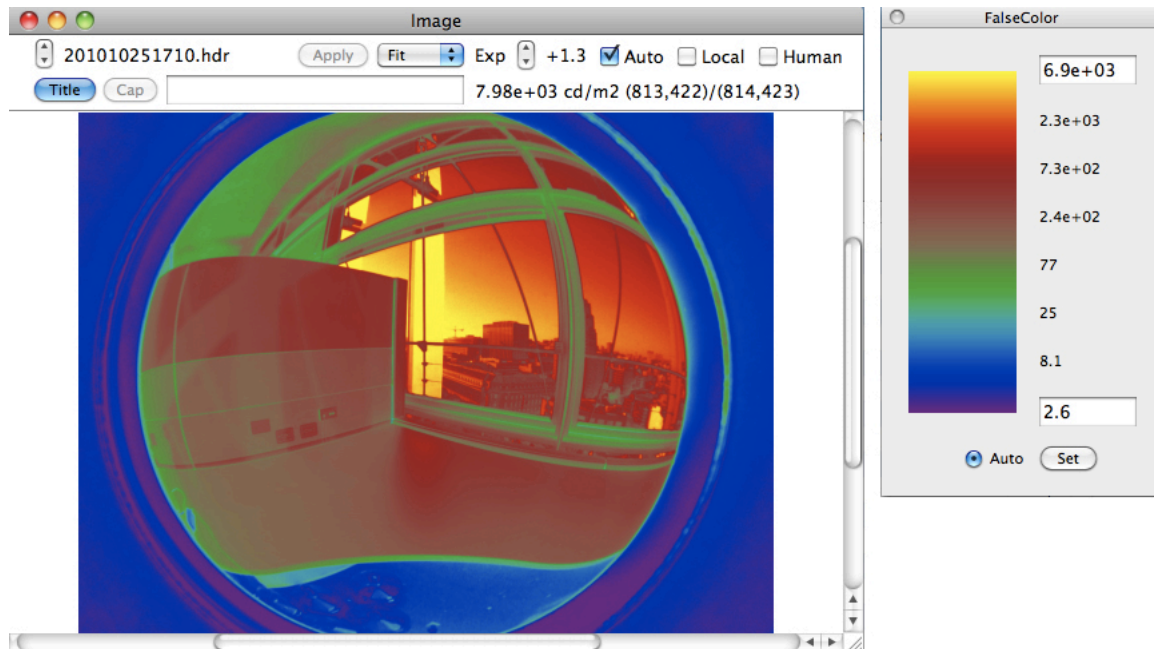
To measure interior roller shade position and scene luminance, a digital camera (Canon PowerShot A570) with a wide-angle lens converter (Opteka HD<sup>2</sup> 0.20X Professional

Super AF fisheye lens, real angle of view = 174 deg.) was installed at each participant's workstation (**figure 4.12**). Each camera's firmware was modified using a variant of the Canon Hacker's Development Kit (CHDK) called Stereo Data Maker (SDM). SDM enables features in the camera including a capacity to be controlled automatically using scripting. This feature was used to automate the acquisition of exposure-bracketed sets of JPEG images, which in turn were combined to generate high dynamic range (HDR) luminance images for visual comfort analysis. Bracketed sets of images were acquired every 5 minutes from 6AM to 8PM PST for the duration of each test phase. Each sequence of bracketed .JPEG images was then composited into a single HDR image using the Radiance lighting simulation software tool *hdrgen*. **Figure 4.13** illustrates the process of exposure bracketing used.



**Figure 4.13** Example of exposure bracketing of low dynamic range (i.e. JPEG) images for compositing into a single HDR image.

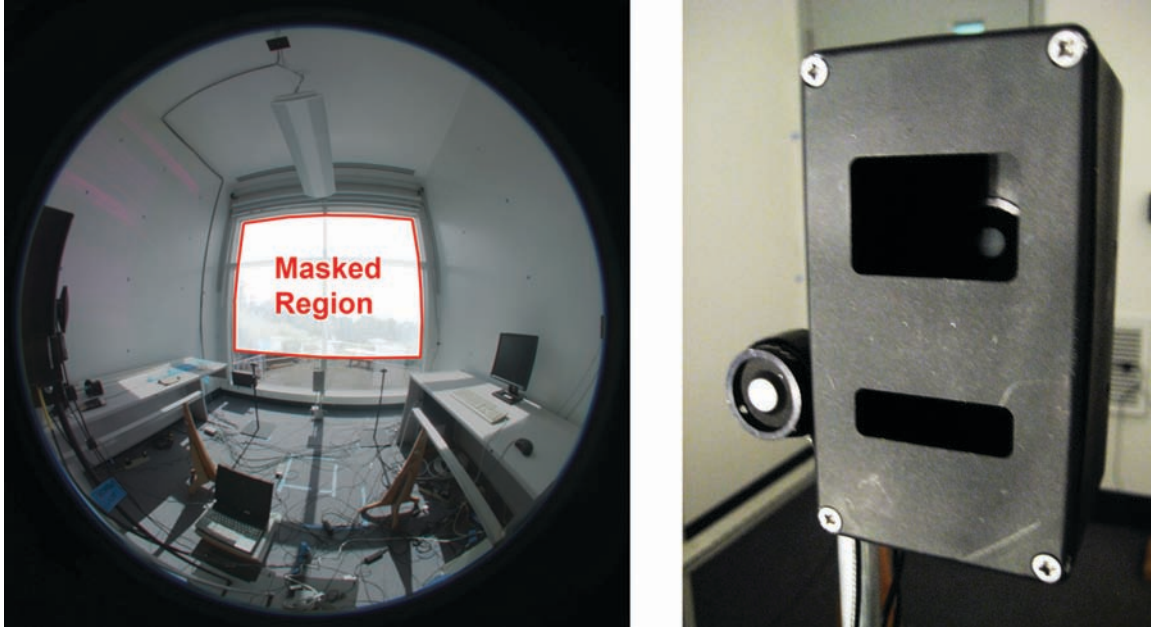
High dynamic range images store luminance data on a “per-pixel” scale, enabling both the definition and analysis of an arbitrary number of pre-defined regions within the camera's field of view, and the possibility of detecting glare sources to compute discomfort glare metrics. In computer graphics, the original HDR format (Radiance RGBE) was developed for the lighting simulation engine Radiance in order to record the photometric conditions of synthetic lighting environments (Ward 1991, 1994). In following years, techniques were developed to produce HDR images from real-world scenes (Debevec 1997, Mitsunaga & Nayar 1999) by compositing multiple, exposure-bracketed, low dynamic range (LDR) images (e.g., JPEG) into a single HDR image. Motivated by the possibility of using HDR in real spaces for photometric analysis, methods are now available to produce calibrated HDR images, commonly referred to as luminance maps (Inanici & Galvin, 2004).



**Figure 4.14** Example HDR image of the exterior glass fins viewed from the NW perimeter zone workspace. The HDR image is displayed using the software program *Photosphere* and is displayed with a falsecolor tone-mapping of luminance values. Yellow indicates luminances above  $7000 \text{ cd/m}^2$ .

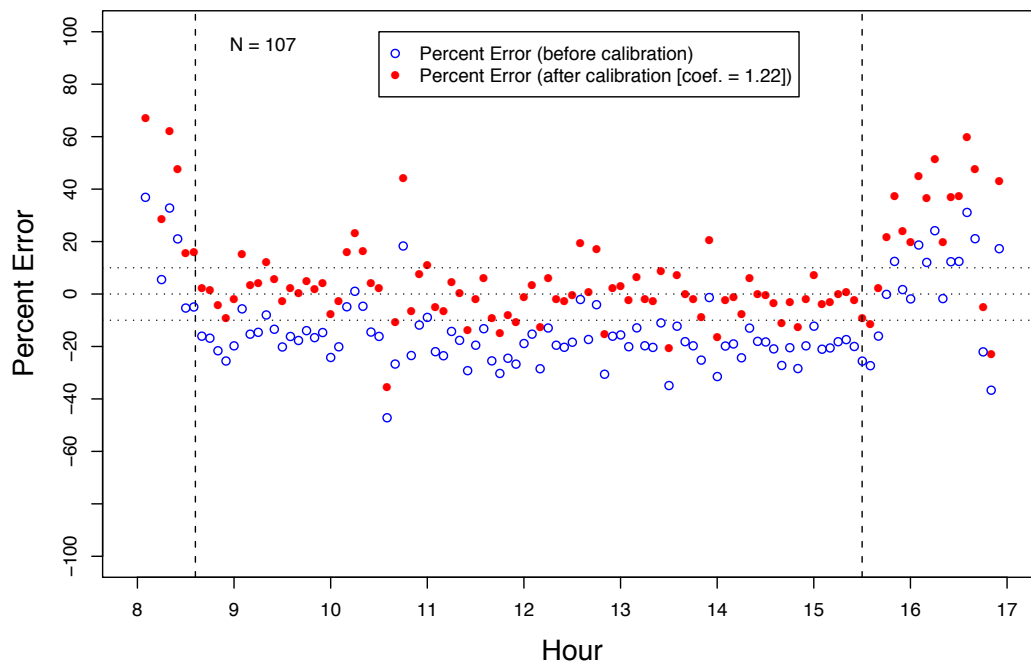
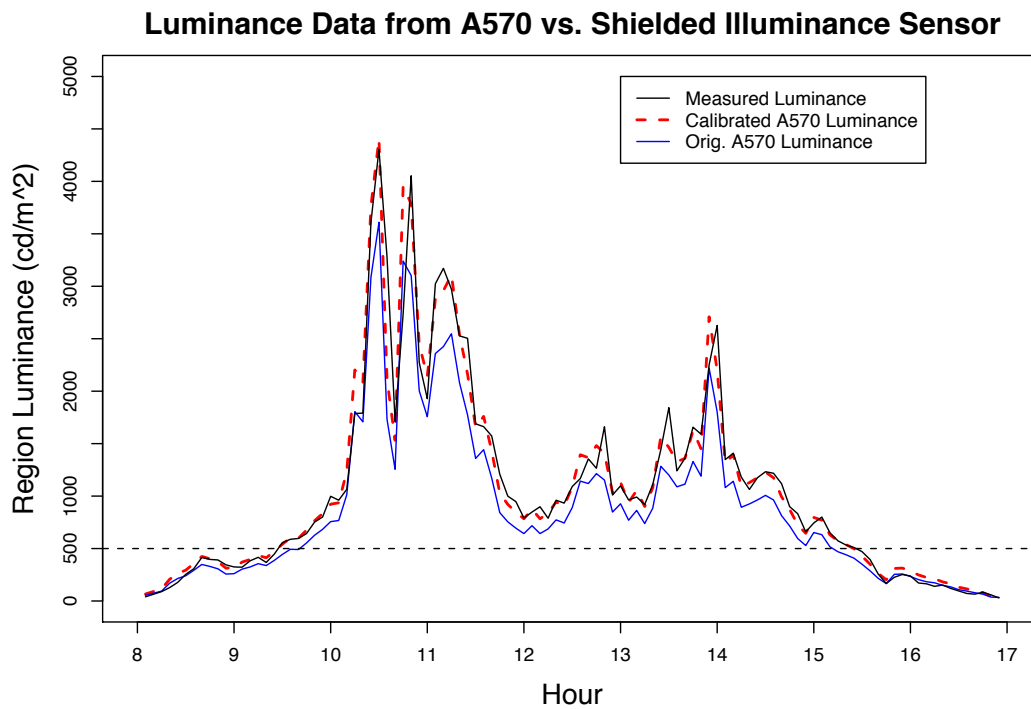
#### 4.7.3.3.1 Calibration of the HDR-enabled cameras

To quantify measurement errors associated with use of these HDR data, a study was conducted over a day with clear sky conditions from 8:00 to 17:00 PST in one cell of the Lawrence Berkeley Windows and Daylighting Testbed facility. A procedure was developed to compare the HDR data derived from the digital cameras used in this study to a calibrated shielded illuminance sensor. The shielded illuminance sensor was “masked” to measure the average luminance of the window region of the test cell (excluding the lower 30 inches). A camera was located adjacent to the shielded illuminance sensor and a “mask” was created using a Radiance process to calculate the average luminance of the identical window region as viewed from the camera (**figure 4.14**).



**Figure 4.15** Shielded illuminance sensor (right) and “masked” region used to calculate the average window luminance for comparison to the shielded sensor.

The average luminance of the window region calculated from each HDR image (acquired at 5 min. intervals) was then compared with a reading acquired simultaneously from the reference sensor. A comparison is illustrated in **figure 4.15**. The results show that when the average window luminance exceeds  $500 \text{ cd/m}^2$ , average window luminance calculated from the HDR image is, on average, 18% below the value recorded by the reference sensor. After a global scaling of each HDR image by a coefficient of 1.22, the HDR image data are comparable to the reference (mean = 0.1%, SD = 11%, max = 44%, N = 88 images). However, when the target is below  $500 \text{ cd/m}^2$ , the accuracy of the HDR images diminishes significantly, and consistently overestimates scene luminances (mean = 40%, SD = 23%, max = 66%, N = 25 images). Because the analysis of HDR data in this study focuses on discomfort glare conditions, where the average luminance of the potential glare source is likely to be significantly larger than  $500 \text{ cd/m}^2$ , the HDR data are considered to be of acceptable level of accuracy and measures are expected to be within + / - 10%.



**Figure 4.16** Comparison of measures of average window luminance from HDR image data to reference shielded illuminance sensor before and after HDR data were uniformly scaled by a calibration coefficient (coef. = 1.22).

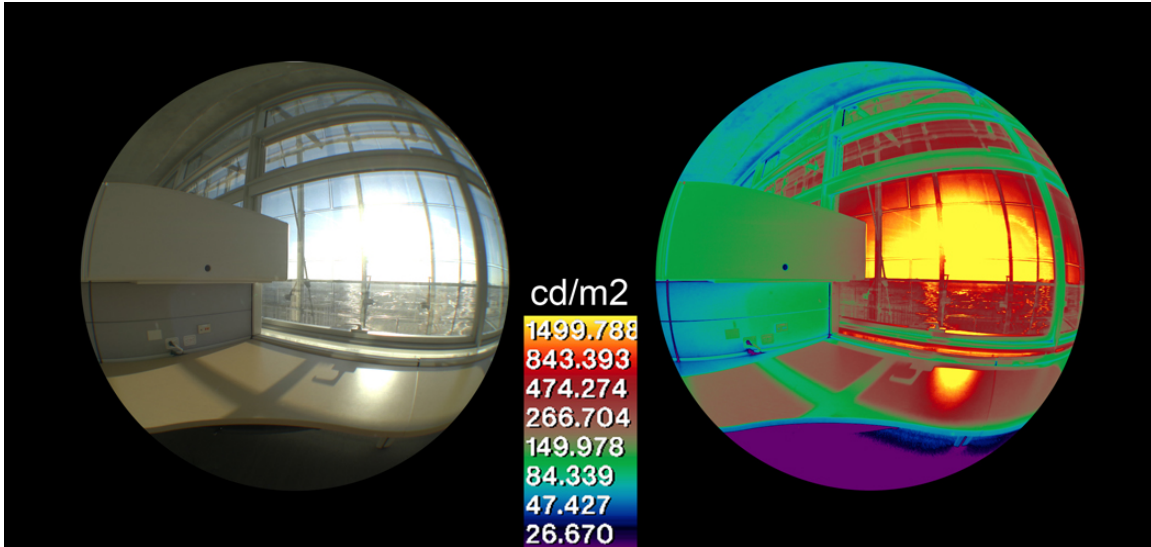


#### 4.6.3.3.2 Point of view luminance measures

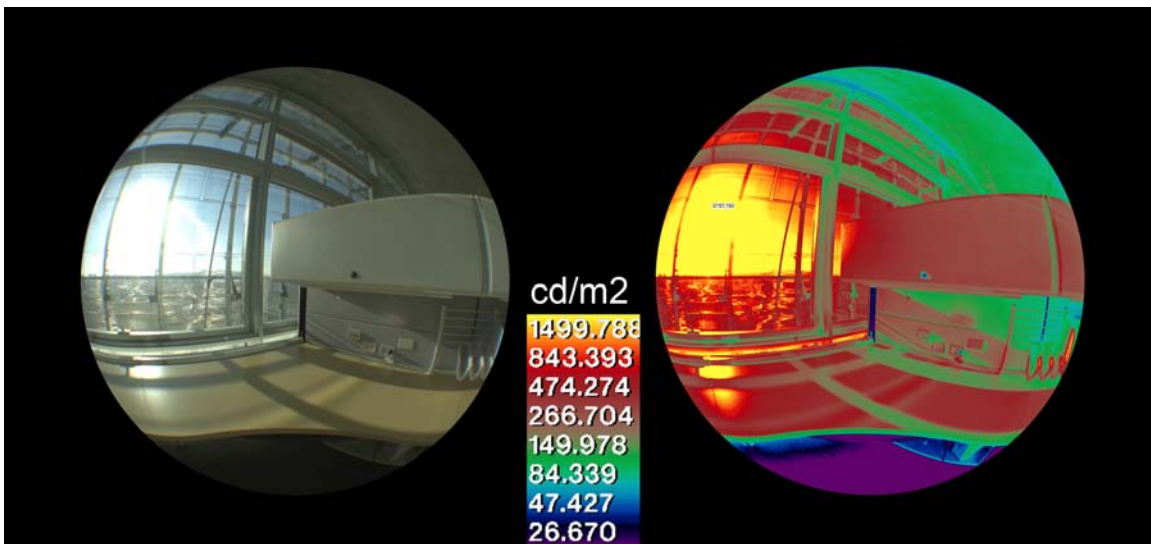


**Figure 4.17** Position of HDR camera equipment located in two vacant workstations on the SE facade. East-facing view (left) and south-facing view (right).

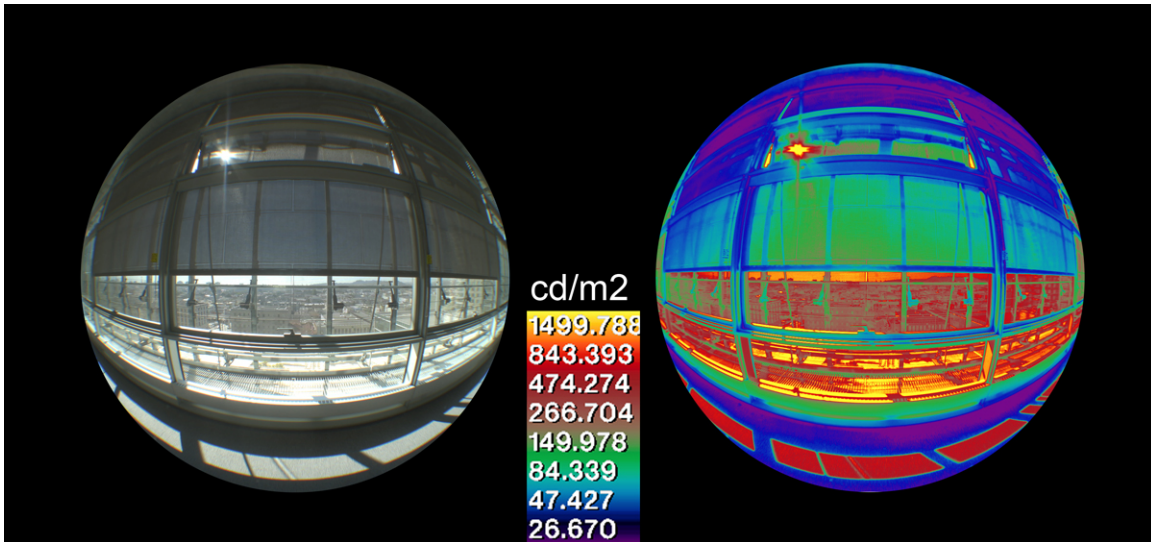
To examine existing luminance-based predictors for visual discomfort from the viewpoint of perimeter zone workstations, two HDR cameras were placed in vacant workstations to simulate the task views of building occupants working along the facade. **Figure 4.17** provides an example of the positioning of the cameras during phase 2 in vacant SE facade perimeter workstations for the south-facing view (right) and the east facing view (left). Data were collected during the study with the shades fully retracted as shown in **figure 4.18** and **figure 4.19**. To record data representative of workspaces where the shades were lowered, an additional camera was used to record a generic shaded view condition (**figure 4.20**). Due to the lack of additional vacant workspaces, data for this view condition were acquired in an area without workstation partitions. And, due to the lack of additional cameras available, the camera was oriented perpendicular to the facade (the camera was located the same distance from the façade as the other two cameras). This procedure was similarly applied to acquire “point-of-view” luminance data for the NW perimeter zone.



**Figure 4.18** Generic viewpoint for east-facing workstation orientation (SE facade) showing luminance conditions recorded using HDR imaging with roller shades raised. Luminance values are represented with a falsecolor log-scale where yellow indicated values above  $2000 \text{ cd/m}^2$ .

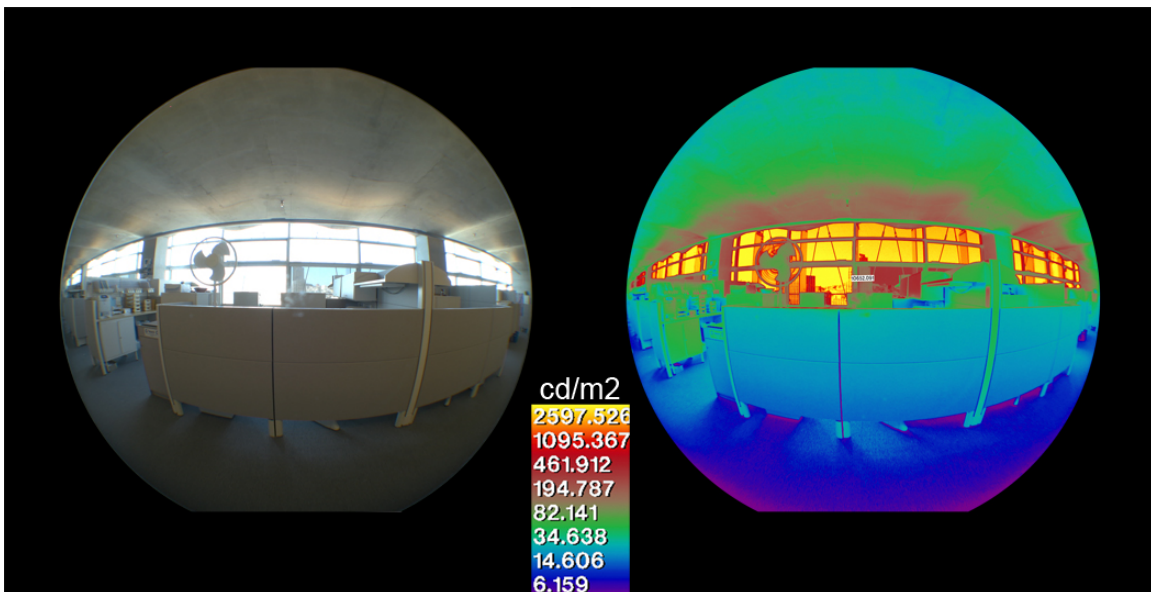


**Figure 4.19** Generic viewpoint for south-facing workstation orientation (SE facade) showing luminance conditions recorded using HDR imaging with roller shades raised. Luminance values are represented with a falsecolor log-scale where yellow indicated values above  $2000 \text{ cd/m}^2$ .



**Figure 4.20** View of generic shaded facade view (SE view orientation). Luminance values are represented with a falsecolor log-scale where yellow indicated values above 2000  $\text{cd/m}^2$ .

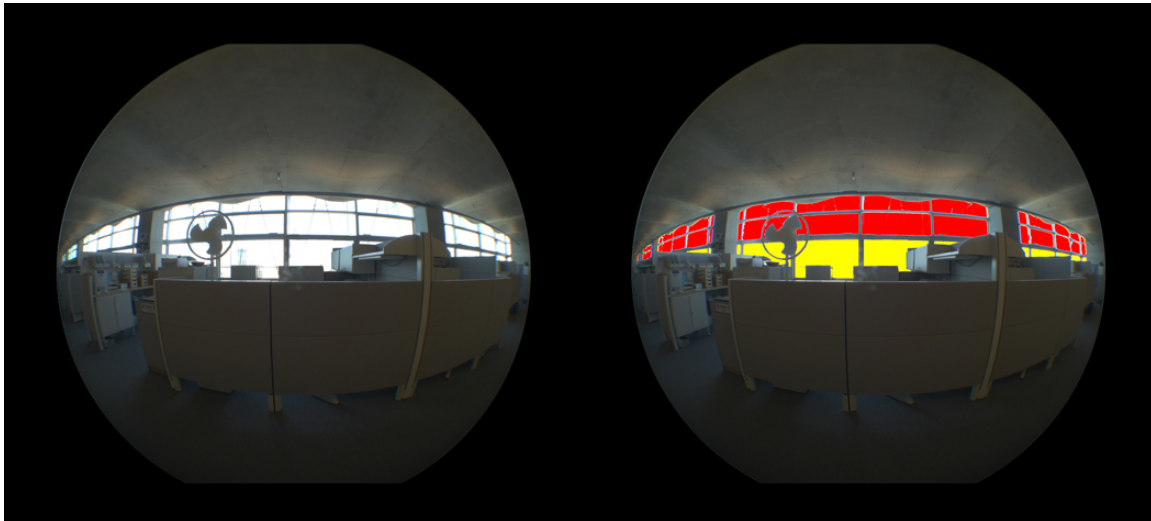
Simulated views were not necessary for participants located in core workspaces since the HDR camera could be located sufficiently close to the participant's head to closely match the participant's view of the facade. **Figure 4.21** provides an example of a view from a core workspace showing potential glare sources.



**Figure 4.21** Example view from participant workstation located in the core (view faces the NW facade). Luminance values are represented with a falsecolor log-scale where yellow indicated values above 4000  $\text{cd/m}^2$ .

#### 4.6.3.3.3 Processing HDR image data

To examine the luminance conditions associated with visual discomfort, two general approaches were taken to obtain quantitative information from the HDR images acquired. The first approach was to define regions within each view and calculate summary statistics for each region. For each view, the upper window region, lower window region, of the image were defined. In addition, the inverse (i.e. all interior surfaces) was defined. For each of these regions, the average region luminance and maximum region luminance were calculated. Because HDR images were acquired at 5-minute intervals throughout the (6:00 – 20:00 PST) monitoring period each day, this resulted in time-series data for average and maximum window luminance for each region. Analysis of region luminance data are discussed in Chapter 6 and Chapter 7. An example of a core workspace view is shown in **figure 4.22**, where the upper window region is defined in red, and the lower window region is defined in yellow. The region boundaries were drawn to avoid obstructions between the camera and the window (e.g. columns, portable fans) in order to more accurately record the luminance conditions resulting from view to the outdoors.



**Figure 4.22** Example view from a core workspace showing the regions of the HDR image defined to calculate summary statistics (average, maximum) for each region at 5-minute intervals throughout the (6:00 – 20:00 PST) daily monitoring period.

The second approach was to calculate glare metrics for each HDR image using the Radiance program *findglare* (Ward, 1992).

Although an HDR image provides a highly detailed representation of the visual environment, there remains the challenge of determining what regions in the image constitute a glare source in order to compute glare discomfort metrics. Addressing this issue is presently dealt with by specifying a threshold value for glare: either an absolute value (e.g., all sources above  $2000 \text{ cd/m}^2$ ) or a ratio between a given pixel and the average luminance of the task or entire scene (e.g., 4:1). There is currently limited guidance for what this threshold value should be, or what method to use in order to

represent the glare sensitivity of a human observer. In the development of *evalglare*<sup>1</sup>, a tool to predict the probability of discomfort glare (DGP) from hemispherical luminance maps, Wienold and Christoffersen (2006) defined glare as any pixel four times greater in luminance than the average luminance of a circular visual task zone with an angle of  $\sim 0.53$  sr. However, Wienold and Christoffersen did not indicate how the ratio of 4:1 was arrived at in favor of other possible ratios. In this study, the threshold for glare was defined as any pixel greater than 7-times the luminance of the average scene luminance. This is the default criteria used by the Radiance program *findglare*. The average luminance of the scene was used to compute the ratio because (due to the positioning of the cameras) measurement of the complete task view was not always possible. The approach used by *findglare* to identify glare sources is called “thresholding,” where the image is divided orthogonally into equal samples and if a particular sample is above a designated threshold value, then *findglare* assumes it must be part of a glare source. When a sample above the threshold value is found, it is merged with neighboring contiguous glare samples. Two glare samples are considered contiguous if they are separated by at most one non-glare sample. This allowed separation is to avoid the breakup of something like a window with venetian blinds into an unreasonable number of sources. The output of *findglare* is the centroid, solid angle, and average luminance of each glare source identified. In this study, these values were then processed by another Radiance program *glarendx* to compute the Hopkinson-Cornell Daylight Glare Index (DGI) (Hopkinson, 1962), the Unified Glare Rating (UGR) (CIE, 1995), the CIE glare index (CGI) (Einhorn, 1969, 1979) and interior global vertical illuminance for each image. Similar to the region-based approach, this resulted in time-series glare metric data for each camera view. Analysis of glare metric data are discussed in Chapter 6 and Chapter 7.

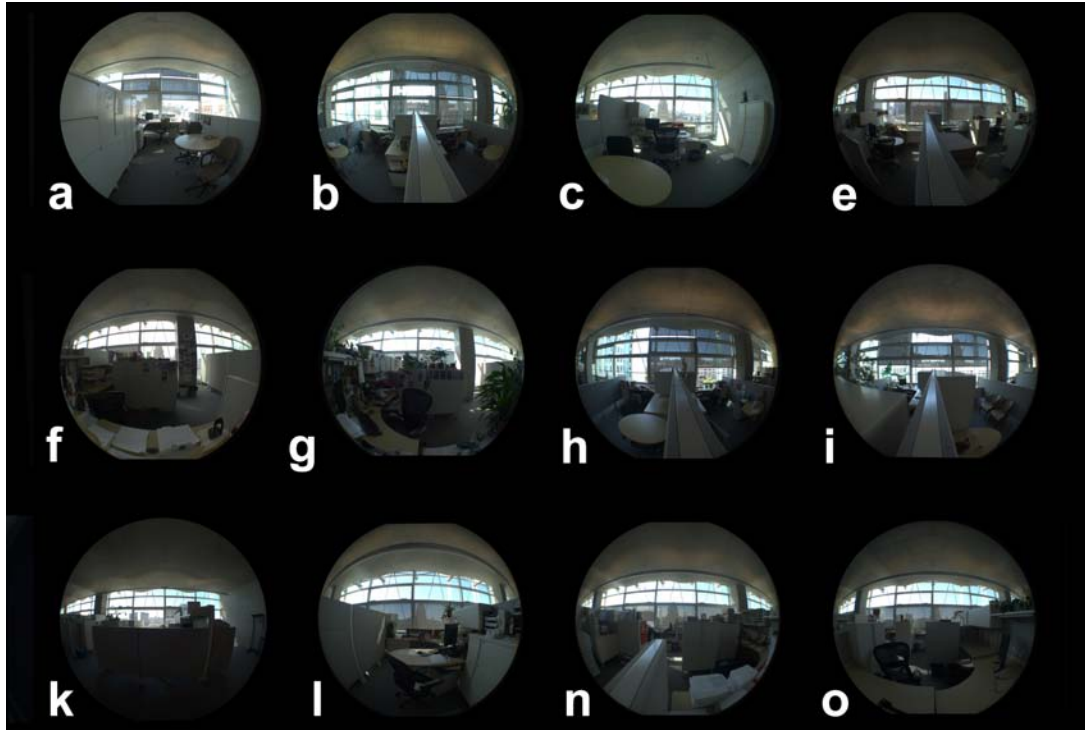
#### 4.6.3.4 Interior roller shade operation

Time-lapse high dynamic range (HDR) imaging was used to monitor occupant control of shading devices at each participant’s workstation on a 5-minute interval. **Figure 4.23** shows the view from each of 12 cameras used to monitor shade control on the NW facade during Phase 1. Based on the layout of workstations in relation to the facade, each occupant was observed to be adjacent to (and have direct control over) 2 vision window roller shades. Where shades were installed on the upper two sets of window sections, occupants had control over a total of 6 window section shades (2 lower and 4 upper). In addition, the facade includes an additional window section below desk height (from 0 to 30 inches above the floor) that was consistently occluded by furniture. Therefore, each occupant was typically adjacent to 8 total windows, where the lowest 2 were permanently occluded by furniture. In this study, the term *facade section* (as opposed to window section) refers to 4.35m (14.3 ft) by 3.8m (12.5 ft) section of the facade corresponding to 8 window sections (2 horizontally and 4 vertically). The majority of participants in this study were observed to have control over one *facade section*.

---

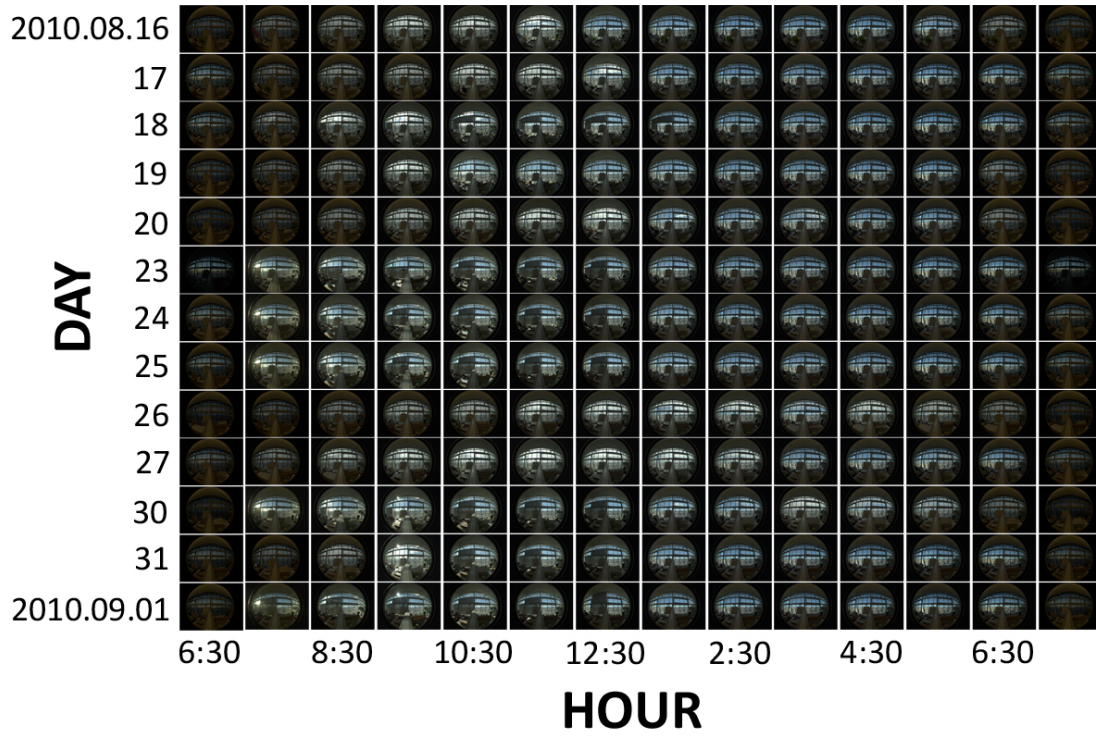
<sup>1</sup> Evalglare was not used in this study due to the fact that the program was unable to process the HDR images generated using the Canon A570 digital cameras.

Each camera's field of view included one or more facade sections. Facade sections were categorized into three groups: 1) facade sections adjacent to participants, 2) sections adjacent to non-participants, and 3) sections adjacent to unoccupied areas. "Unoccupied areas" in this context refers to areas such as spaces were not workstations for individuals but instead were used for copiers, office supplies, storage etc.

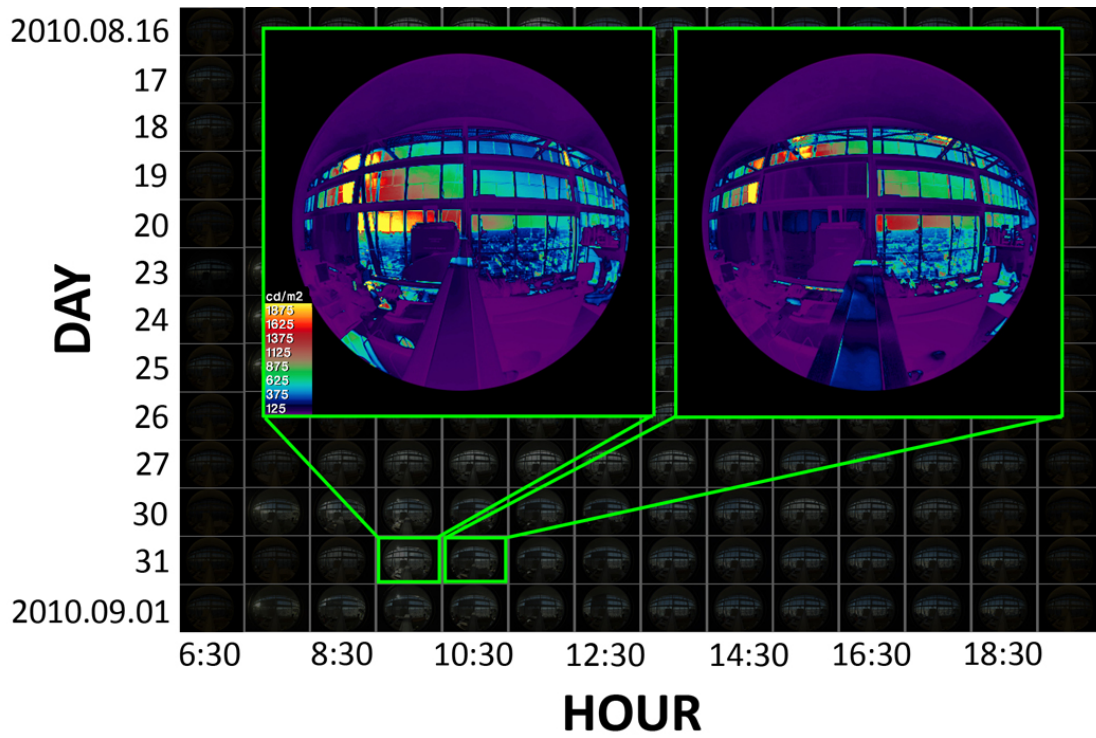


**Figure 4.23** View from each of 12 of the cameras used to monitor the NW perimeter zone during Phase 1.

Images were acquired daily at 5 minute intervals from 6AM to 8PM PST (168 HDR images per day). HDR images were resized to (320 by 240px) using the *Radiance* program *pfilt*, resulting in images with file sizes of approximately (0.26 MB). All images from a given camera were then compiled into (692px by 650px) movies (.mov) using the image processing software program *Graphic Converter*. The filename of each image was encoded to correspond to the time when the image was acquired and then displayed in the movie. Each movie was examined visually to determine the state of shading devices using the *occlusion index* method described in the following paragraphs.

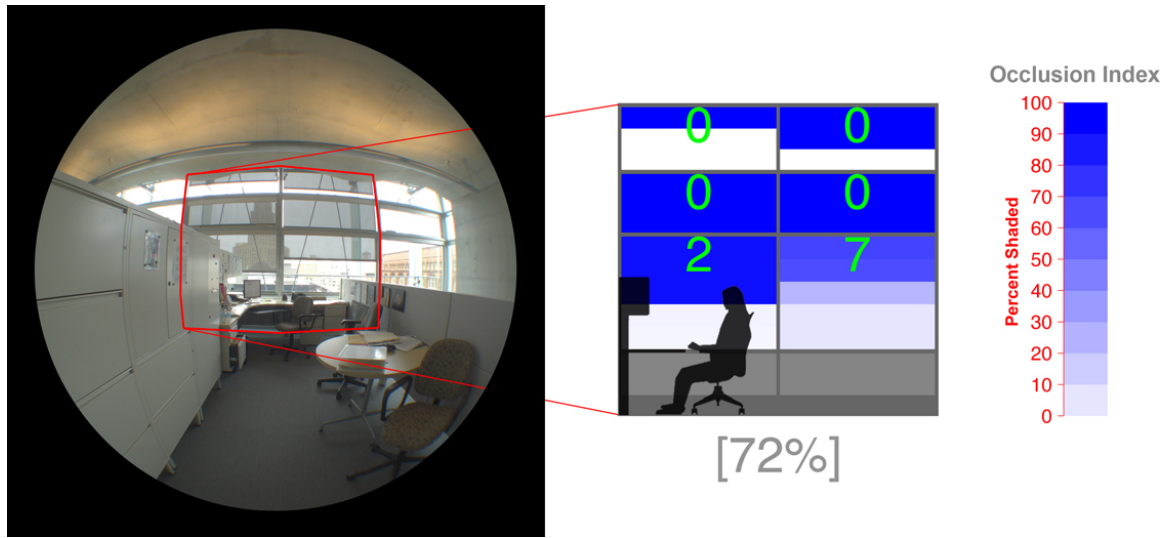


**Figure 4.24** Visualization of time-lapse imaging from a viewpoint of one facade section showing one image per hour.



**Figure 4.25** Time-lapse movies of shade control were observed and changes to shade position logged in a spreadsheet format.

An *occlusion* index was used to code the shade position systematically from visual inspection of each movie. The term *occlusion* in this context refers to the blocking of a glazed opening by an interior roller shade or piece of furniture. The occlusion index denotes the percent area of each individual window section that is occluded by roller shade fabric or furniture at a given point in time on a scale of 0 to 100% (where 100% denotes full occlusion, i.e. the shade is fully deployed to cover the window). Positions were categorized into 4 levels of occlusion for the upper window regions (i.e., 0, 33, 66, and 100%) and 6 levels for the lower window (i.e., 0, 20, 40, 60, 80, 100%).



**Figure 4.26** The facade occlusion index developed to summarize position and frequency of operation of shading devices. Numbers shown in green indicate the number of times each individual shade was operated during Phase 1 (NW perimeter zone). The number in brackets [72%] indicates the average facade section occlusion index.

Over the course of a given test phase, some shades were moved by occupants to multiple positions, resulting in multiple occlusion index scores (e.g. 33% for several days, followed by 66% for several days). Therefore, an additional indicator, the *average window occlusion index* was used to summarize the occlusion of each window over time. The average window occlusion index is simply a time-weighted average of all occlusion index scores for a given window. For example, if a window had an occlusion index of 100% for the first 5 days and 0% for the following 5 days, then the average window occlusion index would be 50%. An average window occlusion index of 50% would also result from a window that was 50% occluded over an entire test phase, a case where the shade was never moved. **Figure 4.26** provides an illustration of window occlusion index indicating average façade section occlusion, how individual window section shades were positioned, and the frequency of shade operation.

Of interest in this study is the overall level of occlusion of sections of the facade adjacent to occupants. Therefore, a final indicator, the *average facade occlusion index* was used to summarize the occlusion of each facade section over a single test phase (e.g. Phase 1, July 12 – 29). The average facade occlusion index is simply the area-weighted average



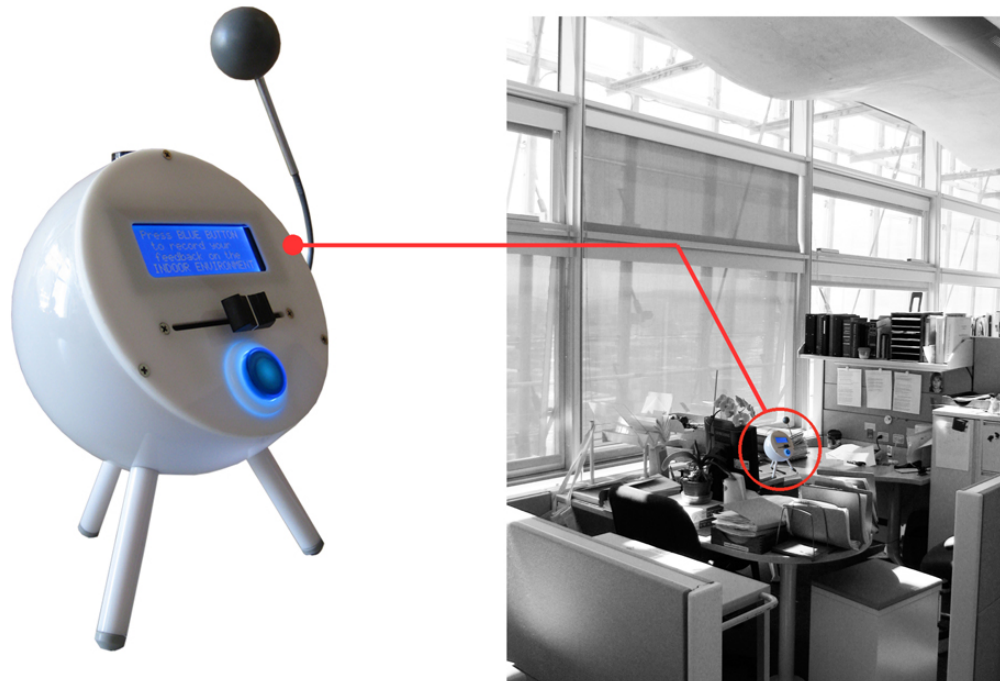
of the 8 window sections adjacent to a given occupant. Therefore, it includes the lowest two window sections (20% of the facade area) which are effectively occluded permanently by furniture. Therefore, the average facade occlusion index has a range from 20% to 100% occlusion.

#### 4.6.4 Desktop polling stations

Lighting conditions in a daylit space are highly variable. Time of day, exterior weather, position of shading devices are all factors that influence the intensity and distribution of daylight. Consequently, acquiring field measures of daylight illuminance descriptive of the conditions experienced by occupants is extremely challenging. Assessment of visual discomfort conditions leads to increasing challenges, as the luminance conditions associated with visual discomfort may only occur over a short period of time each day, or only under certain weather conditions (e.g. clear sky conditions, bright clouds). Despite the limited time these conditions are present, they may characterize occupant's overall assessment and opinions of the space (and may lead to the permanent use of shading devices or building retrofits). And, to validate indicators of daylight sufficiency or visual discomfort with subjective data, the procedure must simultaneously record the subjective assessment of occupants. This latter challenge requires repeated responses from the occupant over a range of daylighting conditions to reduce the level of variability inherent in subjective responses from human beings in addition to daylight. These challenges can arguably be claimed to serve as the basis for the reliance on controlled laboratory studies in the development of existing discomfort glare metrics. Similarly, the practical issues associated with visiting a site repeatedly and controlling for time of day, exterior weather conditions, the position of shading devices and the individual work schedules of occupants can be argued to serve as the basis for "opportunistic" sampling of occupants or intervention-based field studies (e.g. where the shades are positioned by the researcher).

To address these challenges, a desktop polling station device was developed to serve as an interface for occupants to record their subjective assessment of environmental conditions multiple times each day over multiple weeks. The purpose of the polling station is to pair physical and subjective measures to create a data set that can be used to validate existing indicators for daylight sufficiency and visual discomfort. The following sections describe the desktop polling stations used in this study. The measurement protocol involving the polling stations is described in **section 4.6.6**.

#### 4.6.4.1 Overview



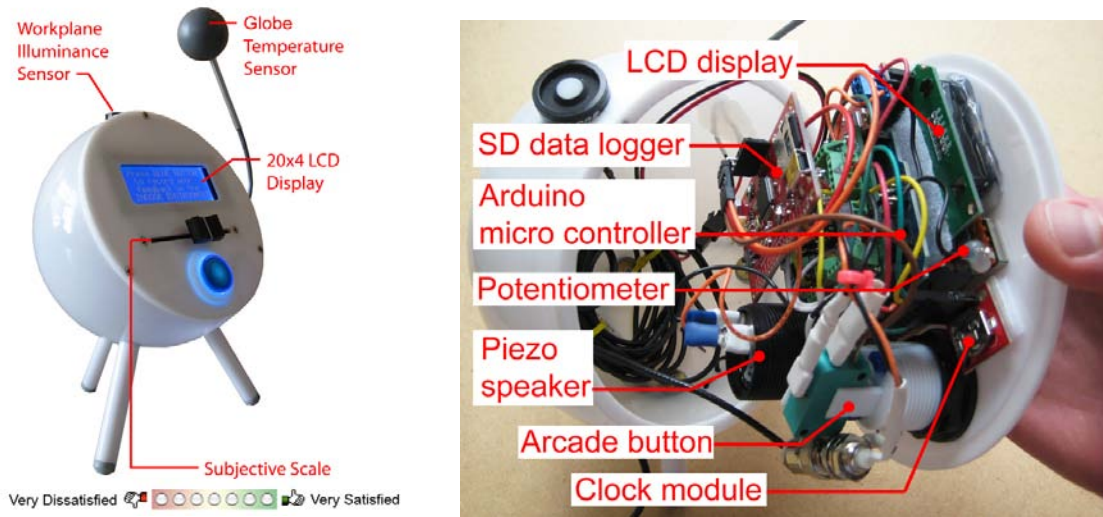
**Figure 4.27** Desktop polling station.

Measures of participant subjective assessment, globe temperature, and global horizontal illuminance were acquired using a novel desktop polling station device (**figure 4.27**). The desktop polling station was developed using the Arduino open-source electronics prototyping platform, a microcontroller and associated software developed to enable quick, intuitive, and low-cost prototyping of devices capable of sensing and responding to the physical world. The microcontroller on the board is programmed using the Arduino programming language (based on *Wiring*<sup>2</sup>) and the Arduino development environment (based on *Processing*<sup>3</sup>). A view of the components of a polling station is shown in **figure 4.28**.

---

<sup>2</sup> <http://wiring.org.co/>

<sup>3</sup> <http://processing.org/>



**Figure 4.28** Desktop polling station (left) and internal view of Arduino microcontroller and associated components (right).

#### 4.6.4.2 Subjective measures

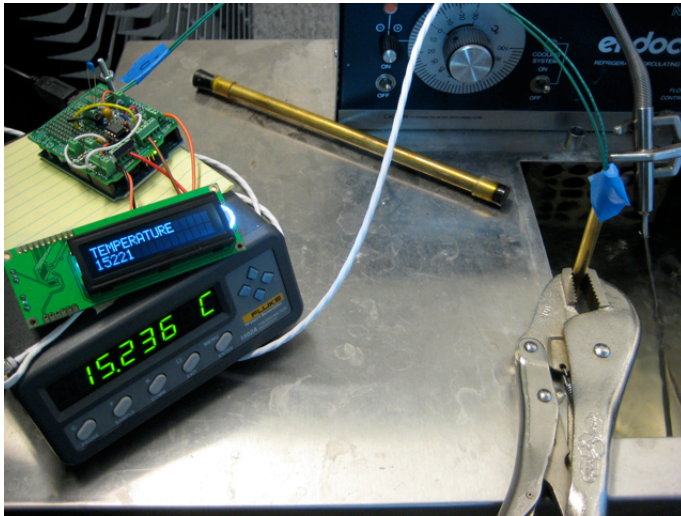


**Figure 4.29** Example data entry sequence: (left) IEQ question is displayed to the user on the screen, (center) user selects desired subjective response, (right) after user has selected response arcade button is pressed to record response and advance to next question.

The user interface was designed to be intelligible without the need for printed instructions or a device tutorial. The interface, as shown in **figure 4.27**, consists of an 80-character LCD screen, horizontal slide-potentiometer, and “arcade-style” push-button. Using this interface, users can input subjective feedback at any time throughout the day, or in response to visual or audible prompts from the polling station triggered by physical measures or time-based triggers. Participants begin a survey by pressing the button to initiate a short 7-question IEQ survey. Users then respond by recording their subjective response to a sequence of simple IEQ questions displayed on the device’s LCD screen by adjusting the slide potentiometer. As the potentiometer is adjusted, the LED screen displays the potentiometer’s position on a subjective scale using text (e.g. “Slightly satisfied”). Responses are confirmed and recorded by pressing the arcade button.

#### 4.6.4.3 Physical measures

Globe temperature was measured using a globe thermometer. When in a state of equilibrium, a globe thermometer indicates the combined influence of radiative and convective heat exchange with a particular environment (e.g. a particular air temperature, air velocity, and temperatures of surrounding surfaces in an office) (Fountain, 1987). The sensor used in this study is an epoxy encapsulated precision thermistor (brand = Measurement Specialties, type = 44016RC precision thermistor, resistance = 10,000 Ohms at 25 degrees C) suspended inside a spherical shell (ping pong ball spray painted 50% matt grey). Prior to assembly, thermistors were calibrated in a thermal bath to within +/- 0.1 deg. C (**figure 4.30**). Illuminance measures were made using a cosine-corrected LI-COR photometric sensor (type = LI-210, nominal accuracy = 3%). LI-COR illuminance sensors were calibrated using a reference LI-COR illuminance sensor connected to a LI-COR LI-250 light meter to within 3% of the reference.



**Figure 4.30** Calibration of thermistors in thermal bath at LBNL using a precision digital thermometer.

#### 4.6.4.4 Prototype development

The objective of the design was to improve on existing methods of collecting occupant feedback (typically via computer-based “pop-up” windows) by detaching the interface from the participant’s computer screen, allowing responses during non-computer-based tasks, and using ambient (visible, audible) prompts rather than directly interrupting participant’s primary visual task. **Figure 4.31** presents early prototypes and designs for the desktop polling station.



**Figure 4.31** Examples of early concept sketches (center) and physical prototypes (left and right).

#### 4.6.4.5 Operational reliability and user interface testing

Following assembly, all 15 polling stations were run continuously for two weeks to verify reliability of autonomous data logging of temperature and illuminance measures as well as examine drift of onboard clock modules, the degradation of LCD screens and the reliability of the Arduino hardware and software (**figure 4.32**). After a reasonable level of confidence was obtained from operational reliability testing, a select number of polling stations were given to research colleagues and volunteers for initial tests in real office environments by unfamiliar users (**figure 4.33**). These tests had varying objectives, primarily focused on examining the wording of questions for intelligibility and examining the reliability of the user interface. Following initial tests, user feedback indicated the need for audible prompts in addition to visual prompts (i.e. blinking screen and button) to call attention to the polling station. Prior to the addition of audible prompts, prompts in daylight spaces were often not noticeable due to the relatively low light output from the LCD screen and LED within the arcade button. A piezo electric device was added to allow audible tones to be played as an additional prompting mechanism. Vibration motors were also considered, however this method was discarded as the movement of the polling station became difficult to control. Later testing was performed to determine the appropriate volume and duration of audible prompts as well as to examine if the frequency of prompting (eventually established as 45 minute intervals) became annoying after prolonged exposure (e.g. 1 to 2 weeks of daily use). As a precaution, a “snooze” function was added to allow participants to “snooze” the polling station for a period of 15 minutes if the prompting became annoying. Using informal testing with volunteers, a prompt interval of 45 minutes with a snooze function was confirmed to be acceptable.



**Figure 4.32** Final assembly and inspection of polling stations (left) and operational reliability testing (right).



**Figure 4.33** Polling station testing by volunteer in a daylight open-plan office located in the David Brower Center, Berkeley, CA.

#### 4.6.5 Subjective questionnaire

As another component of the study, each participant was emailed a link to a web-based profile questionnaire. The profile questionnaire had several objectives. The first was to gather basic demographic and contextual information on study participants such as age and gender as well as hours of computer use per day. A second objective was to collect information on the general reasons that occupants controlled shading devices, used task lighting, and made personal modifications to their workspaces. A third objective was to provide open-ended questions for occupants to provide comments on the sources of visual discomfort and any general issues with the indoor environment. Finally, the questionnaire included questions regarding participant's "overall" level of satisfaction with the IEQ factors defined in this study: thermal comfort, daylight sufficiency, view, and visual comfort. The survey questionnaire was implemented using a free student account with the online survey software platform *SurveyGizmo* (<http://www.surveygizmo.com/>).

#### 4.6.6 Measurement protocol



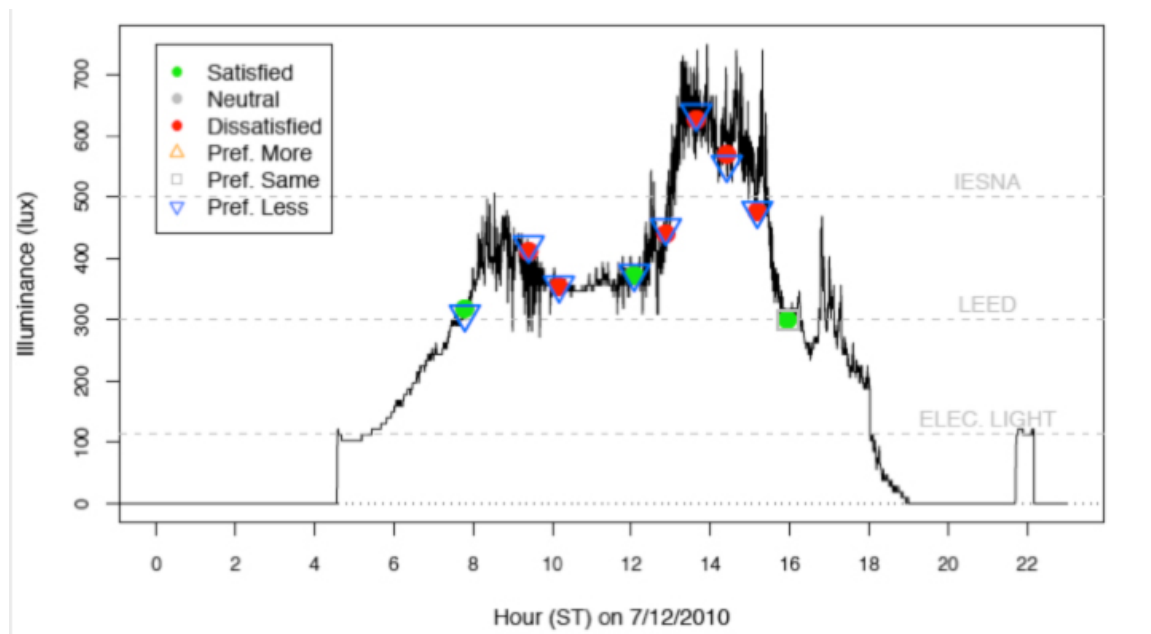
**Figure 4.34** Delivery (left) and placement (right) of desktop polling stations.

To begin a phase of the field study, a polling station was delivered to each participant's workstation at least one workday in advance of the start date for the monitoring phase. The polling station was located on the desk adjacent to (and within arms reach) of the participant (**figure 4.34**). Polling stations in perimeter zone workspaces were located on the desk adjacent to the facade at approximately 0.6m (2 ft) from the window. If the participant was present at the time of delivery, the procedure for recording data using the desktop polling station was reviewed and any questions regarding the intent of the polling station survey questions were resolved. If the participant was not present, a 2-page document describing the study and explaining the polling station user interface was left with the polling station. The participant was then contacted by phone or email to confirm that there were no unanswered questions regarding the study. A common question regarded when participants were expected to record subjective responses throughout the day and "how many" responses they were expected to record per day. Participants were instructed that they could record responses at any time throughout the day and that there



was no expectation for the maximum or minimum number of responses. This aspect of the study design was framed to encourage participants to record discomfort conditions when they occurred, which could not be easily predicted or scheduled. However, as user testing of early prototypes revealed, volunteers quickly forgot about the polling station if no prompting mechanism was included. Therefore, participants were encouraged to also record subjective data following polling station prompts.

Participants were prompted to interact with the polling station at 45-minute intervals by an audible prompt consisting of three short “chirps” produced by a piezoelectric speaker. The audio prompt lasted approximately 2 seconds and was followed by a 15 minute ambient visual “blinking” prompt produced by an LED within the pushbutton and a modulation of the LCD screen brightness. If the polling station received no signal from an occupant after 15 minutes it reverted to a passive state. Occupants were instructed that if the prompt became distracting or annoying it could be suppressed by moving the horizontal slider when the polling station was in the prompt state.



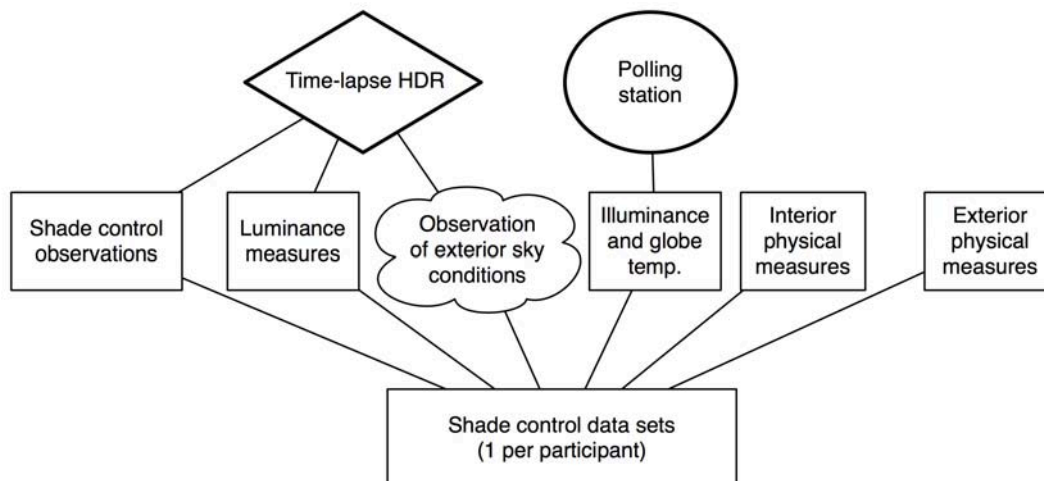
**Figure 4.35** Occupant subjective assessment of daylight conditions (Q3, Q4) paired with physical measures of horizontal workplane illuminance.

**Figure 4.35** provides an example of response frequency over one day for a single occupant. In addition, the figure shows the pairing of subjective responses to Q3 (“How satisfied are you with the amount of daylight in your workspace right now?”) and Q4 (“Would you prefer more or less daylight right now?”) with physical measures of horizontal workplane illuminance. Red dots indicate dissatisfaction with the amount of daylight and the blue triangles indicate a preference for less daylight in the workspace. It is important to note in this figure the “spike” in illuminance in the early AM and again at 22:00. This indicates the contribution of the overhead fluorescent ambient lighting. A procedure for subtracting the contribution from ambient electrical lighting is described in **Appendix Section G**. Because occupants of daylit office spaces are often working in a

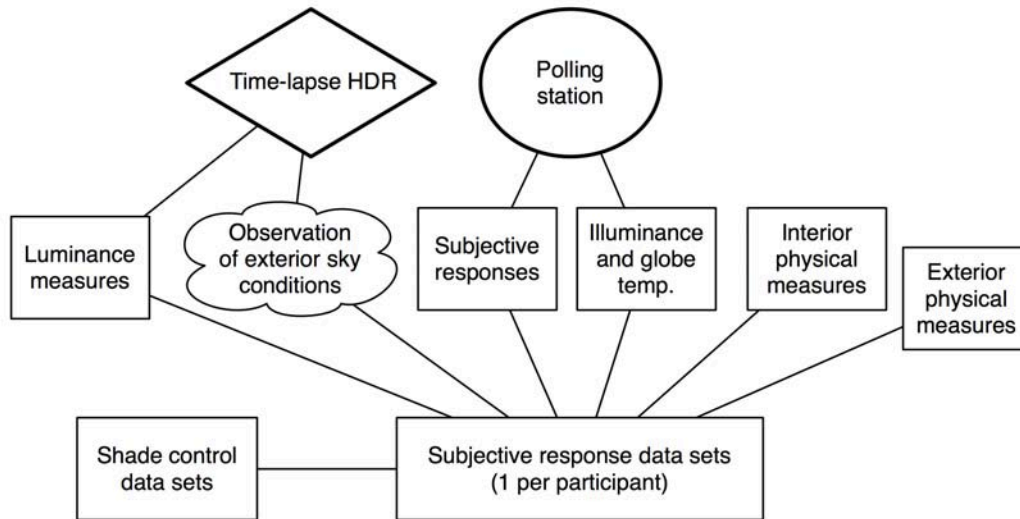
mixture of daylight and electrical lighting, the pairing of subjective assessment of daylight sufficiency and preference is not direct. The researcher must consider how much influence the electrical ambient lighting system (as well as the potential use of task lighting) contributes to the occupant's subjective response. This issue is addressed in Chapter 8. As a result of the relatively low level of illuminance from the electrical ambient lighting system compared with daylight during occupied hours in perimeter zone workspaces, this issue did not present significant problems to the analysis for these zones. For core zones, where illuminance was delivered primarily from electrical ambient lighting, the analysis of subjective responses to questions of daylight sufficiency became more challenging.

#### 4.6.7 Data processing

Two substantial data processing exercises were required to produce data in the format needed for analysis. The first exercise involved processing of time-lapse observation of occupant shade control behavior. For each shade control action, the time, control direction (e.g. raise or lower), shade location (e.g. lower, middle, upper window), shade occlusion index (e.g. 50% shaded) and participant ID were recorded. Time-series measures for predictor variables (e.g. window luminance, transmitted solar irradiance etc.) were then paired with each control action to perform statistical analyses and to generate visualizations of shade positioning over time. Data from sources that were not acquired simultaneously were paired based on a time-weighted average of the nearest two (e.g. before and after) time-series measures. Data sets for analysis of occupant subjective response were created using a similar procedure to pair subjective and physical measures based on time. **Figure 4.36** shows the process used to create the shade control data sets for analysis of shade positioning, frequency of operation, and examination of shade operation in relation to physical measures of environmental variables.



**Figure 4.36** Diagram of sources of data used to create final data sets for analysis of shade control behavior.



**Figure 4.37** Diagram of sources of data used to create final data sets for analysis of occupant subjective assessments.

**Figure 4.37** shows the process used to create the data sets for each participant that included data from the desktop polling stations. These data sets were used to examine subjective assessments in relation to simultaneous physical measures and electrical lighting energy consumption.

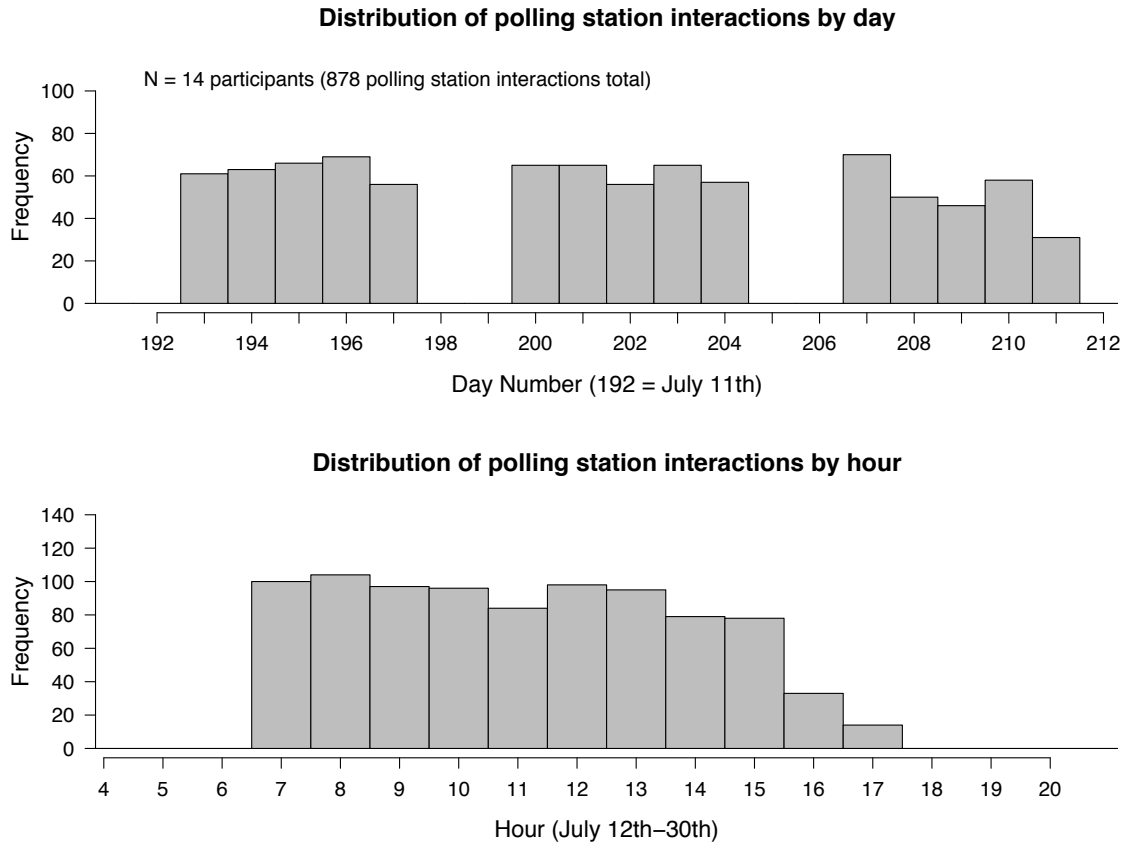
#### 4.6.8 Data diagnostics and initial visual exploration of responses

Following the first monitoring phase of the study (Phase 1), the distribution of study participant subjective responses was examined over the multi-week monitoring period as well as in aggregate (i.e. all days) distributed hourly. The primary objective of this analysis was to examine the responses of individuals as well as the group in aggregate to assess how frequently participants were interacting with the polling stations and to examine how interactions were distributed over time. The term “interaction” in this context refers to one complete interaction with the desktop polling station (e.g. answering the short 7-question IEQ survey).

##### 4.6.8.1 NW perimeter zones

**Figure 4.38** presents the distribution of interactions for all Phase 1 participants in aggregate over the 15-workday monitoring phase (upper histogram) and in aggregate by hour (lower histogram). Across the (N=14) participants in Phase 1, a total of 878 interactions were recorded, or an average of 4.2 interactions per participant per workday. Hourly data are shown in Standard Time. Because occupancy of the building was based on daylight savings time (DLST), 7:00 AM as shown in the figure corresponds to 8:00 AM from the perspective of study participants. Based on feedback from building

occupants during Phase 1, the “wake-up” time for the desktop polling stations was reset from 8:00 AM to 6:00 AM (DLST) to accommodate the study participants who arrived as early as 6:00 AM (DLST). This change was made at the beginning of Phase 2. Because daylighting conditions associated with visual discomfort were found to occur in the afternoon when the NW facade received direct sun, the lack of subjective assessments in the early AM during phase 1 is not anticipated to significantly affect the visual discomfort analysis. However, the lack of data did diminish the number of subjective assessments for low daylight illuminance levels.

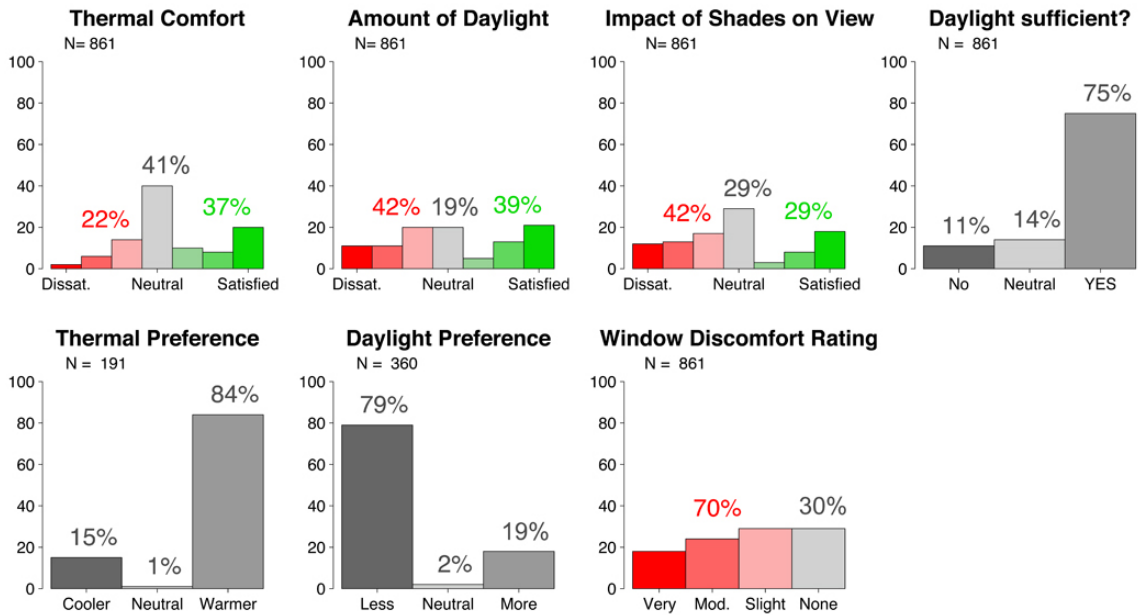


**Figure 4.38** Reporting frequency histograms for Phase 1 (NW perimeter zones).

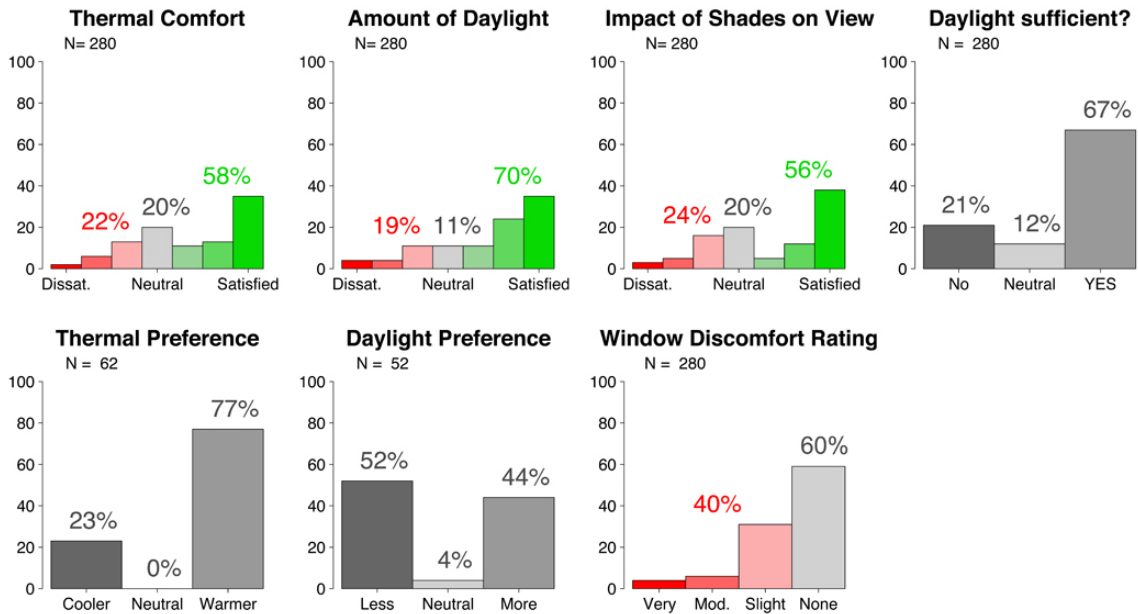
**Figure 4.38** shows that the daily frequency of interactions for Phase 1 is fairly consistent for the first two weeks, and diminishes during the third week. Similarly, in aggregate on an hourly basis, the frequency of interactions diminishes towards the end of the day. Because daylight illuminance and glare can be highly variable in response to daily and hourly (and even instantaneous) changes in sun and sky conditions, the relatively even distribution of interactions over time and the response rate was considered sufficient to proceed with the repeated measures method for the following phases.

**Figures 4.39** presents responses from all participants to the seven repeated-measures polling station questions during Phase 1. This format of representation was used early in

analysis to examine how subjective responses for each question was distributed across the subjective scale. As an example, in **figure 4.39**, the responses of the group to Q3 “Amount of daylight” indicate that the daylighting conditions created both satisfactory conditions during Phase 1, when all responses were considered in aggregate. In addition to viewing each group in aggregate, the responses for each individual participant were summarized, an exercise that showed that responses to the repeated measures questions were reasonably distributed across the subjective response scales for most participants for all questions. In other words, the majority of participants were both “satisfied” and “dissatisfied” with indoor environmental conditions of interest in the study depending on the time that the question was asked. These results were used to gain confidence in the method and its underlying assumption that occupant “point-in-time” assessments varied in response to the magnitude of physical measures of indoor environmental conditions at a given time.



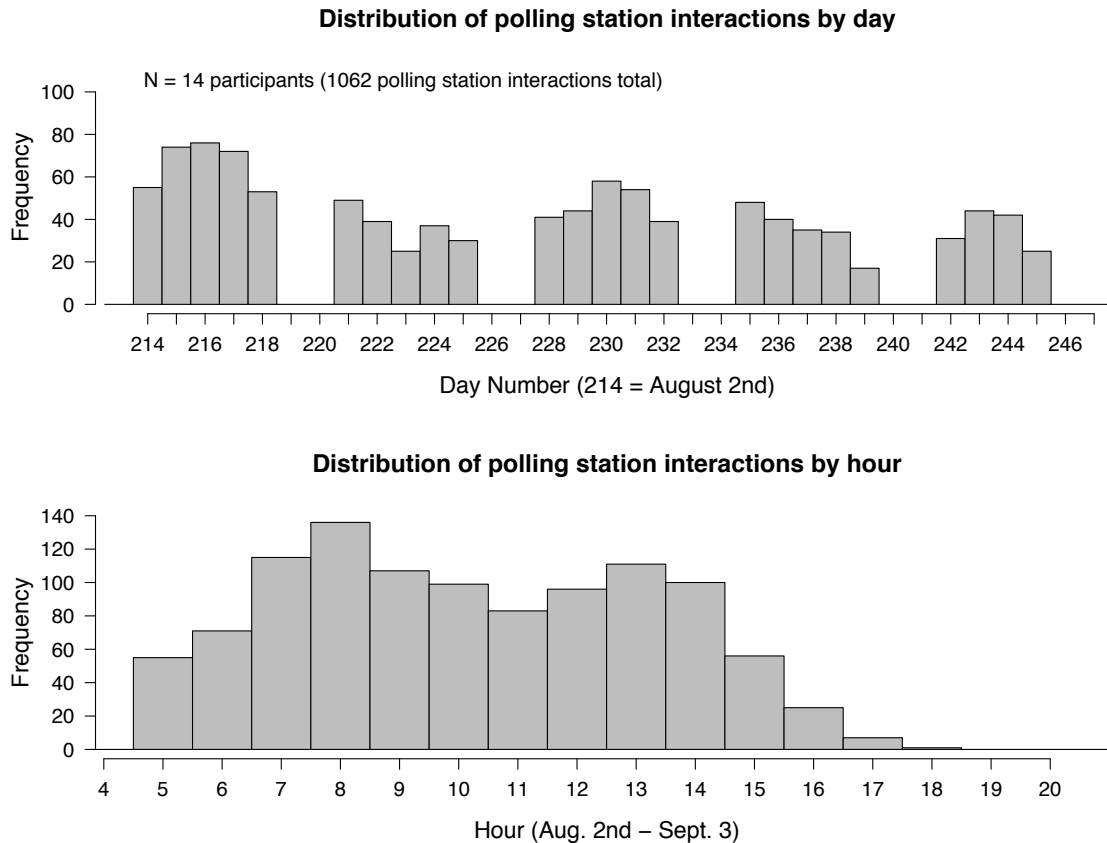
**Figure 4.39** Aggregate subjective assessments to polling station questions from all participants in Phase 1 (NW, Summer Solstice).



**Figure 4.40** Aggregate subjective assessments to polling station questions from all participants in for Phase 4 (NW, Fall Equinox).

#### 4.6.8.2 SE perimeter zones

**Figure 4.41** shows the reporting frequency for the Phase 2 (SE perimeter zone) participants. In contrast to Phase 1, the daily and hourly frequency of interactions is more variable. The hourly distribution (lower histogram), shows a significant number of responses recorded in the early morning, indicating that a number of study participants arrived at or before 6AM (DLST). During Phase 2 of the study (August 2 – Sept 3), the sun rose at approximately 6:30 (DLST), therefore subjective data were recorded for the SE perimeter zone through the full path of the sun across the facade. As shown by the upper histogram, Phase 2 was extended for an additional two weeks (with the consent of study participants) because the first two-and-a-half weeks of the study were predominantly overcast and dynamic sky conditions. Therefore, Phase 2 response frequencies were examined to determine if participants interacted with the polling stations in the additional two weeks. Overall, the frequency of interactions in aggregate for Phase 2 participants during the first week was similar to Phase 1 (approximately 5 interactions per participant per day). However, for the following weeks of the study, the frequency of interactions diminished to between 2 to 4 interactions per participant per day.



**Figure 4.41** Reporting frequency histograms for Phase 2 (SE perimeter zones).

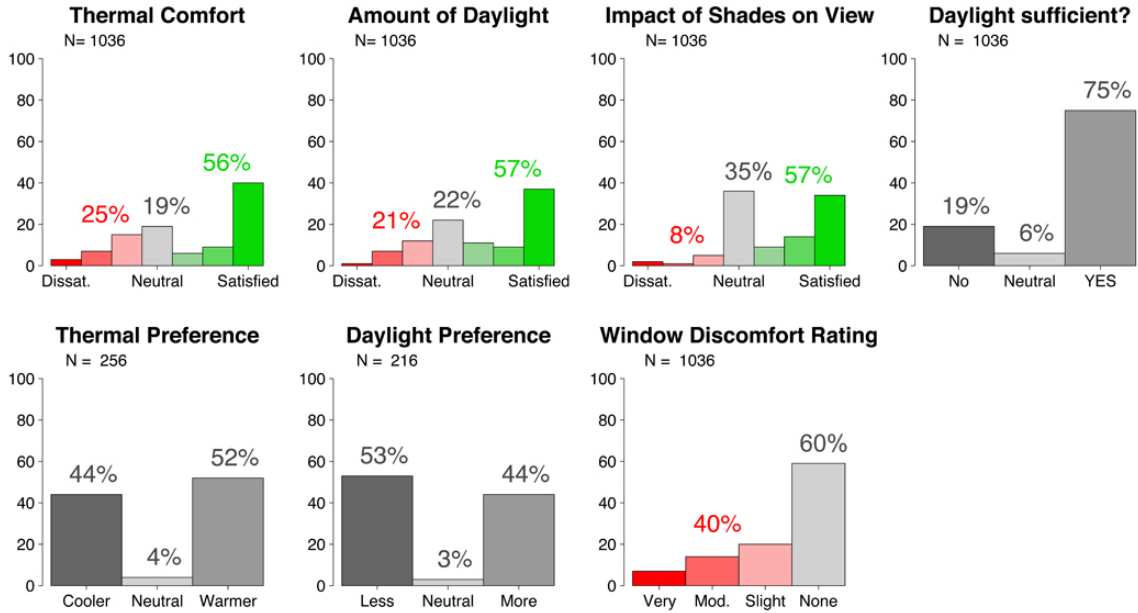


Figure 4.42 Aggregate subjective assessments to polling station questions for Phase 2.

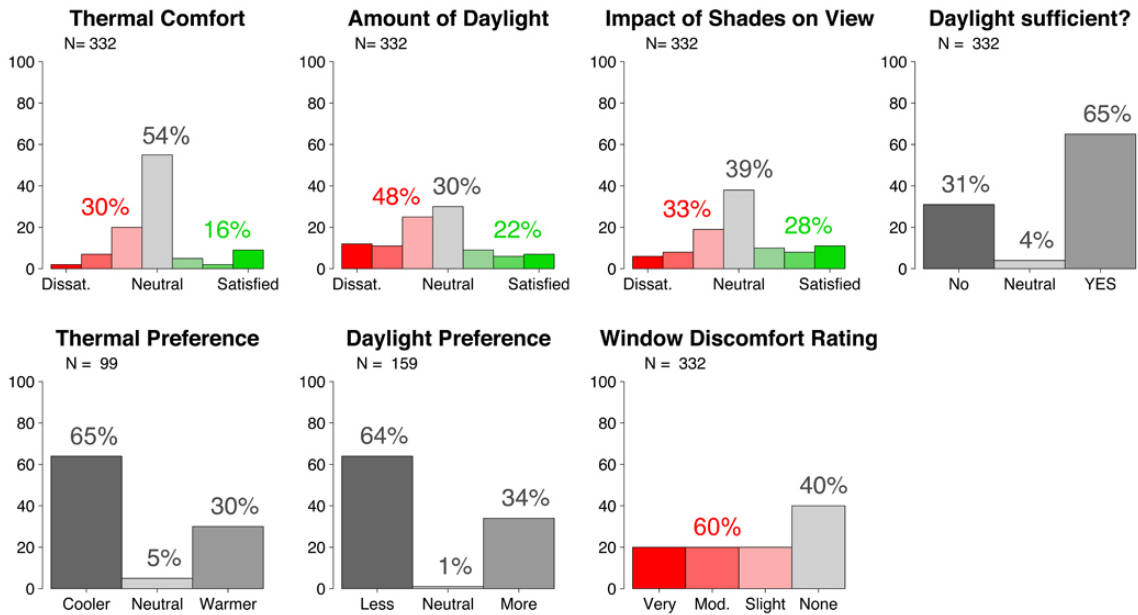
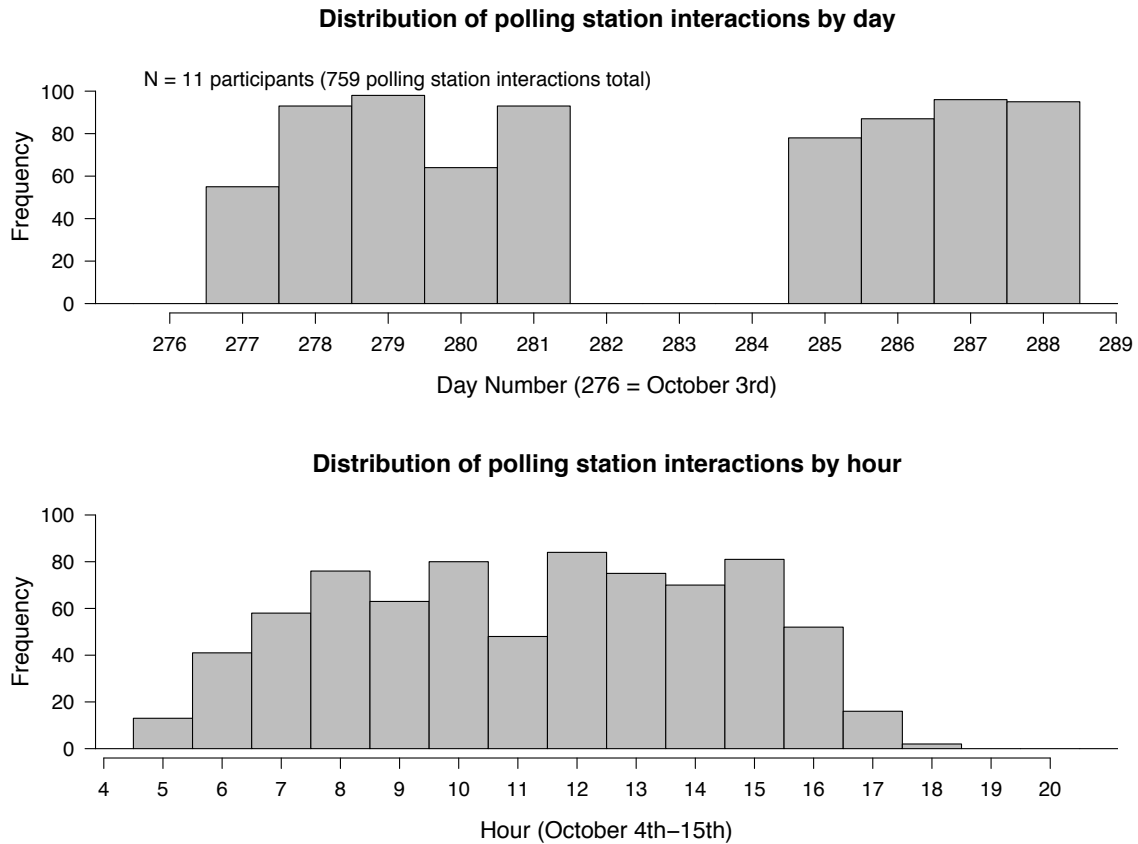


Figure 4.43 Aggregate subjective assessments to polling station questions for Phase 5.

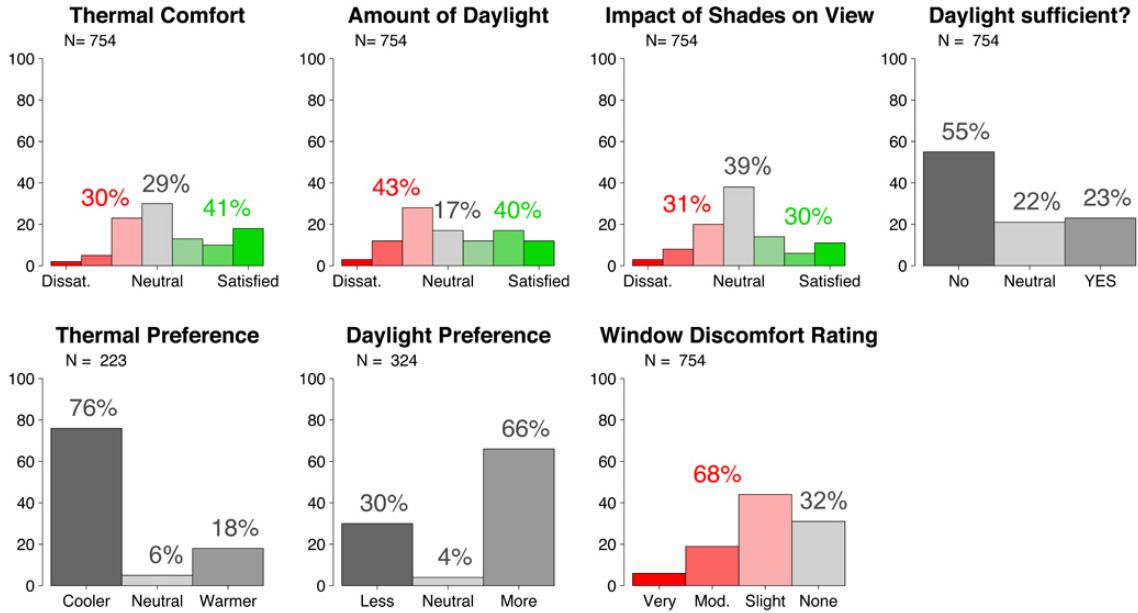


### 4.6.8.3 Core zones

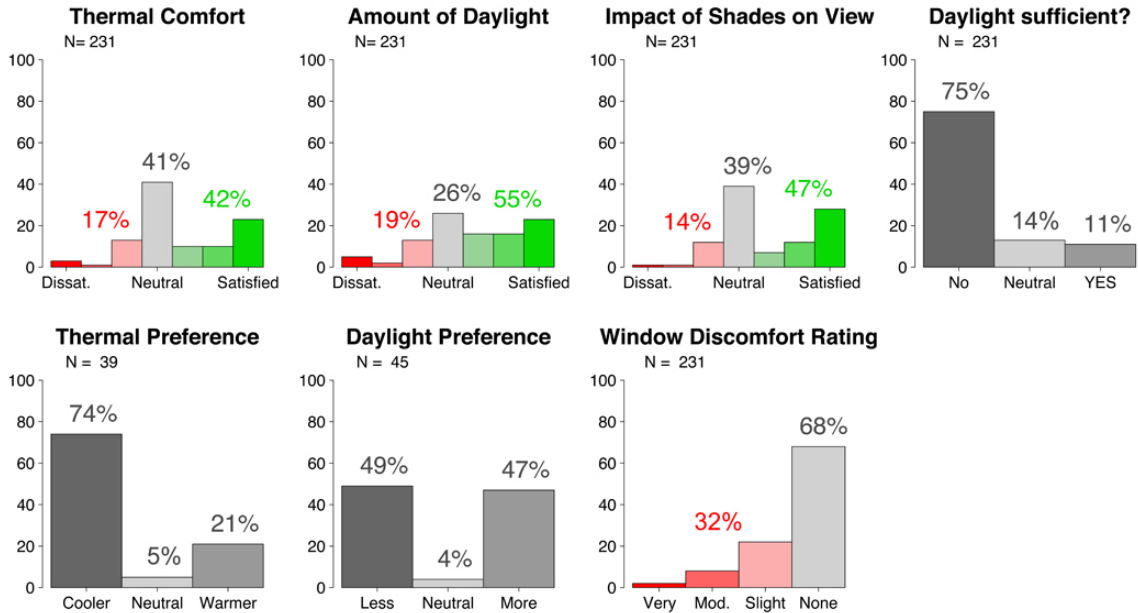
**Figure 4.44** shows the frequency of participation from workspaces located in the core zones of the SFFB. Overall, Phase 3 participants interacted with the polling stations an average of 6 times per day per participant. Results for the follow-up monitoring phases (Phases 4, 5, and 6) are similar to the initial phases and are presented in **appendix section H**.



**Figure 4.44** Reporting frequency histograms for phase 3 (core zones). Hourly data are shown in Standard Time (i.e. 5AM corresponds to 6AM for study participants).



**Figure 4.45** Aggregate subjective assessments to polling station questions for Phase 3.



**Figure 4.46** Aggregate subjective assessments to polling station questions for Phase 6.

## 4.7 Summary

The methods used in this research were developed to examine issues of shade operation, visual comfort, daylight sufficiency and visual connection to the outdoors from the perspective of building occupants performing real working tasks in buildings. To collect subjective data in the field, novel methods were developed to collect repeated measures subjective data paired with simultaneous physical measures. The primary methodological contributions of this research are twofold: (1) novel methods for recovering shade positions and frequency of operation from interior time-lapse imaging of the facade and for measuring interior luminance conditions using low cost, autonomous HDR-enabled digital cameras, and (2) a novel desktop polling station for recording repeated subjective measures from occupants in the field. The primary benefit of these contributions is considered to be their minimal intervention into the “normal” work tasks and behaviors of building occupants. Using the methods described in this chapter, a body of data were collected to examine the relationship between occupant operation of shading devices and existing shade control behavioral models and for new logistic regression models of shade operation to be developed. Further, a body of data were collected to examine the relationship between subjective assessments and existing indicators of successful daylighting (e.g. visual comfort, daylight sufficiency, and visual connection to the outdoors). The following chapters present the results and analysis of the research questions posed to address these topics.

## CHAPTER 5

### SHADE POSITIONING AND FREQUENCY OF OPERATION

*Illuminating interiors with natural light yields further sustainable design benefits. With an average floor-to-ceiling height in the tower of 13 feet, daylight reaches 85% of the workspaces. Powered lighting are used only when individuals are at their desks and are automatically dimmed or turned off when daylight is available.*

*A third accomplishment is the Federal Building's high performance workplace in the upper tower. The narrow floor plates and the fact that the private offices are relegated to the interior mean that almost all have breathtaking views of the city or the bay.*

-GSA<sup>1</sup>



**Figure 5.1.** Interior view from core workstations showing interior roller shades lowered and electrical ambient lighting on. Image acquired under clear sky conditions on November 4 at 10:15 AM PST.

---

<sup>1</sup> U.S. General Services Administration (2007). [San Francisco Federal Building](#).

## 5.1 Introduction

The claims made for the SFFB's "sustainable design benefits" related to daylight transmission and views were made prior to the facade retrofits with solar control film and interior roller shades. As discussed in Chapter 3, a solar control film (0.24 VLT, 0.39 SHGC) and interior roller shades (3% openness factor) were added to all windows above desk height on the SE facade and interior roller shades (5% openness factor) were added to the lower row of vision windows on the NW facade. These retrofits were made in response to occupant requests for a greater level of solar and glare control. The addition of solar control film and roller shades to facades with large areas of high visible light transmittance (VLT) glazing is not unique to the SFFB. As discussed in Chapter 2, field data describing occupant control of shading devices are extremely limited, and current day criteria used to predict the deployment of shading devices and assumptions for the frequency of operation vary widely. In addition, the application of existing assumptions to facades subdivided into a lower (view) zone and upper (daylight) zone is ambiguous because of the more complex shading configurations available to occupants. Because interior shading devices significantly reduce the daylight admitted by glazed areas of the facade (and obscure the views available to the outdoors), it is important to measure how interior shading devices are controlled by occupants as well as examine if the stated objectives of sufficient daylight and views are achieved from the perspective of occupants when shades are in use. Finally, to predict daylight availability during design, it is important to have evidence from buildings indicating the level of shading in use to compare against design expectations.

This chapter reports the results and analysis of time-lapse observation of occupant control of roller shades on the SFFB NW and SE facades. The primary objective of the analysis was to examine two common (and conflicting) hypotheses for occupant control of shading devices. The first hypothesis assumes that occupants deploy shading devices in response to the magnitude of transmitted vertical irradiance incident on the workspace and retract shading devices on a daily basis (either the following day, or when the stimulus no longer exceeds the threshold for deployment). This "active operator" hypothesis is common in computer simulations of daylight availability (Lee and Selkowitz, 1995; Reinhart, 2002; HMG, 2010) and will be introduced into the next version of the LEED daylighting credit compliance procedure. The second, "worst case scenario" hypothesis, emerges from studies of buildings in use (Rubin, 1978; Rea, 1984; Foster and Oreszczyn 2001; Inkarojrit, 2005) and is based on observations that occupants appear to position shading devices according to the "worst case" solar control condition, an impression based on perceptions formed over weeks or months, and rarely change the shading devices thereafter. Whether occupants behave as "active operators" or position shades for "worst case" solar control conditions has a significant effect on daylight availability and view.

In addition, all studies reviewed for this research were conducted in buildings where the facade was not subdivided into a lower (view) zone and upper (daylight) zone. Therefore, direct application of assumptions for shade control behavior is ambiguous for buildings

such as the SFFB, where each occupant adjacent to the SE facade can potentially lower the shades for only the row of vision windows to reduce discomfort and keep the upper rows of windows unshaded for daylight transmission to the interior workstations. Therefore, it is necessary to test a third hypothesis. This “selective operator” hypothesis assumes that the upper row of windows is less likely to be shaded by occupants adjacent to the facade because glare associated with the upper windows will be outside of the occupant’s immediate field of view. The longitudinal method of time-lapse observation enabled these three hypotheses to be tested by recording the position of shades and frequency of operation thus allowing a comparison of measured results to those predicted by existing behavioral models.

This chapter begins with an overview of the shade control behavioral models selected for comparison. Subsequent sections describe the scope of monitoring for the NW facade and the solar conditions that occurred during the two monitoring phases. **Section 5.3.3** presents results for the NW facade sections observed. **Section 5.4** presents similar context and results for the SE facade sections observed. In total, 128 individual shades were observed on the NW facade and 240 individual shades on the SE facade.

The following questions were used to guide the analysis:

1. Are roller shades exercised dynamically in response to the magnitude of physical environmental conditions?
2. How are roller shades typically positioned on sections of the facade adjacent to occupant workstations?
3. How does the positioning of roller shades and frequency of operation observed in the SFFB compare to the outcomes predicted by existing shade control behavioral models?

Additional questions related to the reasons for shade positioning and operation, as well as predictive logistic regression models of shade operation developed from physical measures paired with shade operations, are presented in Chapter 6.

## 5.2 Overview and selection of shade control behavioral models

As discussed in Chapter 3, transmitted vertical irradiance is one of the most common physical measures used to predict the operation of shading devices. In the following sections, time-series data of transmitted vertical irradiance at the workstation (with interior shades retracted) were used as inputs to four prominent behavioral models to develop a set of predictions for the frequency of shade operation. Time-lapse observation of occupant control of shading devices was then compared to each prediction to examine the models' accuracy in predicting frequency of operation and overall level of window occlusion.

It is important to note that existing behavioral models were primarily developed for single occupancy offices with venetian blinds where a single occupant is assumed to operate a single blind (or, where multiple windows exist, occlude all windows equally). In application to an open plan office where the facade is subdivided into horizontal bands of vision windows and upper clerestory windows, no guidance exists for how predicted changes in overall occlusion level would manifest among the multiple shading devices available for a given occupant. For example, where a single occupant has control over 6 unique interior roller shades, a change in occlusion level could involve a change in the position of one, multiple, or all shades. And if a behavioral model predicts that shades will be retracted, should we assume that all shades are completely retracted by the occupant? And similarly, should we assume that when a threshold is exceeded, all shades adjacent to a given occupant are fully lowered? In the context of the SFFB, this would typically result in 6 unique shades lowered and then raised each day, totaling 12 operations. Given the substantial number of shades available to each occupant, a conservative assumption was made for the “active operator” model predictions (**table 5.2** and **table 5.3**), in which occupants were predicted to make two shade operations per day on each day the threshold was exceeded.

The first behavioral model is the ( $50 \text{ W/m}^2$ ) threshold criteria implemented in the simulation program *Lightswitch Wizard* (Reinhart, 2002). This model predicts the operation of interior venetian blinds as a factor in estimating annually electrical lighting energy reduction from daylighting. In Reinhart's model, blinds are assumed to be fully lowered when the transmitted vertical irradiance exceeds ( $50 \text{ W/m}^2$ ) and fully raised at the start of the following workday. The second model examined is the ( $95 \text{ W/m}^2$ ) threshold criteria used by Lee and Selkowitz (1995) to predict the operation of interior venetian blinds. This model was used while simulating the performance of integrated envelope and lighting strategies. In this model, shading devices are assumed to be fully lowered (or fully raised) on an hourly basis in response to incident radiation values that are either above or below the threshold. In addition, the threshold corresponds closely to the threshold of  $100 \text{ W/m}^2$  derived by Inkarojrit (2005) in a field study of (N=25) participants where  $100 \text{ W/m}^2$  corresponds to a 90% probability that an occupant will lower venetian blinds). The third model selected is the simple behavioral model implemented in the 2012 draft of the LEED Daylighting credit. This model uses the criteria of presence of direct sun on interior workspaces to determine the position of

manually operated interior shading devices. In this model, shades are considered to be retracted if they are not required to block direct sun on interior workspaces.

The final model selected for examination is a probabilistic model developed by Inkarojrit (2005) from the field study noted above. Unlike the previous three models described which operate on a binary threshold criteria, this model predicts the *probability* that a shading device will be lowered based on the intensity of transmitted vertical irradiance. For example, using this model, there is a 50% likelihood that a shade will be lowered when the transmitted vertical irradiance is 13 W/m<sup>2</sup>. Similarly, at 13 W/m<sup>2</sup>, 50% of the shades on a given facade would be lowered. As the intensity of the stimulus increases, the probability of shades being lowered increases, so that at 100 W/m<sup>2</sup>, the model predicts that 90% of shades on a given facade will be lowered. There is no explicit guidance for how to model the raising of shading devices using this model. The model assumes that “building occupants will adjust their window blinds according to the worst case scenario,” and therefore uses the maximum transmitted vertical irradiance to predict the level of window occlusion. The model does not explicitly state if the maximum daily, weekly, monthly, or annual level of transmitted vertical irradiance should be used. In this study, the maximum level observed during each multi-week test phase was used to predict the average level of window occlusion. A summary of the models selected is presented in **Table 5.1**.

**Table 5.1** Summary of shade control behavioral models investigated

Predictor	Criteria for lowering	Criteria for raising
Reinhart, 2002	If irradi. > 50 W/m <sup>2</sup>	Shades raised on arrival on following workday
Lee and Selkowitz, 1995	If irradi. > 95 W/m <sup>2</sup>	If irradi. < 95 W/m <sup>2</sup> , shades raised after one hour
LEED, 2012	If direct sun incident on workspace	If no direct sun incident on workspace, shades raised
Inkarojrit, 2005	If irradi. = 13 W/m <sup>2</sup> 50% probability	NA, shades are not raised



### 5.3 Northwest facade

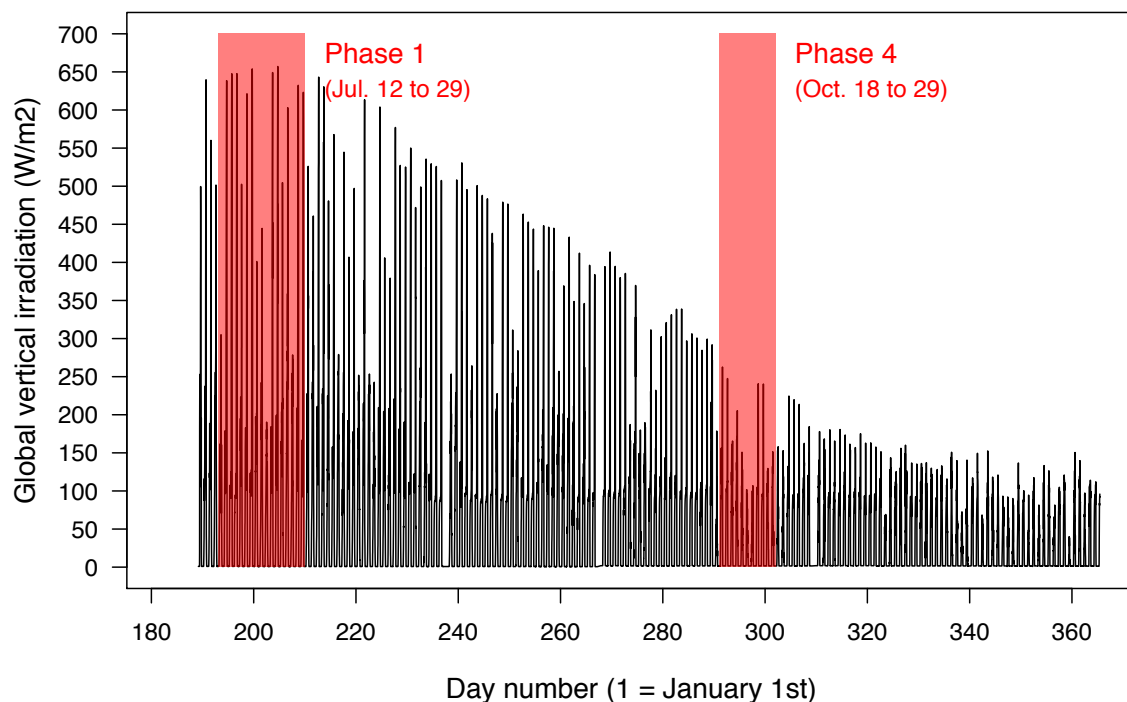
To control for differences in solar orientation and facade retrofit conditions, data to examine existing shade control models was collected from the NW and SE perimeter zones in separate phases. For analysis of the NW perimeter zones, the majority of participants were located on the 15th and 16th floors of the SFFB, where interior roller shades were added to the vision windows only (**figure 5.2**, left). An additional (N=3) participants were located on the 8th floor, where interior roller shades were added to both the upper two rows of windows as well as the row of vision windows (**figure 5.2**, right). In the following sections, results for participants from the 8th floor are presented separately.



**Figure 5.2** Overview of NW facade workstations where interior roller shades were added to the row of vision windows only (left) and to the upper two rows of windows in addition to the vision windows (right). The openness factor for shades in both images is the same (5%). The difference in perceived transparency is the result of different camera exposure settings.

### 5.3.1 Scope of monitoring

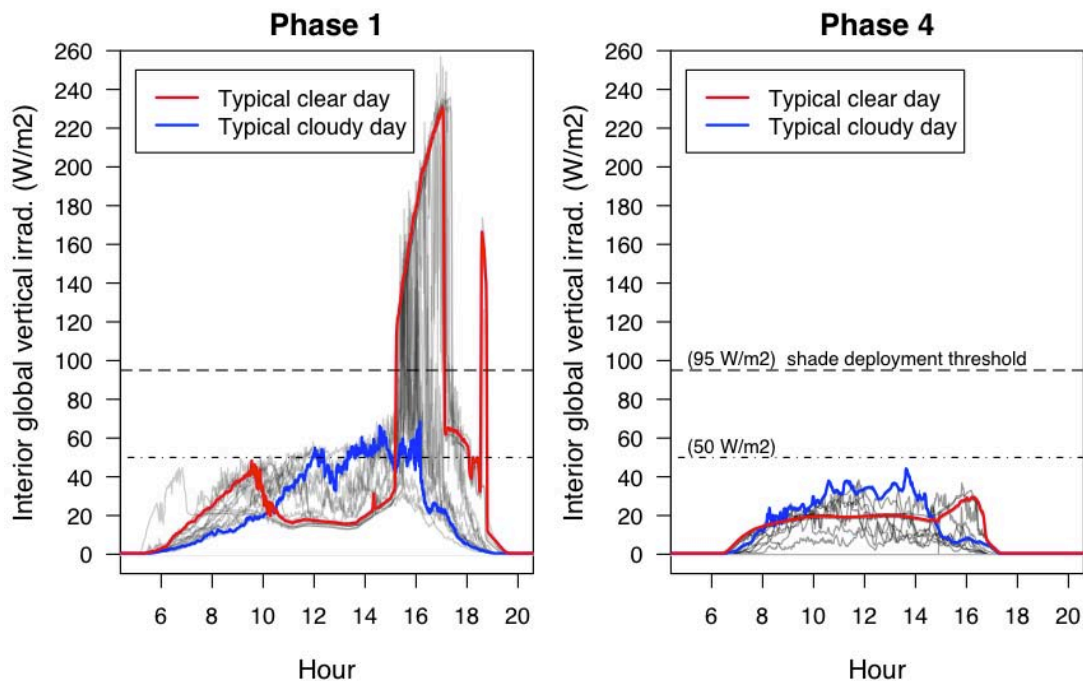
Sections of the NW facade were observed in two separate phases of the study (Phase 1 and Phase 4) to examine the potential effect of seasonal changes in solar and climate on occupant positioning and frequency of shade operation (as well as subjective assessment of IEQ conditions, dealt with in later chapters). As shown in **figure 5.3**, the monitoring periods were conducted at times of the year where the NW facade received quite different levels of solar radiation. Phase 1 was conducted near the summer solstice from July 12 to July 30, 2010 (15 workdays) and involved (N=11) participants. Phase 4 was conducted 3 weeks after the fall equinox (September 23) from October 18 to October 29, 2010 (10 workdays) and involved (N=12) participants (10 from Phase 1 and one additional participant).



**Figure 5.3** Seasonal variation in global vertical irradiance incident on the NW facade of the SFFB. The sensor was positioned such that it was unshaded by the exterior vertical translucent louvers (as shown in **figure 4.7**).

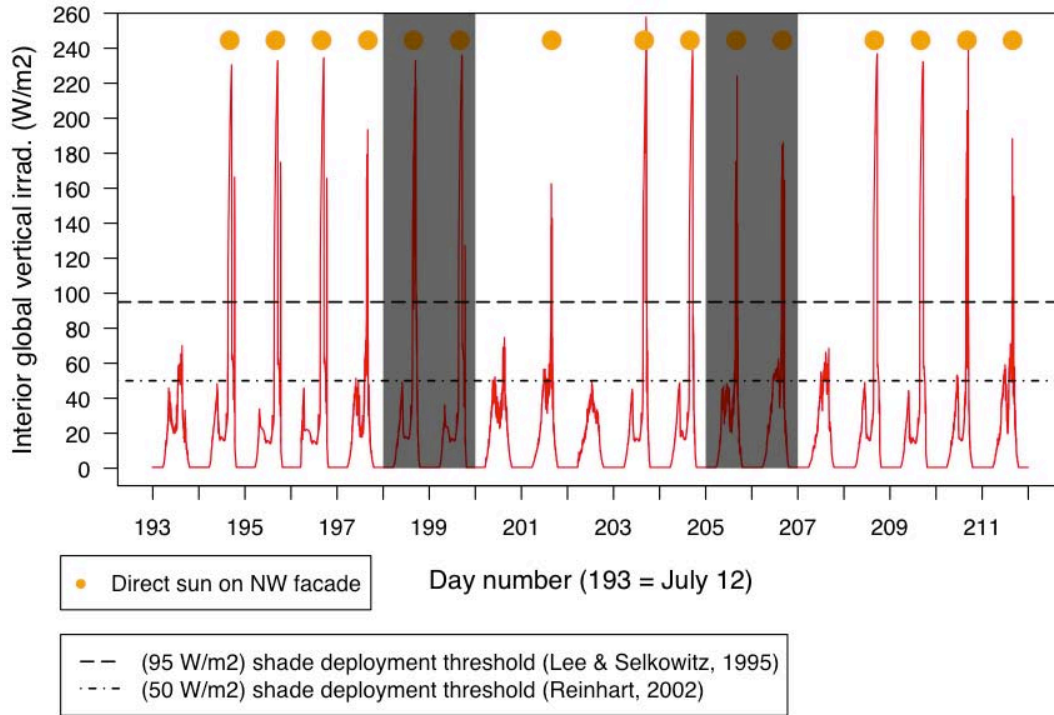
### 5.3.2 Observed facade solar exposures and model predictions

Sky conditions during Phase 1 and Phase 4 were predominantly clear in the afternoon when direct sun was incident on the NW facade. Sky conditions in the AM were often dynamic and included a combination of clear, cloudy and overcast sky conditions during both phases. **Figure 5.4** shows the daily variation in transmitted vertical irradiance for Phase 1 and Phase 4 (with interior roller shades retracted). Transmitted vertical irradiance was measured at the center of the vision window at a height of 1.27m (50”) from the floor as shown in **figure 4.10**. As shown in **figure 5.4** (left), the exterior vertical translucent fins intercepted solar radiation for only a portion (approximately half) of the time the facade was in direct sun. The spike in late afternoon (~19:00) (**figure 5.4** (left)) shows the level of transmitted vertical irradiance once the exterior translucent fin no longer shaded the sensor. Comparison between Phase 1 and Phase 4 shows the seasonal change in the intensity of transmitted vertical irradiance, and the absence of direct solar radiation during Phase 4.



**Figure 5.4** Seasonal variation in interior global vertical irradiance incident on workspaces adjacent to the NW facade (when interior shades are retracted).

**Figure 5.5** shows the daily variation in transmitted vertical irradiance over the Phase 1 monitoring period. Based on the measured data shown in **figure 5.5**, **table 5.2** shows the total number of shade operations predicted by each model identified in **table 5.1**. **Table 5.3** presents the predictions for Phase 4. The following sections compare observed results to these predictions.



**Figure 5.5** Measured transmitted vertical irradiance incident on workspaces adjacent to the NW facade during Phase 1 (July 12 to 30, 2010). Measurements were taken at a vacant workstation with the shades retracted. Weekends are indicated by grey.

**Table 5.2** Summary of behavioral model predictions for shade operation during Phase 1

Predictor	Threshold criteria	Number of workdays threshold exceeded	Total shade operations predicted (per person)	Average hours per day windows shaded (6AM - 6PM)	Average level of window occlusion (6AM - 6PM)
Reinhart	Irrad. > 50 W/m <sup>2</sup>	14	28	3.3	37%
Lee and Selkowitz	Irrad. > 95 W/m <sup>2</sup>	11	22	2	17%
LEED, 2012	direct sun	11	22	1.8	15%
Inkarojrit	P(W/m <sup>2</sup> )	NA	NA	NA	97%

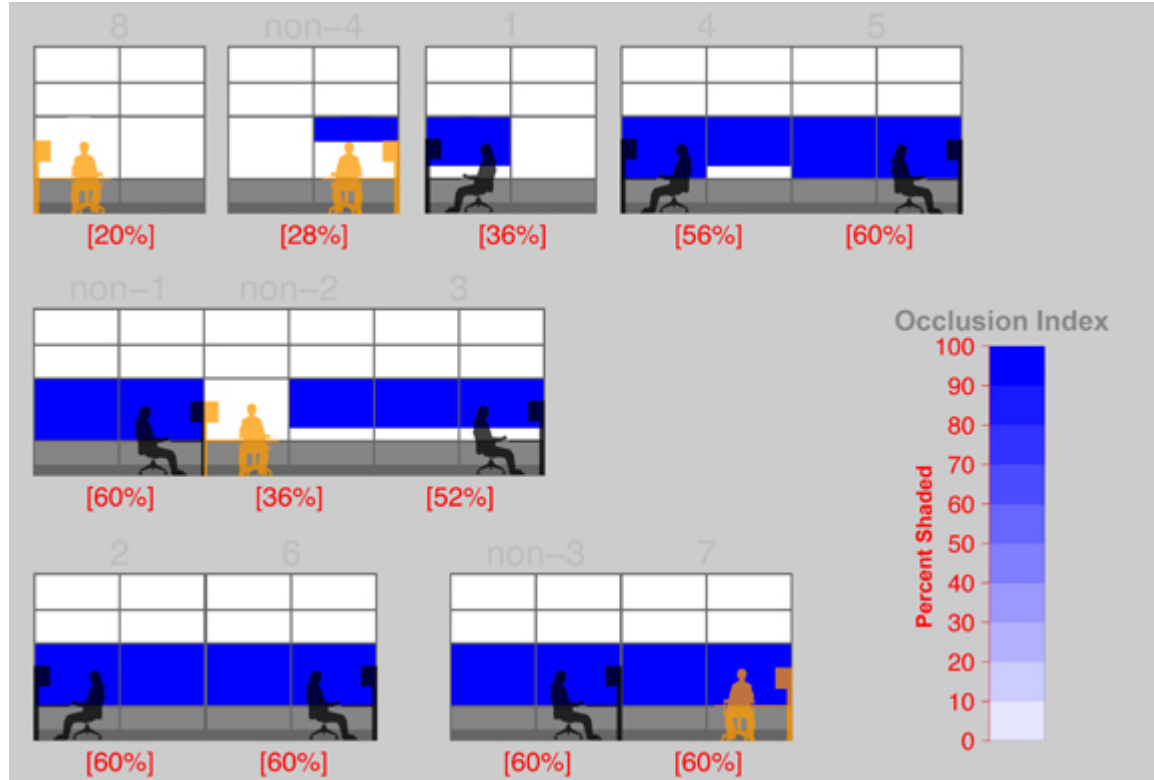
**Table 5.3** Summary of behavioral model predictions for shade operation during Phase 4

Predictor	Threshold criteria	Number of workdays threshold exceeded	Total shade operations predicted (per person)	Average hours per day windows shaded (6AM - 6PM)	Average level of window occlusion (6AM - 6PM)
Reinhart	Irrad. > 50 W/m <sup>2</sup>	0	0	0	0%
Lee and Selkowitz	Irrad. > 95 W/m <sup>2</sup>	0	0	0	0%
LEED, 2012	Direct sun	10	20	2.5	21%
Inkarojrit	P(W/m <sup>2</sup> )	NA	NA	NA	80%

### 5.3.3 Observed northwest window occlusion

The following sections present window occlusion results for the NW facade sections monitored. As described in Chapter 3, the windows on the NW facade were not retrofit with solar control film, and are not shaded by an exterior metal scrim. Results are shown graphically with a composite interior elevation that summarizes all observed shade positions over the monitoring phase in a single image (as described in Chapter 4). Sections of facade where shades were installed on the upper two rows of “daylight zone” windows are shown separately from zones with only lower shades. In addition, each monitoring phase (e.g. Phase 1, Phase 4) is shown separately to enable visual comparisons between seasonal changes in window occlusion levels. Because facade sections were observed on multiple floors and in multiple areas, the figures represent “composite” interior elevations and are not representative of physical adjacency, any complete floor, or the entire building. The elevation sections are ordered from left to right by the least occluded section observed to the most occluded. Human figures are included to indicate the position of occupants at each workstation in relation to adjacent roller shades. Occupancy was not monitored during the study. Figures shown in orange indicate occupants that have modified the original configuration of their workstation to face 180-degrees away from the facade.

### 5.3.3.1 Phase 1 (NW sections without upper shades)

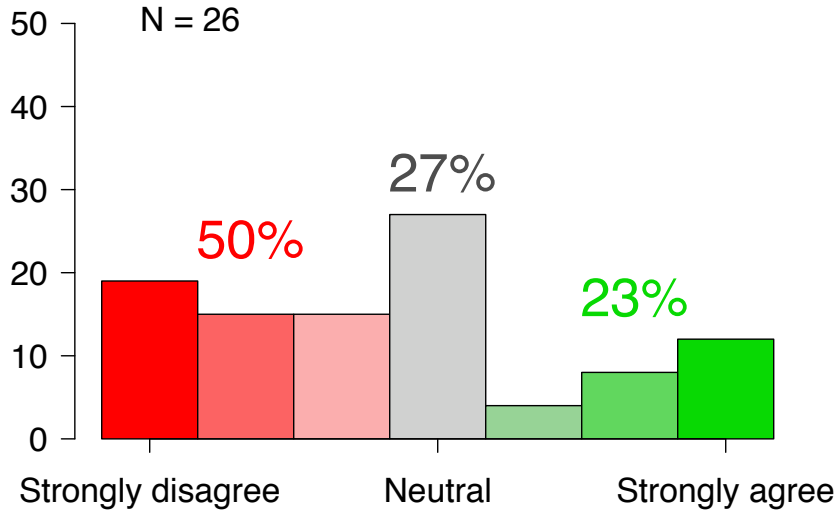


**Figure 5.6** Summary of facade occlusion for sections of the NW facade without interior roller shades installed on the upper two rows of windows for Phase 1 (July 12 to 29, 2010).

**Figure 5.6** is a composite of interior elevations created from observation of time-lapse HDR imaging of multiple sections of the NW facade and provides a graphical summary of the level of facade occlusion for each facade section observed during Phase 1. Facade sections were photographed from 6AM July 12 to 8PM July 30, 2010 at 5-minute intervals during occupied hours (6AM – 8PM PST), resulting in images characterizing 15 workdays. In general, the position of each occupant relative to the facade resulted in an individual controlling shades for two adjacent vision windows. Informal interviews and observation of time-lapse images indicated that the shades for a given workspace were only operated by the individual assigned to that workspace. To examine how individual shade control behavior may be influenced by perceived effects on the comfort of coworkers, results from the web-based survey questionnaire were examined. Each participant was asked two questions in (agree / disagree) format to assess the influence of perceptions of coworker comfort on shade control behavior. The (agree / disagree) questions were: “I keep the shades in my workspace LOWERED more often than I would prefer for the comfort of my coworkers,” and, “I keep the shades in my workspace RAISED more often than I would prefer for the comfort of my coworkers.” Results to the questions are presented in figure 5.7 and figure 5.8. The results suggest that, for the

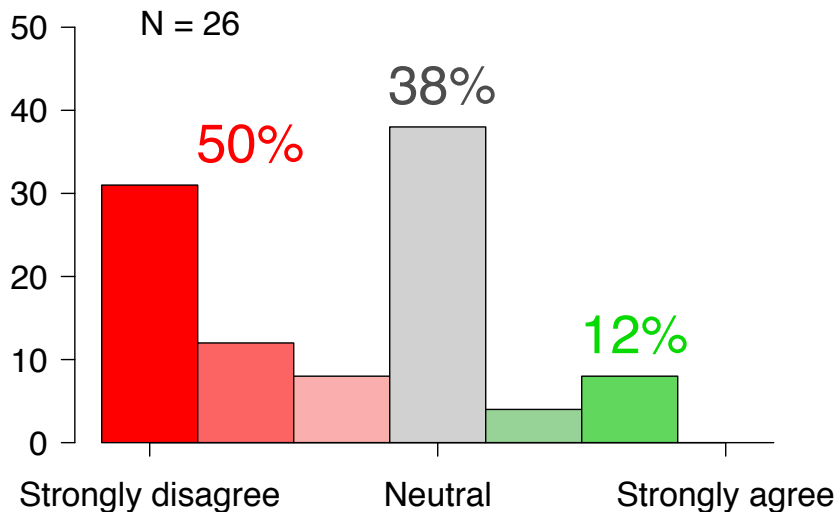
majority of participants, shade control behavior was not influenced by concern for the comfort of coworkers.

**I keep the shades LOWERED for the comfort of coworkers**



**Figure 5.7** Summary of responses to the (agree / disagree) survey question: “I keep the shades in my workspace LOWERED more often than I would prefer for the comfort of my coworkers.”

**I keep the shades RAISED for the comfort of coworkers**



**Figure 5.8** Summary of responses to the (agree / disagree) survey question: “I keep the shades in my workspace RAISED more often than I would prefer for the comfort of my coworkers.”



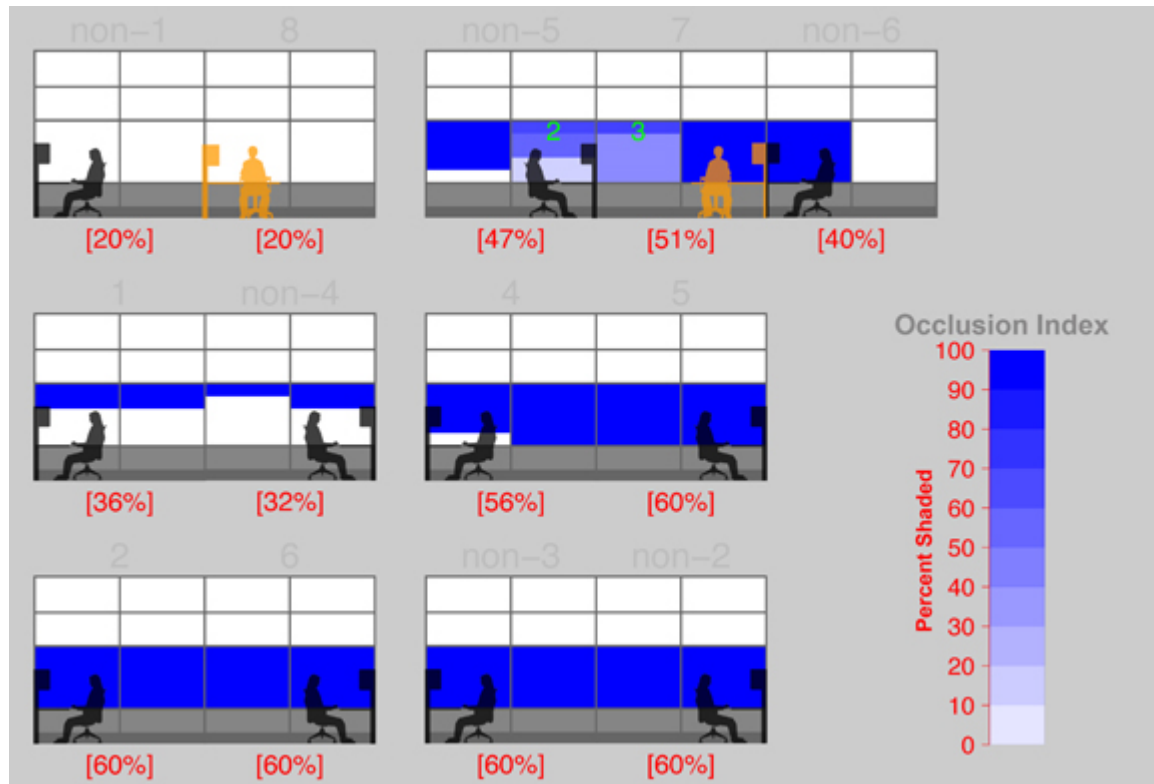
In **figure 5.6**, the average level of facade occlusion is summarized for each facade section in brackets, where a section consists of 8 windows (2 horizontally, by 4 vertically). Workstations are oriented at a 45-degree angle to the facade and face outward. To indicate both position and view orientation, occupants are represented as silhouettes, where left-facing silhouettes represent a west-facing view orientation and right-facing silhouettes represent a north-facing view orientation. Numbers shown in green indicate the total number of times that a given shade was adjusted during the monitoring phase. A shade with no green number indicates that the shade was not adjusted (i.e. static) during the monitoring phase.

In addition to the (N=8) facade sections adjacent to (and operated by) participants in the subjective portion of this study, an additional (N=4) facade sections adjacent to occupied workstations were observed. These additional “non-participants” are identified in **table 5.4** as “non-1, non-2” etc. In total, 12 facade sections without upper shades were observed, corresponding to (N=12) occupants, 24 operable interior roller shades (lower windows only), and 96 individual windows. **Table 5.4** provides a quantitative summary of individual levels of facade occlusion and frequency of shade operation. As shown in **table 5.4**, no shade operations were observed during the three-week test interval (Phase 1). The average level of facade occlusion for all (N=12) facade sections was 49% (taking into account the contribution of furnishings that occluded the lowest row of windows). For the portion of the facade where shades were provided (i.e. the row of vision windows), the average level of occlusion was 73%.

**Table 5.4** Summary of NW facade occlusion for Phase 1 (no shades installed on upper windows)

No.	View dir.	Occlusion index			Number of shade operations (over 14 workdays)	
		Upper win.	Lower win.	Facade	Upper win.	Lower win.
1	W	NA	40%	36%	NA	0
2	W	NA	100%	60%	NA	0
3	W	NA	80%	52%	NA	0
4	W	NA	100%	60%	NA	0
5	N	NA	90%	56%	NA	0
6	N	NA	100%	60%	NA	0
7	away	NA	100%	60%	NA	0
8	away	NA	0%	20%	NA	0
non-1	W	NA	100%	60%	NA	0
non-2	W	NA	40%	36%	NA	0
non-3	N	NA	100%	60%	NA	0
non-4	W	NA	20%	28%	NA	0
N = 12			Avg.=73%	Avg.=49%	Total=0	

### 5.3.3.2 Phase 4 (NW sections without upper shades)



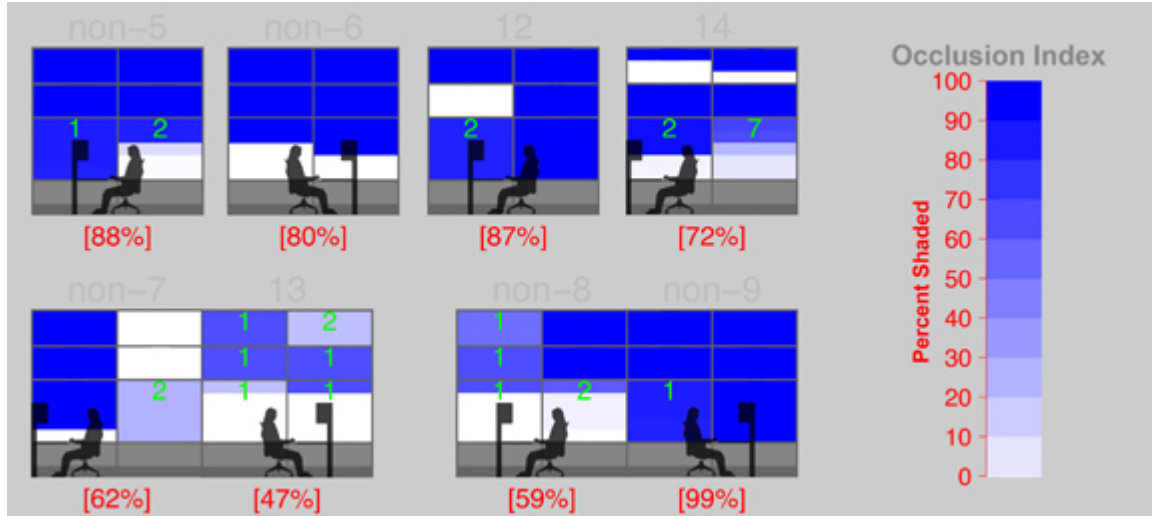
**Figure 5.9** Summary of window occlusion for sections of the NW facade without interior roller shades installed on the upper two rows of windows for Phase 4 (October 18 to 29, 2010).

**Figure 5.9** shows the level of window occlusion of the NW facade without interior roller shades installed for Phase 4. A comparison between Phase 1 and Phase 4 (**figure 5.6** and **figure 5.9**) shows that the level of window occlusion is similar between the two phases. Comparing the average level of vision window occlusion between phases (using only the results of participants who participated in both phases), the occlusion index changed only slightly, from 76% to 73%. This is notable because, as shown in **figure 5.4**, the facade and interior workspaces received significantly lower levels of vertical radiation in Phase 4 compared with Phase 1. For example, in Phase 4, the interior vertical radiation never exceeded two of the three thresholds for shade deployment ( $50 \text{ W/m}^2$  or  $95 \text{ W/m}^2$ ) (**table 5.1**). **Table 5.5** presents a summary of facade occlusion and frequency of shade operation for each participant in Phase 4.

**Table 5.5** Summary of NW facade occlusion for Phase 4 (no shades installed on upper windows)

No.	View dir.	Occlusion index			Number of shade operations (over 10 workdays)			
		Upper win.	Lower win.	Facade	Upper win.	Lower win.	Total	Average per day
1	W	NA	40%	36%	NA	0	0	0
2	W	NA	100%	60%	NA	0	0	0
4	W	NA	90%	56%	NA	0	0	0
5	N	NA	100%	60%	NA	0	0	0
6	N	NA	100%	60%	NA	0	0	0
7	away	NA	78%	51%	NA	3	0.3	0
8	away	NA	0%	20%	NA	0	0	0
non-1	W	NA	0%	20%	NA	0	0	0
non-2	N	NA	100%	60%	NA	0	0	0
non-3	W	NA	100%	60%	NA	0	0	0
non-4	N	NA	30%	32%	NA	0	0	0
non-5	N	NA	68%	47%	NA	2	0.2	0
non-6	W	NA	50%	40%	NA	0	0	0
N = 13			Avg.=66%	Avg.=46%		Total=5	Avg.=0.04	Avg.=0

### 5.3.3.3 Phase 1 (NW sections with upper shades)



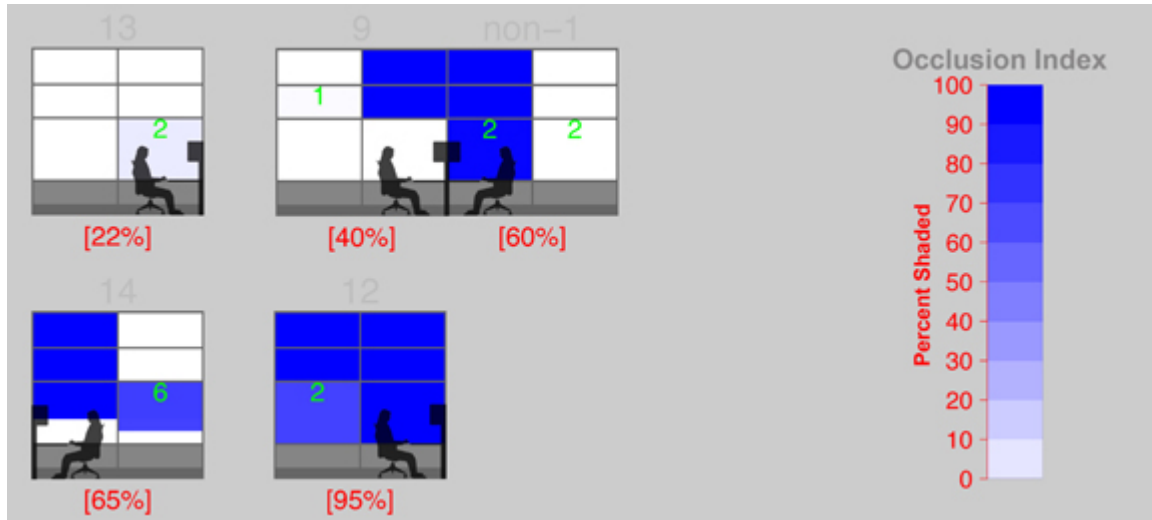
**Figure 5.10** Summary of facade occlusion for sections of the NW facade with interior roller shades installed on the upper two rows of windows for Phase 1 (July 12 to 30, 2010).

**Figure 5.10** summarizes the level of facade occlusion for (N=8) facade sections on the NW during Phase 1 for regions of the NW facade where interior roller shades *were* installed on the upper two sets of windows (in addition to the lower windows). Of the (N=8) sections observed, (N=3) represent sections adjacent to study participant workstations and an additional (N=5) represent sections adjacent to “non-participant” workstations. In total, 48 interior roller shades and 64 individual windows were observed for this group. Results indicate that, on average, interior shades and furnishings occluded 74% of the facade sections observed. And, in contrast to the (N=0) shade operations observed for Phase 1 in the regions of the NW facade where no shades were installed on the upper two rows of windows, **table 5.6** shows that shades were operated for facade sections with upper shades, however the frequency of operation was relatively low. In addition, the level of occlusion for the upper window regions was 80% on average. As will be discussed in Chapter 6, this aligns with survey comments indicating that the upper windows are a source of visual discomfort for occupants working adjacent to the facade. The vision windows were less occluded than the NW perimeter zone group without upper shading devices (56% vs. 73% respectively) **table 5.6**.

**Table 5.6** Summary of NW facade occlusion for Phase 1 (with shades installed on upper windows)

No.	View dir.	Occlusion index			Number of shade operations (over 14 workdays)			
		Upper win.	Lower win.	Facade	Upper win.	Lower win.	Total	Average per day
12	W	75%	93%	87%	2	0	2	0.14
13	N	50%	55%	62%	0	2	2	0.14
14	W	75%	55%	72%	2	7	9	0.64
non-1	W	100%	70%	88%	1	2	3	0.21
non-2	N	100%	50%	80%	0	0	0	0
non-3	N	58%	9%	47%	5	2	7	0.50
non-4	N	81%	16%	59%	2	3	5	0.36
non-5	W	100%	97%	99%	0	1	1	0.07
N = 8		Avg.=80%	Avg.=56%	Avg.=74%	Tot.=12	Tot.=17	Tot.=29	Avg.=0.26

### 5.3.3.4 Phase 4 (NW sections with upper shades)



**Figure 5.11** Summary of facade occlusion for sections of the NW facade with interior roller shades installed on the upper two rows of windows for Phase 4 (October 18 to 29, 2010).

**Figure 5.11** summarizes the level of facade occlusion for (N=4) participants adjacent to the NW facade during Phase 4 for regions of the facade where interior roller shades were installed on the upper two sets of windows. A (N=1) single adjacent “non-participant” was also observed. A visual comparison of **figure 5.10** and **figure 5.11** indicates that levels of facade occlusion were similar between Phase 1 and Phase 4 for two of the three participants who participated in both phases (participants 12 and 14). Similar to Phase 1, on average, the level of window occlusion was greater for upper windows compared to vision windows and both upper and vision windows had significant levels of occlusion (50% and 40% respectively). And similar to Phase 1, vision window shades were operated more frequently than upper window shades (14 of the 15 total shade operations were of vision window shades).

**Table 5.7** Summary of NW facade occlusion for Phase 4 (with shades installed on upper windows)

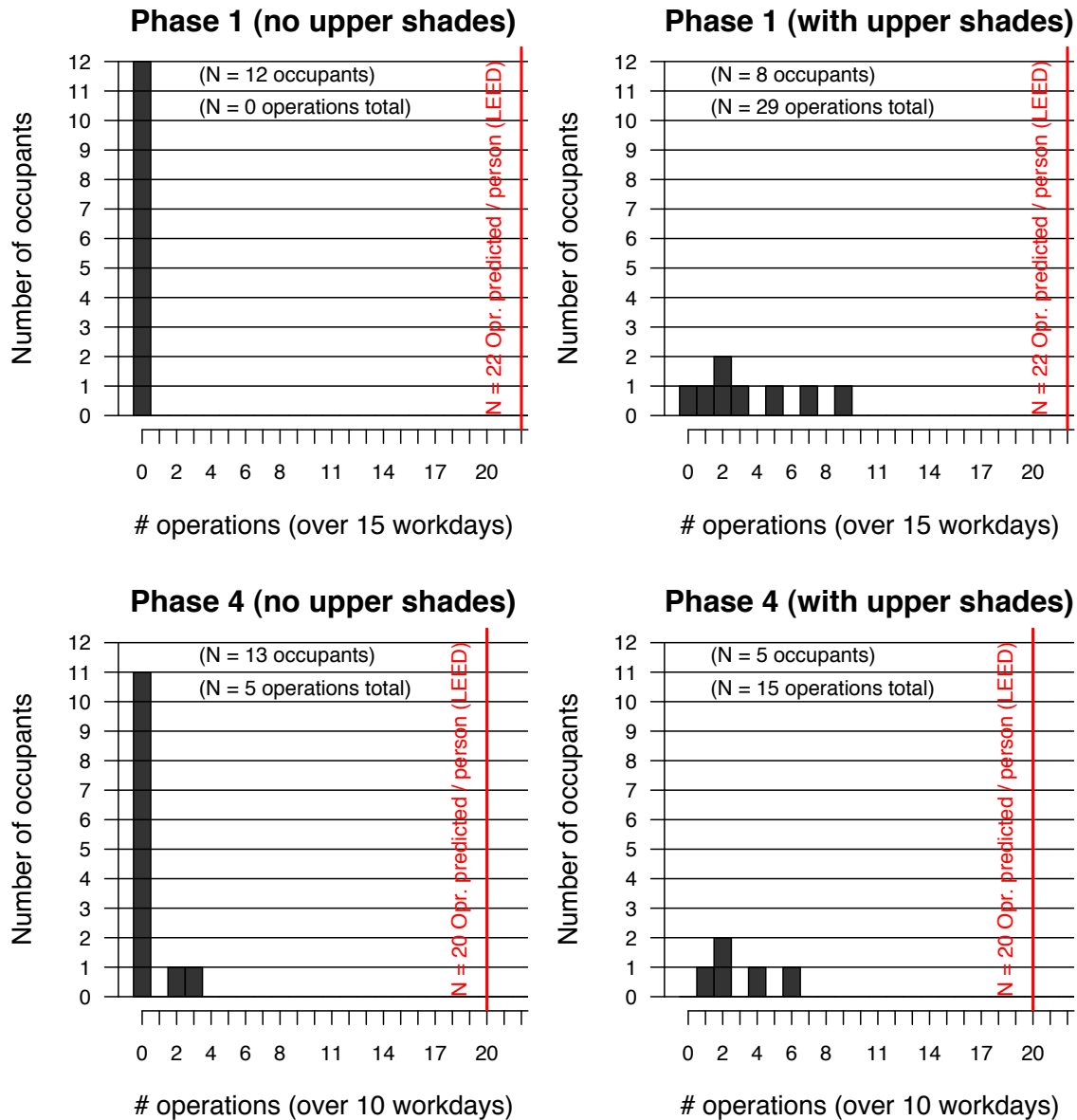
No.	View dir.	Occlusion index			Number of shade operations (over 10 workdays)			
		Upper win.	Lower win.	Facade	Upper win.	Lower win.	Total	Average per day
9	N	50%	0%	40%	1	0	1	0.10
12	W	100%	87%	95%	0	2	2	0.20
13	N	0%	4%	22%	0	2	2	0.20
14	W	50%	61%	65%	0	6	6	0.60
non-1	W	50%	49%	60%	0	4	4	0.40
N = 5		Avg.=50%	Avg.=40%	Avg.=56%	Total=1	Total=14	Total=15	Avg.=0.30

### 5.3.4 Summary for the NW facade

Occupant control of shading devices serves as a first-order indicator of the effectiveness of the unshaded facade in creating comfortable indoor environmental conditions. The level of facade occluded by shading devices and frequency of shade operation have implications for interior daylight availability, visual comfort, and visual connection to the outdoors. Therefore, it is important to compare existing assumptions regarding when shades will be lowered and raised to observations from buildings in use since shade state is important for predictions of daylight availability, view, occupant comfort, and electric lighting demand. The following two sections compare the observed levels of occlusion and frequency of operation for the NW facade to existing shade control behavioral models.

#### 5.3.4.1 Frequency of shade operation

**Figure 5.12** presents a distribution of occupants by total number of shade operations observed (per person) during Phase 1 and Phase 4, comparing facade sections with upper shades to sections with shades on only the vision windows. During Phase 1, the (Reinhart, 2002) behavioral model predicted (N=28) total shade operations per person and the Lee & Selkowitz (1995) and LEED (2012) models both predicted (N=22) (**table 5.2**). A vertical red line is shown to indicate the (N=22) shade operations predicted by the LEED (2012) model. The results show that the numbers of shade operations observed were substantially lower than those predicted by any of the 3 “active operator” models. Notably, no shade operations were observed during Phase 1 (15 workdays) for the (N=12) occupants who did not have upper shades and only 5 total operations were observed for the (N=13) occupants for the same facade condition in Phase 4. In comparison, the facade condition where occupants had shades on both upper and vision windows resulted in more frequent operation of shading devices for both Phase 1 and Phase 4, however frequencies remained much lower than assumed by “active operator” models.

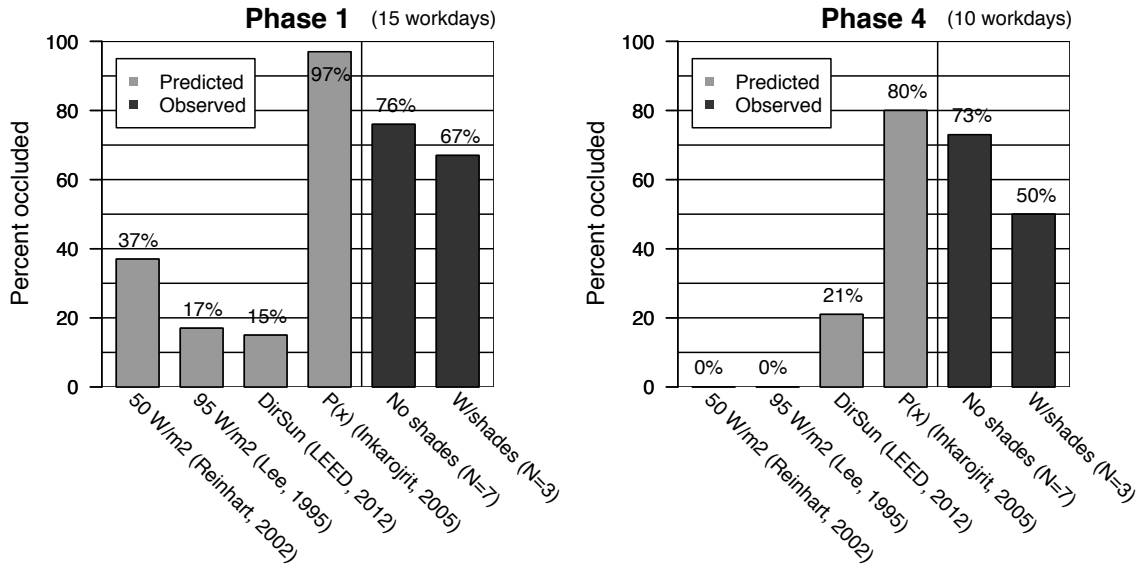


**Figure 5.12** Distribution of occupants by total number of shade operations observed (per person) during Phase 1 and Phase 4, comparing facade sections “with upper shades” to sections with shades on only the vision windows (i.e. “no upper shades”).



### 5.3.4.2 Predicted vs. observed levels of window occlusion

**Figure 5.13** compares the observed level of window occlusion for Phase 1 and Phase 4 with the levels predicted by the 4 shade operation behavioral models. For participants who only had shades on the vision windows, the summary values (i.e. Phase 1 = 76%, Phase 4 = 73%) represent the average level of vision window occlusion. For participants who had shades on both upper “daylight zone” and lower vision windows (W/shades), the summary value represents the average level of window occlusion for vision windows and upper windows.



**Figure 5.13** Comparison of levels of occlusion predicted to levels observed on NW facade for the subset of participants who participated in both Phase 1 and Phase 4 (N = 10). The graph used the subset of participants who participated in both phases to more directly examine the possibility of a seasonal change in the level of facade occlusion.

As shown in **figure 5.13**, each of the 3 “active operator” models significantly underestimated the average level of window occlusion for both Phase 1 and Phase 4. As illustrated by the interior elevation graphics (**figures 5.6, 5.9, 5.10, 5.11**), the difference in outcomes results primarily from the low frequency (or lack) of operation of interior shades. In other words, the results show that shades are not retracted on a daily basis, thus leading to greater levels of occlusion than assumed by the “active operator” models. In contrast, model 4 overestimated the level of window occlusion for both phases, but was closer to the levels actually observed. It is important to note that because model 4 predicts the state of a shading device in terms of fully retracted or fully deployed, the model is not capable of describing the individual occlusion levels observed, which represent considerable variation between fully retracted and fully deployed states. For example, for the facade condition with upper shades, occupants typically shaded the upper two rows of windows completely and left one or both of the vision windows partially unshaded. This is a significantly different behavioral outcome than a facade with a proportional amount of fully shaded and fully unshaded workspaces. In addition, the overestimation of window occlusion by model 4 in Phase 1 is partly due to the model’s

sensitivity to the “worst case” solar condition, where observations show that even in “worst case” solar conditions, occupants prefer to leave a portion of the vision windows unshaded and perhaps reduce discomfort by other means such as facing away from windows rather than deploying interior shading devices to occlude the entire window. However, in aggregate, the “worst case scenario” model best described the overall state of window occlusion for both phases.

## 5.4 Southeast facade

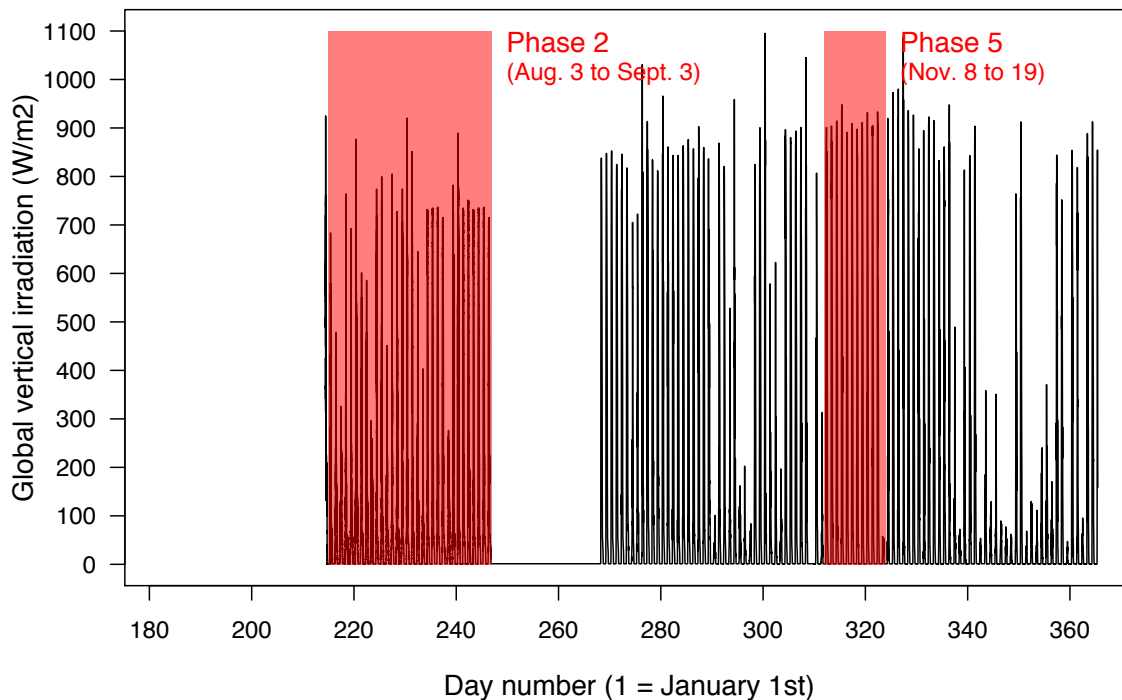
The following sections present a parallel analysis and summary of frequency of shade operation and window occlusion for the SE facade. Participants for Phase 2 and Phase 5 were located on the 14th, 15th and 16th floors of the SFFB, with the majority of participants on the 16th floor. In addition to the exterior metal screen (50% openness at normal incidence) acting as a window shading element, all windows on the SE facade were retrofit with solar control film (0.24 VLT, 0.39 SHGC) and interior roller shades (3% openness) with the exception of the row of windows below desk height. Resulting from the shade retrofit, all participants in workstations adjacent to the facade had control over 6 individual roller shades (2 vision window and 4 upper-clerestory windows) (**figure 5.14**).



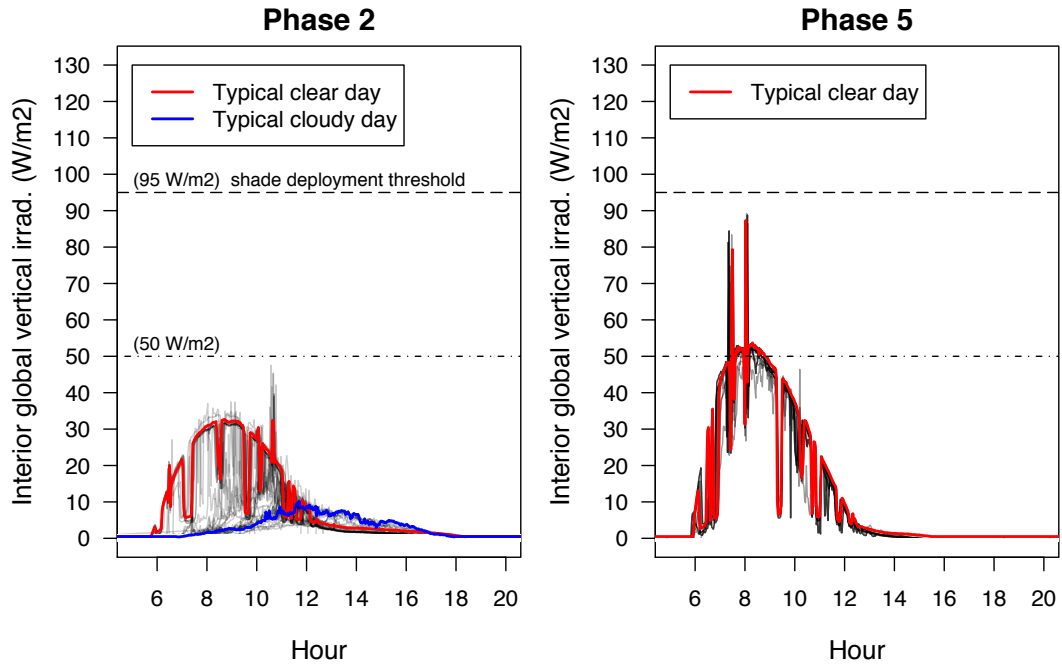
**Figure 5.14** Example perimeter workstation adjacent to the SE facade showing location of interior roller shades. Image taken on November 1st at 10:20 AM PST.

### 5.4.1 Scope of monitoring

Sections of the SE facade were observed in two separate phases of the study (Phase 2 and Phase 5) to examine the potential effect of seasonal changes in solar and climate conditions as shown in **figure 5.15**. Phase 2 was conducted from August 2 to September 3, 2010 (25 workdays) and involved (N=14) participants. Phase 5 was conducted from November 8 to 19, 2010 (10 workdays) and involved (N=8) participants (5 from Phase 2 and three additional participants). Sky conditions during Phase 2 were often foggy or cloudy in the AM during the first two-and-a-half weeks, with only a few days of direct sun incident on the SE facade during the period (**figure 5.17**). To collect data representative of direct sun conditions, Phase 2 was extended (with the permission of participants) for an additional two weeks. During these additional weeks, sky conditions were predominantly clear. Sky conditions during Phase 5 were predominantly clear. Under clear sky conditions, the SE facade received direct sun from sunrise until approximately 1:45 PM PST during Phase 2 (and until approximately 2:50 PM PST during Phase 5).



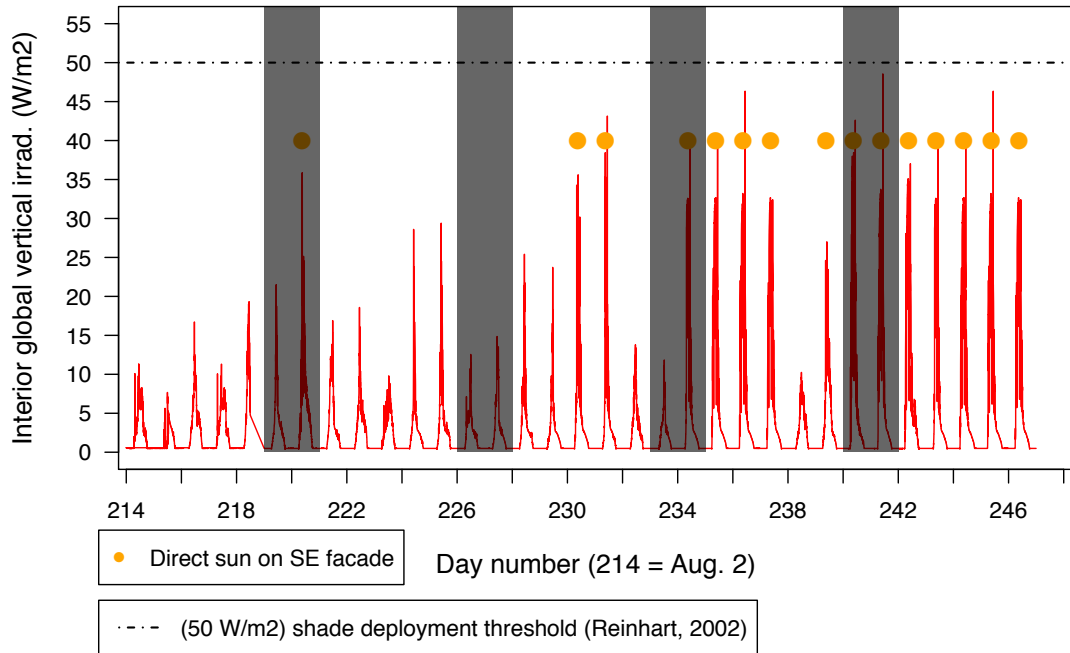
**Figure 5.15** Seasonal variation in global vertical irradiance incident on the SE facade of the SFFB (sensor was positioned such that it was unshaded by the exterior metal screen, as shown in **figure 4.7**).



**Figure 5.16** Daily variation in interior global vertical irradiance incident on workspaces adjacent to the SE facade (when interior shades are retracted) for Phase 2 and Phase 5. There were no cloudy or overcast days, during Phase 5.

#### 5.4.2 Observed facade solar exposures and model predictions

**Figure 5.17** shows the measured transmitted vertical irradiance incident on workspaces adjacent to the SE facade during Phase 2 (Aug. 3 to Sep. 3, 2010). Measurements were taken at a vacant workstation with the shades retracted. Weekends are indicated by grey. An orange dot is used to identify each day (N=11 workdays) where direct sun was observed on the SE facade from a visual inspection of time-lapse HDR images. Based on these data, **table 5.8** presents the total number of shade operations and overall level of window occlusion predicted for Phase 2 by the 4 shade operation behavioral models chosen for investigation. **Table 5.9** presents predictions for Phase 5. The following sections compare the behavior of occupants to these predictions for Phase 2 and Phase 5.



**Figure 5.17** Measured transmitted solar irradiance incident on workspaces adjacent to the SE facade during Phase 2 (Aug. 2 to Sep. 3, 2010).

**Table 5.8** Summary of behavioral model predictions for shade operation during Phase 42 (SE facade)

Predictor	Threshold criteria	Number of workdays threshold exceeded	Total shade operations predicted (per person)	Average hours per day windows shaded (6AM - 6PM)	Average level of window occlusion (6AM - 6PM)
Reinhart	Irrad. > 50 W/m <sup>2</sup>	0	0	0	0%
Lee and Selkowitz	Irrad. > 95 W/m <sup>2</sup>	0	0	0	0%
LEED, 2012	Direct sun	11	22	2.9	24%
Inkarojrit	P(W/m <sup>2</sup> )	NA	NA	NA	81%

**Table 5.9** Summary of behavioral model predictions for shade operation during Phase 5 (SE facade)

Predictor	Threshold criteria	Number of workdays threshold exceeded	Total shade operations predicted (per person)	Average hours per day windows shaded (6AM - 6PM)	Average level of window occlusion (6AM - 6PM)
Reinhart	Irrad. > 50 W/m <sup>2</sup>	10	20	1.1	88%
Lee and Selkowitz	Irrad. > 95 W/m <sup>2</sup>	0	0	0	0%
LEED, 2012	Direct sun	10	20	6.5	54%
Inkarojrit	P(W/m <sup>2</sup> )	NA	NA	NA	90%

### **5.4.3 Southeast window occlusion results**

The following sections present window occlusion results for the SE facade sections monitored. Because facade sections were observed on multiple floors and in multiple areas, the figures represent “composite” interior elevations and are not representative of any complete floor, or the entire building.



### 5.4.3.1 Phase 2 (SE facade)

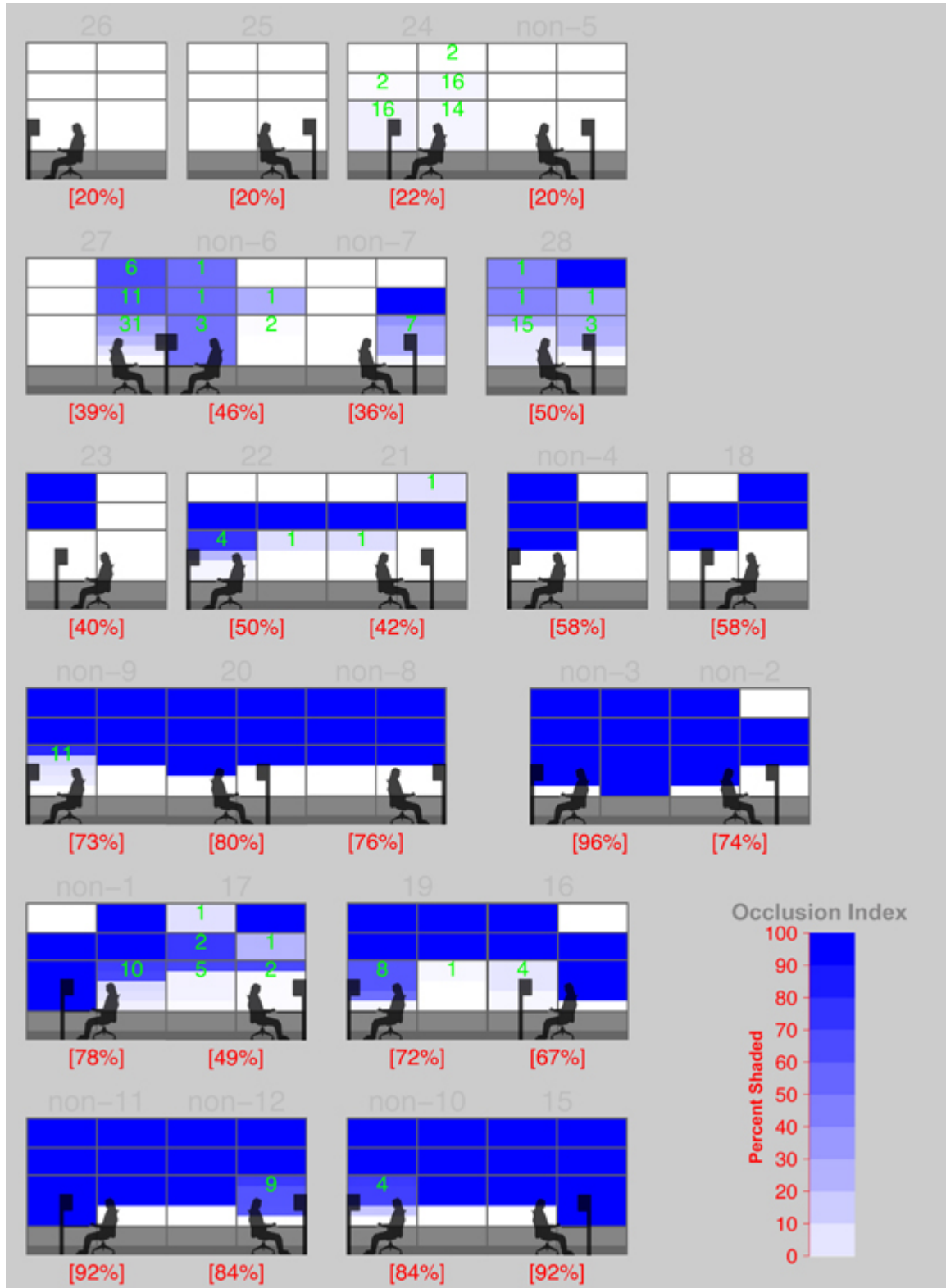


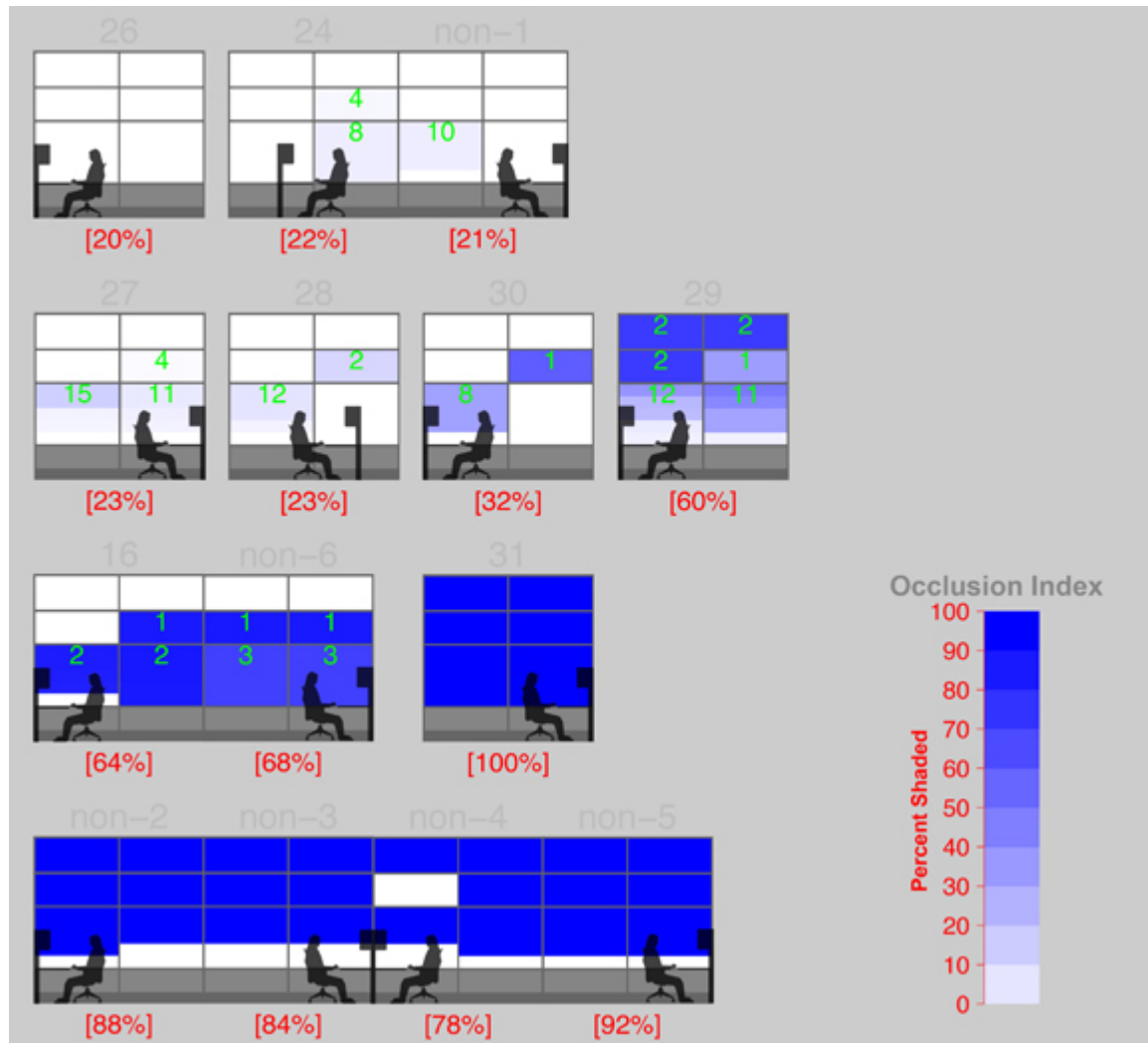
Figure 5.18 Summary of SE facade occlusion for Phase 2 (Aug. 2 to Sept. 3, 2010).

**Figure 5.18** shows the level of window occlusion for Phase 2. In addition to the (N=14) study participant workspaces observed, an additional (N=12) adjacent “non-participant” workspaces were observed. In total this resulted in (N=26) occupants and 156 unique roller shades. Summary data for Phase 2 is presented in **table 5.10**.

**Table 5.10** Summary of SE facade occlusion for Phase 2

No.	View dir.	Occlusion index			Number of shade operations (over 25 workdays)			
		Upper win.	Lower win.	Facade	Upper win.	Lower win.	Total	Average per day
15	S	100%	80%	90%	0	0	0	0
16	E	75%	44%	59%	0	4	4	0.16
17	S	55%	17%	36%	4	7	11	0.44
18	E	75%	20%	48%	0	0	0	0
19	E	100%	31%	65%	0	9	9	0.36
20	S	100%	50%	75%	0	0	0	0
21	S	53%	3%	28%	1	1	2	0.08
22	E	50%	26%	38%	0	5	5	0.20
23	E	50%	0%	25%	0	0	0	0
24	E	1%	5%	3%	20	30	50	2.00
25	S	0%	0%	0%	0	0	0	0
26	E	0%	0%	0%	0	0	0	0
27	S	34%	13%	23%	17	31	48	1.92
28	S	58%	18%	38%	3	18	21	0.84
non-1	E	75%	71%	73%	0	10	10	0.40
non-2	S	75%	60%	68%	0	0	0	0
non-3	E	100%	90%	95%	0	0	0	0
non-4	E	75%	20%	48%	0	0	0	0
non-5	S	0%	0%	0%	0	0	0	0
non-6	E	37%	28%	32%	3	5	8	0.32
non-7	S	25%	15%	20%	0	7	7	0.28
non-8	E	100%	40%	70%	0	0	0	0
non-9	E	100%	34%	67%	0	11	11	0.44
non-10	E	100%	60%	80%	0	4	4	0.16
non-11	E	100%	80%	90%	0	0	0	0
non-12	S	100%	60%	80%	0	9	9	0.36
N = 26		Avg.=63%	Avg.=33%	Avg.=58%	Total=48	Total=151	Total=199	Avg.=0.32

### 5.4.3.2 Phase 5 (SE facade)



**Figure 5.19** Summary of SE facade occlusion for Phase 5 (November 8 to 19, 2010).

**Figure 5.19** shows the level of window occlusion for Phase 5. Compared with Phase 2, Phase 5 had a lower number of study participants (N=8), of which most (N=6) participated in Phase 2. The lower number was primarily due to the relocation of a number of staff (for organizational reasons) on the 15th and 16th floors between Phase 4 and Phase 5 that led to fewer Phase 2 participants remaining adjacent to the SE facade. In addition to the study participant workspaces an additional (N=6) adjacent “non-participant” workstations were observed, resulting in a total of (N=14) facade sections and 84 roller shades. Occlusion results are summarized in **table 5.11**.

**Table 5.11** Summary of SE facade occlusion for Phase 5

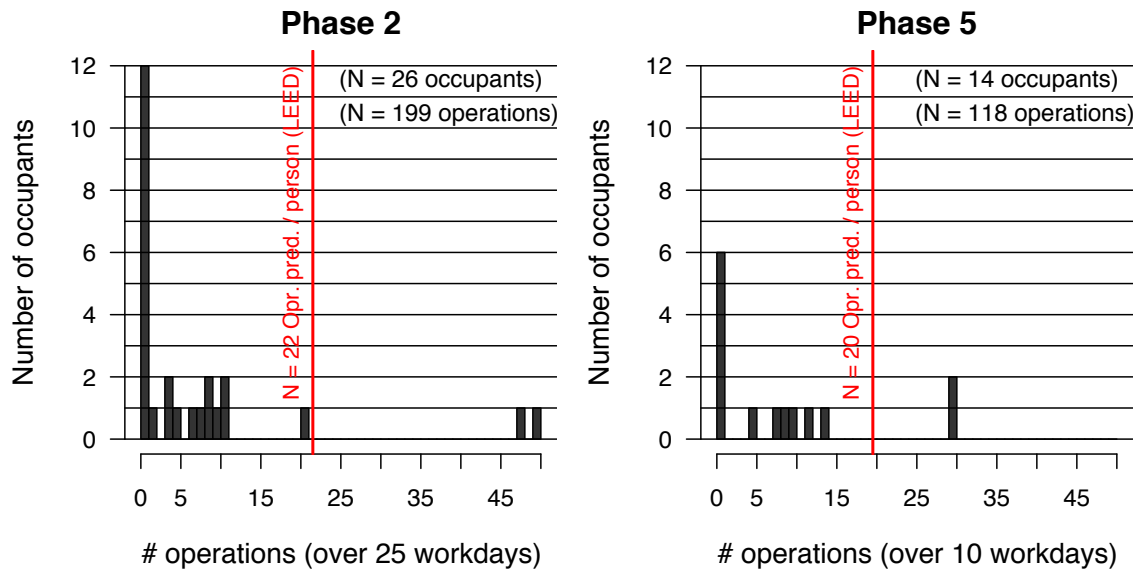
No.	View dir.	Occlusion index			Number of shade operations (over 10 workdays)			
		Upper win.	Lower win.	Facade	Upper win.	Lower win.	Total	Average per day
16	E	23%	86%	64%	1	4	5	0.50
24	E	1%	4%	22%	4	8	12	1.20
26	E	0%	0%	20%	0	0	0	0
27	S	0%	7%	23%	4	26	30	3.00
28	S	4%	4%	23%	2	12	14	1.40
29	E	67%	32%	60%	7	23	30	3.00
30	E	16%	15%	32%	1	8	9	0.90
31	S	100%	100%	100%	0	0	0	0
non-1	S	0%	3%	21%	0	10	10	1.00
non-2	E	100%	70%	88%	0	0	0	0
non-3	S	100%	60%	84%	0	0	0	0
non-4	E	75%	70%	78%	0	0	0	0
non-5	S	100%	80%	92%	0	0	0	0
non-6	S	45%	75%	68%	2	6	8	0.80
N = 14		Avg.=45%	Avg.=43%	Avg.=55%	Total=21	Total=97	Total=118	Avg.=0.84

### 5.4.4 Summary analysis

The following two sections compare the observed levels of SE facade occlusion and frequency of operation to existing shade control behavioral models.

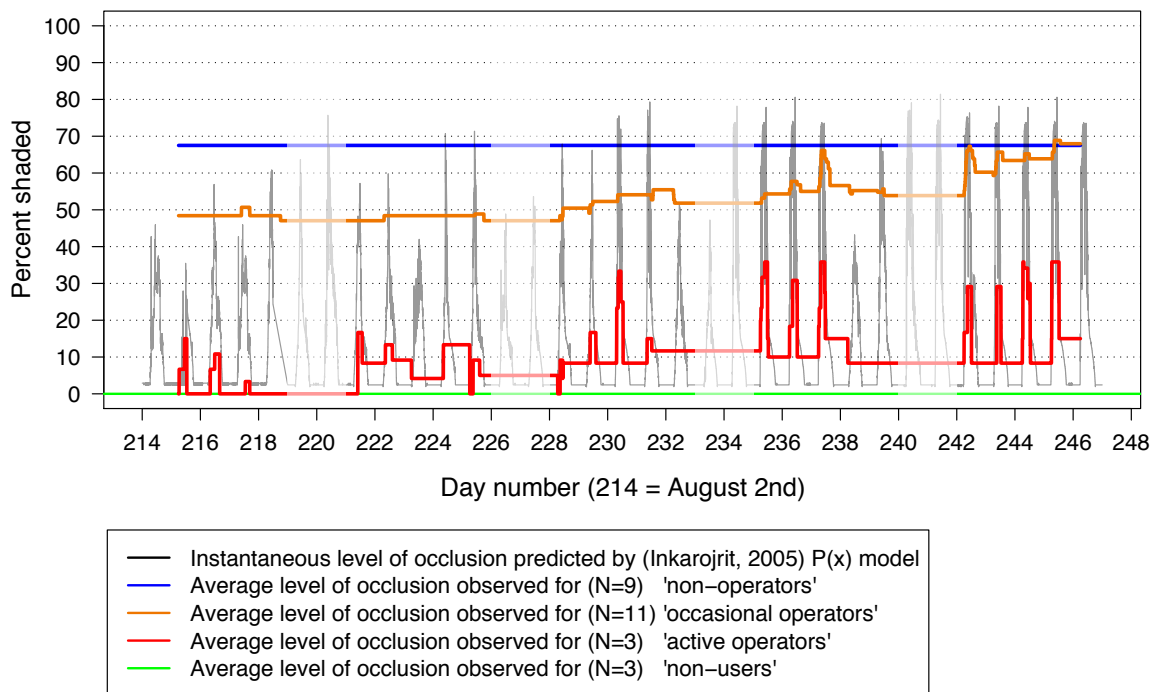
#### 5.4.4.1 Frequency of shade operation

**Figure 5.20** shows the distribution of occupants (both participants and adjacent “non-participants”) by total number of shade operations observed (per person) during Phase 2 and Phase 5. During Phase 2, behavioral models 1 and 2 predicted zero shade operations because the thresholds for deployment ( $50 \text{ W/m}^2$  and  $95 \text{ W/m}^2$ ) were never exceeded. As a result of the 11 days of direct sun observed during Phase 2, model 3 (LEED, 2012) assumes a total of 22 operations per person, resulting from one deployment and one retraction per day in response to direct sun incident on the workspace. Similar to the results for the NW facade, the results for the SE show that the numbers of shade operations observed were substantially lower than those predicted by any of the 3 “active operator” models for the majority of occupants. Notably, 12 of the (N=26) occupants did not operate interior roller shades during Phase 2, and 6 of (N=14) participants did not operate shades during Phase 5. The remainder of occupants either operated shades occasionally, but below the frequency assumed by “active operator” models, or “actively,” where the total number of operations was close to (or exceeded) the number of operations predicted. As shown in **figure 5.18** over half of the total shade operations for Phase 2 were performed by 3 of the 26 occupants.



**Figure 5.20** Distribution of occupants (SE participants and adjacent occupied workspaces) by number of shade operations observed over 25 workdays during Phase 2 (August 2 to September 3, 2010) and Phase 5 (November 8 to 19, 2010).

As a result of the high level of variation in shade operations between individuals, groups were formed to categorize shade operation behavior and examine its relation to levels of facade occlusion. For example, of the (N=12) occupants who did not operate shading devices during Phase 2, the majority (N=9) had high levels of facade occlusion, however (N=3) did not use shades at all. Therefore, the group with zero operations was split into two groups: “non-operators” and “non-users,” where non-users (as illustrated by the interior elevations **figure 5.18** and **5.19**) never lowered shading devices (resulting in window occlusion levels of 0%). Of the occupants who did operate shading devices, groups of “occasional” and “active” operators were formed, where “active operators” had (> 20) operations for Phase 2 and (> 10) operations for Phase 5. Dividing Phase 2 occupants based on these 4 groups of shade control behavior, a relationship was found between frequency of operation and level of window occlusion, where a pattern of fewer shade operations was associated with higher levels of window occlusion. This result supports the conventional wisdom underlying the (Inkarojrit, 2005) model, that occupants will adjust shades to the “worst case” solar control condition.

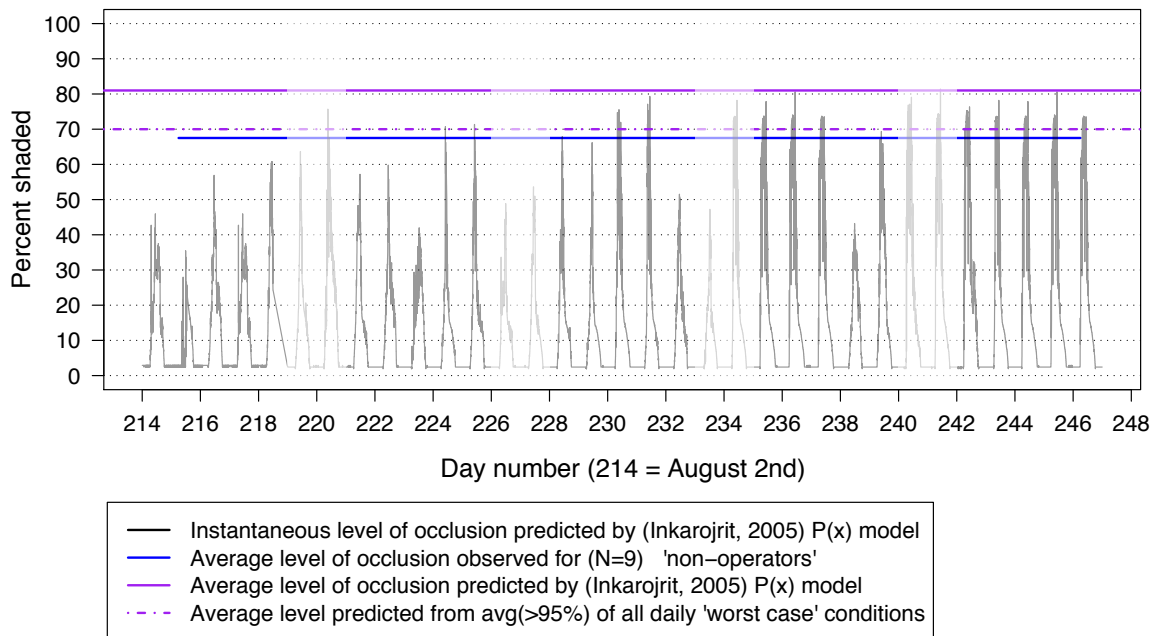


**Figure 5.21** Comparison of occlusion levels between the four shade operation behaviors identified.

**Figure 5.21** illustrates the difference in window occlusion (percent shaded) between the four approaches to shade operation (or lack of use) identified. Excluding “non-users” (green line), “active operators” (red line) are shown to have the lowest levels of window occlusion as well as produce the largest variations in occlusion on a daily basis. In addition, “active users” appear to both lower and raise shades in response to the magnitude of solar conditions and this behavior appears to correlate with the probability of window occlusion predicted by the (Inkarojrit, 2005) model. Because the transmitted

vertical irradiance never exceeded the deployment thresholds specified in “active operator” models (Reinhart, 2002) and (Lee and Selkowitz, 1995), it is important to note that the results show occupants lower shading devices in response to solar conditions below existing threshold assumptions. It is also important to note that “active operators” were observed to adjust levels of window occlusion within a range of 0-40% rather than 0-100% (fully unshaded, fully shaded) as predicted by all of the “active operator” models. In contrast to the behavior assumed in the (Inkarojrit, 2005) model, rather than adjusting shading devices to a “worst case” condition, “active operators” keep shades retracted and deploy the level of shading required to control solar and daylighting conditions in the location of their visual task (i.e. computer, keyboard and desk). While the “active operator” control behavior observed supports the assumption that some occupants will lower and raise shading devices on a daily basis in response to the magnitude of solar conditions, it is important to note that the group of “active operators” represented only a small portion of the shade control behavior observed on the SE facade (3 of 26 occupants in Phase 2 and 6 of 14 occupants in Phase 5).

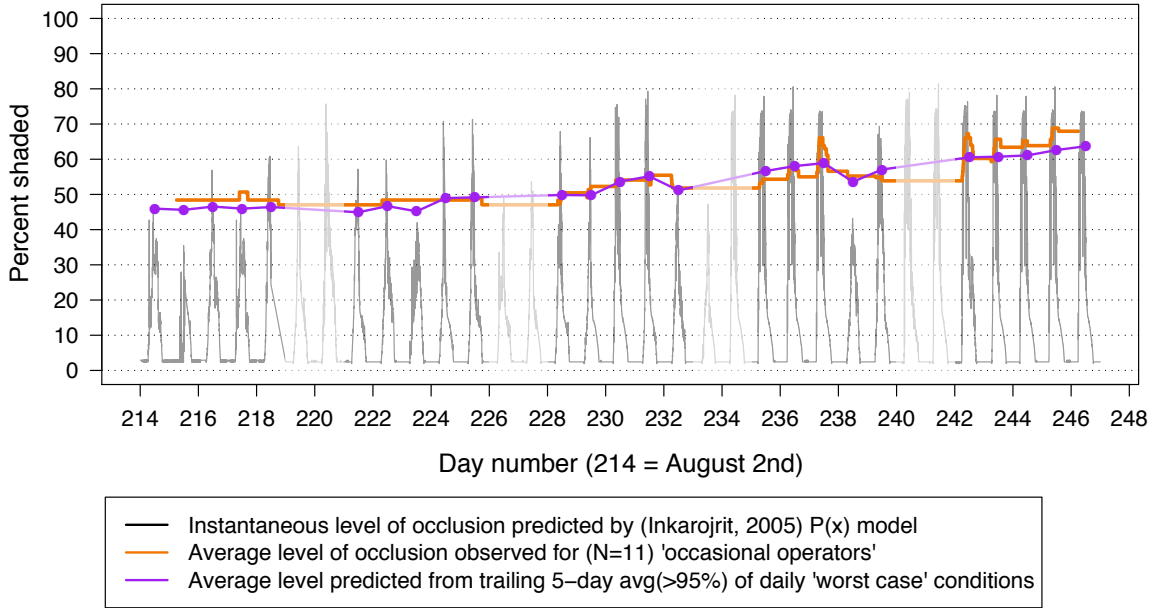
The group with the largest level of window occlusion (and the second largest group in both Phase 2 and Phase 5) was the “non-operator” group, where shade position was not observed to change for any window over the duration of the test phase. Results for this group show that individuals produced levels of window occlusion ranging from 40% to 96%, with an average level of window occlusion for the group of 68% for Phase 2 (N=9) and 86% for Phase 5 (N=5). A summary of predicted and observed levels of occlusion for Phase 2 and Phase 5 is presented in the following section (5.4.4.2). Based on the lack of shade operations, the “active operator” models are not applicable to this group and significantly underestimate the observed level of window occlusion. In contrast, the (Inkarojrit, 2005) model, which assumes that occupants lower shades in response to the “worst case” solar conditions and do not adjust them, overestimates the level of window occlusion. By predicting occlusion level based on the maximum transmitted vertical irradiance, the (Inkarojrit, 2005) model predicts an occlusion level of 81% which, although above the level observed (68%), is closer than the 3 “active operator” models. Based on the observed level of occlusion produced by the “non-operator” group in Phase 2, the (Inkarojrit, 2005) model was found to be more accurate when occlusion was predicted from the average of the greatest 5% of transmitted vertical irradiance rather than the maximum value. This improvement in accuracy suggests that occupants lower shades to a limit that is set by “near-worst-case” conditions rather than the most extreme conditions experienced. **Figure 5.22** compares the original prediction from the (Inkarojrit, 2005) model and the modification based on “near-worst-case” conditions to results observed during Phase 2.



**Figure 5.22** Comparison of observed level of window occlusion for “non-operator” group to levels predicted from model 4 (solid purple line) and a modification to model 4 (dashed purple line) based on “near-worst-case” conditions.

The final group, “occasional operators” is shown in **figure 5.23**. “Occasional operators” included over a third of (N=11, of 26) occupants observed during Phase 2 and represent the single largest group. During Phase 2, the overall level of window occlusion for the “occasional operators” group was found to change in response to the magnitude of solar conditions, however the behavior was distinct from the “active operators” group in that perceptions appear to be formed over multiple days rather than in response to the magnitude of conditions for a single day. In Phase 2, where the first two-and-a-half weeks were predominantly cloudy, overall window occlusion for the “occasional operators” group was significantly lower than the “non-operators” group (50% vs. 68%). However, it gradually increased to a comparable level following two additional weeks with more frequent clear sky conditions and direct sun. A modification of the (Inkarojrit, 2005) model, using a 5-day trailing average of “near-worst-case” conditions computed for each day from the average of the top 5% of transmitted vertical irradiance was found to describe this behavior (**figure 5.23**). This “occasional operator” modification represents a new addition to existing shade control behavioral models and provides an approach for modeling behavior over weekly changes in sun and sky conditions that is not well described by “active operator models” or by the assumption that shades are configured in response to “worst case” solar conditions and never adjusted (Inkarojrit, 2005).

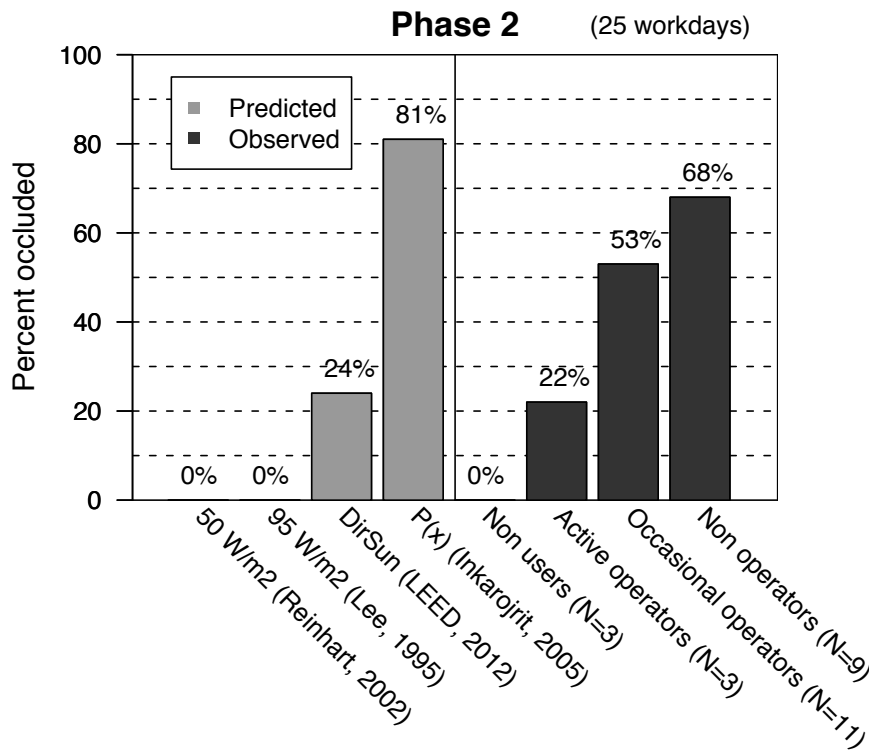




**Figure 5.23** Comparison of observed level of window occlusion for “occasional operator” group to level predicted from a modification to model 4 using a 5-day trailing average of “near-worst-case” conditions.

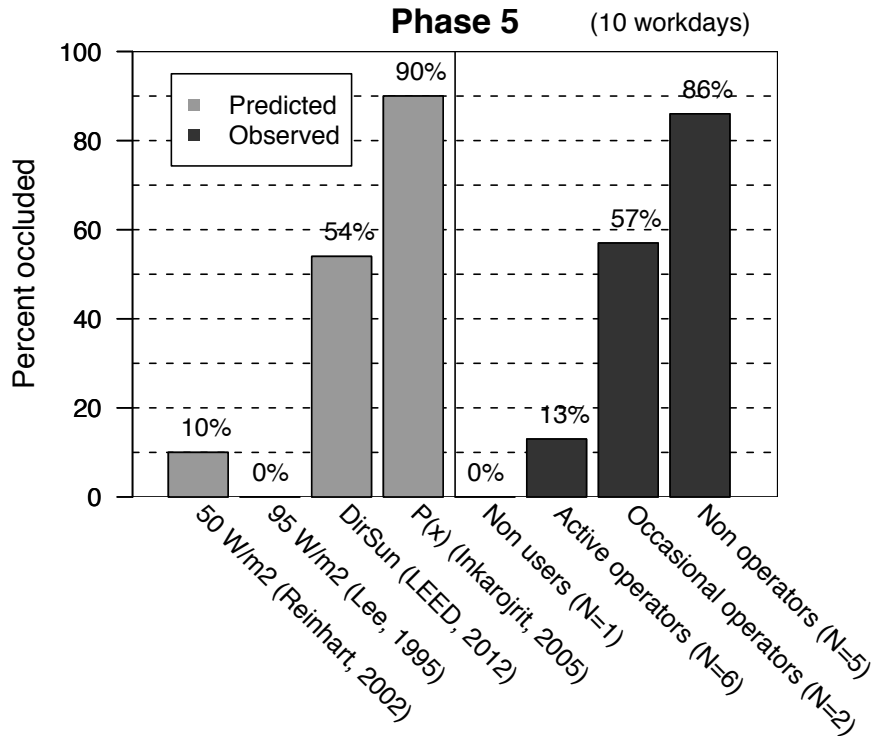
#### 5.4.4.2 Predicted vs. observed levels of window occlusion

**Figure 5.24** compares predicted and observed levels of window occlusion for Phase 2. Similar to results from the NW facade, the “active operator” models were found to underestimate the level of window occlusion for the majority of occupants (N=11 occasional operators and N=9 non-operators). Although the “worst case” model (Inkarojrit, 2005), overestimated the level of window occlusion for occupants that operated shading devices, it was the closest in predicting the level of window occlusion for occupants who deployed shading devices but never adjusted them (N=9 “non-operators”) and better than the Reinhart (2002) and Lee and Selkowitz (1995) models for predicting the level of window occlusion produced by the “occasional operator” group (N=11). As a result of the attenuation of transmitted vertical irradiance produced by the exterior metal screen and the solar control film retrofit, the deployment thresholds for the Reinhart (2002) and Lee and Selkowitz (1995) models were never exceeded, leading to predictions of 0% window occlusion. The more general assumption for shade operation used in the LEED (2012) model based on presence of direct sun was found to predict the overall level of occlusion for “active operators” reasonably well, however this group represented only a small number (N=3) of the total number of occupants observed during Phase 2 (N=26).



**Figure 5.24** Comparison of daily average level of window occlusion predicted to levels achieved on SE facade during Phase 2 by the four different shade control behaviors identified.

**Figure 5.25** compares predicted and observed levels of window occlusion for Phase 5. Compared with Phase 2, which consisted of a combination of clear and non-clear sky conditions over 25 workdays, Phase 5 consisted of 10 workdays of clear sky conditions and direct sun on the SE facade. In addition, as a result of seasonal changes in solar position, the SE facade received a greater level of solar radiation during Phase 5 (Nov. 8 to 19) compared with Phase 2 (Aug. 2 to Sept. 3) leading to periods each day when the transmitted vertical irradiance exceeded the deployment threshold specified in the (Reinhart, 2002) model ( $50 \text{ W/m}^2$ ). Results for Phase 5 show a significant amount of variation in level of window occlusion between predictions as well as between shade control behavior groups. Among predictors, the (Inkarojrit, 2005) model was again the closest to predicting the level of occlusion observed for “non-operators,” but significantly overestimated the level of window occlusion for occupants who operated shading devices. In contrast, the Reinhart (2002) model significantly underestimated the level of window occlusion for “non-operators,” but was closest to predicting the average level of window occlusion for the “active operator” group.



**Figure 5.25** Comparison of daily average level of occlusion predicted to levels achieved on SE facade during Phase 5 by four different behavioral types.

## 5.5 Summary of results

This chapter compared the frequency of shade operation and level of window occlusion predicted by existing behavioral models for interior shade control to observations made of (N=31) unique occupant workstations in the NW and SE perimeter zones of the SFFB. The results from this portion of the study, summarized below, lead to a number of questions regarding the effect of interior shade position on daylight sufficiency, available view, and electrical lighting energy outcomes. These questions are presented and addressed in the following chapters.

1. Are roller shades exercised dynamically in response to the magnitude of physical environmental conditions?
  - a. Observed shade control behavior was compared to predictions from three “active user” shade control models that assume occupants adjust interior shading devices on a daily basis in response to the magnitude of transmitted vertical irradiance (Reinhart, 2002; Lee and Selkowitz, 1995) or the presence of direct sun on interior workspaces (LEED Daylighting credit, 2012). Results showed that the majority of occupants operated shading devices far less frequently or not at all, leading to significantly greater levels of window occlusion than predicted by each of the “active user” models.
    - i. The total number of shade operations was found to be highly variable between individuals, with a small number of occupants responsible for the majority of operations, and a large number of occupants performed few (or no) shade operations over a given multi-week test interval.
    - ii. Among occupants adjacent to the SE facade, four distinct shade control behaviors were identified based on frequency of operation: “non-user,” “non-operator,” “occasional operator,” and “active operator,” where higher frequencies were associated with lower levels of window occlusion.
  - b. Although the NW facade received significantly lower maximum levels of transmitted vertical irradiance during Phase 4 (42 W/m<sup>2</sup>, October 18 to 29) compared to Phase 1 (233 W/m<sup>2</sup>, July 12 to 30), the seasonal decrease in the magnitude of transmitted vertical irradiance did not result in lower levels of window shading. This result contrasts with the assumption that occupants deploy shading devices only when the transmitted vertical irradiance exceeds a threshold of 50 W/m<sup>2</sup> (Reinhart, 2002).
  - c. Similarly, lower maximum levels of transmitted vertical irradiance on the SE facade during Phase 2 (32 W/m<sup>2</sup>, Aug 2 to Sept 3) compared to Phase 5 (53 W/m<sup>2</sup>, Nov 8 to 19) did not result in significantly lower levels of

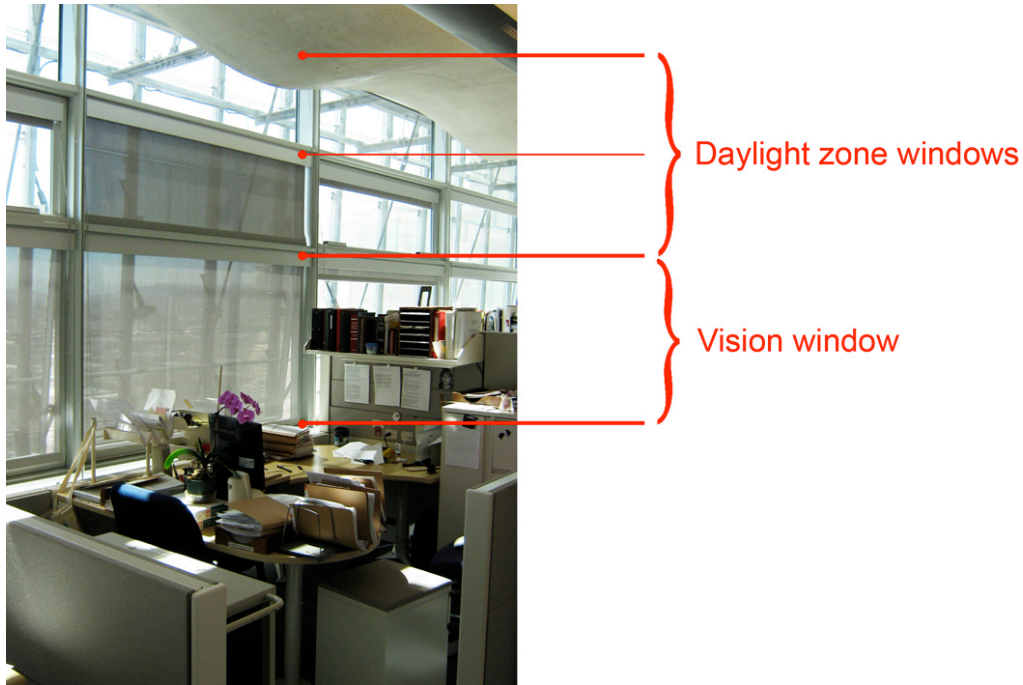
window occlusion for the majority of occupants observed. This result supports conclusions from existing field studies that shade positions are primarily based on perceptions formed over long periods of time ranging from weeks to months that have little to do with the seasonal variation in solar conditions (Rubin 1978, Rea 1984, Foster and Oreszczyn 2001).

2. How are roller shades typically positioned on sections of the facade adjacent to occupant workstations?
  - a. The positioning of shading devices and the low frequency of operation resulted in occlusion of approximately half of the glazing above desk height on both facades where shades were installed on all windows (NW = 67%, 50% for Phase 1 and Phase 4 respectively; SE = 56%, 44% for Phase 2 and Phase 5 respectively). On the NW facade, where shades were added to the vision windows only, (76%, 73% for Phase 1 and Phase 4 respectively) of the vision window was occluded on average..
  - b. Results from “patterns” of operation show that nearly all occupants varied the level of window shading vertically (upper sections were more shaded) and horizontally (adjacent lower window was either more shaded, or less shaded than non-adjacent lower window depending on view orientation relative to the facade). Because existing behavioral models assume that an occupant will control shades for all available windows identically, and either fully retract or fully deploy shades, the observed patterns explain a portion of the error between predictions and observed results.
  - c. The lowest 20 to 40% of vision windows was often unshaded on both the NW and SE facades, leaving a localized view zone to the exterior affording a view below the horizon.
  - d. The upper two rows of windows, designed for daylight transmission to the core, were predominantly shaded on both NW and SE facades.

3. How does the positioning of roller shades and frequency of operation observed in the SFFB compare to the outcomes predicted by existing shade control behavioral models?
  - a. The average level of window occlusion observed was consistently higher than the level predicted by the “presence of direct sun” assumption for shade control implemented in the 2012 version of the LEED daylighting credit compliance criteria.
  - b. The level of window occlusion predicted by the probabilistic model developed by Inkarojrit (2005) overestimated the average level of window occlusion for occupants who operated shading devices, but was the most accurate model for predicting the level of window occlusion for occupants who deployed shades but did not operate them the multi-week test phases (“non-operators”). Because “non-operators” represented a larger portion of occupants than “active operators,” this model is considered to be a better basis for predicting the state of shading devices than “active operator” models.
    - i. The Inkarojrit (2005) model was found to be more accurate for the “non-operator” group when the model was applied to an average of the top 5% of transmitted vertical irradiance (i.e. “near-worst-case” conditions) rather than the maximum (“worst case”) value.
  - c. During Phase 2, the overall level of window occlusion for the “occasional operators” group was found to change in response to the magnitude of solar conditions, however the behavior was distinct from the “active operators” group in that perceptions appear to be formed over multiple days rather than in response to the magnitude of conditions at a given time. This behavior is not described by existing shade control behavioral models, and represented a over a third of Phase 2 occupants (N=11, or 26).
    - i. To model this type of shade control behavior, a new “occasional operator” model is proposed. This model is based on a 5-day trailing average of “near-worst-case” solar conditions (the average of the upper 5% of daily measured transmitted vertical irradiance) and has applicability in annual daylight simulation to more accurately describe the “inertia effects” of window occlusion.

## CHAPTER 6

### LOGISTIC REGRESSION MODELS OF SHADE CONTROL BEHAVIOR



**Figure 6.1** Occupant workstation adjacent to SE facade showing location of vision window shades and upper “daylight zone” window shades.

#### 6.1 Introduction

Although results from Chapter 5 showed that relatively few of the observed occupants actively operated their interior shading devices, a better understanding of the physical conditions associated with the operation of interior shading devices is desirable. Studying buildings in use can provide valuable information characterizing the environmental conditions acceptable to building occupants when shading devices are operated actively to enable daylight transmission. This chapter presents an analysis of shade operation events observed in the southeast perimeter zones of the San Francisco Federal Building. To examine potential differences between operation of vision window shades and upper “daylight zone” window shades, the operation of each section was analyzed separately. The primary objective of the analysis was the development of predictive models for occupant operation of shading devices that can be used to predict potential daylight availability in spaces where occupants actively operate shading devices.

The following questions were used to guide the analysis:

1. Are roller shades operated in response to the stimulus intensity of interior physical variables (e.g. transmitted vertical irradiance, average or maximum window luminance)?
2. Can logistic models based on measures of interior physical variables be used to predict operation of roller shades? If so, what variables best predict behavior and with what level of accuracy?
3. How do models for operation of the daylight zone window shades compare to models for operation of the vision window shades?
4. How do logistic models of roller shade operation developed from field data collected in the SFFB compare to existing theoretical and empirically derived models for shade operation?

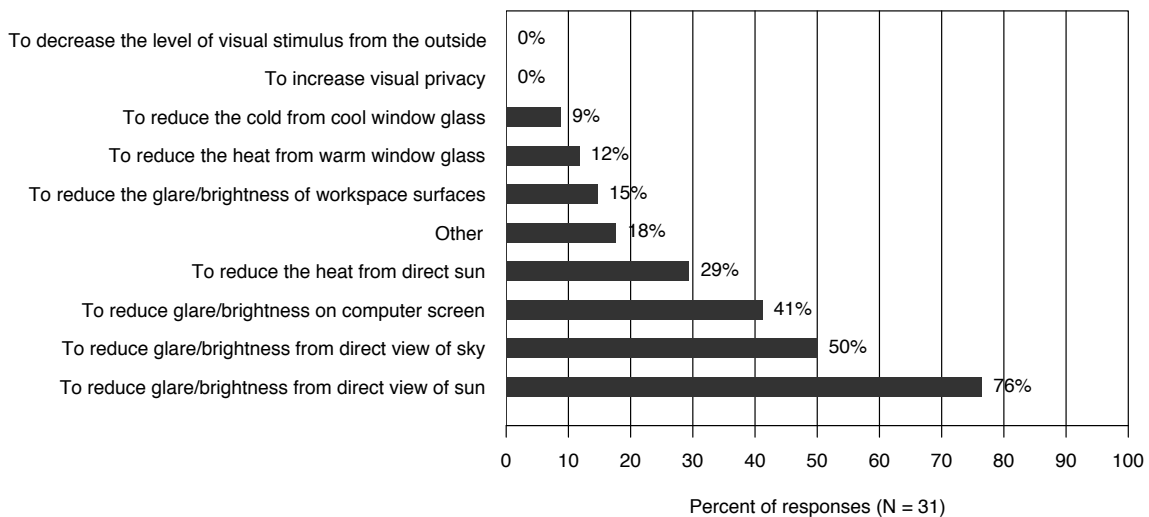


## 6.2 Shade operation data

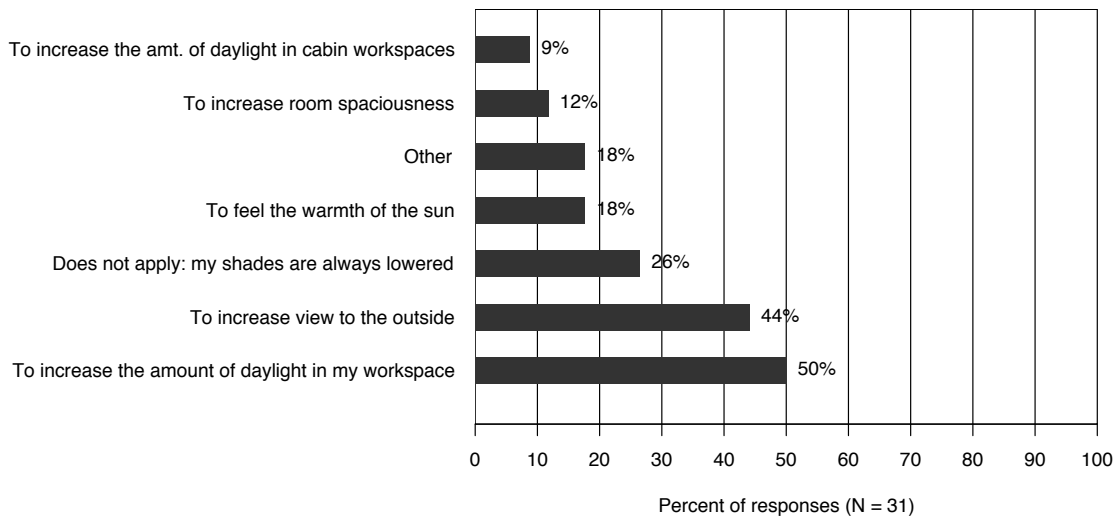
In total, 317 shade operations were observed in the SE perimeter zone during Phase 2 (Aug. 2 – Sept. 3) and Phase 5 (Nov. 15 – 29). In order to examine shade control events in relation to physical measures from the polling stations, the analysis included only data from occupants who participated in the subjective portion of the study, resulting in a total of 245 shade operations observed from (N=14) unique participants. This data set was used as a basis to generate and examine logistic regression models developed from a set of “candidate” independent variables that have the potential to predict shade operations. To examine potential differences in the variables and stimulus intensities associated with operation of the vision window shades and the upper daylight zone shades, observations for each zone of window shades were treated as separate groups during analysis and are compared in the figures presented in **section 6.4**.

### 6.2.1 Selection of independent variables

To model the physical conditions associated with shade operation, a set of candidate variables was selected for comparison with subjective responses. Several criteria were used to select a set of candidate variables. First, variables were included that have the potential to quantify the sources of discomfort identified from survey questionnaires as reasons for shade deployment. **Figure 6.2** summarizes responses to the question: (1) “What are the reasons that you LOWER (i.e. pull down) the roller shades in your workstation? Please select all that apply.” This question was included in survey questionnaires distributed to participants located in the NW and SE perimeter zones and was completed by (N=31) participants. **Figure 6.3** summarizes responses to a similar question regarding reasons for RAISING shades.



**Figure 6.2** Survey responses indicating reasons for lowering roller shades.



**Figure 6.3** Survey responses indicating reasons for raising roller shades.

Responses indicated that visual discomfort and direct sun control are the primary reasons for shade deployment and that increasing daylight transmission and views are the primary reasons for raising shades. Comments from participants in the SE perimeter zones (presented below) identified visual discomfort primarily in terms of glare associated with the position of the sun:

- (1) *“The glare is so bad from the sun that I have now resorted to keeping the shades down all of the time. As a result, I don't get much daylight or a view so I have to keep the lights on the whole time. It also makes me feel slightly disconnected from the outside.”*
- (2) *“The morning sun is the worst but it only lasts a couple hours, fine rest of day.”*
- (3) *“The glare from the sun and reflection from the windows are most important.”*

In consideration of survey comments, the average luminance ( $L_{upWin}$ ) and maximum luminance of the windows were considered potential variables for logistic models of shade operation. Because the results from Chapter 6 (shade operation) indicated that occupants operate the vision window shades differently than the upper daylight zone shades, the average luminance ( $L_{upWin}$ ) and maximum luminance of the upper two rows of windows ( $L_{upMax}$ ) were differentiated from the lower vision window ( $L_{lwWin}$ ), ( $L_{lwMax}$ ) in the analysis of the HDR images using the masking technique described in Chapter 4.

Second, variables for visual discomfort suggested from the field analysis of the SFFB conducted by LBNL (2007) were included. In the field analysis, the IESNA recommended luminance contrast ration limits of (1:3:10) between primary task, near field, and far field surfaces were used as criteria to define a discomfort threshold limit of  $2000 \text{ cd/m}^2$  (based on a computer-based visual task of constant luminance ( $200 \text{ cd/m}^2$ )). Therefore, variables were defined during processing of HDR data to express the ratio of

the average (and maximum) luminance of the upper and lower windows (combined) to a computer-based visual task of constant luminance ( $200 \text{ cd/m}^2$ ) ( $R_{\text{CPU}}$ ,  $R_{\text{CPUmax}}$ ). Similarly, variables were defined to express the ratio between the windows and the remaining interior surfaces ( $R_{\text{win}}$ ,  $R_{\text{winMax}}$ ). A diagram showing how these ratios were defined during processing of HDR data is shown in Chapter 4.

Thirdly, variables used in previous simulation and empirically based studies<sup>1</sup> of manual operation of shading devices were selected. In addition to maximum and average window luminance (recommended by Inkarorjrit, 2005), interior and exterior vertical irradiance ( $\text{Irrad}_{\text{intVert}}$ ,  $\text{Irrad}_{\text{extVert}}$ ) were selected. Exterior vertical irradiance, is used as an indicator in observational field studies where building interiors are not accessible (Tokel, 2006; Mahdavi, 2008). Although both irradiance measures may correlate with subjective responses, interior transmitted vertical irradiance measures the level of irradiance experienced in the workspace and is therefore considered a more accurate predictor of the physical conditions acceptable or comfortable for occupants. In addition, measures of interior horizontal illuminance ( $\text{Illum}$ ) and horizontal daylight illuminance ( $\text{Illum}_{\text{dlt}}$ ) were selected. These variables are proposed by (HMG, 2010) and the USGBC LEED Daylight EQ credit as indicators of visual discomfort that are likely to be associated with shade operation.

Fourthly, variables were selected based on recommendations from existing performance measurement protocols for the measurement of glare. These include glare metrics recommended to predict visual discomfort from large area sources (e.g. windows). The glare metrics included are:

- (1) The Daylight Glare Index ( $\text{DGI}_{7x}$ ,  $\text{DGI}_{2000}$ ) (Hopkinson, 1962), recommended by the International Energy Agency (IEA) Solar Heating and Cooling (SHC) Program Task 21 daylighting performance monitoring procedures (1999).
- (2) The Unified Glare Rating (UGR) (CIE, 1995), recommended by the Commission Internationale de l'Eclairage and the ASHRAE Performance Measurement Protocols (PMP) for commercial buildings (ASHRAE, 2010).
- (3) The CIE glare index (CGI), recommended by (Einhorn, 1969, 1979).
- (4) Interior global vertical illuminance ( $\text{Illum}_{\text{intVert}}$ ), recommended by (Inkarorjrit, 2005; Osterhaus, 1998).

Because the position, number, and boundaries of glare sources are constantly changing in a daylit scene, the DGI allows the user to specify a threshold luminance to establish what areas of the field of view constitute a glare source. Two approaches were taken. The first was to define a glare source as any luminance value 7-times greater than the average scene luminance ( $\text{DGI}_{7x}$ ). This is the approach used in the default calculation of the DGI by the Radiance program *findglare*. The second approach was to define glare as any

---

<sup>1</sup> For a summary of indicators for shade operation implemented in simulation and empirically based studies see table 5.4 from (Inkarorjrit, 2005).

source greater than  $2000 \text{ cd/m}^2$ , ( $\text{DGI}_{2000}$ ) after the approach taken by (LBNL, 2007), where  $2000 \text{ cd/m}^2$  indicates a luminance contrast of [10:1] between the source and a  $200 \text{ cd/m}^2$  visual task.

Finally, an approximation of Mean Radiant Temperature (MRT) was included as additional variable with a possible relationship to shade operation. MRT has been suggested in previous research to predict shade operation resulting from occupant discomfort associated with both visual and thermal sensations that can occur simultaneously in spaces that receive direct sun (Inkarojrit, 2005).

### **6.2.2 Description of independent variables**

All independent variables selected for analysis are shown in **tables 6.1 – 6.2** along with descriptive statistics. The descriptive statistics were calculated from the physical measures paired with shade operations and are presented in separate groups for events where shades were raised and lowered. *N* indicates the number of participants followed by the total number of observations indicated in parenthesis. Because quantitative variables associated with light can include extreme values, the median of each variable is shown rather than the mean. To illustrate the differences between the conditions associated with operation of the vision window shades and the upper daylight zone window shades, data for each facade zone are presented in separate tables.

**Table 6.1** Descriptive statistics for vision window roller shade operations for both SE monitoring phases combined.

Variable	Unit	(Raise shade)				(Lower shade)			
		N = 14 (92 observations)				N = 14 (94 observations)			
		Median	SD	Min.	Max.	Median	SD	Min.	Max.
MRT	deg. F	76	2	68	81	75	2	70	80
Illum	Lux	415	1506	72	8983	906	2259	136	8983
Illum <sub>dlt</sub>	Lux	374	1504	4	8914	811	2258	39	8913
Illum <sub>inVert</sub>	Lux	416	284	43	1482	973	778	147	3050
Irrad <sub>exVert</sub>	W/m <sup>2</sup>	196	190	4	660	494	273	36	912
Irrad <sub>inVert</sub>	W/m <sup>2</sup>	4	5	0	23	18	18	2	72
L <sub>upWin</sub>	cd/m <sup>2</sup>	208	176	29	1258	379	399	32	1705
L <sub>maxUpWin</sub>	cd/m <sup>2</sup>	486	2686	57	24797	1247	9377	101	45260
L <sub>lwWin</sub>	cd/m <sup>2</sup>	592	262	40	1218	1105	921	232	3488
L <sub>maxLwWin</sub>	cd/m <sup>2</sup>	1527	750	117	3061	6836	20528	796	46540
R <sub>win</sub>	NA	5	3	1	13	6	5	2	18
R <sub>winMax</sub>	NA	774	988	97	6229	313	427	61	2205
R <sub>CPU</sub>	NA	2	1	0	6	4	2	1	9
R <sub>CPUmax</sub>	NA	8	4	1	15	34	103	4	233
DGI <sub>2000</sub>	NA	2	5	-3	16	13	7	-3	21
DGI <sub>7x</sub>	NA	1	6	-18	13	6	9	-12	21
CGI	NA	6	7	0	20	18	9	0	29
UGR	NA	4	6	-2	17	15	8	-1	26

**Table 6.2** Descriptive statistics for upper daylight zone roller shade operations for both SE monitoring phases combined.

Variable	Unit	(Raise shade)				(Lower shade)			
		N = 14 (29 observations)				N = 14 (30 observations)			
		Median	SD	Min.	Max.	Median	SD	Min.	Max.
MRT	deg. F	75	2	71	80	75	2	72	80
Illum	Lux	415	914	155	3957	785	1607	197	6293
Illum <sub>dlt</sub>	Lux	380	909	57	3893	694	1599	163	6236
Illum <sub>inVert</sub>	Lux	443	424	43	1640	858	497	292	2487
Irrad <sub>exVert</sub>	W/m <sup>2</sup>	174	150	9	532	549	227	70	785
Irrad <sub>inVert</sub>	W/m <sup>2</sup>	4	8	0	42	14	13	0	48
L <sub>upWin</sub>	cd/m <sup>2</sup>	208	443	29	2016	681	430	221	1600
L <sub>maxUpWin</sub>	cd/m <sup>2</sup>	367	999	124	4567	2509	11629	553	44678
L <sub>lwWin</sub>	cd/m <sup>2</sup>	618	589	56	2261	891	533	381	3488
L <sub>maxLwWin</sub>	cd/m <sup>2</sup>	1436	15462	117	45609	2400	8418	796	46540
R <sub>win</sub>	NA	8	3	2	15	7	3	2	11
R <sub>winMax</sub>	NA	945	1445	179	6229	308	192	91	1025
R <sub>CPU</sub>	NA	2	2	0	9	5	2	2	9
R <sub>CPUmax</sub>	NA	7	77	1	228	12	42	4	233
DGI <sub>2000</sub>	NA	0	8	-3	21	11	6	0	19
DGI <sub>7x</sub>	NA	4	8	-10	21	0	6	-6	18
CGI	NA	0	10	0	28	16	7	0	29
UGR	NA	0	9	-2	25	13	6	0	24

### 6.2.3 Scaling of independent variables

The physiological sensation of brightness, like many other physiological sensations (e.g. smell, sound, touch), increases proportionally to the logarithm of the stimulus intensity (i.e. luminance) (Fechner, 1860). To scale the distributions of data, all variables (with the exception of MRT, and the glare indices) were scaled using a log transform prior to applying statistical methods to relate subjective responses to stimulus intensity.

### 6.2.4 Intercorrelation of independent variables

To examine the correlation among the variables selected, intercorrelation analysis using the Pearson method was done for each phase independently (using the R function *cor*). Intercorrelation was not found to vary significantly for subsets of data. Therefore, correlations are presented for all shade operation data in **table 6.3**.

**Table 6.3** Correlation among independent variables.

	MRT	Illum	Illum <sub>dlt</sub>	Illum <sub>inVert</sub>	Irrad <sub>exVert</sub>	Irrad <sub>inVert</sub>	L <sub>upWin</sub>	L <sub>maxUpWin</sub>	L <sub>lwWin</sub>	L <sub>maxLwWin</sub>	R <sub>win</sub>	R <sub>winMax</sub>	R <sub>CPU</sub>	R <sub>CPUmax</sub>	DGI <sub>2000</sub>	DGI <sub>7x</sub>	CGI	UGR	
MRT	1.0																		
Illum	0.2	1.0																	
Illum <sub>dlt</sub>	0.2	1.0	1.0																
Illum <sub>inVert</sub>	0.1	0.3	0.3	1.0															
Irrad <sub>exVert</sub>	0.3	0.4	0.4	0.7	1.0														
Irrad <sub>inVert</sub>	0.2	0.3	0.4	0.8	0.8	1.0													
L <sub>upWin</sub>	0.1	0.1	0.1	0.3	0.2	0.2	1.0												
L <sub>maxUpWin</sub>	0.1	0.1	0.1	0.3	0.3	0.2	0.5	1.0											
L <sub>lwWin</sub>	0.0	0.3	0.3	0.9	0.5	0.7	0.2	0.1	1.0										
L <sub>maxLwWin</sub>	-0.2	0.2	0.2	0.7	0.3	0.5	-0.2	-0.1	0.8	1.0									
R <sub>win</sub>	-0.2	-0.1	-0.1	-0.2	-0.4	-0.3	0.0	-0.1	0.1	0.2	1.0								
R <sub>winMax</sub>	-0.3	-0.2	-0.2	-0.5	-0.5	-0.4	-0.4	-0.2	-0.4	-0.2	0.3	1.0							
R <sub>CPU</sub>	0.0	0.3	0.3	0.9	0.5	0.7	0.6	0.3	0.9	0.6	0.1	-0.5	1.0						
R <sub>CPUmax</sub>	-0.1	0.3	0.3	0.8	0.4	0.6	0.1	0.4	0.8	0.9	0.1	-0.3	0.7	1.0					
DGI <sub>2000</sub>	0.0	0.3	0.3	0.8	0.4	0.5	0.3	0.3	0.7	0.7	0.2	-0.4	0.8	0.8	1.0				
DGI <sub>7x</sub>	0.1	0.2	0.2	0.5	0.1	0.2	-0.2	0.1	0.6	0.7	0.3	-0.2	0.4	0.7	0.6	1.0			
CGI	0.0	0.3	0.3	0.8	0.5	0.5	0.3	0.3	0.8	0.7	0.1	-0.5	0.8	0.8	1.0	0.6	1.0		
UGR	0.0	0.3	0.3	0.8	0.4	0.5	0.3	0.3	0.8	0.7	0.2	-0.4	0.8	0.8	1.0	0.7	1.0	1.0	

The results of the intercorrelation analysis show that a number of variables were strongly correlated with each other. In **table 6.3**, correlations greater or equal to ( $r = 0.5$ ) are colored grey for easier visual inspection. Strong correlations were found among measures of window luminance and the glare indices. A strong correlation was also found among nearly all variables and interior global vertical illuminance (Illum<sub>inVert</sub>). Because the glare metrics are fundamentally based on luminance contrasts, correlation

among metrics and between metrics and absolute measures of window luminance indicates that the variables are responding with a similar relationship to the same basic phenomena. Similarly, because luminance ratios (e.g.  $R_{CPU}$ ,  $R_{CPU_{max}}$ ) were defined using measures of window luminance (e.g.  $L_{lwWin}$ ,  $L_{lwMax}$ ) as one of their terms, correlation between these variables is expected. To control for strong correlations among predictor variables, a stepwise logistic regression technique was used in R to identify and rank statistically significant single-variable logistic models (*stepAIC* from the package MASS, using *forward selection* with 1 *step*).

### 6.2.5 Binary classification of shade operations

For the logistic regression technique used in this analysis, the response variable is assumed to be one of two possible disjoint outcomes (e.g. occupant RAISES shade, occupant LOWERS shade). As shown in Chapter 5, occupants were observed to position shades over the vision windows in a range of positions in addition to fully lowered and fully raised. The shades for the upper daylight zone windows were typically observed to be positioned in a fully lowered or fully raised position. In the following analysis, all operations for the vision window shades were included and assigned a [1] if the shade was at least partially raised and a [0] if the shade was at least partially lowered. Therefore, the models for the vision window shades represent events where shades were completely lowered/raised as well as partial adjustments.

## 6.3 Single-variable logistic models

The following sections describe the process used to evaluate, rank, and select single-variable logistic regression models to predict occupant control of roller shades.

### 6.3.1 Evaluation of single-variable logistic models

Using stepwise logistic regression (with forward selection), candidate logistic models were ranked based on the Akaike Information Criterion (AIC) (Akaike, 1974). Forward selection refers to the process used to select the predictor variables. In forward selection, the automated process begins with a model that has no variables. A single variable model is created for each of the candidate predictor variables and the model with the lowest AIC is returned. The remaining variables are also returned ranked in ascending order by AIC. The AIC is a measure used to assess the relative goodness of fit of a statistical model. Although the AIC provides a tool for model selection among a set of candidate models, the AIC does not explain how well a model fits the data in an absolute sense. For example, the AIC will not indicate if all candidate models fit poorly. Therefore, as an indicator of goodness of fit, the percent of correct responses (%-cor.) was used. The percent of correct responses was found by applying the model to the original data and comparing the predictions to the occupants' subjective responses.

### 6.3.2 Ranking of single-variable logistic regression models

**Table 6.4** shows the resulting ranking of single-variable logistic regression models generated from candidate variables. Models are ranked separately for predicting the operation of vision window shades and upper daylight zone shades. Models based on maximum window luminance were found to be the highest-ranked for both groups. Models based on absolute measures and ratios of average window luminance were also highly ranked, and were ranked higher as predictors for the upper window shades than for the lower. Finally, measures of interior global vertical irradiance ( $Irrad_{inVert}$ ) and illuminance ( $Illum_{inVert}$ ) were highly ranked. The ranking of the glare metrics was variable between groups, with the UGR ranked the highest. However, models based on glare metrics were less accurate predictors than the more “basic” variables of absolute luminance measures and vertical illuminance or irradiance, the latter two being much easier to acquire in the field. Measures of horizontal illuminance ( $Illum$ ,  $Illum_{dlt}$ ) and Mean Radiant Temperature (MRT) were among the lowest ranked predictors.



**Table 6.4** Ranking of logistic regression models of candidate variables.

Lower "vision" window shade				Upper "daylight zone" window shades			
N = 14 (186 observations)				N = 14 (59 observations)			
Variable	Rank	AIC [260]	%-cor.	Variable	Rank	AIC [84]	%-cor.
$L_{\max LwWin}$	1	158	71%	$L_{\max UpWin}$	1	53	74%
$R_{CPU\max}$	2	159	71%	$R_{CPU}$	2	53	73%
$Illum_{inVert}$	3	178	69%	$L_{upWin}$	3	60	69%
$R_{CPU}$	4	179	69%	$Irrad_{exVert}$	4	63	67%
$Irrad_{inVert}$	5	182	69%	$Irrad_{inVert}$	5	69	64%
$L_{lwWin}$	6	186	67%	$Illum_{inVert}$	6	70	63%
$R_{winMax}$	7	199	65%	$R_{winMax}$	7	70	61%
UGR	8	200	64%	$L_{lwWin}$	8	77	58%
CGI	9	201	64%	$R_{win}$	9	77	57%
$DGI_{2000}$	10	208	63%	UGR	10	78	55%
$Irrad_{exVert}$	11	210	62%	$DGI_{2000}$	11	79	56%
$L_{\max UpWin}$	12	227	59%	CGI	12	80	54%
$Illum_{dt}$	13	236	56%	$Illum_{dt}$	13	81	53%
$L_{upWin}$	14	236	56%	$Illum$	14	82	54%
$Illum$	15	237	56%	$DGI_{7x}$	15	83	53%
$DGI_{7x}$	16	249	54%	$R_{CPU\max}$	NA	84	51%
MRT	17	252	53%	$L_{\max LwWin}$	NA	84	51%
$R_{win}$	NA	261	50%	MRT	NA	85	50%

### 6.3.3 Selection of single-variable logistic models

Selection of models for further analysis from the list of candidates was based on an assessment of the overall ranking of the model in both groups. Models were selected that ranked among the top 6 for both groups. In addition to the greatest level of accuracy (as determined by the number of correct responses (%-cor.), models were selected because they are based on measures that can be acquired using conventional approaches (e.g. vertical irradiance and illuminance) or they represent more recent approaches (e.g. HDR imaging).

Although not ranked among the top 6 models, models based on the Unified Glare Rating (UGR) and horizontal daylight illuminance ( $Illum_{dit}$ ) were also included for further analysis. The UGR was included to examine the probability of shade operation in relation to the UGR values considered to be below the discomfort threshold of 19 specified in the ASHRAE Performance Measurement Protocol (PMP). This examination was of interest because designers may assume UGR values below 19 indicate visually comfortable conditions, where the lowering of shading devices would be unlikely. Horizontal daylight illuminance ( $Illum_{dit}$ ) was included for comparison to existing assumptions for shade operation (made in simulations of annual daylight availability) based on threshold levels of ( $Illum_{dit}$ ). The logistic regression models are presented in **tables 6.5** and **table 6.6** for the lower vision window shades and upper daylight zone shades respectively.

**Table 6.5** Logistic regression models selected (vision window shades).

N = 14 (186 observations)						
Variable	Units	Rank	AIC [260]	( $B_0$ )	( $B_1$ )	%-cor.
$L_{maxLwWin}$	cd/m <sup>2</sup>	1	158	-14.14	4.23	71%
$R_{CPU}$	NA	4	179	-3.20	5.75	69%
$L_{lwWin}$	cd/m <sup>2</sup>	6	186	-16.44	5.75	67%
$Illum_{inVert}$	lux	3	178	-14.19	5.09	69%
$Irrad_{inVert}$	W/m <sup>2</sup>	5	182	-3.17	3.60	69%
UGR	NA	8	200	-1.62	0.17	64%
$Illum_{dit}$	lux	13	236	-4.10	1.48	56%

**Table 6.6** Logistic regression models selected (upper daylight zone shades).

N = 14 (59 observations)						
Variable	Units	Rank	AIC [84]	(B <sub>0</sub> )	(B <sub>1</sub> )	%-cor.
L <sub>maxUpWin</sub>	cd/m <sup>2</sup>	1	53	-11.87	3.93	74%
R <sub>CPU</sub>	NA	2	53	-1.24	4.12	73%
L <sub>upWin</sub>	cd/m <sup>2</sup>	3	60	-10.71	4.12	69%
Illum <sub>inVert</sub>	lux	6	70	-12.75	4.53	63%
Irrad <sub>inVert</sub>	W/m <sup>2</sup>	5	69	-2.02	2.40	64%
UGR	NA	10	78	-0.82	0.09	55%
Illum <sub>dit</sub>	lux	13	81	-3.28	1.19	53%

#### 6.4 Comparison of models to existing assumptions for visual discomfort

The independent variables used to generate the logistic regression models are all indicators of visual rather than thermal discomfort. Given that the primary reasons given by subjects in the subjective survey portion of this study for the operation of roller shades were related to visual discomfort, in the following sections, models are compared to existing assumptions for discomfort to examine the relationship between existing discomfort criteria and observed shade control behavior.

##### 6.4.1 Average and maximum window luminance

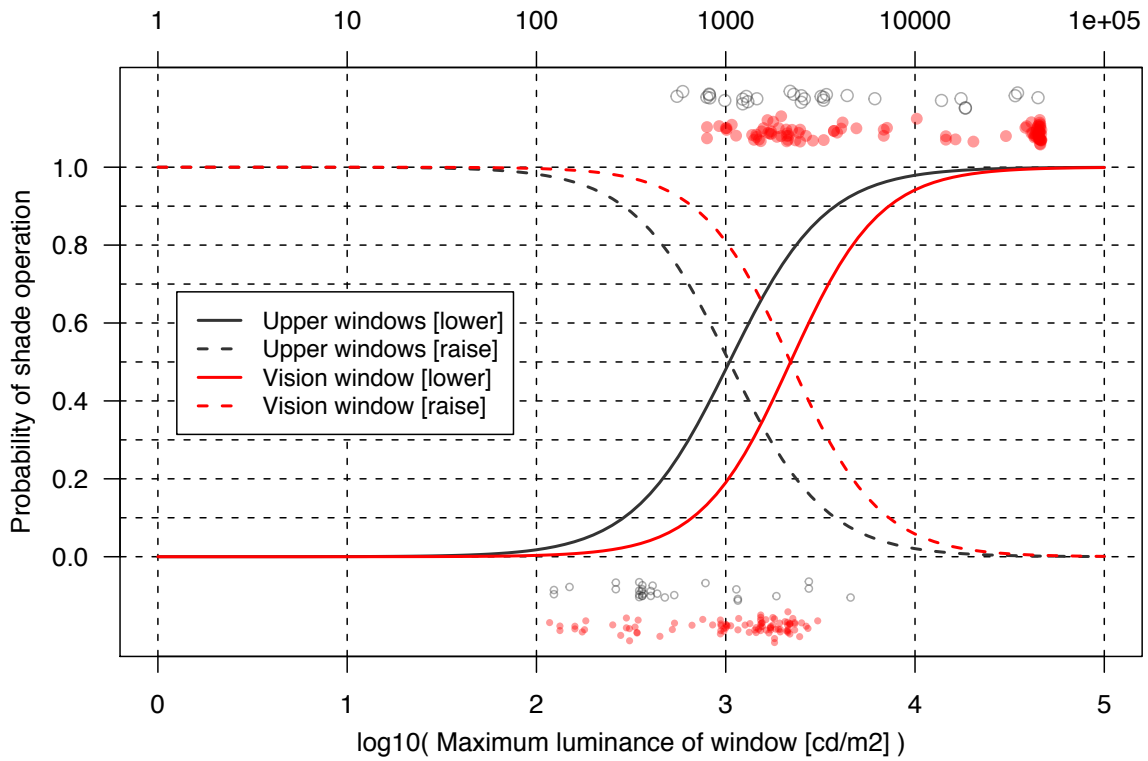
Measures of maximum window luminance were found to be the highest ranked predictors for both shade groups. **Figure 6.4** shows the logistic regression models from **table 6.5** and **table 6.6** for maximum window luminance. A primary purpose of the “passive” method of observation implemented in this study was to collect data associated with the raising or lowering of shades without intervention in the behavior patterns typical of study participants. In **figure 6.4**, the dashed lines indicate the probability that shades will be raised, and the solid lines indicate the probability that shades will be lowered. Because each observation in the data set represents either a decision by the study participant to raise or lower a shade at a specific instant in time, the dashed curves are simply inverted versions of the solid curves. However, they represent an important attribute of the data, because the models serve the dual purpose of modeling both shade lowering events *and* shade raising events.

**Figure 6.4** shows that, in support of conventional wisdom, the probability of a shade being lowered increases with the stimulus intensity and the probability of a shade being raised decreases with stimulus intensity. For reference, physical measures were acquired at unoccupied workstations where the windows were unshaded, therefore the stimulus intensity recorded simultaneously with shade raising events corresponds to the stimulus experienced by the participant *after* the shade was raised. For example, **figure 6.4** shows

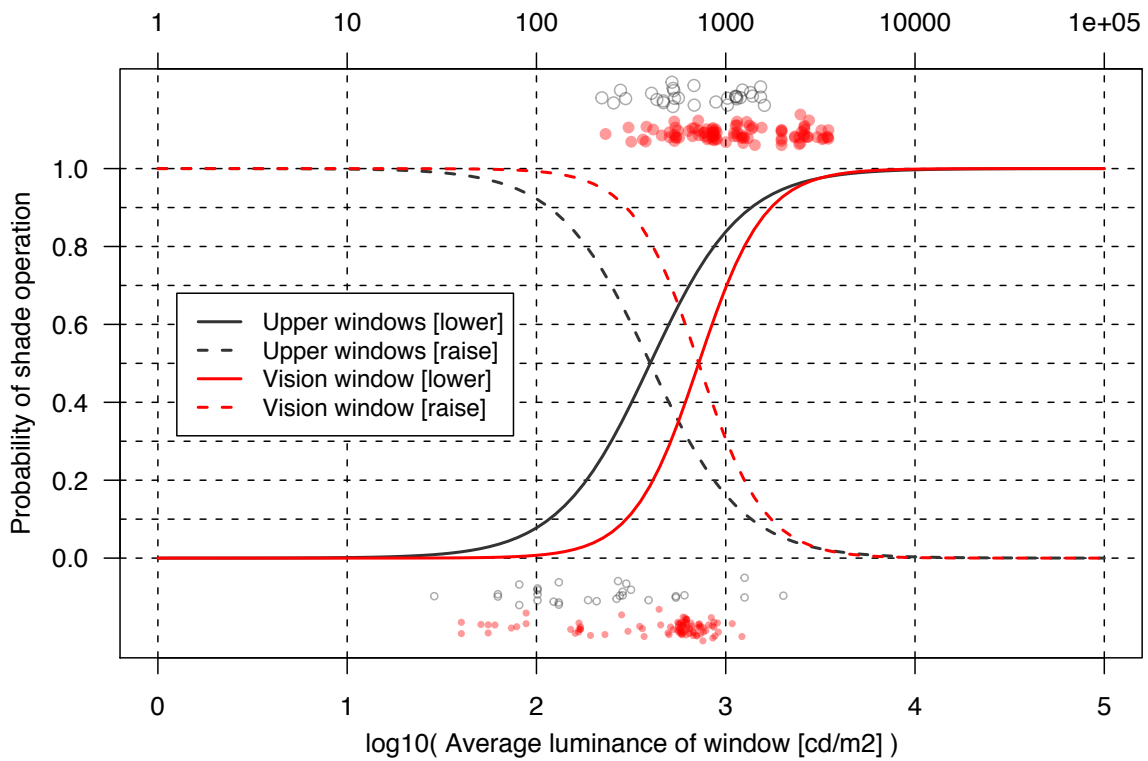
a 0.8 probability that a vision window shade (dotted red line) will be raised when the maximum luminance of the *unshaded* vision window is 1000 cd/m<sup>2</sup>. This approach was used because (assuming that the shade is not immediately lowered again) the measure indicates a luminance level acceptable to the participant. In figure 6.4, and all subsequent figures showing logistic models, the scatter plot of dots within the figure indicates the stimulus intensity measured for each raise or lower event observed. “Lowering” events are shown above ( $y = 1$ ) and “raising” events are shown below ( $y=0$ ). The color red is used to indicate the daylight window shades and black is used to indicate the vision window shades.

**Figure 6.4** also shows that there is a difference between models for the upper daylight zone shades and vision window shades, where participants show a higher probability for lowering the upper shades for any given maximum luminance. This result contradicts the common assumption that building occupants located adjacent to the facade will be less sensitive to the luminance of upper daylight zone windows based on their location outside the occupant’s foveal vision (i.e. outside the cone of vision oriented towards the participant’s visual task).

As shown in **figure 6.5**, models based on measures of average window luminance show a similar relationship to that found with maximum window luminance, where participants show a higher probability for lowering upper daylight zone shades than vision window shades for any given average luminance. One can speculate that the difference in tolerance for upper daylight zone and vision window luminances is related to the different amenities provided each facade zone. The upper zone enables daylight transmission and view towards the sky only, where the vision zone enables daylight transmission as well as views to the major sources of visual information (e.g. the horizon, buildings, movement of people and vehicles). Therefore, participants may be more tolerant of excessive window luminances from the lower window because they are less willing to obscure their view to the outdoors.



**Figure 6.4** Logistic regression models for maximum window luminance.

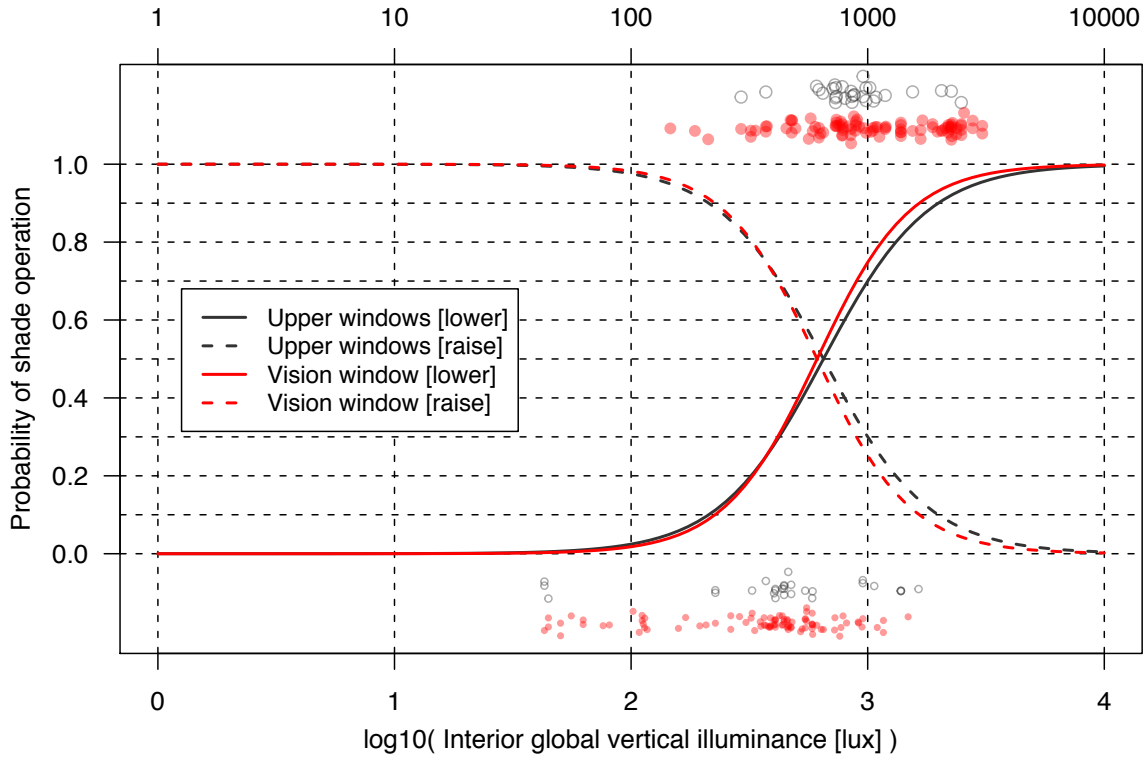


**Figure 6.5** Logistic regression models for average window luminance.

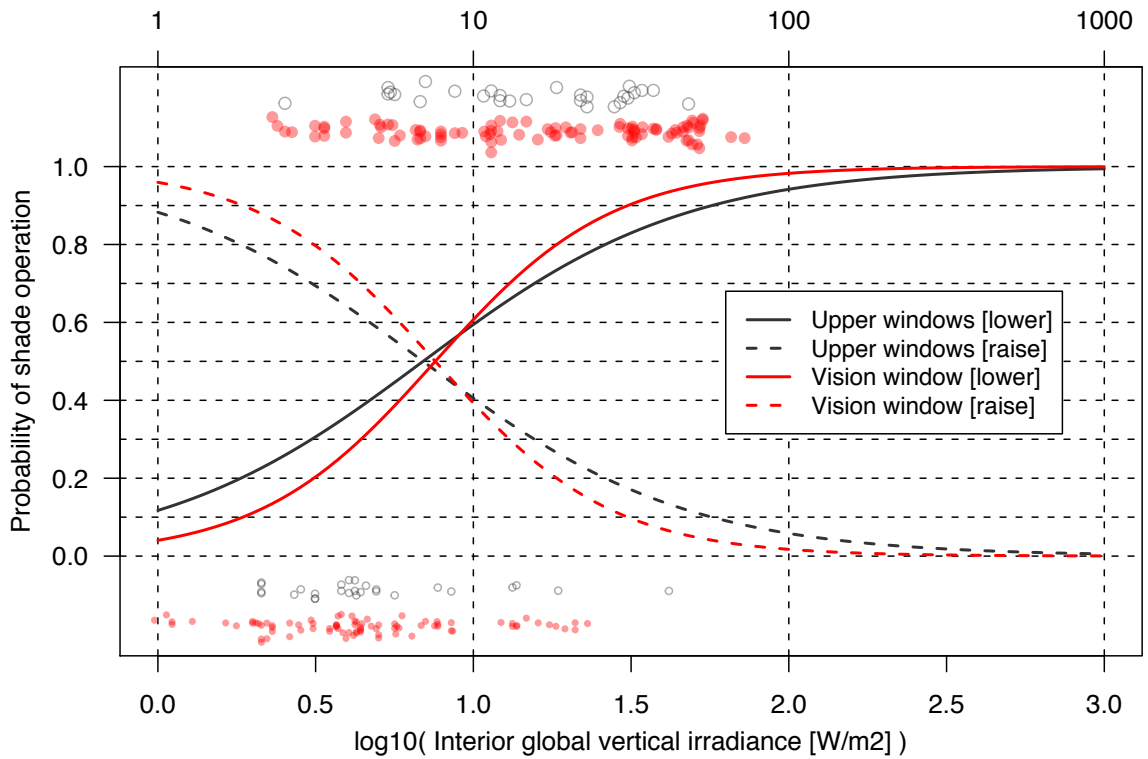
#### 6.4.2 Interior global vertical illuminance and irradiance

**Figure 6.6** shows the logistic models for interior global vertical illuminance. In contrast to the measures acquired from HDR imaging, where the luminance of individual facade regions can be differentiated and measured independently, global vertical illuminance integrates the luminance of the hemispherical scene into a single value. Therefore, although the variable resulted in a highly ranked logistic models, the measure was not capable of identifying the differences in behavior such as those discussed in the preceding paragraph. Thus, this model is more suitable to spaces where interior luminance conditions are affected by a single large source, rather than multiple sources than can be shaded independently.

**Figure 6.7** shows the logistic models for interior global vertical irradiance. Measures of illuminance and irradiance are related directly by the efficacy of the light source. For the daylighting conditions measured at the SFFB, the efficacy of the sky during most hours of the day was found to be approximately 110 lux/Watt. Therefore, the models shown in **figure 6.6** and **figure 6.7** are similar. However, measures of global vertical illuminance were derived from the HDR data and are therefore associated with the position of the camera which is in turn associated with the orientation of the occupant. Measures of interior global vertical irradiance were acquired at the interior face of the vision window glass. Therefore, the two variable represent different frames of reference in a spatial sense. The models of irradiance (**figure 6.7**) show that the 0.5 probability of the vision window shades being lowered occurs at approximately 8 W/m<sup>2</sup> and the 0.95 probability occurs at 50 W/m<sup>2</sup>. This result is lower than the assumptions of the theoretically derived venetian blind operation thresholds used by (Choi et al., 1984) of (63 W/m<sup>2</sup>) and (Lee et. al. 1995) of (95 W/m<sup>2</sup>). The results are also lower than the empirically derived venetian blind models used by (Reinhart, 2001) and (Newsham, 1996), which assume windows will remain unshaded until the irradiance exceeds (50 W/m<sup>2</sup>) and (223 W/m<sup>2</sup>) respectively. The results are closest to the empirically derived model created by (Inkarojrit, 2005) where a probability of 0.5 occurs at an interior global vertical irradiance of 13 W/m<sup>2</sup>. Although the simple threshold model proposed by (Reinhart, 2001) of 50 W/m<sup>2</sup> matches closely with the high probability that shades will be deployed (p = 0.95), the Reinhart model does not account for the high probability of shade deployment that exists below (50 W/m<sup>2</sup>).



**Figure 6.6** Logistic regression models for interior global vertical illuminance.



**Figure 6.7** Logistic regression models for interior global vertical irradiance.

### 6.4.3 IESNA luminance contrast ratio limit and UGR

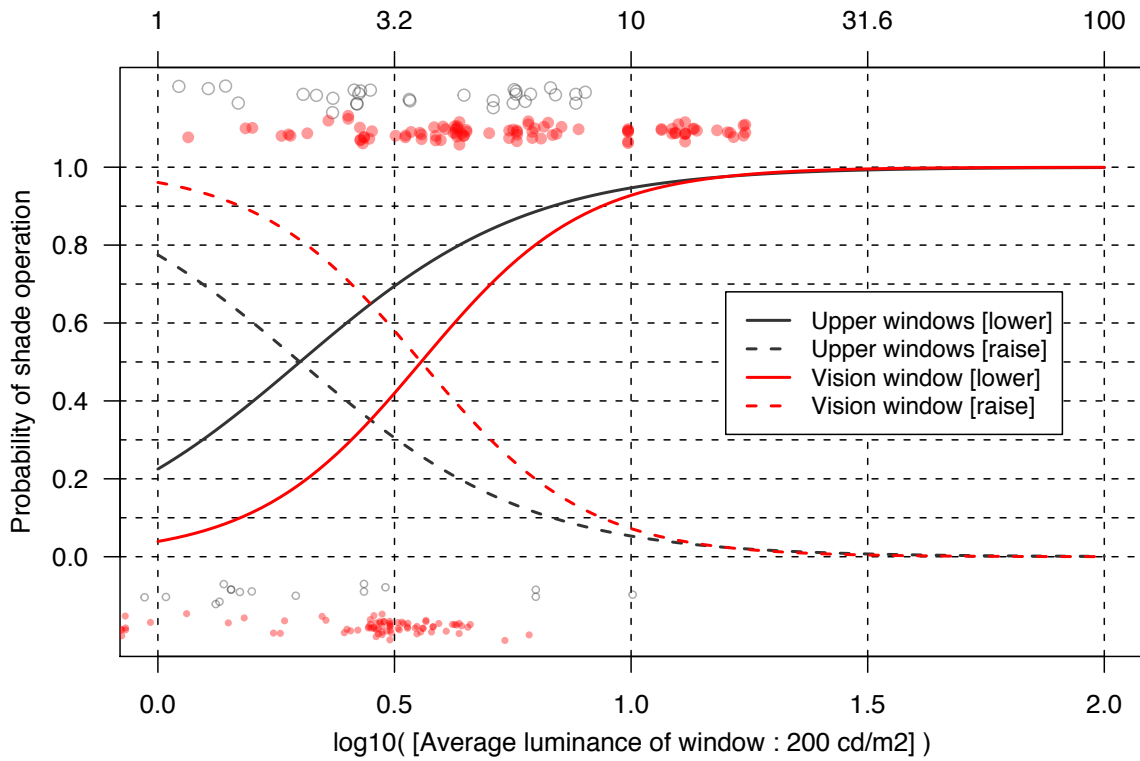
**Figure 6.8** shows the logistic regression models for the luminance contrast ratio between average window luminance and a theoretical 200 cd/m<sup>2</sup> visual task ( $R_{CPU}$ ). Models based on ( $R_{CPU}$ ) were highly ranked for both window groups. In comparison to the contrast ratio limits recommended by the IESNA of [1:3:10] between the visual task, “near”, and “distant” surfaces, the results for the vision shade operation model show a high probability ( $p = 0.5$ ) of shades being lowered at a ratio of [1:3] and a probability close to ( $p = 1$ ) when the ratio exceeds [1:10]. And, identical to the pattern shown in **figure 6.4**, participants showed a lower probability for lowering shading devices for the vision window shades than upper daylight zone shades. Regardless of whether the window is defined to be a “near” or “distant” surface, corresponding to a threshold limit of [1:3] or [1:10] respectively, exceeding either ratio limit is associated with high probability that shades will be lowered. However, results based on contrast ratio limits can be misleading, as the ratios are based on measures of average window luminance. Where the distribution of luminance across the window surface is highly variable, measures of average window luminance do not register extreme luminance levels that may create a source of discomfort and result in the lowering of shading devices. Therefore, measures based on average window luminance are considered to be less applicable for situations where the luminance distribution of the windows is anticipated to be highly variable, such as complex fenestration systems with specular surfaces or views that include direct view of the solar disc. In these settings models based on maximum luminance are considered to be more applicable.

In addition to the ambiguities associated with the calculation of average surface luminance when using contrast ratio limits, additional ambiguities are introduced in defining what constitute the boundaries of the “visual task,” “near,” and “distant” surfaces. Comparison of the models in **figure 6.8** shows that different threshold limits apply to different “near” surfaces (i.e. the vision region and upper daylight zone region). Although contrast ratio limits were found to be highly ranked for both groups (and thus among the most accurate in regard to modeling observed behavior), the models are considered to be “site specific” and therefore the probabilities are likely to change if applied to another daylight perimeter zone environment. Therefore, as a result of these ambiguities, contrast ratio limits are considered to be more applicable to highly regularized environments (e.g. test labs) where the boundaries defined for regions and view positions are fixed.

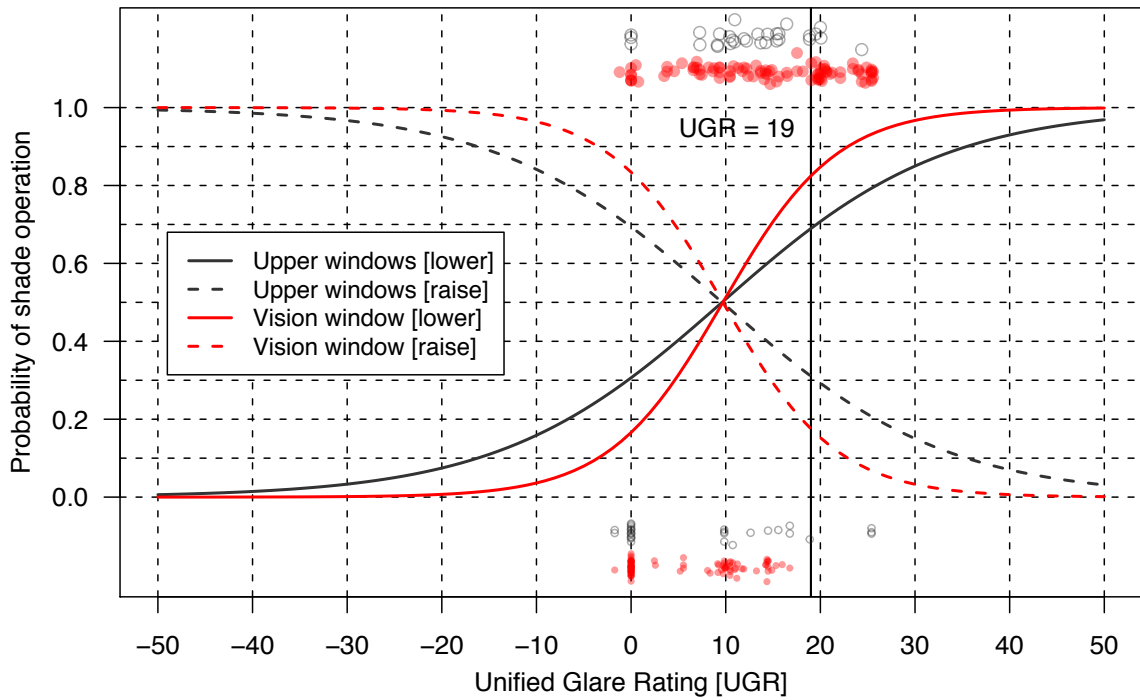
Models based on the Unified Glare Rating (UGR) (**figure 6.9**) were found to be less accurate for both groups than more “basic” indicators of vertical illuminance and irradiance. In addition, existing criteria for interpreting the results of the UGR metric results were found to underestimate the discomfort conditions that lead to the lowering of shading devices. A vertical black line is shown to indicate the maximum allowable UGR rating (UGR = 19) recommended by the IESNA and the ASHRAE Performance Measurement Protocols (PMP) for office spaces. In contrast with this recommendation, the results show that UGR ratings below (UGR = 19) are associated with a high



probability of shades being lowered, suggesting that visual discomfort occurs at UGR values below 19.



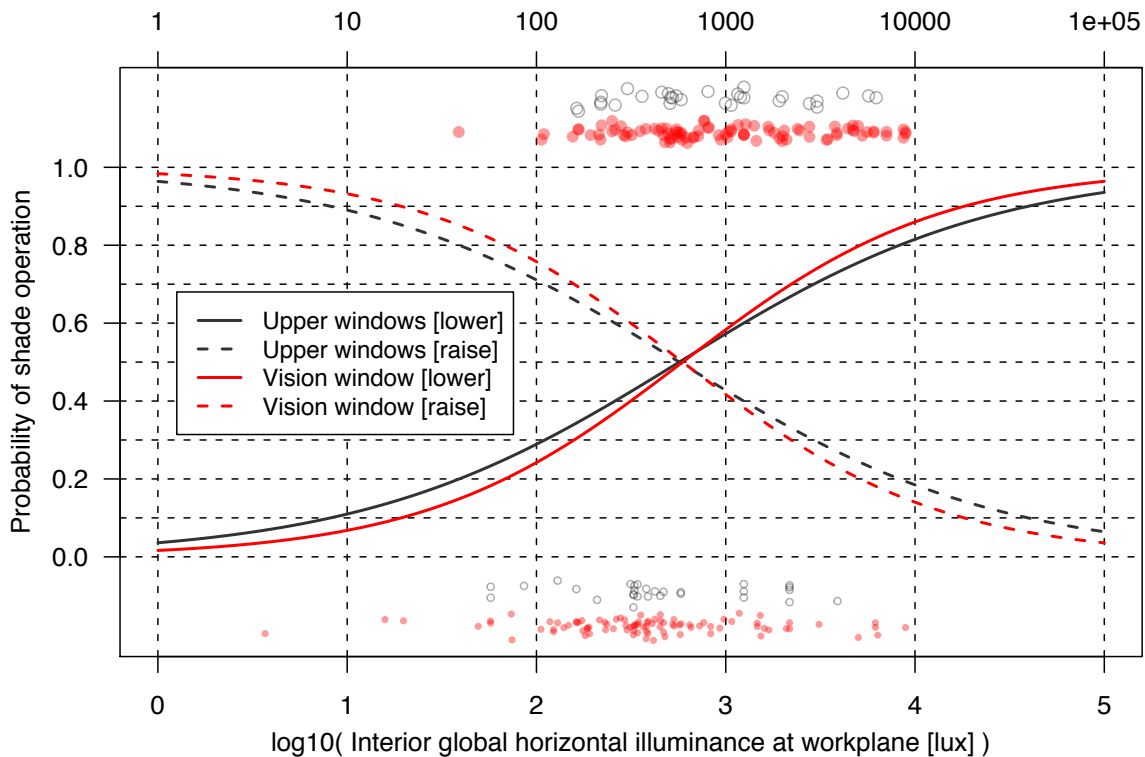
**Figure 6.8** Logistic regression models of luminance ratio [window : 200 cd/m<sup>2</sup> task].



**Figure 6.9** Logistic regression models of the Unified Glare Rating (UGR).

#### 6.4.4 Horizontal illuminance

Logistic regression models generated from measures of global horizontal daylight illuminance measured at the workplane were found to be among the lowest ranked predictors for the operation of shading devices. Because global horizontal daylight illuminance ( $I_{lum,dlt}$ ) is the most common (and often the only) indicator used in simulation of daylighting system performance, models are presented to examine how existing assumptions for visual discomfort and shade operation associated with threshold levels of ( $I_{lum,dlt}$ ) compared to models of observed behavior. Existing assumptions for illuminance-based thresholds for shade deployment are used in annual simulations of daylight availability to calculate daylighting indicators such as Useful Daylight Illuminance (UDI) and Daylight Autonomy (DA). In the calculation of UDI, daylight illuminance values below 2000 lux are considered to be “useful” while values above 2000 lux are considered to be associated with visual discomfort and the potential deployment of shading devices. In contrast to this assumption, the results observed (**figure 6.10**) show approximately a ( $p = 0.6$ ) probability that shades will be lowered at illuminance levels of 1000 lux. Therefore, even based on the most optimistic assumptions for the frequency of shade operation, the models suggest that simulations assuming windows to be unshaded at interior daylight illuminance levels exceeding 1000 lux are likely to significantly overestimate the amount of daylight available on an annual basis. As another example, in simulation of annual daylight availability, (HMG, 2010) assume that shades will be deployed when the horizontal daylight illuminance exceeds 4000 lux.



**Figure 6.10** Logistic regression models of daylight illuminance.

### 6.4.5 Logistic regression model operation thresholds

**Table 6.7** presents the estimated threshold values for each of the variables selected as a predictor for shade operation. The summary shows thresholds for increasing probabilities of shades being lowered. Comparison of the threshold levels for the vision window shade models and the upper daylight zone shade models shows that participants are, in general, accepting of greater stimulus levels from the lower window region.

**Table 6.7** Estimated threshold values at ( $p = 0.2$ ), ( $p = 0.5$ ) and ( $p = 0.95$ ) for physical environmental variables.

Variable	Units	Lower "vision" window shade			Upper "daylight zone" shades		
		Probability shade will be lowered			Probability shades will be lowered		
		[0.2]	[0.5]	[0.95]	[0.2]	[0.5]	[0.95]
$L_{\max L_{wWin}}$	$cd/m^2$	1034	2200	10923	464	1046	5864
$R_{CPU}$	NA	2.0	3.6	11.7	0.3	1.3	31.3
$L_{lwWin}$	$cd/m^2$	413	720	2338	184	399	2071
$Illum_{inVert}$	lux	326	611	2315	321	650	2904
$Irrad_{inVert}$	$W/m^2$	3	8	50	2	7	117
UGR	NA	1	10	27	-7	10	44
$Illum_{dt}$	lux	68	592	58324	39	569	167637

## 6.5 Summary and conclusions

This chapter examined the physical environmental conditions associated with occupant operation of roller shades in the SE perimeter zone. Using single-variable logistic regression as a tool to model behavior, operation of shades was found to be related to the stimulus intensity of a number of independent variables. The results support existing studies that demonstrate that shade operation can be predicted from physical measures (Inkarojrit, 2005), but highlight a number of issues associated with existing assumptions for the stimulus intensity associated with shade operation. Although the models presented in this chapter are “predicative” in the sense that they show a relationship between stimulus intensity (e.g. maximum window luminance) and an observed shade control action, they are not directly applicable for predicting the actions of building occupants due to the requirement for an additional assumption for how frequently occupants respond to the stimulus. Given this constraint, simulated results using the models developed in this study should be interpreted to predict “best case” scenarios for daylight availability which should be viewed along with “occasional operator” and “non-operator” scenarios.

Although this chapter presents models that describe the behavior of building occupants in relation to environmental conditions that cause visual discomfort, the chapter does not address if the positioning of roller shades results in satisfactory visual comfort conditions. This question is addressed next in Chapter 7. Conclusions to this chapter are summarized in the following points:

1. Are roller shades operated in response to the stimulus intensity of interior physical variables (e.g. transmitted global vertical irradiance, average or maximum window luminance)?
  - a. Roller shade operations were found to be related to the stimulus intensity of a number of interior physical variables, where the probability of a shade lowering event increased with stimulus intensity. Because each operation represented a decision by the participant to either lower or raise a shade, the models can also be interpreted to predict shade raising events, where the probability of a shade raising event increases with a decrease in stimulus intensity.
2. Can logistic models based on measures of interior physical variables be used to predict operation of roller shades? If so, what variables best predict behavior and with what level of accuracy?
  - a. A number of logistic regression models generated from independent variables were examined in relation to shade operation actions and found to be reasonably accurate based on the metric of the percent of correct responses predicted (%-cor).

- b. Models based on measures of maximum and average window luminance (acquired from HDR imaging) were found to be the most accurate. More “basic” measures of interior vertical illuminance and irradiance were also found to be among the most accurate predictors. However, these latter measures, which integrate the variation in irradiance or illuminance of a 180-degree view into a single measure, were less capable of differentiating between important differences in how shades were operated, such as the greater tolerances to high luminances for vision windows. Glare indices and measures of horizontal illuminance were found to be among the least accurate.
3. How do models for operation of upper daylight zone window shades compare to models for operation of vision window shades?
  - a. Participants were found to operate the upper daylight zone shades differently than the vision window shades. Participants showed a higher probability for lowering the upper shades for any given stimulus intensity. This result contradicts a common assumption made when subdividing the facade to include an upper daylight zone (and increasing floor-to-ceiling-height). It is assumed that building occupants located adjacent to the facade will be less sensitive to the luminance of upper daylight zone windows based on the upper windows’ location outside the occupant’s foveal vision (i.e. outside the cone of vision oriented towards the participant’s visual task).
4. How do logistic models of roller shade operation developed from field data collected in the SFFB compare to existing theoretical and empirically derived models for shade operation?
  - a. Overall, the models from the SFFB showed high probabilities for shade deployment at stimulus levels below thresholds used by existing models. All existing indicators examined were found to overestimate the stimulus intensity associated with the lowering of shades, leading to overestimations of daylight availability based on even the most “optimistic” assumptions for the frequency of shade operation. In addition, comparison between models for the lower “vision window” shades and upper daylight zone shades illustrates ambiguities associated with applying existing single-zone assumptions for shade control thresholds to facades with multiple zones. The results suggest that simulation of subdivided facades should consider that zones might be operated differently by occupants.

CHAPTER 7  
LOGISTIC REGRESSION MODELS  
OF  
VISUAL DISCOMFORT

### 7.1 Introduction

As established in Chapter 5, the majority of study participants positioned shading devices in a lowered position and adjusted them less frequently than predicted by “active operator” behavioral models. Although these results are descriptive of occupant behavior, they do not show if the shading of the facade resulted in visually comfortable conditions for occupants, particularly for the NW perimeter zone, where no shades were added to the upper to rows of windows. In addition, prior survey work and the polling station data show a frequent number of visual discomfort responses. To improve the comfort of the SFFB, as well as the design of future daylight buildings, it is important to identify and measure the physical conditions associated with visual discomfort responses and report results that can be used to better predict when discomfort will occur.

This chapter presents the results from an analysis of visual discomfort responses from polling station data. In total, this analysis involved repeated-measures data from (N=44) unique participants located in the NW perimeter zones (N=12), SE perimeter zones (N=18) and Core zones (N=14) comprising a total of 3443 subjective assessments of visual discomfort. Subjective responses were paired with near-simultaneous physical measures of interior and exterior environmental conditions. The objective of this analysis was to identify the physical variables associated with visual discomfort and to create predictive models that describe the relationship between stimulus intensity and subjective levels of discomfort.

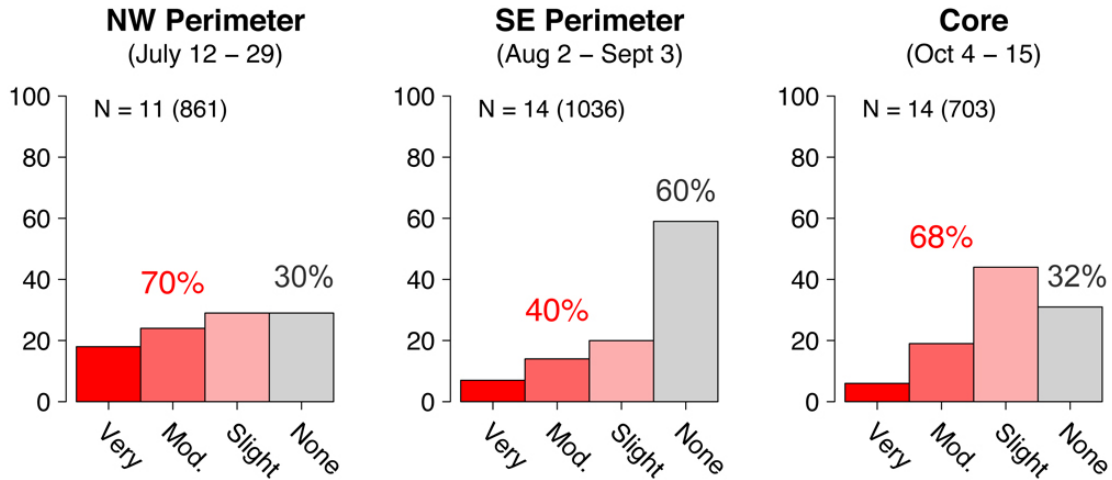
The following questions were used to guide the analysis:

1. How frequent are the responses of visual discomfort in each zone (i.e. NW, SE, Core)? And, what is the magnitude of perceived discomfort (e.g. “slight”, “moderate,” “very uncomfortable”)?
2. How do the results of existing methods and metrics recommended for measuring and assessing visual discomfort compare with subjective responses?
3. Can new logistic models based on physical measures of indoor environmental conditions be used to predict discomfort responses? If so, what variables best predict visual discomfort and with what level of accuracy? And, how does the probability of discomfort compare with the stimulus intensity of a given variable?

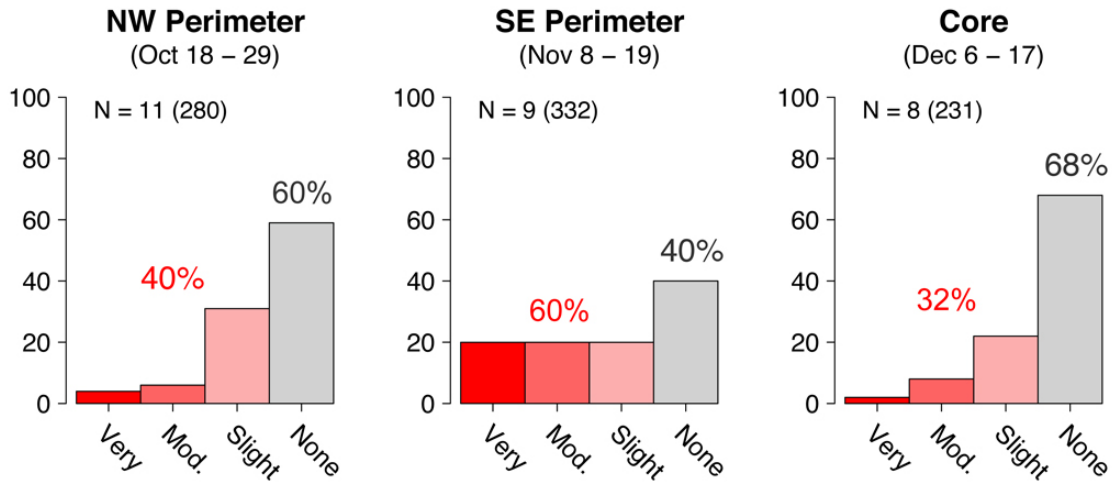
## 7.2 Review of polling station responses

To examine the frequency and subjective magnitude of visual discomfort for each monitoring phase, responses from the polling station data were reviewed. **Figure 7.1** and **figure 7.2** show the responses of participants to the polling station question/request (Q6): “Please rate your level of VISUAL DISCOMFORT from WINDOWS right now.” Based on the assumption that responses are distributed evenly over each test phase (as shown in **figures 4.38, 4.41, and 4.44**), these results indicate significant periods of time where windows were a source of at least a “slight” level of visual discomfort. For the perimeter zones, the most severe conditions were recorded during the test phase where each zone received greater exposure to low-angle sun. For example, during Phase 1 (July 12-29, for the NW) and during Phase 5 (November 8 – 19 for the SE), 70% and 60% of all responses indicated discomfort from windows and 18% and 20% of all responses rated the level of discomfort from windows as “very uncomfortable.” Participants in the core zones also recorded a significant number of discomfort responses.





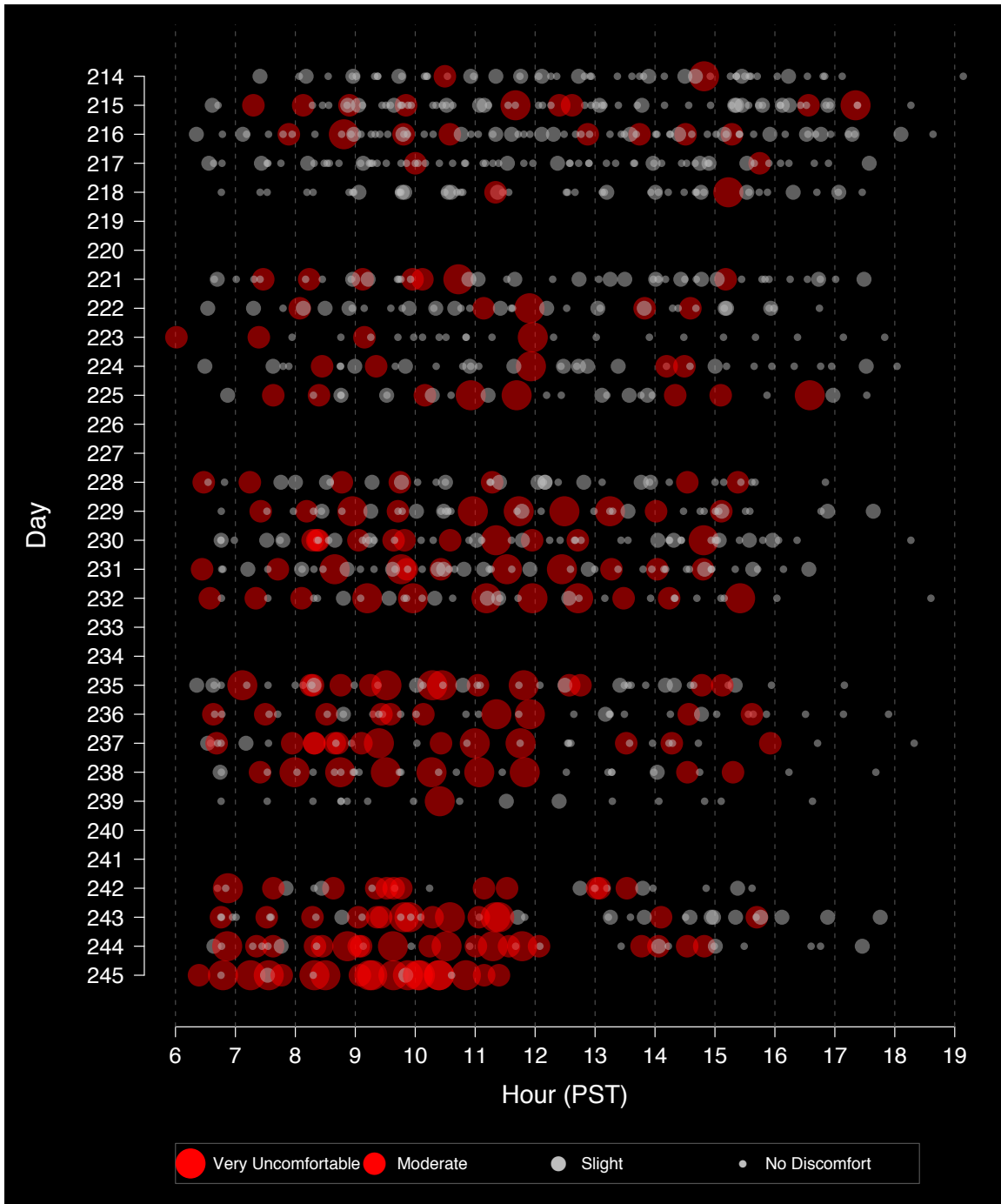
**Figure 7.1** Summary of occupant subjective responses to (Q6) for Phases 1, 2, 3. *N* indicates the number of participants, followed (in parenthesis) by the total number of responses recorded for the group.



**Figure 7.2** Summary of occupant subjective responses to (Q6) for Phases 4, 5, 6.

To examine how subjective responses were distributed over time, a customized plotting function was created using R to visualize all responses to polling station question (Q6). **Figure 7.3** presents an example of this method of visualization for the SE perimeter zone during Phase 2 (Aug. 2 – Sept. 3). For **figure 7.3**, the y-axis represents each day of the monitoring interval and the x-axis indicates the time of day. Subjective responses are indicated by circles that vary in diameter based on the magnitude of the subjective response. Larger diameters indicate greater magnitudes of discomfort, where responses of “moderate” and “very uncomfortable” are indicated with the color red and responses of “slight” and “no” discomfort are indicated with grey. A level of transparency is applied to each response in order to better visualize multiple responses that occur at a similar time. This method of exploratory visualization confirmed that the overall

distribution of responses was relatively even across days and time of day, and illustrated a pattern showing that discomfort responses during the first two weeks were infrequent and evenly distributed across the day, compared with the final two weeks where they were more frequent, of greater magnitude, and predominantly clustered before noon. Since the first two weeks were predominantly foggy/overcast sky conditions, the latter two weeks were predominantly clear, and the intermediate week was dynamic, the patterns evident in **Figure 7.3** support occupant comments that visual discomfort conditions were primarily associated with direct sun on the SE facade. The following sections describe the analysis done to identify the physical variables associated with occupant subjective assessment of visual discomfort from windows and present the results in the form of single-variable predictive models.



**Figure 7.3** Distribution of polling station responses to (Q6) by day (y-axis) and by hour (x-axis) for the SE perimeter zone group (N=14, 1033 observations) from August 2, to Sept. 3, 2010.

### 7.2.1 Selection of independent variables

To model the physical conditions associated with visual discomfort, a set of “candidate” variables was selected to compare to subjective responses. Several criteria were used to select the set of candidate variables. First, variables were selected that have the potential to measure sources of visual discomfort identified by study participants in survey questionnaire responses. For example, comments from study participants in NW perimeter zones identified view of direct sun and glare from unshaded upper windows, neighboring building surfaces, and sky conditions as sources of visual discomfort. Comments from participants in the SE perimeter zones identified visual discomfort primarily in terms of glare associated with a direct view of the sun. Participants located in the core zones did not respond to open-ended comments related to visual discomfort from windows.

-Example survey comments (NW perimeter zones)

*“The upper tier of windows (3rd tier) that have no shades are the biggest problem. There is no way to limit the sun, but especially the glare, that constantly comes through there.”*

*“I just want to reiterate that the glare is the biggest problem in this building. It is a problem all day long, and is worse at some times of the day and in some locations than others. Sometimes you can't even tell who you are looking at if they are standing in front of a window; all you see is a silhouette. We need more shades, because the two upper tiers of windows, which is where the glare/sunlight mostly comes from, don't have shades. It is very annoying on a daily basis.”*

*“Light and glare conditions change frequently, subject to a variety of constantly changing factors, including position and angle of sun, location of nearby buildings and their surface and the angle and condition of sunlight, fog or cloud cover.”*

*“Large contrast in light levels between windows and other surfaces.”*

-Example survey comments (SE perimeter zones)

*“The glare is so bad from the sun that I have now resorted to keeping the shades down all of the time. As a result, I don't get much daylight or a view so I have to keep the lights on the whole time. It also makes me feel slightly disconnected from the outside.”*

*“The morning sun is the worst but it only lasts a couple hours, fine rest of day.”*

*“The glare from the sun and reflection from the windows are most important.”*

In consideration of survey comments and discussions with participants prior to the study, the average luminance ( $L_{upWin}$ ) and maximum luminance of the upper two rows of windows ( $L_{upMax}$ ) were differentiated from the lower vision window ( $L_{lwWin}$ ), ( $L_{lwMax}$ ) in the analysis of the HDR images. In addition, variables associated with the magnitude of solar exposure (exterior vertical solar irradiance ( $Irrad_{extVert}$ ) and interior transmitted vertical solar irradiance ( $Irrad_{inVert}$ ) were included. Resulting from the location of core participants at distances (20 – 35 ft.) from the facade, ( $Irrad_{inVert}$ ) was only considered applicable to analysis of perimeter zones. Finally, the set contains variables associated with the amount of light delivered to the workplane including horizontal illuminance ( $Illum$ ) and horizontal daylight illuminance ( $Illum_{dlt}$ ). These latter variables are proposed by HMG (2010) and the USGBC LEED Daylight EQ credit as indicators of visual discomfort that are likely to be associated with shade deployment.

Second, variables suggested from the analysis of the SFFB field study conducted by LBNL (2007) were included. These variables are identical to those used selected in Chapter 6 as predictors for shade operation and are described in **section 6.2.1**.

Finally, variables were selected based on recommendations from previous research and the factors used in existing performance measurement protocols. These protocols include glare metrics developed to predict visual discomfort from large area sources (e.g. windows). The glare metrics ( $DGI_{2000}$ ,  $DGI_{7x}$ , CGI, UGR) are identical to the ones used in Chapter 6 and are described in **section 6.2.1**.

Finally, the daylight factor (DF) and Mean Radiant Temperature (MRT) were included as additional variables to examine their potential relation to visual discomfort. The DF has primarily been used to assess daylight sufficiency, but is also recommended as an indicator of excessive daylight transmission that can lead to visual discomfort. For example the Green Studio Handbook (Kwok and Gronzik, 2007) recommends that the DF remain below 5% to avoid visual discomfort. MRT has been suggested in previous research to predict occupant discomfort associated with both visual and thermal sensations that can occur simultaneously in spaces that receive direct sun (Inkarojrit, 2005).

## 7.2.2 Description of independent variables

All independent variables selected for the visual discomfort analysis are shown in **tables 7.1 – 7.3** along with descriptive statistics. The descriptive statistics were calculated from a set of physical measures directly paired with subjective responses (i.e. not a set containing all time-series measures).  $N$  indicates the number of participants for each monitoring phase followed by the total number of observations indicated in parenthesis. To illustrate the variation in magnitude of independent variables by zone location (e.g. NW, SE, core) and over seasonal changes (e.g. near-equinox vs. near-solstice), statistics are presented separately for each monitoring phase. Because quantitative variables associated with light can include extreme values, the median of each variable is shown rather than the mean.

**Table 7.1** Descriptive statistics for NW perimeter zone independent variables associated with visual comfort votes from polling stations.

Variable	Unit	Phase 1 (July 12 - 29)				Phase 4 (October 18 - 29)			
		N = 12 (861 observations)				N = 10 (280 observations)			
		Median	SD	Min.	Max.	Median	SD	Min.	Max.
MRT	deg. F	73	1	69	86	74	2	69	80
Illum	Lux	534	1154	28	10479	503	821	56	5552
Illum <sub>dlt</sub>	Lux	431	1158	8	10369	454	831	4	5528
Illum <sub>inVert</sub>	Lux	1071	2405	142	14918	740	1273	40	4715
Irrad <sub>exVert</sub>	W/m <sup>2</sup>	103	126	19	650	74	43	1	265
Irrad <sub>inVert</sub>	W/m <sup>2</sup>	23	34	5	239	18	10	0	38
DF	NA	0.8%	3%	0%	26%	2%	4%	0.1%	21%
L <sub>upWin</sub>	cd/m <sup>2</sup>	1980	2277	730	12762	1805	1720	2	7343
L <sub>maxUpWin</sub>	cd/m <sup>2</sup>	4785	8564	1400	40373	3021	4203	17	25481
L <sub>lwWin</sub>	cd/m <sup>2</sup>	605	322	235	1980	712	340	1	1437
L <sub>maxLwWin</sub>	cd/m <sup>2</sup>	2647	1489	533	10442	2120	1147	14	6836
R <sub>win</sub>	NA	4	10	0	137	3	3	0	14
R <sub>winMax</sub>	NA	78	160	4	1488	54	69	5	485
R <sub>CPU</sub>	NA	11	9	6	52	12	7	0	32
R <sub>CPUmax</sub>	NA	36	34	12	203	31	20	0	132
DGI <sub>2000</sub>	NA	11	10	-11	27	3	11	-5	26
DGI <sub>7x</sub>	NA	0	6	-11	12	0	6	-20	14
CGI	NA	17	11	-5	39	9	12	0	33
UGR	NA	14	10	-8	33	5	12	-3	29

**Table 7.2** Descriptive statistics for SE perimeter zone independent variables associated with visual comfort votes from polling stations.

Variable	Unit	Phase 2 (August 2 - September 3)				Phase 5 (November 8 - 19)			
		N = 14 (1030 observations)				N = 10 (332 observations)			
		Median	SD	Min.	Max.	Median	SD	Min.	Max.
MRT	deg. F	75	3	68	84	76	2	69	89
Illum	Lux	407	1540	28	9580	303	1545	36	8983
Illum <sub>dlt</sub>	Lux	345	1532	3	9530	239	1554	0	8914
Illum <sub>inVert</sub>	Lux	406	323	0	1791	309	717	1	3162
Irrad <sub>exVert</sub>	W/m <sup>2</sup>	118	224	1	804	351	347	1	928
Irrad <sub>inVert</sub>	W/m <sup>2</sup>	3	6	0	35	3	14	0	74
DF	NA	1%	6%	0%	25%	0.8%	8%	0%	20%
L <sub>upWin</sub>	cd/m <sup>2</sup>	103	315	4	2480	121	276	0	1498
L <sub>maxUpWin</sub>	cd/m <sup>2</sup>	367	7337	6	44678	514	14660	1	46424
L <sub>lwWin</sub>	cd/m <sup>2</sup>	327	356	4	1701	383	712	1	3352
L <sub>maxLwWin</sub>	cd/m <sup>2</sup>	1073	6364	17	41421	1942	19796	2	46773
R <sub>win</sub>	NA	4	3	0	17	2	3	0	17
R <sub>winMax</sub>	NA	571	1120	109	16231	363	20367	59	269373
R <sub>CPU</sub>	NA	1	1	0	10	1	2	0	9
R <sub>CPUmax</sub>	NA	4	32	0	207	7	71	0	232
DGI <sub>2000</sub>	NA	0	6	-14	18	6	7	-1	21
DGI <sub>7x</sub>	NA	0	6	-20	16	7	6	-21	21
CGI	NA	4	8	-8	24	12	9	0	29
UGR	NA	2	7	-11	20	8	8	0	26

**Table 7.3** Descriptive statistics for core zone independent variables associated with visual comfort votes from polling stations.

Variable	Unit	Phase 3 (October 4 - 15)				Phase 6 (December 6 - 17)			
		N = 14 (703 observations)				N = 8 (231 observations)			
		Median	SD	Min.	Max.	Median	SD	Min.	Max.
MRT	deg. F	75	2	70	82	76	1	70	78
Illum	Lux	288	104	108	1446	236	43	159	356
Illum <sub>dlt</sub>	Lux	57	116	1	1396	36	25	2	121
Illum <sub>inVert</sub>	Lux	905	683	79	3870	446	331	78	1224
Irrad <sub>exVert</sub>	W/m <sup>2</sup>	79	101	1	650	48	33	1	125
DF	NA	0.1%	8%	0%	16%	0.2%	38%	0%	14%
L <sub>upWin</sub>	cd/m <sup>2</sup>	2584	1758	9	9187	1749	1504	9	4917
L <sub>maxUpWin</sub>	cd/m <sup>2</sup>	6196	4628	46	37697	3123	3098	37	26950
L <sub>lwWin</sub>	cd/m <sup>2</sup>	207	1440	2	5836	109	108	11	503
L <sub>maxLwWin</sub>	cd/m <sup>2</sup>	1600	2552	9	17860	523	2774	28	26950
R <sub>win</sub>	NA	22	14	0	57	15	11	0	32
R <sub>winMax</sub>	NA	13	9	0	46	5	4	0	13
R <sub>CPU</sub>	NA	279	67	82	904	10	14	0	135
R <sub>CPUmax</sub>	NA	31	23	0	188	134	65	95	365
DGI <sub>2000</sub>	NA	25	12	-3	28	21	11	0	28
DGI <sub>7x</sub>	NA	20	10	-5	25	21	9	-9	26
CGI	NA	28	13	0	33	24	13	0	31
UGR	NA	26	12	0	30	22	12	0	29

**Tables 7.1 – 7.3** identify a number of important differences in the physical conditions recorded for each zone. Although there were moderate changes in the summary statistics between the initial and second monitoring phase for each group (e.g. Phase 3 vs. Phase 6), the largest differences were found between groups. For example, average and maximum window luminances were lower for the SE perimeter zone compared with the NW as a result of the solar control film and exterior metal scrim applied to the SE facade. In addition, the upper two rows of windows on the SE facade were predominantly shaded, where as the majority of responses from the NW perimeter zone (and NW-facing participants in the core) were from areas without interior roller shades installed on the two upper rows of windows. Therefore, NW perimeter zone participants and the NW-facing core participants assessed much “brighter” window luminances. However, as a result of the orientation of the building, SE perimeter zone participants experienced more hours with a direct view of sun, leading to a greater maximum window luminance values and larger variation (SD). Finally, the summary statistics indicate that the glare indices ( $DGI_{2000}$ ,  $DGI_{7x}$ , CGI, UGR) were much lower for the perimeter zones compared to the core.

### **7.2.3 Scaling of independent variables**

The physiological sensation of brightness, like many other physiological sensations (e.g. smell, sound, touch), increases proportionally to the logarithm of the stimulus intensity (i.e. luminance) (Fechner, 1860). Therefore, all variables (with the exception of MRT, the glare indices, and the luminance ratios) were scaled using a log transform prior to using statistical methods to relate subjective responses to stimulus intensity.

### **7.2.4 Intercorrelation of independent variables**

To examine the correlation among the variables selected, intercorrelation analysis using the Pearson method was done for each phase independently (using the R function *cor*). Intercorrelations were found to vary primarily between zones (i.e. NW vs. SE vs. Core). Therefore, intercorrelations are presented for the NW, SE and Core zones separately in **tables 7.4 – 7.6**.



**Table 7.4** Intercorrelation among independent variables for NW perimeter zones.

	MRT	Illum	Illum <sub>dlt</sub>	Illum <sub>inVert</sub>	Irrad <sub>exVert</sub>	Irrad <sub>inVert</sub>	DF	L <sub>upWin</sub>	L <sub>maxUpWin</sub>	L <sub>lwWin</sub>	L <sub>maxLwWin</sub>	R <sub>win</sub>	R <sub>winMax</sub>	R <sub>CPU</sub>	R <sub>CPUmax</sub>	DGI <sub>2000</sub>	DGI <sub>7x</sub>	CGI	UGR	
MRT	1																			
Illum	0.4	1																		
Illum <sub>dlt</sub>	0.4	1.0	1																	
Illum <sub>inVert</sub>	0.0	0.3	0.3	1																
Irrad <sub>exVert</sub>	0.2	0.4	0.4	0.3	1															
Irrad <sub>inVert</sub>	0.1	0.4	0.4	0.7	0.6	1														
DF	0.1	0.6	0.6	0.1	0.0	0.1	1													
L <sub>upWin</sub>	0.2	0.2	0.2	0.1	0.4	0.1	0.1	1												
L <sub>maxUpWin</sub>	0.1	0.4	0.4	0.3	0.8	0.4	0.2	0.6	1											
L <sub>lwWin</sub>	0.0	0.3	0.3	0.9	0.2	0.6	0.2	0.2	0.2	1										
L <sub>maxLwWin</sub>	0.3	0.4	0.4	0.2	0.7	0.3	0.0	0.4	0.8	0.2	1									
R <sub>win</sub>	-0.1	-0.2	-0.2	0.2	0.0	0.1	-0.2	0.2	0.0	0.2	0.0	1								
R <sub>winMax</sub>	-0.3	-0.4	-0.4	-0.1	-0.2	-0.2	-0.2	-0.2	-0.2	-0.2	-0.2	0.6	1							
R <sub>CPU</sub>	0.2	0.3	0.3	0.5	0.4	0.4	0.1	0.9	0.6	0.6	0.5	0.3	-0.3	1						
R <sub>CPUmax</sub>	0.2	0.4	0.4	0.3	0.8	0.4	0.1	0.6	1	0.2	0.9	0.0	-0.2	0.6	1					
DGI <sub>2000</sub>	-0.1	0.3	0.3	0.8	0.2	0.5	0.1	-0.1	0.2	0.8	0.2	0.1	-0.1	0.3	0.2	1				
DGI <sub>7x</sub>	0.1	0.1	0.1	0.0	0.2	0.0	-0.1	0.0	0.2	-0.1	0.3	-0.1	-0.1	0.0	0.2	0.3	1			
CGI	0.0	0.3	0.3	0.8	0.3	0.6	0.1	0.0	0.2	0.8	0.2	0.1	-0.2	0.4	0.2	1	0.3	1		
UGR	0.0	0.3	0.3	0.8	0.2	0.5	0.1	0.0	0.2	0.8	0.2	0.1	-0.2	0.4	0.2	1	0.3	1	1	

**Table 7.5** Intercorrelation among independent variables for SE perimeter zones.

	MRT	Illum	Illum <sub>dlt</sub>	Illum <sub>inVert</sub>	Irrad <sub>exVert</sub>	Irrad <sub>inVert</sub>	DF	L <sub>upWin</sub>	L <sub>maxUpWin</sub>	L <sub>lwWin</sub>	L <sub>maxLwWin</sub>	R <sub>win</sub>	R <sub>winMax</sub>	R <sub>CPU</sub>	R <sub>CPUmax</sub>	DGI <sub>2000</sub>	DGI <sub>7x</sub>	CGI	UGR	
MRT	1																			
Illum	0.3	1																		
Illum <sub>dlt</sub>	0.3	1	1																	
Illum <sub>inVert</sub>	0.3	0.4	0.4	1																
Irrad <sub>exVert</sub>	0.5	0.5	0.5	0.5	1															
Irrad <sub>inVert</sub>	0.3	0.4	0.4	0.7	0.5	1														
DF	0.0	0.2	0.2	0.0	0.0	0.0	1													
L <sub>upWin</sub>	0.2	0.2	0.2	0.4	0.3	0.3	0.0	1												
L <sub>maxUpWin</sub>	0.2	0.2	0.2	0.2	0.5	0.2	0.0	0.1	1											
L <sub>lwWin</sub>	0.1	0.2	0.2	0.7	0.3	0.7	0.0	0.4	0.0	1										
L <sub>maxLwWin</sub>	0.1	0.2	0.2	0.4	0.5	0.4	0.0	0.1	0.5	0.4	1									
R <sub>win</sub>	-0.1	-0.1	-0.1	0.0	-0.3	0.0	0.0	0.4	-0.2	0.4	-0.1	1								
R <sub>winMax</sub>	-0.1	0.0	0.0	-0.1	-0.1	-0.1	0.0	-0.1	0.0	-0.1	0.0	0.0	1							
R <sub>CPU</sub>	0.2	0.2	0.2	0.7	0.3	0.7	0.0	0.8	0.1	0.9	0.3	0.4	-0.1	1						
R <sub>CPUmax</sub>	0.2	0.3	0.3	0.4	0.6	0.4	0.0	0.1	0.8	0.3	0.9	-0.2	0.0	0.2	1					
DGI <sub>2000</sub>	0.3	0.4	0.4	0.7	0.6	0.4	0.0	0.3	0.3	0.5	0.5	0.0	-0.1	0.5	0.5	1				
DGI <sub>7x</sub>	0.4	0.1	0.1	0.3	0.3	0.1	-0.1	0.0	0.2	0.2	0.4	0.0	-0.1	0.1	0.4	0.5	1			
CGI	0.4	0.4	0.4	0.7	0.6	0.5	0.0	0.4	0.3	0.5	0.5	0.0	-0.1	0.5	0.5	1	0.5	1		
UGR	0.3	0.4	0.4	0.7	0.6	0.4	0.0	0.3	0.3	0.5	0.5	0.0	-0.1	0.5	0.5	1	0.5	1	1	

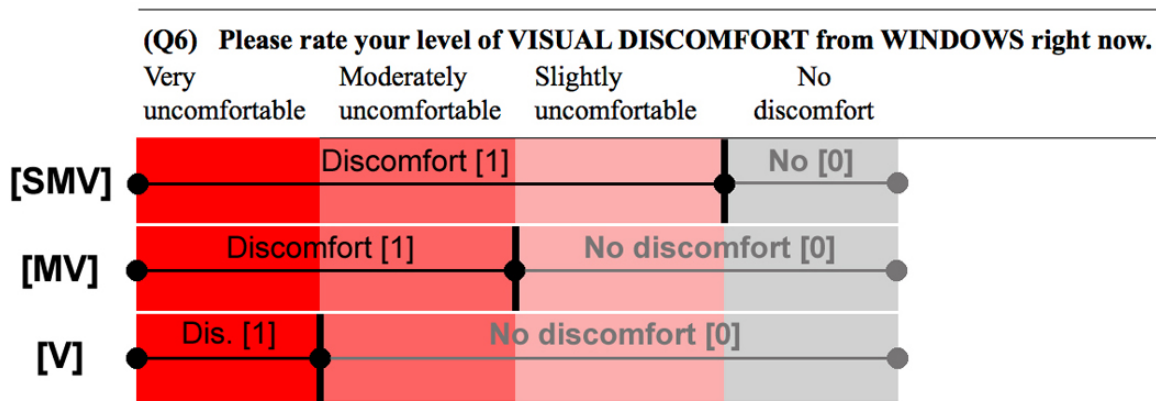
**Table 7.6** Intercorrelation among independent variables for Core zones.

	MRT	Illum	Illum <sub>dlt</sub>	Illum <sub>inVert</sub>	Irrad <sub>exVert</sub>	Irrad <sub>inVert</sub>	DF	L <sub>upWin</sub>	L <sub>maxUpWin</sub>	L <sub>lwWin</sub>	L <sub>maxLwWin</sub>	R <sub>win</sub>	R <sub>winMax</sub>	R <sub>CPU</sub>	R <sub>CPUmax</sub>	DGI <sub>2000</sub>	DGI <sub>7x</sub>	CGI
MRT	1																	
Illum	0.2	1																
Illum <sub>dlt</sub>	0.1	1	1															
Illum <sub>inVert</sub>	0.3	0.4	0.6	1														
Irrad <sub>exVert</sub>	0.3	0.2	0.2	0.3	1													
DF	-0.1	-0.1	-0.1	-0.2	-0.2	1												
L <sub>upWin</sub>	0.2	0.3	0.5	0.9	0.3	-0.2	1											
L <sub>maxUpWin</sub>	0.1	0.2	0.4	0.7	0.4	-0.2	0.6	1										
L <sub>lwWin</sub>	0.4	0.4	0.6	0.9	0.3	-0.2	0.6	0.5	1									
L <sub>maxLwWin</sub>	0.2	0.4	0.5	0.8	0.3	-0.2	0.6	0.7	0.8	1								
R <sub>win</sub>	0.2	0.1	0.4	0.8	0.2	-0.2	1	0.5	0.5	0.4	1							
R <sub>winMax</sub>	-0.3	-0.4	-0.3	-0.5	-0.4	0.4	-0.2	-0.4	-0.6	-0.6	0.0	1						
R <sub>CPU</sub>	0.3	0.3	0.6	1	0.3	-0.2	1	0.6	0.8	0.7	0.9	-0.3	1					
R <sub>CPUmax</sub>	0.2	0.3	0.5	0.8	0.4	-0.2	0.7	0.9	0.7	0.9	0.5	-0.5	0.7	1				
DGI <sub>2000</sub>	0.2	0.3	0.5	0.9	0.3	-0.2	0.9	0.7	0.7	0.6	0.9	-0.3	1	0.7	1			
DGI <sub>7x</sub>	0.1	0.2	0.5	0.9	0.2	-0.2	0.9	0.6	0.6	0.6	0.9	-0.1	0.9	0.7	1	1		
CGI	0.2	0.3	0.5	0.9	0.2	-0.2	0.9	0.7	0.7	0.7	0.9	-0.3	0.9	0.7	1	1	1	
UGR	0.2	0.3	0.5	0.9	0.2	-0.2	0.9	0.7	0.7	0.7	0.9	-0.3	0.9	0.7	1	1	1	1

The results of the intercorrelation analysis show that a number of variables were strongly correlated with each other, and that correlations varied by zone (i.e. NW, SE, Core). In the **tables 7.4 – 7.6**, correlations greater or equal to ( $r = 0.5$ ) are colored grey for easier visual inspection. Variables measured in the Core zones were found to have the largest number of strong correlations. For the Core zones, strong correlations were found among the various glare indices as well as with the glare indices and interior vertical illuminance (Illum<sub>inVert</sub>), the daylight factor (DF), and several of the computed luminance ratios. Because the various glare indices are fundamentally based on luminance contrasts, correlation between various metrics as well as with the luminance contrast ratios indicate that the correlations are driven by the same basic phenomena. Similarly, because luminance ratios were defined using the measures of window luminance (e.g. L<sub>lwWin</sub>, L<sub>lwMax</sub>) as one of their terms, correlation between these variables is expected. To control for strong correlations among predictor variables, a stepwise logistic regression technique was used in R to identify and rank single-variable logistic models (*stepAIC* from the package (MASS), using *forward selection* with 1 *step*).

### 7.2.5 Binary classification of subjective assessments

For the logistic regression technique used in this analysis, the response variable is assumed to be one of two possible disjoint outcomes (e.g. visual discomfort, or the absence of visual discomfort), where the probability of the outcome is related to an explanatory variable. Because the subjective scale used to record ratings of visual discomfort included multiple discrete steps (e.g. “slight,” “moderate,” “very uncomfortable”) to register varying magnitudes of discomfort, a classification was required to simplify the subjective responses to a binary form (e.g. “no discomfort”, vs. “discomfort). To preserve the variation recorded using the 4-point scale, three different classifications of the subjective data were analyzed. The first considered all magnitudes of visual discomfort (e.g. “slight,” “moderate,” “very”) as discomfort and assigned a [1] to all such responses and a [0] to responses of “no discomfort.” The second considered magnitudes of (“moderate” and “very”) as discomfort (i.e. [1]) and assigned a value of [0] to responses of (“slight” and “no”) discomfort. Finally, the third considered only responses of (“very uncomfortable”) as discomfort (i.e. [1]). These divisions are shown in **figure 7.4** and labeled as [SMV], [MV], and [V] respectively in the following analysis.



**Figure 7.4** Graphic representation of the three binary classifications used to define visual discomfort for logistic regression analysis.

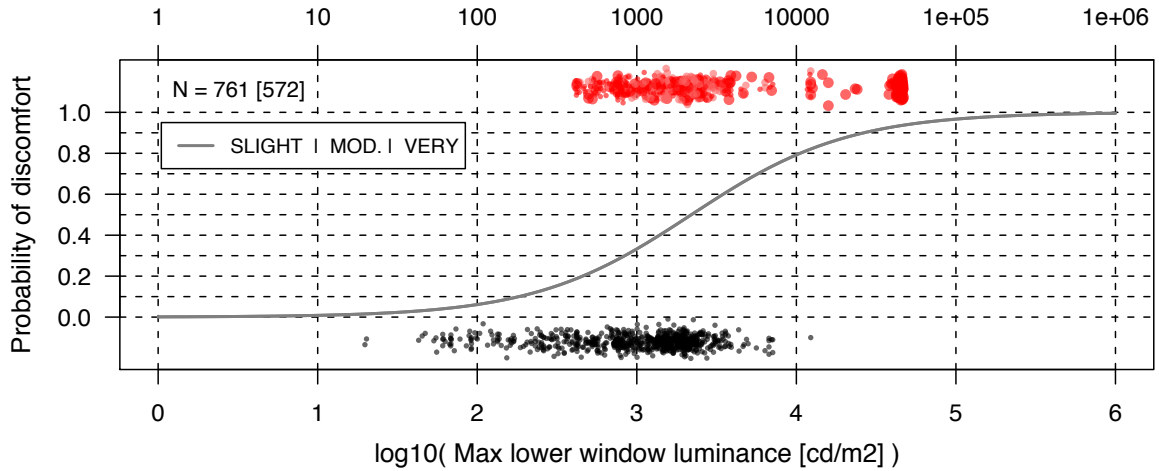
For each candidate independent variable, logistic models were then generated in R using the generalized linear model function (*glm, family = binomial*) for each of three binary divisions of the data ([SMV], [MV], [S]).

**Figures 7.5 – 7.7** present an example outcome using the three classifications of discomfort described above. The data set is from the SE perimeter zones (N=18 participants) and includes data from both test phases (Aug. 2 – Sept. 3 and Nov. 8 - 19). For this group, the maximum luminance of the lower (vision) window ( $L_{\max LwWin}$ ) was found to be the best predictor of visual discomfort. Maximum luminance, in this context, refers to the highest luminance at any location in the window at the point in time when the subjective response was recorded. The procedure used for model selection is described in the following sections. **Figure 7.5** shows the logistic model generated to predict discomfort based on the (SMV) binary classification of discomfort (i.e. all responses of “slight,” “moderate” and “very uncomfortable”). At the top of the figure, all

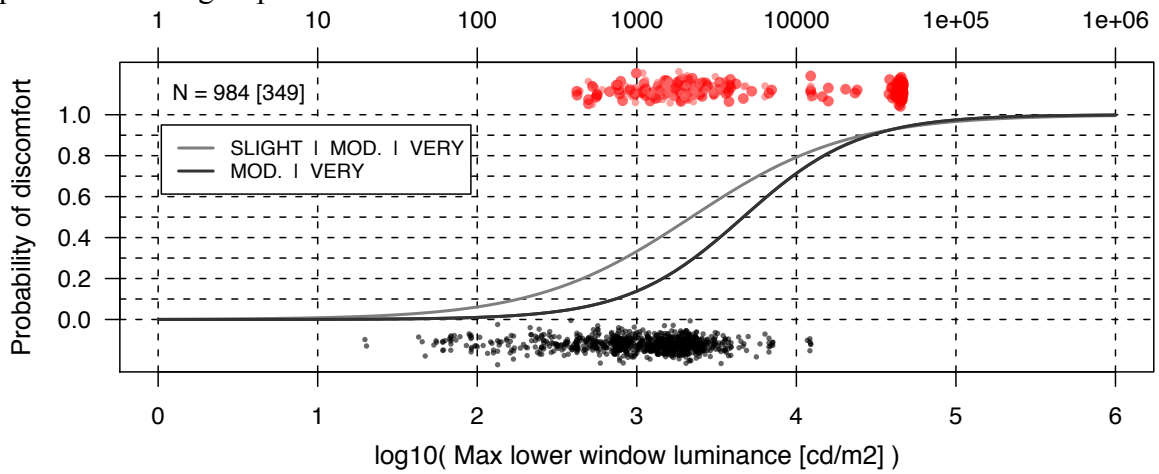
responses of “slight,” “moderate” and “very uncomfortable” are shown as red dots distributed over a log<sub>10</sub> scale of the independent variable. At the bottom of the figure, all responses of “no discomfort” are distributed as grey dots. For both groups of dots, the vertical (y-direction) scatter was applied to better visualize multiple responses recorded near the same stimulus intensity. The scale at the top of the figure indicates the unscaled values of the variable (i.e. 10, 100, 1000 cd/m<sup>2</sup> etc.). *N* indicates the total number of responses categorized as “no discomfort” followed by “discomfort” in parenthesis. For example, in **figure 7.5**, there were 1333 total responses, where 761 were categorized as “no discomfort” and 572 were categorized as “discomfort.” The grey logistic curve shows the probability of discomfort in relation to the intensity of maximum window luminance, where 0 indicates a 0% chance that participants will perceive windows to be “slight,” “moderate,” or “very uncomfortable” and 1 indicates a 100% chance.

**Figures 7.6 - 7.7** add additional logistic curves that classify discomfort in terms of “moderate” and “very uncomfortable” responses only (MV) and “very uncomfortable” responses only (V). Using separate logistic curves for increasingly severe classification of visual discomfort illustrates the significance of *where* discomfort is defined along the subjective scale. For example, using the SMV curve, one can identify that there is a 0.3 probability of at least “slight” discomfort when the maximum window luminance exceeds 1000 cd/m<sup>2</sup>. However, using the (MV) curve, the probability the discomfort being “moderate” or “very uncomfortable” is only about 0.1, and using the (V) curve, the probability of “very uncomfortable” is less than 0.05.

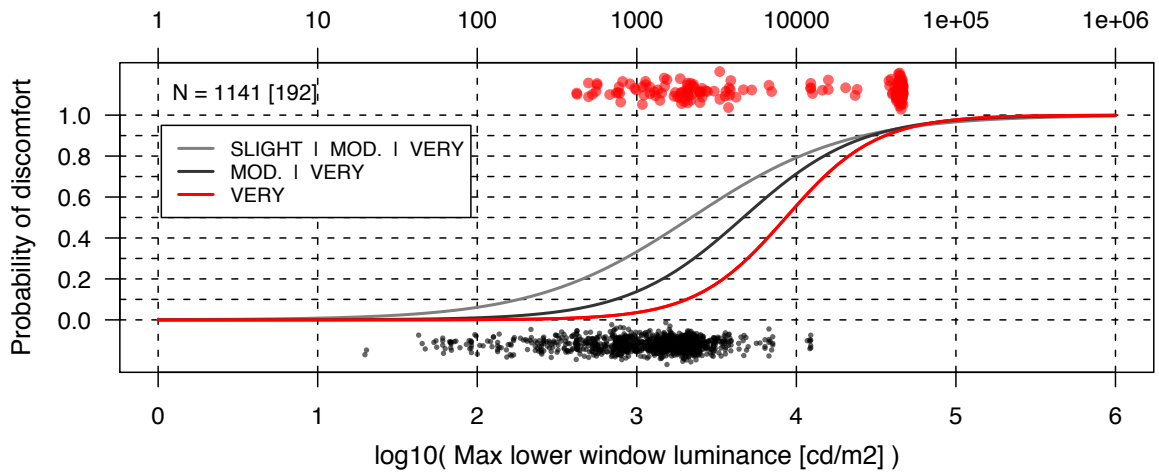
Each of the three models has advantages and disadvantages. For example, the SMV model enables all “discomfort” responses to be identified, however the model does not differentiate between “slight” and “very uncomfortable” conditions. In addition, models generated based on the SMV criteria were found to be less accurate in general based on the measure of the percentage of correct responses predicted, than models that define discomfort as “moderate” and “very uncomfortable” responses only (MV), or “very uncomfortable” conditions only (V). Overall, the accuracy of models was found to improve as the criteria for discomfort was made more severe. To address these limitations, three logistic models representing increasingly severe criteria for discomfort (i.e. SMV, MS, V) were generated for each independent variable.



**Figure 7.5** Logistic model of visual discomfort from windows (SMV model) from SE perimeter zone group.



**Figure 7.6** Logistic model of visual discomfort from windows (adding MV model).



**Figure 7.7** Logistic model of visual discomfort from windows (adding V model).

### 7.3 Single-variable logistic models

The following sections describe the process used to evaluate, rank, and select single-variable logistic regression models to predict occupant visual discomfort from windows. It is important to note that these data represent subjective responses collected after fixed (e.g. exterior metal screen, solar control film (SE facade) and exterior vertical glass fins (NW facade)) and movable (e.g. interior fabric roller shades and personal workspace modifications) have been implemented (or deployed) for solar and glare control.

#### 7.3.1 Evaluation of single-variable logistic models

Candidate logistic models were ranked based on the AIC using the same procedure described in **section 6.3.1**. The stepwise logistic regression technique was applied to data where discomfort was defined as all “slight,” “moderate,” and “very uncomfortable” votes (SMV) and the percent of correct responses was found for each of the three categorizations of glare discomfort (SMV, MV, and V).

#### 7.3.2 Ranking of single-variable logistic regression models

**Tables 7.7 – 7.8** show the resulting ranking of single-variable logistic regression models generated from candidate variables for the NW, SE and Core zones respectively. For each zone (e.g. NW perimeter zone), the influence of time of year (e.g. Phase 1 (July 12 – 29) vs. Phase 4 (October 18 – 29)) and view orientation (e.g. north-facing vs. west-facing) were examined by applying the stepwise logistic regression technique to data subsets defined by phase and by view orientation. The rank order of models was not found to change significantly between test phases for any of the three groups. However, the accuracy of models generated from data in the Core zones was found to decrease significantly (in terms of %-correct responses) when the SE-facing and NW-facing view orientations were combined. Therefore, the two view-orientations were treated as separate groups as shown in **table 7.8**.

**Table 7.7** Ranking of logistic regression models of candidate predictor variables for visual discomfort (for all measures recorded in NW and SE perimeter zones).

NW Perimeter zones (July 12 - 29) and (October 18 - 29) N = 12 (1124 observations)						SE Perimeter zones (August 2 - Sept. 3) and (Nov. 8 - 19) N = 18 (1333 observations)					
Variable	Rank	AIC [1535]	% -correct responses			Variable	Rank	AIC [1704]	% -correct responses		
			SMV	MV	V				SMV	MV	V
$L_{upWin}$	1	796	78%	68%	81%	$L_{maxLwWin}$	1	1135	72%	79%	89%
$R_{CPU}$	2	851	76%	68%	82%	$R_{CPUmax}$	2	1318	68%	78%	89%
$L_{maxUpWin}$	3	900	75%	68%	82%	$L_{maxUpWin}$	3	1451	64%	71%	80%
$L_{lwWin}$	4	1136	66%	65%	81%	UGR	4	1485	63%	70%	78%
$R_{CPUmax}$	5	1248	62%	65%	82%	CGI	5	1487	63%	70%	78%
$Irrad_{exVert}$	6	1336	59%	64%	80%	$Irrad_{inVert}$	6	1492	62%	69%	76%
$Irrad_{inVert}$	7	1395	57%	64%	80%	$Irrad_{exVert}$	7	1502	62%	70%	78%
$L_{maxLwWin}$	8	1482	53%	60%	79%	$DGI_{2000}$	8	1502	62%	70%	77%
$Illum_{dlt}$	9	1491	53%	59%	78%	$Illum_{inVert}$	9	1512	61%	67%	75%
$Illum$	10	1498	53%	59%	78%	$DGI_{7x}$	10	1579	60%	68%	76%
$R_{winMax}$	11	1516	52%	59%	78%	$Illum_{dlt}$	11	1584	59%	66%	74%
MRT	12	1518	52%	59%	78%	$Illum$	12	1590	59%	66%	74%
$Illum_{inVert}$	13	1519	60%	65%	82%	$R_{winMax}$	13	1596	59%	66%	73%
$DGI_{7x}$	14	1528	52%	59%	78%	$L_{lwWin}$	14	1620	58%	65%	73%
$DGI_{2000}$	15	1531	51%	58%	78%	$R_{CPU}$	15	1653	57%	64%	73%
UGR	NA	1536				$L_{upWin}$	16	1657	57%	64%	73%
$R_{win}$	NA	1536				MRT	17	1661	57%	64%	73%
CGI	NA	1536				$R_{win}$	18	1700	55%	63%	72%
DF	NA	1536				DF	NA	1704			

The variable found to be the best predictor of visual discomfort for the NW perimeter zone was the average luminance of the upper two rows of windows ( $L_{upWin}$ ) (AIC = 796, %-correct = 78%, 68%, 81%). This result supports participant comments that the upper two rows of windows are a source of visual discomfort. In addition to the average luminance, the maximum luminance of the upper window ( $L_{maxUpWin}$ ) was also highly ranked. In contrast, the various glare indices were ranked the lowest among the predictor variables.

For the SE perimeter zone, the maximum luminance of the lower (vision) window ( $L_{maxLwWin}$ ) was ranked the highest (AIC = 1135, %-correct = 72%, 79%, 89%), along with the maximum luminance of the upper windows ( $L_{upWin}$ ). In contrast to the NW perimeter zone, average window luminances ( $L_{lwWin}$ ,  $L_{upWin}$ ) were among the lowest ranked predictors. Both results support comments from the SE perimeter as well as on-site observations that suggest a view of direct sun is the primary source of discomfort. In addition, because the majority of participants maintained the interior roller shades on the SE facade in a lowered state, the combination of shade fabric with solar control film and the exterior metal screen resulted in relatively low average window luminances (median



= 327 cd/m<sup>2</sup>, **table 7.2**), but did not completely block direct view of the solar disc (max window luminance = 44,678 cd/m<sup>2</sup>).

Between the NW and SE data sets, the ranking of the various glare indices and luminance contrast ratio limits was highly variable. For example, the UGR and CGI were not highly ranked for the NW, but were highly ranked for the SE. In addition, the ratio between the average luminance of the window-wall (upper and lower windows) and a constant visual task of (200 cd/m<sup>2</sup>) luminance (R<sub>CPU</sub>) was highly ranked for the NW, but poorly ranked for the SE.

Measures of horizontal illuminance (Illum , Illum<sub>dlt</sub>), used as indicators of visual discomfort in the calculation of the Useful Daylight Illuminance daylighting metric (UDI) were found among the lower ranked predictors for both NW and SE perimeter zones. These indicators were able to differentiate between “no discomfort” and (SMV) with only slighting better accuracy than random chance (53% and 59% for the NW and SE zones respectively vs. random = 50%). Accuracy improved, however, if predicting (MV) or (V).

**Table 7.8** Ranking of logistic regression models of candidate predictor variables for visual discomfort for all measures recorded in core zones.

Core zones (NW-facing) (Oct. 4 - 15) and (Dec. 6 - 17) N = 10 (672 observations)						Core zones (SE-facing) (Oct. 4 - 15) and (Dec. 6 - 17) N = 4 (245 observations)					
Variable	Rank	AIC [871]	%correct responses			Variable	Rank	AIC [341]	%correct responses		
			SMV	MV	V				SMV	MV	V
R <sub>CPUmax</sub>	1	552	73%	76%	95%	L <sub>maxUpWin</sub>	1	298	57%	66%	94%
L <sub>maxLwWin</sub>	2	599	72%	75%	94%	R <sub>CPUmax</sub>	2	300	57%	67%	94%
L <sub>maxUpWin</sub>	3	636	70%	71%	92%	L <sub>maxLwWin</sub>	3	318	54%	64%	88%
Irrad <sub>exVert</sub>	4	642	69%	74%	93%	L <sub>upWin</sub>	4	318	54%	63%	88%
Illum <sub>inVert</sub>	5	660	68%	71%	92%	UGR	5	319	54%	65%	93%
R <sub>CPU</sub>	6	662	68%	73%	93%	CGI	6	320	54%	65%	93%
CGI	7	668	68%	71%	91%	DGI <sub>2000</sub>	7	320	54%	65%	93%
L <sub>upWin</sub>	8	673	68%	72%	92%	R <sub>CPU</sub>	8	321	54%	63%	88%
UGR	9	678	68%	70%	91%	R <sub>win</sub>	9	323	54%	62%	88%
DGI <sub>2000</sub>	10	679	67%	70%	91%	Illum <sub>inVert</sub>	10	324	54%	61%	87%
L <sub>lwWin</sub>	11	708	66%	70%	92%	DGI <sub>7x</sub>	11	328	53%	65%	92%
DGI <sub>7x</sub>	12	724	65%	69%	91%	L <sub>lwWin</sub>	12	328	53%	61%	87%
Illum <sub>dlt</sub>	13	762	62%	71%	92%	MRT	13	329	52%	61%	88%
Illum	14	809	59%	69%	92%	Illum <sub>dlt</sub>	14	335	52%	61%	87%
DF	15	819	58%	69%	91%	R <sub>winMax</sub>	15	335	51%	61%	87%
R <sub>win</sub>	16	827	58%	70%	91%	DF	16	338	50%	60%	87%
MRT	17	850	56%	69%	91%	Illum	NA	343			
R <sub>winMax</sub>	18	864	55%	68%	91%	Irrad <sub>exVert</sub>	NA	343			

**Table 7.8** shows the ranking of predictor variables for the core zones, and shows rankings separately for NW-facade-facing and SE-facade-facing view orientations. Similar to the perimeter zones, variables based on maximum luminances were found to be highly ranked for both view orientations. Overall, the glare indices performed better in the core zone than for the perimeter zones, but were still ranked below more direct measures of window luminance. Models of horizontal illuminance were among the lowest-ranked predictors.

### 7.3.3 Selection of single variable logistic models

In **section 7.2.5**, **figures 7.5 – 7.7** presented the logistic regression models created to predict visual discomfort based on three separate classifications of discomfort and using a single predictor variable and a single data set (SE perimeter zone group). This discussion expands the analysis of logistic regression models based on additional predictor variables and zones, with an emphasis on examining the models that ranked highly across all zones. The selection of logistic models was based on an assessment of the ranking of models as well as the desire for models that can be applied to both core and perimeter zones. Models were selected based on a high ranking in at least one analysis (i.e. NW, SE, NW-facing core, SE-facing core). Overall, measures of maximum window luminance ( $L_{\max\text{UpWin}}$ ,  $L_{\max\text{LwWin}}$ ) and the ratio of average or maximum window luminance to a visual task of ( $200 \text{ cd/m}^2$ ) ( $R_{\text{CPU}}$ ,  $R_{\text{CPUmax}}$ ) ranked the highest among all four groups. Average luminance of the upper two rows of windows ( $L_{\text{upWin}}$ ) was a highly ranked predictor for all groups except the SE perimeter zone, however it became reasonably accurate for the SE perimeter as the criteria for visual discomfort was made more severe (57%, 64%, 75%) therefore it was included for comparison to the other groups. Finally, interior vertical solar irradiance ( $\text{Irrad}_{\text{intVert}}$ ) was moderately ranked for both NW and SE perimeter zones and was included for comparison between NW and SE perimeter zones but is not applicable to core zones.

**Tables 7.9 – 7.12** provide a summary of the logistic models generated for each group from the variables selected. For each variable, three models were generated indicating the probability of visual discomfort based on three increasingly severe classifications of discomfort (e.g. SMV, MV, V). In the following tables, models who's ranking includes an asterisk (\*) ranked poorly but were generated for visual comparison of trends between groups. The percent of correct responses for each model is indicated in the column titled (%-cor.).

**Table 7.9** Logistic regression models (NW perimeter zones).

NW perimeter zones (July 12 - 29) and (October 18 - 29)											
N = 12 (1124)		[1535 ]	SMV			MV			V		
Variable	Rank	AIC	(B <sub>0</sub> )	(B <sub>i</sub> )	%-cor.	(B <sub>0</sub> )	(B <sub>i</sub> )	%-cor.	(B <sub>0</sub> )	(B <sub>i</sub> )	%-cor.
L <sub>upWin</sub>	1	796	-22.99	7.23	78%	-13.59	3.79	68%	-16.03	4.10	81%
R <sub>CPU</sub>	2	851	-4.40	0.41	76%	-3.04	0.15	68%	-4.07	0.13	82%
L <sub>maxUpWin</sub>	3	900	-18.92	5.44	75%	-11.83	2.96	68%	-13.58	3.07	82%
L <sub>lwWin</sub>	4	1136	-23.55	8.47	66%	-15.86	5.24	65%	-20.33	6.35	81%
R <sub>CPUmax</sub>	5	1248	-2.29	0.07	62%	-2.24	0.03	65%	-3.35	0.03	82%
Irrad <sub>inVert</sub>	7	1395	-2.81	2.33	57%	-4.58	2.66	64%	-6.01	2.83	80%
L <sub>maxLwWin</sub>	8*	1482	-5.01	1.59	53%	-8.71	2.32	60%	-14.12	3.56	79%

**Table 7.10** Logistic regression models (SE perimeter zones).

SE perimeter zones (August 2 - Sept. 3) and (Nov. 8 - 19)											
N = 18 (1333)		[1704 ]	SMV			MV			V		
Variable	Rank	AIC	(B <sub>0</sub> )	(B <sub>i</sub> )	%-cor.	(B <sub>0</sub> )	(B <sub>i</sub> )	%-cor.	(B <sub>0</sub> )	(B <sub>i</sub> )	%-cor.
L <sub>maxLwWin</sub>	1	1135	-9.17	2.70	72%	-11.01	3.04	79%	-14.19	3.68	89%
R <sub>CPUmax</sub>	2	1318	-1.39	0.04	68%	-2.12	0.04	78%	-3.28	0.05	89%
L <sub>maxUpWin</sub>	3	1451	-9.31	3.02	64%	-7.99	2.36	71%	-7.76	2.05	80%
Irrad <sub>inVert</sub>	6	1492	-1.52	1.71	62%	-2.18	1.95	69%	-2.91	2.16	76%
L <sub>lwWin</sub>	14*	1620	-3.79	1.24	58%	-4.20	1.22	65%	-4.33	1.07	73%
R <sub>CPU</sub>	15*	1653	-1.13	0.25	57%	-1.60	0.26	64%	-2.13	0.27	73%
L <sub>upWin</sub>	16*	1657	-9.85	4.117	57%	-9.36	3.66	64%	-10.15	3.69	73%

**Table 7.11** Logistic regression models (NW-facing core).

Core zones (NW-facing) (Oct. 4 - 15) and (Dec. 6 - 17)											
N = 10 (672)		[871 ]	SMV			MV			V		
Variable	Rank	AIC	(B <sub>0</sub> )	(B <sub>i</sub> )	%-cor.	(B <sub>0</sub> )	(B <sub>i</sub> )	%-cor.	(B <sub>0</sub> )	(B <sub>i</sub> )	%-cor.
R <sub>CPUmax</sub>	1	552	-3.32	0.14	73%	-4.22	0.08	76%	-8.02	0.11	95%
L <sub>maxUpWin</sub>	2	599	-20.84	5.78	72%	-22.15	5.41	75%	-37.15	8.70	94%
L <sub>maxLwWin</sub>	3	636	-7.56	2.58	70%	-7.98	1.96	71%	-15.72	3.68	92%
R <sub>CPU</sub>	6	662	-2.49	0.24	68%	-3.43	0.13	73%	-5.63	0.15	93%
L <sub>upWin</sub>	8	673	-15.50	4.79	68%	-15.70	4.13	72%	-18.34	4.39	92%
L <sub>lwWin</sub>	11*	708	-3.74	1.82	66%	-4.34	1.13	70%	-7.52	1.66	92%

**Table 7.12** Logistic regression models (SE-facing core).

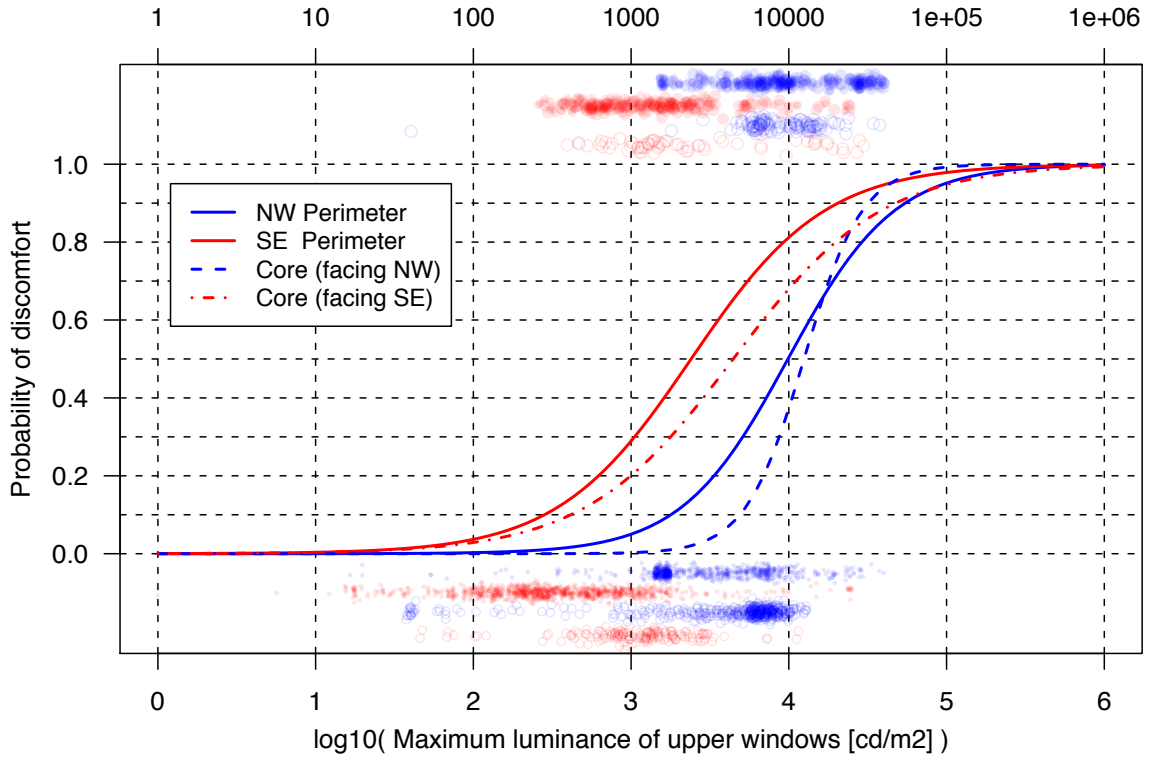
Core zones (SE-facing) (Oct. 4 - 15) and (Dec. 6 - 17)											
N = 4 (245)		[341 ]	SMV			MV			V		
Variable	Rank	AIC	(B <sub>0</sub> )	(B <sub>1</sub> )	%-cor.	(B <sub>0</sub> )	(B <sub>1</sub> )	%-cor.	(B <sub>0</sub> )	(B <sub>1</sub> )	%-cor.
L <sub>maxUpWin</sub>	1	298	-7.83	2.49	57%	-7.79	2.14	66%	-19.78	4.91	94%
R <sub>CPUmax</sub>	2	300	-1.05	0.12	57%	-1.62	0.05	67%	-4.49	0.07	94%
L <sub>maxLwWin</sub>	3	318	-5.63	1.79	54%	-7.36	2.01	64%	-10.45	2.40	88%
L <sub>upWin</sub>	4	318	-6.89	3.22	54%	-7.63	3.10	63%	-15.42	5.81	88%
R <sub>CPU</sub>	8*	321	-1.59	2.11	54%	-2.41	1.88	63%	-4.58	2.35	88%
L <sub>lwWin</sub>	12*	328	-5.04	2.32	53%	-5.27	1.98	61%	-5.22	1.21	87%

## 7.4 Comparison of models to existing indicators

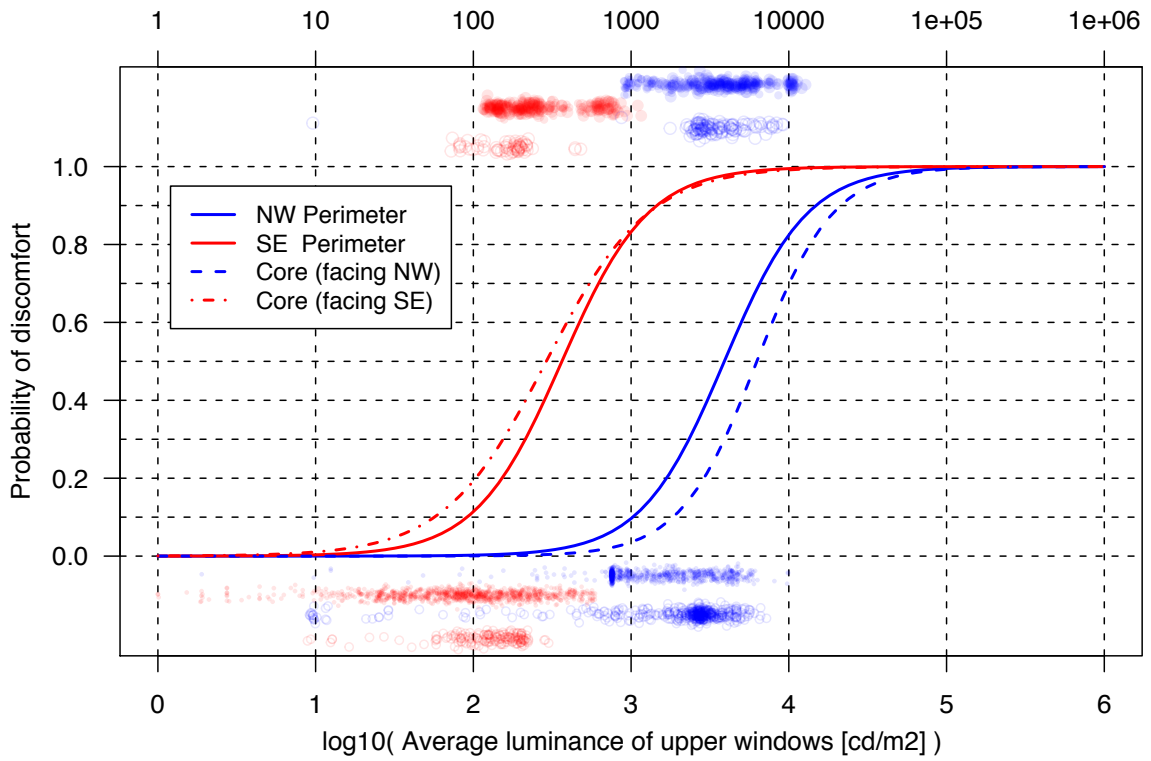
The results from this analysis provide a body of evidence to aid an understanding of the physical conditions acceptable to occupants of daylit core and perimeter spaces in use and the physical conditions associated with the increasing probability of visual discomfort. To examine the applicability of existing indicators of visual discomfort to predict discomfort conditions, four glare indices (DGI<sub>7x</sub>, DGI<sub>2000</sub>, UGR, CGI) and four interpretations of the IESNA recommended luminance contrast ratio limits (R<sub>win</sub>, R<sub>winMax</sub>, R<sub>CPU</sub>, R<sub>CPUmax</sub>) were examined in relation to subjective data. In addition, the common indicators of interior global vertical illuminance (Illum<sub>inVert</sub>), horizontal illuminance (Illum, Illum<sub>dlt</sub>), interior global vertical irradiance (Irrad<sub>inVert</sub>) and the daylight factor (DF) were examined. Finally, measures of average and maximum window luminances were examined. The applicability of existing indicators to the subjective assessments collected in the SFFB is summarized below by general indicator category.

### 7.4.1 Average and maximum luminance logistic models

Measures of maximum and average window luminance of the upper two rows of windows were found to be the highest ranked predictors overall within and between zones. **Figures 7.8 – 7.9** compare logistic models generated from measures of average and maximum window luminance. In each figure, a curve is drawn representing the logistic model generated from the (MV) visual discomfort criterion (**tables 7.9 – 7.12**) for each zone (i.e. NW, SE, Core (NW-facing), Core (SE-facing)). Because the majority of predictor variables were transformed using a logarithmic transform prior to analysis, the y-axis for the majority of figures is a logarithmic scale. For these figures, an additional scale showing the original units is drawn at the top of the figure. Because the (MV) criterion was used, the dots at the top of the figure show the distribution of responses of “moderate” and “very uncomfortable” and the dots at the bottom of the figure show the distribution of responses of “no discomfort” and “slightly uncomfortable.”

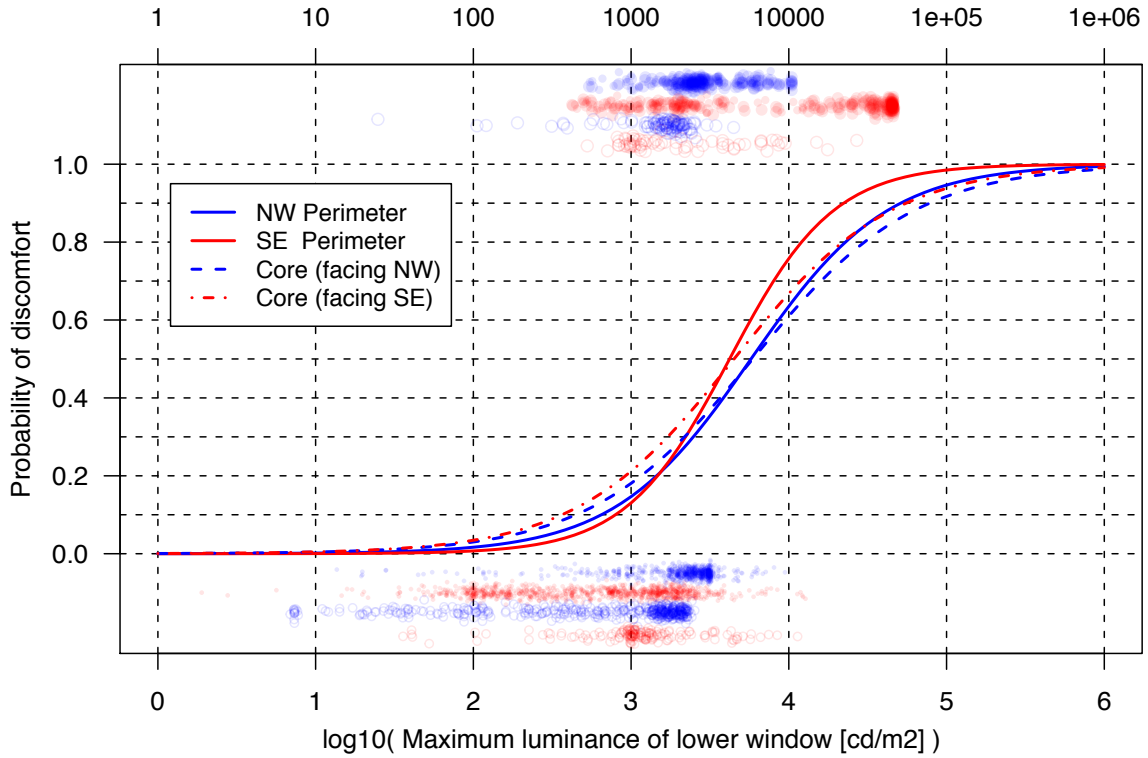


**Figure 7.8** Maximum luminance of the upper two rows of windows ( $L_{\max\text{UpWin}}$ ).

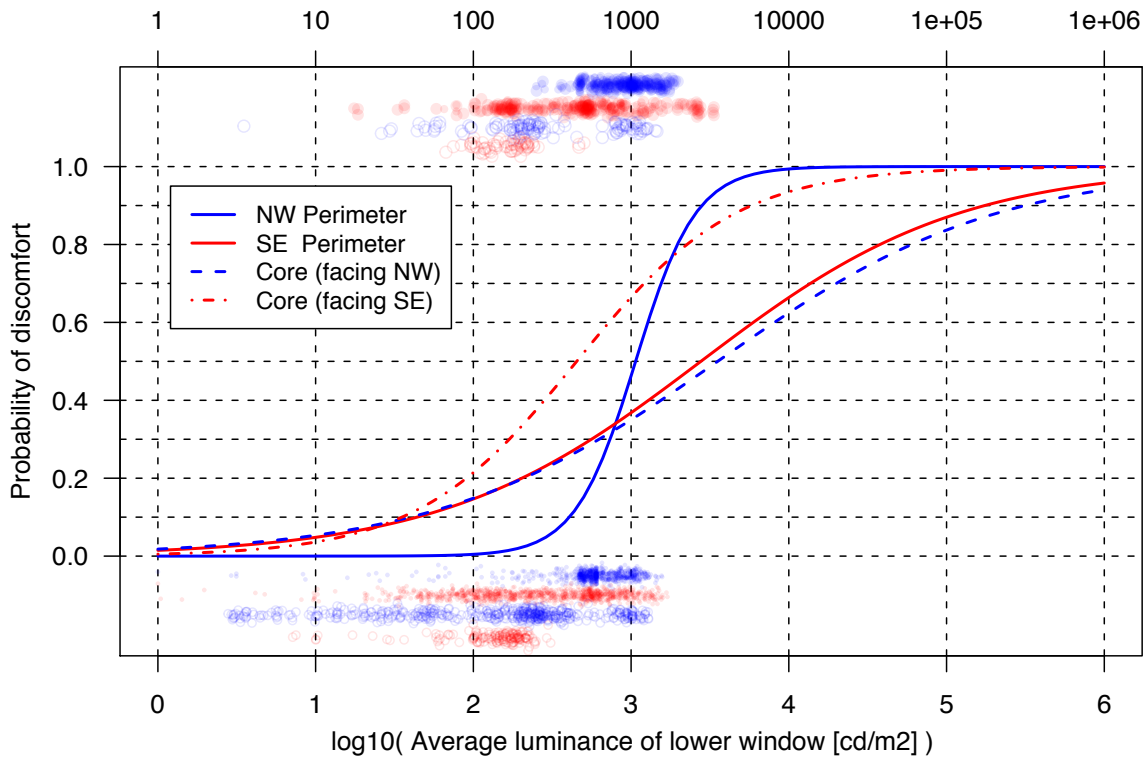


**Figure 7.9** Average luminance of the upper two rows of windows ( $L_{\text{upWin}}$ ).

The comparison of logistic models between zones illustrates a number of important issues related to the location and view-orientation of participants. First, **figure 7.8** shows that the probability of discomfort is variable between zones. For example, SE perimeter zone and SE-facing Core models are similar and show a higher probability of discomfort compared with the NW perimeter zone and NW-facing Core groups for any given maximum luminance. A similar trend is shown for average luminances (**figure 7.9**). One can speculate that the difference in sensitivity between view orientations (NW-facade vs. SE-facade) is related to overall lower magnitude of window luminances for interior views of the SE facade as a result of the window film, upper window shading devices, and exterior metal screen. It is important to note that the probability of discomfort for the SE perimeter model becomes increasingly similar to the NW perimeter model as the magnitude of maximum window luminance exceeds  $10,000 \text{ cd/m}^2$ , suggesting that, for extreme maximum values, the differences between groups introduced by the facade solar control features is less significant.



**Figure 7.10** Maximum luminance of the lower (vision) window ( $L_{\max LwWin}$ ).



**Figure 7.11** Average luminance of the lower (vision) window ( $L_{lwWin}$ ).

**Figures 7.10** shows logistic models for the maximum window luminances of the lower (vision) window region ( $L_{\max LwWin}$ ) for each group. In comparison to other variables selected, the regression models for maximum lower window luminance ( $L_{\max LwWin}$ ) were the most similar between zones. Maximum lower window luminance was also highly ranked as a predictor for all zones (SE perimeter = 1st, NW-facing Core=3rd, SE-facing Core=3rd) with the exception of the NW perimeter, where it was moderately ranked (8th) but remained accurate for predicting “very uncomfortable” conditions (%-correct = 79%).

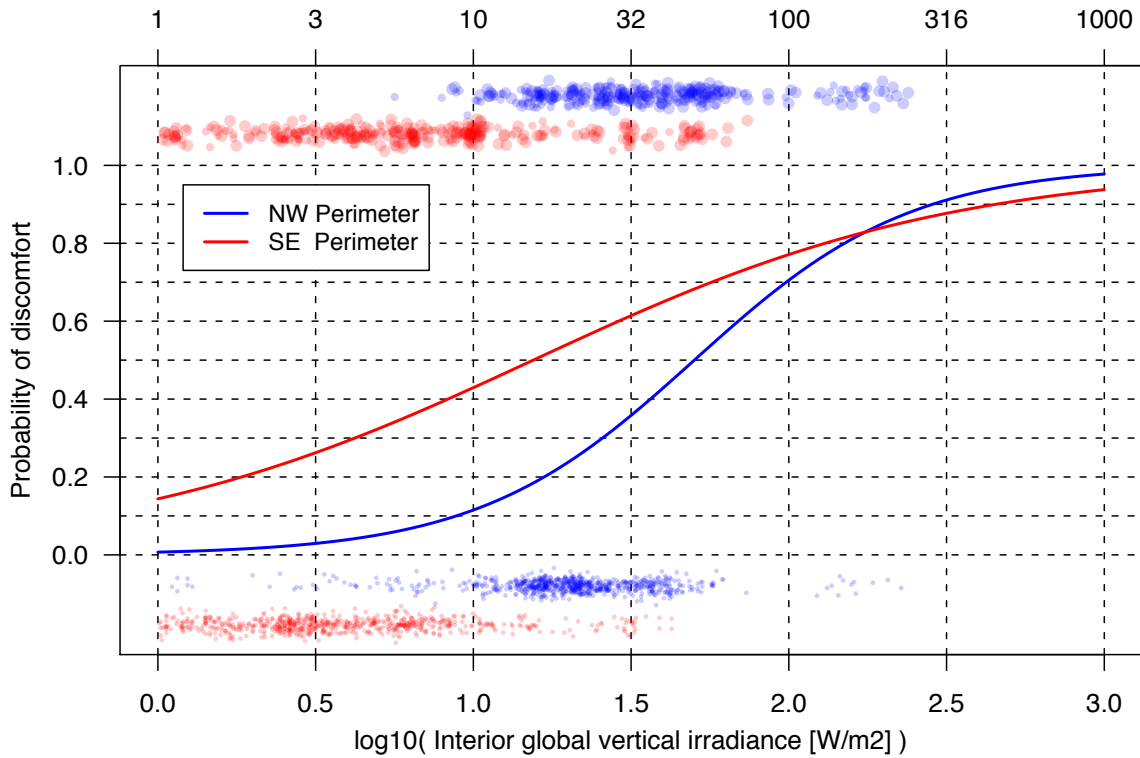
**Figure 7.11** shows the logistic models for the average luminance of the lower (vision) windows ( $L_{lwWin}$ ). In contrast to maximum luminance ( $L_{\max LwWin}$ ), the average luminance of the lower window was only found to be a highly ranked predictor for the NW perimeter zone (4th). Logistic models are shown for the other zones to illustrate the variation in the probability of discomfort when the average luminance of the lower window is used as a predictor. One can speculate that the low ranking of average window luminance as a predictor for the SE perimeter zone and SE-facing Core zone models (14th and 12th respectively) is related to the maximum luminance values that occurred simultaneously. Where there are significant variations between average and maximum window luminances simultaneously, such as a shaded window with view of direct sun through shade fabric, the measure of average window luminance may not register the discomfort condition as accurately as the measure of maximum luminance. The higher ranking of models based on maximum values supports this hypothesis. The low ranking of average lower window luminance for the NW-facing core model (11th) is explained by the fact that the NW-facing Core group viewed an unshaded upper window that was significantly “brighter” than the lower windows, which were predominantly shaded. Therefore one can speculate that the responses for this group are most strongly affected by the magnitude of the upper window luminance. In support of this hypothesis, the ranking of logistic models showed that ( $L_{\max UpWin}$ ) and ( $R_{CPU\max}$ ) were the best predictors for this group.

#### 7.4.2 Interior global vertical illuminance and irradiance

Among all of the models examined, interior global vertical irradiance was moderately ranked ( $Irrad_{inVert}$ ) and interior global illuminance ( $Illum_{inVert}$ ) was among the lower-ranked predictors. **Figure 7.12** shows logistic regression models of ( $Irrad_{inVert}$ ) for the NW and SE perimeter zone groups. A number of models for shade operation have been proposed based on this measure and differ widely in the assumptions made for the conditions acceptable to occupants before they will lower shading devices. The models do share an assumption that occupants will tolerate an unshaded window condition until the irradiance threshold is exceeded. A summary of shade deployment thresholds implemented in simulation is provided by (Inkarojrit, 2005). As examples, (Reinhart, 2002) implemented a shade deployment threshold of 50 W/m<sup>2</sup> to predict occupant discomfort and the deployment of shading devices, (Lee and Selkowitz, 1995) used a higher threshold (95 W/m<sup>2</sup>). What is notable about the results shown in **figure 7.12** is that there is a high probability of visual discomfort at significantly lower irradiance levels. Therefore, the results suggest that simulation based on existing thresholds may lead to



unrealistic assumptions for the position of shading devices. In addition to conditions that are likely to be visually uncomfortable if shades are modeled as raised. In addition, **figure 7.12** suggests that the tolerance level of occupants is related to the range (maximum and minimum) and average irradiance experienced over an extended period of time. For example, NW perimeter participants, (who are adjacent to a facade that was not retrofit with solar control film and does not have an exterior perforated metal solar control screen) were subject to a greater overall magnitude of solar irradiance but were less sensitive compared with the SE perimeter zone participants.



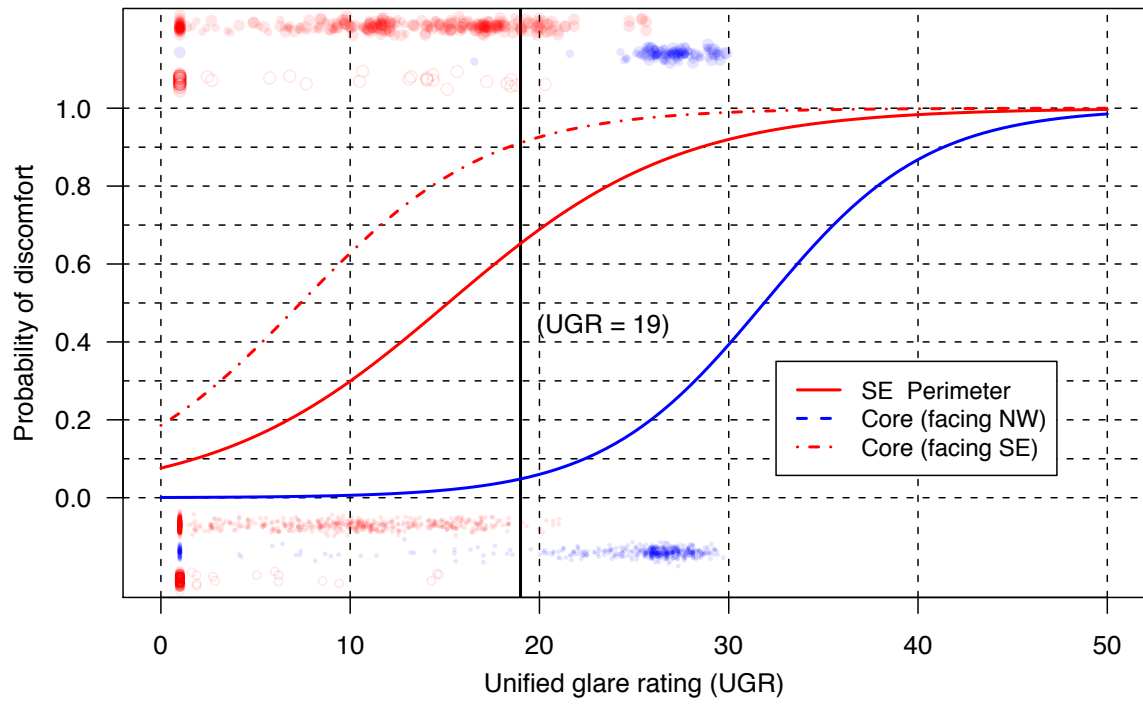
**Figure 7.12** Interior global vertical irradiance ( $Irrad_{inVert}$ ).

### 7.4.3 Glare indices

Overall, logistic regression models that predict visual discomfort based on existing glare indices ( $DGI_{7x}$ ,  $DGI_{2000}$ , UGR, CGI) were among the lowest-ranked predictors. The percent of correct responses predicted by these models was often low compared with other models, and the relative ranking of models between zones was highly variable. Logistic models based on glare indices were among the middle or lowest ranked models for the NW-facing Core group and NW perimeter zone group respectively, and based on the AIC, the UGR or CGI models were found to be the least-preferred models for the NW perimeter zone group (**tables 7.9 – 7.12**). In contrast, for the SE perimeter group, the glare indices (UGR, and CGI) were ranked highly (3rd, 4th respectively) and relatively high for the SE-facing Core group. In addition to the limited applicability between zones, interpretation of the results of the logistic models is not consistent between zones.

For example, using the Unified Glare Rating, (UGR), intended for general applicability in buildings, **figure 7.13** shows that the probability of discomfort is highly variable between groups, where the largest differences are related to NW vs. SE location and view orientation (a model for the NW perimeter zone group is not shown because the model was found to have an AIC greater than the null hypothesis). In Figure 7.12, a vertical black line is shown to indicate the maximum allowable UGR rating (UGR = 19) recommended by the IESNA and the ASHRAE Performance Measurement Protocols (PMP) for office spaces. As shown in **figure 7.13**, maintaining a UGR below 19 results in a very low probability of visual discomfort for NW-facing Core participants, but significantly higher probabilities for the SE perimeter zone group and SE-facing core group.

The variation between zones illustrates a potentially significant problem in using a single threshold recommendation (e.g.  $UGR \leq 19$ ) for all office daylighting conditions. The author of the UGR notes that the metric requires “calibration” in real spaces (Einhorn, 1979) and the results from this analysis suggest that spaces that include direct view of the solar disc have a high probability of discomfort at UGR values significantly lower than existing recommendations.

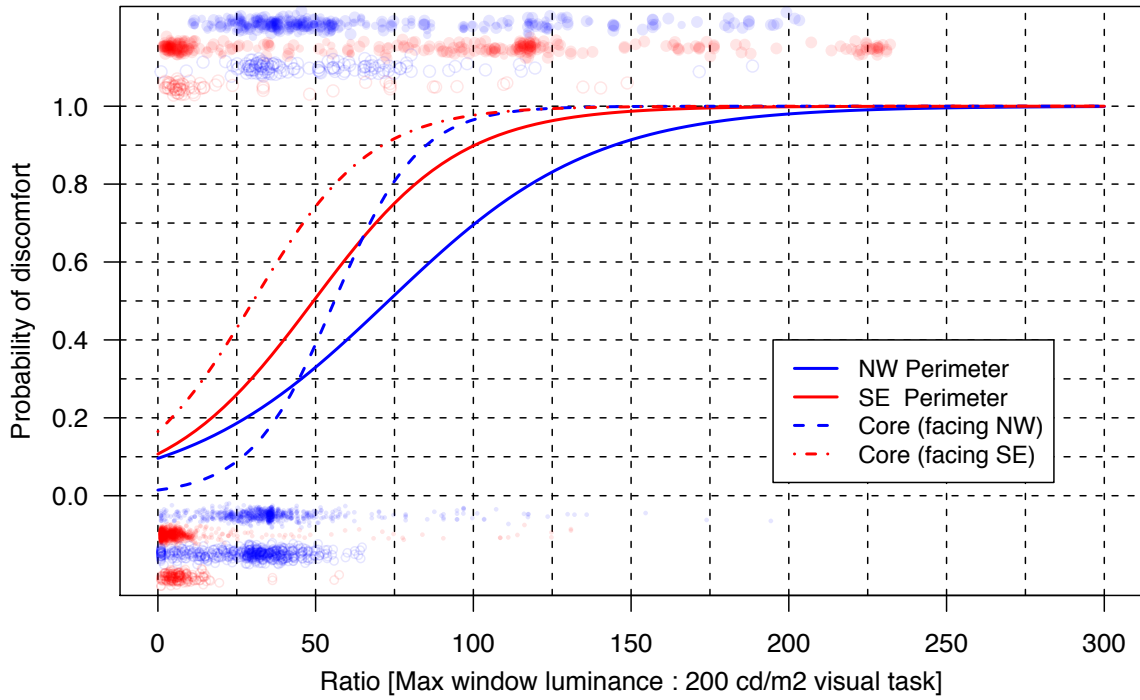


**Figure 7.13** The Unified Glare Rating (UGR).

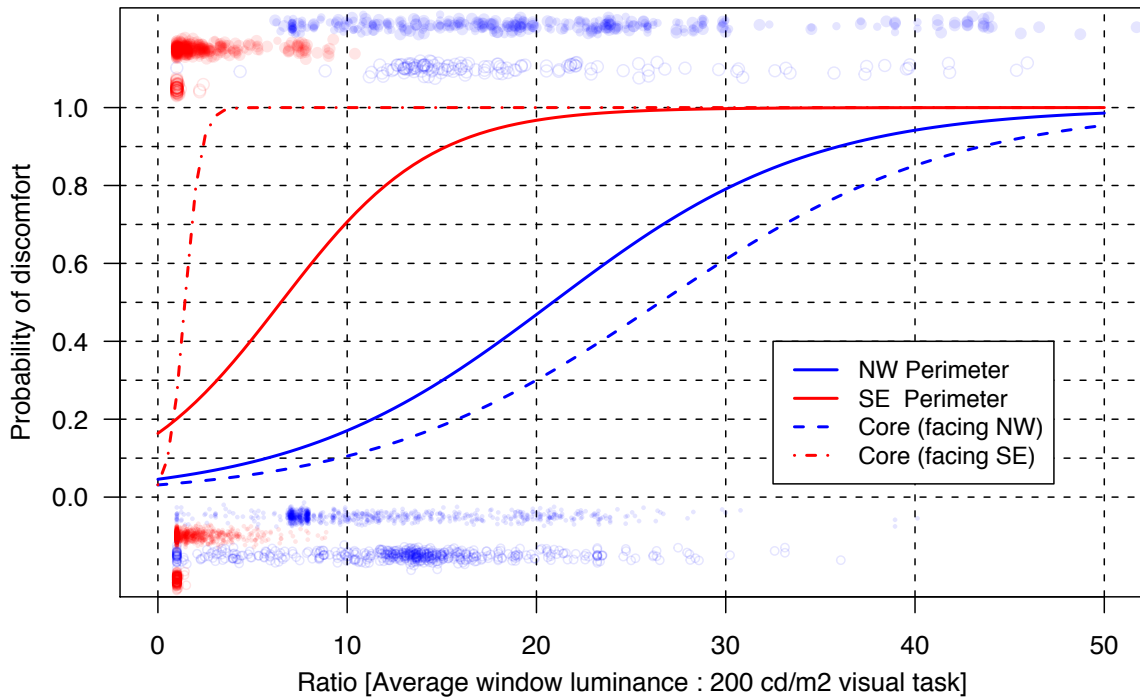
#### 7.4.4 IESNA luminance contrast ratio limits

**Figures 7.14** and **7.15** show logistic models for each zone generated from luminance contrast ratios. **Figure 7.14** shows models that describe the probability of discomfort as the ratio between maximum window luminance and a visual task of ( $200 \text{ cd/m}^2$ ) ( $R_{\text{CUPmax}}$ ) increases. This luminance contrast ratio, ( $R_{\text{CUPmax}}$ ) was found to be one of the highest ranked predictors among all zones (NW perimeter=5th, SE perimeter=2nd, NW-facing Core=1st, SE-facing Core=2nd). **Figure 7.15** shows logistic models generated from the ratio of average window luminance to a ( $200 \text{ cd/m}^2$ ) reference ( $R_{\text{CPU}}$ ). ( $R_{\text{CPU}}$ ) ranked highly for the NW perimeter zone and NW-facing Core group (2nd and 6th), but ranked poorly for the SE perimeter zone (15th) and ranked moderately for the SE-facing Core group (8th). Comparison between **figure 7.14** and **figure 7.15** shows that the probability of discomfort is again variable between groups, where variability is significantly greater when the ratio is computed using average window luminance. For ( $R_{\text{CUPmax}}$ ), participants located in the Core zones are also shown to be more sensitive to ??? compared with perimeter zone participants for any given luminance contrast ratio. For ( $R_{\text{CPU}}$ ), the SE-facing Core participants are the most sensitive, although one can again speculate that the greater sensitivity of the SE-facing participants to the ratio of average window luminance to visual task is related to the occurrence of extreme maximum luminances (solar disc) simultaneously with low average window luminances.

The IESNA recommends a maximum luminance ratio of [1:3:10] between primary task, near field, and far field surfaces (IESNA, 2005). **Figures 7.14** and **7.15** illustrate an extreme variation in the relationship between the contrast ratio and subjective assessment of discomfort based on whether the ratio is computed from the average or maximum window luminance. When the ratio is computed using average window luminance, the subjective outcomes are highly variable depending on zone location and view orientation. Therefore, the results suggest that general application of a single contrast ratio limit may lead to misleading results. As an example, the NW perimeter and NW-facing core groups showed less than a 0.2 and 0.1 probability (20%, 10% chance) of discomfort respectively when the average window luminance exceeded the recommended ratio [1:10], (based on an assumed  $200 \text{ cd/m}^2$  visual task). In contrast, the SE perimeter and SE-facing groups exceeded the 0.5 probability of “moderate” or “very uncomfortable” at ratios below the recommended limit. When the ratio was computed using the maximum window luminance, the models generally showed greater tolerance for discomfort. For example, the NW perimeter zone group (using  $R_{\text{CPUmax}}$ ) showed only a 0.3 probability (30% chance) of discomfort when the ratio reached [1:50].



**Figure 7.14** Ratio of max. window luminance to a ( $200 \text{ cd/m}^2$ ) visual task ( $R_{\text{CUPmax}}$ ).



**Figure 7.15** Ratio of average window luminance to a ( $200 \text{ cd/m}^2$ ) visual task ( $R_{\text{CPU}}$ ).

### 7.4.5 Horizontal illuminance

Variables associated with the magnitude of interior illuminance (horizontal illuminance ( $I_{lum}$ ) and horizontal daylight illuminance ( $I_{lum_{dlt}}$ ) are proposed by (HMG, 2010) and the USGBC LEED Daylight EQ credit as indicators of visual discomfort. The variables ( $i_{lum}$ ) and ( $i_{lum_{dlt}}$ ) were found to be moderately ranked indicators of discomfort for the perimeter zones and poorly ranked as indicators in the Core zones. Therefore, discomfort models based on vertical measures (e.g. global vertical illuminance or irradiance) are preferred. And measures based on average and maximum window luminances are considered the most accurate for predicting visual discomfort from windows.

### 7.4.6 Logistic regression model visual discomfort thresholds

The probability of visual discomfort can be approximated by applying the regression coefficients from a model provided in **Tables 7.9 – 7.12** to the following equation:

$$P(X) = \frac{1}{1 + e^{-z}}$$

where  $z = \alpha + \beta X$

$P(X)$  Probability of visual discomfort

$\alpha, \beta$  estimated regression coefficients

**Equation 7.1** Probability of visual discomfort.

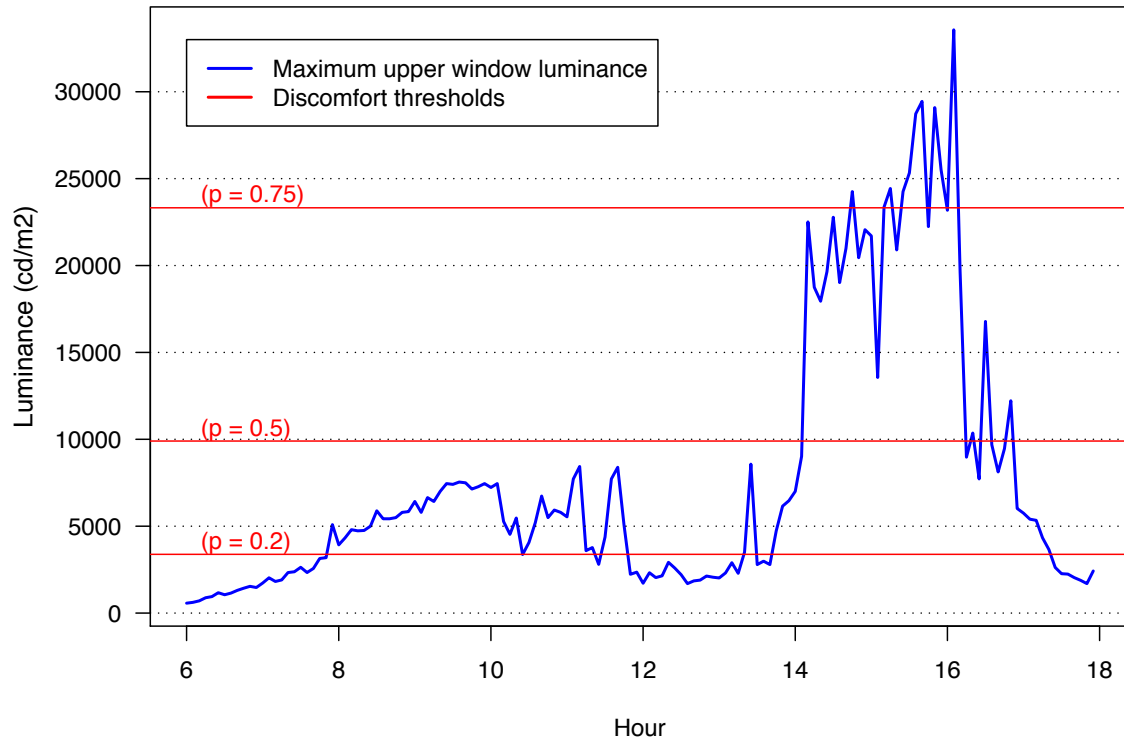
**Tables 7.13 – 7.14** show estimated threshold values for the luminance-based predictors found to be the most consistently high-ranked. The thresholds were estimated using the [MV] discomfort classification (i.e. predicting Moderate or Very uncomfortable discomfort from windows). As an example, for the NW perimeter group, the probability of visual discomfort reaches 0.5 at a maximum upper window luminance of 5680  $\text{cd/m}^2$  (**Table 7.13**). Although these thresholds provide important guidance for designers in regard to the luminance conditions likely to cause visual discomfort, a comparison between groups shows that implementation and interpretation in simulation is not a simple process. As discussed in prior sections of this chapter, discomfort thresholds were found to vary between groups, and in general based on distance from the facade. As an example, participants located in the core zones were generally tolerant of greater upper window luminances compared to the perimeter zone groups. And, the NW perimeter zone groups (which were exposed to greater maximum luminances were less sensitive in general compared to the SE perimeter zone groups. As a result of the relatively few participants in each group and the quasi-experimental design of the study, direct implementation of the logistic regression models developed in this study should be considered as descriptive of a general building population. Further validation with significantly greater numbers of subjects and buildings is recommended.

**Table 7.13** Estimated visual discomfort threshold values at (p = 0.2), (p = 0.5) and (p = 0.90) for luminance-based predictors (NW perimeter and NW-facing core groups).

Variable	Units	NW perimeter group (N = 12)			NW-facing core group (N = 10)		
		Probability of discomfort [MV]			Probability of discomfort [MV]		
		[0.2]	[0.5]	[0.90]	[0.2]	[0.5]	[0.90]
$L_{\max LwWin}$	$cd/m^2$	1430	5680	50300	2310	11800	15500
$L_{lwWin}$	$cd/m^2$	580	1060	2800	410	6900	NA
$L_{\max UprWin}$	$cd/m^2$	3380	9900	NA	6900	12400	31600
$L_{UprWin}$	$cd/m^2$	1660	3800	14600	2900	6300	21500
$R_{CPU\max}$	NA	28	74	150	35	53	80
$R_{CPU}$	NA	11	20	35	16	26	43

**Table 7.14** Estimated visual discomfort threshold values at (p = 0.2), (p = 0.5) and (p = 0.90) for luminance-based predictors (SE perimeter and SE-facing core groups).

Variable	Units	SE perimeter group (N = 18)			SE-facing core group (N = 4)		
		Probability of discomfort [MV]			Probability of discomfort [MV]		
		[0.2]	[0.5]	[0.90]	[0.2]	[0.5]	[0.90]
$L_{\max LwWin}$	$cd/m^2$	1460	4200	22100	940	4600	56800
$L_{lwWin}$	$cd/m^2$	200	2800	55000	90	460	5900
$L_{\max UprWin}$	$cd/m^2$	630	2430	20700	980	4360	46500
$L_{UprWin}$	$cd/m^2$	150	360	1440	100	290	1480
$R_{CPU\max}$	NA	18	53	108	5	32	76
$R_{CPU}$	NA	1	6	15	0.5	1.3	2.5



**Figure 7.16** Maximum upper window luminance from the NW perimeter zone for an example day (7/19/2010) showing application of estimated discomfort thresholds ( $p = 0.2$ ,  $p = 0.5$ ,  $p = 0.75$ ).

The **figure 7.16** provides an example of the application of discomfort thresholds to measured field data to examine the periods of the day when the upper daylight zone windows on the NW perimeter were a source of visual discomfort.

## 7.5 Summary and conclusions

This chapter described the results of the analysis of visual discomfort for NW perimeter, SE perimeter and Core zones of the SFFB. The following points summarize the results of the analysis:

1. How frequent are the responses of visual discomfort in each zone (i.e. NW, SE, Core)? And, what is the magnitude of perceived discomfort (e.g. “slight”, “moderate,” “very uncomfortable”)?
  - a. Discomfort was frequently recorded in all zones, despite the positioning of shading devices. This outcome contrasts with the assumption that the lowering of shading devices “restores” comfort conditions for occupants.



2. How do the results of existing methods and metrics recommended for measuring and assessing visual discomfort compare with subjective responses?
  - a. Overall, variables obtained from simple statistics applied to predefined regions of HDR images were found to be more accurate predictors of visual discomfort than existing glare metrics currently recommended for visual comfort assessment in daylight spaces (DGI, UGR, CGI).
  - b. The existing criteria for interpreting the results of glare metrics and IESNA recommended luminance contrast ratio limits were shown to apply poorly in predicting subjective responses. Although logistic models based on luminance ratios using maximum window luminance were found to be among the best predictors of discomfort, the probability of discomfort was variable between zones, where participants with frequent, direct view of the solar disc (SE perimeter and SE-facing Core) showed a higher probability of visual discomfort compared with groups viewing the NW facade for any given ratio.
  - c. HDR imaging presents a significant advantage over illuminance sensors for assessing visual discomfort in the field. The principle advantage demonstrated in this analysis is to isolate maximum values and to define an arbitrary number of regions within the scene for analysis (e.g. upper window region, lower window region) rather than integrating all of the variation in scene luminance into a single illuminance or irradiance value. These capabilities enabled more accurate predictors of visual discomfort.
3. Can logistic models based on physical measures of indoor environmental conditions be used to predict discomfort responses? If so, what variables best predict visual discomfort and with what level of accuracy? And, how does the probability of discomfort compare with the stimulus intensity of a given variable?
  - a. Single variable logistic regression models generated from physical variables were shown to be capable of modeling the subjective response of study participants (for any individual region of the SFFB) with a reasonable level of accuracy. The accuracy of the logistic models was found to improve when the criteria for visual discomfort was defined in more severe terms. For example, models that defined discomfort as votes of “moderate” and “very uncomfortable” were more accurate than models that defined discomfort as votes of “slight,” “moderate” and “very uncomfortable.”
  - b. The probability of discomfort was found to be variable between groups for any given stimulus value. Overall, groups of participants located on the NW perimeter zones or NW-facing Core zones were subject to a greater magnitude of luminance conditions compared with SE perimeter zone and

SE-facing Core groups and, in general, showed a lower probability of discomfort for any given stimulus value. One can speculate from this trend that building occupants' perception of visual discomfort is moderated by both visual adaptation to overall "brighter" luminance conditions as well as personal modifications and habituation to the office environment over an extended period of time. Therefore, universal application of discomfort threshold criteria is likely to lead to misleading predictions for both the conditions that may be acceptable to building occupants as well as the conditions that are likely to cause discomfort.

- c. Measures of average and maximum luminances of the upper two rows of windows were often above the 50% discomfort threshold (MV) estimated using logistic regression models. This result contrasts with the assumption that unshaded windows above head height will not be a source of visual discomfort for building occupants seated along the perimeter, a common assumption used in the subdivision of the facade into an upper "daylight" zone and lower "view" zone. This reasoning was followed when the SFFB was retrofit with interior roller shades). This result is supported by occupant comments and observations of shade positioning that show that interior shades on the upper two rows of windows are often lowered by those seated below them. It is important to note, however, that the logistic models showed participants generally had a lower sensitivity to upper window luminance compared to the lower (vision) window.
- d. Measures of average window luminance using HDR imaging were found to be the most accurate variable for predicting visual discomfort for regions of the SFFB where occupants did not have frequent view of the solar disc. Where there are significant variations between average and maximum window luminances simultaneously, such as a shaded window with view of direct sun through shade fabric, averaging a relatively small area of extreme luminance with a large area of low luminance is unlikely to register the discomfort condition as accurately as the measure of maximum luminance. The higher ranking of models based on maximum luminance for the SE perimeter zone and SE-facing Core group supports this hypothesis.

## CHAPTER 8

### DAYLIGHT SUFFICIENCY RESULTS

*If you can build the tower floors narrow, they are 65' wide, you can have access to natural light for everyone.*

-Supervisory architect, GSA Region 9<sup>1</sup>

*As a result of the tower's narrow profile and strategic integration of structural, mechanical and electrical systems, the building provides natural ventilation to 70% of the work area in lieu of air conditioning, and affords natural light and operable windows to 90% of the workstations.*

-Morphosis Architects<sup>2</sup>

#### **8.1 Introduction**

The design team for the SFFB set ambitious goals for the level of daylight transmission achieved to illuminate perimeter and core workspaces. This chapter examines if the broadly stated goal of daylight sufficiency for perimeter and core workspaces is achieved in use. As a study of a building in use, the circumstance evaluated includes the original design and subsequent post occupancy modifications such as the facade retrofits made to reduce solar transmission on the SE facade and interior roller shades installed to provide occupants some control over window transmission of daylight and solar heat gain. Performance in regard to daylight sufficiency is examined through analysis of occupant subjective assessments and temporally paired physical measures collected using the desktop polling stations.

The first section of this chapter presents the polling station questions used to assess occupant satisfaction with (and preference for) the amount of daylight in their workspace and summarizes the frequency and magnitude of subjective assessments for each monitoring phase. The next three sections present the results for the NW perimeter, SE perimeter, and Core monitoring phases respectively. For each section, subjective assessments are compared to physical measures and discussed in relation to the outcomes predicted by existing quantitative indicators of daylight sufficiency. The final section compares the level of daylight autonomy and daylight factors achieved by the SFFB in use with the Daylight Autonomy criteria proposed to assess compliance with the LEED 2012 draft Daylight EQ credit and with the original 2% DF criteria predicted for the SFFB prior to facade retrofits.

---

<sup>1</sup> Building efficiency case study : San Francisco Federal Building (GSA). Video. Rocky Mountain Institute 2008.

<sup>2</sup> <http://morphopedia.com/projects/san-francisco-federal-building> (accessed 7/22/2011).

The following questions were used to guide the analysis:

1. How do the levels of daylight transmission and levels of satisfaction compare between zones (e.g. NW perimeter, SE perimeter, Core)?
2. How does occupant subjective assessment of the amount of daylight in their workspace compare to the outcomes predicted by quantitative performance indicators of daylight sufficiency?
3. Does occupant satisfaction with the amount of daylight in their workstation increase with the physical magnitude of daylight illuminance at the workplace? Do better indicators of occupant satisfaction exist?
4. How do subjective assessments of visual discomfort compare to the daylight illuminances assumed to be acceptable for visual comfort (e.g. 300 – 2000 lux)?

## 8.2 Summary of subjective assessments of AMOUNT of daylight

Responses to the subjective questionnaire administered by the CBE in the SFFB in 2009 indicated significant levels of dissatisfaction with the “AMOUNT” of light in their workspace (25%, 27%, and 14% dissatisfied for the NW, SE, and Core zones respectively). These results were discussed in Chapter 3, **section 3.6**. Polling station questions (Q3) and (Q4) were included in the study to examine the relationship between physical magnitude of illuminance in the workspace with occupant satisfaction. Question 3 is phrased similarly to the CBE survey:

(Q3) “How satisfied are you with the AMOUNT of DAYLIGHT in your workspace right now?”

Question four (Q4) is a branching question that examines the preferences of participants who recorded negative responses to (Q3). Question 4 is phrased:

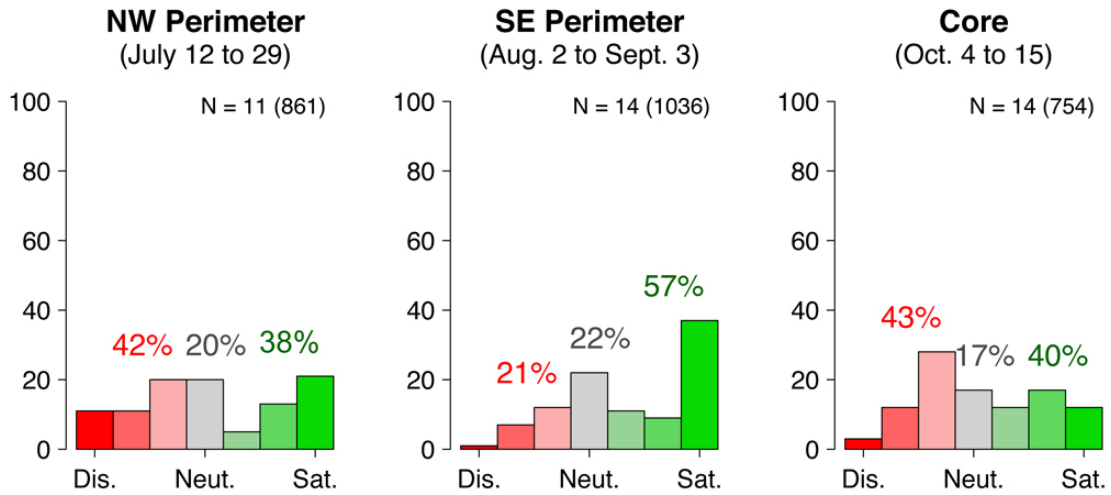
(Q4) “Would you prefer LESS or MORE daylight in your workspace right now?”

**Figures 8.1** and **8.2** summarize the responses to (Q3) and (Q4) for the initial monitoring phase for each zone (i.e. NW, SE, core). For **figure 8.1**, the x-axis represents the 7-point subjective scale and each bar represents the percent of total responses during the monitoring phase. N indicates the number of participants followed by the total number of responses for all participants in parenthesis. The three numbers shown above each bar graph represent the total percentage of “dissatisfied,” “neutral,” and “satisfied” responses for the monitoring phase. **Figure 8.2** displays the preference for daylight change of respondents who were dissatisfied with the amount of daylight in their workspace. **Figure 8.3** and **figure 8.4** summarize the responses to the same two questions for the follow-up monitoring phases for each zone.

The results show substantial levels of dissatisfaction with the amount of daylight in both perimeter and core zones. When participants were dissatisfied with the amount of daylight in the perimeter zones, the majority of dissatisfied participants recorded a preference for *less* daylight rather than more during all monitoring phases. This preference was most extreme for the NW perimeter zone during Phase 1 (July 12 – 29) (79% of dissatisfied preferred less daylight) and most extreme for the SE perimeter zone during Phase 5 (Nov. 8 – 19) (64% of dissatisfied preferred less daylight). This result is notable, given the high percentage of the SE facade that was shaded by roller shades during each monitoring phase. The majority of dissatisfied responses recorded in the core zones, however, indicated a preference for *more* daylight during Phase 3 (Oct. 4 – 15) (66%), and *less* during Phase 6 (Dec. 6 – 17) (49%). However, there were a lower percentage of dissatisfied responses to (Q3) during Phase 6 compared to Phase 3 (19% vs. 43%) and almost half of the responses (47%) indicated a preference for *more* daylight. In aggregate, the results suggest that the magnitude of daylight in the perimeter zone workspaces is often greater than the level preferred by occupants, and that the magnitude of daylight in the core workspaces is often less than the level preferred.

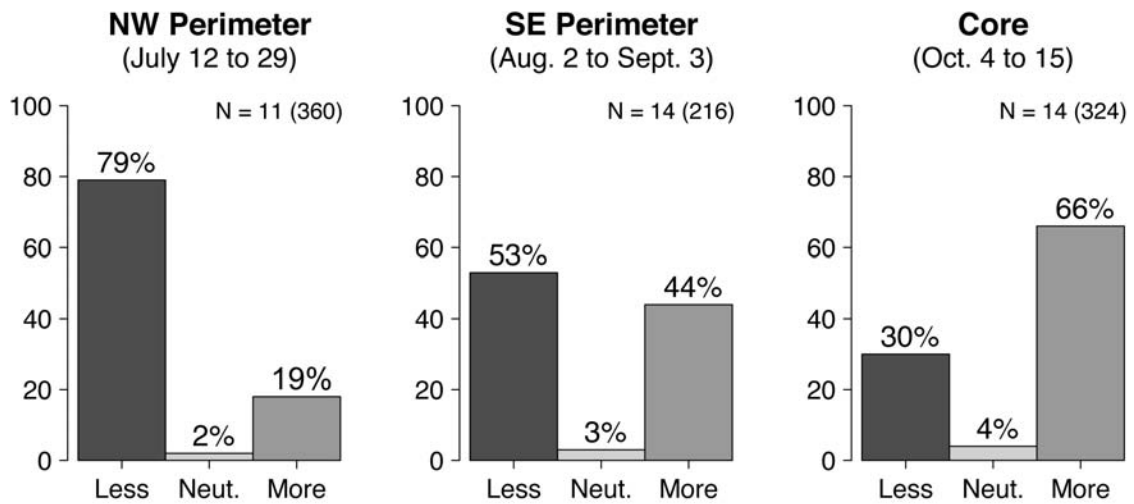
The following sections examine subjective responses in relation to the magnitude of daylight illuminance for each monitoring phase.

**(Q3) How satisfied are you with the AMOUNT of DAYLIGHT in your workspace right now?**



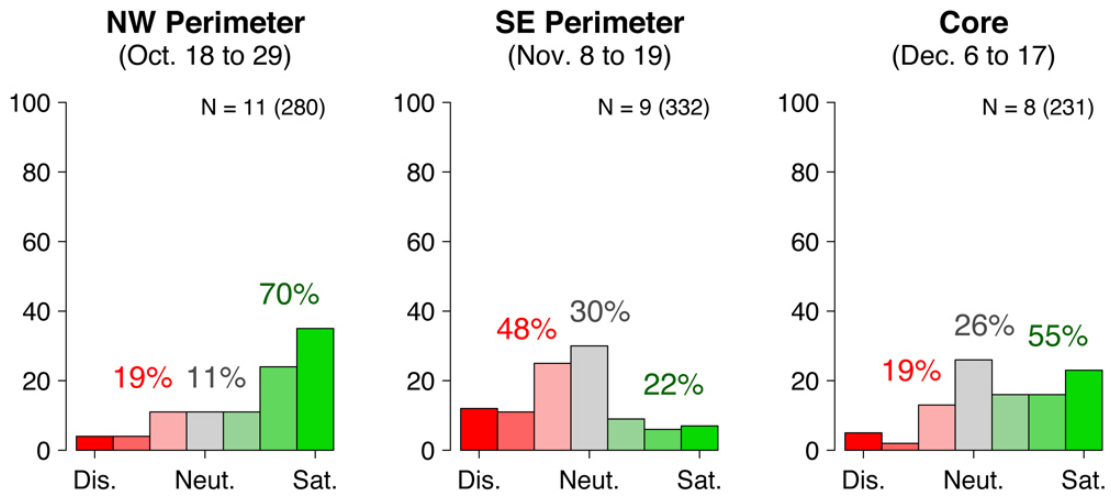
**Figure 8.1** Distribution of subjective responses to (Q3, satisfaction with daylight) for Phases 1,2,3.

**(Q4) [If dissatisfied] Would you prefer LESS or MORE daylight in your workspace right now?**



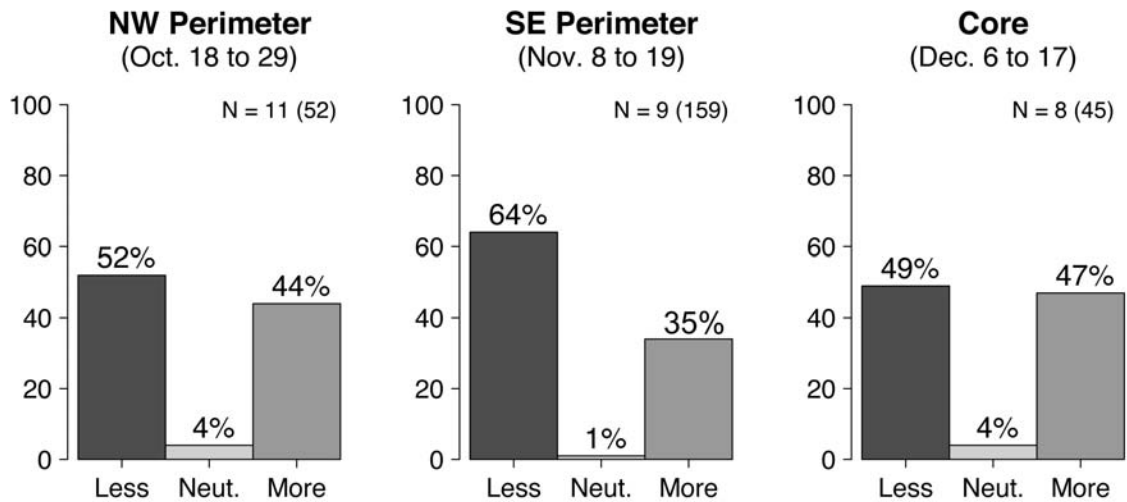
**Figure 8.2** Distribution of subjective responses to (Q4, preference for daylight change) for dissatisfied responses to (Q3) for Phases 1,2,3.

**(Q3) How satisfied are you with the AMOUNT of DAYLIGHT in your workspace right now?**



**Figure 8.3** Distribution of subjective responses to (Q3) for Phases 4,5,6.

**(Q4) [If dissatisfied] Would you prefer LESS or MORE daylight in your workspace right now?**



**Figure 8.4** Distribution of subjective responses to (Q4) for dissatisfied responses to (Q3) for Phases 4,5,6.

### 8.3 NW perimeter zones

**Figure 8.5** compares subjective responses to (Q3) to the intensity of daylight illuminance measured simultaneously at the polling station during Phase 1 (July 12 – 29) and **figure 8.6** presents the same comparison for Phase 4 (Oct. 15 – 29). **Table 8.1** provides a summary of the interior and exterior daylighting conditions for both monitoring phases. The statistics summarize time-series illuminance measures from (6:00 – 19:00 PST) and summarize data from all polling stations in aggregate. As shown in **table 8.1**, the magnitude of vertical illuminance on the NW facade was significantly lower for Phase 4 compared to Phase 1, and resulted in a lower median illuminance in participant workspaces.

**Table 8.1** Summary of interior and exterior illuminance conditions (6:00 – 18:00 PST).

Phase	Total illuminance at workplane (lux)			Daylight illuminance at workplane (lux)			Exterior vertical illum. at NW facade (lux)		
	Median	Max	SD	Median	Max	SD	Median	Max	SD
(1) July 12 - 29	523	15504	1548	475	15487	1555	11828	72123	19161
(4) Oct. 18 - 29	394	10253	860	355	10229	873	6377	30526	5758

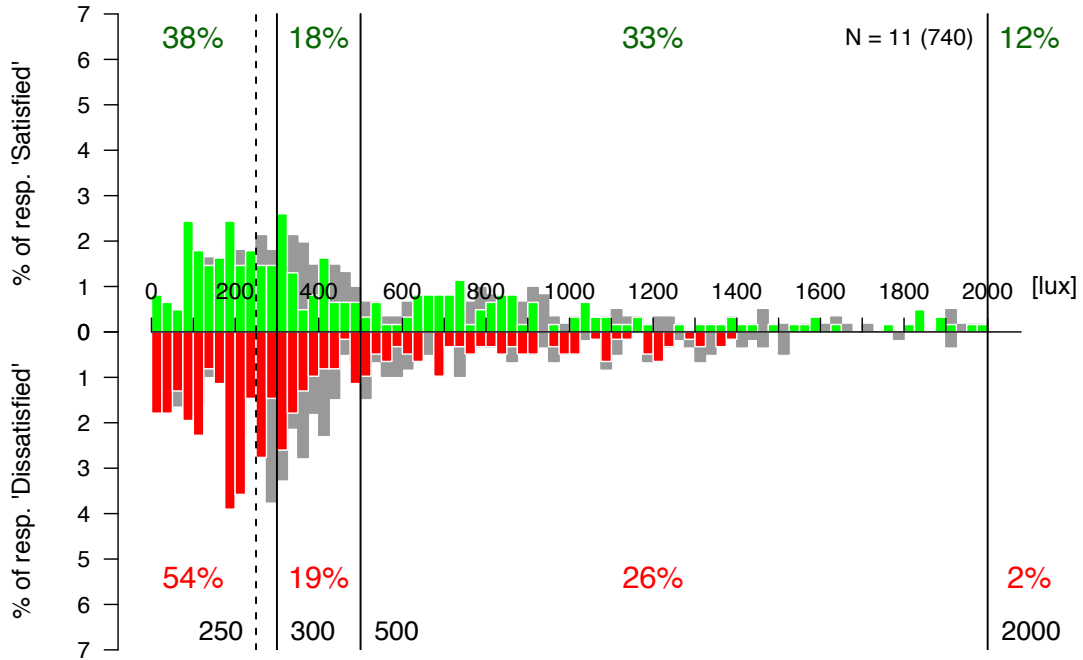
The figures show the distribution of all “satisfied” responses (i.e. slightly, moderately, very) in green and all “dissatisfied” responses (i.e. slightly, moderately, very) in red. N indicates the total number of participants for the monitoring phase followed by the total number of responses among all participants in parenthesis. Because the interior lighting conditions represent a combination of daylight and electrical ambient lighting, the distribution of responses to daylight illuminance is shown in color (i.e. green and red) over the distribution of responses to the original measure of total workplane illuminance (i.e. daylight + electrical lighting) which is represented as grey. As shown in **table 8.1**, the contribution of electrical lighting to total illuminance was small, therefore the distribution of responses to daylight illuminance results in a slight shift to the left relative to the original distribution shown in grey.

Vertical lines are drawn to indicate threshold levels of 250, 300, 500, and 2000 lux. The range (250 – 2000 lux) corresponds to the range of daylight illuminances required for compliance with the LEED 2012 Daylight EQ credit measurement compliance option. Levels above 2000 lux are considered to be associated with glare and levels below 250 lux are considered to be insufficiently dim. Thresholds of 300 lux and 500 lux are common recommendations for standard workplane illuminance for offices with computer-based and paper-based tasks respectively (IESNA, 2005). Numbers are shown for each vertical subdivision (0 – 300, 301 – 2000, >2000) to indicate the percent of total responses. For example, in **figure 8.5**, 38% of (N = 740) responses indicated satisfaction with the amount of daylight when the daylight illuminance was below 300 lux and 54% indicated dissatisfaction (the remaining responses indicated “neutral”).

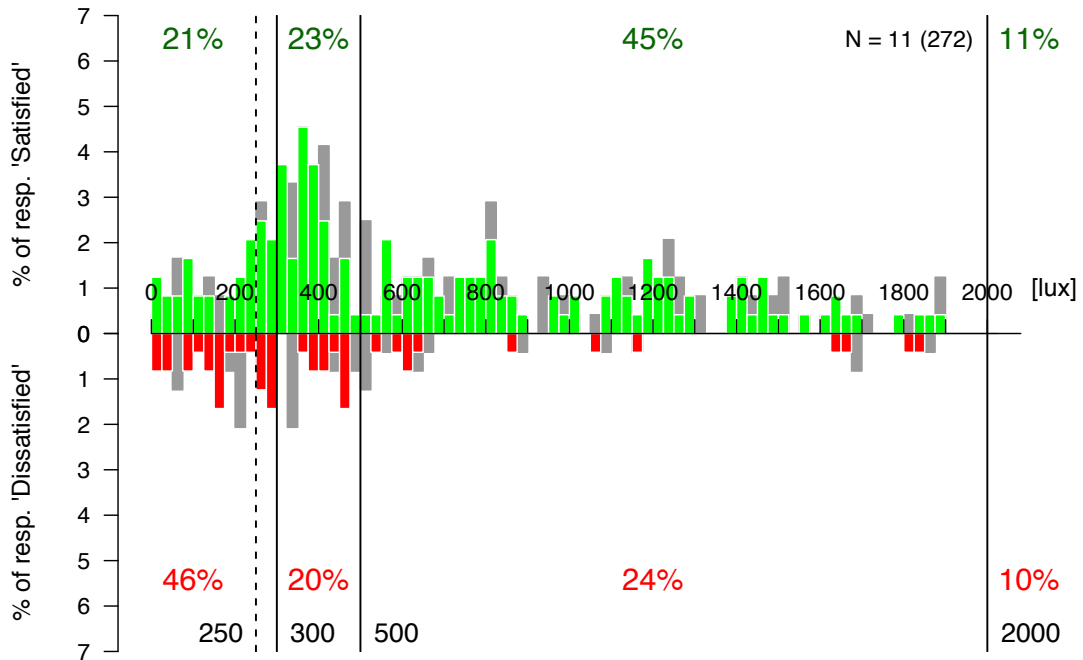


**Figure 8.5** and **figure 8.6** show that a large percentage of satisfied responses were recorded at daylight illuminance levels below 500 lux. For example, during Phase 1 56% of satisfied responses were recorded at daylight illuminance levels below 500 lux. This result suggests that occupants are satisfied with daylight illuminances below the standard workplane illuminances recommended by code and industry recommendations for electrical illumination, and differs from the approach for assessing daylighting performance used by (Reinhart, 2002) where the daylight autonomy threshold (500 lux) was based on the Canadian Labor Code requirement of 500 lux for offices spaces. Similarly, the large percentage of satisfied responses recorded at daylight illuminance levels below 300 lux (38% and 21% respectively for Phase 1 and Phase 4) suggest that the measure of horizontal illuminance (the sole measurement underlying the LEED Daylight EQ credit simulation compliance criteria) is not a very effective metric for assessing occupant satisfaction with the amount of daylight in their workspace. This conclusion is demonstrated by the relatively balanced distribution of satisfied vs. unsatisfied responses at varying illuminance values.

Comparison between **figure 8.5** and **figure 8.6** shows that the overall proportion of satisfied responses to dissatisfied responses increased during Phase 4, where, as shown in **table 8.1**, the NW facade received a lower exterior global vertical illuminance levels.



**Figure 8.5** Distribution of binned responses to (Q3) in the NW perimeter zone workspaces for Phase 1 (July 12 – 29).<sup>3</sup>

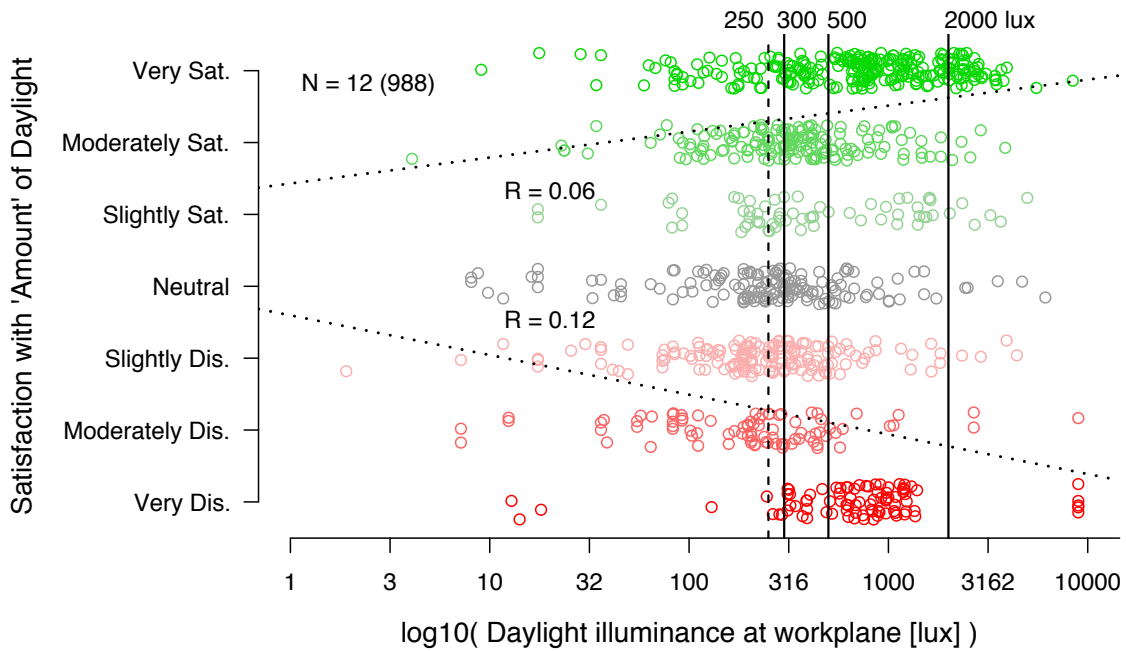


**Figure 8.6** Distribution of binned responses to (Q3) in NW perimeter zone workspaces for Phase 4 (October 15 – 29).

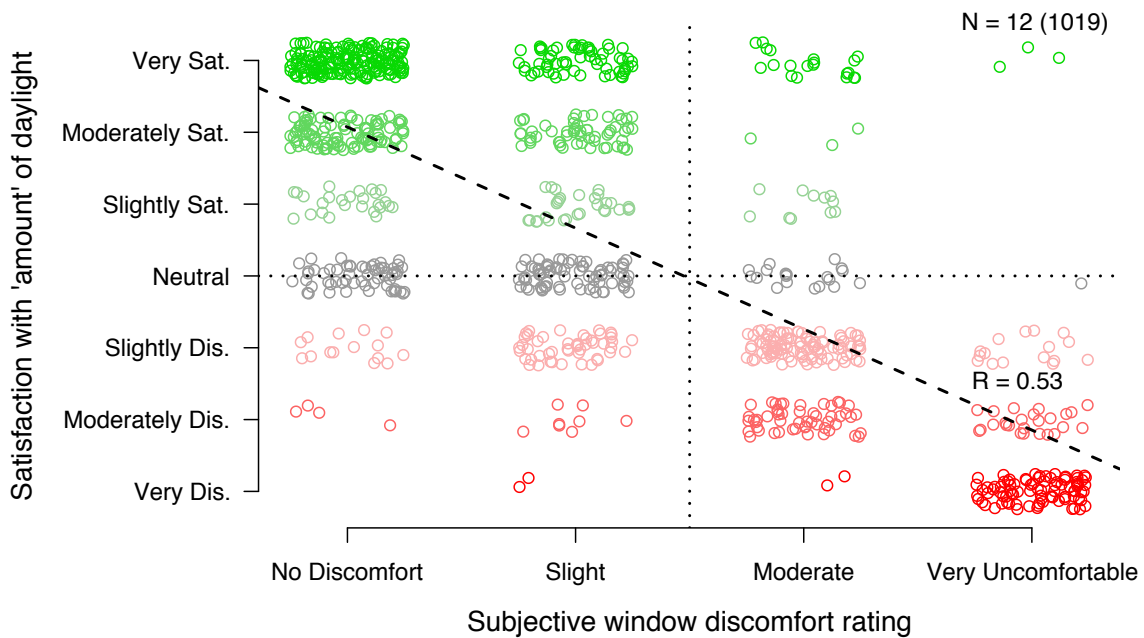
<sup>3</sup> Grey bars indicate original measure of total workplane illuminance (i.e. daylight + electrical light). Colors indicate daylight illuminance levels alone (i.e. with contribution of electrical lighting removed).

Linear regression was used to test the hypothesis that occupant satisfaction with the amount of daylight in their workstation increases with the physical magnitude of daylight illuminance at the workplane. No statistically significant model was found to describe the relationship between the 7-point subjective scale used for (Q3) and daylight illuminance. However, statistically significant ( $p < 0.001$ ) models were found to describe the relationship between the subjective responses to (Q3) when satisfaction and dissatisfied responses were treated as separate groups. **Figure 8.7** shows the relationship between daylight illuminance and the subjective responses to (Q3) for Phase 1 and Phase 4 combined (a log<sub>10</sub> scale is used on the x-axis to represent daylight illuminance). The figure shows that both satisfaction and dissatisfaction are correlated with the magnitude of daylight illuminance. For example, the distribution of both “very satisfied” responses and “very dissatisfied” responses are clustered at greater illuminance values compared with the “neutral” responses. This result both supports and conflicts with the assumption that “maximizing” (i.e. increasing) daylight illuminance will increase occupant satisfaction levels with the amount of daylight in their workstation.

Because the majority of dissatisfied responses to (Q3) were associated with a preference for less daylight, subjective responses to (Q3) were compared to associated window discomfort ratings (Q6) to examine the relationship between satisfaction with the amount of daylight and satisfaction with potential discomfort from windows. **Figure 8.8** shows that levels of satisfaction with the amount of daylight were strongly correlated with window discomfort ratings, where, nearly all satisfied responses to (Q3) were associated with window discomfort ratings of “slight” or “no discomfort.” And, nearly all responses of “very dissatisfied” were associated with window discomfort ratings of “very uncomfortable.” Because relatively few (2% and 10%) dissatisfied responses were recorded (during Phase 1 and Phase 4 respectively) at daylight illuminance levels above 2000 lux, this result differs from the assumption underlying both Useful Daylight Illuminance range of (100 – 2000 lux) (Rogers, 2006) and the LEED 2012 Daylight EQ credit (300 – 2000 lux) that illuminances below 2000 lux will not be associated with visual discomfort. The strong statistical relationship between dissatisfaction with the amount of daylight and window discomfort at daylight illuminance levels below 2000 lux suggests that additional indicators are required beyond calculations or measures of horizontal workplane illuminance to predict the successful outcome of daylit spaces.



**Figure 8.7** Distribution of subjective responses to (Q3) for the NW perimeter zone by daylight illuminance for Phase 1 and Phase 4 combined. The vertical scattering in each cluster was added as a graphical technique to reduce overlapping of data points.



**Figure 8.8** Distribution of subjective responses to (Q3) for the NW perimeter zone by subjective window discomfort rating (Q4) for Phase 1 and Phase 4 combined.

The clustering of “very satisfied” responses in the “no discomfort” column means that the majority of “very satisfied” responses to (Q3, amount of daylight) were recorded at nearly the same time as the perception of “no discomfort” from windows. This outcome suggests a relationship between satisfaction with daylight and the absence of glare discomfort from window which is not accounted for in current approaches to assessing daylight sufficiency.

## 8.4 SE perimeter zones

**Table 8.2** provides a summary of the interior and exterior daylighting conditions for both monitoring phases for the SE perimeter zones. The statistics summarize time-series illuminance measures from (6:00 – 19:00 PST) and interior measures summarize data from all polling stations in aggregate. As shown in **table 8.2**, the magnitude of vertical illuminance on the SE facade was significantly higher for Phase 5 compared to Phase 2, but resulted in a lower median illuminance in participant workspaces.<sup>6</sup>

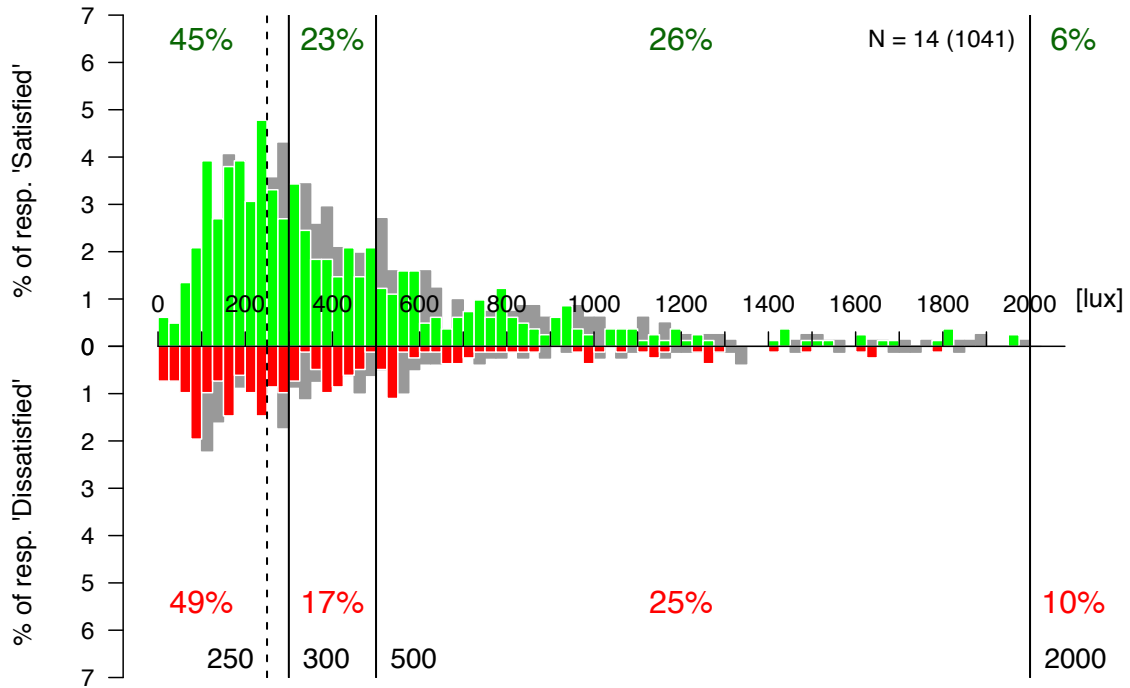
**Table 8.2** Summary of interior and exterior illuminance conditions for SE perimeter zones.

Phase	Total illuminance at workplane (lux)			Daylight illuminance at workplane (lux)			Exterior vertical illum. at SE façade (lux)		
	Median	Max	SD	Median	Max	SD	Median	Max	SD
(2) Aug. 2 - Sep. 3	370	9594	1405	317	9580	1405	9872	102181	23797
(5) Nov. 8 - 19	243	8983	1913	180	8983	1916	31086	106961	39093

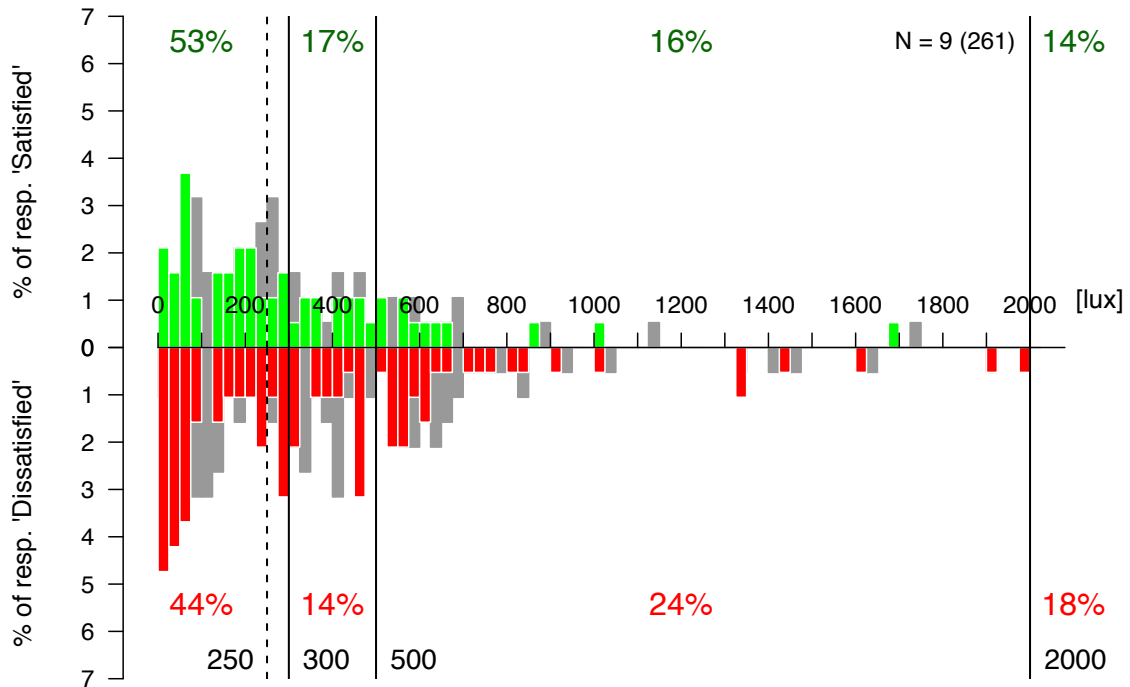
**Figure 8.9** and **figure 8.10** show that, similar to the results from the NW perimeter zones, a large percentage of satisfied responses were recorded at daylight illuminance levels below 500 lux. For example, during Phase 2 (68%) of satisfied responses were recorded at daylight illuminance levels below 500 lux, and (70%) during Phase 5. Furthermore, ( in Phase 2 (45%) and Phase 5 (53%) of satisfied responses were recorded at daylight illuminance levels below 300 lux. This result again conflicts with existing assumptions used to establish thresholds for minimum acceptable daylight illuminance for assessing daylighting performance.

Because only 6 of the original participants participated in Phase 5, comparison between **figure 8.9** and **figure 8.10** is of limited use. However, comparison between Phase 2 and Phase 5 suggests that the greater proportion of dissatisfied responses during Phase 5 may be related to the increased levels of daylight illuminance on the SE facade as suggested by a similar pattern found between the NW perimeter monitoring phases.

<sup>6</sup> The decrease in median workplate illuminance was due to the inclusion of non-daylit hours during Phase 5 (i.e. before sunrise and after sunset) in the period of the day analyzed (6:00 – 19:00 PST) . The period of the day analyzed was determined by the schedule of the electrical lighting.

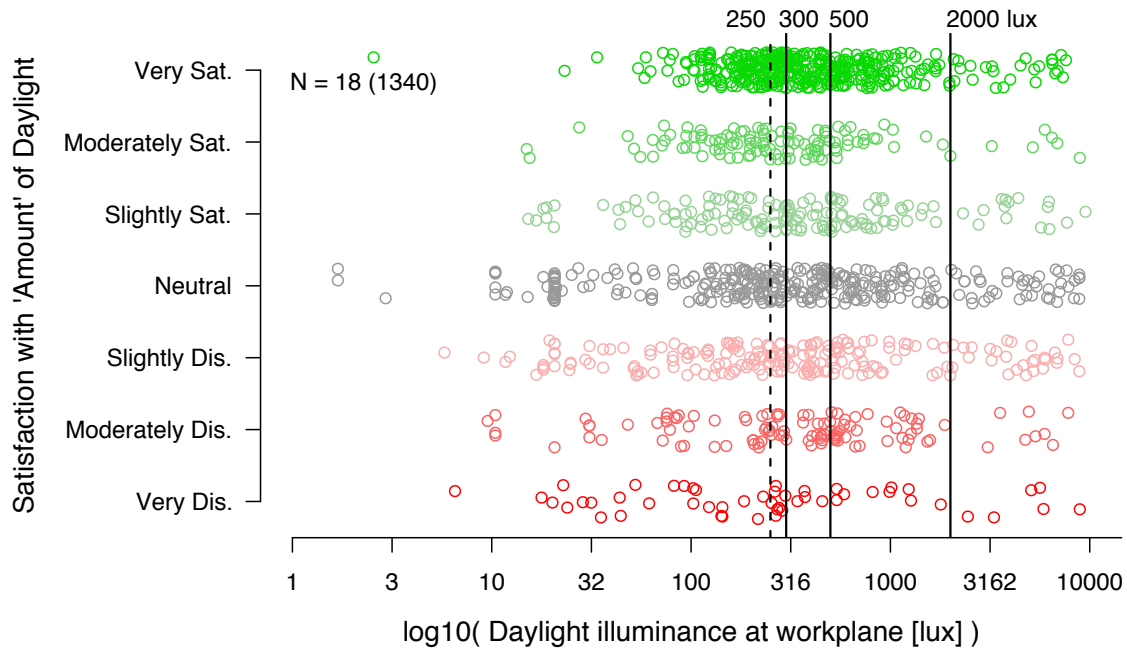


**Figure 8.9** Distribution of responses to (Q3) in SE perimeter zone workspaces for Phase 2 (Aug. 2 – Sept. 3).



**Figure 8.10** Distribution of responses to (Q3) in SE perimeter zone workspaces for Phase 5 (Nov. 8 - 19).

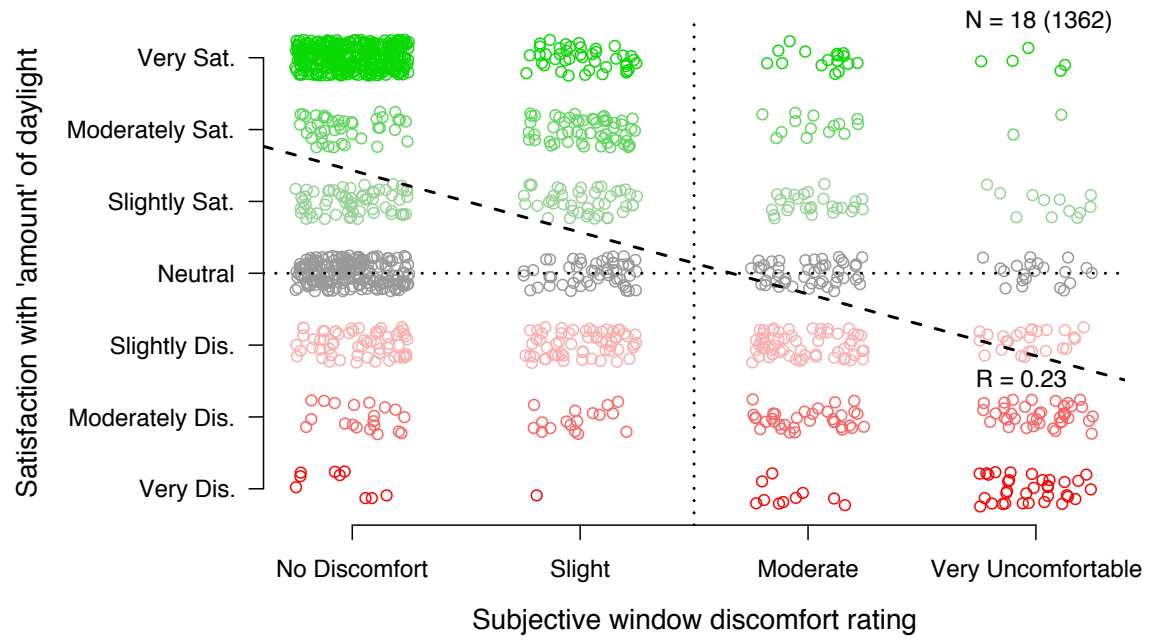
In contrast to the results found for the NW perimeter zone, no statistically significant relationship was found between physical measures of daylight illuminance and occupant satisfaction with the amount of daylight in their workspace. As shown in **figure 8.11**, all seven responses to (Q3) are distributed over both low and high daylight illuminance levels and fall outside the recommended range of existing indicators.



**Figure 8.11** Distribution of subjective responses to (Q3) by daylight illuminance for Phase 2 and Phase 5 combined.

However, as shown in **figure 8.12**, a statistically significant ( $p < 0.001$ ) relationship was again found between satisfaction with the amount of daylight (Q3) and window discomfort rating (Q6). The results for the SE perimeter data, which again show a large amount of dissatisfaction associated with visual discomfort from windows (at daylight illuminance levels below 2000) suggest that predictions or measures of horizontal workplane illuminance are poor indicators of occupant satisfaction and are likely to underestimate the level of visual discomfort that can occur in daylit spaces.





**Figure 8.12** Distribution of subjective responses to (Q3) by subjective window discomfort rating (Q4) for Phase 2 and Phase 5 combined.

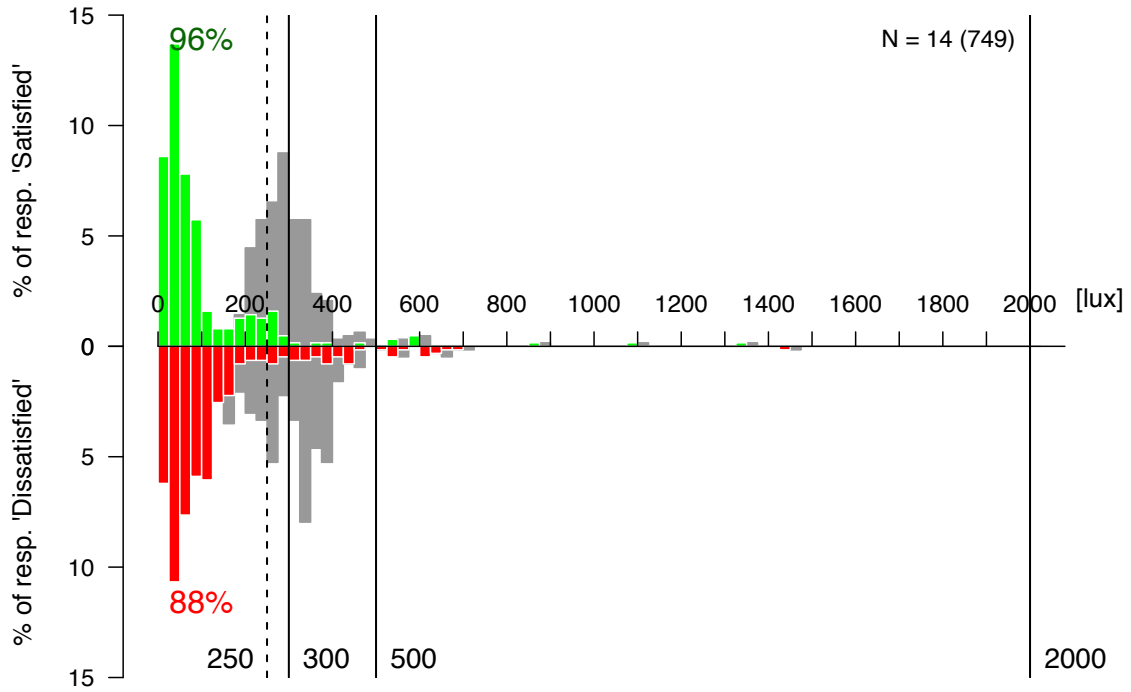
## 8.5 Core zones

**Table 8.3** provides a summary of the interior and exterior daylighting conditions for the Core zones for both monitoring phases. The statistics summarize time-series illuminance measures from (6:00 – 19:00 PST) and summarize data from all polling stations in aggregate. As shown in **table 8.3**, the magnitude of horizontal illuminance on the roof was lower during Phase 6 compared to Phase 3. And, in contrast to the perimeter zones where daylight was the primary source of ambient illumination, daylight represented approximately 15% or less of the total workplane illuminance (i.e. daylight + electrical light) during occupied hours.

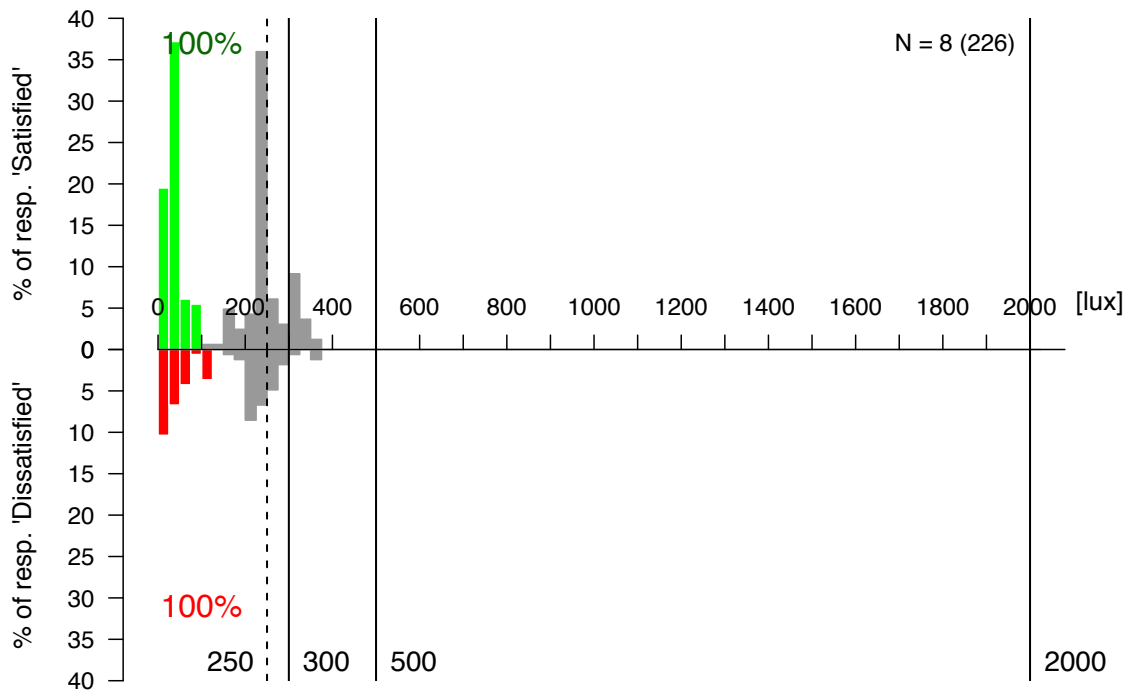
**Table 8.3** Summary of interior and exterior illuminance conditions for core zones.

Phase	Total illuminance at workplane (lux)			Daylight illuminance at workplane (lux)			Exterior illuminance on roof (lux)		
	Median	Max	SD	Median	Max	SD	Median	Max	SD
(3) Oct. 4 - 15	300	3071	125	44	2800	60	47797	102126	27529
(6) Dec. 6 - 17	226	543	54	17	254	23	12384	82114	16402

**Figure 8.13** and **figure 8.14** show that nearly all responses were recorded at total illuminance levels below 500 lux (shown in grey), and 96% and 100% of all satisfied responses to (Q3) (shown in color) were recorded at daylight illuminances below 300 lux for Phase 3 and Phase 6 respectively. This result shows that participants in the core zones were satisfied with daylight illuminance levels below the recommended thresholds of existing daylight sufficiency performance indicators, however the result is ambiguous because of the substantial contribution of electrical lighting to core workstations during the study. In other words, if the electrical ambient lighting was switched off, participants would have been exposed to significantly lower levels of ambient lighting and this condition would likely influence satisfaction with the amount of daylight.

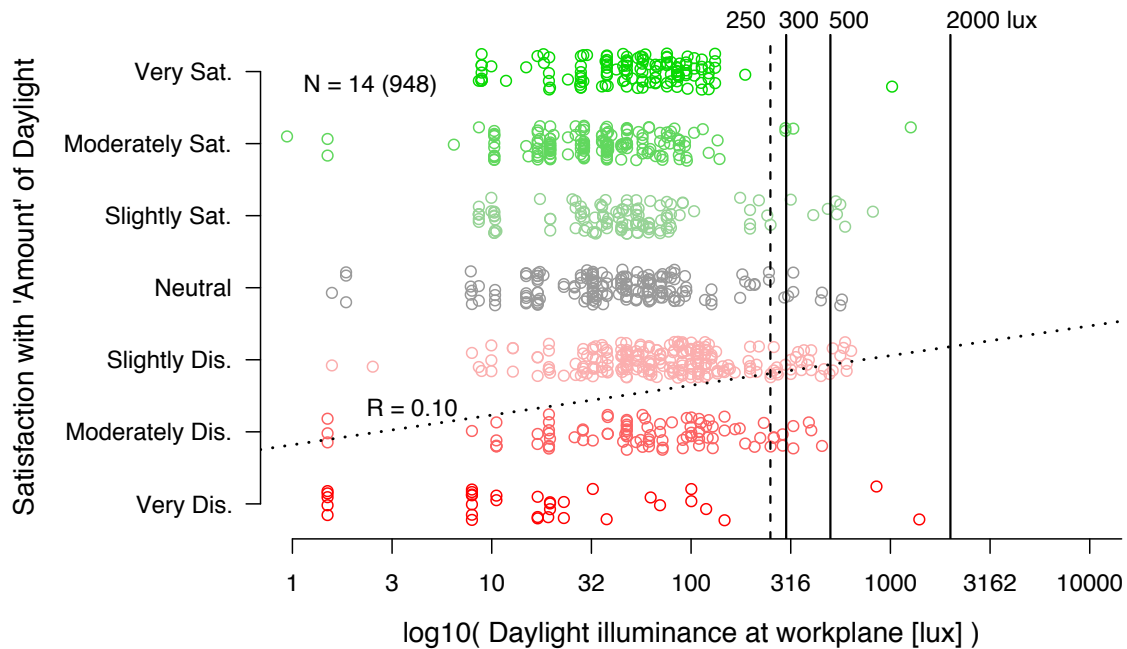


**Figure 8.13** Distribution of responses to (Q3) in core workspaces for Phase 3 (October 4 - 15).



**Figure 8.14** Distribution of responses to (Q3) in core workspaces for Phase 6 (December 6 - 17).

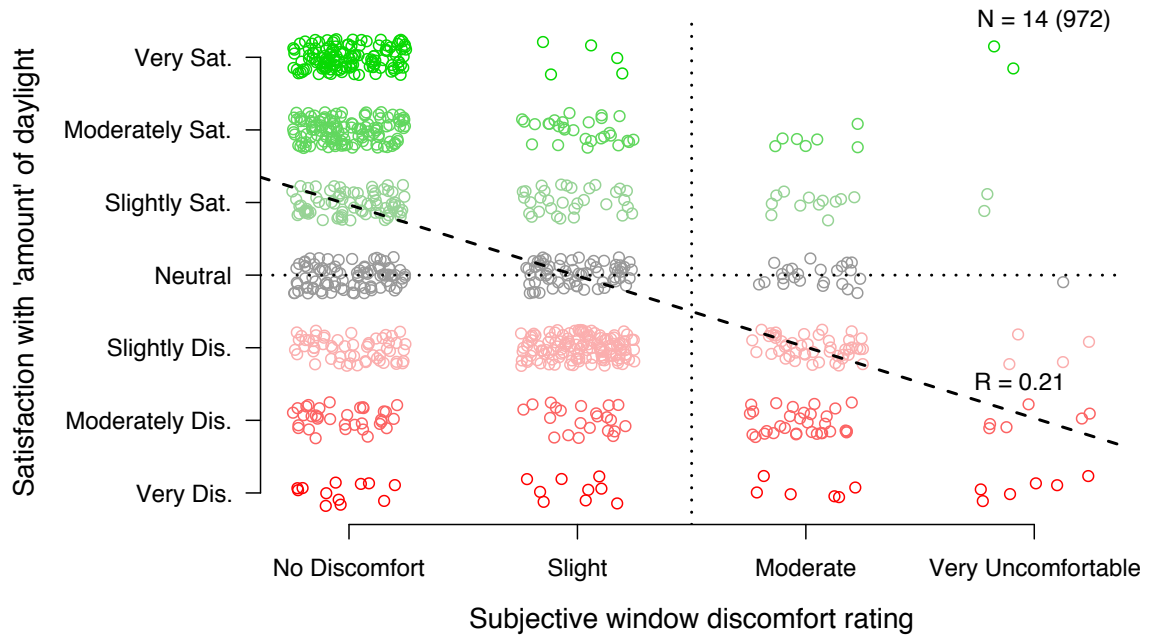
As with the data sets from the NW and SE perimeter zones, no statistically significant relationship was found between measures of daylight illuminance at the workplane and levels of satisfaction with the amount of daylight (Q3). However, a statistically significant ( $p < 0.001$ ) relationship was found when the 7-point scale was reduced to include only dissatisfied responses. This model (**figure 8.15**) shows that the level of dissatisfaction decreases with the magnitude of daylight illuminance. However, increased magnitudes of daylight illuminance were not correlated to increased levels of satisfaction with the amount of daylight. And, overall, daylight illuminance was a poor predictor of participant’s level of satisfaction with the amount of daylight in their workstation.



**Figure 8.15** Distribution of subjective responses to (Q3) by daylight illuminance for Phase 3 and Phase 6 combined.

Similar to the results for the NW and SE perimeter zones, responses to (Q3) correlated ( $R=0.21$ ) with window discomfort ratings (Q6) as shown in **figure 8.16**. And, nearly all responses of “very satisfied” were associated with window discomfort ratings of “no discomfort.” This result supports findings from the perimeter zone that participants consider visual discomfort when assessing their level of satisfaction with the magnitude of daylight illuminance in their workspace. And, assessments of discomfort from windows by occupants in the core zones were observed when daylight illuminance levels were below the thresholds recommended by daylight performance indicators. These results emphasize the importance of indicators related to visual discomfort in occupants satisfaction ratings. Daylight performance indicators based on measures of workplane illuminance fail to characterize the frequency and magnitude of visual discomfort that can occur in daylit spaces, particularly core zones where bright but distant windows may produce a strong, and potentially uncomfortable, visual presence while contributing little to daylight illuminance levels. However, unlike the results from the perimeter zones,

responses to (Q3) of “slightly,” moderately” and “very dissatisfied” were more evenly distributed across a range of window discomfort ratings.



**Figure 8.16** Distribution of subjective responses to (Q3) by subjective window discomfort rating (Q4) for Phase 3 and Phase 6 combined.

## 8.6 Daylight autonomy

To examine the performance of the SFFB in relation to the compliance criteria proposed in the 2012 draft of the LEED Daylight EQ credit, daylight autonomy (DA) was calculated for each test phase. The 2012 draft LEED Daylight credit requires that 75% of all occupied spaces “achieve a minimum DA value of 50%, based on an annual illuminance of 30 footcandles” (i.e. 323 lux). DA results for each monitoring phase are presented in **table 8.4** for the NW perimeter, SE perimeter, and Core zones respectively. DA was calculated by totaling the time-series observations of horizontal daylight illuminance from all polling stations recorded between (6:00 – 19:00 PST) and dividing the total number of observations that complied with the DA criteria by the total number of observations. The time interval (6:00 – 19:00 PST) was chosen because it corresponds to the schedule for the electrical ambient lighting. Because the LEED criteria do not specify the occupied hours of the building to be used in the DA calculation, this interval is somewhat arbitrary. Therefore, a less “strict” interpretation is also presented which calculates DA using the interval (sunrise – sunset). Finally, because the core zones resulted in a DA of 0% based on both intervals, the Continuous Daylight Autonomy (Cont.DA) metric is also presented, which assigns partial weighing to daylight illuminances below the minimum threshold.

The tables show that the only period of the year when a zone complied with the LEED DA criteria was Phase 1 (**table 8.4**) when the “occupied hours” are considered to be from (6:00 – 19:00 PST). When the occupied hours are relaxed to (sunrise – sunset), (essentially not penalizing the performance of the space for hour when the sun is below the horizon), the NW perimeter zone complies for both Phase 1 and Phase 4. The SE perimeter zone (with exterior metal scrim and retrofit window film), does not comply for either monitoring phase, but comes relatively close during Phase 2. The core zones do not comply and do not achieve daylight autonomy for any period of time during either phase. The core zones did, however, result in a Cont.DA of 15% and 8% during Phase 3 and Phase 6 respectively.

**Table 8.4** DA performance for the NW perimeter, SE perimeter, and Core zones.

Zone	Phase	6:00 - 19:00 PST		Sunrise - Sunset	
		DA	Cont.DA	DA	Cont.DA
NW Perimeter	(1) July 12 - 29	57%	82%	57%	82%
	(4) Oct. 18 - 29	45%	70%	62%	87%
SE Perimeter	(2) Aug. 2 - Sep. 3	43%	79%	44%	79%
	(5) Nov. 8 - 19	22%	50%	28%	63%
Core	(3) Oct. 4 - 15	0%	15%	0%	17%
	(6) Dec. 6 - 17	0%	8%	0%	9%

## 8.7 The Daylight Factor

As discussed in Chapter 3, the indicators and criteria used in LEED to assess daylighting performance are revised with each edition. The draft 2012 Daylight EQ credit compliance criteria are different than the criteria that were used to certify the SFFB. The SFFB earned the LEED Daylight EQ credit (v. 2.1) based on a daylight factor (DF) criteria. The DF is defined by (Moon and Spencer, 1942) as, “the ratio of the internal illuminance at a point in a building to the unshaded, external horizontal illuminance under a CIE overcast sky.” The DF is calculated in LEED v2.1 using an equation of window and floor area, window geometry, visible light transmittance, and window height that does not account for interior shade presence or positioning or future retrofits to the building such as those that occurs at the SFFB. One of the issues with assessing compliance with the DF in the field is that real skies rarely meet the criteria of the CIE overcast sky. In real life, particularly in San Francisco during the monitoring phases of the study, sky conditions varied between cloudy, dynamic and clear, all of which produce higher global horizontal illuminances than the CIE overcast sky. **Table 8.5** provides a summary DF levels achieved, based on calculations using measured data, on an hourly basis in the Core zones during Phase 3 and Phase 6. Each value represents the average daylight factor for that hour among all desktop polling stations. Values are given only for the hours where the sun was above the horizon for the entire hour. **Table 8.5** shows that under the sky conditions observed during the monitoring phases (clear and dynamic for Phase 3, cloudy for Phase 6), the Core zones achieve only a small fraction of the 2.0% DF required to comply with the LEED version 2.1 Daylight credit.

**Table 8.5** Hourly average daylight factor calculations for Core zones.

Phase	7:00	8:00	9:00	10:00	11:00	12:00	13:00	14:00	15:00	16:00
(3) Oct. 4 - 15	0.29%	0.17%	0.11%	0.09%	0.07%	0.06%	0.07%	0.08%	0.15%	0.37%
(6) Dec. 6 - 17	NA	0.39%	0.22%	0.18%	0.15%	0.15%	0.15%	0.18%	0.33%	NA

## 8.8 Summary and conclusions

This chapter examined the performance of the SFFB in terms of occupant satisfaction with the amount of daylight in their workspaces at two separate periods of the year for the three zones involved in the study (NW perimeter, SE perimeter, and Core). Occupant subjective assessments were compared to simultaneous physical measures to examine the applicability of existing illuminance thresholds used to define minimum acceptable levels of illumination (for daylight autonomy and from existing recommendations from the electrical lighting industry). Finally, the daylight autonomy of each space was calculated and compared to the quantitative criteria used to predict daylight sufficiency for green building certification. The main findings are summarized in the following points:

1. How do the levels of daylight transmission and levels of satisfaction compare between zones (e.g. NW perimeter, SE perimeter, Core)?
  - a. The level of daylight admitted to the NW and SE perimeter zones was often found to be in excess of the level preferred by occupants. Despite the significant fraction of the facade shaded by interior roller shades (and solar control film on the SE facade), a large percentage of all subjective assessments in the perimeter zones indicated “dissatisfaction” with the amount of daylight in their workspaces, where the majority of dissatisfied responses (albeit often a slim majority) were paired with preference for less daylight. The level of dissatisfaction (Q3) and proportion of preferences for less daylight (Q4) were found to be greater for each perimeter zone during the monitoring phase where the facade received the greater level of solar exposure. For example, 42% of NW perimeter zone responses to (Q3) indicated “dissatisfaction” during Phase 1 (July 12 - 29), with 79% of “dissatisfied” responses indicating a preference for “less” daylight. However during Phase 4 (Oct. 15 – 29), where the NW facade received lower levels of solar exposure due to seasonal variation in the sun’s position, only 21% of responses to (Q3) indicated dissatisfaction, with 52% of “dissatisfied” responses indicating a preference for “less” daylight. This result is notable given that the NW perimeter zone (Phase 1) was the only monitoring period to comply with the LEED 2012 draft Daylight EQ Credit daylight autonomy criteria of minimum 50% DA during occupied hours (6:00 – 19:00).
  - b. The level of daylight transmission in the Core zones was found to be insufficient based on the subjective responses from study participants as well as from analysis of physical measures. Daylight contributed to less than 15% of the total illuminance measured in the core zones during occupied hours and resulted in a median daylight illuminance of 44 lux (SD = 60 lux) and 17 lux (SD = 23 lux) respectively for Phase 3 and Phase 6. This result is significantly lower than the levels of daylight transmission anticipated by the 2% daylight factor calculations used for compliance with the LEED v. 2.1 EQ Daylight credit. For comparison,



under a CIE overcast sky of 10,000 lux, a 2% daylight factor corresponds to an interior daylight illuminance of 500 lux. The median daylight illuminance achieved in the core zones during Phase 3 and Phase 6 corresponds to roughly 9% and 3% respectively of this target value. Despite the low levels of daylight transmission, 40% and 55% of subjective responses to (Q3) reported satisfaction with the amount of daylight in their workspace for Phase 3 and Phase 6 respectively. However, given the significant contribution of electrical ambient illumination to the core workstations, this result cannot be taken to suggest that participants in core workspaces are accepting of lower levels of daylight illuminance than occupants in the perimeter zones. This result demonstrates that assumptions for daylight availability based solely on variables of visible light transmittance and glazed area of the facade are likely to overestimate daylight availability of buildings in use, where occupant control of shading devices and retrofit modifications can result in significantly lower levels of daylight transmission.

2. How does occupant subjective assessment of the amount of daylight in their workspace compare to the outcomes predicted by quantitative performance indicators of daylight sufficiency?
  - a. Thresholds for minimum acceptable daylight illuminance used in the LEED 2012 draft Daylight EQ Credit are higher than the daylight illuminance required for occupant satisfaction with the amount of daylight in their workspace. A large percentage of satisfied responses in the perimeter zones (38% and 21% for the NW, 45% and 53% for the SE) were recorded at daylight illuminance levels below 300 lux. This result challenges the assumption underlying the LEED 2012 draft Daylight EQ credit compliance criteria that daylight illuminances below 300 lux are insufficient for occupant satisfaction. The result supports the definition of Useful Daylight Illuminance (UDI) proposed by (Nabil and Mardaljevic 2005) which extends the definition of “useful daylight” to a range of (100 – 2000 lux). Thresholds for minimum acceptable daylight illuminance are additionally problematic because measures of daylight illuminance were found to be a poor and ambiguous predictor of occupant satisfaction with the amount of daylight in their workspace. This finding is discussed in the following point.
3. Does occupant satisfaction with the amount of daylight in their workstation increase with the physical magnitude of daylight illuminance at the workplane? Do better indicators of occupant satisfaction exist?
  - a. Physical measures of daylight illuminance were not found to be effective as a predictor of occupant satisfaction with the amount of daylight in the workspace when a 7-point satisfaction scale (with both negative and positive poles) was compared to simultaneous measures of daylight

illuminance. Although correlations were found for subjective assessments of the amount of daylight when the 7-point satisfaction scale was reduced to binary “satisfied” and “dissatisfied” levels, the results were conflicting. For example, for the NW façade participants, the level of both satisfaction and dissatisfaction were found to increase with the magnitude of daylight illuminance at the workplane. This result conflicts with the conventional assumption that “maximizing” the amount of daylight transmission will have a positive effect on occupant satisfaction with the amount of daylight in the workspace.

- b. Subjective assessment of visual discomfort from windows was found to be a better predictor of occupant satisfaction with the amount of daylight in their workspace than physical measures of daylight illuminance. Participant’s level of satisfaction with the amount of daylight in their workspace was correlated to the near-simultaneous window discomfort ratings where, for all zones, the level of satisfaction with the amount of daylight in the workspace was found to increase as the level of visual discomfort reported from windows decreased. For example, nearly all responses of “very satisfied” with the amount of daylight were paired with responses of “no discomfort” from windows. Similarly, the majority of “very dissatisfied” responses were paired with window discomfort ratings of “moderate” or “very uncomfortable.” This result suggests that building occupants consider visual discomfort when assessing their level of satisfaction with the magnitude of daylight illuminance in their workspace thus emphasizing the importance of indicators of visual discomfort.
4. How do subjective assessments of visual discomfort compare to the daylight illuminances assumed to be acceptable for visual comfort (e.g. 300 – 2000 lux)?
    - a. Nearly all responses of visual discomfort from windows were recorded under daylight illuminances less than the threshold level assumed for visual discomfort (2000 lux). The result suggests that daylight performance indicators based on measures of workplane illuminance are likely to underestimate the frequency and magnitude of visual discomfort that can occur in daylit spaces.

## CHAPTER 9

### RESULTS AND ANALYSIS OF VISUAL CONNECTION TO THE OUTDOORS

*A third accomplishment is the Federal Building's high performance workplace in the upper tower. The narrow floor plates and the fact that the private offices are relegated to the interior mean that almost all have breathtaking views of the city or the bay.*

-GSA<sup>1</sup>

#### 9.1 Introduction

“Maximize access to daylight and views” was one of the original objectives stated in the preliminary program and feasibility study for the San Francisco Federal Building (Kaplan McLaughlin Diaz, 1994). As stated in the above quotation, the visual connection to the exterior environment is considered one of the central accomplishments of the SFFB tower. A design phase application of the simple method required for the LEED v2.2 View credit compliance suggested the design would provide a satisfactory level of visual connection to the exterior for interior workspaces. The LEED V2.2 method required that the design, “achieve direct line of sight to the outdoor environment via vision glazing between 2’6” and 7’6” above finish floor for building occupants in 90% of all regularly occupied areas.” For the floors examined in this study, the LEED Calculator 2.0 indicated that over 90% of workspaces would have “sufficient views” on the basis of LEED’s direct line of sight criteria.

This chapter examines if the broadly stated goal of “sufficient views” for perimeter and core workspaces is achieved in use given that significant portions of the NW and SE facades were observed to be covered by interior roller shades (as shown in Chapter 5) and given the potential reduction in perceived view from the exterior metal scrim and solar control film on the SE facade. Performance in regard to view is examined through analysis of occupant subjective assessments from the polling stations paired with simultaneous measures of facade occlusion using time-lapse HDR imaging. Performance is additionally examined through analysis of “overall” subjective assessments collected using the one-time survey questionnaire.

The following questions were used to guide the analysis:

1. How does the intent of the LEED Daylight and View EQ credits compare with occupant beliefs about the importance of sufficient daylight and views for feeling connected to the outdoors?

---

<sup>1</sup> U.S. General Services Administration (2007). San Francisco Federal Building.

2. Overall, are occupants satisfied with their level of visual connection to the outdoors? If not, what are the causes of their dissatisfaction?
3. What is the relationship between overall level of satisfaction with visual connection to the exterior and overall level of satisfaction with personal workspace, and with the building overall?
4. What is the relationship between the position of the roller shades and “point-in-time” subjective assessments of visual connection to the outdoors?

## **9.2 Occupant assessment of LEED Daylight and View EQ credit intent**

The stated intent of the LEED Daylight and View EQ credits (v. 2.2 2005) is to:

*Provide for the building occupants a connection between indoor spaces and the outdoors through the introduction of daylight and views into the regularly occupied areas of the building.*

In the LEED 2012 draft View EQ credit the intent, while stated separately for daylight and view, remains the same:

*To give building occupants a connection with the natural outdoor environment by providing quality views.*

To examine the level of agreement between the intent of the LEED Daylight and View EQ credits and occupants’ beliefs about the importance of sufficient daylight and views for feeling connected to the outdoors, two questions were asked in the web-based survey questionnaire. This survey questionnaire was administered to study participants once during the six-month study at the beginning of the first monitoring phase that the participant participated in. The survey was administered to record occupant “overall” subjective assessments with environmental factors, their workspace and the building, to examine beliefs about the importance of daylight and view for connection with the outdoors, and to provide a channel for “open-ended” comments. The questions assessing occupants’ beliefs about the importance of sufficient daylight and views for feeling connected to the outdoors were structured in an agree / disagree format and were stated as follows:

[Please indicate whether you agree or disagree with the following statements]

(Q1) It is important for me to have sufficient daylight in my workspace to feel connected to the outdoors.

(Q2) It is important for me to have an unobstructed view from my workspace to feel connected to the outdoors.

Figure 9.1 and figure 9.2 present the results of the (N = 40) participants who responded to the questionnaire.

**Sufficient daylight is important for feeling connected to outdoors**

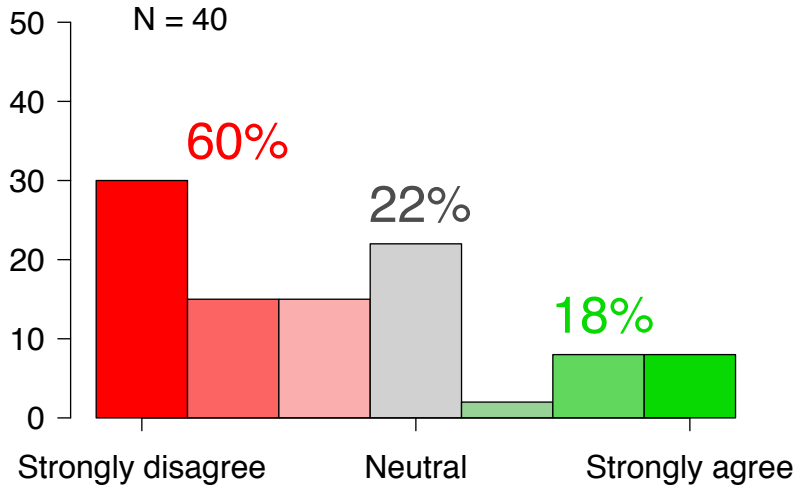


Figure 9.1 Subjective responses to (Q1).

**Unobstructed view is important for feeling connected to outdoors**

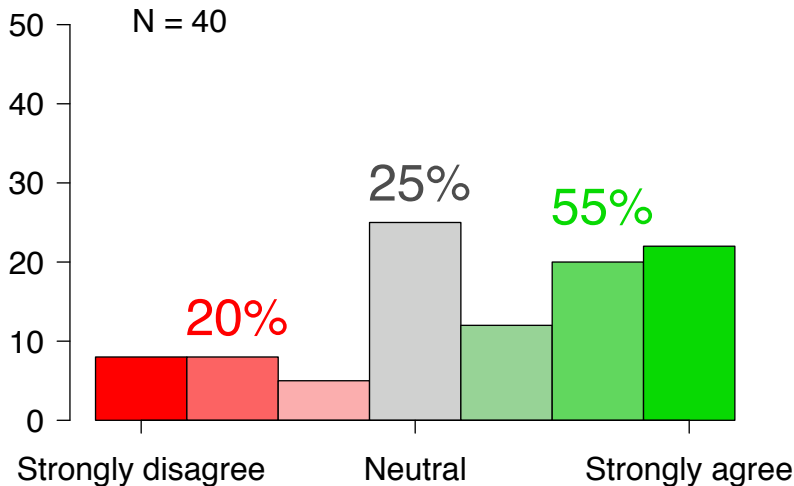
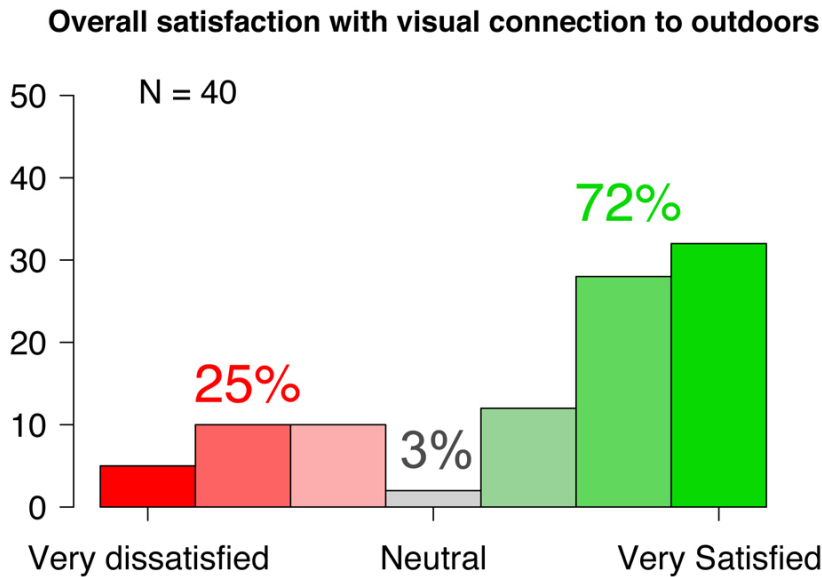


Figure 9.2 Subjective responses to (Q2).

A comparison between the results presented in figure 9.1 and figure 9.2 shows that the intent of the LEED Daylight EQ credit was not considered important to the majority of participants for feeling connected to the outdoors, with the largest percentage of responses indicating “strongly disagree.” In contrast, participants generally agreed that the intent of the LEED View EQ credit was important for feeling connected with the outdoors.

### 9.3 Occupant level of satisfaction with visual connection to the outdoors

**Figure 9.3** presents the overall satisfaction of occupants with their level of visual connection to the outdoors and includes responses from participants located in both perimeter zones and core zones. The results show that, overall, the SFFB achieved satisfactory views for 72% of the participants who responded to the one-time survey questionnaire. The distribution of dissatisfied responses is presented in **table 9.1**. **Table 9.1** shows that the majority of dissatisfied responses were from the core and NW perimeter zones, with the largest percentage of dissatisfied responses (38%) recorded in the core zones. The reasons for dissatisfaction, (collected using a branching question in the survey) are presented in **table 9.2**.



**Figure 9.3** Overall level of satisfaction with visual connection to the outdoors.

### 9.3.1 Sources of dissatisfaction

**Table 9.2** presents the reasons for dissatisfaction for the (N=10) participants who indicated some level of dissatisfaction with visual connection to the exterior. Overall, the majority of responses are related to issues of visual discomfort. This result is notable given the possible options for objects that obscure or restrict views.

**Table 9.1** Summary of participants dissatisfied with visual connection to outdoors.

	NW	SE	Core	Total
Number of participants	12	15	13	40
Number of participants dissatisfied	4	1	5	10
Percent of participants dissatisfied with visual connection to outdoors	33%	7%	38%	25%

**Table 9.2** Reasons for dissatisfaction with visual connection to outdoors.

	NW	SE	Core	Total
Brightness from windows makes view uncomfortable	4	1	4	9
Contrast in light levels between my computer and windows makes view uncomfortable	3	1	1	5
I have had to build personal shading devices and these restrict my view	3	1	0	4
Workspace partitions or other interior objects obscure my view	1	0	2	3
Exterior glass fins restrict my view	2	NA	0	2
Other, please specify:	1	1	0	2
Roller shade fabric obscures my view	1	0	0	1
Exterior metal screen obscures my view	NA	1	0	1

This result is further supported by occupant responses to the “Other, please specify” category:

*Due to constant discomfort levels related to the sun/glare, the shades are down continuously, which limits the view. They are also not easy to get to. (NW perimeter zone).*

*The glass fins sometime deflect sun into the cubicle, usually later in the day. The upper tier of windows (3rd tier) that have no shades are the biggest problem. There is no way to limit the sun, but especially the glare, that constantly comes through there. We squint our eyes all day long when facing the windows. We end up with tired eyes and sometimes headaches if the glare is really bad that day. I had to change my computer monitor position so I am not facing the windows, which is now an awkward set-up, and use empty boxes to prevent light/glare from coming between the shade and the window sill. (NW perimeter zone).*

*There is almost always an annoying reflection of light coming from either outside or inside on the window. The film applied to the windows was a big mistake. It simply makes the view out the window appear smoggy. It did nothing to cut down the glare problem and was applied not more than a month before the shades were installed, which did make a positive difference. The view out the windows below desk level, which do not have the film applied, have a far superior view. (SE perimeter zone).*

In the second comment, it is worth noting that the dissatisfaction with view was related to having to turn away from the facade. Personal shading devices, several examples of which are presented in **figure 9.4**, were also indicated as a reason for dissatisfaction. It is also interesting to note that the exterior metal screen, which has a 50% openness at normal incidence, did not emerge as a source of dissatisfaction with the visual connection to the outdoors. This is notable given that, due to mechanical issues, the operable exterior scrim panels in the vision zone of the facade were never tilted to an open position during the study.

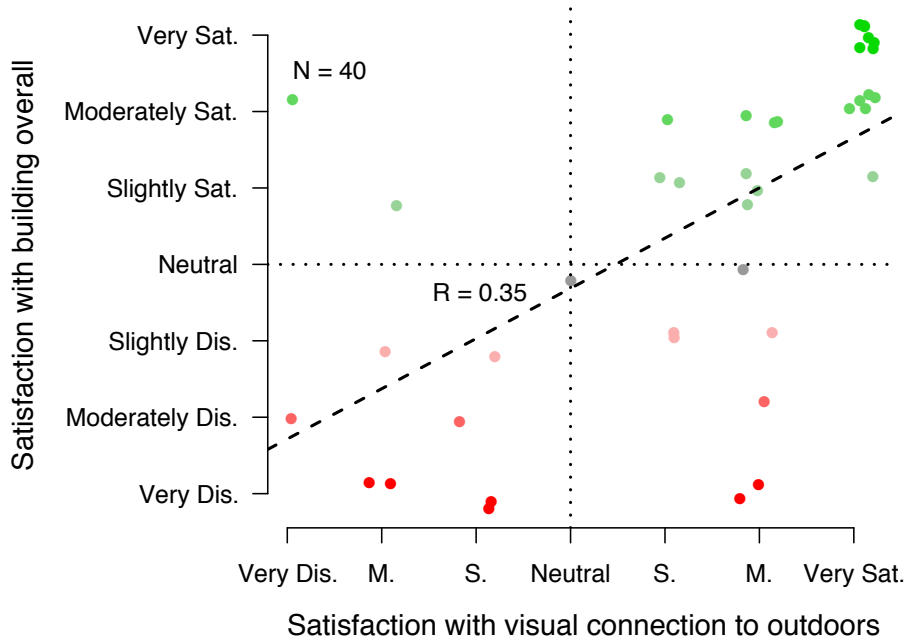




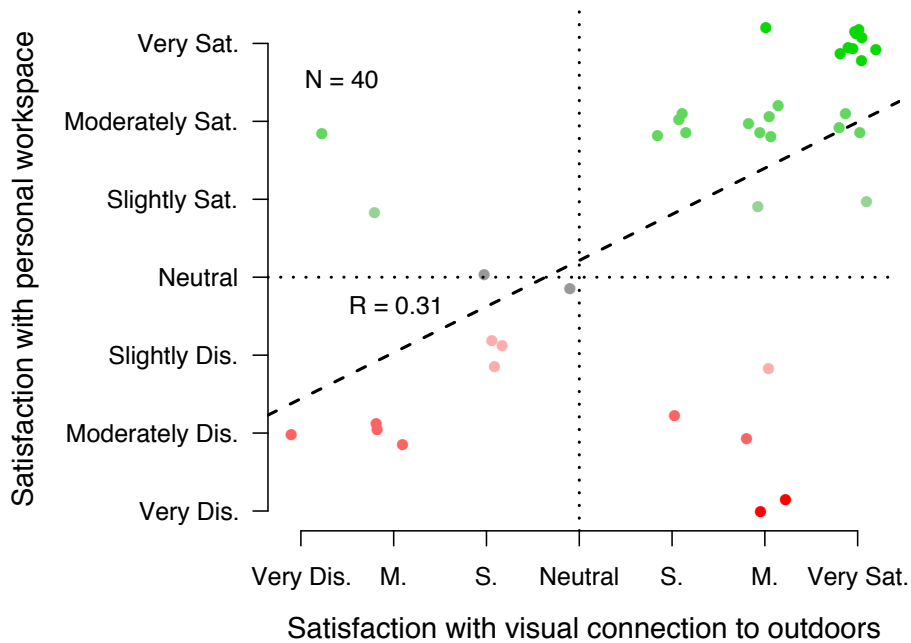
**Figure 9.4** Examples of personal modifications found to also restrict views to the outdoors (SE, SE, and NW facades respectively).

#### **9.4 Satisfaction with visual connection to the exterior and satisfaction with personal workspace and building overall**

Subjective levels of satisfaction with the visual connection to the outdoors were found to have a strong positive correlation to occupant's overall level of satisfaction with their personal workstation ( $r = 0.59$ ) as well as their overall level of satisfaction with the SFFB ( $r = 0.56$ ). **Figure 9.5** and **figure 9.6** present the distribution of responses for overall level of satisfaction with the building and with personal workspace in comparison to satisfaction with visual connection to the outdoors respectively. Points are colored by the magnitude of satisfaction with the building, where red colors indicate levels of dissatisfaction and green colors indicate levels of satisfaction. The regression models show that as satisfaction with visual connection to the exterior increases, overall satisfaction with the SFFB ( $R = 0.35$ ) and with their personal workstation ( $R = 0.31$ ) increases. The results do not imply that occupant satisfaction with visual connection to the exterior causes the levels of satisfaction with personal workspace or (with the SFFB) to change, it merely identifies that the factors are strongly related. However, this relationship supports conventional wisdom that visual connection to the exterior is an important consideration in assessing building performance. Further, the results support the intent of the LEED green building rating system to establish the provision of quality views for building occupants as a performance objective.



**Figure 9.5** Overall level of satisfaction with the SFFB by overall level of satisfaction with visual connection to outdoors.

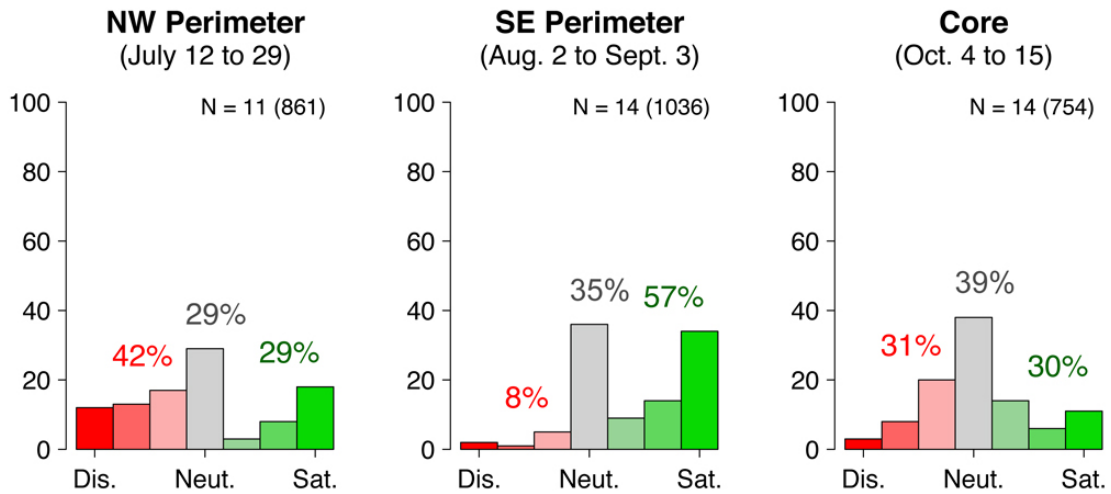


**Figure 9.6** Overall level of satisfaction with personal workspace by overall level of satisfaction with visual connection to outdoors.

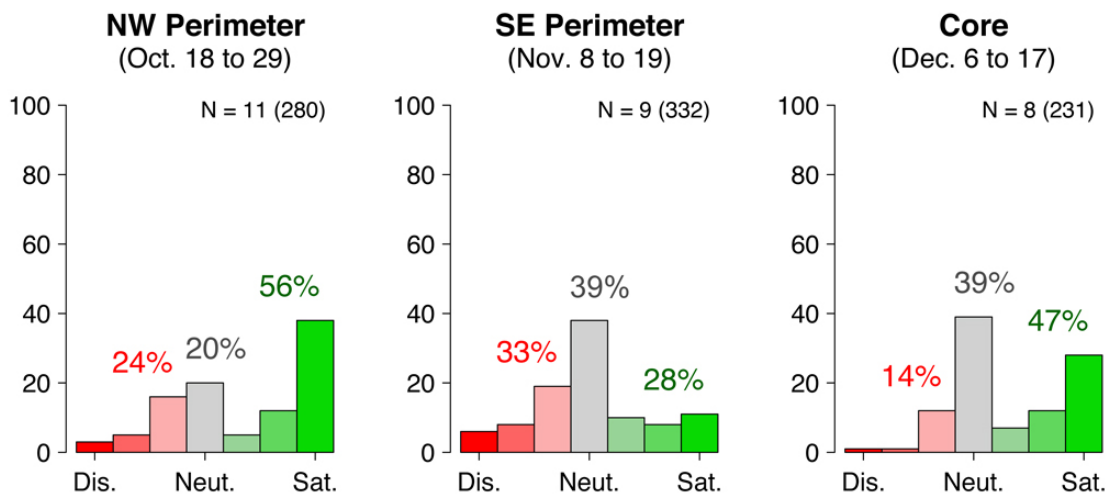
### 9.5 Shade position and subjective assessment of visual connection to the outdoors

Given the high proportion of the facade glazing observed to be shaded by roller shades, an objective in the analysis of polling station responses was to examine the relationship between subjective assessments of roller shade positioning on visual connection to the exterior with varying levels of facade occlusion using “point-in-time” data. **Figure 9.7** and **figure 9.8** show the distribution of responses to polling station question 5 (Q5):

**(Q5) How satisfied are you with the position of the shades on your view to the outdoors right now?**



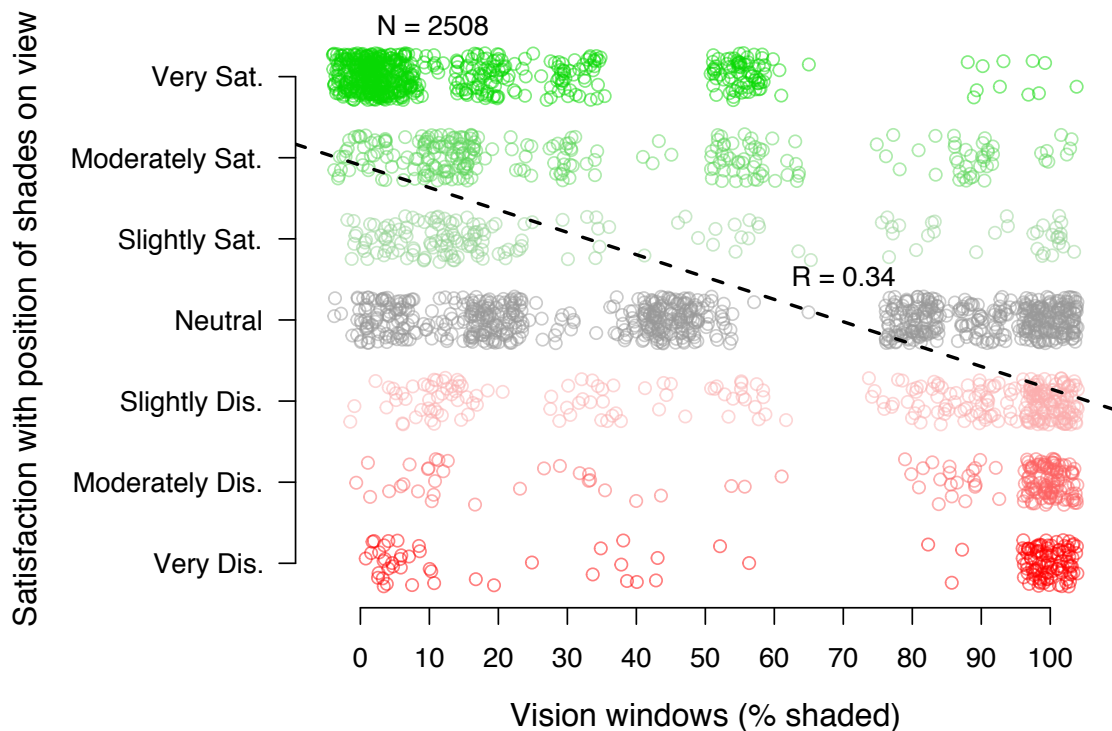
**Figure 9.7** Distribution of responses to (Q5) during Phases 1, 2, and 3.



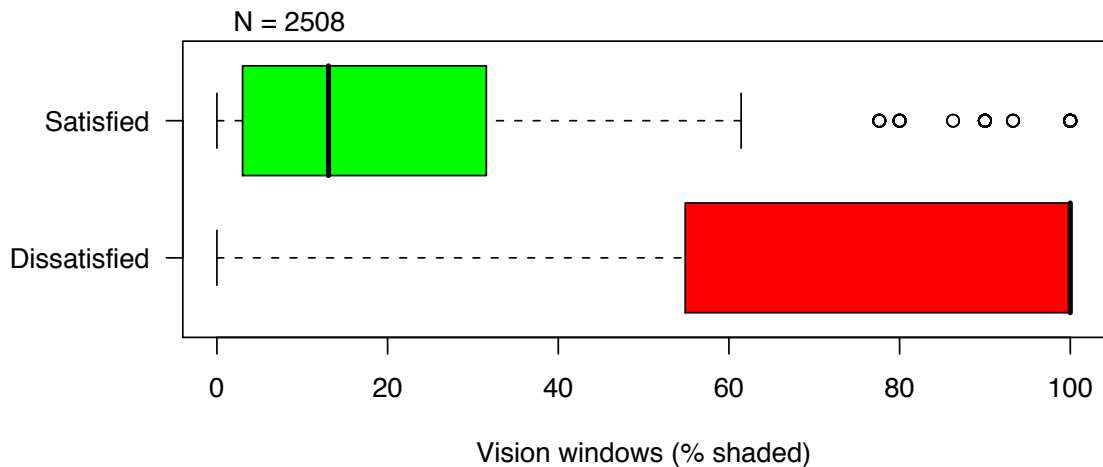
**Figure 9.8** Distribution of responses to (Q5) during Phases 4, 5, and 6.

**Figure 9.7** and **figure 9.8** show that occupants were frequently dissatisfied with the position of the shades on their visual connection the outdoors, where the greatest

frequency of negative responses was observed in the NW perimeter zone during Phase 1. During this phase, 42% of all responses indicated some level of dissatisfaction, where only 29% indicated some level of satisfaction. To examine the causes of dissatisfaction, levels of satisfaction with visual connection to the outdoors were compared with simultaneous measures of window occlusion level, where the level of occlusion for the upper two rows of “daylight zone” windows and the lower row of “vision” windows were compared separately. No correlation was found between satisfaction level and window occlusion for the upper two rows of windows. However, the occlusion level (% shaded) for the vision windows was strongly correlated ( $r = 0.58$ ) to satisfaction with the position of the shades. **Figure 9.9** presents the distribution of subjective responses for the (N=30) perimeter zone participants by occlusion level of the lower windows.



**Figure 9.9** Satisfaction with position of shades on visual connection to outdoors (Q5) by occlusion level of vision windows for (N=30) perimeter zone participants.



**Figure 9.10** Box-and-whisker plot showing distributions of satisfied and dissatisfied responses by lower window occlusion level.

**Figure 9.10** summarizes the relationship found in **figure 9.9**, where the majority of satisfied responses to (Q5) were found for levels of lower window occlusion ranging from 0% shaded to approximately 30% shaded. This result supports observations that occupants often positioned the vision window shades in a partially lowered position. The majority of dissatisfied responses were recorded when the vision windows were observed to be fully shaded (median of dissatisfied responses = 100% shaded), with the remaining responses recorded at lower window occlusion levels exceeding approximately 60% shaded.

Because the method of recording facade occlusion was developed to analyze the behavior of perimeter zone occupants, the occlusion index during monitoring of the core zones was not calculated. This was additionally the result of the practical issue of having to annotate the position of significantly more shades for each core participant view based on the greater area of facade viewed. Therefore, polling station responses from core participants were not compared to detailed and time-variable descriptions of the configuration of roller shades. The images presented in **figure 9.11** and **figure 9.14** show two views from the core to the exterior (NW and SE respectively). **Figure 9.11** shows that views of the NW facade resulted in high contrast between windows and surrounding interior surfaces. This condition was indicated by participants as a source of dissatisfaction with visual connection to the exterior (**table 9.2**). **Figure 9.11** and **figure 9.12** are both the same HDR image, with different levels of exposure applied to illustrate that, were occupants able to visually adapt to the exterior lighting conditions, an unobstructed view to the outdoors was present. However, due to the high level of contrast, as illustrated by the level of saturation in **figure 9.11**, the view may have been “obstructed” by the viewer being unable to change his or her visual adaptation level from low interior luminances to brighter exterior conditions. In contrast, the view to the SE facade, although obscured by shading devices (as well as solar control film and the exterior perforated metal screen), has a significantly lower contrast ratio between the view and adjacent interior surfaces due to the reduced level of window luminance (**figure**

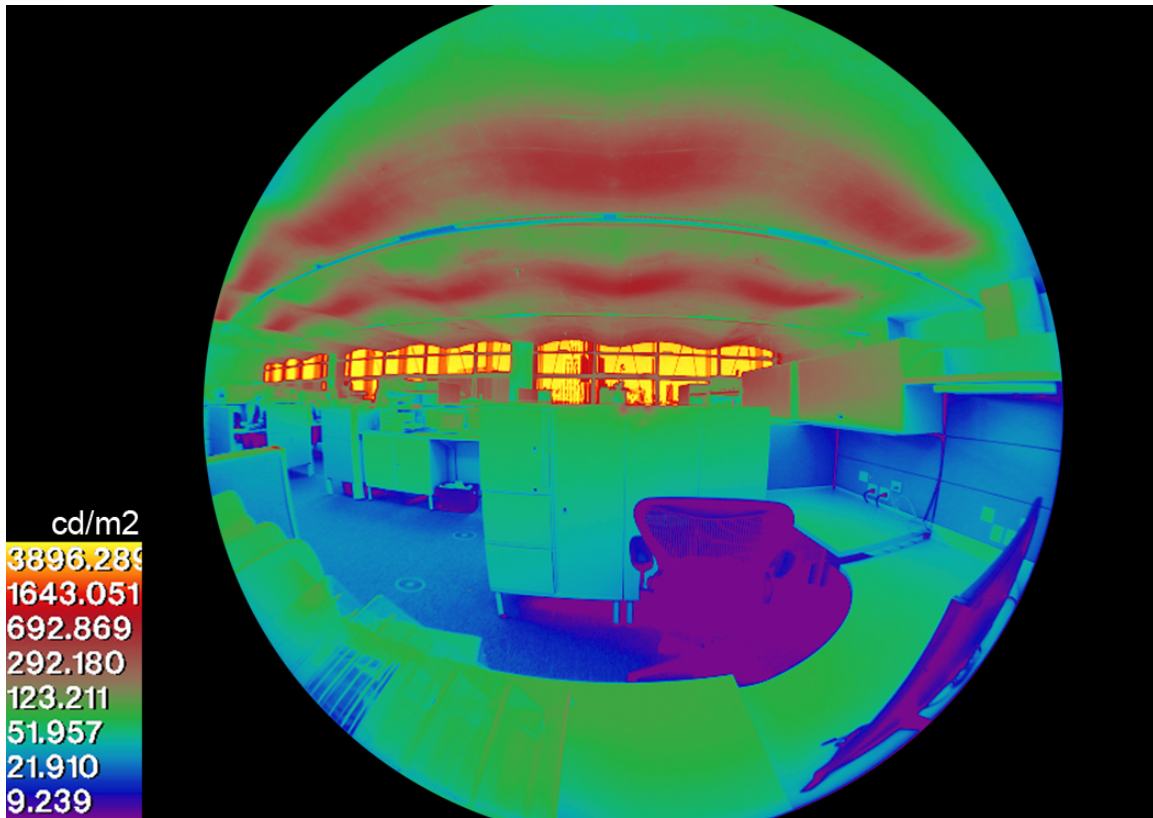
**9.14).** One can speculate that, given the option between an unobstructed view of high luminance contrast and a “screened” view of comparably lower contrast, occupants may prefer the latter. This question was not investigated in this study.



**Figure 9.11** View from core workspace to NW facade showing potential loss of view as a result of high contrast between windows and surrounding interior surfaces.



**Figure 9.12** The same image as in **figure 9.11**, with the exposure adjusted to illustrate that an unobstructed view content is present.



**Figure 9.13** The same image as in **figure 9.11**, with a false color luminance mapping showing the contrast between interior surfaces of low luminance and windows of comparably high luminance (yellow  $\geq 6000$   $\text{cd/m}^2$ ). Image acquired at 14:20 PST on October 11.

In the scene shown in **figure 9.13**, the luminance for the majority of the window view is greater than  $6000 \text{ cd/m}^2$ . This is approximately 30-times to 60-times greater than the interior surface luminance. As discussed in Chapter 7, average and maximum window luminances were found to be among the strongest predictors of visual discomfort, where average window luminances of  $6300 \text{ cd/m}^2$  for the upper windows were found to be associated with a 50% probability of discomfort for participants located in the core zones who faced the NW facade (**table 7.13**). Therefore, although the view remained relatively unobstructed for this viewpoint, the view was made uncomfortable due to the need for the viewer to visually adapt from relatively dim interior surfaces luminances to a significantly brighter window view, as well as to accommodate the luminance contrast between the window view and relatively darker interior surfaces when looking outdoors.



## 9.6 Summary of results

This chapter examined the performance of the SFFB in regard to occupant satisfaction with visual connection to the outdoors. The results showed that, overall, the majority (72%) of participants were satisfied with their level of visual connection to the outdoors despite the significant proportion of the glazing observed to be covered by roller shades. Several sources of dissatisfaction were identified, the majority of which were associated with visual discomfort. A summary of the key findings is provided in the following points:

1. How does the intent of the LEED Daylight and View EQ credits compare with occupant beliefs about the importance of sufficient daylight and views for feeling connected to the outdoors?
  - a. Participants generally disagreed with the assumption that sufficient daylight is important to feel connected to the outdoors. Participants generally agreed that an unobstructed view is important to feel connected to the outdoors. The result showing that participants generally agreed that an unobstructed view is important to feel connected to the outdoors supports efforts by the USGBC and other green building rating systems to incentivize satisfactory levels of visual connection to the outdoors for all building occupants.
2. Overall, are occupants satisfied with their level of visual connection to the outdoors? If not, what are the causes of their dissatisfaction?
  - a. Overall, the majority of participants who responded to the questionnaire were satisfied with their level of visual connection to the outdoors (72%,  $N = 40$ ). This result is notable given the significant area of vision glazing shaded by roller shades reported in Chapter 5.
  - b. The majority of sources of dissatisfaction were related to brightness and contrast caused by windows that made views to the outdoors uncomfortable or required personal modifications to reduce visual discomfort or provide solar control that in turn obstructed views.
3. What is the relationship between overall level of satisfaction with visual connection to the exterior and overall level of satisfaction with personal workspace, and with the building overall?
  - a. Subjective levels of satisfaction with visual connection to the exterior were found to have a strong positive correlation to occupant's overall level of satisfaction with their personal workstation ( $r = 0.59$ ) as well as their overall level of satisfaction with the SFFB ( $r = 0.56$ ). This relationship

supports conventional wisdom that provision of a satisfactory level of visual connection to the exterior is an important consideration in assessing IEQ of buildings in use.

4. What is the relationship between the position of the roller shades and “point-in-time” subjective assessments of visual connection to the outdoors?
  - a. Perimeter zone occupants were found to be satisfied with visual connection to the outdoors even when a large fraction of the glazed area of the facade was covered by roller shades. Based on 2508 “point-in-time” observations of occupant satisfaction with the position of roller shades (Q5) on the level of visual connection to the outdoors among (N=30) perimeter zone study participants, no correlation was found between the position of the upper two rows of “daylight zone” shades and occupant satisfaction with visual connection to the exterior. In contrast, level of satisfaction was strongly correlated with the position of lower shades. The majority of satisfied responses to (Q5) were recorded when the lower window was between 0 and 30% shaded. This result supports observations that occupants often positioned the vision window shades in a partially lowered position that screens the view above the horizon but preserves urban views. The majority of dissatisfied responses were recorded when the vision windows were fully shaded, with the remaining responses recorded at lower window occlusion levels exceeding approximately 60% shaded.

## CHAPTER 10

### RESULTS AND ANALYSIS OF ELECTRICAL LIGHTING ENERGY CONSUMPTION

*Ambient light, the general illumination in an office, comes from sunlight channeled through the windows and reflected off walls and ceilings to extend its reach with minimum glare and intensity. With an average overall ceiling height in the tower of 13 feet, natural daylight will penetrate deep into work spaces. Powered lights are also provided to supplement the natural light. Through simple sensors, the building's automated systems manage the balance between powered and natural daylight. The powered lights are on only when people are at their workspaces. Together, these approaches reduce energy used for lighting by approximately 26 percent.*

-Morphosis, 2011<sup>1</sup>

*Illuminating interiors with natural light yields further sustainable design benefits. With an average floor-to-ceiling height in the tower of 13 feet, daylight reaches 85% of the workspaces. Powered lighting are used only when individuals are at their desks and are automatically dimmed or turned off when daylight is available.*

-GSA<sup>2</sup>

*Are the photosensors correctly controlling the electric lights?  
What are the energy savings from the daylighting controls?*

-Diamond et. al.<sup>3</sup>

#### 10.1 Introduction

The design of the electrical lighting in the tower section of the SFFB consists of a combination of task and overhead ambient lighting fixtures. One of the central objectives of this research was testing whether the SFFB, in use, reduces electrical lighting energy consumption by transmitting sufficient daylight to workplaces and dimming the overhead electrical lighting when daylight is available. In this chapter, electrical lighting energy reduction is considered from several perspectives. The analysis begins by examining the SFFB in terms of effective electrical Lighting Power Density (LPD) and energy

---

<sup>1</sup> <http://morphopedia.com/projects/san-francisco-federal-building>

<sup>2</sup> U.S. General Services Administration (2007). San Francisco Federal Building.

<sup>3</sup> Questions for the SFFB Evaluation Team, 2006.

consumption of the overhead electrical lighting in comparison to a code<sup>4</sup> baseline building ( following the (NREL, 2005) recommendations for reporting lighting energy performance. From an energy perspective, effective LPD and energy consumption are the primary indicators of daylighting performance. However, they provide no indication of how efficiently energy is being used to deliver a service that is needed for occupants to work comfortably. Therefore, the analysis proceeds to examine the level of electrical lighting delivered to the workplane in relation to electrical lighting power and how it varies in response to the transient levels of daylight in the workspace. Finally, to identify if energy is consumed unnecessarily, the analysis examines occupant subjective assessment of daylight sufficiency as an additional indicator and presents an estimate of the energy consumed by the lighting system when daylight levels were perceived to be sufficient to work comfortably with the overhead electrical lighting turned off. Electrical lighting energy consumption of the individual task lighting was not monitored in this study due to practical constraints. However, observations and self-reported frequency of task lighting use were used to examine the relationship between task lighting usage and available daylight.

The following questions were used to guide this analysis:

Existing indicators of minimum workplane illuminance for offices:

1. What is the relationship between minimum workplane illuminance recommendations for offices (e.g. 300 – 500 lux) and occupant subjective assessment of sufficient daylight to work comfortably without overhead electrical lighting?

Performance of photocontrols:

1. Are photocontrols working effectively to reduce electrical lighting power in response to daylight at the scale of an entire floor?
2. Are photocontrols working effectively to reduce electrical lighting power in response to daylight at the scale of individual perimeter zones?
3. Is lighting power reduced in response to daylight in open-plan core zones?

Energy consumption:

1. How much energy is consumed per person per day by the overhead electrical ambient lighting system?
2. What fraction of this energy is consumed when the level of daylight illuminance is perceived by occupants to be sufficient to work comfortably without overhead electrical ambient lighting?

---

<sup>4</sup> Title-24 (2005)

This chapter is organized into 5 sections. **Section 10.2** presents an overview of the design of the electrical lighting system and discusses the available methods of automated and manual lighting controls. **Section 10.3** describes the method and scope of electrical lighting power monitoring and discusses limitations encountered in obtaining reliable and comprehensive electrical lighting power data. **Section 10.4** examines the response of the overhead electrical lighting system to available daylight using effective LPD and workplane illuminance as indicators of performance and reports resulting energy consumption in terms of energy consumed per person per day. **Section 10.5** introduces subjective data from polling stations to identify the fraction of energy consumed per day when daylight levels were perceived by occupants to be sufficient to work comfortably without overhead electrical lighting and for comparison to existing standards for ambient workplane illuminance in offices.

## 10.2 Electrical lighting system

The following sections describe the design of the electrical lighting system in the tower section of the SFFB and describe the automated and manual means of control.

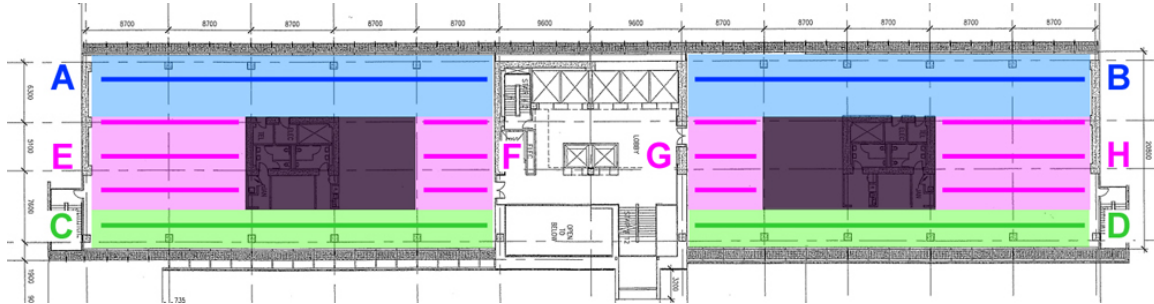
### 10.2.1 Lighting system design

The design of the electrical lighting in the tower section of the SFFB consists of a combination of task and ambient lighting fixtures. The overhead ambient lighting consists of direct/indirect pendant luminaires controlled by an automated lighting control system. Task lighting is described in **section 10.2.2.3**. As show in **figure 10.1**, each floor of the tower section is divided into four perimeter lighting zones and a number of additional core lighting zones. The core zones vary in number and area depending on each floor's unique core layout. **Figure 10.1** shows the four perimeter lighting zones typical of each floor in the tower section. Each NW perimeter lighting zone consists of five 8.7m (28.5 ft) by 6.3m (20.6 ft) bays, resulting in a space 43.5m (143 ft) long with an area of 274m<sup>2</sup> (2949 ft<sup>2</sup>). Each SE perimeter lighting zone consists of five 8.7m (28.5 ft) by 4.3m (14.1 ft) bays, resulting in a space 43.5m (143 ft) long with an area of 187m<sup>2</sup> (2013 ft<sup>2</sup>). The NW perimeter zone is larger than the SE to accommodate two rows of workspaces parallel to the facade. The SE perimeter zone consists of one row of workspaces.



**Figure 10.1** Typical tower floor plan showing location of 4 perimeter photo-controlled lighting zones (NW = blue, SE = green). Interior zones (purple) varied by floor. Blue and green horizontal lines indicate location of overhead luminaires.

**Figure 10.2** presents the lighting zone configuration for the 16<sup>th</sup> floor as a specific example. The areas indicated in purple represent the floor area on the 16<sup>th</sup> floor that contains open plan workspaces, including six 8.7m (28.5 ft) by 10.2m (33.5 ft) bays totaling 532m<sup>2</sup> (5729 ft<sup>2</sup>). The remaining floor area (indicated in dark purple) represents a service core (bathrooms, storage closets, kitchen, copiers, etc.). The perimeter zones (indicated in blue and green) are also configured in an open-plan office layout. The letter designations (e.g. A, B, C, etc.) refer to specific lighting zones, each of which can be controlled individually. A description of controls is provided in **Section 10.2.2.1**.



**Figure 10.2** Floor plan showing lighting zones for the 16<sup>th</sup> floor. Horizontal lines indicate location of overhead luminaires.



**Figure 10.3** Typical perimeter lighting zone on the NW (left) and SE (right) sides of the SFFB. NW perimeter lighting zones include two rows of workspaces parallel to the facade.

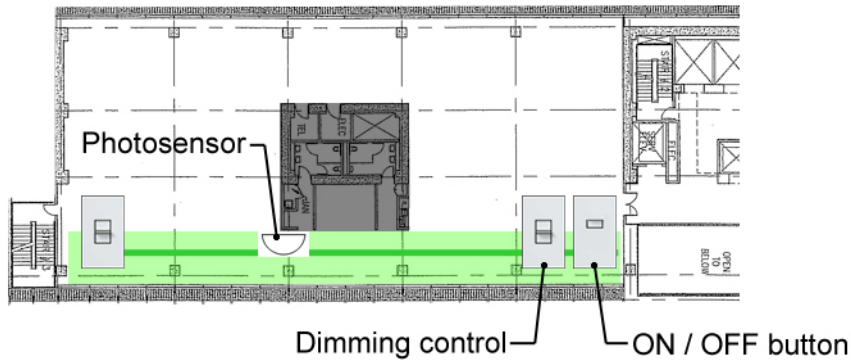


**Figure 10.4** Image of open-plan core lighting zone H located on the 16th floor.

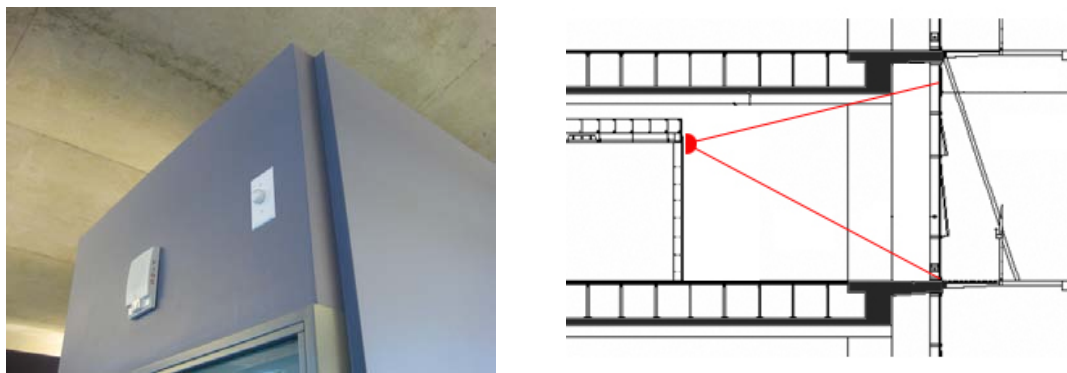
### 10.2.2 Electrical lighting controls

Each perimeter lighting zone is illuminated by multiple luminaires with fluorescent dimming ballasts T-5 3500K 4-foot fluorescent lamps. Each perimeter zone is controlled by wall controls, photosensors, or remotely by building management staff using the web-interface to the automated lighting control system. **Figure 10.5** shows the location of the controls for a typical SE perimeter zone. Each perimeter lighting zone is wired to two sets of wall controls and a single photosensor (**figure 10.6**). Non-perimeter lighting zones (e.g. “cabin” spaces and open-plan workspaces in the core) are wired to wall controls but are not wired to photosensors. Lighting in the cabin zones is controlled by occupancy sensors. Because the objective of the research was to study open plan workspaces, monitoring of electrical lighting energy consumption for the cabin zones was outside the scope of the study. Each open-plan perimeter and core lighting zone is controlled uniformly, therefore any change to the lighting controls effects the lighting for the entire zone. Perimeter zone photosensors were mounted on a vertical wall surface at approximately 8-feet above the floor and faced normal to the plane of the façade as shown in **figure 10.6**. Perimeter zone overhead lighting was controlled using the photosensor in a “closed-loop” configuration. In contrast to an “open-loop” configuration, where the sensor does not observe the output of the process it is observing (e.g. a photosensor mounted on the outside of the building), the closed-loop configuration allows the sensor to observe the output. Therefore, if daylight is diminished in the perimeter zone due to the lowering of shades, the closed-loop control will respond to increase the output of the overhead electrical lighting. As a result, in a closed-loop configuration, occupant shade control behavior can strongly affect the energy consumption of the photocontrolled lighting.





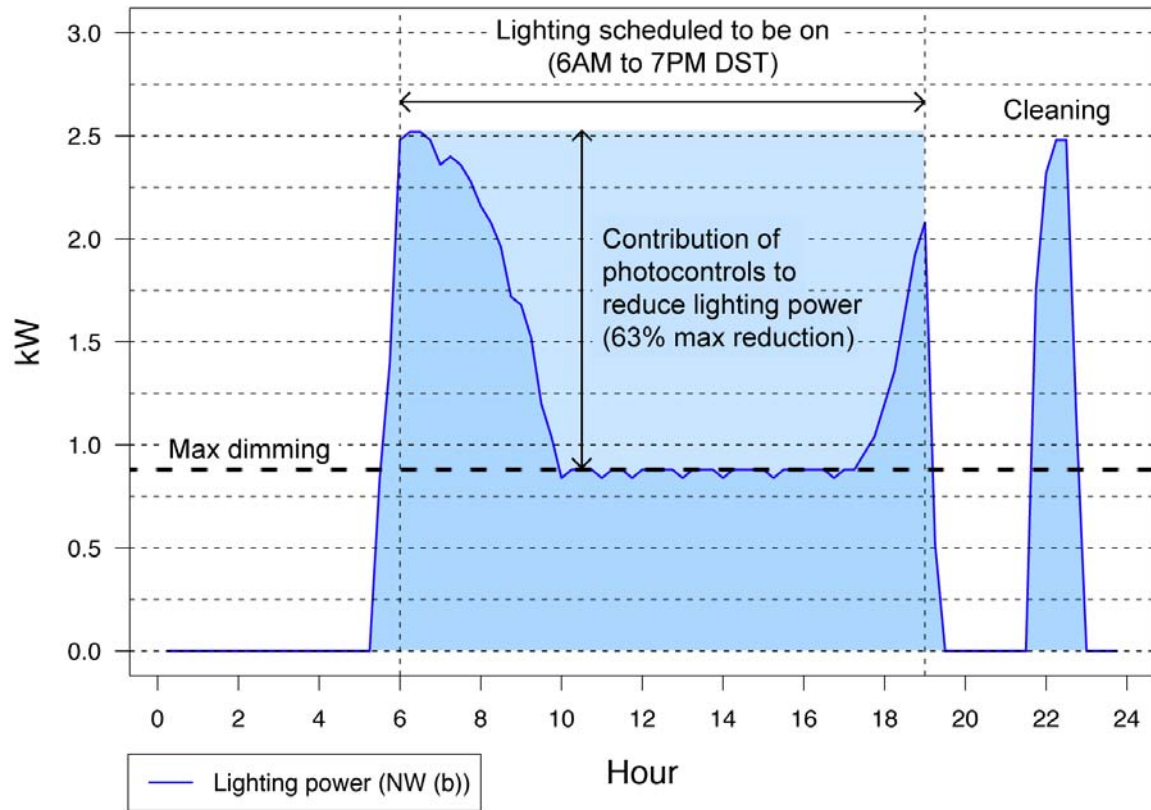
**Figure 10.5** Location of wall controls and photosensor for typical perimeter zone.



**Figure 10.6** Photosensors were mounted on a vertical wall surface at approximately 8-feet above the floor. The sensor has a global field of view and faces normal to the plane of the facade. The view angle that includes the facade encompasses approximately 43 degrees (vertically) as shown in the righthand diagram.

### 10.2.2.1 Automated control of lighting zones

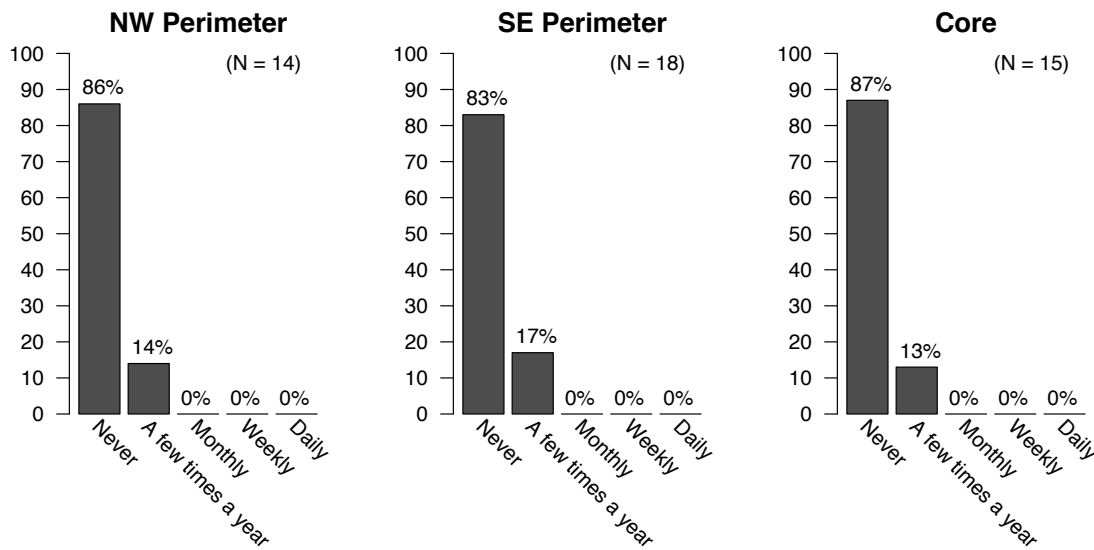
During the study, the overhead electrical lighting for all perimeter and core open-plan zones was turned on automatically in the morning at 6:00 AM and off in the evening at 7:00 PM DST each workday. An additional on/off cycle was often observed after working hours as the result of building staff switching lighting back on to performing routine cleaning. **Figure 10.7** provides an example profile of the lighting power for a typical NW perimeter lighting zone showing the contribution of photocontrols to the reduction in lighting power. The profile represents average lighting power over 15-minute intervals (the maximum sample rate allowed by the automated lighting control system). In **section 10.4.2**, lighting power is divided by floor area to determine the lighting power density (LPD) for each zone.



**Figure 10.7** Example daily lighting power profile for the NW perimeter zone (NW (b), 16<sup>th</sup> floor) during Phase 1 (July 26, 2010). The horizontal dashed line indicates the maximum possible dimming for the ballasts used.

### 10.2.2.2 Occupant control of lighting zones

The wall-mounted dimming controls allowed occupants to adjust the lighting setpoint of a given lighting zone. By adjusting the sliding switch on the wall control vertically, occupants could reduce the light output of the overhead electrical lighting on a continuous scale from 0 – 100%. For the perimeter zones controlled by photosensors, the wall control adjusted the maximum light output for the zone but did not disable the photosensor control. For example, if the wall control for a photocontrolled zone was set at 50%, then the luminaires would reduce light output by 50%, and make further reduction beyond 50% if daylight was sufficient. The state of the wall control was preserved when lighting was switched off by the lighting schedule and resumed in the AM of the following workday. Although wall controls for the lighting zone were available to occupants, results from the survey questionnaire (**figure 10.8**) show that the majority of participants from each zone (~85%) never used the wall controls and the remaining participants (~15%) only used the wall controls a few times a year.



**Figure 10.8** Frequency of overhead electrical lighting control usage for NW, SE and core participants.

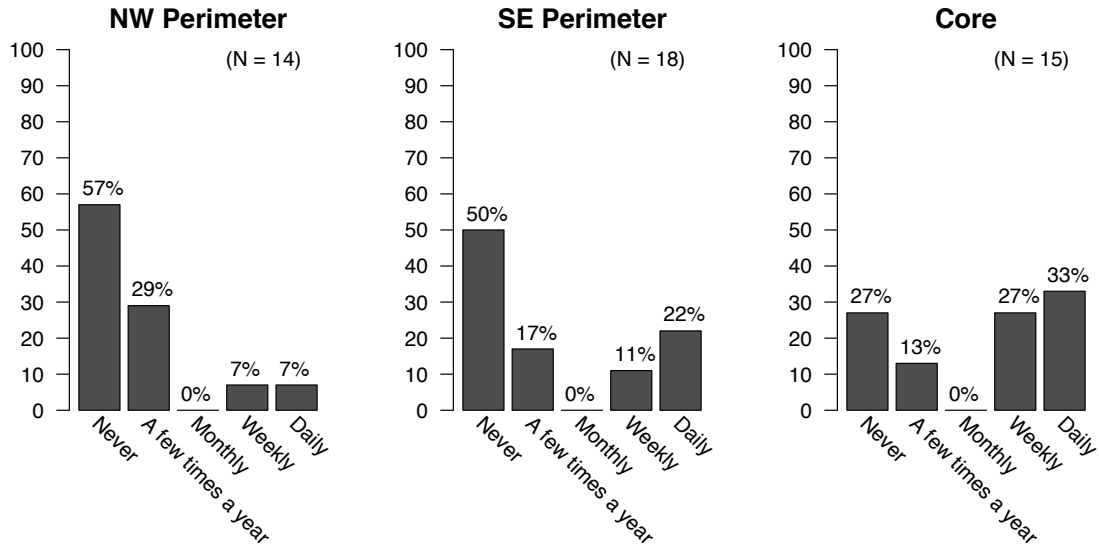
### 10.2.2.3 Occupant control of task lighting

In addition to overhead electrical lighting, each occupant workspace included a task light installed on the underside of a shelf adjacent to the occupant's computer monitor. This light is controlled manually by a switch mounted on the fixture.



**Figure 10.9** Location of task lighting installed in workspace partitions on NW (left) and SE (right) perimeter zones. Note occupant intervention for glare control in righthand image.

**Figure 10.10** presents task lighting usage results from the survey questionnaire. Overall, task lighting usage was infrequent. However, several participants who worked with the shades predominantly lowered were observed to turn on task lights during daylight hours. Survey comments and informal interviews of these participants confirmed that task lighting was primarily used to provide sufficient illuminance for task visibility. As shown in **figure 10.9**, for one participant the task light was a source of glare. The occupant addressed this issue by covering a portion of the fixture with paper to reduce the luminance of the lamps in the field of view.



**Figure 10.10** Frequency of task light usage for participants located in NW, SE and core zones.



**Figure 10.11** Examples of supplemental task lighting added to SE workspaces where the facade was shaded by *ad-hoc* opaque devices (e.g. bulletin boards).

In addition to the installed workspace task lighting, occupants who occluded the SE facade with *ad-hoc* opaque devices (bulletin boards) were observed to install additional task lighting (**figure 10.11**). Informal interviews of these occupants confirmed that the opaque devices were used to reduce visual discomfort from direct view of the solar disc in the morning and from excessive sky brightness while viewing a computer monitor. Interviews also confirmed that task lights were switched on during working hours to provide sufficient illuminance for task visibility.

### **10.3 Monitoring electrical lighting power**

#### **10.3.1 The automated lighting control system**

In the SFFB lighting zones are networked together to allow building lighting control and energy monitoring from a web-based graphical user interface (**figure 10.12**). Several limitations were found when obtaining energy data from the automated lighting control system. The primary limitation was related to the reliability of the routers used to report the lighting power for each zone. Often during the study, one or more lighting zones on a given floor would report “zero” power when direct observation of the lighting zone confirmed that lighting was on. This issue could only be resolved by locating and manually resetting the router associated with the zone. An additional limitation was the maximum allowable file size of each report, which was not explicitly stated by the automated lighting control system. For example, requesting all lighting zones for one floor over multiple weeks and at the maximum available sample rate (15 minute interval) would cause the operating system (Windows 95) to stall, requiring the computer and all associated applications to be restarted. Because access to the automated lighting control system and all trouble-shooting of lighting controls could only be performed by building management staff, limitations of staff time required that the study focus on data available from properly-reporting zones.

#### **10.3.2 Scope of monitoring**

During the study, lighting power data were obtained from individual lighting zones corresponding to the location of study participants. For example, during Phase 1 (July 12 to 29, 2010), conducted on the NW perimeter of the SFFB, data were obtained from NW perimeter lighting zones on floors 8, 15, and 16. Although obtaining lighting power data continuously for all zones on all 18 floors of the tower section would have provided a more complete assessment of the performance of the overhead electrical lighting system, the limitations noted above related to defining and generating reports and lack of access to the automated lighting control system interface made this task impractical. Therefore, the performance of each perimeter lighting zone was assessed in terms of two sets of multi-week data acquired over the 6-month study. Because the performance of lighting zones was not found to vary substantially between test phases, additional weeks of data are not expected to significantly change the results based on these subsets of data.

**Table 10.1** Scope of lighting zone monitoring

Zone	Monitored periods	Floors
NW Perimeter zones	Jul. 22 to Aug. 6	8, 15, 16
	Oct. 1 to Oct. 31	8, 14, 15, 16
	Nov. 1 to Dec. 16	8, 14, 15, 16
SE Perimeter zones	Aug. 2 to Sept. 24	8, 14, 15, 16
	Nov. 1 to Dec. 16	8, 15, 16
Core zones	Oct. 1 to Oct. 31	16
	Nov. 1 to Dec. 16	16
Whole floor	Jul. 22 to Aug. 6	16

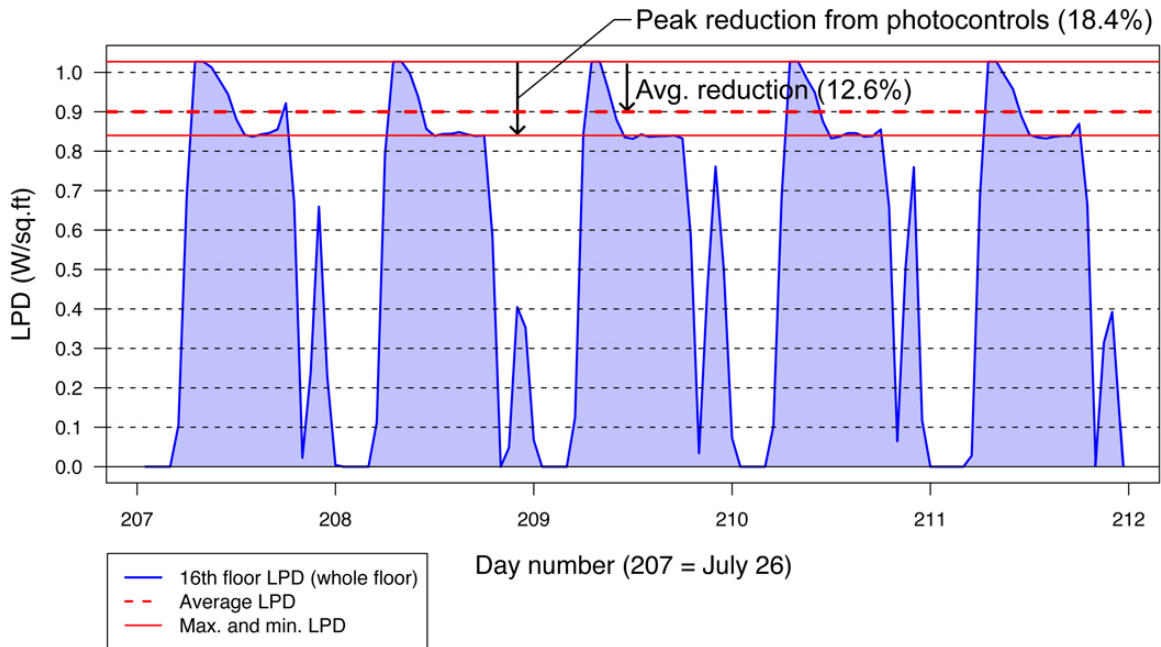
To assess the performance of the daylighting strategy from the perspective of electrical lighting energy minimization, the following sections focus on the individual photo-controlled perimeter zones (zones A,B,C,D, **figure 10.1**) from multiple floors and the open plan core zones (zones E,F,G,H, **figure 10.1**) from the 16th floor.

To report the amount of the electrical lighting load that was reduced by daylight, the “whole floor” lighting power for the 16th floor is also presented. The 16th floor varies from the other floors of the tower section in that the floor plan includes 6 bays of open plan office in the core section. In comparison, the core zones of the other floors contain a mixture of “cabin” offices and storage space that was found to be unoccupied during significant periods of the study. Although this resulted in lower overall energy consumption for these floors, the variation in “whole floor” energy consumption was the result of programmatic differences and patterns of occupancy rather than the effective use of daylight. Therefore, the results for “whole floor” energy focus on the 16th floor because it contains open plan offices in the core that were consistently occupied during the study and that routinely required illuminance either by electrical lighting or daylighting. Lighting power data were acquired at a 15-minute sample rate for perimeter lighting zones and at an hourly sample rate for “whole floor” lighting power. In both cases, the raw data represent the average lighting power over the sample interval.

## 10.4 Response of the overhead electrical lighting system to available daylight

The following sections are organized as responses to the specific research questions addressing the broad issue of daylighting as a strategy for reducing electrical lighting energy consumption.

### 10.4.1. Are photocontrols working effectively to reduce electrical lighting power in response to daylight at the scale of an entire floor?



**Figure 10.12** “Whole-floor” effective LPD for the overhead electrical lighting for one workweek (July 26 – 30, 2010) for the 16th floor. Average and minimum effective LPD are calculated from data acquired between 6AM – 7PM DST.

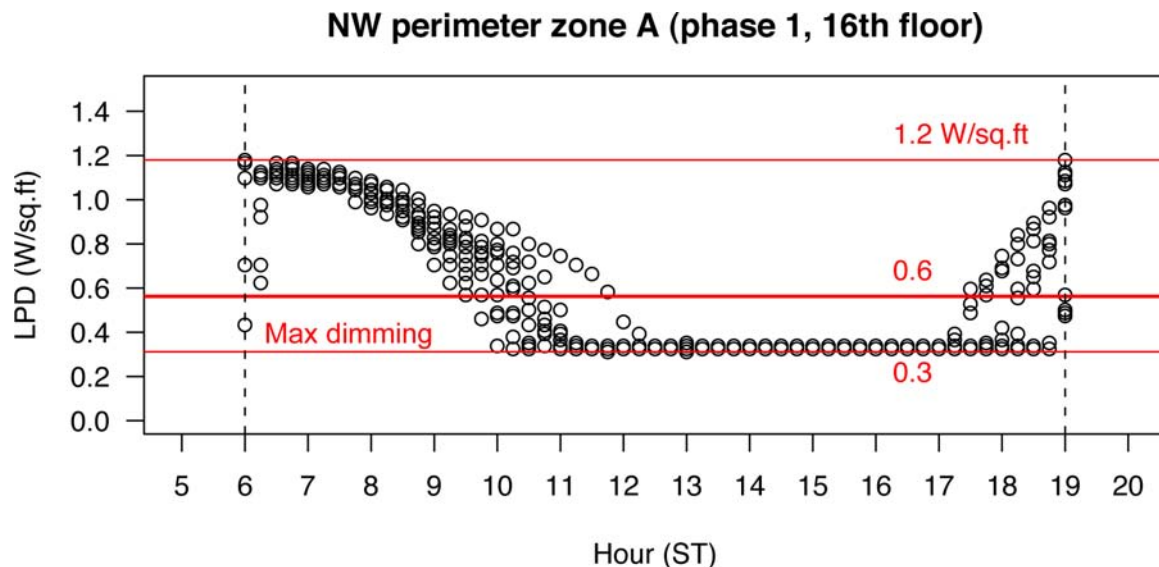
**Figure 10.12** shows the 16th floor “whole-floor” LPD for an example week with predominantly clear sky conditions (July 26 to 30, 2010). The LPD was calculated by dividing the average hourly lighting power for all electrical lighting zones by the gross area of the floorplate (excluding the elevator and stair core). Average and minimum LPD are calculated from 6AM – 7PM DST. The figure shows that the average LPD for the floor is below the maximum LPD allowed based on the California energy code “complete building” compliance method ( $1.0 \text{ W/ft}^2$  (installed) +  $0.2 \text{ W/ft}^2$  (task); Title-24 (2005)). However, the contribution of photocontrols accounts for a relatively small reduction in whole-floor effective LPD, and task lighting is not taken into account in the monitored results show in **figure 10.12**. From a maximum effective LPD of  $1.03 \text{ W/ft}^2$ , the maximum reduction achieved by photocontrols was (18.4%) and the average daily LPD reduction (during working hours 6AM – 7PM DST) was 12.6%. This was due in part to the fact that only the perimeter lighting zones were found to be controlled by



photosensors. The core lighting zones were not controlled by photosensors and examination of core lighting energy data showed that the lighting power remained at 100% for the duration of the lighting schedule. Core zones were never found to have been switched off by occupants via wall controls or by occupancy sensors.<sup>10</sup> Consequently, at the scale of an entire floor, the contribution of photocontrols is significantly lower than the 26% reduction anticipated during design.

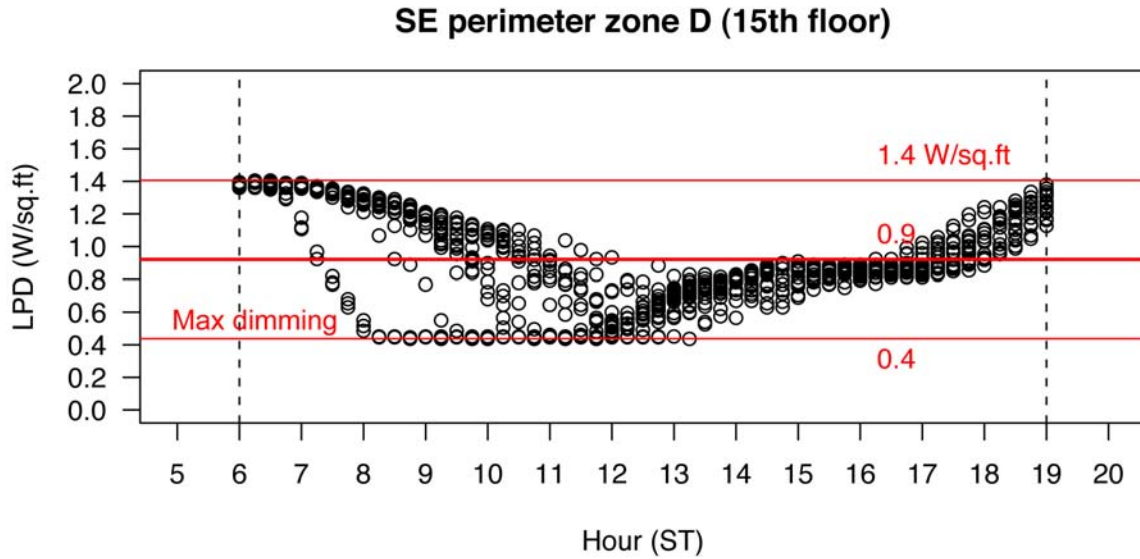
#### 10.4.2 Are photocontrols working effectively to reduce electrical lighting power in response to daylight at the scale of individual perimeter zones?

To examine LPD specifically for open-office zones, the average lighting power (over a 15 minute interval) for each open-office lighting zone was divided by zone floor area. **Figure 10.13** presents the daily variation in LPD for one NW perimeter lighting zone (zone A, 16th floor) from July 12 to August 6, 2010. Horizontal red lines indicate the maximum, minimum and average (bold) LPD over the monitored period. **Figure 10.14** presents the daily variation in LPD for one SE perimeter lighting zone (zone D, 15th floor) from August 2 to September 24, 2010.



**Figure 10.13** Daily variation in LPD for NW perimeter lighting zone B (16th floor) from July 12 to August 6, 2010.

<sup>10</sup> Review of electrical lighting plans and observation revealed that the open plan lighting zones were not controlled by occupancy sensors.



**Figure 10.14** Daily variation in LPD for SE perimeter lighting zone D (15th floor) from August 2 to September 24, 2010.

As described in the scope of monitoring (**section 10.3.2**, photocontrolled perimeter lighting zones from multiple floors (**figure 10.1**, zones A,B,C,D) and core lighting zones from the 16th floor (**figure 10.1**, zones E,F,G,H) were analyzed over several monitoring periods between July and December 2010. Results for the photocontrolled perimeter lighting zones are presented in the following tables (**10.2** and **10.3**), which are organized by orientation (i.e. NW, SE). The average LPD of the zone (Avg.) and the average reduction in LPD (% Dim) between 6AM and 7PM DST are used as indicators of performance. “NA” indicates periods where data was unavailable due to loss of communication with the network routers (leading to an inability to generate reports).

**Table 10.2** Lighting power indicators for NW perimeter lighting zones

Zone name	Jul. 22 to Aug. 6			Oct. 1 to Oct. 31			Nov. 1 to Dec. 16		
	LPD (W/ft <sup>2</sup> )			LPD (W/ft <sup>2</sup> )			LPD (W/ft <sup>2</sup> )		
	Max.	Avg.	% Dim	Max.	Avg.	% Dim	Max.	Avg.	% Dim
16 A	1.2	0.6	50%	NA	NA	NA	NA	NA	NA
16 B	0.9	0.4	56%	0.9	0.5	44%	NA	NA	NA
15 A	1.1	0.5	55%	1.2	0.6	50%	1.2	0.6	50%
15 B	1.2	0.6	50%	1.2	0.6	50%	0.9	0.5	44%
14 A	NA	NA	NA	1.1	0.7	36%	NA	NA	NA
14 B	NA	NA	NA	1.1	0.5	55%	NA	NA	NA
08 A	1.2	0.6	50%	1.1	0.5	55%	NA	NA	NA
08 B	1.2	0.6	50%	1.2	0.6	50%	NA	NA	NA
	Avg.	0.6	52%		0.57	49%		0.55	47%

**Table 10.3** Lighting power indicators for SE perimeter lighting zones

Zone name	Aug. 2 to Sept. 24			Nov. 1 to Dec. 16		
	LPD (W/ft <sup>2</sup> )			LPD (W/ft <sup>2</sup> )		
	Max.	Avg.	% Dim	Max.	Avg.	% Dim
16 C	1.4	0.9	36%	NA	NA	NA
16 D	0.9	0.8	11%	0.9	0.8	11%
15 C	1.2	1.2	0%	1.4	0.9	36%
15 D	1.4	0.9	36%	1.4	1	29%
14 C	1.4	1.4	0%	NA	NA	NA
14 D	1.4	1.1	21%	NA	NA	NA
08 C	1.1	1.1	0%	1.3	1.3	0%
08 D	1.4	0.9	36%	NA	NA	NA
	Avg.	1.0	17%		1.00	19%

**Tables 10.2 – 10.3** show significant differences in performance between the NW and SE perimeter lighting zones using average LPD (Avg.) and average percent dimmed from installed power (% Dim) as indicators. For the NW zones, all zones monitored were found to reduce electrical lighting power in response to daylight on a daily basis, and the average daily percent reduction was similar between zones (min = 36%, max = 56%, average (all zones) = 49%). Although data for all zones were not available for all three monitoring periods, the available data show similar performance across monitoring periods (average = 52%, 49%, 47% respectively). Overall, the contribution of photocontrols to LPD reduction for the NW zones exceeded that anticipated by Title-24 (2005) lighting power adjustment factors (30% reduction) or used in the EnergyPro simulations (30% reduction) run to predict whole-building energy consumption of the SFFB. As a result of dimming, the installed LPD (1.2 W/ft<sup>2</sup>) was reduced to an average

effective LPD of approximately  $0.6 \text{ W/ft}^2$  during the interval when lighting was scheduled to be on (6AM – 7PM DST). The average LPD achieved for the NW zones was found to be significantly lower than the maximum allowed LPD for open-plan offices by ASHRAE 90.1, 2004 of  $1.1 \text{ W/ft}^2$  using the space-by-space method.

In comparison to the NW zones, photocontrols were found to have less of an influence on effective LPD for the SE zones for two reasons. First, several of the SE zones were found to have photosensor control disabled throughout one or more monitoring periods. As shown in **table 10.3**, this resulted in an average LPD very close to the maximum LPD. However, these zones were found to have lower maximum LPDs ( $1.1 \text{ W/ft}^2$ ) compared to the zones where photocontrols were enabled ( $1.4 \text{ W/ft}^2$ ). This is explained by how the wall-control switch is used to override the default behavior of the lighting zone control. If the dimmer switch is set in an intermediate position, (and if photocontrols have been disabled), then the light level will remain constant throughout the day (and following days). The second reason appears to be the state of shading devices on the SE facade. Because the zones on the NW facade do not include roller shades on the upper two rows of windows (with the exception of floor 8), the photosensors on the NW consistently view a portion of the facade that remains unshaded. In contrast, the SE facade includes both roller shades on all windows as well as a solar control film and exterior perforated metal screen (50% openness at normal incidence) that further reduce visible light transmittance. Based on an analysis of the positioning of shading on the SE facade (Chapter 5), upper shades were consistently lowered and vision window shades were consistently found to be at least partially lowered. Therefore, for the SE zones where photocontrols were enabled, lighting power was reduced in response to daylight, however the average percent reduction (6AM – 7PM DST) was lower (min = 11%, max = 36%, average of all enabled zones = 27%) compared to the NW zones.

With less effective contribution from photocontrols as well as a relatively smaller zone floor area (**figure 10.1**), average LPD was found to be significantly higher for the SE perimeter lighting zones compared to the NW zones. Over both monitoring periods, (Aug. 2 - Sept 24 and Nov. 1 - Dec. 16), the average LPD for all monitored SE zones was  $1.0 \text{ W/ft}^2$ . This result is comparable to the maximum LPD allowed by Title-24 (2005) for installed lighting in open-offices *without* photocontrols ( $1.0 \text{ W/ft}^2$ ). For zones where photocontrols were enabled, the average LPD was only slightly lower ( $0.9 \text{ W/ft}^2$ ).

### 10.4.3 Is lighting power reduced in response to daylight in open-plan core zones?

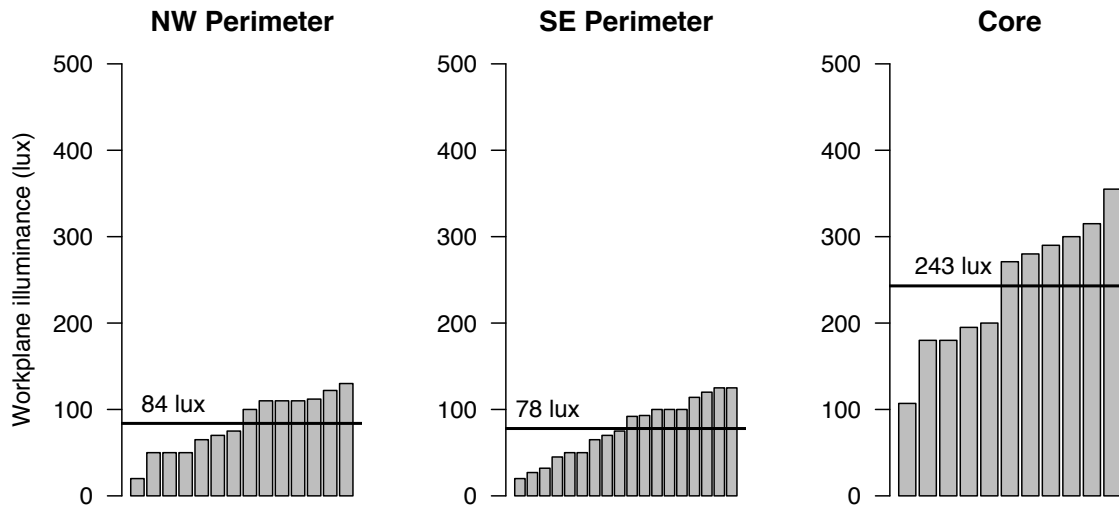
**Table 10.4** presents the average LPD for the open plan core zones (E,F,G,H, **figure 10.1**) from the 16th floor. Although occupants in these zones had access to wall-controls that would enable the lighting to be dimmed or switched off during periods of the day with sufficient daylight, the analysis of each zone showed that lights were never manually dimmed (or turned off) during either of the monitoring periods. As a result of the greater density of lighting fixtures in these zones as well as the boundaries drawn to define the core zones (**figure 10.1**), the average LPD ( $2.0 \text{ W/ft}^2$ ) is significantly higher than the NW and SE perimeter zones and above the current (2011) maximum LPD allowed for open-offices in Title 24 (2005) ( $1.0 \text{ W/ft}^2$ ).

**Table 10.4** Average lighting power for core lighting zones

Zone name	Oct. 1 to Oct. 31	Nov. 1 to Dec. 16
	LPD ( $\text{W/ft}^2$ )	LPD ( $\text{W/ft}^2$ )
	Avg.	Avg.
16 E	1.9	1.9
16 F	2.1	2.1
16 G	2.1	2.1
16 H	1.7	1.7
	Avg.	2.0

#### 10.4.4 What is the contribution of the overhead electrical lighting system to workplane illuminance?

This section focuses on the contribution of overhead electrical lighting to illuminance of the workplane. Workplane illuminance levels are a metric persistently used by the electrical lighting industry (IESNA) to assess lighting quality. **Figure 10.15** shows the illuminance level recorded at each participant's desktop polling station during the evening (i.e. no daylight contribution) with task lights off and when overhead electrical lighting was at full output. The horizontal line indicates the average illuminance level among all polling stations in each zone. As described in Chapter 4, polling stations were placed adjacent to the participant. Therefore this measure gives a general representation of the illuminance level delivered to the workplane, although some variation should be expected due to the specific location of each polling station at each workspace. The results show that in general, the electrical lighting in both NW and SE perimeter zones was significantly lower than (IESNA, 2005) recommended workplane illuminance level (300 lux) for open-offices with primarily computer-based tasks. The levels in the core zones were significantly higher, however this is due to a greater concentration of lighting fixtures and corresponds to that zone's higher LPD.



**Figure 10.15** Horizontal workplane illuminance from overhead electrical lighting measured at the polling station during the evening cleaning cycle when no daylight was present and task lighting was switched off.

### 10.4.5 How efficient is the overhead electrical lighting system in terms of workplane illuminance delivered per watt?

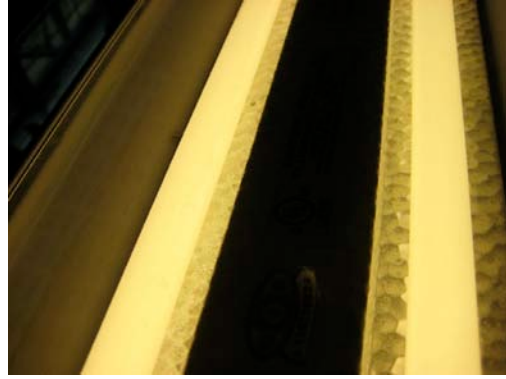
To assess the level of illuminance delivered in relation to the power required, an “efficiency” metric of  $(\text{W}/\text{ft}^2) / 100 \text{ lux}$  was used after (Field et al., 1997). For example, if  $1.2 \text{ W}/\text{ft}^2$  is used to deliver 84 lux (on average) in the NW perimeter lighting zones, then the corresponding efficiency is  $(1.2 \text{ W}/\text{ft}^2 / 84) * 100 = 1.43 (\text{W}/\text{ft}^2) / 100 \text{ lux}$ . **Table 10.5** presents the efficiency results for the NW, SE and core zones. By viewing the performance of the electrical lighting system in terms of efficiency rather than power, the performance is revealed to be significantly worse than most conventional overhead direct/indirect fluorescent lighting systems. For comparison, the IESNA states that an average workplane illuminance of 350 lux can be achieved with a LPD of 1.06 using linear direct/indirect overhead fixtures<sup>13</sup>, leading to a “industry standard” efficiency of approximately  $0.3 (\text{W}/\text{ft}^2) / 100 \text{ lux}$ . Compared to this baseline, the fixtures in the SE perimeter zone require approximately 6 times the power of an industry standard overhead fluorescent lighting system to deliver the same level of illuminance to the workplane.

**Table 10.5** Efficiency for each zone type

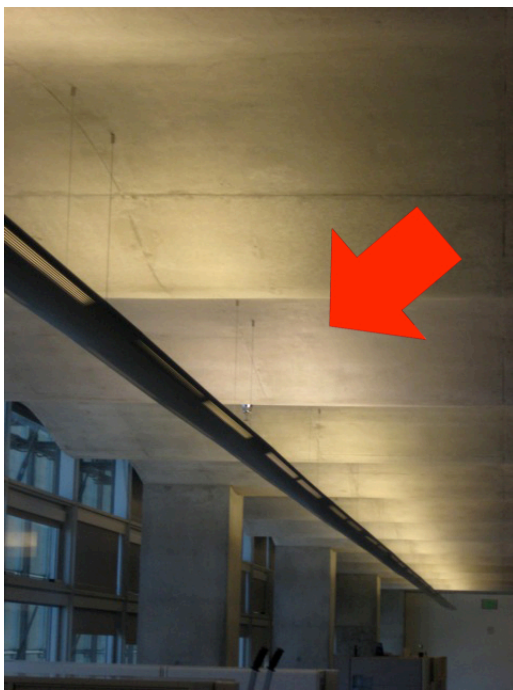
	Efficiency $(\text{W}/\text{ft}^2) / 100 \text{ lux}$
NW perimeter zones	1.42
SE perimeter zones	1.79
Core zones	0.82

Based on field observation of a number of overhead fixtures, one reason for the lighting system’s relatively low efficacy is dust accumulation on the reflective surfaces of the luminaires as well as the lamps themselves. **Figure 10.16** illustrates the level of dust accumulation and **figure 10.17** illustrates the effect of dust on the color of the light output. Another contributor to reduced efficiency is the low visible light reflectance of the concrete ceiling (~40% visible light reflectance is typical for standard concrete), which is used as a reflecting surface by the direct/indirect luminaires.

<sup>13</sup> <http://lpd.ies.org/cgi-bin/lpd/LPDSpace.pl?sid=39&stxt=Office%20-%20open%20plan> (accessed 10/10/2011)



**Figure 10.16** View of dust accumulation on fluorescent lamps and reflectors.



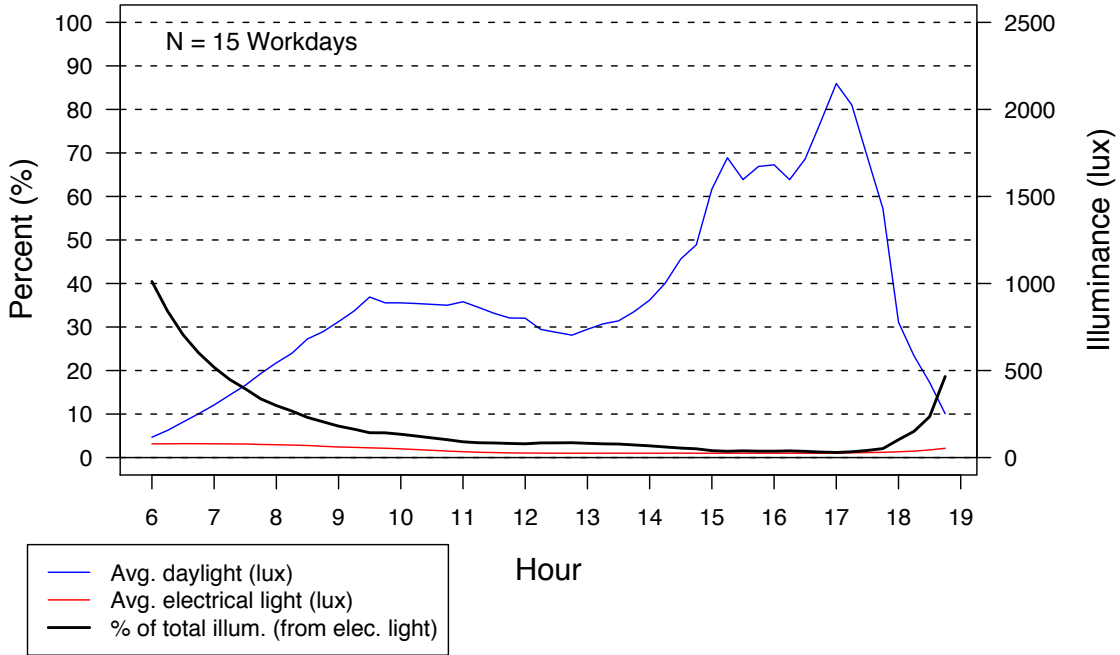
**Figure 10.17** View of SE perimeter lighting zone luminaires showing a single luminaire that has been cleaned of dust and re-lamped.



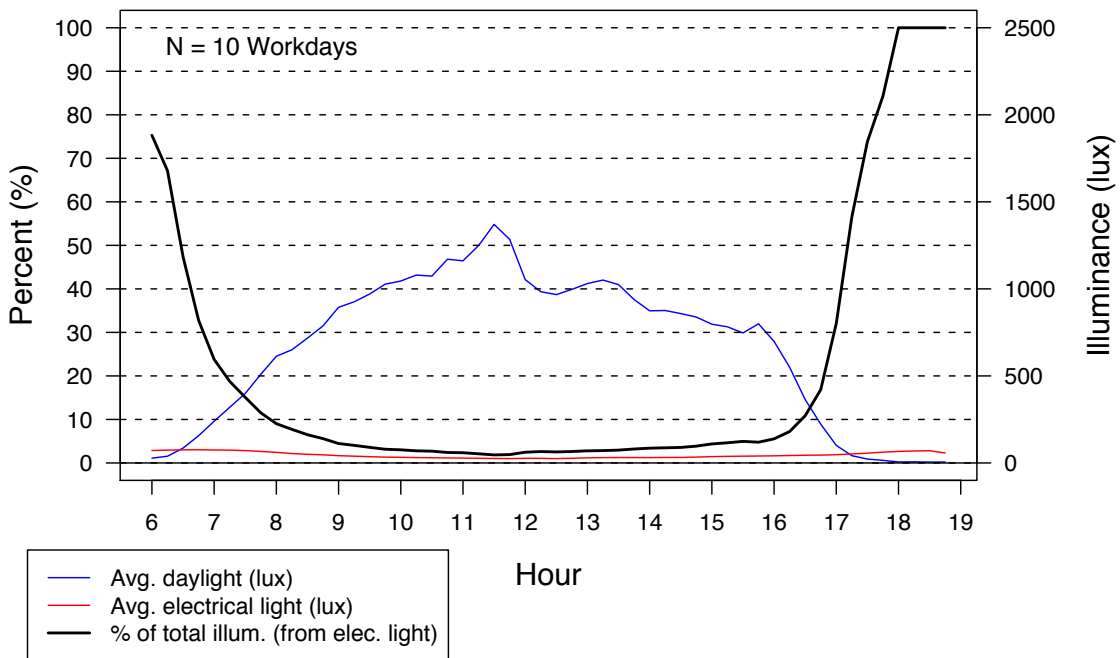
#### **10.4.6 What is the contribution of overhead electrical lighting to total illuminance at the workplane?**

**Figures 10.18 – 10.23** present an approximation of the contribution of the overhead electrical lighting system to the total illuminance measured at the polling station. For each figure, the daylight contribution (blue) and electrical light contribution (red) are shown as the average from all polling stations at each time interval. The percent-contribution of electrical lighting to total illuminance (black) is calculated as the ratio of electrical lighting to total measured workplane illuminance (electrical lighting is approximated using the method described in Chapter 4).

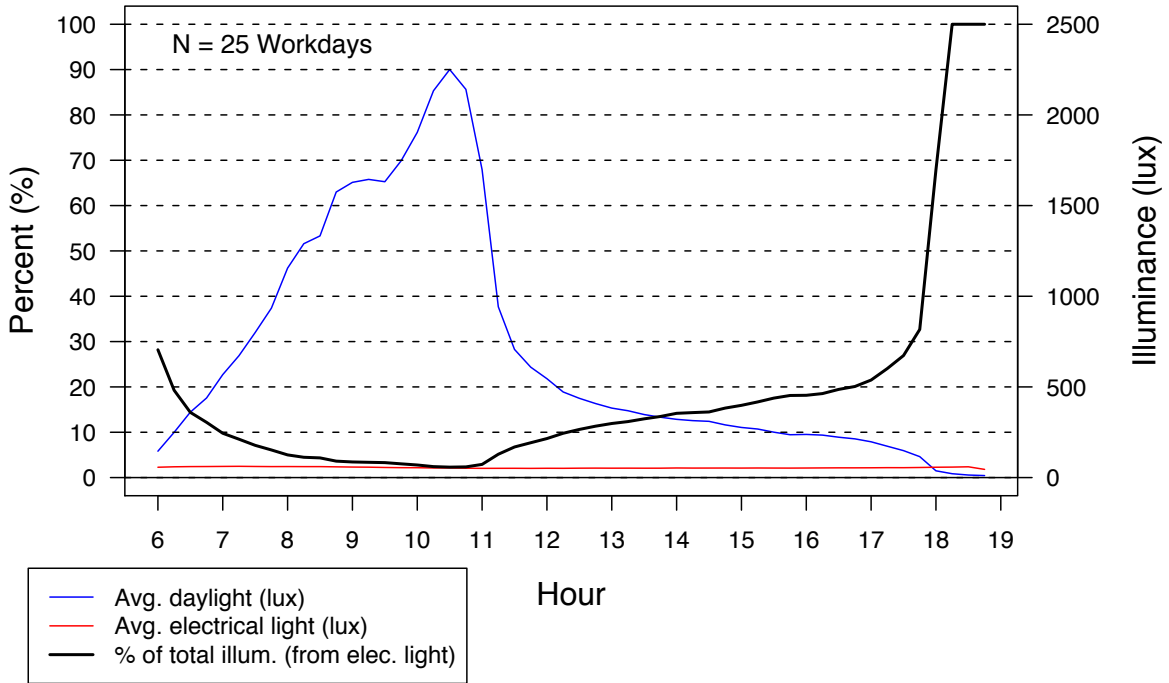
**Figures 10.18 – 10.23** show that workspaces located in the core received significantly lower levels of daylight compared to workspaces located in the perimeter zones: approximately 50 lux on average during phase 3 (Oct. 18 to 29) and less than 50 lux during Phase 6 (Dec. 6 to 17). In addition, where the electrical lighting system in the perimeter zones was found to contribute to less than 10% of total workplane illuminance during the majority of the day on average, the electrical lighting system in the core zones was found to contribute to between 80% to 100% of total workplane illuminance on average. Therefore, because participants responded to a predominantly “daylight stimulus” in the perimeter zones and a predominantly “electrical light stimulus” in the core zones, the analysis proceeds with data from the perimeter zones to identify the levels of daylight illuminance considered to be sufficient to work without overhead electrical lighting.



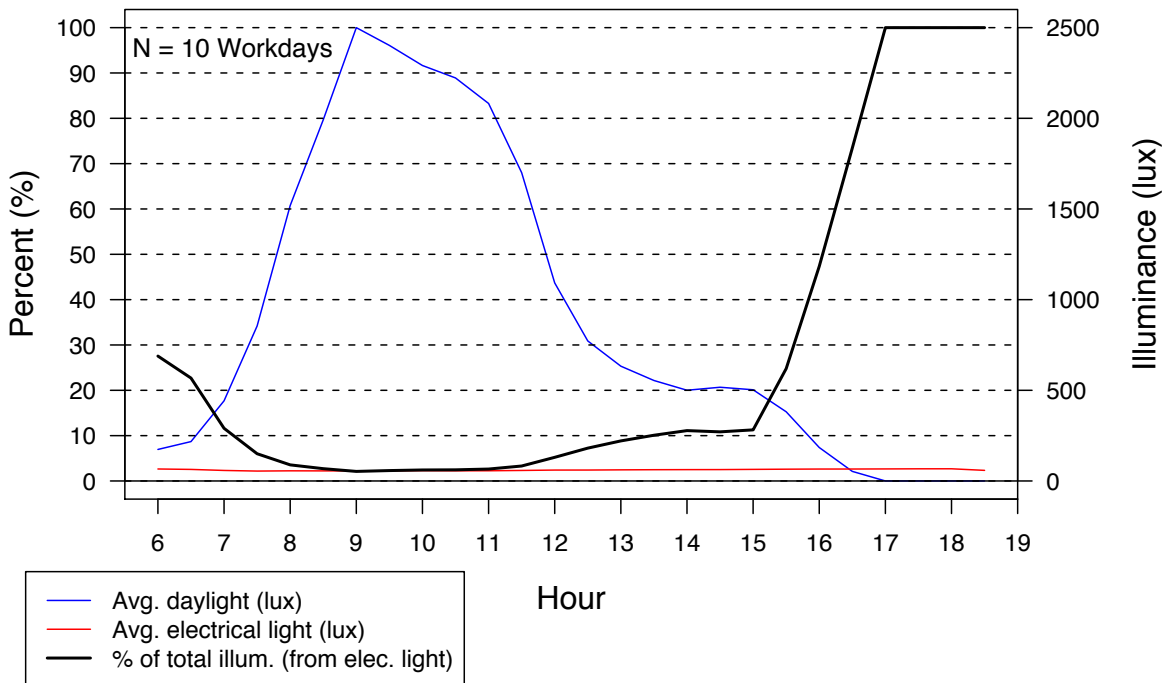
**Figure 10.18** Average electrical illuminance as a percentage of total illuminance measured at the polling station. NW perimeter zone, Phase 1 (N = 11) participants.



**Figure 10.19** NW perimeter zone, Phase 4 (N = 11) participants.



**Figure 10.20** SE perimeter zone, Phase 2 (N = 14) participants.



**Figure 10.21** SE perimeter zone, Phase 5 (N = 9) participants.

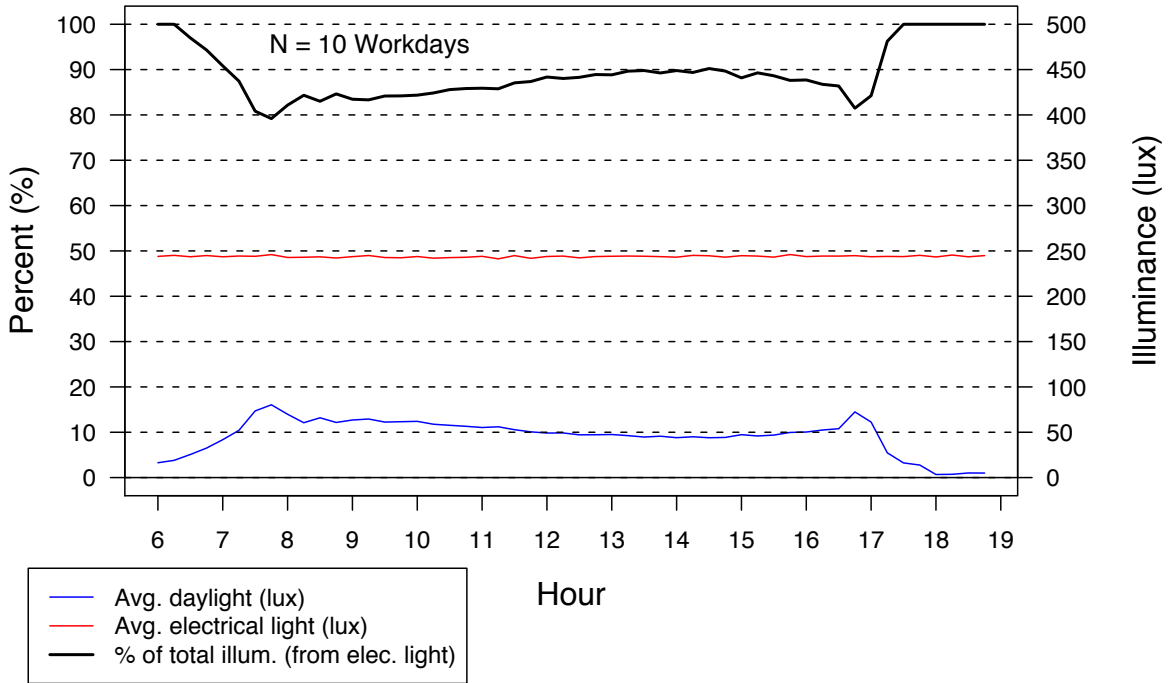


Figure 10.22 Core zones, Phase 3 (N = 11) participants.

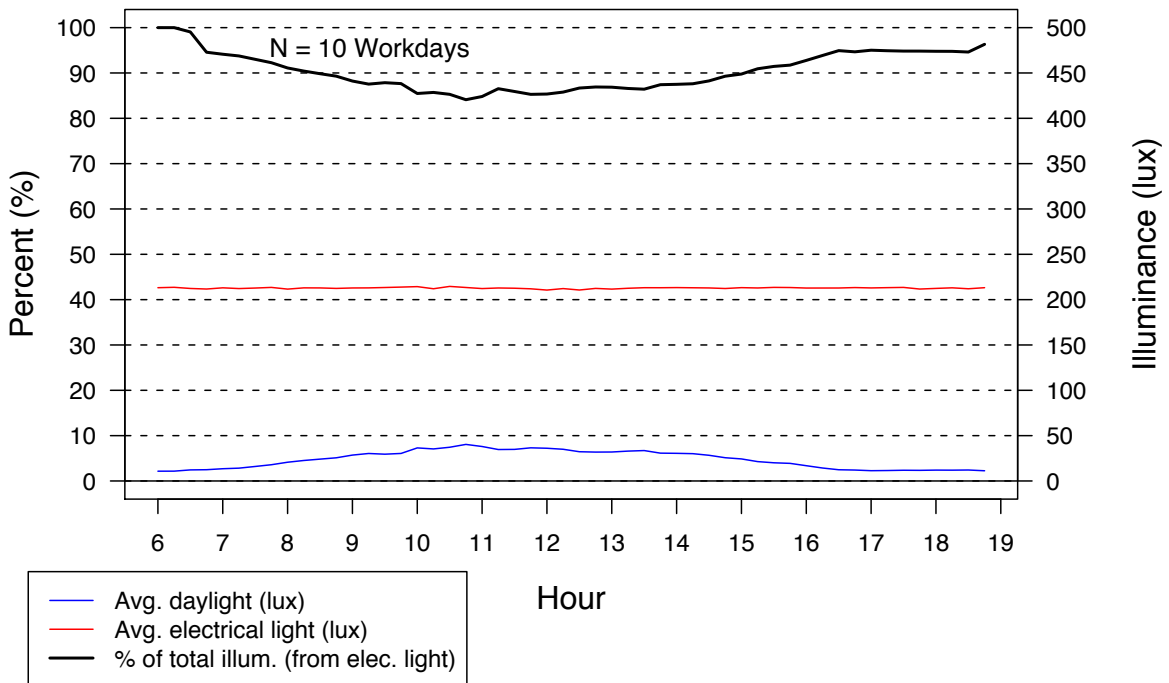


Figure 10.23 Core zones, Phase 6 (N = 8) participants.

#### 10.4.7 What is the energy consumption of the overhead electrical lighting system?

**Table 10.6** summarizes the average daily energy consumed by each zone type (i.e. NW, SE, core) by taking the average LPD (from 6AM – 7PM DST) for all zones within each type and multiplying by the 13 hours of scheduled lighting. This method does not account for the additional energy that was used in the evening during the cleaning cycle. To create an approximate estimate of the daily overhead electrical lighting energy consumed “per person”, the area of each zone was divided by (200 ft<sup>2</sup>), which corresponds to a typical estimate for gross floor area required per person in commercial open office space planning.

**Table 10.6** Average daily electrical lighting energy consumption by zone and (per person)

Zone	Area (ft <sup>2</sup> )	Baseline T-24 2005 (1W/ft <sup>2</sup> )		Monitored (6AM - 7PM DST)	
		(kWh / day)	(kWh / day) / person*	(kWh / day)	(kWh / day) / person*
NW	2949	38.3	2.6	21.1	1.4
SE	2013	26.2	2.6	27.2	2.7
Core	955	12.4	2.6	24.8	5.2

The results presented in **table 10.6** show that the energy consumption per person ranges from 1.4 kWh to 5.2 kWh per day depending on zone location. In the NW perimeter zone, this level of energy consumption is roughly equivalent to one conventional 100 W incandescent light bulb per person (burning continuously for 13 hours each day (and roughly equivalent to six 100 W bulbs per person in the core zones). Given that the overhead electrical lighting system was supplemented by daylight for the majority of the 13-hour workday used in the analysis (6AM – 7PM DST), and given that contribution of the electrical lighting system to workplane illuminance was found to be relatively low compared to industry recommended levels (e.g. 300 – 500 lux for offices spaces, IESNA), subjective assessments of daylight sufficiency from polling station data were examined to determine what fraction of daily energy consumed by the electrical lighting system was perceived as necessary by occupants to work comfortably and what fraction was unnecessary due to the transmission of sufficient daylight.

## 10.5 Occupant assessment of daylight sufficiency

The following sections introduce occupant subjective assessment of interior daylight sufficiency. Occupant subjective assessments are analyzed to examine the relationship between total energy consumed and energy consumed when occupant subjective assessments indicated the perception that daylight was sufficient to work comfortably without overhead electrical lighting.

### 10.5.1 What fraction of electrical lighting energy was consumed when occupants perceived daylight levels to be sufficient to work comfortably without overhead electrical lighting?

To address this question, subjective responses to polling station data were examined. The polling station survey included the question:

(Q7) “*Could you work comfortably with the electric lights turned OFF right now?*”

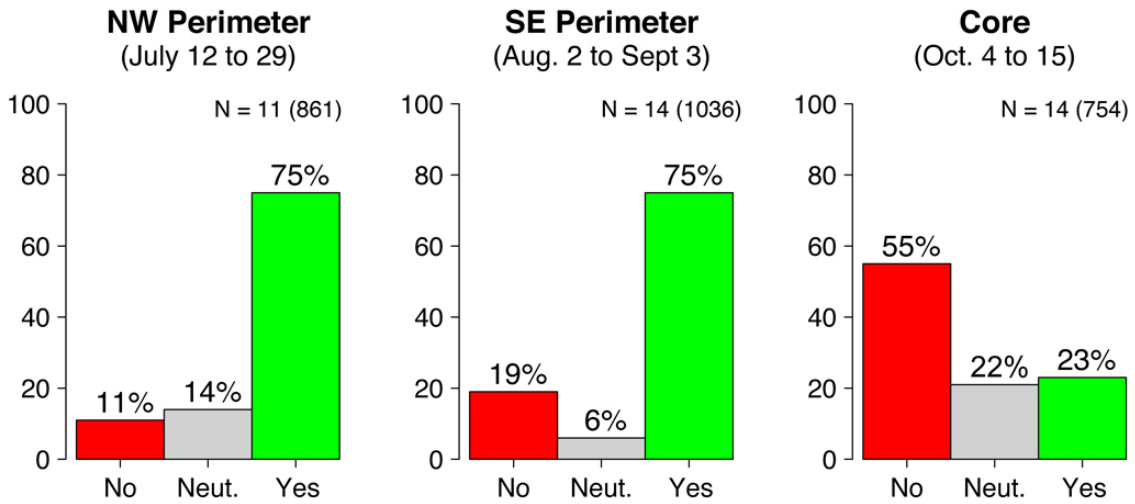
*YES, there is enough daylight to turn electric lights OFF.*

*Don't know (neutral)*

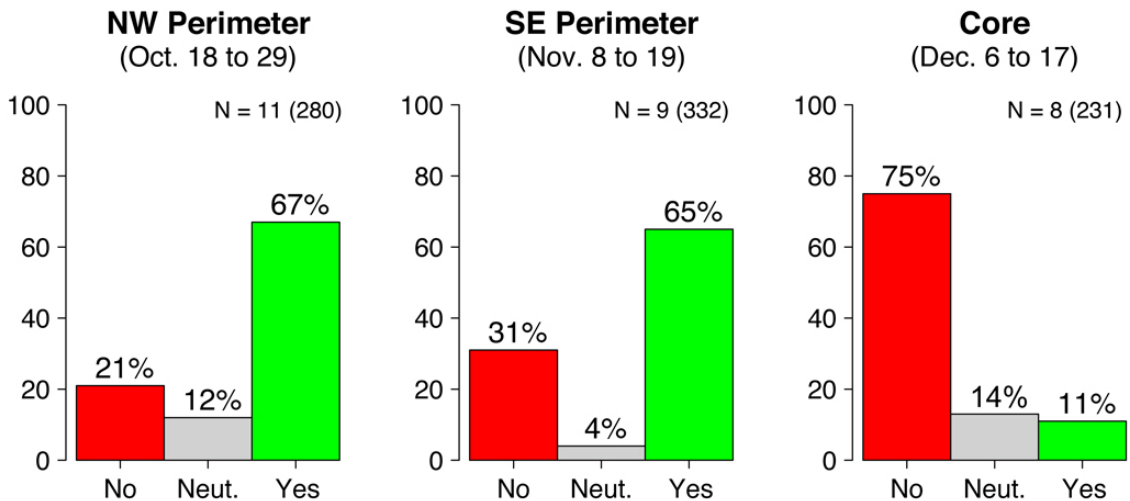
*NO, there is not enough daylight to turn electric lights OFF.*

Participants were instructed at the beginning of the study that “electric lights” referred to the overhead fluorescent lights only (i.e. not task lights). Therefore, participants were instructed that they could respond with “YES” while still working with task lighting turned on. **Figure 10.25** presents the aggregate responses to this question for Phases 1-3 of the study, which correspond to the initial phases for the NW, SE, and core zones respectively. **Figure 10.26** presents results for Phases 4-6, which represent the “follow-up” phases conducted for each zone. For each bar graph, “N” represents the number of participants, followed by the total number of responses to the question among all participants (in parenthesis).

**(Q7) Could you work comfortably with the electric lights turned OFF right now?**



**Figure 10.24** Aggregate subjective responses to (Q7) from polling stations for Phases: 1, 2, 3.



**Figure 10.25** Aggregate subjective responses to (Q7) from polling stations for “follow-up” Phases: 4, 5, 6.

The majority of subjective responses for the perimeter zone groups (65% to 75%) indicate that participants perceived sufficient levels of daylight for the electrical lighting to be turned off. In contrast, the majority of responses from the core zones indicate the perception of insufficient levels of daylight. Broad comparisons between the initial and follow-up test phase for each zone (e.g. NW perimeter zone (July 12 to 29 vs. Oct. 18 to 29)) suggest that subjective assessments of daylight sufficiency may change slightly in response to seasonal changes in daylight availability. For example, all three zones show a decrease in the percentage of total responses that indicate the perception of sufficient

daylight to work comfortably with the electric lighting turned off (8%, 10%, 12% decreases for NW, SE, and Core groups respectively). Based on the results from Chapter 4 that show subjective responses were distributed relatively evenly over each workday, the results from **figures 10.25** and **10.26** can be broadly interpreted as representative of the periods of time during occupied hours for each test phase where daylight conditions were perceived to be sufficient or insufficient for overhead electrical lighting to be turned off.

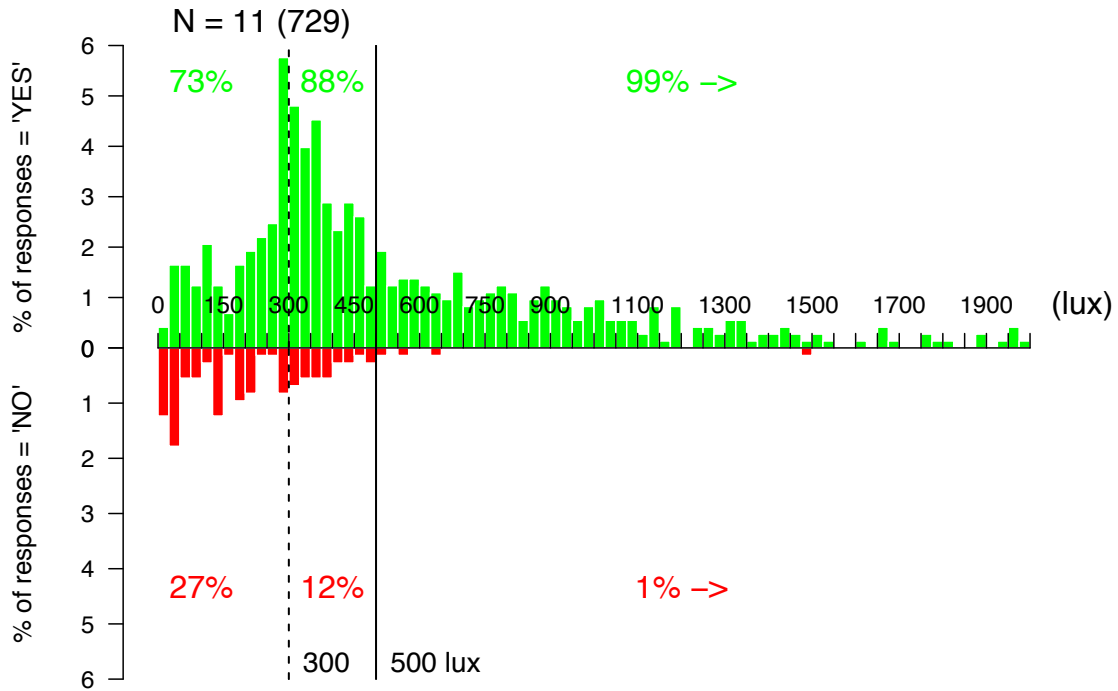
**Figures 10.24** and **10.25** suggest that the NW and SE perimeter zones could operate without the contribution of overhead electrical lighting for a significant fraction of operating hours based on the perception of occupants. And, in contrast, in the core zones daylight was rarely perceived in quantities sufficient to eliminate the use of overhead electrical lighting. To investigate the relationship between occupant perceptions of daylight sufficiency (Q7) with daylight levels achieved in occupant workspaces, subjective responses were compared to simultaneous measures of workplane illuminance recorded at the polling station. The objective of this approach was to assess the illuminance conditions associated with occupant perception of sufficient levels of ambient lighting. The assessment does not report occupant perception of the conditions associated with the need for task lighting. Therefore, in the following discussion, the discussion of the potential to reduce electrical lighting energy through the use of daylight refers to minimizing use of the overhead electrical lighting system. Although further reductions in energy use can theoretically be achieved through the elimination of, (or minimization of) the need for task lighting, this issue was not investigated in the scope of this study. Because the ambient lighting perceived by occupants in both perimeter and core zones included a combination of daylight, overhead electrical lighting, (and, in some cases, task lighting), perceptions of daylight sufficiency are compared to simultaneous measures of “total” workplane illuminance (i.e. daylight and overhead electrical lighting). The contribution of task lighting to the measurement is considered to be negligible, due to the placement of the polling stations in a location in each workspace where the sensor was away from the light output from task lighting. Therefore, the measure of total workplane illuminance captured (as much as possible) the ambient lighting condition of the workspace. This method is problematic in that it compares a subjective assessment of daylight sufficiency to a physical measure that includes both daylight and overhead electric lighting. However, due to the relatively low percentage contribution of overhead electrical lighting to total illuminance levels measured in the perimeter zone workspaces (from <1% to 20% during most occupied hours (**figures 10.18 - 10.21**)), this approach was considered acceptable for analysis of subjective assessments recorded in the perimeter zones. This method was not considered acceptable for core zones due to the fact that overhead electrical lighting represented over 80% of total workplane illuminance (**figure 10.22, 10.23**).

**Figures 10.26 - 10.29** are histograms that compare occupant perception of daylight sufficiency (Q7) to concurrently measured workplane illuminance for the NW and SE perimeter zones. Each figure represents data in aggregate for one Phase (e.g. NW, July 12 to 29). Data are divided into workplane illuminance “bins” in increments of 25 lux, where the responses to the polling station question: “*Could you work comfortably with*

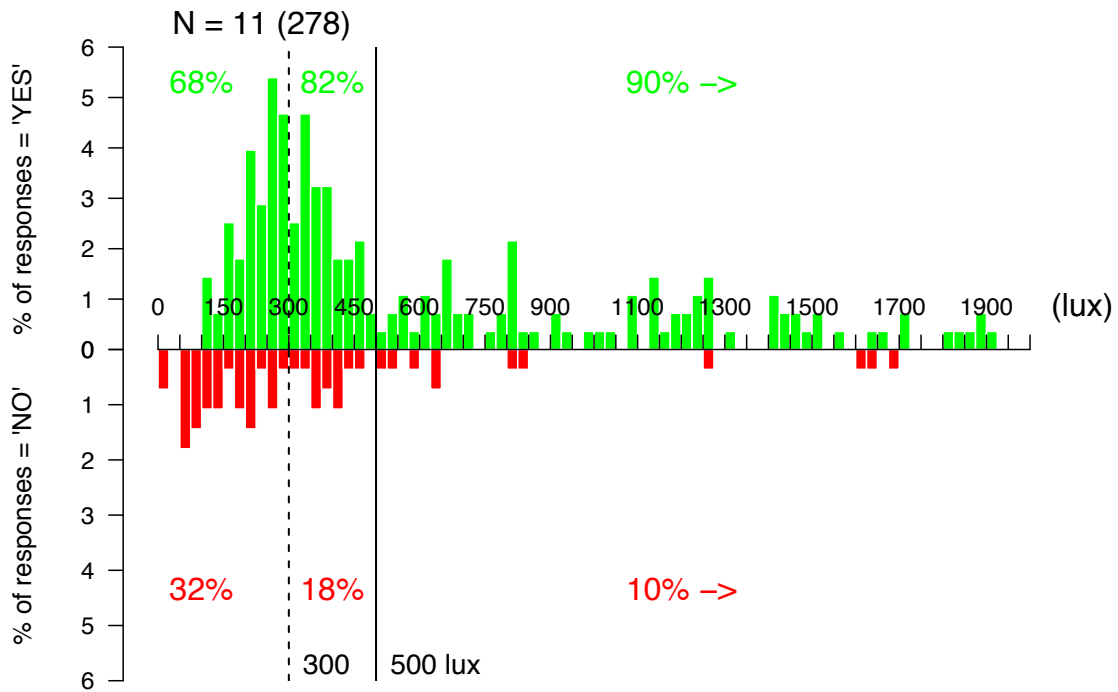


*the electric lights turned OFF right now?*” is shown as a percentage of the total number of (YES, NO) responses (“neutral” responses were omitted from the analysis). Vertical lines are drawn on each figure indicating two common workplane illuminance thresholds used to define daylight sufficiency: 300 lux (HMG, 2010; LEED/BREEAM Daylighting credit, 2012), and 500 lux (Reinhart, 2002). Results are presented on a scale from (0 – 2000 lux). Although subjective responses were recorded at illuminance levels above (1000 lux), these responses represent a relatively small percent of total responses (< 3%) and consist of predominantly “YES” responses. The percent of “YES” and “NO” responses for each subset of illuminance levels (0-300, 300-500, >500 lux) is shown on each figure (green for “YES” responses and red for “NO” responses). “N” indicates the number of participants for each phase, followed by the total number of responses (in parenthesis).

**(Q7) Could you work comfortably with the electric lights turned OFF right now?**

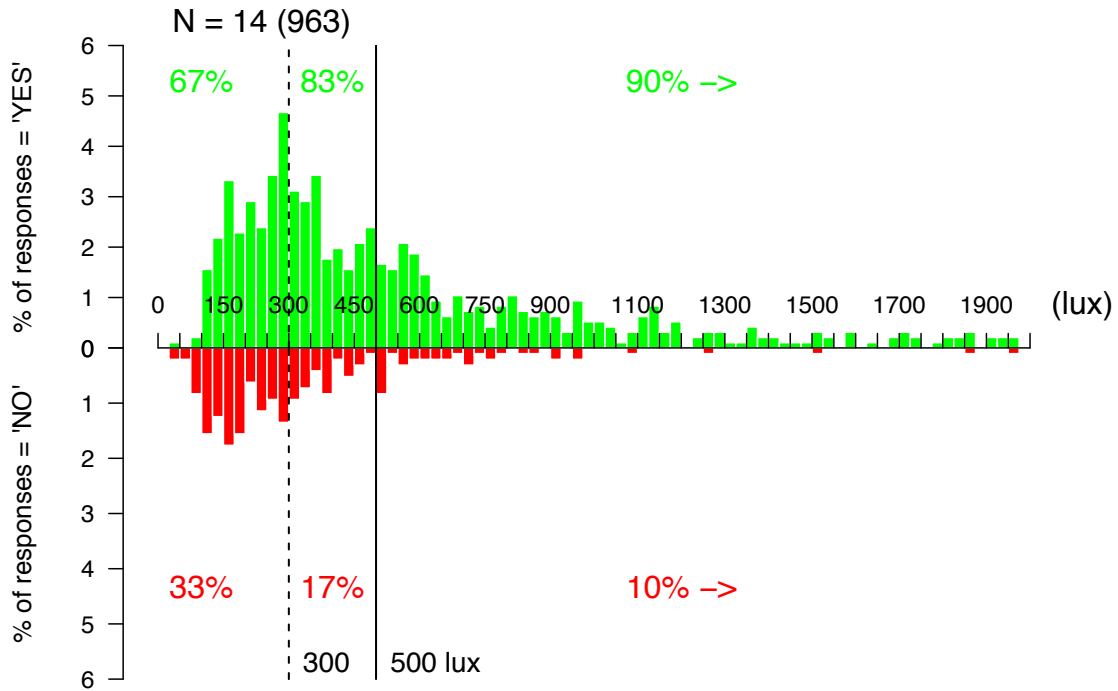


**Figure 10.26** Distribution of responses to (Q7) for NW perimeter zone (July 12 to 29).

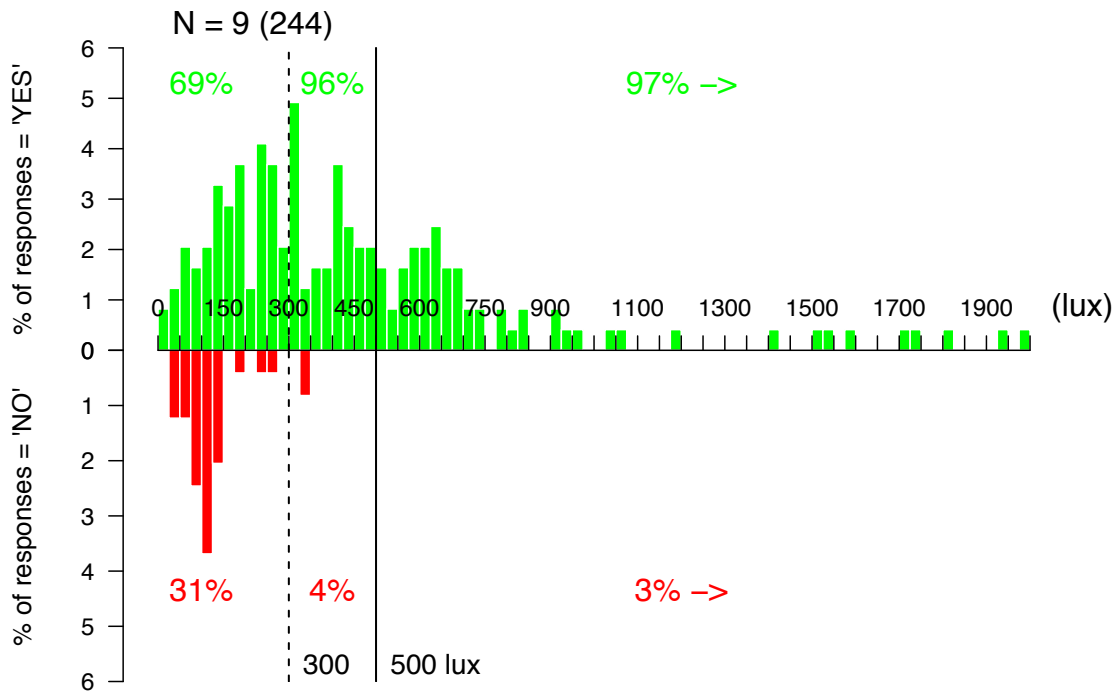


**Figure 10.27** Distribution of responses to (Q7) for NW perimeter zone (Oct. 18 to 29).

**(Q7) Could you work comfortably with the electric lights turned OFF right now?**



**Figure 10.28** Distribution of responses to (Q7) for SE perimeter zone (Aug. 2 - Sept. 3).



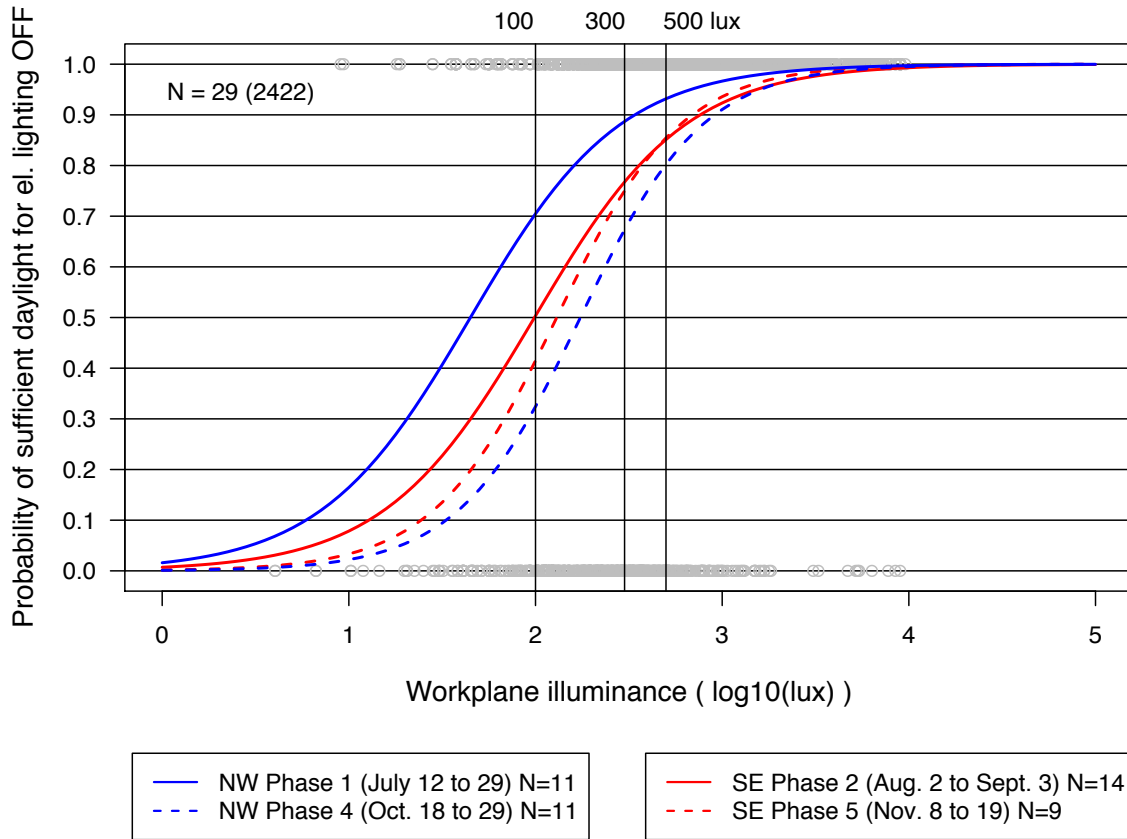
**Figure 10.29** Distribution of responses to (Q7) for SE perimeter zone (Nov. 8 to 19).

Results presented in **figures 10.26 - 10.29** show that participants indicated the perception of sufficient daylight to work comfortably with the electric lighting OFF when workplane illuminance levels were below the thresholds currently used to predict daylight sufficiency. Approximately 65% to 70% of all responses recorded at workplane illuminance levels between (0-300 lux from combined daylight, and overhead light sources) indicate the perception of sufficient daylight to work comfortably without overhead electric lighting and approximately 80% to 95% of responses for illuminance levels between (300 to 500 lux from combined sources). In addition, the results show a general trend of less frequent “NO” responses as the magnitude of workplane illuminance increases. This trend agrees with results from previous studies of electrical lighting control behavior conducted in single and multi-occupancy offices, where the probability of occupants turning off electrical lighting was found to increase with the magnitude of available daylight (Hunt, 1980; Love, 1998). However, it is important to note that in this study, although responses indicated a perception of sufficient daylight to work with overhead electrical lighting turned off, survey results and monitoring of electrical lighting power showed that occupants almost never operated the controls for the open-office overhead electrical lighting.

To test the hypothesis that the probability of occupant perception of daylight sufficiency (Q7) could be predicted as a function measured workplane illuminance, logistic regression was used as a method to examine responses to (Q7) in binary form (0 = “NO”, 1 = “YES”) in relation to the magnitude of workplane illuminance at the polling station. **Figure 10.30** presents the probability of a “YES” response to (Q7) as a function of measured workplane illuminance at the polling station. Vertical lines are drawn to indicate levels of (100, 300, and 500 lux). Because facade orientation and seasonal changes in solar position were considered confounding factors in this study, a separate model was applied to each phase (1,2,4,5) of data. Data from (N=29) unique participants were used, totaling 2422 unique responses to (Q7) for Phases 1,2,4 and 5 combined. The p-value was used to determine if the intercept and predictor were statistically significant and the percentage of correct prediction (% correct) was used as an indicator of “goodness of fit” for each model. The models generated for each group of data were found to correctly predict between 77% and 90% of observed responses. Summary information for each model is presented in **table 10.7**.

**Table 10.7** Summary of logistic regression models of daylight sufficiency (Q7)

Model	N	N obs.	Intercept	Predictor	% Correct	Significance
NW Phase 1	11	732	-4.12	2.50	89%	p < 0.0001
NW Phase 4	11	287	-6.84	3.06	82%	p < 0.0001
SE Phase 2	14	971	-4.94	2.48	82%	p < 0.0001
SE Phase 5	9	315	-6.39	3.02	77%	p < 0.0001



**Figure 10.30** Logistic model of (Q7): *perception of sufficient daylight to work comfortably without overhead electrical lighting*, as a function of workplane illuminance (expressed on a log10 scale).

**Figure 10.30** shows that for each group of participants located in the NW and SE perimeter zones, the perception of sufficient daylight increased with the magnitude of workplane illuminance. In addition, the models show a high probability that occupants will perceive daylight to be sufficient at workplane illuminance levels below existing threshold indicators of daylight sufficiency (e.g. 300 lux, LEED, 2012; 500 lux, Reinhart, 2002). For example, the model based on data from the NW perimeter zone during Phase 1 (July 12 to 29) shows a 67% probability of sufficient daylight at a workplane illuminance of 100 lux, and an 89% probability at 300 lux. In addition, the variation between models suggests that facade orientation and seasonal changes in exterior solar conditions may influence perceptions of daylight sufficiency. For example, the probability of a “YES” response at 100 lux decreased for both NW and SE perimeter zone follow-up phases.

## 10.5.2 Comparison of SFFB photocontrolled lighting to idealized models

**Figures 10.31 – 10.34** compare the performance of the NW and SE perimeter zones to several idealized models using reduction in lighting power density in response to daylight illuminance (measured at the polling station) as an indicator of performance. For each participant, time-series daylight illuminance was compared to perimeter zone LPD. The assumption used to assess performance is that when there is sufficient daylight illuminance, overhead electrical lighting is not necessary and the LPD should be *minimized*. Minimized in this context refers to the fact that even in a fully-dimmed state, the ballasts used for photocontrolled fluorescent lighting require power. For example, the minimized power for the NW perimeter zone was found to be approximately 25% of installed power (resulting in a minimum LPD of approximately 0.3 W/ft<sup>2</sup> when fully-dimmed compared to a maximum LPD of approximately 1.2 W/ft<sup>2</sup>). On each figure, the average measured LPD from the SFFB perimeter zone is shown with a red dot for each bin of measured daylight illuminance values (0-100, 101-300, 301-500, >500 lux). A red line is then drawn from the maximum LPD, through each binned average, to the minimum LPD to illustrate LPD reduction in response to available daylight. The idealized models used for comparison are:

[A], a Title-24 (2005) compliant (LPD = 1.0 W/ft<sup>2</sup>) photocontrolled overhead fluorescent lighting system that can be controlled at the resolution of individual workspaces and “tops up” workplane illuminance to a threshold of 350 lux. When daylight illuminance is above 350 lux at the workplane, the LPD is reduced to (0.25 W/ft<sup>2</sup>) and is never switched off. It is important to note that this model is different than the zone lighting concept implemented at the SFFB for overhead lighting. The principal difference is that the zone lighting concept illuminates a much larger zone that contains a large number of workspaces, each of which do not have personal control<sup>18</sup> over the overhead electrical lighting.

[B], a conventional fluorescent lighting system delivering 350 lux (without photocontrols) that can be controlled at the resolution of individual workspaces and is switched off by occupants with increasing probability as the magnitude of daylight illuminance at the workplane increases (using the corresponding logistic model derived in **table 10.7**). Using this model, LDP is reduced by assuming that fewer workspaces will have lights on as daylight levels increase.

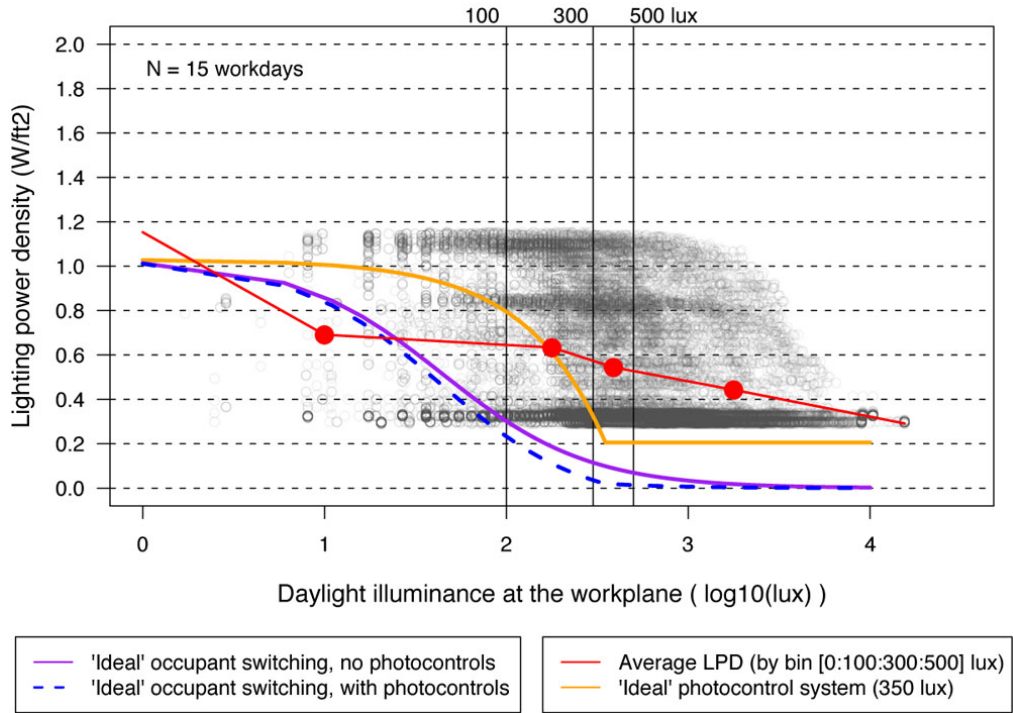
[C], a combination of [A] and [B], where the “ideal” photocontrolled lighting is switched off with increasing probability as daylight levels increase. The lighting power data for each figure correspond to the test phase used to collect subjective data from participants in each zone and include only workdays and only the hours between (6:00 AM and 7:00 PM DST).

Idealized models can be useful to illustrate the amount of energy that is consumed when daylight is considered to be sufficient by both “conventional” (e.g. 350 lux threshold) and

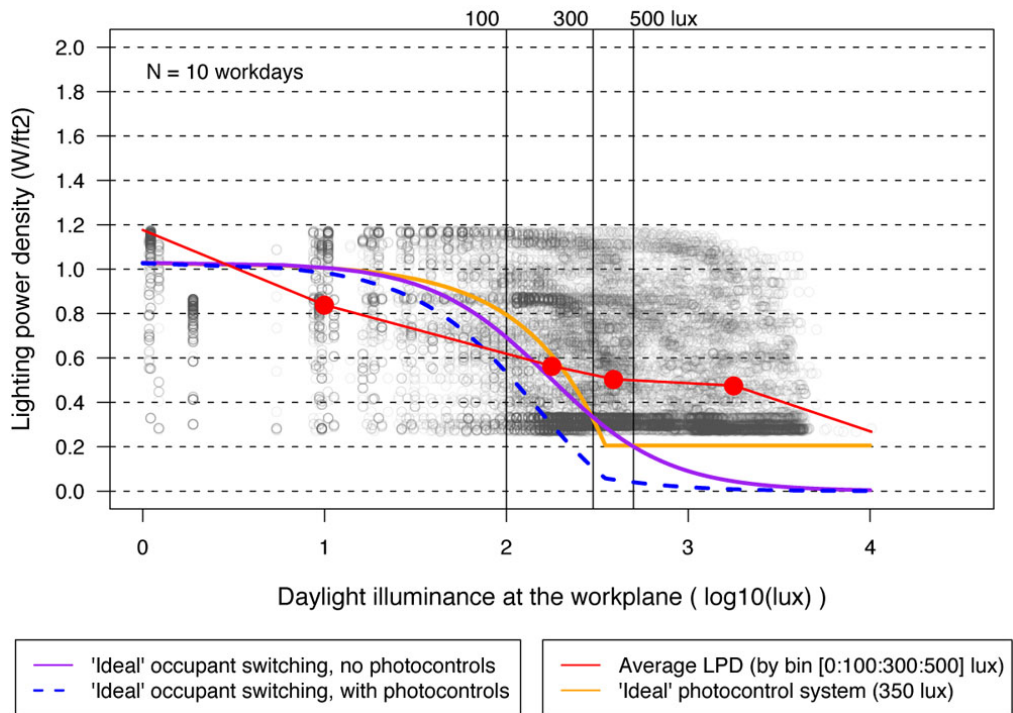
---

<sup>18</sup> For example, one occupant cannot adjust his or her overhead ambient electrical lighting without simultaneously adjusting the lighting for the entire zone.

occupant-defined (i.e. logistic models) definitions. The models are not intended to represent the actual behavior that should be expected from photocontrolled lighting in open plan workspaces in real buildings, or for the switching behavior of occupants with manually controlled overhead electrical lighting. Field studies of buildings in use show that photocontrolled ambient lighting seldom achieves the level of electrical lighting energy reduction anticipated (HMG, 2006) and that manually controlled electrical ambient lighting systems are rarely switched off by occupants in daylit spaces. However, to achieve the objective as described by the architect: to “absolutely obviate the need for electrical lighting” energy for electrical lighting should not be used when daylight is perceived by occupants to be sufficient to work comfortably. Therefore, the models illustrate the level of energy consumption that could potentially be avoided by using daylight should effective photocontrol systems emerge or occupants become rigorous in exercising switches. Energy outcomes of the lighting power profiles shown in **figures 10.31 – 10.34** are presented in **figure 10.35**. It is important to note that the energy performance assessment does not consider occupancy. Although occupancy monitoring was not within the scope of this study, the frequency and distribution of polling station responses across each workday illustrate that each participant did not use the building for the full 13 hours of the electrical lighting schedule. Therefore, additional energy reduction could be achieved by turning off the overhead electrical lighting when occupants are not present at their workspace. In the following energy assessment, the building is considered fully occupied for the duration of the 13-hour (6:00 AM – 7:00 PM DST) electrical lighting schedule.

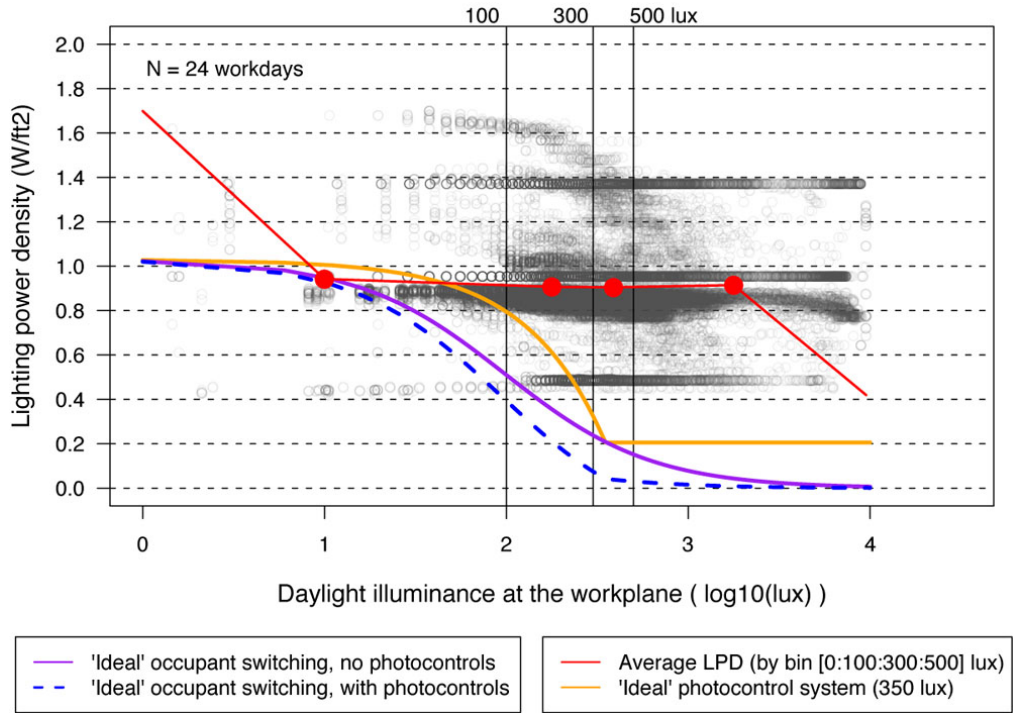


**Figure 10.31** LPD for NW perimeter zones during Phase 1 (July 12 – 29).

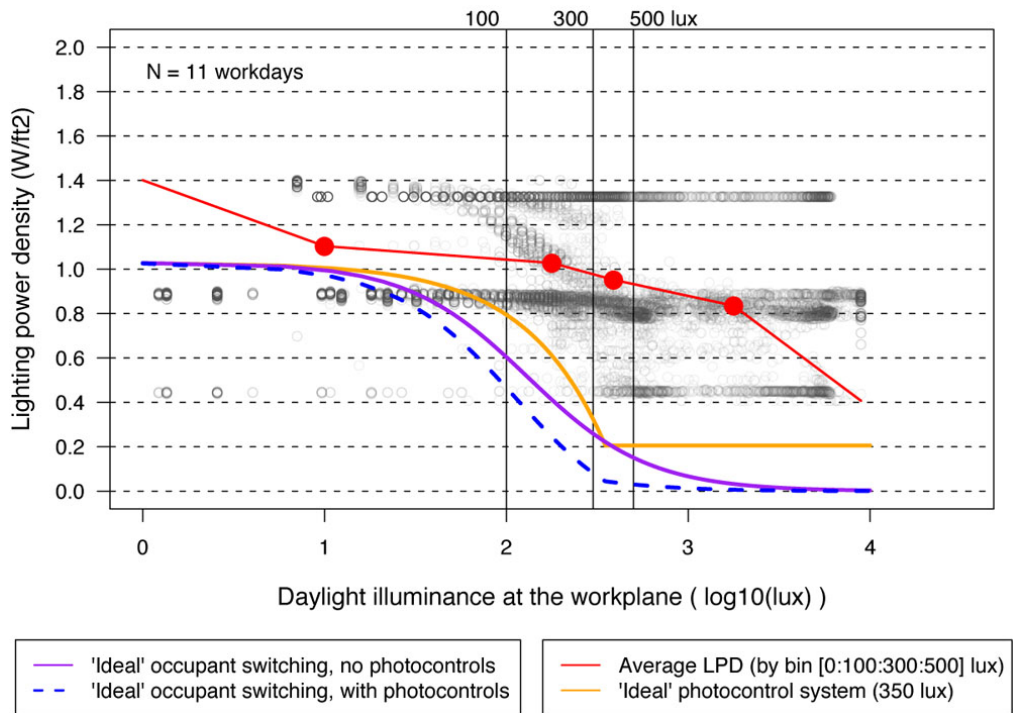


**Figure 10.32** LPD for NW perimeter zones during Phase 4 (Oct. 18 – 29).





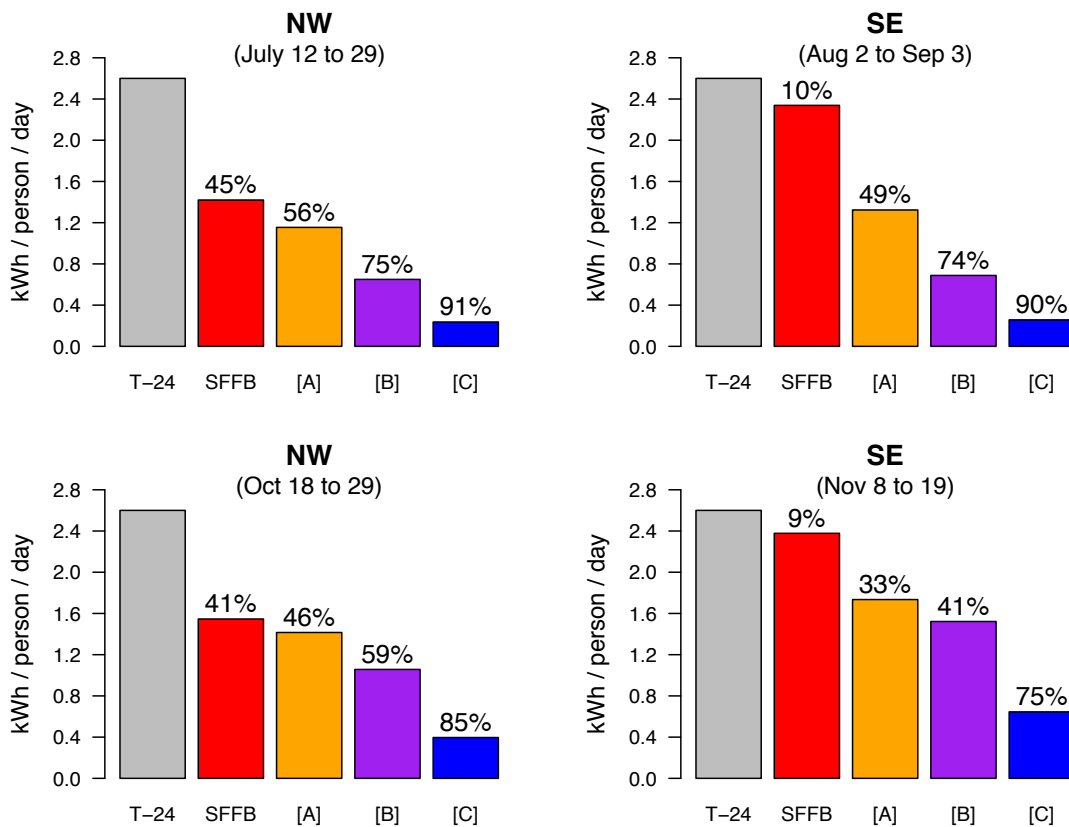
**Figure 10.33** LPD for SE perimeter zones during Phase 2 (Aug. 2 – Sept. 3).



**Figure 10.34** LPD for SE perimeter zones during Phase 5 (Nov. 8 – 19).

### 10.5.3 How much electrical lighting energy could theoretically be reduced if electrical lighting were controlled based on occupant perception of insufficient daylight?

**Figure 10.35** presents the electrical lighting energy (kWh) consumed per person\* per day (6AM – 7PM DST) for each perimeter zone (by phase), and compares measured energy consumption (SFFB) to the three models ([A], [B], [C]) as well as to a Title-24 (2005) baseline (T-24). The baseline represents a 1.0 W/ft<sup>2</sup> overhead ambient lighting system without photocontrols that is on for the duration of the SFFB’s 13-hour lighting schedule (6AM – 7PM DST). Because occupancy was not monitored in this study, energy consumed “per person” was estimated by multiplying LPD and the lighting schedule by an area of 200 ft<sup>2</sup>. Therefore, the baseline lighting energy use per person per day represents: (1 W/ft<sup>2</sup>) \* (200 ft<sup>2</sup>) \* (13 hours) = 2.6 kWh. Data for **figure 10.35** are summarized in **table 10.8**. Energy reduced from the baseline is expressed as a percentage above each bar.



**Figure 10.35** Daily (per person) perimeter zone electrical lighting energy consumption. Measured vs. “idealized” models vs. T-24 (2005) baseline.

**Figure 10.35** shows that during periods of the year between the summer solstice and autumn equinox (June 21 - Sept. 22), occupant switching of overhead electrical ambient

lighting (model [B]) has the potential to reduce baseline lighting energy consumption by approximately 75% for both NW and SE perimeter zones. This is notable given the substantial level of shading observed during the study (Chapter 5). In addition, “ideal” occupant control of overhead electrical ambient lighting (based on subjective assessment of daylight sufficiency) is shown to perform better than “ideal” photocontrolled lighting using a threshold setpoint of 350 lux. This is primarily due to the significant period of each day when daylight levels are sufficient to cause the system to fully dim, yet the fully dimmed system continues to consume energy. For periods of the year after the autumn equinox, performance is shown to decrease for the models as well as for the SFFB. This is partly due to a decrease in the number of hours of daylight available during the 13-hour lighting schedule (6AM – 7PM DST) (**table 10.8**), however, for the SE zones, this decrease is also likely due to the increase in the deployment of shading devices as a defense against the low winter sun..

**Table 10.8** Perimeter zone electrical lighting energy consumption

Zone	Phase	Hours of daylight per day	Hours per day daylight illuminance at workplane above (lux) threshold			Lighting energy (kWh) consumed per person (200 ft <sup>2</sup> ) per day (6AM - 7PM)				
			(100)	(300)	(500)	T-24	SFFB	[A]	[B]	[C]
NW	1 (July 12 to 29)	14.5	11	8	6	2.6	1.4	1.2	0.6	0.2
NW	4 (Oct. 18 to 29)	11	10	6	4	2.6	1.5	1.4	1.1	0.4
SE	2 (Aug. 2 to Sept. 3)	13	11	6	4	2.6	2.3	1.3	0.7	0.3
SE	5 (Nov. 8 to 19)	10	7	5	4	2.6	2.4	1.7	1.5	0.6

## 10.6 Summary and conclusions

Even with the facades' transmission attenuated by interior shades, and solar control film on the SE, the level of daylight transmission achieved in the perimeter zones was perceived by many participants to be sufficient to work comfortably with the overhead electrical lighting system turned off for the majority of daylit hours during the year. In addition, results showed that many participants indicated the perception of sufficient daylight to work comfortably with the overhead electrical lighting OFF when workplane illuminance levels were below existing thresholds used to predict daylight sufficiency. Approximately 65% to 70% of all responses recorded at workplane illuminance levels between (0-300 lux) indicate the perception of sufficient daylight to work comfortably without electric lighting and approximately 80% to 95% of responses for illuminance levels between (300 to 500 lux). In contrast, the daylight levels achieved in the core zones were rarely considered to be sufficient to work comfortably without supplemental overhead electrical lighting. The result was no reduction in electrical lighting energy consumption as well as greater frequency of task light usage in the core zones (27% weekly, 33% daily) compared with the perimeter zones (**figure 10.10**).

In the perimeter zones, issues related to maintenance and low reflectivity of the ceiling combined with photocontrolled-dimming resulted in predominantly daylight illuminance during occupied hours. In this context, a high probability was found for the perception of sufficient daylight to work comfortably. Significantly below the criteria used by LEED, or for the threshold for photocontrolled lighting.

## CHAPTER 11

### DISCUSSION OF RESULTS

*In our whole career, we are going to produce two dozen, three dozen buildings, we don't make that much effect on the world, but, if it's seen as a prototype, that spins off more kind-of ideas like that, then you realize that it actually has huge, huge potential. . . . Some people may like the building and some not, but it's much less important than asking what the building does and does not do.*

-Thom Mayne, Principal, Morphosis<sup>1</sup>

#### 11.1 Introduction

If the daylighting strategies implemented in the SFFB are to be considered a prototype for future buildings to emulate, it is important to examine how the strategies perform from the perspective of occupants and in regard to electrical lighting energy consumption. In this research, daylighting performance was assessed by studying three fundamental and interrelated indicators: occupant behavior, occupant satisfaction with indoor environmental quality (IEQ), and electrical energy consumption for overhead lighting. Investigation of occupant behavior encompassed retrofits to the facade completed by building management in response to occupant complaints (e.g. installation of solar control film and interior fabric roller shades) as well as operation of the shading devices and informal modifications to the facade and personal workspace (e.g. cardboard over windows, use of umbrellas etc.). Investigation of occupant satisfaction encompassed IEQ factors of visual comfort, daylight sufficiency and visual connection to the outdoors. To study these indicators in the field, novel tools were developed and applied using a longitudinal study design that paired repeated-measures of occupant subjective assessment with quantitative measures of the physical environmental. The study had three primary objectives:

1. Examine if perimeter and core zones within a daylit office building designed to achieve objectives of electrical lighting energy reduction and LEED Daylighting EQ credit compliance maintain acceptable levels of visual comfort.
2. Develop a field-based method to record occupant subjective assessments paired with physical environmental measures with minimal intervention to typical occupant behavioral patterns, workspace conditions, and work tasks.
3. Examine the applicability of existing shade control models and indicators of daylight sufficiency, visual comfort, and view commonly used during design to predict the daylighting performance of office spaces. Where gaps are found in

---

<sup>1</sup> Design: e2: Greening the Federal Government, Season 2 : Ep. 2 (25:17).

existing knowledge, develop predictive models that can be used to better anticipate shade control behavior or occupant satisfaction.

The previous six chapters reported results and analysis addressing specific research questions formed for each topic covered in this dissertation: facade occlusion and frequency of shade operation (Chapter 5), shade control behavioral models (Chapter 6), visual discomfort and discomfort models (Chapter 7), subjective assessment of daylight sufficiency for IEQ (Chapter 8), subjective assessment of visual connection to the outdoors (Chapter 9), and subjective assessment of daylight sufficiency for electrical lighting energy reduction (Chapter 10).

This chapter presents a discussion of daylighting performance that connects key findings drawn from these multiple research topics. The chapter is organized into two broad sections. The first section (**section 11.2**) discusses the design strategies implemented in the SFFB to enhance daylight availability and views for occupants and to reduce electrical lighting energy consumption. This section concludes with lessons learned and implications for the application of these design strategies in future buildings. The second section (**section 11.3**) discusses lessons learned from investigation of the applicability of existing shade control models and performance indicators for daylight sufficiency, visual discomfort and views. The focus of this latter discussion is on implications for the use of existing assumptions in the prediction of daylight availability and visual comfort during design.

## 11.2 Lessons learned from the SFFB as a case study

This section revisits the design strategies implemented in the SFFB to deliver useful daylight to building occupants and reduce electrical lighting energy while also attending to requirements for occupant visual comfort. As discussed in Chapter 3, comparison between the consideration given to thermal comfort concerns during design and the consideration given to visual comfort highlights an important contrast in the level of engagement by design teams with these two broad and overlapping aspects of indoor environmental quality. To examine the performance of the SFFB during design in regard to thermal comfort, the design team relied on an emerging consensus-based thermal comfort model and used established criteria for determining acceptable and unacceptable outcomes. From the initial design stage, the design team worked in collaboration with experts in both naturally ventilated buildings and energy modeling. During design, computer simulations of annualized performance were done for several facade design options using validated energy modeling software to balance energy objectives with occupant thermal comfort and to minimize cost and complexity. Following construction, the building was evaluated by the same group that assisted in design to examine if measured performance matched explicitly stated design criteria. In contrast, no documentation was found describing methods or analysis used to assess visual comfort during design. Where references are made to daylighting or solar control objectives, the following seven features of the building are identified as evidence of achieving effective daylighting:

1. Floor-to-ceiling high visible light transmittance (VLT) glass window wall system.
2. Extended (13 foot) floor-to-ceiling height and vertically subdivided window wall.
3. Exterior solar control devices.
4. Task / ambient split electrical lighting with ambient lighting dimmed by photocontrols.
5. Light reflective properties of interior surfaces.
6. Shallow (65 feet) floor plate depth.
7. Interior layout of open-plan workspaces arrayed along the perimeter with low partition heights and cellular or open-plan workspaces in the core zones.

In the following sections, the implications for the success or failure of each of these features of the building are discussed in regard to the relevant findings from this study's investigation of occupant behavior, occupant satisfaction with IEQ factors of daylight sufficiency, visual comfort and view, and electrical lighting energy consumption. The objective of this discussion is to identify lessons learned to inform designers considering future use of these strategies to achieve daylighting objectives.

### 11.2.1 High VLT glazing and large window-to-wall ratio (WWR)



**Figure 11.1** Interior view of the SE perimeter zone prior to occupancy showing floor to ceiling high VLT glass window wall typical for both NW and SE facades.

Large areas of high VLT glazing are one of the most common features of buildings promoted as symbols of “sustainable,” “high performance,” or “energy efficient” design. This approach is based on assumption that making the facade as transparent as physically possible to visible light will have a direct relationship to the amount of interior daylight available, leading to greater percentage of the floor area illuminated with daylight and a greater level of visual connection to the outdoors. In addition to being a popular architectural design trend, this strategy is directly incentivized by green building rating systems (e.g. LEED<sup>3</sup>), standards for the design of energy efficient buildings (e.g. ASHRAE/IESNA Standard 90.1, BSR/ASHRAE/USGBC/IESNA Standard 189.1) and energy code lighting power adjustments for photocontrolled electrical lighting (Title 24-6). All of these systems/standards/codes predict daylight availability based on relatively simple calculations of effective aperture, a function of window area and visible light transmittance, with limited (or no) consideration for occupant operation of shading devices or the consequences of visual discomfort. To examine the effective daylight transmission of highly glazed facades in use, this research began with asking the following broad research question:

---

<sup>3</sup> For example, the LEED Daylight EQ credit (2009) “potential technologies and strategies” suggests that designers should “design the building to maximize interior daylighting.”



- In prominent daylit buildings in use, what modifications have been made to the building facade in response to issues of occupant comfort related to solar control and glare?

The SFFB provided a suitable test site to begin to answer this question by considering the facade retrofits, personal workspace modifications and positioning of interior roller shades to reduce discomfort from solar conditions. Influenced by an early objective of “maximizing daylight and views for all occupants” (Kaplan McLaughlin Diaz, 1994), the NW and SE facades are glazed from floor to ceiling with high VLT glazing, a technology that enables 67% visible light transmittance. Results from observation of shade positioning showed that participants located in the NW perimeter zones shaded between 66% and 73% of the facade glazing where shades were installed (and between 55% and 58% for the SE perimeter zones on average). The level of reduction in “effective” VLT observed has implications for the level of physical transparency assumed by designers to be acceptable for occupants working adjacent to the facade.

Because shades on both facades were lowered adjacent to participant workspaces and rarely adjusted, the effective light transmittance of the facade was significantly lower than the level enabled by the design. For the NW facade, the effective visible light transmittance of shaded portions of the facade resulted in approximately 14% of the daylight transmission enabled by the high VLT glazing (or approximately<sup>4</sup> 9% of the available daylight resource). The decision by the majority of study participants to maintain interior shades and ad hoc defenses in a lowered position and rarely (or never) adjust them indicates that the initial design assumption of floor-to-ceiling high VLT glazing and exterior solar control devices was inadequate to maintain an acceptable level of visual comfort. Discussion of shade control behavioral models begins in **Section 11.3**.

Of the two principal facades, due to the greater attenuation of daylight by solar control film and shades on the SE, the NW perimeter zones resulted in the greatest levels of daylight illuminance at the workplane and the lowest levels of electrical lighting energy consumption. And, notably, the NW perimeter zones were the only zones to comply with the LEED 2012 draft Daylight EQ credit (Daylight Autonomy compliance method). However, these potentially positive outcomes were frequently achieved at the expense of occupant visual comfort and satisfaction with visual connection to the outdoors. In addition, while photocontrols were found to reduce electrical lighting energy consumption in response to daylight, the contribution of the overhead electrical ambient lighting was often perceived by occupants to be unnecessary to work comfortably<sup>5</sup> as a result of the level of interior daylight illuminance. The conflict between potentially successful daylight illuminance and electrical lighting energy consumption outcomes with concerns regarding occupant visual discomfort highlights the importance of field-evaluation techniques that include subjective assessment and for reliable predictors of discomfort during design.

---

<sup>4</sup> This assumption is based on multiplication of visible light transmission of the high VLT glazing (67%) by the VLT of the shade fabric (14%).

<sup>5</sup> Using only task lighting as an electrical light source.

## 11.2.2 Extended floor-to-ceiling height

*With an average overall ceiling height in the tower of 13 feet, natural daylight will penetrate deep into work spaces.*

- Morphosis Architects<sup>6</sup>



**Figure 11.2** NW perimeter workspace (left) and NW perimeter zone (right).

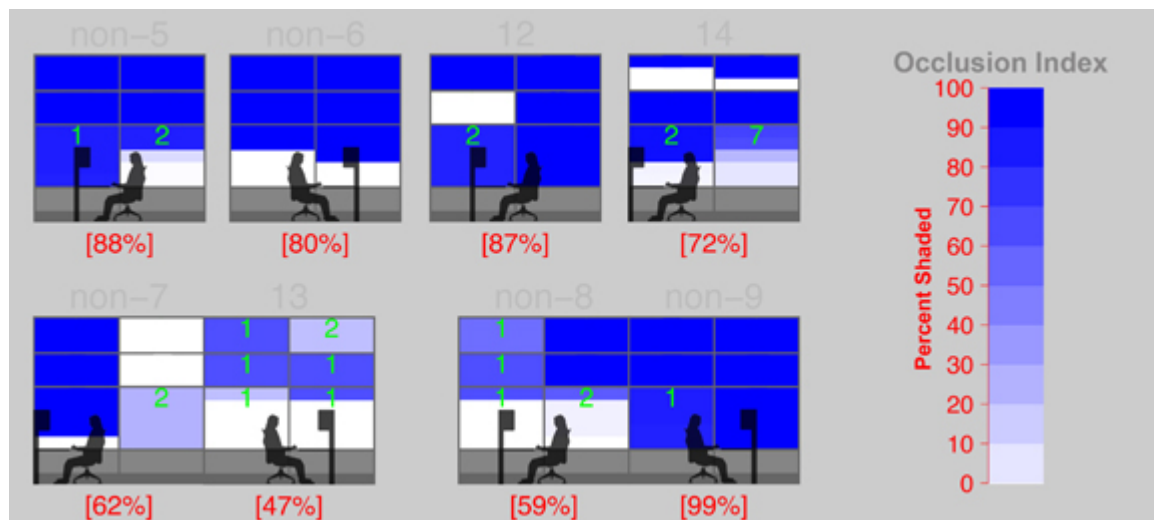
The SFFB's average floor-to-ceiling height of 13 feet is significantly greater than that of conventional commercial office construction (typically 9 feet). Although the above quotation does not explicitly reference any daylighting design guidance (i.e. "rules of thumb") the assumption of a "daylight zone" which extends into the building a distance from 1.5 to 2.5 times the window head height is commonly stated in daylighting design guidance (O'Connor et. al., 1997; IESNA, 2000; Lechner, 2009; Grondzik, 2011; Marsh, 2011). Based on this assumption, increasing the window head height is a common design strategy to increase the depth of useful daylight penetration. During the retrofits made to the NW facade to address occupant complaints of glare discomfort, the upper two rows of windows were not retrofit with roller shades on the majority of floors. This decision was based on the assumption that providing shades in the vision zone only (see **figure 11.2**) would be adequate for visual comfort due to the fact that the NW facade orientation results in less hours where occupants would directly view the sun through the upper windows compared with the SE facade orientation. The decision to forego shades on the upper rows of windows was based in part on the objective of maintaining sufficient daylight transmission in the perimeter zone for electrical lighting energy reduction.

Although unshaded upper two rows of daylight zone windows on the NW facade enabled greater levels of daylight transmission (in comparison to the SE), the unshaded upper

<sup>6</sup> <http://morphopedia.com/projects/san-francisco-federal-building> (accessed 8/21/11)

windows were also identified as a source of visual discomfort by study participants. From the analysis of visual discomfort (Chapter 7), both average and maximum upper window luminances were found to be the strongest predictors of visual discomfort, and the average and maximum window luminances of the upper windows were often in excess of the levels found to have a 50% probability of discomfort.

In addition, on the 8<sup>th</sup> floor, where shades were installed on the daylight zone rows of windows, shades were observed to be lowered continuously for the majority of upper daylight zone windows adjacent to occupant workstations (**Figure 11.3**). Although observations were for a relatively small number of individuals (N = 8), the positioning suggests that, for the current state of the SFFB, shades for upper windows are required for occupants to have sufficient control over visual discomfort, and if present will be lowered by occupants. Due to the fact that views through the daylight zone windows are of the sky (and therefore contain less visual information than views available from the vision windows, the upper windows could be retrofit with an optical louver system (see **figure 11.14**) that would control glare while redirecting daylight to the ceiling rather than blocking it. Similar to the NW, on the SE facade, the daylight zone was found to have a greater level of occlusion by interior shades compared to the vision zone. In addition, analysis of shade operation behavior showed that occupants lowered the upper shades at lower stimulus levels compared with the vision zone.



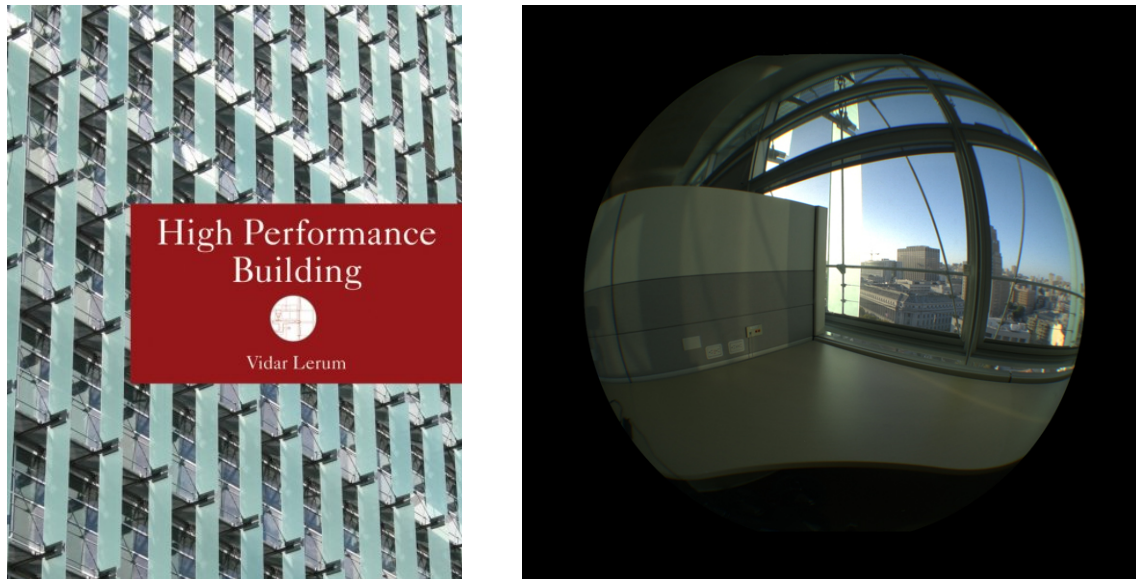
**Figure 11.3** Shades were lowered for upper zones of the NW facade when they were provided (8th floor). This figure is repeated from Chapter 5.

The observed positioning of upper shades (when they were present) as well as the levels of visual discomfort found from the unshaded upper windows conflicts with the assumption that the facade can be divided into a lower vision zone and upper daylight zone, where the upper window region will not be a source of visual discomfort for occupants located adjacent to the perimeter glazing. Additionally, as the primary function of the upper window region delivering daylight to the building interior, the reduction in light transmission by shade fabric significantly diminishes its effectiveness.

### 11.2.3 Exterior solar control devices

The following two sections discuss the performance of the exterior solar control devices on the NW and SE facades respectively in regard to observations of shade positioning/operation, luminance analysis using HDR imaging, personal workspace modifications (**figure 11.6**), and subjective assessments of visual comfort.

#### 11.2.3.1 NW facade exterior solar control devices



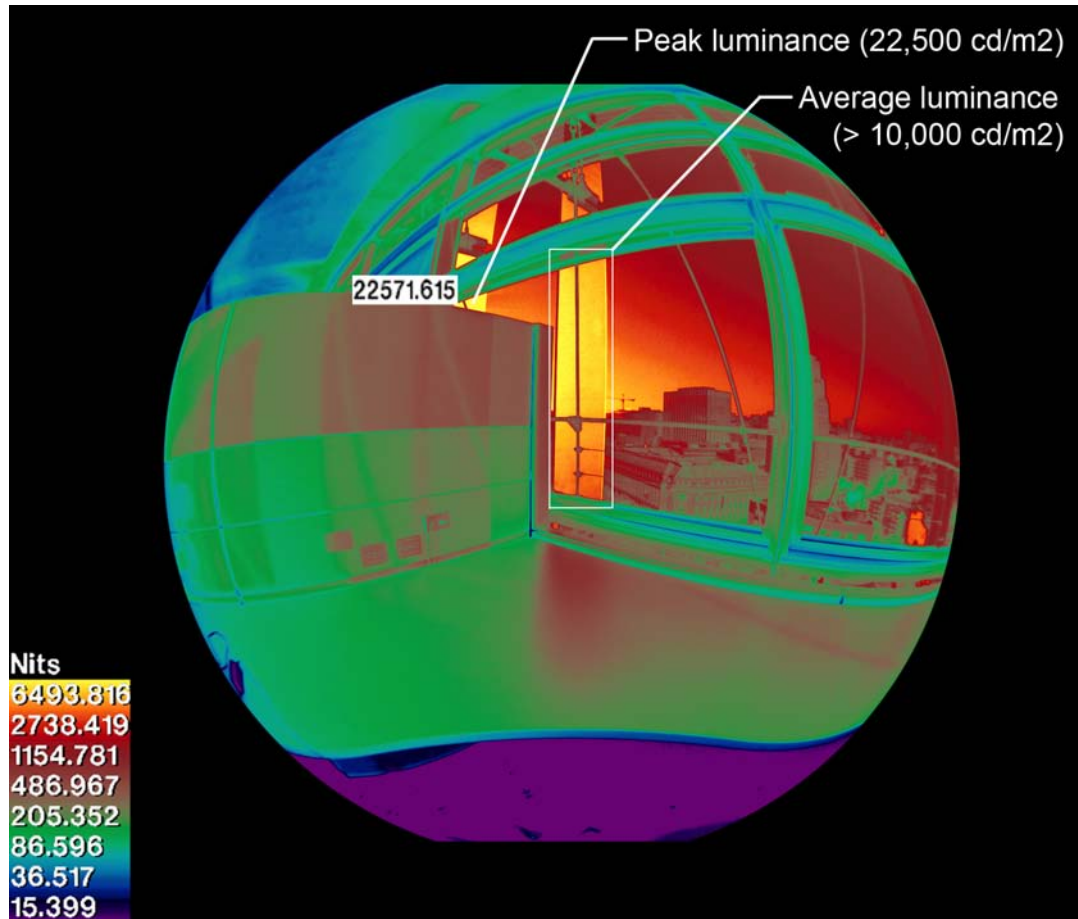
**Figure 11.4** Exterior vertical glass fins presented on the cover of the book High Performance Building (left) and an interior view of NW facade and perimeter zone (right).

Exterior shading, which is a common recommendation for controlling solar gain and maintaining visual comfort for occupants (U.S.G.B.C.), is the dominant architectural feature of the NW facade. Notably, images of the vertical glass are found on the cover of three books claiming to present successful examples of “green,” “integrated,” or “high performance” design (**figure 11.4**). However, the shade positioning and visual discomfort conditions observed in the building are strong indicators that the exterior glass fins do not provide an acceptable level of visual comfort for occupants. A central problem with the vertical glass fins is that they do not continuously block direct sun penetration during occupied hours.<sup>7</sup> An additional, and perhaps more significant problem is that the louvers themselves become a source of visual discomfort when direct sun is transmitted through their translucent assembly. The effects are significant, as shown in **figure 11.5**, where an unshaded view of the exterior fin results in luminances in excess of

---

<sup>7</sup> See Chapter 6.

22,500 cd/m<sup>2</sup>, approximately twice the luminance (~10,000 cd/m<sup>2</sup>) of a bare, 34 Watt T-12 fluorescent light bulb.<sup>8</sup>



**Figure 11.5** HDR image of exterior glass fin showing peak luminances in excess of 22,500 cd/m<sup>2</sup> and average fin luminance in excess of 10,000 cd/m<sup>2</sup>. Image acquired at 5:25 PST on 10/25/2010 looking west.

<sup>8</sup> Grondzik et. al., p. 632, MEEB, 2009.



**Figure 11.6** Examples of interior workspace modifications to control direct sun and reduce window luminance observed in the NW perimeter zones.

### 11.2.3.2 SE facade exterior solar control devices

*A folded, perforated metal sunscreen shades the full-height glass window wall system and a mutable skin of computer-controlled panels adjusts to daily and seasonal climate fluctuations.<sup>9</sup>*

-Morphosis Architects

*...acknowledging that high solar gains through the glass of the southeast facade would not only be uncomfortable for the occupants but may serve to deplete the thermal mass of its charge during the morning hours through long-wave radiative exchange between the warmed low level surfaces and the nightcooled thermal mass above. Thus the exterior shade was introduced not only to provide solar protection but also to allow for a form-based visible architecture with a standard repeatable floorplan.*

-McConahey et. al., 2002



**Figure 11.7** Architectural rendering showing anticipated daylighting conditions for the SE perimeter zone (left) and image of the SE perimeter zone under similar clear sky conditions (right).

The central architectural feature of the SE facade is an exterior layer of perforated metal panels (50% openness). As indicated by the above quotations, the screen was designed to provide solar shading for both occupant comfort and to reduce solar heating of the structure. And, identical to the NW facade, the SE facade was originally clad with a window wall system of high VLT (0.67) glass. Although photocontrols enabled a moderate reduction in effective LPD for the SE perimeter zones when compared to the maximum LPD allowed by code (Chapter 10), the retrofits made to the SE facade, the observed position of roller shades, and the subjective assessments of occupants present a number of implications for this “filtering” or “screening” approach to solar control.

<sup>9</sup> <http://morphopedia.com/projects/san-francisco-federal-building> (accessed 2/19/2009)

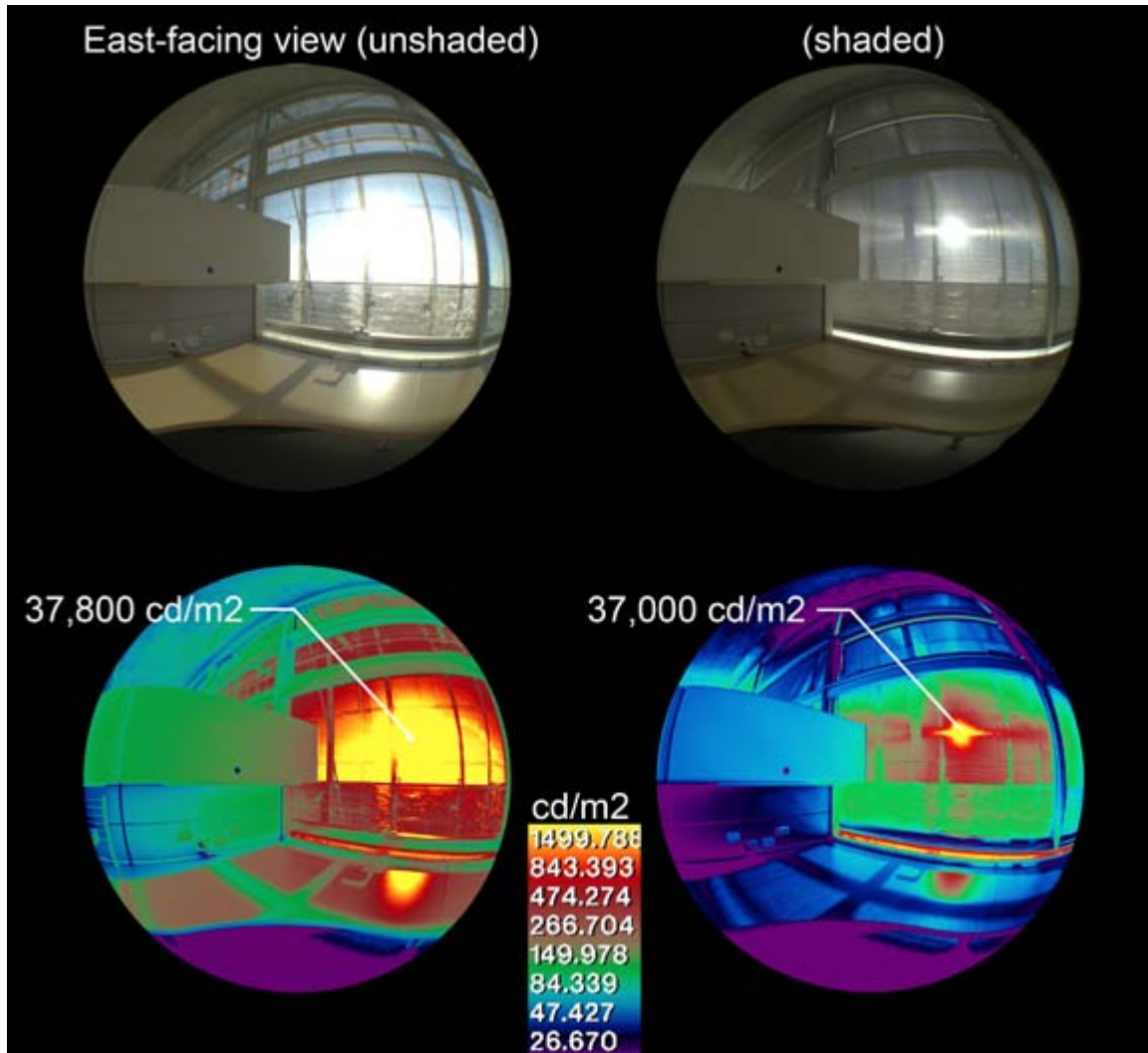
First, as exemplified by **figure 11.7**, results from the observation of occupant shade positioning demonstrated that the majority of the facade adjacent to occupied workstations was consistently shaded by interior roller shades despite the significant level of reduction in solar radiation produced by the exterior metal screen, the facade glazing and retrofitted solar control film. After installation of the (0.24) VLT solar control film and interior shades, the effective VLT achieved by the SE facade with shades in their typical position was approximately 2% of the visible light enabled by the original (0.67) VLT glazing and 50% openness exterior perforated metal screen. When considering all of the materials taken together, the transmission factor equates to approximately 0.5% of the available daylight resource. This outcome contrasts with the original design intent and U.S.G.B.C. guidance to “maximize daylight and views” and contributed to the SE perimeter zones failing to achieve the level of daylight autonomy needed for compliance with the 2012 LEED draft Daylight EQ credit (daylight autonomy compliance method). Despite the significant reduction in daylight transmission resulting from the interior shading devices, a high proportion of subjective responses recorded in the SE perimeter zones indicated visual discomfort from windows and a preference for less daylight. The occurrence of discomfort responses when the facade was in a predominantly shaded state conflicts with the assumption that the provision of fabric shading devices will enable sufficient control over visual discomfort. Examples of issues with this assumption can be found in examining the personal workspace modifications made by occupants adjacent to the SE perimeter zone. Discussions with participants indicated that these modifications were made to “supplement” the level of solar control available from the architectural layers of the facade (e.g. perforated panels, VLT glazing, solar control film, and interior roller shades) and were principally directed toward blocking a direct view of the solar disc.





**Figure 11.8** Examples of personal workspace modifications made to block direct view of the solar disc.

As illustrated by **figure 11.8**, the combined effect of exterior metal scrim, solar control film, and interior fabric roller shade remains inadequate for controlling the luminance of the solar disc, leading to occupants adding personal solar control features to their individual workspaces. The luminance measures shown in **figure 11.9** for the unshaded condition are likely to be significantly greater than the value reported of  $37,800 \text{ cd/m}^2$ , as this value represents a level close to the saturation point found for the camera settings used. The primary lesson illustrated by the images shown in (**figure 11.8** and **figure 11.9**) is that window views that include the path of the sun require solar control features that completely block a direct view of the solar disc from the vantage point of occupants.



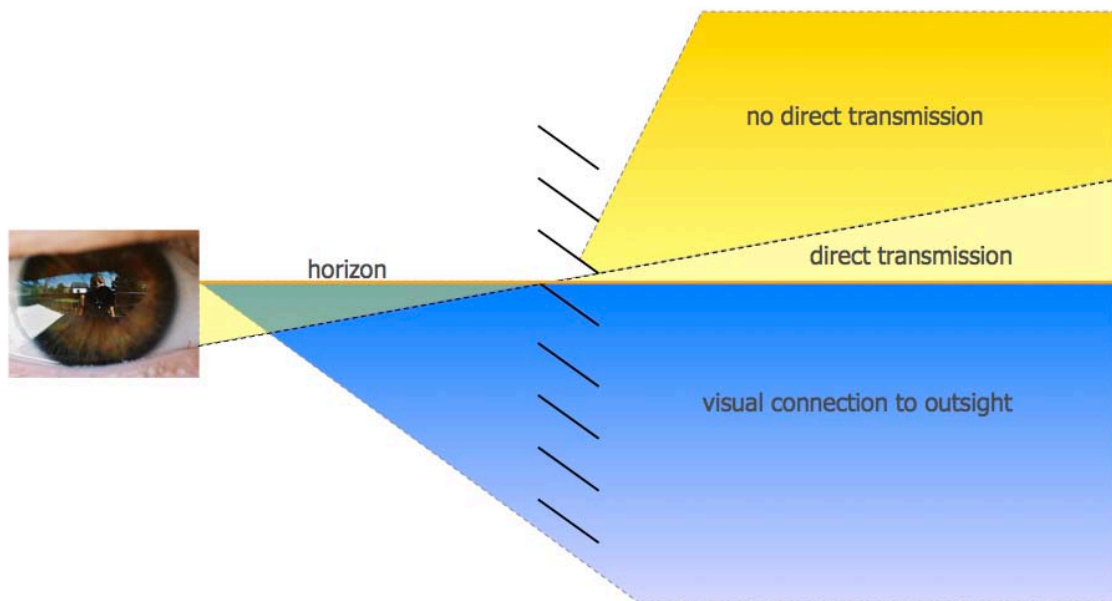
**Figure 11.9** Generic viewpoint for east-facing workstation orientation (SE facade) showing unshaded (left) and shaded (right) luminance conditions recorded using HDR imaging<sup>11</sup>. Image on left acquired at 9:10AM ST on 11/12/2010. Image on right acquired at 9:10 AM ST on 11/17/2011. Luminance values are represented with a falsecolor log-scale where yellow indicated values above 2000 cd/m<sup>2</sup>.

Finally, the positioning of shading devices serves to significantly diminish the potential effect of the “mutable skin of computer-controlled panels” because the view zone created by the actuation of the exterior perforated metal panels (as anticipated in the rendering shown in **figure 11.7** is obscured by shade fabric. The actuation of the panels was, however, not a factor during this study due mechanical issues that resulted in the panels being in a closed position throughout the study. The observed positioning of shading devices, which have an openness factor of 3% on the SE, (significantly less than the

<sup>11</sup> It is important to note that HDR imaging is not suitable for accurately measuring the luminance of the sun, as the CCD sensor will “saturate” above a threshold determined by the exposure bracketing established for compositing HDR images from low dynamic range (JPEG) images.

perforated exterior metal screen's openness factor of 50%), illustrates a central misconception for the level of solar control required for occupant comfort and calls into question the significant time, cost and technical effort made to attempt to actuate the exterior metal panels.

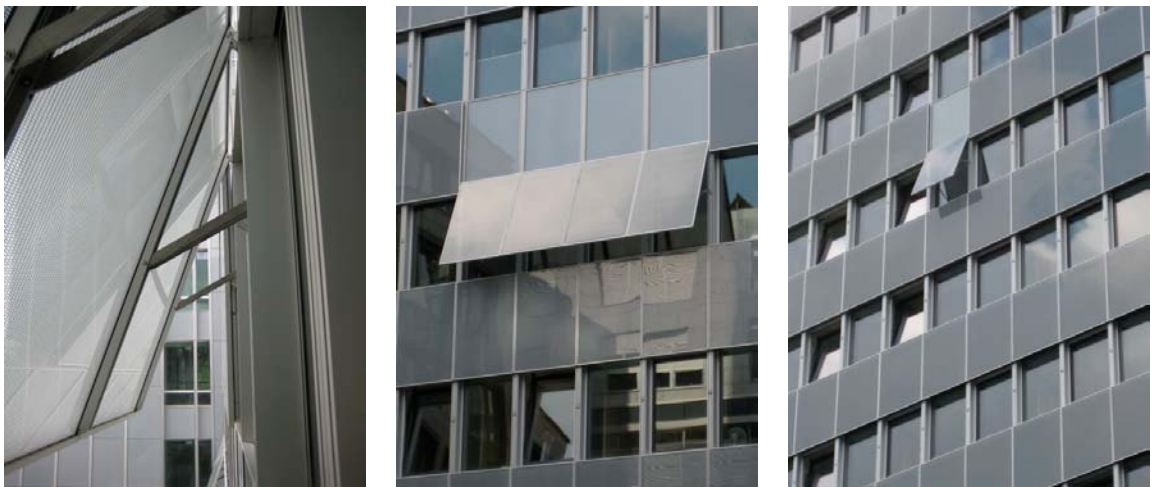
It is important to note that the failure of the 50% perforated exterior metal screen to provide adequate solar and glare control for occupants does not indicate that an exterior solar control screen cannot be effective as design strategy. Nor does it indicate a failure to choose the appropriate amount of perforation that would be "acceptable" to occupants. Rather, in the case of the SFFB, the performance issues are a consequence of the effectively 2-dimensional geometry of the screen. Because the screen consists of a flat sheet of metal with holes punched in it, the level of shading is directly proportional to the angle of incidence of the sun (where normal incidence leads to 50% solar transmittance). By designing a screen where the 3-dimensional geometry is conceived in consideration of solar geometry, solar transmittance can be reduced to zero for the majority of hours the facade receives direct sun, while maintaining view to the outdoors as well as transmission of ambient daylight. Completely blocking direct sun penetration (and thus view of the solar disc from the interior) is critical for maintaining visual comfort in an open office environment where computer-based tasks are performed. A section diagram showing how solar control can be achieved while maintaining the perception of visual transparency using expanded metal is provided in **figure 11.10**. Therefore, exterior metal screens that provide effective solar control while preserving the perception of visual transparency are achievable if designed sectionally in consideration of solar geometry.



**Figure 11.10** Diagram showing solar cut-off and view angles for a section of expanded metal screen. Image from Prof. Dipl.-Ing. Mathias Wambsganß of ip5 ingenieurpartnerschaft (<http://www.ip5.de/>).



**Figure 11.11** Revitalisierung Haupthaus KfW, Frankfurt (Architekten Theiss and ip5 ingenieurpartnerschaft, 2003 - 2007). Images taken looking through a moveable exterior metal panel at varying distances (0.2, 1, 3 meters). The panel consists of glass, expanded metal, and a PVB interlayer.



**Figure 11.12** Exterior view showing movable exterior solar control screen.

**Figures 11.11** and **11.12** show views of the interior and exterior of the Revitalisierung Haupthaus KfW, Frankfurt by Architekten Theiss and ip5 ingenieurpartnerschaft (2003 – 2007). This project presents an example of an exterior metal screen developed based on the diagram shown in **figure 11.10**. By adjusting the tilt of the exterior panel, the cut-off angle can be controlled to block direct sun and the panel can be completely retracted during overcast sky conditions or times when the facade does not receive direct sun.

#### 11.2.4 Shallow floor plate depth and open-plan office layout

*As a result of the tower's narrow profile and strategic integration of structural, mechanical and electrical systems, the building provides natural ventilation to 70% of the work area in lieu of air conditioning, and affords natural light and operable windows to 90% of the workstations.*<sup>12</sup>

-Morphosis Architects

*If you can build the tower floors narrow, they are 65' wide, you can have access to natural light for everyone.*<sup>14</sup>

-Maria Ciprazo, supervisory architect, GSA Region 9

The decisions to design both facades as floor-to-ceiling high VLT glass window walls, extend the floor-to-ceiling height to 13 feet, limit the depth of the floor plate to 65 feet, and create open-plan workspaces (with low partition heights) along the perimeter were all influenced by the objective of achieving sufficient levels of daylight transmission and views for workspaces located in the core. Therefore, the subjective assessments and electrical lighting energy data from the core zones are perhaps the most appropriate indicators of the success or failure of the overall daylighting concept. The majority of workspaces located in the core zones of the tower section consist of enclosed cellular offices with translucent glass walls. This study was conducted in open-plan sections of the tower (**figure 11.13**) because these zones were considered to be more representative of conventional commercial office interiors.

---

<sup>12</sup> <http://morphopedia.com/projects/san-francisco-federal-building> (Accessed 2/19/2009)

<sup>14</sup> Building efficiency case study : San Francisco Federal Building (GSA). Video. Rocky Mountain Institute 2008.



**Figure 11.13** Example of open-plan core zone investigated during the study.

Results showed that daylight in the open plan core zone was rarely considered satisfactory by occupants, and rarely considered sufficient to work comfortably without supplemental overhead electrical lighting. Throughout both core zone monitoring phases (Phase 3, Phase 6) physical measures of horizontal workplane illuminance showed that daylight represented less than 10% of the workplace illuminance in the core zones, where the median daylight illuminance at participants' workstations was 44 lux during Phase 3 and 17 lux during Phase 6. For comparison, compliance with the LEED Daylight EQ credit requirement of 2% daylight factor leads to the assumption that the "daylit" zones of the building will achieve 500 lux daylight illuminance under a 10,000 lux uniform overcast sky. Although a 10,000 lux uniform overcast sky was not observed during the phases where the core zones were monitored, the daylight factor during the day never exceeded (0.1%), roughly one twentieth of the value required for the LEED credit.

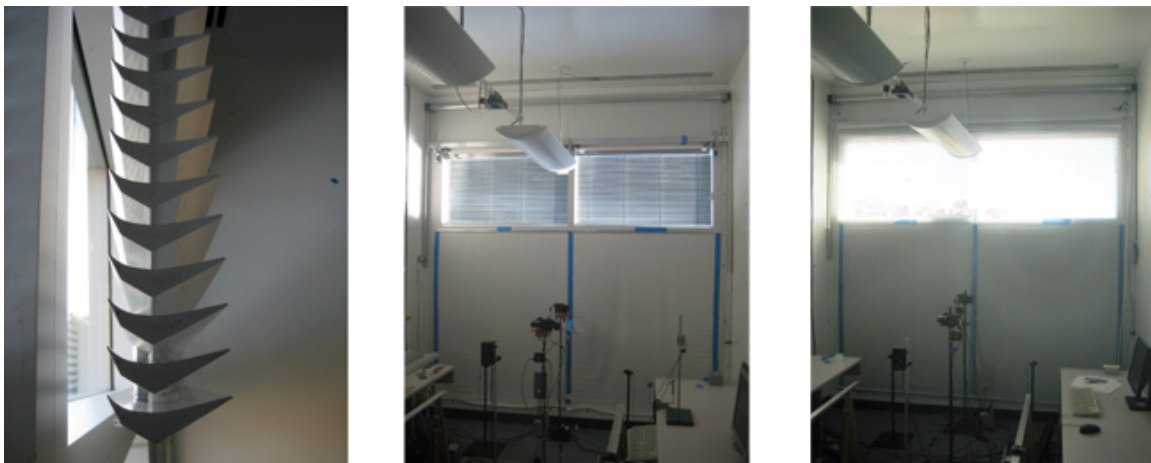
Despite the relatively low levels of daylight illuminance achieved in the core workspaces, analysis of polling station data showed that occupants frequently reported visual discomfort. And, although the majority of participants located in the core zones were satisfied overall with their level of visual connection to the exterior, the core zone participants reported the highest percentage of dissatisfied responses (38%). Notably, the sources of dissatisfaction were related to issues of visual discomfort associated with available views rather than with the degree of visual obstruction created by the interior shading devices.

Analysis of electrical lighting energy consumption (Chapter 10) showed that electrical lighting energy was not reduced in the core lighting zones monitored. In contrast to the perimeter zones, overhead electrical lighting in the core zones was not controlled by

photosensors. Although wall-mounted lighting controls were available to occupants for switching off (or dimming) the overhead electrical ambient lighting during the day, monitored electrical lighting energy data showed that occupants never switched off or dimmed the overhead lighting. In addition, the self-reported frequency of task light usage in the core was greater than in the perimeter zones. Therefore, from both an energy perspective and an IEQ perspective, the core zones failed to achieve sufficient daylighting through the basic strategy of “maximizing daylight” by providing large areas of high VLT glazing. The primary lesson to be learned from this outcome is that maintaining sufficient daylight transmission to interior core zones requires acceptable visual comfort conditions for occupants located along the perimeter.

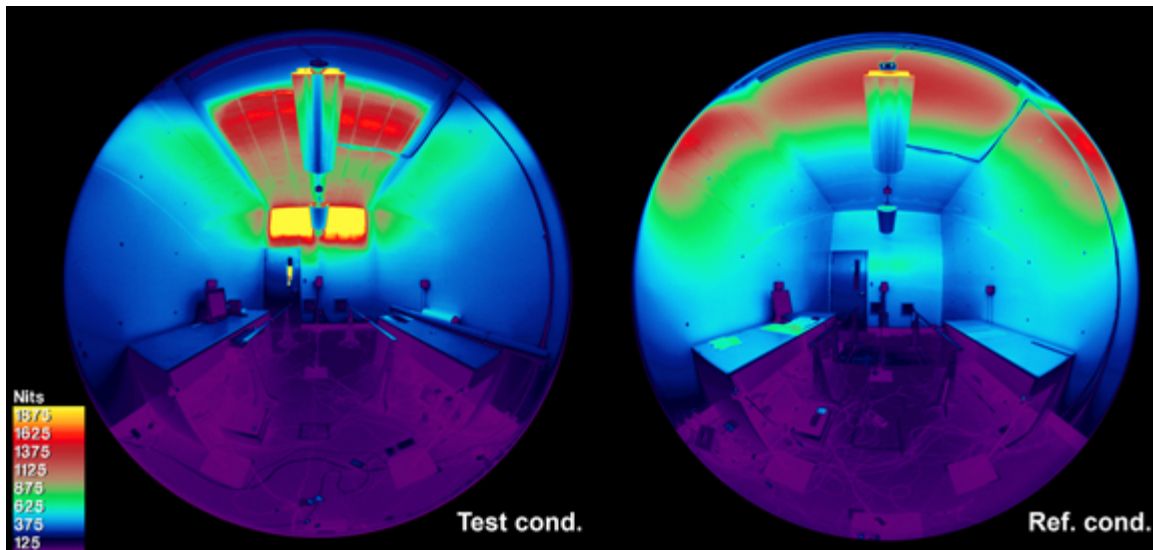
However, the diminished level of daylight available in the core workspaces is only partly related to the addition of the solar control film and the significant level of facade covered with roller shades. The outcome is also the result of the relatively low<sup>16</sup> light reflectance of the exposed concrete ceilings and perimeter wall. By increasing the light reflectance of the ceiling surface and using a diffuse finish to control specular reflections, the ceiling could be used more efficiently to distribute daylight transmission to the interior. In addition to increasing the quantity of reflected light, a greater surface reflectance would reduce the contrast ratio between the window and interior surfaces.

Further improvements could be made through the addition of an interior light shelf to the facade, or by retrofitting the upper daylight zone glazing with an optical louver system (OLS) that is designed to with a specular finish to the top surface to redirect light to the ceiling while controlling glare and blocking direct sun.



**Figure 11.14** Left: Side view an example OLS (Lightlouver™) prior to being installed on the inward face of the daylight glazing at the Daylight Test Facility at Lawrence Berkeley National Laboratory. The unit is slid on the horizontal brackets at the top of the OLS into the frame cavity. Middle: Interior view of the OLS after installation. Right: Interior view of a venetian blind reference condition.

<sup>16</sup> The light reflectance of the concrete was not measured in this study. However, the solar reflectance of concrete with fly-ash admixtures typically range from (0.35 to 0.5) (Medgar et. al., 2008).



**Figure 11.15** High dynamic range luminance map of test OLS condition (left) and reference venetian blind condition (right), acquired simultaneously on February 7, 2010 at 12:22 PST (clear sky conditions) with falsecolor tone mapping (yellow indicates luminance  $\geq 2000$  cd/m<sup>2</sup>).



**Figure 11.16** Lightlouver™ OLS installed in National Renewable Energy Laboratory (NREL) Research Support Facility (RSF).



### 11.2.5 Photocontrolled overhead electrical ambient lighting

*Through simple sensors, the building's automated systems manage the balance between powered and natural daylight. The powered lights are on only when people are at their workstations. Together, these approaches reduce energy used for lighting by approximately 26 percent.*

-Morphosis<sup>17</sup>

*Illuminating interiors with natural light yields further sustainable design benefits. With an average floor-to-ceiling height in the tower of 13 feet, daylight reaches 85% of the workspaces. Powered lighting are used only when individuals are at their desks and are automatically dimmed or turned off when daylight is available.*

-GSA<sup>18</sup>

As discussed in Chapter 10, photocontrols were not implemented in the core lighting zones studied, and no reduction in electrical lighting energy occurred through manual control. Therefore, the discussion of photocontrolled lighting is restricted to discussion of the perimeter zones. To examine the performance expectations stated in the above quotations, this research asked the following broad research question:

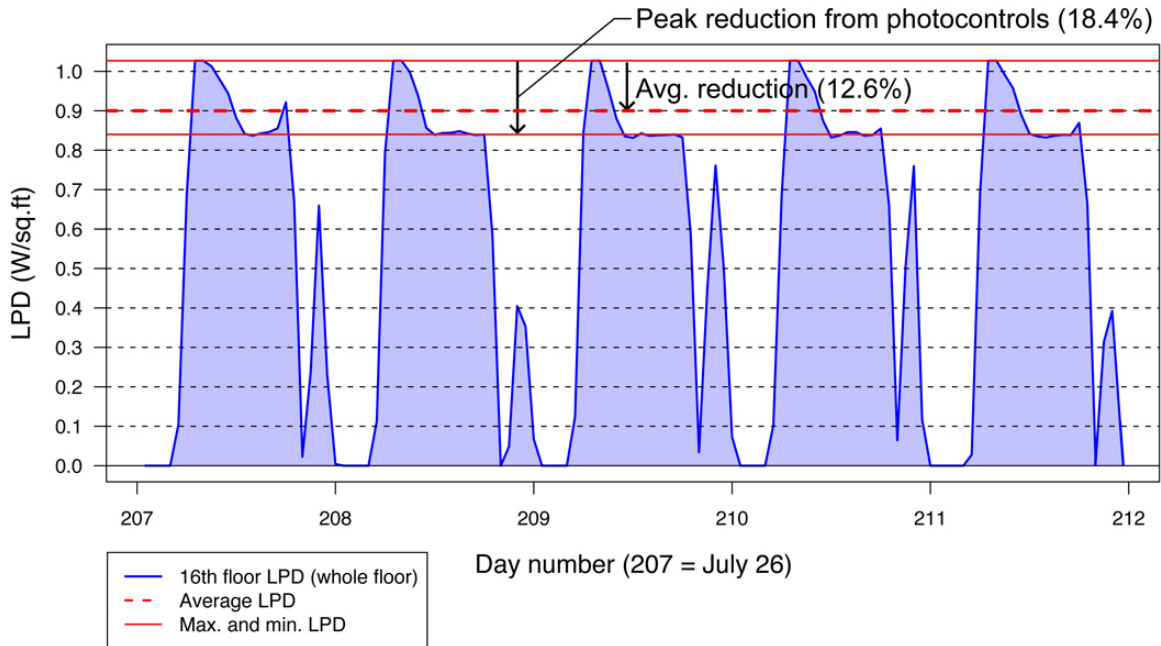
- Are photocontrols working effectively to reduce electrical lighting power in response to the transient contribution of daylight? And, how does the level of energy reduced in the perimeter zones compare to the core zones, and at the scale of an entire floor?

Prior to discussing the performance of the photocontrolled perimeter zone lighting, it is important to note that the electrical lighting energy reduction was less than anticipated in the above quotations when the percent-reduction is considered at the scale of the whole-floor lighting load. As discussed in Chapter 10, from a maximum effective LPD of 1.03 W/ft<sup>2</sup> (for the overhead electrical lighting), the maximum reduction achieved by photocontrols was (18.4%) and the average daily lighting power reduction (during working hours 6AM – 7PM DST) was 12.6% (**figure 11.17**). Therefore, at the scale of an entire floor, the contribution of photocontrols is significantly lower than the 26% reduction anticipated during design.

---

<sup>17</sup> <http://morphopedia.com/projects/san-francisco-federal-building> (Accessed 2/19/2009)

<sup>18</sup> U.S. General Services Administration (2007). San Francisco Federal Building.



**Figure 11.17** Whole-floor effective lighting power density (LPD) for one workweek (July 26 – 30, 2010) for the 16th floor. Average and minimum LPD are calculated from data recorded between 6AM – 7PM DST. (Reproduced from Chapter 10).

Analysis of the photocontrolled perimeter lighting zones revealed that electrical lighting energy consumption was not directly related to interior daylight availability. Although the predominantly lowered positioning of shading devices on the SE perimeter zone and solar control film were found to limit the effectiveness of the photocontrolled dimming of the overhead electrical lighting, the greater than anticipated energy consumption of the overhead electrical lighting in the perimeter zones was also related to the fact that the dimming control was found to have been overridden by a setting from the automated lighting control system software interface. This resulted in extended periods of time when the overhead electrical lighting system remained in a full or partial-output mode and did not dim in response to available daylight. This outcome has implications for the typical assumption of “ideal” photocontrol performance often made in simulation (e.g. ASHRAE 90.1 compliance), where the level of electrical lighting energy reduction achieved from photocontrols is assumed to be directly proportional to the quantity of interior daylight available.

Existing LPD baselines are based on a minimum workplane illuminance from overhead electrical lighting. For offices, a LPD of 1.0 W/ft<sup>2</sup> should enable an average workplane illuminance of approximately 300 – 500 lux using common commercially available florescent lighting. This research investigated this assumption with the following research question:

- What is the relationship between workplane illuminance recommendations for offices (e.g. 300 – 500 lux) and occupant subjective assessment of sufficient

daylight to work comfortably without overhead electrical lighting (i.e. working only with optional task lighting)?

In the perimeter zones, issues related to maintenance and low reflectivity of the ceiling combined with photocontrolled-dimming resulted in overhead electrical lighting delivering less than 10% of total workplane illuminance during occupied hours. In this context, logistic regression models developed from subjective assessments showed a high probability for occupant perception of sufficient daylight to work comfortably using only task lighting throughout the majority of occupied hours.

Results showed that participants indicated the perception of sufficient daylight to work comfortably with the overhead electrical lighting OFF when workplane illuminance levels were below industry standards for workplane illuminance. Approximately 65% to 70% of all responses recorded in the perimeter zones at workplane illuminance levels between (0-300 lux) indicated the perception of sufficient daylight to work comfortably without overhead electrical lighting and approximately 80% to 95% of responses for illuminance levels between (300 to 500 lux). It is important to note that, as described above, occupants in the perimeter zones were assessing a predominantly daylit space, where only a small fraction (< 10%) of the total workplane illuminance was from overhead electrical lighting. The result suggests the objective of “daylight autonomy” can be achieved routinely in daylit perimeter zones where occupants perform both computer-based and paper-based tasks. This is perhaps the most significant outcome from the examination of the perimeter zones from an energy perspective. This outcome has implications for the current maximum LPD requirements in Title-24 (2005) as well as ASHRAE 90.1. Both assume that compliant buildings should be allowed a LPD of 1.0 W/ft<sup>2</sup> with an additional 0.2 W/ft<sup>2</sup> added for task lighting in perimeter zones. Based on this assumption, energy “savings” are considered in relation to the energy consumed by this “baseline” condition. Results from this study suggest that a more aggressive and ambitious baseline can be established in perimeter zone spaces where daylight is available via sidelighting.

### 11.2.6 Summary of lessons learned

*The designer of this building obsessively focused upon temperature and maximization of light to the detriment of all other factors. The windows open automatically to adjust for temperature, but cannot take into account differences between areas of a floor, and have no capacity to take into account external noise or wind. The automatic adjustment of the fluorescent light takes away the occupants ability to make necessary adjustments. The design may save money and be more green, but it ends up being an irradiated and uncomfortable place to work.*

-Phase 1 study participant

The quotation presented above contains the central lesson the SFFB offers as a case study in daylighting performance, a lesson related to the overall balance of daylighting and view objectives with occupant visual comfort. As noted earlier in this dissertation, in contrast to the consensus-based standard available to assess thermal comfort in buildings, both in design and operation, there is significantly less guidance for how to consider potential issues of occupant visual discomfort during design. The reliance of architects on rules of thumb and design intuition, or green building compliance criteria during design is due, at least in part, to a paucity of performance data collected from buildings in use describing the interior daylight illuminance conditions acceptable to building occupants and the lighting conditions associated with visual discomfort. This topic is discussed further in the following section (**Section 11.3**). In the case of the SFFB, significant efforts were made to “maximize” daylight transmission to perimeter and core zones to achieve theoretical daylight illuminance “targets” that were found to be significantly higher than the levels acceptable to (or preferred by) occupants. Occupant comfort concerns were primarily addressed with exterior solar control devices that reducing solar loads without adequately controlling luminance levels. These efforts resulted in significant levels of visual discomfort leading in turn to the installation and deployment of interior shades and films in the perimeter zones, significant levels of visual discomfort in the core zones, and significantly lower daylight illuminance in the core zone than anticipated.

The lessons learned are summarized in the following points:

1. Exterior solar shading devices that either diffuse (i.e. translucent glass fins) or screen (i.e. 50% perforated metal panels) direct beam solar radiation were found to be problematic for visual comfort. Exterior solar shading devices that are capable of completely blocking direct view of solar disc from occupant workspaces are necessary for occupants to work comfortably without lowering interior shading devices.
2. Exterior solar control devices similar to the screen implemented on the SE facade have the potential for effective solar control for occupant comfort while

- maintaining the perception of visual transparency. To maintain comfort for occupants, the screen should be designed 3-dimensionally in response to solar geometry to completely block direct sun penetration during the majority of hours the facade receives direct sun.
3. The (0.24) VLT solar control film added to the SE facade and interior roller shades added to the NW and SE facades to reduce visual discomfort from windows were found to significantly reduce the level of daylight transmission to the core zones.
  4. Interior roller shades were insufficient to create comfortable visual conditions for occupants and were often observed to be “supplemented” with personal modifications that enabled the view of the solar disc to be completely blocked.
  5. Where the facade is subdivided to create an upper “daylight zone” as a strategy to increase daylight transmission to the core, provide devices (such as an interior light shelf) or optical louver system to shield the view of occupants working adjacent to the perimeter zone from excessive upper window luminances and redirect daylight to the ceiling. Alternatively, occupants are likely to request interior shading devices for the daylight zone and are likely to keep them in a lowered position.
  6. Ceiling surfaces should have high light reflectance (e.g. 80%) and a diffuse finish to control specular reflections.
  7. Enable building occupants to easily reconfigure their primary visual task orientation in response to daily and seasonal variations in interior daylight and glare conditions.
  8. The behavioral modifications to the facade and workspaces resulted from insufficient control over the level of opacity of the facade. Where occupant workspaces are located adjacent to the facade, reduce the window-to-wall ratio (WWR) to provide opaque sections of facade.
  9. Provide occupants with the ability to control (e.g. switch on, off, and dim) the individual overhead electrical ambient lighting fixtures above their workspace.
  10. The overhead lighting system should be configured to turn off overhead electrical lighting automatically when an occupant leaves his or her workspace for an extended period of time.
  11. Regularly clean overhead lighting fixtures and lamps to maintain efficient light output.

### **11.3 Lessons learned from examination of the applicability of daylighting performance indicators in the field assessment of the SFFB**

There is a growing effort both in the daylighting research community and through consensus-based green building rating systems to differentiate daylit buildings based on quantitative performance indicators. Invariably, the indicator used is a metric based on physical measures (or simulated values) of horizontal workplane illuminance. As a result, there is an emphasis placed by designers on facade designs that demonstrate through simulation that the required quantitative criteria are achieved. However, there is currently limited evidence from the field demonstrating that achieving the criteria specified leads to occupants who are satisfied with interior daylighting conditions, or that failing to meet the criteria leads to dissatisfied occupants. In addition, existing methods make theoretical (or no) assumption for the potential impact of occupant control of shading devices or the potential visual discomfort that may occur simultaneously with achieving illuminance targets. The following section discusses the implications of the results for shade control on existing methods of predicting daylight availability. The next section discusses the implications of daylighting strategies that place emphasis on achieving existing horizontal illuminance-based criteria on occupant visual comfort.

### 11.3.1 Shade positioning and frequency of operation

The operation of interior shading devices by occupants plays a significant role in the level of effective light transmittance of the facade glazing and available visual connection to the outdoors. To examine the frequency of shade operation, the following broad research question was asked:

- What is the relationship between the shade operation behavior predicted by existing behavioral models and the behavior observed?

To address this question, three hypotheses for occupant control of interior shading devices were examined. The first hypothesis assumes that occupants deploy shading devices in response to the magnitude of solar radiation incident on the workspace and retract shading devices on a daily basis (either the following day, or when the stimulus no longer exceeds the threshold for deployment). This “active operator” is common in computer simulations of daylight availability (Lee and Selkowitz, 1995; Reinhart, 2002; HMG, 2010) and will be introduced into the next version of the LEED daylighting credit compliance procedure. It can be argued that the active operator hypothesis also underlies the decision of designers to use large areas of high visible light transmittance (VLT) glazing, where an assumption is made that the level of daylight transmission enabled by the high VLT glazing will not be significantly reduced by occupant operation of shading devices. In other words, the transmissive properties of the facade will be used to good effect when available daylight is low and interior shading devices will be lowered when, and only when, daylight would be excessive. The second, “worst case scenario” hypothesis, emerges from studies of buildings in use (Rubin, 1978; Rea, 1984; Foster and Oreszczyn 2001; Inkarojrit, 2005) and is based on observations that occupants often position shading devices according to “worst case” solar control conditions, determined from perceptions formed over weeks or months, and rarely change them. Whether occupants behave as “active operators” or position shades for “worst case” solar control conditions has a significant effect on daylight availability and view. Prior studies were conducted in buildings where the facade was not subdivided into a lower (view) zone and upper (daylight) zone. Therefore, it is unclear how applicable the assumptions for shade control behavior based on prior studies would be for buildings such as the SFFB, where each occupant adjacent to the SE facade could potentially lower the shades for the row of vision windows to reduce discomfort while keeping the upper rows of windows unshaded for daylight transmission to the interior workstations. Therefore, it was necessary to test a third hypothesis. This “selective operator” hypothesis assumes that the upper row of windows is less likely to be shaded by occupants adjacent to the facade because glare associated with the upper windows will be outside of the occupant’s field of view.

Results from time-lapse observation of shade positioning (Chapter 5) showed that relatively few of the study participants behaved as “active operators.” Instead, the majority of study participants shaded over half of the high VLT glazing in the vision zone and an even greater portion of glazing in the daylight zone. They rarely (or never) adjusted the shade position. Overall, this outcome most closely matched the outcome predicted by the “worst case” behavioral model Inkarojrit (2005) and conclusions made

from previous studies of buildings in use based on exterior observations of shade position, e.g. Rubin (1978), Rea (1984), Foster and Oreszczyn (2001). This outcome suggests a pattern of behavior in the SFFB that has implications for current approaches to predicting daylight availability based on effective aperture calculations that use only the visible light transmittance of the glazing and window area as terms. In addition, the observed behavior conflicts with the basic assumption for the position of shading devices being introduced to the 2012 draft of the LEED Daylight EQ credit simulation-based compliance method. Where the approach emerging in LEED recognizes that shades play an important role in the level of daylight achieved in buildings, it also relies on what appear to be optimistic assumptions for occupant shade operation. Shade operation behavior observed in the SFFB study showed that shades were rarely adjusted over either daily or seasonal changes in sun and sky conditions, a finding that suggests simulation-based approaches to assessing interior daylight availability should consider a range of possible outcomes and include weighted “active operator” and “worst case” scenarios as concurrent outcomes.

To investigate the relationship between the stimulus intensities used in simulation to predict shade control behavior and the stimulus intensities observed in the field, this research asked the following broad research question:

- How do the stimulus intensities currently used in shade control behavioral models to predict the operation of shading devices compare to the intensities observed in the field?

Based on observations of 245 shade operations observed among (N=14) study participants collected over the course of the study, a number of single-variable logistic regression models were produced to describe the stimulus intensities associated with occupant decisions to raise and lower interior roller shades under regular working conditions. Overall, the probability of shade lowering events agreed with the probabilistic models developed by Inkarojrit (2005) from field data. When compared to threshold-based models, e.g. Lee et. al. (1995), Reinhart (2002), the probabilistic models developed from the SFFB showed a high probability that shades would be lowered at stimulus intensities defined as acceptable<sup>19</sup> by the threshold models (e.g. transmitted solar radiation < 50 w/m<sup>2</sup>). This outcome suggests that threshold-based models, when applied in an open-plan context with a highly glazed facade, may overestimate the daylight delivered to building interiors by assuming that the unshaded window conditions are acceptable to building occupants. Therefore, even under the most ideal scenario of widespread active occupant control of shading devices, this research suggests that existing threshold-based models may overestimate the time that windows will remain unshaded. However, due to the limited number of study participants who operated shading devices regularly in this study, as well as the fact that the study population is drawn from a single building, conclusions based on the data are limited in scope. .

---

<sup>19</sup> And, therefore, shades are assumed to remain raised.



In regard to “more accurately” predicting occupant behavior in simulations of daylight availability, application of the behavioral models developed in this study in simulation is not direct. In addition to the issues related to the infrequency of shade operation discussed above, occupant shade control behavior was found to vary in response to a range of additional factors. First, participants operated shading devices in the vision zone far more frequently than in the upper daylight zone. In addition, participants tended to operate adjacent shades in the vision zone differently, keeping one raised for view and the adjacent one lowered to reduce visual discomfort. Further, participants lowered shades in the upper daylight zone at lower stimulus intensities compared to the lower vision zone. Therefore, the assumption that a building occupant will raise or lower all shades simultaneously is problematic, and appears even more unrealistic as occupants are required to operate an increasing number of shades distributed both vertically and horizontally along the facade. Despite these issues, the assumption that ... is common in existing approaches to simulate occupant shade control. This research suggests that different criteria apply for shade control in the daylight zone and vision zone of the facade and further suggests that occupants in highly glazed buildings are likely to create more complex shading configurations than the “completely raised” or “completely lowered” configurations assumed in existing simulation based approaches for predicting daylight availability.

The investigation into shade control behavior undertaken in this study suggests that the challenge of addressing the gap between assumptions of interior daylight availability made during design and the actual outcomes in buildings in use can only be partially addressed by improving knowledge of the environmental conditions associated with shade operation. Even with better knowledge for the discomfort conditions associated with the lowering of shading devices, one must make assumptions for how frequently occupants will raise shades. This latter assumption is likely to depend on a number of factors unique to each building and occupant population, such as the potential impact of an occupant’s decision to raise or lower shading devices on the comfort of nearby co-workers, ease of access to and control of shading devices, or an occupant’s knowledge of (and engagement with) the idea of the daylighting concept as a strategy for energy reduction. In this study, the complex configurations of facade shading and personal modifications created by the majority of occupants suggest that occupants will accept and may prefer regions of the facade to be opaque (or heavily screened) simultaneously with smaller regions that are highly transmissive and through which views remain unobstructed. Furthermore, shade control behavior for buildings that have areas of opaque facade may result in different shade control behavior than that in fully glazed facades as a result of the potential for occupants to adjust their primary task view towards opaque areas of the facade. Ultimately it is important to investigate the performance any popular daylighting strategy in the field to establish realistic performance expectations. The final section discusses the contributions of this study to existing knowledge of the interior daylighting and visual comfort conditions acceptable to occupants.

### 11.3.2 Balancing daylight transmission with visual comfort

The delivery of sufficient daylight to building occupants and the provision of unobstructed views to the outdoors are central objectives of facade design strategies implemented in buildings promoted as “green,” “sustainable,” or “high performance.” The central lesson from this research is that these daylighting objectives must be in concert with provisions for solar and glare control to maintain occupant visual and thermal comfort. Results from this study show that existing illuminance thresholds for daylight sufficiency overestimate the minimum daylight illuminance levels acceptable to occupants and underestimate the thresholds associated with visual discomfort. In addition, the physical measure of workplane illuminance, the primary performance indicator used in simulation to judge the effectiveness of daylighting strategies, was found to be a poor and often ambiguous performance indicator. For example, no statistically significant relationship was found between physical measures of horizontal workplane illuminance and occupant satisfaction with the amount of daylight in their workspace during several test phases of the study. During the other test phases, the relationship was ambiguous: the magnitude of satisfaction and dissatisfaction both increased with stimulus intensity. In addition, study participants in both perimeter and core zones often judged the interior daylighting conditions to be sufficient when the total workplane illuminance was below existing threshold criteria for daylight autonomy or the electrical lighting industry’s workplane illuminance standards (e.g. 300, 500 lux). Therefore, this research does not support the use of horizontal illuminance threshold criteria (e.g. Daylight Autonomy, LEED Daylight EQ Credit compliance method) as the principal, much less sole, basis for evaluating daylighting performance. .

In contrast to physical measures of workplane illuminance, subjective measures of visual comfort were found to be strongly correlated with occupant satisfaction with the amount of daylight in their workspace. Perhaps one of the most valuable contributions of this study is the finding showing that when occupants are satisfied with visual comfort conditions there is a high probability that they will be satisfied with the amount of daylight in their workspace, in ways that are relatively insensitive to the amount of daylight present. This finding suggests that greater emphasis should be placed on visual comfort as an indicator of daylighting performance during design when the majority of occupants are in reasonably close proximity to windows, such as the conditions of this study (e.g. < 30 feet). Similarly, less emphasis should be placed on achieving daylight illuminance targets, where overly exuberant efforts to transmit daylight to the interior are likely to lead to occupant discomfort and the lowering of shading devices. A reduction in emphasis by green building rating systems and energy standards on physical transmission levels of facade assemblies would enable strategies that use more modest glazed areas to avoid being “screened out” from consideration as potentially successful examples of daylighting.

As discussed in Chapter 2, data from buildings in use describing the visual conditions acceptable to building occupants and the conditions associated with visual discomfort are extremely limited in availability. In this study, a total of 3443 subjective assessments of visual discomfort among (N=44) participants were analyzed to identify the physical

variables associated with visual discomfort and to model the relationship between stimulus intensity and subjective levels of discomfort. Logistic models of visual discomfort are provided in Chapter 7 based on both conventional measures (e.g. vertical irradiance) and more detailed measures (e.g. luminance distributions obtained from HDR images) to predict discomfort. Designers could implement these models directly using variables available from both energy simulation programs (e.g. Energy Plus) as well as daylighting simulation software capable of generating predictions of surface luminance (e.g. Radiance). In addition, the logistic models provide a framework for interpreting the results from physical measurements collected in buildings in use.

## CHAPTER 12

### CONCLUSIONS

#### 12 Conclusions

##### 12.1 Conclusions

This research used a longitudinal field study involving (N=44) occupants performing regular work tasks in perimeter and core office spaces in the San Francisco Federal Building to assess the daylighting performance of the building in use. Daylighting performance was assessed by studying three fundamental and interrelated aspects of performance: occupant behavior, electrical lighting energy consumption, and occupant satisfaction with the indoor environmental quality factors of visual comfort, daylight sufficiency and view. The study had three primary objectives:

1. Examine if the perimeter and core zones of this daylit office building, designed to achieve objectives of electrical lighting energy reduction and LEED Daylighting EQ credit compliance, maintain acceptable levels of visual comfort.
2. Develop a field-based method to record occupant subjective assessments paired with concurrent physical environmental measures in a manner resulting in minimal intervention to typical occupant behavioral patterns, workspace conditions, and work tasks.
3. Examine the applicability of existing shade control models and indicators of daylight sufficiency, visual comfort, and view used by designers to predict the daylighting performance of office spaces. Where gaps are found in existing knowledge, develop predictive models that can be used to better predict shade control behavior or occupant satisfaction.

A number of research questions were formed to address these objectives. To answer questions related to occupant control of interior roller shades, time-lapse images of interior facade elevations were used to monitor the position and frequency of operation of roller shades adjacent to study participant workspaces over the duration of the study. Observed shade positioning and frequency of operation were then compared to the behavior predicted by existing shade control models as well as to the initial assumptions of the design team for the level of daylight transmission achievable through the facade. To answer questions related to range of environmental conditions acceptable to occupants, novel desktop polling stations were developed and used to gather subjective responses with concurrent physical measures of interior or exterior environmental conditions. These data were then compared to the outcomes predicted by existing quantitative performance indicators of daylight sufficiency and visual discomfort.

There are two notable outcomes from this dissertation. The first is a detailed description of the performance of the SFFB relative to its daylighting objectives based on an assessment conducted after the facades were retrofit with interior shading devices and a solar control film was added to the SE facade. These results show that shading devices adjacent to observed workspaces were positioned to shade the majority of the high visible light transmission glazing and, once in place, were rarely operated by occupants. Despite the significant reduction in daylight transmission resulting from the interior shading devices (as well as the solar control film on the SE facade), in the perimeter zones a high proportion of occupant subjective responses indicated visual discomfort from windows and a preference for less daylight. However, the amount of daylight in the perimeter zones was perceived by occupants to be sufficient to work comfortably without overhead ambient electrical lighting for the majority of daylight hours each day. In contrast, available daylight in the core zones was rarely perceived to be sufficient by participants to work comfortably without the overhead electrical lighting and overhead electrical lighting in the core zones (which was not controlled by photo-sensors) was never switched off or dimmed by occupants during the study. In addition, the proportion of subjective responses indicating visual discomfort recorded in the core workspaces was substantial (Phase 3, 68%; Phase 6, 32%), and was comparable to the NW perimeter zones (Phase 1, 70%; Phase 4, 40%) and SE perimeter zones (Phase 2, 40%; Phase 5, 60%). These results bring into question the efficacy of a number of daylighting strategies implemented in the SFFB and their status as prototypes for achieving the objectives of daylight sufficiency and electrical lighting energy reduction while maintaining comfortable conditions for occupants.

The second outcome from this dissertation is an examination of existing guidance for the design of daylit buildings. Existing guidance, in this context, refers to shade control behavioral models and daylighting performance indicators of daylight sufficiency and visual discomfort. These indicators, and the criteria used to interpret their results, are used during design to evaluate the daylighting performance of design alternatives (e.g. compliance with the LEED Daylighting EQ credit) as well as to measure and assess the performance of buildings in use (e.g. ASHRAE Performance Measurement Protocols). Results from this study show that existing illuminance thresholds for daylight sufficiency overestimate the daylight illuminance levels acceptable to occupants and underestimate the prevalence of visual discomfort. In addition, an analysis of subjective assessments of visual discomfort paired with physical measures found that existing indicators of visual discomfort often underestimate the level of visual discomfort and are less accurate predictors of discomfort compared to basic statistics computed from HDR images (e.g. maximum window luminance). Finally, the majority of existing shade control behavioral models were found to underestimate the magnitude of physical environmental conditions associated with occupants lowering shading devices, and significantly overestimate the frequency of shade operation (i.e. raising and lowering), leading to results that overestimate interior daylight availability. These results have implications for both the criteria used to define sufficient levels of daylight illuminance set as “targets” for daylit buildings as well as the assumptions made for the level of occupant intervention (via control of shading devices) in buildings designed to achieve these “targets.”

To improve the guidance available to designers attempting to implement daylighting as a strategy to reduce electrical lighting energy consumption and enhance (or at least maintain) IEQ, logistic regression models were developed from field data to predict occupant control of shading devices and visual discomfort. Based on observations of 245 shade operations observed among (N=14) study participants, a number of single-variable logistic regression models were produced to describe the environmental conditions associated with occupant decisions to raise and lower interior roller shades under regular working conditions. In addition, a total of 3443 subjective assessments of visual discomfort among (N=44) participants were analyzed to examine the physical variables associated with visual discomfort and to model the relationship between stimulus intensity and subjective levels of discomfort. Logistic models for shade operation and visual discomfort are provided that use either conventional measures (e.g. vertical irradiance) or more detailed measures (e.g. luminance distributions obtained from HDR images) to predict discomfort. Designers can implement these models directly using variables available from both energy simulation programs (e.g. Energy Plus) as well as daylighting simulation software capable of generating HDR images (e.g. Radiance). In addition, these models provide a baseline for interpreting the results from physical measurements collected in buildings that is based on evidence from buildings in use.

It is important to note that this study was conducted in a limited area of the SFFB and involved a modest number of occupants (N=44) relative to the population of the building (2000 people at full occupancy). Therefore, performance outcomes should be considered in the context of the zones of the building that were examined.

### **12.1 Suggestions for future work**

This study introduces a number of possible areas for future research, which are outlined below:

Continued research in additional daylit buildings: It is important to emphasize that the conclusions drawn from this study are based on data collected in a single building. There is an enormous potential to develop a better understanding of both the shade control behavior and daylighting conditions acceptable to building occupants through the application of similar methods to additional buildings. One of the significant barriers to drawing broad conclusions for the behavior or preferences of building occupants in daylit spaces emerges from the poverty of data relating occupant behavior or subjective assessments to physical daylighting conditions in real buildings. This study developed a polling station device and measurement protocol that can be easily deployed in additional daylit buildings to begin to collect a body of data relating subjective assessments to physical environmental measures. Although there are bound to be numerous challenges in the analysis of data collected from buildings of different use, vintage, climate, solar orientation, solar control strategies, floor-plan arrangement, materials of construction, and occupant populations, it is the belief of this author that analysis of this data across buildings will lead to a greater context to understand the performance of daylighting and solar control strategies.

Relate “point in time” subjective assessments to overall subjective assessments of the indoor environment: In this study, repeated “point in time” subjective measures were collected from occupants using the desktop polling stations, and single “overall” assessments (of satisfaction with personal workspace, building overall etc.) were collected using a web-based survey questionnaire. However, a framework for analyzing the relationship between repeated subjective assessments of transient conditions against overall assessments was not established. For example, how can one determine how a particular occupant’s exposure to relatively infrequent but extremely uncomfortable glare may influence their overall assessment of their environment? In other words, an avenue for additional research would be to examine how varying patterns of transient environmental conditions lead occupants to form overall impressions of satisfaction with the indoor environment or take actions such as raising or lowering shading devices. For example, as demonstrated in Chapter 6, a group of “occasional operators” were found to make adjustments to shading devices based on impressions of the level of shading required that appeared to be formed over the previous several days rather than instantaneously (as an automated shading system would behave).

Compare occupant assessments of daylighting as a qualitative component of the indoor environment with occupant assessment of daylighting as an energy-saving strategy: In this study, two questions were asked of study participants using the polling stations to address the topic of daylight sufficiency. The first question addressed occupant satisfaction and was based on the notion that occupant satisfaction with daylight is related to the perceived AMOUNT of daylight. The other question addressed daylight sufficiency from an energy-saving perspective. Given the substantial interest in the concept of daylight sufficiency in climate based daylighting simulation, and the growing use of simulation in green building rating systems and professional practice, it is important to establish a consistent set of survey questions to measure daylight sufficiency from the perspective of building occupants. Lacking a consistent set of survey questions, it remains unclear what concept of daylight sufficiency occupants should be asked to assess. For example, should daylight sufficiency be assessed in regard to the occupant’s assessment of whether or not energy is being consumed unnecessarily by the electrical lighting system? Or, should daylight sufficiency be assessed using a broader definition that encompasses additional qualitative factors (sufficient to feel connected with the outdoors, stimulated and awake, etc.)?

Include monitoring of occupancy to develop better metrics for electrical lighting energy performance: Additional work could improve on the methods used in this field study by including monitoring occupancy at each workspace. To establish appropriate metrics for energy use, it is obvious that it is important to know what fraction of the day an occupant is at their workspace when the overhead electrical lighting is on. Occupancy sensing could be added to similar polling station devices and occupancy rates could be used to develop metrics for electrical lighting efficiency that relate energy consumption to occupancy.

Study social factors for energy-efficient behavior in an open-plan context: In the context of a shared workspace such as the open plan zones of the SFFB, the actions of any given

occupant to adjust local indoor environmental conditions are likely to have some affect on those of his or her neighbors. This is particularly apparent in the configuration of the overhead electrical lighting system, where an entire side of one half of a single floor of the tower section is controlled as a single zone. It is also apparent that the configuration of shading devices for one workspace adjacent to the facade may limit daylight or be insufficient to control glare or direct sun for either a neighboring workspace or for workspaces away from the facade. The process for how a group resolves the configuration of facade shading over time has, to this author's knowledge, not been studied, and is likely to be relevant to accurately predict the positioning of shading devices in an open-plan context. Of particular interest for research may be to study differences in group behavior when the group has knowledge (or a belief) that an action will lead to energy reduction (or enhance co-worker well being) compared with when the group knows or believes that their behavior will not influence energy consumption (or may negatively affect co-worker well-being).



## Appendix A: Approval Letter from the U.C. Berkeley Committee for Protection of Human Subjects (CPHS)

### NOTICE OF APPROVAL FOR HUMAN RESEARCH

**DATE:** *March 18, 2010*  
**TO:** *Charles C BENTON, Arch  
Cain Diaz, CEDR, KYLE STAS Konis, PhD, Arch*  
**CPHS PROTOCOL NUMBER:** *2009-11-358*  
**CPHS PROTOCOL TITLE:** *Occupant control of roller shades in a daylit open-plan office*  
**FUNDING SOURCE(S):** *NONE*

A *new* application was submitted for the above-referenced protocol. The Committee for Protection of Human Subjects (CPHS) or Office for the Protection of Human Subjects (OPHS) has reviewed and approved the application by *exempt* review procedures.

**Effective Date: November 13, 2009**

This approval is issued under University of California, Berkeley Federalwide Assurance #00006252.

If you have any questions about the above, please contact the Office for the Protection of Human Subjects staff at Tel (510) 642-7461; Fax (510) 643-6272; or Email [ophs@berkeley.edu](mailto:ophs@berkeley.edu) .

Thank you for your cooperation and your commitment to the protection of human subjects in research.

Sincerely,

Rebecca Dianne ARMSTRONG  
Committee for Protection of Human Subjects

## Appendix B: Amended Approval Letter from the CPHS

### NOTICE OF APPROVAL FOR HUMAN RESEARCH

**DATE:** *April 20, 2010*  
**TO:** *Charles C BENTON, Masters, Arch  
Cain Diaz, CEDR, KYLE STAS Konis, PhD, Arch*  
**CPHS PROTOCOL NUMBER:** *2009-11-358*  
**CPHS PROTOCOL TITLE:** *Occupant control of roller shades in a daylit open-plan office*  
**FUNDING SOURCE(S):** *NONE*

A *amendment* application was submitted for the above-referenced protocol. The Committee for Protection of Human Subjects (CPHS) or Office for the Protection of Human Subjects (OPHS) has reviewed and approved the application by *exempt* review procedures.

**Effective Date: April 20, 2010**

This approval is issued under University of California, Berkeley Federalwide Assurance #00006252.

If you have any questions about the above, please contact the Office for the Protection of Human Subjects staff at Tel (510) 642-7461; Fax (510) 643-6272; or Email [ophs@berkeley.edu](mailto:ophs@berkeley.edu) .

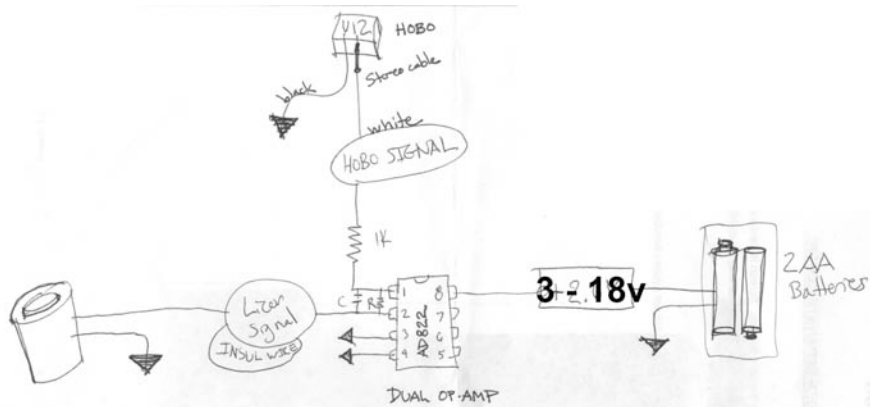
Thank you for your cooperation and your commitment to the protection of human subjects in research.

Sincerely,

Rebecca Dianne ARMSTRONG  
Committee for Protection of Human Subjects

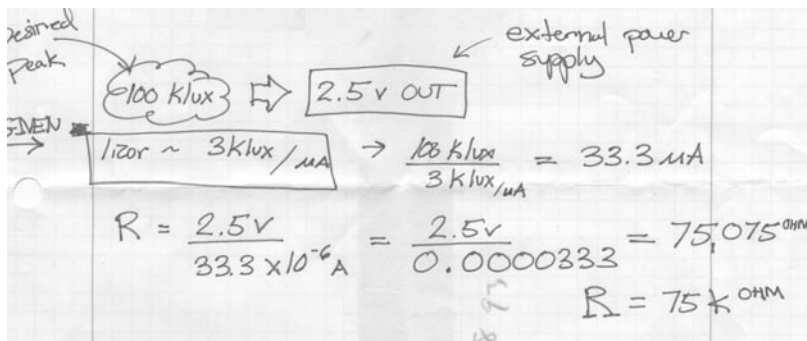
## Appendix C: Illuminance Logging Equipment Design

All global illuminance measures were made using cosine-corrected LI-COR photometric sensors (type = LI-210, nominal accuracy = 3%). The LI-COR 210 measures illuminance as related to the *CIE Standard Observer* curve. All global irradiance measures were made using cosine-corrected LI-COR radiometric sensors (type = LI-200, nominal accuracy = 3%). Measures were logged using the (0-2.5 V) external input of a 12-bit HOBO U12 series temperature/RH (+ 2 external inputs) data logging device.

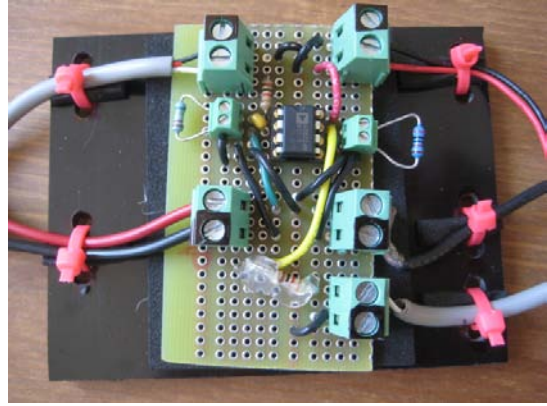


**Figure A.1** AD822 op-amp schematic.

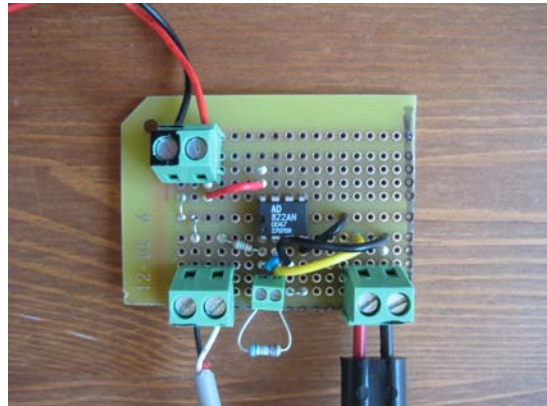
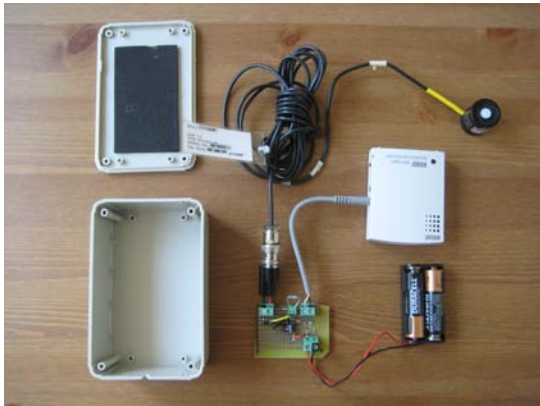
For both sensor types, current output is directly proportional to visible (or total solar) radiation. To amplify the signal output from the LI-COR sensors to a (0-2.5 V range), an op-amp circuit was built using an AD822 single-supply, rail-to-rail low power FET-input op amp (figure X). The sample range (e.g. 0 – peak (lux)) was determined by specifying a resistor using **figure A.2**.



**Figure A.2** Derivation of resistance value from desired voltage range/peak signal (lux).



**Figure A.3** Exterior illuminance and irradiance measurement and data logging device (left) and dual op-amp circuit (right).



**Figure A.4** Interior illuminance data logging device (left) and op-amp circuit (right).

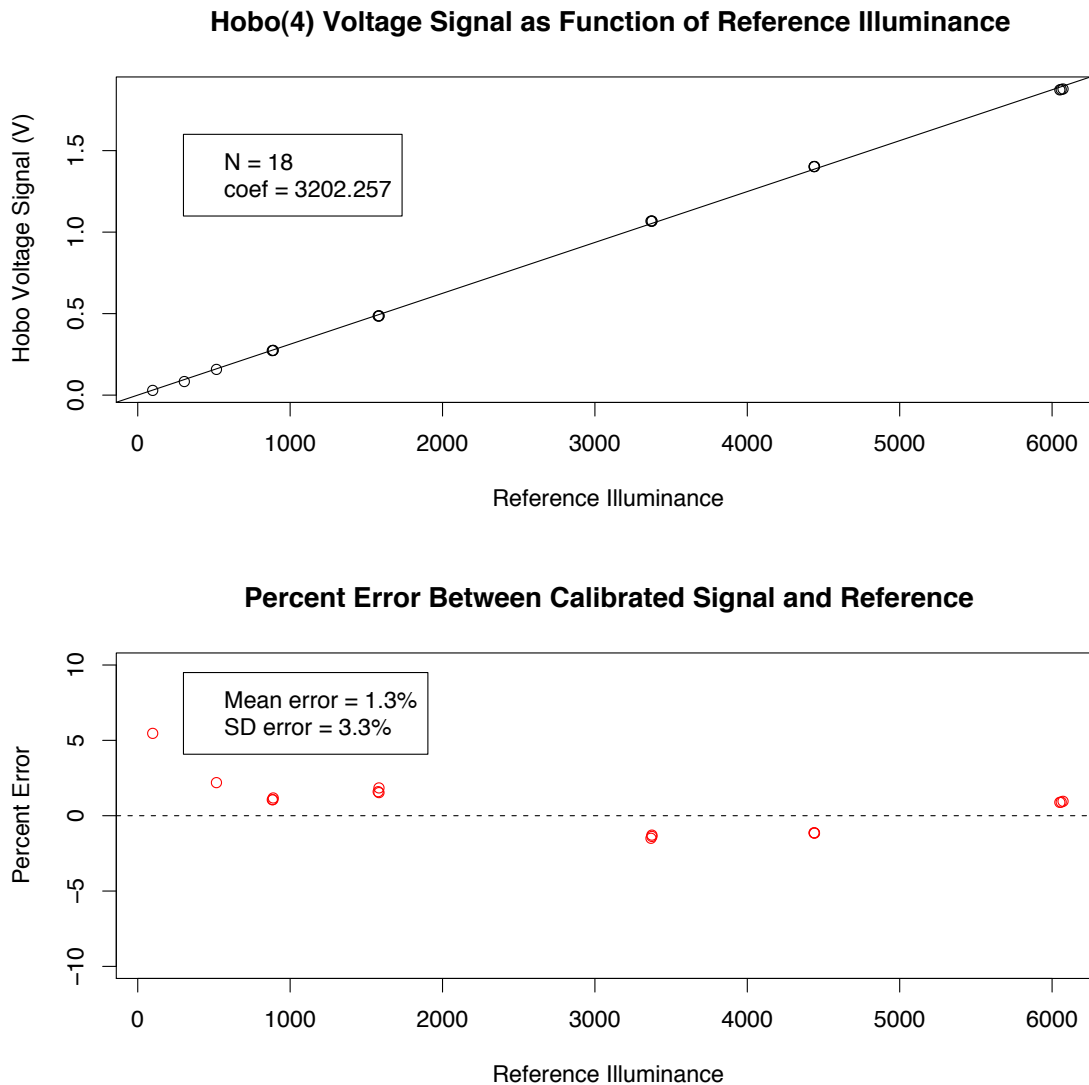
## Appendix D: Method of Calibration for Illuminance Measurement Equipment

All illuminance sensors were calibrated using the same reference measurement and the same general method described below. The reference was a calibrated LI-COR LI-210 connected to a LI-COR LI-250 light meter. Sensors were paired with the reference (**figure A.5**) and placed under a range of daylighting conditions to acquire sample readings at approximately equally-divided steps over the sensor's dynamic range (0-7000 lux). **Figure A.5** shows the interior horizontal illuminance sensors and present an example of the method used to determine the appropriate coefficient to scale each sensor's voltage signal (0-2.5 V) to global illuminance (lux) accurately.



**Figure A.5** Five LI-COR illuminance sensors calibrated using a reference LI-COR illuminance sensor connected to a LI-COR LI-250 light meter.

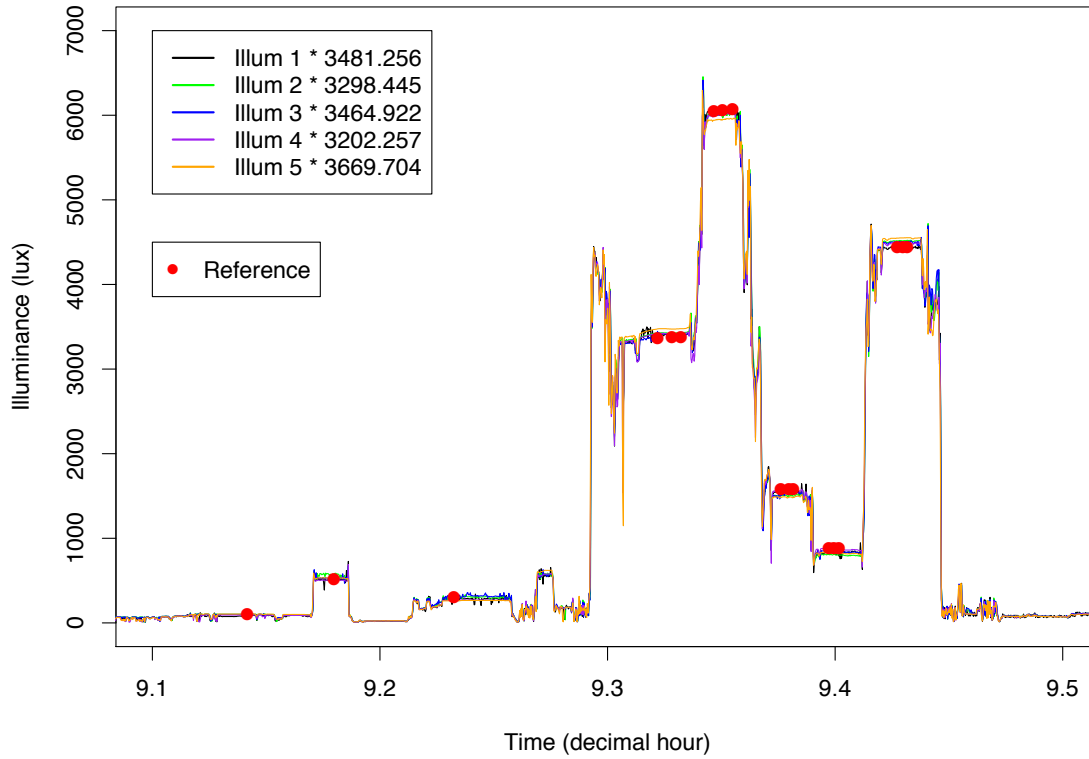
In the above figure, each illuminance sensor was connected to a Hobo data logging device and set to acquire readings every second. Approximately three readings were taken from the light meter under each lighting condition, and the time at which each reading was taken was logged using an i-pod touch that had been time-synchronized with the computer used to initialize the data loggers.



**Figure A.6** Example data from one illuminance sensor showing linear relationship between reference (measured) illuminance values and amplified voltage signal.

**Figure A.6** presents an example of one instrument’s data and shows that, as expected, the voltage signal was directly proportional to the magnitude of the reference illuminance measurement. A coefficient was then found by fitting a liner model (forced fitting through the origin) to the data using the statistical software program R’s “lm” function. To determine that the error between the measured values and the model was not significant, the lower plot (figure X) displays this error as a percentage. The mean and standard deviation of the errors was consistent for all sensors (mean = 1-2%, SD = 2-4%).

### Illuminance Signals After Calibration



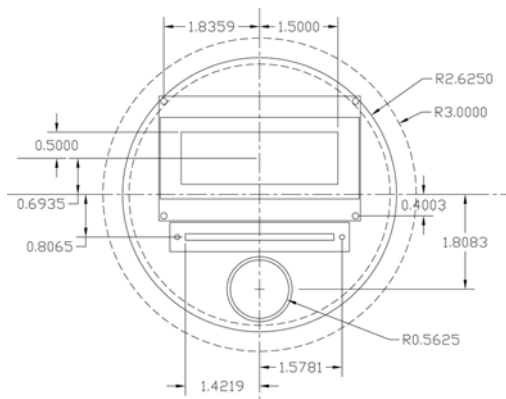
**Figure A.7** Results for five illuminance sensors using coefficients determined in calibration to scale voltage signal.

**Figure A.7** shows the original time-series data (voltage signal 0-2.5 V) scaled by the individual coefficients found using the linear model method described above. The red dots indicate the reference measures acquired using the light meter. This figure confirms that the coefficients result in an acceptable level of accuracy for each of the five interior illuminance sensors.

## Appendix E: Polling Station Fabrication



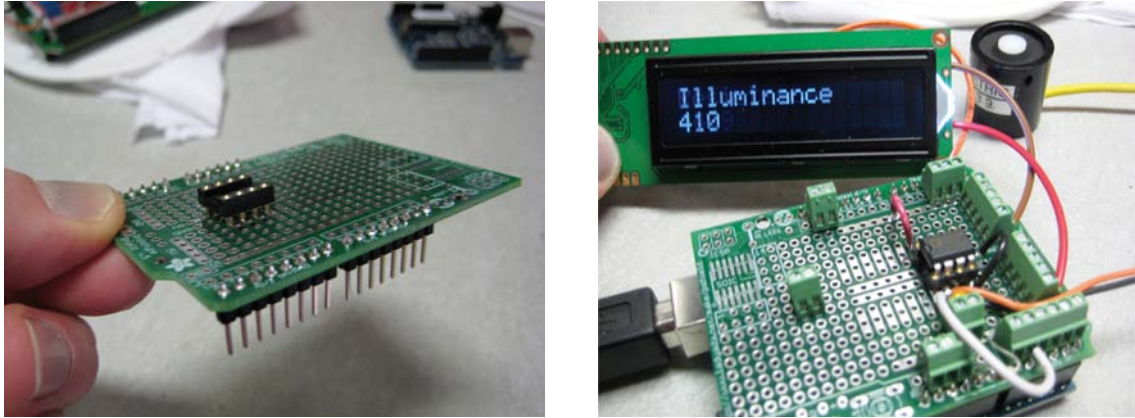
**Figure A.8** Removal of neck from 6" necked white acrylic globe using lathe (left), milling of hole for photosensor (right).



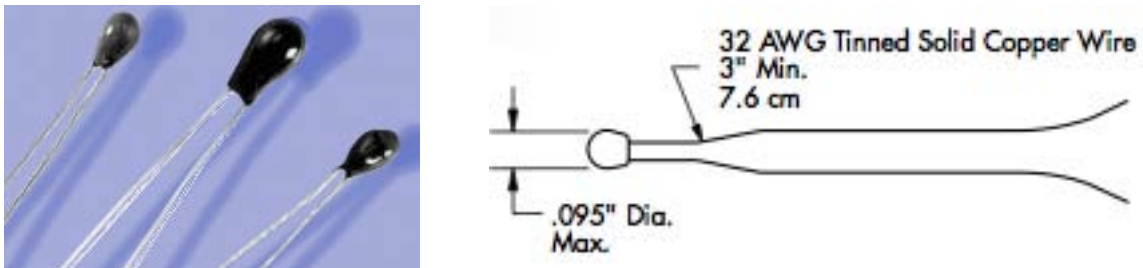
**Figure A.9** Dimensional drawing (left) and milling of acrylic faceplate (right).



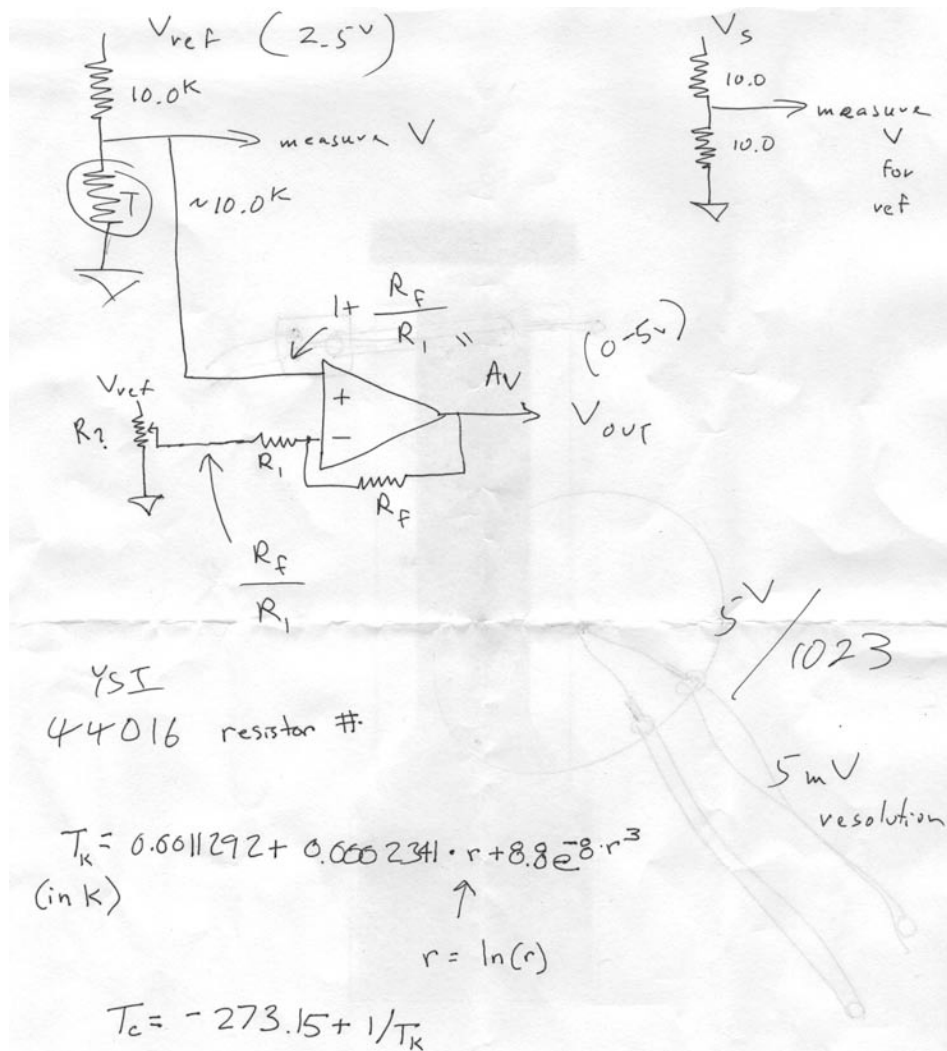
## Appendix F: Integration of Illuminance and Temperature Sensing with the Arduino Microcontroller



**Figure A.10** The Adafruit Proto Shield for Arduino PCB, used to organize the circuitry for the polling stations (left) and validation of the op-amp circuit used to read the licor photometer (right).

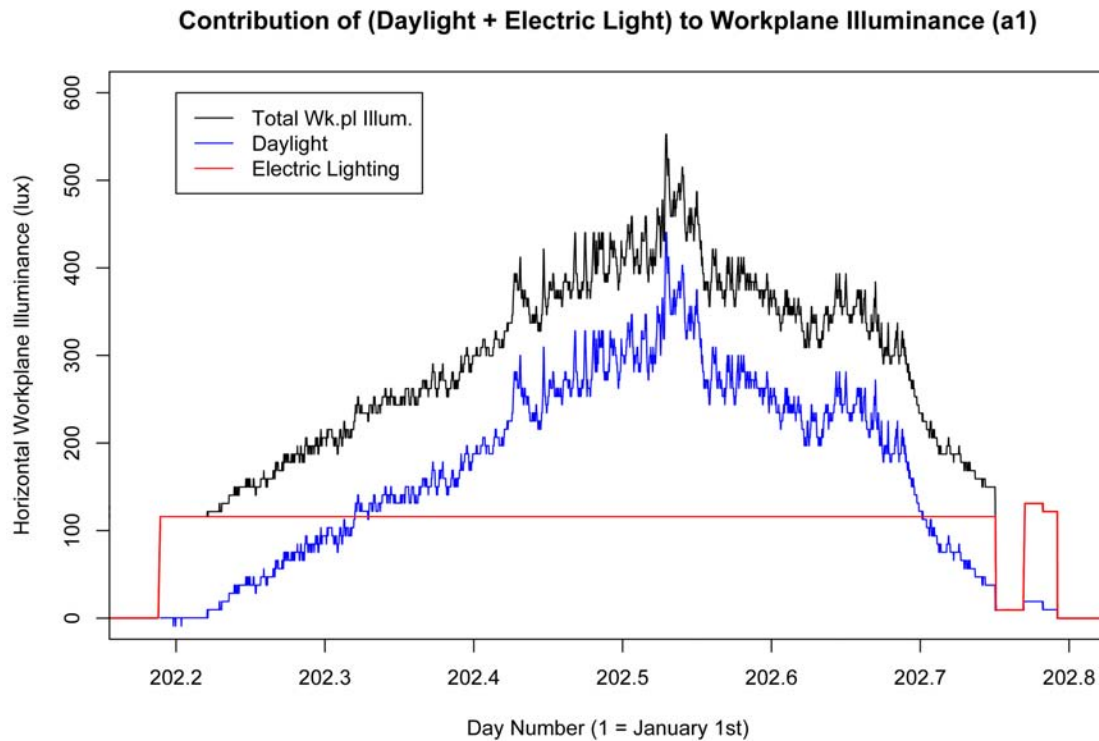


**Figure A.11** Thermistor used: (brand = Measurement Specialties, type = 44016RC precision thermistor, resistance = 10,000 Ohms at 25 degrees C, epoxy encapsulated for general use).



**Figure A.12** Op-amp circuit used to integrate the 44016RC precision thermistor with the Arduino for temperature sensing.

## Appendix G: Method for Subtracting the Contribution of Electrical Ambient Lighting From Measures of Horizontal Workplane Illuminance



**Figure A.13** Contribution of electric lighting to total workplane illuminance.

**Figure A.13** shows the contribution of electrical lighting for a day when the overhead lighting system was set to full output. For conditions where the overhead lighting system was in a dimming state, the contribution of electrical overhead lighting was assumed to be reduced in proportion to measured electrical lighting power, where 30% lighting power was assumed to correspond to 10% lighting output. Full lighting output for each workstation was obtained from illuminance measures taken at the polling station during the night when the lights were switched on to full output for cleaning.

## Appendix H: Instructions for Study Participants

### Desktop Polling Station Instructions for Participants

Primary researcher: Kyle Konis  
Ph.D Candidate  
Center for the Built Environment  
University of California, 390 Wurster Hall #1839  
Berkeley, CA 94720-1839  
[kkonis@berkeley.edu](mailto:kkonis@berkeley.edu)  
206 303 9786

#### **Purpose of this study**

The purpose of this study is to conduct research on the indoor environmental quality in buildings in order to inform and improve the design of future buildings. This study is designed to study occupant satisfaction with daylight and glare in open-office spaces by collecting feedback from occupants over a range of sun and sky conditions and relating these survey data to physical measurements of illuminance, luminance (brightness), and temperature.

#### **The desktop polling station**

A desktop polling station will be located on your desk for a period of two or three weeks. The polling station is a device designed to enable you to record your subjective impressions of the changing daylight and glare conditions that you experience in your workspace by responding to a short (1-2 minute) “right now” survey multiple times throughout each day.

#### **How do I record my responses?**

To begin the survey, PRESS the blue button. A question will appear on the screen. The horizontal slider is then used to select your response to the question. Move the slider around to select your response. When you are sure that you have the response that you want, PRESS the blue button to record it and to move on to the next question. If for some reason you stop in the middle of the survey, don’t worry, the polling station will “time out” after a few minutes and go back to its original state.

**\*IMPORTANT NOTE:** The polling station runs a “right now” survey, so make sure that you are recording your response to the environmental conditions that you are experiencing at that time, and not to general or overall impressions of thermal or lighting conditions in the building.

#### **When should I record responses?**

You should record a response any time you perceive changes in your level of satisfaction with the thermal comfort, daylight, or glare in your workspace. For example, when you start to notice glare from windows, or, at points during the day when you would prefer

more (or less) daylight in your workspace. You can record as many responses as you want to during the day and can respond at any time you choose.

\*You are encouraged to record both the conditions that cause satisfaction as well as the conditions that cause dissatisfaction.

**Will the polling station remind me if I do not respond for a while? (YES)**

To ensure that sufficient data are collected during a range of sun and sky conditions, the polling station will prompt you to take the “right-now” survey if you have not recorded data for over one hour.

To get your attention, the polling station will begin to blink. If you do not want to take the survey at that time, you can move the horizontal slider to “snooze” the polling station.

**Can I open and close the shades when I want to? (YES)**

Please operate shading and lighting devices as you do normally. This study is not meant to intervene on your normal operation of shading or electrical lighting in any way.

**Can I move the polling station around on my desk during the study? (NO)**

The polling station includes a built-in illuminance sensor and temperature sensor that measure light levels and temperature at regular intervals throughout the day. You are asked to place the polling station at a location within easy reach of your primary work area. Once it is placed it should not be moved during the two-week test interval. If it is moved, it should be moved back to its original position.

**Can I unplug the polling station?**

You should keep the polling station plugged in for the duration of the 2-week study. The polling station will automatically go to sleep at night to conserve power.

**What if there is a problem with my polling station during the study?**

The desktop polling stations are prototypes and may behave in strange or unpredictable ways. If you experience any issues with the polling station, please contact Kyle Konis at [kkonis@berkeley.edu](mailto:kkonis@berkeley.edu) (206) 303 9786.

**Can co-workers input data into my polling station? (NO)**

Each polling station should only be used by the participant that it is assigned to.

**Risks and benefits**

There are no foreseeable risks or discomforts involved in participating in this study. The anticipated benefit of these procedures is a better understanding of people's sensitivity to glare and satisfaction with daylight conditions to inform future design of daylight workspaces. All data and survey responses will be kept confidential as is required by the UC Berkeley's Committee for the Protection of Human Subjects. The final published study will be publicly available but no information will be included that would enable the public to determine the details of any individual, such as your office location or your individual survey responses to the indoor environment.

**Alternatives**

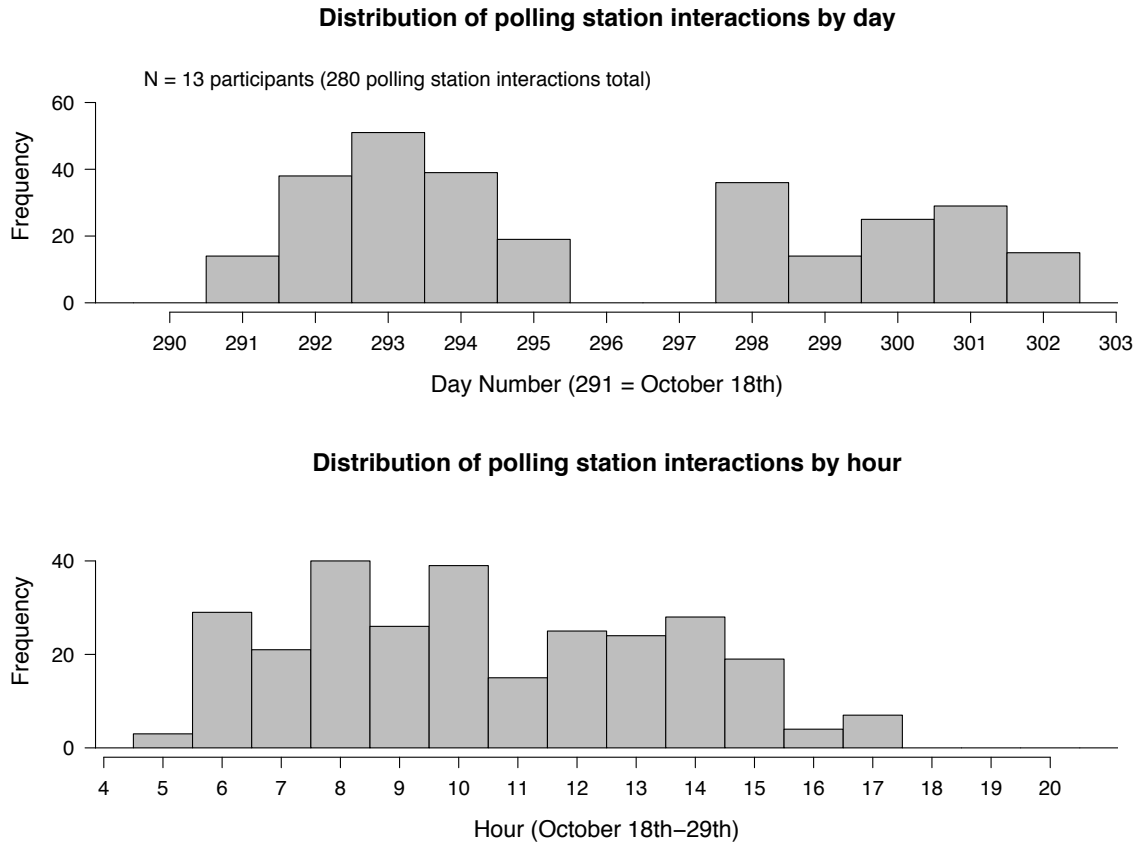
You are free to choose not to participate in this research study at any time.

**Questions / Concerns**

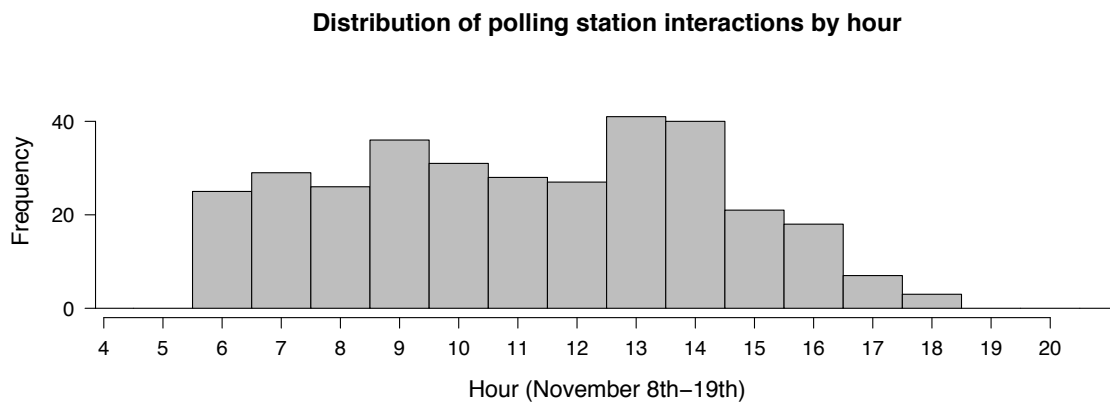
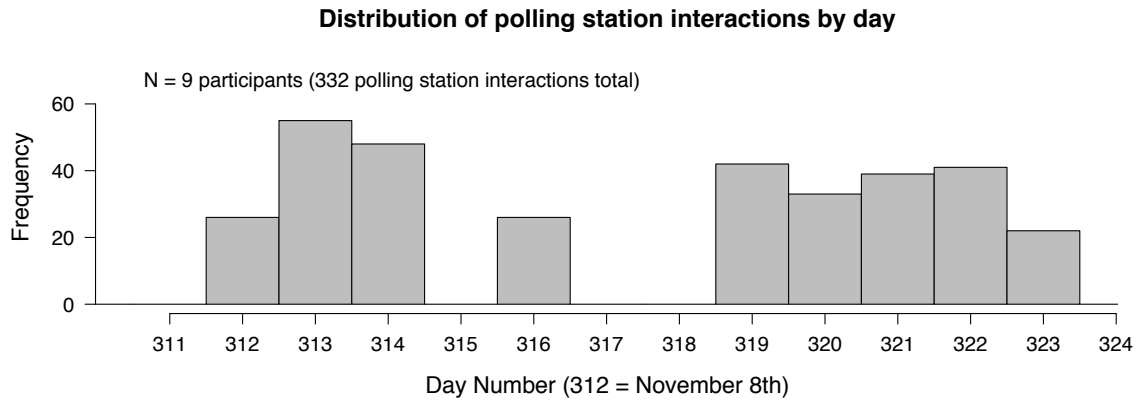
This work is being conducted by Kyle Konis as part of his dissertation research. If you have any questions about this study, please contact Kyle Konis at (206) 303-9786 or by sending an email to [kkonis@berkeley.edu](mailto:kkonis@berkeley.edu).

If you have any additional concerns at any time, please contact Charles Benton, UC Berkeley dissertation advisor at [crisp@berkeley.edu](mailto:crisp@berkeley.edu) or Eleanor Lee, Staff Scientist, Lawrence Berkeley National Laboratory, and primary GSA contact at (510) 486-4997, [eslee@lbl.gov](mailto:eslee@lbl.gov).

## Appendix I: Reporting frequencies for Phases 4, 5, and 6



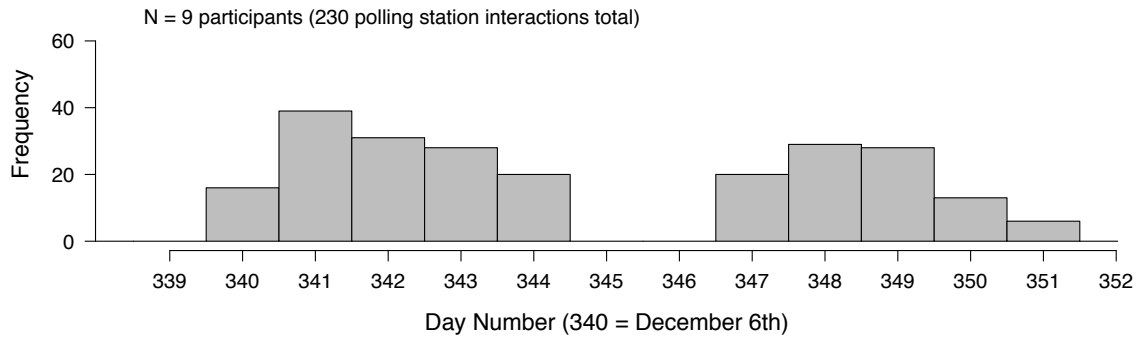
**Figure A.14** Reporting frequency histograms for Phase 4 (NW perimeter zones).



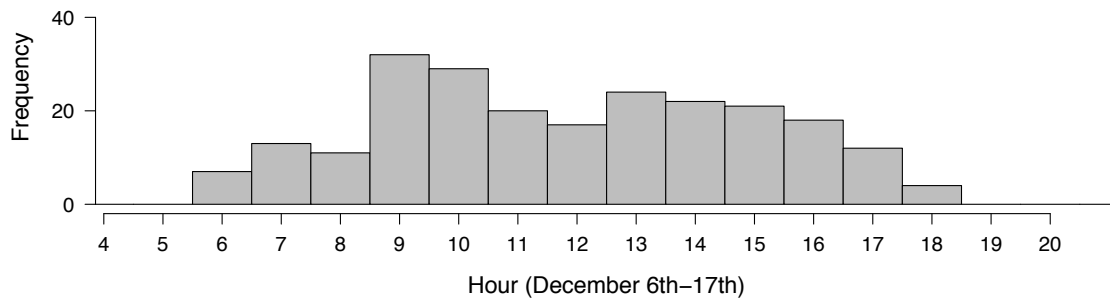
**Figure A.15** Reporting frequency histograms for Phase 5 (SE perimeter zones).



### Distribution of polling station interactions by day



### Distribution of polling station interactions by hour



**Figure A.16** Reporting frequency histograms for Phase 6 (core zones).

## Appendix J: Web-based Occupant Survey

---

### Getting Started...

1.) Please enter the letter code (e.g. "A", "B") that is written on the underside of your desktop polling station in the field below.

---

2.) When you are at your workspace, approximately what percent of the time are you using a computer (on average)?

- 1 hour each day or less
  - 2-3 hours each day
  - 3-4 hours each day
  - 5-6 hours each day
  - 7-8 hours each day
  - 9 or more hours each day
- 

### Age

3.) How old are you?

- Under 20
  - 20 - 29
  - 30 - 39
  - 40 - 49
  - 50 - 59
  - 60 - 69
  - 70 and over
- 

### Thermal Comfort

4.) Overall, how satisfied are you with the TEMPERATURE in your workspace?

- Very Satisfied
- Moderately Satisfied
- Slightly Satisfied
- Neutral
- Slightly Dissatisfied
- Moderately Dissatisfied
- Very Dissatisfied

) In WARM/HOT weather, the temperature in my workspace is: (check all that apply)

- Often too warm/hot
- Often too cool/cold

**5.) In COOL/COLD weather, the temperature in my workspace is: (check all that apply)**

- Often too warm/hot
- Often too cool/cold

**6.) When is this most often a problem? (Check all that apply)**

- Morning
- Afternoon
- Evening
- Weekends / Holidays
- Monday mornings
- Other. Please describe:

**7.) How would you best describe the SOURCE of this discomfort? (Check all that apply)**

- Humidity too high (damp)
- Humidity too low (dry)
- Air movement too high
- Air movement too low
- Incoming sun
- Window frame/glass is too cold
- Window frame/glass is too hot
- Concrete ceiling is too cold
- Concrete ceiling is too hot
- Drafts from window vents
- Drafts from floor vents
- Thermostat is inaccessible
- Thermostat is operated by other people
- My area is hotter/colder than other areas
- Clothing policy is not flexible
- Other. Please describe:

---

## **View**

**8.) Overall, how satisfied are you with your visual connection to the outside from your workspace?**

- Very Satisfied
- Moderately Satisfied
- Slightly Satisfied
- Neutral
- Slightly Dissatisfied
- Moderately Dissatisfied
- Very Dissatisfied

**) What best describes the source of dissatisfaction? (Check all that apply)**

- Exterior metal screen restricts my view
- Flaps in metal screen never open
- Workspace partitions or other interior objects restrict my view
- I have had to build personal shading devices and these restrict my view
- Contrast in light levels between my computer and windows makes view uncomfortable
- Brightness from windows makes view uncomfortable
- Other. Please specify:
- Roller shade fabric restricts my view

**) Any other comments related to the design of the window wall in regard to your satisfaction with your VIEW(s)?**

---

---

---

---

---

## **Visual Comfort**

**9.) Overall, how satisfied are you with your level of VISUAL COMFORT in your workspace?**

- Very Satisfied
- Moderately Satisfied
- Slightly Satisfied
- Neutral
- Slightly Dissatisfied
- Moderately Dissatisfied
- Very Dissatisfied

**) When during the day is this most often a problem? (Check all that apply)**

- before 8:00 am
- 8:00 to 10:00 am
- 10:00 to 12:00pm
- 12:00 to 2:00 pm
- 2:00 to 4:00 pm
- 4:00 to 6:00 pm
- after 6:00 pm

**10.) At what time of year is VISUAL DISCOMFORT caused by sunlight / daylight most often a problem? (Check all that apply)**

- Fall
- Winter
- Spring
- Summer

**11.) Under what kinds of weather/sky conditions is VISUAL DISCOMFORT most often a problem? (Check all that apply)**

- Cloudy sky
- Foggy / overcast sky
- Clear / sunny sky
- Other. Please describe:

**12.) How would you best characterize the SOURCE of visual discomfort? (Check all that apply)**

- Upper "clerestory" windows are often too bright/glaring when roller shades are UP (i.e. retracted)
- Lower windows are often too bright/glaring when roller shades are UP (i.e. retracted)
- Upper "clerestory" windows are often too bright/glaring even when roller shades are DOWN (lowered)
- Lower windows are often too bright/glaring even when roller shades are DOWN (lowered)
- Light reflecting off of exterior metal screen
- Light reflecting off of interior glass walls
- Reflections on my computer screen
- Direct sun in my workspace
- View of direct sun through shade fabric
- Large contrast in light levels between windows and other surfaces
- Other. Please specify:

---

## **Sensitivity**

**13.) Please rate your level of sensitivity to GLARE / visual discomfort caused by sun/daylight, with 1 being the least sensitive and 7 being the most sensitive.**

- 1 (Least Sensitive)
- 2
- 3
- 4
- 5
- 6
- 7 (Most Sensitive)

---

## **Exterior Perforated Metal Screen**

**14.) Overall, how satisfied are you with the effectiveness of the exterior perforated metal screen to REDUCE any potential DISCOMFORT caused by sunlight / daylight?**

- Very Satisfied
- Moderately Satisfied

- Slightly Satisfied
- Neutral
- Slightly Dissatisfied
- Moderately Dissatisfied
- Very Dissatisfied

**) What best describes the source of your dissatisfaction?**

- View of SUN through screen is often uncomfortable
- View of bright SKY/CLOUDS through screen is often uncomfortable
- Metal screen causes uncomfortable REFLECTIONS
- Other. Please describe:
- Direct SUN through screen often makes me TOO HOT

---

## **Roller Shade Effectiveness**

**15.) Overall, how satisfied are you with the effectiveness of the roller shades to REDUCE any potential DISCOMFORT caused by sunlight / daylight?**

- Very Satisfied
- Moderately Satisfied
- Slightly Satisfied
- Neutral
- Slightly Dissatisfied
- Moderately Dissatisfied
- Very Dissatisfied

**) What best describes the source of your dissatisfaction?**

- Direct SUN through shade fabric often makes me TOO HOT
- View of bright SKY/CLOUDS through shade fabric is uncomfortable
- View of buildings / urban environment through shade fabric is uncomfortable
- Shades do not adequately cover bright / glaring window glass
- Other. Please describe:
- View of the SUN through shade fabric is uncomfortable

---

## **Operation of Roller Shades**

**16.) How FREQUENTLY do you ADJUST (i.e. raise or lower) the roller shades in your workstation?**

- Daily
- Weekly
- Monthly
- A few times each year
- Never

**17.) Overall, how satisfied are you with your ability to ADJUST the amount of light in your workspace using the roller shades?**

- Very Satisfied
- Moderately Satisfied
- Slightly Satisfied
- Neutral
- Slightly Dissatisfied
- Moderately Dissatisfied
- Very Dissatisfied

**) What factors best describe the source of your dissatisfaction?**

- The shade fabric lets in too much light, even when the shades are down
- There are too many individual shades that I need to operate
- Shade adjustments take too much time
- Shade cords (controls) are difficult to reach from my workspace
- I can't adjust the shades the way I want to because it may cause others to be uncomfortable
- Windows and shades are not aligned with workstations
- Other. Please specify:
- The shades have to be down so I can work comfortably

---

**Operation of Roller Shades (continued)**

**18.) What are the reasons that you LOWER (i.e. pull down) the roller shades in your workstation? (Check all that apply)**

- To reduce glare/brightness from the sun
- To reduce glare/brightness from the sky
- To reduce the glare/brightness from other buildings
- To increase visual privacy (e.g. reduce views from the outside)
- To decrease the level of visual stimulus from the outside (e.g. moving cars)
- To reduce the heat from direct sun entering my workspace
- To reduce the heat from warm window glass
- To reduce the cold from cold window glass
- Other. Please specify:

---

**Operation of Roller Shades (continued)**

**19.) What are the reasons that you RAISE (i.e. retract) the roller shades in your workstation? (Check all that apply)**

- To feel the warmth of the sun
- To increase the amount of daylight in my workspace
- To increase the amount of daylight in the central "cabin" workspaces
- To increase view to the outside
- To increase room spaciousness
- Other. Please specify:

Does not apply: my shades are always lowered

---

## **Ease of Operation**

**20.) Overall, how satisfied are you with the "ease of operation" of the roller shades?**

- Very Satisfied
- Moderately Satisfied
- Slightly Satisfied
- Neutral
- Slightly Dissatisfied
- Moderately Dissatisfied
- Very Dissatisfied

**) What factors best describe the source of dissatisfaction? (Check all that apply)**

- Shades make too much noise when adjusted
  - Shade require too much force to operate
  - Shade cords are difficult to reach from my workstation
  - Shades occasionally get jammed when adjusted
  - There are too many shades that have to be adjusted
  - Adjustments take too much time
  - Other. Please specify:
- 

## **Operation of Desk/Task Lights**

**21.) How frequently do you turn ON the desk light in your workstation?**

- Daily
- Weekly
- Monthly
- A few times each year
- Never
- Not applicable: I do not have a desk lamp / task light

**) What are the main reasons that you turn on your task/desk light? (Check all that apply)**

- To improve visibility for reading paper documents
- To make the space feel brighter
- To help balance the contrast in light levels between the desk surface and bright windows
- Other. Please specify:

**) Overall, how satisfied are you with your ability to ADJUST the amount of light in your workspace by using your desk light?**

- Very Satisfied



- Moderately Satisfied
  - Slightly Satisfied
  - Neutral
  - Slightly Dissatisfied
  - Moderately Dissatisfied
  - Very Dissatisfied
- 

## **Operation of Overhead Florescent Lights**

**22.) How frequently do you operate the "ON, OFF, or dimming" controls for the overhead florescent lights?**

- Daily
- Weekly
- Monthly
- A few times each year
- Never

**) Overall, how satisfied are you with your ability to ADJUST the amount of light in your workspace by operating the controls for the overhead florescent lights?**

- Very Satisfied
- Moderately Satisfied
- Slightly Satisfied
- Neutral
- Slightly Dissatisfied
- Moderately Dissatisfied
- Very Dissatisfied

**) What factors best describe the cause of your dissatisfaction?**

- Lighting controls are located too far away
  - Lighting controls are confusing
  - I can't adjust the overhead lights the way I want to because it may make others uncomfortable
  - Light from overhead lighting is not sufficient
  - Other. Please specify:
- 

## **Personal Modifications**

**23.) Do you CURRENTLY use any of the following "personal modifications" to REDUCE potential DISCOMFORT caused by sunlight / daylight? (Check all that apply)**

- Sunglasses
- Hat with brim (to shade face and eyes)
- Umbrella (or umbrella-like device)
- Cardboard or other material attached to windows

- Cardboard or other material attached to workstation partitions
- Move/reposition computer monitor throughout the day
- Shading devices attached to computer monitor
- Adjust work schedule to avoid times of day that are uncomfortable
- Other
- I do not currently use any "personal modifications"

**) Please describe the "personal modifications" that you currently use to reduce DISCOMFORT from sun / daylight.**

---



---



---



---

**24.) Overall, how satisfied are you with the effectiveness of these "personal modifications" to reduce DISCOMFORT caused by sunlight / daylight?**

- Very Satisfied
- Moderately Satisfied
- Slightly Satisfied
- Neutral
- Slightly Dissatisfied
- Moderately Dissatisfied
- Very Dissatisfied

---

### **Agree / Disagree**

**25.) "It is important for me to have sufficient daylight in my workspace so that I can feel connected with the outdoors."**

- Strongly agree
- Moderately agree
- Slightly agree
- Neutral
- Slightly disagree
- Moderately disagree
- Strongly disagree

**26.) "It is important for me to have a view to the outside so that I can feel connected with the outdoors."**

- Strongly agree
- Moderately agree
- Slightly agree
- Neutral
- Slightly disagree
- Moderately disagree
- Strongly disagree

---

## **Agree / Disagree (Cont.)**

**27.) "I keep the shades in my workspace LOWERED more often than i want to for the comfort of coworkers."**

- Strongly agree
- Moderately agree
- Slightly agree
- Neutral
- Slightly disagree
- Moderately disagree
- Strongly disagree

**28.) "I keep the shades in my workspace RAISED more often than i want to for the comfort of coworkers."**

- Strongly agree
- Moderately agree
- Slightly agree
- Neutral
- Slightly disagree
- Moderately disagree
- Strongly disagree

---

## **Productivity**

**29.) Overall, does the SUNLIGHT / DAYLIGHT in your workspace enhance or interfere with your ability to get your job done?**

- Strongly enhances
- Moderately enhances
- Slightly enhances
- Neutral
- Slightly interferes
- Moderately interferes
- Strongly interferes

---

## **Final Assessment**

**30.) All things considered, how satisfied are you with your personal workspace?**

- Very Satisfied
- Moderately Satisfied
- Slightly Satisfied
- Neutral
- Slightly Dissatisfied

- Moderately Dissatisfied
- Very Dissatisfied

**31.) How satisfied are you with the building overall?**

- Very Satisfied
- Moderately Satisfied
- Slightly Satisfied
- Neutral
- Slightly Dissatisfied
- Moderately Dissatisfied
- Very Dissatisfied

**32.) Please describe any other issues related to SUN / DAYLIGHT in your workspace that are important to you.**

---

---

---

---

**33.) Any additional comments or recommendations about your personal workspace or building overall?**

---

---

---

---

---

**Thank You!**

**Thank you for taking the time to fill out this survey!**

---

## References

- Akaike, Hirotugu (1974). "A new look at the statistical model identification". IEEE Transactions on Automatic Control 19 (6): 716–723.
- ASHRAE Standard 55-2004, Thermal Environmental Conditions for Human Occupancy, Atlanta: ASHRAE Inc.
- Atif M.R. et al. 1997. Daylighting monitoring protocols and procedures for buildings. A report of Task 21 / Annex 29, Daylight in Buildings. October, 1997.
- Atif. M.R. and A. Galasiu. 2003. Energy performance of daylight-linked automatic lighting control systems in large atrium spaces: report on two field-monitored case studies. Energy and Buildings 35 441-461.
- Attmann, Osman. 2010. Green Architecture, Advanced Technologies and Materials. McGraw-Hill. [BOOK, SFFB on cover]
- Baird, George. 2010. Sustainable Buildings in Practice: What the Users Think. Routledge, NY. [BOOK]
- Brager G. S., de Dear R. A standard for natural ventilation. ASHRAE Journal. 2000: 42: 21-28.
- Burrell, Galen and Cassie Waddell, P.E. (ARUP). Presentation to the Center for the Built Environment. November 16, 2010.
- Begemann, G. et al. (1997). Daylight, artificial light and people in office environment, overview of visual and biological responses, Industrial Economics 20 (1997) 231-239.
- Boubekri, M. and Boyer, L.L. (1992). Effect of Window Size and Sunlight Presence on Glare, Lighting Research and Technology, 24(2), 69-74.
- Bordass, W. (1994) Daylight use in open-plan offices: The opportunities and the fantasies. Paper to the CIBSE Lighting Conference, Cambridge.
- Bordass, W. et al. (2001). Assessing building performance in use 3: energy performance of buildings. Building Research and Information (2001) 29(2), 114-128.
- Boyce, P. R. (2003). Human Factors in Lighting 2nd Edition. Taylor & Francis, London.
- Carrilho da Graca G., Linden P.F., Haves P., McConahey E. 2004. Design and testing of a control strategy for a large naturally ventilated office building.
- CIE, Ocular lighting effects on human physiology and behavior, Commission Internationale de l'Eclairage Publication 158:2004, 2004.

Chauvel, P., Collins, J.B., Dogniaux, R., and Longmore, J. (1982). Glare from Windows: Current Views of the Problem”, *Lighting Research and Technology*, 14(1), 31-46.

Cohen, Robert, Standeven, Mark, Bordass, Bill and Leaman, Adrian. 2001. Assessing building performance in use 1: the Probe process. *Building Research & Information*, 29:2, 85 – 102.

Collins, B. L. (1975). *Windows and people: A literature survey. Psychological reaction to environments with and without windows.* Washington DC: National Bureau of Standards.

Deru, et al. (2005). Procedure to Measure Indoor Lighting Energy Performance. Technical Report. NREL/TP-550-38602.

Diamond, R. (2006, July 21). Questions for the SFFB Evaluation Team. Lawrence Berkeley National Laboratory.

Diamond, R., Fisk, B., Waldeck, R., Brager, G., Heerwagen, J., & Zimring, C. (2007, February 14). Documenting Design Intent for the San Francisco Federal Building.

Diamond, R., Haves, P., Lee, E., Apte, M., & Fisk, B. (2007, May 8). Evaluating the San Francisco Federal Building: An Interim Report. Lawrence Berkeley National Laboratory.

DIN 5034 Tageslicht in Innenräumen, Deutsches Institut für Normung, 1999.

Durlach, J., Pages, N., Bac, P., Bara, M. Cuiet-Bara, A. (2002) Biorhythms and possible central regulation of magnesium status phototherapy, darkness therapy and chronological forms of magnesium depletion. *Magn. Res.* 15: 49–66.

Einhorn, H.D. A new method for the assessment of discomfort glare, *Lighting Research and Technology* 1 (4) (1969) 235–247.

Einhorn, H.D. Discomfort glare: a formula to bridge differences, *Lighting Research and Technology* 11 (2) (1979) 90–94.

Einhorn, H. D. (1998). Unified Glare Rating (UGR): Merits and application to multiple sources. *Lighting Research and Technology*, 30(2), 89-93.

Escuyer M. and Fontoynt (2001). Testing in situ of automatic ambient lighting plus manually controlled task lighting: office occupants reactions, in: *Proceedings of the 9<sup>th</sup> European Lighting Conference (Lux Europa), Reykjavik, Iceland, 92001*, pp. 70-75.

Energy Information Administration (EIA). 2008. The 2003 Commercial Buildings Energy Consumption Survey (CBECS).  
[http://www.eia.gov/emeu/cbecs/cbecs2003/detailed\\_tables\\_2003/2003set19/2003pdf/e05.pdf](http://www.eia.gov/emeu/cbecs/cbecs2003/detailed_tables_2003/2003set19/2003pdf/e05.pdf)

Accessed 3/21/2011

EIA. U.S. DOE. Energy Indicators in the U.S. Commercial Buildings Total Energy Consumption.

[http://www1.eere.energy.gov/ba/pba/intensityindicators/total\\_residential.html](http://www1.eere.energy.gov/ba/pba/intensityindicators/total_residential.html)

[http://www1.eere.energy.gov/ba/pba/intensityindicators/total\\_commercial.html](http://www1.eere.energy.gov/ba/pba/intensityindicators/total_commercial.html)

Accessed 3/21/2011

Fechner, G.T. (1860). Elemente der Psychophysik. Vol. I available in English translation as Elements of psychophysics. New York, NY: Rinehart and Winston, 1966.

Floyd D. and D. Parker (1995). Field Commissioning of a daylight-dimming lighting system. FSEC-PF-283.

Fountain, Marc. 1987. Accuracy versus response time. Choosing a globe thermometer for thermal comfort measurements. CEDR-WP03-93.

M. Foster, T. Oreszczyn, Occupant control of passive systems: the use of venetian blinds, Building and Environment 36 (2001) 149–155.

Field J., J Soper, P Jones, W Bordass & P Grigg (1997). Energy performance of occupied non-domestic buildings: assessment by analysing end-use energy consumptions, Building Services Engineering Research and Technology 18(1) 39-46.

Fitch , James Marston. American Building: The Environmental Forces That Shape It Oxford University Press, Incorporated, ISBN 0195110404 (0-19-511040-4)

Georg A, Graf W, Schweiger D, Wittwer V, Nitz P, and Rose Wilson H, 1997. Switchable Galzing with a Large Dynmic Range in Total Solar Energy Transmittance (TSET). Solar Energy 62[3], 215-228.

U.S. General Services Administration, Public Buildings Service, Office of Applied Science: WorkPlace Matters, 2007.

Granderson, Jessica, Ph.D. 2011. “Building Performance Monitoring, Control, and Information Systems.” Lawrence Berkeley National Laboratory Environmental Energy Technologies Division seminar, January 6.

Graw, P., Hans-Joachim, H., Georg, L., Wirz-Justice, A. (1998) Sleep deprivation response in seasonal affective disorder during a 40-h constant routine. J. Affective Disorders 48(1): 69–74.

Guth S.K. and J.F. McNelis. 1959. "A discomfort glare evaluator," *Illuminating Engineering*, vol. 54, pp. 398-406.

Halonen, J. and Lehtovaara (1995). Need of individual control to improve daylighting utilization and user satisfaction in integrated lighting systems, in *Proceedings of the 23<sup>rd</sup> Session of the CIE*, New Delhi, India, Vienna, Austria: CIE (1995), pp. 200-203.

Haves, P, PF Linden, and G Carrilho Da Graca. Use of simulation in the design of a large, naturally ventilated office building. *Building serv eng res technol* 2004; 25; 211.

Heerwagaen, J. H., & Orians, G. H. (1986). Adaptations to windowlessness: A study of the use of visual décor in windowed and windowless offices. *Environment and Behavior*, 18, (5), 623-639.

Heerwagen, J. H., & Heerwagen, D. R. (1986, April). Lighting and psychological comfort. *Lighting Design + Application*, 16(4), pp. 47-51.

Heschong Mahone Group. 2003. *Windows and Offices: A Study of Office Worker Performance and the Indoor Environment*. CEC technical report.

Heschong Mahone Group. 2005. *Sidelighting photocontrols field study*. Technical report to Northwest Energy Efficiency Alliance, Pacific Gas and Electric company, and Southern California Edison.

Heschong, L., M. Saxena, R. Higa. 2010. "Improving Prediction of Daylighting Performance." In *Proceedings of the ACEEE 2010 Summer Study on Energy Efficiency in Buildings*. Washington, D.C.: American Council for an Energy-Efficient Economy.

Hopkinson, R.G. and Bradley, R.C. (1960). Glare from Very Large Sources. *Illuminating Engineering*, 55, 288-297.

Huizenga, C., H. Zhang, P. Mattelaer, T. Yu, E. Arens, and P. Lyons (2006). *Window Performance for Human Thermal Comfort*. Final report to the National Fenestration Rating Council, February, 2006.

Inanici M, Galvin J. 2004. Evaluation of high dynamic range photography as a luminance mapping Technique. Lawrence Berkeley National Laboratory. <<http://escholarship.org/uc/item/9h61f5h8>> Accessed 2011 10 Jan.

Inoue T, Kawase T, Ibamoto T, Takakusa S, and Matsuo Y, 1988. The development of an optimal control system for window shading devices based on investigations in office buildings. *ASHRAE Transactions* 104, 1034-1049.

IEA SHC Task 21 (2000). [Daylight in buildings](#).



Kibert, Charles, J. 2007. *Sustainable Construction: Green Building Design and Delivery*, Second Edition. John Wiley and Sons, NJ.

Lam, William M.C. (1977). Perception and Lighting As Formgivers for Architecture. McGraw-Hill, Inc.

Laouadia and Parekh (2007). Complex fenestration systems: towards product ratings for indoor environment quality, *Lighting Res. Technol.* 39,2 (2007) pp. 109–122

Laurentin C. et al. (1998). Manual control of artificial lighting in a daylit space, in: 3<sup>rd</sup> International Conference on Indoor Air Quality, Ventilation and Energy Conservation in Buildings, Lyon, France, (1998), pp. 175-180.

Lee E S, Selkowitz S E, 1995. The Design and Evaluation of integrated envelope and lighting control strategies for commercial buildings. *ASHRAE Transactions*, Chicago, II 101[1], 326-342. January 28-February 1.

Lee, E., & Clear, R. (2007, March 13). San Francisco Federal Building Technical Solutions for the South Facade. Lawrence Berkeley National Laboratory.

Lee, E., Clear, R., Diamond, R., & Selkowitz, S. (2006, December 8). Preliminary Assessment of Visual Comfort in the New San Francisco Federal Building. Lawrence Berkeley National Laboratory.

Lerum, Vidar. 2008. High-Performance Building. John Wiley and Sons, Inc., Hoboken, New Jersey.

Leslie, R.P., R. Raghavan, O. Howlett, C. Eaton. 2005. "The potential of simplified concepts for daylight harvesting." *Lighting Research and Technology* 37(1):21-38.  
Likert, Rensis (1932). "A Technique for the Measurement of Attitudes". *Archives of Psychology* 140: 1–55.

Lindsay, C.R.T., & Littlefair, P.J. (1993). *Occupant use of venetian blinds in offices* (PD 233/92). Watford: Building Research Establishment.

Loisos and Ubbelohde (2009). Lighting design in net zero buildings, step one: daylight. Powerpoint presentation, ASHRAE conference on Net Zero buildings, CA, 2009.

Lynes, J.A. (1977). Discomfort glare and visual distraction, *Light. Res. Technol.*, 9, 51-2.

Mahdavi A, Mohammadi A., Kabir E., Lambeva L. 2008. Occupants' operation of lighting and shading systems in office buildings. *Journal of Building Performance Simulation*. Vol. 1, No. 1, 57-65.

Maile, T., Haves, P., and Linden, P. (2006). Measurements in Naturally Ventilated Spaces: San Francisco Federal Building.

McIntyre, D.A. "Seven Points Scales of Warmth," *Building Services Engineer*, 1978. 45: p. 215-226.

McIntyre, D.A. *Indoor Climate*. London, Applied Science Publishers, Ltd. 1980.

Mills, E. and N. Borg. 1999. "Trends in Recommended Lighting Levels: An International Comparison." *Journal of the Illuminating Engineering Society of North America* 28(1):155-163.

Mitsunaga T, Nayar SK. 1999. IEEE Conference on computer vision and pattern recognition (CVPR), Vol.1, 374-380.

Moe, Kiel. 2008. *Integrated Design in Contemporary Architecture*. Princeton architectural press. [BOOK, SFFB is on cover]

Moon P, & Spencer D E. 1942. Illumination from a non-uniform sky. *Illum. Eng.* (N.Y.), 37, 707-726.

Moore, T., et al. 2002. Long-term patterns of use of occupant controlled office lighting. *Lighting Res. Technol.* 35,1 pp. 43-59.

Moore-Ede et al. 1997. Medical implications of shift work. *Ann. Rev. Med.* 1985. 36:607-17

Morphopedia: Projects: San Francisco Federal Building. (2009, May 9). Retrieved February 5, 2010, from Morphosis Architects: <http://morphopedia.com/projects/san-francisco-federal-building>

Nabil A. and Mardaljevic J. (2005). Useful Daylight Illuminance: A New Paradigm to Access Daylight in Buildings. *Lighting Research & Technology*, 37(1), 41-59.

Ne'eman E, & Hopkinson, R. G. (1970). Critical minimum acceptable window size: A study of window design and provision of a view. *Lighting Research and Technology*, 2, 17-27.

Newsham G R, 1994. Manual Control of Window Blinds and Electric Lighting: Implications for Comfort and Energy Consumption. *Indoor Environment* 3, 135-144.

Nicol, J.F. (2001). Characterizing occupant behavior in buildings: Towards a stochastic model of occupant use of windows, lights, blinds, heater and fans. *Proceedings of the Seventh International IBPSA Conference, Rio de Janeiro, Brazil, August 13-15, 2001*, 1073-1078.

O'Neill, B., A. Tzempelikos, A. Athienitis. 2007. "Daylight and luminaire control in a perimeter zone using an automated venetian blind." 2nd Canadian Solar Buildings Conference

Osterhaus, W.K.E. 1993. Office lighting: A review of 80 years of standards and recommendations. Proceedings of the 1993 IEEE Industry Applications Society annual meeting, October 2-8, 1993 in Toronto, Ontario, Canada.

Osterhaus, W.K.E. (1998). Brightness as a reliable and simple indicator for discomfort glare from large area glare sources. In International Commission on Illumination (CIE), The First CIE Symposium on Lighting Quality (pp. 113-124). Vienna, Austria: CIE.

Osterhaus, W.K.E., & Bailey, I.L. (1992). Large area glare sources and their effect on visual discomfort and visual performance at computer workstations. Proceedings of the 1992 IEEE Industry

Pacific Gas and Electric Company. 1999. Daylighting Initiative, Office Application: Phillip Burton Federal Building Case Study.

PNNL-SA-55888 (2007). Analysis of Building Envelope Construction in 2003 CBECS–Post-1980 Buildings.

PNNL-SA-55594 (2007). Analysis of Building Envelope Construction in 2003 CBECS–Pre-1980 Buildings.

PNNL. (2010). Post Occupancy Evaluation of the San Francisco Federal Building. Prepared for the U.S. General Services Administration under Contract DE-AC05-76RLO1830 with Battelle Memorial Institute.

Rea, M. (1984). Window blind occlusion: a pilot study. *Building and Environment*, 19(2), 133-137.

Reinhart, C.F., K. Voss. 2003. “Monitoring manual control of electric lighting and blinds.” *Lighting Research and Technology* 35(3):243-258.

Reinhart, C. F. et al. (2006). Dynamic daylight performance metrics for sustainable building design. National Research Council of Canada. NRCC-48669. <<http://irc.nrc-cnrc.gc.ca>>

Rea M, editor. 2000. The IESNA Lighting Handbook. 9th ed. New York: The Illuminating Engineering Society of North America. Luminance ratio limits; ch. 11, pp. 16-18.

Rogers Z. (2006). Daylighting Metric Development Using Daylight Autonomy Calculations In the Sensor Placement Optimization Tool. Boulder, Colorado, USA: Architectural Energy Corporation  
<http://www.archenergy.com/SPOT/download.html>

Rosenthal, N., Sack, D., Gillin, J. (1984) Seasonal affective disorder: A description of the syndrome and preliminary findings with light therapy. *J. General Psychiatry* 41:72–80.

Rubin, A. I., Collins, B.L. & Tibbott, R.L. (1978). *Window blinds as a potential energy saver - A case study (NBS Building Science Series 112)*. Washington, DC: U.S. Department of Commerce, National Bureau of Standards.

Seidl, M. (1984). Requirements for the Daylighting of Dwellings and Work Places – Standardization Based on Research. *Energy and Buildings*, 6 (1984) 191-195.

SmithGroup Inc. and Morphosis. (2001). Final Concept Report: San Francisco Federal Building.

Tuaycharoen N. and Tragenza P.R. (2007). View and discomfort glare from windows.

Tokel, H.S. 2006. User Control Actions in Buildings: A Case Study of Shading. Masters thesis. Technical University of Vienna.

Torcellini P. et al. (2005). Evaluation of the low-energy design and energy performance of the Zion National Park Visitors Center. NREL/TP-550-34607.

Torcellini P. et al. (2006). Lessons learned from field evaluation of six high-performance buildings. NREL/CP-550-36290.

U.C. Berkeley Center for the Built Environment (CBE) 2008. Occupant Indoor Environmental Quality (IEQ) Survey™.  
<http://www.cbe.berkeley.edu/research/survey.htm>  
Berkeley, CA: Center for the Built Environment

U.S. General Services Administration (2007). [San Francisco Federal Building](#).

U.S. Green Building Council (2009). LEED 2009 for New Construction and Major Renovations. Reference guide.

US Green Building Council. (2006). LEED-NC (Leadership in Energy and Environmental Design) Version 2.2.  
[www.usgbc.org/LEED/](http://www.usgbc.org/LEED/)

U.S. Green Building Council (from David Leites, GSA). (2009). LEED for New Construction v2.1 Project Checklist: New San Francisco Federal Building.

Veitch, J. A., Hine, D. W., & Gifford, R. (1993). End users' knowledge, preferences, and beliefs for lighting. *Journal of Interior Design*, 19(2), 15-26.

Vos, J.J. (1984). Disability glare – a state of the art report, *CIE J.* 3, 39-53.

Walleisa, J. (2004). San Francisco Federal Building. Cambridge MA: Harvard Design School Center for Design Informatics.

Ward G. 1991. Real Pixels. Graphics Gems II, edited by James Arvo, Academic Press.

Ward G. 1992. Radiance Visual Comfort Calculation.

<<http://radsite.lbl.gov/radiance/refer/Notes/glare.html>> Accessed 2011 10 Jan.

Ward G. 1994. The RADIANCE Lighting Simulation and rendering system. Computer Graphics (Proceedings of Siggraph 94).

Wirz-Justice, A. (1998) Melatonin: New advances in sleep research and treatment. Eur. Neuropsychopharmacol. 8(2): S92.