



Representing Language Essays in Honor of Judith Aissen

Edited by
Rodrigo Gutiérrez-Bravo
Line Mikkelsen
Eric Potsdam

ISBN 0-9836-9380-3

The authors of the individual chapters in this volume retain copyright of their respective contributions.

Published 2011 by

Linguistics Research Center
Department of Linguistics
1156 High Street
University of California
Santa Cruz, CA 95064

These papers are also available at the University of California eScholarship Repository:
http://escholarship.org/uc/lrc_aissen

Printed on demand by:

Booksurge Publishing
<http://booksurge.com>

TABLE OF CONTENTS

Introduction	v
Raúl Aranovich Shifty Objects in Romance	1 – 14
Telma Can Pixabaj and Nora C. England Nominal Topic and Focus in K'ichee'	15 – 30
Sandra Chung, William Ladusaw, and James McCloskey Sluicing(:) Between Structure and Inference	31 – 50
Jessica Coon and Robert Henderson Two Binding Puzzles in Mayan	51 – 67
Louis Goldstein Back to the Past Tense in English	69 – 88
Colette Grinevald The Expression of Path in Jakaltek Popti (Mayan): When Directionals Do It All	89 – 104
Rodrigo Gutiérrez-Bravo External and Internal Topics in Yucatec Maya	105 – 119
Jorge Hankamer Auxiliaries and Negation in English	121 – 135
Alice C. Harris Clitics and Affixes in Batsbi	137 – 155
John B. Haviland Nouns, Verbs, and Constituents in an Emerging 'Tzotzil' Sign Language	157 – 171
Brian D. Joseph On Pronoun-Personal Affix Connections: Some Light from Algonquian	173 – 179
Vera Lee-Schoenfeld From Clause Union to Restructuring to Beyond Coherence	181 – 197
Robert D. Levine SGF Coordination in English: Light vs. Heavy Stylistic Inversion and the Status of <i>pro</i>	199 – 217

John Moore	219 – 238
Judgment Types and the Structure of Causatives	
David M. Perlmutter	239 – 256
On the Weak Expletive Paradigm in Germanic	
Paul M. Postal	257 – 271
Variability Among English Raising-Determined Objects	
Anne Sturgeon	273 – 286
The Middlefield in Slavic: Evidence from Czech	
Alan Timberlake	287 – 304
Individuation in Russian and Spanish Differential Object Marking	
Ellen Woolford	305 – 320
PF Factors in Pronominal Clitic Selection in Tzotzil	

INTRODUCTION

We are pleased to present this collection of papers to Judith Aissen. Through them, the editors and contributors celebrate Judith in her roles as colleague, mentor, teacher, researcher, and friend and we offer this festschrift with great pleasure.

Judith is one of those rare scholars who moves comfortably between empirical and theoretical domains of linguistics and makes contributions to both. Although her research contributions to the field are too numerous to mention, we think that two characteristics stand out.

First, Judith has made contributions to an extraordinary range of syntactic theories: Transformational Grammar, Relational Grammar, Arch Pair Grammar, Government and Binding, and Optimality Theory. The diversity of theories to be found in Judith's research and teaching reflects a belief that theories should be regarded not as gospel set in stone, but rather as tools to investigate intricate and puzzling phenomena in language, with the theory being used to make sense of these phenomena. This eclectic approach has secured a very large audience for Judith's work. Her research is cited in both the formal and functional literatures, in descriptive and typological research, and in works specific to Mayan, Spanish, Amerind, and Romance linguistics. In recent years, Judith has made seminal theoretical contributions in Optimality-theoretic syntax, specifically in the areas of Harmonic Alignment and Constraint Conjunction: as of today, it is probably fair to say that current typological theory on Differential Object Marking is essentially based on her research.

Second, few things stand out more in Judith's work than her crystal-clear elucidation of complex and interesting language data. Judith's research achieves this, we believe, through a combination of effective use of different sources of data (elicitation, text examples, published data) and insightful representations of these complex data. This particular hallmark of Judith's work can be found in her early work on causative constructions and clause union in Spanish, through her work on Tzotzil, topic, focus, and the formal representation of Mayan clause structure, and lastly in her more recent work on markedness, voice, and Differential Object Marking. One consequence is that Tzotzil is currently one of the best studied Amerind languages.

In addition to recognizing her intellectual contributions to the field, a perhaps even greater pleasure of bringing together this volume in Judith's honor is that it is a celebration of Judith herself. Those of us that have had the privilege of working with Judith cherish her warmth and generosity, combined in the best possible way with intellectual integrity. Judith is also an outstanding teacher, mentor, and advisor. It is very clear to us that this is because Judith is dedicated heart and soul to passing on to others the scientific knowledge that she herself has acquired and developed throughout her long and fruitful career. This commitment to the people around her is nowhere more visible than in her work with Mayan languages and the people who speak them. Judith conducts syntax workshops in Guatemala and Mexico primarily for students who are native speakers of Mesoamerican languages. These workshops play an important role in the development of a cadre of professional native-speaker Mayan linguists, who in turn are shaping Mayan linguistics and language preservation efforts. In these efforts, Judith is generously giving back to the communities she works with.

For these contributions, and more, we honor Judith. We hope that these papers reflect the breadth of Judith's work and its impact.

In closing, we would like to thank Maggie Bardacke and the Linguistics Research Center for assistance with the web publishing, Jim Clifford for the cover photograph, and Anne Sturgeon and Alexandra Martin for the cover design.

Rodrigo Gutiérrez-Bravo

Line Mikkelsen

Eric Potsdam

June 2011

SHIFTY OBJECTS IN ROMANCE

Raúl Aranovich
UC Davis
raranovich@ucdavis.edu

Across the Romance languages, impersonal reflexives vary with respect to which objects can control agreement. This paper offers an account of such variation within Optimality Theory. In languages that exclude accusative-marked objects from impersonal reflexives, a constraint favoring agreement outranks those constraints responsible for differential object marking. The ranking is the inverse one in languages that allow accusative objects. This results in a pattern in which only the unmarked objects can control agreement.

1. Introduction: Shifty objects

Across languages, there are very strong implicational tendencies about which constituents control verb agreement. If there is only one controller allowed in a clause, it is usually the subject. If there is a second controller allowed, it is usually the primary object (Moravcsick 1988). Exceptions to this tendencies, from languages as diverse as English, Southern Tiwa, Georgian, and Tzotzil, are discussed in Aissen 1990. But in an earlier paper (Aissen 1973), she uncovers a case of verb agreement controlled by an object in Spanish, a language that only allows for subject controllers. The Spanish example in (1) is an impersonal reflexive sentence, in which the verb agrees with the plural object *apartamentos* ‘apartments’.

- (1) Se alquilan apartamentos.
SE rent.3PL apartments
‘Apartments are rented.’

Aissen refers to objects like *apartamentos* in (1) as ‘shifty objects’, because they appear to behave like subjects. Her claim is that shifty objects control agreement by analogy with the subjects they resemble. Some Spanish direct objects are marked in a way that makes them formally distinct from subjects, and therefore different from those objects that can pass for subjects in the impersonal reflexive. This phenomenon is known as Differential Object Marking (DOM). These marked objects, Aissen notices, always fail to control agreement in the Spanish impersonal reflexive.

In this paper, I revisit Aissen’s (1973) analysis of shifty objects, considering her recent proposal for a formalization of DOM in Optimality Theory (Aissen 2003). I argue that the agreement pattern in Spanish impersonal reflexives is the result of a ranking in which the constraints that enable morphosyntactic marking of some objects outrank the constraint responsible for object agreement. I also show that variation in the mutual rankings of these

constraints result in systematic differences across Spanish, Italian, Piedmontese, and Romanian, a representative sample of the Romance languages.

2. Agreement with nominative objects

Impersonal reflexive constructions like the ones in (1), in which the verb agrees with a postverbal argument, are very common across the Romance languages. Examples from Italian, Piedmontese, and Romanian are provided in (2).

- (2) a. Ieri si prezero le palle. (Italian)
 yesterday SE caught.3PL the balls
 ‘Yesterday, the balls were caught.’
- b. Cheich vira as fravo fin-a doi beu. (Piedmontese)
 sometimes 3SG.S.SE shod.3PL up-to two oxen
 ‘Sometimes up to two oxen are shod.’
- c. S’ au prins mingi-le. (Romanian)
 SE has.PL caught ball.PL-the.PL
 ‘The balls have been caught.’

Following Aissen’s (1973) analysis of Spanish, I suggest that the arguments that control agreement in these impersonal constructions are objects. Support for the hypothesis that the controller in sentences like (1) is an object, and not a postverbal subject, comes from its inability to control the missing subject of adverbial clauses, as in (3).¹ Notice that the corresponding passives are grammatical (4).

- (3) a. *Se lavan estas cortinas sin perder el color.
 SE wash.3PL these curtains without losing the color
 ‘These curtains are washed without fading.’
- b. *Se inoculó a los sobrevivientes antes de dar consentimiento.
 SE inoculated.3SG to the survivors before of give consent
 ‘The survivors were inoculated before giving their consent.’
- (4) a. Estas cortinas fueron lavadas sin perder el color.
 these curtains were washed without losing the color
 ‘These curtains were washed without fading.’
- b. Los sobrevivientes fueron inoculados antes de dar consentimiento.
 the survivors were inoculated before of give consent
 ‘The survivors were inoculated before giving their consent.’

The agent of impersonal reflexives like those in (1) and (2) is arbitrary in reference, and it is never expressed overtly. Because these sentences do not have an overt subject, they are classified

¹ Aissen (1973) develops an argument based on the fact that topicalization of the object, which requires a pronoun, also fails to trigger agreement. Perlmutter (1983) argues that the object of an Italian impersonal reflexive is an object based on its ability to license the partitive clitic *ne*. Additional arguments can be found in Belletti (1982).

as impersonal, in spite of their agreement patterns (Perlmutter 1983, Perlmutter and Postal 1984). In Relational Grammar, these sentences are analyzed as having a ‘dummy’ subject (i.e. a covert expletive), which acts as a stand-in for the object to establish verb agreement.²

Some of the relational elements of this analysis are incorporated into the treatment of existential sentences in Lexical-Functional Grammar, but without the multistratal architecture. Bresnan (1994) argues that the associate NP *a snake* in an existential sentence like (5) is an object that controls agreement.

(5) There are snakes in the grass.

Bresnan suggests that the subject expletive fails to control agreement because it does not carry nominal features (expletives that are derived from nominal expressions, like English *it* or French *il*, on the other hand, always determine agreement on the verb as invariable 3rd person singular). But instead of resorting to any sort of anaphoric relation to transfer the person and number features of the object onto the expletive, Bresnan allows the object to control agreement directly. Her argument is that objects can also control agreement in locative inversion constructions like (6).

(6) Among the guests was sitting my friend Rose.

The subject of a construction like (6), Bresnan argues, is a locative prepositional phrase. Like expletive there, PPs do not have person and number features, so they cannot control agreement. But because they are not pronominal, no anaphoric relation can be established between the PP and the object. The verb agrees with the object because the object is the most prominent constituent (in functional terms) that is appropriate as a controller.

A similar situation arises in some Icelandic passives (Zaenen *et al.* 1985). In Icelandic, there are verbs that assign lexical case to one of their arguments. (7a) shows the dative object (*honum* ‘he.DAT’) of the verb *gaf* ‘gave’. In (7b), the passive version of (7a), the dative argument is realized as a dative subject. In Icelandic, some argument must be marked nominative. The lexical case must be preserved, so the object that normally would receive structural accusative is assigned nominative instead. The secondary object *peningarnir* ‘money.PL’ is now in the nominative, and it controls agreement.

(7) a. Hann gaf honum peningana.
 he.NOM gave he.DAT the.money.ACC
 ‘he gave him the money.’

² The Brother-in-Law relation between the dummy subject and the object is established when the 2-arc headed by the dummy overruns the 2-arc headed by the object. The dummy is promoted to 1 in a structure with multiattachment, indicated by the presence of the reflexive pronoun. Aissen (1990) generalizes this idea to other cases in which an arc overruns another arc headed by a potential controller. Many of these ideas find analogous expression in other frameworks. Silent expletives in an anaphoric relation with the object have also been proposed in the Government and Binding framework (Belletti 1982, Cinque 1988). Moore (1994) presents a formulation of multiattachment in the GB framework, based on Generalized Chains.

- b. Honum voru gefnir peningarnir.
 he.DAT were given.NOM.MP the.money.NOM.MP
 ‘He was given the money.’

What all of these cases have in common is that the subject of the construction cannot control agreement, either because it lacks nominal features, or because they are hidden behind a preposition or a case feature (as argued in Andrews 1990 for Icelandic). In those circumstances, a nominative object takes over as controller of agreement. I will apply this analysis to the impersonal reflexive examples in (1) and (2). I argue that the subject of an impersonal reflexive is unable to control agreement, lacking the appropriate nominal features. An accusative-marked object cannot control agreement either. Under those circumstances, the verb appears in the third person singular by default. But when the object is not marked accusative, its person and number features become available for verbal agreement, and the object emerges as the controller.

3. Extending the empirical range of the Analogic Rule

Very often, however, objects are marked for case, and are therefore unable to control agreement. Aissen (1973) notices that, in the Spanish impersonal reflexive construction, the verb never agrees with accusative pronouns or prepositional objects (marked in Spanish by the preposition *a*).

- (8) a. Se felicit-a/*-an a los amigos.
 SE congratulate-3SG/-3PL to the friends
 ‘One’s friends are congratulated.’
 b. Se los alquil-a/*-an.
 SE them rent-3SG/-3PL
 ‘They are rented.’

The “shifty objects” of Spanish, on the other hand, are always unmarked, formally indistinguishable from subjects. First, shifty objects lack the formal coding of accusative complements when they function as objects. Only those nominal complements that are not marked with *a* are able to control agreement. Second, shifty objects occur in positions where subjects can also occur, since Spanish has postverbal subjects. According to Aissen, because objects in impersonal reflexives look just like subjects when they are not marked for case, the role of agreement controller, which subjects normally have, is extended to these objects by analogy. She proposes the following rule to account for the agreement patterns in Spanish:

- (9) **Analogic Agreement Rule:** A verb in S_1 agrees with an NP which is not its subject NP_1 , just in case S_1 is structurally identical to an S of a different derivation whose subject occupies the position corresponding to that of NP_1 . (Aissen 1973:15)

The prepositional objects of Spanish are an instance of Differential Object Marking (DOM), since only some objects are marked by *a*. Bossong (1991, 1998) notices the great crosslinguistic

variation in the kinds of objects that are differentially marked, but he also points out that these tend to be at the top of a prominence scale based on their animacy and definiteness features. In Spanish, object marking is obligatory for personal pronouns, proper nouns, and also with definite or specific human-referring nouns (Aissen 2003). In other Romance languages the extent of DOM is narrower. If the agreement patterns found in Romance impersonal reflexives are the result of analogy, the prediction is that agreement will co-vary with DOM.

Impersonal reflexives in Italian seem to provide evidence to support the prediction made on the basis of the Analogic Agreement Rule. In Italian, all non-pronominal objects are unmarked, being indistinguishable from postverbal subjects (10a). But object pronouns like *mi* ‘me’, *ti* ‘you.ACC’, *lo* ‘him’, are distinguished from subject pronouns like *io* ‘I’, *tu* ‘you.NOM’, *egli* ‘he’ by their case marking. (10b) and (10c) illustrate the usage of second person pronouns. The pronoun *ti* in (10b) is a clitic (or weak) pronoun, but Italian also has tonic (strong) pronouns in object function. Their use is illustrated in (10d).

- (10) a. Ha visto **Ugo**?
has seen Ugo
‘Did he see Ugo?’
- b. **Ti** vedo.
you.ACC see.1SG
‘I see you.’
- c. Mi chiese cosa **tu** volessi.
me asked.3SG thing you.NOM wanted
‘He asked me what you wanted.’
- d. Invito **te**, non lui.
invite.1SG you.ACC, not him
‘I am inviting you, not him.’

In Italian, then, DOM separates pronominal objects from non-pronominal ones. The prediction made by the Analogic Agreement Rule is that only pronominal objects will be unable to control agreement in the Italian impersonal reflexive construction. This prediction is borne out. Italian inanimate-referring nominal objects are able to control agreement, as in (2b). On the other hand, object personal pronouns do not control agreement in impersonal reflexives. This is shown in (11a). The crucial example is (11b). Unlike Spanish, Italian does not code human definite objects differently from other nominal objects. The analogic rule predicts that even human objects should be able to control agreement in impersonal reflexives. (11b) shows that this prediction is fulfilled.

- (11) a. Ieri le/li si preze/*prezero.
yesterday them.F/M.ACC se caught.3SG/caught.3PL
‘Yesterday they were caught.’
- b. Ieri si prezero/*preze i laddri.
yesterday se caught.3PL/caught.3SG the thieves
‘The thieves were caught yesterday.’

4. Obligatory object agreement in impersonal reflexives

There are some exceptions to the Analogic Rule, however, that require a revision of the analysis. First, not every unmarked object is able to control agreement. Some Italian strong object pronouns are indistinguishable from subject pronouns. The third person singular pronouns *lui* ‘him’ and *lei* ‘her’ are used as a subject pronoun in the colloquial language. *Egli* is restricted to the literary style, according to Lepschy and Lepschy (1977). The neutralization between subject and object strong pronouns is more pronounced for the plural forms *noi* ‘we/us’, *voi* ‘you.NOM.PL/ACC.PL’, and *loro* ‘they/them’.³ However, *loro* fails to control agreement in an impersonal reflexive (12a). In addition, there are some unmarked nominal objects in Spanish which sometimes fail to control agreement (12b). This is typically the case with indefinite objects (Aissen 1973).⁴

- (12) a. *Ieri si prezero loro.
 yesterday SE caught.3PL them
 ‘Yesterday, they were caught.’
 b. %Se alquiler apartamentos.
 SE rent.3SG apartments
 ‘Apartments for rent.’

Thus, in its strongest, biconditional form, the analogical rule cannot stand. I will replace it with a weaker condition on agreement in impersonal passives:

- (13) **Impersonal Reflexive Controller Condition:** An object controls agreement in an impersonal reflexive only if it is not marked accusative.

Second, there are languages in which accusative objects never occur in impersonal reflexives. In Romanian and Piedmontese, for instance, the verb always agrees with the patient. This is in spite of the fact that DOM is also observed in these languages. Like Spanish, Romanian codes pronominal objects and highly individuated objects (proper nouns, human nouns) in a way that distinguishes them from subjects, by means of the preposition *pe*. Piedmontese, on the other hand, is similar to Italian, since it does not mark nominal objects differently from subjects, but it preserves case distinctions in its system of clitic pronouns (the neutralization between subject and object strong pronouns, which is only partial in Italian, is complete in Piedmontese). In addition to a distinct set of object clitics, Piedmontese has a system of obligatory subject clitic pronouns: *i-* ‘1SG/PL, 2PL’, *të-* ‘2SG’, *a-* ‘3SG/PL’ (Riva 1980). Illustrative examples are provided in (14).

³ The tonic accusative singular pronouns *te* ‘you.ACC’ and *me* ‘me’ are clearly different from their nominative counterparts. A distinction in case is still preserved in the plural for the object clitic pronouns *ci* ‘us’ *vi* ‘you.ACC.PL’ and *li/le* ‘them.M/F’.

⁴ Cf. also the Italian example *si compra due penne* ‘one buys two pens’, without agreement. Lepschy and Lepschy remark that a sentence like this one is “far less common” (Lepschy and Lepschy 1977: 216) than the corresponding sentence in which the object controls agreement.

- (14) a. Chièl a guarda sò fieul ant lë specc.
 he 3SG.S look.3SG his son before the mirror
 ‘He looks at his son in the mirror.’ (Parry 1998:67)
- b. Mi i conosso chièl e chila.
 I 1SG.S know.1SG he and she
 ‘I know him and her.’
- c. Noi i pioroma.
 we 1PL.S cry.1PL
 ‘we cry.’
- d. Mi i la speto.
 I 1SG.S 3SG.F.ACC wait.1SG
 ‘I wait for her.’

Neither Romanian nor Piedmontese impersonal reflexives can occur with accusative-marked objects (Dobrovie-Sorin 1994, Parry 1998). A *pe* marked complement cannot occur in a Romanian impersonal reflexive (15a). A human complement shifts to an unmarked argument that controls agreement (15b), and so does a pronoun (15c). In Piedmontese, if the patient is pronominal, it cannot be marked accusative either, showing up as a nominative clitic pronoun that controls agreement (16).

- (15) a. *In școala asta se pedepsește prea des pe elevi.
 in school this SE punish.3SG too frequently ACC students
 ‘Students are punished too frequently in this school.’ (Dobrovie-Sorin 1994: 105)
- b. S’ au prins hoți-i.
 SE has.3PL caught thief.PL-DET.PL
 ‘The thieves have been caught.’
- c. Ele s’ au prins.
 They.F.PL SE has.PL caught
 ‘They have been caught.’
- (16) A sê sciaira nen bin.
 3SG.S SE see.3SG NEG well
 ‘It cannot be seen well.’ (Parry 1998:86)

In Romanian and Piedmontese, then, there must be an agreement controller. Because of the IPC condition, however, accusative-marked objects would not be eligible as controllers in the impersonal reflexive construction. In order to force these objects to become agreement controllers, the grammars of Piedmontese and Romanian remove the accusative marking from their objects in impersonal reflexive clauses. Spanish and Italian, on the other hand, prioritize DOM to the expense of having a controller for verb agreement.⁵ In the next section I will develop

⁵ An alternative approach is to distinguish between two types of reflexive constructions with arbitrary agents, only one of which is truly impersonal. Cinque (1988) distinguishes between argumental-*si* and non-argumental-*si*. Only non-argumental-*si* is compatible with accusative objects (when the reflexive is non-argumental, the subject is a non-pleonastic empty pronoun that is assigned the role of arbitrary agent). Dobrovie-Sorin (1994, 1995) has a similar

an account of this interaction in the framework of Optimality Theory, following Aissen's (2003) proposal.

5. An OT account of nominative object agreement

As a first step, I propose a set of constraints to account for the generalization that nominative objects emerge as agreement controllers only when the subject cannot do so. Clauses with nominative objects, then, are a marked option. They only emerge when the requirement that the verb agrees with one of its arguments cannot be satisfied by the subject. The kind of violable constraints that this analysis requires can be modeled in Optimality Theory.

The constraints on agreement that I propose are defined in (17). AGR is violated if the verb has no agreement features. Clauses in which the verb agrees with the object incur violations of *AGR(OBJ). Since the data show that agreeing with a subject is the least marked option, but showing no agreement is the most marked, the ranking of the constraints has to be as in (17c).

- (17) a. AGR: The (extended) head of IP specifies PERS and NUM features for some GF in its predicate argument structure.
 b. *AGR(OBJ): The (extended) head of IP does not specify PERS and NUM features for the OBJ in its predicate argument structure.
 c. AGR >> *AGR(OBJ)

A consequence of the ranking in (17c) is that the verb will agree with the subject whenever possible, even if there is an object in the clause. This is shown in (18). Tableau (1) represents a competition in which a candidate with subject agreement beats two rivals: one with object agreement, another one without agreement. The candidate with subject agreement is the most harmonic one because it does not violate any of the markedness constraints.

- (18) The child *is*/**are* opening presents.

- (19) Tableau 1: English transitive sentences

	AGR	*AGR(OBJ)
☞ The child _i is _i opening presents _j		
The child _i are _j opening presents _j		*!
The child _i is _∅ opening presents _j	*!	

In an English existential sentence like (5), on the other hand, the verb agrees with the object. The candidate with object agreement wins in Tableau (2), in spite of incurring a violation of

proposal, but she distinguishes an accusative-SE from a nominative-SE. Blevins (2003), working within HPSG, distinguishes passive constructions, in which an “external” argument is deleted, and impersonal constructions, in which the external argument is suppressed. Since impersonal constructions do not change verb valency, they can occur with direct objects (whether nominative or accusative).

*AGR(OBJ), because the candidate without agreement is less harmonic. Notice that the competition is only between two candidates. A candidate agreeing with the expletive *there* is just not provided by GEN (UG has no mechanism for agreeing with a constituent that has no person or number features).

(20) Tableau 2: English existential sentences

	AGR	*AGR(OBJ)
☞ There are _i snakes _j in the grass		*
There is _∅ snakes _j in the grass	*!	

In Spanish impersonal reflexives, as in English existential constructions, the competition is between a candidate with object agreement, and a candidate without an agreement controller. When the object is not case-marked, the verb of the winning candidate agrees with the object.

(21) Tableau 3: Spanish impersonal reflexives

	AGR	*AGR(OBJ)
☞ Se alquilan _i apartamentos _i .		*
Se alquila _∅ apartamentos _i .	*!	

When the object of an impersonal reflexive is case-marked, however, the winning candidate has no agreement controller. In fact, the candidate without agreement seems to be the only one entering the competition, since GEN will not provide a candidate in which the verb agrees with a case-marked complement. But there is another alternative. As in the Icelandic example in (7b), it would be possible for the object to shed its case marker to satisfy the constraint that the verb has an agreement controller. In Spanish, the candidate with the case marked object wins. But in other languages (e.g. Romanian) the alternative candidate emerges as the winner. Clearly, this contrast must be the effect of a constraint (or constraints) favoring case-marked objects. This constraint dominates AGR in Spanish, but not in Romanian (or Icelandic, for that matter). In the next section I will show that Aissen's (2003) OT analysis of DOM provides such constraints.

6. Optimizing differential object marking and agreement control

The aim of Aissen's (2003) OT approach to DOM is to formalize Bossong's observation that "the higher in prominence a direct object, the more likely it is to be case marked". Prominence is determined by two scales, one related to animacy, the other one related to definiteness.

- (22) a. Animacy scale: Human > Animate > Inanimate
 b. Definiteness scale: Personal Pronoun (PRO) > Proper Noun (PN) > Definite NP > Indefinite specific NP > Non-specific NP

The scales in (22) are incorporated into a formal model of DOM by harmonic alignment. They are associated with the binary scale of grammatical relations in (23), yields the sub-hierarchies of markedness constraints in (24).

(23) SUBJECT(Su) > OBJECT(Oj)

(24) a. *Su/Inan >> *Su/Anim >> *Su/Hum

b. *Su/NSpec >> *Su/Spec >> *Su/Def >> *Su/PN >> *Su/PRO

c. *Oj/Hum >> *Oj/Anim >> *Oj/Inan

d. *Oj/PRO >> *Oj/PN >> *Oj/Def >> *Oj/Spec >> *Oj/Nspec

The constraints in (24c-d) formalize the hypothesis that the higher an argument is on the definiteness or the animacy scale, the more marked it is. Iconicity and economy mandate that whatever additional morphosyntactic marking will be added to an object, it will first be added to the more marked objects. To achieve this, the constraints in (24c-d) are conjoined with $*\emptyset_C$, a constraint penalizing absence of case marking. The effects of these constraints are neutralized by $*STRUC_C$, a constraint that disfavors clauses with additional case marking. Different rankings of $*STRUC_C$ result in different systems of DOM. For Italian and Piedmontese, the relevant dimension for DOM is definiteness, since only pronominal objects are marked for accusative case. By ranking $*STRUC_C$ just below $*Oj/PRO$ & $*\emptyset_C$, as in (25), the right outputs are selected. Candidates with accusative objects incur a violation of $*STRUC_C$, but a candidate with a marked pronominal object is more harmonic than its rival, which violates the high-ranked constraint $*Oj/PRO$ & $*\emptyset_C$.

(25) $*Oj/PRO$ & $*\emptyset_C$ >> $*STRUC_C$ >> $*Oj/PN$ & $*\emptyset_C$ >> ... >> $*Oj/Nspec$ & $*\emptyset_C$

(26) Tableau 4: Pronominal object

OBJ = PRO	$*Oj/PRO$ & $*\emptyset_C$	$*STRUC_C$	$*Oj/PN$ & $*\emptyset_C$
☞ V - OBJ _{ACC}		*	
V - OBJ	*!		

(27) Tableau 5: Proper noun object

OBJ = PN	$*Oj/PRO$ & $*\emptyset_C$	$*STRUC_C$	$*Oj/PN$ & $*\emptyset_C$
V - OBJ _{ACC}		*!	
☞ V - OBJ			*

In Spanish and Romanian, on the other hand, both definiteness and animacy play a role in DOM. To capture the joint effect of the two hierarchies, Aissen proposes a set of complex markedness

constraints, arranged in a lattice based on their relative degree of markedness.⁶ For expository purposes, I simplify her model, conflating the definiteness and animacy scales into the single hierarchy in (28a). Since more objects are marked accusative in Spanish and Romanian than in Italian and Piedmontese, the ranking of *STRUC_C must be lower in the grammars of the former languages. The precise distribution of the prepositional objects in these two languages is a very complex issue, with a lot of variation in the data. Simplifying matters again for expository purposes, I will assume that for both languages human-referring objects constitute the cutoff point. *STRUC_C, then, is ranked just below *Oj/Hum & *∅_C, as in (28b).⁷

- (28) a. *Oj/PRO & *∅_C >> *Oj/PN & *∅_C >> *Oj/Hum & *∅_C >> *Oj/Anim & *∅_C >> *Oj/Inan & *∅_C
 b. ... >> *Oj/Hum & *∅_C >> *STRUC_C >> *Oj/Anim & *∅_C >> ...

It is possible now to account for the interaction between DOM and object agreement in impersonal reflexives. The insight that I am trying to capture is that in Romanian and Piedmontese object agreement preempts object marking, but in Italian and Spanish it is the other way around. The constraint responsible for culling candidates without object agreement among impersonal reflexives is AGR. In those languages that do not allow accusative marked objects in impersonal reflexives, AGR outranks all the constraints that penalize unmarked objects. In those languages where retaining the object marker is a priority, the constraints that penalize unmarked objects dominate AGR. The rankings for the different languages are shown in (29).

- (29) a. Spanish: ... >> *Oj/Hum & *∅_C >> *STRUC_C >> *Oj/Anim & *∅_C >> ... >> **AGR**
 b. Italian: *Oj/PRO & *∅_C >> *STRUC_C >> *Oj/PN & *∅_C >> ... >> **AGR**
 c. Romanian: **AGR** >> ... >> *Oj/Hum & *∅_C >> *STRUC_C >> *Oj/Anim & *∅_C >> ...
 d. Piedmontese: **AGR** >> *Oj/PRO & *∅_C >> *STRUC_C >> *Oj/PN & *∅_C >> ...

Notice that when AGR does not outrank any of the constraints responsible for DOM, the normal pattern of object marking emerges, even in impersonal reflexives. In Spanish and Italian, then, objects cannot shed their case marking to satisfy the requirement that there be an agreement

⁶ If *STRUC_C outranks one of the complex constraints, other constraints that are less prominent in the lattice are also outranked by *STRUC_C. To illustrate with a fragment, the combined effect of the sub-scales Hum > Anim and Def > Spec yields the four complex constraints in (A), with two of them in a mutual relationship of non-domination (indicated by ‘~’).

- (A)
$$\begin{array}{c} *STRUC_C \\ \hline *Oj/Hum-Spec \ \& \ * \emptyset_C \ \>> \ *Oj/Anim-Spec \ \& \ * \emptyset_C \ \sim \ *Oj/Hum-Nspec \ \& \ * \emptyset_C \ \>> \ *Oj/Anim-Nspec \ \& \ * \emptyset_C \end{array}$$

In Spanish, the preposition *a* is obligatory with definite and indefinite-specific, human-referring nouns. Thus, *STRUC_C is outranked by *Oj/Hum-Spec & *∅_C. Non-specific nouns are never marked with *a*, so *STRUC_C must outrank *Oj/Hum-Nspec & *∅_C. *STRUC_C floats with *Oj/Anim-Spec & *∅_C, resulting in optional *a* marking for animate specific nouns.

⁷ In Romanian, DOM is obligatory for pronouns and proper nouns, but impossible with inanimate and non-specific nouns. Matters are similar in Spanish, but human definite and indefinite specific nouns are also obligatorily marked.

controller. But when the object is unmarked, then the candidate that satisfies agreement is the winner.

(30) Tableau 6: Human-referring object in Spanish impersonal reflexives

OBJ = Hum	*Oj/Hum & *∅ _C	*STRUC _C	*Oj/Inan & *∅ _C	AGR
☞ V _∅ OBJ _{ACC}		*		*
V _i OBJ _i	*!			
V _∅ OBJ _i	*!			*

(31) Tableau 7: Inanimate-referring object in Spanish impersonal reflexives

OBJ = Inan	*Oj/Hum & *∅ _C	*STRUC _C	*Oj/Inan & *∅ _C	AGR
V _∅ OBJ _{ACC}		*!		*
☞ V _i OBJ _i			*	
V _∅ OBJ _i			*	*!

7. Conclusions

When Aissen (1973) formulated her Analogic Agreement Rule to account for agreement with the object in Spanish impersonal passives, she was well aware that she was proposing an analysis that was outside of what transformational theories allowed at that time.

“As an interesting consequence, notice that the analogic rule of Object Agreement must know which NP is the subject of the S being analogized to. This cannot be determined on the basis of position since subjects occur in both preverbal and postverbal position. In order for object agreement to know that a particular NP is the subject, it must know that the NP has undergone Subject Postposing at an earlier stage of the derivation. If this is correct, then the rule of Object Agreement, in addition to being transderivational, is also global.” (Aissen 1973: 17)

It took linguistic theory two more decades since Aissen wrote that paragraph to develop a model in which grammaticality was not determined by local, derivational rules, but by a set of violable constraints that evaluate a set of structures globally and in parallel. With the advent of Optimality Theory (Prince and Smolensky 1993), it became possible to formalize analyses like the one Aissen proposes.

Analogy always operates on the surface forms of related structures, licensing one by reference to the other. OT is a surface-oriented model, in which different processes may apply to satisfy a single output constraint. Thus, objects become the controllers of verbal agreement in Romance impersonal reflexive constructions to satisfy AGR when the subject is unable to do so.

OT is also global, in the sense that candidates are evaluated by all constraints at once. Impersonal reflexives with object agreement satisfy AGR, but they may at the same time violate the constraints responsible for case marking. The conflict is resolved by the relative ranking of these constraints, resulting in the various cross-linguistic patterns discussed in this paper. As our discipline makes progress, then, new explicit models are able to incorporate insights that seemed to elude formalization at an earlier stage. Aissen (1973) tells us that it often pays to venture beyond one's familiar theoretical horizons.

References

- Andrews, Avery D. 1990. Case structures and control in Modern Icelandic. *Syntax and Semantics 24: Modern Icelandic syntax*, eds. Joan Maling and Annie Zaenen, 187-234. San Diego: Academic Press.
- Aissen, Judith. 1973. Shifty objects in Spanish. *Papers from the ninth regional meeting, Chicago Linguistic Society*, eds. Claudia Corum, T. Cedric Smith-Stark, Ann Weiser, 11-22. Chicago: Chicago Linguistic Society.
- Aissen, Judith. 1990. Toward a theory of agreement controllers. *Studies in Relational Grammar 3*, eds. Paul Postal and Brian D. Joseph, 279-320. Chicago: University of Chicago Press.
- Aissen, Judith. 2003. Differential object marking: Iconicity vs. economy. *Natural Language and Linguistic Theory* 21:435-483.
- Belletti, Adriana. 1982. Morphological passive and pro-drop: The impersonal construction in Italian. *Journal of Linguistic Research* 2:1-33.
- Blevins, James P. 2003. Passives and impersonals. *Journal of Linguistics* 39: 473-520.
- Bossong, Georg. 1991. Differential object marking in Romance and beyond. *New analyses in Romance linguistics: Selected papers from the XVIII linguistic symposium on Romance languages*, eds. Dieter Wanner and D. Kibbee, 143-170. Amsterdam: John Benjamins.
- Bossong, Georg. 1998. Le marquage différentiel de l'objet dans les langues d'Europe. *Actance et valence dans les langues de l'Europe*, ed. Jack Feuillet, 193-258. Berlin: Mouton de Gruyter.
- Bresnan, Joan. 1994. Locative inversion and the architecture of Universal Grammar. *Language* 70:72-131.
- Cinque, Guglielmo. 1988. On *si* constructions and the theory of *arb*. *Linguistic Inquiry* 19:521-581.
- Dobrovie-Sorin, Carmen. 1994. *The syntax of Romanian*. Berlin: Mouton de Gruyter.
- Dobrovie-Sorin, Carmen. 1995. Syntactic configurations and reference: *se/si* in Romance. *Grammatical theory and Romance languages*, ed. Karen Zagana, 73-86. Amsterdam: Benjamins.
- Griva, Guido. 1980. *Grammatica della lingua piemontese*. Turin: Andrea Viglono & C. Editori.
- Lepschy, Anna Laura, and Giulio Lepschy. 1977. *The Italian language today*. London: Hutchinson.
- Moore, John. 1994. Reflexives, reflexive passives, and generalized chains. *Proceedings of the XII West Coast Conference on Formal Linguistics*, eds. Erin Duncan, Donca Farkas, and Philip Spaelti, 389-404. Stanford: CSLI Publications.

- Moravcsik, Edith A. 1988. Agreement and markedness. *Agreement in natural language*, eds. Michael Barlow and Charles A. Ferguson, 89-106. Stanford: CSLI publications.
- Parry, Mair. 1998. The Reinterpretation of the reflexive in Piedmontese: 'Impersonal' *SE* constructions. *Transactions of the Philological Society* 96:63-116.
- Perlmutter, David. 1983. Personal vs. impersonal constructions. *Natural Language and Linguistic Theory* 1:141-200.
- Perlmutter, David and Paul M. Postal. 1984. Impersonal passives and some relational laws. *Studies in Relational Grammar II*, eds. David Perlmutter and Carol Rosen, 126-170. Chicago: Univ. of Chicago Press.
- Prince, Alan, and Paul Smolensky. 1993. *Optimality theory: Constraint interaction in Generative Grammar*. Technical Report TR-2, Center for Cognitive Science, Rutgers University, New Brunswick.
- Zaenen, Annie, Joan Maling, and Höskuldur Thráinsson. 1985. Case and grammatical functions: the Icelandic passive. *Natural Language and Linguistic Theory* 3:441-483.

NOMINAL TOPIC AND FOCUS IN K'ICHEE'*

Telma Can Pixabaj
University of Texas at Austin
kaantelma@mail.utexas.edu

Nora C. England
University of Texas at Austin
nengland@mail.utexas.edu

The study of topic and focus in Mayan languages has received considerable attention, including most prominently the work of Aissen (1992). We analyze topic and focus of nominals in K'ichee'. We confirm that there are two preverbal positions in K'ichee', the topicalization position followed by the focus position, and that there are two different functions for each position: continuing and contrastive topicalization, and (roughly) contrastive focus and focus of new information. Topicalization of either type is followed by an intonational pause, while focus is not. Contrastive topicalization and contrastive (type I) focus are marked by the use of an emphatic particle (*are k'u* and *are*, respectively); type I focus further requires the use of antipassive or agent focus when the focused noun is the subject of a transitive verb. Taking into account position, pauses, and morphosyntax, then, all four functions are distinct, at least in some contexts. We did not find clear evidence of internal and external topics in K'ichee', unlike the closely related language Tz'utujil (Aissen 1992).

1. Introduction

Although significant advances in the study of topic and focus in Mayan languages have been made, their description in K'ichee' is not yet complete. To briefly summarize previous work, Norman (1977) identified two preverbal positions for Mayan languages (which are basically verb initial languages): one for topic (clause initial) and the other for focus (before the verb). Aissen (1992) analyzed the topic position as covering two different things: internal topic and external topic. She suggested that Tz'utujil, another K'ichee'an (proper) language, has both kinds of topic. External topic in Tz'utujil functions to indicate contrastive new or switch topics while the internal topic functions to indicate continuing topics. England (1997) showed that K'ichee' also has two kinds of topic—continuing or switch—and additionally showed that it has two kinds of focus—contrastive focus and what she called non-contrastive emphasis. England 2009 refined that analysis somewhat. Can Pixabaj (2004) analyzed the possibilities for marking and following topics in K'ichee' discourse, and Can Pixabaj 2009 showed that the particle *wi* functions to indicate focus of adjuncts and predicates.

* We gave a version of this paper at the Conference on Indigenous Languages of Latin America IV at the University of Texas at Austin in October of 2009. We gratefully acknowledge helpful comments by B'alam Mateo, Judith Aissen, and Jürgen Bohnemeyer.

Starting with this base, we are interested here in the nominal structures that have been called “topicalization” and “(contrastive) focus” in K’ichee’. We are largely restricting the discussion to noun phrases headed by nouns. In particular, we are interested in defining structurally the preverbal positions that can be filled by noun phrases in K’ichee’, and then analyzing the characteristic use of each kind of preverbal constituent, based on their occurrence in texts. What we are adding to the previous studies of K’ichee’ is the following:

- A consideration of the role of intonation in these structures. We have not yet been able to do a complete study of intonation, but we have analyzed the data in terms of the presence of a pause after each fronted nominal. The conclusions thus far are that the topicalized nominals in independent clauses have a pause while focused nouns do not.
- A better analysis of the contexts in which focus is used. We can reaffirm that there are two kinds of focus, one which has been called contrastive focus and we call ‘type I focus’, and the other for the presentation of new(ish) or reintroduced information, which England 1997 called non-contrastive emphasis and we call ‘type II focus’. Type I focus is used to affirm the certainty of the information as well as contrast it; that is, it has an assertive function. Among the functions of type II focus are those of introducing new information, mentioning some information for the first time (it can be new information or implied but previously unmentioned information), and reintroducing shared information after a gap of a number of clauses (and sometimes doing so using a new noun to refer to it).
- An analysis that change of topic in K’ichee’ can be at the same time contrastive, following Aissen (1992). We refer to this as ‘contrastive topicalization’.
- A consideration of the differences between definite and indefinite nominals. Indefinites are restricted to contrastive uses; that is, they are used for focus or for contrastive (switch) topicalization, but not for continuing topicalization.
- An analysis of the syntactic functions of topicalized or focused nominals. Previously it had been shown that, with one restriction, they can function as any direct argument, for instance transitive subject, intransitive subject, transitive object, or the subject of a nonverbal predicate (England 1997). The restriction is, as almost all research on Mayan languages has noted, that a focused nominal cannot be the subject of a transitive verb. For that constituent to be focused, the verb must be converted to an antipassive or agent focus verb.¹ Additionally, however, a nominal constituent that has been extracted from or is in apposition to a prepositional or relational adjunct or which is a possessor can be topicalized or focused.
- A preliminary analysis of the distinction between internal and external topics. Nominal topics of either type have a following pause (in which they are like external topics). Semantically they have two functions: to continue with the same topic (characteristic of internal topics) or to change and contrast topics (characteristic of external topics). It is not

¹ Agentive focus in K’ichee’ uses the same verb form as the antipassive, but the verb agrees with the patient instead of the agent. The patient is therefore a direct argument of the verb and the agent is neither a direct argument nor is it introduced by a relational noun, as would be the case with an adjunct. It is an option which may be selected instead of antipassive if the object is equal to or higher than the subject in the person hierarchy 1>2>3pl>3sg.

possible to embed contrastive topics (like external topics). It is possible to embed continuing topics (like internal topics), but when there is only one preverbal nominal the resulting structure is indistinguishable from type II focus. Therefore pauses do not distinguish the two kinds of topicalization, and clause embedding is only unambiguous when two nominals occur preverbally in the embedded clause (exceedingly rare).

2. Characteristics of K'ichee'

K'ichee' is a Mayan language spoken in Guatemala by about a million people. It has basic constituent order VOS, as in (1), and permits any order according to different pragmatic conditions (England 1991).

- (1) X-ø-u-yup-ub'a u-wach r-a'chi ka-ø-cha',²
 CPL-B3s-A3s-closed-P>T A3s-eye DET-man INC-B3s-say
 'The man closed his eyes, they say...' {Tex10:138}

It marks subjects and objects on verbs or nonverbal predicates according to an ergative pattern in which one set of morphemes (Set A) is used for transitive subjects and another (Set B) is used for transitive objects, intransitive subjects and subjects of nonverbal predicates, as in (2). Possessors of nouns are also marked with Set A (2e). K'ichee' does not have split ergativity.

- (2) a. Intransitive Subject (Set B)
 X-ee-wa'-ik.
 CPL-B3p-eat-SS
 'They ate.' (Can Pixabaj 2004:28)
- b. Transitive Object (Set B)
 X-ee-qa-riq-o.
 CPL-B3p-A1p-meet-SS
 'We met them.' (Can Pixabaj 2004:28)
- c. Transitive Subject (Set A)
 X-in-ki-ch'ab'ee-j.
 CPL-B1s-A3p-speak.to-SS
 'They spoke to me.' (Can Pixabaj 2004:28)
- d. Subject of Nonverbal Predicate (Set B)
 Ee k'oo-l-ik.
 B3p EXIST-PSL-SS
 'They are (in a place).' (Can Pixabaj 2004:33)

² The alphabet used here is a practical alphabet. Symbols have their expected phonetic values except b' = [β], ch = [tʃ], j = [χ], tz = [ts], x = [ʃ], y = [j], VV = [V:], ' = [ʔ]. Abbreviations: A Set A, AFF affectionate, AGT agentive, AP antipassive, B Set B, CL classifier, COM comitative, CPL completive, DAT dative, DEM demonstrative, DET determiner, DIR directional, EMPH emphatic, EXIST existential, FOC focus, INC incomplete, INTS intensifier, IRR irrealis, IV intransitive verb, MOV movement, NEG negative, p plural, P>I intransitive derived from positional, P>T transitive derived from positional, PART particle, PAS passive, PAT patient, PERF perfect, PL plural, PREP preposition, PRO pronoun, PSL positional predicate, RN relational noun, s singular, SS status suffix, TOP topic.

- e. ki-q'ab'
 A3p-hand
 'their hands'

Additionally, K'ichee' has various levels of definiteness of nominals. We consider those that have no article or possessor, or have only the indefinite article *jun* to be "indefinite", while we consider those that are accompanied by one of the definite articles *wa*, *le*, *ri* (with or without the indefinite article), are possessed, are accompanied by demonstratives, or are proper names to be "definite". We are thus collapsing some of the distinctions that K'ichee' makes, but have found that this broad "definite/indefinite" distinction is adequate for our purposes here.

The source of examples and the base for the analysis of discourse that is presented here consists of five texts with more than 1,800 clauses. Four of the texts are from Santa Lucía Utatlán; the other (Text 10) is from Nahualá. Texts 1 and 2 were collected by OKMA; texts 9, 10, and 20 were collected by Telma Can, and text 10 is included in Can Pixabaj 2004.

3. Topicalization and focus of the noun phrase

Topicalized (3) or focused (4) constituents appear before the predicate. The topicalized constituent has a pause, as in (3), but a focused noun does not have a pause,³ as in (4).

- (3) i sin Julya'n, x-ø-kaanaj kan pa le kaye
 and AFF Julián CPL-B3s-stay DIR:remaining PREP DET street
 '...and don Julián stayed in the street.' {Tex20:166}

An encounter between Ubico and don Julián was described in the 20 clauses previous to example (3); topicalization is used here to indicate that the local topic of this clause is don Julián. He is a continuing topic, but not immediately; Ubico is the local topic of the previous clause. In example (4), explicitly contrastive focus between the parents and the speaker is established.

- (4) are r-in-taat x-i'l-ow-ik, in, na x-ø-inw-il taj.
 EMPH DET-A1s-father CPL-B3p+see-AP-SS 1sPRO NEG CPL-B3s-A1s-see IRR
 '...it was my parents who saw it, I didn't see.' {Tex20:238-240}

Normally, topics are shared information and as a consequence are definite. Nouns with focus can be definite or indefinite. Thus, a nominal before the verb with no article or with the article *jun* is focused, as in (5). When it has *jun* it is focus of new information. Here, a priest opens a box and there is a baby inside. Presumably he didn't expect to find a baby, so there is an implicit contrast between the new information and what he expected.

³ It can be seen that the focused pronoun in the second part of the clause in (4) has a pause. Intonation is different for pronouns and nouns. We do not consider pronouns further here.

- (5) jun laj ne' ø-k'o ch-u-paam
 a small baby B3s-EXIST PREP-A3s-RN:inside
 '...a baby was inside...' {Tex1:81}

However, a fronted indefinite can be followed by a pause, in the restricted context of being part of a list. In this case the pause after the indefinite nominal signals that another nominal different from the mentioned nominal will follow, as in (6). Here there is a pause after the fronted constituent, a list is expected and it is an incomplete fragment if it does not continue. *Jun* is both the number 'one' and the indefinite article. Its use here may be ambiguous.

- (6) jun chaj, ka-ø-r-aj le a Xwan,
 a pine INC-B3s-A3s-want DET CL Juan
 jun k'isiis, ka-ø-r-aj le a Te'k...
 a cypress INC-B3s-A3s-want DET CL Diego
 'Juan wants a pine, Diego wants a cypress...'

If there is topicalization and focus in the same clause, the topic comes before the focus.

- | | | | | |
|-----|-----|--|-----|--|
| | TOP | | FOC | |
| (7) | a. | Le a Xwan, are le al Mari'y x-ø-u-ch'ab'ee-j. | | |
| | | DET CL Juan EMPH DET CL María CPL-B3s-A3s-speak.to-SS | | |
| | | 'It was Maria that Juan spoke to (and not anyone else).' | | |
| | b. | *Are le al Mari'y le a Xwan, x-ø-u-ch'ab'ee-j. | | |
| | | EMPH DET CL Maria DET CL Juan CPL-B3s-A3s-speak.to-SS | | |
| | | Intended: 'It was Maria (and not anyone else) that Juan spoke to.' | | |

3.1. Topicalization

If a nominal precedes the verb in the first position as above and has no special marker such as *are* or a special verb form when it is the subject of a transitive verb, we are calling the structure "topicalization", following common practice in Mayan linguistics. In general such structures indicate the local continuing topic of the clause, but are not syntactically obligatory. That is, topics can be found in their unmarked position after the verb; they are fronted for pragmatic rather than syntactic reasons. It is possible to topicalize any direct argument as well as constituents that are not direct arguments. In the cases of those that are not direct arguments, they have to be extracted from adjuncts (either prepositional or relational phrases) or possessive noun phrases in order to be topicalized as plain noun phrases, or they may be in apposition to a noun in an adjunct. Entire adjuncts can be topicalized as well (England 1997); we do not discuss them here. Examples of the various functions that topicalized nominals can have are illustrated in (8) through (13).

- (8) Topicalization of transitive subject:
 Ri k'aq-an-eel, iii b'yeen ø-u-b'an-om k'ax ch-k-e
 DEM hunt-AP-AGT eh INTS B3s-A3s-do-PERF bad PREP-A3p-RN:DAT
 s-taq-a'waj-iib'.
 AFF-PL-animal-PL
 'The hunter had done much damage to the animals.' {Tex10:77}

The hunter in (8) was introduced in the previous clause and is here established as the local topic and continues as such for three more clauses, with only anaphoric reference. In (9), a boy was left alone in the kitchen of the priest's residence where, seven clauses previously, he finds bread. The bread is the general topic from that point on, but at this point it has not been explicitly mentioned for five clauses. In the clause cited here it is both the general and local topic and is re-mentioned as a fronted and topicalized element.

- (9) Topicalization of transitive object:
 i kwando ri' ri kaxlan-wa, k-ø-u'-riq-a'
 and when DEM DET Spanish-tortilla INC-B3s-MOV+A3s-find-SC
 'and the bread, when he found it...' {Tex1:369}

- (10) Topicalization of intransitive subject:
 i r-winaq, ya x-e-q'i'taj-ik
 and DET-person now CPL-B3p-tire-SS
 '...and the people had tired now...' {Tex9}

The three clauses before the example in (10) talk about the main character Ch'iloX taking people in order to eat them; this clause fixes attention on the people as a continuing local topic. In (11), an important man, the master of the mountain, was introduced 24 clauses previously and was identified again four clauses previously. This clause establishes him as the local continuing topic.

- (11) Topicalization of subject of a nonverbal predicate:
 Ri' ri nim-alaj achi, ø-t'uy-ul pa r-aqan ja
 DEM DET big-INTS man B3s-sitting-PSL PREP A3s-foot house
 'That important man was seated in the porch of the house...' {Tex10:155}
- (12) Topicalization of a constituent that is not a direct argument: a phrase in apposition to the complement of a dative (which is itself not mentioned and not marked because it is third person singular, *che* comes from *chi re*):
 porke toq'ob' u-wach, ??? k-ø-i-b'an k'ax ch-e
 because poor A3s-RN:in.front (inaudible)INC-B3s-A2p-do bad PREP-RN:DAT
 '...because poor thing, you do it damage...' {Tex10:38}

The clauses before example (12) distinguish between good trees and bad trees for making firewood; this clause talks about the damage that can be done to good trees, further clarified in

the following clause. Thus 'poor thing' refers to those trees which should not be cut, as already stated, and is therefore a continuing topic. In example (13), the previous clause introduces the horse; this clause continues talking about the horse.

- (13) Topicalization of a constituent that is not a direct argument: Possessor of the subject:
 Per r-u'-kej, ma ka-ø-chak'-ak' r-uk'a',
 but DET-A3s-horse PART INC-B3s-standing-IV A3s-horn
 'But his horse carried its horns upright...' (Lit: 'His horse, its horns were standing.')

{Tex10:98}

It should be noted that a number of the previous examples seem to topicalize a constituent precisely because more than one participant is referred to in the previous clauses, for instance in examples (10) (distinguishing between Ch'iloj and the people), (11) (distinguishing between the master of the mountain and the hunter), or (12) (good trees and bad trees for making firewood). The topicalization helps to differentiate the actual local (clausal) topic from the other possible topics. There is therefore some element of contrast in these examples of topicalization. However, they are different in structure from contrastive focus, as we shall see in the following section. In addition, they seem to be somewhat different in meaning as well, because although they pick out one of several possible referents, they do not appear to establish or refer to an active contrast among the referents. That is, there is no implied polarity ('it is this, not that'), but rather a simple identification of what the topic is.

3.2. Focus I

Besides lacking a pause after the nominal, (contrastive) focus of definite nominals requires one of the particles *are* or *xow* before the nominal (or some similar mechanism that indicates focus), as in (14).

- (14) Are ri achi x-ø-war kan-oq.
 EMPH DET man CPL-B3s-sleep DIR:remaining-SS
 'It was the man who stayed sleeping.'

This kind of focus (often referred to as contrastive focus in the Mayan literature) also has a special verbal form: the focus of a transitive subject is not possible; the verb must be converted into an antipassive or agent focus verb, as in (15). This is a characteristic of focus that has been widely recognized and commented on for Mayan languages. If the antipassive is used, the lexical patient is in an oblique phrase headed by the relational noun *reech*, as in (15a).

- (15) a. Are le al Ixkaaj x-ø-loq'-ow r-eech le ja.
 EMPH DET CL Ixkaaj CPL-B3s-buy-AP A3s-RN:PAT DET house
 'It was Ixkaaj who bought the house.'

- b. *Are le al Ixkaaj x-ø-u-loq' le ja.⁴
 EMPH DET CL Ixkaaj CPL-B3s-A3s-buy DET house
 Intended: 'It was Ixkaaj who bought the house.'

As with topicalization, focused nominals can be any direct argument or another kind of constituent extracted from its phrase. Adjuncts can also be focused without extraction, but we do not discuss them here (see Can Pixabaj 2009 and England 1997 for treatments of adjuncts). The examples from (16) to (21) show the possibilities for focusing nominals. Example (16) explicitly contrasts 'my parents' with 'me', identified negatively in the previous clause ('it wasn't I who saw.')

- (16) Focus of transitive subject: the verb has been converted to an antipassive:
 pero are r-in-taat k-e-tzjo-n-ik
 but EMPH DET-A1s-father INC-B3p-recount-AP-SS
 '...but it was my parents who recounted (it).' {Tex20:51}

In example (17), the previous clauses say that Ubico did good for 'us, the indigenous people'. There is an implicit contrast here between indigenous and non-indigenous people, always present in the cultural context of Guatemala.

- (17) Focus of transitive object:
 porke are r-natural-iib' x-ø-u-to'-o
 because EMPH DET-natural-PL CPL-B3s-A3s-help-SS
 '...because it was the indigenous people that he helped...' {Tex20:319}

- (18) Focus of intransitive subject (passive):
 Entons k'i taq kosa⁵ x-ø-riq-itaj-ik pa taq wa' we lugar je.wa'.
 well many PL thing CPL-B3s-find-PAS-SS PREP PL DEM DEM place here
 'Well, there were many things that they found in this place.' {Tex2:49}

The previous example, (18), follows eleven clauses in which the many things (mostly money) are described. That is, the things were not few, nor unimportant. In (19), the previous eleven clauses specify the celebrations done by the religious brotherhoods for the Patron Saint's Day festival.

- (19) Focus of subject of a nonverbal predicate:
 are taq la' ø-qa-kostumbre
 EMPH PL DEM B3s-A1p-custom
 '...those are the customs...' {Tex2:112}

⁴ In the dialect of K'ichee' spoken by Telma Can, this is ungrammatical without the antipassive/agentive or the use of *are k'u* instead of *are* (see section 3.4 below on contrastive topicalization). For speakers who use *aree* instead of *are k'u* for contrastive topicalization, this is grammatical but there is a pause after *Ixkaaj*.

⁵ The nominal is a type of plural indefinite, which is why *are* is not used. The same is true of (20) and (21).

- (20) Focus of a constituent that is not a direct argument: complement of a locative RN:
 ulew taq b'o'j ø-k'o pwaq ch-u-pam
 earth PL pot B3s-EXIST money PREP-A3s-RN:inside
 '...they were large earthen (clay) pots that had money inside.' {Tex2:45}

The clause before example (20) introduces the large pots; this clause specifies that they are of clay rather than metal. Example (21) is the clause that specifies that the 'poor thing' seen above in example (12) is in fact the 'good trees', rather than the 'bad trees'. The contrast was set up in previous clauses that detail which trees should be cut.

- (21) Focus of a constituent that is not a direct argument: complement of a dative (unmarked because it is third person singular, *che* comes from *chi re*):
 je'la taq chee' k-ø-i-b'an k'ax ch-e
 handsome PL tree INC-B3s-A2p-do bad PREP-RN:DAT
 '...to good trees you do damage.' {Tex10:39}

To summarize, then, the structure discussed here includes the lack of a pause after the fronted nominal, the use of *are* or *xow* if the nominal is definite, and the use of the antipassive or agent focus form of the verb if the fronted nominal is a transitive subject in its normal postverbal order. Contrast is usually explicit but can be implicit, as in example (17). The structure operates much like English cleft in terms of usage and meaning.

3.3. Focus II

There is another kind of focus in which the contrast is more often implicit. The use of this kind of emphasis is principally to give new information, mention a participant for the first time, or reintroduce information. That is, it is not used for explicit contrast of old information. Just as with the first kind of focus, this kind of focus has no pause, but it is different in that it does not use *are* or *xow* (or any other mechanism that shows contrastive focus) and it does not use a special form of the verb when the emphasized constituent is the transitive subject. The examples from (22) to (24) show the three principal contexts for this kind of focus. The focused constituent in (22) is the subject of a transitive verb⁶ and it can be noted that the verb is transitive rather than antipassive or agent focus. In (23) the focused nominals are the subjects of two clauses, the first of which has an intransitive verb (in the perfect) and the second of which has a transitive verb (also in the perfect). Example (22) was the first clause of a recording; the speaker is identifying the person who will speak, from a pool of all who are present.

⁶ It is interesting to reflect here on John DuBois' research on the discourse basis of ergativity (1987). It should be noted that DuBois claimed that it is rare, but not impossible, for new information to be presented as the subject of a transitive verb. K'ichee' does not contradict that assertion; examples such as (22) are indeed rare. England (1989) further claimed that K'ichee' has begun to grammaticalize the restriction, in that for at least some speakers it is ungrammatical to present new information as the subject of a transitive verb in unmarked VOS constituent order. Instead, SVO order is required, as in this example. It appears that the use of a Focus II structure, then, makes it possible to introduce new information as the subject of a transitive verb in K'ichee'.

- (22) Focus II: for first mention of a participant:

Chanim, le don Santiago k-ø-u-tzijoj cha-q-e jas le
 now DET don Santiago INC-B3s-A3s-tell PREP-A1p-RN:DAT what DET
 u-'istoria r-ech we jun tinamit Santa Lu's
 A3s-history A3s-RN:POS DET a town Santa Lucía
 'Now don Santiago will recount the history of the town of Santa Lucia.' {Tex2:1-2}

Two clauses before example (23) the master of the hills arrives at his corral, and here the specific animals in the corral are introduced as new information. The use of *are* before *le koyo't* occurs within the relative clause [*are le koyo't*] and does not have scope over the nouns in the matrix clause. *Kitijom q'aaq'* is idiomatic; it literally says 'they had eaten fire'.

- (23) Focus II: presentation of new information:

Le s-taq le lawe, ka-ø-cha', le s-taq ib'ooy, le lawe,
 DET AFF-PL DET "lawe" INC-B3s-say DET AFF-PL armadillo DET "lawe"
 ka-ø-cha', le kumatz, le tz'i' are le koyo't
 INC-B3s-say DET snake DET dog EMPH DET coyote
 e sok-otaj-naq, ø-ki-tij-om q'aaq'.
 B3p wound-PAS-PERF B3s-A3p-eat-PERF fire
 'The lawes (as they say), the armadillos, the lawes (as they say), the snakes, the dogs
 (that were coyotes) had been wounded, had been consumed by fire.' {Tex10:193-195}

The focused constituent in example (24), 'the man', was spoken of about 50 clauses ago, using *rajawal* 'master'.

- (24) Focus II: reintroducing a participant:

es ke ri achi, ri r-ajaw w-u'lew rii', ø-k'o jun
 it.is that DET man DET A3s-master DET-land DEM B3s-EXIST a
 u-tajkil aw-uuk'
 A3s-errand A2s-RN:COM
 '...it is that the man, he who is the master of this land, has an errand with you...'
 {Tex10:131-132}

3.4. Contrastive topicalization

Additionally, the functions of topic and focus can be combined in the context of changing the topic and at the same time contrasting it with the previous topic. In this case the nominal has mixed characteristics; it has a pause, there is no special verb form, it can be indefinite, or definite with *are*, in the phrase *are k'u*. Examples (25) and (26) illustrate the contexts.

In clauses before the example in (25) the topic was the hunter, now it is the master of the mountain where he went to hunt.

- (25) Contrastive topicalization with change of topic:
 Tonse are k'u ri r-ajaw-al u-winaq-il ri' ri
 well EMPH PART DET A3s-master-ABST A3s-person-ABST DEM DET
 jjub', jawi r-qas k-ø-e'-k'aqa-n-a wi,
 ill where DET-always INC-B3s-MOV-hunt-AP-SS EMPH
 x-ø-tak'-i' r-oyowaal
 CPL-B3s-standing-P>I A3s-anger
 'Well, on the other hand the master of that hill, where he always went to hunt, got mad.'
 {Tex10:81-83}

In lists of changing activities, *are k'u* is used with the last topic to close the list of contrasts.

- (26) a. ri al Ixchel, x-ø-u-tzak kinaq',
 DET CL Ixchel CPL-B3s-A3s-cook beans
 'Ixchel cooked beans,'
 b. ri al Ixxik', x-ø-u-k'ili-j iik
 DET CL Ixxik' CPL-B3s-A3s-toast-SS chili
 'Ixxik' toasted chilis,'
 c. are k'u ri al Nikte', x-ø-u-lej ri wa.
 EMPH PART DET CL Nikte' CPL-B3s-A3s-make.tortilla DET tortilla
 'while Nikte' made tortillas.'

In the example in (26) it can be seen that the first two clauses are not any different from clauses with continuing topicalization, but here they indicate a change in topic. Chaining related clauses together in this way is always used for changes in topic. In this context, the initial clauses establish changes in topic, and it is the final clause with *are k'u* that establishes a contrast.

In fact, the pragmatic differences between the two kinds of topicalization are small. Continuing topics do not have to continue from the immediately previous clause; they may continue from a clause a little farther back (but not too far away). Contrastive topicalization can also be used for topics that were mentioned a few clauses ago, or can be much more distant. One difference between the two is that with contrastive topicalization, the speaker is indicating that attention is shifting entirely from one topic to another, while with a continuing topic the speaker may be picking out a topic from several possibilities without signaling a complete shift of attention. That is, contrastive topicalization implies a change in topic as well, but changing the topic does not necessarily involve contrast. In the end, speaker judgments about clarity of information and other pragmatic matters are what drive the choices.

3.5. Summary and discussion

There are therefore four different functions for nominals before the verb:

	pause	<i>are</i> (with definites)	antipassive (with STV)
continuing topicalization	yes	no	no
contrastive topicalization	yes	yes (<i>are k'u</i>) (last); no (not last clause)	no
focus I	no	yes	yes
focus II	no	no	no

Table 1: Topicalization and Focus Structures

It can be noted that, except for a pause, continuing topicalization and focus II functions are not distinct. Since transcriptions of K'ichee' do not reliably indicate pauses, they are often ambiguous as to whether a speaker is topicalizing a constituent or focusing on (usually) new information. Context helps, and speech of course is much less ambiguous.

A further question is, if there are two positions before the verb, which of the four functions is coded by each position? Here it is necessary to use constructed sentences, given that none of the clauses in the database had two nominals before the verb.⁷ In general, where there are two nominals before the verb, the second is focused and marked with *are*:

- (27) Ri al Ixchel, are ri kinaq' x-ø-u-tzak-o.
 DET CL Ixchel EMPH DET beans CPL-B3s-A3s-cook-SS
 'It is the beans (and nothing else) that Ixchel cooked.'

If the clause is the last in a list of different activities and participants (as in (26)), the topic is marked with *are k'u* and it is the first nominal in the clause (28).

- (28) are k'u ri al Ixchel, are ri kinaq' x-ø-u-tzak-o.
 EMPH PARTDET CL Ixchel EMPH DET beans CPL-B3s-A3s-cook-SS
 '...but as for Ixchel, it is beans that she cooked.'

The only clauses that it has been possible to construct with two nominals before the verb where one is type II focus (new information) are genealogies. Such examples are found to be marginal by most speakers, either because the verb 'beget' is no longer used, or because they are unacceptable without *are* with the second nominal, or for both reasons. The examples were constructed on models from the sixteenth century. The topic is in the first position and focus of new information is in the second position. Example (29) is understood to be talking about the father and introducing the daughter as new information.

- (29) Ri taat Ajpub', ri alaj ali Ixch'umiil x-ø-u-mi'alaaj.
 DET CL Ajpub' DET small CL Ixch'umiil CPL-B3s-A3s-beget
 'Ajpub' begat Ixch'umiil.' (England 1997; data from Saqijix López)

⁷ Except for clauses with phrases in apposition; these have two nominals but both have the same referent.

Are k'u can be used with the first nominal and *are* with the second (30). In this way it is possible to show that topicalization and contrastive topicalization occupy the first position, while type I focus and type II focus occupy the second position. It can further be noted that pauses are correlated with position; those nominals that occupy first position are also those that have a pause.

- (30) ?Are k'u ri taat Ajpub', are ri alaj al Ixch'umiil x-ø-u-mi'alaaj.
 EMPH PARTDET CL Ajpub' EMPH DET small CL Ixch'umiil CPL-B3s-A3s-beget
 'As for Ajpub', it is Ixch'umiil that he begat.' (England 1997: data from Saqijix López, modified by Telma Can⁸)

With the addition of position, the characteristics of each kind of nominal are:

	pause	<i>are</i>	antipassive	position
continuing topicalization	yes	no	no	first
contrastive topicalization	yes	yes (<i>are k'u</i>) (last); no (not last clause)	no	first
focus I	no	yes	yes	second
focus II	no	no	no	second

Table 2: Characteristics of Fronted Nominals

4. External or internal topic?

Another question that needs to be addressed has to do with the category of topic. Aissen (1992) has raised the issue of the possibility of having external or internal topics in Mayan languages. The question then is whether topicalization in K'ichee' creates an internal or external topic, or whether instead the two kinds of topicalization correspond to the difference between internal and external topics. The characteristics appear to be mixed. As has been seen, there is a pause that separates the topic from the rest of the clause, which Aissen takes as characteristic of external topics. This would suggest that both kinds of topic are external. However, topics can occur in embedded clauses, as in (31), which is something that Aissen (1992:74) suggests is compatible with internal topics. In (31) the verb in the embedded clause is not an antipassive (showing that the fronted subject is not type I focus), but now there is no pause after *unaan*, the subject. That is, the structure of the embedded clause is the same as an independent clause with topicalization, except that there is no pause after the topicalized noun. As a consequence it would also be possible to analyze the embedded clause as type II focus, which only differs from topicalization in that it lacks a pause (and in the position of the fronted nominal, when there are two). We do not know which it is. Since the sentence is constructed, there is no natural context from which to analyze meaning.

⁸ López does not use *are k'u*, she only uses *aree* for switch topicalization. The example has been changed in accordance with the dialect spoken by Can, but even with the change the example is less acceptable to Can than it was to López. The original example was fully grammatical for López.

- (31) ri al Ixchel, k-ø-u-chomaaj [chi ri u-naan x-ø-u-loq'
 DET CL Ixchel INC-B3s-A3s-think PREP DET A3s-mother CPL-B3s-A3s-buy
 ulo jun ak']
 DIR:toward a chicken
 'Ixchel thinks that her mother bought a chicken.'

If a pause is inserted after *unaan*, then a list is expected, and without it the utterance is an incomplete fragment, as in (32) (compare to (6), where the same expectation arises with indefinites).

- (32) ri al Ixchel, k-ø-u-chomaaj [chi ri u-naan, x-ø-u-loq'
 DET CL Ixchel INC-B3s-A3s-think PREP DET A3s-mother CPL-B3s-A3s-buy
 ulo jun ak'...]
 DIR:toward a chicken
 'Ixchel thinks that her mother bought a chicken...' (while, for instance, her sister bought something else, and so on)'

It is possible to construct a sentence with two nominals before the verb in the embedded clause, as in (33), but then there is a definite pause after the first one (*unaan*), which results in the same structure as is found in independent clauses. That is, intonation again functions to distinguish between topicalization and focus when there are two preverbal nouns.

- (33) ri al Ixchel, k-ø-u-chomaaj [chi ri u-naan, jun ak'
 DET CL Ixchel INC-B3s-A3s-think PREP DET A3s-mother a chicken
 x-ø-u-loq' ulo-q]
 CPL-B3s-A3s-buy DIR:toward-SS
 'Ixchel thinks that as for her mother, it was a chicken she bought.'

As is expected, a focused noun can also be embedded; it has *are* and the verb is antipassive (34).

- (34) ri al Ixchel, k-ø-u-chomaaj [chi are ri u-naan
 DET CL Ixchel INC-B3s-A3s-think PREP EMPH DET A3s-mother
 x-ø-loq'-ow ulo r-eech ri jun ak']
 CPL-B3s-buy-AP DIR:toward A3s-RN:PAT DET a chicken
 'Ixchel thinks that it was her mother who bought a chicken.'

Because of the pause that separates the topic from the rest of the clause in independent clauses, the characteristics of the topicalized nominal in K'ichee' are not in agreement with what Aissen (1992) takes to be the internal topic in Tz'utujil. In a footnote (p. 73, fn. 30), however, she suggests that Tz'utujil also can have external topics that function to switch the topic, like those introduced by *are k'u* in K'ichee'. She also suggests (p. 76, fn. 39) that if there are external topics in Tz'utujil, it would be expected that they could co-occur with internal topics in the same

clause. In K'ichee', it is not possible to construct examples with two nominal topics; compare (35) with (27).

- (35) *ri al Ixchel, ri kinaq', x-ø-u-tzak-o
 DET CL Ixchel DET beans CPL-B3s-A3s-cook-SS
 ('Ixchel cooked beans.')

The differences between simple topicalization of continuing topics and the contrastive topicalization of switched topics do not correspond exactly to the characteristics that Aissen analyzes as differentiating internal and external topics, because, as has been seen, there is a pause in both cases. What does correspond to this difference is that it is not possible to embed contrastive topics (36), while it is possible to embed continuing topics, as in (32), and possibly (31). The latter, however, is ambiguous as to whether it is topicalization or type II focus. The possibilities for embedding suggest that continuing topics are internal while contrastive or switch topics are external.

- (36) *ri al Ixchel, k-ø-u-chomaaj [chi are k'u ri u-naan
 DET CL Ixchel INC-B3s-A3s-think PREP EMPH PART DET A1s-mother
 x-ø-u-loq' ulo jun ak']
 CPL-B3s-A3s-buy DIR:toward a chicken
 ('Ixchel thinks that on the other hand her mother bought a chicken.')

The characteristics, then, are mixed. Syntactically there are two structures; these may correspond to external and internal topics and they certainly correspond to contrastive and continuing topics. Phonologically, however, the structures are not differentiated, as far as we can tell.

5. Conclusions

In summary, we have encountered the following:

- If the structure is N V, without the use of *are* and without the antipassive or agent focus, it can be the result of topicalization or focus. If it is topicalization it is given information and there is a pause. If it is focus, however, the information is new or reintroduced and there is no pause. Thus there are two structures:
 N, V (continuing topicalization)
 N V (type II focus)
- If the structure is *are* (*k'u*) N V, there are two possibilities. If it consists of *are* and the nominal, it is type I focus, there is no pause, and the antipassive or agent focus is used. If it consists of *are k'u* and the nominal, it is contrastive topicalization, there is a pause, and the antipassive or agent focus are not used. Again there are two structures:
are k'u N, V (contrastive topicalization)
are N V (type I focus)

- If the structure is *jun* N V, there are also two possibilities. Either the nominal is focused and new information, or it is topicalized and part of a list, in which case it has a pause. So once more there are two structures:
jun N, V (topicalized in a list)
jun N V (focus of new information)
- If the structure is N₁ N₂ V; N₁ is topicalization (of either type) and N₂ is focus (of either type). The structure is therefore:
N, N V (topicalization plus focus)
- The use of the pause corresponds to a difference between topicalization and focus in independent clauses, but it apparently does not correspond to a difference between internal and external topics. The analysis with regard to internal and external topics is still not clear because the syntax and the phonology do not correspond exactly.

What is clear in K'ichee' is that there are two preverbal positions, each with two functions that can be formally defined. The definition is mostly morphosyntactic and relies on first, constituent order, and then on the use of *are* or *are k'u* for type I focus and contrastive topicalization respectively, and the required use of antipassive or agent focus for type I focus of a transitive subject. In addition, a phonological pause marks topicalization but not focus (of either type). We have tried to match labels as accurately as possible to these four functions, but they are language-specific and the labels may differ from the same labels used for similar phenomena in other languages. We hold, however, that the different functions described here are fundamentally ways to make distinctions in information structure in K'ichee', and as such can be adequately described by terms such as "topicalization" and "focus".

References

- Aissen, Judith. 1992. Topic and focus in Mayan. *Language* 68:43-80.
- Can Pixabaj, Telma. 2004. La topicalización en K'ichee': Una perspectiva discursiva. Guatemala: Licenciatura thesis, Universidad Rafael Landívar.
- Can Pixabaj, Telma. 2009. The particle *wi* in K'ichee': A focus marker. Paper presented at SSILA, Berkeley, University of California.
- Dayley, Jon. 1985. *Tzutujil grammar*. Berkeley: University of California Press.
- DuBois, John W. 1987. The Discourse Basis of Ergativity. *Language* 63:805-855.
- England, Nora C. 1989. Grammaticalization of discourse constraints in K'ichean Mayan languages. Paper presented at the annual meetings of the American Anthropological Association, Washington, D.C.
- England, Nora C. 1991. Changes in basic word order in Mayan languages. *IJAL* 57:446-486.
- England, Nora C. 1997. Topicalización, enfoque y énfasis. *Cultura de Guatemala*, año XVIII, vol. II:273-288. Guatemala: Universidad Rafael Landívar.
- England, Nora C. 2009. Revisiting topic and focus in K'ichee'. Paper presented at CELCNA, Salt Lake City, University of Utah.
- Norman, William. 1977. Topic and focus in Mayan. Paper presented at the Taller Maya II, San Cristóbal de las Casas, Chiapas, México.

SLUICING(:) BETWEEN STRUCTURE AND INFERENCE*

Sandra Chung, William Ladusaw, James McCloskey
University of California, Santa Cruz
schung@ucsc.edu, ladusaw@ucsc.edu, mcclosk@ucsc.edu

Investigations of sluicing since Chung, Ladusaw, and McCloskey 1995 have profitably explored two approaches to this ellipsis process that differ significantly from ours. In one, the ellipsis site is created by deletion of a fully articulated TP in which *Wh*-movement has applied. In the other, the ellipsis site contains no internal structure at all, and its reference is resolved via pragmatic inference. Here we reconsider some of the theoretical issues, focusing on sprouting, the subtype of sluicing in which the remnant of ellipsis has no overt correlate in the antecedent clause. We discuss evidence, some of it new, which suggests that sprouting involves the re-use of existing material, much as we originally proposed.

1. Goals

In this paper, we reconsider some of the theoretical issues raised by sluicing, taking as a starting point our 1995 article in *Natural Language Semantics* (henceforth CLM). Our aims are to (i) incorporate some of the insights and empirical discoveries that have emerged since (especially in the work of Jason Merchant), (ii) refocus attention on the subtype of sluicing that we earlier called sprouting, and (iii) pursue an analysis driven by the core intuition that at least this species of ellipsis involves the re-use of existing linguistic material. Our goal in this will be to illuminate the interaction between formal linguistic structure and discourse interpretation in ellipsis processing.

Sluicing is the ellipsis of all but the interrogative phrase of a constituent question. In CLM, we distinguished two subtypes of sluicing, which we called *merger* and *sprouting*. In merger, the interrogative phrase that is the remnant of ellipsis has an overt *correlate* in the antecedent clause, as shown in (1) (with the correlate italicized):

- (1) a. They've made an offer to *a phonologist*, but I'm not sure which one.
b. She insulted *somebody* but she won't tell me who.

In sprouting, the interrogative phrase that is the remnant of ellipsis has no overt correlate within the antecedent clause, as seen in (2):

- (2) a. They were firing, but at what was unclear.
b. She applied for the position but nobody could figure out why.
c. He finished on time, but with whose help?

* We are very happy to dedicate this paper to Judith Aissen, our friend and colleague of many years. The research reported on here grows out of a Symposium on Ellipsis which was held at the 2006 Meeting of the Linguistic Society of America in Albuquerque, New Mexico. We are grateful to all who took part for their help. We are especially grateful to Jason Merchant for the excellence of his ongoing work in this area and for the many insights and challenges that he continues to provide.

In such cases, the remnant *Wh*-phrase can correspond to an implicit argument of the predicate of the antecedent (as in (2a)), or an adjunct (as in (2b) and (2c)).

At the workshop out of which this paper grew, three approaches, broadly speaking, to the analysis of ellipsis emerged:

APPROACH 1: The ellipsis site is an anaphoric element without internal structure, whose reference must be resolved in the same way as the reference of any anaphoric element is resolved, by way of pragmatic inference. It is unclear to us whether anyone currently adopts this approach in its pure form, but its appeal is clear.

APPROACH 2: The ellipsis site is empty and unstructured at surface structure, but its content is supplied by re-using (recycling, copying) an already built syntactic structure, with its interpretation, from some accessible point elsewhere in the discourse (Williams 1977, Fiengo and May 1994, Lappin 1999, CLM).

APPROACH 3: The ellipsis site has internal structure, which is constructed in exactly the same way as any audible piece of syntactic structure. The ellipsis site may, however, go unpronounced—be rendered silent—if it is sufficiently similar to some antecedent XP in some accessible position elsewhere in the discourse (Ross 1969, Sag 1976, Hankamer 1979, Lasnik 2001, Merchant 2001).

Of these, the second and third approaches are much closer to each other than either is to the first, since both assume detailed syntactic structure within the ellipsis site; they differ, however, in what they assume about how that structure comes to be there.

Following CLM, Merchant 2001—and, ultimately, Ross 1969—we hold that at some point in the derivation of examples like (1) and (2) the ellipsis site contains a fully fleshed-out syntactic object; there is ‘syntax in the silence’, to use Merchant’s term. The phenomena discussed below show sensitivity to syntactic properties that we take to be difficult to integrate into an approach to sluicing which assumes only mechanisms of pragmatic inference. We assume that the remnant *Wh*-phrase is contained within a CP (see especially Merchant 2001:Chap. 2). We further assume that what is missing in sluicing is the complement of whatever head it is in a given language that attracts interrogative *Wh*-phrases to its specifier—Manetta 2005, 2006, Grebenyova 2006. That is, what is missing in sluicing is all but the edge of a phase defined by a head which drives *Wh*-Movement to its specifier.

This general characterization yields for English the conclusion that the missing material in a sluicing construction is the TP complement of interrogative C. Therefore, (2a) has the skeletal structure shown in (3).

(3) They were firing, but [_{CP} at what C [_{TP}]] was unclear

Sluicing, then, involves either the reduction to silence of the TP complement of C (as in APPROACH 3, e.g. Romero 1998, Merchant 2001), or else the recovery of a suitable TP from the discourse context, supplying the content for the empty TP in (3), as in APPROACH 2 (for instance, CLM).

APPROACH 3 (deletion under identity or givenness) is the standard view in current research in the Principles and Parameters framework and in the Minimalist Program. Jason Merchant’s (2001) book, along with important work done around the same time by Maribel Romero (1998)

and Howard Lasnik (1999), were particularly important in establishing that view. In these works, the core properties of sluicing are taken to derive from semantic conditions—such as givenness and focal parallelism—which govern deaccenting and elision. For Merchant, for example, the crucial elements are those in (4):

- (4) a. Sluicing is derived by PF deletion of a fully articulated TP in which *Wh*-movement has applied.
 b. This deletion (like deletion in general) is subject to a semantic licensing condition, in that TP can be deleted only if it is E-GIVEN.

E-givenness is in turn defined as in (5):

- (5) An expression E counts as E-GIVEN iff it has a salient antecedent A and,
 1.A entails the focus-closure of E
 2.E entails the focus-closure of A

What these requirements amount to in essence is the requirement that the non-focused portions of the antecedent TP and the elided TP must entail each other.

Such theories give an admirably successful account of merger, but they arguably do not generalize well to sprouting (see Chung 2005 and below). Here we take a different tack: taking the sprouting cases as our starting point, we explore the idea that the interpretation of this subtype of sluicing is best understood as involving the re-use of existing linguistic material (APPROACH 2).

2. Use and Re-Use

The central notion of *use* that we appeal to is, as might be expected, fundamentally pragmatic. To use linguistic material is to introduce it into the collaborative game of constructing shared contexts. Accepting this, to *re-use* linguistic material is to take an already-constructed syntactic object with an interpretation, one which has already been deployed in discourse processing, and to re-deploy it, with its interpretation, in a new and different context. We assume a model of discourse structure along the lines of that explored in Ginzburg 1996, Büring 2003, and Farkas and Bruce 2010, in which questions under discussion (Ginzburg's (1996) QUD) are recorded and in which the items so recorded are syntactic objects paired with their denotations. These syntactic objects are presumably LF representations in the sense familiar from Government and Binding Theory and its derivatives, and so may differ in important ways from the representations relevant for determining phonological form (in the framework of Chomsky 2001, for instance, all uninterpretable features will have been removed). We assume a framework for the interpretation of questions and sluices along lines developed by AnderBois 2010a,b, which has the great advantage of letting us better understand why disjoint terms pattern similarly to wide-scope indefinites in their ability to license sluicing (CLM:268–269). We will have more to say later about some of the interpretive issues.

The re-use of linguistic material must be carefully distinguished from independent, and distinct, introductions of an expression. In (6), we clearly want to say that there are two independent token expressions of the DP *a lawyer*.

providing for (11):

- (11) [CP at what C [TP they were firing]]
- ↓
- [CP *at what* C [TP they were firing *at what*]]

Importantly, this operation is not specific to sluicing, but is an instance of the more generally available operation that gives rise to multiple syntactic occurrences of a phrase. That is, it is (the inverse of) Chomsky's (2001) *Internal Merge*. This is the natural updating of our 1995 proposal in a changed theoretical context.

The featural interactions in (10) and (11) are routine. If, for instance, interrogative *Wh*-movement is driven by the combination of features [Q], [WH], and [EPP] on a C-head, then insertion of the interrogative phrase into the specifier of C in (10) satisfies only the third—the [EPP] property. On the assumption that command, rather than the specifier-head relation, is the crucial relation underpinning syntactic agreement relations (Chomsky 2001, 2008), the interrogative and *Wh*-features on C (and the corresponding features on the *Wh*-phrase) will be checked only when the lower occurrence of the phrase *at what* in (11) is created—an occurrence within the command domain of interrogative C. Within the framework of Phillips (2003)—left to right, top-down structure building—the necessary operation has a particularly natural home and is probably indistinguishable from routine applications of *Wh*-movement.¹

This updating of our 1995 proposal has a number of interesting consequences. First, it eliminates the need for some stipulations required under the earlier proposal: for example, that only traces can be added. Second, it preserves the empirical range of our earlier account of sprouting. Third, it deals naturally with some more recent empirical discoveries in a way that CLM did not.

We note as an aside that the syntactic objects which are copied or re-used will have to be abstract enough to permit certain morphological ‘mismatches’ between the antecedent and the apparent requirements of the ellipsis site. This is to allow such cases as (12) (Merchant 2001, 2005a):

- (12) a. Decorating for the holidays is easy if you know how.
 b. I'll fix the car if you tell me how.
 c. I can't play quarterback. I don't even know how.
 d. I remember meeting him, but I don't remember when.
 e. John seems to be happy and I can guess why.

It seems reasonable to hope that these mismatches will reflect the kinds of differences between surface syntax and LF syntax that we alluded to earlier.

¹ Our general approach to sluicing is very much in harmony with the research program laid out in Phillips and Lewis 2009, in the sense that the grammatical computation for sluicing structures that we develop seems to mirror what the processor must do when faced with the task of comprehending a sluice. For the production task, matters seem a little less clear.

3. Consequences—Old and New

3.1. Albert's Generalization

In the cases for which this mechanism must be appealed to, there can be no amnestying of island and ECP effects. We thus understand an important property of sluicing. As noticed originally by Chris Albert, reported by CLM, and confirmed recently in experimental work by Yoshida et al. (2010), island violations are not repaired in sprouting (although they are famously repaired under merger; see Ross 1969, CLM, Merchant 2001).

Consider, for instance, the examples in (13):

- (13) a. *Sandy was trying to work out which students would speak, but she refused to say who to.
 b. *Agnes wondered how John could eat, but it's not clear what.
 c. *That Tom will win is likely, but it's not clear which race.
- (14) a. *Sandy is very curious to see which students will be able to solve the homework problem, but she won't say how.
 b. *Clinton is anxious to find out which budget dilemmas Panetta would be willing to tackle, but he won't say how.

We will call this observation *Albert's Generalization*, for its discoverer.

If the operation responsible for creating multiple syntactic occurrences in Internal Merge is governed by the standard array of island and ECP effects, then we expect those effects to appear in the subtype of sluicing for which this operation is crucial—namely, in the sprouting cases.

3.2. Fixed Diathesis Effects

We also understand another set of properties of sluicing. As observed first by Lori Levin (1982), the interpretation of the elided TP in sluicing is limited by lexical choices made in the antecedent TP. Compare (15a) with (15b), for instance.

- (15) a. He served the soup, but I don't know to who(m).
 b. He served some of the guests, but I don't know what.

The examples in (15) contrast sharply with the impossible (16):

- (16) *He served the soup, but I don't know who(m).

The problem here is that there are, essentially, two distinct but related verbs *serve*, which can be illustrated crudely as in (17):

- (17) a. $serve_1$: <server> <meal> <diner>
 SUBJ OBJ DATIVE
 b. $serve_2$: <server> <diner> <meal>
 SUBJ OBJ1 OBJ2

What goes wrong in a case like (16) is that the antecedent clause contains *serve*₁ while the elided clause contains *serve*₂. This is an impossibility under our proposal, one which follows, on our view, from the fact that the missing material in a sluice is supplied by the re-use of a TP already constructed from an array of lexical choices. There can be no subsequent return to the lexicon in constructing the missing TP of the ellipsis site.²

The effect seems to be quite general. The examples in (18) show the same effect for the verb *send*.

- (18) a. He sent a package, but I can't find out who to.
 b. *He sent a package, but I can't find out who.
 c. He sent a package, but I can't find out who he sent it to.
 d. ?He sent a package, but I can't find out who he sent it.

What goes wrong in (18b) is that the antecedent TP and the elided TP employ different argument structures for the verb *send*: the antecedent TP employs the argument structure illustrated in (18c), whereas the elided TP employs that illustrated in (18d).

Observations made by Jason Merchant (Merchant (2005a)) suggest the same conclusion. Beth Levin (2003) observed that the examples in (19a) and (19b) are close to synonymous, but involve different versions of the verb *embroider*.

- (19) a. They embroidered a table-cloth with peace signs.
 b. They embroidered peace signs on a table-cloth.

Despite the semantic equivalence of (19a) and (19b), it is impossible, as Merchant points out, to mix and match different versions of the verb under sluicing. That is, one cannot have a remnant *Wh*-phrase which implies one version of the verb *embroider* while the antecedent TP is built around a different one. This is seen in the dual impossibility of (20):

- (20) a. *They embroidered something with peace signs, but I don't know what on.
 b. *They embroidered something on the table-cloth, but I don't know what with.³

Observations such as these pose severe challenges for purely inference-based approaches to ellipsis resolution.

Merchant (2005a) has observed a similar effect in cases such as (21), involving the causative-inchoative alternation. In English, an example such as (21):

- (21) They plan to close one of the schools, but they won't tell us which one.

²The lexical entries in (17) are meant to be illustrative only. The central conclusion is unaffected if the different argument structures for *serve* are realized syntactically via different arrays of functional heads ('light verbs') within the *vP*. Such differences still reflect different lexical choices.

³(20b) is well-formed on a different and irrelevant reading—according to which the *with*-PP is an instrument rather than a third argument of *embroider*.

cannot be interpreted as in (22):

(22) They plan to close one of the schools, but they won't tell us which one will close.

Once again, this falls under our larger observation, since causative and inchoative *close* must reflect distinct lexical choices—the first used in the antecedent, the second (impossible) in the ellipsis site. Merchant (2005a) observes that the point can be made more clearly in a language where the case system lets one identify the grammatical function of the remnant interrogative phrase. Greek is such a language, and once more (as can be seen in (23b)), the effect is as we now expect it to be:

- (23) a. Eklisan ena dhromo, alla dhen ksero pjon.
 close-PL3 a-ACC road-ACC but not know-S1 which-ACC
 'They closed a road, but I don't know which.'
 b. *Eklisan ena dhromo, alla dhen ksero pjios.
 close-PL3 a-ACC road-ACC but not know-S1 which-NOM
 'They closed a road, but I don't know which.'

(23b) must reflect the inchoative form of *close* in the ellipsis site, but the transitive form in the antecedent clause—an impossible situation, given our general proposal.

The same pattern can be seen at work in the opposite direction in a case such as (24):

(24) *The window suddenly closed, but I don't know who.

In a case such as this, we have the inchoative form in the antecedent and the transitive form in the ellipsis site—an impossibility given our proposal. This is a case where it is particularly clear that a treatment of sluicing based solely on pragmatic inference would not be adequate to the facts. For (24), it is hard to see why the antecedent clause would not make salient a proposition like *Someone suddenly closed the window*.

Finally, this set of observations further extends to the impossibility of voice mismatches under sluicing (see Merchant 2001, Chung 2005, AnderBois 2010b):

- (25) a. The candidate was abducted but we don't know who by/by who.
 b. *Somebody abducted the candidate, but we don't know by who.
 c. Somebody abducted the candidate, but we don't know by who he was abducted.

As long as active and passive structures involve different lexical selections (in one sense or another), we can understand the ill-formedness of (25b) in the same terms as (24) and earlier examples: the lexical resources used in the ellipsis site must necessarily be the same as those out of which the antecedent TP is constructed. This we see as one of the consequences of re-use of existing linguistic material.⁴

Verb phrase ellipsis, as is well known, behaves differently (Kehler 2002:53):

⁴Eric Potsdam (2007) observes that voice mismatches seem to be possible under sluicing in Malagasy. We must take the position that such observations provide evidence for Pearson's (2005) reanalysis of 'voice' in Malagasy in terms of something like *Wh*-Agreement—see also Chung 2005 and Potsdam (2007:fn.11) for discussion of alternatives.

- (26) a. This problem was to have been looked into, but obviously nobody did.
 b. In March, four fireworks manufacturers asked that the decision be reversed, and on Monday the ICC did.
 c. Actually I have implemented it with a manager, but it doesn't have to be.
 d. The janitor should remove the trash whenever it is apparent that it needs to be.

Following Merchant 2007, 2008, we take cases like (26) to involve ellipsis of the complement of the voice-determining head—a level of structure at which active and passive verbal phrases are indistinguishable, both in terms of the lexical resources used in their construction and in terms of the structures projected.

3.3. Chung's Generalization

We are also now in a position to understand a more recent discovery. Merchant (2001) demonstrated that exactly those languages which permit preposition stranding under *Wh*-movement also permit prepositions to be stranded in the elided TP of sluicing. Chung 2005 has observed that even in preposition-stranding languages, prepositions cannot be stranded in the elided TP in sprouting cases—when the interrogative phrase that is the remnant of ellipsis has no overt correlate in the antecedent clause. Compare (27), in which the interrogative phrase is a PP, with (28), in which the interrogative phrase is the object of a stranded preposition.

- (27) a. They're jealous but it's unclear of who/who of.
 b. Last night he was very afraid, but he couldn't tell us of what/what of.
 c. Mary was flirting, but they couldn't say with who/who with.
 d. We're donating our car, but it's unclear to which organization.
 e. The UN is transforming itself, but into what is unclear.
- (28) a. *They're jealous but it's unclear who.
 b. *Last night he was very afraid, but he couldn't tell us what.
 c. *Mary was flirting, but they couldn't say who.
 d. *We're donating our car, but it's unclear which organization.
 e. *The UN is transforming itself, but what is unclear.

Of course, preposition stranding in the absence of ellipsis is unproblematic:

- (29) a. They're jealous but it's unclear who they're jealous of.
 b. Last night he was very afraid, but he couldn't tell us what he was very afraid of.
 c. Mary was flirting, but they couldn't say who she was flirting with.
 d. We're donating our car, but it's unclear which organization we're donating it to.
 e. The UN is transforming itself, but what it is transforming itself into is unclear.

The puzzle here is why (28a–e) cannot be derived from (29a–e). We call this *Chung's Generalization*, also for its discoverer.

These observations are deeply puzzling for APPROACH 3—specifically, for the view that ellipsis is the reduction to silence of a syntactic object whose content is 'given' in some sense

(among many others, see Romero 1998, Merchant 2001). On that view, it is hard to see how we might distinguish the derivation in (30) from that in (31). Note the even more severe difficulty posed by these observations for APPROACH 1, which involves only mechanisms of pragmatic inference. Such theories too easily locate suitably salient content with which to fill out the interpretation of the *Wh*-phrase. There is no challenge whatever in computing in context what the interpretations of (28) ought to be.

- (30) a. She is jealous, but we don't know [of who [she is jealous of who]].
 b. She is jealous, but we don't know [of who []].
- (31) a. She is jealous, but we don't know [who [she is jealous of who]]
 b. *She is jealous, but we don't know [who []].

But these observations already follow inevitably from our proposals. (28a), for example, would begin with the fragment in (32):

- (32) [unclear [_{CP} who C [_{TP}]]]

Re-using the antecedent TP will produce (33):

- (33) [unclear [_{CP} who C [_{TP} they're jealous]]]

But from (33), the only structure that can be created by way of the Internal Merge operation is that in (34), which subsumes a violation of the lexical requirements of the adjective *jealous*.

- (34) [unclear [_{CP} *who* C [_{TP} they're jealous *who*]]]

So as long as those requirements must be respected—either at the point at which the DP *who* is (re)merged, or else at LF (if there is such a level), then the impossibility of (28a) is expected rather than puzzling. In fact, on this view, (28a) is impossible for exactly the same reason that (35) is impossible—a unification which seems entirely natural:

- (35) *Who are they jealous?

As far as we are aware, there is no comparably natural treatment of these observations available at present under other approaches to sluicing.

4. A Complementary Difficulty

The problem posed by the observations of (28) for versions of APPROACH 3 under a condition of givenness is that the requirement of givenness appears to be met but sluicing fails. But there is also a range of cases in which the requirement of givenness clearly is not met, but in which sluicing nevertheless succeeds (Chung 2005).

- (36) a. He put in a bid but I couldn't tell on whose behalf.
 b. She went to the movies but we don't know who with.
 c. She finished the project but we don't know with whose help.

- d. He's on the no-fly list but it's totally unclear for how long.
- (37) a. She was babbling away, but about what, I have no idea. (RTE radio, December 31, 2005)
- b. ... with Argentina and Brazil increasingly worried about where they would get their oil and at what price. (*New York Times*, May 5, 2006)
- c. I agree with the NYT Executive Editor that the public did benefit from the Times' disclosures about NSA and Treasury surveillance, though it's impossible to know at what cost. (David Ignatius, *Washington Post*, July 5, 2006)
- d. Batwoman is set for a comicbook return. But what as? (<http://news.bbc.co.uk/>, Friday, June 2, 2006)

Cases such as (37) are handled without elaboration by the proposal sketched earlier. It is at best unclear how they can be understood in a world in which sluicing is deletion under semantic 'identity' or givenness. Such a view would require that the pairs of propositions in (38)–(43) be in the required relation (equivalence, mutual entailment, or whatever):

- (38) a. [he put in a bid]
b. [he put in a bid on someone's behalf]
- (39) a. [she went to the movies]
b. [she went to the movies with someone]
- (40) a. [she finished the project]
b. [she finished the project with someone's help]
- (41) a. [he's on the no-fly list]
b. [he's on the no-fly list for some length of time]
- (42) a. [she's babbling away]
b. [she's babbling away about something]
- (43) a. [where they would get their oil]
b. [where they would get their oil at some price]

But in none of these cases does the proposition expressed by the (a) example entail the proposition expressed by the (b) example. In the case of (43), for instance, getting oil does not entail that the oil be obtained for a price (there are many ways of obtaining oil other than buying it). Similarly for (42)—one can babble without babbling about anything. And in (38), the proposition that he put in a bid does not entail that he put in a bid on someone's behalf. We believe that the observation is quite general.

Given that the (b) examples entail the (a) examples, accommodation is sometimes suggested as a means of upgrading the interpretation of the antecedent clause in such cases so that equivalence or mutual entailment could be achieved (see Fox 1999 for one such proposal). The challenge, it seems to us, would be to constrain accommodation so that it would permit sluicing in (37), for instance, but not in many of the ill-formed cases that we considered earlier—in (24), (25b), or in (28), for example.

In contrast, our proposal handles all of these cases without elaboration, because it requires only that the elided TP be a monotonic extension, both syntactically and semantically, of the antecedent TP. Internal merge can add new material to an antecedent clause in the ellipsis site, as long as lexical and morphosyntactic requirements are satisfied. From this it follows that there will be no general requirement that the interpretation of the antecedent clause be equivalent to, or even entail, the interpretation of the elided clause.

Nominal-internal cases (Chung 2005) make the same point:

- (44) a. She's reading something, but I don't know from which textbook.
 b. She's eating a pizza, but I don't know from which restaurant.
 c. She's editing a manuscript, but I don't know from what period.

Such cases are perfectly natural, but there is no entailment here from the interpretation of the antecedent to the interpretation of the missing TP.

5. Semantic Consequences of Re-Use

In the view presented here, the empirical patterns surveyed above are seen as consequences of understanding sluicing as the re-use of existing linguistic material. So far we have been concerned with the lexical and syntactic consequences of re-use—with the phenomena that support the assumption that 'the syntax in the silence' is simply an interpreted syntactic object, which has already been used in the discourse and which now serves as a resource in interpreting the sluice.

We now consider the semantic consequences of this re-use. In particular, we investigate whether the syntactic re-occurrences of TP's in sluices are understood as uses of the TP's in the strongest pragmatic sense—that the syntactic object in the ellipsis site counts as being introduced into the collaborative game of constructing shared contexts.

We conclude that in the case of sluicing, it does not—in contrast to (some) other types of ellipsis, notably VP ellipsis. We will see that sluices are understood as if the re-use of a familiar linguistic expression constitutes re-use of its interpretation as well.

Here we will make the case by examining the interpretation of referential indefinites which are subject to a novelty condition on their discourse reference (Heim 1982). As a result of the novelty condition, each syntactic token of an indefinite introduces a new discourse referent. That is, (45a) is interpreted as involving two perpetrators, in contrast to (45b).

- (45) a. Someone committed a crime on Monday and someone committed a crime on Tuesday.
 b. Someone committed a crime on Monday and he committed a crime on Tuesday.

We will follow common terminology and say that each token of *someone* above introduces a distinct discourse referent. Similarly, in (46) Jill and Jack know similar things, but we assume that their knowledge involves distinct perpetrators.

- (46) Jill knows that someone committed a crime, and Jack knows that someone committed a crime.

The embedded questions in (47) behave similarly, in that the two syntactic tokens of the indefinite *a crime* are associated with distinct discourse referents.

- (47) Jill asked where someone had committed a crime, and Jack asked when someone had committed a crime.

The association of an indefinite with a discourse referent can be used as a probe for the act of using the indefinite. Each use, in this strongly pragmatic sense, is expected to involve creation of a new discourse referent. If we want to know whether a distinct syntactic occurrence of an indefinite counts as a distinct pragmatic use of the indefinite, we can use this probe. Distinct discourse referents indicate distinct pragmatic uses; same discourse referent indicates that the second syntactic occurrence doesn't count pragmatically as a use—but rather, in our terms, as a re-use.

If ellipsis in general involves the re-use of a familiar linguistic expression, we should ask whether that re-occurrence counts as a new pragmatic use of the expression. If re-occurrence constitutes a new use, then indefinites occurring in an ellipsis ought to trigger new discourse referents despite their silence. If re-occurrence does not constitute a new use, but merely re-use, then the indefinite will not be associated with the creation of a new discourse referent: the interpretation of the second occurrence would involve the discourse marker associated with its first (and only) independent use.

Our current work suggests that ellipses are not uniform in this regard. Sluicing, at least, involves re-occurrences that are not interpreted pragmatically as new uses. In most cases, the material in the elided TP seems to be unable to introduce new discourse referents. Compare (47) with (48):

- (48) Jill asked where someone had committed a crime, and Jack asked when.

The only natural interpretation of this example, it seems, is that Jack's question is about the same perpetrator, and the same crime, that Jill's question is about; in other words, (48) can be paraphrased 'Jill asked where person *x* had committed crime *y*, and Jack asked when *x* had committed *y*'. This is the interpretation that would be expected if the discourse markers employed in the antecedent TP are carried over into the interpretation of the elided TP. Similarly, in (49):

- (49) Where someone commits a crime doesn't determine how.

the only natural interpretation is that it is false that where the random person *x* commits crime *y* determines how *x* commits *y*.

The non-synonymy of (47) and (48) is replicated in the example pairs in (50)–(54). In each pair, the indefinite that putatively occurs in the sluice in the (b) example cannot be understood as introducing a new discourse referent:

- (50) a. We know what someone was reading, but we don't know to who someone was reading.
 b. We know what someone was reading, but we don't know to who.
- (51) a. Although we know who someone spoke to, we don't know what someone spoke (to

- someone) about.
- b. Although we know who someone spoke to, we don't know what about.
- (52) a. Jill wondered why Tracy dated a student, and Fred wondered for how long Tracy dated a student.
b. Jill wondered why Tracy dated a student, and Fred wondered for how long.
- (53) a. A high government official was critical of the *New York Times*, but it's not clear what other newspapers a high government official was critical of.
b. A high government official was critical of the *New York Times*, but it's not clear what other newspapers.
- (54) a. Someone from Santa Cruz talked to SAM, but we're not sure who else someone from Santa Cruz talked to.
b. Someone from Santa Cruz talked to SAM, but we're not sure who else.

At one level, the observation that the same discourse markers are employed in the elided TP as in the antecedent TP seems expected. It ought to follow immediately from our proposal that sluicing involves re-use of existing linguistic material; specifically, from the claim that the content of the elided TP is supplied by copying of the antecedent TP, including its intepretation and associated discourse markers. (We appeal to copying rather than the Internal Merge operation here, because the relation must be able to operate across sentences uttered by different participants in discourse.)

However, the patterns illustrated in (50)–(54) are profoundly surprising when viewed from the perspective of a general theory of ellipsis.

Since Hankamer and Sag 1976, it has been recognized that one of the hallmarks of ellipsis is precisely the ability of elided material to introduce new discourse referents. Consider, for instance, the VP ellipsis in (55a), which has an interpretation synonymous with (55b)—one in which each syntactic token of *a book* introduces a new discourse marker.

- (55) a. Kate is reading a book, and I am too.
b. Kate is reading a book, and I am reading a book too.

The ability of elided material to introduce new discourse referents lies behind the missing antecedent phenomenon, which is used by Hankamer and Sag as a diagnostic of ellipsis as opposed to deep anaphora (Grinder and Postal 1971, Hankamer and Sag 1976).

- (56) a. *I've never ridden a camel, and it was of the two-humped variety.
b. I've never ridden a camel, but Ivan has, and it was of the two-humped variety.

If the missing antecedent phenomenon is truly characteristic of ellipsis, then we need to ask whether it is sluicing that is atypical in its interpretation and, if so, why it should be.

We conjecture here that the contrast is correlated with the size of the ellipsis site. Sluicing and VP ellipsis differ in whether the content that must be supplied by copying of an antecedent XP is larger or smaller than the domain of existential closure, which we take to be the smallest constituent in which all the predicate's arguments have had a chance to be introduced (see Chung and Ladusaw 2004). In sluicing, the missing content is larger than the domain of existential closure, so that the

re-used expression has a complete interpretation in terms of a discourse model. The re-occurrence of the expression in the sluice simply provides that model to the interpretation.

In VP ellipsis, on the other hand, the missing content is smaller than the domain of existential closure, so any indefinites that are copied over from the antecedent VP can become existentially closed ‘again’ in the new domain, with the result that new discourse markers will be introduced. From this follow examples like (56b) (on the relevant interpretation), and the missing antecedent phenomenon.

The observation that there are cases of sluicing in which the elided material cannot introduce new discourse referents is both novel and—we believe—undeniable for examples of the type (50)–(54).

It remains to be seen whether the observation is fully general; notice, to begin with, that the examples cited above all involve sprouting. Even without a definitive answer, however, we can bring the preceding discussion to bear on another sluicing pattern that CLM could not account for, namely, the phenomenon of vehicle change.

5.1. Sluicing, E-type Anaphora, and Vehicle Change

As Romero (1998:67–69) and Merchant (2001:201–204) observe, and as Kyle Rawlins has also pointed out to us, theories of sluicing that impose a syntactic identity condition on the elided TP and the antecedent TP encounter a challenge in examples like (57).

- (57)
- a. The Deans know who resigned, but they’re not sure for what reasons.
 - b. He told us which kids were eating, but he couldn’t tell us how much.
 - c. That’s a gazebo. But I don’t know who built it or why. (Merchant 2001:201)
 - d. What interveners are able to ‘get out of the way’, and how? (Merchant 2001:202)
 - e. Always, when a female physicist has been nominated, she wants to know for which award.
 - f. Every female physicist who has been nominated wants to know for which award.

In cases like this, we cannot express what the elliptical sentence means without the ellipsis by simply pronouncing the supposed antecedent in place of the ellipsis. We must change the indefinite DP or the interrogative phrase to a pronoun. Following Fiengo and May 1994, we will refer to this phenomenon as *vehicle change*. The elided TP’s in (57) have interpretations equivalent to the interpretations of the non-elided questions in (58), which contain E-type pronouns.

- (58)
- a. The Deans know who resigned, but they’re not sure for what reasons he resigned.
 - b. He told us which kids were eating, but he couldn’t tell us how much they were eating.
 - c. That’s a gazebo. But I don’t know who built it or why s/he built it.
 - d. What interveners are able to ‘get out of the way’, and how are they able to get out of the way?
 - e. Always, when a female physicist has been nominated, she wants to know for which award she has been nominated.
 - f. Every female physicist who has been nominated wants to know for which award she

has been nominated.

But if the non-elided questions in (58) are the source of the ellipses in (57), then sluicing cannot require syntactic identity, because the E-type pronouns in the elided TP aren't identical to anything in the antecedent TP.

Such a syntactic mismatch, if real, could not be easily handled by CLM (or by Chung 2005). But in the context of our discussion of the interpretive consequences of the re-use of linguistic material in sluicing, it is natural to ask whether the syntactic mismatch in (57) is real or apparent. If we are right that sluicing involves the re-use of a fully interpreted TP from previous discourse, but that this re-use does not allow new discourse markers to be introduced, then a way of rising to the challenge posed by (57) is at hand.

The elided TP's in these examples do not, as a matter of morphosyntactic substance, contain pronouns at all. The E-type pronoun effect in interpretation is the natural result of the assumption that the antecedent TP is copied with its closed interpretation, including discourse markers.

Specifically, after copying, (57a) has the structure shown in (59).

- (59) The Deans know [_{CP} *who*₁ [_{TP} *who*₂ resigned]], but they're not sure [_{CP} for what reasons [_{TP} *who*₃ resigned]].

In (59), *who*₁ and *who*₂ are different syntactic occurrences of a single token of *who*, related by Internal Merge. In the ellipsis, *who*₃ is a further syntactic occurrence of this token of *who*, related to the other two by the larger re-use of TP that sluicing involves. The E-type pronoun interpretation of *who*₃ is, on this view, a natural consequence of the assumptions needed to interpret structures like the antecedent, in which multiple syntactic occurrences of a phrase correspond to a single pragmatic use.

This, we think, is a satisfying resolution to one of the most difficult issues faced by the account of sluicing we advanced some fifteen years ago and return to here.

6. The Broader Picture and Some Open Issues

Part of the excitement of research on ellipsis is that every new investigation seems to raise as many questions as it resolves. In this spirit, we would like to conclude by pointing to some issues raised by the line of thought pursued here.

First, how far-reaching is the generalization that new discourse referents cannot be introduced by material inside the ellipsis in sluicing? The judgements we reported for examples (50)–(54) strike us as very clear. But other types of examples suggest that material inside the ellipsis site might be able to introduce new discourse markers after all. Consider (60).

- (60) MARY was swindled by a lawyer, and it's not clear WHO ELSE.

In (60), the elided question seems to be about who other than Mary was swindled, with no requirement that the lawyer be the same one who swindled Mary. What distinguishes this example from those discussed earlier is that *else* is associated with a *Wh*-phrase which, in its origin site, c-commands the indefinite in the ellipsis. When this relation does not hold, as in (61), the more

general pattern re-emerges: the ellipsis introduces no new discourse referents.

(61) A lawyer swindled MARY, and it's not clear WHO ELSE.

Clearly there is some systematicity to the contrast between (60), on the one hand, and (50)–(54) and (61), on the other. Consider also (62):

(62) Joe was swindled by a lawyer—Mary doesn't know how many times.

The elided question in (62) allows an interpretation in which every time Joe was swindled, he was swindled by a different lawyer. In this interpretation, the indefinite in the re-used TP must have narrow scope. What we are tempted to propose for interpretations of this type is that the meaning of the indefinite is composed by Restrict (in the sense of Chung and Ladusaw 2004)—a mode of composition that would lead to the indefinite being associated with no discourse marker at all. The antecedent clause in (62), in other words, would be roughly synonymous with *Joe was lawyer-swindled*.

Some initial evidence appears to support this view. When distinct discourse markers are introduced by distinct syntactic tokens of an indefinite, they can collectively serve as antecedents for a plural pronoun.

(63) A woman committed a crime on Monday and a woman committed a crime on Tuesday.
They were the same woman.

The same is true even when some of the markers are introduced within VP ellipsis.

(64) Kate has ridden a camel and Ivan has, too. They were the same camel.

But in contrast to the naturalness of these examples, there is something distinctly odd about the plural pronoun in (65):

(65) #Joe was swindled by a lawyer—Mary doesn't know how many times. They were the same lawyer.

This oddness we take as an indication that the narrow-scope reading of *a lawyer* in (62) involves Restrict, and no discourse marker is introduced. If so, there is no counterevidence here to our claim that no new discourse referents are introduced inside the ellipsis in sluicing. Clearly, though, further probing is required.

Another large issue is how the observations and arguments developed here are to be integrated with the body of evidence (developed by Merchant 2001 especially) which argues in favor of PF deletion approaches to sluicing. We fully recognize the force of these arguments. What is striking is that the evidence in question seems to come entirely from the merger cases. Put differently, PF deletion accounts, like Merchant's, offer admirably successful accounts of merger, but deal less well with sprouting. Our approach does a good job of handling sprouting, but is less successful when faced with the merger cases (and especially the connectivity effects they exhibit). What remains elusive is a successful unified account of sluicing. Presumably, such a unification

will involve a reconceiving of the apparent choice between deletion and re-use, a reconceiving that we cannot yet imagine.⁵

Finally, our discussion adds to the list of known contrasts between sluicing and VP ellipsis: tolerance of voice mismatches, island repair, cross-linguistic generality, and now the missing antecedent phenomenon. The contrast we discuss here raises a question about the pragmatic consequences of the ‘re-use’ of processed linguistic material as a resource for interpreting ellipsis sites. If VP ellipsis and sluicing are to be treated uniformly, then it must be the case that re-use of a coherently interpreted TP-sized unit differs in a principled way from re-use of a VP-sized unit, in terms of the pragmatic consequences. This strikes us as a speculation well worth exploring.

References

- AnderBois, Scott. 2010a. Focus and un informativity in (Yukatek) questions. Manuscript, available at <http://anderbois.googlepages.com>.
- AnderBois, Scott. 2010b. Sluicing as anaphora to issues. Paper presented at SALT 20, University of British Columbia and Simon Fraser University, April 29–May 1, 2010.
- Büring, Daniel. 2003. On d-trees, beans, and accents. *Linguistics and Philosophy* 26:511–545.
- Chomsky, Noam. 2001. Derivation by phase. in *Ken Hale: A life in language*, ed. Michael Kenstowicz, 1–52. Cambridge, Mass.: MIT Press.
- Chomsky, Noam. 2008. On phases. in *Foundational issues in linguistic theory: Essays in honor of Jean-Roger Vergnaud*, eds. Robert Freidin, Carlos Otero, and Maria Luisa Zubizarreta, 133–166. Cambridge, Mass.: MIT Press.
- Chung, Sandra. 2005. Sluicing and the lexicon: The point of no return. in *BLS 31, Proceedings of the Thirty-First Annual Meeting of the Berkeley Linguistics Society*, eds. Rebecca Cover and Yuni Kim, 73–91. Berkeley, Calif.: Department of Linguistics, UC Berkeley.
- Chung, Sandra, and William Ladusaw. 2004. *Restriction and saturation*. Cambridge, Mass.: MIT Press.
- Chung, Sandra, William Ladusaw, and James McCloskey. 1995. Sluicing and logical form. *Natural Language Semantics* 3:239–282.
- Culicover, Peter, and Ray Jackendoff. 2005. *Simpler syntax*. Oxford and New York: Oxford University Press.
- Farkas, Donka, and Kim Bruce. 2010. On reacting to assertions and polar questions. *Journal of Semantics* 27:81–118.
- Fiengo, Robert, and Robert May. 1994. *Indices and identity*. Cambridge, Mass.: MIT Press.
- Fox, Danny. 1999. Focus, parallelism and accommodation. in *SALT 9*, eds. Tanya Mathews and Devon Strolovich. Department of Linguistics, Cornell University: CLC Publications.
- Fox, Danny, and Howard Lasnik. 2003. Successive-cyclic movement and island repair: The difference between sluicing and VP-ellipsis. *Linguistic Inquiry* 34:143–154.

⁵ Recent work by Howard Lasnik (2009), responding in part to an earlier version of the material developed here, takes a step in this direction in maintaining deletion for the merger cases, but analyzing the sprouting cases by way of a combination of deletion and the kind of lowering that we appeal to in Section 2.

- Ginzburg, Jonathan. 1996. Dynamics and the semantics of dialogue. in *Language, logic, and computation*, ed. J. Seligman. Stanford, Calif.: CSLI Publications.
- Ginzburg, Jonathan, and Ivan Sag. 2000. *Interrogative investigations: The form, meaning and use of English interrogatives*. Stanford, Calif.: CSLI Publications.
- Grebenyova, Lydia. 2006. Sluicing puzzles in Russian. in *Proceedings of the Annual Workshop on Formal Approaches to Slavic linguistics 14 (FASL 14)*, 151–171. Ann Arbor, Michigan: Michigan Slavic Publications.
- Grinder, John, and Paul M. Postal. 1971. Missing antecedents. *Linguistic Inquiry* 2:269–312.
- Hankamer, Jorge. 1979. *Deletion in coordinate structures*. New York: Garland Publishing.
- Hankamer, Jorge, and Ivan Sag. 1976. Deep and surface anaphora. *Linguistic Inquiry* 7:391–428.
- Heim, Irene. 1982. The semantics of definite and indefinite noun phrases. Doctoral Dissertation, University of Massachusetts, Amherst.
- Kehler, Andrew. 2002. *Coherence in discourse*. Stanford, Calif.: CSLI Publications.
- Lappin, Shalom. 1999. An HPSG account of antecedent-contained ellipsis. in *Fragments: Studies in ellipsis and gapping*, eds. Shalom Lappin and Elabbas Benmamoun, 68–97. Oxford and New York: Oxford University Press.
- Lasnik, Howard. 1999. On feature strength: Three minimalist approaches to overt movement. *Linguistic Inquiry* 30:197–217.
- Lasnik, Howard. 2001. When can you save a structure by destroying it? in *Proceedings of the North East Linguistic Society 31*, eds. Minjoo Kim and Uri Strauss, 301–320. Amherst, Mass.: GLSA.
- Lasnik, Howard. 2009. Island repair, non-repair, and the organization of the grammar. in *Inter-Phases*, ed. Kleantes K. Grohmann, 339–353. Oxford and New York: Oxford University Press.
- Levin, Beth. 2003. Objecthood and object alternations. Handout from a talk given at the Department of Linguistics, UCLA, May 2nd 2003. Available at <http://www.stanford.edu/~belevin>.
- Levin, Lori. 1982. Sluicing: A lexical interpretation procedure. in *The mental representation of grammatical relations*, ed. Joan Bresnan, 590–654. Cambridge, Mass.: MIT Press.
- Manetta, Emily. 2005. *Wh*-expletives in Hindi-Urdu: The *v*P phase. Presented at the January 2006 meeting of the Linguistics Society of America, Albuquerque, New Mexico.
- Manetta, Emily. 2006. Peripheries in Kashmiri and Hindi-Urdu. Doctoral Dissertation, University of California, Santa Cruz.
- Merchant, Jason. 2001. *The syntax of silence: Sluicing, islands, and the theory of ellipsis*. Oxford and New York: Oxford University Press.
- Merchant, Jason. 2002. Swiping in Germanic. in *Studies in comparative Germanic syntax*, eds. C. Jan-Wouter Zwart and Werner Abraham, 289–315. Amsterdam: John Benjamins.
- Merchant, Jason. 2005a. Revisiting syntactic identity conditions. Paper presented at the Workshop on Identity in Ellipsis, UC Berkeley, October 8, 2005.
- Merchant, Jason. 2005b. Sluicing. in *The Blackwell companion to syntax*, eds. Martin Everaert and Henk van Riemsdijk. Oxford: Blackwell.
- Merchant, Jason. 2007. Voice and ellipsis. Manuscript, University of Chicago, available at <http://home.uchicago.edu/~merchant/publications.html>.

- Merchant, Jason. 2008. An asymmetry in voice mismatches in VP-ellipsis and pseudogapping. *Linguistic Inquiry* 39:169–179.
- Merchant, Jason. forthcoming. Variable island repair under ellipsis. in *Topics in ellipsis*, ed. Kyle Johnson. Cambridge: Cambridge University Press.
- Pearson, Matthew. 2005. The Malagasy subject/topic as an A-bar element. *Natural Language and Linguistic Theory* 24:381–457.
- Phillips, Colin. 2003. Linear order and constituency. *Linguistic Inquiry* 34:37–90.
- Phillips, Colin, and Shevaun Lewis. 2009. Derivational order in syntax: Evidence and architectural consequences. To appear in *Directions in Derivations*, C. Chesi, ed., Elsevier.
- Potsdam, Eric. 2007. Malagasy sluicing and its consequences for the identity condition on ellipsis. *Natural Language and Linguistic Theory* 25:577–613.
- Romero, Maribel. 1998. Focus and reconstruction effects in wh-phrases. Doctoral Dissertation, University of Massachusetts, Amherst.
- Ross, John R. 1969. Guess who? in *CLS 5: Papers from the fifth regional meeting of the Chicago Linguistic Society*, eds. Robert Binnick, Alice Davison, Georgia Green, and Jerry Morgan, 252–286. Chicago, Illinois: Chicago Linguistic Society.
- Sag, Ivan. 1976. Deletion and logical form. Doctoral Dissertation, MIT.
- Williams, Edwin. 1977. Discourse and logical form. *Linguistic Inquiry* 8:101–139.
- Yoshida, Masaya, Isaac Rottman, Jiyeon Lee, and Michael Walsh Dickey. 2010. Islands under the predicted structure. Poster presentation at the 23rd Annual CUNY Conference on Human Sentence Processing, March 18–21, 2010, New York University.

TWO BINDING PUZZLES IN MAYAN*

Jessica Coon
MIT
jcoon@mit.edu

Robert Henderson
UCSC
rmh@ucsc.edu

This paper examines binding puzzles in two Mayan languages and proposes an analysis which unifies two otherwise different-looking constructions: the Chol applicative and the K'ichee' agent focus (AF). In both the Chol applicative and the K'ichee' AF, subjects are banned from binding object possessors. That is, the equivalents of English *Maria bought her own tortillas* or *It was Juan who burned his own foot* are impossible in the relevant constructions (though they are possible under a reading in which the subject and object's possessor are not coreferential). We propose that in both types of construction, binding of the object's possessor by the subject is blocked by an intervening ν head. In the Chol (low) applicative, this is the head added to introduce the applied argument. In the K'ichee' AF, this is the head needed to introduce the subject; we may think of this as a type of high applicative. In this paper we show that the similar binding restrictions in these two different languages are easily accounted for under a theory which ties the availability of binding to locality with domains defined by ν heads, such as the minimal pronoun approach of Kratzer (2009).

1. Introduction

Mayan languages have a rich set of voice alternations with varied morphosyntactic constraints on their application. From agent focus, to applicatives, to passives, Judith Aissen has thought more deeply than anyone else about the conditions under which these alternations can take place, as well as their subsequent effects on clause structure. In this paper we follow her lead by considering two different voice alternations in two different Mayan languages, each of which has a strikingly similar effect on the availability of intraclausal binding relations.

The languages in question are Chol and K'ichee'. We first consider Chol's *-be* applicative and its relation to binding. What we find is that 3rd person subjects must bind 3rd person possessors of direct objects (Aissen's (1999) *extended reflexive*) unless the verb takes *-be*, in which case, the object possessor must be free. The second construction we consider is Agent Focus (AF) in K'ichee', which detransitivizes a predicate without demoting either transitive argument. Crucially, predicates with AF morphology block binding from subject position. Just as in Chol, we see in

* We first began comparing notes on Chol and K'ichee' in a workshop led by Judith at CIESAS-Sureste in Mexico in 2006. We are both grateful for her influence and guidance in our own work, as well as for her pioneering research into the structure of Mayan languages. We are indebted to Nicolás Arcos López, Doriselm Gutierrez Gutierrez, and Juan Vázquez for consulting on Chol data. We also want to thank David Pesetsky and Norvin Richards for reading and commenting on an earlier draft of this paper, as well as Ryan Bennett, Amy Rose Deal, Omer Preminger, and Matt Tucker for discussing the analysis at various points. All errors are of course our own. Authors' names are listed in alphabetical order.

K'ichee' that a voice alternation forces certain pronouns—which may be bound in plain transitive clauses—to be free.

This paper provides an analysis that unites the behavior of these two constructions within a *minimal pronouns* approach to binding (Kratzer 2009). In this framework free variables are λ -bound by a local v (little “v”) head and share features with the DP specifier of the binding head. What brings together the Chol applicative and the K'ichee' AF is that both alternations add arguments through additional clausal structure. This blocks binding by increasing the intraclausal distance between co-arguments that would have been otherwise able to support a binding relationship in a standard transitive clause.

Section 2 presents a detailed description of the binding facts in Chol and K'ichee'. Their analysis begins in §3. Here we sketch an analysis of binding in terms of locality domains defined by v P domains, and use it to account for the behavior of binding in Chol extended reflexives in §3.1. Section 3.2 extends the analysis to binding in K'ichee' AF clauses. In §4 we show that the *Minimal Pronouns* approach of Kratzer (2009) correctly handles the Mayan facts. The paper concludes in section 5.

2. Two Binding Puzzles

This section presents the two binding puzzles from Chol and K'ichee' that form the empirical core of this work. In each case we find that binding relations that could hold in a plain transitive clause are blocked once the verb undergoes voice change. We first consider Chol *extended reflexives*, which are in complementary distribution with the *-be* applicative. We then introduce K'ichee' agent focus, which interrupts object binding from subject position.¹

2.1. Chol Extended Reflexives

Chol is spoken by around 150,000 people in southern Mexico and belongs to the Tzeltalan branch of the Mayan language family. Like many languages, Chol has an applicative, *-be*, which promotes indirect objects to full (primary object) argument status, as shown in (1).² In the plain transitive in (1a) the recipient, *aläl* ‘child’, must be introduced by a preposition, *cha'añ*. In the applicative construction in (1b), the recipient is promoted to a full verbal argument—a “primary object” in the sense of Dryer 1986—which, like a regular transitive object, controls absolutive agreement on the verb (here null third person). The theme receives secondary object status; it does not control verbal agreement.

¹ Though both *-be* applicatives and agent focus constructions are common within the Mayan family, Chol does not have an agent focus and K'ichee' does not have a productive applicative. In Chol, both ergative and absolutive arguments may be freely extracted.

² Abbreviations used in glosses are: 1,2,3 – 1st, 2nd, 3rd persons; ABS – absolutive; AF – agent focus; APPL – applicative; CAUS – causative; CL – noun class clitic; CLF – cleft; CP – completive; DET – determiner; ERG – ergative; FOC – focus marker; ITV – intransitive; P – plural; PASS – passive; PL – plural; PERF – perfective participle; PRFV – perfective; REFL – reflexive; TV – transitive verb suffix.

(1) a. TRANSITIVE

Tyi k-ch'äx-ä-Ø_i ja'_i cha'añ aläl.
 PRFV ERG1-boil-TV-ABS3 water for child
 'I boiled water for the child.'

b. APPLICATIVE

Tyi k-ch'äx-be-Ø_i ja' aläl_i.
 PRFV ERG1-boil-APPL-ABS3 water child
 'I boiled the child water.'

What concerns us in this paper is the interaction between *-be* and binding between subject and object possessors. In a Chol transitive construction with two third person arguments, if the object is possessed by a third person, the possessor *must* be co-referential with the subject. This can be seen in sentences like those in (2). This contrasts with the English equivalents, where the gloss is ambiguous between co-reference and disjoint reference. Aissen (1999), discussing Tzotzil, labels this type of construction the *extended reflexive*.

(2) EXTENDED REFLEXIVES

a. Tyi i_i-boñ-o-Ø y_{i/*j}-otyoty jiñi wiñik.
 PRFV ERG3-paint-TV-ABS3 ERG3-house DET man
 'The man painted his (own) house.'

(cannot mean: 'The man painted his/her (someone else's) house.')

b. Tyi i_i-mäñ-ä-Ø i_{i/*j}-waj aj-Maria.
 PRFV ERG3-buy-TV-ABS3 ERG3-tortilla CL-Maria
 'Maria bought her (own) tortilla.'

(cannot mean: 'Maria bought his/her (someone else's) tortillas.')

The only way to break the binding relationship between the subject and the object possessor in (2) is to use the applicative morpheme *-be*. Example (4) shows that *-be* renders the possessor obligatorily disjoint from the subject, when it would otherwise have to be bound.³

(3) a. Tyi k-boñ-o-Ø y-otyoty.
 PRFV ERG1-paint-TV-ABS3 ERG3-house
 'I painted his house.'

b. Tyi k-boñ-be-Ø y-otyoty.
 PRFV ABS1-paint-APPL-ABS3 ERG3-house
 'I painted his house.'

³ Interestingly, these facts only hold for clauses in which the transitive subject and the theme's possessor are both *third person*. In a construction in which the subject is first person and the theme's possessor is third person, for example, the applicative is possible but not obligatory. We do not address this issue here.

(4) APPLICATIVES

- a. Tyi *i*_i-boñ-**be**-Ø *y*_{*i/j}-otyoty *jiñi* *wiñik*.
 PRFV ERG3-paint-APPL-ABS3 ERG3-house DET man
 ‘The man painted his/her (someone else’s) house.’
 (cannot mean: ‘The man painted his own house.’)
- b. Tyi *i*_i-māñ-**be**-Ø *i*_{*i/j}-waj *aj*-Maria.
 PRFV ERG3-buy-APPL-ABS3 ERG3-tortilla CL-Maria
 ‘Maria bought his/her (someone else’s) tortillas.’
 (cannot mean: ‘Maria bought her own tortillas.’)

Below we propose an analysis to account for why binding is obligatory in (2) and why it is blocked when the verb takes the *-be* applicative.

2.2. K’ichee’ Agent Focus

The previous section showed that in Chol, verbal voice blocks otherwise obligatory binding. K’ichee’ presents another case where voice, specifically agent focus, constrains binding. K’ichee’ belongs to the K’ichean branch and is spoken in the highlands of Guatemala by close to one million people. Like many Mayan languages, K’ichee’ does not allow the free extraction of transitive subjects (hereafter *agents*). If at least one argument of a transitive clause is third person, agent extraction requires the verb to appear in the special AF form. In some dialects of K’ichee’, AF is a true antipassive voice. That is, the predicate becomes intransitive and the object is demoted (Mondloch 1981). In most dialects though, AF clauses differ from true antipassives in that the verb is rendered morphologically intransitive, while still retaining the ability to take two full DP arguments like standard transitive predicates. The construction is exemplified in (5a–5b).

(5) AGENT FOCUS

- a. Jas *x*-Ø-chap-ow *le* *wah?*
 who CP-ABS3-eat-AF DET tortilla
 ‘Who touched the tortilla?’
- b. Jas *x*-Ø-chap-ow-ik
 who CP-ABS3-touch-AF-ITV
 ‘Who touched it?’

Notice in (5a) that while the predicate takes two full arguments, there is only a single instance of absolutive agreement, as in intransitive clauses. Further evidence that the clause is morphologically intransitive is that the verb takes the intransitive status suffix *-ik* in (5b). This suffix is deleted when not phrase final, and is thus not present in (5a).

One way to think of AF clauses is that they present a way to express a transitive relation with intransitive morphology. The puzzle that arises is that the binding possibilities between transitive coarguments are dependent on whether the verb bears AF or standard transitive morphology. For instance, Mondloch (1981) shows that the agent of an AF clause cannot bind a reflexive object anaphor, as shown in (6). Instead, a standard transitive clause like (7) must be used.

That is, in (7), we find no AF despite the fact that the agent is focused.⁴

- (6) *Aree jun kumatz b'aq'ati-**n**-aq r-iib' (Mondloch 1981, p.233)
 FOC one snake roll-AF-PERF ERG3-SELF
 'It was a snake that coiled itself (around the tree).'
- (7) Aree jun kumatz u-b'aq'ati-**m** r-iib' (Mondloch 1981, p.233)
 FOC one snake ERG3-roll-TV.PERF ERG3-SELF
 'It was a snake that coiled itself (around the tree).'

Similarly, extended reflexives are impossible in AF clauses. Example (8) shows that the agent and an object possessor cannot be co-referential in an AF clause. Once again, this meaning can only be expressed with a standard transitive clause like (9).⁵

- (8) Aree lee a Xwaan x-Ø-k'at-**ow** r-aqan. (Mondloch 1981, p.235)
 FOC DET CF Juan CP-ABS3-burn-AF ERG3-foot
 'Juan is the one who_i burned his_{*i/j} foot.'
- (9) Aree lee a Xwaan x-Ø-u-k'at r-aqan. (Mondloch 1981, p.237)
 FOC DET CF Juan CP-ABS3-ERG3-burn ERG3-foot
 'Juan is the one who_i burned his_{i/*j} foot.'

To show that it is truly binding that is blocked in extended reflexives, example (10) presents the same fact with the quantifier *majun* 'no one'. A quantifier cannot bind an object possessor in an AF clause. Only the transitive clause in (11) permits the bound reading.

- (10) Majun x-Ø-k'am-**ow** ulo r-ixayil.
 No.one CP-ABS3-bring-AF hither ERG3-wife
 No one_i brought his_{*i/j} wife.
- (11) Majun x-Ø-u-k'am ulo r-ixayil.
 No.one CP-ABS3-ERG3-bring hither ERG3-wife
 No one_i brought his_{i/*j} wife.

The K'ichee' data present a similar effect as seen in Chol. Intraclausal binding relations are

⁴ An important question, which we cannot answer here, is why examples like (7) are grammatical at all. If agent extraction forces agent focus, and binding is blocked in AF clauses, then sentences with both should be simply ineffable. The important fact is that there are other instances where AF is not required with agent focus, for example with two local person arguments (i.e. first person acting on second person). It seems that AF is only required in those cases where it is easy to confuse whether the extracted argument is the subject or the object. There is no such confusion with bound pronouns because they could not be bound unless the extracted argument was the subject. While this does not explain this synchronic fact of the grammar, the fact that (7) is grammatical fits within a wider pattern in the language.

⁵ Note that the agent focus morpheme in (8) is different from that in (6). The reason is that root transitives, like the former, take the *-ow* suffix, while derived transitives take *-n*.

not stable under voice alternations. Specifically, subjects no longer make good binders once the verb takes AF morphology. The next section builds a unified analysis of Chol and K'ichee' that explains the distribution of bound pronouns and reveals the fundamental similarities between *-be* applicatives and AF.

3. Analysis

In this section we present our analysis of the Chol and K'ichee' constructions discussed above. In both we argue that the relevant voice construction involves the introduction of a *v* head, which blocks binding between the subject and the possessor in question. Defining binding domains in terms of *v* heads, we show, gives the correct result. In the section that follows, we show how Kratzer's (2009) *Minimal Pronouns* approach correctly captures these facts.

3.1. Chol Analysis

Recall that in Chol a third person subject must bind a third person possessor, as in (12), repeated from (2b). We can use examples like (12)—which we'll refer to as '3-3.POSS' clauses—to illustrate the first part of the analysis.

- (12) Tyi i_i-mäñ-ä-Ø i_{i/*j}-waj aj-Maria.
 PRFV ERG3-buy-TV-ABS3 ERG3-tortilla CL-Maria
 'Maria bought her (own) tortilla.'
 (cannot mean: 'Maria bought his/her (someone else's) tortillas.')

Assume that in 3-3.POSS clauses, the possessor pronoun must be an anaphoric pronominal element with unvalued ϕ -features.⁶ In the framework of Kratzer 2009, discussed in section 4, we term all such elements *minimal pronouns* and represent them as [*n*]. This restriction is stated in (13).

- (13) 3-3POSS RESTRICTION
 In a clause with a third person subject and a third person object possessor, the possessor must be realized as a minimal pronoun, [*n*].

A sentence like (12) has a structure like example (14). The agent is generated in the specifier of a transitive *v*, instantiated by the harmonic vowel "status suffix" *-ä* (Coon 2010a,b). The minimal pronoun possessor, [*n*], is generated in the specifier a nominal projection, here labelled *Poss* (see Coon 2009 for more on Chol possessive constructions).

⁶ We currently do not have an analysis of this constraint, though there are plausible directions for future research. For instance, Reinhart (1983, p.167) proposes a "pragmatic strategy" in which bound variables are uniformly preferred over non-bound pronouns to express the same meaning. If a 3.3POSS clause with a disjoint possessor expresses the same meaning as a 3.3POSS *-be* clause, then we should have to use the *-be* clause since it employs a bound pronoun. Crucially, we would have to say that this "pragmatic" competition between forms only comes into play when there is an ambiguity between bound and unbound interpretations for a pronoun, i.e., when both are 3rd person.

(14) EXTENDED REFLEXIVE

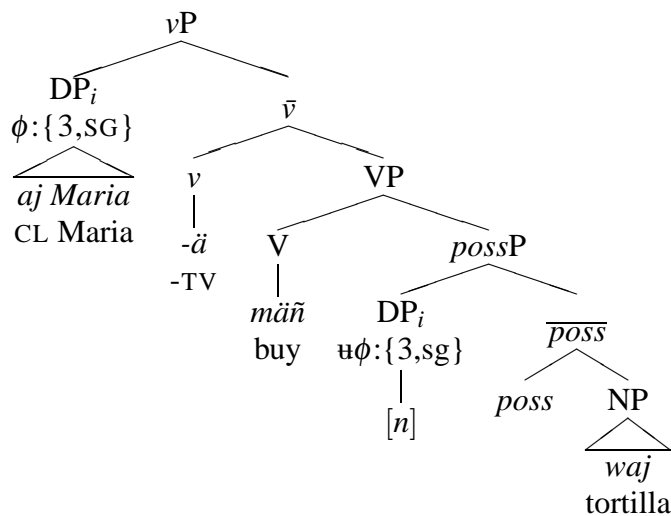

The minimal pronoun begins the derivation with unvalued ϕ -features ($u\phi$). It is bound by the agent and thus acquires the features $\{3, SG\}$. As a possessor we assume it will receive genitive case and be spelled out as the third person ergative morpheme *i-* in *i-waj* ‘her tortilla’. The fact that object possessors in 3-3.POSS constructions must be anaphors gives us the result that third person subjects must bind and share features with third person possessors, which is precisely what we see with extended reflexives. The mechanics of this feature sharing are described in detail in §4.

With this basic framework in place, we now turn to the account of why the *-be* applicative blocks this otherwise obligatory binding relationship. Compare again the extended reflexive construction in (12) above with the applicative-bearing form in (15), repeated from (4b).

- (15) Tyi i_t -määñ-**be**- \emptyset $i_{*i/j}$ -waj aj-Maria.
 PRFV ERG3-buy-APPL-ABS3 ERG3-tortilla CL-Maria
 ‘Maria bought his/her (someone else’s) tortillas.’
 (cannot mean: ‘Maria bought her own tortillas.’)

In addition to promoting indirect objects, *-be* also participates in *external possession* constructions (see Payne and Barshi 1999), in which it promotes the *possessor* of the theme to primary object status. In this construction, the theme’s possessor is realized both via possessive (ergative) marking on the possessed NP, and also via absolutive morphology on the predicate, where it is interpreted as an *affectee*. Examples are given in (16).

(16) EXTERNAL POSSESSION

- a. Tyi i -k’ux-**be**-**yoñ** **k**-ok j iñi ts’i’.
 PRFV ERG3-bite-APPL-ABS1 ERG1-leg DET dog
 ‘The dog bit my leg.’
- b. Tyi k -tsääñ-sä-**be**-**yety** **a**-chityam.
 PRFV ERG1-die-CAUS-APPL-ABS2 ERG2-pig
 ‘I killed your pig.’

Returning now to the Chol binding constructions we began with, we see that the applicative used for disjoint reference in examples like (15) is simply another instance of external possession. In (17), as well as in (15) above, the absolutive agreement on the predicate tracks the applied argument (which is also marked as a possessor on the theme) just like in the constructions in (16). Recall that third person absolutive is null in Mayan languages.

- (17) Tyi i-k'ux-be-Ø y-ok jiñi ts'i'
 PRFV ERG3-bite-APPL-ABS3 ERG3-leg DET dog
 'The dog_i bit his_{*i/j} (someone else's) leg.'

Example (17) would have a structure like (18). We treat *-be* as the morphological realization of a little *v* head that introduces an applied argument in its specifier. This argument behaves as a primary object, for example, controlling verbal object agreement. The THEME argument is the complement of the *v* head hosting *-be*. The Chol *-be* is thus a *low applicative* in the sense of Pylkkänen 2002: it mediates a relationship between two nominal arguments.

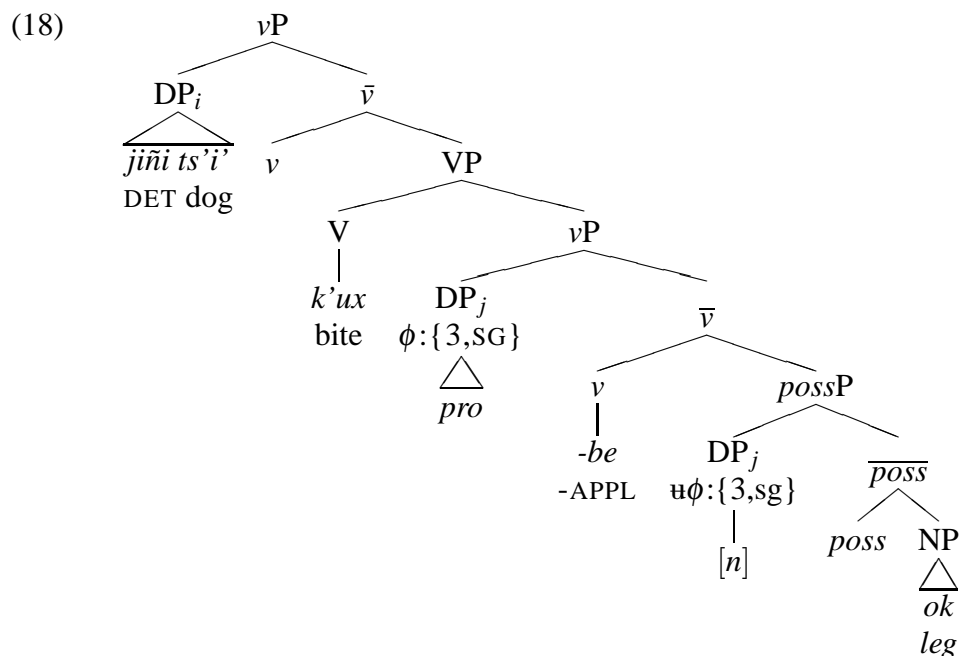

Assume following (13) that a minimal pronoun is generated in the specifier of *possP*, just as in the extended reflexive construction. The crucial difference is that with the addition of *-be* there is a new potential binder for this anaphor: the applied object *pro*. If we assume that binding of the minimal pronoun is limited to the smallest *vP* containing it, we correctly predict that the applied argument binds and shares features with the possessor [*n*]. This is exactly what we find with external possession constructions more generally. In particular, we generate the disjointness requirement for sentences like (15) and (17). The subject cannot bind the applied object (which in turn binds the minimal pronoun) without resulting in a Condition B violation.⁷

3.2. Extending the Analysis to K'ichee'

The previous section showed that binding is blocked in the applicative construction because the intervening functional structure forces the anaphoric possessor pronoun to be bound by the applied argument. By extension, we argue that the similar binding data in K'ichee' AF clauses is due to fact that they too involve an applicative head introducing an argument. This allows us to generate the correct binding facts and leads to an important insight about the structure of AF clauses, which have few analogues cross-linguistically.

Recall that AF clauses are distinguished by containing two full arguments, but intransitive verbal morphology as below (repeated from (5a-5b)). As described in Aissen (1999), we may thus think of AF constructions as being morphologically intransitive, yet semantically transitive.

(20) AGENT FOCUS

- a. Jas x-Ø-chap-ow le wah?
 who CP-ABS3-eat-AF DET tortilla
 'Who touched the tortilla?'
- b. Jas x-Ø-chap-ow-ik
 who CP-ABS3-touch-AF-ITV
 'Who touched it?'

Prime evidence for the morphological intransitivity of AF clauses is the fact that the verb carries the intransitive status suffix *-ik*, as in (20b), which only appears with root and derived intransitives, as shown in (21) and (22b), respectively. For example, the transitive root *chap* 'touch' takes the transitive status suffix *-o* in (22a), but when it is passivized (22b), it takes the same status suffix as

⁷ There is one way to achieve coreference between the subject and the possessor, namely, when the applied argument is the reflexive pronoun, *-bä* 'self'. The reflexive must be bound by the agent, and in turn binds the anaphoric possessor. If binding is limited to *vPs*, we correctly predict that co-reference between the subject and the theme's possessor is possible in exactly those cases in which the binding relationship is mediated by an intervening element, as illustrated in (19).

- (19) Tyi i-k'ux-be-Ø i-bä y-ok jiñi ts'i'.
 PRFV ERG3-bite-APPL-ABS3 ERG3-SELF ERG3-leg DET dog
 'The dog bit his own leg.'

root intransitives like (21).⁸

(21) x-Ø-war-ik
CP-ABS3-sleep-ITV
'He slept.'

(22) a. x-Ø-u-chap-o
CP-ABS3-ERG3-touch-TV
'He touched it.'

b. x-Ø-chaap-ik
CP-ABS3-touch.PASS-ITV
'He was touched.'

Crucially, the root *chap* takes the same intransitive status suffix with AF morphology as it does in the passive. Since all intransitives take *-ik*, and status suffixes can be analyzed as the realization of a little *v* head (see Coon 2010a,b), we take all intransitives, including AF clauses, to include an intransitive v_{ITV} shell. Since intransitive clauses license only one argument and therefore permit only absolutive agreement, we correctly predict that AF clauses should exhibit a single agreement morpheme.

What we need to understand now is how AF clauses allow two non-oblique arguments if the clause is built around an intransitive *v*. We propose that AF morphology has a crucial role to play here. Just as the *-be* applicative introduces a third argument in a ditransitive construction, we make the novel proposal that AF morphology is a *high applicative* in the terminology of Pylkkänen (1999, 2002), introducing the agent in its specifier and relating it to the event. The resulting structure is shown in (23).

(23) K'ICHEE' AGENT FOCUS

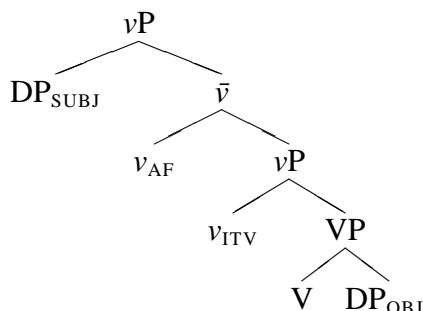

If the v_{AF} head is in charge of introducing the external argument and assigning it inherent AF case, then we correctly predict that AF clauses should exhibit intransitive verbal morphology, but permit two full semantic arguments.

⁸ Historically, a CVC root transitive was passivized by the addition of the morpheme *-h-* to produce a CVhC syllable. The root passive is indicated by length in modern K'ichee' because of a sound change turning all CVhC syllables into CVVC syllables (Campbell 1977).

Now consider the implications of this analysis for binding. In a normal transitive clause like (24), the subject sits in the specifier of a v_{TV} . Assuming as above that binding domains are defined by vP , the subject can thus bind a minimal pronoun in object position, shown in (25). Following Kratzer (2009), we assume that v heads introducing binders carry a reflexive feature, discussed below. The minimal pronoun comes to bear the features $\{3,PL,REFL\}$ and will thus be spelled out as the third person plural reflexive clitic pronoun *kiib*'.

- (24) Le achi-jaab' x-ki-kunata-j k-iib'
 DET man-PL CP-ERG3P-cure-TV ERG3P-REFL
 'The men cured themselves.'

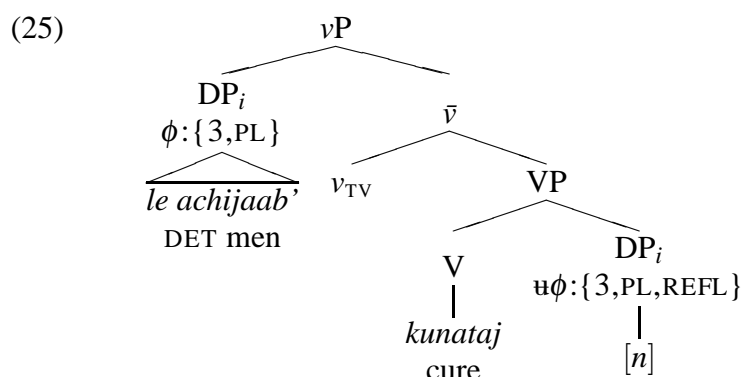

Now consider the ungrammatical case of an object reflexive in an AF clause. The agent is no longer introduced by the transitive v_{TV} head. Instead, it is an applied argument introduced by the higher v_{AF} head.

- (26) *Aree jun kumatz u-b'aq'ati-n-aq r-iib'. (Mondloch 1981, p.233)
 FOC one snake ERG3-roll-AF-PERF ERG3-SELF
 'It was a snake that coiled itself (around the tree).'

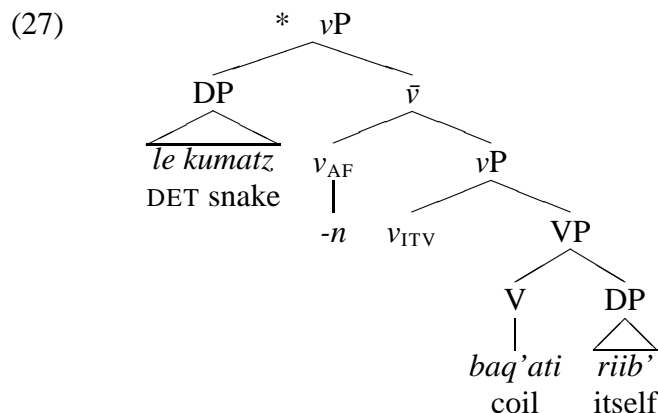

With the syntax in (27), we correctly predict that binding should be blocked. Binding of the

reflexive must take place within the minimal vP containing that reflexive, but in the AF clause, the minimal vP is v_{TV} . This head, however, does not introduce the DP that would be required to antecede the object in (26). Instead the subject is introduced by the higher v_{AF} head, and is thus too far away to bind the object pronoun. In this situation we predict that all binding should be blocked—including in extended reflexives constructions like that in (8) above—which is the case.

4. Kratzer 2009

In the preceding section we presented an analysis of both Chol applicatives and K'ichee' AF constructions. By defining binding domains in terms of v heads, we correctly accounted for the binding facts discussed above, though only a sketch of the mechanism of binding and feature sharing was presented. In this section we spell out the details of this binding using the framework of Kratzer (2009) (which builds on ideas in Heim (1994); Kratzer (1998); von Stechow (2003)). The core difference from classical approaches is that binding is established through λ -operators associated with v heads. If we require binding to be established by a λ -operator associated with the closest v head, we replicate the correct predictions we saw above. First, it provides a straightforward analysis of binding in *-be* applicative clauses in Chol. By applying an argument, *-be* introduces another v head blocking binding from subject position. Turning to K'ichee', we saw that the AF construction also requires an additional v shell, but this time, to introduce the focused agent. This blocks the otherwise available binding relationship between subject and object, and shows the underlying similarity between the Chol and K'ichee' data: voice alternations that result in additional v structure alter binding relations.

4.1. Minimal Pronouns and Binding

To illustrate the basic approach, we return to a Chol 3-3.POSS (*extended reflexive*) construction in (12) and (14) above. Traditional approaches to binding treat antecedent DPs as pronoun binders. Through establishing the antecedent-pronoun binding relationship, the two come to be coreferential and must share features. On Kratzer's (2009) analysis, bound pronouns enter the derivation as indices impoverished of features. Variables accumulate features and achieve their surface forms by sharing features with other local DPs. Crucially, this feature-sharing only takes place under binding, which presents the second distinctive feature of Kratzer's minimal pronouns approach: all binding is done by v heads (Adger and Ramchand 2005; Reinhart and Reuland 1991, 1993). These v heads mediate feature sharing through Spec-Head agreement. We now spell out the approach in detail.

A bound pronoun enters the derivation as a bare index, which we represent with the numerical feature $[n]$. A binding v head will bear another instance of the feature $[n]$ and introduce a λ -operator at LF binding n as in (28).⁹

⁹ To save space in trees, hereafter we do not show independent λ nodes, but annotate the v head introducing the λ -operator as $v_{\lambda[n]}$

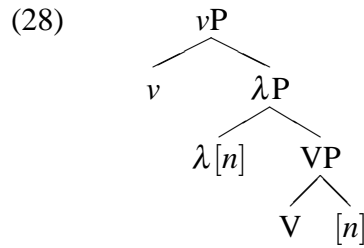

- (29) a. $\llbracket V \rrbracket^g = \lambda x \lambda e. P(x)(e)$
 b. $\llbracket [n] \rrbracket^g = g(n)$
 c. $\llbracket VP \rrbracket^g = \lambda e. P(n)(e)$
 d. $\llbracket \lambda P \rrbracket^g = \lambda x. \llbracket VP \rrbracket^{x/n} = \lambda x \lambda e. P(x)(e)$

Example (29) shows that a reflexive predicate is formed when a ν head binds an object minimal pronoun, as expected. Normally a predicate of type $\langle e, \langle et \rangle \rangle$ would take a pronoun with index $[n]$ and yield a predicate of events. Since the variable is free, the entity satisfying the internal argument would be given by the assignment function, namely $g(n)$. The difference in (29) is that the ν head introduces a λ -operator that rebinds the object variable. When this composes with the agentive ν head, via predicate modification, we get the reflexive predicate in (30b).

- (30) a. $\llbracket \nu \rrbracket^g = \lambda x \lambda e. \mathbf{agent}(x)(e)$
 b. $\llbracket \nu P \rrbracket^g = \lambda x \lambda e. P(x)(e) \wedge \mathbf{agent}(x)(e)$

While λ -binding from ν correctly generates the reflexive meaning for object bound pronouns we must add two more principles so that bound minimal pronouns can share features with the DP specifier of the binding ν head. First we define the notion of ϕ -feature unification.

- (31) **Definition: Unification** (Kratzer 2009, p.195)
 Given feature sets ϕ_1, \dots, ϕ_n associated with expressions a_1, \dots, a_n , define their unification as $\bigcup \{\phi_1, \dots, \phi_n\}$.

Unification permits the definition of Spec-Head feature agreement as in (32).

- (32) **Definition: Spec-Head Agreement** (Kratzer 2009, p.196 ex.19)
 When a DP occupies the specifier position of a head that carries a λ -operator, their ϕ -feature sets unify.

Given that a ν head bearing a λ -binder will inherit the features of the DP in its specifier, we can define feature transmission under binding as in (33), which passes these features to the minimal pronoun.

- (33) **Definition: Feature Transmission under Binding** (Kratzer 2009, p.195 ex.18)
 The ϕ -feature set of a bound DP unifies with the ϕ -feature set of the verbal functional head that hosts its binder.

Although the *Minimal Pronouns* approach to binding was developed in particular to deal with bound indexicals, these same ideas also explain the behavior of binding in Chol *-be* applicatives and K'ichee' agent focus.

4.2. Chol

In the Chol *extended reflexive* in (12)–(14) above, the possessor of the theme originates as a minimal pronoun bearing the index feature $[n]$. Even though it is embedded within the theme argument and does not compose directly with the verb, it can be bound by a λ -binder introduced by the nearest v head. We translate the possessive head *poss* as in (34). It takes a predicate and the possessor and returns the unique individual that satisfies the predicate and stands in the contextually specified relation R with the possessor.¹⁰

$$(34) \quad \llbracket \textit{poss} \rrbracket^g = \lambda P \lambda x \iota y. P(y) \wedge R(x)(y)$$

Assuming the translation in (34), the interpretation of the VP is as in (35). Example (36) illustrates how the λ -binder introduced by v rebinds the possessor pronoun and introduces the external argument which will satisfy both the agent relation and the possessor relation, producing the extended reflexive meaning in (37).

$$(35) \quad \llbracket VP \rrbracket^g = \lambda e. \textit{buy}'(\iota y. \textit{tortilla}'(y) \wedge R([n])(y))(e)$$

$$(36) \quad \llbracket \bar{v} \rrbracket^g = \lambda x \lambda e. \textit{buy}'(\iota y. \textit{tortilla}'(y) \wedge R(x)(y))(e)$$

$$(37) \quad \llbracket vP \rrbracket^g = \lambda e. \textit{buy}'(\iota y. \textit{tortilla}'(y) \wedge R(\textit{maria})(y))(e) \wedge \mathbf{agent}(e)(\textit{maria})$$

After existential closure of the event argument, example (37) will be true just in case there is an event of buying the unique tortilla that stands in the R relation with Maria and Maria is the agent of that event.

Given that possessors in Chol 3-3.POSS clauses enter the derivation as minimal pronouns, we can account for the obligatory reflexive interpretation if v heads host λ -binders. We ensure that the possessor matches in features with its binding due to Spec-Head agreement and feature transmission under binding. Since the DP *ajMaria* sits in the specifier of a v -head hosting a λ binder, their feature sets unify. The minimal pronoun then inherits these features via feature transmission under binding as in (38).

$$(38) \quad \begin{array}{ccccc} \textit{ajMaria} & \leftrightarrow & v_{\lambda[n]} & \leftrightarrow & [n] \\ \{3,SG\} & \text{Spec-Head Agr} & \{n\} & \phi\text{-Transmission under binding} & \{n\} = \{3,SG\} \cup \{n\} \end{array}$$

Following the same logic, we correctly achieve the disjoint reference of the applicative constructions like the one illustrated in (18) above. Given that λ -binding takes place at the closest

¹⁰ We are not committed to this uniqueness analysis of the definiteness of possessed NPs. It is an approximation of convenience. What really matters for our purposes is the possessor does not satisfy the verbal predicate but the contextually given possessor relation.

v head, only the applicative v head can host a λ -binder for the possessor pronoun. We therefore correctly predict that the applied argument must be bound and share features with the possessor.

4.3. K'ichee'

Turning now to K'ichee', we consider again the reflexive forms in (24) and (25) above. As before, the λ -operator forms the reflexive predicate in (39), which will compose with the subject to give the correct reflexive interpretation.

$$(39) \quad \llbracket \bar{v} \rrbracket^g = \lambda x \lambda e. \text{cure}(x)(e) \wedge \mathbf{agent}(x)(e)$$

As noted above, we assume that v heads introducing binders carry a reflexive feature. This makes sense since many languages morphologically mark reflexive predicates. For languages that have special reflexive pronouns, this feature will be transferred to the bound pronoun via feature unification, which will ensure that it is spelled out in the appropriate form. Example (40) gives the result of feature sharing under binding for the structure in (25) above.

$$(40) \quad \begin{array}{ccccccc} \textit{le achijaab}' & & \leftrightarrow & & v_{\lambda, [n]} & & \leftrightarrow & & [n] \\ \{3, \text{PL}\} & \text{Spec-Head Agr} & & \{n, \text{REFL}\} & \phi\text{-Trans under binding} & & & \{n\} & = \{3, \text{PL}, \text{REFL}\} \cup \{n\} \end{array}$$

The ungrammatical agent focus reflexive form in (27) above is correctly ruled out: the subject is introduced in a v P distinct from that containing the minimal pronoun, and binding is therefore impossible.

Finally, the analysis makes an important prediction that is borne out concerning the relationship between reflexive semantics and reflexive morphology. Notice that the two are slightly decoupled here. Namely, a v head hosting a λ -binder will bear a reflexive feature and transmit it to a minimal pronoun in binds. But a pronoun could also simply enter the derivation with a reflexive feature. In this case, binding would not be necessary for the realization of the reflexive pronoun and so we would predict that it should be able to appear in an AF clause. This is precisely what happens in the K'ichee' *urgent imperative*. Mondloch (1981) discusses examples like (41). The verb bears imperative morphology, but the addition of the reflexive clitic pronoun *riib'* gives in the emphatic urgent interpretation.

$$(41) \quad \begin{array}{llll} \textit{tij-ow} & \textit{r-iib}' & \textit{le} & \textit{a-wa} \\ \text{eat-AF} & \text{ERG3-SELF} & \text{DET} & \text{ERG2S-food} \\ \text{'Eat your food quick!'} & & & \end{array}$$

Crucially, the urgent imperative appears in the AF form. In precisely the case where semantic binding is not at issue we find that reflexive morphology can appear in AF clauses. Moreover, the reflexive can only appear in the third person singular form. This is predicted if third person singular features are unspecified. Since the pronoun can acquire no more features through binding, the pronoun will end up with the reflexive feature alone and be spelled out in the default third person reflexive form.

5. Conclusion

In this paper we began with two binding puzzles related to different voice constructions in the Mayan languages Chol and K'ichee'. In Chol we saw that an intervening v head (the applicative *-be*) introducing an applied object blocked binding from subject. In K'ichee' we saw that AF morphology also blocks object binding from subject. This led us to propose a new analysis of AF clauses in which the external argument is introduced as a high applicative. By treating Chol *-be* clauses and K'ichee' AF clauses in this symmetric way (i.e., as low and high applicatives respectively), we were able to present a uniform analysis of their similar binding facts. Each type of applicative introduces a new v head. If binding domains are determined by locality within a v domain, the similar binding effects in Chol and K'ichee' make sense. We then implemented this idea in the *Minimal Pronouns* approach of Kratzer (2009), which ties binding to local λ -operators introduced by v heads, giving us the correct v head binding domains. Moreover, since this theory decouples the semantics of binding from its morphological reflex, it makes good predictions about those cases where semantic binding and bound pronoun morphology diverge, such as in the case of the K'ichee' urgent imperative.

References

- Adger, David, and Gillian Ramchand. 2005. Merge and Move: Wh-dependencies revisited. *Linguistic Inquiry* 36:161–193.
- Aissen, Judith. 1999. Agent focus and inverse in Tzotzil. *Language* 75:451–485.
- Campbell, Lyle. 1977. Quichean linguistic prehistory. *University of California Publications in Linguistics*, 81, Berkeley: University of California Press.
- Coon, Jessica. 2009. Interrogative possessors and the problem with pied-piping in Chol. *Linguistic Inquiry* 40:165–175.
- Coon, Jessica. 2010a. Complementation in Chol (Mayan): A theory of split ergativity. Doctoral Dissertation, MIT, Cambridge, MA.
- Coon, Jessica. 2010b. Rethinking split ergativity in Chol. *International Journal of American Linguistics* 76:207–253.
- Dryer, Matthew S. 1986. Primary objects, secondary objects, and antitativity. *Language* 62:808–845.
- Heim, Irene. 1994. Puzzling reflexive pronouns in de se reports. Ms. MIT.
- Kratzer, Angelika. 1998. Scope or pseudoscope? Are there wide-scope indefinites? *Events and grammar*, ed. Susan Rothstein, 163–196. Dordrecht: Kluwer.
- Kratzer, Angelika. 2009. Making a pronoun: Fake indexicals as windows into the properties of pronouns. *Linguistic Inquiry* 40:187–237.
- Mondloch, James. 1981. Voice in Quiche-Maya. Doctoral Dissertation, SUNY Albany.
- Payne, Doris, and Immanuel Barshi. 1999. External possession: What where, how, and why. *External Possession*, 3–29. Amsterdam: John Benjamins Publishing Company.
- Pylkkänen, Liina. 1999. Causation and external arguments. *MIT Working Papers in Linguistics* 35:161–183.
- Pylkkänen, Liina. 2002. Introducing Arguments. Doctoral Dissertation, Massachusetts Institute of Technology.

- Reinhart, Tanya. 1983. *Anaphora and semantic interpretation*. London: Croom Helm.
- Reinhart, Tanya, and Eric Reuland. 1991. Anaphors and logophors: An argument structure perspective. *Long-Distance Anaphora*, ed. Jan Koster and Eric Reuland, 283–322. Cambridge University Press.
- Reinhart, Tanya, and Eric Reuland. 1993. Reflexivity. *Linguistic inquiry* 24:657–720.
- von Stechow, Arnim. 2003. Feature deletion under semantic binding: Tense, person, and mood under verbal quantifiers. *Proceedings of NELS 33*, ed. Makoto Kadowaki and Shigeto Kawahara, 397–403. Amherst, MA: GLSA.

BACK TO THE PAST TENSE IN ENGLISH*

Louis Goldstein
University of Southern California and Haskins Laboratories
louisgol@usc.edu

The allomorphy of the English regular past tense suffix is analyzed within the framework of a dynamical gestural coordination grammar. In this analysis, the suffix has an invariant gestural representation, and the allomorphy results from the coordination of the invariant suffix with the gestures of the stem. Acoustically plausible output forms for all allomorphs are shown to be generated by a computational dynamical model of gestural planning and production incorporating this analysis. Evaluating more than just plausibility is not possible, however, as it is also shown that there is still much we do not know empirically about the resulting forms, despite how frequently the allomorphy has been discussed in the literature.

1. Introduction

The regular alternation of the English Past tense is commonly taught in introductory linguistics and phonology classes (the latter of which was one of the origins of my friendship with Judy Aissen). Yet at the same time, this relatively simple alternation has provided important challenges and has been a touchstone for novel theoretical approaches and techniques in phonology (from extrinsic rule ordering to connectionism to optimality theory to wug-testing). Here we re-consider (yet again) the allomorphy of the English regular past-tense, this time within a dynamical, articulatory framework in which (i) the combinatorial units of phonology are abstract vocal tract constriction actions, (ii) held together by dynamical principles of coordination, and in which (iii) phonological grammars explicitly characterize the stable patterns of coordination employed by a language and the possible context-governed shifts in pattern that the language exhibits.

The last thirty years has seen development of a dynamical approach to cognition, in which a single formal language (nonlinear dynamics) is used to model both the qualitative (discrete) and quantitative (continuous) aspects of complex systems, including those underlying cognition and action (Kelso, Scholz, & Schöner 1986, Kugler & Turvey 1987, Turvey 1990, Kelso 1995). The key idea is that qualitative cognitive categories can be

* This work was supported by NIDCD DC008780. Many thanks to Khalil Iskarous, Adam Lammert and Hosung Nam for helpful discussion, and to Diamandis Gafos and Emily Nava for comments on earlier drafts. Discussions with Jean-Roger Vergnaud in the seminar we co-taught were very influential. The title of the paper has two personal senses (in addition to a third which is a pop culture reference to movies such as “Back to the Future”). One sense is a re-connection with Judy Aissen, along the lines we first connected. A second sense is that a very preliminary version of this paper was drafted by Cathe Browman and me, for a talk she presented at the 7th International Phonology and Morphology Conference in Krems, Austria, in 1992. The text has been lost in the sands of time. When we wrote it, we did not have much data, and the model had not developed to the point that we could evaluate acoustic output. But the basic ideas were pretty much there. So this is really her paper as much as it is mine.

understood as the stable (low-dimensional) modes of a nonlinear dynamical system, defined as a differential equation in a continuous state space. Due to the nonlinearities in such systems, changing one or more of the differential equation's parameter values (*control* parameters) in a continuous fashion can lead to lawful shifts in the qualitative (categorical) state of the system. A classic example of this (Haken, Kelso & Bunz 1985) can be observed in how oscillating limbs are coordinated with each other. When the rate of oscillation is increased, the system will exhibit a qualitative shift from the two limbs moving 180 degrees out of phase with one another to the limbs moving in phase.

The development of Articulatory Phonology (Browman & Goldstein 1990a,b; 1992a; 1995) was an early attempt to apply these ideas in the domain of phonological *representation*. By defining the primitives of phonology to be speech gestures, each of which is modeled by a dynamical system that regulates the motion of articulators in the formation of constrictions (see section 2 below), it became possible to *lawfully* relate qualitative, phonological representations (in terms of gestures and their coordination in time) to continuous physical movement. (Browman & Goldstein 1995). An important consequence of this lawful relation is that it is possible to use articulatory (and acoustic) data to directly test hypotheses about phonological structure (Gafos & Goldstein in press). So for example, Browman & Goldstein (1990c) and Zsiga (1995) showed that the output of certain (post-lexical) assimilation processes was a phonological representation that included all of the gestures of the non-assimilated forms, but in a different temporal relation (more overlap in time). No gestures were deleted or changed.

More recently, dynamical systems have been applied more widely in phonology, to include processes of phonological planning (Nam 2007, Gafos & Kirov 2009, Nam, Goldstein & Saltzman 2009), interactions among phonological units during planning of the sort that result in speech errors (Goldstein, Pouplier, Chen, Saltzman & Byrd 2007), and certain types of sound change (Parrell to appear, Hsieh 2010). These examples show how the nonlinear properties of the relevant dynamical systems can cause qualitative shifts as a function of changes in a (continuous) control parameter. For example, Parrell (to appear) has investigated an ongoing sound change in Western Andalusian Spanish, in which the h-stop sequences that result from lenition of coda /s/ to [h] are (qualitatively) reorganized into aspirated stops. As Torreira (2007a,b) has argued this can be viewed as a shift in coordination of a glottal abduction gesture and an oral constriction gesture from a sequential (anti-phase) mode of coordination mode to a (dynamically more stable) synchronous (in-phase) mode. Parrell's experiment provides quantitative evidence for the nonlinear dynamical system analysis, including dependence on speaking rate (the shift occurs more frequently as speaking rate increases), and increased variability of intergestural coordination for the tokens that lie between the two stable modes.

The most general application of these ideas to phonology can be found in the work of Gafos (e.g., Gafos 2006, Gafos & Benus 2006), in which the synchronic phonological grammar itself is a nonlinear dynamical system. Individual constraints can be formalized as nonlinear dynamical equations whose modes correspond to the preferred value or values of gesture targets or of intergestural coordination parameters. Through the dynamical interaction of multiple constraints and through modulation of a constraint's control parameters by the current state of the system, contextually appropriate shifts in targets are selected. Gafos & Benus (2006b) account for experimental data on transparency in Hungarian vowel harmony using this kind of dynamical grammar system.

Analysis of allomorphy in the regular English past tense is particularly interesting to discuss in light of these theoretical developments, because it shows how understanding of these alternations can result from maintaining *both* a dynamical theory of representation (gestures and their coordination) and also a dynamical theory of grammar. As we will see, one of the alternates is completely predictable from the hypothesis that phonological units are gestures and that affixation operates by specifying a dynamical coordination relation between stem and affix. The other very nicely demonstrates the need for some nonlinear system that effectively governs the *selection* of coordination relations, though the formal development of that system will be left for the future.

2. Dynamical Representation in Phonology: Articulatory Phonology

Articulatory phonology (Browman & Goldstein 1992a, 1995) hypothesizes that the combinatorial units of phonology are abstract, dynamical representations of speech production actions, called *gestures*. These gestural actions have as their goals the formation and release of constrictions within the vocal tract. The abstract language in which gestural representations are defined, dynamical systems, is different from the abstract symbolic system employed in classical phonological representations, but it is nonetheless abstract in two relevant senses, roughly, temporal and spatial. The temporal sense follows from the fundamental insight of dynamical systems, as conceived by Newton. The insight is that while we typically observe continuous change when we look at the world, it is possible to find events during which the continuous change is the lawful consequence of mathematical relationships (the dynamical system) whose parameters do *not* change over the time span of the event. For example, a falling body is constantly accelerating from when it is dropped to when it hits the ground. But the equation of motion that describes that motion is unchanging during that event. Likewise, when we observe the articulators of the vocal tract during speech, they are constantly in motion and their velocities are changing. But research over the last 25 years has shown that (to a first approximation) the motion and velocity change can be modeled as the lawful consequence of the individual gestures' dynamical systems (their equations of motion). Importantly, each gesture is an event that is active in the vocal tract for some fixed interval of time, during which its equation of motion (including the specification of its parameter values) is fixed and unchanging. The temporal discreteness of gestures is one of the properties that allows them to function as combinatorial units of phonology.

Gesture dynamics are also abstract spatially. Each gesture is defined as a task (Saltzman & Munhall 1989) that forms (or releases) a constriction within the vocal tract. The equation of motion for these tasks do not govern the positions of individual vocal tract articulators, but rather the abstract quantities of the constriction size (and location), formed with a given *constricting device* in the vocal tract (Lips, Tongue Tip (TT), Tongue Body (TB), Glottis (GLO), and Velum(VEL)). The same constriction can (and is) achieved with different combinations of articulator motions in different contexts. Such differences are lawful consequences of the individual gestures' dynamical specifications and their patterning in time, as formalized within the task dynamics model (Saltzman & Munhall 1989) that underlies Articulatory Phonology representations. Thus, each gesture has a contextually invariant parameter specification, which allows gestures to function as combinatorial phonological units. Contrasting gestures can differ in the constricting devices they control or their parameter specifications. For example, /t/ and /s/

are represented by gestures that differ in their values for the constriction degree (CD) of the tongue tip.

Putting together the temporal and spatial abstractness of gestures, it is possible to display the dynamical control for a given phonological form over time in a *gestural score*. Each box in the gestural score represents the interval of time (along the horizontal axis) during which that gesture's dynamical equation of motion is *active*. For example, the gestural score in Fig. 1 for the utterance *nap* shows the activation intervals for the gestures of each of the constricting devices composing this form. For example, at the left (beginning of the utterance), there are gestures corresponding to the initial /n/: a wide velic constriction (*VEL-wide*) that opens the aperture to the nasal cavity, and a closure gesture of the tongue tip (*TT-clo*) followed immediately by a release of the tongue tip constriction (*TT-rel*). Closures, as well as consonant gestures of other constriction degrees (e.g., those appropriate for fricatives (*critical*), and liquids/glides (*narrow*)), are typically followed by actively-controlled releases. The gesture of the tongue body (*TB-wide*) forms the constriction for the vowel. Note that the gestures overlap in time. This is perhaps not surprising for the gestures that compose individual segments (e.g., *VEL-wide* and *TT-clo* for /n/), but it is also found for gestures that compose successive segments (*TT-clo*, *TB-wide*). *LA-clo* and *LA-rel* are lip closure and release gestures (LA=Lip Aperture).

A gestural score displays activation of gestures over continuous time. However, the actual time of activation of individual gestures varies considerably as a function of the prosodic context and speaking rate, and so the gestural score in Fig. 1 depicts a canonical production of *nap*. Due to this variation, the gestural score itself is not an abstract, invariant phonological representation of temporal organization. However, it is hypothesized that there is some dynamical representation of the coordination of gestures in time that is *characteristic* of that particular utterance from which the activation times in particular contexts can emerge lawfully. Recent work (e.g., Saltzman, Nam, Krivokapic & Goldstein 2008) has developed a dynamical model of speech gesture planning, in which the coordination of gestures is modeled by assigning each gesture to an internal oscillator, or clock, that is responsible for triggering it in real time, and by specifying dynamical coupling relations between pairs of gesture clocks. The ensemble of multiply-coupled clocks is a nonlinear dynamical system.

Research over the last 25 years on coordination of rhythmic movements of multiple limbs (Haken, Kelso & Bunz 1985, Turvey 1990) has revealed that there are two qualitatively distinct modes of coupling oscillators that are intrinsically stable and are readily performed without requiring any learning: *in-phase* (the most stable and most accessible) and *anti-phase* (180° degrees out of phase). The planning model hypothesizes that these discrete modes are employed in coupling gestures' clocks, and that they form the basis for a dynamical model of syllable structure (Goldstein, Saltzman & Byrd 2006, Nam 2007, Nam et al. 2009). Onset consonant gesture clocks are hypothesized to be coupled in-phase with the vowel gesture clock. Since the clocks trigger gesture activation, onset consonant gestures and vowel gestures are triggered synchronously. Evidence for this synchrony in triggering can be found in kinematic data showing rough synchrony in the onset of articulator movements for the onset consonant and the vowel (Löfqvist & Gracco 1999). The accessibility of this mode can also contribute to an account of the

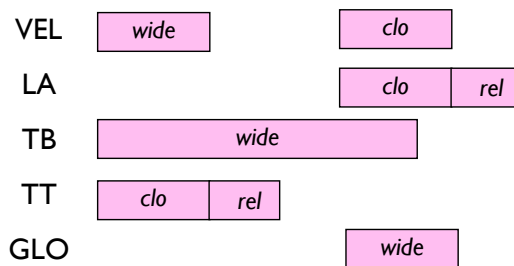

Figure 1. Gestural Score for *nap*

typological preference for onsets over codas (Goldstein et al. 2006). The clock of a coda consonant is hypothesized to be coupled anti-phase with the vowel gesture clock, and the triggering of the coda consonant gesture will be delayed by 180° from the triggering of the vowel. (The amount of time corresponding to 180° will depend on the frequency of the clocks, which will depend on speaking rate.) Thus, in-phase coupling is used to model observed patterns of *synchronous* gestural coordination, while anti-phase is used to model *sequential* coordination. Fig. 2 shows the coupling relations among the clocks for the utterance *nap*. (The clocks for the release gestures have been left out to keep the figure simple, as is the *VEL-clo* gesture for /p/).

The display in Fig. 2 is a graph, in which the nodes correspond to gestures and the edges correspond to coupling relations. Such *coupling graphs* can be taken to be part of the phonological representation of utterances, and contrast among graphs can be defined either in the set of nodes, or in the topology of the links. In-phase coupling is represented by green edges without arrows and anti-phase coupling is represented by red edges and arrow heads pointing to the gesture that is triggered later. Specification of order of triggering is required for any coupling relation that is not in-phase (ie., synchronous). Within the model, planning and production of a form begins with the graph. During planning, oscillators are set in motion, coupled according to the graph specifications. Over time, the coupling causes the clocks to settle into stable phase relations, and once they are stabilized, the clocks trigger their associated gestures.

While in-phase and anti-phase coupling can be performed without any learning, other *eccentric* coupling modes (arbitrary relative phases) can be learned, in order to perform more difficult coordination tasks, such as juggling or drumming. Here we hypothesize that eccentric coupling is used to coordinate consonant gestures in an onset or coda cluster (and in some cases across syllables). This can be one of the reasons that clusters are acquired relatively late by children (Nam et al. 2009), and why they are relatively marked typologically. The particular eccentric coupling employed may differ from language to language (Zsiga 2000, Yanagawa 2006, Goldstein, Chitoran & Selkirk 2007). Onset clusters have been investigated extensively and have been shown, across a wide variety of languages, to exhibit a competitive coupling topology in which all onset Cs are in-phase coupled with the vowel, but also coupled to one another either anti-phase or eccentrically (e.g., Browman & Goldstein 2000, Goldstein, Chitoran & Selkirk 2007, Nam 2007, Saltzman et al. 2008, Hermes, Grice, Mücke, & Niemann 2008, Shaw, Gafos, Hoole & Zeroual 2009, Marin & Pouplier 2010). However, our focus in this paper is on the less-studied coda clusters. In English, at least, there is evidence (Byrd 1995, Honorof & Browman 1995, Marin & Pouplier 2010) that the first coda consonant (C_1) is coupled anti-phase to the vowel and that a following C_2 is eccentrically coupled to the first. The relative timing of consonant gestures in coda clusters in English can be illustrated by the gestural score in Fig. 3 for the word *apt* (glottal and velic gestures are left out for simplicity). C_2 (TT) activation is triggered roughly halfway between the onset of C_1 (LA) and the time that C_1 is deactivated and its release begins. That is, C_2 *overlaps* C_1 by half of its duration. This coordination relation between

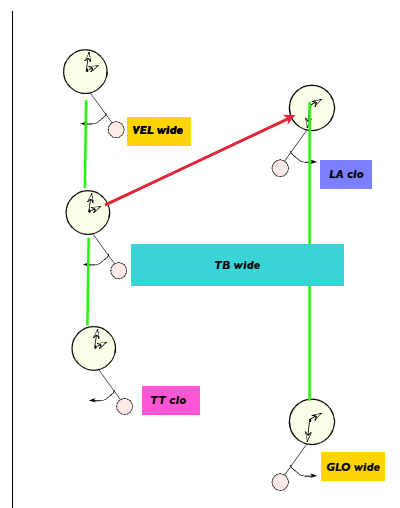

Figure 2. Coupling graph for *nap*

C1-clo and *C2-clo* we will refer to as *shingled* or *semi-overlapped*. In the TaDA model (last paragraph in section 2), consonant gestures are active for 60° of their clock's cycle. Therefore, shingled coordination can be achieved by an eccentric coupling of 30°, which is employed for CLO-CLO coupling in coda.

This gestural score for *apt* can be produced by the coupling graph in Fig. 4. The eccentric coupling relation between the *LIP-clo* and *TT-clo* is represented in blue (lightest shading). Note that the *clo* and *rel* gestures of a given constriction (LIP, TT) are connected with a *black* headed arrow (darkest shading). This eccentric coupling relation between *clo* and *rel* is a special one, with the *rel* being triggered automatically when the *clo* is deactivated (“abutting” activations). This coordination is not the same as the shingled coordination of two Cs in a cluster.

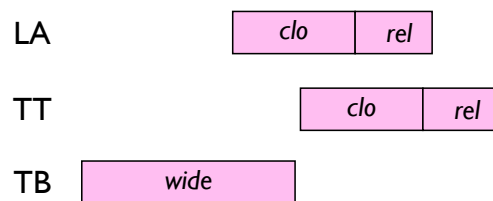

Figure 3. Gestural score for *apt*

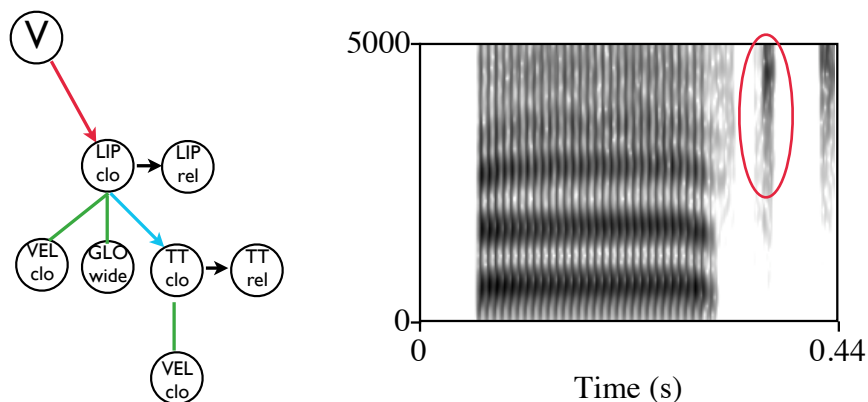

Figure 4. Coupling graph and spectrogram of TaDA output for *apt*

The coupling graph model of syllable structure, the coupled oscillator model of planning, the task-dynamic model of articulator coordination, and an articulator-based vocal tract shaping model are all integrated into the computational system called TaDA (Nam, Goldstein, Saltzman & Byrd 2004). The output of TaDA (time-varying constrictions and vocal tract shapes) can be input into the Hlsyn model (Hanson & Stevens 2002), to generate simulated aerodynamics and output sound. The spectrogram in Fig. 4 shows the audio output when the coupling graph is input to TaDA. Note that the /p/ is acoustically released (the release burst is circled in the spectrogram). Shingled coordination will typically result in release of heterorganic CC clusters, although when speech rate in the model is increased, the release can disappear. This is consistent with the fact that C1 in such clusters in English can be produced with audible releases or without them.

3. Gestural Representation of English Regular Past-Tense Allomorphs

As is well known, the regular English past-tense suffix takes three phonological forms:

/-d/ in most contexts; /-t/ following voiceless consonants (except /t/); and /-Vd/ following coronal (oral) stops, where V has been represented as /ə/ or /ɪ/. By employing dynamical gestural representations, however, it is possible to assign the suffix a *single* representation, namely a (sub)-graph consisting of a Tongue Tip (TT) closure gesture, coupled with a velic closure (active closure of the soft palate to insure that the closure is non-nasal), and with a TT release gesture. The varying allomorphs result from principles that determine how that subgraph is coordinated with the coupling graph of the stem, and from the articulatory, aerodynamic, and acoustic consequences of the resulting composite graph. The main generalization for coupling of the morphological suffix is this:

- (1) Couple the TT closure gesture of the suffix graph like a coda consonant:
 - a. anti-phase to the V, if the stem ends in V
 - b. eccentric (30°) to a stem-final C to produce semi-overlapped coordination (CLO-CLO coupling)

3.1. Voicing Alternation: /-d/ vs. /-t/

The /-d/ and /-t/ allomorphs can be analyzed as resulting from *identical* coordination patterns. The difference in voicing is hypothesized to result from the aerodynamic *consequences* of coordinating the hypothesized suffix subgraph with stem graphs that differentially affect the probability that voicing will be produced. Note that there is nothing in the representation of the suffix graph itself that directly controls voicing (no glottal abduction gesture that would inhibit voicing, no larynx lowering or oral cavity expansion gestures that would enable voicing to continue during a closure interval). In that sense the graph is bit like a traditional archiphoneme (Trubetzkoy 1939). Stem graphs that end in oral closure gestures and with glottal abduction gestures will inhibit the likelihood that the closure and release caused by the suffix gestures will be produced with observable voicing. These differing consequences can be observed by inputting the relevant coupling graphs to the TaDA/HLsyn model, which computes the articulatory, aerodynamic and acoustic consequences of the pattern of constriction gestures in the vocal tract. In evaluating the output, it is important to note that there is no quantitative, acoustic data (to my knowledge) on the voicing properties of some of these forms as produced by native speakers. So for example, while a form like *nabbed* is analyzed as having the /-d/ suffix, it is unclear how frequently the final coronal closure and release is actually produced with periodic vibration, given that (phonologically and perceptually) voiced stops in English are often not produced with such vibration. So the point of the examples presented below is to demonstrate that attachment of an invariant suffix to a stem can have a *variety* of voicing consequences, consistent with the aerodynamic properties of the stem gestures, and consistent with the distribution of the traditional allomorphs. Detailed comparison of the model's output with that of native speakers will not be attempted here.

First we consider the case of a stem-final vowel. According to (1a), the TT gesture is coupled to the vowel in anti-phase mode. Fig. 5 shows the coupling graph for the past tense of the verb *sew*. The shaded graph nodes correspond to subgraph for the suffix. This context is optimally favorable for voicing, as there is high airflow and phonation during the vowel. A

spectrogram of the output from TaDA on the right shows that the TT closure and its release are both voiced, as is consistent with the traditional description of this allomorph as being voiced /d/.

Now, let us consider a stem-final voiced C, for example the word *dimmed*. Here, according to (1b), the TT gesture of the suffix should be shingled to the final C of the stem. This CLO-CLO coupling is eccentric with 30 degree phase offset. Fig. 6 shows this coupling graph for *dimmed*, along with the spectrogram of the acoustic output from TaDA for this coupling graph. The velic opening (*VEL-wide*) gesture coordinated with the lip closure (*LA-clo*) of the /m/ results in nasalization and also contributes to favorable conditions for voicing. Voicing can be observed through the nasal closure, and even into oral closure, and the release is voiced. Some devoicing occurs during closure, the aerodynamic result of a complex of events including: onset of velic closure, release of lip closure, and formation of TT closure.

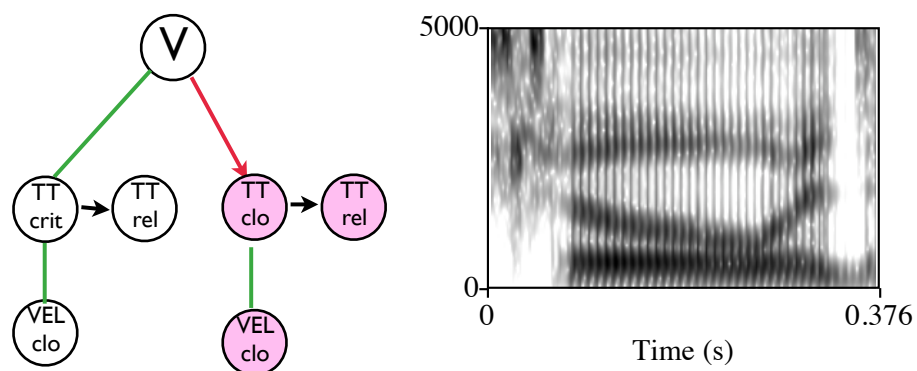

Figure 5. Coupling graph and spectrogram of TaDA output for *sewed*

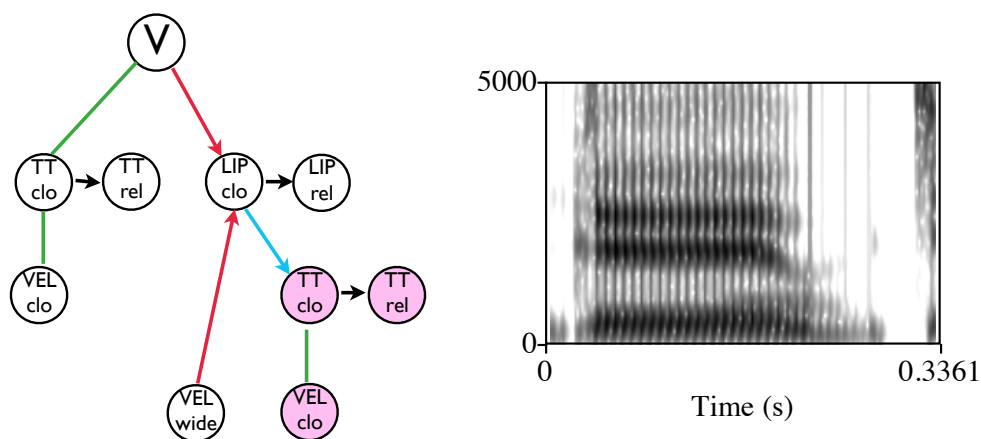

Figure 6. Coupling graph and spectrogram of TaDA output for *dimmed*

We can contrast the output voicing in this case with the results when the suffix graph is coordinated to the stem for *nap*, as in Fig. 7. The *TT-clo* gesture of the suffix is coupled to the *LA-clo* gesture of the stem, exactly as in *dimmed*. Now however, because of the glottal abduction

gesture (*GLO-wide*) coupled to the lip closure, and because there is velic closure instead of velic opening (as in *dimmed*), conditions are maximally *unfavorable* for voicing, and we can see that *no* voicing is found during the lip closure, its release, the tongue tip closure, or its release. This state of affairs is consistent with the description of the allomorph of the past tense as /-t/ in this condition. Note, however, the the phonological form of the suffix (the coupling subgraph) and its coupling to the stem are both identical in this case and in *dimmed*. The difference in output acoustics is caused by the aerodynamic interactions of stem and suffix gestures.

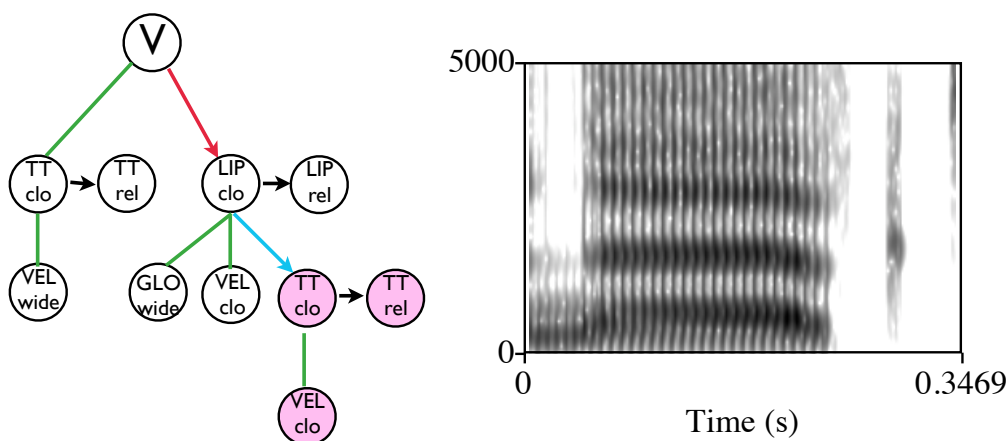

Figure 7. Coupling graph and spectrogram of TaDA output for *napped*

Finally, we examine the case of a stem-final voiced stop, as in *nabbed*. The expectation here is that the aerodynamic consequences of coupling the suffix graph to the stem graph would be a voiced coronal stop, if it is to be consistent with the /-d/ allomorph. As can be seen in Fig. 8 however, while the closure for the /b/ is largely voiced, its release, and the coronal stop closure and its release are all voiceless. Presumably this is due to the aerodynamic consequences of the extended closure interval caused by the multiple stops. Although there is a short release between the lip and tongue tip closures, it is very short and perhaps does not afford a return to pressure conditions that allow glottal vibration. However, the output sounds like a good exemplar of *nabbed*. While there has been no systematic acoustic study of voicing in these contexts, a spectrogram of one natural production of *nabbed* is also shown in Fig. 8. It is strikingly like that of the model: there is voicing during the lip closure, but everything after that is voiceless.

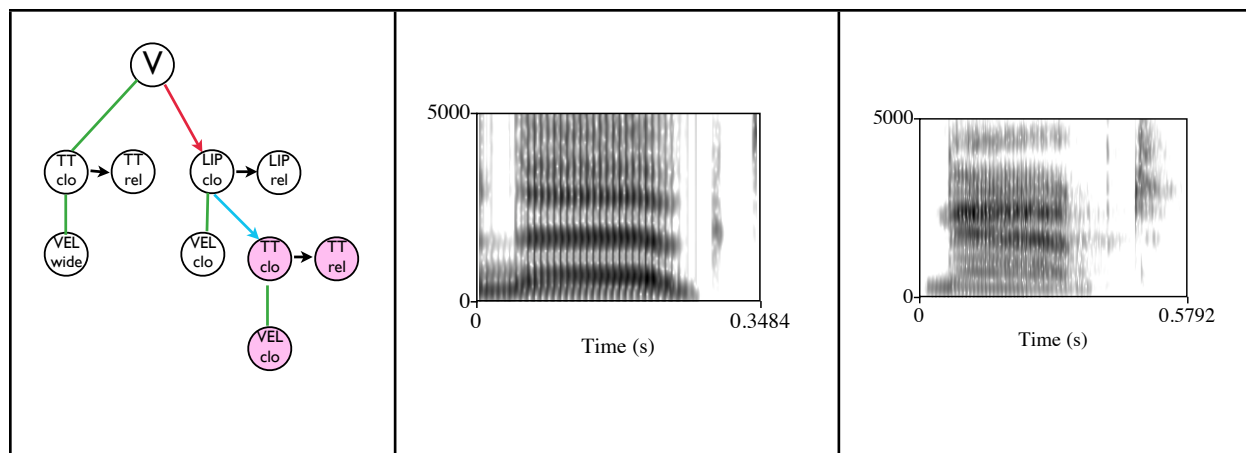

Figure 8. Coupling graph (left), spectrogram of TaDA output for *nabbed* (center), spectrogram of natural token of *nabbed* (right).

To summarize then, we hypothesized that the past tense could be represented as an invariant coupling sub-graph, composed of *TT-clo*, *VEL-clo* and *TT-rel* gestures. Coupling the *TT-clo* gesture to the stem in a manner consistent with its being treated as an (additional) coda consonant in the stem-final syllable leads to acoustic output that varies with the nature of the stem-final consonant, with a distribution consistent with the traditional statement of /-d/ vs. /-t/ allomorphy. Importantly, however, if we take the coupling graphs to be the phonological representation of these forms, we note that there is no phonological alternation here, and no allomorphy. The abstract phonological representation of the suffix and its coupling is invariant. Output variability is due to the aerodynamic consequences of the stem gestures.

3.2 Syllabicity Alternation: /-d/ vs. /-Vd/

When the past-tense subgraph is coordinated to stems ending in /t/ or /d/ using the coordination principle in (1), then the resulting form does not have a reduced vowel (/ə/ or /ɨ/) between the stem-final coronal and the suffix coronal. (The actual model output is discussed in detail below.) So this allomorph needs to be analyzed as resulting from a change in the stem suffix or in the operative coordination principle (or both). Because a grammar in Articulatory Phonology operates on coordination relations, it is possible for the grammar to account for the systematic occurrence of a vowel (particularly a reduced one) in some context, without requiring that the vowel results from deploying a vowel gesture with a constriction task (or target). Rather, the observed vowel interval can emerge from coordination of two consonant gestures (C_1C_2) in a temporal relation such that C_1 is completely released before C_2 begins to be formed. This will leave a temporal gap between the constrictions whose vocal tract shape is not determined by a vowel target, but rather by the articulator motions resulting from the release of C_1 and by movement of individual articulators to their rest postures when they are not being controlled by any active gesture. The formalization of this type of temporal-only grammatical specification using coordination constraints plays a key part in Gafos' analysis of template phonology in Moroccan Arabic (Gafos 2002).

Since a ‘targetless’ temporal gap will be relatively unconstricted and variable (its vocal tract shape will largely be determined by flanking consonants and vowels), this kind of (temporal-only) control seems a plausible model for reduced vowels, such as the one that appears in the /-Vd/ plural allomorph. Browman & Goldstein (1992b) tested the hypothesis that (lexical) schwa vowels in English were ‘targetless’ in this sense, but they had to reject the hypothesis. There was evidence that there was a specific constriction target associated with those schwa vowels. However, the reduced vowels of the plural affix (e.g., *roses*) have been shown (Flemming & Johnson 2007) to be acoustically different from the lexical schwa vowels in final syllables (e.g., *Rosa’s*), as is consistent with the transcription of the plural (and past tense) affixes as [ɨ], but the lexical reduced vowel as [ə], a tradition going back to Trager & Smith (1951). Flemming & Johnson showed that the plural affix vowel is higher (has a lower F1) than the one found in final lexical schwas. Since the tongue shape in these vowels is also relatively fronted (F2 in their study ranges from 1750 to 2200 Hz), the acoustics seem consistent with a largely coronal fricative configuration, but with a lowered tongue tip. Thus, these reduced vowels appear to be good candidates for purely temporal gaps between release of one coronal and formation of the next. Given the similar transcriptions for the past-tense suffix vowels and given the similar coronal context, these appear to be good candidates as well.

The targetless hypothesis for the past tense affix was tested by Smorodinsky (2001). She collected kinematic data from the tongue, jaw, and lips (using electroarticulography, EMA) while speakers read utterances like those in (2), with near-minimal pairs of lexical vs. past-tense affix vowels:

- (2) “If Cheetah’d even known” (lexical)
 “If cheated even once” (affix)

The full vowels surrounding the reduced vowel were symmetric (same vowel preceding and following) and pairs were constructed using all the full monophthongs of English. She found that the position of the tongue receivers during the affix vowels were more correlated with the positions of the flanking full vowels than was the case for the lexical vowels. This was taken as evidence that the affix vowels could be produced with no active tongue body control: the shape during those vowels emerges from the shape of the flanking vowels and consonants. While these results are consistent with the targetless analysis, there is a methodological problem using the EMA device for this purpose, as it can only measure the position of the front part of the tongue, and for schwa-type vowels, it is possible that there are significant tongue-shaping events occurring posterior to the tool’s reach. Recently, these results have been replicated using real-time MRI (Lammert, Goldstein & Narayanan 2010), which affords a dynamic, mid-sagittal view of the entire vocal tract from lips to larynx.

These results suggest that it is plausible to analyze the /-Vd/ allomorph as involving same suffix subgraph as for the other two allomorphs, but differing only in how the suffix subgraph is coordinated to the stem. How does the coupling differ these allomorphs? Fig. 9 shows the coupling graph and resulting spectrogram for two coupling alternatives. On the left (a), the coupling is the same as that specified for the other allomorphs: the *TT-clo* gesture of the suffix is shingled to the final constriction gesture of the stem, using eccentric CLO-CLO coupling. The result of this is just a longer /d/ closure (partly voiced and partly voiceless). On the right (b), the

TT-clo gesture of the suffix is shingled to the final *release* gesture of the stem instead of the closure (REL-CLO coupling). As the spectrogram shows, this coordination yields a (targetless) vowel between the two tongue tip closures, and is therefore a possible model for this allomorph. If this is right, then all the regular past tense forms can be predicted from a single coupling subgraph for the affix, and two qualitatively different coordination patterns: (a) shingling the *TT-clo* of the affix with the final constriction gesture of the stem and (b) shingling the *TT-clo* of the affix with the final release gesture of the stem. Accounting for this qualitative shift in coordination pattern thus becomes the challenge for a dynamical account of the past tense.

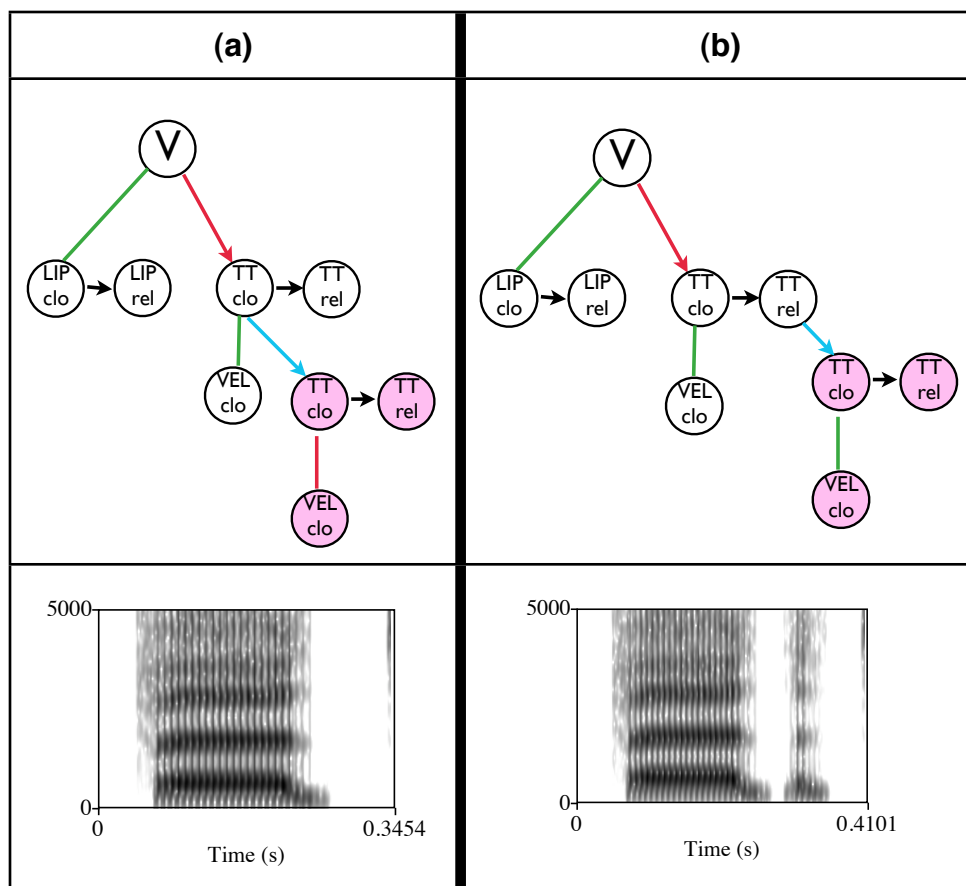

Figure 9. Coupling graph and spectrograms of TaDA output for two models of *padded*: (a) CLO-CLO shingling. (b) REL-CLO shingling

4. Dynamical Coordination Grammar for Past-tense Allomorphy

To begin approaching such an account, consider first the outcome of the general coda principle (1) in the case where the stem ends in a TT closure, as in Fig. 9(a). Note that there is no release of the stem's tongue tip gesture visible in the spectrogram, despite the fact when the stem ends in a LIP closure (*nabbed*), as in Fig. 8, the same coupling graph does result in a release of the lips before the TT closure. Why do the two graphs have outputs that differ in this way?

The shingled coordination we have been assuming produces a pattern of gestural activation shown in Fig. 10. As explained earlier, the C_2 gesture is activated at a time halfway between the time of activation of C_1 and the time it gets to its target. This means that C_2 will only get halfway to its target when active control of C_1 closure ends, and the release of that constriction begins. So if C_1 and C_2 are controlling distinct constricting devices (as in the Lip-TT case), the articulatory release of C_1 's constriction will result in an aerodynamic release of the pressure trapped behind that constriction, and thus a measurable acoustic burst, as we see in Fig. 8. However, in the case where the two gestures control the same constricting device (as in the TT-TT case), at the end of activation of C_1 closure, C_2 is already active with the goal of producing the same closure as C_1 , so release of the constriction does not happen, and the result is no burst, as we see in Fig. 9a. (The parameter blending model in TaDA (Saltzman & Munhall 1989) has the effect of suppressing a release gesture if it is active concurrently with a constriction gesture of the same constricting device.) These different consequences of the same C-C coordination pattern were shown by Gafos (2002) to have a variety of phonological consequences on the process of template satisfaction in Moroccan Colloquial Arabic (MCA). In the template that requires a CC sequence at the end of a form in a coordination relation similar to that in (1), homorganic C-C sequences are avoided by a variety of phonological mechanisms.

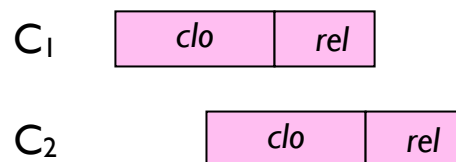

Figure 10. Gestural score for shingled closures

So how can the grammar account for the avoidance of (final) C-C sequences in both MCA and English? Gafos proposes a gestural version of the OCP, banning identical overlapping gestures. However, in English, final homorganic nasal-stop sequences appear to allow the CLO-CLO coordination pattern. Fig. 11 shows this coupling graph and output spectrogram for the word *panned*. The coupling is exactly the same as in the non-occurring version of *padded* in Fig. 9a. This graph produces the right result for *panned*, while when REL-CLO coupling is employed (not shown), an additional uncontrolled vowel appears in the output. Thus, the relevant OT constraint cannot be stated *solely* at the level of oral constriction gestures. For the similar phenomenon in MCA, Gafos (2002) suggests that that overlapping oral constriction gestures are banned just when they both have the same sonority. However, the sonority approach appears to miss a generalization. When we consider the behavior of the plural suffix in English, it appears to be quite similar to that of the past tense, in that the plural allomorphs (/z/, /s/, /ɪz/) differ in voicing and syllabicity. The suffix could once again be represented with an invariant gestural sub-graph, with the allomorphy resulting from aerodynamic effects and from a shift (from CLO-CLO to REL-CLO) in how the suffix is coupled to the stem. It would be desirable, therefore, to have a single account for both. However, the environment that triggers the alternate (REL-CLO) coordination pattern in the case of the plural is not limited to identical oral constriction gestures (e.g., *busses*), but also includes cases in which the stem ends in an palatoalveolar sibilant (e.g., *bushes*). Baković (2005a,b) accounts for these forms with a constraint banning sequences of coronals with distinct articulatory place specifications, though it is not clear why this constraint fails to rule out forms like *paths*.

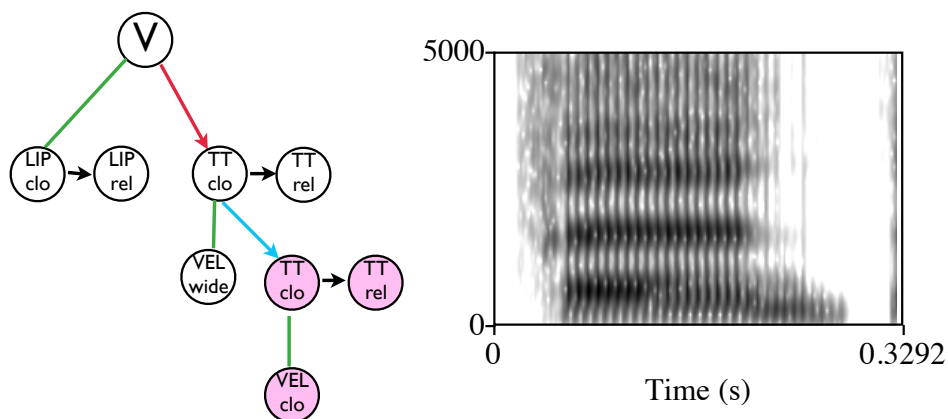

Figure 11. Coupling graph and spectrogram of TaDA output for *panned*

One alternative is to hypothesize that the inflectional suffixation requires some change in the vocal tract output. Evidence that such a principle is operative in English also comes from studies (Guy 1991, Walker 2008) showing that final coronal stop deletion in clusters in English is partly conditioned by morphological status: /t/ in a monomorphemic form (e.g. *perfect*) deletes more readily than when it is the past suffix (*packed*). (These apparent deletions may also result from gestural overlap, rather than elimination of the coronal gesture, see Browman & Goldstein, 1990c). A complete formal dynamical account along these lines has not been constructed. Apart from anything else (like the fact that it is a difficult problem), there is insufficient data to do so. Nonetheless, the broad outlines of such an approach will be illustrated here.

Browman & Goldstein (1989) developed the idea that from an aerodynamic point of view, the vocal tract can be modeled abstractly as a set of pipes connected either in series or parallel in a hierarchical arrangement. They showed that Constriction Degree at various tube levels in the hierarchy—Gesture, Tongue, Oral Cavity, Vocal Tract—may all be relevant to the foundation for phonological natural classes and generalizations. For these purposes, CD is coarsely categorized aerodynamically: Closed, Critical (Turbulence), Open. Using this approach, the past-tense affixation can be associated with the preferred aerodynamics in (3):

- (3) Change CD at the VT level in going from stem to affix.

For example in *sewed*, CD changes from Open (for the vowel) to Closed during the coronal closure. In *napped*, there is an Open interval when the lip closure is released before the coronal closure. Of course, it is possible that at some speaking rates, this release disappears. It is exactly this type of data that would be relevant to developing a formal account. Of particular interest would be to see if the probability of release is influenced not only by rate, but also morphological status (e.g., *napped* vs. *apt*). With a slight sharpening of CD categories, replacing Critical with two categories, corresponding to Wake Turbulence and Channel Turbulence, respectively, the same principle will work with English plurals. The plural *bushes* requires the REL-CLO coupling, because without it there would be no CD change: the end of the stem and the suffix both exhibit wake turbulence. However, *cuffs* and *paths* appears to employ CLO-CLO coupling, in which there is a change from channel turbulence to wake turbulence.

In order to instantiate the preference in (3) within the coupled oscillator model, it would be necessary to develop a graph-dynamical model that changes the topology of the coupling graph based on feedback from an internal model of the speech output. Such a model has not yet been developed. However, the grammatical consequences of such a model can be formalized macroscopically using the grammar dynamics approach to constraint interaction (Gafos 2006, Gafos & Benus 2006).

In this approach, nonlinear differential equations are used to model the likelihood that the phonological system will settle to one or more *attractor* states along a linguistically-relevant continuous variable, referred to generally as an order parameter. In our case, the order parameter should describe the coordination of the suffix with the stem. To treat this as a (potentially) continuous variable, we allow the suffix *TT-CLO* to be coupled to both the preceding *CLO* and *REL*, with differing coupling strengths. The order parameter can then be their *relative* coupling strengths (defined as the log of the ratio: strength(REL-CLO) / strength(CLO-CLO)). Thus, CLO-CLO coupling would have a negative value of the order parameter, while CLO-REL would have a positive value.

The differential equation required is one with at least two possible attractor states. A cubic polynomial is the simplest function that can accomplish this. The tilted anharmonic oscillator is one such function, and is shown (slightly simplified) in (4):

$$(4) \quad \dot{x} = f(x, R) = R + x - x^3$$

where x represents the value of the order parameter, \dot{x} is its time-derivative, and R is a constant that influences the layout of attractor states in a manner to be shown below. This system has been used to model perceptual categorization of speech (Tuller et al. 1994), vowel harmony in Hungarian (Gafos & Benus 2006), and the location of nuclear pitch accents in English vs. Spanish (Nava 2010). The stable states of such a system can be graphically examined by plotting the *potential* of the system $V(x)$ as a function of the value of the order parameter. Since the change in the order parameter is proportional to the slope of the potential, values of the order parameter where the potential has zero slope are stable states. The potential function ($V(x)$) associated with $f(x,R)$ is plotted in Fig. 12, for the case where $R = 0$.

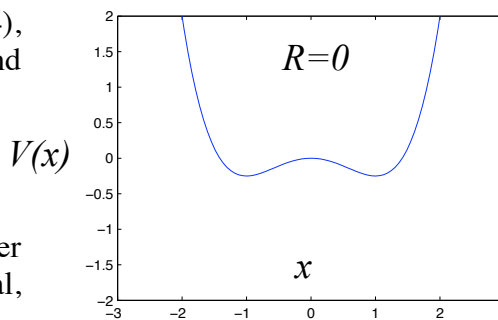

Figure 12. Potential function of (4) when $R=0$

To interpret such figures, imagine that the potential defines a surface, and the value of the order parameter changes over time like a ball dropped onto that surface. There are two stable states where the ball can settle, one with a positive value of x (corresponding to *REL-CLO* coupling), and one with a negative value of x (corresponding to *CLO-CLO* coupling). Of course, these two stable states actually occur in different contexts. This contextual effect can be modeled by the value of R , which is a control parameter that governs the overall tilt of the potential. Setting $R < 0$ results in a single stable state at a negative value of relative coupling strength (*CLO-CLO* coupling), while setting $R > 0$ results in a single stable state with a positive value of relative

coupling strength (REL-CLO coupling). Fig. 13 shows the effect of setting $R=-1$ on the left, and $R=1$ on the right. Thus the *quantitative* value of R acts like a knob that can be used to switch the system between its two stable states. The value of R could be set to a negative value in the general case, but it is turned up to some positive value when the output would not yield a change in CD.

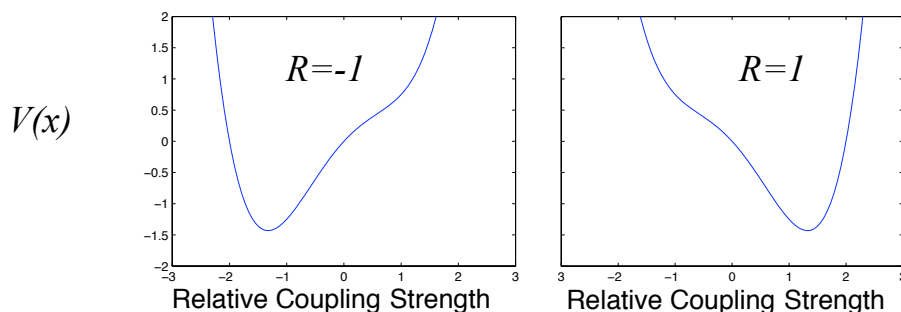

Figure 13. Potential function for the log of relative coupling strength of CLO-CLO and REL-CLO coupling

This analysis may appear to have a lot of theoretical baggage, just to switch coordination patterns between two different contexts. Why is this preferable to a learned rule or constraint ranking that sets the coordination appropriately in the defined contexts? The advantage of the dynamical model would be demonstrated if the selection of coupling modes depended on some *quantitative* variable, as well as the qualitative morpho-phonological conditioning of dependence on CD change. To see a possible role for quantitative conditioning, we need to consider some irregular past-tense forms, for words like those in (5):

(5) shed, spread, put, let, set, cut, hit, beat, shut, hurt, cost, cast, burst

While these are usually thought of as having an irregular zero-suffix, it is possible to analyze them as having the regular past-tense subgraph, but an irregular coordination pattern, i.e. they choose the CLO-CLO coordination pattern, rather than the REL-CLO pattern. (We ignore for the present the expectation that if they are formed with a suffix and the CLO-CLO coordination, the past-tense final stop should be a bit longer than that of the bare stem, another point on which there are no data.) In addition, there are verbs that (in my experience) can be produced either using CLO-CLO (irregularly) or REL-CLO, for example: *slot* (I have heard both *slot* and *slotted*) and possibly *bat* (in a baseball context: *She bat .300 last year*). Also in Albright and Hayes' (2003) wug-test study of English past tense, participants gave variable responses to the nonce verbs in (6) that included a substantial (>10%) number of responses in which there was no change in the past-tense form, which can be analyzed as resulting from CLO-CLO coupling.

(6) glead, glit, gude

Suppose an experiment like Albright and Hayes' were undertaken under conditions that manipulated speaking rate. It would not be surprising if speaking rate pushed the distribution of

responses in the direction of the shorter forms that result from CLO-CLO coordination. This speaking rate effect could then be modeled by making the value of R dependent on speaking rate as well as CD change.

5. Conclusion

We have presented an analysis of the regular English past tense allomorphy, in which the suffix is represented by one invariant coupling graph that couples to the stem in two qualitatively distinct coupling modes. A nonlinear grammar-dynamical system that can switch the coupling modes was sketched, though its details are missing. It is striking that pursuing an explicit dynamical account of something as apparently simple as the regular English past tense revealed not only some small new insights and generalizations, but also revealed just how much we do not know and what kinds of new experiments might inform us further.

References

- Albright, Adam and Bruce Hayes. 2003. Rules vs. analogy in English past tenses: a computational/experimental study. *Cognition* 90:119-161.
- Baković, Eric. 2005a. Antigemination, assimilation and the determination of identity. *Phonology* 22:279-315.
- Baković, Eric. 2005b. Partial Identity Avoidance as Cooperative Interaction. *Rutgers Optimality Archive*, R698.
- Browman, Catherine P. and Louis Goldstein. 1989. Articulatory gestures as phonological units. *Phonology* 6:201-251.
- Browman, Catherine P. and Louis Goldstein. 1990a. Gestural specification using dynamically-defined articulatory structures. *Journal of Phonetics* 18:299-320.
- Browman, Catherine P. and Louis Goldstein. 1990b. Representation and reality: physical systems and phonological structure. *Journal of Phonetics* 18:411-424.
- Browman, Catherine P. and Louis Goldstein. 1990c. Tiers in articulatory phonology, with some implications for casual speech. *Papers in laboratory phonology, vol. 1, Between the grammar and physics of speech*, eds. John Kingston and Mary Beckman, 341-376. Cambridge, UK: Cambridge University Press.
- Browman, Catherine P. and Louis Goldstein. 1992a. Articulatory phonology: an overview. *Phonetica* 49:155-180.
- Browman, Catherine P. and Louis Goldstein. 1992b. "Targetless" schwa: an articulatory analysis. *Papers in laboratory phonology II: Gesture, segment, prosody*, eds. Gerry Docherty and D. Robert Ladd, 26-56. Cambridge, UK: Cambridge University Press.
- Browman, Catherine P. and Louis Goldstein. 1995. Dynamics and articulatory phonology. *Mind as motion: Explorations in the dynamics of cognition*, eds. Robert Port and Tim van Gelder, 175-194. Cambridge, MA: MIT Press.
- Browman, Catherine P. and Louis Goldstein. 2000. Competing constraints on intergestural coordination and self-organization of phonological structures. *Bulletin de la Communication Parlée* 5:25-34.

- Byrd, Dani. 1995. C-centers revisited. *Phonetica* 52:285-306.
- Flemming, Edward and Stephanie Johnson. 2007. Rosa's roses: Reduced vowels in American English. *Journal of the International Phonetic Association* 37:83-96.
- Gafos, Adamantios. 2002. A grammar of gestural coordination. *Natural Language and Linguistic Theory* 20:269-337.
- Gafos, Adamantios I. 2006. Dynamics in grammar: Comment on Ladd and Ernestus & Baayen. *Laboratory phonology 8: Varieties of phonological competence*, eds. Louis Goldstein, Douglas H. Whalen, and Catherine Best, 51-79. Berlin/New York: Mouton de Gruyter.
- Gafos, Adamantios I. and Stefan Benus. 2006. The dynamics of phonological cognition. *Cognitive Science* 30:905-943.
- Gafos, Adamantios I. and Louis Goldstein. in press. Articulatory representation and organization. *Handbook of laboratory phonology*, eds. Abigail Cohn, Cécile Fourgeron, and Marie Huffman. Oxford, UK: Oxford University Press.
- Gafos, Adamantios I. and Christo Kirov. 2009. A dynamical model of change in phonological representations: The case of lenition. *Approaches to phonological complexity*, eds. François Pellegrino, Egidio Marisco, and Ioana Chitoran, 219-240. Berlin/New York: Mouton de Gruyter.
- Goldstein, Louis, Dani Byrd, and Elliot Saltzman. 2006. The role of vocal tract gestural action units in understanding the evolution of phonology. *From action to language: The mirror neuron system*, ed. Michael Arbib, 215-249. Cambridge: Cambridge University Press.
- Goldstein, Louis, Ioana Chitoran, and Elizabeth Selkirk. 2007. Syllable structure as coupled oscillator modes: Evidence from Georgian and Tashliht Berber. *Proceedings of the XVI International Congress of Phonetic Sciences*, eds. Jürgen Trouvain and William Barry, 241-244.
- Goldstein, Louis, Hosung Nam, Elliot Saltzman, and Ioana Chitoran. 2009. Coupled Oscillator Planning Model of Speech Timing and Syllable Structure. *Frontiers in phonetics and speech science*, eds. Gunnar Fant, Hiroya Fujisaki, and Jiaxuan Shen, 239-250. Beijing: The Commercial Press.
- Goldstein, Louis, Marianne Pouplier, Larissa Chen, Elliot Saltzman, and Dani Byrd. 2007. Dynamic action units slip in speech production errors. *Cognition* 103:386-412.
- Guy, Gregory. 1991. Explanation in variable phonology: An exponential model of morphological constraints. *Language Variation and Change* 3:1-22.
- Haken, Hermann, J.A. Scott Kelso, and H. Bunz. 1985. A theoretical model of phase transitions in human hand movements. *Biological Cybernetics* 51:347-356.
- Hanson, Helen, and Ken Stevens. 2002. A quasiarticulatory approach to controlling acoustic source parameters in a Klatt-type formant synthesizer using Hlsyn. *Journal of the Acoustical Society of America* 112:1158-82.
- Hermes, Anne, Martine Grice, Doris Mücke, and Hendrik Niemann. 2008. Articulatory indicators of syllable affiliation in word initial consonant clusters in Italian. *Proceedings of the 8th International Seminar on Speech Production*, eds. Rudolf Sock, Susanne Fuchs, and Yves Laprie, 433-436. Strasbourg, France: INRIA.
- Honorof, Douglas and Catherine P. Browman. 1995. The center or edge: How are consonant clusters organized with respect to the vowel? *Proceedings of the XIIIth International*

- Congress of Phonetic Sciences*, eds. Kjell Elenius and P. Branderud, 552-555. Stockholm: KTH and Stockholm University.
- Hsieh, Fang-Ying. 2010. Gesture reorganization in Mandarin tone 3 sandhi. *Journal of the Acoustical Society of America* 128:2458 (abstract).
- Kelso, J. A. Scott. 1995. *Dynamic patterns: The self-organization of brain and behavior*. Cambridge, MA: MIT Press.
- Kelso, J. A. Scott, John P. Scholz, and Gregor Schöner. 1986. Nonequilibrium phase transitions in coordinated biological motion: Critical fluctuations. *Physics Letters* 118:279-284.
- Kugler, Peter N. and Michael T. Turvey. 1987. *Information, natural law, and the self-assembly of rhythmic movement*. Hillsdale, NJ: Erlbaum.
- Lammert, Adam, Louis Goldstein and Shrikanth Narayanan. 2010. Gestural control in the English past-tense suffix: an articulatory study using real-time MRI. Presented at 12th Conference on Laboratory Phonology. Albuquerque, NM.
- Löfqvist, Anders and Vincent Gracco. 1999. Interarticulator programming in VCV sequences: Lip and tongue movements. *Journal of the Acoustic Society of America* 105:1854-1876.
- Marin, Stefania and Marianne Pouplier. 2010. Temporal organization of complex onsets and codas in American English: Testing the predictions of a gestural coupling model. *Motor Control* 14:380-407.
- Nam, Hosung. 2007. Syllable-level intergestural timing model: Split-gesture dynamics focusing on positional asymmetry and moraic structure. *Laboratory phonology 9*, eds. Jennifer Cole and José Hualde, 483-506. Berlin/New York: Mouton de Gruyter.
- Nam, Hosung, Louis Goldstein, and Elliot Saltzman. 2009. Self-organization of syllable structure: a coupled oscillator model. *Approaches to phonological complexity*, eds. François Pellegrino, Egidio Marisco, and Ioana Chitoran, 299-328. Berlin/New York: Mouton de Gruyter.
- Nam, Hosung, Louis Goldstein, Elliot Saltzman, and Dani Byrd. 2004. TADA: An enhanced, portable Task Dynamics model in MATLAB. *Journal of the Acoustic Society of America* 115:2430 (abstract).
- Nava, Emily. 2010. Connecting phrasal and rhythmic events: Evidence from second language speech. Doctoral dissertation, University of Southern California.
- Parrell, Ben. to appear. The role of gestural phasing in Western Andalusian Spanish aspiration. *Journal of Phonetics*.
- Saltzman, Elliot and Kevin Munhall. 1989. A dynamical approach to gestural patterning in speech production. *Ecological Psychology* 1:333-382.
- Saltzman, Elliot, Hosung Nam, Jelena Krivokapic, and Louis Goldstein. 2008. A task-dynamic toolkit for modeling the effects of prosodic structure on articulation. *Proceedings of the 4th International Conference on Speech Prosody (Speech Prosody 2008)*, eds. Plinio Barbosa, Sandra Madureira, and César Reis. Campinas: Editora RG/CNPq.
- Shaw, Jason, Adamantios I. Gafos, Philip Hoole, and Chakir Zeroual. 2009. Syllabification in Moroccan Arabic: Evidence from patterns of temporal stability in articulation. *Phonology* 26:187-215.
- Smorodinsky, Iris. 2001. Schwas with and without active gestural control. *Journal of the Acoustical Society of America* 109:2446 (abstract).

- Torreira, Francisco. 2007a. Pre- and postaspirated stops in Andalusian Spanish. *Segmental and prosodic issues in Romance phonology*, eds. Pilar Prieto, Joan Mascaró, and Maria-Josep Solé, 67-82. Amsterdam/Philadelphia: John Benjamins.
- Torreira, Francisco. 2007b. Coarticulation between aspirated-s and voiceless stops in Spanish: an interdialectal comparison. *Selected Proceedings of the 9th Hispanic Linguistics Symposium*, eds. Nuria Sagarra and Almeida Jacqueline Toribio, 113-120. Somerville, MA: Cascadilla Press.
- Trager, George. L. and Henry Lee Smith. 1951. *An outline of English structure (Studies in Linguistics: Occasional Papers 3)*. Norman, OK: Battenburg Press.
- Trubetzkoy, Nikolai. 1939. Grundzüge der Phonologie. *Travaux du cercle linguistique de Prague* 7.
- Tuller, Betty, Pamela Case, Mingzhou Ding, and J.A. Scott Kelso. 1994. The nonlinear dynamics of speech categorization. *Journal of Experimental Psychology* 20: 3-16.
- Turvey, Michael T. 1990. Coordination. *American Psychologist* 45:938-953.
- Walker, James A. 2008. Form, function, and frequency in phonology: (t/d)-Deletion in Toronto. Paper presented at *NWAV, 37*, Houston, TX.
- Yanagawa, Mariko. 2006. Articulatory timing in first and second language: A cross-linguistic study. Doctoral dissertation, Yale University.
- Zsiga, Elizabeth C. 1995. An acoustic and electropalatographic study of lexical and post-lexical palatalization in American English. *Phonology and phonetic evidence: Papers in laboratory phonology IV*, eds. Bruce Connell and Amalia Arvaniti, 282-302. Cambridge: Cambridge University Press.
- Zsiga, Elizabeth C. 2000. Phonetic alignment constraints: Consonant overlap and palatalization in English and Russian. *Journal of Phonetics* 28:69-102.

THE EXPRESSION OF PATH IN JAKALTEK POPTI (MAYAN): WHEN DIRECTIONALS DO IT ALL*

Colette Grinevald
Université Lumière-Lyon2 & DDL UMR 5596
colette.grinevald@univ-lyon2.fr

This paper demonstrates the interesting distribution of path information in Jakalteq Popti', a Mayan language of Guatemala. It considers how, in the expression of caused motion, this information is distributed between adpositional, verbal and directional systems. The analysis contrasts an interesting neutralization of source and goal information in the system of relational nouns that function as spatial adpositions, with the detailed path information provided by an elaborate system of suffixed directionals of verbal origin.

1. Introduction

This paper describes the interesting encoding of the expression of the source and goal of caused motion events (of the type “to put X in Y”/ “to take X out of Y”) in (Jakalteq) Popti',¹ a Mayan language of Guatemala. It shows how this particular encoding is best understood in the context of the complex distribution of path information in this language, between three types of elements—verb roots, adpositional elements and directionals. It shows how adpositional relational nouns only express the static relation that holds prototypically between the two spatial entities involved (figure and ground) and never motion, and how verb roots used in caused motion events do not express motion themselves either, and how both happen in the context of a rich system of directionals that bears the burden of expressing all the elements of motion on a path.

The paper will present a quick overview of the typological framework espoused for the study of the linguistic expression of space, before proposing the parameters to be considered when studying the linguistic expression of the notion of PATH as the facts of Popti' demand it.

* This is a portion of a longer paper given several times orally and never published (2002 conference on Adpositions of Movement in Leuven, in the 2003 organized session on PATH at the SSILA meetings, and in 2004 at the University of Tromsø). It has been reframed here within the approach espoused in the ongoing research project “Trajectoire” of the French Fédération de Typology. The examples are transcribed in the practical orthography of the official alphabets of Guatemala. Hence the change from ‘Jacalteq’ of the early publications on the language (such as Craig 1977 and 1979) to the orthography ‘Jakalteq’ today. The additional more recent change of name from Jakalteq to Popti' decided by the community has been matched by the change of name of the present author from Craig to Grinevald. I would, in addition, like to acknowledge here productive discussions with Anetta Kopecka, Jean-Michel Fortis and Miyuki Ishibashi, colleagues of the Trajectoire project.

¹ Jakalteq Popti' is a Mayan language of the Q'anjob'alan branch of the family, one of the major Western Mayan branches, which includes several closely related languages spoken in the Cuchumatanes mountain area of the department of Huehuetenango. It is today one of the most endangered languages of Guatemala, abandoned by the younger generations, although still spoken by about 40,000 speakers. For an overview of the sociolinguistics of Guatemala today, a country with one of the highest proportions of Indian population of all America, and one of the most intense language planning laboratories of the hemisphere, see Grinevald 2002.

The actual Popti' case study will then proceed with the description of the expression of common caused motion events of traditional Jakalteq life. It is argued there that the expression of source and goal grounds does not participate in the expression of path of motion itself in this language, and therefore does not pertain to a discussion of the kind of (a)symmetry between source and goal relevant for other languages. This position is further supported by the demonstration of the compensatory use of a large system of directionals, and the striking centrality of these directionals to express the notion of PATH in all expressions of spatial events in the language, whether they involve motion or not in fact.

2. About a typological approach to the expression of PATH

This section will quickly review the elements to be taken into account to describe the expression of PATH in any language, starting with basic notions of the study of space, then of the study of PATH and its encoding.

2.1. The basics of the expression of space: framework and references

The essentials of the terms to be used for the description of the expression of motion event include the three elements of *figure, ground and spatial relation* (as per Talmy 1985, Vandeloise 1986),² the two major types of situations where PATH may be expressed: a) *Motion events*, which can be spontaneous or caused motion, and include the non motion static location, b) to which must be added the cases of *fictive motion* (the river crosses town), or *path of Vision* (as in: he looked through the window into the hut), the initial typology of constructions (Talmy 1985, 2000) as either *verb-framed* (with lexical conflation of PATH in verb, as in the French 'monter/descendre', or *satellite-framed* (with a grammatical expression of PATH, as in the English 'go up/go down'),³ and the notions of the encoding being *overt vs. covert*, and the spatial information being *distributed* throughout the construction, across the different elements carrying spatial information (Talmy 1985, 2000, and Sinha & Kuteva 1995).

² With the following characteristics:

- a *figure* that is static or moving, idealized as a point in space or identified by its physical or functional specificity of spatial entity
- a *ground* that is also idealized as a point in space or considered as a spatial entity (characterized also by its contour/boundary, functional use, nature).
- a *spatial relation* not strictly of geometric semantics but, more often than initially recognized, conveying pragmatic/cultural information.

³ More recent amendments have specified that it is not a matter of a typology of languages but rather of a typology of coding strategies (allowing for languages with a mix of strategies), on one hand, and, on the other hand, that one must include at least a third type, that of *serialized constructions* (with the possibility of many degrees of syntacticization and even lexicalization of verbs complexes).

- Whether *lexical or grammatical* means are used, with the contrast of verb- vs satellite-framed constructions, and various types of complex verb stem formation in between.
- What the language specific variations are, regarding:

–The *density of the encoding* of segments of the PATH (à la Givón), i.e. how many points of the PATH are identified between origin and end points. Consider, for instance, the semantic value of the various goal oriented English prepositions: ‘...toward Y... to Y... almost to Y...all the way to Y... into Y’.

–A rather common *a-symmetry of encoding of source and goal*, when the point of origin is not being treated linguistically the same way as the end point.⁷ This is in fact the major issue to be taken up here in this case study of the expression of caused motion in Jakalteq Popti’.

–The *markedness of boundary crossing*, reflected linguistically, in particular in that boundary crossing would appear to be more salient than time linearity.⁸

–The fact that adpositions may specify the *nature of the ground* together with spatial information, combining topological information and ground information as in ‘in-water’ vs. ‘in-forest’ etc...a situation reported for a number of Native American languages.

–The fact that *information about the spatial entity of the figure* may be associated to the expression of PATH.⁹

- What the language specific inventory of grammatical categories available to encode PATH is:¹⁰

⁷ Ishibashi (to appear) discusses Japanese examples of different types of a-symmetries between the expression of source vs goal ground (a matter of overt expression or not, or of differential morphosyntactic treatment of the two types of ground). The Popti’ case is actually a question of unexpected morphosyntactic symmetry, to be discussed later.

⁸ This can be illustrated by the specific order of prepositions and particles in English, where the marker of boundary crossing takes linear priority over that of the marker of either extreme points, whether origin or end of the PATH, in a mixed spatio-temporal line, as in ‘to get *out off*’ vs. to go *into* (*to in).

⁹ As discussed in Grinevald 2006, some languages exhibit a propensity for specifying information on the configuration of the spatial entity of the figure, adding information in the expression of basic locative constructions and sometimes motion. For instance, as underlined in Grinevald 2004, Q’anjob’alan languages like Popti’ contrast with Tzeltalan languages like Tzeltal on this account, in that they do not make much use of their positionals. See also the systematic use of posture information in the expression of motion events in the Chibchan languages cited in Grinevald 2006 (or in on-going work on the Ese Ejja language of Bolivia by Vuillermet (2009)).

¹⁰ This inventory is partly a synthesis of the data shared by a number of Amerindianists at the 2003 SSILA organized session on the expression of PATH.

It is worth making a note of the fact that the grammatical categories to be listed below are not uniquely dedicated to the expression of space, but rather that part of their inventories is used to express the notions of PATH under consideration here.

–The *adpositional system* and the case system, the boundary between the two being sometimes difficult to establish. Within the cover term of adpositionals one should include the phenomenon of relational nouns,¹¹ (such as ‘at the foot of X’, ‘in front of X’) more common in many Native American languages than standard invariable adpositions).

–Sets of *verbal ‘satellites’*, affixed or free morphemes, with their more or less traditional terminology for certain language families. See the ‘verb(al) particles’ of English (derived from either prepositions or adverbs), or the directionals (free particles or affixes derived from motion verbs) of the kind found in Jakaltek Popti’ (as seen below).¹²

This paper will concentrate on the interesting interaction and distribution of spatial information in a Mayan language between relational nouns functioning as spatial adpositions of the sort mentioned in (a) above and an elaborate system of directionals of verbal origin of the sort mentioned in (b), to point to the interesting neutralization of the information provided by the adpositional system in the expression of source and goal of a path of caused motion events in that language.

3. Source and goal in caused motion events in Jakaktek Popti’

3.1. Four stories of caused motion to tell

The situations to be discussed correspond to four common events in the life of the Jakalteks a while back (the seventies, years of intensive fieldwork on the language), when there was no road and no electricity in the town of Jacaltenango. At that time, women cooked on fires on the floor of their kitchen and kept the clothes in wooden trunks. And when people went to the main town of Huehuetenango, they had to either catch beaten down mini buses that took three times as many people as there were seats to accommodate them so that getting in and out of them difficult, or to hail overloaded trucks that transported goods and tightly pressed people, in and out of which they had to hop with equally great effort. In both cases, it was transport one had to be ready to get in and out of, up into and down from, pushed up in or pulled down from. Sometimes one also had to help push them or wait next to them for whatever time was necessary to repair them, since they often broke down or got stuck in the mud and holes during the worst of the rainy season.¹³ These four caused motion events are given in (3) A through D:

¹¹ Known in the French literature on space as Noms de Localisation Interne (or NLI). See Aurnague 1996, and Aurnague, Hickmann & Vieu (to appear).

¹² In this domain of ‘satellites’, one can find also verbal prefixes (commonly grammaticalized adpositions discussed under the label of verbal prefixes or preverbs), as well as adverbial preverbs (of a more lexical nature usually).

¹³ That is, exactly the months of July and August which correspond to the so-called ‘summer vacation’ period of foreign northern academics. Hence the fact that the field linguist author of this article commonly heard the kind of constructions used as examples here during her summer field stays.

(3) Cases of typical situations of motion events observed in daily life of Jacaltenango:

	<i>Movement</i>	<i>Figure</i>	<i>Ground</i>
A.	cause-move	POT	FIRE
B.	cause-move	SHIRT	CHEST
C.	cause-move	PERSON	BUS
D.	cause-move	PERSON	TRUCK

The illustrations of these motion events below in (4) are meant to contrast the two possible phases of getting into a situation and getting out of it, and cases of bounded (chest and bus) vs. unbounded (fire and truck) ground:¹⁴

(4) Grounds of common motion events:

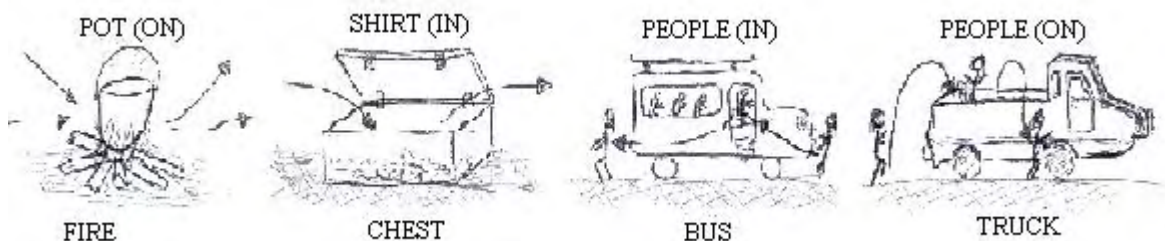

The ground of the motion events is either the end point (goal) or the point of origin (source) of the movement of the figure, as schematized in (5):

(5) Sequential phases of the motion events considered

- a. *figure* is moved to > *GOAL ground*
 b. *figure* is moved from < *SOURCE ground*

In order to understand the encoding of these situations of caused motion in Jakalteq Popti', closer examination of their pragmatics is needed actually. What needs to be taken into account first is the prototypical topological relation that holds between those figures and grounds (ON vs IN), and then the nature of that relation, more notional than strictly speaking spatial in fact, as shown below in (6). Another interesting pragmatic consideration to explain the encoding of figure and ground of caused motion in Popti' is the notion of the purpose of the motion, in that what will matter most in the end in this language is the nature of the functional relation that holds between the figure and the ground (this was one of the main points of the study of French spatial

¹⁴ The drawings show only simple spontaneous motion of getting into or down from buses, and not the cause motions of being pushed or pulled by someone else to get in and out of buses or up and down the back of open trucks, although such caused motions are what the Popti' examples below will refer to.

prepositions by Vandeloise (1986)).¹⁵ In fact, the ground is utilized for a particular purpose, for activities taken to be essential to daily life and basic survival (at least in the target language at the time of fieldwork more than three decades ago, as already mentioned). See (6) below:

(6) Prototypical figure/ground type of relations :

<i>figure</i>	<i>SPATIAL RELATION</i>	<i>ground</i>	<i>functional type of relation</i>
pot	ON	fire	SUPPORT
shirt	IN(SIDE)	chest	INCLUSION/CONTAINMENT
person	IN(SIDE)	bus	INCLUSION/CONTAINMENT
person	ON	truck	SUPPORT/CONTAINMENT

Consider further the difference of pragmatic markedness in the physical arrangement between figure and ground in the situations given in (7), where a set (a) of prototypical situations is contrasted to another set (b) of marked, un-expected or non-traditional situations:

(7) Ground as a functional location:

<i>Unmarked situations</i>	<i>Marked situations</i>
figure/ground (prototypical function)	figure/ground (possible function?)
a. pot/fire (to cook)	a'. pots/truck (to transport to market?) pot/chest (to keep, hide, transport?)
b. shirt/chest (to store)	b'. shirts/truck (to transport to market? to move?) shirt/fire (to burn in case of epidemic?)
c. person/truck (to transport)	c'. person/chest (of child hiding?) person/fire (of corpse being incinerated?)

As will be seen below, Jakalteq relies on what the functional unmarked situation is at the moment of expressing caused movement. This contrasts with the way English and French express caused motion scenes of the types mentioned above.

3.2. How English and French talk of the scenes

English is a “satellite-framed” language while French has been considered to be a typical “verb-framed” language, the language exhibiting typical difference in the “distribution” of the spatial information. English has in total three different elements to express PATH: lexical verb roots, verbal particles and prepositions which are capable of expressing motion.

¹⁵ In his discussion of situation of use of the preposition ‘*dans*’ with the progression of a jewelry in a jewelry box, dog half way in a doghouse, floors held partway in a vase and finally big fish held in one hand, to illustrate the notion of containment and control, independent of the actual size of the ground with respect to the figure.

- (8) a. to *put* the pot *on* the fire
 b. to put it *up* on the fire
- (9) a. to *take* the pot *off* the fire
 b. to take it *down* off the fire

One can observe; a) the lexicalization of CAUSED-MOTION+PATH by their conflation in the verb (*put/take*); b) the possible use of an extra verb particle (*up/down*) as a PATH “satellite”, particularly in constructions where the figure is in an anaphoric form, and; c) the difference between a primarily static preposition to express goal/end point (*on*) and a strictly dynamic preposition to express source/point of origin (*off*).

In French, PATH information is distributed between verb (which co-lexicalizes motion) and prepositions which can also be sensitive to the difference between static and motion events.¹⁶

- (10) mettre/poser la marmite sur le feu
 put the pot on the fire
- (11) enlever la marmite du feu
 take off the pot from (the) fire

One can note in French; a) The lexicalization of CAUSED-MOTION+PATH by conflation in the verb (*mettre/enlever*), and; b) The same difference between an essentially static preposition to express the goal/end point (*sur*) and an essentially dynamic preposition to express the source/point of origin of the caused movement (*du*).

3.3. Expression of caused motion in Jakaltek Popti’¹⁷

When compared to the European languages considered, Jakaltek Popti’ exhibits a very different distribution of spatial information. Most striking is the absence of dynamic adpositions and the systematic use of a static spatial relational noun. These relational nouns only express the prototypical/functional relation that holds between figure and ground, and remain the same whether the motion expressed is considered from the initial or the end point of the path. Noteworthy also is the absence of path information in the verb root. The point of this paper is to point to the distribution of spatial information throughout the sentences, and to link the absence

¹⁶ As amply demonstrated and argued in Kopecka 2004, French is not strictly speaking only a verb-framed language but rather a mixed language with some traces of a period where it too had path satellites in the form of verbal prefixes. This is shown in this example with the verb ‘*enlever*’ where one can still recognize the prefix *en-* (from *ex-*) which has been lexicalized. The process of verbal prefixation is more evident with a verb like ‘*porter*’, for instance, as in ‘*porter/apporter/emporter/déporter*’. The main point here remains, however, that there are indeed dynamic prepositions in French, as there were in English.

¹⁷ A mini-crash course on Jakaltek Popti’ grammar will be given in section 4.2 below. The examples of this section are meant to simply illustrate the distribution of spatial information throughout the sentence. Directionals: DIR, noun classifiers: CL and relational nouns: RN will be taken up later. The level of transcription is meant to emphasize the distribution of spatial semantic information and does not show morphophonemics of the verb forms.

of motion information in adpositional and verbal roots to the compensatory presence of directional suffixes that distinguish the different kinds of displacement.

(12) ‘Pot on fire’ scenes:

- a. a’-ah-toj tx’otx’ xhalu y-ib’anh q’a’.
 move-up-away earth pot its-ON fire
 (Lit. ‘Move-up-away the (earth) pot on the fire’)
 ‘Put the pot on the fire!’
- b. a’-ay-tij tx’otx’ xhalu y-ib’anh q’a’.
 move-down-this way earth pot its-ON fire
 (Lit. ‘Move-down-this way the (earth) pot on the fire’)
 ‘Take the pot down from the fire!’

(13) ‘Clothes in chest’ scenes:

- a. a’-ok-toj q’ap kamixhe y-ul te’ kaxha.
 move-in-away CL/cloth shirt its-IN CL/wood chest
 (Lit. ‘Move-in-away the (cloth) shirt its-inside of the (wood) chest’)
 ‘Put the shirt in the chest!’
- b. a’-el-tij q’ap kamixhe y-ul te’ kaxha.
 move-out-this way CL/cloth shirt its-IN CL/wood chest
 (Lit. ‘Move-out-toward the (cloth) shirt its-inside of the (wood) chest’)
 ‘Take the shirt out of the chest!’

(14) ‘People in truck’ scenes:

- a. xk-in ha-ten-ik-toj y-ul karo.
 ASP-me you-move-in-away its-IN truck
 (Lit. ‘You moved me in-away in the truck’)
 ‘You pushed me into the truck’
- b. xk-in ha-ten-il-tij y-ul karo.
 ASP-me you-move-out-this way its-IN truck
 (Lit. ‘You moved me out-toward in the truck’)
 ‘You pulled me out of the truck’
- c. xk-in ha-ten-ay-tij y-ul karo.
 ASP-me you-move-down-this way its-IN truck
 (Lit. ‘You moved me down-toward in the truck’)
 ‘You pulled me down from the truck’

The first remark to be made concerns the semantics of the Jakalteq Popti’ verbal root used in these sentences. In (12) and (13) *a’(a)* is a verb that means literally ‘to give’ but has multiple derived usages. When used with directionals it has a sense of causative (‘to give-to go up/down’ meaning ‘to make it happen that it goes up/down’, glossed here as a generic verb ‘to move’). In (14) *ten* also refers to caused motion but emphasizes the action of holding or grabbing while making something move (‘*empujar*’ in Spanish), while the directionals specify the

direction of the movement (unlike ‘push/pull’ or ‘*pousser/tirer*’ with built in deixis, in English and French respectively). Hence the Jakaltek Popti’ verbs mean caused motion in both cases, but without any path information, which the directional satellites provide.

The distribution of spatial information therefore differs from the English and French examples, in that there is no lexicalization by conflation of a PATH element in the verb root, with steady use of the same verb for ‘hold and move’, but rather a system of directionals, as verbal “satellites” expressing in great detail various elements of PATH with constant static relational nouns used as adpositional-type elements. The main point of examples (12, 13, 14) was to demonstrate the static nature of the relational nouns used in expressions of caused movement. The result of this lack of dynamic use of the relational noun contrasts with the more familiar situation of European languages in which source and goal are also treated the same from a morpho-syntactic point of view, but where source and goal are introduced by different prepositions.

What is special in the Mayan situation, therefore, is that while source and goal are treated the same from a morphosyntactic point of view, there is a sort of neutralization of the contrast between the two extreme points of a path since the same relational noun is used in both cases. What is at stake here is what this means in the debate about the concept of (a-)symmetry in the expression of source and goal. It would appear that, in this language, the adpositions do not directly participate in the expression of PATH, but rather ignore the contrastive notions of source and goal. Their function seems to be to simply express the static topological relation that prototypically holds between a figure and a ground, independent of any motion event.

4. The ubiquitous expression of PATH through directionals in Jakaltek Popti’

While the previous section showed how the adpositional system plays no role in the actual expression of PATH in the grammar of Jakaltek Popti’, this section will show how that information is concentrated in an elaborate directional system. Information on this system of directionals, including their morpho-syntactic status, lexical origin and complete inventory, as well as their semantics and discourse use can be found in Craig 1994, to be partly repeated here. As will also be shown, directionals are not only used in dynamic situations of (caused) motion but, more generally, in all situations spatially conceivable, including static location, as demonstrated in Grinevald 2006, also partly repeated here.¹⁸ Two new points are being made here, beyond these previous studies: first, that the information about the source or goal of a motion on a PATH is provided by the directionals, although indirectly, and, second, that they actually do it in an interesting symmetrical way.

4.1. Basic information about directionals

Table 1 shows how the ten directionals are organized in three semantically and collocationally distinct paradigms (DIR1, DIR2, DIR3, where the numbering corresponds to their respective distance from the verbal root); and how they are all products of the grammaticalization of motion verbs, with one exception of unattested lexical source in the contemporary language.

¹⁸ And of course they are present in many metaphorical expressions.

DIRECTIONALS (satellites)		from	MOTION VERBS (lexical)
DIR3	<i>perspectivizing/ deictic</i>		
-toj ¹⁹	‘away’	to-yi	‘to go’
-tij	‘toward’	tit-a	‘come !’(defective)
DIR2	<i>orientation in space</i>		
-(a)h- ²⁰	‘up’	ah-i	‘to go up’
-(a)y-	‘down’	ay-i	‘to go down’
-(e/i)k’-	‘across’	ek’-i	‘to cross’
OR	<i>boundary crossing</i>		
-(o/e/i)k-	‘inward’	ok-i	‘to enter’
-(e/i)l-	‘outward’	el-i	‘to exit’
DIR1	<i>spatial/adverbial manner/aspect</i>		
-pax-	‘back, again’	pax-i	‘to return’
-kan-	‘still, for good’	kan-i	‘to stay’
-kanh-	‘upward, suddenly’	?	

Table 1: DIR of Jakalteq Popti’

The inventory includes therefore two subsets of DIR2, directionals for vector or absolute directions (up/down/across) that are in complementary distribution with directionals for boundary crossing (in/out), and a set of DIR3 that are a pair of deictic perspectivizing directionals (away/towards). The set of DIR1 has undergone semantic extension and is used more often with manner adverbial semantics than with strictly spatial semantic.²¹

4.2. Directionals but no motion

The directionals of Jakalteq Popti’ actually express the more general notion of PATH, independent of whether there is motion (more specifically ‘displacement’) or not. This is shown by their use as verbal satellites in two cases of non motion events. One is with verbs of perception or locution, with which the directionals trace the trajectory between protagonists,

¹⁹ Actually, DIR+suffix oj#.

²⁰ With morphophonological variant in presence of the existential ay-, as -ha.

²¹ It is noteworthy (for a functional typological linguist) that it is specifically the set with aspectual and manner semantics that is the closest to the verb root.

calculated from a chosen point of reference (marked here REF) that determines the choice of the deictic DIR3, either as ‘away’ or ‘toward’.

In (15) below, the scene is considered from the man’s position (REF) down in the street, while in (16) the point of reference (REF) is the woman, up at a window:

- (15) a. xil-**ah-toj** naj(REF) tet ix.
 saw-*up-away* CL/man to CL/woman
 ‘He saw her [up.away].’
- b. xil-**ay-tij** ix naj (REF).
 saw- *down-toward* CL/woman CL/man
 ‘She saw him [down.toward].’
- (16) a. xtiyoxhli-**ah-tij** naj tet ix (REF).
 saluted- *up-toward* CL/man to CL/woman
 ‘He said hello [up.toward] to her.’
- b. xta'wi-**ay-toj** ix (REF) tet naj.
 responded-*down.away* CL/woman to CL/man
 ‘She answered him [down.away].’

Discursively, the use of directionals in Jakalteq Popti’ is reminiscent of the use of verbal particles in English, the difference being a more systematic use of the directionals in individuated referential scenes.²²

The other construction in which the use of directionals is noticeable in Jakalteq Popti’ is in the expression of Basic Locative Constructions.²³ The language emphasizes information about the path of a trajectory projected between the static figure and ground objects and, like European languages, says nothing about the dimensions and contour of the figure. This is said in contrast to the work done on the use of positionals in Basic Locative constructions in the neighbouring Tzeltal language that was crucial in refuting the universality of adpositions as the main locus of spatial information in Basic Locative Constructions.²⁴

The basic template of the Basic Locative Construction of Jakalteq Popti’ is therefore the combination of an existential copula with directionals. Certain combinations of directionals are very common, such as the ones given below in (17) for situations of support rendered as ON in English, and in (18) for situations involving some sense of insertion and containment, corresponding to IN in English:

²² It is interesting to draw a parallel between the use of directionals in scenes with specific spatial reference, individuated events, and the use of noun classifiers, another characteristic of this language, in the same circumstances of referentiality.

²³ Fieldwork was carried out in 2002 to collect data on Basic Locative Constructions in Jakalteq Popti’ using the same kind of experimental material developed at the MPI-Nijmegen (Bowped materials) that had been used for Tzeltal.

²⁴ See Brown’s 1994 study of positional locative predicates demonstrating how the language emphasizes the shape and contour of the figure through an extensive use of positionals while underplaying the spatial information about its localization.

- (17) ON in Jakalteq Popti' =EXIST + UP +AWAY
 a. ahatoj
 b. <ay-ah-toj (with irregular morphophonemics)
 exist-DIR2: up-DIR3: away
 c. typical situations:



Man on roof

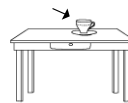

Cup on table

- (18) IN in Jakalteq Popti' = EXIST+IN/ENTER+AWAY
 a. ayiktoj
 b. <ay-ik-toj
 exist-DIR2: in-DIR3: away
 c. typical situations:

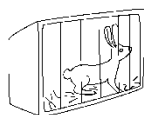

Rabbit in the cage



Cigarette in mouth

This combination of directionals is used in resultative situations that have involved boundary crossing, and express a notion of '(horizontal) insertion'. However, in a few cases, the deictic directional chosen was DIR3 *-tij* 'toward', and not DIR3 *-toj* 'away', pointing to interesting pragmatics in the use of such directionals. Instances of the use of *-tij*, are given in (19) and (20) below.

- (19) Marked situation with EXIST+DOWN+*TOWARD*
 a. ahajtij
 b. <ay-ay -tij
 exist-down-toward
 c. situation:

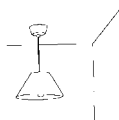

Lamp down from ceiling

- (20) Other marked situations with EXIST+OUT/EXIT+*TOWARD*
- a. ayiltij
 - b. <ay-il- tij
exist-out-toward
 - c. situations:

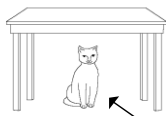

Cat under table



Dog in dog house

The use of the directional DIR3 *-tij* ‘toward’ provides a marked choice of perspective on the scenes, imputing some force dynamics to the figure being located, with the viewer taken as the point of reference. In (19)–*tij* evokes how the light of the lamp beams down toward the viewer, referring to the function of the lamp which is to provide light; meanwhile, in the two scenes of (20), *-tij* attributes to the animate figures some consciousness of a path of vision directed toward the viewer. As explained by a native speaker, it is *-tij* “because they are looking at us”. The literal translation of the basic locative constructions would therefore be something as given in (21), in which the directionals describe a path of vision originating with the figure and directed at the viewer or external point of reference, all in a perfectly static situation.

- (21) a. (Lit. ‘The cat is [(looking) coming out.this way] under the table’.)
b. (Lit. ‘The dog is [(looking) coming out.this way] in the dog house’.)

5. On the distributedness of the encoding of PATH.

Jakaltek Popti’ is very explicit about the expression of the spatial notion of PATH; it does not do it the way European languages do it, and it does more of it in a more systematic way. The specificities of this language are that; a) it relies extensively on the use of a particular type of verbal satellites known in Mayan linguistics as directional; b. it argues for a notion of PATH as a projected spatial relation between a figure and a ground in all types of spatially situated scenes, whether they involve motion or not (i.e. also in static events, such as those expressed by Basic Locative Constructions, or with verbs of perception or locution), and; c) it demonstrates the interest in taking into account the notion of distribution of information, in particular between the adpositional system and the verbal satellite system of directionals. In fact the Jakaltek Popti’ adpositional system, in this case a set of relation nouns, does not partake in the expression of the contrast between source and goal of a PATH of motion events. Rather, it uniquely expresses the static relation that holds between figure and ground, emphasizing functional over spatial topological semantics. In this context the directional system can be said to compensate by carrying the load of the expression of PATH.

Finally, this particular pattern of distribution of spatial information contributes interestingly to on going discussion of (a)symmetry in the expression of source and goal (see Ishibashi, to appear). First, it shows a neutralization of the contrast source-goal in the adpositional phrases expressing ground, when much of the discussion on (a)symmetry has concentrated on those particular elements. Second, it attracts attention to a large system of directionals whose function seems to include compensating for this absence of PATH information in adpositional phrases, by indirectly, but symmetrically, providing source-goal information.

References

- Aurnague, Michel. 1996. Les noms de localisation interne : Tentative de caractérisation sémantique à partir de données du Basque et du Français, *Cahiers de Lexicologie* 69:159-192.
- Aurnague, Michel, Laure Vieu and Andrée Borillo. 1997. Représentation formelle des concepts spatiaux dans la langue. *Langage et cognition spatiale*, ed. M. Denis, 69-102. Paris: Masson.
- Aurnague, Michel, Maya Hickmann and LaureVieu. 2007. *The categorization of spatial entities in language and cognition*. Amsterdam/Philadelphia: John Benjamins.
- Bowerman, Melissa. 1996. Learning how to structure space for language: A cross linguistic perspective. *Language and space*, eds P. Bloom, M. A. Peterson, L. Nadel and M. F. Garret, 385-436. Cambridge, Ma: MIT Press.
- Brown, Penelope. 1994 The INS and ONS of Tzetzal locative expressions: The semantics of static descriptions of location. *Linguistics* 32:743-790.
- Craig, Colette. 1977. *The structure of Jacaltec*. Austin: University of Texas Press.
- Craig, Colette. 1979. Jacaltec: Field work in Guatemala. *Languages and their speakers*, ed. T. Shopen, 3-57. Cambridge (MA): Winthrop Publishers (1987, 2nd Edition: University of Pennsylvania Press).
- Craig, Colette. 1994. Jacaltec directionals: Their meaning and their function. *Languages of The World* 7:23-36.
- Givón, Tom. 2001. *Syntax I, II*. Amsterdam/New York: John Benjamins.
- Grinevald, Colette. 2002. Linguistique et langues Mayas du Guatemala. *Faits de Langues Meso-Amérique, Caraïbes, Amazonie* 20:17-27.
- Grinevald, Colette. 2006. The expression of static location in a typological perspective. *Space in languages: Linguistic systems and cognitive categories*, eds. M. Hickmann and S. Robert, 29-58. Amsterdam/Philadelphia: John Benjamins.
- Ishibashi, Miyuki. To appear. The expression of ‘putting’ and ‘taking’ events in Japanese: the asymmetry of source and goal revisited. *Put and take events: A crosslinguistic perspective*, eds A. Kopecka and B. Narasimhan Amsterdam/Philadelphia: John Benjamins.
- Kopecka, Anetta. 2004. Etude typologique de l’expression de l’espace: Localisation et déplacement en Français et en Polonais. Doctorat de 3^{ème} cycle, Université Lumière Lyon II.
- Quesada, J. Diego. 2000. *A grammar of Teribe*. Munich: Lincom Europa.

- Sherzer, Joel. 1995. Your friend is peeing standing up: Kuna verbalpositional suffixes in grammatical/discourse/social/cultural/poetic context. *Proceedings of the Second Annual Symposium about Language and Society*, eds. I. P. Silberman and J. Loftin, 99-107. Austin: University of Texas.
- Sinha, Chris and Tania Kuteva. 1995. Distributed spatial semantics. *Nordic Journal of Linguistics* 18:167-199.
- Slobin, Dan I. 1991. Learning to think for speaking: Native language, cognition and rhetorical style. *Pragmatics* 1:7-26.
- Talmy, Léonard. 1985. Lexicalization patterns: Semantic structure in lexical form. *Language typology and syntactic description* Vol. III, ed. T. Shopen, 57-148. Cambridge: Cambridge University Press.
- Talmy, Leonard. 2000. *Toward a cognitive semantics*. Cambridge, Ma: MIT Press.
- Vandeloise, Claude. 1986. *L'espace en Français*. Paris: Editions du Seuil.
- Vuillermet, Marine. 2009. Ese Ejja posture verbs can't stand still (and sometimes side step). Paper presented at the *Conference on Indigenous Languages of Latin America-IV*. Austin, Texas.

EXTERNAL AND INTERNAL TOPICS IN YUCATEC MAYA *

Rodrigo Gutiérrez-Bravo
El Colegio de México
rogutierrez@colmex.mx

This paper provides a description of topicalization in Yucatec Maya (Mayan, Mexico) based on Aissen's (1992) classic analysis of topics and foci in Mayan languages. The relevant data for this description are taken for the most part from oral narratives. While evidence of the existence of external topics in Yucatec Maya has been recently provided by Skopeteas & Verhoeven (2009a,b), in this paper evidence is provided that Yucatec Maya also has topics that behave like internal topics. I argue that there are two different ways of interpreting this state of affairs. One is that Yucatec has both external and internal topics, a possibility that Aissen herself considers for Tzotzil. The other possibility is that the external/internal distinction is not relevant in Yucatec and that topics in this Mayan language are structurally altogether different from the topics proposed by Aissen. Some preliminary evidence is presented supporting this latter possibility.

1. Introduction

Mayan languages, which are for the most part verb initial, regularly allow for argument-initial orders that result from topicalization. This is illustrated in (1) and (2) for two different VOS Mayan languages, Tzotzil (Chiapas, Mexico) and Tz'utujil (Guatemala).¹

* I would like to thank the audience of the *X Encuentro de Lingüística del Noroeste* (Hermosillo, Mexico, November 2008) and Line Mikkelsen for helpful feedback on numerous issues discussed in this paper. All remaining errors are my own. The research reported here was supported in part by the National Council for Science and Technology of Mexico (CONACYT), grant SEP-2004-CO1-47613.

¹ The abbreviations used in this paper are the following:

ABS	absolutive	EP	epenthesis	NUMC	numeral classifier
ASP	aspect	ERG	ergative	PART	participle
CAUS	causative	HAB	habitual	PASS	passive
CL	clitic	IND	indicative	PL	plural
COMP	complementizer	ITER	iterative	PPF	present perfect
CP	completive	IRR	irrealis	PRF	perfect
DET	determiner	LOC	locative	SG	singular
DM	demonstrative	NEG	negation	TOP	topic
DUR	durative	NEX	negative existential	TRNS	transitive

The glosses ERG and ABS correspond to what is known in traditional Mayan linguistics as the *A* and *B* pronominal series. It should be noted that ergativity in Yucatec is split on the basis of aspect, and hence not every instantiation of a pronominal element labeled as ERG or ABS necessarily bears an ergative or absolutive grammatical relation. Where relevant, the bound nature of clitics is signaled by “=”.

- (1) TzOTZIL
 [a ti antz-e]; jun=yo'on ta=xkom ____ i
 TOP DET woman-CL happily stays
 'The wife stays at home happily...' (taken from Aissen 1992:49)
- (2) Tz'UTUJIL
 [ja ch'ooy]; ma x-uu-tij ta ja kéeso ____i.
 the rat NEG ASP-ERG.3-eat IRR the cheese
 'The rat didn't eat the cheese.' (taken from Aissen 1992:72)

The topic position in Mayan languages is in turn different from the position occupied by foci, which corresponds to the position to the immediate left of the verb. The relative order of topic and focus is illustrated in (3) and (4) for Tzotzil and Tz'utujil, respectively.

- (3) TzOTZIL
 [TOPIC a ti prove tzeb-e] [FOCUS sovra] ch'ak'bat.
 TOP DET poor girl-CL leftovers was.given
 'It was leftovers that the poor girl was given.' (taken from Aissen 1992:51)
- (4) Tz'UTUJIL
 [TOPIC ja gáarsa] [FOCUS cheqe ch'uu'] n-ee-ruu-tij .
 the heron only fish ASP-ABS.3PL-ERG.3-eat
 'It's only fish that the heron eats.' (taken from Aissen 1992:72)

Although these word order facts had been regularly observed in the literature on Mayan languages, Aissen's (1992) seminal analysis on topics and foci in Mayan languages was the first to identify that even though all Mayan languages allow preverbal topics in the position immediately to the left of the focus position, not all these topics are equal. Aissen observed that the topics of Mayan languages like Tzotzil and Jakaltek (Guatemala) are in fact prosodically, syntactically and pragmatically different from the topics of other Mayan languages like Tz'utujil. Aissen observes that the topics of Tzotzil (and Jakaltek) are less integrated into basic clause structure, and so she suggests that the differences between the topics of Tzotzil and those of Tz'utujil are directly related to different structural properties. Specifically, in Aissen's analysis the topics of Tz'utujil surface in [Spec, C], a clause-internal position, and consequently they are analyzed as internal topics (see also Aissen 1999). The topics of Tzotzil (and Jakaltek), on the other hand, are taken to be base-generated in a position external to the sentence as a whole (i.e. they are not derived by movement). This difference is illustrated in (5), where E stands for Expression. Aissen further takes the focus position in both languages to be [Spec, I].

(5) a. Internal topic

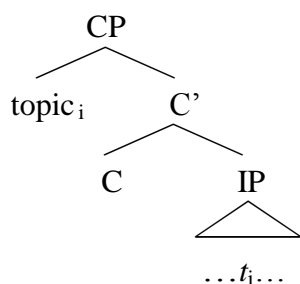

b. External topic

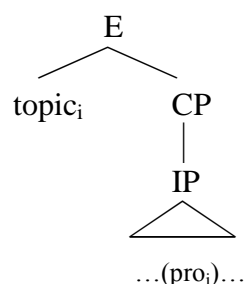

In this paper, I provide a description of topics in Yucatec Maya (the Mayan language spoken in the Yucatán Peninsula, México; henceforth *Yucatec*). The goal of this description is to determine whether the sentence topics of Yucatec are external or internal. For this purpose, I use Aissen's original diagnostics for external and internal topics. My conclusion is that Yucatec has topics that show the behavior characteristic of external *and* topics that show the behavior characteristic of internal topics. I argue that there are two possible interpretations of this state of affairs. The first one is that Yucatec is a language that has both external and internal topics. This possibility was in fact suggested by Aissen herself (Aissen 1992:73, fn. 30), since she observed that there is some evidence that Tz'utujil also has external topics besides the internal topics characteristic of this language, with each kind of topic serving different pragmatic functions. The second possibility is that topics in Yucatec are altogether insensitive to the external/internal distinction, and hence that they are different from both the structures in (5). I provide some preliminary evidence in favor of the latter possibility.

This paper is structured as follows. In section 2, I introduce some preliminaries of the syntax of Yucatec that will later be used to identify sentence topics in the language. In section 3, I present the evidence that indicates that Yucatec has topics like the external topics found in Tzotzil. In section 4, I present the evidence that shows that Yucatec also has topics like the internal topics of Tz'utujil. In section 5, I discuss the analytical implications of this state of affairs for Aissen 1992, and in section 6, I present my conclusions.

2. Topics in Yucatec Maya

2.1. Preliminary Description

Most clauses in Yucatec consist minimally of the verb and a proclitic (glossed ERG) cross-referencing the subject of the verb. Most of the time, the proclitic is preceded by an auxiliary particle or verb. The main verb in turn displays a series of suffixes (glossed ABS) that agree with the object. This minimal structure is shown in (6).²

² All Yucatec examples are presented according to the orthographic conventions of the *Academia de la Lengua Maya de Yucatán* and so they do not necessarily reflect their phonetic form accurately. Unless specifically indicated, the name after each example corresponds to the source in my corpus that the example is taken from; all the texts in the corpus used for this study correspond to oral narratives; they all correspond to the 'eastern' variety of Yucatec, spoken in the east and south of the state of Yucatán and in the state of Quintana Roo. The narratives *Gigante*

- (6) K-in w-il-ik-ech.
 HAB-ERG.1SG EP-see-IND-ABS.2SG
 ‘I see you.’

For the purpose of structural description I assume that the verb heads the VP and that the aspect particle and the ergative pronoun together form the head of IP (Gutiérrez-Bravo and Monforte 2008). I further assume that an unexploded CP in turn is the maximal projection that immediately dominates IP, just as in the analysis in Aissen 1992. In Yucatec, intransitive clauses in the completive aspect and some intransitive clauses in irrealis mood are constituted by the verb alone, as in (7). In these cases I assume the same structure as the one for (6), with the exception that in these cases I^0 is null. None of my assumptions regarding the nature of V^0 and I^0 in Yucatec are in any way crucial for the discussion that follows.

- (7) Sa’at- \emptyset .
 lose.PASS-ABS.3SG
 ‘He/she/it got lost.’

Now, Yucatec has a number of syntactic properties that make it different from most other Mayan languages, word order being the one that is most immediately obvious (see Durbin and Ojeda 1978). Specifically, the precise characterization of word order in Yucatec is still an ongoing debate, with some works describing it as VOS (Bohnenmeyer 2002, Skopeteas and Verhoeven 2005, Skopeteas and Verhoeven 2009a, Skopeteas and Verhoeven 2009b), and other works arguing that SVO is the unmarked word order of the language’s transitive clauses (Briceño Chel 2002, Gutiérrez-Bravo and Monforte 2008, Gutiérrez-Bravo and Monforte 2010). Here I adopt the latter analysis and hence I assume that constructions like (8) and (9) are instances of unmarked word order and not of subject topicalization.³

- (8) Le ko’olel-o’ t-u ts’-aj- \emptyset u ma’alob nook’.
 DM woman-CL CP-ERG.3 put-PRF-ABS.3SG ERG.3 good clothes
 ‘...and the woman put on her good clothes...’ Góngora Pacheco (1990:19)
- (9) Teen k-in ch’ak-ik- \emptyset u che’-il.
 1SG HAB-ERG.1SG chop-IND-ABS.3SG ERG.3 tree-RL
 ‘I used to chop its trees (the cornfield’s).’ (MDG-B:136)

(Roberto Salazar), *Sapo* (Humberto Medina) and *Sonámbulo* (Eduardo Pat) were collected during fieldwork in Laguna Kaná, Quintana Roo, in 1996-1997. Examples labeled as MDG-B are taken from narratives in Monforte *et al.* (2011). These narratives were collected during fieldwork in Timul and Peto, southern Yucatán, in 2006-2007. The absence of a corpus reference indicates an elicited example.

³ For the specific details of how the SVO order is derived in Yucatec, I refer the reader to Gutiérrez-Bravo and Monforte 2010.

A direct consequence of this assumption is that non-focal, preverbal subjects cannot be automatically taken to be sentence topics.⁴ With this one exception, however, identifying sentence topics in Yucatec is fairly straightforward. I now present the criteria used from here on to characterize topicalized XPs. These are the criteria with which the corpus examples were selected.

2.2. Word Order

Although preverbal word order cannot be used as a diagnostic for subject topicalization in transitive clauses, it is a reliable diagnostic for topicalization in most other cases. For instance, most studies of word order in Yucatec agree that the unmarked word order of intransitive clauses is VS (see Skopeteas and Verhoeven 2005, and Gutiérrez-Bravo and Monforte 2010), as in (10). Hence in intransitive clauses with fronted definite subjects, the subject can be taken to be a sentence topic, as in (11).⁵

- (10) Lekan lúub-uk-ø le ka'anal ja' ...
 when fall-IRR-ABS.3SG DM tall water
 'When the rain falls...'
 (MDG-B:13)

- (11) Pues si le kool-o' beychaj-ø-i'.
 yet if DM cornfield-CL be.possible.PRF-ABS.3SG-LOC
 'Yet it was possible (to do) the cornfield there.'
 (Gigante-96)

Similarly, given the VO order of Yucatec, in clauses with fronted definite objects, the object can be taken to be a sentence topic, as in (12).

- (12) [Lel-o']_i ma' k il-m-aj-ø ______i to'on-i'.
 DM-CL NEG ERG.1PL see-PPF-PRF-ABS.3SG 1PL-NEG
 'That, we did not get to see it.'
 (MDG-B:133)

2.3. The Topic Clitic =e'

Yucatec has a phrasal enclitic =e' that signals sentence topics, similar to the topic particles found in other Mayan languages like Tzotzil (see (1) above). Examples are presented below.

⁴ This is in fact entirely independent of whether or not the SVO analysis of Yucatec is assumed. Skopeteas and Verhoeven (2009b), for instance, assume that the unmarked word order of Yucatec is VOS. However, they still acknowledge that Yucatec has preverbal subjects that are neither topics nor foci.

⁵ It is important to control for definiteness in these cases, since, in the absence of other cues for topicality, fronted bare intransitive subjects and direct objects in Yucatec regularly function as foci and not as topics.

- (13) Tumen leti'=e' k-u beet-ik-ø jun p'iit u ti'al-i'.
 because 3SG=TOP HAB-ERG.3 make-IND-ABS.3SG one bit ERG.3 for-CL
 'Because he, he made a bit of it for himself.' (MDG-B:132)
- (14) [Tuláakal ba'ax k'a'abéet-ø teen]=e'; k-in taa-s-ik-ø ____i.
 all what necessary-ABS.3SG 1.SG=TOP HAB-ERG.1SG come-CAUS-IND-ABS.3SG
 'Everything that was necessary to me, I would bring.' (MDG-B:30)

In principle, the topic clitic should be the most reliable diagnostic for identifying a topicalized XP in Yucatec. Unfortunately, this topic clitic diagnostic has one limitation. Yucatec has a fair number of phrasal enclitics with different syntactic, semantic and intonational functions. The more prominent of these are a set of distal deictic clitics (see Hanks 1990 and Lehmann 1998) that encode the relative distance between the speaker and a nominal referent according to the following scale: =a' D1 (i.e. "this"), =o' D2 (i.e. "that") and =e' D3. Now, a number of functional elements obligatorily require the presence of one of these distal clitics. The nominal determiner *le* in (10) and (11) is precisely one of these elements. However, in Yucatec only one clitic is allowed to attach to the right edge of an XP. When two different clitics originating from two different sources would be expected to appear, one of them is suppressed. And, specifically, when the topic clitic and one of the deictic clitics compete for this unique position, it is the distal clitics that win. This is the reason why no topic enclitic is observed in the right edge of the topicalized XPs in the examples in (11) and (12); its presence is blocked by the distal clitic *-o'*.

The example in (15) is particularly telling in this respect. In this example a temporal adjunct has been fronted from its unmarked postverbal position. We are further certain that it has been fronted to a topic position because it appears to the left of the focus position (see §1), which in this case is occupied by a different temporal adverbial (compare with examples (3) and (4)).⁶ However, the deictic clitic =o' associated with *le* blocks the presence of the topic clitic =e' and so we have a clear case of a sentence topic that does not bear the topic clitic.

- (15) [Le tiempo k-in w-a'al-ik-ø teeçh]=o', [FOCUS téemprano]
 DM time HAB-ERG.1SG EP-say-IND-ABS.3s 2SG=CL early
 k lik'-il meyaj.
 ERG.1PL raise-IND work
 'At that time I'm telling you (about), we would rise EARLY to work.' (MDG-B:26)

In spite of this limitation, the topic clitic can still be used to identify topics not introduced by the determiner *le* and to distinguish unmarked preverbal transitive subjects (such as the subject of (9)) from true topicalized transitive subjects like the one in (13). Hence I regularly use this clitic as a diagnostic for topicality in what follows.

⁶ In Mayan languages, the focus position to the immediate left of the verb or auxiliary is unique (see Aissen 1992 for details). Hence we can rule out the possibility that the leftmost temporal expression in this example is also a focus.

3. External Topics in Yucatec

In this section I present the data that shows that Yucatec has topics like the external topics of Tzotzil and Jakaltek. Two recent studies on topicalization in Yucatec, Skopeteas and Verhoeven 2009a, and Skopeteas and Verhoeven 2009b, conclude that topics in this language are external according to Aissen's characterization. These works, however, do not discuss the complete number of diagnostics that Aissen gives to identify external topics. Still, I have indeed found in my corpus examples of topicalization that cover the whole range of diagnostics originally proposed by Aissen. I now present the relevant data.

Aissen notes as a first defining characteristic of the external topics of Tzotzil and Jakaltek that they are separated from the sentence that follows by an intonational pause. In similar way, in an instrumental study Avelino (2009) observes that Yucatec topics that bear the topic clitic =*e*' are separated from the rest of the clause by an intonational pause, represented in (17) with a comma. In contrast, in (16) no intonational pause between the preverbal subject and the remainder of the clause is observed (I refer the reader to Avelino's work for the complete pitch tracks and other instrumental evidence of this contrast). This is the first piece of evidence that Yucatec has external topics like those of Tzotzil and Jakaltek.

(16) Le áak-**o'** t-u jaan-t-aj- \emptyset su'uk.
 DM turtle-CL CP-ERG.3 eat-TRNS-PRF-ABS.3SG grass
 'The turtle ate grass.'

(17) Le áak=**e'**, t-u jaan-t-aj- \emptyset su'uk.
 DM turtle=**TOP** CP-ERG.3 eat-TRNS-PRF-ABS.3SG grass
 'The turtle ate grass.'

(Avelino 2009:9)

This evidence, however, is probably not as strong as we would like. This is because the subject NP is introduced by the demonstrative determiner *le*, and so, strictly speaking, it is not possible to tell whether the =*e*' clitic in (17) is truly the topic clitic or instead the homophonous distal clitic D3 discussed in §2.3.⁷ Fortunately, the remaining diagnostics developed by Aissen (1992) to identify external topics provide clearer results in Yucatec.

Secondly, Aissen (1992) points out that external topics can be doubled by a pronominal element, very much in the way that dislocated XPs are in many European languages. This is indeed what is observed in Yucatec. Skopeteas and Verhoeven (2009a) provide the example in (18) as a case in point and further argue that it is evidence that topics in Yucatec are external. In fact these doubled topical XPs need not be lexical in Yucatec. As shown in examples (19) and (20), it is quite common for the doubled sentential topic to be a pronominal element itself. As can be seen in (17) and further examples in this section, external topics are not necessarily doubled by a pronominal element. This is presumably related to the fact that Yucatec, like Tzotzil, is a *pro*-drop language.

⁷ One reason to think that the =*e*' clitic in (17) is in fact the topic clitic is that the presence of the D2 distal clitic =*o*' in (16) does not bring with it an intonational pause like the one observed in (17). It would thus be odd if some of the clitics in the distal clitic paradigm brought with them an intonational pause but others didn't.

- (18) **Le ah koonol-o', leti'** tun y-áalkab.⁸
 DM master seller-CL 3SG DUR.ERG.3 EP-run
 'The vendor, he's running.'
 (Skopeteas & Verhoeven 2009a:165)
- (19) **To'on=e'**, jach u jaajil-e', mina'an-ø **to'on** mix jun p'éel quincena.
 1PL=TOP very ERG.3 truth-TOP NEX-ABS.3SG 1PL not.even one NUMC salary
 'Because us, truly, we don't even have a salary'
 (Lit. 'Because us, truly, not even a salary exists for us.')
- (20) Tumen **leti'=e'** jach way Timul-e' **leti'-e'**.
 because 3SG=TOP very here Timul-CL 3SG-CL
 'Because he, he really is from here from Timul.'

Thirdly, as a result of this property Aissen concludes that external topics are base-generated. She goes on to show that, consequently, it is not surprising that external topics can be extracted from island contexts in Tzotzil. Again, sentence topics can be found in Yucatec that show this behavior. In (21) the topic corresponds to the subject of the relative clause embedded in an NP, as indicated by the underscore.

- (21) Pues **leti'ob=e'**_i [_{NP} le meyaj [_{RC} ____i k-u beet-ik-ø-o'ob]]_i=o'
 since 3PL=TOP DM work HAB-ERG.3 do-IND-ABS.3SG-PL-CL
 ma' u ti'al-o'ob-i'.
 NEG ERG.3 for-PLUR-NEG
 'Because them, the work (they) did was not for their benefit.'

The last diagnostic proposed by Aissen is the possibility of external topics to function as hanging topics. These are understood here to be sentence topics that are not linked, via coreference or binding, to any element in the following sentence (Aissen 1992:70). Once again, there are topics in Yucatec that display this behavior. Two examples are presented below, one of which has a pronoun as a sentence topic, while the other one has a full lexical XP in this function.

- (22) Tuben **leti=e'** [ma' p'il-a'an-ø u y-ich ka' líik'-ij].
 because 3SG=TOP NEG open-PART-ABS.3SG ERG.3 EP-eye COMP raise-ABS.SG.PRF
 'Because he, his eyes were not open when he rose up.'
- (23) Le **Nenela'-o'** [t-u máan u tóok-la'an-t-ø-o'ob u
 DM Nenela-CL DUR-ERG.3 pass ERG.3 burn-ITER-TRNS-ABS.3-PL ERG.3
 y-otoch y-éet wíinik-il-o'ob].
 EP-house EP-fellow man-RL-PLUR
 'As to (the town of) **Nenelá**, they went burning down the houses of their fellow men.'

⁸ The gloss and free translation of this example are my own.

It might be argued that (22) is not the best example of a hanging topic. This is because the topicalized third person pronoun *leti'* can be claimed to be the true lexical possessor of the nominal expression *u yich*, 'his eyes', as in *u yich leti'*, 'his eyes of him'. In this kind of construction, the possessor is a full XP that is cross referenced by the third person ergative proclitic *u*, which functions as an instance of possessor agreement in nominal expressions in Yucatec (as in many other Mayan languages). Consequently, it could be claimed that *leti'* in (22) is not a hanging topic, but rather the possessor NP extracted via movement. Even if this were the case, this claim cannot be extended to (23), though. In this case, the nominal expression *Nenela'* is not linked to any element of the clause that follows it. Observe that Yucatec does actually have the grammatical means of cross-referencing displaced locative XPs via a locative pronominal enclitic *=i'*, which regularly attaches to the main verb of a clause, as in example (11). This clitic, however, is not observed in (23), which points to the conclusion that *Nenela'* in this case is indeed a hanging topic. Further evidence for the existence of hanging topics in Yucatec can also be found in Skopeteas and Verhoeven 2009a.

As such, Yucatec displays topics that show all the diagnostics for external topics. This corroborates the observation by Skopeteas and Verhoeven (2009a,b) that there are topics in Yucatec that are external in nature. However, in the following section I provide evidence that shows that Yucatec also has topics like the internal topics of Tz'utujil.

4. Evidence for Internal Topics in Yucatec

In this section I present the data that shows that Yucatec also has internal topics and, as such, it cannot be grouped with languages that only have external topics. Aissen observes four properties of the internal topics of Tz'utujil that distinguish them from the external topics of Tzotzil and Jakalteq. As I discuss in what follows, there are topics in Yucatec that show three of these four properties, specifically, topicalization of 3rd person pronouns, the possibility of embedded topicalization, and the possibility to have topicalized XPs functioning as continuing topics.⁹ Regarding the first property of internal topics, Yucatec readily allows the topicalization of 3rd person pronouns as illustrated in the examples below.

(24) Pero **leti'**=e' k-u p'áat-al te' jool-o'.
 but 3SG=TOP HAB-ERG.3 stay-IND LOC door-CL
 'But she would stay at the door (of the corral).' (MDG-B:27)

(25) Entonces **leti'**=e' ka t-u k'eb-aj-ø u jool le caja-o'.
 then 3SG=TOP COMP CP-ERG.3 open-PRF-ABS.3SG ERG.3 lid DM box-CL
 'Then he opened the box's lid.' (Sapo-13)

⁹ The fourth property that distinguishes internal from external topics is the absence of an intonational pause between the topic and the clause that follows. However, a full instrumental analysis, which cannot be undertaken here, is required to accurately determine whether or not this intonational pause is absent in the data presented in this section. See also §5 below.

It could be argued that the possibility of having topicalized 3rd person pronouns cannot be taken as conclusive evidence that Yucatec has internal topics, since examples (20), (21) and (22) also show topicalized 3rd person pronouns, but they are instead clear cases of external topics. Granting that this argument might be correct (see §5), Yucatec still shows the other two syntactic diagnostics that characterize the internal topics of Tz'utujil.

First, Yucatec shows embedded topics. This is illustrated in examples (26) and (27), where fronted topics are included in regular brackets and the embedded CP that functions as the complement of the matrix verb is signaled in boldface. This property is expected if topics are allowed to have [Spec, C] as their landing site,¹⁰ but it is unexpected if topics are only allowed to surface in a base-generated position external to the utterance as a whole.

- (26) U ts'o'ok ka in w-a'al-ø teeche-e'¹¹ [**CP** [_{TOP} le tiempo táan
 ERG.3 end COMP ERG.1 EP-say-ABS.3SG 2SG-CL DM time DUR
 u meen-t-ik-ø]=o', [_{TOP} kan taa-k-ø]=e', táan u
 ERG.3 do-TRNS-IND-ABS.3SG=CL when come-IRR-ABS.3SG=TOP DUR ERG.3
 jats'-ik-en].
 beat-IND-ABS.1SG
 'Lastly, I'll tell you that at that time when he used to do it (get intoxicated), when he
 came (back home), he would beat me.' (MDG-B:29)
- (27) J-taal¹² in w-a'al-ik-ø teeche-e' de [**CP** que [_{TOP} le kool]_i=o',
 CP-come ERG.1SG EP-say-IND-ABS.3SG 2SG-CL of that DM cornfield=CL
 ts'o'ok-a'an-ø _____i].
 finish-PART-ABS.3SG
 'I've come to tell you that the cornfield has (now) been done.' (Gigante-89)

The examples above are from oral narratives, but it is also significant that I have found robust and productive use of internal topics in elicitations carried out for the purpose of determining how pronominal reference works in Yucatec. Specifically, when presented with the Spanish equivalent of clauses like (28), where the subject of the embedded complement clause *must* be different from the subject of the matrix clause, speakers systematically produce constructions like (29), where the embedded subject is realized as a topicalized third person pronoun. Observe that examples like (29) provide particularly strong evidence for the existence of internal topics in Yucatec, since they simultaneously show two of the defining properties of internal topics, namely, topicalization of third person pronouns and the possibility of the sentence topic to appear in an embedded context.

¹⁰ Or to adjoin regularly to CP when there is more than one topic, as in (26), where two temporal expressions are topicalized.

¹¹ The clitic =e' in this example and in (27) and (29) is homophonous but different from the topic clitic (see §2.3). Specifically, it seems that this clitic optionally signals the right edge of an intonational phrase, just like the clitic =un in Tzotzil described in Aissen 1992.

¹² In this context, the verb *taal* 'to come' should be inflected with the 1st person singular absolutive suffix /-en/. I take the absence of this suffix to simply be a speech error.

- (28) *The man* said that *she* got lost in the jungle.
- (29) Le nojoch máak=o t-u y-a'al-aj-ø=e' [letí=e' sa'at-ø
 DM big person-CL CP-ERG.3 EP-say-PRF-ABS.3SG=CL 3SG=TOP lose.PASS-ABS.3SG
 ich k'áax].
 in jungle
 'The man said that she got lost in the jungle.'

Secondly, in the examples below I present the evidence that these topics can be continuing topics, which is again a property that corresponds to internal and not to external topics. Aissen notes that external topics correspond to new or shifted topics. Consequently, once that a referent has been established as a topic it is not referred to again using an external topic until the topic shifts. This is not what is observed in Yucatec. Instead topics in Yucatec are like the topics of Tz'utujil in that they do not need to shift or refer to a new topic, but instead they can (and in fact regularly do) refer to a continuing topic over a span of discourse. This can be observed in the two adjacent clauses in the text fragment presented in (30)-(31). The preceding part of the narrative that this text fragment comes from mentions how the narrator and her family were about to go out to the town square for a festival when they suddenly noticed two strangers lurking in the vicinity. The strangers later turned out to be thieves.¹³

- (30) Pero to'on=e' ma' k ojel máax-i'...
 but 1PL=TOP NEG ERG.1PL know who-NEG
 'But we did not know who they were....' (MDG-B:26)
- (31) to'on=e', ka jóok'-o'on, to'on=e' bin-o'on.
 1PL=TOP COMP exit-ABS.1PL 1PL=TOP go-ABS.1PL
 'We, when we walked out (of the house), we just left.' (MDG-B:26)

Summing up, the data presented in this section show that topics in Yucatec display most of the properties that are characteristic of the internal topics of Tz'utujil. As such, it is not accurate to classify Yucatec with Mayan languages that have external topics only, such as Tzotzil and Jakaltek. In the following section, I briefly discuss the implications that this has for the standard distinction made between Mayan languages that have external topics only and those that only have internal topics.

5. Discussion

Having presented evidence that Yucatec has both external and internal topics, it is natural to ask if there is some morphosyntactic cue that systematically distinguishes the two kinds of topics in this language. However, so far I have found no evidence to this effect. For instance, the topic clitic =e' might seem to be a natural candidate for such a morphosyntactic cue. But this clitic

¹³ In (30), *ojel* 'know' is a verboid that does not appear with the aspect particles characteristic of Yucatec clauses (§2.1); see Verhoeven 2007.

does not appear exclusively with either kind of topic. It is found both with external topics (as in examples (17) and (19-22)), and with internal topics (as in examples (24), (25), and (29-31)). Another altogether different cue that might distinguish internal and external topics in Yucatec might be the intonational break that is observed after external topics in general (as in (17)), but not after the internal topics of Tz'utujil (Aissen 1992:73). However, to corroborate this possibility, a complete instrumental analysis is required of the data where internal topics are observed, and such an analysis cannot be undertaken here.

Because of this absence of a systematic cue to distinguish internal and external topics in Yucatec, one might be inclined to analyze every topic in this language as being external, or alternatively, to analyze every topic as internal. A possible analysis of the data presented so far could then be that all topics in Yucatec are external; it would just happen that external topics in Yucatec (in contrast with those of Tzotzil and Jakaltek) show some of the properties that are characteristic of the internal topics of Tz'utujil, such as topicalization of third person pronouns and the possibility to function as continuing topics. However, this analysis is hard to reconcile with the data from embedded topicalization in (26), (27), and (29), where it is clear that the topicalized NPs in these examples are sentence-internal and not sentence external. The other alternative (i.e. an analysis where all the sentence topics of Yucatec are clause internal and hence derived by movement) seems in turn to be readily falsified by the Yucatec data showing hanging topics and extraction of topics from island contexts.

As such, two different analyses of the Yucatec data come to mind. Following Aissen's (1992:73, fn. 30) observation that Tz'utujil appears to have both external and internal topics (see §1), it can be claimed that Yucatec has the two kinds of topics illustrated in (5). If this is the correct analysis, then the relevant crosslinguistic distinction would be between Mayan languages that have both external and internal topics, like Yucatec and Tz'utujil, and Mayan languages that have external topics only, like Tzotzil and Jakaltek. It is worth mentioning that the possibility of a language having both internal and external sentence topics is actually not as odd as it would appear to be from a purely Mayan perspective. Albeit with a number of important differences, evidence can be found in Spanish that some topics are very closely integrated with the clause, whereas others instead seem to be prefixed or adjoined to the clause (see Zubizarreta 1998 and Gutiérrez-Bravo 2005).

There is, however, a different possibility altogether, namely, that topics in Yucatec are insensitive to the external/internal distinction, and so that they are altogether different from both the topics of Tzotzil (and Jakaltek) and those of Tz'utujil. In order to situate this possibility in the bigger picture provided by Aissen's (1992) analysis, it is worth considering its central contributions again. At the heart of Aissen's analysis is the proposal that in Mayan languages topics generated by movement (internal topics) systematically have a landing site, [Spec, C], which is different from the structural position occupied by base-generated topics (external topics), which is external to the clause. Now, as previously observed, topics in Yucatec cannot be analyzed as being exclusively internal or external. Rather, if anything, they would appear to show the properties of *both* external and internal topics. An analysis can thus be developed that derives a third kind of topic by combining two of the structural properties that Aissen proposes to establish the external/internal distinction. Specifically, it can be proposed that the topics of Yucatec are base-generated in the left edge of the clause and not derived via movement (like the

topics of Tzotzil and Jakaltek), but that they are base generated in [Spec, C] (thus occupying the same structural position as the internal topics of Tz'utujil), as in (32).

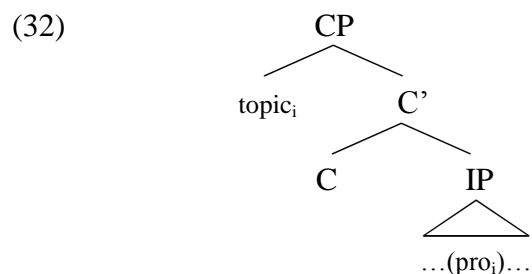

This analysis has a number of advantages. It accounts for the fact that topics in Yucatec can function as hanging topics and that they are insensitive to island contexts, since the topic does not undergo movement at any point. Crucially, this analysis also accounts for the fact that topics in Yucatec are observed in embedded contexts like (26), (27), and (29), where, as just mentioned, it is clear that the topicalized NPs in these examples are sentence-internal and not sentence external. This analysis further makes an interesting prediction. Since this analysis does not make a distinction between external and internal topics, it is expected that we should find topicalized XPs that simultaneously exhibit properties characteristic of external and internal topics, for instance, a hanging topic in an embedded context or a topic extracted from an island that simultaneously functions as a continuing topic.¹⁴ Now recall from §4 that the use of topicalized third person pronouns cannot be used as conclusive evidence for the internal nature of a topic since topicalized third person pronouns are found in Yucatec in contexts that clearly correspond to external topics such as (20), (21) and (22). These are precisely cases where we see a topic simultaneously displaying a property characteristic of external topics and a property characteristic of internal topics, and hence provide evidence in favor of the analysis in (32). This evidence should probably only be considered preliminary at this point, since (in principle, at least) a more thorough corroboration of this analysis requires a larger number of cases of topics simultaneously showing the complete range of properties of external and internal topics. A corpus larger than the one used for this paper is required for this purpose, and hence I leave this issue open for future investigation.

6. Conclusions

In this paper I have provided a description of topicalization in Yucatec Maya following Aissen's (1992) classic analysis of topics and foci in Mayan languages. The data for this description is taken mostly from oral narratives. An inspection of the data corroborates the observation made in Skopeteas and Verhoeven (2009a,b) that topics in Yucatec show properties similar to those of

¹⁴ Moreover, such behavior can be used to empirically distinguish between this proposal and the previous alternative where it is instead claimed that Yucatec has both external and internal topics, each kind with the formal properties originally proposed in Aissen's analysis, since in the previous alternative we do not expect to find a topic simultaneously displaying the properties of external and internal topics. I am thankful to Line Mikkelsen for detailed discussion of these latter issues.

the external topics of Tzotzil and Jakaltek. However, the data also clearly indicates that topics in Yucatec can exhibit the properties of the internal topics of Tz'utujil. I have concluded from these data that topics in Yucatec cannot be characterized as being exclusively external or exclusively internal. I have suggested that there are two ways of understanding this state of affairs. The first one is that Yucatec is a language that has both external and internal topics, a possibility originally suggested by Aissen for Tz'utujil. If this is the correct analysis, the relevant crosslinguistic distinction should be understood as a distinction between Mayan languages that have both internal and external topics (Yucatec and Tz'utujil) and Mayan languages that have only external topics (Tzotzil and Jakaltek). Alternatively, topics in Yucatec can be analyzed as being altogether different from both the topics of Tzotzil/Jakaltek and those of Tz'utujil. Specifically, I have proposed an alternative where topics in Yucatec are base-generated in [Spec, C]. Hence they occupy the same structural position as the internal topics of Tz'utujil, but they are not derived via movement, just like the external topics of Tzotzil and Jakaltek. Further research should clarify which of these two alternatives is correct.

References

- Aissen, Judith. 1992. Topic and focus in Mayan. *Language* 68:43-80.
- Aissen, Judith. 1999. External possessor and logical subject in Tz'utujil. *External possession*, eds. Doris L. Payne and Immanuel Barshi, 167-193. Amsterdam/Philadelphia: John Benjamins.
- Avelino, Heriberto. 2009. Intonational patterns of topic and focus in Yucatec Maya. *New perspectives in Mayan linguistics*, eds. Heriberto Avelino, Jessica Coon and Elisabeth Norcliffe, 1-22. Cambridge, Mass: MIT Working Papers in Linguistics.
- Bohnenmeyer, Jürgen. 2002. *The grammar of time reference in Yucatec Maya*. Munich: Lincom Europa.
- Briceno Chel, Fidencio. 2002. Topicalización, enfoque, énfasis y adelantamiento en el maya yucateco. *La organización social entre los mayas prehispánicos, coloniales y modernos*, eds. V. Tiesler Blos, R. Cobos and M. Greene Robertson, 374-387. Mexico City/Mérida: INAH/UADY.
- Durbin, Marshall, and Fernando Ojeda. 1978. Basic word order in Yucatec Maya. *Papers in Mayan linguistics*, ed. Nora England, 69-77. Columbia: University of Missouri.
- Góngora Pacheco, María Luisa. 1990. *U tzikbalilo'ob Oxkutzcaab yéetel Mani*. Mérida, Yucatán: Maldonado Editores.
- Gutiérrez-Bravo, Rodrigo. 2005. *Structural markedness and syntactic structure: a study of word order and the left-periphery in Mexican Spanish*. New York: Routledge/Taylor and Francis.
- Gutiérrez-Bravo, Rodrigo, and Jorge Monforte. 2008. La alternancia sujeto-inicial/verbo-inicial y la Teoría de Optimidad. *Teoría de Optimidad: Estudios de sintaxis y fonología*, eds. Rodrigo Gutiérrez-Bravo and Esther Herrera Zendejas, 61-99. Mexico City: El Colegio de México.

- Gutiérrez-Bravo, Rodrigo, and Jorge Monforte. 2010. On the nature of word order in Yucatec Maya. *Information structure in indigenous languages of the Americas*, eds. J. Camacho, R. Gutiérrez-Bravo and L. Sánchez, 139-170. Berlin: Mouton de Gruyter.
- Hanks, William. 1990. *Referential practice: Language and lived space among the Maya*. Chicago: The University of Chicago Press.
- Lehmann, Christian. 1998. *Possession in Yucatec Maya*. Munich: Lincom Europa.
- Monforte, Jorge, Lázaro Dzul, and Rodrigo Gutiérrez-Bravo. 2011. *Narraciones mayas*. Mexico City: Instituto Nacional de Lenguas Indígenas.
- Skopeteas, Stavros, and Elisabeth Verhoeven. 2005. Postverbal argument order in Yucatec Maya. *Sprachtypologie und Universalienforschung (STUF)* 58:347-373.
- Skopeteas, Stavros, and Elisabeth Verhoeven. 2009a. Distinctness effects on VOS order: Evidence from Yucatec Maya. In *New perspectives on Mayan linguistics*, eds. Heriberto Avelino, Jessica Coon and Elisabeth Norcliffe, 157-174. Cambridge, Mass.: MIT Working Papers in Linguistics.
- Skopeteas, Stavros, and Elisabeth Verhoeven. 2009b. The interaction between topicalization and structural constraints: Evidence from Yucatec Maya. *The Linguistic Review* 26:239-259.
- Verhoeven, Elisabeth. 2007. *Experiential constructions in Yucatec Maya*. Amsterdam/Philadelphia: John Benjamins.
- Zubizarreta, María Luisa. 1998. *Prosody, focus and word order*. Cambridge, Mass.: MIT Press.

AUXILIARIES AND NEGATION IN ENGLISH*

Jorge Hankamer
University of California at Santa Cruz
hank@ucsc.edu

This paper explores the structure of infinitival clauses in English. It is generally assumed that *to* in infinitival clauses is of category T; but this assumption leads to a problem when we consider the position of *not* in infinitival clauses, and in particular the usual order of Subject - not - to - VP observed there. A fairly long chain of inference leads to the conclusion that *to* in infinitival clauses is indeed a T, but the *not* in negated infinitival clauses is an adjunct.

1. Introduction

Since Pollock 1989, it has been generally accepted within transformational-generative frameworks that the order Subject-Auxiliary-Negative-Verb ... in finite negative clauses such as (1) is the result of movement of an auxiliary verb to the position of T:¹

(1) Harvey has not washed his pig.

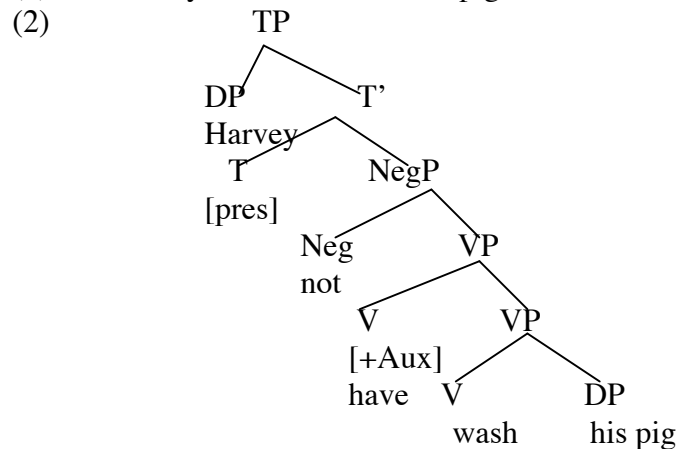

One could question whether Neg is a head on the clausal spine, as shown in (2), or an adjunct to VP. I will deal with this below, in section 2.2.

The Auxiliary verbs (Auxes) can be defined as those verbs that can move to T in this way. These will of course, along with perfect *have*, include the main verb (copula) *be*, as well as its two cousins, the progressive *be* and the passive *be*:

(3) I am not a pig.

* I would like to thank Sandy Chung and Eric Potsdam for comments on an earlier draft.

¹ I am using the expression "move to T" loosely. In fact, since the information in T is not lost as a result of this movement, it is probably best to assume that the V *adjoins* to T.

- (4) Harvey was not washing his pig.
 (5) The pig was not washed by Harvey.

Thus we can adopt the feature [+Aux] as picking out the class of verbs that can undergo this movement.²

There is not, however, general agreement about a number of details. Among these are whether the Modals are Ts or Vs that (like other Auxes) move to T; whether *not* in a sentence like (1) is an adjunct or a head; and most prominently, what the story is about Auxiliaries, *to*, and Negation in nonfinite clauses:

- (6) For Harvey not to have finished his ice cream, the noise in the street must have been really loud.

A common assumption is that *to* is a T, as are the Modals—this would explain why *to* never cooccurs with a modal in its own clause. But if this is correct, the T *to* and the Neg *not* seem to be in the opposite order from what is assumed for finite clauses.

The goal of this paper is to unravel this conundrum, and that will require a complete and explicit analysis of the behavior of Auxiliary verbs, *to*, and *not*, both in finite and nonfinite contexts.

2. Auxiliaries and Negation in the Finite Clause

This section will establish a few background assumptions about the nature of Auxiliaries and Negation in finite clauses.

2.1. Auxiliaries

As noted in the introduction, Auxiliaries are just Verbs that have the [+Aux] property, i.e. the property that they can move to finite T. In a given clause, only one Aux undergoes this movement, and it is always the highest one in the stack of verbs. For V->T movement to occur, the T must be occupied by [+/-past] (i.e. must not contain a Modal or any other Aux). It seems that the highest Aux in a clause *must* undergo this movement, if it can:

- (7) *Harvey not has washed his pig.
 (8) *Harvey does not have washed his pig.

A sentence like (7) is ungrammatical because, as we shall see below, the presence of the *not* prevents the realization of Tense on the Verb *have*, and (8) is what we would expect if *do*-support could apply to save the day. This obligatoriness of the movement of an Aux to T when possible, together with the fact that an Aux is happy to stay put when movement to T is impossible, may pose a difficulty for a feature-driven theory of movement, for it cannot be any

² What is a [+Aux] verb varies from dialect to dialect: in British English, at least in some dialects, the main verbs *have* and *need* are [+Aux].

need on the part of the Aux that drives it to move; and on the other hand there is an alternative way for T to get expressed via do-support. I will not worry about that, and simply say that an Aux has to move to T if it can.

Since Auxes are the only verbs that can move to T, and only T undergoes T->C movement, it is no surprise that Auxes are the only Verbs that appear before the Subject in Yes-No Questions. The fact that Auxes are the only Verbs that undergo contraction with *not* can presumably also be linked to the fact that they are the only Verbs that can move past *not* to the T position, if we assume that Contraction is really an adjunction of *not* to a preceding T.

Auxes also seem to be the only Verbs that license VP Ellipsis, and this property cannot be reduced to movement:

- (9) He ate it, but he shouldn't have.
 (10) The bowl was empty, though we didn't expect it to be.

So it remains a mystery why the property of being able to move to T should correlate with the property of licensing VP ellipsis. That is a puzzle I would dearly like to see figured out.

2.2. Clausal Negation in Finite Clauses

There are two reasons to treat the clausal negation morpheme *not* in finite clauses as a head in the clausal spine (as indicated in (2)), rather than as an adjunct to VP.

First, if it were an adjunct, we would have no explanation for why it blocks realization of finite Tense on a non-Auxiliary verb:

- (11) *Harvey not kissed the gorilla.
 (12) Harvey almost kissed the gorilla.
 (13) Harvey never kissed the gorilla.

As we see in (12) and (13), adverbs adjoined to VP do not block the realization of Tense on the V, but *not* does. If we assume that *not* heads a projection in the clausal spine, and that the realization of Tense on a non-Auxiliary V is the result of postsyntactic Lowering (or an equivalent morphological process), we can say that Lowering is blocked by an intervening head but not by an intervening adjunct.

Second, as argued in Potsdam 1997, *not* can license VP Ellipsis:

- (14) They suggested that I should kiss the gorilla, but I would rather not.
 (15) You could bring your gorilla into the house, but I would prefer that you not.³

Adverbs cannot perform this licensing function:

- (16) *You usually don't bring your gorilla into the house, but I would prefer that you always.

³ Example (15), based on an observation by Baltin (1993) (see also Potsdam 1997), is particularly interesting, because in such a subjunctive clause there is no other potential licenser at all.

(17) *I sometimes have to kiss the gorilla, but I would rather never.

It seems likely that VP Ellipsis is subject to a licensing condition (Lobeck 1995, Potsdam 1997, Merchant 2005) requiring the elided VP to be the complement of a licensing head.⁴ A VP-modifying adjunct would not count as such a licenser. So my analysis will assume that clausal-negation *not* is the head of a NegP (or SigmaP⁵) situated between T and V.

This analysis entails that an Aux can move past an intervening Neg head to get to T, and consequently that the Head Movement Constraint of Travis (1984) cannot be correct. I assume a kind of *typed* HMC, where a head cannot move past a head of the *type* it needs to move to. For Vs, the type is T, or perhaps more generally a family including T and v, Voice, Aspect, ... (but not Sigma or Neg). Thus the reason only the highest [+Aux] Verb moves to T is that no other is close enough.

2.3. What are the Modals?

A standard assumption is that Modals are Ts, which would account for their position above Neg. There is another possibility, which is that the Modals are [+Aux] Verbs, which originate below Neg but above all the other Auxes. Being the highest [+Aux] V in the clausal structure, a Modal would always move to T.

In finite clauses these two hypotheses would appear to be equivalent syntactically. As we shall see in section 3, the question of what Modals are interacts with the question of what *to* is, and with what happens in participial clauses, so this issue will be considered there.

2.4. Dummy *do*

I will assume that the three forms of *do* (*do*, *did*, *does*) that appear to surface as Auxiliaries are in fact spellouts of finite T when T is prevented by some process or configuration from being realized as the form of a Verb that is its sister or the head of its sister's complement.

Nearly every conceivable hypothesis about the origin of the dummy *do* has been explored and espoused somewhere. I adopt an analysis that links the appearance of dummy *do* to the isolation (by any process or configuration) of T from its normal spellout site, which is on a V that T locally governs.⁶

In a normal case, either an Auxiliary V will have raised to T or not. If one has, the configuration is as in (18):

⁴ I do not subscribe to the notion that *every* kind of ellipsis requires a licensing head. Gapping, for example, manifestly does not.

⁵ Since it doesn't seem to matter for English, I will remain agnostic about whether the phrase headed by 'not' is a NegP or a more general SigmaP, which might also be headed by a positive polarity morpheme, as occurs in some languages, such as Spanish. For convenience, I will henceforth call this projection NegP.

⁶ This is the essential insight of the old "*do* support" analyses, but they usually did not include all the cases and did not really work.

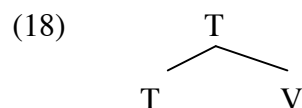

and T is spelled out as a suffix on V or as a form of V.

If no Auxiliary was there to raise, the configuration is as in (19):

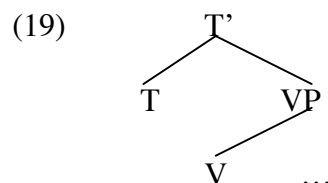

In both cases, T c-commands V and there is no other head that c-commands V. This is what I will call local government.

The dummy *do* appears in all circumstances where T fails to locally govern V at surface structure (or wherever you want to call it when the syntax proper is finished). This happens in five circumstances:

(a) When an overt Neg intervenes, and there is no [+Aux] V moving to T:

(20) She did not answer the question.

(b) When T moves to C by T->C Movement:

(21) Does your mother wear combat boots?

(c) When the VP is elided, and there is no Aux:

(22) She does.

(d) When the VP is preposed:

(23) We thought she would put on the combat boots, and put on the combat boots she did.

(e) When the clause is emphatically affirmed. This case needs some discussion, because it has not generally been understood. Emphatic affirmation of a clause, in the general case, involves contrastive stress on whatever is in T:

(24) Harvey CAN tame gorillas.

(25) Harvey HAS tamed gorillas.

(26) Harvey IS taming gorillas.

When there is no Aux or Modal, emphatic affirmation cannot be expressed by stressing the V:

(27) Harvey TAMED gorillas.

Sentence (27) is grammatical, but is not an emphatic affirmation of (28):

(28) Harvey tamed gorillas.

Rather, (27) contrasts the verb *tamed* with something else Harvey might have done with gorillas. The emphatic affirmation of (28) is (29):

(29) Harvey DID tame gorillas.

I propose to treat emphatic affirmation as a requirement that stress fall on T, and this is incompatible with T being realized as a suffix on or a form of the main V. Thus a stressed T must be realized as a T, just as a moved or stranded one is.⁷

Within the framework of Distributed Morphology (Halle and Marantz 1993), a straightforward way to implement this is to assume that when T locally governs a V and is not required to be stressed, it will be realized as a suffix on or a form of the host V; otherwise it must be spelled out as the appropriate form of *do*. A simple way to do this is to simply say that the forms *do*, *did*, and *does* are spellouts of T, and the most unspecified ones, so that they will arise exactly when no more specifically determined spellout is available (which, of course, will be exactly when T is isolated from a host V).⁸

2.5. Summary

I have assumed a clausal skeleton like (30):

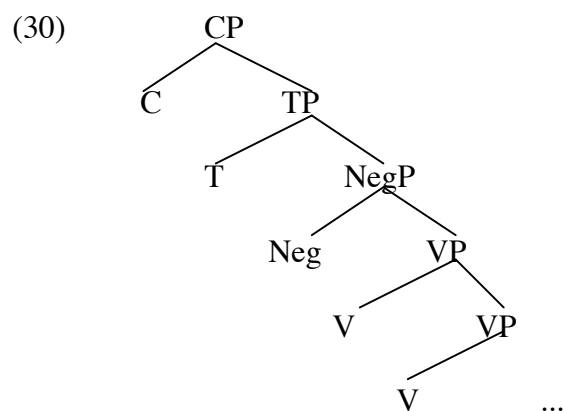

⁷ An alternative would be to assume that in emphatic affirmation there is a positive Sigma head between T and V.

⁸ It would also be possible to assume, as Embick and Noyer (2001) do, that *do* is inserted as a V, which then interacts with Tense in the usual way. The assumption that these forms of *do* are merely expressions of finite T, however, seems more straightforward.

And the following are the central assumptions about lexical categories:

- T can take either NegP or VP as a complement (in Grimshaw (2005)'s terms, NegP and TP are extended projections of V). Neg takes VP as a complement.
- [+Aux] Vs move to T across the intervening head Neg (because it is the wrong type for Vs to move to). I assume, of course, that they *adjoin* to T, preserving the information in each node.
- Modals are either Ts, or they are Vs that (like other [+Aux] Vs) move to T.
- Dummy *do* is a spellout of T when it is stranded (cannot be realized as an affix on or a form of a V).

3. Nonfinite Clauses

Nonfinite clauses in English come in at least two kinds: infinitival clauses (with *to*) and participial clauses (with *-ing*).⁹ I will focus on infinitival ones, but the participial ones have many of the same properties.

A striking property of nonfinite clauses is that they never contain Modals:

- (31) *For Harvey to would leave might be nice.
 (32) *Harvey's woulding leave surprised everyone.

It is this property that provides the best reason for assuming that the Modals are of the category T. First, if infinitival clauses are TPs, the most obvious candidate for the head T is *to*. This *to* could be selected by the C (*for*, when overt) of the containing CP. If we then in addition assume that the Modals are of category T, the fact that they never appear in infinitival clauses would follow straightforwardly.

Participial clauses also never contain Modals, though they do contain other Auxiliaries:¹⁰

- (33) Harvey's having already washed the car saved us some time.
 (34) The car's already having been washed saved us some time.
 (35) The car's being impounded by the police was rather inconvenient.

⁹ The term 'clause' is being used loosely here, to denote a syntactic object that more or less corresponds to a proposition. In fact, following Abney 1987, I will assume that participial constructions are neither CPs nor TPs, but rather just DPs, so perhaps they should not be called clauses at all. Nevertheless, I will continue to call them clauses, for convenience.

¹⁰ As noted by Ross (1972), there is something bad about a sequence of two Verbs in the *-ing* form in a row:

- (i) *Harvey's being talking was not surprising.
 (ii) Harvey's having been talking for that long was not surprising.

If we adopt (a version of) the Abney (1987) analysis¹¹ of these clauses, as in (36), the explanation for the absence of Modals is that there is no T:

(36)

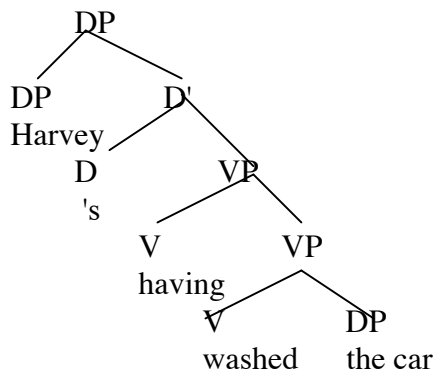

Note that the "subject" of a participial clause is in the specifier of D.

This, then, I take to be the standard view:

- Modals are Ts
- *to* is a T
- *to* is selected by C[*for*]
- There is no T at all in participial clauses.

4. Negation in Nonfinite Clauses

4.1. A Puzzle

A difficulty arises, however, when we consider the syntax of (apparently) clausal negation in nonfinite clauses:

(37) Harvey prefers not to be in the limelight.

(38) For Harvey not to have eaten the ice cream, the noises must have been very loud.

If *to* is a T, the order of *to* and *not* is not as expected.¹² What can account for this?

¹¹ Abney assumed that the *-ing* suffix heads a NP projection, but that seems to do no useful work. See LaCara 2010.

¹² The order "to not" is in general possible, but that seems to be constituent negation of the VP, and in any case is not the preferred order when clausal negation is intended.

I will consider and reject several possibilities. First, let us dismiss a movement of T downward to a position below Neg. That would be downward movement, to a putative lower head position for which there is no motivation. Similarly, let us dismiss a movement of Neg to a position above T. The only virtue of such a movement would be that it is not downward. This movement could not be to C, since the C *for* can be overt (as can the subject intervening):

(39) For Harvey not to have eaten the ice cream ...

and there is no motivation for a Head position for *not* to move to, existing just in infinitival clauses.¹³

Less easy to dismiss is the possibility that the hierarchical order of Neg and T is reversed in infinitival clauses (T above Neg in finite clauses, T below Neg in infinitival clauses); yet I think we can dismiss it. The main reason is that it is hard to see how these different orders could be insured. The usual assumption is that a head selects the category of its complement and sometimes the head of its complement. So it would be no surprise if finite T could select Neg and nonfinite T could not; and also no surprise if Neg could select nonfinite T but not finite T. But then what would prevent a structure like (40), corresponding to a sentence like (41)? (I assume do-support would come into play, since the finite T would have no V to get realized on.)

(40)

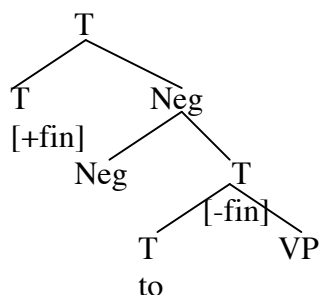

(41) *Harvey does not to swim.

Or, with a Modal in the upper T:

(42) *Harvey will not to swim.

There does not seem to be any way¹⁴ to assure the order Neg-T in nonfinite clauses that does not rely on inventing two different Negs, with no other distinguishing property than that one

¹³ The movements considered and rejected in the text are syntactic Head movements. One might wonder whether, within the framework of Distributed Morphology (Halle and Marantz 1993) the order of *to* and *not* might not result from a postsyntactic lowering or local dislocation. I believe those possibilities can be rejected too, after a couple of things have been established. See section 4.2.

sits above nonfinite T (and never below finite T) and the other the opposite. So I think we can dismiss this possibility too.

4.2. The Nature of *to* and *not* in Infinitival Clauses

In this subsection I will argue that '*to*' is a head in the clausal spine; but also that if *to* is a head in the clausal spine, *not* in infinitival constructions cannot be.

There are two very good reasons to assume *to* is a head. First, it appears to be selected by the *C for*. This indicates that it is either the head of a complement or a dissociated morpheme. That it is not a dissociated morpheme is clearly demonstrated by the second fact, which is that it licenses VP Ellipsis:

(43) They invited me to kiss the gorilla, but I didn't want to.

So it seems fairly safe to assume that *to* is the head of a projection in the clausal spine.

But if it is, then *not* cannot be a head in the spine above *to*. If it were, neither the *C for* nor any other head above Neg could select *to*. Note also that the two reasons for assuming that *not* in finite clauses is a head in the spine are absent here. Those were (a) in finite clauses, *not* blocks realization of finite Tense on the V below it; and (b) *not* in finite clauses licenses VP Ellipsis.

Situation (a) does not hold, because there is no finite Tense to be realized; if we consider the licensing of VPE in nonfinite clauses, it looks like *not* does not license VPE here:¹⁵

(44) *How can you ask me to wash the dishes, and then ask me not?

(45) *I asked Harvey to wash the car, but I expected him to not.

Compare (46), where the licenser is clearly *to*:

(46) I asked Harvey to wash the car, but I expected him not to.

¹⁴ A reviewer suggested that perhaps T *can* select across a Neg head, citing the fact that Modals in T require the Verb below Neg to be in the base form:

(i) Kim will not laugh/*laughs/*laughing/*laughed.

I do not regard the base form here as involving selection, however. Rather, the base form is a default that appears when nothing else is selected.

¹⁵ Pullum (1982:201-202) noticed that VP Ellipsis is not licensed after *not* when it is preceded by a nonfinite Auxiliary:

(i) *By three o'clock I will have finished but you will have not. [Pullum's (30a)]

He observes also that VP Ellipsis is similarly not licensed after *not* when it is preceded by infinitival *to*:

(ii) *You usually pay a lot of attention to what McCoy says, but you ought to not. [Pullum's (31)]

Both of these facts follow automatically if the *not* in these cases is constituent negation, and constituent negation is adjoined. In fact, constituent negation never licenses VP Ellipsis.

It is here that we can see that a postsyntactic lowering or local dislocation of *to* to the other side of *not* is implausible. VP Ellipsis is clearly licensed in the syntax, even before such syntactic operations as T->C movement:

(47) You won't sell that gorilla, will you?

So we must explore the possibility that *not* in infinitival clauses is an adjunct.

4.3. Adjunct to What?

Now we have to determine what *not* adjoins to in infinitival clauses. The first conclusion will be that it cannot be adjoined to a TP headed by *to*.

Consider the structure (49) of the clause (48), assuming that *to* is a T:

(48) for Harvey to have eaten the ice cream

(49)

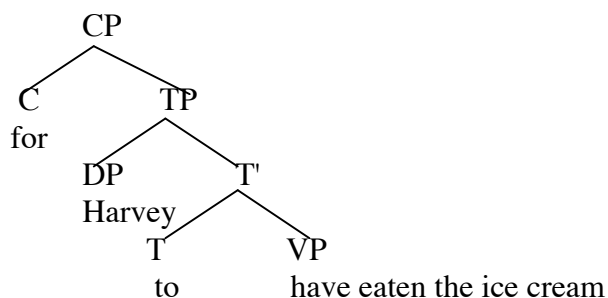

The sentence we are interested in is (50):

(50) For Harvey not to have eaten the ice cream, the noises must have been very loud.¹⁶

Where could *not* be adjoined in such a structure? It is clear that it could not be adjoined to TP, for then the order of the subject and *not* would not be as observed. It cannot be adjoined to the VP complement of *to*, because then the order of the subject and *to* would not be as observed. If structure (49) is in fact correct, the only place *not* could be adjoined is to the T'. This would be impossible if we believe, as I did once, that there is no adjunction to intermediate bar-level constituents.

Another possibility, of course, is that *not* here is an adjunct to some higher functional projection above the *to* phrase (in which case I would assume it to be a silent nonfinite T, and *to*

¹⁶ I am carefully choosing an example where it should be clear that the DP between *for* and *not* is the subject of the embedded clause. For even more certainty, we could choose an example with a dummy subject there:

(i) For there not to have been any objections, the proposal must have been exquisitely worded.

something else). Eric Potsdam (p.c.) has pointed out to me, however, that there are apparent cases of adjunction of adverbs to T' in finite clauses:

- (51) He probably will deny everything.
 (52) He sometimes has broken promises.

Here the adverb, like the *not* in (50), is located between the subject and something that is generally assumed to be in T. This pattern is replicated in infinitival clauses, when the adverb is in the prescribed pre-*to* position:

- (53) For Harvey suddenly to disappear ...

So rather than invent otherwise unmotivated higher projections for these elements to adjoin to, I will assume that adverbs can in general adjoin to X' constituents (at least to T'). In (50), I assume the *not* is similarly adjoined to the T' headed by *to*.

4.4. What is *to*?

The head *to*, then, is a T. Pullum (1982) argued that *to* is a V, in which case the structure would presumably be as in (54):

(54)

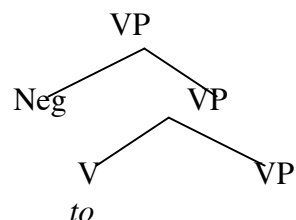

There is a problem with this, though, and it shows up in finite clauses. Recall that there the structure is as in (55):

(55)

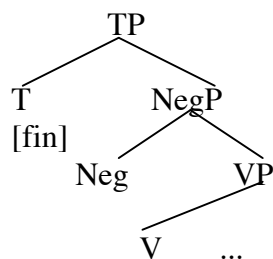

Here Neg is a head that intervenes between finite T and VP. Selectionally, this did not pose a difficulty because finite T does not appear to impose any constraints on the head of the VP below it, permitting any V that can appear there. But if *to* is a V, it should then be able to appear in finite clauses below Neg, as in (56):

(56) *Harvey will not to go.

As we saw earlier, this does not work. For this reason, I think we must reject the possibility that *to* in infinitival clauses is a V. It is, as is generally assumed, a T.¹⁷

4.5 Now What is the Structure?

We have concluded that *to* is a head in the clausal spine; that *not* in infinitival clauses is an adjunct; that *to* is a T; and that *not* is adjoined to the T' headed by *to*:¹⁸

(57)

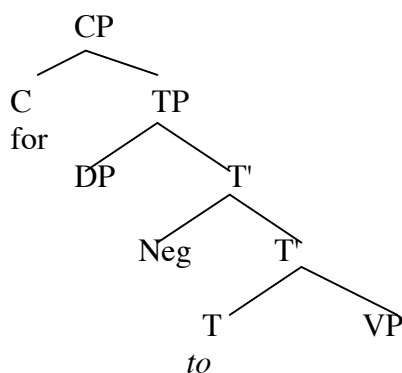

And the subject sits, as indicated, in the specifier of the TP headed by *to*. *C for* selects *to* as the head of its complement.

¹⁷ A fact to be noted about *to* is that if it is a T, it is a T that cannot be emphatically affirmed:

(i) *We expected her TO eat the apple.

In fact there seems to be no way to emphatically affirm a nonfinite clause, while any finite clause can be emphatically affirmed, whether embedded or not. This may indicate that emphatic affirmation is associated with a Sigma projection, and that nonfinite Ts do not select for a Sigma projection. Note that subjunctives, which do permit a Sigma (Neg) projection, also permit emphatic affirmation:

(ii) We request that you not eat the eggplant.

(iii) We request that you DO eat the eggplant.

Thanks to Eric Potsdam (p.c.) for opening up this line of thought.

¹⁸ I assume, as should be obvious, that Neg here is both maximal and minimal, i.e. it is a head that does not itself project. This is not the place for it, but I assume the same thing for all adverbs.

Here is a summary of the conclusions of this section:

- *to* is a T.
- *not* in nonfinite clauses is adjoined to *to*'s T' (i.e. syntactically a kind of constituent negation).
- Modals are still (finite) T. They don't cooccur with *to* because both are instances of T. They don't occur in participial clauses because there is no T there.

5. Conclusion

First a summary of the argument:

In section 2 of this paper, I gave reasons to assume that Neg in finite clauses is a head in the clausal spine.

In section 4, I showed that assuming the same status for Neg in infinitival clauses leads to apparently insurmountable difficulties, since there does not appear to be any way to insure the observed order of C - Subject - Neg -to - VP under that assumption. I argued then that since *to* clearly is a head, *not* must be an adjunct, and that it is adjoined to the T' headed by *to*. The subject, then, sits in the specifier of the *to* phrase.

The chain of argument is long, and long chains of arguments are vulnerable to attacks on the weak links. Thus I invite anybody who does not like this analysis to try to break any of the links, and see where that leads. This problem is interesting precisely because it is so hard.

As I see it, here are the crucial turns where I have relied on a theoretical assumption which one might choose to abandon, and thus reach a different conclusion:

- I have assumed that VP Ellipsis must be licensed by a head.
- I have assumed that a head can select the head of its complement, but selection cannot reach past an intervening head.
- I have assumed that there is adjunction to intermediate bar-level constituents, at least to T'.
- I rejected the possibility that there are two Neg heads, differing only in that one exists only below finite T and the other only above nonfinite T.

This is the hardest paper that I ever wrote, and I happily dedicate it to Judith, who never shied away from hard problems.

References

- Abney, Steven. 1987. The English noun phrase in its sentential aspect. Doctoral dissertation, MIT.
- Baltin, Mark. 1993. Negation and clause structure. Ms., New York University, New York.
- Embick, David and Rolf Noyer. 2001. Movement operations after syntax. *Linguistic Inquiry* 32:555-595.
- Grimshaw, Jane. 2000. Locality and extended projection. *Lexical specification and insertion*, eds. Peter Coopmans, Martin Everaert, Jane Grimshaw. Amsterdam: John Benjamins.
- Halle, Morris and Alec Marantz. 1993. Distributed morphology and the pieces of inflection. *The view from Building 20: Essays in linguistics in honor of Sylvain Bromberger*, eds. Kenneth Hale and Samuel Jay Keyser, 111-176. Cambridge, MA. MIT Press.
- LaCara, Nicholas. 2010. Verbal ellipsis in the nominal domain. UCSC MA Paper, Santa Cruz.
- Lobeck, Anne. 1995. *Ellipsis: functional heads, licensing, and identification*. Oxford University Press.
- Merchant, Jason. 2005. Fragments and ellipsis. *Linguistics and Philosophy* 27:661-738.
- Pollock, Jean-Yves. 1989. Verb-movement, universal grammar, and the structure of IP. *Linguistic Inquiry* 20:365-424.
- Potsdam, Eric. 1997. NegP and subjunctive complements in English. *Linguistic Inquiry* 28: 533-541.
- Pullum, Geoffrey. 1982. Syncategorematicity and English infinitival to. *Glossa* 16:181-215.
- Ross, John Robert. 1972. Doubl-ing. *Linguistic Inquiry* 3:61-86.
- Travis, Lisa. 1984. Parameters and effects of word order variation. Doctoral dissertation, MIT.

CLITICS AND AFFIXES IN BATSBI*

Alice C. Harris
University of Massachusetts Amherst
acharris@linguist.umass.edu

Batsbi agreement markers are evaluated here on the Zwicky-Pullum criteria for distinguishing clitics from affixes, together with five additional criteria, and it is argued that they are affixes with one or two properties otherwise characteristic of clitics.

In recent work, a number of scholars have argued that the category “clitic” is not clearly distinguishable from affixes, on the one hand, and from function words, on the other. Some have argued that the “clitics” of (certain) Romance languages are not actually clitics, but affixes (see Culbertson 2010 for a recent summary). Everett (1996) argues against the notion “clitic” in general, and within the framework of Canonical Typology, Spencer and Luís (to appear) point out that, cross-linguistically, clitics often have affix-like properties and vice versa.

In Batsbi, an endangered language of the Nakh-Daghestanian family, there are problems with the characterization of a set of person-number-case agreement markers. Are these suffixes or enclitics? The set of markers at issue seems to have developed relatively recently, certainly since the split of Batsbi (also known as Bats or Tsova-Tush) with its closest relatives, Chechen and Ingush. I argue here that while these markers in Batsbi demonstrate one or two exceptional characteristics, it is clear that they are suffixes. Thus, the Batsbi data do not support abandoning the category “clitic”. In fact, with the one or two exceptions mentioned, affixes and clitics in Batsbi are clearly differentiated.

In section 1 below, I describe the system of person-number-case agreement markers in Batsbi, and in section 2, I apply a variety of criteria to identify these as affixes or clitics. I show in section 3 how Batsbi affixes are systematically distinguished from clitics, and in section 4 I summarize the paper.

1. The System of Person-Number-Case Agreement in Batsbi

Batsbi inherited gender-number agreement, and this remains productive in the language and has interesting properties of its own (Harris 2008, 2009). In the present paper, however, I discuss

* The research reported here was supported in part by the National Science Foundation under grants BCS 0215523 and BCS 0745522. I am grateful to the NSF and to my main consultant on Batsbi, Naira Tsiskarishvili.

instead an innovative pattern of suffixal person-number-case agreement.

As discussed by Holisky and Gagua (1994), both transitive and intransitive verbs in Batsbi agree with their subjects or objects in person and number (see also Holisky 1994:144). The independent pronouns and agreement suffixes are shown in (1).

(1)	Absolutive		Ergative	
	Independent form	Agreement form	Independent form	Agreement form
1SG	so	-s ^w	as	-(a)s
2SG	ho	-h ^w	aħ	-(a)(ħ)
1EX	txo	-tx ^w	atx	-(a)tx
2PL	šu	-š ^w	eš	-eš, -iš

The ergative independent pronoun and agreement suffixes differ systematically from the absolutive forms in having an initial *a-* and in lacking the final *-o* of the absolutive forms of the independent pronoun or its reduced form, *-^w*, found in the corresponding agreement suffixes (see Holisky and Gagua 1994:153). Some of the tense-aspect-mood categories of Batsbi are marked with vocalic suffixes, and these immediately precede the agreement suffixes; when this *a-* follows other vowels, it is lost.

Direct objects may condition agreement, but this is not illustrated in this section. When it is subject or object, the first person inclusive pronoun, *vai/ve*, is not suffixed but remains a separate word, often an enclitic (see Holisky and Gagua 1994:177-178); an example is given in (2e) below. Subjects and objects in the third person do not condition person-number-case agreement in the verb.

(2) illustrates agreement with a subject in the ergative (which is often omitted).

- (2) a. meq dah=kek'-y-i-n-as¹
 bread(y/y).ABS PV=cut-CM-TR-AOR-1SG.ERG
 'I sliced the bread.'

¹The following abbreviations are used in glossing: ABS absolutive, AOR aorist, CM class (gender-number) marker, CON contact case, DAT dative, ERG ergative, EX/EXCL exclusive, F feminine, GEN genitive, IMPF imperfect, INCL inclusive, INTR intransitive, M masculine, NEG negative, PL plural, PRES present, PV preverb, Q question, SG singular, TR transitive. In examples, gender-class markers required by a noun are listed in parentheses following the noun gloss, with the singular marker before a slash, and the plural after. An equal sign (=) marks clitics. "Dict" abbreviates Kadzgiže and Kadzgiže 1984. Throughout, /y/ is a glide; other symbols have their IPA values. Lip-rounding in Batsbi is traditionally written as <ö> or <ü>, depending on its source, but here it is written as <^w>. Examples not otherwise attributed are from the author's fieldwork.

- (6) (so) tas-y-al-i-s^w
1SG.ABS fell-CM-INTR-PRES-1SG.ABS
'I fall down (by accident).'
- (7) (as) q'iul ye†-n-as
1SG.ERG lose.weight-AOR-1SG.ERG
'I lost weight' (e.g. I went on a diet).
- (8) (so) q'iul ya†-e-s^w
1SG.ABS lose.weight-PRES-1SG.ABS
'I lose weight' (e.g. I've been sick).

The person-number-case suffixes interact with gender-number prefixes as shown in (9), using the masculine gender (*v/b*) and the feminine gender (*y/d*). ('Go' is an intransitive verb that takes only ergative subjects in the first and second persons.)

- | | | |
|--------|--|--|
| (9) a. | y-uit'-as
F.SG-go-1SG.ERG
'I (female) am going' | v-uit'-as
M.SG-go-1SG.ERG
'I (male) am going' |
| b. | y-uit'-a(h)
F.SG-go-2SG.ERG
'you (female) are going' | v-uit'-a(h)
M.SG-go-2SG.ERG
'you (male) are going' |
| c. | y-uit'
F.SG-go
'she is going' | v-uit'
M.SG-go
'he is going' |
| d. | d-uit'-atx
F.PL-go-1.EX.ERG
'we (females) are going' | b-uit'-atx
M.PL-go-1EX.ERG
'we (males) are going' |
| e. | d-uit'-eš
F.PL-go-2PL.ERG
'y'all (females) are going' | b-uit'-eš
M.PL-go-2PL.ERG
'y'all (males) are going' |
| f. | d-uit'
F.PL-go
'they (females) are going' | b-uit'
M.PL-go
'they (males) are going' |

The status of the gender-number marking is not at issue, but it provides a more complete view of agreement in the language.

I have written the person-number-case agreement markers as suffixes, but they do have one or

two characteristics of clitics, as shown in the next section.

2. Suffix or Enclitic?

Zwicky and Pullum (1983) provide now-classic tests to distinguish affixes from clitics, and most of these can be applied to Batsbi.²

- A. Clitics can exhibit a low degree of selection with respect to their hosts, while affixes exhibit a high degree of selection with respect to their stems.
- B. Arbitrary gaps in the set of combinations are more characteristic of affixed words than of clitic groups.
- C. Morphophonological idiosyncrasies are more characteristic of affixed words than of clitic groups.
- D. Semantic idiosyncrasies are more characteristic of affixed words than of clitic groups.
- E. Syntactic rules can affect affixed words, but cannot affect clitic groups.
- F. Clitics can attach to material already containing clitics, but affixes cannot.

(Zwicky and Pullum 1983:503-504)

Ergative and absolutive agreement markers³ in (1) do not have identical characteristics, so I consider them separately below. Both sets of markers occur exclusively with verbs (never with nouns or adjectives, for example), so with respect to criterion A they behave like affixes. As illustrated above in (2), first person inclusive does not agree, though other first and second persons do. This is surely an arbitrary gap and is thus, according to criterion B, characteristic of affixes, not clitics.

Regarding criterion C, we find unpredictable variation in the form of the second person plural form of both absolutive and ergative agreement markers. For example, (10a) gives the more regular first person exclusive absolutive form for comparison, and (10b) the second person plural.

- (10) a. *datx^w* ‘we (FEMALE, EXCL) are’
 b. *deš^w* ‘y’all (FEMALE) are’

The verb root here is *-a-*. Lip-rounding in the second person plural derives from the final vowel **u*, while in other person-number combinations it derives from **o*, and that may cause the difference

²After this paper had been completed, I remembered a presentation by Kojima in 2008. Not only do our approach and analysis differ, the facts we found are not identical. This may be because he worked exclusively with texts and happened not to find certain constructions. It would be more interesting if our differences are due to the age of our consultants, as I expect. While I do not have time to do justice to his paper here, I look forward to addressing his findings in detail at some time in the future.

³ I use this description as a neutral term, implying neither affix nor clitic. I do so on the basis of arguments in Harris 2002 that clitics, too, can mark agreement.

in the value of the root vowel. Notice, however, that the effect is different in the imperfect, where the person-number-case marker is immediately preceded by the imperfect marker *-ra*.

- (11) a. *daratx^w* ‘we (EXCL) were’
 b. *daris^w* ‘y’all were’

This may be an example of a morphophonological idiosyncrasy, thus tentatively indicating status as an affix.

I am not aware of any instances where the meaning of the verb stem and agreement marker is not predictable from the sum of its parts. However, the criterion as stated is only that such idiosyncrasies “are more characteristic of affixed words than of clitic groups”, which seems to be intended as an indication of affixhood if it is positive, while giving no indication one way or the other if it is negative. Further, in most languages we can expect the meaning of a verb and an affixed agreement marker to be predictable from the meanings of the parts. On this basis, I believe we can discount this criterion in this instance.

The kinds of movement rules that can test criterion E do not occur in Batsbi; conjoining and gapping treat verbs and their agreement markers as single words, not as clitic groups. For example, in conjoining, neither the absolutive marker, in (12), nor the ergative marker, in (13), can be omitted.

- (12) a. *so bader d-ik’-oš y-a-s^w sk’ol-i*
 I.ABSL child(d/d).ABSL CM-take-ABSL CM-be-1SG.ABS school(y/y)-in
 y-ot’u-š y-a-s^w
 CM-go-ABSL CM-be-1SG.ABS
 ‘I am taking the child and am going to the school.’
 b. **so bader d-ik’-oš y-a-s^w, sk’ol-i*
 I.ABSL child(d/d).ABSL CM-take-ABSL CM-be-1SG.ABS school(y/y)-in
 y-ot’u-š y-a
 CM-go-ABSL CM-be
- (13) a. *as qor dargo-b-o-s ye bubk’-i*
 I.ERG apple(b/d).ABS plant-CM-PRES-1SG.ERG and flower(d/d)-PL.ABS
 lañ-d-o-s
 pick-CM-PRES-1SG.ERG
 ‘I will plant an apple [tree] and pick flowers.’

- b. *as qor dargo-b-o-s ye bubk'-i
 I.ERG apple(b/d).ABS plant-CM-PRES-1SG.ERG and flower(d/d)-PL.ABS
 laħ-d-o/laħd^w
 pick-CM-PRES

The (b) examples are marked as ungrammatical for the intended meaning; they are grammatical if interpreted with a third person subject in the second clause.

In gapped sentences the verb, together with the agreement marker, is omitted.

- (14) a. manana-s qor-i laħ-d-i-eⁿ, as k'i msxal⁴
 Manana-ERG apple(b/d)-PL.ABS pick-CM-TR-AOR I.ERG though pear(b/d).ABS
 laħ-d-i-n-as.
 pick-CM-TR-AOR-1SG.ERG
 'Manana picked apples, [and] I picked pears.'
- b. manana-s qor-i laħ-d-i-eⁿ, as k'i msxal
 Manana-ERG apple(b/d)-PL.ABS pick-CM-TR-AOR I.ERG though pear(b/d).ABS
 'Manana picked apples, [and] I pears.'
- (15) ħo meli-ex qerʔ-i-ħ, so k'i bʃarc'-ax.
 you.ABS fox(d/d)-PL.CON fear-PRES-2SG.ABS I.ABS though wolf(b/y)-PL.CON
 'You fear foxes, [and] I wolves.'

In (14b), the form *laħdinas* 'I picked', is gapped, including the marker of the first person singular ergative. Example (15) contains an intransitive verb with an argument in the so-called contact case. Here the form *qerʔ-i-š^w* 'I fear' is gapped, including the marker of the first person singular absolutive. The syntax treats both verbs as single words with affixes, not as clitic groups.

While the previous criteria indicate on the whole that both types of markers are affixes, not clitics, the final criterion apparently contradicts this. Clitics may generally occur further from the verb stem than affixes or other clitics but not closer than affixes. In Batsbi there are at least two enclitics that can interact with person-number-case makers—=*i*, the yes-no question marker, and =(y)e 'and'. I consider the latter to be a clitic because it can alternatively occur as an independent word, although this is not one of Zwicky and Pullum's criteria. (16) shows this as a clitic following person markers.

⁴ Most nouns denoting fruit and vegetable produce have no plurals, but 'apples' is an exception.

- (16) y-ik'-eⁿ-s=e y-it-eⁿ-s.
 CM-take-AOR-1SG.ABS=AND CM-leave-AOR-1SG.ABS
 'S/he took me and left me.'

However, (16) is irrelevant to our question, since a clitic can follow either a clitic or an affix.

I consider the question marker, =i, to be a clitic because it fits criterion A; it may occur on the verb or on other constituents. Examples (17-19) illustrate the question particle enclitic to a verb, a noun, and the negation marker, respectively.

- (17) y-ot'w=i kalik?
 CM-go=Q city
 'Is she going to the city?'
- (18) kalik=i y-uit'-a(h)?
 city=Q CM-go-2SG.ERG
 'Are you going to the city? Is it the city you're going to?'
- (19) kalik cw=i w-uit'-a(h)?
 city not=Q CM-go-2SG.ERG
 'Aren't you going to the city?'

When =i occurs with agreement markers, it occurs closer to the root than they, a sure sign that they must be clitics, not affixes.⁵

- (20) a. y-ik'-o-s
 CM-take-PRES-1SG.ERG
 'I take her'
- b. y-ik'-w-iy-as?
 CM-take-PRES-Q-1SG.ERG
 'Do I take her?'

⁵ There is some indication that it is the question clitic that behaves in a strange way here, not the agreement markers. For example, we find forms such as (i), where the question clitic seems to be inside the imperfect suffix, -ra.

(i) let'-r<=i>a-s=hoⁿ?
 help-IMP<Q>-1SG.ABS=you.DAT
 'was I helping you?'

Since behavior of =i has not been studied adequately, I will not pursue this here.

- (21) a. qir[†]-r-eš
fear-IMPF-2PL.ABS
'You are afraid.'
- b. qir[†]-r-i-eš
fear-IMPF-Q-2PL.ABS
'Are you afraid?'

In (20b), the first person singular ergative agreement marker follows the question clitic; in (21b) the second person singular absolutive marker does so. Thus, criterion F seems to indicate that both sets of agreement markers are clitics.

In addition to Zwicky and Pullum's six criteria, clitics are often said to attach to phrases, while affixes attach to words (e.g. Klavans 1985:117-118). An example of this is the well-known clitic-like property of certain Turkish affixes that permits them to occur on only a single conjunct, often referred to as "suspended affixation". Batsbi agreement markers do not show suspended affixation and in this respect behave like affixes, not like clitics.

- (22) a. qor dargo-b-in-**atx** ye bubk'-i laḥ-d-in-**atx**.
apple(b/d).ABS plant-CM-AOR-1EX.ERG and flower(d/d)-PL pick-CM-AOR-1EX.ERG
'We planted an apple [tree] and picked flowers.'
- b. *qor dargo-b-in ye bubk'-i laḥ-d-in-**atx**.
- c. *qor dargo-b-in-**atx** ye bubk'-i laḥ-d-in.

In (22a), both verbs have the first person plural exclusive ergative marker. In (22b) the marker is omitted from the first verb, and in (22c) from the second, and both sentences are ungrammatical in the intended meaning. Examples (23) show the same facts with absolutive agreement.

- (23) a. kalik y-ik'-eⁿ-s=e osi y-it-eⁿ-s^w
city CM-take-AOR-1SG.ABS=and there CM-leave-AOR-1SG.ABS
'He/she/they took me to Tbilisi and left me there'
- b. *kalik y-ik'-eⁿ=e osi y-it-eⁿ-s^w
- c. *kalik y-ik'-eⁿ-s=e osi y-it-eⁿ

Thus, Batsbi agreement markers behave like word-level affixes, not like phrase-level clitics.

Two phonological criteria also arise in Batsbi. These are discussed with reference to the agreement markers in Harris 2009:283-284. First, final vowel reduction applies in polysyllabic words; reduction of [u] and [o] shows up as rounding of the preceding consonant, while reduction

of [i] and [e] shows up as palatalization. In each case, the vowel can optionally be completely lost.⁶ This tests our markers in two ways. First, the set of (monosyllabic) independent pronouns in the absolutive all end in a back vowel, and the agreement markers all have a reduced vowel, as shown in (1), (4), (6), (8), (10), (11), etc. This indicates that the latter are parts of a polysyllabic word, not independent words.

Second, the fact that word-final vowels are reduced predicts that if the agreement markers were clitics, the vowels immediately preceding them, being word-final on this assumption, would reduce. This occurs with the clitic *=(y)e* in (16), but it does not occur with agreement markers, as shown in (24) and (25).

- (24) a. *y-aγ-o-s*
 CM-come-PRES-1SG.ERG
 ‘I (F) come’
- b. *y-aγ-o-ḥ*
 CM-come-PRES-2SG.ERG
 ‘you (F) come’
- c. *y-aγ-^w*
 CM-come-PRES
 ‘she comes’
- (25) a. *mil-y-o-s^w*
 be.cold-CM-PRES-1SG.ABS
 ‘I (F) am cold’
- b. *mil-y-o-ḥ*
 be.cold-CM-PRES-2SG.ABS
 ‘you (F) are cold’
- c. *mil-o-y*
 be.cold-PRES-CM

Example (24c) shows clearly that the *-o* that marks present tense can reduce. Examples (24a,b) show that this reduction does not occur when *-o* is followed by one of the ergative agreement markers; (24a,b) show the same for absolutive agreement markers. (In (25c) the final *-o* does not reduce but metathesizes with the preceding CM, *-y*; this process is regular but occurs only with certain morphemes, including CMs.) The fact that present-tense *-o* does not reduce when it immediately precedes agreement markers, as in (24a,b) and (25a,b) shows that *-o* is not word-final,

⁶ In practice word-final [i] and [e] are completely lost today. The vowel [a] is sometimes said to be an exception to this rule, but word-final [a] is lost in some contexts.

and hence that the agreement markers are parts of the words.

The second phonological test that can be applied to our agreement markers is word-final reduction of [n]. Word-final [n] is realized as nasalization of the preceding vowel. This reduction is apparently productive in paradigms such as the following.

- (26) a. **v-ex-n-as**
 /v-ax-en-as/
 CM-go-AOR-1SG.ERG
 ‘I (M) went’
- b. **v-ex-n-a(h)**
 /v-ax-en-ah/
 CM-go-AOR-2SG.ERG
 ‘you (M) went’
- c. **v-ax-eⁿ**
 /v-ax-en/
 CM-go-AOR
 ‘he went’

The underlying form of the aorist marker is *-en* (or *-in* with some other lexemes); the [e] undergoes syncope when followed by a CVC sequence⁷ (here *nVC*), including the *-a(h)* second person singular marker which itself may be reduced. In (26c), where the aorist marker is not followed by a person marker, the final [n] is reduced, realized as nasalization of the preceding vowel. (The vowel of the root, *-ax-* is changed as a result of syncope.) Although in native words [n] is generally reduced only in word-final position, it is optionally reduced before absolutive agreement markers, as shown in (27), but not before ergative ones, as in (26) above.

- (27) a. **mil-iy-eⁿ-s^w**
 be.cold-CM-AOR-1SG.ABS
 ‘I (F) was cold’
- b. **mil-iy-eⁿ-h^w**
 be.cold-CM-AOR-2SG.ABS
 ‘you (F) were cold’
- c. **mil-iy-eⁿ**
 be.cold-CM-AOR
 ‘she was cold’

⁷There are additional constraints on syncope, but they have not yet been studied thoroughly enough to state them precisely.

This process seems to suggest that the absolutive agreement markers are clitics, while the ergative ones are affixes.

In general, affixes are more integrated into the phonology of the word than are clitics. This is a point reiterated in Spencer and Luís 2009, having been made many times before. Our agreement markers condition various changes in the root, as can be seen by comparing first person forms, which have agreement markers, with third person forms, which never have person-number-case markers.

- (28) a. qir[†]-ra-s
 /qer[†]-i-ra-so/
 fear-PRES-IMPF-1SG.ABS
 ‘I feared it’
- b. qer[†]-i-r
 /qer[†]-i-ra/
 fear-PRES-IMPF.3
 ‘s/he feared it’

Generally, in the Batsbi verb, syncope occurs when a vowel is followed by CVC. In (28a) the quality of the root vowel is affected by the omitted *-i* PRES. In (28b) word-final *a* is omitted, but omission of this vowel does not affect the quality of any preceding vowel (Mikelaže 1977). The point here is that the consonant of the absolutive agreement marker in (28a) provides part of the context in which syncope of *-i* occurs in the imperfect. A similar effect for ergative agreement markers is found with the verb ‘went’ in (26) above. This is an affix-like property, and both ergative and absolutive markers show it.

The criteria considered above and their results are summarized in Table 1. “Affix” means that the results of application of this test suggest that the marker is an affix, and *mutatis mutandis* for “clitic”. Parentheses indicate a tentative conclusion. Empty cells indicate that the criterion is not indicative for Batsbi.

	Ergative person-number-case suffix	Absolute person-number-case suffix
Criterion A (degree of selection of hosts)	Affix	Affix
Criterion B (arbitrary gaps in combinations)	Affix	Affix
Criterion C (morphophonological idiosyncrasies)	(Affix)	(Affix)
Criterion D (semantic idiosyncrasies)		
Criterion E (syntactic rules)	Affix	Affix
Criterion F (placement of clitics)	Clitic	Clitic
Phrase level attachment (“suspended affixation”)	Affix	Affix
V reduction applied to agreement marker	Affix	Affix
V reduction applied to stem	Affix	Affix
<i>n</i> reduction	Affix	Clitic
Integration into phonology of the word	Affix	Affix

Table 1. Summary of results of tests for affix-/cliticness.

My interpretation of these mixed results is as follows. First, criterion D is really only the lack of any evidence to the contrary. As discussed in section 2, I believe we can discount this criterion in this instance.

With regard to criterion F, the occurrence of the question clitic, =*i*, between the root and the agreement markers is a potentially indicative criterion. However, in Harris 2002 I showed that there can be exceptions to this criterion; in Udi clitics can and do occur inside words and even inside morphemes. This evidence has been accepted both by specialists in Udi (Schulze (2002)) and by morphologists (e.g. Anderson (2005)). In the same vein, I believe that we can conclude that Batsbi agreement markers are affixes, as is consistent with most of their properties. This entails either (a) that the clitic =*i* has the affixal property of occurring inside words under certain circumstances (like Udi clitics), or (b) that the agreement affixes have the clitic-like property of occurring after the question clitic, or (c) both.

Application of *n*-reduction in environments immediately preceding absolute agreement markers is also a genuine concern, especially since it is inconsistent with the other phonological criterion, which applies in two ways. At the very least *n*-reduction establishes that the ergative agreement markers behave differently (in this one respect) from absolute agreement markers.

There are two possible interpretations of this. First, it is possible that *n*-reduction is no longer productive, and that absolutive agreement, clearly a recent phenomenon, took place after *n*-reduction became unproductive. Mikelaže (2008:123) shows that in borrowed words, *n* is lost not only word-finally, but also word-medially. It would appear to be difficult for learners to acquire the *n*-reduction rule, since some forms are systematic exceptions. For example, while the genitive case usually ends in [Vⁿ], the dative usually ends in [Vn]. Holisky and Gagua (1994) give the following examples.

- (29) a. čaiⁿ ‘bear (GEN)’
 b. čain ‘bear (DAT)’

The dative is said to be “protected” by a vowel that is reduced, but this may be difficult to learn, since the reduced vowel is never apparent. However, the various allomorphs of the aorist marker may be too complex for a speaker to keep track of if *n*-reduction is not a productive phonological rule. Our alternative is to conclude that absolutive agreement markers are, on the whole affixes, but that they have one clitic-like phonological property, not “counting” for *n*-agreement, and one clitic-like morphosyntactic property, discussed in the preceding paragraph. I tentatively conclude that this second alternative is the correct analysis.

3. Distinguishing Agreement Markers from True Clitic Pronouns

In addition to the considerations above, the agreement markers listed in (1) should be considered affixes because they are consistently distinct from real clitic pronouns in Batsbi in five respects:

- (i) Agreement is obligatory, while cliticization of pronouns is optional.
- (ii) Agreement may cooccur with an independent pronoun realizing the same argument, while clitics are the sole realizations of their arguments.
- (iii) Clitics may cooccur with person-number-case agreement markers, but person-number-case agreement markers themselves cannot cooccur with other markers of the same type.
- (iv) Agreement markers differ in form from the corresponding pronouns, while clitics retain the full form of non-cliticized independent pronouns.
- (v) Word-final vowel reduction does not apply before agreement markers but does apply before clitics.

These language-specific differences are discussed in greater detail below.

First and second person dative and locative pronouns often cliticize, and direct objects in these

persons also may cliticize when the verb does not agree with them. The first person plural inclusive often cliticizes. Apart from the inclusive, subject pronouns do not cliticize.

(i) Agreement is obligatory, while cliticization of pronouns is optional. Person-number-case agreement is obligatory under the following conditions: (a) If the direct object is third person or if there is no direct object (the verb is intransitive), first and second person subject pronouns condition agreement. (b) If the subject is third person, first and second person direct objects condition agreement. (c) If both subject and direct object are first or second person, either may condition agreement.⁸ The third person never conditions agreement, nor does the first person inclusive. Dative experiencers and indirect objects do not condition agreement. Older sources on Batsbi say that agreement is optional, and this was probably true of an earlier generation of speakers, possibly even of the oldest speakers today. But younger speakers (the youngest reliable speakers of Batsbi were born before 1965) consider agreement obligatory. Obligatoriness of agreement is illustrated in (30), and optionality of cliticization in (31).

- (30) a. so y-a-s^w alisa
 I.ABS CM-be Alice
 ‘I am Alice.’
 b. *so y-a alisa
 I.ABS CM-be Alice
 ‘I am Alice.’
- (31) a. aḥ y-ik’-o-s^w
 you.ABS CM-take-PRES-1SG.ABS
 ‘You will take me.’ [In answer to ‘Who will take you?’]
 b. aḥ y-ik’-o-s=so.
 you.ABS CM-take-PRES-1SG.ABS=1SG.ABS
 ‘You will take me.’ [In answer to ‘Who will take you?’]

Example (30b) is ungrammatical because it has no agreement with a first person subject pronoun. In (31a) the direct object, with which the verb does not agree, has cliticized. The verb cannot show person-number-case agreement with both the subject and the object in a single form.

(ii) Agreement may cooccur with an independent pronoun realizing the same argument, while clitics are the sole realizations of their arguments. (31b) is an example of cooccurrence, as is (30a); (14a) illustrates this for a pronoun in the ergative case. Examples in (32) show that this is impossible for true clitics.

⁸ The conditions under which one or the other triggers agreement have not yet been studied adequately.

- (32) a. ven c'eril d-aʔ-it-ieⁿ
 us.INCL.DAT letter(d/d).ABS CM-come-CAUS-AOR
 'She/he/they sent a letter to us (INCL).'
- b. c'eril d-aʔ-it-ieⁿ =ven
 letter.ABS CM-come-CAUS-AOR=us.INCL.DAT
 'She/he/they sent a letter to us (INCL).'
- c. *ven c'eril d-aʔ-it-ieⁿ =ven
 us.INCL.DAT letter(d/d).ABS CM-come-CAUS-AOR=us.INCL.DAT

It is possible for the inclusive pronoun to be an independent word, as in (32a), or a clitic, as in (32b); but it is not possible for it to occur in both positions, as in (32c).

Not only is this a way in which real clitic pronouns in Batsbi differ from our agreement markers, viewing the agreement markers as clitics would introduce problems for the syntax, since both independent pronouns and clitic pronouns are viewed by many as heads in the syntax. A single argument should not be represented by more than one head.

(iii) Clitics may cooccur with person-number-case agreement markers, but person-number-case agreement markers themselves cannot cooccur with other markers of the same type. In (33), the clitic =*so* 'me' occurs with the agreement marker -*h* '2nd person singular ergative', and in (34), the clitic =*šu* 'y'all' cooccurs with -(*a*)*tx* '1st person plural exclusive ergative'. These sentences show that clitics can occur with agreement markers.

- (33) (ah) ix-it-o-(h)=so
 you.ERG enter-CAUS-PRES-2SG.ERG=me.ABS
 'You let me in.'
- (34) ix-it-o-tx=šu
 enter-CAUS-PRES-1EX.ERG=y'all.ABS
 'We let y'all in.'
- (35) ix-it-o-s^w
 enter-CAUS-PRES-1SG.ABS
 'She/he/it/they let me in.'
- (36) *ix-it-o-h-s^w
 enter-CAUS-PRES-2SG.ERG-1SG.ABS
 'You let me in.'

(35) shows that direct objects can condition agreement, and (36) shows that such agreement cannot cooccur with subject agreement. Thus, clitics and agreement markers differ in this behavior.

Speakers may occasionally use a coreferential clitic after the verb form, as in this example.

- (37) aħ y-ik'-o-s^w / aħ y-ik'-o-s=so.
 you.ERG CM-take-PRES-1SG.ABS you.ERG CM-take-PRES-1SG.ABS=I.ABS
 'You take me.'

The second example shows the optional presence of an enclitic pronoun. If the *-s* were also a clitic, we would have repetition of the same clitic, which seems unlikely and is not otherwise possible in Batsbi. Although examples like (37) occur only rarely, they bolster the case that agreement markers are affixes, not clitics.

(iv) Agreement markers differ in form from the corresponding pronouns, as shown in (1), while clitics retain the full form of non-cliticized independent pronouns, though they are uniformly unstressed.

- (38) d-ax-d-i-eⁿ=ve
 CM-bring-CM-TR-AOR=INCL
 'he/she/they brought us (INCL)'

Word-final vowels in polysyllabic words undergo reduction or loss, but the *e* in *ve* is not reduced, showing that it is a distinct phonological word. It is particularly noticeable that the absolutive clitic pronoun in (37) above occurs with an unreduced vowel, while the corresponding agreement marker in the same example must undergo vowel reduction.

(v) Word-final vowel reduction does not apply before agreement markers but does apply before clitics. (39) illustrates the present tense marker that occurs with this verb.

- (39) te†-o-s (Dict 277b)
 give-PRES-1SG.ERG
 'I give it'
- (40) manana-s nan-en bubk'-i te†-^w.
 Manana-ERG mother-DAT flower-PL.ABS give-PRES
 'Manana gives flowers to mother.'
- (41) manana-s bubk'-i te†=soⁿ
 Manana-ERG flower-PL give=me.DAT
 'Manana gives flowers to me.'

The *-o* PRES is reduced in word-final position, as in (40), where the third person subject does not

condition agreement. The present tense marker is likewise reduced (and even disappears) when followed by the clitic ‘to me’, as in (41).

In this section I have examined five ways in which true pronominal clitics in Batsbi differ from the ergative and absolutive agreement markers shown in (1). The clitic pronouns include direct objects (in the absolutive), indirect objects and experiencers (both in the dative), first person plural inclusive pronouns in any grammatical relation or case, and sometimes arguments expressed in other oblique cases. The fact that agreement markers consistently differ from clitic pronouns in these five respects confirms the view tentatively formed in the preceding section, that agreement markers are affixes with one (in the case of ergative agreement) or two (in the case of absolutive agreement) clitic-like behaviors. This conclusion supports the view that there is a difference between clitics and affixes, but that there may be exceptions to some criteria for distinguishing them. Overall these are affixes; the clitic-like behavior is the exception.

References

- Anderson, Stephen R. 2005. *Aspects of the theory of clitics*. Oxford: Oxford University Press.
- Culbertson, Jennifer. 2010. Convergent evidence for categorial change in French: From subject clitic to agreement marker. *Language* 86:85-132.
- Everett, Daniel L. 1996. *Why there are no clitics: An alternative perspective on pronominal allomorphy*. Arlington, TX: Summer Institute of Linguistics.
- Harris, Alice C. 2002. *Endoclititics and the origins of Udi morphosyntax*. Oxford: Oxford University Press.
- Harris, Alice C. 2008. Explaining exuberant agreement. *Linguistic theory and grammatical change: The Rosendal papers*, ed. Thorhallur Eythorsson, 265-283. Amsterdam: Benjamins.
- Harris, Alice C. 2009. Exuberant exponence in Batsbi. *Natural Language and Linguistic Theory* 27:267-303.
- Holisky, Dee Ann. 1984. Anomalies in the use of the ergative case in Tsova-Tush (Batsbi). *Papers from the Third Conference on the Non-Slavic Languages of the USSR (Folia Slavica 7.1 & 7.2)*, ed. Howard I. Aronson, 181-194. Columbus, OH: Slavica.
- Holisky, Dee Ann. 1987. The case of the intransitive subject in Tsova-Tush (Batsbi). *Lingua* 71:103-132.
- Holisky, Dee Ann. 1994. Notes on auxiliary verbs in Tsova-Tush (Batsbi). *Non-Slavic languages of the USSR: Papers from the Fourth Conference*, ed. Howard I. Aronson, 143-159. Columbus, OH: Slavica.

- Holisky, Dee Ann and Rusudan Gagua. 1994. Tsova-Tush (Batsbi). *The indigenous languages of the Caucasus, 4: North East Caucasian, Part 2*, ed. Riëks Smeets, 147-212. Delmar, N.Y.: Caravan Press.
- Kadagiᶑe, Davit, and Nik'o Kadagiᶑe. 1984. *C'ova-tušur-kartul-rusuli leksik'oni* [Tsova-Tush-Georgian-Russian dictionary]. Tbilisi: Mecniereba.
- Klavans, Judith L. 1985. The independence of syntax and phonology in cliticization. *Language* 61:95-120.
- Kojima, Yasuhiro. 2008. Person agreement and cliticization of personal pronouns in Batsbi. Presented at Workshop, "Morphological Variation and Change in Languages of the Caucasus", 13th International Morphology Meeting, Vienna.
- Mikelaᶑe, Maq'vala. 1977. Xmovanta redukcia bacbur enaši [Reduction of vowels in the Batsbi language]. *Macne*, 1977, 3, 118-127.
- Mikelaᶑe, Maq'vala. 2008. *Int'erperent'uli p'rocesebi c'ovatušur enaši, I nac'ili: leksik'a da ponologia* [Interference processes in the Tsova-Tush language: Part I: Lexicon and phonology]. Tbilisi: Iak'ob Gogebašvilis Saxelobis Telavis Saxelmc'ipo Universit'et'i.
- Schulze, Wolfgang. 2004. Review article: Alice C. Harris *Endoclitics and the origins of Udi morphosyntax*, Oxford. *Studies in Language* 28:419-441.
- Spencer, Andrew and Ana Luí. To appear. The canonical clitic. *Canonical morphology and syntax*, ed. Dunstan Brown, Marina S. Chumakina and Greville G. Corbett. Oxford: Oxford University Press.
- Zwicky, Arnold M. and Geoffrey K. Pullum. 1983. Cliticization vs. inflection: English *n't*. *Language* 59:502-513.

NOUNS, VERBS, AND CONSTITUENTS IN AN EMERGING 'TZOTZIL' SIGN LANGUAGE

John B. Haviland
UCSD
jhaviland@ucsd.edu

Zinacantec Family Homesign (ZFHS) is a new sign language developed in a single household in highland Chiapas, Mexico, where the deaf signers are surrounded by speakers of Tzotzil (Mayan). Such a new language challenges easy assignment of such foundational linguistic elements as 'part-of-speech' categories and concomitant analysis of clause structure, especially syntactic expression of verbs and their arguments.

1. Introduction

Judith Aissen, in "Topic and Focus in Mayan" (Aissen 1992), made one of her characteristic contributions simultaneously to syntactic theory, to linguistic typology, and to Mayan linguistics. Much less significantly—except to me—she also contributed to my own understanding of the mutually informing relationships between formal syntax and the facts of Tzotzil, a language (I had thought) I knew well. In this case, perhaps her first published excursion into one particular syntactic paradigm of the many she has used to good effect, she demonstrated how certain formal representations, here involving phrase structure and intonation, could elucidate facts of clause structure, its layering, and the resulting "positions" in linear order in several languages, including Tzotzil.

One advantage of working seriously with different theoretical paradigms for syntax, as Aissen has done throughout her career, is that it allows one to experiment with competing choices of taken-for-granted theoretical elements: linguistic primitives, grammatical relations, and axioms of analysis. That the basic concepts of a grammatical paradigm both define and are in turn defined by the resulting descriptive constructs illustrates both the troubling circularity (and seeming ethnocentrism) of linguistic theory and the potential strength of playing off alternate theoretical models against each other in the context of empirical observations about people's language use. There is a similar advantage to Aissen's varied choice of field languages and her career-long attention to the "exotic" languages of Mesoamerica as foils for linguistic theorizing. It thus seemed to me appropriate in honoring Judith's retirement, and thanking her for a small part of what I have learned from her, to try to test some of these same choices of primitives, relations, axioms, and theories. How better to do so than to try to apply them to an entirely *new* language?

2. ZFHS

For the past couple of years I have been studying what I have called Zinacantec Family Homesign (ZFHS), a manual sign-language emerging in a single extended family of Zinacantec

Indians from Chiapas, Mexico, whose hearing members are Tzotzil speakers.¹ In 1976 a daughter, Jane, was born to my ritual kinsmen Mario and Rose, who already had three older living daughters. Jane never began to speak, although she was sent to school for part of a year, after which she remained at home, as in fact many other Zinacantec girls her age did. Six years later another brother, Frank, was born, and he, too, failed to begin to speak. Both children were labeled *uma?* ‘dumb’—a word which in Tzotzil has the same unfortunate polysemy as its English gloss—and raised more or less exclusively by their mother and older siblings. In 1986 another daughter, Terry, was born, and although she also remained silent until she was well over two years old, she suddenly began to speak Tzotzil, as though the silence of her two nearest siblings had until then left her unmotivated to talk. It was only at this point that medical diagnosis revealed to the family what perhaps should have been obvious: that both Jane and Frank were profoundly deaf. Finally, in 1988—when his older deaf sister was already twelve years old—a youngest sibling, Will, was born, also deaf (although for a short period a Chiapas doctor prescribed for him a hearing aid which he soon abandoned). What thus presumably began as a typical “homesign” system developed for mutual communication by Jane and the rest of her hearing family was over the span of a decade extended to a medium of communication for the three, and then, four siblings who used it as their only means of interaction, with each other and to a lesser extent with the other hearing members of the family. Added to this mix, five years later, was a niece—Rita—who, although hearing, grew up largely in the company of her signing aunts and uncles and thus became fluent in their emerging sign language.

I have known all of these children—now young adults—since they were born. Their unique linguistic circumstances have cried out for systematic investigation, despite the children’s reluctance to sign in public and their general abashedness about the stigma of their deafness. As it happens, Mario, the father, was also a major collaborator in my ongoing research on Tzotzil ritual language and co-speech gesture, as well as an old friend. When in 2008 the work on ABSL by my UCSD colleague Carol Padden and her associates (see for example Sandler, Meir, Padden, and Aronoff 2005; Meir, Padden, Aronoff, and Sandler 2007) inspired me to undertake research on ZFHS, Mario and his children readily agreed. By then Jane had her own (hearing) son, Victor, now a 3-year-old bilingual signer and Tzotzil speaker, who is the beginning (and perhaps also the end) of the second generation of this miniature ZFHS speech community.² (See the genealogical chart in Figure 1.)

¹ The research has been sponsored by NSF award BCS-0935407, administered by the Center for Research on Language (CRL) at UCSD. My principal debts are to the ZFHS signers themselves, acknowledged here by their pseudonyms: Jane, Frank, and Will, as well Terry, Rita, and Victor.

² Despite claims by Fox Tree (2009) that conventionalized emblematic hand gestures are widely shared in communities of speakers of Mayan languages in Guatemala and Chiapas and are also reported in the sign-languages of deaf communities in the region, this tiny group of ZFHS speakers has had no contact with any such outside communities, nor indeed with any other deaf people, except, perhaps, as mediated by commonalities in co-speech gesture in the region. ZFHS must therefore be considered to be essentially their own creation.

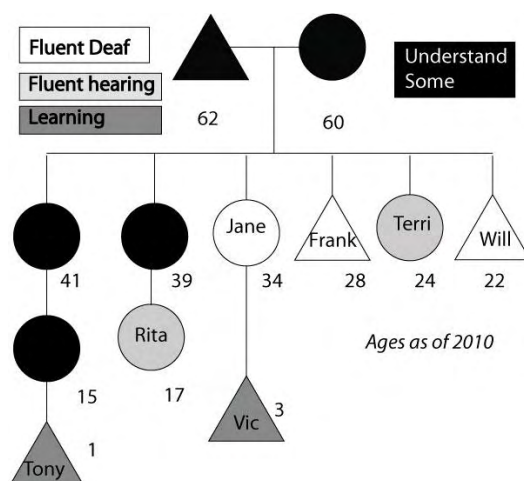

Fig. 1. Genealogy of the extended household where ZFHS is spoken.

3. The problem: constituency and argument structure

Largely because of my initial ignorance about sign-language, but partly as a result of a methodological decision to try to approach ZFHS as much as possible on its own terms, I have tried to focus on specific formal properties of ZFHS with as few preconceptions about manual linguistic modalities as I could manage. My initial thought, in trying to apply Aissen's work on Tzotzil clause structure to ZFHS, was to compare linear constituent order in the two languages, both as a theoretical matter, and because if any spoken language can be imagined to have influenced ZFHS it is Tzotzil, since the hearing signers in the tiny ZFHS speech community are Tzotzil speakers. In this paper my concern is a much more basic question: can one even distinguish, on formal linguistic grounds, nominal from verbal constituents in ZFHS, and if so what consistent ordering of constituents can be observed?

Simple reflection (as well as a vast literature in sign language linguistics, summarized neatly in Napoli and Sutton-Spence 2010) shows that manual sign languages have a potential for non-linearity interestingly different from that of spoken language alone. Thus, although various sorts of gestural, prosodic, and rhythmic phenomena put the lie to them, standard representations of speech are largely linear, whatever further "underlying" hierarchical structure we may attribute to two dimensional strings of putative "segments." In sign languages, where multiple simultaneous articulators may be involved—minimally, in ZFHS at least, the body itself, and its parts, especially the two hands and other limbs, as well as facial expression and gaze—representations (and more importantly the communicative resources from which they derive) necessarily involve higher orders of dimensionality. The question of the "linear order"—i.e., unfolding in time—of signed "constituents" is thus complicated from the start by the presence of multiple articulators and the ubiquity of simultaneous predication.

Nonetheless, discrete, apparently segmentable units do unfold sequentially in ZFHS, and insofar as grammatical properties can be ascribed to such segments it is possible to describe their raw linear ordering. In this brief, first consideration of the question of clause structure in ZFHS I will concentrate on methods, theoretical considerations, and inherent descriptive difficulties in my first attempts to identify and characterize "constituents" in this emerging sign language.

Trying to apply familiar axiomatic notions of syntax to a novel signed medium, with very little independent evidence available about structure (from glosses, bilinguals' interpretations, or an established tradition of analysis) can, I hope, illustrate foundational principles of linguistic analysis, especially when applied, as Aissen herself has done, to a previously un- or under-described language

4. The hammer and block example

As a first example of ZFHS and to illustrate some of the methods involved in my research thus far, consider the following short signed performance. In one elicitation task using a familiar pseudo-experimental paradigm, I asked one or two signers, the Describers, to watch a short video sequence—in this case drawn from recordings of everyday family events—and then to recount what they had seen to other signers, the Matchers. The Matchers, in turn, were presented with an array of video stills and asked to pick the one which corresponded to the clip described. If the Matchers failed, the Describers continued to elaborate their descriptions until a correct match was achieved. The method, though subject to various pitfalls, attempts to control referential “content” via the stimulus video, while at once exhibiting both production and comprehension strategies in the language under investigation. In (1), Jane describes a clip in which her infant son Victor is seen picking up from the ground a hammer and a block of wood and walking off with both objects in hand (see figure 2).



Figure 2: Victor carries a block and hammer.

- (1) Jane describes block and hammer clip (20100318a)
- a. HEY!³ (RH up in quick wave at interlocutor, a standard pragmatic turn opener)
 - b. HEIGHT (LH up with horizontal palm face down, a size-shape specifier for height)
 - c. VICTOR (RH with flat palm oriented down, showing the short stature of Jane's son Victor, the two-sign combination serving as a virtual proper name for the little boy)
 - d. PICKS UP? GROUND? (RH reaches sharply down below the table, out of view, then RH up again)
 - e. HAMMER (RH fist hits raised LH fist 3 times, see Figure 3)

³ For ease of presentation, ZFHS is presented in the form of putative English glosses (in CAPS) for individual signs, each gloss followed by a brief prose description of the physical form of the sign itself, using ASL handshape abbreviations, supplemented from time to time by illustrative video stills. Other abbreviations include R=right, L=left, RH=right hand, LH=left hand, BH=both hands, M=Matcher.



Figure 3: Jane “hammers” her two fists

Based on the original video stimulus, a reasonable free gloss for this little performance (whether or not one would want to characterize it as a signed sentence or clause—a matter to which I return below) would be, “Listen, Victor picks up (from the ground) a hammer.” The apparent order of “constituents” in the main predication would thus be SVO (in marked contrast with Tzotzil’s robust VOS order), where both ‘Victor’ and ‘hammer’ are notional nominal arguments.

Nonetheless, when presented with a video of Jane’s utterance in isolation, her sister Terry, my bilingual signing-hearing consultant, glossed it as “Listen, Victor hammers something this way”—reading, that is, the two-handed pounding motion not as glossed above as ‘hammer (noun)’ but as ‘hammer (verb)’ (and apparently offering no gloss for the gesture in 1d). Has Terry misunderstood Jane? Has Jane mis-signed or perhaps misinterpreted the original stimulus video (in which a hammer, but no hammering, appears)? Does ZFHS, a very young language, provide no clear way to distinguish hammers from hammering? Is this even the right way to think about the signs in question? The thrust of this brief chapter is to consider how, if at all, ZFHS signals such a distinction between potentially ambiguous expression of cognate nouns and verbs.

Fortunately, the interactive context of the task yields further information beyond the signed performances themselves and their glosses by consultants. First, the fact that Matchers must demonstrate their understanding of Describers’ utterances by picking a matching still frame imposes a minimal standard of referential adequacy on signed descriptions, which either facilitate a successful match or do not. Moreover, the vaguely competitive nature of the experimental design means that signers are free—in fact eager—to criticize one another for what they consider sloppy, inaccurate, or otherwise deficient descriptions of the stimulus video clips. Thus, in the case of Jane’s performance in (1), the Matcher cannot find a good matching photograph and asks for clarification, evidence for at least some referential inadequacy in Jane’s first formulation. The Matcher asks whether she has understood correctly that the film is about Victor, and then she somewhat hesitantly picks an incorrect still frame in which Victor appears to be moving his hands rapidly. This error in turn prompts first Jane (example 2), and then her brother Will (example 3), to try further elaborations—in the latter case, a reformulation replete with metalinguistic critique in which he faults his older sister for signing incorrectly. Such reformulations allow us to exploit the familiar Labovian insight (Labov 1972) that people, in interactive repetition after apparent misunderstanding, tend to “standardize” or “correct” linguistic form in some ideologically motivated way, giving such repetitions special value as evidence for “grammaticality.”

Jane begins her second performance in (2) in a discourse context which allows her to elide the notional subject, Victor. Her interlocutor has immediately beforehand asked “Is it Victor (you’re describing)?” Jane nods and then launches into her reformulation.

(2) Jane tries again

- a. HEY! (LH with index finger pointed at M, with accompanying vocalization⁴)
- b. A HAMMER (gaze down to grasping RH, then R fist pounds L fist 3 times)
- c. HOLDS/CARRIES (BH down, gaze to hands, quick gaze up at M, both hands move L to R under table, held still briefly while gaze searches area)
- d. A HAMMER (while still searching with gaze, two quick pounds of R fist onto L fist, gaze returns to M)

A reasonable interpretation of this sequence would be “[Victor] has a hammer, [he] picks up a hammer (and something else),” although when glossing even this second sequence in isolation Terry rendered it as “my child pounds something,” again interpreting the pounding motion as a verb rather than a noun. Several details of the signing here give us clues about how Jane tries to convey that it is an object she is talking about rather than an action, and these details suggest how morphosyntax develops in a young sign language. In (2b) Jane starts with a quick glance at her right hand, which appears to be in a grasping configuration, before repeating her three-stroke fist pounding motion (see Figure 4). The glance and the grasping hand configuration conspire to produce something like a nominal specifier: thing-held-in-hand, suggesting that the following iconic pounding action should be taken as a nominal “characterizer” rather than as a verb. Furthermore, in (2d), while Jane still seems to be searching for a visually accessible resource to help her characterize the second object Victor picks up in the stimulus video (a small block of wood), she performs an apparently *reduced* form of the pounding gesture, with two very quick fist pounds (see Figure 5).



Figure 4: “holds a hammer”



Figure 5: reduced pounding gesture

Jane’s brother Will is the youngest of the deaf siblings, and his version of ZFHS represents the final development of the first generation of signers. (Will of course had the benefit of being born into a tiny speech community where his teenaged elder siblings had already had

⁴ Because several signers, including the Matcher here, have normal hearing, ZFHS routinely employs a series of partly interpretable vocalizations designed, apparently, for hearing addressees.

nearly a decade to elaborate their communicative resources.) During Jane's second recounting of the video, Will breaks in to give his own elaborated description of the original stimulus video: "Victor picks up something—a hammer; [he] picks up two things and walks off carrying them."

(3) Will re-describes the scene

- a. VICTOR (RH palm down flat showing child's height)
- b. PICK UP (RH moves sharply downward, with palm out and open)
- c. OBJECT-GRASPED (RH moves up slightly, forms grasping hand with thumb and index fingers, gaze to his RH)
- d. A HAMMER (while moving gaze to Matcher, RH lifts in a loose fist and approaches bunched LH in a single hammering stroke, gaze to Matcher)
- e. PICKS UP [PLURAL OBJECT] (RH lifts again, gaze to ground, RH opens to open palm grasping hand, reaches down to ground, gaze to RH; RH closes to grasping hand, moves right, opens and closes again, and retracts upwards in grasping handshake)
- f. WALKS OFF (CARRYING THE OBJECTS) (body straightens up, gaze to matcher, RH still down to side with grasping fist, both feet lift in walking pantomime⁵)

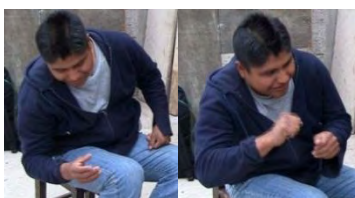

Figure 6: Will signs hammer object

The instructive contrast is at (3c-d) where Will gazes directly at his clearly classifying "held-object" hand—something I have called a 'haptic specifier'—and follows with an extremely quick and abbreviated hammering motion (at which he does not gaze) to denote the hammer Victor picks up and carries (see figure 6). After Will's description the Matcher immediately chooses the correct still frame. It is presumably because in her first attempt to describe the video in (1) Jane both omits a haptic classifier and fails to reduce the hammering motion that she was misunderstood.

By contrast, to illustrate how ZFHS represents 'hammer' (or less contentiously 'pound') as a verb, consider Jane's description in (4) of another video clip in which Victor is shown actually pounding on the same block of wood with the same hammer.

(4) Jane signs "Victor hammers a block."

- a. HEY! (RH rises, waves twice at M)
- b. VICTOR (RH 5-hand palm down, showing "height," moves up slightly to show height of Victor, slight head nod, no hold)
- c. WEARING HOOD (BH, palms facing in, move up to sides of head and forward, no hold)

⁵ ZFHS, a very young sign language with exuberant use of pantomime, thus does not seem to accord with Napoli and Sutton-Spence's remark (about ASL and BSL) "that the use of the feet is highly marked in sign languages and would only be accepted in language play or other exceptional situations" (2010 p 653).

- d. BLOCK (BH move down in grasping configuration, gaze to hands, then BH move slightly outwards showing rectangular dimensions of the wood block, gaze to M, hold)
- e. POUND (BH move downwards, LH clasp right fist in preparation, then both arms brought up and down with BH clasped, in ‘hammering’ motion, twice)

Although there are both a noun ‘hammer’ and a cognate verb in English, it is not obvious from Jane’s performances that this is true in ZFHS. Thus, contrast the pounding motion she offers as part of signing the noun ‘hammer’ in Figures 3 or 5 (or Will’s in Figure 6)—in which one hand seems to play the part of the instrument itself (and the other the thing it pounds on) with how she performs the pounding verb in (4e), miming the action of the hammerer as shown in Figure 7.⁶ Note, too, that she makes no explicit mention of the hammer as an argument in (4), instead singling out the block of wood in (4d) as an apparent object, and only indirectly representing the hammer in the form of the hammering motion and the clasped hands around a presumed hammering instrument.



Figure 7. Jane signs ‘pounding’ or ‘hammering.’

5. Constituency in ZFHS

Using notional propositions (which involve, minimally, a predicate and the entities predicated about) one can assign global glosses to the signed performances in the examples given. In this sense one can note the linear order of occurrence of sign-vehicles which appear to correspond to verbs and their arguments, but trying to read anything corresponding to syntactic “word order” out of such facts is clearly problematic. Thus, in (1) the raw order of occurrence would give SVO order, whereas in (2) and (4) the result would be something like (S)OVO and SOV respectively.

Trying to describe true clause structure, and to distinguish full from elliptical clauses or those with appositions, is itself a complicated matter, since in a young language like ZFHS formal tests for syntactic constituency are problematic. Sandler et al (2005) describe a combination of semantic and prosodic criteria (largely having to do with nonmanual expression on the face) for delimiting constituents in ABSL. How appropriately to parse ZFHS utterances into constituents remains difficult without more confident glossing⁷ and more systematic study of prosodic processes than I have yet achieved. I have relied instead on motion-based parsing

⁶ On the basis of a contrast between ASL and ABSL, Carol Padden (p.c.) points out two different kinds of lexical strategies for signing the names for tools and other instruments, one which concentrates on the object itself (in some ways like Jane’s signing of hammer) and another which mimes the handling of the object by a tool user.

⁷ Remember that Terry, the native-speaking consultant mentioned above, at least initially disagreed with the interpretations I have presented of Jane’s utterances in both (1) and (2), an interesting issue in its own right but one beyond the scope of this paper.

methods derived from the study of co-speech gesture (Kendon 2004) to delimit clause-like constituents and their parts in ZFHS. In Kendon's terminology, a 'gesture unit' is "the entire *excursion*, from when the articulators begin to depart from a position of relaxation until the moment when they finally return to one" (Kendon 2004:111). Within a single gesture unit Kendon distinguishes one or more phases—which he calls 'gesture phrases'—each of which minimally includes a 'stroke,' the "phase of the movement excursion closest to its apex" when "the hand or hands tend to assume postures or *hand shapes* that ... are better defined than elsewhere in the excursion." The stroke is also the phase of movement "when the 'expression' of the gesture ... is accomplished." Each stroke (which may involve as well a 'post-stroke hold' when "the articulator is sustained in the position at which it arrived at the end of the stroke") may also be associated with a preceding preparatory movement and a final 'recovery' or retraction back to rest (Kendon 2004:112).

On the basis of Kendon's detailed analysis of complex gesture units with multiple component gesture phrases, I have tried to formulate a simple phrase-structure grammar of the following form, where U represents a 'gesture unit,' G a 'gesture phrase' (or, informally, a "gesture"), N what Kendon calls the 'nucleus' of a gesture phrase, P a preparatory movement, S a 'stroke,' H a 'post-stroke hold,' and R a 'recovery' or return to rest position.

(5) Tentative PS "grammar" for gesture units

- a. $U \rightarrow G^+ R$ (where + is the "Kleene plus"—like * without the empty string)
- b. $G \rightarrow P N^+$
- c. $N \rightarrow S (H)$

The crucial parsing issue defined by such a grammar is the nature of the transitions from one gestural stroke to another: a gesture unit containing just one gesture phrase will bracket the gesture nucleus with one preparatory movement and a final recovery or return to rest position ($U[G[P N] R]$). A gesture unit with multiple gesture phrases will involve a transition from one gesture phrase to the next with no intervening return to rest position ($U[G \dots G R]$). The grammar also contemplates a closer binding between gesture nuclei in which one stroke (and possible subsequent hold) moves directly to another stroke with no intervening preparatory movement (e.g., $U[G[P N \dots N] R]$).⁸ Dividing a gestural stream up into units thus implies a judgment about recovery to "rest" position to distinguish the major units, and then judgments about the location of individual strokes and the junctures between them (including delicate questions of timing and gaze) to locate internal subdivisions in complex gesture units.

Applying such a raw gestural parsing to ZFHS allows a series of useful distinctions. It first allows one to isolate full signed utterances, which are bracketed by rest position—tentatively equivalent to signed sentences. It then allows the analyst to individuate component phrases. A simplified "tree" for Jane's signed utterance in (4), where still frames correspond to individual lettered lines, appears in Figure 8. The sequence is bracketed by the initial excursion of the hands before (4a) and their final return to rest after (4e). In between the hands are in

⁸ The nature of these nuclei, and how they are linked—whether, for example, reduplications of substantially the same stroke (and hold) are different from directly linked sequences of different strokes—is not yet clear from empirical studies, including analysis of complex gesture units shared with me by Adam Kendon (p.c.).

continual motion except for a brief hold at the end of the stroke at (4d). The dual pounding motions in (4e) with no intervening holds or preparatory strokes are also linked as two component nuclei of a single complex gesture phrase. If we are justified on grounds of the movement dynamics in calling this a single sentence, and if we consider as extra-clausal the pragmatic attention-getting initial sign, glossed “Hey!” above at (4a), it seems reasonable to record the constituent order for the central clause here as Subject⁹ Object Verb.

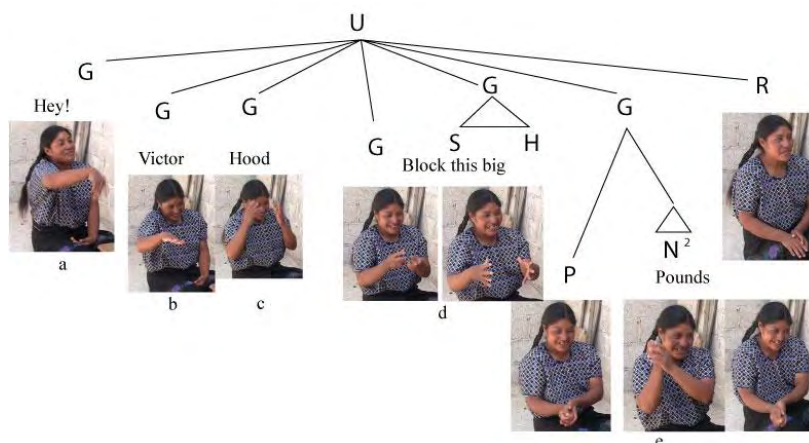

Figure 8: Jane signs, “Hey, hooded Victor hammers a rectangular block.”

By contrast, many descriptions of stimulus videos produced more than one “gesture unit,” potentially confounding any easy assignment of apparent constituents to linear “positions” within a “clause.” Here is a single example in which Jane describes a scene in which the author’s wife pours salt into a cooking pot. Her description involves two separate gesture units and distributes the notional arguments of the apparent verb between them. The sequence is illustrated in Figure 9, where each still frame corresponds to a line in (6).

(6) Jane describes EC pouring salt into pot (20100318a 18:42)

- a. SALT (from rest, gaze to M, RH index finger up to touch tongue)
- b. POUR (RH quickly turns palm up, cupped,
- c. INTO HAND (LH in grasping O hand “drops” something into RH from above twice, gaze to hands, up to M)
- d. MOVE (HOLDING) (gaze to RH, palm up slightly bent B hand, RH moves right and gaze follows it)
- e. DROP (gaze quickly to M, RH flips over palm downwards, slight downward bob of head)
- f. (RH hand retracts while gaze remains on M; LH has remained still at waist height)
- g. (0.7 seconds pause with gaze on M)
- h. HIM (LH index finger points up in direction of author, gaze follows, with vocalization, then gaze to M)

⁹ How to analyze the syntactic relationship between (4a) and (4b)—glossed VICTOR, HOOD, presumably to denote the little boy’s wearing of a hooded sweatshirt—is a matter I will not speculate about here.

- i. TALL (LH 5 hand sweeps up backhanded to high above head with palm out, vocalization)
- j. (LH retracts to lap, slight nod, gaze remains on M)

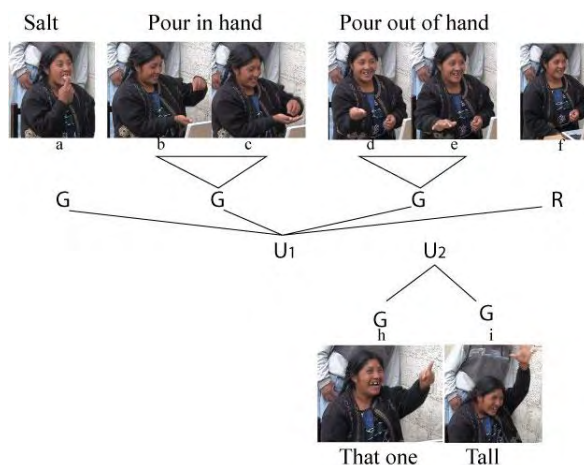

Figure 9. Jane describes EC pouring salt.

Although the raw sequence of signs that denote verbs or their notional arguments in this description is OVS, in fact Jane appears to have produced a concatenation of several distinct gesture units, the first of the form OV¹⁰ with no overt subject, and the second an apparent nominal phrase (“Him, tall”¹¹) almost as an afterthought to specify the subject of the previous phrase. We might thus notate the order of constituents in this short performance as OV, S, where separate clause-like units are separated by commas, to distinguish signed-phrases which correspond to gesture units from “lists” or concatenations of such phrases. To be sure, one may expect some overlap of arguments to characterize even the latter lists, just as the second gesture unit here resembles a right-dislocated or appositive “Subject” argument elided in the first gesture unit; but such structures seem different from the grammatically tighter linking of signs within “gesture units.”

¹⁰ There is clearly more internal structure to the sequence of two-handed signs in (6b-e) than is adequately captured by the shorthand notation V; notably there occurs an interesting figure/ground switch between the two hands, as well as a serial-verb-like structure in (6d-e). One of the striking findings of experimental work is how different two-handed co-speech gestures are from two-handed gestures in so-called “non-verbal gesture”—that is, in enforced pantomime where gesture is used to communicate in circumstances where speech is prohibited. Singleton, Goldin-Meadow, and McNeil (1995:300-301) report that “asymmetrical two-handed gestures are rare in gesticulation. Moreover the underlying function of an asymmetrical two-handed gesture in gesticulation appears to be related to differentiating the logical relationships of the thought structures that the gesture represents. In contrast, in nonverbal gesture, asymmetrical two-handed gestures are quite frequent and appear to have a more linguistic function—that of establishing and maintaining dual object reference.”

¹¹ Interestingly, this combination of signs—a pointing gesture to the author, who was co-present, plus the apparently redundant gesture for tall (since for a Zinacantec the author is excessively tall)—does *not* refer to the author, but rather to his wife—who is also tall by Zinacantec standards. The (neo)Gricean processes of inference that drive such an interpretation are interesting but beyond the scope of this paper.

Seen from this point of view, Jane's original descriptions of Victor carrying block and hammer above seem to evidence the constituent orders SVO in example (1), and OV, O in example (2), since the hands seem to be temporarily suspended at the end of (2c). Will's reformulation in (3) is more problematic from the point of view of constituency because, although the raw order of denoted elements seems to be SOV, the signing seems to exemplify a structure not contemplated by the PS-grammar in (5), namely, one with a kind of insertion sequence at (3c-d). Thus, as illustrated in Figure 6 above, Will signs what I have interpreted as the nominal 'hammer' by combining a grasping handshape with a rapid, stylized hammering motion. To introduce this notional argument of the following verbs 'pick up' and 'carry' he apparently interrupts the complex verbal sign itself midstream, starting it with the first part of the verb—an open hand "about to grasp" starting downwards—and then abandoning the sign to insert the 'hammer' sequence—a clasping hand specifier plus the single hammering motion, illustrated in Figure 6. At that he point he apparently *recycles* the interrupted verbal sequence (see Figure 10, where the small letters correspond to lines in (3) above). The movement pattern here suggests a signed analogue of speaker self-repair, a frequent feature of conversational talk¹² (and for that reason alone, I would suggest, further evidence for the linguistic organization of ZFHS). Such a gestural organization, however, complicates any assignment of constituent order; we may perhaps notate the utterance as S-O-V (where the dashes indicate the inserted repair sequence) and recognize that Will seems to find it appropriate to mention the notional object (or one of them) explicitly before finishing the verb itself.

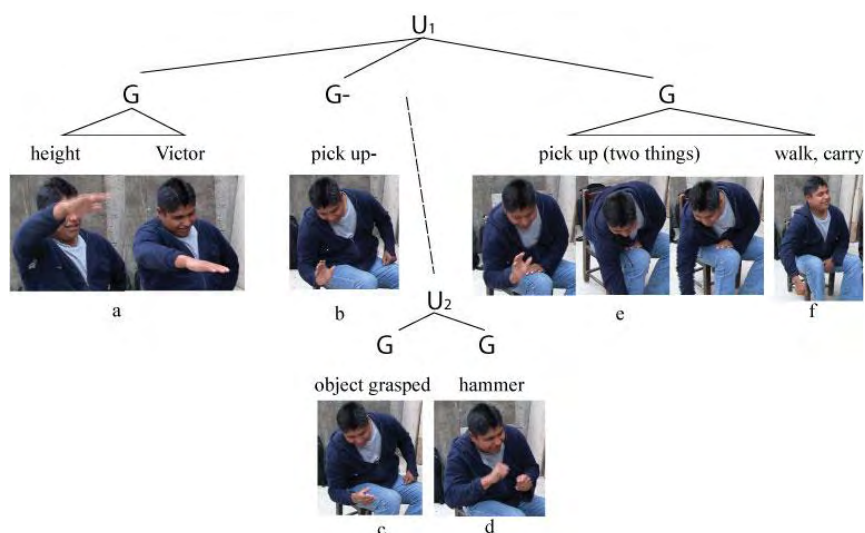

Figure 10: Will interrupts and restarts 'pick up' verb.

As an aside, note that Will's reformulation of his sister's failed description of the original video sequence departs in another way from the mini-grammar in (5), and this departure is also reminiscent of conversational speech. Will's turn, like many we have seen in ZFHS, begins with

¹² Although rarely described in co-speech gesture (see, for example, McNeill and Duncan 2000; Chen, Harper and Quek, 2002; Seyfeddinipur 2006) and thus not directly considered in Kendon's (2004) description of the gesture unit. On repair, see the classic formulation in Sacks, Schegloff and Jefferson (1974).

a conventionalized pragmatic turn-opener: a stylized waving or pointing hand directed at the interlocutor, and routinely glossed into Tzotzil by consultants as *k'elavil* 'look and see' or even *kaltik ava'i* 'listen, let me tell you.' Normally, the sign, which I usually gloss into English as HEY!, is followed without pause or retraction by the rest of the utterance; it therefore serves as an initial gesture phrase (G) in a longer gesture unit (U). Will begins his utterance in (3) with just such a HEY! sign; but Jane is simultaneously finishing her second description of the video stimulus. Will must thus wait until he actually has his interlocutor's attention before launching into his own description, and he does so not by retracting his waving hand to a rest position but instead by raising it high in the air (Figure 11), partly in preparation for the following "height" sign which forms part of the proper name for Victor, the subject of Will's first clause, and partly as a turn place-holder (not unlike the protracted *uh* of English or *este* of Spanish). The movement is thus held, but not at the end of a 'stroke' but rather between strokes or, perhaps, at the end of a preparatory movement; and the length of this 'hesitation' seems to respond not to grammar, exactly, but rather to the interactive engagement of the interlocutors.



Figure 11. Will requests his interlocutor's attention, and holds his hand high waiting for it.

6. Nouns, verbs, and constituents in ZFHS

Early studies of homesigners by Susan Goldin-Meadow and her colleagues¹³ argued that deaf children raised in hearing families without exposure to a sign language exhibited in their spontaneously generated systems of manual communication constituent order regularities (for example, placing patients and intransitive actors before predicates), and that there was formal evidence to suggest a noun-verb distinction—without which, of course, even notional thematic roles could hardly be assigned to putative arguments. In her earliest studies of homesign (e.g., Goldin-Meadow & Feldman 1977, Feldman, Goldin-Meadow, & Gleitman 1978, Goldin-Meadow & Mylander 1983) Goldin-Meadow considered only pointing gestures to be “nominal,” assigning iconic or “characterizing” gestures to the category of predicates. Careful examination of formal patterns in emerging homesign morphology (Goldin-Meadow, Butcher, Mylander, & Dodge 1994) later led the same researchers to differentiate between verbs, which showed nascent patterns of agreement (through spatial “displacement”), and nouns, which displayed various kinds of “abbreviation” in form (simplification of motion patterns, reduction of two- to one-handed gestures) with respect to cognate verbal gestures.

With ZFHS verbal constituents, two notable kinds of apparent morphology can be observed that would allow us to distinguish them from nominal constituents: verbs agree with their arguments, using deictic, anaphoric, and classifier-like mechanisms; and they frequently appear to be serialized. Not illustrated in this paper is verb agreement signaled by displacing the

¹³ See especially summaries in Goldin-Meadow 1993, 2003

performance of a motion in the direction of a signaled subject, but we have seen typical ways in which other arguments can be ‘incorporated’ into mimed verbs: Jane’s handling handshape suggesting the instrument held in her hand in Figure 7; the transferring hands of Figure 9; or the alternately open and grasping hands for ‘picking up’ of multiple objects in Figure 10. The sequencing of verbs into linked chains—gesture phrases with multiple nuclei—has also been apparent in nearly every ZFHS example.

With ZFHS nouns, we have seen instances of the sort of “abbreviation” or reduction in the performance of putative nominal arguments (see again Figures 5 and 6) by contrast with fully pantomimed verbal counterparts. More obvious emergent morphology is the use of haptic specifiers—usually handshapes which show the size and shape of an object and give an indication of how it is manipulated, often accompanied by explicit signer gaze (which may itself represent a sort of inflection for definiteness)—preceding a characterizing expression, the whole corresponding to a nominal phrase. This is what we see for ‘hammer’ in Figures 4 and 6, and there are many other examples in the conventional lexicon of ZFHS. Furthermore, the ‘characterizing’ expression may itself be frozen, as in my favorite example, the sign for ‘chicken’ where one first shows the size of the bird and then demonstrates the jerking motion traditionally used to break its neck—even if, as shown in Figure 12, the chicken in question is only a chick and thus, presumably, not liable to imminent execution.



Classifier: TINY THING Neck breaking pantomime
Figure 12. Will signs ‘chick’

Thus, even the few examples presented here suggest a set of emerging morphosyntactic categories and possible clausal argument positions. If one restricts oneself only to *reformulated* or ‘corrected’ descriptions of video stimuli—on Labovian principles mentioned above—and assigns apparent arguments to presumed Subject or Object categories on the basis of the putative referential content of the stimuli themselves, in a small corpus of around 100 apparent single-gesture-unit ZFHS ‘clauses’ there does seem to be a tendency toward (S)OV order: 76% follow such a pattern (37% SV, 34% OV, 5% SOV), with non-conforming orders falling into three infrequent types (11% VO, 8% VS, and 5% SVO). In a young language like ZFHS one might suppose that nascent categories may be less than fully categorical, and that different partial patterns developing in the language may together conspire to produce categorical effects. Thus, for example, this word order *tendency* where nominal arguments precede verbs, supplemented by optional or occasional morphological marking on nouns and verbs, may produce an increasingly robust pattern of clause structure, especially in the speech of the youngest signer.

References

- Aissen, Judith. 1992. Topic and focus in Mayan. *Language* 61(1):43-80.
- Chen, Lei, Mary Harper, and Francis Quek. 2002. Gesture patterns during speech repairs. *Proceedings of the 4th IEEE International Conference on Multimodal Interfaces (ICMI'02)*, 155-160.
- Feldman, Heidi, Susan Goldin-Meadow, and L. Gleitman. 1978. Beyond Herodotus: the creation of language by linguistically deprived deaf children. *Action, symbol, and gesture: The emergence of language*, ed. A. Lock, 351-414. New York: Academic Press.
- Fox Tree, Eric. 2009. Meemul Tzijj: An indigenous sign language complex of Mesoamerica. *Sign Language Studies* 9(3):325-366.
- Goldin-Meadow, Susan. 1993. When does gesture become language? A study of gesture used as a primary communication system by deaf children of hearing parents. *Talk, language, and cognition in human language*, eds. K. R. Gibson & T. Ingold, 63-85. New York; Cambridge University Press.
- Goldin-Meadow, Susan. 2003. *The resilience of language*. New York, Hove: Psychology Press.
- Goldin-Meadow, Susan, Cynthia Butcher, Carolyn Mylander, & Mark Dodge. 1994. Nouns and verbs in a self-styled gesture system: What's in a name? *Cognitive Psychology* 27, 259-319.
- Goldin-Meadow, Susan, and Heidi Feldman 1977. The development of language-like communication without a language model. *Science* 197:401-403.
- Goldin-Meadow, Susan, and C. Mylander. 1983. Gestural communication in deaf children: the non-effects of parental input on language development. *Science* 221:372-374.
- Kendon, Adam. 2004. *Gesture: Visible action as utterance*. New York: Cambridge University Press
- Labov, William. 1972. *Sociolinguistic patterns*. Philadelphia: University of Pennsylvania Press.
- McNeill, David, and Susan D. Duncan. 2000. Growth points in thinking-for-speaking. *Language and gesture*, ed. D. McNeill, 141-161. Cambridge: Cambridge University Press.
- Meir, Irit, Carol Padden, Mark Aronoff, and Wendy Sandler. 2007. Body as subject. *Journal of Linguistics* 43:531-63.
- Napoli, Donna Jo, and Rachel Sutton-Spence. 2010. Limitations on simultaneity in sign language. *Language* 86(3):647-662.
- Sacks, Harvey, Emmanuel Schegloff, and Gail Jefferson. 1974. A simplest systematics for the organization of turn-taking for conversation. *Language* 50:696-735.
- Sandler, Wendy, Irit Meir, Carol Padden, and Mark Aronoff. 2005. The emergence of a grammar: Systematic structure in a new language. *Proceedings of the National Academy of Sciences*, 102(7), 2661-2665.
- Seyfeddinipur, Mandana. 2006. Disfluency: interrupting speech and gesture. Ph.D. dissertation, Radboud Universiteit, Nijmegen (MPI series in psycholinguistics #39).
- Singleton, J.L., Susan Goldin-Meadow, and David McNeill. 1995. The cataclysmic break between gesticulation and sign: Evidence against a unified continuum of gestural communication. *Language, gesture, and space*, eds. K. Emmorey & J. Reilly, 287-311. Hillsdale, N.J.: Laurence Erlbaum

ON PRONOUN-PERSONAL AFFIX CONNECTIONS: SOME LIGHT FROM ALGONQUIAN*

Brian D. Joseph
The Ohio State University
joseph.1@osu.edu

Many languages show connections between personal pronouns and verbal person affixes, understandably, since both are often functionally equivalent with identical real-world referents. This relationship is variously manifested. First, pronouns can affect corresponding personal affixes in form (as in New Mexican Spanish *hablaba-nos* ‘we were speaking’, for older *-mos*, based on the free pronoun *nos(otros)*). Second, the ending can affect the pronoun, like *hablabanos* but with opposite directionality, as in Judeo-Spanish *mosotros* ‘we’ for older *nosotros*, based on the ending *-mos*. Yet another manifestation, in the “canon” of grammaticalization theory, involves pronouns as the historical source of personal affixes (cf. Givón 1971, Lehmann 1982). Importantly, too, there are countervailing processes that build up rather than reduce pronouns, as shown by Hale (1982) for Warlpiri. I examine here the pronoun-affix connection in Plains Cree, and argue that it shows an elaborative, not reductive, connection. I then use that evidence, with reference as well to Modern Greek, as a caution for grammaticalization theory with its intense interest in the source of affixes as opposed to that of pronominal systems more generally.

There is an undeniable relationship in language between personal pronouns and verbal affixes that mark person (recognizing of course that not all languages have such affixes). The existence of such a connection is understandable, given that both personal pronouns and personal affixes have the same real-world referents and are thus functionally equivalent in a certain sense. They may of course differ in some ways, e.g. pragmatically with regard to matters of emphasis, as in languages like Spanish or Greek, typical “pro-Drop” languages, where the occurrence of an overt pronoun is emphatic in ways that the mere appearance of verbal affixes alone is not, as in (1):

- (1) a. *Escribo / γραφο* ‘I write’
 b. *Yo escribo / εγo γραφο* ‘I write’ (i.e., “I am the one who is writing”)

The final *-o* on the verbs and the pronouns *yo/εγo* fill (or refer to, at least) the same argument slot semantically (subject, in this case) but the presence of the pronoun in (b) adds a pragmatic effect that is absent in (a).

* It is a great pleasure to be in a position to write a paper honoring Judith Aissen, from whom I learned much during my graduate work at Harvard University. Not only was I a student in several of her classes but she also served as my primary academic advisor for a few years before she left to take a position at Yale. She was then an exemplary teacher, whose style I have tried to emulate in my own approach to teaching, and as a scholar, she was equally formidable. It is fair to say that without her guidance and the knowledge of and enthusiasm for the study of syntax, I would not have produced the dissertation that I did, on a topic in the historical syntax of Greek (Joseph 1978/1990). I salute you, Judith, and happily dedicate this small contribution to you!

This connection between pronouns and affixes is manifested in several ways. First, there are well-documented and well-understood cases in which a pronoun has affected the form of corresponding personal affixes. For instance, as discussed in Joseph 2004, dialectally in Macedonian and Bulgarian a first person plural (1PL) ending *-ne* occurs, as in *sne* ‘we are’, *vidofne* ‘we saw’ (Mac.), as opposed to the more widespread *-me*, as in standard Macedonian *sme/vidofme*, and this innovative *-ne* is best explained as the ending being affected analogically by the free pronoun *nie* ‘we’. Similarly, in early Slavic, as discussed in Dunkel 2002, the first person dual ending *-vě* occurs for expected *-va*, due, apparently, to the influence of the dual pronoun *vě*. Further, in New Mexican Spanish, the innovative 1PL ending *-nos* occurs for more widely distributed and etymologically prior *-mos* as a result of pressure from the free pronoun *nos(otros)*, as demonstrated by Janda (1995).¹

Second, another reflection of this connection comes from instances in which the pronoun is affected by the ending; this involves the same sort of pressure as that described above, but with the opposite directionality. Spanish provides a pertinent example, in that there are dialects, including Judeo-Spanish, that have *mosotros* as the 1PL pronoun, instead of the more usual *nosotros*, where the 1PL ending *-mos* seems to provide the best basis for explaining the innovative, and etymologically unexpected, initial consonant of the pronominal form.

There is yet another manifestation of this relationship, one that is to be found in what may be called the “canon” of grammaticalization theory: pronouns as the historical source of personal affixes. Lehmann (1982), for instance, offers the following scenario for the development of verbal agreement markers:

- | | | | | | | | | | |
|-----|------------|----|---------------------|----|---------------------|----|----------------|----|----------------|
| (2) | lexically | => | free | => | clitic | => | agglutinative | => | fusional |
| | empty noun | | personal
pronoun | | personal
pronoun | | personal affix | | personal affix |

This notion actually has a long history, extending back at least to the early work on Indo-European morphology by Franz Bopp, who noticed the obvious relationship within reconstructed Proto-Indo-European between the *-m-* of first person singular and plural endings and the *-m-* of oblique forms of the 1st person pronoun, as in (3):

- (3) AccSg **me*, DatSg **me-bhei*, (etc.) ~ 1SG **-m(i)* / 1PL **-mes*

And, to bring this closer to the area of study, geographically speaking at least, that the honorand is best known for,² we can point to the early work on Zapotec and other languages of Oaxaca by de Angulo (1926), who, in looking into Zapotec, Mixtec, Chinantec, Mazatec, Cuicatec, Chatino, and Chocho, suggested that some of these languages can be viewed as being “essentially monosyllabic [and] ... undergoing an evolution toward the development of a system of pronominal suffixes ... [which] can be traced through a series of dialectical variations all the

¹ For some other such examples, see Joseph 2004, 2006.

² I have in mind, of course, Judith’s important work on Mayan, especially Tzotzil (e.g., Aissen 1987), though I note that Judith has done important work on Spanish syntax (e.g., Aissen and Perlmutter 1983), work that I was privileged to hear about first-hand from her while a student in the mid 1970s.

way from a mere repetition of the pronoun after the verb, through agglutination, to fused ‘inflection’ of verbal endings”. Thus for de Angulo, the Cuiatec verb forms in (4a-b):

- (4) a. nu reenu
 1PL.EXCL.PRONOUN eat+1PL.EXCL
 ‘We (Excl.) are-eating’
 b. inya reenya
 3PL.PRONOUN eat+3PL
 ‘They are-eating’

show the “suffixes *-nu* and *-nya*” and he notes that they involve “repetitions of the independent pronoun”. He thus had in mind a pronoun-to-verb-ending line of development as a way of characterizing the differences among some of these languages and some dialects within these languages with regard to person marking.

Moreover, the development of free pronouns into affixal markers has been documented in the relatively recent history of French by Sauvageot (1962) and Auger (1993). Such studies mean that this well-recognized development is not subject to the potential whims and pitfalls one encounters when dealing with reconstructed material and to the inevitable speculativeness that such data occasions; rather it can be taken as instantiated within the known history of at least one language.³ In these accounts, the pronominal forms in a French string like (5):

- (5) je=le=vois
 I him see
 ‘I see him’

have characteristics of affixes (showing morphological idiosyncrasy in certain ways, for instance) and thus are no longer free pronouns, but neither are they simply phonologically cliticized onto the verb.

It is fair to wonder whether there can be countervailing processes that build up rather than reduce pronouns, and this issue is the real focus of the present discussion. That is, in addition to all of the foregoing, there is yet another way that the relationship between pronouns and verb endings can be realized, and this is exemplified nicely by some Algonquian data, though parallels with similar situations in Australian languages and in Modern Greek can be adduced. In the end, moreover, these developments provide the basis for a cautionary warning for grammaticalization and its intense interest in where affixes come from as opposed to where pronominal systems more generally come from.

First, by way of introducing the issue, it can be noted that various Australian languages exhibit a pronominal system with bound elements on verbs that are quite different from their corresponding independent form. For instance, as discussed in Hale 1982, Warlpiri has an

³ The fact that this sort of development can be documented for at least one language, namely French, means that Bopp’s internal reconstruction of the origins of the Indo-European personal endings may well be right; however, as with most internal reconstruction, and especially that done on a reconstructed proto-language, it is impossible to be completely certain as to its correctness.

independent pronominal subject form *nganimpa-rlu*, shown in (6) in bold, and a reduced bound pronoun consisting of the discontinuous pieces *rna...lu*, shown in (6) in italics:

- (6) Pura -mi =nya =*rna*=ngku=*lu* **nganimpa-rlu**=ju?
 follow -PRES =INTRG =1PL.EXCL=2SG.OBJ 1PL.ERG =DEF
 ‘Do we follow you?’

Such forms have been conjectured by Hale (1973:340) to have arisen as follows:

The source of pronominal clitics in Walbiri is in fact independent pronouns which, at some stage in the prehistory of the language, became unstressed and were attracted into clitic position (that is, second position) in accordance with a principle of clitic placement which is extremely widespread among languages of the world. The processes of destressing and cliticizing pronouns eventually became an obligatory rule and subsequently, independent pronouns were re-created from other sources available to the language, such as oblique forms of pronouns like those found in possessive or other functions not normally subject to cliticization. Such a sequence of events seems quite suggestive and is, moreover, entirely compatible with the synchronic state of affairs in which pronominal clitics no longer necessarily resemble, in phonological constituency, the determiners which they most closely approximate in grammatical feature composition.

When the phonological forms are as different as they are in Warlpiri, Hale’s scenario, even if just speculative, is quite reasonable and believable.

But there are cases where the phonological forms are somewhat similar, sharing a fair amount of phonological material. In such instances, unlike the Warlpiri situation, there is rather the potential for thinking in terms of the second type of relationship, the one enshrined in the grammaticalization canon, in which the affixal form is a reduction of the independent form (as in the first part of Hale’s scenario), even though, as it turns out, it may not be the right view.

An example of that sort is offered by Plains Cree, which shows both affixes and pronouns, as in (7), whose phonological forms are close enough to suggest a relationship via the reduction scenario, starting from the use of free pronouns as the subject of verbs and drawing on stresslessness, as Hale suggests; positing reduction of the strong forms would thus be a way to account for the origin of the affixal elements:

- (7) a. Affixes: 1st person: *ni-*; 2nd person: *ki-*
 b. Free pronouns: 1st person: *nīya*; 2nd person: *kīya*
 e.g. *kī-wāpin* ‘you have a vision’; *tanisi kīya* ‘How (are) you?’

These forms have overlapping phonological material, sharing *n* and a high front vowel in the 1st person and *k* and a high front vowel in the 2nd person, though it must be admitted that the vowel is short in the affix and long in the full form. Not only that, but Cree also has a morphophonemic reduction of some sequences of VyV to a long vowel, V: (Wolfart 1973:81), and a short outcome, such as is found in the personal affixes, could plausibly be accounted for if, as Hale suggests for Warlpiri, the reduction occurred in a weak prosodic context; admittedly the particular vowels involved in the pronouns are not ones that occur in the morphophonemically reduced sequences, but by assuming that the weak prosodic context took in a wider range of

input sequences, one at least gets close to the desired result. Thus, contraction of *kīya* could yield a presumed *kī* from which the short *ki* could plausibly have arisen; it must be recognized that these steps are ad hoc assumptions but at least they are phonologically natural.

Still, once one takes a more comprehensive set of data into consideration, the picture alters somewhat, in a few ways. First, as shown in (8), *ki/ni* are used to mark possession too:

(8) *ki-maskisin* (2nd – ‘shoe’) / *ni-maskisin* (1st – ‘shoe’) => ‘your/my shoe’

This means that they are not just *verbal* person markers but rather are person markers more generally, and their use in possession constructions would not necessarily be amenable to the same sort of reduction scenario; in particular, the strong pronominal forms are not generally used in possessive constructions. Second, although the reduction of *kīya* to *ki* seems plausible, it is really so only for Plains Cree; dialectally within Cree, the Plains Cree *-y-* in this word finds correspondents with *-l-* (Moose Cree), *-n-* (Swampy Cree), and *-d-* (Woods Cree), sounds that are more robust phonologically and thus less likely to delete. And, this is so also across Algonquian, where the pronoun has forms with medial *-l-*, *-n-*, etc. Finally, *ki/ni* are used in pronoun-like derivation, as in what Wolfart (1973: 38) calls the “affirmative” pronoun: *kīsta* / *nīsta* ‘you/I too’.

All of these additional facts suggest that the strong forms *kīya/nīya* are built up out of the affixes *ki/ni*, added onto some other material, rather than *ki/ni* being reductions of *kīya/nīya*. Indeed, the reconstruction of Algonquian personal pronouns found in Bloomfield 1946 takes this very view: “A set of personal pronouns is based on a suffix *-iil-* with prefixes . . . [e.g.] *niila ‘I’”, and this seems to be generally agreed on, in that other available Algonquian sources (e.g. Aubin 1975) do not dispute this account. Thus, the pronouns consist of prefixal person marker *ki-/ni-* combining with a “base”, the exact analysis of which, as a root or a stem or whatever, is not at issue here. That is, the Cree case is really rather like the Australian situation, where the strong form is built from a weak form taken as the starting point. Thus, even when one is dealing with phonological similarity between affixal forms and strong pronominal forms of person marking, caution is needed when it comes to drawing historical inferences about the forms in question; phonological similarity does not always point to the full-form-reducing-to-affix scenario.

The situation in Modern Greek with regard to strong versus weak pronominal forms is instructive here, since one finds similar-looking forms for which the history can be documented. In particular, the Modern Greek accusative forms are those given in (9), with strong forms that are opposed to weak forms:

(9) 1SG.Strong: *eména* 1SG.Weak: *me*
 2SG.Strong: *eséna* 2SG.Weak: *se*

Based on the similarity in form between the strong and weak forms in (9), with *me* in both 1SG forms and *se* in both 2SG forms, if one only had the modern forms to work with and had no access to the history involved, one could (quite reasonably) take *me/se* to be reductions from *eména/eséna*. In fact, though, the *-na* in the strong forms represents the result of two additions

onto older strong forms, *emé/esé*. These accretions took place in two waves, and consisted, first, of the vowel-stem accusative marker *-n* being added to the strong pronominal form ending in *-e*, which apparently was treated as a vowel-final stem, and second, of the consonant-stem accusative marker *-a* being added to the newly created strong forms *emén/esén*, treated as consonant-final stems. The Ancient Greek forms were as in (10):⁴

(10)	1SG.Strong:	emé	1SG.Weak:	me
	2SG.Strong:	sé	2SG.Weak:	se

meaning that the modern weak forms continue the ancient weak forms directly, while the strong forms have been independently reshaped.

As noted above, there is an important lesson in all of this for those who look to grammaticalization as a way of doing language history. In particular, all too often conclusions are drawn from nothing more than a correspondence of two similar forms at some synchronic stage; while that might be warranted on occasion and even in general, what Algonquian and Greek show is that in particular cases the actual history can be quite different. Moreover, with the Australian evidence added in, it is clear from these cases that morphological change is not always reductive in nature.

References

- Aissen, Judith L. 1987. *Tzotzil clause structure*. Berlin: Springer.
- Aissen, Judith L. and David M. Perlmutter. 1983. Clause reduction in Spanish. *Studies in Relational Grammar 1*, ed. David M. Perlmutter, 360-403. Chicago: The University of Chicago Press.
- Aubin, George F. 1975. *A Proto-Algonquian dictionary*. Ottawa: National Museums of Canada.
- Auger, Julie. 1993. More evidence for verbal agreement-marking in colloquial French. *Linguistic perspectives on Romance languages: Selected papers from the XXI Linguistic Symposium on Romance Languages, Santa Barbara, February 21–24, 1991*, ed. William J. Ashby, Marianne Mithun and Giorgio Perissinotto, 177-198. Amsterdam: John Benjamins.
- Bloomfield, Leonard. 1946. Algonquian. *Linguistic structures of native America*, ed. Cornelius Osgood, 85-129. New York: Viking Fund Publications.
- De Angulo, Jaime. 1926. The development of affixes in a group of monosyllabic languages of Oaxaca. *Language* 2:119-133.
- Dunkel, George. 2002. *eg'ō and *ag'ō, eg'H-ōh₁ and *h₂ég'-oh₁: Perseveration and the primary thematic ending *-ō. *Indogermanische Syntax. Fragen und Perspektiven*, ed. Hans Hetterich, 89-103. Wiesbaden: Reichert.
- Givón, Talmy. 1971. Historical syntax and synchronic morphology: An archeologist's field trip. *Chicago Linguistic Society* 7, 394-415. Chicago Linguistic Society, Chicago, IL.
- Hale, Kenneth L. 1973. Person marking in Walbiri. *A festschrift for Morris Halle*, ed. Stephen Anderson and Paul Kiparsky, 308-344. New York: Holt, Rinehart and Winston, Inc.

⁴ The Post-Classical strong form *esé* most likely has the initial *e-* analogically based on the first person form.

- Hale, Kenneth L. 1982. Some essential features of Warlpiri main clauses. *Papers in Warlpiri grammar: In memory of Lothar Jagst*, ed. Stephen Swartz, 217-315. Berrimah, Australia: Summer Institute of Linguistics.
- Janda, Richard D. 1995. From agreement affix to subject “clitic”—and bound root: *mos* > *-nos* versus (-)*nos*(-) and *nos-otros* in New Mexican and other regional Spanish dialects. *Chicago Linguistic Society* 31, 118-139. Chicago Linguistic Society, Chicago, IL.
- Joseph, Brian D. 1978/1990. *Morphology and universals in syntactic change: Evidence from Medieval and Modern Greek*. Ph.D. Dissertation, Harvard University (1978). [Printed and distributed by the Indiana University Linguistics Club. Expanded and updated version published by Garland Publishers (Outstanding Dissertations in Linguistics Series), 1990].
- Joseph, Brian D. 2004. Typological and areal perspectives on the reshaping of a Macedonian verbal ending. *Macedonian Studies. Papers from the 5th International Macedonian-North American Conference on Macedonian Studies 1-4 May 2003 at The Ohio State University (Ohio State Working Papers in Slavic Studies 4)*, ed. Brian D. Joseph & Mary Allen Johnson, 143-151. Columbus: The Ohio State University Department of Slavic and East European Languages and Literatures.
- Joseph, Brian D. 2006. On connections between personal pronouns and verbal endings in the Balkans. *Studia Carolinensia: Papers in linguistics and folklore in Honor of Charles E. Gribble*, ed. by Robert Rothstein, Ernest Scatton, and Charles Townsend, 177-188. Bloomington, In.: Slavica Publishers.
- Lehmann, Christian. 1982. *Thoughts on grammaticalization: A programmatic Sketch*. Vol. I. (Arbeiten des Kölner Universalien-Projekts, Nr. 48), Köln [2., revised edition, Erfurt 2002 (Arbeitspapiere des Seminars für Sprachwissenschaft der Universität Erfurt, No. 9)].
- Sauvageot, Aurélien. 1962. *Français écrit, français parlé*. Paris: Librairie Larousse.
- Wolfart, H. Christoph. 1973. *Plains Cree: A grammatical study*. (*Transactions of the American Philosophical Society* n.s. 63.5). Philadelphia: The American Philosophical Society.

FROM CLAUSE UNION TO RESTRUCTURING TO BEYOND COHERENCE*

Vera Lee-Schoenfeld
University of Georgia
vleesch@uga.edu

Germanic coherence phenomena have in common with Romance clause union and restructuring phenomena that grammatical operations are allowed to transcend an embedded clause boundary, i.e. involve an element from a lower clause interacting with an element from a higher clause. The focus here is on German possessor raising and pronominal binding as diagnostics for the transparency/opacity of infinitival complement clauses, as well as other clause-like domains. Appealing to (and providing further support for) Wurmbrand's (2001) typology of infinitival clause size, this contribution shows that functional and lexical restructuring predicates can, but reduced non-restructuring and full clausal non-restructuring predicates cannot be transparent for possessor raising and pronominal binding. Ultimately, it will be shown that opacity-inducing domains are headed by categories that are phase-defining.

1. Introduction

The terms CLAUSE UNION, RESTRUCTURING, and COHERENCE have all been used to describe and analyze phenomena involving an embedded clause that is transparent for grammatical interactions with the embedding matrix clause. In this contribution, which summarizes key parts of Lee-Schoenfeld 2007, I will briefly address the respective origins of the three terms and the types of transparency phenomena they are associated with and then focus on two constructions occurring in German that can serve as diagnostics for the transparency/opacity of infinitival complement clauses: pronominal binding and possessor raising.

Non-reflexive pronouns embedded in an infinitival domain can only be bound by a nominal in the matrix clause if the infinitival clause boundary is opaque to grammatical interactions with clause-external elements. Possessor raising, on the other hand, which involves a nominal (the possessor) moving from the specifier of another nominal (the possessee) higher into the verbal domain, is only possible if the possessor-possessee complex is embedded in a transparent infinitival domain.

The traditional coherence diagnostics for Germanic languages are designed to test for the presence of a full finite clause (CP) boundary, but Wurmbrand (2001) provides evidence for more subtle transparency effects involving smaller clausal domains, like TP, *v*P, and VP. Investigating new reliable diagnostics for Wurmbrand's typology of infinitival clause size, I propose German pronominal binding and possessor raising as coherence test because they reliably probe for the presence of an agentive *v*P (or, more generally, for the presence of a phase-boundary) and are based on relatively robust grammaticality judgments.

* Thank you, Judith! *Beyond coherence: The syntax of opacity in German* (Lee-Schoenfeld 2007) is a slightly revised version of my 2005 UCSC dissertation, and the material for neither the dissertation nor the book would have come together without your guidance and expertise in your role as my adviser.

2. (Non)finite Complementation and Transparency

2.1. The Phenomenon

Consider the English examples in (1). The perception verb *saw* takes a complement that consists of the pronominal *them* and the nonfinite predicate *leaving town*. The cleft-construction in (1b) confirms that the accusative-marked pronominal forms a constituent with the embedded predicate.

- (1) a. Mary saw them leaving town.
 b. What Mary saw was [them leaving town].

Given that the embedded nonfinite domain consists of a subject and a predicate, where *them* is the subject of *leaving town*, just as *Mary* is the subject of *saw*, we expect the nonfinite domain to exhibit clausal behavior. The fact that the embedded subject bears accusative, as opposed to nominative case, however, indicates that it is the matrix verb which case-licenses this nominal, and thus, that case-checking must span the nonfinite clause boundary. As shown in (2), where the embedded subject bears nominative case, case-checking does not span the clause-boundary in the case of a finite complement clause.

- (2) Mary saw that they were leaving town.

The examples in (3) provide even more striking evidence of the contrast in transparency between nonfinite and finite domains.

- (3) a. They were seen [__ leaving town].
 b. *They were seen [that __ were leaving town].
 c. They_i saw [each other_i negotiating].
 d. *They_i saw [that each other_i were negotiating].

The embedded subject in (3a) can cross the nonfinite domain boundary and become the subject of the matrix clause, bearing nominative case. Movement of the embedded subject into subject position of the (higher) matrix clause is impossible, however, in the case of the finite complement clause in (3b). Similarly, examples (c-d) illustrate that the matrix subject can bind the anaphoric element *each other* across the nonfinite domain boundary in (c), but not across the finite boundary in (d).

In fact, this difference in transparency of embedded complement clauses goes beyond the finite-nonfinite distinction. As illustrated by the German data in (4)-(6), there are transparency contrasts even *within* the class of constructions involving nonfinite complementation.

- (4) a. Er ließ [den Hund laufen].
 he let the.ACC dog run
 'He let the dog run.'

- b. Der Hund wurde [__ laufen] gelassen.
 the.NOM dog was.PASS run let
 ‘The dog was allowed to run.’
- (5) a. Er hat versucht [den Hund zu schlagen].
 he has tried the.ACC dog to hit
 ‘He tried to hit the dog.’
 b. Der Hund wurde versucht [__ zu schlagen].
 the.NOM dog was.PASS tried to hit
 ‘They (impersonal) tried to hit the dog.’
- (6) a. Er hat behauptet [den Hund zu vermissen].
 he has claimed the.ACC dog to miss
 ‘He claimed to miss the dog.’
 b. *Der Hund wurde behauptet [__ zu vermissen].
 the.NOM dog was claimed to miss
 Intended: ‘They (impersonal) claimed to miss the dog.’

All three constructions in (4)-(6) have a matrix verb which takes an infinitival complement. The ACCUSATIVUS CUM INFINITIVO (AcI) in (4) is syntactically equivalent to the English perception verb construction in (1). As in English, the subject of the nonfinite complement is accusative-marked in its base position (a), but can become the nominative-marked subject of the matrix clause (b). Unlike the infinitive in (4), the embedded verbs in (5) and (6), are accompanied by the infinitive marker *zu* ‘to’. Notice also that the accusative-marked nominal in (5) and (6) is the direct object, not the subject of the nonfinite verb. Both *versuchen* ‘try’ in (5) and *behaupten* ‘claim’ in (6) are traditionally analyzed as SUBJECT CONTROL verbs: the matrix subject controls a null pronominal element (PRO) in the subject position of the infinitival complement. The constructions differ, however, in that the complement of *versuchen* is transparent, and the complement of *behaupten* is opaque to so-called LONG PASSIVE movement of the embedded direct object into the subject position of the matrix clause.

Since Gunnar Bech’s (1955/57) celebrated work on the syntax of German infinitive constructions, the contrast in transparency evident in (5) and (6) has been referred to as KOHÄRENZ ‘coherence’ versus INKOHÄRENZ ‘non-coherence’. Matrix verbs which allow grammatical operations to cross the domain boundary of their infinitival complements are coherence (transparency)-inducing, while matrix verbs which do not are non-coherence (opacity)-inducing.

2.2. Accounting for the Phenomenon

Since Bech (1955/57) identified the existence of these two classes of infinitive constructions, various approaches have been taken to account for the contrast between them. The phenomenon is a cross-linguistic one, as the coherence/non-coherence distinction holds not only for Germanic languages like German and Dutch but also for many other languages, among them Spanish,

Italian, and Japanese (see e.g. Aissen & Perlmutter 1976, 1983, Rizzi 1978, and Miyagawa 1987). While the term ‘coherence’ is used primarily for Germanic, other terms for the same phenomenon, in particular ‘clause union’ and ‘restructuring’, are used more broadly. The term ‘clause union’ originated in the Relational Grammar (RG) literature and refers to a process by which all dependents of the embedded verb become dependents of the matrix verb. This process was first recognized in connection with causative constructions in Romance and was extended to certain infinitival constructions in Spanish by Aissen & Perlmutter (1976, 1983). Their main claim was that the well-known clitic-climbing phenomenon (where a clitic which is a semantic argument of an embedded verb cliticizes to a higher verb) is a consequence of clause union. Certain “trigger” verbs optionally cause matrix and embedded domain to merge into a single clause. The universal character of clause union phenomena is confirmed by the fact that, in all languages which have grammatical operations spanning clause-boundaries, there are two classes of verbs, those which can, and those which cannot trigger transparency (Wurmbrand 2001). The members of these two classes vary from language to language and even from speaker to speaker, but there are verbs that are considered universally transparency/opacity-inducing. For instance, TRY (e.g. German *versuchen* and Spanish *tratar*) is always transparency-inducing, while CLAIM/AFFIRM (e.g. German *behaupten* and Spanish *afirmar*) is always opacity-inducing.

Early accounts of the clause union/coherence phenomenon cast in a generative transformational framework were proposed by Aissen (1974) for Turkish and French and by Evers (1975) for German and Dutch. In these works, a clause union/coherent structure is argued to be derived by raising of the embedded verb into the matrix clause, where the two verbs form a unit. This raising process then causes pruning of the leftover embedded structure, so that nominal complements originating in the embedded clause become part of the matrix VP. The term ‘restructuring’ was originally used by Rizzi (1978), who argued that a restricted class of matrix verbs in Italian govern a rule, the so-called ‘restructuring rule’, which optionally transforms an underlying bi-clausal structure into a mono-clausal one and thus creates a unique verbal complex consisting of both matrix and embedded verb.

Besides VERB RAISING (Aissen 1974, Evers 1975), Rizzi’s restructuring rule, and other derivational approaches,¹ which have in common that a bi-clausal structure is transformed, in one way or another, into a mono-clausal one, there are also non-derivational approaches. Characteristic of the latter type of approaches is that they do not assume that every infinitival complement starts out as a full clause (CP). Haider (1993), for example, argues that infinitival complements in German are transparent to local grammatical operations when matrix and embedded verb are base-generated as a verbal complex with a complex projection base ($V \rightarrow V_{\text{inf}} V_{\text{matrix}}$) and blended argument structures. According to Wurmbrand (2001), certain matrix verbs and their complements form a coherent unit because the complements of these matrix verbs (which Wurmbrand calls ‘restructuring predicates’) are introduced into the derivation as subclausal, that is they are phrases which lack a tense/agreement and nominative case position and thus must at least be smaller than TP and CP (see also Moore (1996) and Chung (2003) who make similar proposals for Spanish and Chamorro, respectively). As discussed below,

¹ Among the derivational approaches proposed for German are processes known as REANALYSIS (Haegeman & van Riemsdijk 1986, von Stechow & Sternefeld 1988), EVACUATION (Fanselow 1989), and ABSTRACT INCORPORATION (Grewendorf & Sabel 1994, based on Baker 1988). For a cross-linguistic RG account, see Gibson & Raposo 1986.

Wurmbrand's typology of infinitival clause size goes beyond the binary distinction between coherence-inducing and non-coherence-inducing predicates, and the results of the research presented here provide further evidence for Wurmbrand's more fine-grained distinctions.

3. Possessor Raising and Pronominal Binding as Coherence Tests: Diagnosing Infinitival Complexity

According to Bech's (1955/57) binary distinction between coherent versus non-coherent infinitive constructions in German, the difference in transparency between the infinitival complements in (4)-(6) above is explained as follows. The AcI-introducing verb *lassen* 'let, allow, have' in (4) and the control verb *versuchen* 'try' in (5) enter into a coherent construction with their infinitival complements, i.e. take complements smaller than CP, while the control verb *behaupten* 'claim' in (6) enters into a non-coherent construction, i.e. takes a full CP-complement.

As shown in Wurmbrand 2001, this distinction between coherence and non-coherence, that is, between matrix verbs entering into a transparent construction and matrix verbs entering into an opaque construction with their infinitival complement, is not sufficient. There are control verbs like *planen* 'plan' whose complements are transparent for PRONOUN FRONTING (see (7a)), a classic coherence diagnostic testing for a CP-boundary, but not for long passive (see (7b)).

- (7) a. weil ihn der Hans [__ zu reparieren] plante.
 because it.MASC the Hans to repair planned
 '...because Hans planned to repair it.'
- b. *dass der Traktor [__ zu reparieren] geplant wurde.
 that the.NOM tractor to repair planned was.PASS
 Intended: '... that they (impersonal) planned to repair the tractor.'
 (Wurmbrand 2001: 267-268)

Based on long passive and scrambling as probes for the presence of an agentive vP-boundary, Wurmbrand proposes the following typology of infinitival complements. AcI-introducing verbs like *lassen* 'let, allow, have', along with modals and raising verbs, are classified as obligatorily transparency-inducing FUNCTIONAL RESTRUCTURING (FR) predicates. Control verbs like *versuchen* 'try' are classified as optionally transparency-inducing LEXICAL RESTRUCTURING (LR) predicates whose complements are either full CPs or bare VPs. Control verbs like *planen* 'plan' are classified as REDUCED NON-RESTRUCTURING (RNR) predicates whose complements are bigger than a bare VP but smaller than a full CP, namely a vP or TP. Finally, control verbs like *behaupten* 'claim' are classified as FULL NON-RESTRUCTURING predicates.

3.1. The German Possessor Dative Construction (PDC)

German possessor datives, if analyzed as undergoing possessor raising (in line with Landau 1999), provide support for Wurmbrand's distinction between LR and RNR predicates. The following offers some background on the German PDC and motivates a movement account of the construction.

In order to make sense of the dual function of so-called ‘external possessors’, which play the role of not only possessor but also affectee, I argue that the German PDC, exemplified in (8), is best analyzed as possessor raising.

- (8) Tim hat der Nachbarin das Auto gewaschen.
 Tim has the.DAT neighbor the car washed
 ‘Tim washed the neighbor’s car for her.’

The possessor (here *der Nachbarin*), starts its life in the position that possessors normally occupy, namely the specifier of the possessed DP. Since it needs to check case but cannot do so if the D-head of the possessee lacks the ability to license genitive case, it needs to move into a higher verbal projection that can fulfill its needs. In a syntactic derivation that includes an affectee *vP* projection, but no extra DP (besides the possessee, the possessor, and the subject) that can be assembled from the numeration, the case-seeking possessor will move into the specifier of the inherently dative-case-licensing affectee *vP*.² A control or binding analysis of the PDC (see e.g. Hole 2005), cannot straightforwardly explain its strict locality requirements.³ If the possessor dative does not move but is merged directly into the specifier of the affectee *vP* and controls or binds a PRO or null anaphor inside the possessed DP, we have no account of the fact that a possessor dative may not be separated from the possessee by a clause (*vP/TP*) or PP-adjunct boundary. As shown in (9)-(10), neither a control nor a binding analysis captures this.

- (9) a. Jan_i hat dem Direktor versprochen [_{vP/TP} PRO_i zur Party zu kommen].
 Jan has the.DAT director promised to.the party to come
 ‘Jan promised the director to come to the party.’
 b. *Tim hat seiner Schwester_i geplant [_{vP/TP} PRO_i das Radio heile zu machen].
 Tim has his.DAT sister planned the radio intact to make
 Intended: ‘Tim planned to fix his sister’s radio for her.’
- (10) a. Der Direktor_i lässt Jan nicht [_{pp} neben sich_i] arbeiten.
 the director lets Jan not next.to self work
 ‘The director doesn’t let Jan work next to him.’
 b. *Tim musste Lena_i [_{pp} neben Ø_i dem Sessel] aufräumen. (Ø = null anaphor)
 Tim had.to Lena.DAT next.to the armchair up.tidy
 Intended: ‘Tim had to tidy up next to Lena’s armchair for her.’

² When the D-head of the possessed DP *can* license genitive case, possessor raising does not happen. What may look like a possessor dative in examples like (i) is a so-called ‘ficiary’ dative (see McIntyre 2006).

- (i) Er hat der Maria Nathans Radio wieder heile gemacht.
 he has the.DAT Maria Nathan’s radio again intact made
 ‘He fixed Nathan’s radio for Maria.’

Maria is an affectee (happy the radio is fixed) but not a possessor and is introduced via external, not internal merge.

³ Hole (2005), who gives a binding account of the PDC, has to stipulate that dative binding may not cross a clause boundary.

The (a)-examples show that a PRO in a classic control context *is* and German anaphors *can be* coindexed with an antecedent DP on the other side of a clause or PP-adjunct boundary. As illustrated in the ungrammatical (b)-examples, where the possessor position inside the possessed nominal is represented as a PRO and an anaphor, respectively, a possessor dative cannot be that kind of non-local antecedent. Example (11a) below shows that the possessor in (9b) is grammatical as part of the infinitive clause, not as part of the matrix clause. And the possessor in (10b) would be grammatical if the PP were an argument of the verb (as in *Tim wollte Lena [ppauf den Fuß] treten*. ‘Tim wanted to step on Lena’s foot.’).

Getting back to Wurmbrand’s distinction between LR predicates like *versuchen* ‘try’ and RNR predicates like *planen* ‘plan’, *versuchen* allows movement of the possessor dative from the embedded domain into the matrix clause, *planen* does not.

- (11)a. Tim hat versucht/geplant [_{INF} seiner Schwester das Radio heile zu machen].
 Tim has tried/planned his.DAT sister the radio intact to make
 ‘Tim tried/planned to fix his sister’s radio.’
- b. Tim hat seiner Schwester versucht/*geplant [_{INF} ___ das Radio heile zu machen].
 Tim has his.DAT sister tried/planned the radio intact to make
 ‘Tim tried/planned to fix his sister’s radio.’

While it is hard to determine whether instances of scrambling are A-movement, and thus whether they are a good diagnostic for the presence of *vP*, the situation is more straightforward with the PDC. The case-seeking possessor dative cannot raise higher than the closest A-position. The fact that *versuchen* does but *planen* does not allow a possessor dative to move out of its complement therefore suggests that only the complement of the latter includes a subject-introducing and accusative-case-checking (agentive) *vP*. This confirms Wurmbrand’s claim that *versuchen* and *planen*, although both verbs pass classic coherence tests like pronoun fronting, cannot simply be categorized as coherent. One can take a bare VP-complement, which is characteristic of Wurmbrand’s LR predicates, while the other takes a bigger *vP* or TP-complement, which in turn is characteristic of Wurmbrand’s RNR predicates.

3.2. Binding in AcI-constructions

Binding in German AcI-constructions corroborates the need to go beyond coherence (again, in the sense of Bech 1955/57). The possessor raising diagnostic, illustrated in (8), supports Wurmbrand’s restructuring typology as far as control verbs go (i.e. the distinction between LR and RNR predicates), but the binding diagnostic, specifically, pronominal binding in AcI-constructions, suggests that AcI-introducing verbs are misanalyzed as a type of FR predicate. They do not necessarily enter into a transparent construction with their complements. As shown in (12), AcI-complements with unergative and transitive infinitives (see (b) and (c)) are clearly bigger than a bare VP because they contain a ‘subject’, and AcI-introducing causative and perception verbs clearly differ from modals and raising verbs in that they constitute a lexical domain separate from the infinitival domain. Thus, the AcI-constructions in (12b-c) each have two lexical domains with two referentially distinct subjects.

- (12) a. Der kleine Junge ließ [_{AcI} den Stein fallen].
 the little boy let the.ACC rock fall
 ‘The little boy let the rock fall.’
- b. Die Eltern lassen [_{AcI} das Kind spielen].
 the parents let the.ACC child play
 ‘The parents let the child play.’
- c. Der Professor sieht [_{AcI} den Studenten den Artikel lesen].
 the professor sees the.ACC student the.ACC article read
 ‘The professor sees the student read the article.’

Despite their syntactic dependence on the matrix predicate—AcIs cannot be extraposed and do not constitute a separate tense or negation domain—unergative and transitive AcIs can be considered “semantically complete” and must be bigger than a bare VP.⁴ Only the unaccusative AcI in (12a) can be argued to consist of nothing but a VP and thus form a completely coherent unit with the matrix domain. Since it is well-established that AcIs are generally smaller than TP (see e.g. Haider 1993), they can maximally consist of a subject-containing (agentive) vP.

Given that vP functions as binding domain for reflexives and pronominals, which is the focus of section 4, the pronominal binding facts in (13)⁵ are an indication of the possible degrees of AcI-complexity, more specifically, of two different AcI-clause-sizes.⁶

- (13) a. Die Spieler_i hören [_{AcI} die Fans sie_i anfeuern].
 the players hear the fans them on.cheer
 ‘The players hear the fans cheer them on.’
- b. Die Großmutter_i lässt [_{AcI} die Krähe ihr_{7i} auf den Kopf fliegen].
 the grandmother lets the crow her on the head fly
 ‘The grandmother lets the crow fly onto her head.’
- c. Der kleine Junge_i lässt [_{AcI} den Stein ihm_{*i} auf den Kopf fallen].
 the little boy lets the rock him on the head fall
 ‘The little boy lets the rock fall on his head.’

Since the pronominals in (13a) and (b) can refer to the matrix subject and are thus free in the AcI-complement,⁷ the transitive infinitive in (a) and the unergative infinitive in (b) must project

⁴ The distinction between a bare VP and more complex verbal structure is based the commonly held assumption that the external (proto-agent or agentive) argument is introduced by *v*, in the verbal shell above the lexical VP (see Hale & Kaiser 1993, Chomsky 1995, and Kratzer 1996).

⁵ Having established that the subject of an AcI bears accusative case and that this may result in two accusative-marked nominals in a row, I will no longer indicate case-markings in the glosses of AcI-examples.

⁶ These and the following judgments are based on informal questionnaire-based studies which are described and documented thoroughly in the appendix of Lee-Schoenfeld 2007. Native speakers rated sentences on a scale from 1 (readily acceptable) to 5 (completely unacceptable). I marked an average rating of 2.5 as ? and of 3.5 as ??.

⁷ Although (13b) is judged worse than (13a), both are clearly better than (13c). So, a “?”-judgment should still be considered “acceptable”, while a “*?”-judgment should be considered “unacceptable” (see sect. 4.3 for more discussion of the difference between sentences judged as marginally and fully acceptable).

an agentive *vP*. The unaccusative infinitive in (c), on the other hand, as part of an *AcI*-complement within which a pronominal cannot be free, must lack an agentive *vP*-projection. This unaccusative *AcI* may be argued to be either a bare *VP* or a defective “verbalizer” *vP*.

4. Binding: A Phase-based Account

Since the binding diagnostic just discussed is based on the assumption that *vP* is a pronominal binding domain, allowing a syntactically bound pronominal to be free, this section lays out in detail the motivation for this assumption. In particular, I will show that the relevant binding domain for both pronominals and reflexives is the minimal phase containing the anaphoric element. If this is tenable, then agentive *vPs*, which have been argued to be phase-defining by many (see e.g. Chomsky 2000, 2001, Fox 2000, and Nissenbaum 2000), must be one of the phrase-types that qualify as binding domains.

4.1. Non-complementarity

While there is clear-cut complementarity of reflexive and pronominal in constructions involving a matrix verb with a finite clausal complement (see (14)),⁸ there is potential overlap when the matrix verb takes an *AcI* as its complement (see (15)). The apparently long-distance reflexives in (15a-d), marked as coreferent with the matrix subject, range from fully to marginally acceptable.

(14) Die Spieler_i hören [_{CP} dass die Fans_j sich_{j/*i}/sie_{i/*j} anfeuern].
 the players hear that the fans self/they on.cheer
 ‘The players hear the fans cheer them/themselves on.’

(15) a. Martin_i hört [_{VP} seinen Freund_j über sich_{i/j}/ihn_{i/*j} reden].
 Martin hears his friend about self/him talk
 ‘Martin hears his friend talk about him/himself.’

b. Die Großmutter_i lässt [_{VP} die Katze_j sich_{i/j}/ihr_{i/*j} auf den Kopf langem].
 the grandmother lets the cat self/her on the head grab
 ‘The grandmother lets the cat swipe itself/her at the head.’

c. Die Mutter_i lässt [_{VP} die Kleine_j sich_{i/j}/ihr_{i/*j} die Schokolade in den Mund stecken].
 the mother lets the little.one self/her the chocolate in the mouthstick
 ‘The mother lets the little girl stick the chocolate in her mouth.’

d. Die Spieler_i hören [_{VP} die Fans_j sich_{i/j}/sie_{i/*j} anfeuern].
 the players hear the fans self/they on.cheer
 ‘The players hear the fans cheer them/themselves on.’

The reason I include (15d) is that, although the long-distance binding option of *sich* sounds almost entirely bad here, it is still more plausible of an option than in (14). Taking the perspective of the players, and knowing that fans do not usually cheer themselves on, there does

⁸ Reflexive binding in German is a reliable indicator of the complexity of the material intervening between anaphor and antecedent because, unlike in English, there are no exempt anaphors (see Kiss 2001).

seem to be a way to accept the long-distance reflexive. The same, however, cannot be said about (14), where a CP-boundary intervenes between matrix subject and reflexive, so we are not dealing with an exempt anaphor here (see footnote 8).

Interestingly, the binding possibilities in constructions involving a complex DP (with a possessor in its specifier) seem to parallel those in AcI-constructions. Just as in the examples in (15), the reflexive embedded in the complex DP in (16) can be bound by either the embedded or the matrix subject, with varying degrees of acceptability.

- (16) Martin_i hört nicht gern [_{DP} Thorstens_j Geschichten über sich_{i/j}/ihn_{i/*j}].
 Martin hears not with-pleasure Thorsten's stories about self/him
 'Martin doesn't like to hear Thorsten's stories about himself/him.'

A DP needs to be complex (i.e. have a specifier that is filled with at least a covert possessor/subject) in order to provide these binding possibilities. A plain DP like that in (17) does not allow for a pronominal to be bound by the matrix subject.

- (17) Martin_i hat [_{DP} Angst vor sich_i/ihm_{*i} (selbst)].
 Martin has fear of self/him (self.EMPHATIC)
 'Martin is afraid of himself.'

The binding possibilities observed thus far can be summarized as follows. A reflexive cannot be bound across a CP boundary, but it can be bound across an agentive *v*P and a complex DP boundary, while a pronominal is free inside a CP, an agentive *v*P, and a complex DP. Unsurprisingly, the non-complementarity is thus a result of the domain in which the reflexive can be bound being bigger than the domain in which the pronominal must be free. The following is a first stab at defining the binding conditions for reflexive and pronominal.

- (18) a. A reflexive must be bound within the minimal TP containing it.
 b. A pronominal must be free within the minimal agentive *v*P or complex DP containing it.

In order to improve on at least the disjunction inside the statement describing the distribution of pronominals in (18b), it would be desirable to find a way of representing "agentive *v*P and complex DP" as a single, unified domain. This can be done relatively easily since both agentive (i.e. transitive and unergative) *v* and D have been argued to be (strong) phase-defining categories (see Chomsky 2000, 2001, Fox 2000, Nissenbaum 2000, McCloskey 2000, and Svenonius 2004). The condition in (18b) can therefore be restated as follows:

- (18) b.' A pronominal must be free within the minimal phase containing it.⁹

Given that the two domains are distinct (TP in (18a) versus minimal phase in (18b')), cases of complementarity do not fall out entirely naturally from the analysis thus far. The obvious

⁹ By "minimal phase containing it", I mean the most deeply embedded phase that properly contains the anaphoric element; elements at the phase-edge are not properly contained in the phase (see Lee-Schoenfeld 2007: 151).

solution is to posit the same binding domain for both pronominal and reflexive. If this domain is the phase, as proposed in (18b'), instances of complementarity like the example of finite complementation in (14) follow straightforwardly, and if analyzed as resulting from the reflexive gaining access to the higher phase, the non-complementarity in (15) can be explained by reflexive movement to the embedded phase-edge.

4.2. Covert Reflexive Raising and Binding by Phase

Safir (2004) compares the German reflexive *sich* to the French reflexive clitic *se* and proposes that raising of *sich* is the covert version of overt reflexive clitic movement in French. Appealing to this parallel between German and French reflexives in order to explain instances of seemingly long-distance binding in German, Safir suggests “that covert clitic movement from prepositional object position is possible for German *sich* and that certain causative constructions permit the domain of covert clitic movement to pass a specified subject” (p. 162). Following Safir (as well as Chomsky (1986)), I argue that reflexives, unlike pronominals, may covertly raise to their phase-edge to gain access to contents of the higher phase. Unlike Safir, however, I assume that the possibility of covert movement exists even for non-PP-embedded reflexives. Given the well-known parallel between the binding behavior of French clitics and A-movement (Kayne 1975), this seems like a reasonable move. Both clitics and A-moved phrases can engage in apparently unbounded grammatical interactions by means of establishing successive-cyclic local relations, and it is precisely in response to phenomena involving successive-cyclicality that the Minimalist Program proposes movement via phase-edges. As for this movement being covert, within the framework of the Copy Theory of Movement, the only difference between covert and overt movement is the pronunciation of the lower instead of the higher copy of the moved element (see e.g. Boskovic 2001, Bobaljik 2002, and Reintges, LeSourd, & Chung 2005).

Seeing that reflexives are generally grammatically active in ways that pronominals are not—reflexives, for example, must be syntactically bound, while pronominals can refer to an antecedent mentioned in previous discourse or may not have a linguistic antecedent at all—it is not surprising that reflexives do but pronominals do not have the ability to reach the phase-edge. The binding domain for both reflexive and pronominal can now accurately be described as the minimal phase containing the anaphoric element (“its phase”), and the binding conditions in (18) can be revised as given here in (19):

- (19) a. A reflexive must be bound in its phase.
 b. A pronominal must be free in its phase.

This accounts naturally for cases of complementarity, and cases of non-complementarity are a result of the reflexive being clitic-like in having the ability of moving to the phase-edge.

4.3. PP as Binding Domain

Just focusing on *vP* and *DP*, phasehood is not the only way to conceptually unify the relevant binding domains for reflexive and pronominal. Both agentive *vPs* and complex *DPs* host a ‘subject’ in their specifier, so the reason that a syntactically bound pronominal is free if properly

contained in these domains could be that it is separated from its antecedent by a specified subject. One could simply invoke the SPECIFIED SUBJECT CONDITION (SSC) (Chomsky 1973) then. The data in (20), however, showing instances of non-complementarity in sentences with PP-embedded anaphoric elements, suggest that phasehood covers more ground than the SSC.

- (20) a. Welches kleine Boot ließ er_i einfach [PP neben sich_i/ihm_i] untergehen?
 which little boat let he simply next.to self/him under-go
 ‘Which little boat did he simply let sink next to him?’
- b. Er_i sah [PP direkt vor sich_i/ihm_i] eine Schlange auf dem Boden.
 he saw directly in.front.of self/him a snake on the floor
 ‘He saw directly in front of him/himself a snake on the floor.’
- c. Er_i setzte den großen Teddybären [PP neben sich_i/ihn_{2i}].
 he sat the big teddy-bear next-to self/him
 ‘He sat the big teddy bear next to himself/him.’

Just as the data in (15) and (16), which show non-complementarity in *v*P_s and DP_s, these PP-data illustrate the possibility for both the reflexive and the pronominal to be bound by the matrix subject. Only in this case, there is no intervening embedded subject. All that separates the pronominals in (20a-c) from their antecedent is a PP-boundary, but, as shown in (21), not just any PP-boundary allows for a pronominal to be free.

- (21) Die Frau_i interessiert sich nur [PP für sich_i/sie_{*i}] (selbst).
 the woman interests self only for self/her (self.EMPHATIC)
 ‘The woman is only interested in herself.’

What the PPs in (20) have in common and what differentiates them from the PP in (21) is that they are headed by Ps which assign their own θ -role to their respective complements. Unlike in (21), where the reflexive verb *sich interessieren für* ‘be interested in’ both selects the preposition and assigns the θ -role to the object of the preposition, the θ -requirements of the verbs in (20) do not reach into the prepositional domain. The PPs in (20a-b) are adjuncts, and, although the locative PP in (20c) is an argument of the verb *setzen* ‘sit, place’, the preposition here still assigns its own θ -role. The verb selects a locative P, but the exact thematic relation this P establishes between the prepositional argument and the verb is not determined by the verb.¹⁰ In Hestvik’s (1991) terms, PPs that are characterized by independent and phrase-internally complete θ -role assignment are a COMPLETE FUNCTIONAL COMPLEX (CFC) and thus a binding domain despite being subjectless. If θ -independent PPs are phases, just like CPs, agentive *v*P_s, and complex DP_s, we can account for the cases of non-complementarity in (20) without appealing to the binding-specific construct CFC. This finds support from the idea of phases being domains that are self-sufficient and in a way “saturated” and also from Baltin’s (1982) argument that extraction from PP proceeds by way of its specifier. Assuming that “saturation”

¹⁰ Since the judgments on the acceptability of the pronominal in (20c) vary, there may be speakers for whom argument PPs cannot be θ -independent.

and extraction via the specifier of a phrase are viable diagnostics for phasehood, PPs are indeed a reasonable addition to the class of potentially phase-defining constituents.

The phase-based binding system just laid out then accounts for all the cases of “long-distance”- bound reflexives and free pronominals discussed here. What has not been accounted for is that a reflexive bound by the matrix subject is somehow less readily acceptable when not embedded in a PP. The reflexives in (15c-d), for example, are only marginally acceptable, while those in (15a) and (20a) are judged as perfectly grammatical. A possible explanation, in line with Grewendorf 1983, is that θ -independent PPs are generated as adjoined to the embedded phase-edge, outside of the lexical VP. This would ensure that reflexives inside PPs like those in (15a) and (20a) are accessible to the higher phase without covert raising to the embedded ν P-phase-edge. The marginality of “long-distance” reflexives that are not PP-embedded (see (15c-d)) could be a result of speakers’ having to make the extra step of covert reflexive raising a part of the derivation.¹¹ PPs, at least, whether or not they clearly are θ -independent (the *über*-PP in (15a) may not be) are easily construed as adjoined to the edge of the verbal domain and thus automatically part of the higher phase.¹²

4.4. Possessor Raising by Phase

Both the German possessor dative construction and binding into AcIs and other sub-clausal domains point to ν , D, P, and C as potentially phase-defining categories. Exactly what types of ν , D, and P-heads qualify as (strong) phases is the focus of much recent work (see e.g. Legate 2003, Abels 2003, Svenonius 2004, and Lee-Schoenfeld 2007).

As shown in sections 3.1 and 4, agentive ν Ps are opaque, while defective verbalizer ν Ps (which may be argued to close off any “bare” VP) are transparent for possessor raising and binding. How do malefactive/benefactive (affectee) ν Ps, the target of possessor raising, behave when it comes to transparency for grammatical interactions? Since case-checking, even if it is not coupled with movement, cannot cross phase-boundaries, examples like (22), an unaccusative AcI-construction, suggest that affectee ν Ps are not opacity-inducing and thus not phase-defining.

- (22) Der kleine Junge [_{ν P(agent)} lässt [_{ν P(aff)} seinem Freund
 the little boy lets his.DAT friend
 [_{ν P(def)} den Stein auf den Kopf fallen]].
 the.ACC rock on the head fall
 ‘The little boy lets the rock fall on his friend’s head.’

¹¹ Note, however, that covert reflexive raising to the edge of PP, as opposed to ν P, must be less of a derivational complication. Otherwise, the reflexives in (15a) and (20a) would be trapped in their PP-phases.

¹² It remains to be explained why the long-distance binding possibility for the reflexive is most readily acceptable in (15b), a little less acceptable in (15c), and even less acceptable in (15d). In none of these examples is the reflexive embedded in a PP. The answer to this question may have to do with the degree of agentivity attributed to the AcI-subject. The cat in (15b) could be considered less agentive than the little girl in (15c), and the little girl could in turn be considered less agentive than the players in (15d). It seems that the weaker the degree of agentivity, the easier it is to interpret the reflexive as bound to the higher subject, on the other side of the agentive ν P-boundary. In fact, if speakers coerce weakly agentive AcI-constructions into a non-agentive, i.e. unaccusative, and thus transparent structure, they have found another way to avoid covert reflexive raising.

The AcI-subject *den Stein* checks accusative case with the matrix *v*. At the same time, the possessor *seinem Freund* raises to the specifier of the dative-case-licensing affectee *vP*. If affectee *vPs* were phases, the static Agree relation between the AcI-subject *den Stein* and the matrix *v* would not be possible to establish. Despite hosting an external argument, affectee *vPs* then pattern with defective verbalizer *vPs*, not with agentive *vPs*.

Getting back to binding, consider again the unaccusative AcI in (13c), repeated here as (23). A defective verbalizer *vP*, within which a pronominal bound by the matrix subject cannot be free, is a domain that is transparent for binding.

- (23) Der kleine Junge_i lässt [_{vP(def)} den Stein ihm_{*i} auf den Kopf fallen].
 the little boy lets the rock him on the head fall
 ‘The little boy lets the rock fall on his head.’

As we just saw in (22), an unaccusative AcI is also precisely the type of domain that is transparent for possessor raising. The possessor dative in (22) has the possibility of moving across the AcI-subject into the matrix clause. This is not the case in transitive AcI-constructions like (24), with an agentive AcI-subject, here *Willi*. The agentive *vP*-boundary induces opacity.

- (24) *Maja lässt ihrer Freundin [_{vP} Willi __ die Füße massieren].
 Maja lets her.DAT friend.FEM Willi the feet massage
 Intended: ‘Maja lets Willi massage her friend’s feet.’

As for DPs and PPs, the pronominal binding diagnostic indicates that they can be phases. DPs must be complex, i.e. have (at least a covert) possessor in their specifier, and PPs, which are inherently subjectless, must be θ -independent and thus, in a sense, semantically “complete” in order to be opaque for pronominal binding. This can be extended to possessor raising as well. The θ -independent PP-adjunct in (10b), repeated here in (25b), for example, blocks, i.e. is opaque for possessor raising, while the θ -dependent PP-argument in (25a) is transparent.

- (25) a. Er stand der Braut [_{PP} auf __ der Schleppe].
 he stood the.DAT bride on the train
 ‘He stood on the bride’s train.’
 b. *Tim musste Lena [_{PP} neben __ dem Sessel] aufräumen.
 Tim had-to Lena.DAT next-to the armchair up.tidy
 Intended: ‘Tim had to tidy up next to Lena’s armchair for her.’

Although things get a little more complicated when it comes to the transparency/opacity of DPs in possessor raising contexts, the facts ultimately support the analysis I propose here (for a detailed discussion, see Lee-Schoenfeld 2007:174-178). As for CPs, they are inherently subjectless, and the reflexive binding facts in section 4.1 clearly show that they are opacity-inducing. Once again, this is confirmed by possessor raising. The verb *bedauern* ‘regret’, for

example, takes a full CP-complement, and it is impossible for a possessor dative to move beyond it.

- (26) *Tim hat der Nachbarin bedauert
 Tim has the.DAT.FEM neighbor.FEM regretted
 [_{CP} dass er — das Auto waschen musste].
 that he the car wash had.to
 ‘Tim regretted that that he had to wash the neighbor’s car.’

5. Conclusion

Taking a step back and returning to the overarching theme of this contribution, we have seen the following parallel. Just like embedded clause clitics in Romance languages, which can “climb” into the matrix clause in a clause union/restructuring environment (Aissen 1974, Evers 1975, Aissen & Perlmutter 1976, 1983, and Rizzi 1978), possessor datives in German can raise to an affectee vP projected by a higher verb in a coherent construction. And, as already pointed out by Kayne in 1975, A-movement (like possessor raising) and binding are governed by the same locality constraints, making both types of phenomena effective diagnostics for structural complexity.

References

- Abels, Klaus. 2003. Successive cyclicity, anti-locality, and adposition stranding. Doctoral dissertation, University of Connecticut, Storrs.
- Aissen, Judith. 1974. The syntax of causative constructions. Doctoral dissertation, Harvard University, Cambridge, Ma. (1978. New York: Garland.)
- Aissen, Judith and David Perlmutter. 1976. Clause reduction in Spanish. *Berkley Linguistic Society* 2, 1-30. (1983. *Studies in Relational Grammar* 1. Chicago: The University of Chiago Press.)
- Baker, Mark. 1988. *Incorporation*. Chicago: The University of Chicago Press.
- Baltin, Mark. 1982. A landing site theory of movement rules. *Linguistic Inquiry* 13:1-38.
- Bech, Gunnar. 1955/57. *Studien über das deutsche Verbum infinitivum*. 2nd edition 1983. Tübingen: Niemeyer.
- Bobaljik, Jonathan. 2002. A-chains at the PF-interface: Copies and ‘covert’ movement. *Natural Language and Linguistic Theory* 20:197-267.
- Boskovic, Zeljko. 2001. *On the nature of the syntax-phonology interface: Cliticization and related phenomena*. Amsterdam: Elsevier.
- Chomsky, Noam. 1973. Conditions on transformations. *A festschrift for Moris Halle*, eds. S. Anderson and P. Kiparsky, 232-286. New York: Holt, Rinehard and Winston.
- Chomsky, Noam. 1986. *Knowledge of language: Its nature, origin, and use*. New York: Praeger.
- Chomsky, Noam. 1995. The minimalist program. Cambridge, Ma: MIT Press.
- Chomsky, Noam. 2000. Minimalist inquiries: The framework. *Step by step: Essays on minimalist syntax in honor of Howard Lasnik*, eds. R. Martin, D. Michaels, and J. Uriagereka, 89-156. Cambridge, Ma: MIT Press.

- Chomsky, Noam. 2001. Derivation by phase. *Ken Hale: A life in language*, ed. M. Kenstowicz, 1-51. Cambridge, Ma: MIT Press.
- Chomsky, Noam. 2006. On phases. *Foundational Issues in Linguistic Theory*, eds. R. Freidin, C. Otero, and M.-L. Zubizarreta, 133-166. Cambridge, Ma: MIT Press.
- Chung, Sandra. 2003. Restructuring and verb-initial order in Chamorro. *Syntax* 7:199-233.
- Evers, Arnold. 1975. The transformational cycle in Dutch and German. Doctoral dissertation, University of Utrecht, The Netherlands.
- Fanselow, Gisbert. 1989. Coherent infinitives in German. *Syntactic phrase structure phenomena in noun phrases and sentences*, eds. C. Bhatt, E. Löbel, and C. Schmidt, 1-16. Amsterdam: Benjamins.
- Fox, Danny. 2000. *Economy and semantic interpretation*. Cambridge, Ma: MIT Press.
- Gibson, Jeanne and Eduardo Raposo. 1986. Clause union, the stratal uniqueness law and the chômeur relation. *Natural Language and Linguistic Theory* 4:295-331.
- Grewendorf, Günther. 1983. Reflexivierung in deutschen A.c.I.-Konstruktionen – Kein transformationsgrammatisches Dilemma mehr. *Groninger Arbeiten zur Germanischen Linguistik* 23:120-196.
- Grewendorf, Günther and Joachim Sabel. 1994. Long Scrambling and incorporation. *Linguistic Inquiry* 25:263-308.
- Haegeman, Liliane and Henk van Riemsdijk. 1986. Verb projection raising, scope, and the typology of rules affecting verbs. *Linguistic Inquiry* 17:417-466.
- Haider, Haider. 1993. *Deutsche Syntax – Generativ*. Tübingen: Narr.
- Hale, Kenneth and Samuel Keyser. 1993. On argument structure and the lexical expression of syntactic relations. *The view from Building 20*, eds. K. Hale & S. Keyser, 53-109. Cambridge, Ma: MIT Press.
- Hestvik, Arild. 1991. Subjectless binding domains. *Natural Language and Linguistic Theory* 9: 455-496.
- Hole, Daniel. 2005. Reconciling “possessor” datives and “beneficiary” datives – Toward a unified voice account of dative binding in German. *Event arguments: Foundations and applications*, eds. C. Maienburg and A. Wöllstein-Leisten, 213-242. Tübingen: Narr.
- Kayne, Richard. 1975. *French syntax: The transformational cycle*. Cambridge, Ma: MIT Press.
- Kiss, Tibor. 2001. Anaphora and exemptness. A comparative treatment of anaphoric binding in German and English. *Proceedings of the 7th International Conference on Head-Driven Phrase Structure Grammar*, 182-197. Stanford: CSLI Publications.
- Kratzer, Angelika. 1996. Severing the external argument from its verb. *Phrase structure and the lexicon*, eds. J. Rooryck and L. Zaring, 109-137. Dordrecht: Kluwer.
- Landau, Idan. 1999. Possessor raising and the structure of VP. *Lingua* 107:1-37.
- Lee-Schoenfeld, Vera. 2007. *Beyond Coherence: The syntax of opacity in German*. Amsterdam: Benjamins.
- Legate, Julie. 2003. Some interface properties of the phase. *Linguistic Inquiry* 34:506-516.
- McCloskey, James. 2000. Quantifier float and Wh-movement in an Irish English. *Linguistic Inquiry* 31:57-84.

- McIntyre, Andrew. 2006. The interpretation of German datives and English *have*. *Datives and other cases*, eds. W. Abraham, D. Hole, and A. Meinunger, 185-211. Amsterdam: Benjamins.
- Miyagawa, Shigeru. 1987. Restructuring in Japanese. *Issues in Japanese linguistics*, eds. T. Imai and M. Saito, 273-300.
- Moore, John. 1996. *Reduced constructions in Spanish*. New York: Garland Publishers.
- Nissenbaum, Jon. 2000. Investigations of covert phrase movement. Doctoral dissertation, MIT, Cambridge, Ma.
- Reintges, Chris, Philip LeSourd, and Sandra Chung. 2005. Movement, *wh*-agreement, and apparent *wh*-in-situ. *Wh-movement on the move*, eds. L. Cheng and N. Corver, 165-194. Cambridge, Ma: MIT Press.
- Rizzi, Luigi. 1978. A restructuring rule in Italian. *Recent transformational studies in European languages*, ed. S. Keyser, 113-158. Cambridge, Ma: MIT Press.
- Safir, Ken. 2004. *The Syntax of anaphora*. Oxford: Oxford University Press.
- Stechow, Arnim von and Wolfgang Sternefeld. 1988. *Bausteine syntaktischen Wissens*. Opladen: Westdeutscher Verlag.
- Svenonius, Peter. 2004. On the edge. *Peripheries*, eds. D. Adger, C. de Cat, and G. Tsoulas, 259-287. Dordrecht: Kluwer.
- Wurmbrand, Susi. 2001. *Infinitives: Restructuring and clause structure*. Berlin: Mouton de Gruyter.

SGF COORDINATION IN ENGLISH: LIGHT VS. HEAVY STYLISTIC INVERSION AND THE STATUS OF *pro**

Robert D. Levine
Ohio State University
levine@ling.ohio-state.edu

Like German, English exhibits a construction in which an apparently complete clause exhibiting stylistic inversion is conjoined with a VP. A straightforward treatment of this class of coordination is available if we assume that two VPs have been conjoined whose common subject is linearized on the right edge of the first VP, as proposed in Kathol and Levine 1992; a counteranalysis of the coordination as clausal conjunction with a *pro* subject yields a set of predictions that appear to fail across the board in the face of contrary data. These same contraindications, however, pose comparable problems for the account offered in Kathol and Levine 1992. There is, however, a resolution to the difficulty which supports the latter, but not the *pro* solution, viz., the distinction between Heavy Inversion and Light Inversion offered in Culicover and Levine 2001. On this approach, the apparent counterexamples to the linearization-based solution turn out to instantiate a fundamentally different species of structure from stylistic inversion, reflecting heavy NP shift of subjects. If the HI/LI distinction is on the right track, then the class of contraindications to the analysis in Kathol and Levine 1992 essentially vanishes, since all such examples belong to the class of pseudo-inverted structures, which the linearization approach does not need to give an account of.

1. Locative Inversion in English: some background

The phenomenon commonly referred to as *locative* (or *stylistic*) inversion has been intensively studied since the late 1970s, serving as the pivot for a variety of claims and counterclaims in a continuously changing theoretical landscape. Analyses of examples such as

(1) Into the room strode Robin.

*This paper is an outgrowth of the analysis of locative inversion in Kathol and Levine 1992, and much of the thinking behind the linearization analysis which is the formal platform of this paper was carried out collaboratively with Andreas Kathol, whose many signal contributions to linguistic theory include pioneering work on the linearization framework introduced by Michael Reape. I am also much indebted to my colleague Peter Culicover for many productive discussions during our joint research on English stylistic inversion reported in Culicover and Levine 2001, which supplied another piece of the puzzle. Finally, my heartfelt thanks to Emma Pease at CSLI for some crucial eleventh-hour L^AT_EX wizardry. All errors and shortcomings are mine alone.

The following symbols and abbreviations are used in the discussion below:

Symbol	Meaning	Symbol	Meaning
\oplus	list append	HPSG	Head-driven Phrase Structure Grammar
\otimes	sequence union	SI	stylistic inversion
ξ	the empty list	HI	Heavy inversion
\in_{list}	list membership	LI	Light Inversion
\prec	linear precedence	WCO	Weak Crossover
		P&P	Principles and Parameters

have been variously analyzed along essentially two alternative lines:

- *Into the room* is an extracted complement of *strode*, whose empty subject is linked by one or another mechanism to the postverb NP *Robin* (see Bowers 1976 and Emonds 1976 for early statements of this analysis and Coopmans 1989 for a more recent version of the analysis couched in P&P terms). The chief motivation behind this analysis appears to be that it provides a motivation for the apparent island effect associated with SI: **Who_i did on the dresser stand a picture of t_i ?*; Bowers argues that the analysis is supported by cases such as *In the garden is a statue, isn't there*, where familiar properties of tag question might be invoked to suggest something like the equivalent of an empty *there* subject (cf. *In the garden there is a tree, isn't there*. The problem, of course, is that in the vast majority of cases, there is no evidence of a covert *there*: **Into the room strode Robin, didn't there*; moreover, the pioneering work of Robert Kluender (1998 in particular) on the processing basis of Subjacency effects, which has generated an increasingly comprehensive literature on the nonsyntactic bases of islandhood (see, e.g., Kluender and Kutas 1993a, Kluender and Kutas 1993b, Kluender 2004, Sag et al. 2007, Sag et al. 2008, Hofmeister and Sag 2010) make it seem unlikely that the erratic and frequently defeasible effects grouped under the rubrics 'subjacency' and 'wh-island constraint' have any basis in configurational properties reflecting the combinatorics of the grammar itself.

- *Into the room* is the subject of *strode* and *Robin* a selected complement, with both arguments mapped to semantic relations corresponding respectively to those of ordinary topicalized complement and subjects (see Bresnan 1990, Bresnan 1994, Culicover and Levine 2001 for arguments on behalf of this position). The argument here is that the PP in initial position in SI clauses actually has properties reflecting subjecthood rather than filler status. But a major empirical challenge to such analyses exists: the phenomenon of SGF ('subject-gap-in-fronted-construction') co-ordination, a familiar problem in German syntax which has an unexpected reflex in English.

There are however other possibilities. The particular analysis I want to consider further in this paper, given in Kathol and Levine 1992 presents a novel treatment of English locative inversion constructions couched in what has come to be called the Linearization Framework: phrase structure hierarchy may be mapped to linear precedence relations in a nonconcatenative fashion, so that ordering relations may be stated directly among terminal elements in phrase structure trees which are not sisters. More specifically, we assume two distinct components of grammatical descriptions: VAL(ence) specifications, which identify the combinatorial potential of lexical heads and which thus contribute significantly to the definition of constituency, and DOM specifications, which define the subcomponents of linguistic expressions which are subject to linear order restrictions with respect to each other. Crucially, there is no direct relationship between these two subdomains of attributes: elements which belong to different constituents are nonetheless subject to order relations with respect to each other as long as relevant properties corresponding to them appear on the same DOM list. The mechanisms which this kind of analysis relies on have been explored at length in a number of varieties (see, e.g., Reape 1996, Kathol 1995) and need not be repeated here here. Briefly, we assume that words have the general feature geometry in (2):

$$(2) \left[\begin{array}{l} \text{word} \\ \text{DOM-OBJ } \boxed{1} \left[\begin{array}{l} \text{dom-obj} \\ \text{PHON } \boxed{2} \\ \text{SYNSEM|HEAD|UNION } \textit{bool} \end{array} \right] \\ \text{DOM } \langle \boxed{1} \rangle \end{array} \right]$$

DOM specifications are lists of DOM-OBJ values, whose values on phrasal signs can be fixed in a number of ways; we assume for concreteness, that V_s are in general specified as [UNION +], that since UNION is a HEAD feature it propagates up the head path, and that phrases in English are subject to the general constraint

$$(3) \left[\begin{array}{l} \text{phrase} \\ \text{DTRS } \bigoplus_{j=1}^k \left(\left\langle \left[\begin{array}{l} \text{DOM-OBJ|SYNSEM|HEAD|UNION } - \\ \text{DOM } \boxed{j} \end{array} \right] \right\rangle \right) \otimes \left(\bigoplus_{h=k+1}^n \left\langle \left[\begin{array}{l} \text{DOM-OBJ|SYNSEM|HEAD|UNION } + \\ \text{DOM } \boxed{h'} \end{array} \right] \right\rangle \right) \\ \text{DOM } \left(\bigotimes_{j=1}^k \boxed{j} \right) \otimes \left(\bigotimes_{h=k+1}^n \boxed{h'} \right) \end{array} \right]$$

where \otimes denotes the sequence union (or, more informally, ‘shuffle’) operation introduced in this theoretical context in Reape 1993, which essentially shuffles together an arbitrary number of lists, preserving the order of elements from any given list in the output.¹

¹Formally, the sequence union operator appears in Reape 1993 with the following definition, where ξ is the empty list, X, Y, Z are arbitrary lists, and $\alpha \oplus \beta$ denotes the append of the lists α and β :

- i. $\otimes(\xi, \xi, \xi)$
- ii. $\otimes(X, Y, Z) \supset \otimes(\langle a \rangle \oplus X, Y, \langle a \rangle \oplus Z)$
- iii. $\otimes(X, Y, Z) \supset \otimes(X, \langle a \rangle \oplus Y, \langle a \rangle \oplus Z)$

The first clause of the definition identifies the shuffle of two empty lists as the empty list. The next two clauses in effect constitute instructions on how to recursively construct longer lists given the shuffle operation on shorter lists; thus, the second clause specifies that when X and Y are shuffled to yield Z , the shuffle of one of the input lists with a second list one element longer appends that added element to Z . Here the first clause in effect serves as the basis of an induction defined by ii. and iii.: shuffling $\langle a \rangle$ and $\langle b \rangle$ respectively with the empty list corresponds (bearing in mind that for any list α , $\alpha = \alpha \oplus \xi$) to the inferences

$$\begin{aligned} \otimes(\xi, \xi, \xi) &\supset \otimes(\langle a \rangle \oplus \xi, \xi, \langle a \rangle \oplus \xi), \\ \otimes(\xi, \xi, \xi) &\supset \otimes(\xi, \langle b \rangle \oplus \xi, \langle b \rangle \oplus \xi), \text{ i.e.,} \\ \otimes(\langle a \rangle, \xi, \langle a \rangle), \otimes(\xi, \langle b \rangle, \langle b \rangle) \end{aligned}$$

from which it immediately follows that

$$\otimes(\langle a \rangle, \langle b \rangle) \in \{ \langle a, b \rangle, \langle b, a \rangle \}$$

in turn entailing—given the possibilities of parsing $\otimes(\langle c \rangle, \langle a, b \rangle)$ as $\otimes(\langle c \rangle \oplus \xi, \langle a, b \rangle)$, $\otimes(\langle c \rangle, \langle a, b \rangle \oplus \xi)$ or $\otimes(\langle c \rangle, \langle a \rangle \oplus \langle b \rangle)$ —that

$$\otimes(\langle c \rangle, \langle a, b \rangle) \in \{ a, b, c \}, \{ a, c, b \}, \{ c, a, b \}$$

and so on. Taking a string to be a list with linear positions bijectively mapped to location in the list structure, the sequence union of two lists ζ, ϑ will be the set of all strings whose membership is the set union of the memberships of ζ and ϑ and in which, for any $\zeta_j \in_{list} \zeta, \vartheta_k \in_{list} \vartheta, \zeta_i \prec \zeta_j$ in ω (where $\omega \in \otimes(\zeta, \vartheta)$) iff $\zeta_i \prec \zeta_j$ in ζ for all i, j , and likewise for ϑ_h, ϑ_k for all h, k , and where, over all the strings in $\otimes(\zeta, \vartheta)$, for all m, n, ζ_n and ϑ_m stand in all

The feature UNION plays a critical role in all analyses which combine a tecto/phenogrammatical distinction—where combinatorial structure is detached from linear ordering constraints—with a phrase structure theory of representation which does not accept ‘tangled trees’ along the lines of McCawley 1982, Ojeda 1987, Ojeda 1988, and Blevins 1990; it in effect controls the way in which subparts of constituents are ordered with respect to each other when the constituents combine to form a larger constituent. When the value of UNION on the head of a constituent C is $-$, the familiar axiom of tree algebra, whereby all descendents of C preserve the precedence relation holding between C and all other nodes in the tree, is maintained, so that C ’s terminal yield reflects the simple concatenation of the terminal strings of its subconstituents. But when the value of UNION is $+$, C ’s head and its complements combine not by concatenation, but by the sequence union operation, and the terminal string corresponding to C will reflect the partial mixing together of the phonological forms associated with various of C ’s descendents. The DTRS list is in effect partitioned into the yield, under sequence union, of two sublists; one of which comprises members all of whom have [UNION $-$] values, the other of which has exclusively [UNION $+$]. When the head of the phrase is [UNION $+$], the first list contributes the shuffled list of its elements’ respective DOMAIN-OBJECT values, singleton lists containing (subportions of) their own descriptions, but not the contents of their DOM values (hence the operation of \otimes over \boxed{I} , not \boxed{I}' , in (3)); the second list however contributes the result of shuffling all of the DOM values belonging to its respective elements. Thus nonunionable daughters contribute nothing but parts of their own description, while unionable elements contribute the content of their domain specifications, which may include the descriptions of a substantial number of their descendents.

In effect, then, the constraint in (3) dictates the form of an object (i.e., the DOM list) on any sign C , in virtue of which constraint the structural components of C ’s unionable daughters are shuffled together with C ’s nonunionable daughters. Which categories take which value for UNION, and under what conditions, is determined by language-parochial conditions. We can assume, for present purposes, that in English, fully saturated categories are always UNION $-$, as are all projections of non-*verb* head types. PHON values are subject to the constraint in (4), where \oplus is ordinary append:

$$(4) \left[\begin{array}{l} \text{sign} \\ \text{PHON } \bigoplus_{i=1}^n \boxed{I}' \\ \text{DOM } \bigoplus_{i=1}^n \boxed{I} \left[\text{PHON } \boxed{I}' \right] \end{array} \right]$$

linear relationships with respect to each other that respect the precedence conditions just stated (which are imposed by general LP statements of the kind introduced in Gazdar et al. 1985. The shuffle relation thus treats two lists exactly like two packs of cards whose respective members have, after shuffling, one of n possible linear ordering relations to each other but with no change in the order of the cards with respect to the order in their original pack; in the case of the \otimes operation on lists, however, the shuffle relation itself identifies the set containing all n possible orderings.

Linear order is thus a direct reflection of the structure of the DOM list, and—crucially—is only indirectly related to constituent structure. Exploiting this significant degree of independence between the combinatorial and sequential dimensions of representation, the linearization framework has proven strikingly successful in providing compact treatments of precedence phenomena in languages with relatively free constituent ordering, including German (Reape 1993, Kathol 1993, Kathol 1995, Reape 1996, Kathol 2000) and Warlpiri (Donohue and Sag 1999), and sheds considerable light on various structure/order mismatch phenomena in Japanese (see Gunji 1999, Yatabe 2001, Yatabe 2007), Portuguese (see Crysmann 1997), Fox (Crysmann 1999), Serbo-Croatian (Penn 1999), French (Bonami et al. 1999) and, most notably during the past few years, in the analysis of ellipsis phenomena in a variety of languages (see the papers by Yatabe already cited, Crysmann 2003, Chaves 2008, Hofmeister 2010 and references cited in these sources).

The particular linear order which shows up on legal DOM lists of signs in some language will reflect parochial ordering constraints in that language. For German, these constraints typically involve fixed linear positioning zones standardly referred to as topological fields. For English, linear precedence constraints have standardly been taken to make reference solely to category specifications under the assumption, referred to in Gazdar et al. 1985 as Exhaustive Constant Partial Ordering, that such ordering restrictions are constant across categories. This approach to linear ordering needs major revision, however, in the linearization framework. Along slightly different lines from Kathol and Levine 1992, suppose that VPs whose DOM values contain finite verbs (corresponding to their heads) also specify in their DOM lists an element specified as [ORD first], which normally shares its SYNSEM specification with that verb's subject, with the constraints given in (5) in force:

- (5) a. [first] \prec V[fin]
 b. V[fin] \prec [\neg first]

Consider how ordinary declarative sentences are licensed in this system. There will be a set of familiar combinatorial constraints, expressed variously as schemata or as type restriction, which will yield the sentence *Robin strode into the room* along the lines in (6):

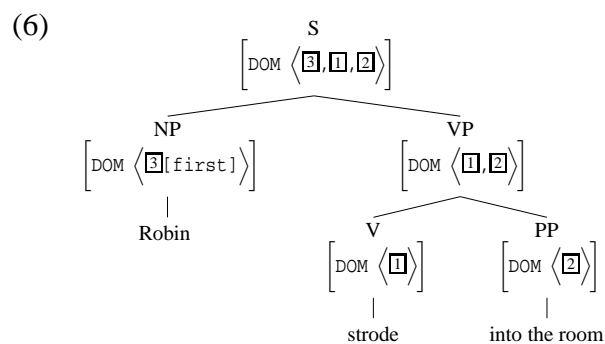

But verbs which sponsor stylistic inversion have the somewhat unusual property of allowing their PP complement, rather than their subject, to appear with a [first] specification on the verb's

mother's DOM list. We also assume that such verbs form an attachment relationship to a linearly following complement along lines discussed in Dowty 1996. Assuming such a possibility, we will automatically license the following structure:

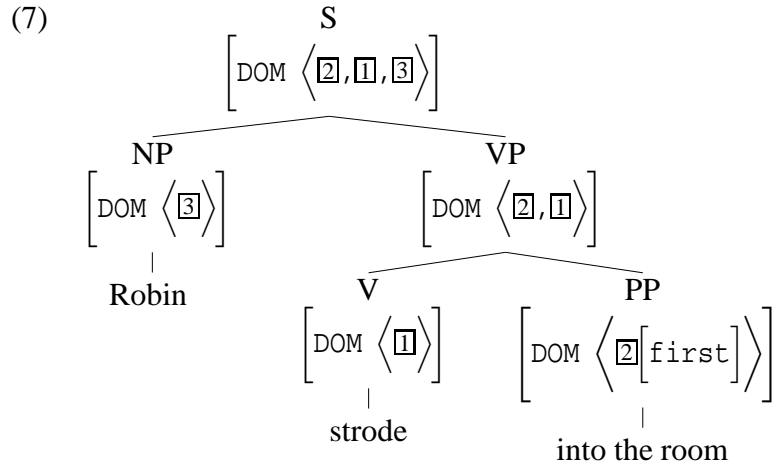

Structurally, that is, the postverb NP in stylistic inversion is taken to satisfy the SUBJ specification and the preverb PP the COMPS requirement, and the constituent structure of (1) is taken to be exactly the same as its unverted counterpart. Inversion reflects the linear projection of phrase structure, not phrase structure itself.

This kind of analysis has been worked out in detail for German in a number of monograph-length accounts, including Reape 1993, Kathol 1995, and Kathol 2000. But German aside, what justification could there be for an account of any English phenomenon along these lines? The answer is that this account seems strongly motivated by the existence of so-called SGF coordination, extensively studied in German in Kathol 1995, Kathol 2000, and illustrated in (8):

- (8) a. Into the room strode Robin boldly and snatched the microphone from the astonished speaker's hand.
 b. So into the room strides Robin boldly and snatch*(es) the microphone from the astonished speaker's hand.
 c. So into the room stride the twins boldly and snatch(*es) the microphone from the astonished speaker's hand.

As argued in Kathol and Levine 1992, there is no doubt that the second VP in (8a) does not predicate over the initial PP *into the room*; rather, the second VP is understood as combining with the NP *Robin*, which therefore has to be understood as the unquestionable subject for the second VP; note the agreement pattern in (8b)-c. But if the postverb NP counts as the subject of the second conjunct, then the null hypothesis is that it is also the subject of the initial inversion VP, and that what (8) is a case of VP coordination; any other treatment would require either an empty subject for the following cause (as discussed below) or require coordination of S and VP, with the subject

of the latter somehow uniquely interpreted in. Neither the approach which takes locative inversion to have a PP subject nor that which assumes a topicalized PP and an empty subject coindexed with a postposed NP can, in the absence of theoretically bizarre coindexing mechanisms, capture the fact that in (8), the postverb NP is indeed the subject of the second VP: in both cases, a constituent buried within the first VP somehow has to combine simultaneously with both the VP that contains it and the second conjunct, an apparent structural impossibility.

By contrast, the treatment of such examples is straightforward on the linearization approach, because the separation of linear position and combinatoric structure lets us treat SGF phenomena as normal coordination, while accounting for the seemingly anomalous ordering facts. Linear precedence is determined by constraints that apply to the content of DOM lists, which do not necessarily correspond in any way to the phrase structure hierarchy determined, ultimately, by the valence of lexical heads. The lexically idiosyncratic ordering properties of SI verbs interact with the syntax of ordinary VP coordination to yield SGF coordination without the need to posit eccentric phrase structural configurations, along the following lines.

We start by restricting the automatic unionability of VPs to headed structures; coordinate structures in HPSG are generally taken to be nonheaded, so that the possibilities involving coordinated VPs require a separate statement. In particular, we assume that there is a general condition on coordinate structure which requires all conjuncts but the first to be UNION –. In any coordination of VPs, therefore, all of the DOM values of the non-left-peripheral daughter conjuncts will appear compacted, as it were, in their mother’s DOM specification. The left peripheral daughter conjunct alone can appear with a UNION + specification—in which case the constraint in (3) will license the structure in (9) representing the sentence in (8):

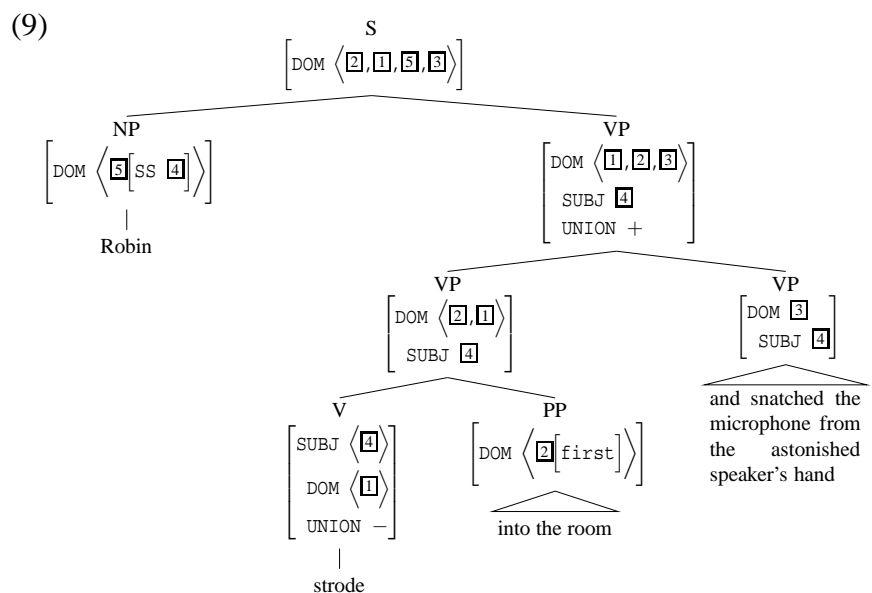

The key point is that, once again, structure and order are independently defined, and little more need be said to license examples such as (8) than is needed to handle simple cases of uncoordinated stylistic inversions such as (1). In contrast, for approaches which take stylistic inversion to reflect a different structure from uninverted clauses, examples such as (8), taken to be VP coordinations, represent a major embarrassment.

2. *pro* as a Nonsolution

The obvious way out for adherents of such approaches is to deny that (8) is an instance of VP coordination. If, instead, it actually instantiates a coordination of clauses, the second of which has a phonologically null subject, then the problem posed by (8) goes away at once, and with it a good deal of the advantage of a linearization-based analysis of English stylistic inversion. I will however argue that the null subject solution is empirically deficient to a degree that effectively rules it out as a response to the challenge of examples such as (8). To ground the argument, I will take as my target a proposal that (8) reflects the structure in (10).²

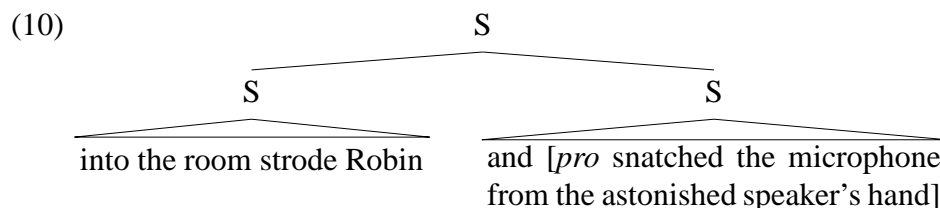

where *pro* is a null definite pronoun, originally proposed in Suñer 1982) to account for the possibility of unpronounced anaphoric elements in governed positions in Spanish. On the assumption that (10) is the solution to the problem posed by (8), *pro* bears the same kind of reference relation to the subject of the preceding clause that *he* does in, e.g.,

(11) Into the room strode Robin_{*i*} boldly, and he_{*i*} snatched the microphone from the astonished speaker's hand.

2.1. Presentational *there*

Fittingly, the first kind of evidence that the *pro* solution fails appeals to data from presentational *there* constructions—a class of phenomena first brought to the attention of theoretical syntacticians in a paper by Judith Aissen (1975), whom this volume honors. It turns out that neither existential nor presentational *there* constructions—the latter often noted as highly parallel to stylistic inversion clauses (see, e.g., Coopmans 1989)—allow coordinations analagous to (8).

²I follow here the assumption, first defended in Ross 1967 and adopted in much previous and current literature on the syntax of coordination, that the conjunct/disjunct particles are syntactically included in the second of two coordinated constituents.

- (12) a. There's [a huge lion]_i in the closet and *(he)_i is really, really hungry.
 b. There is buried in that grave an unknown member of Robin's family, and *(he)_i has found eternal rest.
 c. There emerged from the room two harried spokesmen for the police department, and *(they)_i spent half an hour bitterly criticizing us.

One might suppose that *pro* is restricted in its appearance to 'internal' positions, where it is preceded by enough lexical material to provide it with an antecedent, as in (10). But then the unequivocal badness of such examples demands explanation. In the data in (12), none of the environments are antipronominal, as the possible occurrence of overt pronouns makes clear. In order to neutralize these data as counterexamples, it seems necessary to argue that not only that there is some crucial structural difference between *there* sentences and stylistic inversions, but that these differences plausibly motivate the appearance of *pro* as a subject in a clause conjoined to an instance of the latter (as in (8) but not the former (10))—a strategy which bears an obvious, and heavy, burden of proof.

2.2. Not just Null Pronouns, but Null Auxiliaries too

Any explanation along the lines just alluded to needs to take into account another set of data which represent a severe problem for the *pro* account.

- (13) a. That policy the Provost has already implemented, and thereby shown himself to be an enemy of faculty rights.
 b. [That policy [the Provost]_i has already implemented e] and [_S thereby *pro*_i [_V e] shown himself to be an enemy of faculty rights]
 c. *That policy the Provost has already implemented, and thereby he shown himself to be an enemy of faculty rights.
 d. [That policy [the Provost]_i has already implemented e] and [_S thereby he_i [_V e] shown himself to be an enemy of faculty rights]

If a *pro* analysis is really available for English, then we would expect that in the absence of further stipulations we could freely conjoin two sentences where the second conjunct was *pro*. A staunch defender of the Coordinate Structure Constraint, for example, might wish to claim that the apparent Coordinate Structure Constraint violation in (13a) reflected just such a coordination, which would limit the entire domain of extraction to the first conjunct, negating the putative violation. But the problem with this suggestion is clear when the structure it imposes on (13a) is made slightly more explicit, as in (13b). If the *thereby* conjunct is a separate clause, then where does the past participial morphology of its verb come from? On the assumption that auxiliary morphosyntax is determined strictly locally, which I don't think is controversial, we must further posit a null auxiliary as well, which presumably corresponds either to a mysterious null pro-verb, or else to a null version of *have*. In either case, it is highly suspicious that the only time this form can appear—if that's the

right word—in a clause is when there is a preceding phonological overt *have* in an IMMEDIATELY PRECEDING conjoined clause:

- (14) a. The Provost *(has) shown himself to be an enemy of faculty rights.
 b. The Provost has implemented this policy, will not budge from it, and thereby *??(has) shown himself to be an enemy of faculty rights.

But there is worse to come. For it turns out that not only is this null auxiliary confined to a clause following an immediately preceding conjunct with an overt *have*, it also requires a null subject of its own, as we see from (13c)-d, which make clear that a violation of this restriction bars the occurrence of the null auxiliary—an outcome that should not follow in the null lexical analysis, since there is no functional linkage between the empty subject and the empty auxiliary which could possibly motivate the badness of (13c). The range of utterly unmotivated stipulations which have to be invoked to make this analysis work is thus quite impressive, and I would be very surprised if someone were to voluntarily take on the job of defending it, given the fact that *all* of the observations in question fall out if what we are looking at in (13) is a conjunction of VPs, not of clauses.

So all things considered, it seems as though a clausal analysis of the second conjunct in examples such as (13) is empirically suspect. What makes this conclusion relevant in the present context is that we have exactly the same pattern with SI sentences, as e.g. in (15):

- (15) a. Into the room had come Robin, bold as you please, and taken the microphone from the astonished speaker's hand
 b. *Into the room had come Robin, bold as you please, and he taken the microphone from the astonished speaker's hand.

Precisely the same reasoning applies here as in the uninverted cases. The only conditions where we find the past participial forms in such coordinations are those where we find them in noninversion cases such as (13):

- (16) *Into the room much earlier came Robin and stolen the letter.

Again, the right conjunct subject must be covert in order for the putative null auxiliary to occur (e.g., (15b)). Therefore, exactly the same considerations which militate against the *pro* analysis of (13) are severe contraindications to a parallel analysis of (15a). But then it follows that we must be able to license (15a) without recourse to *pro*, i.e., in parallel fashion to (13) via a conjoined VP analysis.

2.3. Raising/Inversion Structures

It has been known for decades that raising constructions can interact with apparent cases of stylistic inversion:

(17) Across that bridge appeared to continue to pour without end a horde of terrified refugees

Interestingly, however, these inversion structures do not support SGF coordination, though the uninverted examples analogues are fine, as are the unequivocally clausal analogues with overt pronominal subjects:

- (18) a. *Across that bridge continued to pour without end a horde of terrified refugees and scrambled up the bank on the opposite side.
 b. A horde of terrified refugees continued to pour without end across that bridge and scrambled up the bank on the opposite side.
 c. Across that bridge appeared to continue to pour without end a horde of terrified refugees, and they scrambled up the bank on the opposite side.

Again, it is hard to imagine what the conditions in such examples could be that would block the occurrence of *pro*, but not an overt pronoun, when a raising verb was part of the inversion clause in the left conjunct. Here again, in the absence of a convincing account that links the apparently quite disparate conditions constraining the occurrence of *pro* on this account, it seems necessary to reject the latter as empirically untenable.

2.4. Inverted Quantified NPs in Coordinate Structures

The last piece of evidence is not distributional but semantic. The null pronominal *pro* presumably differs from an overt pronoun such as *they* only in being an empty category; its semantics should, on any reasonably constrained theory of such empty pronouns, be the same as that of overt weak definite pronouns. In particular, we would not expect *pro* to differ significantly insofar as its ability to receive an interpretation as a bound variable, rather than referential anaphoric element. Consider from this point of view the contrast between (19) and (20):

- (19) a. Into those woods could go NO ONE I know and emerge alive.
 b. Into those woods goes NO one and comes out alive.
 (20) *Into those woods could go [*no* one I know]_i and he_i emerges alive.

The important points to consider in connection with these examples is that a bound anaphor reading is not possible when a pronoun's intended binder is separated from the pronoun across a clausal barrier. On the *pro* analysis, the bound anaphor readings in (19) should be impossible and, since the use of a negative quantifier rules out a spurious coindexation under a group or some other possible reading, the example should have the status of an invocation of a quantified NP in the first conjunct and a reference to some individual from prior discourse in the second—stylistically awful, of course—parallel to the only possible interpretation of the linguistic expression in (20). The flagrant failure of this prediction therefore constitutes additional evidence, if more were needed, that we do not have a coordination of clauses in (19), and therefore that we must license such sentences as conjunctions of VP.

3. Raising, SGF Coordination and Heavy vs. Light Inversion

3.1. The Problem

There is, however, another side to the story, for certain evidence invoked earlier to show the untenability of the *pro* analysis might also seem to have unpleasant consequences for the linearization proposal sketched at the outset. In particular, the data in (18) appear to challenge whatever linearization analysis one might provide to account for (17): if we license (17) by essentially the same domain formation mechanism that we use to license (1), why can we not build SGF coordinations in parallel fashion to those we can construct with (1) as a first conjunct. In Kathol and Levine 1992, such data are not treated in detail, but the sketch of their licensing provided does indeed treat them as instances of recursive unioning of the domain of the infinitival complement into that of the VP headed by the selecting verb. In the present context, we could imagine that

- raising verbs (as vs. control verbs) may select VP[inf, UNION +] complements; and
- we generalize the constraints in (5) to the form in (21).

- (21) a. [first] < V
 b. V < [¬ first];

- and we add a constraint to the effect that a selecting V precedes any other V in the domain of the phrase of which it is the head.

Nothing could be easier, apparently. The interaction of these assumptions straightforwardly licenses the structure in (22b) for the sentence in (22a):

- (22) a. Across that bridge continued to pour a stream of terrified refugees.

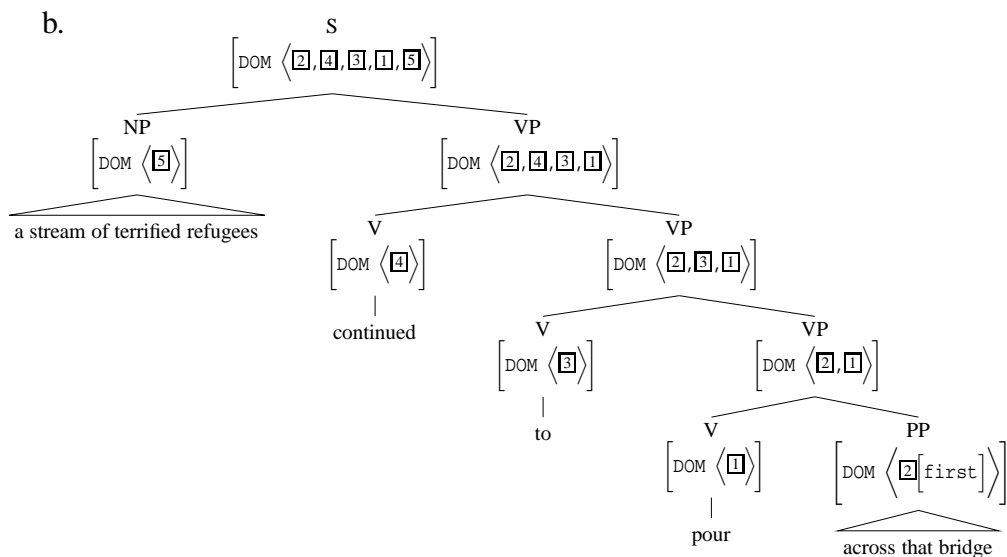

On the other hand, control verbs, which do not select [UNION +] VPs, fail to license analogous structures:

(23) *Across that bridge tried to cross a stream of terrified refugees.

This account is so simple that it seems too good to be true, and it is. For one thing, there is no obvious basis for the correlation between the raising/control distinction on the one hand and the possibility/impossibility of selection for UNION + complements. Still worse, of course, is the fact already alluded to that this account falls in with the *pro* account in mispredicting the status of (18a), for on the basis of (22b) we would expect to find (24) parallel to (8):

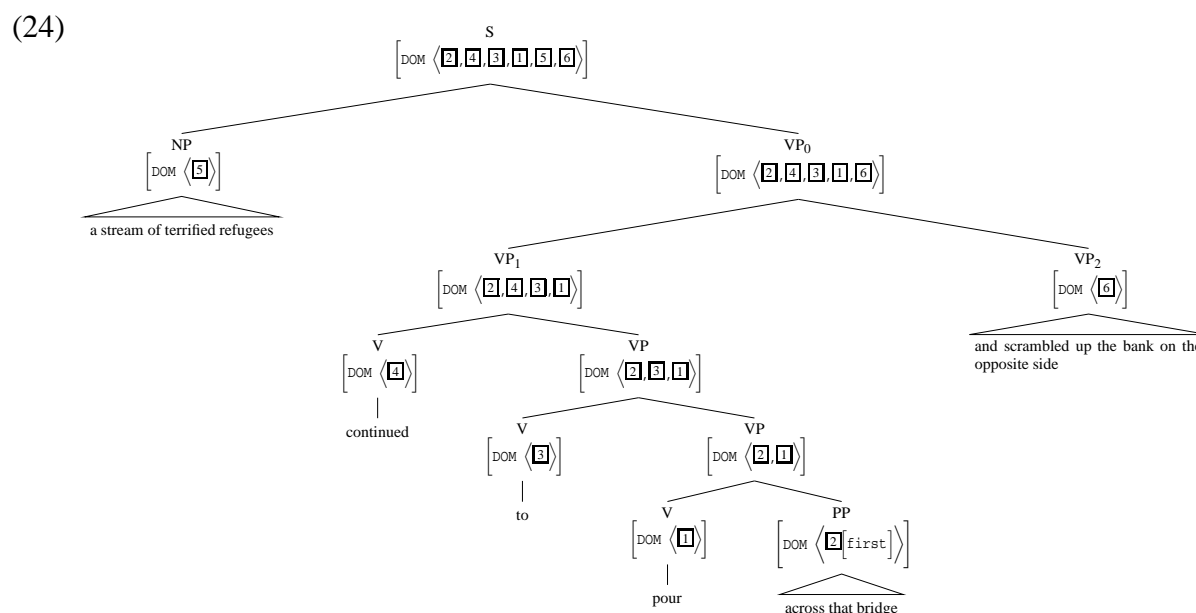

Clearly, a way is needed out of the dilemma such data pose.

3.2. The Solution

A promising place to start is with the obvious: the difficulty posed by (24) is clearly an artefact of the assumption that raising inversion examples such as (17) are bona fide instances of the same phenomenon as (1) or (25):

(25) Across that bridge poured the refugees.

This is an assumption that has been made from the 1970s on, one which is central to arguments about stylistic inversion in Gazdar et al. 1982, Levine 1989, Rochemont and Culicover 1990, Bresnan 1994, and numerous others, apart from Kathol and Levine 1992. But it has to my knowledge never actually been defended, and as noted in Culicover and Levine 2001, it faces a number of severe contraindications:

- as already noted, raising inversion constructions cannot participate in SGF coordinations;
- it is extremely widely agreed among native speakers of English that postverbal NPs in raising inversion constructions must be heavy, as shown in (26);

(26) Into the room appeared to be walking (slowly) $\left\{ \begin{array}{l} \text{a very large caterpillar} \\ \text{*Robin} \end{array} \right\}$.

- and precisely the same restrictions hold in the case of unergative heads which are claimed to license stylistic inversion:

(27) a. In the main restaurant were dining $\left\{ \begin{array}{l} \text{a voracious horde of Tolstoy scholars} \\ \text{*the twins} \end{array} \right\}$.

b. In the bedroom slept a cluster of desperately tired refugees (*and kept waking up in terror all night).

Most important, these observations do not represent a random collection of facts. Culicover and Levine (2001), whose analysis is couched in a P&P framework, show that certain crucial diagnostics, particularly weak crossover phenomena, strongly point to a major structural dichotomy amongst types of English main verb inversions. One type, what one might call ‘classical’ locative or stylistic inversion (SI), is exhibited in (1), and has the striking property that its preposed PP displays insensitivity to WCO effects:

- (28) a. Into every dog_i 's cage peered its_i owner. (SI)
 b. Next to none of the winning dogs_i stood its_i owner. (SI)
 c. In no dog_i 's cage hung its_i collar. (SI)

(Culicover and Levine 2001, pp.289–290.)

In contrast, main verb inversions with obligatorily heavy postverb NPs—including cases where the latter is separated from the verb by adverbial material, or instances where the verb is unergative rather than unaccusative, or the raising inversion phenomena—are quite evidently sensitive to WCO effects.

- (29) a. *Into every dog_i 's cage its_i owner peered t. (Topicalization, WCO)
 b. *Next to none of the winning dogs_i its_i owner stood t. (Topicalization, WCO)
 c. *Next to none of the winning dogs_i did its_i owner stand.
 (Neg inversion, WCO)
 d. *In no dog_i 's cage was hanging on a hook its_i most attractive and expensive collar.
 (Neg inversion, WCO)

(Culicover and Levine 2001, p.290.) In P&P terms, the contrast argues for a different structural location for the preverb PP in the two cases (A-position for LI, \bar{A} position for HI), while the heaviness restriction on the kinds of cases I've just alluded to points strongly towards a rightward shift of a heavy subject to an adjoined position external to the main VP, as argued in Culicover and Levine 2001.

If this proposal is on the right track, then we have an immediate account of the of why we cannot get (18). Given a configuration such as (30), representing the underlying structure for HI according to Culicover and Levine 2001), the structure necessary to license (18), given in (30), seem undervivable:

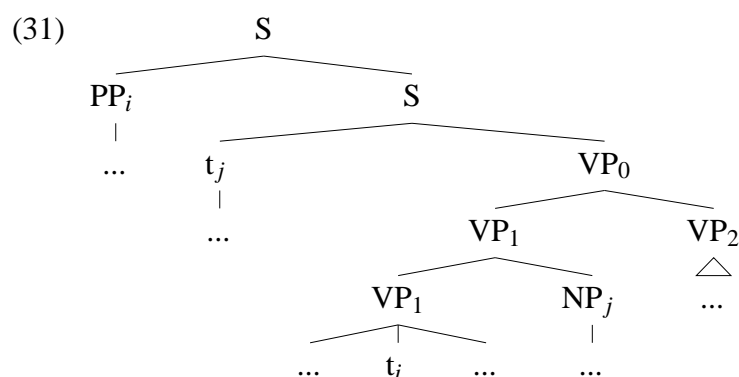
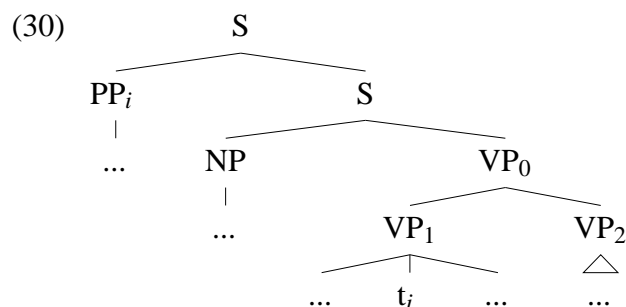

For the Culicover and Levine 2001 proposal, the chief difficulty is not explaining (18) but identifying a structure that could be the source of SGF coordination. Clearly the linearization proposal differs significantly from that in Culicover and Levine 2001, but the crux of the matter is that it is not necessary for linearization proponents to accept the conclusion in the latter that the PP is a true subject in order to adopt the conclusion that LI and HI are distinct constructions. If one accepts what I think is the very strong distributional evidence that there are two quite separate structures involved, one involving some kind of heavy shift of a subject and the other something quite different, then the explanation for (18) under the linearization account is straightforward: linearization is not the basis for data such as (17), and hence the recursive domain formation process which gives rise to structures such as (8) is barred at the threshold from giving rise to (24). In a nutshell, linearization is only responsible for LI phenomena; HI phenomena have a different source and no predictions about the possible form such phenomena can take follow from the possibilities open to LI phenomena. (This conclusion does not offer a way out to the *pro* hypothesis, however, since there is no apparent reason, regardless of what is going on in the first conjunct—LI or HI—why *pro* could not be a subject in the second conjunct.)

4. Conclusion

If the line of reasoning proposed in the preceding section is correct, then the linearization approach can justifiably disregard HI phenomena as a class of contraindications. Assume that the class of verbs which support LI in English is, as has often been claimed, just some subset of the unaccusative verbs, and that only finite VPs may be positively specified for the [UNION] feature. Then, so far as I am aware, all of the phenomena which exhibit the specific properties that Culicover and Levine use as probes for LI emerge straightforwardly via the mechanisms introduced in the first section of this paper.

There are of course many loose ends which space constraints make impossible to pursue here. But there is one outstanding problem which cries out to be at least noted: Kathol and Levine 1992 summarizes a number of observations that argue against the subjecthood of the preposed PP and on behalf of the postverb NP, and those observations carry significant weight. But then what about the fact that these PPs nonetheless display, in common with genuine subjects, the robust immunity to WCO effect emphasized by Culicover and Levine 2001 and illustrated above in (28)–(29)? Several proposals in constraint-based frameworks, such as Pollard 1995 and Sag and Fodor 1994, yield as a key WCO environment the class of structures in which a subject contains a pronoun coindexed with an operator in the QSTORE of some complement on the same ARG-ST list, e.g., **His parents inspire awe in no adolescent*. But on the linearization account, the relations among the arguments of the head in a sentence such as *In no dog's cage hung its collar*, on the bound variable reading of the pronoun, are exactly the same, yet the sentence is impeccable. In fact, so far as the relevant command relations are concerned, this example is identical to **Its collar hung in no dog's cage*. Clearly, linear order plays an even greater role in the identification of the relevant WCO environment than is recognized in Pollard's proposals and Sag's reformulations of them. If the linearization approach to stylistic inversion proves well-founded, such a result would not be surprising; work by Suichi Yatabe (2001, 2007) for example, presents persuasive evidence that semantic composition makes crucial reference to linearization domains. It seems reasonable therefore to see the WCO immunity of stylistically inverted subjects as constituting no special problem for the proposal outlined above—although, as always, the devil is in the details.

References

- Aissen, Judith. 1975. Presentational *there* insertion: a cyclic root transformation. In *Papers from the Eleventh Meeting of the Chicago Linguistic Society*, 1–14.
- Blevins, James. 1990. Syntactic complexity: evidence for discontinuity and multidomination. Doctoral dissertation, University of Massachusetts, Amherst, MA.
- Bonami, Olivier, Danièle Godard, and Jean-Marie Marandin. 1999. Constituency and word order in French subject extraction. In *Constraints and resources in natural language syntax and semantics*, ed. Gosse Bouma, Erhard Hinrichs, Geert-Jan M. Kruift, and Richard Oehrle. 21–

40. Stanford, Ca.: CSLI.
- Bowers, John. 1976. On surface grammatical relations and the structure-preserving hypothesis. *Linguistic Analysis* 2:225–242.
- Bresnan, Joan. 1990. Levels of representation in locative inversion: a comparison of English and Chichewa. Ms., Stanford University: Stanford, CA.
- Bresnan, Joan. 1994. Inversion and the architecture of universal grammar. *Language* 70:72–131.
- Chaves, Rui P. 2008. Linearization-based word-part ellipsis. *Linguistics and Philosophy* 31:261–307.
- Coopmans, Peter. 1989. Where stylistic and syntactic processes meet: Locative Inversion in English. *Language* 65:728–751.
- Crysmann, Berthold. 1997. Cliticization in European Portuguese using parallel morpho-syntactic constraints. In *Proceedings of the LFG 97 Conference*, 1–14. Stanford, Ca: Center for the Study of Language and Information.
- Crysmann, Berthold. 1999. Morphosyntactic paradoxa in Fox. In *Constraints and resources in natural language syntax and semantics*, ed. Gosse Bouma, Erhard Hinrichs, Geert-Jan M. Kruift, and Richard Oehrle. 41–62. Stanford, Ca.: CSLI.
- Crysmann, Berthold. 2003. An asymmetric theory of peripheral sharing in HPSG. In *Proceedings of Formal Grammar 2003*. 1–17. Vienna, Austria: European Summer School in Language, Logic and Information.
- Culicover, Peter W., and Robert Levine. 2001. Stylistic inversion in English: a reconsideration. *Natural Language and Linguistic Theory* 19:283–310.
- Donohue, Catherine, and Ivan Sag. 1999. Domains in Warlpiri. Paper presented at the 6th International Conference on Head-driven Phrase Structure Grammar, University of Edinburgh.
- Dowty, David. 1996. Towards a minimalist theory of syntactic structure. In *Discontinuous constituency*, ed. Arthur Horck and Wuetsje Sijtsma. 11–62. Berlin: Mouton de Gruyter.
- Emonds, Joseph. 1976. *A transformational approach to English syntax: root, structure-preserving and local transformations*. New York: Academic Press.
- Gazdar, Gerald, Ewan Klein, Geoffrey K. Pullum, and Ivan Sag. 1982. Coordinate Structures and Unbounded Dependencies. In *Developments in generalized phrase structure grammar*, ed. Michael Barlow, Daniel Flickinger, and Ivan Sag. 38–68. Bloomington, Indiana: Indiana University Linguistics Club.
- Gazdar, Gerald, Ewan Klein, Geoffrey K. Pullum, and Ivan Sag. 1985. *Generalized phrase structure grammar*. Cambridge, Ma.: Harvard University Press.
- Gunji, Takao. 1999. On lexicalist treatments of Japanese causatives. In *Studies in contemporary phrase structure grammar*, ed. Robert D. Levine and Georgia Green. 119–160. Cambridge and New York: Cambridge University Press.
- Hofmeister, Philip. 2010. A linearization account of *either...or* constructions. *Natural Language and Linguistic Theory* 28:275–314.

- Hofmeister, Philip, and Ivan Sag. 2010. Cognitive constraints and island effects. *Language* 86:366–415.
- Kathol, Andreas. 1993. Linearization and coordination in German. In *Papers in syntax*, ed. Andreas Kathol and Carl Pollard. 117–152. Ohio State University: Department of Linguistics (Ohio State University Working Papers in Linguistics 42).
- Kathol, Andreas. 1995. *Linearization-Based German Syntax*. Ph. D. dissertation, Ohio State University; printed by Faculteit der Letteren, Rijksuniversiteit Groningen.
- Kathol, Andreas. 2000. *Linear syntax*. Oxford: Oxford University Press.
- Kathol, Andreas, and Robert D. Levine. 1992. Inversion as a linearization effect. In *Proceedings of NELS 23*. 207–221. University of Massachusetts, Amherst: Department of Linguistics.
- Kluender, Robert. 1998. On the distinction between strong and weak islands: a processing perspective. In *The limits of syntax*, ed. Peter Culicover and Louise McNally. 241–279. New York: Academic Press.
- Kluender, Robert. 2004. Are subject islands subject to a processing account? In *Proceedings of WCCFL 23*. 101–125. Somerville, Ma: Cascadilla Press.
- Kluender, Robert, and M. Kutas. 1993a. Bridging the gap: evidence from ERPs on the processing of unbounded dependencies. *Journal of Cognitive Neuroscience* 5:196–214.
- Kluender, Robert, and M. Kutas. 1993b. Subjacency as a processing phenomenon. *Language and Cognitive Processes* 8:573–633.
- Levine, Robert D. 1989. On focus inversion: syntactic valence and the role of a SUBCAT list. *Linguistics* 27:1013–1055.
- McCawley, James. 1982. Parentheticals and discontinuous constituent structure. *Linguistic Inquiry* 13:91–106.
- Ojeda, Almerindo. 1987. Discontinuity, multidominance and unbounded dependency in generalized phrase structure grammar. In *Discontinuous constituency*, ed. Geoffrey Huck and Almerindo Ojeda. 257–282. New York: Academic Press.
- Ojeda, Almerindo. 1988. A linear precedence account of cross-serial dependencies. *Linguistics and Philosophy* 11:141–200.
- Penn, Gerald. 1999. A generalized domain-based approach to Serbo-Croatian second position clitic placement. In *Constraints and resources in natural language syntax and semantics*, ed. Gosse Bouma, Erhard Hinrichs, Geert-Jan M. Kruift, and Richard Oehrle. 119–136. Stanford, Ca.: CSLI.
- Pollard, Carl. 1995. Linear and hierarchical factors in weak crossover. Ms., Ohio State University, Columbus, OH.
- Reape, Michael. 1993. A formal theory of word order: a case study in West Germanic. Doctoral dissertation, University of Edinburgh.
- Reape, Michael. 1996. Getting things in order. In *Discontinuous constituency*, ed. Arthur Horck and Wuetsje Sijtsma. 209–253. Berlin: Mouton de Gruyter.

- Rochemont, Michael, and Peter W. Culicover. 1990. *English focus constructions and the theory of grammar*. Cambridge: Cambridge University Press.
- Ross, John R. 1967. Constraints on variables in syntax. Doctoral dissertation, Massachusetts Institute of Technology, Cambridge, MA (published as *Infinite syntax!* by Ablex, Norwich, N. J., 1986).
- Sag, Ivan, and Janet D. Fodor. 1994. Extraction without traces. In *Proceedings of the thirteenth annual meeting of the West Coast Conference on Formal Linguistics*. 365–384. Stanford: CSLI.
- Sag, Ivan A., Philip Hofmeister, Inbal Arnon, Neal Snider, and T. Florian Jaeger. 2008. Processing accounts for superiority effects. Ms., Stanford University, Stanford, CA.
- Sag, Ivan A., Philip Hofmeister, and Neal Snider. 2007. Processing complexity in subadjacency violations: the complex noun phrase constraint. In *Proceedings of the 43rd annual meeting of the Chicago Linguistic Society*. 215–229. Chicago: CLS.
- Suñer, Marguerite. 1982. Big PRO and little pro. Ms., Cornell University, Ithaca, N.Y.
- Yatabe, Shuichi. 2001. The syntax and semantics of left-node raising in Japanese. In *Proceedings of the 7th International Conference on Head-driven Phrase Structure Grammar*. 325–344. Stanford, Ca.: Center for the Study of Language and Information.
- Yatabe, Shuichi. 2007. Evidence for the linearization-based theory of semantic composition. In *Proceedings of the 13th International Conference on Head-driven Phrase Structure Grammar*. 323–343. Stanford, Ca.: Center for the Study of Language and Information (online site: <http://csli-publications.stanford.edu/>).

JUDGMENT TYPES AND THE STRUCTURE OF CAUSATIVES*

John Moore
University of California, San Diego
moorej@ucsd.edu

This paper examines two types of *hacer* causative constructions in Spanish. Various properties of these constructions suggest that they should respectively be analyzed as involving ECM and object control. Notwithstanding, the putative object control causatives constructions contrast with uncontroversial object control constructions in a number of respects. To resolve this paradox, this paper proposes that the contrasting behavior between the causatives follows from a fundamental difference in judgment types, whereby the embedded clause of one construction represents athetic judgment and that of the other a categorical judgment. I argue that control properties associated with one of the causative constructions are a consequence of the predication associated with categorical judgments. In addition, the interpretive correlates of the thetic/categorical distinction accounts for the interpretation of indefinite causees. In this way, it is possible to posit a single causative predicate, *hacer*, whose contrasting syntactic and semantic properties follow from the different realizations afforded by this contrast in judgment type.

1. Introduction

Romance causatives have been the subject of intense research for the last thirty five years. As illustrated for Spanish in (1), these constructions consist of a causative predicate (*hacer* ‘make’), a causee argument (*Pedro*), and an event argument (*[leer el libro]* ‘[read the book]’):

- (1) Curro le hizo [leer el libro]_{Event} a Pedro.
Curro him-IO made-3SG read-INF the book DOM Pedro¹
‘Curro made *Pedro* [read the book]_{Event}.’

A long-standing controversy in the study of Romance causative constructions has to do with the valence of the causative predicate. At issue is whether the causative predicate is a two-place or a

* I am indebted to S.- Y. Kuroda, Farrell Ackerman, and Errapel Mejias-Bikandi for discussion leading up to the present version and to the many Spanish speakers who have provided judgments; all short-comings are my responsibility. I also owe special gratitude to Judith Aissen, whose penetrating questions during my dissertation defense two decades ago led me to rethink many aspects of Spanish causatives, ultimately resulting in the present work.

¹ The following abbreviations will be used in the glosses: 1, 3 ‘1st, 3rd person’, DO ‘direct object’, DOM ‘differential object marker’, INF ‘infinitive’, and IO ‘indirect object’, PL ‘plural’, SG ‘singular’, and SUBJ ‘subjunctive’.

three-place predicate. Two interpretations of these positions, where the contrast is implemented as ECM versus object control, are illustrated in (2):²

- (2) Approaches to causative valence:
- a. 2-place, ECM analysis: *hacer* selects a sentential event only. *Hacer* exceptionally Case-marks the subject of the event argument.
 - b. 3-place, control analysis: *hacer* selects both an NP causee and a sentential event. The causee controls the subject of the event argument.

Following Dorel's 1980 analysis of French causatives, Moore 1996 argues that Spanish has two homophonous causative predicates, *hacer*₁ and *hacer*₂, which respectively have the selectional properties in (2a-b).³ This approach provides a way to account for a number of alternations found in Spanish causative constructions. With *hacer*₁ causatives, we find that the causee tends to be post-infinitival, is encoded alternatively as a direct or indirect object, and tends to be construed as undergoing indirect causation. Furthermore, *hacer*₁ causatives exhibit various mono-clausal properties. These phenomena are consistent with an analysis where *hacer*₁ selects a VP complement, and the causee is an exceptionally Case-marked, post-posed VP-internal subject:⁴

² This paper compares the implementations of the two- versus three-place predicate accounts in (2). Thus, at issue is whether the causative predicate selects an object controller or not. Arguments presented below do not exclude the possibility of a three-place account, such as the one proposed in Alsina 1992, where the three-place predicate is realized in the argument structure but not in the phrase structure; indeed, the complex predicate account in Ackerman and Moore 1999, which I adopt below, is similar to Alsina's approach in this respect. Analyses that are in the spirit of the ECM approach are presented in Aissen 1979, Aissen and Perlmutter 1976/1983, Burzio 1986, Gibson and Raposo 1986, and Ordóñez 2007, among many others. Analyses that specifically propose a control account are Bordelois 1974 and 1988, Strozer 1976, and Fauconnier 1983.

³ Abeillé et. al. 1997 and Abeillé et. al. 1998 present an HPSG account of French causatives that makes a similar distinction, as does Norcliffe 2007, for Spanish.

⁴ The VP-complement proposal for causative and related constructions was first presented in Strozer 1976 and Zagana 1982; it was revived in a number of later works (e.g., Rosen 1990, Pearce 1990, Picallo 1990, and Moore 1996). Throughout I will cast my analysis within a minimally articulated syntactic framework. For concreteness I have represented mono- versus bi-clausality as a contrast between VP- and IP-complements. Nevertheless, I do not believe that the points made here are crucially tied to this mid-1980s GB tradition. Most, if not all, of my analysis could be cast in a number of different frameworks. Crucially, some notion of mono- versus bi-clausality is needed; this could be represented via clause reduction as in a Relational Grammar framework, as VP- complements versus a 'flat' VP structure V'-complements, as in Abeillé et. al. 1997, Abeillé et. al. 1998, and Norcliffe 2007's HPSG accounts, as a doubly headed VP as in Alsina's 1996 LFG account, as AgrSP- versus VP-complements as in a post-Pollock Principles and Parameters approach (cf. Guasti 1993), or as a difference in degree of transparency (cf. Langaker 1995). Hence, a theoretical distinction between mono- and bi-clausal complement types is crucial, while the theoretical implementation could be translated into any of these approaches. Also crucial to my account is the possibility of two subject positions. Roughly following work in the tradition of the VP-Internal Subject Hypothesis (Zagana 1982, Kuroda 1988, Koopman and Sportiche 1991, among others), I represent these as Spec of VP and Spec of IP (or TP) (cf. Gutierrez-Bravo 2005 and 2007, López 2009); however, this can be cached out in a number

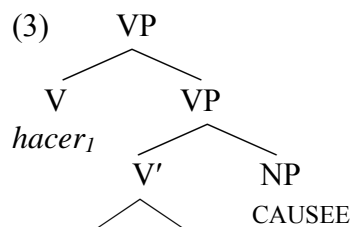

In contrast, *hacer*₂ causatives favor a pre-infinitival causee that is encoded as a direct object and is construed as directly affected by the causation. These constructions lack the mono-clausal properties associated with *hacer*₁. A bi-clausal, direct object control analysis can account for these facts:

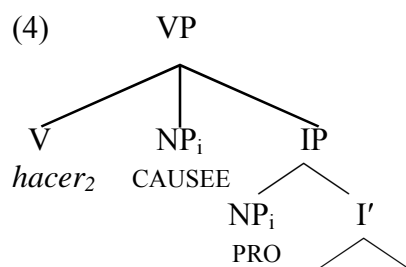

Hence, the strength of this account is that it factors these contrasting aspects of Spanish causatives into a structural ambiguity that makes the correct correlations with respect to subject position, Case-marking and clausality.

The success of this approach notwithstanding, it is problematic because of systematic syntactic differences between *hacer*₂ causatives and other object control constructions (Treviño 1990 and 1992 and Farrell 1995). It also incorrectly predicts, given Mejías-Bikandi and Moore's 1994 discussion of Mapping Principle effects, that the quantificational force of indefinite *hacer*₂ causees and direct object controllers should be identical.

As an alternative, I propose that the *hacer*₁/*hacer*₂ distinction follows from a fundamental difference in judgment type, whereby *hacer*₁ constructions represent embeddedthetic judgments and *hacer*₂ embedded categorical judgments. Building on work by Kuroda (1972, 1995), Mejías-Bikandi (1993), Ladusaw (2000), and others, I propose that the syntactic and semantic differences between the two causative constructions is a consequence of the basic cognitive distinction in judgment type, as illustrated in (5):

- (5) *hacer* selects a reduced, VP-complement,thetic judgment ('*hacer*₁')
 -or- it selects a full, IP-complement, categorical judgment ('*hacer*₂')

of ways, e.g., Spec of VP versus left-dislocation (Alexiadou and Anagnostopoulou 1998), or as a difference in profiling, as in Achard's 1996 Cognitive Grammar approach. Again, what is important is that the data imposes such a partition that reflects such a basic distinction.

The significance of this approach is that it provides a novel example of grammatical consequences of the *thetic/categorical* distinction. In particular, it entails that some types of syntactic selection may be keyed to this basic cognitive distinction.

2. The *thetic/categorical* contrast

Based on a 19th century philosophical tradition (cf. Marty 1918), Kuroda (1972) proposes that grammatical phenomena may be keyed to contrasting COGNITIVE ACTS; in particular, to the contrast between *thetic* and *categorical* judgments described in (6):

- | | |
|---|---|
| (6) a. Thetic/simple judgment
[_{event} There is a cat in the room] | b. Categorical/double judgment
[_{prop} [_{subj} Three cats] are in the room]] |
|---|---|

Note that while presentational-*there* constructions unambiguously represent *thetic* judgments, the example in (6b) could potentially represent either a *thetic* or *categorical* judgment. *Thetic* judgments represent the mere recognition of an event; hence, their linguistic expression may be called a description. In contrast, *categorical* judgments are expressed by a predication where the subject is singled out and applied to a predicate.

2.1. Tree splitting

Diesing (1992) proposes a distinction that turns out to be very similar to the *thetic/categorical* contrast. She proposes that the mapping between a syntactic and semantic representations is mediated by a tree-splitting procedure, whereby a clause is divided into VP-internal and VP-external material:

- (7) Tree splitting (Diesing 1992)
- | | |
|--------------------|------------------------|
| [_{IP} NP | [_{VP} ...]] |
| Restrictive clause | nuclear scope |

The Mapping Hypothesis in (8) determines what goes in the restrictive clause and what goes in the nuclear scope of the semantic representation.

- (8) Mapping Hypothesis:
Material from the VP is mapped into the nuclear scope.
Material external to the VP is mapped into a restrictive clause.

Following Milsark 1974 and Carlson 1980, Diesing employs the Mapping Hypothesis to determine which indefinite nominals receive a strong interpretation, and which receive a weak construal. Under the assumption that the Mapping Principle operates at a level where there is a

contrast between VP-internal/external subjects, the strong/weak construals of the italicized NPs in (9-10) are predicted:⁵

- (9) a. There are *two firemen* in the firehouse. cardinal only (weak)
 b. *Two firemen* are in the firehouse. partitive (strong) or cardinal (weak)
- (10) a. There are *firemen* in the firehouse. existential only (weak)
 b. *Firemen* are in the firehouse. generic (strong) or existential (weak)

Kuroda (1995) and Ladusaw (2000) point out the parallels between Diesing's tree splitting system and thethetic/categorical distinction. As summarized in (11), athetic judgment may be viewed as corresponding to a simple VP-clause, and a categorical judgment corresponds to a bifurcated IP:

- (11) a. Thetic (simple) judgment → [IP [VP *Three cats* are in the room]].⁶
 b. Categorical (double) judgment → [IP *Three cats* [VP are in the room]].

Ladusaw 2000 derives the weak/strong contrast from thethetic/categorical distinction as a consequence of the assumptions in (12):

- (12) a. Thetic judgment → unselective existential closure over its constituents
 b. Categorical judgment → subject is first affirmed, then the property is applied to it

Unselective existential closure yields weak construals, whereas the affirmation of the subject entails its presupposition, hence a strong construal. Both these researchers suggest that the syntactic manifestations of these judgment types can be along the lines proposed by Diesing; i.e., it can be cached out as a contrast in syntactic subject positions.

2.2. Spanish clause structure

While the mapping betweenthetic/categorical judgments and different English clause structures must take place at a rather abstract level of representation (see note 5), other languages seem to encode this distinction more directly. Mejías-Bikandi (1993) argues that the alternative word

⁵ According to the VP-Internal Subject Hypothesis subjects may originate inside the VP and may move to the specifier of a higher functional projection by s-structure. In English, it is normally assumed that all subjects occur in this higher position at s-structure for Case reasons. Following May 1985, Diesing assumes that some subjects may reconstruct to their d-structure positions. If the Mapping Hypothesis applies after this reconstruction, the indefinite subjects that reconstruct to a VP-internal position will be mapped to the nuclear scope, and receive a weak interpretation (via existential closure), while those that remain in the higher position at LF are mapped to the restrictive clause and receive a strong interpretation.

⁶ The examples in (11) represent LFs, post-reconstruction. Strictly speaking, *are* should be outside of the VP.

orders in Spanish encode the thematic/categorical distinction directly at S-structure. (13) illustrates verb-initial and subject-initial word orders (see also Martínez Caro 2007):

- (13) a. Jugaban *tres niños* en el patio. VSX
 played-3PL three children in the patio
 b. *Tres niños* jugaban en el patio. SVX
 three children played-3PL in the patio
 ‘Three kids played in the patio.’

Under the fairly standard analysis in (14), the word order alternation corresponds to a contrast in the structural position of the subject (VP-internal in (14a) vs. VP-external in (14b)).⁷

- (14) a. VSX: [_{IP} [_{I'} *jugaban*_k [_{VP} **tres niños** *e*_k en el patio]]].
 b. SVX: [_{IP} **tres niños**_i [_{I'} *jugaban*_k [_{VP} *ei* *e*_k en el patio]]].

Mejías-Bikandi argues that different subject positions correspond to different judgment types, as illustrated in (15):

- (15) a. VSX → thematic judgment
 b. SVX → categorical judgment (sometimes)⁸

Support for his proposal comes from the Mapping Hypothesis effects illustrated in (16):

- (16) a. Jugaban *tres niñas* al truque. weak, cardinal
 played-3PL three girls to-the hopscotch
 ‘There were *three girls* playing hopscotch.’
 b. *Tres niñas* jugaban al truque. strong, partitive
 three girls played-3PL to-the hopscotch
 ‘*Three (of the) girls* played hopscotch.’

Given Ladusaw’s 2000 link between the interpretation of indefinites and the thematic/categorical distinction, (16) provides evidence that the thematic/categorical judgments may be directly encoded by the alternative subject positions of Spanish root clauses.

⁷ As discussed in note 4, the analyses in (14) might be translated into a number of implementations; see references cited there.

⁸ Mejías-Bikandi claims (15b) is structurally ambiguous between representations with VP-external and VP-internal subjects, and notes the possibility of a weak, existential interpretation of the subject. As Byrne (1998) notes, pre-verbal subjects can, in some circumstances, be part of an all-focus sentence, where the sentence represents a thematic judgment. Similar arguments are presented in Gutierrez-Bravo 2005 and 2008 and López 2009, in terms of whether the pre-verbal subject is a topic or part of a neutral, all-focus sentence. Since it is not clear that the subject-initial all-focus interpretation is possible in embedded contexts, I will ignore this possibility in what follows.

3. Thetic and categorial judgments in Spanish causatives

This section argues for a single two-place causative predicate that is able to select either judgment type with respect to its complement:⁹

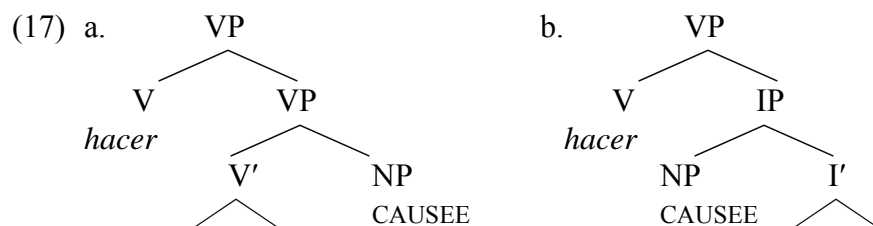

embedded thetic judgment (*'hacer₁'*) embedded categorial judgment (*'hacer₂'*)

The analysis in (17) is motivated by the position of the causee, whether the constructions exhibit mono- or bi-clausal properties, the directness of causation, the Case-marking of the causee, and the interpretation of indefinite causees. We will see that there is a crucial correlation between these dimensions of causative constructions, and that an analysis in terms of judgment types provides a means of deriving these effects.

3.1 Causee position and clause structure

The two causative constructions under consideration differ in the position of the causee argument. As illustrated in (18), the causee may occur either after or before the embedded event; I will refer to these as post-infinitival causee and pre-infinitival causee constructions.¹⁰

- (18) a. Pedro le hizo [pagar los tragos] a *un marinero*.
 Pedro him-IO made-3SG [pay-INF the drinks] DOM a sailor
 'Pedro made *a sailor* [pay for the drinks].'
- b. Hicimos a *Marta* [leer los libros].
 made-1PL DOM Marta [read the books]
 'We made *Marta* [read the books].'

⁹ The structures in (17) bring up the issue of judgment types in embedded contexts. This is not without precedent – most relevant to the present discussion are proposals that use these notions in small clause complements, e.g., Lenci 1994, Raposo and Uriagereka 1995, and Basilico 2003. Kuroda (2003) addresses this issue directly with respect to categorial judgments in Japanese *ni*-causatives, basing his account, in part, on an earlier version of this paper.

¹⁰ Examples such as (18b) appear to be more common in Peninsular dialects, although I find that some speakers of Latin American Spanish allow them as well. This may account for the conflicting judgments found in the literature. For example, Aissen and Perlmutter (1976/1983) provide data from dialects that disallow examples like (18b), while Treviño (1992) and Moore (1996) note that both constructions (18) are accepted by some, but not all, speakers.

Notice that this contrast in word order is similar to the verb-initial and subject-initial orders found in root clauses. Crucial evidence for analyses in (17) comes from several effects that correlate with this word order contrast.

First, there is evidence that post-infinitival causee constructions are mono-clausal, while pre-infinitival causee constructions are bi-clausal. One way to implement this is to assume that the former involve VP-complements, while the later have IP-complements. Evidence for this contrast in clausality comes from clitic climbing and embedded sentential negation.

Clitic climbing is generally taken to be a clause-bounded phenomenon. As illustrated in (19), post-infinitival causee constructions allow, and in fact, strongly favor, clitic climbing; this argues for the mono-clausality of this construction.¹¹

- (19) Pili se lo_i hizo [_{VP} [comprar ec_i] a Javi].
 Pili him-IO it_i -DO made-3SG [_{VP} [buy-INF ec_i] DOM Javi]
 ‘Pili made Javi buy it.’

Pre-infinitival causee constructions, on the other hand, disallow clitic climbing, as illustrated in (20); this is accounted for if we assume this construction to be bi-clausal.

- (20) *? Se lo_i hicimos [_{IP} al mecánico [arreglar ec_i]].
 him-IO it_i -DO made-3PL [_{IP} DOM=the mechanic [fix-INF ec_i]]
 ‘We made the mechanic fix it.’

Sentential negation is often taken to be indicative of a functional category above VP (e.g. IP, NegP). As illustrated in (21), embedded negation is marginal when the causee is post-infinitival, but allowed when the causee is pre-infinitival:

- (21) a. ? Les hicieron [_{IP} *no* [_{VP} divulgar la noticia] a los periodistas].
 them-IO made-3PL [_{IP} not [_{VP} divulge-INF the news] DOM the journalists]
 b. Les hicieron [_{IP} a los periodistas *no* [_{VP} divulgar la noticia]].
 them-IO made-3PL [_{IP} DOM the journalists not [_{VP} divulge-INF the news]]
 ‘They made the journalist not divulge the news.’

The presence of negation in (21b) argues for the bi-clausality of pre-infinitival causee constructions.¹² The fact that negation is marginally allowed in (21a) suggests that post-infinitival causee constructions can sometimes be bi-clausal as well.

¹¹ In (19), the clitic lo_i is co-indexed with an empty category (ec_i) in object position. It is not important for present purposes whether this empty category is considered a trace, *pro*, or even if it exists at all (as it would not under HPSG or LFG approaches). The indirect object clitic, which corresponds to the causee, is realized as *se* due to a morpho-syntactic rule. Note that causee clitics always attached to the matrix verb.

¹² Evidence that the negation in (21b) can be sentential and not constituent negation comes from the wide scope found in with respect to purpose clauses, as in (i); here the embedded verb is not negated (i.e. the news was revealed),

Finally, (22) shows the incompatibility of embedded negation and clitic climbing. This supports the relationship between embedded negation and bi-clausality and between clitic climbing and mono-clausality.¹³

- (22) * Se la_i hicieron [IP a los periodistas *no* [VP divulgar ec_i]].
 them-IO it_i -DO made-3PL [IP DOM the journalists not [VP divulge-INF ec_i]]
 ‘They made the journalists not divulge it.’

To summarize, then, we find a contrast in clausality, based on the position of the causee. This parallels the VP-internal and VP-external subject positions found in root clauses, and is consistent with a thematic/categorical contrast:

- (23) *hacer* [VP [V' ...] CAUSEE] MONO-CLAUSAL
hacer [IP CAUSEE [VP ...]] BI-CLAUSAL

3.2 Singling out the causee

We saw that thematic judgments differ from categorical judgments in that the latter ‘singles’ out a particular participant and uses it as the subject of a predication. Post- and pre-infinitival causee constructions do something very similar. In particular, pre-infinitival causees appear to be singled out in two ways: they appear to bear a thematic relationship to the causative verb, and they express direct causation.

With respect to the thematic properties of causee arguments, notice that post-infinitival causees do not show selectional restrictions, as illustrated in (24):

rather the VP and adjunct are negated together – note the neg-raising in the English translation (see Iatridou 1990 and Potsdam 1997 for similar tests):

- (i) Les hicieron a los periodistas *no* divulgar la noticia para ganar el premio,
 them-IO made-3PL DOM the journalists not divulge the news in-order win-INF the prize
 sino para que la supiera la gente.
 rather in-order that it-DO knew-SUBJ the people
 ‘They didn’t make the journalists divulge the news to win the prize, rather so people would know about it.’

¹³ Post-infinitival causee constructions may be marginally bi-clausal, as shown by negation in (21a); as expected, clitic climbing is also disallowed:

- (i) Se la_i hicieron [*no* divulgar ec_i a los periodistas].
 them-IO it_i -do made-3PL [not divulge-INF ec_i DOM the journalists]
 ‘They made the journalists not divulge it.’

- (24) a. Hicieron [VP trabajar a Curro]. no selectional restrictions
 made-3PL [VP work-INF DOM Curro]
 ‘They made Curro work.’
 b. Hicimos [VP funcionar la lavadora].
 made-1PL [VP run-INF the washing machine]
 ‘We made the washing machine run.’

On the other hand, (25) shows that pre-infinitival causees do exhibit selectional restrictions:

- (25) a. Hicieron [IP a Curro trabajar]. selectional restrictions
 made-3PL [IP DOM Curro work-INF]
 ‘They made Curro work.’
 b.* Hicimos [IP la lavadora funcionar].
 made-1PL [IP the washing machine run-INF]
 ‘We made the washing machine run.’

In addition, pre-infinitival causees pattern like controllers with respect to Passive Synonymy; (26a-b) are not synonymous:

- (26) a. Hicimos [IP al médico examinar a Pedro].
 made-3PL [IP DOM=the doctor examine-INF DOM Pedro]
 ‘We made the doctor examine Pedro.’
 b. Hicimos [IP a Pedro ser examinado por el médico].
 made-3PL [IP DOM Pedro be-INF examined by the doctor]
 ‘We made Pedro be examined by the doctor.’

Both selectional restrictions and the lack of synonymy in active/passive pairs suggest that the pre-infinitival causee bears a thematic relation to the causative verb. Such evidence is lacking when the causee is post-infinitival.¹⁴

Another way that the pre-infinitival causee appears to be singled out has to do with direct causation. In order to see this, we need to provide some background on the case-marking of Spanish causees. The case-marking of the causee appears to be determined by two (potentially conflicting) criteria; on the one hand, transitivity plays the role described in (27):

- (27) Case-marking based on transitivity:
 a. If the embedded clause is intransitive, the causee is a direct object.
 b. If the embedded clause is transitive, the causee is an indirect object.
 (cf. Aissen and Perlmutter 1976/1983, among others)

¹⁴ We should also expect synonymy under passivization when the causee is post-infinitival; it is difficult to judge such examples, however, as the relevant passivized examples are marginal at best.

The effects of (27) are illustrated in (28):

- (28) a. *La* hicieron [trabajar mucho]. embedded intransitive → DO cause
 her-DO made-3PL [work-INF a lot]
 ‘They made *her* work a lot.’
 b. *Le* hicieron [leer el libro]. embedded transitive → IO cause
 her-IO made-3PL [read-INF the book]
 ‘They made *her* read the book.’

On the other hand, the causee’s case-marking may be determined by the directness of causation, as described in (29) (cf. Strozer 1976):

- (29) Case-marking based on directness of causation:
 a. Indirect causation yields an indirect object causee.
 b. Direct causation yields a direct object causee.

The effects of (29) are illustrated in (30):

- (30) a. indirect causation → IO cause:
Le hice [probarlo] diciéndole que era riquísima.
 her-IO made-1SG [taste-INF=it-DO] telling=her-IO that was-3SG delicious
 I had *her* taste it by telling her it was delicious.
 b. direct causation → DO cause:
La hice probarlo a la fuerza.
 her-DO made-1SG taste-INF=it-DO by force
 ‘I made *her* taste it by force.’ (Strozer 1976, 6.90 b, a)

Note that the DO causee in (30b) is ‘unexpected’, given the embedded transitive clause. Thus, the transitivity criterion appears to provide the default; however, this may be over-ridden by the directness of causation criterion; the interaction between the two case-making strategies is discussed in detail in Ackerman and Moore 1999.

Treviño (1990) provides an argument that ‘unexpected’ DO causees correspond to the pre-infinitival causee position. This is based on the similar extraction behavior around pre-infinitival causees and unexpected DOs in (31a-b):

- (31) a. * *Qué_i* hicieron [IP a *Pedro* [VP comprar *e_i*]]?
 what_i made-3PL [IP DOM *Pedro* [VP buy-INF *e_i*]]
 ‘What did they make *Pedro* buy?’
 b. ?? *Qué_i lo* hicieron [IP comprar *e_i*]
 what_i him-DO made-3PL [IP buy-INF *e_i*]
 ‘What did they make him buy?’ (Treviño 1990, 30a)

In (32) we see that post-infinitival and IO causees pattern alike in allowing extractions:

- (32) a. Qué_i hicieron [VP comprar e_i a Pedro]?
 what_i made-3PL [VP buy-INF e_i DOM Pedro]
 ‘What did they make Pedro buy?’
 b. Qué_i le hicieron [VP comprar e_i]?
 what_i him-IO made-3PL [VP buy-INF e_i]
 ‘What did they make him buy?’ (Treviño 1990, 30b)

Thus, there is evidence that the direct causation associated with unexpected DOs is related to the pre-infinitival position.¹⁵

To summarize, then, pre-infinitival causees are singled out as thematically related to the causative verb and denote direct causation. This is in contrast with post-infinitival causees, which are not singled out in these ways.

- (33) Post-infinitival causee - not thematically related to causative verb; indirect causation
 Pre-infinitival causee - thematically related to the causative verb; direct causation

These contrasts are consistent with the thematic/categorical contrast based on whether or not the embedded subject is singled out.

To flesh out this analysis a bit more, let us assume that in the context of a complement to a causative verb, the effect of singling out the subject is to focus the force of causation on that subject. In a sense, the essence of direct causation is an act where an individual is singled out to effect the embedded event; in other words, the caused event is applied to the causee in a predication, which forms the basis of a categorical judgment. Accordingly, the subject of the embedded categorical judgment undergoes direct causation as a consequence being singled out. In turn, singling out the embedded subject yields an attenuated agentivity, by the loss of volitionality (see Ackerman and Moore 1999). Attenuated agentivity is only possible with animate causees; hence, the selectional restrictions associated with a pre-infinitival causee are explained as a consequence of direct causation. Similarly, the lack of synonymy in embedded actives and passives follows from the fact that the lack of volitionality is entailed with respect to different arguments. Hence, once we attribute the directness of causation to the singling out of a causee in an embedded categorical judgment, the remaining characteristics of *hacer*₂ constructions follow, as illustrated in (34):

¹⁵ The data in (30-32) come from Latin American varieties of Spanish, where the contrast between direct and indirect object clitics is fairly transparent (e.g. *lo/la* vs. *le*). In Standard Spanish, indirect object clitics double (sometimes obligatorily), while direct object clitics do not. If, as argued, preinfinitival causees correspond to direct objects, then one might wonder why we find the indirect object clitic *le* doubling a pre-infinitival causee in examples like (20a). This, and similar examples, represent Peninsular varieties where *le* can refer to human direct objects and can, in some cases, double.

- (34) categorical judgment → singling out causee → direct causation
 → selectional restrictions, passive anti-synonymy¹⁶

3.3. Indefinite Interpretation

An additional contrast between post- and pre-infinitival causee constructions has to do with the interpretation of indefinite causees. Post-infinitival indefinite causees favor a weak interpretation, as discussed in Mejías-Bikandi and Moore 1994, and illustrated in (35):

- (35) a. Hicimos [VP [V' cazar ratones] a tres gatos]. cardinal
 made-1PL [VP [V' hunt-INF mice] DOM three cats] (? partitive)
 'We made three cats hunt mice.'
 b. Pedro le hace [VP [V' cazar ratones] a un gato]. existential
 Pedro him-IO make-3SG [VP [V' hunt-INF mice] DOM a cat] (?generic)
 'Pedro makes a cat hunt mice.'

In contrast, pre-infinitival indefinite causees seem to require a strong interpretation:

- (36) a. Hicimos [IP a tres gatos [VP cazar ratones]]. partitive
 made-1PL [IP DOM three cats [VP hunt-INF mice]]
 'We made three of the cats hunt mice.'
 b. Pedro le hace [IP a un gato [VP cazar ratones]]. generic
 Pedro him-IO make-3SG [IP DOM a cat [VP hunt-INF mice]]
 'Pedro makes cats hunt mice.'

These contrasts follow from the Mapping Hypothesis, given the VP/IP contrast proposed in (17). Furthermore, these facts parallel similar contrasts with post- vs. pre-verbal subjects in root clauses (2.2). Given the connection between weak/strong andthetic/categorical argued for in Kuroda 1995 and Ladusaw 2000, these contrasts support athetic/categorical distinction in causative constructions.¹⁷

¹⁶ The chain of reasoning in (34) requires some notion of construction or of a generalized complex predicate, along the lines of Ackerman and Moore's 1999 proposal, even when the causative construction is bi-clausal. Under their account, the causee role (or its equivalent) is part of the lexical entry of a complex predicate that includes the causative and base predicates, along with their arguments. The direct object Case assignment is also lexically determined, in accordance with their Paradigmatic Selection Principle. Taken together with the present proposal, we might say that singling out the causee in an embedded categorical judgment forces the selection of a lexical entry that entails direct causation – the direct object Case then follows.

¹⁷ A similar contrast in the interpretation of bare plurals is discussed in Basilico 2003; this work analyzes verbal small clauses as representingthetic judgments and adjectival small clauses as categorical judgments. Significantly, bare plural subjects of verbal small clauses have weak interpretations, whereas those of adjectival clauses have strong interpretations.

3.4. Against a control analysis

The data presented with respect to pre-infinitival causees appear to be consistent with two analysis in (37):

- (37) a. NP *hacer* NP_i [IP PRO_i [VP ...]] 3-place, control analysis
 b. NP *hacer* [IP NP [VP ...]] 2-place, categorical judgment analysis

While the thematic properties of the causee and the direct causation facts might lead one to favor a control analysis, these might just as well be attributed to the ‘singling out’ of the embedded subject in a categorical judgment analysis. Arguments against the control analysis come from comparing these causatives with uncontroversial object control constructions, such as those with the direct object control verb *forzar* ‘force’. Systematic differences between *forzar* constructions and causatives suggest that the two constructions require different analyses.

First, the controller in *forzar* constructions freely passivizes and can be a reflexive:

- (38) a. *Los niños_i fueron forzados e_i a [PRO_i leer el libro].*
 the children_i were-3PL forced e_i to [PRO_i read-INF the book]
 ‘The children were forced to read the book.’
 b. *Yo_i me_i forcé (a mi mismo_i) a [PRO_i leer ese libro].*
 I_i myself_i forced-1SG (DOM myself_i) to [PRO_i read-INF that book]
 ‘I forced myself to read that book.’

However, as pointed out in Treviño 1990, the same is not true of causees, as illustrated in (39); Farrell 1995 makes the same point for Brazilian Portuguese.

- (39) a. *?* Los niños_i fueron hechos e_i leer el libro.*
 the children_i were-3PL made e_i read-INF the book
 ‘The children were made to read the book.’
 b. *?* Curro_i se_i hizo (a si mismo_i) leer ese libro.*
 Curro_i himself_i made-3SG (DOM himself_i) read-INF that book
 ‘Curro made himself read that book.’

The data related to the interpretation of indefinites are analyzed here in terms of judgment type and its relation to Mapping Hypothesis effects. Another possible framework to approach these facts would be in terms of information packaging (Vallduví 1992, Lambrecht 1994, among others). These two types of analyses are not, necessarily incompatible, but it is beyond the scope of this paper to contrast them. Under the information packaging approach, the strong interpretation of pre-infinitival causees would be a function of their status as topics, or old information. With respect to discourse effects associated with pre-infinitival causees in French *laisser* causatives, Hyman and Zimmer 1976 and Achard 1996 discuss the topicality of this position. Kemmer and Verhagen 1994 notes that Dutch accusative-marked causees are more topical than causees with other encodings; again, these approaches are consistent with the basic analysis of the Spanish facts proposed here.

Secondly, the Mapping Hypothesis effects found in causatives contrast with the interpretation of indefinites in *forzar* constructions. As (40) illustrates, an indefinite controller of *forzar* may have either a strong or weak interpretation:

- (40) a. Hicimos a tres gatos cazar ratones. partitive only
 made-1PL DOM three cats hunt-INF mice
 ‘We made *three of the cats* hunt mice.’
 b. Pedro forzó a dos gatos a cazar ratones. partitive or cardinal
 Pedro forced-3SG DOM two cats to hunt-INF mice
 ‘Pedro made *two (of the) cats* hunt mice.’

Thus, there is evidence that pre-infinitival causative constructions need to be distinguished from object control constructions, casting doubt on the appropriateness of an object control analysis for causatives.

4. Conclusion

I would like to conclude by discussing further issues that arise when one postulates embeddedthetic and categorical judgments in infinitival causative constructions. In particular, the relationship between thethetic/categorical distinction and Carlson’s 1980 stage-/individual-level contrast. This, in turn, has implications for the theory of selection.

A central point in Kuroda 1995 and Ladusaw 2000 is the relationship between judgment types and predicate classes. Descriptively, we find the correlations in (41):

- (41) Thetic Judgment *Individual-Level Predicate
 Stage-Level Predicate
 Categorical Judgment Individual-Level Predicate
 Stage-Level Predicate

The only restriction is thatthetic judgments disallow individual-level predicates; this can be seen by the unacceptability of a (thetic) *there*-construction and an individual-level predicate (42a), as well as the impossibility of a weak construal of the subject of an individual-level predicate (42b):

- (42) a. * There were *three students* intelligent.
 b. *Three students* were intelligent. strong reading only - categorical judgment

In addition to the categorical judgment with an individual-level predicate in (42b), we find categorical judgments with stage-level predicates. The possibility of such a categorical judgment is illustrated by the possibility of a strong reading in (43):

- (43) *Three students* were drunk. strong reading possible - categorical judgment

In essence, these data comprise the empirical basis of Milsark's Generalization (Milsark 1974, Carlson 1980), which Ladusaw (2000:236) derives as in (44):

- (44) a. Individual-level predicates denote properties.
 b. Stage-level predicates denote descriptions.
 c. The basis of athetic judgment is a description.
 d. The basis of a categorical judgment is a property predicated of an object.
 e. Only strong NPs denote objects.

Milsark's Generalization follows: individual-level predicates must have strong subjects. By assuming that properties may not form the basis ofthetic judgments, the incompatibility between individual-level predicates andthetic judgments is derived. To account for the possibility of categorical judgments with stage-level predicates, Ladusaw and Kuroda assume a type-shifting mechanism whereby a stage-level predicate, which normally denotes an eventive description, may represent a property; i.e., "The property of being a participant in an eventuality of that description" (Ladusaw 2000:238). Hence, the example in (43) is the result of this type-shift, and involves the predication of a (derived) property to a strong NP object in a categorical judgment.

Turning now to the proposed analysis of Spanish causatives, one might expect that an embedded clause with post-infinitival causees should be headed by stage-level predicates, as these are analyzed as selecting embeddedthetic judgments, while pre-infinitival causee constructions should allow embedded stage- and individual-level predicates, consistent with their analysis as selecting embedded categorical judgments. However, these expectations are only partly realized. While both constructions allow embedded stage-level predicates, neither allows an embedded individual-level predicate. In (45), *hablar francés*, like its English counterpart 'speak French', is ambiguous between 'talk in French' and 'know how to speak French', the former a stage-level predicate and the latter individual-level. As indicated by the translation, the individual-level reading is infelicitous when embedded under a causative predicate, regardless of whether this embedded clause is, by hypothesis, the basis of athetic or categorical judgment.¹⁸

- (45) a. Ese maestro hizo hablar francés a los estudiantes.
 that teacher made-3PL speak-INF French DOM the students
 b. Ese maestro hizo a los estudiantes hablar francés.
 that teacher made-3PL DOM the students speak-INF French
 'That teacher made the students talk French.'
 # 'That teacher made the students know French.'

¹⁸ Indeed, previous discussions of judgment types in the complements of perception verbs have limited them tothetic judgments (e.g., Lenci 1994, Raposo and Uriagereka 1995, and Basilico 2003). Lenci extends this requirement to the Italian causative *rendere* 'render'. Kuroda (2003), however, discusses the possibility of a categorical judgment embedded in a Japanese *ni*-causative.

The issue, then, reduces to why categorical judgments embedded under causative predicates disallow individual-level predicates. The answer must lie in the semantics of the causative predicate. The essence of causation is that a causative event brings about a state of affairs that is contingent on the causative event (cf. Rosen 1990). This effectively requires that the caused state or event have a temporal dimension, which in turn requires that the caused state or event be expressed by a stage-level predicate. Recall, however, that stage-level predicates are able to form part of the basis of a categorical judgment by means of the type-shifting mechanism mentioned above. Thus, while a causative predicate semantically selects an event headed by a stage-level predicate, this may be realized as the basis of either athetic or categorical judgment. If the embedded clause forms the basis of athetic judgment, then the stage-level predicate forms part of an eventive description, which also includes the causee; if the clause forms the basis of a categorical judgment, then the description type-shifts to become a property that is applied to the causee.

This approach has implications for the theory of selection. Since Grimshaw 1979 and 1981, and Pesetsky 1982, there has been a move to eliminate syntactic selection (c-selection) and derive its effects largely from semantic selection (s-selection). While this is often stated as a promissory note (e.g. Chomsky and Lasnik 1993), and has been debated (e.g., Odijk 1997), many would agree that when possible, the nature of a complement should be dictated by the semantic properties of the head which selects it.

The analysis presented here takes a different approach. The causative predicate s-selects an event with a stage-level predicate, regardless of whether the complement is realized as a VP or IP. The c-selection, in this case, is keyed to the judgment type, which corresponds to a cognitive act on the part of the speaker. There is yet a further dissociation: recall there was evidence that the pre-infinitival causee appears to bear a thematic relationship with the causative verb (being subject to selectional restrictions and undergoing direct causation). Rather than treating this as direct s- or c-selection, as entailed under the control account, these effects were argued to be a consequence of the embedded categorical judgment. Again, we find dissociation between syntax, semantics, and judgment types. To the extent this work motivates that judgment types play an explanatory role in the analyses of these Spanish causatives, it argues that semantics and cognitive acts play independent roles in determining complement selection. If other aspects of c-selection cannot be reduced to either of these, we are left with independent selectional roles for all three.

References

- Abeillé, Anne, Danièle Godard, and Philip H. Miller. 1997. Les causatives en français: un cas de compétition syntaxique. *Langue Française* 115:62-74.
- Abeillé, Anne, Danièle Godard, and Ivan A. Sag. 1998. Two Kinds of composition in French complex predicates. *Complex predicates in nonderivational syntax, Syntax and semantics* 30, eds. Erhard Hinrichs, Andreas Kathol and Tsuneko Nakazawa, 1-41. San Diego: Academic Press.

- Achard, Michel. 1996. Two causative/perception constructions in French. *Cognitive Linguistics* 7:314-357.
- Ackerman, Farrell and John Moore. 1999. Syntagmatic and paradigmatic dimensions of causee encodings. *Linguistics and Philosophy* 22:1-44.
- Alexiandou, Artemis and Elena Anagnostopoulou. 1998. Parameterizing AGR: Word order, V-movement, and EPP-checking. *Natural Language and Linguistic Theory* 16:491-539.
- Aissen, Judith L. 1979. *The syntax of causative constructions*. New York: Garland.
- Aissen, Judith L. and David M. Perlmutter. 1976. Clause reduction in Spanish. *Berkeley Linguistic Society* 2, 1-30. Berkeley Linguistic Society, Berkeley, Ca.
- Aissen, Judith L. and David M. Perlmutter. 1983. Clause reduction in Spanish (revised from Aissen and Perlmutter 1976). *Studies in Relational Grammar 1*, ed. David M. Perlmutter, 360-403. Chicago: The University of Chicago Press.
- Alsina, Alex. 1992. On the argument structure of causatives. *Linguistic Inquiry* 23:517-56.
- Alsina, Alex. 1996. *The role of argument structure in Spanish: The evidence from Romance*. Stanford: CSLI Publications.
- Basilico, David. 2003. The topic of small clauses. *Linguistic Inquiry* 34:1-35.
- Bordelois, Ivonne A. 1974. The grammar of Spanish causative complements. Doctoral dissertation, MIT.
- Bordelois, Ivonne A. 1988. Causatives: From lexicon to syntax. *Natural Language and Linguistic Theory* 6:57-94.
- Burzio, Luigi. 1986. *Italian syntax: A Government and Binding approach*. Dordrecht: Reidel.
- Byrne, William. 1998. Information structure, judgment types, and the interpretation of indefinites in Spanish. Doctoral dissertation, University of California, San Diego.
- Carlson, Gregory N. 1980. *Reference to kinds in English*. New York: Garland.
- Chomsky, Noam and Howard Lasnik. 1993. The theory of principals and parameters. *An international handbook of contemporary research*, Volume 1, eds. Joachim Jacobs, Arnim von Stechow, Wolfgang Sternefeld, and Theo Vennemann, 506-569. Berlin: Walter de Gruyter. [Reprinted in Chomsky, Noam. 1995. *The Minimalist Program*, 13-127. Cambridge, Ma.: MIT Press.]
- Contreras, Heles. 1991. On the position of subjects. *Perspectives on phrase structure: Heads and licensing (Syntax and semantics, vol. 25)*, ed. Susan D. Rothstein, 63-79. San Diego: Academic Press.
- Diesing, Molly. 1992. *Indefinites*. Cambridge, Ma: The MIT Press.
- Dorel, Martine A. 1980. The two verbs *faire* in French expressions of causation. *Contemporary studies in Romance languages, proceedings of the eighth annual symposium on Romance languages*, ed. Frank H. Nuessel, 27-47. Bloomington: Indiana University Linguistics Club.
- Farrell, Patrick. 1995. Backward control in Brazilian Portuguese. *Eastern States Conference on Linguistics* 11, 116-127. Cornell University, Ithaca, NY.
- Fauconnier, Gilles. 1983. Generalized union. *Communication and Cognition* 16:3-37.

- Gibson, Jeanne D. and Eduardo P. Raposo. 1986. Clause union, the stratal uniqueness law and the chômeur relation. *Natural Language and Linguistic Theory* 4:295-331.
- Grimshaw, Jane. 1979. Complement selection and the lexicon. *Linguistic Inquiry* 10:279-326.
- Grimshaw, Jane. 1981. Form, function, and the language acquisition device. *The logical problem of language acquisition*, eds. C. L. Baker and John J. McCarthy, 165-182. Cambridge, Ma: The MIT Press.
- Guasti, Maria Teresa. 1993. *Causative and perception verbs: A comparative study*. Torino: Rosenberg and Selier.
- Gutiérrez-Bravo, Rodrigo. 2005. *Structural markedness and syntactic structure: A study of word order and the left periphery in Mexican Spanish*. New York: Routledge.
- Gutiérrez-Bravo, Rodrigo. 2007. Prominence scales and unmarked word order in Spanish. *Natural Language and Linguistic Theory* 25:235-271.
- Hyman, Larry M. and Karl E. Zimmer. 1976. Embedded topic in French. *Subject and topic*, ed. Charles N. Li, 189-211. New York: Academic Press.
- Iatridou, Sabine. 1990. About Agr(P). *Linguistic Inquiry* 21:551-577.
- Kemmer, Suzanne, and Arie Verhage. 1994. The grammar of causatives and the conceptual structure of events. *Cognitive Linguistics* 5:115-156.
- Koopman, Hilda and Dominique Sportiche. 1991. The position of subjects. *Lingua* 85:211-258.
- Kuroda, S.-Y. 1972. The categorical and thetic judgment: Evidence from Japanese syntax. *Foundations of Language* 9:153-185.
- Kuroda, S.-Y. 1988. Whether we agree or not: A comparative syntax of English and Japanese. *Linguisticae Investigationes* 12:1-47.
- Kuroda, S.-Y. 1995. Sentences, judgments and propositions. Ms., University of California, San Diego.
- Kuroda, S.-Y. 2003. Judgments, point of view, and the interpretation of causee noun phrases. *Functional structure(s), form and interpretation: Perspectives from East Asian languages*, eds. Yen-hui Audrey Li and Andrew Simpson, 201-221. London: RoutledgeCurzon.
- Ladusaw, William A. 2000. Thetic and categorical, stage and individual, weak and strong. *Negation and polarity: Syntactic and semantic perspectives*, eds. Laurence Horn and Yasuhiko Kato, 232-242. New York: Oxford University Press.
- Lambrecht, Knud. 1994. *Information structure and sentence form: Topic, focus, and the mental representations of discourse referents*. Cambridge: Cambridge University Press.
- Langacker, Ronald. W. 1995. Raising and transparency. *Language* 71:1-62.
- Lenci, Alessandro. 1994. Specificity constraints inside small clauses. Ms., Scuola Normale Superiore, Pisa.
- López, Luis. 2009. *A derivational syntax for information structure*. Oxford: Oxford University Press.
- Martínez Caro, Elena. 2007. Pragmatic frames, the thetic-categorical distinction and Spanish constituent order. *Alfa* 51:119-142.
- Marty, Anton. 1918. *Gesammelte Schriften*, 2, Band. 1, Abteilung. Halle: Niemeyer.

- May, Robert. 1985. *Logical form: its structure and derivation*. Cambridge, Ma: The MIT Press.
- Mejías-Bikandi, Errapel. 1993. Syntax, discourse, and acts of the mind: A study of the indicative/subjunctive contrast in Spanish. Doctoral dissertation, University of California, San Diego.
- Mejías-Bikandi, Errapel and John Moore. 1994. Spanish causatives and indefinites: Evidence for VP-complementation. Paper presented at the 68th Meeting of the Linguistic Society of America, Boston, Ma.
- Milsark, Gary. 1974. *Existential sentences in English*. Doctoral dissertation, MIT.
- Moore, John. 1996. *Reduced constructions in Spanish*. New York: Garland.
- Norcliffe, Elisabeth. 2007. Constructing Spanish complex predicates. *HPSG 07*, 194-213. Stanford: CSLI Publications. <http://csli-publications.stanford.edu/HPSG/8/norcliffe.pdf>.
- Odiijk, Jan. 1997. C-selection and s-selection. *Linguistic Inquiry* 28:365-371.
- Ordóñez, Francisco. 2007. Cartography of postverbal subjects in Spanish and Catalan. *Romance Languages and Linguistic Theory* 2005, eds. Sergio Baauw, Frank Drijkoningen and Manuela Pinto, 259-280. Amsterdam: John Benjamins.
- Pearce, Elizabeth. 1990. *Parameters in Old French syntax: Infinitival complements*. Dordrecht: Kluwer Academic Publishers.
- Pesetsky, David. 1982. Paths and categories. Doctoral dissertation, MIT.
- Picallo, M. Carme. 1990. Modal verbs in Catalan. *Natural Language and Linguistic Theory* 8:285-312.
- Potsdam, Eric. 1997. NegP and subjunctive complements in English. *Linguistic Inquiry* 28:533-541.
- Raposo, Eduardo and Juan Uriagereka. 1995. Two types of small clauses (toward a syntax of theme/rheme relations). *Syntax and Semantics, Volume 28: Small Clauses*, eds. Anna Cardinaletti and Maria Teresa Guasti, 179-206. New York: Academic Press.
- Rosen, Sara Thomas. 1990. *Argument structure and complex predicates*, New York: Garland.
- Strozer, Judith. 1976. Clitics in Spanish. Doctoral dissertation, University of California, Los Angeles.
- Treviño, Esther. 1990. Non-canonical subjects in Spanish: Evidence from causative and psych verbs. Ms., University of Ottawa.
- Treviño, Esther. 1992. Subjects in Spanish causative constructions. *Romance languages and modern linguistic theory*, eds., Paul Hirschbühler and Konrad Koerner, 309-324. Amsterdam: John Benjamins.
- Vallduví, Enric. 1992. *The informational component*. New York: Garland.
- Zagona, Karen. 1982. Government and proper government of verbal projections, Doctoral dissertation, University of Washington.

ON THE WEAK EXPLETIVE PARADIGM IN GERMANIC*

David M. Perlmutter
University of California, San Diego
dperlmutter@ucsd.edu

German, Yiddish, and Icelandic have a weak expletive paradigm (WEP): expletives appear in only one of the four subject positions in which they appear in the strong expletive paradigm (SEP) of other Germanic languages. We account for the distribution of WEP expletives and argue that the only difference between the clause structures underlying the WEP and the SEP is that WEP expletives are covert in the other three environments. We then argue that WEP expletives both overt and covert are subjects. Arguing against representing covert expletive subjects as syntactic constituents lacking a phonological representation, we propose a novel way to represent them based on representing grammatical relations and linear precedence in different structures. We then show that just three constraints are sufficient to account for the expletive paradigms in Germanic. The grammars underlying the WEP languages, the SEP languages, and Dutch (which has both paradigms) differ only in the ranking of two constraints. Our data and arguments come from Dutch, German, and Yiddish, with occasional reference to other Germanic languages.

1. Goals

The V2 Constraint (1) defines one of the major clause types (2) in most Germanic languages. (3) indicates the unmarked position of subjects in each. (4a-d) illustrate the strong expletive paradigm (SEP) in Dutch. Expletive *er* is arguably a subject, occupying the same positions in (4) as other subjects. In the weak expletive paradigm (WEP), expletives appear in initial subject position (3a), as in (5a), but not in positions (3b-d) in (5b-d). The SEP-WEP contrast divides the Germanic languages considered here into the groups in (6).

- (1) The V2 Constraint: The finite verb must be in second position in the clause.
- (2) V2 (verb-second) clauses: Declaratives
V1 (verb-first) clauses: Yes-no questions, narrative style in Yiddish and Icelandic, others
VF (verb-final) clauses: Most subordinate clauses in Dutch and German

* It is a pleasure to dedicate this paper to Judith Aissen in recognition of her exemplary teaching, research, and contributions to the study of grammatical relations, to the documentation and analysis of understudied languages, and to Relational Grammar, Arc Pair Grammar, and Optimality Theory. I am indebted to Ian Abramson, Elke Riebeling, Jerrold Sadock, Tessa Verhoef, Stefan de Winter, and Annie Zaenen for help with data, to Line Mikkelsen for extraordinary editorial work, to audiences at the University of California, San Diego and the University of Toronto and to Eric Bakovic, Bill Davies, Géraldine Legendre, Joan Maling, Stephen Marlett, Line Mikkelsen, Paul Postal, Annie Zaenen, and especially John Moore for helpful discussion and/or comments on earlier versions of this paper. All errors and shortcomings are my own.

In (4-5) the expletive is in bold and the finite verb is italicized. Maling and Zaenen (1978) report on two varieties of Dutch: Dutch B has only the SEP in (4), while Dutch A has both the SEP in (4) and the WEP in (5), which is like (4) but without *er* in (4b-d). Our references to Dutch refer to Dutch A unless indicated otherwise.

- (3) Unmarked positions for subjects:
- V2 initial subject position: **Subject** – V – X
 - V2 postverbal subject position: {Topic, WH} – V – **Subject** – X
 - V1 subject position: V – **Subject** – X
 - VF subject position: Complementizer – **Subject** – X – V
- (4) Strong expletive paradigm (SEP): (Dutch)
- V2: **Er** *werd* hier de hele nacht gedanst.
EXPL was here the whole night danced
'There was dancing here all night.'
 - V2: De hele nacht *werd* **er** hier gedanst.
the whole night was EXPL here danced
'All night there was dancing here.'
 - V1: *Werd* **er** hier de hele nacht gedanst?
was EXPL here the whole night danced
'Was there dancing here all night?'
 - VF: ... omdat **er** hier de hele nacht gedanst *werd*.
because EXPL here the whole night danced was
'...because there was dancing here all night.'
- (5) Weak expletive paradigm (WEP): (German)
- V2: **Es** *wurde* hier die ganze Nacht getanzt.
EXPL was here the whole night danced
'There was dancing here all night.'
 - V2: Die ganze Nacht *wurde* (***es**) hier getanzt.
the whole night was EXPL here danced
'All night there was dancing here.'
 - V1: *Wurde* (***es**) hier die ganze Nacht getanzt?
was EXPL here the whole night danced
'Was there dancing here all night?'
 - VF: ... weil (***es**) hier die ganze Nacht getanzt *wurde*.
because EXPL here the whole night danced was
'...because there was dancing here all night.'
- (6) SEP: Danish, Dutch B, Norwegian, Swedish
WEP: German, Yiddish, Icelandic (GYI)
Both SEP and WEP: Dutch A

We address the problems in (7), using descriptive terminology where necessary to avoid theoretical assumptions not necessary for our solutions, which eschew derivations, movement rules, and much currently assumed constituent structure in favor of violable ranked declarative Optimality-Theoretic constraints.

- (7) Problem 1: How is a grammar to account for the distribution of WEP expletives?
Problem 2: Are WEP clauses in which no expletive appears subjectless?
Problem 3: Are WEP expletives subjects?
Problem 4: How are covert expletive subjects to be represented?

Problem 5: How different are the grammars underlying the WEP, the SEP, and Dutch?

2. The Surface Distribution of WEP Expletives

Zaretski 1929:236 stated generalization (8) about the WEP expletive *es* in Yiddish, which holds for expletives in German and Icelandic as well.¹ It makes the prediction in (9).

First, the V2 generalization explains why *es* can appear in German declaratives like (5a) and (10a) but not in the corresponding interrogatives (5c) and (10b). Declaratives are V2 clauses subject to (1), while interrogatives are V1 clauses, which are not. Since (10c) is felicitous with question intonation, (10b) is ruled out not because it is a question, but because it is a V1 clause.

Second, the V2 generalization explains a contrast between German and Yiddish. If (10a) is put in a German subordinate clause, as in (11), *es* cannot appear. (9) explains this: German subordinate clauses like (11) do not allow WEP expletives because they are VF clauses. But in Yiddish, *es* must appear after the complementizer in subordinate clauses like (12a) because subordinate clauses in Yiddish are V2 clauses subject to the V2 Constraint, whose domain excludes the complementizer *az*. The finite verb must be in second position in this domain (Zaretski 1929:253), which accounts for the ungrammaticality of (12b).² The German-Yiddish contrast illustrated by (11-12) follows from the VF-V2 contrast in their subordinate clauses.

Third, the V2 generalization explains a contrast internal to German: *es* cannot appear in subordinate clauses like (11), but does appear in those like (13) with bridge verbs because, like main clauses, they are subject to the V2 Constraint (1); *würde* must be second in (13).

(8) Zaretski's generalization: WEP expletives appear [only] where needed to prevent the verb from being in initial position [in violation of the V2 Constraint].

(9) The V2 generalization: WEP expletives appear only in V2 clauses.

(10) a. Es wird jemand morgen kommen. (V2) (German)

EXPL will someone tomorrow come

'Someone will come tomorrow.'

b. Wird (*es) jemand morgen kommen? (V1)

will EXPL someone tomorrow come

'Will someone come tomorrow?'

c. Es wird jemand morgen kommen? (V2)

EXPL will someone tomorrow come

'Someone will come tomorrow?'

¹ Zaretski's generalization, noted independently in some traditional grammars and in generative work (Haiman 1974:16-23, Breckenridge 1975, Maling and Zaenen 1978:490-492, Safir 1985, Müller 2000:48, among others), answers the questions in (21) that Vikner 1995:186 leaves open. The generalizations in section 2 are in Haiman (1974:16-23), Vikner (1995), and references cited there.

² Yiddish *es*, realized as *s* in (12a), forms a prosodic unit with the verb; nothing can come between them. This is why Zaretski 1929:235 calls it a prefix. The finite verb *vet* is italicized. (12a) also shows that this Yiddish construction does not obey the Definiteness Constraint (29a) on the expletive's associate that holds in Dutch (cf. section 3 below) and is prominent in the analyses of Safir 1985, Vikner 1995, and others. Vikner 1995:177 claims that this constraint, which does not hold in Yiddish, is a consequence of the licensing requirements he proposes.

- (11) Ich weiss, dass (*es) jemand morgen kommen wird. (German)
 I know that EXPL someone tomorrow come will
 ‘I know that someone will come tomorrow.’
- (12) a. Ikh veys, az s’ vet morgn kumen Moyshe.
 I know that EXPL will tomorrow come Moyshe
 ‘I know that Moyshe will come tomorrow.’ [Zaretski 1929:253] (Yiddish)
- b. *Ikh veys, az vet morgn kumen Moyshe.
 I know that will tomorrow come Moyshe
- (13) Sie dachte, es würde hier die ganze Nacht getanzt. (German)
 she thought EXPL would.be here the whole night danced
 ‘She thought there would be dancing here all night.’

Fourth, the V2 generalization explains a contrast internal to Yiddish. Contrasting with main and subordinate V2 clauses, Yiddish uses V1 clauses in narrative style, as in (14a-d), the first stanza of a lullaby.³ (14a, c) are existential sentences that in ordinary discourse would have the expletive *es*, as in (15a/16a). (15b/16b) show it is a WEP expletive. (17) illustrates the expletive’s exclusion from V1 narrative style (cf. (14)), which generalization (9) predicts.

- (14) a. *Shteyt* in feld a beyemele.
 stands in field a tree.DIM.SG
 ‘In the field there stands a little tree.’
- b. *Hot* es grine tsvaygelekh.
 has it green branch.DIM.PL
 ‘It has little green branches.’
- c. *Zitst* daroyf a feygele.
 sits on.it a bird.DIM.SG
 ‘On it there sits a little bird.’
- d. *Makht* es tsu di eygelekh.
 closes it the eye.DIM.PL
 ‘It closes its little eyes.’
- (15) a. Es shteyt in feld a beyemele.
 EXPL stands in field a tree.DIM.SG
 ‘In the field there stands a little tree.’
- b. In feld shteyt (*es) a beyemele.
 in field stands EXPL a tree.DIM.SG
 ‘In the field there stands a little tree.’
- (16) a. Es zitst daroyf a feygele.
 EXPL sits on.it a bird.DIM.SG
 ‘On it there sits a little bird.’

³ The verbs in (14a-d) are italicized. The *es* in (14b, d) is not an expletive but an anaphoric pronoun whose antecedents are *a beyemele* and *a feygele* in (14a, c). The last word in each line is a “second diminutive” (Perlmutter 1988), used both to indicate smallness and as terms of endearment. It is common in songs and poems for children.

- b. Daroyf zitst (*es) a feygele.
 on.it sits EXPL a bird.DIM.SG
 ‘On it there sits a little bird.’
- (17) a. *Shteyt* (*es) in feld a beyemele.
 stands EXPL in field a tree.DIM.SG
 ‘In the field there stands a little tree.’
- b. *Hot* es grine tsvaygelekh.
 has it green branch.DIM.PL
 ‘It has little green branches.’
- c. *Zitst* (*es) daroyf a feygele.
 sist EXPL on.it a bird.DIM.SG
 ‘On it there sits a little bird.’
- d. *Makht* es tsu di eygelekh.
 closes it the eye.DIM.PL
 ‘It closes its little eyes.’

Zaretski’s generalization also predicts (18), as seen in the contrast between (5a) and (5b). It extends to V2 subordinate clauses, as in the contrast between (12) and (19) in Yiddish and between (13) and (20) in German. In all three cases, *es* cannot appear if there is a topic in initial position. As (18) makes clear, Zaretski’s generalization answers the questions in (21).⁴

- (18) Within V2 clauses, WEP expletives must appear in initial position and only there.
- (19) a. Ikh veys, az morgn vet (*es) Moyshe kumen. (Yiddish)
 I know that tomorrow will EXPL Moyshe come
 ‘I know that Moyshe will come tomorrow.’
- b. Ikh veys, az Moyshe vet (*es) morgn kumen.
 I know that Moyshe will EXPL tomorrow come
 ‘I know that Moyshe will come tomorrow.’
- c. Ikh veys, az kumen vet (*es) Moyshe morgn.
 I know that come will EXPL Moyshe tomorrow
 ‘I know that Moyshe will come tomorrow.’
- (20) a. Sie dachte, hier würde (*es) die ganze Nacht getanzt. (German)
 she thought here would.be EXPL the whole night danced
 ‘She thought there would be dancing here all night.’
- b. Sie dachte, die ganze Nacht würde (*es) hier getanzt.
 she thought the whole night would.be EXPL here danced
 ‘She thought there would be dancing here all night.’
- (21) a. Why can’t WEP expletives appear in postverbal subject position (3b)?
 b. Why must WEP expletives appear in preverbal subject position (3a)?

⁴ Vikner 1995:186 leaves open these questions, rephrased here in more descriptive terms.

Optimality Theory (OT) provides the means to incorporate Zaretski's generalization into a grammar. To account for the WEP we propose *Expl (22).⁵ Ranking *Expl below V2 in (24) captures Zaretski's insight. *Expl stars any candidate sentence with expletive *es*, but the higher-ranked V2 Constraint is violated if the verb is not in second position. Only in that case will violations of *Expl be grammatical. This ensures that *es* will appear where needed to shield the verb from initial position, but not elsewhere. The candidate set (discussed in section 6) includes sentences with the expletive in all possible positions as well as sentences without it.

To illustrate briefly, (25) lists two candidates for (5a), with and without *es* in subject position. (25a) violates *Expl, while (25b) violates V2. Since V2 outranks *Expl, (25a) wins. For (5b), (26a) violates V2 and *Expl, while (26b) violates neither and qualifies as grammatical. V1 and VF clauses (5c) and (5d) are not subject to the V2 Constraint and *Expl rules out the candidates with *es*. Thus, the V2 Constraint ensures that the verb will be in second position and *Expl stars sentences with an overt expletive. The ranking in (24) puts expletives in initial position in V2 clauses but not elsewhere, accounting for the WEP in all four WEP languages.⁶

- (22) *Expl: A sentence with an overt expletive is ill-formed.
 (23) V2 Constraint: If a constituent A and the finite verb V are clause mates and A precedes V, then there is no other clause mate B of V that precedes V.⁷
 (24) An Optimality-Theoretic Solution (OTS): V2 >> *Expl
 (25) a. Es wurde hier die ganze Nacht getanzt. (Violates *Expl) [Sentence (5a)]
 EXPL was here the whole night danced
 'There was dancing here all night.'

⁵ I assume that the *es* with weather verbs and in German sentences like *Es ist deutlich, dass er schuldig ist* 'It is clear that he is guilty', which appear in all four subject positions in (3), are not true expletives (Leys 1979, Cardinaletti 1990a, 1990b, Vikner 1995). If they *are* expletives, GYI have both strong and weak expletives, which can then be distinguished by a lexical feature [+/- Strong]. *Expl can then be formulated as: *Expl[- Strong]. Such a feature is shown in section 6 not to be needed to distinguish SEP and WEP expletives in Dutch.

⁶ Müller 2000:48-50 and Legendre 2001:1-11 propose OT analyses of overt WEP expletives in German, but do not deal with the concerns of sections 3-6 below. They use versions of Full-Interpretation (Chomsky 1991:437-444) to star sentences with an expletive. Müller 2000:22, 29, 55, 213 states Full-Int as "Expletive insertion is forbidden." Legendre's 2001:5 formulation "Lexical items must contribute to the interpretation of a structure" is closer to Grimshaw's 1997:374 "Lexical conceptual structure must be parsed." Like Avoid-Pronoun (Chomsky 1981:65, Cardinaletti 1990b:17-18) before it, Full-Int has been used to account for pro-drop. This requires an account of why GYI and Dutch, with verbs inflected for the subject's person and number, don't have pro-drop, a problem discussed by Safir 1985, Cardinaletti 1990a, 1990b, and others. Chomsky's 1991 version of Full-Int requires that all elements be interpreted at D-structure, PF, and LF in his framework at that time. Since Full-Int raises issues not relevant here, I use *Expl, which makes explicit exactly what is needed to account for the WEP in Germanic – no more, no less. The possibility that a constraint more general than *Expl might be appropriate is left open. Similarly, the V2 Constraint as stated here and in the literature is not universal. The question of whether it is a special case of a more general universal constraint is left open here. At issue is the OT claim that all constraints are universal (McCarthy and Prince 1993, Prince and Smolensky 1993).

⁷ This yields an additional violation for each additional constituent that precedes V. It presupposes constraints that state which clause types (declarative, yes-no questions, subordinate, etc.) are subject to the V2, V1, and VF constraints in each language (cf. Maling and Zaenen's 1981 suggestion that V1 and V2 filters are associated with requests for information and declaratives, respectively, in Germanic). There is some variation within Germanic, e.g. narrative style uses V1 clauses in Yiddish and Icelandic and most subordinate clauses are VF in Dutch and German.

- b.*Wurde hier die ganze Nacht getanzt. (Violates V2)
 was here the whole night danced
- (26) a.*Die ganze Nacht wurde es hier getanzt. (Violates *Expl)
 The whole night was EXPL here danced
- b. Die ganze Nacht wurde hier getanzt. [Sentence (5b)]
 the whole night was here danced
 ‘All night there was dancing here.’

3. Evidence for Covert WEP Subjects

The discovery of evidence for covert expletive subjects in Italian (Perlmutter 1983, Burzio 1986), Russian (Perlmutter and Moore 2002), and many other languages raises the question of whether WEP clauses in which no expletive appears are subjectless or have covert expletive subjects. If the latter, covert expletive subjects in Germanic would contrast with other pronominal subjects, which must be overt. The WEP would then be fully parallel to the SEP, whose expletives appear in all four subject positions and are uncontroversially subjects.

For evidence we turn to the Dutch Indefinite Extraposition (IE) construction in (27b/28b), where expletive subjects have visible effects on another nominal. (27a/28a) are V2 clauses whose subjects are in initial subject position. In the IE construction (27b/28b) the expletive *er* appears in subject position. The nominal that pivots between subject and nonsubject positions in such pairs we call the “pivot nominal.” The Definiteness Constraint (29a) requires that it be indefinite, ruling out *Piet* and *mijn vrienden* in (27b/28b), which are like the *there*-construction in English: the expletive *er* is the subject and the italicized pivot nominal is its “associate.” (30) states the structural differences between (27a/28a) and (27b/28b). As in English, Associate Agreement (31) accounts for verb agreement in (27b/28b).

- (27) a. Iemand/Piet kwam gisteren door de achterdeur binnen.
 someone/Piet came.SG yesterday through the back.door in
 ‘Someone/Piet came in yesterday through the back door.’
- b. *Er* kwam gisteren door de achterdeur *iemand* (*Piet) binnen.
EXPL came.SG yesterday through the back.door someone Piet in
 ‘Someone (*Piet) came in yesterday through the back door.’
- (28) a. Enkele/Mijn vrienden kwamen gisteren door de achterdeur binnen.
 several/my friends came.PL yesterday through the back.door in
 ‘Several/My friends came in yesterday through the back door.’
- b. *Er* kwamen gisteren door de achterdeur *enkele* (*mijn) *vrienden* binnen.
EXPL came.PL yesterday through the back.door several my friends in
 ‘Several (*My) friends came in yesterday through the back door.’
- (29) a. Definiteness Constraint: The pivot in the IE construction must be indefinite.
 b. The associate determines verb agreement through Associate Agreement (31).
- (30) How the (b)-sentences differ structurally from the (a)-sentences:
 a. The expletive in initial subject position is the subject of the (b)-sentences.

b. Thus the pivot is not the subject but the expletive's associate in the (b)-sentences.⁸

- (31) Associate Agreement: Where the agreement controller is an expletive, agreement is determined by its associate (Perlmutter 1983: 161, with updated terminology).⁹

We now argue that in V2, V1, and VF clauses in Dutch, which has both the SEP and the WEP, hypothesized covert expletive subjects have the same effects on the pivot nominal as overt ones. In each case, we find a nominal that determines verb agreement but must be indefinite and occurs in a nonsubject position, like the associates of overt expletive subjects. We conclude that these nominals have these properties because they *are* associates – of covert expletive subjects.

Preverbal subjects in Dutch V2 clauses can be definite or indefinite, as in (27a/28a). The italicized nominals in (32a-b), however, determine verb agreement but (i) are in a nonsubject (fourth) position and (ii) must be indefinite. What needs to be explained is why they have these properties rather than others. If (32a-b) were subjectless, we would have no explanation. If (32a-b) have covert expletive subjects and *iemand* and *enkele vrienden* are their associates in the IE construction, however, everything falls into place. They are in a nonsubject position because they are not subjects. They are indefinite due to the Definiteness Constraint (29a). Associate Agreement, needed for (27b/28b) with an overt expletive, accounts for agreement. Confirming evidence comes from SEP sentences (33a-b), in which those nominals are the associates of overt *er* from the SEP and therefore have the same properties as in (32a-b).

- (32) a. Gisteren kwam door de achterdeur *iemand* (*Piet) binnen.
 yesterday came.SG through the back.door someone Piet in
 'Yesterday someone (*Piet) came in through the back door.'
- b. Gisteren kwamen door de achterdeur *enkele* (*mijn) *vrienden* binnen.
 yesterday came.PL through the back.door several my friends in
 'Yesterday several (*my) friends came in through the back door.'
- (33) a. Gisteren kwam *er* door de achterdeur *iemand* (*Piet) binnen.
 yesterday came.SG EXPL through the back.door someone Piet in
 'Yesterday someone (*Piet) came in through the back door.'
- b. Gisteren kwamen *er* door de achterdeur *enkele* (*mijn) *vrienden* binnen.
 yesterday came.PL EXPL through the back.door several my friends in
 'Yesterday several (*my) friends came in through the back door.'

Analogous arguments can be made for the V1 and VF clauses (34a-b) and (35a-b), where

⁸ With an expletive as subject, the pivot nominal is a *chômeur*, a nonsubject and the expletive's "brother-in-law" ("associate") in Relational Grammar (Perlmutter 1983, Perlmutter and Zaenen 1984, among many others). In §3 we draw freely on data and arguments in Perlmutter and Zaenen (1984), as does Safir 1985 in his arguments in the GB framework for covert subjects in Dutch and German. It is a consequence of the Relational Grammar Active Dummy Law (Perlmutter 1983:184) that an expletive must form a chain with an associate if possible. Chomsky 1991:441-443 proposed deriving this from Full-Interpretation (cf. fn. 6 and Vikner 1995:177).

⁹ This descriptive statement (needed for the *there*-construction in English) suffices for present purposes. Aissen 1990:280-287 offers a theory in which Associate Agreement is a special case of a more general phenomenon characterized in terms of the overrun relation (Johnson and Postal 1980). Associate Agreement is cross-linguistically common but not universal. It is absent in the IE construction in French (*Il_{SG} est_{SG} arrivé 4 inspecteurs_{PL}* 'There arrived 4 inspectors') and in impersonal constructions in Choctaw, Kannada, and Tamil (Perlmutter 1983:187-193).

the agreement controllers are in nonsubject positions (not immediately postverbal in V1, not after the complementizer *dat* in VF clauses) and must be indefinite. If (34a-b) and (35a-b) are subjectless, why do obligatorily indefinite nominals in nonsubject positions determine agreement? This follows if they are the associates of covert expletive subjects in the IE construction. They are in a nonsubject position because they are not subjects and indefinite due to the Definiteness Constraint (29a) on the IE construction. Associate Agreement, needed for sentences with an overt expletive, accounts for agreement. Confirming evidence comes from (36-37), where the effects attributed to covert expletives in (34-35) result from overt ones.

- (34) a. Kwam door de achterdeur *iemand* (*Piet) binnen?
 came.SG through the back.door someone Piet in
 ‘Did someone (*Piet) come in through the back door?’
 b. Kwamen door de achterdeur *enkele* (*mijn) *vrienden* binnen?
 came.PL through the back.door several my friends in
 ‘Did several (*my) friends come in through the back door?’
- (35) a. Ik verwachtte dat voor Marie’s handtas *niemand* (*Piet) zou terugkomen.¹⁰
 I expected that for Marie's purse no.one Piet would.SG come.back
 ‘I expected that no one (*Piet) would come back for Marie’s purse.’
 b. Ik verwachtte dat voor Marie’s handtas *enkele* (*mijn)
 I expected that for Marie's purse several my
vrienden zouden terugkomen.
 friends would.PL come.back
 ‘I expected that several (*my) friends would come back for Marie’s purse.’
- (36) a. Kwam *er* door de achterdeur *iemand* (*Piet) binnen?
 Came.SG EXPL through the back.door someone Piet in
 ‘Did someone (*Piet) come in through the back door?’
 b. Kwamen *er* door de achterdeur *enkele* (*mijn) *vrienden* binnen?
 came.PL EXPL through the back.door several my friends in
 ‘Did several (*my) friends come in through the back door?’
- (37) a. Ik verwachtte dat *er* voor Marie’s handtas
 I expected that EXPL for Marie's purse
niemand (*Piet) zou terugkomen.
 no.one Piet would.SG come.back
 ‘I expected that no one (*Piet) would come back for Marie’s purse.’
 b. Ik verwachtte dat *er* voor Marie’s handtas
 I expected that EXPL for Marie's purse
enkele (*mijn) *vrienden* zouden terugkomen.
 several my friends would.PL come.back
 ‘I expected that several (*my) friends would come back for Marie’s purse.’

If the agreement controllers in (32) and (34-35) were themselves subjects, their nonsubject position and their obligatory indefiniteness would not be accounted for. There would also be no

¹⁰ Heavy contrastive stress can make the starred variants in (35) acceptable (Annie Zaenen, p.c.).

explanation of why these nominals have the same properties as expletives' associates in sentences with overt expletives such as (27b/28b), (33), and (36-37).

Our arguments for covert expletives in Dutch exploit Associate Agreement (31) and the Definiteness Constraint (29a). In each clause type, the nominal that determines agreement differs from subjects in that it appears in a nonsubject position and must be indefinite. These anomalies are explained as covert expletive effects: the anomalous nominal is not the subject but the associate of a covert expletive subject in the IE construction. That is why it determines verb agreement, appears in a nonsubject position, and must be indefinite. The corresponding Dutch sentences with overt SEP subjects have the same properties, confirming the analysis.

There are several relevant differences between Dutch and GYI. First, in GYI the fact that overt expletives are nominative provides another argument (in addition to their subject position) that they are subjects.¹¹ Second, expletives' associates are nominative as well, as in (38), due to Associate Case (39). Third, since GYI have only the WEP and not the SEP (unlike Dutch, which has both), it is not possible to verify analyses of the WEP through comparison with its SEP counterparts. Finally, while associates must be indefinite in the IE construction in Dutch, there is no such restriction in the corresponding construction in Yiddish, as (12a) shows. As in Dutch, verb agreement in GYI is determined by the associate of an expletive subject, as (38a-b) show.

- (38) a. Es iz frier geshtanen [a sheyner boym]_{NOM} in field.¹² (Yiddish)
 EXPL.NOM.SG is.SG earlier stood a beautiful tree in field
 'There previously stood a beautiful tree in the field.'
- b. Es zaynen frier geshtanen [sheyne beymer]_{NOM} in field.
 EXPL.NOM.SG are.PL earlier stood beautiful trees in field
 'There previously stood beautiful trees in the field.'
- (39) Associate Case: The associate of an expletive subject has the case of the expletive.¹³
- (40) a. In feld iz (*es) frier geshtanen [a sheyner boym]_{NOM}.
 In field is.SG EXPL.NOM.SG earlier stood a beautiful tree
 'In the field there previously stood a beautiful tree.'
- b. In feld zaynen (*es) frier geshtanen [sheyne beymer]_{NOM}.
 In field are.PL EXPL.NOM.SG earlier stood beautiful trees
 'In the field there previously stood beautiful trees.'

The argument for covert expletive subjects in Yiddish V2 clauses with a topic comes from their associates' behavior. If (40a-b) were subjectless, some ad hoc device would be needed to account for the fact that the bracketed nominals in a nonsubject position are nominative and determine agreement. But if (40a-b) have covert expletive subjects, Associate Case and Agreement, needed independently for sentences like (38a-b) with overt expletives, do the job.

If the bracketed nominals in (40a-b) were subjects, on the other hand, there would be no

¹¹ For additional evidence, see section 4. Case is irrelevant in contemporary Dutch, which has case distinctions only in pronouns. Expletive *er* is the locative pronoun 'there', which does not show case distinctions.

¹² The bracketed associates can also follow *in feld* in (38), with somewhat different discourse properties.

¹³ This descriptive statement (Perlmutter 1983:163 with updated terminology) suffices for present purposes. Like Associate Agreement (cf. fn. 10), Associate Case is not universal. Kannada has Associate Case but not Associate Agreement. Telugu has the reverse and Choctaw and Tamil have neither (Perlmutter 1983:187-193).

explanation of why they appear in a nonsubject (fifth) position.¹⁴

Yiddish V1 clauses in narrative style provide a parallel argument. Nominative nominals like *a beyemele* and *a feygele* in (41a, c) from the lullaby (14/41) might seem to be subjects because of agreement, as (42) shows. But in (41a, c) they are in a nonsubject position: in V1 clauses, subjects, like *es* in (41b, d), are in second position. This is not because they are pronouns,¹⁵ as replacing (41b, d) with (43a, b) shows. A generalization uniting V1 clauses in yes-no questions and narrative style is that the subject immediately follows the finite verb.

- (41) a. *Shteyt* in feld a beyemele.
 stands in field a tree.DIM.SG
 ‘In the field there stands a little tree.’
 b. *Hot* es grine tsvaygelekh.
 has it green branch.DIM.PL
 ‘It has little green branches.’
 c. *Zitst* daroyf a feygele.
 sits on.it a bird.DIM.SG
 ‘On it there sits a little bird.’
 d. *Makht* es tsu di eygelekh.
 closes it the eye.DIM.PL
 ‘It closes its little eyes.’
- (42) a. *Shteyen* in feld tsvey beyemelekh.
 stand.PL in field two tree.DIM.PL
 ‘In the field there stand two little trees.’
 b. *Zitsen* daroyf tsvey feygelekh.
 sit.PL on.it two birds.DIM.PL
 ‘On them there sit two little birds.’
- (43) a. *Hot* dos beyemele grine tsvaygelekh.
 has the tree.DIM.SG green branch.DIM.PL
 ‘The little tree has little green branches.’
 b. *Makht* dos feygele tsu di eygelekh.
 closes the bird.DIM.SG the eye.DIM.PL
 ‘The little bird closes its little eyes.’

(41a, c) are existential sentences. Their expletive subjects (cf. (15a) and (16a)) are covert in (41a, c) as WEP subjects of V1 clauses. Hence *a beyemele* and *a feygele* are associates of covert expletive subjects, which accounts for case and agreement and explains why they are not immediately postverbal. This also argues against their being subjects.

¹⁴ Prince (1988, 1993), who analyzes the discourse function of this Yiddish construction, treats associates as subjects and consequently posits an ad hoc Subject Postposing rule that moves such “subjects” to a nonsubject position to the right, and another rule inserting *es* in initial position. Under our analysis, the pivot’s position results from its nonsubjecthood, which is itself a consequence of the expletive’s subjecthood, as in (30). It also accounts for V2 clauses with a topic or WH-element and V1 clauses, which Prince does not address. Her important contribution is to show the discourse motivation for the expletive construction whose syntactic structure is analyzed here.

¹⁵ These are not expletives but anaphoric pronouns referring to *a beyemele* and *a feygele*, respectively.

4. The Subjecthood of WEP Expletives

SEP expletives, which appear in all four subject positions, have been recognized as subjects. WEP expletives, overt only in initial subject position, often have not. Overt WEP expletives in initial position have sometimes been viewed as place holders rather than subjects; sentences with covert WEP subjects have been viewed as subjectless. We now argue that both overt and covert WEP expletives are subjects and against the idea that overt WEP expletives are just place holders.

There are five arguments that overt WEP expletives are subjects.¹⁶ First, their subjecthood has a consequence: the pivot nominals are *not* subjects. That is why they appear in nonsubject positions in Dutch and Yiddish and why they must be indefinite in the IE construction in Dutch. Second, it accounts for their associates' ability to determine verb agreement through Associate Agreement (31). Third, it explains why in GYI the associate is in the nominative case, as in (38), due to Associate Case (39). Fourth, it explains why overt WEP expletives appear in initial subject position. *Expl accounts for their absence from other subject positions. Fifth, it explains why overt WEP expletives (*es* in German and Yiddish, *thath* in Icelandic) are nominative pronouns.

The first three arguments for the subjecthood of overt WEP expletives hold for covert ones as well; only the last two, which depend on their being overt, do not carry over to the covert ones. The expletive effects in (44) are found with both overt and covert expletive subjects; their associates behave like the nonsubjects they are syntactically but determine verb agreement and are nominative in GYI. Internal to Dutch, the same clauses can have either overt or covert expletive subjects, which are alike syntactically and morphologically, as shown in §3. WEP expletives in GYI and Dutch and SEP expletives in Dutch show the same effects.¹⁷

- (44) Expletive effects: Syntactically the expletive behaves as subject and the associate does not, while for agreement and case the associate acts as though it were the subject.
- (45) The Associate Limitation: The associate relation is relevant only for morphological marking (agreement and case) (Perlmutter 1983:182, with updated terminology).

The expletive effects in (44) affecting agreement and case are not universal (cf. fns. 10 and 14). The Associate Limitation (45) predicts what appears to be universal.

While the OTS (24) instantiates his generalization, Zaretski 1929:235-236 argued against calling Yiddish *es* a subject or even a "fictive subject;" he said it is more correct to view it as a "fictive constituent" that prevents the verb from being in first position. Similarly, generativists have posited a rule inserting expletives, sometimes as place holders.¹⁸ Viewing WEP expletives as place holders rather than subjects leads to misanalyzing their associates as subjects because they determine verb agreement and are in the nominative case in GYI. This fails to account for their nonsubject syntactic behavior. With covert expletives' associates misanalyzed as subjects, the true subjects (covert expletives) go unrecognized.

¹⁶ Vikner 1995:184-86 comes to the same conclusion based on reasoning internal to his framework. Following Cardinaletti 1990a, 1990b, he argues that expletives are generated in IP-spec, where they get case, and obligatorily move to CP-spec. This makes them fully parallel to other subjects in his terms.

¹⁷ Dutch exhibits associates' morphological effects only with verb agreement, since Dutch has case only in personal pronouns, which the Definiteness Constraint (29a) excludes from the IE construction.

¹⁸ Cf. Haiman 1974:23, Breckenridge 1975, Maling and Zaenen 1978:490-492, Safir 1985:248-252, among others.

In brief, overt WEP expletives in GYI are nominative pronouns in a subject position and display the expletive effects in (44). Where *Expl suppresses overt expletives, they are covert and display the expletive effects in (44) as well. The OTS (24) correctly predicts the alternation of overt and covert WEP expletives, which correspond to all four subject positions and are in complementary distribution in a full paradigm that makes them fully parallel to SEP expletives, whose subjecthood is not controversial.

Thus, Dutch and Yiddish (for GYI) provide evidence for covert WEP subjects of sentences that appear to be subjectless because their subjects are suppressed by *Expl.¹⁹ This supports the Subject Universal, the claim that universally each sentence has a subject.²⁰

5. How are Covert Expletive Subjects to be Represented?

The evidence in §3 for generalization (46) raises the question of how covert expletive subjects are to be represented. Two arguments against assumption (47) can be based on that in (48).

- (46) In environments where *Expl suppresses expletives, expletive subjects are covert.
- (47) Covert expletives are syntactic constituents that lack a phonological representation.
- (48) Syntactic constraints do not look at phonological representations.

The first argument comes from the V2 Constraint. Given (48), V2 would be satisfied with a phonologically empty expletive in clause-initial position and the finite verb as the second syntactic constituent. The result would be an ungrammatical sentence beginning with a verb.

A second argument comes from *Expl. It stars candidates with an overt expletive, suppressing WEP expletives that would appear in noninitial subject positions, where there is evidence for covert expletive subjects. Given (48), how can *Expl, a syntactic constraint, star sentences with overt but not covert expletive subjects if both are dominated by the same syntactic node, differing only in whether they have a phonological representation?

- (49) What does *Expl do such that its suppression of expletive subjects makes them covert?
- (50) The Bistructural Theory: Grammatical relations and the linear order of constituents are represented in different structures: relational or R-structures and linear or L-structures.
- (51) The Covert Expletive Hypothesis: Expletive subjects are represented as such in R-structure. Overt ones are present in L-structure; covert ones are not. A clause with an expletive subject in R-structure but not in L-structure has a covert expletive subject.

Generalization (46) raises the question in (49). The Bistructural Theory (50) of syntactic representation²¹ provides an answer. Relational or R-structures²² and linear or L-structures are

¹⁹ Cf. also Safir's 1985 arguments based on assumptions in the GB framework.

²⁰ "Subject Universal" is a cover term for what the Final 1 Law of Relational Grammar (Perlmutter and Postal 1974, 1977, 1983), the Subject Condition of Lexical Functional Grammar (Bresnan 2001: 311), and the Extended Projection Principle of GB Theory (Chomsky 1982) and its successors have in common.

²¹ This idea goes back to the origins of Relational Grammar in Perlmutter and Postal (1974, 1977) and is also central to Lexical Functional Grammar (Bresnan 2001 and the references cited there).

²² For present purposes, R-structures can be thought of as expressing the information in final strata in the relational

relevant for different constraints. For example, for the Subject Universal (the claim that universally each sentence has a subject) what is relevant is whether some constituent bears the subject relation in R-structure; linear order is irrelevant. The V2 Constraint, on the other hand, is sensitive only to constituency and linear order. It is satisfied if exactly one clause mate of the finite verb (regardless of its dominating node or grammatical relation) precedes it in L-structure.

In the mapping from R-structure to L-structure, the set of alternative L-structures for each R-structure is presented to the ranked constraints for evaluation. R-structures are the “input,” L-structures the “output” in the OT sense.

The Bistructural Theory makes possible the Covert Expletive Hypothesis (51), which solves the *Expl problem in (49). *Expl stars L-structures with an expletive subject. Where V2 is not violated, a winning L-structure L_i has no expletive. If the corresponding R-structure R_i has an expletive subject, L_i has a covert expletive subject. There is no need to specify that *Expl affects only “overt” expletives, as in (22). That expletive subjects suppressed by *Expl are covert follows from the Covert Expletive Hypothesis and the architecture of the theory.

The problem of preventing the V2 Constraint from allowing phonologically empty covert expletives in initial position is solved as well. Since covert expletives are not present in L-structure, there is no such thing as a covert expletive in initial position.

6. How Just Three Constraints Account for the WEP, the SEP, and Dutch

The Bistructural Theory and the Covert Expletive Hypothesis provide a solution to Problem 5: how different are the grammars of the WEP, the SEP, and Dutch? For the WEP, the key is to ensure that the candidate set for an R-structure with an expletive includes L-structures without one. Given the function that generates candidate sets in OT, any number of input elements may be absent. Grammars therefore include faithfulness constraints to ensure that the output reflects the input in specific ways. MAX-IO (for “Input-Output”) in phonology requires each segment in the input to be present in the output. We adopt this as MAX-RL (for “R-structure/ L-structure”): there is one violation for each R-structure constituent not present in L-structure. (52-54) are among the constraints mapping R-structures onto L-structures.²³ To ensure covert expletives’ absence from L-structures, *Expl must outrank MAX-RL, yielding the ranking in (55).

- (52) MAX-RL: If A is a constituent in R-structure R_i , A is a constituent in L-structure L_i .
(Requires each element in R-structure to have a correspondent in L-structure).
- (53) *Expl: If A is an expletive in R-structure R_i , A is not present in L-structure L_i .
- (54) V2: If V is a finite verb in L-structure L_i , then there is one and only one clause mate A of V that precedes V in L_i .
- (55) Constraint ranking for the WEP: V2 >> *Expl >> MAX-RL

networks of Relational Grammar (Perlmutter and Postal 1977, 1983). The issue of how much more is needed is beyond the scope of this paper. Lexical Functional Grammar has extensively developed analogously separate representations, called F-structure and C-structure (Bresnan 2001).

²³ Other constraints specify linear precedence relations among constituents, among other things. Since expletives are represented as subjects in R-structure, the constraints responsible for the linear position of subjects in L-structures will ensure that expletives appear in subject positions in L-structure.

(56-57) illustrate the results.²⁴ An L-structure without an expletive corresponding to an R-structure expletive violates MAX-RL but satisfies higher-ranked *Expl. *Ceteris paribus* it prevails, as in (56). (57a) violates *Expl, but (57b, c) violate higher-ranked V2. Expletive *es* never occurs postverbally in the WEP because that always violates *Expl, as in (56b). (56-57) also show that R-structures with different topics and without a topic evoke different candidate sets.²⁵ If (56-57) were in the same candidate set, then (56a), which violates only MAX-RL, would prevail over (57a), which violates higher-ranked *Expl and would not qualify as grammatical.

- | | | |
|------|--|-----------------|
| (56) | Topic: <i>die ganze Nacht</i> ; Subject: <i>es</i> (Expl); FinV: <i>wurde</i> | [Sentence (5b)] |
| a. | Die ganze Nacht wurde hier getanzt: [*MAX-RL]
the whole night was here danced | |
| b. | *Die ganze Nacht wurde es hier getanzt: *(Expl)! | |
| c. | *Die ganze Nacht es wurde hier getanzt: *V2! [*(Expl)] | |
| (57) | Subject: <i>es</i> (Expl); FinV: <i>wurde</i> | [Sentence (5a)] |
| a. | Es wurde hier die ganze Nacht getanzt: [*(Expl)]
EXPL was here the whole night danced | |
| b. | *Wurde hier die ganze Nacht getanzt: *V2! [*MAX-RL] | |
| c. | *Wurde es hier die ganze Nacht getanzt: *V2! [*(Expl)] | |

In V1 and VF clauses, where V2 is not active, *Expl violations are fatal. This explains the absence of overt expletives in V1 and VF clauses in the WEP.

The grammar underlying the SEP differs from that underlying the WEP in one respect: MAX-RL outranks *Expl in (58), ensuring the presence of expletives in all four subject positions and thereby accounting for the SEP.

- (58) Constraint ranking for the SEP: V2 >> MAX-RL >> *Expl

The coexistence of the WEP and SEP in Dutch presents three problems. First, since *Expl rules out expletives in noninitial positions in the WEP, why doesn't it rule them out in the SEP in Dutch as well? Dutch sentences with *er* in noninitial positions would then not be accounted for. Second, is a feature needed to distinguish WEP and SEP expletives in Dutch? Third, and most importantly, it is desirable to eschew ad hoc devices and to use the same constraints that account for the WEP and SEP in the other languages to account for them in Dutch as well. But how can the same language have the contrasting rankings in (55) and (58)?

Our solution is that *Expl and MAX-RL are equally ranked in Dutch. This yields the

²⁴ The first line in (56-57) states some of the information in R-structure. An exclamation point indicates a fatal violation. Violations that do not affect the outcome are in square brackets. *(Expl) indicates a single violation of *Expl. For ease of exposition, the candidates considered here obey the highly-ranked Topic constraint: If A is a topic in R-structure and B is a (non-topic) clause mate of A, then A precedes B in L-structure.

²⁵ Legendre 2001 observes that they answer different questions. (58a) answers "When/How long was there dancing?" while neutral (57a) answers "What happened?" She marks fronted constituents with the features [noteworthy] and/or [new], which yields distinct inputs for sentences with and without a topic and with different topics. The different inputs result in different candidate sets, as required for our analysis. Solutions along these lines and others are possible; the issue is left open here.

ranking in (59) with the effects in (60): (60a, b) each have one violation. Neither is more decisive than the other, so (60a, b) are “tied” and both qualify as grammatical.

(59) Constraint ranking in Dutch: V2 >> {*Expl, MAX-RL}

(60) Topic: *de hele nacht*; Subject: *er*(Expl); FinV: *werd*

- | | | | | | | | |
|----|-----------|-------|------|------|----------|------------|------------------------|
| a. | De hele | nacht | werd | hier | gedanst: | [* MAX-RL] | [Like (5b)] |
| | the whole | night | was | here | danced | | |
| b. | De hele | nacht | werd | er | hier | gedanst: | [*(*Expl)] [Like (4b)] |
| | the whole | night | was | EXPL | here | danced | |

(59) resolves the paradox. It uses *Expl to account for the WEP in Dutch while accounting for the SEP as well. It doesn't require a feature to distinguish SEP and WEP expletives. Having V2 outrank *Expl in (59) accounts for the asymmetry in Dutch between initial position in V2 clauses, where expletive *er* is obligatory, and all other subject positions, where it is optional. The same constraints as in the other languages account for both the SEP and the WEP.

Dutch bears on the theoretical issue discussed by Prince and Smolensky (1993:Ch. 4, fn. 31) of whether all the constraints are strictly ranked. They assume that they are, given the absence of evidence that in some language a pair of constraints must be unranked. (59) is an example of just such a crucial nonranking, interpreted here as equal ranking. Müller (1999, 2000) gives other examples of equally ranked constraints. The possibility that any two (or more) constraints may be equally ranked greatly expands the factorial typology, the enumeration of all possible grammars that can be constructed through different rankings of a given set of constraints. That the factorial typology generated by the three possible rankings of MAX-RL and *Expl is attested in Germanic supports this expansion.

Just three ranked constraints are needed to account for all three expletive systems in Germanic. The rankings in (55), (58), and (59) yield the WEP, the SEP, and the Dutch system. V2 ranks highest. With *Expl ranked above MAX-RL in GYI, below MAX-RL in the SEP languages, and with *Expl and MAX-RL equally ranked in Dutch, all three logically possible rankings of these two constraints are attested within Germanic. This demonstrates the efficacy of constraint ranking to account both for individual languages and for cross-linguistic variation.

References

- Aissen, Judith. 1990. Towards a theory of agreement controllers. *Studies in Relational Grammar* 3, eds. Paul M. Postal and Brian D. Joseph, 279-320. Chicago and London: University of Chicago Press.
- Breckenridge, Janet. 1975. The post-cyclicity of *es*-insertion in German. *Papers from the Eleventh Regional Meeting of the Chicago Linguistic Society*. Chicago: University of Chicago.
- Bresnan, Joan. 2001. *Lexical-Functional syntax*. Oxford: Blackwell.
- Burzio, Luigi. 1986. *Italian syntax: A government-binding approach*. Dordrecht: Reidel.
- Cardinaletti, Anna. 1990a. *Es, pro, and sentential arguments in German*. *Linguistische Berichte* 126:135-164.

- Cardinaletti, Anna. 1990b. *Impersonal constructions and sentential arguments in German*. Padua: Unipress.
- Chomsky, Noam. 1981. *Lectures on government and binding*. Dordrecht: Foris.
- Chomsky, Noam. 1982. *Some concepts and consequences of the theory of government and binding*. Cambridge, MA: MIT Press.
- Chomsky, Noam. 1991. Some notes on economy of derivation and interpretation. *Principles and parameters in comparative grammar*, ed. Robert Freidin, 417-454. Cambridge, MA: MIT Press. Reprinted in Noam Chomsky. 1995. *The Minimalist Program*. Cambridge, MA: MIT Press.
- Grimshaw, Jane. 1997. Projection, heads, and optimality. *Linguistic Inquiry* 28:373-422.
- Haiman, John. 1974. *Targets and syntactic change*. The Hague: Mouton.
- Johnson, David E. and Paul M. Postal. 1980. *Arc Pair Grammar*. Princeton, NJ: Princeton University Press.
- Legendre, Géraldine. 2001. An introduction to Optimality Theory in syntax. *Optimality-Theoretic syntax*, eds. Géraldine Legendre, Jane Grimshaw, and Sten Vikner, 1-27. Cambridge, MA: MIT Press.
- Leys, Odo. 1979. Zur Systematisierung von *Es*. *Deutsche Sprache* 79:28-34.
- Maling, Joan and Annie Zaenen. 1978. The nonuniversality of a surface filter. *Linguistic Inquiry* 9:475-497.
- Maling, Joan and Annie Zaenen. 1981. Germanic word order and the format of surface filters. *Binding and filtering*, ed. Frank Heny, 255-278. London: Croom Helm.
- McCarthy, John and Alan Prince. 1993. Prosodic morphology I: Constraint interaction and satisfaction. <http://roa.rutgers.edu/view.php?id=590>.
- Müller, Gereon. 1999. Optionality in Optimality-Theoretic syntax. *Glott International*, 4/5:3-8.
- Müller, Gereon. 2000. *Elemente der optimalitätstheoretischen Syntax*. Tübingen: Stauffenburg.
- Perlmutter, David M. 1983. Personal vs. impersonal constructions. *Natural Language and Linguistic Theory* 1:141-200.
- Perlmutter, David M. 1988. The Split Morphology Hypothesis: Evidence from Yiddish. *Theoretical morphology*, eds. Michael Hammond and Michael Noonan, 79-100. San Diego: Academic Press.
- Perlmutter, David M. and John Moore. 2002. Language-internal explanation: The distribution of Russian impersonals. *Language* 78:619-636.
- Perlmutter, David M. and Paul M. Postal. 1974. Lectures on Relational Grammar. Summer Linguistic Institute, University of Massachusetts at Amherst.
- Perlmutter, David M. and Paul M. Postal. 1977. Toward a universal characterization of passivization. *Proceedings of the Third Annual Meeting of the Berkeley Linguistics Society*. Berkeley, CA: University of California, Berkeley. Reprinted 1983 in *Studies in Relational Grammar 1*, ed. David M. Perlmutter, 3-29. Chicago and London: University of Chicago Press.
- Perlmutter, David M. and Paul M. Postal. 1983. Some proposed laws of basic clause structure. *Studies in Relational Grammar 1*, ed. David M. Perlmutter, 81-128. Chicago and London: University of Chicago Press.
- Perlmutter, David M. and Annie Zaenen. 1984. The Indefinite Extraposition construction in

- Dutch and German. *Studies in Relational Grammar 2*, eds. David M. Perlmutter and Carol G. Rosen, 171-216. Chicago and London: University of Chicago Press.
- Prince, Alan and Paul Smolensky. 1993. *Optimality Theory: Constraint interaction in generative grammar*. Technical Report, Rutgers Center for Cognitive Science, Rutgers University, New Brunswick, NJ and Dept. of Computer Science, University of Colorado at Boulder. Published 2004. Malden, MA and Oxford: Blackwell Publishing.
- Prince, Ellen F. 1989. Yiddish WH-clauses, subject-postposing, and topicalization. *ESCOL '88*, eds. J. Powers and K. de Jong, 403-415. Columbus, OH: Ohio State University.
- Prince, Ellen F. 1993. On the discourse functions of syntactic form in Yiddish: Expletive *es* and subject-postposing. *The Field of Yiddish*, 5th collection, eds. D. Goldberg, M. Herzog, B. Kirshenblatt-Gimblett, and D. Miron, 59-86. Evanston, IL and New York: Northwestern University Press and YIVO.
- Safir, Kenneth. 1985. *Syntactic chains*. Cambridge: Cambridge University Press.
- Vikner, Sten. 1995. *Verb movement and expletive subjects in the Germanic languages*. New York and Oxford: Oxford University Press.
- Zaretski, A. 1929. *Yidishe gramatik* (Newly revised edition). Vilna: Vilner Farlag fun B. Kletskin.

VARIABILITY AMONG ENGLISH RAISING-DETERMINED OBJECTS*

Paul M. Postal
New York University
paul.postal@nyu.edu

Appealing to a typology of English verbal objects developed and argued for in Postal, in press, the present article provides a new justification for a raising view of the objects of the verb class:

(i) {*bear, desire, hate, like, love, need, prefer, want, wish*}.

A raising view of the objects of such verbs has been controversial since first advanced in Postal 1974. Most subsequent work dealing with the topic has rejected it, on the basis of contrasts between the objects of the verb class in (i) and those of more stereotypical raising to object verbs like *believe* and *prove*. But this work argues that the typology alluded to at the outset reveals a raising analysis of the object structures occurring with the verbs in (i) to be as regular as that occurring with verbs like *believe* in spite of the contrasts which have been taken to undermine a raising analysis of the former. A key element of the argument is a documentation that objects of the verbs in (i) divide into two grammatically distinct classes in a way which matches the general object typology in Postal, in press.

1. Background

1.1. Whines and Excuses

Although most grammatical traditions regard English object DPs as a single undifferentiated group, called *direct objects*, (hereafter, *2 objects*), Postal, in press argues for a fundamental tripartite typology, illustrated by the animate highlighted forms in (1) and the inanimate ones in (2):

- (1) a. Victor questioned *Carol Longley*.
b. Victor wrote *Carol Longley*.
c. The director wanted *Carol Longley* as the lead character.
- (2) a. Bob didn't buy/clean/destroy *that substance*.
b. The bottle didn't leak *that substance*.
c. Bob didn't lack/near *any tools*.

It is claimed that only (1a) and (2a) contain 2 objects, while (1b) and (2b) illustrate the traditional *indirect object* relation (hereafter: *3 objects*) and that (1c) and (2c) instantiate a relation with no traditional name or recognition (hereafter: *4 objects*). It is further argued that ditransitive clause objects like those highlighted in (3) are a 3 object and 4 object in that order.

* I am indebted to Haj Ross for many helpful comments on the draft of this work.

- (3) Rupert sent *Carol Langley* back a note.

In a better constructed universe than this one, the present article, rather, the much longer version of which this one is an excerpt, would have been, as originally intended, a late chapter of Postal, in press. That having proved impossible, the background needed to understand some of the present necessarily very sketchy fragment remains alas in the earlier chapters of Postal, in press as does most of the support for the claims just alluded to. But some evidence for the typology appears in section 5.

1.2. A Controversial Object Class

Postal 1974:176-187 considered several classes of English verbs taking a DP followed by an infinitival complement where the DP was arguably the final complement subject (hereafter: 1). Members of one class containing *want* were called *W-verbs*; these were assumed to also include *expect, hate, intend, like, mean, need, prefer* and *wish*. *W-verbs* were taken to contrast as a group with another set of verbs containing *believe*, with the same gross characteristic, called there *B-verbs*.¹ I refer to the postverbal DPs associated with these verbs as *W-objects* and *B-objects* respectively. Contrasts between the constructions include the fact that the former verbs have infinitival complements which designate states of affairs and tend to have future orientation, while the complements of the latter verbs denote propositions. Moreover, the former verbs occur in other (see (4)) sentences with the element *for* preceding the DP, whereas none of the latter do. And the former all have control variants in which the complement has no overt final 1, a characteristic not found with B-verbs.

The present article focuses on the objects of a verb set partially disjoint from that specified in Postal 1974 but sufficiently coextensive that I also use the denotation *W-object* for them. They include objects of a subset of the original collection {*hate, like, need, prefer, want, wish*}, as well as *bear, desire and love*. Typical W-object structures are illustrated by the *for*-less variants in (4):

- (4) a. Karen would hate/like/love (for) people to give more blood.
 b. Harriet needs/would prefer/wants/wishes (for) there to be more participation in her fascism seminar.

Rosenbaum 1967 proposed that W-object structures involve the deletion of the complementizer seen in (4). Bresnan 1972, 1976 advocated a parallel analysis, and related treatments occur in Chomsky and Lasnik 1977, McCawley 1998:141, and Kayne 1984:38. The last of these three stated:

¹ Kayne 1984:45, n. 33 observed that Postal's (1974) mixing of *expect, intend* and *mean* with the present set of W-verbs was confusing. He suggested correctly that while such verbs may have W-verb analyses, they are also B-verbs, and that the ways in which they seem to differ from other W-verbs (e.g. in permitting their objects to passivize) are associated regularly with the B-verb analysis, not anomalously with the W-verb one.

- (5) “Obviously, we want to follow Bresnan (1972) in distinguishing B-verbs from W-verbs by considering that the latter take [_S for [_S John to leave]]”

I refer to the essential commonality of the view in these works as the *no-raise position (NoRO)*. If NoRO is correct, W-objects are not even objects but poorly named nonfinite complement subjects which happen to immediately follow a main verb.

Postal (1974:especially 176-187) presented a sharply different perspective within which W-object structures were viewed as subcases of the B-object pattern in (6):

- (6) Edgar believed/found/proved New Haven to be an exciting place.

As there argued and now widely accepted, B-objects are main clause constituents and arguably also subjects of the complement, hence instances of a *raising to object (RO)* pattern.² See also Postal and Pullum 1988, Postal 2004:Chapter 3.

Bach 1977:647-648 expressed skepticism about the claim that W-object structures represent RO, finding it inferior to the NoRO proposal of Bresnan 1972. Lasnik and Saito 1991:336 followed Bach and took B-object/W-object contrasts to suggest that at best only the latter involve raising. The present remarks suggest that despite Bach's (1977) (supportable) claim that Postal (1974) failed to convincingly motivate the RO conclusion for W-objects, despite Lasnik and Saito's claim that such structures do not involve raising and despite Kayne's claim that something like Bresnan's analysis is obvious, it is the RO view of W-objects that is in fact correct. What drives the present view is the three-way object distinction from Postal, in press mentioned at the outset. For that variegated view of objects offers a novel way to account for the sort of facts which have seemed to render an RO view of W-objects problematic.

² Their principal ground for that conclusion is a supposed anaphoric contrast between (ia-b) based on a model from Postal 1974:

- (i) judgments from Lasnik and Saito 1991
 a. ?Joan wants him_i to be successful even more fervently than Bob's_i mother does
 b. ?*Joan believes him_i to be a genius even more fervently than Bob's_i mother does

I do not perceive this difference and find (ia) as bad as (ib), which needs no question mark for me. These are in effect the same judgments I gave in 1974:

- (ii) Postal 1974:184
 I would hate/like/prefer/want/wish *(for) him_i to become famous even more strongly than Bob_i does/would.

Moreover, Baltin 2001 also gives judgments conflicting with any inference from (ia) that *him* is exclusively in the complement clause. These also reveal a contrast linked to the presence of *for*:

- (iii) Baltin 2001:250
 a. *Sally would prefer him¹ to be the candidate even more fervently than Bob¹ would.
 b. Sally would prefer for him¹ to be the candidate even more fervently than Bob¹ would.

Baltin's judgments here are consistent with those of Postal (1974:184) and thus also fail to support the position of Lasnik and Saito 1991.

2. Properties Which W-objects Share with B-objects

A key element of the current argument is that while grammatically distinct, W-objects and B-objects share a number of properties justifying the claim that both are main clause objects, and not, as a NoRO analysis would have it, superficial constituents of complement clauses. Space limitations require documentation of the commonalities supporting the RO claim to be extremely sketchy. The properties of the different object types will be indicated by giving minimal pairs with otherwise largely parallel B-verb structures and sometimes also with parallel finite complement cases where the nonobject status of the corresponding DP is not in question.

Property one: pronominal obviation:

- (7) a. Brenda₁ believes (that) she₁ became a werewolf.
 b. *Brenda₁ believes her₁ to have become a werewolf.
 c. *Brenda₁ wants/would hate/like/love her₁ to become a werewolf.

Property two: reciprocal distribution:

- (8) a. *Those nurses believe (that) each other are telepathic.
 b. Those nurses believe each other (with total confidence) to be telepathic.
 c. Those nurses want/wish/would hate/like/love each other to be stingy with their time.

Property three: inseparability from the main verb:

- (9) a. The captain believes very strongly that those prisoners are telepaths.
 b. The captain believes (*very strongly) those prisoners to be telepaths.
 c. McCawley 1998:140
 *Everyone wants, of course, John to resign.
 d. The captain would hate/like/love (*very much) those prisoners to be tortured.

The ill-formed examples in (9) contrast with the versions having a *for* after the adverbial.

Property four: grammaticality of post-object *main clause modifying* adverbial modifiers:

- (10) a. The captain believes with all his heart that those prisoners are innocent.
 b. *The captain believes (that) those prisoners with all his heart are innocent.
 c. The captain believes those prisoners in his heart to be innocent.
 d. The captain wishes/would hate/love those prisoners with all his heart to be freed. (see Baltin 2001:251)

Property five: resistance to pseudoclefting:

- (11) a. What the captain believes is that those prisoners are innocent.
 b. *What the captain believes is those prisoners to be innocent.
 c. Postal 1974:18
 *What he wants/wishes is us to lose.
 d. McCawley 1998:140
 *What everyone wants is John to resign. (contrast: What everyone wants is for John to resign.)
 e. *What the captain wishes/would hate/love is those prisoners to be released.

Property six: impossibility of non-*Wh* infinitivals:

- (12) a. Herb believes that to say that would be illegal.
 b. *Herb believes to say that to be illegal.
 c. *Herb wants/would hate/like/love to say that to be illegal.

Property seven: impossibility of certain types of *Not*-initial quantified DPs:

- (13) a. Sandra believed/proved (that) not every porcupine had been treated.
 b. *Sandra believed/proved not every porcupine to have been treated.
 c. *Sandra wishes/would hate/like/love not every porcupine to be treated.

These seven properties grouping W-objects with B-objects are, except for two where it is logically precluded, independently characteristic of single objects *in simple clauses*:

- (14) a. Brenda₁ believes her_{*1/2}.
 b. The nurses believe each other.
 c. (i) The nurses believe (*very strongly) that claim.
 (ii) The nurses want (*very sincerely) that result.
 d. ---
 e. ---
 f. (i) Ed signaled to Sally to stay in the vehicle.
 (ii) *Ed signaled to stay in the vehicle to Sally.
 g. *The nurses believe/want not every advertisement.

The five relevant comparable properties reveal a solid basis for claiming that, like B-objects, W-objects are main clause objects. Thus, under the assumption that they also represent final 1s of the infinitival complements, this argues that they have raised out of those complements, as an RO analysis claims.

3. Properties for Which (All) W-objects Contrast with B-objects

Despite the grammatical similarities between B-objects and W-objects just noted, properties with respect to which W-verb structures systematically *contrast* with B-verb structures are well known. Again, the presentation of relevant facts must be very terse.

Property one: (Bresnan 1972:254-157, Postal 1974:178-179, Bach 1977:643, Kayne 1984:37, Postal 1993:363), W-objects cannot be periphrastic passive targets but B-objects can be:

- (15) a. Greta believed/proved the patient to be unstable.
 b. The patient was believed/proved by Greta to be unstable.
 c. Greta wants/wishes the patient to be operated on.
 d. *The patient was wanted/wished by Greta to be operated on.
 e. Romeo would hate/like/love Gwen to be more amorous.
 f. *Gwen would be hated/liked/loved by Romeo to be more amorous.

Property two: where W-objects cannot be the targets of the clausal *object raising* construction, B-objects can be:

- (16) a. That prisoner was difficult to believe/prove to deserve a new trial.
 b. *That prisoner is easy to hate/want/wish to deserve a new trial.

The claimed grammaticality of (16a) *clashes* with many judgments in the past literature, including judgments *of mine*. And while the claim that W-objects do *not* feed object raising is largely uncontroversial, the claim that B-objects do certainly is, as shown by the following judgments:

- (17) a. Berman 1974:295, 304
 *John is difficult to believe to have made such a mistake.
 b. Postal 1974:194, 200, n. 9
 (i) *Bill is hard to believe to be insane.
 (ii) *Melvin will be easy to prove to be guilty.
 c. Jackendoff 1975:445
 (i) Joe is easy to believe to have intentionally seduced Mary.
 (ii) Mary is easy to believe to intentionally have been seduced by Joe.
 d. Chomsky 1977:113-114m n. 33 (based on observations of John Kimball)
 *Smith was easy for Jones to expect to recover.
 e. Jacobson 1992:271
 ?The cat would be quite easy to let out of the bag.
 f. McCawley 1998
 *The cat was easy to let out of the bag.

- g. Postal 2004:125
- (i) The cat will be easy to prove to be out of the bag.
 - (ii) The jury is easy to show to still be out on that proposal.

My conclusions from this conflicting data are that (i) there are likely different varieties of English, one permitting object raising of a B-object, another not; and (ii) the ban for the latter dialect is sufficiently weak or marginal that it can change over time. Relevant to this claim, the existence of dialects accepting object raising of B-objects is documentable via the Web:

- (18) a. There are also other beliefs that skepticism considers to be unjustifiable or extremely difficult to prove to be true. (www.zewex.com/paper2.htm - Lebanon)
- b. This is often the problem that battered wives encounter, as a reaction to continuous acts over a period of time is more difficult to prove to be a spur of ... (web.ukonline.co.uk/ruth.buddell/chapter1.htm)
- c. While that kind of boast can be difficult to prove to be true, (www.associatedcontent.com/.../oz_gentlemens_club_in_clearwater_florida.html)

But the amount of searching that yielded (18) failed to turn up any object raised W-objects.

Property three: W-objects cannot be the targets of the nominal object raising construction, whereas for me B-objects can be. Again though variation renders the situation for nominal-internal object raising rather parallel to that previously gone over for (clausal) object raising. So Berman (1974:31) specifically indicated that the gaps could *not* be B-objects, citing (19a-b):

- (19) a. *an impossible man to expect to be up to date on these issues
- b. *an impossible man to believe to be involved in that escapade

But for me, these are fine. Testing a W-object/B-object contrast only makes sense for those (unlike Berman) for whom the B-object cases are well-formed. And for me the following W-object examples contrast with (19):

- (20) a. *an impossible man to hate/want/wish to be up to date on these issues
- b. *an impossible woman (for them) to want/wish to be involved in that escapade
- c. *a strange kind of person (for you) to like to be made fun of (compare: ok a strange kind of person (for you) to believe to have been made fun of)

And there are also clear B-object/W-object contrasts in (21):

- (21) a. Jeremy is a strange man (for them) to assume/believe to have voted for Sigorsky.
- b. *Jeremy is a strange man (for them) to want to vote for Sigorsky.
- c. That was an odd claim (for them) to (have bothered to) prove to be false.
- d. *That was an odd claim (for them) to (admit to) want/hate to be false.

Overall then, the data of this section illustrate that while B-objects and W-objects share many properties, they also *sharply* contrast in others. This yields what has been in effect a recurrent mystery. It might be formulated as a clash between conflicting pressures to provide B-object and W-object structures parallel analyses to capture their similarities but distinct analyses to capture their contrasts. Traditional approaches to these domains of either the RO or NoRO varieties have never provided a way to achieve these partially conflicting goals. The problem was in effect noted by Bach:

- (22) Bach 1977:264
 “W-verbs...constitute a challenge for the taxonomic devices of Postal’s grammar. The problem is that these verbs pass most of the tests for R-triggers [raising triggers: PMP]; all of the new arguments which Postal adduces for the existence of Raising apply to these verbs. However, there are problems with the traditional criteria. For example, applying Passive to the output of Raising on these verbs yields the following...”

He then gave bad passive data parallel to (15d, f).
 The point was in effect reiterated in:

- (23) McCawley 1998:140
 “In view of the alternation between forms in which *want* is accompanied by *for* and forms in which it lacks *for*, it is difficult to decide what is responsible for the oddity of analogs to the examples that show that the NP following *believe* is its surface direct object.”

And the issue is again clearly stated in:

- (24) Baltin 2001:249-250
 “There is another class of verbs which occurs with nominal plus infinitive sequences, exemplified by the verbs *want*, *like*, *hate*, and *prefer*. These verbs, interestingly enough, do not allow the immediately following nominals to be passivized:
 (80) a. *John is wanted to win.
 b. We want John to win.
 (81) a. *John would be liked to win.
 b. We would like John to win.
 These verbs have yet another interesting characteristic: they can all allow the infinitive to be introduced by the complementizer *for*, in contrast to the verbs that allow the following nominal to be passivized:
 (84) I would want for John to win.
 (85) I would like for John to win.
 (86) I would hate for John to win.
 (87) I would prefer for John to be the candidate.
 We might account for the behavior of the two classes of verbs by allowing subject-to-object raising for the verbs that do not take infinitives with overt complementizers

(such as *believe* and *prove*), and disallowing it for verbs that do take overt complementizers, such as *want* and *prefer*. The failure of the subjects of the infinitival complements of the verbs of the latter class to be A-moved in the passive construction would then be a consequence of the restriction noted in the last section on subject-to-subject raising occurring across an overt complementizer. The non-occurrence of the complementizers, as in the (b) examples of (80)-(83), would be due to PF deletion.

The problem with this bifurcation into two classes of verbs that take infinitival complements is that when we return to the original evidence, given above, for subject-to-object raising, we predict a disparity in behavior between the two classes that is non-existent. For example, it seems that a nominal intervening between a matrix verb and following infinitive binds into a final matrix adverbial with verbs of the *want*-class, but only when the complementizer *for* is absent:

- (88) *Sally would prefer him' to be the candidate even more fervently than Bob' would.
 (89) Sally would prefer for him' to be the candidate even more fervently than Bob' would.

Similarly, an adverb that intervenes between the matrix postverbal nominal and the infinitive can modify the matrix clause just as easily when the verb is of the *want*-class as it can if the verb is of the *believe*-class. Again, significantly, the presence of the complementizer *for* seems to affect acceptability:

- (90) I would love (*for) Sally with all my heart to be the one to get the job.

It is striking that the complementizer's presence, forcing an analysis in which the pre-infinitival nominal is in the complement sentence, prevents a pre-infinitival adverb from taking matrix scope, and correlates with the nominal's failure to bind material in the matrix sentence." "Of course, the failure of the postverbal nominal to passivize when the verb is of the *want*-class requires an account."

That is, in current terms, Baltin noticed that RO was arguably as present in the transparent W-verb cases as in B-verb cases, leaving the failure of W-objects (but not B-objects) to passivize unexplained. The paradox is stronger since, as observed earlier, W-objects also lack other properties of B-objects. Baltin suggested no basis for these differences.

4. Two Types of W-objects

Before proposing a new approach to the mystery cited in the previous section, it is important to introduce a further characteristic of the class of W-verbs which was entirely overlooked in my 1974 discussion (and in many others). Namely, for at least some speakers, W-objects fall into two distinct subclasses, defined by the main verbs they associate with, designated as in (25):

- (25) a. W_I -objects = those of {*like, need, want, wish*}
 b. W_{II} -objects = those of {*bear, hate, love, prefer*}

Two clear differences are that while W_I -objects as well as their constituents are in general left-extractable, W_{II} -objects and their constituents are not:

- (26) a. [Which socialist] would Nora like/does she need/want/would she wish (an associate of) to win the election?
 b. [No socialist] would Nora ever like/need/want/wish (an associate of) to win any election.
- (27) a. *[Which socialist] would Nora hate/love (an associate of) to win the election?
 b. *[No socialist] would Nora hate/love (an associate of) to win the election.
- (28) a. *[Which linguist] can Nora not bear (an associate of) to address her seminar?
 b. *[No such linguist] can Nora bear (an associate of) to address her seminar.

Limited previous recognition of a W_I -object/ W_{II} -object contrast was found in Bresnan 1972:155-156, which cited:

- (29) a. Which do you wish to be sent to your husband?
 b. ?Which facts would I most hate to fall into the hands of my enemies?

While insignificant on its own, Bresnan added:

- (30) Bresnan 1972:156
 “*Love* and *hate* are the most resistant to extraction of the subject, and this may be related to the fact that they often retain the *for* in, e.g., *I('d) love (it) for...*, *I('d) hate (it) for...*”

Given that the objects of *love* and *hate* are here assigned to the W_{II} -verb class, to a nonnegligible extent, Bresnan had recognized the distinction at issue.

A third property distinguishing W_I -from W_{II} -objects in my dialect is that only the former can, like B-objects, be instantiated by members of the slang NPI set {*dick*, *jack(shit)*, *shit*, *squat*, ... }:

- (31) a. Edmund didn't like/want/wish *squat/jack shit* to go wrong at such ceremonies.
 b. *Edmund didn't hate/love/wouldn't prefer *squat/jackshit* to go wrong at such ceremonies.
 c. Edmund didn't believe/prove *squat/jackshit* to have gone wrong at such ceremonies.

A fourth property distinguishing W_I -from W_{II} -objects in my dialect is that the latter, unlike the former and B-objects, cannot form in situ nonrestrictive human relative pronouns:

- (32) a. Marcus, assuming/believing/proving *whom* to know the murderer would be foolish, is coming for dinner
 b. That candidate, liking/wanting/wishing *whom* to contribute money would be natural, is well-funded.
 c. *That candidate, hating/loving *whom* to contribute money would be natural, has suspicious backers.

The contrasts in this section show that despite properties grouping all W-objects together, some grammatical characteristic differentiates W_I -objects and W_{II} -objects. That difference is obviously not explicable by NoRO claims that B-objects instantiate RO but that no W-objects do.

5. A New Proposal

It is the failure of W-object behavior to match that of B-objects in clear respects, that is, the ‘oddity’ referenced by McCawley in (23), which has in significant part motivated denial or skepticism about an RO analysis of W-objects. The reasoning implicit or otherwise in the rejection of an RO analysis of W-verb structures has run something like this.

- (33) If W-object cases represented RO, W-objects would behave like B-objects, in turn, behave like unquestioned 2 objects in simple clauses. Since this is far from fully the case, W-objects do not represent RO. A clear instance of this reasoning is seen in Baltin 2001:249-250.

The overall data I have sketchily presented suggest that B-objects, W_I -objects and W_{II} -objects represent three partially distinct outcomes from the raising of infinitival complement 1s. I claim that the distinctions documented among the three types are understandable under hypothesis (34):

- (34) a. B-objects = 2 objects
 b. W_I -objects = 4 objects
 c. W_{II} -objects = 3 objects

This hypothesis imposes itself because it can be shown *independently of infinitival complement structures* that the properties documented here for B-objects, W_I -objects and W_{II} -objects are respectively characteristic of the three object types.³ That is:

³ Kayne 1984:33-37 briefly discussed verbs taking complement structures of the form (i):

(i) V + DP + (*to) infinitive

The items in question, which Kayne 1984 dubbed L-verbs, included *let, make, have, get, see* and *watch*, as in e.g.:

- (35) a. Like B-objects, independent 2 objects can be targets for periphrastic passivization, clausal object raising, nominal object raising, can be instantiated by the slang NPIs, can be in situ human relative pronouns and both they and their subconstituents can be left-extracted;
- b. Like W_I -objects, independent 4 objects cannot be targets for periphrastic passivization, clausal object raising or nominal object raising but can be instantiated by the slang NPIs, can be in situ human relative pronouns and they and their subconstituents can be left extracted;
- c. Like W_{II} -objects, independent 3 objects cannot be targets for any of the cited constructions, cannot be instantiated by the slang NPIs, cannot be in situ human relative pronouns and neither they nor their subconstituents can be left extracted.

Space prohibits extensive documentation of these claims, which is however found in Postal, in press. Here I will just give a sprinkling based on the forms in (1) and (2):

- (36) a. Carol Longley was questioned by Victor/hard for Victor to question.
 b. *Carol Longley was written by that producer/*a difficult person for a successful producer to write.
 c. *Carol Longley was wanted by the director/*impossible for the committee to want.
- (37) a. Which model did Victor question (a friend of)?
 b. *Which model did that director write (a friend of)?
 c. Which model did the director want (a friend of) as his assistant?
- (38) a. Bob didn't buy/clean/destroy dick/jack/jackshit/squat.
 b. *The bottle didn't leak dick/jack/jackshit/squat.
 c. Bob didn't lack/near dick/jack/jackshit/squat.

-
- (ii) Kayne 1984:33
 a. Mary let John leave.
 b. They made him confess.
 c. The priest had them repent.
 d. Her stupidity got us thrown in jail.
 e. They watched him dive into the pool.

Kayne 1984 noted several parallels between W-verb structures and L-verb structures. And in fact L-verb objects arguably represent RO but are also either 3 objects or 4 objects. Note the impossibility of passives (Kayne 1984:35):

- (iii) *Karen was let/made/had/watched leave in tears.

Space precludes detailed discussion.

- (39) a. Carol Longley, questioning whom would be unwise of you, is outside.
 b. *Carol Longley, writing whom would be impossible for that producer, is outside.
 c. Carol Longley, wanting whom as a participant is understandable, is outside.

6. Two Further Observations about Raised Objects

Two additional phenomena provide further support for the view that B-objects are properly taken as 2 objects while W-objects of either type are not. First, all W-objects are incompatible with the gaps associated with extraction of the form *as*, while B-objects are not:

- (40) a. Ted is a vampire, as they assumed/believed/proved to have been recognized by the doctor.
 b. *Ted is a vampire, as they would like/love/want/wish to be recognized by the doctor.

Second, there is a parallel distributional distinction for *locative inversion*, also for me compatible in a clear sense with B-objects but not with either type of W-object:

- (41) a. To those students, Ed assumed/believed/proved to have been sent directly several inappropriate catalogs.
 b. *To those students, Ed would hate/like/love/want/wish to be sent directly several inappropriate catalogs.

Given what has come before, examples like (40a) and (41a) are initially puzzling. For they seem to represent RO environments without it being clear what has raised, there being no overt object in such clauses, which is also the case for the ungrammatical (40b) and (41b). My view is that in all these cases, what has raised is a covert expletive (see Postal, 2004:Chapter 1 for the locative inversion case). The relevance of covert expletives to *as* and locative inversion structures is supported by cases like the following, where the expletives can be overt:

- (42) a. Ted is not, as (it) first appeared/looked/seemed, that kind of werewolf.
 b. To Ted, (there) appear/look/seem to have been sent some inappropriate brochures.

If so, the contrasts between the a and b examples of (40) and (41) can, given hypothesis (34), reduce to the following condition, stated informally:

- (43) The expletives associated with *as* and locative inversion can be covert only if they are 1s or 2 objects.

Principle (43) allows (40a), (41a) and both variants of (42a-b) while correctly blocking (40b) and (41b). It also rightly allows cases like (44a-b) on the easily justified assumption that the main verb *allow* takes 2 objects (note the good passives in (44c-d)):

- (44) a. On that table she allowed to remain many uneaten rat carcasses.
 b. Wilhelm was an ex-convict, as she allowed to be noted at the meeting.
 c. Many uneaten rat carcasses were allowed to remain on that table.
 d. That was allowed to be noted at the meeting.

Finally under the assumption of note 3 that L-objects also only take 3 or 4 objects, (43) also rightly blocks (45c):

- (45) a. Greta allowed/let that (to) be noted.
 b. Two and two is seven, as Greta allowed to be noted.
 c. *Two and two is seven, as Greta had be noted.

7. Conclusions

7.1. Passivization

A principle point in the literature touched on several times above is that unlike B-objects, W-objects do not feed periphrastic passivization. By analyzing the former as 2 objects, the latter as 3 or 4 objects, I claim that this contrast falls out from principle (7.3) of Chapter 7 of Postal, in press. This rule plus other constraints discussed there (i) bar passivization of all *single object* 3 and 4 objects, permit passivization of *ditransitive* 3 objects subject to at least one further general constraint common to many dialects,⁴ and permit ditransitive 4 object passivization under quite narrow conditions and only in some dialects. Thus under hypothesis (34), the B-object/W-object passivization contrast which has figured strongly in rejection of an RO analysis of W-objects is perfectly regular even under such an analysis and lends no support to a NoRO view.

7.2. Open Issues

The argumentation that W-objects instantiate RO, divide into two types and represent 3 objects or 4 objects, even if valid, leaves a host of issues about RO in these cases (among others) undetermined. Specifically, it remains to consider whether there is a single RO phenomenon whose main clause output is then somehow differentiated with respect to the relational outcome or whether there are multiple types, e.g. raising to 2 object, to 3 object and to 4 object. I believe the former is correct but this is a complex matter, one heavily involved with theoretical assumptions and is impossible to treat within the space confines of this work.

⁴ The major constraint barring ditransitive passivization in many dialects is that drawing the distinction noted in Fillmore 1965 between e.g.:

- (i) a. Elvira sold Gwen that yacht.
 b. Gwen was sold that yacht by Elvira.
 (ii) a. Elvira bought Gwen that yacht.
 b. *That yacht was bought Gwen by Elvira.

References

- Bach, Emmon. 1977. The theoretical implications of subject raising. *Foundations of Language* 14:257-285.
- Baltin, Mark. 2001. A-movements. *The handbook of contemporary syntactic theory*. eds. Mark Baltin and Chris Collins, 226-254. Oxford, England: Blackwell.
- Berman, Arlene. 1974. Adjectives and adjective complement constructions in English. Doctoral Dissertation, Harvard University.
- Bresnan, Joan W. 1972. Theory of complementation in English syntax. Doctoral Dissertation, MIT.
- Bresnan, Joan W. 1976. Nonarguments for raising. *Linguistic Inquiry* 7:485-501.
- Chomsky, Noam. 1977. *Essays on form and interpretation*. Amsterdam: North Holland.
- Chomsky, Noam and Howard Lasnik. 1977. Filters and control. *Linguistic Inquiry* 8:425-504.
- Fillmore, Charles J. 1965. Indirect object constructions in English and the ordering of transformations. The Hague: Mouton and Company.
- Jackendoff, Ray. 1975. *Tough* and the trace theory of movement rules. *Linguistic Inquiry* 6:437-464.
- Jacobson, Pauline. 1992. The lexical entailment theory of control and the *tough* construction. *Lexical matters*, eds. Ivan A. Sag and Anna Szabolcsi, 269-299. Stanford, California: CSLI.
- Kayne, Richard S. 1984. *Connectedness and binary branching*. Dordrecht, Holland: Foris Publications.
- McCawley, James D. 1998. *The syntactic phenomena of English*. Chicago: The University of Chicago Press.
- Postal, Paul M. 1974. *On raising*. Cambridge, Ma.: MIT Press.
- Postal, Paul M. 1993. Parasitic gaps and the across-the-board phenomenon. *Linguistic Inquiry* 24:735-754.
- Postal, Paul M. 2004. *Skeptical linguistic essays*. New York: Oxford University Press.
- Postal, Paul M. in press. *Edge-based clausal grammar*. Cambridge, Ma.: MIT Press.
- Postal, Paul M. and Geoffrey K. Pullum. 1988. Expletive noun phrases in subcategorized positions. *Linguistic Inquiry* 19:635-670.
- Rosenbaum, Peter S. 1967. *The grammar of English predicate complement constructions*. Cambridge, Ma.: MIT Press.

THE MIDDLEFIELD IN SLAVIC: EVIDENCE FROM CZECH*

Anne Sturgeon
Harvard University
anne.sturgeon@gmail.com

In Slavic, information structural movements to the left and right peripheries have been described and analyzed in great detail in the literature. The syntax of non-peripheral domains in Slavic, however, is not thoroughly understood. Using Czech as a test case, I identify and examine the nature of movement within the middlefield, which I identify as the domain between the inflectional and verbal head positions. To the peripheries, movement is shown to be A-bar, but movement to the middlefield exhibits characteristics of A-movement. This analysis of the syntax of the Czech middlefield explains certain surprising characteristics of wh-movement. Wh-movement exhibits traits of both A- and A-bar movement: movement is not clause-bounded (A-bar movement), but WCO effects are not found (A-movement). To explain this apparent contradiction, I suggest that all wh-expressions first move to the middlefield, amnestying WCO effects, and then the highest wh-expression in that domain raises to the left periphery.

1. Introduction

Research on word order in Slavic languages has focused primarily on the syntax of the left and right peripheries and their role in structuring information, while the syntactic behavior of XPs within what I will call the middlefield has remained largely unexplored. The syntax of this domain is interesting for several reasons. First, as opposed to movement to the peripheries, which is A-bar, movement to the middlefield exhibits characteristics of A-movement (new binding relationships can be established and movement is clause-bounded). Second, understanding the behavior of this domain allows us to understand surprising characteristics of wh-movement. Wh-movement in Czech is an A-bar operator movement (details given in §3.1), but does not exhibit the weak crossover effects (WCO) which are expected with this type of movement, see (1).

- (1) Kterého právníka₁ nenávidí jeho₁ klienti?¹
which lawyer.ACC hates his clients.NOM
Lit: ‘Which lawyer₁ do his₁ clients hate?’

* I would like to thank Judith Aissen, Vera Gribova, Shin Ishihara, Emily Manetta, James McCloskey, and the audience from the 2008 LSA conference for their helpful comments on this project. I thank my primary Czech consultants, Kristina Valentinová and Zuzana Kartousová, for their help with the data. All remaining errors are my own.

¹ Abbreviations are as follows: *C* (complementizer), *PST* (past), *INF* (infinitive), *COND* (conditional), *AUX* (auxiliary), *CL* (clitic), *REFL* (reflexive), *REL* (relative pronoun), *PRT* (particle), *SG* (singular), *PL* (plural), *ACC* (accusative), *DAT* (dative), *NOM* (nominative).

In (1), the accusative DP, *kterého právníka* ('which lawyer') co-varies with the subject of the clause, *jeho klienti* ('his clients'). WCO effects are expected in A-bar movement contexts, but not in instances of A-movement. I show that wh-movement in Czech exhibits characteristics of both A- and A-bar movement due to their unique syntax.

An explanation for this surprising facet of Czech wh-movement is found in the syntax of the middlefield. Czech, like other Slavic languages, exhibits multiple wh-movement, but only the initial wh-expression appears in a left peripheral specifier position. Lower wh-expressions are shown to be positioned in the middlefield, not above it, as some researchers have suggested (Rudin 1988, Richards 2001, among others). Crucially, this position of the middlefield elements is responsible for the surprising behavior of wh-movement exhibited in (1).

To explain this facet of wh-movement, I will locate the middlefield in the Czech clausal syntax and demonstrate that movement to this domain is A-movement, which is distinct from movement to the left periphery, which is A-bar movement. Wh-expressions appear in both the middlefield and the left periphery; this accounts for their dual behavior.

2. Czech Clause Structure: Locating the Middlefield

Though SVO in unmarked utterances, Czech is primarily a discourse configurational language in which structural positions at the left and right edges of the clause are identified with specific discourse functions: continuing topic, contrastive topic and focus. Two structural positions serve to delineate domains within the clause: the position of the lexical verb in the vP (v^0) and the inflectional head (I^0). Lexical verbs are shown to head the lowest vP projection and to remain low in the syntax. The inflectional head delimits the left peripheral A-bar position ([Spec, IP]) which hosts XPs instantiating continuing topic, contrastive topic and focus discourse functions, as well as most wh-expressions. The middlefield consists of the domain between these heads, v^0 and I^0 .

My approach to the syntax of the left periphery departs from the well-known approach of Rizzi 1997. I assume that XPs associated with a topic, contrastive topic or focus discourse function, as well as wh-expressions, are found in structural positions at the left periphery (for a similar approach to Czech see Lenertová 2001). With the exception of dislocated XPs, all these elements are found primarily within the IP projection. Not only is an exploded CP not necessary for Czech, the CP projection hosts only wh-expressions (and even then only under certain circumstances); [Spec, IP] is the target left peripheral position for leftward A-bar movements.

It may appear that I have simply moved the various elements down one projection. However, I argue that this is not the case. Given the low position of the verb in Czech (it heads the lowest vP projection) and the fact that only one left peripheral XP is possible, it is not necessary to posit an exploded CP or to even make use of the CP projection in most cases. Independent evidence suggests that languages require both an inflectional and a verbal domain. If no additional functional projections are regularly needed by the language, it is preferable to avoid them for reasons of economy of representation (see Chomsky 1991).

2.1. The Inflectional Domain

The inflectional head delimits the singular left peripheral A-bar position as well as serving as the left edge of the middlefield. This head position is filled by pronominal and verbal clitics. Following Fried 1994, Veselovská 1995 and Lenertová 2001, I assume Czech clitics are positioned syntactically in I^0 . The clause-initial position, [Spec, IP] is filled by a single XP associated with one of three discourse functions: contrastive topic, topic or focus.

[Spec, IP] is not a position associated with case licensing, but, rather, it is an A-bar position associated with an EPP feature. This position is filled in one of two ways: by raising of the highest XP within the vP domain (often the nominative subject) or by attraction of an XP with a particular discourse function (contrastive topic or focus). In unmarked contexts, SVO word order surfaces. The highest verbal argument, the subject in (2), raises to [Spec, IP], due to the EPP feature on I^0 . A tree for (2) is provided in (3).

- (2) [IP Jan si [vP koupil knížku.]]
 Jan REFL-CL bought book.ACC
 ‘Jan bought himself a book.’

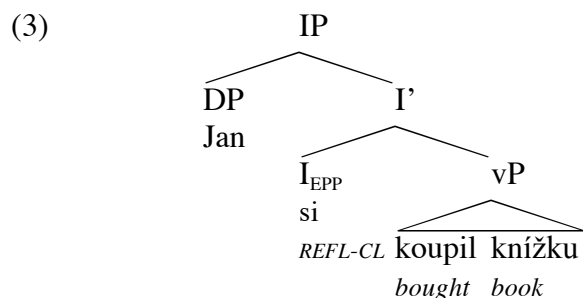

Only one element can precede the clitic cluster. Both alternative orders of the arguments are ungrammatical, (4a-b).

- (4) a. *Honzovi knížku jsem dala.
 Honza.DAT book.ACC AUX.1SG.CL gave
 Intended: ‘I gave Honza a book.’
 b. *Knížku Honzovi jsem dala.
 book.ACC Honza.DAT AUX.1SG.CL gave
 Intended: ‘I gave Honza a book.’

Elements other than the nominative subject often appear in [Spec, IP]. I assume that when I^0 is associated with an operator feature (such as *wh*, focus or contrastive topic), the highest XP with the appropriate featural make-up raises to satisfy the EPP and check the operator feature on I^0 . In (5b), the focused constituent, *knížku* (‘book’), moves to [Spec, IP] to satisfy the EPP on I^0 and to check its focus operator feature (for a more detailed discussion, see Sturgeon 2008).

- (5) a. Co jsi koupila Honzovi k svátku?
 what AUX.2SG.CL bought Honza.DAT towards name-day
 ‘What did you buy Honza for his name day?’
- b. [Knížku_F]_i jsem mu koupila t_i.
 book.ACC AUX.1SG.CL him.CL bought
 ‘I bought him a book_F.’

The structure for (5b) is provided in (6).

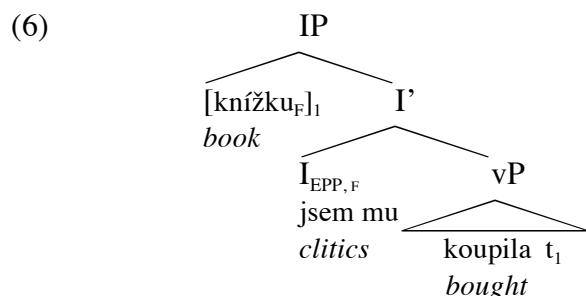

The accusative object is focused and, as such, moves to [Spec, IP] to satisfy the featural requirements of the inflectional head. Clitics appear in I⁰.

2.2. The Verbal Domain

The position of the lexical verb is important because it delimits the right edge of the middlefield (the span between I⁰ and v⁰). In Czech, the lexical verb remains low; as in English, it raises from V⁰ to v⁰ but no higher (see also Veselovská 1995). Evidence for a low position of the lexical verb comes from two main sources, from the position of VP adverbs and from VP ellipsis (VPE).

To demonstrate that the verb in Czech remains low, Veselovská 1995 appeals to work by Emonds 1978 and Pollock 1989. They diagnose the position of the verb in English and French using the structural position of VP adverbs such as *often*. VP adverbs adjoin to the highest projection of the VP domain, for me, the vP. Thus, if they precede the verb, the verb must remain within the verbal domain. If, on the other hand, a VP adverb follows the verb, the verb must raise into the inflectional domain. Familiar evidence from English and French is given below. The VP adverb, *often*, appears before the verb in English, (9a), and after it in French, (9b); this suggests a low position for the English verb (no V⁰-to-I⁰ raising) and a higher position for the verb in French.

- (7) a. James often kisses (*often) Marie.
- b. Jean (*souvent) embrasse souvent Marie
 Jean often kisses often Marie
 ‘Jean often kisses Marie.’ (Pollock 1989: (4))

The position of VP adverbs in Czech patterns with that of English. The adverb *often* must precede the verb if it has sentential scope, example (10).

- (8) Honza často líbá (*často) Marii.
 Honza often kisses often Marie
 ‘Honza often kisses Marie.’ (Veselovská 1995: 83, (7))

This evidence suggests that the verb remains within the vP in Czech, raising from V^0 to v^0 , by assumption, but no higher.² VP adverbs can precede or follow auxiliaries, suggesting that they head vP projections, (9).

- (9) Zeměměřič (často) bude (často) zpracovávat zakázky v různých lokalitách.
 land-surveyor often will often work.INF orders in various locations
 ‘Land-surveyors will *often* work on jobs at various locations.’
 (www.gepro.cz/new/clanky/atlas_.htm)

Additional evidence that the lexical verb remains low in the syntax can be found in VP ellipsis. Czech allows multiple auxiliaries in a clause and any of these can be stranded in VP ellipsis, see (10).

- (10) Já budu muset udělat zkoušku, ale ty *nebudeš (muset)*
 I will must.INF pass.INF exam but you NEG-will must.INF
 [~~udělat zkoušku~~].
 pass.INF exam
 ‘I will have to pass the exam, but you *won't (must)*[~~have to pass the exam~~].’

In VPE, the fact that only auxiliaries, but not lexical verbs, can be stranded points to a low position for lexical verbs (see Goldberg 2005 for a discussion of V-stranding in Hebrew, Irish and Swahili). This is illustrated in (11).

- (11) *Honza si koupil nové auto, ale Petr *nekoupil*₁ [_{VP} t₁ ~~nové auto~~].
 Honza REFL-CL bought new car, but Petr NEG-bought new car
 Intended: ‘Honza bought a new car, but Petr didn't [~~buy a new car~~].’

The impossibility of lexical verb stranding in VPE provides further evidence for an analysis of the verbal domain in which lexical verbs remain low in the syntax, raising from V^0 to v^0 , but no higher. Since VP adverbs obligatorily precede the verb and VP ellipsis can only strand auxiliaries (and not lexical verbs), I argue that the lexical verb raises no higher than the head of the lowest vP projection.

² For Veselovská 1995, the verb raises to the head of an AgrO projection which immediately dominates the VP.

2.3. The Czech Middlefield

The positions between the I^0 and the lexical verb in v^0 constitute the middlefield. Any number of scrambled elements, (12), can adjoin to vP in any order. In both (12a) and (12b), the XPs could appear in either order.

- (12) a. Já bych prádlo z okna nikdy nepověsil.
 I COND.CL laundry from window never NEG-hung
 ‘I would never hang my laundry from the window.’
 (www.okoun.cz/boards/nikdy_bych...)
- b. Já jsem včera večer od Matyáška zase dostala takovou nakládačku...
 I AUX.1SG.CL yesterday night from Matyášek again got such kick
 ‘Again last night I got such a kick from Matyášek...’
 (www.emimino.cz/modules.php?name=News&file=article&sid=4400)

The following schematic tree provides an overview of the proposed Czech clause structure, (13).

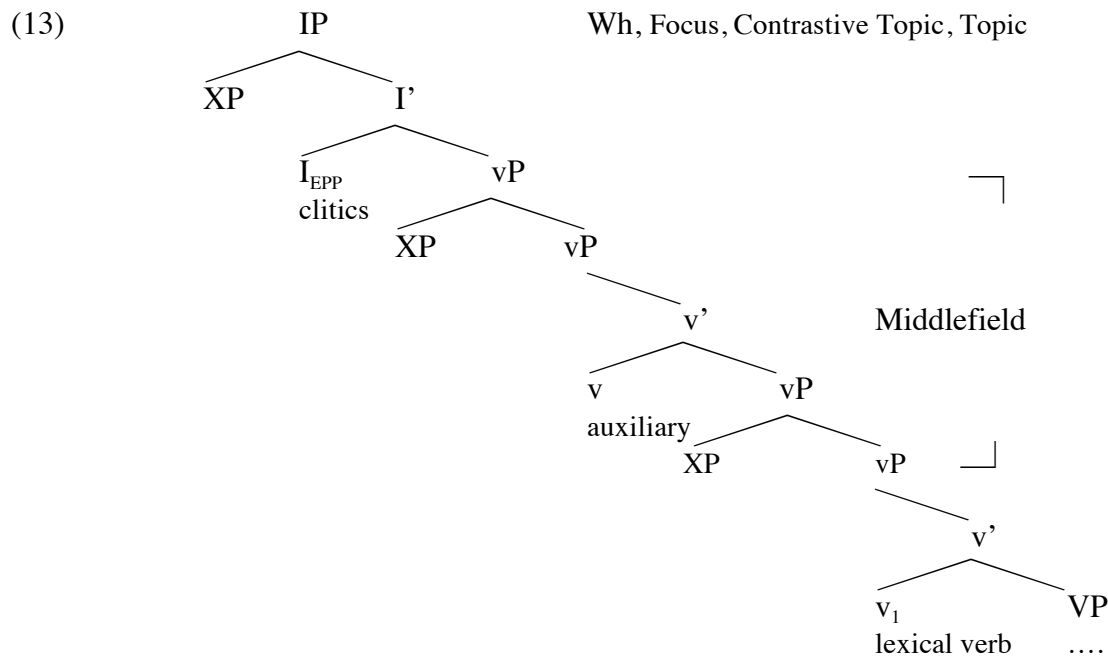

3. Syntactic Domains and Movement Types

The cover term *scrambling* has often been used to describe word order variation. Researchers have teased apart distinct types of movements with respect to their behavior (see Mahajan 1990 for Hindi, Nemoto 1999 for Japanese, Grewendorf and Sabel 1999 and Hinterhoelzl and Pili 2003 for German, Bošković 2004 for Russian and Serbo-Croatian, among many others). The following are characteristics of A-movement: new binding relationships can be established after movement and movement is clause-bounded. A-bar movement, on the other hand, is not clause-

bounded and no new binding relationships can be established following movement. Different domains in Czech are associated with distinct types of movement. Movement to [Spec, IP] exhibits characteristics of A-bar movement, while movement to the middlefield, the vP domain, exhibits characteristics of A-movement.

3.1. A-bar Movement and [Spec, IP]

Operator movements to the left periphery exhibit characteristics of A-bar movement. In the following examples I consider contrastive topicalization. Other types of operator movement to the left periphery, focus and wh-movement, behave in a similar manner (see Sturgeon 2008). Contrastive topicalization to [Spec, IP] is not clause-bounded, see (14).³

- (14) a. There are four students in the class and three still don't have textbooks.
 b. [*Honzovi*₁]_{CT} mi řikali, že učitel ji už dal *t*₁, ale ostatním_{CT} ještě ne.
 Honza.DAT me.DAT told.PL C teacher it.CL already gave but others still no
 Lit: 'To *Honza*_{CT} they told me the teacher gave it *t*₁, but to the others_{CT} he hasn't yet.'

New binding relationships *cannot* be established after the movement of a contrastively topicalized element. Binding relationships are evaluated strictly after reconstruction. Examples (15) and (16) exhibit WCO.

- (15) *Každého kluka₁ by jeho₁ matka napomenula ve školě.
 every boy.ACC COND.CL his mother scolded in school
 Intended: 'Every boy₁ was scolded by his₁ mother at school.'

(16) is ungrammatical under a bound reading.

- (16) Žádnému₁ politiku nevěří jeho_{2/*1} sousedé.
 no politicians.DAT NEG-trust his neighbors.NOM
 'No₁ politician is trusted by his_{2/*1} neighbors.'

Movement to [Spec, IP] exhibits familiar characteristics of A-bar movement: movement is not clause-bounded and binding relationships are evaluated after reconstruction, not at the surface positions of the XPs. Interestingly, A-movement to the middlefield prior to movement to the left periphery appears not to be available to contrastive topics, as it is to wh-expressions. Theory-internally, this can be explained by the features associated with contrastive topic movements; they must be checked after movement of the XP_{CT} to [Spec, IP]. Wh-elements can check their features via static Agree with I⁰ (see section 4.2). It is also the case that contrastive topics, as opposed to wh-expressions, can only be interpreted in the left peripheral position. This may be due to the particular prosodic contour (rise-fall) associated with them. Wh-expressions, on the other hand, are not associated with this type of intonational contour.

³ It is also possible to extract contrastively topicalized elements out of embedded subjunctive and non-finite clauses and this movement obeys island constraints (see Sturgeon 2008).

3.2. A-movement and the Middlefield

Unlike movement to [Spec, IP], movement to the middlefield exhibits characteristics of A-movement: new binding relationships can be established and movement is clause-bounded.^{4, 5} Compare (17) with (15), above. WCO is amnestied by movement to the middlefield, but not by movement to [Spec, IP].

- (17) Včera každého₁ kluka jeho₁ matka napomenula.
 yesterday every boy.ACC his mother.NOM scolded
 ‘Yesterday every₁ boy was scolded by his₁ mother.’
 Lit: ‘Yesterday every boy₁ his₁ mother scolded.’

The same pattern emerges in (18) (compare to (16)).

- (18) Nikdy žádnému₁ politiku jeho₁ sousedé nevěří.
 never no politician.DAT his neighbors.NOM NEG-trust
 ‘No₁ politician is ever trusted by his₁ neighbors.’

⁴ Note that Czech differs from another Slavic language, Serbo-Croatian. In Serbo-Croatian, movement to the left periphery *can* amnesty WCO violations, suggesting that [Spec, IP] is an A-position. Richards 2001 provides (i) as an example.

- (i) Nijednom₁ policaru njegov₁ susjedi ne vjeruju
 no politician.ACC his neighbors.NOM not trust
 ‘No₁ politician is trusted by his₁ neighbors.’

Kučerová 2007, however, suggests that unstressed Czech *given* elements that move to the left periphery, unlike stressed elements, such as contrastive topics and foci, also undergo A-movement and new binding relationships can be established from a left peripheral position (see also Hinterhoelzl and Pili 2003 for German). Further investigation into the relationship between discourse function and WCO is an area for future research.

⁵ Richards 2001 follows Bošković 1998 in noting that A-scrambling does not affect binding conditions such as Condition A. Condition A is still evaluated after reconstruction, see (i). Binding of *his son* by *Honza* is possible even though c-command between the binder and the bindee does not hold at the surface; these relations are established in the base positions of the two arguments.

- (i) Včera ji svému₁ synovi Honza₁ dal.
 yesterday it.CL self's son.DAT Honza gave
 ‘Yesterday Honza₁ gave it to his₁ son.’

Hinterhoelzl and Pili 2003 cite similar data from German. Two explanations are given for this anomaly. First, they note that for some speakers A-movement creates new binding possibilities and eliminates old ones, but not for all. Second, all reflexive pronouns in Czech (and some in German) are subject oriented. For this reason, new binding relationships cannot be established through A-movement since the new binder will not be in an appropriate structural position. Examining the behavior of reciprocals, which are not subject-oriented in Czech, is likely a fruitful area for future research.

Additionally, movement to the middlefield is clause bounded. It is not possible for movement from an embedded clause to target a position in the middlefield, (19) (compare to (14b)).

- (19) *Petr_{si} *Honzovi*₁ myslí, že učitel ji dal *t*₁.
 Petr REFL.CL Honza.DAT thinks C teacher.it.CL gave
 Intended: ‘Petr thinks Honza₁ that the teacher gave it *t*₁.’

Movement to [Spec, IP] exhibits familiar characteristics of A-movement: movement is clause-bounded and new binding relationships can be established after movement.

I posit that movement to the middlefield is adjunction to vP. I remain agnostic on the exact mechanism of the movement (see Miyagawa 2005 for an EPP-style analysis). The following characteristics of the middlefield in Czech support this analysis. First, elements that move to this domain can appear in any order, which is characteristic of adjunction. Second, movement of XPs to the middlefield is not required by Czech syntax; it does not satisfy the featural requirements of particular functional heads. Also, there is no independent evidence of additional functional projections between v^0 and I^0 in Czech. Internal arguments are assigned case in their base positions; there is no evidence that internal arguments must raise out of VP. For German, Hinterhoelzl and Pili 2003 suggest that A-movement to the middlefield targets specifiers of functional projections licensing clitics. This seems unlikely for Czech as clitics are syntactically positioned higher, in I^0 .

4. Further Predictions of the Analysis: Wh-Movement

4.1. The Puzzle

Wh-movement in Czech presents a puzzle: fronted wh-expressions exhibit behavior of both A- and A-bar movements. Like participants in A-bar movement, their movement is not clause-bounded. They can be extracted out of finite complements to the bridge verb *myslet* (‘to think’), (20).⁶

- (20) *Koho*₁ myslíš, že Marie pozvala *t*₁ na tu párty?
 who.ACC thinks.2SG C Marie invited on that party
 ‘Who₁ do you think Marie invited *t*₁ to the party?’

But, like XPs that have undergone A-movement, they do not exhibit WCO effects, see (21), repeated from (1).

- (21) *Kterého právníka*₁ nenávidí jeho₁ klienti?
 which lawyer.ACC hates his clients.NOM
 Lit: ‘Which lawyer₁ do his₁ clients hate?’

⁶ It is also possible to extract wh-expressions out of embedded subjunctive and non-finite clauses. Wh-expressions also obey island constraints (for more details, see Sturgeon 2008).

I explain this apparent anomaly in the next section, but first, I briefly lay out basic assumptions about Czech wh-movement. Czech is a multiple wh-fronting language and has been characterized by Rudin 1988 as a -Multiply Filled Specifier language ([-MFS]), like Polish and Serbo-Croatian (see Sturgeon 2008 for more evidence). One wh-phrase undergoes movement to the left periphery ([Spec, IP]) to satisfy the featural requirements of the inflectional head (which has the features, [wh, U/q]). Additional wh-expressions are positioned lower in the structure. This contrasts with +MFS languages (such as Bulgarian) which have multiple specifier positions at the left edge of the clause which hosts multiple wh-expressions.

These two types of multiple wh-movements explain certain differences between languages. An example of such a difference is sensitivity to wh-islands. Due to the multiple specifier positions in +MFS languages, wh-expressions have multiple ‘escape hatches’ out of wh-islands and lack wh-island effects, while -MFS languages lack this option and exhibit wh-islands. Czech exhibits long distance wh-movement, see (20), but movement out of wh-islands is not possible, see (22). Since there is only one specifier position in the embedded domain, this is expected.

- (22) **Komu*₂ by tebe zajímalo koho₁ Marie představila t₁ t₂?
 who.DAT COND.3SG.CL you.ACC interested who.ACC Marie introduced
 Intended: ‘To whom₂ do you wonder who₁ Marie introduced t₁ t₂?’

A detailed analysis of wh-movement in Czech is provided in the next section.

4.2. Predictions of a Low Adjunction Site

Why do Czech wh-questions lack WCO effects? The answer lies in the position of non-initial wh-expressions. The position of these expressions has been the subject of some debate. Rudin 1988 and Richards 2001 assume that they adjoin to IP. New evidence from Czech, however, suggests that non-initial wh-phrases target a lower functional projection, vP (see also Stjepanović 1998; Bošković 1997, 2002). If that were, indeed, the case, multiple wh-questions should exhibit certain characteristics. First, they, like middlefield non-wh-XPs, should follow second-position clitics and precede the lexical verb, see (23).

- (23) *Komu* by kdo *by co dal?
 who.DAT COND-CL who.NOM COND-CL what.ACC gave
 ‘Who would give what to whom?’

Second, middlefield elements should be able to intervene between wh-expressions. This is shown in (24).

- (24) *Kde* jsi (včera večer) koho (včera večer) komu představila?
 where AUX.2SG.CL last night who.ACC last night who.DAT introduced
 ‘Where did you introduce who to whom last night?’
 Lit: ‘Where did (last night) who (last night) who introduce?’

The adjoined XP, *včera večer* ('last night'), can either precede the non-initial wh-expressions or intervene between them.⁷

Third, since auxiliaries, such as *will*, head vP projections, middlefield wh-expressions, like other middlefield XPs, should both precede and follow auxiliaries, see (25).⁸

- (25) Kdo (*bude*) koho (*bude*) volit?
 who will who.ACC will vote-for.INF
 'Who *will* vote for whom?'
 (www.ahasweb.cz/hovory/23.htm)

Given this evidence, I suggest that non-initial wh-expressions in Czech are positioned in the middlefield. The derivation proceeds as follows: all wh-expressions undergo A-movement to adjunction sites in the vP domain, then the highest wh-expression in the middlefield undergoes an additional movement to [Spec, IP] to satisfy the featural requirements of both the wh-expression and I⁰ (for a similar analysis, see Richards 2001 for Serbo-Croatian).

Following standard analyses, I assume that Czech wh-movement is an operator-variable A-bar construction (for current approaches to operator movement in Minimalism see Reinhart 1998, Fox 2002). An interpretable wh-operator feature, *q*, appears on I⁰, as well as an uninterpretable wh feature. Wh-expressions have an uninterpretable *q* feature and an interpretable wh feature on the head of their phrase. Thus, both the probe and the goal are active as both are associated with uninterpretable features. Czech has overt wh-movement, so the probe is associated with an EPP feature which motivates overt movement of the first wh-expression into its specifier. The *q*-feature on non-initial wh-phrases is checked by I⁰ via static Agree, but there are no additional leftward movements. Lower wh-expressions, thus, share the structural behavior of other middlefield elements: they are positioned between v⁰ and I⁰, they can both precede and follow auxiliary verbs and co-occur with other middlefield XPs. Also, like other middlefield XPs, wh-expressions in Czech can occur in any order; there are no superiority effects in Czech. (26) illustrates the range of word order possibilities in matrix wh-questions.

- (26) a. Komu by kdo co dal?
 who.DAT COND.CL who.NOM what.ACC gave
 'Who would give what to whom?'
 Lit: 'To whom would who what give?'
 b. Komu by co kdo dal?
 who.DAT COND.CL what.ACC who.NOM gave
 c. Co by kdo komu dal?
 what.ACC COND.CL who.NOM who.DAT gave
 d. Co by komu kdo dal?
 what.ACC COND.CL who.DAT who.NOM gave

⁷ Speakers prefer the adjunct to precede the second and third wh-phrases, rather than split them, but both orders are reported to be possible.

⁸ This was first noted in Meyer 2003.

Embedded contexts also lack superiority effects, (27).

- (27) Přestal se starat, co si kdo o čem myslí.
 stopped REFL-CL care.INF what REFL-CL who about what thinks
 ‘He stopped caring about who thought what about what.’ (Meyer 2003: (8))

This lack of superiority effects is expected if *wh*-expressions first A-scramble to the *vP* domain and then the highest *wh*-expression in that domain raises to [Spec, IP]. The tree in (29) illustrates the structure of (28).

- (28) Komu kdo co dal?
 who.DAT who.NOM what.ACC gave
 ‘Who gave what to whom?’

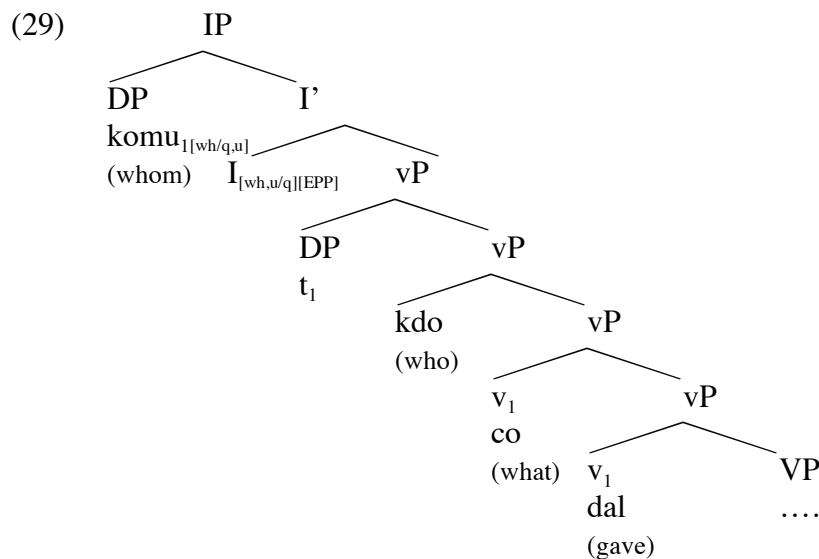

This A-scrambling to the *vP* domain also amnesties WCO effects in *wh*-questions. New binding relationships can be established between *wh*-expressions in the middlefield. *Wh*-expressions exhibit characteristics of both A- and A-bar movement due to the fact that movement of *wh*-phrases proceeds first through adjunction to *vP* and then to an A-bar position at the left edge of the clause.

5. Conclusion

Surprising contrasts between left peripheral and middlefield binding relationships in (15), (16) on the one hand and (17), (18) on the other can be explained through analyzing middlefield movement as A-movement and left peripheral movement as A-bar. Also, the apparent contradiction of *wh* questions not showing WCO effects is also explained here. *Wh*-expressions

first undergo A-movement to the vP domain, and then the highest wh-expressions raises to [Spec, IP]. WCO effects are obviated by the first movement of the wh-expressions because new binding relationships can be established after A-movement. These new relationships are maintained after the final A-bar movement of the highest wh-expression.

References

- Bošković, Željko. 1997. Fronting wh-phrases in Serbo-Croatian. *Annual Workshop on Formal Approaches to Slavic Linguistics*, 86-107. Ann Arbor, MI: Michigan Slavic Publications.
- Bošković, Željko. 1998. Wh-phrases and wh-movement in Slavic. Paper presented at the Comparative Slavic Morphosyntax Workshop. Bloomington, Indiana.
- Bošković, Željko. 2002. On multiple wh-fronting. *Linguistic Inquiry* 33:351-83.
- Bošković, Željko. 2004. Topicalization, focalization, lexical insertion and scrambling. *Linguistic Inquiry* 35:613-38.
- Chomsky, Noam. 1991. Some notes on the economy of derivation and representation. *Principles and parameters in comparative grammar*, ed. Robert Freidin, 417-54. Cambridge, MA: MIT Press.
- Emonds, Joseph. 1978. The verbal complex in French. *Linguistic Inquiry* 9:151-175.
- Fox, Danny. 2002. Antecedent contained deletion and the copy theory of movement. *Linguistic Inquiry* 33:63-96.
- Fried, Mirjam. 1994. Second-position clitics in Czech: Syntactic or phonological? *Lingua* 94:155-75.
- Goldberg, Lotus. 2005. Verb-stranding VP ellipsis: A cross-linguistic study. Doctoral dissertation, McGill.
- Grewendorf, Günter and Joachim Sabel. 1999. Scrambling in German and Japanese: Adjunction versus multiple specifiers. *Natural Language and Linguistic Theory* 17:1-65.
- Hinterhoelzl, Roland and Diana Pili. 2003. Argument shift phenomena across language types. Ms., Humboldt Universitaet and Università de Siena.
- Kučerová, Ivona. 2007. The syntax of givenness. Doctoral dissertation, MIT.
- Lenertová, Denisa. 2001. On clitic placement, topicalization and CP-structure in Czech. *Current issues in Slavic linguistics*, eds. Uwe Junghanns G. Zybatow, G. Mehlhorn and L. Szucisch, 294-305. Berlin: Peter Lang.
- Mahajan, A. K. 1990. The A/A-bar distinction and movement theory. Doctoral dissertation, MIT.
- Meyer, Roland. 2003. On multiple wh-fronting and wh-clustering in Czech. *Annual Workshop on Formal Approaches to Slavic Linguistics*, 393-412. Ann Arbor, MI: Michigan Slavic Publications.
- Miyagawa, Shigeru. 2005. On the EPP. *Perspectives on phases*, eds. Norvin Richards and Martha McGinnis, 201-236. Cambridge, MA: MIT Press.
- Nemoto, Naoko. 1999. Scrambling. *Handbook of Japanese linguistics*, ed. Natsuko Tsujimura, 122-50. Malden, MA: Blackwell Publishers.
- Pollock, Jean-Yves. 1989. Verb movement, UG and the structure of IP. *Linguistic Inquiry* 20:365-424.

- Reinhart, Tanya. 1998. Wh-in-situ in the framework of the Minimalist Program. *Natural Language Semantics* 6:29-56.
- Richards, Norvin. 2001. *Movement in language: Interactions and architectures*. Oxford: Oxford University Press.
- Rizzi, Luigi. 1997. The fine structure of the left periphery. *Elements of grammar*, ed. Liliane Haegeman, 281-337. Dordrecht: Kluwer.
- Rudin, Catherine. 1988. On multiple questions and multiple wh-fronting. *Natural Language and Linguistic Theory* 6:445-501.
- Stjepanović, Sandra. 1998. Short distance movement of *wh*-phrases in Serbo-Croatian. Paper presented at the Comparative Morphosyntax Workshop. Spencer, Indiana.
- Sturgeon, Anne. 2008. *The Left Periphery: The interaction of syntax, pragmatics and prosody in Czech*. Amsterdam: John Benjamins.
- Veselovská, Ludmila. 1995. Phrasal movement and X⁰ morphology: Word order parallels in Czech and English nominal and verbal projections. Doctoral Dissertation, Univerzita Palackého.

INDIVIDUATION IN RUSSIAN AND SPANISH DIFFERENTIAL OBJECT MARKING

Alan Timberlake
Columbia University
at2205@columbia.edu

Russian and Spanish both have processes of differential object marking which respond to the same parameters—animacy, definiteness/referentiality. These parameters, broadly speaking, involve individuation, the extent to which the referent is conventionally or in context presented as an individual with multiple properties that might be relevant. Individuation is not limited to the reference of the noun phrase but extends upwards to the semantics of the predicate and event the sense of the predication in context, whether individuating or existential.

1. Introduction

Many languages use more than one case or case equivalent to mark direct objects. Taking as my point of departure Judith Aissen’s study of differential object marking—a favorite of students and instructor alike—I want to return to the question of how speakers make choices between differential object markers and, in the process, point to some similarities between differential object marking in Russian and Spanish.

2. Differential object marking in Russian: animate accusative

Russian has two contrary processes of differential object marking, both of which, paradoxically, use the genitive case. In one process, animate nouns whose syntactic case is accusative substitute genitive forms for the accusative, subject to morphological restrictions. Substitutions are marked in boldface in the partial sketch of morphology in Table 1.

Table 1: *Russian nominal morphology (partial)*

declension / noun	gloss	NOM SG	ACC SG	GEN SG	NOM PL	ACC PL	GEN PL
DI / INAN MSC	‘table’	stol	stol	stola	stoly	stoly	stolov
DI / AN MSC	‘bull’	byk	byka	byka	byki	bykov	bykov
DII / INAN FEM	‘map’	karta	kartu	karty	karty	karty	kart
DII / AN FEM	‘wife’	žena	ženu	ženy	ženy	žen	žen
DII / AN MSC	‘Alyosha’	Aleša	Alešu	Aleši	Aleši	Aleš	Aleš

In the singular, masculine nouns of Declension I use the same form for the nominative and accusative if they are inanimate (*vižu stol*_{NOM=ACC.SG} ‘I see a/the table’), but animate nouns use the genitive form for the accusative (*vižu byka*_{ACC=GEN.SG} ‘I see a/the bull’). Nouns of Declension II have distinct nominative and accusative forms in the singular. Animate nouns of this declension

do not use the genitive for the accusative, whether feminine (*žena*_{NOM.SG} ‘wife’, *vižu ženu*_{ACC.SG} ‘I see wife’, not **vižu ženy*_{GEN.SG}) or masculine (*Aleša*_{NOM.SG}, *vižu Alešu*_{ACC.SG} ‘I see Alyosha’, not **vižu Aleši*_{GEN.SG}). In the plural, animate nouns of all declensions and genders use the genitive form for the accusative (*vižu bykov*_{ACC=GEN.PL} ‘I see bulls’, *vižu žen*_{ACC=GEN.PL}, ‘I see wives’, *vižu Aleš*_{ACC=GEN.PL} ‘I see the Alyoshas’). Thus the use of the “the animate accusative” (prompting the convenient notation “ACC=GEN”) is sensitive to gender, number, and declension class; it is a morphological substitution of genitive morphemes for accusative.

In the second process of differential object marking, Russian often uses the genitive instead of the accusative for direct objects of negated verbs, as in *ja ne pomnju imeni*_{GEN.SG} ‘I don’t remember a/the name’. The process is a syntactic case substitution.¹ The two processes differ in the extent to which there is variation. There is no longer much variation in the animate accusative. Almost all nouns are blindly consistent: a noun uses the animate accusative or it does not, in all contexts, depending on whether the noun is lexically considered animate. For example, the noun *morskie kon’ki* ‘seahorses’ uses the animate form in all contexts, even for lifeless carcasses in a curiosity shop:

- (1) Očen’ postepenno babočki stali **vytesnjat’ sušenyx morskix kon’kov**_{ACC=GEN.PL}.²
 ‘Very gradually butterflies began **to crowd out dried seahorses.**’

‘Seahorse’ is typical of the vast majority of nouns: usage is completely conventionalized.

Only a dozen or so nouns show variation; these refer to lower-order animals (plural (*morskie*) *gubki* ‘(sea) sponges’) or abstract categories (plural *osoby* ‘persons’). Let us look for a moment at the variation, such as it is. For plural ‘sponges’ the animate accusative (genitive form) is used if the noun refers to living beings in their natural habitat ((2)) or in discussions of their biological status of sponges ((3)):

- (2) V načale 1900 g. Èlias Stadiatos s gruppoy drugix grečeskix nyrjal’ščikov **lovil morskix gubok**_{ACC=GEN.PL} u poberež’ja nebol’sogo skalistogo ostrova Andikitira...³
 ‘Early in 1900 Elias Stadiatos, with a group of other Greek divers, **was hunting sponges** on the shore of the small rugged island of Antikythera...’
- (3) **Gubok**_{ACC=GEN.PL} **izučajut** nemnogie zoologi.⁴
 ‘Few zoologists **study sponges.**’

¹ The genitive of negation spreads throughout a noun phrase, as in *Nikakogo*_{GEN.SG} *sud’i*_{GEN.SG} *my tam ne našli* ‘no judge did we find there’, where both adjective and noun are genitive. Animacy is different. There are animate masculine nouns in Declension II. They do not express animacy themselves (the noun is unambiguously accusative), but an adjective does (*vižu milogo*_{ACC=GEN.SG} *Alešu*_{ACC.SG} ‘I see kind Alesha’), leading to a situation in which the two constituents of a single noun phrase use different morphologies to express one case. Accordingly, the animate accusative is a morphological substitution (which Comrie 1989 calls a “genitive-like accusative”), the genitive of negation, a syntactic substitution of one case for another.

² <http://lib.ru/NABOKOW/pilgram.txt>, accessed 3.18.2010.

³ <http://myrt.ru/news/inter/699-antikaterskijj-mekhanizm-drevnijj-kompjuter.html>.

⁴ http://5ka.su/ref/biology/0_object79649.html.

In contrast, the inanimate accusative (identical to the nominative) is used when the sponges are removed from their habitat and are manipulated as objects by human agents:

- (4) S drevnejšix vremen ženščiny **ispol'zovali morskije gubki**_{ACC=NOM.PL} dlja predotvraščeniya beremennosti.⁵
 'From ancient times women have **used sponges** to prevent pregnancy.'
- (5) V kačestve suvenira možno **priobresti prirodnye morskije gubki**_{ACC=NOM.PL}.⁶
 'It's possible **to acquire natural sea sponges** as souvenirs.'

Usage, then, depends on the sense of the verb as the action affects the object 'sponges'.

A more interesting noun is *mikrob* 'microbe', which shows variation as object of the infinitive *najti* 'to find'. Once dubious examples are eliminated from a Google search,⁷ the two variants occur with equal frequency: 20xx inanimate *najti mikroby*_{NOM=ACC.PL}, 18xx animate *najti mikrobov*_{ACC=GEN.PL}. Inanimate *mikroby* is used in examples like these:

- (6) **Najti mikroby**_{NOM=ACC.PL} s vysokim soderžaniem proteina, sposobnye potrebljat' uglevodorody, ne tak už legko.⁸
 'It's not so easy **to find microbes** with a high protein content capable of breaking down hydrocarbons.'
- (7) V nej [lente] neredko možno **najti mikroby**_{NOM=ACC.PL} stolbnjaka.⁹
 'In it [adhesive tape] not infrequently it is possible **to find tetanus microbes**.'

Both (6) and (7) comment on the possible event of discovery; the communicative focus is on the possible existence of the event. Specific kinds of microbes are mentioned, but not in order to contrast one type with another. In contrast, the animate form *mikrobov*_{ACC=GEN.PL} is used when the discovery of microbes is presupposed as conceivable and the communicative focus is on one component of the event opposed to possible alternatives: the condition for discovery in (8) (existence occurs even in a clean house, despite expectations to the contrary) or the specific type of microbe (opposed to other hypothetical varieties) in (9):

- (8) Daže v samom čistom dome možno **najti mikrobov**_{ACC=GEN.PL}.¹⁰
 'Even in the cleanest of houses it is possible **to find microbes**.'
- (9) ... ved' emu ne udalos' **najti mikrobov**_{ACC=GEN.PL}, vyzyvajuščix bešenstvo, poskol'ku èto virusy, otkrytye namnogo pozže.¹¹
 '... he [Pasteur] wasn't successful **in finding the microbes** that trigger madness, inasmuch as the cause is viruses, which were discovered much later.'

⁵ <http://www.lor.inventech.ru/gyn/gyn0240.shtml>.

⁶ <http://turist.by/turkey/bodrum>.

⁷ Search by Google (English) using Cyrillic (2.6.2010). Russian sites, more than English, repeat other sites; I eliminated duplications and metaphorical uses of the noun.

⁸ <http://www.himi.oglib.ru/bgl/913/477.html>, accessed 2.6.2010.

⁹ <http://www.mash.oglib.ru/bgl/5758/268.html>, accessed 2.6.2010.

¹⁰ <http://www.sleepcomfort.ru/sovet.php>, accessed 2.6.2010.

¹¹ <http://www.consilium-medicum.com/media/article/11428>, accessed 2.6.2010.

In brief summary of the Russian animate accusative: almost all nouns obey a rigid rule, such that a given noun uses the animate accusative if the noun in general refers to animate beings, regardless of whether the entity is actually alive in a specific context. Only a small number of nouns still show variation. For some ('sponges') variation depends on the sense of the collocation of verb and noun: manipulating a living being vs. inanimate object. With a very few nouns ('microbe') variation is correlated with a discourse concern, existentiality vs. differentiation. What's left of variation in the expression of animacy—there used to be more in at earlier stages of development—shows that there can be differences in the degree of freedom of usage (or conversely, the degree of conventionalization).

3. Differential object marking in Russian: genitive of negation

Let us turn now to the genitive of negation, another kind of differential object marking in Russian. In this process the object of a transitive negated verb may in principle appear in either the accusative or the genitive. A dozen or so factors have been noted which are correlated with the choice of case, among them (listed in the order favoring accusative \geq favoring genitive): proper \geq common, animate (personal) \geq inanimate (non-personal), singular \geq plural, declension II singular (the *žena* type, with unambiguous accusative singular) \geq other singular declensions, count \geq abstract, implicit definiteness (specificity) \geq indefiniteness (non-specificity), perfective \geq imperfective aspect, irrealis \geq realis mood, assertion \geq interrogative.¹² The first half dozen factors relate to the degree of individuation of the noun, that is, the extent to which the referent is understood as an individual distinct from other tokens or as a token of a class of entities distinct from other classes. The more individuated the referent of the noun, the less likely it is to appear in the genitive when the verb is negated (Timberlake 1975).

Individuation can be extended to transitive predicates, as in the typology in Table 2:

Table 2: *Existentiality / individuation of the verb, Russian genitive of negation (Ueda 1993)*

lexical group	verbs	ACC / total (%ACC)
existential	<i>imet'</i> 'have', <i>znat'</i> 'know', <i>videt'</i> 'see', <i>deržat'</i> 'hold, keep', <i>najti</i> 'find', <i>dopustit'</i> 'permit', <i>polučit'</i> 'receive', <i>pisat'</i> 'write'	14 / 122 (11.5%)
neutral	<i>peremenit'</i> 'exchange', <i>ljubit'</i> 'maintain affection for', <i>osmotret'</i> 'examine', <i>brosit'</i> 'change position by throwing', <i>vdet'</i> 'direct through opening in needle', <i>unesti</i> 'carry away'	41 / 90 (45.1%)
individuating	<i>sčitat'</i> 'consider', <i>naznačit'</i> 'appoint, designate', <i>oglušit'</i> 'cause to go deaf', <i>izvit'</i> 'wind'	9 / 18 (50%)

At one extreme are predicates like *sčitat'* 'consider', *naznačit'* 'appoint, designate', *nazvat'* 'name', whose objects are effectively subjects; these predicates presume an individual which already has a set of known properties and they add an additional property to the individual, stated in the form of an predicative adjective or noun in the instrumental case. Similar are causatives of states such as *oglušit'* 'cause to go deaf', *izvit'* 'cause to become winding in shape', which change one accidental property of an established individual with independent properties. Such

¹² Summarized in Timberlake 1975, documented in Mustajoki 1985.

predicates can be termed individuating. At the opposite extreme, *imet'* 'have' reports on the presence of an attributive (non-referential) entity (or absence, under negation). *Imet'* is a strong existential and almost always takes a genitive object when negated. Similarly though not as virulently existential are verbs like *znat'* 'know' or *videt'* 'see', which report the presence or absence of an entity in someone's cognitive or perceptual sphere ('I know/see *x*' = '*x* exists in my sphere of knowledge/perception'). 'Know' and 'see', then, are weakly existential. Verbs reporting change in the location of the patient (*donesti* 'carry up to', *vdet'* 'place into, as a thread into a needle') are intermediate. The frequency of the genitive for objects of negated verbs follows the hierarchy from existential verbs (most frequent genitive), through neutral to individuating verbs (least frequent genitive). Thus the concept of "individuation" can be generalized from the level of the argument to the semantics of the predicate.

An analogous concept is relevant at the level of discourse. The perfective verb *soxranit'* 'preserve', when negated, can take either the genitive (as in (10–11), immediately below) or the accusative (as in (12–13), further below):

- (10) Nu a to, čto vy **ne soxranili dokumentov**_{GEN.PL} o pokupke i daže ne pomnite, gde pokupali, èto uže, izvinite, vaši problemy.¹³
 'Well, and the fact that you **haven't preserved documents** proving purchase and you can't even remember where you made the purchase, that, excuse me, is your problem.'
- (11) Situacija usugubljaetsja ešče i tem, čto pri pokupke ètogo avto ja **ne soxranil dokumentov**_{GEN.PL}, podtverždajuščix ego stoimost'.¹⁴
 'The situation is further compounded by the fact that in buying that auto I **did not preserve documents** proving its cost.'

The genitive in (10–11) is consistent with a focus on the non-existence of documents at the present time and the consequences of that non-existence.

- (12) Vo vremja vojny vse, kto vyxodil iz plena i **ne soxranil dokumenty**_{NOM=ACC.PL}, rasstrelivali.¹⁵
 'During the war all those who left captivity and **did not preserve documents** were shot.'
- (13) K tomu že bank **ne soxranil dokumenty**_{NOM=ACC.PL} po operacijam 2002 goda, kotorye po zakonu podležat xraneniju v tečenie pjati let.
 'In addition the bank **did not preserve documents** for its operations in 2002, which by law are supposed to be kept for a period of five years.'

In contrast, the accusative of (12–13) differentiates something in the predication. In (12), those POWs who are defined by the lack of documents suffered a fate different from those who had documents; in (13), the non-preservation of documents did not occur in the actual world though it could have occurred in another possible world (indeed, a world mandated by law). Thus with

¹³ <http://forum.navitel.su/>, accessed 3.14.10.

¹⁴ <http://www.forum.skoda-club.ru/viewtopic.php?t=27590>, accessed 3.14.10.

¹⁵ <http://newsforums.bbc.co.uk/ws/en/complaint!default.jspa?messageID=1345193&complaintThreadID=11026> accessed 3.14.10.

this collocation of object noun and verb, the choice of case is correlated with a difference in existentiality vs. differentiation, or individuation, on the level of discourse.

Generalizing, the choice of genitive and accusative under negation signals a distinction of existentiality vs. individuation (differentiation), potentially on different layers: the object (proper vs. common, animate vs. inanimate, etc.), the predicate in its relation to the object (existential vs. individuating), or discourse (existentiality vs. differentiation).

4. Differential object marking in Spanish

Let us take this idea of layering and apply it to the process of marking objects of transitive verbs in Spanish with the preposition *a*.¹⁶ As of course is familiar, the use of *a* is very likely with nouns referring to human beings, a little less regular with nouns referring to animals, and exceptional with inanimate nouns. And is also well-known, for a given degree of animacy, use of *a* is more likely to the extent the noun is definite. In short, the *a* of Spanish is a marker of individuation, though animacy outranks referential individuation.

Here I want to take another look at two contexts that have been discussed in the literature on Spanish *a*. The first is objects of verbs with modal content like *aguardar* ‘await’ or *buscar* ‘seek’. Bello (1977:§893) noted long ago that *aguardar a un criado* ‘await a servant’ is used “cuando el que le aguarda piensa determinadamente en uno” (when the person who is waiting is thinking specifically of a certain one) while *aguardar un criado* is appropriate “cuando para el que le aguarda es indifferente el individuo” (when, for the person who is waiting, it is indifferent which individual). Bello cites a further minimal pair:

- (14) Fueron **a buscar a un médico** experimentado, que **gozaba** de una grande reputación.
 ‘They went to **look for an experienced doctor**, who **enjoyed** a great reputation.’
- (15) Fueron **a buscar un médico extranjero** que **conociera** las enfermedades del país.
 ‘They went to **look for a foreign doctor** who **would know** the country’s diseases.’

The variant with *a*, seen in (14), has a specific indefinite reading (‘a known individual’), and the verb of the subsequent relative clause is realis (*gozaba* in (14)). In the variant lacking *a* in (15) the noun has a non-specific, or attributive, reading: that is, “the speaker wishes to assert something about whatever or whoever fits that description.”¹⁷ Since the referent is hypothetical, the verb of the subsequent descriptive relative clause is subjunctive (*conociera* in (15)). Following Bello, we derive a three-way contrast: *buscar al médico que V_{INDC}* ‘to search for the doctor who...’ (definite referent, indicative dependent clause) / *buscar a un médico que V_{INDC}* ‘to search for a certain doctor who...’ (indefinite specific referent, indicative dependent clause) / *buscar un médico que V_{SBJV}* ‘to search for a (any) doctor who...’ (attributive indefinite referent, subjunctive dependent clause). Tacitly, the fourth combination *buscar a un médico que V_{SBJV}* is precluded. This paradigm has been codified in subsequent discussions.¹⁸

At first glance some examples on the internet support this description:

¹⁶ Thanks to Elkin Gutiérrez for consultation on Spanish.

¹⁷ Donnellan 1966.

¹⁸ For example, García and van Putte 1995.

- (16) No resistió más y **buscó a una mujer** llamada Lilith Lanou.¹⁹
 ‘He could resist no longer and **sought a woman** named L. L.’
- (17) A la hora de casarse, Bush **buscó una mujer que fuera** lo más diferente posible que su madre: cálida, no fría; tímida, no enérgica; doméstica, no política.
 ‘When it came time to marry, Bush **sought a woman who would be** as different as possible from his mother: passionate, not cold; timid, not energetic; domestic, not political.’

In (16), with *a*, a specific woman is sought; in (17), without *a*, the future president sought to marry someone, indifferent who, as long as it is someone who “fits that description.” This pair fits Bello’s analysis.

In actuality, usage on the web is not so cleanly divided between specific indefinite and non-specific (attributive) indefinite. All four variants—with or without *a*, with subjunctive or indicative in the relative clause—occur on the web (in the genre of personals). The results, shown in Table 3, are twice surprising. First, the canonical combination of *busco a una mujer que sabe* _{INDC...}, with *a* and indicative, is in fact rare. ((16) is one of the few examples I’ve found.) In this genre of text, *busco a una mujer que sepa* _{SBJV...}, in which *a* is followed by a relative clause with the subjunctive, is quite frequent; given the genre of text, the desired object is attributive in reference, and yet it is preceded by *a*.

Table 3: Google search for *buscar (a) mujer que...*

<i>busco a una mujer que sabe</i> _{INDC...} ...	‘I seek a woman who knows...’	5
<i>busco a una mujer que sepa</i> _{SBJV...} ...	‘I seek a woman who would know...’	375,000
<i>busco una mujer que sabe</i> _{INDC...} ...	‘I seek a woman who knows...’	482,000
<i>busco una mujer que sepa</i> _{SBJV...} ...	‘I seek a woman who would know...’	41,300

Accessed Feb 20, 2010 (Google, Spanish language)

Second, in a relative clause subordinate to *busco una mujer* (without *a*), the subjunctive is actually less frequent than the indicative. In short, the paradigm codified in the literature is not confirmed by contemporary usage on the internet.

As a second construction, let us consider the use of *a* with inanimate objects of verbs of association (*modificar* ‘modify’, *acompañar* ‘accompany’, *sustituir* ‘substitute’), positioning (*preceder* ‘precede’, *seguir* ‘follow’ [Bello 1977:§897]), and definition (*identificar* ‘identify’, *especificar* ‘specify’, *llamar* ‘name’, *considerar* ‘consider’, *designar* ‘designate’, *definir* ‘define’, *caracterizar* ‘characterize’).²⁰ These verbs all predicate a relationship between an inanimate object and a locus of orientation; the object is sometimes marked with *a*. Following the lead of Weissenrieder (1991), I looked at how *caracterizar* ‘to characterize’ is used in Luján’s treatise on adjectives. I found 9 tokens of forms of *caracterizar* (two of them conjoined

¹⁹ Accessed 10.02.2006. When I originally accessed this and the next example (17), I failed to record the URLs; they are no longer on the web.

²⁰ Weissenrieder 1991:147, with citations of earlier literature.

with another verb). In three instances the object occurred with *a*; the subject was an abstract property construed as a characteristic of the object, as in:

- (18) la entonación ‘entre comas’ que **caracteriza a las cláusulas apositivas...** (Lujan 1980:122)
 ‘the “between-commas” intonation **which characterizes appositive clauses...**’

Similar are: *componentes... que caracterizan y distinguen a estos dos tipos* (Lujan 1980:38–39) ‘components... which characterize and distinguish these two types’; *varias características importantes que caracterizan a la cláusula apositiva* ‘various characteristics which characterize the appositive clause’ (Lujan 1980:77). In contrast, there were six tokens without *a*, five of which involved an agent (or an analytic framework metonymic of an agent) that formulates or provides a characterization, as in:

- (19) Un análisis adecuado debe **caracterizar esta relación** de hiponimia. (Lujan 1980:38)
 ‘A satisfactory analysis should **characterize this relation** of hyponymy.’

Thus in the usage of Luján’s treatise, there is a sharp division between two senses of *caracterizar*: an agent providing a characterization (no *a*) as opposed to an abstract property that states a characteristic property (with *a*).

Only one example (the ninth of this small sample) did not fit this pattern:

- (20) Precedido por un artículo, el adjetivo pronominal con un nombre propio **caracteriza el estilo de la lengua escrita** (Lujan 1980:85)
 ‘Preceded by an article, the pronominal adjective with a proper noun **is characteristic of the style of written language...**’

(20) has an abstract characteristic as subject and so at first blush is semantically analogous to (18), but unlike (18), (20) does not have *a* preceding the object. For this reason, the phrases *caracteriza el estilo* and *caracteriza al estilo* ‘characterizes the style’ appeared to be worth further investigation. A Google search for these phrases revealed real variation (Table 4):

Table 4: Google search for “caracteriza {el/al} estilo”

phrase	raw number of tokens
<i>caracteriza el estilo</i>	152,000
<i>caracteriza al estilo</i>	356,000
<i>que caracteriza el estilo</i>	375,000
<i>que caracteriza al estilo</i>	292,000

Accessed Feb 20, 2010 (Google, Spanish language)

It is puzzling that the number of tokens of *que caracteriza el estilo* with *que* exceeds the number of tokens of that phrase without *que*. Be that as it may, the two variants, with or without *a*, occur with frequencies on the roughly same order of magnitude.

Because the number of tokens is prohibitively large, I contented myself with the exploratory measure of extracting the first 50 tokens of *caracteriza el estilo* and the first 50 of *caracteriza al estilo* that appeared in the search.²¹ I first counted types of subjects, divided into: relativizing *que*, interrogative *qué*, indefinite *algo* ‘something’, SVO order (*piedras rústicas y lajas caracterizan el estilo local* ‘rustic stone and flagstone characterize the local style’), or VOS order (*caracteriza al estilo de Bécquer cierta vaguedad* ‘what characterizes Bécquer’s style is a certain vagueness’), as tabulated in Table 5.

Table 5: *Distribution of “a” in “caracteriza {el/al} estilo,” by subject*

<i>subject</i>	<i>xx tokens without a</i> (% of tokens without a)	<i>xx tokens with a</i> (% of tokens with a)
relative <i>que</i>	41 (82%)	44 (88%)
interrogative <i>qué</i>	0 (0%)	2 (4%)
indefinite <i>algo</i>	2 (4%)	2 (4%)
noun, SVO	6 (12%)	0 (0%)
noun, VOS	1 (2%)	2 (4%)

The numbers don’t reveal much. As it happens, the subject of *caracteriza {el/al} estilo* is almost always the relativizer *que* in both variants, which tells us nothing about what conditions *a*. Two minor points: SVO order prevents *a* and interrogative *qué* elicits *a*, as in *¿Qué caracteriza al estilo de vida adolescente actual?*²²

Another thought was that perhaps the degree of individuation might influence usage. But in all cases the noun *estilo* is definite. Could the possessor affect usage? Table 6 records the behavior of *estilo*: possessed by a proper noun, modified by adjectives describing cultural movements (*berlinés* ‘Berlin’, *mudéjar* ‘Muslim’), possessed by a common noun, or without possessor (and including tokens with a descriptive adjective such as *distintivo* ‘distinctive’).

Table 6: *Distribution of “a” in “caracteriza {el/al} estilo,” by possessor noun*

<i>estilo modified by...</i>	<i>xx tokens without a</i> (% of tokens without a)	<i>xx tokens with a</i> (% of tokens with a)
proper noun possessor	20 (40%)	18 (36%)
adjective of specific culture	9 (18%)	12 (24%)
common noun possessor	17 (34%)	15 (30%)
no possessor / descriptive adjective	4 (8%)	5 (10%)

A proper noun possessor (*el estilo decadente de Rachilde* ‘the decadent style of Rachilde’, *al estilo pictórico de Miguel Angel* ‘the visual style of Miguel Angel’) is slightly more frequent than a common noun possessor, but that is true of sentences with or without *a*, so the possessor tells us nothing about which contexts favor or disfavor *a*. Thus these two tangible parameters—

²¹ Excluding duplications and excluding tokens that could not be accessed or manipulated on the first page reached (including Google Book pages). I almost eliminated the seven examples with human subjects (six with *el estilo*, one with *al estilo*) and replaced them the next examples in the search.

²² http://www.dircom.udel.edu.pe/index.php?t=2010/febrero/397_04.

subject, possessor/modifier as possible measure of individuation—have dominant patterns that occur both with and without *a*, and accordingly tell us nothing about the use of *a* or its absence.

Another methodological tactic is to stare at the examples and see if there is a difference in the sense of the sentences with and without *a*. This approach seems promising, at least if we select the most explicit examples and extrapolate from them. A simple example of *caracteriza el estilo* is (21), where the possessor (celebrities) and their distinct style are taken for granted. The new information is the property (shoulder bags) associated with this style.

- (21) Si hay algo **que caracteriza el estilo de las celebrities** de todo el mundo es su gusto por llevar un buen bolso colgado del brazo. Esta es la lista de los más buscados del invierno.²³
 ‘If there is anything that **is characteristic of the style of celebrities** throughout the world it is the predilection for carrying a shoulder bag. Here is a list of the most sought after this winter.’

As noted earlier in Table 6, the order SVO (where S = characteristic property, O = style) favors omitting *a*, possibly because this order is used to introduce a property that had not previously been named, like Oolong tea in (22) in a description of a tea house:

- (22) El té Oolong, servido en pequeñas teteras, **caracteriza el estilo** de esta casa de té.²⁴
 ‘Oolong tea, served in small teapots, **is characteristic of the style** of this tea house.’

In (23), the collocation is modified by *precisamente*, which focuses on the degree of fit of the property (here, the conceptualism of Góngora) with a given style (Baroque):

- (23) Su mayor error fue confundir impersonalidad con objetividad. **Lo que caracteriza el estilo de Wyler es precisamente** la objetividad.²⁵
 ‘His main fault was to confuse impersonality with objectivity. That which characterizes the style of Wyler is precisely objectivity.’

These examples lacking *a* are assertions of existence: given a known style, let us describe it by establishing the existence of one or more associated properties.

Sentences with *al estilo* have a different function. When *a* is used, it differentiates one style from others; the properties that are named differentiate this style from others:

- (24) Definitivamente el estilo es "Funk", este proviene de la mezcla del Jazz (de aquí sus acordes), Soul y Rock & Roll, algo **que caracteriza al estilo** es el uso de acordes de 4 o mas sonidos moviendose muy ritmicamente al igual que el bajo en "Slap"...²⁶
 ‘Definitely the style is "Funk", it comes from the mixture of Jazz (whence its chords),

²³ <http://www.cienporcienmujer.com/moda/los-bolsos-favoritos-de-las-famosas-36303.htm>.

²⁴ <http://beijing.runweb.com/page-910-lang-ES-2V-page,Cultura-china-de-te.html>.

²⁵ http://www.archivodeprensa.edu.uy/r_monegal/bibliografia/prensa/artpren/film/cine_04.htm.

²⁶ <http://www.hispasonic.com/comunidad/acordes-con-septima-estilo-jazz-t193917.html>.

Soul, and Rock & Roll, something **which characterizes the style** is the use of chords of 4 or more notes moving very rhythmically as with “Slap” bass...’

Here one musical style (Funk) is differentiated from others; a specific musical technique is said to be its distinctive property. In (25) the contemporary state of affairs is differentiated from the prior state of world health; multiple distinctive features are listed:

- (25) Los malos hábitos de alimentación y la vida sedentaria **que caracteriza al estilo de vida actual** son los principales responsables de la alta incidencia de sobrepeso, obesidad, resistencia a la insulina y Diabetes que está afectando a la población mundial.²⁷
 ‘Bad dietary habits and sedentary life **which is characteristic of the contemporary lifestyle** are the main factors responsible for the high incidence of excess weight, obesity, insulin resistance and diabetes which affect the world’s population.’

A minimal pair occurs on one site in a discussion of journalistic styles ((26)):

- (26) Características generales...
 Los dos rasgos esenciales **que caracterizan el estilo periodístico** son: su uso utilitario y su propósito de comunicación.

...

Propiamente hablando, no hay un único estilo periodístico, sino tres modalidades distintas, cada una de las cuales puede ser considerada como un estilo periodístico diferenciado de los otros:

- El estilo informativo
- El estilo de sollicitación de opinión
- El estilo ameno

6.8.1.1 El estilo informativo

...

La tercera condición... consiste en ofrecer al lector un resumen completo de los elementos básicos que están presentes en el suceso que se pretende describir y que se muestra en el primer párrafo... La técnica de la pirámide invertida **caracteriza al estilo informativo**.²⁸

‘General Features ...

There are two essential features that **characterize journalistic style**: utility and purpose of communication.

...

Strictly speaking, there is no single style of journalism, but rather three different modes, each of which can be considered distinct from the others:

- reporting style
- opinion style

²⁷ <http://www.diabetesaldia.com/Default.aspx?SecId=300>.

²⁸ http://www.umce.cl/~cipumce/publicaciones/cuadernos/facultad_de_historia/metodologia/cuaderno_09/redaccion_informativa_tipos_de_redaccion.htm.

entertaining style

6.8.1.1 The reporting style

...

The third condition... is to offer the reader a complete overview of the basic elements that are present in the event which is described and recorded in the first paragraph... The inverted-pyramid technique **characterizes the reporting style.**'

The first token of *caracteriza*, in which the object lacks *a*, provides a general characterization of journalism (given that we are talking about journalism, let us provide some *características generales*). The second part of (26) provides a typology of three styles and a statement of the property that differentiates “reporting style” (with *a*) from the other two styles.

To summarize, the variation in the sentences cited above relates to existentiality vs. differentiation (individuation) on the discourse level. *Caracterizar el estilo* establishes the existence of a property associated with a known and presumably unique entity, while *caracterizar al estilo* differentiates one style from others which might be under discussion, and names the distinctive properties. That is to say, with inanimate objects of verbs of relation (association, position, definition), the choice of *a* is not purely a function of the reference of the noun, but is correlated with different discourse concerns.

5. Individuation in general

Let me end the discussion by mentioning two general issues. The discussion above suggests that, in the usage of any construction, some possibilities are more fixed (or conventionalized), some open to fluid discourse operations. Recall that, in Russian, almost all nouns that (typically, by convention) refer to living beings take the animate accusative even when they refer to the carcasses of once living beings. Conventionalization might help us understand how it is that changes such as the expression of animacy are perpetuated over time. Evidently usage that was experimental or variable at one stage gets conventionalized and prompts or allows further extensions of variable usage. As I suggested in Timberlake 1999, “Change proceeds in a cyclical fashion. Each new phase of innovation relies on the conventionalization of the previous innovation.” I confess I am not at all sure how to represent the difference between conventionalized as opposed to fluid grammar. One familiar possibility is to list as many distinct factors as possible that seem to be involved and describe variation in terms of these factors; on the order of a dozen were recorded for the Russian genitive of negation (Timberlake 1975) and Spanish *a* (notably Isenberg 1968). One can then create a branching tree of possibilities (as in Isenberg and, with a different theoretical background, Aissen 2003). With a branching tree one could try to weight the variables and calculate the contribution of each, as in the variable rules developed by Cedegren and Sankoff (1974). Variable rules seem admirably suited to describing variation within texts or in a community, but variable rules describe a probability, a contribution of each variable. A speaker, in choosing a form in a given linguistic and extralinguistic context, has to somehow weigh factors and arrive at a binary decision; it won't help a speaker to know that the genitive of negation in Russian or the *a* in Spanish has a likelihood of .53 for a certain constellation of features; a choice must be made.

Diachronically a branching tree of features suggests that languages check off nodes one by one in discrete fashion. In fact, change in usage proceeds gradually for any given node; more than one node change at the same time, though some nodes change earlier than others. At any stage, for a given combination of features, there will be competition between the two forms of the construction, with or without *a*. For example, García (1993) examined the use of *a* over four centuries from El Cid (end of the twelfth century) through two versions of Cavallero Zifar (early thirteenth, late fourteenth) to Cervantes’ Don Quixote (c. 1600), as repeated in Table 7.

Table 7: “a” with animate direct objects in four Old Spanish texts (García 1993:39)

	El Cid (c. 1200)	Cavallero Z (early 13th c.)	Cavallero Z (late 14th c.)	Don Quixote (c. 1600)
definite singular	50%	65%	72%	90%
indefinite singular	20%	20%	43%	57%
definite plural	16%	6%	37%	67%
indefinite plural	17%	0%	12%	23%

The change does not occur by first generalizing *a* for one feature or feature combination, such as definite singular, before moving to the next cell or feature combination. In a similar fashion, certain verbs (*matar* ‘kill’) are more likely to take *a* than other verbs (*tomar* ‘take’), but it is not the case that any one verb (such as *matar*) generalized *a* completely before the next verb began to use *a* (von Heusinger 2008). Rather, the same hierarchical factors remain active over the long period of gradual extension of the use of *a* over time.

To describe this kind of scenario, we might avoid the usual approach, which is to construct a single rule for picking the expression of a concept—for example, a single rule telling us when to use *a*, when not, for direct objects. Instead, we might treat the two possibilities—direct object marked by no preposition and direct object marked by *a*—as separate constructions²⁹ and then ask when it is appropriate to use each. True, when usage is highly conventionalized, one of the other construction will predominate or exclude the other; thus in modern Spanish, the construction with *a* is used obligatorily with definite human direct objects. Much usage is parceled out in complementary fashion between the two constructions, a fact which can give the impression that a single rule chooses one or the other expression of objects of a transitive verb. But at every historical stage there are contexts or configurations where both constructions can be used. In such instances of variation (“optional usage”), if we posit two constructions, then we can perhaps understand how they would both be possible but be used with different, vague, discourse overtones like existentiality vs. differentiation. García (1993:43–44) states the problem well:

What ultimately determines the presence of *a* is an overall judgment of focus-worthiness based on the entire reference-in-context complex. The diachronic question is, of course, how the overall judgment of focus-worthiness could become more and more lenient, since we find *a* spreading, over time, into more referential types/contexts.

²⁹ “Trafarety” (templates), as they were called in Živov & Timberlake 1997.

Leaving aside the question of whether focus-worthiness is the right concept to determine the use of *a* (I would prefer existentiality vs. individuation/differentiation), García's comments points to the question of variable usage and gradual change: how to state at any synchronic stage that use of *a* is more or less likely for some combination of features and how to state a gradual change over time in the degree of preference for one or another variant. This degree of "leniency" could be called the problem of calibration: the parameters of grammar do not really change (e.g., *a* is consistently favored by proper, definite, personal, singular nouns) but the usage does change, and does so in an incremental fashion. My best guess is that we need to fine-tune statements of usage to reflect degrees of insistence on the vague discourse consideration. For example, in *El Cid*, *a* is generally not used in discussions of marrying off the two definite daughters of Cid, but *a* is used when there is a contrast in the sentence; as *a* expands over time, the condition for using *a* will become, well, more lenient. Whether that is a fruitful approach to the problem of calibration remains to be seen. I only want to suggest that, even if we describe usage in terms of competing constructions, it will be a challenge to calibrate the choice between variants.

A second issue is the broad question of what motivates differential object marking. Questions of this sort are very familiar to Slavists, who, under the aegis of Roman Jakobson (notably Jakobson 1936), have looked for the *Gesamtbedeutung* of morphological forms, that is, an abstract, global semantic parameter that would characterize every use of the form in every context. For example, one might suggest, as Jakobson did, that the genitive case indicates a restriction on the participation of an entity in the predication. This abstract characterization motivates the genitive of negation well, since negation excludes the object from participation; to describe contemporary Russian, where there is variation between accusative and genitive for objects of negated verbs, one could say that genitive means the object is *thoroughly* excluded.

Spanish *a* has spawned a number of similar global interpretations:³⁰ *a* avoids ambiguity with the subject; *a* marks animacy, or definiteness, or a combination of the two features, which is to say, individuation; *a* marks high transitivity, or kinesis (or individuation plus kinesis (Kliffner 1995)); *a* marks focus-worthiness (García 1993) or topicality, especially marked by a pleonastic pronoun (Melis 1995); *a* is used to the extent the object is subject-like; *a* is used to the extent the object is atypical (Laca 1995). Each of these proposed principles has a certain justification, but each has imperfections.

It is worth making explicit that similar considerations have been at play in the historical development of animacy in Russian and in Spanish. The parameters that elicit the expression of animacy—a high degree of animacy, a high degree of referential uniqueness—have affected the development of both processes. The parameters involved in animacy are the inverse of the parameters involved in the Russian genitive of negation. The genitive of negation is inhibited by exactly those factors which promote marking of animacy: animacy and referential uniqueness inhibit the genitive of negation but favor marking animacy. In the genitive of negation, there is no real question of ambiguity of subject and object. This fact suggests that whatever is at play in these processes is more abstract than the functionalist need to avoid ambiguity.

In early work on the genitive of negation (Timberlake 1975), I suggested that individuation is a concept that generalizes over many of the more specific factors involved in the

³⁰ Reviewed with clarity in Pensado 1995.

choice between accusative and genitive. Individuation answers the question that is implicit in Comrie's 1979 cross-linguistic demonstration that differential object marking marks definite objects in some languages (Uzbek, Persian) and animacy in others (Russian, Spanish). The parallelism between the two parameters, and the fact that they are mutually supportive (as in Spanish), suggests that the two considerations form a "natural class." In what sense? Individuation: animate beings are conventionally understood as individuals more readily than inanimate entities; referentially unique entities are individuated from others in a class. In the same vein it is perhaps instructive to think of the "animacy hierarchy" as it applies to the expression of number cross-linguistically (Corbett 2008) as an individuation hierarchy, since it includes distinctions such as pronouns vs. nouns, proper vs. common, and count vs. mass; these are all distinctions of individuation rather than animacy in the strict sense.³¹

That said, the concept of individuation needs refinement. Evidently individuation is relevant not just at the level of nouns; the concept extends to verbs and ultimately to discourse, when it might better be called differentiation. And it is important to say that the opposite of individuation is existentiality. Existentiality means that the concern of the discourse is with establishing the existence of something (a situation or entity) as opposed to its absence. Existentiality is opposed to individuation, which means concern with differentiation of something (situation or entity) from alternatives deemed relevant.

Why existentiality and individuation (or differentiation)? I would suggest that the distinction is one of the fundamental things we do with language. Language can be used to address the question of whether a situation or entity exists; that is existentiality. Or language can presume existence and then differentiate possibilities: this entity as opposed to others, this property of an entity as opposed to another property, this possible event as opposed to other alternative worlds, and so on. An independent illustration of this difference comes from Jacalteco (Craig 1977). Sentences that assert possession (a form of existentiality) normally have an overt existential marker *ay* of suspicious etymology (27):

- (27) ay-xa cawing w-unin
 exist-already two my-child
 'I already have two children.'

The existential marker disappears when one constituent is emphasized ((28)):

- (28) cawang-xa w-unin
 two-already my-child
 'I already have *two* children!'

In (28) the number of actual children is contrasted with other possible quantities, and when that happens, the proposition has "shifted from a statement of existence to the presupposition of existence" (Craig 1977:22). That is to say, (27) is existential, while (28), by virtue of its concern with alternate possible quantities, is differential.

³¹ As implicitly in Silverstein 1976, explicitly in Comrie 1989:186, 194–95.

Why should the difference between existentiality and differentiation be relevant to objects in particular?³² Individuated entities have an existence independent of the specific proposition. There are other things one could say about them in addition to how they are affected in the given proposition. Their long-term interest to the speaker is not limited to the simple question of existence or non-existence. In describing the scene of the mother's death in an autobiography, the speaker says *ja ne pomnju Andrijušu*_{ACC.SG} 'I do not remember Andryusha'—with accusative, not genitive of negation. Were the author to use the genitive here, it would suggest she lacks any memory of her half-brother Andrey, which of course is not the case—he exists and is a permanent part of her world knowledge. What she is negating here is memory of a quite restricted property, whether he was present on the occasion of the mother's death. The restriction of the failure of memory to one property, among many properties that are known and could be relevant of the highly individuated proper animate noun Andrey, is the reason why the accusative, not the genitive, is used for this object of a negated verb used. When the object entity has multiple properties that are known and possibly relevant, or when the event is one of several possible scenarios that could be envisioned, the given proposition is only one of the properties one might think of in connection with the entity. Because the referent has an independent existence, the operation of pinning a property on the entity is indirect, incomplete, accidental and not essential. In contrast, the genitive of negation would in fact be used when reference is attributive and the question is whether anything at all is remembered: *ja ne pomnju morja*_{GEN.SG} 'I don't remember the sea (= there being any sea).'

Reverse this reasoning and we have the diachronic motivation for adapting the dative preposition to become the marker of animate direct objects in Spanish: the attribution of properties approaches but does not encompass the whole informational relevance of the patient, in analogy to the way in which moving something towards a goal or beneficiary merely adds something to that goal or beneficiary but is not essential to its definition.³³ The autonomy of animate patients contrasts with the absence of autonomy characteristic of mass objects that are conventionally associated with a certain predicate, as is true of, say, *tea* and *drink*. Such undifferentiated objects and contourless actions of the type *drink tea* often lead to quasi-incorporation of the object and partial or significant detransitivization of an otherwise transitive verb (many examples are cited in Hopper and Thompson 1980:257–59). There is a gradation from thoroughly internal patients without autonomous referential properties to neutral patients to autonomous patients, who are to an extent above the fray and who are not exhaustively defined by a given proposition.³⁴ Differential object marking is used to mark one or the other end point of this scale: either indefinite objects (or incorporated objects) are marked as internal (by incorporation and detransitivization—or the genitive case if the verb is negated in Russian) or

³² As possible motivations for animacy, Comrie (1989:198–99) mentions but criticizes “topic-worthiness” and “salience” (said to be “essentially the same thing” as individuation) on the grounds they will lead to circularity. It may be too rigid to think of individuation strictly in terms of nominal reference. Individuation and its opposite, existentiality, are fundamental ways of conceptualizing events and entities. What we see in differential object marking is conventionalization of typical patterns of usage: animates are more likely to be individuated, etc. Inevitably there will be circularity.

³³ Laca 1995:74–77.

³⁴ Laca (1995) restates individuation as “autonomía referencial” (autonomous reference).

individuated objects (animate, definite) are given special morphological marking because they have value and interest to the speaker beyond the given proposition. I would suggest, then, that differential object marking and individuation have to do not so much with the external, real-world properties of objects as with their (conventional) significance in the speaker's world. This concern can be relevant at the level of the object itself or the collocation of verb and patient or the level of discourse.

References

- Aissen, Judith. 2003. Differential object marking: Iconicity vs. economy. *Natural Language and Linguistic Theory* 21:435–448.
- Bello, Andrés. 1977. *Gramática de la lengua castellana (anotada por R. J. Curevo)*. Buenos Aires: Ediciones Anaconda.
- Cedergren, Henrietta J. and David Sankoff. 1974. Variable rules: Performance as a statistical reflection of competence. *Language* 50:333–355.
- Comrie, Bernard. 1979. Definite and animate direct objects: A natural class. *Linguistica Silesiana* 3:13–21.
- Comrie, Bernard. 1989. *Language universals and linguistic typology. Syntax and morphology*. 2nd edn. Oxford: Basil Blackwell.
- Corbett, Greville. 2000. *Number*. Cambridge, UK; New York: Cambridge UP.
- Craig, Colette. 1977. *The structure of Jacalteco*. Austin: U of Texas P.
- Donnellan, Keith. 1966. Reference and definite descriptions. *The Philosophical Review* 75: 281–304.
- García, Erica C. 1993. Syntactic diffusion and the irreversibility of linguistic change: personal *a* in Old Spanish. *Sprachwandel und Sprachgeschichte: Festschrift für Helmut Lüdtke zum 65. Geburtstag*, ed. J. Schmidt-Radefeldt and A. Harder, 33–50. Tübingen: Narr.
- García, Erica and Floriman van Putte. 1995. La mejor palabra es la que no habla. *El complemento directo preposicional*, ed. Carmen Pensado, 113–132. Madrid: Visor.
- Hopper, Paul and Sandra Thompson. 1980. Transitivity in grammar and discourse. *Language* 56:251–299.
- Isenberg, Horst. 1968. *Das direkte Objekt im Spanische*. *Studia grammatica*, 9. Berlin: Akademie-Verlag.
- Jakobson, Roman. 1936. Beitrag zur allgemeinen Kasuslehre. *Travaux du Cercle Linguistique de Prague* 6:240–288.
- Kliffner, Michael D. 1995. El “A” personal, la *kínesis* y la individuación. *El complemento directo preposicional*, ed. Carmen Pensado, 93–111. Madrid: Visor.
- Laca, Brenda. 1995. Sobre el uso del acusativo preposicional en español. *El complemento directo preposicional*, ed. Carmen Pensado, 61–92. Madrid: Visor.
- Luján, Marta. 1980. *Sintaxis y semántica del adjetivo*. Madrid: Cátedra.
- Melis, Chantal. 1995. El objeto directo personal en *El Cantar de Mio Cid*. Estudio sintactico-pragmatico. *El complemento directo preposicional*, ed. Carmen Pensado. Madrid: Visor, 133–163.

- Mustajoki, A. 1985. *Padež dopolnenija v russkix otricatel'nyx predložnijax. Izyskanija novyx metodov v izučeníi staroj problemy*. *Slavica Helsingiensia*, 2. Helsinki.
- Pensado, Carmen. 1995. El complemento directo preposicional: estado de la question y bibliografía comentada. *El complemento directo preposicional*, ed. Carmen Pensado, 11–60. Madrid: Visor.
- Silverstein, Michael. 1976. Hierarchy of features and ergativity. *Grammatical categories in Australian languages*, ed. R.M.W. Dixon, 112–171. Canberra: Australian Institute of Aboriginal Studies.
- Timberlake, Alan. 1975. Hierarchies in the genitive of negation. *Slavic and East European Journal* 19:123–138.
- Timberlake, Alan. 1999. Change as *kairos* and *khronos*. Paper presented at International Conference on Historical Linguistics XIV, Vancouver, British Columbia, 14 August 1999.
- Ueda, Masako. 1993. Set-membership interpretations and the genitive of negation. *Russian Linguistics* 17:237–262.
- von Heusinger, Klaus. 2008. Verbal semantics and the diachronic development of DOM in Spanish. *Probus* 20:1–31.
- Weissenrieder, M. 1991. A functional approach to accusative *a*. *Hispania* 74:146–156.
- Živov, V. M. and Alan Timberlake. 1997. Rasstavajas' so strukturalizmom. *Voprosy jazykoznanija* 46.3: 3–14.

PF FACTORS IN PRONOMINAL CLITIC SELECTION IN TZOTZIL*

Ellen Woolford
University of Massachusetts
woolford@linguist.umass.edu

Aissen's work on agreement in Tzotzil helps shed light on current theoretical questions involving the relative roles of syntax and PF in cross-referencing systems. Tzotzil shows that a language can have two distinct series of pronominal clitics, in different positions, which cross-reference the same argument. Under the account proposed here, both series are generated in syntax, and at the syntax/PF interface the decision is made to spell-out one or the other, or both, based partially on constraints involving phonology and prosodic structure.

1. Introduction

This paper was stimulated by the complex and puzzling facts about agreement in the Mayan language Tzotzil described in Aissen 1987. This book, like Aissen's entire body of research over the past thirty years, continues to be extremely important for addressing current theoretical questions and stimulating new questions. This paper builds on the generalizations concerning agreement in Tzotzil in Aissen 1987 to explore the question of the relative roles of syntax and PF in producing complex surface cross-referencing patterns.

The central problem involves an interesting difference between Tzotzil and other Mayan languages. The other Mayan languages fall into two groups with respect to the position of the Set B series which cross-references objects in transitive constructions (Bricker 1977). In languages such as Jacaltec (Craig 1977) Set B forms precede the verb as in (1), but in languages such as Yucatec Maya (Bricker 1981) Set B forms are suffixed to the verb, as shown in (2).

(1) Ch -ach w- ila. [Jacaltec]
ASPECT 2ndSetB 1stSetA see
'I see you.'
(Craig 1977:90)

(2) T- inw- il -ah -eč. [Yucatec Maya]
COMPLETIVE- 1stSetA see PERFECTIVE 2ndSetB
'I saw you.'
(Bricker 1981 (2))

Tzotzil differs from both groups in that it has two series/subsets of Set B forms, one in each position. The prefixed series is shown in (3), while the suffixed series is shown in (4):¹

* I would like to thank Elizabeth Selkirk and Matt Wolf for valuable discussion of the phonological and prosodic issues in this paper.

¹ J is a voiceless glottal spirant.

syntax. The prefixed series is adjoined to the VP (a phrasal clitic, in the terminology of Marantz 1988), while the suffixed series is adjoined to the verb (a head clitic in Marantz's terminology).² In syntax, these are only feature bundles (Chomsky 2000, Halle and Marantz 1993). At PF, the determination is made as to which bundle(s) will be spelled out, and this decision involves phonological and prosodic constraints, in addition to the need to spell out features.

The presence of the aspect head matters, I argue, because this allows the phrasal clitic to be suffixed to that head, in the configuration in (8).

(8) (_{Pwd} aspect-clitic (_{Pwd} SetA-verb))

This is preferable to suffixing the head clitic to the verb, as in (9), because a clitic in that position interferes with the desired alignment of the right edge of the verb stem with the right edge of the prosodic word; nevertheless that is the only choice when there is no aspect head:

(9) (_{Pwd} SetA-verb-clitic)

The configuration in (9) is also used even when an aspect head is present in the one exceptional case where the configuration in (8) would produce a vowel vowel sequence.

An important point is that undesirable prosodic configurations involving a clitic can be avoided by simply not spelling out that clitic, but this option is limited by the fact that certain features must be spelled out (first and second person and plural). However, it is not necessary to spell out both clitics in Tzotzil if these features can be spelled out on one clitic.

There is an interesting generalization pointed out in this paper that needs to be accounted for, involving an asymmetric pattern of redundancy avoidance in Tzotzil.

(10) The choice of which features to spell on the suffixed Set B form depends on what features are spelled out in the prefixed Set B form, but not vice versa.

I show that this asymmetry is expected under the hypothesis that morphemes are spelled out one at a time at PF (as in Wolf 2008), if the prefixed form is spelled out first in Tzotzil.

These complex Tzotzil facts from Aissen's work are theoretically important in that they show that a language can have two series of clitics in different positions which cross-reference the same argument, and that decisions about which of these clitics will surface cannot be made until the syntax/PF interface because phonological and prosodic considerations are involved.

This paper is organized as follows. In section 2, the Set A forms of Tzotzil, which cross-reference transitive subjects, are briefly discussed as background to the analysis of the Set B forms. Section 3 focuses on the choice between the prefixed and suffixed series of Set B forms, and the role of phonology and prosody in that choice. Section 4 turns to situations in which both the prefixed and suffixed Set B forms are spelled out in the same clause. This section focuses on the puzzle of why the prefixed form is used even when it is entirely redundant, and shows how the asymmetrical redundancy pattern of these data support Wolf's (2008) hypothesis that in the

² I follow Klavans 1995 in assuming that pronominal clitics are adjoined syntax, but this assumption is not crucial.

decision as to which morpheme to insert from the lexicon, there is no ‘look ahead’ to morphemes not yet spelled out, but there is ‘look back’ to consider features already spelled out by a morpheme already inserted.

2. Set A Variants

Although the focus of this paper is on the process of selecting Set B forms in Tzotzil, we begin with a brief look at the Set A forms as background. The Set A prefixes, which are used to cross-reference transitive subjects in Tzotzil, attach to the left edge of the verb stem (Aissen 1987:43).³ The Set A forms are inside the same prosodic word as the verb, by the evidence that syllabification is possible across the morpheme boundary. There are two sets of Set A allomorphs, and the choice depends on the initial sound of the verb stem. One Set A allomorph series attaches to a vowel initial stem, and the other to a consonant initial stem.⁴

(11) Set A Prefixes (Aissen 1987:43)

	Prevocalic Forms	Preconsonantal Forms
1 st	k-	j-
2 nd	av-	a-
3 rd	y-	s-

Aissen (1987:43) gives the following examples to illustrate the use of these forms. In these examples, the object is third person and is thus not (overtly) cross-referenced. In the first set of examples, we see the prevocalic subset of Set A forms:

(12) K- il -oj.
1stSetA see PERFECT
‘I/we have seen it.’

(13) Av- il -oj.
2ndSetA see PERFECT
‘You have seen it.’

(14) Y- il -oj.
3rdSetA see PERFECT
‘He/she/they have seen it.’

We see in these examples that the consonant of the Set A form becomes the onset of the syllable whose vowel is initial in the verb root.

The examples below show the preconsonantal variants of the Set A forms:

³ I follow Aissen (1987) in using the traditional labels, Set A and Set B, for the cross-referencing forms of Tzotzil.

⁴ According to Aissen (1987:43), “all verb stems have an underlying initial consonant.” The vowel initial stems have an underlying initial glottal stop which deletes after a Set A form.

- (15) J- man -oj.
 1stSetA buy PERFECT
 ‘I/we have bought it.’
- (16) A- man -oj.
 2ndSetA buy PERFECT
 ‘You have bought it.’
- (17) S man -oj.
 3rdSetA buy PERFECT
 He/she/they have bought it.’

I follow the standard assumption of the Minimalist Program (Chomsky 2000), incorporated from Distributed Morphology (e.g. Halle & Marantz 1993) that cross-referencing elements are present in syntax, but only in the form of a feature bundle. The selection of an allomorph to insert to spell-out a Set A form cannot take place until the verb stem has been spelled out at PF, given that the choice of Set A allomorph depends on the initial sound of the verb stem.

Let us now turn to the selection of Set B forms in Tzotzil, where the decision involves something more dramatic than choosing an allomorph to fill one particular slot.

3. Phonology and the Selection of a Set B Series

The forms used to cross-reference objects and intransitive subjects are labeled Set B in Tzotzil, as in other Mayan languages, although as noted in the introduction to this paper, Tzotzil is different in having two Set B series which occupy different positions in the verbal complex. One precedes the Set A form, which precedes the verb stem, while the other Set B series suffixes to the verb stem.

- (18) aspect-SetB-SetA-verb-perfect-SetB

Reasons for considering the two Set B series as distinct series (rather than the same series spelled out in two different places at PF) include the fact that the forms in each series are morphologically distinct, and the fact that they encode different features. The prefixed series marks only person, while the suffixed series marks both person and number. An additional motivation behind this assumption is a conservative view of the abilities of PF, limiting it to spelling out (and in some cases linearizing) what is present in syntax. The morphemes in the two Tzotzil Set B series are listed in (19).

(19) The Set B Cross-referencing Forms in Tzotzil (from Aissen 1987:44)

Prefixed Series		Suffixed Series	
1st	-i-	1sg	-on
2nd	-a-	2sg	-ot
		1pl.incl	-otik
		1pl.excl	-otikotik
		2pl	-oxuk
		pl	-ik

Haviland (1981) and Aissen (1987) assume a zero 3rd person Set B prefix.

3.1. Selecting a Set B Series

Aissen (1987:44-45) gives us the descriptive generalization governing which Set B series is used in any particular clause:

- (20) The prefixed forms are used when an aspect prefix is present;
 otherwise the suffixed forms are used with one exception.
 (This exception is discussed below in section 3.2).

Although the choice of a series depends on aspect, this is not an aspect split in the typological sense (where one form is used in the perfective and another in the imperfective). In Tzotzil, what matters is the presence of an aspect prefix, not its meaning. The prefixed Set B forms must follow an aspect prefix, as in the examples in (21), while the suffixed Set B forms can occur in clauses with no aspect prefix, as in (22):

- (21) a. Stak' ch- a- j- kolta.
 can INCOMPLETE **2ndSetB** 1stSetA help
 'I can help you.' (Aissen 1987:15 (63), from Laughlin 1977)
- b. L- i- s- chanubtas.
 COMPLETE **1stSetB** 3rdSetA teach
 'He taught me.' (Aissen 1987:61 (2a))
- (22) a. J- mala -oj -oxuk.
 1stSetA wait PERFECT **2plSetB**
 'I have waited for you(pl).' (Aissen 1987:48 (20b))

- b. Tal -em -on.⁵
 come PERFECT **1sgSetB**
 ‘I have come.’ (Aissen 1987:44 (9d))

Why does the presence of an aspect suffix matter? Aissen (1987) gives us a clue in the way she lists these Set B morphemes, as *-i-* and *-a-*. That is, she essentially lists these morphemes as prefixes with additional subcategorization information indicating that they must be preceded by another morpheme. But why? I suggest that the answer involves phonology and prosodic structure. These Set B forms are prohibited in the initial position of a prosodic word. There are two possible reasons for this prohibition. One is related to the fact that both of the morphemes in the prefixed series of Set B forms are vowels; without a preceding aspect morpheme the result would be a prosodic word that begins in a vowel. We can see this in the ungrammatical version of the (b) example in (22), shown below:

- (23) *(_{Pwd} i- tal -em)
1stSetB come PERFECT
 ‘I have come’ (ungrammatical version)

This violates the phonological constraint known as Onset, which prohibits syllables that lack an onset consonant. Although this constraint is violable in Tzotzil, it is better if there is an alternate morpheme to use that does not produce this violation in the first place (following Wolf 2008). There is an alternative morpheme to use in Tzotzil, although it is in a different position: the suffixed Set B form. Using only the suffixed Set B form produces a prosodic word that begins with the verb stem, which is always a consonant initial form in Tzotzil, as in the grammatical version of the (b) example in (22), repeated below:

- (24) (_{Pwd} tal -em -on)
 come PERFECT **1stSetB**
 ‘I have come’ (grammatical version)

The second possible reason for the prohibition against beginning a prosodic word with a Set B form holds if the forms in this series are prosodic clitics, elements that are not parsed as independent prosodic words. The prosodic clitic would need to be parsed inside the prosodic word associated with the verb. However, this violates a prosodic constraint that requires the left edge of the verb stem to align with the left edge of a prosodic word (McCarthy and Prince 1993, Selkirk (in press)):

- (25) *(_{Pwd} clitic-verb stem)

The left edges of the verb stem and the prosodic word can be aligned if Tzotzil spells out a suffixed form of Set B instead of a prefixed form, as in (26):

⁵ The morphological form of the perfect suffix differs for transitive and intransitive stems (Aissen 1987:42).

(26) (_{Pwd}Verb stem-clitic)

The presence of an aspect head changes things because it provides something for the phrasal clitic to suffix to, outside the prosodic word that surrounds the verb stem, allowing both edges of the verb stem to be aligned with a prosodic word.⁶

(27) (_{Pwd} aspect-clitic (_{Pwd} verb stem))

To show this more formally, we need to state and rank these constraints, and show how the candidates compete to satisfy them. The constraint that requires the left edge of the verb stem align to the left edge of a prosodic word is formulated below:

(28) LEFT ALIGN-STEM Align (Stem, L, PrWd, L)

Align the left edge of every verb stem to the left edge of a prosodic word.

The stricter alignment constraint that requires both edges of a verb stem to be aligned to a prosodic word is formulated here as a Match constraint, following Selkirk (to appear):⁷

(29) MATCH (VSTEM, PRWD) The left and right edges of a verb stem must correspond to the left and right edges of a prosodic word.

I will assume that the stricter match constraint is ranked below the left alignment constraint in Tzotzil, but the results actually follow regardless of the relative ranking of these two constraints.

(30) Tzotzil ranking: LEFT ALIGN-STEM >> MATCH (VSTEM, PRWD)

The tableau below shows the competition that occurs when no aspect head is present in syntax. The input from syntax contains both Set B clitics, one preceding the verb stem and one following. The (a) candidate in this tableau spells out just the suffixed Set B form, while (b) spells out only the prefixed Set B form, and (c) spells out both. The left alignment constraint eliminates candidates (b) and (c) leaving candidate (a) as the winner.

⁶ Note that the choice of whether or not to use a prefixed form of the Set B series is not determined by the phonological properties of the preceding aspect morpheme. In fact, the reverse is true. There are allomorphs of the completive aspect prefix *l-* and *ʔi* (*ʔ* is a glottal stop) and the choice of which one to insert is determined by the following environment (Aissen 1987:41-42).

⁷ I assume here that the verb stem is the material under the V node from syntax, including any prefixes and suffixes that spell out features contained in that node. Here, these include the Set A agreement features and the aspect suffix.

(31) Without an Aspect Head

input from syntax: clitic verb stem clitic	LEFT ALIGN-STEM	MATCH (VSTEM, PRWD)
→a. (_{Pwd} verb stem-clitic)		*
b. (_{Pwd} clitic-verb stem)	*!	*
c. (_{Pwd} clitic-verb stem-clitic)	*!	**

A more complete picture would show why a (d) candidate that spells out neither clitic does not win. In fact, that candidate does win when the clitics are third singular. I assume here that a higher ranked constraint requires the spell out of a local (first or second person) cross-referencing feature on some clitic.⁸ A complete picture also needs to account for why both clitics are not spelled out here; we postpone that discussion until section 4.

Now let us turn to the competition that occurs when the input from syntax contains an aspect head. Here we consider not only which clitic is spelled out, but differences in the prosodic structure of the candidates. The candidates in (a) and (b) have a flat prosodic structure, and differ only in which of the two clitics is spelled out. The candidates in (c) and (d) have a recursive prosodic word structure, and differ in which clitic is spelled out. Both constraints find fault with both flat candidates in (a) and (b); in neither is the verb stem left aligned to the edge of the prosodic word. But the left alignment constraint is satisfied by both candidates (c) and (d) where the recursive structure provides a left edge for the verb stem to align to. It is the match constraint that makes the decision here, penalizing candidate (c) for the fact that the right edge of the verb stem does not align with a prosodic word.

(32) With an Aspect Head

input from syntax: aspect clitic verb stem clitic	LEFT ALIGN-STEM	MATCH (VSTEM, PRWD)
a. (_{Pwd} aspect-verb stem-clitic)	*!	**
b. (_{Pwd} aspect-clitic-verb stem)	*!	*
c. (_{Pwd} aspect (_{Pwd} verb stem-clitic))		*!
→d. (_{Pwd} aspect-clitic (_{Pwd} verb stem))		

In the next section, we turn to the exception noted by Aissen (1987) to the generalization that the prefixed form of Set B is used if an aspect prefix is present.

3.2. The Exception and its Phonological Cause

We now turn to the exception to the generalization in (20) that a prefixed form of Set B is used whenever an aspect prefix is present. Aissen (1987:45) tells us that the exceptional examples

⁸ A more complete picture would also include an account of why a candidate with a recursive prosodic word structure such as (_{Pwd} clitic (_{Pwd} verb stem)) does not win in tableau (31). Given that the prefixed Set B clitics are single vowels, this would produce a vowel initial word, violating ONSET. It might also be barred by other constraints on prosodic structure. See Werle 2009 for a detailed discussion of the constraints and constraint rankings that determine how clitics will be treated in the prosodic structure in Selkirk's framework.

have a second person subject and a first person object; in this configuration, no prefixed Set B form is used even though an aspect prefix is present:

- (33) Ch- a- mil -on.
 INCOMPLETEIVE 2ndSetA kill **1sgSetB**
 ‘You are going to kill me.’ (Aissen 1987:45 (10a))

At first glance, one might suspect that this exception is a person hierarchy effect. That is, the ungrammaticality of the version with a prefixed form of Set B, shown in (34) below might appear to be due to the fact that the second person Set A form is closer to the left edge of the verb than is the first person Set B form:

- (34) *Ch- i- a- mil
 INCOMPLETEIVE **1stSetB** 2ndSetA kill

Such a person alignment violation is disallowed in some languages, e.g. Yimas, where a first person form must align the left edge of the verb (Foley 1991, Woolford 2003). However, we can exclude the person alignment hypothesis for Tzotzil because of examples such as the following, where a third person Set A form intervenes between the first person Set B form and the left edge of the verb:

- (35) L- i- s- maj a-tot.
 COMPLETEIVE **1stSetB** 3rdSetA hit 2nd-father
 ‘Your father hit me.’ (Aissen 1987:40)

Instead, I argue that the ungrammaticality of (34) is actually due to phonology, specifically to the need to avoid the VV sequence. The grammatical version in (33) can be syllabified without any vowel initial syllables, as in (a) below, and thus incurs no violations of the ONSET constraint which requires all syllables to begin with a consonant. The ungrammatical version cannot be syllabified without an onset violation, as shown in (b) below.

- (36) a. Ch-a-.mi.l-on [no onset violation]
 b. Ch-i-.a-.mil [one onset violation]

The reason that the exceptional examples are only those with a second person subject is an accident of the fact that only the second person Set A forms are vowel initial. The reason that all the exceptional examples have a first person object is that a third person object would be cross-referenced by a zero form, and a configuration of a second person object with a second person subject would require a reflexive construction. Thus, this just happens to be the only person combination that would produce a VV sequence and a consequent ONSET violation.

Now, one might ask why Tzotzil does not simply ‘repair’ such onset violations, instead of selecting a suffixed Set B form. Wolf (2008) argues that the grammar prefers to insert a morpheme that avoids a phonological problem (when such a morpheme is available), rather than

inserting a form that causes a problem and requires subsequent repair. Moreover, Wolf points out that there are languages where the relevant faithfulness constraints are ranked higher than the onset constraint, with the result that ONSET violations cannot be repaired. In that situation, avoiding the creation of the problem is the only option. In fact, Tzotzil tolerates onset violations when there is no alternate morpheme to insert to avoid the violation. This occurs, for example in (37), involving a transitive verb with a second person subject, a third person singular object (not overtly cross-referenced) and no aspect prefix. Since both allomorphs of the second person Set A form are vowel initial, and a Set A form must prefix to the verb in a transitive, there is no alternative that avoids the ONSET violation:

- (37) Av- il -oj.
 2ndSetA see PERFECT
 ‘You have seen it.’

4. Co-occurrence of the two Set B Series

We now turn to the analysis of examples where both the prefixed and suffixed Set B series are spelled out in the same clause:

- (38) L- i- s- pet -otik.
 COMPLETIVE 1stSetB 3rdSetA carry 1PL.INCLUSIVESetB
 ‘He carried us(inclusive).’ (Aissen 1987:1 (2))

- (39) Ch- i- s- mil -otikotik.
 INCOMPLETIVE 1stSetB 3rdSetA kill 1PL.EXCLUSIVESetB
 ‘He is going to kill us(exclusive).’ (Aissen 1987:47 (18b))

When does this double cross-referencing occur, and why? An important factor is that the prefixed Set B forms do not encode number; thus, in order to mark number, a suffixed form must be used. That much seems straightforward. But why is the prefixed form also used in the above examples, given that it is redundant? That is, the prefixed Set B form in these examples encodes only person, but person is also encoded in the suffixed Set B forms. The answer cannot be that the prefixed form is obligatory, because, as we have seen above, there are examples where only the suffixed series of Set B is used. Moreover, the prefixed form is not obligatory even in examples where the suffixed form is needed to encode number; the following example has a plural suffixed form and no prefixed form of Set B:

- (40) S- mala -oj -otikotik.
 3rdSetA wait PERFECT 1PL.EXCLUSIVESetB
 ‘He has waited for us(exclusive).’ (Aissen 1987:47 (19b))

Aissen gives us a descriptive generalization as to when the prefixed form cooccurs with a suffixed form of Set B.

- (41) “In those contexts where set B prefixes are required (i.e., on forms with an aspectual prefix), the suffix cooccurs with the appropriate set B prefix. Otherwise (i.e. on forms without an aspect prefix), the suffix occurs alone.” (Aissen 1987:47)

At first, this might not seem to tell us much, since the above generalization could be rephrased as ‘use Set B prefixed forms when they are required’. But Aissen is actually telling us something extremely significant: the conditions that determine when a prefixed form of Set B must be used are independent of whether or not a Set B suffix is *also* used.

- (42) The decision as to whether to spell-out the prefixed series of Set B is made completely independently of whether or not the suffixed series of Set B will also be spelled-out.

It is as if the grammar first determines whether to spell-out the prefixed Set B form, and then only later makes a determination as to whether to also spell-out the suffixed Set B form. Interestingly, this is the kind of situation one expects to find given the hypothesis explored in Wolf 2008 that morphemes are inserted/spelled-out one by one, and that there is no ‘look-ahead’ to consider what features will be spelled out by morphemes that have not yet been inserted. If the prefixed Set B form is spelled out first, it encodes all the features it can, with no ‘knowledge’ of what features might be spelled out later on the suffixed Set B form.

There is ‘look-back’, however, as Wolf’s account predicts. If the suffixed Set B form is spelled out second, it can ‘see’ what cross-referencing features have already been spelled out by the prefixed form spelled out first. In example (43) below, which lacks a prefixed form of Set B, the suffixed form spells out all the features it can, both the 2nd person and plural number features of the object. In contrast, in example (44), where there is a prefixed Set B form which encodes 2nd person, the suffixed morpheme that is selected encodes only number. Redundant encoding of person is avoided.

- (43) J- mala -oj -oxuk.
 1stSetA wait PERFECT **2ndplSetB**
 ‘I have waited for you(pl).’ (Aissen 1987:48 (20b))

- (44) Ch- a- j mil -ik.
 INCOMPLETEIVE **2ndSetB** 1stSetA kill **pluralSetB**
 ‘I’m going to kill you (pl).’ (Aissen 1987:49 (24b))

Note that this plural suffixed form *-ik* does not encode second person, as we can see from the fact that it can be used to mark number on third person objects (where the Set B prefix is zero):

- (45) 7i- j- mil -ik.
 COMPLETIVE 1stSetA kill PLURAL
 ‘I killed them’ (Aissen 1987:49 (24a))

The example in (44) above shows that the choice of a suffixed form is informed by the knowledge of which features, if any, have already been spelled out in the prefix ‘slot’. This is what Wolf (2008) means when he says that ‘look back’ is allowed by the grammar.

The situation is different in examples involving a first person plural object because there is a feature besides person and number that needs to be encoded: the inclusive/exclusive distinction. The prefixed Set B form only spells out person, while the suffixed Set B form *-ik* only spells out number, so that combination would fail to spell out the inclusive or exclusive feature. However, the lexicon does not (and perhaps logically cannot) contain a suffixed Set B form that encodes the inclusive/exclusive distinction without also encoding the first person feature. Thus redundancy in spelling out the first person feature is inevitable:

- (46) L- i- s- pet -otik.
 COMPLETIVE 1stSetB 3rdSetA carry 1PL.INCLUSIVESetB
 ‘He carried us (inclusive).’ (Aissen 1987:1 (2))

Redundancy is avoided in examples where all of the features of the object have already been encoded in a prefixed form of SetB, by simply not spelling out any suffixed form of Set B.

- (47) L- i- s- chanubtas.
 COMPLETIVE 1stSetB 3rdSetA teach
 ‘He taught me.’ (Aissen 1987:61 (2a))

The intuitive idea of this approach seems clear and appealing, but an apparent paradox arises when we try to construct a formal account of this data within Wolf’s 2008 approach, where morphemes are inserted one by one. The paradox is this:

- (48) Tzotzil Paradox

The aspect head must be present in order for the prefixed Set B form to be spelled out, but the prefixed Set B form must be spelled out before the aspect head is, because the choice of allomorph for spelling out the completive aspect head depends on what follows it.

Building on a suggestion by Selkirk (personal communication) that the answer might involve syntax and the consequent mapping to prosodic structure under her Match approach, plus a suggestion from Wolf (personal communication) that the grammar must be able to see the aspect head or its prosodic boundary at the point at which the decision is made as to which clitic to spell out, I offer the following speculation as to one line of thought for solving this apparent paradox: At the syntax/PF interface, before any morphemes have been spelled out, idealized prosodic structure is constructed obeying Selkirk’s (to appear) Match constraints, so that each head maps to a prosodic word, and each phrase maps to a phonological phrase, etc. In this initial interface structure, the prosodic structure surrounds only feature bundles, and so the grammar

an aspect head, with its associated prosodic word, but not the morpheme that will eventually spell out that aspect head.

5. Conclusion

In this paper, we have seen several ways in which the complex Tzotzil agreement patterns described in Aissen 1987 are extremely relevant to current research questions involving the relative roles of syntax and PF in the morphology of agreement, the effect of prosodic structure on the spell-out of morphemes, and the influence of phonology on morpheme spell out. Tzotzil is unusual among the Mayan languages in having two distinct series of pronominal clitics generated in syntax which are sometimes both spelled out at PF. We have seen evidence in this paper that the decision as to which of the two series of Set B of cross-referencing forms to use is actually a decision as to which to spell out at PF, and phonology and prosodic structure play an important role in that choice. Another important conclusion is that the interesting asymmetric redundancy pattern of Tzotzil provides additional support for the idea explored in Wolf 2008 that morphemes are inserted/spelled-out at PF one by one, with no ‘look ahead’ to morphemes not yet spelled out. In Tzotzil, the prefixed series of Set B is inserted without regard to whether or not the suffixed series is also present. In contrast, both the presence of, and the form of, the suffixed Set B series are affected by what features the prefixed series has already spelled out.

References

- Aissen, Judith. 1987. *Tzotzil clause structure*. Dordrecht: D. Reidel.
- Bricker, Victoria. 1977. Pronominal inflection in the Mayan Languages. Occasional Paper 1. New Orleans: Middle American Research Institute Tulane University and the Zemurray Foundation.
- Bricker, Victoria. 1981. The source of the ergative split in Yucatec Maya. *Journal of Mayan Linguistics* 2:83-127.
- Chomsky, Noam. 2000. Minimalist inquiries: the framework. *Step by step*, eds. Roger Martin, David Michaels and Juan Uriagereka, 89-155. Cambridge, Massachusetts: MIT Press.
- Craig, Colette. 1977. *The structure of Jacalteco*. Austin: University of Texas Press.
- Foley, William. 1991. *The Yimas language of New Guinea*. Stanford: Stanford University Press.
- Halle, Morris and Marantz. 1993. Distributed Morphology and the pieces of inflection. *The view from building 20: Essays in linguistics in honor of Sylvain Bromberger*, eds. Kenneth Hale and Samuel Jay Keyser, 111-176. Cambridge, Massachusetts: MIT Press.
- Haviland, John. 1981. *Sk'op soz'leb: El Tzotzil de San Lorenzo Zinacantan*. Mexico City: Universidad Nacional Autónoma de México.
- Klavans, Judith. 1995. *On clitics and cliticization*. New York: Garland.
- Laughlin, Robert. 1977. *The great Tzotzil dictionary of San Lorenzo Zinacantan*. Washington D.C.: Smithsonian Institution Press.
- McCarthy, John. 2007. *Hidden generalizations: Phonological opacity in optimality theory*. London: Equinox.
- McCarthy, John and Alan Prince. 1993. Generalized alignment. *Yearbook of Morphology*, eds. Geert Booij & Jaap van Marle, 79-153. Dordrecht: Kluwer.

- Marantz, Alec. 1988. Clitics, morphological merger, and the mapping to phonological structure. *Theoretical morphology: Approaches in modern linguistics*, eds. Michael Hammond and Michael Noonan, 253–70. San Diego: Academic Press.
- Selkirk, Elizabeth. In press. The syntax-phonology interface. *The handbook of phonological theory*, eds. John Goldsmith, Jason Riggle, and Alan Yu. Malden, MA: Blackwell.
- Werle, Adam. 2009. Word, phrase, and clitic prosody in Bosnian, Serbian, and Croatian. Doctoral dissertation, University of Massachusetts, Amherst.
- Wolf, Matthew. 2008. *Optimal interleaving: Serial phonology-morphology interaction in a constraint-based model*. Doctoral dissertation, University of Massachusetts, Amherst.
- Woolford, Ellen. 2003. Clitics and agreement in competition: Ergative cross-referencing patterns. *Papers in Optimality Theory II*, 421-449. GLSA, University of Massachusetts, Amherst.