

UC Riverside

International Organization of Citrus Virologists Conference Proceedings (1957-2010)

Title

Citrus Exocortis Disease—1976 to 1986

Permalink

<https://escholarship.org/uc/item/0w3269zf>

Journal

International Organization of Citrus Virologists Conference Proceedings
(1957-2010), 10(10)

ISSN

2313-5123

Author

Semancik, J. S.

Publication Date

1988

DOI

10.5070/C50w3269zf

Peer reviewed

Citrus Exocortis Disease—1976 to 1986

J. S. Semancik

About 10 years ago, it was my pleasure to review for this organization our understanding of the citrus exocortis disease from data developed during the period 1965-75 (25). The assignment for that 10-yr period was less imposing than the task presented by the developments from 1976-86, simply because of the formative state of our knowledge of small pathogenic RNAs, or viroids. The most significant data presented was the discovery of herbaceous hosts which facilitated the purification and bioassay of the exocortis agent and ultimately contributed to the detection of the infectious RNA species (33) which became known as the citrus exocortis viroid (CEV).

With the revelation of this new molecular species, the succeeding 10 years has brought a surge of data defining the biophysical structure and conformation of CEV as one of the more studied examples of what has become an ever growing group of plant pathogens. In addition, from these fundamental studies of the viroid molecule, a new model for a novel RNA structure has been developed.

In reference to the biological interactions of CEV, it is interesting to recall the perspectives advanced in that earlier review stating that “. . . a unique form of pathogenic molecule may suggest a unique form of replication and pathogenesis.” and, more specifically, that “. . . definition of a minimal infectious molecule as a free-RNA by physical studies should not be extrapolated to the *in vivo* association of the viroid with the host cell . . .” In spite of the dramatic accomplishments in the definition of the molecular properties of CEV during the past 10 years, our understanding of the biological activity and interactions with the host cell is markedly lacking

and still subject to the above admonitions.

With an admittedly biased perspective, it is the design of this review to not only provide a summary of the advances in our understanding of the exocortis disease, with a particular focus on the agent, but also to lobby for the positions: 1) that viroids are not simply a form of “diminutive” virus; 2) that the citron bioassay reaction constitutes an index for many viroids, some of which may not be associated with classical exocortis disease expression; and 3) that if we can accept a viroid as a “small, transmissible, nuclear RNA which acts to control plant development,” perhaps, it need not be so feared as a consummate plant pathogen.

TOPICS OF DISCUSSION

As a prelude to cataloguing recent advances in the definition of the exocortis disease, it must be recognized that improved procedures for detection and purification of viroids have particularly focused our attention on the physical properties of the causal agent. These studies have been well served by the significant improvements made in:

- 1) Polyacrylamide gel electrophoresis (PAGE) under denaturing conditions, dPAGE, which has permitted the resolution of infectious linear and circular molecular forms of viroids;

- 2) Ethidium bromide and silver staining which have greatly enhanced the resolution of low concentrations of viroid molecules;

- 3) Molecular hybridization utilizing radioactive probes which has permitted screening and detection of homology relationships among viroids; and

4) Selective host systems which have allowed biological differentiation of different viroids as well as preparation of homogeneous highly-purified viroid preparations.

With the application of these procedures, highly significant contributions have been made in what seems almost an ordered series of accomplishments with, A) an impressive characterization of viroid structure and nucleotide sequencing, B) a partial definition of replication components, and C) elucidation of some clues as to the process of viroid pathogenesis and viroid-host cell interactions. These topics will provide the central theme for this review.

In compensation for having this synthesis provided, the reader will be subjected to a final section on "perspectives and speculations." These thoughts will be directed to some more specific and hopefully constructive questions including:

1) What is the citrus exocortis viroid?

2) Can some useful "working classification" of viroids affecting citrus be proposed at this time?

3) Are viroids agents of disease and/or host genome expression?

This discussion will focus on the integration of recently developed data which indicates the presence of a complex of viroids, evidenced not only in molecular terms, but also by observations of host reactions.

STRUCTURE AND NUCLEOTIDE SEQUENCING

Many advances in the description of the unique molecular structure and in nucleotide sequencing of viroids have been made by R. H. Symons and colleagues. Definition of the unique structural features of the viroid molecule has provided direction for the development of detection procedures and definition of the essential properties required of putative viroids.

Circular and linear infectious molecular forms. Most notable in

this definition is the confirmation of the presence of two infectious molecular forms, the covalently-closed, single-stranded circular and the corresponding linear structures. Both of these molecules migrate as a single RNA species when analyzed by standard conditions of PAGE. However, by employing denaturing conditions (dPAGE), usually involving the incorporation of 8 M urea in the gels, two distinct populations can be detected which migrate as discrete bands.

Enhanced resolution of these PAGE bands at concentrations as low as 100 pg has been obtained with silver staining. This entire process is demonstrated in figure 1. Of fundamental importance to the detection of viroids is the characteristically slow migration of the circular viroid form with respect to other small RNA molecules. These can be resolved from the background of host RNA which does not typically contain similar molecules at high concentration. The differential migration rates of the circular and linear forms can be enhanced in low pH gels (23).

Characteristic symptoms of the severe exocortis disease agent were observed when either the circular or linear forms of CEV were recovered and inoculated into *Gynura aurantiaca* (20). Furthermore, both forms of CEV could be detected in extracts of tissues inoculated with either molecular species, suggesting that the two forms are biologically equivalent.

Nucleotide sequencing of CEV. Direct RNA sequencing as well as sequencing of recombinant DNA clones has permitted reconstruction of the complete viroid "genome" of different strains of CEV (17, 36). All strains contained 371 nucleotides, the largest sequence reported thus far for viroids. Up to 27 nucleotide differences involving exchanges, insertions, and deletions were detected (fig. 2). The CEV strains with large nucleotide differences were derived from field sources which caused

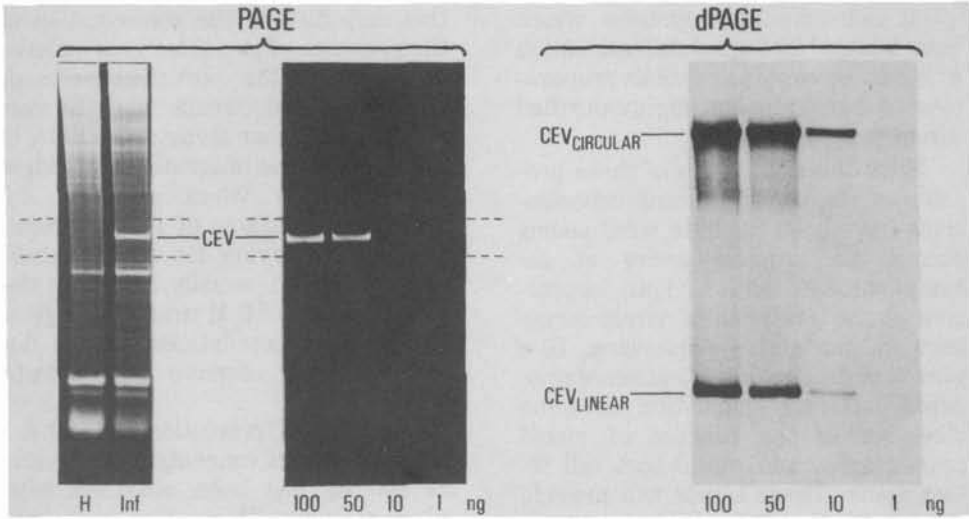

Fig. 1. Polyacrylamide gel electrophoresis under standard (PAGE) and denaturing conditions (dPAGE) in the presence of 8M urea. Gels containing nucleic acid preparations (2M LiCl soluble) from healthy (H) and CEV infected (Inf) tissues (left) or a standard concentration series of purified CEV (middle) were stained with ethidium bromide after electrophoresis to determine position of CEV. For analysis by sequential electrophoresis on dPAGE, gel segment containing CEV band was excised as indicated (---) and applied to the top of a second gel for dPAGE. Resolution of the circular and linear forms of CEV as well as the increased sensitivity of silver staining is presented in the gel at the right.

dwarfing of orange trees on trifoliolate orange rootstocks without scaling the rootstock (37). Since the strains were purified from chrysanthemum, a potential screening host for viroids, the pathogenic effect noted in citrus may have resulted from a complex of viroids and not a single viroid as sequenced here. The mixture of viroids in

field sources now appears to be a common occurrence in the exocortis disease (10).

Field Variants of CEV. More recently, Visvader and Symons (38) while sequencing cDNA clones of isolate CEV-J reported 11 new variants, suggesting the isolate was comprised of a mixture of viroid RNA species.

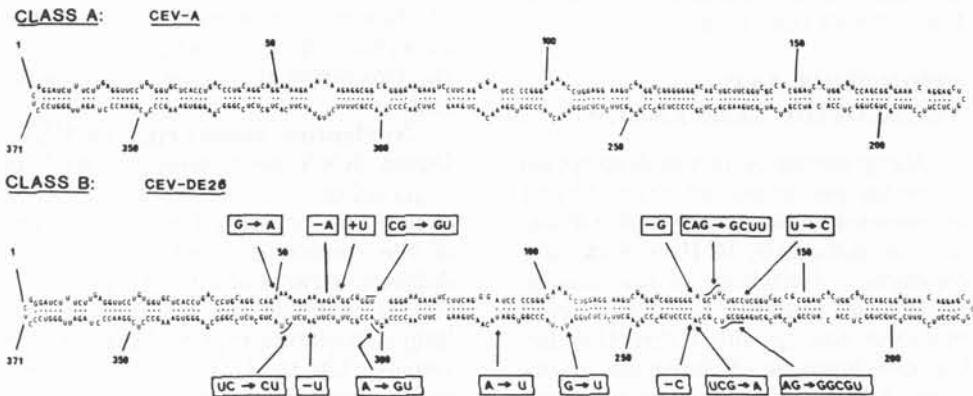

Fig. 2. Primary and proposed secondary structures of citrus exocortis viroid, Australian isolate (CEV-A) and a variant with 27 nucleotide changes (CEV-DE26). Class A sequences are found in severe isolates when tested on tomato while Class B are found in mild isolates. Reproduced from Visvader and Symons (38).

The variants were grouped into two classes (fig. 2) on the basis of pathogenicity on tomato. These CEV variants were within a range of 5 nucleotides (370-375) and should not be equated with the distinct viroids reported by Duran-Vila *et al.* (9, 10) which are smaller than CEV by 30-100 nucleotides and, in general, lack homology with CEV. With the long field life of citrus trees, it seems feasible that these variants may originate during the process of viroid replication, whereas multiple infections with distinct viroids result from mechanical inoculation during cultural practices.

Inspection of the nucleotide sequence of the infectious CEV molecule does not indicate an ability to support *in vivo* translation of proteins (36). This is corroborated by protein analyses of viroid-infected plant materials which indicated the absence of any viroid specified protein products in diseased tissues (8). In addition, this structural information suggested that viroid replication was probably a highly host-dependent process.

With the recent advances made in the custom synthesis of specific oligonucleotides (1), fabrication of specific probes complementary to the established viroid sequences is an interesting possibility which in turn could be applied to the survey for viroids by molecular hybridization. In this way, the exchange of infectious agents would not be necessary between locations where either the disease itself, or certain virulent isolates were hitherto unknown. And yet, positive identification could still be made, provided the fidelity of the probe had been determined. This prospect presents a striking example of the potential application of fundamental experimental data to practical purposes when the lines of communication among researchers of dissimilar persuasions are maintained.

"Domains" in viroid structure. A striking feature of viroids in general is the consistency among the confor-

mational models which can be constructed from sequence analyses. From the smallest reported viroids of about 247 nucleotides for avocado sunblotch and coconut cadang-cadang, to the largest of 371 nucleotides for citrus exocortis, all can be depicted with a common, highly self-complementary rigid rod construction containing single-stranded regions. How this model, derived from *in vitro* biophysical studies, is related to the *in vivo* nature of the viroid may hold the key to the understanding of interactions with host components resulting in the pathogenicity.

A recently proposed model by Keese and Symons (19) assigns five specific structural and functional "domains" to general regions in the viroid nucleotide sequence (fig. 3). The "conserved central core," which is retained in all viroids, is believed critical to the viroid replication process. The two "terminal domains" appear to be exchanged among viroids and this, therefore, suggests their possible role in the origin and evolution of viroids. Positioned between these domains is a "pathogenic region" and a "variable region." It has been suggested that both of these regions contain sequences which function in viroid pathogenicity by affecting either the intensity of symptom expression or the efficiency of viroid replication.

Construction of infectious cDNA clones of CEV (35) has provided a vehicle for the *in vitro* synthesis of viroid mutants. Chimaeric cDNA clones derived from variants of CEV that produce either mild or severe symptoms on tomato (39) demonstrated the primary control of symptom severity by the "pathogenic domain" even though the "variable domain" also may influence viroid concentration. Despite the theoretical significance of these observations, extrapolations from the tomato reaction cannot as yet be made to the expression of the exocortis scaling and dwarfing symptoms in the field.

Nevertheless, a fundamental conclusion of these studies, which con-

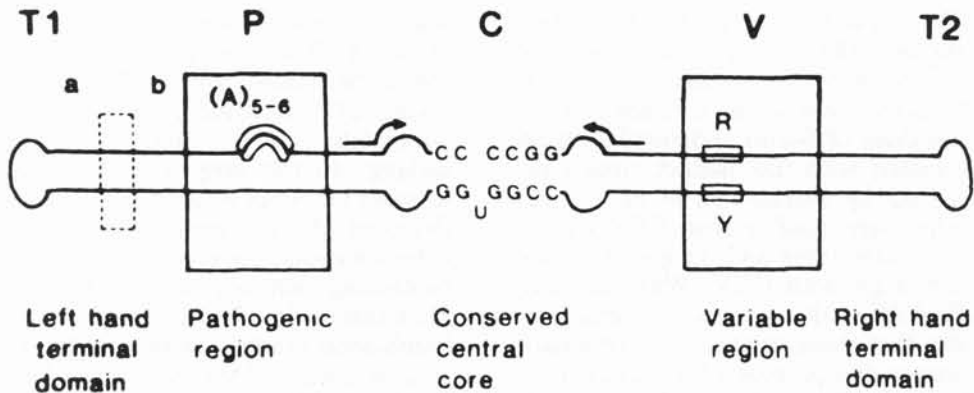

Fig. 3. Proposed model for five domains (T1, P, C, V, and T2) in a generalized viroid molecule as determined from a comparison of sequence homologies among viroids. Reproduced from Keese and Symons (19).

trasts markedly with the action of viruses, is that the nucleotide sequence and structure alone govern the biological activity of the viroid molecule.

COMPONENTS FOR CEV REPLICATION

Viroid complementary RNA template. In the previous review of the exocortis disease for the IOCV (25), data was presented which indicated that viroid complementary sequences were contained in DNA-rich preparations, suggesting therefore that viroid sequences may be contained in the host genome. This error has now been corrected with the description of CEV complementary RNA sequences (15, 16). It can now be concluded that the plant genome does not contain viroid complementary sequences equivalent to a single complete viroid molecule (3, 41).

Nuclear locus of accumulation and CEV synthesis by a DNA-dependent RNA polymerase II-like enzyme. As a prelude to the characterization of a "viroid replicating complex", it was essential to determine the subcellular distribution of CEV. Although it is difficult to construct an accurate pattern of viroid accumulation by analysis of subcellular fractions from tissue homogenates, nuclear-rich preparations were shown to

consistently contain the highest concentration of CEV (31).

Cell-free, nuclear-rich preparations were then utilized to demonstrate CEV synthesis *in vitro* (14). By evaluating the optimum conditions for viroid synthesis plus the effect of specific polymerase inhibitors such as alpha-amanitin, it was possible to ascribe DNA-dependant RNA polymerase II-like properties to the CEV synthesizing enzyme (28).

These data suggest that because of the unusual structure and conformation of the viroid molecule, a host enzyme which normally transcribes DNA is also able to synthesize the viroid RNA. This indicates an unusual degree of host dependency as well as implicates a subtle mechanism for host interaction which results in the altered plant development we view as symptomatic of disease.

The viroid as a small nuclear RNA. Monitoring the synthesis of CEV under the controlled conditions provided by tomato cell suspension cultures demonstrated that the viroid could become a persistent component of the cell nucleic acid profile (20). The viroid RNA appeared to be regulated much as the host 7S RNA and displayed a pronounced survival advantage over host RNA species, even in senescing cells. This stability might be attributed to the inherent struc-

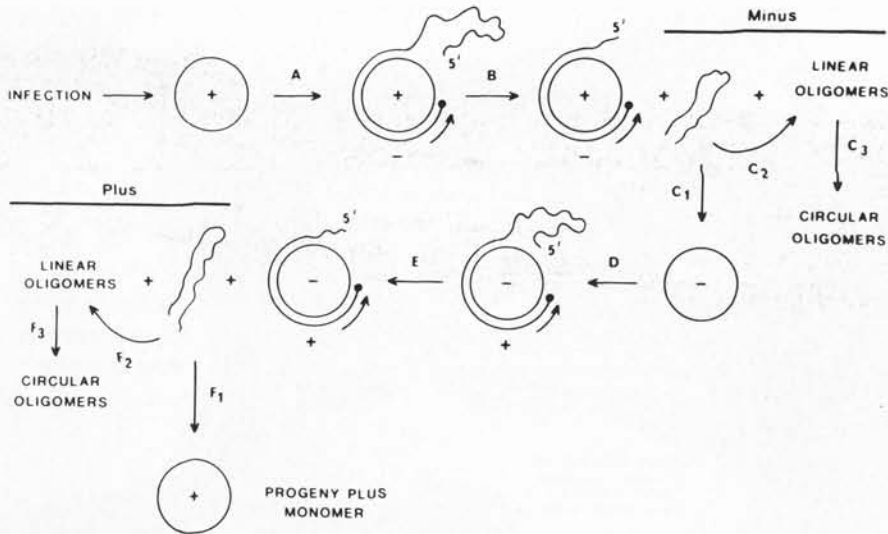

Fig. 4. "Rolling circle" model for the replication of viroids. Reproduced from Hutchins *et al.*, (18).

tural integrity of the basically ds-RNA viroid framework.

Studies with the citrus exocortis viroid have been instrumental in the formulation of our current understanding of the factors required for viroid replication. Detection and characterization of viroid complementary RNA and multimeric viroid forms have resulted in the general acceptance of a "rolling circle" model (fig. 4) defining intermediary molecular forms involved in viroid replication. With the development of cell-free viroid synthesizing systems and the culture of viroid-infected cells, a view has emerged of the dependency of viroid replication on a host plant enzyme and the intimate association of CEV with the host nucleus as a persistent small nuclear RNA.

Since symptomless carriers of CEV are common, it follows that viroid replication and viroid pathogenesis are not inexorably connected. Nevertheless, the nuclear site of viroid accumulation does provide direction to the search for the locus of viroid synthesis and pathogenesis. We might also question the term "symptomless" carrier, except as a purely operational definition, since pathogenic responses become per-

ceived only when a visible host reaction is stimulated. A myriad of subtle biochemical and developmental effects may exist but remain masked below the level of our current detection, just as the viroids themselves were for many years.

MOLECULAR PATHOGENESIS AND CELL INTERACTIONS

The expressions of the exocortis disease in the field and in indicator plants utilized in bioassay procedures are well known. Therefore, this section will attempt to integrate information on viroid-host cell interactions to expose possible events involved in viroid pathogenesis. Figure 5, taken from a recent, more detailed discussion of viroid pathogenesis (27), depicts key features characterizing the invasion of cells by viroids, and more specifically, CEV. As a consequence of the replication and accumulation of viroid progeny, specific structural and metabolic distinctions between healthy and CEV-infected cells become apparent. At present, it is still difficult to discern what level of interdependency or interrelation exists among these various observations, or to specify the primary event(s) which may trigger the process of viroid

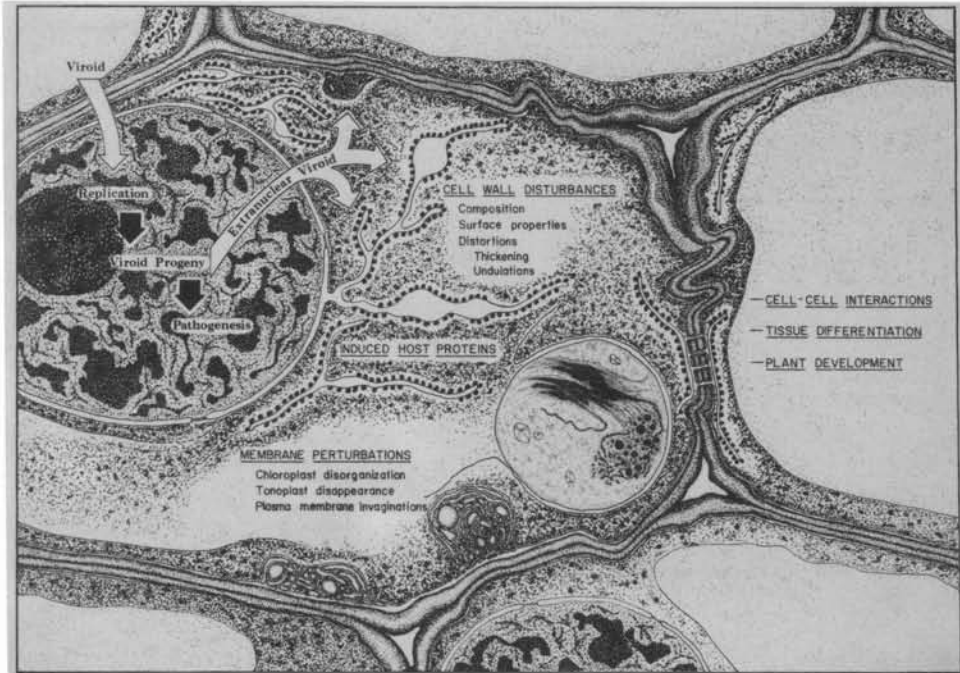

Fig. 5. Representation of possible interactions and responses in viroid infected cells. Reproduced from Semancik and Conejero (27).

pathogenesis. However, since no viroid-related products have been identified thus far, the viroid molecule, in the role of a specific small nuclear RNA, must be considered as the prime candidate to act as the "signal" which reacts with host "factors" to set this process in progress.

Alteration in cell wall structure.

The diverse observations which have been made in early cytological studies suggesting cell wall aberrations (22) and membrane perturbations (32) can now be related to the case presented for reduced expansive cell growth and cell wall composition alterations (40) in CEV-infected cells. The substantial increase in the hydroxyproline-rich glycoproteins and arabinogalactan residues in CEV-infected cell walls may be related to such effects as, 1) the increased thickening of cell walls and 2) the reduction in expansive cell growth. The change in the relative proportion of B-1,3-glucans and their uneven deposition (40) on the cell wall surface may account for the marked reduction in protoplast release from

CEV-infected tissues and cells (21). This implies the possible alteration in cell-cell adhesion and the resultant reduction of intercellular spaces in CEV tissues. It is, therefore, reasonable to conclude that these alterations may constitute significant factors in the gross developmental symptoms induced by CEV in host plants.

Metabolic distinctions with CEV infection. From the above, it seems likely that some major changes have been effected in the carbohydrate metabolism of CEV-infected cells. It is at the same time surprising that no dramatic alterations have been detected in nucleic acid processes in the same plant materials (20). The viroid does not appear to induce any qualitative or quantitative differences in the host nucleic acid composition. In fact, we may find that the viroid molecules sustained in "symptomless carrier" host plants may assume the character of a normal constituent of the host nucleic acid profile.

Protein profiles and CEV infection. Although no evidence has

emerged for the existence of a viroid-specified protein product, a significant body of data has been accumulated from the laboratory of Professor V. Conejero to indicate the enhancement of host-specified proteins with CEV infection (6, 7, 8). Two low molecular weight proteins amplified in CEV-infected tissues, CEV-P₁ and CEV-P₂, have been related in size to similar protein products accumulating in senescing tissues (fig. 6).

These and similar proteins induced in response to a broad range of pathogens as well as Ag⁺ ions (5) are probably related to the general class of "pathogenesis-related" or "PR" proteins (34) stimulated as a result of pathologically altered metabolism. The identity and function of these cytoplasmic proteins is unclear at present. However, interference in the regulation of some nuclear coded genes, such as that for the small subunit of ribulose diphosphate carboxylase, may be involved.

Phytohormone imbalance. Because of the association of viroids with apex tissues and the eventual produc-

tion of a dwarfing reaction, experimental attention has been directed to the possible intermediary role of phytohormones in viroid pathogenesis. Direct analysis of phytohormones from field and greenhouse grown viroid infected plants is intrinsically difficult and, therefore, has produced contradictory results (37).

Reduced root initiation in CEV-infected *Gynura aurantiaca* has been related to a reduction in an auxin-like substance (13). However, when tomato tissues infected with CEV were exposed to a wide range of indoleacetic acid concentrations (fig. 7), no induction of root initiation was observed (11). These observations suggest a possible aberration in auxin utilization by viroid affected tissues and/or a morphological impairment of these tissues, perhaps related to the cell wall changes noted above, which obviates the expected response to auxins.

Enhanced production of ethylene has been correlated with the induction of symptoms such as severe stunting, epinasty, chlorosis, premature senescence and inhibition of root-

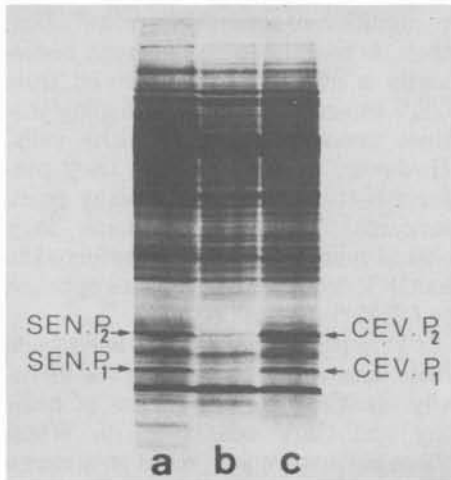

Fig. 6. Protein patterns on SDS-polyacrylamide slab gel (14%) of extracts from *Gynura aurantiaca* from a) 4-yr-old healthy plants, b) uninoculated controls, and c) CEV-infected plants 1.5 months after inoculation. Positions of CEV-P₁ and -P₂ and "senescence" proteins SEN-P₁ and -P₂ are indicated. Reproduced from Conejero *et al.*, (6).

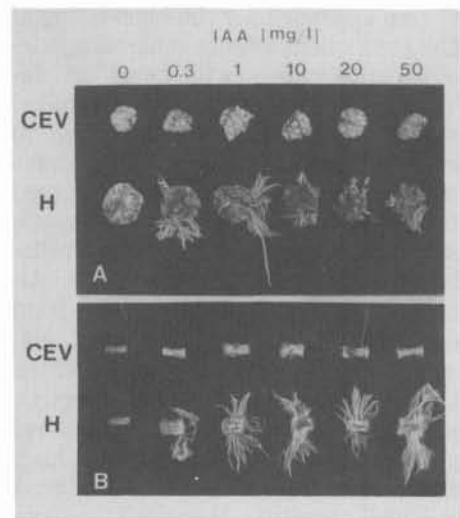

Fig. 7. Response of healthy (H) and citrus exocortis viroid-infected (CEV) tomato leaf disk (A) and stem segment (B) tissues after 2 weeks in standard culture medium with added indoleacetic acid (IAA). Reproduced from Duran-Vila and Semancik (11).

ing. Since these host responses can be observed with viroid infection, it is not surprising that an increase in ethylene evolution has been detected in CEV-infected tissues and cells in culture (Conejero *et al.*, unpublished). To complete the linkage, administration of the ethylene precursor, ethephon, to healthy tomato plants produces a syndrome analogous to that found with viroid infection and the induction of proteins identical to those which are enhanced in CEV-infected tomato.

This listing of interrelating factors presents a most suggestive collection from which to construct any number of variations to explain the affect of viroid infection on host metabolism. Nevertheless, assignment of a primary role at this time to any of the components discussed appears premature and, in fact, the entire ensemble may reflect a cascade of secondary metabolic responses triggered in tissues confronted by any external stimulus such as the viroid.

VIROID "CONTAINING" CELL CULTURES—A SYSTEM WITH A FUTURE?

An approach for the elucidation of the component events controlling viroid pathogenesis will focus on development of more highly controlled systems. The callus culture (fig. 8) and cell suspension (fig. 9) systems for continuous growth of cells derived from healthy and CEV-infected tissue (21) have already demonstrated reliability and interesting potentials. Although not necessarily derived from a single cell, selection of small colonies of cells produced cultures which have retained consistent growth properties over a period of several years. Equally important, the high viroid titer (20) and the CEV-induced cell wall structure changes (40) have been maintained in these cultures. This demonstrates that viroid-induced lesions observed with intact tissues can persist in disorganized cell cultures, thus adding validity to the

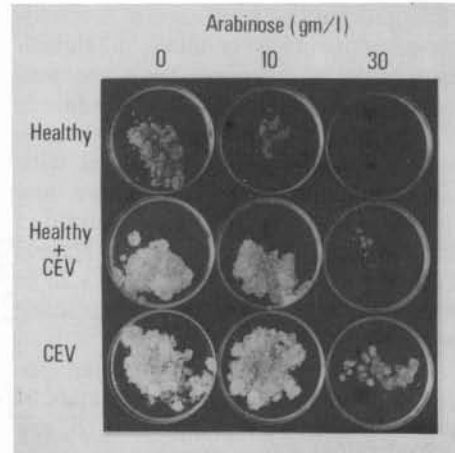

Fig. 8. Callus cells derived from healthy or CEV-infected tomato plants grown for 6-8 weeks as pure cultures (top and bottom) or as an equal mix (center) of cells on standard medium supplemented with arabinose at the indicated concentrations (Duran-Vila, unpublished).

system as a tool to expose primary events in viroid pathogenesis.

What, then, are some properties of these cells derived from CEV-infected tomato plants? First, I would like to advance the proposition that disease in a general sense is but the recognition of some "difference". But, then, is merely to be different necessarily a disease? Cells derived from CEV-infected tissues do display distinct properties from healthy cells. However, in some aspects they perform better than their healthy counterparts. Therefore, perhaps they should more accurately be referred to as CEV "containing" cells as opposed to CEV "infected" cells.

This point of view has been born from data which documents the virtually identical growth curves of healthy and CEV cells (fig. 9). When these cells were subjected to a range of temperature conditions, the CEV containing cells, in fact, outperformed the healthy cells. CEV cells in general displayed an enhanced longevity in culture as well as resistance to elevated levels of phytohormones and to additives to the culture medium such as the pentose, arabinose, as pre-

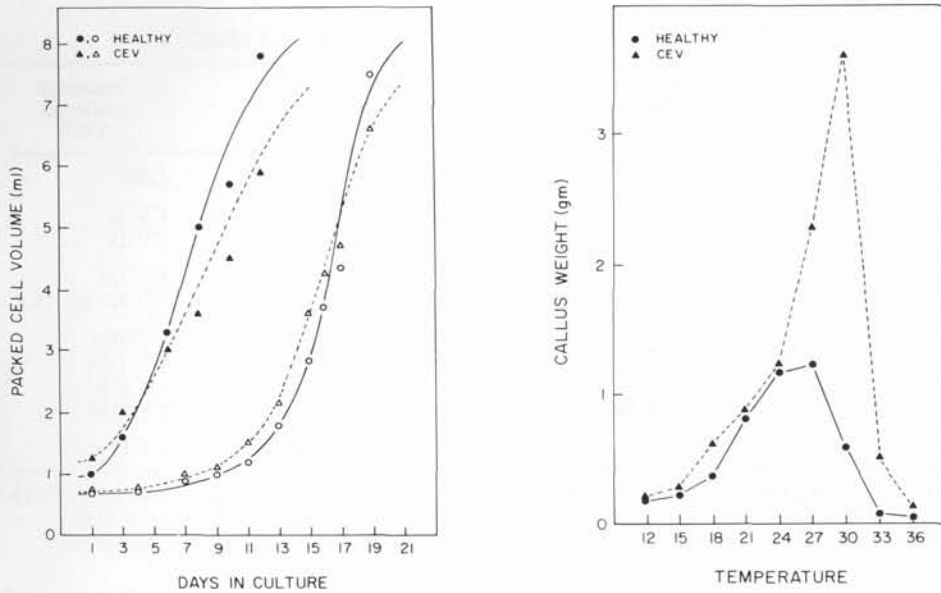

Fig. 9. Growth rate of tomato suspension cells derived from healthy and CEV-infected tissues (left panel) with cells initiated from log phase (solid symbols) or stationary phase (open symbols) cells. Fresh weight of calli derived from healthy and CEV-infected tissues (right panel) after cultures were held at the indicated temperatures for 3 weeks. Reproduced from Marton *et al.*, (21).

sented in figure 8. Can these observations be extrapolated to suggest that viroid containing cells may possess persistent altered properties induced by the presence of the viroid which may reflect one or more agriculturally desirable traits? This proposition will reappear in the concluding section of this review. For now, we are left with but the intuitive confidence that this system may be exploited to provide clues as to 1) the primary events of viroid pathogenesis, and, 2) the persistent lesions introduced by exposure to the viroids.

WHAT IS THE CITRUS EXOCORTIS VIROID?

With the considerable collection of data that has been summarized in this review under the title, "The Citrus Exocortis Disease", it seems almost quizzical to introduce this section as a question. However, recent investigation (9, 10, 24) of "mild" and "moderate" isolates of CEV has necessitated a reconsideration of the detection and classification of these forms of the exocortis disease.

Once Etrog citron became accepted as the standard bioassay host for the exocortis disease, verification of the production of the classical bark scaling reaction on trifoliolate orange was in most cases discontinued. This practice, accepted for reasons of time and cost economy, assumed a common identity for all disease sources producing a reaction on citron. Furthermore, any moderation of the severe stunting, leaf epinasty and rugosity, petiole wrinkle and browning reactions was considered the consequence of a less virulent form of the same pathogen.

With the published results as summarized in table 1, as well as the recent extension of this information with the detection of new citrus viroids from California and Spain (10), it has become evident that a number of distinct viroids, as first judged by molecular size, have been detected in "exocortis" sources. Therefore, the citron reaction can no longer be considered as a specific assay for the classical exocortis syndrome until the source is also tested on trifoliolate orange.

TABLE 1
CITRUS VIROIDS (CV) AS RELATED TO PREVIOUS REPORTS

Phytopathology 75:946-949 (1985)	Virology 150:75-84 (1986)	Viroid isolates		Consensus catalogue (1986)
		California	Spain	
	CEV	CEV	CEV	CEV
"CVaV" ^z	RNA-I	Ia	Ia	CV-Ia
		Ib	—	CV-Ib
(RNA-IIa) (RNA-IIb)	RNA-II	IIa	IIa	CV-IIa
		IIb	IIb	CV-IIb (CCaV) ^y
(RNA-IIIb)	RNA-III	IIIa	—	CV-IIIa
		IIIb	IIIb	CV-IIIb
		—	IIIc	CV-IIIc
		—	IIId	CV-IIId
		IV	—	CV-IV

^z"CVaV" indicates the main viroid component in the "Citrus Variable Viroid" as reported in reference no. 24 and now known to be comprised of a mixture of CV-Ib, CV-IIa, CV-IIb, and CV-IIIb.

^y(CCaV) indicates "Citrus Cachexia Viroid" the causal viroid of the citrus cachexia disease (30).

Although this view suggests a reduced confidence in the discrimination of a widely accepted bioassay host, in pragmatic terms, the citron reaction becomes even more valuable as a broad indexing host for citrus viroids in general. It is only essential that the researchers involved in viroid indexing do not ascribe all reactions observed in citron to CEV and, further, not even to the several agent(s) that may produce symptoms of the exocortis disease. From this perspective it may be found that the different synonyms accepted for the exocortis disease, such as, "scaly butt" and "Rangpur lime disease" may actually describe a related family of distinct diseases induced by a quite different complement of viroids.

A "CATALOGUE" OF CITRUS VIROIDS (CV)

Physical and biological data from which a catalogue of the "citrus viroids" (CV) can be proposed is presented in table 2. It should be emphasized that the motivation for this proposal resides in the desire to formulate valid comparisons of viroids important in different citrus growing areas of the world. The division of CVs into five groups results from the different parameters considered in

table 5 and not the endorsement of any particular classification system.

The broad range of molecular size (275-371 nucleotides) of the citrus viroids is well beyond what would be expected for strains of the same pathogen. Molecular hybridization homology tests using DNA probes complementary to the major reported citrus viroids, CEV, the CV-Ib component of the "CVaV" source, and CCaV, support this position. A distinction of type CEV, the CV-I group and the CV-II group is clearly implied. The lack of broad homologies relating the recently detected CVs to the three best described citrus viroids is, indeed, surprising.

With the recent advances in the characterization of the citrus viroids by physical and biological parameters, it becomes essential that a correction be made in the terminology made by Schlemmer *et al.* (24) for the citron variable viroid (CVaV). The recognition of the increased numbers of citrus viroids has been brought about largely by improved detection procedures involving sequential PAGE and dPAGE coupled with silver staining. The initial report of CVaV (24) as a distinct viroid associated with a moderate exocortis-like reaction on citron, was based upon the detection of a new viroid of

TABLE 2
PHYSIOLOGICAL AND BIOLOGICAL RELATIONSHIPS AMONG "CITRUS VIROIDS" (CV)

Consensus catalogue (1986)	Bases ^z	cDNA hybridization			CF-11 Cellulose ^y		Infectivity ^x		
		CEV	CV-Ib	CCaV	Ethanol 25%	Elution 20%	Citron	Cucumber	Gynura
CEV	371	++++	±	-	-	++++	++++	+	++++
CV-Ia	340	-	++++	-	-	++++	++	-	-
CV-Ib	330	-	++++	-	-	++++	++	-	-
CV-IIa	-	-	-	++	++++	±	+	+++	-
CV-IIb (CCaV)	300	-	-	++++	++++	±	+	++	-
CV-IIIa	-	-	-	-	++++	±	++	-	-
CV-IIIb	290	-	-	- ^w	-	++++	++	-	-
CV-IIIc	-	-	-	NT		NT	++	-	-
CV-IIId	-	-	-	NT		NT	++	-	-
CV-IV	275	+	-	-	+++	±	++	+	-

^zBy comparison with Citrus Exocortis Viroid (CEV) and Avocado Sunblotch Viroid (ASV) in denaturing PAGE.

^yCF-11 cellulose elution indicates ethanol percentage to begin specific viroid elution.

^xInfectivity: (++++) = symptomatic, severe;
(+++)= symptomatic, moderate;
(++) = symptomatic, mild;
(+) = symptomless, infected;
(-) = symptomless, not infected.

^wNT = not tested.

about 330 nucleotides while employing the less sensitive ethidium bromide staining procedure. The name "citron variable viroid" was coined to describe the variable nature of the symptom expression that resulted in plants grown under different environmental conditions.

In the reanalysis of the CVaV isolate by Duran-Vila *et al.*, (9), it was demonstrated that in addition to the prominent 330-nucleotide viroid, three other viroids could also be detected after silver staining. Therefore, since the given name "citron variable viroid" was based upon the biological expression of an isolate which contained a composite of four distinct viroids, it seems inappropriate to single out even the most prominent one of the four viroids as the causal agent of the symptom expression on citron. Furthermore, we are now aware that a synergistic effect can be produced when two viroids are inoculated to citron. It also seems reasonable to assume that once the four viroid components of the CVaV isolate have been tested individually on citron, the "variable" nature of the symptom expression may not persist.

With this information, it can be recommended that the term "citron variable viroid" be abandoned in favor of the more general designation CV-Ib, in keeping with the proposed scheme for the organization of citrus viroids. Thus, following this grouping, the four viroids which are contained in the original "CVaV" isolate represent CV-Ib, CV-IIa, CV-IIb and CV-IIIb. It is further suggested that until a specific disease or distinct symptom characteristic can be attributed to these viroids, the above terminology be retained.

Therefore, the only specific names for members of the citrus viroid family (table 1, 2) that seem appropriate at this time are the citrus exocortis viroid, (CEV) and the citrus cachexia viroid, (CCaV).

Specific elution from CF-11 cellulose has been introduced as a simple practical approach to discriminate

subtle differences in the conformation of closely related viroids (26). An almost preparative separation of CEV and CV-1 group viroids from most members of the CV-II, -III, and -IV groups can be accomplished using this technique (table 2).

Biological segregation with screening hosts presents an additional parameter from which to construct specific CV groupings. The comparison of reactions on citron, cucumber, and *Gynura* emphasize the importance of citron as the "universal" CV host as well as the practical importance of cucumber and *Gynura* as selective hosts (table 2). More specifically, cucumber has recently become invaluable in the identification of CCaV (30). It is also truly fortuitous that the body of the physical studies on CEV was performed on viroid purified from *Gynura*, the highly selective host for CEV, thus obviating the possible confusion introduced by a mixed viroid population.

VIROIDS—AGENTS OF DISEASE AND/OR HOST GENOME EXPRESSION

At the outset of this presentation, the audience was forewarned that the position would be advocated that viroids should not be considered simply as a grouping of diminutive plant viruses. Hopefully, this prejudice has been successfully advanced by the data discussed. With this concluding section, a more speculative and somewhat controversial perspective for the possible positive applications of viroids for the benefit of agriculture will be advanced. This position is not totally new nor highly innovative but, perhaps, can be best characterized as a proposition whose time has come, at least for a discussion. In the absence of thoughtful consideration by such bodies as the IOCV, the risk emerges that such efforts will be attempted, but without guidance or direction in experimental protocol.

One of the basic tenants of plant pathology is the propagation of the

cleanest possible plant materials for dissemination to producers. Even though this guide must still be advocated in principle, the significant new findings in the area of viroid detection and characterization indicate perhaps, a less rigid and yet compatible posture can be assumed for viroids. The level of our knowledge of viroids has recently increased very dramatically, instilling us with a new confidence in our ability to control the consequences of viroid biological activity. Therefore, why not at least explore the possibility that plant growth and development might be customized by the selective introduction of controlling RNA elements, i.e. *VIROIDS*?

From a historical perspective, disease-causing agents have been employed for the control of animal diseases as in the case of vaccination with attenuated viruses. Certainly, the "cross-protection phenomenon" for plant viruses has seen selective application and remains a subject of considerable interest and investigation. For those who would dismiss any discussion of the purposeful dissemination of viroids as irresponsible or even unethical, I would suggest that the alternate expression, "cross-inoculation", might represent a more accurate expression for what has become known as "cross-protection."

We are witnessing modern, even revolutionary approaches to the alteration of plant properties by recombinant DNA technology and the integration of "foreign genetic information" into plant species. Although this field is fraught with significant inherent difficulties before the ultimate desired expression is attained, it remains an approach which offers considerable exciting promise and a similar desire to exploit a "pathogen" genome for beneficial purposes.

While not questioning the gigantic investment already made to this genome-sized endeavor, it would not seem inappropriate to propose a proportionate note for the potential of the smallest of all replicating "genetic" elements involved in plant develop-

ment. Perhaps, the viroids need not be stigmatized with the mantle of consummate plant pathogens. As agents which can markedly influence the expression of the host genome, the viroids are natural vehicles for host "*EXPRESSION ENGINEERING*."

Much of what we have presented earlier in this review can be used to support this perspective. Viroids, in general, are nuclear, persistent, and biologically-active molecules. Another view of what we might define as the initiation of "pathogenesis" could focus on the viroid molecule interacting with a low copy number messenger RNA active only during a highly temporally limited period during the early stages of plant development. As a consequence, a completely different developmental sequence of events from normal is triggered which results in a dramatically different plant form.

An example of the specific plant characters which might be altered due to viroid action is tree size which has already been well advanced in successful attempts at dwarfing (4). The potential for an influence on seediness (2) plus the more speculative leads observed with cell culture systems such as hormone (herbicide) resistance, thermal tolerance, and fruit quality (ethylene) remain to be explored.

As a final theme, I would like to offer a word of encouragement from the realm of the world of "empirical or intuitive science." Perhaps, some of what has been proposed here has already been accomplished and therefore, the concept need not be quite so heretical in appearance. In the various schemes that have been employed to develop agriculturally desirable and, particularly, vegetatively propagated plant varieties, perhaps selection has already been made for a plant whose form or productivity is influenced by the presence of viroids. It has come as some considerable surprise to us that viroids can be detected in every commercial grapevine variety source which we have tested

in California and Spain to date (12, 29, Duran-Vila, unpublished) and it may be that viroid infection is corre-

lated with some desirable attribute of the plant culture or the derived plant product.

LITERATURE CITED

1. Bar-Joseph, M., D. Segev, S. Twizer, and A. Rosner
1985. Detection of avocado sunblotch viroid by hybridization with synthetic oligonucleotide probes. *J. Virol. Methods* 10: 69-73.
2. Bitters, W. P., N. Duran-Vila, and J. S. Semancik
1987. Effect of citrus exocortis viroid (CEV) on flower and fruit structure and development on 'Etrog' citron. *Plant Dis.* 71: 397-399.
3. Branch, A. and E. Dickson
1980. Tomato DNA contains no detectable regions complementary to potato spindle tuber viroid as assayed by southern hybridization. *Virology* 104: 10-26.
4. Broadbent, P., J. B. Forsyth, K. P. Bevington, and R. J. Hutton
1986. Citrus tree size control with dwarfing agents. *Citrograph* 72: 8-10.
5. Conejero, V. and A. Granell
1986. Stimulation of a viroid-like syndrome and the impairment of viroid infection in *Gynura aurantiaca* plants by treatment with silver ions. *Physiol. and Mol. Pl. Path.* 29: 317-323.
6. Conejero, V., I. Picazo, and P. Segado
1979. Citrus exocortis viroid (CEV): Protein alteration in different hosts following viroid infection. *Virology* 97: 454-456.
7. Conejero, V., P. Segado, J. M. Belles, and A. Granell
1983. Citrus exocortis viroid (CEV): New data regarding the low molecular weight polypeptides associated with viroid infection. *Neth. J. Pl. Path.* 89: 308-309.
8. Conejero, V. and J. S. Semancik
1977. Exocortis viroid: Alteration in the proteins of *Gynura aurantiaca* accompanying viroid infection. *Virology* 77: 221-232.
9. Duran-Vila, N., R. Flores, and J. S. Semancik
1986. Characterization of viroid-like RNAs associated with the citrus exocortis syndrome. *Virology* 150: 75-84.
10. Duran-Vila, N., J. A. Pina, J. F. Ballester, J. Juarez, C. N. Roistacher, R. Rivera-Bustamante, and J. S. Semancik
1986. The citrus exocortis disease: A complex of viroid RNAs, p. 152-164. *In Proc. 10th Conf. IOCV. IOCV, Riverside.*
11. Duran-Vila, N. and J. S. Semancik
1982. Effects of exogenous auxins on tomato tissue infected with the citrus exocortis viroid. *Phytopathology* 72: 777-781.
12. Flores, R., N. Duran-Vila, V. Pallas, and J. S. Semancik
1985. Detection of viroid and viroid-like RNAs from grapevine. *J. Gen. Virol.* 66: 2095-2102.
13. Flores, R. and J. L. Rodriguez
1981. Altered pattern of root-formation on cuttings of *Gynura aurantiaca* infected by citrus exocortis viroid. *Phytopathology* 71: 964-966.
14. Flores, R. and J. S. Semancik
1982. Properties of a cell-free system for synthesis of citrus exocortis viroid. *Proc. Natl. Acad. Sci. USA* 79: 6285-6288.
15. Grill, L. K. and J. S. Semancik
1978. RNA sequences complementary to citrus exocortis viroid in nucleic acid preparations from infected *Gynura aurantiaca*. *Proc. Natl. Acad. Sci. USA* 75: 896-900.
16. Grill, L. K., V. I. Negruk, and J. S. Semancik
1980. Properties of the complementary RNA sequences associated with infection by the citrus exocortis viroid. *Virology* 106: 24-33.
17. Gross, H. J., G. Krupp, H. Domday, M. Raba, H. Albery, C. H. Lossow, K. Ramm, and H. L. Sanger
1982. Nucleotide sequence and secondary structure of citrus exocortis and chrysanthemum stunt viroid. *Eur. J. Biochem.* 121: 249-257.
18. Hutchins, C., P. Keese, J. E. Visvader, P. D. Rathjen, J. L. McInnes, and R. H. Symons
1985. Comparison of multimeric plus and minus forms of viroids and virusoids. *Plant Mol. Biol.* 4: 293-304.
19. Keese, P. and R. H. Symons
1985. Domains in viroids: Evidence of intermolecular RNA rearrangements and their contribution to viroid evolution. *Proc. Natl. Acad. Sci. USA* 82: 4582-4586.
20. Lin, J. J. and J. S. Semancik
1985. Coordination between host nucleic acid metabolism and citrus exocortis viroid turnover. *Virus Res.* 3: 213-230.

21. Marton, L., N. Duran-Vila, J. J. Lin, and J. S. Semancik
1982. Properties of cell cultures containing the citrus exocortix viroid. *Virology* 122: 229-238.
22. Momma, T. and T. Takahashi
1982. Ultrastructure of hop stunt viroid-infected leaf tissue. *Phytopath. Z.* 104: 211-221.
23. Rivera-Bustamante, R., R. Gin, and J. S. Semancik
1986. Enhanced resolution of circular and linear molecular forms of viroid and viroid-like RNA by electrophoresis in a discontinuous-pH system. *Anal. Biochem.* 156: 91-95.
24. Schlemmer, A., C. N. Roistacher, and J. S. Semancik
1985. A unique, infectious RNA associated with citron showing symptoms typical of citrus exocortix viroid. *Phytopathology* 75: 946-949.
25. Semancik, J. S.
1976. Citrus exocortix disease—1965 to 1975, p. 79-89. *In Proc. 6th Conf. IOCV.* IOCV, Riverside.
26. Semancik, J. S.
1986. Separation of viroid RNAs by cellulose chromatography indicating conformational distinctions. *Virology* 155: 39-45.
27. Semancik, J. S. and V. Conejero-Tomas
1987. Viroid pathogenesis and expression of biological activity, p. 71-126. *In Viroids and Viroid-like Pathogens.* CRC Publishing, Boca Raton, FL.
28. Semancik, J. S. and K. L. Harper
1984. Optimal conditions for cell-free synthesis of citrus exocortix viroid and the question of specificity of RNA polymerase activity. *Proc. Natl. Acad. Sci. USA* 81: 4429-4433.
29. Semancik, J. S., R. Rivera-Bustamante, and A. C. Goheen
1987. Widespread occurrence of viroid-like RNAs in grapevine. *Amer. J. Enology and Viticulture* 38: 35-40.
30. Semancik, J. S., C. N. Roistacher, and N. Duran-Vila
1986. A new viroid is the causal agent of the citrus cachexia disease, p. 125-135. *In Proc. 10th Conf. IOCV.* IOCV, Riverside.
31. Semancik, J. S., D. Tsuruda, L. Zaner, J. L. M. C. Geelen, and L. G. Weathers
1976. Exocortix disease: Subcellular distribution of pathogenic (viroid) RNA. *Virology* 69: 669-676.
32. Semancik, J. S. and W. J. Vanderwoude
1976. Exocortix viroid: Cytopathic effects at the plasma membrane in association with pathogenic RNA. *Virology* 69: 719-726.
33. Semancik, J. S. and L. G. Weathers
1972. Exocortix disease: Evidence for a new species of "infectious" low molecular weight RNA in plants. *Nature New Biology* 237: 242-244.
34. Van Loon, L. C.
1985. Pathogenesis-related proteins. *Plant Mol. Biol.* 4: 111-116.
35. Visvader, J. E., A. C. Forster, and R. H. Symons
1985. Infectivity and *in vitro* mutagenesis of monomeric cDNA clones of citrus exocortix viroid indicates the site of processing of viroid precursors. *Nucleic Acid Res.* 13: 5843-5856.
36. Visvader, J. E., A. R. Gould, G. E. Bruening, and R. H. Symons
1982. Citrus exocortix viroid: Nucleotide sequence and secondary structure of an Australian isolate. *FEBS Letters* 137: 288-292.
37. Visvader, J. E. and R. H. Symons
1983. Comparative sequence and structure of different isolates of citrus exocortix viroid. *Virology* 130: 232-237.
38. Visvader, J. E. and R. H. Symons
1985. Eleven new sequence variants of citrus exocortix viroid and the correlation of sequence with pathogenicity. *Nucleic Acid Res.* 13: 2907-2920.
39. Visvader, J. E. and R. H. Symons
1986. Replication of *in vitro* constructed viroid mutants: location of the pathogenicity-modulating domain of citrus exocortix viroid. *The EMBO Jour.* 5: 2051-2055.
40. Wang, M. C., J. J. Lin, N. Duran-Vila, and J. S. Semancik
1986. Alteration in cell wall composition and structure in viroid-infected cells. *Physiol. Mol. Plant Path.* 28: 107-124.
41. Zaitlin, M., C. L. Niblett, E. Dickson, and R. B. Goldberg
1980. Tomato DNA contains no detectable regions complementary to potato spindle tuber viroid as assayed by solution and filter hybridization. *Virology* 104: 1-9.