

Lawrence Berkeley National Laboratory

Recent Work

Title

HARD-ROCK TUNNELING USING PULSED ELECTRON BEAMS

Permalink

<https://escholarship.org/uc/item/1946553z>

Authors

Avery, Robert T.

Keefe, Denis

Brekke, Tor L.

et al.

Publication Date

1975-03-01

Presented at the Particle Accelerator Conference,
Washington, D.C., March 12-14, 1975.
To be published in IEEE Trans. Nuclear Science
NS-22, No. 3, June 1975

LBL-3377

c. 2

HARD-ROCK TUNNELING USING PULSED ELECTRON BEAMS

Robert T. Avery, Denis Keefe, Tor L. Brekke, and Iain Finnie

March 1975

Prepared for the U. S. Energy Research and Development
Administration under Contract W-7405-ENG-48
with the financial support of the National Science
Foundation (RANN) under NSF Grant AG-393

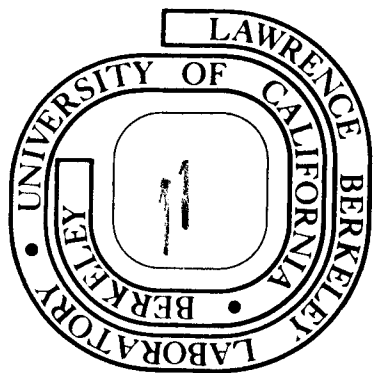

TWO-WEEK LOAN COPY

*This is a Library Circulating Copy
which may be borrowed for two weeks.
For a personal retention copy, call
Tech. Info. Division, Ext. 5545*

LBL-3377
c. 2

DISCLAIMER

This document was prepared as an account of work sponsored by the United States Government. While this document is believed to contain correct information, neither the United States Government nor any agency thereof, nor the Regents of the University of California, nor any of their employees, makes any warranty, express or implied, or assumes any legal responsibility for the accuracy, completeness, or usefulness of any information, apparatus, product, or process disclosed, or represents that its use would not infringe privately owned rights. Reference herein to any specific commercial product, process, or service by its trade name, trademark, manufacturer, or otherwise, does not necessarily constitute or imply its endorsement, recommendation, or favoring by the United States Government or any agency thereof, or the Regents of the University of California. The views and opinions of authors expressed herein do not necessarily state or reflect those of the United States Government or any agency thereof or the Regents of the University of California.

Robert T. Avery and Denis Keefe

and

Tor L. Brekke and Iain Finnie

Lawrence Berkeley Laboratory
University of California
Berkeley, CaliforniaCollege of Engineering
University of California
Berkeley, CaliforniaSummary

It has been demonstrated that intense sub-micro-second bursts of energetic electrons cause significant pulverization and surface spalling of a variety of rock types. The spall debris generally consists of sand, dust, and small flakes. If carried out at rapid repetition rate this can lead to a promising technique for increasing the speed and reducing the cost of underground excavation of tunnels, mines, and storage spaces. The conceptual design features of a Pulsed Electron Tunnel Excavator capable of tunneling approximately ten times faster than conventional drill/blast methods is presented.

Introduction

There is a national need for more rapid and economical methods of tunneling for undergrounding of power plants, energy storage facilities (compressed air, hydro, fuel, thermal, etc.), transmission lines, 300 mph inter-city trains, urban transit, factories and warehouses. The surface environment can be greatly improved as a result. For soil and soft rock, mechanical moles have already speeded up tunneling rates significantly. However, for hard rock, drill/blast methods are slow, with advance rates seldom exceeding 2.5-3.0 m (8-10 ft.) per 8-hour shift. Thus, there remains a need for great improvement in hard rock tunneling rates.

Rock Spalling by Pulsed Electron Beams

The successful spalling of granite, basalt, greenstone and other rocks using single high-current high-voltage (1-4 MV) electron pulses of less than 1 μ s duration have been reported previously.^{1,2} More recently, spalling also has been successfully demonstrated³ in experiments using the ~ 9 MV Hermes II accelerator at Sandia-Albuquerque which delivered 64 kJ per shot to each rock sample. The resulting spall and debris for several single-pulse shots are shown in Fig. 1. The spalls were 7-15 mm deep by 120-130 mm diameter with volume removed (neglecting any corners knocked off) of 51-82 cm³. This corresponds to specific energies (energy deposited/volume removed) of 0.78 to 1.25 kJ/cm³.

Generally, the depth of the spall is found to vary roughly as the voltage of the electrons, and the volume of the spall roughly as the energy content (joules) of the beam pulse. Hard rocks spall almost as readily as soft rocks. Generally, wet rocks spalled somewhat more than dry rocks. The fracture mechanisms occurring on this very short time-scale are becoming better understood^{3,4} and are primarily due to tension induced by stresswaves caused by thermomechanical expansion pressures, supplemented in the case of wet rocks by thermally-induced pressure within the interstitial water. Experimental results have been related successfully to the brief times required for initiation and propagation of cracks in rocks.

Specific Energy for a Useful Excavating Accelerator

The foregoing experiments were carried out at existing available accelerators under a limited range of

operating conditions. In particular, the radial distribution of beam intensity typically was sharply peaked in the center with relatively large tails; also all experiments were carried out on a single-shot basis. A more uniform current distribution could require as little as one-third as much specific energy. Further, if rapid-fire operation were used, there is reason to believe that larger volume of spalls would result because of heating and/or incipient cracking produced by preceding pulses. Thus, for a rapid repetition-rate accelerator designed specially for excavation, it is reasonable to expect lower specific energies (perhaps 100-400 J/cm³ or less) than the ~1.0 kJ/cm³ reported above. For design purposes, a value of 250 J/cm³ is assumed. In arriving at the required accelerator output, a 25% allowance is added to the foregoing value to compensate for losses in windows and in the air, and for albedo, x-ray production, etc.

Example Pulsed Electron Tunnel Excavator

This paper concentrates on an example accelerator with 9 MW average beam power, which would thus be capable of removing 104 m³ (136 cu. yds.) of rock per hour, or in other words advance a 6.4 m (21 ft.) diameter tunnel at a rate of 3.2 m (10.6 ft) per hour. This is about an order-of-magnitude greater advance rate than by present-day drill/blast techniques.

In order to assess the possibilities of this technique for rapid tunneling, the conceptual design of a Pulsed Electron Tunnel Excavator has been prepared.^{5,6} Several features of this excavator are shown in Figures 2 through 6. Note that the accelerator proper is just one element -- though a large one -- in the overall design, which also integrates provisions for major construction functions such as tunnel lining, muck removal and ventilation on a continuous basis. Access is available to handle unusual circumstances which might be encountered.

A linear induction accelerator^{7,8,9} producing electron pulses (5 MV, 5 kA, 1.0 μ s = 25 kJ) at a 360 Hz rate has been selected for this example, thus providing the required average electron beam power output of 9 MW. All of the beam parameters proposed have been met or exceeded in existing electron-beam machines, but not simultaneously. Extension of accelerator performance to these parameters would require development of some components but appears to be well within the state-of-the art.

The accelerator will consist of 64 accelerating modules each producing 80 kV pulsed voltage. A module may be thought of as a pulse transformer in which the transformer cores are driven by a pulse-forming network connected to the primary windings and in which the electron beam constitutes the secondary circuit.

The electron beam pulses will be scanned by a combination of (slow) mechanical and (fast) magnetic means across the rock at the tunnel face in a prescribed pattern. The requirements for the scanning system are severe as it must transmit 9 MW of electron beam from high vacuum to air, must scan in a reasonably precise manner, and must survive for long time-periods in the hostile tunnel environment without being damaged by either the spall debris or the electron beam. Several promising approaches are under consideration. One

* Work supported by the National Science Foundation under the auspices of the U.S. Energy Research and Development Administration.

consists of passing the electrons through a directly water-cooled foil window¹⁰ for high-vacuum isolation followed by a modestly-evacuated mechanically-moved snout at the end of which is a moveable foil window (located about 10 cm from the rock face). Other possibilities include such schemes as 1) a series of beam apertures which provide vacuum grading, 2) rotating beam apertures which are open only momentarily, when the beam is pulsed 3) a hundred or so individual windows with electromagnetic scanning, or 4) a water film flowing on the outside of a window. Further study of the scanning system is needed, but it appears that some one or combination of methods will prove suitable.

The spall debris is mostly sand, dust, and small flakes, but larger pieces may be produced also. The bulk of the debris will be picked up pneumatically at the face and then placed in an hydraulic slurry pipeline for transport to the tunnel entrance. Slurry transport is a fast, continuous and economical technique¹¹ for transporting large volumes of muck. Large pieces will be coped with by a conveyor at the face and then crushed and slurry-transported. A belt conveyor and muck cars are shown also, but they may not be needed.

Tunnel support and lining will be provided by partial tunnel shield (surrounding the scanner) followed immediately by casting of the final concrete lining using either slipform or extrusion means. Concrete supplies will be transported to the face by pipe or conveyor. Alternatively, pre-cast concrete segments or structural steel sets could be placed instead, but they would require interruption of accelerator operation during their installation.

The accelerator will produce intense x-rays during operation. The operating crew will be fully protected by a shielding system of concrete, water and safety doors built into one unit of the excavator. The several meters of rock cover which is (by definition) over the tunnel protects the general public. Recent irradiations of rock samples at Berkeley show that there is no induced radioactivity; thus when the machine is turned off, the crew can approach the tunnel-face immediately.

Ozone will be produced when the electron beam passes through air to reach the rock face. Pneumatic suction at the face followed by the negative-pressure exhaust ventilation duct will transport the ozone to the tunnel entrance where it will be diluted with air or chemically treated.

Conclusion

Sub-microsecond intense pulses of electrons are highly effective in spalling rock. Supplied at a rate of hundreds of times per second, they provide a technique that could lead to a Pulsed Electron Tunnel Excavator capable of converting hard-rock tunneling from a batch process into a rapid continuous process with possibly a ten-fold increase in advance rates compared to the conventional drill/blast method. Further study and development of components followed by construction of pilot and demonstration excavators are needed to prove the economic practicality of such an approach.

Acknowledgements

This program has been aided greatly by the work and cooperation of such a large number of people, not only at our institutions but also at other laboratories and in industry, that we regret that space limitations prevent us from here acknowledging them individually. We thank NSF for financial support under NSF Grant AG-393 and ERDA/AEC for use of facilities.

References

1. R. Avery, D. Keefe, T. Brekke, and I. Finnie, "Shattering Rock with Intense Bursts of Energetic Electrons", IEEE Trans. Nucl. Sci. NS-20, No. 3 (1973) [LBL-1391].
2. R. Avery, D. Keefe, T. Brekke, and I. Finnie, "Use of Intense Sub-Microsecond Electron Bursts to Produce Rock Shattering", Advances in Rock Mechanics II B, Proc. 3rd Congress of Intl. Soc. Rock Mech., Natl. Acad. Sci. (1974) [LBL-2137].
3. R.T. Avery, "Study of Rock Shattering by Intense Bursts of Energetic Electrons", D. Eng. Thesis, U. of Calif. (1974) [LBL-3019].
4. O. Vardar, "Fracture of Brittle Solids Under Multi-axial and Dynamic Loading", Ph.D. Thesis, U. of Calif. (1975) [LBL-3240].
5. C.P. Adkins and T.L. Brekke, "Some Construction Considerations for Tunneling with the Energetic Electron Burst Method", UCID-3719 (1975).
6. R. Avery, D. Keefe, T. Brekke, and I. Finnie, "Rock Shattering with Energetic Electrons -- A New Method for Hard-Rock Tunneling", LBL-3246. (To be published, 1975).
7. J.W. Beal, N.C. Chrostofilos, and R.E. Hester, "The Astron Linear Accelerator", IEEE Trans. Nucl. Sci. NS-16, No. 3, (1969).
8. R. Avery, et.al., "The ERA 4 MeV Injector", IEEE Trans. Nucl. Sci. NS-18, No. 3, (1971) [UCRL-20174].
9. J.E. Leiss, "Modern Electron Linacs and New User Needs", Proc. 1972 Proton Linac Conf., LASL Report LA-5115 (1972).
10. J.E. Leiss, private communication.
11. R.R. Faddick and J.W. Martin, "Pneumatic-Hydraulic Material Transport System for Rapid Excavation of Tunnels", Report DOT-TST-75-17, (1975).

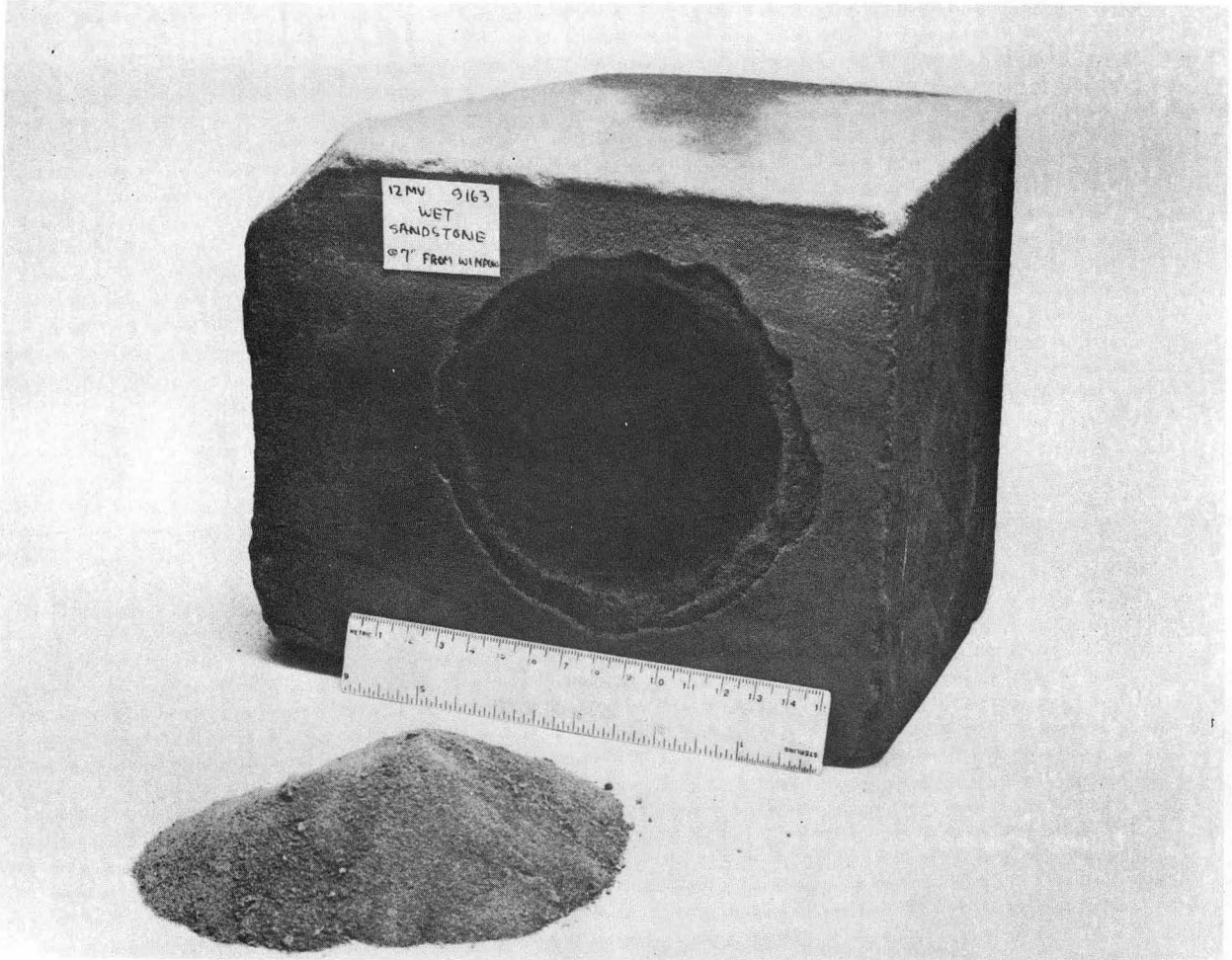

CBB 741-342

Fig. 1a. SANDSTONE (compr. strength = 6,200 psi) Spalling produced by bombardment with a single pulse of electrons (9 MV, 45 kA, 0.16 μ s = 64 kJ).

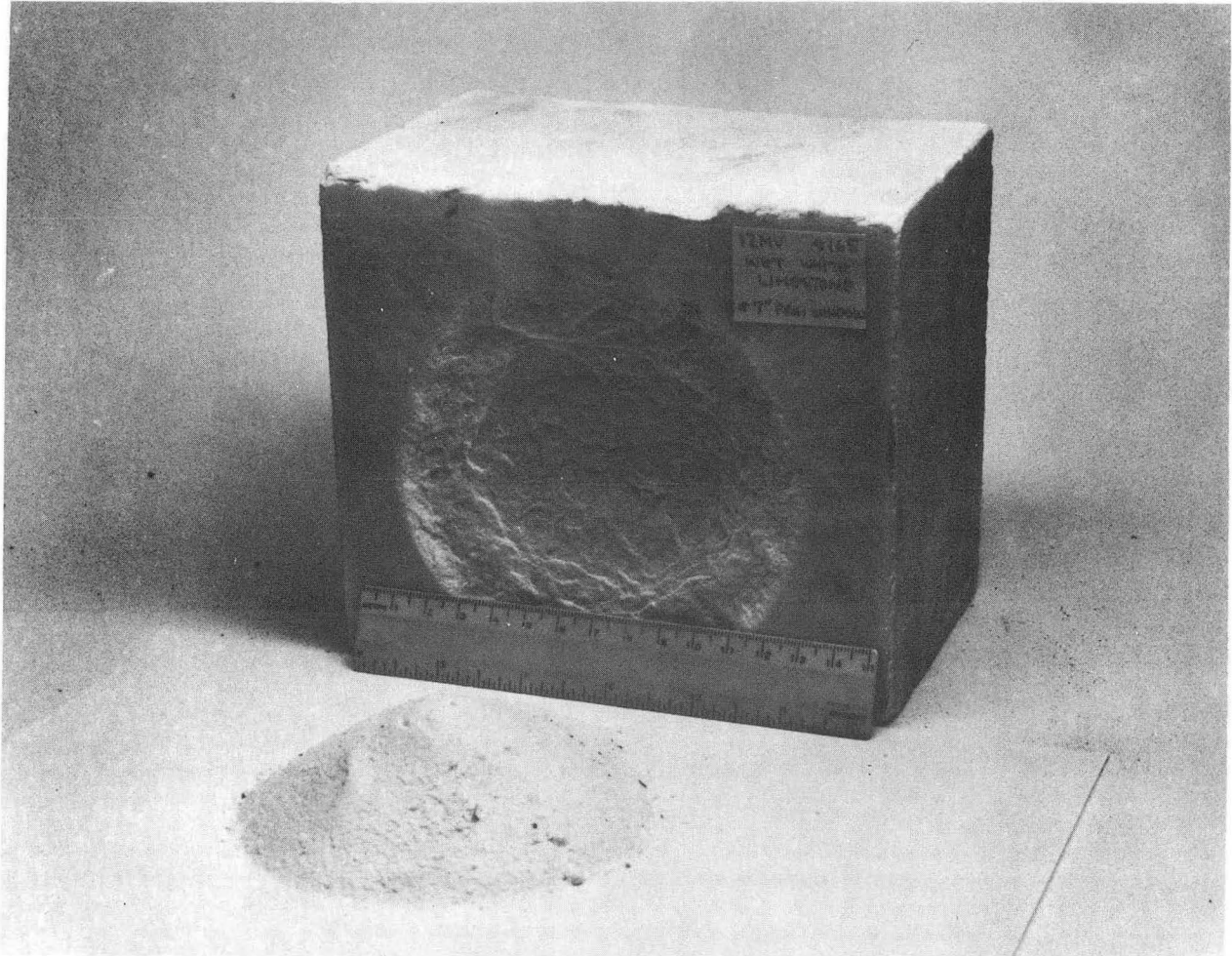

CBB 741-340

Fig. 1b. LIMESTONE (compr. strength = 8,400 psi) Spalling produced by bombardment with a single pulse of electrons (9 MV, 45 kA, $0.16 \mu\text{s}$ = 64 kJ).

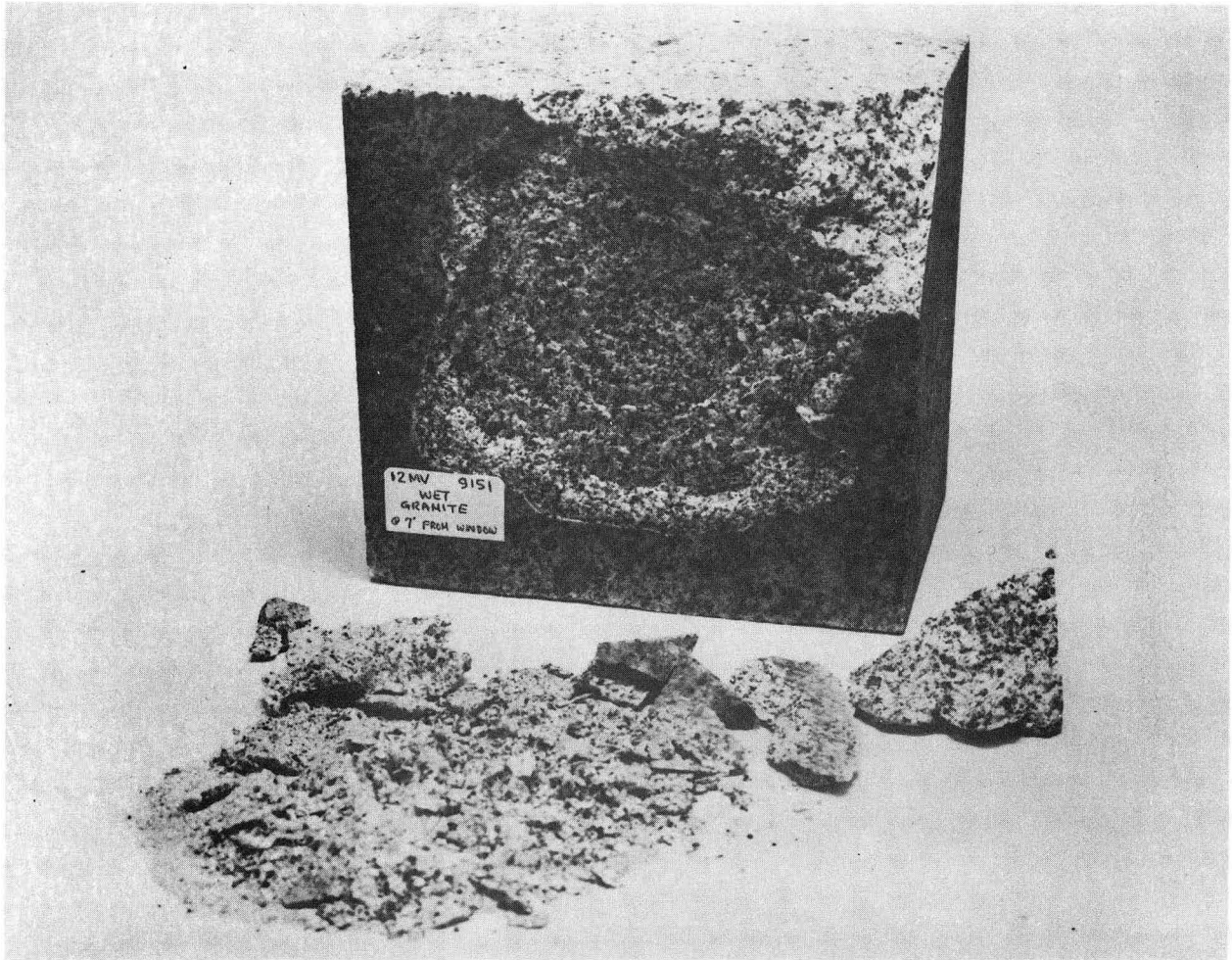

CBB 741-345

Fig. 1c. GRANITE (compr. strength = 26,000 psi) Spalling produced by bombardment with a single pulse of electrons (9 MV, 45 kA, 0.16 μ s = 64 kJ).

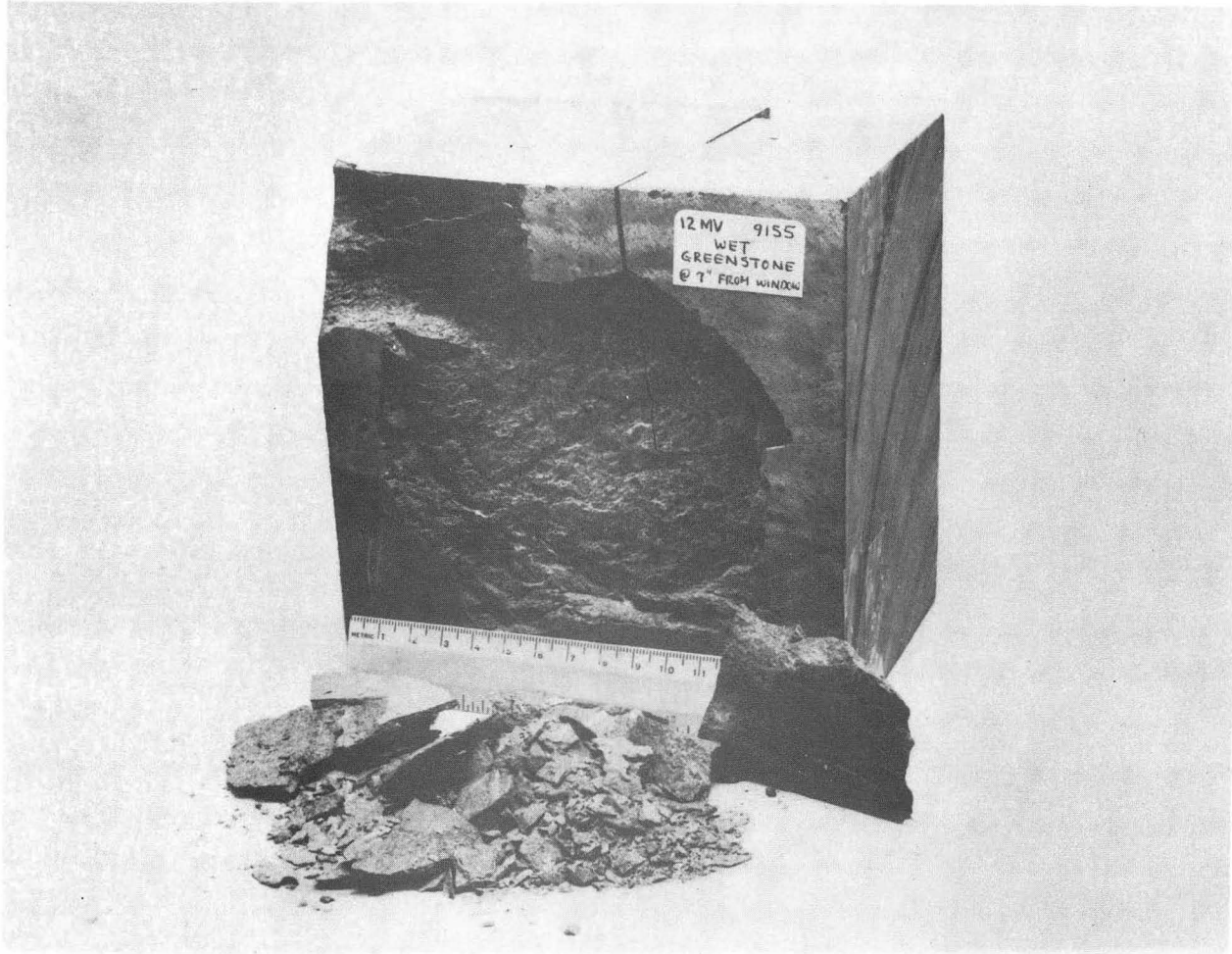

CBB 741-344

Fig. 1d. GREENSTONE (compr. strength = 40,000 psi) Spalling produced by bombardment with a single pulse of electrons (9 MV, 45 kA, 0.16 μ s = 64 kJ).

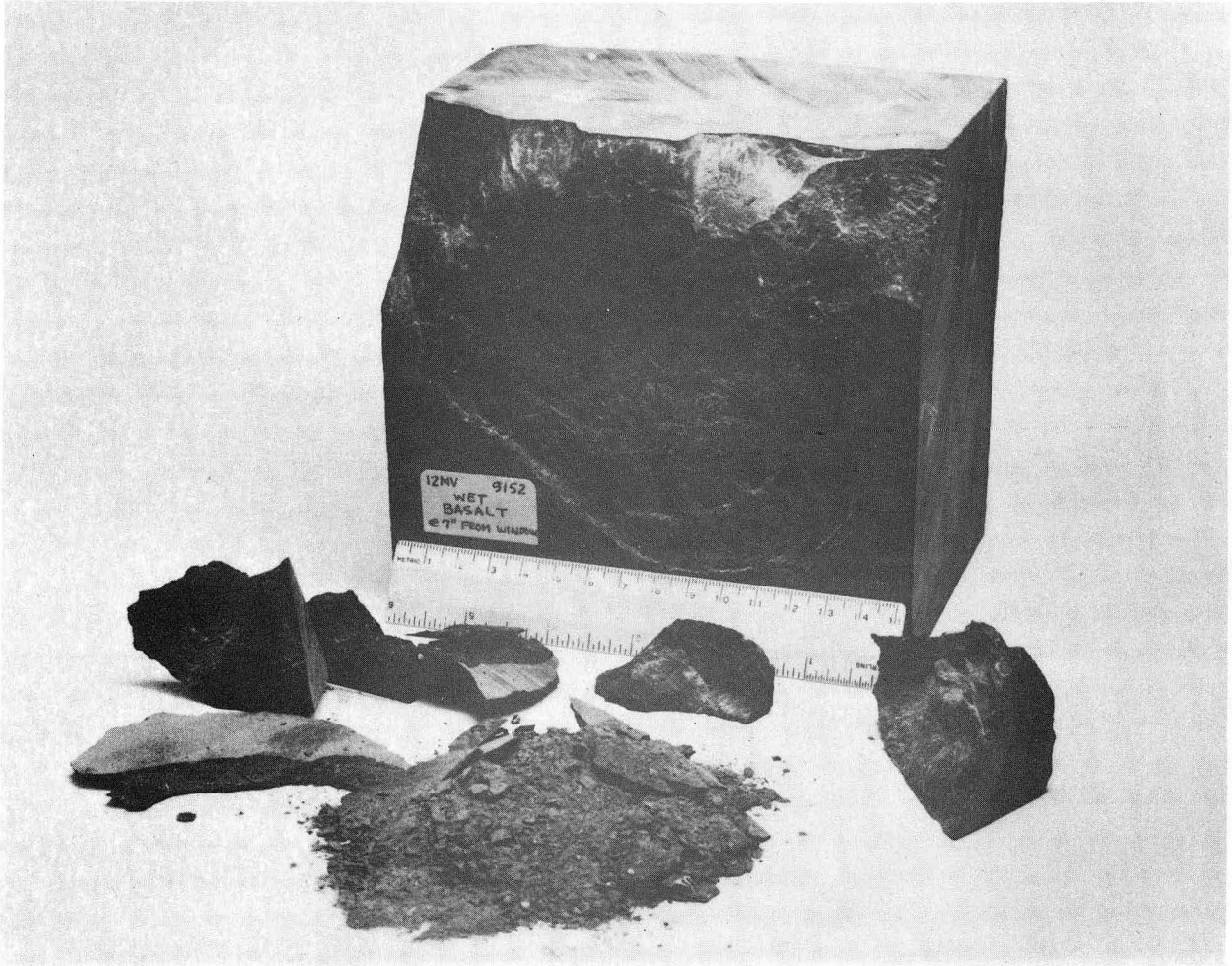

CBB 741-347

Fig. 1e. BASALT (compr. strength = 46,000 psi) Spalling produced by bombardment with a single pulse of electrons (9 MV, 45 kA, $0.16 \mu s = 64 \text{ kJ}$).

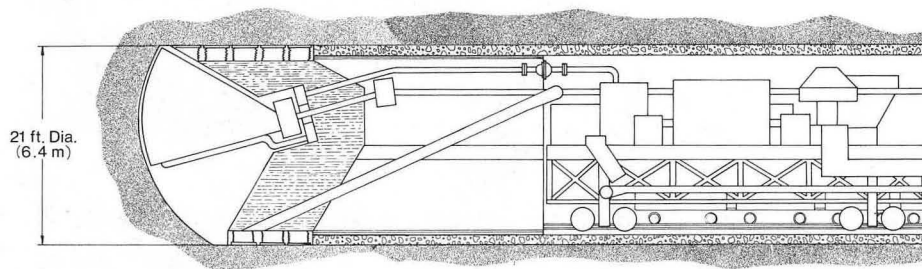

21 ft. Dia.
(6.4 m)

UNIT 1

TELESCOPING BEAM PIPE
MOVABLE SCANNER
INITIAL RADIATION SHIELD
MUCKING
ATMOSPHERE CONTROL
FINAL TUNNEL LINING

UNIT 2

BEAM TRANSPORT
PNEUMATIC EQPT.
HYDRAULIC SLURRY EQPT.

XBL 753-712

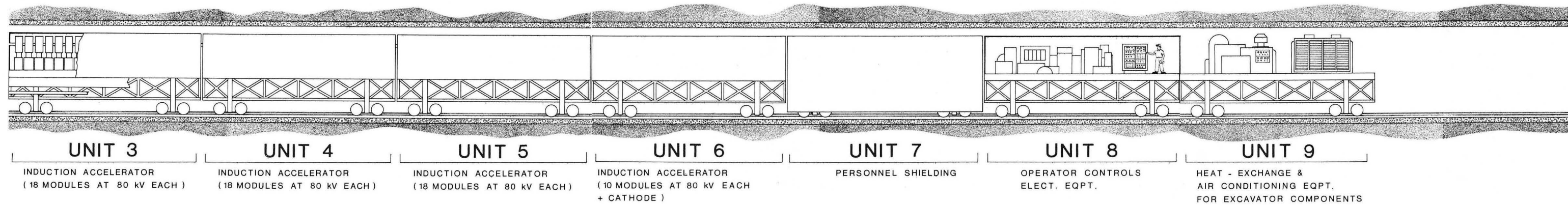

XBL 753-713

Fig. 2. Conceptual example of a Pulsed Electron Tunnel Excavator capable of advancing a 21-foot (6.4m) diameter tunnel through hard rock at 10.6 (3.2m) per hour.

ELECTRICAL BLOCK DIAGRAM

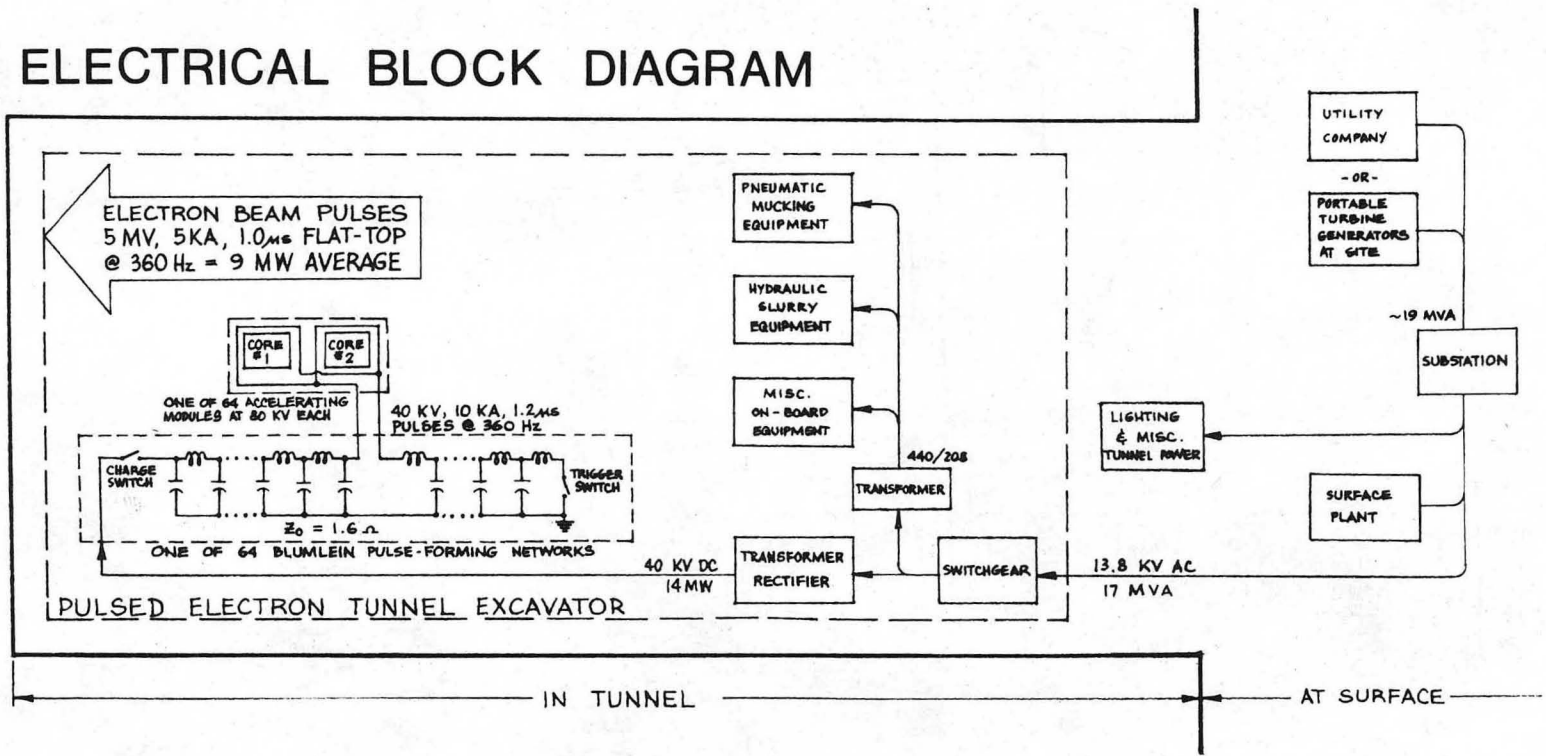

XBL 753-518

Fig. 3. Electrical Block Diagram

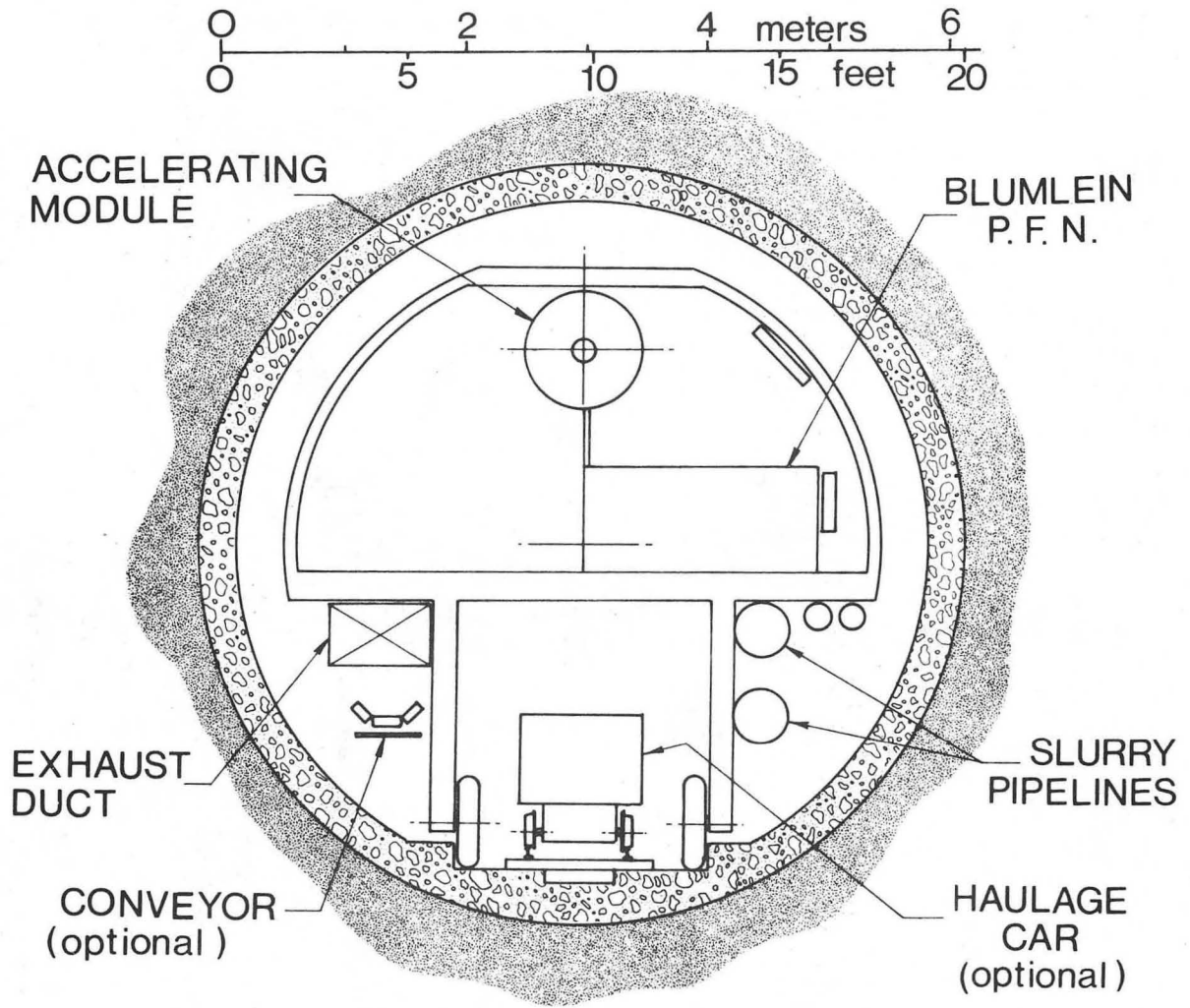

TYPICAL SECTION AT ACCELERATOR UNIT

XBL 753-555

Fig. 4. Cross-section through accelerating unit of Pulsed Electron Tunnel Excavator.

SCHEMATIC OF ONE OF THE
64 ACCELERATING MODULES

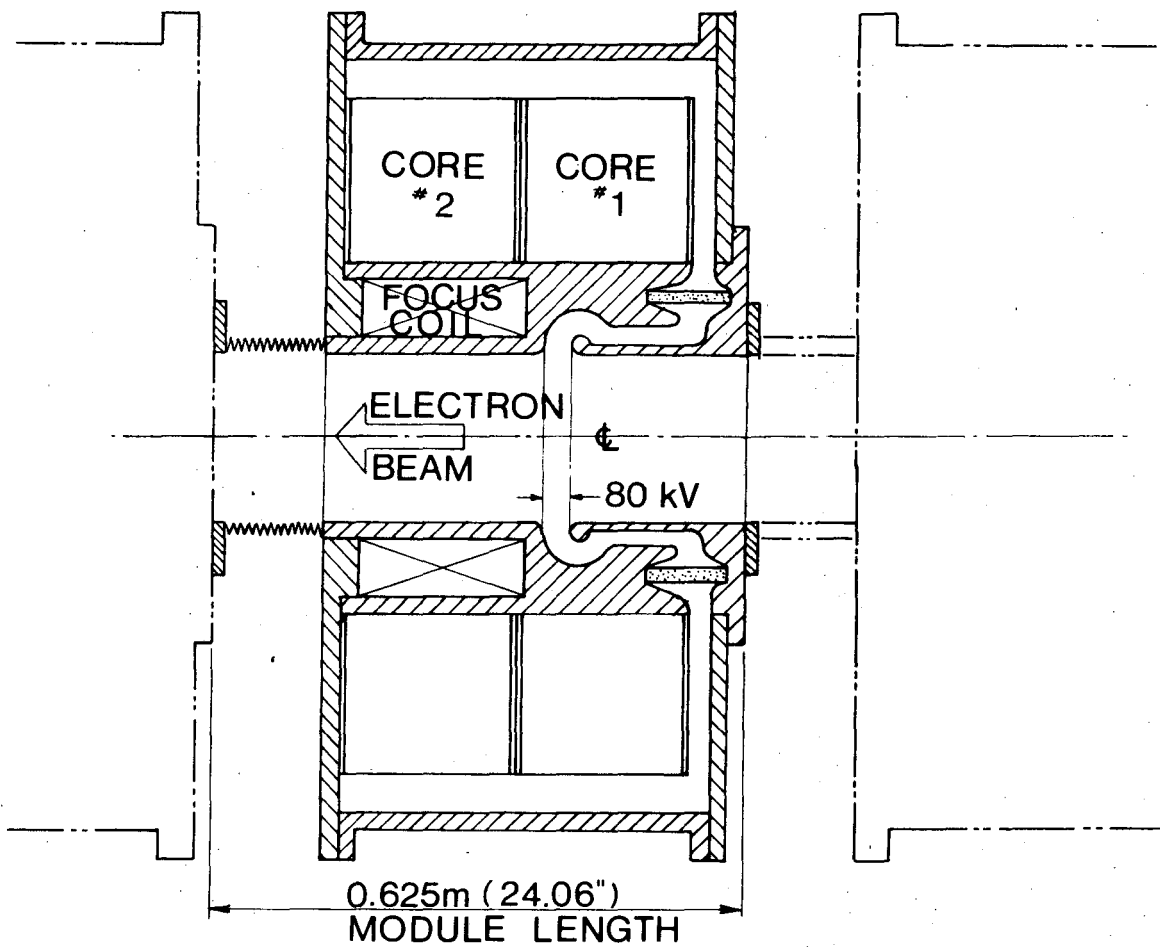

XBL 753-535

Fig. 5. Schematic of one of the 64 accelerating modules.

MUCKING, AIR & WATER BLOCK DIAGRAM

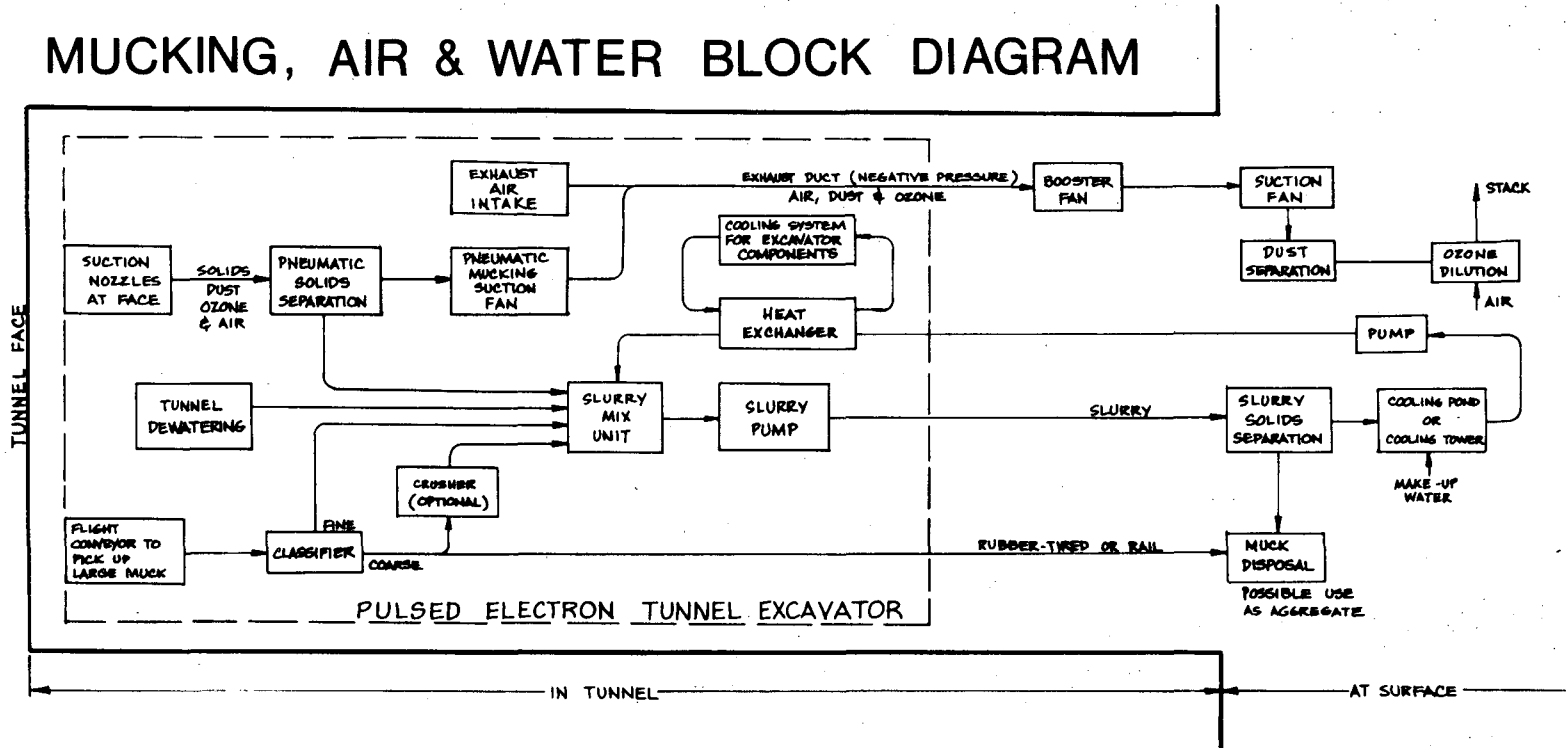

Fig. 6. Mucking, air and water block diagram.

LEGAL NOTICE

This report was prepared as an account of work sponsored by the United States Government. Neither the United States nor the United States Energy Research and Development Administration, nor any of their employees, nor any of their contractors, subcontractors, or their employees, makes any warranty, express or implied, or assumes any legal liability or responsibility for the accuracy, completeness or usefulness of any information, apparatus, product or process disclosed, or represents that its use would not infringe privately owned rights.

TECHNICAL INFORMATION DIVISION
LAWRENCE BERKELEY LABORATORY
UNIVERSITY OF CALIFORNIA
BERKELEY, CALIFORNIA 94720