

Agreement, case, and switch-reference in Amahuaca

by

Emily Catherine Clem

A dissertation submitted in partial satisfaction of the

requirements for the degree of

Doctor of Philosophy

in

Linguistics

in the

Graduate Division

of the

University of California, Berkeley

Committee in charge:

Professor Amy Rose Deal, Chair

Professor Peter Jenks

Professor Line Mikkelsen

Professor Darya Kavitskaya

Summer 2019

Agreement, case, and switch-reference in Amahuaca

Copyright 2019
by
Emily Catherine Clem

Abstract

Agreement, case, and switch-reference in Amahuaca

by

Emily Catherine Clem

Doctor of Philosophy in Linguistics

University of California, Berkeley

Professor Amy Rose Deal, Chair

This dissertation probes the nature of the syntactic operation of Agree through the lens of the morphosyntax of Amahuaca, an endangered Panoan language of the Peruvian Amazon. I take as my empirical focus two interrelated case studies in Amahuaca syntax: 1) the split ergative case system, and 2) the extensive switch-reference system. In the domain of case, I argue that overt ergative case morphology in Amahuaca expones agreement of the transitive subject with multiple functional heads. This leads to a distinction between the features needed for abstract ergative case (agreement only with *v*), and the features needed to trigger overt ergative case (agreement with both *v* and T). This distinction between abstract and morphological case factors into the analysis of the switch-reference system of Amahuaca, which I argue is sensitive to abstract case. In addition to case-sensitivity, Amahuaca's switch-reference system shows the typologically unusual property of tracking the reference of all arguments of the verb, not only subjects. I propose that this system arises through adjunct complementizer agreement that probes both the adjunct and matrix arguments directly through cyclic expansion of the probe. Through these two investigations, I conclude that Amahuaca provides support for a narrowly cyclic model of Agree in which each instance of Merge defines a new cycle of Agree (Rezac 2003, 2004; Béjar and Rezac 2009). Further, the empirical facts can be most straightforwardly accounted for if we assume that some probes are insatiable, agreeing with all possible goals in their search space (Deal 2015b). Finally, despite the fact that some agreement in Amahuaca appears to be long distance, I argue that the data can be captured under the fairly conservative assumption that Agree is always under c-command and is always phase-bound.

To the Amahuaca

Contents

Contents	ii
List of Tables	v
List of Abbreviations	vi
1 Introduction	1
1.1 Background on Amahuaca	3
1.2 Summary and structure of the dissertation	5
2 Background on the structure of Amahuaca	7
2.1 Phonology	7
2.2 Morphology	10
2.2.1 Case marking	10
2.2.2 Number marking	14
2.2.3 Person marking	16
2.2.4 Tense marking and agreement	18
2.2.5 Aspect marking	18
2.3 Syntax	19
2.3.1 The matrix clausal spine	19
2.3.2 Verb movement	23
2.3.3 Object shift	24
2.3.4 Scrambling	25
2.3.5 Sample derivation of a matrix clause	33
2.3.6 Dependent clauses	34
2.3.6.1 Switch-reference clauses	35
2.3.6.2 Relative clauses	38
2.3.6.3 Distinguishing switch-reference and relative clauses	39
2.3.7 DP-internal structure	47
2.4 Summary	52

3	Amahuaca case as agreement with functional heads	54
3.1	Inherent and dependent ergative case	56
3.2	Amahuaca case marking and word order	59
3.3	Amahuaca ergative is neither inherent nor dependent	63
3.3.1	Amahuaca ergative is not an inherent case	63
3.3.2	Amahuaca ergative is not a dependent case	66
3.4	The analysis: Ergative case as agreement with multiple heads	73
3.5	Category features and switch-reference	82
3.6	Nominative case as a feature complex	85
3.7	Summary	89
3.7.1	Consequences for a theory of case	89
3.7.2	Implications for Agree	90
4	Amahuaca switch-reference and cyclicity in Agree	91
4.1	Amahuaca agreeing complementizers	93
4.1.1	The structure of switch-reference clauses	93
4.1.2	Agreement in switch-reference clauses	99
4.2	Cyclic Agree: The framework	103
4.3	Insatiability, cyclic expansion, and maximal projection probes	105
4.4	Previous analyses	113
4.4.1	Accounts of switch-reference parasitic on agreeing T	114
4.4.2	Non-reference-tracking accounts of switch-reference	123
4.4.3	Bound anaphor accounts of complementizer agreement	127
4.4.4	Summary of previous analyses	130
4.5	Predictions and typology	131
4.6	Summary	135
4.6.1	Consequences for a theory of switch-reference	135
4.6.2	Implications for Agree	135
5	Conclusion	137
5.1	Empirical contributions and analytical insights	137
5.1.1	Agree and differential case marking	137
5.1.2	Agree and switch-reference	139
5.2	Theoretical implications for the characterization of Agree	140
A	Switch-reference markers	145
A.1	Illustration of switch-reference markers	145
A.1.1	Sequential action paradigm	145
A.1.2	Immediately sequential action paradigm	146
A.1.3	Simultaneous action paradigm	147
A.1.4	Subsequent action paradigm	148

A.2	Contrasts not encoded by switch-reference markers	149
A.2.1	Abstract case of marked clause subjects	149
A.2.2	Transitivity with default markers	149
A.2.3	Object coreference	150
A.2.4	Reference of possessors and objects of postpositions	151

Bibliography		153
---------------------	--	------------

List of Tables

2.1	Consonant inventory	8
2.2	Vowel inventory	9
2.3	Regular case morphology	11
2.4	Truncated ergative syllables from nouns and adjectives in Hyde 1980	12
2.5	Full pronouns	16
2.6	Subject clitics	16
2.7	Tense markers and subject agreement	18
2.8	Matrix aspect markers	18
3.1	Switch-reference markers (partial “after” series)	83
4.1	Sequential switch-reference markers	102
4.2	Sequential switch-reference markers (repeated)	132
4.3	Simultaneous switch-reference markers	132
4.4	Subsequent switch-reference markers	133

List of Abbreviations

1	first person	NEG	negation
2	second person	NOM	nominative
3	third person	OS	object = intransitive subject
ACC	accusative	PERF	perfect
AM	associated motion	PFV	perfective
APPL	applicative	PL	plural
C	complementizer	POSS	possessive
CNTEXP	counter-expectation	PRES	present
DECL	declarative	PST	past
DEM	demonstrative	SA	subject = transitive subject
DS	different subject	SG	singular
EMPH	emphatic	SIM	simultaneous
ERG	ergative	SO	subject = object
GEN	genitive	SQ	sequential
HAB	habitual	SS	subject = intransitive subject
IMMSQ	immediately sequential	SSA	subject = subject (intransitive or transitive)
INT	interrogative	SUB	subsequent
INTR	intransitive	TAM	tense/aspect/modality
IPFV	imperfective	TR	transitive
LG	long form	YEST	yesterday

Acknowledgments

This dissertation would never have been possible without the influence and support of countless people. To everyone who has played a role in the development of these ideas and in my growth as a scholar and an individual, I am incredibly grateful. Whether or not your name appears below, I thank you so much for helping me to make it to this point.

First and foremost, I thank the members of the Amahuaca community who gave so generously of their time to collaborate with me on this project. Without their patience, dedication, and expert knowledge, this dissertation would not exist. I am especially grateful to my very first Amahuaca teacher, José Piño Bonangué, and to my other primary consultants: Celia Sampi Ríos, Celia Soria Pérez, and one speaker who wishes to remain anonymous. I would also like to thank numerous other community members who have worked with me over the years, including Ricardo Cachiqui, María Juana Maquinista, Esperanza Pérez Fernández, Juan Piño Miqueas, Floria Piño Ríos, Zoila Piño Ríos, Carmen Ríos Miqueas, Pedro Ruiz Dionisio, Edinson Soria Cauper, and María Venacho Campos.

I am incredibly grateful to the members of my dissertation committee for the tremendous amount of feedback and support they have given me throughout the lifespan of this project. I thank Amy Rose Deal for being the most fantastic advisor I could imagine. Your ability to cut to the heart of an issue and to identify the bigger picture implications is inspiring. You have taught me to be a more rigorous and critical scholar and a more generous teacher and mentor. Thank you to Line Mikkelsen for encouraging me to identify connections between seemingly disparate ideas and phenomena and for instilling in me an appreciation for the vast history of scholarship that our work builds upon. To Peter Jenks, thank you for inspiring me to pursue syntax and for always keeping me excited and amazed by language. I also thank Dasha Kavitskaya for reminding me to not forget the non-syntacticians in the room and for helping me to frame the implications of my work in an accessible way.

I also owe a great deal to the many individuals who helped me to become a better fieldworker over the years. I am grateful to Deborah Morton for introducing me to linguistic fieldwork and Jefferson Barlew for helping me to hone my elicitation skills and teaching me to be meticulous in data collection. I thank Lev Michael for guiding me to Amahuaca as a fieldwork language and Chris Beier for offering valuable advice in preparing to go to Peruvian Amazonia for the first time. To my wonderful fieldwork buddies, Kelsey Neely and Zach O'Hagan, I couldn't have made it through four summers of fieldwork without the two of you. Thank you to Kelsey for showing me the ropes in Sepahua, diagnosing my tropical illnesses, and chatting all things Panoan; and to Zach for making days in Sepahua feel like we were almost back in Oakland with your visits from Kitepampani. You both inspire me as fieldworkers, and I have been so lucky to have you as friends, colleagues, and fellow travelers over the years. I also thank the wonderful people who have shown me hospitality and friendship during my travels in Peru, including Leah Brown, Michaela Johnke, Martha Luna Mogrovejo, and Ken and Joy Swift. For the financial support that made my fieldwork possible during graduate school, I am very thankful for having received four Oswalt Endangered Language Grants.

I have been so grateful to call the UC Berkeley Department of Linguistics home for the last five years. The inspiration, support, guidance, and friendship of so many members of the department made my time in graduate school absolutely wonderful. For advice and direction, especially early on in the program, I thank Andrew Garrett, Larry Hyman, and Sharon Inkelas. To Geoff Bacon, Andrew Cheng, Ginny Dawson, Erik Maier, Alice Shen, and Amalia Skilton, thanks for being the #bestcohort I could have ever asked for and for giving me some of the most fun memories of the last five years. Thanks to Hannah Sande for encouraging me to come to Berkeley, for being an amazing roommate, and for keeping me on track with writing. For being willing to drop everything, anywhere, at any time to talk linguistics, I thank Nico Baier and Nik Rolle. For generally making my time in grad school more enjoyable through your friendship I thank all of my fellow grad students over the years, including Kenny Baclawski, Maddy Bossi, Meg Cychosz, Emily Drummond, Steph Farmer, Greg Finley, Karee Garvin, Schuyler Laparle, Myriam Lapierre, Florian Lionnet, Jack Merrill, Julia Nee, and Tessa Scott. I am also grateful for the exceptional undergraduates who I had the privilege of working with while I was at Berkeley, especially those who worked so tirelessly sifting through data as my research apprentices through the LRAP program: Eric Chen, Evy Najarian, Mellania Sog, Mineru Suzuki, Catherine Wharton, and Yvette Wu. Finally, I thank Belén Flores, Paula Floro, and Ron Sprouse for saving me so many headaches along the way.

In addition to my time at Berkeley, I spent the spring semester of 2018 as a visiting student at MIT, and I thank everyone who offered their insight, advice, and friendship to me during my time there. I am grateful to David Pesetsky for being my sponsor and for challenging me to think about old puzzles from a new perspective. I also thank Norvin Richards for reminding me how exciting language can be. To Michelle Yuan, thanks for helping me to feel welcome, for chatting all things ergative, and for keeping me sane while job searching. I also thank the many other grad students who made my time at MIT memorable, including Athulya Aravind, Chris Baron, Kenyon Branan, Sherry Chen, Yadav Gowda, Cora Lesure, Elise Newman, Mitya Privoznov, Carrie Spadine, Abdul-Razak Sulemana, and Danfeng Wu.

Before Berkeley and MIT, there was The Ohio State University. Were it not for my time there as an undergraduate, I would have never discovered linguistics. For introducing me to linguistics and encouraging me to pursue it further, I thank Craig Roberts. I am also grateful to the other wonderful teachers and mentors who guided me along the way and eventually helped me in my decision to go to graduate school, in particular Cynthia Clopper, Brian Joseph, Becca Morley, and Dave Odden.

My work has benefited immensely over the years from the feedback of numerous linguists. For helpful conversations and questions I thank Karlos Arregi, Mark Baker, András Bányi, Bernat Bardagil Mas, Željko Bošković, Livia Camargo Souza, Jessica Coon, Doreen Georgi, Vera Gribanova, Claire Halpert, Emily Hanink, Boris Harizanov, Laura Kalin, Stefan Keine, Maria Kouneli, Ruth Kramer, Julie Legate, Tom McFadden, Gereon Müller, Andy Murphy, Andrew Nevins, Mark Norris, Omer Preminger, Ivy Sichel, Adam Singerman, Sandhya Sundaresan, Maziar Toosarvandani, Jenneke van der Wal, Philipp Weisser, and Erik Zyman. The material in Chapter 3 was greatly improved via the feedback of four anonymous NLLT

reviewers. Likewise, the comments of audiences at various venues, including NELS 49, Multiple Agreement across Domains 2018, and IGRA at the University of Leipzig, were very helpful in developing the content of Chapter 4.

To my family and friends, thank you for your patience during this process and for helping me to maintain some semblance of a life outside of linguistics. I have been so grateful for the friendship of so many, including Sarah Alberg, Chris Allison, Mitzi Allison, Charlotte Ashlock, Amy Deverell, Marcus Ewert, Katie Kinkopf, Rebecca Miller, Siy Sakamoto, Andi Steward, and Greg Steward II.

Finally, I most certainly would not have made it through this whole process without the love, encouragement, and unwavering support of my amazing husband John Hodges Drake VIII. I am so grateful for the sacrifices you made to make all of this possible. Thank you for pushing me to take risks to pursue my passions and for believing that I could do the thing even in the midst of my biggest doubts.

Chapter 1

Introduction

The syntactic operation of Agree was first introduced by Chomsky (2000, 2001) as a mechanism for feature valuation between a probe and a goal. The subsequent two decades have given rise to a wealth of research seeking to understand this operation. The research on Agree has sought on the one hand to understand and refine the characterization of the operation itself. Another line of inquiry has sought to understand what the empirical coverage of this mechanism is and specifically how it may figure in phenomena of dependency formation that extend beyond the simplest cases of ϕ -feature covariance between a functional head and a DP. This dissertation seeks to further our understanding in both domains.

With respect to understanding the detailed mechanics of the operation of Agree, the body of work following Chomsky (2000, 2001) has pursued a variety of directions, which has raised many issues and questions for the theory. The content of this dissertation will engage with several of the questions raised by the past two decades of work on Agree. One such question that has been explored is the nature of the structural relationship between the probe and goal. Under Chomsky’s original characterization of Agree, it was assumed that the probe must c-command the goal. Subsequent research has explored a variety of positions with respect to this assumption. For example, some have argued that instead the reverse relationship must hold: the goal must c-command the probe (Wurmbrand 2012a,b; Zeijlstra 2012; Bjorkman and Zeijlstra 2019, among others). Others have defended the more traditional assumption that downward probing (i.e. probing under c-command) is involved in Agree (Bošković 2007; Preminger 2013, among others). Still others have argued that directionality of probing is variable (Baker 2008; Carstens 2016, among others). In this dissertation I will argue that even probe-goal relationships that may not straightforwardly appear to involve a probe c-commanding a goal can be reduced to general downward Agree under c-command.

Another question that has grown out of the continued research on the nature of Agree is whether a single probe can interact with multiple goals. The original formalization of Agree assumed that a probe interacted only with the most local goal, with locality defined in terms of “closest c-command” (Chomsky 2000: 122). While most models of Agree assume some similarly-defined version of locality, a question that has been raised is whether a probe

may agree with additional goals beyond the most local one in its domain. Theories that have assumed that this is indeed possible can be divided into different subtypes. For example, theories of Multiple Agree assume that a single probe can simultaneously enter into an Agree relation with multiple DPs in its c-command domain (Hiraiwa 2001; Anagnostopoulou 2005; Nevins 2007, 2011, among others). Meanwhile theories of Cyclic Agree assume that a probe may enter into Agree relations with multiple goals in a sequential fashion until it is satisfied (Béjar 2003; Rezac 2003, 2004; Béjar and Rezac 2009, among others). I will argue in the chapters that follow that a single probe can indeed agree with multiple goals, proceeding in a cyclic fashion.

In addition to investigating one-to-many mappings between probes and goals, the literature on Agree has also explored whether many-to-one mappings are possible. That is, can a single syntactic element serve as the goal for multiple probes? Under traditional views of Agree, nominal goals are subject to the Activity Condition (Chomsky 1995b, 2001), and cannot enter into further Agree relations once they have been assigned structural case (which was taken to occur under Agree). However, subsequent work has questioned the existence and universality of the Activity Condition. For example, some authors have suggested that features other than case can figure into the determination of whether a nominal remains active or not (Rezac 2003; Carstens 2011, among others). Others have argued that the Activity Condition is parameterizable as either a macroparameter (Baker 2008) or a microparameter (Oxford 2017). Finally, it has even been argued that the Activity Condition is entirely unnecessary (Nevins 2005). I will argue in this dissertation that a single goal can interact with multiple probes, even for the same features. I will provide evidence that multiple heads in the clausal spine can enter into Agree relations with a single nominal.

A final question that has been the subject of extensive investigation in the literature on Agree relates to the structure of probes. In the simplest model of Agree, a ϕ -probe simply consists of an unvalued ϕ -feature. However, complex patterns of agreement, especially those displaying hierarchy effects, have been argued to provide evidence that probes can be more highly specified. Some accounts have assumed that probes can be keyed to certain features within the ϕ -geometry, rather than indiscriminately being satisfied by any ϕ -feature (Béjar 2003; Béjar and Rezac 2009, among others). An extension of this concept that has been pursued by Deal (2015c) argues that, not only can a probe be specified with a certain feature that will satisfy it (i.e. cause it to stop probing), but it can also be specified with a set of features that it can additionally interact with (i.e. copy). In this dissertation I will adopt an interaction and satisfaction model of agreement, demonstrating that this means of structuring the representation of probes provides an elegant way of defining a probe that can agree with all possible goals in its domain, which I argue to be empirically necessary.

As mentioned earlier, in addition to exploring the formalization of the operation of Agree, the last 20 years of research have also produced a wealth of literature seeking to understand which empirical phenomena can be accounted for with Agree technology. The types of phenomena that researchers have sought to subsume under Agree are incredibly varied. They include (but are not limited to) Person-Case Constraint effects (Béjar and Rezac 2003; Anagnostopoulou 2005; Nevins 2007, among others), nominal concord (Carstens 2001, 2011,

2016; Baker 2008; Kramer 2009; Danon 2011, among others), negative concord (Zeijlstra 2004; Haegeman and Lohndal 2010, among others), sequence of tense (Zeijlstra 2012, among others), binding (Hicks 2009; Kramer 2009; Rooryck and Vanden Wyngaerd 2011, among others), control (Landau 2000, among others), ergative case assignment (Deal 2010; Režac et al. 2014, among others),¹ and switch-reference (Camacho 2010; Assmann 2012; Arregi and Hanink 2018, among others). In this dissertation I concern myself with the latter two phenomena. I argue that a purely Agree-based analysis is able to account for typologically interesting patterns of split-ergative marking and switch-reference, providing greater empirical coverage than existing non-Agree-based analyses (and faring better than alternative Agree-based analyses as well).

The empirical testing ground for these claims is the language Amahuaca (Panoan; Peru). I explore the morphosyntax of the language in depth, based on my original fieldwork. I provide two main case studies to substantiate the claims about Agree that I have alluded to here. The first is a system of split-ergative marking that is dependent on the syntactic position of the subject DP. The second case study is the extensive switch-reference system of the language, which encodes information about the reference of both subjects and objects. I argue that both of these domains provide evidence that Agree proceeds cyclically, under *c-command*, with many-to-one and one-to-many mappings between probes and goals.

In the remainder of this introductory chapter I first provide background on the Amahuaca language itself and the data collection that formed the basis of this dissertation. I then turn to a more detailed summary of the structure of the dissertation and its main empirical and theoretical observations and claims.

1.1 Background on Amahuaca

Amahuaca (also written <Hamunvaka> [ʔamiŋwaka] in the official orthography), is a Panoan language spoken in Peru and Brazil. Fleck (2003) classifies Peruvian Amahuaca as belonging to the Headwaters subgroup of the Nawa group within the Mainline branch of Panoan. Fleck notes that Peruvian Amahuaca displays similarities with the languages of the Chama subgroup, such as Shipibo-Konibo, which he speculates is due to contact. Indeed, while Amahuaca certainly shares a large portion of its lexicon with languages of the neighboring Yaminawa dialect complex (Headwaters subgroup), its syntax is divergent from other languages within its subgroup (for example, it is not as polysynthetic, and its alignment system is different).

Amahuaca is spoken in communities along the Aguaytía, Curanja, Curiuja, Inuya, Las Piedras, Mapuya, Purus, Sepahua, Upper Ucayali, and Yuruá rivers in the Ucayali and Madre de Dios regions of Peru and in the state of Acre in Brazil (Eberhard et al. 2019). Estimates of the number of Amahuaca speakers vary widely. The most recent census data from Peru puts the population of native Amahuaca speakers at 328 (Instituto Nacional de

¹Note that nominative and accusative case assignment were already taken to be consequences of Agree by Chomsky (2000).

Estadística e Informática 2017). This is significantly higher than an SIL count done in 2000, which estimated the number of speakers in Peru was between 90 and 130 (Gordon 2005). It also is far above the rough estimate of 100 speakers in Peru given by Crevels (2012), based on a count of an ethnic population of 247 in 1993. The number of speakers living in Brazil is also murky. According to counts from 1995, the speaker population in Brazil was 220 (Eberhard et al. 2019). However, Brazil census data from 2010 does not list any Amahuaca speakers, even though Panoan languages with as few as 3 speakers are reported (Instituto Brasileiro de Geografia e Estatística 2010).² To contextualize these numbers a bit, as far back as 1999 it was reported that children were not learning the language in Peru (Gordon 2005), and more recent reports say that transmission is limited to only the most remote communities (Eberhard et al. 2019). I have personally worked with speakers of Amahuaca who originate from communities on the Sepahua, Inuya, and Yuruá rivers and have visited Amahuaca communities on the Sepahua and Las Piedras rivers. In Sepahua, most speakers are Spanish-dominant in terms of their daily communication. Few individuals under the age of 35 have more than a passive understanding of the language. I would estimate the number of speakers in Sepahua at approximately 40, including semi-speakers and those that have moved from other communities in the last two decades. In Boca Pariamanu on Las Piedras, the community is ethnically Amahuaca but there are no remaining speakers of the language, the last speaker having passed away in recent years. On the Inuya and Yuruá rivers, I know that there are adult speakers, and there is a teacher who teaches the language in a school in Inuya. I do not have further information about the speaker populations in these areas. Given this information, I assume that the 520 speaker estimate given by Eberhard et al. (2019) is likely too high, but that the 100 speaker estimate given by Crevels (2012) is likely too low.

I have worked with a total of 14 Amahuaca speakers (9 female), with a majority of my work being conducted in the communities of Nuevo Rosario, 7 de Junio, and San Francisco, in the town of Sepahua in Atalaya Province, Ucayali, Peru.³ These speakers all live in Sepahua and originate from Sepahua as well as from communities on the Inuya and Yuruá rivers. The age of these speakers ranges from 26 to approximately 80. All speakers have knowledge of Spanish but range from Amahuaca dominant to Spanish dominant. Amahuaca is still used as a language of daily communication, but Spanish is the most commonly used language in the neighborhoods where these speakers live. The majority of the data in this dissertation come from work with 4 primary consultants (3 female), ranging in age from approximately 35 to 75. These data were collected during 4 separate trips, one per year in 2015–2018, totaling 5.5 months of fieldwork.

A majority of the previous work on the Amahuaca language was conducted by a series of linguists with the Summer Institute of Linguistics (SIL) and was carried out from the late

²The Brazil census does contain a category of unspecified Panoan languages with a population of 846 listed. It is possible that this number contains some Amahuaca speakers who identified as a speaker of a Panoan language but did not specifically list Amahuaca as their language.

³Some data were collected through work in Puerto Maldonado, Madre de Dios, Peru, but with a speaker from Sepahua.

1940s through the early 2000s. Descriptive and analytical works include a phoneme inventory (Osborn 1948), a couple of sketches on tone (Russell and Russell 1959; Hyde and Loos 1975), an MA thesis that is a transformational grammar (Russell 1965), a chapter about reflexives (Hyde 1973), a dictionary (Hyde 1980), a chapter on switch-reference (Sparing-Chávez 1998), and two collections on basic grammatical properties by the two main SIL linguists who worked on the language (Sparing-Chávez 2012; Russell 2014). Additionally, there is a series of pedagogical materials and books of stories created by the SIL in collaboration with the Peruvian Ministry of Education (e.g. Ministerio de Educación 1960, 1961, 1984, 1985, 1986, 1988; Instituto Lingüístico de Verano 1993). In addition to this work by the SIL, there is a PhD dissertation on the phonetics and phonology of the language (Karadamou 2018).

Aside from work on Amahuaca itself, there has also been work on some of the topics explored in this dissertation in other Panoan languages. For example, Panoan systems are of particular interest to the study of switch-reference since they tend to exhibit the unusual property of tracking the transitivity of clauses in addition to tracking argument identity. Work specifically on switch-reference in Panoan includes descriptions and analyses of the phenomenon in Capanahua (Camacho and Elías-Ulloa 2001), Cashinahua (Montag 2005), Kakataibo (Zariquiey 2016), and Shipibo(-Konibo) (Valenzuela 2005; Camacho 2010; Baker and Camargo Souza 2018). Of these sources, only Camacho and Elías-Ulloa (2001), Camacho (2010), and Baker and Camargo Souza (2018) provide formal analyses of switch-reference, and I will discuss these accounts further in Chapter 4. In addition to works specifically focused on switch-reference, broader morphosyntactic descriptions of several Panoan languages discuss their switch-reference systems. Examples include descriptions of Kakataibo (Zariquiey 2011, 2018), Matis (Ferreira 2005), Matses (Fleck 2003), Shanenawa (Cándido 2004), Shipibo (Valenzuela 2003), and Yaminawa (Neely 2019). Case is also a topic of interest in Panoan languages since some languages, such as Amahuaca, display a tripartite system and since transitivity plays such a central role in the grammar of these languages (see, e.g. Valenzuela 2003). In addition to case being discussed in the morphosyntactic descriptions mentioned previously, ergative case in Shipibo has recently been analyzed in the theoretical literature as well (Baker 2014; Baker and Bobaljik 2017). This work will be further discussed in Chapter 3.

1.2 Summary and structure of the dissertation

This dissertation is divided into three main content chapters. The first provides necessary background data and argumentation about the structure of Amahuaca. The second and third chapters constitute case studies of Agree within the grammar of the language.

As mentioned, Chapter 2 provides background on Amahuaca. As outlined above, there is almost no formal work on the structure of Amahuaca. Therefore, it is necessary to develop an analysis of the morphosyntax of the language from the ground up. After providing a brief overview of some relevant information about the phonology and morphology of the language, I delve into the syntax. I examine the basic structure of the clause, and I discuss operations

of movement that can affect word order and test their properties. This understanding of the clausal structure lays the groundwork for understanding the relationship between case and word order discussed in Chapter 3. I also provide diagnostics for distinguishing two different types of dependent clauses in Amahuaca (switch-reference clauses and relative clauses), since their surface morphosyntactic similarity has led to them being grouped together in previous literature (Sparing-Chávez 1998, 2012). This is crucial since only one type of dependent clause, namely switch-reference clauses, is the empirical focus of Chapter 4.

In Chapter 3, I turn to the first case study of the role of Agree in Amahuaca morphosyntax. The focus of this chapter is on the somewhat unusual pattern of split-ergative case marking in Amahuaca’s tripartite case system. Interestingly, overt ergative case only appears on transitive subject DPs that have moved out of their externally merged position. I analyze morphological ergative case as being the exponence of agreement with two functional heads in Amahuaca: transitive *v* and T. I argue that this Agree-based structural view of ergative case is able to capture the relationship between case and movement in Amahuaca more straightforwardly than inherent or dependent theories of ergative case assignment. I also argue that this view of morphological case as exponing multiple features lends a very straightforward way of accounting for the focus-sensitive nominative case marking in Amahuaca. Finally, I demonstrate that treating morphological ergative (and nominative) case as exponence of multiple features allows for a natural distinction between “abstract” and morphological case. Only the full set of relevant features yields morphological case, but a subset of those features can indicate abstract case. Abstract case is leveraged by the language’s switch-reference system, which is the topic of Chapter 4.

The second case study of Agree within Amahuaca syntax is covered in Chapter 4. This chapter analyzes the switch-reference system of Amahuaca, which is typologically unusual in multiple respects. I demonstrate that the switch-reference system is sensitive to abstract case and tracks the reference of both subject and object DPs. In developing an analysis that can account for these properties, I demonstrate that switch-reference can be accounted for purely in terms of Agree. I argue that the seemingly long-distance dependencies involved in tracking referential identity among all arguments of two clauses do not pose a problem for theories of locality in Agree if we accept two assumptions about the nature of Agree. First, a Cyclic Agree model, in theory, allows for maximal projections to serve as probes through cyclic expansion of a probe’s domain on successive cycles of probing. Assuming that maximal projections can indeed probe allows a probe located high in an adjunct clause to probe directly into the matrix clause. Second, an interaction and satisfaction model of Agree allows us to define a probe that will probe all DPs in its c-command domain, allowing the same probe to uniformly agree with both subject and object. I demonstrate that combining the predictions of these two models of Agree yields a straightforward way of treating switch-reference in a purely Agree-based framework and results in greater empirical coverage than previous accounts.

The conclusion offered in Chapter 5 highlights the ways in which the case studies presented in this dissertation shape our understanding of both the mechanics and empirical coverage of the operation of Agree.

Chapter 2

Background on the structure of Amahuaca

As discussed in the introduction, Amahuaca is an endangered Panoan language of the Peruvian and Brazilian Amazon. It is underdocumented and there is very little previous formal linguistic work on the language. Therefore, one contribution of the current work is to provide a description of some of the basic patterns of the language in order to form the basis for further analysis. In this chapter, I offer a descriptive overview and analysis of some important aspects of the language in order to lay the groundwork for the more focused analysis of Chapters 3 and 4. I begin in Section 2.1 with a description of the phonological inventory of the language and basic phonotactics. This section is not intended to provide a thorough overview of the phonology of Amahuaca, but rather serves to clarify some of the orthographic conventions that I will utilize throughout. In Section 2.2, I then turn to a brief discussion of some of the morphology that will appear frequently in examples throughout. I touch on morphology at the DP level, including case marking and number marking, I consider how person is marked in various locations in the clause, and I outline verbal temporal morphology. Finally, in Section 2.3 I consider basic patterns of the syntax. I offer arguments for the proposed clausal structure and movement operations of both heads and phrases, and I demonstrate the *A'*-status of scrambling in the language. I also provide morphosyntactic diagnostics for distinguishing two types of dependent clauses in the language – relative clauses and switch-reference clauses. I end the discussion of Amahuaca syntax with a brief description of DP syntax before summarizing the major points of this chapter in Section 2.4.

2.1 Phonology

The earliest description of the phonology of Amahuaca that I am aware of was written by Henry Osborn and dates to 1948. The phoneme inventory given below is similar to the inventory given by Osborn, with the major difference being the inclusion of an alveolar affricate, included by later authors, such as Russell (1965), but not discussed by Osborn. The

consonant phonemes of Amahuaca are given in Table 2.1 with the orthographic symbol(s) used to represent each phoneme given in angle brackets, <>, next to the IPA symbol if the orthographic representation differs from the standard IPA representation. The orthography used is that which was approved by the Peruvian Ministry of Education in 2016. It is taken largely from the Spanish-based orthography developed by the SIL, with the only difference being that the symbols <c> and <qu>, which were both used to represent the stop /k/ in the SIL orthography (<c> before <a>, <o>, and <u>, and <qu> before <i>), have been collapsed to the single symbol <k>. I do not offer arguments for the contrastive status of each phoneme here, but I refer interested readers to Karadamou (2018: 375-406) for discussion of this issue.

	Bilabial	Alveolar	Post-Alveolar	Palatal	Velar	Glottal
Plosive	p	t			k	? <h>
Nasal	m	n				
Tap		r <r>				
Fricative		s <z>	ʃ <sh>	ç <x>		h <j>
Affricate		ts̆ <tz>	tʃ̆ <ch>			
Approximant	w <v>			j <y>		

Table 2.1: Consonant inventory

As seen in Table 2.1, Amahuaca has four voiceless oral stops, /p/, /t/, /k/, and /?/. All of the stops can appear as onsets. In the orthography, <h> is always written at the beginning of words that would otherwise be vowel-initial, but its realization is somewhat variable word-initially. Glottal stop is also variably realized in a syllable-final position, depending on the prosodic shape of the word, with it commonly appearing after high-toned syllables, as in (1).

- (1) <joni> ‘man’ : [hòn^dí] ~ [hòn^díʔ]

This occurrence of glottal stop is not consistently represented in the orthography, and so I omit it here. Amahuaca additionally has two nasal stops, /m/ and /n/, which can serve as onsets. Foot-medially before oral vowels, they are realized as post-oralized nasal stops. They are realized as fully nasal foot-medially before nasal vowels as well as foot-initially. These realizations are demonstrated in (2).

- (2) a. <xano> ‘woman’ : [çán^dò]
 b. <xanon> ‘woman.ERG’ : [çán^dò̃]
 c. <nami> ‘meat’ : [nàm^bí]

There is an alveolar tap in Amahuaca, which can serve as an onset. Amahuaca has four fricatives, /s/, /ʃ/, /ç/, and /h/. Only the three sibilants can contrastively serve as codas.

The place of articulation of the three sibilants has been characterized differently by different authors. Osborn represents these three phonemes as /θ/, /s/, and /x/, noting that his /s/ involves contact of the “central part of the tongue against the alveolar ridge” (1948: 189), and notes that his /x/ can often be palatalized. Here I represent these three sibilants as /s/, which is realized as dental for some speakers; /ʃ/, which, as noted by Osborn, involves constriction between the alveolar ridge and a portion of the tongue which is not the tip; and /ç/, which is typically realized as palatalized rather than velar or the retroflex reflex found in some other Panoan languages (e.g. Yaminawa; Neely 2019: 249).¹ The two affricates of Amahuaca are /tʃ/ and /tʃ̃/. As mentioned previously, the alveolar affricate was not included in Osborn’s (1948) phoneme inventory, but is included in subsequent sources. Finally, Amahuaca has two approximants, the labio-velar /w/ and palatal /j/.

Turning now to the vowel inventory of Amahuaca, there are four contrastive vowel qualities, each with nasal and oral variants, shown in Table 2.2.

	Front	Central	Back
High	i ì <in>	ɨ <u> ỹ <un>	
Mid			o õ <on>
Low		a ã <an>	

Table 2.2: Vowel inventory

As indicated in the table, the four vowel qualities are /i/, /a/, /ɨ/, and /o/, which is sometimes realized as [u]. Nasality on vowels is orthographically represented as an <n> following the vowel. Vowels contrast in length in Amahuaca, as shown in (3), and long vowels are orthographically represented as a doubled grapheme (i.e. <aa> = /aː/, etc.).

- (3) a. <mapo> ‘head’ : [mápò]
 b. <mapoo> ‘clay’ : [mápòː]

Tone is also contrastive in Amahuaca, with two contrastive levels, high and low. While roots are lexically specified for tone, minimal tone pairs are quite rare. A tonal minimal pair is given in (4).

- (4) a. <jíri> ‘eat’ : [hírì]
 b. <jirí> ‘feed’ : [hìrí]

Tone sandhi substantially affects the realization of tone in Amahuaca (Russell and Russell 1959), and most authors do not represent tone in the orthography, a decision which I follow here.²

¹Karadamou (2018) represents the phoneme that I represent with /ç/ as /ʃ̃/.

²On the infrequent occasion that tone does serve to differentiate two lexical items which would otherwise be ambiguous in the morphosyntactic context, I follow the convention of using <ˈ> over a vowel to represent high tone, as in (4).

Amahuaca syllable structure is consistently CV(C). All consonant phonemes are able to serve as onsets in the language, while the only permissible codas are /s/, /ʃ/, and /ç/.³ No onset or coda clusters are permitted. The nucleus of a syllable can be comprised of a single monophthongal vowel, long or short, or a diphthong. The minimal prosodic word in Amahuaca is bimoraic. A word can be composed of one heavy syllable, with a heavy syllable consisting of a syllable with a long vowel or diphthong, or two syllables.⁴ The majority of roots in Amahuaca are disyllabic.

2.2 Morphology

In this section, I will discuss some of the morphemes that will occur frequently in the examples throughout the dissertation. This is not intended to be an exhaustive list of all derivational and inflectional morphology in the language. For a list of many Amahuaca morphemes, along with illustrative examples, I refer the reader to Appendix A of Hyde 1980 and Chapter 7 of Sparing-Chávez 2012. I will first discuss morphology of the nominal domain, focusing first on case morphology, then turning to a discussion of the purported “plural” marker of Amahuaca (which I will argue is not actually plural), and finally outlining the paradigms of pronouns and subject markers. Then I will turn to the morphology of the verbal domain, discussing the paradigms of tense and aspect markers.

2.2.1 Case marking

Amahuaca displays a tripartite case system for core arguments of the verb. The case of arguments will be the topic of Chapter 3. The intransitive subject (S) can receive overt case marking (typically =*x*), as seen in (5). The transitive subject (A) can also receive overt case marking (typically =*n*), as shown in (6). Object (O) DPs are morphologically unmarked for case, as demonstrated by (6). In ditransitives both objects surface in a morphologically unmarked form, as in (7).

- (5) **vaku**{*=**n** / =**x**}=mun rakuu=xo=nu
 child{=ERG / =NOM}=C be.afraid=3.PST=DECL
 ‘The **child** was afraid.’

³Note that /ʔ/ can sometimes appear as a coda, but it does not appear to be contrastive in coda position.

⁴Hyde’s (1980) dictionary of Amahuaca contains a few head words that consist of a single syllable with a nasal vowel. I do not analyze nasal vowels as being bimoraic. Instead, I note that these items are all subject markers, to be discussed below, which, like functional items in the language, typically form a prosodic word with the material immediately to their left.

- (6) **xano**{=n / *=x}=mun **chopa**{*=n / *=x}
 woman{=ERG / =NOM}=C clothes{=ERG / =NOM}
 patza=hi=ki=nu
 wash=IPFV=3.PRES=DECL
 ‘The **woman** is washing **clothes**.’
- (7) joni=n=mun **xano jiriti** hinan=hi=ki=nu
 man=ERG=C woman food give=IPFV=3.PRES=DECL
 ‘The man is giving the **woman food**.’⁵

These contrasts suggest an underlyingly tripartite case system where ergative and nominative case are overtly marked in Amahuaca. The unmarked form for nominals appears to be a morphological default in Amahuaca rather than signaling accusative case directly. Evidence that this is a default comes from differential case marking – both transitive and intransitive subjects can surface in a morphologically unmarked form in the right syntactic and discourse contexts. This differential subject marking is the focus of Chapter 3, and I set it aside for now. The basic argument case morphology of the language is summarized in Table 2.3.⁶

Case	Argument marked	Form (SG/PL)
NOM	S	=x / -vaux
ERG	A	=n / -vaun
ACC/default	S/A/O	∅ / -vo

Table 2.3: Regular case morphology

In Table 2.3, it is worth pointing out that there is a distinct form given for the plural for each case value. Case typically surfaces as an enclitic on the entire DP in Amahuaca. However, when the final morpheme in the DP is the “plural” marker *-vo*, the case marking is expressed as a portmanteau with this marker. I discuss the status of this marker *-vo* below.

Before moving on from the topic of case marking, it is important to discuss apparent “allomorphy” of case marking in Amahuaca. For many DP-internal elements in Amahuaca,⁷

⁵What I gloss here as ‘food’ can actually be decomposed into the verb *jiri* ‘eat’ and the nominalizer *-ti*. This nominalizer is not very productive synchronically in Amahuaca.

⁶I set aside here case marking for non-arguments, such as genitive and locative case. Note that both of these cases morphologically resemble ergative marking in much of the paradigm. However, they come apart from ergative with pronouns. For example, there is some variation between speakers with genitive marking, but for first person singular, the ergative form is *hiyan* while the genitive form is *hun*. Note that genitive pronouns are distinct from inalienable possessive markers which occur with bound roots, typically kinship terms (e.g. *-pa* ‘father’, *hu-pa* ‘my father’).

⁷I intend to include more than just nouns in this group of words since any element that occurs at the right edge of the DP can host the case enclitic. Given that DP-internal word order is relatively free, this means that elements of many categories can appear in this position. There are examples of nouns, adjectives, quantifiers, and numerals that undergo the type of segmental alternations described here in case-marked versus unmarked contexts.

the case marked form of the word contains additional segmental material beyond the case marker and the root that appears in morphologically unmarked contexts. Specifically, these words contain an additional syllable at the end of the root before the case marker.⁸ An example of this alternation is given in (8) for a noun and (9) for an adjective.

- (8) a. **kapuu**=mun rutu=hi joni=ki=nu
 alligator=C kill=IPFV man=3.PRES=DECL
 ‘The man is killing the alligator.’
- b. **kaputon**=mun Floria pi=xo=nu
 alligator.ERG=C Floria bite=3.PST=DECL
 ‘The alligator bit Floria.’
- (9) ‘That tall man is eating meat.’
- a. jaa **chii** joni=n=mun nami pi=hi=ki=nu
 DEM tall man=ERG=C meat bite=IPFV=3.PRES=DECL
- b. jaa joni **chaitan**=mun nami pi=hi=ki=nu
 DEM man tall.ERG=C meat bite=IPFV=3.PRES=DECL

In Table 2.4 I list the forms of all of the extra final syllables found in ergative-marked forms of nouns and adjectives listed in Hyde’s (1980) dictionary. Nominative forms typically include the extra syllable but with a final *x* instead of a final *n*.

C-initial	V-initial
<i>chin</i>	<i>an</i>
<i>kan</i>	<i>in</i>
<i>kun</i>	<i>on</i>
<i>man</i>	<i>un</i>
<i>nan</i>	
<i>nin</i>	
<i>non</i>	
<i>nun</i>	
<i>pan</i>	
<i>tan</i>	
<i>ton</i>	
<i>xon</i>	

Table 2.4: Truncated ergative syllables from nouns and adjectives in Hyde 1980

One potential way to analyze this pattern is in terms of allomorphy of the case marker; another is in terms of root allomorphy. Under the latter analysis, which I will adopt here,

⁸There are two examples of words with two additional syllables in their ergative form given by Hyde (1980). These are the noun *korokoro* ‘turkey’, the ergative form of which is *korokorokaton*, and *voxni* ‘grey-haired’, the ergative form of which is *voxnikaton*.

the root would be truncated to omit the final syllable in non-case-marked contexts. One reason to treat this as allomorphy of the root rather than the case marker is that the choice of which final syllable is used in ergative contexts is not predictable from the shape of the root. Therefore, each root in the language would have to be specified for which form of the ergative marker it occurred with, constituting a case of lexically-conditioned allomorphy rather than phonologically-conditioned allomorphy. Interestingly, since nominative-marked roots also contain an extra syllable and differ from ergative-marked roots only in that the final *n* is replaced with *x*, lexically-conditioned allomorphy of the nominative marker would have to be separately encoded, somewhat redundantly. This repetition of the final *n* in all of the ergative forms (and *x* in all of the nominative forms) gives reason to think that the more accurate way to segment all of these forms would be simply $\text{Root}=n$ rather than $\text{Root}=(C)Vn$ – that is, to assume that the case marker is regular in all forms, namely that it is consistently $=n$, while the roots alternate between a truncated and full form. The root allomorphy analysis is also attractive since additional changes to some roots are triggered in the contexts where these extra syllables occur. For example, the placement of high tone can shift, as in (10a), the vowel preceding the extra syllable can become oral instead of nasal, as in (10b), or the vowel preceding the extra syllable can shorten, as in (10c).⁹

- (10) a. <hoxnú> ‘moonlight’ → <hóxnupán> ‘moonlight.ERG’ (Hyde 1980: 40)
 b. <nónon> ‘duck’ → <nónomán> ‘duck.ERG’ (Hyde 1980: 62)
 c. <shánoo> ‘viper’ → <shánopán> ‘viper.ERG’ (Hyde 1980: 77)

An additional type of change involves the vowel-initial syllables in the second column of Table 2.4. These always occur with roots that would otherwise be consonant final or would terminate in a nasal vowel. They cause the final consonant to resyllabify as the onset of the additional syllable, and in roots with a nasal vowel, the result is that the nasality on the vowel is lost and is instead realized as an alveolar nasal onset of the added syllable. These different types of changes to roots vary in predictability. Finally, it is worth noting that the number of extra syllables instantiated in Table 2.4 is quite large were we to assume they represented multiple allomorphs of the case marker. The large number of possible syllables is more in line with a truncation account where these syllables simply represent the final syllables of roots. The fact that not all possible CV combinations are represented in these final syllables is not entirely unexpected given that some languages are known to have reduced syllable inventories farther into the word (see, e.g., Hyman and Inkelas 1997 for Tiene (Bantu; Democratic Republic of the Congo)). Overall, the pattern outlined here suggests that the simpler analysis is to treat extra syllables in ergative and nominative forms, along with the changes to the root that they trigger, as part of the underlying representation of the root. This would mean that in case-marked contexts the full form of the root is realized with

⁹This vowel length change, in particular, speaks in favor of a truncation analysis because it appears to exhibit a form of compensatory lengthening. When the final syllable is present, the vowel is short, but when the final syllable is deleted, the vowel preceding the deleted material becomes long.

a fully regular ergative (=n) or nominative (=x) enclitic.¹⁰ In contexts where case marking is lacking, the root is truncated to lose the final syllable, and other processes may apply, such as lengthening of the final vowel. The resulting picture is that case morphology is fully regular (with the exception of its portmanteau realization with “plural” *-vo*, discussed just below).

2.2.2 Number marking

Aside from case marking, another type of morphology that commonly occurs on nouns is the “plural” marker *-vo*. While this marker has typically been glossed as plural (see, e.g., Sparing-Chávez 2012), it does not appear to have true plural semantics. It can appear only with human nouns,¹¹ but human nouns can receive a plural interpretation without it, and it can appear on human nouns receiving a singular interpretation. The example in (11) shows a noun without *-vo*, the subject *jonin* ‘men’, that receives a plural interpretation and triggers the plural subject marker *kan*. In (12) we see an example where *vaku* ‘child’ receives a singular interpretation regardless of whether it surfaces with or without *-vo*.

- (11) **joni=n=mun** jono kiyoo=vi rutu=hi **kan=ki=nu**
 man=ERG=C peccary all=EMPH kill=IPFV 3PL=3.PRES=DECL
 ‘The men are killing all of the peccaries.’

- (12) **vaku(-vo)** muka=kun=mun xano=n chopa patza=hi=ki=nu
 child-PL play=DS.SQ=C woman=ERG clothes wash=IPFV=3.PRES=DECL
 ‘After the child played, the woman is washing clothes.’

I set aside here the question of what the exact semantic contribution of this morpheme is, but note that it typically appears on plural human nouns in the examples in this dissertation (and I will continue to gloss it PL in such instances). Aside from the marker *-vo*, number is not marked on nouns in Amahuaca. Instead, Amahuaca bare nouns have general number (Corbett 2000; Rullmann and You 2006; Wilhelm 2008; Bale et al. 2011; Paul 2012; Kramer 2017, among others). This means that each noun means something like ‘one or more Ns’ (i.e. the denotation includes both atoms and their sums). Bare nouns in Amahuaca are not ambiguous between a singular form and a plural form (i.e. there is not simply a singular and plural form that happen to be homophonous for all nouns), rather the denotation of the bare noun is neutral for number. This can be demonstrated by testing for ambiguity (Zwicky and Sadock 1975; Rullmann and You 2006; Kramer 2017). Consider the sentence in (13) with a truly ambiguous noun.

¹⁰I am aware of one truly irregular root. The root *hino* ‘dog’ becomes *hinan* in the ergative. This is the only root I am aware of where a root vowel changes quality in the ergative.

¹¹One apparent exception is its use in forming clan terms. It can attach to animal terms to form clan names. For example, one Amahuaca clan name is *rono-vo*, meaning roughly ‘snake people’. Additionally, sometimes speakers occasionally accept *-vo* as a seeming plural with the names of large game animals, such as *hino* ‘jaguar’, but this is rare and may be due to interference from these clan terms.

- (13) Juanu=n=mun hino hiin=xo=nu
 Juan.LG=ERG=C jaguar/dog see=3.PST=DECL
 ‘Juan saw a jaguar/dog.’

Here we see that this sentence can mean that Juan saw a dog or a jaguar because the form *hino* is ambiguous between the meaning ‘dog’ and ‘jaguar’. Now consider a possible follow up to this utterance.

- (14) *Context: Juan saw a jaguar, and I utter (13) followed by:*
 Maria=n rivi=mun hiin=xo=ki
 Maria=ERG also=C see=3.PST=DECL
 ‘Maria also saw (one).’
 ✓ Maria saw a jaguar.
 # Maria saw a dog.

Here we see that if (13) is uttered in a context where Juan saw a jaguar, followed by the sentence in (14) which lacks an overt object DP, the only possible interpretation of (14) is that Maria saw a jaguar. An interpretation where Maria saw a dog is not possible. Therefore, we can see that when a noun is truly ambiguous, the interpretation must be held constant. This can be contrasted with the interpretation of number with bare nouns. The sentence in (15) means that Juan found one or more tapirs.

- (15) Juanu=n=mun haa vuchi=xo=nu
 Juan.LG=ERG=C tapir find=3.PST=DECL
 ‘Juan found one or more tapirs.’

If *haa* ‘tapir’ (along with other bare nouns) were ambiguous between singular and plural in the same way as *hino* is ambiguous between the meaning ‘dog’ and ‘jaguar’ we would expect that the interpretation of a sentence like (16) should have to hold constant either a singular or plural interpretation in a similar fashion to the pattern we saw in (14). However, that is not the case.

- (16) *Context: Juan found multiple tapirs, and I utter (15) followed by:*
 Maria=n rivi=mun vuchi=xo=ki
 Maria=ERG also=C find=3.PST=DECL
 ‘Maria also found (one or more).’
 ✓ Maria found one tapir.
 ✓ Maria found multiple tapirs.

Here, if this follow up is uttered in a context where Juan found multiple tapirs, two possible readings are available. It is possible for a “matching” reading, where Maria also found multiple tapirs. However, a reading where Maria found only one tapir is also possible. This

is unexpected if the noun *haa* ‘tapir’ is ambiguous between singular and a proper plural. It is exactly the predicted pattern, though, if *haa* instead is number neutral and means ‘one or more tapirs’. Therefore, I conclude that bare nouns in Amahuaca have general number. Because bare nouns can be used both where English uses singular nouns and where English uses plural nouns, in examples throughout I have attempted to provide English translations of Amahuaca bare nouns that reflect the context in which a sentence was uttered or the number marking in the Spanish translation that was offered.

2.2.3 Person marking

In contrast to nouns in Amahuaca, pronouns are overtly marked for number, with distinct singular and plural pronouns for all persons. The form of the pronouns is given in Table 2.5.

	SG	PL
1	hiya	noku
2	miya	mato
3	jaa	jato

Table 2.5: Full pronouns

The forms given in Table 2.5 are the default forms for the pronouns – the forms that are not overtly marked for case. These forms appear as object pronouns. Transitive and intransitive subject pronouns are formed by adding regular ergative ($=n$) or nominative ($=x$) marking to these forms. For subject pronouns it is very uncommon for them to appear in the unmarked form. Typically, the use of a full pronoun (rather than *pro*-drop) signals narrow focus and results in case marking.¹²

In addition to full pronouns, Amahuaca has a series of subject clitics that indicate the person and number of the subject. These appear in a fairly fixed position in the clause, but the position depends on the presence of aspect marking. The forms of these subject clitics are given in Table 2.6.

	SG	PL
1	hun	non
2	min	man
3	jan	kan

Table 2.6: Subject clitics

In matrix clauses, the use of these clitics for local persons is obligatory, and they can double emphatic full pronouns. For third person arguments, these clitics are typically used if there

¹²I will discuss the connection between nominative case and focus in Chapter 3.

is no overt subject DP or if the overt subject DP is a pronoun, but speakers vary in whether they use these clitics to double non-pronominal DPs, with it being more common for speakers to double plural DPs with *kan* than to double singular DPs with *jan*.

In sentences in the perfective aspect (which is not overtly marked), the subject clitic surfaces in a position after the clitic *=mun*, which is a second position clitic, and will be discussed further in Section 2.3. This holds true for all of the clitics except the third person plural, which surfaces after the verb. This pattern is demonstrated in (17).

- (17) a. hiya=x=mun=**hun** pakuu=ku=nu
 1SG=NOM=C=1SG fall=1.PST=DECL
 ‘I fell.’
- b. jato=x=mun riohko=**kan**=xo=nu
 3PL=NOM=C fall.PL=3PL=3.PST=DECL
 ‘They fell.’¹³

We see in (17a) that the first person singular clitic *hun* cliticizes to the clitic *=mun* to its left.¹⁴ It appears before the verb. Note that occasionally speakers permit elements to intervene between *=mun* and the subject marker, though this pattern is infrequent and is often judged to be ill-formed. However, in perfective contexts, the subject clitic never follows the verb.¹⁵ This is true for all clitics except the third person plural clitic *kan*. As seen in (17b), *kan* follows the verb, appearing between the verb and the tense marker.

In contexts with other aspect markers, which are all overt, the situation is different. Here, the subject clitics all appear in the same post-verbal position, consistently forming a prosodic unit with the sentence-final tense and mood particles, as demonstrated in (18).

- (18) a. hiya=x=mun pakuu=hi **hun**=ka=nu
 1SG=NOM=C fall=IPFV 1SG=1.PRES=DECL
 ‘I am falling.’
- b. jato=x=mun riohko=hi **kan**=ki=nu
 3PL=NOM=C fall.PL=IPFV 3PL=3.PRES=DECL
 ‘They are falling.’

¹³‘Fall’ is like many Amahuaca verbs, especially motion-related verbs, that have a distinct form when used with a plural subject. This plural verb form can be used regardless of the person of the subject, as shown with a first person plural subject in (i).

(i) noku=x=mun=non riohko=ku=nu
 1PL=NOM=C=1PL fall.PL=1.PST=DECL
 ‘We fell.’

¹⁴Note that I will typically write a subject clitic as a separate word in this context to highlight the position of the clitic *=mun* since it can be used to diagnose constituency.

¹⁵This is with the exception of instances where the verb moves to a position before the second position clitic *=mun*. The derivation of this word order will be discussed in Section 2.3.

In (18a), we see that the first person singular clitic *hun* now appears after the imperfective aspect marker and before tense marking. The same is true for the third person plural clitic *kan* in (18b).

2.2.4 Tense marking and agreement

In addition to subject clitics that indicate the person and number of the subject, Amahuaca also indicates the person of the subject via agreement on the tense markers. Amahuaca has two series of tense markers, one indicating present and one past. These tense markers differ in form based on the person of the subject. A full paradigm of the tense markers is given in Table 2.7.

Tense	Subject Person		
	1	2	3
Present	=ka	=ki	=ki
Past	=ku	=ku	=xo

Table 2.7: Tense markers and subject agreement

Here we can see that the form of the present tense marker with a first person subject is *=ka* while it is *=ki* with a second or third person subject. For past tense, the form is *=ku* when the subject is a local person, first or second, and *=xo* when it is third person.

2.2.5 Aspect marking

In addition to these tense markers, other temporal morphology that will figure in many of the examples throughout is aspect marking. As mentioned previously, perfective aspect is not overtly marked in Amahuaca matrix clauses. The other aspect markers are phonologically overt and typically surface as verbal enclitics. Their placement will be discussed further in Section 2.3.

Habitual	=nox
Imperfective	=hi
Perfect	=hax
Perfective	∅
Prospective	=katzi

Table 2.8: Matrix aspect markers¹⁶

¹⁶I indicate here that these are the forms of aspect marking found in matrix clauses, because aspect marking in other types of clauses follows a distinct pattern.

In Table 2.8 we can see that there are four overt aspect markers found in Amahuaca. These indicate habitual, imperfective, perfect, and prospective meanings. There is one other class of verbal morphology that indicates more specific temporal information and appears to be almost “adverbial” in terms of the types of meanings encoded. An example of such a morpheme would be *=shin* ‘yesterday’. These more specific temporal modifiers co-occur with other tense and aspect morphology and can appear in the same morphological form in all clause types – matrix clauses, relative clauses, and switch-reference clauses. On the other hand, true aspect markers appear in different forms (and are sometimes lacking overtly) according to clause type, and different clause types make different numbers of distinctions. For example, while relative clauses can contain specific temporal modifiers like *=shin* ‘yesterday’, they only mark a two-way aspect contrast between perfective *=ha* and imperfective *=hai*, contrasting with the fuller matrix paradigm of aspect marking. Switch-reference clauses, too, can contain temporal markers of the *=shin* type, but all other temporal information is encoded in the switch-reference marker itself, rather than in separate aspect morphemes. This behavior across clause types helps to divide seemingly aspectual temporal markers into two classes – those which are invariant and those which differ by clause type – with the latter appearing to be ‘true’ aspect marking.

With this understanding of the basic morphological categories that frequently appear in the nominal and verbal domain, I now turn to a discussion of Amahuaca syntax.

2.3 Syntax

Amahuaca is mixed-headed with baseline SOV word order. It allows scrambling of all arguments and adjuncts, and is both head- and dependent-marking. In this section I will first discuss the basic clause structure of Amahuaca matrix clauses. I will begin by identifying the functional heads in the clausal spine and then identifying the types of movement that the verb in Amahuaca can undergo. I will then turn to a discussion of the properties of DP movement to various positions in the Amahuaca clause. Finally, I will discuss the syntax of domains other than the matrix clause, overviewing the structure of adjunct switch-reference clauses, relative clauses, and DPs.

2.3.1 The matrix clausal spine

In matrix clauses in Amahuaca, all heads in the verbal extended projection are head-final, with the exception of AspP and CP. These two projections serve as “landmarks” in the clause, along with T, which serves to delineate the right edge of the clause.

Amahuaca has a second position clitic *=mun*, which is preceded by exactly one XP, as demonstrated in (19) with a DP, (19a); a PP, (19b); and an adjunct clause, (19c).¹⁷

¹⁷ Like many of the inflectional morphemes of Amahuaca, *=mun* is a phonologically weak element which cliticizes to the element it linearly follows. I assume, following Zwicky and Pullum (1983), that the positioning of morphophonological clitics in a sentence is syntactically governed. That is, these phonologically weak

- (19) a. [DP jaa joni chaita=**n**] =**mun** nami pi=hi=ki=nu
 DEM man tall.LG=ERG =C meat bite=IPFV=3.PRES=DECL
 ‘That tall man is eating meat.’
- b. [PP nihi muran] =**mun** joni=**n** jiriti vuna=**xo**=nu
 forest inside =C man=ERG food look.for=3.PST=DECL
 ‘The man looked for food in the woods.’
- c. [CP joni=**n** xuki jova=**hain**] =**mun** xano vua=**xo**=nu
 man=ERG corn cook=DS.SIM =C woman sing=3.PST=DECL
 ‘While the man cooked corn, the woman sang.’

As seen in (19), =*mun* always follows one phrasal constituent, regardless of the category or prosodic size of the constituent. On the basis of these syntactic second position effects, I propose that the clitic =*mun* is in C. This is on analogy with patterns of V2 in Germanic languages, in which the second position verb is typically analyzed as being in C (den Besten 1983; deMena Travis 1984; Holmberg and Platzack 1995; Zwart 1997, among many others). It has been hypothesized that some syntactically-placed second position clitics are similarly located in a head in the C domain (see, e.g., Wilder and Čavar 1994 and Tomić 1996 for Serbo-Croatian (South Slavic) second position clitics, King 1996 for Serbo-Croatian, Czech (West Slavic), and Slovak (West Slavic) second position clitics, Paul 2001 for the Malagasy (Austronesian; Madagascar) second position yes-no particle *ve*, and Black 1992 for Shipibo (Panoan; Peru) second position mood clitics that are very similar to the Amahuaca clitics in question), and I adopt this assumption here. Further evidence for =*mun* being in the C domain comes from the fact that it is required in declarative matrix clauses, but disappears in questions, imperatives, and non-matrix clauses.¹⁸ If =*mun* is in C, this suggests that CP is head-initial in Amahuaca matrix clauses. Under these assumptions, the constituent to the left of =*mun* will be in Spec,CP. This position must obligatorily be filled in Amahuaca, reflecting an EPP feature on C. Movement to Spec,CP is associated with information structural effects, which will be discussed further below and in Chapter 3.

The second landmark in the Amahuaca clause is the cluster of tense and mood clitics that appears at the far right edge of the clause. These two clitics always surface in the order tense–mood and always appear clause-finally, modulo prosodically offset right dislocation. The mood clitic typically takes the form =*nu* in declarative clauses. It is null in interrogatives, and takes the form =*hu* in imperatives. The morphemes that instantiate T show person agreement with the subject, as seen in (20), and they encode a present versus past distinction, as seen in (21).

clitics form syntactically independent elements. As can be seen in (19), the amount of phonological material preceding =*mun* does not matter. Rather, the clitic’s placement is sensitive to syntactic constituency.

¹⁸This is consistent with Rizzi’s (1997) characterization of Force in his split CP model. However, as will be discussed below, narrow-focused constituents move to the specifier of this head, which is evidence that it also has properties of Focus. For present purposes, I make the simplifying assumption that CP is not split in Amahuaca and accordingly speak simply of a CP projection.

- (20) a. hiya=x=mun hun rakuu=**ku**=nu
 1SG=NOM=C 1SG be.afraid=1.PST=DECL
 ‘I was afraid.’
- b. vaku=x=mun rakuu=**xo**=nu
 child=NOM=C be.afraid=3.PST=DECL
 ‘The child was afraid.’
- (21) a. jaa=x=mun pakuu=hi jan=**ki**=nu
 3SG=NOM=C fall=IPFV 3SG=3.PRES=DECL
 ‘He is falling.’
- b. jaa=x=mun jan pakuu=**ki**=nu
 3SG=NOM=C 3SG fall=3.PRES=DECL
 ‘He fell.’ (just now)
- c. jaa=x=mun jan pakuu=**xo**=nu
 3SG=NOM=C 3SG fall=3.PST=DECL
 ‘He fell.’ (earlier)

In (20), the alternation between *=ku* and *=xo* indicates the person of the subject, with *=ku* indicating first person and *=xo* indicating third person. In (21a), we see a present tense sentence, indicated by the tense marker *=ki*, with imperfective aspect (*=hi*). The contrast between (21b) and (21c) illustrates a minimal contrast between the present tense marker *=ki* and the past tense marker *=xo* with perfective aspect, which is unmarked. The alternation between present and past tense serves to indicate a more recent versus a more temporally distant event, with the recent past interpretation of the sentence with present tense marking arising due to the perfective aspect.¹⁹ The meaning of these markers as well as the fact that they show subject agreement is consistent with them being in T. The clause-final position of these morphemes thus suggests that T (along with Mood) is subject to head-final linearization in Amahuaca.

The final landmark in the Amahuaca clause is aspect. As mentioned in Section 2.2, the overt aspect markers in Amahuaca indicate imperfective (*=hi*), habitual (*=nox*), perfect (*=hax*), and prospective (*=katzi*). When aspect is not overtly marked, sentences receive a perfective interpretation, as in (21b) and (21c). Examples illustrating a contrast in aspect markers are given in (22).

- (22) a. kuntii=mun choka=**hi** xano=ki=nu
 pot=C wash=IPFV woman=3.PRES=DECL
 ‘The woman is washing a pot.’

¹⁹Note that the past interpretation of present perfective corresponds to De Wit’s (2017) ‘retrospective strategy’ of present perfective resolution.

- b. kuntii=mun choka=**nox** xano=ki=nu
 pot=C wash=HAB woman=3.PRES=DECL
 ‘The woman washes pots.’

In (22a), we see the imperfective aspect marker *=hi*, while in (22b), we see the habitual aspect marker *=nox*. The choice of aspect marker indicates a contrast between a currently ongoing action in (22a) versus an action that characterizes the woman in general but need not be ongoing at the time of utterance in (22b).

As seen in (22), the subject DP can appear to the right of aspect, intervening between aspect and tense. The ability of aspect to appear sentence-medially (i.e. to the left of the subject) suggests that it is a head-initial projection, as schematized in (23).

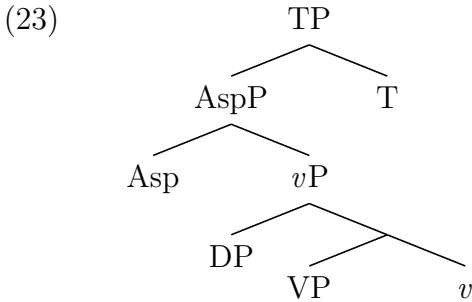

Assuming that low subjects are in their externally merged position in *Spec, vP*, and that *vP* is the complement of *Asp*, a head-initial *AspP* straightforwardly allows for the post-aspect position of subjects.²⁰ I will assume, therefore, that *AspP* is a head-initial projection in Amahuaca, splitting the matrix clause into a pre-aspect middle field, where scrambling occurs, and a post-aspect domain that contains arguments in their externally merged positions.

²⁰Note that the structure proposed in (23) violates the Final-Over-Final Condition (FOFC), which mandates that head-final projections cannot dominate head-initial projections within the same extended projection (Biberauer et al. 2014; Sheehan et al. 2017). In (23), the head-final TP projection dominates the head-initial *AspP* projection. If FOFC is derived as a constraint on rightward movement (Zeijlstra 2016) rather than stemming from Kayne’s (1994) Linear Correspondence Axiom or direct restrictions on headedness of projections, this is not an issue. The proposal for the Amahuaca structures involves no rightward movement, except for head movement between adjacent heads, which is permitted under Zeijlstra’s (2016) model. An alternative approach postulating a head-final *Asp* which undergoes movement to a medial position (presumably in at least some instances undergoing head movement as a complex head with the verb) faces the challenge of identifying the projection targeted by movement. If movement targeted a head-initial projection as its landing site, there would still need to be a head-initial projection between *T* and *v*, and so the FOFC violation would remain in place. Assuming a head-initial *AspP* (together with Zeijlstra’s treatment of FOFC) therefore seems to be the most straightforward account, given the lack of evidence that *Asp* can ever occur further to the right. I refer the reader to Clem 2018c for a more detailed discussion of FOFC as it relates to this structure in Amahuaca.

2.3.2 Verb movement

As observed in the examples in (22), one position in which the verb can appear is immediately before aspect marking. However, the Amahuaca verb can appear in multiple positions in the structure. This raises the question of what types of movement the verb can undergo. I will argue here that the verb in Amahuaca can undergo head movement to a clause-medial position. I will also demonstrate that the verb can appear clause-initially, which I assume happens through remnant VP fronting.

When the verb appears immediately before aspect, the subject can either appear to the right of aspect, intervening between aspect and tense, (24), or in one of multiple positions to the left of the verb, depending on whether it is the object or subject that is moved to Spec,CP, as seen in (25).

- (24) *kuntii=mun choka=hi xano=ki=nu*
 pot=C wash=IPFV woman=3.PRES=DECL
 ‘The woman is washing a pot.’

- (25) ‘The woman is washing a pot.’
- a. *kuntii=mun xano=n choka=hi=ki=nu*
 pot=C woman=ERG wash=IPFV=3.PRES=DECL
- b. *xano=n=n=mun kuntii choka=hi=ki=nu*
 woman=ERG=C pot wash=IPFV=3.PRES=DECL

As mentioned above, the availability of a post-aspect position of the subject (and object) suggests that aspect is a head-initial projection. In order to derive an immediately pre-aspect position of the verb, I assume that the verb undergoes head movement through *v* to Asp to form a complex head with aspect.²¹

While head movement seems to be one option for movement of the Amahuaca verb, it does not seem to be the only type of movement that the verb can undergo. The verb can also appear sentence-initially in Spec,CP before the second position clitic =*mun*, as in (26).

- (26) *choka=mun xano=n kuntii=hi=ki=nu*
 wash=C woman=ERG pot=IPFV=3.PRES=DECL
 ‘The woman is washing a pot.’

The appearance of the verb in this initial phrasal position suggests that VPs can also undergo remnant movement, with verb-initial structures analyzed as in (27).²²

²¹I assume that the null perfective aspect marker does not trigger head movement of the verb and *v*, a point that will be important for deriving a lack of differential ergative case marking in perfective clauses. This is discussed further in Chapter 3.

²²In Chapter 3 I assume that head movement of V to Asp occurs in the narrow syntax, with the ability to affect agreement possibilities. This raises an interesting question of how remnant VP movement and head movement of the verb are related and timed with respect to one another. I propose that neither remnant VP

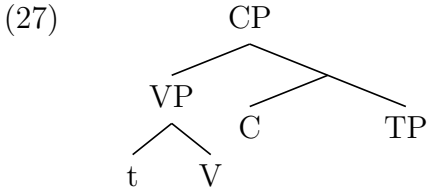

2.3.3 Object shift

The availability of remnant fronting of VP suggests that object DPs vacate the VP. This is reminiscent of German scrambling, in which the object DP moves out of VP to a position higher in the structure (Thráinsson 2001; Vikner 1994). Following Roberts (2010), I assume that object DPs in languages with scrambling escape the *v*P phase by moving to a specifier of *v*P. When the subject and object both remain in *v*P (i.e. when they appear to the right of aspect), the only available position for the object is to the right of the subject, as in (28).

- (28) ‘The man is killing the peccary.’²³
- a. rutu=mun=hi joni **jono**=ki=nu
 kill=C=IPFV man peccary=3.PRES=DECL
 - b. * rutu=mun=hi **jono** joni=ki=nu
 kill=C=IPFV peccary man=3.PRES=DECL

This suggests that the object DP is attracted to an inner specifier position of *v*P; it tucks in (Richards 1999). From this position it can, but does not have to, subsequently move higher in the clause to a position to the left of aspect. This *v*P edge position appears to be the highest A-position of the object – the object is accessible for agreement on the *v*P edge, as will be discussed with respect to the switch-reference system in Chapter 4. Further movements available to the object are all A'-movement, discussed below.

This object shift appears to be obligatory. That is, non-remnant VP movement is impossible, as shown in (29).

- (29) ‘The man finds capybaras.’
- a. vuchi=mun hamun=nox joni=ki=nu
 find=C capybara=HAB man=3.PRES=DECL

movement nor head movement of V bleeds the other. Rather, in structures where both movements occur, only the instance of V within the remnant VP will be pronounced since a segment of its projection (namely the maximal VP) asymmetrically *c*-commands the lower copy of V that forms a complex head in Asp. Interestingly, inflectional material like aspect is an enclitic in Amahuaca, and can be hosted by constituents other than the verb, such as the object DP in (26). This is one potential way in which Amahuaca differs from languages that exhibit verb doubling in predicate fronting constructions (e.g. Hebrew (Semitic); Landau 2006) – there is no morphophonological need to pronounce the verb low to host inflection.

²³The sentence in (28b) is ungrammatical on the intended reading but is grammatical on the reading ‘The peccary is killing the man’.

- b. * hamun vuchi=*mun*=nox joni=*ki*=nu
 capybara find=*C*=HAB man=*3*.PRES=*DECL*

In (29b), we see that it is ungrammatical for the object DP *hamun* ‘capybara’ to front along with the verb to the initial position before =*mun*. This suggests that there is not an option for verb movement to the initial position in which the verb and object still form a constituent. Therefore, I assume that objects obligatorily vacate the VP in Amahuaca, moving to the *vP* edge.

2.3.4 Scrambling

Though the current proposal involves the assumption that the baseline word order for matrix clauses is SOV, this word order is often obscured in actual examples due to movement of the verb as well as both DP arguments. In the previous section I discussed object shift. In this section I will focus on further movement possibilities for DPs in matrix clauses, which can be considered under the umbrella of ‘scrambling’. I will demonstrate that movement of the object across the subject in the middle field or to the clause-initial focus position always constitutes *A'*-movement. I will make this argument largely upon the basis of weak crossover (WCO) effects, supplementing this with data from binding Condition C where possible.

In order to examine WCO, I will be relying on data that involve the element *tzova*, which has the distribution of a negative polarity item (NPI) in being restricted to occurring in downward entailing environments.²⁴ When *tzova* appears with negation, it is used as a negative indefinite, as seen in (30), and when it occurs in an interrogative clause it functions as the *wh*-word, as demonstrated by (31).²⁵

- (30) **tzova**=x=*mun* vua=*yama*=xo=*nu*
 who=*NOM*=*C* sing=*NEG*=*3*.PST=*DECL*
 ‘No one sang.’

- (31) **tzova**=x=*ra* vua=*hax*
 who=*NOM*=*INT* sing=*TAM*
 ‘Who sang?’

Here I will be considering the negative indefinite use of *tzova*. If *tzova* appears as the subject, it is able to bind a possessive pronoun in the object, as demonstrated in (32).

²⁴The Amahuaca item *kiyoo* is typically translated as a universal quantifier. However, when it occurs with a pronoun that should be bound to receive the desired interpretation, speakers typically require a plural pronoun. This raises the possibility that *kiyoo* is actually a definite and is not able to truly bind a variable, similar to English *all*. Therefore, I focus on the NPI *tzova*, since it can more clearly serve as a binder for pronominal elements.

²⁵The second position clitic =*mun* and the sentence-final particle =*nu* are not present in questions, and the realization of tense and aspect morphology is sometimes different in interrogative versus declarative matrix clauses. Therefore I have chosen to focus on the use of *tzova* with negation since it offers a more straightforward comparison to diagnose the properties of various positions in matrix declaratives.

- (32) **tzova**_i=n=mun **jan**_i hino vuchi=yama=xo=nu
 who=ERG=C 3SG.GEN dog find=NEG=3.PST=DECL
 ‘No one_i found her_i dog.’

Here the NPI *tzovan*, translated as ‘no one’, is able to bind the third singular possessor of the object, *jan*. This yields an interpretation where no individual was able to find her own dog. This baseline example shows that when the subject c-commands the object, a *tzova* subject is indeed able to bind an element within the object.

Having established that *tzova* is able to act as a binder for a possessive pronoun, we can now use this to diagnose what type of movement the object DP undergoes. This can be done through WCO (Wasow 1972). WCO usually arises through A'-moving a quantificational element across a coindexed pronoun that did not originally c-command the quantificational expression. When a quantificational element undergoes A'-movement to a position above a non-c-commanding pronoun, a bound reading of the pronoun is typically degraded and only a free reading of the relevant pronoun is possible. The degradedness of the sentence with a bound interpretation is referred to as a WCO effect. WCO effects provide us with a useful tool for diagnosing A- versus A'-movement (see, e.g., Mahajan 1990). If movement of a quantificational expression across a non-c-commanding pronoun results in a WCO effect, the relevant movement can be taken to be A'-movement. Mahajan (1990) shows that for languages like Hindi (Indo-Aryan), some types of scrambling show properties of A-movement, including not inducing a WCO effect, while other types of scrambling behave like A'-movement in inducing a WCO effect. I will demonstrate that scrambling above the *vP* is uniformly of the second type in Amahuaca, showing WCO effects and therefore being A'-movement.

First I will consider movement of the object into the middle field to the left of aspect while the subject stays in Spec,*vP*, surfacing to the right of aspect. When a quantificational object undergoes scrambling to a position in the middle field, only a free interpretation of the possessor of the subject is possible, as demonstrated in (33).

- (33) hovi hi=kun=mun **tzova**_j chivan-vo=yama=hi **jan**_{i/*j}
 rain do.INTR=DS.SQ=C who follow-AM=NEG=IPFV 3SG.GEN
 hatapa=ki=nu
 chicken=3.PRES=DECL
 ‘After it rained, her_{i/*j} chicken is following no one_j.’

Here, the object is the NPI *tzova*, and the possessor of the subject must be interpreted as free. The bound reading where no one is being followed by her own chicken is impossible. This WCO violation indicates that the step of movement that results in the object being higher than the subject in (33) is A'-movement. If instead the low subject is quantificational and the object contains a possessive pronoun, the pronoun may be bound, as in (34).

question. In this instance, it is the subject DP that appears in the initial position preceding the second position clitic. This suggests that this position is a focus position.

The association of the initial position with focused constituents is not restricted to question and answer pairs. Other contexts which trigger focus, such as corrective contexts, also result in the focused constituent being fronted to the initial position, as demonstrated in (41).

- (41) a. hatza=mun choka=hi xano=ki=nu
 manioc=C wash=IPFV woman=3.PRES=DECL
 ‘The woman is washing manioc.’
 b. maki, joni=n=mun hatza choka=hi=ki=nu
 no man=ERG=C manioc wash=IPFV=3.PRES=DECL
 ‘No, THE MAN is washing manioc.’

In (41b) the part of the sentence that is being corrected from (41a) is the DP *joni* ‘man’, which replaces the DP *xano* ‘woman’. This subject DP is fronted to the initial position before the clitic =*mun*. This initial position, then, seems to be a general purpose focus position.

It is important to note that there is only a one way implication between focus and fronting. Constituents that receive a narrow focus interpretation are fronted, but not all fronted constituents receive a narrow focus interpretation. This is demonstrated by the example in (42) below.

- (42) *Context: You see a group of people gathered around a tree and you ask, ‘What happened?’.* Someone responds:
joni=mun pakuu=xo=nu
 man=C fall=3.PST=DECL
 ‘A man fell.’

In (42), the context is such that the entire sentence is new information and therefore there should be no narrow focus. Still, the subject DP *joni* ‘man’ appears in initial position before C. This DP does not receive a narrow focus interpretation, a fact which is corroborated by the lack of nominative case on the subject, which will be discussed further in Chapter 3. The obligatoriness of a constituent in Spec,CP even in contexts that lack a narrow focus can be derived from an EPP feature on C.

Movement to the initial Spec,CP position in Amahuaca shows hallmarks of A'-movement, like scrambling in the middle field. The example in (43) shows a baseline example of the NPI *tzova* in the initial focus position binding a possessive pronoun that is lower than it in the clause.

- (43) **tzova**=**n_i**=mun **jan_i** hatapa chivan-vo=yama=xo=nu
 who=ERG=C 3SG.GEN chicken follow-AM=NEG=3.PST=DECL
 ‘No one_i followed her_i chicken.’

Here in (43), the bound interpretation of the possessive pronoun *jan* in the object DP is possible. This contrasts with the situation found in (44a). In this example, the NPI is the object, and it is unable to bind a possessive pronoun in the subject. The example in (44b) demonstrates that even when the object undergoes movement to the initial focus position higher than the subject in the middle field, it is still unable to result in a bound interpretation of the possessive pronoun without incurring a WCO violation.

- (44) ‘Her_{i/*j} chicken followed no one_j.’
- a. **jan**_{i/*j} hatapana=n=mun **tzova**_j chivan-vo=yama=xo=nu
3SG.GEN chicken.LG=ERG=C who follow-AM=NEG=3.PST=DECL
- b. **tzova**_j=mun **jan**_{i/*j} hatapana=n chivan-vo=yama=xo=nu
who=C 3SG.GEN chicken.LG=ERG follow-AM=NEG=3.PST=DECL

The WCO effect demonstrated by the example in (44b) suggests that movement to the initial focus position in Amahuaca constitutes A'-movement, just like the other patterns of scrambling we have considered thus far.

This conclusion that movement to the initial position must be A'-movement is further supported by data from Condition C. First, consider Condition C with possessors. In (45), we see a baseline example that shows that a coreferential reading of an R-expression subject and the pronominal possessor of an object is possible, regardless of whether the object or the subject has moved to the initial focus position.

- (45) ‘Martha_i is looking for her_i cat.’
- a. **Marta**=n_i=mun **jan**_i mishiito vuna=hi=ki=nu
Martha=ERG=C 3SG.GEN cat look.for=IPFV=3.PRES=DECL
- b. **jan**_i mishiito=mun vuna=hi **Marta**_i=ki=nu
3SG.GEN cat=C look.for=IPFV Martha=3.PRES=DECL

Here in (45), *jan* ‘his/her’ can freely refer to Martha, regardless of the relative position of the subject and object. This contrasts with the example in (46) where the subject is a pronominal and the possessor of the object is an R-expression.

- (46) ‘S/he_{i/*j} is looking for Martha’s_j cat.’
- a. **jaa**=n_{i/*j}=mun **Marta**=n_j mishiito vuna=hi jan=ki=nu
3SG=ERG=C Martha=GEN cat look.for=IPFV 3SG=3.PRES=DECL
- b. **Marta**=n_j mishiito=mun *pro*_{i/*j} vuna=hi jan=ki=nu
Martha=GEN cat=C look.for=IPFV 3SG=3.PRES=DECL

Here in (46a), we see that when the pronominal subject occurs in a position higher than the R-expression possessor of the object, a coreferential reading of the possessor is not permitted – this would result in a Condition C violation. Interestingly, when the possessed object moves to the initial focus position, as in (46b), this does not ameliorate the Condition C violation. In this configuration, a coreferential interpretation is also unacceptable. This indicates that

movement to the initial position does not change the calculus of binding relationships, but instead forces reconstruction. In contrast, short scrambling in languages like Hindi can change the calculus of Condition C and does not force reconstruction, which leads Mahajan (1990) to conclude that this type of scrambling is A-movement. The fact that scrambled DPs obligatorily reconstruct for Condition C in Amahuaca suggests that the movement involved in scrambling is instead A'-movement. This finding is consistent with the data from WCO.

We see a similar pattern with Condition C effects involving relative clauses. In (47), we see that it is possible to have a coreferential interpretation between an R-expression inside a relative clause on the matrix subject and a pronominal matrix object.

- (47) ‘The peccary that Juan_i found is chasing him_i.’
- a. **jaa**_i=mun chivan-vo=hi [**Juanu**=**n**_i jono vuchi=ha]=ki=nu
 3SG=C chase-AM=IPFV Juan.LG=ERG peccary find=PFV=3.PST=DECL
- b. **jaa**_i=mun [**Juanu**=**n**_i jono vuchi=hato]=n
 3SG=C Juan.LG=ERG peccary find=PFV.LG=ERG
 chivan-vo=hi=ki=nu
 chase-AM=IPFV=3.PST=DECL

In both examples in (47), the object pronoun in the matrix clause has scrambled to the initial focus position. Regardless of whether the matrix subject, containing the relative clause with the R-expression *Juan*, is in its base position, as in (47a), or has scrambled to the middle field, as in (47b), no Condition C violation is triggered. This suggests that the position of the matrix object pronoun before the second position clitic is not a position from which it can bind into the subject. This is consistent with this initial focus position being an A'-position. This conclusion is further supported by the fact that the reverse configuration, where the matrix subject is a pronoun and the matrix object contains a coreferential R-expression in a relative clause is ungrammatical, as shown in (48).

- (48) [**Juanu**=**n**_j jono vuchi=ha]=mun **jaa**=**n**_{i/*j} chivan-vo=hi
 Juan.LG=ERG peccary find=PFV=C 3SG=ERG chase-AM=IPFV
 jan=ki=nu
 3SG=3.PST=DECL
 ‘He_{i/*j} is chasing the peccary that Juan_j found.’

Here we see that the matrix subject cannot corefer with the name *Juan* in the relative clause. This would constitute a Condition C violation. The unavailability of this interpretation holds even if the object containing the relative clause undergoes movement to the initial position. This is consistent with the conclusion that movement to the initial position does not affect binding relationships and is therefore A'-movement. This is schematized in (49).²⁷

²⁷Once again, it is not crucial for me that this movement of the object begin from a position in the middle field rather than from a position on the *vP* edge to the right of aspect marking.

$$(49) \quad \begin{array}{c} \text{DP}_{\text{OBJ}} = \text{C} \text{ DP}_{\text{SUBJ}} \text{ --- } \text{V} = \text{Asp} = \text{T} = \text{Mood} \\ \uparrow \quad \quad \quad \downarrow \\ \quad \quad \quad \text{A}' \quad \quad \quad \end{array}$$

The final type of movement I will consider is rightward extraposition to a clause-final position. In matrix clauses, it is possible for a single constituent to appear after the clause-final tense and mood particles at the far right edge of the clause. The DP that occurs in this position shows case connectivity with the matrix clause, as illustrated in (50) for ergative and (51) for accusative.

(50) ‘They are killing a peccary.’

- a. jono=mun **jato=n** rutu=hi kan=ki=nu
 peccary=C 3PL=ERG kill=IPFV 3PL=3.PRES=DECL
- b. jono=mun rutu=hi kan=ki=nu **jato=n**
 peccary=C kill=IPFV 3PL=3.PRES=DECL 3PL=ERG

(51) ‘Everyone is killing a peccary.’

- a. **jono**=mun kiyoo=vini=n rutu=hi kan=ki=nu
 peccary=C all=EMPH.LG=ERG kill=IPFV 3PL=3.PRES=DECL
- b. rutu=mun kiyoo=vini=n=hi kan=ki=nu **jono**
 kill=C all=EMPH.LG=ERG=IPFV 3PL=3.PRES=DECL peccary

In (50) we see that ergative case shows case connectivity in extraposition. The plural pronoun *jaton* in (50a) shows ergative case in the middle field. When it undergoes extraposition to the clause-final position in (50b), it retains that case marking. The fact that the DP remains ergative in the clause-final position is consistent with this structure being derived via movement of the pronoun rather than base generation in a right peripheral position. The presence of ergative case also suggests that this is a high position in the clause, rather than representing a low subject position. This is because ergative case is, in general, associated with subjects that have moved at least as high as Spec,TP, as will be argued for in Chapter 3. The examples in (51) serve to demonstrate that ergative is not a case assigned to all DPs in this extraposed position. Rather, the case of the DP in this position at the far right reflects the expected matrix case value. In (51a) the object DP *jono* ‘peccary’ is in an unmarked form when it appears in initial position. It remains unmarked when it undergoes extraposition in (51b).

Like the other types of movement considered here, extraposition to the clause-final position also shows properties of A'-movement. First, consider Condition C effects with possessors. Extraposition is unable to repair a Condition C violation, as seen in (52).

(52) ‘He_{i/*j} saw Pedro’s_j father.’

- a. **Pedro=n_j** ja-pa=mun *pro*_{i/*j} jan hiin=xo=nu
 Pedro=GEN 3SG.POSS-father=C 3SG see=3.PST=DECL
- b. **jaa=n_{i/*j}**=mun jan hiin=xo=nu **Pedro=n_j** ja-pa
 3SG=ERG=C 3SG see=3.PST=DECL Pedro=GEN 3SG.POSS-father

In (52a), we see that the R-expression possessor, *Pedro*, of the object cannot corefer with the subject of the clause. This would result in a Condition C violation. When the object undergoes extraposition to a clause-final position in (52b), the two expressions still cannot corefer. This means that movement to this final position does not affect binding relationships and is A'-movement. This conclusion is supported by data from Condition C effects involving relative clauses, as shown in (53).

- (53) 'The peccary that Juan_i had found killed him_{i/j}.'
- a. [Juanu=**n**_i jono vuchi=hato]=n=mun rutu=xo=nu **jaa**_{i/j}
 Juan.LG=ERG peccary find=PFV.LG=ERG=C kill=3.PST=DECL 3SG
- b. rutu=mun [Juanu=**n**_i jono vuchi=hato]=n=xo=nu **jaa**_{i/j}
 kill=C Juan.LG=ERG peccary find=PFV.LG=ERG=3.PST=DECL 3SG

In both of the examples in (53), the pronominal object *jaa* is extraposed and is able to corefer with the subject, *Juan*, of the relative clause on the matrix subject. This is true regardless of whether the matrix subject is in the initial focus position, as in (53a), or lower in the middle field, as in (53b). If extraposition constituted A-movement to a position higher than the subject in either example, we would expect extraposition of the pronominal object to trigger a Condition C violation. The fact that a coreferential reading is possible suggests that this movement is A'-movement. This conclusion is schematized in (54).²⁸

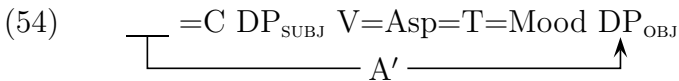

To summarize the findings of this section, operations of movement that reorder the subject and object by moving to or within the middle field, to the initial focus position, or to the clause-final position all show the hallmarks of A'-movement. These types of movement display WCO effects and do not change the hierarchical relationship between the subject and object in a way that affects the calculus of Condition C violations.

2.3.5 Sample derivation of a matrix clause

Given the previous discussion of structure and movement in matrix clauses, we can now understand the full structure of a transitive matrix clause. The proposed overall clausal structure for the sentence in (55) is given in (56).

²⁸I do not intend to suggest with this schematic representation that extraposed word orders are necessarily derived via rightward movement. Instead, such structures could involve leftward movement of the object followed by remnant movement of the clause to a higher position. It is also not necessary that such movement proceed from the initial Spec,CP position (though the remnant movement account would require the DP that would undergo extraposition to be the highest element in the clause at some step in the derivation). However, regardless of the analysis, it is crucial that the initial position before the second position clitic =*mun* is filled on the surface even in structures that involve extraposition.

- (55) *kuntii=mun choka=hi xano=ki=nu*
 pot=C wash=IPFV woman=3.PRES=DECL
 ‘The woman is washing a pot.’

- (56) O=C V=Asp A=T=Mood

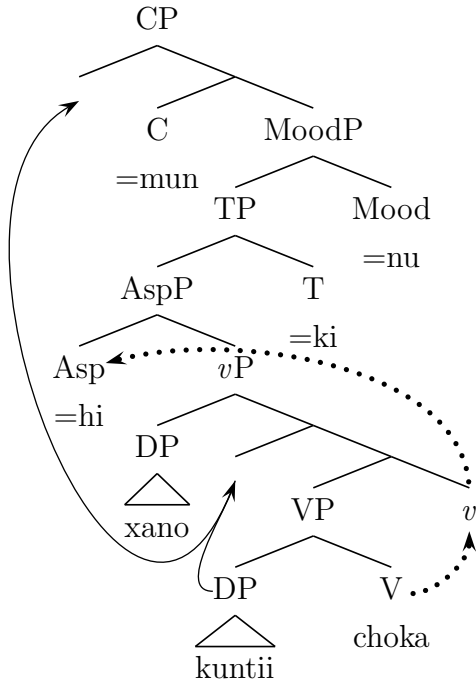

In the tree in (56), the object DP *kuntii* ‘pot’ is externally merged as the complement of the verb *choka* ‘wash’ and the subject DP *xano* ‘woman’ is externally merged in the specifier of *vP*. The object moves out of VP into an inner specifier of *vP*, in keeping with the evidence from remnant VP fronting that object shift is obligatory. The verb then undergoes head movement through *v* to Asp to form a complex head and arrive in its sentence-medial position. Finally, the object A'-moves to Spec,CP. In Chapter 3 I will discuss in more detail the derivation of various word orders and their interaction with case marking.

2.3.6 Dependent clauses

In addition to matrix clauses, which have been discussed so far, Amahuaca has two main types of dependent clauses: switch-reference clauses and nominalized relative clauses.²⁹ The difference between these two classes of clauses has been somewhat murky in the literature on Amahuaca and other Panoan languages (see below for a discussion of this issue in Amahuaca (Sparing-Chávez 1998, 2012) and Shipibo (Valenzuela 2003; Camacho 2010)). In general, authors seem to agree that there are (at least) two classes of dependent clauses across

²⁹Amahuaca does not utilize true complement clauses for indirect speech and other attitude reports. I discuss below how attitude reports are expressed with switch-reference clauses.

Panoan, but categorizing which clauses belong to which category has proved to be a difficult task. In this section I provide diagnostic differences to distinguish these two types of clauses in Amahuaca. These diagnostics serve to delineate which clauses are true switch-reference clauses. These clauses will be the topic of Chapter 4.

2.3.6.1 Switch-reference clauses

First, we turn to switch-reference (SR) clauses. For the purpose of this dissertation, I will consider SR to be morphological marking in a dependent clause that indicates whether an argument of the dependent clause is or is not coreferential with an argument of the clause that hosts it. As will be argued in Chapter 4, Amahuaca SR clauses are adjunct CPs that attach high in the matrix clause. They terminate in a SR marker that indicates three basic types of information. First, the SR marker indicates the temporal relationship between the two clauses with the three main paradigms corresponding to meanings roughly like English ‘after’ (sequential; SQ), ‘while’ (simultaneous; SIM), and ‘before’ (subsequent; SUB). A basic contrast between the simultaneous and sequential paradigms is seen in (57) versus (58).

(57) [jaa=x vua=hi]=mun xano chirin=xo=nu
 3SG=NOM sing=SS.SIM=C woman dance=3.PST=DECL
 ‘While she sang, the woman danced.’

(58) [jaa=x vua=hax]=mun xano chirin=xo=nu
 3SG=NOM sing=SS.SQ=C woman dance=3.PST=DECL
 ‘After she sang, the woman danced.’

In (57), the SR clause marked with =*hi* indicates a simultaneous temporal relationship between the two clauses, much like ‘while’. The example in (58) differs only in the choice of =*hax* as the SR marker. This indicates a sequential temporal relationship between the two clauses, much like English ‘after’. SR clauses can also be used to express purpose readings, as demonstrated in (59).

(59) [[ha=xankin] Maria=n xuki jova=kun]=mun
 do.TR=SA.SUB Maria=ERG corn cook=DS.SQ=C
 Jaunu=n (rokon) ha=xo=nu
 Juan.LG=ERG CNTEXP do.TR=3.PST=DECL
 ‘Maria cooked corn in order to eat it, but Juan ate it.’

Here in (59) we see two nested SR clauses. The innermost clause has the marker =*xankin*, which is usually used to indicate a temporal relationship similar to ‘before’. However, in this clause, it is instead used for a purpose reading. Maria’s action of cooking corn was completed with the purpose of her eating the corn (with the verb *ha* ‘do’ here used to mean ‘eat’ as it commonly does).³⁰ However, as the matrix clause indicates, Juan ate the corn, not Maria.

³⁰The verb *ha* is a semantically bleached transitive verb that is used for a variety of meanings when the verb meaning can be recovered from context.

Therefore, this ‘before’ clause does not indicate that the action of its clause was completed subsequent to the action of the clause it adjoins to. In fact, the action of this ‘before’ clause is never actually realized. Instead, this clause indicates the intended purpose of the action of the clause to which it is adjoined.

The second type of information that the SR markers encode is (non-)coreference relationships between arguments of the clause with the SR marker, which I will refer to as the ‘marked clause’ following Munro (1979) and Haiman and Munro (1983), and the clause to which the marked clause adjoins, which I will call the ‘reference clause’, also following Munro (1979) and Haiman and Munro (1983). We see a contrast between a construction where the subject of the marked clause is coreferential with the subject of the reference clause in (60) and one where the marked clause subject is disjoint in reference from the subject of the reference clause in (61).

- (60) [jaa=x_i vua=kin]=mun xano=n_i xuki jova=xo=nu
 3SG=NOM sing=SA.SIM=C woman=ERG corn cook=3.PST=DECL
 ‘While she_i sings, the woman_i cooks corn.’

- (61) [joni_i vua=hain]=mun xano=n_j xuki jova=xo=nu
 man sing=DS.SIM=C woman=ERG corn cook=3.PST=DECL
 ‘While the man_i sings, the woman_j cooks corn’

In (60) the third person singular pronoun *jaax* in the marked clause is construed as coreferential with the subject *xanon* ‘woman’ of the reference clause. This is typically referred to as a ‘same subject’ clause and the SR marker takes the form =*kin*. In (61), the subject *joni* ‘man’ of the marked clause is disjoint from the subject of the reference clause. Here, the form of the SR marker is =*hain* instead of =*kin*. This is typically referred to as a ‘different subject’ clause. In the discussion that follows, as well as in Chapter 4, it will become clear that a simple same versus different subject contrast is not sufficient to characterize the Amahuaca SR system since the reference of arguments other than subjects is also tracked by the SR system.

A third piece of information that the SR markers of Amahuaca encode is information about the abstract case of arguments that stand in coreference relationships, which I will refer to as ‘pivots’ following Stirling (1993). This is demonstrated by the contrast between the two same subject constructions in (62) and (63).

- (62) [jaa=x_i vua=hi]=mun xano_i chirin=xo=nu
 3SG=NOM sing=SS.SIM=C woman dance=3.PST=DECL
 ‘While she sang, the woman_i danced.’

- (63) [jaa=x_i vua=kin]=mun xano=n_i xuki jova=xo=nu
 3SG=NOM sing=SA.SIM=C woman=ERG corn cook=3.PST=DECL
 ‘While she_i sang, the woman_i cooked corn.’

In both of the examples in (62) and (63) the marked clause subject is coreferential with the reference clause subject. What differs between these two clauses is the case of the subject in the reference clause. In (62), the reference clause pivot is an intransitive subject with abstract nominative case, and the form of the SR marker is *=hi*. In (63), on the other hand, the reference clause pivot is a transitive subject with ergative case and the form of the SR marker is instead *=kin*. Thus, SR markers indicate temporal relationships between clauses, (non-)coreference of arguments, and abstract case of pivots.

In the SR examples seen so far, and indeed in the majority of SR examples that will be seen in this dissertation, the SR marked clause is a temporal or purpose adjunct clause. Interestingly, SR clauses have another common use that corresponds less clearly to the use of adjunct clauses in English. SR clauses are used in attitude reports, as seen in (64).

- (64) [hino koshi ka=kun]=mun Juanu=n yohi=xo=nu
 dog quickly go=DS.SQ=C Juan.LG=ERG say=3.PST=DECL
 ‘Juan said that the dog had run.’³¹

We see in (64) that the matrix clause verb is *yohi* ‘say’, and the content of the reported speech is within a SR clause.³² As will be discussed further in Chapter 4, SR clauses are adjuncts that attach high in the clause. Even when used in attitude reports, such as in (64), SR clauses do not appear to syntactically be complements of the verb, but rather they appear in a high position in the matrix clause. This can be demonstrated, for example, by the fact that a Condition C violation is not triggered when an R-expression within a SR clause is coreferential with a matrix pronominal element, as shown in (65).³³

- (65) ‘Pedro_i said that he_i had slept.’
 a. Pedro=n_i=mun [*pro*_i hoxa=xon] yohi=xo=nu
 Pedro=ERG=C sleep=SA.SQ say=3.PST=DECL
 b. [Pedro_i hoxa=xon]=mun *pro*_i yohi=xo=nu
 Pedro sleep=SA.SQ=C say=3.PST=DECL

In (65a), the R-expression *Pedro* is in the matrix clause, as evidenced by its ergative case marking, since the subject of *yohi* ‘say’ typically surfaces with ergative case. On the other hand, in (65b), the R-expression now appears in the SR clause before the second position clitic, where it surfaces in an unmarked form as an intransitive subject. In this structure, no Condition C violation is triggered, suggesting that the SR clause does not originate below the position of the matrix subject, since movement to the initial position typically forces

³¹The expression *koshi ka* ‘go quickly’ is often used to mean ‘run’, and I will sometimes translate it simply as ‘run’ in English.

³²The subject of the attitude verb *yohi* ‘say’ typically surfaces with ergative case. The verb *yohi* is one of a small class of attitude verbs that can occur with a proleptic DP object and that take ergative case on the subject. The other verbs in this class are *honan* ‘know’, *nama* ‘dream’, *ninka* ‘hear’, and *shinan* ‘think’.

³³Here I indicate phonologically null pronominal arguments with *pro* to be explicit about the structure I assume. Note that I do not follow this convention in all examples.

reconstruction for Condition C, as shown in Section 2.3.4. This suggests that SR clauses are never complements of the matrix verb, even when they are used for attitude reports, such as indirect speech reports. Therefore, setting aside instances of direct quotation, Amahuaca does not appear to utilize true complement CPs.

2.3.6.2 Relative clauses

The other broad category of dependent clauses in Amahuaca is nominalized relative clauses. Relative clauses (RCs) in Amahuaca can be internally or externally headed. Internally headed relative clauses (IHRCs) terminate in a perfective (=ha) or imperfective (=hai) aspect marker followed by a case marker that bears the appropriate matrix case value for its argument position. Externally headed relative clauses (EHRCs) also bear one of the aspect markers. The head noun occurs to the right of the aspect marker and receives matrix case marking. These two types of RCs are exemplified in (66).

- (66) ‘The alligator that the man quickly found bit Maria.’
- a. [koshi joni=n kapuu vuchi=hato]=n=mun Maria pi=xo=nu
 quickly man=ERG alligator find=PFV.LG=ERG=C Maria bite=3.PST=DECL
- b. [koshi joni=n vuchi=ha] kaputo=n=mun Maria
 quickly man=ERG find=PFV alligator.LG=ERG=C Maria
 pi=xo=nu
 bite=3.PST=DECL

In (66a) we see an IHRC functioning as the transitive subject of the matrix clause and bearing the corresponding ergative case. In (66b) we see the corresponding structure with an EHRC. Here the head noun *kaputon* ‘alligator’ is to the right of the perfective marker of the RC and bears the matrix ergative case since it is at the right edge of the DP. Note that the perfective marker is =hato in (66a), but =ha in (66b). This is related to the issue discussed in Section 2.2 of whether to consider the extra syllable found on some words with case marking to be part of the root or the case marker. When ergative marking immediately follows the perfective morpheme =ha, the resulting form is =haton (including the ergative marker). Following the decision to treat final syllables as belonging to the root, I segment this string as =hato=n.³⁴ The example in (67) shows that this alternation between =ha and

³⁴It is purely accidental that both =hato in (66a) and kaputo in (66b) have the extra syllable *to* in the ergative form. One might conclude from these examples that RCs must always be marked with a case marker =ton, regardless of the position of the head. However, the example in (ii) demonstrates that if the external head does not independently require the extra syllable *to* in its ergative form, the case marker =n is used with no change to the root.

- (ii) [roho vuchi=ha] joni=n=mun nami pi=hi=ki=nu
 howler.monkey find=PFV man=ERG=C meat bite=IPFV=3.PRES=DECL
 ‘The man who found a howler monkey is eating meat.’

=hato is not driven by the clause being internally or externally headed, but rather is due to the presence or absence of case marking after the aspect marker.

(67) ‘The dog followed the man who had sung.’

- a. [joni vua=*ha*]=mun hinan chivan-vo=xo=nu
 man sing=PFV=C dog.ERG follow-AM=3.PST=DECL
- b. [vua=*ha*] joni=mun hinan chivan-vo=xo=nu
 sing=PFV man=C dog.ERG follow-AM=3.PST=DECL

Here in (67a), the IHRC has the form *=ha* of the perfective marker, in contrast to what was seen in (66a). This is because the IHRC is functioning as a matrix object and, therefore, does not receive overt case. With no case marking to trigger the additional syllable, the *=ha* form of the aspect marker surfaces. The same form surfaces in the EHRC in (67b).

2.3.6.3 Distinguishing switch-reference and relative clauses

As mentioned previously, there is some debate in the literature about the status of SR clauses and RCs in Panoan, and whether various piece of morphology should be categorized as belonging to the paradigm of SR markers or the paradigm of RC aspect markers. The most extensive sources available on these clauses in Amahuaca are Sparing-Chávez 1998 and 2012. Sparing-Chávez discusses SR under the label ‘interclausal reference’. She divides interclausal reference markers into Set A markers and Set B markers, and notes that many of the Set B markers “function as relative clause markers” (Sparing-Chávez 1998: 464). She claims that the main difference between the two sets is their “focus”, noting that the Set A markers “primarily relate events to one another”, while the Set B markers relate “participants (subjects or objects) to events” (Sparing-Chávez 1998: 464). Sparing-Chávez does not provide any further diagnostics for distinguishing the two sets of markers or for distinguishing RCs from SR clauses (in fact, it is not clear from her discussion whether she views the RC/SR distinction as being a true distinction in Amahuaca). In other literature on Panoan languages, the task of distinguishing these two types of clauses has also proved problematic. For example, Valenzuela (2003) assumes that the Shipibo morpheme *-a* has both a SR and a RC function, but Camacho (2010) crucially relies on the assumption that *-a* only occurs in RCs.³⁵ In what follows, I discuss several ways in which clauses with SR markers and RCs differ from each other in terms of their syntax. These syntactic differences can be used as diagnostics to distinguish the two types of clauses.

The first major difference between SR clauses and RCs is their distribution in matrix clauses. RCs have the distribution of nominals, while SR clauses do not. Many surface

³⁵Interestingly, the cognate marker *=ha* in Amahuaca also has a somewhat unclear status. Sparing-Chávez (1998, 2012) groups it with Set B markers, the more RC-like paradigm, but Hyde (1980) groups it with the markers that Sparing-Chávez categorizes as Set A. The diagnostics I will propose here point to the fact that there are two *=ha* markers, one which functions as a perfective aspect marker in RCs, and another which is a SR marker that indicates that the adjunct clause object is coreferential with the intransitive subject of the matrix clause.

positions in the Amahuaca clause, such as the initial focus position, can be occupied by elements of various categories. However, the *vP*-internal positions of the subject and object, to the right of overt aspect marking, are only able to be occupied by nominals. We do find RCs occurring in this position, as shown in (68b).

- (68) ‘The man who always sleeps is singing quickly.’
- a. [joni hoxa=hai]=mun koshi vua=hi=ki=nu
 man sleep=IPFV=C quickly sing=IPFV=3.PRES=DECL
- b. koshi=mun vua=hi [joni hoxa=hai]=ki=nu
 quickly=C sing=IPFV man sleep=IPFV=3.PRES=DECL

In (68a), we see an IHRC appearing in the initial position, and in (68b) we see that it is possible for that same RC to appear to the right of aspect marking, where the matrix subject originates. In contrast, SR clauses cannot appear to the right of aspect marking, as demonstrated in (69b).

- (69) ‘After the woman_i sang, she_i is washing manioc.’
- a. [xano vua=xon]=mun hatza choka=hi=ki=nu
 woman sing=SA.SQ=C manioc wash=IPFV=3.PRES=DECL
- b. *hatza=mun choka=hi [xano vua=xo(n)]=ki=nu
 manioc=C wash=IPFV woman sing=SA.SQ=3.PRES=DECL

We see in (69a) an example of a SR clause in initial position in the matrix clause. In (69b) the same clause appears after the matrix imperfective aspect marker, and the result is ungrammaticality. Note that in this position the SR clause remains ungrammatical even if the final *n* is dropped from the SR marker. As will be discussed in Chapter 3, ergative subjects in Amahuaca show differential subject marking, with subjects appearing to the right of aspect marking lacking ergative case. If this SR clause were instead an IHRC, we would expect it to surface without ergative case marking in this position. One might think that the final *n* in the SR marker =*xon* is, in fact, simply the ergative case marker. (This possibility is especially attractive since =*xo* is the form used to cross-reference accusative (unmarked) DPs in the matrix clause.) However, dropping this *n* does not improve the acceptability of the SR clause in the low subject position. SR clauses simply cannot occupy this position in the matrix clause. This constitutes the first diagnostic for distinguishing SR clauses from RCs.

- (70) **RC vs. SR Diagnostic 1:** RCs may appear in the low subject position to the right of aspect marking. SR clauses may not.

Another difference between the two types of dependent clauses in Amahuaca is their ability to have an external head to the immediate right of the final morpheme of the clause. As we have already seen in (66), repeated in (71), it is possible for RCs to have internal or external heads.

- (71) ‘The alligator that the man quickly found bit Maria.’
- a. [koshi joni=*n* kapuu vuchi=*hato*]=*n*=mun Maria pi=*xo*=nu
 quickly man=ERG alligator find=PFV.LG=ERG=C Maria bite=3.PST=DECL
- b. [koshi joni=*n* vuchi=*ha*] kaputo=*n*=mun Maria
 quickly man=ERG find=PFV alligator.LG=ERG=C Maria
 pi=*xo*=nu
 bite=3.PST=DECL

When a RC has an external head, as in (71b), the external head appears to the right of the final marker of the RC, in this case the perfective aspect marker, and it surfaces with matrix case marking. Crucially, this external head still forms a constituent with the RC, as indicated by the position of the matrix second position clitic =*mun* after the RC and its head. It is not similarly possible for SR clauses to have an “external head”. That is, the pivot of the SR clause may not appear as a constituent with the SR clause but to the right of the final marker of the SR clause, as shown in (72b).

- (72) ‘After the woman_{*i*} washed clothes, she_{*i*} cooked manioc.’
- a. [xano=*n* chopa patza=*xon*]=*n*=mun hatza
 woman=ERG clothes wash=SA.SQ=C manioc
 jova=*hi*=*ki*=nu
 cook=IPFV=3.PRES=DECL
- b. * [chopa patza=*xo(n)*] xano=*n*=mun hatza jova=*hi*=*ki*=nu
 clothes wash=SA.SQ woman=ERG=C manioc cook=IPFV=3.PRES=DECL

In (72a), the pivot of the SR clause, *xanon* ‘woman’, appears internal to the SR clause. In (72b), the pivot now appears outside of the SR clause, to the right of the SR marker, but still forming a constituent with the SR clause before the matrix second position clitic. This is ungrammatical. Once again, one might be worried that this ungrammaticality is due to facts about the case marking. If the dependent clause in (72b) were a RC, we would expect case marking to only appear on the head rather than on the edge of the clause adjacent to the aspect marker. And, once again, as discussed previously, one might be concerned that the SR marker =*xon* actually contains the ergative =*n* as its final element. However, dropping this *n* in (72b) and allowing ergative to surface only on the pivot does not improve the acceptability of the sentence. Thus, this constitutes a second diagnostic for distinguishing SR clauses from RCs.

- (73) **RC vs. SR Diagnostic 2:** RCs may have an external head that forms a constituent with the RC. SR clauses may not.

A third difference between Amahuaca RCs and SR clauses is the distribution of ergative case within the two types of clauses. In object RCs, transitive subjects receive ergative case marking as expected. This is demonstrated in (74).

- (74) [joni=n roho vuchi=hato]=n=mun nami
 man=ERG howler.monkey find=PFV.LG=ERG=C meat
 pi=hi=ki=nu
 bite=IPFV=3.PRES=DECL
 ‘The howler monkey that the man found is eating meat.’

We see in (74) that it is grammatical for the transitive subject of the relative clause *jonin* ‘man’ to surface with ergative case when the object heads the IHRC. The situation changes when the subject heads the IHRC. In subject RCs, the transitive subject does not surface with ergative case.

- (75) [joni roho vuchi=hato]=n=mun nami pi=hi=ki=nu
 man howler.monkey find=PFV.LG=ERG=C meat bite=IPFV=3.PRES=DECL
 ‘The man who found a howler monkey is eating meat.’

Here in (75), the transitive subject of the IHRC is now construed as the head. In order for this reading to be available, the subject surfaces in an unmarked form – it does not surface with ergative case.³⁶ This pattern is reminiscent of syntactic ergativity, in which an ergative subject cannot undergo A'-extraction. Syntactic ergativity has been noted in IHRCs in Shipibo, another Panoan language, by Valenzuela Bismark (2006). Interestingly, in Shipibo, the only repair strategy mentioned by Valenzuela Bismark is to instead use an EHRC. There are no restrictions on which argument may serve as the head of an EHRC in Shipibo. In Amahuaca this repair strategy is also an option – a transitive subject may freely serve as the head of an EHRC, as shown in (76).

- (76) [roho vuchi=ha] joni=n=mun nami pi=hi=ki=nu
 howler.monkey find=PFV man=ERG=C meat bite=IPFV=3.PRES=DECL
 ‘The man who found a howler monkey is eating meat.’

What is interesting about the Amahuaca pattern that makes it distinct from the pattern in Shipibo is the other repair strategy available in Amahuaca. In order to form a transitive subject IHRC, the ergative case on the subject may simply be omitted, as was seen in (75). Valenzuela Bismark (2006) does not mention this type of strategy as a possible repair in Shipibo. How such structures that lack ergative case are derived is an interesting question that falls outside of the scope of the current discussion. However, what is important for our purposes is the fact that the heads of IHRCs systematically lack ergative case (modulo

³⁶ There is a slight amount of variation in these judgments. All speakers prefer for the transitive subject to be unmarked when it is construed as the internal head of the RC. Speakers sometimes accept sentences with ergative case marking on the transitive subject head of an IHRC. However, they note that this forces a special “emphasis” on the ergative subject. Overt pronouns and *wh*-words in IHRCs tend to be more acceptable with ergative case when they serve as the head of the RC. This suggests that only focused ergatives can be heads of IHRCs, since *wh*-words or full overt pronouns in their typical uses are foci. If the transitive subject serves as the head and is not a focus, it does not surface with ergative case.

the focus facts discussed in footnote 36 in this chapter), thus showing evidence of syntactic ergativity.

This pattern of syntactic ergativity is not seen for SR clauses in Amahuaca, as demonstrated by the example in (77).

- (77) [joni*(=n) roho vuchi=xon]=mun nami pi=hi=ki=nu
 man=ERG howler.monkey find=SA.SQ=C meat bite=IPFV=3.PRES=DECL
 ‘After the man_i found a howler monkey_j, he_{i/*j} is eating meat.’

Here in (77), despite the fact that the transitive subject of the SR clause is the pivot (it must be construed as coreferential with the matrix subject), it obligatorily surfaces with ergative case. This matches the pattern found in matrix clauses, where all transitive subjects that appear higher than aspect marking must surface with overt ergative case. Crucially, it is distinct from the pattern seen with RCs. If the dependent clause in (77) were an IHRC with *joni* ‘man’ as the head, we would expect *joni* to surface without ergative case due to the syntactic ergativity effects observed in IHRCs. Therefore, the obligatory nature of ergative case in SR clauses points to another difference between the two types of dependent clauses. RCs display syntactic ergativity – the head may not be marked with ergative case – while SR clauses show no such restrictions. This diagnostic is given in (78).

- (78) **RC vs. SR Diagnostic 3:** IHRCs show syntactic ergativity. SR clauses do not.

This discussion of syntactic ergativity leads into another difference between RCs and SR clauses in Amahuaca. Notice that the same clause-final morphology is used in RCs regardless of whether the head is the subject or object. This can be seen by comparing (74) and (75). In these two examples, the only difference is whether the subject surfaces with ergative case. The clause-final aspect marking and case marking remains the same. This is a general pattern found in RCs – the same RC morphology freely allows subjects or objects to be interpreted as the head (with transitive subjects lacking ergative case in subject RCs). This contrasts with the situation found in SR clauses. The choice of SR marker forces a particular DP to be interpreted as the pivot. For example, in (77), the pivot is obligatorily the subject. There is no available reading where it is the howler monkey that is eating meat. In fact, for all but one of the SR markers I will consider in Chapter 4, the marked clause pivot is the subject. For the only SR marker that allows a marked clause object pivot, it only allows an object pivot – the subject may not be interpreted as the pivot. Therefore, for each SR marker there is only one possible interpretation for the pivot; there is no flexibility. This constitutes a fourth diagnostic difference between SR clauses and RCs.

- (79) **RC vs. SR Diagnostic 4:** RC morphology allows for flexibility in the choice of head. SR morphology allows for no flexibility in the choice of pivot.

A further diagnostic difference between the two types of dependent clauses in Amahuaca concerns patterns of matrix case marking. RCs in Amahuaca are clauses that receive the

typical case marking expected for their grammatical function in the matrix clause. In contrast, SR clauses do not receive case marking directly, but rather cross-reference the abstract case (which could also be conceptualized as grammatical function) of the DP in the matrix clause that is coreferential with the SR pivot. This leads to a potential expected difference between the two clauses. If RCs are case-marked directly in the matrix clause, this would lead us to expect that differential case marking should affect RCs in the same way that it affects other DPs. If SR clauses merely track the (abstract) case of a matrix argument, we would expect one of two possible patterns – either the form of the SR marker should covary with the presence or absence of overt case on the matrix argument (if overt case is relevant) or the form of the SR marker should align with a grammatical function and should not vary based on presence or absence of overt case (if abstract case is relevant). The second pattern is, in fact, the one that holds in Amahuaca, resulting in a difference between RCs and SR clauses. To demonstrate this difference, consider the RCs in (80).

- (80) ‘The man who had washed yams fell.’
- a. [joni kari choka=ha]=mun pakuu=xo=nu
 man yam wash=PFV=C fall=3.PST=DECL
- b. [joni kari choka=hato]=x=mun pakuu=xo=nu
 man yam wash=PFV.LG=NOM=C fall=3.PST=DECL

In (80a) we see an example of an IHRC that serves as the matrix subject. It is unmarked for case, which is quite common for intransitive subjects. This means that the RC surfaces with the same morphology it would have were it functioning as a matrix object. In (80b), we see the same RC, now appearing with overt nominative case. As will be discussed in Chapter 3, intransitive subjects can appear with nominative case when they are focused. Thus, by comparing these two examples, we see that differential case marking indeed affects nominative case marking for RCs. Differential case marking also affects ergative case for RCs, as shown in (81).

- (81) ‘The peccary that he_i found is chasing Juan_i.’
- a. [jan jono vuchi=hato]=n=mun Juan chivan-vo=hi=ki=nu
 3SG peccary find=PFV.LG=ERG=C Juan chase-AM=IPFV=3.PRES=DECL
- b. Juan=mun chivan-vo=hi [jan jono vuchi=ha]=ki=nu
 Juan=C chase-AM=IPFV 3SG peccary find=PFV=3.PRES=DECL

In Chapter 3 I will demonstrate that transitive subjects that appear to the right of aspect marking surface in a morphologically unmarked form while transitive subjects that appear to the left of aspect surface with ergative case. We see this same pattern mirrored in (81). When the RC appears to the right of the imperfective aspect marker, as in (81b), it surfaces without overt case marking. In contrast, when the RC surfaces to the left of the aspect marker, as in (81a), it surfaces with ergative case. We therefore see that both types of differential case marking in Amahuaca, differential nominative marking and differential ergative marking, treat RCs like regular DPs.

The same pattern is not found with SR clauses. In sequential SR clauses, the SR marker that is used to cross-reference matrix intransitive subjects is *=hax*, as in (82), while the marker used to cross-reference matrix objects is *=xo*, as in (83).

- (82) [jaa= x_i vua= $\overline{\text{hax}}$]=mun xano $_i$ chirin= xo =nu
 3SG=NOM sing=SS.SQ=C woman dance=3.PST=DECL
 ‘After she $_i$ sang, the woman $_i$ danced.’

- (83) [jaa= x_i vua= $\overline{\text{xo}}$]=mun hinan xano $_i$ chivan-vo= xo =nu
 3SG=NOM sing=SO.SQ=C dog.ERG woman chase-AM=3.PST=DECL
 ‘After she $_i$ sang, the dog chased the woman $_i$.’

We might expect that if *=hax* and *=xo* represented nominative versus unmarked case, respectively, that the marker *=xo* could serve to cross-reference the matrix intransitive subject in certain contexts due to patterns of differential subject marking. This is not the pattern that we find. Instead, *=hax* must always be used to cross-reference the matrix intransitive subject, regardless of context. This is demonstrated in (84).

- (84) ‘After the woman $_i$ planted corn, she $_i$ is singing quickly.’
 a. koshi=mun [xano=n xuki vana= $\overline{\text{hax}}$] vua=hi=ki=nu
 quickly=C [woman=ERG corn plant=SS.SQ] sing=IPFV=3.PRES=DECL
 b. *koshi=mun [xano=n xuki vana= $\overline{\text{xo}}$] vua=hi=ki=nu
 quickly=C [woman=ERG corn plant=SO.SQ] sing=IPFV=3.PRES=DECL

Here we see in (84a) the grammatical form of SR marking used to cross-reference a matrix intransitive subject (something with abstract nominative case). The example in (84b) with *=xo* instead of *=hax* is ungrammatical. This means that the form of the SR marker usually used to cross-reference unmarked object DPs cannot be freely used to cross-reference other types of unmarked DPs like unfocused subjects. This suggests that the clause-final morphological marking seen in SR clauses is not case marking. Otherwise we would expect it to be subject to differential subject marking. It is uncommon for nominative-marked DPs to appear in the middle field – they typically appear in the initial focus position or are extraposed to a clause-final position. Therefore, we would expect the SR clause to be in the best possible position to remain unmarked for case in (84b) were it subject to normal case-marking conditions. However, the SR marker still must be *=hax* in this position, leading to the conclusion that SR clauses are not subject to differential nominative marking. As discussed in relation to (69b), it is ungrammatical for SR clauses to appear to the right of aspect marking, regardless of the form of the SR marker. Therefore, it is impossible to truly test whether these clauses could be subject to differential ergative marking. However, the general picture that emerges from the distribution of SR markers and case morphology suggests that SR clauses are not nominal in nature and are not subject to case marking. This distinction between RCs and SR clauses is summarized in (85).

- (85) **RC vs. SR Diagnostic 5:** RCs are subject to differential case marking. SR clauses are not.

The final difference I consider here between SR clauses and RCs is islandhood. On this point, there is some variation among speakers. However, the oldest speakers with seemingly the most conservative grammars show island effects for RCs but not for SR clauses. For the current purposes I will consider focus movement to the initial position out of dependent clauses. For this type of extraction, there was more homogeneity among the speakers I consulted compared to *wh*-movement. Two of the three speakers that I worked with on this task consistently rejected focus movement out of RCs and the third typically rejected it with a few exceptions. An example illustrating attempted focus movement out of an IHRC is shown in (86).

- (86) ‘The man who found a howler monkey is eating meat.’
- a. [joni roho vuchi=hato]=n=mun nami pi=hi=ki=nu
man howler.monkey find=PFV.LG=ERG=C meat bite=IPFV=3.PRES=DECL
- b. *roho=mun [joni vuchi=hato]=n nami pi=hi=ki=nu
howler.monkey=C man find=PFV.LG=ERG meat bite=IPFV=3.PRES=DECL

In (86b), we see that it is ungrammatical for a non-head argument to be moved out of a RC to the initial focus position. This means that RCs are islands for movement. We can compare this to focus movement out of SR clauses, which is grammatical, as shown in (87).

- (87) ‘After the woman_i cooked meat, she_i washed manioc.’
- a. [xano=n nami jova=xon]=mun hatza choka=xo=nu
woman=ERG meat cook=SA.SQ=C manioc wash=3.PST=DECL
- b. nami=mun [xano=n jova=xon] hatza choka=xo=nu
meat=C woman=ERG cook=SA.SQ manioc wash=3.PST=DECL

We see in (87b) that it is grammatical to extract a non-pivot argument from a switch-reference clause. Here the non-pivot undergoes focus movement to the initial position. This type of extraction was grammatical for all of the speakers I consulted. This suggests that SR clauses are not islands for extraction.

- (88) **RC vs. SR Diagnostic 6:** RCs show island effects. SR clauses do not.

The six diagnostics I have proposed here for differentiating SR clauses and RCs provide a useful set of tests to divide these two types of dependent clauses in Amahuaca. This method for differentiating these two types of clauses based on their syntactic properties is important for identifying which morphological markers belong to the series of SR markers versus RC aspect and case morphology. This will be particularly important for the discussion of SR clauses in Chapter 4. The literature on SR has been unclear on whether the reference of object DPs can be tracked in SR systems, and the account I provide of SR relies on the

assumption that objects are accessible pivots for SR. This assumption has been questioned for other Panoan languages, like Shipibo, with accounts like that of Camacho (2010) crucially relying on the fact that seemingly object-tracking SR markers are not truly SR markers but are instead RC markers. The diagnostics I have proposed here are specific to Amahuaca and may or may not generalize to other Panoan languages. However, it is important to note that the controversial object-tracking markers in Amahuaca pattern with other SR morphology based on the diagnostics proposed here, as will be discussed further in Chapter 4. This provides support for allowing object pivots within systems of SR.

2.3.7 DP-internal structure

Finally, with respect to the syntax of Amahuaca, it is useful to consider the structure of DPs. Amahuaca allows fairly flexible word order within the DP, and allows both continuous and discontinuous DPs. First I will discuss continuous DPs, and then I will turn to a brief discussion of some of the possible patterns of discontinuous DPs in the language.

In continuous DPs in Amahuaca the word order is fairly flexible. The one consistent property of DPs with respect to ordering is that case always surfaces as the final element of the DP. This suggests that case is a DP enclitic. The ordering of other elements is less rigid. In DPs with only two elements, the two elements can typically occur in either order. In DPs with three or more elements, the picture is more complicated and there is some degree of inter-speaker variability with respect to DP-internal word order. Here I report on data from a task where I presented speakers with all logically possible word order permutations of DPs containing three elements over a series of elicitation sessions and asked for acceptability judgments. (Note that the case marker was consistently given as the final element since case is unable to surface elsewhere in the DP.) These DPs were presented in a carrier sentence in which they were the transitive subject. The form of this sentence was typically as given in (89).

- (89) DP=mun nami pi=hi=ki=nu
 DP=C meat eat=IPFV=3.PRES=DECL
 ‘X is eating meat.’

I provide judgments below for the orders that were accepted or rejected by all four speakers who I consulted on this task. I do not include the orders on which speakers did not agree. I assume that the variable judgments for other word orders may be due to the fact that some orders require more marked information structure that some speakers were more willing to accommodate than others. Therefore, some of the variable unacceptability may have been due to information structural infelicity in the context that speakers imagined rather than ungrammaticality. I leave the question of the interaction of information structure and DP-internal word order as an open area for further investigation in the future.

First, consider DPs with a numeral, an adjective, and a noun. As mentioned previously and as seen in the examples in (90), case must always surface as the final element, but there

is some flexibility in the order of other elements.³⁷

- (90) ‘two tall men’
- a. ravuu joni chaita=n
two man tall.LG=ERG
 - b. joni chaii ravuta=n
man tall two.LG=ERG
 - c. *chaii ravuu joni=n
tall two man=ERG

In both of the grammatical examples, note that ergative case is the final element (due to the DP being elicited in a carrier sentence in which it was the transitive subject), regardless of which word surfaces as the last word of the DP. We see in (90a) that the order numeral–noun–adjective is grammatical. The example in (90b) shows that the order noun–adjective–numeral is also grammatical. However, the order adjective–numeral–noun was judged to be ungrammatical.

Next, consider DPs with a quantifier, an adjective, and a noun, as in (91).

- (91) ‘all the tall men’
- a. kiyoo joni chaita=n
all man tall.LG=ERG
 - b. joni chaii kiyopa=n
man tall all.LG=ERG
 - c. *chaii joni kiyopa=n
tall man all.LG=ERG

The example in (91a) demonstrates that the order quantifier–noun–adjective is possible, and the example in (91b) shows that the order noun–adjective–quantifier is also acceptable. The order adjective–noun–quantifier is unacceptable, as shown in (91c).

Now consider DPs with a demonstrative, adjective, and noun, as in (92).

- (92) ‘that tall man’
- a. jaa joni chaita=n
DEM man tall.LG=ERG
 - b. jaa chaii joni=n
DEM tall man=ERG
 - c. *chaii jaa joni=n
tall DEM man=ERG
 - d. *chaii joni jaa=n
tall man DEM=ERG

³⁷In all of the examples that contain the word *chaii* ‘tall’ as the final element, one speaker used the ergative form *chaiipan* instead of *chaitan*.

- e. *joni chahi jaa=n
man tall DEM=ERG

We see that both possible orders with the demonstrative first are grammatical – demonstrative–noun–adjective order is given in (92a), and demonstrative–adjective–noun order is given in (92b). The order adjective–demonstrative–noun was judged ungrammatical by all of the speakers I consulted, as indicated in (92c). Additionally, both orders with the demonstrative as the final element in the DP are ungrammatical, as shown in (92d) for the order adjective–noun–demonstrative and as shown in (92e) for the order noun–adjective–demonstrative.

A similar pattern can be seen with DPs involving a demonstrative, numeral, and noun, as given in (93).

- (93) ‘those three men’
- a. jaa kimisha joni=n
DEM three man=ERG
- b. jaa joni kimishana=n
DEM man three.LG=ERG
- c. *kimisha jaa joni=n
three DEM man=ERG
- d. *joni jaa kimishana=n
man DEM three.LG=ERG

Here, both orders that involve an initial demonstrative are grammatical. The example in (93a) shows that the order demonstrative–numeral–noun is possible, and (93b) shows that the order demonstrative–noun–numeral is also possible. On the other hand, both orders that involve a medial demonstrative are ungrammatical. This can be seen for the order numeral–demonstrative–noun in (93c) and for the order noun–demonstrative–numeral in (93d).

Finally, we see another similar pattern emerging in DPs with a quantifier, demonstrative, and noun, as in (94).

- (94) ‘all those men’
- a. jaa joni kiyopa=n
DEM man all.LG=ERG
- b. jaa kiyoo joni=n
DEM all man=ERG
- c. *joni jaa kiyopa=n
man DEM all.LG=ERG

Once again, both demonstrative-initial orders are judged to be possible. We see that demonstrative–noun–quantifier order is grammatical in (94a) and that demonstrative–quantifier–noun order is grammatical in (94b). The order noun–demonstrative–quantifier in (94c) is ungrammatical.

From these DPs we have examined, we can arrive at the following generalizations. All DP-internal elements with the exception of demonstratives can appear as the final element of the DP (excluding the final case marker). This includes nouns, adjectives, numerals, and quantifiers. Nouns, numerals, and quantifiers can all appear as the initial element in a DP as well. The most restricted elements are demonstratives. Demonstratives consistently occur as the first element of a DP if they are present, and other orders of demonstratives are usually judged to be unacceptable.

Now, we turn to discontinuous DP structures. In Amahuaca it is possible for a noun and one or more of its modifiers to be linearly non-adjacent. Various types of modifiers can be separated from the noun to form a discontinuous nominal. This is illustrated in (95) for an adjective, (96) for a numeral, and (97) for a quantifier.

(95) ‘The tall man is looking for a paca.’

- a. [joni chaita=n]=mun hano vuna=hi=ki=nu
man tall.LG=ERG=C paca look.for=IPFV=3.PRES=DECL
- b. [chaita=n]=mun [joni=n] hano vuna=hi=ki=nu
tall.LG=ERG=C man=ERG paca look.for=IPFV=3.PRES=DECL

(96) ‘Two men are looking for capybaras.’

- a. [ravuu joni=n]=mun hamun vuna=hi=ki=nu
two man=ERG=C capybara look.for=IPFV=3.PRES=DECL
- b. [ravuta=n]=mun [joni=n] hamun vuna=hi=ki=nu
two.LG=ERG=C man=ERG capybara look.for=IPFV=3.PRES=DECL

(97) ‘All the men are killing a peccary.’

- a. [kiyoo=vi joni=n]=mun jono rutu=hi=ki=nu
all=EMPH man=ERG=C peccary kill=IPFV=3.PRES=DECL
- b. [joni=n]=mun jono [kiyoo=vini=n] rutu=hi=ki=nu
man=ERG=C peccary all=EMPH.LG=ERG kill=IPFV=3.PRES=DECL

In (95b) we see that the adjective *chaitan* ‘tall’ is separated from the noun *jonin* ‘man’. A similar pattern is seen for the numeral *ravutan* ‘two’ in (96b). Finally, in (97b) we see the same pattern with the quantifier *kiyoovinin* ‘all’. These examples illustrate a few important points about discontinuous DPs in Amahuaca. First, they illustrate that discontinuous constituents may be separated by different amounts of material. In (95b) and (96b) only the second position clitic splits the DP, while in (97b) an additional DP intervenes between the two pieces of the DP. The amount of intervening material does not depend on the type of modifier that is separated from the noun. Second, these examples show that when a DP is split, both pieces surface with the case associated with the DP. In continuous DPs, it is not possible for case to surface on multiple DP-internal elements, as illustrated in (98).

- (98) [kiyoo=vini>(*=**n**) joni*(=**n**)]=mun jono rutu=hi=ki=nu
 all=EMPH.LG=ERG man=ERG=C peccary kill=IPFV=3.PRES=DECL
 ‘All the men are killing a peccary.’

In (98) we see that it is obligatory for ergative case to surface on the noun but ungrammatical for it to surface on the quantifier. This is consistent with case being a DP enclitic since ergative case here must surface at the right edge of the DP. The fact that both pieces of a discontinuous DP surface with case suggests that each piece is treated as a DP. Interestingly, the only time that a discontinuous DP is allowed to mismatch in case is in differential case marking contexts. When the conditions are met for only one half of the DP to remain unmarked for case, there is a mismatch in the case marking of a discontinuous DP. This is shown in (99) for ergative case.

- (99) [kiyoo=vini=**n**]=mun jono rutu=hi [joni(*=**n**)]=ki=nu
 all=EMPH.LG=ERG=C peccary kill=IPFV man=ERG=3.PRES=DECL
 ‘All the men are killing a peccary.’

As will be discussed further in Chapter 3, transitive subjects that appear to the right of aspect marking remain unmarked for case. Here, the quantifier *kiyoovinin* appears to the left of aspect and surfaces with ergative case. The noun that serves as its restrictor, however, remains to the right of aspect. Here it must surface in an unmarked form, as is expected for DPs in this position. The analysis of patterns of case marking in discontinuous DPs is beyond the scope of the current work, but see Clem and Dawson 2019 for an analysis of these data and similar data crosslinguistically.

The third interesting thing to note about the discontinuous DPs presented thus far is that the noun and the modifier may occur in either order in the sentence. The order modifier–noun is attested in (95b) and (96b), and the order noun–modifier is attested in (97b). It appears that each piece of a discontinuous DP is subject independently to regular types of A'-movement. Interestingly, this flexibility is restricted when we consider configurations where one element of the discontinuous DP remains in the base position of the argument, as in (100).

- (100) ‘The black dog is chasing a chicken.’
- a. hatapa=mun chivan=hi [**hino chaho**]=ki=nu
 chicken=C chase=IPFV dog black=3.PRES=DECL
 - b. [**chaho=**n****]=mun hatapa chivan=hi [**hino**]=ki=nu
 black=ERG=C chicken chase=IPFV dog=3.PRES=DECL
 - c. * [**hinan**]=mun hatapa chivan=hi [**chaho**]=ki=nu
 dog.ERG=C chicken chase=IPFV black=3.PRES=DECL

The example in (100a) shows that it is possible for a noun with an adjective modifier to appear in the base position of the subject on the *vP* edge to the right of aspect marking. In (100b), we see that it is possible to split the adjective from the noun by moving the adjective

higher in the clause and leaving the noun in the base position of the subject. However, the opposite pattern where the adjective remains in the base position is ungrammatical, as shown in (100c).

Also noteworthy is that this same pattern holds for DPs with more than one modifier. The piece that remains stranded in the base position of the subject must contain the noun, as illustrated by the examples in (101).

- (101) ‘Three black dogs are chasing a chicken.’
- a. hatapa=mun chivan=hi [**hino chaho kimisha**]=ki=nu
chicken=C chase=IPFV dog black three=3.PRES=DECL
 - b. [**kimishana=n**]=mun hatapa chivan=hi [**hino chaho**]=ki=nu
three.LG=ERG=C chicken chase=IPFV dog black=3.PRES=DECL
 - c. [**chaho kimishana=n**]=mun hatapa chivan=hi [**hino**]=ki=nu
black three.LG=ERG=C chicken chase=IPFV dog=3.PRES=DECL
 - d. * [**hinan**]=mun hatapa chivan=hi [**chaho kimisha**]=ki=nu
dog.ERG=C chicken chase=IPFV black three=3.PRES=DECL

We see in (101) that a DP may be split such that the noun and one modifier remain together and the second modifier is separated, as in (101b). It is also possible to split the DP such that both modifiers remain together and the noun is stranded alone, as in (101c). What is ungrammatical is to strand a piece of the DP that does not contain the noun in the base position of the subject, as in (101d). I assume that this ungrammaticality is due to the nature of the movement operations that result in split DPs, a matter which I set aside here but which is addressed in Clem and Dawson 2019.

From this discussion of DPs it is important to remember for the examples that will be seen in the following chapters that word order within the DP is flexible, but that case is always marked at the right edge. It is also good to note that a single DP may be split into multiple linearly discontinuous elements, subject to the restrictions we have encountered here.

2.4 Summary

In this chapter we have seen some of the basics of the phonology of Amahuaca and how the orthography represents different contrastive phonemes. We have also encountered some of the morphological paradigms that will factor heavily in the examples to come. Additionally, I have laid the groundwork for an understanding of the syntactic structure of Amahuaca, which I will build upon in Chapters 3 and 4. Specifically, we have seen what the basic clause structure is for matrix clauses, and we have seen evidence that scrambling in Amahuaca shows properties of A'-movement. We have also examined the differences between the two main types of dependent clauses in Amahuaca – relative clauses and switch-reference clauses. This distinction has helped us to delineate the focus of Chapter 4, which is concerned with

the analysis of switch-reference. Finally, we have briefly looked at the structure of DPs, in particular noting that DPs can be discontinuous in Amahuaca. With this understanding of some of the basic structural facts about Amahuaca, we are now ready to turn to an analysis of some of the more intricate patterns of case and agreement in the language.

Chapter 3

Amahuaca case as agreement with functional heads

The mechanisms by which case is assigned have long been the subject of exploration in the literature, and the assignment of ergative case has been a topic of particular debate. While some cases, like nominative, have been argued to be structural, and due to Agree under *c*-command with a functional head, efforts to account for ergative case have turned to different explanations. On the one hand, the connection between ergative case and the role of agent has motivated accounts in which ergative case is inherent, and tied to the agent θ -position, or at the very least to the position as external argument of a transitive *v* (Woolford 1997, 2006; Legate 2006, 2008, among others). Other accounts have instead tried to capture the connection between ergative case and transitivity by proposing that ergative is actually a dependent case assigned on the basis of a relationship between two nominals (Yip et al. 1987; Marantz 1991; Baker 2014, 2015; Baker and Bobaljik 2017, among others). Under the latter view, Agree with functional heads plays no direct role in the assignment of case; these heads serve only to delimit domains in which configurational relationships between DPs are assessed for case assignment.

In this chapter, I introduce novel data on ergative case in Amahuaca and discuss the problems these data pose for both inherent and dependent accounts of ergative case.¹ In Amahuaca, the assignment of ergative case is sensitive to movement of the subject. When a transitive subject appears to the left of aspect marking, as in (102a), it must bear the ergative case marker *=n*. When the subject appears to the right of aspect, however, as in (102b), this marker is not permitted. Note that similar reorderings have no effect on the case marking of intransitive subjects, (103), or objects, (104).

(102) ‘The **man** is killing the peccary.’

- a. **joni*(=n)=mun jono rutu=hi=ki=nu**
 man=ERG=C peccary kill=IPFV=3.PRES=DECL

¹The majority of the content of this chapter is drawn from Clem 2018b.

- b. jono=mun rutu=**hi** joni(*=**n**)=ki=nu
peccary=C kill=IPFV man=ERG=3.PRES=DECL

(103) ‘The **children** are arriving.’

- a. **vaku-vo**=mun nokoo=**hi**=ki=nu
child-PL=C arrive=IPFV=3.PRES=DECL
- b. nokoo=mun=**hi** **vaku-vo**=ki=nu
arrive=C=IPFV child-PL=3.PRES=DECL

(104) ‘The man is killing the **peccary**.’

- a. **jono**=mun rutu=**hi** joni=ki=nu
peccary=C kill=IPFV man=3.PRES=DECL
- b. rutu=mun=**hi** joni **jono**=ki=nu
kill=C=IPFV man peccary=3.PRES=DECL

The inherent case view struggles to capture this pattern, because ergative is assigned in situ to the external argument on this view. Since inherent case assignment bleeds structural case assignment, leftward movement is not predicted to interfere with case marking. The interrelatedness of movement and case is reminiscent of accusative case assignment in Sakha (Turkic; Russia), which has been argued to provide support for a dependent case analysis (Baker and Vinokurova 2010). However, I will demonstrate that the particular interactions of movement and case in Amahuaca pose challenges for current versions of dependent case theory. This is because (in contrast to the situation in Sakha) the relevant movement is not one that changes c-command relationships between arguments or the case domain in which the moving argument finds itself.

These challenges can be overcome, I argue, on a view of ergative case that is neither strictly inherent nor strictly dependent, but rather combines insights from both views. On the treatment of ergative case in Deal 2010, ergative arises for subject DPs that both acquire features reflecting the presence of an object (recalling dependent case) and participate in Agree with functional heads, including *v* (recalling inherent and more traditional structural views of case assignment). On this type of view, ergative case realizes a feature complex, rather than an atomic feature. I show that this approach both captures the generalization about word order and ergative case marking in Amahuaca and yields insights into the nature of nominative marking in the language. Additionally, it has interesting implications for the treatment of switch-reference, which will be discussed further in Chapter 4. Overall, the picture that emerges suggests that Amahuaca morphological case, in general, does not reflect simplex case features but rather expones complex feature bundles.

In the following sections I examine the Amahuaca data in further detail and illustrate why an account in which ergative case marking is the result of multiple Agree operations is the most empirically adequate solution for the puzzle that these data present us with. In Section 3.1, by way of prologue, I briefly summarize the relevant aspects of both an inherent and dependent ergative case account. In Section 3.2, I introduce the range of key

ergative case data in Amahuaca that a theory must be able to account for. In Section 3.3, I argue that a dependent case account along the lines of Baker 2015 is not adequate to account for the Amahuaca data, illustrating why these patterns do not lend themselves to a view of case in which functional heads play a minimal role. I also discuss why a view of ergative as an inherent case fares no better, even if clausal bifurcation à la Coon 2013a,b is assumed. In Section 3.4, I lay out the analysis of ergative case as exponing multiple agreement relationships, specifically agreement with v and T, along the lines of Deal 2010. I show how this account combines insights of inherent and dependent approaches and allows the Amahuaca case and movement generalization to be captured. In Section 3.5 I introduce further Amahuaca data from the language’s switch-reference system, illustrating how the view of ergative case as the exponence of multiple Agree operations yields insight into case-sensitive switch-reference patterns. In Section 3.6, I briefly discuss Amahuaca’s focus-sensitive nominative marking, demonstrating how nominative case also lends itself to a view of case as a feature complex. Finally, in Section 3.7 I offer concluding remarks on the topic of case.

3.1 Inherent and dependent ergative case

How ergative case is assigned has been a topic of much debate, due, in part, to the fact that there is a great deal of crosslinguistic variation in the details of which arguments receive morphological ergative marking. Additionally, there are seemingly both syntactic and semantic components involved, with notions such as subjecthood, transitivity, and θ -roles all playing a part in ergative case assignment. Given the empirical diversity of ergative systems, it is likely that ergative case is not derived via a single mechanism crosslinguistically, but rather has different sources in different languages. Here I discuss two of the main views of ergative case assignment that have emerged in the literature.²

On the one hand, ergative has been hypothesized to be an inherent case assigned by a transitive v to an argument that it θ -marks (Woolford 1997, 2006; Legate 2006, 2008, among others). Under this view, case is assigned directly by the relevant functional head to an argument in a particular θ -position, which for ergative case is Spec, v P where the external argument is introduced, as seen in (105).

²There are, of course, many other views of ergative systems that have been proposed in the literature besides those outlined here. Overviews of a broader range of such analyses can be found in Johns 2000 and Deal 2015a.

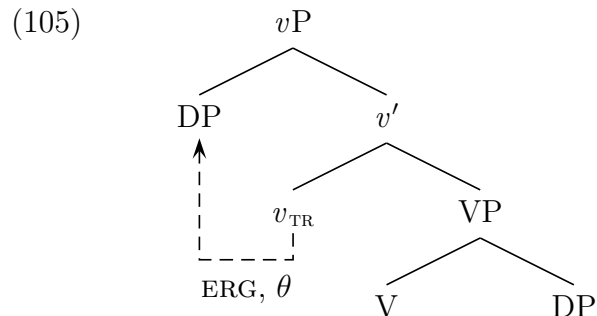

It has been noted that the tie between ergativity and the specific θ -role of agent is tenuous (Comrie 1978; Bruening 2007; Baker 2014; Baker and Bobaljik 2017). Non-agent transitive subjects, such as causes or instruments, can be marked ergative (Woolford 2006), and agent subjects of unergatives do not pattern in a uniform manner across languages. For example, in Western Basque (Isolate), subjects of unergatives receive ergative case (Aldai 2009), as predicted by an agent-oriented view of ergative case, but in many ergative languages unergative subjects receive nominative or absolutive case. To address this issue, Woolford (2006) and Legate (2008) have proposed that an additional transitivity condition be added to the connection between θ -roles and ergative case. Under this view, ergative case is assigned to the external argument of a transitive v , rather than to any (agent) external argument. I will demonstrate in the following sections that even this transitivity-oriented inherent view of ergative case is unable to account for case marking in Amahuaca.

The second major view of ergative case assignment takes ergative to be a dependent case, tied to the presence of another DP in the structure (Marantz 1991; Baker and Vinokurova 2010; Baker 2014, 2015; Baker and Bobaljik 2017, among others). There are variations on this theory which differ slightly; I will take the model most thoroughly articulated in Baker 2015 as my point of comparison. I make this choice because many other implementations of dependent case theory are not as explicit about details of the model that will be crucial to the coming discussion, such as the timing of case assignment and various types of movement. Under the Baker 2015 view, a dependent case (such as ergative or accusative) is assigned on the basis of c-command relationships between DPs, which are evaluated in particular case domains. These case domains are tied to phases, and, as a result, case is determined in phase-based spell out domains. For a language that has a dependent ergative case rule, ergative case will be assigned to the higher of two nominals in a c-command relationship within a domain. Baker's ergative case rule is given in (106).

- (106) Dependent ergative case rule (Baker 2015: 49, modified slightly)³
 If there are two distinct DPs in the same spell out domain such that DP1 c-commands DP2, then value the case feature of DP1 as ergative unless DP2 has already been marked for case.

³In keeping with the DP hypothesis, I have modified the case rule to use DP where Baker (2015) uses NP. For the data considered here, this distinction does not affect the results.

it is important to consider the details of timing since movement after case assignment can obscure the relevant configurations for dependent case.

In summary, there are three ways in which movement is predicted to affect case marking under the view outlined above. First, movement can change c-command relationships between nominals, with a consequence for the determination of which nominal is eligible for the dependent case. Second, movement can result in nominals moving into domains that are keyed to different case rules. Third, movement can produce or eliminate a local relationship with a case competitor. In the following sections, I will show that none of these effects of movement can fully account for the range of case-marking data in Amahuaca. I conclude that, while movement and case are related in Amahuaca, they are not related in a way that is predicted by a dependent case account. In the next section, I lay the groundwork for this argument by considering the basic clause structure and case-marking patterns that Amahuaca displays.

3.2 Amahuaca case marking and word order

As demonstrated in (102), ergative case marking in Amahuaca is sensitive to differences in word order. In this section, I will give an overview of the main patterns of case-marking alternations.

As discussed in Chapter 2, Amahuaca’s case system has two types of case markers for core arguments of the verb, plus unmarked nouns. Intransitive subjects (S) can be marked with $=x$ and transitive subjects (A) can be marked with $=n$. Object DPs (O) remain unmarked. Instances of these case markers are given in (108) and (109), repeated from Chapter 2.⁴ Observe that $=x$ is available only for S arguments, while $=n$ is available only for A arguments.

(108) **vaku**{ $*=n$ / $=x$ }= mun **rakuu** $=xo=nu$
 child{ $=ERG$ / $=NOM$ }= C be.afraid= $3.PST=DECL$
 ‘The **child** was afraid.’

(109) **xano**{ $=n$ / $*=x$ }= mun **chopa**{ $*=n$ / $*=x$ }
 woman{ $=ERG$ / $=NOM$ }= C clothes{ $=ERG$ / $=NOM$ }
 patza= $hi=ki=nu$
 wash= $IPFV=3.PRES=DECL$
 ‘The **woman** is washing **clothes**.’

This pattern suggests an underlying tripartite case system with nominative, ergative, and accusative case, where accusative is morphologically unmarked. A complication to the picture in (108) and (109) is a pattern of differential subject marking in Amahuaca, which has

⁴In Section 3.6 I will show that the nominative case marker $=x$ (though not the ergative $=n$) encodes focus in addition to case. I set this complication aside for the time being, and do not indicate focus in translations until Section 3.6.

been noted in descriptions of the language dating back to Russell (1965: 66).⁵ Both types of subjects (transitive and intransitive) can surface in the morphologically unmarked form under the right conditions, suggesting that the unmarked form is actually a type of default (Legate 2008), rather than marking accusative or absolutive case directly. I will return to a discussion of nominative case marking in Section 3.6, but for now, I will focus on the conditioning of ergative case marking.

As mentioned previously, ergative case marking is sensitive to word order, which reflects structural differences in the position of the DP. We can divide the patterns of word order and case marking into two distinct sets of possibilities: those involving sentences with overtly marked aspect and those involving sentences where aspect is not marked. Though these two types of sentences show different possibilities in terms of case marking, Amahuaca does not exhibit a traditional TAM split in the marking of ergative case (in contrast, e.g., to Hindi-Urdu (Indo-Aryan); Mahajan 1990); ergative case is available with all aspectual categories. In transitive sentences with overtly marked aspect (either =*hi* for imperfective, =*hax* for perfect, =*nox* for habitual, or =*katzi* for prospective), there are seven possible word orders, which result in two different case-marking patterns for A arguments. The examples in (110) represent all of the attested word order and case marking combinations; other combinations of case marking and word order permutations are judged to be ungrammatical.⁶

(110) ‘The **man** is killing the peccary.’

- a. **joni=n**=mun jono rutu=hi=ki=nu
 man=ERG=C peccary kill=IPFV=3.PRES=DECL
- b. jono=mun **joni=n** rutu=hi=ki=nu
 peccary=C man=ERG kill=IPFV=3.PRES=DECL
- c. rutu=mun **joni=n** jono=hi=ki=nu
 kill=C man=ERG peccary=IPFV=3.PRES=DECL
- d. rutu=mun jono **joni=n**=hi=ki=nu
 kill=C peccary man=ERG=IPFV=3.PRES=DECL

⁵Additional work which mentions this pattern in Amahuaca includes Hyde (1980: 146) and Sparing-Chávez (2012). It has also been discussed in comparative work on Panoan, which mentions a similar but distinct pattern in Chacobo (Loos 1973, 1999). With respect to the Amahuaca pattern, Sparing-Chávez (2012) notes that split ergativity is conditioned by the presence of overt aspect marking in the clause. She observes that when overt aspect marking is absent, ergative case surfaces. When overt aspect marking is present, however, she makes the generalization that only “pragmatically marked” subjects, which she shows only in initial position, receive nominative or ergative case marking (Sparing-Chávez 2012: 4-5). Here I refine the characterization of the Amahuaca pattern, demonstrating that even non-initial subjects receive ergative case marking, so long as they surface to the left of aspect marking. This pattern is different from the pattern of nominative marking, which does appear to be conditioned by information structure in a way consistent with Sparing-Chávez’s characterization, as discussed in Section 3.6.

⁶I set aside here those sentences involving extraposition to the far right. As discussed in Chapter 2, these extraposition structures show case connectivity, and when a transitive subject undergoes extraposition it always surfaces with ergative case.

- e. *rutu*=mun=hi **joni** *jono*=ki=nu
kill=C=IPFV man peccary=3.PRES=DECL
- f. *rutu*=mun *jono*=hi **joni**=ki=nu
kill=C peccary=IPFV man=3.PRES=DECL
- g. *jono*=mun *rutu*=hi **joni**=ki=nu
peccary=C kill=IPFV man=3.PRES=DECL

In (110a)-(110d), the subject is marked ergative. In (110e)-(110g), on the other hand, the subject remains unmarked.

The pattern found with sentences lacking overt aspect marking is slightly different. These sentences, which receive a perfective interpretation, do not allow the orders found in (110e)-(110g), and thus always result in the A argument being marked ergative. All of the attested grammatical word order and case combinations for perfective sentences are given in (111); other word order permutations are judged to be ungrammatical, as are sentences lacking ergative case marking.⁷

(111) ‘The **man** killed the peccary’

- a. **joni=n**=mun *jono* ha=xo=nu
man=ERG=C peccary do.TR=3.PST=DECL
- b. *jono*=mun **joni=n** ha=xo=nu
peccary=C man=ERG do.TR=3.PST=DECL
- c. ha=mun **joni=n** *jono*=xo=nu
do.TR=C man=ERG peccary=3.PST=DECL
- d. ha=mun *jono* **joni=n**=xo=nu
do.TR=C peccary man=ERG=3.PST=DECL

As seen in the above examples, without overt aspect marking, an A argument always surfaces with ergative case. For now, I will focus on examples with overt aspect marking, like those in (110), because it is there that an alternation is seen. However, I will return to a discussion of sentences without overt aspect in Section 3.4.

Taking into account only sentences that have overt aspect marking, we can schematize the possible word orders as in (112).⁸

⁷As mentioned in Chapter 2, the verb *ha* glossed ‘do.TR’ is a general purpose transitive verb in Amahuaca. It can be used for a transitive action if the meaning of the verb can be recovered from context. In these sentences it is used to mean ‘kill’. The same pattern of case and aspect marking is found with this verb as with full lexical verbs like *rutu* ‘kill’.

⁸Here and in following schematic representations I leave out Mood, which invariably surfaces following T.

(112)	a.	A=ERG	C		O	V	ASP		T
	b.	O	C	A=ERG		V	ASP		T
	c.	V	C	A=ERG	O		ASP		T
	d.	V	C	O	A=ERG		ASP		T
	e.	V	C				ASP	A	O T
	f.	V	C	O			ASP	A	T
	g.	O	C			V	ASP	A	T

Examining the distribution of ergative case, the descriptive generalization in (113) emerges.

(113) **Amahuaca ergative case generalization**

If a transitive subject appears to the right of aspect, it is not marked ergative; otherwise, it receives ergative case marking.

I propose that this generalization stems from the fact that the subject DP occupies a different structural position when it is case marked compared to when it is unmarked. Recall that in Chapter 2 I argued that aspect is a head-initial projection in Amahuaca. This means that its complement, *vP*, occurs to its right. This is demonstrated in the representation of matrix clause structure shown in (114).

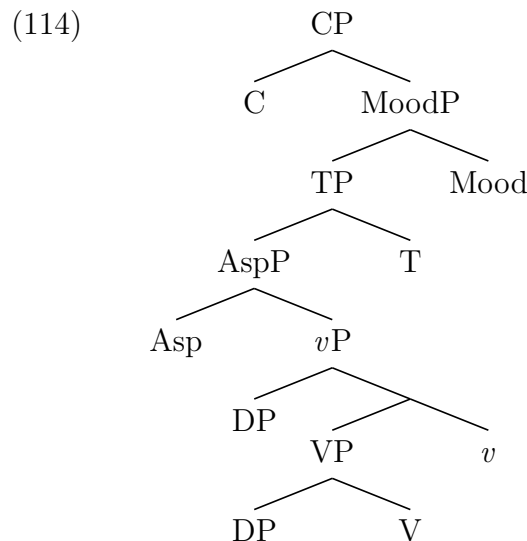

Given this structure, we see that DP arguments that appear to the right of aspect are those that remain internal to *vP*, while those that surface to the left of aspect have undergone movement to a position higher in the clause. Based on this, we can conclude that when a subject stays low in the structure, in its externally merged position in Spec,*vP*, it is unmarked. Only when it moves further up in the structure (specifically through Spec,TP, as I will argue) does it receive ergative case marking. Thus movement feeds ergative case marking.

3.3 Amahuaca ergative is neither inherent nor dependent

As discussed in Section 3.1, the assignment of ergative case has been analyzed in many ways, with inherent and dependent views of ergative case emerging as major contenders in recent work. In this section, I will argue that neither of these views can account for the Amahuaca case-marking patterns that were outlined in Section 3.2.

3.3.1 Amahuaca ergative is not an inherent case

The most straightforward version of an inherent case account of Amahuaca ergativity appears to be a non-starter since it is subjects that remain in situ in their externally merged position as the external argument of *v* that are *not* marked ergative. DPs that are externally merged in Spec,*v*P are exactly the DPs that an inherent case account would predict to be ergative.

A modified inherent case account along the lines of Coon 2013a,b, which takes unmarked subjects to be the result of clausal bifurcation with an aspectual auxiliary, seems potentially more promising. This is because unmarked subjects are only possible with overtly marked aspect in Amahuaca. Under this view, aspectual auxiliaries split the clause, creating two case assignment domains. The lower domain contains the main verb and the object. The higher domain contains an intransitive aspectual auxiliary and the subject, which is treated as an S argument since it is the subject of this intransitive auxiliary. This is illustrated in (115).

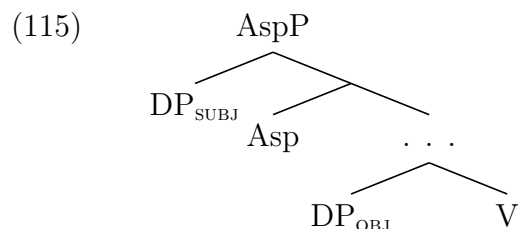

If we were to apply this view to Amahuaca, we could assume that perfective clauses, which lack overt aspect marking, do not contain an aspectual auxiliary and therefore will always result in ergative case on the subject, since the clause will never be bifurcated. In clauses with overtly marked aspect, we could assume that the aspect markers are auxiliaries that bifurcate the clause. With overt aspect, unmarked subjects would be externally merged as the subject of an intransitive aspectual auxiliary while ergative-marked subjects would be merged in Spec,*v*P as the subject of a transitive main verb. The view of Amahuaca clausal syntax laid out in Chapter 2 and schematized in (114) is hard to reconcile with this type of account since unmarked subjects are actually those that appear *lower* than the aspect marker. This is not what we would expect if they were introduced by an aspectual auxiliary.

A potential solution is to reconsider the assumptions about the syntax of the clause. Perhaps unmarked subjects are, indeed, introduced higher by an aspectual auxiliary and

marked subjects are those which are introduced in the lower transitive domain containing the main verb and the object. This would mean that sentences like (110g) have a structure as in (116).⁹

- (116) jono_i=mun [[t_i rutu] =hi **joni**] =ki=nu
 peccary=C kill IPFV man 3.PRES=DECL
 ‘The man is killing the peccary.’

In (116), the object (which moves to Spec,CP) is externally merged in the lower domain with the verb *rutu* ‘kill’. The subject *joni* ‘man’ is not merged in this domain. Instead, the subject is externally merged as the subject of the imperfective aspectual auxiliary. As the subject of an intransitive auxiliary, *joni* does not receive ergative case. A similar structure where ergative is assigned would look like (117).

- (117) jono_i=mun [[**joni=n** t_i rutu] =hi] =ki=nu
 peccary=C man=ERG kill IPFV 3.PRES=DECL
 ‘The man is killing the peccary.’

In (117), the ergative-marked subject is externally merged in the lower domain with the object. This domain is transitive, which means that the subject will be assigned inherent ergative case.

What is puzzling from the perspective of such an account is the obligatoriness of ergative marking on A arguments that appear in initial position in Amahuaca. It is ungrammatical for the subject in (118), repeated from (110a), to surface in the unmarked form.

- (118) **joni*(=n)**=mun jono rutu=hi=ki=nu
 man=ERG=C peccary kill=IPFV=3.PRES=DECL
 ‘The man is killing the peccary.’

In (118), if it were possible for the subject to have been externally merged as the subject of the intransitive auxiliary and then moved to the initial position, we would expect that it could surface without ergative marking. This is impossible. This is especially puzzling since arguments which move to the initial position always surface with the case appropriate for the clause from which they originated, even if moving from a dependent clause, as shown in (119)-(121) for nominative, ergative, and accusative (unmarked) case.¹⁰

⁹I am intentionally vague about the precise details of the alternative clausal structure discussed here. These structures must depart radically from the view of clausal syntax that I laid out in Chapter 2, and it is not clear to me how to reconcile this alternative view completely with the full range of Amahuaca facts outside of the domain of case marking. The basic issues for a bifurcation analysis are not tied to one particular conception of the structure. Therefore, I abstract away from the details to highlight the challenges for the bifurcation approach.

¹⁰Rightward extraposition in Amahuaca displays a similar pattern with respect to ergative case. Extraposition shows case connectivity, as discussed in Chapter 2, and it is impossible for the subject of a clause with a transitive main verb to surface in the unmarked form when it is extraposed.

- (119) **xano**_i=**x**=mun [t_i nokoo=kun] joni=n hatza jovaa
 woman=NOM=C arrive=DS.SQ man=ERG manioc cooked
 ha=xo=nu
 do.TR=3.PST=DECL
 ‘After the woman arrived, the man ate manioc.’
- (120) **joni**_i=**n**=mun [t_i hamun vuchi=shin=hax] jumu naki ka=xo=nu
 man=ERG=C capybara find=YEST=SS.SQ river to go=3.PST=DECL
 ‘The man found a capybara yesterday and went to the river.’
- (121) **hatza**_i=mun [xano=n t_i vana=kun] joni jo=xo=nu
 manioc=C woman=ERG plant=DS.SQ man come=3.PST=DECL
 ‘After the woman planted manioc, the man came.’

Since we can see that case is typically preserved in extraction to the left edge, it is unclear why unmarked subject DPs are ungrammatical in this position when the main verb of their clause is transitive. To rule this out, we would have to propose some independent mechanism to block movement to Spec,CP for subjects which are externally merged as arguments of Asp.

An additional fact which is potentially problematic for a clausal bifurcation story is the lack of ergative case marking in an example like (110e), repeated as (122).

- (122) rutu=mun=hi **joni** jono=ki=nu
 kill=C=IPFV man peccary=3.PRES=DECL
 ‘The man is killing the peccary.’

In (122), the object is to the right of the subject and aspect. This is compatible with two possible derivations – one where the object is externally merged in this position and another where it arrives at this position via movement. If the object were externally merged in this position to the right of the subject, that could be because it, too, is selected by the auxiliary in such a constructions, like the subject. However, if that were true, it would be unclear why this domain would not then be considered transitive with the subject *joni* eligible for ergative marking. As mentioned, another possibility would be for the object to be externally merged in the lower domain with the main verb and move into this higher position. However, this would constitute an instance of rightward movement, which has been argued to be dispreferred or ruled out entirely (Ackema and Neeleman 2002; Abels and Neeleman 2012). The question would then be how to constrain such instances of rightward movement.¹¹

¹¹A further potential concern for a clausal bifurcation account from a typological perspective is the fact that the Amahuaca split is not a canonical TAM split. Variation between ergative-marked A arguments and unmarked A arguments is present even within a single aspectual category. That is to say the same aspect categories appear in clauses with and without ergative marking on transitive subjects. Additionally, it is not the case that unmarked subjects occur with one set of (progressive) aspectual categories and marked subjects

I conclude that a clausal bifurcation account, while more adequate than a simpler version of an inherent case account, is still unable to account for the full range of Amahuaca data without other stipulations. It does not appear that unmarked subjects are introduced by an intransitive aspectual auxiliary and lack ergative case for this reason.

3.3.2 Amahuaca ergative is not a dependent case

We turn now to a dependent case account. We might expect more promising results since dependent case theory is designed, in part, to capture the interactions of movement and case assignment (Baker and Vinokurova 2010). Given the configurational nature of case assignment in a dependent case model, movement should be able to feed and bleed case assignment, as outlined in Section 3.1. Since movement to a higher position in Amahuaca appears to feed ergative case assignment, this seems like a good candidate for a dependent case account. However, we will see that no singular, unified set of assumptions can characterize case domains such that low subjects remain unmarked while moved subjects receive ergative case. Additionally, a dependent case account offers no insightful way to capture the generalization in (113) that it is the position of the subject with respect to aspect that is the predictor of the case of the subject. Dependent case misses the generalization that, in Amahuaca, it is the position of DPs with respect to functional heads, rather than other DPs, which determines morphological case.

Recall Baker's ergative case rule from (106), repeated in (123) below.

- (123) Dependent ergative case rule (Baker 2015: 49, modified slightly)
 If there are two distinct DPs in the same spell out domain such that DP1 c-commands DP2, then value the case feature of DP1 as ergative unless DP2 has already been marked for case.

As outlined in Section 3.1, the spell out domains for case assignment are tied to phases. Specifically, the phase heads for clausal case assignment assumed in Baker's (2015) model are *v* and C. The complements of the phase heads (VP and TP) are the spell out domains in which case assignment is evaluated. Therefore, there are four possibilities for the domains in which the ergative case rule can be active. A language can assign ergative in only VP, in only TP, in VP and TP, or in neither VP nor TP.

Since Amahuaca has ergative-marked DPs, the option of assigning ergative at neither domain is obviously incorrect. The first option I will consider is one in which the ergative case rule is active only in the VP. In monotransitive predicates this rule would result in no DPs being marked ergative. Since only the object DP is generated in VP, there would be no VP-internal c-command relationship between two DPs, and no DP would be assigned case

occur with another set of (completive) aspectual categories. Instead all overt aspect markers (imperfective, perfect, habitual, prospective) allow for the possibility of unmarked subjects. Coon (2013b: 197) notes, however, that an aspect split triggered by all aspect markers is, in principle, possible, so long as the aspect markers are expressed by auxiliaries.

by the ergative rule. If a predicate contains more than one DP in the complement of *v*, we expect a different outcome. Specifically, we would expect the higher of the two nominals to receive ergative case marking. That is, we expect dative case to be syncretic with ergative. This is not what we find. Instead, both arguments are unmarked, as seen in (124).

- (124) joni=n=mun **xano** **jiriti** hinan=hi=ki=nu
 man=ERG=C woman food give=IPFV=3.PRES=DECL
 ‘The man is giving the woman food.’

In this example we would expect *xano* ‘woman’ to be marked with the ergative marker if it *c*-commands the DP *jiriti* ‘food’. However, it remains unmarked. Therefore, it appears that the ergative rule should not be keyed to VP in Amahuaca. This also rules out an account in which ergative is keyed to both VP and TP, though this account would be no different for subjects than the option where the ergative rule is keyed only to TP.

This leaves us with the fourth and final option for the domain of ergative case assignment, which is keying the rule only to TP. In evaluating this possibility, I will first assume that the surface position of a DP reflects the position in which it was evaluated for case. This amounts to assuming that movement within a phase precedes case assignment. (Later I will discuss an alternative view where some movement follows case assignment.) Under this assumption, a dependent case account correctly derives (110c), repeated as (125), below.

- (125) [_{CP} [_{VP} *t_i* rutu] =mun [_{TP} **joni_j=n** jono_i=hi [_{vP} *t_j* *t_i* *t_{vP}*] =ki]=nu]
 kill =C man=ERG peccary=IPFV =3.PRES=DECL
 ‘The man is killing the peccary.’

In this configuration, the subject and object DPs are both within TP with the subject higher than the object. This results in the subject being marked with ergative case via the rule in (123).

This same set of assumptions can also derive the pattern seen in (110g), repeated in (126).

- (126) [_{CP} jono_i=mun [_{TP} rutu=hi [_{vP} **joni** *t_i* [_{VP} *t_i* *t_v*]] =ki]=nu]
 peccary=C kill=IPFV man =3.PRES=DECL
 ‘The man is killing the peccary.’

In this structure, the object DP has moved to Spec,CP before the complement of C is spelled out. This results in only one DP being present in TP when case is assigned. Because there are no *c*-command relationships, no DP is assigned ergative case, resulting in the unmarked object and subject that we find.

While this account can derive the patterns in (125) and (126), it cannot capture the patterns of ergative marking in (110a) and (110b), repeated below as (127a) and (127b), respectively.

A summary of how this version of a dependent case accounts fares with respect to the word order patterns in (112) is given in (130). When (=ERG) is shown in parentheses this indicates an instance of over-assignment of ergative case – the attested pattern lacks ergative case but the dependent case account predicts ergative. When =~~ERG~~ is crossed out this indicates an instance of under-assignment of ergative case – the attested pattern has ergative case but the dependent case account predicts that ergative should not be assigned.

(130)	a.	A=ERG	C		O	V	ASP			T
	b.	O	C	A=ERG		V	ASP			T
	c.	V	C	A=ERG	O		ASP			T
	d.	V	C	O(=ERG)	A=ERG		ASP			T
	e.	V	C				ASP	A(=ERG)	O	T
	f.	V	C	O(=ERG)			ASP	A		T
	g.	O	C			V	ASP	A		T

As seen in (130), only two of the seven word orders, (130c) and (130g), are correctly captured by this model of ergative case assignment.

Under the most straightforward interpretation of the dependent case model we do not obtain the desired results. We might therefore ask whether the facts can be accounted for by reference to a factor other than the domains in which case rules are active. In the previous discussion, it was assumed that surface positions reflect the positions at which DPs were spelled out and evaluated for case. As mentioned above, this amounts to assuming that all movement within a phase happens prior to the evaluation of c-command relationships for case. However, as discussed in Section 3.1, Baker (2015) proposes that some types of movement may be timed after case assignment. If we assume that movement and case assignment within a phase can be interleaved, a dependent case account is able to capture more (though still not all) of the Amahuaca data. The main issue that we will see for this type of account is the prediction that the subject should always surface with ergative case since a copy of the object on the *vP* edge will be able to serve as a case competitor within the TP case domain. Unmarked transitive subjects are predicted not to exist.

One type of movement that Baker (2015) assumes can “follow” case assignment is scrambling. He appeals, as discussed in Section 3.1, to the idea that scrambling is a form of adjunction and that adjuncts can be spelled out later than specifiers and complements (Baker 2015: 264-272). If specifiers and complements are spelled out first and dependent case is calculated based only on these positions of DPs, subsequent scrambling and spell out of these DPs in their scrambled positions will not affect case. If we assume this revised, more complex approach to the timing of case assignment and scrambling in Amahuaca, we can correctly derive the pattern in (110d), repeated in (131).

- (131) [CP [VP t_i rutu] =mun [TP jono_i **joni_j=n=hi** [vP t_j ~~jono_i~~ t_{VP}]
kill =C peccary man=ERG=IPFV peccary
=ki]=nu]
=3.PRES=DECL
‘The man is killing the peccary.’

The crucial idea here is that object movement to the surface position involves scrambling. If we assume that the subject and the lower copy of the object in Spec,*v*P are spelled out first and evaluated for case, this results in the subject being marked with ergative case. The copy of the object that is scrambled across the subject is then spelled out later and does not affect case. The lower copy of the object that was the case competitor is then not pronounced.

Baker (2015) also considers how the timing of movement to Spec,CP interacts with case assignment. *Wh*-movement is taken to not typically affect case assignment (Baker 2015: 270-271). The reasoning behind this is that it moves a DP out of the domain of case evaluation. However, it must be assumed that a lower copy within TP is still evaluated in the spell out of TP to avoid the problem, mentioned above, of no DP receiving case. If we assume that movement to Spec,CP cannot establish a new c-command relationship for case assignment but that the lower copy of the moved element can still count as a case competitor, the patterns in (110a) and (110b), repeated as (132a) and (132b), respectively, can be derived.

- (132) ‘The man is killing the peccary.’
- a. [CP **joni_j=n=mun** [TP jono_i rutu=hi [vP ~~joni_j~~ ~~jono_i~~ [VP t_i t_v]]
man=ERG=C peccary kill=IPFV man peccary
=ki]=nu]
=3.PRES=DECL
- b. [CP jono_i=mun [TP **joni_j=n** rutu=hi [vP t_j ~~jono_i~~ [VP t_i t_v]]
peccary=C man=ERG kill=IPFV peccary
=ki]=nu]
=3.PRES=DECL

In both of the examples in (132), if a lower copy of the element that undergoes movement to Spec,CP is evaluated in TP, the subject will c-command the object and receive ergative case. In (132a), the copy of the subject on the edge of *v*P c-commands the copy of the object on the *v*P edge, and the subject is assigned ergative. However, the subject DP is not pronounced in this position (nor is the object). Instead, the copy of the subject that is moved to Spec,CP is pronounced with the ergative case that it inherits from the lower copy. In (132b), what is important is that a lower copy of the object DP within TP is evaluated as a case competitor for the subject. This results in the subject receiving ergative case. The lower copy of the object is then deleted since it is the higher copy in Spec,CP that is pronounced.

While this solution that assumes a lower copy will be evaluated in TP when a DP undergoes scrambling or movement to Spec,CP derives the facts in (132), it poses a problem

(135)	a.	A=ERG	C		O	V	ASP			T
	b.	O	C	A=ERG		V	ASP			T
	c.	V	C	A=ERG	O		ASP			T
	d.	V	C	O	A=ERG		ASP			T
	e.	V	C				ASP	A(=ERG)	O	T
	f.	V	C	O			ASP	A(=ERG)		T
	g.	O	C			V	ASP	A(=ERG)		T

We can see here in (135) that only four of the seven word order and case assignment patterns are correctly derived. The examples in (135e)-(135g) are incorrectly predicted to have ergative case on the subject. Therefore, while this version of a dependent case account fares better than the first version we considered (it correctly accounts for four, rather than only two patterns), it still falls short of being able to capture the full range of Amahuaca data.

Finally, one might wonder whether treating Asp as the crucial lower phase head might yield the desired results, given the importance of the position of aspect in the surface generalization in (113). If we keep the rest of the assumptions we have adopted, this would mean that the lower case domain would be the complement of Asp: *vP*. No ergative case would be assigned here. Then, ergative case would be assigned in TP, as before. The problem with this account is that the subject and object are always in a c-command relationship within *vP*. Even if they both move into TP to a configuration where the subject c-commands the object, this c-command relationship will not be new since the subject previously c-commanded the object in a lower position. For the application of dependent case rules, only new c-command relationships are considered. This facet of the theory is crucial for Baker’s treatment of ditransitives as well as dyadic unaccusatives (2015: 230-246). Given that the c-command relationship between the subject and object will never be new in the TP case domain, we would expect that the subject would never be assigned ergative case in Amahuaca.¹⁴

Returning now to the second, most successful set of assumptions we considered, it is not accidental that the same crucial configuration is involved in the three structures which cannot be accounted for: (133), (134a), and (134b). In all of these structures, the subject remains in Spec,*vP*. It is in these configurations, where the subject remains to the right of aspect, that ergative case is not assigned, as stated in (113). A dependent case account is unable to derive this generalization about the position of the subject with respect to aspect and the

(iii) kuntii=mun [MoodP choka=hi kan=ki=nu] xano=ztirazi=n
pot=C wash=IPFV 3PL=3.PRES=DECL woman=each=ERG
‘Each woman is washing a pot.’

Even if extraposition to a position that was not at the extreme right edge but instead was within TP were also possible, it is unclear why this type of extraposition would not allow the copy of the extraposed element to count as a case competitor. This is because extraposition to the far right, as seen in (iii), would have to be analyzed as allowing a copy of the extraposed element to enter into case competition within TP, given the ergative case marking on the extraposed subject.

¹⁴An additional undesirable feature of such an analysis is that positing crosslinguistic variability in what heads are relevant for dependent case domains results in a significantly less constrained theory.

marking of case. Even if the addition of further complications to the theory could yield the empirical facts, a dependent case account seems to miss the insight that it is the position of the subject relative to functional heads, rather than to other DPs, that predicts whether the subject surfaces with ergative case. This strongly suggests that Amahuaca ergative case is not assigned on the basis of a configurational relationship between two DPs, with functional heads delimiting only the domains of evaluation. Instead, functional heads play a more active role in the assignment of ergative case in Amahuaca. If we assume that multiple functional heads figure in the assignment of case, this allows us to capture the interaction of movement and case marking while avoiding the issues seen above with a purely configurational account of case. It is this type of account that I pursue in the following section.

3.4 The analysis: Ergative case as agreement with multiple heads

As seen in Section 3.2, it is only when a subject DP has moved out of its externally merged position in Spec,*v*P that it is marked ergative. The proposal I argue for in this section is that in order for a DP to be marked ergative, it must enter an Agree relation with multiple functional heads. Specifically, following Deal’s (2010) account of Nez Perce (Sahaptian; USA) and Sahaptin (Sahaptian; USA) ergatives, an ergative DP must agree with a *v* that has already agreed with another DP, and it must agree with T. The category features from these functional heads that are received via Agree will be spelled out as ergative case in the course of Vocabulary Insertion. Only when a DP has agreed with both of these functional heads can the ergative vocabulary item be inserted to mark the subject DP as ergative.

The first Agree operation that an ergative DP participates in is one with *v*. Following Deal’s (2010) analysis of Nez Perce, I assume that Amahuaca *v* always establishes an Agree relationship with DPs in both its complement and specifier. This means that all subjects and objects will agree with a transitive *v* in their externally merged positions. I assume that this agreement proceeds cyclically, in the sense of Rezac 2003 and 2004 and Béjar and Rezac 2009. In Amahuaca (like in Nez Perce and Sahaptin), first, a transitive *v* probes its complement, and agrees with the object DP. I assume that Agree operations involve bidirectional feature exchange, with the probe receiving features from the goal and the goal receiving features from the probe that indicate which head it has agreed with. When *v* probes its complement, it passes on its category feature to the object DP, and the object passes on a bundle of ϕ -features to *v*. This transmission of a [v_{TR}] feature to the object can be seen as the marking of the object with accusative case.¹⁵ (This corresponds to one of two suggestions about accusative case made by Pesetsky and Torrego 2001.)¹⁶ The results of this Agree operation are schematized in (136).

¹⁵I discuss in Section 3.5 the need for a distinction between v_{TR} and v_{INTR} .

¹⁶A question that arises is whether ergative case can surface if accusative case is not assigned. A testing ground for this would be with verbs that assign some case other than accusative, such as dative, to their objects. However, objects in Amahuaca consistently surface in a morphologically unmarked form. Note

(136)

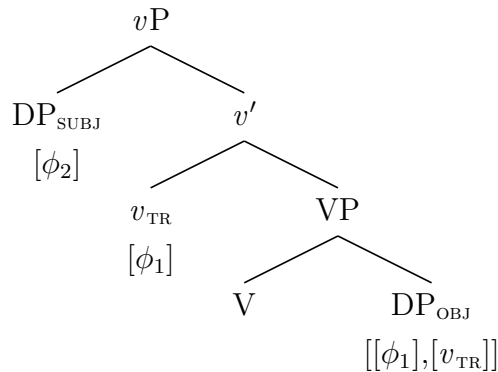

After v has agreed with the object DP in its complement, it then probes its specifier through cyclic expansion (Rezac 2003, 2004; Béjar and Rezac 2009).¹⁷ At this point of v 's agreement with the subject DP, v has its category feature plus the ϕ -features it received from agreeing with the object DP. This entire bundle $[v, \phi]$ is passed on to the subject DP.¹⁸ I assume a non-flat feature structure such that this complex bundle, received by the subject in a single Agree operation, remains differentiated as a whole from the features already present on the subject DP. This hierarchical structure of features is represented with square brackets. In the Agree operation between the subject and v , the DP also passes on a bundle of ϕ -features to v . This results in v having two bundles of ϕ -features. The results of this second operation are shown in (137).

(137)

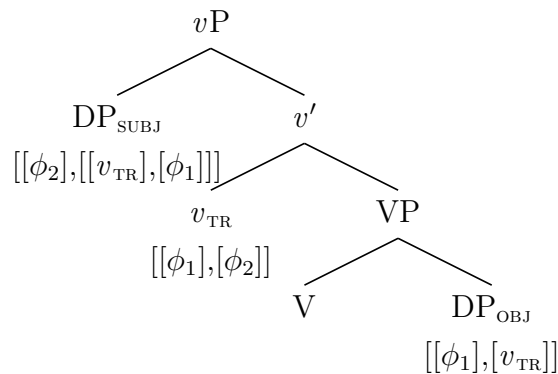

that both indirect and direct objects in Amahuaca are morphologically unmarked, as was shown in (124). This means that accusative and dative are syncretic. It is therefore not possible to tell from a morphological standpoint whether Amahuaca has monotransitive constructions with dative objects. Another testing ground would be with clausal complements. However, dependent clauses in the language are switch-reference clauses, and it is unclear whether these clauses are ever truly complements to V, even with verbs like ‘say’, as discussed in Chapter 2.

¹⁷Note that I will discuss the concept of cyclic expansion in greater detail in Chapter 4.

¹⁸I will not represent some of the details of the internal structure of feature bundles when it does not have any consequences for the analysis. For instance, the bundle $[[v_{TR}], [\phi]]$ that appears on transitive subjects can also be represented as simply $[v, \phi]$ since a transitive v is the only type of v that will have agreed with an object DP and since the extra layer of structure around the category feature and ϕ bundle plays no significant role.

Note that the featural manipulations discussed to this point make it possible to characterize the transitive subject in featural terms: it is the DP which bears $[v, \phi]$ in addition to its own ϕ -features. We will see in the discussion of switch-reference in Section 3.5 that this complex of features is grammatically relevant in Amahuaca. It is not, however, sufficient to license the insertion of the ergative case morpheme. If it were, we would expect to find all A arguments with ergative marking, even those that remain in situ. In addition to agreeing with v , a subject DP must also interact with T to be marked ergative.

Amahuaca T has a ϕ -probe, resulting in person-based agreement on tense markers, as we saw in Chapter 2. This agreement pattern is demonstrated in (138) with the past tense marker.

- (138) a. hiya=x=mun hun rakuu=**ku**=nu
 1SG=NOM=C 1SG be.afraid=1.PST=DECL
 ‘I was afraid.’
- b. vaku=x=mun rakuu=**xo**=nu
 child=NOM=C be.afraid=3.PST=DECL
 ‘The child was afraid.’

As seen in (138), the form of the tense marker changes based on the person of the subject: the past tense morpheme is =*ku* when the subject is first person, but =*xo* when the subject is third person.

How exactly does T come to share the features originating with the subject? This is a particularly important question since T always shows subject-based agreement, regardless of the case or syntactic position of the subject. Therefore, T must be able to receive the subject’s ϕ -features without the subject being marked with ergative case. Because of the feature exchange via Agree between the subject and v , the ϕ -features from the subject are present on both the subject DP and v . This means that there are two possible goals for the ϕ -probe on T that could result in T bearing the features of the subject. This follows on the assumption that features on a head are not treated differently than features on a DP, in keeping with indirect agreement accounts such as those explored by Legate (2005) and Adger and Ramchand (2005) (cf. Forbes 2018: 131, who argues that probes can be relativized to search for uninterpretable features on another probe). As shown in Section 3.2, the Amahuaca verb can appear sentence-medially before aspect, suggesting that the verb moves to this position from its lower position. Once the verb head-moves to Asp through v , the complex head in Asp bears the subject’s ϕ -features due to the fact that they are present on v . This configuration has the notable property that neither v nor the subject DP asymmetrically c-commands the other, plausibly resulting in the ϕ -features on both being accessible to the ϕ -probe on T. This lack of c-command is illustrated in (139).

(139)

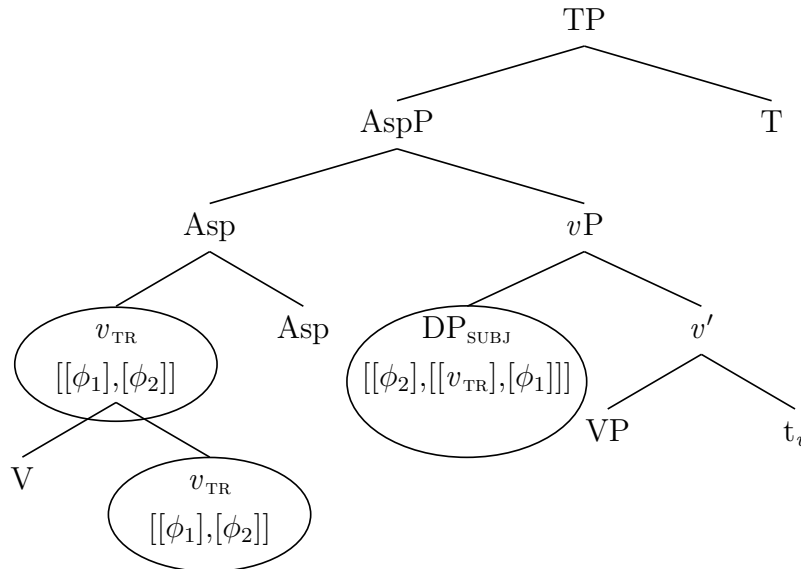

The core idea is that equidistance between v and the subject DP in this configuration allows T to receive the subject's ϕ -features in either of two ways. It can receive them by exchanging features with the head-moved v or via Agree with the subject DP directly. The availability of these two options recalls Alexiadou and Anagnostopoulou's (1998) parametrization of AGR such that its features can be checked by head movement of the verb or by phrasal movement of a nominal. Amahuaca, I propose, allows both options to satisfy the ϕ -probe on T: Agree with another verbal head and Agree with a DP.

If T exchanges features with the complex head in Asp, the subject remains in situ and does not interact with T. Since the subject DP and T never enter into an Agree relation directly, the subject never receives any features from T. It remains in Spec, vP with its own ϕ -features plus the bundle $[v, \phi]$ that it received from v via Agree. This is the type of structure that we find with fronted objects, as in (140) and (141).

- (140) jono=mun rutu=hi joni=ki=nu
 peccary=C kill=IPFV man=3.PRES=DECL
 'The man is killing the peccary.'

(141) O=C V=Asp A=T=Mood

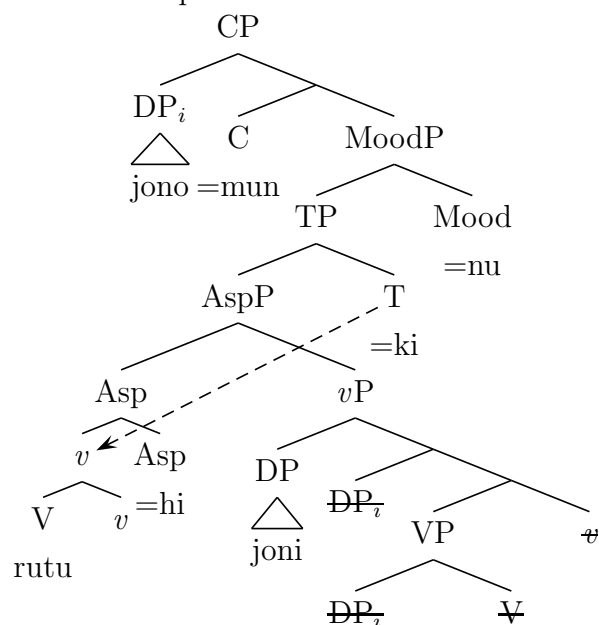

In (141), the subject is externally merged in Spec,*v*P, and the object is merged as the complement of V. In this configuration, *v* probes first its complement, agreeing with the object, and then its specifier, agreeing with the subject. The object vacates the VP to an inner specifier of *v*P, and the verb head-moves through *v* to Asp, as discussed in Chapter 2. Since the complex head in Asp contains the subject's ϕ -features that *v* received via Agree, T can participate in an Agree relation directly with *v* in Asp, as represented by the arrow. This results in the subject remaining in situ, unmarked. The object then moves to Spec,CP due (I assume) to feature driven movement for information structural reasons.

There is also a second option for how agreement with T can unfold. Instead of agreeing with *v*, the goal of the probe on T can be the subject DP itself, since the subject is not asymmetrically c-commanded by any closer goal. If T agrees with the subject, I assume that the subject obligatorily moves to Spec,TP. Miyagawa (2010) proposes that a motivation for movement can be to indicate the functional relationship between a head and a nominal that it has agreed with. I assume following this type of reasoning that when the relationship between T and the DP subject is direct, rather than mediated by *v*, movement of the subject indicates this direct relationship. Upon agreeing with T, the subject receives a [T] feature which it bears in addition to the features received from *v*. It is this combination of features, received in two separate Agree operations with functional heads, that will cause this moved subject to be marked ergative. We can see this type of configuration in (143), which represents the structure of (142).

(142) joni=n=mun jono rutu=hi=ki=nu
 man=ERG=C peccary kill=IPFV=3.PRES=DECL
 'The man is killing the peccary.'

(143) A=ERG=C O V=Asp=T=Mood

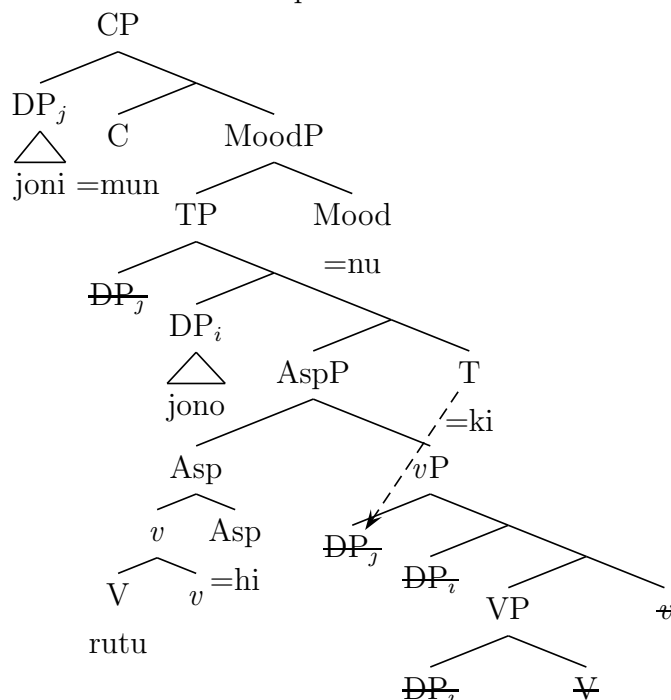

In (143), agreement of the arguments with *v* and movement of the verb proceed as in (141). The object also vacates VP by moving to an inner specifier of *v*P, as seen previously. Unlike in the previous example, however, in this structure, T agrees with the subject DP directly, instead of receiving the subject's ϕ -features from *v*. This causes the subject to move out of *v*P to Spec,TP and, because it has gained a [T] feature, to be marked ergative. Meanwhile, the object also moves out of its position on the *v*P edge into a higher position in the middle field. Finally, the subject moves to Spec,CP for information structural reasons.

The subject in (143) will be marked ergative because it has both the features received through agreement with a transitive *v* ($[v,\phi]$), as well as the feature [T] received through agreement with T. We can assume that the vocabulary item for ergative case is specified for this combination of features, as in (144), and will only be inserted when a DP has entered an Agree relationship with both *v* and T.

(144) Ergative (preliminary)
 $[v,\phi],[T] \leftrightarrow /n/$

To see how this proposal allows us to capture the generalization in (113) about the distribution of ergative case marking in Amahuaca, consider the representations from (112), repeated in (145) below.

(145)	a.	A=ERG	C		O	V	ASP		T
	b.			A=ERG		V	ASP		T
	c.	V	C	A=ERG	O		ASP		T
	d.	V	C	O	A=ERG		ASP		T
	e.	V	C				ASP	A	O T
	f.	V	C	O			ASP	A	T
	g.	O	C			V	ASP	A	T

The structures in (145b) and (145g) both represent constructions where the object is fronted to Spec,CP. In (145b), T has agreed directly with the subject, which has moved up to Spec,TP. In (145g), we see the other possibility where T has received ϕ -features from v , and the subject remains in situ in Spec, v P, unmarked for case. Likewise, in (145c)-(145f) we see four structures involving remnant fronting of VP. In (145c), T has agreed with the subject, which has moved to Spec,TP and is marked ergative. (The object has also scrambled in the middle field.¹⁹) In (145d), we see the same Agree option, but the object has subsequently scrambled over the subject. In (145e), we see the second option for feature exchange. In this structure, T has received ϕ -features from v , and the unmarked subject stays low. The example in (145f) shows the same agreement option, but with the object moving into the middle field. It is only in constructions with a fronted subject, like (145a), where we don't see both agreement possibilities attested. If the subject does not stay in its externally merged position, it will always agree with T and be marked ergative. The fact that a subject must agree with T to move to Spec,CP could potentially be due to a constraint in Amahuaca that movement to Spec,CP must proceed through the TP edge. (For some precedents for this idea see Assmann et al. 2015, Deal 2016, and references therein.) This analysis thus predicts the attested word orders and corresponding case-marking patterns, capturing the generalization in (113). Morphological ergative case requires a direct agreement relationship between the transitive subject and T, which triggers movement of the subject to Spec,TP. This Spec,TP position is to the left of Asp, meaning that ergative subjects will be those that appear to the left of aspect.

In addition to being able to account for the ergative case generalization in (113), this proposal is also able to account for the distribution of ergative case in sentences that lack aspect marking. In Section 3.2, it was noted that in sentences that lack overt aspect marking, subjects always appear with ergative case. We have now seen that the head movement of V and v to Asp allows T to exchange ϕ -features with v instead of probing the subject. This possibility allows the subject to stay low and remain unmarked. I propose that in sentences that lack overt aspect marking, this head movement to Asp does not occur. (This could be because the relevant Asp head does not have the features necessary to trigger head

¹⁹It is worth noting that there are no attested orders where the object remains on the v P edge while the subject moves to Spec,TP. This could potentially be derived by assuming that if T values its ϕ -probe by agreeing directly with a DP argument, it attracts both arguments. Given the wealth of crosslinguistic variation in the triggers and effects of object movement, the properties of Amahuaca object movement are of substantial interest and are the subject of ongoing work.

movement or because these structures simply lack an Asp projection altogether.) Without head movement of v , this means that the highest ϕ -features accessible to T will always be the subject's, and there will be no option of T exchanging features with v instead. That is because in these structures the subject asymmetrically c-commands v , as can be seen in (146).²⁰

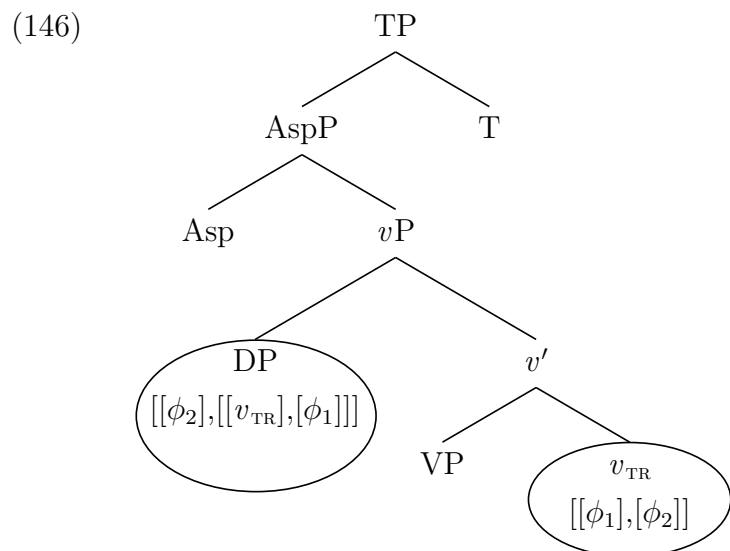

This means that in sentences without overt aspect marking, subject DPs will invariably enter an Agree relationship directly with T, move to Spec,TP, and be marked ergative. This option follows straightforwardly on the approach I have outlined in this section, where head movement of v to Asp plays a crucial role in allowing A arguments to avoid ergative case.²¹

Having established the features necessary for a subject to be marked ergative, we now return to the vocabulary items for Amahuaca case markers. As we have seen, the Amahuaca ergative marker must minimally be specified for the feature [T] and the internally complex bundle $[v, \phi]$. Assuming that all DPs will bear the category feature [D], this leads to the revised vocabulary item for ergative case in (147).²²

²⁰Even if vP has the same features as the head of the phrase, v , it does not c-command the subject DP (it dominates it), and will therefore not count as “closer” to T based on c-command. What is crucial in this configuration is that there is no segment of v that asymmetrically c-commands the subject DP. Thus, the DP will count as unambiguously closer to T.

²¹Julie Anne Legate (p.c.) has suggested an alternative analysis where ergative is uniformly assigned to transitive subjects but is not realized when the DP is in Spec, vP . Crucially such an analysis would need to account for why transitive subjects always surface with ergative case in perfective sentences, which lack overt aspect marking. The equidistance story presented here is able to account for why it is only in sentences with overt aspect marking that the transitive subject is able to remain in Spec, vP . Additionally, a morphological account that appealed to syntactic position directly would require that vocabulary items or impoverishment rules for D be able to refer to the external syntax of the DP. This information is not part of the feature content of D, and it is worth considering whether such non-local information should be able to affect Vocabulary Insertion.

²²Specifying the category feature [D] as part of the vocabulary item predicts that ergative case should

- (147) Ergative (revised)
 [D],[v,ϕ],[T] \leftrightarrow /n/

The bundle [v,ϕ] is the result of agreement with a transitive v which has already agreed with another DP. This captures the generalization that it is only subjects of transitive clauses that are marked ergative, not intransitive subjects or objects. The specification for the feature [T] ensures that in situ subjects will not receive ergative case marking, only subjects that have agreed with T and moved.

We then have two options for how to treat unmarked subjects, as well as accusative arguments. It is possible that there is no accusative case marker, since object DPs bear no overt case marking. However, it is also possible that there is a null case suffix ($=\emptyset$) which surfaces on accusative DPs. This null suffix would not be specified for accusative features. Instead, as in languages in which absolutive is simply the default (Legate 2008), this null marker would be a default case marker specified only for the category feature [D]. If we assume standard competition mechanisms of Distributed Morphology (Halle and Marantz 1993), the most highly specified vocabulary item that matches the featural content will be inserted. This means that the unmarked form will be the default when no more highly specified vocabulary item can be inserted. This ranking between the ergative and “accusative” markers is shown in (148).

- (148) Ergative vs. default
 [D],[v,ϕ],[T] \leftrightarrow /n/
 [D] \leftrightarrow / \emptyset /

This analysis captures the insight of the dependent case literature that the presence of ergative depends on the presence of another DP lower in the clause. This is achieved via Agree with v . If v has agreed with an object DP, it will bear ϕ -features by the time it has agreed with the subject. This will cause the subject to receive the feature bundle [v,ϕ] when it agrees with v . If there is no lower DP for v to agree with, as in an intransitive predicate, the subject DP will only receive a [v] feature, ruling out the possibility of ergative case marking.

What this account is able to capture that a dependent case account struggles to capture is the interaction of case marking and movement that we find in Amahuaca. Because the insertion of the ergative case marker is dependent on the presence of a [T] feature on a DP,

only be realized at the DP level, once per DP. This is the pattern found in Amahuaca where ergative case is a DP enclitic and where case cannot be marked on multiple elements within a single continuous DP, as discussed in Chapter 2 and as shown again in (iv).

- (iv) joni(*=n) kiyoo=vini=n=mun jono rutu=hi=ki=nu
 man=ERG all=EMPH.LG=ERG=C peccary kill=IPFV=3.PRES=DECL
 ‘All the men are killing a peccary.’

This featural specification is also in line with the fact that the language lacks determiners, which would presumably be realized in D.

ergative case will only be marked when an A argument has agreed with T. This agreement triggers subsequent movement to Spec,TP, resulting in the observed relationship between syntactic position and ergative case. As seen in Section 3.3.2, an account in which functional heads only delimit case domains, as in dependent case theory, is unable to straightforwardly capture this pattern of interaction between movement and ergative case assignment. Instead, functional heads must play a more integral role in the assignment of ergative case. Specifically, ergative case is exponence of agreement with two functional heads, *v* and T.

3.5 Category features and switch-reference

If ergative case is indeed the exponence of agreement with multiple functional heads, as argued for in the previous section, we expect that the features received from each of these Agree operations might have separate effects in other parts of the grammar. Specifically, since all subjects will agree with *v*, but not all subjects will agree with T, this account predicts that features received from *v* might have effects independent of whether agreement with T has also happened. This prediction is borne out.

Amahuaca, like many Panoan languages, has a rich switch-reference system which encodes information about the relationship between the arguments of matrix and dependent clauses, as well as about the temporal relationship between the clauses (Sparing-Chávez 1998, 2012). A more thorough description and analysis of this system will be the topic of Chapter 4, but I comment briefly here on one relevant aspect of it. Throughout, I use the term ‘marked clause’ for the clause which hosts the switch-reference marker and ‘reference clause’ for the clause which hosts the other argument in the (non-)coreference relationship, following Munro (1979) and Haiman and Munro (1983). In marked clauses, the switch-reference marker indicates coreference or non-coreference of an argument of the marked clause with an argument of the reference clause. Where coreference is indicated, the form of the switch-reference marker indicates whether the coreferential reference clause DP is an S, A, or O argument.²³ What is crucial for present purposes is that these markers are not sensitive to morphological case marking. Instead, I argue that they track features received from agreement with *v*.

As mentioned previously, in addition to encoding information about the coreferentiality of arguments, switch-reference markers also encode information about the temporal relationship between the marked clause and the reference clause, resulting in multiple paradigms of these markers. The examples in (149)-(151) show one set of switch-reference markers which encode that the action of the marked clause precedes the action of the reference clause.

²³Note that the sensitivity of some subject markers to the grammatical function of the reference clause subject – S versus A – or, similarly, to the transitivity of the reference clause, is a common feature in Panoan switch-reference systems. Valenzuela (2003) refers to this property as ‘participant agreement’.

- (149) Marked clause subject coreferential with reference clause S
 [jaa=x_i vua=**hax**]=mun **xano**_i chirin=xo=nu
 3SG=NOM sing=SS.SQ=C woman dance=3.PST=DECL
 ‘After she_i sang, the woman_i danced.’
- (150) Marked clause subject coreferential with reference clause A
 [jaa=x_i vua=**xon**]=mun **xano**=n_i xuki jova=xo=nu
 3SG=NOM sing=SA.SQ=C woman=ERG corn cook=3.PST=DECL
 ‘After she_i sang, the woman_i cooked corn.’
- (151) Marked clause subject coreferential with reference clause O
 [jaa=x_i vua=**xo**]=mun hinan **xano**_i chivan-vo=xo=nu
 3SG=NOM sing=SO.SQ=C dog.ERG woman chase-AM=3.PST=DECL
 ‘After she_i sang, the dog chased the woman_i.’

In (149), the subject of the bracketed marked clause is coreferential with the bolded subject of the reference clause (in this case the matrix clause), which is the subject of the intransitive verb *chirin* ‘dance’. The switch-reference marker =*hax* indicates that the coreferential reference clause argument is an intransitive subject. In (150), the marked clause subject is coreferential with the subject of the reference clause as well. However, in this example, the matrix verb is the transitive verb *jova* ‘cook’. In this case, the switch-reference marker =*xon* indicates that the coreferential reference clause argument is an A argument. Finally, in (151), the reference clause verb is also transitive. In this example, though, the marked clause subject is coreferential with the reference clause object *xano* ‘woman’. This is indicated by the switch-reference marker =*xo*. This portion of the switch-reference paradigm is summarized in Table 3.1.

marked clause argument	coreferential reference clause argument	form
S/A	S (NOM)	= <i>hax</i>
S/A	A (ERG)	= <i>xon</i>
S/A	O (ACC)	= <i>xo</i>

Table 3.1: Switch-reference markers (partial “after” series)

These switch-reference markers are sensitive to the three core cases of Amahuaca’s tripartite case system: nominative, ergative, and accusative. However, what is important to note about these switch-reference markers is that they do not track the *morphological* case of the argument that they mark coreference with. That is to say that a DP need not be overtly marked ergative or nominative in the reference clause to trigger the appropriate switch-reference marker in the marked clause. Instead, these markers appear to be sensitive

to abstract case differences between reference clause DPs, regardless of whether these features are realized overtly as morphological case. This can be seen clearly in the examples in (152) and (153).

- (152) $[pro_i \text{ hoxa}=\text{shara}=\boxed{\text{hax}}]=\text{mun ka}=\text{hi} \quad \mathbf{xano}_i=\text{ki}=\text{nu}$
 sleep=well=SS.SQ=C go=IPFV woman=3.PRES=DECL
 ‘After she_i slept well, the woman_i is going.’

- (153) $[pro_i \text{ hoxa}=\text{shara}=\boxed{\text{xon}}]=\text{mun kuntii choka}=\text{hi} \quad \mathbf{xano}_i=\text{ki}=\text{nu}$
 sleep=well=SA.SQ=C pot wash=IPFV woman=3.PRES=DECL
 ‘After she_i slept well, the woman_i is washing pots.’

In both (152) and (153), the reference clause subject DP *xano* ‘woman’ surfaces in the unmarked form because it remains in situ. In (152), this DP is the subject of the intransitive verb *ka* ‘go’, and triggers the nominative switch-reference marker in the marked clause. In (153), however, the same DP is the subject of the transitive verb *choka* ‘wash’, and triggers the ergative switch-reference marker in the marked clause. These two DPs are morphologically case-marked in the same way (i.e. unmarked), yet they trigger different switch-reference markers. This must mean that the switch-reference system tracks something other than morphological case or the full complex of features necessary for overt case marking.

We must then ask what features these switch-reference markers are sensitive to. In (152) and (153), the subject DP remains in situ. It does not move out of *v*P and therefore does not agree with T. Under the current analysis, the lack of agreement with T is reflected by the fact that the subject in (153) does not receive ergative case. What features differentiate these two DPs then? As outlined in Section 3.4, *v* will always probe its complement and specifier. All subject and object DPs will therefore receive features from *v* in their externally merged positions. It is these features from *v* that differentiate the two subjects in (152) and (153), in a way that is reminiscent of inherent case. In (152), *v* has not agreed with any other DPs, so the subject receives only a category feature from *v*. In contrast, in (153), by the time *v* agrees with the subject, it has already agreed with the object DP. Therefore, as we have seen previously, it passes on the bundle $[v, \phi]$ to the subject.

The details of the syntactic mechanisms underlying switch-reference will be discussed more extensively in Chapter 4. However, I will briefly consider here what implications abstract case has for Vocabulary Insertion for switch-reference markers. In short, we can say that the switch-reference marker *=xon* will be inserted when the coreferential DP in the reference clause is abstractly ergative – when it bears the feature bundle $[v, \phi]$. The switch-reference marker *=hax* will be inserted when the coreferential reference clause subject DP is abstractly nominative, bearing the feature $[v_{\text{INTR}}]$. Finally, the switch-reference marker *=xo* will be inserted when the coreferential reference clause DP is abstractly accusative, that is, when it bears the feature $[v_{\text{TR}}]$ without an extra ϕ -bundle. No other features of the reference clause DPs (such as [T]) need to be appealed to for the switch-reference markers.

We have seen, then, that the switch-reference system of Amahuaca supports the analysis of ergative case as exponing multiple Agree operations. Specifically, it provides evidence

that even DPs that are not morphologically marked have abstract featural differences based on agreement with *v*. For A arguments, ergative switch-reference is triggered solely by these features from *v*, but ergative case marking requires a second Agree operation between the subject and T. Notably, neither an inherent nor dependent case account can capture how a DP could behave as ergative for some purposes, like switch-reference, but not others, like morphological case, since case assignment is the result of one syntactic relationship in both of these accounts. However, a theory of case in which ergative is the result of relationships with multiple functional heads can capture these patterns. This system, in effect, allows for a distinction between transitive subject as a “grammatical function” (determined in situ) and transitive subject as a case category. It does this, however, without appeal to any notion of grammatical function that goes beyond constituency and Agree relations. In the next section we will see that nominative marking, like ergative marking, also requires more than the features received from an agreement relationship with *v*, providing additional support for the idea that case marking can exponence multiple features.

3.6 Nominative case as a feature complex

Amahuaca nominative case marking, like ergative, appears to be sensitive to multiple syntactic relationships. Specifically, nominative case is sensitive to focus, appearing only on focused DPs. This suggests that exponence of complex feature bundles, rather than atomic case features, is characteristic of the Amahuaca case system more generally.

To understand the focus properties of nominative case in Amahuaca, it is first necessary to understand how the language typically marks focus. As first discussed in Chapter 2, Amahuaca has a second position clitic *=mun* in C, which is preceded by exactly one XP in Spec,CP. The obligatoriness of a constituent in Spec,CP can be derived from an EPP feature on C.

As mentioned previously, if a phrase is focused, it appears in the initial position in Spec,CP, as shown in (154) with a focused object, and (155) with a focused subject.

- (154) a. jau=ra joni=n rutu=hax
 what=INT man=ERG kill=TAM
 ‘What did the man kill?’
- b. jono=mun joni=n rutu=xo=nu
 peccary=C man=ERG kill=3.PST=DECL
 ‘The man killed A PECCARY.’
- (155) a. tzova=n=ra jono rutu=hax
 who=ERG=INT peccary kill=TAM
 ‘Who killed the peccary?’

- b. jaa joni=n=mun jono rutu=xo=nu
 DEM man=ERG=C peccary kill=3.PST=DECL
 ‘THAT MAN killed the peccary.’

In the question and answer pair in (154), the object DP *jono* ‘peccary’ in (154b) corresponds to the *wh*-word in (154a), and it appears in the initial position before =*mun*. In contrast, in the pair of sentences in (155), the subject DP *jaa jonin* ‘that man’ in (155b) corresponds to the *wh*-word of the preceding question. In this instance, it is the subject DP that appears in the initial position preceding the second position clitic, suggesting that this position is a focus position. Similar effects are seen with corrective contexts in Chapter 2, which suggests that this position before =*mun* is a general purpose focus position. There is, however, only a one way implication between focus and fronting. Constituents that receive a narrow focus interpretation are fronted, but not all fronted constituents receive a narrow focus interpretation. This will be further exemplified by (158) below.

In Amahuaca, nominative marking is triggered only when an S argument is focused. This is illustrated in the contrast between (156) and (157).²⁴

- (156) a. jau kuza=hi=ra xano-vo=ki
 what do=IPFV=INT woman-PL=3.PRES
 ‘What are the women doing?’
 b. hoxa=mun=hax **xano-vo**=ki=nu
 sleep=C=PERF woman-PL=3.PRES=DECL
 ‘The women are SLEEPING’.
- (157) a. tzova=x hoxa=hax=ra=ki
 who=NOM sleep=TAM=INT=3.PRES
 ‘Who is sleeping?’
 b. **xano-vaux**=mun hoxa=hax=ki=nu
 woman-PL.NOM=C sleep=PERF=3.PRES=DECL
 ‘THE WOMEN are sleeping.’

In (156), the *wh*-question in (156a) should focus the verb, and in the response in (156b), the non-initial plural subject *xanovo* ‘women’ is unmarked for case. In (157), in contrast, the *wh*-question in (157a) should focus the subject, and in the corresponding response in (157b), the subject appears in the initial focus position with the nominative form of the plural marker *-vaux*.

Unlike with ergative marking, descriptively, nominative marking is not fully predictable based on surface position. While the contrast between (156b) and (157b) might make it seem like the presence or absence of nominative case is, like ergative, due to a difference in whether

²⁴As noted in Chapter 2, the Amahuaca plural marker surfaces as a portmanteau expounding plural and case. The nominative form of the plural marker is *-vaux* and the ergative form is *-vaun*. The form *-vo* acts as the default form of the plural.

the nominative DP has moved and agreed with T, this is not an accurate generalization. As mentioned above, the relationship between focus and fronting is not biconditional. It is possible for unfocused subjects to appear initially in contexts that lack a constituent with a narrow focus interpretation. In contexts with wide focus on the entire sentence, the initial S argument is unmarked for case, as seen in (158).

(158) *Context: You see a group of people gathered around a tree and you ask, ‘What happened?’.* Someone responds:

joni(#=**x**)=**mun** pakuu=**xo**=**nu**
 man=**NOM**=**C** fall=**3.PST**=**DECL**
 ‘A man fell.’

In (158), the presence of the second position clitic =*mun*, which is in C, indicates that the subject is in Spec,CP, just as the nominative-marked subject in (157b). Therefore, syntactic position does not seem to play a direct role in whether a DP is marked nominative or not. Instead, nominative marking is sensitive to focus.

If nominative marking is, in fact, conditioned by focus, it is important to establish that the nominative marker =*x* (or *-vaux* for plurals), is not simply a general focus marker. Specifically, given that Amahuaca exhibits an underlyingly tripartite case system, it is important to establish that this marker can only be used on S arguments, and not on A or O arguments, if it is indeed related to case. This is what we find.

The marker =*x* is incompatible with focused objects, as demonstrated in (159).

- (159) a. jau choka=**hi**=**ra** xano=**ki**
 what wash=**IPFV**=**INT** woman=**3.PRES**
 ‘What is the woman washing?’
 b. **kari**(*=**x**)=**mun** choka=**hi** jan=**ki**=**nu**
 yam=**NOM**=**C** wash=**IPFV** 3SG=**3.PRES**=**DECL**
 ‘She is washing YAMS.’

In (159b), the focused object *kari* ‘yams’, which should be accusative, cannot surface with the marker =*x*. It must surface in the unmarked form. This suggests that the =*x* is not a focus marker that is compatible with accusative arguments.

The ungrammaticality of =*x* with the transitive subject in (160b) also indicates that it is not simply a focus marker for subjects.

- (160) a. hatza=**mun** choka=**hi** xano=**ki**=**nu**
 manioc=**C** wash=**IPFV** woman=**3.PRES**=**DECL**
 ‘The woman is washing manioc.’
 b. *maki, **joni**(=**n**)=**x**=**mun** hatza choka=**hi**=**ki**=**nu**
 no man=**ERG**=**NOM**=**C** manioc wash=**IPFV**=**3.PRES**=**DECL**
 ‘No, THE MAN is washing manioc.’

In the corrective context in (160b), the focused A argument *joni* ‘man’ cannot surface with the marker =*x*. The incompatibility of =*x* with A arguments holds even if the ergative marker is not present on the subject DP.

The incompatibility of the marker =*x* with focused A and O arguments provides evidence that it does not mark focus alone. If it were a focus marker unrelated to case, we would expect any focused DP (and perhaps other types of constituents) to be able to surface with this marker. This suggests that the marker in question actually does serve to mark nominative case, but only on focused S arguments.²⁵

If we assume, as with fronted ergative DPs, that fronted nominative DPs agree with T and pass through Spec,TP, a fronted S argument will bear the feature [T], distinguishing it from a fronted O argument, which does not agree with T.²⁶ Additionally, the nominative-marked DP must bear a focus feature, since only focused S arguments receive nominative case. The vocabulary item for the nominative marker, along with the previously posited ergative and default case markers, is given in (161).

(161) Ergative vs. nominative vs. default

[D],[<i>v</i> , ϕ],[T]	\leftrightarrow	/n/
[D],[T],[Foc]	\leftrightarrow	/x/
[D]	\leftrightarrow	/∅/

This nominative marker will be in competition with the more highly specified ergative marker, which will block its insertion on focused A arguments. Further, as seen before for ergative case, if an S argument does not have all of the features necessary for the nominative marker to be inserted, the DP will surface in the unmarked form.

This sensitivity of nominative marking to features from T shows that functional heads must play a crucial role in Amahuaca case marking more generally, beyond ergative case. The additional sensitivity to focus demonstrates that Amahuaca case morphology expones bundles of features rather than single case features.

²⁵A similar connection between case and information structure has been discussed for Tibeto-Burman languages that show “optional” ergative or “agentive” marking (Chelliah and Hyslop 2011). In some of the languages that show optional case marking it appears that both pragmatic and syntactic factors are at play in determining whether subjects receive agentive case marking. Note, though, that, unlike in Amahuaca, these patterns do not concern S arguments specifically. (They typically involve A arguments.)

²⁶Nominative DPs will also be distinguished from accusative DPs by the fact that accusative DPs will have received the feature [*v*_{TR}] from agreeing with *v*, while nominative DPs will have received the feature [*v*_{INTR}]. In principle, either of these features ([T] or [*v*_{INTR}]) could serve to distinguish focused S arguments from focused O arguments. Interestingly, intransitive subjects that remain in their externally merged positions cannot surface with nominative case. I assume that DPs in this position cannot be focused, but this pattern could also be due to the fact that the nominative marker is sensitive to interaction with T.

3.7 Summary

3.7.1 Consequences for a theory of case

In this chapter I have introduced a pattern of ergative case marking in Amahuaca that is sensitive to the syntactic position of the transitive subject. Subjects which remain low are not marked ergative, while subjects which have moved up to at least Spec,TP receive ergative case marking. In a view of case in which it is the morphological exponence of a configurational relationship between two DPs, it is difficult to account for why the structural relationship between a DP and T should affect case marking. Instead, these data point to an analysis in which functional heads play a crucial role in case assignment. It is important to note, however, that the analysis here departs from the traditional implementation of ergative case as assigned directly by a functional head, namely *v*. Instead, the account I pursue relies on the relationship between the transitive subject and two functional heads, *v* and T.

This account is able to capture both the insight of the transitivity condition of Woolford (2006) and the insight from the dependent case literature about the crucial role of a DP lower in the structure. This is implemented through the Agree operations between *v* and DPs. Since the insertion of the ergative morpheme is sensitive to the feature bundle [*v*, ϕ] it can be inserted only when the *v* that agrees with the subject has already agreed with a lower DP. In addition to capturing this insight about transitivity, the account pursued here is also able to incorporate the importance of the structural relationship between T and the ergative DP in Amahuaca. It is this fact that previous approaches to ergativity are unable to capture.

Furthermore, the switch-reference system of the language, introduced in Section 3.5, provides evidence that DPs can have abstract features which differentiate them along the lines of case without being morphologically case marked. These data, which will be discussed further in the next chapter, support the analysis of ergative as deriving from multiple Agree operations rather than from a single syntactic relationship with a head or another DP, a fact which previous accounts cannot capture.

These patterns from Amahuaca suggest, then, that case cannot always be the exponence of a relationship between nominals – in at least some languages, functional heads must play a more direct role in case assignment than simply delimiting phases and, by extension, case domains. Crucially, in contrast to what has been argued for previously, the Amahuaca data also provide evidence that ergative case may be derived from a relationship with multiple functional heads, rather than a single head. This account leaves open the possibility, however, that ergative case in some languages may be inherent or dependent, in line with the literature that shows that there is considerable diversity in the properties of ergative case systems crosslinguistically. In exploring how many languages have an Amahuaca-like ergative system, it may be fruitful to look for other instances of ergative case associated with particular structural configurations, specifically ergative case assigned in Spec,TP. The expectation is that other ergative systems may exhibit a similar pattern of complex ergative case derived from multiple Agree operations, which highlights the role of functional heads

in case marking and provides evidence that even ergative case can be the morphological reflection of a structural relationship between heads and nominals.

3.7.2 Implications for Agree

The arguments made in this chapter also have interesting consequences for our understanding of the operation of Agree. I have argued that category features of heads that host probes can be passed on to goals via the establishment of Agree dependencies. This idea has precursors in the work of Pesetsky and Torrego (2001) and Deal (2010) on case assignment. Rather than treating goals as having unvalued features such as [$uT: _$] that must be valued via Agree, I have instead assumed that Agree involves bidirectional feature copying between the probe and goal. This means that a DP in Amahuaca need not always interact with T (for instance), because there are no features on the DP that must be valued by such a probe. However, interaction with T, when it occurs, can have morphological consequences (such as overt realization of case), since features from T are copied onto its goal.

Another fact that I have assumed about Agree in this chapter is that it can proceed in a cyclic fashion. I have argued that v first probes its complement, agreeing with the object, and then probes its specifier, agreeing with the subject. This type of Cyclic Agree has been proposed by Rezac (2003, 2004) and Béjar and Rezac (2009). In this chapter, I have used this assumption of cyclicity to account for how the presence of an object in the clause is reflected on the transitive subject. In the next chapter, I will lay out the framework of Cyclic Agree in more detail and will offer an additional argument for this approach to Agree from the domain of switch-reference in Amahuaca.

Chapter 4

Amahuaca switch-reference and cyclicity in Agree

The model of Cyclic Agree (Rezac 2003, 2004; Béjar and Rezac 2009) allows variability in the search domain of a probe. A probe on a head will first probe its *c*-command domain – the complement of the head. However, if the probe is not satisfied by the goal(s) it encounters on this cycle of probing (or if it encounters no goal), the probe can reproject along with the label of the head that hosts it. This results in a probe on the intermediate level projection. The new *c*-command domain of the probe contains the specifier, which can now be a goal for Agree.

As Rezac (2003: 158) notes, this type of cyclic expansion is made possible by Bare Phrase Structure (BPS; Chomsky 1995a,b), in particular the assumption that there is no distinction between the label of the head and the label of the intermediate level projection. Interestingly, given the assumptions of BPS, there is also no formal distinction between intermediate and maximal projections. Therefore, the prediction of Cyclic Agree coupled with BPS is that maximal projections should also be able to serve as probes. This falls out from the same type of cyclic expansion that is necessary to derive probes on intermediate projections to facilitate Spec-Head agreement.

It is typically difficult to test this prediction. For many common probes for which cyclic expansion has been proposed, such as *v*, the *c*-command domain of the maximal projection only contains the head that selects it. On the assumption that this head (e.g. T, Asp, or similar) is merged without its own ϕ -features, there is no new goal for ϕ -Agree in the *c*-command domain of the maximal projection. It is thus difficult to tell whether the maximal projection is syntactically inert or is probing unsuccessfully. However, adjunction structures provide exactly the right type of testing ground for this prediction since adjuncts are not selected by a head and thus contain more material in their *c*-command domains than a single functional head.

In this chapter I argue that this prediction of Cyclic Agree and BPS is borne out in the type of structure seen in (162).

(162)

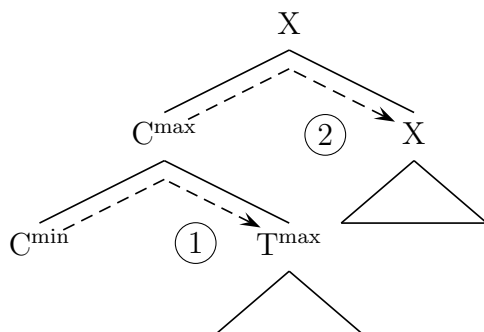

In (162), the minimal projection of adjunct C first probes its c-command domain, T^{\max} . However, the probe remains unsatisfied after this first cycle of Agree. When C reprojects to form a maximal level projection, the probe on C reprojects as well as part of the label. The second cycle of Agree then involves a probe on C^{\max} probing the c-command domain of the maximal projection.

Specifically, I argue for the existence of this type of structure in Amahuaca switch-reference (SR) clauses, which display an agreeing adjunct C that can agree not only with DPs in its own clause, but also with DPs in the clause to which it adjoins. In Amahuaca, I argue that adjunct C^{\min} first probes DPs in its c-command domain, namely the adjunct clause. Because the probe on C remains unsatisfied, it reprojects. This allows adjunct C^{\max} to probe its c-command domain and agree with DPs in the matrix clause to which it is adjoined. The data from Amahuaca therefore provide novel support for a cyclic model of Agree. They also suggest that cyclic expansion and probe reprojection is fully generalizable. It is not limited to intermediate projections. Instead, even maximal projections can serve as probes.

The structure of the chapter is as follows. In Section 4.1, I discuss the pattern of agreeing adjunct C in Amahuaca. I explore the syntactic structure of the relevant adjunct SR clauses and illustrate the various patterns of agreement that are possible on adjunct C involving both adjunct and matrix arguments. In Section 4.2, I discuss the framework of Cyclic Agree in more depth to lay the groundwork for the analysis of the Amahuaca pattern. In Section 4.3, I demonstrate that the pattern of agreeing adjunct C in Amahuaca can be straightforwardly derived by assuming that C probes in two cycles, with the second cycle of probing involving a probe on the maximal projection. I compare this analysis with previous analyses of SR and complementizer agreement in Section 4.4, concluding that a Cyclic Agree account provides greater empirical coverage and requires the introduction of less additional technology than alternative accounts. Finally, I explore some questions and typological predictions raised by this style of account in Section 4.5 and offer concluding remarks in Section 4.6.

4.1 Amahuaca agreeing complementizers

The empirical focus of this chapter will be on adjunct SR clauses in Amahuaca. These clauses are often translated as temporal adjuncts, but they serve a wide range of purposes that extends beyond the use of temporal adjuncts in languages such as English (for example, purpose clauses and attitude reports). In these clauses, the element that indicates the temporal relationship between clauses is an enclitic that typically surfaces on the verb of the adjunct clause, as shown in (163).¹

- (163) [jaa= x_i vua= $\overline{\text{xon}}$]=mun xano= n_i xuki jova= $xo=nu$
 3SG=NOM sing=SA.SQ= C_{MATRIX} woman=ERG corn cook=3.PST=DECL
 ‘After she_i sang, the woman_i cooked corn.’

The morpheme =*xon* in (163) indicates that the two clauses are related sequentially (rather than simultaneously) and that the action of the adjunct clause (the singing) took place prior to the action of the matrix clause (the cooking). It corresponds roughly to a meaning like ‘after’. For simplicity, I will initially focus only on ‘after’ clauses, but ‘while’ and ‘before’ clauses show similar behavior and distribution. I will return to a discussion of these other SR clause types in Section 4.5.

4.1.1 The structure of switch-reference clauses

SR clauses in Amahuaca are large enough to contain various types of arguments and adjuncts and to allow multiple types of movement internal to them. This is consistent with them being full CPs. These clauses can contain all arguments of the verb overtly, as seen in (164) with a transitive verb and (165) with an intransitive verb.

- (164) [**xano= n_i** chopa patza= $\overline{\text{xon}}$]=mun *pro_i* hatza
 woman=ERG clothes wash=SA.SQ= C_{MATRIX} manioc
 jova= $hi=ki=nu$
 cook=IPFV=3.PRES=DECL
 ‘After the woman_i washed clothes, she_i is cooking manioc.’
- (165) [**kiyoo= $vini=x_i$** nokoo= $\overline{\text{xon}}$]=mun *pro_i* hatza
 all=EMPH.LG=NOM arrive=SA.SQ= C_{MATRIX} manioc
 jova= $kan=xo=nu$
 cook=3PL=3.PST=DECL
 ‘After everyone_i arrived, they_i cooked manioc.’

Like (163), these examples feature the enclitic =*mun*, a second position clitic that is in the matrix C position.² It is always preceded by exactly one syntactic constituent regardless of

¹See the example in (170b) for an instance of this enclitic surfacing on a DP object instead.

²In this chapter I gloss =*mun* as C_{MATRIX} , instead of simply C, to avoid confusion. This element is not the adjunct clause complementizer. Instead, I argue that SR markers themselves lexicalize adjunct C.

that constituent’s size, as demonstrated in Chapter 2. This provides evidence in favor of the bracketing given in (164) and (165). In (164), the ergative-marked subject *xanon* ‘woman’ and the unmarked object *chopa* ‘clothes’ appear overtly in the adjunct clause. Likewise, in (165), the nominative-marked subject *kiyoovinix* ‘everyone’ appears in the adjunct clause. Based on the arguments in Chapter 3 that subject case marking involves interaction with T, the availability of overt ergative and nominative case marking in these clauses provides evidence that there is at least a TP layer.

SR clauses can also host adverbs, as seen in (166) with the adverb *koshi* ‘quickly’ and (167) with the adverb *moha* ‘already’. (Given the possibility of overt arguments in all positions in Amahuaca SR clauses, I assume that missing arguments, as in (166), represent *pro* rather than PRO.)

- (166) [*pro*_{*i*} **koshi** ka= $\overline{\text{xon}}$]=mun xano=*n*_{*i*} hatza vana=*xo*=*nu*
 quickly go=*SA.SQ*=*C_{MATRIX}* woman=*ERG* manioc plant=*3.PST*=*DECL*
 ‘After she_{*i*} went quickly, the woman_{*i*} planted manioc.’

- (167) [**moha** xano=*x*_{*i*} nokoo= $\overline{\text{xon}}$]=mun jato=*n*_{*i*} hatza
 already woman=*NOM* arrive=*SA.SQ*=*C_{MATRIX}* *3PL*=*ERG* manioc
 xoka=*kan*=*xo*=*nu*
 peel=*3PL*=*3.PST*=*DECL*
 ‘After the women_{*i*} had already arrived, they_{*i*} peeled manioc.’

Finally, these adjunct clauses can also themselves contain other adjunct SR clauses, as shown in (168).

- (168) [[*pro*_{*i*} kari choka= $\overline{\text{xon}}$] *pro*_{*i*} hatza xoka= $\overline{\text{xon}}$]=mun xano=*n*_{*i*} xuki
 yam wash=*SA.SQ* manioc peel=*SA.SQ*=*C_{MATRIX}* woman=*ERG* corn
 jova=*xo*=*nu*
 cook=*3.PST*=*DECL*
 ‘[After she_{*i*} peeled manioc [after she_{*i*} washed yams]], the woman_{*i*} cooked corn.’

In (168), one adjunct clause is nested within another.³ (Note that the entire adjunct structure occurs in the position to the left of =*mun* in matrix C.) The resulting reading is that the woman first washed yams, then peeled manioc, then cooked corn.

In addition to being able to host these various elements, SR clauses also allow clause-internal scrambling, like matrix clauses, as seen in (169).

³Many languages with SR are so-called ‘clause-chaining’ languages (Dooley 2010). Multiple SR clauses can occur with a single matrix clause. In Amahuaca, such chains represent (at least) two distinct structures. In utterances with more than one SR clause, the clauses can appear in a nested structure or a stacked structure. In a nested structure, each SR clause adjoins within the next, while in a stacked structure each SR clause adjoins directly to the matrix clause. The choice of SR marker and the position of the second position clitic =*mun* can help to disambiguate between the two structures. In (v) we see an example with nested SR clauses, and in (vi) we see an example with stacked SR clauses.

(169) ‘After I cooked paca, I peeled manioc.’

- a. [hiya=n hano jova=xon]=mun hun hatza vuro=ku=nu
 1SG=ERG paca cook=SA.SQ=C_{MATRIX} 1SG manioc peel=1.PST=DECL
- b. [hano hiya=n jova=xon]=mun hun hatza vuro=ku=nu
 paca 1SG=ERG cook=SA.SQ=C_{MATRIX} 1SG manioc peel=1.PST=DECL

In (169a) we see the base SOV word order, but in (169b) the object has scrambled above the subject to result in OSV word order in the adjunct clause.

In addition to argument scrambling, verbs can also move to be clause-initial within SR clauses, as in (170).

- (v) [[hiya=n_i hun hatza vana=hain] Maria=n_j hun vaku jirí=kun]=mun
 1SG=ERG 1SG manioc plant=DS.SIM Maria=ERG 1SG.GEN child feed=DS.SQ=C_{MATRIX}
 hiya=n_i rivi jan vaku jirí=hi hun=ka=nu
 1SG=ERG also 3SG.GEN child feed=IPFV 1SG=1.PRES=DECL
 ‘[After Maria fed my kids [while I planted manioc]], I, too, am feeding her kids.’
 (*Alternatively* ‘While I planted manioc, Maria fed my kids, so I, too, am feeding her kids.’)
- (vi) [hiya=n_i hatza vana=kin]=mun [Maria=n_j hun vaku jirí=kun] hiya=n_i
 1SG=ERG manioc plant=SA.SIM=C_{MATRIX} Maria=ERG 1SG.GEN child feed=DS.SQ 1SG=ERG
 rivi jan vaku jirí=hi hun=ka=nu
 also 3SG.GEN child feed=IPFV 1SG=1.PRES=DECL
 ‘[While I plant manioc], [after Maria fed my kids], I, too, am feeding her kids.’
 (*Alternatively* ‘Maria fed my kids, so while I plant manioc, I, too, am feeding her kids.’)

In (v), both clauses have different subject (DS) markers. This is because the first person subject of the first clause is disjoint from the subject *Maria* of the second clause, which is the immediately superordinate clause. Likewise, *Maria* is disjoint from the first person matrix subject. The fact that the first clause cross-references the subject of the second SR clause rather than the first person subject of the matrix clause indicates that the first SR clause is adjoined within the other SR clause. (SR in Amahuaca does not skip clauses when hierarchical structure is taken into account.) The position of the second position clitic =*mun* confirms the given bracketing. Both clauses appear before =*mun*, meaning that they form a constituent to the exclusion of the matrix material. These two pieces of morphological evidence suggest that this example exhibits a nested structure.

The structure exemplified by the sentence in (vi) is different. Here, despite the same linear order of the two SR clauses, the first clause contains a same subject marker while the second still has a different subject marker. This is because both SR clauses now cross-reference the matrix subject, which is first person. The fact that both clauses can cross-reference the matrix subject is due to the fact that they exhibit a stacked structure, meaning that the matrix clause is the immediately superordinate clause for both of the SR clauses. This is confirmed by the position of the second position clitic here. The second position clitic =*mun* must now appear after the first SR clause, indicating that the two SR clauses do not form a single constituent now. This proposed difference in structure also aligns with the meaning differences between (v) and (vi).

The SR patterns found with nested and stacked SR clauses can easily be accounted for under the analysis I offer in Section 4.3, so long as we assume that Agree is phase-bound. This will prevent the agreeing SR probe from agreeing into another CP phase. The characterization of SR agreement as being phase-bound is consistent with other SR patterns in Amahuaca, such as the fact that DPs introduced in a PP and DP possessors cannot be tracked by the SR system, as shown in Appendix A.

(170) ‘After the woman_i boiled the meat, she_i ate it.’

- a. [xano=n_i nami kovin=xon]=mun *pro*_i ha=xo=nu
 woman=ERG meat boil=SA.SQ=C_{MATRIX} do.TR=3.PST=DECL
- b. [**kovin** xano=n_i nami=xon]=mun *pro*_i ha=xo=nu
 boil woman=ERG meat=SA.SQ=C_{MATRIX} do.TR=3.PST=DECL

In (170b) we see that the verb has moved to the initial position within the SR clause, resulting in VSO order. This resembles verb-initial orders in matrix clauses that I argued in Chapter 2 were derived via remnant VP fronting. Remnant VP fronting targets Spec,CP in matrix clauses, and absent any evidence to the contrary, I assume that the same position is the target of VP movement in SR clauses as well. This suggests that SR clauses contain a CP layer.

This evidence from the availability of case-marked arguments and various types of adjuncts, as well as from the acceptability of DP scrambling and remnant VP movement, within SR clauses suggests that they are quite large syntactically. I follow previous literature on SR within Panoan and more broadly in assuming that these clauses are full CPs (Finer 1984, 1985; Watanabe 2000; Camacho 2010, among others).

We now turn to the external syntax of these adjunct CPs. These clauses always appear relatively high in the matrix clause. The most common positions for them are in clause peripheral positions, either clause-initially (to the left of =*mun*), as in (171a), or extraposed to a clause-final position, as in (171b). It is also possible for these clauses to appear in a non-peripheral position. Specifically, some matrix material can move to an A'-position above the adjunct clause, as shown with the matrix subject in (171c).⁴ Note that in this case, the matrix subject appears to the left of =*mun* and the adjunct clause appears to the right of =*mun*.

(171) ‘After she_i sang, the woman_i is washing manioc.’

- a. [*pro*_i vua=xon]=mun xano=n_i hatza
 sing=SA.SQ=C_{MATRIX} woman=ERG manioc
 choka=hi=ki=nu
 wash=IPFV=3.PRES=DECL
- b. xano=n_i=mun hatza choka=hi=ki=nu [*pro*_i
 woman=ERG=C_{MATRIX} manioc wash=IPFV=3.PRES=DECL
 vua=xon]
 sing=SA.SQ
- c. xano=n_i=mun [*pro*_i vua=xon] hatza
 woman=ERG=C_{MATRIX} sing=SA.SQ manioc
 choka=hi=ki=nu
 wash=IPFV=3.PRES=DECL

⁴The Spec,CP position occupied by the subject in (171c) can be independently shown to be an A'-position by weak crossover, as outlined in Chapter 2.

The example in (171a) suggests that the SR clause may occupy the specifier of matrix C, accounting for its position before *=mun*. The example in (171c) suggests that these clauses may also occupy a lower position within the matrix clause. However, it is ungrammatical for SR clauses to appear below aspect marking, as seen by the unacceptability of the minimally different example in (172).

- (172) * xano= n_i =mun hatza choka=hi [pro_i vua= $\overline{\text{xon}}$]=ki=nu
 woman=ERG=C_{MATRIX} manioc wash=IPFV sing=SA.SQ=3.PRES=DECL
 ‘After she_{*i*} sang, the woman_{*i*} is washing manioc.’

Recall that the position to the right of aspect marking that the SR clause occupies in (172) is where matrix arguments appear when they remain in their base positions, as discussed in Chapters 2 and 3. Therefore, the ungrammaticality of (172) suggests that it is not possible for these adjunct CPs to be merged below the base position of matrix arguments. It is important to note that this does not seem to be due to the prosodic size of these clauses. As discussed in Chapter 2, it is grammatical for nominalized internally headed relative clauses to appear in this low position. This is demonstrated again in (173). This indicates that the restriction on the position of adjunct CPs is truly a syntactic restriction, rather than being due to their prosodic properties.

- (173) Juan_{*i*}=mun chivan-vo=hi [jan_i jono vuchi=ha]=ki=nu
 Juan=C_{MATRIX} chase-AM=IPFV 3SG peccary find=PFV=3.PRES=DECL
 ‘The peccary that he_{*i*} found is chasing Juan_{*i*}.’

In principle, the ungrammaticality of structures like (172), with an adjunct clause to the right of aspect, could reflect the unavailability of a merge position for the adjunct CP in the *vP* region of the clause. Alternatively, it could reflect a requirement that the clause move to a higher position. Deciding between these two options requires consideration of connectivity effects. Given that the structures in question necessarily involve multiple clauses, the clearest potential evidence comes from Condition C. If adjunct clauses originated below the merge position of main clause subjects, and subsequently underwent A'-movement higher in the clause (e.g. to Spec,CP), we would expect to find reconstruction for Condition C. Thus R-expressions in the adjunct clause would be unable to occur in the presence of a coindexed matrix subject. This expectation is not met: regardless of the relative position of an R-expression and coreferential pronoun in (174) and (175), no Condition C violation is triggered.

- (174) ‘After Maria_{*i*} went quickly, she_{*i*} washed clothes.’
 a. [pro_i koshi ka= $\overline{\text{xon}}$]=mun Maria= n_i chopa patza=xo=nu
 quickly go=SA.SQ=C_{MATRIX} Maria=ERG clothes wash=3.PST=DECL
 b. [Maria_{*i*} koshi ka= $\overline{\text{xon}}$]=mun pro_i chopa patza=xo=nu
 Maria quickly go=SA.SQ=C_{MATRIX} clothes wash=3.PST=DECL

In (174a) we see an example of an R-expression subject *Maria* in the matrix clause and a coreferential *pro* subject in the SR clause. In (174b) we find the reverse situation. The R-expression is now in the SR adjunct clause and the *pro* is in the matrix clause. Thus we can see by comparing the two examples that an R-expression can be overt in either the adjunct clause or the matrix clause with a coreferential *pro* in the other clause without triggering a Condition C violation. The lack of a Condition C violation in (174b) is especially surprising from the point of view of an account that would posit a low attachment site for SR clauses with subsequent A'-movement to Spec,CP of the matrix clause. The grammaticality of this example suggests that the adjunct clause does not reconstruct to a position below the coindexed matrix *pro*. The example in (175) shows that the situation is no different if the matrix clause contains an overt pronoun.

- (175) jaa=n_i=mun [Maria_i koshi ka=xon] chopá patza=xo=nu
 3SG=ERG=C_{MATRIX} Maria quickly go=SA.SQ clothes wash=3.PST=DECL
 ‘After Maria_i went quickly, she_i washed clothes.’

In (175) an R-expression subject appears in the adjunct clause and a coreferential overt third person singular pronoun *jaan* appears as the subject of the matrix clause. Here the matrix pronoun moves to an A'-position above the adjunct clause, but because this Spec,CP position is not an A-position, as discussed in Chapter 2, no Condition C violation is incurred. These data suggest, then, that even if adjunct CPs surface in a position higher than their base attachment site, they do not reconstruct to a position lower than the highest A-position of the matrix arguments.

Given these data regarding the internal and external syntax of SR clauses in Amahuaca, I propose the basic structure in (176) for these adjunct clauses.

(176)

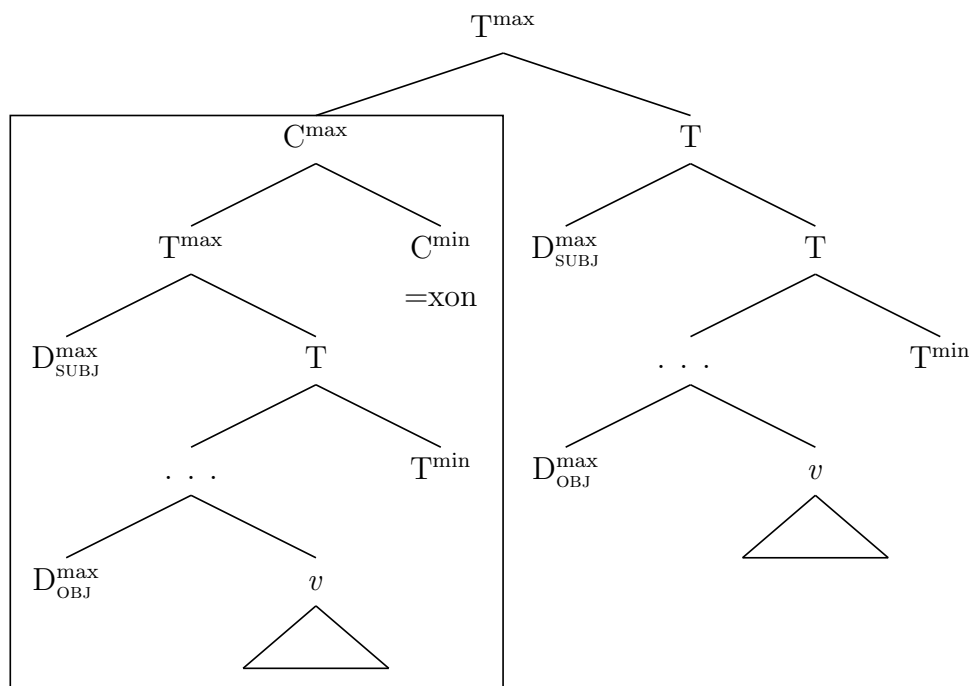

As can be seen in (176), the adjunct clause (boxed) constitutes a maximal projection of C, with the SR marker *=xon* lexicalizing C itself.⁵ These clauses adjoin to a projection of matrix T, above the position of the matrix subject and object.⁶ This attachment site is consistent with the ungrammaticality of SR clauses appearing to the right of aspect, as shown in (172), as well as the evidence just seen from Condition C for the lack of reconstruction effects.⁷ I assume that adjunct clauses, like other adjuncts, can undergo subsequent A'-movement from this position to occupy Spec,CP of the matrix clause.

4.1.2 Agreement in switch-reference clauses

Thus far, all examples of SR clauses have been given with the morpheme *=xon* in C indicating a sequential temporal relationship between the adjunct and matrix clause. However, this is not the only form that the morpheme indicating sequential action can take. In fact,

⁵I assume that adjunct CP is head-final, while matrix CP is head-initial, as discussed in Chapter 2. Camacho (2010) makes the same assumption for the CP of SR clauses versus matrix clauses in Shipibo (Panoan; Peru).

⁶Here I represent the object DPs in both the matrix and adjunct clauses as being outside the VP. This is in keeping with the evidence from remnant VP fronting that objects undergo object shift to Spec,vP, as discussed in Chapter 2. As shown in (170b), the same type of remnant VP fronting pattern found in matrix clauses appears to hold in adjunct clauses, suggesting that adjunct clause objects also undergo object shift.

⁷This attachment site at the TP level may also be related to the fact that SR clauses are dependent on matrix T for their tense interpretation. However, I leave the semantic interpretation of SR clauses as an open question for future research.

there are five distinct enclitics that fall within this paradigm.⁸ The choice among these morphemes is governed by coreference relationships between arguments in the matrix and adjunct clauses. This sensitivity to argument coreference between two clauses is the type of phenomenon that Jacobsen (1967) coined the term ‘switch-reference’ to describe. He defined SR as occurring when “a switch in subject or agent . . . is *obligatorily* indicated in certain situations by a morpheme, usually suffixed, which may or may not carry other meanings in addition” (Jacobsen 1967: 240, emphasis original).⁹ Following Munro (1979) and Haiman and Munro (1983), I will use the term ‘marked clause’ to refer to the clause that bears the morphological marker of SR, and I will refer to the clause that contains the other argument in the (non-)coreference relationship as the ‘reference clause’.¹⁰ As Jacobsen’s definition suggests, SR markers often encode more information than coreference between arguments. In Amahuaca, one of the additional meanings that SR markers contribute is information about the temporal relationship between clauses. Further, when an argument of the marked clause is coreferential with an argument of the reference clause, the form of the SR enclitic is sensitive to the abstract case of the relevant arguments. This pattern of sensitivity to argument coreference, temporal information, and grammatical function or case has been discussed in the descriptive literature on Amahuaca, most notably by Sparing-Chávez (1998, 2012) who refers to this phenomenon as ‘interclausal reference’. I draw on Sparing-Chávez’s descriptive account of SR markers in Amahuaca, and the meanings that I provide for the SR markers discussed here are largely the same as those she gives. However, it is important to note that she considers SR clauses and relative clauses together under the umbrella of interclausal reference. I here discuss only clauses which truly involve SR, drawing on the diagnostics proposed in Chapter 2 to distinguish these from relative clauses.

The first of the five relevant sequential action SR enclitics, the now-familiar *=xon*, is exemplified again in (177).

- (177) [jaa=x_i vua=xon]=mun xano=n_i xuki jova=xo=nu
 3SG=NOM sing=SA.SQ=C_{MATRIX} woman=ERG corn cook=3.PST=DECL
 ‘After she_i sang, the woman_i cooked corn.’

In this example, the subject of the marked (adjunct) clause is coreferential with the subject of the reference (matrix) clause, and the reference clause subject is the subject of the transitive verb *jova* ‘cook’. The use of *=xon* indicates the coreference of the two subjects, as well as the fact that the reference clause subject bears abstract (and in this example overtly marked)

⁸I set aside here a sixth form that is a portmanteau of third person plural subject agreement and a disjoint SR marker. See footnote 17 in this chapter for more details.

⁹I will show in this section that a characterization of SR in terms of the reference of subjects or agents only is not sufficient. Amahuaca SR can also indicate coreference relationships involving object DPs.

¹⁰In the simplest cases the marked clause will be an adjunct clause and the reference clause will be a matrix clause. However, because it is possible to nest SR clauses, this one-to-one mapping will not always hold. In a nested structure, one adjunct clause will take another adjunct clause as its reference clause. This higher adjunct clause, in addition to serving as a reference clause for the lower adjunct, will also be a marked clause that takes the matrix clause as its reference clause.

ergative case. In (178), we see a minimally different example where the reference clause subject is the subject of the intransitive verb *chirin* ‘dance’.

- (178) [jaa=x_i vua=hax]=mun xano_i chirin=xo=nu
 3SG=NOM sing=SS.SQ=C_{MATRIX} woman dance=3.PST=DECL
 ‘After she_i sang, the woman_i danced.’

Here there is still coreference between the two subject DPs, and this is indicated by the form =*hax* in adjunct C. The contrast between =*xon* in (177) and =*hax* in (178) indicates that these morphemes are sensitive to the distinction between the abstract nominative case associated with the intransitive subject (S) in (178) versus the abstract ergative case associated with the transitive subject (A) in (177).¹¹ In (179) the marked clause subject is coreferential with the reference clause object DP, as indicated by the form =*xo*.

- (179) [jaa=x_i vua=xo]=mun hinan xano_i chivan-vo=xo=nu
 3SG=NOM sing=SO.SQ=C_{MATRIX} dog.ERG woman chase-AM=3.PST=DECL
 ‘After she_i sang, the dog chased the woman_i.’

This example demonstrates that coreference relationships involving object DPs can also figure in the calculus of the form of adjunct C. This is particularly interesting since much of the literature on SR beyond Panoan has assumed that only subjects figure in SR marking.¹² The marker =*xo* here also shows sensitivity to the unmarked abstract accusative case of the language. Comparing (177), (178), and (179), then, we see sensitivity to all three case values of Amahuaca’s tripartite system.¹³ In (180), we see the final coreference marker of

¹¹Note that both transitive and intransitive matrix subjects in SR constructions can appear in a form that is morphologically unmarked for case, as seen for the intransitive subject in (178). As discussed in Chapter 3, these DPs that lack overt morphological case are still featurally differentiated due to their interaction with *v*. It is the feature (bundle) gained through agreement with *v* that serves to distinguish DPs in terms of abstract case.

¹²I will discuss how the Amahuaca system and the analysis I offer of it relates to the broader typology of SR marking in Section 4.5.

¹³Further evidence that the SR system is indeed sensitive to case comes from the treatment of indirect objects and objects introduced by an applicative. These DPs always surface in an unmarked (accusative) form, like direct objects and unlike subjects, which systematically vary between a case-marked and unmarked form. Thus, all three types of objects appear to have the same case, and indeed, they are treated identically by the SR system. When the marked clause subject is coreferential with the reference clause indirect or applied object, the same form =*xo* that is seen in (179) is used. This pattern is illustrated in Appendix A. Because all coreference relationships involving the marked clause subject and a reference clause object of any kind trigger =*xo*, this creates ambiguity when there is more than one object in the reference clause. For example, this happens in ditransitive constructions, as illustrated in (vii).

- (vii) [pro_{i/j} nokoo=xo]=mun joni=n Maria_i kankan_j maro=xo=nu
 arrive=SO.SQ=C_{MATRIX} man=ERG Maria pineapple buy=3.PST=DECL
 ‘After she_i/it_j arrived, the man bought pineapple_j from Maria_i.’

In (vii), it is ambiguous whether Maria arrived or whether a shipment of pineapple arrived. Both readings

the sequential action paradigm. Here the marked clause object is coreferential with the intransitive subject of the reference clause and adjunct C takes the form *=ha*.

- (180) [joni=n **xano_i** vuchi=ha]=mun **xano_i** ka=xo=nu
 man=ERG woman find=OS.SQ=C_{MATRIX} woman go=3.PST=DECL
 ‘After the man found the woman_i, the woman_i went.’

This example illustrates that the marked clause object, and not just the reference clause object, can affect the SR marking.

Notably, if no DP arguments are coreferential, a distinct default form *=kun* of adjunct C is used, as shown in (181).

- (181) [joni_i vua=kun]=mun xano_j chirin=xo=nu
 man sing=DS.SQ=C_{MATRIX} woman dance=3.PST=DECL
 ‘After the man_i sang, the woman_j danced.’

I assume that this marker *=kun*, which I gloss as a different subject marker, does not explicitly encode disjoint reference, but rather serves as a morphological default. Reason to think that this marker is a default is that it can be used when a marked clause object is coreferential with a reference clause transitive subject or when the objects of two clauses are coreferential.¹⁴ The full paradigm of the possible forms of adjunct C in sequential action SR clauses as a factor of coreference across clauses is given in Table 4.1.

		Reference		
		S	A	O
Marked	S	<i>=hax</i>	<i>=xon</i>	<i>=xo</i>
	A			
	O	<i>=ha</i>	<i>=kun</i>	

Table 4.1: Sequential switch-reference markers

In Table 4.1 we see that there is an asymmetry between the reference and marked clauses in sensitivity to the abstract case of the subject (or, alternatively, the distinction between intransitive subject (S) and transitive subject (A)). The S versus A status of the reference clause subject is reflected in the choice of SR marker, but the S versus A distinction is collapsed in the marked clause. Interestingly, the characterization of case laid out in Chapter 3 allows for exactly this type of asymmetry. In matrix clauses, both marked and unmarked

are possible in the right context. This behavior supports the treatment of SR marking as being sensitive to abstract case. Both *Maria* and *kankan* ‘pineapple’ bear abstract accusative case in the matrix clause in (vii). Therefore, both are able to trigger the marker *=xo*, leading to the ambiguity.

¹⁴See Appendix A for examples illustrating that some of the cells that are collapsed in Table 4.1 are indeed non-contrastive for the purpose of SR.

transitive subjects are possible. This means that it is possible for the transitive subject to agree with T or to remain low and agree only with v . That means that the only consistently available features to distinguish the abstract case or grammatical function of a matrix clause argument will be the features received from v . These features provide a three-way distinction between $[v_{\text{INTR}}]$ (abstract NOM/S), $[v, \phi]$ (abstract ERG/A), and $[v_{\text{TR}}]$ (abstract ACC/O). On the other hand, adjunct clauses share with perfective matrix clauses the property of lacking unmarked transitive subjects. The transitive subject always surfaces with ergative case. Like perfective matrix clauses, adjunct clauses lack overt aspect marking that surfaces in a clause-medial position. Following the analysis given for perfective clauses, I assume that v therefore does not undergo head movement to Asp in adjunct clauses. This means that T in adjunct clauses will always agree directly with the subject. The result is that adjunct clause subjects, both S and A, will consistently bear a feature [T]. This feature allows for a unified treatment of adjunct clause subjects in the SR system. In contrast, there is no feature that consistently unifies S and A arguments in matrix clauses, yielding the attested three-way split in the SR morphology with respect to matrix argument case.

While SR has been shown to have diverse properties crosslinguistically, it has been noted that many systems of SR share similarities with complementizer agreement and can potentially be analyzed as involving an agreeing complementizer (Watanabe 2000; Arregi and Hanink 2018). Drawing on the insight of these accounts, I will argue that the pattern of SR in Amahuaca involves an agreeing adjunct C. Rather than being sensitive to person and number features, this agreeing element is sensitive to referential indices (which I will model as ϕ -features, following Rezac 2004), allowing for the sensitivity to coreference relationships (cf. Finer 1984, 1985; Arregi and Hanink 2018, among others). It is also sensitive to case features, allowing for the sensitivity to (abstract) case. Particularly interesting for our purposes is that this adjunct C can reflect features of both marked and reference clause arguments. To account for this pattern, I propose that cyclic expansion of the probe on C allows it to agree directly with DPs in the clause to which adjunct CP is adjoined. In the following section I introduce the core Cyclic Agree machinery that I make use of.

4.2 Cyclic Agree: The framework

In accounting for the pattern of agreeing adjunct C in Amahuaca, I will assume that a probe's c-command domain can be cyclically expanded by successive instances of Merge, allowing the probe to agree with arguments in its own clause, but also in the matrix clause. This will be implemented via Cyclic Agree (Rezac 2003, 2004; Béjar and Rezac 2009).

The data which originally motivated Rezac's cyclic approach to Agree were patterns of 'agreement displacement' (or 'eccentric agreement'; Hale 2001). Agreement displacement generally refers to instances where the usual controller of agreement does not control agreement, and where ϕ -agreement is instead controlled by a different argument. Typically this takes the form of an external argument exceptionally controlling agreement that is usually controlled by the internal argument. Rezac (2003) analyzes such cases of agreement dis-

placement as involving a probe that usually agrees with a DP in its complement, but can exceptionally agree with a DP in its specifier if no accessible DP in the complement of the probe hosts the relevant ϕ -features.

This ability of a probe to agree with a DP in its specifier is not a stipulation and does not come with a generalized commitment to “upward Agree”. Instead Rezac argues that it falls out naturally from the c-command condition on Agree, fine-grained cyclicity in the syntactic derivation, and the assumptions of Bare Phrase Structure (BPS; Chomsky 1995b). First, when a head that contains a probe is merged, the probe searches its c-command domain (Rezac 2003: 159). It agrees with any eligible DPs in its complement (eligibility is determined by a combination of activity and locality (i.e. closest c-command), the details of which do not concern us here). If a probe cannot be valued by a DP in its complement (due to feature underspecification), this cycle of probing ends without the unvalued, uninterpretable feature on the probe being deleted. When the head hosting the probe reprojects to label the intermediate level projection, the probe on the head that still contains an unvalued feature reprojects as well.¹⁵ The c-command domain of this new segment of the probe is the specifier of its phrase. The probe is then able to probe this expanded c-command domain and agree with a DP in its specifier. This is exemplified for v in (182). First, the minimal projection of v probes its c-command domain, which contains the object DP. Next, the intermediate projection of v probes its c-command domain, which contains the subject DP.

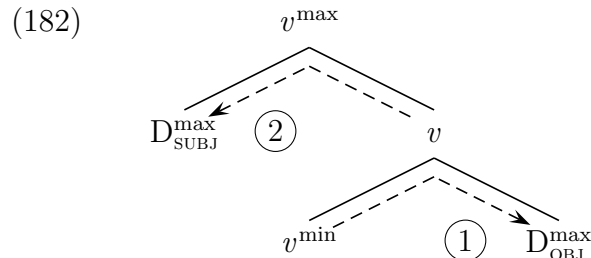

This style of account based on probe reprojection relies on the lack of a formal distinction between a head (X^0) and intermediate level projection (X'), foregrounded by BPS. Rezac argues that the search domain of a probe α cannot be naturally restricted to its complement because the complement has no privileged status. Rather the complement is simply the sister of α on first merge. The specifier is also a sister of α and should also be an eligible search space for α if α always probes its sister. The explanation, then, for why probes do not always agree with elements in their specifier lies in the notion of cyclicity. If all of the unvalued features on α have already been valued when the head that hosts it reprojects, it will not be able to probe again on a second cycle.

¹⁵My interpretation of Rezac’s analysis assumes that Merge and labeling/projection are two separate operations, with the relationship of sisterhood (and thus c-command) created by Merge, but with the resulting structure being labeled after Agree operations take place. For a precedent for the idea that labeling is not simultaneous with Merge see Chomsky 2013. Note that, in keeping with the version of narrow cyclicity that I adopt here, I do not assume that labeling only takes place at the phase level.

In Rezac 2003, the only instances of agreement displacement that are considered involve internal arguments that are underspecified for person or number features. Third person and singular number are taken to lack a representation in the syntax (in at least some languages). This means that a person probe cannot be valued by a third person goal because the goal lacks a person feature altogether. Béjar and Rezac (2009) expand the expected typology of agreement displacement by proposing that the feature structure of probes can be more highly articulated. For example, a probe could be keyed specifically to a SPEAKER feature, with first person fully valuing the probe, but any local person valuing more features of a probe (i.e. PARTICIPANT) than a third person argument. With this revised understanding of probes, then, it is possible that a probe can agree with a goal that is specified for person features on the first cycle of Agree, but still continue to probe on a second cycle if it has not been fully satisfied.

At the heart of Cyclic Agree accounts lies the observation that an unsatisfied probe is treated no differently on an intermediate projection of α than on a minimal projection of α . In both positions it can probe its sister. Crucially, in BPS, there is no formal distinction between the label of a maximal projection and an intermediate level projection. Thus the same reasoning that leads us to expect that an intermediate projection of α should be able to serve as a probe predicts that the maximal projection of α should also be able to probe its c-command domain if the probe remains unsatisfied. This is because the same projection algorithm that labels intermediate projections is employed to label maximal projections. The same conditions that allow a head (and an associated probe) to reproject to the intermediate level projection will allow this same label to reproject to a maximal level projection. Therefore, if an intermediate level projection can host a probe, a maximal projection can host a probe as well. This is the prediction of Cyclic Agree coupled with BPS.

In most cases it is not possible to test this prediction of the model. With common probes, such as *v* and T, the sister of the maximal projection will be the head that selects it. Therefore, the expanded c-command domain will not contain any goals that are merged with the types of inherent features that the probe is searching for. In this scenario, it is not possible to tell whether the maximal projection probes fruitlessly or is inert. However, in the following section I will argue that agreeing adjunct C yields exactly the right testing ground to evaluate this prediction, and that the prediction is borne out.

4.3 Insatiability, cyclic expansion, and maximal projection probes

As outlined in the previous section, the prediction of a Cyclic Agree model, given the assumptions of BPS, is that maximal projections should be able to probe their c-command domain if the probe associated with the projection remains unsatisfied. No further additions to the theory are necessary to derive this outcome – rather, some stipulation would be needed to block it. I will argue that the pattern of agreeing adjunct C in Amahuaca SR clauses is

derived via this type of cyclic expansion of the probe’s domain to the c-command domain of the maximal projection. Therefore, this prediction of Cyclic Agree is borne out in the Amahuaca system.

In order to account for the Amahuaca pattern of agreeing C I will adopt one further piece of technology, which, like Cyclic Agree, is independently motivated from outside of the domain of SR. I have so far spoken informally of a probe remaining unsatisfied after probing, as a necessary condition for it probing again. This notion of satisfaction (and, correspondingly, unsatisfiedness) draws on Deal’s (2015c) notion of satisfaction features for probes. Satisfaction features can be defined as particular featural specifications that cause probes to stop probing. Following Deal, I assume that a probe can interact with (i.e. copy back) other features in the set of ϕ -features even if those features will not serve to satisfy the probe. I illustrate this system of interaction and satisfaction with an example of Nez Perce (Sahaptian; USA) complementizer agreement drawn from Deal 2015c. In Nez Perce, the ϕ -probe on C is specified as having the satisfaction feature [ADDR(ESSEE)] – it is satisfied by and halts its probing only upon reaching a second person argument. However, the probe can interact with (copy back to itself) all ϕ -features. If it encounters a first person argument, it can also copy the features of that argument onto the probe and may expone those features. It can also expone other features in the ϕ -feature geometry, such as number features. The fact that the probe on Nez Perce C is satisfied only by the feature [ADDR] but can interact with other features yields a pattern of agreement that is sensitive to the syntactic position of second person arguments relative to other arguments in the clause. Consider the examples in (183) versus (184).

(183) ke-**m** kaa *pro_{subj}* cewcew-téetum *pro_{obj}*
 C-2 then 2SG telephone-TAM 1SG
 ‘when **you** call me’ (Nez Perce; Deal 2015c: 184)

(184) ke-**m-ex** kaa *pro_{subj}* cewcew-téetu *pro_{obj}*
 C-2-1 then 1SG telephone-TAM 2SG
 ‘when **I** call **you**’ (Nez Perce; Deal 2015c: 184)

In (183), the subject is second person and the complementizer only expones second person features; it does not show agreement with the first person object. In contrast, in (184) the object is second person and the complementizer expones the first person features of the subject as well as the second person features of the object. The reason that only the complementizer in (184) shows first person agreement stems from the fact that the second person argument occupies a lower position in (184) versus (183). In (183), the second person argument is highest. The probe on C will encounter the second person subject first and will be satisfied by the [ADDR] feature, causing it to halt its search. In (184), on the other hand, the first argument that C’s probe encounters will be the first person subject. It will interact

with this argument, copying its features back to the probe, but it will not be satisfied since first person arguments lack an [ADDR] feature. This means that C will continue to probe past the subject and will encounter the second person object. Because C interacts with both a first and second person argument (and because the agreement morphemes for first and second person are not in direct competition in Nez Perce), it will expone both first person and second person agreement. It is the ability to define satisfaction conditions that allows the probe to keep searching its c-command domain after interacting with a goal (see Halpert 2019 for another example of this type of pattern analyzed under an interaction and satisfaction model). Defining broader interaction conditions ensures that the probe will be able to copy back and expone more features in the geometry than the feature that satisfies it.

A distinctive feature of this theory is the natural way in which the separation of interaction and satisfaction conditions makes it possible to define an “insatiable” probe (Deal 2015b). If a probe entirely lacks satisfaction conditions, it will never stop probing until it reaches a phase boundary. Instead it will probe and interact with all potential goals in its search domain.¹⁶ With this notion of probe insatiability and Cyclic Agree, we are ready to examine the Amahuaca system of agreeing C in detail.

I propose that Amahuaca adjunct C hosts an insatiable probe. This means that adjunct C will probe all DPs in its c-command domain. First, when C^{\min} is merged it will probe its sister. This will contain the subject and the object of the adjunct clause, since object DPs undergo shift to the vP edge, escaping the vP phase. (Recall the evidence for object shift from remnant VP fronting discussed in Chapter 2.) In this first cycle of agreement, the probe on C will copy features from both of the arguments of the adjunct clause, as schematized in (185).

(185)

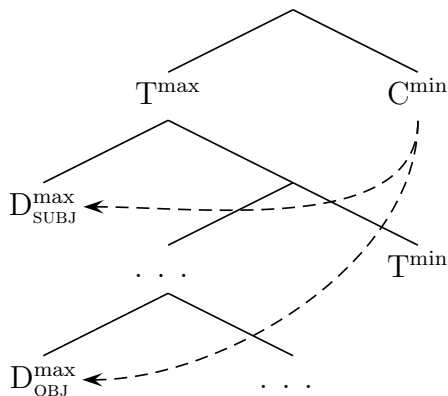

Because C’s probe is insatiable, C will remain unsatisfied after first cycle probing, regardless of the feature specifications of the adjunct clause arguments. This means that when C

¹⁶What is needed to model the Amahuaca system is a way for a probe to enter into an Agree relation with all DPs in the adjunct and matrix clause. Probe insatiability is one way to model this. Any competitor for an interaction and satisfaction model of Agree would have to provide some way of allowing a probe to target all DPs in its c-command domain.

reprojects to form a maximal projection, the probe on C will be reprojected as well and can probe again on a second cycle. The c-command domain of this new segment of C, C^{\max} , will contain the matrix (or reference) clause arguments. This is because C^{\max} adjoins high in the matrix clause, above the highest A-position of the matrix subject and object, as evidenced by the lack of Condition C effects discussed in Section 4.1.1. This means that on the second cycle of Agree, C^{\max} will be able to probe into the matrix clause directly and agree with the matrix subject and object, as seen in (186).

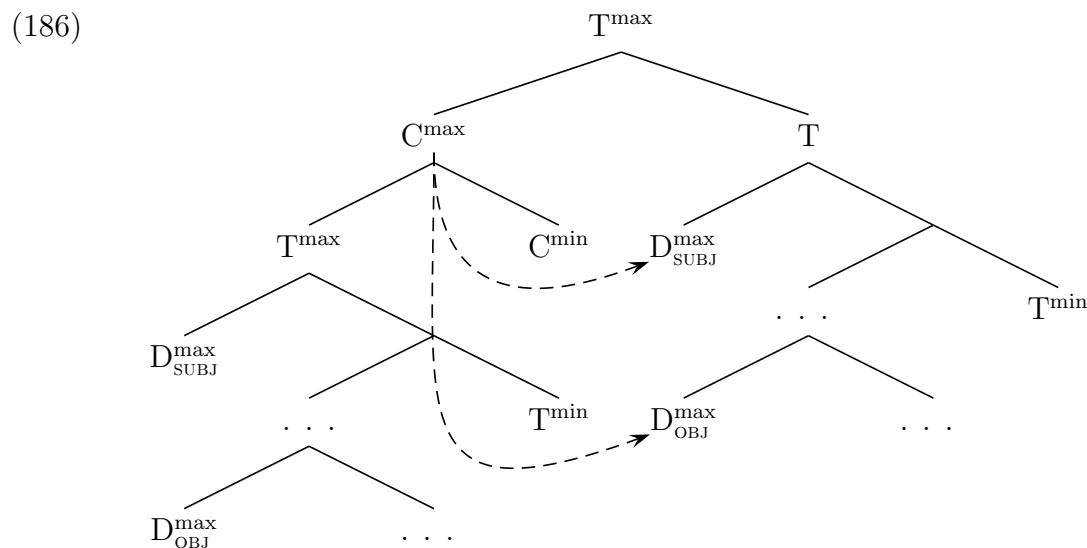

After this cycle of probing, C will not reproject again, and neither will the probe that it hosts. This means that C’s probing will come to an end after this second cycle of probing. At this point, C will contain the features of both the matrix (reference) and adjunct (marked) clause arguments.

It is now worth considering what features on C will be relevant for determining the form of the vocabulary item that is inserted. Unlike prototypical ϕ -probes, Amahuaca adjunct C does not generally covary with the person and number features of any arguments of the two relevant clauses.¹⁷ Instead, it is sensitive to argument coreference and to the abstract case of arguments. Sensitivity to coreference can be captured by assuming that C copies syntactically represented referential indices, which I assume are part of the bundle of ϕ -features, following Rezac (2004; see also Hicks 2009, Kratzer 2009, Moulton 2009, Deal 2017b, and Arregi and Hanink 2018, among others, for the idea that indices can be present through the syntactic derivation and are similar to other features that DPs can bear, such as person features).

¹⁷ This is true for instances of C that indicate argument coreference, but is more complicated for those that indicate that there is no coreference relationship between arguments. Here person and number features are relevant for the spell out of C. Specifically, if the subject of an ‘after’ clause is a third person plural DP, the form of C will be *=havan* instead of the expected *=kun*. This suggests that the probe on C does copy person and number features from the arguments that it interacts with, even if it does not typically expone those features.

Now we must consider how abstract case features are transmitted to C under Agree. Recall that the Amahuaca case system is tripartite, showing a morphological distinction between nominative, ergative, and accusative case. This means that all three types of arguments (S, A, and O) are distinct in terms of the case features associated with them. As discussed in Chapter 3, the features received from Agree with v differentiate all three types of DPs at an abstract level, even though they are not sufficient to license overt case marking. This means that the abstract featural representation of case in terms of features gained from v is sufficient to distinguish these DPs for the purpose of selecting the correct morpheme to spell out adjunct C, even in configurations where case is unmarked morphologically. The question, though, is how such features are copied to C, since case features are not typically assumed to be part of the ϕ -geometry. The idea that case can affect Agree relations is not without precedent in the literature (see, e.g., Chomsky 2000 on activity, Béjar and Rezac 2003 on PCC effects, Preminger 2014 on case discriminating agreement, and Deal 2017a on syntactic ergativity, among others). However, it is not typically assumed that case features are copied onto probes (though Georgi 2013 does assume this).

Recall that we are assuming a distinction between the set of features that satisfy a probe and the set of features that a probe may interact with. Deal (2015c) hypothesizes that a probe that is satisfied by a ϕ -feature interacts with the full set of ϕ -features, according to the formulation in (187).

(187) Interaction (Deal 2015c: 180)

A probe may interact with feature set F even if it may only be satisfied by feature set G, where $F, G \subseteq \Phi$ (the set of ϕ -features) and $F \neq G$

Under these assumptions, a probe may essentially interact with all ϕ -features, regardless of its satisfaction conditions. The problem, then, is that case features are not typically assumed to fall into the set of ϕ -features. Notably, this is only an issue if we assume that interaction conditions are uniformly restricted to ϕ for all ϕ -probes. I will consider two solutions to this problem here. The first solution assumes that interaction is constrained by feature geometries, while the second assumes that interaction conditions can be comprised of disjoint feature sets.

Baier (2018) proposes that ϕ -probes interact with a larger set of features, within which ϕ -features are embedded. Specifically, in analyzing anti-agreement, Baier argues that all ϕ -probes interact with the feature set \mathcal{F} , which contains both ϕ -features and A' -features. If we adopt the assumption that ϕ -features are indeed embedded in a larger geometry, this would allow us to capture the fact that case features can be copied to a probe via Agree. Specifically, we could assume that case-related features comprise a feature set \mathcal{K} , which is embedded within the larger set \mathcal{F} proposed by Baier. The feature sets A' , \mathcal{K} , and ϕ could form a flat feature structure within \mathcal{F} , as in (188).

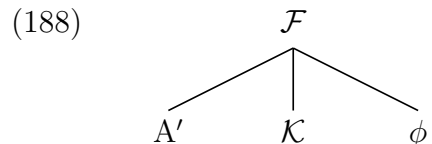

Alternatively, we might assume a hierarchical organization of these sets within \mathcal{F} . For example, \mathcal{K} and ϕ could form part of a larger set, call it \mathcal{D} – features that can appear on DP. This set \mathcal{D} and the set A' could then fall under \mathcal{F} , as in (189).¹⁸

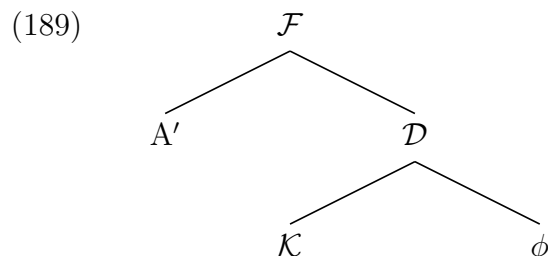

Assuming a feature geometry like the one in (188) or (189), we could simply adopt Baier’s (2018) interaction hypothesis in order to account for the transmission of case features to a probe in Amahuaca. If all ϕ -probes interact with the set \mathcal{F} , this would straightforwardly allow case features to be copied to the probe.

An alternative hypothesis that is consistent with the Amahuaca data is that interaction is not restricted by feature geometries. Rather, interaction conditions can be specified in terms of multiple disjoint sets of features. If we make this assumption about interaction conditions, then defining a probe that will copy back case features is straightforward. We can specify the interaction conditions of the probe on Amahuaca adjunct C as $\{\phi, \mathcal{K}\}$. This will allow the probe to copy back ϕ -features, including referential indices, as well as case features from all DP goals. For the purpose of the Amahuaca data, both hypotheses we have considered here will derive the desired results. I leave it as an open question for future research in other empirical domains whether interaction conditions are constrained by feature geometries.

We now turn to the details of Vocabulary Insertion. If two of the DPs that Amahuaca C has agreed with share the same referential index, this will license the insertion of one of the various coreference markers in C. The choice of marker will be determined by the abstract case features of the DPs that are involved. The proposed vocabulary items for the series of sequential action SR markers are given in (190).

¹⁸Even in a non-flat geometry, it is not crucial that \mathcal{K} be located at a lower position in the feature geometry than A' . The geometry in (189) is one possible organization, and it may be compatible with the assumptions of Coon et al. (2019) that \mathcal{F} is divided into A' and \mathcal{D} features. I am unaware of any crosslinguistic generalization regarding an implicational relationship between case agreement and A' -agreement that would motivate a higher or lower position of \mathcal{K} with respect to A' .

(190) Sequential SR vocabulary items

[[SQ, [i, T]] [i, v _{INTR}]]	↔	/hax/
[[SQ, [i, T]] [i, [v, φ]]]	↔	/xon/
[[SQ, [i, T]] [i, v _{TR}]]	↔	/xo/
[[SQ, [i, v _{TR}]] [i, v _{INTR}]]	↔	/ha/
[SQ]	↔	/kun/

Note, first, that for each of the four coreference markers there are five relevant features that must be matched for a vocabulary item to be inserted. The feature [SQ] indicates that a sequential temporal relationship holds between the two clauses. This feature serves to distinguish markers in this paradigm from SR markers in other paradigms, such as the simultaneous paradigm. In addition to this temporal meaning, each of the coreference markers indicates something about the featural content of two DPs that the probe has agreed with, indicated in two separate bundles within brackets.¹⁹ In the formulation of these vocabulary items I assume that the features on probes are structured, as indicated by the use of square brackets. I propose that feature bundles on probes are structured in two different ways. First, bundles of features copied from a single goal remain differentiated as a unit from the features copied from distinct goals (see Deal’s 2015c discussion of first person plural inclusive morphology in Nez Perce for an argument that such differentiation is needed at some stages of Vocabulary Insertion). This type of structure is needed to ensure that index and case features copied from a single DP remain associated with each other and are together differentiated from the index and case features copied from all other DPs. Second, I assume that a layer of structure is added when a probe reprojects. This means that the features received on a second cycle of Agree (in this case, features of the reference clause arguments) will be distinguishable from features received on the first cycle of Agree (in this case, features of the marked clause arguments). For the current account we need not assume that an additional layer of structure is needed to distinguish the order in which goals were agreed with on a single cycle. Note that it is necessary for Béjar and Rezac (2009) to assume that features received on the first cycle of agreement are sometimes treated differently than features received on the second cycle of agreement for the purpose of Vocabulary Insertion. They accomplish this by assuming that morphemes are sensitive to which projection of the probe they spell out (e.g. v^{\min} , v , etc.). This approach will not yield the desired results in Amahuaca, since all SR morphology is inserted after both cycles of probing. However, the structured feature bundles I assume provide an alternative way of capturing this sensitivity that is compatible with the Amahuaca data, as well as the data discussed by Béjar and Rezac (2009).

Consider now the specific vocabulary items in (190). We see that the vocabulary item for =*hax* indicates that a marked clause argument and reference clause argument share a referential index. This is represented by *i* in the two feature bundles, which signifies that the value of the indices of the two DPs must match. An additional condition on the

¹⁹Note that if one or both of the clauses involved is transitive, C will have agreed with more than two DPs. Only the features of DPs in coreference relationships will be relevant for choosing between vocabulary items. The features of the other DPs will be ignored.

insertion of this vocabulary item is that the marked clause DP, which corresponds to the first, most embedded DP bundle, is a subject. This is achieved through the feature [T]. Recall from Chapter 3 that in order for ergative case to surface, a subject DP must enter into an agreement relationship with T and receive a [T] feature. In SR marked clauses, all transitive subjects surface with ergative case – there are no unmarked transitive subjects in these clauses.²⁰ This suggests that subjects in marked clauses always agree directly with T, meaning that the feature [T] will appear on all subjects, both transitive and intransitive. The final condition upon the insertion of *=hax* is that the reference clause DP is an intransitive subject (i.e. that it has abstract nominative case). This final condition is enforced by the feature [*v*_{INTR}] on the reference clause DP, in keeping with the analysis of Chapter 3 that agreement with an intransitive *v* distinguishes intransitive subjects from other arguments. This feature can be thought of as an abstract nominative case feature. The vocabulary item *=xon* is minimally different from *=hax*. It indicates that the coreferential reference clause argument is a transitive subject, via the feature bundle [*v*, ϕ], which can be thought of as abstract ergative case, following the arguments in Chapter 3. The enclitic *=xo* indicates that the relevant reference clause argument is an object. This is indicated by the feature [*v*_{TR}], which is equivalent to abstract accusative case. The morpheme *=ha* is inserted when the marked clause object ([*v*_{TR}]) is coreferential with a reference clause intransitive subject ([*v*_{INTR}]). Finally, the marker *=kun* is only sensitive to the temporal relationship between the clauses and not to coreference relationships. Assuming standard competition mechanisms in Distributed Morphology (Halle and Marantz 1993), this marker will serve as the default and will be inserted when no more highly specified vocabulary item can be inserted in C.

To illustrate how this proposal works for an example, consider the sentence in (191).

- (191) [jaa=*x*_i vua=xon]=mun xano=*n*_i xuki_j jova=*xo*=*nu*
 3SG=NOM sing=SA.SQ=C_{MATRIX} woman=ERG corn cook=3.PST=DECL
 ‘After she_i sang, the woman_i cooked corn.’

When the adjunct clause C has completed both cycles of probing it will have agreed with the adjunct clause subject and the matrix clause subject and object. This means that adjunct C will (minimally) have the features shown in (192a).²¹

- (192) a. Features of adjunct C in (191)
 [[SQ,[*i*,*v*_{INTR},T,Foc]] [*i*,[*v*, ϕ],T] [*j*,*v*_{TR}]]
 b. Features of *=xon* vocabulary item
 [[SQ,[*i*,T]] [*i*,[*v*, ϕ]]]

²⁰This mirrors the pattern found in matrix perfective clauses. Like perfective clauses, SR clauses lack an aspect marker that linearly splits the clause. Thus the explanation given in Chapter 3 for consistent ergative marking in perfective clauses (namely, a lack of head movement from *v* to Asp, bleeding indirect agreement between T and *v*) can derive the ergative case pattern in SR adjunct clauses. It is also worth noting here that intransitive subjects are not obligatorily case marked in SR clauses (once again mirroring the behavior of matrix perfective clauses). This is because nominative case require focus, not just agreement with T.

²¹I do not represent person and number features here. Since these will be third person singular for all of the involved DPs, they may actually be unspecified.

Here C contains sequential temporal information, the features of an overtly nominative-marked DP from the first cycle of agreement, the features of an overtly ergative-marked DP from the second cycle, and the features of an object (accusative) DP from the second cycle. Crucially, the nominative and ergative DPs share a referential index. We can see that the features of the SR marker *=xon* in (192b) are a subset of the features on C. Moreover, there is no vocabulary item in (190) that matches a larger subset of the features on C. Therefore, *=xon* will be inserted. In this derivation, the features of the object DP, while copied to C, do not affect Vocabulary Insertion, because there is not a vocabulary item that matches the features of the coreferential subject DPs and indicates anything about the object (nor is there a vocabulary item that indicates explicitly that either subject is disjoint from an object.) Further, many of the features related to the morphological exponence of case on the two subject DPs do not affect the choice of SR marker since there is no SR marker that is more highly specified to indicate the full set of features needed for morphologically overt nominative or ergative case rather than abstract case.

The account outlined here builds on the insight of Watanabe (2000) that SR is a form of complementizer agreement. Rather than exponing agreement with arguments in only one clause, as in typical cases of complementizer agreement, SR expones agreement directly with arguments in two different clauses (Arregi and Hanink 2018). An advantage of the current account’s formalization of this idea is its parsimony: all of the technology needed to account for this pattern of SR has been argued to be independently necessary on the basis of evidence from distinct empirical domains. There are independent arguments for Cyclic Agree (see Rezac 2003 and Béjar and Rezac 2009 on agreement displacement crosslinguistically), for insatiable probes (see Deal 2015b on Nez Perce verbal agreement), and for treating indices as ϕ -features (see Rezac 2004 on English copy raising constructions). The combination of these existing technologies and assumptions yields the correct results for SR without further stipulation. In the following section I will compare the current analysis with previous accounts of similar phenomena and will demonstrate that this account gives better empirical coverage while also avoiding the introduction of additional mechanisms into the theory.

4.4 Previous analyses

Most formal accounts of SR can be divided into two basic categories: accounts which rely on some mechanism of tracking referential indices and those which assume reference tracking is not directly involved. In this section I consider both types of accounts of SR.²² I also consider

²²Note that the set of accounts considered here is not exhaustive. Among other things, I set aside most accounts that concern themselves with what has been termed ‘non-canonical switch-reference’ (Stirling 1993). Non-canonical SR refers to a phenomenon where subjects that are disjoint can trigger “same subject” marking or subjects that are coreferential can trigger “different subject” marking – that is, it is not the referential indices of arguments, or any notion of sameness of arguments, that is tracked. In systems that allow such “unexpected” same or different subject marking, it has been argued that the SR system is sensitive to sameness of topic situation rather than argument coreference (McKenzie 2012). The Amahuaca system (along with many other systems of SR), does not show evidence of this non-canonical pattern of SR marking.

an account of upward-oriented complementizer agreement (Diercks 2013) that suggests a straightforward extension to account for SR. I demonstrate that all three types of approaches face empirical challenges when faced with the full range of Amahuaca data. Here I will focus on three specific facets of the Amahuaca pattern that prove to be difficult to capture under competing analyses: 1) the sensitivity of SR to the reference of object DPs, 2) the simultaneous availability of overt coreferential subjects in both the marked and reference clause, and 3) the high attachment site of SR clauses.

4.4.1 Accounts of switch-reference parasitic on agreeing T

The first set of accounts of SR that I will consider represents the traditional assumption that reference tracking is directly involved in SR (Finer 1984, 1985; Watanabe 2000; Camacho 2010). Often these accounts posit that patterns of SR are parasitic on agreement on T (or some close equivalent – Infl, AgrS, etc.). These accounts propose that subject agreement on T is interpreted as SR through some mechanism at the CP level, the exact details of which vary from account to account. Since subject agreement is what is relevant for SR, these accounts (implicitly or explicitly) rule out object tracking of the type found in Amahuaca. They take this to be a welcome prediction, to the extent that they address it, since it has been widely assumed (often implicitly) that subjects are the only arguments relevant for SR. The prediction of these accounts is that all examples that involve non-coreferential subjects should receive different subject marking (in my system, default marking), regardless of coreference relationships involving other arguments. In this section I will show how this prediction is problematic, given the Amahuaca data.

The first theory to be considered under the umbrella of those that involve more or less direct reference tracking is the account of Finer (1984, 1985). Finer’s account of SR using mechanisms of the Binding Theory served as a departure point for many later generative accounts of SR (Hale 1992; Watanabe 2000; Nonato 2014, among others). I will not consider here all of the updates that have been proposed to Finer’s theory since most rely on the same basic mechanisms of binding and face similar challenges.

Finer analyzes SR as part of generalized Binding Theory – that is, Binding Theory which involves A’-positions and not only A-positions (Aoun 1986). He argues that same subject (SS) markers are A’-anaphors while different subject (DS) markers are A’-pronominals. The basic idea is that the matrix C and the embedded C,²³ which surfaces as a SR marker, each have features of the subjects of their respective clauses. If they share the same features, the embedded C is A’-bound in its governing category (Finer assumes C itself is an A’-position) and surfaces as a SS marker. If they have different features, the embedded C is A’-free in its governing category and surfaces as a DS marker.

Getting into the details of the analysis, Finer posits that C receives the features of the subject via T in both matrix and embedded clauses, since T agrees with the subject. He

²³Throughout I will uniformly refer to T and C, even though the accounts I consider may use slightly different, but essentially equivalent, labels for these projections.

assumes that the matrix clause is the governing category for the embedded C. This means that any coindexed, c-commanding element in an A'-position in the matrix clause can A'-bind the embedded C. If the matrix and embedded subjects are coindexed, both matrix and embedded T and C will receive this index. This will result in a SS marker – an anaphor. If, instead, matrix and embedded subjects have distinct indices, the matrix and embedded T and C will have different indices and embedded C will surface as a DS marker – a pronominal. These two possible structures are shown in (193) and (194), adapted from Finer (1985).

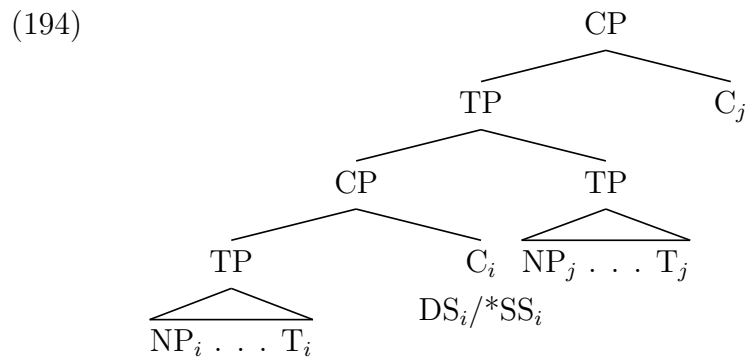
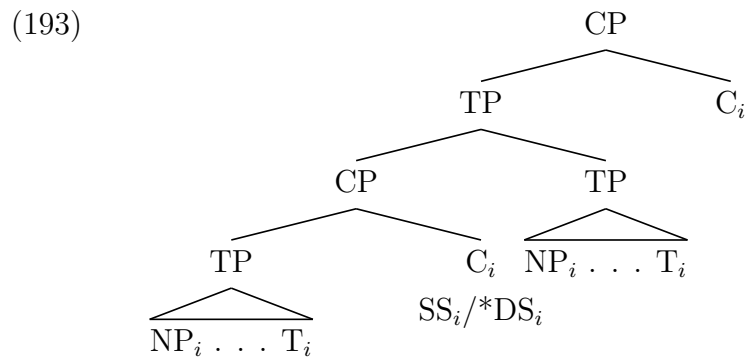

In (193) the SS marker surfaces since the subjects of both clauses are coindexed. The DS marker is ruled out in this structure because it would constitute a Condition B violation – it would be a pronominal bound in its governing category. In (194) we see the opposite pattern. The two subjects are not coindexed and the DS marker surfaces. The SS marker is ruled out, due to Condition A – if the SS marker surfaced it would be a free anaphor.

Finer argues that a binding theoretic account of SR is desirable because it accounts for three crucial properties of SR – its obligatoriness, its locality, and its subject-orientation. By obligatoriness, Finer means that when a SS marker is licensed, a DS marker is ruled out, and vice versa. If these are simply A'-versions of familiar anaphors and pronominals, this behavior is expected. In most configurations, only a pronominal or only an anaphor is licensed for a particular indexation. By locality, Finer refers to the fact that SR is sensitive to the index of the subject in the immediately superordinate clause and cannot “look” higher up in the structure. This is accounted for by assuming that the conditions on SS

versus DS markers are sensitive only to elements within their governing category (i.e. the immediately superordinate clause). Finally, by subject-orientation, Finer means that SR systems generally track only subjects, not objects. Since the SR markers Finer proposes receive indices from T, which, in turn, receives its index from the subject, this is expected. However, the view sketched out by Finer makes predictions about when object-orientation should be possible. Finer assumes that an A'-element with the object's features would occur internal to VP. If this element were in the embedded VP it could then be c-commanded by matrix C to derive a pattern of OS marking – that is, a special SR marker indicating that the embedded object is coreferential with the matrix subject.²⁴ However, Finer claims that the reverse pattern should not be possible. If an A'-element bearing the matrix object's index is within the matrix VP, it will not c-command the embedded C. He argues that this should rule out SO marking – a marker that indicates the embedded subject is coreferential with the matrix object. However, this is exactly the type of coreference relationship that Amahuaca =*xo* indicates, which is a problem for this type of account.²⁵

Watanabe (2000) offers an update of Finer's (1984; 1985) account of SR into Minimalism. He proposes that the ϕ -features of the subject are copied onto T via Agree. He proposes that T undergoes head movement to C, resulting in the ϕ -features of the subject being on a complex head in C. This pattern of feature copying and head movement is argued to take place in both SR and complementizer agreement.

We now turn to the pieces of Watanabe's analysis that are specific to SR. The feature copying and head movement to C is argued to happen in both the matrix and the embedded clause. This results in a c-command relationship between the formal features of the matrix subject on matrix C and the formal features of the embedded subject on embedded C. Watanabe argues that ϕ -features that were moved to the embedded C are associated with binding features (Chomsky and Lasnik 1993) [\pm pronominal] and [\pm anaphoric] that are in C. This makes these ϕ -features candidates for binding by the ϕ -features on matrix C. The generalization about the realization of SS versus DS is then the same as Finer's: SS morphology realizes bound ϕ -features while DS morphology realizes free ϕ -features. These possibilities are shown in (195) and (196), adapted from Watanabe (2000: 174). Note that I use indices on ϕ -bundles and DPs as a notational convention to indicate coreferentiality. Arrows indicate head movement of T, and dashed lines indicate which DP a ϕ -bundle corresponds to.

²⁴ Finer (1985) mentions that this pattern of OS marking may be attested in Yup'ik's (Eskimo-Aleut; USA) fourth person system (Payne 1979). He does not, however, provide details of how such an account would work. For example, it is unclear how an element in the embedded VP would be able to be sensitive to features of head in the matrix clause since its governing category would presumably be the embedded clause.

²⁵The Amahuaca morpheme =*haito* from the simultaneous action SR paradigm shows this SO coreference pattern as well.

(195)

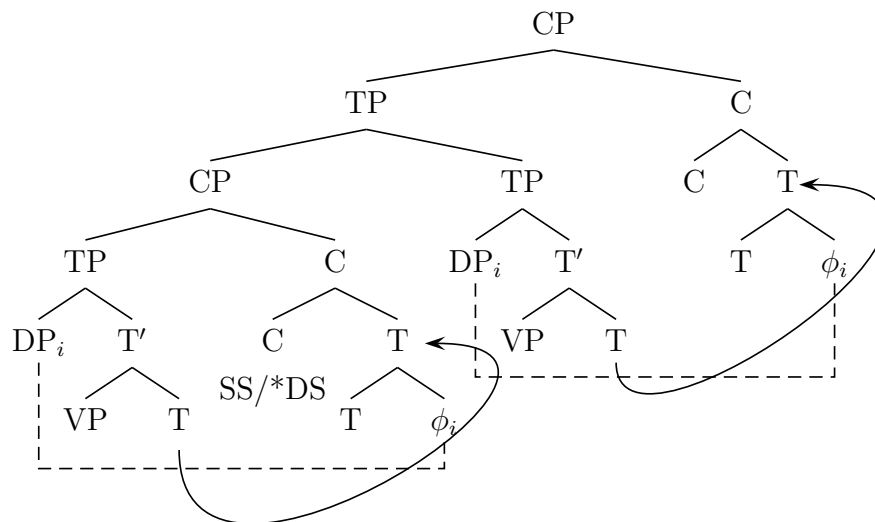

(196)

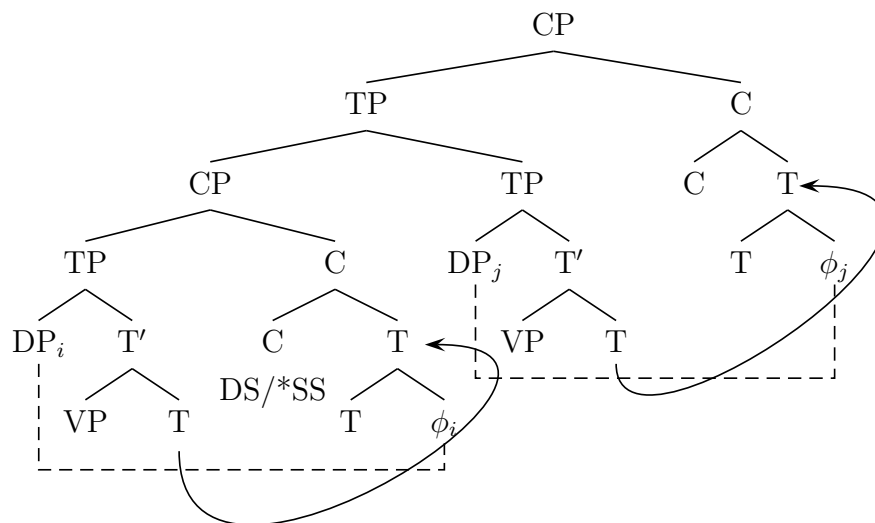

In (195), the ϕ -features of the embedded clause subject in C are in a relationship of referential dependency with the ϕ -features of the matrix subject in matrix C. This is the configuration that leads to SS marking. In (196) there is no such referential dependency, and DS marking is used.

For Watanabe, the features present on C in both clauses are always the features of the subject of that clause. This is because C receives features from T via head movement and T receives the features of the subject via subject agreement. Therefore, like Finer's (1984; 1985) account, this update shares the property of allowing only subject coreference relationships to figure in SR.²⁶

An account which differs somewhat from the Finer-style binding approach to SR but which I will still consider under the umbrella of reference-tracking theories of SR that are

²⁶Watanabe (2000) does not address the potential pattern of OS marking that Finer (1985) mentions. See footnote 24 in this chapter for more details.

parasitic on agreeing T is that of Camacho (2010). Like other reference-tracking theories, it does involve exchange of ϕ -features between clauses to yield SS marking. However, it differs from the theories discussed thus far in assuming that the SR head does not establish referential dependency with a superordinate C.

Camacho’s analysis of SR is designed to account for the transitivity sensitivity of Panoan SR systems, based mostly on data from Shipibo.²⁷ Like in Amahuaca, SS constructions in Shipibo have a different form of marking depending on whether the matrix subject is a transitive or intransitive subject. He argues that SS marking is triggered by an uninterpretable case feature on the SR marker. This feature is present only in SS clauses, triggering agreement between the two clauses. In DS clauses this Agree operation does not take place.

Camacho posits that the case feature on SS morphemes is composed of an uninterpretable ϕ -feature and an uninterpretable tense feature. The $u\phi$ feature on the SS marker triggers the SR morpheme in C to establish an agreement dependency with the subject of its clause, which is also in a dependency with T. Camacho assumes that only the matrix T has valued interpretable T features, so the uT feature on the SS marker will result in it probing matrix T.²⁸ Since matrix T will have agreed with the matrix clause subject it will bear the matrix subject’s ϕ -features. Camacho assumes that the ϕ -features on the agreeing heads must be the same in order for the Agree operation to be successful.²⁹ This operation is schematized in (197) with dashed lines indicating pathways of feature valuation via Agree.

²⁷Another analysis of SR within Panoan is that offered by Camacho and Elías-Ulloa (2001) for Capanahua. Under their analysis, SR constructions involve conjoined clauses. The verb of each clause undergoes head movement to the highest head in its clause and these two heads agree with each other, passing on information about the arguments of the verb. The morphosyntactic details of this proposal are not fully fleshed out, making it hard to evaluate for Amahuaca. However, the fact that head movement of the verb in Amahuaca does not proceed higher than aspect (with the verb surfacing clause-medially) seems problematic for their account.

²⁸Note the similarity here to Assmann’s (2012) treatment of Quechua SR. Assmann assumes that the SR clause T in Quechua has an unvalued tense feature, which causes it to probe the matrix T. The two T heads can only successfully enter an Agree relation if all of the features on them match. Since both instances of T will have agreed with the subject of their respective clause this means the subject must be the same for Agree to take place. Under Assmann’s account, SS marking is the reflex of successful tense agreement while DS marking is a default value inserted when Agree fails.

²⁹Camacho discusses a few possible scenarios with respect to the ϕ -features from the two subjects. One scenario is that one of the two subjects is *pro* and lacks valued ϕ -features. In this case, the link established via Agree will actually result in feature valuation of the ϕ -features of this *pro* with the ϕ -features of the overt argument in the other clause. This valuation can happen from SR clause to matrix clause or vice versa. However, like in Amahuaca, in Shipibo it is possible to have an overt subject in both clauses (Camacho and Elías-Ulloa 2010). In this case, Camacho assumes that both subjects have their own valued ϕ -features, but that “some grammatical principle ensures that the ϕ -feature values of the two agreeing categories cannot have contradictory indices” (Camacho 2010: 261). Only in discussion of two overt subjects does Camacho bring up the role of indices in this system, but he is not explicit about what the status of indices is in his theory. Presumably they are part of ϕ -feature bundles and are necessary to distinguish coreferential versus noncoreferential third person DPs, even though the Agree mechanism for SR is stated in terms of person and number features only.

(197)

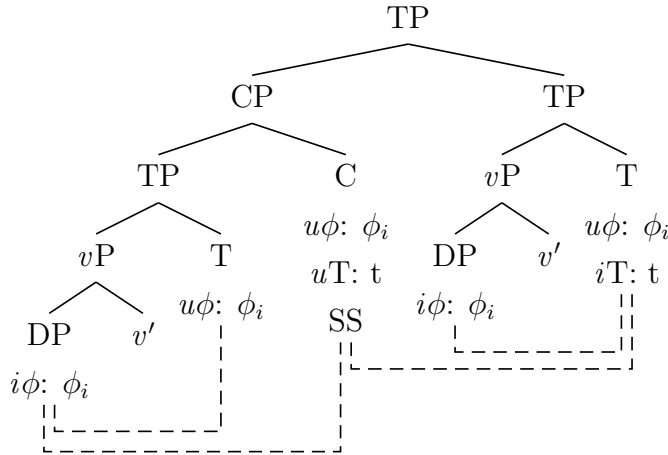

In (197), the two subject DPs, the two instances of T, and the SR clause C all have the same ϕ -features via Agree. The C also shares a T feature with matrix T. This configuration represents a SS clause.

In DS clauses, Camacho argues that no such Agree relation is established between the SR marker (C) and other elements. He assumes that DS markers lack $u\phi$ and uT (i.e. they lack an uninterpretable case feature) and thus do not participate in Agree. This structure is shown in (198).

(198)

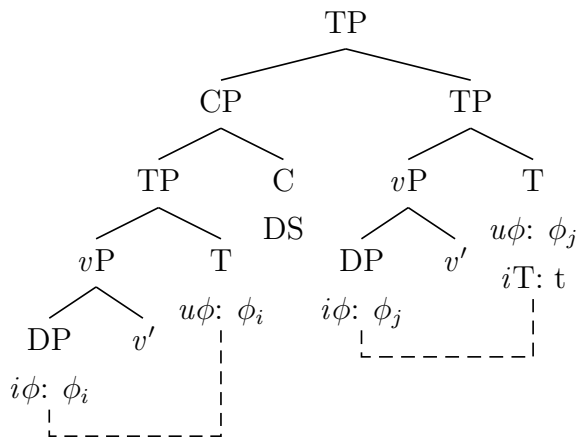

In (198) the only exchange of ϕ -features is between the subject and T of each clause. There is no cross-clausal agreement. Note, too, that the ϕ -features of the two subjects are distinct (which I indicate with an index). There is nothing in the derivation of a DS structure that actually rules out coreference of subjects. Camacho relies on a type of economy condition to rule out coreferential DS structures. He argues that spreading ϕ -features via Agree (as in a SS derivation) is more economical than merging the same ϕ -features twice in two separate DPs. So the availability of a SS derivation with Agree will block a more costly DS structure.³⁰

³⁰It is not clear to me how this solution rules out DS structures with two overt subjects when SS structures

Like the other reference-tracking accounts, Camacho’s system is not designed to allow for object tracking since agreement between clauses is mediated through T, which agrees with the subject. However, Valenzuela (2003) argues that Shipibo has a SR marker *-a* that indicates that the object of the SR clause is coreferential with the subject of the matrix clause. This marker is cognate with Amahuaca’s SR marker *=ha*, which indicates coreference of the SR clause object with the matrix intransitive subject. Camacho briefly mentions the purported SR marker *-a* in Shipibo, but notes that, at the very least, a homophonous marker exists in the relative clause system. He chooses to analyze *-a* as a relative clause marker, then, rather than as a true SR marker, which puts it outside the scope of his account.

Interestingly, applying the diagnostics discussed in Chapter 2 for distinguishing relative clauses from SR clauses, we see that the cognate Amahuaca *=ha*, when used in object = intransitive subject constructions, does show behavior of a SR clause marker. However the marker *=ha* also functions as an aspect marker in relative clauses. The fact that there are two separate *=ha* markers, one for relative clauses and one for SR clauses, can be shown via extraction tests. Recall that relative clauses are islands while SR clauses are not. When *=ha* is used in an object = intransitive subject construction (which is where Shipibo *-a* should be used as a SR marker), the *=ha*-marked clause is not an island for movement. This is demonstrated in (199).

- (199) ‘Who cooked the manioc that fell?’ (*Literally* ‘After who cooked the manioc_{*j*}, it_{*j*} fell?’)
- a. [tzova=**n** hatza_{*j*} jova=**ha**]=ra *pro*_{*j*} pakuu=hax
 who=ERG manioc cook=OS.SQ=INT fall=TAM
- b. **tzova=n**_{*i*}=ra [t_{*i*} hatza_{*j*} jova=**ha**] *pro*_{*j*} pakuu=hax
 who=ERG=INT manioc cook=OS.SQ fall=TAM

In (199) we see *=ha* clauses whose object *hatza* ‘manioc’ is coreferential with the *pro* matrix subject. The subject of each *=ha* clause is a *wh*-word *tzovan*. In *wh*-questions in Amahuaca, the *wh*-word need not overtly move to a position before the second position interrogative clitic *=ra*. However, movement of the *wh*-word to a position before *=ra* is possible and mirrors focus movement of a constituent to the position before *=mun* in declaratives. In (199a) we see a configuration where the entire *=ha* clause that contains a *wh*-word appears before *=ra*, while the *wh*-word itself remains in its usual subject position within the *=ha* clause. In (199b) we see that it is also possible for the *wh*-word *tzovan* to move out of the *=ha* clause to the position before *=ra*. The clause marked with *=ha* here is not an island.

with two overt subjects are possible. Camacho remarks that this economy condition is not at play when there is an overt subject in both clauses since overt DPs will enter the derivation with valued ϕ -features. However, he only considers an example with disjoint subjects. The other point he makes regarding a scenario with two overt subjects is the following: “Notice that if both clauses have a coindexed DP, the structure would result in a violation of Principle C of the Binding Theory” (Camacho 2010: 263). However, this would clearly not be the case if the two DPs were pronouns (pronouns are not subject to Principle C), and a Principle B violation could not rule out such a configuration either since the pronouns would be in separate CPs (a fact which presumably allows two pronominal subjects in SS constructions).

We can therefore conclude that this clause must be a SR clause rather than a relative clause. This means that *=ha* can function as a SR marker in Amahuaca.

There appears to be another homophonous *=ha* in Amahuaca that serves as a relative clause aspect marker. That is, not all clauses marked with *=ha* behave like SR clauses. Some *=ha* clauses are islands, as demonstrated in (200).

- (200) ‘Who saw the man that the alligator bit?’ (*Literally* ‘The alligator bit the man that who saw?’)
- a. [tzova=**n** joni hiin=**ha**]=ra kaputo=**n** pi=**hax**
 who=ERG man see=PFV=INT alligator.LG=ERG bite=TAM
- b. *tzova=**n**_i=ra [t_i joni hiin=**ha**] kaputo=**n** pi=**hax**
 who=ERG=INT man see=PFV alligator.LG=ERG bite=TAM

In (200), we see *=ha* clauses, the object of which serves as the matrix clause object. Once again, the subject of the *=ha* clauses is the *wh*-word *tzovan*. In (200a), the entire *=ha* clause appears before *=ra*. Crucially, in (200b), when the *wh*-word *tzovan* moves out of the *=ha* clause to appear before *=ra*, the result is ungrammatical. This means that the *=ha* clause here is an island, consistent with it being a relative clause. Thus, in Amahuaca, *=ha* clauses that involve coreference between their object and the matrix clause intransitive subject can be SR clauses, while other *=ha* clauses are relative clauses. This matches what has been reported for Shipibo *-a* by Valenzuela (2003), namely that *-a* can appear in relative clauses or in object = subject SR clauses. Therefore, in Amahuaca, at least, we cannot set aside clauses with *=ha* as outside of the scope of an account of SR, as Camacho (2010) proposes to do for Shipibo *-a* clauses. This means that the lack of ability to accommodate object tracking is a true shortcoming of Camacho’s account.

Let us summarize one of the persistent issues we have seen in all of the accounts of SR discussed so far. Because all of these accounts involve C receiving ϕ -features from an instance of T that has agreed with the subject, they predict that only subject tracking should be possible in SR (modulo Finer’s brief mention of OS marking discussed in footnote 24 in this chapter). SR markers should never be sensitive to coreference relationships involving object DPs. This is not the pattern that we find in Amahuaca. Instead, Amahuaca SR markers can be sensitive to features of both the matrix object and the adjunct clause object, as seen in (201) and (202), respectively.

- (201) [jaa=**x**_i vua=**xo**]=mun hinan **xano**_i chivan-vo=**xo**=nu
 3SG=NOM sing=SO.SQ=C_{MATRIX} dog.ERG woman chase-AM=3.PST=DECL
 ‘After she_i sang, the dog chased the woman_i.’

- (202) [joni=**n** **hino**_i hiin=**ha**]=mun *pro*_i koshi ka=**hi**=**ki**=nu
 man=ERG dog see=OS.SQ=C_{MATRIX} quickly go=IPFV=3.PRES=DECL
 ‘After the man saw the dog_i, it_i is running.’

In (201), the adjunct clause subject is coreferential with the matrix clause object *xano* ‘woman’, and the form of adjunct C is *=xo* to indicate this coreference relationship. Crucially,

the DS marker *=kun* is not used here, as would be predicted by these accounts which assume that only coreference relationships of subjects matter for SR. In (202), the reverse pattern holds. The adjunct clause object *hino* ‘dog’ is coreferential with the matrix subject. Here, adjunct C takes the form *=ha*, indicating this coreference pattern. Once again, the DS marker is not used as predicted by accounts that assume that only subject tracking is possible. Therefore, if we take the accounts of Finer, Watanabe, and Camacho at face value, they are unable to account for the full pattern of SR in Amahuaca.

We could imagine an extension of these accounts that would admit object tracking. If T hosts an insatiable probe, it could agree with both the subject and the object. Thus, when the features from T are on C, the features of the object would be present on C as well. While this type of account is certainly possible, it would require substantially reworking the mechanisms at the C level in each account that determine which SR marker is grammatical, since the features of more than one argument from each clause would be present on C. It is also hard to reconcile this type of insatiable T account with the attested pattern of agreement on T in Amahuaca. Amahuaca matrix tense markers indicate the person of the subject, as shown in (203) and (204).

(203) *hiya=x=mun* *hun rakuu=**ku**=nu*
 1SG=NOM=C_{MATRIX} 1SG be.afraid=1.PST=DECL
 ‘I was afraid.’

(204) *vaku=x=mun* *rakuu=**xo**=nu*
 child=NOM=C_{MATRIX} be.afraid=3.PST=DECL
 ‘The child was afraid.’

In (203), the subject is first person and the form of the past tense marker is *=ku*. In contrast, in (204), the subject is third person and the past tense marker is *=xo*. Even in transitive clauses, T always indexes the subject of the clause and never the object, as shown by (205) and (206).

(205) *Maria=n=mun* *hiya hiin=**xo**=nu*
 Maria=ERG=C_{MATRIX} 1SG see=3.PST=DECL
 ‘Maria saw me.’

(206) *Maria=n=mun* *jaa hiin=**xo**=nu*
 Maria=ERG=C_{MATRIX} 3SG see=3.PST=DECL
 ‘Maria saw him.’

Despite the fact that the object in (205) is first person and the object in (206) is third person, both clauses use the form of the past tense marker *=xo* to index the third person subject *Maria*.

The fact that Amahuaca T never inflects for object person is puzzling were we to assume that T hosts an insatiable ϕ -probe. It would simply be a morphological accident that T

always agrees with all DPs in its clause but only ever reflects the features of the subject. Instead, the more straightforward assumption is that T and C probe separately (Carstens 2003; Haegeman and van Koppen 2012, among others).³¹ T in Amahuaca hosts a probe that is satisfied by any ϕ -features, deriving a pattern where it invariably agrees with the highest DP in its c-command domain – the subject. (Recall from Chapter 3 that T can instead agree with the subject’s features on v if v is high enough in the clause.) In contrast, as already discussed, C’s probe lacks satisfaction conditions – it is insatiable. This means that C will agree with all DPs in its c-command domain, deriving the pattern of object-sensitive SR.

Another type of issue for the accounts of SR discussed in this section is the fact that they require additional mechanisms to be added to the grammar, and these mechanisms are not motivated beyond the domain of SR. For example, the accounts of Finer (1984, 1985) and Watanabe (2000) both rely on some mechanism of binding between matrix and adjunct C. Outside of the domain of SR, this type of binding is unnecessary and unmotivated. The account of Camacho (2010) requires something like an output filter that penalizes merging two pronouns with the same ϕ -features in a single derivation to avoid undesired instances of DS marking. This type of filter does not appear to be necessary for domains beyond SR. This is another way in which the account proposed here is more attractive than its competitors. All of the necessary technology used in the current account has been argued to be independently needed on the basis of evidence from domains outside of SR. The current account of SR therefore relies only on combining mechanisms that are already available in the grammar.

4.4.2 Non-reference-tracking accounts of switch-reference

Some recent accounts of SR have departed from the traditional assumption that some mechanism of referential index tracking lies at the heart of SR. These accounts instead seek to reduce SR to a special case of some more widely attested phenomenon like control (Georgi 2012) or coordination (Keine 2012, 2013). These accounts differ substantially in their implementation, but what they have in common is the assumption that a SS construction should be able to contain only one instance of a subject DP, a prediction which does not align with

³¹Arregi and Hanink (2018) offer an account of SR in Washo (Isolate; USA) which relies on the traditional assumption that reference tracking is directly involved in SR, but which is not parasitic on agreeing T. Instead, they assume, as I do here, that C probes independently. However, their account, like the ones considered in this section, is designed to rule out object tracking in SR, since object tracking is not possible in Washo. They accomplish this by assuming that C can only agree with nominative arguments, restricting agreement to subjects. Even if this case requirement on C’s goal were removed, this would not yield a system that could account for Amahuaca SR without further modification. Specifically, the bidirectional Agree account that they pursue requires that the matrix arguments c-command the probe on SR C, which is difficult to reconcile with the high attachment site of Amahuaca SR clauses. Further, they assume that SS marking is a morphological default, while disjoint reference is explicitly encoded by the DS marker. As discussed earlier, the Amahuaca facts suggest the opposite, namely that DS marking is actually the morphological default.

the empirical picture we see in Amahuaca (Clem 2018a).³²

First, consider the account of Georgi (2012), who argues for a control-based analysis of SR. She argues that SS structures are obligatory control structures, while DS structures do not involve control. The SS marker itself indicates that the subject was moved out of the marked clause.

Georgi assumes that SS clauses are TPs with a defective T. This T is unable to case-mark the subject DP of its clause, whether that subject is an external argument, or the internal argument of an unaccusative *v*, which does not assign case. This means that the subject of the marked clause remains active in the derivation since it has not been assigned case. Adopting the movement theory of control (Boeckx et al. 2010), Georgi argues that a DP that remains active in a lower clause can move to check the selectional feature of the superordinate *v*. In the upstairs clause, this DP is then assigned case. Georgi argues that SS marking is the spell out of defective T in the embedded clause, and specifically assumes that it spells out a T that does not c-command a DP in its accessible domain, that is, a T in a clause out of which the subject has been moved.³³ The structure for a SS clause is illustrated in (207).

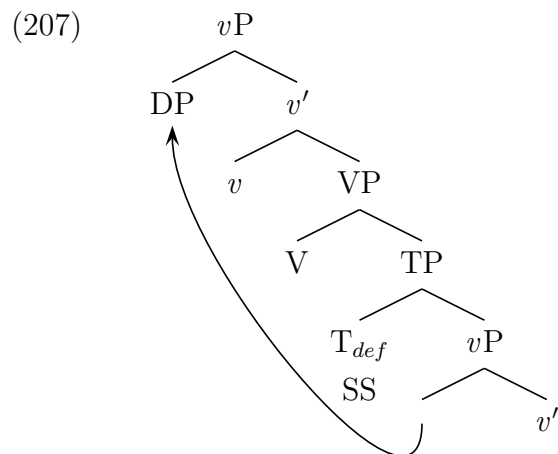

In (207) the embedded subject moves to check the selectional features of the upstairs *v*, leaving no DP in the lower clause. This results in the defective T of the lower clause being spelled out as a SS marker.

In contrast to SS clauses, Georgi argues that the T in DS clauses is able to assign case to its subject. That means this version of T is not defective. Georgi takes the fact that DS markers are sometimes fused with subject agreement markers as evidence for the non-defective nature of this T. She argues that DS marking is the spell out of non-root, non-defective T, which c-commands a DP in its phase. This proposal for DS structures is illustrated by the example structure in (208).

³²I choose to highlight the problem of overt subjects for these two accounts. However, both accounts face additional challenges, such as how to account for the high attachment site of Amahuaca SR clauses and how to derive distinct SR markers that indicate reference relationships involving object DPs.

³³Georgi notes that for her this means that the moved subject leaves no copy or trace in the lower clause.

(208)

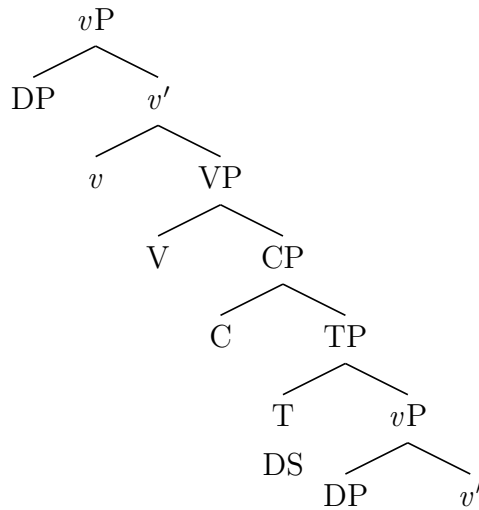

In (208), the embedded subject remains in the downstairs clause and the non-root T is spelled out as a DS marker.

Under Georgi's account, then, SS versus DS marking comes down to how many DPs are in the numeration and what type of T is merged in the lower clause. If there are fewer DPs than what is needed to meet selectional requirements and a defective T is merged, the subject of the lower clause will check the selectional features of the higher *v*, resulting in SS marking, as in (207). If a non-defective T is merged, the derivation will crash since the selectional requirements of the upstairs *v* will not be met due to a shortage of DPs. If there is a sufficient number of DPs in the numeration and a non-defective T is merged, no DP movement from the marked to the reference clause will occur, resulting in DS marking as in (208). If a defective T is merged, the embedded subject will not move and will not be case-marked, causing the derivation to crash. This type of account is hard to reconcile with the fact that Amahuaca SS constructions can have overt subjects in both clauses. If SS marking is always the spell out of a defective T, the subject of the SS clause in such constructions should not be licensed and the derivation should crash.

Keine (2012, 2013), like Georgi (2012), argues that SS constructions involve fewer DPs than DS constructions. However, his approach is quite different in that he analyzes SR clauses as involving coordination, rather than subordination, and argues that the SS/DS distinction reflects a difference in coordination height.³⁴

Keine argues that SS marking reflects low coordination, that is, VP coordination. In a VP coordination structure, there will only be one subject DP, which will be introduced by *v* above the coordinate structure. Therefore, the two predicates will have the same subject.

³⁴Note that this is in conflict with Weisser's (2012; 2016) claim that there is no SR in coordination structures. Of the three languages that Keine (2013) takes as case studies, Weisser claims that the Amele (Nuclear Trans New Guinea; Papua New Guinea) structures in question involve clause chaining and that the relevant Kiowa (Kiowa-Tanoan; USA) constructions do not involve SR but rather a tight versus loose coordination distinction. Weisser briefly mentions Seri (isolate; Mexico) only to say that its purportedly non-canonical SR can actually be analyzed as true SR.

Keine argues that the SS marker is the context-sensitive spell out of the coordinator when it coordinates VPs. In contrast, Keine argues that DS marking involves high coordination, that is, *vP* coordination. When two *vP*s are coordinated, each will contain its own subject. Therefore, the two predicates will have different subjects. The DS marker is the context-sensitive spell out of the coordinator when it coordinates two *vP*s.³⁵ These two structures are illustrated in (209) and (210), adapted from Keine (2013: 772).

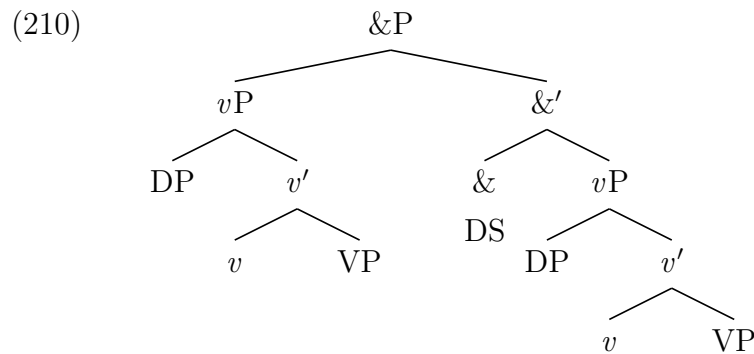
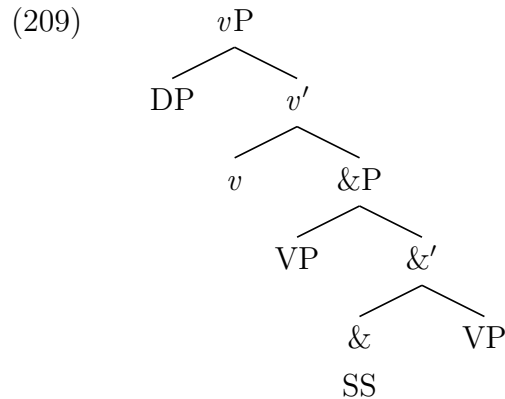

In (209) we see the coordinator coordinating two VPs and being realized as a SS marker. In (210), the coordinator is coordinating two *vP*s and is realized as a DS marker. This account suffers from the same issues as Georgi's (2012) analysis. It predicts that a SS construction should only be able to have one overt subject DP. Additionally, because SS versus DS marking comes down to a difference between whether coordination is above or below the external argument, this account cannot derive patterns where a SR marker indicates coreference of the object of one clause and subject of another – even VP coordination will allow for two distinct internal arguments at all times.

While the two non-reference-tracking accounts considered here differ significantly in terms of the technology used, they share an unwelcome prediction. In both of these accounts, the

³⁵The presentation of Keine's analysis given here is actually an oversimplification of his Vocabulary Insertion account. The languages considered by Keine differ in the patterns of SR involving things like weather predicates and in the use of SR markers for other types of coordination. Therefore which coordinator Keine analyzes as default versus context-sensitive differs by language.

explicit prediction is that SS clauses should only contain one subject DP, either because the same DP occupies the external argument position in both clauses at some point in the derivation or because a single external argument is introduced by one instance of *v* above the level of coordination. This prediction does not align with the attested distribution of overt subject DPs in SS structures in Amahuaca (Clem 2018a). As discussed previously, SR adjunct clauses in Amahuaca can contain all arguments of the verb overtly, including the subject. This holds regardless of whether the adjunct clause is marked as same or different subject. As seen in (211), an overt nominative-marked subject DP appears in the adjunct clause. A coreferential ergative-marked subject pronoun appears in the matrix clause.

- (211) [moha **xano**=**x_i** nokoo=(xon)]=mun **jato**=**n_i** hatza
 already woman=NOM arrive=SA.SQ=C_{MATRIX} 3PL=ERG manioc
 xoka=kan=xo=nu
 peel=3PL=3.PST=DECL
 ‘After the women_i arrived, they_i peeled manioc.’

Under accounts which predict only one subject DP in a SS structure, it is unclear how to derive the presence of two overt subjects in (211). The problem is made especially acute since the two DPs do not match in case and since one is a pronoun while the other contains a full NP. The difference in case and other content of these two DPs suggests that they constitute two separate subject DPs.

4.4.3 Bound anaphor accounts of complementizer agreement

The final alternative style of analysis I will consider here has been proposed to account for systems of complementizer agreement that do not involve SR. Specifically, it has been proposed to handle cases of upward-oriented complementizer agreement – that is, when an embedded complementizer agrees with an argument in the superordinate clause. Diercks (2013) argues that upward-oriented complementizer agreement does not actually involve the C of a complement clause probing all the way up to agree directly with a matrix DP. Instead, he argues that this pattern of agreement results from local agreement between complement C and a bound anaphor in its specifier.

Diercks focuses on upward-oriented complementizer agreement in Lubukusu (Bantu; Kenya). In Lubukusu, complementizer agreement in an embedded clause is always with the subject of the immediately superordinate clause. Diercks argues that this agreement pattern arises through what he terms ‘Indirect Agreement’. Spec,CP of the embedded clause hosts a null reflexive pronoun. In Lubukusu, this anaphor is strictly subject oriented, patterning with long-distances reflexives in languages like Icelandic and Mandarin. Diercks argues that this null anaphor is bound by the subject of the higher clause, causing its ϕ -features to covary with the ϕ -features of the higher subject. Embedded C then enters into a local Spec-Head agreement relationship with this bound anaphor, causing the form of C to covary with the ϕ -features of the higher overt argument. A structure illustrating this analysis is given in (212), with the solid line indicating binding and the dotted line indicating agreement.

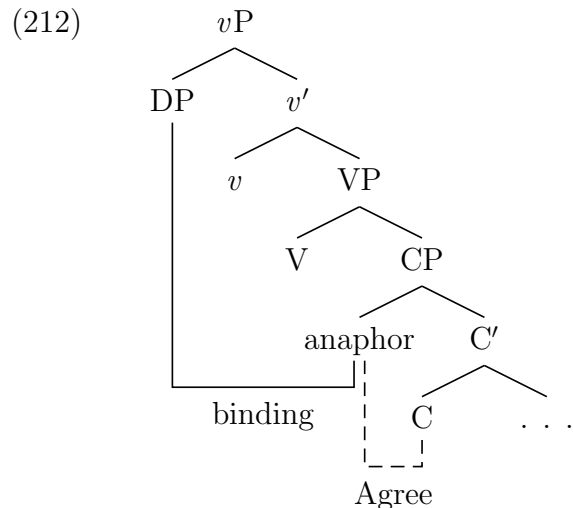

In (212) the matrix subject DP in Spec,*v*P binds the anaphor in Spec,CP of the embedded clause. The embedded complementizer agrees with this bound anaphor.

We could imagine that perhaps SR involves both downward- and upward-oriented complementizer agreement. The C of the adjunct clause could agree with a DP in its complement as well as with a bound anaphor in its specifier. This second step is similar to the proposal of Baker and Camargo Souza (2018) for how SR clause C enters into an Agree relation with the matrix subject. They assume C agrees with an operator in Spec,CP that is controlled by the matrix subject. However, this type of account faces challenges in view of the evidence for a high attachment site for SR clauses in Amahuaca. There is no distributional evidence that suggests that adjunct CPs can surface low enough in the structure to allow the binding of an anaphor in their specifier. The bound anaphor account was proposed for agreeing instances of C that appear in complement clauses, where the matrix arguments c-command the CP and can therefore bind the anaphor. In contrast, the Amahuaca SR structure involves an agreeing C in an adjunct clause. Furthermore, as shown in Section 4.1.1, these adjunct clauses always surface above the highest A-position of the matrix arguments. This would mean that these clauses would be too high to allow the matrix subject to c-command and bind an anaphor in their specifier.³⁶

Even if Amahuaca adjunct CPs were to originate lower than the matrix arguments and obligatorily move to their high surface position in the structure, they do not undergo reconstruction for Condition C, as seen in (213).

³⁶Note that some languages do show SR in complement clauses. For example, this pattern is reported for embedded nominalized clauses in Washo (Arregi and Hanink 2018). It is possible that for these languages a bound anaphor account along the lines of the one sketched here is a plausible analysis. C could still be an insatiable probe, agreeing with DPs in its complement and then agreeing with a bound anaphor in its specifier through probe reprojection. When the insatiable probe reprojected to the maximal projection level, it could continue to probe. However, the only material in the c-command domain of C^{max} in a complement position would be the head that selects the maximal projection, such as V. This head presumably would not have a referential index, and therefore this third cycle of probing would not encounter any possible goals.

- (213) [Floria= n_i Maria $_j$ hiin= \overline{xo}]=mun Maria= n_j Floria $_i$
 Floria=ERG Maria see=SO.SQ= C_{MATRIX} Maria=ERG Floria
 chivan-vo= xo =nu
 chase-AM=3.PST=DECL
 ‘After Floria $_i$ saw Maria $_j$, Maria $_j$ chased Floria $_i$.’

Here, the R-expressions *Maria* and *Floria* appear both in the adjunct clause and the matrix clause and there is no Condition C violation. This means that the adjunct clause does not undergo reconstruction to a position below the matrix arguments. However, in this structure, the SR marker =*xo* indicates coreference of the adjunct subject and the matrix object.³⁷ For this type of pattern to arise under a bound anaphor account, the anaphor in the specifier of the adjunct clause would have to be bound by the matrix object, *Floria*. However, for an anaphor in the adjunct clause to be bound by the matrix object, the adjunct CP would have to reconstruct to a position below the matrix object DP. If there is no reconstruction for Condition C in such structures, it is unclear how there could simultaneously be reconstruction for the binding of this anaphor.

An additional issue for this style of account arises when we consider the nature of the agreement relationship between C and the anaphor in its specifier. Under a purely downward model of Agree (absent probe reprojection), Spec-Head agreement requires some additional explanation since the head does not c-command its specifier. One proposal for how to subsume Spec-Head agreement under a general theory of downward Agree is the type of Cyclic Agree model outlined here. Through probe reprojection, the probe on an intermediate projection does c-command the specifier, thus allowing Spec-Head agreement to be an instance of the more general Agree under c-command. If Cyclic Agree is assumed in order to derive agreement with the anaphor in Spec,CP, the question arises as to why cyclic expansion cannot result in the probe reprojecting to the level of C^{max} and continuing to probe its c-command domain, as in (214).

³⁷There is no dedicated marker that indicates that the adjunct clause object is coreferential with a matrix transitive subject. Instead, the default marker =*kun* is used. Since =*xo* is more highly specified in its featural content than =*kun*, it is used here.

(214)

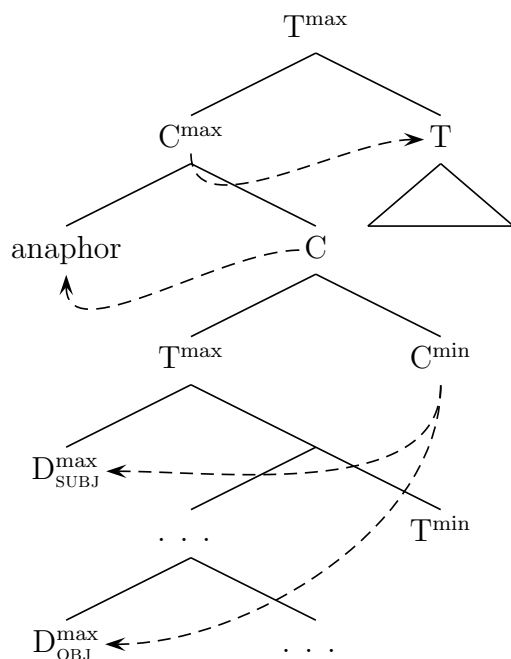

In (214), C^{\min} first probes its c-command domain, agreeing with the adjunct clause arguments. Through cyclic expansion, the probe located at the intermediate projection level then probes the anaphor in Spec,CP. If cyclic expansion allowed adjunct C^{\max} to probe into the matrix TP, this would make agreement with the bound anaphor in Spec,CP redundant. The same features received from the anaphor on the second cycle of Agree could be received directly from the matrix argument itself on the third cycle of Agree. To avoid this redundancy, we would need a stipulation to rule out a third cycle of Agree involving a probe on C^{\max} . Given the fact that the labels of the various projections of C are assumed to be formally identical under BPS, it is unclear how such a stipulation could be derived.

4.4.4 Summary of previous analyses

In conclusion, all of the alternative accounts examined here face empirical challenges given the full range of data in Amahuaca. The distribution of overt subject DPs, the sensitivity of SR to object DPs, and the lack of Condition C reconstruction effects for SR adjunct clauses are all problematic for previous accounts of SR. Not only is the current analysis able to account for the full range of data, but it does so utilizing only technology that has been independently argued to be necessary for phenomena beyond SR. In contrast, other accounts of SR often rely on some mechanism that is specific to SR, such as binding between complementizers, or require unattractive stipulations, like an economy condition penalizing overt coreferential DPs, to derive the desired patterns. Thus both the empirical coverage and the simplicity of the current account give it an advantage over competing analyses.

4.5 Predictions and typology

Now that we have seen how the current Agree-based account of SR compares to its competitors in terms of empirical coverage of the Amahuaca data, it is worth considering the predictions of the current style of account as well as how it can handle the typology of SR systems. In this section, the focus will be on two particular questions that the current analysis raises. First, why do most SR systems look empirically different from Amahuaca in allowing only subjects to be tracked? Second, why do we not see more evidence for maximal projections serving as probes?

With respect to the first question, it is worth emphasizing that Amahuaca does indeed display a profile that is typologically unusual for SR systems. In general, SR systems only allow subject coreference relationships to figure in the calculus of SR marking.³⁸ However, sensitivity to objects is not entirely absent in other SR systems. For example, it is a feature found in many other Panoan languages aside from Amahuaca (Valenzuela 2003; van Gijn 2016), and it has been argued to exist in Warlpiri (Pama-Nyungan; Australia) as well (Austin 1981; Legate 2002: 125). The question then arises as to how to derive a subject-only tracking system under the current style of analysis, given that it was developed with both subject and object tracking in mind. The current account suggests several possibilities of how such systems could arise.

First of all, a language could lack object shift. Object shift in Amahuaca is what allows objects to be visible to a high probe on C. If objects remained within the *vP* phase, they would be inaccessible goals for Agree. Therefore, if a language lacked object shift, it could display a subject-only pattern of SR, even if everything else involved in the syntax of SR functioned as in Amahuaca. The insatiable probe on C would encounter only the marked clause subject on the first cycle of Agree. Upon reprojection of the probe, second cycle Agree would only encounter the reference clause subject. Therefore, the pattern of SR would be sensitive only to referential indices of the two subject DPs, giving the simple same versus different subject pattern found in the majority of languages with SR.

A second option for deriving subject-only tracking lies in the nature of the probe on C and the case alignment of the language. If a language displayed accusative alignment, a case discriminating probe on C could yield a pattern of subject-only tracking. It is well-known that many languages restrict agreement to DPs with certain case values, suggesting that probes can be case discriminating (Preminger 2014; Deal 2017a). Further, if such patterns of case discrimination in agreement are constrained by a case hierarchy like that proposed by Marantz (1991), the expected patterns of case-sensitive agreement are not random (Bobaljik 2008). Specifically, we expect the most unmarked case values to be most likely to be goals

³⁸Further typological work on SR that spans multiple geographic areas is needed to assess how strong this trend is. There are large surveys that focus on particular geographic locations (see, e.g., McKenzie 2015 for North America and Roberts 1997 for Papua New Guinea). In the survey work that has been done, it certainly seems like subject tracking is the norm. For example, McKenzie states, “SR has never been observed in North American languages to track objects, applicatives, or any nominal arguments except subjects” (2015: 425).

for a case-discriminating probe. In an accusative system, the unmarked value for case will be nominative. Therefore, with a probe on C that agreed only with the unmarked case, only nominative DPs would be able to be tracked by the SR system.³⁹ This could yield a pattern of subject tracking even if object DPs were high enough in the structure to be accessible to C. Due to the more marked case of the object, it would not be able to be a goal for Agree.

A final route to a subject-only tracking system that is suggested by the current account is morphological syncretism. The probe on C could successfully agree with objects, but the language could simply lack dedicated morphology to spell out patterns of coreference involving objects due to syncretism in the paradigm. One reason to think that morphological syncretism may be at play in deriving a paucity of object tracking crosslinguistically comes from within Amahuaca itself. Specifically, when we compare different paradigms of SR markers in Amahuaca, it appears that morphological syncretism is involved in collapsing several of the possible distinctions. In this chapter, the focus has been on the sequential action SR paradigm, since it is in this paradigm that we see the fullest number of morphological contrasts in the SR system. If we compare this paradigm, shown in Table 4.2, to the paradigms for simultaneous and subsequent action SR clauses, seen in Table 4.3 and Table 4.4, respectively, we see successively more syncretisms in the paradigms.

		Reference		
		S	A	O
Marked	S	<i>=hax</i>	<i>=xon</i>	<i>=xo</i>
	A			
	O	<i>=ha</i>	<i>=kun</i>	

Table 4.2: Sequential switch-reference markers (repeated)

		Reference		
		S	A	O
Marked	S	<i>=hi</i>	<i>=kin</i>	<i>=haito</i>
	A			
	O	<i>=hain</i>		

Table 4.3: Simultaneous switch-reference markers

³⁹Arregi and Hanink (2018) assume that SR CPs attach below matrix arguments in Washo and argue that agreement between SR C and the matrix subject is therefore an instance of upward Agree. They propose that the probe on SR C is case discriminating to explain how the probe is able to “skip over” the object DP of the main clause to agree with the nominative subject DP.

		Reference		
		S	A	O
Marked	S	<i>=katzi/</i>	<i>=xankin</i>	
	A	<i>=xanni</i> ⁴⁰		
	O	<i>=non</i>		

Table 4.4: Subsequent switch-reference markers

In the sequential action series of SR markers (corresponding roughly to ‘after’), the default marker *=kun* is used for only two cells of the coreference paradigm. In this paradigm, tracking of both the marked and reference clause objects is possible. In the simultaneous action series (corresponding roughly to ‘while’), the default marker *=hain* is used for all coreference relationships involving the marked clause object. Only the object in the reference clause triggers a distinct coreference marker. Finally, in the subsequent action series (corresponding roughly to ‘before’), all object tracking in both clauses has been collapsed to the default marker *=non*. There is no evidence that simultaneous and subsequent action clauses differ significantly in their syntax from their sequential action counterparts. Their distribution in matrix clauses and ability to host overt material is the same. They differ morphologically only in the form of the SR marker. Therefore, it appears that morphological syncretism is plausibly responsible for the variation that we find in the ability of SR markers to indicate coreference relationships involving objects across the paradigms. Given that syncretism plays a role even within the Amahuaca system, it is reasonable to assume that at least some languages may lack object tracking in some or all of the paradigm due to similar syncretisms.

In languages that display subject-only tracking, it should be possible to independently test for some of the relevant factors to see which path to subject-only tracking is utilized. Is there independent evidence for object shift from domains such as binding and crossover? If not, then the object may remain too low to be accessible to C’s probe. Can only DPs bearing a single (unmarked) case value be targeted for SR or can quirky case subjects also be tracked? If only the most unmarked DPs can be tracked via the SR system, then C’s probe may be case-discriminating. If there is no evidence in a given language for the first two ways of deriving subject-only tracking, then morphological syncretism may play a role. Given the fact that there are multiple routes to a subject-only tracking system, such systems are predicted to arise frequently. This aligns with the typological picture that we see, where these systems appear to be much more common than those that allow for the tracking of objects.

⁴⁰The marker *=xanni* does appear to indicate subsequent action and coreference of the adjunct subject and matrix intransitive subject, as does *=katzi*. However, *=xanni* is more restricted, and occurs only with the matrix verb *ka* ‘go’ in the examples I have been able to collect. The marker *=katzi* does not appear to have any such restrictions with respect to the choice of matrix verb. Examples of these markers are given in Appendix A.

Another question that the current account raises is why we do not find more maximal projections that function as probes. In order to answer this question, it is worth considering where we tend to find probes to begin with. Some of the most commonly assumed probes in the clausal domain are v , T, and complement C. For each of these heads, the c-command domain of the maximal projection of the head will contain only the head that selects it. For instance, the c-command domain of T^{\max} will contain only C. Therefore, the only way that we would ever be able to tell whether the maximal projection had searched its c-command domain would be if it successfully agreed with the selecting head. Given that functional heads in the clausal spine are typically not merged with the type of features that the probes are searching for, Agree will typically fail to find a goal in the c-command domain of the maximal projection. Therefore, it is possible that maximal projections probe, but that Agree (at least on this cycle of probing) fails in the sense of Béjar 2003 (see also Preminger 2014).

In contrast, the c-command domain of adjuncts provides a more illuminating testing ground. If we turn to adjunct C, as in the current account, it is possible that we actually see quite a number of languages that have probing maximal projections, given that a large number of languages have SR systems. It is also plausible that other types of agreeing adjuncts may involve cyclic expansion leading to maximal projections that probe their c-command domain. For example, Lubukusu ‘how’ agrees in ϕ -features with the highest argument in its c-command domain (Carstens and Diercks 2013). Carstens and Diercks note that this behavior is somewhat puzzling if we assume that the probe is located on the head, but can be easily accounted for if we assume that the probe is instead located at the maximal projection level. This pattern can be very straightforwardly derived in the current system without assuming that probes can originate on maximal projections. Because this adjunct only contains the agreeing ‘how’ element itself, if the probe originates on the minimal projection of this adjunct, its c-command domain will not contain any possible goals. This means that the probe will remain unsatisfied and will be able to reproject to the maximal projection level, accounting for the ability of ‘how’ to agree with elements in the c-command domain of its maximal projection.⁴¹ (For a similar treatment see also Carstens 2016.⁴²) Examining further instances of agreeing adjuncts (and specifiers) may prove to be a fruitful line of inquiry in discovering how common this pattern of maximal projections serving as probes through cyclic expansion is crosslinguistically.

⁴¹Note that this agreeing ‘how’ element may actually be a simultaneously minimal and maximal projection. If it is, then probe reprojection would not be necessary to derive the pattern of agreement.

⁴²Carstens does not assume that the Lubukusu probe must originate on the maximal projection, but she does not employ systematic cyclic expansion to derive this result. Instead she assumes that probing is limited to the c-command domain of the head for one round of probing but then becomes directionality free if the features of the probe are not matched by any goal in its c-command domain.

4.6 Summary

4.6.1 Consequences for a theory of switch-reference

In this chapter I have offered an Agree-based account of Amahuaca SR. I have argued that, despite having the appearance of a long-distance, cross-phasal dependency, SR can actually be analyzed as involving a series of local phase-bound dependencies, mediated by an agreeing complementizer. Framing the analysis in terms of complementizer agreement draws on the insight of Watanabe (2000), but the analysis I provide demonstrates that we need not invoke binding to account for the distribution of same and different subject marking. This means that the current account is unlike accounts which rely on binding, such as *Finer 1984 and 1985, Hale 1992, Watanabe 2000, and Nonato 2014*, and is instead more in line with purely Agree-based analyses of SR, such as *Camacho 2010 and Arregi and Hanink 2018*. I have also argued that agreement between C and the arguments involved in SR is direct, rather than being mediated by a functional head like T (contra *Camacho 2010*) or a controlled null argument (contra *Baker and Camargo Souza 2018*).

In terms of the empirical contributions of this chapter, I have argued that both matrix and adjunct clause objects in Amahuaca can figure in the calculus of coreference relationships for the purpose of SR. These cases cannot be reduced to instances of relative clauses, in contrast to what has been argued by *Camacho (2010)* for purported object-tracking SR markers in Shipibo.⁴³ This places Amahuaca among the small number of languages for which object-sensitive switch-reference has been reported. The fact that such languages exist means that any theory of SR that aims to account for the crosslinguistic picture must provide some mechanism for tracking objects. As demonstrated here, many previous theories instead have explicitly ruled out object tracking, assuming that it was unattested.

4.6.2 Implications for Agree

The analysis of SR I have offered in this chapter relies on the technology of Cyclic Agree (*Rezac 2003, 2004; Béjar and Rezac 2009*). I have put forth an argument that the logical prediction of Cyclic Agree and BPS is that maximal projections should be able to probe their c-command domain (that is, if a probe remains unsatisfied after earlier cycles of Agree). I have also shown that this prediction is borne out in the domain of agreeing adjunct C in SR constructions in Amahuaca. Therefore, I take the assumption that maximal projections can indeed be probes to be desirable in two respects. First of all, it avoids unattractive (and potentially difficult to implement) stipulations in a cyclic theory of Agree. It is unclear how we could ensure that maximal projections could never serve as probes through cyclic

⁴³*Sparing-Chávez (1998, 2012)* does argue that objects figure in the interclausal reference system of Amahuaca. However, she does not distinguish systematically between SR clauses and relative clauses. This means that she does not entirely rule out a treatment of seeming object-tracking SR in terms of relative clauses. To my knowledge, other sources that mention object tracking in Amahuaca, such as *Hyde 1980*, do not provide any tests to show that these markers are unambiguously SR markers.

expansion, given the evidence that intermediate projections can probe and the lack of formal distinction between intermediate and maximal projections. Even stipulating a limit on the number of possible cycles of Agree could not derive this outcome, given that not all projections will contain segments between the minimal and maximal projection. Second, it yields a simple and straightforward way of accounting for SR that has greater empirical coverage than previous analyses and that does not resort to introducing any new technology that is specific to SR. By assuming this type of Cyclic Agree model, we account for the seemingly non-local nature of SR, without sacrificing well-supported assumptions about locality and directionality in Agree. Rather than circumventing conditions on c-command, the type of apparent long-distance agreement that we see in SR can be taken simply as an indication of cyclic expansion of the probe's domain. This view that maximal projections can serve as probes therefore allows us to preserve a view where Agree is always local (i.e. phase-bound) and is always under c-command.

Chapter 5

Conclusion

This dissertation has explored the mechanism of Agree (Chomsky 2000, 2001) through the lens of the morphosyntax of Amahuaca. I have discussed applications of Agree technology to expanded empirical domains drawing on Amahuaca data, and I have examined the consequences that such analytical moves have for a refinement of our understanding of the mechanism of Agree. To conclude this work, I summarize first the empirical contributions of the two case studies in this dissertation and second the broader implications for syntactic theory, specifically the theory of Agree.

5.1 Empirical contributions and analytical insights

This dissertation was divided into two interrelated case studies in Amahuaca morphosyntax. The first case study involved a typologically unusual pattern of split ergativity that is sensitive to the syntactic position of the transitive subject. The second case study explored the extensive system of switch-reference (SR) in Amahuaca, including the typologically rare pattern of sensitivity to object DPs and abstract case in SR. In both of these domains, I demonstrated that an Agree-based analysis could more straightforwardly account for the empirical facts than alternative analyses. Thus, I concluded that Agree can figure in the assignment of ergative case and can be the mechanism underlying SR. Here I summarize the details of these two case studies.

5.1.1 Agree and differential case marking

In Chapter 3 I discussed the pattern of split ergativity found in Amahuaca. The empirical generalization that I made is that subjects in their base position do not surface with overt case marking, while transitive subjects that move higher in the clause do surface with overt ergative case. Interestingly, ergative case isn't the only case in Amahuaca to exhibit differential case marking. As discussed in Chapter 3, nominative case also shows a pattern of differential case marking (though, crucially, this pattern is distinct from the pattern observed

with ergative). I argued upon the basis of differential ergative and nominative marking that morphological case is the exponence of bundles of features rather than the spell out of a single atomic case feature.

For ergative case, the bundle of features that is exponed contains features that were received through Agree relations with multiple functional heads. Specifically, I argued that ergative case expones agreement with a transitive v and T (Deal 2010). The fact that v must be transitive (i.e. must have agreed with an object DP), ensures that only the subjects of transitive clauses will be marked with ergative case. This captures the insight of the inherent case literature that transitive v is involved in the assignment of ergative case (Woolford 1997, 2006; Legate 2006, 2008). It also captures the central role of an object DP lower in the clause for the assignment of ergative case in the dependent case literature (Yip et al. 1987; Marantz 1991; Baker and Vinokurova 2010; Baker 2014, 2015; Baker and Bobaljik 2017). Crucially, however, under the account offered in Chapter 3 agreement with v is a necessary but not sufficient condition for being marked with ergative case. A transitive subject must also enter into a direct Agree relation with T and move to Spec,TP to be marked with morphological ergative case. This captures the empirical generalization that only transitive subjects that have moved out of their base position (and through Spec,TP) surface with ergative case. This style of analysis demonstrates that at least some instances of ergative case crosslinguistically are structural, assigned under Agree. Interestingly, though, at least in Amahuaca, Agree with one functional head does not license ergative case marking. Rather, multiple Agree relations are necessary for ergative case to be marked.

As mentioned before, nominative case also displays a pattern of differential case marking in Amahuaca. However, this pattern differs empirically from the pattern of differential ergative marking found in Amahuaca. Nominative case is marked only on intransitive subjects that are narrow foci. Thus, while nominative case marking is typically correlated with focus movement to Spec,CP, nominative case is not tied to syntactic position like ergative case, but rather to an information structural value. I argued in Chapter 3 that overt nominative case, like ergative case, expones a complex bundle of features. Specifically, it indexes agreement with T as well as a focus feature. Agreement with T is what distinguishes the DP as a subject. However, this is not sufficient to license nominative case marking, since not all subjects are marked nominative. The focus feature must additionally be present in order for overt case marking to occur.¹ Thus, one consequence of this account is that case exponence can be directly sensitive to information structural features.

In the characterization of ergative case laid out here, the first feature relevant for case marking is a feature received from Agree with v . As discussed in Chapter 3, nominative DPs, too, will have agreed with v (specifically v_{INTR}). Thus, features from v serve to distinguish the three types of core arguments of the verb – the transitive subject (A), intransitive subject (S), and object (O). Divorcing these features from overt morphological case marking allows us

¹Recall that transitive subjects are not marked with the nominative marker even when focused. This is because the ergative and nominative case morphemes are in competition and the ergative is more highly specified in terms of its featural content.

to define abstract case (or, alternatively, grammatical function) separately from the features that morphological case expones. Since abstract case is always determined low in the clause – internal to the *v*P – all DPs will bear indications of abstract case. In the second case study in this dissertation, I demonstrated how abstract case plays a crucial role in the grammar of SR in Amahuaca, further justifying a distinction between morphological and abstract case. I turn to an overview of this second case study now.

5.1.2 Agree and switch-reference

In Chapter 4 I explored the complex system of SR found in Amahuaca. I demonstrated that SR marking is sensitive to three basic types of information: 1) temporal relationships between clauses, 2) (non-)coreference of all arguments of two clauses, and 3) abstract case of coreferential arguments. The first observation is not unusual from a typological perspective, but the second two are somewhat unexpected. Since the first characterization of SR by Jacobsen (1967), it has been assumed by many authors that SR is a subject-oriented phenomenon (and, indeed, it appears to be in many languages). However, the reference of object DPs is also relevant for SR in Amahuaca, as has been noted by Sparing-Chávez (1998, 2012). With respect to the third empirical observation, only Panoan languages instantiate sensitivity to the case of coreferential DPs, to my knowledge. As I demonstrated in Chapter 4, existing analyses of SR fail to capture one or both of these two empirical facts about Amahuaca. Therefore, the focus of the chapter was on developing an analysis of SR that could account for both object and case sensitivity.

As I demonstrated in Chapter 4, a purely Agree-based analysis of SR is straightforwardly able to capture sensitivity to the reference of all arguments of the verbs in two clauses as well as to the abstract case of coreferential arguments. I argued that SR involves complementizer agreement (Watanabe 2000; Arregi and Hanink 2018), and that this complementizer agreement is cyclic. First, the complementizer agrees with DPs in its own clause, and then it agrees with DPs in the clause to which its clause adjoins through cyclic expansion (Rezac 2003, 2004; Béjar and Rezac 2009). If C is not restricted to agreeing with only subjects, but instead is able to directly agree with all DPs, object sensitivity is straightforwardly derived. Additionally, if C is able to copy back the case features on DPs it agrees with, case sensitivity can also easily be captured.

It is in formalizing the sensitivity to case that we can draw an interesting connection to the analysis of case marking in Chapter 3. Crucially SR is not sensitive to overt morphological case, but is rather sensitive to something like the grammatical function (or abstract case) of the relevant arguments. As discussed above, assuming that morphological case expones a combination of multiple features allows us to straightforwardly account for instances where abstract case and morphological case seem to diverge. It is exactly this type of pattern that SR instantiates. SR is sensitive to a subset of features necessary for morphological case marking – specifically, it is only sensitive to the features a DP receives from *v* through Agree.

The analysis of SR laid out in Chapter 4 thus connects to the analysis given for case assignment in Chapter 3. Also, like ergative case marking, SR can be captured by an

analysis that is based purely on Agree. The fact that SR C can agree directly with DPs in both its clause and the clause to which it adjoins eliminates the need to posit some other mechanism for SR besides Agree, such as binding (Finer 1984, 1985; Watanabe 2000) or control (Georgi 2012; Baker and Camargo Souza 2018). The analysis I proposed also avoids positing other complications to the grammar of SR such as economy conditions and output filters (Camacho 2010). Thus a purely Agree-based analysis of SR is simpler than other existing analyses and has greater empirical coverage of features like object tracking and case sensitivity.

We can conclude, then, from the two case studies presented here that Agree-based analyses are able to account for complex patterns of case assignment and SR in a way that more straightforwardly captures the empirical patterns than competing analyses. Further they are able to capture the interrelatedness of the abstract versus morphological case distinction of Amahuaca and its system of SR.

5.2 Theoretical implications for the characterization of Agree

In addition to their implications for theories of case and SR, the analyses of ergative case assignment and SR laid out in Chapters 3 and 4 and summarized above have implications for our general understanding of the nature of Agree. As outlined in Chapter 1, the research on Agree since Chomsky (2000, 2001) proposed the operation has raised many questions about the details of this mechanism of the grammar. This dissertation lends support to some of the existing proposals for Agree and challenges other assumptions, as I will outline below.

First of all, the notion of activity has been contentious in the literature on Agree, with some challenging Chomsky's (2001) particular characterization of activity based on patterns of seeming agreement with the same goal multiple times (e.g. Carstens 2011), and others proposing that the Activity Condition is entirely unnecessary (e.g. Nevins 2005). In this dissertation, the fact that a single DP can enter into an Agree relation with multiple probes is a crucial assumption. In my treatment of ergative case, morphological case is the result of agreement with both *v* and T. This means that a transitive subject DP must remain active after agreeing with *v* in order to be a goal for agreeing T. This view of case where abstract and morphological case are distinct problematizes a characterization of activity that is based on whether a DP has already received case or not. In order to preserve this type of view, it would be necessary to determine which notion of case, abstract or morphological, is relevant for activity. From the mere fact that overt ergative case can be assigned, it would seem that abstract case is not the relevant notion. If it were, T would not be able to agree with a DP that had already agreed with *v*. Instead, if we were to assume that only morphological case could deactivate a DP, this would not solve the problem.² This can be seen by considering

²More precisely the assumption that I wish to pursue here is that the full set of features necessary to trigger morphological case is not the relevant notion. This alternative characterization avoids the problem

the SR system. As proposed in Chapter 4, SR involves agreement between C and multiple DPs. Crucially, overtly case-marked DPs can be targeted for additional Agree operations by SR C. Therefore, the full range of features necessary for morphological case also cannot deactivate a DP for the type of Agree involved in SR. This problem is not solved by assuming that activity can be parameterized by feature (Rezac 2003). Rezac assumes that deactivation amounts to building a shell around a DP that creates an intervention effect for a particular feature. Thus, features like person and number could be deactivated independently. We might assume that different features are involved in agreement with T versus agreement with SR C. Thus while a successful Agree dependency with T might result in deactivation of person features (given the person sensitivity of overt ϕ -agreement on T), it might leave referential indices active and accessible to a probe on C. Even this parameterized version of activity seems to fall short for Amahuaca, though. We can see this if we consider so-called ‘clause chains’ in the language. As mentioned in Chapter 4, adjunct SR clauses can be successively nested within one another. This means that a DP in an intermediate clause could be the goal for agreement with a SR C in a lower clause as well as the SR C of its own clause. This means that the same features must be accessible for two Agree operations. If we put together only the evidence from case assignment and SR, the same DP can be the goal for up to four Agree operations – one with v , one with T, and one each with two distinct instances of C. Therefore, I tentatively conclude that the Activity Condition does not appear to hold for Amahuaca, consistent with views that take it to be parameterizable (Baker 2008; Oxford 2017). I leave it as an open question whether activity plays a role in the grammar of other languages.

Another question that has been discussed extensively in the literature on Agree is whether the same probe can agree with multiple goals. This is, in a way, the flip side of activity for DPs. Instead of asking whether a DP goal that has been agreed with can remain active for future Agree operations, the question is whether a probe can remain “active” and probe further goals after having already successfully agreed with a goal. In this dissertation, I have adopted the model of Cyclic Agree (Rezac 2003, 2004; Béjar and Rezac 2009), which assumes that a single probe may enter into Agree relations with multiple goals in a cyclic manner. One of the more crucial components of this model that I have utilized is the notion of cyclic expansion. This is the idea that a probe may be reprojected as part of the label of a branching node if it remains unsatisfied. The technology of cyclic expansion has allowed me to capture two distinct processes in Amahuaca – one in the domain of case assignment and the other in the domain of SR. In discussing ergative case in Chapter 3, I assumed that v agrees with its complement and then its specifier. This allows v to “pass on” information about the presence of an object DP to the subject in the form of the bundle $[v, \phi]$, which serves as an indication of abstract ergative case. This agreement pattern can be derived by assuming that v probes the c-command domain of the head, encountering the object. The probe on v then reprojects to the intermediate projection level and probes the c-command

of assuming that morphological material is visible to the narrow syntax for the determination of licit Agree operations.

domain of the intermediate projection, agreeing with the subject. Another domain in which I leveraged cyclic expansion was in the account of SR in Chapter 4. I argued that adjunct complementizers agree with DPs in their own clause. Through cyclic expansion the probe on C is reprojected to the maximal projection level. This allows C to probe the c-command domain of its maximal projection, agreeing directly with DPs in the clause to which the maximal CP is adjoined. I argued that this view where maximal projections can be probed is the logical prediction of Cyclic Agree coupled with Bare Phrase Structure (Chomsky 1995a,b). I demonstrated that this prediction is desirable since it is borne out in systems of SR. The case studies considered here thus provide support for cyclicity in agreement of the type proposed in Cyclic Agree models. The same probe can agree with multiple goals, and it is possible for a probe to agree with a goal in the c-command domain of any segment of the probe, even at the maximal projection level.

The mechanism of cyclic expansion relies on the notion of a probe being unsatisfied. Early versions of Cyclic Agree (e.g. Rezac 2003) assumed simple unstructured person and number probes. Therefore, the only way for a probe to remain unsatisfied was for it to not encounter a goal with any person or number features. In this dissertation, however, I have adopted a more fine-grained model of probes. Specifically, I have adopted the interaction and satisfaction model of Deal (2015c). This model allows us to define a probe's interaction conditions (the set of features it can copy back) separately from its satisfaction conditions (the set of features that will cause it to halt its search). This allows a probe to agree successfully and copy features from a goal without necessarily being satisfied and ceasing to probe further. Interestingly, this separation of interaction and satisfaction allows us to define an insatiable probe – a probe that lacks satisfaction conditions and will agree with all possible goals in its c-command domain (Deal 2015b). Probe insatiability has figured in both case studies in this dissertation. In the realm of case assignment, the cyclically agreeing probe on *v*, discussed just above, agrees with both the object and the subject. This happens regardless of what the ϕ -features of the object are. This means that there are no possible ϕ -features that the object can have that cause the probe on *v* to halt its search. Thus, we can characterize *v* as an insatiable probe in Amahuaca. Likewise, in the domain of SR, adjunct C will probe all DPs in its clause and in the clause to which it adjoins regardless of the ϕ -features of any of the DPs present. Therefore, adjunct C can also be characterized as an insatiable probe. Crucially, any competitor to an interaction and satisfaction model would have to be able to provide some way of defining a probe that will agree with all possible goals in its domain. Sometimes it is assumed that when a head shows agreement with multiple arguments that head contained multiple probes (see, e.g., Georgi 2013). However, the patterns found in Amahuaca cannot be elegantly captured by simply assuming that the relevant heads contain a certain number of probes. For example, in a SR clause, there could be anywhere from two (in the case of two intransitive clauses) to six (in the case of two ditransitive clauses) DPs in the domain of agreeing C. The fact that the SR marker shows the same sensitivity to coreference of arguments regardless of how many DPs are in the two clauses suggests that C must be able to agree with as many arguments as there are in the clause. A multiple probe account would have to stipulate that the number

of probes merged always had to match the number of DPs in the structure. While this is an unattractive stipulation in any situation, it seems particularly problematic since the number of probes on adjunct C would have to be sensitive to the number of DPs in the matrix clause before the adjunct CP was actually merged with the matrix clause. In contrast, an insatiable probe does not give rise to such issues – it will only stop probing when it has exhausted its search space. I conclude that the patterns considered in this dissertation provide substantial empirical support for probe insatiability, and by extension an interaction and satisfaction model of Agree.

Another question related to the structured representation of probes that I explored in this dissertation was how agreement with multiple goals and cyclic expansion are encoded on the probe. The first issue arises when we consider what happens once a probe successfully copies back features of two goals. One possibility is that all of the copied features will simply be mixed in a single set of features (cf. Deal’s 2015c “bag of features”). The second possibility is that the features copied from each DP will remain differentiated from the features copied from each other DP (cf. Deal’s 2015c structured list). The data from SR discussed in Chapter 4 provide evidence that the features of each goal must remain separated from the features of each other goal when they are copied back to the probe. This evidence comes from the fact that the form of the SR marker is sensitive to both referential index and abstract case, and crucially that the relevant abstract case features must be associated with one of the coreferential DPs. For example, to insert the same subject marker that indicates a matrix (or, more precisely, reference clause) ergative subject (*=xon*), it is not simply sufficient that C agreed with two coreferential DPs and one (potentially distinct) ergative DP. The ergative case cannot come from a different DP than one of the matching referential indices came from. (That is, we cannot insert *=xon* when an adjunct clause subject is coreferential with a matrix object simply because there was an ergative subject in the matrix clause.) This means that the index features and case features of each DP must remain bundled together on the probe for the purpose of choosing a vocabulary item to insert. A second question I explored was how cyclic expansion affects the structure of a probe. I proposed that probe reprojection adds a layer of structure to the probe. This allows the goals agreed with on the first cyclic of Agree to be differentiated from the goals agreed with on a second cycle. For SR C, this provided a necessary way of distinguishing adjunct from matrix arguments since, for instance, the SR marker used to indicate coreference of an adjunct subject and matrix object differs from the marker used to indicate coreference of an adjunct object and matrix subject. On the account I gave of SR, adjunct arguments are those agreed with on the first cycle, and therefore more deeply embedded in the structure of the probe. Matrix arguments are those agreed with on the second cycle, and thus in the outermost layer. This notion of probe structure resulting from cyclic expansion also has a potentially welcome application for the indirect agreement relationship between T and *v* discussed in connection with unmarked transitive subjects in Chapter 3. T must expone the features of the subject and not the object, but both sets of ϕ -features are present on *v*. However, if the object’s features are more embedded as the result of probe reprojection, we can characterize T as spelling out only the features of the outermost ϕ -bundle on *v*. Thus, there is evidence from

both the case system and the SR system of Amahuaca that the featural representation of probes is structured in a way that reflects the history of the derivation.

Finally, another issue that the case studies in this dissertation provide insight into is the role of locality and *c*-command in Agree. In particular, the patterns seen in systems of SR appear, at first glance, to be potentially challenging for traditionally held views that Agree requires the probe to *c*-command the goal and that Agree is phase-bound. However, I have shown that in adopting a Cyclic Agree model, which allows the location of the probe to systematically change throughout the derivation, we can account for SR without loosening the *c*-command requirement on probing. In SR, cyclic expansion allows maximal projections to be probes, and the *c*-command domain of the maximal projection of the SR adjunct clause will contain the DPs of the clause to which it is adjoined. Cyclic expansion therefore allows the SR probe in an adjunct clause to agree directly with DPs in the matrix clause and reduces this dependency to an instance of Agree under *c*-command. We see, then, that while patterns of SR (and, in general, probing out of an adjunct) seem problematic for assumptions about *c*-command, they can straightforwardly be derived without resorting to loosening the *c*-command requirement on agreement or positing variable directionality of probing (pace Baker 2008; Arregi and Hanink 2018; Carstens 2016). SR also provides evidence that Agree must be local, despite the seeming long-distance dependencies involved. As just mentioned, cyclic expansion reduces the agreement involved in SR to local Agree under *c*-command, and it is crucial that this Agree operation is, in fact, local. If the type of Agree involved in SR were not restricted by phasehood, we might expect the SR probe to agree into other phases, agreeing into DPs, PPs, and other adjunct CPs. Instead, only core arguments of the verb can be tracked by the SR system of Amahuaca – possessors, obliques introduced by postpositions, and DPs within more deeply nested CPs cannot be tracked. This pattern suggests that, indeed, phases are the relevant notion of locality for agreement. Thus, the case studies in this dissertation support a very conservative view of Agree which requires the probe to *c*-command the goal and which is always phase-bound.

In summary, through detailed and sustained exploration and analysis of Amahuaca morphology this dissertation provides evidence for several conclusions about the operation of Agree, some of which lend support to existing proposals and others that are more novel. First, activity is not relevant for all languages – some languages allow a single DP to be the goal for multiple Agree operations. Second, Agree proceeds cyclically with cyclic expansion allowing the search domain of the probe to be expanded. Next, maximal projections can serve as probes through cyclic expansion, as predicted by Bare Phrase Structure. A probe may interact with a goal without that goal satisfying the probe. Probes may be insatiable – some probes can agree with every possible goal in their *c*-command domain. The representation of probes is structured, and the structure reflects the derivational history. Agree is always under *c*-command, with the probe *c*-commanding the goal, and finally, Agree is strictly local.

Appendix A

Switch-reference markers

This appendix offers more data on the system of switch-reference (SR) in Amahuaca. I illustrate each of the SR markers and discuss what contrasts are and are not encoded by the system.

A.1 Illustration of switch-reference markers

In this section I give examples of each of Amahuaca's SR markers within the sequential action ('after'), immediately sequential action ('just after'), simultaneous action ('while'), and subsequent action ('before') paradigms.

A.1.1 Sequential action paradigm

=*hax*: marked clause subject = reference clause intransitive subject

- (215) [jaa= x_i vua= $\overline{\text{hax}}$]=mun xano $_i$ chirin= $xo=nu$
3SG=NOM sing=SS.SQ=C_{MATRIX} woman dance=3.PST=DECL
'After she $_i$ sang, the woman $_i$ danced.'

=*xon*: marked clause subject = reference clause transitive subject

- (216) [jaa= x_i vua= $\overline{\text{xon}}$]=mun xano= n_i xuki jova= $xo=nu$
3SG=NOM sing=SA.SQ=C_{MATRIX} woman=ERG corn cook=3.PST=DECL
'After she $_i$ sang, the woman $_i$ cooked corn.'

=*xo*: marked clause subject = reference clause direct object (217), indirect object (218), or applied object (219), resulting in potential ambiguity (220)

- (217) [jaa= x_i vua= $\overline{\text{xo}}$]=mun hinan xano $_i$ chivan-vo= $xo=nu$
3SG=NOM sing=SO.SQ=C_{MATRIX} dog.ERG woman chase-AM=3.PST=DECL
'After she $_i$ sang, the dog chased the woman $_i$.'

- (218) [jaa=x_i vua= $\overline{\text{xO}}$]=mun vaku-vaun xano_i jau jova
 3SG=NOM sing=SO.SQ=C_{MATRIX} child-PL.ERG woman flower
 hinan=xo=nu
 give=3.PST=DECL
 ‘After she_i sang, the children gave the woman_i a flower.’
- (219) [jaa=x_i vua= $\overline{\text{xO}}$]=mun vaku-vaun xano_i
 3SG=NOM sing=SO.SQ=C_{MATRIX} child-PL.ERG woman
 chirin=xon=xo=nu
 dance=APPL=3.PST=DECL
 ‘After she_i sang, the children danced for the woman_i.’
- (220) [pro_{i/j} nokoo= $\overline{\text{xO}}$]=mun joni=n Maria_i kankan_j maro=xo=nu
 arrive=SO.SQ=C_{MATRIX} man=ERG Maria pineapple buy=3.PST=DECL
 ‘After she_i/it_j arrived, the man bought pineapple_j from Maria_i.’

=*ha*: marked clause object = reference clause intransitive subject

- (221) [joni=n xano_i vuchi= $\overline{\text{ha}}$]=mun xano_i ka=xo=nu
 man=ERG woman find=OS.SQ=C_{MATRIX} woman go=3.PST=DECL
 ‘After the man found the woman_i, the woman_i went.’

=*havan*: 3PL marked clause subject

- (222) [jato=x_i vua= $\overline{\text{havan}}$]=mun xano_j chirin=xo=nu
 3PL=NOM sing=3PL.DS.SQ=C_{MATRIX} woman dance=3.PST=DECL
 ‘After they_i sang, the woman_j danced.’

=*kun*: default

- (223) [joni_i vua= $\overline{\text{kun}}$]=mun xano_j chirin=xo=nu
 man sing=DS.SQ=C_{MATRIX} woman dance=3.PST=DECL
 ‘After the man_i sang, the woman_j danced.’

A.1.2 Immediately sequential action paradigm

=*tan*: marked clause subject = reference clause subject (transitive or intransitive)

- (224) [jaa=x_i vua= $\overline{\text{tan}}$]=mun xano_i chirin=xo=nu
 3SG=NOM sing=SSA.IMMSQ=C_{MATRIX} woman dance=3.PST=DECL
 ‘Just after she_i sang, the woman_i danced.’
- (225) [jaa=x_i vua= $\overline{\text{tan}}$]=mun xano=n_i xuki jova=xo=nu
 3SG=NOM sing=SSA.IMMSQ=C_{MATRIX} woman=ERG corn cook=3.PST=DECL
 ‘Just after she_i sang, the woman_i cooked corn.’

A.1.3 Simultaneous action paradigm

=*hi*: marked clause subject = reference clause intransitive subject

- (226) [jaa=x_i vua=hi]=mun xano_i chirin=xo=nu
 3SG=NOM sing=SS.SIM=C_{MATRIX} woman dance=3.PST=DECL
 ‘While she sang, the woman_i danced.’

=*kin*: marked clause subject = reference clause transitive subject

- (227) [jaa=x_i vua=kin]=mun xano=n_i xuki jova=xo=nu
 3SG=NOM sing=SA.SIM=C_{MATRIX} woman=ERG corn cook=3.PST=DECL
 ‘While she_i sang, the woman_i cooked corn.’

=*haito*: marked clause subject = reference clause direct object (228), indirect object (229), or applied object (230)

- (228) [jaa=x_i vua=haito]=mun hinan xano_i chivan-vo=xo=nu
 3SG=NOM sing=SO.SIM=C_{MATRIX} dog.ERG woman chase-AM=3.PST=DECL
 ‘While she_i sang, the dog chased the woman_i.’

- (229) [jaa=x_i vua=haito]=mun vaku-vaun xano_i jau jova
 3SG=NOM sing=SO.SIM=C_{MATRIX} child-PL.ERG woman flower
 hinan=xo=nu
 give=3.PST=DECL
 ‘While she_i sang, the children gave the woman_i a flower.’

- (230) [jaa=x_i vua=haito]=mun vaku-vaun xano_i
 3SG=NOM sing=SO.SIM=C_{MATRIX} child-PL.ERG woman
 chirin=xon=xo=nu
 dance=APPL=3.PST=DECL
 ‘While she_i sang, the children danced for the woman_i.’

=*haivan*: 3PL marked clause subject

- (231) [jato=x_i vua=haivan]=mun xano_j chirin=xo=nu
 3PL=NOM sing=3PL.DS.SIM=C_{MATRIX} woman dance=3.PST=DECL
 ‘While they_i sang, the woman_j danced.’

=*hain*: default

- (232) [joni_i vua=hain]=mun xano_j chirin=xo=nu
 man sing=DS.SIM=C_{MATRIX} woman dance=3.PST=DECL
 ‘While the man_i sang, the woman_j danced.’

A.1.4 Subsequent action paradigm

=*katzi*: marked clause subject = reference clause intransitive subject¹

- (233) [jaa=x_i vua=katzi]=mun xano_i chirin=xo=nu
 3SG=NOM sing=SS.SUB=C_{MATRIX} woman dance=3.PST=DECL
 ‘Before she_i sang, the woman_i danced.’

=*xanni*: marked clause subject = reference clause intransitive subject²

- (234) [pro_i vua=xanni]=mun xano_i ka=xo=nu
 sing=SS.SUB=C_{MATRIX} woman go=3.PST=DECL
 ‘The woman was going to dance.’ (*Literally* ‘Before she_i danced, the woman_i went.’)

=*xankin*: marked clause subject = reference clause transitive subject

- (235) [jaa=x_i vua=xankin]=mun xano=n_i xuki jova=xo=nu
 3SG=NOM sing=SA.SUB=C_{MATRIX} woman=ERG corn cook=3.PST=DECL
 ‘Before she_i sang, the woman_i cooked corn.’

=*novo*: 3PL marked clause subject

- (236) [jato=x_i vua=novo]=mun xano_j chirin=xo=nu
 3PL=NOM sing=3PL.DS.SUB=C_{MATRIX} woman dance=3.PST=DECL
 ‘Before they_i sang, the woman_j danced.’

=*non*: default

- (237) [joni_i vua=non]=mun xano_j chirin=xo=nu
 man sing=DS.SUB=C_{MATRIX} woman dance=3.PST=DECL
 ‘Before the man_i sang, the woman_j danced.’

¹For one of the four main speakers with whom I collected data, =*katzi* can also be used when the marked clause subject is coreferential with a reference clause transitive subject as in (viii). Other speakers reject this type of example.

(viii) % [jaa=x_i vua=katzi]=mun xano=n_i xuki jova=xo=nu
 3SG=NOM sing=SS.SUB=C_{MATRIX} woman=ERG corn cook=3.PST=DECL
 ‘Before she_i sang, the woman_i cooked corn.’

²The marker =*xanni* appears to only be used with the matrix verb *ka* ‘go’ in the examples I have. Speakers have rejected this marker with other matrix verbs.

A.2 Contrasts not encoded by switch-reference markers

A.2.1 Abstract case of marked clause subjects

As seen above, only the abstract case of transitive and intransitive subjects in the reference (matrix) clause affects the form of the SR marker. Transitive and intransitive marked clause subjects are not treated differently from one another. This is illustrated by the lack of contrast between the form of the SR marker in (238) and (239). In (238) the marked clause subject is an intransitive subject, while in (239) the marked clause subject is a transitive subject. In both instances, the SR marker =*hax* is used.

(238) [jaa= x_i chirin= $\boxed{\text{hax}}$]=mun xano $_i$ vua=xo=nu
3SG=NOM dance=SS.SQ=C_{MATRIX} woman sing=3.PST=DECL
'After she $_i$ danced, the woman $_i$ sang.'

(239) [jaa= n_i xuki jova= $\boxed{\text{hax}}$]=mun xano $_i$ vua=xo=nu
3SG=ERG corn cook=SS.SQ=C_{MATRIX} woman sing=3.PST=DECL
'After she $_i$ cooked corn, the woman $_i$ sang.'

I discussed in Chapter 4 the fact that adjunct clause transitive subjects are always marked with ergative case, providing evidence that the subjects of adjunct clauses always agree with T. This means that all adjunct clause subjects can be unified with the feature [T]. Matrix clause subjects do not consistently agree with T and therefore do not consistently share a feature that distinguishes them as subjects. Thus, the SR system encodes the three-way split according to abstract case rather than a simple subject/object split for reference clauses.

A.2.2 Transitivity with default markers

Camacho's (2010) analysis of Panoan SR assumes that the type of distinction that I have analyzed as indicating abstract case (or grammatical function) instead indicates the transitivity of the reference clause. He notes that this transitivity agreement is not present in different subject constructions, which he takes to indicate that cross-clausal agreement does not occur in different subject clauses. In this dissertation I have instead argued that the seeming "transitivity" sensitivity shown in SR markers is, in fact, agreement indicating abstract case features of a DP that stands in a coreference relationship with another DP. This abstract case tracking does not occur when there are no coreferential DPs in the two clauses in a SR construction. This falls out straightforwardly under the analysis I presented in Chapter 4 if we assume that "different subject" marking is instead a morphological default that does not indicate anything about (non-)coreference of any arguments. These markers would not be expected to single out the abstract case value of a particular DP to expone if they do not generally indicate relationships between DPs.

The fact that such transitivity or case agreement is indeed lacking for all default SR markers in Amahuaca can be shown by comparing (223) with (240), (232) with (241), and (237) with (242).

- (240) [joni_i vua=kun]=mun xano=n_j xuki jova=xo=nu
 man sing=DS.SQ=C_{MATRIX} woman=ERG corn cook=3.PST=DECL
 ‘After the man_i sang, the woman_j cooked corn.’
- (241) [joni_i vua=hain]=mun xano=n_j xuki jova=xo=nu
 man sing=DS.SIM=C_{MATRIX} woman=ERG corn cook=3.PST=DECL
 ‘While the man_i sang, the woman_j cooked corn.’
- (242) [joni_i vua=non]=mun xano=n_j xuki jova=xo=nu
 man sing=DS.SUB=C_{MATRIX} woman=ERG corn cook=3.PST=DECL
 ‘Before the man_i sang, the woman_j cooked corn.’

A.2.3 Object coreference

Even in the sequential SR paradigm, which shows the largest number of morphological contrasts, there is no dedicated marker that indicates that the object of the marked clause is coreferential with the object of the reference clause. Likewise, there is no dedicated marker that indicates that the marked clause object is coreferential with the reference clause transitive subject. Instead, syncretism results in both of these coreference patterns being realized with the default marker =*kun*. This is illustrated for a construction where the objects of the two clauses are coreferential in (243). The default marker must be used, and it is ungrammatical to substitute, for example, the marker =*xo*, which indicates coreference of the marked clause subject and reference clause object. Additionally, I have been unable to find through elicitation or text-based work a distinct SR marker for this coreference relationship.

- (243) ‘After Juan found the peccary_i, Maria killed it_i.’
- a. [Juanu=n jono_i vuchi=kun]=mun Maria=n *pro*_i
 Juan.LG=ERG peccary find=DS.SQ=C_{MATRIX} Maria=ERG
 rutu=xo=nu
 kill=3.PST=DECL
- b. * [Juanu=n jono_i vuchi=xo]=mun Maria=n *pro*_i
 Juan.LG=ERG peccary find=SO.SQ=C_{MATRIX} Maria=ERG
 rutu=xo=nu
 kill=3.PST=DECL

A similar situation is seen in (244) for a construction where the object of the marked clause is coreferential with the transitive subject of the matrix clause. There is no dedicated SR marker that indicates this coreference pattern, and the default =*kun* must be used. It

is ungrammatical to substitute the marker *=ha*, which indicates coreference of the marked clause object with an intransitive subject of the reference clause.

- (244) ‘After the man found the peccary_{*i*}, the peccary_{*i*} ate fruit.’
- a. [joni=n jono_{*i*} vuchi=kun]=mun jono=n_{*i*} jii vimi
 man=ERG peccary find=DS.SQ=C_{MATRIX} peccary=ERG tree fruit
 ha=xo=nu
 do.TR=3.PST=DECL
- b. * [joni=n jono_{*i*} vuchi=ha]=mun jono=n_{*i*} jii vimi
 man=ERG peccary find=DS.SQ=C_{MATRIX} peccary=ERG tree fruit
 ha=xo=nu
 do.TR=3.PST=DECL

A.2.4 Reference of possessors and objects of postpositions

The analysis of SR given in Chapter 4 was based on the mechanism of Agree. If we assume that Agree is phase-bound, this means that we should expect that DPs trapped within phasal constituents should not be accessible to the agreeing SR head. Indeed, this is the pattern that we find. SR cannot show sensitivity to coreferential elements that are trapped within phases such as PPs and DPs. This phase-based account also derives the pattern seen with so-called ‘clause chains’ in Chapter 4 where each SR marker is sensitive only to the arguments of its own clause and the clause to which it adjoins, but not to the arguments of any other clause adjoined within either of those two clauses. If SR clauses are CP phases, they should not be transparent for agreement.

The example in (245) shows that it is not possible for SR marking to be sensitive to the reference of a DP within a PP. Here, the pronoun introduced by *vutan* ‘with’ in the matrix clause is coreferential with the subject of the adjunct clause, and the default marker *=kun* is used.

- (245) [*pro*_{*i*} jan nokoo=kun]=mun **jaa**_{*i*} **vutan** muka=hi vaku=ki=nu
 3SG arrive=DS.SQ=C_{MATRIX} 3SG with play=IPFV child=3.PRES=DECL
 ‘After he_{*i*} arrived, the child is playing with him_{*i*}.’

If instead of *=kun* the marker *=hax* is used, this forces a reading where it is the child who arrived, as seen in (246). I am unaware of a non-default SR marker that can be used to indicate coreference with the object of a postposition. Presumably this is because PP is a phase and SR C cannot agree into PP to probe the DP within it.

- (246) [*pro*_{*i*} nokoo=hax]=mun **jaa**_{*j*} **vutan** muka=hi vaku_{*i*}=ki=nu
 arrive=SS.SQ=C_{MATRIX} 3SG with play=IPFV child=3.PRES=DECL
 ‘After she_{*i*} arrived, the child_{*i*} is playing with him_{*j*}.’

We find a similar situation with material within the DP, namely possessors. In (247) we see an example where the subject of the adjunct clause is coreferential with the possessor of the matrix subject and the default marker =*kun* is used.

- (247) [Maria_i nokoo=kun]=mun **jan**_i **vaku** hoxa=xo=nu
 Maria arrive=DS.SQ=C_{MATRIX} 3SG.GEN child sleep=3.PST=DECL
 ‘After Maria_i arrived, her_i child slept.’

If the SR marker =*hax* is used, this results in a reading where it is the child, and not Maria who arrived, as shown in (248).

- (248) [*pro*_i nokoo=hax]=mun **Maria=n**_j **vaku**_i hoxa=xo=nu
 arrive=SS.SQ=C_{MATRIX} Maria=GEN child sleep=3.PST=DECL
 ‘After he_i arrived, Maria’s_j child_i slept.’

Substituting another coreference marker, such as =*xo*, yields ungrammaticality, as in (249).

- (249) * [*pro*_i nokoo=xo]=mun **Maria=n**_i **vaku** hoxa=xo=nu
 arrive=SS.SQ=C_{MATRIX} Maria=GEN child sleep=3.PST=DECL
 Intended: ‘After she_i arrived, Maria’s_i child slept.’

The patterns observed with possessors can be explained by the same logic used for PPs. If we assume that DP is a phase, only the features of the head of the DP will be accessible to the probe on SR C. Any material further embedded within DP, such as another DP possessor, will be trapped within the phase and will be inaccessible for agreement.

Bibliography

- Abels, Klaus, and Ad Neeleman. 2012. Linear asymmetries and the LCA. *Syntax* 15:25–74.
- Ackema, Peter, and Ad Neeleman. 2002. Effects of short-term storage in processing rightward movement. In *Storage and computation in the language faculty*, ed. Sieb G. Nooteboom, Fred Weerman, and Frank N. K. Wijnen, volume 30 of *Studies in Theoretical Psycholinguistics*, 219–256. Dordrecht: Kluwer Academic Publishers.
- Adger, David, and Gillian Ramchand. 2005. Merge and move: *Wh*-dependencies revisited. *Linguistic Inquiry* 36:161–193.
- Aldai, Gontzal. 2009. Is Basque morphologically ergative? Western Basque vs. Eastern Basque. *Studies in Language* 33:783–831.
- Alexiadou, Artemis, and Elena Anagnostopoulou. 1998. Parametrizing AGR: Word order, *V*-movement and EPP-checking. *Natural Language & Linguistic Theory* 16:491–539.
- Anagnostopoulou, Elena. 2005. Strong and weak person restrictions: A feature checking analysis. In *Clitic and affix combinations*, ed. Lorie Heggie and Francisco Ordóñez, volume 74 of *Linguistics Today*, 199–235. Amsterdam: John Benjamins.
- Aoun, Joseph. 1986. *Generalized binding: The syntax and logical form of wh-interrogatives*. Dordrecht: Foris.
- Arregi, Karlos, and Emily Hanink. 2018. Switch reference in Washo as multiple subject agreement. In *NELS 48: Proceedings of the Forty-Eighth Annual Meeting of the North East Linguistic Society*, ed. Sherry Hucklebridge and Max Nelson, volume 1, 39–48. Amherst, MA: Graduate Linguistics Student Association.
- Assmann, Anke. 2012. Switch-reference as interclausal tense agreement: Evidence from Quechua. In *Perspectives on switch-reference: Local modeling and empirical distribution*, ed. Philipp Weisser, 41–81. Leipzig: Institute für Linguistik, Universität Leipzig.
- Assmann, Anke, Doreen Georgi, Fabian Heck, Gereon Müller, and Philipp Weisser. 2015. Ergatives move too early: On an instance of opacity in syntax. *Syntax* 18:343–387.
- Austin, Peter K. 1981. Switch reference in Australia. *Language* 57:309–334.

- Baier, Nico. 2018. Anti-agreement. Doctoral Dissertation, University of California, Berkeley.
- Baker, Mark C. 2008. *The syntax of agreement and concord*. Cambridge: Cambridge University Press.
- Baker, Mark C. 2014. On dependent ergative case (in Shipibo) and its derivation by phase. *Linguistic Inquiry* 45:341–379.
- Baker, Mark C. 2015. *Case: Its principles and its parameters*. Cambridge: Cambridge University Press.
- Baker, Mark C., and Jonathan David Bobaljik. 2017. On inherent and dependent theories of ergative case. In *The Oxford handbook of ergativity*, ed. Jessica Coon, Diane Massam, and Lisa deMena Travis, 111–134. Oxford: Oxford University Press.
- Baker, Mark C., and Livia Camargo Souza. 2018. Agree without agreement: Switch-reference and reflexive voice in two Panoan languages. Ms., Rutgers University.
- Baker, Mark C., and Nadya Vinokurova. 2010. Two modalities of case assignment: Case in Sakha. *Natural Language & Linguistic Theory* 28:593–642.
- Bale, Alan, Michaël Gagnon, and Hrayr Khanjian. 2011. Cross-linguistic representations of numerals and number marking. In *Proceedings of SALT 20*, ed. Nan Li and David Lutz, 582–598. Ithaca, NY: CLC Publications.
- Béjar, Susana. 2003. Phi-syntax: A theory of agreement. Doctoral Dissertation, University of Toronto.
- Béjar, Susana, and Milan Rezac. 2003. Person licensing and the derivation of PCC effects. In *Romance linguistics: Theory and acquisition*, ed. Ana Teresa Pérez-Leroux and Yves Roberge, volume 244 of *Current Issues in Linguistic Theory*, 49–62. Amsterdam: John Benjamins.
- Béjar, Susana, and Milan Rezac. 2009. Cyclic Agree. *Linguistic Inquiry* 40:35–73.
- den Besten, Hans. 1983. On the interaction of root transformations and lexical deletive rules. In *On the formal syntax of the Westgermania*, ed. Werner Abraham, 47–131. Amsterdam: John Benjamins.
- Biberauer, Theresa, Anders Holmberg, and Ian Roberts. 2014. A syntactic universal and its consequences. *Linguistic Inquiry* 45:169–225.
- Bjorkman, Bronwyn M., and Hedde Zeijlstra. 2019. Checking up on (ϕ -)Agree. To appear, *Linguistic Inquiry*.

- Black, H. Andrew. 1992. South American verb second phenomena: Evidence from Shipibo. In *Syntax at Santa Cruz*, ed. H. Andrew Black and James McCloskey, volume 1, 35–63. Santa Cruz, CA: Syntax Research Center, University of California, Santa Cruz.
- Bobaljik, Jonathan David. 2008. Where’s phi? Agreement as a post-syntactic operation. In *Phi-theory: Phi features across interfaces and modules*, ed. Daniel Harbour, David Adger, and Susana Béjar, 295–328. Oxford: Oxford University Press.
- Boeckx, Cedric, Norbert Hornstein, and Jairo Nunes. 2010. *Control as movement*, volume 126 of *Cambridge Studies in Linguistics*. New York: Cambridge University Press.
- Bošković, Željko. 2007. On the locality and motivation of Move and Agree: An even more minimal theory. *Linguistic Inquiry* 38:589–644.
- Bruening, Benjamin. 2007. On diagnostics of structural case and the nature of ergative case: A reply to Woolford 2006. Ms., University of Delaware.
- Camacho, José. 2010. On case concord: The syntax of switch-reference clauses. *Natural Language & Linguistic Theory* 28:239–274.
- Camacho, José, and José Elías-Ulloa. 2001. Coordination and switch-reference: Evidence from Capanahua. Ms., Rutgers University.
- Camacho, José, and José Elías-Ulloa. 2010. Null subjects in Shipibo switch-reference systems. In *Information structure in indigenous languages of the Americas: Syntactic approaches*, ed. José Camacho, Rodrigo Gutiérrez-Bravo, and Liliana Sánchez, 65–85. Berlin: Mouton de Gruyter.
- Cândido, Gláucia Vieira. 2004. Descrição morfossintática da língua Shanenawa (Pano). Doctoral Dissertation, Instituto de Estudos da Linguagem, Universidade Estadual de Campinas.
- Carstens, Vicki. 2001. Multiple agreement and case deletion: Against ϕ -(in)completeness. *Syntax* 4:147–163.
- Carstens, Vicki. 2003. Rethinking complementizer agreement: Agree with a case-checked goal. *Linguistic Inquiry* 34:393–412.
- Carstens, Vicki. 2011. Hyperactivity and hyperagreement in Bantu. *Lingua* 121:721–741.
- Carstens, Vicki. 2016. Delayed valuation: A reanalysis of goal features, “upward” complementizer agreement, and the mechanics of case. *Syntax* 19:1–42.
- Carstens, Vicki, and Michael Diercks. 2013. Agreeing how? Implications for theories of agreement and locality. *Linguistic Inquiry* 44:179–237.

- Chelliah, Shobhana L., and Gwendolyn Hyslop. 2011. Introduction to special issue on optional case marking in Tibeto-Burman. *Linguistics of the Tibeto-Burman Area* 34:1–7.
- Chomsky, Noam. 1995a. Bare Phrase Structure. In *Evolution and revolution in linguistic theory*, ed. Héctor Campos and Paula Kempchinsky, 51–109. Washington, D.C.: Georgetown University Press.
- Chomsky, Noam. 1995b. *The minimalist program*. Cambridge, MA: MIT Press.
- Chomsky, Noam. 2000. Minimalist inquiries: The framework. In *Step by step: Essays on minimalist syntax in honor of Howard Lasnik*, ed. Roger Martin, David Michaels, and Juan Uriagereka, 89–155. Cambridge, MA: MIT Press.
- Chomsky, Noam. 2001. Derivation by phase. In *Ken Hale: A life in language*, ed. Michael Kenstowicz, 1–52. Cambridge, MA: MIT Press.
- Chomsky, Noam. 2013. Problems of projection. *Lingua* 130:33–49.
- Chomsky, Noam, and Howard Lasnik. 1993. The theory of principles and parameters. In *Syntax: An international handbook of contemporary research*, ed. Joachim Jacobs, Arnim von Stechow, Wolfgang Sternefeld, and Theo Vennemann, volume 1, 506–569. Berlin: Walter de Gruyter.
- Clem, Emily. 2018a. Against non-reference-tracking theories of switch-reference. *Proceedings of the Linguistic Society of America* 3:29:1–9.
- Clem, Emily. 2018b. Amahuaca ergative as agreement with multiple heads. To appear, *Natural Language & Linguistic Theory*.
- Clem, Emily. 2018c. Disharmony and the Final-Over-Final Condition in Amahuaca. Ms., University of California, Berkeley.
- Clem, Emily, and Virginia Dawson. 2019. The emergence of case matching in discontinuous DPs. Ms., University of California, Berkeley.
- Comrie, Bernard. 1978. Ergativity. In *Syntactic typology: Studies in the phenomenology of language*, ed. Winfred P. Lehmann, 329–394. Austin: University of Texas Press.
- Coon, Jessica. 2013a. *Aspects of split ergativity*. Oxford: Oxford University Press.
- Coon, Jessica. 2013b. TAM split ergativity (parts I-II). *Language and Linguistics Compass* 7:171–200.
- Coon, Jessica, Nico Baier, and Theodore Levin. 2019. Mayan agent focus and the ergative extraction constraint: Facts and fictions revisited. Ms., McGill University.
- Corbett, Greville G. 2000. *Number*. Cambridge: Cambridge University Press.

- Crevels, Mily. 2012. Language endangerment in South America: The clock is ticking. In *The indigenous languages of South America: A comprehensive guide*, ed. Lyle Campbell and Verónica Grondona, volume 2 of *The World of Linguistics*, 167–234. Berlin: Mouton de Gruyter.
- Danon, Gabi. 2011. Agreement and DP-internal feature distribution. *Syntax* 14:297–317.
- De Wit, Astrid. 2017. *The present perfective paradox across languages*. Oxford: Oxford University Press.
- Deal, Amy Rose. 2010. Ergative case and the transitive subject: A view from Nez Perce. *Natural Language & Linguistic Theory* 28:73–120.
- Deal, Amy Rose. 2015a. Ergativity. In *Syntax - Theory and analysis. An international handbook*, ed. Tibor Kiss and Artemis Alexiadou, volume 1, 654–708. Berlin: Mouton de Gruyter.
- Deal, Amy Rose. 2015b. Interaction and satisfaction in ϕ -agreement. Handout of talk presented at Interaction of Grammatical Building Blocks colloquium, Universität Leipzig.
- Deal, Amy Rose. 2015c. Interaction and satisfaction in ϕ -agreement. In *NELS 45: Proceedings of the Forty-Fifth Annual Meeting of the North East Linguistic Society*, ed. Thuy Bui and Deniz Özyıldız, volume 1, 179–192. Amherst, MA: Graduate Linguistics Student Association.
- Deal, Amy Rose. 2016. Cyclicity and connectivity in Nez Perce relative clauses. *Linguistic Inquiry* 47:427–470.
- Deal, Amy Rose. 2017a. Syntactic ergativity as case discrimination. In *Proceedings from WCCFL 34*, ed. Aaron Kaplan, Abby Kaplan, Miranda K. McCarvel, and Edward J. Rubin, 141–150. Somerville, MA: Cascadilla Proceedings Project.
- Deal, Amy Rose. 2017b. Towards an etiology of outer indices. In *A schrift to fest Kyle Johnson*, ed. Nicholas LaCara, Keir Moulton, and Anne-Michelle Tessier, 107–117. Linguistics Open Access Publications.
- Deal, Amy Rose. 2019. Raising to ergative: Remarks on applicatives of unaccusatives. *Linguistic Inquiry* 50:388–415.
- Diercks, Michael. 2013. Indirect agree in Lubukusu complementizer agreement. *Natural Language & Linguistic Theory* 31:357–407.
- Dooley, Robert A. 2010. *Exploring clause chaining*. SIL Electronic Working Papers. Dallas: SIL International.

- Eberhard, David M., Gary F. Simons, and Charles D. Fennig, ed. 2019. *Ethnologue: Languages of the world*. Dallas: SIL International, twenty-second edition. Online version: <http://www.ethnologue.com>.
- Ferreira, Rogério Vicente. 2005. *Língua matis (Pano): Uma descrição gramatical*. Doctoral Dissertation, Instituto de Estudos da Linguagem, Universidade Estadual de Campinas.
- Finer, Daniel L. 1984. The formal grammar of switch-reference. Doctoral Dissertation, University of Massachusetts Amherst.
- Finer, Daniel L. 1985. The syntax of switch-reference. *Linguistic Inquiry* 16:35–55.
- Fleck, David W. 2003. A grammar of Matses. Doctoral Dissertation, Rice University.
- Forbes, Clarissa. 2018. Persistent ergativity: Agreement and splits in Tsimshianic. Doctoral Dissertation, University of Toronto.
- Georgi, Doreen. 2012. Switch-reference by movement. In *Perspectives on switch-reference: Local modeling and empirical distribution*, ed. Philipp Weisser, 1–40. Leipzig: Institute für Linguistik, Universität Leipzig.
- Georgi, Doreen. 2013. Deriving the distribution of person portmanteaux by relativized probing. In *NELS 42: Proceedings of the Forty-Second Annual Meeting of the North East Linguistic Society*, ed. Stefan Keine and Shayne Sloggett, volume 1, 155–168. Amherst, MA: Graduate Linguistics Student Association.
- van Gijn, Rik. 2016. Switch reference in Western South America. In *Switch reference 2.0*, ed. Rik van Gijn and Jeremy Hammond, 153–206. Amsterdam: John Benjamins.
- Gordon, Raymond G., Jr., ed. 2005. *Ethnologue: Languages of the world*. Dallas: SIL International, fifteenth edition. Online version: <http://www.ethnologue.com/15>.
- Haegeman, Liliane, and Marjo van Koppen. 2012. Complementizer agreement and the relation between C⁰ and T⁰. *Linguistic Inquiry* 43:441–454.
- Haegeman, Liliane, and Terje Lohndal. 2010. Negative concord and (Multiple) Agree: A case study of West Flemish. *Linguistic Inquiry* 41:181–211.
- Haiman, John, and Pamela Munro, ed. 1983. *Switch reference and universal grammar*. Amsterdam: John Benjamins.
- Hale, Ken. 1992. Subject obviation, switch reference, and control. In *Control and grammar*, ed. Richard K. Larson, Sabine Iatridou, Utpal Lahiri, and James Higginbotham, 51–77. Dordrecht: Kluwer.
- Hale, Ken. 2001. Eccentric agreement. In *On case and agreement*, ed. Pablo Albizu and Beatriz Fernández, 15–48. Bilbao: Euskal Herriko Unibertsitatea.

- Halle, Morris, and Alec Marantz. 1993. Distributed Morphology and the pieces of inflection. In *The view from building 20: Essays on linguistics in honor of Sylvain Bromberger*, ed. Kenneth Hale and Samue Jay Keyser, 111–176. Cambridge, MA: MIT Press.
- Halpert, Claire. 2019. Raising, unphased. *Natural Language & Linguistic Theory* 37:123–165.
- Hicks, Glyn. 2009. *The derivation of anaphoric relations*, volume 139 of *Linguistik Aktuell/Linguistics Today*. Amsterdam: John Benjamins.
- Hiraiwa, Ken. 2001. Multiple Agree and the defective intervention constraint in Japanese. In *Proceedings of the 1st HUMIT student conference in language research (HUMIT 2000)*, ed. Ora Matushansky, Albert Costa, Javier Martin-Gonzalez, Lance Nathan, and Adam Szczegielniak, volume 40 of *MIT Working Papers in Linguistics*, 67–80. Cambridge, MA: MITWPL.
- Holmberg, Anders, and Christer Platzack. 1995. *The role of inflection in Scandinavian syntax*. Oxford: Oxford University Press.
- Hyde, Richard, and Eugene E. Loos. 1975. A few thoughts regarding high tone in Amahuaca. *Información de Campo* (Peru).
- Hyde, Sylvia. 1973. El verbo reflexivo del amahuaca. In *Estudios panos II*, ed. Eugene E. Loos, number 11 in Serie Lingüística Peruana, 9–51. Yarinacocha, Peru: Instituto Lingüístico de Verano.
- Hyde, Sylvia. 1980. *Diccionario Amahuaca*. Number 7 in Serie Lingüística Peruana. Yarinacocha, Peru: Instituto Lingüístico de Verano.
- Hyman, Larry M., and Sharon Inkelas. 1997. Emergent templates: The unusual case of Tiene. In *Proceedings of the Hopkins Optimality Workshop/Maryland Mayfest 1997*, ed. Viola Miglio and Bruce Morén, volume 5 of *Maryland Working Papers in Linguistics*, 92–116. College Park, MD: University of Maryland.
- Instituto Brasileiro de Geografia e Estatística. 2010. *Censo demográfico 2010: Características gerais dos indígenas, resultados do universo*. Rio de Janeiro: IBGE.
- Instituto Lingüístico de Verano. 1993. *Nan jahaahaxmun janox nonhcanu: Así vivimos*. Peru: Instituto Lingüístico de Verano.
- Instituto Nacional de Estadística e Informática. 2017. Censos nacionales 2017: XII de población, VII de vivienda y III de comunidades indígenas. Retrieved from <http://censos2017.inei.gob.pe/redatam/>.
- Jacobsen, William H. 1967. Switch-reference in Hokan-Coahuiltecan. In *Studies in South-Western ethnolinguistics*, ed. Dell H. Hymes and William E. Bittle, 238–263. The Hague: Mouton.

- Johns, Alana. 2000. Ergativity: A perspective on recent work. In *The first Glot International state-of-the-article book*, ed. Lisa L.-S. Cheng and Rint Sybesma, 47–73. New York: Mouton de Gruyter.
- Karadamou, Charitini. 2018. The phonetics, phonology and morphology of Amawaka, an endangered Panoan language of the Amazon basin. Doctoral Dissertation, University of Bern.
- Kayne, Richard S. 1994. *The antisymmetry of syntax*. Linguistic Inquiry monographs. Cambridge, MA: MIT Press.
- Keine, Stefan. 2012. Switch-reference as coordination. In *Perspectives on switch-reference: Local modeling and empirical distribution*, ed. Philipp Weisser, 107–164. Leipzig: Institute für Linguistik, Universität Leipzig.
- Keine, Stefan. 2013. Deconstructing switch-reference. *Natural Language & Linguistic Theory* 31:767–826.
- King, Tracy Holloway. 1996. Slavic clitics, long head movement, and prosodic inversion. *Journal of Slavic Linguistics* 4:274–311.
- Kramer, Ruth. 2009. Definite markers, phi-features, and agreement: A morphosyntactic investigation of the Amharic DP. Doctoral Dissertation, University of California, Santa Cruz.
- Kramer, Ruth. 2017. General number nouns in Amharic lack NumP. In *Asking the right questions: Essays in honor of Sandra Chung*, ed. Jason Ostrove, Ruth Kramer, and Joseph Sabbagh, 39–54. Santa Cruz, CA: Linguistics Research Center.
- Kratzer, Angelika. 2009. Making a pronoun: Fake indexicals as windows into the properties of pronouns. *Linguistic Inquiry* 40:187–237.
- Landau, Idan. 2000. *Elements of control: Structure and meaning in infinitival constructions*. Dordrecht: Kluwer.
- Landau, Idan. 2006. Chain resolution in Hebrew V(P)-fronting. *Syntax* 9:32–66.
- Legate, Julie Anne. 2002. Warlpiri: Theoretical implications. Doctoral Dissertation, Massachusetts Institute of Technology.
- Legate, Julie Anne. 2005. Phases and cyclic agreement. In *Perspectives on phases*, ed. Martha McGinnis and Norvin Richards, volume 49 of *MIT Working Papers in Linguistics*, 147–156. Cambridge, MA: MITWPL.
- Legate, Julie Anne. 2006. Split absolutive. In *Ergativity: Emerging issues*, ed. Alana Johns, Diane Massam, and Juvénal Ndayiragije, number 65 in *Studies in Natural Language and Linguistic Theory*, 143–171. Dordrecht: Springer.

- Legate, Julie Anne. 2008. Morphological and abstract case. *Linguistic Inquiry* 39:55–101.
- Loos, Eugene. 1973. La señal de transitividad del sustantivo en los idiomas panos. In *Estudios panos I*, ed. Eugene Loos, number 10 in Serie Lingüística Peruana, 133–184. Yarinacocha, Peru: Instituto Lingüístico de Verano.
- Loos, Eugene. 1999. Pano. In *The Amazonian languages*, ed. R. M. W. Dixon and Alexandra Y. Aikhenvald, 227–250. Cambridge: Cambridge University Press.
- Mahajan, Anoop Kumar. 1990. The A/A-bar distinction and movement theory. Doctoral Dissertation, Massachusetts Institute of Technology.
- Marantz, Alec. 1991. Case and licensing. In *Eastern States Conference on Linguistics*, ed. Germán Westphal, Benjamin Ao, and Hee-Rahk Chae, 234–253. Cornell University, Ithaca, NY: Cornell Linguistics Club.
- McKenzie, Andrew. 2012. The role of contextual restriction in reference-tracking. Doctoral Dissertation, University of Massachusetts Amherst.
- McKenzie, Andrew. 2015. A survey of switch-reference in North America. *International Journal of American Linguistics* 81:409–448.
- Ministerio de Educación. 1960. *Quiricá 1*. Peru: Ministerio de Educación.
- Ministerio de Educación. 1961. *Quiricá 2*. Peru: Ministerio de Educación.
- Ministerio de Educación. 1984. *Quiricá 4: Libro de lectura y escritura N^o 4, Amahuaca*. Peru: Ministerio de Educación.
- Ministerio de Educación. 1985. *Quiricá 3: Libro de lectura y escritura N^o 3, Amahuaca*. Peru: Ministerio de Educación.
- Ministerio de Educación. 1986. *Quiricá 5: Libro de lectura y escritura N^o 5, Amahuaca*. Peru: Ministerio de Educación.
- Ministerio de Educación. 1988. *Quiricá 6: Libro de lectura y escritura N^o 6, Amahuaca*. Peru: Ministerio de Educación.
- Miyagawa, Shigeru. 2010. *Why agree? Why move? : Unifying agreement-based and discourse configurational languages*. Cambridge, MA: MIT Press.
- Montag, Richard. 2005. Participant referencing in Cashinahua. SIL International.
- Moulton, Keir. 2009. Natural selection and the syntax of clausal complementation. Doctoral Dissertation, University of Massachusetts Amherst.
- Munro, Pamela, ed. 1979. *Studies of switch-reference*, volume 8 of *UCLA Papers in Syntax*. Los Angeles: University of California.

- Neely, Kelsey. 2019. The linguistic expression of affective stance in Yaminawa (Pano, Peru). Doctoral Dissertation, University of California, Berkeley.
- Nevins, Andrew. 2005. Derivations without the Activity Condition. In *Perspectives on phases*, ed. Martha McGinnis and Norvin Richards, volume 49 of *MIT Working Papers in Linguistics*, 287–310. Cambridge, MA: MITWPL.
- Nevins, Andrew. 2007. The representation of third person and its consequences for person-case effects. *Natural Language & Linguistic Theory* 25:273–313.
- Nevins, Andrew. 2011. Multiple agree with clitics: Person complementarity vs. omnivorous number. *Natural Language & Linguistic Theory* 29:939–971.
- Nonato, Rafael. 2014. Clause chaining, switch reference, and coordination. Doctoral Dissertation, Massachusetts Institute of Technology.
- Osborn, Henry. 1948. Amahuaca phonemes. *International Journal of American Linguistics* 14:188–190.
- Oxford, Will. 2017. The Activity Condition as a microparameter. *Linguistic Inquiry* 48:711–722.
- Paul, Ileana. 2001. *Ve* as a second-position clitic. *Oceanic Linguistics* 40:135–142.
- Paul, Ileana. 2012. General number and the structure of DP. In *Count and mass across languages*, ed. Diane Massam, 99–112. Oxford: Oxford University Press.
- Payne, Thomas E. 1979. Who’s kissing who: The fourth person in Yup’ik Eskimo. In *Studies of switch-reference*, ed. Pamela Munro, volume 8 of *UCLA Papers in Syntax*, 65–88. Los Angeles: University of California.
- Pesetsky, David, and Esther Torrego. 2001. T-to-C movement: Causes and consequences. In *Ken Hale: A life in language*, ed. Michael Kenstowicz, 355–426. Cambridge, MA: MIT Press.
- Polinsky, Maria, and Eric Potsdam. 2001. Long-distance agreement and topic in Tsez. *Natural Language & Linguistic Theory* 19:583–646.
- Preminger, Omer. 2013. That’s not how you agree: A reply to Zeijlstra. *The Linguistic Review* 30:491–500.
- Preminger, Omer. 2014. *Agreement and its failures*. Cambridge, MA: MIT Press.
- Režac, Milan, Pablo Albizu, and Ricardo Etxepare. 2014. The structural ergative of Basque and the theory of Case. *Natural Language & Linguistic Theory* 32:1273–1330.
- Rezac, Milan. 2003. The fine structure of cyclic Agree. *Syntax* 6:156–182.

- Rezac, Milan. 2004. Elements of cyclic syntax: Agree and Merge. Doctoral Dissertation, University of Toronto.
- Richards, Norvin. 1999. Featural cyclicity and the ordering of multiple specifiers. In *Working Minimalism*, ed. Samuel D. Epstein and Howard Lasnik, 127–158. Cambridge, MA: MIT Press.
- Rizzi, Luigi. 1997. On the fine structure of the left periphery. In *Elements of grammar*, ed. Liliane Haegeman, 281–337. Dordrecht: Springer.
- Roberts, Ian. 2010. *Agreement and head movement: Clitics, incorporation, and defective goals*. Cambridge, MA: MIT Press.
- Roberts, John R. 1997. Switch-reference in Papua New Guinea: A preliminary survey. In *Papers in Papuan linguistics no. 3*, ed. Andrew Pawley, 101–241. Canberra: The Australian National University.
- Rochemont, Michael. 1998. Phonological focus and structural focus. In *The limits of syntax: Syntax and semantics 29*, ed. Peter Culicover and Louise McNally, 337–364. New York: Academic Press.
- Rooryck, Johan, and Guido Vanden Wyngaerd. 2011. *Dissolving binding theory*. Oxford: Oxford University Press.
- Rullmann, Hotze, and Aili You. 2006. General number and the semantics and pragmatics of indefinite bare nouns in Mandarin Chinese. In *Where semantics meets pragmatics*, ed. Klaus von Stechow and Ken Turner, volume 16 of *Current Research in the Semantics/Pragmatics Interface*, 175–196. Oxford: Elsevier.
- Russell, Robert. 1965. A transformational grammar of Amahuaca (Pano). Master's thesis, The Ohio State University.
- Russell, Robert. 2014. *Interesting features of the Amahuaca language*. Dallas: SIL International.
- Russell, Robert, and Dolores Russell. 1959. Syntactotonomics in Amahuaca (Pano). *Série Lingüística Especial* 1:128–167.
- Sheehan, Michelle, Theresa Biberauer, Ian Roberts, and Anders Holmberg. 2017. *The Final-Over-Final Condition: A syntactic universal*. Linguistic Inquiry monographs. Cambridge, MA: MIT Press.
- Sparing-Chávez, Margarethe. 1998. Interclausal reference in Amahuaca. In *Handbook of Amazonian languages*, ed. Desmond C. Derbyshire and Geoffrey K. Pullum, volume 4, 443–485. Berlin: Mouton de Gruyter.

- Sparing-Chávez, Margarethe. 2012. *Aspects of Amahuaca grammar: An endangered language of the Amazon basin*. Dallas: SIL International.
- Stirling, Lesly. 1993. *Switch-reference and discourse representation*. Cambridge: Cambridge University Press.
- Thráinsson, Höskulder. 2001. Object shift and scrambling. In *The handbook of contemporary syntactic theory*, ed. Mark Baltin and Chris Collins, 148–202. Oxford: Blackwell.
- Tomić, Olga Mišeska. 1996. The Balkan Slavic clausal clitics. *Natural Language & Linguistic Theory* 14:811–872.
- deMena Travis, Lisa. 1984. Parameters and effects of word order variation. Doctoral Dissertation, Massachusetts Institute of Technology.
- Valenzuela, Pilar. 2003. Transitivity in Shipibo-Konibo grammar. Doctoral Dissertation, University of Oregon.
- Valenzuela, Pilar. 2005. Participant agreement in Panoan. In *Secondary predication and adverbial modification: The typology of depictives*, ed. Nikolaus P. Himmelmann and Eva F. Schultze-Berndt, 259–298. Oxford: Oxford University Press.
- Valenzuela Bismark, Pilar. 2006. Aspectos morfosintácticos de la relativización en shipibokonibo (pano). *Boletim do Museu Paraense Emílio Goeldi. Ciências Humanas* 1:123–134.
- Vikner, Sten. 1994. Scandinavian object shift and West Germanic scrambling. In *Studies on scrambling: Movement and non-movement approaches to free word-order phenomena*, ed. Norbert Corver and Henk van Riemsdijk, 487–517. Berlin: Mouton de Gruyter.
- Wasow, Thomas. 1972. Anaphoric relations in English. Doctoral Dissertation, Massachusetts Institute of Technology.
- Watanabe, Akira. 2000. Feature copying and binding: Evidence from complementizer agreement and switch reference. *Syntax* 3:159–181.
- Weisser, Philipp. 2012. Is there switch-reference marking in coordinated clauses? In *Perspectives on switch-reference: Local modeling and empirical distribution*, ed. Philipp Weisser, 165–190. Leipzig: Institut für Linguistik, Universität Leipzig.
- Weisser, Philipp. 2016. Is there switch-reference marking in coordinated clauses? In *Switch reference 2.0*, ed. Rik van Gijn and Jeremy Hammond, volume 114 of *Typological Studies in Language*, 93–114. Amsterdam: John Benjamins.
- Wilder, Chris, and Damir Čavar. 1994. Long head movement? verb movement and cliticization in Croatian. *Lingua* 93:1–58.

- Wilhelm, Andrea. 2008. Bare nouns and number in Dëne Sùliné. *Natural Language Semantics* 16:39–68.
- Woolford, Ellen. 1997. Four-way Case systems: Ergative, nominative, objective, and accusative. *Natural Language & Linguistic Theory* 15:181–227.
- Woolford, Ellen. 2006. Lexical Case, inherent Case, and argument structure. *Linguistic Inquiry* 37:111–130.
- Wurmbrand, Susi. 2012a. Parasitic participles in Germanic: Evidence for the theory of verb clusters. *Taal en Tongval* 64:129–156.
- Wurmbrand, Susi. 2012b. The syntax of valuation in auxiliary-participle constructions. In *Coyote working papers: Proceedings of the 29th West Coast Conference on Formal Linguistics*, ed. Jaehoon Choi, E. Alan Hogue, Jeffrey Punske, Deniz Tat, Jessamyn Schertz, and Alex Trueman, 154–162. Tucson: University of Arizona.
- Yip, Moira, Joan Maling, and Ray Jackendoff. 1987. Case in tiers. *Language* 63:217–250.
- Zariquiey, Roberto. 2011. A grammar of Kashibo-Kakataibo. Doctoral Dissertation, La Trobe University.
- Zariquiey, Roberto. 2016. Target, embedding and switch-reference constructions in Kakataibo. In *Switch reference 2.0*, ed. Rik van Gijn and Jeremy Hammond, 473–492. Amsterdam: John Benjamins.
- Zariquiey, Roberto. 2018. *A grammar of Kakataibo*, volume 75 of *Mouton Grammar Library*. Berlin: Mouton de Gruyter.
- Zeijlstra, Hedde. 2004. Sentential negation and negative concord. Doctoral Dissertation, University of Amsterdam.
- Zeijlstra, Hedde. 2012. There is only one way to agree. *The Linguistic Reveiw* 29:491–539.
- Zeijlstra, Hedde. 2016. Explaining FOFC without the LCA. Presentation at the 47th Annual Meeting of the North East Linguistic Society.
- Zwart, C. Jan-Wouter. 1997. *Morphosyntax of verb movement: A minimalist approach to the syntax of Dutch*. Dordrecht: Kluwer.
- Zwicky, Arnold M., and Geoffrey K. Pullum. 1983. Cliticization vs. inflection: English N'T. *Language* 59:502–513.
- Zwicky, Arnold M., and Jerrold M. Sadock. 1975. Ambiguity tests and how to fail them. In *Syntax and semantics*, ed. John P. Kimball, volume 4, 1–36. New York: Academic Press.