

UC Berkeley

UC Berkeley Previously Published Works

Title

Model Predictive Control of an Integrated Continuous Pharmaceutical Manufacturing Pilot Plant

Permalink

<https://escholarship.org/uc/item/2qs325z0>

Journal

Organic Process Research & Development, 21(6)

ISSN

1083-6160

Authors

Mesbah, Ali
Paulson, Joel A
Lakerveld, Richard
[et al.](#)

Publication Date

2017-06-16

DOI

10.1021/acs.oprd.7b00058

Peer reviewed

Model Predictive Control of an Integrated Continuous Pharmaceutical Manufacturing Pilot Plant

Ali Mesbah,^{*,‡,§} Joel A. Paulson,[‡] Richard Lakerveld,[§] and Richard D. Braatz^{||}

[‡]Department of Chemical and Biomolecular Engineering, University of California, Berkeley, California 94720, United States

[§]Department of Chemical and Biomolecular Engineering, The Hong Kong University of Science and Technology, Clear Water Bay, Kowloon, Hong Kong

^{||}Department of Chemical Engineering, Massachusetts Institute of Technology, Cambridge, Massachusetts 02139, United States

ABSTRACT: This paper considers the model predictive control (MPC) of critical quality attributes (CQAs) of products in an end-to-end continuous pharmaceutical manufacturing pilot plant, which was designed and constructed at the Novartis-MIT Center for Continuous Manufacturing. Feedback control is crucial for achieving the stringent regulatory requirements on CQAs of pharmaceutical products in the presence of process uncertainties and disturbances. To this end, a key challenge arises from complex plant-wide dynamics of the integrated process units in a continuous pharmaceutical process, that is, dynamical interactions between several process units. This paper presents two plant-wide MPC designs for the end-to-end continuous pharmaceutical manufacturing pilot plant using the quadratic dynamic matrix control algorithm. The plant-wide MPC designs are based on different modeling approaches—subspace identification and linearization of nonlinear differential-algebraic equations that yield, respectively, linear low-dimensional and high-dimensional state-space models for the plant-wide dynamics. The closed-loop performance of the plant-wide MPC designs is evaluated using a nonlinear plant simulator equipped with a stabilizing control layer. The closed-loop simulation results demonstrate that the plant-wide MPC systems can facilitate effective regulation of CQAs and flexible process operation in the presence of uncertainties in reaction kinetics, persistent drifts in efficiency of filtration units, temporary disturbances in purity of intermediate compounds, and set point changes. The plant-wide MPC allows for incorporating quality-by-design considerations into the control problem through input and output constraints to ensure regulatory compliant process operation.

INTRODUCTION

In recent years, there has been a growing interest in the pharmaceutical industry to adopt more sophisticated synthesis and manufacturing approaches.^{1,2} The paradigm shift from conventional batch pharmaceutical manufacturing to continuous manufacturing is driven by demands for enhanced sustainability, reliability, and cost-effectiveness, as well as to enable the implementation of novel synthesis pathways.³ *Integrated continuous manufacturing* (ICM) offers new avenues for substantially reducing the environmental footprint, manufacturing times, and costs compared to existing batch pharmaceutical processes.^{4–6} In addition, ICM creates opportunities for increased use of online monitoring (i.e., process analytical technology⁷) for *online feedback control* to achieve consistently high-quality product in the presence of process uncertainties and disturbances by taking corrective actions before the product goes off-spec.

Online feedback control is an alternative to the so-called *design space* strategy in pharmaceutical manufacturing.^{8,9} A design space is defined as the multidimensional space of *critical process parameters* (CPPs)—input variables and process parameters—that have been demonstrated to result in acceptable *critical quality attributes* (CQAs) of the product. The design space strategy is to operate the CPPs within the design space and possibly use the design space to inform feedforward control actions for counteracting measured process variations. Such a strategy enables a robust process operation, in that known process variations within the design space (due to uncertainties

and disturbances) can be accounted for without feedback control.¹⁰ However, the establishment of a high-dimensional design space for ICM processes can be expensive. Also, interactions between several process units connected through a network of mass and energy streams can result in very little flexibility in process operation, with a design space that is practically too small to operate within.¹¹ On the other hand, when the product CQAs are monitored in real time, feedback control can be applied to keep the CQAs within their admissible limits by actively manipulating CPPs to counteract process variations. As such, feedback control can enable more robust and flexible process operation compared to the design space strategy.

The feedback control of a continuous pharmaceutical manufacturing plant requires handling the complex plant-wide dynamics of the integrated process units. Advanced control of isolated process units (e.g., crystallizers, thin-film processing units, granulation units, compaction units, etc.) in pharmaceutical processes has been extensively investigated (e.g., see refs 12–18 and the references therein). On the other hand, the shift from batch processing to ICM critically hinges on harnessing the multivariable dynamics of a plant that is composed of several interconnected units with recycle, bypass, and heat streams. The dynamic interactions between various process units in an ICM process can significantly increase the complexity of the plant-wide dynamics, possibly leading to a poor performance of

Received: February 21, 2017

Published: May 17, 2017



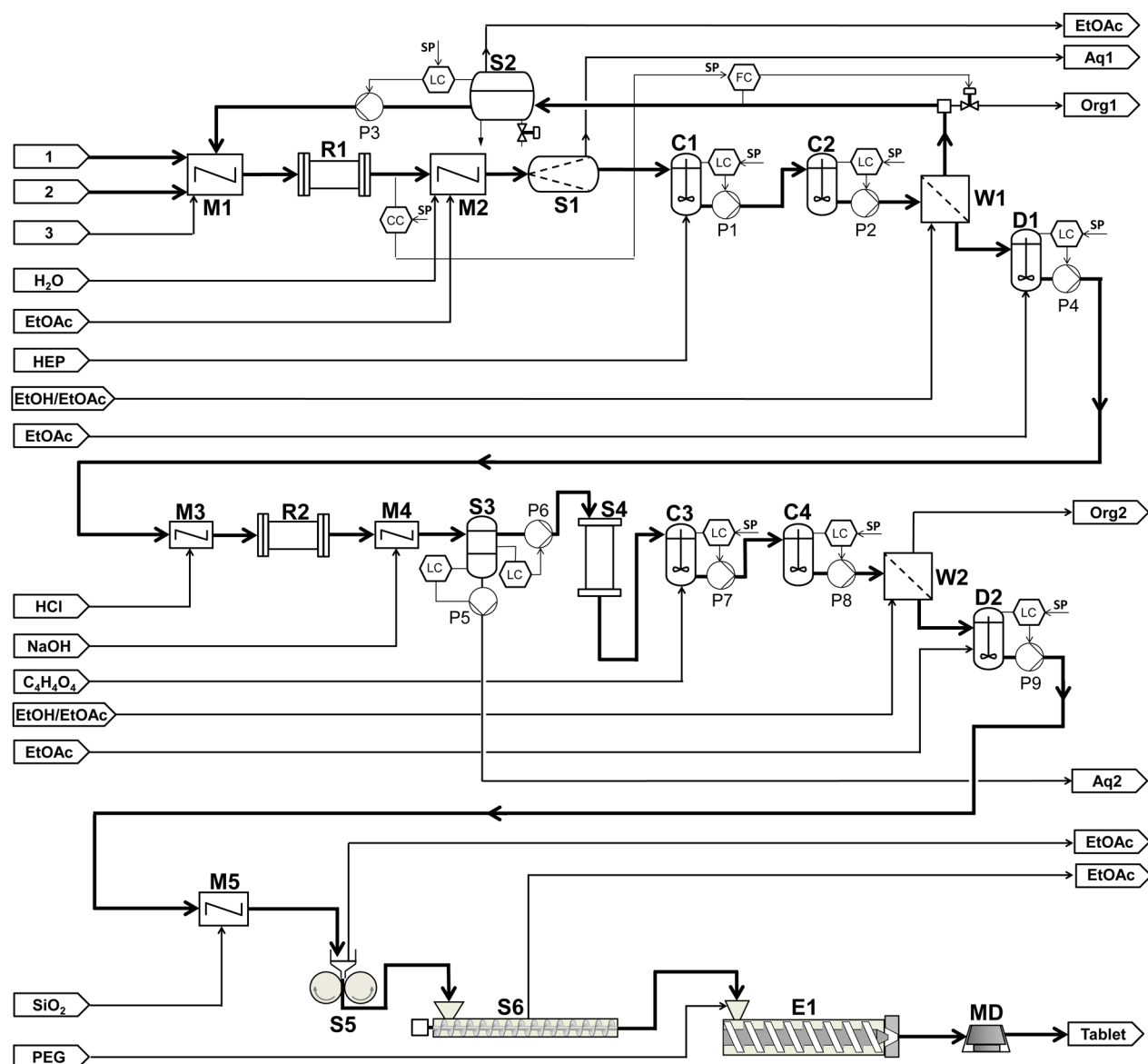

Figure 1. Integrated continuous pharmaceutical manufacturing pilot plant equipped with a stabilizing control layer. R reactor, S separator, C crystallizer, M mixer, W washing/filtering unit, D dilution tank, E extruder, MD molding unit, P pump, CC concentration control, FC flow control, LC level control, SP set point.

decentralized control systems. This necessitates design of plant-wide control strategies that can systematically account for the complex plant-wide dynamics of the integrated process units, so that the stringent regulatory requirements on the CQAs of the end product can be effectively realized in the presence of process uncertainties and disturbances.

This article investigates plant-wide control of an end-to-end integrated continuous pharmaceutical manufacturing pilot plant, which was designed and constructed at the Novartis-MIT Center for Continuous Manufacturing. The ICM pilot plant includes chemical synthesis, purification, formulation, and tableting for manufacturing a pharmaceutical product from start (synthesis of intermediate compounds) to finish (molded tablets in final dosage form) in a fully continuous mode.¹⁹ The dynamics of the pilot plant are described by a nonlinear plant simulator,²⁰ consisting of nearly 8000 state variables. [Certain features of the plant simulator (e.g., recycle streams, online PAT sensors) were not implemented in the real ICM pilot plant.] This work uses the model predictive control (MPC) strategy²¹ to design two plant-

wide control systems for the ICM pilot plant. MPC is the most widely applied approach for advanced control of complex dynamical systems due to its ability to systematically deal with the multivariable dynamics of systems with multiple inputs and outputs, system constraints, and competing sets of control objectives. The plant-wide MPC systems are designed using the *quadratic dynamic matrix control* (QDMC) algorithm,²² which relies on an input-output description of plant-wide dynamics. The input–output framework of QDMC is independent of the state dimension and therefore can alleviate the prohibitive computational cost associated with real-time control of ICM plants. As such, QDMC can be implemented for real-time control of ICM plants with high state dimension since they have a relatively small number of inputs (CPPs) and outputs (CQAs). In addition, QDMC enables incorporating output constraints into the control problem, which is particularly important for online control of pharmaceutical manufacturing since any quality-by-design considerations (i.e., CQAs) can be explicitly addressed in the plant-wide MPC system.

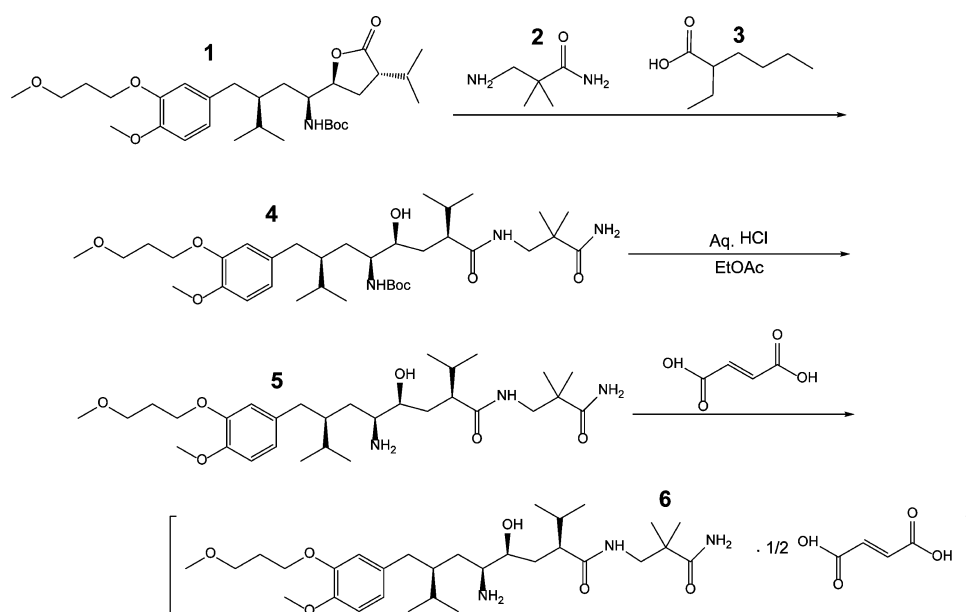

Figure 2. Synthetic reactions from intermediate 1 to active pharmaceutical ingredient 6.

This article extends our previous work on plant-wide MPC of the ICM pilot plant²³ by considering two different modeling approaches (thereby, two plant-wide MPC designs) for obtaining a linear time-invariant (LTI) approximation of the nonlinear plant dynamics. In the first modeling approach, subspace identification²⁴ is adopted to identify a low-dimensional state-space description for the plant dynamics using input/output data (generated by the plant simulator) around some desired steady-state operating condition. Alternatively, in the second modeling approach, the model equations (i.e., a set of nonlinear differential algebraic equations, DAEs) are linearized around the steady-state operating condition to arrive at a high-dimensional state-space model based on first principles. Both modeling approaches are validated against predictions of the nonlinear plant simulator. The developed LTI models of the plant-wide dynamics are then used to characterize the finite step response (FSR) dynamics of the pilot plant, based on which the plant-wide QDMC systems are designed. To formulate the control problem, a dynamic sensitivity analysis is performed using the plant simulator to identify the inputs that have the largest influence on the plant-wide dynamics relevant to feedback control of the ICM pilot plant. The closed-loop performance of both plant-wide QDMC systems is evaluated on the nonlinear plant simulator, which is equipped with a basic stabilizing control layer. Various operating scenarios, including uncertainties in reaction kinetics, persistent drifts in efficiency of filtration units, temporary disturbances in purity of intermediate compounds, and set point changes, are considered to demonstrate the operational versatility of the plant-wide QDMC systems for the ICM pilot plant under study. In addition, the performance of the plant-wide QDMC systems is compared against that of a plant-wide regulatory control system presented in ref 25.

The structure of the article is as follows. The integrated continuous pharmaceutical manufacturing pilot plant is first presented. This is followed by the description of the data-driven and first-principles modeling approaches adopted for obtaining a LTI representation for the nonlinear plant-wide dynamics using the existing plant simulator. The formulation of the plant-wide MPC problem for the ICM plant is outlined next, which is

followed by the simulation results of the plant-wide QDMC and regulatory control systems for various operating scenarios.

PROCESS DESCRIPTION

A schematic representation of the integrated continuous pharmaceutical manufacturing pilot plant is depicted in Figure 1 (see refs 19 and 26 for a detailed description). The target active pharmaceutical ingredient (API) is aliskiren hemifumarate (compound 6 in Figure 2), which is synthesized from aliskiren (intermediate compound 5). The process consists of several units for synthesis and purification of intermediates and the API, followed by a series of downstream units in which excipients are added to the API and tablets are formed. The process starts with mixing the intermediate compound 1 with amine 2 and acid catalyst 3 (see Figure 2), which is then fed to a tubular reactor (R1) to produce the intermediate compound 4. Water and ethyl acetate (EtOAc) are added to the reactor outlet stream to solubilize the reagents and to cool the mixture (M2). The two-phase stream is separated in a membrane-based liquid–liquid separator (S1), from which an aqueous-phase stream (Aq1) containing 2 and 3 is purged. The outlet stream of S1 (containing 1 and 4) is fed into a two-stage, mixed suspension, mixed product removal (MSMPR) crystallization unit (C1 and C2) to crystallize the intermediate compound 4 by antisolvent heptane (HEP) addition and cooling. The crystallization slurry is then fed into a continuous filter (W1) to wash and filter crystals with ethanol (EtOH) and EtOAc to remove mother liquor. The permeate stream of the filter unit W1 contains a substantial amount of reactant 1 and, therefore, is recycled back to reactor R1. A flash evaporator (S2) is used to remove EtOAc from the recycled stream. A fraction of the material in the recycle loop is purged (Org1) to avoid excessive buildup of impurities (i.e., reaction byproducts).

The purified crystals of the intermediate compound 4 in the outlet stream of W1 are diluted with EtOAc in a dilution tank (D1) to adjust the concentration of 4 for the second reaction (i.e., 4 to 5 in Figure 2). The slurry of compound 4 in EtOAc is mixed with aqueous hydrogen chloride and fed into a tubular reactor (R2) to perform acid-catalyzed removal of the Boc

protecting group (Boc = *tert*-butoxycarbonyl) from **4**. The reactor outlet stream, which contains the second intermediate compound **5**, is quenched with sodium hydroxide (NaOH) to neutralize the acid catalyst. The two-phase mixture is then separated in a decanter (S3), from which the aqueous phase (Aq2) is purged. The organic-phase stream containing compound **5** is passed through an adsorption column (S4) to remove the traces of water. The API **6** is formed in a reactive crystallization step (C3), in which fumaric acid reacts with the second intermediate compound **5**. The API is initially synthesized in the first MSMR vessel (C3), and the yield is further increased in a second MSMR vessel (C4). The API crystals are purified in a combined washing and filtration unit (W2), similar to W1, and then fed into a dilution tank (D2) to adjust the concentration of the API wet cake by adding EtOAc.

Prior to tablet formulation, the first excipient (SiO₂) is added to the crystal slurry to improve the flowability of the needle-shaped API crystals. This is followed by two drying steps. The bulk of EtOAc is evaporated in a double drum dryer (S5), and subsequently, the traces of the solvent are removed in a screw dryer (S6). The dried powder is then mixed with polyethylene glycol (PEG) to improve the stability of the final tablets. The powder mixture is conveyed to an extruder (E1), which is coupled to a molding unit (MD) that forms tablets with a defined geometry. At the end of the process, the solvent content, total impurity content, and API dosage of the final tablets are measured using a near-infrared instrument. In addition, the production rate of the tablets is measured. In this study, the potential CPPs consist of flow rates of all the inlet reactant, solvent, and excipient streams to the process. The API dosage and total impurity content constitute the CQAs of the manufactured tablets.

The ICM pilot plant depicted in Figure 1 is equipped with a stabilizing control layer to maintain sufficient holdup in each vessel. The stabilizing control layer consists of proportional-only level controllers (LC), which regulate the outlet flow rate from the vessel using a pump (P). In addition, a control loop is established to reject disturbances in the recycle stream to reactor R1. An in-line measurement instrument is used in the outlet stream of the reactor to measure the concentration of the reaction effluents, utilized for controlling the concentration of the byproducts recycled back to R1. The concentration is controlled by cascade control of the flow rate of the purge stream (Org1), where the manipulated variable of a concentration controller (CC) serves as the set point of a flow controller (FC) implemented on the purge stream (see ref 25 for the design of the stabilizing control layer).

CONTROL-RELEVANT PROCESS MODELING

This section describes two modeling approaches to obtain a linear time-invariant description of the plant-wide dynamics in terms of a state-space model that can be used for designing the plant-wide MPC. A plant simulator is utilized to simulate the nonlinear dynamics of the end-to-end integrated continuous pharmaceutical manufacturing pilot plant.²⁰ The plant simulator is developed in the JACOBIAN simulation platform (RES Group, Inc.) based on first-principles models, i.e., species mass, energy, momentum, and other conservation equations and rate expressions that describe physicochemical phenomena such as chemical reaction and crystallization kinetics and washing/filtration characteristics. The stabilizing control layer depicted in Figure 1 is incorporated into the plant simulator.

Identification of a Low-Dimensional Model. System identification is the construction of models for dynamical systems from measured input/output data using statistical methods.²⁴ System identification is an alternative to first-principles modeling of complex systems, when the latter approach is too involved or the complexity of a first-principles model makes its use prohibitively expensive (e.g., for real-time control). An identified model is typically developed specifically for a certain application to trade-off model complexity versus accuracy given the application requirements.

In this study, the subspace identification approach (e.g., see ref 27) is used to obtain a low-dimensional description of the plant-wide dynamics in the form of a LTI state-space model

$$\dot{x}(t) = Ax(t) + Bu(t) + w(t) \quad (1a)$$

$$y(t) = Cx(t) + Du(t) + n(t) \quad (1b)$$

where A , B , C , and D denote the system state-space matrices, t denotes time, $x \in \mathbb{R}^{n_x}$ denotes the state variables, \dot{x} is the derivative of x with respect to time, $u \in \mathbb{R}^{n_u}$ denotes the system inputs, $y \in \mathbb{R}^{n_y}$ denotes the system outputs (i.e., CQAs), $w \in \mathbb{R}^{n_x}$ denotes the process noise, and $n \in \mathbb{R}^{n_y}$ denotes the measurement noise. Subspace identification involves two steps: (i) the model order n_x and a state sequence \hat{x} are determined by projecting row spaces of the input/output data block Hankel matrices and applying a singular value decomposition; and (ii) a least-squares problem is solved to obtain the state-space matrices.²⁸

Prior to system identification, a dynamic sensitivity analysis is performed using the plant simulator to determine the *potential* CPPs (i.e., all possible inputs) to which the CQAs and the production rate are most sensitive (Figure 3). This step identifies the CPPs within the ICM pilot plant since these manipulatable inputs have the largest influence on the plant-wide dynamics relevant to control of the CQAs. Only the CPPs are used to excite the pilot plant (i.e., plant simulator) to generate sufficiently informative input–output data for identification of a state-space model (eq 1). A reduction of potential CPPs to relevant CPPs reduces experimentation times and unnecessary process perturbations during the data collection. More generally, the reduction simplifies the control system by choosing not to manipulate inputs that are unnecessary for control of the CQAs. The results of the dynamic sensitivity analysis indicate that the flow rates of the streams 2 and 3, H₂O, and NaOH in the pilot plant (see Figure 1) have a negligible effect on the CQAs and, therefore, are not considered as CPPs. On the other hand, even though the flow rates of the HEP and maleic acid streams have a relatively large influence on the CQA profiles, these CPPs cannot be utilized for the plant-wide control due to practical considerations pertaining to the process operation (see ref 25).

The CPPs that can be manipulated for controlling the CQAs are listed in Table 1. These CPPs, along with purity of stream 1 that is considered as a measured disturbance, are excited in a multistep fashion to generate input/output data for identification of the plant-wide dynamics. Canonical variate analysis (CVA) subspace identification²⁹ is used to identify an LTI state-space model of 12th order (i.e., $n_x = 12$ in eq 1). The subspace identification is performed using the MATLAB function `n4sid`. The predictions of the identified model are compared against an independent data set in Figure 4. These results suggest that the identified low-dimensional model provides an adequate description of the steady-state process behavior.

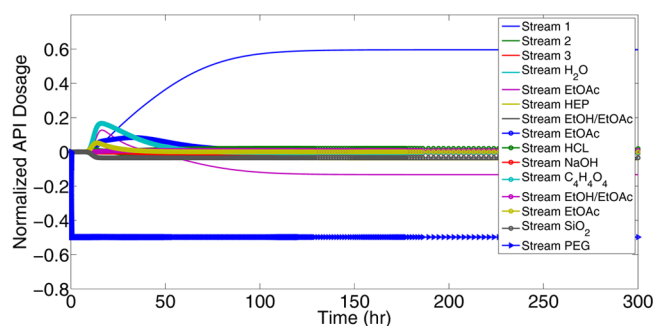

(a) API dosage

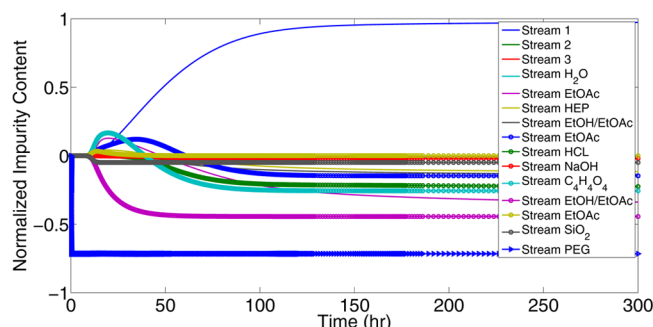

(b) Total impurity content

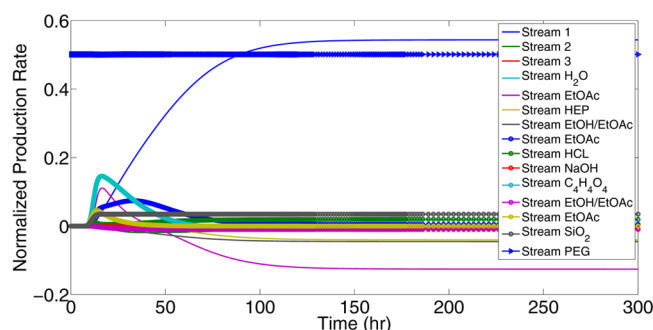

(c) Production rate

Figure 3. Dynamic sensitivity analysis of the critical quality attributes and the production rate with respect to the potential critical process parameters (the streams are ordered as in Figure 1).

Table 1. CPPs Used for Plant-Wide Identification and Control (Streams Ordered as in Figure 1)

flow rate of stream 1 (compound 1 in Figure 2)
flow rate of stream EtOAc
flow rate of stream EtOH/EtOAc
flow rate of stream EtOAc
flow rate of stream HCl
flow rate of stream EtOH/EtOAc
flow rate of stream EtOAc
flow rate of stream SiO ₂
flow rate of stream PEG

Linearization of the High-Dimensional Plant-Wide Model. The plant simulator describes the plant-wide dynamics by a set of nonlinear continuous-time differential algebraic equations

$$0 = F(\dot{z}(t), z(t), v(t), u(t), \theta) \quad z(0) = z_0 \quad (2)$$

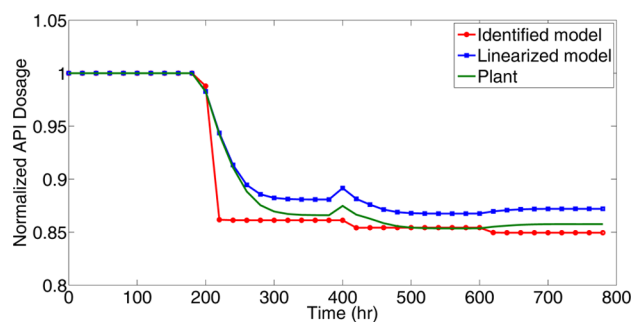

(a) API dosage

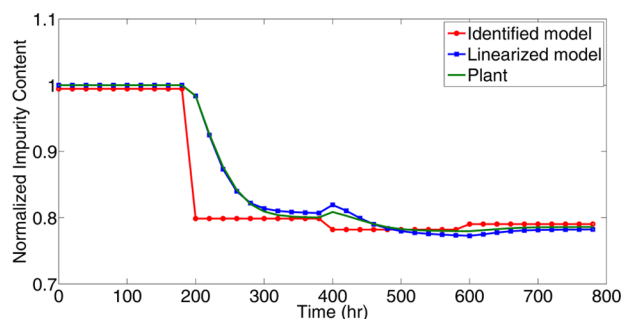

(b) Total impurity content

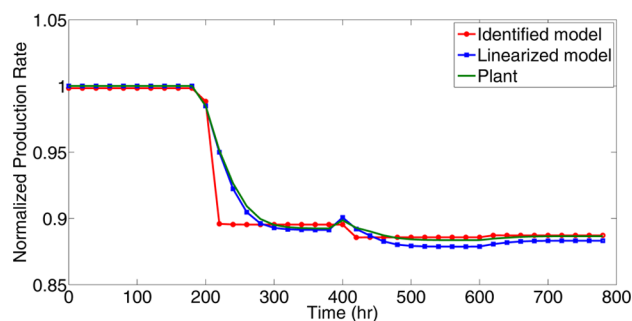

(c) Production rate

Figure 4. Comparison of the identified and linearized models with respect to an independent data set generated using the plant simulator.

where $z \in \mathbb{R}^{n_z}$ denotes the differential state variables, \dot{z} denotes the derivative of z with respect to time, $z(0) = z_0$ denotes consistent initial conditions, $v \in \mathbb{R}^{n_v}$ denotes the algebraic state variables, $\theta \in \mathbb{R}^{n_\theta}$ denotes the system parameters, and $F: \mathbb{R}^{2n_z+n_v} \rightarrow \mathbb{R}^{n_z+n_v}$ denotes the $n_z + n_v$ equations describing the nonlinear system dynamics. The system state vector is comprised of the differential and algebraic state variables denoted by $x = [z^T v^T]^T \in \mathbb{R}^{n_x}$ with $n_x = n_z + n_v$ and the superscript “T” referring to the vector transpose. The system outputs (i.e., $y \in \mathbb{R}^{n_y}$) are algebraically related to x , u , and θ . Hence, y can be included in the definition of x in eq 2 as algebraic state variables to simplify notation.

The Taylor series expansion can be used to obtain an LTI state-space approximation of eq 2 around a steady-state operating point (e.g., ref 30),

$$M\dot{x}(t) = A(x(t) - x_{ss}) + B(u(t) - u_{ss}) \quad (3)$$

with the subscript “ss” being the steady-state solution (i.e., $x(\infty) = x_{ss}$ that satisfies eq 2 given $u(\infty) = u_{ss}$, $\dot{z}(\infty) = 0$, and θ). The system matrices in eq 3 are defined by

$$M = \begin{bmatrix} \frac{\partial F}{\partial z}|_{ss} & \mathbf{0}_{n_x \times n_v} \end{bmatrix} \quad (4a)$$

$$A = - \begin{bmatrix} \frac{\partial F}{\partial z}|_{ss} & \frac{\partial F}{\partial v}|_{ss} \end{bmatrix} \quad (4b)$$

$$B = - \frac{\partial F}{\partial u}|_{ss} \quad (4c)$$

where $\frac{\partial F}{\partial \alpha}|_{ss}$ denotes the Jacobian of the function F with respect to the variable α evaluated at the steady state such that the ij^{th} element is the partial derivative of F_i with respect to α_j , and $\mathbf{0}_{n_x \times n_v}$ denotes a zero matrix of size n_x by n_v . The state-space model (eq 3) is high dimensional with 7613 state variables ($n_z = 6087$ and $n_v = 1526$). The system inputs consists of the CPPs listed in Table 1 ($n_u = 9$).

The system matrices (eq 4) are derived efficiently using the automatic differentiation feature of DAEPACK,³¹ which takes a Fortran-based system model as input and generates the Jacobian matrices of the model. A Fortran version of eq 2 was generated using a code generation patch to the JACOBIAN simulation platform, in which the plant simulator is implemented. The consistent initial conditions for the high-dimensional state-space model are obtained by solving the sparse linear set of equations in eq 3 at $t = 0$

$$\underbrace{\begin{bmatrix} \frac{\partial F}{\partial v}|_{ss} & \frac{\partial F}{\partial z}|_{ss} \end{bmatrix}}_{A_{\text{initial}}} \begin{bmatrix} \tilde{v}_0 \\ \tilde{z}_0 \end{bmatrix} = \underbrace{B\tilde{u}_0 - \frac{\partial F}{\partial z}|_{ss}\tilde{z}_0}_{b_{\text{initial}}} \quad (5)$$

where \tilde{x} denotes the deviation variable form of x (i.e., $\tilde{x} = x - x_{ss}$) and x_0 denotes the initial condition of x [i.e., $x_0 = x(t = 0)$]. For the given initial inputs \tilde{u}_0 and set of differential state values \tilde{z}_0 , eq 5 is solved to determine the remaining unknowns \tilde{v}_0 and \tilde{z}_0 . In this study, the stiff differential-algebraic equation solver ode15s in MATLAB is used to solve eq 3 with the consistent initial conditions given by eq 5.

The predictions of the state-space model (eq 3) are shown in Figure 4. The high-dimensional model can adequately predict the dynamics of the nonlinear plant simulator. The simulation results suggest that the high-dimensional model (locally) describes the transient dynamics more accurately than the identified low-dimensional model. The first-principles nature of the linearized model leads to more accurate representation of process dynamics at the expense of computational complexity due to the significantly larger state dimension.

PLANT-WIDE MODEL PREDICTIVE CONTROL

The quadratic dynamic matrix control (QDMC) algorithm is used to design a plant-wide MPC system for the ICM pilot plant.²² QDMC is particularly advantageous for ICM processes as the optimization that is solved online is independent of the state dimension of the original model (eq 3).

As listed in Table 1, the process has nine CPPs that can be used as manipulated variables (i.e., control inputs). Let $u_k \in \mathbb{R}^9$ denote a vector of these values at sampling time k . The control objective is to regulate the API dosage and production rate of the manufactured tablets to follow desired set point trajectories in

the presence of process uncertainties and disturbances, while ensuring that the total impurity content of the tablets remains below an admissible threshold. These three quantities define the CQAs of the system, which are stacked into vector $y_k \in \mathbb{R}^3$

$$y_k = [\text{API}(t_k), \text{PR}(t_k), \text{IMP}(t_k)]^T$$

where $\text{API}(t)$ is the API dosage at time t , $\text{PR}(t)$ is the production rate at time t , and $\text{IMP}(t)$ is the impurity content at time t , and $t_k = t_0 + k\delta t$ is the actual time corresponding to index k for a fixed sampling time δt .

Using the finite step response (FSR) model of length N (see Figure 5) of the form $y_k = y_{ss} + \sum_{i=1}^{N-1} S_i \Delta u_{k-i} + S_N(u_{k-N} - u_{ss})$,

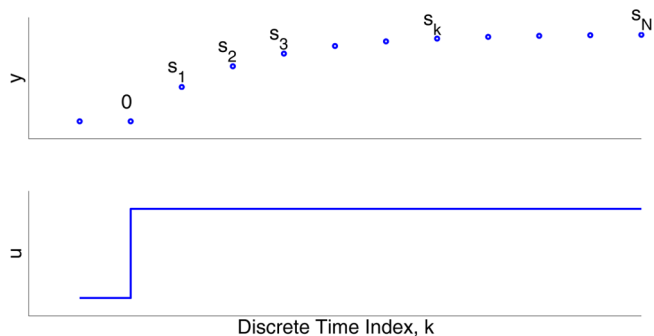

Figure 5. Finite step response model.

which can be computed by simulating a unit step on either eq 1 or eq 3, we can predict the future evolution of the CQAs at time $k + l$, $0 < l < N$ as a function of the future CPP moves

$$\begin{aligned} y_{k+l|k} &= \sum_{i=1}^l S_i \Delta u_{k+l-i|k} && \text{(effect of future moves)} \\ + y_{ss} + \sum_{i=l+1}^{N-1} S_i \Delta u_{k+l-i|k} + S_N(u_{k+l-N} - u_{ss}) && \text{(effect of past moves)} \\ + d_{k+l|k} && \text{(predicted disturbances)} \end{aligned} \quad (6)$$

where S_i is the i^{th} unit step response coefficient matrix of the system and $\Delta u_k = u_k - u_{k-1}$. Writing this in matrix-vector form for $l = 1, 2, \dots, N_p$ results in

$$\begin{bmatrix} y_{k+1|k} \\ \vdots \\ y_{k+N_p|k} \end{bmatrix} = \begin{bmatrix} y_{k+1|k}^0 \\ \vdots \\ y_{k+N_p|k}^0 \end{bmatrix} + \mathbf{G} \begin{bmatrix} \Delta u_{k|k} \\ \vdots \\ \Delta u_{k+N_c-1|k} \end{bmatrix} + \begin{bmatrix} d_{k+1|k} \\ \vdots \\ d_{k+N_p|k} \end{bmatrix} \quad (7)$$

where N_p is the prediction horizon, N_c is the control horizon (after which the input moves are set to zero $\Delta u_{k+j|k} = 0$ for all $j \geq N_c$), and \mathbf{G} is the dynamic matrix

$$\mathbf{G} = \begin{bmatrix} S_1 & 0 & 0 & \cdots & 0 & 0 \\ S_2 & S_1 & 0 & \cdots & 0 & 0 \\ \vdots & \vdots & \ddots & \ddots & \ddots & \ddots \\ S_j & S_{j-1} & S_{j-2} & \cdots & \cdots & S_{j-N_c+1} \\ \vdots & \vdots & \vdots & & & \vdots \\ S_{N_p} & S_{N_p-1} & S_{N_p-2} & \cdots & \cdots & S_{N_p-N_c+1} \end{bmatrix}$$

and $y_{k+l|k}^0 = y_{ss} + \sum_{i=l+1}^{N-1} S_i \Delta u_{k+l-i|k} + S_N(u_{k+l-N} - u_{ss})$ is the contribution to $y_{k+l|k}$ due to past input moves (sometimes

referred to as the “free response” of the system). The future disturbances, which represent unmodeled effects to the plant, are not known to the controller; hence they must be estimated. QDMC uses the “additive disturbance method” in which $d_{k|k} = y_k^{\text{meas}} - y_{k|k}^0$ is estimated based on the current feedback measurement of the CQAs, denoted by y_k^{meas} , and the predicted disturbance is assumed to be equal to the present value into the future, i.e., $d_{k+i|k} = d_{k|k}$ for all $i \geq 0$. This rule has been shown to be optimal for systems with integrating disturbances.³²

The optimal control problem to be solved at each sampling time k is defined as

$$\min_{\Delta u_{k|k}, \dots, \Delta u_{k+N_c-1|k}} \sum_{i=0}^{N_p-1} (y_{k+i+1|k} - y_{\text{SP}})^T W_y (y_{k+i+1|k} - y_{\text{SP}}) + \Delta u_{k+i|k}^T W_u \Delta u_{k+i|k} \quad (8a)$$

$$\text{subject to: FSR prediction equations (7)} \quad (8b)$$

$$0.8u_{\text{ss}} \leq u_{k+i|k} \leq 1.2u_{\text{ss}}, \quad i = 0, \dots, N_c - 1 \quad (8c)$$

$$[0 \ 0 \ 1]y_{k+i+1|k} \leq \text{IMP}_{\text{max}}, \quad i = 0, \dots, N_p - 1 \quad (8d)$$

where u_{ss} is the steady-state input value and $\text{IMP}_{\text{max}} = 1.08 \text{ IMP}_{\text{ss}}$ is the maximum allowed impurity content equal to 8% of its steady-state value. The objective function (eq 8a) penalizes deviations from the predicted CQAs and their respective desired set point y_{SP} and future changes in the inputs. These terms are weighted by user-chosen matrices W_y and W_u that should be tuned to achieve the best possible performance. Equation 8b represents the model predictions of the CQAs as a function of future input moves. Equation 8c is the input constraints that force the CPPs to stay within chosen bounds, and eq 8d is the constraints on the impurity content. This optimization can be formulated as a convex quadratic program that can efficiently be solved to global optimality using interior point or active set methods (see ref 22 for further details).

The output weight matrix W_y in the objective function is selected such that the API dosage more effectively follows its respective set point trajectory than the production rate. This difference in importance is because the API dosage is the primary CQA of the manufactured tablets, which cannot be compromised due to stringent regulatory requirements. The impurity content requirements of tablets are addressed through an output constraint that should be fulfilled at all times (eq 8d). Hence, the degrees of freedom of the process (i.e., CPPs) can be exploited intelligently to achieve the desired API dosage (and with lesser importance the desired production rate), while satisfying the impurity content limit of tablets during the process operation. In addition, eq 8 enables incorporating the QbD considerations into the control problem through input constraints to ensure regulatory compliant process operation.

The plant-wide QDMC system is implemented in a receding-horizon mode, as illustrated in Figure 6, which requires online solution of the optimal control problem (eq 8) over the control horizon N_c at every time instant k . Online measurements of the CQAs are used to continuously update the prediction model at each sampling time instant through the disturbance update rule. This measurement feedback addresses the effects of uncertainties and disturbances on optimal process operation. The solution of eq 8 is the sequences of input values $\Delta u_{k|k}^*, \dots, \Delta u_{k+N_c-1|k}^*$. Only the first element $u_k = u_{k-1} + \Delta u_{k|k}^*$ is applied to the ICM pilot plant. Once new measurements of the CQAs become available at the sampling time instant $k+1$, the prediction horizon shifts one

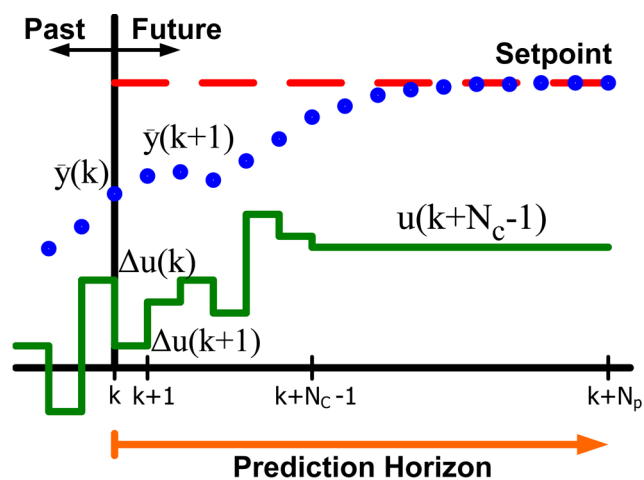

Figure 6. Receding-horizon implementation of the plant-wide QDMC system.

sample ahead, and the optimization procedure is repeated. The receding-horizon implementation of the control system partly mitigates performance degradation due to model uncertainties and process disturbances.

RESULTS AND DISCUSSION

This section presents the closed-loop simulation results of the plant-wide model predictive control of the integrated continuous pharmaceutical manufacturing pilot plant under various scenarios pertaining to process uncertainties and disturbances. Two plant-wide QDMC systems are designed by using the low-dimensional identified model (eq 1) and the high-dimensional linearized model (eq 3) to obtain the finite step response models in the optimal control problem (eq 8). The plant-wide QDMC systems based on the low-dimensional identified and high-dimensional linearized models are labeled as SS-MPC and LM-MPC, respectively. The closed-loop simulation results are obtained by applying the optimal control inputs to the nonlinear plant simulator. The CQAs are sampled every 5 min and are fed back to the control systems to update the prediction model. The performance of the plant-wide QDMC systems is compared to that of a plant-wide regulatory control system that consists of multiloop proportional-integral controllers (see ref 25). The plant-wide QDMC and regulatory control systems are mounted on top of a stabilizing control layer integrated into the plant simulator to ensure stable process operation. The simulation results also include an open-loop case, where only the stabilizing control layer is used. In what follows, the normalized CQA profiles are obtained by normalizing the actual CQA values with respect to the desired steady-state CQA values.

Parametric Uncertainties in Reaction Kinetics. To investigate the effect of parametric uncertainties on the performance of the plant-wide QDMC systems, a gradual change in synthesis of the intermediate and API compounds in reactors R1 and R2 (see Figure 1) is induced by defining the reaction kinetics as

$$\frac{k_{R1,1}(t)}{k_{R1,1}^0} = \begin{cases} 1 - 0.005t & \text{if } t < 20 \\ 0.90 & \text{if } t \geq 20 \end{cases}$$

$$\frac{k_{R2,2}(t)}{k_{R2,2}^0} = \begin{cases} 1 + 0.01t & \text{if } t < 100 \\ 2.0 & \text{if } t \geq 100 \end{cases}$$

where $k_{R1,1}$ and $k_{R2,2}$ denote the rate constants for the intermediate and API compound synthesis reactions, respectively (see Tables 1 and 2 in ref 20), and $k_{R1,1}^0$ and $k_{R2,2}^0$ denote the nominal values of the rate constants.

Figure 7 depicts the closed-loop simulation results for the plant-wide QDMC and regulatory control systems, as well the

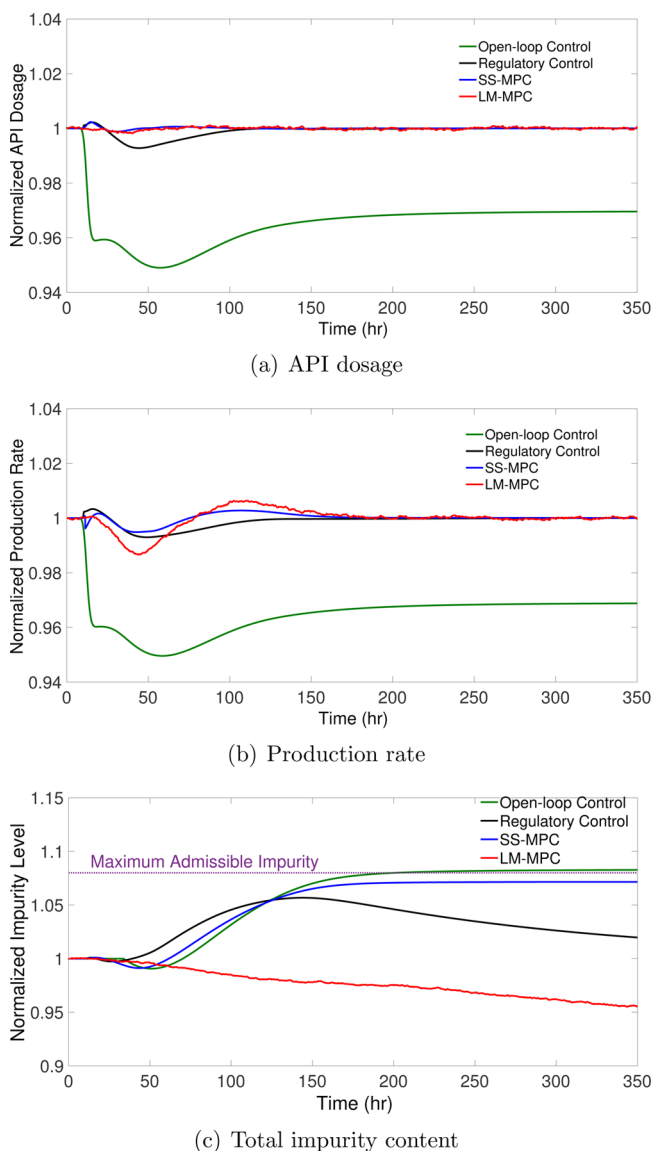

Figure 7. Closed-loop control of the ICM pilot plant with the plant-wide MPC and regulatory control systems in the presence of parametric uncertainties in the intermediate and API synthesis reaction kinetics (reactors **R1** and **R2** in Figure 1). Two plant-wide QDMC systems based on the low-dimensional identified model (SS-MPC) and the high-dimensional linearized model (LM-MPC) are designed. The performance of the plant-wide control systems is compared to that of an open-loop control case, in which only the stabilizing control layer is in place.

open-loop case where only the stabilizing control layer is used for level control. As can be seen, in the open-loop case with no active control the ICM pilot plant cannot be retained at the desired steady-state operating condition in the presence of process uncertainties (i.e., the normalized API dosage and production rate profiles do not remain at 1.0 in Figure 7a and b, respectively). In addition, the impurity level violates its maximum admissible level in the open-loop case, leading to production of off-spec

tablets. This observation calls for active control of the ICM pilot plant so as to be able to fulfill the stringent regulatory requirements for the CQAs of the manufactured tablets.

The simulation results demonstrate the ability of plant-wide MPC in effectively dealing with process uncertainties, as the API dosage and production rate profiles can follow the set point trajectories closely (i.e., the normalized profiles remain close to 1.0). Figure 7a shows that both plant-wide QDMC systems with the underlying low-dimensional identified model (SS-MPC) and the high-dimensional linearized model (LM-MPC) outperform the regulatory control system in terms of maintaining the desired API dosage specification. The improved product quality is due to the ability of MPC to deal with multivariable dynamics of the ICM pilot plant, while multiloop PID controllers cannot accomplish this systematically. Although the improvement gained in the API dosage set point tracking is approximately 1% using the plant-wide QDMC systems as compared to the plant-wide regulatory control system, the difference is significant in pharmaceutical manufacturing since the CQAs of the tablets cannot be compromised. Figure 7c clearly shows the ability of plant-wide MPC in constraint handling (i.e., circumventing violation of the maximum admissible impurity level). Note that the plant-wide regulatory control system maintains the impurity level at some prespecified value using a PI controller (see ref 25), and therefore, the impurity level profile remains at 1.0. However, by explicitly incorporating the CQA constraints into the control framework, the plant-wide MPC systems are able to systematically exploit the extra degrees of freedom of the process to more effectively achieve the regulatory requirements for the other CQAs (e.g., the API dosage in this scenario).

Persistent Disturbance in Filtration Units. The effect of persistent disturbances on plant-wide control of the ICM pilot plant is investigated by persistently decreasing the washing efficiency in the filtration units **W1** and **W2** (see Figure 1) as

$$\frac{K_{W,1}(t)}{K_{W,1}^0} = \frac{K_{W,2}(t)}{K_{W,2}^0} = \begin{cases} \exp(-0.002t) & \text{if } t < 200 \\ 0.70 & \text{if } t \geq 200 \end{cases}$$

where $K_{W,1}^0$ and $K_{W,2}^0$ are the nominal values for the wash factor in the filtration units **W1** and **W2**, respectively (ref 20). The closed-loop simulation results are depicted in Figure 8. The plant-wide QDMC systems (especially SS-MPC) are seen to lead to effective tracking of the set point trajectories and, therefore, enable operation of the ICM pilot plant around the desired steady-state operating point effectively in the presence of the persistent disturbances. The plant-wide QDMC system with the low-dimensional identified model (SS-MPC) slightly outperforms the plant-wide regulatory control system in terms of achieving smoother set point tracking. Yet again, open-loop control with the stabilizing control layer results in a substantial degradation of the CQAs of tablets due to significant and persistent process disturbances.

Temporary Disturbance in the Purity Level of the Intermediate Compound. The purity level of the intermediate compound **1** (stream **1** in Figure 1) is changed, i.e.,

$$x_1(t) = \begin{cases} 0.975 & \text{if } 50 \leq t \leq 200 \\ 0.99 & \text{otherwise} \end{cases}$$

to investigate the ability of the plant-wide control systems to deal with temporary disturbances. The closed-loop simulation results indicate that the plant-wide QDMC systems outperform the plant-wide regulatory control system, in particular for the API

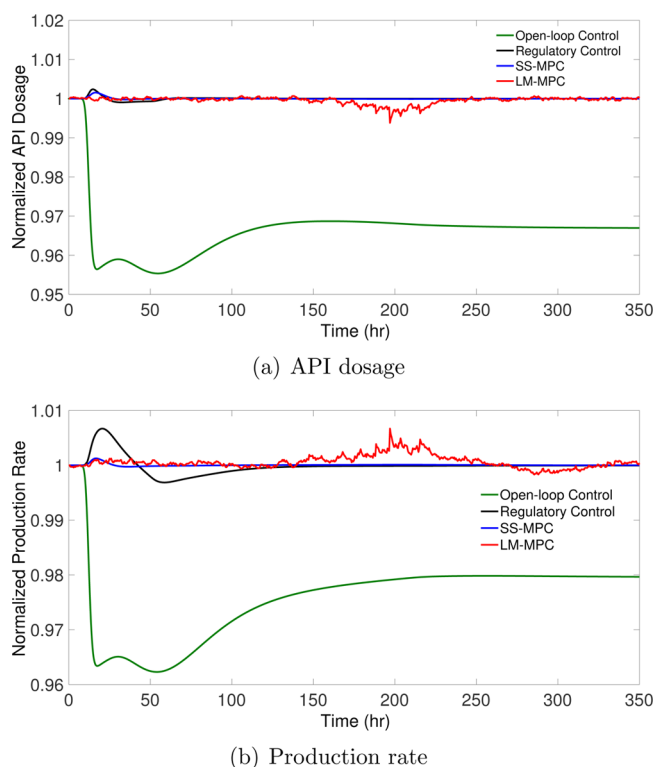

Figure 8. Closed-loop control of the ICM pilot plant using the plant-wide MPC and regulatory control systems in the presence of persistence disturbance in the filtration units (filter units W1 and W2 in Figure 1). Two plant-wide QDMC systems based on the low-dimensional identified model (SS-MPC) and the high-dimensional linearized model (LM-MPC) are designed. The performance of the plant-wide control systems is compared to that of an open-loop control case, in which only the stabilizing control layer is in place.

dosage set point tracking (see Figure 9). Both SS-MPC and LM-MPC enable maintaining the API dosage tightly at the desired set point in the presence of feed impurities, which is important in industrial-scale pharmaceutical manufacturing as it requires robust fulfillment of the regulatory requirements for CQAs in terms of coping with process changes and disturbances.

Step Increase in the Production Rate. The ability of the plant-wide control systems in dealing with set point changes is evaluated by changing the production rate set point by 5% (see Figure 10b, set point change starts at 100 h). As can be seen in Figure 10a, the plant-wide QDMC systems enable tracking the API dosage set point trajectory more closely than the plant-wide regulatory control system. In addition, the plant-wide QDMC systems lead to faster transition dynamics to the new set point, as shown in Figure 10b. The plant-wide MPC results in production of less off-spec tablets during the production rate set point change and, therefore, offers more flexibility in the operation of the ICM pilot plant.

CONCLUSIONS

This article presents two plant-wide MPC systems for an end-to-end continuous pharmaceutical manufacturing pilot plant built at the Novartis-MIT Center for Continuous Manufacturing. Two modeling approaches—subspace identification and linearization of the plant-wide model in the form of a set of nonlinear DAEs—are investigated to obtain a linear low-dimensional and high-dimensional representation of the nonlinear plant dynamics, respectively. The quadratic dynamic matrix control algorithm is

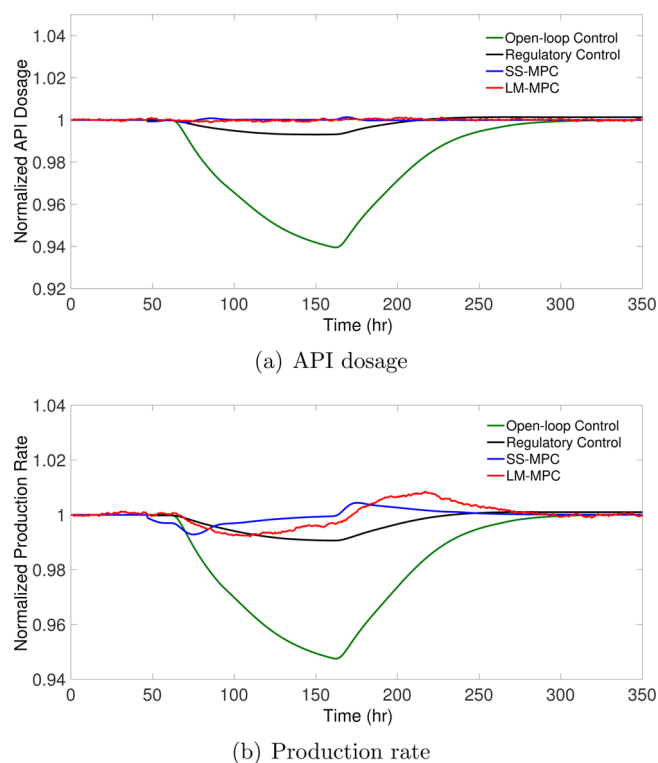

Figure 9. Closed-loop control of the ICM pilot plant using the plant-wide MPC and regulatory control systems in the presence of temporary disturbance in the purity level of the intermediate compound 1 (stream 1 in Figure 1). Two plant-wide QDMC systems based on the low-dimensional identified model (SS-MPC) and the high-dimensional linearized model (LM-MPC) are designed. The performance of the plant-wide control systems is compared to that of an open-loop control case, in which only the stabilizing control layer is in place.

applied for designing an input–output control framework for the plant-wide MPC of the integrated continuous manufacturing pilot plant, independent of the plant state dimension.

The subspace identification method can be straightforwardly applied to derive a low-order, data-driven model of an ICM process when a sufficient amount of informative data can be generated through perturbations of the CPPs during process operation. In the simulations, no noticeable control performance loss was incurred using the low-order subspace model for the ICM process at hand. In practice, however, excessive perturbations may be required during the identification experiments required for developing an accurate subspace model, resulting in a large amount of off-spec material. An alternative to subspace identification is to develop a process model based on first-principles independent of plant experimentation, e.g., first-principles models built and validated using laboratory-scale data. Since first-principles models of ICMs are generally nonlinear and computationally expensive for use for online control, the process models can be linearized using Taylor series and then directly converted to an efficient input–output model for use in the QDMC algorithm. The closed-loop simulation case studies indicate that the plant-wide MPC systems designed using the linearization-based and subspace modeling approaches lead to comparable closed-loop performance for various operating scenarios pertaining to process uncertainties, disturbances, and set point changes in the ICM process under study. Since both modeling approaches require, respectively, a detailed set of model equations or enough informative process data, the choice

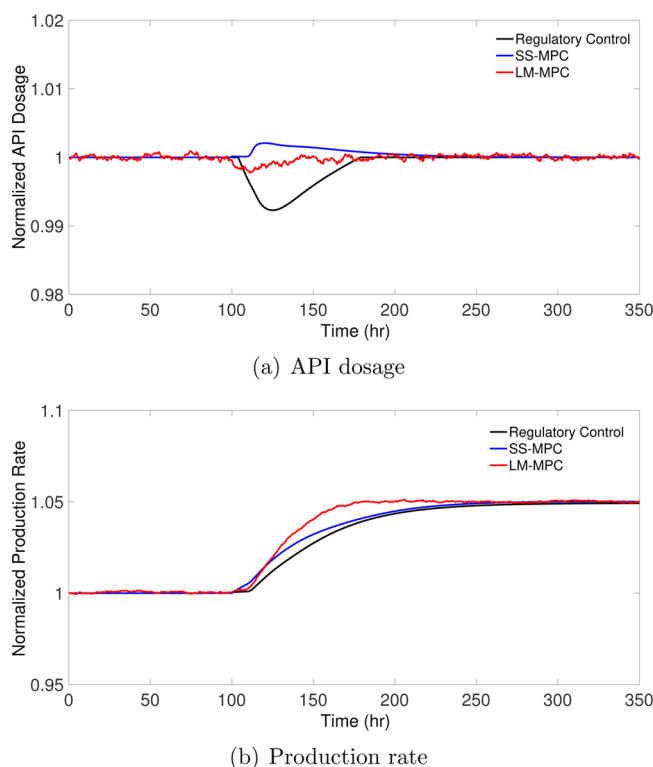

Figure 10. Dynamic response of the ICM pilot plant to a 5% step increase in production rate introduced at 100 h. The pilot plant is in closed-loop operation with the plant-wide MPC and regulatory control systems. Two plant-wide QDMC systems based on the low-dimensional identified model (SS-MPC) and the high-dimensional linearized model (LM-MPC) are designed.

of the modeling approach in practice hinges on the availability of process data or first-principles process models for a given application. Irrespective of the modeling approach, this paper demonstrates that plant-wide MPC facilitates effective regulation of CQAs and flexible process operation in the presence of different types of process uncertainties and disturbances. In addition, plant-wide MPC enables incorporating the QbD considerations into the control formulation through input and output constraints to ensure regulatory compliant process operation. As such, the control design can explicitly address the stringent regulatory requirements in the pharmaceutical industry.

AUTHOR INFORMATION

Corresponding Author

*Phone: +1 510-642-7998, fax: +1 510-642-4778. E-mail: mesbah@berkeley.edu.

ORCID

Ali Mesbah: 0000-0002-1700-0600

Richard Lakerveld: 0000-0001-7444-2678

Notes

The authors declare no competing financial interest. A preliminary version of this manuscript was presented at the American Control Conference in Chicago, Illinois held on July 1–3, 2015.

ACKNOWLEDGMENTS

Financial support from Novartis is acknowledged.

REFERENCES

- (1) Leuenberger, H. New trends in the production of pharmaceutical granules: Batch versus continuous processing. *Eur. J. Pharm. Biopharm.* **2001**, *52*, 289–296.
- (2) Suresh, P.; Basu, P. Improving pharmaceutical product development and manufacturing: Impact on cost of drug development and cost of goods sold of pharmaceuticals. *Journal of Pharmaceutical Innovation* **2008**, *3*, 175–187.
- (3) Poechlauer, P.; Manley, J.; Broxterman, R.; Gregertsen, B.; Ridemark, M. Continuous processing in the manufacture of active pharmaceutical ingredients and finished dosage forms: An industry perspective. *Org. Process Res. Dev.* **2012**, *16*, 1586–1590.
- (4) Roberge, D. M.; Zimmermann, B.; Rainone, F.; Gottspomer, M.; Eyholzer, M.; Kockmann, N. Microreactor technology and continuous processes in the fine chemical and pharmaceutical industry: Is the revolution underway? *Org. Process Res. Dev.* **2008**, *12*, 905–910.
- (5) Benaskar, F.; Ben-Abdelmoumen, A.; Patil, N. G.; Rebroy, E. V.; Meuldijk, J.; Hulshof, L. A.; Hessel, V.; Krtschil, U.; Schouten, J. C. Cost analysis for a continuously operated fine chemicals production plant at 10 kg/day using a combination of microprocessing and microwave heating. *J. Flow Chem.* **2011**, *1*, 74–89.
- (6) Schaber, S. D.; Gerogiorgis, D. I.; Ramachandran, R.; Evans, J. M. B.; Barton, P. I. Economic analysis of integrated continuous and batch pharmaceutical manufacturing: A case study. *Ind. Eng. Chem. Res.* **2011**, *50*, 10083–10092.
- (7) Wu, H.; Khan, M. A.; Hussain, A. S. Process control perspective for process analytical technology: Integration of chemical engineering practice into semiconductor and pharmaceutical industries. *Chem. Eng. Commun.* **2007**, *194*, 760–779.
- (8) Lionberger, R. A.; Lee, S. L.; Lee, L.; Raw, A.; Yu, L. X. Quality by design: Concepts for ANDAs. *AAPS J.* **2008**, *10*, 268–275.
- (9) Kishida, M.; Braatz, R. D. Skewed structured singular value-based approach for the construction of design spaces: Theory and applications. *IET Control Theory & Applications* **2014**, *8*, 1321–1327.
- (10) Yu, L. X. Pharmaceutical quality by design: Product and process development, understanding, and control. *Pharm. Res.* **2008**, *25*, 781–791.
- (11) Harinath, E.; Foguth, L. C.; Braatz, R. D. A robust dual-mode MPC approach to ensuring critical quality attributes in Quality-by-Design. *Proceedings of the American Control Conference*, 2016; pp 2041–2046.
- (12) Wang, F. Y.; Ge, X. Y.; Balliu, N.; Cameron, I. T. Optimal control and operation of drum granulation processes. *Chem. Eng. Sci.* **2006**, *61*, 257–267.
- (13) Hsu, S. H.; Reklaitis, G. V.; Venkatasubramania, V. Modeling and control of roller compaction for pharmaceutical manufacturing. Part II: Control system design. *Journal of Pharmaceutical Innovation* **2010**, *5*, 24–36.
- (14) Mesbah, A.; Landlust, J.; Huesman, A. E. M.; Kramer, H. J. M.; Jansens, P. J.; Van den Hof, P. M. J. A model-based control framework for industrial batch crystallization processes. *Chem. Eng. Res. Des.* **2010**, *88*, 1223–1233.
- (15) Ramachandran, R.; Arjunan, J.; Chaudhury, A.; Ierapetritou, M. G. Model-based control-loop performance of a continuous direct compaction process. *Journal of Pharmaceutical Innovation* **2011**, *6*, 249–263.
- (16) Nagy, Z. K.; Braatz, R. D. Advances and new directions in crystallization control. *Annu. Rev. Chem. Biomol. Eng.* **2012**, *3*, 55–75.
- (17) Mesbah, A.; Nagy, Z. K.; Huesman, A. E. M.; Kramer, H. J. M.; Van den Hof, P. M. J. Nonlinear Model-based Control of a Semi-industrial Batch Crystallizer using a Population Balance Modeling Framework. *IEEE Transactions on Control Systems Technology* **2012**, *20*, 1188–1201.
- (18) Mesbah, A.; Versypt, A. N. F.; Zhu, X.; Braatz, R. D. Nonlinear Model-based Control of Thin-film Drying for Continuous Pharmaceutical Manufacturing. *Ind. Eng. Chem. Res.* **2014**, *53*, 7447–7460.
- (19) Mascia, S.; Heider, P. L.; Zhang, H.; Lakerveld, R.; Benyahia, B.; Barton, P. I.; Braatz, R. D.; Cooney, C. L.; Evans, J. M. B.; Jamison, T. F.; Jensen, K. F.; Myerson, A. S.; Trout, B. L. End-to-end continuous

manufacturing of pharmaceuticals: Integrated synthesis, purification, and final dosage formation. *Angew. Chem., Int. Ed.* **2013**, *52*, 12359–12363.

(20) Benyahia, B.; Lakerveld, R.; Barton, P. I. A plant-wide dynamic model of a continuous pharmaceutical process. *Ind. Eng. Chem. Res.* **2012**, *51*, 15393–15421.

(21) Morari, M.; Lee, J. H. Model predictive control: Past, present and future. *Comput. Chem. Eng.* **1999**, *23*, 667–682.

(22) Garcia, C. E.; Morshedi, A. M. Quadratic programming solution of dynamic matrix control (QDMC). *Chem. Eng. Commun.* **1986**, *46*, 73–87.

(23) Mesbah, A.; Paulson, J. A.; Lakerveld, R.; Braatz, R. D. Plant-wide model predictive control for a continuous pharmaceutical process. *Proceedings of the American Control Conference*, 2015; pp 4301–4307.

(24) Ljung, L. *System Identification: Theory for the User*; Prentice Hall PRC: Piscataway, NJ, 1999.

(25) Lakerveld, R.; Benyahia, B.; Braatz, R. D.; Barton, P. I. Model-based design of a plant-wide control strategy for a continuous pharmaceutical pilot plant. *AIChE J.* **2013**, *59*, 3671–3685.

(26) Heider, P. L.; Born, S. C.; Basak, S.; Benyahia, B.; Lakerveld, R.; Zhang, H.; Hogan, R.; Buchbinder, L.; Wolfe, A.; Mascia, S.; Evans, J. M. B.; Jamison, T. F.; Jensen, K. F. Development of a multi-step synthesis and workup sequence for an integrated, continuous manufacturing process of a pharmaceutical. *Org. Process Res. Dev.* **2014**, *18*, 402–409.

(27) Qin, S. J. An overview of subspace identification. *Comput. Chem. Eng.* **2006**, *30*, 1502–1513.

(28) van Overschee, P.; Moor, B. L. D. *Subspace Identification for Linear Systems: Theory – Implementation - Applications*; Kluwer Academic Publishers: Norwell, MA, 1996.

(29) Larimore, W. E. Canonical variate analysis in identification, filtering and adaptive control. *Proceedings of the IEEE Conference on Decision and Control*, 1990; pp 596–604.

(30) Bequette, B. W. *Process Control: Modeling, Design, and Simulation*; Prentice Hall Professional: Piscataway, NJ, 2003.

(31) Tolsma, J.; Barton, P. I. DAEPACK: An open modeling environment for legacy models. *Ind. Eng. Chem. Res.* **2000**, *39*, 1826–1839.

(32) Lee, J. H. Robust Inferential Control: A Methodology for Control Structure Selection and Inferential Control System Design in the Presence of Model/Plant Mismatch. Ph.D. Thesis, California Institute of Technology, Pasadena, CA, 1990.