

UC Berkeley

Research Reports

Title

Design Of A Machine Vision-based, Vehicle Actuated Traffic Signal Controller

Permalink

<https://escholarship.org/uc/item/2rq0957h>

Authors

Cassidy, Michael
Coifman, Benjamin

Publication Date

1998

CALIFORNIA PATH PROGRAM
INSTITUTE OF TRANSPORTATION STUDIES
UNIVERSITY OF CALIFORNIA, BERKELEY

Design of a Machine Vision-Based, Vehicle Actuated Traffic Signal Controller

Michael Cassidy, Benjamin Coifman
University of California, Berkeley

**California PATH Research Report
UCB-ITS-PRR-98-7**

This work was performed as part of the California PATH Program of the University of California, in cooperation with the State of California Business, Transportation, and Housing Agency, Department of Transportation; and the United States Department of Transportation, Federal Highway Administration.

The contents of this report reflect the views of the authors who are responsible for the facts and the accuracy of the data presented herein. The contents do not necessarily reflect the official views or policies of the State of California. This report does not constitute a standard, specification, or regulation.

Report for MOU 221

February 1998

ISSN 1055-1425

Design of a Machine Vision-Based, Vehicle Actuated Traffic Signal Controller.

Michael Cassidy
cassidy@euler.berkeley.edu

and

Benjamin Coifman
zephyr@eecs.berkeley.edu
<http://www.cs.berkeley.edu/~zephyr>

Institute of Transportation Studies
109 Mc Laughlin Hall
University of California
Berkeley, CA 94720

1. Abstract

The primary goal of this project is to design a signal controller algorithm to capitalize on the extended information provided by wide-area detection at isolated intersections. The title of the work emphasizes machine vision, or video image processing, because that technology promises to be the first viable wide-area detector; however, the results of this work could be applied to any wide-area detector capable of detecting vehicles over the entire length of the so called "dilemma zone" on each approach to the intersection. Where the dilemma zone is defined as the area between the legal stopping distance (i.e., the location upstream of which all drivers are legally required come to a stop in response to the yellow phase), and the minimum stopping distance, beyond which point, most drivers pass through the intersection in response to the yellow.

The scope of this work is restricted to isolated intersections because control issues are different for isolated intersections and arterials. Sizable benefits from vehicle actuated (VA) control can be realized at isolated intersections.

Machine vision tools are rapidly approaching the stage where they can be used for wide-area vehicle detection at intersections. To bypass the on-going development cycle, this project developed a control algorithm assuming the detectors are fully functional. Using computer simulation, we evaluated different control strategies and compared the performance of the proposed wide-area detection system with conventional signal controllers. The results show that wide-area VA control can yield significant improvements over conventional VA control strategies. Once wide-area detectors become available, the control algorithm can serve as the foundation for a prototype system.

2. Introduction and Executive Summary

The goal of this research project is to improve system performance and safety at isolated signalized intersections via emerging wide-area vehicle detection technologies. Wide-area based VA signal control promises an equitable means to improve intersection productivity by reducing travel time, or delay, for all users. Another benefit would be increased safety because the controller is responsive to drivers' actions, not just their presence.

Although VA control has been in operation for over 40 years, conventional systems fail to use strategies that realize the full advantages of this control. Conventional VA strategies terminate the green indication some time after the discharging vehicle queue has traveled through the intersection. For impulse detectors, the signal controller monitors vehicle headways passing the detector until a measured headway exceeds some pre-specified duration. Consequently, the green

interval is terminated a specified time *after* a demand reduction has been detected. This practice can reduce intersection throughput if the end of queue enters the intersection before the initiation of yellow. A second efficiency loss occurs with conventional VA strategies because the controller always allocates a fixed yellow time (which in some cycles, is more than needed).

In this project, we developed and tested a vehicle actuated traffic signal control algorithm using wide-area detectors. Unlike existing control systems that rely on one or more point detectors to infer operating conditions, the wide-area controller uses measured information about vehicles along the entire intersection approach. With these observations, the wide-area based controller allocates right-of-way based on observed needs rather than estimated or inferred conditions. System improvements are reflected in operating performance (e.g., traveler delay) and in safety. The wide-area based system can function in concert with 2070 controllers or any modern, computer-based traffic signal controller.

Although no functional wide-area vehicle detectors exist, machine vision tools such as the PATH Roadwatch vehicle tracker [1], are rapidly approaching the stage where they can be used at intersections. To bypass the development cycle, this project developed a control algorithm based on the assumed performance of the Roadwatch vehicle tracker. Using computer simulation, we evaluated four different control strategies and compared the performance of the proposed wide-area detection system with conventional signal controllers.

Four control strategies are simulated in this study:

1. Conventional impulse detector VA control, this strategy models the state of the practice using point detectors and serves as the base line for the other strategies.
2. Improved impulse detector VA control, this strategy incorporates several theories proposed by Newell [2] for improving intersection efficiency using conventional impulse detectors. These efficiencies have yet to be adopted into standard practice.
3. Fixed length clearance interval, wide-area detection VA control, this strategy extends Newell's theories to wide-area detection while adopting a clearance interval in accordance with standard practice.
4. Variable length clearance interval, wide-area detection VA control, further efficiencies can be realized by assigning a safe clearance interval based on the current state of the system. In any given cycle, the required clearance interval may be shorter than the fixed clearance interval.

Although strategy 4 (i.e., the use of variable length clearance intervals) can yield greater efficiencies than strategy 3, the fixed clearance interval variant was included for two reasons: first, the variable clearance interval strategy depends on a fail-safe detector, but, the final performance of

emerging wide-area detector technology is unknown. Second the variable clearance interval is a dramatic change from standard practice. Wide-area detection can improve intersection performance while following standard practice for clearance interval duration.

After presenting the background and controller design in detail, the paper presents the intersection simulation model. Next, simulation results from eight different intersection configurations are presented (as summarized in Table 6-9). Each configuration is examined using at least two of the different control strategies and some configurations are examined with as many as four of the strategies. The paper concludes by examining the feasibility of wide-area detection and suggests directions for further work.

3. Background and Motivation

3.1 Theory

G. F. Newell [2] noted that there are two features of vehicle actuated control that offer advantages over fixed time signalization: the capability to respond to cyclic fluctuations in arrival rate and the capability to reduce the lost time incurred when changing the signal indications from green to red. However, conventional practice fails to realize benefits through the latter feature.

When impulse detectors are applied in the conventional way, the signal controller relies upon point detection to identify when the last queued vehicle has passed the detector, as inferred by a headway exceeding some pre-specified duration (i.e., the critical headway). When the end of the queue is detected, the controller terminates the green indication. Because standard practice is to locate detectors too close to the intersection, the last queued vehicle enters the intersection before the controller has identified the end of the queue. In other words, the queue has cleared the intersection before the end of the green time so the latter portion of the green and the subsequent yellow interval are not used to serve discharging vehicles. In the event that a free-flow vehicle is upstream of the detector (but close enough to the intersection to be entitled entry), the controller always allocates a clearance interval of sufficient duration to allow such a vehicle to proceed, even if no such vehicle is actually present.

Strategies proposed by Newell [2] can improve the efficiency of VA intersections. Newell argued that total traveler delay can be reduced by terminating the green time before the entire discharging vehicle queue has actually entered the intersection. In this way, the clearance interval is used for serving queued vehicles and the intersection almost continually discharges traffic at a maximum rate.

In short, Newell advocated strategies which only serve queued vehicles in each cycle. With these strategies, detectors are placed sufficiently far in advance of the intersection (i.e., at the so-called "legal stopping distance") so that the detection of the critical headway guarantees that, at the initiation of the yellow interval, all free-flow vehicles are upstream of the detector and therefore legally required to stop and await intersection entry in the following cycle. Thus, only vehicles discharging from the queue enter the intersection. As these slower-moving vehicles in the discharging queue adopt a shorter stopping distance, the required yellow duration can be reduced.

The benefits of reducing signal lost time stem from the resulting chain reaction which is realized cycle after cycle:

1. the initial red phase will not be characterized by immediate queue formation,
2. queues in the conflicting direction(s) are served "earlier" in the cycle,
3. the green interval returns "earlier" to the subject direction.

Although Newell's control strategies can dramatically reduce vehicle delay, as shown in later sections of this report, they suffer from the limitations of point detectors. The following limitations can be remedied by the wide-area based controller:

- Newell's strategies seek to reduce the required yellow time by terminating the green interval *before* free-flow vehicles have passed the legal stopping distance on the intersection approach. At the yellow initiation, the end of the discharging queue would be, in the ideal, too close to the intersection to stop in response to the yellow indication. This latter consideration relies upon inferred vehicle positions based upon some "calibrated" measure of average vehicle speed. The conventional control system can not respond to variations in vehicle travel times. This limitation compromises safety and efficiency.
- On high-speed intersection approaches, Newell's strategies avoid the use of longer yellow intervals required for free-flow vehicles by moving the detector further upstream of the intersection. Consequently, yellow initiation occurs when the end of the discharging queue is relatively far in advance of the stop bar. This creates a probability that vehicles (i.e., motorists) in the discharging queue stop in response to the yellow indication. The residual queueing erodes operating efficiencies.
- Traditional signal controllers infer the end of the queue by measuring a critical headway occurring at the point detector. An inattentive motorist failing to notice the green indication can create a headway in the traffic stream which the controller falsely interprets as the end of the queue. The resulting premature termination of green time can create significant residual queueing.

- At most VA intersections, opposing traffic movements are controlled by the same signal phase. Substantial inefficiencies in operation occur when unbalanced directional demands cause the queue to vanish in one direction before the other. Similar inefficiencies occur when unbalanced queue lengths exist in adjacent lanes on the same approach.

3.2 Improved Safety and Variable Clearance Intervals

Currently, both VA and fixed time signal control strategies use an invariable yellow time. The yellow time is allocated so that a driver traveling at free flow speed at any location on the intersection approach will have sufficient time to either clear the intersection or perceive the yellow signal and safely come to a complete stop. In other words, the yellow time is set to the upper limit, as dictated by free flow vehicles at the upstream end of the *dilemma zone*, i.e., at the legal stopping distance.

In many cycles, the pre-specified yellow time is unnecessarily long. Queued vehicles discharge at speeds slower than the free flow speed and thus, have a shorter stopping time. If no free flow vehicles are present, the clearance interval can be safely decreased to one that accommodates the lower speeds of the discharging queue. If a free flow vehicle is present upstream of the legal stopping distance, it would be required to stop regardless of the clearance interval. On the other hand, if there is a free flow vehicle within the *dilemma zone*, it may be downstream of the legal stopping distance and thus, the vehicle may not require the full fixed time clearance interval.

Fixed time signals, by definition, can not respond to these varying conditions and conventional VA strategies do not attempt to address this issue. By using a wide-area detector, the controller can establish vehicle positions and velocities. Thus, the controller can allocate just enough clearance time to allow the vehicles to clear the intersection safely and to reduce the loss time that occurs when the intersection is not serving any vehicles. One key feature is the fact that the controller can dynamically respond to traffic at all locations on the approach. So, the controller continually updates the duration of the clearance interval as dictated by the approaching vehicles. At the initiation of yellow, it always allocates a clearance interval long enough to allow any vehicle in the *dilemma zone* to clear the intersection should the driver choose to proceed during the yellow indication.

In the event that a driver attempts to enter the intersection after the maximum clearance interval, which would be set to the conventional fixed time clearance interval for the approach, the wide-area based controller can implement an additional level of safety. Specifically, it could present a short all-red phase to allow the offending motorist to safely clear the intersection, although, this practice may encourage violations.

Under the variable length clearance interval control strategy, we do not take yellow time from approaching drivers. Rather, we take unused yellow time while providing the necessary safeguards to ensure safe operation of the intersection. As previously noted, the strategy depends on a fail-safe detector.

3.3 Complementary PATH Research

The first generation of true wide-area detectors are being developed under PATH sponsorship [1]. These systems are based on machine vision and they are rapidly approaching the application stages. Ultimately, these tools could become an integral component of an intelligent vehicle - highway system. Thus far, the main focus of the PATH machine vision work has been for freeway applications. However, it would require only a small commitment to generalize these technologies for intersections and city traffic. The machine vision tools could provide the necessary input for an innovative signal controller based on the improved strategies described in this paper. The PATH machine vision tools promise to overcome the conventional surveillance limitations via wide-area detection.

4. Controller Design

This project has developed a wide-area based VA controller to monitor the entire intersection approach (the *dilemma zone* in particular) and to assess the signal timing needs continually. Safety and performance improvements are primarily realized through two means:

- 1) Utilization of the clearance interval to discharge vehicles. Conventional VA strategies terminate the green indication after the last vehicle in queue enters the intersection. Lost time is reduced by terminating the green interval *before* the last vehicle in a discharging queue crosses the stop bar but *after* the driver at the end of the queue is sufficiently close to the intersection to insure he/she will proceed through the intersection. In this way, the entire green interval and the initial portion of the yellow interval will be used to serve discharging vehicles.
- 2) Reduction of the required (i.e., safe and legal) clearance interval by only extending yellow time to those arriving vehicles choosing legally to enter the intersection. Conventional VA strategies allocate a fixed yellow time of a sufficient duration to allow intersection entry to free-flow vehicles which may be at, or just downstream of, the legal stopping distance. When no such vehicles are present at the initiation of the yellow interval, the yellow time is unnecessarily

long. We employ a signal strategy that seeks to serve only queued vehicles each cycle. The yellow interval is displayed for the time required to serve vehicles in the discharging queue. Extensions to the yellow time occur only for the durations required to serve free-flow vehicles (i.e., motorists) who are legally entitled to enter the intersection and have actually opted to do so.

To evaluate the benefits of wide-area detection, we have modeled several different intersection configurations under four different control strategies. These control strategies are outlined in the following four subsections.

4.1 Conventional Impulse Detector VA Control

This control strategy models the state of the practice using impulse detectors upstream of the stop bar and serves as the base line for the other control strategies in this project. During the red phase, the controller allocates a short fixed green time and an additional green time for each vehicle that passes the detector during the red phase. The allocated green time ensures that if the queue does not reach the detector, the vehicles will still be allocated sufficient green time to clear the intersection. Whereas, if the queue overruns the detector, the fixed green time ensures that the queue will be in motion at the detector location before the controller starts looking for headways. During the green phase, the controller looks for a pre-specified critical headway at the detector after the initially-allocated green time elapses. When a critical headway is observed, or if the green has timed out at the maximum green, the controller initiates a clearance interval of fixed duration.

Following conventional practice, the impulse detectors in adjacent lanes are wired together (often, these adjacent lanes are also wired together with the opposing lanes, but this practice is not included in the current study). Thus, the controller looks for the critical headway across all lanes simultaneously. On intersections near saturation, it is uncommon to observe a large headway across ALL lanes, even after the queue has dissipated and thus, the controller usually times out at the maximum green. This phenomena can be observed in the results of this study, in particular Sections 6.5-6.7 show that the average green is close to the maximum green time for some intersection configurations.

Note that there is a common "solution" to the problem of looking for a critical headway across all lanes simultaneously. The controller looks for progressively shorter critical headway until finally observing a headway that exceeds the reduced critical headway. Following theories proposed by Newell [2], Cassidy, Chuang & Vitale [3] have demonstrated that the impulse detector based control strategy outlined in the next section is superior to looking for a progressively

decreasing critical headway, thus, we do not attempt to model the progressively decreasing critical headway in this project.

4.2 Improved Impulse Detector VA Control

Before proceeding to wide-area detection, we look at ways to improve VA control using traditional impulse detectors. This control strategy incorporates several theories proposed by Newell [2] for improving intersection efficiency using conventional detectors. The red phase and clearance intervals are treated similar to the conventional strategy outlined above.

Unlike conventional practice, the detectors are decoupled and monitored independently. The controller looks for a critical headway in each lane, independent of the other lanes. During the green interval, a given direction is regarded as clear as soon as the queue dissipates in at least one lane. Thus, the controller responds as soon as demand drops and it does not have to differentiate between a short headway in a single lane and a short headway caused by vehicles in two different lanes. On one way streets, the controller initiates the clearance interval as soon as the given direction clears, while on two way streets, the controller waits for both directions to clear and initiates the clearance interval as soon as the second direction clears. The improved strategy has yet to be adopted into standard practice.

4.3 Fixed Length Clearance Interval, Wide-Area Detection VA Control

Extending Newell's theories to wide-area detection, the controller monitors vehicles along the entire intersection approach. The queue is monitored and extended under all phases using the same principles: a vehicle is added to the queue when the vehicle decelerates to a specified threshold below the free flow velocity or, when the vehicle's headway falls below a threshold, regardless of the location on the approach. Once a vehicle has entered the queue, it is considered part of the queue until it passes the stop bar. Thus, disturbances during dissipation (e.g., an inattentive driver with a long headway) do not cause premature termination of the green. In practice, some modification would be necessary to allow for parking and mid-block turning maneuvers. Note that in this strategy, the controller only needs to know the spatial position and velocity of the end of queue in each lane. It does not keep track of the number of vehicles

During the green phase, the controller initiates the clearance interval as soon as the queue has dissipated in at least one lane in BOTH directions. Where queue dissipation is defined as the first instant when the last queued vehicle has passed its minimum stopping distance,

$$\text{minimum stopping distance} = \frac{v^2}{2a_{\max}} \quad (1)$$

v = vehicle velocity

a_{\max} = maximum reasonable deceleration

Then, the controller assigns a clearance interval in accordance with standard practice, i.e., the interval is sufficiently long to serve a free flow vehicle at the legal stopping distance,

$$\text{legal stopping distance} = \frac{v_{ff}^2}{2a_r} \quad (2)$$

v_{ff} = free flow velocity on the given approach

a_r = a "reasonable" deceleration that drivers should be willing to tolerate

4.4 Variable Length Clearance Interval, Wide-Area Detection VA Control

Further efficiencies can be realized by assigning a safe clearance interval based on the current state of the system. This controller is identical to the one outlined in the previous section with one exception: in any given cycle, the clearance interval may be shorter than the fixed clearance interval required for a free flow vehicle at the legal stopping distance. At the initiation of the clearance interval, the controller follows all vehicles at or beyond the free flow legal stopping distance and allocates sufficient yellow time for the entire population to safely enter the intersection. So, for the i -th vehicle,

$$\text{required yellow time}_i = \frac{x_i}{v_i} \quad (3)$$

and for the given direction,

$$\text{net yellow time} = \max(\text{required yellow time}_i) \quad (4)$$

if a given vehicle decelerates, but is not stopping in response to the yellow signal, the net yellow time may be extended up to the required yellow time for a free flow vehicle at the legal stopping distance.

For two opposing directions, one direction will clear before the other in most cycles. The direction that clears first may require a longer clearance interval than the queued direction. The

controller anticipates queue dispersal in the queued direction and initiates the longer clearance interval in the free flowing direction so that clearance intervals in both directions end simultaneously. Thus, the controller minimizes the time that the intersection is serving vehicles at a lower rate.

5. Model Design

The basic model simulates an isolated intersection with two one-way or two two-way streets. Each approach can have one or two lanes. Distance is measured in continuous units (ft) and vehicles are assumed to have an effective length of 24 ft (7.3 m). Vehicles are not allowed to turn at the intersection because of the unique issues involved in the control of turning traffic [2].

Because the wide-area controllers and the improved impulse detector based controller initiate the clearance interval when demand drops in ONE lane, the remaining vehicles from the other lane are allowed to distribute themselves evenly over the two lanes at the initiation of red, thus, preventing unrealistic amounts of residual queueing. Lane changes are not allowed at any other time. This constraint does not limit simulation performance.

Figure 5-1 shows a flow chart for the intersection model. Each iteration of the model simulates 1 second of time. The primary measure of effectiveness in this study is average delay per vehicle (as defined in Section 5.5). The following sections will address each of the model components in more detail. Before examining the sub-components, Figure 5-2 shows concurrent vehicle trajectories from two opposing one-way streets at an intersection under wide-area control. Note that the initiation of red typically is not characterized by queue formation, as predicted by Newell.

5.1 Steady State and Sample Size Requirements

We went to great lengths to ensure that the simulated intersection had reached steady state before collecting statistics. Following Son, Cassidy & Madanat [4], numerous simulation runs were made to establish the amount of simulated time required for the intersection to come to steady state.

Toward this end, over 500 runs of 10 simulated hours were conducted and queue lengths were measured every n seconds. The distribution of queue length over all runs at each sample time (i.e., n , $2n$, $3n$, ...) was calculated and steady state conditions began at the time when all subsequent distributions became statistically identical. This procedure was applied to the scenario

Figure 5-1, Flow Chart for the Simulation Model

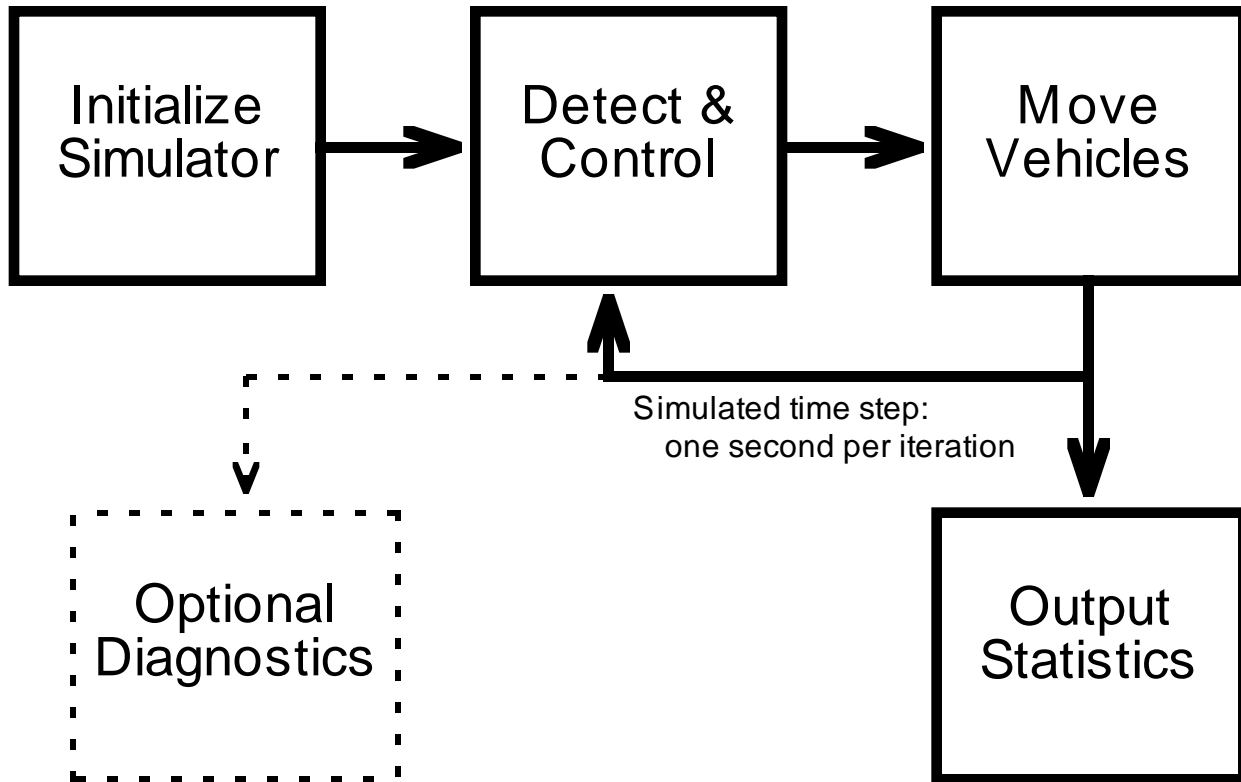
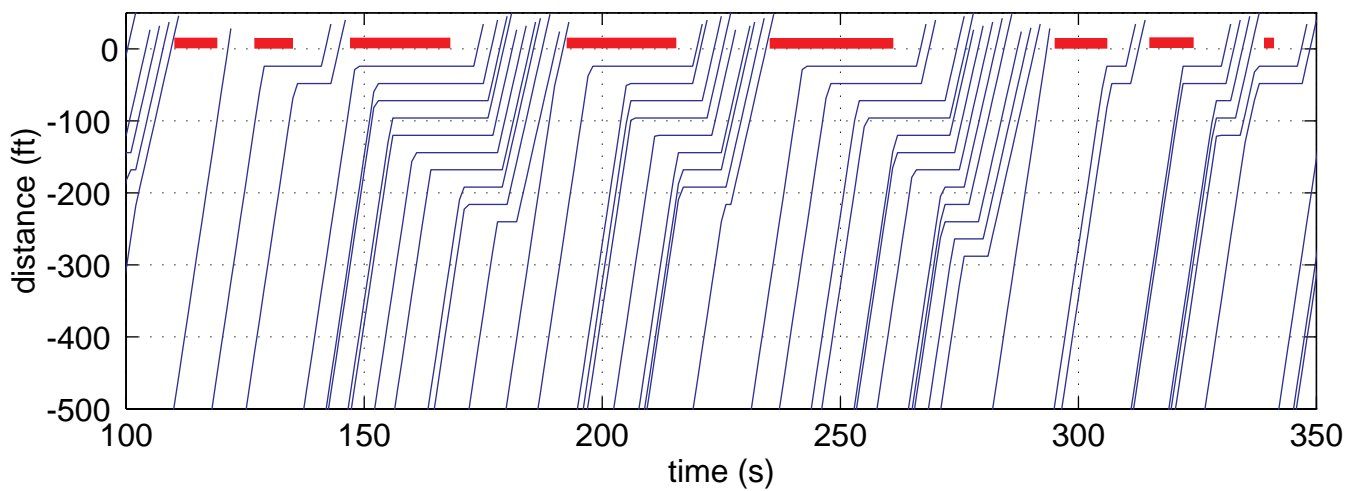
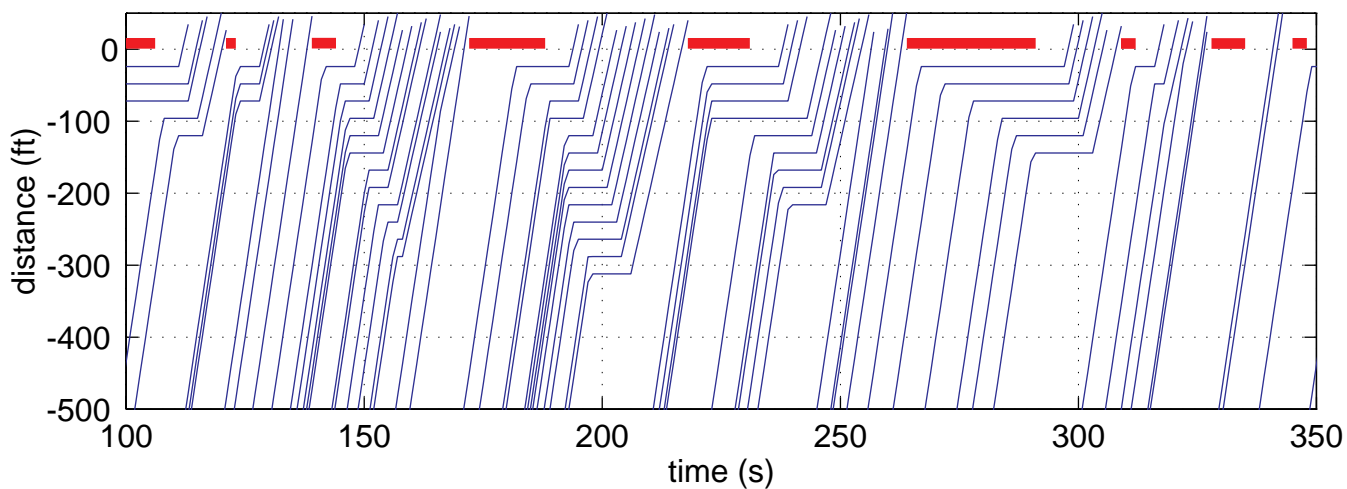

Figure 5-2, Concurrent Vehicle Trajectories From the Intersection of Two Conflicting, Single Lane, One-Way Streets Under Wide-Area Control. The Red Phases are Indicated by Thick Horizontal Lines at Zero Distance. Note How the Initial Red Phase Typically is not Subject to Immediate Queue Formation.



with highest demand so that the measured initialization time would be more than sufficient for the remaining scenarios. The pre-study also established a sufficient sample period (1000 seconds) to ensure that sequential delay measurements are independent from each another.

Once the initialization time was known, 400 independent simulations of 1000 seconds each were made for each condition, with a total of over 110 simulated hours in steady state per condition. The primary measure of effectiveness in this study is average delay per vehicle and each independent simulation yields a single measurement of average delay. The mean of the 400 independent measurements is used to estimate the (true) average delay per vehicle in the given condition with the following confidence interval:

$$\text{confidence interval} = \frac{z \cdot \sigma}{\sqrt{m}} \quad (5)$$

z = selected confidence level (95%)

σ = sample standard deviation

m = number of samples per condition (400)

5.2 Initialization

The initialization module sets up the various parameters for the intersection such as the lane configuration, detector locations, surveillance area, free flow velocity, etc..

5.3 Detection and Control

First the module detects vehicles. For impulse detectors, the module checks to see how many vehicles passed the detector location during the past iteration. For the wide-area detector, the module finds all of the vehicles on the approach and measures their speed. Then, it implements any necessary control based on the observed conditions in accordance to the given controller strategy (as outlined in Section 4).

5.4 Vehicle Motion

A great deal of work was devoted to building models that faithfully replicate intersection traffic features. Drivers respond to the signal aspects and to the vehicles ahead of them. Drivers select from three discrete velocity levels (free flow, discharging queue and stopped).

5.4.1 Arrivals and Departures

Vehicle arrivals at the isolated intersection are modeled as a Poisson process and each lane is treated independently [6]. A vehicle is deleted once it is sufficiently downstream of the stop bar so that it can no longer affect any vehicle upstream of the stop bar.

5.4.2 The Drivers' Decision to Stop

At the initiation of yellow, a driver may decide to proceed through the intersection or come to a stop. Many factors influence this decision, including the vehicle location on the approach when the yellow is first displayed. Sheffi & Mahmassani [7] calculated the probability of stopping as a function of distance for high approach speeds. Cassidy, Chuang & Vitale [3] calibrated these values for a range of speeds. The current model uses Cassidy, Chuang & Vitale's values to determine the probability of stopping. Table 5-1 summarizes the values:

Table 5-1, Probability of Stopping at Initiation of Yellow

Vel (mph)	Distance to stop bar (ft)															
	25	50	75	100	125	150	175	200	225	250	275	300	325	350	375	400
20	0	0.16	0.99	1	1	1	1	1	1	1	1	1	1	1	1	1
30	0	0	0	0.12	0.86	0.98	1	1	1	1	1	1	1	1	1	1
35	0	0	0	0	0	0.20	0.88	1	1	1	1	1	1	1	1	1
40	0	0	0	0	0	0	0.12	0.32	0.90	1	1	1	1	1	1	1
50	0	0	0	0	0	0	0	0	0	0	0.01	0.02	0.26	0.79	0.99	1

5.4.3 Driver Start-Up Times

Earlier work has shown that vehicles' discharge headways vary as a function of position within the queue [8]. Cassidy, Chuang & Vitale [3] measured queue discharge headways at the stop bar of a signalized intersection. Their analysis found that the first headway (defined as the time between the initiation of green and the time the first vehicle crosses the stop bar) and the second headway (difference between the time the second vehicle crosses the stop bar and the time the first vehicle crosses the stop bar) conform to Normal distributions with distinct means and variances. All subsequent headways could be combined into a single Type I Gumble distribution. Table 5-2 summarizes the distributions:

Table 5-2, Distribution of Queue Discharge Headways

Headway Number	Distribution	Mean (sec)	Variance (sec ²)
First Headway	Normal	2.88	0.449
Second Headway	Normal	2.17	0.130
All Subsequent Headway's	Type I Gumble	1.92	0.462

In the same study, Cassidy, Chuang & Vitale used field tests with a floating car to measure the discharge velocity and found that for a "fully accelerated" queue, this velocity is approximately 20 mph. The model incorporates this work to calculate the discharge headways and then back calculate the vehicle start time as a function of distance to the stop bar.

5.5 Output Statistics

As noted earlier, the primary measure of effectiveness in this study is average delay per vehicle, where a vehicle's delay is defined as the difference between the measured travel time on the intersection approach and the travel time at free flow velocity. Vehicle arrival times are recorded at a location upstream of the assumed maximum queue length, as shown by the Arrivals curve in Figure 5-3. Throughout data collection, tests of individual vehicle velocity are used to verify that the queue does not overrun the upstream recording location. Departure times are recorded as vehicles pass the stop bar, as shown by the Departures curve in Figure 5-3. Following queueing theory, a Virtual Arrival curve is calculated by shifting the Arrivals curve by the free flow travel time, thus, the Virtual Arrival curve simply indicates the time vehicles would have arrived at the stop bar if there were no delay due to the intersection. The (horizontal) difference between the Departure curve and Virtual Arrival curve for the i -th vehicle indicates the delay that vehicle incurred due to the intersection. Summing the delay over n vehicles (i.e., the area between the Virtual Arrival curve and the Departure curve) and dividing by n yields the average delay for the sample of n vehicles.

6. Simulation Results

Following the Model Design from Section 5, eight different intersection configurations were simulated, each with different approach attributes (e.g., one lane vs. two lane approaches, different free flow velocities, etc.). For each intersection configuration, two to four different control strategies (as outlined in Section 4) were tested and each control strategy was evaluated for over 110 simulated hours under steady state conditions. Perhaps not surprisingly, the greatest benefits from wide-area surveillance were realized at intersections near saturation (see sections 6.1, 6.5, 6.6). The following constants were used in the simulations:

All detectors

minimum green time = 2 seconds

maximum green time = 61 seconds

Figure 5-3, An Illustration of the Delay Calculation Following Queueing Theory

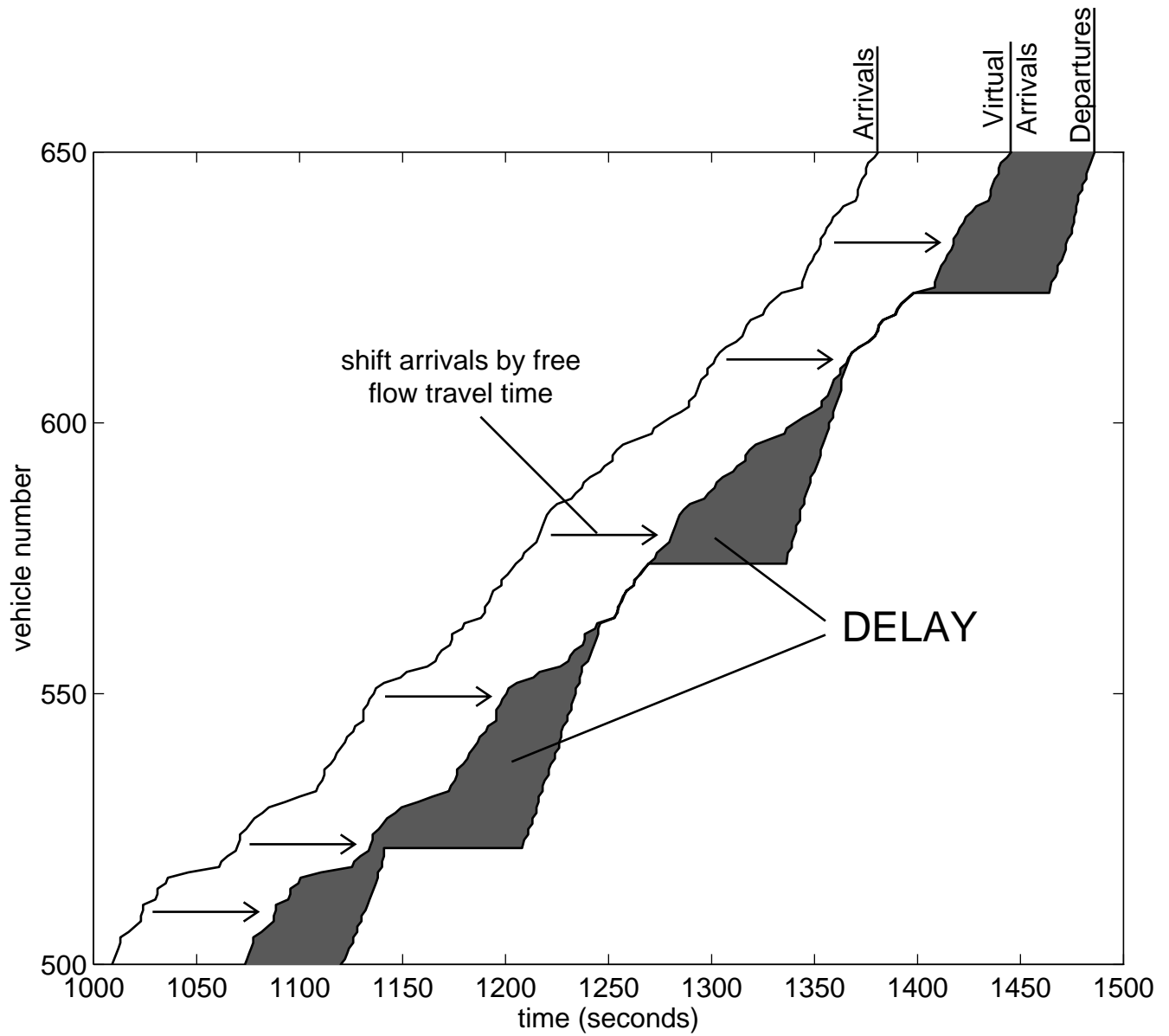

Wide-area detectors

threshold velocity = $0.75 * \text{free flow velocity}$

threshold headway = 4 seconds

Impulse detectors

detectors 150 ft upstream of stop bar [9]

critical headway = 4 seconds

extra time per vehicle during red = 3 seconds

6.1 Scenario 1

2 approaches

1 lane per approach

Free flow velocity of 30 mph

Average arrival rate of 800 vphpl

This is the simplest intersection considered in the study, with two one-way streets and a single lane per approach as shown in Figure 6-1. The simulation results for this intersection configuration under three different control strategies are shown in Table 6-1. The wide-area controller realized a 62 percent delay reduction from the conventional controller. Also note that the variable clearance interval provides additional delay reductions over the fixed clearance interval. Finally, note that the Improved Impulse Detector Controller is identical to the Conventional Impulse Detector Controller for single lane approaches.

Figure 6-1, Intersection Configuration for Scenario 1.

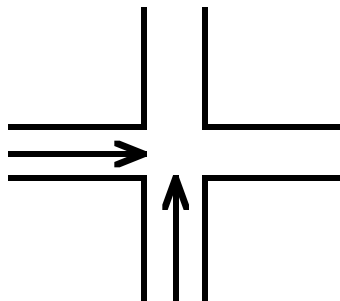

Table 6-1, Controller Performance for Scenario 1.

Detection		Avg. Green (sec)	Average Delay (sec)	+/- Confidence Interval (sec)	Percent Improvement
Impulse		33.57	26.35	0.96	-
Wide-Area	Fixed Clearance Interval	10.80	11.82	0.31	55%
Wide-Area	Variable Clearance Interval	9.47	9.93	0.24	62%

6.2 Scenario 2

2 approaches

2 lanes per approach

Free flow velocity of 30 mph

Average arrival rate of 800 vphpl

Before proceeding to two-way streets, we examine the performance at an intersection of one-way, two lane streets, as shown in Figure 6-2. The simulation results for this intersection configuration under three different control strategies are shown in Table 6-2. With this intersection configuration, the wide-area controller realized a 50 percent delay reduction over the conventional controller.

Figure 6-2, Intersection Configuration for Scenario 2.

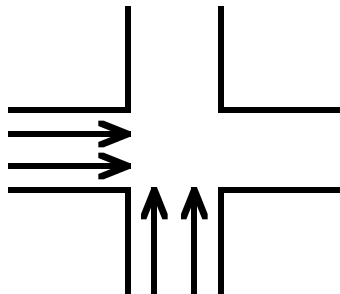

Table 6-2, Controller Performance for Scenario 2.

Detection		Avg. Green (sec)	Average Delay (sec)	+/- Confidence Interval (sec)	Percent Improvement
Impulse	Conventional	57.16	32.85	0.38	-
Impulse	Improved	24.56	23.25	0.43	29%
Wide-Area	Variable Clearance Interval	10.81	16.54	0.21	50%

6.3 Scenario 3

- 4 approaches
- 1 lane per approach
- Free flow velocity of 30 mph
- Average arrival rate of 800 vphpl

Next, consider the intersection of two-way streets with a single lane on each approach, as shown in Figure 6-3. The simulation results for this intersection configuration under two different control strategies are shown in Table 6-3. In this configuration, the wide-area controller realized a 41 percent delay reduction over the conventional controller.

Figure 6-3, Intersection Configuration for Scenario 3.

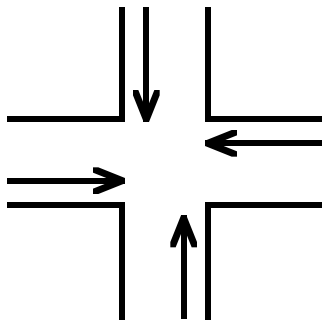

Table 6-3, Controller Performance for Scenario 3.

Detection	Avg. Green (sec)	Average Delay (sec)	+/- Confidence Interval (sec)	Percent Improvement
Impulse	52.35	32.96	0.68	-
Wide-Area Variable Clearance Interval	26.74	19.58	0.57	41%

6.4 Scenario 4

- 4 approaches
- 2 lanes per approach
- Free flow velocity of 40 mph
- Average arrival rate of 480 vphpl

Scenarios 4-6 examine the same four way intersection with two lanes per approach under different demand conditions. The simulation results for low demand, Scenario 4, under all four

control strategies are shown in Table 6-4. In this scenario, the wide-area controller realized a 45 percent delay reduction over the conventional controller. However, the Improved Impulse Detector Controller performed slightly better with an average delay per vehicle approximately 0.5 seconds shorter.

Under the low demand, the average green time is very short for the improved impulse controller and both of the wide area controllers. Since both of the wide area controllers initiate the clearance interval as soon as the queue has dissipated in at least one lane in BOTH directions, but potentially before all lanes clear, discharging vehicles occasionally get cut off in the lanes that do not clear. Since the conflicting directions may not have sufficient demand to warrant switching so rapidly, the snappy response of the wide-area detection increases delay slightly.

The short green times suggest that VA control may not be warranted in this low demand scenario; however, controller performance could be improved by checking demand on the conflicting directions before switching priority. This check was not conducted in the current model because it was assumed that under the suite of test scenarios, a sufficient number of vehicles would arrive on the conflicting directions before the green returned to them.

Figure 6-4, Intersection Configuration for Scenario 4.

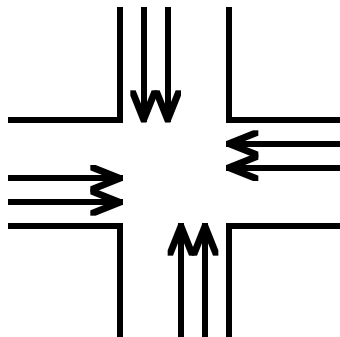

Table 6-4, Controller Performance for Scenario 4.

Detection		Avg. Green (sec)	Average Delay (sec)	+/- Confidence Interval (sec)	Percent Improvement
Impulse	Conventional	45.96	20.43	0.13	-
Impulse	Improved	7.18	10.60	0.09	48%
Wide-Area	Fixed Clearance Interval	5.49	11.44	0.05	44%
Wide-Area	Variable Clearance Interval	5.46	11.28	0.05	45%

6.5 Scenario 5

4 approaches

2 lanes per approach

Free flow velocity of 40 mph

Average arrival rate of 800 vphpl

The benefits of wide-area control are more apparent when the intersection (from Scenario 4) has higher demand of 800 vphpl. The simulation results for high demand under all four control strategies are shown in Table 6-5. In this configuration, the wide-area controller realized a 29 percent delay reduction over the conventional controller while the improved impulse detector strategy only realized a 9 percent delay reduction.

Note that the conventional controller times out in virtually every cycle with an average green of 61 seconds. In other words, the conventional VA control is not responsive to drivers at all. Under the high demand, it is rare that a critical headway is observed across both lanes simultaneously in a given direction.

Figure 6-5, Intersection Configuration for Scenario 5.

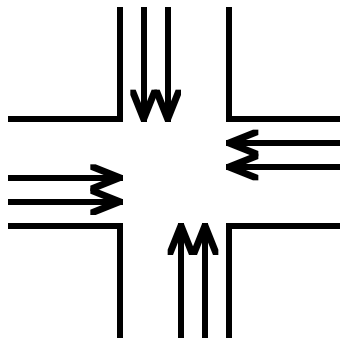

Table 6-5, Controller Performance for Scenario 5.

Detection		Avg. Green (sec)	Average Delay (sec)	+/- Confidence Interval (sec)	Percent Improvement
Impulse	Conventional	60.92	38.61	0.41	-
Impulse	Improved	43.98	35.16	0.83	9%
Wide-Area	Fixed Clearance Interval	30.49	29.63	0.45	23%
Wide-Area	Variable Clearance Interval	28.04	27.42	0.42	29%

6.6 Scenario 6

4 approaches

2 lanes per approach

Free flow velocity of 40 mph

Mixed average arrival rate of

800 vphpl, North & West

480 vphpl, East & South

All of the preceding scenarios have assumed balanced demand on opposing approaches. Controller performance with unbalanced directional demand is investigated in this experiment. The simulation results for high demand under all four control strategies are shown in Table 6-6. As with Scenario 5, the conventional controller times out almost every cycle. The greatest benefits, 40 percent delay reduction, are realized with the wide-area controller using a variable clearance interval.

Figure 6-6, Intersection Configuration for Scenario 6.

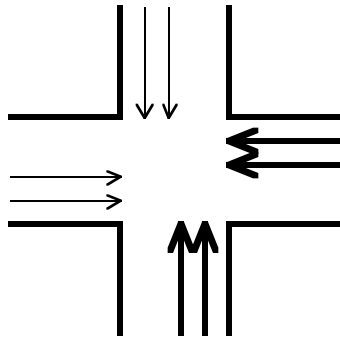

Table 6-6, Controller Performance for Scenario 6.

Detection		Avg. Green (sec)	Average Delay (sec)	+/- Confidence Interval (sec)	Percent Improvement
Impulse	Conventional	60.25	32.63	0.36	-
Impulse	Improved	25.93	23.72	0.47	27%
Wide-Area	Fixed Clearance Interval	18.62	21.66	0.35	34%
Wide-Area	Variable Clearance Interval	16.45	19.69	0.30	40%

6.7 Scenario 7

- 4 approaches
- 2 lanes per approach
- Free flow velocity of 30 mph
- Average arrival rate of 800 vphpl

The setup for this scenario is identical to Scenario 5, except that the free flow velocity is 10 mph slower. The simulation results for this intersection configuration under three different control strategies are shown in Table 6-7. In this configuration, the wide-area controller realized a 43 percent delay reduction over the conventional controller. Again, the conventional controller can not detect the demand drop by looking at two lanes simultaneously and the signal times out on almost every cycle.

Figure 6-7, Intersection Configuration for Scenario 7.

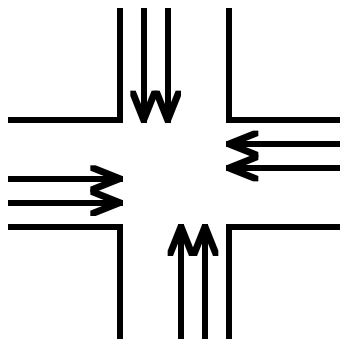

Table 6-7, Controller Performance for Scenario 7.

Detection		Avg. Green (sec)	Average Delay (sec)	+/- Confidence Interval (sec)	Percent Improvement
Impulse	Conventional	60.85	34.73	0.27	-
Impulse	Improved	39.25	27.71	0.36	20%
Wide-Area	Variable Clearance Interval	19.31	19.71	0.27	43%

6.8 Scenario 8

- 4 approaches
- 2 lanes per approach
- free flow velocity of 50 mph
- Mixed average arrival rate of
 - 800 vphpl, North & West
 - 480 vphpl, East & South

This scenario was designed with the Improved Impulse Detector Controller for the base line, thus, the Conventional Controller was excluded from the experiments. The results in Table 6-8 show that, under certain conditions, the Improved Impulse Detector Controller can perform almost as good as the Wide-Area Detection Controller.

Figure 6-8, Intersection Configuration for Scenario 8.

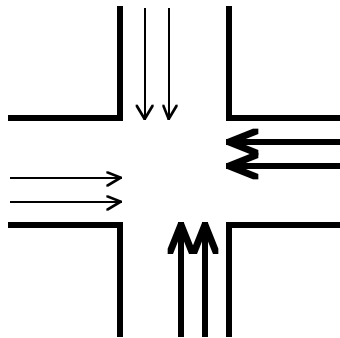

Table 6-8, Controller Performance for Scenario 8.

Detection		Avg. Green (sec)	Average Delay (sec)	+/- Confidence Interval (sec)
Impulse	Improved	40.36	36.97	0.77
Wide-Area	Variable Clearance Interval	32.91	35.16	0.83

6.9 Summary of Results

Table 6-9 summarizes the results from all eight scenarios.

Table 6-9, Summary of Controller Performance under all 8 Scenarios

scenario	free flow			detection and control (CI = Clearance Interval)		avg. green (sec)	average delay		percent improvement
	number of approaches	number of lanes	velocity (mph)				velocity (mph)	demand (vphpl)	
1	2	1	30	800	Impulse	33.57	26.35	0.96	-
					Wide Area	10.80	11.82	0.31	55%
					Wide Area	9.47	9.93	0.24	62%
2	2	2	30	800	Impulse	57.16	32.85	0.38	-
					Impulse	24.56	23.25	0.43	29%
					Wide Area	10.81	16.54	0.21	50%
3	4	1	30	800	Impulse	52.35	32.96	0.68	-
					Wide Area	26.74	19.58	0.57	41%
4	4	2	40	480	Impulse	45.96	20.43	0.13	-
					Impulse	7.18	10.60	0.09	48%
					Wide Area	5.49	11.44	0.05	44%
					Wide Area	5.46	11.28	0.05	45%
5	4	2	40	800	Impulse	60.92	38.61	0.41	-
					Impulse	43.98	35.16	0.83	9%
					Wide Area	30.49	29.63	0.45	23%
					Wide Area	28.04	27.42	0.42	29%
6	4	2	40	480/800	Impulse	60.25	32.63	0.36	-
					Impulse	25.93	23.72	0.47	27%
					Wide Area	18.62	21.66	0.35	34%
					Wide Area	16.45	19.69	0.30	40%
7	4	2	30	800	Impulse	60.85	34.73	0.27	-
					Impulse	39.25	27.71	0.36	20%
					Wide Area	19.31	19.71	0.27	43%
8	4	2	50	480/800	Impulse	40.36	36.97	0.77	-
					Wide Area	32.91	35.16	0.83	5%

7. Feasibility

All of the control algorithms tested in this study could be implemented using existing controller technology. The unknown factor in the system is the detector. Machine vision promises to be the first viable wide-area detector and experience from the PATH Roadwatch real time vehicle tracker has shown that machine vision tracking is feasible. However, the current Roadwatch system has been optimized for freeway applications. First, vehicle features are detected in an initialization region, then the features are tracked as the vehicles pass through the field of view and finally the features are grouped into vehicles after they have exited the region of interest. This approach is not well suited for the intersection environment because information is only extracted after a vehicle has left the region of interest. At an intersection, it is necessary to know information about the traffic stream before it leaves the surveillance area.

For the Fixed Length Clearance Interval, Wide-Area Detection VA Control strategy, the controller only needs to know the spatial end of queue and its velocity. It does not need to know the number of vehicles in the queue or, for that matter, where one vehicle ends and another begins. The machine vision vehicle tracker could be modified for intersection control by processing the features while they are still in the region of tracking and yield a *rough group* to represent the areas of roadway occupied by an unknown number of vehicles, thereby avoiding the much more difficult task of segmenting distinct vehicles. The *rough group* positions and velocities could be used to track the end of queue while it is still in the field of view and supply sufficient input to the fixed clearance interval wide-area detection VA controller. The variable clearance interval controller, however, would require knowledge about all vehicles on the approach and further detector development is necessary before this strategy can become a viable and safe alternative.

For the most part, other image processing systems tend to fall into two categories. The so called *second generation* systems that mimic loop detectors, but provide little if any additional information. Then there are the third *generation systems*, which attempt to track discrete vehicles. The second generation systems do not provide enough information to be true wide-area detectors while the third generation systems typically have not solved the problems associated with segmenting discrete vehicles under difficult lighting conditions or in the presence of partial occlusion.

There are a few image processing systems that do not fit into the above categories and could serve as starting points for wide-area based intersection control. The systems provide new information, not available from point detectors, but they do not attempt to track discrete vehicles. For example, Rourke & Bell [10] demonstrate a simple image processing system for queue detection and congestion monitoring that does not require much computing power (their detector uses an IBM PC ca. 1990). The key to keeping the system simple is the fact that it only monitors a

line of pixels down the center of a lane, ignoring the rest of the image. With such a system, it is impossible to segment discrete vehicles, but it is easy to measure the length (i.e., distance) of the queue. The system as presented appears to be vulnerable to shadows and occlusions from neighboring lanes. These difficulties could be overcome by creating a hybrid system that addresses these problems, then, uses Rourke & Bell's linear detection region method. Judicious use of optical flow, without segmenting discrete vehicles, should solve the occlusion problem and there are several existing algorithms to eliminate shadows that could be applied.

Daviet, Morin, Blosseville & Motyka [11] present another strategy, they monitor the entire intersection approach and note which areas have changing luminosity on the pixel level. Their assumptions are (i) that vehicle movement will result in changing luminosity and (ii) that vehicle movement is the only event that will cause such a change. Generally, assumption (i) will hold, but as previously noted, shadows and occlusion from neighboring lanes can invalidate assumption (ii). Some higher level processing would be necessary to remove shadows and address occlusion to make this system a viable detector for intersection control, but again, the system does not need to segment discrete vehicles.

8. Conclusions and Further Research Directions

8.1 Implications for Operators

Wide-area detection if functioning properly, can substantially reduce delay at isolated intersections. For some of the scenarios considered in this work, the wide-area controller exhibited delay reductions on the order of 50 percent from the conventional control strategy. The benefits of the wide-area control are realized because the controller can respond AS SOON AS demand drops. Once a field deployable wide-area detector becomes available, tests should be conducted using the non-traditional control algorithm outlined in this paper.

Wide-area detection is not cost effective for all intersections, there are some cases where judicious use of impulse detectors can yield performance improvements similar to the wide-area detector (e.g., Scenario 8 in Section 6.8). Once a wide-area technology is advanced enough to be deployed in the field, its performance should be characterized and further simulation should be conducted to establish when wide-area detection is warranted.

Finally, operators should re-examine how they use the existing detector infrastructure. This work has shown that monitoring lanes independently, rather than wiring multiple detector inputs together, can yield significant delay reductions as well. The scenarios examined in this study showed as much as a 29 percent delay reduction when the impulse detectors were decoupled.

8.2 Implications for Detector Design

Current image processing vehicle detectors on the market fall into two categories: second generation systems which mimic loops and third generation systems that (attempt to) track discrete vehicles. The second generation systems do not provide sufficient information for true wide-area control while the third generation systems tend to be too complex and run into problems segmenting vehicles on the approach.

The fixed time, wide-area controller needs to know where the queue ends spatially and how fast it is moving. The controller does not use any information about how many vehicles are in the queue. Modifying an existing third generation detector to track moving objects (platoons of unknown numbers) could allow the detector to extract the spatial end of queue while bypassing the difficult task of segmenting discrete vehicles.

9. REFERENCES

[1] Malik, J., et al, *Traffic Surveillance and Detection Technology Development: New Traffic Sensor Technology Final Report*, PATH, University of California, Berkeley, CA, 1997.

[2] Newell, G.F., *Theory of Highway Traffic Signals*, Institute of Transportation Studies, University of California, Berkeley, 1989.

[3] Cassidy, M., Chuang, Y., and Vitale, J., "Reexamining Vehicle-Actuation Strategies at Isolated Signalized Intersections", *Journal of Transportation Engineering*, Vol 122, No3, May/Jun 1996, ASCE, pp 235-240.

[4] Son, Y., Cassidy, M., and Madanat, S., "Evaluating Steady-State Assumption for Highway Queueing System", *Journal of Transportation Engineering*, Vol 121, No 2, Mar/Apr 1995, ASCE, pp 182-190.

[6] May, A., *Traffic Flow Fundamentals*, Prentice-Hall, NJ, 1990.

[7] Sheffi, Y. and Mahmassani, H., "A Model of Driver Behavior at High Speed Signalized Intersections", *Transportation Science*, Vol 15, No 1, Feb. 1981.

[8] Transportation Research Board, Special Report 209, *Highway Capacity Manual*, National Research Council, Washington, DC, 1985

[9] Kell, J., and Fullerton, I., *Manual of Traffic Signal Design, 2nd ed.*, Institute of Transportation Engineers, Washington, DC, 1991

[10] Rourke, A. and Bell, M., "Queue Detection and Congestion Monitoring Using Image Processing", *Traffic Engineering + Control*, Sep 1991, pp 412-421

[11] Daviet, B., Morin, J., Blosseville, J., and Motyka, V., "Video Image Processing for Toll Operation Evaluation", *Proc. of the Second International Conference on Applications of Advanced Technologies in Transportation Engineering*, ASCE, 1991, pp 353-357