

Lawrence Berkeley National Laboratory

Recent Work

Title

The GEO-SEQ project Results

Permalink

<https://escholarship.org/uc/item/38t0x3p6>

Author

Benson, Sally M.

Publication Date

2004-04-26

The GEO-SEQ Project Results

Sally M. Benson¹, Larry R. Myer¹, J G. Blencoe³, M. D. Cakici⁷, David Cole³, William Daily⁶,
Thomas Daley¹, Christine A. Doughty¹, S. Fisher³, William Foxall⁶, William Gunter⁴,
Mark Holtz⁵, J. Horita³, G. Michael Hoversten¹, Susan Hovorka⁵, K. Jessen⁷,
James W. Johnson⁶, B.M. Kennedy³, Kevin G. Knauss⁶, Anthony Kovscek⁶, David Law⁴,
Marcelo J. Lippmann¹, Ernest L. Majer¹, Bert van der Meer⁸, Gerry Moline³,
Robin L. Newmark⁵, Curtis M. Oldenburg¹, Franklin M. Orr, Jr.⁷, A.V. Palumbo³, J. C. Parker³,
Tony J. Phelps³, Karsten Pruess¹, Abelardo Ramirez⁶, Shinichi Sakurai⁵, and Chin-Fu Tsang¹,
Y. Wang⁷, J. Zhu⁷

¹*Lawrence Berkeley National Laboratory, Berkeley, CA*

³*Oak Ridge National Laboratory, Oak Ridge, TN*

⁴*Alberta Research Council, Edmonton, Alberta, Canada*

⁵*University of Texas at Austin, Austin, TX*

⁶*Lawrence Livermore National Laboratory, Livermore, CA*

⁷*Stanford University, Stanford, CA*

⁸*Netherlands Institute of Applied Geoscience, Utrecht, The Netherlands*

April 26, 2004

Support for this work was provided by the Assistant Secretary for Fossil Energy, Office of Coal and Power Systems and the Office of Natural Gas and Petroleum Technology, through the National Energy Technology Laboratory; and the Director, Office of Science, Office of Basic Energy Sciences, of the U.S. Department of Energy under Contract No. DE-AC03-76SF00098.

Table of Contents

Introduction

Reducing Sequestration Costs Through Co-optimization:

Co-optimization of Carbon Sequestration and Oil and Gas Recovery	2
Carbon Sequestration with Enhanced Gas Recovery (CSEGR)	8
Co-Disposal of CO ₂ , H ₂ S, NO ₂ , and SO ₂	12

Development and Demonstration of Monitoring Technology

Sensitivity Modeling and Optimization of Geophysical Monitoring Technologies	17
Field Data Acquisition for CO ₂ Monitoring Using Geophysical Methods	21
Sensitivity of Geophysical Measurements	30
Feasibility of Monitoring CO ₂ Injection at the South Liberty Oil Field, Texas, Using Surface and Downhole Tiltmeters	34
Application of Natural and Introduced Tracers for Providing Process Optimization Information	40

Enhancement and Comparison of Simulation Models

Enhancement of Numerical Simulators for CO ₂ Sequestration in Deep, Unminable Coal Seams	49
Intercomparison of Reservoir Simulation Models for Oil, Gas, and Brine Formations	55

New Methods and Information for Capacity Assessment

Improving the Methodology for Capacity Assessment	60
Capacity Assessment for the Frio Formation, Texas	66

Frio Brine Pilot Project

CO ₂ Injection in the Frio Brine Formation Pilot	72
Optimal Monitoring Design for the Frio Pilot Test	76

Introduction

Initiated in 2000, the GEO-SEQ Project has conducted applied research and development studies that have yielded new methods and approaches for reducing the cost and risk of geologic sequestration. Research is conducted by an interdisciplinary team of scientists and engineers from five research institutions in the United States, one in Canada, and one in Europe, working with four private-sector partners: BP, ChevronTexaco, En Cana, and Statoil

The main accomplishments of the Project to date are summarized in the following sections. (Additional information, including publications prepared by the GEO-SEQ team to date, can be found at <http://www-esd.lbl.gov/GEOSEQ/>.) To reduce costs, it has been shown that enhanced oil recovery (EOR) methods can be optimized to increase the fraction of the reservoir holding CO₂ while holding the ultimate oil recovery constant. The technical and economic feasibility of enhanced gas recovery (EGR) with sequestration was established. Geochemical studies show that large amounts of H₂S co-injected with CO₂ should not prove problematic in terms of reservoir processes, while small amounts of SO₂ would lead to unacceptably low pH. These results are of value in assessing the use of impure waste streams as a means to reduce overall sequestration costs. To reduce sequestration risks, a methodology for site-specific selection of subsurface monitoring technologies has been demonstrated, baseline data needed for interpretation of isotopic tracers used to monitor reservoir processes have been developed, and a new definition of formation capacity factor for use in assessing sequestration efficiency has been established. Field tests of monitoring technology have also been carried out at CO₂ EOR projects. A recent code comparison study has shown that currently available simulation codes can model physical and chemical processes arising from geologic storage of CO₂, with quantitatively similar results.

Finally, the current focus of the Project is a collaboration with the Texas Bureau of Economic Geology (TBEG) to conduct the Frio Pilot Brine Formation CO₂ Injection Test. This test will provide important information for validation of measurement, monitoring, and verification (MMV) methodologies, validation of conceptual models for CO₂ behavior, and experience for larger-scale sequestration demonstration projects.

Reducing Sequestration Costs Through Co-optimization

Co-optimization of Carbon Sequestration and Oil and Gas Recovery

A.R. Kavscek, Y. Wang, J. Zhu, M.D. Cakici, K. Jessen, and F.M. Orr, Jr.
Stanford University, Stanford, CA

Objectives:

The goals of this research are to (1) improve our ability to predict the interactions between reservoir heterogeneity, mobility of injected and resident fluids, phase behavior, and gravity; (2) develop techniques for selecting optimum gas composition for injection, and (3) elucidate the mechanisms by which CO₂ utilization is increased during oil and gas recovery operations. One premise throughout is that CO₂ sequestration should be conducted so as to maximize any incremental oil or gas production, thereby offsetting the costs of CO₂ compression and transportation.

Background:

First attempts at large-scale sequestration, the Sleipner West aquifer-storage project withstanding, will likely be concentrated in the area of injection of anthropogenic CO₂ into sedimentary basins containing oil or gas. About 1.4 bcf per day (6900 tonnes/day) of CO₂ are currently injected for oil recovery in the U.S. Replacing this naturally occurring CO₂ with anthropogenic CO₂ would have a minor, but measurable, effect on overall CO₂ emissions. However, CO₂ is injected into only a small fraction of reservoirs, and it is estimated that upwards of 80% of oil reservoirs worldwide might be suitable for CO₂ injection based upon oil recovery criteria alone. These facts, combined with the generally extensive geologic characterization of oil reservoirs and the maturity of CO₂-oil recovery technology, make oil reservoirs attractive first targets as CO₂ sinks.

Nevertheless, CO₂ storage in oil reservoirs is not a straightforward transfer of fossil fuel production technology, as others have suggested. Consider that among other factors, considerable engineering effort has been directed toward minimizing the amount of CO₂ needed to recover a barrel of oil because the purchase cost of CO₂ is directly related to profitability. On the other hand, when the objective of CO₂ injection is to increase the amount of CO₂ left behind at the end of the recovery process, the approach to the design question changes considerably. The simultaneous production of oil or gas and maximization of the volume of CO₂ in place is referred to here as *co-optimization*.

Results:

Project work focused on oil reservoirs and coalbed methane fields individually. Results are discussed accordingly.

- Oil Recovery—

The first step in a combined sequestration and oil recovery project is the location of possible sites for such a project. In short, aspects including reservoir depth, storage capacity, formation thickness, permeability, and the state of reservoir seals must be considered in concert (Kavscek 2002). Once a site has been identified, the workflow for design of a co-optimized process is as follows (Wang and Kavscek, 2003):

1. Describe the reservoir incorporating uncertainty in the distribution of permeability.

2. Quantify the magnitude of uncertainty with respect to flow prediction and CO₂ retention.
3. Choose an appropriate injection gas composition. Economics dictate either maximizing the injected concentration of CO₂ or minimizing the purchase cost of injectant.
4. Identify reservoir processes that jointly maximize oil production and the volume of CO₂ in place while minimizing the production and cycling of CO₂.
5. Design well placement and completions to reduce the preferential flow of injected gas through high-permeability zones.
6. As required and as economics dictate, implement gas mobility control to increase the time required for the transport of injectants to a producer.

Our research contributed to Items 2 through 6 in the workflow. Briefly, typical methods for quantifying uncertainty employ exhaustive flow simulations of multiple stochastic realizations of the geological architecture of a reservoir. Such approaches are computationally intensive and time consuming. We developed and tested an analytical streamline-based proxy for full reservoir simulation, allowing rational selection of a representative subset of equiprobable reservoir models that encompass uncertainty (Wang and Kovscek, 2003). Testing was conducted using a 3D, heterogeneous, and stochastic reservoir model, including a 15-component reservoir fluid with a gravity of 24°API. Reservoir shape is anticlinal and bounded by faults and an aquifer. Four injectors are located near the flanks of the reservoir and 4 producers near the crest.

Considerable effort was directed toward maximizing field wide oil recovery and sequestration of CO₂ (Jessen et al., 2003; Cakici and Kovscek, 2003). Figure 1 summarizes an essential problem when conventional water-alternating gas recovery techniques are applied for sequestration. Specifically, Figure 1(a) plots the fraction of the reservoir volume filled with CO₂. It illustrates that water employed to reduce the tendency of CO₂ to channel selectively through the reservoir fills a substantial volume of pore space, blocking the access of CO₂. By way of background, the figure presents fully compositional numerical simulation results of field-wide CO₂ storage for the reservoir model described above. Scenarios have used pure CO₂ as an immiscible injection gas and a solvent gas composed of about 2/3 by-mole CO₂.

Figure 1 compares water-alternating-gas (WAG) drive mode with immiscible and miscible gas injection, gas injection after waterflood (GAW), and a scheme employing active well control (WC) based on the producing gas-oil ratio (GOR). The first two scenarios are designed so that the mobilities of the injected phases in the reservoir are reduced. In the last scenario, production wells are actively controlled to limit the amount of produced gas and increase the contact of gas with reservoir volume. Control parameters are the producing GOR and the injection pressure. In all cases, oil production is discounted by the equivalent amount of energy needed to compress produced gas. Schemes that incur excessive gas cycling pay a penalty with respect to oil production.

Figure 1(a) illustrates that the well control scheme with immiscible CO₂ injection sequesters roughly 2.5 times the CO₂ of an optimized WAG process. Further, Figure 1(b) shows that oil production obtained from pure CO₂ injection with well control is on par with that obtained in an optimized WAG process. In general, gas-controlled production of pure CO₂ appears to limit gas cycling and maximize CO₂ storage, while allowing identical ultimate oil recovery as compared to WAG. Figure 1(b) shows, additionally, that oil recovery is greatest as a result of miscible gas injection. With miscible gas injection, the local displacement efficiency approaches unity and

recovery is maximized. Among the scenarios with miscible gas injection, well-controlled injection resulted in oil recovery 7–12% greater than the other cases and approaches 80% of the oil in place. As compared to cases employing pure CO₂, recovery from schemes using solvent is over 30% greater.

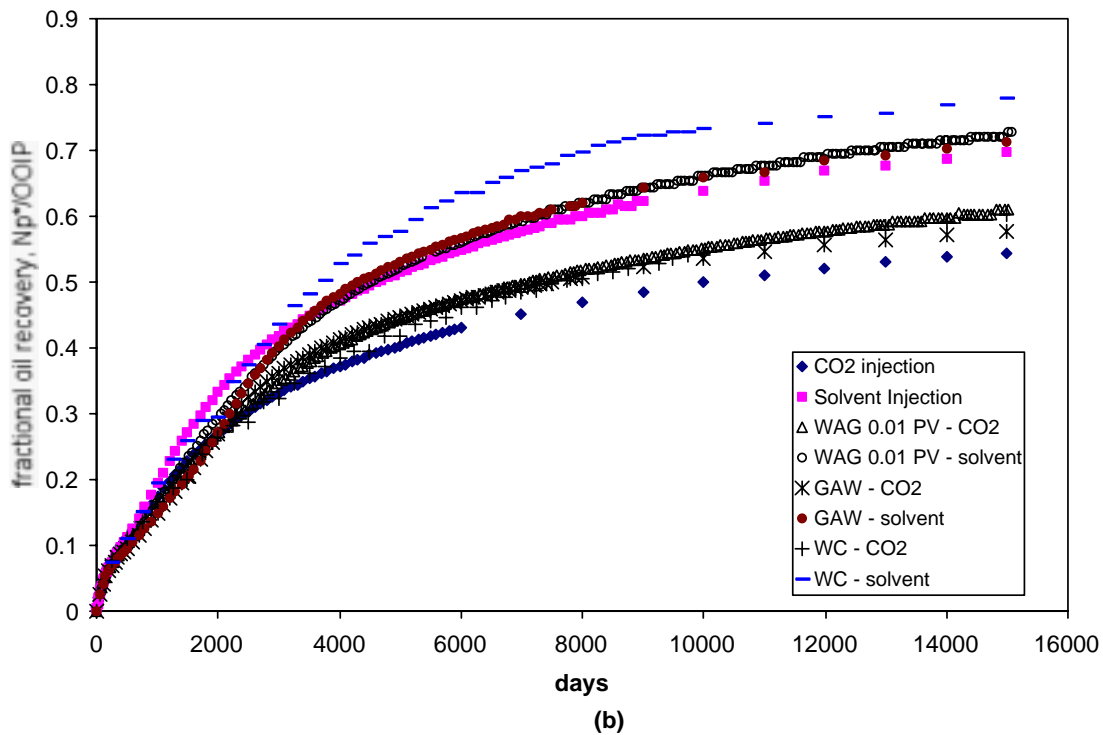
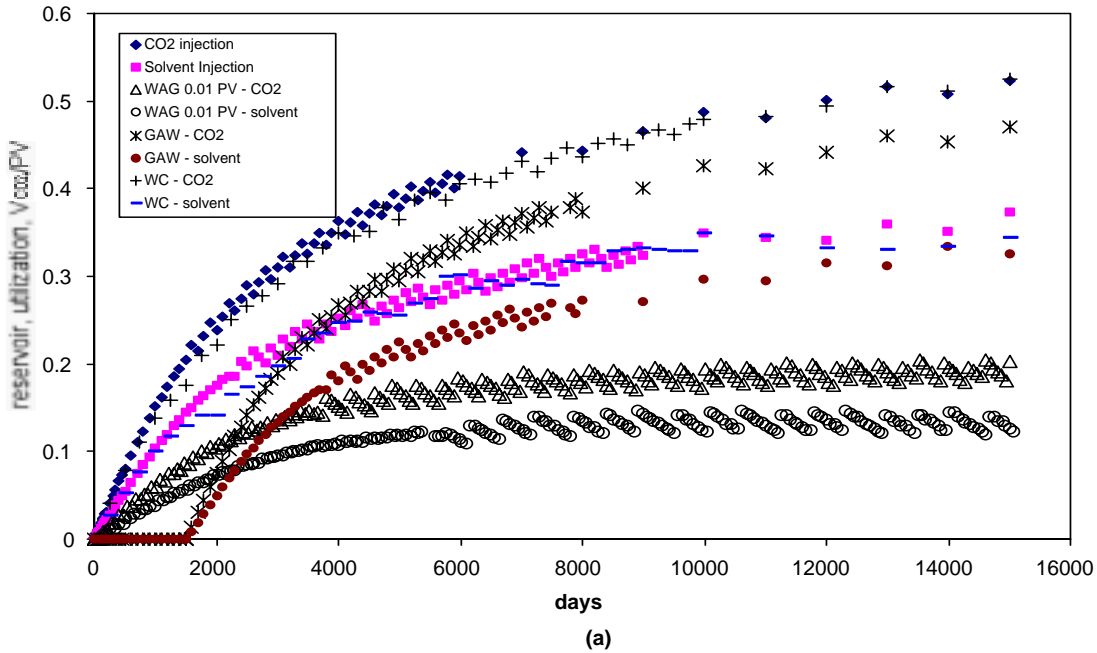

Figure 1. (a) Reservoir utilization and (b) oil recovery performance of different gas injection processes from a 3D, heterogeneous, compositional reservoir example

- Coalbed Methane—

We now turn briefly to results associated with sequestration in coalbed methane fields. CO₂ and nitrogen (N₂) are effective displacement agents for enhancing recovery of coalbed methane (ECBM). One important aspect of ECBM is the adsorption and desorption behavior of gas mixtures on coalbeds. Transport of the desorbed gas through coalbeds has not been examined in detail to date. We used the method of characteristics to describe adsorption and desorption of an arbitrary number of gas components from coalbed surfaces (Zhu et al., 2001; 2003). The injection gas composition is also arbitrary. Figure 2 illustrates a representative result. Flow is assumed to be one-dimensional. The gas injected is 75% (by mole) N₂ and 25% CO₂, and approximates an enriched combustion gas. The y-axis represents concentration and the x-axis represents wave velocity (ξ/t). Hence, the solution is self-similar and stretches with time but does not change shape. Due to the strongest affinity of CO₂ for the coal surfaces among the three components, most of the variation in the composition of CO₂ occurs upstream near the injection point. CO₂ adsorbs strongly and is separated from both N₂ and CH₄. Note the bank of N₂ at ξ/t of roughly 0.6. Downstream of the N₂ bank, the interaction of N₂ and CH₄ via adsorption/desorption is evidenced by a continuous variation. The N₂ adsorbs less strongly than CH₄ and so does not displace CH₄ as effectively as CO₂. This is a zone of variation containing N₂ intermixed with CH₄.

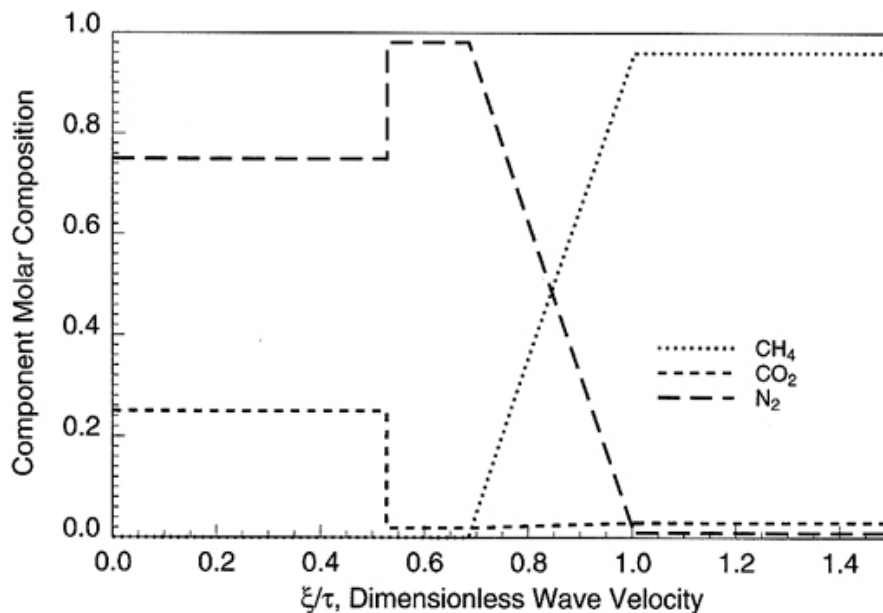

Figure 2. Representative solution profile for gas injection (25% CO₂ and 75% N₂) into a one dimensional, homogeneous coalbed

Implications for Geologic Sequestration:

One can envision two fundamentally different scenarios for CO₂ sequestration in oil reservoirs. In the first, anthropogenic CO₂ is provided at a cost competitive with naturally occurring CO₂. Anthropogenic CO₂ is substituted, but the economic drivers remain unchanged. That is, processes are typically designed to obtain maximum oil while injecting minimum CO₂. In the second, storage of CO₂ provides revenue. The design question changes considerably as the volumes of oil recovered and CO₂ stored are both maximized. In the latter case, conventional reservoir engineering WAG techniques for control of gas mobility appear to be inappropriate. Reservoir

pore space is loaded with water that might otherwise be filled with CO₂. Thus, the screening and selection criteria for candidate reservoirs also change, as discussed elsewhere (Kovscek, 2002).

With respect to sequestration in coalbed methane fields, there appears to be a high degree of synergy between sequestration and methane recovery. CO₂ has a great affinity for coalbed surfaces. As such, it is an effective displacement agent with the local displacement efficiency approaching 100%. In ternary systems, the composition of the injection gas has little effect on the amount of time to recover all CH₄ originally in place. However, injection gas composition has a significant effect on the produced gas composition and the time to breakthrough of the injection gas. In this sense, CO₂ is a superior injection gas.

Recommendations for Future Work:

Active well control to limit the producing gas-oil ratio appears to be a technique consistent with the goals of storage co-optimization from oil reservoirs. Nevertheless, a suite of gas-mobility control options needs to be developed to limit that volume of injection gas that is cycled through the reservoir. A topic that needs to be considered in much greater detail is the beneficial effect of chemicals on the storage capacity of an oil reservoir. For instance, the addition of small amounts of surfactant to the aqueous phase and a WAG ratio that is 95 to 99% CO₂ by volume could be keys to reducing premature CO₂ breakthrough at production wells and reducing the cycling of CO₂ through a reservoir. Ultimately, a reservoir simulator incorporating foam physics and the interaction of foam with oil is needed. This general framework exists currently, but the physics of foam in porous media are not completely understood, and so the reservoir simulation description is incomplete and (hence) not predictive. Further experimental and theoretical research is needed to understand, for instance, the ability of foam to trap and immobilize gas as a function of surfactant properties, pressure gradient, and rock properties.

Similarly, CO₂ is currently only used for oil recovery of relatively light oils ($^{\circ}\text{API} > 22$). In these lighter oils, it is generally possible to develop multi-contact miscibility with the oil. However, carbon dioxide injection may benefit the recovery of heavy oils ($^{\circ}\text{API} < 22$). Some effort should be devoted to exploring how petroleum recovery practice might be expanded to include carbon dioxide injection into heavier, more viscous oils, where the CO₂ is immiscible with the oil.

There are several avenues that should be explored in the area of coalbed methane. These include: improved understanding, from an experimental perspective, of the transport and geophysical properties of coals, including wettability, sorption behavior, and the effect of stress on the pore- and core-level physics of displacement. Additionally, our past work describing enhanced coalbed methane production should be expanded to two-phase flow (gas and water) as well as the effect of stress on coalbeds. With process physics delineated in one-dimensional media, simulation in three-dimensions should be considered.

Conclusions:

- For co-optimized oil recovery and CO₂ storage—
Unit mobility ratio streamlines correlate approximately with results from non-unit mobility ratio reservoir simulation. Streamlines provide important information about the connectivity, or lack thereof, among injectors and producers and the distribution of heterogeneities within a reservoir. The process of defining the distribution of reservoir performance via comprehensive flow simulation is simplified by replacing it with sampling from the uniform distribution of unit-mobility-ratio-streamline results.

The goal to sequester maximum carbon dioxide, while not diminishing oil recovery rate or ultimate oil recovery from an oil reservoir, is substantially different from the goals of oil recovery alone.

Active well control using the producing GOR and injection pressure as control parameters is effective at increasing the fraction of the reservoir holding CO₂. At the same time simulation results predict that ultimate oil recovery is the same as that from an optimized WAG recovery process.

Well completions can be designed to create injection profiles that reduce the adverse effects of preferential flow of injected gas through high permeability zones.

- In coalbeds—

In systems with two gas components, shock solutions occur when a more strongly adsorbing gas mixture is injected. Continuous variation occurs when the injection gas is less strongly adsorbing than the initial gases.

In ternary systems, CO₂ moves through coal in a plug-like fashion, whereas N₂ propagates more rapidly than CO₂. Hence, coalbeds appear capable of effecting a chromatographic separation of CO₂ and N₂. This behavior is not predicted by two-component models.

- An injection gas rich in N₂ yields a greater initial recovery rate but earlier breakthrough of injected N₂. Thus, N₂ must be separated from produced gas for a substantial period of time.
- Injection of a gas rich in CO₂ yields recovery of CH₄-rich gas for a greater period of time, reducing the amount of separation that is required.
- CO₂ can be separated from N₂ in a coalbed, at the cost of compressing the injected CO₂/N₂ mixtures and separating produced N₂/CH₄ mixtures.

Related Publications:

Cakici, M.D., and A.R. Kovscek, Geologic storage of carbon dioxide and enhanced oil recovery II: Cooptimization of storage and recovery. *Energy Conversion and Management*, to be submitted.

Jessen, K., L.C. Sam-Olibale, A.R. Kovscek, and F.M. Orr, Jr., Increasing CO₂ storage in oil recovery. *First National Conference on Carbon Sequestration*, Sponsored by the National Energy Technology Laboratory, Washington, DC, May 14–17, 2001.

Jessen, K., A.R. Kovscek, and F.M. Orr, Jr., Increasing CO₂ storage in oil recovery. *Energy Conversion and Management*, submitted June 2003.

Kovscek, A.R., Screening criteria for CO₂ storage in oil reservoirs. *Petroleum Science and Technology*, **20**(7 and 8), pp. 841–866, 2002.

Kovscek, A.R. and Y. Wang, Geologic storage of carbon dioxide and enhanced oil recovery I: Uncertainty quantification employing a streamline-based proxy for reservoir flow simulation, *Energy Conversion and Management*, to be submitted.

Zhu, J., K. Jessen, A.R. Kovscek, and F.M. Orr, Jr., Recovery of coalbed methane by gas injection. *SPE 75255 Proceedings of the SPE/DOE Thirteenth Symposium on Improved Oil Recovery*, Tulsa, OK April 13–17, 2002.

Zhu, J., K. Jessen, A.R. Kovscek, and F.M. Orr, Jr., Analytical solutions for coalbed methane displacement by gas injection. *Society of Petroleum Engineers Journal*, 2003.

Carbon Sequestration with Enhanced Gas Recovery (CSEGR)

Curtis M. Oldenburg and Sally M. Benson
Lawrence Berkeley National Laboratory, Berkeley, CA

Objectives:

The objectives of this task were to investigate the technical and economic feasibility of injecting CO₂ into depleting natural gas reservoirs for carbon sequestration with enhanced gas recovery (CSEGR). Because CSEGR has never been carried out in any actual reservoir, the approach we have taken to feasibility assessment is numerical simulation. The modeling of CSEGR required that we enhance existing numerical reservoir simulation tools to handle CH₄-CO₂ real gas mixtures and related processes. With these newly developed simulation capabilities, we applied the simulator to CSEGR scenarios based on the Rio Vista Gas Field, which is close to potential CO₂ sources in the San Francisco Bay Area, and is also the largest onshore natural gas field in California. During the course of the work, we extended the study to investigate a post-CSEGR use of the CO₂-filled reservoir, namely CH₄ storage using CO₂ as the cushion gas.

Results:

The properties of supercritical CO₂ appear to favor CSEGR. Specifically, CO₂ is denser and more viscous than CH₄, and these properties will tend to diminish mixing between the two gases during the displacement and repressurization process. Mixing of CO₂ and CH₄ is by advective and diffusive processes and, under conditions of low-permeability cap rock, may require the dusty gas modeling capability that we added to the simulator in this project. Repressurization is much faster than mass transport in the reservoir, ensuring that CH₄ pressure can be increased with associated enhancement in production rate over some time period without degrading the quality of the produced gas. Injection and production strategies can be designed to take advantage of the contrast in CO₂ and CH₄ properties to limit mixing and delay breakthrough. For example, Figure 1 shows a three-dimensional simulation of a quarter five-spot well pattern with CO₂ injection in the lower levels of the reservoir and CH₄ production from the upper levels. As shown in the figure, the injection has essentially filled the reservoir from the bottom up, thus delaying the breakthrough of CO₂ to the production interval. We estimate that for typical well spacings and injection and production rates at Rio Vista, 5–10 years of CSEGR could be carried out before significant CO₂ breakthrough occurs.

Using assumptions based on today's costs for implementing CSEGR at a reservoir like Rio Vista, we found that CSEGR is potentially cost effective. Results for three different volume ratios of CO₂ injected to CH₄ produced are presented in Figure 2. Subsidies for CO₂ storage were not included; these could offset higher CO₂ supply costs associated with capture and separation from flue gas streams.

Once a reservoir is filled with CO₂ following CSEGR, it could be beneficially used as a CH₄ gas storage reservoir. The large increase in density as CO₂ transitions from gaseous to supercritical conditions makes CO₂ a potentially effective cushion gas. A plot of reservoir pressure vs. time for an idealized two-dimensional reservoir filled with CO₂ into which CH₄ is injected is presented in Figure 3. As shown, approximately 30% more CH₄ could be stored in such a gas storage reservoir for the same pressure increase.

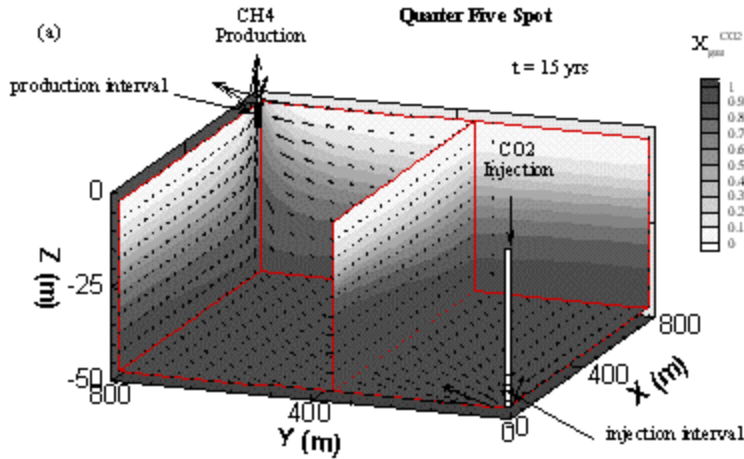

Figure 1. Mass fraction of CO₂ for injection into a CH₄ reservoir for the case in which CO₂ is injected low in the reservoir and CH₄ is produced from high in the reservoir

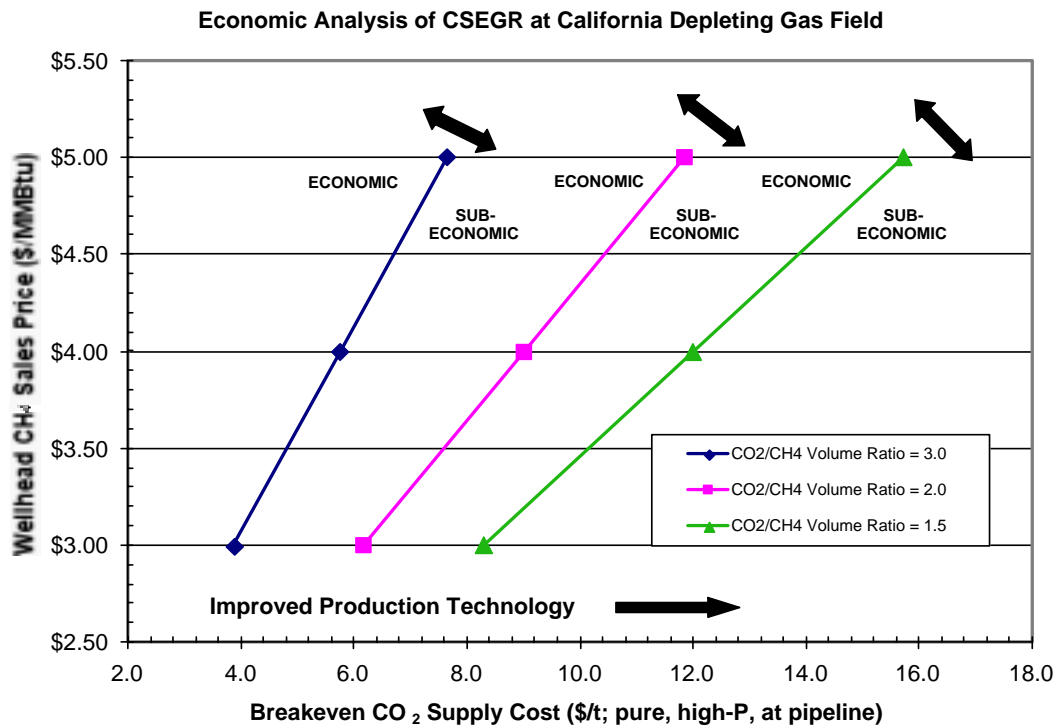

Figure 2. Break-even costs of CO₂ as a function of CH₄ sales price for three different injection volume ratios

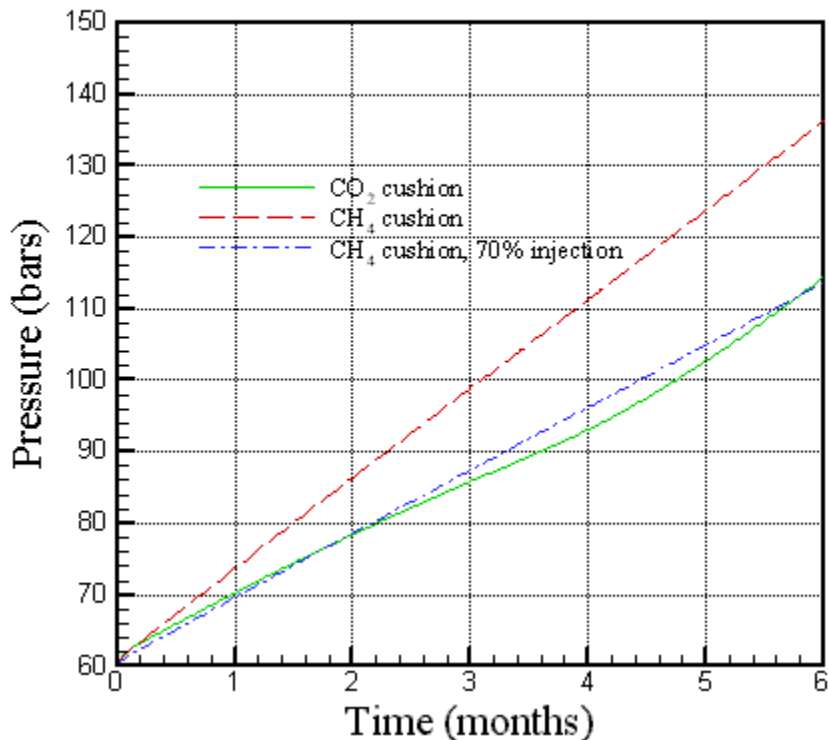

Figure 3. Pressure vs. time for CH₄ injection into a gas-storage reservoir for three different cases

Implications for Geologic Sequestration:

Depleting gas reservoirs are low-risk storage sites, based on a proven record of gas recovery and integrity against gas escape. The existing infrastructure and history of land use favor natural gas reservoirs as early candidates for CO₂ storage. During the injection process, CH₄ production can be enhanced and accelerated, thus offsetting the costs of CO₂ injection and potentially resulting in a net profit, depending on CH₄ selling price, CO₂ supply costs, and other factors. Once the reservoir is full of CO₂ after CSEGR, the reservoir could potentially be used beneficially for gas storage, with CO₂ as the cushion gas.

Recommendations for Further Work:

- Additional numerical simulations that consider full nonisothermal effects of injection are needed to examine potential cooling effects near the well bore and injection zone.
- Studies are needed to investigate the performance of shale seals in contact with supercritical CO₂.
- Laboratory studies are needed to determine gas relative permeability and residual gas saturations for CH₄-CO₂ displacement processes over a range of pressures and temperatures.
- With the present simulation-based results showing potential technical and economic feasibility, a field pilot study of the processes studied here is essential.

Conclusions:

Based on our simulation work, the injection of CO₂ into depleting natural gas reservoirs appears to be technically and economically feasible. Once the reservoir is filled with CO₂, it may be

further exploited as a natural gas storage reservoir by taking advantage of the large density change that CO₂ undergoes as it transitions from subcritical to supercritical conditions. A pilot injection study is needed to make further progress in demonstrating the feasibility of CSEGR.

Related Publications

- Oldenburg, C.M., S.H. Stevens, and S.M. Benson, Economic feasibility of carbon sequestration with enhanced gas recovery (CSEGR). *Energy*, in press.
- Oldenburg, C.M., S.W. Webb, K. Pruess, and G.J. Moridis, Mixing of stably stratified gases in subsurface reservoirs: a comparison of diffusion models. *Transport in Porous Media*, in press.
- Oldenburg, C.M., Carbon sequestration in natural gas reservoirs: enhanced gas recovery and natural gas storage. *Proceedings of the TOUGH Symposium 2003*, Lawrence Berkeley National Laboratory, Berkeley, California, May 12–14, 2003.
- Oldenburg, C.M., D.H.-S. Law, Y. LeGallo, and S.P. White, Mixing of CO₂ and CH₄ in gas reservoirs: Code comparison studies. In: *Greenhouse Gas Control Technologies*, **1**, pp. 443–448, J. Gale and Y. Kaya, eds., *Proceedings of the 6th International Conference on Greenhouse Gas Control Technologies*, Elsevier, August 2003.
- Oldenburg, C.M., Carbon dioxide as cushion gas for natural gas storage. *Energy&Fuels*, **17**, pp. 240–246, 2003.
- Oldenburg, C.M., K. Pruess, and S.M. Benson, Process modeling of CO₂ injection into natural gas reservoirs for carbon sequestration and enhanced gas recovery. *Energy&Fuels*, **15**, pp. 293–298, 2001.
- Oldenburg, C.M. and S.M. Benson, CO₂ injection for enhanced gas production and carbon sequestration. *Society of Petroleum Engineers Journal*, SPE-74367, Proceedings of IPCEM 2002, Villahermosa, Mexico, Feb. 10–12, 2002.
- Oldenburg, C.M., S.M. Benson, and K. Pruess, Effects of reservoir heterogeneity on carbon dioxide injection into depleted natural gas reservoirs. *Geol. Soc. America Fall Meeting*, Reno, Nevada, October 2001.
- Oldenburg, C.M. and S.M. Benson. Carbon sequestration with enhanced gas recovery: Identifying candidate sites for pilot study. In: *First National Conference on Carbon Sequestration*; Washington, D.C.; May 14–17, 2001.
- Webb, S.W., Modification of TOUGH2 to include the dusty gas model for gas diffusion. *Sandia National Laboratories Report SAND2001-3214*, October 2001.

Co-Disposal of CO₂, H₂S, NO₂, and SO₂

Kevin Knauss

Lawrence Livermore National Laboratory, Livermore, CA

Objectives:

Lowering the costs of front-end processes could dramatically lower the overall costs of carbon sequestration. One approach is to sequester less-pure CO₂ waste streams that are less expensive or require less energy to separate from flue gas. The objective of this subtask is to evaluate the impact of this impure CO₂ waste stream on geologic sequestration.

Background:

The cost of geological carbon sequestration is dominated by the costs of separating CO₂ from the flue gas and compressing the separated CO₂. These two processes can account for 75% or more of the total cost. One possible approach to cost reduction is to sequester less-pure CO₂ waste streams that are less expensive or require less energy to separate from flue gas or a coal gasification process. Typical co-contaminants in the gas waste stream are the acid-producing gases: H₂S, SO₂, and NO₂. The increased acidity produced by the co-contaminant gases in water could result in adverse effects to carbon sequestration (e.g., well bore and caprock seal integrity compromised or porosity loss due to clay production or impeding the solubility and mineral CO₂ trapping mechanisms). However, at least one of these acid gases (H₂S—sour gas) is routinely injected for disposal purposes, so this suggests that other gases might also be co-injected. To evaluate the possibility of co-injection, we must use both computational and experimental methods.

Research Approach and Results:

We began our study by conducting a large number of, first, equilibrium thermodynamic rock-water-gas interaction geochemical simulations and, later, chemical kinetic simulations. In both instances, the model system was static and transport was not considered. This greatly simplified computation allowed us to investigate the interactions in extremely specific geochemical detail. This geochemically detailed phase of our work permitted us to evaluate the adequacy of both our thermodynamic and kinetic geochemical data and allowed us to acquire the requisite missing data. It also permitted us to explore a large area of geochemical and mineralogical space to identify the aqueous species and mineral phases (both primary and secondary) that should be active in each simulation. Thus, the subsequent more computationally intensive reactive transport simulations could be reduced in scope to include only the necessary chemical components.

In the preliminary simulations, we used simplified, generic reservoir rocks defined as follows. The feldspathic sandstone reservoir consisted of 88.5% quartz, 9% K-feldspar, 1% calcite, 0.5% siderite, 0.5% pyrite, and 0.5% muscovite. The siderite was added to the mix as a proxy for solid solution of Fe in the calcite. The muscovite was added as a proxy for all clay-like phases, e.g., illite. The carbonate reservoir consisted of 49.25% calcite, 49.25% dolomite, 0.75% siderite and 0.75% pyrite. Both generic reservoirs were assumed to have 33% porosity. The simplified brine composition consisted of 0.7 m NaCl. Equilibrium thermodynamic and chemical kinetic (no transport) simulations were done using the codes EQ3/6 and REACT. These simulations permitted us to define generic waste gas phase compositions based on actual field experience (in the case of H₂S) or chemically reasonable gas fugacities that result in aqueous pH values of no

less than pH 1 (in the cases of NO_2 and SO_2). We made numerous simulations for the two generic reservoirs (sandstone and carbonate) and four injected gas compositions (CO_2 , $\text{CO}_2 + \text{H}_2\text{S}$, $\text{CO}_2 + \text{NO}_2$ and $\text{CO}_2 + \text{SO}_2$).

Based on the preliminary simulations, we proceeded to reactive transport simulations using the code CRUNCH. Coupling a chemical model with fluid flow allows us to simulate the results of injection into a specific heterogeneous rock formation and account for mineralogical changes along the flow path. The reactive transport approach is essential for calculating the spatial distribution of porosity change, because reaction products tend to be distributed along a flow path. We simulated two groundwater flow regimes that occur in series in time for each generic reservoir and gas waste stream. The first was the radial flow imposed by CO_2 injection, and the other was the subsequent slow regional linear flow characteristic of the post-injection phase. The reactive transport simulations spanned the same eight combinations of reservoir and gas injection identified above.

More recently, we have simulated the reactive transport processes expected to occur at a proposed CO_2 injection pilot study in the Frio Formation, in Texas. In this case, we used the actual formation mineralogy and water chemistry. To simulate a longer-term injection process, we simulated injecting for 5 y, followed by a 95 y post-injection phase of slow regional groundwater flow. As an example of the many reactive transport simulations mentioned above, we show some results from the Frio simulation. In Figure 1, the results are plotted groundwater composition and carbonate minerals at the end of the 100 y simulation.

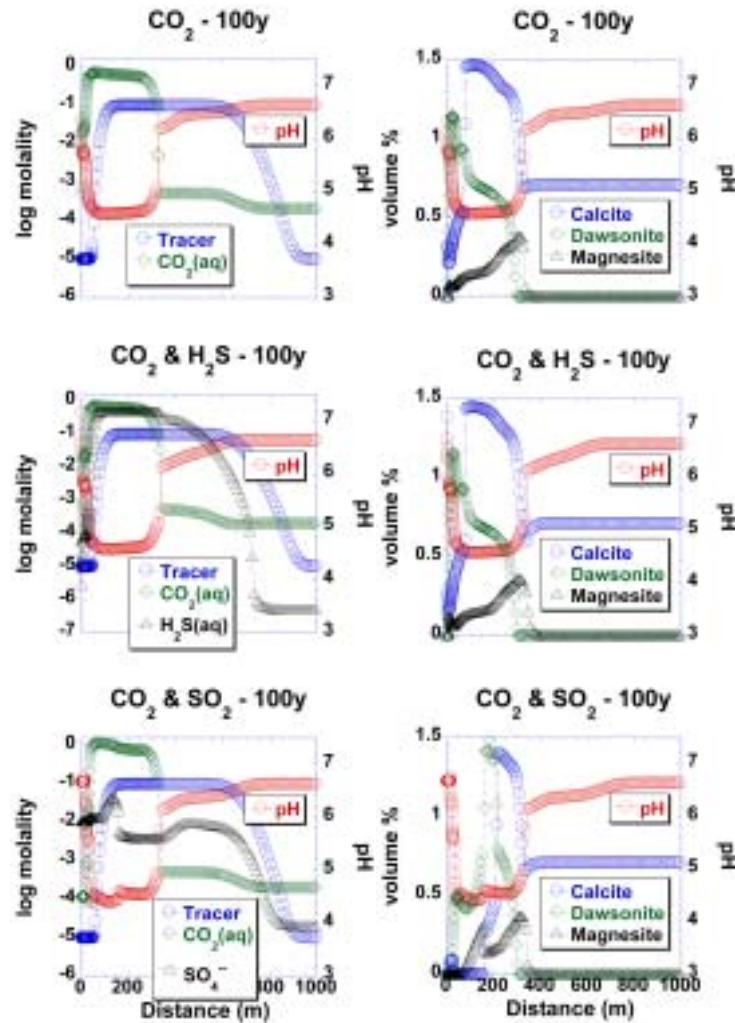

Figure 1. Groundwater composition and carbonate mineral distribution at 100 y following injection of CO₂, CO₂ + H₂S and CO₂ + SO₂

This simulation suggests that significant amounts of carbon can be sequestered essentially permanently as carbonate minerals in the Frio Formation.

Recently, we started benchmarking the reactive transport simulations, using a specially designed plug-flow reactor capable of mimicking the temperature, pressure, and flow conditions in a real CO₂ injection process. These experiments use the actual reservoir fluids and rocks, as well as high-pressure gas injection. This benchmarking is critical in evaluating the validity of our predictions. Given that our performance assessment of CO₂ sequestration will of necessity be based almost exclusively on reactive transport modeling, we need to have a high degree of confidence in our results.

Implications for Geological Sequestration:

These preliminary simulations suggest that large amounts of co-injected H₂S should not prove problematic for a CO₂ injection process in terms of impact on sequestration. In the case of SO₂, if conditions allow the S to be oxidized to sulfate (and this reaction is thermodynamically favored), only minor amounts of this gas could be tolerated, owing to the extremely low pH generated. The potential for porosity loss from the formation of anhydrite will also need to be assessed. For NO₂, the situation is intermediate between H₂S and SO₂: significantly more NO₂

than SO₂ could be tolerated, but the amount may be similarly limited by the potential for oxidation to nitrate.

Future Work:

The lack of kinetic data concerning dawsonite dissolution or growth rate is a problem. Experimental determination of these rates under likely CO₂ sequestration conditions is urgently needed. It is critically important that we conduct well-designed reactive transport experiments to benchmark the simulators that we use. Although our ability to simulate dissolution kinetics appears to be relatively advanced, we have few tests of the simulator's ability to accurately model mineral growth. This is a serious deficiency in all sequestration studies done to date, here and elsewhere. We are presently conducting plug-flow reactor experiments that perfectly mimic conditions in a CO₂ injection process that may be used for this validation purpose. Significantly more reactive transport model validation needs to be done before we can have confidence in the simulation results. Most work to date has focused on geochemical interactions with reservoir rock. We also need to investigate the chemical impact on caprock seal integrity. The potential for and rate of SO₂ and NO₂ oxidation in the subsurface needs to be evaluated. Finally, we need to investigate near-field chemical interactions with concrete used in well bore seals and, in particular, evaluate the potential for near-field anhydrite formation in the case of SO₂ co-injection, especially in carbonate reservoirs.

Related Publications:

- Knauss, K.G., J.W. Johnson, and C.I. Steefel, Evaluation of the impact of CO₂, co-contaminant gas, aqueous fluid and reservoir rock interactions on the geologic sequestration of CO₂. *Chem. Geol.*, submitted and in review, 2003.
- Knauss, K.G., J.W. Johnson, and C.I. Steefel, CO₂ sequestration in the Frio Fm, TX: Evaluation of the impact of CO₂, co-contaminant gas, aqueous fluid and reservoir rock interactions. *Proceedings of the Second National Conference on Carbon Sequestration*, 2003.
- Knauss, K.G., J.W. Johnson, and C.I. Steefel, Evaluation of the impact of CO₂, contaminant, aqueous fluid and reservoir rock interactions on the geologic sequestration of CO₂. *Proceedings of the 28th International Conference on Coal Utilization & Fuel Systems*, 2003.
- Knauss K.G., C.I. Steefel, J.W. Johnson, and L.H. Boram, Impact of CO₂, contaminant gas, aqueous fluid, and reservoir rock interactions on the geologic sequestration of CO₂. Geological Society of America National Meeting, 2002.
- Knauss K.G., J.W. Johnson, C.I. Steefel, and J.J. Nitao, Evaluation of the impact of CO₂, aqueous fluid, and reservoir rock interactions on the geologic sequestration of CO₂, with special emphasis on economic implications. *Proceedings of the First National Conference on Carbon Sequestration*, 2001.

Development and Demonstration of Monitoring Technology

Sensitivity Modeling and Optimization of Geophysical Monitoring Technologies

G. M. Hoversten

Lawrence Berkeley National Laboratory, Berkeley, CA

Objectives:

The objectives of this task are threefold: (1) to demonstrate a methodology for and carry out an assessment of the effectiveness of candidate geophysical monitoring techniques; (2) to provide and demonstrate a methodology for designing an optimum monitoring system, including source and receiver locations and well spacing; and (3) to provide and demonstrate a methodology for interpreting geophysical data and reservoir data, including use of inversion algorithms, in order to obtain high-resolution reservoir images.

The ultimate methodology for linking geophysical and reservoir parameters is to develop formal joint geophysical imaging algorithms for simultaneously inverting different types of geophysical data—to find a common, self-consistent earth model. The initial stages of this work have concentrated on the demonstration of a methodology for combining time-lapse changes in electric conductivity and compressional- and shear-wave velocity with a detailed rock-properties model, to produce quantitative estimates of the change in reservoir pressure and fluid saturations.

Background:

Crosswell electromagnetic (EM) and seismic data were acquired during CO₂ injection into the Lost Hills Oil field in California. Data were recorded prior to and during the CO₂ injection. By using well log data, we developed a detailed rock properties model that related changes in the electrical and seismic properties of the reservoir to changes in pressure and fluid saturations. The rock-properties model was used to constrain inversion of the time-lapse data sets to produce time-lapse changes in the seismic compressional, shear, and electrical conductivity as CO₂ was injected. These time-lapse changes in geophysical parameters were combined with the rock-properties model to produce changes in reservoir pressure and fluid saturations (including changes in hydrocarbon gas, water, and CO₂ saturations).

A critical step was to first remove the effects of the change of reservoir pressure and water saturation by combining the EM and shear-wave velocity changes. Once the effects of reservoir pressure and water saturation changes were stripped off, the changes in acoustic velocity were used to map changes in CO₂ saturation within the reservoir.

Results:

We have used a rock-properties model, shown in Figure 1, based on a close packing of spherical grains in conjunction with Gassmann's equation, to simulate the relationships between reservoir parameters of the Lost Hills diatomite and seismic compressional and shear velocities. A volumetric mixing law models bulk density. Parameters of the rock-properties model are derived by a simultaneous fitting of compressional velocity and density logs, using a simplex L1-norm minimization, given the observed porosity and fluid-saturation logs as well as measured pressure, temperature, and oil properties. Although the spherical grain model may not ideally represent the

microscopic structure of the diatomite, the model accurately predicts the bulk seismic velocities and densities as a function of the fluid saturations, pressure, and porosity, as measured by log data and measurements made on core samples.

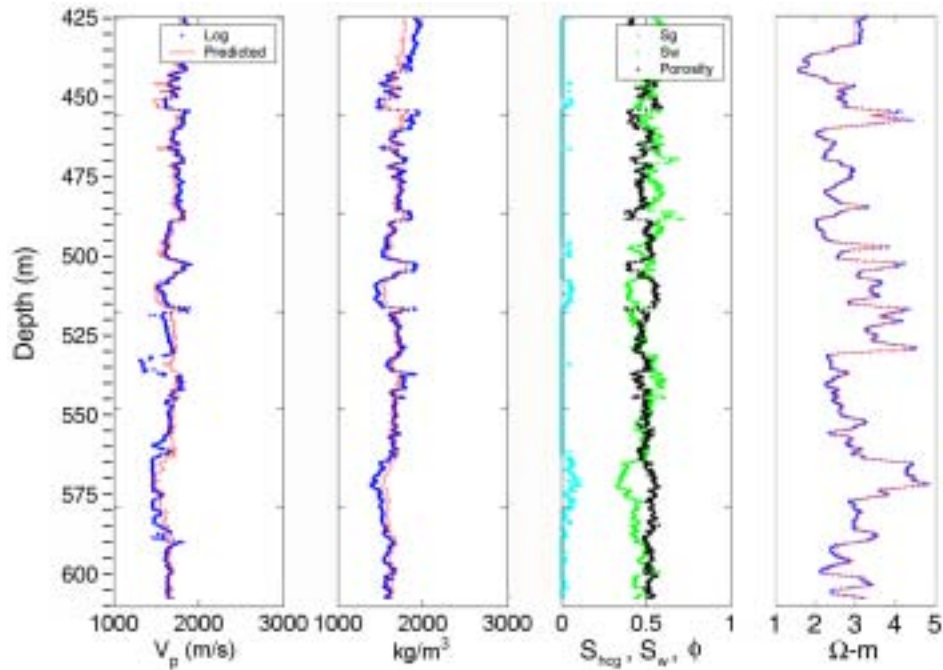

Figure 1. Rock-properties model uses logged porosity (black), water saturation (green), and gas saturation (light blue) as inputs in a multiparameter regression to predict the velocity (left panel), density (second from left panel), and electrical resistivity (right panel).

Calculations using the derived rock-properties model show that the rock-bulk shear velocity primarily depends on pressure changes, with the effects of water saturation changes on shear velocity being of second order. Calculations also show that the presence of even a small amount of hydrocarbon gas strongly affects the relationships between V_p and the reservoir parameters. The influence of gas on compressional velocity makes it impossible to separate the effects of changes in hydrocarbon gas saturation, CO_2 gas saturation, and the effects on the oil caused by dissolved CO_2 on V_p , without additional independent information. Crosswell EM data was used to provide estimates of changes in electrical conductivity σ that are directly related to changes in water saturation, thus providing an estimate of the change in water saturation that is independent from the seismic data.

To predict quantitatively the location and amount of CO_2 in the crosswell image plane (Figure 2), the change of P-wave velocity is decomposed into (1) the part that can be predicted by the estimated changes in water saturation and pressure, and (2) the part predictable by a change in CO_2 content. The process relies on the assumption that the CO_2 will first dissolve in the oil and will only enter the gas phase after the oil has absorbed the maximum amount of CO_2 possible for the *in situ* pressure and temperature conditions. Using this procedure, we have demonstrated that by combining seismically derived changes in compressional and shear velocity with EM-derived changes in electrical conductivity, we can make estimates of pressure change, water saturation change, and CO_2 gas/oil ratio in a complex reservoir containing oil, water, hydrocarbon gas, and injected CO_2 . The resulting predicted CO_2 /oil ratio, R_{CO_2} , is better correlated with logged unit

boundaries than are any of the images of changes in geophysical parameters. The size of the predicted CO₂-rich zones correlates with the amount of CO₂ that enters the formation through each perforation. The predicted ΔR_{CO_2} images indicate that a significant portion of the injected CO₂ is filling the upper portions of the section above the intended injection interval. These conclusions are validated by CO₂ injectivity measurements made in the 11-8WR Well.

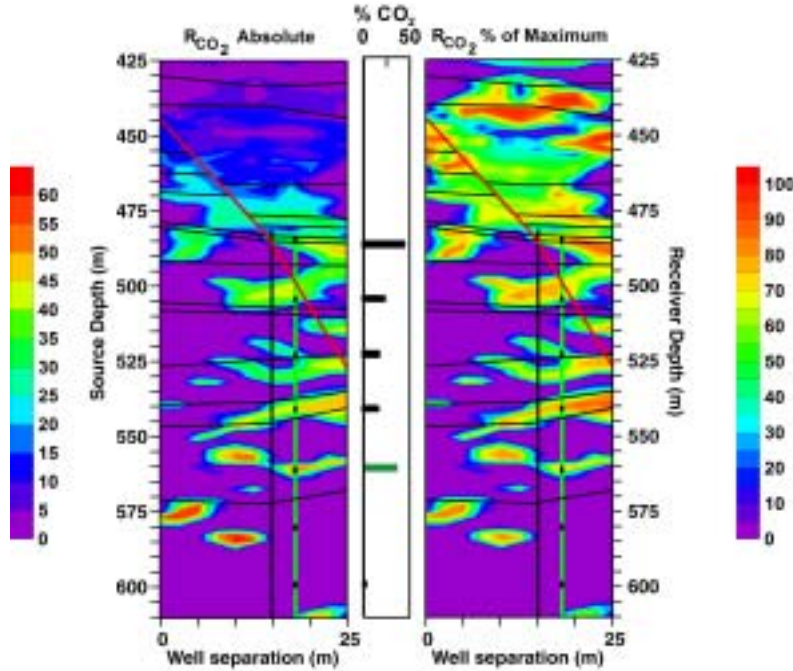

Figure 2. Predicted CO₂/oil ratio (R_{CO_2}). Left side shows absolute R_{CO_2} , right side shows R_{CO_2} as a percent of the maximum value for the given pressure and temperature. Major unit boundaries are shown as black subhorizontal lines, estimated location of the previous water injection fracture is shown as a vertical black line, estimated location of the CO₂ injection fracture is shown as a vertical green line, perforation intervals for CO₂ injection are shown as black dots on top of the CO₂ injection fracture, and the mapped location of a fault zone is shown as a red diagonal line.

While we have tried to produce quantitative estimates of the CO₂ in place by estimating the CO₂/oil ratio, the values of this ratio depend on our assumptions about the partitioning of CO₂ between oil and gas phases. In addition, the assumed values of *in situ* hydrocarbon gas affect the estimates of the CO₂/oil ratio, so that the absolute values of our estimates may be in error. The main advantage of the approach described in this paper is the decoupling of the effects of pressure and water saturation changes from those caused by CO₂. This produces the improved spatial correlation between the estimated CO₂/oil ratio and the CO₂ injectivity logs when compared to the geophysical change images.

This analysis relies on many assumptions that were required because the project was not originally designed to use this methodology. In future applications, the number of assumptions could be substantially reduced by design. In particular, considerable benefit could be drawn from repeat logging of the wells with a full suite of logs. This would provide control points for the ΔP , ΔS_w , ΔS_g , ΔV_p , ΔV_s , and $\Delta \sigma$, all of which would serve to greatly constrain the problem. Log measurements of the geophysical parameters would provide information for better starting

models, with constraints on the velocity, density, and electrical conductivity at the well locations. Additionally, measurements of S_{CO_2} and the amount of CO_2 dissolved in the oil would provide a basis for determining the partitioning of the residual velocity between the two, as well as eliminate the need to assume that all of the CO_2 dissolves in the oil before CO_2 gas is evoked as a mechanism of velocity change.

CONCLUSIONS

We have demonstrated that by combining seismically-derived changes in V_p and V_s with EM-derived changes in σ , estimates of the changes in pressure, water saturation, gas saturation and the CO_2 gas oil ratio can be made in a complex reservoir containing oil, water, hydrocarbon gas and introduced CO_2 . The resulting predictions of the changes in the CO_2 gas saturation, and gas/oil ratio, are better correlated with logged unit boundaries than are any of the changes in geophysical parameters by themselves. The changes in the images of CO_2 gas saturation and gas/oil ratio indicate that a significant portion of the injected CO_2 is filling the upper portions of the section above the intended injection interval. These conclusions are validated by CO_2 injectivity measurements made in the 11-8WR well.

RECOMMENDATIONS FOR FUTURE WORK

This analysis relies on many assumptions that were required because the project was not originally designed to use this methodology. In future applications, the number of assumptions could be substantially reduced by design. In particular, considerable benefit could be drawn from repeat logging of the wells with a full suite of logs. This would provide control points for the ΔP , ΔS_w , ΔS_g , ΔV_p , ΔV_s , and $\Delta \sigma$, all of which would serve to greatly constrain the problem. Log measurements of the geophysical parameters would provide information for better starting models, with constraints on the velocity, density, and electrical conductivity at the well locations. Additionally, measurements of S_{CO_2} and the amount of CO_2 dissolved in the oil would provide a basis for determining the partitioning of the residual velocity between the two, as well as eliminate the need to assume that all of the CO_2 dissolves in the oil before CO_2 gas is evoked as a mechanism of velocity change.

Related Publications:

- Hoversten, G.M., P. Milligan, J. Byun, J. Washbourne, L.C. Knauer, and P. Harness, Crosswell electromagnetic and seismic imaging: An examination of coincident surveys at a steam flood project. LBNL-48703; *Geophysics* (in press), 2003.
- Hoversten, G.M., R. Gritto, J. Washbourne, and T.M. Daley, Pressure and fluid saturation prediction in a multicomponent reservoir, using combined seismic and electromagnetic imaging. *Geophysics*, **68**, pp. 1580–1591, 2003.
- Hoversten, G. Michael; R. Gritto, T. Daley, E.L. Majer, and L. Myer. Crosswell seismic and electromagnetic monitoring of CO_2 sequestration. Presented at the *GHGT-6. Kyoto*, Japan. October 1-4, 2002. pp. 371-376, LBNL-51281 Ext. Abs., 2002.
- Roland Gritto, M. Thomas Daley, and Larry R. Myer. Imaging of CO_2 Injection During an Enhanced-Oil-Recovery Experiment. Presented at the *Underground Injection Science and Technology Symposium*. Berkeley, CA. October 22-25, 2003. pp. 1-12, LBNL-52626, 2003.

Field Data Acquisition for CO₂ Monitoring Using Geophysical Methods

Robin Newmark, William Daily, and Abelardo Ramirez
Lawrence Livermore National Laboratory, Livermore, CA

Objectives:

If geologic formations are used to sequester carbon dioxide (CO₂) for long periods of time, it will be necessary to verify the containment of injected CO₂ by assessing leaks and flow paths. The objective of this work is to demonstrate the applicability of electrical resistance tomography (ERT) for remotely monitoring CO₂ sequestration. We have conducted field trials to evaluate the effectiveness of using well casings as very long electrodes with the goal of producing images of CO₂ migration at very low cost, with no interruption to field operations and without the need for additional drilling.

Background:

ERT has been around for almost three decades, but previous ERT was accomplished by using arrays of small electrodes either on the surface or in boreholes (cross borehole ERT). For the work reported herein, the electrodes are the steel casings lining the boreholes. These casings are often many thousands of feet long and can be used for imaging. The result is an image of resistivity change that is a composite of all the formation changes along the casing length. The inversion is therefore only two-dimensional and can discriminate only lateral changes of resistivity in the reservoir. This is a consequence of electrodes being long compared to their separation. The current flow is primarily horizontal so that there is very little information about vertical reservoir structure.

Our initial work consisted of numerical modeling to define the sensitivity of the method given the operational and field conditions, and to calculate parameters needed to define instrumentation requirements and to design the field surveys. Detection limits were tested: for example, is it possible to detect changes in a layer only 10 m thick that is buried 1,000 m deep? Electrical resistivity changes in such a thin bed will alter the current flow near a well casing, but only over a very small part of such a long electrode. Sensitivity is proportional to the current density, and only about 1% of the total current would enter such a thin layer, so that its effect on measurable parameters will be small. To successfully image a target using a small number of very long electrodes, we need to constrain the measurement system requirements. The transmitted current required to produce received voltages above the noise level must be estimated. We calculated that it would be necessary to supply relatively large currents, several amperes or more, because casings would have a very large surface area exposed to the formation. A 3,280-foot (1,000 m), 10-inch casing (0.254 m diameter) has a surface area in contact with the ground of more than 538 feet² (50 m²), making it an excellent electrical ground. Because the current is distributed over this entire area, the voltage gradients it produces in the ground are small, and the received voltages are very small. These and many other issues were studied using numerical models. Numerical modeling was carried out for multiple field conditions, including the Vacuum Field in New Mexico and the Frio in Texas.

Previous work had demonstrated the potential for electrical resistance imaging using casings as long electrodes to monitor fluid changes in an oil field. The Belridge Field near Lost Hills, near Bakersfield, California, is a steam-flood secondary oil recovery field. Using eight vertical

casings, we monitored the progress of the steam flood over part of the reservoir, as shown in Figure 1. The very small but perceptible decreases in resistivity along the left edge and in the right corner of the March difference are interpreted as early evidence of steam invasion in these areas. By May, these same locations have become even more conducting. The trend is broken in the July image, and the formation has become even more resistive along the uppermost edge. We discovered after processing this data that there were repeated boiler outages during the May-to-July period, causing a mini-collapse of the steam chest. The survey results are consistent with this operational change. The November image picks up the same trend seen in March and May, and so implies that the steam-flood collapse was short-lived and that the steam flow paths active earlier in the year were reactivated in November. A thin zone near the central left side of the survey area remained less changed than the surrounding region, which would indicate a barrier to steam flow. Independent surveys performed by a commercial contractor in this area suggest that this zone was not affected by the steam. Notice that the field in the lower left side of the image did not change resistivity after March 1999. A reservoir engineer could use this information to plan a strategy for encouraging a sweep of this region.

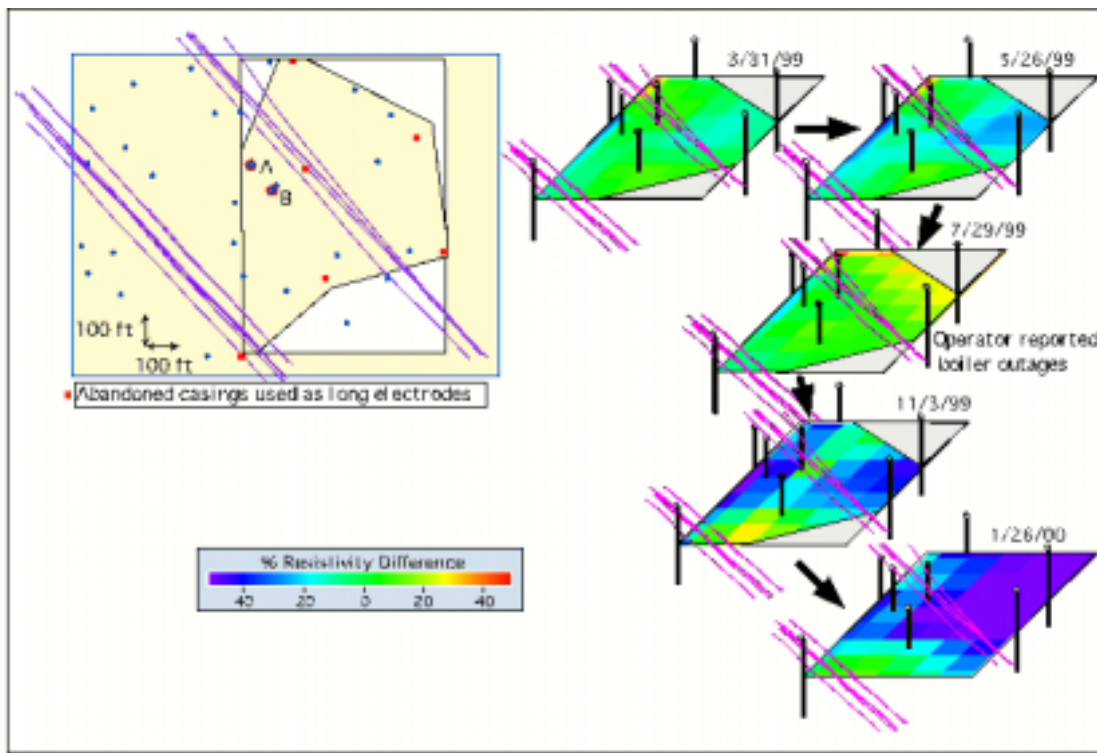

Figure 1. Time-lapse casing ERT results from Belridge Field, California

Results:

- Vacuum Field: CO₂

Applying the methodology discussed above to a CO₂ flood, we designed a field program at the Vacuum Field at Hobbs, New Mexico. The Vacuum Field is a CO₂ flood into a producing oil reservoir. The well pattern is a 45 acre 9 spot, and the producing formation, only 80 to 100 feet thick, is at 5,000 feet depth. Initial numerical studies indicated that signal strength would be sufficient to detect CO₂ movement given the operator’s planned injection strategy. Initial measurements included both point and long electrode surveys, to aid in calibration. In addition, a

commercial vendor collected crosswell induction surveys, enabling comparison among the three methods.

The baseline and subsequent surveys have been described in previous reports. Complicating factors included changes in instrumentation and the operator's strategy, which involved dramatically reducing the amount of CO₂ injected in this portion of the field. To address this issue, we expanded the survey region to include a zone in which CO₂ injection was beginning. Over the past several months, we have obtained time-lapse surveys to monitor CO₂ movement over this expanded survey area. Changes in instrumentation, damage caused by lightning strikes, and high noise levels have made these larger datasets difficult to interpret. While we now have the ability to overcome these issues, we do not have a consistent pair of datasets to assess a time interval. Here, we discuss time-lapse surveys collected over the original survey area, a 9 spot extended to the north to include two additional wells.

The survey area included four rows of wells. The bottom row consisted of production wells, as does the second from the top row. The second row of wells were injectors into which water was being injected. The two wells in the top row are CO₂ injection wells. The first time interval, from May 16 to September 11, shown in Figure 2, shows little change in resistivity except for the region bounded by Wells 42, 143, 50, and 150, which shows decreasing resistivity. Most of the injected water is going into Wells 150 and 50. This steady water input could account for this resistivity decrease if the water is displacing oil as it moves toward Well 143. In addition, if this water is displacing oil, then we expect to see higher oil production at 143, and indeed this well is the best producer, as demonstrated by a higher oil-to-water ratio in the produced fluids (Figure 3). The relative stability over the rest of the region is consistent with the low injected volumes and low produced volumes in the other wells.

The next time interval, May 16 to December 5, shows changes that continue the trend around Wells 150, 50, 42, and 143, but also have a new conductive anomaly to the north and a resistive anomaly near Well 50. The resistive anomaly near Well 50 may be a result of a large dissolved gas content of the pore fluid. We postulate that such could form as a combination of two factors. First, water injection was terminated in Well 50, and simultaneously a large increase in gas was seen in several of the production wells, with an especially large increase in the adjacent well (122). The hypothesis is that as the water pressure dropped, electrically conductive water was replaced by electrically resistive gas, creating a gas bubble near Well 50.

The conducting anomaly in the northern part of the field is more difficult to explain. It may be related to a large gas production spike that occurs between September and December. If this spike is a result of a widespread pressure disequilibrium in the formation (i.e., all the production wells in the area except 159), then fluid movement in response could have likewise been widespread. The anomaly may result from pore fluid redistribution during this pressure release.

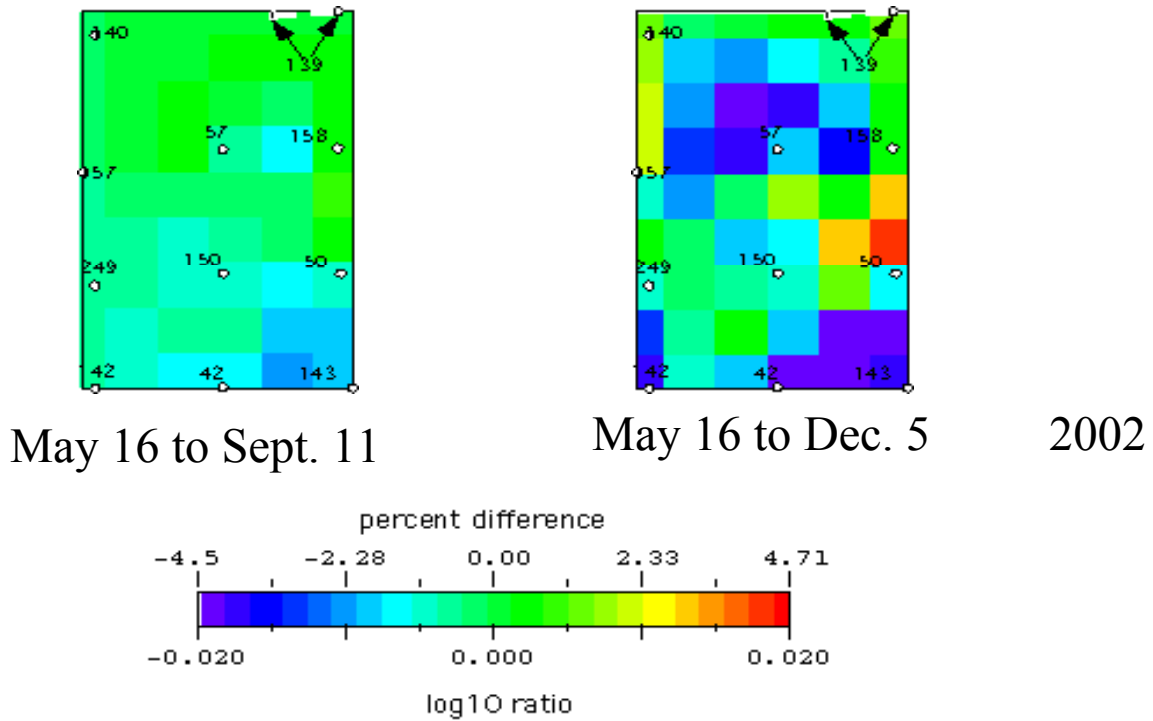

Figure 2. Time-lapse casing ERT surveys from the Vacuum Field, New Mexico, with respect to a May 16, 2002, baseline: May 16 to September 11 (left) and May 16 to December 5 (right)

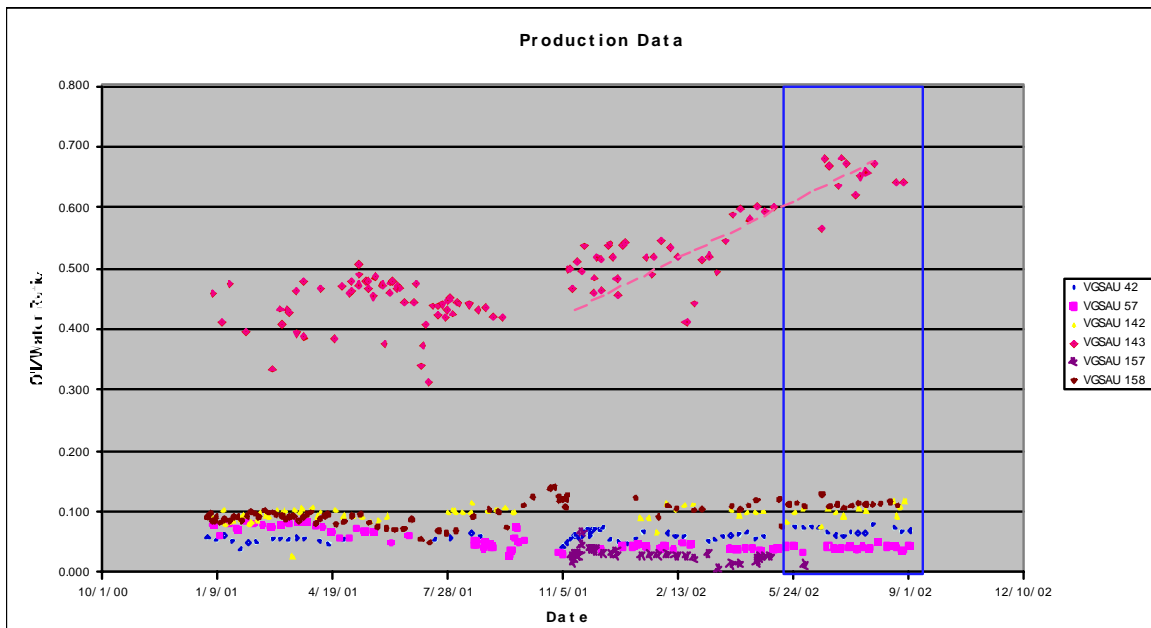

Figure 3. Production data for wells in the ERT survey area; timeframe corresponding to the first time-lapse shown in Figure 2 is highlighted in the blue box.

Ultimately, long-term, low-cost monitoring will be necessary. Using this methodology, very inexpensive long-term monitoring can be achieved by using a single measurement system: (1) to monitor a large (hundreds of acres) area, (2) to monitor this area for several (perhaps 10 years) years, and (3) to communicate with the system via a land-line or satellite connection to initiate

data collection, retrieve data, set system parameters, etc., in order to minimize the need for field deployment. We have successfully demonstrated the practicality of such a system by operating our data acquisition system, located in New Mexico, remotely from California, over a commercially available satellite Internet communications link.

- Frio Field—

Numerical models were developed to assess the sensitivity of the casing ERT methods to detect and monitor CO₂ movement from injection at the Frio Field. The forward model used the existing wells that were assumed to be available for imaging, which resulted in an asymmetric pattern of nine wells. CO₂ injection was simulated to occur at 1,828 m depth as a change in resistivity. Two target shapes, with a modest contrast in resistivity, were considered: a slab-like block of 0.5 ohm-m in a region of background resistivity of 1 ohm-m, and a narrow, fingerlike anomaly migrating from the injection well, but not intersecting the monitoring well (Figure 4).

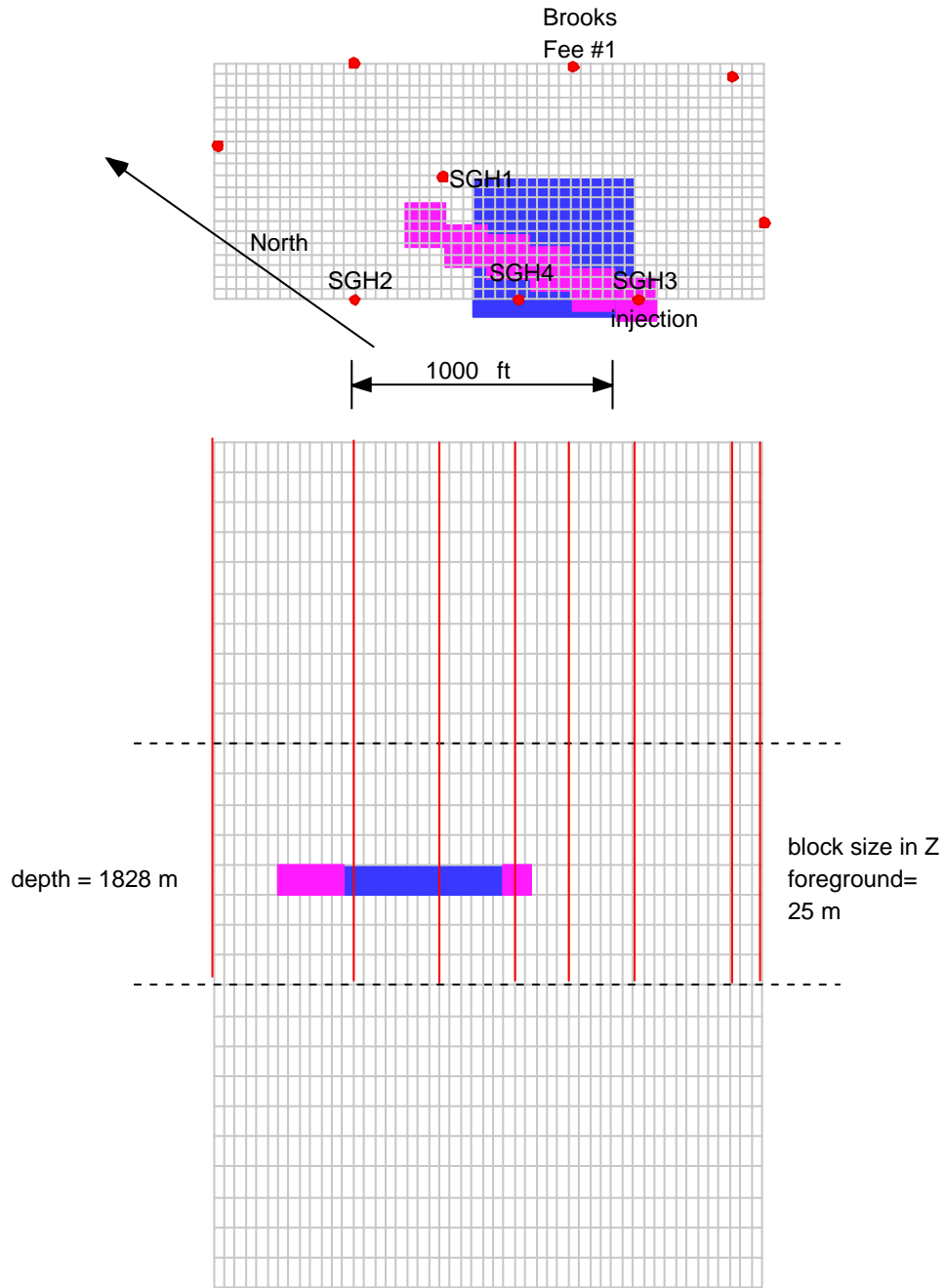

Figure 4. Forward model for Frio injection, based on an early pilot project injection scenario

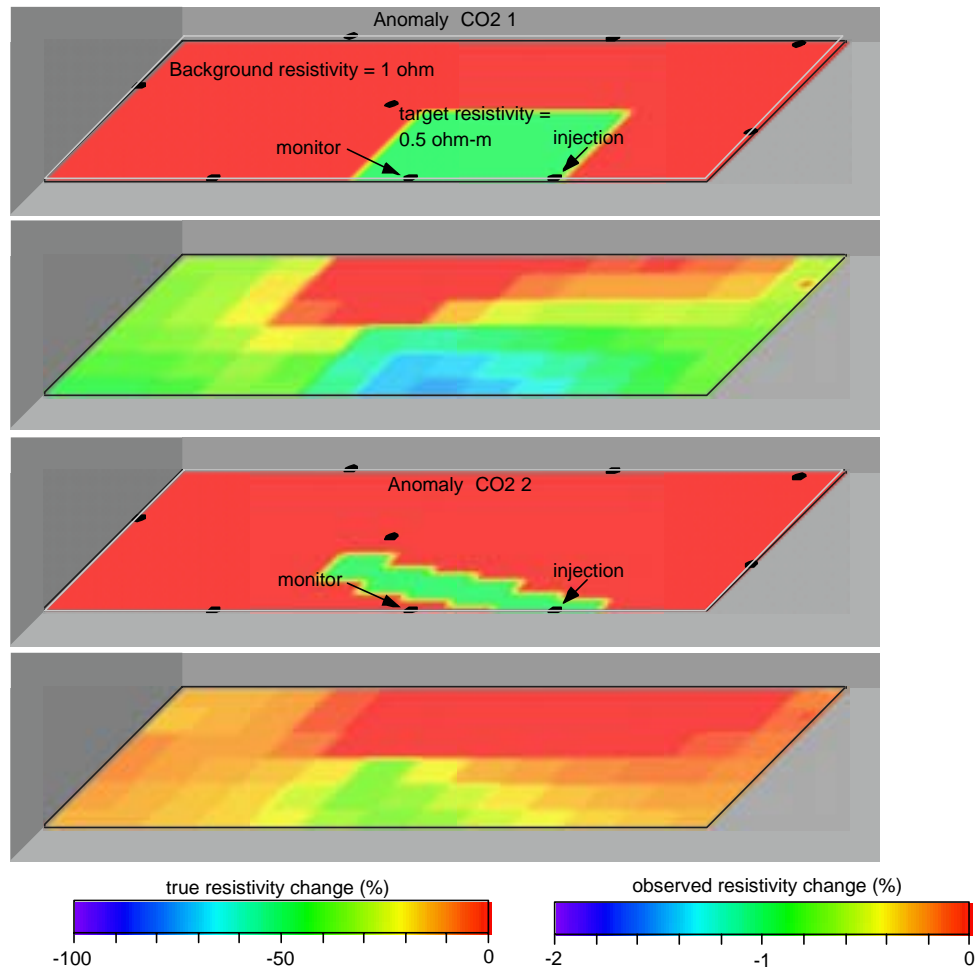

Figure 5. Simulated casing ERT results for two anomaly configurations

By assessing the relative signal strength expected, we can develop an optimal field survey design for the project. Figure 5 shows model results indicating total changes on the order of a percent. Overall, the low signal strength places strong constraints on the data collection protocol. As the operational strategy was refined for the Frio project, the injection volume decreased below that which is considered sufficient to consider deploying casing ERT. At present, ERT is not planned for the Frio pilot.

Implications for Geologic Sequestration:

In the course of this work, we refined and partially demonstrated casing ERT for monitoring the sequestration of CO₂ in a deep geologic repository. The method has been tested at two different secondary oil recovery sites: A steam flood and a CO₂ flood. Because of operational conditions, confirmation of the interpreted results depends on inference at present. As CO₂ injection continues in the field, it is likely that its presence will be detected; however, insufficient volumes were injected in the original survey pattern to be detected, and we are only now able to collect data of sufficient quality over the expanded survey area to process time-lapse surveys where significant changes owing to the presence of CO₂ are anticipated. However, the time-lapse surveys show changes consistent with operational changes across the survey areas and are consistent with independent measurements (i.e., production records).

The method yields low-resolution tomographs of lateral fluid movement, with no disruption to normal operations. While higher resolution is desirable, this method has some important advantages. First, no new infrastructure (e.g., monitoring well) is required. Second, because there are no moving sensors (e.g., sondes as in crosswell tomography), long-electrode ERT is easily automated and has even been controlled remotely using a satellite communications link. This makes practical on-demand, real-time monitoring, requiring minimal deployment of field personnel. An added benefit is that even though existing well casings are used as electrodes, there is no interruption to normal field operations—the wells can continue to produce or inject while being used to monitor the field. These factors are particularly appealing for applications in which other operations are occurring, such as in CO₂ enhanced oil recovery. This method complements other higher-resolution methods. Changes detected using a low-resolution method such as this can be investigated through deployment of a higher-resolution method; the advantage here is that the more costly high-resolution survey can be focused on the region of interest, rather than be used as an overall survey method.

Recommendations:

Long-electrode ERT has two limitations that could be addressed to advantage. First, image interpretation is currently qualitative. It is possible to infer where fluids are moving and where they are not moving, and it is possible to infer how far they have moved. Linking this approach with a reservoir hydraulic model will make possible a direct estimate of changes in fluid saturation throughout the image. Second, images are severely underdetermined (there is too little data to constrain the large number of unknowns in an image), making results sensitive to measurement error. Other data, such as magnetic or measured volumes of injected and extracted fluids, could be used as inversion constraints to make the method much more robust to errors and possibly improve resolution.

Next Steps:

This work has focused on detecting and monitoring CO₂ injection under different reservoir conditions. However, for both practical, regulatory and public approval aspects, it will also be necessary to address important issues involving caprock and seals. These are already important for the near-term aspects of injection, but become increasingly important at the longer time frames relevant to conducting and verifying sequestration of CO₂.

Long-term integrity of the caprock and seals depends on the coupled, local evolution of thermal, hydrological, geochemical, and mechanical properties. We know we can pump CO₂ underground in a safe manner, at least in many reservoir conditions. However, the conditions under which injection of CO₂ will be conducted for sequestration purposes differ in many respects from those in which our EOR experience has been obtained. While there has been some work to address the impacts of CO₂ on reservoir rock, little work has been done to assess the CO₂ impact on the integrity of caprock and seals. These impacts will determine the effectiveness of geologic sequestration. Storing CO₂ in the subsurface for very long time periods, possibly in the presence of other waste gases, may result in substantially different conditions over time frames for which we have little experience. This will certainly become an issue when the business aspects of sequestration arise—How much did you sequester? Did it remain in the ground? Can you verify this? If emission credits are to be obtained and brokered, there must be agreement on the means to verify the volumes sequestered for long time frames. We have discussed the question of leaks from the storage reservoir; characterizing the potential for leakage, and what the flux rate might

be, will be crucial. (Perhaps more important is what the consequences of some finite flux might be.)

To address these issues, we must develop performance criteria for caprock and seals based on our ability to detect and monitor. We must characterize potential caprock and seals. Using numerical simulations and laboratory experiments, we must investigate the geophysical response to different seal performance. An essential component of this work will be to verify performance and benchmark simulators with laboratory and field tests of sufficient scale to gain practical and relevant experience.

Related Publications:

- Daily, W., A., Ramirez, R. Newmark, and K. Masica, Reservoir monitoring using geophysical tomography. *Leading Edge*, in preparation, 2003.
- Newmark, R., W. Daily, and A. Ramirez, Electrical resistance tomography using steel cased boreholes as electrodes. Extended Abs., *SAGEEP 99*, Oakland, California, March 14–18, 1999.
- Newmark, R.L., W. Daily, and A. Ramirez, Imaging production and stimulation using steel-cased boreholes. Presented at the GSA/AAPG Joint Meeting, Cordilleran Section, Geological Society of America, and Pacific Section, American Association of Petroleum Geologists, Universal City, California, April 2001.
- Newmark, R.L., A.L. Ramirez, and W.D. Daily, Monitoring carbon dioxide sequestration using electrical resistance tomography (ERT): Sensitivity studies. Presented at the First National Conference on Carbon Sequestration, Washington, D.C., UCRL-JC-140527, May 14–17, 2001.
- Newmark, R.L., A. Ramirez, and W. Daily, Geophysical imaging using electrical resistance tomography (ERT): controlled laboratory sensitivity studies. Presented at the American Geophysical Union Fall Meeting, San Francisco, California, December 2001.
- Newmark, R.L., A.L. Ramirez, and W.D. Daily, Monitoring carbon dioxide sequestration using electrical resistance tomography (ERT): A minimally invasive method. *Proceedings of the 6th International Conference on Greenhouse Gas Control Technologies (GHGT-6)*, (September 30–October 4, 2002), Kyoto, Japan, UCRL-JC-148146, 2002.
- Newmark, R., W. Daily, and A. Ramirez, Electrical resistance tomography field trials to image CO₂ sequestration. Abstract presented at the AGU Fall Annual Meeting, San Francisco, California, December 2003 (submitted).
- Ramirez, A., R. Newmark, and W. Daily, Geophysical monitoring of carbon dioxide sequestration using electrical resistance tomography (ERT): Sensitivity studies. *J. Environmental and Engineering Geophy.*, in press, UCRL-JC-150548rev1, 2003.

Sensitivity of Geophysical Methods

Larry R. Myer¹, G. Michael Hoversten¹, and Erika Gasperikova¹
Lawrence Berkeley National Laboratory, Berkeley, CA

Objectives:

In order to begin to assess the sensitivity of MMV methods for detecting subsurface leaks from CO₂ storage reservoirs, a study was performed to evaluate how small a volume of CO₂ could be detected in the subsurface by surface seismic methods. Numerical simulations were performed using a model based on Texas Gulf Coast geology. Both the spatial resolution, and the contrast in seismic properties produced by introduction of CO₂, were evaluated.

Background:

Monitoring of geologic sequestration projects will be needed to manage the process of filling the reservoir, verify the amount of CO₂ sequestered in a particular volume, and detect leaks. It is natural to consider geophysical techniques because of the large body of experience in their application within the petroleum industry, although other techniques—including hydrologic pressure testing, geochemical tracers, and surface deformation—also are potentially applicable as part of sequestration monitoring. The scale of sequestration projects will be similar to, or greater than, that of petroleum reservoirs. With current technology, the only practical approach to achieving the required spatial coverage at reservoir scale is to use surface techniques. Of the currently available surface techniques, surface reflection seismic is the most highly developed and provides the highest spatial resolution. For monitoring of sequestration projects, the most likely mode of application would be time-lapse, in which the difference between two surveys would be used to evaluate the movement of the CO₂.

The sensitivity of geophysical methods depends, first of all, on the contrast in geophysical properties produced by introduction of CO₂. There must be a sufficient contrast in the measured geophysical property to enable detection. In our study, rock-physics models were used to calculate anticipated contrasts in seismic velocity and impedance in brine-saturated rock when CO₂ is introduced. The phase behavior of CO₂ greatly influences property contrasts over the depth and temperature range of interest in geologic sequestration projects.

Sensitivity also depends critically on the spatial resolution of the method. For any given contrast in properties, the size of the region containing CO₂ also must be sufficient to generate an interpretable signal at the surface. For seismic methods, the most important factor is the ratio of the dimensions of the target to the wavelength of the propagating waves. To begin to put bounds on the minimum CO₂ volume which might be detected seismically, we simulated the reflected wavefield for a wedge-shaped region of varying dimensions. The wedge is a rough approximation of the plume shape formed by CO₂ injected into (or leaking into) the base of the sand layer. The width of the wedge was based on the size of the first Fresnel zone. Object size, in addition to contrasts in physical properties, affects the amplitude of the reflection when it is on the order of one Fresnel zone or smaller. CO₂ volumes of this size may be detected but not easily characterized.

Results

Because surface seismic techniques analyze the reflectivity of the subsurface, a measure of the sensitivity of surface seismic techniques for monitoring can be obtained from analyzing the changes in reflectivity caused by the presence of CO₂. This study investigated reflectivity changes as a function of depth for CO₂ in brine formations. It was assumed that fluid pressures are given by the normal hydrostatic gradient for water. A thermal gradient of 10° C per 1,000 ft was assumed. It was also assumed that CO₂ is injected only into the sands, which have a porosity of 20%. Calculations were carried out for both consolidated sandstone with clay cement and an unconsolidated sand. Shale density and shale velocity as a function depth were obtained from well logs considered typical of a Texas Gulf Coast geologic setting.

In Figure 1, reflectivity is calculated as a function of depth for a boundary between shale and sandstone. Figure 1 shows that the reflection from the shale-sand interface decreases in amplitude with increasing depth before CO₂ injection. As CO₂ is injected, at shallow depth, is a reflectivity greatly declines primarily because of the reduction in sand velocity, which is approaching that of the shale. Only a small amount of CO₂ (0.01 saturation) is required to cause the velocity reduction, which is consistent with the known effect of “gas-like” fluids. This effect is not observed below 4,000 ft, where the seismic properties of CO₂ are more “liquid-like.” For unconsolidated sand at higher levels of saturation, reflectivity goes to zero and then begins to increase in the negative direction. This means that the amplitude of the reflection would go to zero and then start to increase with a change in phase. For consolidated sand, the effect of CO₂ is to reduce reflectivity at all depths. The effects of saturation are less for the consolidated sand because of the rigidity of the rock frame. If the shale velocity were higher than the sand velocity, the effects of saturation shown in Figure 1 would be reversed. That is, at shallow depths, a small amount of CO₂ would increase the amplitude of the reflection from the shale boundary.

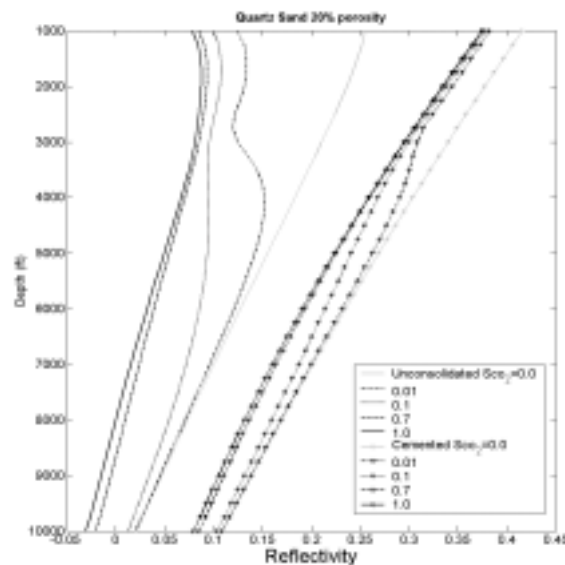

Figure 1: Reflectivity of a shale-sand boundary where sand has 20% porosity and S_{CO_2} refers to the CO₂ saturation in the sand

Figure 2 shows the model used as a basis for evaluating the spatial resolution of surface seismic measurements. The CO₂ saturation in the wedge was assumed to be 50%. The seismic wave center frequency was 30 Hz, consistent with observations of the frequency content of surface seismic in Texas Gulf Coast sediments. Calculations were carried out for wedge widths of 160 m, 320 m, and 480 m, where the diameter of the first Fresnel zone is about 320 m. The thickness of the sand layer containing the wedge varied from 5 m to 100 m.

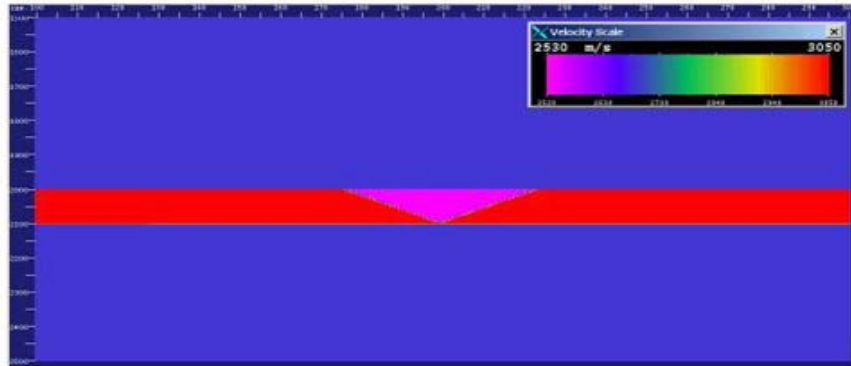

Figure 2: Velocity model for the seismic calculations, showing a wedge containing CO₂ in a sand layer

The calculated reflected wavefield for the case of a 160 m wide wedge in a 30 m thick sand layer is shown in Figure 3. A strong reflection is generated by the impedance contrast between the sand layer and the shale. In this example, there is very little impedance contrast between the shale and the sand containing CO₂. The presence of the CO₂ wedge is indicated by a reflection generated by an impedance contrast between the CO₂ and the brine in the sand. Wedge width is less than a Fresnel zone, and the layer thickness is on the order of the layer tuning thickness. This, even though the CO₂ wedge is detected, interpretation of the reflection for fluid properties would be difficult because of geometric effects.

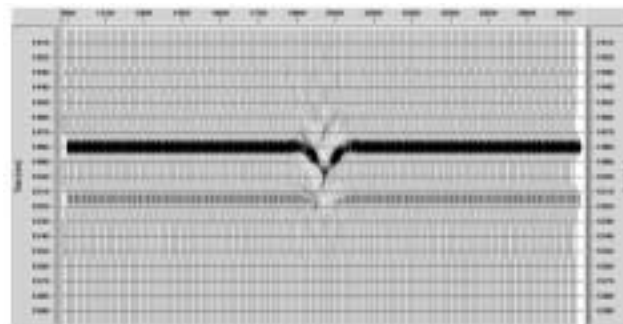

Figure 3: Reflection from a 30 m thick layer containing a wedge of width 160 m

Implications for Geologic Sequestration

Results indicated that a “small” CO₂ volume, but one detectable by surface seismic methods, would be on the order of 20,000 tons for a sequestration reservoir in Texas Gulf Coast formations. This is somewhat less than the CO₂ production in one day for a 1,000 MW coal-fired power plant. If it accumulated over the course of a year, it would constitute a leak rate of about

0.2%. Though the presence of such a volume could be detected, reflections would still be contaminated by geometrical effects, so it would be difficult to quantitatively determine properties such as CO₂ saturation.

Recommendations for Future Work

Because of the number of variables influencing surface seismic measurements, it will be necessary, particularly in the early stages of geologic sequestration, to evaluate each site in order to determine the minimum volume of CO₂ that could be detected as a leak. However, studies like those reported here provide valuable first-order approximations to guide further work. It is recommended that additional studies be performed using subsurface properties representative of other regions in the U.S. These studies should also include more realistic assumptions about the shape of the CO₂ plume and the saturation distribution within the plume. The detection of CO₂ in a through-going fault is another leakage scenario that needs to be specifically addressed.

Conclusions

Surface reflection seismic is the most highly developed surface geophysical technique and will provide the highest spatial resolution of all techniques. Analysis of the changes in reflectivity due to the presence of CO₂ provides one measure of the sensitivity of surface seismic for monitoring. Numerical simulations were performed using a model based on Texas Gulf Coast geology. Changes in impedance can cause the amplitude of measured reflections to increase, decrease, or possibly disappear depending on the detailed velocity structure of a specific site. Changes in reflectivity decreased as properties of CO₂ became “liquid-like”. Spatial resolution was evaluated using models in which a wedge represented a plume of CO₂ in a saturated sand layer at 2,000 m depth. For conditions assumed in this study, the minimum sand thickness for imaging a wedge of width 160 m was 10 m. A wedge large enough to prevent contamination of reflections by geometrical effects had a width of about 480 m in a 100 m thick sand.

Related Publication:

- Larry R. Myer, G. Michael Hoversten, and Erika Gasperikova. Sensitivity and cost of monitoring geologic sequestration using geophysics. Presented at the *GHGT-6*. Kyoto, Japan, 1: pp. 377-384, LBNL-51296 Ext. Abs., 2002.
- G. M. Hoversten, and Larry R. Myer. Monitoring of CO₂ sequestration using integrated geophysical and reservoir data. *Proceeding of the Fifth International Conference on Greenhouse Gas Control Technologies*, pp. 305-310, 2000.
- L. Myer, Laboratory measurement of geophysical properties for monitoring of CO₂ sequestration. Presented at the *1st National Conference on Carbon Sequestration*, Morgantown, WV. May 14-17, 2001. **Session 6A**, LBNL-47643, 2001.

Feasibility of Monitoring CO₂ Injection at the South Liberty Oil Field, Texas, Using Surface and Downhole Tiltmeters

William Foxall

Lawrence Livermore National Laboratory

Objectives:

We carried out synthetic modeling of the ground deformation that may result from injection of 5,000 tonnes into the brine-saturated Frio B sand at the South Liberty Field. This modeling was performed to enable a preliminary assessment of the feasibility of using surface and downhole tilt measurements to map the subsurface distribution of CO₂ volume and pressure as a function of time through the pilot test. This assessment is based on (1) whether the surface and subsurface deformation is large enough to be detected by high-sensitivity tiltmeters, and (2) whether the deformation patterns are diagnostic of CO₂ spatial distribution within the formation.

Results:

The deformation modeling we have carried out to date is preliminary and intended to provide order-of-magnitude estimates of surface and downhole tilt amplitudes and patterns. The pore pressure distributions calculated from preliminary flow modeling performed by LBNL, using TOUGH2, formed the basis for the deformation modeling. The LBNL modeling is described at http://esd.lbl.gov/GEOSEQ/pilot_sims/pilot_sims_main.html. Specifically, we used the pressure distributions resulting from the base homogeneous model UQ02 at 100 days, provided by Chris Doughty, LBNL. (Subsequent models, based on somewhat smaller volumes injected over shorter time periods at higher rates, yield roughly similar final pressure distributions.)

We represented the entire 6 m thick upper B sand layer as a single thin square slit inflated by the increase in pressure, ΔP , above initial hydrostatic conditions. The inflated slit was modeled as a finite opening-mode dislocation (Figure 1) having x (SE, along strike) and y (NE) dimensions of 170 m, based on the zone of significant gas saturation and pressure increase in the flow model. The dislocation dips 15° SW and is centered within a homogeneous elastic half-space at a depth of 1,500 m. This source model is appropriate given the large (≈ 30) ratio of length to thickness of the flow zone. The pressure increase throughout the slit was assumed to be a uniform 0.6 Mpa, taken as the average of the ΔP profiles along x and y through the injection well shown in Figure 2. The normal opening (Burger's vector), u_z , of the dislocation was estimated using the relation (Sneddon, 1946) between the normal displacement, u_z^{\max} , at the center of a uniformly pressurized circular ("penny-shaped") crack equal in area to the square dislocation:

$$u_z^{\max} = ((2(1 - \nu))/\pi\mu)\alpha\Delta P$$

where ν , μ and α are Poisson's ratio, rigidity, and crack radius, respectively. The uniform opening (u_z) of the dislocation was taken as the average of the elliptically shaped distribution of displacement of the Sneddon crack. The circular crack and square dislocation models generate almost identical surface deformation fields when the source depth is greater than about twice the source dimension (e.g., Davis, 1983). Tilt fields were computed with the computer program SYNEF (B. Foxall, unpublished), which utilizes the dislocation Green's functions of Okada (1985).

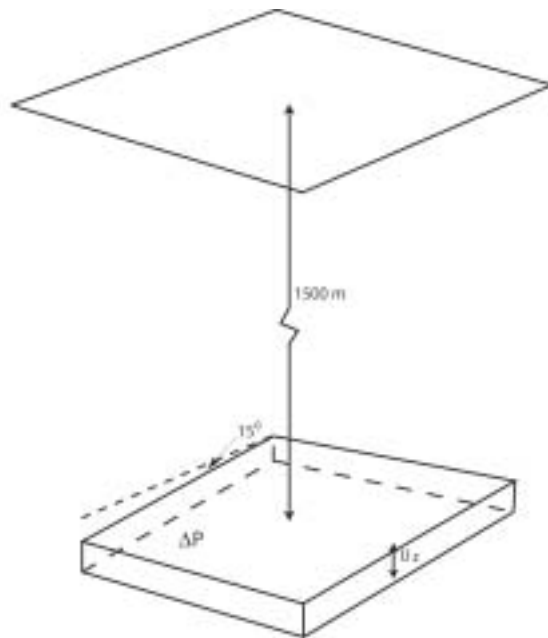

Figure 1: Dislocation model

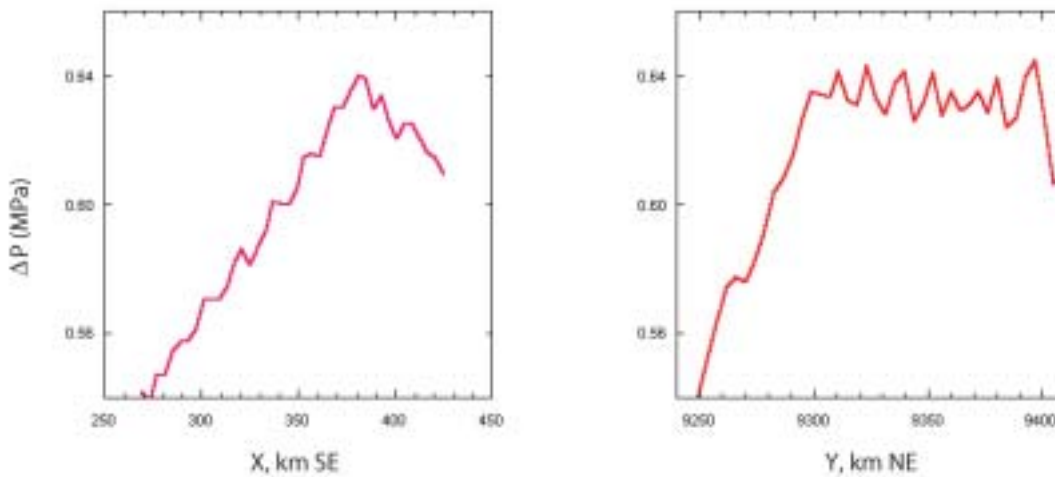

Figure 2 : Pressure change profiles along X and Y through the injection well from LBNL TOUGH2 model UQ02. X and Y coordinates correspond to the LBNL model.

Choice of the half-space elastic constants influences the calculated deformation not only through the Green's functions, but also in the estimation of u_z by the above relationship, and hence the source strength. We have not yet investigated the elastic properties of the specific formations at the South Liberty field, but, for these preliminary simulations, use two generic sets of values for sedimentary rocks. The elastic constants and resulting source dislocation displacements are given in Table 1.

Table 1. Half-space elastic constants, and opening displacements resulting from uniform pressure increase of 0.6 Mpa

Model	ν	μ (Mpa)	α (mm)
1	0.30	1.0×10^4	4.0
2	0.25	1.5×10^4	2.9

Discussion of Results:

The surface tilt fields computed from the two models are shown in Figure 3. Model 1 predicts tilt values in the range 10-20 nanoradians, which should be detectable with an array of tiltmeters installed in shallow (6-12 m) boreholes. Modern tiltmeters that are routinely deployed for hydrofracture monitoring and mapping are generally capable of detecting signals as small as 10 nanoradians or less under typical oilfield noise conditions. Model 2 also predicts detectable surface tilt, but tilt amplitudes are lower and approach the detection threshold.

Figure 3 shows that the surface tilt field is sensitive to the change in fluid volume within the source layer. However, surface tilt probably would not provide constraint on the shape of the pressurized, gas-infiltrated zone because of the large (≈ 9) ratio of source depth to source dimension. This is indicated by the close similarity of the Model 1 finite source tilt field in Figure 3a to that generated by a point source of equal strength shown in Figure 4. Significant asymmetry in the CO₂ and pressure distribution that results in a shift of the source centroid would likely be detectable. However, with the possible exception of the UQ07 (combined injection and pumping, low pressure) model, such asymmetry is not seen in the LBNL models.

Figure 5 shows downhole tilt profiles predicted in Well SGH 3, located approximately 130 m SE of the planned injection well. SGH 3 is available as a monitoring well. Unlike the surface tilts, the deformation at depth in the vicinity of the source at this short offset is sensitive to the assumed geometry and nature of the source, and hence the computed profiles are only very rough approximations. However, the modeling provides order-of-magnitude estimates in the 1–10 microradian range, which represents a large signal readily measurable by a downhole tiltmeter array. The shapes of the profiles are sensitive indicators of the vertical extent of the zone of increased pore pressure and gas volume, while the amplitudes are sensitive to the distance of the pressure front from the array. Therefore, given the magnitude of the signal at 100 days (in this model), these results suggest that the vertical and lateral (at least in the SE quadrant) growth of the CO₂ plume could be mapped by continuous downhole tilt measurements during the injection experiment.

Continuous downhole tilt mapping of the pilot injection appears feasible, based on the estimated cost of deploying a 12-tool vertical array over the 5-day period currently envisioned for the experiment. However, the current estimate does not include the cost of reentering Well SGH 3. This has not yet been finalized, but may be significant.

100 DAYS

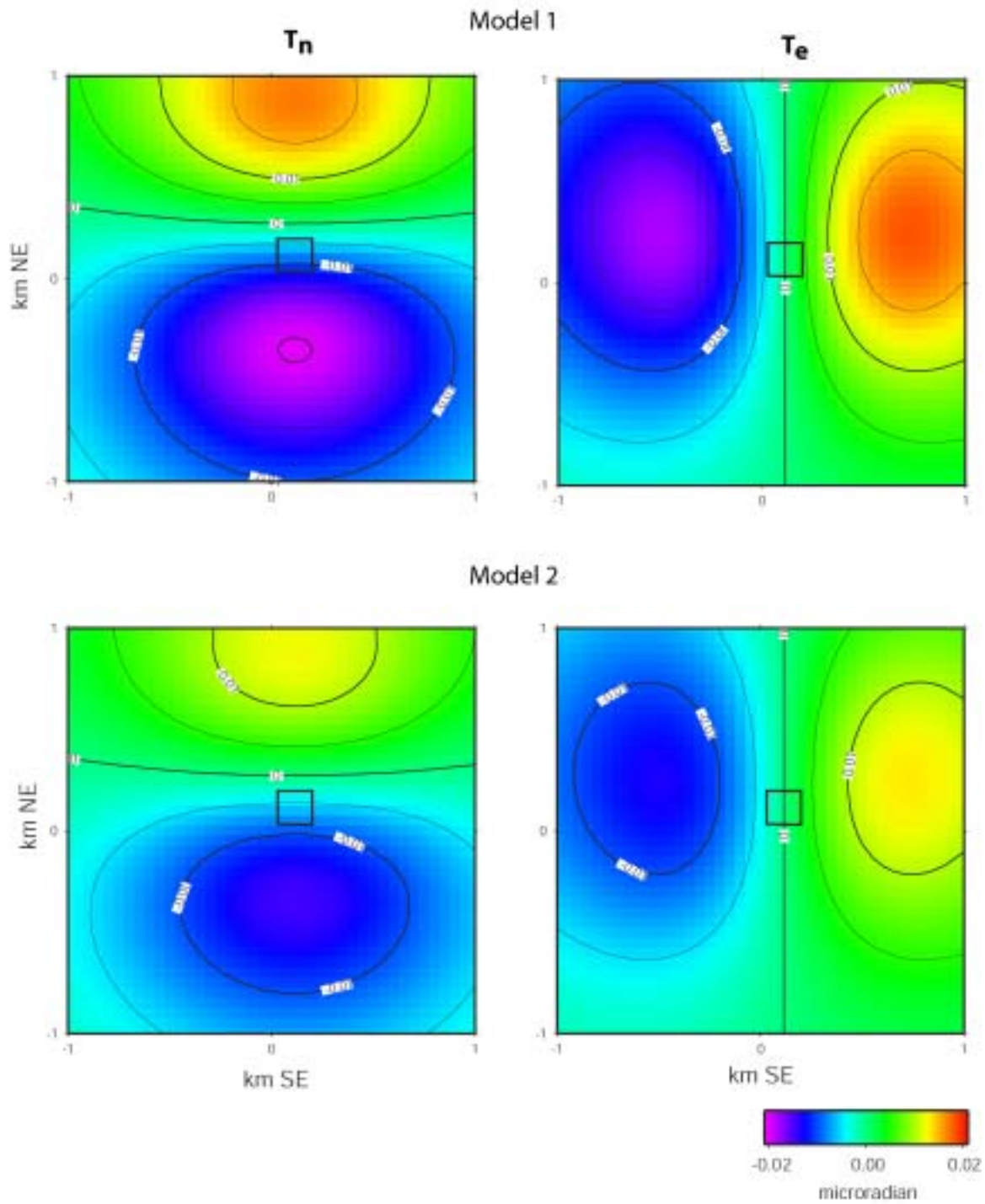

Figure 3 : North and south components of surface tilt for Models 1 and 2. Contour interval 0.005 microradians. Dislocation source shown as black square.

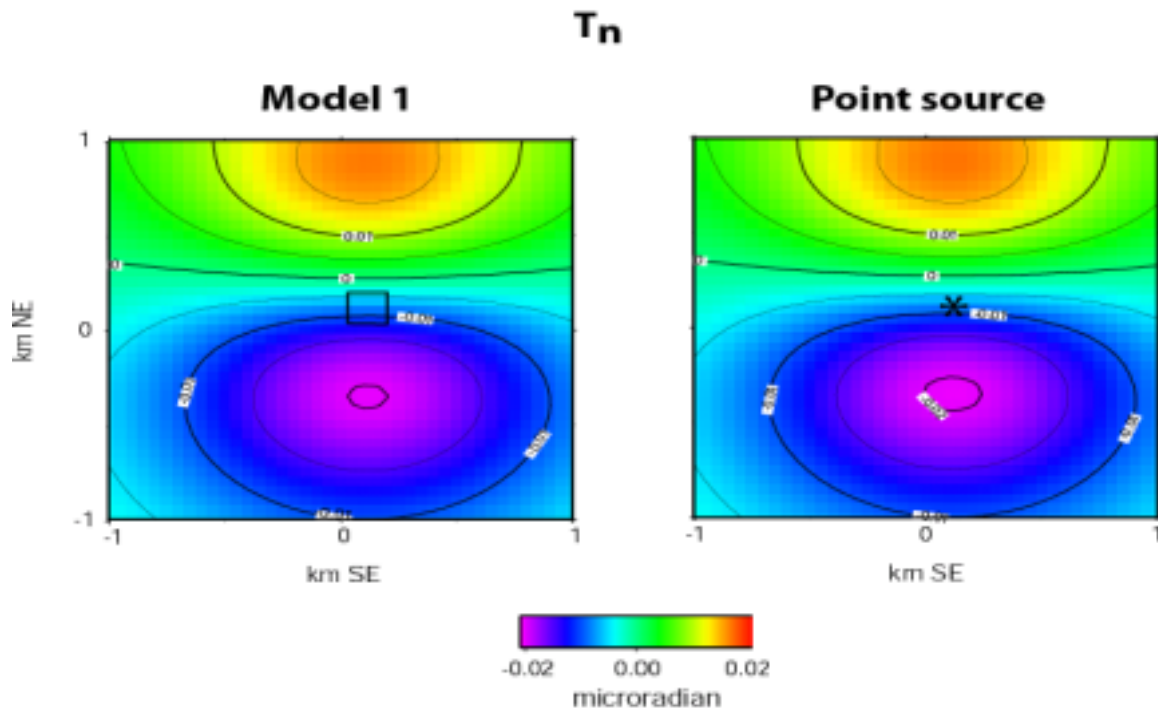

Figure 4: Comparison of north components of surface tilt from Model 1 and point source (star) of equal strength.

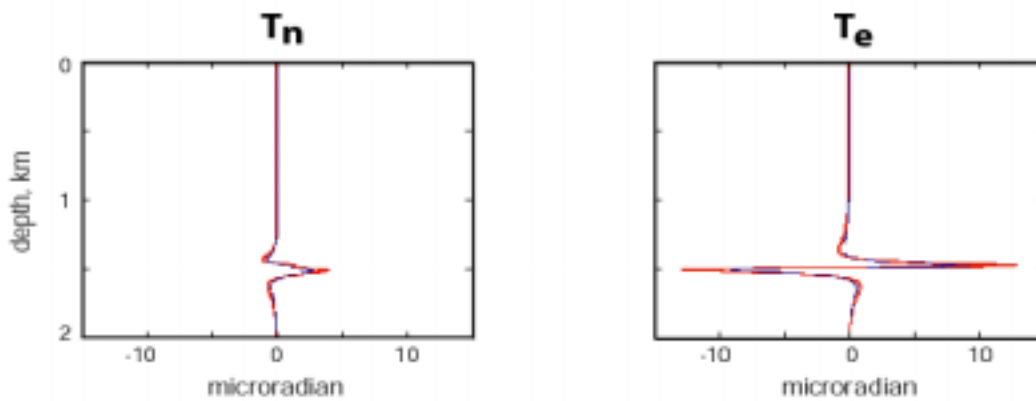

Figure 5: Downhole tilt profiles in well SGH 3 at 130 m offset. Red - Model 1, blue - Model 2.

Conclusions:

Simple dislocation modeling, based on pressure changes simulated by TOUGH2 modeling of the injection of 5,000 tonnes of CO₂, indicate that tilt generated by deformation of the Frio B sand reservoir would be detectable by surface tiltmeters. While the modeling indicates that surface tilt field would be sensitive to the volume and pressure changes within the reservoir, it suggests that the tilt field may not be diagnostic of the CO₂ plume shape, owing to the depth of the reservoir relative to the calculated dimensions of the plume. In contrast, the modeling results indicate that large tilt signals sensitive to the vertical and lateral extent of the plume would be readily measurable by a downhole tilt array deployed in Well SGH 3, 130 m to the SE of the injection well. The results suggest that continuous downhole tilt monitoring could map the growth of the plume, at least in the SE quadrant. The modeling results in general are somewhat sensitive to the choice of elastic properties, and the calculated downhole profiles are only rough approximations, owing to the sensitivity of the modeling at this close offset to the assumed nature of the source. More refined modeling should use the actual elastic parameters that may be available for formations within the South Liberty field. The highly idealized modeling discussed here treats the entire CO₂-inundated layer as a single dislocation source and (like the TOUGH2 modeling) does not consider the actual poroelastic mechanism of deformation within the reservoir. In effect, the models assume that all of the change in fluid volume in the reservoir is converted to strain in the surrounding medium.

References:

- Davis, P.M., Surface deformation associated with a dipping hydrofracture. *Journal of Geophys. Res.*, **88**, pp. 5826–5834, 1983.
- Okada, Y., Surface deformation due to shear and tensile faults in a half space. *Bull. Seismol. Soc. Am.*, **75**, pp. 1135–1154, 1985.
- Sneddon, I.N., The distribution of stress in the neighborhood of a crack in an elastic solid. *Proc. Roy. Soc. (London)*, **187**, pp.229–260, 1946.

Application of Natural and Introduced Tracers for Providing Process Optimization Information

D.R. Cole¹, T.J. Phelps¹, S. Fisher¹, J.G. Blencoe¹, J. Horita¹, B.M. Kennedy², J.C. Parker¹, A.V. Palumbo¹, G.R. Moline¹, M.C. van Soest²

¹Oak Ridge National Laboratory, Oak Ridge, TN

²Lawrence Berkeley National Laboratory, Berkeley, CA

Objective:

The long-range goal of this effort is to provide methods to interrogate the subsurface that will allow direct improvement of CO₂ sequestration during EOR, ECBM, EGR, or use of brine formations. Our effort at Oak Ridge National Laboratory (ORNL) focused on exploring the power of natural and introduced tracers to decipher the fate and transport of CO₂ injected into the subsurface, as well as other relevant processes. These methods have the potential to provide near-real-time information on process optimization. The resulting data may be used also to calibrate and validate the predictive models designed for (a) estimating CO₂ residence time, reservoir storage capacity, and storage mechanisms, (b) testing injection scenarios for process optimization, and (c) assessing the potential leakage of CO₂ from the reservoir. Field test application of the tracer concept can and should be conducted in concert with the geophysical and inverse-modeling methods summarized elsewhere in this report, thereby providing a means for calibrating the transport model and aiding in interpreting the time-series geophysical data.

Background:

Identifying and quantifying the processes affecting CO₂ transport for a given subsurface environment are essential to predicting the residence time of CO₂ and estimating the storage characteristics and capacity of that reservoir. While reservoir models can be designed to simulate those processes, the accuracy of these models depends upon input parameters that adequately represent *in situ* conditions, and upon careful validation through field tests. Tracer studies have become an important technique for *in situ* subsurface characterization, allowing detailed interrogation of complex systems, which have components moving, mixing, and reacting.

Naturally occurring elements, such as the stable isotopes of the light elements (O, H, C, S, N), noble gases and their isotopes (He, Ne, Ar, Kr, Xe), and radioactive isotopes (e.g., tritium, ¹⁴C, ³⁶Cl, ¹²⁵I, ¹²⁹I, ¹³¹I), have been used extensively to determine the sources of fluid and gas species and their mechanisms of migration, assess the extent of fluid/rock interactions, and quantify the residence times of fluids in the subsurface. While naturally occurring constituents and their isotopic compositions have the advantage of being readily available in most systems, injected tracers (and their isotopes) can be introduced into a system in different combinations, and at different concentrations and frequencies, to allow for maximum retrieval of information on subsurface conditions relevant to the fate and transport of CO₂. By measuring changes in the concentration ratios of multiple tracers along the transport pathway, we can make inferences regarding losses (e.g., sequestration through diffusion, reaction, or partitioning) and the mechanisms contributing to those losses. In this way, the tracers act together as chemical probes to provide a bulk measure of those subsurface properties that control mass transfer along actual transport pathways.

Results:

Introduced Tracers

- **Objective A—**

To test the utility of periodically introduced multiple tracers for enhancing and interpreting transport processes and breakthrough behavior.

- **Accomplishment A:—**

Multi-tracer experiments were conducted on cores to investigate the relationship between fracture characteristics and two processes impacting the transport of trace constituents: matrix diffusion and sorption. In these studies, bromide and PIPES were used as nonreactive diffusive tracers, and Rhodamine-WT was used as a reactive (sorptive) tracer. The predicted aqueous diffusion coefficients for PIPES and Rhodamine-WT are nearly identical, but an order of magnitude lower than that of bromide. Therefore, separation of the breakthrough curves for bromide and PIPES was indicative of matrix diffusion, while separation of the breakthrough curves for PIPES and Rhodamine-WT was indicative of sorption. A large tailing effect during the flushing phase was observed as the tracers desorb from mineral surfaces and diffuse out of low-permeability pore spaces when concentration gradients between the fractures and matrix reverse. Careful choice of tracers allows measurement of the relative impact of these two processes on transport.

- **Objective B—**

Evaluate the suitability of various gas tracers for use in sequestration field tests through assessment of known properties and estimated predictions of their behavior at conditions relevant to subsurface reservoirs.

- **Accomplishment B—**

Perfluorocarbon tracer (PFT) technology is not a new field, but much of the information needed to design quantitative laboratory and field studies is either nonexistent or obscure. Using data available in the literature, we have modeled an assortment of PFTs properties including their diffusivities in air and water, sorption (i.e., retardation coefficients), and partitioning into hydrocarbons at conditions appropriate for CO₂ sequestration, with particular emphasis on conditions expected in the Frio, Texas, system. Based on these results, we have identified four PFTs that are nontoxic, stable at high temperatures and pressures, easily detectable at very low concentrations (ppt), essentially nonreactive, and present in normal environments at extremely low background concentrations. These include perfluoromethyl cyclopentane (PMCP), perfluoromethyl cyclohexane (PMCH), perfluorodimethyl cyclohexane (PDCH), and perfluorotrimethyl cyclohexane (PTCH) (F2 Chemicals, Lancashire, England).

- **Objective C—**

To construct a laboratory flow system for gas tracer and stable isotope testing under conditions relevant for subsurface CO₂ injection and sequestration.

- **Accomplishment C—**

The dynamic flow system is shown in the photograph given as Figure 1. This system gives us the capability of assessing the relative interactions of gas tracers such as the perfluorocarbons (PFCs) with a variety of reservoir materials over a range of temperatures (up to ~80°C) and

pressures (up to 300 bars) appropriate for proposed injection scenarios. The system is comprised of several features: (a) carrier gas and He reservoirs, (b) brine reservoir, (c) tracer gas injection volume, (d) gas homogenization reservoirs, (e) brine flow line, (f) sample loop, and (g) gas chromatograph (Hewlett-Packard 5890). Helium is used to sparge other gases as well as in the measurement of porosity of the solid contained in the sample loop. The sample coil is 20 feet long (or 40 feet if need be) and has been initially filled with Ottawa sand (0.5–0.8 mm diameter grain size). The sample coil length and diameter can be varied according to the specific application. Brine or hydrocarbon can be pumped into the coil prior to initiating gas flow. The brine line and the coil are composed of 2507 steel, which is highly resistant to corrosion. Carrier gas and tracer gas(es) are thoroughly mixed prior to flow in gas homogenization reservoirs. Multiple flow paths permit repeated “reloading” of the system with carrier gases that contain different types and amounts of tracer gases. Pressure and flow are generated by use of either a HPLC pump or manual screw-press. Pressure and temperature are monitored and recorded continuously during each experiment via a customized version of LabView.

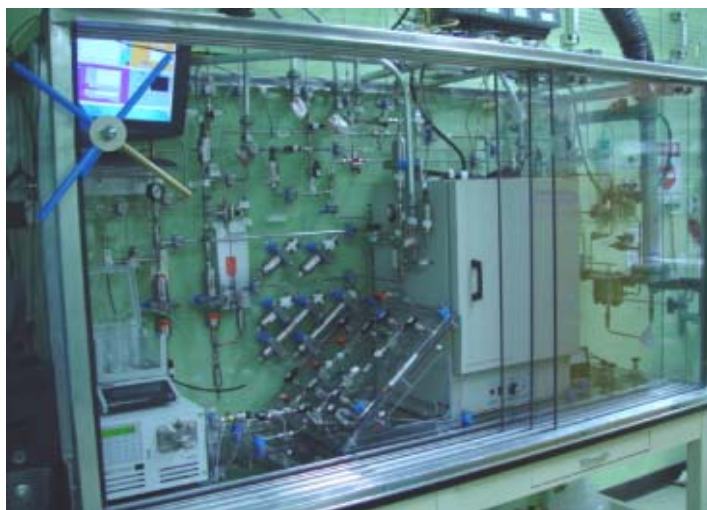

Figure. 1. Photograph of the ORNL dynamic flow system. Overall dimensions are approximately 5 ft long × 3 ft high × 2 ft deep. The HPLC and manual pumps located on the left are used to push fluids and apply pressure to the system. The 20 ft coiled flow-column is housed in the oven, which is capable of temperatures to 100°C. The on-line gas chromatograph is off the photo to the right.

- Objective D—

Develop gas chromatograph analytical protocols for separation and detection of PFTs at low concentrations, and initiate laboratory-scale reservoir rock experiments using the dynamic flow system to isolate various transport and solid matrix-tracer interactions (e.g., sorption).

- Accomplishment D—

A great deal of effort was devoted to quantifying the optimum conditions required for adequate separation of the four PFT at concentrations in the <pg range. A 50 m long megabore 0.53 mm I.D. AlOH₂, chromatographic column, with a N₂ carrier gas having an 8 min temperature program from 120–150°C, provided the best conditions for cleanly separating the PTFs of interest, including the isomers of PTCH. This information is not only crucial from an experimental point of view, but is invaluable for planned use of the PFTs under the rigors of field test monitoring.

Initial testing of the dynamic flow system involved He porosimetry measurements and an examination of the retention behavior of a single PFT—perfluorodimethyl cyclohexane (PDCH)—on Ottawa sand grains ranging from 600 to 850 μm. These tests were conducted at a pressure of ~50 bars using N₂ as the pressure medium. The initial injectate was composed of a mixture of 7 pg/cc of PDCH homogenized with N₂ and flowed at a constant rate of 3cc/min. Upon exiting the flow-through column, concentrations of PDCH and its isomers were determined, based upon the standard curve to be on the order of 0.1 pg, corresponding to our predictions. The observed concentrations approached 10-fold above the baseline. Results from these preliminary experiments have demonstrated the viability of a reproducible working system that is sensitive to low levels of detection and capable of distinguishing physical and geochemical parameters affecting long-term sequestration of CO₂.

Natural Stable Isotope Tracers

- Objective A—

Use mass-balance and reaction-path models to quantify carbon and oxygen isotope shifts of CO₂ interactions with solids and brine.

- Accomplishments A—

Equilibrium isotope partitioning calculations were used to constrain the magnitude of C and O isotope shifts accompanying CO₂ interaction with solids, brine, and brine + hydrocarbons. Our models take into consideration the temperature of the interaction, the compositions of all phases, and their relative proportions during reaction. Anthropogenic CO₂ derived from coal or natural gas power plants typically have a depleted δ¹³C signal (~ -30 to -38‰ vs PDB) but a somewhat enriched δ¹⁸O signal (~ 0 to +10‰ vs VSMOW). Using these ranges of values, we modeled the isotopic shifts in C and O as a plume of CO₂ undergoes reaction with progressively more of a particular carbon (e.g., HCO₃⁻, calcite, hydrocarbon) and/or oxygen (e.g., calcite) source during transport through the reservoir. In all cases, the carbon isotope values of the CO₂ become less negative, whereas the oxygen isotope values can become either enriched or depleted depending on the initial oxygen isotope signal of the host rock. The fact that CO₂ contains two natural isotopic tracers makes it particularly useful in resolving subsurface processes such as gas-water-rock interaction, fluid mixing, and leakage.

- Objective B—

Conduct chemical, mineralogical, and isotopic characterization of Lost Hills, California, and other reservoir analog materials (e.g., quartz, calcite, clay).

- Accomplishments B—

Mineralogical, isotopic, and chemical characterizations were completed on Lost Hills core provided by Mike Morea of ChevronTexaco, along with similar assessments of Frio sandstone supplied by Paul Knox of the Texas Bureau of Economic Geology. Standard techniques such as optical petrography, scanning electron microscopy (SEM), X-ray diffraction (XRD), gas source isotope ratio mass spectrometry (IRMS), and gas chromatography-mass spectrometry (GC-MS) were used to characterize these materials. For example, the Lost Hills samples were dominated by opaline SiO₂ with minor amounts of clay and varying concentrations of total organic C, ranging from 7 to 13 wt.%. This analytical effort was crucial for establishing a baseline for these materials prior to their use in a number of experimental studies, such as isotope partitioning and CO₂ adsorption/desorption.

- Objective C—

Conduct batch carbon and oxygen isotope partitioning experiments and determine the CO₂ adsorption and desorption isotherms on Lost Hills core and related geologic materials (including Frio sand).

- Accomplishment C—

To better quantify the behavior of CO₂ in the subsurface, we conducted a series of batch experiments on isotopic partitioning between CO₂ and geological media, including Lost Hills core, as a function of temperature and pressure. A number of geological materials (quartz, calcite, montmoillonite, Lost Hills core, LH 1-4) were reacted with CO₂ at different temperatures (20, 35, 50°C) and pressures (up to ~0.06 bar). In all cases, the carbon isotopes of the free gas were enriched relative to the initial starting compositions, whereas for oxygen, the opposite trend was observed. In general, the largest magnitude partitioning was observed between CO₂ and the hydrocarbon-bearing Lost Hills core samples. For carbon, there was an obvious trend of increasing partitioning (several ‰) with increasing organic carbon content. There is a tendency for the partitioning to increase with increasing temperature for the hydrocarbon-bearing samples, but not for the crystalline materials such as calcite. These results have two implications for the monitoring of CO₂ during injection testing. First, the temperature dependence of the adsorption process can be ignored for CO₂ interaction with crystalline host lithologies, but not in cases where hydrocarbons are present. Second, the difference in the direction of enrichment between hydrocarbon-bearing and nonhydrocarbon-bearing host rocks as a function of temperature might provide a possible further means to determine what horizons the CO₂ interacted with.

- Objective D—

Characterize isotopic and gas compositions of the Lost Hills system during CO₂ injection.

- Accomplishments D—

Gas and isotope chemistry have been monitored during the CO₂/water injectivity tests conducted in the Belridge Diatomite of the Monterey Formation in the ChevronTexaco Lost Hills Oil Field, California. Sampling was conducted periodically from Aug. 2000 through Oct. 2002. The carbon isotopes indicate that indigenous reservoir CO₂ was significantly different from the CO₂ injectate by ~50‰. The contribution of CO₂ injectate can be quantified by mass-balance modeling of these data (Figure 2). This approach demonstrates that increases in CO₂ and more depleted ¹³C values correlate with periods of CO₂ injection. During water-flood events, the CO₂ contents decrease and the ¹³C values return to more reservoir-like in magnitude. Certain wells communicate with the injection wells far more readily than others, which may be controlled, in

part, by faults that strike NE-SW. Oxygen isotope values in the CO₂ demonstrate that the gas has equilibrated with the reservoir water in the temperature range of 40-60°C. Trends in noble gas chemistry and isotopes (e.g., F¹³²Xe vs 1/[³⁶Ar]) confirm mixing between indigenous reservoir fluids and injected CO₂.

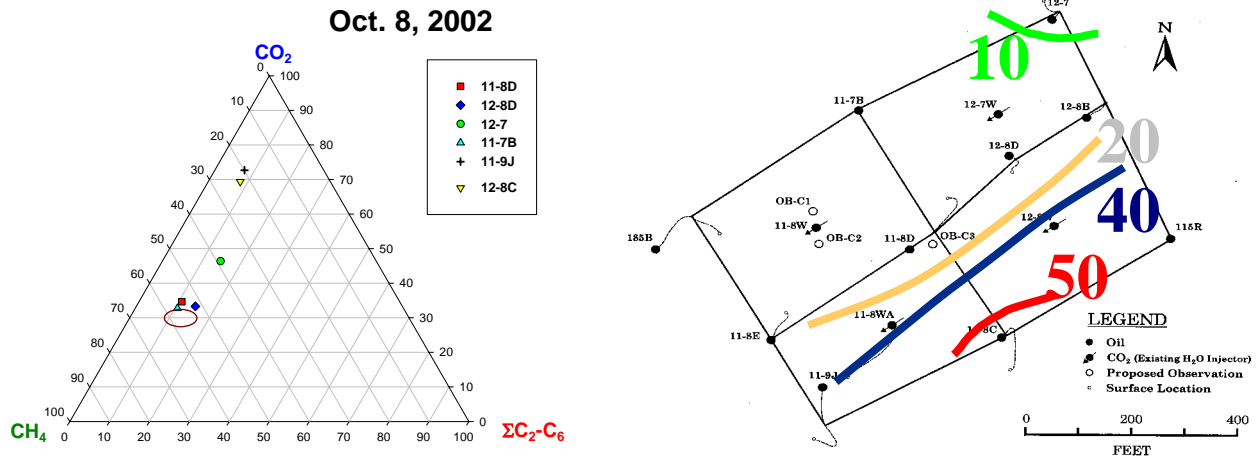

Figure 2. (a) Gas chemistry for monitoring wells sampled on October 8, 2002, approximately 28 days after CO₂ injection was terminated. Oval area designates the chemistry of indigenous reservoir gases; (b) Contours of the percent contribution of pure CO₂ injectate on October 8, 2002, based on mass balance of both chemical and isotopic results.

Implications for Geological Sequestration:

Simultaneous injection of multiple tracers can be used to isolate and in some cases quantify specific processes affecting solute transport, including diffusion into low-permeability materials, sorption, partitioning into nonaqueous phase liquids, partitioning into trapped gas phases, and perhaps most importantly, monitoring leakage of the sequestered carbon dioxide. The conservative gas tracers provide a measure against which to improve mass-balance determinations for the nonconservative tracers, particularly the injected CO₂. Multiple tracer methods have been shown to significantly reduce the uncertainty of transport simulations by constraining both reservoir characteristics (e.g., effective porosity) and *in situ* mass-transfer coefficients (e.g., diffusion or sorption coefficients).

Anthropogenic CO₂ injection into subsurface formations provides two unique source terms, carbon and oxygen isotopes. By accounting for how these isotopes vary during the injection process, we can (a) understand complex natural geochemical processes involving CO₂ in the subsurface, and (b) quantitatively assess and monitor both short- and long-term consequences of subsurface CO₂ injection and sequestration, and possible leakage from the system.

Recommendations for Further Work:

Our follow-on effort will focus primarily on application of both introduced gas tracers and stable carbon and oxygen isotopes to the Frio CO₂ injection test scheduled for sometime later this year. We have already prepared a preliminary experimental and field sampling plan for introduced and

natural tracers. In addition, we have characterized representative CO₂ gas obtained from PraxAir's Hydrogen 1 plant in Texas City, Texas. We anticipate having to do more characterization of gases actually brought on site during the test. We will characterize the chemistry, mineralogy and stable isotopes of representative Frio core samples obtained from the drilling of the injection well. These core samples (chips and disaggregated sand) will be used in both CO₂ sorption experiments and in our Sequestration Flow Simulator (SFS) at conditions relevant to those expected for the Frio injection horizons. These efforts complement the main thrust of our future work, which is to execute our plan for: (a) introduction of multiple gas tracers during CO₂ injections at Frio, (b) gas and fluid sampling at specified time intervals, (c) sample analysis, and (d) interpretation of gas tracer and isotope results, with follow-on integration into both transport and geophysical models.

Conclusions:

The assessment of stable isotopes complemented by multiple PFTs significantly enhances interpretations of subsurface carbon dioxide transport processes, breakthrough behavior, and monitoring assurances necessary for regulatory and public acceptance of geological sequestration.

Stable isotopes and inert gaseous PFT tracers are well suited for use in assessing, measuring and monitoring sequestration in field-scale tests based on their historical use, known properties, and modeled predictions of behavior at conditions relevant to subsurface reservoirs.

The robust and versatile dynamic flow facility and its associated gas chromatographic system are well suited for gas tracer and stable isotope testing under conditions relevant for subsurface CO₂ injection and sequestration. The associated gas chromatographic system is also directly applicable for assessing samples from field-scale tests and is capable of separating and detecting <pg quantities of multiple PFT tracers simultaneously.

Based on results from this project, a strategy has been developed for implementation of stable isotope and added-gaseous PFT monitoring that includes the following elements: (a) introduction of multiple gas tracers during CO₂ injections at Frio (b) gas and fluid sampling, (c) analysis of samples, and (d) interpretation of gas tracer and isotope results.

Related Publications:

Blencoe, J.G., D.R. Cole, J. Horita, and G.R. Moline, Experimental geochemical studies relevant to carbon sequestration. *Proceedings of 1st National Conference on Carbon Sequestration*, Washington, DC, May 15–17, 2001.

Chacko, T, D.R. Cole, and J. Horita, Equilibrium oxygen, hydrogen and carbon isotope fractionation factors applicable to geological systems. In: *Stable Isotope Geochemistry*, J.W. Valley and D.R. Cole, eds., *Rev. in Mineralogy and Geochemistry*, **43**, pp. 1-81, 2001.

Chu, X., D.R. Cole, and H. Ohmoto, Kinetics of carbon isotope exchange involving intra- and intermolecular reactions in the system CO₂-CH₄-acetic acid at 230–250°C. *Chem. Geol.*, submitted, 2004. (Partial funding from the Geosciences Program, Office of Basic Energy Sciences, DOE).

Cole, D.R., and S. Chakraborty, Rates and mechanisms of isotope exchange. In: *Stable Isotope Geochemistry*, J.W. Valley and D.R. Cole, eds., *Rev. in Mineralogy and Geochemistry*, **43**, pp. 83–223, 2001.

- Cole, D.R., J. Horita, and L.R. Riciputi, Fundamental studies of stable isotope exchange in systems relevant to energy utilization. *Proceedings of the 11th Annual V. M. Goldschmidt Conference*, Hot Springs, VA, May 20–24, 2001.
- Cole, D.R., J. Horita, M.C. van Soest, B.M. Kennedy, and M.F. Morea, Gas chemistry and isotope monitoring during the Lost Hills, CA, CO₂ injection test. *Proceedings of the 2nd Annual Conference on Carbon Sequestration*, 2003.
- Fisher, L.S., D.R. Cole, J.G. Blencoe, G.R. Moline, J.C. Parker, and T.J. Phelps, High-pressure flow-through column for assessing subsurface carbon sequestration. *Proceedings of the 2nd Annual Conference on Carbon Sequestration*, 2003.
- Horita, J., J.G. Blencoe, and D.R. Cole, Fundamental geochemical research on long-term carbon sequestration in subsurface environments. *Proceedings of the AAPG Annual Mtg.*, Denver, Colorado, June 3–6, 2001.
- Valley, J.W., and D.R. Cole, eds., Stable Isotope Geochemistry. *Reviews in Mineralogy and Geochemistry*, **43**, 2001.

Enhancement and Comparison of Simulation Models

Enhancement of Numerical Simulators for Greenhouse Gas Sequestration in Deep, Unminable Coal Seams

David H.-S. Law and W. D. (Bill) Gunter
Alberta Research Council (ARC) Inc., Edmonton, Alberta, Canada

Objectives:

To improve simulation models for capacity and performance assessment of CO₂ sequestration in deep, unminable coal seams.

Background:

It is believed that, in general, the existing numerical simulators developed to model the primary coalbed methane (CBM) recovery process do not have the capability to handle the more complicated mechanisms involved in the CO₂ sequestration processes in coalbeds. These mechanisms include: (1) coal matrix swelling/shrinkage due to gas adsorption/desorption on coal surfaces; (2) compaction and dilation of the natural fracture system due to stress changes; (3) diffusion of mixed gas between the coal matrix and the natural fracture system; (4) movement of water between the coal matrix and the natural fracture system; (5) adsorption/desorption of mixed gas at the coal surface; and (6) nonisothermal adsorption caused by differences in temperatures between the coalbed and injected CO₂.

A CBM simulator comparison study has been conducted, in general following the approach used by a series of Society of Petroleum Engineers (SPE) simulator comparison studies. Development and selection of sample test problems is made on the basis of major mechanisms expected to occur in the CO₂ sequestration processes in coalbeds, taking into account the existing simulation capabilities and the needs of improvement. Part I of this study, which included two problem sets dealing with a single well test (i.e., “micro-pilot test”) and a CO₂ sequestration process in an inverted five-spot pattern (see Figures 1a and 1b) with pure CO₂ injection, emphasized the comparison of the performance of CBM simulators, which have only the features to model the primary CBM recovery process. This allows most simulators to participate in the initial stage of the study.

At later stages, Parts II and III, more problem sets were developed that addressed more complicated process mechanisms. In these cases, improvement on some of the existing CBM simulators by incorporating the additional aforementioned features is necessary. Part II is the extension of the two problem sets in Part I, but with CO₂-enriched flue gas injection (i.e., 50% CO₂ and 50% N₂). Part III, with more complex problem sets, is the extension of the problem set in Part I dealing with CO₂ sequestration process with pure CO₂ injection in an inverted five-spot pattern. The first problem set investigates the effect of gas desorption time (or gas diffusion) between the coal matrix and the natural fracture system. The second problem set investigates the effect of natural fracture permeability changes as a function of natural fracture pressure and adsorbed gas content (i.e., coal shrinkage/swelling). A complete description of the problem sets as offered to the participants is available on the Internet at <http://www.arc.ab.ca/extranet/ecbm> (password can be obtained by contacting David Law at law@arc.ab.ca). These test problems do not necessarily represent real field situations. Finally, in Part IV, performance of CBM

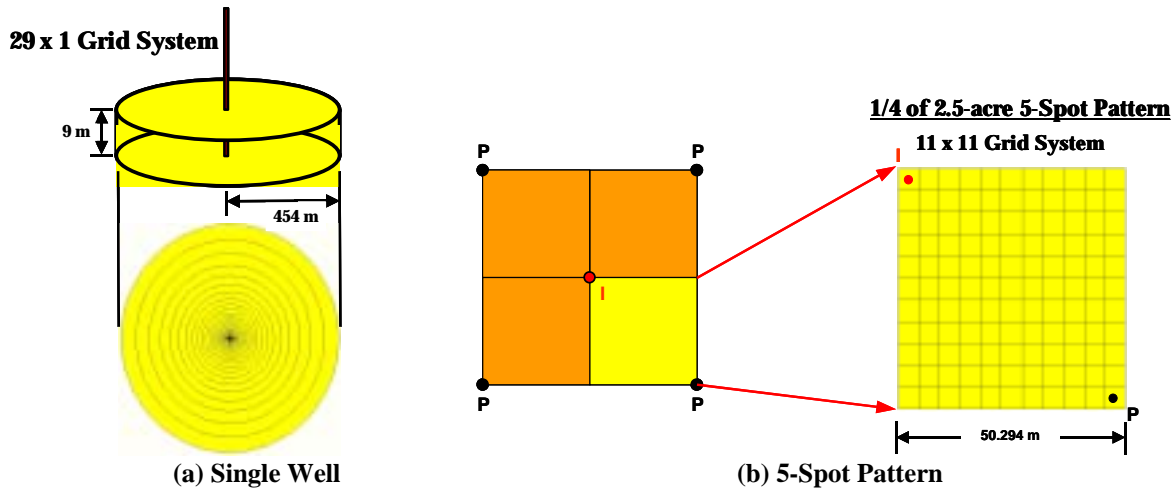

Figure 1. Schematic diagram of grid systems used in test problems

simulators are compared for their capability to history-match field-test data collected by ARC through performing “micro-pilot tests” by pure CO₂ and flue gas injection into coalbeds in Alberta, Canada.

Eight numerical simulators have participated in the comparison study: (1) GEM, Computer Modelling Group (CMG) Ltd., Canada; (2) ECLIPSE, Schlumberger GeoQuest, U.K.; (3) COMET, Advanced Resources International (ARI), U.S.A.; (4) SIMED II, Netherlands Institute of Applied Geoscience TNO, The Netherlands/Commonwealth Scientific and Industrial Research Organization (CSIRO), Australia; (5) GCOMP, BP-Amoco, U.S.A.; (6) METSIM 2, Imperial College, U.K.; (7) MoReS, Shell International, The Netherlands; and (8) COALCOMP, Pennsylvania State University (PSU). ARC’s field test data have been released under a confidential agreement with ARC to use these field data in the comparison study only, to all of the participants except ECLIPSE. The seven participants in Part IV have made the necessary improvements in their simulators.

Three workshops have been held in Calgary, Canada (June 2000), Houston, U.S.A. (March 2002) and Tokyo, Japan (September 2003) . These workshops have included invited participants with expertise in numerical modeling, laboratory measurements and field operations to discuss the comparison results of the problem sets to date, the development of more complex problem sets, process mechanisms that are and are not in the existing CBM numerical simulators (and their importance), how to represent these mechanisms correctly numerically, and the path forward.

Results:

All participants were first asked to provide the initial gas-in-place (IGIP) (i.e., total adsorbed and free gas amounts of CH₄ in the coalbed) in their simulation for screening of errors in input entry. It was found that there is good agreement within a few percent errors between different CBM simulators. All participants were then asked to provide detailed numerical results such as: (1) CH₄, CO₂ and N₂ production rates; (2) well bottom-hole pressures; (3) production gas compositions; and (4) CO₂ and/or N₂ distributions (i.e., gas mole fractions) in the coal natural fracture system at given times.

Figures 2–4 show examples of comparison results for Parts I, II, and III. Figure 2a shows comparisons of CH₄ production rates for primary CBM recovery and enhanced CBM recovery with pure CO₂ (Part I) and CO₂-enriched flue gas (Part II) injection in an inverted five-spot pattern. In these cases, all simulations instantaneously mimic diffusion between the coal matrix and the natural fracture system. All simulators show enhancement of CH₄ production due to gas injection. Figure 2b shows comparisons of CH₄ production rates for the cases of gas desorption times equal to 38.6 and 77.2 days (Part IIIa) with pure CO₂ injection in an inverted five-spot pattern. It is noted that the longer gas desorption time corresponds to the slower gas diffusion rate between the coal matrix and the natural fracture system, while desorption time equal to zero mimics instantaneous gas diffusion. Figure 3 shows comparisons of CO₂ distribution as CO₂ mole fraction in the gas phase in the natural fracture system after 30, 60, and 90 days with pure CO₂ injection in an inverted five-spot pattern (Part I). The contour plots represent ¼ of the 5-spot pattern, with injector located at the upper left-hand corner and the producer located at the lower right-hand corner. Figure 4a shows the stress-dependent permeability relationships based on the Palmer and Mansoori Theory provided for Part IIIb. For Young’s modulus, $E = 3.068 \times 10^6$ kPa, significant permeability rebound occurs, caused by coal matrix shrinkage when pressure decreases and CH₄ is being desorbed. On the other hand, for $E = 1.999 \times 10^6$ kPa, permeability rebound is nonexistent, because in this case stress effects dominate over coal matrix shrinkage. Figure 4b shows comparisons of CH₄ production rates for the cases of Young’s modulus given above (Part IIIa) with pure CO₂ injection in an inverted five-spot pattern.

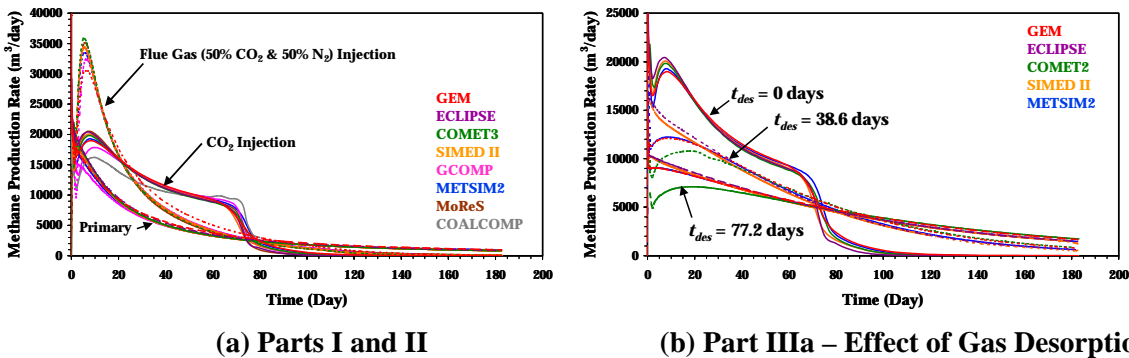

Figure 2. Comparisons of methane production rates for Parts I, II and III (CO₂ and flue gas injection in inverted five-spot pattern)

In general, there is very good agreement between the results from the different CBM simulators. Detailed comparison results for Parts I, II, and III have been updated continuously on the Internet at <http://www.arc.ab.ca/extranet/ecbm>.

At this stage, history-match results have been received for Part IV from GEM, COMET, SIMED II, GCOMP, METSIM2, and COALCOMP. An example of history-match results using GEM for the micro-pilot with pure CO₂ injection is given in Figure 5, for a comparison between numerical prediction and field data of well bottom-hole pressure and production gas composition.

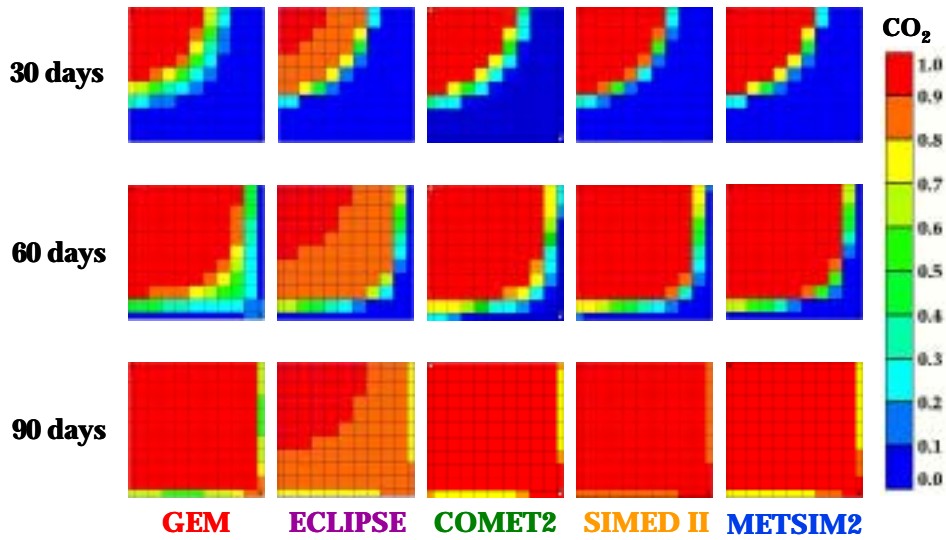
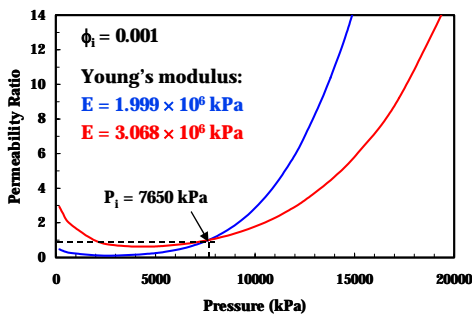
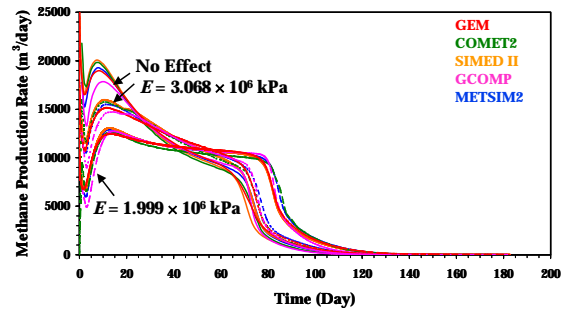

Figure 3. Comparisons of CO₂ distributions as CO₂ mole fraction in gas phase in coal natural fracture system for Part I (CO₂ injection in inverted five-spot pattern)



(a) Palmer & Mansoori Theory



(b) Part IIIb - Effect of Permeability Variation

Figure 4. Comparisons of methane production rates for Part IIIb (CO₂ injection in inverted five-spot pattern)

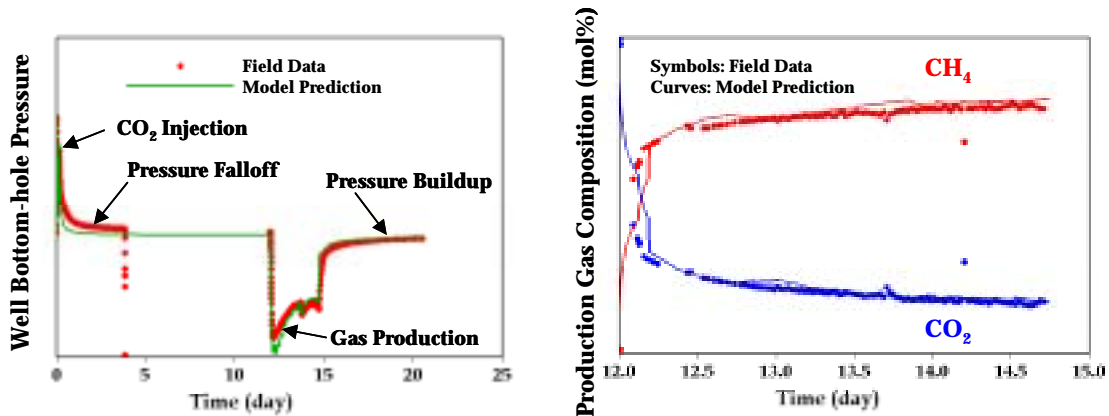

Figure 5. Comparisons of numerical prediction using GEM and ARC's micro-pilot test field data with pure CO₂ injection (Part IV)

Conclusions:

In general, there is very good agreement between the results from the different CBM simulators for Parts I, II, and III. The differences between the predictions from different simulators may result from a variety of reasons:

- Possible different initialization procedure (e.g., initial gas-in-place)
- Possible different dual porosity approach in the simulators
- Possible different diffusion model in the simulators
- Handling of wells (e.g., $\frac{1}{4}$ well in 5-spot pattern)
- Tolerance on the convergence of iterations
- Selection of numerical control parameters

There were commitments from many CBM simulator developers that resulted in significant improvement in modeling of CO₂ sequestration processes in coalbeds over the past few years. Also, many CBM simulator developers commented that the timing of the comparison study was good because it provided an opportunity to test the newly improved features in their CBM simulators.

The improved CBM simulators are quite capable of history- matching the ARC's field data in Part IV. However, the methodologies used by different participants in the history match are quite inconsistent, mainly because the special features (e.g., stress and multi-component gas-adsorbed dependent fracture-permeability variation) needed to history-match the field data are formulated quite differently in the CBM simulators. Even though different approaches are used, all history matches indicate the significant effects of permeability variation caused by stress and adsorbed gas content, as well as by mixed gas diffusion between the coal matrix and the natural fracture system during the micro-pilot tests. Given that we lack experimental measurements for the geomechanical swelling/shrinkage characteristics of coal and mixed gas diffusion/adsorption, more studies of this kind are necessary to justify the parameters used in the history match. Finally, more field tests are essential in the validation of the CBM simulators under realistic field situations.

Recommendations for Further Work:

Better understanding is needed of the process mechanisms involved in the CO₂ sequestration processes within coalbeds. This better understanding would be based on more field tests and more laboratory studies of the coal geomechanical characteristics, coal swelling/shrinkage characteristics, and mixed gas diffusion/adsorption. Such work is essential for further improvement of the CBM simulators.

Implications for Geologic Sequestration:

The injection of greenhouse gases (e.g., CO₂ or CO₂ gas mixtures) in coalbeds is probably one of the more attractive options among all underground CO₂ sequestration possibilities: the CO₂ is stored while the recovery of CBM is enhanced. The revenue from methane (CH₄) production can offset the expenditures of the sequestration operation.

In addition, this study indicates that numerical simulators can be useful tools in developing the technologies of GHG sequestration in coalbeds and enhanced coalbed methane (ECBM) recovery, once they have been validated by history-matching of field data. The CBM simulator comparison study provided an essential test and evaluation of how well these numerical simulators can model complicated process mechanisms.

Related Publications:

- Gunter, W.D., and D.H.-S. Law, Enhanced coalbed methane recovery and CO₂ storage: Simulation issues and model comparison. Paper presented at *The International Workshop on "Present Status and Outlook of CO₂ Sequestration in Coal Seams"*, Tokyo, Japan, September 5, 2002.
- Law, D.H.-S., L.G.H. van der Meer, and W.D. Gunter, Modelling of carbon dioxide sequestration in coalbeds: A numerical challenge. Paper presented at the *5th International Conference on Greenhouse Gas Control Technologies (GHGT-5)*, Cairns, Australia, August 13–16, 2000.
- Law, D.H.-S., L.G.H. van der Meer, and W.D. Gunter, Comparison of numerical simulators for greenhouse gas storage in coalbeds, Part I: Pure carbon dioxide injection. Paper presented at the *1st National Conference on Carbon Sequestration*, Washington, D.C., U.S.A., May 14–17, 2001.
- Law, D.H.-S., L.G.H. van der Meer, and W.D. Gunter, Numerical simulation comparison study for enhanced coalbed methane recovery processes, Part I: Pure carbon dioxide injection. Paper SPE 75669 presented at the *SPE/CERI Gas Technology Symposium (GTS)*, Calgary, Alberta, Canada, April 30–May 2, 2002
- Law, D.H.-S., L.G.H. van der Meer, and W.D. Gunter, Comparison of numerical simulators for greenhouse gas storage in coalbeds, Part II: Flue gas injection. Paper presented at the *6th International Conference on Greenhouse Gas Control Technologies (GHGT-6)*, Kyoto, Japan, October 1–4, 2002.
- Law, D.H.-S., L.G.H. van der Meer, and W.D. Gunter, Comparison simulators for greenhouse gas sequestration in coalbeds, Part III: More complex problems. Paper presented at the *2nd Annual Conference on Carbon Sequestration*, Alexandria, Virginia, U.S.A., May 5–8, 2003.
- Law, D.H.-S., and W.D. Gunter, History matching of enhanced coalbed methane (ECBM) production field data. Paper presented at the *2nd International Workshop on "Research Relevant to CO₂ Sequestration in Coal Seams"*, Tokyo, Japan, September 25, 2003.

Intercomparison of Reservoir Simulation Models for Oil, Gas, and Brine Formations

Karsten Pruess and Chin-Fu Tsang
Lawrence Berkeley National Laboratory, Berkeley, CA

Objectives:

The objective of this task was to carry out a code intercomparison study with broad participation from the technical community. This was intended to document current simulation capabilities, to establish technical credibility for simulators, and to stimulate further advances in numerical simulation. Specific objectives were to develop a plan for how the code intercomparison would be organized, formulate test problems, solicit participation from outside groups, collect and compare results, reconcile differences, and write reports and papers summarizing the findings of the study.

Background

Mathematical models and numerical simulation codes are playing an important role in evaluating the feasibility of geologic disposal of greenhouse gases, and they will be necessary tools for designing and operating future disposal systems. In order to serve these functions, simulation codes must be tested to demonstrate that they can adequately represent the physical and chemical processes that would be induced by injection of CO₂ and other gases into geologic formations.

Code intercomparison has been successfully used in other fields, such as petroleum and geothermal reservoir engineering, to evaluate the state of the art of numerical simulation capabilities, and to establish the credibility of simulation results. Geologic disposal of greenhouse gases is a relatively new field of study, and the simulation of processes that would be induced by such disposal poses some new challenges.

Results:

The code intercomparison was launched with a report that included eight proposed test problems dealing with CO₂ disposal into saline aquifers, and oil and gas reservoirs (Pruess, 2000). This report, together with a proposed timetable for the study, was posted on the Internet (<http://www-esd.lbl.gov/GEOSEQ/code/index.html>). We also solicited participation through mailings and e-mail, and through informational material and presentations at technical conferences (Pruess et al., 2001). Preliminary results were collected and compared at a workshop that was held in October 2001 in Berkeley. An example result, for test problem 7, patterned after the Sleipner Vest CO₂ project is shown in Figure 1. The final roster of participants included ten organizations from six countries. Key findings from the study included the following.

- A considerable number of numerical simulation codes is capable of simulating, in realistic, quantitative detail, the important flow and transport processes that would accompany geologic sequestration.
- Agreement between results from different groups and different codes ranges from fair to good.
- All codes attempt to represent fluid properties and thermodynamic data in a realistic fashion, but there is some considerable disagreement between fluid parameters in different codes.

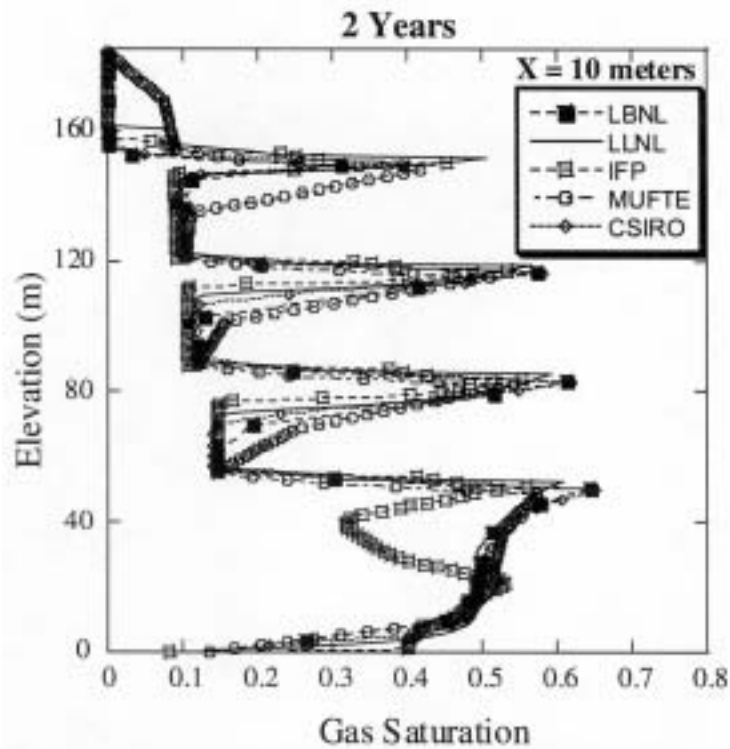
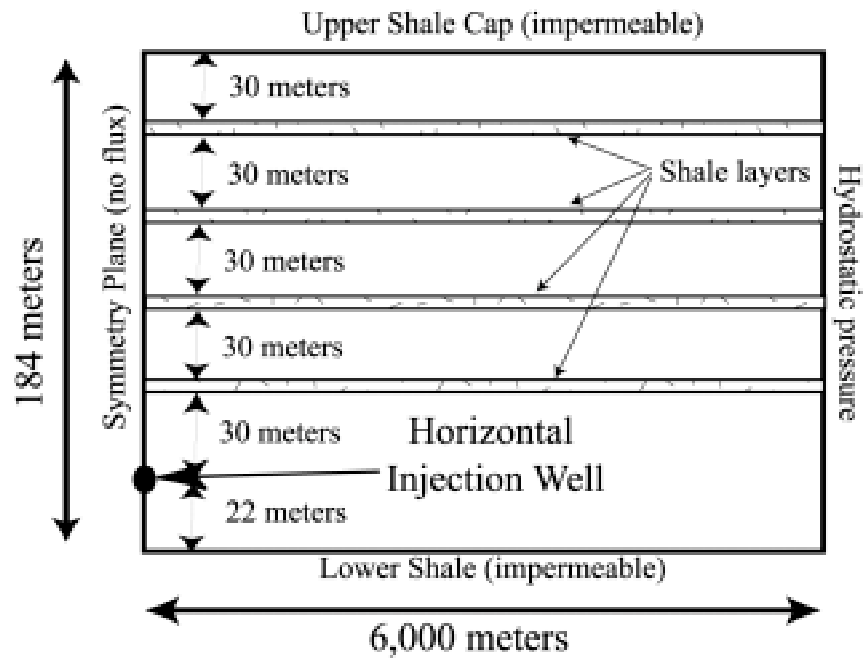

Figure 1. Test Problem 7 of the code intercomparison study involved a 2-D vertical section model patterned after the Sleipner Vest CO₂ project, Norwegian sector of the North Sea. The top frame shows the sequence of sand and shale layers. Simulated vertical profiles for gas saturations at a horizontal distance of 10 m from the injection well, after 2 years of CO₂ injection, are shown in the bottom frame.

- Agreement between simulations of fluid flow and transport, and hydromechanical and geochemical effects, ranged from fair to good. Where discrepancies persisted, they were usually traced to differences in fluid property descriptions.
- The hydro-mechanical test problem was solved by only one code. The interplay of hydrology and geomechanics plays an important role in the integrity of potential geologic disposal sites, and capabilities for modeling such processes need to be strengthened.
- Code developers should also aim for a more accurate description of fluid properties, including PVT data, as well as transport and caloric properties, using up-to-date experimental data.
- Although further improvements in fluid property descriptions are important, it is recognized that in actual practice it would be uncertainties in the conceptual model at a given site that would most strongly affect simulation results.
- The problems investigated here were simplified prototypes of field problems. Further modeling studies should be undertaken on problems that approach the full realism and complexity of actual field problems, to more fully establish the usefulness and credibility of numerical simulation codes for geologic sequestration.

The results of the study are fully documented in a laboratory report (Pruess et al., 2002b) and are given in abbreviated form in Pruess et al. (2002a; 2003). A more detailed report with the LBNL solutions for the saline aquifer problems is available (Pruess and Garcia, 2002).

Implications for Geologic Sequestration:

The intercomparison study has shown that currently available simulation codes can model the physical and chemical processes arising in geologic disposal of CO₂ with quantitatively similar results. This establishes credibility for simulators as practically useful tools for evaluating the feasibility of geologic disposal, for investigating the relative strengths and weaknesses of different disposal schemes, and for designing and analyzing field tests.

Recommendations for Future Work:

The test problems studied here, although prototypical for field problems, make many simplifications and approximations that should be overcome in future work. In all cases it was assumed that the disposal involves pure CO₂, while in reality other gases such as SO_x and NO_x may also be present. Subsurface reservoirs generally have complex heterogeneity on different scales, flows are three-dimensional, and are coupled to geochemical and geomechanical effects. Nonisothermal phenomena may also come into play, and a broad range of time scales is of interest in connection with geologic sequestration. Future code intercomparisons should address coupled processes in fully three-dimensional heterogeneous media. Establishing the realism and accuracy of the physical and chemical process models employed in the simulators is a demanding task, requiring carefully controlled and monitored field and laboratory experiments. More work is needed to improve simulation capabilities for mechanically coupled processes. Only after simulation models have been shown capable of adequately representing real-world observations can they be relied upon for engineering design and analysis.

Conclusions:

The study reported here has documented the capabilities of currently available numerical simulation codes to represent physical and chemical processes that would accompany CO₂ disposal into geologic formations, including oil and gas reservoirs, and brine aquifers. In the course of this study, a number of bugs were found and corrected in several simulation codes. Substantial agreement was found between results predicted from different simulators, but there

are also areas with only fair agreement, as well as some significant discrepancies. Most disagreements could be traced to differences in fluid property descriptions, and this clearly is an area that will require continuing efforts by code developers to assure that realistic results can be obtained. Some disagreements were caused by effects from space and time discretization, while in some cases discrepancies were noted for which no rational explanation could be found. Although code development work undoubtedly must continue, this project has shown that codes are available now that can model the complex phenomena accompanying geologic storage of CO₂ in a robust manner, and with quantitatively similar results.

Related Publications:

- Pruess, K., C.F. Tsang, D. H.-S. Law and C.M. Oldenburg. Intercomparison of simulation models for CO₂ disposal in underground storage Reservoirs. *Lawrence Berkeley National Laboratory Report*, LBNL-47353, October 2000.
- Pruess, K., C.F. Tsang, D. H.-S. Law and C.M. Oldenburg. An intercomparison study of simulation models for geologic sequestration of CO₂. *Proceedings, First National Conference on Carbon Sequestration*, Washington, DC, May 14–17, 2001.
- Pruess, K., A. Bielinski, J. Ennis-King, R. Fabriol, Y. Le Gallo, J. Garcia, K. Jessen, T. Kavscek, D. H.-S. Law, P. Lichtner, C. Oldenburg, R. Pawar, J. Rutqvist, C. Steefel, B. Travis, C.F. Tsang, S. White, and T. Xu. Code Intercomparison builds confidence in numerical models for geologic disposal of CO₂. *Lawrence Berkeley National Laboratory Report LBNL-51200*; Paper F1-4, presented at the *Sixth International Conference on Greenhouse Gas Technologies (GHGT-6)*, Kyoto, Japan, October 1–4, 2002a.
- Pruess, K., J. Garcia, T. Kavscek, C. Oldenburg, J. Rutqvist, C. Steefel, and T. Xu, Intercomparison of numerical simulation codes for geologic disposal of CO₂. *Lawrence Berkeley National Laboratory Report LBNL-51813*, December 2002b.
- Pruess, K., and J. Garcia. Solutions of test problems for disposal of CO₂ in saline aquifers. *Lawrence Berkeley National Laboratory Report LBNL-51812*, December 2002.
- Pruess, K., J. Garcia, T. Kavscek, C. Oldenburg, J. Rutqvist, C. Steefel, and T. Xu. Code intercomparison builds confidence in numerical simulation models for geologic disposal of CO₂. *Energy*, LBNL-52211, 2003. (In press)

New Methods and information for Capacity Assessment

Improving the Methodology for Capacity Assessment

Christine Doughty, Sally M. Benson, and Karsten Pruess
Lawrence Berkeley National Laboratory, Berkeley, CA

Objectives:

Geologic sequestration of CO₂ in brine-bearing formations has been proposed as a means of reducing the atmospheric load of greenhouse gases. For this procedure to have any meaningful impact on the global carbon cycle, vast quantities of CO₂ must be injected into the subsurface and isolated from the biosphere for hundreds or thousands of years. Numerous brine-bearing formations have been identified as having potential for geologic sequestration of CO₂. The objective of this research is to go beyond identification and do quantitative studies of CO₂ sequestration capacity in realistic geologic settings.

Background:

Depths greater than about 800 m below the ground surface are generally considered suitable for CO₂ sequestration. Brine formations found at such depths have few or no competing uses, and may be well characterized if they occur in conjunction with oil- or gas-producing formations. In addition to being far from the biosphere, thus mitigating potential leakage effects, at these depths CO₂ does not form distinct gas and liquid phases. Rather, it exists primarily as an immiscible supercritical phase with a high density, enabling more efficient storage. A small fraction of the CO₂ dissolves in the brine.

We define the capacity factor C as the volume fraction of the subsurface within a defined stratigraphic interval available for CO₂ sequestration. We conceptualize C as the product of five factors: (1) the intrinsic capacity, controlled by multiphase flow and transport phenomena; (2) a gravity capacity factor, controlled by buoyancy forces (although supercritical CO₂ is very dense compared to atmospheric conditions, it is less dense and less viscous than the surrounding brine); (3) a heterogeneity capacity factor, controlled by local geologic variability such as sand channels and shale lenses; (4) a structural capacity factor, controlled by larger-scale geological structures such as anticlines or fault blocks; and (5) the formation porosity ϕ , the fraction of void space within the formation. These five factors are illustrated schematically in Figure 1.

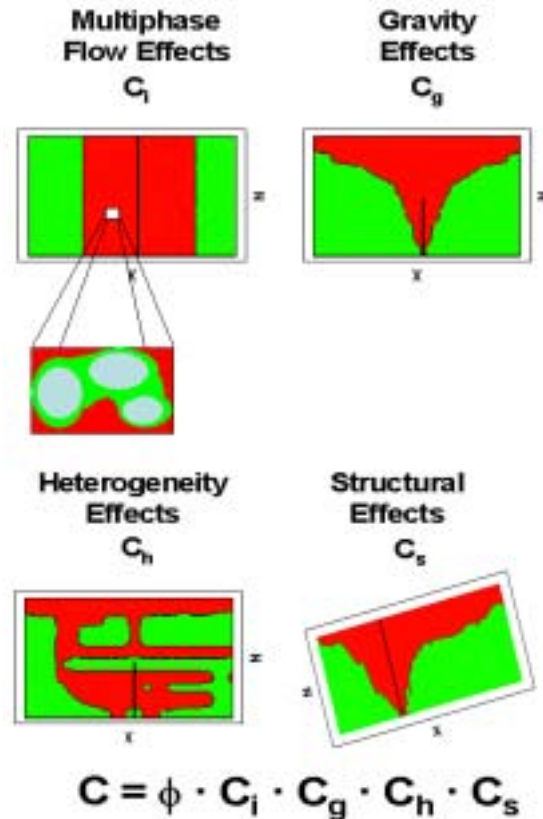

Figure 1. Schematic views of the CO₂ distribution (red) in a brine-saturated formation for increasingly complex model assumptions, and the component of the total capacity factor C that describes the corresponding effects

Analytical solutions are available for studying multiphase flow phenomena and buoyancy flow for simple flow geometries, but for the general problem involving heterogeneous media, a numerical approach is needed. To investigate CO₂ sequestration capacity, we use a version of the numerical simulator TOUGH2, which was enhanced to accurately represent supercritical CO₂ and considers all flow and transport processes relevant for a two-phase (liquid-gas), three-component (CO₂, water, dissolved NaCl) system.

A three-dimensional numerical model is developed of a 1 km × 1 km × 100 m region of a fluvial-deltaic sedimentary formation using transition probability geostatistics (Figure 2). Permeability varies by nearly five orders of magnitude in the model, making preferential flow a significant effect. Our hypothetical sequestration problem specifies that CO₂ is injected at a rate of 0.75 million tonnes per year for a period of 20 years into a well at the center of the model. This injection rate is roughly one-third of the rate at which CO₂ is produced by a 1,200 MW gas-fired power plant.

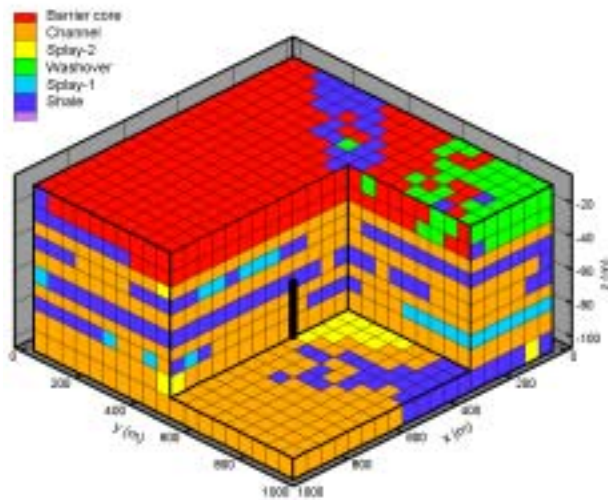

Figure 2. 1 km × 1 km × 100 m TOUGH2 model. Permeability decreases from 700 md for the barrier core to 0.01 md for the shale. Top and bottom boundaries are closed.

Results:

Figure 3 shows simulation results as a series of snapshots of the immiscible CO₂ plume during the injection period. The interplay of gravity and heterogeneity leads to a highly irregular CO₂ distribution, as buoyant CO₂ moves laterally under shale lenses until it finds a gap through which to proceed upward. Figure 4 plots the total capacity factor C as a function of time, as well as showing the contribution from the immiscible gas-like phase (C^{gas}) and CO₂ dissolved in the brine (C^{liq}). Note that C depends on the time in the sequestration process at which it is measured: the C obtained when the storage-volume spill point is first reached can be much smaller than the C obtained for quasi-steady flow conditions. Through a suite of such numerical simulations, we have studied how the five components of C shown in Figure 1 depend on multiphase flow parameters, formation and injection well configuration, and geologic heterogeneity.

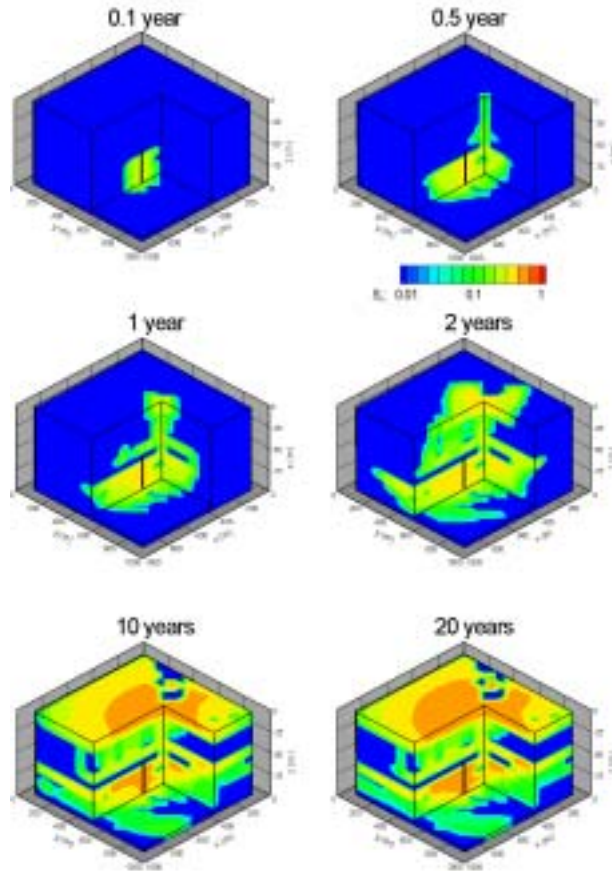

Figure 3. Modeled distribution of the immiscible CO₂ plume during the 20-year injection period

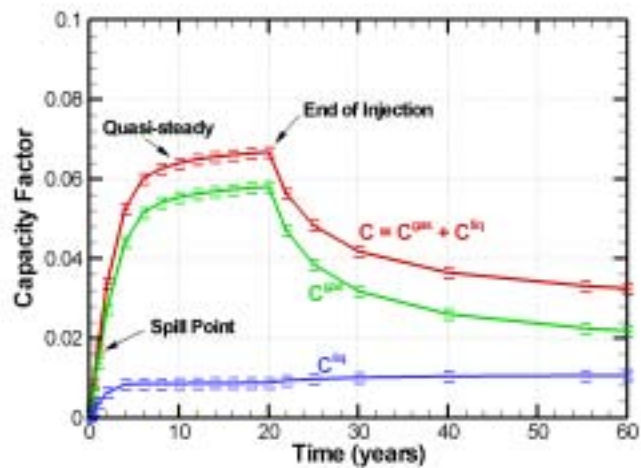

Figure 4. Total capacity factor C as a function of time during and after the 20-year injection period, and its constituents C^{gas} (the immiscible supercritical phase) and C^{liq} (CO₂ dissolved in the brine)

Implications for Geological Sequestration:

Based on our conceptualization of the capacity factor as a product of five terms and the supporting simulation results, we can assess and optimize sequestration capacity:

- Intrinsic capacity factor: C_i depends on the relative permeability to CO_2 and the viscosity ratio between brine and CO_2 . A high C_i means the supercritical CO_2 fills up a large fraction of the pore space compared to the brine, leading to a compact CO_2 plume. Conversely, a low C_i describes a more diffuse plume. Although a larger subsurface volume is required to store a given amount of CO_2 in the latter case, more brine is in contact with immiscible CO_2 , leading to more CO_2 dissolution. Because dissolved CO_2 is not buoyant, it may represent more securely stored CO_2 .
- Gravity capacity factor: C_g increases as intrinsic permeability decreases or medium anisotropy increases (i.e., vertical permeability decreases).
- Heterogeneity capacity factor: C_h increases as the quantity of shale or other low-permeability material bypassed by flow decreases; however, layered-type low-permeability features enhance C_g by diminishing buoyancy flow.
- Structural capacity factor: C_s reflects large-scale geologic features, and may be optimized by careful placement of injection wells.
- Porosity: a large value of ϕ signifies that large pore volume is available for sequestration; however, insofar as permeability is correlated to porosity, a large value of ϕ may predict a low value of C_g .

Recommendations for Further Work:

The present studies should be extended in two directions. First, they can be broadened to larger spatial scales (more heterogeneity, structural traps, sequence of traps) and longer time scales (dissolution and mineral trapping become increasingly important), and extended to other geological settings. Second, many of the flow properties used in the modeling are derived from oil-field experience and need to be determined for CO_2 /brine systems.

Conclusions:

A systematic study of the capacity of the subsurface to sequester CO_2 , using realistic geologic conditions and a sophisticated numerical simulator that incorporates all the relevant multiphase, multicomponent flow and transport processes has enabled us to better understand the physical processes accompanying geologic sequestration of CO_2 . This understanding will allow us to effectively design sequestration scenarios and predict their performance with increased confidence.

Related Publications:

- Doughty, C., K. Pruess, S.M. Benson, S.D. Hovorka, P.R. Knox, and C.T. Green, Capacity investigation of brine-bearing sands of the Frio Formation for geologic sequestration of CO_2 . Presented at the *First National Conference on Carbon Sequestration*, Washington DC, National Energy Tech. Lab., May 14–17, 2001.
- Doughty, C., S.M. Benson, and K. Pruess, Capacity investigation of brine-bearing sands for geologic sequestration of CO_2 , Presented at the *GHGT-6 Conference*, Kyoto, Japan, September 30–Oct. 4, 2002.
- Doughty, C., and K. Pruess, Modeling supercritical CO_2 injection in heterogeneous porous media, *TOUGH Symposium 2003*, Lawrence Berkeley National Lab., Berkeley, California, May 12–14, 2003.

Hovorka, S.D., C. Doughty, P.R. Knox, C.T. Green, K. Pruess, and S.M. Benson, Evaluation of brine-bearing sands of the Frio Formation, upper Texas Gulf Coast for geological sequestration of CO₂. Presented at the *First National Conference on Carbon Sequestration*, Washington DC, National Energy Technology Lab., May 14–17, 2001.

Hovorka, S. D., C. Doughty, S.M. Benson, K. Pruess, and P.R. Knox, Assessment of the impact of geological heterogeneity on CO₂ storage in brine formations: a case study from the Texas Gulf Coast. In: *Geological Storage for Emissions Reduction: Technology*, S.J. Baines, J. Gale, and R.H. Worden, eds., *Geological Society (London) Special Publication* (in press), 2003.

Capacity Assessment of the Frio Formation, Texas

Susan D. Hovorka¹, Christine Doughty², Paul R. Knox¹, and Mark H. Holtz¹

¹University of Texas at Austin, Austin, TX

²Lawrence Berkeley National Laboratory, Berkeley, CA

Objectives:

The objective of the Frio capacity assessment is to apply the conceptual and modeling approaches to a well-known, complex, real subsurface data set in an area where carbon reduction is needed and geologic conditions are favorable. This task is iterative with the capacity assessment described previously and the Frio Pilot test discussed in later sections. Modeling a real data set improves our understanding of the most significant variables that control the performance of CO₂ in the subsurface injection interval.

Background:

Matching annual volumes produced at anthropogenic sources with the available subsurface volumes is one of the initial assessments done to determine if geologic sequestration can have significant impact toward reducing atmospheric releases of CO₂. However, large uncertainties are immediately apparent when attempting to calculate the subsurface volume that a given volume of CO₂ will occupy. It is relatively simple to calculate the volume of fluids in the subsurface from formation thickness, net sandstone thickness within the formation, and average sandstone porosity (Bergman and Winter, 1995; Hovorka et al., 2000). Pore volume calculations were made by extracting the net sand thickness of the Frio at reasonable target depths between 1,000 and 3,000 m below the ground surface and multiplying it by gridded porosity from regional data to calculate brine-filled porosity-height. Porosity-height times cell area for the entire Frio Formation of the Texas coast yielded a volume of 5,840 km³ of brine-filled porosity in sandstone. However, it is apparent that only a fraction of this fluid volume can be replaced by injected CO₂. We undertook application of the conceptual model previously discussed, followed by data collection and modeling experiments to determine which features of the system are most important in controlling capacity

Results:

As discussed previously, conceptualization of capacity resulted in a description of five factors that are multiplied to determine capacity: intrinsic capacity factor (C_i), gravity capacity factor (C_g), heterogeneity capacity factor (C_h), structural capacity factor (C_s), and porosity (ϕ). In addition, we considered the effectiveness of sequestration, which addresses issues such as the short-, intermediate-, and long-term fate of the CO₂. The calculation of the effectiveness involves analysis of escape from the injection interval over time to determine whether sequestration occurs over time periods long enough to achieve significant reduction of atmospheric concentrations over time frames of hundreds of years.

Successive simulations were made using the TOUGH2 simulator, using an evolving sequence of geologic data inputs. In all cases, we considered flow and transport processes in a two-phase (liquid-gas), three-component (CO₂, water, dissolved NaCl) system. We developed five data sets:

1. Realistically constrained probabilistic data
2. Same model adapted to test a specific site
3. Site data from detailed reservoir model
4. Fully deterministic reservoir model

5. Generalized regional model

The first model set began with generation of realistically constrained probabilistic subsurface data at a 1 km reservoir scale, based on reservoir studies and regional trends. Previous work has shown that a sequence of depositional environments (for example, off shore shales, barrier island sandstones, bay shales, fluvial sandstones, and floodplain mudstones) was repeated cyclically many times through the Tertiary sequence of the Gulf Coast. The repetition of depositional environments created a complex but repetitive permeability structure that controls fluid flow in the subsurface. Probabilistic realizations were created using the geometry and distribution of reservoir properties where these facies are well known, and the resulting model layers were then used to populate less well-known subsurface volumes with realistically complex data. The first data sets were created to represent the Frio Formation beneath Cedar Bayou, a location near Houston with both a power plant and a refinery. Simulation with this data set demonstrated the importance of correctly describing the continuity of shale breaks within the sandstone, which influences capacity through the heterogeneity capacity factor.

We then identified a potential field site in south Liberty Oil Field. To test the feasibility of this injection and monitoring experiment, we modified the realistically constrained probabilistic subsurface data set to match what was known about relatively steep reservoir dip, fault compartmentalization, and unit thickness. An iterative series of simulations provided input about gravity capacity factor, which has a significant impact on the long-term migration of the CO₂ updip. In addition, the size of the compartment that is in hydrologic continuity with respect to pressure relative to the amount of CO₂ injection was explored. Simulations were used to estimate the well spacing and amount of CO₂ injected. Capacity in the sense of how much CO₂ is needed to create a plume thick enough to image with seismic and other monitoring techniques, and long enough to extend between the injection and monitoring well, was determined from this model. The resulting experimental design choices—to use a thicker sand for injection with wells very close together to assure breakthrough—resulted directly from model outcomes.

After the site was selected for development of a field pilot, we characterized the injection reservoir using the well-log and 3D seismic data in a typical reservoir characterization approach. Export of the critical deterministic reservoir properties focused our interest on the significance of intrinsic capacity. On the basis of log-derived porosities and a porosity–residual-saturation relationship derived from the literature, including four values from Frio Formation in the Felix Jackson Well (Figure 1), we anticipate residual-gas saturations for the injected CO₂ of approximately 30%. The accumulated points indicate a logarithmic relationship with a high correlation coefficient of 0.85. Depending on the effective residual water saturation under injection conditions, residual-gas saturations could be as low as 5%, which is considered in modeling as an end-member possibility. The CO₂ plume extent is shown to be very sensitive to both residual water saturation during drainage and residual CO₂ saturation during imbibition. We also experimented with the impact of additional compartmentalization by faulting which appears to increase sequestration capacity by favoring filling of all pore space, at the cost of increased pressure and increased risk of leakage.

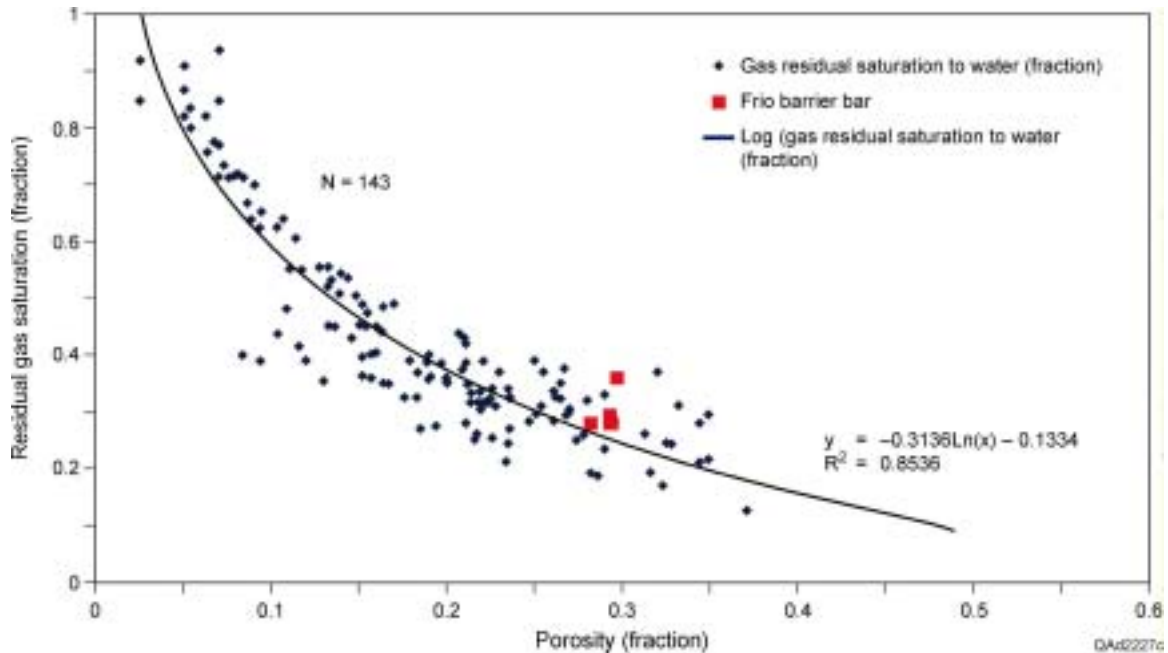

Figure 1. Cross plot of residual gas saturation and porosity for 140 data points collected from the literature and four data points from a Frio sandstone core recovered from the Felix Jackson No 1 Well

Two additional models have been constructed but not yet exported into the simulator. One model is a fully deterministic model of the injection interval, including the interpolated lateral heterogeneities in the reservoir and an improved assessment of leakage across the small faults within the reservoir. Additional data collected when the new injection well is drilled and hydrologically tested are needed for input into this model. The other model is a regional-scale model, in which we attempt to scale up the previous model to a series of structural traps and spill points. This model is created from a detailed structural map and a generalized stratigraphic sequence (Figure 2).

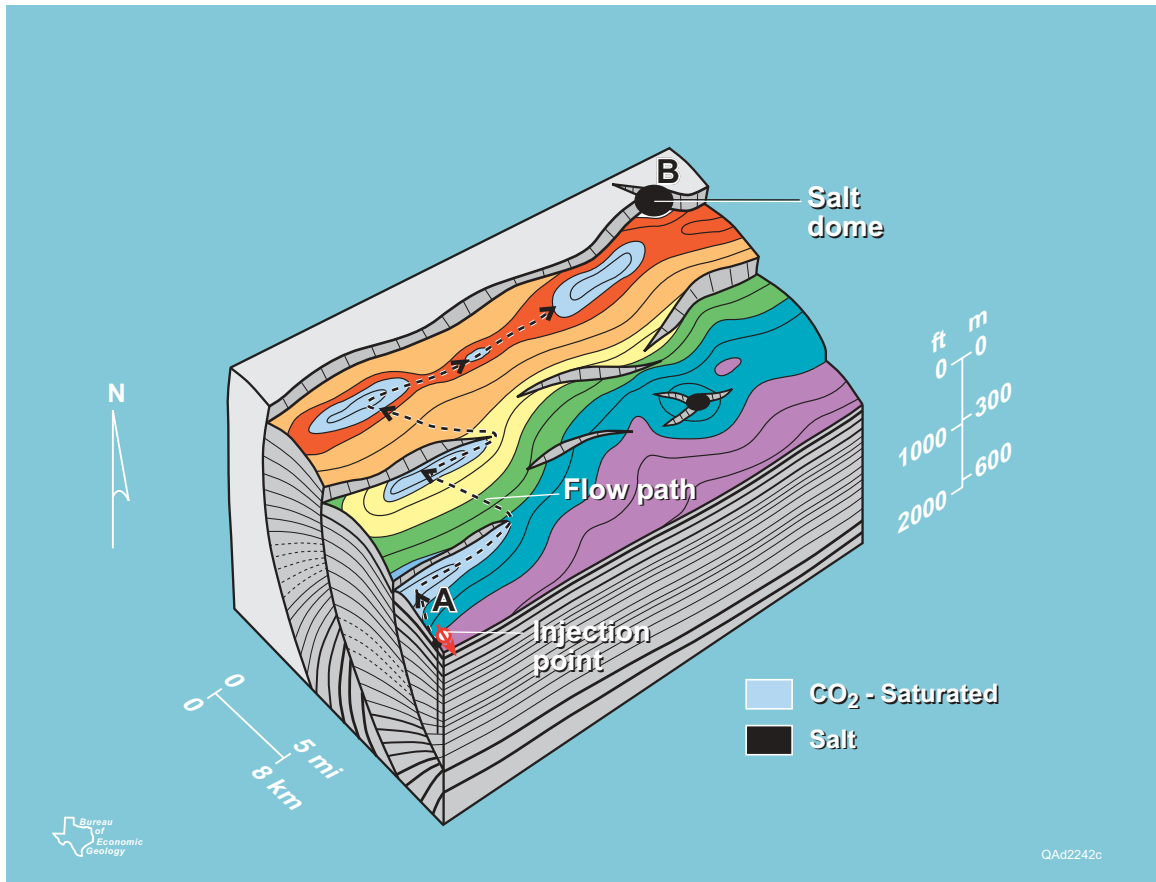

Figure 2. Conceptual model of a flow path through a structurally and stratigraphically complex volume of the subsurface

Implications for Geologic Sequestration:

The conceptualization of the components of capacity are demonstrated to be relevant to real subsurface data and to applied problems. Precise statement of the problem is critical to assess the capacity of a subsurface volume, as well as input of the essential data. However, simplified models are very helpful, because many variables are shown to have relatively minor impact on the performance of the subsurface to store CO₂.

Recommendations for Further Work:

Additional simulations are needed when site data collection is completed, to construct the fully deterministic model and match the model to monitored CO₂ plume behavior. Incorporation of the lessons learned to properly discretize and generalize to a regional scale model is needed to up-scale pilot results and understand the impact of full-scale sequestration at a regional scale.

Related Publications:

- Holtz, M.H., Optimization of CO₂ sequestered as a residual phase in brine-saturated formations. Paper presented at *NETL's Second National Conference on Carbon Sequestration*, Alexandria, Virginia, May 5–8, 2003.
- Holtz, M.H., Pore-scale influences on saline aquifer CO₂ sequestration. Paper presented at the *AAPG Annual Meeting 2003*, Salt Lake City, Utah, May 11–14, 2003.
- Hovorka, S.D., C. Doughty, S.M. Benson, K. Pruess, and P.R. Knox, Assessment of the impact of geological heterogeneity on CO₂ storage in brine formations: A case study from the Texas Gulf Coast. In: *Geological Storage for Emissions Reduction: Technology*, S.J.

- Baines, J. Gale, and R.H. Worden, eds., *Geological Society (London) Special Publication* (in press), 2003.
- Hovorka, S.D., P.R. Knox, and J.A. Raney, What does a permit look like for disposal of carbon dioxide waste plus enhanced recovery of oil and gas? Paper and talk presented to *UIC Conventions at TCEQ Trade Show*, Austin, Texas, May 5, 2003.
- Knox, P.R., C. Doughty, and S.D. Hovorka, Impacts of buoyancy and pressure gradient on field-scale geological sequestration of CO₂ in saline formations. Paper presented at *AAPG Annual Meeting 2003*, Salt Lake City, Utah, May 11–14, 2003, LBNL-51510 Abs.

Frio Brine Pilot Project

CO₂ Injection in the Frio Brine Formation Pilot

Christine Doughty¹ and Susan Hovorka²

¹*Lawrence Berkeley National Laboratory, Berkeley, CA*

²*University of Texas at Austin, Austin, TX*

Objectives:

The objective of the pilot test is to demonstrate that CO₂ can be injected safely and economically into brine formations, that the CO₂ plume can be monitored, and that we understand and can predict the physical and chemical processes accompanying injection.

The objective of the modeling component of the pilot test is to investigate the physical processes controlling the behavior and ultimate fate of CO₂ in the subsurface, to help design the pilot test and to gain a broader understanding of the issues accompanying CO₂ sequestration in brine-bearing formations. A sequence of models was used to design the field experiment to maximize research results and minimize cost and risk. Simplified but realistically constrained subsurface data was input into the model to predict the performance of CO₂ in the subsurface injection interval for various possible experimental designs.

Background:

The site of the brine pilot is the South Liberty Field, located near Houston, Texas. The sequestration target is the upper Frio, a partly marine reworked fluvial-deltaic formation that is regionally extensive beneath the Texas Gulf Coast. The site can be characterized in detail, because wire line logs and a 3D seismic survey are available. At the pilot site on the flank of a salt dome, the upper Frio lies at a depth of 1,500 m and is partially compartmentalized by a complex radial set of faults related to dome pierce (Figure 1). The thick, regionally extensive Anahuac shale provides an upper sealing layer. The Frio is nonproductive of hydrocarbons here, but the Cook Mountain-Yegua formations at a depth of 2400 m are productive. Two idle wells have been made available for the brine pilot, labeled “Injection” and “Monitoring” in Figure 1. Compressed CO₂ from refinery sources will be trucked to the site.

To evaluate CO₂ sequestration scenarios, we use a version of the numerical simulator TOUGH2, which was enhanced to accurately represent supercritical CO₂ and considers all flow and transport processes relevant for a two-phase (liquid-gas), three-component (CO₂, water, dissolved NaCl) system. In the subsurface, supercritical CO₂ forms an immiscible gas-like phase and partially dissolves in the brine. A three-dimensional numerical model is developed of the pilot test site, incorporating vertical property variations as interpreted from local well logs and assigning lateral variability stochastically. As shown in Figure 1, the model is partially closed, with the fault-block bounding faults assumed to form barriers to flow, and the model extending far beyond the wells to the southwest. One small fault within the fault block is also modeled as a barrier to flow. Under the planned sequestration conditions (P = 150 bars, T = 64°C), supercritical CO₂ is strongly buoyant compared to the native brine; hence, the no-flow boundaries should provide a natural trap for the CO₂ plume.

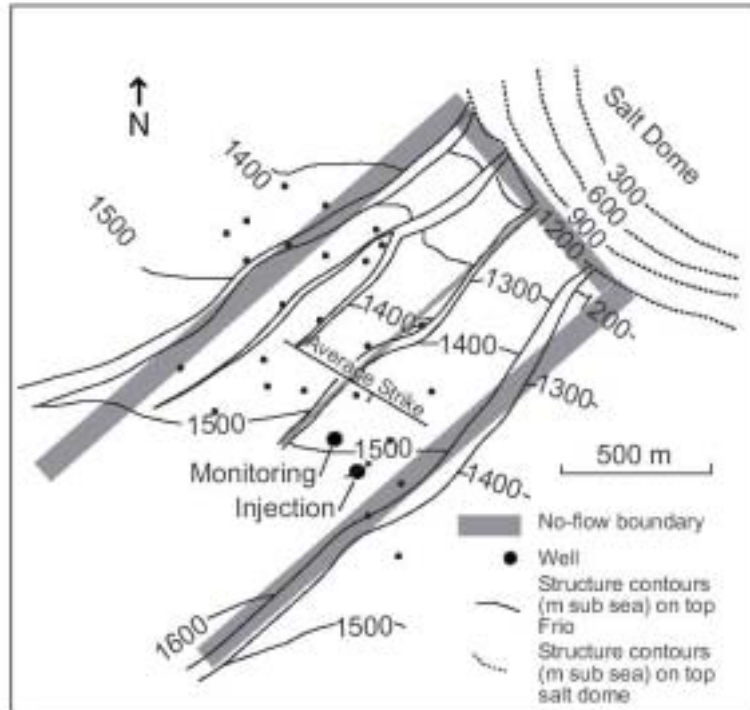

Figure 1. Plan view of South Liberty Field. The new injection well will be located 30 m due south of the monitoring well.

Results:

Two classes of numerical simulations have been conducted: pre-injection site characterization studies involving single-well and multi-well pressure-transient tests; and the injection of CO₂ followed by the evolution of the CO₂ plume under natural conditions. The pre-injection well tests are designed to characterize the flow properties and boundary conditions of the site and provide information on the *in situ* conditions (although nominally brine-saturated, it is plausible that the formation contains a small component of either dissolved or immobile natural gas). This information will influence the ultimate design of the CO₂ injection test.

During the CO₂ injection simulations, we have simulated a number of alternative scenarios, varying three types of model parameters:

- Operational parameters such as injection and monitoring well locations and injection schedule
- Geological features such as the continuity of shale layers, the connectivity of sand channels, and the permeability of faults
- Multiphase flow properties such as relative permeability curves.

The primary conclusion of simulations using the injection and monitoring wells shown in Figure 1 is that the wells are too far apart to make breakthrough of CO₂ at the monitoring well likely, given the limited amount of CO₂ available for injection. Therefore, a new injection well is planned, to be drilled 30 m down-dip (south) of the existing monitoring well.

Simulations assuming that the lateral boundaries of the model are either all open (or all closed) predict a much lower (or much higher) pressure increase accompanying CO₂ injection, but because the injected plume is small relative to the size of the fault block, the lateral boundaries do not affect plume evolution very much.

Simulations show that relative permeability functions have a strong effect on CO₂ plume development. Because most of our knowledge and experience concerning relative permeability for the Frio comes from petroleum reservoirs in which liquid phases displace a pre-existing gas phase, how to choose appropriate relative permeability functions for supercritical CO₂ injection into a brine-saturated formation is still an open question. Snapshots of the simulated CO₂ plume (Figure 2) show the impact of relative permeability. For relative permeability functions with large residual gas saturation S_{gr} , the plume is compact and does not move much under buoyancy forces, because much of the gas is immobile. In contrast, for relative permeability functions with small S_{gr} , the plume is more diffuse. It moves and spreads significantly over time, allowing a much larger fraction of the CO₂ to dissolve in the brine.

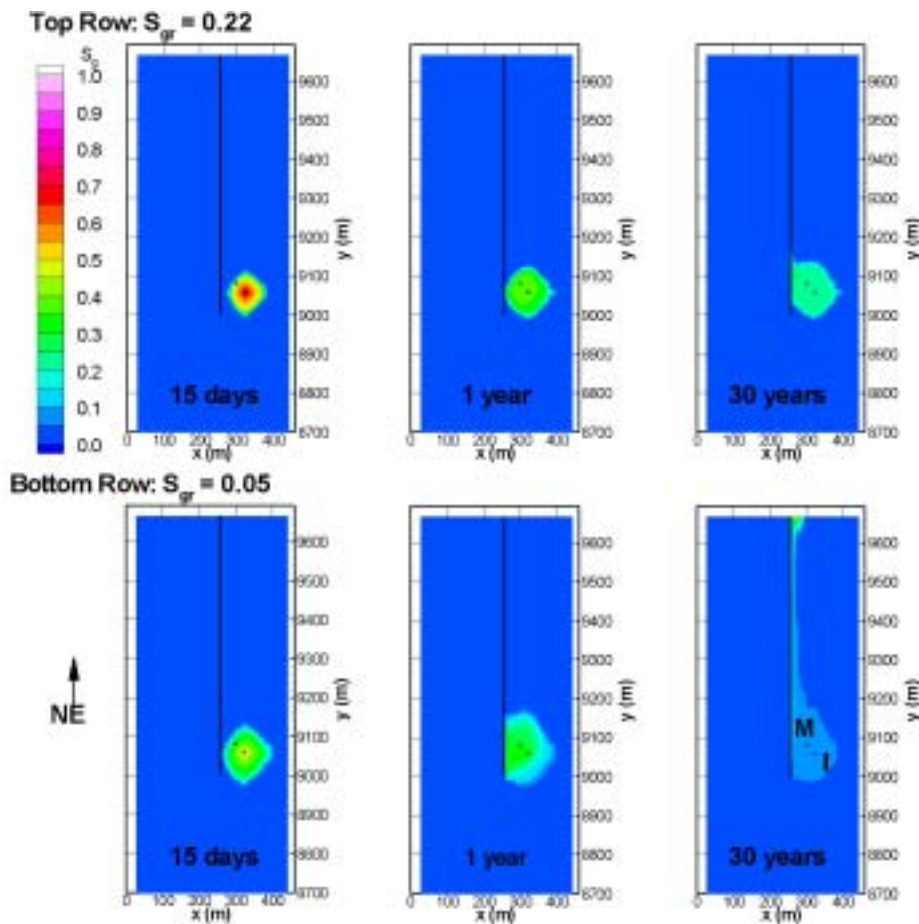

Figure 2. Modeled gas saturation distributions for 15 days of CO₂ injection into the new injection well, for two different values of residual gas saturation S_{gr}

Implications for Geologic Sequestration:

The ability to numerically simulate the complex multiphase flow processes involved in CO₂ injection is critical to developing a good experimental design for the pilot test, just as it will ultimately be for designing successful large-scale sequestration operations.

The residual gas saturation used in the relative permeability functions is a key factor controlling the development of the CO₂ plume. Future laboratory and field work will be directed toward determining appropriate values of S_{gr} for CO₂ injection into brine-bearing formations.

Recommendations for Further Work:

More geologic and hydrologic realism will be incorporated in the model as more data becomes available from drilling the new injection well, from ongoing laboratory studies, from pre-injection well testing, and from the CO₂ injection itself.

Conclusions:

Demonstrating the successful injection of a small CO₂ plume in a brine formation will provide an important step in the development of large-scale geologic sequestration projects by validating the conceptual model and numerical approach. Moreover, modeling results show strong sensitivity to several poorly known properties. We hope to be able to invert pilot-test monitoring data to constrain the models and learn more about broader issues involved in coupled multiphase flow processes associated with CO₂ injection into heterogeneous brine formations.

Related Publications:

- Doughty, C., and K. Pruess, Modeling supercritical CO₂ injection in heterogeneous porous media. Presented at the TOUGH Symposium 2003, Lawrence Berkeley National Lab., Berkeley, Calif., May 12-14, 2003, and submitted to special issue of *Vadose Zone Journal*.
- Doughty, C., K. Pruess, and S.M. Benson, Development of a well-testing program for a CO₂ sequestration pilot in a brine formation. Presented (as an abstract) at the *NETL Second National Conference on Carbon Sequestration*, Alexandria, Virginia, May 5–8, 2003
- Hovorka, S. D., C. Doughty, S.M. Benson, K. Pruess, and P.R. Knox, Assessment of the impact of geological heterogeneity on CO₂ storage in brine formations: A case study from the Texas Gulf Coast. In: *Geological Storage for Emissions Reduction: Technology*, S.J. Baines, J. Gale, and R.H. Worden, eds., *Geological Society (London) Special Publication* (in press), 2003.
- Hovorka, S.D., P.R. Knox, M.H. Holtz, J.S.Yeh, K. Fouad, and S. Sakurai, Tapping the potential for large volume sequestration—Update on the Frio Brine Pilot Project. Presented at the *NETL Second National Conference on Carbon Sequestration*, Alexandria, Virginia, May 5–8, 2003.
- Knox, P.R., C. Doughty, and S.D. Hovorka, Impacts of buoyancy and pressure gradient on field-scale geological sequestration of CO₂ in saline formations. Presented (as an abstract) at the *AAPG Annual Meeting 2003*, Salt Lake City, Utah, May 11–14, 2003

Optimal Monitoring Design for the Frio Pilot Test

Larry Myer¹, Sally Benson¹, David Cole², William Foxall³, Susan Hovorka⁴, G. Mike Hoversten¹, Kevin Knauss³, Ernie Majer¹, Tony Phelps², Karsten Pruess¹, Mark Holtz⁴, Tom Daley¹, Christine Doughty¹, Bill Gunter⁵, Shinichi Sakurai⁴

¹*Lawrence Berkeley National Laboratory, Berkeley, CA*

²*Oakridge National Laboratory, Oakridge, TN*

³*Lawrence Livermore National Laboratory, Livermore, CA*

⁴*University of Texas at Austin, Austin, TX*

⁵*Alberta Research Council, Edmonton, Alberta, Canada*

Objectives:

Design studies were carried out to define field tests and measurements for the monitoring component of the Frio Brine Formation Pilot. The objectives of the monitoring activities are to provide data and information for validation of models used to predict behavior of the CO₂ in the subsurface, and to demonstrate and gain experience in use of techniques for tracking the movement of CO₂ in the subsurface. A multidisciplinary approach is required, including hydrologic, geophysical, and geochemical measurements. Field experience is necessary in order to develop best practices for monitoring of larger-scale geologic sequestration tests, and ultimately, commercial sequestration projects.

Background:

The Frio Brine Formation Pilot involves injection of about 3,000 tons of CO₂ into a 10 m thick brine-saturated sand formation about 1,500 m below surface; a second well is used for observation (see the previous paper in this collection, Doughty and Hovorka's "CO₂ Injection in the Frio Brine Formation Pilot," for more background information). A broad range of candidate monitoring techniques was considered. Selection was based on the need to provide data for validation of predictive models and the need to test a range of techniques for possible measurement, monitoring, and verification (MMV) application. Candidate techniques included:

- Wire-line well logs
- Surface seismic, vertical seismic profiling (VSP), and crosswell seismic
- Electrical geophysical techniques including surface based, such as electrical resistance tomography and self potential, and borehole electromagnetic techniques
- Surface and borehole tilt measurements
- Gravity measurements
- Wellbore pressure measurements
- Wellbore fluid sampling
- Tracer measurements, including noble gases, perfluorocarbons, and isotopes
- Surface soil gas measurements

Modeling was used to help screen techniques and provide a guide to design. The first step was to perform reservoir simulations to give an indication of the change in reservoir pressure, rate of movement and areal extent of the plume, and CO₂ saturation distribution resulting from the planned injection. Additional simulations were then carried out to evaluate potential tracer and hydrologic tests conducted for monitoring purposes. The 3D model used for these simulations was built using available baseline site characterization data, including a 3D seismic survey, well logs and associated petrophysical studies, and other regional hydrologic, geochemical, and geologic studies.

Screening of various geophysical techniques was carried out by using modeling to evaluate the likelihood that a technique would be sensitive to the injected CO₂. The approach was to use the results of the reservoir simulations as input to geophysical models. The reservoir simulations yielded changes in reservoir pressure, areal extent of the CO₂ plume, and changes in saturation. Numerical simulations were then carried out to predict the response of the candidate geophysical technique to the predicted changes in reservoir conditions.

The field application of geophysical techniques is in the time-lapse mode. This involves conducting a baseline survey before CO₂ injection, repeating the same survey at some time after injection and measuring the change in the geophysical response. Since geophysical techniques provide only indirect measurement of many of the parameters of greatest interest (such as fluid pressure, fluid composition, or saturation), there is less ambiguity in interpretation of changes in a geophysical signal than in interpretation of the absolute geophysical measurement.

Results:

- Hydrologic/Geochemical Monitoring Activities

Selected hydrologic and geochemical monitoring activities involve wellbore pressure monitoring, wellbore fluid sampling, pressure transient analysis, and tracer testing. Well completion schematics for the injection and monitoring well are shown in Figure 1. Both completions incorporate a downhole transducer so that pressure and temperature near the sand face can be monitored. Since the hydrostatic level at the site is below the ground surface, a gas lift system is employed in the monitoring well to enable sampling of the wellbore fluids.

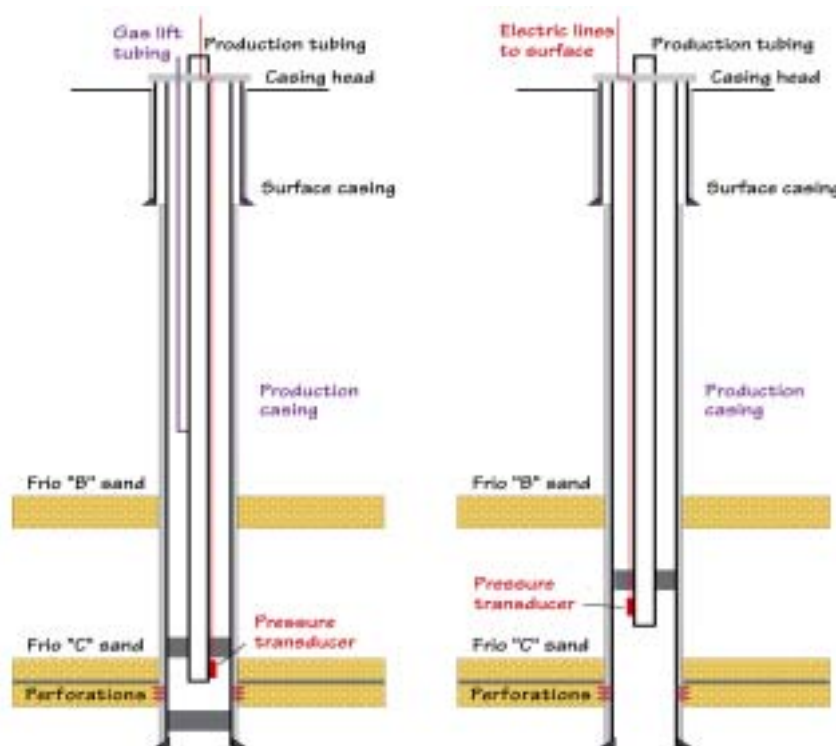

Figure 1. Schematic diagrams of well completions for the monitoring (left) and injection (right) wells.

Fluid sampling is critical for evaluating both the hydrologic and geochemical behavior of the CO₂ plume. Field-testing of fluid samples for CO₂ will be employed as one method of detecting the arrival of the plume at the monitoring well. It also provides information on the phase composition of the produced fluid. These will be compared with predictions of the reservoir simulations. Samples will also be analyzed for major element chemistry and tracers.

Tracers have the potential for providing detailed information on the behavior of injected CO₂. Figure 2 shows results of a reservoir simulation in which argon is injected along with CO₂. The leading edge of the plume shows a high concentration of gas-phase argon relative to gas phase CO₂ because the CO₂ preferentially dissolved in the water. Analysis of noble gas tracer tests will provide information on the average water saturation in the region swept by the CO₂ plume.

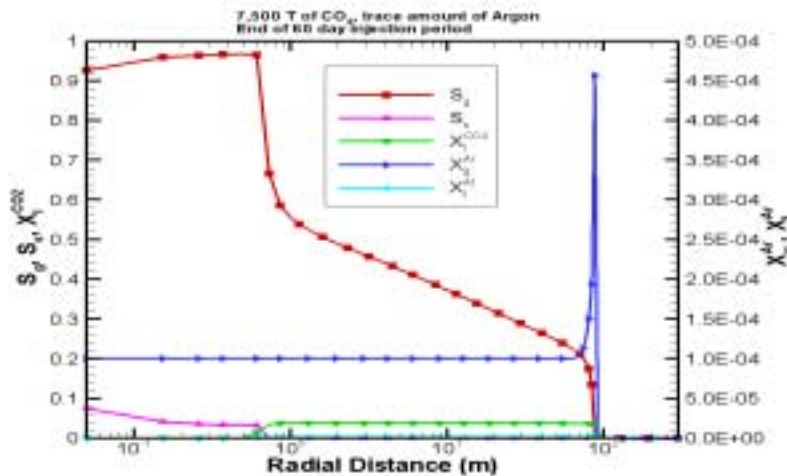

Figure 2. Numerical simulation of profile of saturation and mass fractions of components for injection of argon with CO₂.

Injection of CO₂ will be paused once during the field test. The pressure transients after injection stops and after it begins again will be analyzed, to provide information on the two-phase flow conditions and plume shape as a function of time, as the plume passes through the monitoring well.

- Geophysical Monitoring Activities

A suite of wire-line logs, including porosity, density, lithology, and velocities, provide rock-property data to compare with values used in predictive simulations. Measurements repeated after conclusion of injection will provide information on changes in the near-wellbore region. A neutron probe will be suspended in the monitoring well during the CO₂ injection to provide additional data on arrival of the plume, and subsequent changes in saturation in the rock as the plume passes the monitoring well. Time-lapse crosswell seismic and VSP were selected for monitoring the interwell region. Figures 3 and 4 give results of numerical simulations of VSP and crosswell tests showing the difference in response when CO₂ saturation changes from zero to 100%. The VSP provides additional information to validate interpretation of the surface seismic and is the only technique being tested for mapping the areal extent of the plume. Low-resolution but inexpensive streaming potential will be tested for the first time as a technique for sensing the advancing CO₂ front. Other candidate geophysical techniques were rejected because they would

not be sufficiently sensitive to the injected volume of CO₂ to warrant the expense of attempting the measurement.

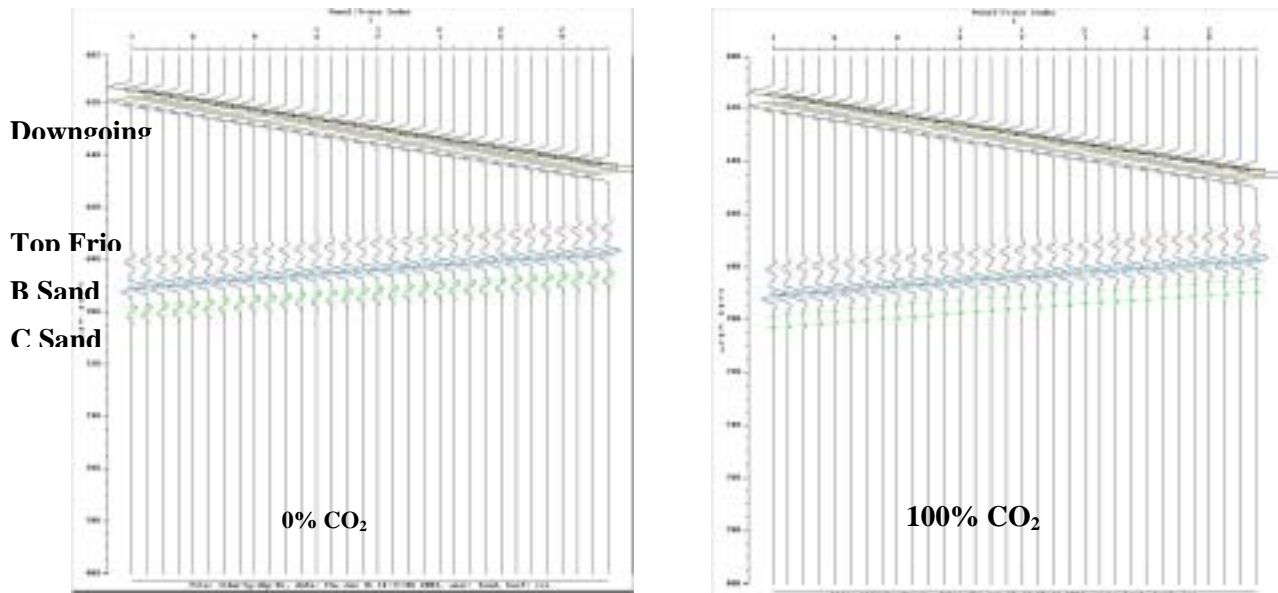

Figure 3. Numerical simulation of VSP results for a model based on geology at the Frio Pilot.

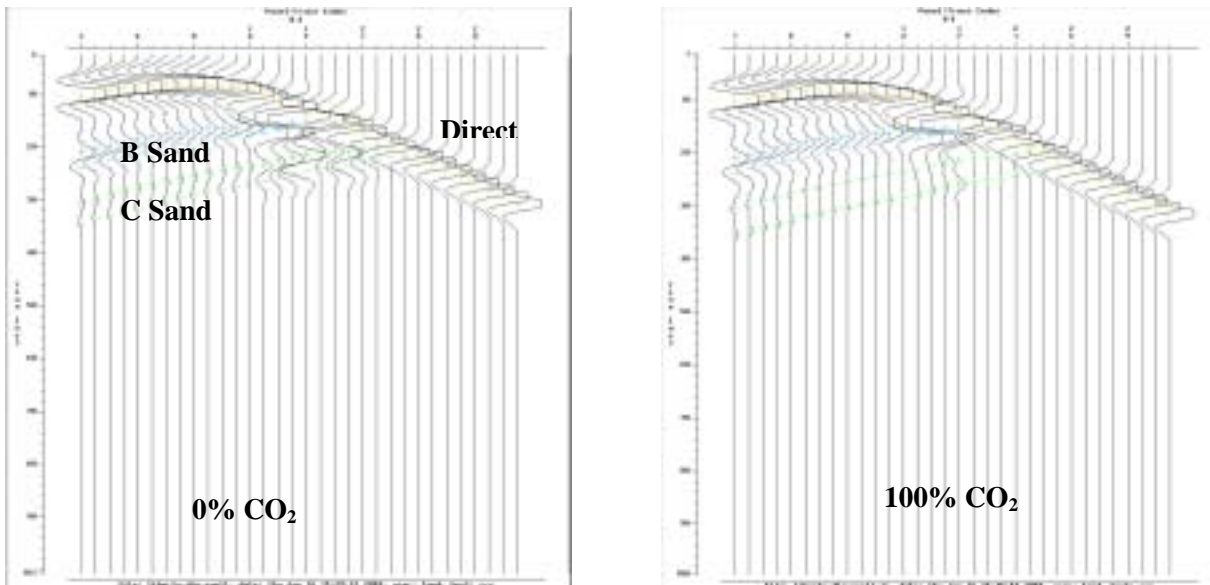

Figure 4. Numerical simulation of Crosswell results for the Frio Pilot model

- Surface CO₂ Monitoring

It is important to monitor potential CO₂ leakage and seepage to insure that injected CO₂ has not leaked along unrecognized fast-flow paths (e.g., a permeable fault) to the shallow subsurface. Although the presence of such flow paths is highly unlikely, it is important to demonstrate that

no seepage is occurring at the site, and to understand the local ecology and its effects on natural CO₂ fluxes and concentration. This activity will be carried out in collaboration with National Energy Technology Laboratory's SEQUIRE surface monitoring efforts. Isotopic composition of CO₂ under stable nighttime conditions will be used to estimate any fossil CO₂ seepage contribution.

Implications for Geologic Sequestration:

MMV will be an essential element of geologic sequestration projects and it is critical to evaluate how well various techniques work for monitoring the movement of CO₂ in the subsurface. The Frio pilot test provides the first opportunity in the U.S. to test MMV techniques for application to CO₂ sequestration in brine formations.

Monitoring at the Frio is also being carried out to validate predictive models. While this is not expected to be a goal of MMV in commercial sequestration projects, at the current early stages of technology development, validation of predictive models provides confidence that they can be reliably used in the future for design of sequestration projects.

Recommendations for Future Work:

Field-scale testing is absolutely essential for validation of MMV techniques and approaches. The selection of MMV techniques is site-specific, because of the large number of factors affecting performance and the variability in conditions between sites. More field tests are therefore needed to evaluate the response of techniques under a range of conditions that could be encountered in sequestration projects. This is particularly important for brine formation sequestration, because of our lack of experience in this area.

Conclusions:

Design studies resulted in the selection of hydrologic, geochemical, and geophysical activities for the monitoring component of the Frio brine formation pilot. Hydrologic activities include pre-injection interference and tracer testing, and pressure transient testing during CO₂ injection. Geochemical activities include wellbore fluid sampling, and noble gas, isotopic and perfluorocarbon tracer measurements. Tracers will be monitored on the surface as well as in the subsurface. Geophysical activities include wire line logs, crosswell and VSP seismic, conducted in a time-lapse mode. These activities will provide data and information for validation of models used to predict behavior of the CO₂ in the subsurface, and to demonstrate and gain experience in use of techniques for tracking the subsurface movement of CO₂.

Related Publication:

Myer, Larry; Hovorka, Susan; Hoversten, Mike; Fouad, Khaled; and Holtz, Mark. Geophysical Characterization and Monitoring for the Frio Pilot Test. *AGU Fall Meeting*. San Francisco, CA. December 8-12, 2003. LBNL-53637 Abs.