

Lawrence Berkeley National Laboratory

Recent Work

Title

REIATIVISTIC HEAVY ION FACILITIESuWORLDWIDE

Permalink

<https://escholarship.org/uc/item/39j2v9nj>

Author

Schroeder, L.S.

Publication Date

1986-05-01

c.2



Lawrence Berkeley Laboratory

UNIVERSITY OF CALIFORNIA

RECEIVED
LAWRENCE
BERKELEY LABORATORY

JUL 16 1986

LIBRARY AND
DOCUMENTS SECTION

Presented at the 2nd Conference on the
Intersections Between Particle and Nuclear Physics,
Lake Louise, Alberta, Canada, May 25-31, 1986

RELATIVISTIC HEAVY ION FACILITIES--WORLDWIDE

L.S. Schroeder

May 1986

TWO-WEEK LOAN COPY
*This is a Library Circulating Copy
which may be borrowed for two weeks.*

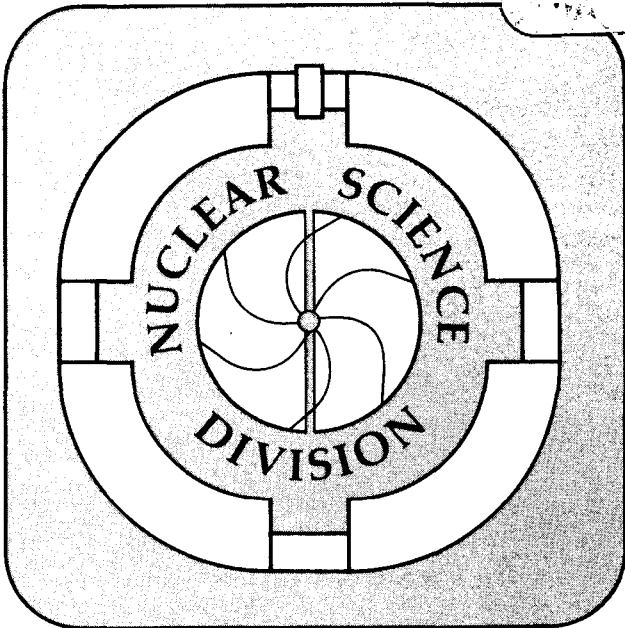

LBL-21673

c.2

DISCLAIMER

This document was prepared as an account of work sponsored by the United States Government. While this document is believed to contain correct information, neither the United States Government nor any agency thereof, nor the Regents of the University of California, nor any of their employees, makes any warranty, express or implied, or assumes any legal responsibility for the accuracy, completeness, or usefulness of any information, apparatus, product, or process disclosed, or represents that its use would not infringe privately owned rights. Reference herein to any specific commercial product, process, or service by its trade name, trademark, manufacturer, or otherwise, does not necessarily constitute or imply its endorsement, recommendation, or favoring by the United States Government or any agency thereof, or the Regents of the University of California. The views and opinions of authors expressed herein do not necessarily state or reflect those of the United States Government or any agency thereof or the Regents of the University of California.

LBL-21673

RELATIVISTIC HEAVY ION FACILITIES--WORLDWIDE

L.S. Schroeder

Nuclear Science Division
Lawrence Berkeley Laboratory
University of California
Berkeley, California 94720

This work was supported by the Director, Office of Energy Research,
Division of Nuclear Physics of the Office of High Energy and
Nuclear Physics of the U.S. Department of Energy under Contract
DE-AC03-76SF00098.

RELATIVISTIC HEAVY ION FACILITIES--WORLDWIDE*

L.S. Schroeder

Nuclear Science Division, Lawrence Berkeley Laboratory
University of California, Berkeley, California 94720

ABSTRACT

A review of relativistic heavy ion facilities which exist, are in a construction phase, or are on the drawing boards as proposals, is presented. These facilities span the energy range from fixed target machines in the 1-2 GeV/nucleon regime, up to heavy ion colliders of 100 GeV/nucleon on 100 GeV/nucleon. In addition to specifying the general features of such machines, I will also outline the central physics themes to be carried out at these facilities, along with a sampling of the detectors which will be used to extract the physics.

INTRODUCTION

The aim of this talk is to provide you with an updated review (May 1986) of relativistic heavy ion facilities throughout the world. As my working definition, "relativistic" will refer to those machines capable of providing beams of heavy ions at kinetic energies ≥ 1 GeV/nucleon. Furthermore, I will include those facilities which are either in the real (operating or under construction) or virtual (proposal) state. Seven facilities survive this classification scheme and are shown on the world map in Fig. 1. They are:

- 1) operating--Bevalac, Dubna, Saturne II, AGS¹ and SPS²
(these latter two are set to operate in late 1986)
- 2) construction phase--SIS 18 at GSI Darmstadt³
- 3) proposal stage--Bevalac Upgrade,⁴ Holifield Upgrade,⁵
Saturne II + MIMAS,⁶ Nuclotron⁷ and RHIC.⁸

It is interesting to note that four of the seven either are or were in a previous life involved only in particle physics research. A fifth, namely RHIC, has the potential of rising out of the ashes of the CBA high energy physics project.

In this talk I will also briefly cover the physics issues that are being or will be addressed at these facilities. Being an experimentalist, I think of a facility as being composed not only of the accelerator but also of the detectors that are used to isolate the interesting physics. So I want to provide you with some idea of the devices that are already operating or will be called upon at future machines. Finally I will end with a time

*This work was supported by the Director, Office of Energy Research, Division of Nuclear Physics of the Office of High Energy and Nuclear Physics of the U.S. Department of Energy under Contract DE-AC03-76SF00098.

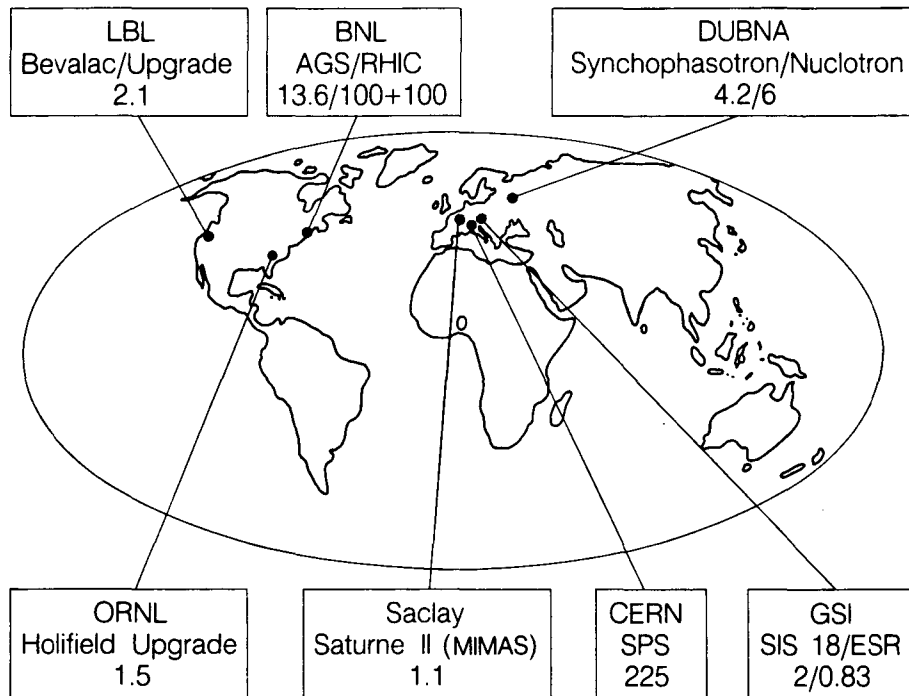

Fig. 1. World map showing location of the relativistic heavy ion facilities. The maximum kinetic energy for each is indicated.

table indicating the fondest dreams of proposers as to when we might expect the new accelerator complexes to be ready for action, and some personal observations.

PHYSICS GOALS

The upper portion of Fig. 2 shows the now familiar phase diagram of nuclear matter (T vs. ρ/ρ_0), which can be probed in heavy ion collisions. However, there are other degrees of freedom which can also be studied in such collisions. As an example, one can cite the isospin (I) degree of freedom, where one studies the limits of proton and neutron number in nuclei. This area is indicated by the chart of the nuclides in the lower portion of Fig. 2. In terms of physics to be studied with the relativistic heavy ion facilities under discussion here, a convenient division into two parts is possible:

- 1) intermediate energy machines ($E < 10$ GeV/nucleon)--used to probe nuclear matter under extreme conditions (T, ρ, I, J, S)
- 2) high energy (quark-matter) machines ($E > 10$ GeV/nucleon)--used to achieve high energy density and thereby produce and study the quark-gluon plasma (QGP).^{9,10}

A. Physics with Intermediate Energy Machines

The general program to be carried out at these machines (Bevalac/Upgrade, Holifield Upgrade, Saturne II + MIMAS, SIS 18 and Synchrophasotron/Nuclotron) includes:

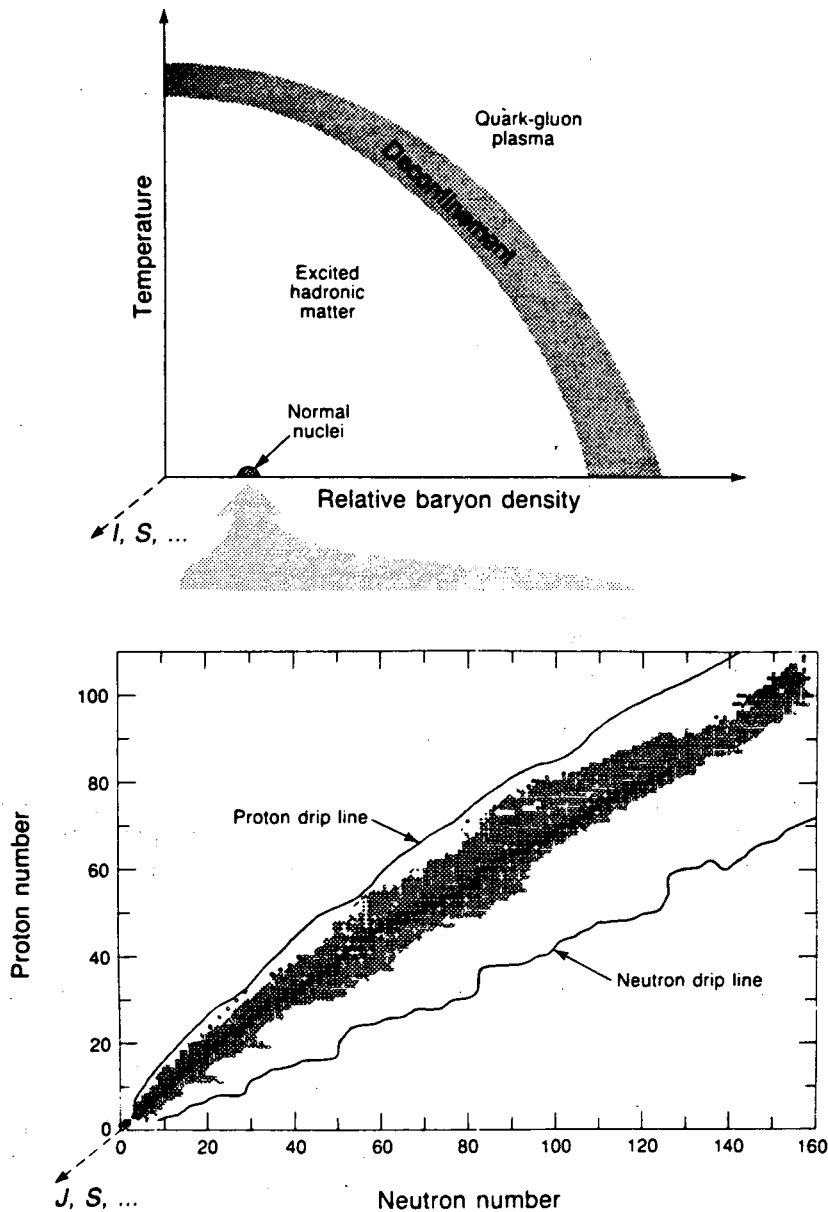

Fig. 2. The phase diagram of nuclear matter and the chart of the nuclides.

- 1) extension of existing studies--à la the present Bevalac program
- 2) new opportunities provided by much higher beams currents (typical increases of 10^2 - 10^3)
- 3) exploiting new techniques such as cooler-storage rings for studying a wide range of phenomena.

It should be noted that by using modern strong focusing synchrotrons, experiments will be greatly enhanced through improved beam quality, duty factor and allow for more flexible machine operation. More specifically, the essential elements of a physics program will include:

- 1) nuclear matter equation of state via measurements of
 - π , K, e^+e^- probes (excitation functions)
 - collective flow
 - composite yields (sensitive to entropy in system)
- 2) liquid-gas phase
- 3) expanding domain of nuclei
 - exotic nuclei
 - radioactive beams
- 4) nuclear dynamics
 - cooperative effects (subthreshold π, K)
 - 1-2 body forces
 - transfer reactions
- 5) nuclear structure
 - decay modes
 - giant resonances
- 6) nuclear astrophysics
- 7) other areas
 - atomic physics
 - biomed applications
 - technology applications

It is clear that a rich and varied program of nuclear physics is accessible with such facilities.

B. Physics with High Energy Machines

The general thrust of these facilities (AGS, SPS, RHIC) will be the exploration of high energy and baryon density in central nucleus-nucleus collisions. This program will include:

- 1) quark-gluon plasma (QGP)--present calculations¹⁰ indicate that energy densities of $\sim 1-2 \text{ GeV}/\text{fm}^3$ are sufficient to produce the QGP
- 2) pushing the equation of state of nuclear/hadronic matter to higher T, ρ
- 3) studying the properties of highly excited hadronic matter (as a necessary by-product of isolating the QGP).

As pointed out in T. Ludlam's talk,¹⁰ at high energies in nucleus-nucleus collisions there are two areas of interest. Somewhere in the range of 1-10 GeV/nucleon in the c.m. frame one expects to achieve maximum baryon density or "nuclear stopping." At energies above 30 GeV/nucleon in each beam, "transparency" sets in and two separate regions can be identified--the fragmentation regions carrying the net baryon number of the colliding systems and a central region mostly occupied by mesons. These two scenarios are sketched in Fig. 3.

Signatures for the formation of quark matter are actively debated. Standard arguments include:¹⁰⁻¹⁶

- 1) studying $\langle p_T \rangle$ as a function of energy density ($\propto dN/dy$)--a first order transition could lead to a flat $\langle p_T \rangle$ curve (analogous to the ice \rightarrow H₂O transition)
- 2) large fluctuations in quantities like dE_T/dy signaling explosions or deflagrations from the QGP
- 3) enhanced yields of strange particles (particularly antihyperons) due to $gg \rightarrow s\bar{s}$ processes in the QGP

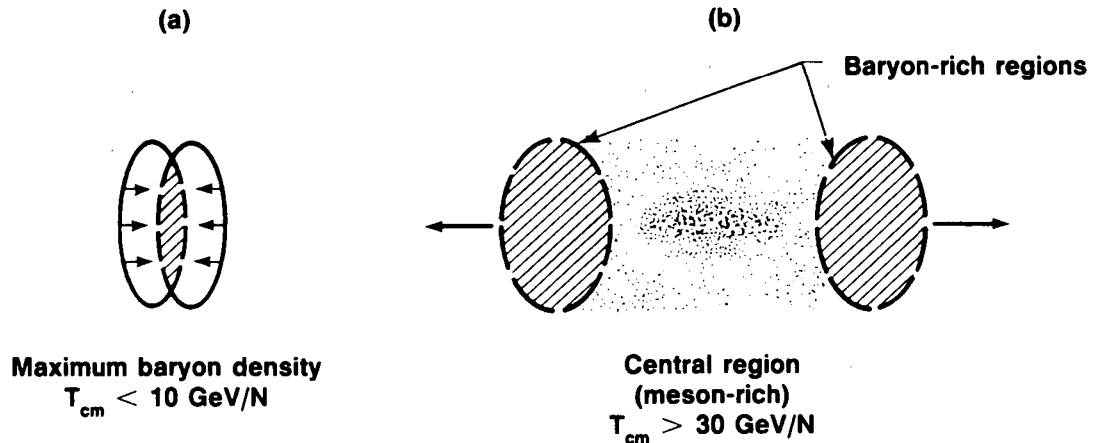

Fig. 3. Characterization of the central collision of high energy nuclei showing a) "nuclear stopping" and b) "transparency" regimes.

- 4) directly studying the plasma phase with weakly interacting probes (γ , e^+e^- , $\mu^+\mu^-$)--these can carry information from the hot, compressed stage of the collision.

To date, no single signature for the QGP has emerged as the prime candidate. In all cases, one must be concerned with the yield of particles from the hadronization phase also, as each experiment will measure contributions from both (hadronic + plasma) phases. In general, this means that each experiment will have to be capable of measuring several observables within a given event and studying their correlations. Thus, some form of global analysis will be required. In addition, experiments will need to study collisions as a function of energy (adjusting energy density) and mass (for light systems only expect production from excited hadronic gas) of the colliding partners. These considerations have profound effects on detector systems.

THE FACILITIES (MACHINES, DETECTORS)

In this section I want to outline the basic parameters of each facility and point out their unique features. In addition, some discussion of detector requirements for nuclear physics experiments will be included. As earlier, I divide this section into two parts--one dealing with intermediate energies, the other higher energies.

A. Intermediate Energy Facilities

Five facilities come under this category: Bevalac/Upgrade, Holifield Upgrade, Saturne II + MIMAS, SIS 18 and the Synchro-phasotron/Nuclotron. Figs. 4-8 show a plan view of each. Table I

Table I MACHINE PARAMETERS

Site	Facility	KE (GeV/N)		Estimated intensity*			
		Ne	U(chg.st.)	Ne/sec	Ne/cycle	U/sec	U/cycle
LBL	Bevalac	2.1	0.96(68 ⁺)	$\sim 10^9$	---	$\sim 3 \times 10^5$	---
	Upgrade	1.92	0.86(68 ⁺)	$\sim 10^{11}$	---	$\sim 4 \times 10^8$	---
ORNL	Holifield Upgrade	1.5	0.45(54 ⁺)	---	$\sim 8 \times 10^{10}$	---	$\sim 2 \times 10^{10}$
Saclay	Saturne II + MIMAS	1.18	0.58(?)	---	$\sim 5 \times 10^{10}$	---	$\sim 2 \times 10^7$
GSI	SIS 18	2.0	1.0(78 ⁺)	$\sim 2 \times 10^{10}$	---	$\sim 4 \times 10^{10}$	---
	ECR	0.83	0.57(92 ⁺)	(see Ref. 3)			
Dubna	Synchro.	4.1	---	---	$\sim 10^5$	---	---
	Nuclotron	6.0	3.5(82 ⁺)	---	$\sim 10^{10}$	---	$\sim 10^9$

*Intensities are quoted either as particles/sec or particles/cycle. For definition of individual machine cycles see Refs. 5, 6 and 7.

lists a typical beam energy for two nuclei (Ne and U) and the corresponding intensities that are expected. One needs to bear in mind that Table I is not meant as a critical evaluator of the overall performance features of these facilities--but rather as a rough comparator of two specific parameters. The reader is strongly urged to consult Refs. 3-7 for more detailed information.

I now briefly describe each of these facilities--starting in the west and moving east.

- 1) Bevalac/Upgrade (Fig. 4): The Bevalac at LBL is at present the only relativistic heavy ion machine capable of accelerating the complete periodic table (p to U) for nuclear physics research. It came on-line in 1974 with beams of $A \leq 56$. In 1982, after installation of the new vacuum liner (providing pressures $\sim \text{few} \times 10^{-10}$ torr), the heavier beams up to uranium became available. Significant studies of compressed nuclear matter have resulted from the uranium upgrade. However, the Bevatron is a weak focusing synchrotron and must be replaced if higher currents of the heavier ions ($A > 100$), as needed by the physics, are to be achieved. In addition, the Bevatron cannot function as an adequate injector for other devices, such as a storage ring. With this in mind, LBL is looking at the possibility of replacing the Bevatron, with a modern strong-focusing synchrotron injected by the existing SuperHILAC. This

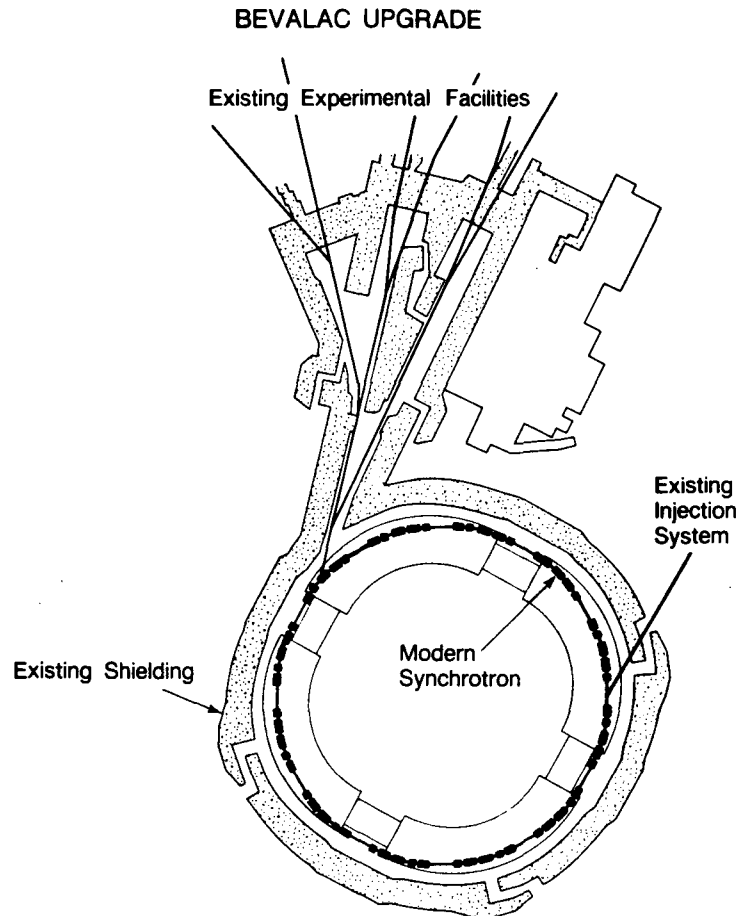

Fig. 4. View of Bevalac Upgrade showing replacement synchrotron and existing experimental hall.

machine would have $(B\rho)_{\max} = 18 \text{ Tm}$. Existing shielding and experimental halls would be used to keep costs down. A future addition of a storage ring with the potential of cooling is being studied. Such a device would be useful for a variety of experiments with radioactive beams, both in and out of the ring, stretcher device for large 4π detector experiments, stripping and re-injection into the main ring to provide higher energies, atomic physics, etc.

- 2) Holifield Upgrade (Fig. 5): The ORNL group has proposed a major upgrade to their existing Tandem facility. This involves a veritable 3-ring circus, including: a 4 Tm accumulator/booster, a 15 Tm main ring and a 10 Tm storage/cooler ring to provide duty factor, resolution ($\Delta p/p \sim 10^{-4}$) and brightness. The full range of projectiles would be available for studies at both high and low energies at high intensities. The facility would use the 25 MV Tandem as its injector, with construction of the synchrotron facility and experimental hall taking place on a "green site" next to the Tandem building. A broad physics program is envisioned.

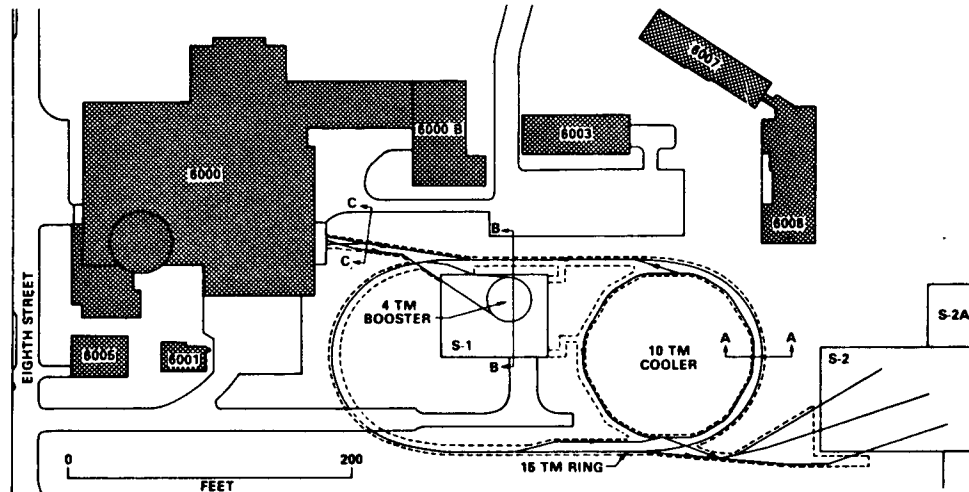

Fig. 5. Site plan for the Holifield synchrotron facility. Existing buildings denoted by cross hatching.

- 3) Saturne II + MIMAS (Fig. 6): The Saturne II facility will be upgraded (by 1987) with the addition of a strong focusing booster synchrotron ring (MIMAS) and a new heavy ion source (Dione). MIMAS will replace the present LINAC. This combination will allow the acceleration of heavier ions and increase intensities of polarized protons and deuterons for nuclear physics research. The heavy ions will be extracted into the existing experimental halls for research in a wide variety of existing detectors.
- 4) SIS 18 + ESR (Fig. 7): GSI has embarked on a major new project (this one is funded!) to produce a modern synchrotron facility injected by their existing UNILAC heavy ion linac. In addition to the main 18 Tm synchrotron ring, they are planning to include an experimental 10 Tm storage ring (ESR) which will incorporate both electron and stochastic cooling--a true state-of-the-art device. They envision a major physics program with the ESR. The thrust of the program with SIS 18 will be to provide beams up to ^{238}U beams at 1-2 GeV/nucleon at high intensity. These beams will be delivered to a new experimental hall (generally using slow extraction) or to the ESR (fast extraction). In the ESR facilities for storing and cooling completely ionized stable and radioactive (produced via projectile fragmentation) beams will be available. The ESR will also have internal target facilities for studies with the cooled circulating beams. They also plan a mode of operation of the ESR in which two beams of completely stripped uranium with different energies can be made to merge in order to study effects of large coulomb fields as discussed at this conference.¹⁷ This facility is expected to turn on for physics research in 1989 and will represent a major new tool for the heavy ion community to exploit.

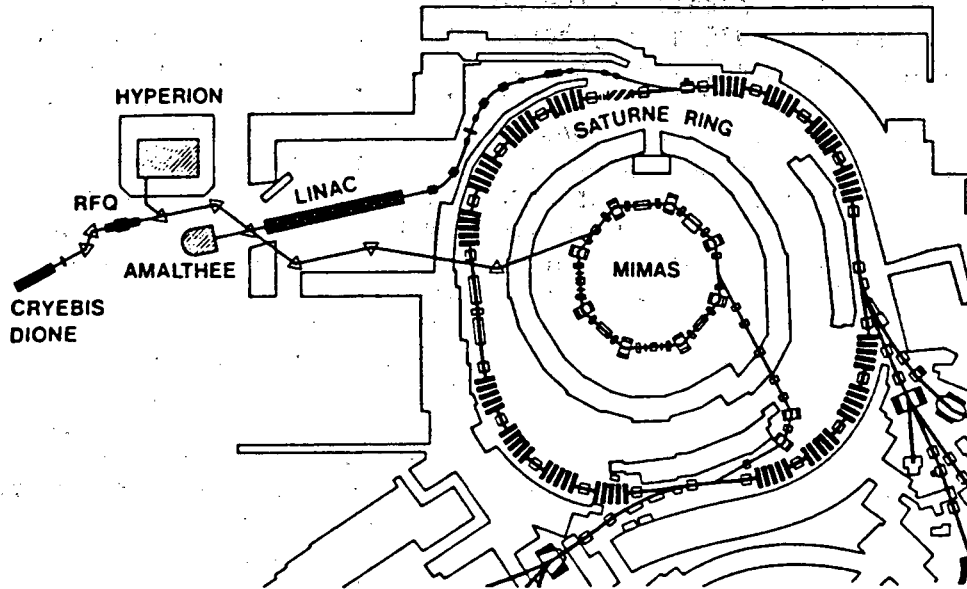

Fig. 6. MIMAS inside the main Saturne II ring together with three ion sources (Hyperion, Cryebis, Dione) and the RFQ pre-injector.

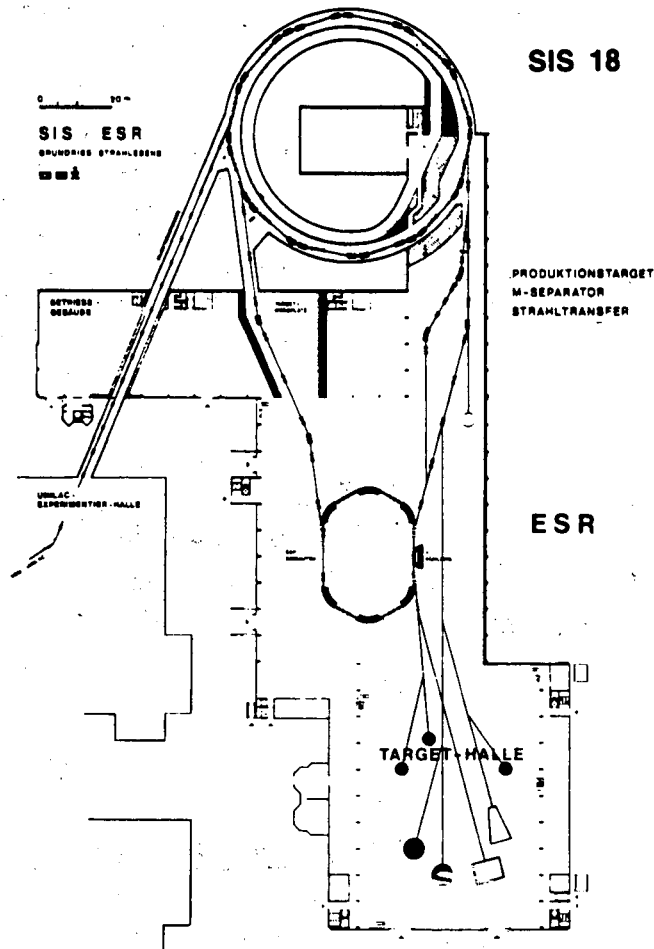

Fig. 7. Plan view of SIS 18 and the experimental storage ring (ESR).

- 5) Synchrophasotron/Nuclotron (Fig. 8): The Synchrophasotron at Dubna is the largest of the weak focusing synchrotrons. Since the early 1970's they have been engaged in a program of research at 3-4 GeV/nucleon with relatively weak beams of light ions ($A < 30$). They have been studying the possibility of placing a new strong focusing synchrotron (Nuclotron) in the tunnel below the Synchrophasotron. The Nuclotron would employ a superconducting design based around a superferric magnet. When coupled with a new ion source they expect to achieve energies up to about 6 GeV/nucleon for $q/m = 1/2$ ions and much higher intensities than presently available. Beams up to uranium would be available for research in the existing experimental halls.

The new facilities being discussed will place heavy demands on detectors, particularly those involving full event measurements. As we already know from Bevalac experience a single streamer chamber photograph will show ~100-200 charged particles being emitted in central collisions of large nuclei at 1-2 GeV/nucleon. For electronic experiments covering a large solid angle this implies the need for a high degree of segmentation to avoid multiple hits and allow full event analysis. An example of such a detector is the GSI/LBL Plastic Ball/Wall shown in Fig. 9. This device contains over 650 elements in the Ball and over 150 elements in the Wall and provides almost 4π coverage. Figure 10 shows the result of a multiplicity measurement with it. Tracking devices such as TPC's and streamer chambers with CCD read-outs are actively being pursued to study interactions at these energies. Of course, not all experiments will involve $\sim 4\pi$ measurements. Magnetic spectrometers with limited apertures will be required to study a variety of phenomena (e.g., excitation functions for subthreshold production, production and delivery of radioactive beams, etc.). A large arsenal of detectors will be needed to exploit the full potential of these facilities.

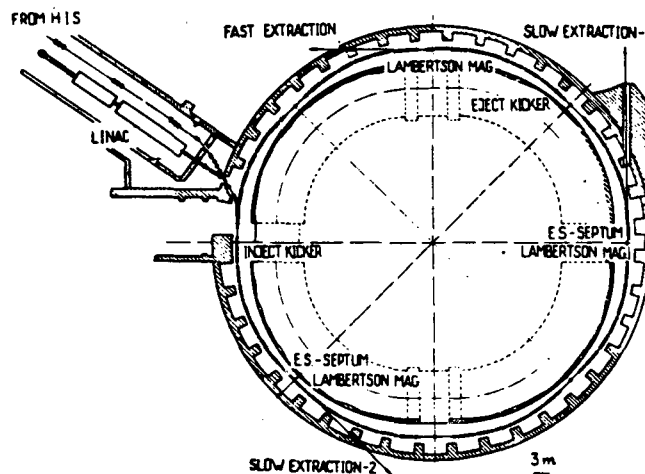

Fig. 8. General layout of Nuclotron at Dubna.

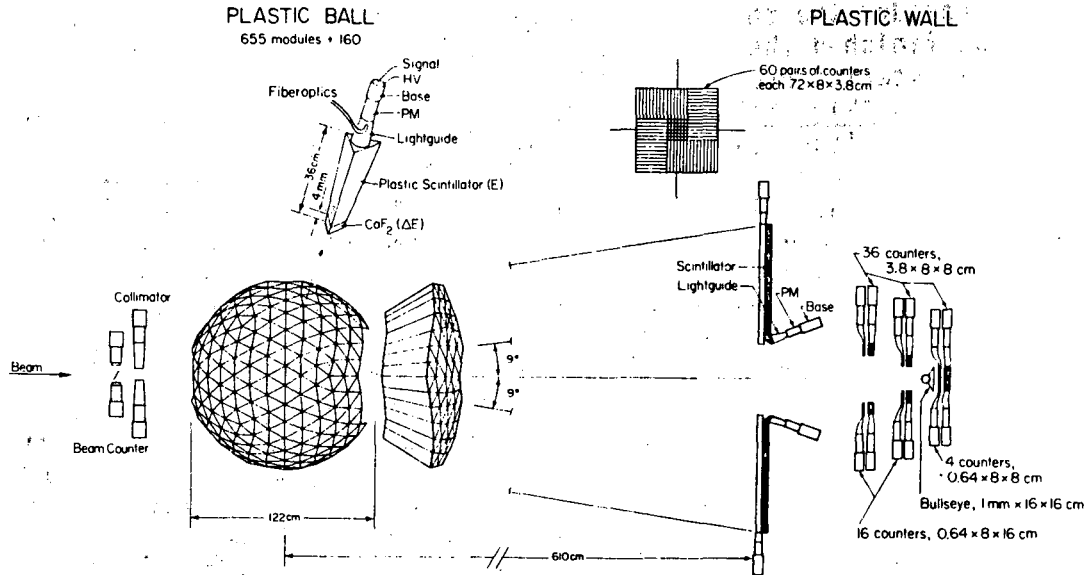

Fig. 9. The GSI/LBL Plastic Ball detector.

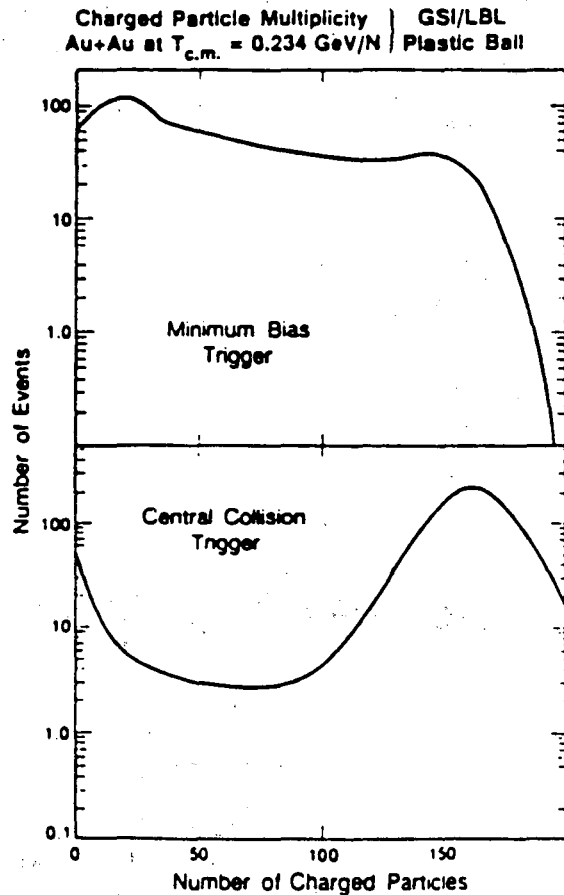

Fig. 10. Charged particle multiplicity distribution for Au + Au collisions studied by GSI/LBL Plastic Ball collaboration at the Bevalac.

B. High Energy Facilities

We next consider the three high energy facilities (AGS/RHIC, SPS). Since we finished the last section on the European side of the Atlantic, we start there and move west.

- 1) SPS at CERN (Fig. 11): In 1980 a proposal was submitted by a GSI/LBL collaboration to accelerate light ions (^{16}O) in the CERN PS for delivery to two experiments--involving the Plastic Ball and a Streamer Chamber. Since that time the program has expanded and now involves a large experimental effort (involving ~300 nuclear and particle physicists) to conduct several major experiments at the CERN SPS.² The initial round of experiments will be carried out in Nov.-Dec. 1986, with a follow-up run in Sept.-Oct. 1987 (with possibly improved ECR source giving ions up to Ca).

To provide light ions to the SPS, a new ECR source built by Geller has been coupled to an RFQ (built by GSI/LBL) and used to inject LINAC 1 at the PS.¹⁸ These components are now in place. ^{16}O ions will be accelerated in the PS, transferred and accelerated in the SPS, where they will be extracted for high energy heavy ion physics experiments at 60-225 GeV/nucleon in both the North and West areas. As indicated earlier, the central theme will be the exploration of high energy and baryon density and the possible production of the QGP. In terms of the diagrams in Fig. 3 one can characterize the SPS (and AGS) program as probing the "nuclear stopping" regime. Table II lists the present makeup of the CERN program.

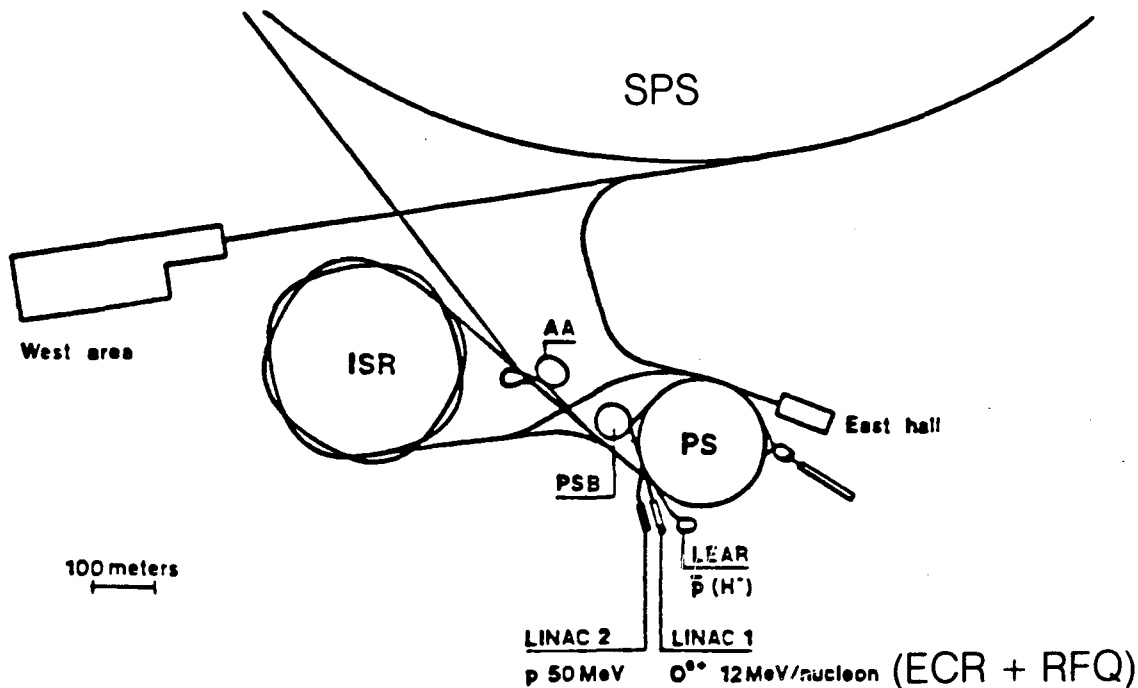

Fig. 11. Layout of the CERN accelerator complex (PS → SPS → heavy ion experiments in West and North (not shown) areas).

Table II SUMMARY OF CERN (SPS) HEAVY ION EXPERIMENTS

Experiment	Main detectors	Partial list of observables
NA34 (HELIOS)	$\sim 4\pi$ calorimetry, tracking, dimuon spectrometer	1,2 particle inclusive, E_T , direct γ , e^+e^- , $\mu^+\mu^-$
NA35 (Str. Ch.)	2m streamer chamber, calorimeters, π^0 detector (PPD)	Λ , $\bar{\Lambda}$, K , $\langle n_{\pi^-} \rangle$, $dN/d\eta$
NA36 (TPC)	TPC, forward calorimeters, multiplicity	strange-antistrange baryons (Λ, \dots, Ω)
NA38 (Quark Search)	Hg (to be analyzed in levitometer)	fractional charge
NA39 (Dimuons)	NA10 dimuon spectrometer, neutral calorimetry	$\mu^+\mu^-$, $\frac{dE_T^0}{dy}$
WA80 (Plastic Ball)	Plastic Ball, forward calorimeters, π^0/γ detector	$\langle M \rangle$, $dN/d\eta$, neutral and charged energy flow, π^0 , direct γ
EMU 1,2,3	Emulsions, plastics	$dN/d\eta$, survey various distributions

At these energies the detectors not only have to respond to much higher fluxes of particles (expect individual events to contain ~ 100 - 1000 particles) but also the strong kinematic focusing which throws everything into a narrow forward cone at a fixed target machine. This imposes strict constraints on the segmentation of detectors. Figure 12 shows a schematic of the NA35 streamer chamber experiment. Shown in plan view is the streamer chamber, along with the downstream bank of calorimeters. These calorimeters can be used to trigger the streamer chamber cameras (UA5 cameras with image intensifiers) on events of interest, e.g., those involving large hadronic or electromagnetic energy deposition. Almost all of the SPS experiments are employing major pieces of high energy physics apparatus used in earlier CERN experiments.

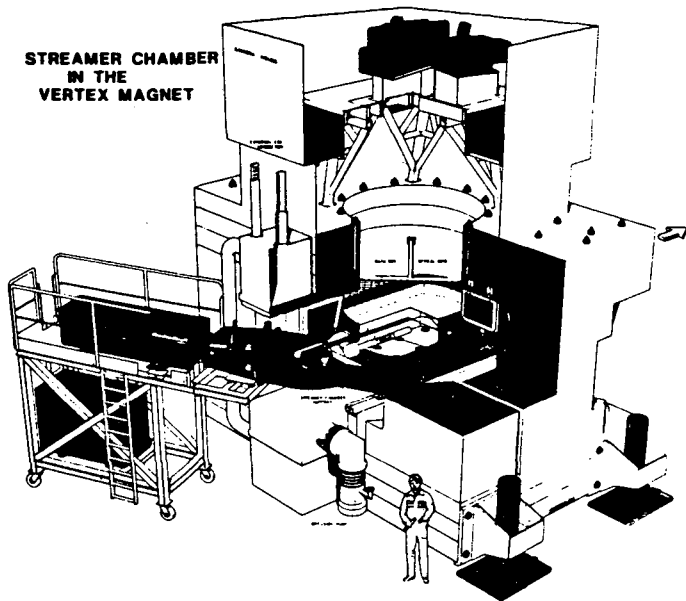
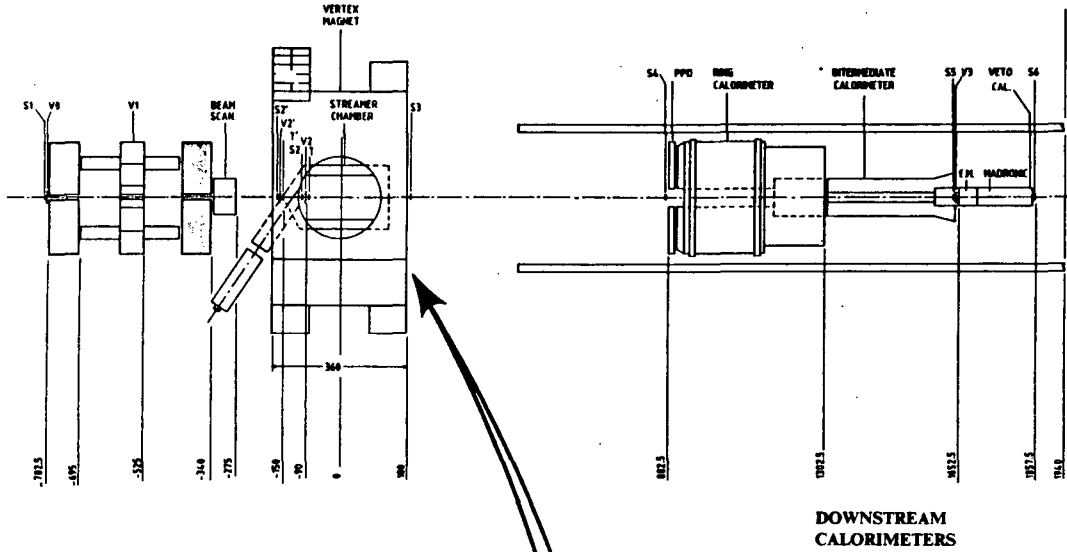

Fig. 12. Plan view of the NA35 streamer chamber experiment at the CERN SPS. An isometric view of the streamer chamber is included (note scale).

- 2) AGS/RHIC (Fig. 13): A major effort has been underway at Brookhaven to provide a new high energy heavy ion capability. This includes:
- completion of the transfer line connecting the BNL Tandem to the AGS to start a light ion ($A \leq 32$) program beginning in late 1986 (energies up to 14 GeV/nucleon)
 - building a booster synchrotron (funds actually provided by high energy physics to increase proton current in AGS) which will allow acceleration of heavy ions up to Au in AGS
 - BNL has submitted a proposal to fill the CBA tunnel with a lattice of superconducting magnets to operate as a Relativistic Heavy Ion Collider (RHIC) at energies up to 100 GeV/nucleon on 100 GeV/nucleon for Au-Au collisions (modest R&D for RHIC was included in the President's FY87 budget submission to Congress).

A major milestone was passed in the week just prior to this Conference when 160 ions were injected and circulated in the AGS. In FY87 about 10 weeks of heavy ion running is expected. Of course, the AGS continues with a strong program of proton experiments. Table III indicates the first round of heavy ion experiments at the AGS.

Now we come to the facility which has the potential of becoming the "crown jewel" of the U.S. heavy ion program--RHIC. The present design⁸ calls for a flexible machine, one capable of providing colliding beams of both symmetric (AA) and unsymmetric (pA) partners. The BNL design employs superconducting magnets ($B = 3.5$ T for dipoles) to reach Au-Au collisions at 100 GeV/nucleon + 100 GeV/nucleon. At this energy, one should have a fully developed central plateau region of about ± 1 units of rapidity in which the meson-rich environment of Fig. 3 can be explored. The rate (counts/sec), R , for any process is given by $R = \sigma \mathcal{L}$, where σ is the cross section of interest (generally interested in central collisions) and \mathcal{L} is the luminosity. The design \mathcal{L} for RHIC is shown in Fig. 14 for four different masses. At top energy one is able to sample ~ 10 -50 central collisions/sec--quite a comfortable rate. The machine has been designed to operate for ~ 10 hours for energies > 30 GeV/nucleon in each beam. Below this energy, storage time falls rapidly. The major culprit responsible for beam loss is expected to be intrabeam scattering.¹⁹ Note also that RHIC can be operated in a fixed target mode--circulating beam on a gas target/fiber--to achieve lower c.m. energies.

For Au-Au collisions at RHIC energies one anticipates literally thousands of particles in each central collision. Workshops^{20,21} on heavy ion collider detectors have been held to study what the appropriate techniques are in such an environment. Many ideas have emerged from these workshops and it is not possible to cover them here. An example of a collider detector is

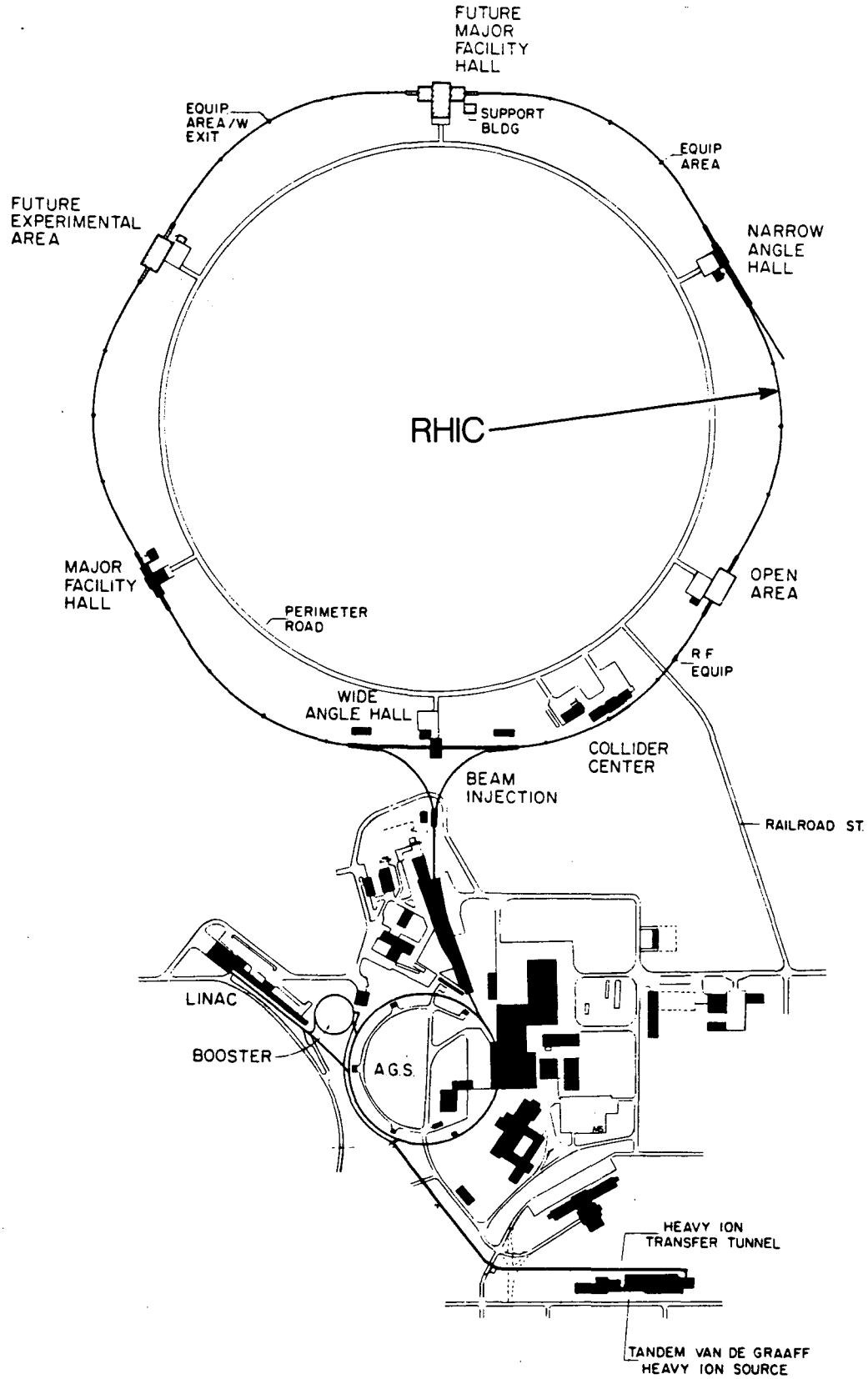

Fig. 13. Layout of AGS/RHIC at BNL.

Table III 1st ROUND HEAVY ION EXPERIMENTS AT AGS

Experiment	Main detectors	Partial list of observables
E-801	Hg (to be analyzed in levitometer)	fractional charge
E-802	large angle magnetic spectrometer, aerogel, cerenkov arrays	semi-inclusive: π^\pm , K^\pm , p^\pm , d , α , $\phi \rightarrow K^+K^-$, multiplicity
E-810	TPC inside MPS, CCD cube	strange-antistrange, baryons (Λ, \dots, Ω), mult.
E-814	forward spectrometer, calorimetry	energy-flow, proj. fragmentation
E-815	emulsion, π^0 -Pb calorimeter	survey
E-825	foils and off-line counting	radiochemical studies
E-793,804, 806,808, 819,826	emulsion/plastic	survey various distributions

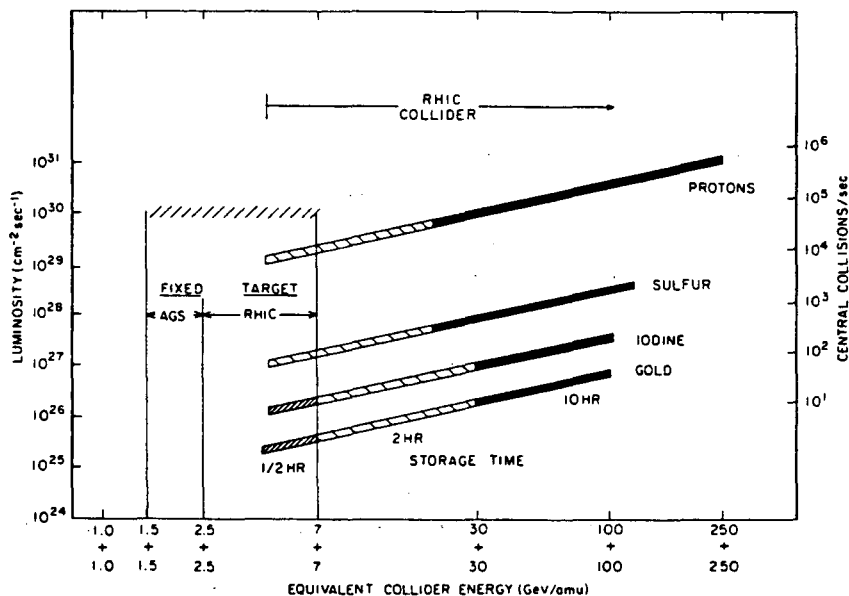

Fig. 14. The design luminosity as a function of collision energy over the energy interval spanned by AGS and RHIC. On left-hand scale, central collisions correspond to impact parameters < 1 fm.

shown in Figs. 15-16. The general notion is to have $\sim 4\pi$ calorimeter coverage with a limited number of ports (e.g., at midrapidity) to sample particles. Thus, the main calorimeter could be used to signal interesting events (e.g., large transverse energy flow) and one would correlate this with observations of particles in the several limited aperture ports surrounding the calorimeter. Additionally, groups are looking at the possibilities of tracking particles--both small and large numbers. Granularity of detectors and questions on particle ID are also being pursued. It is clear that one needs to draw on the experience of the particle physics community to help answer some of those questions.

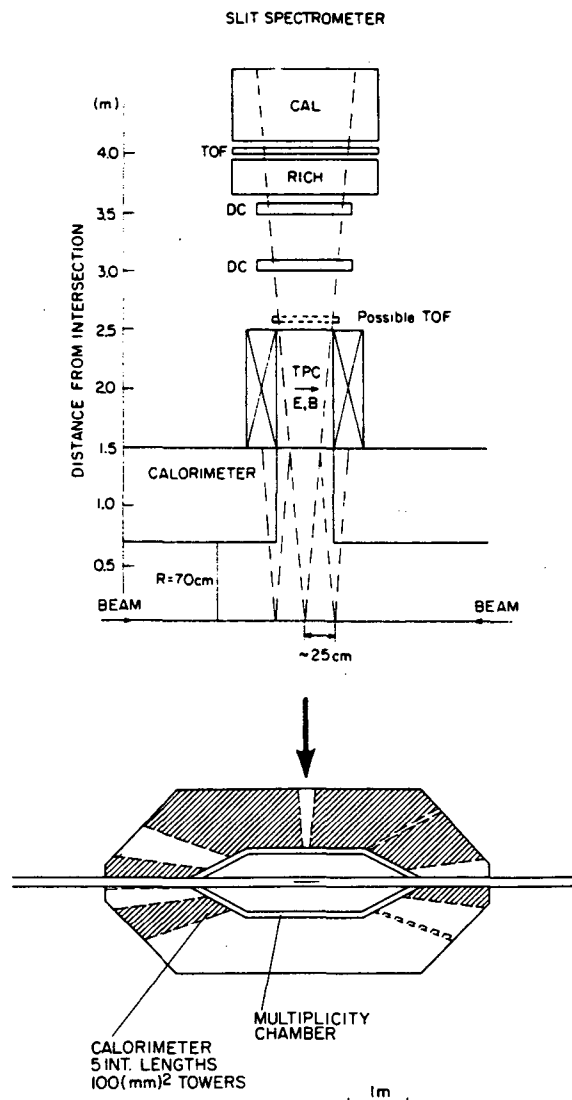

Fig. 15. Concept of 4π calorimeter with small aperture ports instrumented with special-purpose spectrometers such as the midrapidity tracking spectrometer above it (this would provide $\Delta\theta = \Delta\phi = 10^\circ$ at $y = 0$ coverage).

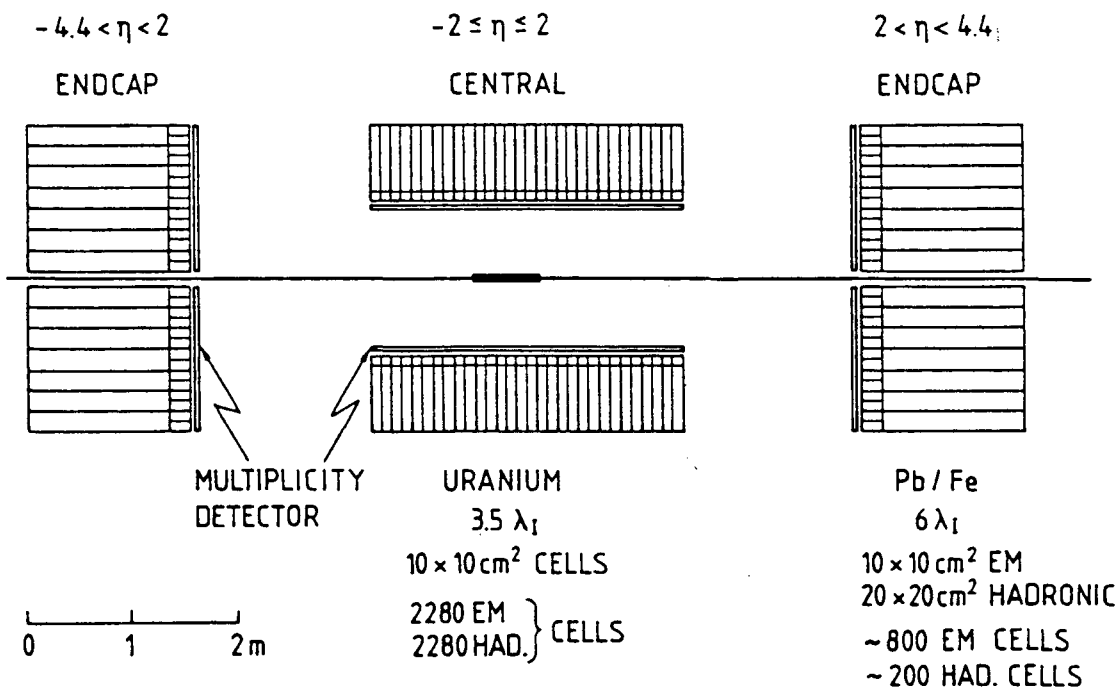

Fig. 16. Exploded view of the 4π calorimeter showing essential elements. Central part would have full azimuthal coverage.

SUMMARY

As we have seen there are five relativistic heavy ion facilities which will be in operation by the end of 1986, with a sixth in the construction phase. Additional new or upgraded facilities are anxiously waiting in the wings for a nod from their friendly funding agency to come on stage. If each were to realize their fondest dreams (and this will surely not happen) then the earliest that we can expect these new facilities is shown below:

- 1) 1987--Saturne II + MIMAS
- 2) 1989--AGS Booster (Au in AGS), SIS 18 + ESR
- 3) 1991--Bevalac Upgrade
- 4) 1992--RHIC
- 5) 1995--Holifield Upgrade

One final note. The era of relativistic heavy ion physics is still in the formative stage, having just begun in the early 1970's. But in that time, we have made tremendous strides in coming to grips with the complexity of these reactions, and are now extracting the interesting physics from them. One measure of the advancement of the field is shown in Fig. 17--a "Livingston curve" for relativistic heavy ion machines. Note that the general trend is similar to that found for high energy proton synchrotrons²²--except with a time displacement of 17-20 years. New and exciting facilities are becoming available to probe both old areas of nuclear physics with high intensity and improved machine performance, and to strike out for the new territory at high energy and baryon density.

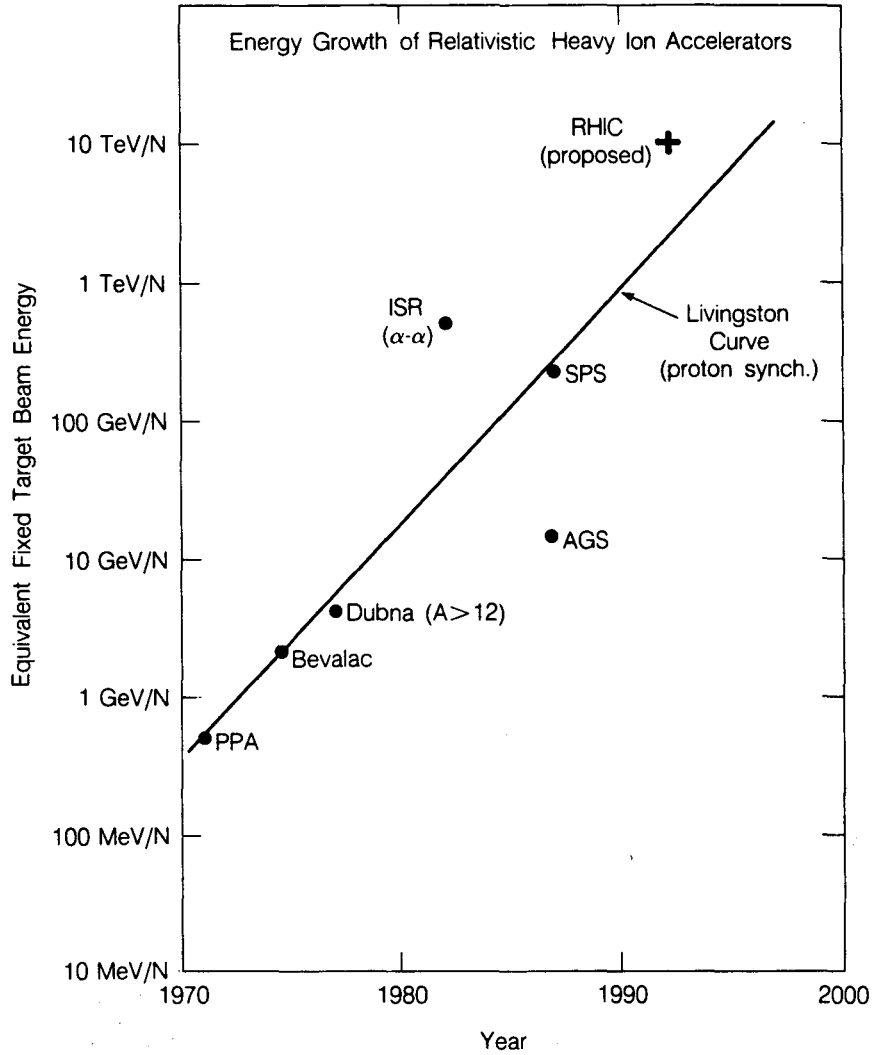

Fig. 17. Energy growth of relativistic heavy ion accelerators.

ACKNOWLEDGMENTS

I wish to thank J. Ball, J. Bartke, P. Kienle, T. Ludlam and G. Young for providing me with material for this report.

REFERENCES

1. R. Palmer, Proceedings of the Meeting on the Intersections Between Particle and Nuclear Physics (Steamboat Springs, 1984), AIP Conference Proceedings No. 123, edited by R. Mischke, p. 197.
2. R. Stock, Nucl. Phys. **A447**, 371 (1985).
3. P. Kienle, Nucl. Phys. **A447**, 419 (1985).
4. The Bevalac Upgrade, LBL PUB-5166 (March 1986).
5. Future Directions in Intermediate Energy Heavy Ion Physics (A Proposed Expansion of the Holifield Facility), ORNL (January 1986).

6. P. Radvanyi, Nucl. Phys. A447, 435 (1985).
7. A.M. Baldin et al., IEEE Transaction on Nucl. Sci., Vol. NS-30, No. 4 (1983), p. 3247.
8. RHIC--Proposal for a Relativistic Heavy Ion Collider, BNL 51932 UC-28 (March 1986).
9. A. Goldhaber, Proceedings of the Meeting on the Intersections Between Particle and Nuclear Physics (Steamboat Springs, 1984), edited by R. Mischke, AIP Conference Proceedings No. 123, p. 21.
10. See talk of T. Ludlam elsewhere in these Proceedings.
11. M. Gyulassy, Nucl. Phys. A418, 59 (1984).
12. L. McLerran, Proceedings of the 4th International Conference on Ultra-Relativistic Nucleus-Nucleus Collisions, Helsinki (1984), edited by K. Kajantie (Springer-Verlag), p. 1.
13. See section on "Signatures of the Quark-Gluon Plasma" to be published in the Proceedings of the 5th International Conference on Ultra-Relativistic Nucleus-Nucleus Collisions, Asilomar (1986), edited by M. Gyulassy and L. Schroeder (North-Holland), to be published as a special edition of Nucl. Phys. A.
14. L. Van Hove, Nucl. Phys. A447, 443 (1985).
15. L. Van Hove, Proceedings of the 5th International Conference on Ultra-Relativistic Nucleus-Nucleus Collisions, Asilomar (1986), edited by M. Gyulassy and L. Schroeder (North-Holland), to be published as a special edition of Nucl. Phys. A.
16. P. Koch, B. Mueller and J. Rafelski (GSI-86-7), to be published in Physics Reports.
17. See talk of J. Greenberg elsewhere in these Proceedings.
18. H. Huseroth, Proceedings of the Bielefeld Workshop--Quark Matter Formation and Heavy Ion Collisions (1982), edited by M. Jacob and H. Satz (World Scientific), p. 253.
19. G.R. Young, Proceedings of the Meeting on the Intersections Between Particle and Nuclear Physics (Steamboat Springs, 1984), edited by R. Mischke, AIP Conference Proceedings No. 123, p.169.
20. Proceedings of the Workshop on Detectors for Relativistic Nuclear Collisions, LBL (March 1984), edited by L. Schroeder, LBL-18227.
21. Proceedings of the RHIC Workshop on Experiments for a Relativistic Heavy Ion collider, BNL (April 1985), edited by P. Haustein and C. Woody, BNL 51921.
22. See for example, W.K.H. Panofsky, IEEE Transactions on Nucl. Sci., Vol. NS-30, No. 4 (1983), p. 3689.

This report was done with support from the Department of Energy. Any conclusions or opinions expressed in this report represent solely those of the author(s) and not necessarily those of The Regents of the University of California, the Lawrence Berkeley Laboratory or the Department of Energy.

Reference to a company or product name does not imply approval or recommendation of the product by the University of California or the U.S. Department of Energy to the exclusion of others that may be suitable.

*LAWRENCE BERKELEY LABORATORY
TECHNICAL INFORMATION DEPARTMENT
UNIVERSITY OF CALIFORNIA
BERKELEY, CALIFORNIA 94720*