

UC Davis

Research Reports

Title

Support for Superpave Implementation: Round Robin Hamburg Wheel-Track Testing

Permalink

<https://escholarship.org/uc/item/3fm0469p>

Authors

Mateos, Angel

Jones, David

Publication Date

2017-12-01

Support for Superpave Implementation: Round Robin Hamburg Wheel-Track Testing

Authors:
A. Mateos and D. Jones

Partnered Pavement Research Center (PPRC) Contract Strategic Plan Element 3.32 (DRISI Task 2672):
Support for Superpave Implementation

PREPARED FOR:

California Department of Transportation
Division of Research, Innovation, and System Information
Office of Materials and Infrastructure Roadway Research

PREPARED BY:

University of California
Pavement Research Center
UC Davis, UC Berkeley



TECHNICAL REPORT DOCUMENTATION PAGE

1. REPORT NUMBER UCPRC-RR-2016-05	2. GOVERNMENT ASSOCIATION NUMBER	3. RECIPIENT'S CATALOG NUMBER
4. TITLE AND SUBTITLE Support for Superpave Implementation: Round Robin Hamburg Wheel-Track Testing	5. REPORT PUBLICATION DATE December 2017	
	6. PERFORMING ORGANIZATION CODE	
7. AUTHOR(S) A. Mateos and D. Jones	8. PERFORMING ORGANIZATION REPORT NO. UCPRC-RR-2016-05	
9. PERFORMING ORGANIZATION NAME AND ADDRESS University of California Pavement Research Center Department of Civil and Environmental Engineering, UC Davis 1 Shields Avenue Davis, CA 95616	10. WORK UNIT NUMBER	
	11. CONTRACT OR GRANT NUMBER 65A0542	
12. SPONSORING AGENCY AND ADDRESS California Department of Transportation Division of Research, Innovation, and System Information P.O. Box 942873 Sacramento, CA 94273-0001	13. TYPE OF REPORT AND PERIOD COVERED Research Report April 2015 – April 2016	
	14. SPONSORING AGENCY CODE	
15. SUPPLEMENTAL NOTES		
<p>16. ABSTRACT</p> <p>A round robin testing program was undertaken between 20 participating laboratories in California to assess the reproducibility of Hamburg Wheel-Track (HWT) test results as part of a Superpave implementation initiative. Each laboratory conducted four HWT tests. Two of the tests were conducted on gyratory-compacted specimens prepared by the University of California Pavement Research Center (UCPRC), and the other two were conducted on gyratory-compacted specimens prepared by each of the participating laboratories using loose mix supplied by the UCPRC. A three-quarter inch mix with five percent PG 64-16 asphalt binder content was sampled from a northern California asphalt plant for the study. Laboratories reported test results in terms of rut depth after 5,000, 10,000, 15,000, and 20,000 wheel passes; number of passes to 0.5 in. (12.5 mm) rut depth; creep slope; stripping slope; and stripping inflection point. Some laboratories also submitted raw test data for further analysis by the UCPRC. An analysis of variance was used to determine which factors had a significant influence on the test results and to determine the indices of precision of the different result variables. Indices of precision could not be determined for all variables due the relatively good performance of the mix. Single-operator variability was relatively high for all variables. Between-laboratory variability was shown to be strongly related to several measurement and result-interpretation aspects that are not fully defined in the AASHTO T 324 test method. This variability was clearly reduced when unique criteria were used in the data analysis.</p>		
17. KEY WORDS Hamburg Wheel-Track Test, Round Robin Testing, Superpave Implementation	18. DISTRIBUTION STATEMENT No restrictions. This document is available to the public through the National Technical Information Service, Springfield, VA 22161	
19. SECURITY CLASSIFICATION (of this report) Unclassified	20. NUMBER OF PAGES	21. PRICE None

Reproduction of completed page authorized

UCPRC ADDITIONAL INFORMATION

1. DRAFT STAGE Final	2. VERSION NUMBER 1				
3. PARTNERED PAVEMENT RESEARCH CENTER STRATEGIC PLAN ELEMENT NUMBER 3.32	4. DRISI TASK NUMBER 2672				
5. CALTRANS TECHNICAL LEAD AND REVIEWER(S) B. Banzon	6. FHWA NUMBER CA182672A				
7. PROPOSALS FOR IMPLEMENTATION None					
8. RELATED DOCUMENTS None					
9. LABORATORY ACCREDITATION The UCPRC laboratory is accredited by AASHTO re:source for the tests listed in this report					
10. SIGNATURES					
A. Mateos FIRST AUTHOR	J.T. Harvey TECHNICAL REVIEW	D. Spinner EDITOR	J.T. Harvey PRINCIPAL INVESTIGATOR	B. Banzon CALTRANS TECH. LEADS	T.J. Holland CALTRANS CONTRACT MANAGER

Reproduction of completed page authorized

DISCLAIMER STATEMENT

This document is disseminated in the interest of information exchange. The contents of this report reflect the views of the authors who are responsible for the facts and accuracy of the data presented herein. The contents do not necessarily reflect the official views or policies of the State of California or the Federal Highway Administration. This publication does not constitute a standard, specification or regulation. This report does not constitute an endorsement by the California Department of Transportation of any product described herein.

For individuals with sensory disabilities, this document is available in alternate formats. For information, call (916) 654-8899, TTY 711, or write to California Department of Transportation, Division of Research, Innovation and System Information, MS-83, P.O. Box 942873, Sacramento, CA 94273-0001.

PROJECT OBJECTIVES

This project is a continuation of PPRC Project 3.18.3 (Superpave Implementation). The objective of this project is to support the implementation of the Superpave hot mix asphalt (HMA) mix design process in California. This will be achieved through the following tasks:

1. Establishment of an annual statewide round robin study for the Hamburg Wheel-Track Test to determine precision and bias statements, and to make recommendations for incorporation of these in revised specifications. If adopted, arrangements for periodic round robin studies will be taken over by the California Department of Transportation's Materials Evaluation and Testing Services Independent Assurance Program.
2. Assess differences between laboratory and plant-produced mixes for performance related tests.
3. Review appropriateness and applicability of quality control/quality assurance (QC/QA) testing on Superpave projects and provide recommendations for revised specifications, if justified.
4. Monitor performance of Superpave projects constructed to date.

This report covers the first task in the study.

Blank page

EXECUTIVE SUMMARY

A round robin study in which 20 laboratories participated has been completed. Each laboratory conducted four Hamburg Wheel-Track (HWT) tests. Two of the tests were conducted on specimens compacted by the University of California Pavement Research Center (UCPRC), and the other two on specimens compacted by each of the participating laboratories using loose mix provided by the UCPRC. A single plant-produced 3/4 in. mix with 5.0 percent PG 64-16 binder was evaluated. The laboratories reported test results in terms of rut depth after 5,000, 10,000, 15,000, and 20,000 wheel passes, number of passes to 12.5 mm (0.5 in.) rut depth, creep slope, stripping slope, and stripping inflection point. Fourteen laboratories submitted the raw test data (all laboratories were requested to submit this information). The main conclusions drawn from this experiment include the following:

- The rutting and moisture resistance of the mix were relatively good. However, a clear stripping phase was reached in approximately 25 percent of the tests conducted on the specimens compacted at the UCPRC.
- Specimens compacted at the participating laboratories had better performance than the specimens compacted at the UCPRC. It is not clear why this occurred, but analysis of the results indicate that specimen air-void content did not contribute to the difference in results.
- Between-laboratory variability related to specimen fabrication was much smaller than the variability introduced by testing and data analysis.
- The type of HWT test device used for testing was shown to be significant only for the rut depth after 5,000 and 10,000 passes (i.e., for results obtained in the early part of the tests).
- Test results from left and right wheels were independent of each other for the two HWT test results specified in Section 39 of the 2015 Caltrans Standard Specifications, namely the number of passes to the stripping inflection point and number of passes to 12.5 mm (0.5 in.).
- Single-operator variability was relatively high (low repeatability) for all variables. This result is believed to be related, at least in part, to the good performance of the mix used for the experiment.
- Between-laboratory variability was relatively high for all variables except for the rut depth after a predetermined number of wheel passes. This high variability was shown to be related to different interpretations of how the rut depth is measured and analyzed. Between-laboratory variability clearly improved when the same criteria were used to analyze the raw data provided by the participating laboratories.
- Comparison of results submitted by the different laboratories to results determined by the UCPRC using the same raw data shows that a high degree of subjectivity was present in the HWT test data analysis conducted by the participating laboratories.
- Precision indices could only be determined for one of the HWT test results specified in Section 39 of the 2015 Caltrans Standard Specifications, namely the number of passes to the stripping inflection point. For this variable, single-operator and multilaboratory coefficients of variation were, respectively, 22 percent and 33 percent. Multilaboratory coefficient of variation would improve to 22 percent if fixed criteria had been used by all laboratories in the analysis. Precision

estimates of the number of passes to 12.5 mm could not be determined due to the very limited number of tests where this threshold value was reached.

- Additional precision statements were formulated for other HWT test results, including creep and strip slopes and rut depth after a predetermined number of wheel passes. These statements may be applicable if Caltrans specifications are revised based on one or more of these variables.

The following recommendations are expected to contribute to improving HWT test single-operator and multilaboratory variability:

- Laboratories conducting HWT testing should receive additional instructions that supplement or clarify aspects of the AASHTO T 324 test method that can be interpreted in different ways. Items that need to be clarified, specified, defined, or expanded include the following:
 - + The length of the wheelpath.
 - + The locations along the wheelpath that should be used to compute rut depth. The capabilities of the different types of HWT test devices should be considered in this definition, since most of them can only record rutting at predefined locations.
 - + The specific procedure that should be used to compute the rut depth from the different measuring locations (i.e., whether the maximum, the average, or any other representative value should be used).
- Detailed guidelines, with examples, should be written for defining the creep and stripping stationary phases and for determining the stripping inflection point since these definitions are currently very subjective. These guidelines should use a general purpose spreadsheet or similar analysis tool since they might not be compatible with the software installed in the different testing machines. These guidelines, along with training, and practice, may lead to more uniform results from different laboratories, thereby reducing between-laboratory variability in data analysis.
- Future round robin study exercises should include both good- and marginal-performing mixes, and should also include a practical exercise in which an additional three sets of raw data are sent to all the participating laboratories for analysis. The results reported by the laboratories could be used to better determine the between-laboratory variability related to data analysis and to prepare more realistic precision statements.

TABLE OF CONTENTS

EXECUTIVE SUMMARY	v
LIST OF TABLES	viii
LIST OF FIGURES	viii
LIST OF ABBREVIATIONS	x
TEST METHODS CITED IN THE REPORT	x
CONVERSION FACTORS	xi
1. INTRODUCTION	1
1.1 Background to the Project	1
1.2 Project Objectives.....	2
1.3 Report Structure	2
1.4 Measurement Units.....	2
2. STUDY APPROACH.....	3
2.1 Introduction	3
2.2 Test Plan Considerations	4
2.2.1 Mix	4
2.2.2 Specimen Fabrication.....	4
2.2.3 Distribution of Specimens.....	5
2.2.4 Round Robin Testing Instructions	6
2.2.5 Round Robin Reporting Instructions	6
2.2.6 Result Reporting	6
2.2.7 Data Analysis by the UCPRC	7
2.2.8 Terminology Used in the Analysis.....	7
3. DATA SUMMARY.....	9
3.1 Introduction	9
3.2 Specimen Air-Void Contents	9
3.3 Rut Depth Measurements	11
4. DATA ANALYSIS.....	19
4.1 Analysis of Data Consistency.....	19
4.2 Statistical Model Definition	24
4.3 Determination of Variance Components	28
4.4 Analysis of Raw Data by the UCPRC	29
4.5 Determination of Variance Components for UCPRC Analysis Results.....	35
4.6 Formulation of Precision Statements.....	35
4.6.1 Precision Statements for Rut Depth after a Predetermined Number of Passes	40
4.6.2 Precision Statements for Creep and Stripping Slopes.....	41
4.6.3 Precision Statements for the Number of Passes to Stripping Inflection Point	41
5. CONCLUSIONS AND RECOMMENDATIONS.....	43
REFERENCES.....	45
APPENDIX A: INSTRUCTION SHEET	47
APPENDIX B: RESULT REPORTING TEMPLATE	49
APPENDIX C: PARTICIPATING LABORATORIES.....	51
APPENDIX D: DATA REPORTED BY LABORATORIES.....	53
APPENDIX E: ANOVA TO DETERMINE SIGNIFICANT FACTORS	71
APPENDIX F: ANOVA TO DETERMINE VARIANCE COMPONENTS	111

LIST OF TABLES

Table 3.1: Summary of Coefficients of Determination (R^2)	11
Table 4.1: Summary Indices of Precision for HWT Test Results	39

LIST OF FIGURES

Figure 2.1: Specimen fabrication plan.....	5
Figure 3.1: Specimen air-void contents.....	9
Figure 3.2: Air-void content histograms.	10
Figure 3.3: Air-void content effect on rut depth.....	11
Figure 3.4: Rut depths on specimens compacted by the UCPRC.	12
Figure 3.5: Rut depths on specimens compacted by participating laboratories.	12
Figure 3.6: Rut depth after 5,000 wheel passes.....	14
Figure 3.7: Rut depth after 10,000 wheel passes.....	14
Figure 3.8: Rut depth after 15,000 wheel passes.....	15
Figure 3.9: Rut depth after 20,000 wheel passes.....	15
Figure 3.10: Number of wheel passes to 12.5 mm rut depth.....	16
Figure 3.11: Creep slope.	16
Figure 3.12: Stripping slope.	17
Figure 3.13: Number of passes to stripping inflection point.	17
Figure 4.1: Rut depth after 5,000 wheel passes.....	20
Figure 4.2: Rut depth after 10,000 wheel passes.....	20
Figure 4.3: Rut depth after 15,000 wheel passes.....	21
Figure 4.4: Rut depth after 20,000 wheel passes.....	21
Figure 4.5: Number of passes to 12.5 mm rut depth.	22
Figure 4.6: Creep slope.	22
Figure 4.7: Stripping slope.	23
Figure 4.8: Stripping inflection point.	23
Figure 4.9: Factors in the ANOVA analysis.	24
Figure 4.10: Factor significance level for HWT test results (SIP = stripping inflection point).	25
Figure 4.11: <i>Machine-type</i> significance level in the ANOVA.	27
Figure 4.12: Machine effect on rut depth after 10,000 passes.....	27
Figure 4.13: Statistical design for the round robin study analysis.....	27
Figure 4.14: Single-operator standard deviation after predefined number of passes.	31
Figure 4.15: Between-laboratory standard deviation after predefined number of passes.	31
Figure 4.16: Multilaboratory standard deviation after predefined number of passes.....	31
Figure 4.17: Single-operator standard deviation for creep and stripping slopes.	31
Figure 4.18: Between-laboratory standard deviation for creep and stripping slopes.	32
Figure 4.19: Multilaboratory standard deviation for creep and stripping slopes.....	32
Figure 4.20: UCPRC analysis of rut depth after 20,000 passes.	32
Figure 4.21: UCPRC analysis of number of passes to 12.5 mm rut depth.....	33
Figure 4.22: UCPRC analysis of creep slope.....	33
Figure 4.23: UCPRC analysis of stripping slope.....	34
Figure 4.24: UCPRC analysis of number of passes to stripping inflection point.....	34
Figure 4.25: Single-operator coefficient of variation for test results.	36
Figure 4.26: Between-laboratory coefficient of variation for test results.....	36
Figure 4.27: Indices of precision for rut depth at predetermined number of passes.	38

Figure 4.28: Indices of precision for creep and stripping slopes..... 38
Figure 4.29: Summary of indexes of precision for HWT test results..... 39

LIST OF ABBREVIATIONS

AASHTO	American Association of State Highway and Transportation Officials
AMRL	AASHTO Materials Reference Laboratory (now AASHTO Accreditation Program [AAP])
ANOVA	Analysis of Variance
ASTM	American Society for Testing and Materials
Caltrans	California Department of Transportation
HMA	Hot mix asphalt
HVS	Heavy Vehicle Simulator
HWT	Hamburg Wheel-Track
IA	Independent Assurance
METS	Materials Engineering and Testing Services
MSE	Mean square error
MST	Mean square of the random factor
NCHRP	National Cooperative Highway Research Program
NR	Number of replicates
PPRC	Partnered Pavement Research Center
QC/QA	Quality control/quality assurance
RAP	Reclaimed asphalt pavement
RSP	Reference Sample Program
SIP	Stripping Inflection Point
SSD	Saturated surface-dry
TRB	Transportation Research Board
TSR	Tensile strength retained
UCPRC	University of California Pavement Research Center

TEST METHODS CITED IN THE REPORT

AASHTO R30	Standard Practice for Mixture Conditioning of Hot-Mix Asphalt (HMA)
AASHTO T 166	Standard Method of Test for Bulk Specific Gravity (Gmb) of Compacted Hot Mix Asphalt (HMA) Using Saturated Surface-Dry Specimens
AASHTO T 324	Standard Method of Test for Hamburg Wheel-Track Testing of Compacted Hot Mix Asphalt (HMA)
AASHTO T 328	Standard Practice for Reducing Samples of Hot Mix Asphalt (HMA) to Testing Size
AASHTO T 331	Bulk Specific Gravity (Gmb) and Density of Compacted Hot Mix Asphalt (HMA) Using Automatic Vacuum Sealing Method
ASTM C670	Standard Practice for Preparing Precision and Bias Statements for Test Methods for Construction Materials
ASTM C802	Standard Practice for Conducting an Interlaboratory Test Program to Determine the Precision of Test Methods for Construction Materials

CONVERSION FACTORS

SI* (MODERN METRIC) CONVERSION FACTORS				
APPROXIMATE CONVERSIONS TO SI UNITS				
Symbol	When You Know	Multiply By	To Find	Symbol
LENGTH				
in	inches	25.4	Millimeters	mm
ft	feet	0.305	Meters	m
yd	yards	0.914	Meters	m
mi	miles	1.61	Kilometers	Km
AREA				
in ²	square inches	645.2	Square millimeters	mm ²
ft ²	square feet	0.093	Square meters	m ²
yd ²	square yard	0.836	Square meters	m ²
ac	acres	0.405	Hectares	ha
mi ²	square miles	2.59	Square kilometers	km ²
VOLUME				
fl oz	fluid ounces	29.57	Milliliters	mL
gal	gallons	3.785	Liters	L
ft ³	cubic feet	0.028	cubic meters	m ³
yd ³	cubic yards	0.765	cubic meters	m ³
NOTE: volumes greater than 1000 L shall be shown in m ³				
MASS				
oz	ounces	28.35	Grams	g
lb	pounds	0.454	Kilograms	kg
T	short tons (2000 lb)	0.907	megagrams (or "metric ton")	Mg (or "t")
TEMPERATURE (exact degrees)				
°F	Fahrenheit	5 (F-32)/9 or (F-32)/1.8	Celsius	°C
ILLUMINATION				
fc	foot-candles	10.76	Lux	lx
fl	foot-Lamberts	3.426	candela/m ²	cd/m ²
FORCE and PRESSURE or STRESS				
lbf	poundforce	4.45	Newtons	N
lbf/in ²	poundforce per square inch	6.89	Kilopascals	kPa
APPROXIMATE CONVERSIONS FROM SI UNITS				
Symbol	When You Know	Multiply By	To Find	Symbol
LENGTH				
mm	millimeters	0.039	Inches	in
m	meters	3.28	Feet	ft
m	meters	1.09	Yards	yd
km	kilometers	0.621	Miles	mi
AREA				
mm ²	square millimeters	0.0016	square inches	in ²
m ²	square meters	10.764	square feet	ft ²
m ²	square meters	1.195	square yards	yd ²
ha	Hectares	2.47	Acres	ac
km ²	square kilometers	0.386	square miles	mi ²
VOLUME				
mL	Milliliters	0.034	fluid ounces	fl oz
L	liters	0.264	Gallons	gal
m ³	cubic meters	35.314	cubic feet	ft ³
m ³	cubic meters	1.307	cubic yards	yd ³
MASS				
g	grams	0.035	Ounces	oz
kg	kilograms	2.202	Pounds	lb
Mg (or "t")	megagrams (or "metric ton")	1.103	short tons (2000 lb)	T
TEMPERATURE (exact degrees)				
°C	Celsius	1.8C+32	Fahrenheit	°F
ILLUMINATION				
lx	lux	0.0929	foot-candles	fc
cd/m ²	candela/m ²	0.2919	foot-Lamberts	fl
FORCE and PRESSURE or STRESS				
N	newtons	0.225	Poundforce	lbf
kPa	kilopascals	0.145	poundforce per square inch	lbf/in ²

*SI is the symbol for the International System of Units. Appropriate rounding should be made to comply with Section 4 of ASTM E380 (Revised March 2003)

Blank page

1. INTRODUCTION

1.1 Background to the Project

The California Department of Transportation's Hveem hot mix asphalt mix design process was officially phased out in July 2015 and replaced with a customized Superpave mix design process that introduced a number of new test procedures. After implementation, a range of issues that required evaluation were identified for further evaluation, the findings from which would be used to optimize and/or refine the process and relevant specification language. These issues included testing standards, laboratory and plant mix comparisons, and quality control/quality assurance (QC/QA) procedures (1).

The Hamburg Wheel-Track (HWT) test (AASHTO T 324) was adopted as a rutting performance and moisture sensitivity test (supplementing the tensile strength retained [TSR] test) as part of the new mix design and QC/QA procedures. However, at the time of initiating this study, no published precision and bias statements had been developed nationally or in California for the AASHTO T 324 test method, although a limited study by AASHTO (37 laboratories, one HWT device type) to develop precision statements was nearing completion (2). Further, prior to the current California Department of Transportation (Caltrans) and University of California Pavement Research Center (UCPRC) study detailed in this report, no statewide interlaboratory reproducibility studies had been undertaken to compare testing equipment or how laboratories interpreted the HWT test method, prepared specimens, and interpreted and reported test results.

This report summarizes the development of and results from the first interlaboratory HWT round robin test program in California. Approximately 40 laboratories in California were operating HWT equipment at the time the study was undertaken. The study was planned according to ASTM C802-14 (*Standard Practice for Conducting an Interlaboratory Test Program to Determine the Precision of Test Methods for Construction Materials*) and ASTM C670-15 (*Standard Practice for Preparing Precision and Bias Statements for Test Methods for Construction Materials*). One plant-produced 3/4 in. mix was sampled for the study from a northern California asphalt plant. Each participating laboratory tested two sets of gyratory-compacted specimens; the first set of specimens was compacted by the UCPRC and the second set was compacted by each laboratory using loose mix provided by the UCPRC. Each laboratory completed four HWT tests, each of which required four specimens (two wheels, two specimens per wheel). Testing was undertaken between July and October 2015. Complete sets of results were received from 20 laboratories, including the UCPRC.

1.2 Project Objectives

This project is a continuation of Partnered Pavement Research Center Strategic Plan Element (PPRC SPE) 3.18.3 (Superpave Implementation). The objective of this project is to support the implementation of the Superpave hot mix asphalt (HMA) mix design process in California and will be achieved through the following tasks:

1. Establish an annual statewide round robin study for the Hamburg Wheel-Track Test to determine precision and bias statements, and to make recommendations for incorporation of these in revised specifications. If these recommendations are adopted, arrangements for periodic round robin studies will be taken over by the California Department of Transportation's Materials Evaluation and Testing Services Independent Assurance Program.
2. Review the appropriateness and applicability of quality control/quality assurance (QC/QA) testing on Superpave projects and provide recommendations for revised specifications, if justified.
3. Monitor the performance of Superpave projects constructed to date.

This report covers the first task in the study.

1.3 Report Structure

This research report presents an overview of the work carried out in meeting the objectives of the study, and is organized as follows:

- Chapter 2 details the study approach.
- Chapter 3 summarizes the results submitted by the participating laboratories.
- Chapter 4 discusses the analysis of the data and development of precision statements.
- Chapter 5 provides conclusions and recommendations.

1.4 Measurement Units

Although Caltrans recently returned to the use of U.S. standard measurement units, metric units have always been used by the UCPRC in the design and layout of Heavy Vehicle Simulator (HVS) test tracks, and for laboratory, HVS, and field test measurements and data storage. In this report, both English and metric units (provided in parentheses after the English units) are provided in general discussion. In keeping with convention, metric units are used in laboratory data analyses and reporting. A conversion table is provided on page xi at the beginning of this report.

2. STUDY APPROACH

2.1 Introduction

According to ASTM C802, a valid and well-written test method is one of the criteria that needs to be met before undertaking an interlaboratory study. AASHTO T 324 (*Standard Method of Test for Hamburg Wheel-Track Testing of Compacted Hot Mix Asphalt [HMA]*) is generally considered to meet this requirement; however, a number of limitations in this test were identified in two recent National Cooperative Highway Research Program (NCHRP) studies that focused on HWT testing (2,3). Caltrans also identified a number of modifications and refinements to the test method, which are included in Section 39 of the Caltrans 2015 Standard Specifications. These Caltrans modifications to the test method include the following:

- Target air voids must equal 7.0 ± 1.0 percent.
- Specimens must be compacted in a gyratory compactor and must be 150 mm in diameter and 60 ± 1 mm high.
- Four test specimens are required to run two tests.
- The two test results must not be averaged.
- Test temperature must be set as follows:
 - + $113 \pm 2^{\circ}\text{F}$ ($45^{\circ}\text{C} \pm 1^{\circ}\text{C}$) for PG 58 binder
 - + $122 \pm 2^{\circ}\text{F}$ ($50^{\circ}\text{C} \pm 1^{\circ}\text{C}$) for PG 64 binder
 - + $131 \pm 2^{\circ}\text{F}$ ($55^{\circ}\text{C} \pm 1^{\circ}\text{C}$) for PG 70 binder and above
- Measurements of the wheel impression must be taken at every 100 passes along the entire length of the specimen.
- The inflection point is defined as the number of wheel passes at the intersection of the creep slope and the stripping slope at maximum rut depth.
- Testing shut off must be set at 25,000 passes.
- Submersion time for samples must not exceed four hours.

Other key requirements listed in ASTM C802 that were considered relevant to this Caltrans/UCPRC study include the following:

- The testing apparatus must be well described in the test method.
- Tolerances must be defined for the most important variables influencing the test results.
- Technicians in participating laboratories must have sufficient experience and competency to run the test.
- The number of laboratories participating in the study must be relatively high.

2.2 Test Plan Considerations

2.2.1 Mix

Given that a primary reason for undertaking the round robin study was to assess the use of the HWT test for QC/QA purposes, loose mix sampled from an asphalt plant was considered to be the most appropriate and economical source of material for preparing specimens since multiple mixes prepared in the laboratory might not have been sufficiently consistent for the purposes of the test. One mix that met Caltrans Hveem mix design specifications (3/4 in Type-A) was therefore sampled from a northern California asphalt plant in April 2015. Aggregates used in the mix were of alluvial origin, the binder grade was PG 64-16, and the binder content was 5.0 percent by weight of the mix. The mix contained no reclaimed asphalt pavement (RAP).

Although use of a single mix for the study was considered a limitation—by preventing testing over a range of potentially moisture sensitive mixes—this approach was adopted due to time and project funding constraints.

Consideration was given to sourcing a moisture sensitive mix for the study to facilitate the analysis of rut depth, creep slope, stripping slope, and stripping inflection point results submitted by the participating laboratories. However, no asphalt plants in northern California produce mixes that would typically fail an HWT test, for obvious reasons. A special mix would therefore have needed to be prepared, but was not considered due to time and project funding constraints.

2.2.2 Specimen Fabrication

Two specimen preparation approaches were evaluated in this round robin study (Figure 2.1), namely:

- Gyrotory-compacted specimens prepared by the UCPRC
- Gyrotory-compacted specimens prepared by each participating laboratory using loose mix supplied by the UCPRC

By following this approach, any variability resulting from specimen preparation at one of the participating laboratories would only influence that laboratory's set of test results, and not the test results for the UCPRC-compacted specimens. However, single-operator compaction variability would be present in both sets of prepared specimens.

During May 2015, the UCPRC prepared 360 gyrotory-compacted specimens at 7.0 ± 1.0 percent air-void content. No additional aging was applied to the mix since it was sampled from an asphalt plant and AASHTO T 324 specifies short-term aging according to AASHTO R30 only for laboratory-produced mix.

Special care was taken when reheating the loose mix before compaction, given that rutting performance of asphalt mixes is known to improve with increased binder aging. Ovens were preheated to 140°C (284°F) and checked to ensure that the set temperature was stable. Loose mix was then placed into the oven and heated for 120 minutes before being removed and compacted in a Superpave gyratory compactor. Compacted specimens were 150 mm (~ 6 in.) in diameter and 63.5 mm (2.5 in.) in height. The air-void content of each specimen was determined using the *CoreLok* automatic vacuum sealing method (AASHTO T 331). The air-void contents of 40 of the specimens were also determined according to the AASHTO T 166 (saturated surface-dry) method so that a reliable correlation could be established between the two air-void content determination methods for this particular mix.

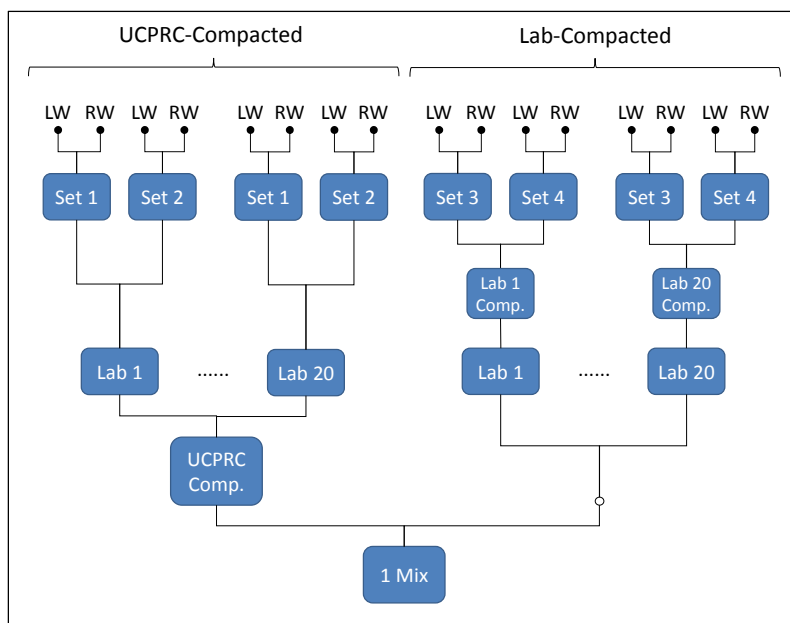

Figure 2.1: Specimen fabrication plan.

2.2.3 Distribution of Specimens

Forty packages consisting of two five-gallon buckets of loose mix and two plastic canisters each containing four gyratory-compacted specimens were delivered to Caltrans in June 2015 for distribution. Compacted specimens were randomly selected before being placed into the canisters. Caltrans then sent the specimens, an instruction sheet (see Section 2.2.4), and a reporting template (see Section 2.2.6) to each participating laboratory as part of the Caltrans Reference Sample Program (RSP) during July 2015. All communication with the participating laboratories was done by Caltrans. The UCPRC did not contact any of the laboratories directly.

2.2.4 Round Robin Testing Instructions

An instruction sheet (see copy in Appendix A) was prepared by the UCPRC in consultation with Caltrans. This sheet covered how to prepare specimens, run the HWT test, and report the results. Each laboratory was asked to conduct four sets of HWT tests (four specimens per set), with each set including two wheels (left and right), as reflected in Figure 2.1. A total of 16 specimens were therefore tested, eight of which were prepared by the UCPRC and eight by the participating laboratory. Specific instructions for testing included the following requirements:

- Determining the air-void contents of the specimens compacted at the UCPRC in addition to the air-void contents of the specimens produced by the participating laboratory
- Setting the HWT testing temperature to 122°F (50°C)
- Setting the test load to 158 lb (71.6 kg)
- Setting the testing rate to 52 passes per minute
- Setting the test termination criteria for when deformation reached a maximum of 24.0 mm (0.94 in.)
- Setting the maximum number of passes to 25,000
- Setting the sampling interval as follows:
 - + Every 20 passes for the first 1,000 passes
 - + Every 50 passes for the second 4,000 passes
 - + Every 100 passes for the remaining passes

2.2.5 Round Robin Reporting Instructions

An *Excel*[®] template was also prepared for reporting the test results (see copy in Appendix B). Required results included the following:

- Rut depth at 5,000 passes (in mm)
- Rut depth at 10,000 passes (in mm)
- Rut depth at 15,000 passes (in mm)
- Rut depth at 20,000 passes (in mm)
- Number of passes to reach 12.5 mm (0.5 in.) rut depth
- Creep slope
- Stripping slope
- Stripping inflection point (pass)
- Visual damage (0 to 5 rating where 5 is most damaged)

Laboratories were also asked to send the raw data files containing rut depth at different longitudinal positions (positions along the wheelpath) versus number of passes.

2.2.6 Result Reporting

Participating laboratories submitted their results to Caltrans as part of the RSP. Results were received from 20 laboratories (see Appendix C) between July and October 2015. Of these 20 laboratories, 14 sent

raw data files in addition to the completed *Excel*[®] result sheet. All results were forwarded to the UCPRC by Caltrans.

2.2.7 Data Analysis by the UCPRC

HWT test results were analyzed following the guidelines in ASTM C802-14 and ASTM C670. Several steps were followed in this analysis, including the following:

1. Analysis of Data Consistency. Data consistency was analyzed following the procedure detailed in Section 10.4 of ASTM C802. Results from the UCPRC-prepared specimens were analyzed independently of the results from the specimens prepared by the participating laboratories. Analysis was conducted independently for each test result variable (i.e., for each one of the reported variables listed in Section 2.2.5). Outliers were removed from the data for further analysis (criteria for identifying outliers are provided in Appendix D).
2. Statistical Model Definition. An analysis of variance (ANOVA) was conducted to determine which factors had the greatest influence on each one of the test result variables. The influence of laboratory, specimen set, and machine type were analyzed. A statistical model was defined using the results of this ANOVA analysis.
3. Determination of Variance Components. An ANOVA analysis was conducted using the model defined in the previous step. Variance components resulting from this analysis were used to estimate the single-operator standard deviation (the statistic underlying the single-operator indices of precision) and the between-laboratory component of the variance (this statistic, together with the single-operator standard deviation, are the statistics underlying the multilaboratory indices of precision).
4. UCPRC Analysis of Raw Data. Raw data (rut depth versus number of passes) were analyzed by the UCPRC using two different approaches. A more conservative approach that is currently used by Caltrans, where the maximum rut depth along the wheelpath was selected as the primary variable, and a less conservative approach, where deformation values at all measuring locations along the wheelpath were averaged. Results of both analyses were compared to values reported by the participating laboratories.
5. Determination of Variance Components for UCPRC Analysis Results. Step 3 was repeated for the analysis of the raw data by the UCPRC.
6. Formulation of Precision Statements. Single-operator (repeatability) and multilaboratory (reproducibility) precision statements were formulated for each HWT test result variable.
7. Formulation of Bias Statements. Bias statements could not be determined for the HWT test because the values determined (result variables) can be defined only in terms of the test method.

2.2.8 Terminology Used in the Analysis

The terminology used in ASTM C802-14 and ASTM C670-15 methods was adopted in this report for the discussion of the statistical analysis of the laboratory testing results. This terminology is defined as follows:

- Single-operator standard deviation, σ_r , (or coefficient of variation, CV_r) is the standard deviation (or coefficient of variation) of test determinations obtained on the same material by a single operator

using the same apparatus in the same laboratory over a relatively short period of time. The term “repeatability” is used in other publications instead of “single-operator”.

- Multilaboratory standard deviation, σ_R , (or coefficient of variation, CV_R) is the standard deviation (or coefficient of variation) of test results obtained on the same material in different laboratories with different operators using different equipment. The term “reproducibility” is used in other publications instead of “multilaboratory”.
- Between-laboratory variance, σ_L^2 , is the component of the multilaboratory variance, σ_R^2 , related to interlaboratory variability.

It should be noted that multilaboratory variability originates from two different sources, one related to the operator (single-operator variability) and the other related to the laboratory (between-laboratory variability). These three standard deviations are related as shown in Equation 2.1. The goal of the statistical analysis is to determine the single-operator standard deviation (σ_r) and between laboratory variance (σ_L), the results of which are used in Equation 2.1 to determine the multilaboratory standard deviation (σ_R), which in turn is used together with the single-operator standard deviation to formulate, respectively, single-operator (repeatability) and multilaboratory (reproducibility) precision statements.

$$\sigma_R^2 = \sigma_L^2 + \frac{\sigma_r^2}{m} \quad (2.1)$$

Where: m = number of test determinations for determining test result (m equals 1 for HWT test following Caltrans specifications, since results of left and right wheels are not averaged)

3. DATA SUMMARY

3.1 Introduction

Twenty laboratories participated in this round robin study. All laboratories conducted the required four HWT tests (two tests on specimens compacted by the UCPRC and the other two on specimens compacted by each laboratory). All laboratories submitted the four tests results as requested in the instruction sheet, while 14 of the 20 laboratories also submitted the requested raw data files containing rut depth versus number of wheel passes. The submitted results are tabulated in Appendix D.

3.2 Specimen Air-Void Contents

Specimen air-void contents are summarized in Figure 3.1 (boxes in the plot reflect first, second, and third quartiles; the ends of the whiskers represent minimum and maximum values). The average air-void contents of the specimens compacted by the UCPRC were slightly lower than those compacted by the participating laboratories. Most specimens tested were within the specified range of 7.0 ± 1.0 percent, as shown in Figure 3.2. However, five of the specimens compacted by the UCPRC had air-void contents outside this range, all of them on the low side, and six of the specimens compacted by the participating laboratories were outside this range, with one on the low side and five on the high side.

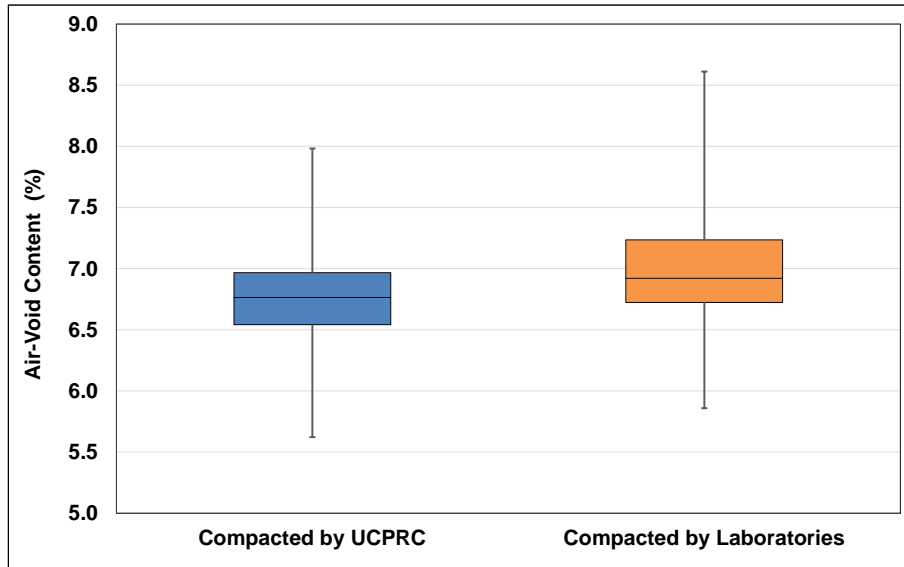

Figure 3.1: Specimen air-void contents.

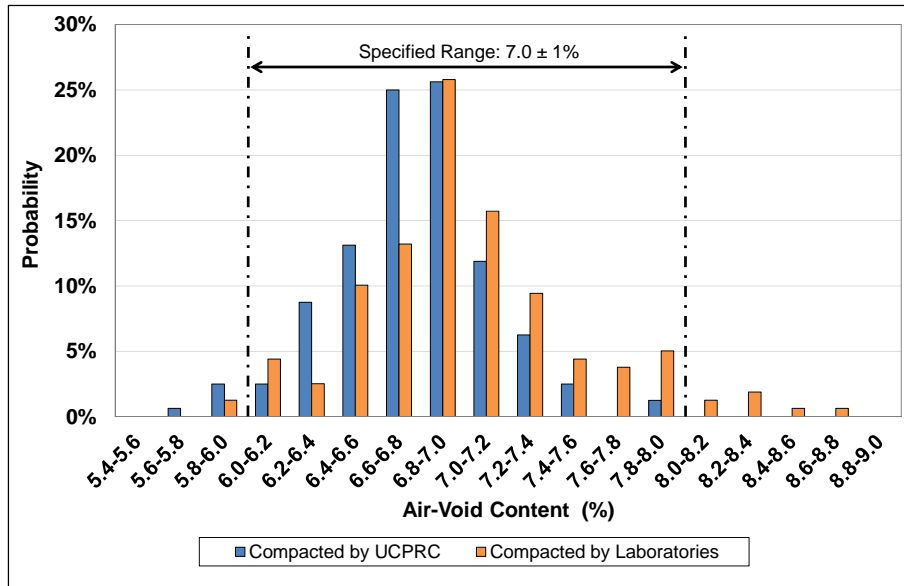

Figure 3.2: Air-void content histograms.

The range in the air-void content of the specimens prepared by the participating laboratories was greater than those prepared by the UCPRC. This was an expected outcome since the interlaboratory component of the variance would be evident in the variability of the specimens compacted by the participating laboratories but was not in the specimens compacted by the UCPRC. In both cases, the range in variation in air-void content was considered to be relatively low. A correlation study was conducted to determine if this variation had an effect on the variability of the test results. Different test results were plotted against the mean air-void content (mean of the two specimens tested with one wheel), and the coefficient of determination (R-squared) was calculated. An example of these plots is shown in Figure 3.3, which indicates that there is no correlation between the rut depth after 20,000 passes and the air-void content of the specimens tested. The R-squared value was 0.034 and 0.026 for the tests conducted on the specimens compacted by the UCPRC and the participating laboratories, respectively, which implies that only about three percent of the variance of the rut depth after 20,000 passes is explained by the variability of the air-void content. Similar correlation values were obtained for the different test result combinations evaluated, including the minimum and maximum air-void contents of the two specimens tested with one wheel, and the air-void content range (maximum minus minimum).

Figure 3.3 shows the R-squared values calculated for each combination of test result and air-void content-related variable. Since the correlation was very poor in all cases, it was concluded that the air-void content was not a source of test variability for this round robin study.

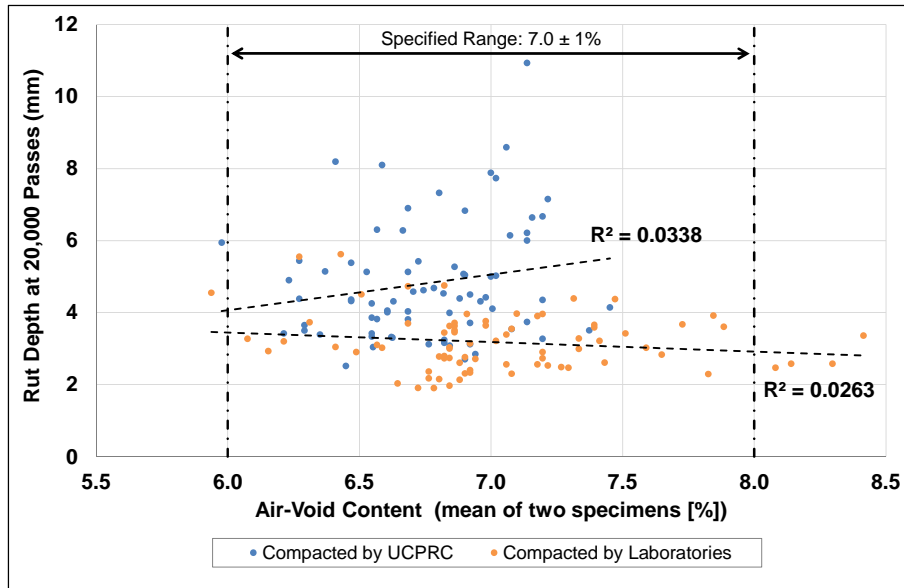

Figure 3.3: Air-void content effect on rut depth.

Table 3.1: Summary of Coefficients of Determination (R^2)

Laboratory	Test Result	Air-Void Content			
		Mean	Minimum	Maximum	Range
Specimens Compacted by UCPRC	Rut Depth at 5,000 passes	0.002	0.005	0.000	0.005
	Rut Depth at 10,000 passes	0.002	0.001	0.002	0.000
	Rut Depth at 15,000 passes	0.003	0.000	0.007	0.009
	Rut Depth at 20,000 passes	0.034	0.022	0.032	0.002
	Passes at 12.5 mm rut depth	0.006	0.005	0.043	0.124
	Creep Slope	0.018	0.011	0.019	0.005
	Strip Slope	0.074	0.065	0.058	0.000
	Passes to Stripping Inflection Point	0.000	0.000	0.001	0.002
Specimens Compacted by Participating Laboratories	Rut Depth at 5,000 passes	0.048	0.051	0.040	0.002
	Rut Depth at 10,000 passes	0.057	0.061	0.048	0.002
	Rut Depth at 15,000 passes	0.058	0.064	0.048	0.004
	Rut Depth at 20,000 passes	0.026	0.024	0.026	0.001
	Passes at 12.5 mm rut depth	No data	No data	No data	No data
	Creep Slope	0.005	0.005	0.004	0.001
	Strip Slope	0.119	0.117	0.107	0.002
	Passes to Stripping Inflection Point	0.059	0.089	0.013	0.129

3.3 Rut Depth Measurements

Comparative plots of the rut depth measurements submitted by the 14 laboratories that sent raw data files for the UCPRC-compacted specimens and those they compacted are shown in Figure 3.4 and Figure 3.5, respectively. Each line in the figures represents the result of one test wheel as an average for all the measuring locations along the wheelpath. A smoothing technique (moving weighted average) was applied after averaging all locations.

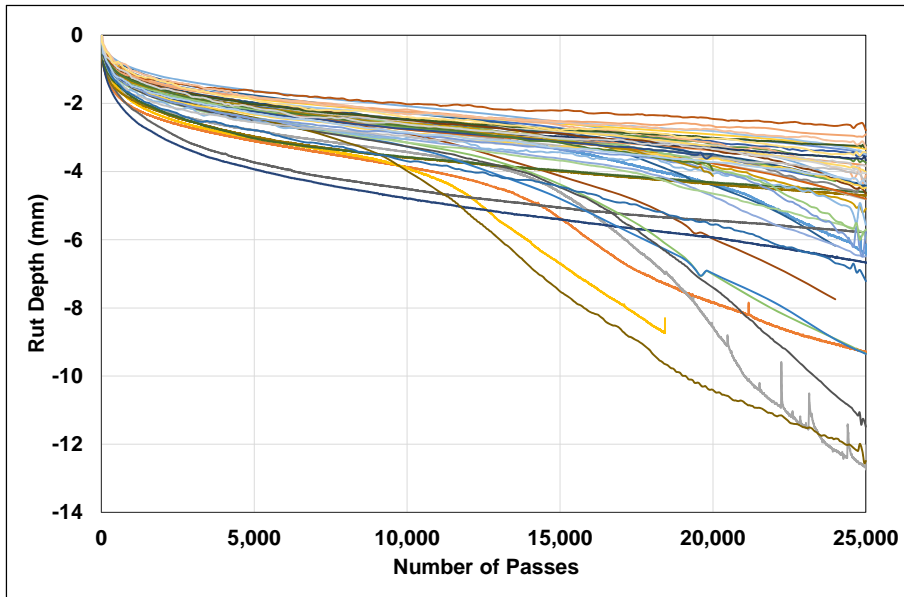

Figure 3.4: Rut depths on specimens compacted by the UCPRC.

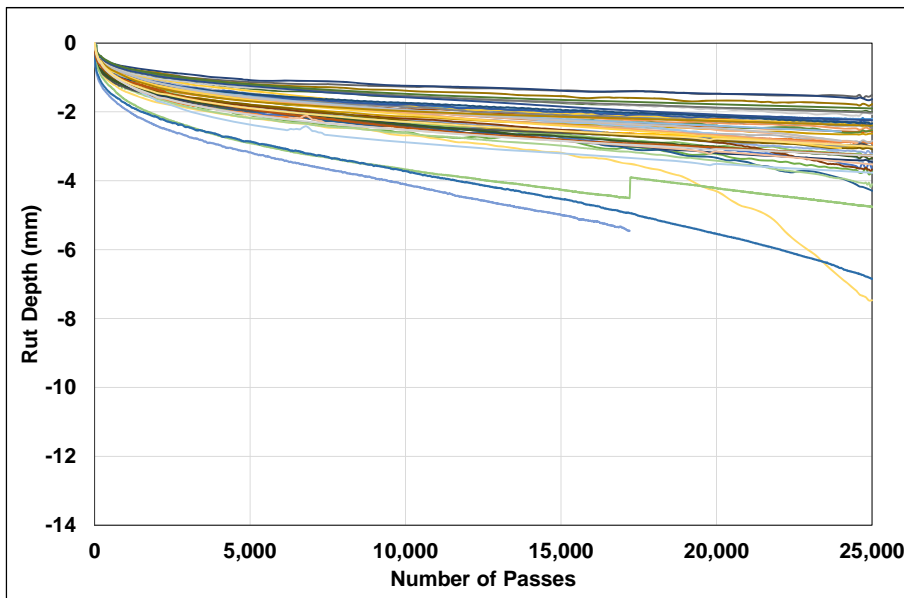

Figure 3.5: Rut depths on specimens compacted by participating laboratories.

The results indicate that overall performance on the specimens compacted by the UCPRC was considerably worse than that on the specimens compacted by the laboratories. Deformation after 25,000 passes on the specimens prepared by the UCPRC was between 2.5 mm and 7.5 mm in most tests, with some test results higher than 8.0 mm. Clear stripping inflection points were observed in more than 10 instances. For the specimens prepared by the participating laboratories, deformation after 25,000 passes was between 2.0 mm and 4.0 mm in most tests, and a clear stripping inflection point was only recorded in one instance.

The differences in performance between the specimens compacted by the UCPRC and the specimens compacted by the participating laboratories were not related to compaction/air-void content, given that specimen air-void contents were lower on the UCPRC-compacted specimens, as discussed in Section 3.2. One possible explanation for the difference in performance between the two sets of specimens is differences in the degree of asphalt binder aging related to oven temperature settings and time spent in the oven during heating of the loose mix prior to specimen fabrication by the participating laboratories. It is also possible that laboratories repeated tests if unsatisfactory results were initially obtained. Each participating laboratory was provided with two five-gallon buckets of loose mix, which is sufficient material to compact multiple specimens and run multiple tests. This approach could have eliminated outliers in the tests on specimens prepared by the participating laboratories, resulting in generally lower standard deviations. Each participating laboratory received only four UCPRC-compacted samples, the exact number required to do the requested testing.

Although a marginal mix with no anti-stripping agent was sought for the study, test results on both sets of compacted specimens indicate that rutting/stripping performance of the mix was relatively good. The 12.5 mm (0.5 in.) threshold value was exceeded in only one case, and the stripping phase did not initiate in most tests. No explanation for the limited number of tests that stripped was identified from the test data submitted.

Summary plots of the tabulated results provided in Appendix D are shown in Figure 3.6 through Figure 3.13. All the laboratories provided data for rut depth after 5,000, 10,000, 15,000, and 20,000 wheel passes, as requested. In some instances the tests appear to have been stopped before the predefined number of passes was reached. Creep slope was not reported in approximately 50 percent of the tests. Some laboratories did not report the creep and stripping slope if a stripping inflection point was not observed.

There was limited variability in the rut depth measurements for both sets of compacted specimens at the defined number of wheel passes (Figure 3.6 through Figure 3.9). Larger variability was evident in the reporting of the creep and stripping slopes and the stripping inflection point (Figure 3.11 through Figure 3.13). These issues are discussed in more detail in Chapter 4.

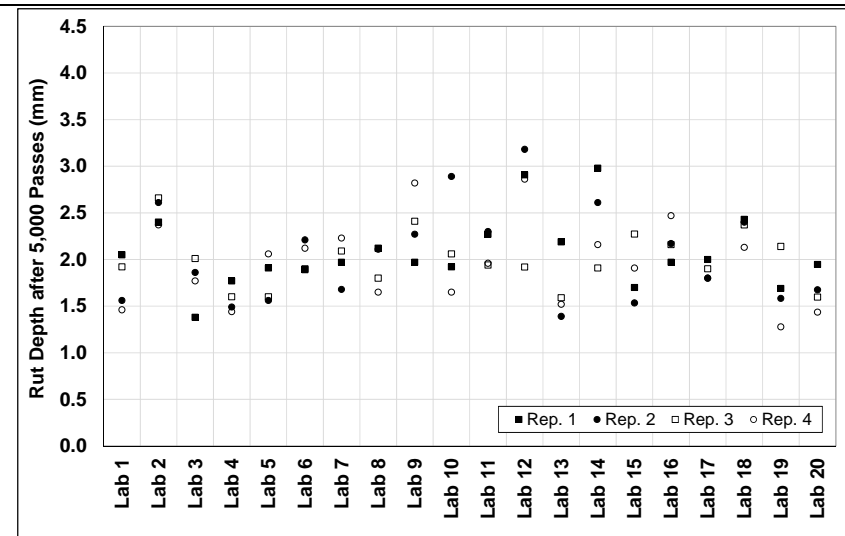
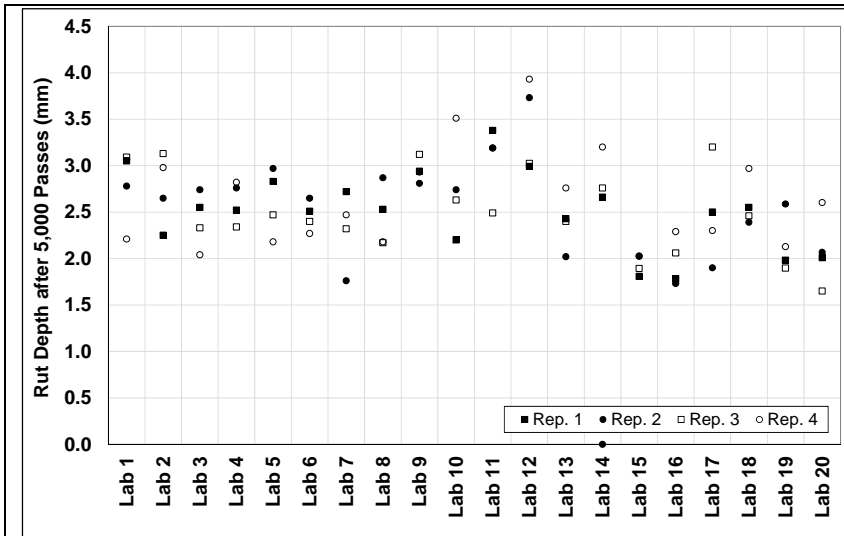

Specimens compacted by the UCPRC

Specimens compacted by participating laboratories

Figure 3.6: Rut depth after 5,000 wheel passes.

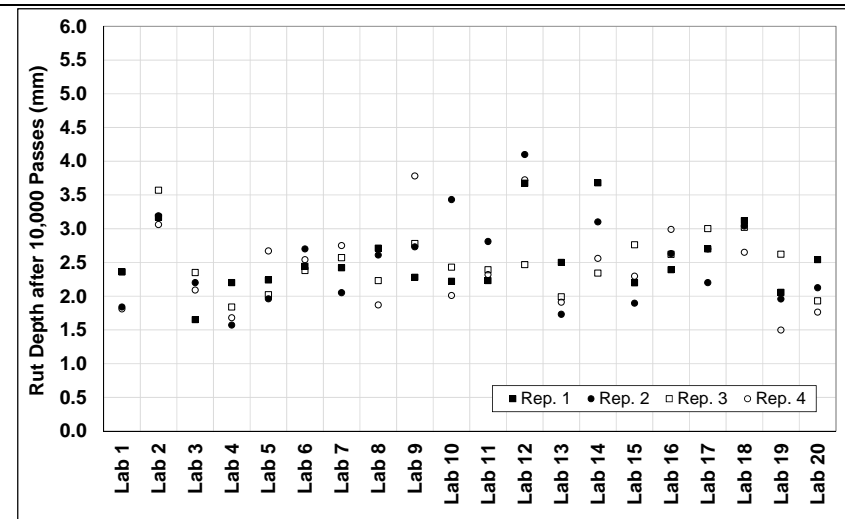
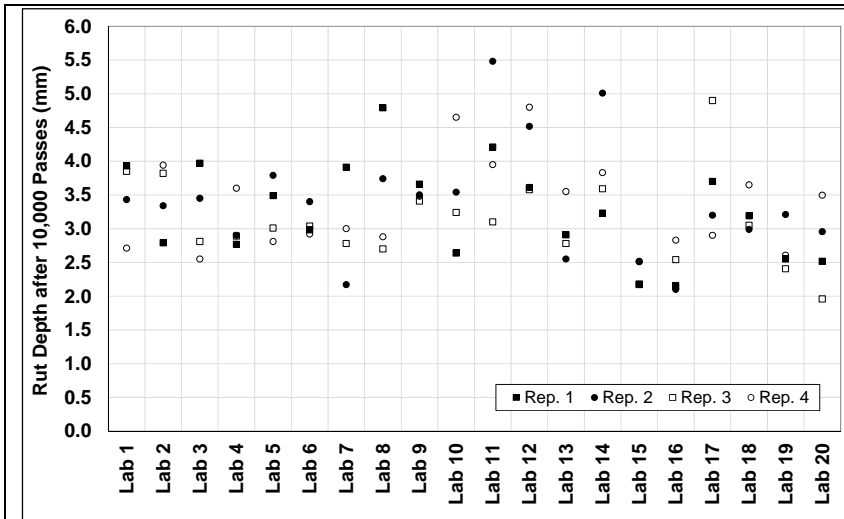

Specimens compacted by the UCPRC

Specimens compacted by participating laboratories

Figure 3.7: Rut depth after 10,000 wheel passes.

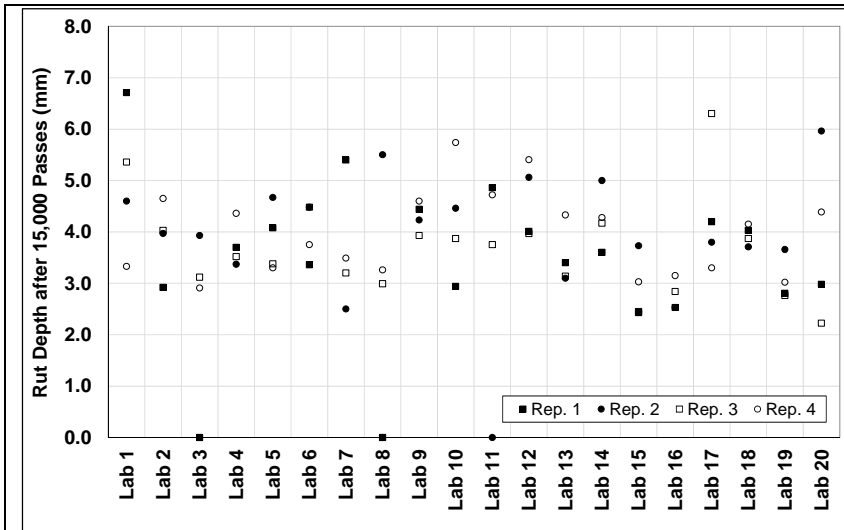

Specimens compacted by the UCPRC

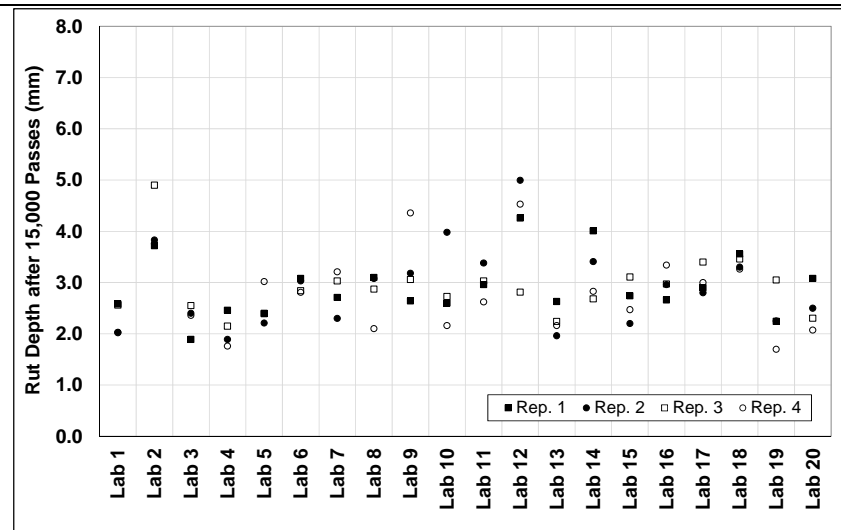

Specimens compacted by participating laboratories

Figure 3.8: Rut depth after 15,000 wheel passes.

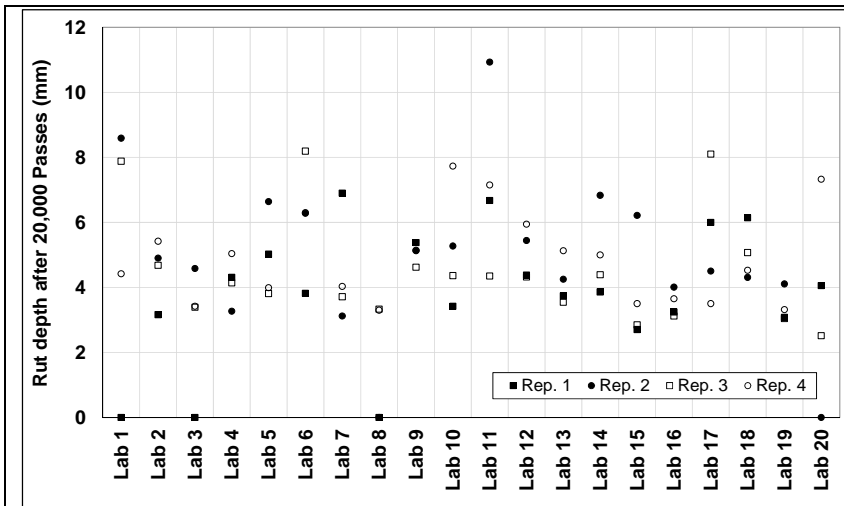

Specimens compacted by the UCPRC

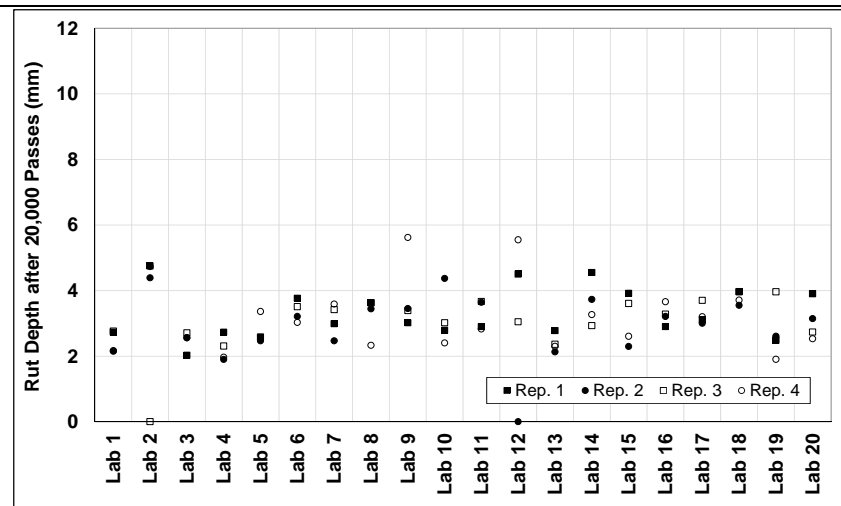

Specimens compacted by participating laboratories

Figure 3.9: Rut depth after 20,000 wheel passes.

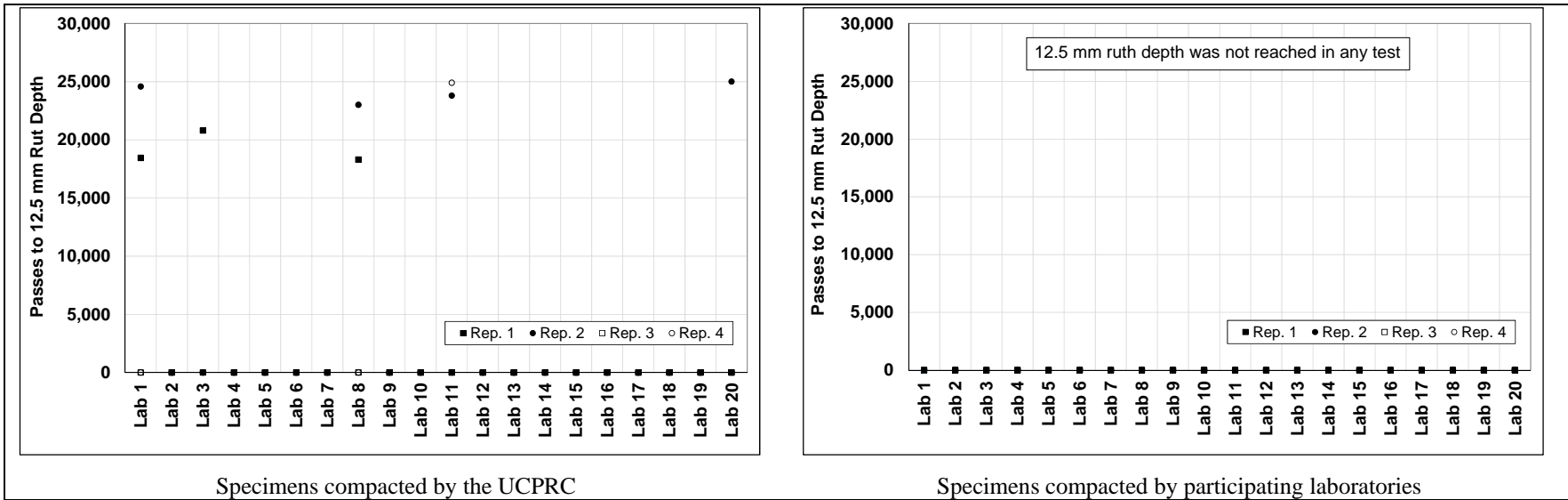

Figure 3.10: Number of wheel passes to 12.5 mm rut depth.

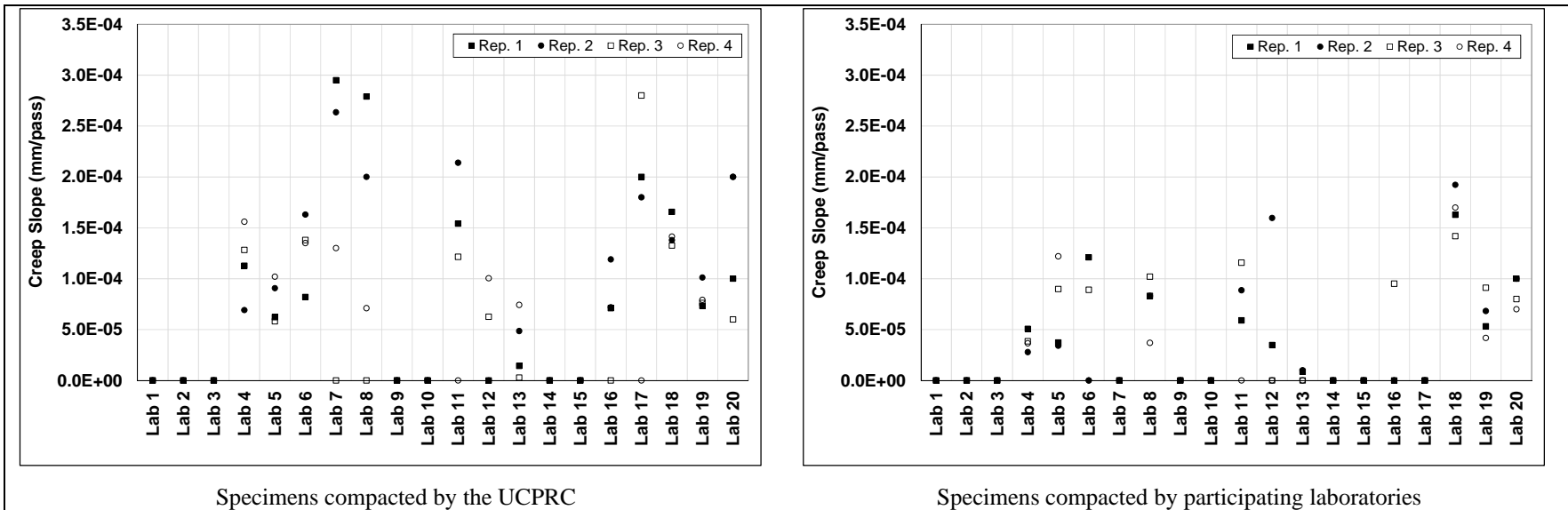

Figure 3.11: Creep slope.

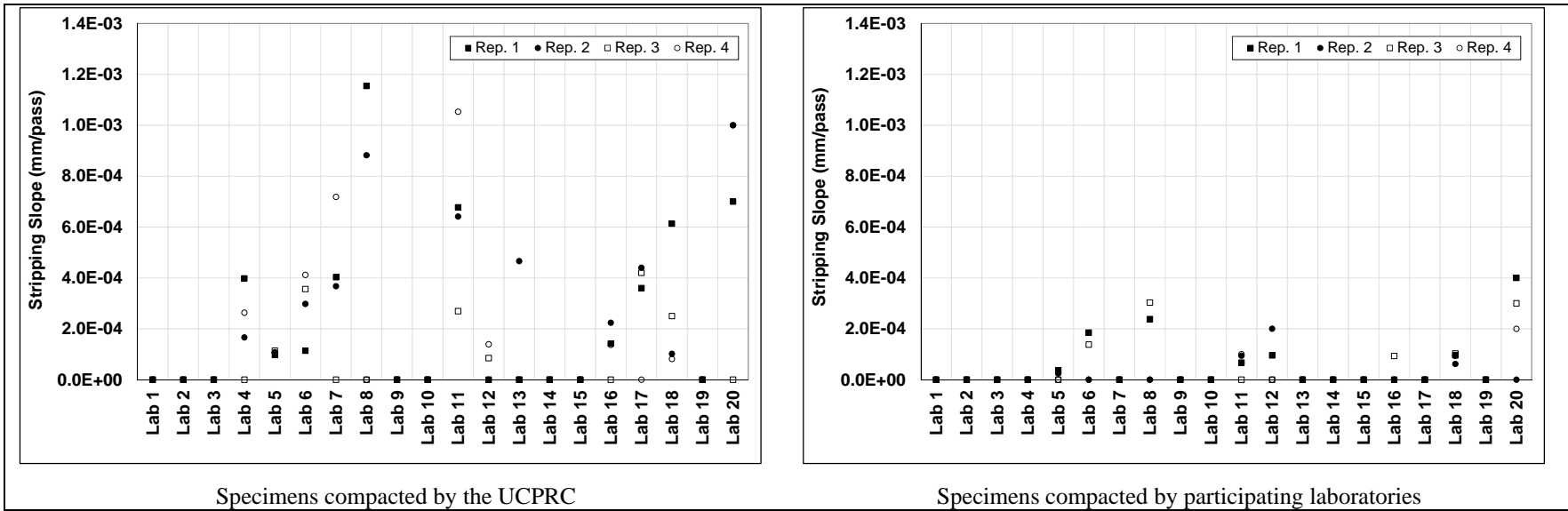

Figure 3.12: Stripping slope.

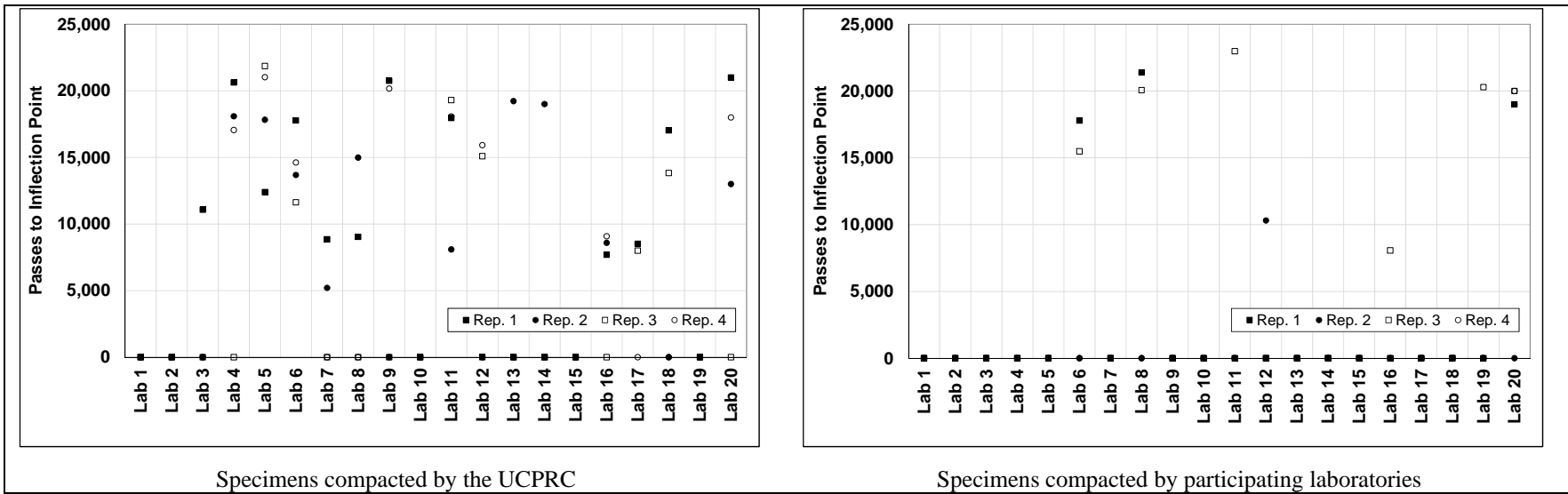

Figure 3.13: Number of passes to stripping inflection point.

Blank page

4. DATA ANALYSIS

4.1 Analysis of Data Consistency

Data consistency was evaluated following the approach described in ASTM C802 (Section 10.5). Test results from the specimens compacted by the UCPRC and specimens compacted by each participating laboratory were analyzed independently. Analysis was also conducted independently for each test result variable. Mean and standard deviation were first calculated for each laboratory using the four replicates (two HWT tests, two wheels per test). These statistics were then compared to the average from all of the laboratories. Individual results were considered as potential outliers when their mean or standard deviation differed considerably from the average of all the results from the other laboratories. This comparison was conducted using the h and k values, as defined in ASTM C802 (Equations 4.1 and 4.2).

$$h_i = \frac{x_i - x_{mean}}{S_{xm}} \quad (4.1)$$

Where: h_i is the h -value of the laboratory i
 x_i is the laboratory i average (mean of four replicates)
 x_{mean} is the average of all laboratories
 S_{xm} is the standard deviation of laboratory averages

$$k_i = \frac{Sr_i}{Sr_{pool}} \quad (4.2)$$

Where: k_i is the k -value of the laboratory i
 Sr_i is the standard deviation of laboratory i (standard deviation of four replicates)
 Sr_{pool} is the pooled standard deviation (square root of the mean of the variance of all laboratories)

The h -value provides an index of how much the laboratory mean result deviates from the mean of other laboratories. Laboratories with an h -value greater than a critical value (in absolute terms) are considered as potential outliers. The critical h -value for 20 laboratories is ± 2.56 (ASTM C802, Table 4). The k -value provides an index of the single-operator variability of each laboratory compared to the other laboratories. Laboratories with a k -value greater than a critical value should be considered as potential outliers. The critical k -value for 20 laboratories and four replicates is 2.00 (ASTM C802, Table 4).

Appendix D contains the HWT test results submitted by the laboratories. Two tables are included in this appendix for each set of test results (one for the specimens compacted by the UCPRC and one for the specimens compacted by each participating laboratory). Potential outliers, which are highlighted in these tables, were discarded in the analyses. The means and standard deviations for the 20 laboratories, with the outliers removed, are presented for the different sets of test results in Figure 4.1 through Figure 4.8.

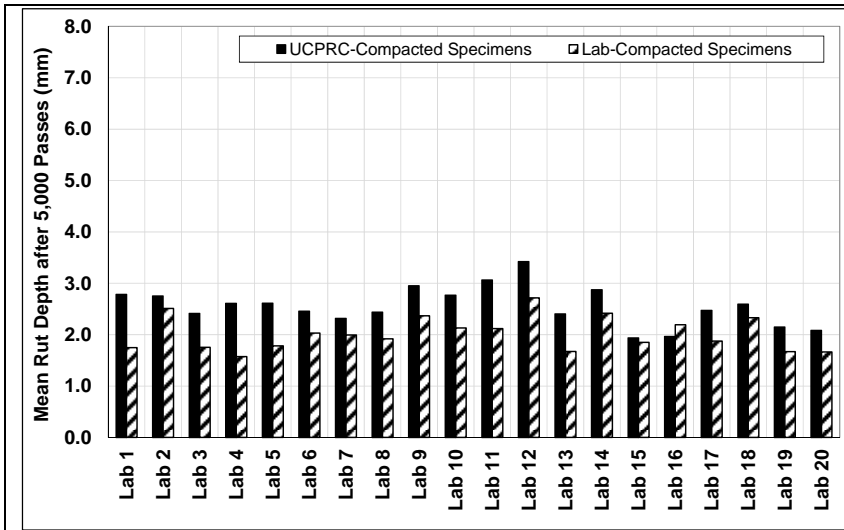

Laboratory mean

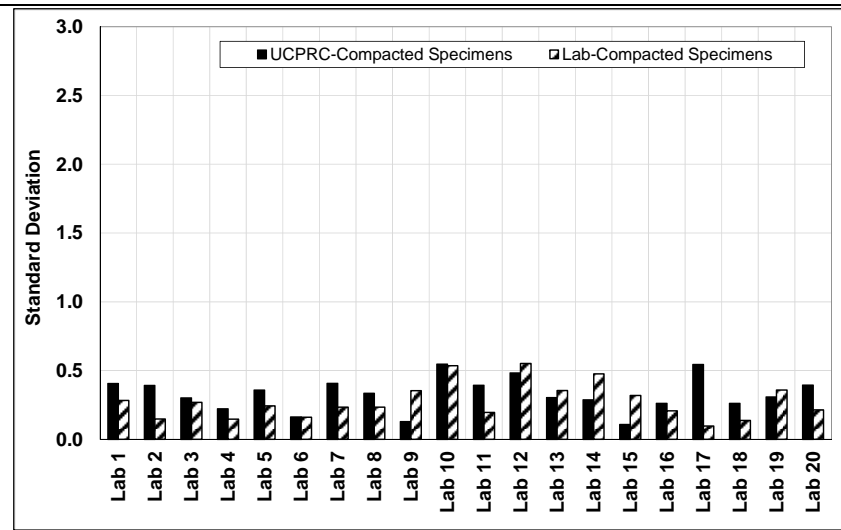

Laboratory standard deviation

Figure 4.1: Rut depth after 5,000 wheel passes.

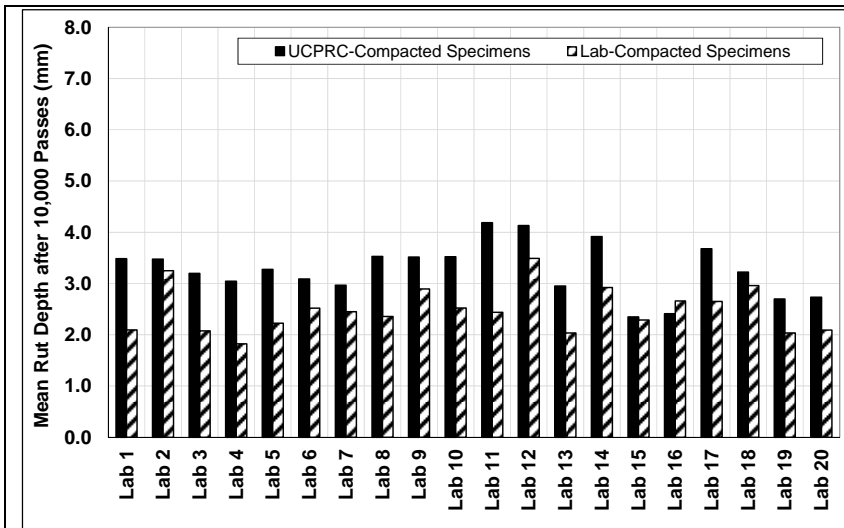

Laboratory mean

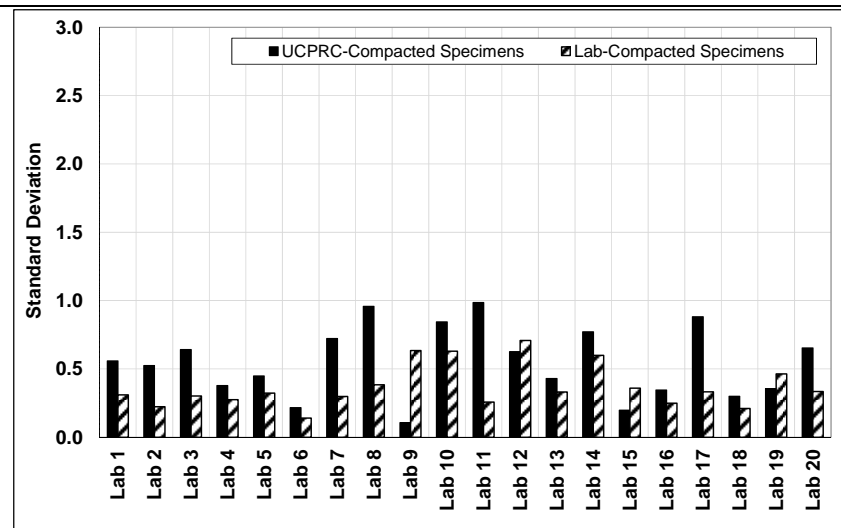

Laboratory standard deviation

Figure 4.2: Rut depth after 10,000 wheel passes.

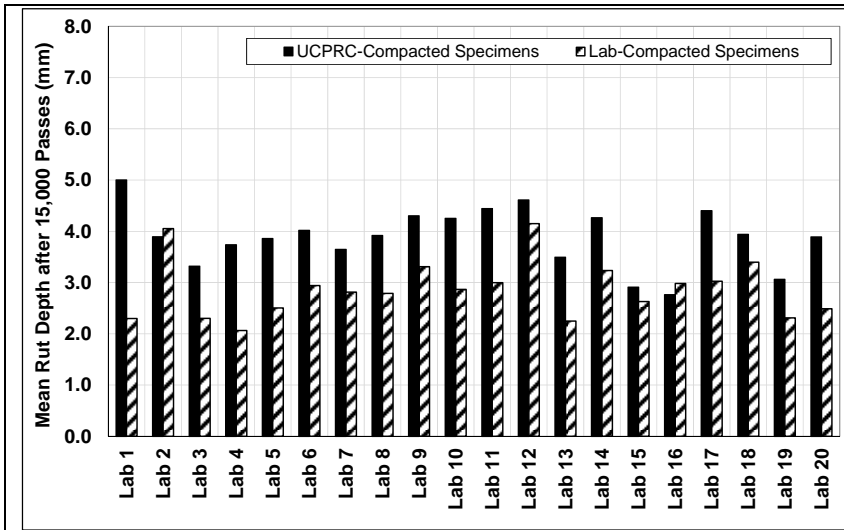

Laboratory mean

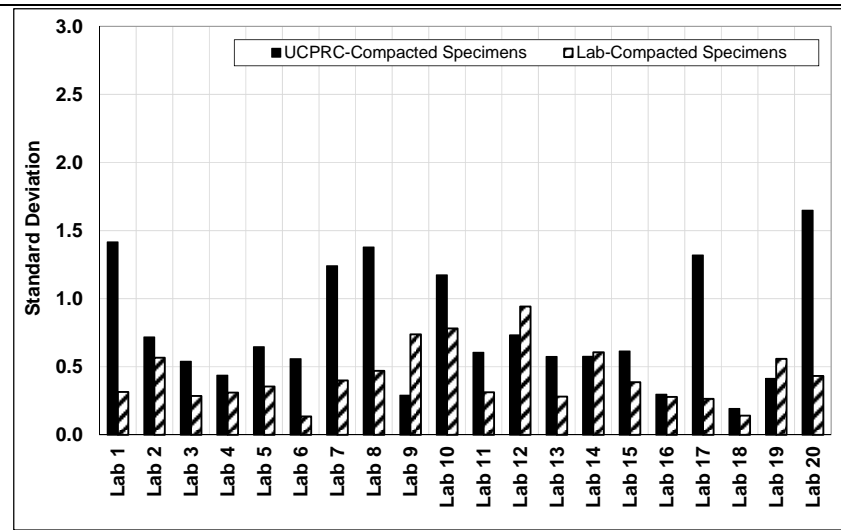

Laboratory standard deviation

Figure 4.3: Rut depth after 15,000 wheel passes.

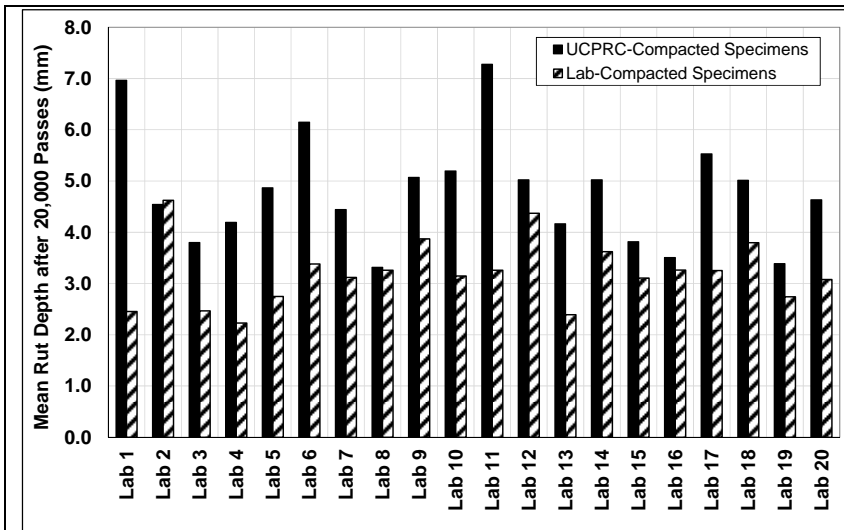

Laboratory mean

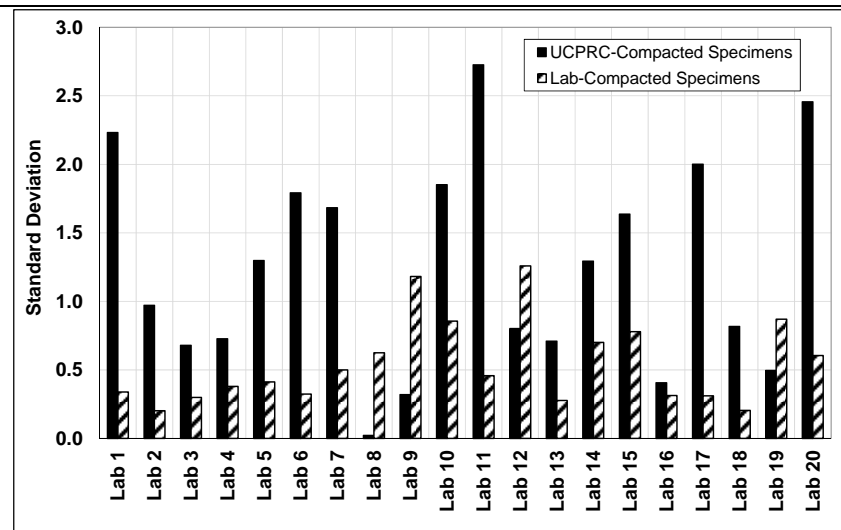

Laboratory standard deviation

Figure 4.4: Rut depth after 20,000 wheel passes.

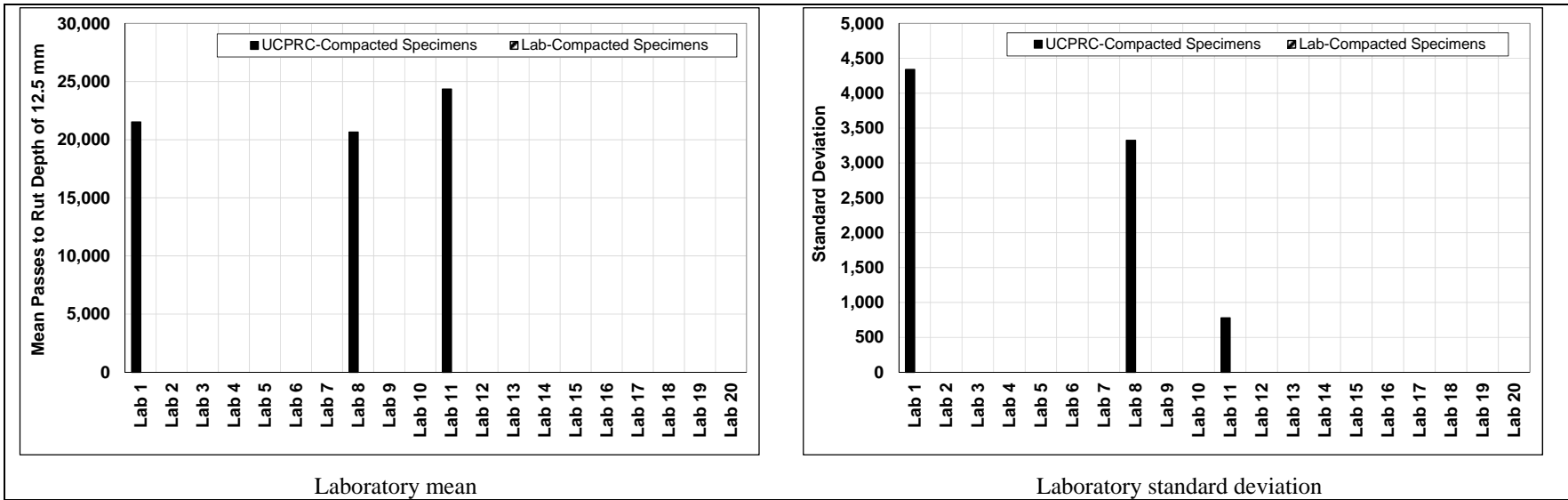

Figure 4.5: Number of passes to 12.5 mm rut depth.

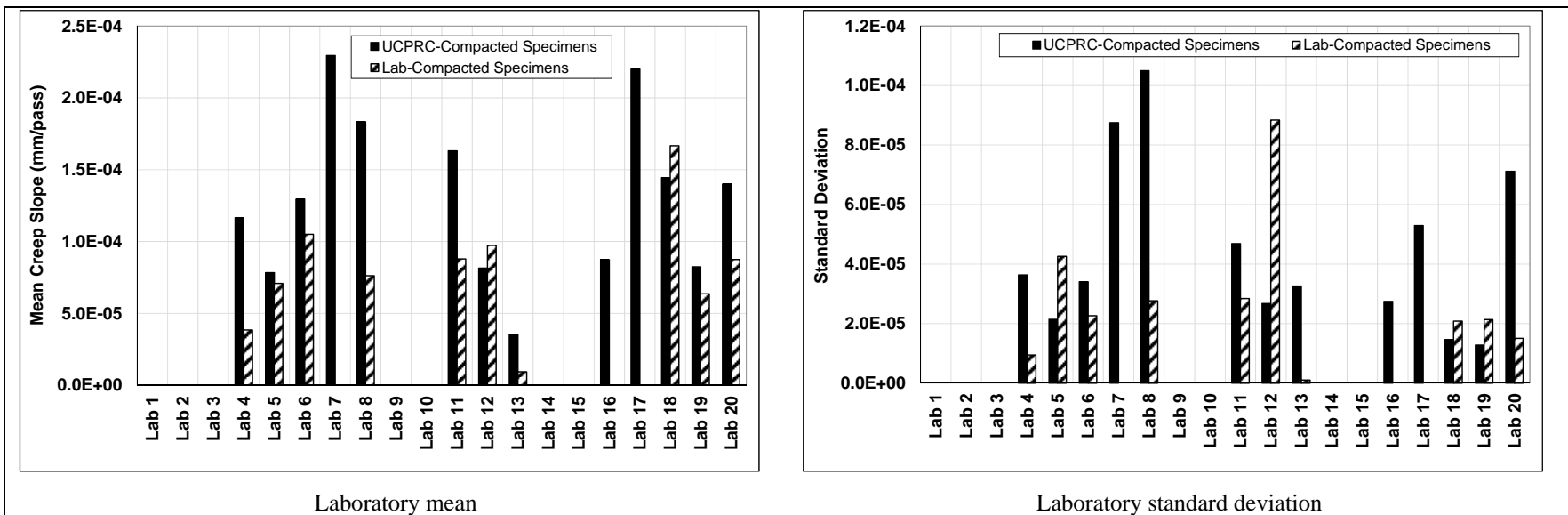

Figure 4.6: Creep slope.

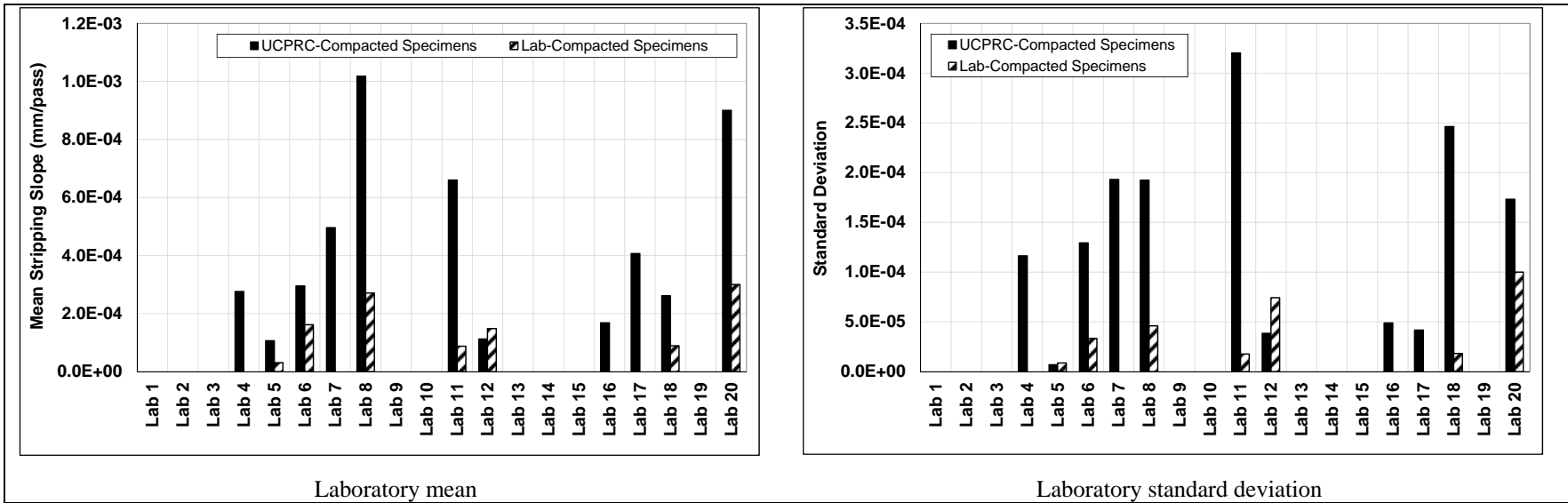

Figure 4.7: Stripping slope.

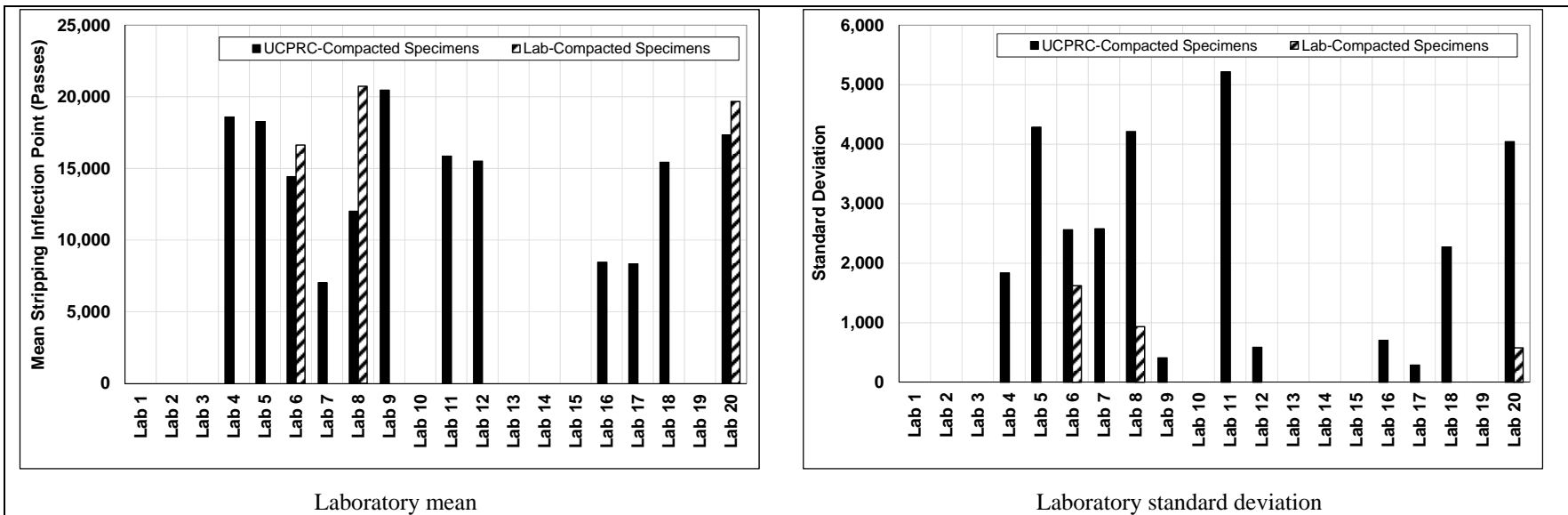

Figure 4.8: Stripping inflection point.

4.2 Statistical Model Definition

An analysis of variance (ANOVA) was conducted to determine which factors had the greatest influence on each one of the test results. Tests conducted on specimens compacted by the UCPRC and by the individual labs were analyzed independently. The following factors were considered in the analysis, as reflected in Figure 4.9:

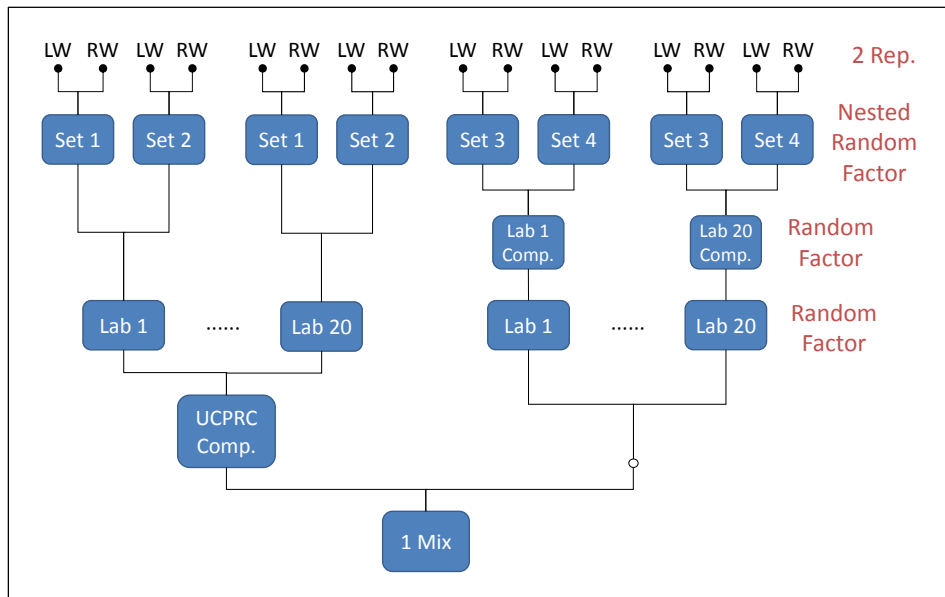

Figure 4.9: Factors in the ANOVA analysis.

- **Laboratory.** Laboratory was regarded as a random factor. The 20 laboratories included in the analysis were each regarded as a representative sample of the population of laboratories that may conduct the modified AASHTO T 324 test for Caltrans.
- **Compaction.** Variability introduced in the compaction process influences both single-operator variability and between-laboratory variability. Between-laboratory variability specifically related to compaction could not be determined in this ANOVA since its effects were confounded by the between-laboratory variability introduced by the testing itself. Single-operator variability related to compaction had similar limitations. Although compaction was regarded as an important factor, its effects could therefore not be specifically determined in this analysis.
- **Set (test).** Each laboratory conducted two tests on the specimens compacted by the UCPRC and two tests on the specimens compacted by that laboratory. The results from each of the two wheels were regarded as two replicates within each HWT test. The *Set* factor was introduced to determine if there was a correlation between the results of the two wheels or, on the contrary, if the results from the two wheels were independent of each other. *Set* was a random factor nested in each laboratory level.

The results from this ANOVA analysis in the form of the output from the *SPSS* statistical software package are included in Appendix E. A summary of the significance level of *Lab* and *Set(Lab)* (i.e., *Set*

nested in *Lab*), is shown in Figure 4.10. Only one case in the *Set(Lab)* was significant (p-value below 0.05). This case was the creep slope on the specimens prepared by the UCPRC. This outcome was related to two particular HWT tests, conducted by Laboratory #7 and Laboratory #8, where the results from both wheels on the equipment indicated poor performance. Since only one case was identified, *Set* was not considered to have a significant influence on HWT test results, and it was not included in subsequent ANOVAs. A similar round robin study conducted by AMRL found that single-wheel HWT test machines presented lower variability for a poor-performing mix than two-wheel machines (all machines used in the study were manufactured by Precision Machine and Welding) (3). It was hypothesized in that study that the dynamic effects of one wheel might influence the performance of the other wheel.

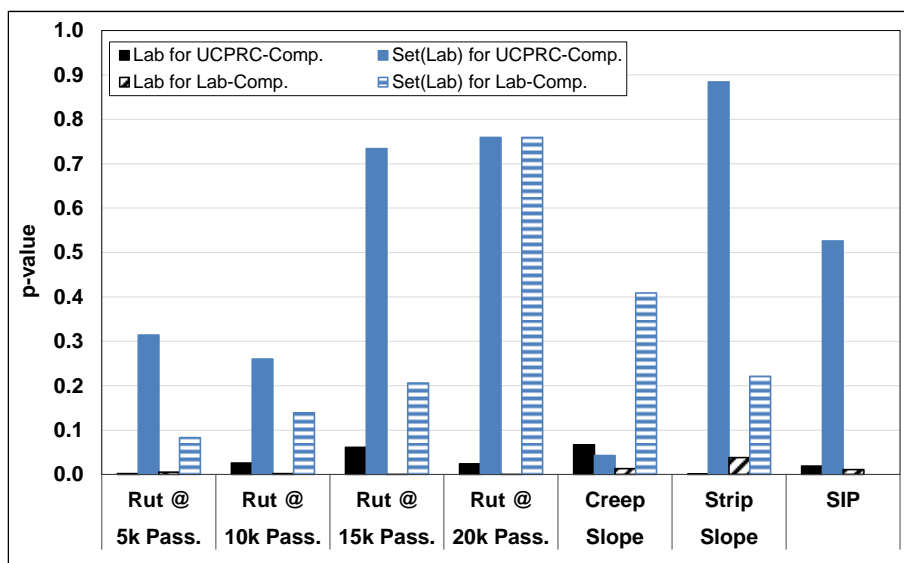

Figure 4.10: Factor significance level for HWT test results (SIP = stripping inflection point).

The participating laboratories in this UCPRC study used HWT machines from four different manufacturers, namely: Pavement Technology Inc., Precision Machine and Welding (PMW), Pine Test Equipment LLC, and Cox and Sons Inc. (Appendix C). During the analysis it was accepted that differences between the machines could potentially influence the test results, as noted by a recent study at Louisiana State University (3) that compared different HWT machines. In that study, differences were also found in terms of how the AASHTO T 324 test method was interpreted and in the test results from the different machines. The most important parameters identified as not being specified in the test method include the following:

- Length of the wheelpath
- Spacing between the rut depth measuring points along the wheelpath
 - + *PMW* machines report the rut depth at 11 locations along the wheelpath from -114 mm to +114 mm in 23 mm increments.

- + *Pavement Technology Inc.* machines report the rut depth at five locations: -97 mm, 32 mm, 0, +32 mm and +99 mm.
- + *Cox and Sons* machines report rut depths at 227 locations from -113 mm to +113 mm in 1.0 mm increments.
- + *Pine Test Equipment* HWT devices report rut depth at a unique location.
- Locations along the wheelpath used to calculate test results.

The four HWT devices used in this study therefore measure rut depths at slightly different locations along the 6 in. (150 mm) wheelpath and during test set up may require users to enter the location or locations on which to base calculations. Other software options available in individual machines include using the maximum rut, the three central locations, or the three locations around the maximum rut. Consequently, the exact same rut depth profile may be interpreted differently by the different device software programs, with some of the influence dependent on the operator's input instructions.

A recent HWT round robin study conducted by AMRL (2) recommended using the average rut depth measured in all 11 locations (only *PMW* devices were used in that AMRL study). Another study (3), which focused on the test characteristics of the same four HWT devices used in the UCPRC study, recommended using the average of five deformation sensors located at -46 mm, -23 mm, 0, + 23 mm, and +46 mm.

A second ANOVA was undertaken to evaluate any potential differences in the results from the four different HWT machines used by the participating laboratories. In this ANOVA, *Machine Type* was included as a fixed factor and *Laboratory* was included as a random factor nested in *Machine Type*. *Machine Type* had four levels, each corresponding to one of the four manufacturers of the equipment used. Results from the specimens compacted by the UCPRC and those compacted by each participating laboratory were analyzed separately. The results of this ANOVA are summarized in Figure 4.11, which clearly indicates the potentially significant influence (p-value below 0.05) that machine type can have on the early test results (rut depth at 5,000 and 10,000 passes), which can be influenced by factors such as different temperature conditioning or wheel resting locations. *Pine* testing machines appeared to report deeper ruts than the other three machine types, as shown in Figure 4.12. Since *Machine Type* was found to only be important for the early test results, this factor was not included in subsequent ANOVAs. Based on these considerations, the round robin study analysis approach shown in Figure 4.13 was adopted (i.e., the *Set* and *Machine Type* factors were not included).

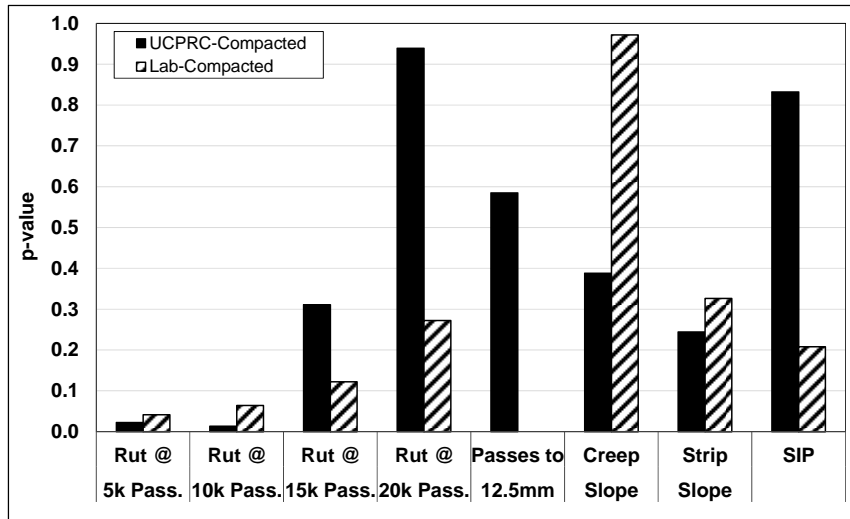

Figure 4.11: Machine-type significance level in the ANOVA.

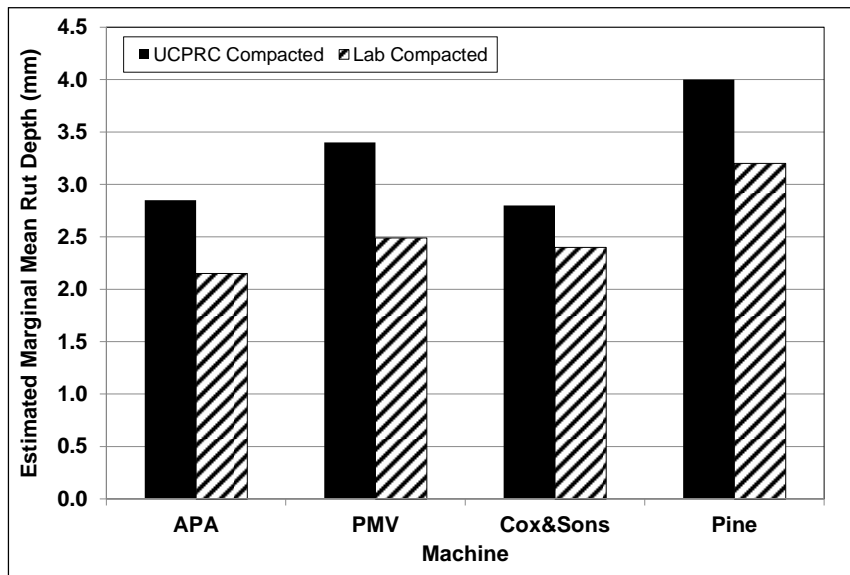

Figure 4.12: Machine effect on rut depth after 10,000 passes.

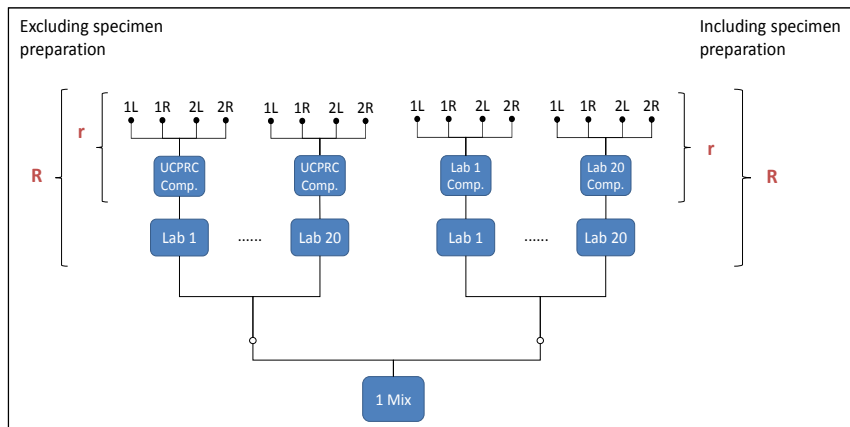

Figure 4.13: Statistical design for the round robin study analysis.

Variability related to specimen compaction influenced results of the tests conducted on the UCPRC-compacted specimens and the specimens compacted by the participating laboratories in different ways. In both cases, the compaction-related single-operator variability influenced the repeatability (r) of the test results. However, the compaction-related between-laboratory variability influenced the results of the tests conducted on specimens compacted by each participating laboratory, but not on those conducted on UCPRC-compacted specimens. For these reasons, similar single-operator variability (repeatability) was expected for the two sources of compacted specimens, while the multilaboratory variability (reproducibility) was expected to be better for UCPRC-compacted specimens. In both cases, the same statistical model was used, as shown in Equation 4.3.

$$Y_{ij} = \mu + \mu_i + \varepsilon_{ij} \quad (4.3)$$

Where: Y_{ij} = replicate j of laboratory i ($i=1, 2, \dots, 20$ and $j = 1, 2, 3, 4$)

μ = true mean of all laboratories

μ_i = laboratory effect, where $\mu_i \sim N(0, \sigma_L)$

ε_{ij} = error, where $\varepsilon_{ij} \sim N(0, \sigma)$

σ = model error

σ_L = between-laboratory standard deviation

The following indices of precision were determined for this statistical model:

- Single-operator standard deviation (repeatability): $\sigma_r^2 = \sigma^2$
- Multilaboratory standard deviation (reproducibility): $\sigma_R^2 = \sigma_L^2 + \sigma^2/m$ ($m = 1$ in this case, since Section 39 of the Caltrans Standard Specifications states that the results of the two wheels must not be averaged.)

4.3 Determination of Variance Components

A third ANOVA was conducted to determine variance components. The statistical model reflected in Equation 4.3 includes a single random factor. The two sources of compacted specimens (UCPRC and participating laboratory) were analyzed independently. *Machine Type* and *Set* were discarded for the analysis, as explained above. An ANOVA table was produced for each variable, after which the mean square error (MSE) and the mean square of the random factor (MST) were used to estimate the model parameters (Equation 4.4 and Equation 4.5).

$$\sigma^2 = \text{MSE} \quad (4.4)$$

$$\sigma_L^2 = (\text{MST} - \text{MSE})/\text{NR} \quad (4.5)$$

Where: σ = model error

σ_L = between-laboratory standard deviation

NR = number of replicates. NR is 4 when the 4 results supplied by all laboratories are used in the analysis. When there are missing data, NR is estimated following the approach detailed in ASTM C802, Appendix X3.

Results from the ANOVA are included in Appendix F (output from the *SPSS* statistical software analyses).

Statistics for rut depth at 5,000, 10,000, 15,000, and 20,000 wheel passes are shown in Figure 4.14 through Figure 4.16. Standard deviations for single-operator and between-laboratory rut depth results increased approximately linearly, versus rut depth. As a consequence, multilaboratory standard deviation also increased with rut depth. As expected, the single-operator standard deviation followed the same pattern for specimens from both sources. Between-laboratory variability was slightly higher for the specimens compacted by the participating laboratories, also as expected, and consequently, the multilaboratory standard deviation was higher for these test results. However, these differences were relatively small, indicating that the variability associated with specimen fabrication had less influence on multilaboratory standard deviation than the variability related to testing and data analysis.

Statistics for creep and stripping slopes are summarized in Figure 4.17 through Figure 4.19. Standard deviations for both single-operator and between-laboratory increased in proportion to slope values, with the proportionality of the rate appearing to be similar for both creep and strip slopes. Single-operator and between-laboratory standard deviations of the two sets of compacted specimens both appeared to follow the same pattern. Between-laboratory variability related to specimen fabrication was again much smaller than the between-laboratory variability related to testing and data analysis.

No attempt was made to estimate the standard deviations associated with the number of passes to 12.5 mm (0.5 in.) rut depth since this result was reported in only eight cases (all for tests on specimens compacted by the UCPRC). The same applies to the stripping inflection point of the tests conducted on specimens compacted by the laboratories, where only 11 results were reported. The single-operator standard deviation of the stripping inflection point for specimens compacted by the UCPRC was 3,212 wheel passes, and the between-laboratory standard deviation was 3,456. The mean number of wheel passes to the stripping inflection point for all tests was 14,306.

4.4 Analysis of Raw Data by the UCPRC

The AASHTO T 324 method requires reporting of several test results that can be determined on the basis of the rut depth curve versus number of passes. However, the method does not specify the length of the wheelpath, which locations or combinations of locations along the wheelpath should be used to determine the rut depth, nor whether the average or the peak value is used. A comparative analysis of the raw data submitted by the laboratories was therefore conducted to determine to what extent test results could

change depending on the analysis software and user interpretation. Two different approaches were used, namely:

- A conservative approach, where the maximum rut depth along the wheelpath was selected and no smoothing technique was used. This approach is currently used by Caltrans.
- A non-conservative approach, where deformation values at all measuring locations along the wheelpath were averaged, and the results smoothed using a weighted moving average.

Test results calculated by the UCPRC were compared to the values submitted by the individual laboratories. These comparisons are presented in Figure 4.20 through Figure 4.24. (Note that points along the abscissa axis in the plots represent cases where the UCPRC could not determine the result, while points along the ordinate axis represent cases where the participating laboratory could not determine or did not report the results. Points at the origin of the coordinates represent cases where neither the participating laboratory nor the UCPRC observed a result.) Observations from the analysis include the following:

- The different analysis software and how users interpreted the results from that software had a notable impact on the results even when all the requirements in the AASHTO T 324 test method were met.
- As expected, correlations between the results of the different approaches appeared to decrease with increased complexity of the variable being determined. For example, the correlation between results from the participating laboratories and the UCPRC's results was higher for rut depth at 20,000 passes (a relatively simple measurement to determine and report) than for the other variables analyzed.
- Correlation was especially poor for the stripping inflection point (Figure 4.24), which is one of the two test results that must be reported as specified in the Caltrans Standard Specifications. In this case, data points along the x-axis represent cases where the laboratory submitting the results observed a stripping inflection point, but the UCPRC analysis did not. Points along the y-axis represent cases where the opposite occurred. The high number of points along the axes and large dispersion of the data indicate a high degree of subjectivity in the calculation of this parameter. Similar results were obtained for the number of passes to 12.5 mm (0.5 in.) rut depth (Figure 4.21), which is the second parameter required by the Caltrans specifications to be reported.
- In some cases, different interpretations by the user made a difference in terms of whether 12.5 mm rut depth was reached or whether a stripping inflection point was observed (Figure 4.21 and Figure 4.24). For this particular mix, the Caltrans specifications require a minimum of 15,000 passes before 12.5 mm rut depth is reached, and 10,000 passes before the stripping inflection point is reached. Different user interpretations would have resulted in the mix not passing the specifications in only a few cases, which could be cause for concern if the results of a mix are close to these limits.

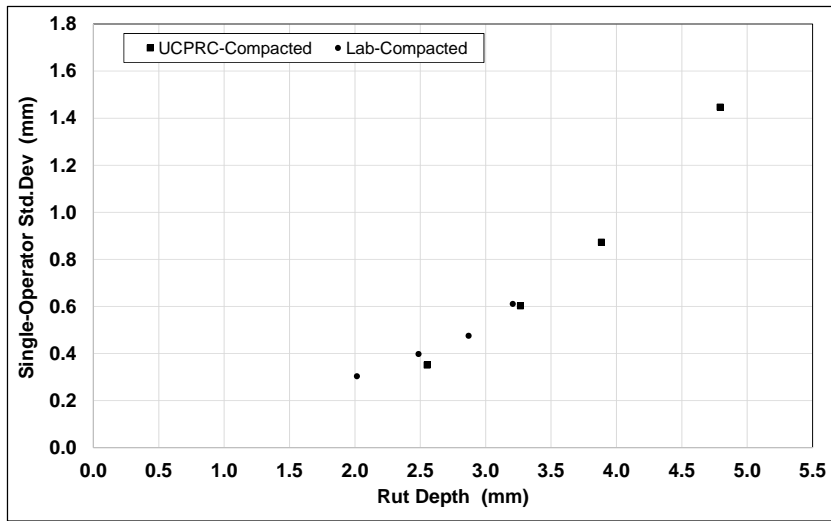

Figure 4.14: Single-operator standard deviation after predefined number of passes.

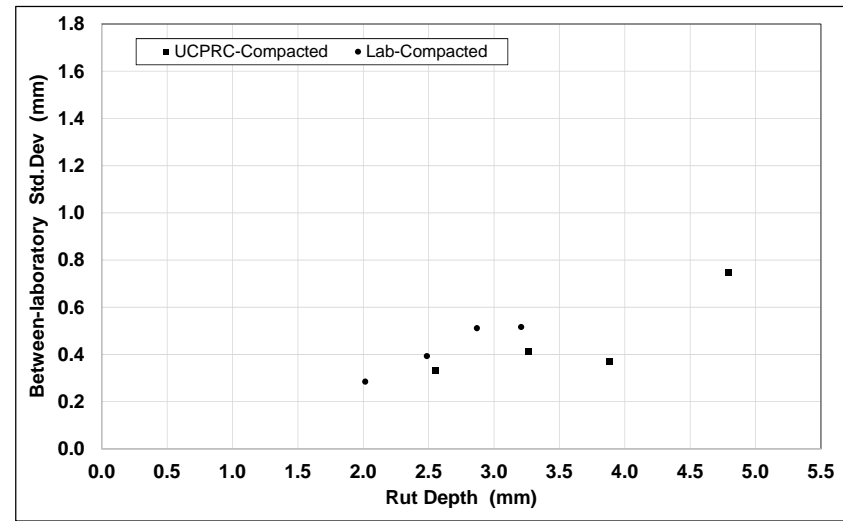

Figure 4.15: Between-laboratory standard deviation after predefined number of passes.

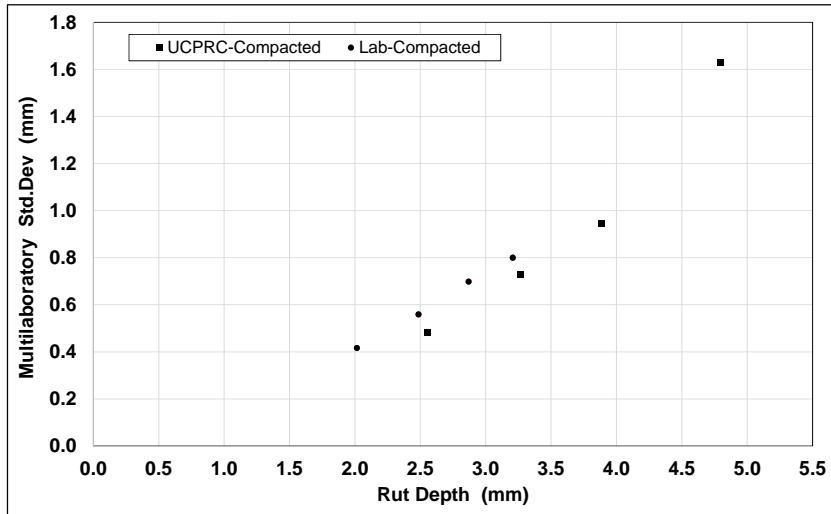

Figure 4.16: Multilaboratory standard deviation after predefined number of passes.

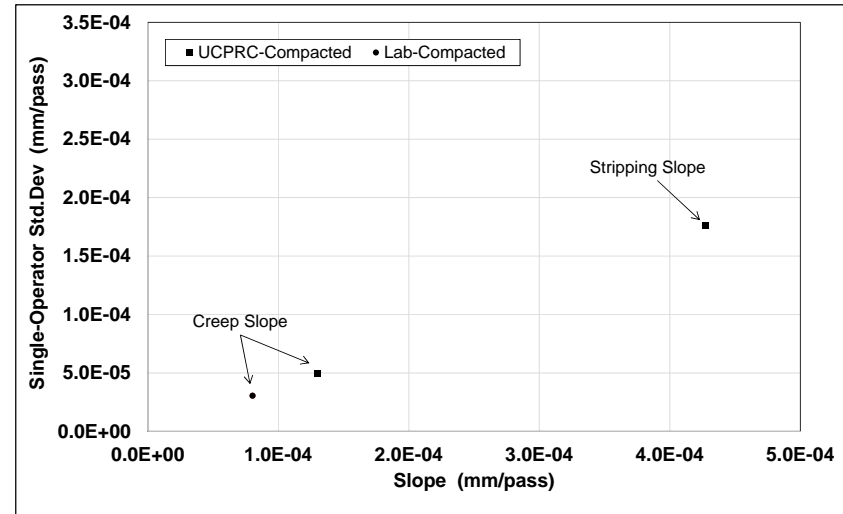

Figure 4.17: Single-operator standard deviation for creep and stripping slopes.

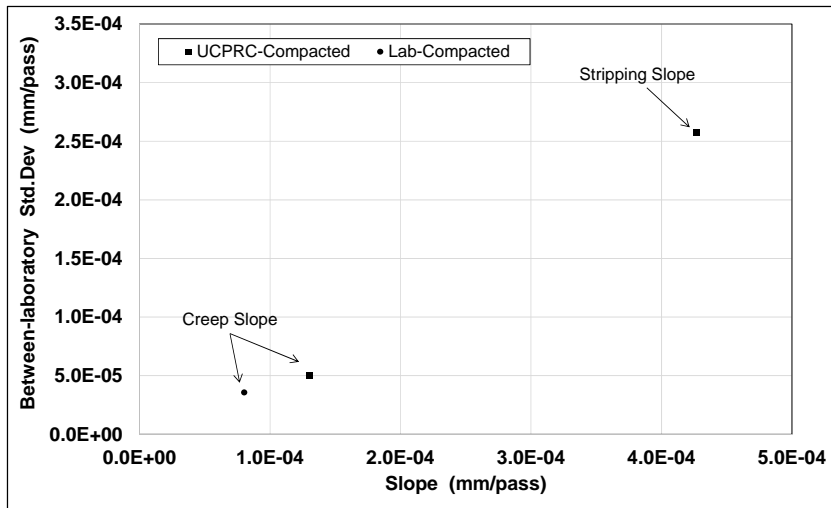

Figure 4.18: Between-laboratory standard deviation for creep and stripping slopes.

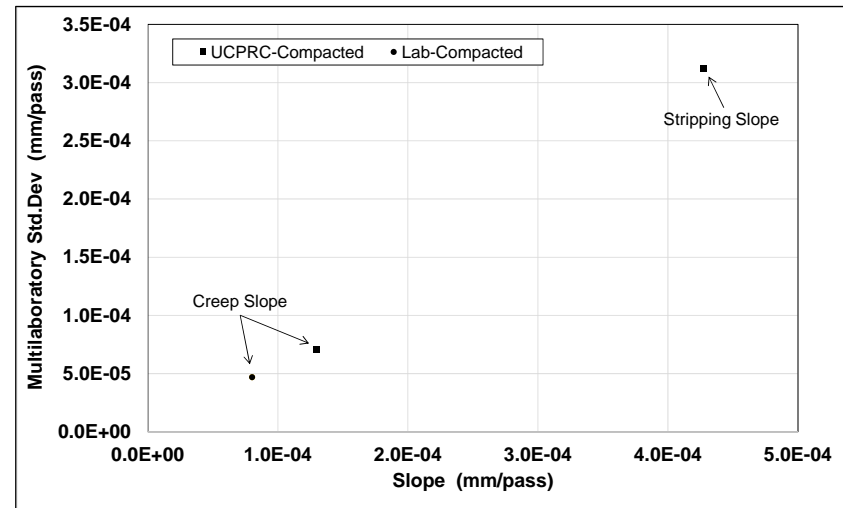

Figure 4.19: Multilaboratory standard deviation for creep and stripping slopes.

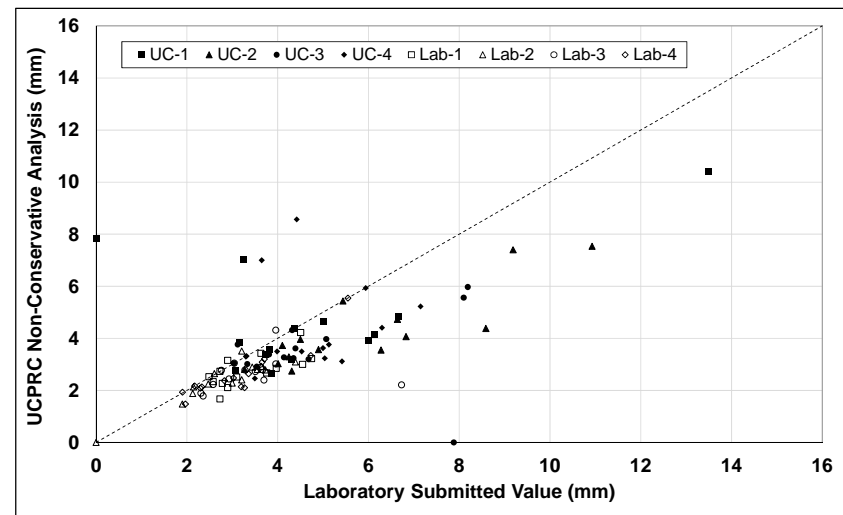
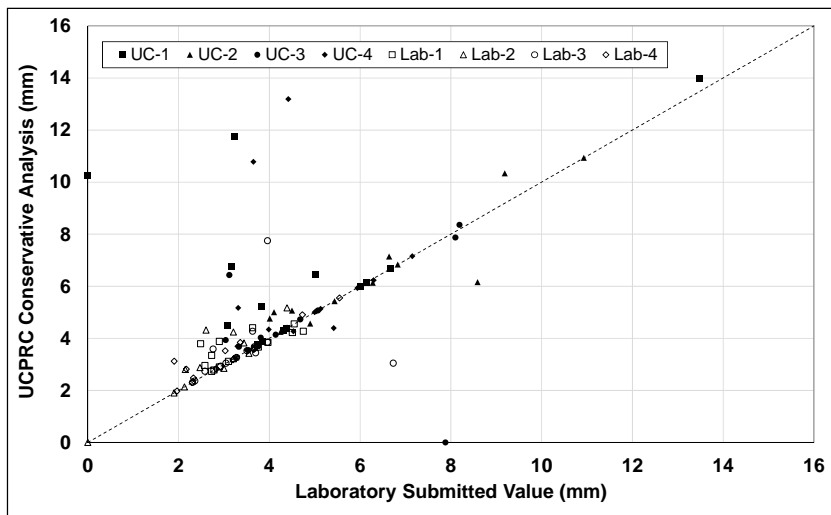

Figure 4.20: UCPRC analysis of rut depth after 20,000 passes.

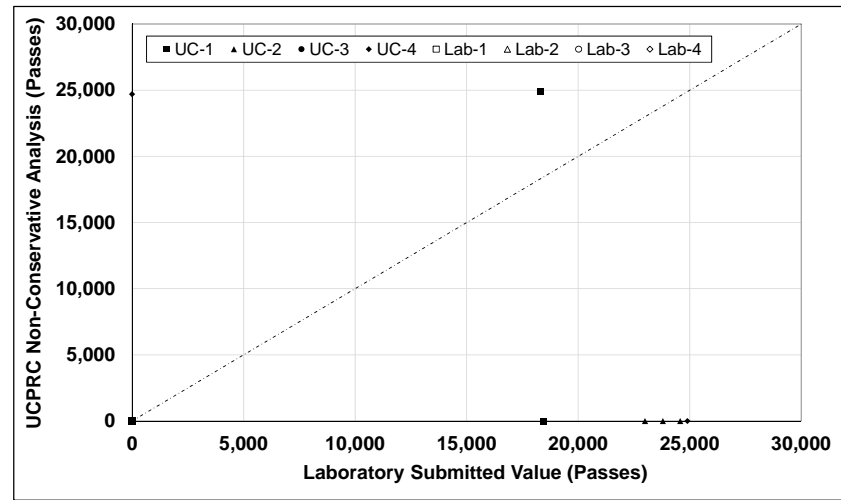
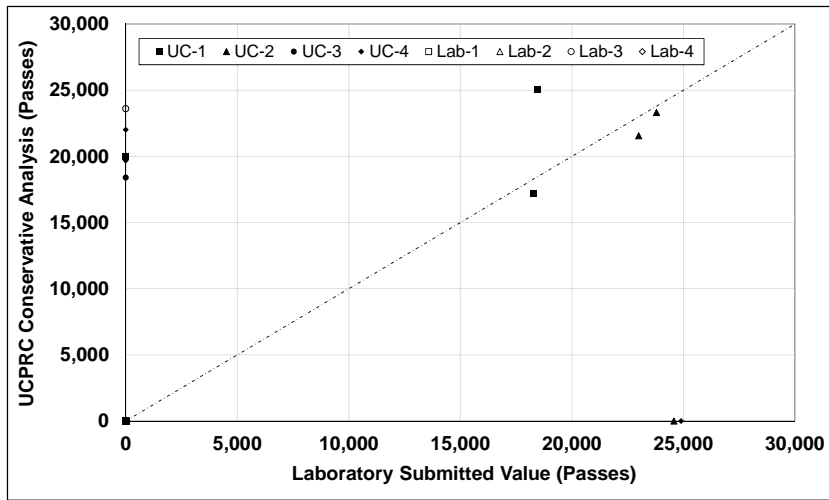

Figure 4.21: UCPRC analysis of number of passes to 12.5 mm rut depth.

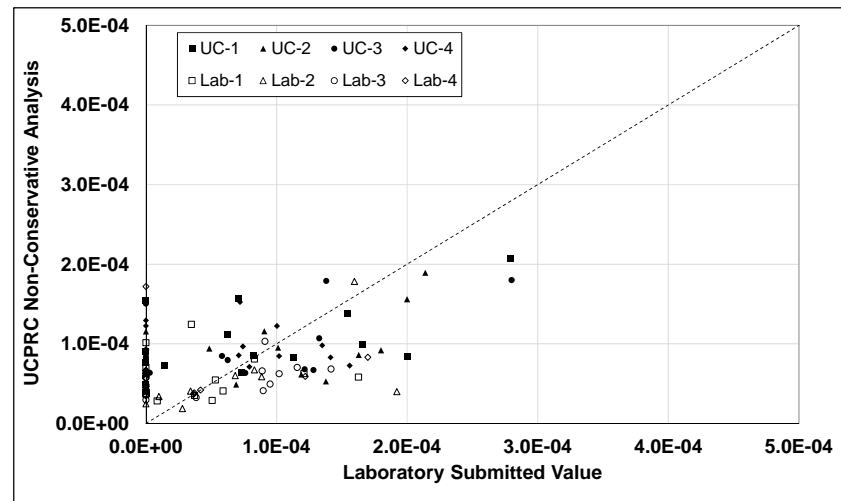
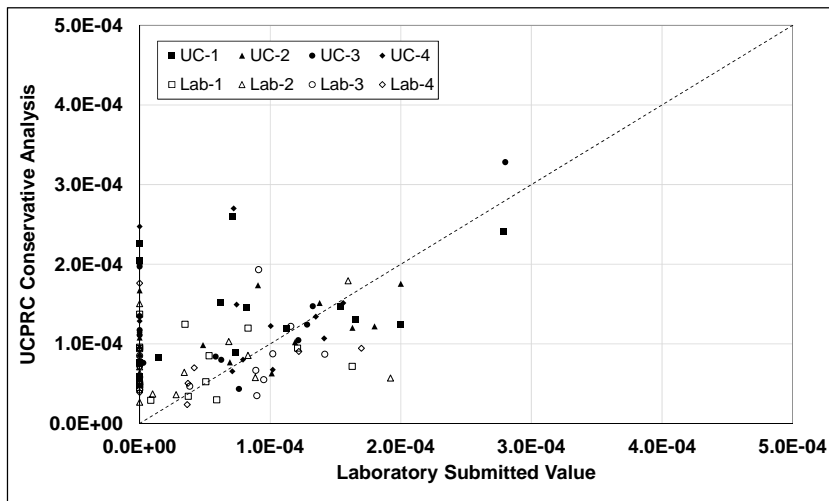

Figure 4.22: UCPRC analysis of creep slope.

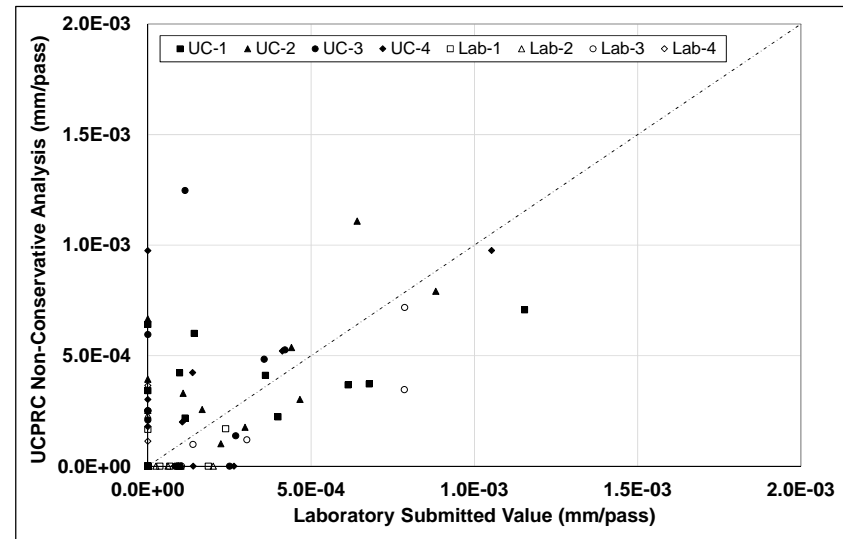
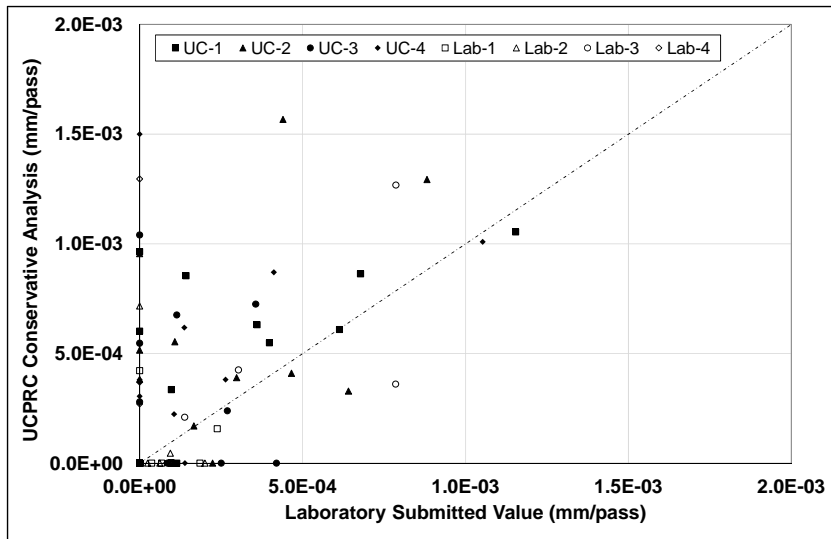

Figure 4.23: UCPRC analysis of stripping slope.

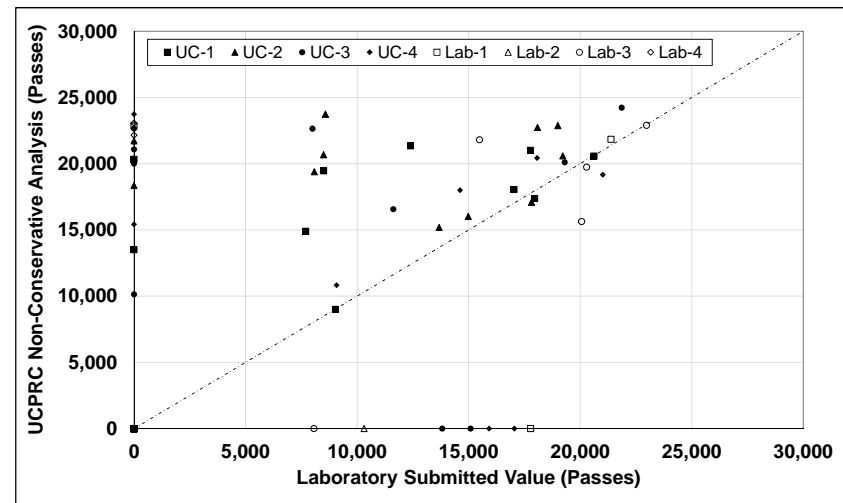
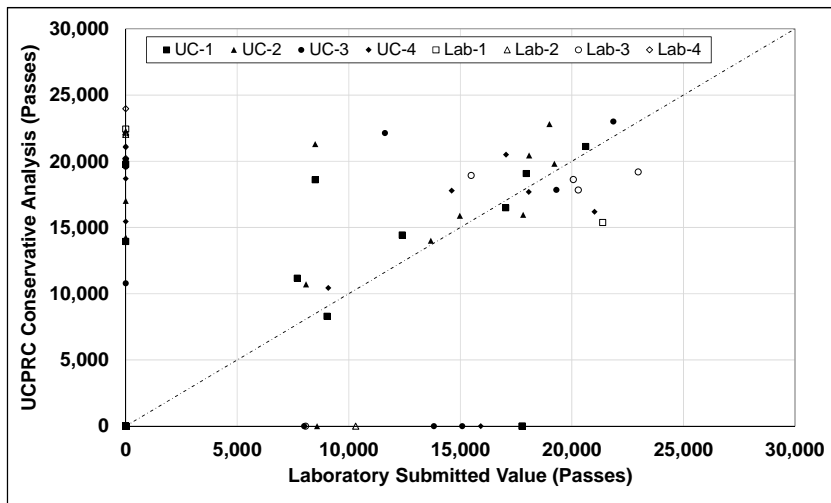

Figure 4.24: UCPRC analysis of number of passes to stripping inflection point.

These observations support the need for clearly stating in the AASHTO T 324 test method and the Caltrans specifications which locations should be used for determining test results and how this determination should be done. However, it should be noted that even if rut depth locations are standardized across all HWT test devices, determination of the creep slope and stripping slope stationary phases and the stripping inflection point is still essentially subjective. Test results can also differ depending on whether or not a smoothing technique is used to remove noise from the “rut versus passes” curve.

4.5 Determination of Variance Components for UCPRC Analysis Results

An ANOVA to determine variance components was repeated using the test results determined using the conservative and non-conservative approaches. Single-operator and between-laboratory coefficients of variation of the different results are shown in Figure 4.25 and Figure 4.26. These figures also include the coefficients of variation obtained for the results submitted by the laboratories. As expected, the single-operator coefficient of variation was not significantly affected by using a specific calculation approach (Figure 4.25). However, a reduction in the coefficient of variation was noted when the data was analyzed using the non-conservative approach, probably due to the use of an average from 11 locations. The main conclusion from Figure 4.26 is that between-laboratory coefficients of variation of creep slope, stripping slope, and stripping inflection point clearly improved when either of the two UCPRC approaches was used (Figure 4.26). This indicates that a significant component of between-laboratory variability was not related to the testing itself, but rather to the approach used by the different laboratories to analyze the raw data. However, little or no improvement in between-laboratory variability was observed for the rut depth results, which was unexpected. It is believed that this lack of improvement was related to the uncertainty in estimating between-laboratory standard deviation, and that this standard deviation was already relatively low for the results submitted by the laboratories. This implies that improvement in the analysis would depend on the uncertainty in the estimation. It should be noted that single-operator and between-laboratory variability could not be determined for all the results related to the stripping phase, given that insufficient data points were available for the estimation.

4.6 Formulation of Precision Statements

The analysis of variance presented in Section 4.3 shows that single-operator and multilaboratory standard deviations of rut depth after a predefined number of passes (Figure 4.14 and Figure 4.16) are not constant, but increase with the mean measured value. The same applies to creep and stripping slopes (Figure 4.17 and Figure 4.19). It was not possible to determine how the standard deviations of number of passes to the stripping inflection point changed with the mean measured value because a single asphalt concrete mix with relatively good moisture resistance properties was used for testing. However, these single-operator

and multilaboratory standard deviations were also expected to increase with the measured mean value. For these reasons, the coefficient of variation, instead of the standard deviation, was used for the formulation of precision statements.

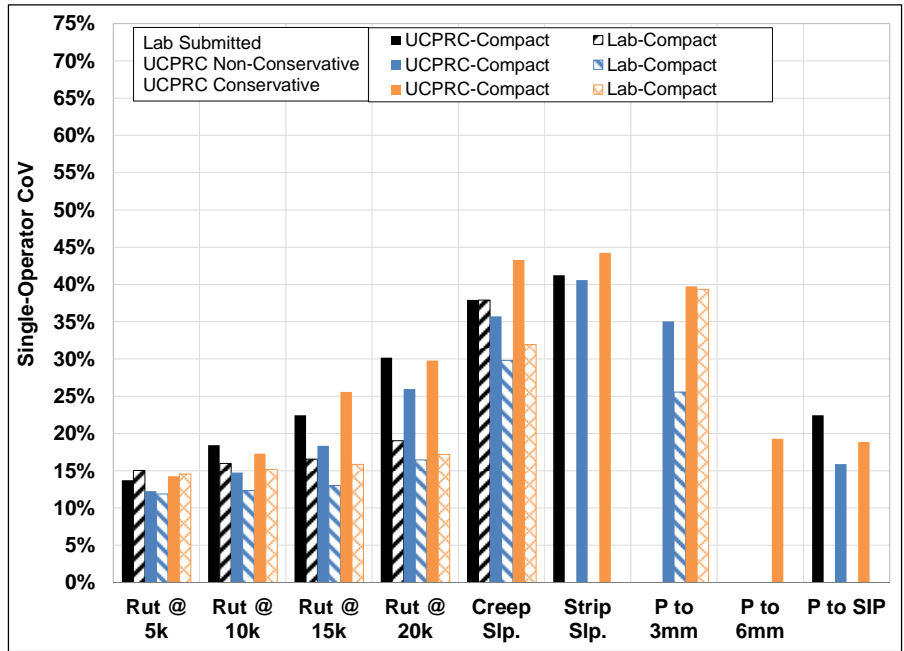

Figure 4.25: Single-operator coefficient of variation for test results.

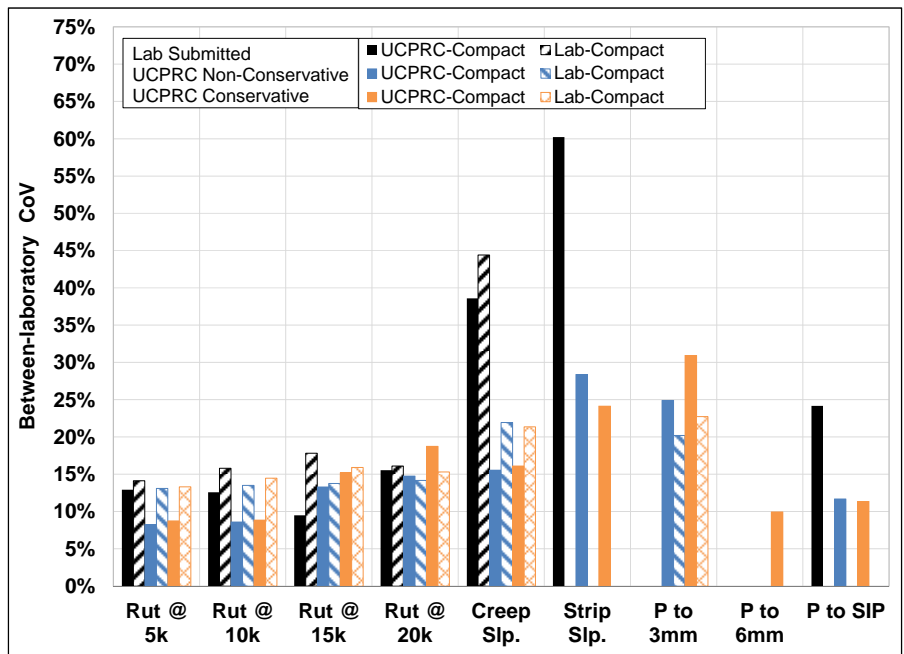

Figure 4.26: Between-laboratory coefficient of variation for test results.

No distinction was made between the specimens prepared by the UCPRC and those prepared by the participating laboratories given that the single-operator standard deviation was similar for both sets of

specimens. Slightly higher between-laboratory variability was observed for results on specimens prepared by the participating laboratories than for results on specimens prepared by the UCPRC. This was attributed to minor variations in the preparation procedures and equipment at the different laboratories. These differences were shown to be much lower than the variability introduced by testing and data analysis.

Coefficients of variation for rut depth are shown in Figure 4.27 and for creep and stripping slopes in Figure 4.28. In both cases, coefficients of variation increased with the mean measured value and therefore unique precision indices could not be set for these variables. Consequently, two new levels were defined for each of these variables in order to better report the precision indices. These values were selected from within the range of results obtained and were set at 3 mm and 6 mm rut depth, and 0.2 mm and 0.6 mm/1,000 passes for the creep and stripping slopes.

Precision indices derived from the coefficients of variation for the creep and stripping slopes submitted by the participating laboratories and after raw data analysis using the conservative approach are also summarized in Figure 4.28. The figure shows the considerable reduction in multilaboratory variability of creep and stripping slopes after unique criteria were used for data analysis. Similar improvements in multilaboratory variability would be expected if more specific instructions were available for data analysis, either in the AASHTO T 324 test method or in Section 39 of the Caltrans Standard Specifications.

A clear reduction in between-laboratory variability was also observed for the number of passes to the stripping inflection point when unique criteria were used for the data analysis (Figure 4.26). Precision estimates for this variable are based on results from specimens compacted by the UCPRC only, due to the lower number of reported stripping slope test results on specimens prepared by the participating laboratories (the mix had relatively good moisture resistance and stripping was not reported in most instances).

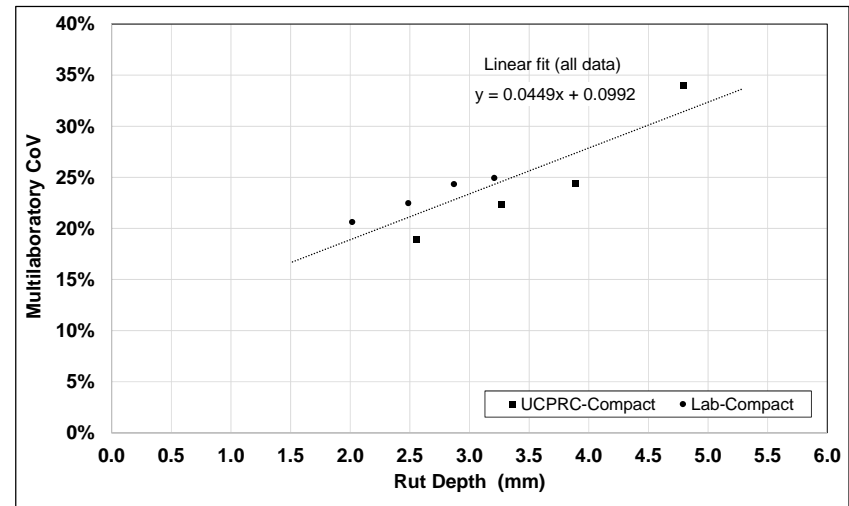
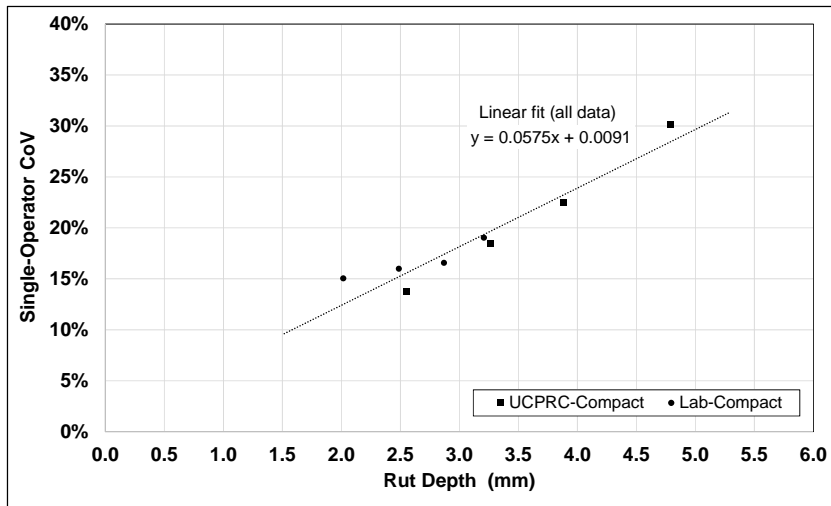

Figure 4.27: Indices of precision for rut depth at predetermined number of passes.

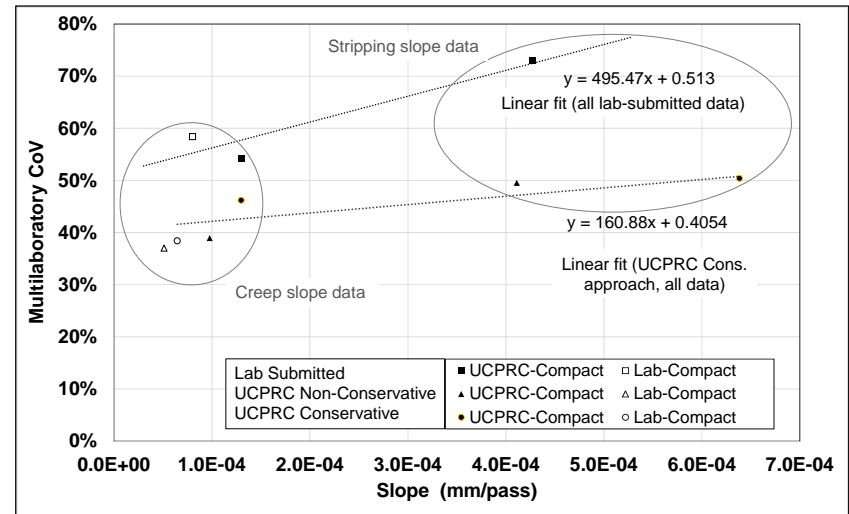
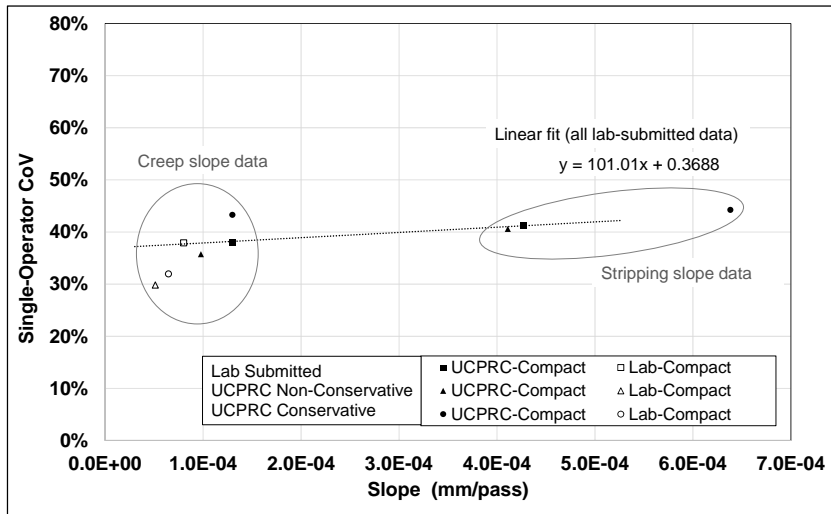

Figure 4.28: Indices of precision for creep and stripping slopes.

A summary of the coefficients of variation for the different HWT test results are presented in Table 4.1 and Figure 4.29. Difference limits (d2s%) as defined in ASTM C670, are also reported in the table. This limit is the maximum acceptable difference (less than 5 percent probability of being exceeded) between two test results, expressed as a percentage of their average. In this study, *test result* is defined as the result of a single wheel, as specified in Section 39 of the Caltrans Standard Specifications (note that AASHTO T 324 requires the average of the results of both wheels).

Table 4.1: Summary Indices of Precision for HWT Test Results

Test Parameter		Coefficient of Variation (%)			
		Lab Submitted Data		UCPRC Cons. Analysis	
		Single-Op.	Multilab.	Single-Op.	Multilab.
Rut depth	Up to 3 mm d2s% limit	18.2 50.8	23.4 65.5	16.0 44.9	20.8 58.2
	Up to 6 mm d2s% limit	35.4 99.1	36.9 103.2	32.0 89.6	36.5 102.1
Creep and stripping Slope	Up to 0.2 mm/1,000 passes d2s% limit	38.9 108.9	61.2 171.4	38.7 108.5	43.8 122.5
	Up to 0.6 mm/1,000 passes d2s% limit	42.9 120.2	81.0 226.9	44.3 124.2	50.2 140.5
Number of passes to 3 mm d2s% limit				39.6 110.8	47.9 134.1
Number of passes to 6 mm d2s% limit				19.3 54.0	21.7 60.7
Number of passes to stripping inflection point d2s% limit		22.5 62.9	33.0 92.3	18.9 52.8	22.0 61.6

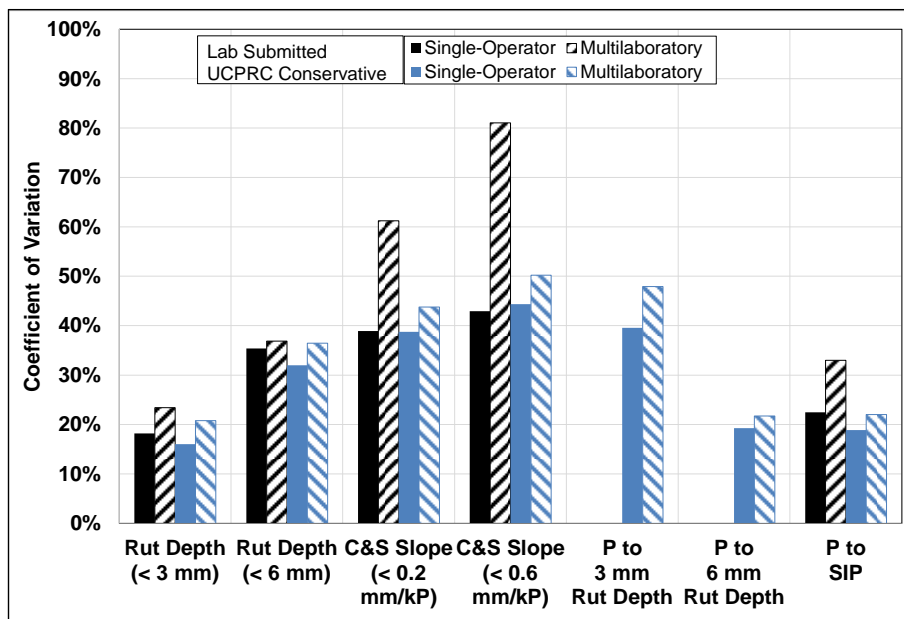

Figure 4.29: Summary of indexes of precision for HWT test results.

The results show that the single-operator coefficient of variation of the results is relatively high (i.e., low repeatability); this was attributed in part to the mix being essentially moisture-resistant, with most

laboratories reporting good results, but a limited number reporting some rutting and creep and stripping slopes. Multilaboratory variability was also relatively high due to the same repeatability issues and to the large inconsistencies introduced by the different rut depth measurement approaches and interpretations in the raw data analysis, which also explains why multilaboratory coefficients of variation of creep and stripping slope and stripping inflection point were considerably higher than the corresponding single-operator coefficients of variation. However, multilaboratory coefficients of variation were not significantly higher than single-operator values when unique criteria were used for data analysis.

A similar round robin study was recently conducted by the AASHTO Materials Reference Laboratory (AMRL) (2). The indices of precision reported by the AMRL study were generally lower than the values summarized in Table 4.1. The AMRL experiment used two asphalt mixes with well-defined rutting and moisture susceptibility performance. One of the mixes was known to be moisture resistant while the other one was known to be moisture sensitive. As explained above, the mix used for this Caltrans round robin study was essentially moisture resistant and most of the test results indicated limited rutting and no stripping. However, a small number of the results submitted by participating laboratories showed relatively deep ruts and/or a stripping phase, which increased the variability of the experiment results.

The main differences in the precision indices between the studies conducted by AASHTO and the UCPRC appear to relate to interpretation of the creep slope and stripping slope, as clarified below:

- In the first test specified in Section 39 of the 2015 Caltrans Standard Specifications, namely the number of cycles to reach the stripping inflection point, the AMRL study reported precision indices for single-operator and multilaboratory coefficients of variation of 23.9 percent and 32.1 percent, respectively. These two values are almost the same as those obtained in this UCPRC study when the test results as submitted by the individual laboratories were used in the analysis (Table 4.1).
- In the second test, namely the number of passes to 12.5 mm (0.5 in.) rut depth, precision statements could not be determined due to the limited number of tests where this threshold value was reached. The AASHTO study reported 16.6 percent and 26.2 percent, respectively for single-operator and multilaboratory coefficients of variation.

4.6.1 Precision Statements for Rut Depth after a Predetermined Number of Passes

The following precision statements are made with respect to the rut depth after a predetermined number of passes, with rut depth defined as the maximum deformation along the total length of the tested sample:

- The single-operator coefficient of variation was found to increase with increasing rut depth. The variation can be expected to be 18 percent for ruts up to 3 mm and 35 percent for ruts up to 6 mm. The results of two correctly conducted tests by the same operator on the same material are not expected to differ from each other by more than 50 percent and 99 percent of their average, for ruts up to 3 mm and 6 mm respectively.

- The multilaboratory coefficient of variation was found to increase with increasing rut depth. The variation can be expected to be 23 percent for ruts up to 3 mm and 37 percent for ruts up to 6 mm. The results of two correctly conducted tests by two different laboratories on the same material are not expected to differ from each other by more than 65 percent and 103 percent of their average, for ruts up to 3 mm and 6 mm respectively.

4.6.2 Precision Statements for Creep and Stripping Slopes

The following precision statements are made with respect to the creep and stripping slopes of the curve *rut depth versus number of passes*, with rut depth defined as the maximum deformation along the total length of the tested sample:

- The single-operator coefficient of variation was found to increase with increasing creep and stripping slopes. The variation can be expected to be 39 percent for slopes up to 0.2 mm/1,000 wheel passes and 43 percent for slopes up to 0.6 mm/1,000 wheel passes. The results of two correctly conducted tests by the same operator on the same material are not expected to differ from each other by more than 109 percent and 120 percent of their average, for slopes up to 0.2 mm/1,000 wheel passes and 0.6 mm/1,000 wheel passes respectively.
- The multilaboratory coefficient of variation was found to increase with increasing creep and stripping slopes. The variation can be expected to be 61 percent for slopes up to 0.2 mm/1,000 wheel passes and 81 percent for slopes up to 0.6 mm/1,000 wheel passes. The results of two properly conducted tests by two different laboratories on the same material are not expected to differ from each other by more than 171 percent and 227 percent of their average, for slopes up to 0.2 mm/1,000 wheel passes and 0.6 mm/1,000 wheel passes respectively. This coefficient of variation is expected to reduce to 44 percent and 50 percent, respectively, for slopes up to 0.2 mm/1,000 wheel passes and 0.6 mm/1,000 wheel passes, if the two laboratories use the same criteria for data collection and analysis. Under these conditions, the results of two properly conducted tests by two different laboratories on the same material are not expected to differ from each other by more than 122 percent and 140 percent of their average, for slopes up to 0.2 mm/1,000 wheel passes and 0.6 mm/1,000 wheel passes respectively.

4.6.3 Precision Statements for the Number of Passes to Stripping Inflection Point

The following precision statements are made with respect to number of passes to the stripping inflection point of the curve *rut depth versus number of passes*, with rut depth defined as the maximum deformation along the total length of the tested sample:

- The single-operator coefficient of variation was found to be 22 percent. The results of two correctly conducted tests by the same operator on the same material are not expected to differ from each other by more than 63 percent of their average.
- The multilaboratory coefficient of variation was found to be 33 percent. The results of two correctly conducted tests by two different laboratories on the same material are not expected to differ from each other by more than 92 percent of their average. This coefficient of variation is expected to reduce to 22 percent if the two laboratories use the same criteria for data collection and analysis.

Under these conditions, results of two correctly conducted tests by two different laboratories on the same material are not expected to differ from each other by more than 62 percent.

5. CONCLUSIONS AND RECOMMENDATIONS

A round robin study in which 20 laboratories participated has been completed. Each laboratory conducted four Hamburg Wheel-Track tests. Two of the tests were conducted on specimens compacted by the University of California Pavement Research Center (UCPRC), and the other two on specimens compacted by each of the participating laboratories using loose mix provided by the UCPRC. A single plant-produced 3/4 in. mix with 5.0 percent PG 64-16 binder was evaluated. The laboratories reported test results in terms of rut depth after 5,000, 10,000, 15,000, and 20,000 wheel passes, number of passes to 12.5 mm (0.5 in.) rut depth, creep slope, stripping slope, and stripping inflection point. Fourteen laboratories submitted the raw test data (all laboratories were requested to submit this information). The main conclusions drawn from this experiment include the following:

- The rutting and moisture resistance of the mix were relatively good. However, a clear stripping phase was reached in approximately 25 percent of the tests conducted on the specimens compacted at the UCPRC.
- Specimens compacted at the participating laboratories had better performance than the specimens compacted at the UCPRC. It is not clear why this occurred, but analysis of the results indicate that specimen air-void content did not contribute to the difference in results.
- Between-laboratory variability related to specimen fabrication was much smaller than the variability introduced by testing and data analysis.
- The type of HWT test device used for testing was shown to be significant only for the rut depth after 5,000 and 10,000 passes (i.e., for results obtained in the early part of the tests).
- Test results from left and right wheels were independent of each other for the two HWT test results specified in Section 39 of the 2015 Caltrans Standard Specifications, namely the number of passes to the stripping inflection point and number of passes to 12.5 mm (0.5 in.).
- Single-operator variability was relatively high (low repeatability) for all variables. This result is believed to be related, at least in part, to the good performance of the mix used for the experiment.
- Between-laboratory variability was relatively high for all variables except for the rut depth after a predetermined number of wheel passes. This high variability was shown to be related to different interpretations of how the rut depth is measured and analyzed. Between-laboratory variability clearly improved when the same criteria were used to analyze the raw data provided by the participating laboratories.
- Comparison of results submitted by the different laboratories to results determined by the UCPRC using the same raw data shows that a high degree of subjectivity was present in the HWT test data analysis conducted by the participating laboratories.
- Precision indices could only be determined for one of the HWT test results specified in Section 39 of the 2015 Caltrans Standard Specifications, namely the number of passes to the stripping inflection point. For this variable, single-operator and multilaboratory coefficients of variation were, respectively, 22 percent and 33 percent. Multilaboratory coefficient of variation would improve to 22 percent if fixed criteria had been used by all laboratories in the analysis. Precision estimates of

the number of passes to 12.5 mm could not be determined due to the very limited number of tests where this threshold value was reached.

- Additional precision statements were formulated for other HWT test results, including creep and strip slopes and rut depth after a predetermined number of wheel passes. These statements may be applicable if Caltrans specifications are revised based on one or more of these variables.

The following recommendations are expected to contribute to improving HWT test single-operator and multilaboratory variability:

- Laboratories conducting HWT testing should receive additional instructions that supplement or clarify aspects of the AASHTO T 324 test method that can be interpreted in different ways. Items that need to be clarified, specified, defined, or expanded include the following:
 - + The length of the wheelpath.
 - + The locations along the wheelpath that should be used to compute rut depth. The capabilities of the different types of HWT test devices should be considered in this definition, since most of them can only record rutting at predefined locations.
 - + The specific procedure that should be used to compute the rut depth from the different measuring locations (i.e., whether the maximum, the average, or any other representative value should be used).
- Detailed guidelines, with examples, should be written for defining the creep and stripping stationary phases and for determining the stripping inflection point since these definitions are currently very subjective. These guidelines should use a general purpose spreadsheet or similar analysis tool since they might not be compatible with the software installed in the different testing machines. These guidelines, along with training, and practice, may lead to more uniform results from different laboratories, thereby reducing between-laboratory variability in data analysis.
- Future round robin study exercises should include both good- and marginal-performing mixes, and should also include a practical exercise in which an additional three sets of raw data are sent to all the participating laboratories for analysis. The results reported by the laboratories could be used to better determine the between-laboratory variability related to data analysis and to prepare more realistic precision statements. The proposed marginal-performing mix will probably need to be specially prepared given that asphalt plants in California are unlikely to produce a standard mix that fails the HWT test.

REFERENCES

1. SIGNORE, J., Harvey, J.T., and Jones, D. 2014. **Performance Based Specifications: Workplan for Support for Superpave Implementation.** Davis and Berkeley, CA: University of California Pavement Research Center (UCPRC-WP-2014-04.1).
2. AZARI, H. 2014. Precision Estimates of AASHTO T 324, “Hamburg Wheel-Track Testing Of Compacted Hot Mix Asphalt (HMA).” **Research Results Digest 390.** Washington, DC: Transportation Research Board, National Cooperative Highway Research Program.
3. LOUAY, N.M., Elseifi, M.A, Raghavendra, A. and Ye, M. 2015. **Hamburg Wheel-Track Test Equipment Requirements and Improvements to AASHTO T 324.** Washington, DC: Transportation Research Board, National Cooperative Highway Research Program (Web-Only Document 219).

Blank page

APPENDIX A: INSTRUCTION SHEET

Dear Participants

Thank you for participating in the round robin study for determining a precision statement for the Hamburg Wheel-Track Test in California. You should have received the following items to complete the round robin study:

1. This instruction sheet.
2. An *Excel*[®] data file.
3. Eight (8) specimens prepared and compacted by the UCPRC for two (2) sets of Hamburg Wheel-Track Tests. Each set has four (4) randomized specimens from the overall production run.
4. Two (2) buckets of loose HMA sufficient to prepare eight (8) specimens within $7\% \pm 1\%$ air-void content measured by the SSD method (AASHTO T 166A).

This round robin study requests your laboratory to conduct Hamburg Wheel-Track Testing on four (4) sets of specimens (total sixteen [16] specimens), and return the test data to Caltrans for statistical analysis and determination of the precision statement. One Hamburg Wheel-Track Test is defined as a test performed using both the left and right wheels, assuming that your Hamburg device is configured with two wheels. Please follow this instruction sheet *in addition to the respective AASHTO and Caltrans standard procedures* for specimen preparation and testing.

Instructions for Compacting Specimens:

1. Refer to “*Section 6.3: Laboratory-Produced HMA*” in AASHTO T 324-14 for specimen preparation.
2. Combine two (2) buckets of loose HMA and use a Quartermaster or similar device to split the material into representative samples for compaction.
3. Compact the specimens with a Superpave gyratory compactor in accordance with AASHTO T 312 at a compaction temperature of 140°C (284°F).
 - a. Pressure: 600 kPa
 - b. Internal angle: 1.16° (external angle 1.25°)
 - c. Compaction mode: height control
 - d. Specimen diameter: 150 mm
 - e. Specimen height: 63.5 mm
 - f. Air-void content: 7.0 percent (Approximately 2,565 grams of the loose HMA provided will yield an average air-void content of 7.0 percent.)
 - g. Extract specimens immediately after compaction. No squaring is needed.
 - h. Mark each specimen’s gyratory ram side with an identifying mark.

Instructions for Determining Bulk Specific Gravity (G_{mb}) of the Specimens:

1. Specimens prepared by the UCPRC were dried prior to shipping. However, if the specimens appear to have had contact with moisture, dry back to constant weight in accordance with AASHTO R47 or AASHTO T 328. The maximum drying temperature is 125 (+/-)°F
2. Measure the G_{mb} of the specimens with the SSD method in accordance with AASHTO T 166A.

3. Record all G_{mb} data in the first sheet of the *Excel*[®] data file. The data sheet is formatted to print as letter size. *All data from UCPRC-compacted specimens must be entered on the first sheet. All the data from specimens compacted by your laboratory must be entered on the second sheet.*
4. The maximum specific gravity of this mix is 2.543.

Instructions for Testing the Specimens:

1. Run the Hamburg Wheel-Track Test in accordance with AASHTO T 324.
2. Cut the specimens to the dimensions in order to fit a pair into the molds required for performing the test.
3. Place the molds into the mounting tray and fit the specimens into the mold. Place the specimens with the gyratory ram face up.
4. Check for a tight, parallel fit at the edge of the specimens. Trim them if needed. The minimum allowable gap between the molds is 3.5 mm. The maximum allowable gap between the two molds is 7.5 mm.
5. After securing the molds and samples into the mounting tray, check if there is any gap between one side of the mold and the tray. Use plaster of paris to fill the gap. Mix the plaster with water at the recommended ratio. Pour the plaster to a height equal to the surface of the mold. If plaster flows underneath the specimen, its thickness cannot exceed 2 mm. Allow the plaster to set for one hour.
6. Fasten the mounting tray into the empty water bath.
7. Start the software supplied with the Hamburg machine, enter the required test information into the computer, and verify the test parameters.
 - a. Date of the test.
 - b. Set the testing temperature to 122°F (50°C).
 - c. Set the load to 158 lb, or lower the test wheel (machine dependent).
 - d. Set the testing rate to 52 passes per minute.
 - e. Set the deformation stopping criteria to 24.0 mm.
 - f. Set the maximum number of passes to 25,000.
 - g. Set the sampling interval as follows:
 - i. Every 20 passes for the first 1,000 passes
 - ii. Every 50 passes for the second 4,000 passes
 - iii. Every 100 passes for the remaining passes.
8. Fill the water bath.
9. Monitor the water temperature. Once the test temperature of 122°F (50°C) has been reached, allow an additional 30 minutes for the specimens to be saturated in the water. There may be a feature in the machine software to automatically delay testing.
10. Start the test after the specimens have been standing in the water for 30 minutes at the test temperature of 122°F (50°C).
11. The test should automatically stop when 25,000 passes have completed or when the deformation has reached 24.0 mm.
12. Fill in the required data in the *Excel*[®] data sheets. *All data from the UCPRC-compacted specimens must be entered on the first sheet. All the data from specimens compacted by your laboratory must be entered on the second sheet.*
13. Email the original raw data files from each Hamburg Wheel-Track Test and the *Excel*[®] data sheets filled out with test results to Caltrans.

APPENDIX B: RESULT REPORTING TEMPLATE

Data Sheet for the Caltrans Hamburg Wheel-Track Test Round Robin for UCPRC-Compacted Specimens									
Data Sheet for the Caltrans Hamburg Wheel-Track Test Round Robin	District Number	Date Material Received	AASHTO T 166A SSD Method	Sample ID					
				Date Tested					
				Mass of Dry Specimen in Air (g)					
				Mass of the Bag (g)					
				Mass of Sealed Specimen in Water (g)					
				Mass of Specimen after Submersion (g)					
				Ratio of Mass of Dry Specimen to Bag					
				Bag Volume Correction Factor					
				Volume					
				Bulk Specific Gravity					
AASHTO T 331 CoreLok Method				Sample ID					
				Date Tested					
				Mass of Dry Specimen in Air (g)					
				Mass of Specimen in Water (g)					
				Mass of Surface-Dry Specimen in Air (g)					
				Volume					
				Bulk Specific Gravity					
AASHTO T 324 Hamburg Wheel-Track Test				Sample ID					
				Date Tested					
				Sample Location (Left / Right Wheel)					
				Temperature (°C)					
				Load, N (lbf)					
				Rut Depth at 5,000 cycles (mm)					
				Rut Depth at 10,000 cycles (mm)					
				Rut Depth at 15,000 cycles (mm)					
				Rut Depth at 20,000 cycles (mm)					
				Number of passes at 12.5 mm rut depth					
				Creep Slope					
				Stripping Slope					
				Stripping Inflection Point (cycle)					
				Visual Damage (0 to 5 rating, 5 is most damaged)					
Laboratory Name	Hamburg Make & Model								

Data Sheet for the Caltrans Hamburg Wheel-Track Test Round Robin for Individual Lab-Compacted Specimens									
Data Sheet for the Caltrans Hamburg Wheel-Track Test Round Robin	District Number	Date Material Received	AASHTO T 166A SSD Method	Sample ID					
				Date Tested					
				Mass of Dry Specimen in Air (g)					
				Mass of the Bag (g)					
				Mass of Sealed Specimen in Water (g)					
				Mass of Specimen after Submersion (g)					
				Ratio of Mass of Dry Specimen to Bag					
				Bag Volume Correction Factor					
				Volume					
				Bulk Specific Gravity					
		Date Material Received	AASHTO T 331 Core-Lok Method	Sample ID					
				Date Tested					
				Mass of Dry Specimen in Air (g)					
				Mass of Specimen in Water (g)					
				Mass of Surface-Dry Specimen in Air (g)					
				Volume					
				Bulk Specific Gravity					
		Laboratory Name	AASHTO T 324 Hamburg Wheel-Track Test	Sample ID					
		Hamburg Make & Model		Date Tested					
				Sample Location (Left / Right Wheel)					
				Temperature (°C)					
				Load, N (lbf)					
				Rut Depth at 5,000 cycles (mm)					
				Rut Depth at 10,000 cycles (mm)					
				Rut Depth at 15,000 cycles (mm)					
				Rut Depth at 20,000 cycles (mm)					
				Number of passes at 12.5 mm rut depth					
				Creep Slope					
				Stripping Slope					
				Stripping Inflection Point (cycle)					
			Visual Damage (0 to 5 rating, 5 is most damaged)						

APPENDIX C: PARTICIPATING LABORATORIES

Table C.1 lists the laboratories that submitted results for the HWT round robin test program. The laboratories are listed in alphabetical order and not in the order used for presenting results in the report.

Table C.1: Participating Laboratories

Laboratory Name (as reported by each laboratory)		Hamburg Testing Device, Make and Model (as reported by each laboratory)
1	CalPortland Construction	Pavement Technologies APA Jr.
2	CGI Technical Services Inc.	Troxler PMW Two-wheel Tracker
3	District 10 Material Laboratory	PMW Wheel Tracker
4	District 2 Materials Lab	PMW Wheel Tracker
5	District 3 Laboratory	PMW Wheel Tracker 60
6	District 5 Material Laboratory	Cox and Sons CS9000
7	District 6 Laboratory	<i>Not reported</i>
8	Earth Systems Southern California	Troxler PMW Wheel Tracker
9	Eastern Sierra Engineering	Troxler PMW
10	Gallagher & Burk	Troxler 120085
11	Garco Testing Laboratories (Tracy, CA)	Troxler PMW Two-wheel Tracker
12	George Reed Inc.	Pine Instruments AFG2AS
13	Pavement Engineering Inc.	James Cox and Sons CS9000-1000
14	RMA Group Inc. (Rancho Cucamonga, CA)	Pine Instruments AFG2AS
15	Skanska (Riverside, CA)	Pavement Technologies APA Jr.
16	Teichert Perkins Caltrans ID 32	Cox and Sons
17	Teichert Vernalis Caltrans ID 99	Troxler PMW
18	Twining Inc. (Sacramento, CA)	PMW Wheel Tracker
19	UCPRC	PMW Wheel Tracker
20	Vulcan Materials Co.	Pavement Technologies APA Jr.

Blank page

APPENDIX D: DATA REPORTED BY LABORATORIES

D.1 Test Results

Test results submitted by the participating laboratories are listed in Table D.1 through Table D.14. The results are tabulated as follows:

- Table D.1: Rut Depth after 5,000 Passes (Compacted by UCPRC)
- Table D.2: Rut Depth after 5,000 Passes (Compacted by Participating Laboratories)
- Table D.3: Rut Depth after 10,000 Passes (Compacted by UCPRC)
- Table D.4: Rut Depth after 10,000 Passes (Compacted by Participating Laboratories)
- Table D.5: Rut Depth after 15,000 Passes (Compacted by UCPRC)
- Table D.6: Rut Depth after 15,000 Passes (Compacted by Participating Laboratories)
- Table D.7: Rut Depth after 20,000 Passes (Compacted by UCPRC)
- Table D.8: Rut Depth after 20,000 Passes (Compacted by Participating Laboratories)
- Table D.9: Passes to 12.5 mm Rut Depth (Compacted by UCPRC)
- Table D.10: Passes to 12.5 mm Rut Depth (Compacted by Participating Laboratories)
- Table D.11: Creep Slope (Compacted by UCPRC)
- Table D.12: Creep Slope (Compacted by Participating Laboratories)
- Table D.13: Stripping Slope (Compacted by UCPRC)
- Table D.14: Stripping Slope (Compacted by Participating Laboratories)
- Table D.15: Stripping Inflection Point (Compacted by UCPRC)
- Table D.16: Stripping Inflection Point (Compacted by Participating Laboratories)

D.2 Key to Terms Used in Tables

- x_i laboratory average (average of 4 replicates for laboratory i)
- Sr_i single-operator standard deviation of laboratory i (standard deviation of the replicates of laboratory i)
- h_i h -value as defined in ASTM C802 (Section 10.5)

$$h_i = (x_i - x_{mean})/S_{xm}$$

where: x_i is the laboratory average, as defined above

x_{mean} is the average of all laboratories (“avg.” value at the bottom of x_i column)

S_{xm} is the standard deviation of laboratory averages (square root of the “var.” value at the bottom of x_i column)

The h -value provides an index of the deviation of the laboratory results from the rest of the laboratories. Laboratories with an h -value greater than a critical value (in absolute terms)

should be considered as potential outliers. The critical h -value for 20 laboratories is ± 2.56 as listed in ASTM C802, Table 4.

k_i k -value as defined in ASTM C802 (Section 10.5)

$$k_i = Sr_i / Sr_{POOL}$$

where: Sr_i is the single-operator standard deviation of laboratory i , as defined above

Sr_{POOL} is the pooled single-operator standard deviation (value at the bottom of the Sr_i column)

The k -value provides an index of the single-operator variability of the laboratory compared to the rest of the laboratories. Laboratories with a k -value greater than a critical value should be considered as potential outliers. The critical k -value for 20 laboratories and four replicates is 2.00 (ASTM C802, Table 4).

Underlined values in orange-shaded cells in the tables below are considered outliers and were not included in the analyses.

Table D.1: Rut Depth after 5,000 Passes (Compacted by UCPRC)

Lab Number	Rut Depth (mm)				Analysis Variables ¹			
	Set 1		Set 2		x_i	Sr_i	h_i	k_i
	Left	Right	Left	Right				
	Rep. 1	Rep. 2	Rep. 3	Rep. 4				
1	3.05	2.78	3.09	2.21	2.78	0.406	0.53	1.04
2	2.25	2.65	3.13	2.98	2.75	0.390	0.45	1.01
3	2.55	2.74	2.33	2.04	2.42	0.301	-0.39	0.77
4	2.52	2.76	2.34	2.82	2.61	0.222	0.09	0.57
5	2.83	2.97	2.47	2.18	2.61	0.357	0.10	0.92
6	2.51	2.65	2.40	2.27	2.46	0.162	-0.29	0.42
7	2.72	1.76	2.32	2.47	2.32	0.407	-0.64	1.05
8	2.53	2.87	2.17	2.18	2.44	0.333	-0.34	0.86
9	2.94	2.81	3.12	2.93	2.95	0.128	0.94	0.33
10	2.20	2.74	2.63	3.51	2.77	0.546	0.49	1.40
11	3.38	3.19	2.49	3.19	3.06	0.392	1.23	1.01
12	2.99	3.73	3.03	3.93	3.42	0.482	2.12	1.24
13	2.43	2.02	2.40	2.76	2.40	0.303	-0.42	0.78
14	2.66	<u>4.41</u>	2.76	3.20	3.26	0.803	1.71	<u>2.07</u>
15	1.81	2.02	1.89	2.03	1.94	0.107	-1.59	0.28
16	1.78	1.73	2.06	2.29	1.97	0.261	-1.52	0.67
17	2.50	1.90	3.20	2.30	2.48	0.544	-0.24	1.40
18	2.55	2.39	2.46	2.97	2.59	0.260	0.05	0.67
19	1.98	2.59	1.90	2.13	2.15	0.308	-1.06	0.79
20	2.01	2.07	1.65	2.60	2.08	0.393	-1.23	1.01
				<i>avg.</i>	2.57	0.388		
				<i>var.</i>	0.160			

¹ Explanation of terms is included at the beginning of this appendix.
Underlined values in orange-shaded cells are considered outliers and were not included in the analyses.

Table D.2: Rut Depth after 5,000 Passes (Compacted by Participating Laboratories)

Lab Number	Rut Depth (mm)				Analysis Variables ¹			
	Set 1		Set 2		x_i	Sr_i	h_i	k_i
	Left	Right	Left	Right				
	Rep. 1	Rep. 2	Rep. 3	Rep. 4				
1	2.05	1.56	1.92	1.46	1.75	0.282	-0.83	0.93
2	2.40	2.61	2.66	2.37	2.51	0.146	1.53	0.48
3	1.38	1.86	2.01	1.77	1.76	0.269	-0.81	0.89
4	1.77	1.49	1.60	1.44	1.58	0.146	-1.37	0.48
5	1.91	1.56	1.60	2.06	1.78	0.242	-0.72	0.80
6	1.89	2.21	1.90	2.12	2.03	0.160	0.04	0.53
7	1.97	1.68	2.09	2.23	1.99	0.234	-0.07	0.77
8	2.12	2.11	1.80	1.65	1.92	0.233	-0.30	0.77
9	1.97	2.27	2.41	2.82	2.37	0.353	1.09	1.17
10	1.92	2.89	2.06	1.65	2.13	0.534	0.35	1.76
11	2.27	2.30	1.94	1.96	2.12	0.194	0.31	0.64
12	2.91	3.18	1.92	2.86	2.72	0.551	2.17	1.82
13	2.19	1.39	1.59	1.52	1.67	0.355	-1.06	1.17
14	2.98	2.61	1.91	2.16	2.42	0.475	1.24	1.57
15	1.70	1.53	2.27	1.91	1.85	0.318	-0.50	1.05
16	1.97	2.17	2.16	2.47	2.19	0.207	0.55	0.68
17	2.00	1.80	1.90	1.80	1.88	0.096	-0.44	0.32
18	2.43	2.40	2.37	2.13	2.33	0.137	0.98	0.45
19	1.69	1.58	2.14	1.28	1.67	0.357	-1.07	1.18
20	1.95	1.68	1.60	1.44	1.66	0.214	-1.09	0.71
					2.02	0.303		
					0.104			

¹ Explanation of terms is included at the beginning of this appendix.

Table D.3: Rut Depth after 10,000 Passes (Compacted by UCPRC)

Lab Number	Rut Depth (mm)				Analysis Variables ¹			
	Set 1		Set 2		x_i	Sr_i	h_i	k_i
	Left	Right	Left	Right				
	Rep. 1	Rep. 2	Rep. 3	Rep. 4				
1	3.93	3.43	3.85	2.71	3.48	0.558	0.42	0.93
2	2.79	3.34	3.82	3.94	3.47	0.524	0.41	0.87
3	3.97	3.45	2.81	2.55	3.20	0.640	-0.14	1.06
4	2.77	2.90	2.89	3.60	3.04	0.378	-0.44	0.63
5	3.49	3.79	3.01	2.81	3.28	0.446	0.02	0.74
6	2.98	3.40	3.04	2.92	3.09	0.216	-0.35	0.36
7	3.91	2.17	2.78	3.00	2.97	0.721	-0.59	1.20
8	4.79	3.74	2.70	2.88	3.53	0.956	0.51	1.59
9	3.66	3.50	3.41	3.48	3.51	0.106	0.48	0.18
10	2.64	3.54	3.24	4.65	3.52	0.843	0.49	1.40
11	4.21	5.48	3.10	3.95	4.19	0.985	1.80	1.64
12	3.61	4.52	3.58	4.80	4.13	0.625	1.69	1.04
13	2.91	2.55	2.78	3.55	2.95	0.428	-0.62	0.71
14	3.23	5.01	3.59	3.83	3.92	0.771	1.27	1.28
15	2.18	2.52	2.17	2.51	2.34	0.196	-1.81	0.33
16	2.15	2.10	2.54	2.83	2.41	0.345	-1.69	0.57
17	3.70	3.20	4.90	2.90	3.68	0.881	0.80	1.46
18	3.19	2.99	3.05	3.65	3.22	0.299	-0.09	0.50
19	2.55	3.21	2.41	2.61	2.69	0.355	-1.12	0.59
20	2.52	2.96	1.96	3.50	2.73	0.653	-1.05	1.08
				<i>avg.</i>	3.27	0.602		
				<i>var.</i>	0.260			

¹ Explanation of terms is included at the beginning of this appendix.

Table D.4: Rut Depth after 10,000 Passes (Compacted by Participating Laboratories)

Lab Number	Rut Depth (mm)				Analysis Variables ¹			
	Set 1		Set 2		x_i	Sr_i	h_i	k_i
	Left	Right	Left	Right				
	Rep. 1	Rep. 2	Rep. 3	Rep. 4				
1	2.36	1.84	2.36	1.81	2.09	0.309	-0.90	0.78
2	3.17	3.19	3.57	3.06	3.25	0.222	1.73	0.56
3	1.65	2.20	2.35	2.09	2.07	0.301	-0.94	0.76
4	2.20	1.57	1.84	1.68	1.82	0.275	-1.51	0.69
5	2.24	1.96	2.02	2.67	2.22	0.322	-0.60	0.81
6	2.44	2.70	2.38	2.54	2.52	0.140	0.06	0.35
7	2.42	2.05	2.57	2.75	2.45	0.297	-0.09	0.75
8	2.71	2.61	2.23	1.87	2.36	0.384	-0.30	0.96
9	2.28	2.73	2.78	3.78	2.89	0.633	0.92	1.59
10	2.22	3.43	2.43	2.01	2.52	0.629	0.08	1.58
11	2.23	2.81	2.39	2.32	2.44	0.257	-0.11	0.65
12	3.67	4.10	2.47	3.72	3.49	0.708	2.28	1.78
13	2.50	1.73	1.99	1.91	2.03	0.330	-1.03	0.83
14	3.68	3.10	2.34	2.56	2.92	0.599	0.98	1.50
15	2.20	1.90	2.76	2.30	2.29	0.359	-0.45	0.90
16	2.39	2.63	2.62	2.99	2.66	0.248	0.39	0.62
17	2.70	2.20	3.00	2.70	2.65	0.332	0.37	0.83
18	3.12	3.04	3.02	2.65	2.96	0.210	1.07	0.53
19	2.06	1.96	2.62	1.50	2.03	0.462	-1.03	1.16
20	2.54	2.13	1.93	1.76	2.09	0.334	-0.90	0.84
				<i>avg.</i>	2.49	0.398		
				<i>var.</i>	0.194			

¹ Explanation of terms is included at the beginning of this appendix.

Table D.5: Rut Depth after 15,000 Passes (Compacted by UCPRC)

Lab Number	Rut depth (mm)				Analysis Variables ¹			
	Set 1		Set 2		x_i	Sr_i	h_i	k_i
	Left	Right	Left	Right				
	Rep. 1	Rep. 2	Rep. 3	Rep. 4				
1	6.71	4.60	5.36	3.33	5.00	1.415	1.23	1.08
2	2.92	3.97	4.03	4.65	3.89	0.718	-0.24	0.55
3	<u>7.41²</u>	3.93	3.12	2.91	4.34	2.092	0.36	1.60
4	3.70	3.37	3.52	4.36	3.74	0.436	-0.45	0.33
5	4.08	4.67	3.38	3.30	3.86	0.645	-0.29	0.49
6	3.36	4.48	4.48	3.75	4.02	0.557	-0.08	0.43
7	5.40	2.50	3.20	3.49	3.65	1.240	-0.57	0.95
8	<u>10.41</u>	5.50	2.99	3.26	5.54	3.436	1.95	<u>2.62</u>
9	4.44	4.23	3.93	4.60	4.30	0.289	0.30	0.22
10	2.94	4.46	3.87	5.74	4.25	1.173	0.24	0.90
11	4.86	<u>8.97³</u>	3.75	4.72	5.58	2.317	2.00	1.77
12	4.01	5.06	3.97	5.41	4.61	0.732	0.71	0.56
13	3.40	3.10	3.14	4.33	3.49	0.574	-0.78	0.44
14	3.60	5.00	4.17	4.28	4.26	0.575	0.25	0.44
15	2.43	3.73	2.45	3.03	2.91	0.614	-1.55	0.47
16	2.53	2.53	2.84	3.15	2.76	0.297	-1.75	0.23
17	4.20	3.80	6.30	3.30	4.40	1.319	0.43	1.01
18	4.03	3.71	3.87	4.15	3.94	0.191	-0.18	0.15
19	2.81	3.66	2.76	3.02	3.06	0.413	-1.35	0.32
20	2.98	5.96	2.22	4.39	3.89	1.649	-0.25	1.26
				<i>avg.</i>	4.07	1.310		
				<i>var.</i>	0.564			

¹ Explanation of terms is included at the beginning of this appendix.
Underlined values in orange-shaded cells are considered outliers and were not included in the analyses.

² This point was regarded as an outlier since the corresponding k_i increased to 2.12 (above the critical value of 2.0) when the other outliers were removed.

³ This point was regarded as an outlier since the corresponding k_i increased to 2.30 (above the critical value of 2.0) when the other outliers were removed.

Table D.6: Rut Depth after 15,000 Passes (Compacted by Participating Laboratories)

Lab Number	Rut Depth (mm)				Analysis Variables ¹			
	Set 1		Set 2		x_i	Sr_i	h_i	k_i
	Left	Right	Left	Right				
	Rep. 1	Rep. 2	Rep. 3	Rep. 4				
1	2.58	2.03	2.56	2.02	2.30	0.315	-1.01	0.66
2	3.72	3.83	4.90	3.76	4.05	0.567	2.10	1.19
3	1.89	2.40	2.55	2.36	2.30	0.285	-1.01	0.60
4	2.46	1.89	2.15	1.76	2.07	0.309	-1.43	0.65
5	2.39	2.21	2.40	3.02	2.51	0.354	-0.65	0.75
6	3.08	3.03	2.84	2.81	2.94	0.135	0.12	0.28
7	2.71	2.30	3.03	3.21	2.81	0.399	-0.10	0.84
8	3.10	3.08	2.87	2.10	2.79	0.470	-0.15	0.99
9	2.64	3.18	3.06	4.36	3.31	0.737	0.78	1.55
10	2.60	3.98	2.73	2.16	2.87	0.781	0.00	1.64
11	2.96	3.38	3.03	2.62	3.00	0.312	0.23	0.66
12	4.26	5.00	2.81	4.53	4.15	0.942	2.27	1.98
13	2.63	1.96	2.24	2.16	2.25	0.281	-1.10	0.59
14	4.01	3.41	2.68	2.83	3.23	0.606	0.64	1.28
15	2.74	2.20	3.11	2.47	2.63	0.387	-0.43	0.81
16	2.66	2.96	2.97	3.34	2.98	0.278	0.20	0.59
17	2.90	2.80	3.40	3.00	3.03	0.263	0.28	0.55
18	3.56	3.30	3.46	3.26	3.40	0.140	0.93	0.29
19	2.24	2.25	3.05	1.70	2.31	0.557	-0.99	1.17
20	3.08	2.50	2.30	2.07	2.49	0.431	-0.68	0.91
				<i>avg.</i>	2.87	0.475		
				<i>var.</i>	0.318			

¹ Explanation of terms is included at the beginning of this appendix.

Table D.7: Rut Depth after 20,000 Passes (Compacted by UCPRC)

Lab Number	Rut Depth (mm)				Analysis Variables ¹			
	Set 1		Set 2		x_i	Sr_i	h_i	k_i
	Left	Right	Left	Right				
	Rep. 1	Rep. 2	Rep. 3	Rep. 4				
1	-	8.59	7.88	4.42	6.96	2.231	1.55	1.06
2	3.16	4.90	4.68	5.42	4.54	0.971	-0.54	0.46
3	<u>11.58²</u>	4.58	3.39	3.42	5.74	3.931	0.50	1.87
4	4.31	3.27	4.14	5.04	4.19	0.727	-0.84	0.35
5	5.02	6.64	3.81	3.99	4.87	1.298	-0.26	0.62
6	3.82	6.28	8.19	6.30	6.15	1.792	0.85	0.85
7	6.90	3.12	3.71	4.03	4.44	1.683	-0.63	0.80
8	<u>13.49</u>	<u>9.19</u>	3.33	3.30	7.33	4.955	1.87	<u>2.36</u>
9	5.38	5.13	4.62	5.14	5.07	0.320	-0.08	0.15
10	3.42	5.27	4.36	7.73	5.20	1.851	0.03	0.88
11	6.67	10.93	4.35	7.15	7.28	2.726	1.82	1.30
12	4.38	5.44	4.32	5.94	5.02	0.801	-0.12	0.38
13	3.74	4.25	3.54	5.13	4.17	0.709	-0.86	0.34
14	3.86	6.83	4.39	5.00	5.02	1.293	-0.13	0.62
15	2.70	6.21	2.85	3.50	3.82	1.636	-1.17	0.78
16	3.24	4.01	3.12	3.65	3.51	0.406	-1.43	0.19
17	6.00	4.50	8.10	3.50	5.53	2.001	0.31	0.95
18	6.14	4.31	5.07	4.53	5.01	0.817	-0.13	0.39
19	3.08	4.11	3.04	3.32	3.39	0.496	-1.54	0.24
20	4.05	<u>10.47³</u>	2.52	7.32	6.09	3.543	0.80	1.69
				<i>avg.</i>	5.16	2.101		
				<i>var.</i>	1.338			

¹ Explanation of terms is included at the beginning of this appendix.
Underlined values in orange-shaded cells are considered outliers and were not included in the analyses.

² This point was regarded as an outlier since the corresponding k_i increased to 2.32 (above the critical value of 2.0) when the other outliers were removed.

³ This point was regarded as an outlier since the corresponding k_i increased to 2.27 (above the critical value of 2.0) when the other outliers were removed.

Table D.8: Rut Depth after 20,000 Passes (Compacted by Participating Laboratories)

Lab Number	Rut Depth (mm)				Analysis Variables ¹			
	Set 1		Set 2		x_i	Sr_i	h_i	k_i
	Left	Right	Left	Right				
	Rep. 1	Rep. 2	Rep. 3	Rep. 4				
1	2.73	2.15	2.76	2.17	2.45	0.338	-1.12	0.51
2	4.75	4.39	<u>6.73</u>	4.73	5.15	1.066	<u>2.74</u>	1.60
3	2.03	2.56	2.71	2.56	2.47	0.298	-1.10	0.45
4	2.73	1.90	2.31	1.97	2.23	0.380	-1.44	0.57
5	2.58	2.47	2.58	3.36	2.75	0.412	-0.70	0.62
6	3.76	3.21	3.51	3.03	3.38	0.323	0.20	0.49
7	2.99	2.47	3.42	3.59	3.12	0.500	-0.17	0.75
8	3.63	3.44	3.63	2.33	3.26	0.625	0.03	0.94
9	3.02	3.45	3.39	5.62	3.87	1.182	0.91	1.78
10	2.79	4.37	3.02	2.40	3.15	0.856	-0.13	1.29
11	2.90	3.64	3.67	2.83	3.26	0.457	0.04	0.69
12	4.51	-	3.05	5.55	4.37	1.258	1.62	1.89
13	2.78	2.13	2.36	2.30	2.39	0.276	-1.20	0.42
14	4.55	3.73	2.93	3.27	3.62	0.701	0.55	1.05
15	3.92	2.29	3.61	2.61	3.11	0.778	-0.18	1.17
16	2.90	3.21	3.28	3.66	3.26	0.312	0.04	0.47
17	3.10	3.00	3.70	3.20	3.25	0.311	0.02	0.47
18	3.97	3.55	3.96	3.71	3.80	0.204	0.80	0.31
19	2.49	2.61	3.96	1.90	2.74	0.870	-0.71	1.31
20	3.90	3.14	2.74	2.53	3.08	0.605	-0.22	0.91
				avg.	3.23	0.665		
				var.	0.490			

¹ Explanation of terms is included at the beginning of this appendix.
Underlined values in orange-shaded cells are considered outliers and were not included in the analyses.

Table D.9: Passes to 12.5 mm Rut Depth (Compacted by UCPRC)

Lab Number	Passes to 12.5 mm Rut Depth				Analysis Variables ¹			
	Set 1		Set 2		x_i	Sr_i	h_i	k_i
	Left	Right	Left	Right				
	Rep. 1	Rep. 2	Rep. 3	Rep. 4				
1	18,444	24,582	-	-	21,513	4,340.221	-0.34	1.36
2	-	-	-	-	-	-	-	-
3	20,800	-	-	-	-	-	-	-
4	-	-	-	-	-	-	-	-
5	-	-	-	-	-	-	-	-
6	-	-	-	-	-	-	-	-
7	-	-	-	-	-	-	-	-
8	18,300	23,000	-	-	20,650	3,323.402	-0.79	1.04
9	-	-	-	-	-	-	-	-
10	-	-	-	-	-	-	-	-
11	-	23,800	-	24,900	24,350	777.817	1.13	0.24
12	-	-	-	-	-	-	-	-
13	-	-	-	-	-	-	-	-
14	-	-	-	-	-	-	-	-
15	-	-	-	-	-	-	-	-
16	-	-	-	-	-	-	-	-
17	-	-	-	-	-	-	-	-
18	-	-	-	-	-	-	-	-
19	-	-	-	-	-	-	-	-
20	-	25,000	-	-	-	-	-	-
				<i>avg.</i>	22,171	3,188		
				<i>var.</i>	3.75E+06			

¹ Explanation of terms is included at the beginning of this appendix.

Table D.10: Passes to 12.5 mm Rut Depth (Compacted by Participating Laboratories)

Lab Number	Passes to 12.5 mm Rut Depth				Analysis Variables ¹			
	Set 1		Set 2		x_i	Sr_i	h_i	k_i
	Left	Right	Left	Right				
	Rep. 1	Rep. 2	Rep. 3	Rep. 4				
1								
2								
3								
4								
5								
6								
7								
8								
9								
10								
11								
12								
13								
14								
15								
16								
17								
18								
19								
20								
				<i>avg.</i>				
				<i>var.</i>				
¹ Explanation of terms is included at the beginning of this appendix.								

Table D.11: Creep Slope (Compacted by UCPRC)

Lab Number	Creep Slope (mm/pass)				Analysis Variables ¹			
	Set 1		Set 2		x_i	Sr_i	h_i	k_i
	Left	Right	Left	Right				
	Rep. 1	Rep. 2	Rep. 3	Rep. 4				
1	-	-	-	-	-	-	-	-
2	-	-	-	-	-	-	-	-
3	-	-	-	-	-	-	-	-
4	1.13E-04	6.91E-05	1.28E-04	1.56E-04	1.17E-04	3.63E-05	-0.33	0.20
5	6.23E-05	9.07E-05	5.82E-05	1.02E-04	7.83E-05	2.14E-05	-0.67	0.12
6	8.20E-05	1.63E-04	1.38E-04	1.35E-04	1.30E-04	3.41E-05	-0.22	0.18
7	2.95E-04	2.64E-04	-	1.30E-04	2.30E-04	8.75E-05	0.66	0.47
8	2.79E-04	2.00E-04	-	7.10E-05	1.83E-04	1.05E-04	0.25	0.57
9	-	-	-	-	-	-	-	-
10	-	-	-	-	-	-	-	-
11	1.54E-04	2.14E-04	1.22E-04	<u>1.44E-03</u>	4.83E-04	6.42E-04	<u>2.88</u>	<u>3.47</u>
12	-	-	6.26E-05	1.00E-04	8.15E-05	2.67E-05	-0.64	0.14
13	1.43E-05	4.86E-05	2.86E-06	7.43E-05	3.50E-05	3.26E-05	-1.05	0.18
14	-	-	-	-	-	-	-	-
15	-	-	-	-	-	-	-	-
16	7.10E-05	1.19E-04	-	7.20E-05	8.73E-05	2.74E-05	-0.59	0.15
17	2.00E-04	1.80E-04	2.80E-04	-	2.20E-04	5.29E-05	0.57	0.29
18	1.66E-04	1.38E-04	1.33E-04	1.41E-04	1.44E-04	1.46E-05	-0.09	0.08
19	7.32E-05	1.01E-04	7.61E-05	7.92E-05	8.24E-05	1.28E-05	-0.63	0.07
20	1.00E-04	2.00E-04	6.00E-05	2.00E-04	1.40E-04	7.12E-05	-0.13	0.39
				<i>avg.</i>	1.55E-04	1.85E-04		
				<i>var.</i>	1.30E-08			

¹ Explanation of terms is included at the beginning of this appendix.
Underlined values in orange-shaded cells are considered outliers and were not included in the analyses.

Table D.12: Creep Slope (Compacted by Participating Laboratories)

Lab Number	Creep Slope (mm/pass)				Analysis Variables ¹			
	Set 1		Set 2		x_i	Sr_i	h_i	k_i
	Left	Right	Left	Right				
	Rep. 1	Rep. 2	Rep. 3	Rep. 4				
1	-	-	-	-	-	-	-	-
2	-	-	-	-	-	-	-	-
3	-	-	-	-	-	-	-	-
4	5.08E-05	2.79E-05	3.84E-05	3.65E-05	3.84E-05	9.41E-06	-0.90	0.11
5	3.73E-05	3.42E-05	8.98E-05	1.22E-04	7.08E-05	4.26E-05	-0.36	0.50
6	1.21E-04	-	8.90E-05	-	1.05E-04	2.26E-05	0.22	0.26
7	-	-	-	-	-	-	-	-
8	8.30E-05	8.30E-05	1.02E-04	3.70E-05	7.63E-05	2.77E-05	-0.27	0.32
9	-	-	-	-	-	-	-	-
10	-	-	-	-	-	-	-	-
11	5.90E-05	8.87E-05	1.16E-04	<u>5.79E-04</u>	2.11E-04	2.47E-04	1.99	<u>2.89</u>
12	3.48E-05	1.60E-04	-	-	9.72E-05	8.84E-05	0.09	1.03
13	8.57E-06	1.00E-05	<u>1.29E-19²</u>	<u>2.39E-19²</u>	4.64E-06	5.39E-06	-1.47	0.06
14	-	-	-	-	-	-	-	-
15	-	-	-	-	-	-	-	-
16	-	-	9.50E-05	-	-	-	-	-
17	-	-	-	-	-	-	-	-
18	1.63E-04	1.92E-04	1.42E-04	1.70E-04	1.67E-04	2.08E-05	1.25	0.24
19	5.32E-05	6.83E-05	9.11E-05	4.18E-05	6.36E-05	2.13E-05	-0.48	0.25
20	1.00E-04	1.00E-04	8.00E-05	7.00E-05	8.75E-05	1.50E-05	-0.08	0.18
				<i>avg.</i>	9.21E-05	8.54E-05		
				<i>var.</i>	3.54E-09			

¹ Explanation of terms is included at the beginning of this appendix.
Underlined values in orange-shaded cells are considered outliers and were not included in the analyses.

² These two points were regarded as outliers due to their reduced value, which was essentially zero.

Table D.13: Stripping Slope (Compacted by UCPRC)

Lab Number	Stripping Slope (mm/pass)				Analysis Variables ¹			
	Set 1		Set 2		x_i	Sr_i	h_i	k_i
	Left	Right	Left	Right				
	Rep. 1	Rep. 2	Rep. 3	Rep. 4				
1	-	-	-	-	-	-	-	-
2	-	-	-	-	-	-	-	-
3	-	-	-	-	-	-	-	-
4	3.98E-04	1.66E-04	-	2.64E-04	2.76E-04	1.16E-04	-0.49	0.70
5	9.73E-05	1.08E-04	1.14E-04	1.06E-04	1.06E-04	6.91E-06	-1.03	0.04
6	1.14E-04	2.98E-04	3.56E-04	4.12E-04	2.95E-04	1.29E-04	-0.42	0.78
7	4.03E-04	3.68E-04	-	7.18E-04	4.96E-04	1.93E-04	0.22	1.16
8	1.15E-03	8.82E-04	-	-	1.02E-03	1.92E-04	1.90	1.16
9	-	-	-	-	-	-	-	-
10	-	-	-	-	-	-	-	-
11	6.78E-04	6.41E-04	2.69E-04	1.05E-03	6.60E-04	3.20E-04	0.75	1.93
12	-	-	8.48E-05	1.39E-04	1.12E-04	3.84E-05	-1.01	0.23
13	-	4.66E-04	-	-	-	-	-	-
14	-	-	-	-	-	-	-	-
15	-	-	-	-	-	-	-	-
16	1.42E-04	2.24E-04	-	1.37E-04	1.68E-04	4.89E-05	-0.83	0.29
17	3.60E-04	4.40E-04	4.20E-04	-	4.07E-04	4.16E-05	-0.07	0.25
18	6.13E-04	1.02E-04	2.50E-04	8.13E-05	2.62E-04	2.46E-04	-0.53	1.48
19	-	-	-	-	-	-	-	-
20	7.00E-04	1.00E-03	-	1.00E-03	9.00E-04	1.73E-04	1.52	1.04
				<i>avg.</i>	4.27E-04	1.66E-04		
				<i>var.</i>	9.70E-08			

¹ Explanation of terms is included at the beginning of this appendix.

Table D.14: Stripping Slope (Compacted by Participating Laboratories)

Lab Number	Stripping Slope (mm/pass)				Analysis Variables ¹			
	Set 1		Set 2		x_i	Sr_i	h_i	k_i
	Left	Right	Left	Right				
	Rep. 1	Rep. 2	Rep. 3	Rep. 4				
1	-	-	-	-	-	-	-	-
2	-	-	-	-	-	-	-	-
3	-	-	-	-	-	-	-	-
4	-	-	-	-	-	-	-	-
5	3.66E-05	2.46E-05	-	-	3.06E-05	8.49E-06	-1.48	0.06
6	1.85E-04	-	1.38E-04	-	1.62E-04	3.32E-05	-0.18	0.23
7	-	-	-	-	-	-	-	-
8	2.38E-04	-	3.03E-04	-	2.71E-04	4.60E-05	0.89	0.32
9	-	-	-	-	-	-	-	-
10	-	-	-	-	-	-	-	-
11	6.71E-05	9.41E-05	<u>7.86E-04</u>	1.00E-04	2.62E-04	3.50E-04	0.81	<u>2.46</u>
12	9.57E-05	2.01E-04	-	-	1.48E-04	7.41E-05	-0.32	0.52
13	-	-	-	-	-	-	-	-
14	-	-	-	-	-	-	-	-
15	-	-	-	-	-	-	-	-
16	-	-	9.30E-05	-	-	-	-	-
17	-	-	-	-	-	-	-	-
18	9.64E-05	6.20E-05	1.03E-04	9.35E-05	8.87E-05	1.82E-05	-0.90	0.13
19	-	-	-	-	-	-	-	-
20	4.00E-04	-	3.00E-04	2.00E-04	3.00E-04	1.00E-04	1.19	0.70
				<i>avg.</i>	1.80E-04	1.42E-04		
				<i>var.</i>	1.02E-08			

¹ Explanation of terms is included at the beginning of this appendix.
Underlined values in orange-shaded cells are considered outliers and were not included in the analyses.

Table D.15: Stripping Inflection Point (Compacted by UCPRC)

Lab Number	Stripping Inflection Point (passes)				Analysis Variables ¹			
	Set 1		Set 2		x_i	Sr_i	h_i	k_i
	Left	Right	Left	Right				
	Rep. 1	Rep. 2	Rep. 3	Rep. 4				
1	-	-	-	-	-	-	-	-
2	-	-	-	-	-	-	-	-
3	11,072	-	-	-	-	-	-	-
4	20,625	18,088	-	17,054	18,589	1,837	1.00	0.49
5	12,397	17,817	21,861	21,016	18,273	4,287	0.92	1.13
6	17,776	13,683	11,625	14,614	14,425	2,560	-0.08	0.68
7	8,843	5,197	-	<u>21,813</u>	11,951	8,733	-0.71	<u>2.31</u>
8	9,026	14,982	-	-	12,004	4,212	-0.70	1.11
9	20,749	-	-	20,168	20,459	411	1.48	0.11
10	-	-	-	-	-	-	-	-
11	17,956	8,085	19,304	18,071	15,854	5,215	0.29	1.38
12	-	-	15,086	15,917	15,502	588	0.20	0.16
13	-	19,222	-	-	-	-	-	-
14	-	19,000	-	-	-	-	-	-
15	-	-	-	-	-	-	-	-
16	7,692	8,583	-	9,082	8,452	704	-1.62	0.19
17	8,500	8,500	8,000	-	8,333	289	-1.65	0.08
18	17,033	-	13,820	-	15,427	2,272	0.18	0.60
19	-	-	-	-	-	-	-	-
20	21,000	13,000	-	18,000	17,333	4,041	0.68	1.07
				<i>avg.</i>	14,717	3,787		
				<i>var.</i>	1.50E+07			

¹ Explanation of terms is included at the beginning of this appendix.
Underlined values in orange-shaded cells are considered outliers and were not included in the analyses.

Table D.16: Stripping Inflection Point (Compacted by Participating Laboratories)

Lab Number	Stripping Inflection Point (passes)				Analysis Variables ¹			
	Set 1		Set 2		x_i	Sr_i	h_i	k_i
	Left	Right	Left	Right				
	Rep. 1	Rep. 2	Rep. 3	Rep. 4				
1	-	-	-	-	-	-	-	-
2	-	-	-	-	-	-	-	-
3	-	-	-	-	-	-	-	-
4	-	-	-	-	-	-	-	-
5	<u>80,948²</u>	<u>82,470²</u>	-	-	81,709	1,076	1.50	0.96
6	17,780	-	15,485	-	16,633	1,623	-0.57	1.45
7	-	-	-	-	-	-	-	-
8	21,385	-	20,064	-	20,725	934	-0.44	0.84
9	-	-	-	-	-	-	-	-
10	-	-	-	-	-	-	-	-
11	-	-	22,975	-	-	-	-	-
12	-	10,312	-	-	-	-	-	-
13	-	-	-	-	-	-	-	-
14	-	-	-	-	-	-	-	-
15	-	-	-	-	-	-	-	-
16	-	-	8,066	-	-	-	-	-
17	-	-	-	-	-	-	-	-
18	-	-	-	-	-	-	-	-
19	-	-	20,290	-	-	-	-	-
20	19,000	-	20,000	20,000	19,667	577	-0.48	0.52
				<i>avg.</i>	34,683	1,118		
				<i>var.</i>	9.86E+08			

¹ Explanation of terms is included at the beginning of this appendix.
Underlined values in orange-shaded cells are considered outliers and were not included in the analyses.

² These values were regarded as outliers since the HWT test was conducted up to 25,000 cycles, and the tripping inflection point can therefore not be higher than 25,000.

APPENDIX E: ANOVA TO DETERMINE SIGNIFICANT FACTORS

```

USE ALL.
COMPUTE filter_$(Comp = 1).
VARIABLE LABELS filter_$(Comp = 1 (FILTER)'.
VALUE LABELS filter_$(0 'Not Selected' 1 'Selected'.
FORMATS filter_$(f1.0).
FILTER BY filter_$.
EXECUTE.
UNIANOVA Rut@5k BY Lab Set
  /RANDOM=Lab Set
  /METHOD=SSTYPE(3)
  /INTERCEPT=INCLUDE
  /PLOT=PROFILE(Lab*Set)
  /CRITERIA=ALPHA(0.05)
  /DESIGN=Lab Set(Lab).

```

Univariate Analysis of Variance

Between-Subjects Factors

	Value Label	N
Laboratory	1	4
	2	4
	3	4
	4	4
	5	4
	6	4
	7	4
	8	4
	9	4
	10	4
	11	4
	12	4
	13	4
	14	3
	15	4
	16	4
	17	4
	18	4
	19	4
	20	4

Between-Subjects Factors

		Value Label	N
Set	1	Set 1 (UCPCR Compacted)	39
	2	Set 2 (UCPCR Compacted)	40

Tests of Between-Subjects Effects

Dependent Variable: Rut@5k

Source		Type III Sum of Squares	df	Mean Square	F	Sig.
Intercept	Hypothesis	507.761	1	507.761	934.128	.000
	Error	10.361	19.061	.544 ^a		
Lab	Hypothesis	10.390	19	.547	3.974	.002
	Error	2.753	20.010	.138 ^b		
Set(Lab)	Hypothesis	2.752	20	.138	1.188	.314
	Error	4.519	39	.116 ^c		

a. .992 MS(Lab) + .008 MS(Error)

b. 1.000 MS(Set(Lab)) + .000 MS(Error)

c. MS(Error)

Expected Mean Squares^{a,b}

Source	Variance Component			
	Var(Lab)	Var(Set(Lab))	Var(Error)	Quadratic Term
Intercept	3.902	1.951	1.000	Intercept
Lab	3.932	1.966	1.000	
Set(Lab)	.000	1.967	1.000	
Error	.000	.000	1.000	

a. For each source, the expected mean square equals the sum of the coefficients in the cells times the variance components, plus a quadratic term involving effects in the Quadratic Term cell.

b. Expected Mean Squares are based on the Type III Sums of Squares.

Profile Plots

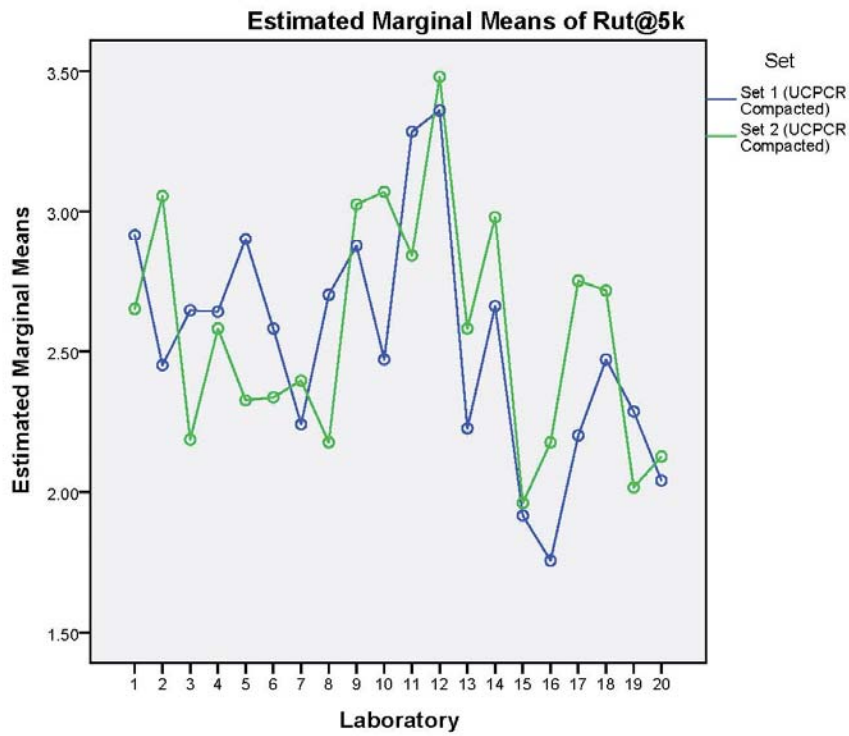

```

UNIANOVA Rut@10k BY Lab Set
  /RANDOM=Lab Set
  /METHOD=SSTYPE(3)
  /INTERCEPT=INCLUDE
  /PLOT=PROFILE(Lab*Set)
  /CRITERIA=ALPHA(0.05)
  /DESIGN=Lab Set(Lab).

```

Univariate Analysis of Variance

Between-Subjects Factors

		Value Label	N
Laboratory	1		4
	2		4
	3		4
	4		4
	5		4
	6		4
	7		4
	8		4
	9		4
	10		4
	11		4
	12		4
	13		4
	14		4
	15		4
	16		4
	17		4
	18		4
	19		4
	20		4
Set	1	Set 1 (UCPCR Compacted)	40
	2	Set 2 (UCPCR Compacted)	40

Tests of Between-Subjects Effects

Dependent Variable: Rut@10k

Source		Type III Sum of Squares	df	Mean Square	F	Sig.
Intercept	Hypothesis	853.340	1	853.340	821.061	.000
	Error	19.747	19	1.039 ^a		
Lab	Hypothesis	19.747	19	1.039	2.471	.026
	Error	8.414	20	.421 ^b		
Set(Lab)	Hypothesis	8.414	20	.421	1.261	.260
	Error	13.347	40	.334 ^c		

a. MS(Lab)

b. MS(Set(Lab))

c. MS(Error)

Expected Mean Squares^{a,b}

Source	Variance Component			
	Var(Lab)	Var(Set(Lab))	Var(Error)	Quadratic Term
Intercept	4.000	2.000	1.000	Intercept
Lab	4.000	2.000	1.000	
Set(Lab)	.000	2.000	1.000	
Error	.000	.000	1.000	

a. For each source, the expected mean square equals the sum of the coefficients in the cells times the variance components, plus a quadratic term involving effects in the Quadratic Term cell.

b. Expected Mean Squares are based on the Type III Sums of Squares.

Profile Plots

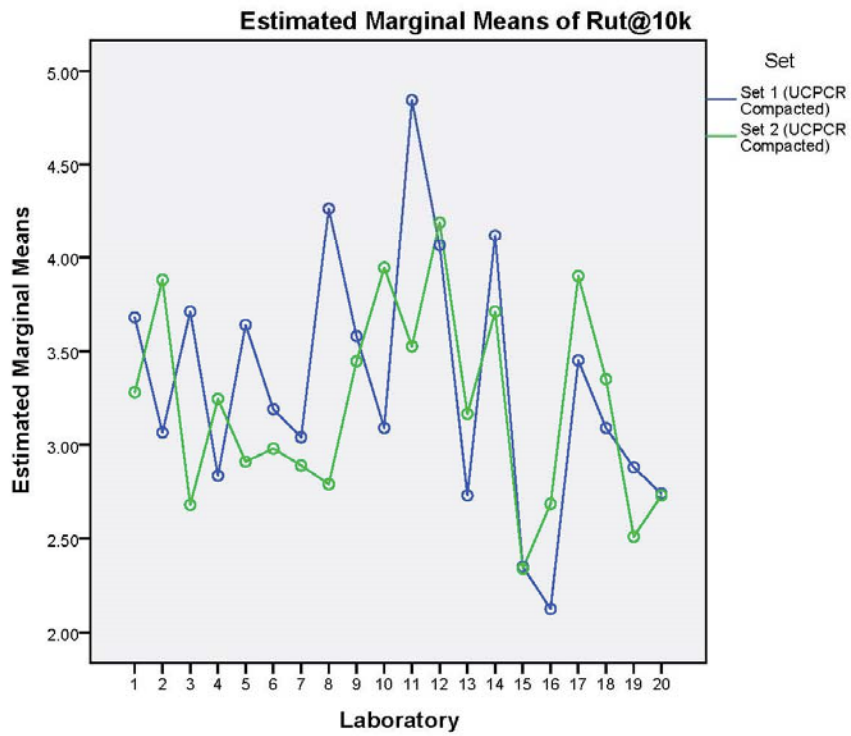

```

UNIANOVA Rut@15k BY Lab Set
  /RANDOM=Lab Set
  /METHOD=SSTYPE(3)
  /INTERCEPT=INCLUDE
  /PLOT=PROFILE(Lab*Set)
  /CRITERIA=ALPHA(0.05)
  /DESIGN=Lab Set(Lab).

```

Univariate Analysis of Variance

Between-Subjects Factors

		Value Label	N
Laboratory	1		4
	2		4
	3		3
	4		4
	5		4
	6		4
	7		4
	8		3
	9		4
	10		4
	11		3
	12		4
	13		4
	14		4
	15		4
	16		4
	17		4
	18		4
	19		4
	20		4
Set	1	Set 1 (UCPCR Compacted)	37
	2	Set 2 (UCPCR Compacted)	40

Tests of Between-Subjects Effects

Dependent Variable: Rut@15k

Source		Type III Sum of Squares	df	Mean Square	F	Sig.
Intercept	Hypothesis	1142.598	1	1142.598	889.476	.000
	Error	25.047	19.499	1.285 ^a		
Lab	Hypothesis	24.583	19	1.294	2.038	.061
	Error	12.725	20.043	.635 ^b		
Set(Lab)	Hypothesis	12.694	20	.635	.765	.734
	Error	30.683	37	.829 ^c		

a. .980 MS(Lab) + .020 MS(Error)

b. .999 MS(Set(Lab)) + .001 MS(Error)

c. MS(Error)

Expected Mean Squares^{a,b}

Source	Variance Component			
	Var(Lab)	Var(Set(Lab))	Var(Error)	Quadratic Term
Intercept	3.721	1.860	1.000	Intercept
Lab	3.797	1.898	1.000	
Set(Lab)	.000	1.900	1.000	
Error	.000	.000	1.000	

a. For each source, the expected mean square equals the sum of the coefficients in the cells times the variance components, plus a quadratic term involving effects in the Quadratic Term cell.

b. Expected Mean Squares are based on the Type III Sums of Squares.

Profile Plots

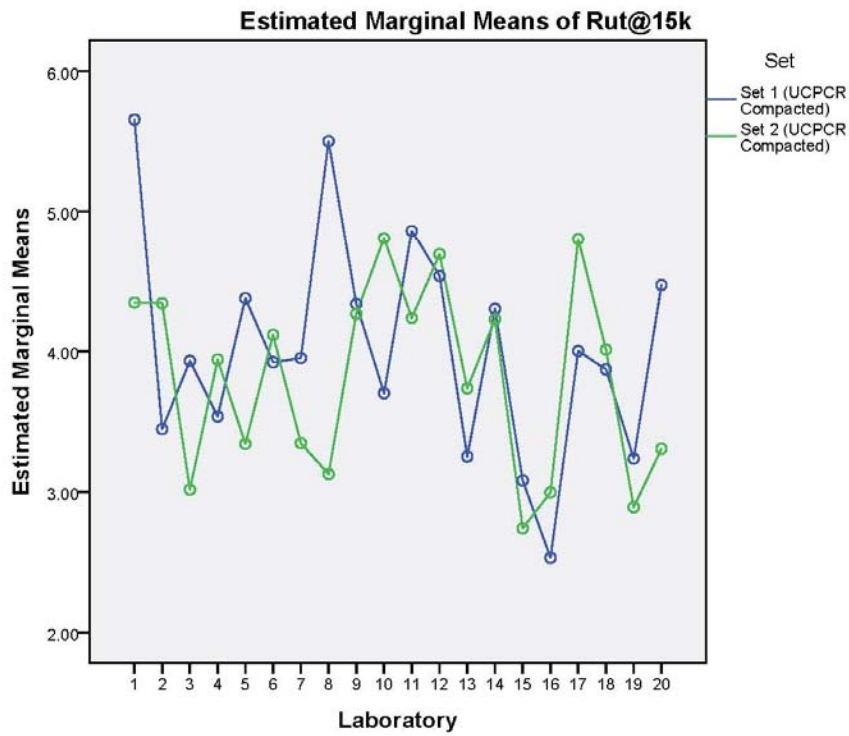

```

UNIANOVA Rut@20k BY Lab Set
  /RANDOM=Lab Set
  /METHOD=SSTYPE(3)
  /INTERCEPT=INCLUDE
  /PLOT=PROFILE(Lab*Set)
  /CRITERIA=ALPHA(0.05)
  /DESIGN=Lab Set(Lab).

```

Univariate Analysis of Variance

Between-Subjects Factors

		Value Label	N
Laboratory	1		3
	2		4
	3		3
	4		4
	5		4
	6		4
	7		4
	8		2
	9		4
	10		4
	11		4
	12		4
	13		4
	14		4
	15		4
	16		4
	17		4
	18		4
	19		4
	20		3
Set	1	Set 1 (UCPCR Compacted)	35
	2	Set 2 (UCPCR Compacted)	40

Tests of Between-Subjects Effects

Dependent Variable: Rut@20k

Source		Type III Sum of Squares	df	Mean Square	F	Sig.
Intercept	Hypothesis	1687.115	1	1687.115	395.847	.000
	Error	82.784	19.424	4.262 ^a		
Lab	Hypothesis	81.774	19	4.304	2.542	.024
	Error	31.990	18.897	1.693 ^b		
Set(Lab)	Hypothesis	32.188	19	1.694	.736	.759
	Error	82.893	36	2.303 ^c		

- a. $.979 \text{ MS(Lab)} + .001 \text{ MS(Set(Lab))} + .020 \text{ MS(Error)}$
- b. $1.002 \text{ MS(Set(Lab))} - .002 \text{ MS(Error)}$
- c. MS(Error)

Expected Mean Squares^{a,b}

Source	Variance Component			
	Var(Lab)	Var(Set(Lab))	Var(Error)	Quadratic Term
Intercept	3.618	1.861	1.000	Intercept
Lab	3.695	1.899	1.000	
Set(Lab)	.000	1.895	1.000	
Error	.000	.000	1.000	

- a. For each source, the expected mean square equals the sum of the coefficients in the cells times the variance components, plus a quadratic term involving effects in the Quadratic Term cell.
- b. Expected Mean Squares are based on the Type III Sums of Squares.

Profile Plots

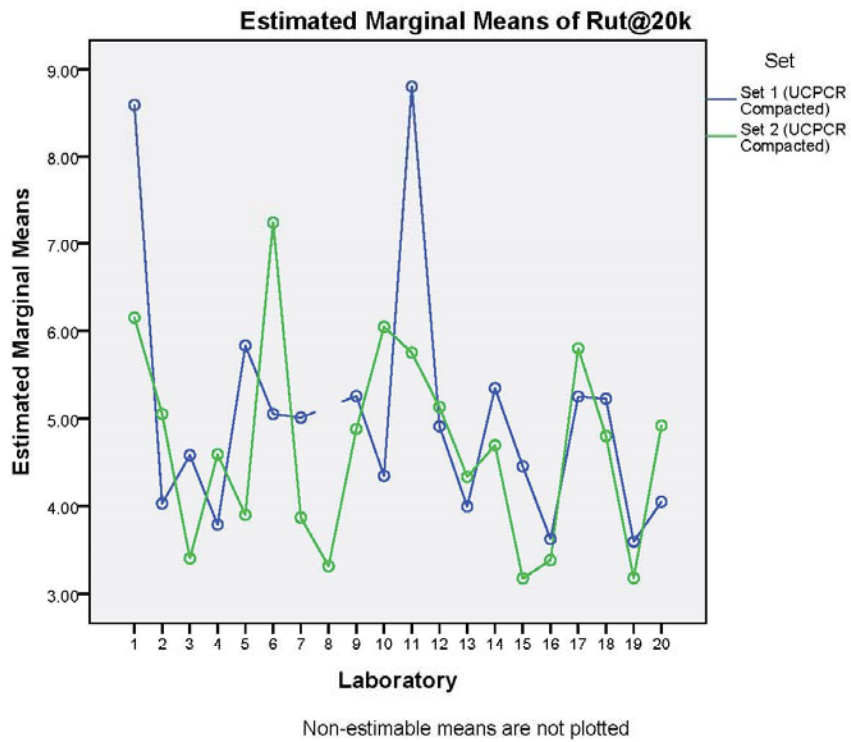

```

UNIANOVA Cy@12.5mm BY Lab Set
  /RANDOM=Lab Set
  /METHOD=SSTYPE(3)
  /INTERCEPT=INCLUDE
  /PLOT=PROFILE(Lab*Set)
  /CRITERIA=ALPHA(0.05)
  /DESIGN=Lab Set(Lab).

```

Univariate Analysis of Variance

Between-Subjects Factors

		Value Label	N
Laboratory	1		2
	3		1
	8		2
	11		2
	20		1
Set	1	Set 1 (UCPCR Compacted)	7
	2	Set 2 (UCPCR Compacted)	1

Tests of Between-Subjects Effects

Dependent Variable: Cy@12.5mm

Source		Type III Sum of Squares	df	Mean Square	F	Sig.
Intercept	Hypothesis	3729421186	1	3729421186	510.574	.000
	Error	40352865.98	5.524	7304375.81 ^a		
Lab	Hypothesis	24606053.50	4			
	Error		^b			
Set(Lab)	Hypothesis	605000.000	1	605000.000	.040	.859
	Error	29882522.00	2	14941261.0 ^c		

a. $.951 \text{ MS(Lab)} - .050 \text{ MS(Set(Lab))} + .099 \text{ MS(Error)}$

b. Cannot compute the error degrees of freedom using Satterthwaite's method.

c. MS(Error)

Expected Mean Squares^{a,b}

Source	Variance Component			
	Var(Lab)	Var(Set(Lab))	Var(Error)	Quadratic Term
Intercept	1.486	1.257	1.000	Intercept
Lab	1.563	1.375	1.000	
Set(Lab)	.000	1.000	1.000	
Error	.000	.000	1.000	

- a. For each source, the expected mean square equals the sum of the coefficients in the cells times the variance components, plus a quadratic term involving effects in the Quadratic Term cell.
- b. Expected Mean Squares are based on the Type III Sums of Squares.

Profile Plots

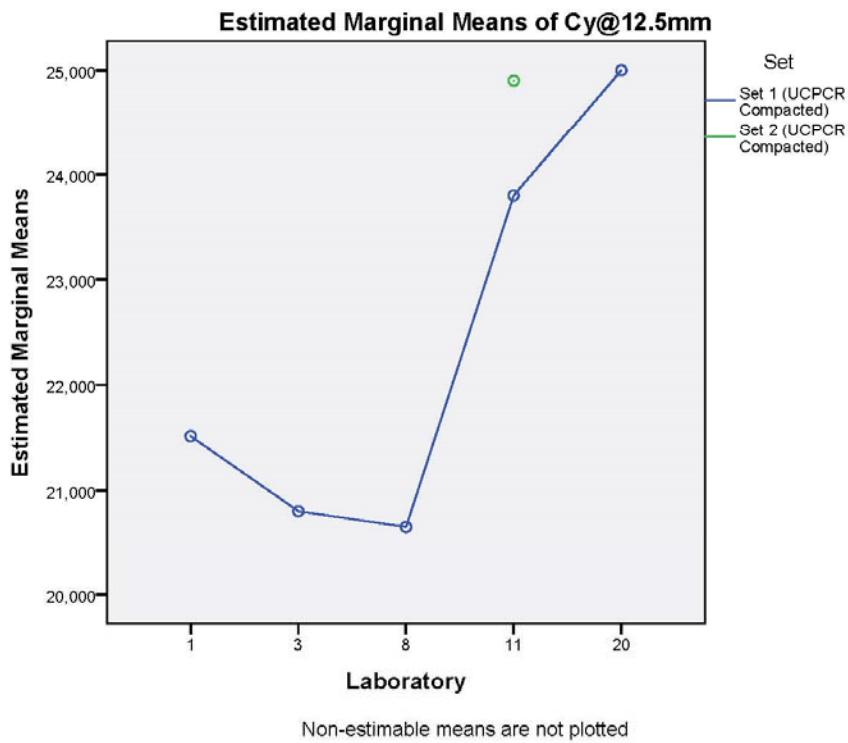

```

UNIANOVA Creep_Slp BY Lab Set
  /RANDOM=Lab Set
  /METHOD=SSTYPE(3)
  /INTERCEPT=INCLUDE
  /PLOT=PROFILE(Lab*Set)
  /CRITERIA=ALPHA(0.05)
  /DESIGN=Lab Set(Lab).

```

Univariate Analysis of Variance

Between-Subjects Factors

		Value Label	N
Laboratory	4		4
	5		4
	6		4
	7		3
	8		3
	11		3
	12		2
	13		4
	16		3
	17		3
	18		4
	19		4
	20		4
Set	1	Set 1 (UCPCR Compacted)	24
	2	Set 2 (UCPCR Compacted)	21

Tests of Between-Subjects Effects

Dependent Variable: Creep_Slp

Source		Type III Sum of Squares	df	Mean Square	F	Sig.
Intercept	Hypothesis	6.708E-7	1	6.708E-7	73.215	.000
	Error	1.110E-7	12.116	9.162E-9 ^a		
Lab	Hypothesis	1.129E-7	12	9.412E-9	2.456	.067
	Error	4.559E-8	11.900	3.831E-9 ^b		
Set(Lab)	Hypothesis	4.571E-8	12	3.809E-9	2.365	.043
	Error	3.221E-8	20	1.611E-9 ^c		

- a. $.969 \text{ MS(Lab)} - .003 \text{ MS(Set(Lab))} + .034 \text{ MS(Error)}$
- b. $1.010 \text{ MS(Set(Lab))} - .010 \text{ MS(Error)}$
- c. MS(Error)

Expected Mean Squares^{a,b}

Source	Variance Component			
	Var(Lab)	Var(Set(Lab))	Var(Error)	Quadratic Term
Intercept	3.216	1.680	1.000	Intercept
Lab	3.320	1.739	1.000	
Set(Lab)	.000	1.722	1.000	
Error	.000	.000	1.000	

- a. For each source, the expected mean square equals the sum of the coefficients in the cells times the variance components, plus a quadratic term involving effects in the Quadratic Term cell.
- b. Expected Mean Squares are based on the Type III Sums of Squares.

Profile Plots

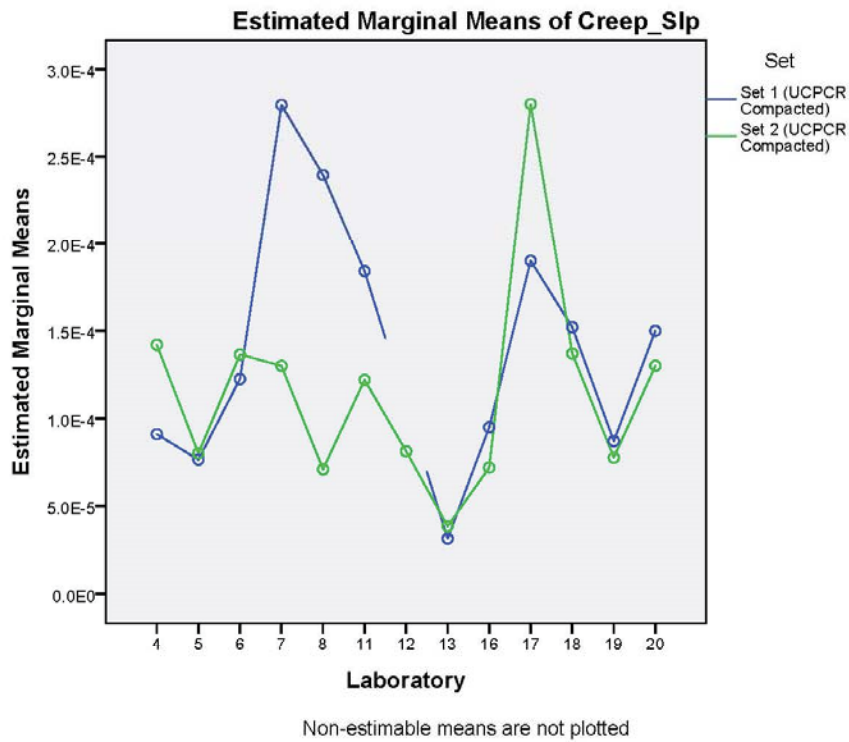

```

UNIANOVA Strip_Slp BY Lab Set
  /RANDOM=Lab Set
  /METHOD=SSTYPE(3)
  /INTERCEPT=INCLUDE
  /PLOT=PROFILE(Lab*Set)
  /CRITERIA=ALPHA(0.05)
  /DESIGN=Lab Set(Lab).

```

Univariate Analysis of Variance

Between-Subjects Factors

	Value Label	N
Laboratory	4	3
	5	4
	6	4
	7	3
	8	2
	11	4
	12	2
	13	1
	16	3
	17	3
	18	4
Set	1	21
	2	15

Tests of Between-Subjects Effects

Dependent Variable: Strip_Slp

Source	Type III Sum of Squares	df	Mean Square	F	Sig.	
Intercept	Hypothesis	5.851E-6	1	5.851E-6	25.505	.000
	Error	2.571E-6	11.206	2.294E-7 ^a		
Lab	Hypothesis	2.651E-6	11	2.410E-7	13.658	.000
	Error	1.577E-7	8.936	1.765E-8 ^b		
Set(Lab)	Hypothesis	1.591E-7	9	1.768E-8	.453	.884
	Error	5.855E-7	15	3.903E-8 ^c		

a. .943 MS(Lab) + .005 MS(Set(Lab)) + .052 MS(Error)

b. 1.002 MS(Set(Lab)) - .002 MS(Error)

c. MS(Error)

Expected Mean Squares^{a,b}

Source	Variance Component			
	Var(Lab)	Var(Set(Lab))	Var(Error)	Quadratic Term
Intercept	2.672	1.547	1.000	Intercept
Lab	2.834	1.632	1.000	
Set(Lab)	.000	1.630	1.000	
Error	.000	.000	1.000	

- a. For each source, the expected mean square equals the sum of the coefficients in the cells times the variance components, plus a quadratic term involving effects in the Quadratic Term cell.
- b. Expected Mean Squares are based on the Type III Sums of Squares.

Profile Plots

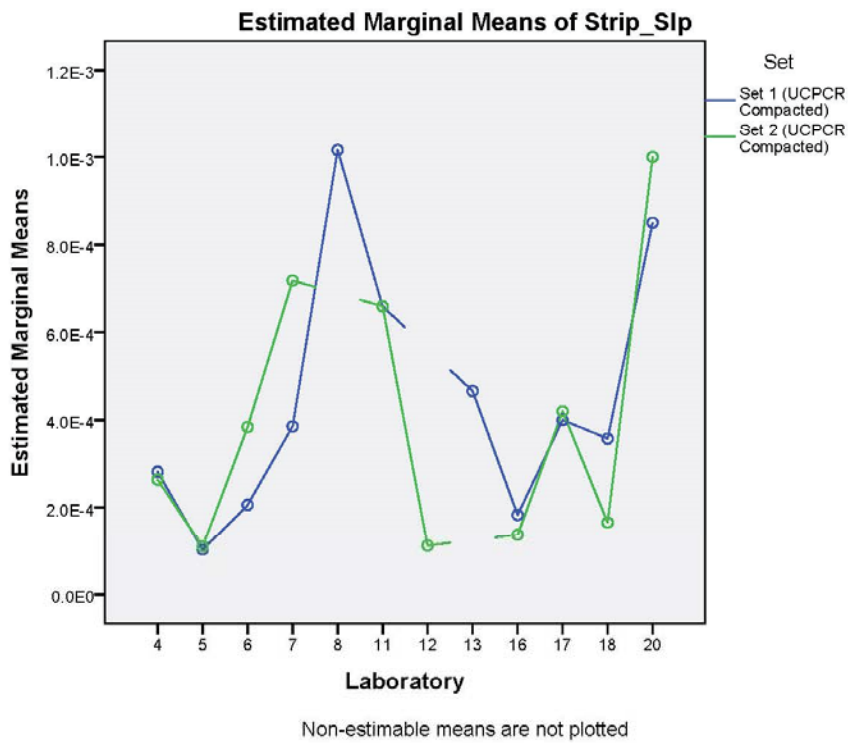

```

UNIANOVA SIP BY Lab Set
  /RANDOM=Lab Set
  /METHOD=SSTYPE(3)
  /INTERCEPT=INCLUDE
  /PLOT=PROFILE(Lab*Set)
  /CRITERIA=ALPHA(0.05)
  /DESIGN=Lab Set(Lab).

```

Univariate Analysis of Variance

Between-Subjects Factors

		Value Label	N
Laboratory	3		1
	4		3
	5		4
	6		4
	7		2
	8		2
	9		2
	11		4
	12		2
	13		1
	14		1
	16		3
	17		3
	18		2
	20		3
Set	1	Set 1 (UCPCR Compacted)	23
	2	Set 2 (UCPCR Compacted)	14

Tests of Between-Subjects Effects

Dependent Variable: SIP

Source		Type III Sum of Squares	df	Mean Square	F	Sig.
Intercept	Hypothesis	6909642031	1	6909642031	180.560	.000
	Error	562519392.3	14.700	38267832.7 ^a		
Lab	Hypothesis	573472267.8	14	40962304.84	4.128	.019
	Error	89419429.36	9.011	9923462.14 ^b		
Set(Lab)	Hypothesis	89307737.25	9	9923081.917	.937	.526
	Error	137711094.0	13	10593161.1 ^c		

a. .911 MS(Lab) + .009 MS(Set(Lab)) + .080 MS(Error)

b. .999 MS(Set(Lab)) + .001 MS(Error)

c. MS(Error)

Expected Mean Squares^{a,b}

Source	Variance Component			
	Var(Lab)	Var(Set(Lab))	Var(Error)	Quadratic Term
Intercept	2.141	1.362	1.000	Intercept
Lab	2.348	1.481	1.000	
Set(Lab)	.000	1.481	1.000	
Error	.000	.000	1.000	

a. For each source, the expected mean square equals the sum of the coefficients in the cells times the variance components, plus a quadratic term involving effects in the Quadratic Term cell.

b. Expected Mean Squares are based on the Type III Sums of Squares.

Profile Plots

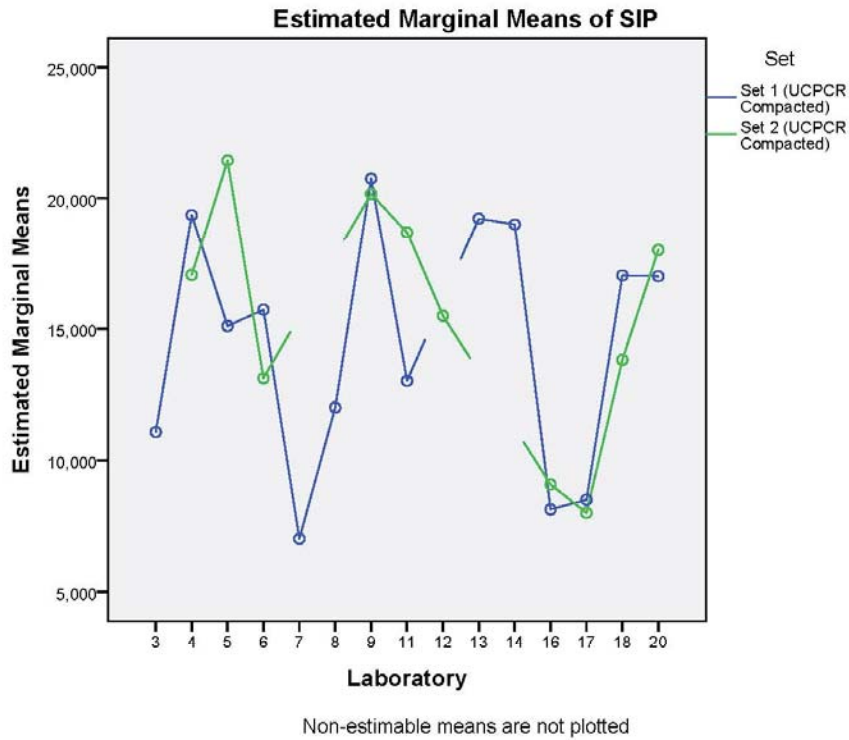

```

USE ALL.
COMPUTE filter_$(Comp = 2).
VARIABLE LABELS filter_$(Comp = 2 (FILTER)'.
VALUE LABELS filter_$(0 'Not Selected' 1 'Selected'.
FORMATS filter_$(f1.0).
FILTER BY filter_$.
EXECUTE.
UNIANOVA Rut@5k BY Lab Set
  /RANDOM=Lab Set
  /METHOD=SSTYPE(3)
  /INTERCEPT=INCLUDE
  /PLOT=PROFILE(Lab*Set)
  /CRITERIA=ALPHA(0.05)
  /DESIGN=Lab Set(Lab).

```

Univariate Analysis of Variance

Between-Subjects Factors

		Value Label	N
Laboratory	1		4
	2		4
	3		4
	4		4
	5		4
	6		4
	7		4
	8		4
	9		4
	10		4
	11		4
	12		4
	13		4
	14		4
	15		4
	16		4
	17		4
	18		4
	19		4
	20		4
Set	3	Set 3 (Lab. Compacted)	40
	4	Set 4 (Lab. Compacted)	40

Tests of Between-Subjects Effects

Dependent Variable: Rut@5k

Source		Type III Sum of Squares	df	Mean Square	F	Sig.
Intercept	Hypothesis	325.221	1	325.221	781.487	.000
	Error	7.907	19	.416 ^a		
Lab	Hypothesis	7.907	19	.416	3.325	.005
	Error	2.503	20	.125 ^b		
Set(Lab)	Hypothesis	2.503	20	.125	1.667	.083
	Error	3.003	40	.075 ^c		

a. MS(Lab)

b. MS(Set(Lab))

c. MS(Error)

Expected Mean Squares^{a,b}

Source	Variance Component			
	Var(Lab)	Var(Set(Lab))	Var(Error)	Quadratic Term
Intercept	4.000	2.000	1.000	Intercept
Lab	4.000	2.000	1.000	
Set(Lab)	.000	2.000	1.000	
Error	.000	.000	1.000	

a. For each source, the expected mean square equals the sum of the coefficients in the cells times the variance components, plus a quadratic term involving effects in the Quadratic Term cell.

b. Expected Mean Squares are based on the Type III Sums of Squares.

Profile Plots

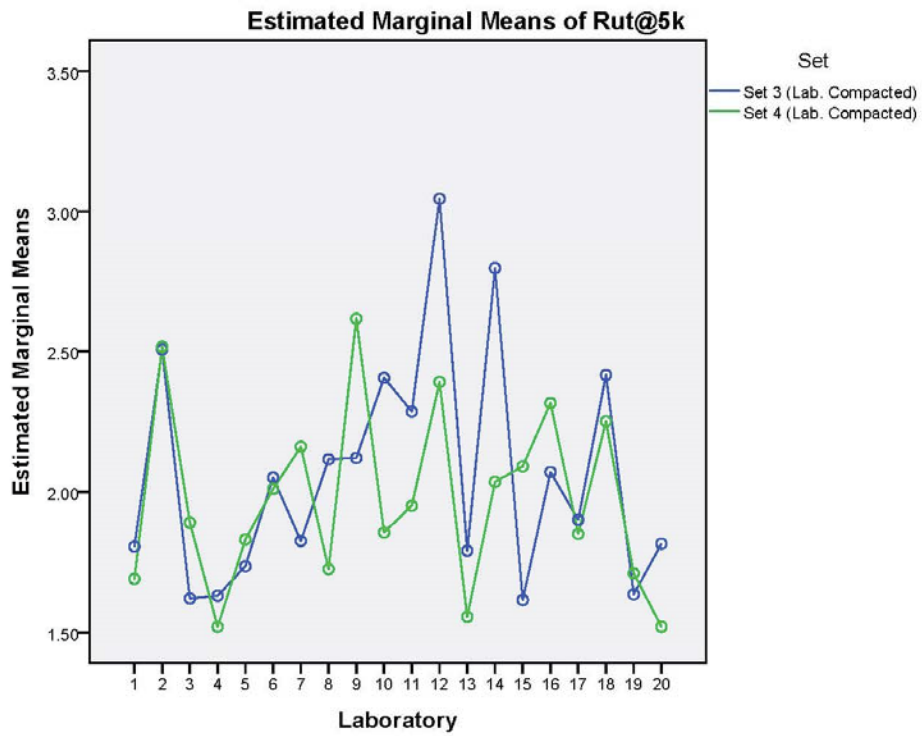

```

UNIANOVA Rut@10k BY Lab Set
  /RANDOM=Lab Set
  /METHOD=SSTYPE(3)
  /INTERCEPT=INCLUDE
  /PLOT=PROFILE(Lab*Set)
  /CRITERIA=ALPHA(0.05)
  /DESIGN=Lab Set(Lab).

```

Univariate Analysis of Variance

Between-Subjects Factors

		Value Label	N
Laboratory	1		4
	2		4
	3		4
	4		4
	5		4
	6		4
	7		4
	8		4
	9		4
	10		4
	11		4
	12		4
	13		4
	14		4
	15		4
	16		4
	17		4
	18		4
	19		4
	20		4
Set	3	Set 3 (Lab. Compacted)	40
	4	Set 4 (Lab. Compacted)	40

Tests of Between-Subjects Effects

Dependent Variable: Rut@10k

Source		Type III Sum of Squares	df	Mean Square	F	Sig.
Intercept	Hypothesis	495.013	1	495.013	638.418	.000
	Error	14.732	19	.775 ^a		
Lab	Hypothesis	14.732	19	.775	3.824	.002
	Error	4.055	20	.203 ^b		
Set(Lab)	Hypothesis	4.055	20	.203	1.490	.139
	Error	5.443	40	.136 ^c		

a. MS(Lab)

b. MS(Set(Lab))

c. MS(Error)

Expected Mean Squares^{a,b}

Source	Variance Component			
	Var(Lab)	Var(Set(Lab))	Var(Error)	Quadratic Term
Intercept	4.000	2.000	1.000	Intercept
Lab	4.000	2.000	1.000	
Set(Lab)	.000	2.000	1.000	
Error	.000	.000	1.000	

a. For each source, the expected mean square equals the sum of the coefficients in the cells times the variance components, plus a quadratic term involving effects in the Quadratic Term cell.

b. Expected Mean Squares are based on the Type III Sums of Squares.

Profile Plots

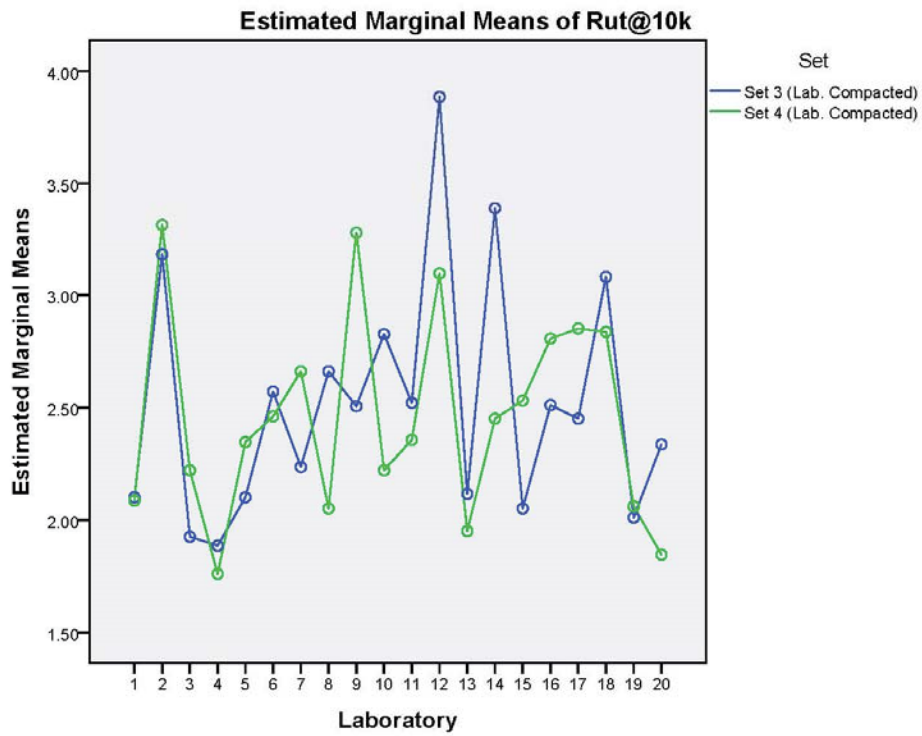

```

UNIANOVA Rut@15k BY Lab Set
  /RANDOM=Lab Set
  /METHOD=SSTYPE(3)
  /INTERCEPT=INCLUDE
  /PLOT=PROFILE(Lab*Set)
  /CRITERIA=ALPHA(0.05)
  /DESIGN=Lab Set(Lab).

```

Univariate Analysis of Variance

Between-Subjects Factors

		Value Label	N
Laboratory	1		4
	2		4
	3		4
	4		4
	5		4
	6		4
	7		4
	8		4
	9		4
	10		4
	11		4
	12		4
	13		4
	14		4
	15		4
	16		4
	17		4
	18		4
	19		4
	20		4
Set	3	Set 3 (Lab. Compacted)	40
	4	Set 4 (Lab. Compacted)	40

Tests of Between-Subjects Effects

Dependent Variable: Rut@15k

Source		Type III Sum of Squares	df	Mean Square	F	Sig.
Intercept	Hypothesis	658.837	1	658.837	517.764	.000
	Error	24.177	19	1.272 ^a		
Lab	Hypothesis	24.177	19	1.272	4.656	.001
	Error	5.465	20	.273 ^b		
Set(Lab)	Hypothesis	5.465	20	.273	1.349	.206
	Error	8.105	40	.203 ^c		

a. MS(Lab)

b. MS(Set(Lab))

c. MS(Error)

Expected Mean Squares^{a,b}

Source	Variance Component			
	Var(Lab)	Var(Set(Lab))	Var(Error)	Quadratic Term
Intercept	4.000	2.000	1.000	Intercept
Lab	4.000	2.000	1.000	
Set(Lab)	.000	2.000	1.000	
Error	.000	.000	1.000	

a. For each source, the expected mean square equals the sum of the coefficients in the cells times the variance components, plus a quadratic term involving effects in the Quadratic Term cell.

b. Expected Mean Squares are based on the Type III Sums of Squares.

Profile Plots

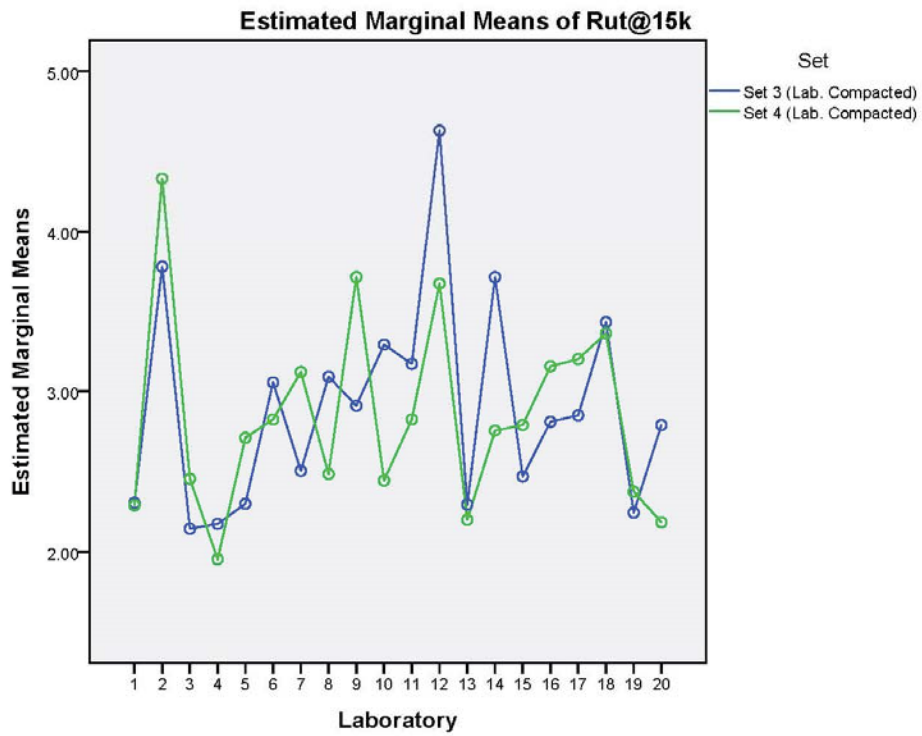

```

UNIANOVA Rut@20k BY Lab Set
  /RANDOM=Lab Set
  /METHOD=SSTYPE(3)
  /INTERCEPT=INCLUDE
  /PLOT=PROFILE(Lab*Set)
  /CRITERIA=ALPHA(0.05)
  /DESIGN=Lab Set(Lab).

```

Univariate Analysis of Variance

Between-Subjects Factors

		Value Label	N
Laboratory	1		4
	2		3
	3		4
	4		4
	5		4
	6		4
	7		4
	8		4
	9		4
	10		4
	11		4
	12		3
	13		4
	14		4
	15		4
	16		4
	17		4
	18		4
	19		4
	20		4
Set	3	Set 3 (Lab. Compacted)	39
	4	Set 4 (Lab. Compacted)	39

Tests of Between-Subjects Effects

Dependent Variable: Rut@20k

Source	Type III Sum of Squares	df	Mean Square	F	Sig.	
Intercept	Hypothesis	785.625	1	785.625	578.061	.000
	Error	26.045	19.164	1.359 ^a		
Lab	Hypothesis	26.083	19	1.373	4.515	.001
	Error	6.090	20.030	.304 ^b		
Set(Lab)	Hypothesis	6.079	20	.304	.742	.759
	Error	15.566	38	.410 ^c		

a. .986 MS(Lab) + .014 MS(Error)

b. .999 MS(Set(Lab)) + .001 MS(Error)

c. MS(Error)

Expected Mean Squares^{a,b}

Source	Variance Component			
	Var(Lab)	Var(Set(Lab))	Var(Error)	Quadratic Term
Intercept	3.810	1.905	1.000	Intercept
Lab	3.864	1.932	1.000	
Set(Lab)	.000	1.933	1.000	
Error	.000	.000	1.000	

a. For each source, the expected mean square equals the sum of the coefficients in the cells times the variance components, plus a quadratic term involving effects in the Quadratic Term cell.

b. Expected Mean Squares are based on the Type III Sums of Squares.

Profile Plots

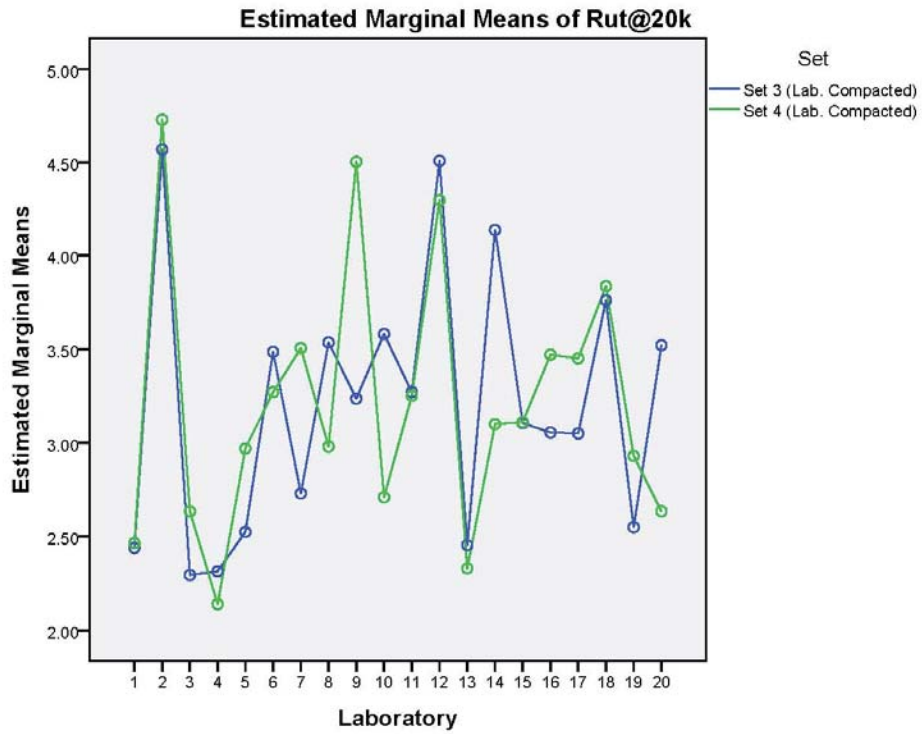

```

UNIANOVA Cy@12.5mm BY Lab Set
  /RANDOM=Lab Set
  /METHOD=SSTYPE(3)
  /INTERCEPT=INCLUDE
  /PLOT=PROFILE(Lab*Set)
  /CRITERIA=ALPHA(0.05)
  /DESIGN=Lab Set(Lab).

```

Univariate Analysis of Variance

Warnings

No valid cases were found.
Execution of this command stops.

```

UNIANOVA Creep_Slp BY Lab Set
  /RANDOM=Lab Set

```

```

/METHOD=SSTYPE(3)
/INTERCEPT=INCLUDE
/PLOT=PROFILE(Lab*Set)
/CRITERIA=ALPHA(0.05)
/DESIGN=Lab Set(Lab).

```

Univariate Analysis of Variance

Between-Subjects Factors

	Value Label	N
Laboratory	4	4
	5	4
	6	2
	8	4
	11	3
	12	2
	13	2
	16	1
	18	4
	19	4
Set	3	19
	4	15

Tests of Between-Subjects Effects

Dependent Variable: Creep_Slp

Source	Type III Sum of Squares	df	Mean Square	F	Sig.	
Intercept	Hypothesis	2.086E-7	1	2.086E-7	43.820	.000
	Error	4.917E-8	10.327	4.761E-9 ^a		
Lab	Hypothesis	5.115E-8	10	5.115E-9	5.177	.013
	Error	8.265E-9	8.366	9.879E-10 ^b		
Set(Lab)	Hypothesis	7.923E-9	8	9.904E-10	1.111	.409
	Error	1.337E-8	15	8.914E-10 ^c		

a. .916 MS(Lab) + .014 MS(Set(Lab)) + .070 MS(Error)

b. .975 MS(Set(Lab)) + .025 MS(Error)

c. MS(Error)

Expected Mean Squares^{a,b}

Source	Variance Component			
	Var(Lab)	Var(Set(Lab))	Var(Error)	Quadratic Term
Intercept	2.768	1.625	1.000	Intercept
Lab	3.022	1.748	1.000	
Set(Lab)	.000	1.792	1.000	
Error	.000	.000	1.000	

- a. For each source, the expected mean square equals the sum of the coefficients in the cells times the variance components, plus a quadratic term involving effects in the Quadratic Term cell.
- b. Expected Mean Squares are based on the Type III Sums of Squares.

Profile Plots

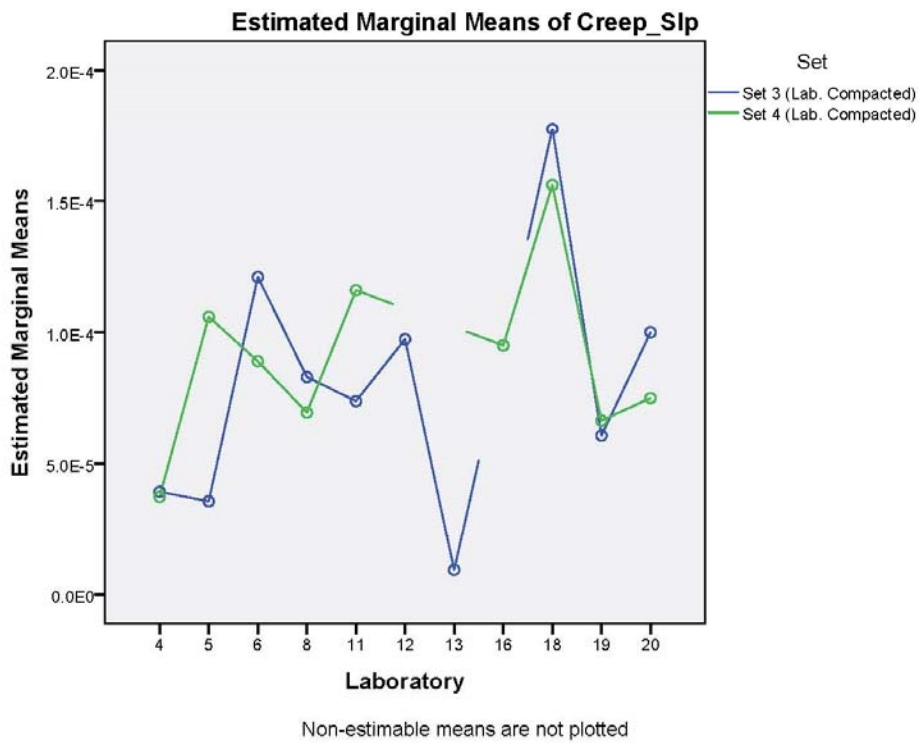

```

UNIANOVA Strip_Slp BY Lab Set
  /RANDOM=Lab Set
  /METHOD=SSTYPE(3)
  /INTERCEPT=INCLUDE
  /PLOT=PROFILE(Lab*Set)
  /CRITERIA=ALPHA(0.05)
  /DESIGN=Lab Set(Lab).

```

Univariate Analysis of Variance

Between-Subjects Factors

	Value Label	N
Laboratory	5	2
	6	2
	8	2
	11	3
	12	2
	16	1
	18	4
	20	3
Set	3 Set 3 (Lab. Compacted)	11
	4 Set 4 (Lab. Compacted)	8

Tests of Between-Subjects Effects

Dependent Variable: Strip_Slp

Source	Type III Sum of Squares	df	Mean Square	F	Sig.	
Intercept	Hypothesis	4.159E-7	1	4.159E-7	18.275	.004
	Error	1.599E-7	7.028	2.276E-8 ^a		
Lab	Hypothesis	1.672E-7	7	2.389E-8	6.089	.038
	Error	1.803E-8	4.596	3.923E-9 ^b		
Set(Lab)	Hypothesis	1.883E-8	5	3.766E-9	1.945	.221
	Error	1.162E-8	6	1.936E-9 ^c		

a. .951 MS(Lab) - .027 MS(Set(Lab)) + .076 MS(Error)

b. 1.086 MS(Set(Lab)) - .086 MS(Error)

c. MS(Error)

Expected Mean Squares^{a,b}

Source	Variance Component			
	Var(Lab)	Var(Set(Lab))	Var(Error)	Quadratic Term
Intercept	2.140	1.340	1.000	Intercept
Lab	2.251	1.448	1.000	
Set(Lab)	.000	1.333	1.000	
Error	.000	.000	1.000	

- a. For each source, the expected mean square equals the sum of the coefficients in the cells times the variance components, plus a quadratic term involving effects in the Quadratic Term cell.
- b. Expected Mean Squares are based on the Type III Sums of Squares.

Profile Plots

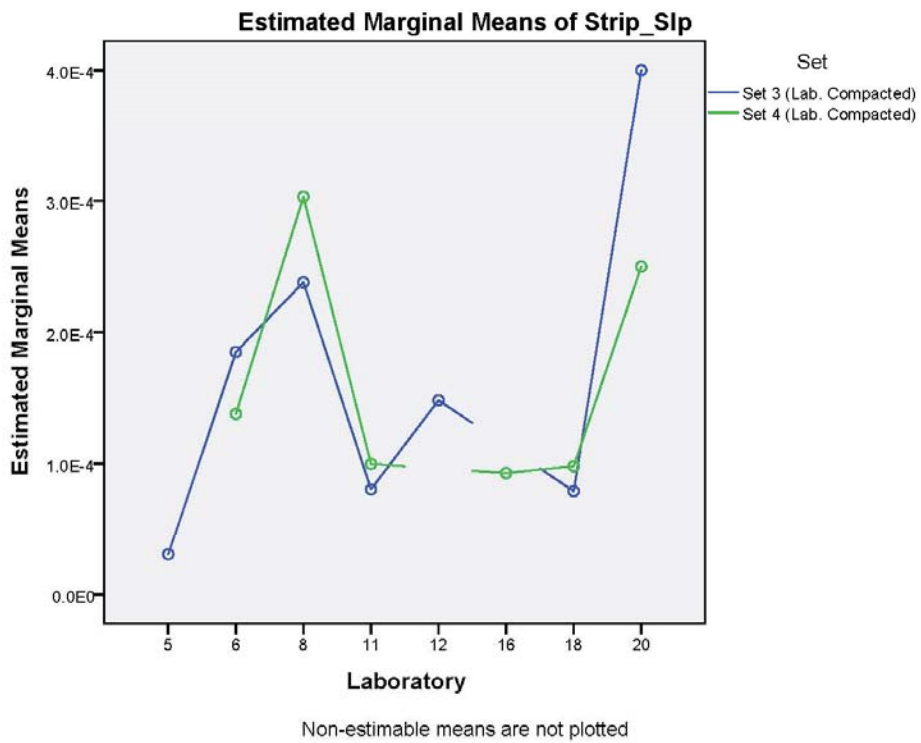

```

UNIANOVA SIP BY Lab Set
  /RANDOM=Lab Set
  /METHOD=SSTYPE(3)
  /INTERCEPT=INCLUDE
  /PLOT=PROFILE(Lab*Set)
  /CRITERIA=ALPHA(0.05)
  /DESIGN=Lab Set(Lab).

```

Univariate Analysis of Variance

Between-Subjects Factors

	Value Label	N
Laboratory	6	2
	8	2
	11	1
	12	1
	16	1
	19	1
	20	3
Set	3 Set 3 (Lab. Compacted)	4
	4 Set 4 (Lab. Compacted)	7

Tests of Between-Subjects Effects

Dependent Variable: SIP

Source		Type III Sum of Squares	df	Mean Square	F	Sig.
Intercept	Hypothesis	2931694749	1	2931694749	85.048	.000
	Error	207045358.8	6.006	34471072.0 ^a		
Lab	Hypothesis	211126139.7	6	35187689.94	26.985	.011
	Error	3911905.937	3	1303968.65 ^b		
Set(Lab)	Hypothesis	4172699.667	3	1390899.889		
	Error	.000	1	.000 ^c		

a. .979 MS(Lab) + .013 MS(Set(Lab)) + .008 MS(Error)

b. .938 MS(Set(Lab)) + .063 MS(Error)

c. MS(Error)

Expected Mean Squares^{a,b}

Source	Variance Component			
	Var(Lab)	Var(Set(Lab))	Var(Error)	Quadratic Term
Intercept	1.448	1.034	1.000	Intercept
Lab	1.479	1.042	1.000	
Set(Lab)	.000	1.111	1.000	
Error	.000	.000	1.000	

- a. For each source, the expected mean square equals the sum of the coefficients in the cells times the variance components, plus a quadratic term involving effects in the Quadratic Term cell.
- b. Expected Mean Squares are based on the Type III Sums of Squares.

Profile Plots

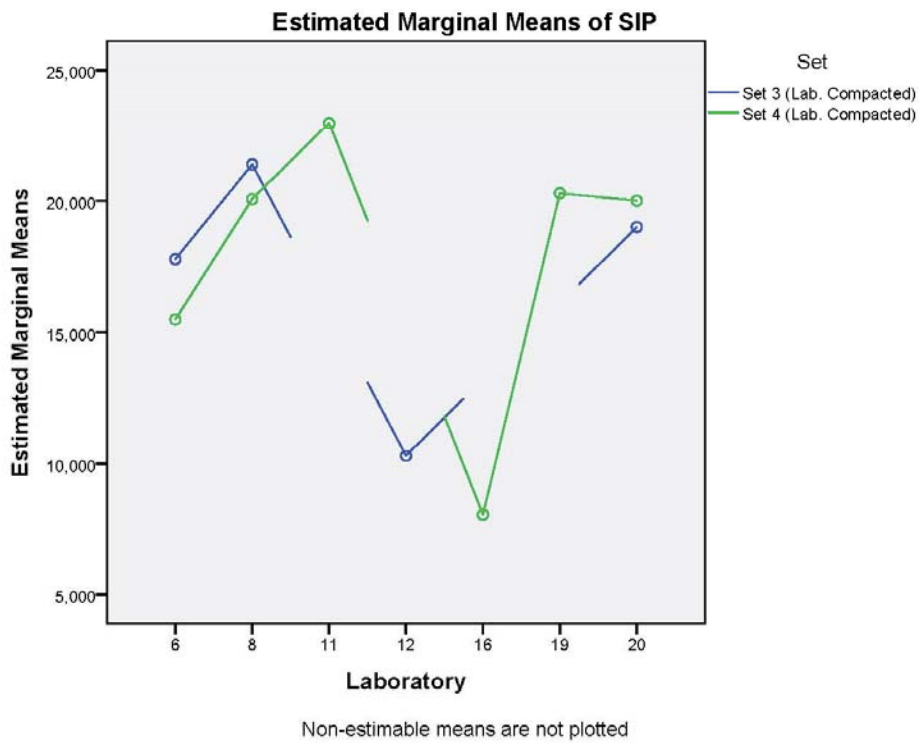

APPENDIX F: ANOVA TO DETERMINE VARIANCE COMPONENTS

```
GET
  FILE='C:\Users\Angel\Google Drive\06.- HWTT RSP (3.32.01)\HWTT Data_V00.Clean.sav'.
DATASET NAME DataSet1 WINDOW=FRONT.
USE ALL.
COMPUTE filter_$=(Comp = 1).
VARIABLE LABELS filter_$ 'Comp = 1 (FILTER)'.
VALUE LABELS filter_$ 0 'Not Selected' 1 'Selected'.
FORMATS filter_$ (f1.0).
FILTER BY filter_$.
EXECUTE.
UNIANOVA Rut@5k BY Lab
  /RANDOM=Lab
  /METHOD=SSTYPE(3)
  /INTERCEPT=INCLUDE
  /PLOT=PROFILE(Lab)
  /CRITERIA=ALPHA(0.05)
  /DESIGN=Lab.
```

Univariate Analysis of Variance

```
[DataSet1] C:\Users\Angel\Google Drive\06.- HWTT RSP (3.32.01)\HWTT Data_V00.Clean.sav
```

Between-Subjects Factors

	N
Laboratory 1	4
2	4
3	4
4	4
5	4
6	4
7	4
8	4
9	4
10	4
11	4
12	4
13	4
14	3
15	4
16	4
17	4
18	4
19	4
20	4

Tests of Between-Subjects Effects

Dependent Variable: Rut@5k

Source	Type III Sum of Squares	df	Mean Square	F	Sig.
Intercept Hypothesis	512.994	1	512.994	930.112	.000
Error	10.497	19.032	.552 ^a		
Lab Hypothesis	10.510	19	.553	4.489	.000
Error	7.271	59	.123 ^b		

a. .996 MS(Lab) + .004 MS(Error)

b. MS(Error)

Expected Mean Squares^{a,b}

Source	Variance Component		
	Var(Lab)	Var(Error)	Quadratic Term
Intercept	3.934	1.000	Intercept
Lab	3.949	1.000	
Error	.000	1.000	

- a. For each source, the expected mean square equals the sum of the coefficients in the cells times the variance components, plus a quadratic term involving effects in the Quadratic Term cell.
- b. Expected Mean Squares are based on the Type III Sums of Squares.

Profile Plots

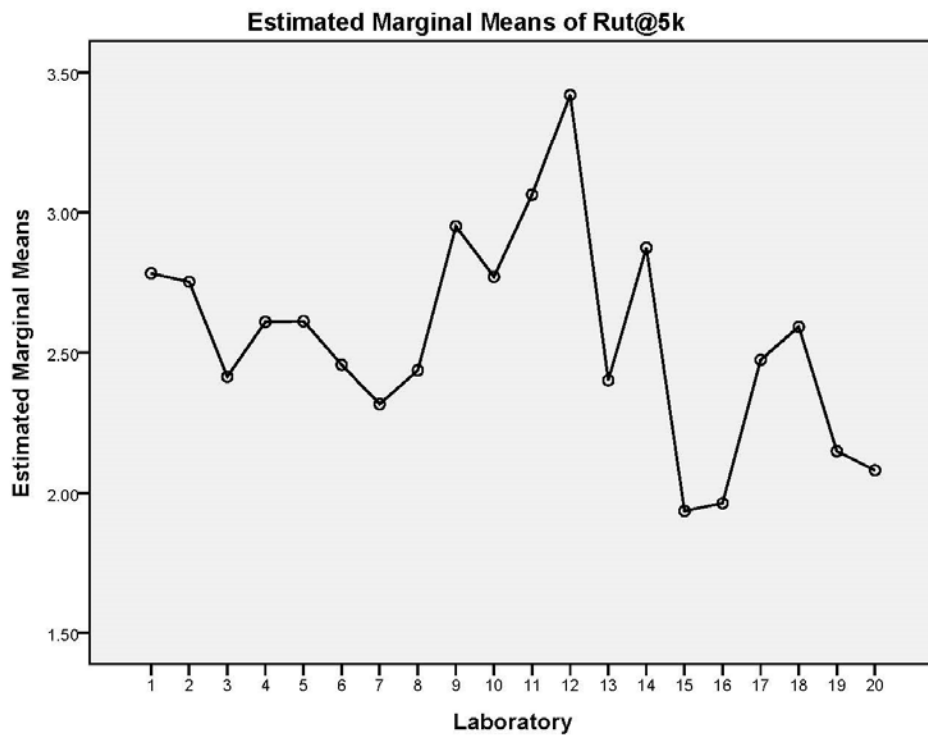

```
UNIANOVA Rut@10k BY Lab
  /RANDOM=Lab
  /METHOD=SSTYPE(3)
  /INTERCEPT=INCLUDE
  /PLOT=PROFILE(Lab)
  /CRITERIA=ALPHA(0.05)
  /DESIGN=Lab.
```

Univariate Analysis of Variance

Between-Subjects Factors

	N
Laboratory 1	4
2	4
3	4
4	4
5	4
6	4
7	4
8	4
9	4
10	4
11	4
12	4
13	4
14	4
15	4
16	4
17	4
18	4
19	4
20	4

Tests of Between-Subjects Effects

Dependent Variable: Rut@10k

Source		Type III Sum of Squares	df	Mean Square	F	Sig.
Intercept	Hypothesis	853.340	1	853.340	821.061	.000
	Error	19.747	19	1.039 ^a		
Lab	Hypothesis	19.747	19	1.039	2.866	.001
	Error	21.761	60	.363 ^b		

a. MS(Lab)

b. MS(Error)

Expected Mean Squares^{a,b}

Source	Variance Component		
	Var(Lab)	Var(Error)	Quadratic Term
Intercept	4.000	1.000	Intercept
Lab	4.000	1.000	
Error	.000	1.000	

a. For each source, the expected mean square equals the sum of the coefficients in the cells times the variance components, plus a quadratic term involving effects in the Quadratic Term cell.

b. Expected Mean Squares are based on the Type III Sums of Squares.

Profile Plots

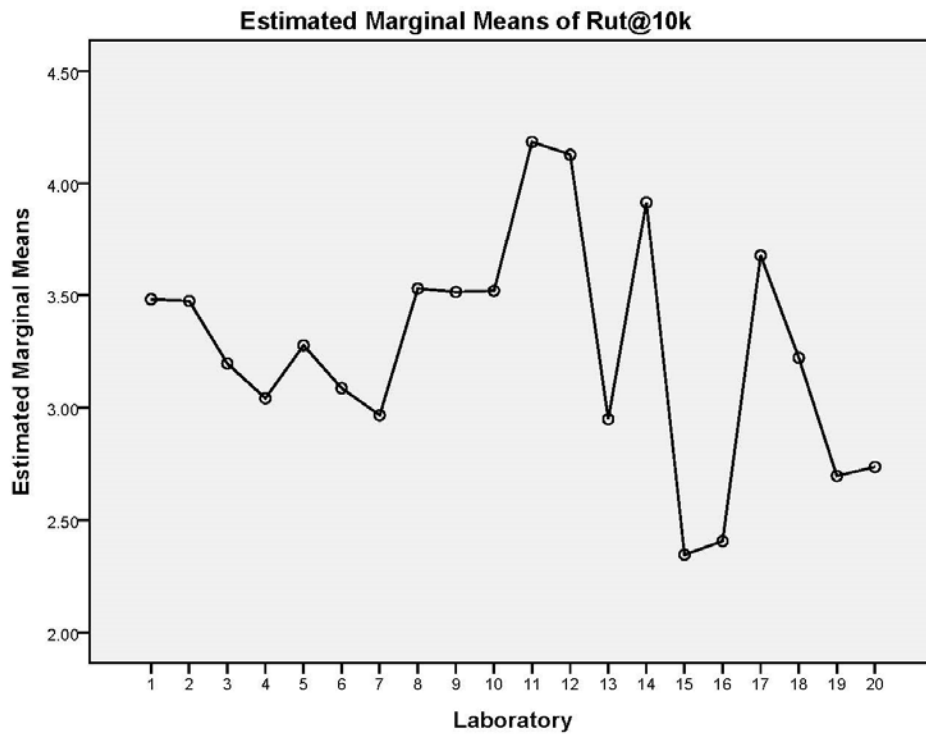

```

UNIANOVA Rut@15k BY Lab
  /RANDOM=Lab
  /METHOD=SSTYPE(3)
  /INTERCEPT=INCLUDE
  /PLOT=PROFILE(Lab)
  /CRITERIA=ALPHA(0.05)
  /DESIGN=Lab.

```

Univariate Analysis of Variance

Between-Subjects Factors

	N
Laboratory 1	4
2	4
3	3
4	4
5	4
6	4
7	4
8	3
9	4
10	4
11	3
12	4
13	4
14	4
15	4
16	4
17	4
18	4
19	4
20	4

Tests of Between-Subjects Effects

Dependent Variable: Rut@15k

Source	Type III Sum of Squares	df	Mean Square	F	Sig.
Intercept	1150.404	1	1150.404	899.170	.000
Hypothesis	24.602	19.229	1.279 ^a		
Error	24.409	19	1.285	1.688	.066
Lab	43.377	57	.761 ^b		
Hypothesis					
Error					

a. .990 MS(Lab) + .010 MS(Error)

b. MS(Error)

Expected Mean Squares^{a,b}

Source	Variance Component		
	Var(Lab)	Var(Error)	Quadratic Term
Intercept	3.810	1.000	Intercept
Lab	3.848	1.000	
Error	.000	1.000	

- a. For each source, the expected mean square equals the sum of the coefficients in the cells times the variance components, plus a quadratic term involving effects in the Quadratic Term cell.
- b. Expected Mean Squares are based on the Type III Sums of Squares.

Profile Plots

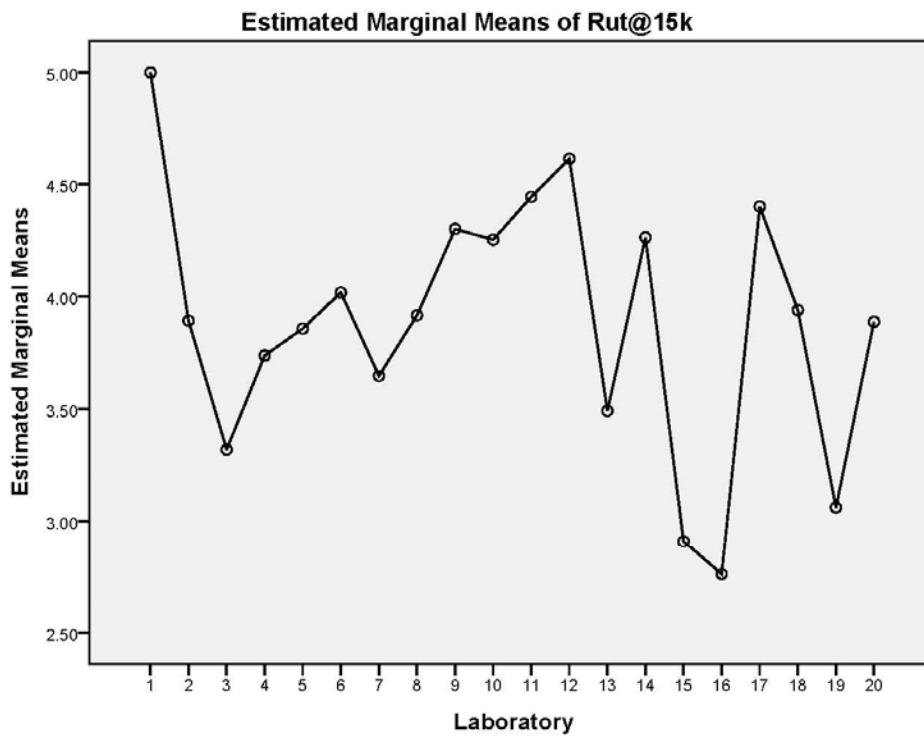

```
UNIANOVA Rut@20k BY Lab
  /RANDOM=Lab
  /METHOD=SSTYPE(3)
  /INTERCEPT=INCLUDE
  /PLOT=PROFILE(Lab)
  /CRITERIA=ALPHA(0.05)
  /DESIGN=Lab.
```

Univariate Analysis of Variance

Between-Subjects Factors

	N
Laboratory 1	3
2	4
3	3
4	4
5	4
6	4
7	4
8	2
9	4
10	4
11	4
12	4
13	4
14	4
15	4
16	4
17	4
18	4
19	4
20	3

Tests of Between-Subjects Effects

Dependent Variable: Rut@20k

Source		Type III Sum of Squares	df	Mean Square	F	Sig.
Intercept	Hypothesis	1671.276	1	1671.276	406.104	.000
	Error	80.565	19.577	4.115 ^a		
Lab	Hypothesis	79.351	19	4.176	1.996	.024
	Error	115.081	55	2.092 ^b		

a. $.971 \text{ MS(Lab)} + .029 \text{ MS(Error)}$

b. MS(Error)

Expected Mean Squares^{a,b}

Source	Variance Component		
	Var(Lab)	Var(Error)	Quadratic Term
Intercept	3.636	1.000	Intercept
Lab	3.746	1.000	
Error	.000	1.000	

a For each source, the expected mean square equals the sum of the coefficients in the cells times the variance components, plus a quadratic term involving effects in the Quadratic Term cell.

b. Expected Mean Squares are based on the Type III Sums of Squares.

Profile Plots

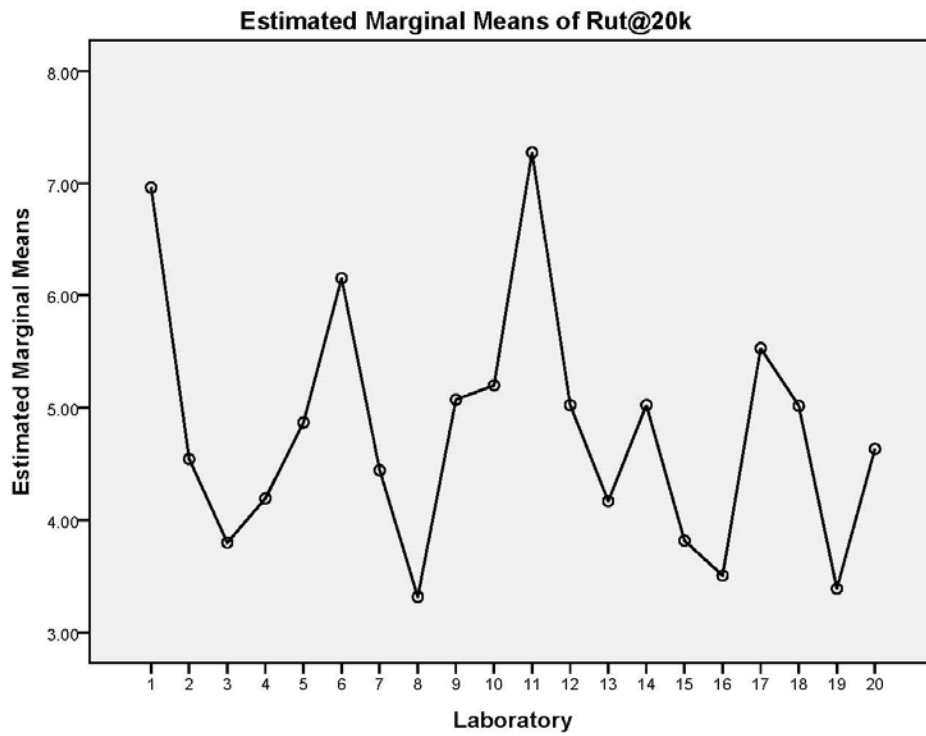

```

UNIANOVA Cy@12.5mm BY Lab
  /RANDOM=Lab
  /METHOD=SSTYPE(3)
  /INTERCEPT=INCLUDE
  /PLOT=PROFILE(Lab)
  /CRITERIA=ALPHA(0.05)
  /DESIGN=Lab.

```

Univariate Analysis of Variance

Between-Subjects Factors

		N
Laboratory	1	2
	3	1
	8	2
	11	2
	20	1

Tests of Between-Subjects Effects

Dependent Variable: Cy@12.5mm

Source		Type III Sum of Squares	df	Mean Square	F	Sig.
Intercept	Hypothesis	3604059991	1	3604059991	554.871	.000
	Error	33578389.43	5.170	6495312.86 ^a		
Lab	Hypothesis	24606053.50	4	6151513.375	.605	.687
	Error	30487522.00	3	10162507.3 ^b		

a. .914 MS(Lab) + .086 MS(Error)

b. MS(Error)

Expected Mean Squares^{a,b}

Source	Variance Component		
	Var(Lab)	Var(Error)	Quadratic Term
Intercept	1.429	1.000	Intercept
Lab	1.563	1.000	
Error	.000	1.000	

a. For each source, the expected mean square equals the sum of the coefficients in the cells times the variance components, plus a quadratic term involving effects in the Quadratic Term cell.

b. Expected Mean Squares are based on the Type III Sums of Squares.

Profile Plots

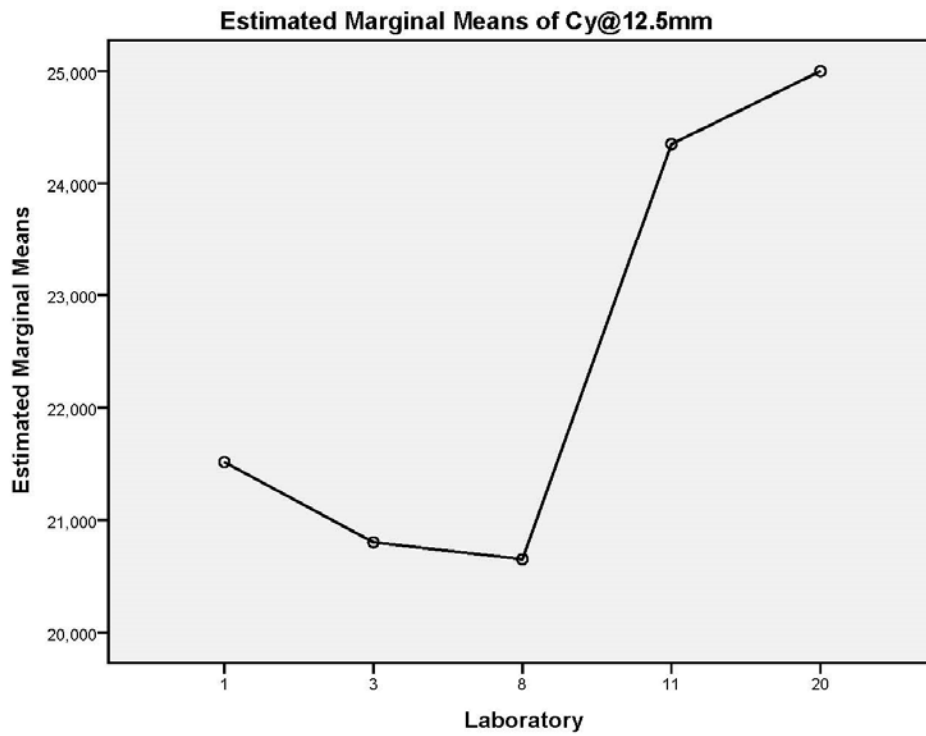

```

UNIANOVA Creep_Slp BY Lab
  /RANDOM=Lab
  /METHOD=SSTYPE(3)
  /INTERCEPT=INCLUDE
  /PLOT=PROFILE(Lab)
  /CRITERIA=ALPHA(0.05)
  /DESIGN=Lab.

```

Univariate Analysis of Variance

Between-Subjects Factors

	N
Laboratory 4	4
5	4
6	4
7	3
8	3
11	3
12	2
13	4
16	3
17	3
18	4
19	4
20	4

Tests of Between-Subjects Effects

Dependent Variable: Creep_Slp

Source	Type III Sum of Squares	df	Mean Square	F	Sig.
Intercept Hypothesis	7.302E-7	1	7.302E-7	67.617	.000
Error	1.319E-7	12.210	1.080E-8 ^a		
Lab Hypothesis	1.336E-7	12	1.113E-8	4.572	.000
Error	7.792E-8	32	2.435E-9 ^b		

a. .962 MS(Lab) + .038 MS(Error)

b. MS(Error)

Expected Mean Squares^{a,b}

Source	Variance Component		
	Var(Lab)	Var(Error)	Quadratic Term
Intercept	3.319	1.000	Intercept
Lab	3.452	1.000	
Error	.000	1.000	

- a. For each source, the expected mean square equals the sum of the coefficients in the cells times the variance components, plus a quadratic term involving effects in the Quadratic Term cell.
- b. Expected Mean Squares are based on the Type III Sums of Squares.

Profile Plots

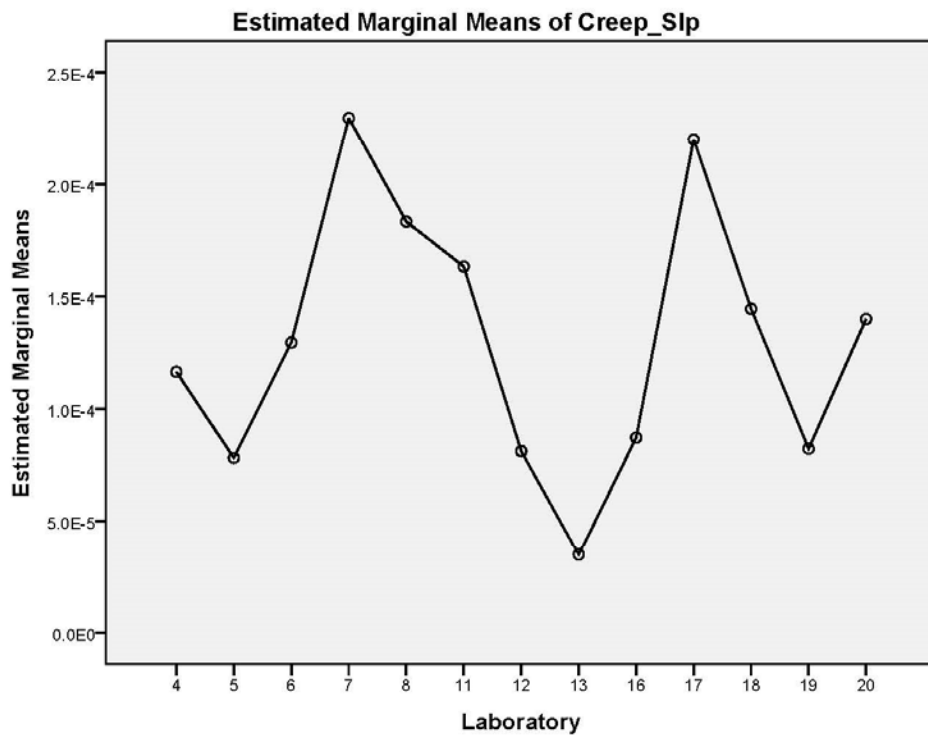

```

UNIANOVA Strip_Slp BY Lab
  /RANDOM=Lab
  /METHOD=SSTYPE(3)
  /INTERCEPT=INCLUDE
  /PLOT=PROFILE(Lab)
  /CRITERIA=ALPHA(0.05)
  /DESIGN=Lab.

```

Univariate Analysis of Variance

Between-Subjects Factors

	N
Laboratory 4	3
5	4
6	4
7	3
8	2
11	4
12	2
13	1
16	3
17	3
18	4
20	3

Tests of Between-Subjects Effects

Dependent Variable: Strip_Slp

Source	Type III Sum of Squares	df	Mean Square	F	Sig.
Intercept	5.712E-6	1	5.712E-6	26.916	.000
Error	2.429E-6	11.447	2.122E-7 ^a		
Lab	2.647E-6	11	2.406E-7	7.756	.000
Error	7.446E-7	24	3.103E-8 ^b		

a. .864 MS(Lab) + .136 MS(Error)

b. MS(Error)

Expected Mean Squares^{a,b}

Source	Variance Component		
	Var(Lab)	Var(Error)	Quadratic Term
Intercept	2.571	1.000	Intercept
Lab	2.975	1.000	
Error	.000	1.000	

- a. For each source, the expected mean square equals the sum of the coefficients in the cells times the variance components, plus a quadratic term involving effects in the Quadratic Term cell.
- b. Expected Mean Squares are based on the Type III Sums of Squares.

Profile Plots

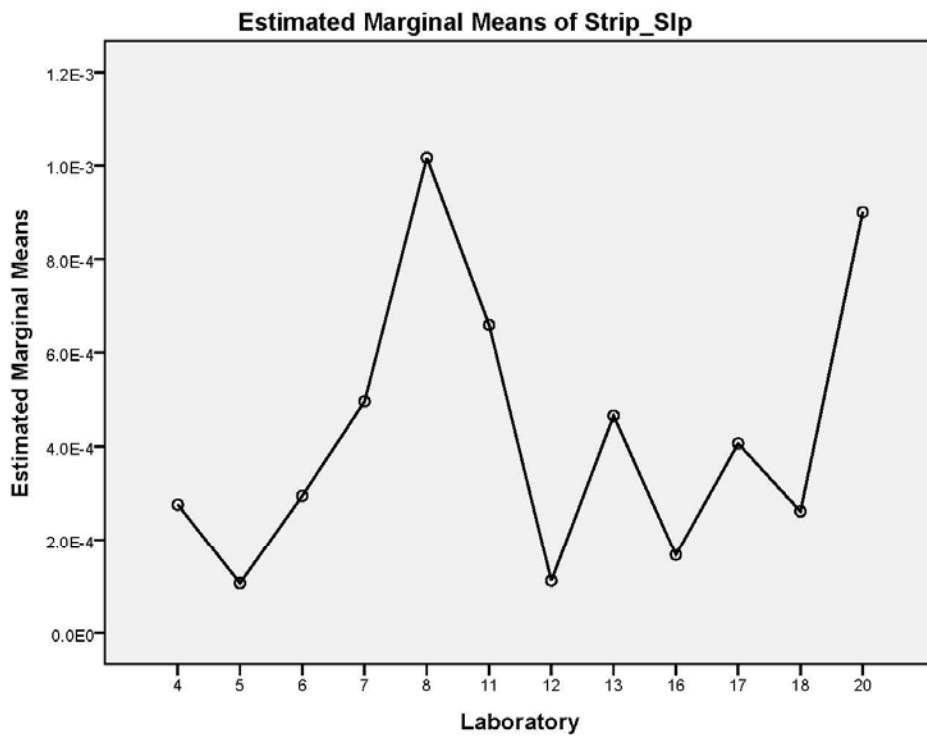

```

UNIANOVA SIP BY Lab
  /RANDOM=Lab
  /METHOD=SSTYPE(3)
  /INTERCEPT=INCLUDE
  /PLOT=PROFILE(Lab)
  /CRITERIA=ALPHA(0.05)
  /DESIGN=Lab.

```

Univariate Analysis of Variance

Between-Subjects Factors

	N
Laboratory 3	1
4	3
5	4
6	4
7	2
8	2
9	2
11	4
12	2
13	1
14	1
16	3
17	3
18	2
20	3

Tests of Between-Subjects Effects

Dependent Variable: SIP

Source	Type III Sum of Squares	df	Mean Square	F	Sig.
Intercept	6438458745	1	6438458745	171.265	.000
Error	584074801.6	15.537	37593478.7 ^a		
Lab	614774539.2	14	43912467.08	4.255	.001
Error	227018831.3	22	10319037.8 ^b		

a. $.812 \text{ MS(Lab)} + .188 \text{ MS(Error)}$

b. MS(Error)

Expected Mean Squares^{a,b}

Source	Variance Component		
	Var(Lab)	Var(Error)	Quadratic Term
Intercept	1.978	1.000	Intercept
Lab	2.436	1.000	
Error	.000	1.000	

- a. For each source, the expected mean square equals the sum of the coefficients in the cells times the variance components, plus a quadratic term involving effects in the Quadratic Term cell.
- b. Expected Mean Squares are based on the Type III Sums of Squares.

Profile Plots

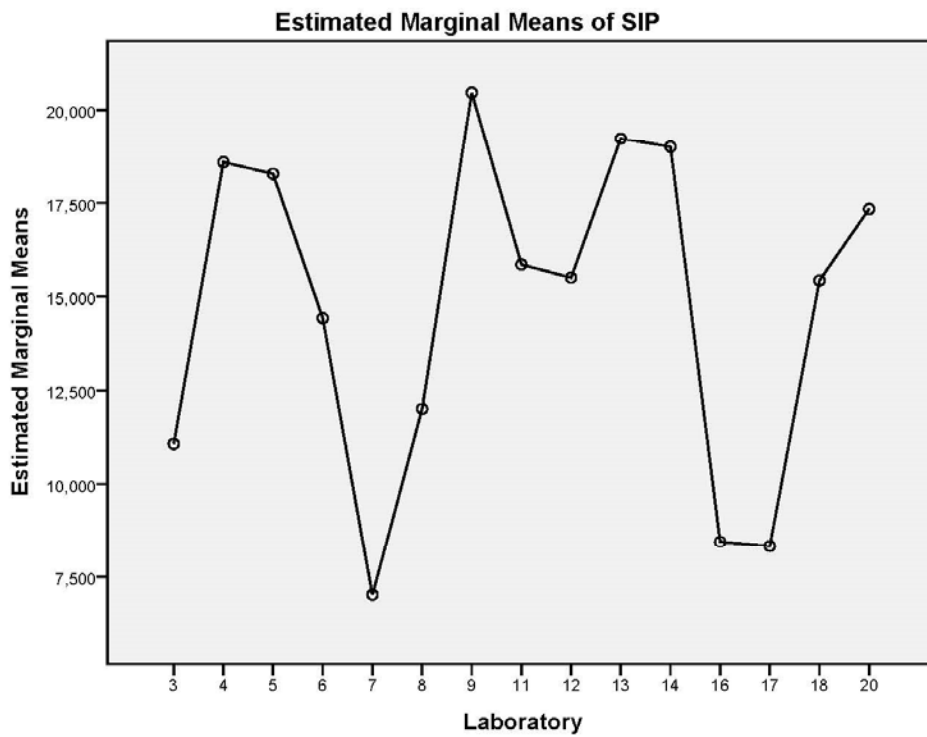

```

USE ALL.
COMPUTE filter_$(Comp = 2).
VARIABLE LABELS filter_$ 'Comp = 2 (FILTER)'.
VALUE LABELS filter_$ 0 'Not Selected' 1 'Selected'.
FORMATS filter_$ (f1.0).
FILTER BY filter_$.
EXECUTE.
UNIANOVA Rut@5k BY Lab
  /RANDOM=Lab
  /METHOD=SSTYPE(3)
  /INTERCEPT=INCLUDE
  /PLOT=PROFILE(Lab)
  /CRITERIA=ALPHA(0.05)
  /DESIGN=Lab.

```

Univariate Analysis of Variance

Between-Subjects Factors

	N
Laboratory 1	4
2	4
3	4
4	4
5	4
6	4
7	4
8	4
9	4
10	4
11	4
12	4
13	4
14	4
15	4
16	4
17	4
18	4
19	4
20	4

Tests of Between-Subjects Effects

Dependent Variable: Rut@5k

Source		Type III Sum of Squares	df	Mean Square	F	Sig.
Intercept	Hypothesis	325.221	1	325.221	781.487	.000
	Error	7.907	19	.416 ^a		
Lab	Hypothesis	7.907	19	.416	4.535	.000
	Error	5.506	60	.092 ^b		

a. MS(Lab)

b. MS(Error)

Expected Mean Squares^{a,b}

Source	Variance Component		
	Var(Lab)	Var(Error)	Quadratic Term
Intercept	4.000	1.000	Intercept
Lab	4.000	1.000	
Error	.000	1.000	

a. For each source, the expected mean square equals the sum of the coefficients in the cells times the variance components, plus a quadratic term involving effects in the Quadratic Term cell.

b. Expected Mean Squares are based on the Type III Sums of Squares.

Profile Plots

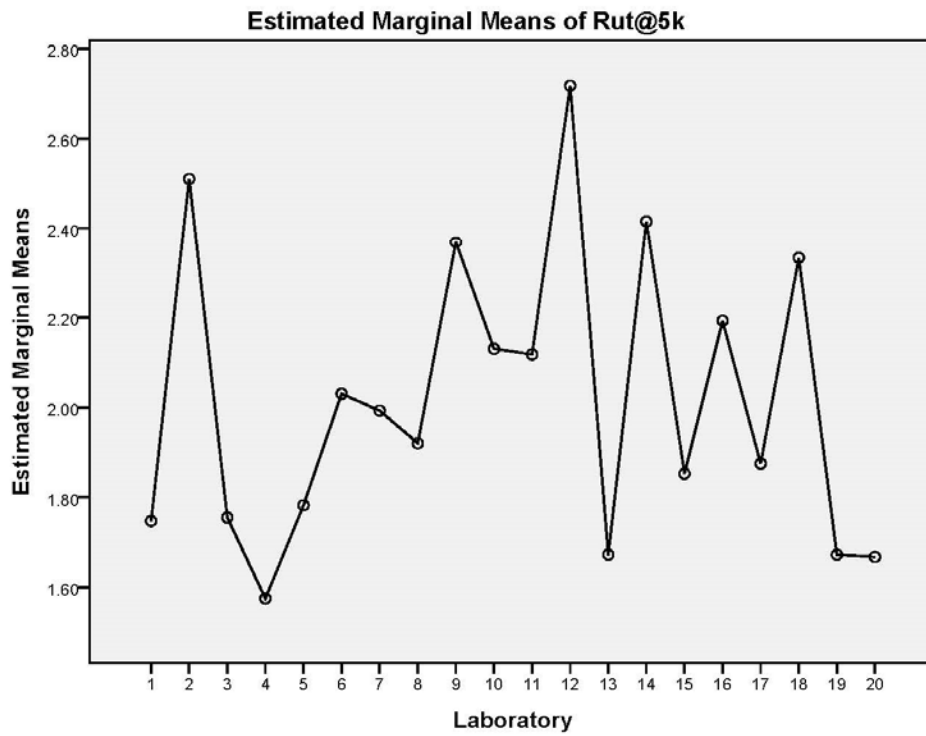

```

UNIANOVA Rut@10k BY Lab
  /RANDOM=Lab
  /METHOD=SSTYPE(3)
  /INTERCEPT=INCLUDE
  /PLOT=PROFILE(Lab)
  /CRITERIA=ALPHA(0.05)
  /DESIGN=Lab.

```

Univariate Analysis of Variance

Between-Subjects Factors

	N
Laboratory 1	4
2	4
3	4
4	4
5	4
6	4
7	4
8	4
9	4
10	4
11	4
12	4
13	4
14	4
15	4
16	4
17	4
18	4
19	4
20	4

Tests of Between-Subjects Effects

Dependent Variable: Rut@10k

Source		Type III Sum of Squares	df	Mean Square	F	Sig.
Intercept	Hypothesis	495.012	1	495.012	638.418	.000
	Error	14.732	19	.775 ^a		
Lab	Hypothesis	14.732	19	.775	4.898	.000
	Error	9.498	60	.158 ^b		

a. MS(Lab)

b. MS(Error)

Expected Mean Squares^{a,b}

Source	Variance Component		
	Var(Lab)	Var(Error)	Quadratic Term
Intercept	4.000	1.000	Intercept
Lab	4.000	1.000	
Error	.000	1.000	

- a. For each source, the expected mean square equals the sum of the coefficients in the cells times the variance components, plus a quadratic term involving effects in the Quadratic Term cell.
- b. Expected Mean Squares are based on the Type III Sums of Squares.

Profile Plots

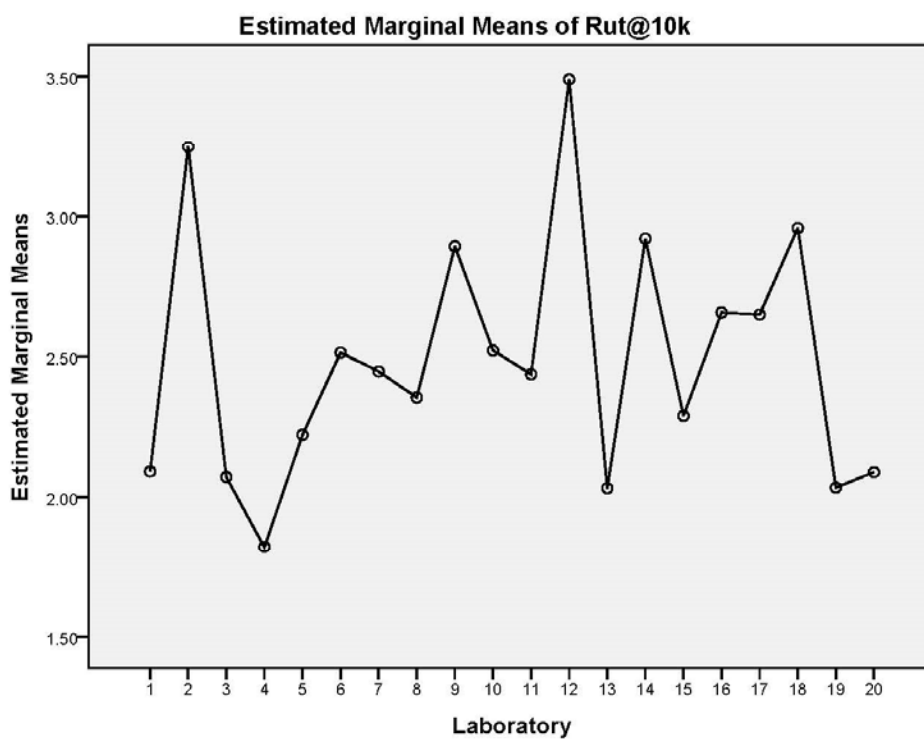

```
UNIANOVA Rut@15k BY Lab
  /RANDOM=Lab
  /METHOD=SSTYPE(3)
  /INTERCEPT=INCLUDE
  /PLOT=PROFILE(Lab)
  /CRITERIA=ALPHA(0.05)
  /DESIGN=Lab.
```

Univariate Analysis of Variance

Between-Subjects Factors

	N
Laboratory 1	4
2	4
3	4
4	4
5	4
6	4
7	4
8	4
9	4
10	4
11	4
12	4
13	4
14	4
15	4
16	4
17	4
18	4
19	4
20	4

Tests of Between-Subjects Effects

Dependent Variable: Rut@15k

Source		Type III Sum of Squares	df	Mean Square	F	Sig.
Intercept	Hypothesis	658.837	1	658.837	517.764	.000
	Error	24.177	19	1.272 ^a		
Lab	Hypothesis	24.177	19	1.272	5.626	.000
	Error	13.570	60	.226 ^b		

a. MS(Lab)

b. MS(Error)

Expected Mean Squares^{a,b}

Source	Variance Component		
	Var(Lab)	Var(Error)	Quadratic Term
Intercept	4.000	1.000	Intercept
Lab	4.000	1.000	
Error	.000	1.000	

a. For each source, the expected mean square equals the sum of the coefficients in the cells times the variance components, plus a quadratic term involving effects in the Quadratic Term cell.

b. Expected Mean Squares are based on the Type III Sums of Squares.

Profile Plots

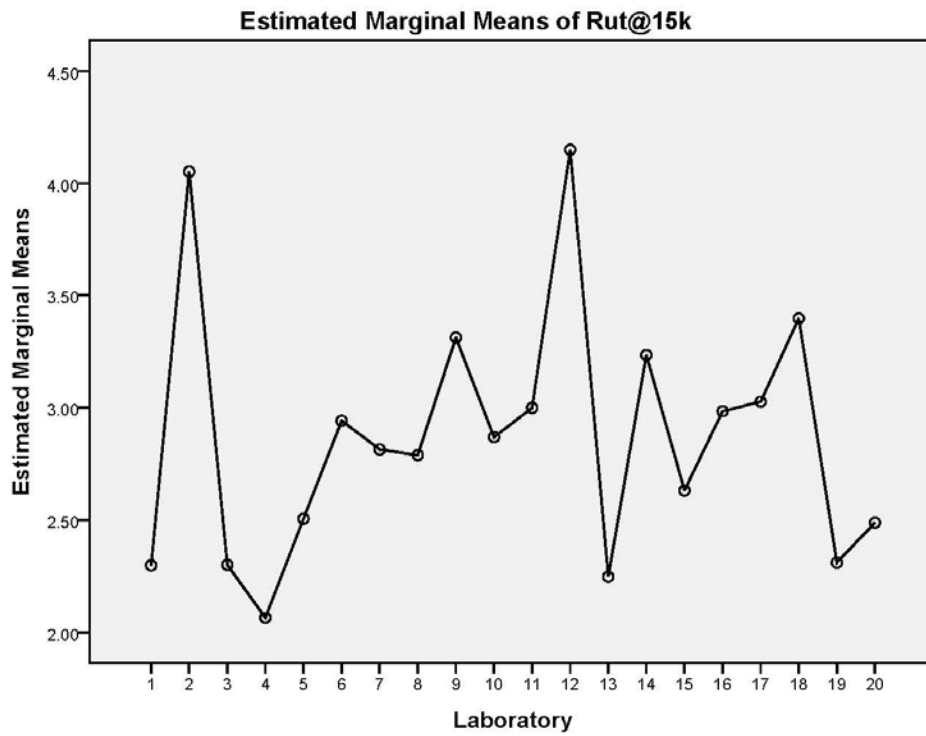

```

UNIANOVA Rut@20k BY Lab
  /RANDOM=Lab
  /METHOD=SSTYPE(3)
  /INTERCEPT=INCLUDE
  /PLOT=PROFILE(Lab)
  /CRITERIA=ALPHA(0.05)
  /DESIGN=Lab.

```

Univariate Analysis of Variance

Between-Subjects Factors

	N
Laboratory 1	4
2	3
3	4
4	4
5	4
6	4
7	4
8	4
9	4
10	4
11	4
12	3
13	4
14	4
15	4
16	4
17	4
18	4
19	4
20	4

Tests of Between-Subjects Effects

Dependent Variable: Rut@20k

Source	Type III Sum of Squares	df	Mean Square	F	Sig.
Intercept Hypothesis	796.764	1	796.764	567.210	.000
Error	26.791	19.072	1.405 ^a		
Lab Hypothesis	26.830	19	1.412	3.784	.000
Error	21.645	58	.373 ^b		

a. .993 MS(Lab) + .007 MS(Error)

b. MS(Error)

Expected Mean Squares^{a,b}

Source	Variance Component		
	Var(Lab)	Var(Error)	Quadratic Term
Intercept	3.871	1.000	Intercept
Lab	3.899	1.000	
Error	.000	1.000	

- a. For each source, the expected mean square equals the sum of the coefficients in the cells times the variance components, plus a quadratic term involving effects in the Quadratic Term cell.
- b. Expected Mean Squares are based on the Type III Sums of Squares.

Profile Plots

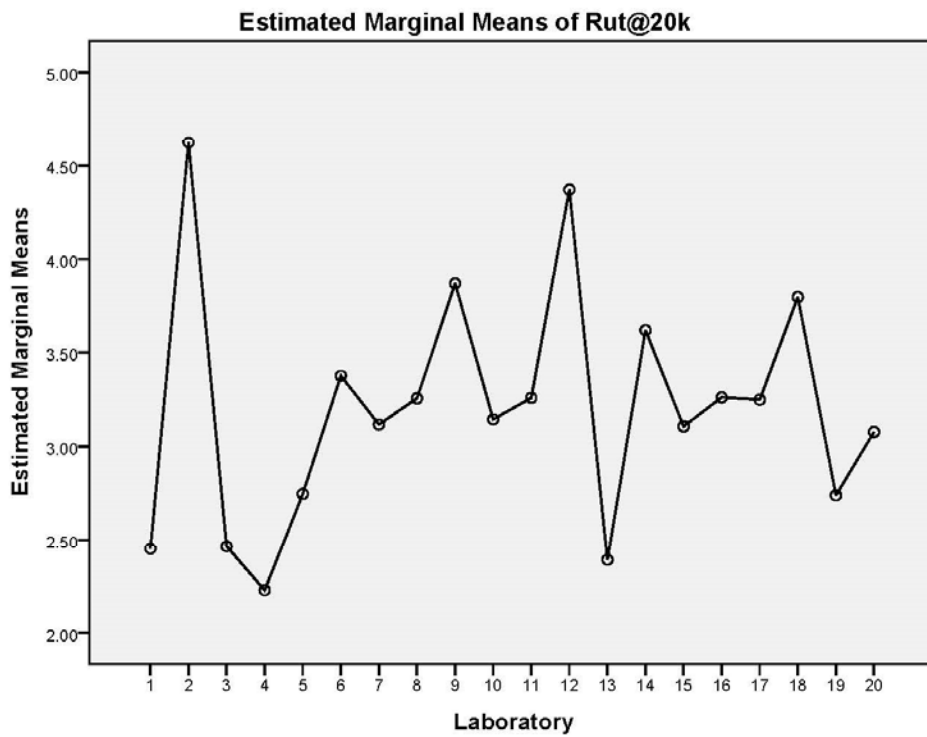

```

UNIANOVA Cy@12.5mm BY Lab
  /RANDOM=Lab
  /METHOD=SSTYPE(3)
  /INTERCEPT=INCLUDE
  /PLOT=PROFILE(Lab)
  /CRITERIA=ALPHA(0.05)
  /DESIGN=Lab.

```

Univariate Analysis of Variance

Warnings

No valid cases were found.
Execution of this command stops.

```

UNIANOVA Creep_Slp BY Lab
  /RANDOM=Lab
  /METHOD=SSTYPE(3)
  /INTERCEPT=INCLUDE
  /PLOT=PROFILE(Lab)
  /CRITERIA=ALPHA(0.05)
  /DESIGN=Lab.

```

Univariate Analysis of Variance

Between-Subjects Factors

	N
Laboratory 4	4
5	4
6	2
8	4
11	3
12	2
13	2
16	1
18	4
19	4
20	4

Tests of Between-Subjects Effects

Dependent Variable: Creep_Slp

Source		Type III Sum of Squares	df	Mean Square	F	Sig.
Intercept	Hypothesis	1.861E-7	1	1.861E-7	42.463	.000
	Error	4.708E-8	10.746	4.382E-9 ^a		
Lab	Hypothesis	5.082E-8	10	5.082E-9	5.489	.000
	Error	2.129E-8	23	9.258E-10 ^b		

a. $.831 \text{ MS(Lab)} + .169 \text{ MS(Error)}$

b. MS(Error)

Expected Mean Squares^{a,b}

Source	Variance Component		
	Var(Lab)	Var(Error)	Quadratic Term
Intercept	2.538	1.000	Intercept
Lab	3.053	1.000	
Error	.000	1.000	

a. For each source, the expected mean square equals the sum of the coefficients in the cells times the variance components, plus a quadratic term involving effects in the Quadratic Term cell.

b. Expected Mean Squares are based on the Type III Sums of Squares.

Profile Plots

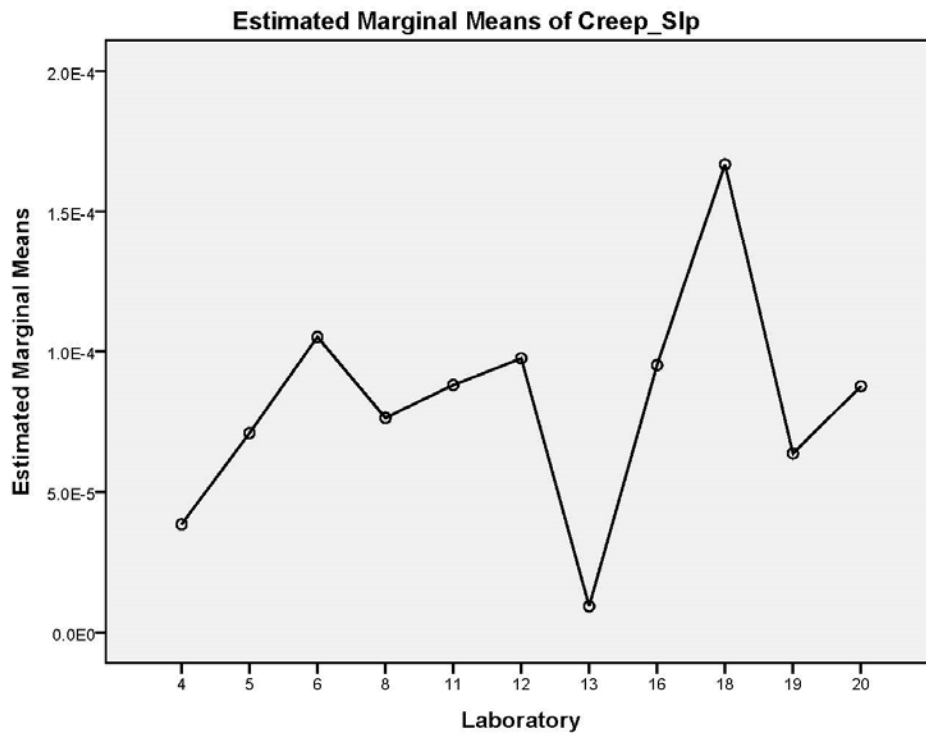

```

UNIANOVA Strip_Slp BY Lab
  /RANDOM=Lab
  /METHOD=SSTYPE(3)
  /INTERCEPT=INCLUDE
  /PLOT=PROFILE(Lab)
  /CRITERIA=ALPHA(0.05)
  /DESIGN=Lab.

```

Univariate Analysis of Variance

Between-Subjects Factors

		N
Laboratory	5	2
	6	2
	8	2
	11	3
	12	2
	16	1
	18	4
	20	3

Tests of Between-Subjects Effects

Dependent Variable: Strip_Slp

Source		Type III Sum of Squares	df	Mean Square	F	Sig.
Intercept	Hypothesis	3.554E-7	1	3.554E-7	17.944	.004
	Error	1.435E-7	7.247	1.980E-8 ^a		
Lab	Hypothesis	1.555E-7	7	2.221E-8	8.023	.001
	Error	3.045E-8	11	2.768E-9 ^b		

a. .876 MS(Lab) + .124 MS(Error)

b. MS(Error)

Expected Mean Squares^{a,b}

Source	Variance Component		
	Var(Lab)	Var(Error)	Quadratic Term
Intercept	2.043	1.000	Intercept
Lab	2.331	1.000	
Error	.000	1.000	

a. For each source, the expected mean square equals the sum of the coefficients in the cells times the variance components, plus a quadratic term involving effects in the Quadratic Term cell.

b. Expected Mean Squares are based on the Type III Sums of Squares.

Profile Plots

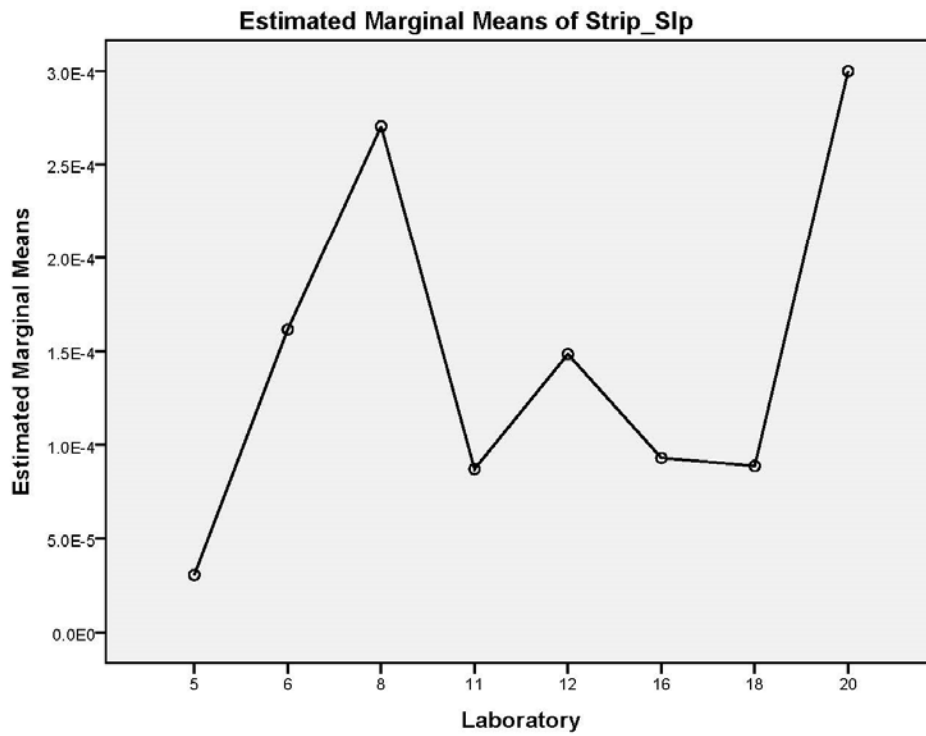

```

UNIANOVA SIP BY Lab
  /RANDOM=Lab
  /METHOD=SSTYPE(3)
  /INTERCEPT=INCLUDE
  /PLOT=PROFILE(Lab)
  /CRITERIA=ALPHA(0.05)
  /DESIGN=Lab.

```

Univariate Analysis of Variance

Between-Subjects Factors

	N
Laboratory 6	2
8	2
11	1
12	1
16	1
19	1
20	3

Tests of Between-Subjects Effects

Dependent Variable: SIP

Source	Type III Sum of Squares	df	Mean Square	F	Sig.
Intercept Hypothesis	2640333333	1	2640333333	85.047	.000
Error	187954003.8	6.054	31045683.2 ^a		
Lab Hypothesis	214068630.5	6	35678105.09	34.201	.002
Error	4172699.667	4	1043174.92 ^b		

a. .866 MS(Lab) + .134 MS(Error)

b. MS(Error)

Expected Mean Squares^{a,b}

Source	Variance Component		
	Var(Lab)	Var(Error)	Quadratic Term
Intercept	1.312	1.000	Intercept
Lab	1.515	1.000	
Error	.000	1.000	

a. For each source, the expected mean square equals the sum of the coefficients in the cells times the variance components, plus a quadratic term involving effects in the Quadratic Term cell.

b. Expected Mean Squares are based on the Type III Sums of Squares.

Profile Plots

