

SITECLIMATE: A Program to Create Hourly Site-Specific Weather Data

E. Arens, Ph.D.
ASHRAE Member

E. S. Lee

F. Bauman, P.E.
ASHRAE Member

L. Flynn

ABSTRACT

Building loads are calculated using hourly weather tapes from the nearest available first-order weather station, or from data summarized from such tapes. These weather stations are often remote from the building site, and in different terrain. The climate experienced on site may be significantly different from that on the weather tape, and as a result the energy use simulated for envelope-dominated buildings can contain substantial error.

A program is described that modifies hourly weather tape data to make them more closely approximate the climate found on building sites. The program is eventually intended to be used by designers, engineers and researchers, who will input both local climate data and a description of the building site's physical surroundings in order to make the data transformations. The method is only partially tested and is still under development.

In this paper, the approach used to modify hourly weather data is discussed, the method of user input is presented, and the individual algorithms are summarized. Future refinements to the program and validation studies are outlined.

KEY WORDS

Building energy, computerized climate data, site-specific weather data, microclimate, weather tapes, solar radiation, temperature, wind.

SITECLIMATE: A Program to Create Hourly Site-Specific Weather Data

E. Arens, Ph.D.
ASHRAE Member

E. S. Lee

F. Bauman, P.E.
ASHRAE Member

L. Flynn

ABSTRACT

Building loads are calculated using hourly weather tapes from the nearest available first-order weather station, or from data summarized from such tapes. These weather stations are often remote from the building site, and in different terrain. The climate experienced on site may be significantly different from that on the weather tape, and as a result the energy use simulated for envelope-dominated buildings can contain substantial error.

A program is described that modifies hourly weather tape data to make them more closely approximate the climate found on building sites. The program is eventually intended to be used by designers, engineers and researchers, who will input both local climate data and a description of the building site's physical surroundings in order to make the data transformations. The method is only partially tested and is still under development.

In this paper, the approach used to modify hourly weather data is discussed, the method of user input is presented, and the individual algorithms are summarized. Future refinements to the program and validation studies are outlined.

INTRODUCTION

In designing a building for a specific site, it is desirable to have climatic information correct for that site. However, it is the present practice in building energy simulation to obtain hourly weather data from the nearest available weather station. There are roughly 450 Weather Bureau and military weather stations collecting hourly or three-hourly data within the United States. These weather stations are often remote from the building site, and their surrounding terrain may be very different from that of the site. The climate recorded at the weather station may therefore differ significantly from that of the site, and as a result the design conclusions reached in a building simulation may contain substantial error.

Edward Arens is an associate professor, Department of Architecture, University of California, Berkeley; Eleanor Lee is a graduate of the Department of Architecture, University of California, Berkeley; Fred Bauman is a laboratory specialist, Department of Architecture, University of California, Berkeley; Lawrence Flynn is a Ph.D. candidate, Department of Mathematics, University of California, Davis.

Proceedings of the ASHRAE/DOE/BTECC Conference,
Thermal Performance of the Exterior Envelopes of Buildings III, December 2-5,
1985.

For example, if we use temperature degree day values published by NOAA (1973) as an indicator of a building's energy use, one may predict an increase of 19 percent in annual heating and a decrease of 34 percent in annual cooling from Washington National Airport to Dulles International Airport, only 25 miles apart in very moderate terrain. Over rougher terrain and greater distances, one may find considerably greater differences. In addition, differences in climate elements other than temperature, such as wind and sunlight, may increase the variation of the predicted result.

Very little attention has been paid to having site-specific data for design purposes. There are exceptions in other design applications: wind engineers involved in structural design, and air pollution meteorologists concerned with plant siting. The former may weigh site factors in creating directional wind speed distributions, sometimes by using wind tunnel simulations of the surrounding roughness. The latter are often involved with industrial projects where the size of the project permits on-site weather monitoring before design is initiated. In general, however, the difficulties of obtaining site-specific data from field monitoring or wind tunnel studies have caused designers to avoid the issue, taking their climate data from the closest large station.

It should be possible to simulate the building site's local climate, given concurrent weather station records and a physical description of the building site. We see two basically different approaches to this problem:

1. To simulate the climate over the building site using a dynamic model of both mesoscale and microscale atmospheric processes, tied to a network of measured stations. Similar climate models are used to predict pollution dispersal over large areas. They require an extensive input of the physical characteristics of the region; input of weather data from a network of stations, including upper level observations; and a lengthy simulation per hour step. The link of the mesoscale to microscale, which is not done in the pollution dispersal models, would be an additional complication. The complexity inherent in such an approach makes it infeasible for normal building design applications.
2. The other alternative is to assume that the hourly observations made at weather stations could be transformed to approximate a nearby site's climate, using generalized relationships linking site physical characteristics to site climate. The transforms would be done on each climate element (such as sun, wind, temperature, and humidity) independently, at a range of scales from the general region of the weather station to the detailed immediate surroundings of the site.

An approach like this would require as input much less information about the site's physical characteristics, and would use readily available NOAA hourly surface observations. The relatively simple transformations of the hour-by-hour data can be run reasonably inexpensively on one or several years of weather tapes. Because it is a very incomplete simulation of the atmospheric processes that determine the site's climate, it cannot be used in regions where mesoscale phenomena such as local winds or wind channeling occur a significant amount of the time. For most locations, such phenomena do not have a major influence on building energy consumption.

GENERAL DESCRIPTION OF THE SITECLIMATE PROGRAM

The program reads the best available hourly weather tapes, computes the averages of the data contained on it, and then makes two types of transformations to each hour's data. First, it can adjust the hourly values using non-hourly climate data more appropriate to the nearby region of the building site than the weather tape itself. The non-hourly climate data is usually in the form of monthly averages as found in published climate summaries. For example, an hourly wind value from the regional weather tape will first be adjusted by the ratio of the weather station's monthly mean to the monthly mean of a possible closer secondary station, in order to bring the wind value closer to that of the site. In this way the user not only makes the data more geographically appropriate, but can also improve the typicality of any single year by giving it monthly averages identical to those of the long-term past. The specific procedures here follow those of a preceding program known as ADJUST. ADJUST has been shown to be effective at representing remote climates for energy calculation purposes (Arens et al., 1980).

Second, the program transforms the resulting hourly values by formulae describing how the site's topography and physical surroundings influence the climate immediately surrounding the proposed building. The formulae operate on each climate element separately, using input variables from a fairly simple description of the building site provided by the user. In the case of the above example, each of the adjusted hourly wind speed values is transformed, first for the upwind regional surface roughness, for any change in height above the ground, for possible hill or ridge amplifications, and finally for various types of wake effects to give a value of the wind approaching the site. Similar approaches are followed for each climatic element.

The resulting hourly tape may then be used for computing the building's climatic effects directly, or could be summarized into various forms of condensed data for simplified calculations on that site. The basic two-step procedure is depicted in Figure 1 (Arens and Flynn, 1982). Below, the method used to input the building site description is presented. A later section describes the specific climatic transformations used in SITECLIMATE.

DESCRIBING THE BUILDING SITE SURROUNDINGS: POLAR PROJECTIONS

Site documentation is expensive, whether by surveys during site visits or by takeoffs from maps and plans. An underlying premise of a program like this is that the description of the site surroundings must provide the input variables for the transformation formulae as efficiently as possible. The variables are drawn from descriptions of: surrounding objects that may obstruct wind and insolation (their size, type, and albedo); the general roughness of the terrain in each upwind direction (open water, flat land, rural terrain with low hills, suburban or rough wooded terrain, or urban center); and the slope of the site, if any.

The cartesian grid (Figures 2, 3 and 4) is the most conventional type of site definition. Three axes must be defined and at least three values entered for each corner or boundary of every site feature. A system like this does not readily allow the user to distinguish the features whose climatic effects are more important from those that are less important. As a result, many points need to be entered, at the expense of time.

An alternative is the polar coordinate system, similar to what one would see through a 180 degree fisheye lens pointed upward. To describe a site through polar projection, the user must choose a single point on the site, and describe the salient features of azimuthal sectors radiating from that point (Figure 5). The boundaries implicit in the sectors, and the masking of more distant site features by closer ones, allow the number of input coordinates to be reduced over that of a cartesian system. If, as is usually the case, the closer obstructions have a more important climatic influence than more distant obstructions screened from view by the closer obstructions, the polar projection's input simplification will not bring about a large penalty in model precision.

In describing the obstructing effect of surrounding objects, SITECLIMATE requires the distance to the obstruction and either the height of the obstruction or the angle to its top. These values may be obtained entirely from a detailed topographic map or site plan, providing all obstructions are shown and the heights of the obstructions are given. Trees are usually impossible to assess from plans alone, and a site visit becomes necessary. If there is a plan of the surroundings that gives the horizontal distance to obstructions, the user can visit the site and obtain all necessary information with this plan, a compass and inclinometer. An upwardly-directed fisheye photograph of known projection can do the same with less time in the field, and there are solar prospecting devices that transfer the overhead hemisphere to polar projections (Figure 6). In the absence of any site plan the user would need to supplement any of these devices with a tapemeasure or pocket rangefinder to obtain the horizontal distances to the obstructions.

There is an option in the input for the user to specify whether the obstruction is both a wind and horizon obstruction (a solar obstruction) or if the obstruction is only a wind obstruction, such as may occur for a building in front of a distant hill. Distant obstructions are described by their altitude alone.

Beyond the obstructions, the roughness of distant terrain can be estimated from maps, aerial photos, and inspection during a site visit. The slope and hill shape can be similarly obtained from topographic maps or site visits.

The site thus described is a single point, and the transformed weather created by SITECLIMATE applies to that point only. The user must exercise judgement as to which point(s) on the site are most appropriate for the building under consideration. SITECLIMATE allows for easy changes in height above or below the chosen point (for multistory buildings, a new zone height may be input and the program will reiterate the calculations producing a new weather tape for the new height), but if examination of another point on the site is required, the description of the obstructions and input process must be repeated based on the new point.

AZIMUTHAL SECTORS USED IN SITECLIMATE

The obstructions, general roughness and slope around the site are described in three sets of azimuthal sectors (shown on Figure 5). The heights of the obstructions and the general roughness factors are averaged over a sector, and

one height (or angle and distance) and one roughness factor is input for a given sector.

1. **Obstructions.** SITECLIMATE allows the user to choose eight (N, NE, E, etc.) or sixteen (N, NNE, NE, etc.) compass sectors around the site point to describe the surrounding obstructions, or to define the sector azimuthal boundaries based on the borders of the obstructions themselves.

The third option is usually preferred, in that it allows a single type of obstruction to be defined within a single sector, and allows any one sector to have a fairly uniform height. Sectors may describe open areas and be very broad. In the case of an open site with a single obstruction, only two sectors are required--one subtending the obstruction itself and one subtending the remainder of the site.

2. **Roughness.** Upwind terrain roughness is handled with a separate set of sectors. Because the roughness of the earth's surface is hard to define, eight equal-sized compass sectors provide sufficient resolution.
3. **Slope.** The exact direction facing downslope (in degrees from true north) may be input and SITECLIMATE uses the slope formulae to transform wind values for the sector defined by the input direction plus or minus 45 degrees.

SITECLIMATE will internally combine the three sets of sectors (obstruction, roughness, and slope) to determine the combined sectors used in calculating adjustments to wind and radiation values. Figure 7 summarizes the input for the example site given in Figures 2-6. A list of the input prompts given by SITECLIMATE is given in the appendix of this paper.

SUMMARY OF CLIMATE TRANSFORMS

Temperature

The user may input average values for the following dry-bulb temperature characteristics: the monthly average, the distribution of daily averages in the month, and the distribution of hourly values in the day. The user chooses the form of 'average temperature' consistent with the input data being used: the average temperature may be either the mean of all hourly values or the mean of daily maximum and minimum, as used in NOAA published records. The program adjusts the tape's hourly values by comparing the averages on the tape with the averages entered by the user, and adjusting by addition or ratios, as appropriate.

Urban heat island effects may be input by the user based on familiarity with local radio weather reports that give daytime and nighttime temperature differences between city and suburbs, between inland and shore, or between towns or locations within a region. Such radio reports are common sources of useful temperature difference information. The Weather Bureau also keeps regional records of this sort in a very limited number of cities. The program uses the input information by adjusting both daily temperature average and daily temperature range.

Temperature is adjusted for elevation change between weather station and site via the NACA Standard Atmosphere (0.0065 deg C/m) (List, 1965). The input tape's elevation is obtained from a code on the tape itself, and the user inputs the elevation of the building site being simulated.

Humidity

Monthly averages of wet-bulb temperature, dewpoint temperature or moisture ratios may be input by the user, and the program will adjust the tape to these values. If this option is not used the humidity values are adjusted subsequent to the dry-bulb temperature adjustments by keeping the dewpoint temperature constant.

Cloud Cover and Solar Radiation

If radiation values are not present on the input tape, SITECLIMATE generates them using either the Kimura-Stephenson algorithm (Kimura and Stephenson, 1969), the Boeing algorithm (Boeing, 1964) or the SOLMET procedure (National Climatic Center, 1979) at the user's choice. Inputs are: the hourly cloud data from the tape, latitude and longitude, time zone information, and atmospheric clearness (determined from whether the site is in a rural/suburban or a large urban area).

The hourly cloud cover values can be adjusted by any monthly averaged cloud data the user may have and wish to input before radiation values are computed. The procedures are the same as those in the ADJUST program (Arens et. al., 1980). The program gives a complete summary of cloud values on the tape for comparative purposes if the user chooses this option.

The hourly cloud cover values may also be adjusted if there is a daily pattern of fog or cloud cover at the site that is not found at the weather station. If the user chooses to specify increased or decreased fog or cloud for a block of time during the day, the program randomly makes the specified change across each level of cloud cover, from 0 to 10 tenths.

If the tape contains radiation values, SITECLIMATE will read the tape values directly. Radiation intensities are adjusted proportionately by any total or direct beam data the user may choose to input. They are also adjusted for transmission loss through the atmosphere if the site and weather station have different clearness: i.e., one is urban and the other rural.

The effects of the site's surroundings on the radiation reaching the site are handled by a description of horizon obstructions. Once the user has entered this information (as described above) SITECLIMATE determines the effects of the obstructions on the direct and diffuse components of radiation at the site reference point.

Hourly beam radiation values are adjusted only when the site reference point is shaded by the horizon obstruction. The amount of adjustment is dependent on the type of obstruction, ranging from solid objects to trees of varying transmissivities. For deciduous trees, transmissivity values are changed between the summer and winter seasons, and follow empirical results from Geiger (1965) and Holzberlein (1979). During the winter months (November through April), the transmissivity of leafless trees is a function of solar altitude (see Table 1).

Diffuse radiation is adjusted based on the fraction of sky left exposed above the horizon line. The distribution of clear and cloudy sky radiation across the sky is assumed to be uniform. The diffuse radiation contribution from the obstructed portion of the sky is computed as the total horizontal insolation times the obstructed reflectance, weighted by the fraction of the total sky covered by the obstruction. The reflectance is either a default (0.2) or a user-entered value.

Wind

Wind speeds are adjusted with a combination of factors that individually account for differences in airflow between the weather station and building site. The wind factors contained in SITECLIMATE address the following issues.

1. Weather station proximity: hourly wind data from the first-order weather station can be initially adjusted using non-hourly (e.g., monthly) wind data from a second-order weather station closer to and more representative of the building site.
2. Terrain roughness: the wind effects of the terrain roughness around the building site (e.g., rural, suburban, or city center) can be taken into account when the terrain is different from that around the weather station.
3. Height above ground: the height above the ground of the site (e.g. a building zone) affects its local wind. When this height is different from that of the weather station, adjustments are made.
4. Hills and escarpments: if the building site is located on the top or windward side of a low hill or escarpment, wind speed adjustments can be made.
5. Wind obstructions: if the building site is located in the wake of upwind obstructions (solid objects such as buildings, trees in leaf, or leafless trees), wind speed adjustments can be made.

The procedure used to calculate the first wind factor listed above (weather station proximity) is identical to that contained in the program ADJUST and has been described elsewhere (Arens, et. al., 1980) Details of the algorithms used to account for roughness, height, slope and obstructions (items #2 - #5 above) are described below.

Terrain Roughness and Height Above The Ground. The roughness of upwind terrain influences the wind velocity on site. Weather stations are typically located at airports in flat open terrain, where wind velocities at any height above ground are higher than they would be at the same height above rougher terrain. To obtain site wind velocities, one must account for the difference in roughness that may exist between the site and the weather station.

In describing the roughness around a site, the user must quantify the roughness extending outward in each possible upwind direction. When SITECLIMATE reads the hourly wind data on the weather station tape, it reads also the direction. This direction is applied to the wind on site; there is no mechanism to provide for flow turning between the weather station and the site. The roughness characteristics in the sector upwind of the site are used to transform the wind on site.

Roughness requires a substantial alongwind distance, or fetch, for its influence to be felt. The higher above ground the measurement point is, the greater this distance. If there is a change in roughness at some point upwind, a new boundary layer is initiated at the changeover point, and propagates upward as the wind moves downwind. There are theoretical treatments of this effect, but in practice they prove very difficult to apply. The roughness boundaries are usually gradual or intermittent, and hard to define. In order to simplify a difficult site description problem, SITECLIMATE adopts a set of assumptions that have been found to give a satisfactory estimate of the effects of roughness and changes in roughness (Bietry et al, 1978).

1. At weather station locations upwind of a change in surface roughness, the wind velocity profile is assumed to be fully developed and well represented by the logarithmic law:

$$U(z) = (u^*/k) \ln(z/z_0) \quad (1)$$

where

U(z) = mean wind speed at height z,
 u* = characteristic friction velocity,
 k = von Karmans's constant (0.4), and
 z₀ = surface roughness length.

2. At distances within 500 m of the roughness change it is assumed that the wind profile is the same as that upwind of the roughness change.
3. At distances beyond 500 m downwind of a roughness change the wind profile is assumed to be a fully developed logarithmic profile characteristic of the downstream roughness. This assumption is acceptable for most buildings. For tall buildings extending high into the boundary layer, distances greater than 500 m from an upwind roughness change are required for the new boundary layer to develop to the necessary height. In these cases the user should input terrain roughnesses extending far from the building, at least ten times the building's height.

Using Equation 1, the modified wind speed downstream of a change in surface roughness can be defined in terms of the nondimensional velocity ratio or 'roughness factor':

$$\begin{aligned} \text{ROGRAT} &= U(z)/U_1(z_1) \\ &= (u^*/u^*_1) [\ln(z/z_0)/\ln(z_1/z_{01})] \end{aligned} \quad (2)$$

where

U(z) = mean wind speed at height z, downwind of roughness change,
 U₁(z₁) = mean wind speed at height z₁, measured at weather station upwind of roughness change,
 u* = friction velocity characteristic of downwind roughness,
 u*_{ref} = friction velocity characteristic of open terrain,
 u*₁ = friction velocity characteristic of upwind roughness,
 z₀ = downwind roughness length, and
 z₀₁ = upwind roughness length.

Using the procedure outlined by Bietry, all roughness factors are defined in terms of a particular reference height and roughness length. The reference conditions are 10 meters height in open terrain ($z_0 = 0.07$ m), to match typical airport weather station conditions. With these values and using the notation:

$$p = u^*/u^*_{ref} \quad (3)$$

Equation 2 can be rewritten as:

$$ROGRAT = 0.2p \ln(z/z_0) \quad (4)$$

When multiplied by the measured wind velocity at the reference weather tape location, the roughness factor ROGRAT predicts the velocity at a height z downwind of a change in roughness from open terrain to a terrain having a characteristic roughness length of z_0 . Note that when z is not equal to 10 meters, Equation 4 also accounts for changes in height between the measurement and site locations. To apply Equation 4, typical values of z_0 and the ratio p are needed. Values for five general terrain categories are listed in Table 2, taken from Bietry.

To demonstrate the range of typical values of the roughness factor, Table 3 lists values of ROGRAT calculated according to Equation 4 for three different heights (5 m, 10 m, and 15 m) and all five terrain categories.

SITECLIMATE allows the user to describe the weather station surroundings if the anemometer is at a different height from the 10 m (30 ft) standard, or if the surrounding terrain has a different roughness from flat terrain. The program uses the above procedure to convert the weather station to standard conditions, from which the site wind conditions are determined.

Hills and Escarpments. As wind flows over a hill, its boundary layer shape is displaced upward. The partial constriction of the flow field results in an acceleration of the wind, especially near the hill surface toward the top. Figure 7 presents a cross-sectional diagram of aerodynamic speed-up over a moderately sloped hill where no flow separation occurs. (On more abrupt slopes, eddies may form and the picture will look somewhat different.) The changes in velocity of any height above a hill can be represented by a model using the parameters defined below. The "slope factor", or "normalized wind speed" is defined as:

$$SLPFAC(x, \Delta z) = \frac{U(x, \Delta z)}{U_0(\Delta z)} \quad (5)$$

where

x is the upwind distance from the top of the slope,
 Δz is the vertical height above the local terrain (equal to $z - z_s(x)$ as on Figure 7),
 $U(x, \Delta z)$ is the mean wind speed at any point, and
 $U_0(\Delta z)$ is the undisturbed upstream wind profile.

Another important quantity is the velocity perturbation:

$$\Delta U = U(x, \Delta z) - U_0(\Delta z) \quad (6)$$

which, in its normalized form, is defined as the "fractional speed-up ratio":

$$\Delta S(x, \Delta z) = \Delta U(x, \Delta z) / U_0(\Delta z) = \text{SLPFAC} - 1 \quad (7)$$

Jackson and Hunt (1975) have provided the most comprehensive analytical theory for predicting airflow over low hills. The solution to their theory leads to the result that the maximum fractional speed-up ratio, ΔS_{max} , will occur near the surface at the hilltop. The value of ΔS_{max} is dependent only on the shape and slope of the hill. Once ΔS_{max} has been calculated the values of ΔS at other sites on the hill can be estimated.

The form of the algorithm used in SITECLIMATE to predict wind speed variations due to low hills ($h/L < 0.5$) is based largely on the simple guidelines described by Taylor and Lee (1984). The algorithm is applicable to moderate to high approach winds ($U_0 > 3$ m/s or 6 mph). It is only suitable for site positions at the hilltop and along the windward slope, in unseparated flow. For site positions on the lee of slopes of hills, flow separation and reversal are such common occurrences that the model cannot be employed there. The algorithm is used in the program only for wind directions within 45 degrees of the downslope direction. For approaching wind flow directions outside of this 90 degree compass sector, the wind is assumed to be moving approximately along the contours of the hill and no acceleration is predicted. The slope algorithm methodology is described below.

1. The user enters the important descriptive parameters including the hill shape which is selected from the list of five hill types in Table 4.
2. The maximum fractional speed-up ratio, ΔS_{max} (at ground level at the top of the hill), is calculated according to the formulas listed in Table 4.
3. The fractional speed-up ratio at the base of the hill is estimated to be -25% of ΔS_{max} and linear interpolation is used to obtain the fractional speed-up ratio at ground level at the building site, $\Delta S_{\text{max, site}}$.
4. An exponential reduction factor, RF, is calculated to account for the reduction with height of ΔS from its maximum value at the surface.

The rate of decay of ΔS is larger for three-dimensional hill shapes than for two-dimensional hills.

5. The slope factor is calculated as follows:

$$\text{SLPFAC} = 1.0 + \text{RF} * \Delta S_{\text{max, site}} \quad (8)$$

Wake Effects Due to Upwind Obstructions. Wind speed is reduced in the wake of upwind obstructions. Wind reduction models are utilized for the three categories of obstructions input for radiation purposes: solid objects such as buildings, evergreen, and deciduous trees. The variables in the wind reduction models are: height of the obstruction, h, height of the prediction point, z, and distance from the obstruction, x (see Figure 9).

The wake effect models used for trees (shelterbelt) and solid objects are discussed briefly below. Because there may be cases where a distant horizon obstruction would block the sun but be too far to have an effect on the wind, while a closer slightly lower obstruction would cause a wind influence, there is an input option for wake-causing obstructions that may be used in these cases.

Wake effects due to a shelterbelt. The wind field near a single shelterbelt is described in Geiger's Climate Near the Ground (1965). From Geiger's summary, one can appreciate the complex nature of the problem. The penetrability and density of the canopy, the shape of the trees, and the arrangement of spaces in the shelterbelt all alter the effectiveness of the shelterbelt. The extent to which a single shelterbelt is able to reduce the wind speed depends basically on the wind direction and the height, breadth, and nature of the shelterbelt.

The SITECLIMATE model for wake effects downwind of shelterbelts utilizes the experimental data from Nageli (1946). The data is presented as the ratio of the wind speed downwind of the obstruction to the wind speed in the open. This ratio is defined in SITECLIMATE as the wake factor:

$$WAK = U(x, z) / U_0(z) \quad (9)$$

where,

x is the downwind distance from the obstruction to the site point, and
z is the vertical distance above ground of the site point, and
U₀(z) is the undisturbed upstream wind profile, and
U(x, z) is the mean wind speed at the site point.

Nageli defines four categories for the density of the shelterbelt: deciduous woods in winter, loose shelterbelt, medium dense shelterbelt, and very dense shelterbelt. SITECLIMATE uses the measurements for the deciduous woods in winter and the very dense shelterbelt, redefining them as leafless trees and trees in leaf respectively. It assumes that the wind is blowing normal to the shelterbelt, thereby overestimating winds that cross the shelterbelt at an oblique angle. The same coefficients are used for individual trees; so edge effects are not reflected by the coefficients. Finally, stability of the atmosphere is not considered as the wind velocity profile is only defined in SITECLIMATE for neutral conditions.

Seasonal wake factors are computed if the obstruction is defined as a deciduous tree. For the summer months (May through October) wake factors for trees in leaf are used; for the winter months (November through April) leafless tree wake factors are used.

Wake effects due to solid obstructions. The extent of the effect of a solid obstruction on the wind speed at the prediction point is also expressed as a ratio of the downwind speed to the wind speed in the open. Here, the complexity lies in the shape and orientation of the obstruction. When the obstruction is obliquely skewed or of varying height and proportions, single parameters are insufficient to define the wind reduction factor. At present, SITECLIMATE utilizes empirical data for the wake factors from Peterka (1975). An obstruction, regardless of its orientation relative to the site prediction point, will reduce the wind by the same amount. Edge effects, stability of the atmosphere and depth of the obstruction are not incorporated.

Figure 10 compares the predicted wake effects of three categories of upwind obstructions using the empirical models in SITECLIMATE. The figure presents non-dimensional velocity profiles for six downwind distances ranging from $x/h = 1$ to 25. The values are representative of measurement points in the vertical plane defined by the wind direction and center of the obstruction.

The major observations from Figure 10 are as follows:

1. In all cases the smallest wake factors (Equation 9) occur at a height equal to the height of the obstruction, h .
2. For prediction points below $z/h = 1$ the wake factor is assumed to remain constant.
3. For prediction points above $z/h = 1$ the wake factor is assumed to increase linearly to unity at a height of $z/h = 2$. Thus, the obstruction is assumed to have no effect on the upwind velocity profile above $z = 2h$. This approximation was deduced from Peterka's experimental data, and corroborated by shelterbelt results in Kittredge (1948). Data on shelterbelts given in Geiger (1965) show wind influences extending above $2h$, so if these are correct SITECLIMATE slightly overestimates wind at heights above the shelterbelt.
4. The above two approximations account for the observed discontinuities at $z/h = 1$.
5. For distances greater than 25 obstruction heights downwind ($x/h \geq 25$), the wind speed is considered to be unaffected.
6. Trees in leaf are observed to have a greater effect on wind speed (smaller wake factors) than both leafless trees and solid barriers.
7. For both types of tree obstructions, the largest wake effect does not occur at a downwind distance of $x/h = 1$, but rather closer to $x/h = 5$. This is indicated by the reversal in the expected order of downwind velocity profiles.

The wake factor used for any hour's wind transformation is obtained by reading the wind direction for that hour, and picking the obstruction description for the upwind compass sector. SITECLIMATE calculates the wind reduction in advance, and prints out a summary of the ratios of site to approach wind for every compass sector, summer and winter, for the user to evaluate.

FUTURE WORK

In the future, we will be testing the accuracy of the program by comparing its predictions against field measurements. This effort can be divided into two major categories.

1. Individual data transforms: We have been testing the accuracy of individual algorithms contained in SITECLIMATE in a program of field measurements. We have concentrated on the wind transforms for slope and wake effects, and the transforms for solar transmission through trees. Because the tree transmission results have proved difficult to generalize, controlled laboratory tests have been planned to study the transmission of the individual radiation components through tree canopies. We have begun tests in a boundary layer wind tunnel to expand our existing data on wake flows around buildings and trees, and to produce a generalized model of these effects.
2. Combined data transforms: Climate data collected simultaneously from official weather stations and selected field stations will be used to test the overall effectiveness of SITECLIMATE's process of transforming the individual climate elements independently. Work has not yet begun in this area.

The field and laboratory testing is an iterative process in which the climate data transforms are improved as necessary in response to the test results and then used for further comparisons. The results of the various field measurement efforts will be reported in separate detailed publications.

CONCLUSIONS

A computer program (SITECLIMATE) has been described which uses a series of largely independent transforms to modify hourly weather tape data, making the data more representative of the microclimate found at a particular building site. The modifications are made sequentially at decreasing scale, from the regional data of the weather station to the immediate surroundings of the site. In many cases, the generation of such site-specific weather data should allow designers, engineers and researchers to significantly improve the accuracy of their building energy performance predictions. Greater confidence in available weather data should not only increase the application and acceptance of climatic design methods, but should also encourage further developments in quantitative design techniques.

In this paper the method of user input has been described and demonstrated to be feasible for many building design applications. The overall program structure has been outlined, including a summary of the individual algorithms presently contained in SITECLIMATE. Future work is described as further development and refinement of the program, and is now under way. The authors welcome suggestions from people working in this area.

REFERENCES

- Arens, E. and Flynn, L. 1982. "SITECLIMATE: a program to create hourly weather tapes for specific building locations." Proceedings, Seventh National Passive Solar Conference, Knoxville, TN, August 30-September 1, 1982.
- Arens, E.; Flynn, L.; Nall, D.; and Ruberg, K. 1980. Geographical extrapolation of typical hourly weather data for energy calculation in buildings. Building Science Series 126, Washington, D.C.: National Bureau of Standards.
- Bietry, J, Sacre, C., and Simiu, E. 1978. "Mean wind profiles and change of terrain roughness," Journal of the Structural Division, ASCE 104, No ST10, pp. 1585-1593.
- Boeing Company. 1964. "Summary of solar radiation observations." Report D2-90577-1. May be found on page III.31 of the DOE-2 engineers manual, LBL-11353, Lawrence Berkeley Laboratory, November 1982.
- Environmental Data Service, National Oceanographic and Atmospheric Administration (NOAA). 1973. "Monthly normals of temperature, precipitation, and heating and cooling degree days 1941-70." Climatology of the U.S. No. 81 Asheville, N.C.: National Climatic Center.
- Geiger, R. 1965. The climate near the ground. Cambridge, Mass.: Harvard University Press.
- Holzberlein, T. 1979. "Don't let the trees make a monkey of you." Proceedings 4th Passive Solar Conference, Kansas City, Missouri. October 3-5, 1979, pp. 416-419.
- Jackson, P.S. and Hunt J.C.R. 1975 "Turbulent wind flow over a low hill." Quarterly Journal of the Royal Meteorological Society, 101, pp. 929-955.
- Kimura, K. and Stephenson, D.G. 1969. "Solar radiation on cloudy days". ASHRAE Transactions.
- Kittredge, J. 1948. Forest influences. New York: Dover Publications, Inc.
- List, R. Smithsonian meteorological tables, Washington D.C.: Smithsonian Press.
- Nageli, W. 1946. "Weitere Untersuchungen uber die Windverhaltnisse im Bereich von Windschutzstreifen." Mitt. schweiz. ZentAnst. forstl. Versuchsw., Vol. 23, pp. 223-276.
- National Climatic Center. 1979. SOLMET volume 2, final report. Asheville, N.C.: National Climatic Center.
- Peterka, J.A. and Cermak, J.E. 1975. "Turbulence in building wakes." Proceedings: 4th International Conference on Wind Effects on Buildings and Structures, London, September 1975. Cambridge: Cambridge University Press, pp. 447 - 463.
- Taylor, P.A. and Lee, R.J. 1984. "Simple guidelines for estimating wind speed variations due to small scale topographical features," Climatological Bulletin of the Canadian Meteorological and Oceanographic Bulletin.

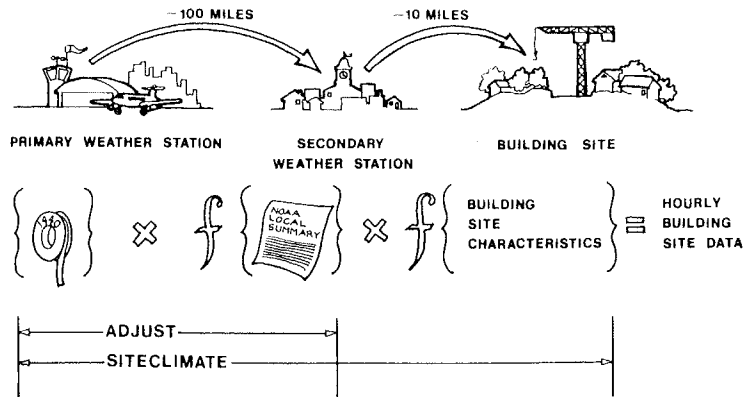

Figure 1. Transformations performed by SITECLIMATE.

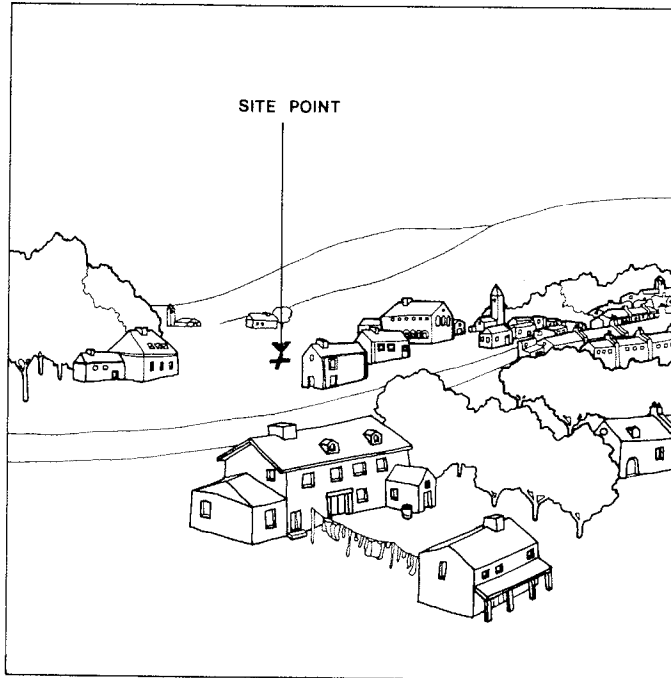

Figure 2. View of site toward the North.

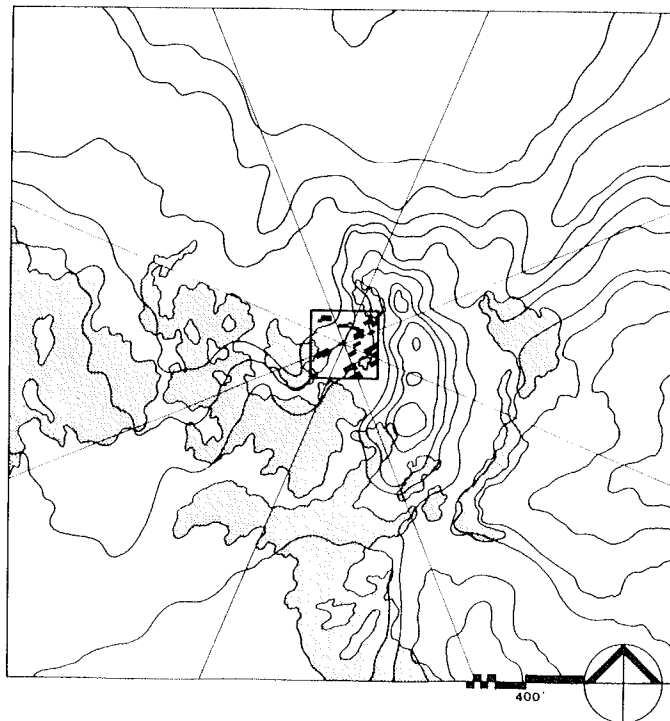

Figure 3. Topographic map of site and surroundings.

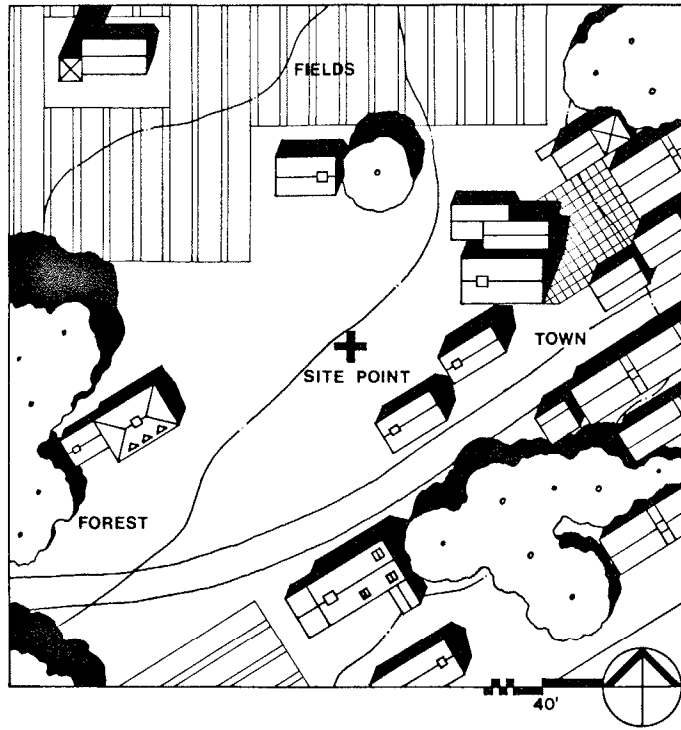

Figure 4. Detailed plan of site.

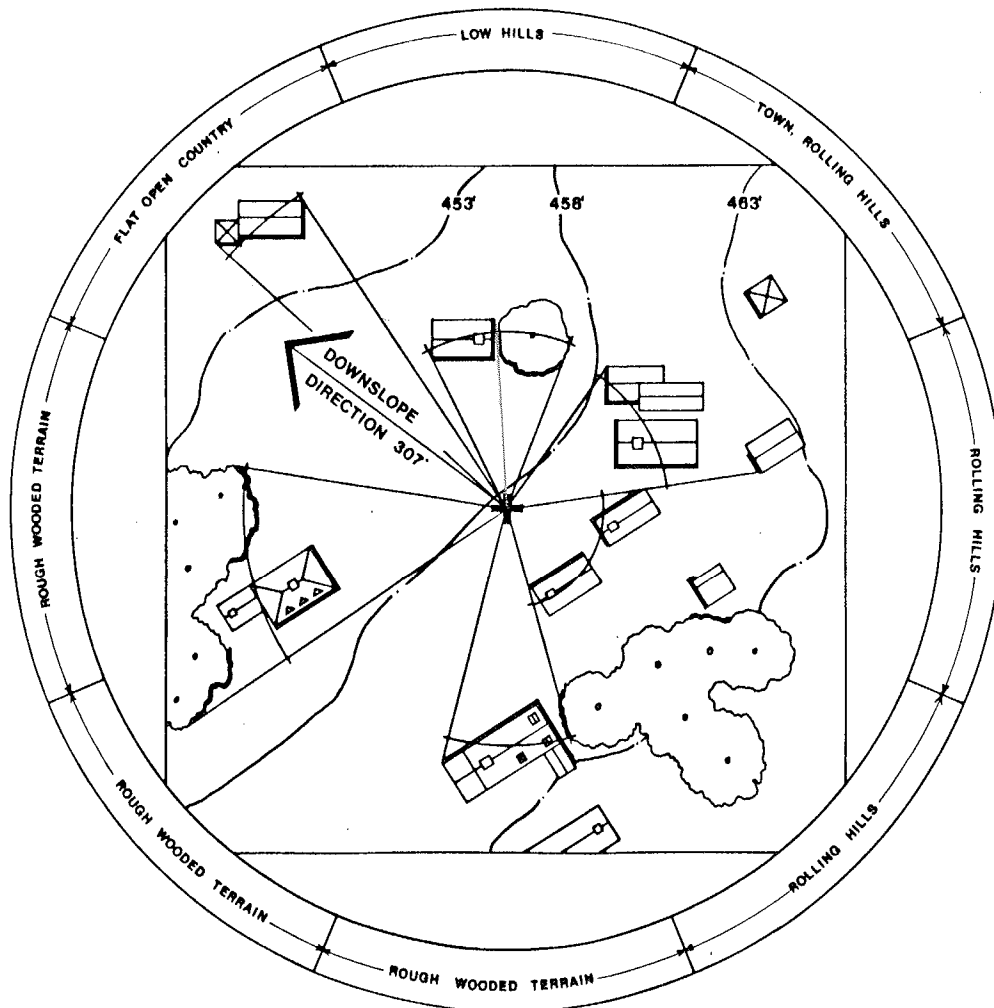

Figure 5. The relationship between obstructions, roughness, and slope sectors.

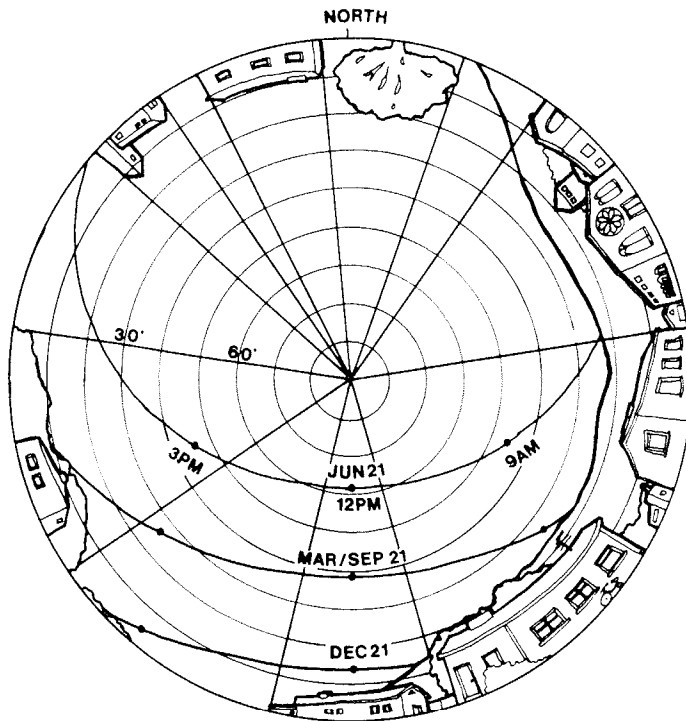

Figure 6. Polar projection of site with sunpaths, showing relationship between near wind obstructions and distant solar obstruction.

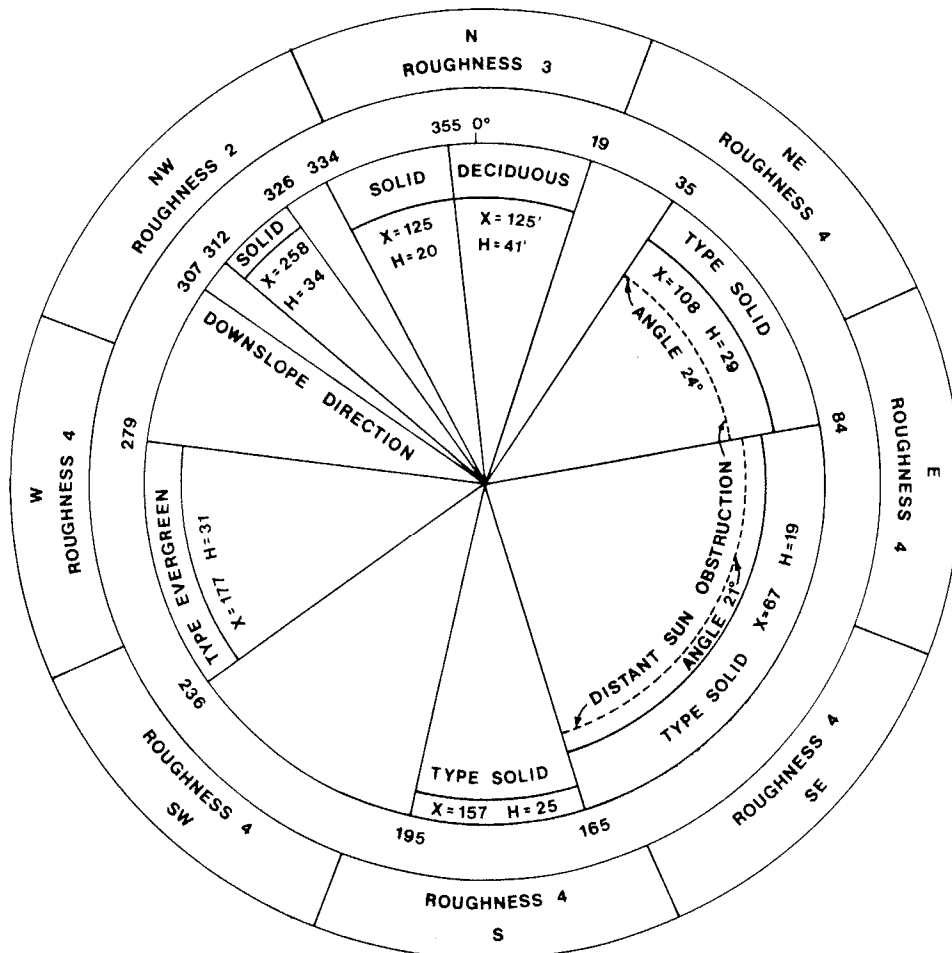

Figure 7. Final site descriptors for roughness, obstruction, and slope sectors including roughness category, downslope direction, height of obstruction, distance to obstruction, and type of obstruction.

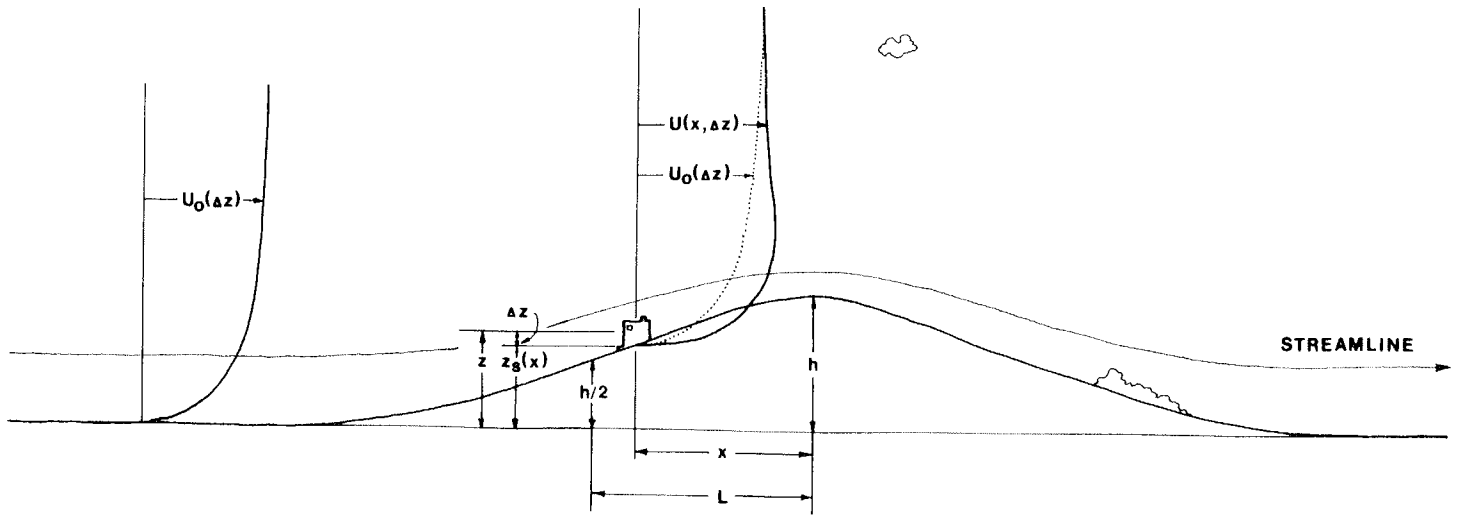

Figure 8. Aerodynamic speed-up over a low hill without separation.

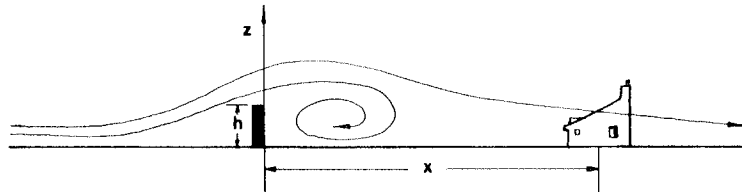

Figure 9. Velocity streamline pattern across a solid barrier.

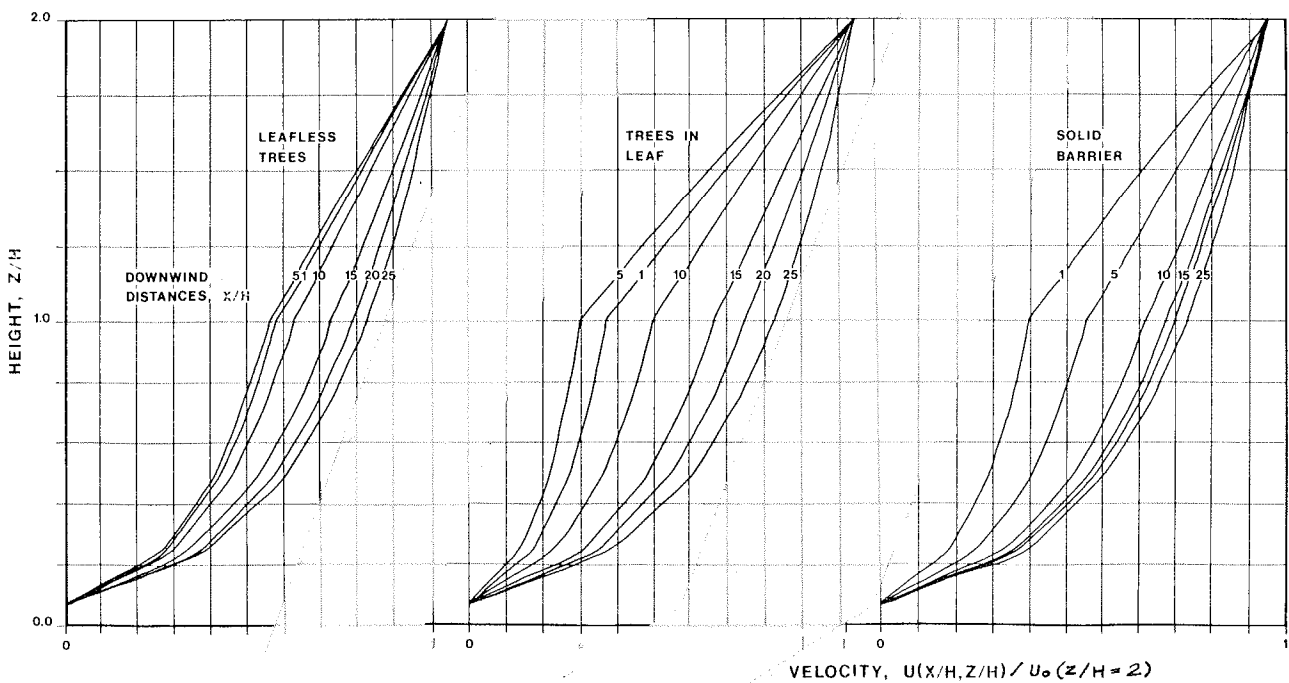

Figure 10. Velocity profiles for three types of obstructions at various downwind distances.