

# UCSF

## UC San Francisco Previously Published Works

### Title

NKG2D triggers cytotoxicity in mouse NK cells lacking DAP12 or Syk family kinases.

### Permalink

<https://escholarship.org/uc/item/3ks6r7kx>

### Journal

Nature immunology, 4(6)

### ISSN

1529-2908

### Authors

Zompi, Simona  
Hamerman, Jessica A  
Ogasawara, Kouetsu  
[et al.](#)

### Publication Date

2003-06-01

Peer reviewed

**The NKG2D receptor triggers cytotoxicity but not cytokine production  
in mouse NK cells lacking DAP12 or Syk and ZAP-70**

Simona Zompi<sup>1</sup>, Jessica A. Hamerman<sup>2</sup>, Kouetsu Ogasawara<sup>2</sup>, Edina Schweighoffer<sup>3</sup>, Victor L. J. Tybulewicz<sup>3</sup>, James P. Di Santo<sup>1</sup>, Lewis L. Lanier<sup>2</sup>, and Francesco Colucci<sup>1</sup>

<sup>1</sup>Department of Immunology, The Pasteur Institut  
25-28, rue Dr. Roux 75015 Paris, France

<sup>2</sup>Department of Microbiology and Immunology, University of California San Francisco  
513 Parnassus Ave. HSE 420, Box 0414, San Francisco, CA 94143-0414

<sup>3</sup>Division of Immune Cell Biology, National Institute for Medical Research  
The Ridgeway, Mill Hill, London NW7 1AA, U.K

Word Counts: Abstract: 112

Text: ca. 4200

Correspondence should be addressed to: FC

[cecco@pasteur.fr](mailto:cecco@pasteur.fr)

☎ + 33.1.45688613

The NKG2D receptor triggers cytotoxicity but not cytokine production in mouse NK cells lacking DAP12 or Syk and ZAP-70. *S Zompi, JA Hamerman, K Ogasawara, E Schweighoffer, VLJ Tybulewicz, JP Di Santo, LL Lanier, and F Colucci*

## **Abstract**

In activated mouse Natural killer (NK) cells, the NKG2D receptor associates with two intracellular adapters, DAP10 and DAP12, which trigger phosphatidylinositol 3-kinase (PI3K) and Syk-family tyrosine kinases, respectively. We found that cytotoxicity, but not cytokine production, could be triggered by NKG2D in activated NK cells lacking DAP12 or Syk-family kinases and inhibition of PI3K blocked NKG2D-mediated cytotoxicity. Thus, the DAP10-PI3K pathway is sufficient to initiate NKG2D-mediated cytotoxicity, while NKG2D-initiated cytokine production is dependent on the DAP12-Syk/ZAP-70 pathway. These results highlight signaling divergence in NKG2D effector functions and suggest that alternative association between receptors and adapters provides a single receptor with a dual on-switch, giving mouse NK cells multiple choices to trigger cytotoxicity.

Activation of NK cells is regulated by opposing forces that trigger inhibitory and stimulatory pathways<sup>1</sup>. The inhibitory pathways are well characterized. Upon binding to major histocompatibility complex (MHC) class I molecules, the phosphorylated immunoreceptor tyrosine-based inhibitory motifs (ITIM) present in the intracytoplasmic domain of inhibitory receptors recruit Src-homology 2 (SH2) domain-bearing tyrosine phosphatase-1 (SHP-1). SHP-1 dephosphorylates critical substrates of protein tyrosine kinases (PTK), blocking NK cells activation<sup>2</sup>. The stimulatory pathways are diverse, and can be initiated by multiple receptors upon binding to antibody-coated cells, adhesion molecules, cytokines, cellular ligands expressed by stressed, infected or transformed cells, and pathogen-associated molecules<sup>3</sup>.

Receptors, such as Fc $\gamma$ RIII and CD94-NKG2C in human and mouse, activating killer cell Ig-like (KIR) receptors and certain natural cytotoxicity receptors (NCR) in humans, and Ly49H and Ly49D in mice, initiate signaling cascades that resemble those triggered by antigen receptors on B and T lymphocytes<sup>4</sup>. They associate with immunoreceptor tyrosine-based activation motif (ITAM)-bearing adaptor molecules, such as CD3, Fc $\gamma$ RIII, or DAP12, which, upon ligand binding, are likely phosphorylated by membrane-associated Src-family PTKs. Once the tyrosines on the ITAMs are phosphorylated, they become docking sites for the intracellular Syk-family PTKs Syk and ZAP-70. The recruited Syk and ZAP-70 are in turn activated and can phosphorylate a number of signaling molecules that initiate NK cellular programs for granule release and-or gene transcription. This eventually results in target cell lysis and production of cytokines and chemokines. While ITAM-mediated signals are absolutely required to generate and activate B and T cells, NK cells are unique in that they are the sole lymphocytes to develop, differentiate, and fully reject class I-deficient tumor cells in the absence of both Syk and ZAP-70<sup>5</sup>.

NKG2D is an activating receptor expressed by human and mouse NK cells, some T cells<sup>6</sup>, and activated mouse macrophages<sup>7</sup>. NKG2D recognizes UL16-binding protein (ULBP)-1, 2, 3 and MHC class I chain-related molecules (MICA and MICB) in man<sup>6,8</sup>, and minor histocompatibility antigen 60 (H-60), retinoid acid early inducible transcript (Rae-1) and murine UL16-binding protein-like transcript 1 (MULT-1) in mice<sup>7,9,10</sup>. Early in ontogeny, most of these ligands are expressed by normal mouse tissues, and, in adult life, by stressed, infected or tumor

cells<sup>11</sup>. Expression of these ligands renders certain tumor cell lines susceptible to NK cell killing, including those that have normal MHC class I expression<sup>12, 13</sup>. Thus, NKG2D can overcome the protection provided by MHC class I expression and is therefore an excellent sentinel system that activates diverse immune cells upon recognition of unhealthy cells<sup>11</sup>. NKG2D homodimers associate with the adaptor molecule DAP10, which does not bear an ITAM but contains a consensus p85 PI3 kinase-binding motif YINM<sup>14</sup>. Because this motif is also found in CD28 and ICOS, NKG2D-DAP10 may mediate co-stimulation rather than full activation. Indeed, NKG2D can substitute for CD28-mediated co-stimulation, but cannot activate T cells in the absence of a TCR-induced signal<sup>15</sup>. In activated mouse NK cells, NKG2D is sufficient to trigger cytokine production<sup>15</sup>, whereas in human NK cells NKG2D requires additional ITAM-mediated signals to initiate cytokine production<sup>16</sup>.

The reason for these differences might be that mouse NK cells express a RNA splice variant of NKG2D (designated NKG2D-short) that associates with DAP12 as well as DAP10, thereby activating Syk/ZAP-70 PTKs-dependent signaling cascades<sup>17, 18</sup>. By contrast, the NKG2D isoform designated NKG2D-long associates only with DAP10 and not DAP12<sup>17, 18</sup>. According to the proposed model, alternative association with two distinct adapters determines the outcome. NKG2D-DAP10 mediates co-stimulation, while NKG2D-DAP12 mediates activation<sup>19</sup>.

Natural cytotoxicity is at least partially dependent upon NKG2D<sup>15</sup>, however, it does not require Syk and ZAP-70<sup>5</sup>. In light of these observations, we have questioned the model according to which activation of NK cells by NKG2D is strictly dependent on the DAP12-Syk/ZAP-70 pathway<sup>17, 18, 19</sup>. To this end, we have studied effector functions of NK cells deficient in either DAP12 or the two Syk family PTKs.

## Results

### Hematopoietic mouse chimeras and NKG2D expression

NK cells can be activated by several receptors that transduce signals using diverse strategies. In mice, NKG2D is a unique receptor in that it can initiate PI3K and Syk/ZAP-70 PTKs pathways, by associating with the adapters DAP10 and DAP12, respectively. Are these pathways equivalent in their capacity to trigger NK cell functions? Do they differentially mediate activation and co-stimulation? Do they differentially regulate NK cell effector functions? To study the role of the DAP12-Syk/ZAP-70 pathway in NKG2D signaling in mouse NK cells, we set out to analyze NKG2D functions in mice deficient in both Syk and ZAP-70 or in DAP12.

To overcome the embryonic lethality of the null mutation in the *Syk* gene<sup>20</sup>, we prepared hematopoietic chimeras by reconstituting RAG-2<sup>-/-</sup>- $\beta$ <sup>-/-</sup> alymphoid mice with fetal liver cells of *Syk*<sup>-/-</sup>-ZAP-70<sup>-/-</sup> embryos. Because these chimeras develop NK, but no B or T cells<sup>5</sup>, we prepared control chimeras in which the alymphoid mice were reconstituted with fetal liver cells of age-matched RAG-1<sup>-/-</sup> embryos. The different groups of mice will be referred to as *Syk*<sup>-/-</sup>-ZAP-70<sup>-/-</sup> chimeras (*Syk*<sup>-/-</sup>-ZAP-70<sup>-/-</sup>  $\square$  RAG-2<sup>-/-</sup>- $\beta$ <sup>-/-</sup>), control chimeras (RAG-1<sup>-/-</sup>  $\square$  RAG-2<sup>-/-</sup>- $\beta$ <sup>-/-</sup>), and alymphoid controls (non-reconstituted RAG-2<sup>-/-</sup>- $\beta$ <sup>-/-</sup> mice). The numbers of splenic NK cells were comparable between the two groups of chimeras, and undetectable in non-reconstituted alymphoid mice (ref. 5, and data not shown). NKG2D expression was detected on virtually all NK cells resident in the spleen, peritoneal cavity, and on IL-2-activated NK cells (Figure 1a-b). The expression levels of NKG2D were slightly higher on NK cells in *Syk*<sup>-/-</sup>-ZAP-70<sup>-/-</sup> (mean fluorescence intensity 79 $\pm$ 6) than control spleens (58 $\pm$ 6, n=4, p=0.01), while no difference was observed in NKG2D expression on IL-2-activated NK cells (55 $\pm$ 13 in *Syk*<sup>-/-</sup>-ZAP-70<sup>-/-</sup> and 56 $\pm$ 17 in controls, n=3).

### The DAP12-Syk/ZAP-70 pathway is dispensable for NKG2D-mediated cytotoxicity in activated NK cells

IL-2 induces the expression of the DAP12-associated splice variant of NKG2D<sup>17, 18</sup>, which in principle recruits and activates Syk PTKs. Should DAP12 be essential for NKG2D

function in activated NK cells, DAP12<sup>-/-</sup> and Syk<sup>-/-</sup>-ZAP-70<sup>-/-</sup> NK cells would equally fail to be activated by NKG2D ligands. We directly tested this by measuring the ability of mutant NK cells to kill Rae-1 $\square$ transfected RMA and Ba/F3 tumor cells (thereafter referred to as RMA-Rae-1 $\square$  and Ba/F3-Rae-1 $\square$  cells), *in vitro*. RMA and Ba/F3 cells do not express ligands for NKG2D<sup>7</sup>, however the ectopic expression of Rae-1 $\square$ overcomes the protection provided by class I and makes cells susceptible to NK cell lysis *in vitro* and *in vivo*<sup>12, 13</sup>. IL-2-activated DAP12<sup>-/-</sup> and Syk<sup>-/-</sup>-ZAP-70<sup>-/-</sup> NK cells could readily lyse both types of Rae-1 $\square$ transfected cells, overcoming the inhibition imposed by the MHC class I expressed by the parental RMA cells (Figure 2a-b) In accordance with published data<sup>5</sup>, IL-2-activated Syk<sup>-/-</sup>-ZAP-70<sup>-/-</sup> NK cells also efficiently killed MHC class I-deficient RMA-S tumor cells and NK-sensitive YAC-1 tumor cells (Figure 2a). Noteworthy, natural killing of YAC-1 targets has been shown to be largely NKG2D-dependent<sup>15</sup>.

One could argue that IL-2 activation non-specifically augments NK cell activity, overcoming possible signaling defects in mutant NK cells. Ly49D and Ly49H are two receptors that activate cytotoxicity through the DAP12-Syk/ZAP-70 pathway. Ly49D enhances killing of CHO tumor cells. In a control experiment, IL-2 did not rescue the defective killing of CHO targets by Ly49D+ purified Syk<sup>-/-</sup>-ZAP-70<sup>-/-</sup> NK cells (57% specific lysis for control and 17% specific lysis for Syk<sup>-/-</sup>-ZAP-70<sup>-/-</sup> NK cells at a 9 to 1 ratio, data not shown). Similarly, IL-2 did not rescue the defective Ly49H-mediated killing of cytomegalovirus m157-bearing target cells by DAP12<sup>-/-</sup> NK cells<sup>21</sup>.

Polyinosinic-polycytidylic acid (Poly I:C) simulates double-strand RNA, which is a signature of viral infection, and induces the production of interferon (IFN)- $\alpha$  and - $\beta$ , which are potent activators of NK cell cytotoxicity, proliferation and migration<sup>22</sup>. Poly I:C also induces the expression of NKG2D-short<sup>17, 18</sup>. Consistent with the data obtained with IL-2-activated NK cells, splenic NK cells from Poly I:C treated Syk<sup>-/-</sup>-ZAP-70<sup>-/-</sup> chimeras could kill RMA-Rae-1 $\square$ cells *in vitro* (Figure 2c). Moreover, the NKG2D-induced killing was specific, because the anti-NKG2D mAb inhibited most killing in both control and Syk<sup>-/-</sup>-ZAP-70<sup>-/-</sup> NK cells (Figure 2d). We conclude that the DAP10-PI3K pathway is sufficient, while the DAP12-Syk/ZAP-70 pathway is dispensable, for NKG2D-mediated cytotoxicity in activated mouse NK cells, at least against the tumors evaluated in our studies.

**Inhibition of PI3K blocks NKG2D-mediated cytotoxicity**

IL-2-activated Syk<sup>-/-</sup>-ZAP-70<sup>-/-</sup> NK cells might use the DAP10-PI3K pathway for NKG2D activation. To test this possibility we measured the capacity of Syk<sup>-/-</sup>-ZAP-70<sup>-/-</sup> NK cells to kill RMA-Rae-1 $\square$ cells *in vitro*, in the presence of increasing doses of the PI3K specific inhibitor LY294002. The lysis of RMA-Rae-1 $\square$ cells in the presence of the DMSO vehicle was considered basal level. The PI3K inhibitor blocked the lysis of RMA-Rae-1 $\square$  cells in a dose-dependent manner, reaching 50-60% inhibition in both Syk<sup>-/-</sup>-ZAP-70<sup>-/-</sup> and control NK cells (Figure 3). Based on these results, we conclude that the PI3K is a key player in the activation of NKG2D function, regardless of the availability of the NKG2D-DAP12-Syk/ZAP-70 pathway.

**NKG2D enhances cytotoxicity in the absence of the DAP12-Syk/ZAP-70 pathway**

In order to directly test the capacity of NKG2D to enhance cytotoxicity in the absence of DAP12 and Syk/ZAP-70, we measured redirected lysis of FcR+ target cells by IL-2-activated NK cells coated with anti-NKG2D mAb. The presence of anti-NKG2D mAb enhanced the cytotoxic activity of both DAP12<sup>-/-</sup> and Syk<sup>-/-</sup>-ZAP-70<sup>-/-</sup> NK cells above background levels of lysis (Figure 4a-b), although the NKG2D-induced enhanced lysis was consistently superior in wild-type NK cells. In contrast, NK1.1-induced enhanced lysis was similar in WT and DAP12<sup>-/-</sup> NK cells (data not shown). Collectively, these results are consistent with the notion that NKG2D can signal in the absence of the DAP12-Syk/ZAP-70 pathway, and that DAP10-stimulated PI3K may be sufficient to trigger NKG2D-mediated cytotoxicity in activated NK cells.

**NKG2D can mediate tumor rejection *in vivo* without Syk/ZAP-70 PTKs**

When injected into mice, class I-negative RMA-S cells and class I-positive RMA-Rae-1 $\square$ cells are eliminated by NK cells, whereas class I positive RMA cells are not<sup>12, 13, 23</sup>. We devised a model system to evaluate the capacity of NK cells to discriminate between multiple different target cells *in vivo*. RMA-S cells and RMA-Rae-1 $\square$ cells were labeled with the vital dye CFSE. Equivalent numbers of RMA-S and RMA-Rae-1 $\square$ cells (2x10<sup>5</sup>) were injected in the peritoneal cavity of different groups of mice, along with the same numbers of mock-transfected



RMA cells. An aliquot of the cell mixture was kept in culture. Forty-eight hours later, the cultured tumor cells were labeled with anti-MHC class I monoclonal Ab and the numbers and relative proportions of the different cell types were calculated. The three tumor cell lines could be readily discriminated by virtue of MHC class I expression and CFSE fluorescence (Figure 5a). RMA-S cells were reproducibly less represented, due to a 2-3-fold slower division rate than RMA and RMA-Rae-1 $\square$  cells (data not shown).

Mice that had received the injection of tumor cells were sacrificed 48-hr later. Consistent with the *in vitro* data, RMA-S cells were somewhat underrepresented in the peritoneal exudate cells (PEC) of alymphoid mice (Figure 5a). Nevertheless, the proportions of RMA, RMA-S and RMA-Rae-1 $\square$  cells in the PEC of alymphoid mice were comparable to those of the cells kept in culture (Figure 5b). This suggests that the cells of the peritoneal cavity of alymphoid mice were not endowed with NK-like activity, regardless of the expression of MHC class I molecules or NKG2D ligands on the tumor cells.

Steady-state numbers of NK cells in the peritoneal cavity were similar in both control chimeras and Syk/ZAP-70- deficient chimeras. Thus, control (n=7) and Syk $^{-/-}$ -ZAP-70 $^{-/-}$  chimeras (n=6) had respectively  $26\pm 6 \times 10^3$  and  $22\pm 9 \times 10^3$  NK cells. The number of NK cells increased following the injection of tumor cells, possibly due to recruitment<sup>24</sup>, reaching  $88\pm 39 \times 10^3$  in control chimeras (n=4) and  $101\pm 10 \times 10^3$  in Syk $^{-/-}$ -ZAP-70 $^{-/-}$  chimeras (n=4). NK cells were undetectable in alymphoid mice, before and after injection of tumor cells (data not shown). The expression of NKG2D on mutant NK cells was comparable to control NK cells in the peritoneal cavity (Figure 1a).

We recovered  $5.9\pm 4.2 \times 10^3$  RMA-Rae-1 $\square$  cells in control chimeras,  $45\pm 17 \times 10^3$  in Syk $^{-/-}$ -ZAP-70 $^{-/-}$  chimeras, and  $285\pm 116 \times 10^3$  in alymphoid mice (Figure 5a-b). That is, Syk $^{-/-}$ -ZAP-70 $^{-/-}$  chimeras had 8.8 fold more RMA-Rae-1 $\square$  tumor cells than control chimeras (p=0.05), but, significantly, 6.3 fold less tumor cells than alymphoid mice (p=0.04). This suggested that NK cell activity, albeit lower than observed in wild-type mice, was triggered by NKG2D in the absence of Syk/ZAP-70 PTKs (Figure 5b). In line with *in vitro* data (Figure 2c), treatment of Syk $^{-/-}$ -ZAP-70 $^{-/-}$  chimeras with Poly I:C prior to the tumor challenge resulted in enhanced elimination of RMA-Rae-1 $\square$  cells (data not shown).

Despite a partial defect in eliminating RMA-Rae-1 $\square$  cells *in vivo*, Syk $^{-/-}$ -ZAP-70 $^{-/-}$

chimeras were comparable to control wild-type chimeras in eliminating RMA-S cells. Only background numbers of RMA-S cells could be recovered in both groups of chimeras ( $1 \pm 0.8 \times 10^3$  in Syk<sup>-/-</sup>-ZAP-70<sup>-/-</sup> and  $0.1 \pm 0.1 \times 10^3$  in control chimeras,  $p=0.3$ ), while at least 100 fold more RMA-S cells were present in alymphoid mice ( $93 \pm 43 \times 10^3$ ,  $p=0.03$  versus both Syk<sup>-/-</sup>-ZAP-70<sup>-/-</sup> and control chimeras). Thus, the Syk-ZAP-70- and NKG2D-independent pathway of natural cytotoxicity was effective in eliminating RMA-S cells *in vivo*, as shown previously<sup>5</sup>. In contrast, the Syk-ZAP-70 pathway was necessary for the full activity of NK cells in order to eliminate RMA-Rae-1<sup>+</sup> cells *in vivo*.

The number of RMA cells recovered in NK competent mice ( $102 \pm 20 \times 10^3$  in Syk<sup>-/-</sup>-ZAP-70<sup>-/-</sup> and  $65 \pm 19 \times 10^3$  in control chimeras,  $p=0.2$ ) was reproducibly lower than recovered in alymphoid mice ( $370 \pm 82 \times 10^3$ ). Thus, a low level of NK cell activity against the parent RMA cells could account for this significant decrease ( $p=0.005$  for Syk<sup>-/-</sup>-ZAP-70<sup>-/-</sup> and  $p=0.002$  for control chimeras). Indeed, a certain low activity of NK cells *in vivo* against class I-positive tumor cells is expected to occur.

These results show that Syk<sup>-/-</sup>-ZAP-70<sup>-/-</sup> NK cells could efficiently eliminate RMA-S cells, while the elimination of class I positive RMA-Rae-1<sup>+</sup> cells was partially impaired. Nevertheless, Syk<sup>-/-</sup>-ZAP-70<sup>-/-</sup> NK cells showed a consistent and significant activity against NKG2D ligand-expressing tumor cells.

#### **Defective NKG2D-triggered cytotoxicity in resting Syk<sup>-/-</sup>-ZAP-70<sup>-/-</sup> NK cells**

Freshly isolated, resting Syk<sup>-/-</sup>-ZAP-70<sup>-/-</sup> NK cells could efficiently kill YAC-1 cells (ref 5 and Figure 6), which express high levels of NKG2D ligands<sup>7, 9</sup>. This activity was inhibited by anti-NKG2D mAb, suggesting that NKG2D-mediated killing of this target is DAP12-Syk/ZAP-70-independent (Figure 6). However, unlike the situation with activated NK cells, and mirroring the *in vivo* situation, Syk<sup>-/-</sup>-ZAP-70<sup>-/-</sup> NK cells were less efficient than wild-type NK cells in killing Rae-1<sup>+</sup>transfected RMA ( $p<0.0001$ ) and Ba/F3 cells ( $p<0.0001$ ) (Figure 6). A time course study of NKG2D-mediated cytotoxicity *in vitro* showed that these differences between mutant and wild-type NK cells were eliminated by day 6-8 of culture in IL-2 (Figure 7).

**The DAP12-Syk/ZAP-70 pathway is required for NKG2D-initiated cytokine production**

In addition to cytotoxicity, one important NK cell effector function is cytokine production. Anti-NKG2D mAb stimulates IFN- $\gamma$  production in mouse, but not in human NK cells (ref. 16 and companion manuscript, ref. 25). How could we explain this species difference? One possible explanation is that NKG2D is an activating receptor in mouse NK cells, while it only functions as a co-receptor in human NK cells. Another possible explanation is that the NKG2D-short isoform that is able to pair with DAP12 exists in activated mouse NK cells, but not in human NK cells.

Both DAP12<sup>-/-</sup> and Syk<sup>-/-</sup>-ZAP-70<sup>-/-</sup> IL-2-activated NK cells failed to produce IFN- $\gamma$  when stimulated with plate-bound anti-NKG2D mAb, yet produced IFN- $\gamma$  in response to IL-12 or control mAb (anti-NK1.1 or anti-CD11b) (Figure 8a-b). These results show that DAP12 is upstream of Syk and ZAP-70 and that NKG2D-initiated IFN- $\gamma$  production is strictly dependent on the DAP12-Syk/ZAP-70 pathway.

## Discussion

Activation of NK cells is the result of the integration of complex signals. The negative regulation generally dominates. Once the sum of positive inputs reaches a given threshold, the negative input is overcome and cellular activation is triggered. This model explains many experimental situations of NK cell biology. While the molecular mechanisms of negative regulation have been largely identified<sup>2</sup>, we have only recently started to understand the receptors and the signaling molecules that drive NK cell activation<sup>3, 4</sup>. Some activating NK cell receptors, like the antigen receptors of B and T lymphocytes and the more broadly expressed FcR, use ITAM-bearing adaptor molecules to transduce activating signals by recruiting the Syk-family PTKs Syk and ZAP-70. In addition, NK cells can be activated by receptors that do not associate with ITAM-bearing adapters, which therefore do not depend on Syk-family PTKs<sup>5</sup>.

The attractiveness of NKG2D as a sentinel system of the innate immune system stems from three features. First, NKG2D binds to diverse ligands expressed by “stressed or altered self”, thereby complementing the missing self-recognition strategy of NK cells<sup>26</sup>. Secondly, these ligands generally are not expressed on healthy cells, but they are induced only upon an insult, such as infection or transformation<sup>11</sup>. Thirdly, NKG2D ligation can drive NK cell activation despite the inhibitory influence of MHC class I molecules expressed on the target cells<sup>12, 13</sup>. Being such an attractive sentinel system, one important question is whether NKG2D alone can trigger NK cell activation, or whether it simply augments NK cell activation above a critical threshold?

NKG2D, like CD28 and ICOS, contains a YINM motif in its cytoplasmic tail<sup>14</sup>. Therefore, NKG2D has been thought to function like CD28 and ICOS, which provide PI3K-dependent co-stimulation of T cells. There is evidence that NKG2D gives co-stimulation to T cells, being able to substitute for CD28<sup>27</sup>, but cannot activate T cells in the absence of Syk family-dependent ITAM signals initiated by the TCR<sup>15</sup>. Thus, in T cells, NKG2D provides co-stimulation, but alone is insufficient to activate the cell. However, the very concept of co-stimulation may not be strictly applicable to NK cell physiology, since they do not express a central activating receptor

such as the antigen receptors in T and B cells. What should be relevant to NK cell activation is to reach a threshold, whatever the nature of the concurrent positive signals. For example, costimulatory molecules such as CD28, CD40 and ICOS cannot activate T cells, but in certain circumstances can all independently trigger cytotoxicity in NK cells<sup>28-30</sup>. NKG2D-DAP10 may qualitatively contribute a signal that is not efficiently inhibited by MHC class I expression by target cells, and is therefore apt to tip the balance towards activation.

We show here that NKG2D-DAP10 is sufficient to trigger cytotoxicity in activated mouse NK cells. In the context of cell-mediated cytotoxicity, it is possible that other signaling receptors cooperate with NKG2D-DAP10 to trigger the lytic event. Indeed, in physiological situations involving interactions between NK cells and potential target cells, NKG2D is likely to be stimulated concomitantly with other receptors. Therefore, experimental systems based on the use of cellular targets expressing NKG2D ligands may be more relevant to physiology than interpretations based on the stimulation of NKG2D with a crosslinking mAb. Our present studies demonstrating the ability of NK cells lacking either DAP12 or Syk family kinases to kill several NKG2D-bearing tumors indicate that pathways other than ITAM-based receptor systems may be of importance.

Why do  $Syk^{-/-}$ -ZAP-70<sup>-/-</sup> mice have a reduced capacity to eliminate tumor cells expressing NKG2D ligands? It is unlikely that the defective cytokine production causes this phenotype, since elimination of tumor cells expressing NKG2D ligands is dependent upon perforin but not IFN- $\gamma$  secretion<sup>31</sup>. NKG2D can initiate only the DAP10-induced PI3K pathway in  $Syk^{-/-}$ -ZAP-70<sup>-/-</sup> or DAP12<sup>-/-</sup> NK cells (Figure 9). However, in wild type NK cells multiple receptors may trigger other signaling cascades, including receptors other than NKG2D that are linked to the Syk/ZAP-70 PTK-dependent DAP12 pathway. The activating signals responsible to initiate cytolytic activity are thought to converge on downstream signaling molecules, including Vav1. In accordance with this model, Vav1<sup>-/-</sup> NK cells have severely impaired NKG2D function (S. Zompi and F. Colucci, unpublished). MHC class I inhibitory receptors may block cellular activation at multiple different levels. In the absence of Syk/ZAP-70 PTKs, the overall activating input will be decreased, making it more difficult to overcome the negative regulation,

yet permitting efficient killing of class I-deficient tumors. In activated NK cells, the negative regulation imposed by MHC class I inhibitory receptors is weaker<sup>26</sup>. On the other hand, in activated mouse NK cells NKG2D can recruit either DAP10-PI3K or DAP12-Syk/ZAP-70, adding to the positive input coming from cytokines such as IL-15, IL-2, IL-12, or IFN- $\gamma$ . In the absence of the DAP12-Syk/ZAP-70 pathway, the positive input is less robust; however, the Syk/ZAP-70-independent positive signals provided by cytokines and other activating receptors may still contribute to the NKG2D-DAP10 signals, overriding the negative regulation imposed by inhibitory receptors. Thus, in activated mouse NK cells, NKG2D can trigger cytotoxicity by using a dual on-switch, utilizing DAP10 or DAP12.

The dual on-switch model for the alternative association of NKG2D with DAP12 and DAP10 is consistent with observations in mice lacking DAP10<sup>17</sup>. Activated NK cells of DAP10<sup>-/-</sup> mice showed a decrease in cytotoxicity against targets expressing NKG2D ligands<sup>17</sup>, similar to what we found when the DAP10-associated PI3K pathway was specifically blocked by a pharmacological inhibitor. Thus, in the absence of DAP12<sup>18, 21</sup> or its associated Syk/ZAP-70 PTKs (this work), and DAP10<sup>17</sup> or its associated PI3K (this work), NKG2D function is retained, albeit reduced. If NKG2D is a dual on-switch receptor, mice deficient for both DAP12 and DAP10 should have a complete defect in NKG2D function.

Analysis of the role of NKG2D in human<sup>16</sup> and mouse<sup>15</sup> NK cells has generated conflicting data. Human NK cells coated with anti-NKG2D mAb showed enhanced killing of FcR+ target cells<sup>16</sup>. In contrast, crosslinking of the receptor by anti-NKG2D mAb in a target cell-free system efficiently induced cytokine production only when a concomitant stimulation of an additional ITAM-bearing activating receptor was added<sup>16</sup>. This suggested that NKG2D worked mainly as a co-stimulatory receptor for cytokine production in human NK cells, but is competent to activate cell-mediated cytotoxicity. Mouse NK cells, when activated with IL-2 or Poly I:C, express a RNA splice variant of NKG2D that can associate with both DAP10 and DAP12<sup>17, 18</sup>. Stimulation of activated mouse NK cells with anti-NKG2D mAb resulted in both enhanced cytolysis of FcR+ target cells, and in cytokine production<sup>15</sup>. The interpretation of these results was that NKG2D in activated mouse NK cells acted as an independent NK cell trigger. Lack of direct

NKG2D-induced cytokine production in human NK cells may be explained by the lack of an human NKG2D isoform that can associate with human DAP12. While our results support the concept that DAP12 is required for NKG2D-induced cytokine production by mouse NK cells (Figure 9), they indicate that ITAM-based signaling is not required for NKG2D-dependent cytotoxicity in mouse or human NK cells (companion manuscript, ref 25). Signaling divergence that segregates cytolytic activity and cytokine production has been documented previously for other NK cell receptors, such as 2B4<sup>32</sup> and for signaling proteins<sup>33</sup>.

Activated CD8+ T cells express both NKG2D isoforms and DAP10, but lack DAP12 expression, recapitulating the situation of activated DAP12<sup>-/-</sup> and Syk<sup>-/-</sup>-ZAP-70<sup>-/-</sup> NK cells, in which only the DAP10-PI3K pathway is available. Why cannot NKG2D trigger responses in activated CD8+ T cells, functioning instead as a costimulatory molecule? First of all, the explanation may be found in the intrinsic properties of NK and T cell biology. While NK cell activation is the result of concurrent signals from multiple receptors able to reach a given threshold sufficient to overcome suppression by inhibitory receptors for MHC class I, T cell activation is dominated by TCR stimulation. Moreover, it may depend upon the response being measured. IFN- $\gamma$  production and proliferation are not induced by NKG2D in CD8+T cells<sup>15, 18</sup>. However, in some circumstances, for example when CD8+ T cells are exposed to high doses of IL-2 in culture, they acquire “Lymphokine Activated Killer” (LAK) activity and behave like NK cells, killing target cells. We suspect in these situations, NKG2D-DAP10 on these T cells may be responsible for this “promiscuous” killing. Whether this occurs *in vivo* is uncertain.

A model has been proposed where “promiscuous” association of mouse NKG2D with the DAP10 and DAP12 adapters determines co-stimulation, or activation<sup>17, 18</sup>. However elegant, this model fails to explain how cytotoxicity can be triggered by NKG2D in Syk<sup>-/-</sup>-ZAP-70<sup>-/-</sup> or DAP12<sup>-/-</sup> activated mouse NK cells. An alternative explanation for the “promiscuous” association of one receptor to distinct adapters and pathways is the availability of a dual on-switch system that can trigger NK cell cytotoxicity in many situations, adding to the redundancy of signaling pathways that can trigger cytotoxicity in NK cells<sup>3</sup>. For example, in an inflammatory microenvironment, the major stimulus for IFN- $\gamma$  production is likely to be IL-12.

Therefore, NKG2D may not be a crucial trigger for cytokine production, but it may be essential to trigger cytotoxicity against “stressed” cells. DAP12 is an adaptor shared by several different receptors, and its availability within the activated cell may be limiting. Being capable to activate an alternative, DAP12-independent pathway, NKG2D gives further multiple choices<sup>26</sup> to NK cells, in addition to the flexibility conferred by the capacity to interact with many ligands. Thus, the versatile association to multiple signaling pathways permits that the threshold for activation of cytotoxicity is achieved in different situations, even when one signaling pathway is not available.



## Methods

### **Mutant mice and hematopoietic mouse chimeras**

Fetal liver chimeras were generated as described. Briefly, 4-6 week old *Rag2*- $\eta^{-/-}$  (H-2<sup>b</sup>) alymphoid mice<sup>34</sup> were irradiated with 300 rads, then received  $5 \times 10^6$  fetal liver cells. Mice that were heterozygous for the *Syk*<sup>tm1Tyb</sup> mutation<sup>20</sup> and homozygous for the *Zap70* mutation<sup>35</sup>, which had been backcrossed for six and two generations, respectively, onto B10.D2 background (H-2<sup>d</sup>), were crossed to generate day 14.5 - 16.5 embryos. In parallel, 129 mice homozygous for the *Rag1* mutation<sup>36</sup>, which had been backcrossed for ten generations onto the C57BL/10 background and for two subsequent generations onto the B10.D2 background (H-2<sup>d</sup>), were crossed to generate age-matched embryos. DAPI12-deficient mice were described previously<sup>37</sup>.

### **A radioactivity-free assay for tumor rejection *in vivo***

Tumor cells lines RMA (mock-transfected), RMA-S and RMA transfected with the NKG2D ligand Rae-1 $\Delta$  (RMA-Rae-1 $\Delta$ ) were cultured in RPMI-1640 (Gibco) supplemented with  $10^{-5}$  M  $\beta$ -mercaptoethanol (Sigma), and 10% FCS, 100  $\mu$ g/ml streptomycin and 100 U/ml penicillin (all from Gibco). When cells were in exponential proliferation, RMA-S and RMA-Rae-1 $\Delta$  were labeled with 5  $\mu$ M of CFSE. Briefly, cells were resuspended in PBS + 2% FCS at  $10^7$ /mL and labeling was done at 37°C for 10 min. After one wash in RPMI-1640 + 10% FCS, cells were resuspended in appropriate volume of PBS + 2% FCS. The same number of RMA cells ( $2 \times 10^5$ ) was labeled with 5  $\mu$ M of vital dye PKH26 (Sigma). RMA were resuspended in the appropriate labeling diluent (Sigma) at  $2 \times 10^7$  cells/mL and mixed with a 2x solution of PKH26 (10  $\mu$ M) for 5 min at room temperature. Such labeling was done in order to discriminate the class I (H-2<sup>b</sup>) positive RMA cells from the host derived cells (H-2<sup>b</sup>) resident in the peritoneal cavity of the chimeras. Thereafter, cells were washed twice in RPMI-1640 + 10% FCS cells and were resuspended in appropriate volume of PBS + 2% FCS. Once the cells labeled, they were mixed together and injected in the peritoneal cavity ( $2 \times 10^5$  cells of each type,  $6 \times 10^5$  total cells in 600  $\mu$ L per mouse). An aliquot of the mixed cells was kept in culture. Forty-eight hours later mice were sacrificed and peritoneal exudate cells (PEC) were recovered.

### Flow cytometry

PEC cells were resuspended in PBS + 2% FCS. For immunofluorescence analysis,  $10^6$  cells were stained with anti-NK1.1 mAb conjugated to APC- and anti-H-2K<sup>b</sup> monoclonal antibody conjugated to biotin (both from PharMingen). Biotin-conjugated antibody was revealed by using streptavidin-PerCP (PharMingen). In parallel, mixed cells cultured *in vitro* were stained. Electronic gates were set to acquire  $1 \times 10^4$  tumor cells positive for CFSE or PKH26. A first gate was set on large cells based on the Forward/Side scatter profile. Then, two gates were set on CFSE and PKH26 positive cells. Final analysis was done on the cells included in these two latter gates. For splenocytes, single cell suspensions were prepared as previously described<sup>34</sup>. Cells were stained with anti-NK1.1 mAb conjugated to PE, or APC, anti-CD122 (IL2R $\beta$ ) mAb conjugated to FITC, and a rat anti-mouse NKG2D mAb (Clone CX5 or CX7); generated as described<sup>38</sup>, and revealed by PE-conjugated Donkey anti-Rat IgG (Jackson Laboratories). Analysis was performed on a FACSCalibur flow cytometer using Cell Quest software (Becton Dickinson).

### NK cell cytotoxicity *in vitro*

A <sup>51</sup>Cr release assay was used to measure NK activity *in vitro* as described<sup>34</sup>. Target cells (YAC-1, RMA, RMA-S, RMA-Rae-1 $\square$  Ba/F3, Ba/F3-Rae-1 $\square$  CHO, Daudi, and 712.221-CD32 transfectants) were labeled with 100  $\square$ Ci of <sup>51</sup>Cr (ICN Pharmaceutical). Red-cell depleted splenocytes were either used fresh, after 30 min of plate adherence to remove most granulocytes and monocytes, or cultured in RPMI-1640 supplemented with 10% FCS,  $10^{-5}$  M  $\square$ -ME, 100  $\square$ g/ml streptomycin, 100 U/ml penicillin, and 100 ng/mL of human IL-2 (Peprotech), corresponding to 1000 U/mL for 5-7 days. For fresh NK cells of Syk<sup>-/-</sup>-ZAP-70<sup>-/-</sup> and control chimeras, since various percentages of NK cells were obtained, the number of effector cells was adjusted by the actual number of NK1.1+CD122+ NK cells.

Splenic mononuclear cells from six to eight week-old C57BL/6 and DAP12<sup>-/-</sup> mice were prepared by passing spleens through a steel mesh, and erythrocytes were lysed in an ammonium chloride solution (Sigma, St. Louis MO). NK cells were enriched by T and B cell depletion. Briefly, spleen cells were incubated with anti-CD4 mAb (clone GK1.5) and anti-CD8 mAb (clone 53-6.7), and thereafter these cells were mixed with magnetic microbeads coated with goat anti-

mouse immunoglobulin (Ig) Ab and goat anti-rat Ig Ab (Advanced Magnetic, Inc, Cambridge, MA). CD4, CD8, and surface Ig (sIg) positive cells were removed by magnetic cell sorting. The CD4-, CD8- and Ig-depleted splenocytes were stained with a PE-conjugated pan-NK cell mAb DX5 (BD PharMingen, San Diego, CA), followed by an incubation with magnetic microbeads coated with anti-PE-Ab (Miltenyi Biotec Inc., Germany). Thereafter, DX5+ cells were isolated by magnetic cell sorting using a MACS (Miltenyi Biotec Inc., Germany). The purity of the DX5+ cells was more than 95%, as determined by flow cytometric analysis. The purified NK cells were cultured in RPMI-1640 supplemented with 10% FCS and  $5 \times 10^{-5}$  M  $\beta$ -mercaptoethanol in the presence of 4000 U/ml human recombinant IL-2, for 5-6 days.

For mAb blocking experiments, fresh NK cells were incubated with the anti-NKG2D Ab CX7 or with the control rat IgG anti I-A mAb for 30 min at room temperature prior to the  $^{51}\text{Cr}$  release assay done with target cells that do not express FcR (YAC-1 or RMA-Rae-1 $\Delta$ ). For R-ADCC, IL-2-activated NK cells were incubated with the anti-NKG2D Ab CX5 (or with the isotype matched control rat anti-mouse I-A) for 15 min at 37°C prior to the  $^{51}\text{Cr}$  release assay done with target cells that express FcR (human Daudi B-cell lymphoma or human 712.221-CD32+ transfectants).

### **Cytokine production**

Tissue culture plates were coated with DOTAP (1 mg/ml, Sigma, St. Louis, MO) for 10 min at room temperature (to enhance antibody binding to the plates), washed with PBS, incubated with monoclonal antibodies (mAbs) diluted in 0.1 M bicarbonate buffer (pH 9.0) for 16 hrs at 4°C, and then washed with PBS. To block Fc receptor-dependent activation, IL-2-activated NK cells were pretreated with soluble anti-CD16/32 mAb 2.4G2 (10 mg/ml) for 30 min. NK cells ( $0.5-1 \times 10^5$ ) were placed in RPMI-1640 containing 10% FCS and IL-2 (1000-2000 U/ml), and were cultured for 18-24 hrs in plates containing the immobilized antibodies. The amount of IFN- $\gamma$  in the culture supernatants was determined with a mouse IFN- $\gamma$ -specific ELISA kit (OptEIA mouse IFN- $\gamma$  set), purchased from BD PharMingen (San Diego, CA) and used according to the manufacturers instructions.

**Statistical analysis**

Student's T-test was done with the Excel software. ANOVA (Statview 5.0, SAS Institute Inc, NC, USA) was used to compare curves.

### Figure legends

**Figure 1. Normal NKG2D expression in the absence of Syk and ZAP-70.** **a)** Fresh cells from spleen and the peritoneal cavity and IL-2-activated (6 days) NK cells were stained with anti-NK1.1 and anti-NKG2D. A representative of four independent experiments is shown; **b)** Fresh splenocytes from Syk<sup>-/-</sup>-ZAP-70<sup>-/-</sup> chimeras were stained with anti-NK1.1 anti-NKG2D mAb (empty histograms) or isotype-matched control (rat IgG anti-I-A<sup>b</sup>, filled histograms). Similar results were obtained with control NK cells.

**Figure 2. NKG2D-mediated cytotoxicity of activated NK cells uncoupled from DAP12, Syk and ZAP-70.** **a)** IL-2 activated NK cells (day 6-10) from Syk<sup>-/-</sup>-ZAP-70<sup>-/-</sup> chimeras (O) and control chimeras (■) were used for killing of the indicated target cells in a 4 hr-chromium release assay at the indicated NK: target cell ratios. Data are mean value ± standard errors from five independent experiments, except for the Ba/F3 assay, where data are mean value ± standard errors from a representative of three independent experiments that gave similar results. **b)** Purified and IL-2-activated wild-type (control, ■), and DAP12<sup>-/-</sup> (O) NK cells (day 4) were used for killing of the indicated target cells in a 4 hr-chromium release assay at the indicated NK: target cell ratios. Data are from one representative experiment; **c)** Mice were administered 100 µg of Poly I:C i.p and 72 hr later the splenic NK cells were used in 4 hr-chromium release assays at the indicated NK: target cell ratios. Data are mean value ± standard errors from two independent experiments. **d)** Splenic NK cells of Poly I:C treated mice were coated with anti-NKG2D mAb prior to co-incubation with the RMA-Rae-1□ cells. Most killing of RMA-Rae-1□ cells was inhibited in the presence of anti-NKG2D blocking mAb, but not in the presence of isotype-matched control Ab (rat IgG anti-mouse I-A). Data are mean value ± standard errors from two independent experiments including NK cells from two control and four Syk<sup>-/-</sup>-ZAP-70<sup>-/-</sup> chimeras.

**Figure 3. A PI3K specific inhibitor blocks NKG2D-mediated cytotoxicity.** IL-2-activated NK cells (day 10) were incubated with the indicated concentrations of LY294002 and subsequently tested for the capacity to kill RMA-Rae1□ cells at a 5:1 NK: target ratio. **a)** One

representative experiment of four; **b)** Inhibition of cytotoxicity caused by PI3K blocking is expressed as the percentage of killing observed in the presence of DMSO vehicle alone. Data are mean value  $\pm$  standard errors from four independent experiments including NK cells from four control wild-type and four Syk<sup>-/-</sup>-ZAP-70<sup>-/-</sup> chimeras.

**Figure 4. NKG2D can enhance killing independently of DAP12 and Syk/ZAP-70.** **a)** IL-2-activated NK cells (day 6) of Syk<sup>-/-</sup>-ZAP-70<sup>-/-</sup> and control chimeras were incubated with rat anti-mouse NKG2D mAb or with a control rat IgG anti-mouse I-A mAb, and then tested for their capacity to kill FcR+ Daudi cells. One representative experiment of seven; **b)** Purified IL-2-activated NK cells of DAP12<sup>-/-</sup> and control mice were incubated with rat anti- mouse NKG2D mAb or with a control rat IgG anti-mouse I-A mAb, and thereafter tested for their capacity to kill 721.221-CD32+ transfectants (FcR+) cells. One representative experiment is shown.

**Figure 5. Rejection of tumor cells expressing NKG2D ligands.** **a)** Equal numbers of RMA-S and RMA-Rae1 $\square$  cells were CFSE labeled and mixed with PKH26-labeled RMA cells. An aliquot of the cell mixture was plated in culture for 48 hr and thereafter analyzed by flow cytometry. A total of  $6 \times 10^5$  tumor cells ( $2 \times 10^5$  of each cell type) were injected i.p. into different groups of mice. Forty-eight hr later, the peritoneal cells were counted and stained with mAbs specific for NK1.1 and H-2K<sup>b</sup>. For flow cytometric analysis, an electronic gate was set on tumor cells based on their characteristic forward and side light scatter profiles. The different cell types could be discriminated by virtue of differential staining and light scattering characteristics. RMA-S and RMA-Rae-1 $\square$  cells were CFSE positive; RMA-S were H-2K<sup>b</sup> negative, whereas RMA-Rae-1g were H-2K<sup>b</sup> positive. RMA cells were CFSE negative but positive for H-2K<sup>b</sup> and PKH26. Absolute numbers ( $\times 10^3$ ) of RMA, RMA-S and RMA-Rae-1 $\square$  cells recovered *in vivo* are indicated for a representative experiment. **b)** Numbers and relative proportions of tumor cells recovered *in vitro* and from the peritoneal cavity of injected mice are shown. Data are pooled from three independent experiments.

**Figure 6. NKG2D-mediated cytotoxicity of resting NK cells is impaired in the absence of Syk and ZAP-70.** Fresh splenocytes from Syk<sup>-/-</sup>-ZAP-70<sup>-/-</sup> chimeras (O) and control wild-type

chimeras (■) were tested for natural cytolysis of the indicated target cells in a 4 hr-chromium release assay at the indicated NK: target cell ratios. Percentages of NK cells in spleens (typically 40-60%) were measured by flow cytometric analysis. Cytotoxicity assays were normalized to contain identical numbers of NK cells at a given effector: target cell ratio. In some experiments, NK cells were coated with rat I anti-mouse NKG2D mAb or rat IgG anti-mouse I-A prior to addition of YAC-1 cells, in order to block NKG2D-mediated killing. Data are mean value  $\pm$  standard errors from three independent experiments, except for the Ba/F3 assay, where data are mean value  $\pm$  standard errors from a representative of three independent experiments that gave similar results.

**Figure 7. A time course study of killing activity against target cells expressing NKG2D ligands.** NK cells from  $Syk^{-/-}$ -ZAP-70 $^{-/-}$  chimeras (O) and of control wild-type chimeras (■) were tested for natural cytolysis of the indicated target cells in a 4 hr-chromium release assay at the indicated NK: target cell ratios and at the indicated times of LAK culture (in complete medium supplemented with 1000 UI/mL IL-2). Percentages of NK cells in the effector populations were measured by flow cytometric analysis and the assays were normalized to contain identical numbers of NK cells at a given effector: target cell ratio. RMA cells do not express NKG2D ligands and were used as negative controls. Each assay is a representative of at least three independent experiments giving similar results.

**Figure 8. The DAP12-Syk/ZAP-70 pathway is essential for NKG2D-mediated IFN- $\gamma$  production.** a) IL-2-activated NK cells of  $Syk^{-/-}$ -ZAP-70 $^{-/-}$  and control wild-type chimeras were stimulated with 5 ng/ml of IL-12, 10-20  $\mu$ g/ml of anti-NKG2D, anti-CD11b, or left unstimulated. One representative of three experiments is shown. b) IL-2-activated NK cells of DAP12 $^{-/-}$  and control mice were stimulated with 5 ng/ml of IL-12, 10-20  $\mu$ g/ml of anti-NKG2D, anti-NK1.1 or left unstimulated. One representative experiment is shown. Unst (unstimulated): this condition refers to basal level of cytokine secretion in presence of IL-2 alone or in presence of a control IgG.

**Figure 9. Model for NKG2D dual on-switch in activated NK cells.** a) In resting mouse NK

cells, the negative regulation dominates. In the absence of DAP12 or Syk family kinases, some positive signals are lacking, raising the threshold for activation. Therefore  $Syk^{-/-}$ - $Zap-70^{-/-}$  resting NK cells can efficiently kill MHC class I-deficient targets, but may fail to kill other targets, including those that express NKG2D ligands. Nevertheless, in normal NK cells, the DAP10-PI3K pathway initiated by NKG2D signaling may be sufficient to trigger cytotoxicity.

**b)** In activated NK cells the positive input is more robust. In mouse NK cells, NKG2D can choose two alternative pathways to trigger cytotoxicity but DAP12-Syk/ZAP-70 is the obliged pathway for IFN- $\gamma$  secretion. In  $Syk^{-/-}$ - $Zap-70^{-/-}$  NK cells only the DAP10-PI3K pathway is functional. This is sufficient, together with cytokine signals, to overcome negative regulation imposed by MHC receptors and trigger cytotoxicity, independently of the DAP12-Syk/ZAP-70 pathway, however IFN- $\gamma$  secretion cannot be induced. Conversely, in  $DAP10^{-/-}$  NK cells, or upon blocking of PI3K, partial NKG2D activity is provided by the alternative DAP12-Syk/ZAP-70 pathway, giving activated mouse NK cells a dual on-switch system that increases the choices for triggering cytotoxicity.



**Acknowledgments**

We thank A. Weiss and T. Kadlecěk for the ZAP-70<sup>-/-</sup> mice, E. Corcuff, O. Richard and T. Chen for skillful help, A. Caraux for critically reading the manuscript, P. Leibson and D. Billadeau for discussions and for sharing unpublished observations. Supported by grants from The Pasteur Institute, Ligue Nationale Contre le Cancer, Association pour la Recherche sur le Cancer, Institut National de la Santé et de la Recherche Médicale (to F.C and JPD), the Medical Research Council (to VJLT), and by NIH R01 CA89294 to LLL. SZ is supported by a grant from Ligue Nationale Contre le Cancer, JAH is supported by a grant from Irvington Institute for Immunological Research, KO is supported by Human Frontier Science Program Long-term Fellowship, ES is supported by European Molecular Biology Organization. LLL is an American Cancer Society Research Professor.

## References

1. Leibson, P. J. Signal transduction during natural killer cell activation: inside the mind of a killer. *Immunity* **6**, 655-61. (1997).
2. Long, E. O. Regulation of immune responses through inhibitory receptors. *Annu Rev Immunol* **17**, 875-904 (1999).
3. Colucci, F., Di Santo, J. P. & Leibson, P. J. Natural killer cell activation in mice and men: different triggers for similar weapons? *Nature Immunology* **3**, 807-813 (2002).
4. Lanier, L. L. On guard--activating NK cell receptors. *Nature Immunol* **2**, 23-7. (2001).
5. Colucci, F. et al. Natural cytotoxicity uncoupled from the Syk and ZAP-70 intracellular kinases. *Nature Immunol* **3**, 288-94. (2002).
6. Bauer, S. et al. Activation of NK cells and T cells by NKG2D, a receptor for stress-inducible MICA. *Science* **285**, 727-9. (1999).
7. Diefenbach, A., Jamieson, A. M., Liu, S. D., Shastri, N. & Raulet, D. H. Ligands for the murine NKG2D receptor: expression by tumor cells and activation of NK cells and macrophages. *Nature Immunol* **1**, 119-26. (2000).
8. Cosman, D. et al. ULBPs, novel MHC class I-related molecules, bind to CMV glycoprotein UL16 and stimulate NK cytotoxicity through the NKG2D receptor. *Immunity* **14**, 123-33. (2001)
9. Cerwenka, A. et al. Retinoic acid early inducible genes define a ligand family for the activating NKG2D receptor in mice. *Immunity* **12**, 721-7. (2000).
10. Carayannopoulos, L. N., Naidenko, O. V., Fremont, D. H. & Yokoyama, W. M. Cutting edge: murine UL16-binding protein-like transcript 1: a newly described transcript encoding a high-affinity ligand for murine NKG2D. *J Immunol* **169**, 4079-83. (2002).
11. Cerwenka, A. & Lanier, L. L. Ligands for natural killer cell receptors: redundancy or specificity. *Immunol Rev* **181**, 158-69. (2001).
12. Diefenbach, A., Jensen, E. R., Jamieson, A. M. & Raulet, D. H. Rae1 and H60 ligands of the NKG2D receptor stimulate tumour immunity. *Nature* **413**, 165-71. (2001).

13. Cerwenka, A., Baron, J. L. & Lanier, L. L. Ectopic expression of retinoic acid early inducible-1 gene (RAE-1) permits natural killer cell-mediated rejection of a MHC class I-bearing tumor in vivo. *Proc Natl Acad Sci U S A* **98**, 11521-6. (2001).
14. Wu, J. et al. An activating immunoreceptor complex formed by NKG2D and DAP10. *Science* **285**, 730-2. (1999).
15. Jamieson, A. M. et al. The Role of the NKG2D Immunoreceptor in Immune Cell Activation and Natural Killing. *Immunity* **17**, 19-29 (2002).
16. Wu, J., Cherwinski, H., Spies, T., Phillips, J. H. & Lanier, L. L. DAP10 and DAP12 form distinct, but functionally cooperative, receptor complexes in natural killer cells. *J Exp Med* **192**, 1059-68. (2000).
17. Gilfillan, S., Ho, E. L., Cella, M., Yokoyama, W. M. & Colonna, M. NKG2D recruits two distinct adapters to trigger NK cell activation and costimulation. *Nature Immunol* **3**, 1150-5. (2002).
18. Diefenbach, A. et al. Selective associations with signaling proteins determine stimulatory versus costimulatory activity of NKG2D. *Nature Immunol* **3**, 1142-9. (2002).
19. Long, E. O. Versatile signaling through NKG2D. *Nature Immunol* **3**, 1119-20. (2002).
20. Turner, M. et al. Perinatal lethality and blocked B-cell development in mice lacking the tyrosine kinase Syk. *Nature* **378**, 298-302 (1995).
21. Arase, H., Mocarski, E. S., Campbell, A. E., Hill, A. B. & Lanier, L. L. Direct recognition of cytomegalovirus by activating and inhibitory NK cell receptors. *Science* **296**, 1323-6. (2002).
22. Biron, C. A., Nguyen, K. B., Pien, G. C., Cousens, L. P. & Salazar-Mather, T. P. Natural killer cells in antiviral defense: function and regulation by innate cytokines. *Annu Rev Immunol* **17**, 189-220. (1999).
23. Karre, K. et al. Selective rejection of H-2-deficient lymphoma variants suggests alternative immune defense strategy. *Nature* **319**, 675-8. (1986).
24. Glas, R. et al. Recruitment and activation of natural killer (NK) cells in vivo determined by the target cell phenotype. An adaptive component of NK cell-mediated responses. *J Exp Med* **191**, 129-38. (2000).

25. Billadeau, D. D., Upshaw, J. D., Schoon, R. A., Dick, C. J. & Leibson, P. J. NKG2D-DAP10 triggers human NK cell-mediated killing via a novel Syk-independent regulatory pathway. *Submitted to Nature Immunol.* (2002).
26. Karre, K. MHC gene control of the natural killer system at the level of the target and the host. *Semin Cancer Biol* **2**, 295-309. (1991).
27. Groh, V. et al. Costimulation of CD8 $\alpha$  T cells by NKG2D via engagement by MIC induced on virus-infected cells. *Nature Immunol* **2**, 255-60. (2001).
28. Hald, J., Rasmussen, N. & Claesson, M. H. Tumour-infiltrating lymphocytes mediate lysis of autologous squamous cell carcinomas of the head and neck. *Cancer Immunol Immunother* **41**, 243-50. (1995).
29. Ogasawara, K., Yoshinaga, S. K. & Lanier, L. L. Inducible costimulator costimulates cytotoxic activity and IFN- $\gamma$  production in activated murine NK cells. *J Immunol* **169**, 3676-85. (2002).
30. Martin-Fontecha, A., Assarsson, E., Carbone, E., Karre, K. & Ljunggren, H. G. Triggering of murine NK cells by CD40 and CD86 (B7-2). *J Immunol* **162**, 5910-6. (1999).
31. Hayakawa Y, et al. Tumor rejection mediated by NKG2D receptor-ligand interaction is dependent upon perforin. *J Immunol* **169**, 5377-81 (2002).
32. Chuang, S. S., Kumaresan, P. R., Mathew, P. A. 2B4 (CD244)-mediated activation of cytotoxicity and IFN- $\gamma$  release in human NK cells involves distinct pathways. *J Immunol* **167**, 6210-6 (2001)
33. Colucci F, et al. Functional dichotomy in Natural killer cell signaling: Vav1-dependent and -independent mechanisms. *J Exp Med* **193**, 1413-24 (2001)
34. Colucci, F. et al. Dissecting NK cell development using a novel alymphoid mouse model: investigating the role of the c-abl proto-oncogene in murine NK cell differentiation. *J Immunol* **162**, 2761-5. (1999).
35. Kadlecsek, T. A. et al. Differential requirements for ZAP-70 in TCR signaling and T cell development. *J Immunol* **161**, 4688-94. (1998).
36. Spanopoulou, E. et al. Functional immunoglobulin transgenes guide ordered B-cell differentiation in Rag-1-deficient mice. *Genes Dev* **8**, 1030-42. (1994).

37. Bakker A. B., et al. DAP12-deficient mice fail to develop autoimmunity due to impaired antigen priming. *Immunity* **13**, 345-53 (2000)
38. Ogasawara, K. et al. Impairment of NK cell function by NKG2D modulation in NOD mice. *Immunity* **18**, 41-45 (2002).

**Zompi et al. Figure 1**

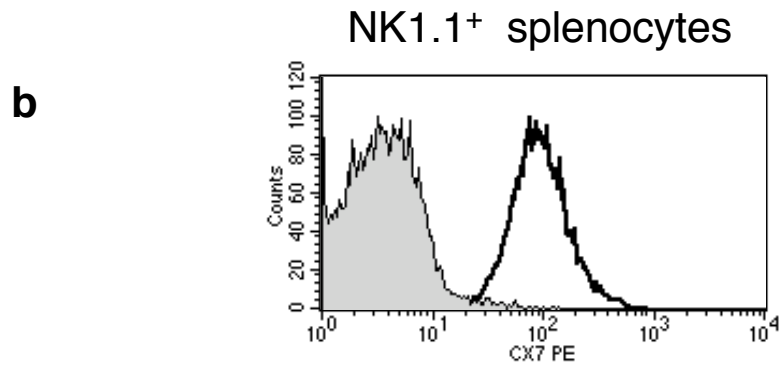
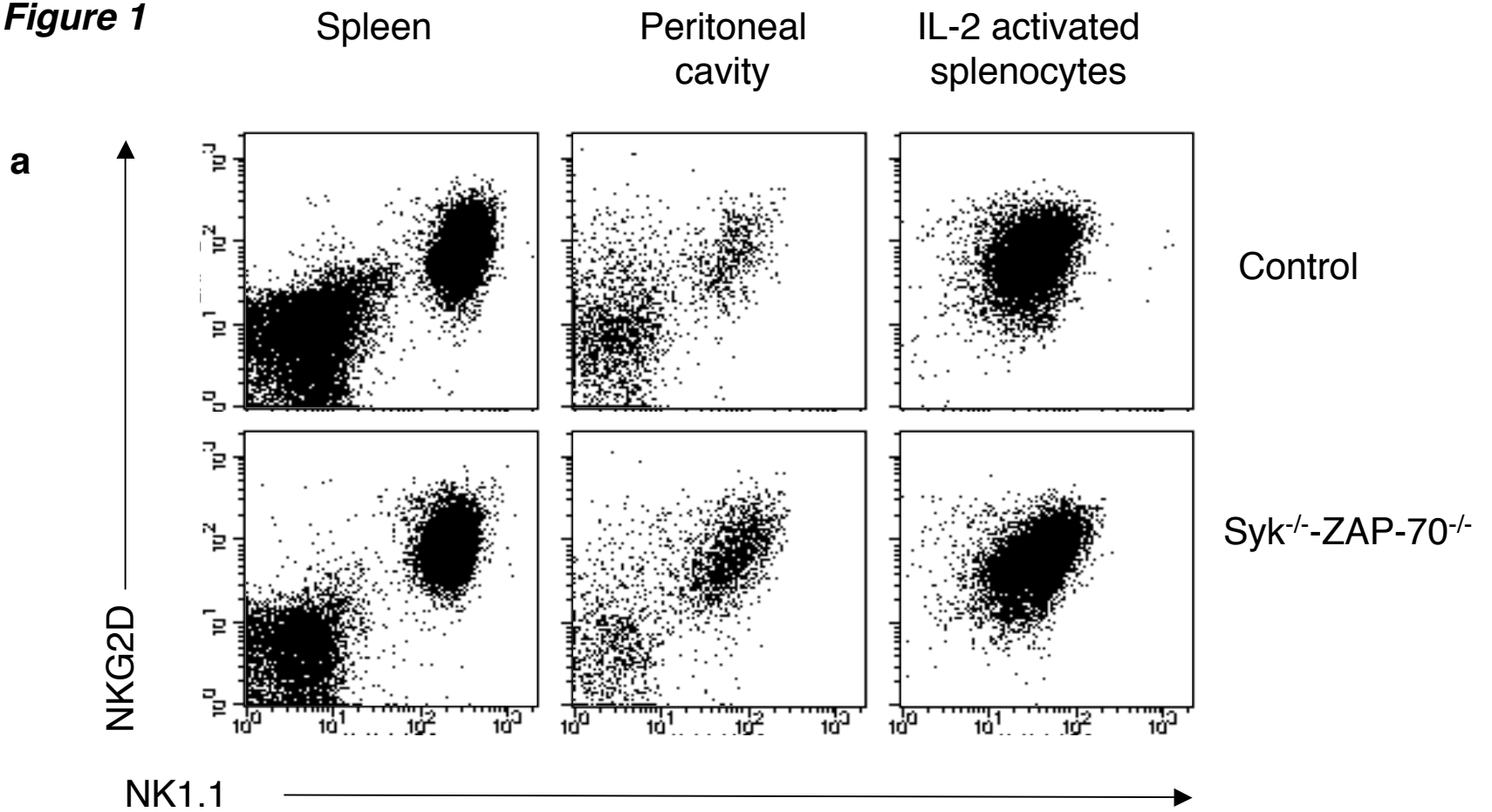

Zompi et al. Figure 2a

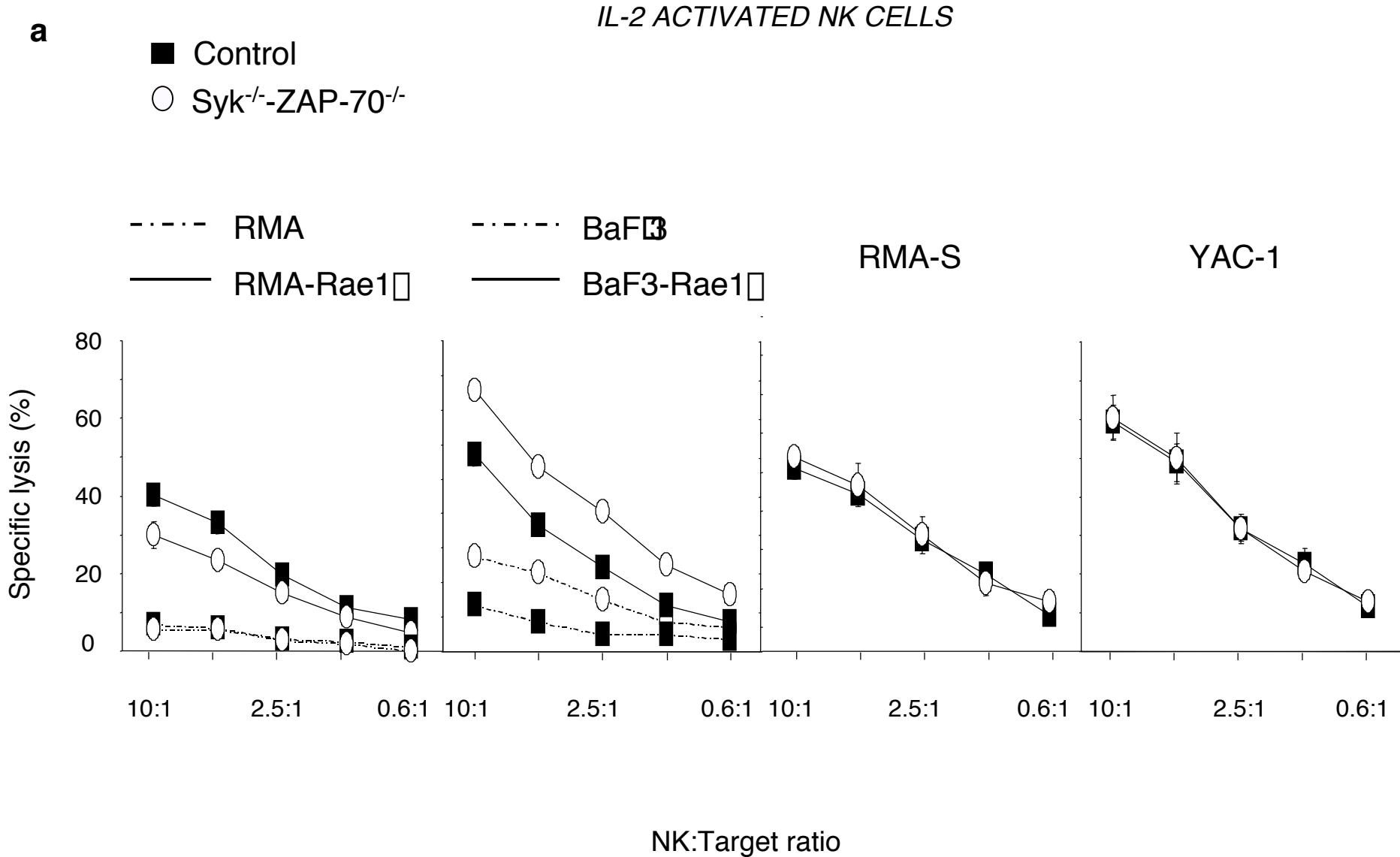

b

■ Control  
○ DAP 12<sup>-/-</sup>

IL-2 ACTIVATED NK CELLS

--- RMA                      - - - - BaF3  
— RMA-Rae1<sup>-/-</sup>                — BaF3-Rae1<sup>-/-</sup>

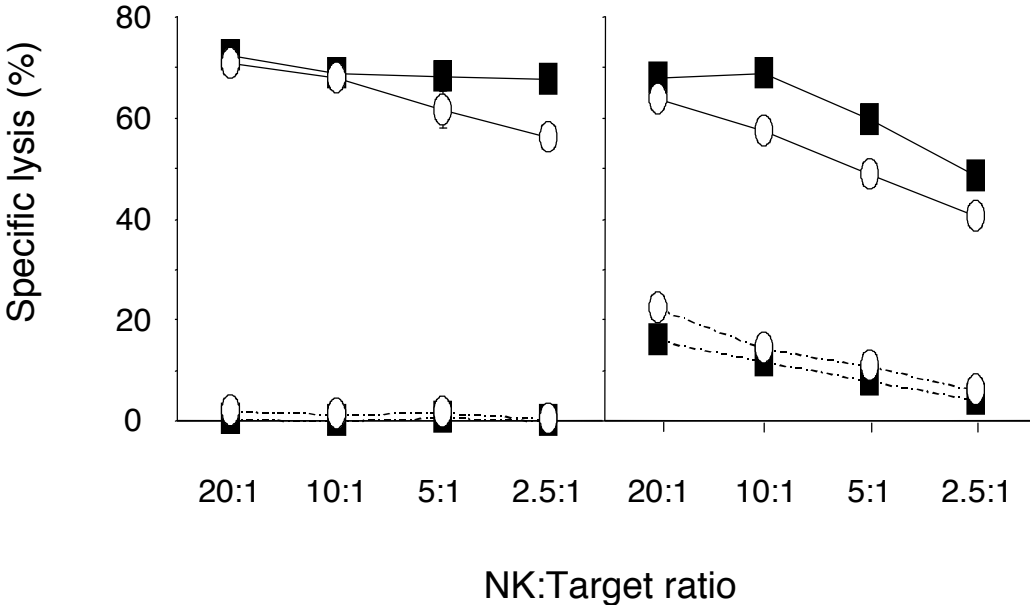



Zompi et al. Figure 2c-d

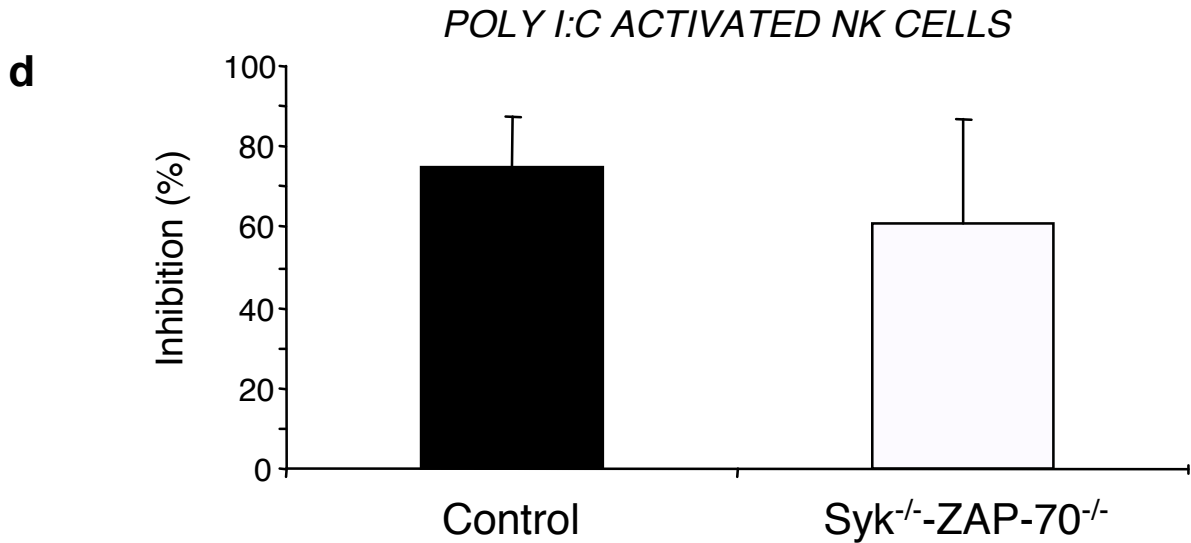
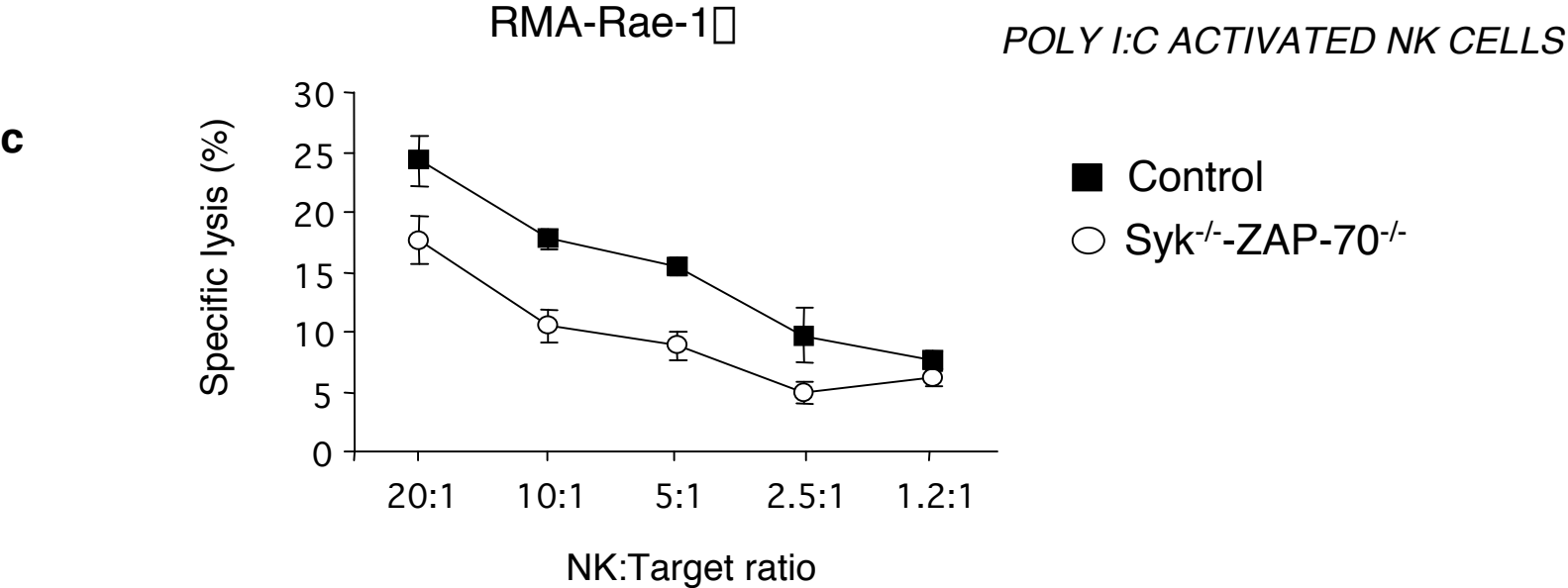

**Zompi et al. Figure 3a-b**

**a**

*IL-2 ACTIVATED NK CELLS*

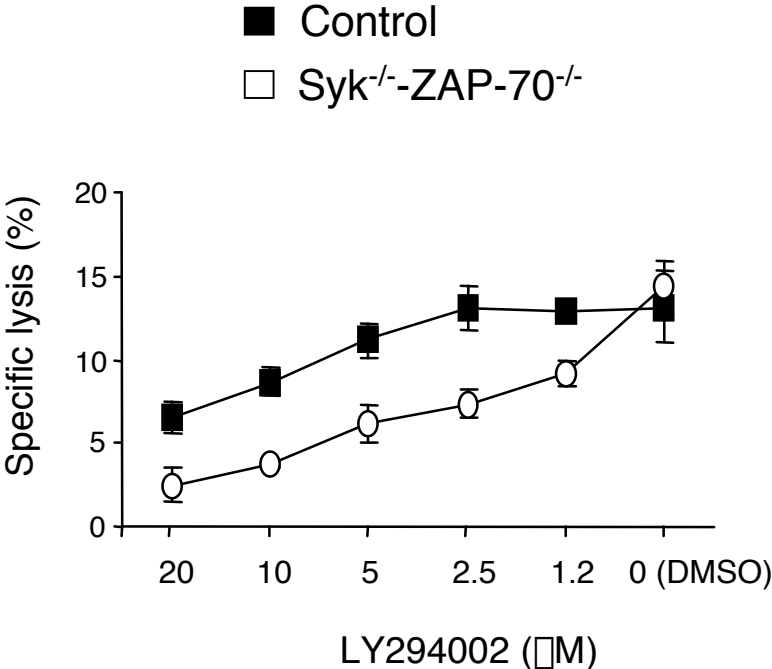

**b**

*IL-2 ACTIVATED NK CELLS*

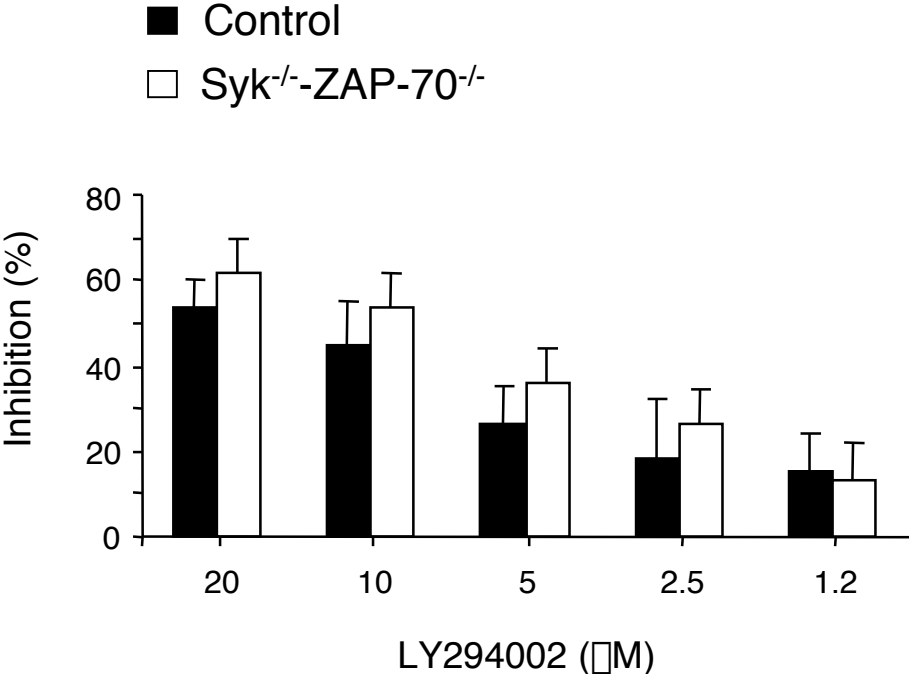

**Zompi et al. Figure 4a-b**

**a**

*IL-2 ACTIVATED NK CELLS*

Control

*Syk*<sup>-/-</sup>-*ZAP-70*<sup>-/-</sup>

▲ Anti-NKG2D Ab  
■ Ctrl Ab

△ Anti-NKG2D Ab  
□ Ctrl Ab

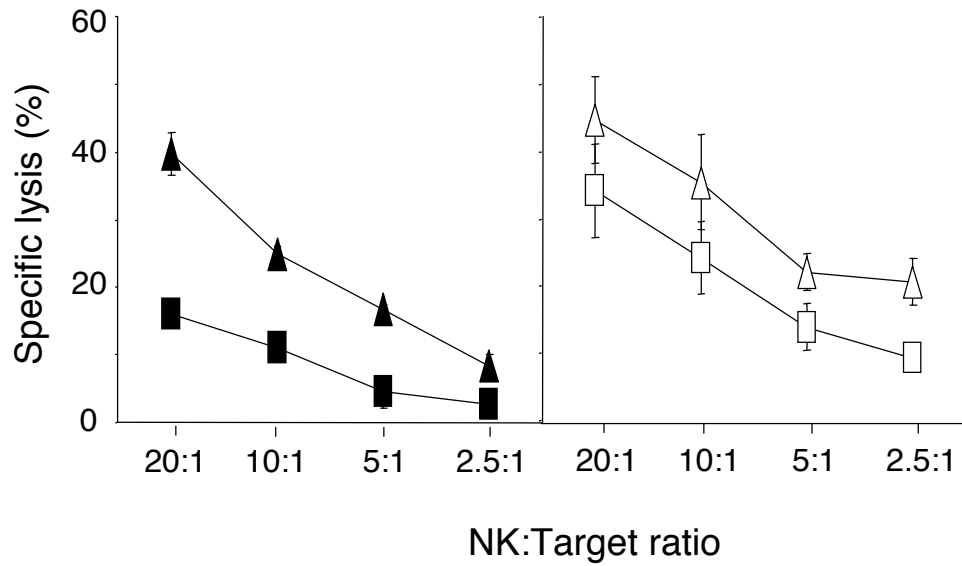

**b**

*IL-2 ACTIVATED NK CELLS*

Control

*DAP12*<sup>-/-</sup>

▲ Anti-NKG2D Ab  
■ Ctrl Ab

△ Anti-NKG2D Ab  
□ Ctrl Ab

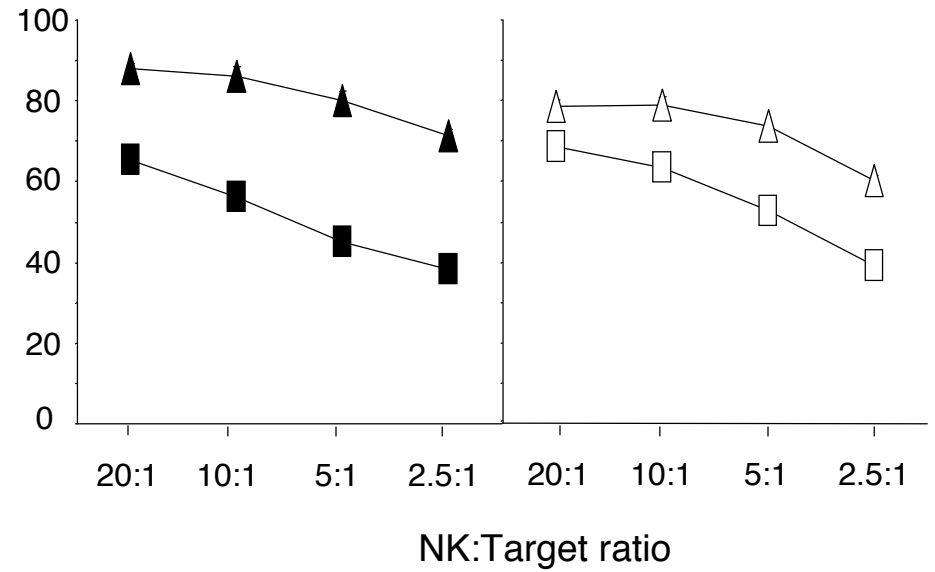

Zompi et al. Figure 5a

a

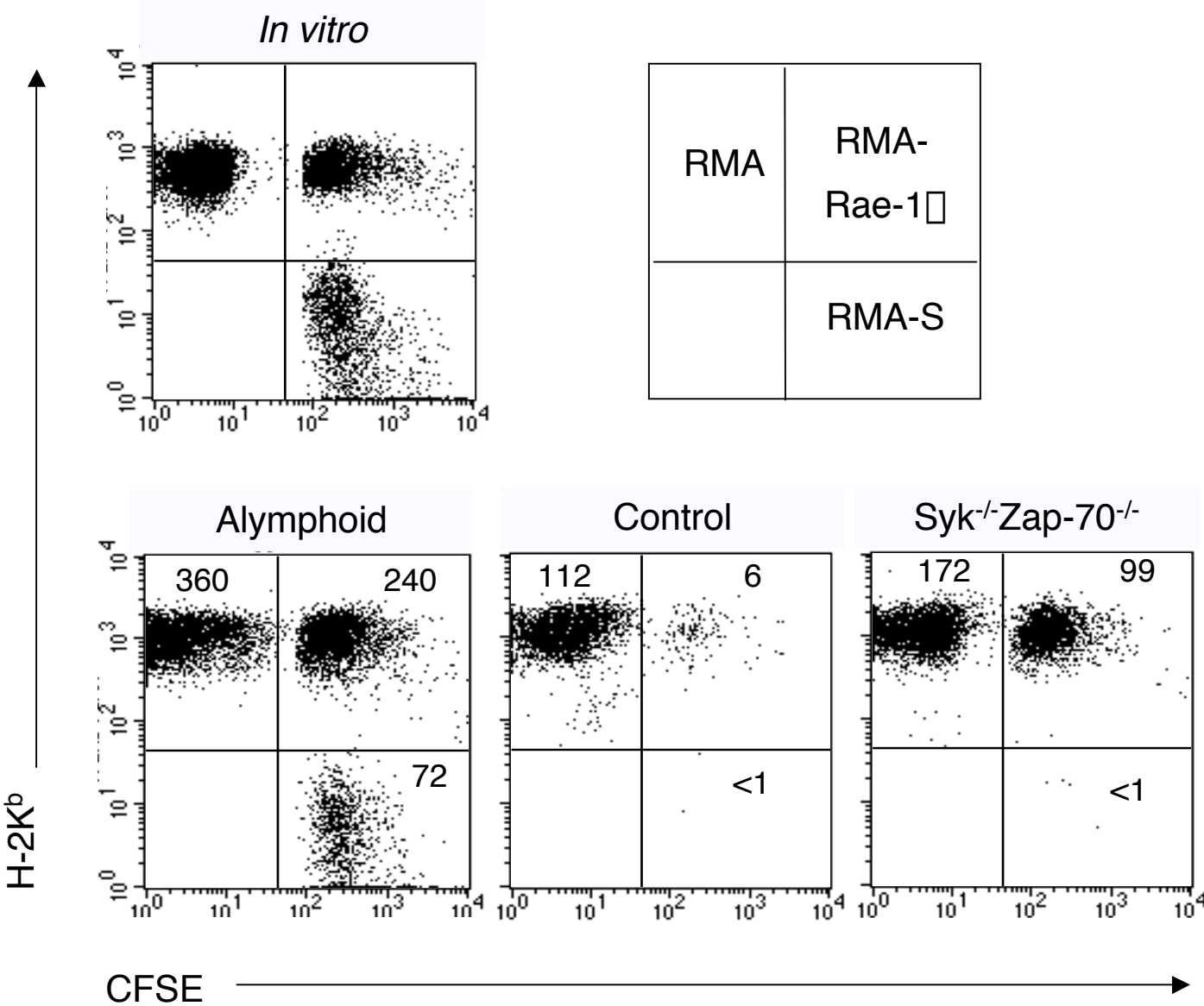

**b**

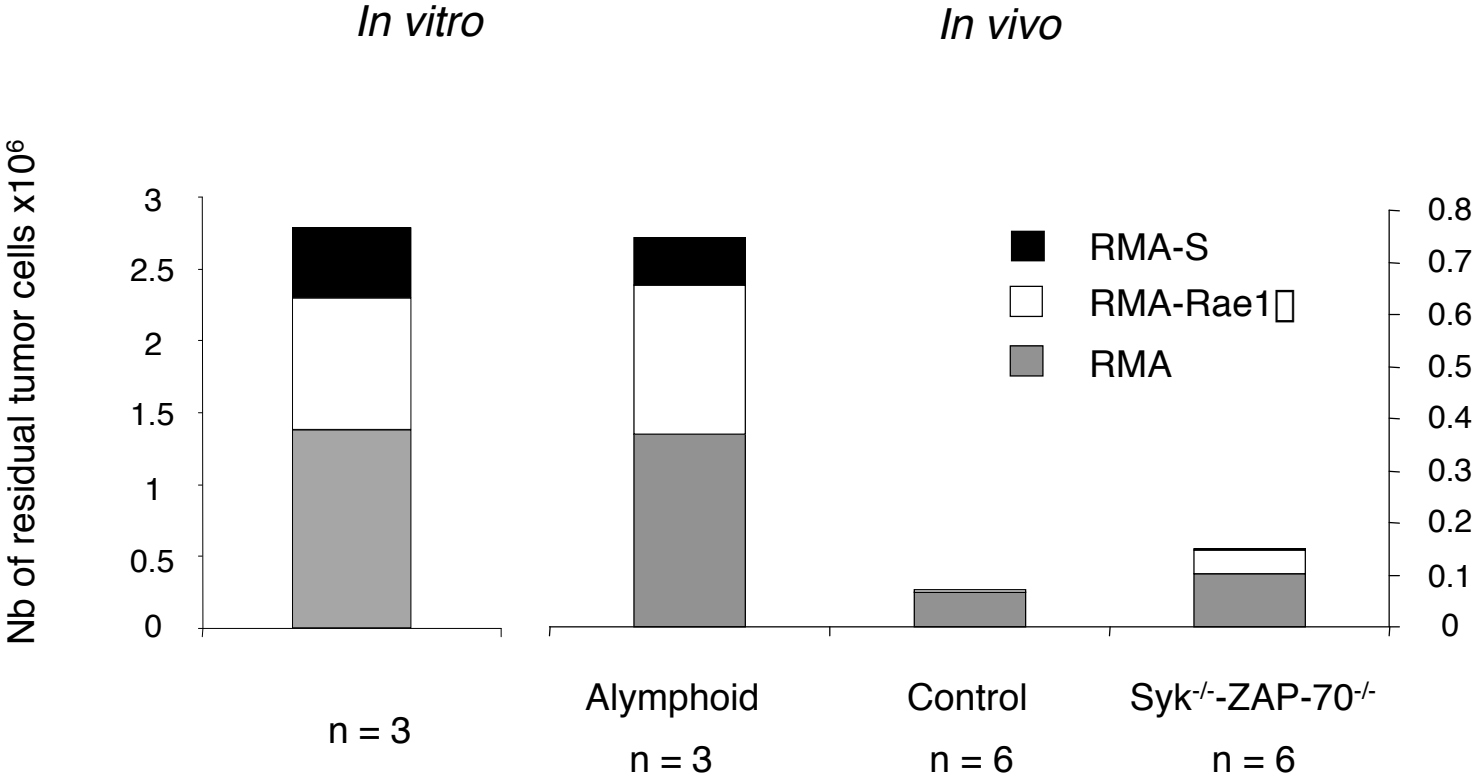

**Zompi et al. Figure 6**

■ Control  
○ *Syk<sup>-/-</sup>-ZAP-70<sup>-/-</sup>*

*RESTING NK CELLS*

----- RMA                      ----- BaF3  
 ——— RMA-Rae1<sup>-/-</sup>                ——— BaF3-Rae1<sup>-/-</sup>

RMA-S

YAC-1

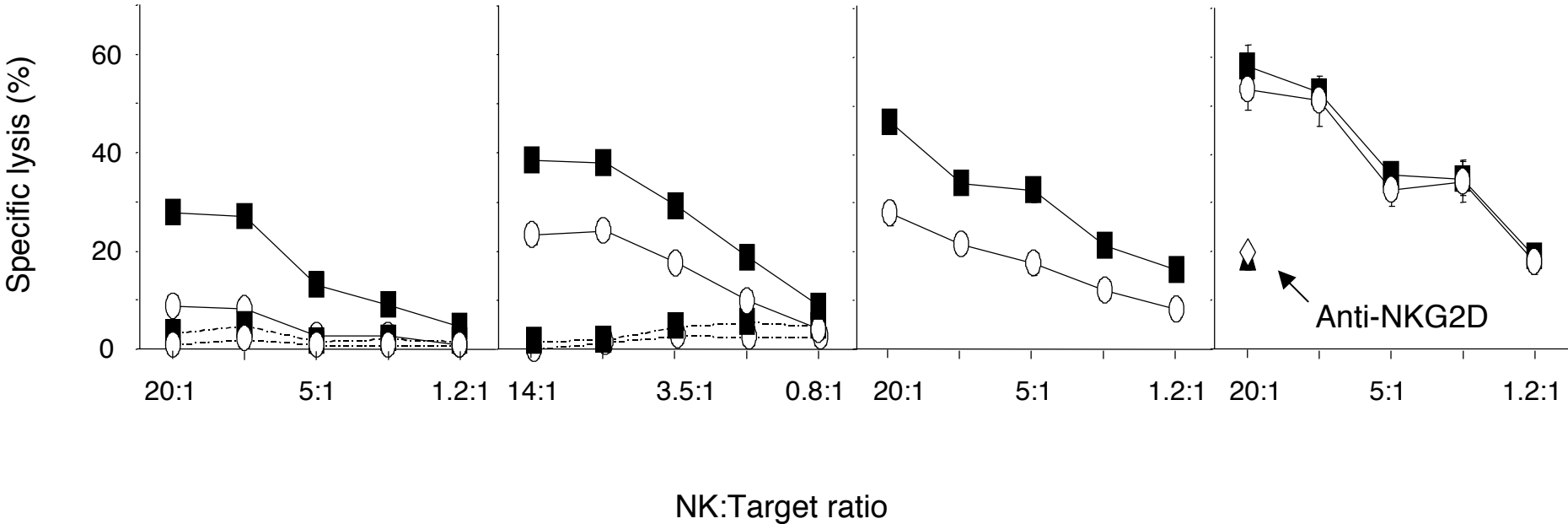

**Zompi et al. Figure 7**

■ Control  
○ *Syk<sup>-/-</sup>-ZAP-70<sup>-/-</sup>*

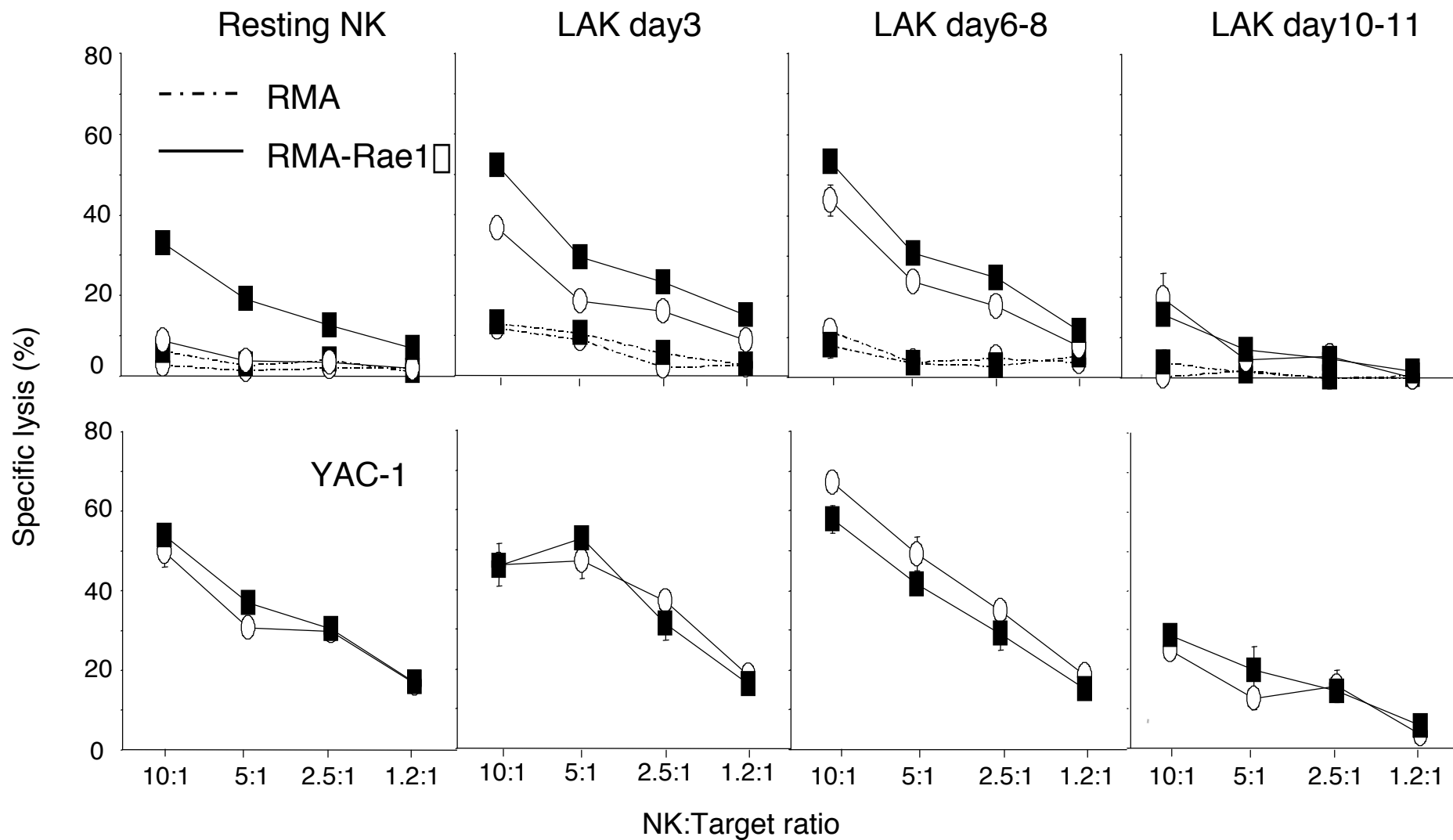

**Zompi et al. Figure 8a-b**

**a**

*IL-2 ACTIVATED NK CELLS*

■ Control  
□ *Syk<sup>-/-</sup>-ZAP-70<sup>-/-</sup>*

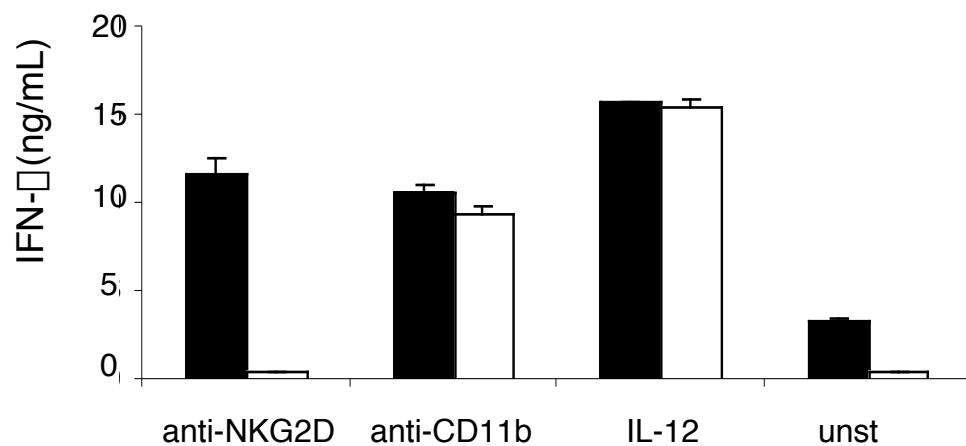

**b**

*IL-2 ACTIVATED NK CELLS*

■ Control  
□ *DAP12<sup>-/-</sup>*

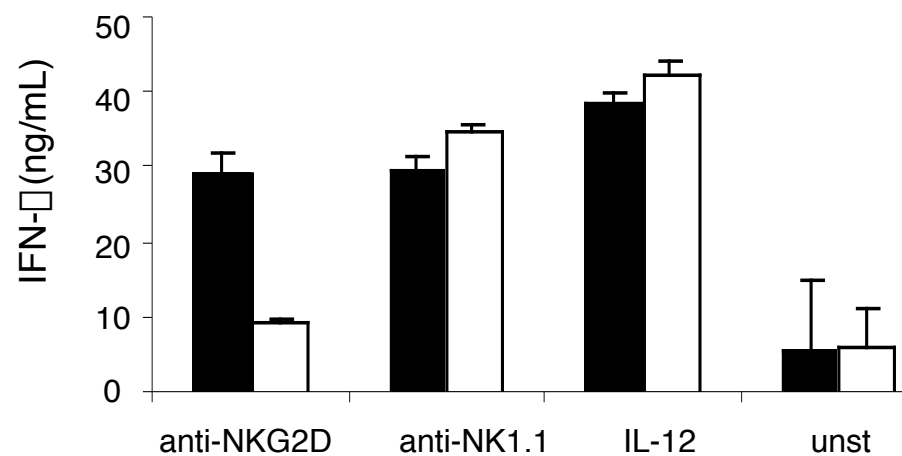



Zompi et al. Figure 9

a. Resting NK cells

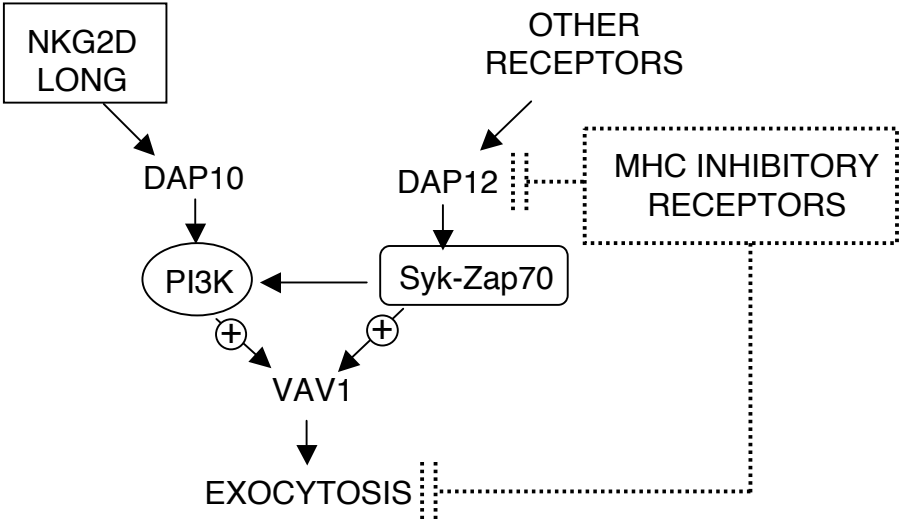

b. Activated NK cells

