

UC Irvine

UC Irvine Previously Published Works

Title

Search for excited τ -leptons and leptoquarks in the final state with τ -leptons and jets in pp collisions at $s = 13$ TeV with the ATLAS detector

Permalink

<https://escholarship.org/uc/item/4ck64157>

Journal

Journal of High Energy Physics, 2023(6)

ISSN

1126-6708

Authors

Aad, G

Abbott, B

Abeling, K

et al.

Publication Date

2023

DOI

10.1007/jhep06(2023)199

Copyright Information

This work is made available under the terms of a Creative Commons Attribution License, available at <https://creativecommons.org/licenses/by/4.0/>

Peer reviewed

Search for excited τ -leptons and leptoquarks in the final state with τ -leptons and jets in pp collisions at $\sqrt{s} = 13$ TeV with the ATLAS detector



The ATLAS collaboration

E-mail: atlas.publications@cern.ch

ABSTRACT: A search is reported for excited τ -leptons and leptoquarks in events with two hadronically decaying τ -leptons and two or more jets. The search uses proton-proton (pp) collision data at $\sqrt{s} = 13$ TeV recorded by the ATLAS experiment during the Run 2 of the Large Hadron Collider in 2015–2018. The total integrated luminosity is 139 fb^{-1} . The excited τ -lepton is assumed to be produced and to decay via a four-fermion contact interaction into an ordinary τ -lepton and a quark-antiquark pair. The leptoquarks are assumed to be produced in pairs via the strong interaction, and each leptoquark is assumed to couple to a charm or lighter quark and a τ -lepton. No excess over the background prediction is observed. Excited τ -leptons with masses below 2.8 TeV are excluded at 95% CL in scenarios with the contact interaction scale Λ set to 10 TeV. At the extreme limit of model validity where Λ is set equal to the excited τ -lepton mass, excited τ -leptons with masses below 4.6 TeV are excluded. Leptoquarks with masses below 1.3 TeV are excluded at 95% CL if their branching ratio to a charm quark and a τ -lepton equals 1. The analysis does not exploit flavour-tagging in the signal region.

KEYWORDS: Exotics, Hadron-Hadron Scattering

ARXIV EPRINT: [2303.09444](https://arxiv.org/abs/2303.09444)

Contents

1	Introduction	1
2	ATLAS detector	3
3	Data and Monte Carlo samples	4
3.1	Signal MC samples	5
3.2	Background MC samples	6
4	Event reconstruction	8
5	Search strategy	9
5.1	Signal region	11
5.2	$Z(\tau\tau)$ control and validation regions	11
5.3	Top control and validation regions	12
5.4	Fake validation regions	12
6	Background and signal estimate	13
6.1	Uncertainties in MC predictions	13
6.2	$Z(\tau\tau)$ background estimate	13
6.3	Top background estimate	14
6.4	Fake background estimate	14
6.4.1	Fake background in Top CR and VR	14
6.4.2	Fake background in SR and in $Z(\tau\tau)$ CR and VR	16
7	Results	17
8	Conclusion	19
	The ATLAS collaboration	27

1 Introduction

The quarks and leptons in the Standard Model (SM) could be composed of more fundamental particles. The constituents are called preons in a model of composite quarks and leptons by Baur, Spira, and Zerwas [1]. The model predicts the existence of excited states towering over the known SM leptonic and quark ground states. A transition of the excited leptons into the ordinary ones would proceed either via interaction with SM gauge bosons (Gauge Interaction, or GI) or via a new type of interaction. In the present analysis, an effective

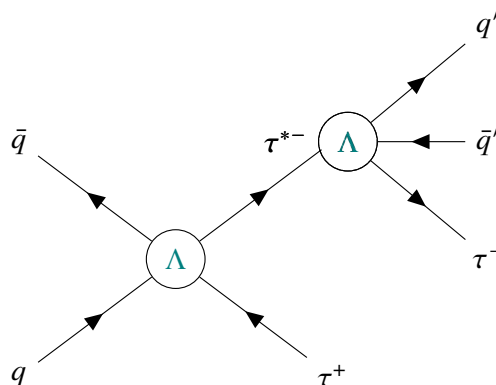

Figure 1. Feynman diagram for τ^* production and decay. The compositeness scale below which eq. (1.1) holds is denoted by Λ .

four-fermion contact interaction (CI) is used. After simplification [1], the CI interaction Lagrangian reads:

$$\mathcal{L}_{\text{CI}} = \frac{(4\pi)^2}{\Lambda^2} \frac{1}{2} j^\mu j_\mu \tag{1.1}$$

where

$$j_\mu = \bar{f}_L \gamma_\mu f_L + \bar{f}_L^* \gamma_\mu f_L^* + \bar{f}_L^* \gamma_\mu f_L + \text{h.c.} \tag{1.2}$$

and Λ is a compositeness scale below which eq. (1.1) holds. In eq. (1.2), f_L and f_L^* stand for left-handed components of ordinary and excited fermion fields, respectively. In pp interactions at the LHC, the GI plays a negligible role in the excited lepton production for $m_{\ell^*} > 300$ GeV and $\Lambda \gtrsim 15$ TeV, the range the analysis reported here focuses on. Both the GI and CI are important in excited lepton decays [2]. However, the CI decays dominate for values of m_{ℓ^*}/Λ larger than 0.1–0.3 depending on the model parameters [3]. As m_{ℓ^*}/Λ nears one, the effective four-fermion CI description becomes inaccurate, with a severity that depends on the underlying physics [1]. The weaker the coupling between an excited lepton and SM gauge bosons, the lower the importance of GI decays. In the analysis reported here, the GI couplings are assumed to be zero. The only non-zero CI term considered is the CI between two quarks and two leptons. The focus of the present search is on the process represented in figure 1. Previous searches for excited tau leptons, τ^* , were done at LEP, with the ALEPH [4], DELPHI [5], L3 [6], and OPAL [7] experiments, and at the LHC, with data collected by the ATLAS experiment at 8 TeV [8]. The last excluded the existence of τ^* with mass below 2.5 TeV for a scenario in which the compositeness scale Λ is equal to the τ^* mass. The study focused on τ^* predicted by the same model [1] as in the current paper, but both the GI and CI decays were considered. However, it is possible to compare these results with the analysis reported here in the regime of m_{ℓ^*}/Λ values close to one or negligible τ^* coupling to the SM gauge bosons. In this regime, the CI decays dominate.

Leptoquarks (LQs) are hypothetical particles predicted by many extensions of the SM [9–16]. Each LQ simultaneously couples to a lepton and a quark, hence its name. Scalar LQs couple to a lepton-quark pair via a Yukawa-type interaction [17], with a Yukawa coupling constant denoted by λ . LQs can also have spin 1, but this scenario is not considered

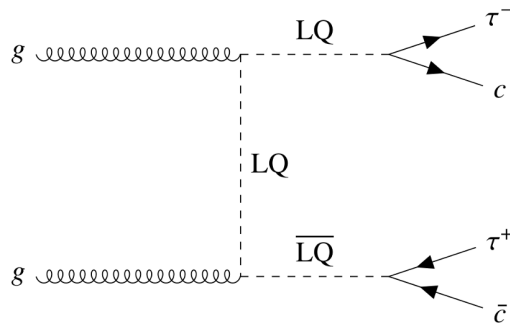

Figure 2. An example Feynman diagram of the LQ pair production and decay in pp collisions at the LHC.

in this analysis. LQs are colour-triplet particles, and they carry a fractional electric charge. Due to their colour charge, they can be produced via the strong interaction in pp collisions at the LHC, as depicted in figure 2. The LQ pair production is mostly insensitive to the Yukawa coupling, λ , [16] in the mass range considered. Many models assume that LQs can couple just to one specific fermion generation. Such an assumption is made in the minimal Buchmüller-Rückl-Wyler (BRW) model [18]. The focus in this work is on the search for a LQ that couples to a τ -lepton and a c -quark, as suggested in ref. [16]. The assumed branching ratio to this fermion pair is one. It is the first ATLAS search for such a LQ. A cross-generation LQ coupling is motivated by recent anomalies in measurements of $R(D)$ and $R(D^*)$ testing lepton flavour universality in low energy experiments [19–24]. If the deviations persist, they are explainable by a particular LQ type coupling to the c -quark– τ -lepton pair [25]. Given that the analysis does not use flavour-tagging of jets in the signal region and the event kinematics are very similar if lighter quarks are considered, the results presented here hold for scenarios in which LQs couple to a τ -lepton and a u -, d - or s -quark, as well. A similar search conducted by CMS [26] using a benchmark model with a LQ coupling to a τ -lepton and a b -quark resulted in a lower mass limit of 1.02 TeV. However, similar to this study, the CMS analysis does not use jet flavour-tagging in the signal region and is also sensitive to the LQ decay study reported here.

2 ATLAS detector

The ATLAS detector [27] at the LHC is a multipurpose particle physics detector with a forward-backward symmetric cylindrical geometry and nearly 4π coverage in solid angle.¹ It consists of an inner tracking detector surrounded by a thin superconducting solenoid, electromagnetic and hadron calorimeters, and a muon spectrometer incorporating three large superconducting air-core toroidal magnets.

¹ATLAS uses a right-handed coordinate system with its origin at the nominal interaction point (IP) in the centre of the detector and the z -axis along the beam pipe. The x -axis points from the IP to the centre of the LHC ring, and the y -axis points upwards. Cylindrical coordinates (r, ϕ) are used in the transverse plane, ϕ being the azimuthal angle around the z -axis. The pseudorapidity is defined in terms of the polar angle θ as $\eta = -\ln \tan(\theta/2)$. Angular distance is measured in units of $\Delta R \equiv \sqrt{(\Delta\eta)^2 + (\Delta\phi)^2}$.

The inner-detector system is immersed in a 2 T axial magnetic field and provides charged-particle tracking in the range of $|\eta| < 2.5$. The high-granularity silicon pixel detector covers the vertex region and typically provides four measurements per track, the first hit normally being in the insertable B-layer (IBL) installed before Run 2 [28, 29]. It is followed by the silicon microstrip tracker (SCT), which usually provides eight measurements per track. These silicon detectors are complemented by the transition radiation tracker (TRT), which enables radially extended track reconstruction up to $|\eta| = 2.0$. The TRT also provides electron identification information based on the fraction of hits (typically 30 in total) above a higher energy-deposit threshold corresponding to transition radiation.

The calorimeter system covers the pseudorapidity range $|\eta| < 4.9$. In the region $|\eta| < 3.2$, electromagnetic calorimetry is provided by barrel and endcap high-granularity lead/liquid-argon (LAr) calorimeters, with an additional thin LAr presampler covering $|\eta| < 1.8$ to correct for energy loss in material upstream of the calorimeters. Hadron calorimetry is provided by the steel/scintillator-tile calorimeter, segmented into three barrel structures in the region $|\eta| < 1.7$, and two copper/LAr hadron endcap calorimeters. The solid angle coverage is completed with forward copper/LAr and tungsten/LAr calorimeter modules optimised for electromagnetic and hadronic energy measurements respectively.

The muon spectrometer (MS) comprises separate trigger and high-precision tracking chambers measuring the deflection of muons in a magnetic field generated by the superconducting air-core toroidal magnets. The field integral of the toroids ranges between 2.0 and 6.0 T m across most of the detector. Three layers of precision chambers, each consisting of layers of monitored drift tubes, cover the region $|\eta| < 2.7$, complemented by cathode-strip chambers in the forward region, where the background is highest. The muon trigger system covers the range $|\eta| < 2.4$ with resistive-plate chambers in the barrel, and thin-gap chambers in the endcap regions.

Events are selected by the first-level trigger system implemented in custom hardware, followed by selections made by algorithms implemented in software in the high-level trigger [30]. The first-level trigger accepts events from the 40 MHz bunch crossings at a rate below 100 kHz, which the high-level trigger reduces further to record events to disk at about 1 kHz.

An extensive software suite [31] is used in data simulation, in the reconstruction and analysis of real and simulated data, in detector operations, and in the trigger and data acquisition systems of the experiment.

3 Data and Monte Carlo samples

The analysis uses $\sqrt{s} = 13$ TeV pp collisions data recorded by the ATLAS experiment in 2015–2018. The integrated luminosity of the data sample is 139 fb^{-1} . The uncertainty in the combined 2015–2018 integrated luminosity is 1.7 % [32], obtained using the LUCID-2 detector [33] for the primary luminosity measurements. The data sample is selected by requiring good conditions for the beams and the ATLAS detector.

Monte Carlo (MC) simulation is used to model signal and background events. Each generated event is processed with a detailed simulation of the ATLAS detector response to

particles. For background samples, the simulation is entirely based on GEANT4 [34]. The signal MC samples are processed with a fast simulation [35] which relies on a parameterisation of the calorimeter response [36].

The effect of multiple interactions in the same and neighbouring bunch crossings (pileup) is modelled by overlaying the simulated hard-scattering event with inelastic pp events generated with PYTHIA 8.186 [37] using the NNPDF2.3LO set of parton distribution functions (PDF) [38] and the A3 set of tuned parameters [39]. The MC events are weighted to reproduce the distribution of the average number of interactions per bunch crossing ($\langle\mu\rangle$) observed in the data. The $\langle\mu\rangle$ value in data is rescaled by a factor of 1.03 ± 0.04 to improve agreement between data and simulation in the visible inelastic pp cross-section [40].

3.1 Signal MC samples

Signal samples simulating the τ^* production are generated with the PYTHIA 8.243 [41] MC generator with parameters set according to the A14 tune [42] and using the NNPDF2.3LO set of PDFs [38]. The EVTGEN [43] generator interfaced with Pythia is used to simulate decays of unstable particles and to model spin correlations and polarisation of particles in decays of hadrons. The τ^* are produced via CI in $q\bar{q}$ scattering. The same interaction governs their decays into a τ -lepton and a $q\bar{q}$ pair. In the decays, all quark flavours are considered when kinematically allowed. The MC generator is configured with the compositeness scale $\Lambda = 10$ TeV, but the result is also interpreted for other values. The signal samples are produced with steps of 100 GeV for masses between 400 GeV and 1 TeV and steps of 250 GeV between 1 TeV and 10 TeV. Uncertainties in the τ^* MC predictions are taken from PDF variations. The NNPDF [38] uncertainty is determined using 100 replicas [44] provided by the LHAPDF6 tool [45]. A second PDF uncertainty component is derived from the differences between predictions obtained with NNPDF2.3LO [38], MMHT2014LO68CL [46] and CT14LO [47].

Simulated events with pair-produced scalar LQs are generated at next-to-leading-order (NLO) in quantum chromodynamics (QCD) with MADGRAPH5_AMC@NLO 2.6.0 [48], using the method described in ref. [49], in which fixed-order NLO QCD calculations [50, 51] are interfaced to PYTHIA 8.230 [41] for the parton shower (PS) and hadronisation. Parton luminosities are provided by the five-flavour scheme NNPDF3.0NLO set of PDFs [52] with $\alpha_s = 0.118$ and the underlying event (UE) is modelled with the A14 tune [42]. MadSpin [53] is used for the decay of the scalar LQ. The coupling parameter λ is set to 0.3, resulting in a LQ width of about 0.2% of its mass [17, 18]. The charge of the LQ is set to $-1/3e$, and the \bar{LQ} has the opposite charge. The LQ is assumed to couple to just one lepton-quark pair, namely $\tau - c$. The kinematics stays the same if an s -quark is used instead of a c -quark. Therefore, any results are applicable to LQs coupling to a light quark and a τ -lepton as well. The signal samples are produced for masses between 500 GeV and 1.7 TeV in steps of 100 GeV. Contributions from higher-order corrections in perturbation theory are estimated by varying the renormalisation, μ_R , and the factorisation, μ_F , scales [44]. The NNPDF [52] uncertainty is determined using 100 replicas [44]. A second PDF uncertainty component is derived from the differences between predictions obtained with NNPDF3.0NLO [52], MMHT2014NLO68CL [46] and CT14 [47]. The uncertainty in α_s is obtained by varying α_s

by ± 0.001 from the nominal value ($\alpha_s = 0.118$). The initial state radiation (ISR) uncertainty is estimated by varying the Var3c parameter of the A14 tune [54]. Total cross-sections of the LQ-pair production are obtained from calculating the pair production of scalar-coloured particles [55–58]. Production of the supersymmetric partners of the top quark is used in these calculations; however, since they have the same production modes as scalar LQs and their pair-production cross-section depends only on their mass, their cross-sections apply also to the model used in this analysis. The cross-sections are computed at approximate next-to-next-to-leading-order (NNLO) in QCD with resummation of next-to-next-to-leading order logarithmic (NNLL) soft gluon terms. The cross-sections do not include lepton t -channel contributions, which are neglected in ref. [49] and may lead to corrections at the per cent level [59].

3.2 Background MC samples

The production of a vector boson (W , Z) and jets (V +jets) is simulated with the SHERPA 2.2.1 [60] generator using NLO matrix elements (ME) for up to two partons, and leading-order (LO) matrix elements for up to four partons calculated with the Comix [61] and OPENLOOPS [62–64] libraries. They are matched with the SHERPA parton shower [65] using the MEPS@NLO prescription [66–69] using the set of tuned parameters developed by the SHERPA authors. The NNPDF3.0NNLO set of PDFs [52] is used and the samples are normalised to an NNLO prediction [70]. Uncertainties in the MC prediction due to higher-order corrections are estimated by varying μ_R and μ_F [44]. Uncertainties due to α_s and the PDF choice are estimated similarly to those for the LQ MC. The uncertainty due to the jet-parton matching scheme (CKKW [68]) is estimated by varying the nominal value of the corresponding scale of 20 GeV to 15 and 30 GeV. The uncertainty related to the resummation scale choice is estimated by varying the nominal value by factors of 0.5 and 2 [60].

The production of $t\bar{t}$ and single top quark (tW , tb , tq) events is modelled using the POWHEG BOX v2 [71–74] generator at NLO with the NNPDF3.0NLO [52] PDF set. In the $t\bar{t}$ sample, only the QCD production is considered. The h_{damp} parameter² for the $t\bar{t}$ sample is set to $1.5 m_{\text{top}}$ [75]. The events are interfaced to PYTHIA 8.230 [41] to model the parton shower, hadronisation, and underlying event, with parameters set according to the A14 tune [42] and using the NNPDF2.3LO set of PDFs [38]. The decays of bottom and charm hadrons are performed by EVTGEN 1.6.0 [43]. In the tW sample, the diagram removal scheme [76] is used to remove interference and overlap with $t\bar{t}$ production. The related uncertainty is estimated by comparison with an alternative sample generated using the diagram subtraction scheme [75, 76]. The uncertainty due to ISR is estimated by simultaneously varying μ_R , μ_F and the Var3c parameter of the A14 tune [54]. The PDF uncertainty is derived from 30 PDF variations according to the PDF4LHC [77] recommendations. The impact of using a different parton shower and hadronisation model is evaluated by comparing the nominal $t\bar{t}$ or single-top quark samples with other event

²The h_{damp} parameter is a resummation damping factor and one of the parameters that controls the matching of POWHEG matrix elements to the parton shower and thus effectively regulates the high- p_T radiation against which the $t\bar{t}$ system recoils.

samples produced with the POWHEG BOX v2 [71–74] generator using the NNPDF3.0NLO [52] PDF set. Events in the latter sample are interfaced with HERWIG 7.04 [78, 79], using the H7UE set of tuned parameters [79] and the MMHT2014LO PDF set [46]. To assess the uncertainty in the matching of NLO matrix elements to the parton shower, the nominal $t\bar{t}$ sample is compared with a sample generated with the MADGRAPH5_AMC@NLO 2.6.0 generator at NLO in QCD using the NNPDF3.0NLO PDF set. For single-top samples, the MADGRAPH5_AMC@NLO 2.6.2 [48] generator with the NNPDF2.3NLO [52] PDF set was used instead. The events were interfaced with PYTHIA 8.230 [41], using the A14 set of tuned parameters [42] and the NNPDF2.3LO PDF set [38]. As previous analyses [80, 81] demonstrated, the modelling of the background produced by top quarks can be improved by correcting all $t\bar{t}$ samples to match their top quark p_T , $t\bar{t}$ mass and $t\bar{t}$ p_T distributions to those predicted at NNLO in QCD and NLO in EW. Top quark pair differential calculations from ref. [82] are used for this correction. The reweighting is done sequentially in the three variables. Uncertainties in the reweighting are due to PDFs, including the photon PDF, QCD scale variations, modelling of more than two QCD emissions, and the order in which the three spectra are reweighted. The full NLO EW correction is taken as uncertainty as well.

Samples of diboson (VV) final states are simulated with the SHERPA 2.2.1 or 2.2.2 [60] generator depending on the process, including off-shell effects and Higgs boson contributions, where appropriate. Fully leptonic final states and semileptonic final states, where one boson decays leptonically and the other hadronically, are generated using matrix elements at NLO in QCD for up to one additional parton and at LO for up to three additional parton emissions. Samples for the loop-induced processes $gg \rightarrow VV$ are generated using LO matrix elements for up to one additional parton emission for both the fully leptonic and semileptonic final states. The matrix element calculations are matched and merged with the SHERPA parton shower based on Catani-Seymour dipole factorisation [61, 65] using the MEPS@NLO prescription [66–69]. The virtual QCD corrections are provided by the OPENLOOPS library [62–64]. The NNPDF3.0NNLO set of PDFs is used [52], along with a dedicated set of tuned parton-shower parameters developed by the SHERPA authors. The only uncertainty considered is due to missing higher-order corrections, which are estimated similarly to those for the V +jets.

Table 1 shows a summary of the MC samples used to simulate the main signal and background processes.

Sample	Generator		PDF	Tune
	ME	PS		
Signal τ^*	PYTHIA 8.243		NNPDF2.3LO	A14
Signal LQ	MG5_AMC 2.6.0	PYTHIA 8.230	NNPDF3.0NLO	A14
V+jets	SHERPA 2.2.1		NNPDF3.0NNLO	SHERPA
$t\bar{t}$	POWHEG BOX v2	PYTHIA 8.230	NNPDF3.0NLO	A14
Single-top	POWHEG BOX v2	PYTHIA 8.230	NNPDF3.0NLO	A14
Diboson	SHERPA 2.2.1 or 2.2.2		NNPDF3.0NNLO	SHERPA

Table 1. Overview of the main MC samples used for the signal and background simulation. MG5_AMC 2.6.0 is an abbreviation for MADGRAPH5_AMC@NLO 2.6.0.

4 Event reconstruction

In the data sample used for the present analysis, the number of pp collisions occurring simultaneously in a bunch crossing varies from about 20 to 70. The locations of individual pp collisions are called vertices, and each of them is reconstructed from at least two tracks with $p_T > 500$ MeV. Additional requirements on the tracks guarantee that they originate in a region where the beams overlap in the transverse plane. The primary vertex is defined as the vertex with the largest sum of squared p_T of its matched tracks [83].

Each electron candidate consists of a track matched to a cluster of energy deposited in the electromagnetic calorimeter [84]. Selection criteria for the track impact parameters are imposed to guarantee that the track originates at the primary vertex. The transverse, d_0 , and longitudinal, z_0 , impact parameters are required to satisfy $d_0/\sigma(d_0) < 5$ and $|z_0 \sin \theta| < 5$ mm where $\sigma(d_0)$ is the uncertainty in d_0 and θ is the track's polar angle. The pseudorapidity of the calorimeter energy cluster must satisfy $|\eta_{\text{cluster}}| < 1.37$ or $1.52 < |\eta_{\text{cluster}}| < 2.47$. The electron candidates are required to have $p_T > 15$ GeV and to be identified as electrons using the *Loose* selection criterion described in ref. [85]. A multivariate algorithm further suppresses non-prompt electrons from b -hadron decays. It is an improved version of the isolation technique described in ref. [86].

Each muon candidate consists of a track reconstructed in the inner detector matched to a track found in the muon spectrometer. Information about the two tracks is combined to get a more precise measurement of the muon momentum [87]. The resulting track is then required to satisfy the same criteria for the impact parameters as electron tracks. Finally, muon candidates are selected if they have $p_T > 7$ GeV, $|\eta| < 2.5$ and satisfy the *High- p_T* identification (ID) described in ref. [87]. Muons are also required to satisfy similar lepton isolation criteria as electrons.

Hadronically decaying τ -lepton candidates, τ_{had} , are reconstructed from energy clusters in the calorimeters and matched inner detector tracks [88–90]. The transverse momentum of τ_{had} cannot be fully reconstructed because of an undetected neutrino. The energy scale of the visible decay products of the τ_{had} is measured using $Z \rightarrow \mu\tau_{\text{had}}3\nu$ events. Five categories (decay modes) of hadronic decays are reconstructed: decays with one matched track and either zero, one or more neutral particles, and decays with three matched tracks and either

zero or more neutral particles. Only τ_{had} s with reconstructed electric charge $|q| = 1$ are selected. Each τ_{had} is required to have $p_{\text{T}} > 20$ GeV, $|\eta| < 1.37$ or $1.52 < |\eta| < 2.5$ and to have a score greater than 0.01 from an ID algorithm based on Recurrent Neural Networks (RNN) [91]. In the MC samples, each τ_{had} candidate is required to geometrically match the generator-level τ , electron, or muon particle. The requirement aims to remove jets (from the hadronisation of quarks or gluons) misidentified as τ_{had} from the MC samples. Background from jets misidentified as τ_{had} is estimated by using a data-driven technique (see section 6.4). However, background from light leptons misidentified as τ_{had} is estimated by using the MC.

Jets are reconstructed from constituents built according to the particle flow algorithm that exploits both the tracks and calorimeter energy clusters [92, 93]. The particle flow objects are passed to the anti- k_t algorithm [94, 95] with a radius parameter of $R = 0.4$ to form jets with a four-momentum recombination scheme. Jet energy is calibrated to the hadronic scale with the effect of pileup removed [93]. In situ jet calibration consists of measurements with Z +jets, γ +jets and multijet events, and it is also used to derive the jet energy scale (JES) uncertainty. Jets are required to have $p_{\text{T}} > 20$ GeV and $|\eta| < 4.5$.

As the data are reconstructed by independent algorithms for each type of object, it is common for the same detector energy depositions to be reconstructed as several different types of objects. For example, a τ_{had} is almost always reconstructed as a jet. It is necessary to remove this ambiguity and keep each object only once. The procedure for removing the redundant reconstructed objects is described in ref. [96].

A multivariate b -tagging algorithm is used to tag jets as originating from a b -quark [97–99]. It exploits information about the impact parameters of displaced tracks and properties of vertices in the jets. The algorithm tags jets with $p_{\text{T}} > 20$ GeV and $|\eta| < 2.5$. A fixed 85% efficiency working point is used to select top-quark-enriched events to estimate this background.

Another multivariate algorithm, the Jet Vertex Tagger (JVT) [100], is used to veto jets with $p_{\text{T}} < 60$ GeV and $|\eta| < 2.5$ if their constituent tracks are not consistent with the primary event vertex. Similarly, a forward Jet Vertex Tagging (fJVT) [101] algorithm vetoes jets with $p_{\text{T}} < 60$ GeV and $|\eta| > 2.5$. If a jet fails either of the two algorithms, then it is rejected.

The missing transverse momentum $\vec{p}_{\text{T}}^{\text{miss}}$ is defined as the negative vectorial sum of transverse momenta of all objects in the event. Soft particle tracks not matched to any object are taken into account via a separate ‘soft term’ [102]. The magnitude of the $\vec{p}_{\text{T}}^{\text{miss}}$ is referred to as $E_{\text{T}}^{\text{miss}}$.

5 Search strategy

A search is made for two hypothetical particles: a τ^* , produced and decayed in the process shown in figure 1, and a LQ, coupling to a τ -lepton and a c -quark. The LQ is produced in a particle-antiparticle pair (see figure 2). Both models predict an excess of events with two τ -leptons and two jets over the SM expectation. In the present analysis, no jet flavour-tagging is used in the signal region, and only hadronic τ -lepton decays are considered. τ^* s

and LQs with masses above 300 GeV and 500 GeV, respectively, are considered in this search; therefore, the number of events with high-momentum jets and τ_{had} s is enhanced in both signal types. The analysis signal region (SR) is designed to select these events. A particularly sensitive variable to the signal is the scalar sum of transverse momenta of the two leading- p_T jets and the two τ_{had} s, referred to as S_T .

The main backgrounds are events containing a Z boson that decays into τ -leptons, $t\bar{t}$ and single top quark events (together referred to as Top), and Fake τ_{had} events. Fake τ_{had} events contain at least one jet misidentified as τ_{had} , and their yields are estimated from data. The shapes of the kinematic distributions of the $Z(\tau\tau)$ and Top backgrounds are estimated from MC, while their total yield is determined from data. Dedicated $Z(\tau\tau)$ and Top control regions (CRs) are used to improve the MC predictions. In addition, small backgrounds such as $Z(\ell\ell)$ (with ℓ being an electron or a muon), diboson, and W production are also considered. These backgrounds contain events where one or two light leptons (mainly electrons) are misidentified as τ_{had} . These events are treated in the same way as backgrounds with real τ -leptons.

The hypothesised existence of τ^* s and LQs is probed in a statistical test based on a profile likelihood ratio test statistic. Background and signal templates are binned in S_T in the SR and both the CRs. Systematic uncertainties are implemented in the likelihood function as parameters with a constraint term (nuisance parameters, or NPs). The NPs control the shape and normalisation of the MC templates used in the binned maximum-likelihood fit. For each systematic uncertainty, an NP is defined so that a value of 0 corresponds to the nominal MC prediction, the values of ± 1 correspond to the $\pm 1\sigma$ systematic variation of the MC template (constructed according to the methodology prescribed for the given systematic uncertainty), and for any value in between the shape is an interpolation between the nominal and varied template. The uncertainty due to the limited sample size of the MC templates is parameterised by NPs with Poisson constraints assigned to each S_T bin of the signal and control regions.

In addition, the fit model has two normalisation factors (NPs without the constraint terms) which control the normalisations of the Top and Z backgrounds, where the Z background consists of all Z decays into charged leptons. The parameter of interest of the analysis is the signal strength μ_{sig} , the normalisation factor of the signal template. Its value and uncertainty are derived in a simultaneous maximum-likelihood fit of the background and signal templates to data in the SR and the two CRs.

For background processes assigned a normalisation factor, Z and Top production, each MC variation is normalised so that its predicted total event yield in the CRs and the SR is the same as the nominal prediction. This normalisation is used because any change in the total yield can always be absorbed into the change of the normalisation factor and has no impact on the parameter of interest. For signal theory uncertainties, the treatment is the same, but the variation of the total yield of signal events is then displayed as an uncertainty band on the predicted cross-section in the limit plot (cf. section 7). The effects of experimental uncertainties (cf. section 6.1) on the total signal event yield are kept at full magnitude.

The background normalisation factors are mostly constrained due to the CRs, which are designed to have a larger sample size and higher purity of events produced by a given

process — $Z(\tau\tau)$ or Top production — than the SR. Therefore, the fit with and without the SR yields similar background predictions. The background modelling of Z , Top, and Fake τ_{had} processes is validated using dedicated validation regions (VRs) for each component.

The likelihood function is built and handled with the HistFitter tool [103] based on the HistFactory [104], RooStats [105], RooFit [106] and MINUIT2 [107] frameworks. A p -value is calculated using asymptotic formulae for the profile likelihood ratio test statistic distribution [108]. The CLs method [109, 110] is used to derive all limits.

5.1 Signal region

The analysis SR consists of events with exactly two reconstructed τ_{had} s and at least two reconstructed jets, as defined in section 4. Events with an electron or a muon are vetoed. The events are triggered with a di- τ_{had} trigger, and the two reconstructed τ_{had} objects must be matched to the trigger objects. The online (offline) p_{T} thresholds for the two τ_{had} s are 35 and 25 GeV (40 and 30 GeV). The leading and subleading τ_{had} in p_{T} are further required to satisfy the *Medium* and *Loose* RNN ID selection criteria [91], respectively. The efficiency of the *Medium* (*Loose*) requirement is 75% (85%) for τ_{had} s with one track and 60% (75%) for τ_{had} s with three tracks. The two τ_{had} s must be geometrically distant from each other, with a criterion $\Delta R > 0.8$, and have opposite signs of the reconstructed electric charge. The collinear di- τ_{had} mass [96, 111], $m_{\tau\tau}^{\text{coll}}$, is required to be larger than 110 GeV to suppress the $Z(\tau\tau)$ background.

The collinear approximation assumes that neutrinos travel in the same direction as the visible τ_{had} decay products and are the only source of $\vec{p}_{\text{T}}^{\text{miss}}$. With this assumption, in the transverse plane, one can decompose the $\vec{p}_{\text{T}}^{\text{miss}}$ vector into two signed components along the directions of the leading and subleading p_{T} of the τ_{had} visible decay products. This provides estimates of the full τ transverse momenta, $p_{\text{T},0}^{\text{coll}}$ and $p_{\text{T},1}^{\text{coll}}$, and the di- τ_{had} invariant mass $m_{\tau\tau}^{\text{coll}}$. For each τ decay, a visible momentum fraction, x , can be calculated from the reconstructed visible transverse momentum, $p_{\text{T}}^{\text{vis}}$, and the estimated full transverse momentum $p_{\text{T}}^{\text{coll}}$, as a ratio $x = p_{\text{T}}^{\text{vis}}/p_{\text{T}}^{\text{coll}}$. If an event contains two genuine τ -lepton decays, these fractions are typically positive for both the leading and subleading τ -lepton decays. However, events with fake τ_{had} s have $\vec{p}_{\text{T}}^{\text{miss}}$ pointing in a random direction, and the fractions can become negative. To suppress events with fake τ_{had} s, the requirements $x_0 > 0.1$ and $x_1 > 0.05$ are used for the leading and subleading τ_{had} , respectively. A selection on the scalar sum of the two reconstructed τ_{had} transverse momenta, L_{T} , is applied: $L_{\text{T}} > 140$ GeV. Besides the requirements on τ_{had} kinematic variables, the two leading jets in p_{T} in the event must have $|\eta| < 2.4$. The leading and subleading jet p_{T} have to satisfy the conditions $p_{\text{T}} > 70$ GeV and 60 GeV, respectively.

In the mass ranges studied, the acceptance-times-efficiency of the SR selection ranges between 3.0 and 7.75% for τ^* and 7.5 and 9.0% for LQ. The maximum is reached for a τ^* mass of 2 TeV and a LQ mass of 1 TeV.

5.2 $Z(\tau\tau)$ control and validation regions

The $Z(\tau\tau)$ CR is defined by selection criteria similar to the SR. Two conditions are different to enrich the region in $Z(\tau\tau)$ events, suppress signal and leave space for a statistically

independent $Z(\tau\tau)$ VR. First, $m_{\tau\tau}^{\text{coll}}$ is required to satisfy $m_{\tau\tau}^{\text{coll}} \in (70, 110)$ GeV to define a region around the Z boson mass peak. Second, L_T must lie in an interval from 100 GeV to 140 GeV. 74% of the events in the $Z(\tau\tau)$ CR originate from Z boson production, and this fraction increases to 90% in the last S_T bin. The fraction of signal events in the region is below 1% for all signal hypotheses described in section 3.1. The $Z(\tau\tau)$ VR is defined by $L_T > 140$ GeV, leaving all the other selection criteria identical to the $Z(\tau\tau)$ CR.

5.3 Top control and validation regions

Defining a Top CR consisting of di- τ_{had} events is difficult. Either there is too much signal or the Top background does not reach high enough values of S_T , needed for reasonable control and validation of the background in a phase space close to the SR. Therefore, the analysis uses a region with exactly one τ_{had} . The events are selected with a single- τ_{had} trigger. The p_T thresholds for the lowest unrescaled single- τ_{had} trigger have changed throughout Run 2. In 2015 and the first part of the 2016 data, the threshold is 80 GeV, corresponding to an offline p_T threshold of 100 GeV. In the second part of the 2016 data, the online (offline) threshold is 125 (140) GeV. In the last part of the 2016 and 2017–2018 data, the online (offline) threshold is 160 (180) GeV. The Top CR definition also has an upper threshold on the reconstructed τ_{had} p_T of 450 GeV in order to remove events containing high-mass signal particles. To enrich the region in Top events, at least four jets (as defined in section 4) are required in each event, out of which two must be b -tagged. Suppression of Fake τ_{had} events is achieved by requiring $E_T^{\text{miss}} > 150$ GeV. 75% of the events in the Top CR originate from Top production, and the fraction decreases to 57% in the last S_T bin. The fraction of signal events in the region is 1% or lower for all τ^* signal hypotheses described in section 3.1. The highest fraction of LQ-pair events in the Top CR is 16%, corresponding to the LQ mass of 500 GeV. The fraction decreases rapidly with increasing LQ mass. The same selection criteria define the Top VR, with only the E_T^{miss} requirement being different: $E_T^{\text{miss}} \in (120, 150)$ GeV.

5.4 Fake validation regions

The Fake background is validated in regions similar to the analysis regions, but with some selection criteria changed to enrich them in jets misidentified as a τ_{had} . A VR for Fake background in the SR is defined by changing the opposite-sign (OS) requirement to same-sign (SS) and by introducing an upper $m_{\tau\tau}^{\text{coll}}$ threshold of 600 GeV to reduce signal leaking in this VR. This VR is referred to as SS Fake VR. To validate the Fake background in the Top CR, a Single- τ_{had} Fake VR is defined by modifying the missing transverse momentum criterion to $E_T^{\text{miss}} \in (30, 50)$ GeV. There is no need for a Fake CR because the Fake background is estimated with a data-driven method. More details of how the Fake background is estimated are given in section 6.4.

6 Background and signal estimate

6.1 Uncertainties in MC predictions

The three main sources of systematic uncertainties considered are theory predictions, the experimental setup, and MC statistical uncertainty. Sources of theoretical uncertainty and their estimates are described in section 3 for each MC sample used in the analysis.

Most experimental systematic uncertainties arise from differences between data and MC. With the use of supporting measurements, the MC simulation is corrected to resemble data as closely as possible (see section 4). Systematic uncertainties from the measurements of these corrections cover the residual differences between data and MC. Differences between the τ -lepton energy scale (TES) in data and MC are estimated by using $Z \rightarrow \tau_\mu \tau_{\text{had}}$ events, measurements of the calorimeter response to single particles and comparisons between simulations using different detector geometries or GEANT4 physics lists [88]. JES uncertainties are estimated by using Z +jets, γ +jets and multijet events and additional components are due to the JES extrapolation to high jet transverse momenta, pile-up JES corrections and quark-flavour effects. Jet energy resolution uncertainties are determined using dijet events and a noise term measurement with random cones [93].

Between MC and data, there are also different efficiencies from the τ_{had} trigger, reconstruction and ID algorithms. The differences are corrected with event weights (scale factors, or SFs), which are functions of the number of τ_{had} s in the event, their p_T , η and the number of matched tracks. The SFs and their uncertainties are estimated by using events with a Z boson or a top-quark that decays into a τ_{had} [88]. Furthermore, SFs are derived to compensate for differences between data and MC for both the efficiency and inefficiency of b -tagging, which are estimated together with their uncertainties using $t\bar{t}$ [98] events. SFs for jet vertex tagging efficiencies are measured using $Z(\mu\mu)$ +jets [100, 101] events.

Each experimental uncertainty NP is assumed to be 100% correlated between the analysis bins and all background and signal processes. The highest ranked NPs are due to the matching of NLO matrix elements to the parton shower in tW MC predictions, and the uncertainty in the interference of the $t\bar{t}$ and tW processes. Another highly ranked NP is due to the TES and it comes from measurements of the calorimeter response to single particles. No NP is strongly pulled or constrained in the fit.

6.2 $Z(\tau\tau)$ background estimate

The Z template is built from simulated $Z(\tau\tau)$ and $Z(\ell\ell)$ events ($\ell = e$ or μ). It is assigned one common unconstrained normalisation factor. In the SR, 93% of the Z background consists of $Z(\tau\tau)$ events; the rest are $Z(\ell\ell)$ events. The $Z(\ell\ell)$ contribution drops to about 4% in the last S_T bin. Figure 3 shows the post-fit S_T spectra and their total uncertainties compared to data in the $Z(\tau\tau)$ CR and VR. The fit with background-only templates is performed using the SR, $Z(\tau\tau)$ and Top CRs. A good agreement between the total background prediction and data validates the modelling of the $Z(\tau\tau)$ background shape. The fitted normalisation factor is compatible with 1.

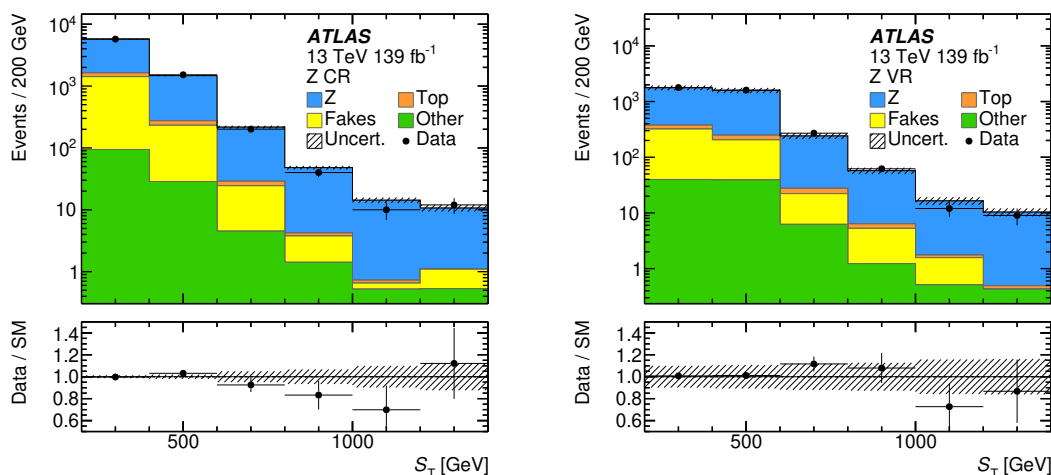

(a) $Z(\tau\tau)$ CR

(b) $Z(\tau\tau)$ VR

Figure 3. Comparison of post-fit S_T spectra with data in the $Z(\tau\tau)$ CR and VR. The hatched band corresponds to the total post-fit uncertainty, considering correlations between the individual NPs. The ratios in the bottom panel are calculated relative to the SM prediction (background-only). The “Other” template consists primarily of diboson background in the $Z(\tau\tau)$ regions. Overflow events are added to the yields in the highest S_T bin.

6.3 Top background estimate

The top background is a sum of $t\bar{t}$ and single top quark production. It is assigned one common unconstrained normalisation factor. In the SR, 91% of the Top background consists of $t\bar{t}$ events; the rest are single top quark events. The single top quark contribution increases with S_T to about 30% in the last bin. However, these fractions change by varying the NP which controls the $t\bar{t}$ - tW interference uncertainty (cf. section 3). The admixtures of $t\bar{t}$ and tW seen in the Top CR and VR, and the SR are similar enough that any differences can be ignored. Modelling of a possible contribution from $t\bar{t} + b$ events to the SR is validated in a dedicated VR, defined by the same selections as the Top CR but requiring the presence of at least three b -tagged jets. Figure 4 shows the post-fit S_T spectra and their total uncertainties compared to data in the Top CR and VR.

The background-only fit described in section 6.2 is performed. A good agreement between the total post-fit background prediction and data is observed. The fitted normalisation factor is compatible with 1.

6.4 Fake background estimate

This section describes the estimate of background due to jets misidentified as τ_{had} . For this purpose, a data-driven Fake Factor (FF) method is used.

6.4.1 Fake background in Top CR and VR

The Fake background templates in the Top CR and VR are constructed using data and MC events taken from anti-ID regions. These regions have the same selection criteria as

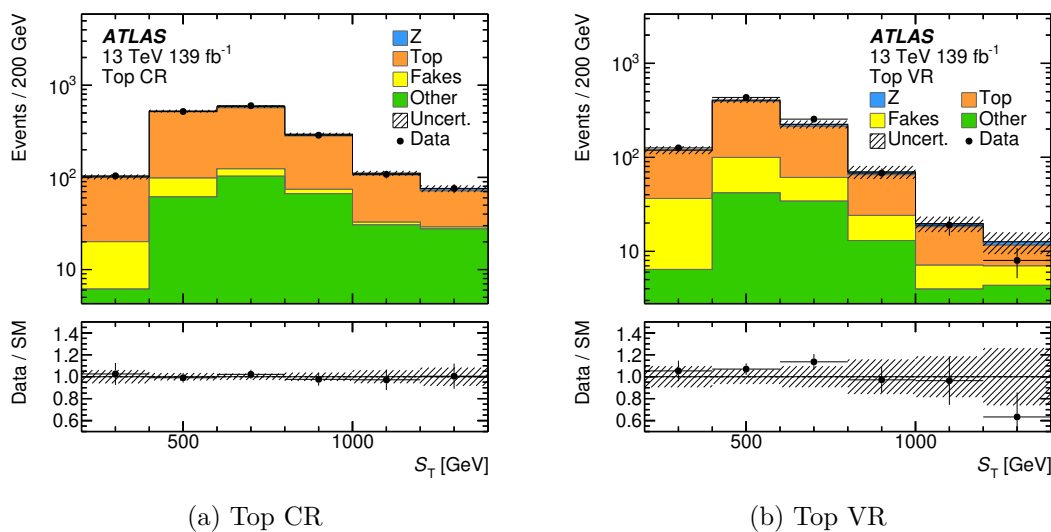
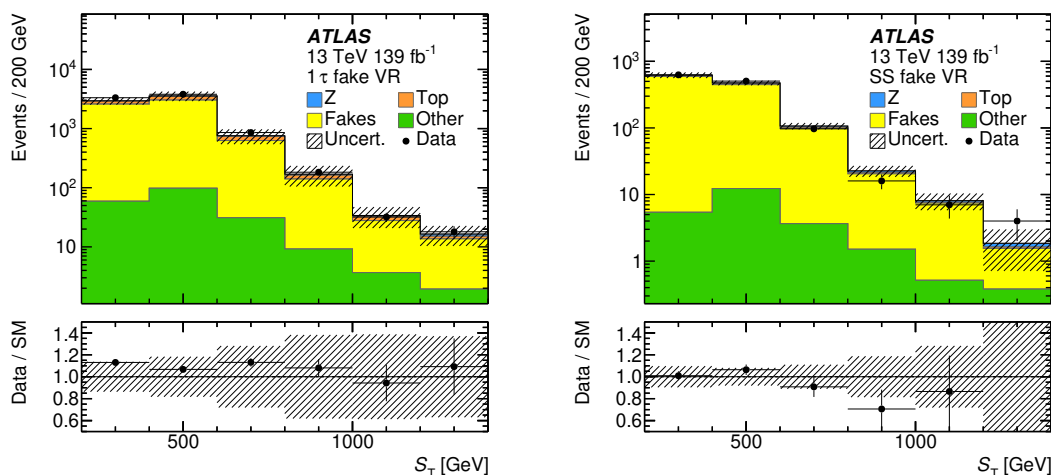

Figure 4. Comparison of post-fit S_T spectra with data in the Top CR and VR. The hatched band corresponds to the total post-fit uncertainty, considering correlations between the individual NPs. The ratios in the bottom panel are calculated relative to the SM prediction (background-only). The “Other” template consists primarily of W background in the Top regions. Overflow events are added to the yields in the highest S_T bin.

the corresponding analysis regions, but with the τ_{had} failing its ID requirement, making the anti-ID regions enriched in Fake background. To make events from the anti-ID regions usable as an estimate of the Fake background in the analysis regions, they must be weighted by FFs to account for different selection efficiencies between τ_{had} ID and anti-ID requirements. The FFs are measured in a region enriched in Fake background, which is orthogonal to both the analysis and anti-ID regions. It is defined by the same selection criteria as the Top CR, but with the E_T^{miss} requirement changed to $E_T^{\text{miss}} < 30$ GeV. The FFs are defined as the ratio of the number of events in which τ_{had} passes the ID criterion over the number of cases when it fails, expressed as a function of the τ_{had} p_T , $|\eta|$ and decay mode. Even though anti-ID and FF-measurement regions contain mostly Fake background, they also contain a small fraction of events with real τ -leptons. This contamination is estimated using the MC and subtracted from data event yields.

There are two sources of systematic uncertainty in the Fake background prediction: statistical uncertainty in the FFs and different composition of Fakes in the FF measurement, and anti-ID regions (Fakes from gluon- and quark-originated jets have different FF). The latter uncertainty is estimated as the difference between the nominal Fake background prediction and two variations. In the first variation, the nominal FF is replaced with an FF measured using quark-enriched Fake events from a dedicated region targeting the $Z(\mu\mu)+\text{jet}$ process. In the second variation, an FF measured in gluon-enriched fake events in a region designed to select mostly dijet events from pile-up collisions is used.

Figure 5a shows a good agreement of the post-fit background prediction with data in the VR, defined in section 5.4. In the region, 84% of events are estimated to be Fake events.



(a) Fake VR for single- τ_{had} events

(b) Fake VR for di- τ_{had} events

Figure 5. Comparison of post-fit S_T spectra with data in the VRs for fake background estimates. The hatched band corresponds to the total post-fit uncertainty, considering correlations between the individual NPs. The ratios in the bottom panel are calculated relative to the SM prediction (background-only). The “Other” template consists primarily of W background in the single- τ_{had} fake VR and diboson background in the di- τ_{had} fake VR. Overflow events are added to the yields in the highest S_T bin.

6.4.2 Fake background in SR and in $Z(\tau\tau)$ CR and VR

The general idea of the fake background estimate in di- τ_{had} events is similar to the one described in the previous section but with some key differences. Because there are two τ_{had} s in the final state, there are three types of events in the anti-ID regions, that depend on whether leading, sub-leading, or both the τ_{had} s fail to satisfy the τ_{had} ID criterion. The first type of events is named Leading anti-ID, the second type Sub-leading anti-ID, and the third type Double anti-ID. Furthermore, because leading and sub-leading τ_{had} s are selected using different τ_{had} ID requirements (*Medium* and *Loose* ID, respectively), two sets of FFs must be measured separately for leading and sub-leading τ_{had} s. When the Fake background template is constructed, the FFs for *Medium* ID are used for Leading anti-ID events, while the FFs for *Loose* ID are used for the Sub-leading anti-ID events. The events with both leptons failing their IDs are weighted with a product of the corresponding FFs and subtracted from the template to remove the double-counting of events with two fake τ_{had} s. Without this subtraction, the double-counting would occur because both the Leading and Sub-leading anti-ID events contain a fraction of events where both the τ_{had} s are misidentified jets.

The FFs for di- τ_{had} events are measured using events with at least one τ_{had} passing the ID criterion, that further satisfy the SS charge requirement and with $m_{\tau\tau}^{\text{coll}} < 110$ GeV or $L_T < 140$ GeV. All the other criteria are identical to the SR, (i.e. the FF measurement region is orthogonal to the SS fake VR defined in section 5.4). The FFs for the leading τ_{had} are measured using events in which the subleading τ_{had} passes its τ_{had} ID and vice-versa for

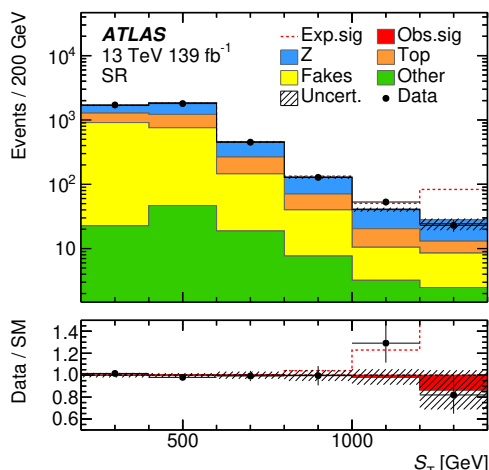

Figure 6. Comparison of total — background plus signal — post-fit S_T spectrum with data in the SR. The hatched band corresponds to the total post-fit uncertainty, considering correlations between the individual NPs. It is centered around the total post-fit prediction. The red histogram corresponds to the signal template for τ^* with a mass of 1500 GeV and the compositeness scale set to $\Lambda = 10$ TeV. Expected (Exp.) and best-fit (Obs.) signal templates are shown. The ratios in the bottom panel are calculated relative to the background-only post-fit predictions (SM). Overflow events are added to the yields in the highest S_T bin.

the sub-leading τ_{had} FFs. The FFs are parameterised as a function of the τ_{had} p_T , $|\eta|$ and decay mode. The method for estimating the systematic uncertainties of the fake background prediction is the same as the one described in the previous section. Figure 5b shows good agreement of the post-fit background prediction with data in the VR. In the region, 93% of events are Fake events.

7 Results

Figure 6 shows data and the post-fit prediction in the SR for one τ^* mass hypothesis. The S_T binning is determined by the requirement of low enough uncertainty due to the limited MC statistics. The expected background and observed data yields are shown in table 2. In ATLAS Run 2 data, 23 events are observed in the most sensitive bin ($S_T > 1200$ GeV) of the signal region, while 28 ± 5 background events are expected. No excess of data over the background expectation is observed.

Figure 7a shows the upper 95% CL limit on the τ^* production cross-section as a function of m_{τ^*} for a fixed value of the CI scale, $\Lambda = 10$ TeV. A τ^* with mass less than 2.8 TeV is excluded at 95% CL for this choice of Λ . Uncertainties in the signal cross-section shown in the plot are estimated as total signal yield variations due to the MC theory uncertainties described in section 3.1 added in quadrature. Figure 7b shows the lower 95% CL limit on Λ as a function of m_{τ^*} . The shaded area corresponds to (Λ, m_{τ^*}) points where the interaction certainly cannot be treated as an effective four-fermion contact interaction [1]. Its boundary

S_T range [GeV]	Other	Fakes	Top	Z	Exp. bkg.	Uncert.	Data
200 – 400	23	887	368	407	1685	35	1711
400 – 600	47	709	464	615	1835	33	1798
600 – 800	19	126	120	189	454	15	451
800 – 1000	7.7	32.4	30.5	58.0	128.6	6.4	128
1000 – 1200	3.2	7.3	9.9	20.6	41.0	2.9	53
> 1200	2.5	6.0	4.5	15.0	28.1	5.0	23

Table 2. Post-fit yields in S_T bins of the SR. The fit was performed for a τ^* with a mass of 1500 GeV. The symmetrised total post-fit uncertainty is shown in the table.

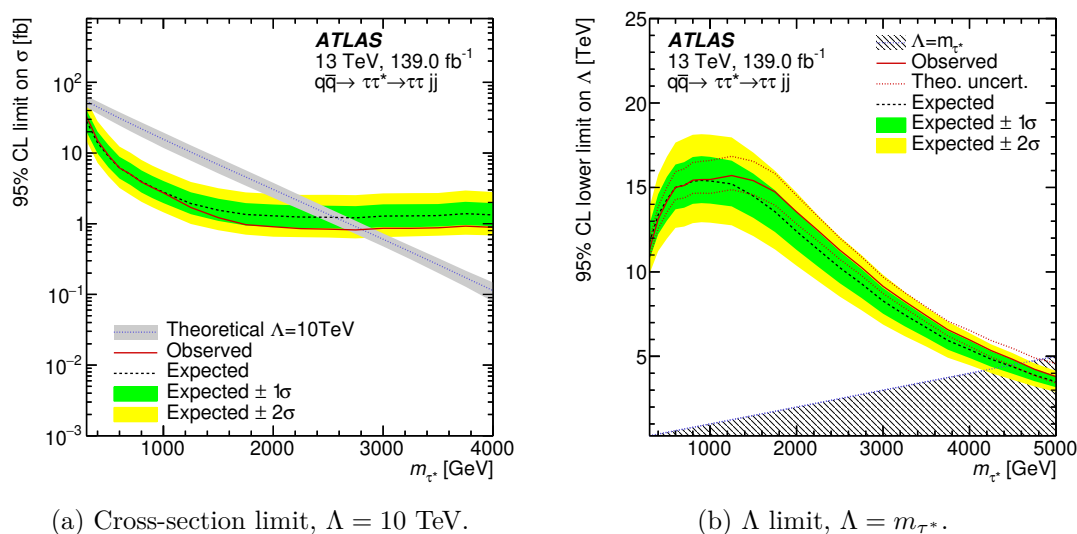

Figure 7. 95% CL limits on selected τ^* model hypotheses. Figure 7a shows the upper 95% CL limit on the τ^* production cross-section as a function of m_{τ^*} for a fixed value of the CI scale, $\Lambda = 10$ TeV. Figure 7b shows the lower 95% CL limit on Λ as a function of m_{τ^*} . The shaded area corresponds to (Λ, m_{τ^*}) points where the interaction cannot be treated as an effective four-fermion contact interaction [1]. The observed and expected limits are shown by the solid red and dashed black lines, respectively. Boundaries of the green (yellow) band display $\pm 1\sigma$ ($\pm 2\sigma$) statistical uncertainty in the expected limit. The dotted blue line and the grey band in figure 7a display the τ^* production cross-section and its uncertainty. The dotted red lines in figure 7b show observed limits on Λ given $\pm 1\sigma$ variations of the signal production cross-section.

is given by a line $\Lambda = m_{\tau^*}$. The intersection of this line with the observed limit gives an upper 95% CL limit on m_{τ^*} of 4.6 TeV for a scenario with $\Lambda = m_{\tau^*}$.

Figure 8 shows the upper 95% CL limit on the LQ production cross-section as a function of mass. Signal cross-sections displayed in the limit plot are computed at approximate NNLO, as described in section 3.1. Leptoquarks with masses below 1.3 TeV are excluded at 95% CL.

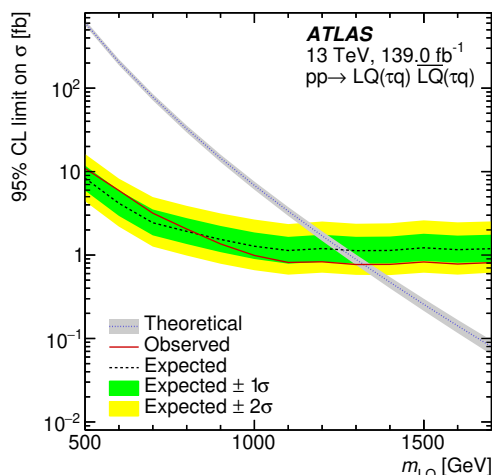

Figure 8. Upper 95% CL limit on the LQ pair production cross-section as a function of mass. The LQ decays into a τ -lepton and a c -quark (or a lighter flavour quark) with a BR of 1. The observed and expected limits are shown by the solid red and dashed black lines, respectively. Boundaries of the green (yellow) band display $\pm 1\sigma$ ($\pm 2\sigma$) statistical uncertainty in the expected limit. The dotted blue line and the grey band display the LQ production cross-section and its uncertainty.

8 Conclusion

A search for τ^* or LQ in events with two τ_{had} s and two or more jets was performed using pp collision data at $\sqrt{s} = 13$ TeV recorded by the ATLAS experiment during the LHC Run 2 in 2015–2018. The total integrated luminosity is 139 fb^{-1} . The τ^* is assumed to be produced and decayed via a four-fermion CI with a τ -lepton and a $q\bar{q}$ pair. The hypothetical LQ is assumed to couple to a c -quark and a τ -lepton and is produced together with its antiparticle via the strong interaction. The BR of the LQ decay is 1. The main backgrounds to the analysis are $Z(\tau\tau)$ and Top production processes, and Fake events. The background is estimated with MC, except for the Fake events whose yields are predicted with a data-driven FF method. No excess of data over the background prediction is observed. τ^* with masses below 2.8 TeV and 4.6 TeV are excluded at 95% CL in scenarios with the CI scale Λ set to 10 TeV and to m_{τ^*} , respectively. For comparison, the previous ATLAS mass limit is 2.5 TeV in the regime $m_{\tau^*} = \Lambda$ [8]. LQs with masses below 1.3 TeV are excluded at 95% CL, assuming the branching ratio for their decay into the c -quark– τ -lepton pair is equal to one. It is the first ATLAS search for such a LQ decay scenario. The analysis does not exploit jet flavour-tagging in the signal region, and the limits hold for hypotheses of a LQ coupling to any lighter quark flavour and the τ -lepton.

Acknowledgments

We thank CERN for the very successful operation of the LHC, as well as the support staff from our institutions without whom ATLAS could not be operated efficiently.

We acknowledge the support of ANPCyT, Argentina; YerPhI, Armenia; ARC, Australia; BMWF and FWF, Austria; ANAS, Azerbaijan; CNPq and FAPESP, Brazil; NSERC,

NRC and CFI, Canada; CERN; ANID, Chile; CAS, MOST and NSFC, China; Minciencias, Colombia; MEYS CR, Czech Republic; DNRF and DNSRC, Denmark; IN2P3-CNRS and CEA-DRF/IRFU, France; SRNSFG, Georgia; BMBF, HGF and MPG, Germany; GSRI, Greece; RGC and Hong Kong SAR, China; ISF and Benoziyo Center, Israel; INFN, Italy; MEXT and JSPS, Japan; CNRST, Morocco; NWO, Netherlands; RCN, Norway; MEiN, Poland; FCT, Portugal; MNE/IFA, Romania; MESTD, Serbia; MSSR, Slovakia; ARRS and MIZŠ, Slovenia; DSI/NRF, South Africa; MICINN, Spain; SRC and Wallenberg Foundation, Sweden; SERI, SNSF and Cantons of Bern and Geneva, Switzerland; MOST, Taiwan; TENMAK, Türkiye; STFC, United Kingdom; DOE and NSF, United States of America. In addition, individual groups and members have received support from BCKDF, CANARIE, Compute Canada and CRC, Canada; PRIMUS 21/SCI/017 and UNCE SCI/013, Czech Republic; COST, ERC, ERDF, Horizon 2020 and Marie Skłodowska-Curie Actions, European Union; Investissements d’Avenir Labex, Investissements d’Avenir IDEX and ANR, France; DFG and AvH Foundation, Germany; Herakleitos, Thales and Aristeia programmes co-financed by EU-ESF and the Greek NSRF, Greece; BSF-NSF and MINERVA, Israel; Norwegian Financial Mechanism 2014-2021, Norway; NCN and NAWA, Poland; La Caixa Banking Foundation, CERCA Programme Generalitat de Catalunya and PROMETEO and GenT Programmes Generalitat Valenciana, Spain; Göran Gustafssons Stiftelse, Sweden; The Royal Society and Leverhulme Trust, United Kingdom.

The crucial computing support from all WLCG partners is acknowledged gratefully, in particular from CERN, the ATLAS Tier-1 facilities at TRIUMF (Canada), NDGF (Denmark, Norway, Sweden), CC-IN2P3 (France), KIT/GridKA (Germany), INFN-CNAF (Italy), NL-T1 (Netherlands), PIC (Spain), ASGC (Taiwan), RAL (U.K.) and BNL (U.S.A.), the Tier-2 facilities worldwide and large non-WLCG resource providers. Major contributors of computing resources are listed in ref. [112].

Open Access. This article is distributed under the terms of the Creative Commons Attribution License ([CC-BY 4.0](https://creativecommons.org/licenses/by/4.0/)), which permits any use, distribution and reproduction in any medium, provided the original author(s) and source are credited. SCOAP³ supports the goals of the International Year of Basic Sciences for Sustainable Development.

References

- [1] U. Baur, M. Spira and P.M. Zerwas, *Excited Quark and Lepton Production at Hadron Colliders*, *Phys. Rev. D* **42** (1990) 815 [[INSPIRE](#)].
- [2] ATLAS collaboration, *Search for excited electrons singly produced in proton-proton collisions at $\sqrt{s} = 13$ TeV with the ATLAS experiment at the LHC*, *Eur. Phys. J. C* **79** (2019) 803 [[arXiv:1906.03204](#)] [[INSPIRE](#)].
- [3] CMS collaboration, *Search for an excited lepton that decays via a contact interaction to a lepton and two jets in proton-proton collisions at $\sqrt{s} = 13$ TeV*, *JHEP* **05** (2020) 052 [[arXiv:2001.04521](#)] [[INSPIRE](#)].
- [4] ALEPH collaboration, *Search for evidence of compositeness at LEP I*, *Eur. Phys. J. C* **4** (1998) 571 [[INSPIRE](#)].

- [5] DELPHI collaboration, *Search for excited leptons in $e^+ e^-$ collisions at $s^{*(1/2)} = 189\text{-GeV}$ to 209-GeV* , *Eur. Phys. J. C* **46** (2006) 277 [[hep-ex/0603045](#)] [[INSPIRE](#)].
- [6] L3 collaboration, *Search for excited leptons at LEP*, *Phys. Lett. B* **568** (2003) 23 [[hep-ex/0306016](#)] [[INSPIRE](#)].
- [7] OPAL collaboration, *Search for charged excited leptons in $e^+ e^-$ collisions at $s^{*(1/2)} = 183\text{-GeV}$ to 209-GeV* , *Phys. Lett. B* **544** (2002) 57 [[hep-ex/0206061](#)] [[INSPIRE](#)].
- [8] ATLAS collaboration, *Search for new phenomena in events with three or more charged leptons in pp collisions at $\sqrt{s} = 8\text{ TeV}$ with the ATLAS detector*, *JHEP* **08** (2015) 138 [[arXiv:1411.2921](#)] [[INSPIRE](#)].
- [9] S. Dimopoulos and L. Susskind, *Mass Without Scalars*, *Nucl. Phys. B* **155** (1979) 237 [[INSPIRE](#)].
- [10] S. Dimopoulos, *Technicolored Signatures*, *Nucl. Phys. B* **168** (1980) 69 [[INSPIRE](#)].
- [11] E. Eichten and K.D. Lane, *Dynamical Breaking of Weak Interaction Symmetries*, *Phys. Lett. B* **90** (1980) 125 [[INSPIRE](#)].
- [12] V.D. Angelopoulos et al., *Search for New Quarks Suggested by the Superstring*, *Nucl. Phys. B* **292** (1987) 59 [[INSPIRE](#)].
- [13] W. Buchmüller and D. Wyler, *Constraints on SU(5) Type Leptoquarks*, *Phys. Lett. B* **177** (1986) 377 [[INSPIRE](#)].
- [14] J.C. Pati and A. Salam, *Lepton Number as the Fourth Color*, *Phys. Rev. D* **10** (1974) 275 [[INSPIRE](#)].
- [15] H. Georgi and S.L. Glashow, *Unity of All Elementary Particle Forces*, *Phys. Rev. Lett.* **32** (1974) 438 [[INSPIRE](#)].
- [16] B. Diaz, M. Schmaltz and Y.-M. Zhong, *The leptoquark Hunter's guide: Pair production*, *JHEP* **10** (2017) 097 [[arXiv:1706.05033](#)] [[INSPIRE](#)].
- [17] A. Belyaev, C. Leroy, R. Mehdiev and A. Pukhov, *Leptoquark single and pair production at LHC with CalcHEP/CompHEP in the complete model*, *JHEP* **09** (2005) 005 [[hep-ph/0502067](#)] [[INSPIRE](#)].
- [18] W. Buchmüller, R. Rückl and D. Wyler, *Leptoquarks in Lepton-Quark Collisions*, *Phys. Lett. B* **191** (1987) 442 [[INSPIRE](#)].
- [19] BABAR collaboration, *Measurement of an Excess of $\bar{B} \rightarrow D^{(*)} \tau^- \bar{\nu}_\tau$ Decays and Implications for Charged Higgs Bosons*, *Phys. Rev. D* **88** (2013) 072012 [[arXiv:1303.0571](#)] [[INSPIRE](#)].
- [20] BELLE collaboration, *Measurement of the branching ratio of $\bar{B} \rightarrow D^{(*)} \tau^- \bar{\nu}_\tau$ relative to $\bar{B} \rightarrow D^{(*)} \ell^- \bar{\nu}_\ell$ decays with hadronic tagging at Belle*, *Phys. Rev. D* **92** (2015) 072014 [[arXiv:1507.03233](#)] [[INSPIRE](#)].
- [21] LHCb collaboration, *Measurement of the ratio of branching fractions $\mathcal{B}(\bar{B}^0 \rightarrow D^{*+} \tau^- \bar{\nu}_\tau) / \mathcal{B}(\bar{B}^0 \rightarrow D^{*+} \mu^- \bar{\nu}_\mu)$* , *Phys. Rev. Lett.* **115** (2015) 111803 [Erratum *ibid.* **115** (2015) 159901] [[arXiv:1506.08614](#)] [[INSPIRE](#)].
- [22] BELLE collaboration, *Measurement of the τ lepton polarization and $R(D^*)$ in the decay $\bar{B} \rightarrow D^* \tau^- \bar{\nu}_\tau$* , *Phys. Rev. Lett.* **118** (2017) 211801 [[arXiv:1612.00529](#)] [[INSPIRE](#)].
- [23] BELLE collaboration, *Measurement of the branching ratio of $\bar{B}^0 \rightarrow D^{*+} \tau^- \bar{\nu}_\tau$ relative to $\bar{B}^0 \rightarrow D^{*+} \ell^- \bar{\nu}_\ell$ decays with a semileptonic tagging method*, *Phys. Rev. D* **94** (2016) 072007 [[arXiv:1607.07923](#)] [[INSPIRE](#)].

- [24] LHCb collaboration, *Measurement of the ratio of branching fractions $\mathcal{B}(B_c^+ \rightarrow J/\psi\tau^+\nu_\tau)/\mathcal{B}(B_c^+ \rightarrow J/\psi\mu^+\nu_\mu)$* , *Phys. Rev. Lett.* **120** (2018) 121801 [[arXiv:1711.05623](#)] [[INSPIRE](#)].
- [25] M. Freytsis, Z. Ligeti and J.T. Ruderman, *Flavor models for $\bar{B} \rightarrow D^{(*)}\tau\bar{\nu}$* , *Phys. Rev. D* **92** (2015) 054018 [[arXiv:1506.08896](#)] [[INSPIRE](#)].
- [26] CMS collaboration, *Search for heavy neutrinos and third-generation leptoquarks in hadronic states of two τ leptons and two jets in proton-proton collisions at $\sqrt{s} = 13$ TeV*, *JHEP* **03** (2019) 170 [[arXiv:1811.00806](#)] [[INSPIRE](#)].
- [27] ATLAS collaboration, *The ATLAS Experiment at the CERN Large Hadron Collider*, 2008 *JINST* **3** S08003 [[INSPIRE](#)].
- [28] ATLAS collaboration, *ATLAS Insertable B-Layer Technical Design Report*, CERN-LHCC-2010-013 (2010).
- [29] ATLAS IBL collaboration, *Production and Integration of the ATLAS Insertable B-Layer*, 2018 *JINST* **13** T05008 [[arXiv:1803.00844](#)] [[INSPIRE](#)].
- [30] ATLAS collaboration, *Performance of the ATLAS Trigger System in 2015*, *Eur. Phys. J. C* **77** (2017) 317 [[arXiv:1611.09661](#)] [[INSPIRE](#)].
- [31] ATLAS collaboration, *The ATLAS Collaboration Software and Firmware*, ATL-SOFT-PUB-2021-001, CERN, Geneva (2021).
- [32] ATLAS collaboration, *Luminosity determination in pp collisions at $\sqrt{s} = 13$ TeV using the ATLAS detector at the LHC*, ATL-CONF-2019-021, CERN, Geneva (2019).
- [33] G. Avoni et al., *The new LUCID-2 detector for luminosity measurement and monitoring in ATLAS*, 2018 *JINST* **13** P07017 [[INSPIRE](#)].
- [34] GEANT4 collaboration, *GEANT4 — a simulation toolkit*, *Nucl. Instrum. Meth. A* **506** (2003) 250 [[INSPIRE](#)].
- [35] ATLAS collaboration, *The ATLAS Simulation Infrastructure*, *Eur. Phys. J. C* **70** (2010) 823 [[arXiv:1005.4568](#)] [[INSPIRE](#)].
- [36] C. ATLAS et al., *The simulation principle and performance of the ATLAS fast calorimeter simulation FastCaloSim*, ATL-PHYS-PUB-2010-013, CERN, Geneva (2010).
- [37] T. Sjöstrand, S. Mrenna and P.Z. Skands, *A Brief Introduction to PYTHIA 8.1*, *Comput. Phys. Commun.* **178** (2008) 852 [[arXiv:0710.3820](#)] [[INSPIRE](#)].
- [38] R.D. Ball et al., *Parton distributions with LHC data*, *Nucl. Phys. B* **867** (2013) 244 [[arXiv:1207.1303](#)] [[INSPIRE](#)].
- [39] ATLAS collaboration, *The Pythia 8 A3 tune description of ATLAS minimum bias and inelastic measurements incorporating the Donnachie-Landshoff diffractive model*, ATL-PHYS-PUB-2016-017, CERN, Geneva (2016).
- [40] ATLAS collaboration, *Measurement of the Inelastic Proton-Proton Cross Section at $\sqrt{s} = 13$ TeV with the ATLAS Detector at the LHC*, *Phys. Rev. Lett.* **117** (2016) 182002 [[arXiv:1606.02625](#)] [[INSPIRE](#)].
- [41] T. Sjöstrand et al., *An introduction to PYTHIA 8.2*, *Comput. Phys. Commun.* **191** (2015) 159 [[arXiv:1410.3012](#)] [[INSPIRE](#)].
- [42] ATLAS collaboration, *ATLAS Pythia 8 tunes to 7 TeV data*, ATL-PHYS-PUB-2014-021, CERN, Geneva (2014).

- [43] D.J. Lange, *The EvtGen particle decay simulation package*, *Nucl. Instrum. Meth. A* **462** (2001) 152 [INSPIRE].
- [44] E. Bothmann, M. Schönherr and S. Schumann, *Reweighting QCD matrix-element and parton-shower calculations*, *Eur. Phys. J. C* **76** (2016) 590 [arXiv:1606.08753] [INSPIRE].
- [45] A. Buckley et al., *LHAPDF6: parton density access in the LHC precision era*, *Eur. Phys. J. C* **75** (2015) 132 [arXiv:1412.7420] [INSPIRE].
- [46] L.A. Harland-Lang, A.D. Martin, P. Motylinski and R.S. Thorne, *Parton distributions in the LHC era: MMHT 2014 PDFs*, *Eur. Phys. J. C* **75** (2015) 204 [arXiv:1412.3989] [INSPIRE].
- [47] S. Dulat et al., *New parton distribution functions from a global analysis of quantum chromodynamics*, *Phys. Rev. D* **93** (2016) 033006 [arXiv:1506.07443] [INSPIRE].
- [48] J. Alwall et al., *The automated computation of tree-level and next-to-leading order differential cross sections, and their matching to parton shower simulations*, *JHEP* **07** (2014) 079 [arXiv:1405.0301] [INSPIRE].
- [49] T. Mandal, S. Mitra and S. Seth, *Pair Production of Scalar Leptoquarks at the LHC to NLO Parton Shower Accuracy*, *Phys. Rev. D* **93** (2016) 035018 [arXiv:1506.07369] [INSPIRE].
- [50] M. Kramer, T. Plehn, M. Spira and P.M. Zerwas, *Pair production of scalar leptoquarks at the CERN LHC*, *Phys. Rev. D* **71** (2005) 057503 [hep-ph/0411038] [INSPIRE].
- [51] M. Kramer, T. Plehn, M. Spira and P.M. Zerwas, *Pair production of scalar leptoquarks at the Tevatron*, *Phys. Rev. Lett.* **79** (1997) 341 [hep-ph/9704322] [INSPIRE].
- [52] NNPDF collaboration, *Parton distributions for the LHC Run II*, *JHEP* **04** (2015) 040 [arXiv:1410.8849] [INSPIRE].
- [53] P. Artoisenet, R. Frederix, O. Mattelaer and R. Rietkerk, *Automatic spin-entangled decays of heavy resonances in Monte Carlo simulations*, *JHEP* **03** (2013) 015 [arXiv:1212.3460] [INSPIRE].
- [54] ATLAS collaboration, *Studies on top-quark Monte Carlo modelling with Sherpa and MG5_aMC@NLO*, ATL-PHYS-PUB-2017-007, CERN, Geneva (2017).
- [55] W. Beenakker et al., *NNLL-fast: predictions for coloured supersymmetric particle production at the LHC with threshold and Coulomb resummation*, *JHEP* **12** (2016) 133 [arXiv:1607.07741] [INSPIRE].
- [56] W. Beenakker et al., *Stop production at hadron colliders*, *Nucl. Phys. B* **515** (1998) 3 [hep-ph/9710451] [INSPIRE].
- [57] W. Beenakker et al., *Supersymmetric top and bottom squark production at hadron colliders*, *JHEP* **08** (2010) 098 [arXiv:1006.4771] [INSPIRE].
- [58] W. Beenakker et al., *NNLL resummation for stop pair-production at the LHC*, *JHEP* **05** (2016) 153 [arXiv:1601.02954] [INSPIRE].
- [59] C. Borschensky, B. Fuks, A. Kulesza and D. Schwartzländer, *Scalar leptoquark pair production at hadron colliders*, *Phys. Rev. D* **101** (2020) 115017 [arXiv:2002.08971] [INSPIRE].
- [60] SHERPA collaboration, *Event Generation with Sherpa 2.2*, *SciPost Phys.* **7** (2019) 034 [arXiv:1905.09127] [INSPIRE].
- [61] T. Gleisberg and S. Hoeche, *Comix, a new matrix element generator*, *JHEP* **12** (2008) 039 [arXiv:0808.3674] [INSPIRE].

- [62] OPENLOOPS 2 collaboration, *OpenLoops 2*, *Eur. Phys. J. C* **79** (2019) 866 [[arXiv:1907.13071](#)] [[INSPIRE](#)].
- [63] F. Cascioli, P. Maierhöfer and S. Pozzorini, *Scattering Amplitudes with Open Loops*, *Phys. Rev. Lett.* **108** (2012) 111601 [[arXiv:1111.5206](#)] [[INSPIRE](#)].
- [64] A. Denner, S. Dittmaier and L. Hofer, *Collier: a fortran-based Complex One-Loop Library in Extended Regularizations*, *Comput. Phys. Commun.* **212** (2017) 220 [[arXiv:1604.06792](#)] [[INSPIRE](#)].
- [65] S. Schumann and F. Krauss, *A Parton shower algorithm based on Catani-Seymour dipole factorisation*, *JHEP* **03** (2008) 038 [[arXiv:0709.1027](#)] [[INSPIRE](#)].
- [66] S. Hoeche, F. Krauss, M. Schönherr and F. Siegert, *A critical appraisal of NLO+PS matching methods*, *JHEP* **09** (2012) 049 [[arXiv:1111.1220](#)] [[INSPIRE](#)].
- [67] S. Hoeche, F. Krauss, M. Schönherr and F. Siegert, *QCD matrix elements + parton showers: The NLO case*, *JHEP* **04** (2013) 027 [[arXiv:1207.5030](#)] [[INSPIRE](#)].
- [68] S. Catani, F. Krauss, R. Kuhn and B.R. Webber, *QCD matrix elements + parton showers*, *JHEP* **11** (2001) 063 [[hep-ph/0109231](#)] [[INSPIRE](#)].
- [69] S. Hoeche, F. Krauss, S. Schumann and F. Siegert, *QCD matrix elements and truncated showers*, *JHEP* **05** (2009) 053 [[arXiv:0903.1219](#)] [[INSPIRE](#)].
- [70] C. Anastasiou, L.J. Dixon, K. Melnikov and F. Petriello, *High precision QCD at hadron colliders: Electroweak gauge boson rapidity distributions at NNLO*, *Phys. Rev. D* **69** (2004) 094008 [[hep-ph/0312266](#)] [[INSPIRE](#)].
- [71] S. Frixione, P. Nason and G. Ridolfi, *A Positive-weight next-to-leading-order Monte Carlo for heavy flavour hadroproduction*, *JHEP* **09** (2007) 126 [[arXiv:0707.3088](#)] [[INSPIRE](#)].
- [72] P. Nason, *A new method for combining NLO QCD with shower Monte Carlo algorithms*, *JHEP* **11** (2004) 040 [[hep-ph/0409146](#)] [[INSPIRE](#)].
- [73] S. Frixione, P. Nason and C. Oleari, *Matching NLO QCD computations with Parton Shower simulations: the POWHEG method*, *JHEP* **11** (2007) 070 [[arXiv:0709.2092](#)] [[INSPIRE](#)].
- [74] S. Alioli, P. Nason, C. Oleari and E. Re, *A general framework for implementing NLO calculations in shower Monte Carlo programs: the POWHEG BOX*, *JHEP* **06** (2010) 043 [[arXiv:1002.2581](#)] [[INSPIRE](#)].
- [75] ATLAS collaboration, *Studies on top-quark Monte Carlo modelling for Top2016*, [ATL-PHYS-PUB-2016-020](#), CERN, Geneva (2016).
- [76] S. Frixione et al., *Single-top hadroproduction in association with a W boson*, *JHEP* **07** (2008) 029 [[arXiv:0805.3067](#)] [[INSPIRE](#)].
- [77] J. Butterworth et al., *PDF4LHC recommendations for LHC Run II*, *J. Phys. G* **43** (2016) 023001 [[arXiv:1510.03865](#)] [[INSPIRE](#)].
- [78] M. Bähr et al., *Herwig++ Physics and Manual*, *Eur. Phys. J. C* **58** (2008) 639 [[arXiv:0803.0883](#)] [[INSPIRE](#)].
- [79] J. Bellm et al., *Herwig 7.0/Herwig++ 3.0 release note*, *Eur. Phys. J. C* **76** (2016) 196 [[arXiv:1512.01178](#)] [[INSPIRE](#)].
- [80] ATLAS collaboration, *Measurements of top-quark pair differential cross-sections in the lepton+jets channel in pp collisions at $\sqrt{s} = 8$ TeV using the ATLAS detector*, *Eur. Phys. J. C* **76** (2016) 538 [[arXiv:1511.04716](#)] [[INSPIRE](#)].

- [81] ATLAS collaboration, *Measurements of differential cross-sections in top-quark pair events with a high transverse momentum top quark and limits on beyond the Standard Model contributions to top-quark pair production with the ATLAS detector at $\sqrt{s} = 13$ TeV*, *JHEP* **06** (2022) 063 [[arXiv:2202.12134](#)] [[INSPIRE](#)].
- [82] M. Czakon et al., *Top-pair production at the LHC through NNLO QCD and NLO EW*, *JHEP* **10** (2017) 186 [[arXiv:1705.04105](#)] [[INSPIRE](#)].
- [83] ATLAS collaboration, *Vertex Reconstruction Performance of the ATLAS Detector at $\sqrt{s} = 13$ TeV*, *ATL-PHYS-PUB-2015-026*, CERN, Geneva (2015).
- [84] ATLAS collaboration, *Electron reconstruction and identification in the ATLAS experiment using the 2015 and 2016 LHC proton-proton collision data at $\sqrt{s} = 13$ TeV*, *Eur. Phys. J. C* **79** (2019) 639 [[arXiv:1902.04655](#)] [[INSPIRE](#)].
- [85] ATLAS collaboration, *Electron and photon performance measurements with the ATLAS detector using the 2015-2017 LHC proton-proton collision data*, *2019 JINST* **14** P12006 [[arXiv:1908.00005](#)] [[INSPIRE](#)].
- [86] ATLAS collaboration, *Evidence for the associated production of the Higgs boson and a top quark pair with the ATLAS detector*, *Phys. Rev. D* **97** (2018) 072003 [[arXiv:1712.08891](#)] [[INSPIRE](#)].
- [87] ATLAS collaboration, *Muon reconstruction performance of the ATLAS detector in proton-proton collision data at $\sqrt{s} = 13$ TeV*, *Eur. Phys. J. C* **76** (2016) 292 [[arXiv:1603.05598](#)] [[INSPIRE](#)].
- [88] ATLAS collaboration, *Measurement of the tau lepton reconstruction and identification performance in the ATLAS experiment using pp collisions at $\sqrt{s} = 13$ TeV*, *ATLAS-CONF-2017-029*, CERN, Geneva (2017).
- [89] ATLAS collaboration, *Reconstruction, Energy Calibration, and Identification of Hadronically Decaying Tau Leptons in the ATLAS Experiment for Run-2 of the LHC*, *ATL-PHYS-PUB-2015-045*, CERN, Geneva (2015).
- [90] ATLAS collaboration, *Identification and energy calibration of hadronically decaying tau leptons with the ATLAS experiment in pp collisions at $\sqrt{s} = 8$ TeV*, *Eur. Phys. J. C* **75** (2015) 303 [[arXiv:1412.7086](#)] [[INSPIRE](#)].
- [91] ATLAS collaboration, *Identification of hadronic tau lepton decays using neural networks in the ATLAS experiment*, *ATL-PHYS-PUB-2019-033*, CERN, Geneva (2019).
- [92] ATLAS collaboration, *Jet reconstruction and performance using particle flow with the ATLAS Detector*, *Eur. Phys. J. C* **77** (2017) 466 [[arXiv:1703.10485](#)] [[INSPIRE](#)].
- [93] ATLAS collaboration, *Jet energy scale and resolution measured in proton-proton collisions at $\sqrt{s} = 13$ TeV with the ATLAS detector*, *Eur. Phys. J. C* **81** (2021) 689 [[arXiv:2007.02645](#)] [[INSPIRE](#)].
- [94] M. Cacciari, G.P. Salam and G. Soyez, *The anti- k_t jet clustering algorithm*, *JHEP* **04** (2008) 063 [[arXiv:0802.1189](#)] [[INSPIRE](#)].
- [95] M. Cacciari, G.P. Salam and G. Soyez, *FastJet User Manual*, *Eur. Phys. J. C* **72** (2012) 1896 [[arXiv:1111.6097](#)] [[INSPIRE](#)].
- [96] ATLAS collaboration, *Measurements of Higgs boson production cross-sections in the $H \rightarrow \tau^+\tau^-$ decay channel in pp collisions at $\sqrt{s} = 13$ TeV with the ATLAS detector*, *JHEP* **08** (2022) 175 [[arXiv:2201.08269](#)] [[INSPIRE](#)].

- [97] ATLAS collaboration, *ATLAS flavour-tagging algorithms for the LHC Run 2 pp collision dataset*, [arXiv:2211.16345](#) [INSPIRE].
- [98] ATLAS collaboration, *ATLAS b-jet identification performance and efficiency measurement with $t\bar{t}$ events in pp collisions at $\sqrt{s} = 13$ TeV*, *Eur. Phys. J. C* **79** (2019) 970 [[arXiv:1907.05120](#)] [INSPIRE].
- [99] ATLAS collaboration, *Optimisation and performance studies of the ATLAS b-tagging algorithms for the 2017-18 LHC run*, [ATL-PHYS-PUB-2017-013](#), CERN, Geneva (2017).
- [100] ATLAS collaboration, *Performance of pile-up mitigation techniques for jets in pp collisions at $\sqrt{s} = 8$ TeV using the ATLAS detector*, *Eur. Phys. J. C* **76** (2016) 581 [[arXiv:1510.03823](#)] [INSPIRE].
- [101] ATLAS collaboration, *Identification and rejection of pile-up jets at high pseudorapidity with the ATLAS detector*, *Eur. Phys. J. C* **77** (2017) 580 [Erratum *ibid.* **77** (2017) 712] [[arXiv:1705.02211](#)] [INSPIRE].
- [102] ATLAS collaboration, *Performance of missing transverse momentum reconstruction for the ATLAS detector in the first proton-proton collisions at $\sqrt{s} = 13$ TeV*, [ATL-PHYS-PUB-2015-027](#), CERN, Geneva (2015).
- [103] M. Baak et al., *HistFitter software framework for statistical data analysis*, *Eur. Phys. J. C* **75** (2015) 153 [[arXiv:1410.1280](#)] [INSPIRE].
- [104] ROOT collaboration, *HistFactory: A tool for creating statistical models for use with RooFit and RooStats*, [CERN-OPEN-2012-016](#), New York University, New York, U.S.A. (2012).
- [105] L. Moneta et al., *The RooStats Project*, *PoS ACAT2010* (2010) 057 [[arXiv:1009.1003](#)] [INSPIRE].
- [106] W. Verkerke and D. Kirkby, *The RooFit toolkit for data modeling*, [physics/0306116](#).
- [107] F. James, *MINUIT Function Minimization and Error Analysis: Reference Manual Version 94.1*, CERN-D-506 (1994) [INSPIRE].
- [108] G. Cowan, K. Cranmer, E. Gross and O. Vitells, *Asymptotic formulae for likelihood-based tests of new physics*, *Eur. Phys. J. C* **71** (2011) 1554 [Erratum *ibid.* **73** (2013) 2501] [[arXiv:1007.1727](#)] [INSPIRE].
- [109] T. Junk, *Confidence level computation for combining searches with small statistics*, *Nucl. Instrum. Meth. A* **434** (1999) 435 [[hep-ex/9902006](#)] [INSPIRE].
- [110] A.L. Read, *Presentation of search results: The CL_s technique*, *J. Phys. G* **28** (2002) 2693 [INSPIRE].
- [111] R.K. Ellis, I. Hinchliffe, M. Soldate and J.J. van der Bij, *Higgs Decay to $\tau^+ \tau^-$: A Possible Signature of Intermediate Mass Higgs Bosons at high energy hadron colliders*, *Nucl. Phys. B* **297** (1988) 221 [INSPIRE].
- [112] ATLAS collaboration, *ATLAS Computing Acknowledgements*, [ATL-SOFT-PUB-2021-003](#), CERN, Geneva (2021).

The ATLAS collaboration

G. Aad [ID](#)¹⁰², B. Abbott [ID](#)¹²⁰, K. Abeling [ID](#)⁵⁵, N.J. Abicht [ID](#)⁴⁹, S.H. Abidi [ID](#)²⁹,
A. Abouhorma [ID](#)^{35e}, H. Abramowicz [ID](#)¹⁵¹, H. Abreu [ID](#)¹⁵⁰, Y. Abulaiti [ID](#)¹¹⁷,
A.C. Abusleme Hoffman [ID](#)^{137a}, B.S. Acharya [ID](#)^{69a,69b,o}, C. Adam Bourdarios [ID](#)⁴, L. Adamczyk [ID](#)^{85a},
L. Adamek [ID](#)¹⁵⁵, S.V. Addepalli [ID](#)²⁶, M.J. Addison [ID](#)¹⁰¹, J. Adelman [ID](#)¹¹⁵, A. Adiguzel [ID](#)^{21c},
S. Adorni [ID](#)⁵⁶, T. Adye [ID](#)¹³⁴, A.A. Affolder [ID](#)¹³⁶, Y. Afik [ID](#)³⁶, M.N. Agaras [ID](#)¹³,
J. Agarwala [ID](#)^{73a,73b}, A. Aggarwal [ID](#)¹⁰⁰, C. Agheorghiesei [ID](#)^{27c}, A. Ahmad [ID](#)³⁶, F. Ahmadov [ID](#)^{38,y},
W.S. Ahmed [ID](#)¹⁰⁴, S. Ahuja [ID](#)⁹⁵, X. Ai [ID](#)^{62a}, G. Aielli [ID](#)^{76a,76b}, M. Ait Tamlihat [ID](#)^{35e},
B. Aitbenchikh [ID](#)^{35a}, I. Aizenberg [ID](#)¹⁶⁹, M. Akbiyik [ID](#)¹⁰⁰, T.P.A. Åkesson [ID](#)⁹⁸, A.V. Akimov [ID](#)³⁷,
D. Akiyama [ID](#)¹⁶⁸, N.N. Akolkar [ID](#)²⁴, K. Al Houry [ID](#)⁴¹, G.L. Alberghi [ID](#)^{23b}, J. Albert [ID](#)¹⁶⁵,
P. Albicocco [ID](#)⁵³, G.L. Albouy [ID](#)⁶⁰, S. Alderweireldt [ID](#)⁵², M. Aleksa [ID](#)³⁶, I.N. Aleksandrov [ID](#)³⁸,
C. Alexa [ID](#)^{27b}, T. Alexopoulos [ID](#)¹⁰, A. Alfonsi [ID](#)¹¹⁴, F. Alfonsi [ID](#)^{23b}, M. Alhroob [ID](#)¹²⁰, B. Ali [ID](#)¹³²,
S. Ali [ID](#)¹⁴⁸, M. Aliev [ID](#)³⁷, G. Alimonti [ID](#)^{71a}, W. Alkakhfi [ID](#)⁵⁵, C. Allaire [ID](#)⁶⁶,
B.M.M. Allbrooke [ID](#)¹⁴⁶, C.A. Allendes Flores [ID](#)^{137f}, P.P. Allport [ID](#)²⁰, A. Aloisio [ID](#)^{72a,72b},
F. Alonso [ID](#)⁹⁰, C. Alpigiani [ID](#)¹³⁸, M. Alvarez Estevez [ID](#)⁹⁹, A. Alvarez Fernandez [ID](#)¹⁰⁰,
M.G. Alviggi [ID](#)^{72a,72b}, M. Aly [ID](#)¹⁰¹, Y. Amaral Coutinho [ID](#)^{82b}, A. Ambler [ID](#)¹⁰⁴, C. Amelung [ID](#)³⁶,
M. Amerl [ID](#)¹⁰¹, C.G. Ames [ID](#)¹⁰⁹, D. Amidei [ID](#)¹⁰⁶, S.P. Amor Dos Santos [ID](#)^{130a}, K.R. Amos [ID](#)¹⁶³,
V. Ananiev [ID](#)¹²⁵, C. Anastopoulos [ID](#)¹³⁹, T. Andeen [ID](#)¹¹, J.K. Anders [ID](#)³⁶, S.Y. Andrean [ID](#)^{47a,47b},
A. Andreatta [ID](#)^{71a,71b}, S. Angelidakis [ID](#)⁹, A. Angerami [ID](#)^{41,aa}, A.V. Anisenkov [ID](#)³⁷, A. Annovi [ID](#)^{74a},
C. Antel [ID](#)⁵⁶, M.T. Anthony [ID](#)¹³⁹, E. Antipov [ID](#)¹⁴⁵, M. Antonelli [ID](#)⁵³, D.J.A. Antrim [ID](#)^{17a},
F. Anulli [ID](#)^{75a}, M. Aoki [ID](#)⁸³, T. Aoki [ID](#)¹⁵³, J.A. Aparisi Pozo [ID](#)¹⁶³, M.A. Aparo [ID](#)¹⁴⁶,
L. Aperio Bella [ID](#)⁴⁸, C. Appelt [ID](#)¹⁸, N. Aranzabal [ID](#)³⁶, V. Araujo Ferraz [ID](#)^{82a}, C. Arcangeletti [ID](#)⁵³,
A.T.H. Arce [ID](#)⁵¹, E. Arena [ID](#)⁹², J-F. Arguin [ID](#)¹⁰⁸, S. Argyropoulos [ID](#)⁵⁴, J.-H. Arling [ID](#)⁴⁸,
A.J. Armbruster [ID](#)³⁶, O. Arnaez [ID](#)⁴, H. Arnold [ID](#)¹¹⁴, Z.P. Arrubarrena Tame [ID](#)¹⁰⁹, G. Artoni [ID](#)^{75a,75b},
H. Asada [ID](#)¹¹¹, K. Asai [ID](#)¹¹⁸, S. Asai [ID](#)¹⁵³, N.A. Asbah [ID](#)⁶¹, J. Assahsah [ID](#)^{35d}, K. Assamagan [ID](#)²⁹,
R. Astalos [ID](#)^{28a}, S. Atashi [ID](#)¹⁶⁰, R.J. Atkin [ID](#)^{33a}, M. Atkinson [ID](#)¹⁶², N.B. Atlay [ID](#)¹⁸, H. Atmani [ID](#)^{62b},
P.A. Atmasiddha [ID](#)¹⁰⁶, K. Augsten [ID](#)¹³², S. Auricchio [ID](#)^{72a,72b}, A.D. Auriol [ID](#)²⁰, V.A. Austrup [ID](#)¹⁷¹,
G. Avolio [ID](#)³⁶, K. Axiotis [ID](#)⁵⁶, G. Azuelos [ID](#)^{108,ac}, D. Babal [ID](#)^{28b}, H. Bachacou [ID](#)¹³⁵,
K. Bachas [ID](#)^{152,q}, A. Bachiu [ID](#)³⁴, F. Backman [ID](#)^{47a,47b}, A. Badea [ID](#)⁶¹, P. Bagnaia [ID](#)^{75a,75b},
M. Bahmani [ID](#)¹⁸, A.J. Bailey [ID](#)¹⁶³, V.R. Bailey [ID](#)¹⁶², J.T. Baines [ID](#)¹³⁴, C. Bakalis [ID](#)¹⁰,
O.K. Baker [ID](#)¹⁷², E. Bakos [ID](#)¹⁵, D. Bakshi Gupta [ID](#)⁸, R. Balasubramanian [ID](#)¹¹⁴, E.M. Baldin [ID](#)³⁷,
P. Balek [ID](#)^{85a}, E. Ballabene [ID](#)^{23b,23a}, F. Balli [ID](#)¹³⁵, L.M. Baltés [ID](#)^{63a}, W.K. Balunas [ID](#)³²,
J. Balz [ID](#)¹⁰⁰, E. Banas [ID](#)⁸⁶, M. Bandieramonte [ID](#)¹²⁹, A. Bandyopadhyay [ID](#)²⁴, S. Bansal [ID](#)²⁴,
L. Barak [ID](#)¹⁵¹, M. Barakat [ID](#)⁴⁸, E.L. Barberio [ID](#)¹⁰⁵, D. Barberis [ID](#)^{57b,57a}, M. Barbero [ID](#)¹⁰²,
G. Barbour [ID](#)⁹⁶, K.N. Barends [ID](#)^{33a}, T. Barillari [ID](#)¹¹⁰, M-S. Barisits [ID](#)³⁶, T. Barklow [ID](#)¹⁴³,
P. Baron [ID](#)¹²², D.A. Baron Moreno [ID](#)¹⁰¹, A. Baroncelli [ID](#)^{62a}, G. Barone [ID](#)²⁹, A.J. Barr [ID](#)¹²⁶,
J.D. Barr [ID](#)⁹⁶, L. Barranco Navarro [ID](#)^{47a,47b}, F. Barreiro [ID](#)⁹⁹, J. Barreiro Guimarães da Costa [ID](#)^{14a},
U. Barron [ID](#)¹⁵¹, M.G. Barros Teixeira [ID](#)^{130a}, S. Barsov [ID](#)³⁷, F. Bartels [ID](#)^{63a}, R. Bartoldus [ID](#)¹⁴³,
A.E. Barton [ID](#)⁹¹, P. Bartos [ID](#)^{28a}, A. Basan [ID](#)¹⁰⁰, M. Baselga [ID](#)⁴⁹, A. Bassalat [ID](#)^{66,b},
M.J. Basso [ID](#)¹⁵⁵, C.R. Basson [ID](#)¹⁰¹, R.L. Bates [ID](#)⁵⁹, S. Batlamous [ID](#)^{35e}, J.R. Batley [ID](#)³²,
B. Batool [ID](#)¹⁴¹, M. Battaglia [ID](#)¹³⁶, D. Battulga [ID](#)¹⁸, M. Bauce [ID](#)^{75a,75b}, M. Bauer [ID](#)³⁶, P. Bauer [ID](#)²⁴,
L.T. Bazzano Hurrell [ID](#)³⁰, J.B. Beacham [ID](#)⁵¹, T. Beau [ID](#)¹²⁷, P.H. Beauchemin [ID](#)¹⁵⁸,

F. Becherer [154](#), P. Bechtle [24](#), H.P. Beck [19,p](#), K. Becker [167](#), A.J. Beddall [21d](#),
V.A. Bednyakov [38](#), C.P. Bee [145](#), L.J. Beemster [15](#), T.A. Beermann [36](#), M. Begalli [82d](#),
M. Begel [29](#), A. Behera [145](#), J.K. Behr [48](#), J.F. Beirer [55](#), F. Beisiegel [24](#), M. Belfkir [159](#),
G. Bella [151](#), L. Bellagamba [23b](#), A. Bellerive [34](#), P. Bellos [20](#), K. Beloborodov [37](#),
N.L. Belyaev [37](#), D. Benckekroun [35a](#), F. Bendebba [35a](#), Y. Benhammou [151](#), M. Benoit [29](#),
J.R. Bensinger [26](#), S. Bentvelsen [114](#), L. Beresford [48](#), M. Beretta [53](#),
E. Bergeaas Kuutmann [161](#), N. Berger [4](#), B. Bergmann [132](#), J. Beringer [17a](#), S. Berlendis [7](#),
G. Bernardi [5](#), C. Bernius [143](#), F.U. Bernlochner [24](#), F. Bernon [36,102](#), T. Berry [95](#),
P. Berta [133](#), A. Berthold [50](#), I.A. Bertram [91](#), S. Bethke [110](#), A. Betti [75a,75b](#), A.J. Bevan [94](#),
M. Bhamjee [33c](#), S. Bhatta [145](#), D.S. Bhattacharya [166](#), P. Bhattarai [26](#), V.S. Bhopatkar [121](#),
R. Bi^{29,ae}, R.M. Bianchi [129](#), G. Bianco [23b,23a](#), O. Biebel [109](#), R. Bielski [123](#), M. Biglietti [77a](#),
T.R.V. Billoud [132](#), M. Bindi [55](#), A. Bingul [21b](#), C. Bini [75a,75b](#), A. Biondini [92](#),
C.J. Birch-sykes [101](#), G.A. Bird [20,134](#), M. Birman [169](#), M. Biros [133](#), T. Bisanz [49](#),
E. Bisceglie [43b,43a](#), D. Biswas [170](#), A. Bitadze [101](#), K. Bjørke [125](#), I. Bloch [48](#), C. Blocker [26](#),
A. Blue [59](#), U. Blumenschein [94](#), J. Blumenthal [100](#), G.J. Bobbink [114](#), V.S. Bobrovnikov [37](#),
M. Boehler [54](#), B. Boehm [166](#), D. Bogavac [36](#), A.G. Bogdanchikov [37](#), C. Bohm [47a](#),
V. Boisvert [95](#), P. Bokan [48](#), T. Bold [85a](#), M. Bomben [5](#), M. Bona [94](#), M. Boonekamp [135](#),
C.D. Booth [95](#), A.G. Borbély [59](#), I.S. Bordulev [37](#), H.M. Borecka-Bielska [108](#), L.S. Borgna [96](#),
G. Borissov [91](#), D. Bortoletto [126](#), D. Boscherini [23b](#), M. Bosman [13](#), J.D. Bossio Sola [36](#),
K. Bouaouda [35a](#), N. Bouchhar [163](#), J. Boudreau [129](#), E.V. Bouhova-Thacker [91](#),
D. Boumediene [40](#), R. Bouquet [5](#), A. Boveia [119](#), J. Boyd [36](#), D. Boye [29](#), I.R. Boyko [38](#),
J. Bracinek [20](#), N. Brahimy [62d](#), G. Brandt [171](#), O. Brandt [32](#), F. Braren [48](#), B. Brau [103](#),
J.E. Brau [123](#), R. Brenner [169](#), L. Brenner [114](#), R. Brenner [161](#), S. Bressler [169](#), D. Britton [59](#),
D. Britzger [110](#), I. Brock [24](#), G. Brooijmans [41](#), W.K. Brooks [137f](#), E. Brost [29](#),
L.M. Brown [165](#), T.L. Bruckler [126](#), P.A. Bruckman de Renstrom [86](#), B. Brüers [48](#),
D. Bruncko [28b,*](#), A. Bruni [23b](#), G. Bruni [23b](#), M. Bruschi [23b](#), N. Bruscinò [75a,75b](#),
T. Buanes [16](#), Q. Buat [138](#), D. Buchin [110](#), A.G. Buckley [59](#), I.A. Budagov [38,*](#),
M.K. Bugge [125](#), O. Bulekov [37](#), B.A. Bullard [143](#), S. Burdin [92](#), C.D. Burgard [49](#),
A.M. Burger [40](#), B. Burghgrave [8](#), O. Burlayenko [54](#), J.T.P. Burr [32](#), C.D. Burton [11](#),
J.C. Burzynski [142](#), E.L. Busch [41](#), V. Büscher [100](#), P.J. Bussey [59](#), J.M. Butler [25](#),
C.M. Buttar [59](#), J.M. Butterworth [96](#), W. Buttinger [134](#), C.J. Buxo Vazquez [107](#),
A.R. Buzykaev [37](#), G. Cabras [23b](#), S. Cabrera Urbán [163](#), D. Caforio [58](#), H. Cai [129](#),
Y. Cai [14a,14e](#), V.M.M. Cairo [36](#), O. Cakir [3a](#), N. Calace [36](#), P. Calafiura [17a](#),
G. Calderini [127](#), P. Calfayan [68](#), G. Callea [59](#), L.P. Caloba [82b](#), D. Calvet [40](#), S. Calvet [40](#),
T.P. Calvet [102](#), M. Calvetti [74a,74b](#), R. Camacho Toro [127](#), S. Camarda [36](#),
D. Camarero Munoz [26](#), P. Camarri [76a,76b](#), M.T. Camerlingo [72a,72b](#), D. Cameron [125](#),
C. Camincher [165](#), M. Campanelli [96](#), A. Camplani [42](#), V. Canale [72a,72b](#), A. Canesse [104](#),
M. Cano Bret [80](#), J. Cantero [163](#), Y. Cao [162](#), F. Capocasa [26](#), M. Capua [43b,43a](#),
A. Carbone [71a,71b](#), R. Cardarelli [76a](#), J.C.J. Cardenas [8](#), F. Cardillo [163](#), T. Carli [36](#),
G. Carlino [72a](#), J.I. Carlotto [13](#), B.T. Carlson [129,r](#), E.M. Carlson [165,156a](#),
L. Carminati [71a,71b](#), M. Carnesale [75a,75b](#), S. Caron [113](#), E. Carquin [137f](#), S. Carrá [71a,71b](#),
G. Carratta [23b,23a](#), F. Carrio Argos [33g](#), J.W.S. Carter [155](#), T.M. Carter [52](#), M.P. Casado [13,j](#),
A.F. Casha [155](#), M. Caspar [48](#), E.G. Castiglia [172](#), F.L. Castillo [63a](#), L. Castillo Garcia [13](#),

V. Castillo Gimenez [ID](#)¹⁶³, N.F. Castro [ID](#)^{130a,130e}, A. Catinaccio [ID](#)³⁶, J.R. Catmore [ID](#)¹²⁵,
V. Cavaliere [ID](#)²⁹, N. Cavalli [ID](#)^{23b,23a}, V. Cavasinni [ID](#)^{74a,74b}, Y.C. Cekmecelioglu [ID](#)⁴⁸, E. Celebi [ID](#)^{21a},
F. Celli [ID](#)¹²⁶, M.S. Centonze [ID](#)^{70a,70b}, K. Cerny [ID](#)¹²², A.S. Cerqueira [ID](#)^{82a}, A. Cerri [ID](#)¹⁴⁶,
L. Cerrito [ID](#)^{76a,76b}, F. Cerutti [ID](#)^{17a}, B. Cervato [ID](#)¹⁴¹, A. Cervelli [ID](#)^{23b}, G. Cesarini [ID](#)⁵³,
S.A. Cetin [ID](#)^{21d}, Z. Chadi [ID](#)^{35a}, D. Chakraborty [ID](#)¹¹⁵, M. Chala [ID](#)^{130f}, J. Chan [ID](#)¹⁷⁰,
W.Y. Chan [ID](#)¹⁵³, J.D. Chapman [ID](#)³², E. Chapon [ID](#)¹³⁵, B. Chargeishvili [ID](#)^{149b}, D.G. Charlton [ID](#)²⁰,
T.P. Charman [ID](#)⁹⁴, M. Chatterjee [ID](#)¹⁹, C. Chauhan [ID](#)¹³³, S. Chekanov [ID](#)⁶, S.V. Chekulaev [ID](#)^{156a},
G.A. Chelkov [ID](#)^{38,a}, A. Chen [ID](#)¹⁰⁶, B. Chen [ID](#)¹⁵¹, B. Chen [ID](#)¹⁶⁵, H. Chen [ID](#)^{14c}, H. Chen [ID](#)²⁹,
J. Chen [ID](#)^{62c}, J. Chen [ID](#)¹⁴², M. Chen [ID](#)¹²⁶, S. Chen [ID](#)¹⁵³, S.J. Chen [ID](#)^{14c}, X. Chen [ID](#)^{62c},
X. Chen [ID](#)^{14b,ab}, Y. Chen [ID](#)^{62a}, C.L. Cheng [ID](#)¹⁷⁰, H.C. Cheng [ID](#)^{64a}, S. Cheong [ID](#)¹⁴³,
A. Cheplakov [ID](#)³⁸, E. Cheremushkina [ID](#)⁴⁸, E. Cherepanova [ID](#)¹¹⁴, R. Cherkaoui El Moursli [ID](#)^{35e},
E. Cheu [ID](#)⁷, K. Cheung [ID](#)⁶⁵, L. Chevalier [ID](#)¹³⁵, V. Chiarella [ID](#)⁵³, G. Chiarelli [ID](#)^{74a}, N. Chiedde [ID](#)¹⁰²,
G. Chiodini [ID](#)^{70a}, A.S. Chisholm [ID](#)²⁰, A. Chitan [ID](#)^{27b}, M. Chitishvili [ID](#)¹⁶³, M.V. Chizhov [ID](#)³⁸,
K. Choi [ID](#)¹¹, A.R. Chomont [ID](#)^{75a,75b}, Y. Chou [ID](#)¹⁰³, E.Y.S. Chow [ID](#)¹¹⁴, T. Chowdhury [ID](#)^{33g},
L.D. Christopher [ID](#)^{33g}, K.L. Chu [ID](#)¹⁶⁹, M.C. Chu [ID](#)^{64a}, X. Chu [ID](#)^{14a,14e}, J. Chudoba [ID](#)¹³¹,
J.J. Chwastowski [ID](#)⁸⁶, D. Cieri [ID](#)¹¹⁰, K.M. Ciesla [ID](#)^{85a}, V. Cindro [ID](#)⁹³, A. Ciocio [ID](#)^{17a},
F. Ciroto [ID](#)^{72a,72b}, Z.H. Citron [ID](#)^{169,ag}, M. Citterio [ID](#)^{71a}, D.A. Ciubotaru [ID](#)^{27b}, B.M. Ciungu [ID](#)¹⁵⁵,
A. Clark [ID](#)⁵⁶, P.J. Clark [ID](#)⁵², J.M. Clavijo Columbie [ID](#)⁴⁸, S.E. Clawson [ID](#)⁴⁸, C. Clement [ID](#)^{47a,47b},
J. Clercx [ID](#)⁴⁸, L. Clissa [ID](#)^{23b,23a}, Y. Coadou [ID](#)¹⁰², M. Cobal [ID](#)^{69a,69c}, A. Coccaro [ID](#)^{57b},
R.F. Coelho Barrue [ID](#)^{130a}, R. Coelho Lopes De Sa [ID](#)¹⁰³, S. Coelli [ID](#)^{71a}, H. Cohen [ID](#)¹⁵¹,
A.E.C. Coimbra [ID](#)^{71a,71b}, B. Cole [ID](#)⁴¹, J. Collot [ID](#)⁶⁰, P. Conde Muiño [ID](#)^{130a,130g}, M.P. Connell [ID](#)^{33c},
S.H. Connell [ID](#)^{33c}, I.A. Connelly [ID](#)⁵⁹, E.I. Conroy [ID](#)¹²⁶, F. Conventi [ID](#)^{72a,ad}, H.G. Cooke [ID](#)²⁰,
A.M. Cooper-Sarkar [ID](#)¹²⁶, A. Cordeiro Oudot Choi [ID](#)¹²⁷, F. Cormier [ID](#)¹⁶⁴, L.D. Corpe [ID](#)⁴⁰,
M. Corradi [ID](#)^{75a,75b}, F. Corriveau [ID](#)^{104,w}, A. Cortes-Gonzalez [ID](#)¹⁸, M.J. Costa [ID](#)¹⁶³, F. Costanza [ID](#)⁴,
D. Costanzo [ID](#)¹³⁹, B.M. Cote [ID](#)¹¹⁹, G. Cowan [ID](#)⁹⁵, K. Cranmer [ID](#)¹¹⁷, D. Cremonini [ID](#)^{23b,23a},
S. Crépé-Renaudin [ID](#)⁶⁰, F. Crescioli [ID](#)¹²⁷, M. Cristinziani [ID](#)¹⁴¹, M. Cristoforetti [ID](#)^{78a,78b,d},
V. Croft [ID](#)¹¹⁴, J.E. Crosby [ID](#)¹²¹, G. Crosetti [ID](#)^{43b,43a}, A. Cueto [ID](#)³⁶, T. Cuhadar Donszelmann [ID](#)¹⁶⁰,
H. Cui [ID](#)^{14a,14e}, Z. Cui [ID](#)⁷, W.R. Cunningham [ID](#)⁵⁹, F. Curcio [ID](#)^{43b,43a}, P. Czodrowski [ID](#)³⁶,
M.M. Czurylo [ID](#)^{63b}, M.J. Da Cunha Sargedas De Sousa [ID](#)^{62a}, J.V. Da Fonseca Pinto [ID](#)^{82b},
C. Da Via [ID](#)¹⁰¹, W. Dabrowski [ID](#)^{85a}, T. Dado [ID](#)⁴⁹, S. Dahbi [ID](#)^{33g}, T. Dai [ID](#)¹⁰⁶, C. Dallapiccola [ID](#)¹⁰³,
M. Dam [ID](#)⁴², G. D’amen [ID](#)²⁹, V. D’Amico [ID](#)¹⁰⁹, J. Damp [ID](#)¹⁰⁰, J.R. Dandoy [ID](#)¹²⁸, M.F. Daneri [ID](#)³⁰,
M. Danninger [ID](#)¹⁴², V. Dao [ID](#)³⁶, G. Darbo [ID](#)^{57b}, S. Darmora [ID](#)⁶, S.J. Das [ID](#)^{29,ae},
S. D’Auria [ID](#)^{71a,71b}, C. David [ID](#)^{156b}, T. Davidek [ID](#)¹³³, B. Davis-Purcell [ID](#)³⁴, I. Dawson [ID](#)⁹⁴,
H.A. Day-hall [ID](#)¹³², K. De [ID](#)⁸, R. De Asmundis [ID](#)^{72a}, N. De Biase [ID](#)⁴⁸, S. De Castro [ID](#)^{23b,23a},
N. De Groot [ID](#)¹¹³, P. de Jong [ID](#)¹¹⁴, H. De la Torre [ID](#)¹⁰⁷, A. De Maria [ID](#)^{14c}, A. De Salvo [ID](#)^{75a},
U. De Sanctis [ID](#)^{76a,76b}, A. De Santo [ID](#)¹⁴⁶, J.B. De Vivie De Regie [ID](#)⁶⁰, D.V. Dedovich [ID](#)³⁸,
J. Degens [ID](#)¹¹⁴, A.M. Deiana [ID](#)⁴⁴, F. Del Corso [ID](#)^{23b,23a}, J. Del Peso [ID](#)⁹⁹, F. Del Rio [ID](#)^{63a},
F. Deliot [ID](#)¹³⁵, C.M. Delitzsch [ID](#)⁴⁹, M. Della Pietra [ID](#)^{72a,72b}, D. Della Volpe [ID](#)⁵⁶, A. Dell’Acqua [ID](#)³⁶,
L. Dell’Asta [ID](#)^{71a,71b}, M. Delmastro [ID](#)⁴, P.A. Delsart [ID](#)⁶⁰, S. Demers [ID](#)¹⁷², M. Demichev [ID](#)³⁸,
S.P. Denisov [ID](#)³⁷, L. D’Eramo [ID](#)⁴⁰, D. Derendarz [ID](#)⁸⁶, F. Derue [ID](#)¹²⁷, P. Dervan [ID](#)⁹², K. Desch [ID](#)²⁴,
K. Dette [ID](#)¹⁵⁵, C. Deutsch [ID](#)²⁴, F.A. Di Bello [ID](#)^{57b,57a}, A. Di Ciaccio [ID](#)^{76a,76b}, L. Di Ciaccio [ID](#)⁴,
A. Di Domenico [ID](#)^{75a,75b}, C. Di Donato [ID](#)^{72a,72b}, A. Di Girolamo [ID](#)³⁶, G. Di Gregorio [ID](#)⁵,
A. Di Luca [ID](#)^{78a,78b}, B. Di Micco [ID](#)^{77a,77b}, R. Di Nardo [ID](#)^{77a,77b}, C. Diaconu [ID](#)¹⁰², F.A. Dias [ID](#)¹¹⁴,

T. Dias Do Vale [142](#), M.A. Diaz [137a,137b](#), F.G. Diaz Capriles [24](#), M. Didenko [163](#),
E.B. Diehl [106](#), L. Diehl [54](#), S. Díez Cornell [48](#), C. Diez Pardos [141](#), C. Dimitriadi [24,161](#),
A. Dimitrievska [17a](#), J. Dingfelder [24](#), I-M. Dinu [27b](#), S.J. Dittmeier [63b](#), F. Dittus [36](#),
F. Djama [102](#), T. Djobava [149b](#), J.I. Djuvsland [16](#), C. Doglioni [101,98](#), J. Dolejsi [133](#),
Z. Dolezal [133](#), M. Donadelli [82c](#), B. Dong [107](#), J. Donini [40](#), A. D’Onofrio [77a,77b](#),
M. D’Onofrio [92](#), J. Dopke [134](#), A. Doria [72a](#), M.T. Dova [90](#), A.T. Doyle [59](#),
M.A. Dragnet [126](#), E. Drechsler [142](#), E. Dreyer [169](#), I. Drivas-koulouris [10](#), A.S. Drobac [158](#),
M. Drozdova [56](#), D. Du [62a](#), T.A. du Pree [114](#), F. Dubinin [37](#), M. Dubovsky [28a](#),
E. Duchovni [169](#), G. Duckeck [109](#), O.A. Ducu [27b](#), D. Duda [52](#), A. Dudarev [36](#),
E.R. Duden [26](#), M. D’uffizi [101](#), L. Duflot [66](#), M. Dührssen [36](#), C. Dülsen [171](#),
A.E. Dumitriu [27b](#), M. Dunford [63a](#), S. Dungs [49](#), K. Dunne [47a,47b](#), A. Duperrin [102](#),
H. Duran Yildiz [3a](#), M. Düren [58](#), A. Durglishvili [149b](#), B.L. Dwyer [115](#), G.I. Dyckes [17a](#),
M. Dyndal [85a](#), S. Dysch [101](#), B.S. Dziedzic [86](#), Z.O. Earnshaw [146](#), G.H. Eberwein [126](#),
B. Eckerova [28a](#), S. Eggebrecht [55](#), M.G. Eggleston [51](#), E. Egidio Purcino De Souza [127](#),
L.F. Ehrke [56](#), G. Eigen [16](#), K. Einsweiler [17a](#), T. Ekelof [161](#), P.A. Ekman [98](#),
Y. El Ghazali [35b](#), H. El Jarrari [35e,148](#), A. El Moussaouy [35a](#), V. Ellajosyula [161](#),
M. Ellert [161](#), F. Ellinghaus [171](#), A.A. Elliot [94](#), N. Ellis [36](#), J. Elmsheuser [29](#), M. Elsing [36](#),
D. Emelianov [134](#), Y. Enari [153](#), I. Ene [17a](#), S. Epari [13](#), J. Erdmann [49](#), P.A. Erland [86](#),
M. Errenst [171](#), M. Escalier [66](#), C. Escobar [163](#), E. Etzion [151](#), G. Evans [130a](#), H. Evans [68](#),
L.S. Evans [95](#), M.O. Evans [146](#), A. Ezhilov [37](#), S. Ezzarqtouni [35a](#), F. Fabbri [59](#),
L. Fabbri [23b,23a](#), G. Facini [96](#), V. Fadeyev [136](#), R.M. Fakhruddinov [37](#), S. Falciano [75a](#),
L.F. Falda Ulhoa Coelho [36](#), P.J. Falke [24](#), J. Faltova [133](#), C. Fan [162](#), Y. Fan [14a](#),
Y. Fang [14a,14e](#), M. Fanti [71a,71b](#), M. Faraj [69a,69b](#), Z. Farazpay [97](#), A. Farbin [8](#), A. Farilla [77a](#),
T. Farooque [107](#), S.M. Farrington [52](#), F. Fassi [35e](#), D. Fassouliotis [9](#),
M. Fauci Giannelli [76a,76b](#), W.J. Fawcett [32](#), L. Fayard [66](#), P. Federic [133](#), P. Federicova [131](#),
O.L. Fedin [37,a](#), G. Fedotov [37](#), M. Feickert [170](#), L. Felgioni [102](#), A. Fell [139](#), D.E. Fellers [123](#),
C. Feng [62b](#), M. Feng [14b](#), Z. Feng [114](#), M.J. Fenton [160](#), A.B. Fenyuk [37](#), L. Ferencz [48](#),
R.A.M. Ferguson [91](#), S.I. Fernandez Luengo [137f](#), M.J.V. Fernoux [102](#), J. Ferrando [48](#),
A. Ferrari [161](#), P. Ferrari [114,113](#), R. Ferrari [73a](#), D. Ferrere [56](#), C. Ferretti [106](#), F. Fiedler [100](#),
A. Filipčić [93](#), E.K. Filmer [1](#), F. Filthaut [113](#), M.C.N. Fiolhais [130a,130c,c](#), L. Fiorini [163](#),
W.C. Fisher [107](#), T. Fitschen [101](#), P.M. Fitzhugh [135](#), I. Fleck [141](#), P. Fleischmann [106](#),
T. Flick [171](#), L. Flores [128](#), M. Flores [33d,ah](#), L.R. Flores Castillo [64a](#), F.M. Follega [78a,78b](#),
N. Fomin [16](#), J.H. Foo [155](#), B.C. Forland [68](#), A. Formica [135](#), A.C. Forti [101](#), E. Fortin [36](#),
A.W. Fortman [61](#), M.G. Foti [17a](#), L. Fountas [9,k](#), D. Fournier [66](#), H. Fox [91](#),
P. Francavilla [74a,74b](#), S. Francescato [61](#), S. Franchellucci [56](#), M. Franchini [23b,23a](#),
S. Franchino [63a](#), D. Francis [36](#), L. Franco [113](#), L. Franconi [48](#), M. Franklin [61](#), G. Frattari [26](#),
A.C. Freegard [94](#), W.S. Freund [82b](#), Y.Y. Frid [151](#), N. Fritzsche [50](#), A. Froch [54](#),
D. Froidevaux [36](#), J.A. Frost [126](#), Y. Fu [62a](#), M. Fujimoto [118](#), E. Fullana Torregrosa [163,*](#),
E. Furtado De Simas Filho [82b](#), M. Furukawa [153](#), J. Fuster [163](#), A. Gabrielli [23b,23a](#),
A. Gabrielli [155](#), P. Gadow [48](#), G. Gagliardi [57b,57a](#), L.G. Gagnon [17a](#), E.J. Gallas [126](#),
B.J. Gallop [134](#), K.K. Gan [119](#), S. Ganguly [153](#), J. Gao [62a](#), Y. Gao [52](#),
F.M. Garay Walls [137a,137b](#), B. Garcia [29,ae](#), C. García [163](#), A. Garcia Alonso [114](#),
A.G. Garcia Caffaro [172](#), J.E. García Navarro [163](#), M. Garcia-Sciveres [17a](#), G.L. Gardner [128](#),

R.W. Gardner [ID](#)³⁹, N. Garelli [ID](#)¹⁵⁸, D. Garg [ID](#)⁸⁰, R.B. Garg [ID](#)^{143,ai}, J.M. Gargan⁵², C.A. Garner¹⁵⁵, S.J. Gasirowski [ID](#)¹³⁸, P. Gaspar [ID](#)^{82b}, G. Gaudio [ID](#)^{73a}, V. Gautam¹³, P. Gauzzi [ID](#)^{75a,75b}, I.L. Gavrilenko [ID](#)³⁷, A. Gavriluk [ID](#)³⁷, C. Gay [ID](#)¹⁶⁴, G. Gaycken [ID](#)⁴⁸, E.N. Gaziz [ID](#)¹⁰, A.A. Geanta [ID](#)^{27b,27e}, C.M. Gee [ID](#)¹³⁶, C. Gemme [ID](#)^{57b}, M.H. Genest [ID](#)⁶⁰, S. Gentile [ID](#)^{75a,75b}, S. George [ID](#)⁹⁵, W.F. George [ID](#)²⁰, T. Geralis [ID](#)⁴⁶, L.O. Gerlach⁵⁵, P. Gessinger-Befurt [ID](#)³⁶, M.E. Geyik [ID](#)¹⁷¹, M. Ghneimat [ID](#)¹⁴¹, K. Ghorbanian [ID](#)⁹⁴, A. Ghosal [ID](#)¹⁴¹, A. Ghosh [ID](#)¹⁶⁰, A. Ghosh [ID](#)⁷, B. Giacobbe [ID](#)^{23b}, S. Giagu [ID](#)^{75a,75b}, P. Giannetti [ID](#)^{74a}, A. Giannini [ID](#)^{62a}, S.M. Gibson [ID](#)⁹⁵, M. Gignac [ID](#)¹³⁶, D.T. Gil [ID](#)^{85b}, A.K. Gilbert [ID](#)^{85a}, B.J. Gilbert [ID](#)⁴¹, D. Gillberg [ID](#)³⁴, G. Gilles [ID](#)¹¹⁴, N.E.K. Gillwald [ID](#)⁴⁸, L. Ginabat [ID](#)¹²⁷, D.M. Gingrich [ID](#)^{2,ac}, M.P. Giordani [ID](#)^{69a,69c}, P.F. Giraud [ID](#)¹³⁵, G. Gliugliarelli [ID](#)^{69a,69c}, D. Giugni [ID](#)^{71a}, F. Giuli [ID](#)³⁶, I. Gkialas [ID](#)^{9,k}, L.K. Gladilin [ID](#)³⁷, C. Glasman [ID](#)⁹⁹, G.R. Gledhill [ID](#)¹²³, M. Glisic¹²³, I. Gnesi [ID](#)^{43b,g}, Y. Go [ID](#)^{29,ae}, M. Goblirsch-Kolb [ID](#)³⁶, B. Gocke [ID](#)⁴⁹, D. Godin¹⁰⁸, B. Gokturk [ID](#)^{21a}, S. Goldfarb [ID](#)¹⁰⁵, T. Golling [ID](#)⁵⁶, M.G.D. Gololo^{33g}, D. Golubkov [ID](#)³⁷, J.P. Gombas [ID](#)¹⁰⁷, A. Gomes [ID](#)^{130a,130b}, G. Gomes Da Silva [ID](#)¹⁴¹, A.J. Gomez Delegido [ID](#)¹⁶³, R. Gonalo [ID](#)^{130a,130c}, G. Gonella [ID](#)¹²³, L. Gonella [ID](#)²⁰, A. Gongadze [ID](#)³⁸, F. Gonnella [ID](#)²⁰, J.L. Gonski [ID](#)⁴¹, R.Y. Gonzalez Andana [ID](#)⁵², S. Gonzalez de la Hoz [ID](#)¹⁶³, S. Gonzalez Fernandez [ID](#)¹³, R. Gonzalez Lopez [ID](#)⁹², C. Gonzalez Renteria [ID](#)^{17a}, R. Gonzalez Suarez [ID](#)¹⁶¹, S. Gonzalez-Sevilla [ID](#)⁵⁶, G.R. Gonzalvo Rodriguez [ID](#)¹⁶³, L. Goossens [ID](#)³⁶, P.A. Gorbounov [ID](#)³⁷, B. Gorini [ID](#)³⁶, E. Gorini [ID](#)^{70a,70b}, A. Gorišek [ID](#)⁹³, T.C. Gosart [ID](#)¹²⁸, A.T. Goshaw [ID](#)⁵¹, M.I. Gostkin [ID](#)³⁸, S. Goswami [ID](#)¹²¹, C.A. Gottardo [ID](#)³⁶, M. Goughri [ID](#)^{35b}, V. Goumarre [ID](#)⁴⁸, A.G. Goussiou [ID](#)¹³⁸, N. Govender [ID](#)^{33c}, I. Grabowska-Bold [ID](#)^{85a}, K. Graham [ID](#)³⁴, E. Gramstad [ID](#)¹²⁵, S. Grancagnolo [ID](#)^{70a,70b}, M. Grandi [ID](#)¹⁴⁶, V. Gratchev^{37,*}, P.M. Gravila [ID](#)^{27f}, F.G. Gravili [ID](#)^{70a,70b}, H.M. Gray [ID](#)^{17a}, M. Greco [ID](#)^{70a,70b}, C. Grefe [ID](#)²⁴, I.M. Gregor [ID](#)⁴⁸, P. Grenier [ID](#)¹⁴³, C. Grieco [ID](#)¹³, A.A. Grillo [ID](#)¹³⁶, K. Grimm [ID](#)^{31,m}, S. Grinstein [ID](#)^{13,t}, J.-F. Grivaz [ID](#)⁶⁶, E. Gross [ID](#)¹⁶⁹, J. Grosse-Knetter [ID](#)⁵⁵, C. Grud¹⁰⁶, J.C. Grundy [ID](#)¹²⁶, L. Guan [ID](#)¹⁰⁶, W. Guan [ID](#)¹⁷⁰, C. Gubbels [ID](#)¹⁶⁴, J.G.R. Guerrero Rojas [ID](#)¹⁶³, G. Guerrieri [ID](#)^{69a,69b}, F. Guescini [ID](#)¹¹⁰, R. Gugel [ID](#)¹⁰⁰, J.A.M. Guhit [ID](#)¹⁰⁶, A. Guida [ID](#)⁴⁸, T. Guillemin [ID](#)⁴, E. Guilloton [ID](#)^{167,134}, S. Guindon [ID](#)³⁶, F. Guo [ID](#)^{14a,14e}, J. Guo [ID](#)^{62c}, L. Guo [ID](#)⁶⁶, Y. Guo [ID](#)¹⁰⁶, R. Gupta [ID](#)⁴⁸, S. Gurbuz [ID](#)²⁴, S.S. Gurdasani [ID](#)⁵⁴, G. Gustavino [ID](#)³⁶, M. Guth [ID](#)⁵⁶, P. Gutierrez [ID](#)¹²⁰, L.F. Gutierrez Zagazeta [ID](#)¹²⁸, C. Gutschow [ID](#)⁹⁶, C. Gwenlan [ID](#)¹²⁶, C.B. Gwilliam [ID](#)⁹², E.S. Haaland [ID](#)¹²⁵, A. Haas [ID](#)¹¹⁷, M. Habedank [ID](#)⁴⁸, C. Haber [ID](#)^{17a}, H.K. Hadavand [ID](#)⁸, A. Hadeef [ID](#)¹⁰⁰, S. Hadzic [ID](#)¹¹⁰, J.J. Hahn [ID](#)¹⁴¹, E.H. Haines [ID](#)⁹⁶, M. Haleem [ID](#)¹⁶⁶, J. Haley [ID](#)¹²¹, J.J. Hall [ID](#)¹³⁹, G.D. Hallewell [ID](#)¹⁰², L. Halser [ID](#)¹⁹, K. Hamano [ID](#)¹⁶⁵, H. Hamdaoui [ID](#)^{35e}, M. Hamer [ID](#)²⁴, G.N. Hamity [ID](#)⁵², E.J. Hampshire [ID](#)⁹⁵, J. Han [ID](#)^{62b}, K. Han [ID](#)^{62a}, L. Han [ID](#)^{14c}, L. Han [ID](#)^{62a}, S. Han [ID](#)^{17a}, Y.F. Han [ID](#)¹⁵⁵, K. Hanagaki [ID](#)⁸³, M. Hance [ID](#)¹³⁶, D.A. Hangal [ID](#)^{41,aa}, H. Hanif [ID](#)¹⁴², M.D. Hank [ID](#)¹²⁸, R. Hankache [ID](#)¹⁰¹, J.B. Hansen [ID](#)⁴², J.D. Hansen [ID](#)⁴², P.H. Hansen [ID](#)⁴², K. Hara [ID](#)¹⁵⁷, D. Harada [ID](#)⁵⁶, T. Harenberg [ID](#)¹⁷¹, S. Harkusha [ID](#)³⁷, Y.T. Harris [ID](#)¹²⁶, N.M. Harrison [ID](#)¹¹⁹, P.F. Harrison¹⁶⁷, N.M. Hartman [ID](#)¹⁴³, N.M. Hartmann [ID](#)¹⁰⁹, Y. Hasegawa [ID](#)¹⁴⁰, A. Hasib [ID](#)⁵², S. Haug [ID](#)¹⁹, R. Hauser [ID](#)¹⁰⁷, M. Havranek [ID](#)¹³², C.M. Hawkes [ID](#)²⁰, R.J. Hawkings [ID](#)³⁶, Y. Hayashi [ID](#)¹⁵³, S. Hayashida [ID](#)¹¹¹, D. Hayden [ID](#)¹⁰⁷, C. Hayes [ID](#)¹⁰⁶, R.L. Hayes [ID](#)¹¹⁴, C.P. Hays [ID](#)¹²⁶, J.M. Hays [ID](#)⁹⁴, H.S. Hayward [ID](#)⁹², F. He [ID](#)^{62a}, Y. He [ID](#)¹⁵⁴, Y. He [ID](#)¹²⁷, N.B. Heatley [ID](#)⁹⁴, V. Hedberg [ID](#)⁹⁸, A.L. Heggelund [ID](#)¹²⁵, N.D. Hehir [ID](#)⁹⁴, C. Heidegger [ID](#)⁵⁴, K.K. Heidegger [ID](#)⁵⁴, W.D. Heidorn [ID](#)⁸¹, J. Heilman [ID](#)³⁴, S. Heim [ID](#)⁴⁸,

T. Heim [17a](#), J.G. Heinlein [128](#), J.J. Heinrich [123](#), L. Heinrich [110,aj](#), J. Hejbal [131](#),
L. Helary [48](#), A. Held [170](#), S. Hellesund [16](#), C.M. Helling [164](#), S. Hellman [47a,47b](#),
C. Helsens [36](#), R.C.W. Henderson [91](#), L. Henkelmann [32](#), A.M. Henriques Correia [36](#), H. Herde [98](#),
Y. Hernández Jiménez [145](#), L.M. Herrmann [24](#), T. Herrmann [50](#), G. Herten [54](#),
R. Hertenberger [109](#), L. Hervas [36](#), N.P. Hesse [156a](#), H. Hibi [84](#), S.J. Hillier [20](#), J.R. Hinds [107](#),
F. Hinterkeuser [24](#), M. Hirose [124](#), S. Hirose [157](#), D. Hirschbuehl [171](#), T.G. Hitchings [101](#),
B. Hiti [93](#), J. Hobbs [145](#), R. Hobincu [27e](#), N. Hod [169](#), M.C. Hodgkinson [139](#),
B.H. Hodgkinson [32](#), A. Hoecker [36](#), J. Hofer [48](#), T. Holm [24](#), M. Holzbock [110](#),
L.B.A.H. Hommels [32](#), B.P. Honan [101](#), J. Hong [62c](#), T.M. Hong [129](#), J.C. Honig [54](#),
B.H. Hooberman [162](#), W.H. Hopkins [6](#), Y. Horii [111](#), S. Hou [148](#), A.S. Howard [93](#),
J. Howarth [59](#), J. Hoya [6](#), M. Hrabovsky [122](#), A. Hrynevich [48](#), T. Hryn'ova [4](#), P.J. Hsu [65](#),
S.-C. Hsu [138](#), Q. Hu [41](#), Y.F. Hu [14a,14e](#), D.P. Huang [96](#), S. Huang [64b](#), X. Huang [14c](#),
Y. Huang [62a](#), Y. Huang [14a](#), Z. Huang [101](#), Z. Hubacek [132](#), M. Huebner [24](#), F. Huegging [24](#),
T.B. Huffman [126](#), C.A. Hugli [48](#), M. Huhtinen [36](#), S.K. Huiberts [16](#), R. Hulsken [104](#),
N. Huseynov [12,a](#), J. Huston [107](#), J. Huth [61](#), R. Hyneman [143](#), G. Iacobucci [56](#),
G. Iakovidis [29](#), I. Ibragimov [141](#), L. Iconomidou-Fayard [66](#), P. Iengo [72a,72b](#), R. Iguchi [153](#),
T. Iizawa [56](#), Y. Ikegami [83](#), A. Ilg [19](#), N. Ilic [155](#), H. Imam [35a](#),
T. Ingebretsen Carlson [47a,47b](#), G. Introzzi [73a,73b](#), M. Iodice [77a](#), V. Ippolito [75a,75b](#),
R.K. Irwin [92](#), M. Ishino [153](#), W. Islam [170](#), C. Issever [18,48](#), S. Istin [21a,ak](#), H. Ito [168](#),
J.M. Iturbe Ponce [64a](#), R. Iuppa [78a,78b](#), A. Ivina [169](#), J.M. Izen [45](#), V. Izzo [72a](#),
P. Jacka [131,132](#), P. Jackson [1](#), R.M. Jacobs [48](#), B.P. Jaeger [142](#), C.S. Jagfeld [109](#), P. Jain [54](#),
G. Jäkel [171](#), K. Jakobs [54](#), T. Jakoubek [169](#), J. Jamieson [59](#), K.W. Janas [85a](#),
A.E. Jaspán [92](#), M. Javurkova [103](#), F. Jeanneau [135](#), L. Jeanty [123](#), J. Jejelava [149a,z](#),
P. Jenni [54,h](#), C.E. Jessiman [34](#), S. Jézéquel [4](#), C. Jia [62b](#), J. Jia [145](#), X. Jia [61](#), X. Jia [14a,14e](#),
Z. Jia [14c](#), Y. Jiang [62a](#), S. Jiggins [48](#), J. Jimenez Pena [110](#), S. Jin [14c](#), A. Jinaru [27b](#),
O. Jinnouchi [154](#), P. Johansson [139](#), K.A. Johns [7](#), J.W. Johnson [136](#), D.M. Jones [32](#),
E. Jones [48](#), P. Jones [32](#), R.W.L. Jones [91](#), T.J. Jones [92](#), R. Joshi [119](#), J. Jovicevic [15](#),
X. Ju [17a](#), J.J. Junggeburth [36](#), T. Junkermann [63a](#), A. Juste Rozas [13,t](#), M.K. Juzek [86](#),
S. Kabana [137e](#), A. Kaczmarska [86](#), M. Kado [110](#), H. Kagan [119](#), M. Kagan [143](#), A. Kahn [41](#),
A. Kahn [128](#), C. Kahra [100](#), T. Kaji [168](#), E. Kajomovitz [150](#), N. Kakati [169](#), I. Kalaitzidou [54](#),
C.W. Kalderon [29](#), A. Kamenshchikov [155](#), S. Kanayama [154](#), N.J. Kang [136](#), D. Kar [33g](#),
K. Karava [126](#), M.J. Kareem [156b](#), E. Karentzos [54](#), I. Karkanias [152,f](#), O. Karkout [114](#),
S.N. Karpov [38](#), Z.M. Karpova [38](#), V. Kartvelishvili [91](#), A.N. Karyukhin [37](#), E. Kasimi [152,f](#),
J. Katzy [48](#), S. Kaur [34](#), K. Kawade [140](#), T. Kawamoto [135](#), E.F. Kay [36](#), F.I. Kaya [158](#),
S. Kazakos [13](#), V.F. Kazanin [37](#), Y. Ke [145](#), J.M. Keaveney [33a](#), R. Keeler [165](#),
G.V. Kehris [61](#), J.S. Keller [34](#), A.S. Kelly [96](#), J.J. Kempster [146](#), K.E. Kennedy [41](#),
P.D. Kennedy [100](#), O. Kepka [131](#), B.P. Kerridge [167](#), S. Kersten [171](#), B.P. Kerševan [93](#),
S. Keshri [66](#), L. Keszeghova [28a](#), S. Ketabchi Haghighat [155](#), M. Khandoga [127](#),
A. Khanov [121](#), A.G. Kharlamov [37](#), T. Kharlamova [37](#), E.E. Khoda [138](#), T.J. Khoo [18](#),
G. Khoriali [166](#), J. Khubua [149b](#), Y.A.R. Khwaira [66](#), M. Kiehn [36](#), A. Kilgallon [123](#),
D.W. Kim [47a,47b](#), Y.K. Kim [39](#), N. Kimura [96](#), A. Kirchhoff [55](#), C. Kirfel [24](#), J. Kirk [134](#),
A.E. Kiryunin [110](#), D.P. Kisliuk [155](#), C. Kitsaki [10](#), O. Kivernyk [24](#), M. Klassen [63a](#),
C. Klein [34](#), L. Klein [166](#), M.H. Klein [106](#), M. Klein [92](#), S.B. Klein [56](#), U. Klein [92](#),

P. Klimek [ID](#)³⁶, A. Klimentov [ID](#)²⁹, T. Klioutchnikova [ID](#)³⁶, P. Kluit [ID](#)¹¹⁴, S. Kluth [ID](#)¹¹⁰,
 E. Kneringer [ID](#)⁷⁹, T.M. Knight [ID](#)¹⁵⁵, A. Knue [ID](#)⁵⁴, R. Kobayashi [ID](#)⁸⁷, S.F. Koch [ID](#)¹²⁶,
 M. Kocian [ID](#)¹⁴³, P. Kodyš [ID](#)¹³³, D.M. Koeck [ID](#)¹²³, P.T. Koenig [ID](#)²⁴, T. Koffas [ID](#)³⁴, M. Kolb [ID](#)¹³⁵,
 I. Koletsou [ID](#)⁴, T. Komarek [ID](#)¹²², K. Köneke [ID](#)⁵⁴, A.X.Y. Kong [ID](#)¹, T. Kono [ID](#)¹¹⁸,
 N. Konstantinidis [ID](#)⁹⁶, B. Konya [ID](#)⁹⁸, R. Kopeliansky [ID](#)⁶⁸, S. Koperny [ID](#)^{85a}, K. Korcyl [ID](#)⁸⁶,
 K. Kordas [ID](#)^{152.f}, G. Koren [ID](#)¹⁵¹, A. Korn [ID](#)⁹⁶, S. Korn [ID](#)⁵⁵, I. Korolkov [ID](#)¹³, N. Korotkova [ID](#)³⁷,
 B. Kortman [ID](#)¹¹⁴, O. Kortner [ID](#)¹¹⁰, S. Kortner [ID](#)¹¹⁰, W.H. KostECKa [ID](#)¹¹⁵, V.V. Kostyukhin [ID](#)¹⁴¹,
 A. Kotsokechagia [ID](#)¹³⁵, A. Kotwal [ID](#)⁵¹, A. Koulouris [ID](#)³⁶, A. Kourkouveli-Charalampidi [ID](#)^{73a,73b},
 C. Kourkouvelis [ID](#)⁹, E. Kourlitis [ID](#)⁶, O. Kovanda [ID](#)¹⁴⁶, R. Kowalewski [ID](#)¹⁶⁵, W. Kozanecki [ID](#)¹³⁵,
 A.S. Kozhin [ID](#)³⁷, V.A. Kramarenko [ID](#)³⁷, G. Kramberger [ID](#)⁹³, P. Kramer [ID](#)¹⁰⁰, M.W. Krasny [ID](#)¹²⁷,
 A. Krasznahorkay [ID](#)³⁶, J.A. Kremer [ID](#)¹⁰⁰, T. Kresse [ID](#)⁵⁰, J. Kretzschmar [ID](#)⁹², K. Kreul [ID](#)¹⁸,
 P. Krieger [ID](#)¹⁵⁵, S. Krishnamurthy [ID](#)¹⁰³, M. Krivos [ID](#)¹³³, K. Krizka [ID](#)²⁰, K. Kroeninger [ID](#)⁴⁹,
 H. Kroha [ID](#)¹¹⁰, J. Kroll [ID](#)¹³¹, J. Kroll [ID](#)¹²⁸, K.S. Krowpman [ID](#)¹⁰⁷, U. Kruchonak [ID](#)³⁸,
 H. Krüger [ID](#)²⁴, N. Krumnack [ID](#)⁸¹, M.C. Kruse [ID](#)⁵¹, J.A. Krzysiak [ID](#)⁸⁶, O. Kuchinskaia [ID](#)³⁷,
 S. Kuday [ID](#)^{3a}, S. Kuehn [ID](#)³⁶, R. Kuesters [ID](#)⁵⁴, T. Kuhl [ID](#)⁴⁸, V. Kukhtin [ID](#)³⁸, Y. Kulchitsky [ID](#)^{37,a},
 S. Kuleshov [ID](#)^{137d,137b}, M. Kumar [ID](#)^{33g}, N. Kumari [ID](#)¹⁰², A. Kupco [ID](#)¹³¹, T. Kupfer [ID](#)⁴⁹,
 A. Kupich [ID](#)³⁷, O. Kuprash [ID](#)⁵⁴, H. Kurashige [ID](#)⁸⁴, L.L. Kurchaninov [ID](#)^{156a}, O. Kurdysh [ID](#)⁶⁶,
 Y.A. Kurochkin [ID](#)³⁷, A. Kurova [ID](#)³⁷, M. Kuze [ID](#)¹⁵⁴, A.K. Kvam [ID](#)¹⁰³, J. Kvita [ID](#)¹²², T. Kwan [ID](#)¹⁰⁴,
 N.G. Kyriacou [ID](#)¹⁰⁶, L.A.O. Laatu [ID](#)¹⁰², C. Lacasta [ID](#)¹⁶³, F. Lacava [ID](#)^{75a,75b}, H. Lacker [ID](#)¹⁸,
 D. Lacour [ID](#)¹²⁷, N.N. Lad [ID](#)⁹⁶, E. Ladygin [ID](#)³⁸, B. Laforge [ID](#)¹²⁷, T. Lagouri [ID](#)^{137e}, S. Lai [ID](#)⁵⁵,
 I.K. Lakomic [ID](#)^{85a}, N. Lalloue [ID](#)⁶⁰, J.E. Lambert [ID](#)¹²⁰, S. Lammers [ID](#)⁶⁸, W. Lampl [ID](#)⁷,
 C. Lampoudis [ID](#)^{152.f}, A.N. Lancaster [ID](#)¹¹⁵, E. Lançon [ID](#)²⁹, U. Landgraf [ID](#)⁵⁴, M.P.J. Landon [ID](#)⁹⁴,
 V.S. Lang [ID](#)⁵⁴, R.J. Langenberg [ID](#)¹⁰³, O.K.B. Langrekken [ID](#)¹²⁵, A.J. Lankford [ID](#)¹⁶⁰, F. Lammi [ID](#)³⁶,
 K. Lantzsch [ID](#)²⁴, A. Lanza [ID](#)^{73a}, A. Lapertosa [ID](#)^{57b,57a}, J.F. Laporte [ID](#)¹³⁵, T. Lari [ID](#)^{71a},
 F. Lasagni Manghi [ID](#)^{23b}, M. Lassnig [ID](#)³⁶, V. Latonova [ID](#)¹³¹, A. Laudrain [ID](#)¹⁰⁰, A. Laurier [ID](#)¹⁵⁰,
 S.D. Lawlor [ID](#)⁹⁵, Z. Lawrence [ID](#)¹⁰¹, M. Lazzaroni [ID](#)^{71a,71b}, B. Le [ID](#)¹⁰¹, E.M. Le Boulicaut [ID](#)⁵¹,
 B. Leban [ID](#)⁹³, A. Lebedev [ID](#)⁸¹, M. LeBlanc [ID](#)³⁶, F. Ledroit-Guillon [ID](#)⁶⁰, A.C.A. Lee [ID](#)⁹⁶,
 S.C. Lee [ID](#)¹⁴⁸, S. Lee [ID](#)^{47a,47b}, T.F. Lee [ID](#)⁹², L.L. Leeuw [ID](#)^{33c}, H.P. Lefebvre [ID](#)⁹⁵, M. Lefebvre [ID](#)¹⁶⁵,
 C. Leggett [ID](#)^{17a}, K. Lehmann [ID](#)¹⁴², G. Lehmann Miotto [ID](#)³⁶, M. Leigh [ID](#)⁵⁶, W.A. Leight [ID](#)¹⁰³,
 W. Leinonen [ID](#)¹¹³, A. Leisos [ID](#)^{152,s}, M.A.L. Leite [ID](#)^{82c}, C.E. Leitgeb [ID](#)⁴⁸, R. Leitner [ID](#)¹³³,
 K.J.C. Leney [ID](#)⁴⁴, T. Lenz [ID](#)²⁴, S. Leone [ID](#)^{74a}, C. Leonidopoulos [ID](#)⁵², A. Leopold [ID](#)¹⁴⁴,
 C. Leroy [ID](#)¹⁰⁸, R. Les [ID](#)¹⁰⁷, C.G. Lester [ID](#)³², M. Levchenko [ID](#)³⁷, J. Levêque [ID](#)⁴, D. Levin [ID](#)¹⁰⁶,
 L.J. Levinson [ID](#)¹⁶⁹, M.P. Lewicki [ID](#)⁸⁶, D.J. Lewis [ID](#)⁴, A. Li [ID](#)⁵, B. Li [ID](#)^{62b}, C. Li [ID](#)^{62a}, C-Q. Li [ID](#)^{62c},
 H. Li [ID](#)^{62a}, H. Li [ID](#)^{62b}, H. Li [ID](#)^{14c}, H. Li [ID](#)^{62b}, J. Li [ID](#)^{62c}, K. Li [ID](#)¹³⁸, L. Li [ID](#)^{62c}, M. Li [ID](#)^{14a,14e},
 Q.Y. Li [ID](#)^{62a}, S. Li [ID](#)^{14a,14e}, S. Li [ID](#)^{62d,62c,e}, T. Li [ID](#)^{62b}, X. Li [ID](#)¹⁰⁴, Z. Li [ID](#)¹²⁶, Z. Li [ID](#)¹⁰⁴, Z. Li [ID](#)⁹²,
 Z. Li [ID](#)^{14a,14e}, Z. Liang [ID](#)^{14a}, M. Liberatore [ID](#)⁴⁸, B. Liberti [ID](#)^{76a}, K. Lie [ID](#)^{64c}, J. Lieber Marin [ID](#)^{82b},
 H. Lien [ID](#)⁶⁸, K. Lin [ID](#)¹⁰⁷, R.A. Linck [ID](#)⁶⁸, R.E. Lindley [ID](#)⁷, J.H. Lindon [ID](#)², A. Linss [ID](#)⁴⁸,
 E. Lipeles [ID](#)¹²⁸, A. Lipniacka [ID](#)¹⁶, A. Lister [ID](#)¹⁶⁴, J.D. Little [ID](#)⁴, B. Liu [ID](#)^{14a}, B.X. Liu [ID](#)¹⁴²,
 D. Liu [ID](#)^{62d,62c}, J.B. Liu [ID](#)^{62a}, J.K.K. Liu [ID](#)³², K. Liu [ID](#)^{62d,62c}, M. Liu [ID](#)^{62a}, M.Y. Liu [ID](#)^{62a},
 P. Liu [ID](#)^{14a}, Q. Liu [ID](#)^{62d,138,62c}, X. Liu [ID](#)^{62a}, Y. Liu [ID](#)^{14d,14e}, Y.L. Liu [ID](#)¹⁰⁶, Y.W. Liu [ID](#)^{62a},
 J. Llorente Merino [ID](#)¹⁴², S.L. Lloyd [ID](#)⁹⁴, E.M. Lobodzinska [ID](#)⁴⁸, P. Loch [ID](#)⁷, S. Loffredo [ID](#)^{76a,76b},
 T. Lohse [ID](#)¹⁸, K. Lohwasser [ID](#)¹³⁹, E. Loiacono [ID](#)⁴⁸, M. Lokajicek [ID](#)¹³¹, J.D. Lomas [ID](#)²⁰,
 J.D. Long [ID](#)¹⁶², I. Longarini [ID](#)¹⁶⁰, L. Longo [ID](#)^{70a,70b}, R. Longo [ID](#)¹⁶², I. Lopez Paz [ID](#)⁶⁷,

A. Lopez Solis [ID](#)⁴⁸, J. Lorenz [ID](#)¹⁰⁹, N. Lorenzo Martinez [ID](#)⁴, A.M. Lory [ID](#)¹⁰⁹, O. Loseva [ID](#)³⁷,
 X. Lou [ID](#)^{47a,47b}, X. Lou [ID](#)^{14a,14e}, A. Lounis [ID](#)⁶⁶, J. Love [ID](#)⁶, P.A. Love [ID](#)⁹¹, G. Lu [ID](#)^{14a,14e},
 M. Lu [ID](#)⁸⁰, S. Lu [ID](#)¹²⁸, Y.J. Lu [ID](#)⁶⁵, H.J. Lubatti [ID](#)¹³⁸, C. Luci [ID](#)^{75a,75b}, F.L. Lucio Alves [ID](#)^{14c},
 A. Lucotte [ID](#)⁶⁰, F. Luehring [ID](#)⁶⁸, I. Luise [ID](#)¹⁴⁵, O. Lukianchuk [ID](#)⁶⁶, O. Lundberg [ID](#)¹⁴⁴,
 B. Lund-Jensen [ID](#)¹⁴⁴, N.A. Luongo [ID](#)¹²³, M.S. Lutz [ID](#)¹⁵¹, D. Lynn [ID](#)²⁹, H. Lyons⁹², R. Lysak [ID](#)¹³¹,
 E. Lytken [ID](#)⁹⁸, V. Lyubushkin [ID](#)³⁸, T. Lyubushkina [ID](#)³⁸, M.M. Lyukova [ID](#)¹⁴⁵, H. Ma [ID](#)²⁹,
 L.L. Ma [ID](#)^{62b}, Y. Ma [ID](#)¹²¹, D.M. Mac Donell [ID](#)¹⁶⁵, G. Maccarrone [ID](#)⁵³, J.C. MacDonald [ID](#)¹⁰⁰,
 R. Madar [ID](#)⁴⁰, W.F. Mader [ID](#)⁵⁰, J. Maeda [ID](#)⁸⁴, T. Maeno [ID](#)²⁹, M. Maerker [ID](#)⁵⁰, H. Maguire [ID](#)¹³⁹,
 A. Maio [ID](#)^{130a,130b,130d}, K. Maj [ID](#)^{85a}, O. Majersky [ID](#)⁴⁸, S. Majewski [ID](#)¹²³, N. Makovec [ID](#)⁶⁶,
 V. Maksimovic [ID](#)¹⁵, B. Malaescu [ID](#)¹²⁷, Pa. Malecki [ID](#)⁸⁶, V.P. Maleev [ID](#)³⁷, F. Malek [ID](#)⁶⁰,
 M. Mali [ID](#)⁹³, D. Malito [ID](#)^{43b,43a}, U. Mallik [ID](#)⁸⁰, C. Malone [ID](#)³², S. Maltezos¹⁰, S. Malyukov³⁸,
 J. Mamuzic [ID](#)¹³, G. Mancini [ID](#)⁵³, G. Manco [ID](#)^{73a,73b}, J.P. Mandalia [ID](#)⁹⁴, I. Mandić [ID](#)⁹³,
 L. Manhaes de Andrade Filho [ID](#)^{82a}, I.M. Maniatis [ID](#)¹⁶⁹, J. Manjarres Ramos [ID](#)^{102,al},
 D.C. Mankad [ID](#)¹⁶⁹, A. Mann [ID](#)¹⁰⁹, B. Mansoulie [ID](#)¹³⁵, S. Manzoni [ID](#)³⁶, A. Marantis [ID](#)^{152,s},
 G. Marchiori [ID](#)⁵, M. Marcisovsky [ID](#)¹³¹, C. Marcon [ID](#)^{71a,71b}, M. Marinescu [ID](#)²⁰, M. Marjanovic [ID](#)¹²⁰,
 E.J. Marshall [ID](#)⁹¹, Z. Marshall [ID](#)^{17a}, S. Marti-Garcia [ID](#)¹⁶³, T.A. Martin [ID](#)¹⁶⁷, V.J. Martin [ID](#)⁵²,
 B. Martin dit Latour [ID](#)¹⁶, L. Martinelli [ID](#)^{75a,75b}, M. Martinez [ID](#)^{13,t}, P. Martinez Agullo [ID](#)¹⁶³,
 V.I. Martinez Outschoorn [ID](#)¹⁰³, P. Martinez Suarez [ID](#)¹³, S. Martin-Haugh [ID](#)¹³⁴, V.S. Martoiu [ID](#)^{27b},
 A.C. Martyniuk [ID](#)⁹⁶, A. Marzin [ID](#)³⁶, D. Mascione [ID](#)^{78a,78b}, L. Masetti [ID](#)¹⁰⁰, T. Mashimo [ID](#)¹⁵³,
 J. Masik [ID](#)¹⁰¹, A.L. Maslennikov [ID](#)³⁷, L. Massa [ID](#)^{23b}, P. Massarotti [ID](#)^{72a,72b},
 P. Mastrandrea [ID](#)^{74a,74b}, A. Mastroberardino [ID](#)^{43b,43a}, T. Masubuchi [ID](#)¹⁵³, T. Mathisen [ID](#)¹⁶¹,
 J. Matousek [ID](#)¹³³, N. Matsuzawa¹⁵³, J. Maurer [ID](#)^{27b}, B. Maček [ID](#)⁹³, D.A. Maximov [ID](#)³⁷,
 R. Mazini [ID](#)¹⁴⁸, I. Maznas [ID](#)^{152,f}, M. Mazza [ID](#)¹⁰⁷, S.M. Mazza [ID](#)¹³⁶, E. Mazzeo [ID](#)^{71a,71b},
 C. Mc Ginn [ID](#)^{29,ae}, J.P. Mc Gowan [ID](#)¹⁰⁴, S.P. Mc Kee [ID](#)¹⁰⁶, E.F. McDonald [ID](#)¹⁰⁵,
 A.E. McDougall [ID](#)¹¹⁴, J.A. Mcfayden [ID](#)¹⁴⁶, R.P. McGovern [ID](#)¹²⁸, G. Mchedlidze [ID](#)^{149b},
 R.P. McKenzie [ID](#)^{33g}, T.C. McLachlan [ID](#)⁴⁸, D.J. McLaughlin [ID](#)⁹⁶, K.D. McLean [ID](#)¹⁶⁵,
 S.J. McMahon [ID](#)¹³⁴, P.C. McNamara [ID](#)¹⁰⁵, C.M. Mcpartland [ID](#)⁹², R.A. McPherson [ID](#)^{165,w},
 T. Megy [ID](#)⁴⁰, S. Mehlhase [ID](#)¹⁰⁹, A. Mehta [ID](#)⁹², D. Melini [ID](#)¹⁵⁰, B.R. Mellado Garcia [ID](#)^{33g},
 A.H. Melo [ID](#)⁵⁵, F. Meloni [ID](#)⁴⁸, A.M. Mendes Jacques Da Costa [ID](#)¹⁰¹, H.Y. Meng [ID](#)¹⁵⁵, L. Meng [ID](#)⁹¹,
 S. Menke [ID](#)¹¹⁰, M. Mentink [ID](#)³⁶, E. Meoni [ID](#)^{43b,43a}, C. Merlassino [ID](#)¹²⁶, L. Merola [ID](#)^{72a,72b},
 C. Meroni [ID](#)^{71a}, G. Merz¹⁰⁶, O. Meshkov [ID](#)³⁷, J. Metcalfe [ID](#)⁶, A.S. Mete [ID](#)⁶, C. Meyer [ID](#)⁶⁸,
 J-P. Meyer [ID](#)¹³⁵, R.P. Middleton [ID](#)¹³⁴, L. Mijović [ID](#)⁵², G. Mikenberg [ID](#)¹⁶⁹, M. Mikestikova [ID](#)¹³¹,
 M. Mikuž [ID](#)⁹³, H. Mildner [ID](#)¹⁰⁰, A. Milic [ID](#)³⁶, C.D. Milke [ID](#)⁴⁴, D.W. Miller [ID](#)³⁹, L.S. Miller [ID](#)³⁴,
 A. Milov [ID](#)¹⁶⁹, D.A. Milstead^{47a,47b}, T. Min^{14c}, A.A. Minaenko [ID](#)³⁷, I.A. Minashvili [ID](#)^{149b},
 L. Mince [ID](#)⁵⁹, A.I. Mincer [ID](#)¹¹⁷, B. Mindur [ID](#)^{85a}, M. Mineev [ID](#)³⁸, Y. Mino [ID](#)⁸⁷, L.M. Mir [ID](#)¹³,
 M. Miralles Lopez [ID](#)¹⁶³, M. Mironova [ID](#)^{17a}, A. Mishima¹⁵³, M.C. Missio [ID](#)¹¹³, T. Mitani [ID](#)¹⁶⁸,
 A. Mitra [ID](#)¹⁶⁷, V.A. Mitsou [ID](#)¹⁶³, O. Miu [ID](#)¹⁵⁵, P.S. Miyagawa [ID](#)⁹⁴, Y. Miyazaki⁸⁹,
 A. Mizukami [ID](#)⁸³, T. Mkrtchyan [ID](#)^{63a}, M. Mlinarevic [ID](#)⁹⁶, T. Mlinarevic [ID](#)⁹⁶, M. Mlynarikova [ID](#)³⁶,
 S. Mobius [ID](#)⁵⁵, K. Mochizuki [ID](#)¹⁰⁸, P. Moder [ID](#)⁴⁸, P. Mogg [ID](#)¹⁰⁹, A.F. Mohammed [ID](#)^{14a,14e},
 S. Mohapatra [ID](#)⁴¹, G. Mokgatitwane [ID](#)^{33g}, B. Mondal [ID](#)¹⁴¹, S. Mondal [ID](#)¹³², G. Monig [ID](#)¹⁴⁶,
 K. Mönig [ID](#)⁴⁸, E. Monnier [ID](#)¹⁰², L. Monsonis Romero¹⁶³, J. Montejo Berlingen [ID](#)⁸³,
 M. Montella [ID](#)¹¹⁹, F. Monticelli [ID](#)⁹⁰, S. Monzani [ID](#)^{69a,69c}, N. Morange [ID](#)⁶⁶,
 A.L. Moreira De Carvalho [ID](#)^{130a}, M. Moreno Llácer [ID](#)¹⁶³, C. Moreno Martinez [ID](#)⁵⁶,

P. Morettini [ID](#)^{57b}, S. Morgenstern [ID](#)³⁶, M. Morii [ID](#)⁶¹, M. Morinaga [ID](#)¹⁵³, A.K. Morley [ID](#)³⁶, F. Morodei [ID](#)^{75a,75b}, L. Morvaj [ID](#)³⁶, P. Moschovakos [ID](#)³⁶, B. Moser [ID](#)³⁶, M. Mosidze [ID](#)^{149b}, T. Moskalets [ID](#)⁵⁴, P. Moskvitina [ID](#)¹¹³, J. Moss [ID](#)^{31,n}, E.J.W. Moyses [ID](#)¹⁰³, O. Mtintsilana [ID](#)^{33g}, S. Muanza [ID](#)¹⁰², J. Mueller [ID](#)¹²⁹, D. Muenstermann [ID](#)⁹¹, R. Müller [ID](#)¹⁹, G.A. Mullier [ID](#)¹⁶¹, A.J. Mullin³², J.J. Mullin¹²⁸, D.P. Mungo [ID](#)¹⁵⁵, D. Munoz Perez [ID](#)¹⁶³, F.J. Munoz Sanchez [ID](#)¹⁰¹, M. Murin [ID](#)¹⁰¹, W.J. Murray [ID](#)^{167,134}, A. Murrone [ID](#)^{71a,71b}, J.M. Muse [ID](#)¹²⁰, M. Muškinja [ID](#)^{17a}, C. Mwewa [ID](#)²⁹, A.G. Myagkov [ID](#)^{37,a}, A.J. Myers [ID](#)⁸, A.A. Myers¹²⁹, G. Myers [ID](#)⁶⁸, M. Myska [ID](#)¹³², B.P. Nachman [ID](#)^{17a}, O. Nackenhorst [ID](#)⁴⁹, A. Nag [ID](#)⁵⁰, K. Nagai [ID](#)¹²⁶, K. Nagano [ID](#)⁸³, J.L. Nagle [ID](#)^{29,ae}, E. Nagy [ID](#)¹⁰², A.M. Nairz [ID](#)³⁶, Y. Nakahama [ID](#)⁸³, K. Nakamura [ID](#)⁸³, K. Nakkalil [ID](#)⁵, H. Nanjo [ID](#)¹²⁴, R. Narayan [ID](#)⁴⁴, E.A. Narayanan [ID](#)¹¹², I. Naryshkin [ID](#)³⁷, M. Naseri [ID](#)³⁴, S. Nasri [ID](#)¹⁵⁹, C. Nass [ID](#)²⁴, G. Navarro [ID](#)^{22a}, J. Navarro-Gonzalez [ID](#)¹⁶³, R. Nayak [ID](#)¹⁵¹, A. Nayaz [ID](#)¹⁸, P.Y. Nechaeva [ID](#)³⁷, F. Nechansky [ID](#)⁴⁸, L. Nedic [ID](#)¹²⁶, T.J. Neep [ID](#)²⁰, A. Negri [ID](#)^{73a,73b}, M. Negrini [ID](#)^{23b}, C. Nellist [ID](#)¹¹⁴, C. Nelson [ID](#)¹⁰⁴, K. Nelson [ID](#)¹⁰⁶, S. Nemecek [ID](#)¹³¹, M. Nessi [ID](#)^{36,i}, M.S. Neubauer [ID](#)¹⁶², F. Neuhaus [ID](#)¹⁰⁰, J. Neundorff [ID](#)⁴⁸, R. Newhouse [ID](#)¹⁶⁴, P.R. Newman [ID](#)²⁰, C.W. Ng [ID](#)¹²⁹, Y.W.Y. Ng [ID](#)⁴⁸, B. Ngair [ID](#)^{35e}, H.D.N. Nguyen [ID](#)¹⁰⁸, R.B. Nickerson [ID](#)¹²⁶, R. Nicolaidou [ID](#)¹³⁵, J. Nielsen [ID](#)¹³⁶, M. Niemeyer [ID](#)⁵⁵, J. Niermann [ID](#)^{55,36}, N. Nikiforou [ID](#)³⁶, V. Nikolaenko [ID](#)^{37,a}, I. Nikolic-Audit [ID](#)¹²⁷, K. Nikolopoulos [ID](#)²⁰, P. Nilsson [ID](#)²⁹, I. Ninca [ID](#)⁴⁸, H.R. Nindhito [ID](#)⁵⁶, G. Ninio [ID](#)¹⁵¹, A. Nisati [ID](#)^{75a}, N. Nishu [ID](#)², R. Nisius [ID](#)¹¹⁰, J-E. Nitschke [ID](#)⁵⁰, E.K. Nkadimeng [ID](#)^{33g}, S.J. Noacco Rosende [ID](#)⁹⁰, T. Nobe [ID](#)¹⁵³, D.L. Noel [ID](#)³², T. Nommensen [ID](#)¹⁴⁷, M.A. Nomura²⁹, M.B. Norfolk [ID](#)¹³⁹, R.R.B. Norisam [ID](#)⁹⁶, B.J. Norman [ID](#)³⁴, J. Novak [ID](#)⁹³, T. Novak [ID](#)⁴⁸, L. Novotny [ID](#)¹³², R. Novotny [ID](#)¹¹², L. Nozka [ID](#)¹²², K. Ntekas [ID](#)¹⁶⁰, N.M.J. Nunes De Moura Junior [ID](#)^{82b}, E. Nurse⁹⁶, J. Ocariz [ID](#)¹²⁷, A. Ochi [ID](#)⁸⁴, I. Ochoa [ID](#)^{130a}, S. Oerdek [ID](#)¹⁶¹, J.T. Offermann [ID](#)³⁹, A. Ogrodnik [ID](#)^{85a}, A. Oh [ID](#)¹⁰¹, C.C. Ohm [ID](#)¹⁴⁴, H. Oide [ID](#)⁸³, R. Oishi [ID](#)¹⁵³, M.L. Ojeda [ID](#)⁴⁸, Y. Okazaki [ID](#)⁸⁷, M.W. O’Keefe⁹², Y. Okumura [ID](#)¹⁵³, L.F. Oleiro Seabra [ID](#)^{130a}, S.A. Olivares Pino [ID](#)^{137d}, D. Oliveira Damazio [ID](#)²⁹, D. Oliveira Goncalves [ID](#)^{82a}, J.L. Oliver [ID](#)¹⁶⁰, M.J.R. Olsson [ID](#)¹⁶⁰, A. Olszewski [ID](#)⁸⁶, Ö.O. Öncel [ID](#)⁵⁴, D.C. O’Neil [ID](#)¹⁴², A.P. O’Neill [ID](#)¹⁹, A. Onofre [ID](#)^{130a,130e}, P.U.E. Onyisi [ID](#)¹¹, M.J. Oreglia [ID](#)³⁹, G.E. Orellana [ID](#)⁹⁰, D. Orestano [ID](#)^{77a,77b}, N. Orlando [ID](#)¹³, R.S. Orr [ID](#)¹⁵⁵, V. O’Shea [ID](#)⁵⁹, R. Ospanov [ID](#)^{62a}, G. Otero y Garzon [ID](#)³⁰, H. Otono [ID](#)⁸⁹, P.S. Ott [ID](#)^{63a}, G.J. Ottino [ID](#)^{17a}, M. Ouchrif [ID](#)^{35d}, J. Ouellette [ID](#)²⁹, F. Ould-Saada [ID](#)¹²⁵, M. Owen [ID](#)⁵⁹, R.E. Owen [ID](#)¹³⁴, K.Y. Oyulmaz [ID](#)^{21a}, V.E. Ozcan [ID](#)^{21a}, N. Ozturk [ID](#)⁸, S. Ozturk [ID](#)^{21d}, H.A. Pacey [ID](#)³², A. Pacheco Pages [ID](#)¹³, C. Padilla Aranda [ID](#)¹³, G. Padovano [ID](#)^{75a,75b}, S. Pagan Griso [ID](#)^{17a}, G. Palacino [ID](#)⁶⁸, A. Palazzo [ID](#)^{70a,70b}, S. Palestini [ID](#)³⁶, J. Pan [ID](#)¹⁷², T. Pan [ID](#)^{64a}, D.K. Panchal [ID](#)¹¹, C.E. Pandini [ID](#)¹¹⁴, J.G. Panduro Vazquez [ID](#)⁹⁵, H. Pang [ID](#)^{14b}, P. Pani [ID](#)⁴⁸, G. Panizzo [ID](#)^{69a,69c}, L. Paolozzi [ID](#)⁵⁶, C. Papadatos [ID](#)¹⁰⁸, S. Parajuli [ID](#)⁴⁴, A. Paramonov [ID](#)⁶, C. Paraskevopoulos [ID](#)¹⁰, D. Paredes Hernandez [ID](#)^{64b}, T.H. Park [ID](#)¹⁵⁵, M.A. Parker [ID](#)³², F. Parodi [ID](#)^{57b,57a}, E.W. Parrish [ID](#)¹¹⁵, V.A. Parrish [ID](#)⁵², J.A. Parsons [ID](#)⁴¹, U. Parzefall [ID](#)⁵⁴, B. Pascual Dias [ID](#)¹⁰⁸, L. Pascual Dominguez [ID](#)¹⁵¹, F. Pasquali [ID](#)¹¹⁴, E. Pasqualucci [ID](#)^{75a}, S. Passaggio [ID](#)^{57b}, F. Pastore [ID](#)⁹⁵, P. Pasuwan [ID](#)^{47a,47b}, P. Patel [ID](#)⁸⁶, U.M. Patel [ID](#)⁵¹, J.R. Pater [ID](#)¹⁰¹, T. Pauly [ID](#)³⁶, J. Pearkes [ID](#)¹⁴³, M. Pedersen [ID](#)¹²⁵, R. Pedro [ID](#)^{130a}, S.V. Peleganchuk [ID](#)³⁷, O. Penc [ID](#)³⁶, E.A. Pender⁵², H. Peng [ID](#)^{62a}, K.E. Pensi [ID](#)¹⁰⁹, M. Penzin [ID](#)³⁷, B.S. Peralva [ID](#)^{82d}, A.P. Pereira Peixoto [ID](#)⁶⁰, L. Pereira Sanchez [ID](#)^{47a,47b}, D.V. Perepelitsa [ID](#)^{29,ae}, E. Perez Codina [ID](#)^{156a}, M. Perganti [ID](#)¹⁰, L. Perini [ID](#)^{71a,71b,*}, H. Pernegger [ID](#)³⁶, S. Perrella [ID](#)³⁶,

A. Perrevoort [113](#), O. Perrin [40](#), K. Peters [48](#), R.F.Y. Peters [101](#), B.A. Petersen [36](#),
 T.C. Petersen [42](#), E. Petit [102](#), V. Petousis [132](#), C. Petridou [152,f](#), A. Petrukhin [141](#),
 M. Pettee [17a](#), N.E. Pettersson [36](#), A. Petukhov [37](#), K. Petukhova [133](#), A. Peyaud [135](#),
 R. Pezoa [137f](#), L. Pezzotti [36](#), G. Pezzullo [172](#), T.M. Pham [170](#), T. Pham [105](#),
 P.W. Phillips [134](#), M.W. Phipps [162](#), G. Piacquadio [145](#), E. Pianori [17a](#), F. Piazza [71a,71b](#),
 R. Piegaia [30](#), D. Pietreanu [27b](#), A.D. Pilkington [101](#), M. Pinamonti [69a,69c](#), J.L. Pinfold [2](#),
 B.C. Pinheiro Pereira [130a](#), A.E. Pinto Pinoargote [135](#), C. Pitman Donaldson [96](#), D.A. Pizzi [34](#),
 L. Pizzimento [76a,76b](#), A. Pizzini [114](#), M.-A. Pleier [29](#), V. Plesanovs [54](#), V. Pleskot [133](#),
 E. Plotnikova [38](#), G. Poddar [4](#), R. Poettgen [98](#), L. Poggioli [127](#), D. Pohl [24](#), I. Pokharel [55](#),
 S. Polacek [133](#), G. Polesello [73a](#), A. Poley [142,156a](#), R. Polifka [132](#), A. Polini [23b](#),
 C.S. Pollard [167](#), Z.B. Pollock [119](#), V. Polychronakos [29](#), E. Pompa Pacchi [75a,75b](#),
 D. Ponomarenko [113](#), L. Pontecorvo [36](#), S. Popa [27a](#), G.A. Popeneciu [27d](#),
 D.M. Portillo Quintero [156a](#), S. Pospisil [132](#), M.A. Postill [139](#), P. Postolache [27c](#),
 K. Potamianos [126](#), P.P. Potepa [85a](#), I.N. Potrap [38](#), C.J. Potter [32](#), H. Potti [1](#),
 T. Poulsen [48](#), J. Poveda [163](#), M.E. Pozo Astigarraga [36](#), A. Prades Ibanez [163](#),
 M.M. Prapa [46](#), J. Pretel [54](#), D. Price [101](#), M. Primavera [70a](#), M.A. Principe Martin [99](#),
 R. Privara [122](#), T. Procter [59](#), M.L. Proffitt [138](#), N. Proklova [128](#), K. Prokofiev [64c](#),
 G. Proto [76a,76b](#), S. Protopopescu [29](#), J. Proudfoot [6](#), M. Przybycien [85a](#), W.W. Przygoda [85b](#),
 J.E. Puddefoot [139](#), D. Pudzha [37](#), D. Pyatiizbyantseva [37](#), J. Qian [106](#), D. Qichen [101](#),
 Y. Qin [101](#), T. Qiu [52](#), A. Quadt [55](#), M. Queitsch-Maitland [101](#), G. Quetant [56](#),
 G. Rabanal Bolanos [61](#), D. Rafanoharana [54](#), F. Ragusa [71a,71b](#), J.L. Rainbolt [39](#),
 J.A. Raine [56](#), S. Rajagopalan [29](#), E. Ramakoti [37](#), K. Ran [48,14e](#), N.P. Rapheeha [33g](#),
 H. Rasheed [27b](#), V. Raskina [127](#), D.F. Rassloff [63a](#), S. Rave [100](#), B. Ravina [55](#),
 I. Ravinovich [169](#), M. Raymond [36](#), A.L. Read [125](#), N.P. Readioff [139](#), D.M. Rebuzzi [73a,73b](#),
 G. Redlinger [29](#), A.S. Reed [110](#), K. Reeves [26](#), J.A. Reidelsturz [171](#), D. Reikher [151](#),
 A. Rej [141](#), C. Rembser [36](#), A. Renardi [48](#), M. Renda [27b](#), M.B. Rendel [110](#), F. Renner [48](#),
 A.G. Rennie [59](#), S. Resconi [71a](#), M. Ressegotti [57b,57a](#), E.D. Resseguie [17a](#), S. Rettie [36](#),
 J.G. Reyes Rivera [107](#), B. Reynolds [119](#), E. Reynolds [17a](#), M. Rezaei Estabragh [171](#),
 O.L. Rezanova [37](#), P. Reznicek [133](#), N. Ribaric [91](#), E. Ricci [78a,78b](#), R. Richter [110](#),
 S. Richter [47a,47b](#), E. Richter-Was [85b](#), M. Ridel [127](#), S. Ridouani [35d](#), P. Rieck [117](#),
 P. Riedler [36](#), M. Rijssenbeek [145](#), A. Rimoldi [73a,73b](#), M. Rimoldi [48](#), L. Rinaldi [23b,23a](#),
 T.T. Rinn [29](#), M.P. Rinnagel [109](#), G. Ripellino [161](#), I. Riu [13](#), P. Rivadeneira [48](#),
 J.C. Rivera Vergara [165](#), F. Rizatdinova [121](#), E. Rizvi [94](#), C. Rizzi [56](#), B.A. Roberts [167](#),
 B.R. Roberts [17a](#), S.H. Robertson [104,w](#), M. Robin [48](#), D. Robinson [32](#),
 C.M. Robles Gajardo [137f](#), M. Robles Manzano [100](#), A. Robson [59](#), A. Rocchi [76a,76b](#),
 C. Roda [74a,74b](#), S. Rodriguez Bosca [63a](#), Y. Rodriguez Garcia [22a](#), A. Rodriguez Rodriguez [54](#),
 A.M. Rodríguez Vera [156b](#), S. Roe [36](#), J.T. Roemer [160](#), A.R. Roepe-Gier [136](#), J. Roggel [171](#),
 O. Røhne [125](#), R.A. Rojas [103](#), C.P.A. Roland [68](#), J. Roloff [29](#), A. Romaniouk [37](#),
 E. Romano [73a,73b](#), M. Romano [23b](#), A.C. Romero Hernandez [162](#), N. Rompotis [92](#),
 L. Roos [127](#), S. Rosati [75a](#), B.J. Rosser [39](#), E. Rossi [126](#), E. Rossi [72a,72b](#), L.P. Rossi [57b](#),
 L. Rossini [48](#), R. Rosten [119](#), M. Rotaru [27b](#), B. Rottler [54](#), C. Rougier [102,al](#),
 D. Rousseau [66](#), D. Rouso [32](#), A. Roy [162](#), S. Roy-Garand [155](#), A. Rozanov [102](#),
 Y. Rozen [150](#), X. Ruan [33g](#), A. Rubio Jimenez [163](#), A.J. Ruby [92](#), V.H. Ruelas Rivera [18](#),

T.A. Ruggeri [ID](#)¹, A. Ruggiero [ID](#)¹²⁶, A. Ruiz-Martinez [ID](#)¹⁶³, A. Rummeler [ID](#)³⁶, Z. Rurikova [ID](#)⁵⁴,
N.A. Rusakovich [ID](#)³⁸, H.L. Russell [ID](#)¹⁶⁵, G. Russo [ID](#)^{75a,75b}, J.P. Rutherford [ID](#)⁷,
S. Rutherford Colmenares [ID](#)³², K. Rybacki⁹¹, M. Rybar [ID](#)¹³³, E.B. Rye [ID](#)¹²⁵, A. Ryzhov [ID](#)³⁷,
J.A. Sabater Iglesias [ID](#)⁵⁶, P. Sabatini [ID](#)¹⁶³, L. Sabetta [ID](#)^{75a,75b}, H.F-W. Sadrozinski [ID](#)¹³⁶,
F. Safai Tehrani [ID](#)^{75a}, B. Safarzadeh Samani [ID](#)¹⁴⁶, M. Safdari [ID](#)¹⁴³, S. Saha [ID](#)¹⁰⁴, M. Sahinsoy [ID](#)¹¹⁰,
M. Saimpert [ID](#)¹³⁵, M. Saito [ID](#)¹⁵³, T. Saito [ID](#)¹⁵³, D. Salamani [ID](#)³⁶, A. Salnikov [ID](#)¹⁴³, J. Salt [ID](#)¹⁶³,
A. Salvador Salas [ID](#)¹³, D. Salvatore [ID](#)^{43b,43a}, F. Salvatore [ID](#)¹⁴⁶, A. Salzburger [ID](#)³⁶, D. Sammel [ID](#)⁵⁴,
D. Sampsonidis [ID](#)^{152,f}, D. Sampsonidou [ID](#)^{123,62c}, J. Sánchez [ID](#)¹⁶³, A. Sanchez Pineda [ID](#)⁴,
V. Sanchez Sebastian [ID](#)¹⁶³, H. Sandaker [ID](#)¹²⁵, C.O. Sander [ID](#)⁴⁸, J.A. Sandesara [ID](#)¹⁰³,
M. Sandhoff [ID](#)¹⁷¹, C. Sandoval [ID](#)^{22b}, D.P.C. Sankey [ID](#)¹³⁴, T. Sano [ID](#)⁸⁷, A. Sansoni [ID](#)⁵³,
L. Santi [ID](#)^{75a,75b}, C. Santoni [ID](#)⁴⁰, H. Santos [ID](#)^{130a,130b}, S.N. Santpur [ID](#)^{17a}, A. Santra [ID](#)¹⁶⁹,
K.A. Saoucha [ID](#)¹³⁹, J.G. Saraiva [ID](#)^{130a,130d}, J. Sardain [ID](#)⁷, O. Sasaki [ID](#)⁸³, K. Sato [ID](#)¹⁵⁷, C. Sauer^{63b},
F. Sauerburger [ID](#)⁵⁴, E. Sauvan [ID](#)⁴, P. Savard [ID](#)^{155,ac}, R. Sawada [ID](#)¹⁵³, C. Sawyer [ID](#)¹³⁴,
L. Sawyer [ID](#)⁹⁷, I. Sayago Galvan¹⁶³, C. Sbarra [ID](#)^{23b}, A. Sbrizzi [ID](#)^{23b,23a}, T. Scanlon [ID](#)⁹⁶,
J. Schaarschmidt [ID](#)¹³⁸, P. Schacht [ID](#)¹¹⁰, D. Schaefer [ID](#)³⁹, U. Schäfer [ID](#)¹⁰⁰, A.C. Schaffer [ID](#)^{66,44},
D. Schaile [ID](#)¹⁰⁹, R.D. Schamberger [ID](#)¹⁴⁵, E. Schanet [ID](#)¹⁰⁹, C. Scharf [ID](#)¹⁸, M.M. Schefer [ID](#)¹⁹,
V.A. Schegelsky [ID](#)³⁷, D. Scheirich [ID](#)¹³³, F. Schenck [ID](#)¹⁸, M. Schernau [ID](#)¹⁶⁰, C. Scheulen [ID](#)⁵⁵,
C. Schiavi [ID](#)^{57b,57a}, E.J. Schioppa [ID](#)^{70a,70b}, M. Schioppa [ID](#)^{43b,43a}, B. Schlag [ID](#)^{143,ai},
K.E. Schleicher [ID](#)⁵⁴, S. Schlenker [ID](#)³⁶, J. Schmeing [ID](#)¹⁷¹, M.A. Schmidt [ID](#)¹⁷¹, K. Schmieden [ID](#)¹⁰⁰,
C. Schmitt [ID](#)¹⁰⁰, S. Schmitt [ID](#)⁴⁸, L. Schoeffel [ID](#)¹³⁵, A. Schoening [ID](#)^{63b}, P.G. Scholer [ID](#)⁵⁴,
E. Schopf [ID](#)¹²⁶, M. Schott [ID](#)¹⁰⁰, J. Schovancova [ID](#)³⁶, S. Schramm [ID](#)⁵⁶, F. Schroeder [ID](#)¹⁷¹,
H-C. Schultz-Coulon [ID](#)^{63a}, M. Schumacher [ID](#)⁵⁴, B.A. Schumm [ID](#)¹³⁶, Ph. Schune [ID](#)¹³⁵,
A.J. Schuy [ID](#)¹³⁸, H.R. Schwartz [ID](#)¹³⁶, A. Schwartzman [ID](#)¹⁴³, T.A. Schwarz [ID](#)¹⁰⁶,
Ph. Schwemling [ID](#)¹³⁵, R. Schwienhorst [ID](#)¹⁰⁷, A. Sciandra [ID](#)¹³⁶, G. Sciolla [ID](#)²⁶, F. Scuri [ID](#)^{74a},
F. Scutti¹⁰⁵, C.D. Sebastiani [ID](#)⁹², K. Sedlaczek [ID](#)¹¹⁵, P. Seema [ID](#)¹⁸, S.C. Seidel [ID](#)¹¹², A. Seiden [ID](#)¹³⁶,
B.D. Seidlitz [ID](#)⁴¹, C. Seitz [ID](#)⁴⁸, J.M. Seixas [ID](#)^{82b}, G. Sekhniaidze [ID](#)^{72a}, S.J. Sekula [ID](#)⁴⁴, L. Selem [ID](#)⁴,
N. Semprini-Cesari [ID](#)^{23b,23a}, S. Sen [ID](#)⁵¹, D. Sengupta [ID](#)⁵⁶, V. Senthilkumar [ID](#)¹⁶³, L. Serin [ID](#)⁶⁶,
L. Serkin [ID](#)^{69a,69b}, M. Sessa [ID](#)^{76a,76b}, H. Severini [ID](#)¹²⁰, F. Sforza [ID](#)^{57b,57a}, A. Sfyrlla [ID](#)⁵⁶,
E. Shabalina [ID](#)⁵⁵, R. Shaheen [ID](#)¹⁴⁴, J.D. Shahinian [ID](#)¹²⁸, D. Shaked Renous [ID](#)¹⁶⁹, L.Y. Shan [ID](#)^{14a},
M. Shapiro [ID](#)^{17a}, A. Sharma [ID](#)³⁶, A.S. Sharma [ID](#)¹⁶⁴, P. Sharma [ID](#)⁸⁰, S. Sharma [ID](#)⁴⁸,
P.B. Shatalov [ID](#)³⁷, K. Shaw [ID](#)¹⁴⁶, S.M. Shaw [ID](#)¹⁰¹, Q. Shen [ID](#)^{62c,5}, P. Sherwood [ID](#)⁹⁶, L. Shi [ID](#)⁹⁶,
X. Shi [ID](#)^{14a}, C.O. Shimmin [ID](#)¹⁷², Y. Shimogama [ID](#)¹⁶⁸, J.D. Shinner [ID](#)⁹⁵, I.P.J. Shipsey [ID](#)¹²⁶,
S. Shirabe [ID](#)⁶⁰, M. Shiyakova [ID](#)³⁸, J. Shlomi [ID](#)¹⁶⁹, M.J. Shochet [ID](#)³⁹, J. Shojaii [ID](#)¹⁰⁵,
D.R. Shope [ID](#)¹²⁵, S. Shrestha [ID](#)^{119,af}, E.M. Shrif [ID](#)^{33g}, M.J. Shroff [ID](#)¹⁶⁵, P. Sicho [ID](#)¹³¹,
A.M. Sickles [ID](#)¹⁶², E. Sideras Haddad [ID](#)^{33g}, A. Sidoti [ID](#)^{23b}, F. Siegert [ID](#)⁵⁰, Dj. Sijacki [ID](#)¹⁵,
R. Sikora [ID](#)^{85a}, F. Sili [ID](#)⁹⁰, J.M. Silva [ID](#)²⁰, M.V. Silva Oliveira [ID](#)³⁶, S.B. Silverstein [ID](#)^{47a},
S. Simion⁶⁶, R. Simoniello [ID](#)³⁶, E.L. Simpson [ID](#)⁵⁹, H. Simpson [ID](#)¹⁴⁶, L.R. Simpson [ID](#)¹⁰⁶,
N.D. Simpson⁹⁸, S. Simsek [ID](#)^{21d}, S. Sindhu [ID](#)⁵⁵, P. Sinervo [ID](#)¹⁵⁵, S. Singh [ID](#)¹⁴², S. Singh [ID](#)¹⁵⁵,
S. Sinha [ID](#)⁴⁸, S. Sinha [ID](#)^{33g}, M. Sioli [ID](#)^{23b,23a}, I. Siral [ID](#)³⁶, E. Sitnikova [ID](#)⁴⁸, S.Yu. Sivoklov [ID](#)^{37,*},
J. Sjölin [ID](#)^{47a,47b}, A. Skaf [ID](#)⁵⁵, E. Skorda [ID](#)⁹⁸, P. Skubic [ID](#)¹²⁰, M. Slawinska [ID](#)⁸⁶, V. Smakhtin¹⁶⁹,
B.H. Smart [ID](#)¹³⁴, J. Smiesko [ID](#)³⁶, S.Yu. Smirnov [ID](#)³⁷, Y. Smirnov [ID](#)³⁷, L.N. Smirnova [ID](#)^{37,a},
O. Smirnova [ID](#)⁹⁸, A.C. Smith [ID](#)⁴¹, E.A. Smith [ID](#)³⁹, H.A. Smith [ID](#)¹²⁶, J.L. Smith [ID](#)⁹², R. Smith¹⁴³,
M. Smizanska [ID](#)⁹¹, K. Smolek [ID](#)¹³², A.A. Snesarev [ID](#)³⁷, S.R. Snider [ID](#)¹⁵⁵, H.L. Snoek [ID](#)¹¹⁴,

S. Snyder [ID](#)²⁹, R. Sobie [ID](#)^{165,w}, A. Soffer [ID](#)¹⁵¹, C.A. Solans Sanchez [ID](#)³⁶, E.Yu. Soldatov [ID](#)³⁷, U. Soldevila [ID](#)¹⁶³, A.A. Solodkov [ID](#)³⁷, S. Solomon [ID](#)²⁶, A. Soloshenko [ID](#)³⁸, K. Solovieva [ID](#)⁵⁴, O.V. Solovyanov [ID](#)⁴⁰, V. Solovyev [ID](#)³⁷, P. Sommer [ID](#)³⁶, A. Sonay [ID](#)¹³, W.Y. Song [ID](#)^{156b}, J.M. Sonneveld [ID](#)¹¹⁴, A. Sopczak [ID](#)¹³², A.L. Soppio [ID](#)⁹⁶, F. Sopkova [ID](#)^{28b}, V. Sothilingam [ID](#)^{63a}, S. Sottocornola [ID](#)⁶⁸, R. Soualah [ID](#)^{116b}, Z. Soumami [ID](#)^{35e}, D. South [ID](#)⁴⁸, S. Spagnolo [ID](#)^{70a,70b}, M. Spalla [ID](#)¹¹⁰, D. Sperlich [ID](#)⁵⁴, G. Spigo [ID](#)³⁶, M. Spina [ID](#)¹⁴⁶, S. Spinali [ID](#)⁹¹, D.P. Spiteri [ID](#)⁵⁹, M. Spousta [ID](#)¹³³, E.J. Staats [ID](#)³⁴, A. Stabile [ID](#)^{71a,71b}, R. Stamen [ID](#)^{63a}, M. Stamenkovic [ID](#)¹¹⁴, A. Stampekis [ID](#)²⁰, M. Standke [ID](#)²⁴, E. Stanecka [ID](#)⁸⁶, M.V. Stange [ID](#)⁵⁰, B. Stanislaus [ID](#)^{17a}, M.M. Stanitzki [ID](#)⁴⁸, M. Stankaityte [ID](#)¹²⁶, B. Stapf [ID](#)⁴⁸, E.A. Starchenko [ID](#)³⁷, G.H. Stark [ID](#)¹³⁶, J. Stark [ID](#)^{102,al}, D.M. Starke [ID](#)^{156b}, P. Staroba [ID](#)¹³¹, P. Starovoitov [ID](#)^{63a}, S. Starz [ID](#)¹⁰⁴, R. Staszewski [ID](#)⁸⁶, G. Stavropoulos [ID](#)⁴⁶, J. Steentoft [ID](#)¹⁶¹, P. Steinberg [ID](#)²⁹, B. Stelzer [ID](#)^{142,156a}, H.J. Stelzer [ID](#)¹²⁹, O. Stelzer-Chilton [ID](#)^{156a}, H. Stenzel [ID](#)⁵⁸, T.J. Stevenson [ID](#)¹⁴⁶, G.A. Stewart [ID](#)³⁶, J.R. Stewart [ID](#)¹²¹, M.C. Stockton [ID](#)³⁶, G. Stoicea [ID](#)^{27b}, M. Stolarski [ID](#)^{130a}, S. Stonjek [ID](#)¹¹⁰, A. Straessner [ID](#)⁵⁰, J. Strandberg [ID](#)¹⁴⁴, S. Strandberg [ID](#)^{47a,47b}, M. Strauss [ID](#)¹²⁰, T. Strebler [ID](#)¹⁰², P. Strizenec [ID](#)^{28b}, R. Strohmer [ID](#)¹⁶⁶, D.M. Strom [ID](#)¹²³, L.R. Strom [ID](#)⁴⁸, R. Stroynowski [ID](#)⁴⁴, A. Strubig [ID](#)^{47a,47b}, S.A. Stucci [ID](#)²⁹, B. Stugu [ID](#)¹⁶, J. Stupak [ID](#)¹²⁰, N.A. Styles [ID](#)⁴⁸, D. Su [ID](#)¹⁴³, S. Su [ID](#)^{62a}, W. Su [ID](#)^{62d,138,62c}, X. Su [ID](#)^{62a,66}, K. Sugizaki [ID](#)¹⁵³, V.V. Sulin [ID](#)³⁷, M.J. Sullivan [ID](#)⁹², D.M.S. Sultan [ID](#)^{78a,78b}, L. Sultanaliyeva [ID](#)³⁷, S. Sultansoy [ID](#)^{3b}, T. Sumida [ID](#)⁸⁷, S. Sun [ID](#)¹⁰⁶, S. Sun [ID](#)¹⁷⁰, O. Sunneborn Gudnadottir [ID](#)¹⁶¹, M.R. Sutton [ID](#)¹⁴⁶, M. Svatos [ID](#)¹³¹, M. Swiatlowski [ID](#)^{156a}, T. Swirski [ID](#)¹⁶⁶, I. Sykora [ID](#)^{28a}, M. Sykora [ID](#)¹³³, T. Sykora [ID](#)¹³³, D. Ta [ID](#)¹⁰⁰, K. Tackmann [ID](#)^{48,u}, A. Taffard [ID](#)¹⁶⁰, R. Tafirout [ID](#)^{156a}, J.S. Tafoya Vargas [ID](#)⁶⁶, R.H.M. Taibah [ID](#)¹²⁷, R. Takashima [ID](#)⁸⁸, E.P. Takeva [ID](#)⁵², Y. Takubo [ID](#)⁸³, M. Talby [ID](#)¹⁰², A.A. Talyshev [ID](#)³⁷, K.C. Tam [ID](#)^{64b}, N.M. Tamir [ID](#)¹⁵¹, A. Tanaka [ID](#)¹⁵³, J. Tanaka [ID](#)¹⁵³, R. Tanaka [ID](#)⁶⁶, M. Tanasini [ID](#)^{57b,57a}, Z. Tao [ID](#)¹⁶⁴, S. Tapia Araya [ID](#)^{137f}, S. Tapprogge [ID](#)¹⁰⁰, A. Tarek Abouelfadl Mohamed [ID](#)¹⁰⁷, S. Tarem [ID](#)¹⁵⁰, K. Tariq [ID](#)^{62b}, G. Tarna [ID](#)^{102,27b}, G.F. Tartarelli [ID](#)^{71a}, P. Tas [ID](#)¹³³, M. Tasevsky [ID](#)¹³¹, E. Tassi [ID](#)^{43b,43a}, A.C. Tate [ID](#)¹⁶², G. Tateno [ID](#)¹⁵³, Y. Tayalati [ID](#)^{35e,v}, G.N. Taylor [ID](#)¹⁰⁵, W. Taylor [ID](#)^{156b}, H. Teagle [ID](#)⁹², A.S. Tee [ID](#)¹⁷⁰, R. Teixeira De Lima [ID](#)¹⁴³, P. Teixeira-Dias [ID](#)⁹⁵, J.J. Teoh [ID](#)¹⁵⁵, K. Terashi [ID](#)¹⁵³, J. Terron [ID](#)⁹⁹, S. Terzo [ID](#)¹³, M. Testa [ID](#)⁵³, R.J. Teuscher [ID](#)^{155,w}, A. Thaler [ID](#)⁷⁹, O. Theiner [ID](#)⁵⁶, N. Themistokleous [ID](#)⁵², T. Theveneaux-Pelzer [ID](#)¹⁰², O. Thielmann [ID](#)¹⁷¹, D.W. Thomas [ID](#)⁹⁵, J.P. Thomas [ID](#)²⁰, E.A. Thompson [ID](#)^{17a}, P.D. Thompson [ID](#)²⁰, E. Thomson [ID](#)¹²⁸, Y. Tian [ID](#)⁵⁵, V. Tikhomirov [ID](#)^{37,a}, Yu.A. Tikhonov [ID](#)³⁷, S. Timoshenko [ID](#)³⁷, E.X.L. Ting [ID](#)¹, P. Tipton [ID](#)¹⁷², S.H. Tlou [ID](#)^{33g}, A. Tmourji [ID](#)⁴⁰, K. Todome [ID](#)^{23b,23a}, S. Todorova-Nova [ID](#)¹³³, S. Todt [ID](#)⁵⁰, M. Togawa [ID](#)⁸³, J. Tojo [ID](#)⁸⁹, S. Tokar [ID](#)^{28a}, K. Tokushuku [ID](#)⁸³, O. Toldaiev [ID](#)⁶⁸, R. Tombs [ID](#)³², M. Tomoto [ID](#)^{83,111}, L. Tompkins [ID](#)^{143,ai}, K.W. Topolnicki [ID](#)^{85b}, E. Torrence [ID](#)¹²³, H. Torres [ID](#)^{102,al}, E. Torro Pastor [ID](#)¹⁶³, M. Toscani [ID](#)³⁰, C. Tosciri [ID](#)³⁹, M. Tost [ID](#)¹¹, D.R. Tovey [ID](#)¹³⁹, A. Traeet [ID](#)¹⁶, I.S. Trandafir [ID](#)^{27b}, T. Trefzger [ID](#)¹⁶⁶, A. Tricoli [ID](#)²⁹, I.M. Trigger [ID](#)^{156a}, S. Trincaz-Duvoid [ID](#)¹²⁷, D.A. Trischuk [ID](#)²⁶, B. Trocme [ID](#)⁶⁰, C. Troncon [ID](#)^{71a}, L. Truong [ID](#)^{33c}, M. Trzebinski [ID](#)⁸⁶, A. Trzupek [ID](#)⁸⁶, F. Tsai [ID](#)¹⁴⁵, M. Tsai [ID](#)¹⁰⁶, A. Tsiamis [ID](#)^{152,f}, P.V. Tsiarehka [ID](#)³⁷, S. Tsigaridas [ID](#)^{156a}, A. Tsirigotis [ID](#)^{152,s}, V. Tsiskaridze [ID](#)¹⁵⁵, E.G. Tskhadadze [ID](#)^{149a}, M. Tsopoulou [ID](#)^{152,f}, Y. Tsujikawa [ID](#)⁸⁷, I.I. Tsukerman [ID](#)³⁷, V. Tsulaia [ID](#)^{17a}, S. Tsuno [ID](#)⁸³, O. Tsur [ID](#)¹⁵⁰, K. Tsurii [ID](#)¹¹⁸, D. Tsybychev [ID](#)¹⁴⁵, Y. Tu [ID](#)^{64b}, A. Tudorache [ID](#)^{27b}, V. Tudorache [ID](#)^{27b}, A.N. Tuna [ID](#)³⁶, S. Turchikhin [ID](#)³⁸, I. Turk Cakir [ID](#)^{3a}, R. Turra [ID](#)^{71a}, T. Turtuvshin [ID](#)^{38,x},

P.M. Tuts [ID](#)⁴¹, S. Tzamarias [ID](#)^{152,f}, P. Tzannis [ID](#)¹⁰, E. Tzovara [ID](#)¹⁰⁰, K. Uchida [ID](#)¹⁵³, F. Ukegawa [ID](#)¹⁵⁷,
 P.A. Ulloa Poblete [ID](#)^{137c,137b}, E.N. Umaka [ID](#)²⁹, G. Unal [ID](#)³⁶, M. Unal [ID](#)¹¹, A. Undrus [ID](#)²⁹,
 G. Unel [ID](#)¹⁶⁰, J. Urban [ID](#)^{28b}, P. Urquijo [ID](#)¹⁰⁵, G. Usai [ID](#)⁸, R. Ushioda [ID](#)¹⁵⁴, M. Usman [ID](#)¹⁰⁸,
 Z. Uysal [ID](#)^{21b}, L. Vacavant [ID](#)¹⁰², V. Vacek [ID](#)¹³², B. Vachon [ID](#)¹⁰⁴, K.O.H. Vadla [ID](#)¹²⁵,
 T. Vafeiadis [ID](#)³⁶, A. Vaitkus [ID](#)⁹⁶, C. Valderanis [ID](#)¹⁰⁹, E. Valdes Santurio [ID](#)^{47a,47b}, M. Valente [ID](#)^{156a},
 S. Valentinetti [ID](#)^{23b,23a}, A. Valero [ID](#)¹⁶³, E. Valiente Moreno [ID](#)¹⁶³, A. Vallier [ID](#)^{102,al},
 J.A. Valls Ferrer [ID](#)¹⁶³, D.R. Van Arneman [ID](#)¹¹⁴, T.R. Van Daalen [ID](#)¹³⁸, P. Van Gemmeren [ID](#)⁶,
 M. Van Rijnbach [ID](#)^{125,36}, S. Van Stroud [ID](#)⁹⁶, I. Van Vulpen [ID](#)¹¹⁴, M. Vanadia [ID](#)^{76a,76b},
 W. Vandelli [ID](#)³⁶, M. Vandenbroucke [ID](#)¹³⁵, E.R. Vandewall [ID](#)¹²¹, D. Vannicola [ID](#)¹⁵¹,
 L. Vannoli [ID](#)^{57b,57a}, R. Vari [ID](#)^{75a}, E.W. Varnes [ID](#)⁷, C. Varni [ID](#)^{17a}, T. Varol [ID](#)¹⁴⁸, D. Varouchas [ID](#)⁶⁶,
 L. Varriale [ID](#)¹⁶³, K.E. Varvell [ID](#)¹⁴⁷, M.E. Vasile [ID](#)^{27b}, L. Vaslin [ID](#)⁴⁰, G.A. Vasquez [ID](#)¹⁶⁵,
 F. Vazeille [ID](#)⁴⁰, T. Vazquez Schroeder [ID](#)³⁶, J. Veatch [ID](#)³¹, V. Vecchio [ID](#)¹⁰¹, M.J. Veen [ID](#)¹⁰³,
 I. Velisek [ID](#)¹²⁶, L.M. Veloce [ID](#)¹⁵⁵, F. Veloso [ID](#)^{130a,130c}, S. Veneziano [ID](#)^{75a}, A. Ventura [ID](#)^{70a,70b},
 A. Verbytskyi [ID](#)¹¹⁰, M. Verducci [ID](#)^{74a,74b}, C. Vergis [ID](#)²⁴, M. Verissimo De Araujo [ID](#)^{82b},
 W. Verkerke [ID](#)¹¹⁴, J.C. Vermeulen [ID](#)¹¹⁴, C. Vernieri [ID](#)¹⁴³, P.J. Verschuuren [ID](#)⁹⁵, M. Vessella [ID](#)¹⁰³,
 M.C. Vetterli [ID](#)^{142,ac}, A. Vgenopoulos [ID](#)^{152,f}, N. Viaux Maira [ID](#)^{137f}, T. Vickey [ID](#)¹³⁹,
 O.E. Vickey Boeriu [ID](#)¹³⁹, G.H.A. Viehhauser [ID](#)¹²⁶, L. Vigani [ID](#)^{63b}, M. Villa [ID](#)^{23b,23a},
 M. Villaplana Perez [ID](#)¹⁶³, E.M. Villhauer [ID](#)⁵², E. Vilucchi [ID](#)⁵³, M.G. Vincter [ID](#)³⁴, G.S. Virdee [ID](#)²⁰,
 A. Vishwakarma [ID](#)⁵², C. Vittori [ID](#)³⁶, I. Vivarelli [ID](#)¹⁴⁶, V. Vladimirov [ID](#)¹⁶⁷, E. Voevodina [ID](#)¹¹⁰,
 F. Vogel [ID](#)¹⁰⁹, P. Vokac [ID](#)¹³², J. Von Ahnen [ID](#)⁴⁸, E. Von Toerne [ID](#)²⁴, B. Vormwald [ID](#)³⁶,
 V. Vorobel [ID](#)¹³³, K. Vorobev [ID](#)³⁷, M. Vos [ID](#)¹⁶³, K. Voss [ID](#)¹⁴¹, J.H. Vossebeld [ID](#)⁹², M. Vozak [ID](#)¹¹⁴,
 L. Vozdecky [ID](#)⁹⁴, N. Vranjes [ID](#)¹⁵, M. Vranjes Milosavljevic [ID](#)¹⁵, M. Vreeswijk [ID](#)¹¹⁴,
 R. Vuillermet [ID](#)³⁶, O. Vujanovic [ID](#)¹⁰⁰, I. Vukotic [ID](#)³⁹, S. Wada [ID](#)¹⁵⁷, C. Wagner [ID](#)¹⁰³,
 J.M. Wagner [ID](#)^{17a}, W. Wagner [ID](#)¹⁷¹, S. Wahdan [ID](#)¹⁷¹, H. Wahlberg [ID](#)⁹⁰, R. Wakasa [ID](#)¹⁵⁷,
 M. Wakida [ID](#)¹¹¹, J. Walder [ID](#)¹³⁴, R. Walker [ID](#)¹⁰⁹, W. Walkowiak [ID](#)¹⁴¹, A. Wall [ID](#)¹²⁸,
 A.Z. Wang [ID](#)¹⁷⁰, C. Wang [ID](#)¹⁰⁰, C. Wang [ID](#)^{62c}, H. Wang [ID](#)^{17a}, J. Wang [ID](#)^{64a}, R.-J. Wang [ID](#)¹⁰⁰,
 R. Wang [ID](#)⁶¹, R. Wang [ID](#)⁶, S.M. Wang [ID](#)¹⁴⁸, S. Wang [ID](#)^{62b}, T. Wang [ID](#)^{62a}, W.T. Wang [ID](#)⁸⁰,
 X. Wang [ID](#)^{14c}, X. Wang [ID](#)¹⁶², X. Wang [ID](#)^{62c}, Y. Wang [ID](#)^{62d}, Y. Wang [ID](#)^{14c}, Z. Wang [ID](#)¹⁰⁶,
 Z. Wang [ID](#)^{62d,51,62c}, Z. Wang [ID](#)¹⁰⁶, A. Warburton [ID](#)¹⁰⁴, R.J. Ward [ID](#)²⁰, N. Warrack [ID](#)⁵⁹,
 A.T. Watson [ID](#)²⁰, H. Watson [ID](#)⁵⁹, M.F. Watson [ID](#)²⁰, G. Watts [ID](#)¹³⁸, B.M. Waugh [ID](#)⁹⁶,
 C. Weber [ID](#)²⁹, H.A. Weber [ID](#)¹⁸, M.S. Weber [ID](#)¹⁹, S.M. Weber [ID](#)^{63a}, C. Wei [ID](#)^{62a}, Y. Wei [ID](#)¹²⁶,
 A.R. Weidberg [ID](#)¹²⁶, E.J. Weik [ID](#)¹¹⁷, J. Weingarten [ID](#)⁴⁹, M. Weirich [ID](#)¹⁰⁰, C. Weiser [ID](#)⁵⁴,
 C.J. Wells [ID](#)⁴⁸, T. Wenaus [ID](#)²⁹, B. Wendland [ID](#)⁴⁹, T. Wengler [ID](#)³⁶, N.S. Wenke [ID](#)¹¹⁰, N. Vermes [ID](#)²⁴,
 M. Wessels [ID](#)^{63a}, K. Whalen [ID](#)¹²³, A.M. Wharton [ID](#)⁹¹, A.S. White [ID](#)⁶¹, A. White [ID](#)⁸,
 M.J. White [ID](#)¹, D. Whiteson [ID](#)¹⁶⁰, L. Wickremasinghe [ID](#)¹²⁴, W. Wiedenmann [ID](#)¹⁷⁰, C. Wiel [ID](#)⁵⁰,
 M. Wielers [ID](#)¹³⁴, C. Wiglesworth [ID](#)⁴², L.A.M. Wiik-Fuchs [ID](#)⁵⁴, D.J. Wilbern [ID](#)¹²⁰, H.G. Wilkens [ID](#)³⁶,
 D.M. Williams [ID](#)⁴¹, H.H. Williams [ID](#)¹²⁸, S. Williams [ID](#)³², S. Willocq [ID](#)¹⁰³, B.J. Wilson [ID](#)¹⁰¹,
 P.J. Windischhofer [ID](#)³⁹, F.I. Winkel [ID](#)³⁰, F. Winklmeier [ID](#)¹²³, B.T. Winter [ID](#)⁵⁴, J.K. Winter [ID](#)¹⁰¹,
 M. Wittgen [ID](#)¹⁴³, M. Wobisch [ID](#)⁹⁷, Z. Wolffs [ID](#)¹¹⁴, R. Wölker [ID](#)¹²⁶, J. Wollrath [ID](#)¹⁶⁰, M.W. Wolter [ID](#)⁸⁶,
 H. Wolters [ID](#)^{130a,130c}, V.W.S. Wong [ID](#)¹⁶⁴, A.F. Wongel [ID](#)⁴⁸, S.D. Worm [ID](#)⁴⁸, B.K. Wosiek [ID](#)⁸⁶,
 K.W. Woźniak [ID](#)⁸⁶, S. Wozniwski [ID](#)⁵⁵, K. Wraight [ID](#)⁵⁹, C. Wu [ID](#)²⁰, J. Wu [ID](#)^{14a,14e}, M. Wu [ID](#)^{64a},
 M. Wu [ID](#)¹¹³, S.L. Wu [ID](#)¹⁷⁰, X. Wu [ID](#)⁵⁶, Y. Wu [ID](#)^{62a}, Z. Wu [ID](#)¹³⁵, J. Wuerzinger [ID](#)¹¹⁰,
 T.R. Wyatt [ID](#)¹⁰¹, B.M. Wynne [ID](#)⁵², S. Xella [ID](#)⁴², L. Xia [ID](#)^{14c}, M. Xia [ID](#)^{14b}, J. Xiang [ID](#)^{64c},

X. Xiao [ID](#)¹⁰⁶, M. Xie [ID](#)^{62a}, X. Xie [ID](#)^{62a}, S. Xin [ID](#)^{14a,14e}, J. Xiong [ID](#)^{17a}, D. Xu [ID](#)^{14a}, H. Xu^{62a}, H. Xu [ID](#)^{62a}, L. Xu [ID](#)^{62a}, R. Xu [ID](#)¹²⁸, T. Xu [ID](#)¹⁰⁶, Y. Xu [ID](#)^{14b}, Z. Xu [ID](#)⁵², Z. Xu [ID](#)^{14a}, B. Yabsley [ID](#)¹⁴⁷, S. Yacoob [ID](#)^{33a}, N. Yamaguchi [ID](#)⁸⁹, Y. Yamaguchi [ID](#)¹⁵⁴, E. Yamashita [ID](#)¹⁵³, H. Yamauchi [ID](#)¹⁵⁷, T. Yamazaki [ID](#)^{17a}, Y. Yamazaki [ID](#)⁸⁴, J. Yan^{62c}, S. Yan [ID](#)¹²⁶, Z. Yan [ID](#)²⁵, H.J. Yang [ID](#)^{62c,62d}, H.T. Yang [ID](#)^{62a}, S. Yang [ID](#)^{62a}, T. Yang [ID](#)^{64c}, X. Yang [ID](#)^{62a}, X. Yang [ID](#)^{14a}, Y. Yang [ID](#)⁴⁴, Y. Yang^{62a}, Z. Yang [ID](#)^{62a,106}, W-M. Yao [ID](#)^{17a}, Y.C. Yap [ID](#)⁴⁸, H. Ye [ID](#)^{14c}, H. Ye [ID](#)⁵⁵, J. Ye [ID](#)⁴⁴, S. Ye [ID](#)²⁹, X. Ye [ID](#)^{62a}, Y. Yeh [ID](#)⁹⁶, I. Yeletsikh [ID](#)³⁸, B.K. Yeo [ID](#)^{17a}, M.R. Yexley [ID](#)⁹¹, P. Yin [ID](#)⁴¹, K. Yorita [ID](#)¹⁶⁸, S. Younas [ID](#)^{27b}, C.J.S. Young [ID](#)⁵⁴, C. Young [ID](#)¹⁴³, Y. Yu [ID](#)^{62a}, M. Yuan [ID](#)¹⁰⁶, R. Yuan [ID](#)^{62b,l}, L. Yue [ID](#)⁹⁶, M. Zaazoua [ID](#)^{35e}, B. Zabinski [ID](#)⁸⁶, E. Zaid⁵², T. Zakareishvili [ID](#)^{149b}, N. Zakharchuk [ID](#)³⁴, S. Zambito [ID](#)⁵⁶, J.A. Zamora Saa [ID](#)^{137d,137b}, J. Zang [ID](#)¹⁵³, D. Zanzi [ID](#)⁵⁴, O. Zaplatilek [ID](#)¹³², C. Zeitnitz [ID](#)¹⁷¹, H. Zeng [ID](#)^{14a}, J.C. Zeng [ID](#)¹⁶², D.T. Zenger Jr [ID](#)²⁶, O. Zenin [ID](#)³⁷, T. Ženiš [ID](#)^{28a}, S. Zenz [ID](#)⁹⁴, S. Zerradi [ID](#)^{35a}, D. Zerwas [ID](#)⁶⁶, M. Zhai [ID](#)^{14a,14e}, B. Zhang [ID](#)^{14c}, D.F. Zhang [ID](#)¹³⁹, J. Zhang [ID](#)^{62b}, J. Zhang [ID](#)⁶, K. Zhang [ID](#)^{14a,14e}, L. Zhang [ID](#)^{14c}, P. Zhang^{14a,14e}, R. Zhang [ID](#)¹⁷⁰, S. Zhang [ID](#)¹⁰⁶, T. Zhang [ID](#)¹⁵³, X. Zhang [ID](#)^{62c}, X. Zhang [ID](#)^{62b}, Y. Zhang [ID](#)^{62c,5}, Y. Zhang [ID](#)⁹⁶, Z. Zhang [ID](#)^{17a}, Z. Zhang [ID](#)⁶⁶, H. Zhao [ID](#)¹³⁸, P. Zhao [ID](#)⁵¹, T. Zhao [ID](#)^{62b}, Y. Zhao [ID](#)¹³⁶, Z. Zhao [ID](#)^{62a}, A. Zhemchugov [ID](#)³⁸, K. Zheng [ID](#)¹⁶², X. Zheng [ID](#)^{62a}, Z. Zheng [ID](#)¹⁴³, D. Zhong [ID](#)¹⁶², B. Zhou¹⁰⁶, H. Zhou [ID](#)⁷, N. Zhou [ID](#)^{62c}, Y. Zhou⁷, C.G. Zhu [ID](#)^{62b}, J. Zhu [ID](#)¹⁰⁶, Y. Zhu [ID](#)^{62c}, Y. Zhu [ID](#)^{62a}, X. Zhuang [ID](#)^{14a}, K. Zhukov [ID](#)³⁷, V. Zhulanov [ID](#)³⁷, N.I. Zimine [ID](#)³⁸, J. Zinsser [ID](#)^{63b}, M. Ziolkowski [ID](#)¹⁴¹, L. Živković [ID](#)¹⁵, A. Zoccoli [ID](#)^{23b,23a}, K. Zoch [ID](#)⁵⁶, T.G. Zorbas [ID](#)¹³⁹, O. Zormpa [ID](#)⁴⁶, W. Zou [ID](#)⁴¹, L. Zwalinski [ID](#)³⁶

¹ Department of Physics, University of Adelaide, Adelaide; Australia

² Department of Physics, University of Alberta, Edmonton AB; Canada

³ ^(a) Department of Physics, Ankara University, Ankara; ^(b) Division of Physics, TOBB University of Economics and Technology, Ankara; Türkiye

⁴ LAPP, Université Savoie Mont Blanc, CNRS/IN2P3, Annecy, France

⁵ APC, Université Paris Cité, CNRS/IN2P3, Paris; France

⁶ High Energy Physics Division, Argonne National Laboratory, Argonne IL; United States of America

⁷ Department of Physics, University of Arizona, Tucson AZ; United States of America

⁸ Department of Physics, University of Texas at Arlington, Arlington TX; United States of America

⁹ Physics Department, National and Kapodistrian University of Athens, Athens; Greece

¹⁰ Physics Department, National Technical University of Athens, Zografou; Greece

¹¹ Department of Physics, University of Texas at Austin, Austin TX; United States of America

¹² Institute of Physics, Azerbaijan Academy of Sciences, Baku; Azerbaijan

¹³ Institut de Física d'Altes Energies (IFAE), Barcelona Institute of Science and Technology, Barcelona; Spain

¹⁴ ^(a) Institute of High Energy Physics, Chinese Academy of Sciences, Beijing; ^(b) Physics Department, Tsinghua University, Beijing; ^(c) Department of Physics, Nanjing University, Nanjing; ^(d) School of Science, Shenzhen Campus of Sun Yat-sen University; ^(e) University of Chinese Academy of Science (UCAS), Beijing; China

¹⁵ Institute of Physics, University of Belgrade, Belgrade; Serbia

¹⁶ Department for Physics and Technology, University of Bergen, Bergen; Norway

¹⁷ ^(a) Physics Division, Lawrence Berkeley National Laboratory, Berkeley CA; ^(b) University of California, Berkeley CA; United States of America

¹⁸ Institut für Physik, Humboldt Universität zu Berlin, Berlin; Germany

¹⁹ Albert Einstein Center for Fundamental Physics and Laboratory for High Energy Physics, University of Bern, Bern; Switzerland

²⁰ School of Physics and Astronomy, University of Birmingham, Birmingham; United Kingdom

- ²¹ ^(a) Department of Physics, Bogazici University, Istanbul; ^(b) Department of Physics Engineering, Gaziantep University, Gaziantep; ^(c) Department of Physics, Istanbul University, Istanbul; ^(d) Istinye University, Sariyer, Istanbul; Türkiye
- ²² ^(a) Facultad de Ciencias y Centro de Investigaciones, Universidad Antonio Nariño, Bogotá; ^(b) Departamento de Física, Universidad Nacional de Colombia, Bogotá; ^(c) Pontificia Universidad Javeriana, Bogota; Colombia
- ²³ ^(a) Dipartimento di Fisica e Astronomia A. Righi, Università di Bologna, Bologna; ^(b) INFN Sezione di Bologna; Italy
- ²⁴ Physikalisches Institut, Universität Bonn, Bonn; Germany
- ²⁵ Department of Physics, Boston University, Boston MA; United States of America
- ²⁶ Department of Physics, Brandeis University, Waltham MA; United States of America
- ²⁷ ^(a) Transilvania University of Brasov, Brasov; ^(b) Horia Hulubei National Institute of Physics and Nuclear Engineering, Bucharest; ^(c) Department of Physics, Alexandru Ioan Cuza University of Iasi, Iasi; ^(d) National Institute for Research and Development of Isotopic and Molecular Technologies, Physics Department, Cluj-Napoca; ^(e) University Politehnica Bucharest, Bucharest; ^(f) West University in Timisoara, Timisoara; ^(g) Faculty of Physics, University of Bucharest, Bucharest; Romania
- ²⁸ ^(a) Faculty of Mathematics, Physics and Informatics, Comenius University, Bratislava; ^(b) Department of Subnuclear Physics, Institute of Experimental Physics of the Slovak Academy of Sciences, Kosice; Slovak Republic
- ²⁹ Physics Department, Brookhaven National Laboratory, Upton NY; United States of America
- ³⁰ Universidad de Buenos Aires, Facultad de Ciencias Exactas y Naturales, Departamento de Física, y CONICET, Instituto de Física de Buenos Aires (IFIBA), Buenos Aires; Argentina
- ³¹ California State University, CA; United States of America
- ³² Cavendish Laboratory, University of Cambridge, Cambridge; United Kingdom
- ³³ ^(a) Department of Physics, University of Cape Town, Cape Town; ^(b) iThemba Labs, Western Cape; ^(c) Department of Mechanical Engineering Science, University of Johannesburg, Johannesburg; ^(d) National Institute of Physics, University of the Philippines Diliman (Philippines); ^(e) University of South Africa, Department of Physics, Pretoria; ^(f) University of Zululand, KwaDlangezwa; ^(g) School of Physics, University of the Witwatersrand, Johannesburg; South Africa
- ³⁴ Department of Physics, Carleton University, Ottawa ON; Canada
- ³⁵ ^(a) Faculté des Sciences Ain Chock, Réseau Universitaire de Physique des Hautes Energies - Université Hassan II, Casablanca; ^(b) Faculté des Sciences, Université Ibn-Tofail, Kénitra; ^(c) Faculté des Sciences Semlalia, Université Cadi Ayyad, LPHEA-Marrakech; ^(d) LPMR, Faculté des Sciences, Université Mohamed Premier, Oujda; ^(e) Faculté des sciences, Université Mohammed V, Rabat; ^(f) Institute of Applied Physics, Mohammed VI Polytechnic University, Ben Guerir; Morocco
- ³⁶ CERN, Geneva; Switzerland
- ³⁷ Affiliated with an institute covered by a cooperation agreement with CERN
- ³⁸ Affiliated with an international laboratory covered by a cooperation agreement with CERN
- ³⁹ Enrico Fermi Institute, University of Chicago, Chicago IL; United States of America
- ⁴⁰ LPC, Université Clermont Auvergne, CNRS/IN2P3, Clermont-Ferrand; France
- ⁴¹ Nevis Laboratory, Columbia University, Irvington NY; United States of America
- ⁴² Niels Bohr Institute, University of Copenhagen, Copenhagen; Denmark
- ⁴³ ^(a) Dipartimento di Fisica, Università della Calabria, Rende; ^(b) INFN Gruppo Collegato di Cosenza, Laboratori Nazionali di Frascati; Italy
- ⁴⁴ Physics Department, Southern Methodist University, Dallas TX; United States of America
- ⁴⁵ Physics Department, University of Texas at Dallas, Richardson TX; United States of America
- ⁴⁶ National Centre for Scientific Research "Demokritos", Agia Paraskevi; Greece
- ⁴⁷ ^(a) Department of Physics, Stockholm University; ^(b) Oskar Klein Centre, Stockholm; Sweden
- ⁴⁸ Deutsches Elektronen-Synchrotron DESY, Hamburg and Zeuthen; Germany
- ⁴⁹ Fakultät Physik, Technische Universität Dortmund, Dortmund; Germany
- ⁵⁰ Institut für Kern- und Teilchenphysik, Technische Universität Dresden, Dresden; Germany
- ⁵¹ Department of Physics, Duke University, Durham NC; United States of America

- ⁵² SUPA - School of Physics and Astronomy, University of Edinburgh, Edinburgh; United Kingdom
- ⁵³ INFN e Laboratori Nazionali di Frascati, Frascati; Italy
- ⁵⁴ Physikalisches Institut, Albert-Ludwigs-Universität Freiburg, Freiburg; Germany
- ⁵⁵ II. Physikalisches Institut, Georg-August-Universität Göttingen, Göttingen; Germany
- ⁵⁶ Département de Physique Nucléaire et Corpusculaire, Université de Genève, Genève; Switzerland
- ⁵⁷ ^(a) Dipartimento di Fisica, Università di Genova, Genova; ^(b) INFN Sezione di Genova; Italy
- ⁵⁸ II. Physikalisches Institut, Justus-Liebig-Universität Giessen, Giessen; Germany
- ⁵⁹ SUPA - School of Physics and Astronomy, University of Glasgow, Glasgow; United Kingdom
- ⁶⁰ LPSC, Université Grenoble Alpes, CNRS/IN2P3, Grenoble INP, Grenoble; France
- ⁶¹ Laboratory for Particle Physics and Cosmology, Harvard University, Cambridge MA; United States of America
- ⁶² ^(a) Department of Modern Physics and State Key Laboratory of Particle Detection and Electronics, University of Science and Technology of China, Hefei; ^(b) Institute of Frontier and Interdisciplinary Science and Key Laboratory of Particle Physics and Particle Irradiation (MOE), Shandong University, Qingdao; ^(c) School of Physics and Astronomy, Shanghai Jiao Tong University, Key Laboratory for Particle Astrophysics and Cosmology (MOE), SKLPPC, Shanghai; ^(d) Tsung-Dao Lee Institute, Shanghai; China
- ⁶³ ^(a) Kirchhoff-Institut für Physik, Ruprecht-Karls-Universität Heidelberg, Heidelberg; ^(b) Physikalisches Institut, Ruprecht-Karls-Universität Heidelberg, Heidelberg; Germany
- ⁶⁴ ^(a) Department of Physics, Chinese University of Hong Kong, Shatin, N.T., Hong Kong; ^(b) Department of Physics, University of Hong Kong, Hong Kong; ^(c) Department of Physics and Institute for Advanced Study, Hong Kong University of Science and Technology, Clear Water Bay, Kowloon, Hong Kong; China
- ⁶⁵ Department of Physics, National Tsing Hua University, Hsinchu; Taiwan
- ⁶⁶ IJCLab, Université Paris-Saclay, CNRS/IN2P3, 91405, Orsay; France
- ⁶⁷ Centro Nacional de Microelectrónica (IMB-CNM-CSIC), Barcelona; Spain
- ⁶⁸ Department of Physics, Indiana University, Bloomington IN; United States of America
- ⁶⁹ ^(a) INFN Gruppo Collegato di Udine, Sezione di Trieste, Udine; ^(b) ICTP, Trieste; ^(c) Dipartimento Politecnico di Ingegneria e Architettura, Università di Udine, Udine; Italy
- ⁷⁰ ^(a) INFN Sezione di Lecce; ^(b) Dipartimento di Matematica e Fisica, Università del Salento, Lecce; Italy
- ⁷¹ ^(a) INFN Sezione di Milano; ^(b) Dipartimento di Fisica, Università di Milano, Milano; Italy
- ⁷² ^(a) INFN Sezione di Napoli; ^(b) Dipartimento di Fisica, Università di Napoli, Napoli; Italy
- ⁷³ ^(a) INFN Sezione di Pavia; ^(b) Dipartimento di Fisica, Università di Pavia, Pavia; Italy
- ⁷⁴ ^(a) INFN Sezione di Pisa; ^(b) Dipartimento di Fisica E. Fermi, Università di Pisa, Pisa; Italy
- ⁷⁵ ^(a) INFN Sezione di Roma; ^(b) Dipartimento di Fisica, Sapienza Università di Roma, Roma; Italy
- ⁷⁶ ^(a) INFN Sezione di Roma Tor Vergata; ^(b) Dipartimento di Fisica, Università di Roma Tor Vergata, Roma; Italy
- ⁷⁷ ^(a) INFN Sezione di Roma Tre; ^(b) Dipartimento di Matematica e Fisica, Università Roma Tre, Roma; Italy
- ⁷⁸ ^(a) INFN-TIFPA; ^(b) Università degli Studi di Trento, Trento; Italy
- ⁷⁹ Universität Innsbruck, Department of Astro and Particle Physics, Innsbruck; Austria
- ⁸⁰ University of Iowa, Iowa City IA; United States of America
- ⁸¹ Department of Physics and Astronomy, Iowa State University, Ames IA; United States of America
- ⁸² ^(a) Departamento de Engenharia Elétrica, Universidade Federal de Juiz de Fora (UFJF), Juiz de Fora; ^(b) Universidade Federal do Rio De Janeiro COPPE/EE/IF, Rio de Janeiro; ^(c) Instituto de Física, Universidade de São Paulo, São Paulo; ^(d) Rio de Janeiro State University, Rio de Janeiro; Brazil
- ⁸³ KEK, High Energy Accelerator Research Organization, Tsukuba; Japan
- ⁸⁴ Graduate School of Science, Kobe University, Kobe; Japan
- ⁸⁵ ^(a) AGH University of Science and Technology, Faculty of Physics and Applied Computer Science, Krakow; ^(b) Marian Smoluchowski Institute of Physics, Jagiellonian University, Krakow; Poland
- ⁸⁶ Institute of Nuclear Physics Polish Academy of Sciences, Krakow; Poland
- ⁸⁷ Faculty of Science, Kyoto University, Kyoto; Japan
- ⁸⁸ Kyoto University of Education, Kyoto; Japan

- ⁸⁹ *Research Center for Advanced Particle Physics and Department of Physics, Kyushu University, Fukuoka; Japan*
- ⁹⁰ *Instituto de Física La Plata, Universidad Nacional de La Plata and CONICET, La Plata; Argentina*
- ⁹¹ *Physics Department, Lancaster University, Lancaster; United Kingdom*
- ⁹² *Oliver Lodge Laboratory, University of Liverpool, Liverpool; United Kingdom*
- ⁹³ *Department of Experimental Particle Physics, Jožef Stefan Institute and Department of Physics, University of Ljubljana, Ljubljana; Slovenia*
- ⁹⁴ *School of Physics and Astronomy, Queen Mary University of London, London; United Kingdom*
- ⁹⁵ *Department of Physics, Royal Holloway University of London, Egham; United Kingdom*
- ⁹⁶ *Department of Physics and Astronomy, University College London, London; United Kingdom*
- ⁹⁷ *Louisiana Tech University, Ruston LA; United States of America*
- ⁹⁸ *Fysiska institutionen, Lunds universitet, Lund; Sweden*
- ⁹⁹ *Departamento de Física Teórica C-15 and CIAFF, Universidad Autónoma de Madrid, Madrid; Spain*
- ¹⁰⁰ *Institut für Physik, Universität Mainz, Mainz; Germany*
- ¹⁰¹ *School of Physics and Astronomy, University of Manchester, Manchester; United Kingdom*
- ¹⁰² *CPPM, Aix-Marseille Université, CNRS/IN2P3, Marseille; France*
- ¹⁰³ *Department of Physics, University of Massachusetts, Amherst MA; United States of America*
- ¹⁰⁴ *Department of Physics, McGill University, Montreal QC; Canada*
- ¹⁰⁵ *School of Physics, University of Melbourne, Victoria; Australia*
- ¹⁰⁶ *Department of Physics, University of Michigan, Ann Arbor MI; United States of America*
- ¹⁰⁷ *Department of Physics and Astronomy, Michigan State University, East Lansing MI; United States of America*
- ¹⁰⁸ *Group of Particle Physics, University of Montreal, Montreal QC; Canada*
- ¹⁰⁹ *Fakultät für Physik, Ludwig-Maximilians-Universität München, München; Germany*
- ¹¹⁰ *Max-Planck-Institut für Physik (Werner-Heisenberg-Institut), München; Germany*
- ¹¹¹ *Graduate School of Science and Kobayashi-Maskawa Institute, Nagoya University, Nagoya; Japan*
- ¹¹² *Department of Physics and Astronomy, University of New Mexico, Albuquerque NM; United States of America*
- ¹¹³ *Institute for Mathematics, Astrophysics and Particle Physics, Radboud University/Nikhef, Nijmegen; Netherlands*
- ¹¹⁴ *Nikhef National Institute for Subatomic Physics and University of Amsterdam, Amsterdam; Netherlands*
- ¹¹⁵ *Department of Physics, Northern Illinois University, DeKalb IL; United States of America*
- ¹¹⁶ ^(a) *New York University Abu Dhabi, Abu Dhabi;* ^(b) *University of Sharjah, Sharjah; United Arab Emirates*
- ¹¹⁷ *Department of Physics, New York University, New York NY; United States of America*
- ¹¹⁸ *Ochanomizu University, Otsuka, Bunkyo-ku, Tokyo; Japan*
- ¹¹⁹ *Ohio State University, Columbus OH; United States of America*
- ¹²⁰ *Homer L. Dodge Department of Physics and Astronomy, University of Oklahoma, Norman OK; United States of America*
- ¹²¹ *Department of Physics, Oklahoma State University, Stillwater OK; United States of America*
- ¹²² *Palacký University, Joint Laboratory of Optics, Olomouc; Czech Republic*
- ¹²³ *Institute for Fundamental Science, University of Oregon, Eugene, OR; United States of America*
- ¹²⁴ *Graduate School of Science, Osaka University, Osaka; Japan*
- ¹²⁵ *Department of Physics, University of Oslo, Oslo; Norway*
- ¹²⁶ *Department of Physics, Oxford University, Oxford; United Kingdom*
- ¹²⁷ *LPNHE, Sorbonne Université, Université Paris Cité, CNRS/IN2P3, Paris; France*
- ¹²⁸ *Department of Physics, University of Pennsylvania, Philadelphia PA; United States of America*
- ¹²⁹ *Department of Physics and Astronomy, University of Pittsburgh, Pittsburgh PA; United States of America*
- ¹³⁰ ^(a) *Laboratório de Instrumentação e Física Experimental de Partículas - LIP, Lisboa;* ^(b) *Departamento de Física, Faculdade de Ciências, Universidade de Lisboa, Lisboa;* ^(c) *Departamento de Física, Universidade de Coimbra, Coimbra;* ^(d) *Centro de Física Nuclear da Universidade de Lisboa, Lisboa;* ^(e) *Departamento de Física, Universidade do Minho, Braga;* ^(f) *Departamento de Física Teórica y del Cosmos, Universidad de*

- Granada, Granada (Spain);^(g) Departamento de Física, Instituto Superior Técnico, Universidade de Lisboa, Lisboa; Portugal
- ¹³¹ Institute of Physics of the Czech Academy of Sciences, Prague; Czech Republic
- ¹³² Czech Technical University in Prague, Prague; Czech Republic
- ¹³³ Charles University, Faculty of Mathematics and Physics, Prague; Czech Republic
- ¹³⁴ Particle Physics Department, Rutherford Appleton Laboratory, Didcot; United Kingdom
- ¹³⁵ IRFU, CEA, Université Paris-Saclay, Gif-sur-Yvette; France
- ¹³⁶ Santa Cruz Institute for Particle Physics, University of California Santa Cruz, Santa Cruz CA; United States of America
- ¹³⁷ ^(a) Departamento de Física, Pontificia Universidad Católica de Chile, Santiago;^(b) Millennium Institute for Subatomic physics at high energy frontier (SAPHIR), Santiago;^(c) Instituto de Investigación Multidisciplinario en Ciencia y Tecnología, y Departamento de Física, Universidad de La Serena;^(d) Universidad Andres Bello, Department of Physics, Santiago;^(e) Instituto de Alta Investigación, Universidad de Tarapacá, Arica;^(f) Departamento de Física, Universidad Técnica Federico Santa María, Valparaíso; Chile
- ¹³⁸ Department of Physics, University of Washington, Seattle WA; United States of America
- ¹³⁹ Department of Physics and Astronomy, University of Sheffield, Sheffield; United Kingdom
- ¹⁴⁰ Department of Physics, Shinshu University, Nagano; Japan
- ¹⁴¹ Department Physik, Universität Siegen, Siegen; Germany
- ¹⁴² Department of Physics, Simon Fraser University, Burnaby BC; Canada
- ¹⁴³ SLAC National Accelerator Laboratory, Stanford CA; United States of America
- ¹⁴⁴ Department of Physics, Royal Institute of Technology, Stockholm; Sweden
- ¹⁴⁵ Departments of Physics and Astronomy, Stony Brook University, Stony Brook NY; United States of America
- ¹⁴⁶ Department of Physics and Astronomy, University of Sussex, Brighton; United Kingdom
- ¹⁴⁷ School of Physics, University of Sydney, Sydney; Australia
- ¹⁴⁸ Institute of Physics, Academia Sinica, Taipei; Taiwan
- ¹⁴⁹ ^(a) E. Andronikashvili Institute of Physics, Iv. Javakhishvili Tbilisi State University, Tbilisi;^(b) High Energy Physics Institute, Tbilisi State University, Tbilisi;^(c) University of Georgia, Tbilisi; Georgia
- ¹⁵⁰ Department of Physics, Technion, Israel Institute of Technology, Haifa; Israel
- ¹⁵¹ Raymond and Beverly Sackler School of Physics and Astronomy, Tel Aviv University, Tel Aviv; Israel
- ¹⁵² Department of Physics, Aristotle University of Thessaloniki, Thessaloniki; Greece
- ¹⁵³ International Center for Elementary Particle Physics and Department of Physics, University of Tokyo, Tokyo; Japan
- ¹⁵⁴ Department of Physics, Tokyo Institute of Technology, Tokyo; Japan
- ¹⁵⁵ Department of Physics, University of Toronto, Toronto ON; Canada
- ¹⁵⁶ ^(a) TRIUMF, Vancouver BC;^(b) Department of Physics and Astronomy, York University, Toronto ON; Canada
- ¹⁵⁷ Division of Physics and Tomonaga Center for the History of the Universe, Faculty of Pure and Applied Sciences, University of Tsukuba, Tsukuba; Japan
- ¹⁵⁸ Department of Physics and Astronomy, Tufts University, Medford MA; United States of America
- ¹⁵⁹ United Arab Emirates University, Al Ain; United Arab Emirates
- ¹⁶⁰ Department of Physics and Astronomy, University of California Irvine, Irvine CA; United States of America
- ¹⁶¹ Department of Physics and Astronomy, University of Uppsala, Uppsala; Sweden
- ¹⁶² Department of Physics, University of Illinois, Urbana IL; United States of America
- ¹⁶³ Instituto de Física Corpuscular (IFIC), Centro Mixto Universidad de Valencia - CSIC, Valencia; Spain
- ¹⁶⁴ Department of Physics, University of British Columbia, Vancouver BC; Canada
- ¹⁶⁵ Department of Physics and Astronomy, University of Victoria, Victoria BC; Canada
- ¹⁶⁶ Fakultät für Physik und Astronomie, Julius-Maximilians-Universität Würzburg, Würzburg; Germany
- ¹⁶⁷ Department of Physics, University of Warwick, Coventry; United Kingdom
- ¹⁶⁸ Waseda University, Tokyo; Japan

- ¹⁶⁹ *Department of Particle Physics and Astrophysics, Weizmann Institute of Science, Rehovot; Israel*
- ¹⁷⁰ *Department of Physics, University of Wisconsin, Madison WI; United States of America*
- ¹⁷¹ *Fakultät für Mathematik und Naturwissenschaften, Fachgruppe Physik, Bergische Universität Wuppertal, Wuppertal; Germany*
- ¹⁷² *Department of Physics, Yale University, New Haven CT; United States of America*
- ^a *Also affiliated with an institute covered by a cooperation agreement with CERN*
- ^b *Also at An-Najah National University, Nablus; Palestine*
- ^c *Also at Borough of Manhattan Community College, City University of New York, New York NY; United States of America*
- ^d *Also at Bruno Kessler Foundation, Trento; Italy*
- ^e *Also at Center for High Energy Physics, Peking University; China*
- ^f *Also at Center for Interdisciplinary Research and Innovation (CIRI-AUTH), Thessaloniki ; Greece*
- ^g *Also at Centro Studi e Ricerche Enrico Fermi; Italy*
- ^h *Also at CERN, Geneva; Switzerland*
- ⁱ *Also at Département de Physique Nucléaire et Corpusculaire, Université de Genève, Genève; Switzerland*
- ^j *Also at Departament de Física de la Universitat Autònoma de Barcelona, Barcelona; Spain*
- ^k *Also at Department of Financial and Management Engineering, University of the Aegean, Chios; Greece*
- ^l *Also at Department of Physics and Astronomy, Michigan State University, East Lansing MI; United States of America*
- ^m *Also at Department of Physics, California State University, East Bay; United States of America*
- ⁿ *Also at Department of Physics, California State University, Sacramento; United States of America*
- ^o *Also at Department of Physics, King's College London, London; United Kingdom*
- ^p *Also at Department of Physics, University of Fribourg, Fribourg; Switzerland*
- ^q *Also at Department of Physics, University of Thessaly; Greece*
- ^r *Also at Department of Physics, Westmont College, Santa Barbara; United States of America*
- ^s *Also at Hellenic Open University, Patras; Greece*
- ^t *Also at Institutio Catalana de Recerca i Estudis Avancats, ICREA, Barcelona; Spain*
- ^u *Also at Institut für Experimentalphysik, Universität Hamburg, Hamburg; Germany*
- ^v *Also at Institute of Applied Physics, Mohammed VI Polytechnic University, Ben Guerir; Morocco*
- ^w *Also at Institute of Particle Physics (IPP); Canada*
- ^x *Also at Institute of Physics and Technology, Ulaanbaatar; Mongolia*
- ^y *Also at Institute of Physics, Azerbaijan Academy of Sciences, Baku; Azerbaijan*
- ^z *Also at Institute of Theoretical Physics, Ilia State University, Tbilisi; Georgia*
- ^{aa} *Also at Lawrence Livermore National Laboratory, Livermore; United States of America*
- ^{ab} *Also at The Collaborative Innovation Center of Quantum Matter (CICQM), Beijing; China*
- ^{ac} *Also at TRIUMF, Vancouver BC; Canada*
- ^{ad} *Also at Università di Napoli Parthenope, Napoli; Italy*
- ^{ae} *Also at University of Colorado Boulder, Department of Physics, Colorado; United States of America*
- ^{af} *Also at Washington College, Chestertown, MD; United States of America*
- ^{ag} *Also at Department of Physics, Ben Gurion University of the Negev, Beer Sheva; Israel*
- ^{ah} *Also at National Institute of Physics, University of the Philippines Diliman (Philippines); Philippines*
- ^{ai} *Also at Department of Physics, Stanford University, Stanford CA; United States of America*
- ^{aj} *Also at Technical University of Munich, Munich; Germany*
- ^{ak} *Also at Yeditepe University, Physics Department, Istanbul; Türkiye*
- ^{al} *Also at L2IT, Université de Toulouse, CNRS/IN2P3, UPS, Toulouse; France*
- * *Deceased*