

Strong linearity:
Three case studies towards a theory of morphosyntactic templatic constructions

by

Jeffrey Craig Good

B.A. (University of Chicago) 1998
M.A. (University of Chicago) 1998
M.A. (University of California, Berkeley) 2000

A dissertation submitted in partial satisfaction of the
requirements for the degree of
Doctor of Philosophy

in

Linguistics

in the

GRADUATE DIVISION
of the
UNIVERSITY OF CALIFORNIA, BERKELEY

Committee in charge:
Professor Larry Hyman, Chair
Professor Andrew Garrett
Professor Johanna Nichols

Fall 2003

The dissertation of Jeffrey Craig Good is approved:

Chair

Date

Date

Date

University of California, Berkeley

Fall 2003

Strong linearity:

Three case studies towards a theory of morphosyntactic templatic constructions

Copyright 2003

by

Jeffrey Craig Good

Abstract

Strong linearity:

Three case studies towards a theory of morphosyntactic templatic constructions

by

Jeffrey Craig Good

Doctor of Philosophy in Linguistics

University of California, Berkeley

Professor Larry Hyman, Chair

The focus of this work is on templatic constructions in morphology and syntax, and its central argument is that their form is consistent with the Strong Linearity Domain Hypothesis. This hypothesis states that all templatic constructions must be coextensive with some prosodic constituent and that their templatic restrictions must be consistent with the characteristic phonology of that constituent.

The introductory chapter lays the groundwork for later discussion, and the primary support for the Strong Linearity Domain Hypothesis comes from three case studies. The first of these is an examination of the ordering restrictions of three verbal extensions found on the Bantu verb stem, the “long” causative, the applicative, and the “short” causative. The second case study is on a minimal-size restriction found in the Chechen core verb phrase.

The final case study is on the order of verbs within serial verb phrases, with a focus on Saramaccan.

While each of the three case studies on its own offers support for the Strong Linearity Domain Hypothesis, taken together they further illustrate how it can model a cline of templatic restrictions, from more specific to less specific, as linguistic constituents go from smaller to larger size.

In addition, each of the case studies can be understood as exemplifying some well-known type of templatic construction. The Bantu case study exemplifies morphosyntactic verbal templates, the Chechen case study exemplifies templates conditioned by special clitics, and the Saramaccan case study exemplifies a class of templatic syntactic phenomena often given the label “constructions”.

The concluding chapter of this work discusses possible explanations for the Strong Linearity Domain Hypothesis. In particular, an evolutionary account is offered wherein it is understood as falling out naturally from a model of the diachronic development of templates in which they arise out of the reanalysis of prosodic restrictions as templatic restrictions.

Professor Larry Hyman
Dissertation Committee Chair

Contents

1	Introduction: Templates, linearity domains, and strong linearity	1
1.0	Opening remarks	1
1.1	Terminology for describing linearity	5
1.1.1	The basics	5
1.1.2	Some comments on the term <i>template</i>	7
1.1.3	Linearity domains	26
1.2	Towards a restrictive theory of strong linearity domains	36
1.2.1	Introduction	36
1.2.2	Subtheory I: Prosodic constituency	37
1.2.3	Subtheory II: The notion of characteristic phonology	44
1.2.4	The Strong Linearity Domain Hypothesis	54
1.3	Applying the Strong Linearity Domain Hypothesis	64
1.3.1	Introduction	64
1.3.2	Example case study I: Serbo-Croatian second-position clitics	65
1.3.3	Example case study II: Leggbó <i>IV</i> - prefix nouns	71
1.3.4	Another look at Bobaljik (2002)	77
1.3.5	Local conclusion	82
1.4	A brief discussion of previous accounts of linearity relations in morphology and syntax	84
1.4.1	Introduction	84
1.4.2	Baker (1988) and the Mirror Principle	85
1.4.3	Embick and Noyer (2001)	89
1.4.4	Bybee (1985)	91
1.4.5	Local conclusion	93
1.5	The three case studies	94
1.5.1	The role of the case study in the present work	94
1.5.2	The three case studies	96
1.5.3	On the bipartite structure of the case studies	103
1.5.4	The Strong Linearity Domain Hypothesis and “templatic residue”	104
1.6	Conclusion	105
2	Causativization and applicativization of the Bantu verb stem: A case study of a morphosyntactic template	107
2.0	Background: Morphosyntactic templates	107
2.1	Introduction to Bantu case study	116
2.1.1	Causativization and applicativization in Bantu	116
2.1.2	The role of this case study in the general analysis	122
2.1.3	The structure of the analysis	122
2.2	Applicativization	126
2.3	Causativization	127

2.4	Proto-Bantu	131
2.4.1	The structure of the Proto-Bantu verb stem	131
2.4.2	The transitive suffix <i>*-j-</i>	135
2.4.3	The causative extension <i>*-ic-</i> and the applicative extension <i>*-id-</i>	138
2.4.4	Causative and applicative ordering restrictions in Proto-Bantu	140
2.4.5	Local conclusion	142
2.5	The relative order of the causative, applicative, and transitive: A survey	142
2.5.1	Basic results	142
2.5.2	Lexicalized suffixes	150
2.5.3	Special forms of the causative, applicative, and transitive when combined	159
2.5.4	The effect of complex suffix combinations	164
2.5.5	Ambiguity of semantic scope for some orders	165
2.5.6	Suffix doubling resulting in different semantics	168
2.5.7	Languages showing productive AC order	171
2.5.8	Local conclusion	180
2.6	Previous analyses of the relative ordering of the verbal suffixes	181
2.6.1	Introduction	181
2.6.2	Baker (1988)	183
2.6.3	Alsina (1999)	204
2.6.4	Hyman (2003a)	218
2.6.5	Local conclusion	225
2.7	The CAT template and the Strong Linearity Domain Hypothesis	229
2.7.1	Overview of argument	229
2.7.2	The Bantu verb stem as a prosodic unit	231
2.7.3	The characteristic phonology of the Bantu verb stem	234
2.7.4	Applying the Strong Linearity Domain Hypothesis to the Bantu data	250
2.7.5	Some notes on why CA is attested instead of AC	262
2.7.6	Local conclusion	272
2.8	Conclusion	273
3	The preverbal enclitic <i>'a</i> and the Chechen verb phrase template: A case study of a templatically-positioned clitic	275
3.0	Background: Clitics and templates	275
3.1	Introduction to Chechen case study	285
3.2	Overview of pertinent aspects of Chechen grammar	291
3.2.1	Nominal inflection and gender classes	291
3.2.2	Clause chaining	293
3.2.3	Word order	294
3.3	The basic structure of the Chechen verb phrase	295
3.4	The clitics found in the Chechen verb phrase	297

3.4.1	Introduction	297
3.4.2	The negative proclitic <i>ca</i>	298
3.4.3	The proclitic <i>ma</i>	299
3.4.4	The enclitic <i>'a</i>	301
3.5	The copy infinitive and the verb phrase template	315
3.5.1	Introduction	315
3.5.2	The focal use of the copy infinitive	315
3.5.3	The obligatory copy infinitive and core the verb phrase template	317
3.5.4	Other uses of the infinitive	321
3.5.5	Why the copy infinitive does not appear to be an object	327
3.5.6	Local conclusion	330
3.6	Previous analyses involving type 5 clitics	332
3.6.1	Introduction	332
3.6.2	Marantz (1988)	333
3.6.3	Halpern (1995)	342
3.6.4	Preverbal <i>'a</i> as a second-position enclitic in its prosodic phrase	344
3.7	The Chechen verb phrase template and the Strong Linearity Domain Hypothesis	346
3.7.1	Overview of argument	346
3.7.2	The Chechen verb phrase as a prosodic constituent	347
3.7.3	The characteristic phonology of the Chechen verb phrase	351
3.7.4	Applying the Strong Linearity Domain Hypothesis to the Chechen verb phrase template	360
3.8	Conclusion	377
4	Saramaccan serial verb phrases and uniformity in serial verb ordering: A case study of a constructional template in the syntax	379
4.0	Background: Topological fields and constructions	379
4.1	Introduction to Saramaccan case study	395
4.2	Serial verb phrases	402
4.2.1	Their descriptive properties	402
4.2.2	A general review of some syntactic analyses of serial verb phrases	408
4.2.3	Carstens (2002)	416
4.2.4	Veenstra (1996)	428
4.2.5	Other explanations for ordering effects: Temporal iconicity and the thematic hierarchy	434
4.2.6	Local conclusion	444
4.3	Saramaccan serial verb phrase ordering and the Strong Linearity Domain Hypothesis	445
4.3.1	Overview of argument	445
4.3.2	Saramaccan phrasal prosody	447
4.3.3	The characteristic phonology of the Saramaccan serial verb phrase	473

4.3.4	Applying the Strong Linearity Domain Hypothesis to Saramaccan serial verb phrases	477
4.3.5	Comments on the attested verb orders in serial verb phrases	486
4.3.6	Local conclusion	491
4.4	Conclusion	492
5	Conclusion: Towards an explanation for the Strong Linearity Domain Hypothesis	496
5.1	Introduction	496
5.2	An evolutionary account of the Strong Linearity Domain Hypothesis	499
5.2.1	Introduction	499
5.2.2	A sketch of an evolutionary approach to grammar	499
5.2.3	An evolutionary explanation for the Strong Linearity Domain Hypothesis	508
5.2.4	Why only reanalyzed prosodic domains can become strong linearity domains	518
5.2.5	Local conclusion	529
5.3	Towards a non-evolutionary account of the Strong Linearity Domain Hypothesis	530
5.3.1	Introduction	530
5.3.2	Optimality Theory	531
5.3.3	PF/LF approaches to grammar	538
5.4	Conclusion	545

Acknowledgments

There are many different classes of people who deserve to be acknowledged for helping me write this dissertation. First and foremost, I would like to thank the Chechen speakers I worked with and my Saramaccan consultants, Henry Leisberger (and the rest of his family) and Rohit Paulus. Without these people, the third and fourth chapters of my dissertation could not have existed in any form.

The next group of people I would like to acknowledge are the members of my committee: Larry Hyman, Andrew Garrett, and Johanna Nichols. Though we certainly do not agree on all matters linguistic, I have always found Larry to be one of the most stimulating people to bounce ideas off of. I suspect at times he wasn't sure why I wanted him to chair this dissertation, but I always knew why: while he professes to be a phonologist, he is really a linguist of much broader skill who has the all-too-rare talent of knowing how to work with real languages, even when their grammars begin to "leak". Andrew Garrett's work (especially the work he has done with Juliette Blevins) has served as the most direct inspiration to the work done here. And, although the arguments I make in this dissertation might, in some places, seem a long way off from the sorts of arguments he makes, were it not for the version of historical analysis learned from him, this particular dissertation would not exist at all. Also, to the extent that this dissertation follows through any of its arguments completely and surveys previous work properly, much of this is due to his keen eye for gaps in all manner of linguistic argumentation. Finally, Johanna Nichols is among the linguists I most respect in the world for her dedication to tirelessly gathering data of all

sorts and putting it together in ways no one else seems to be able to manage to and which are important to everyone. She has been the most immediate influence in my dedication to doing elicitation work and gathering data from understudied languages, and, in my own particular way, I have tried to pattern many aspects of this dissertation based on work she has done.

In addition to the members of my committee, there are various other professors who should be acknowledged: Juliette Blevins' mini-course on evolutionary phonology during my first year of graduate school altered the course of all my future work. Sharon Inkelas has always stood out to me as an island of sanity in the otherwise troublesome world of recent phonological theory. Without her work to build on, I would not have been able to make many of the arguments I have made here. John McWhorter introduced me to Saramaccan—the first necessary step to the creation of chapter four. Rich Rhodes, at different points, gave me interesting ideas which came out in various ways throughout this dissertation. Masha Polinsky gave me some comments at early stages which both changed my choice of case studies and were important in helping me structure the concluding chapter. Sam Mchombo taught me Chichewa, laying the ground work for chapter two. Finally, I would like to single out here one of my instructors from Chicago, Jim McCawley, who unfortunately passed away shortly after I arrived in Berkeley. I am sure he had no idea how much he would influence my work over the years—like so many great minds he has certainly affected people in more ways than he could ever be aware of. To the extent that the syntactic argumentation in this work is clear and to the extent that I am able to make any coherent

syntactic argument, he deserves much of the credit.

I should also thank many of my graduate student peers. First and foremost, thanks go to Bill Weigel who, in many respects, served as my second advisor. His willingness to entertain just about any crackpot idea is the main reason this dissertation is based on one particular crackpot idea. In addition I would like to thank the following people I met during my time at Berkeley who I feel contributed to this dissertation in indirect ways (with no specific comments attached to names so as not to offend anyone and listed in no particular order): Lisa Conathan, Alan Yu, Tess Wood, Mary Paster, Emily Bender, Alyssa Wulf, Laura Buszard-Welcher, and Rosemary Beam de Azcona.

The staff of the Berkeley Linguistics Department also deserves mention: Belén Flores, Paula Floro, and Esther Weiss. Each of these people was a pleasure to work with and Belén, in particular, was crucial to advising me through all the administrative steps that go into being a graduate student.

Finally, I would like to extend my thanks to Lucinda Bingham, Tamas Muller, Danielle Levin, and my parents, five interested non-linguists who were important presences in my life during my time at Berkeley.

1 Introduction: Templates, linearity domains, and strong linearity

1.0 OPENING REMARKS

This work has several complementary goals, and several different strains of argumentation will run through it.

Its narrowest aim, as well as the most prominent one, is to develop a particular restrictive theory of the form templatic constructions. While it is somewhat premature to discuss the core elements of this theory at this point and a proper development of them will have to await elaboration of many concepts in the following sections, it will be possible to get a basic sense of how the argument will develop by going through some of the key terms that will be employed below.

In section 1.1.2 (page 7), I will discuss various uses of the term *template* and ultimately arrive at the definition of the term given below in (1).

- (1) **Template:** A linguistic constituent where linear ordering is the primary dimension along which it is characterized *when such characterization is unexpected*.

The fact that the term *template* is applied only in the case of “unexpected” constructions, makes it somewhat unwieldy as a theoretical term. Because of this, I will develop the concept of the strong linearity domain, which will, here, be understood as a technical term which can be roughly equated with the more descriptive term *template*.

The definition of a strong linearity domain builds off the definition of the more general term, *linearity domain*, which is given in (2).

- (2) **Linearity domain:** A linguistic constituent whose immediate subconstituents bear linear relations with one another.

And, based on this definition, it becomes possible to distinguish between two types of linearity domains, *weak linearity domains* and *strong linearity domains*, definitions of which are given in (3) and (4).

- (3) **Weak linearity domain:** A linearity domain in which all linear relations among constituents can be predicted from their hierarchical relations via a general algorithm.

- (4) **Strong linearity domain:** A linearity domain in which some aspects of the linear relations among constituents must be specified independently of their hierarchical relations.

Fully understanding these terms requires them to be evaluated within some theory of hierarchical relations. For now, though, it will suffice to think of “hierarchical relations” as the basic constituency relations for morphological and syntactic constructions—which are typically schematized with labelled trees. With such an understanding of the term, the difference between a weak linearity domain and a strong one centers, more or less, on the fact that linear relations within weak linearity domains are completely predictable on the basis of an independently motivated aspect of linguistic structure whereas linear relations within strong linearity domains are not.

While the notion of linearity domains applies across all levels of grammar, I will be focusing on linearity domains within morphosyntactic and syntactic constructions here. And I will specifically defend the hypothesis given in (5) with respect to such constructions. This hypothesis is intended to constitute the core of a restrictive theory of the possible form of “templates” in morphology and syntax.

(5) **Strong Linearity Domain Hypothesis:** The boundaries of any strong linearity domain must be coextensive with a prosodic constituent, and its non-predictable linearity restrictions must be consistent with the characteristic phonology of that prosodic constituent.

As can be seen in the definition in (5), the Strong Linearity Domain Hypothesis presupposes a theory of prosodic constituency and the notion of the characteristic phonology of a prosodic constituent. The theory of prosodic phonology employed in this work will be discussed in section 1.2.2 (page 37), and the notion of the characteristic phonology will be developed in section 1.2.3 (page 44).

A defense of the Strong Linearity Domain Hypothesis, which will be discussed in much more detail in section 1.2.4 (page 54), constitutes the most important line of argumentation found in this work. A second line of argumentation falls out from the fact that I will be employing three case studies of morphosyntactic and syntactic constructions in order to defend this hypothesis. All of these constructions can roughly be labelled “templatic” insofar as their linear structure seems to require an analysis in terms of a “template”—that is, some set of slots or relative ordering restrictions which determine where the elements

in some linguistic constituent must appear but which is not predictable from hierarchical structure.

Another argument in this work will be, then, that templatic constructions do exist in morphology and syntax. We will see, in subsequent sections, that the existence of such templates has been debated. Through careful case studies, I hope to present strong evidence that there are truly templatic phenomena in these areas of grammar. However, at the same time, I will argue that such phenomena are constrained by the Strong Linearity Domain Hypothesis. This line of argumentation will constitute, to the best of my knowledge, the first time that anyone has argued simultaneously for the existence of templates in morphology and syntax while attempting to create a broad restrictive theory of what their form can be.¹

While this work is grounded both by the Strong Linearity Domain Hypothesis and case studies of templatic constructions, there is a third, much broader, line of argumentation which will be explicitly and implicitly found within it. I would like it to serve as an opening statement on how we can create a framework for generally understanding linear relations throughout grammar. That is, this work can be understood as a foundational element towards a theory of linearity.

While there are many small theories about how linear relations are realized within the “components” (e.g., phonology, morphology, syntax) of grammar, there is, at present, no comprehensive *linearity theory*.² Thus, while we have theories of phonotactics, morpho-

¹ A research program outlined in McCarthy and Prince (1995) and discussed in section 1.2.4.2 (page 57) can be understood as making a similar argument to this within morphophonology.

² Even in the context of phonology, where linear relations are indisputably central to many phenomena,

tactics, and syntactics, there is no general theory of tactics.

This work certainly will not develop a full-blown linearity theory. However, it is hoped that it will help lead the way for the development of such a theory because, whether or not the Strong Linearity Domain Hypothesis turns out to be a completely valid principle of grammar, we will see that it can be a useful empirical tool for unifying generalizations about linearity within morphological and syntactic structures. It, therefore, may have use as a model for comparable cross-component theories of linearity.

Having clarified some of the different facets of the material to be presented below, I move onto an essential task for managing the rest of the discussion: devising an appropriate terminology for linear relations.

1.1 TERMINOLOGY FOR DESCRIBING LINEARITY

1.1.1 The basics

With respect to the terminology to be used here, the first thing to be pointed out is that I offer no technical linguistic definition for the term *linear order*. Any definition I could offer would be unenlightening, and I take my lead from geometry, where the term *line* is left undefined. As an approximation, we can say that the components of speech must take place along some sort of timeline and that these components can be located at some point along that line. The order that those components have with respect to each other along that line is their linear order.³

linearization itself is rarely discussed explicitly, though see Raimy (2000), which is a notable exception to this.

³ I consider only spoken languages here, and I have no comment on the applicability of the discussion here to signed languages except to say that it is probably largely irrelevant.

From this basic, undefined term, I will develop a number of terms, including *strong linearity domain*, in a technical way. Initially, I will make use of the terms *linear relations* and *linearized*. I offer definitions for each of these in (6) and (7) respectively.

(6) **Linear relations:** A set of relationships between linguistic constituents which specifies how they are realized in linear order.

(7) **Linearized:** A label for a set of linguistic constituents which bear exhaustive linear relations with respect to each other.

In the definitions in (6) and (7), I mean *linguistic constituent* very broadly to include phonological, morphological, and syntactic constituents. We will see that one of the central operating principles of this work is to attempt to relate the linear relations of these three basic types of constituents to each other. So, this broad use of the term constituent will be important in later discussion. However, I will develop no new theory of constituency here and will instead rely on previous work.

As will become clear in later discussion, the definition of linear relations in (6) is not meant to be restricted to simple ordering of morphemes or words. Rather, it is meant to encompass the full range of facts regarding linear realization. In addition to the basic idea of order, this can also include, among other things, effects like stress and intonation which refer to positions found within sets of ordered morphemes or words. Stress, for example, is often placed by referring to linear notions like *initial*, *final*, or *penultimate*. Even when it is *fixed*, it is fixed in some linear position. Stress is, thus, taken to be an aspect of linear

relations here. Similarly, intonational contours are typically overlaid onto some linguistic constituent with reference to its linear boundaries. So, intonation, too, should be included as an aspect of linear relations. These are just two examples illustrating the general range of phenomena encompassed by the term linear relations, as used here. Other examples will be seen in the case studies in subsequent chapters.

1.1.2 Some comments on the term *template*

1.1.2.1 Introduction

The word *template* will come up very frequently over the course of the case studies to be presented here as it is a useful, descriptive term. It has often been well-defined within specific contexts, but less clear is what a general definition of the term might be, and it has been used to describe a wide range of phenomena. Here I will survey various ways it has been used in order to develop a working definition of the term. I will also discuss some grammatical phenomena to which the label *template* has not been applied but which are similar to phenomena to which the term has been applied.

The main goal here will not be to develop some formal definition of the word *template* to be applied in later analyses. Rather, the central concern of this section will be to try to see what commonality lies in the various invocations of the term. Arriving at this definition will, it is hoped, give us insight into the general nature of structures described as “templatic”. When a technical term is required for some phenomenon traditionally understood as “templatic”, I will generally be using the term *strong linearity domain*, which will be defined in section 1.1.3 (page 26).

In the following sections, then, I will summarize some ways the term *template* has been employed in various areas of grammar. I begin with morphophonological templates, since those are the type of templates that are most well-defined and then move to morphosyntactic templates, whose existence has been debated, but are still reasonably well-defined. I will also discuss some proposed instances of phonological and syntactic templates as well as some template-like syntactic phenomena which have not been labelled as such but are of interest here.

1.1.2.2 Morphophonological templates

The most carefully worked out analyses making use of templates have been in the morphophonological domain. In fact, this is the one area of linguistic theory where templates have been generally assumed to be theoretically valid devices. McCarthy and Prince (1995), for example, summarize developments in prosodic morphology, noting the role of templates in these developments. Furthermore, the existence of so-called templatic morphology (i.e. morphophonological templates) is well-accepted as are analyses which make use of “templates”.

Broselow (1995:180–2) has some relevant discussion. She cites data from Sierra Miwok (among other languages) to illustrate the idea of a “skeletal template”. In (8) I give data illustrating the operation of templatic morphology in Northern Sierra Miwok (data taken from (Freeland 1951:94)).

(8)

STEM I	STEM II	STEM III	STEM IV	GLOSS
tuyá:ŋ	tuyáŋ:	túy:aŋ	túyŋa	‘jump’
polá:ŋ	poláŋ:	pól:aŋ	pólŋa	‘fall’
topó:n	topón:	tóp:on	tópno	‘wrap’
huté:l	hutél:	hút:el	hútle	‘roll’
telé:y	teléy:	tél:ey	télye	‘hear’
CVCV:C	CVCVC:	CVC:VC	CVCCV	

In Northern Sierra Miwok, for verbs of a particular type (Freeland’s “type I”), there are four stem classes. Each of these stem classes has a particular CV shape, indicated in the last line in the table in (8). This CV skeleton determines the length of the consonants and vowels and how the consonants and vowels are ordered with respect to each other. The vowels and consonants for each verb are constant, as well as the relative order of the vowels and of the consonants. These limitations on the variation between the stem types of a single verb is what allows the four stem types to be described with CV templates of the sort seen in (8), and analyses making use of such CV templates have been important tools in morphophonological research since the early 1980’s (Kenstowicz 1994:395).

A striking effect of Northern Sierra Miwok templates is illustrated in the data in (9), also taken from Freeland (1951:95).

(9)

STEM I	STEM II	STEM III	STEM IV	GLOSS
hám:e	haméʔ:	hám:eʔ	hámʔe	‘bury’
ʔúp:i	ʔupíʔ:	ʔúp:iʔ	ʔúpʔi	‘dive’
líf:a	liwáʔ:	líf:aʔ	lífʔa	‘speak’
ʔót:i	ʔotíʔ:	ʔót:iʔ	ʔótʔi	‘scatter’
nán:i	nan íʔ:	nán:iʔ	nánʔi	‘find’
CVC:V	CVCVC:	CVC:VC	CVCCV	

Verbs of type III in Northern Sierra Miwok are only lexically specified for two consonants and two vowels. These match with the first four slots of the template. For stem I of

Type III verbs, the matching of consonants and vowels to slots is straightforward. However, the skeletons of the other three stem types have three consonantal slots—one more than the number of lexically specified consonants. Northern Sierra Miwok’s solution to this problem is to uniformly insert a glottal stop into the extra consonantal slot. Such insertion of a “dummy” element is an important templatic effect which will come up again, especially in chapter 3.

While skeletal CV-templates of the sort seen in (8) and (9) are some of the more noticeable types of morphophonological templatic phenomena, a related type of phenomenon is often found in reduplicative and truncative morphology. Such morphological constructions can involve assigning some morphophonological entity a fixed length. For example, as pointed out by McCarthy and Prince (1995:325–6), nickname formation in many languages is determined by mapping a full name to a particular morphophonological shape. McCarthy and Prince (1995) cite the work of Poser (1990) on Japanese nickname formation as an example—some relevant data from Poser (1990) is given in (10).

(10)

REGULAR NAME	NICKNAME
<i>hanako</i>	<i>hana-tyan</i>
<i>yukiko</i>	<i>yuki-tyan</i>
<i>akira</i>	<i>aki-tyan</i>
<i>taroo</i>	<i>taro-tyan</i>
<i>yooko</i>	<i>yoo-tyan</i>
<i>kazuhiko</i>	<i>kazu-tyan</i>
<i>ti</i>	<i>tii-tyan</i>
<i>tiemi</i>	<i>tii-tyan</i>

Some of the regular names in (10) allow for multiple nicknames, but I only give one possible nickname for the purpose of exemplification of the basic pattern. Also, I should

point out that there are nickname formation strategies for Japanese other than the one seen in (10) (see Poser (1990) for extensive discussion). The particular formation seen in (10) uniformly suffixes *tyan* to a bimoraic stem. For names of CVCVCV structure, this means that the nickname stem will have the form CVCV, while other patterns hold for names containing long vowels. In the one example of a name having just CV structure, *ti*, its vowel must be lengthened to create an appropriate nickname stem.

The templatic aspect of the data in (10) is the fixed, bimoraic length of the stem of the nickname. Obviously, additional analysis will be required to account for what segmental material from a given name gets mapped to the bimoraic template. However, for our purposes, what is important is simply the fact that a language may impose a fixed length on some morphological construction. As mentioned above, comparable phenomena are found in reduplication where reduplicative affixes are also often specified as being a fixed length. Instances of such effects in reduplication will be seen in section 2.7.3.2 (page 235) in chapter 2. Such fixed lengths need not be limited to being in moraic in nature—they are also sometimes best characterized in terms of syllables or feet, for example.

As mentioned above, the existence of templates—both CV templates and “length” templates—within the theoretical literature on morphophonology is relatively secure, a point of no small significance to the general argument to be made here.⁴ A summary of the most well-accepted theory of morphophonological templates can be found in McCarthy and Prince (1995). This is a theory which attempts to relate them, in a highly restricted way,

⁴ This does not necessarily mean, however, that there is agreement on how to represent templates formally. Broselow (1995), for example, discusses various approaches to representing templates, including CV skeletons, prosodic templates, and mora-based approaches.

to prosodic constituents. I will discuss it in more detail in section 1.2.4 (page 54). Though I have yet to introduce it properly, as discussed in section 1.0 (page 1), an important line of argumentation in this work is a defense of the Strong Linearity Domain Hypothesis, given in (5). This is also a theory of templates which relates them to prosodic constituents. A relevant point to take from this is that two independent lines of research have converged upon the idea that there is something “prosodic” about templates.

1.1.2.3 Morphosyntactic templates

The place of templates within the morphosyntactic literature is considerably less secure than in the morphophonological literature, though many languages are described as having morphosyntactic templates. The most in-depth recent discussion of such phenomena is in Rice (2000) where she attempts to show that, despite frequent descriptions to the contrary, the Athabaskan verb is not templatic.

Sometimes also referred to as “position-class” or “slot-filler” morphology, morphological templates are used to describe “morphological systems in which morphemes or morpheme classes are organized into a total linear ordering that has no apparent connection to syntactic, semantic, or even phonological organization (Inkelas 1993:560).”

Importantly, the terms “position-class” and “slot-filler” are more specific than the term “template”, and it is possible to have a template without anything resembling slots, as we will see in chapter 2. Instead, a template can manifest itself as an enforced local ordering restriction on some set of elements when they are all present in the same constituent—an example of such a template would be a restriction where two affixes must have a constant

relative order when they both appear on the same stem.⁵

While Rice (2000) takes an essentially non-templatic approach to the structure of the Athabaskan verb, commonly held to have templatic properties, in making her general argument, she presents a clear overview of the various properties commonly attributed to morphosyntactic templates. In (11), I summarize the properties of morphosyntactic templates which Rice (2000:10–14) found reference to in various sources including Simpson and Withgott (1986) and Spencer (1991).

- (11) (i) Morphosyntactic templates may contain obligatorily active linearly-defined positions.
- (ii) Morphosyntactic templates do not produce headed structures.
- (iii) Morphosyntactic templates are not constrained by principles of adjacency (and, thus, allow discontinuous dependencies).
- (iv) Morphosyntactic templates permit “lookahead” where an “outer” morpheme affects the choice of an “inner” morpheme.

Criterion (i) above is actually stated fairly differently from the way Rice stated it. In her version, it simply said that zero-morphemes are characteristics of morphosyntactic templates—the idea being that the lack of overt morphology in a particular position on a verb can sometimes signal specific meaning. In chapter 3, a related property of templatic

⁵ Though she rejects the existence of morphosyntactic templates, Speas (1984:101–2) contains a discussion of different ways of analyzing templates including a distinction between slot-filler analyses and local ordering restriction analyses of the types just outlined above.

systems, that slots require some sort of “filler” element will be important. (Such a filler element was seen in (9) for a morphophonological template.) I collapse the idea of zero morphology and required filler elements, here, into the single idea of an obligatorily active linear positions.

Some work in the theoretical literature, including Rice (2000) from which the criteria in (11) were taken, has argued that, while morphosyntactic templates may be useful descriptive devices, they do not exist as true grammatical objects. Other than Rice (2000), McDonough (2000) is a recent example of this, and earlier examples can be found in Speas (1984, 1990:240–280)—these authors specifically contend that templates are not active in the formation of the complex Athabaskan verb and have tried to show that other principles, both phonological and syntactic, can be used to explain apparent templates.

However, there is other theoretical work which does argue for morphosyntactic templates, some examples being Simpson and Withgott (1986), Stump (1992, 1993), Noyer (1991), Anderson (1992:128–35), Inkelas (1993), and Halpern (1995:191–222).⁶ And, thus, it is fairly clear that, at present, there is no general consensus as to the theoretical status of morphosyntactic templates.

This divide in the literature does not represent a deep division in the basic interpretation of the surface patterns found in the various languages which have been argued to employ

⁶ We will have occasion to refer to many of these works below. The work of Stump (1992, 1993) is noteworthy for formalizing templatic properties of the Bantu languages, which will be the focus of chapter 2. This work can be understood as formalizing a descriptive intuition, common to many descriptive Bantu grammars, which understands the prefixal positions of the Bantu verbs as a series of slots, some of which are optional—a good example of this is Maganga and Schadeberg’s description of the Kinyamwezi verb (Maganga and Schadeberg 1992:97–8)

morphosyntactic templates. Rather, there is general agreement that some languages look more “templatic” than others. What separates these two bodies of work is how they answer the more fundamental question as to whether or not morphosyntactic templates are real grammatical objects. Work arguing against their existence has made use of independently-motivated theoretical tools to show that apparent morphosyntactic templates are, in fact, special cases of non-templatic morphology which, by virtue of various conspiring factors, happen to look “templatic”.

A notable gap in work arguing for the existence of morphosyntactic templates, which will be partially filled in this work, is a specific theory as to what are the possible forms of morphosyntactic templates. One reason why morphophonological templates have received more theoretical support than morphosyntactic templates is almost certainly that restrictive theories have been developed for them, as we shall see in section 1.2.2 (page 37). This observation is not new to this work. For example, Noyer (1991:199) stated, “For [morpho]phonological templates, McCarthy and Prince’s (1990) suggestion that templates are prosodic in character, i.e. they manipulate potential foot shapes in [a] narrow class of possibilities, renders the template approach more plausible. A similar constraint or set of principles would considerably fortify the [morphosyntactic] template approach, but this awaits investigation.”

One of the primary goals of this work is to suggest just such a set of principles for morphosyntactic principles—the Strong Linearity Domain Hypothesis. One will be suggested in section 1.2 (page 36).

A final point to be made regarding morphosyntactic templates is that, outside of theoretical work, there is a large body of more descriptively oriented work, particularly from North American languages, which makes use of morphosyntactic templates. Some examples of this include: Hoijer (1971), Kari (1989), and Young (2000) for Athabaskan; McLendon (1975) for Pomo (a language of the Hokan stock); Kimball (1991) for Koasati (a Muskegean language); Bloomfield (1962) for Menomini (an Algonquian language); Lounsbury (1953) for Oneida; and Maganga and Schadeberg (1992) for Kinyamwezi, a Bantu language. This is just a small sample of the descriptive work making use of templates, and I think it's fair to say that they have been used much more extensively as a descriptive device than a theoretical one.⁷

I will come back to some aspects of morphosyntactic templates in section 2.0 (page 107) in chapter 2 and in section 3.0 (page 275) in chapter 3. Section 2.0 will have further discussion of elaborate verbal templates of the sort found in Athabaskan language, and section 3.0 will discuss some aspects of the status of clitic clusters, of the sort found in, for example, French. While the elements in these clusters commonly receive the label “clitic” suggesting that they are syntactic constituents, they bear a number of affinities to prototypical morphosyntactic templates.

1.1.2.4 Phonological templates

In a recent manuscript, Croft and Vihman (2003) argue for something they term Radical Templatic Phonology. In the first footnote of the manuscript, they give their sense of the

⁷ Of these works, Kari (1989) should be singled out for theorizing the descriptive notion of position class in some detail rather than just making use of a loose definition of the notion.

term “template” as follows, “it describes word-sized patterns at all levels of phonological organization. . . .”

Croft and Vihman (2003) are making a proposal which strongly departs from traditional phonological intuitions: the basic phonological unit is not the segment (or even the syllable) but the word. Segments are emergent categories based on comparisons between particular words. Phonotactic constraints, in such a framework, are also emergent from generalizations over words.

Though they do not formalize it in particular detail, the basic sense that one gets from Radical Templatic phonology is that there are a series of “word templates” in a given language that designate possible kinds of words in the language. These word templates will instantiate the range of possible syllable structures. Crucially, however, these are not simple CV templates. They can also include segmental information if that fits the languages general phonotactics.

For example, though English allows CCC onsets, in words like *strength*, there would be no word-template containing a CCC onset since the facts of English do not in general support an unrestricted three-consonant onset template. Rather, one might find an English word template containing an sCC onset, reflecting the fact that all three-consonant onsets begin with *s* in the language.

Within a general theory of templatic phenomena, of the sort being partially developed here, the proposal of Croft and Vihman (2003) is an interesting one, and it represents an innovative use of the notion of template not unrelated to the notion of strong linearity

domain to be developed shortly. At this early stage of the formulation of Radical Templatic Phonology, however, it is hard to completely understand its significance for the arguments to be presented here, and I will not directly tie in the present work into that of Croft and Vihman (2003), though this might be warranted in the future.

1.1.2.5 Syntactic templates

Importantly, within this context, I have not encountered any work specifically arguing for a “syntactic template”. This is not to say there aren’t syntactic analyses which have a templatic feel—Kathol’s (2000) analysis of German word order and some analyses within Construction Grammar (see, e.g., Kay and Fillmore (1999)) are not dissimilar from structures to which the term “template” is applied. I simply have not encountered the word “template” explicitly invoked to describe a properly syntactic construction. Below, I will briefly discuss some aspects of Kathol’s (2000) work with respect to the idea of a template. First, I will describe some phenomena which have been analyzed using a “semantic template”—which, here, I take to be more clearly labeled a syntactic template.

Awóyalé (1988) proposes what he calls a semantic template to account for the possible combinations of predicates of serial verb phrases. Awóyalé (1988:9) gives the template in (12).⁸

⁸ Within this context, one can imagine other types of “semantic” templates like the appropriate order of multiple adverbial expressions. For example in the English sentence *At 2:00, in 1229 Dwinelle, there will be a meeting* is a more natural order than *In 1229 Dwinelle, at 2:00, there will be a meeting*. It would be possible to suggest, on the basis of such sentences, that there is a TIME-PLACE “semantic” template at the left edge of the English sentence. I am not aware of anyone who has suggested such a thing, however. It would be interesting to examine how such restriction on adverbial expressions might be related to other templatic constructions. For reasons that will become clear with later discussion, I have not considered them in detail here since, when dealing with constructions like these involving optional elements, it becomes difficult to separate their “templatic” properties from their predictable properties, and, in order to examine

(12)

MODALITY	↔	EVENT	↔	STATE
	relational rules		relational rules	

I will have more to say about this template in chapter 4, which is a case study of Saraccan serial verb phrases. For now, what is important to note about the template in (12) is that it is intended to be a representation of the order of predicates in serial verb phrases. These are complex verb phrases which consist of multiple “small” verb phrases joined together into one larger predicate.

The type of data accounted for by Awóyalé’s (1988) template is exemplified in (13), taken from Déchaine (1993:213) who employs Awóyalé’s template in her general theory of predication. This example is from Yoruba.

- (13) *Ọlọpàá [e na olè náà] [s bẹ]*.
 police.AGR flog thief the cut
 “[The] police whipped the thief bloody.” (Déchaine 1993:212)

In (13) a predicate expressing an event (flogging) precedes a predicate expressing a state (cut). The fact that the predicates appear in this order is taken to be accounted for the template in (12) which orders events before states.

As will be clear from the discussion in chapter 4, I believe there is certainly something templatic about serial verb phrases. However, even if we were to adopt all of Awóyalé’s (1988) basic insights, I am not sure that the label “semantic template” is appropriate here. Rather, I think the template in (12) could be better termed a syntactic template—since it is not intended to describe possible semantic structures, but rather syntactic ones. Because of this, it represents the best example of a proposed syntactic template that I am aware of.

the predictions of the Strong Linearity Domain Hypothesis, it is essential to examine constructions where the “templatic residue” (a notion to be discussed in section 1.5.4 (page 104)) can be isolated.

With respect to work like that of Kathol (2000), mentioned above, there is a tradition in some of the literature on German syntax, to make use of the device of a topological field, which bears an affinity to device of the position class proposed for morphological constructions. Kathol (2000) is a recent, thorough work within this tradition, and it dates back to the nineteenth century (see Höhle (1986) for a general overview of this model of German syntax). The basic idea of the theory of topological fields is, “...leaving considerations of constituency and dependency completely aside, the sentence patterns of German can be described in terms of particular classes of linear occurrence (Kathol 2000:47).” Given such a definition, the similarities between the topological field and the position class are fairly clear. Kathol (2000:87) even uses terms like “positional class” in discussing aspects of his topological field analysis.

I will have more to say about topological field analyses of syntactic phenomena in in section 4.0 (page 379) of chapter 4. For now, I will summarize some basic aspects of the approach. The first major idea behind it is to divide the German clauses into three categories, based on the linear order of the elements within them. These categories can be usefully labelled *verb-final*, *verb-initial*, and *verb-second*, based on the position of the finite verb. I give examples of each category in (14). The relevant verbs are bolded in each example. In some cases, the examples contain multiple clauses, in which case I have bracketed the relevant one.

- (14) a. *Ich weiß [daß Otto das Buch **liest**].*
 I know that Otto the book reads
 “I know that Otto is reading the book.” (Kathol 2000:53)

- b. [*Hätte sie später die Blume gegossen*] *dann wäre das Büro schöner.*
 had she later the flower water then were the office nicer
 “If she had watered the flower later, the office would look nicer.” (Kathol 2000:49)
- c. *Peter wird Paul sprechen wollen.*
 Peter will Paul speak want
 “Peter will want to speak to Paul.” (Kathol 2000:59)

The bracketed clause in (14a) is an example of one where the verb appears finally, the bracketed clause in (14b) is an example of one where the verb appears initially, and the sentence in (14c) is a case where the verb is in second position. There are various ways in which the word order differences in (14) could be analyzed, and Kathol (2000) discusses a range of analyses—in some of these the different word orders are treated as secondary effects of other aspects of German syntax.

However, in a topological fields approach, like that espoused by Kathol, the word order of the different sentence types is treated as resulting from the division of the German sentence into a series of position classes where different syntactic elements can be placed. So, for example, finite verbs in main clauses and complementizers are both considered to occupy the *linke Satzklammer* (‘left-clause bracket’) field. This positional analysis is intended to, at least partly, explain why the finite verb is final in complement clauses—the finite verb and the complementizer “compete” for the same position near the left of the clause and the complementizer’s positional requirements override those of the finite verb which, as a result, is forced to appear finally in its clause.

As is probably clear from this example, the elements which can appear in a given position class are not necessarily a syntactic natural class—and, thus, the position classes are

taken to be grammatical objects in their own right. The obvious similarities of this approach to the position-class analyses of morphosyntactic “templates” indicate that the topological fields analysis of German constitutes a good case of a “syntactic” template—even if that specific term has not been applied.

A final potential type of a syntactic template relates to the traditional notion of a second-position clitic. This is a complicated case, however, and will receive thorough treatment in various discussion throughout this work—so, I won’t discuss it here. Such clitics, and their potentially templatic properties, will be introduced in section 1.3.2 (page 65) and will also come up in section 3.0 (page 275) in chapter 3.

1.1.2.6 An informal definition of “template”

At this point, some major and minor uses of the term “template” have been discussed, and I am in a position to offer a definition for the term. I repeat Inkelas’ description of morphological templates here en route to developing a general definition: “morphological systems in which morphemes or morpheme classes are organized into a total linear ordering that has no apparent connection to syntactic, semantic, or even phonological organization (Inkelas 1993:560).”⁹ What is important about this definition, for our purposes, is an expectation which is implicit in it—specifically the expectation that the ordering of morphemes *should* have some connection to syntactic, semantic, or phonological organization.¹⁰ Rec-

⁹ Given the discussion above, it might not be immediately clear how phonological organization might fit into the ordering of morphemes. One instance where phonology is often invoked in this regard is with respect to infixation, as in, for example, the analysis of infixation within Optimality Theory sketched in McCarthy and Prince (1995:358–64).

¹⁰ I do not intend to single out Inkelas (1993) here for this assumption—her definition just encodes it clearly. Importantly, her definition only implicitly includes an expectation that there should be a connection to syn-

ognizing that there is this expectation that the order of morphemes should be connected to something and not simply be governed by a simple statement of linear order is crucial to understanding how the term *template* is used.

Looking back at Rice's four properties of templatic morphological systems given above, three of them, (i), (iii), and (iv), are statements about how linear order plays a role in morphological templates. The statement in (i) says, in effect, that template morphology has obligatory "slots" in some linear structure, the statement in (iii) is a statement about adjacency—an intrinsically linear notion—and the statement in (iv), with its use of the words "inner" and "outer", is essentially a statement about relative linearity. Statement (ii) is even, in some sense, a statement about linearity. It effectively says that morphological templates are not hierarchical structures. The obvious interpretation of this is that the only dimension along which morphological templates have structure is in linear ordering, since linear and hierarchical dimensions have generally been assumed to be two dimensions through which all linguistic structures can be defined.

Shifting the focus from morphological templates to templates generally, one straightforward (but wrong) definition of templatic structures which could be derived from Rice's criteria would be that they are linguistic structures which are best described in terms of linear relations instead of hierarchical ones. This runs into the immediate problem that there is at least one linearly defined structure which is never described as templatic—namely, the lexically-stored string. The Northern Sierra Miwok data seen in (8) and (9) illustrated that tactic, semantic, or phonological principles by mentioning that this is a possibility at all. This expectation is commonly assumed and, generally, seems to go unnoticed, not without reason.

there are word-level phonological phenomena described as templatic. The string is simply not one of them.

In a language like English it is fairly clear that the lexical string, can exhibit unpredictable linear order because of the existence of “linear” minimal pairs.¹¹ For example, it does not seem to be possible to come up with a principled explanation that could predict the lexical opposition between the segmentally equivalent, but linearly different words *pit* and *tip*. We might be able to devise an analysis where, given the three segments *p*, *t*, and *i*, the appearance of the vowel in both words between the consonants is predictable. However, we will always need to specify, in some way, that in one word *p* precedes *t*, while, in the other word, *p* follows *t*. We have, therefore, fairly clear evidence that the string associated with these two lexical items contains a strong linearity domain.

The reason why the phonological string, and many other linearized linguistic constituents, are not considered templatic goes back to the notion of expectations, which we saw was implicit in Inkelas’ definition of morphological templates. The term template isn’t used simply when linear order is the primary dimension along some linguistic constituent is structured. Rather, the term is reserved for those particular cases where (i) linear order is the primary dimension of structure for some linguistic constituent and (ii) this is somehow surprising.

We expect linear order to be the primary dimension along which a string is structured.

So, we don’t call a string “templatic”. We (apparently) don’t expect the morphological

¹¹ However, this is not to say a lexical string would have such properties in all languages. Yip (1989) has suggested otherwise for Cantonese, for example. In that language the size of morphemes and their syllable structure mean that, given a set of segments associated with a lexical item, their order can be predicted.

structure of a word to be essentially linear. When this happens, the term “template” is employed.

The phenomenon seen in the Northern Sierra Miwok data in (9), is labelled templatic since the linear order of the consonant and vowel “slots” in a given verb stem must be stipulated independently of the order of the consonantal and vocalic segments in the verb stem, contrary to our expectations about morphophonological structure. “Length”-oriented templates, like the one seen in (10) for nickname formation in Japanese, are similarly labelled templatic since the general expectation is that a morpheme’s length will be determined by its lexical form—not by the requirements of some particular morphological construction. Furthermore, as illustrated by the quote from Inkelas above, we expect that the order of morphemes in a word will be predictable from the syntax or semantics of the word. When this is not possible, the label “template” is used to describe their order.

Similarly Awóyalé’s (1988) “semantic” template is a statement that the expression of the subevents of a complex event in a serial verb follows a fixed order without that order being predictable by semantic or syntactic considerations. (As with all proposed templates, this is not to say that this ordering relation is not, in fact, predictable—it is simply the case that a templatic analysis implies that such a relation is not predictable.) Finally, Croft and Vihman’s (2003) *Radical Templatic Phonology* is a proposal that the basic units of phonology are not segments but linearized phonological structures. This is an unexpected stipulation of linearity on phonological representations, hence the term “templatic”.

With these ideas in mind, I offer a definition of the term *template* below in (15). This

definition is intended to reflect how I interpret the term has been used and is not intended as a technical one. The technical analog to this descriptive term which will be employed in this work is *strong linearity domain* which I will define below in (18).

- (15) **Template:** A linguistic constituent where linear ordering is the primary dimension along which it is characterized *when such characterization is unexpected*.

Thus, the term template is, essentially, a sort of judgement, relative to expectation, that a linguist can assign to some linearized structure. We can formally describe templates within one particular domain of language—like the morphophonological structure of a verb as seen for Northern Sierra Miwok above. However, it would be difficult (if even possible) to come up with a general formalism for templatic structures since that would require formalizing our expectations as to how “linear” each type of linguistic structure should be.

In order to be able to discuss linear relations more concretely when necessary, in the next section, I will develop the notion of the *strong linearity domain*. This term will, in large part, allow us to avoid the use of the term template when precision is necessary. However, I will still frequently make use of the term template as a useful, pretheoretic term for a structure exhibiting unexpected unpredictable linear properties.

1.1.3 Linearity domains

1.1.3.1 The definitions

In order to develop a technical terminology for templatic phenomena, it is first necessary to develop a basic term for a linguistic constituent over which linear relations hold,

what here will be called a *linearity domain*. A definition is given in (16).

- (16) **Linearity domain:** A linguistic constituent whose immediate subconstituents bear linear relations with one another.

This definition is, on its own, of little use since any uttered linguistic constituent must be ordered and, therefore, be a linearity domain. I thus make the distinction given in the definitions in (17) and (18).

- (17) **Weak linearity domain:** A linearity domain in which all linear relations among constituents can be predicted from their hierarchical relations via a general algorithm.

- (18) **Strong linearity domain:** A linearity domain in which some aspects of the linear relations among constituents must be specified independently of their hierarchical relations.

It should be clear that templates, in the way they have been employed in the works discussed above, constitute strong linearity domains—and that the existence, or lack thereof, of strong linearity domains in morphology and syntax is a question of theoretical interest.

The above definitions in (17) and (18) make reference to hierarchical relations among constituents. I leave open the precise nature of these relations here since there are a large number of complementary and competing theories about the hierarchical organization of grammar. We will examine one theory of the hierarchical structure of phonology in section

1.2.2 (page 37). In morphology and syntax, hierarchical relations are often represented via labelled constituency trees. I will have occasion to refer to such trees at various points in the case studies to be presented below, and I assume that model of such constituency in this work for expediency. Furthermore, there are other obvious types of potentially hierarchical aspects of grammar, like pragmatic phenomena, which I will not discuss here since they won't critically factor into the data to be analyzed.¹²

For the sake of clarity, I should note here that, in my use of the term *general algorithm* in the definition of a weak linearity domain, I have in mind simple parametric statements like: all heads are final, adjectives precede their head noun, prefixes go to the left of their base and affixes to the right, etc. I would specifically like to exclude any morpheme-specific statements like: affix X must precede affix Y unless such a statement could be motivated as being a special case of a more general phenomena. The basic intuition behind the notion of general algorithm is the idea of predictability—weak linear relations can be usefully thought of as predictable strong linear relations as unpredictable. Like with other aspects of this definitions employed by work, the precise interpretation of a general algorithm is theory dependent. The strong linearity domains to be proposed here will be conservative insofar as I will be fairly liberal as to what an appropriate general algorithm could be—thus limiting the potential instances of strong linearity effects.

¹² In section 4.2.5.4 (page 442) I will suggest that we might want to consider another principle, that of temporal iconicity, that can affect linear relations. Such a principle does not obviously lend itself to hierarchical representation. To the extent that such a principle could be active in grammar, we would also want to exclude ordering principles which refer to it as creating strong linearity domains. I leave it out in this discussion for simplicity.

Finally, the definition of “strong linearity domain” is deliberately qualified by saying that *some*, but not necessarily all, of its linear relations are unpredictable. This is because a strong linearity domain will generally interact regularly with certain areas of a language’s grammar, making some of its linearity relations predictable. For example, even in languages with apparent, elaborate position-classes on their verbs, those same verbs will show phonotactics consistent with the syllable structure found elsewhere in the language. Thus, some of their linear relations will remain predictable, even if others are not.

1.1.3.2 Some types of linearity domains

For illustrative purposes, in this section, I’ll briefly discuss two important sources of linearity domains: syntactic and prosodic constituents.¹³ Syntactic constituents, of course, need not necessarily correspond to linearity domains (see, for example, Kathol (2000), discussed above in section 1.1.2.5 (page 18) and below in section 4.0 (page 379) in chapter 4, who suggests the best analysis for German syntax is one where syntactic constituency is represented independently from linear relations), but they can and often do. Prosodic constituents are necessarily linearity domains since they are phonological constituents, and phonological constituents need to be linearized, in order to be pronounced. Prosodic constituency will be discussed briefly here and more thoroughly in section 1.2.2 (page 37).

To make this discussion of linearity domains concrete, in (19) and (20), I give two

¹³ Another sort of linearity domain not discussed here, but which will be important in chapter 2, is the morphological constituent. For our purposes, such constituents are very similar to the syntactic constituents to be discussed below except for the fact that their structure is more likely to be affected by purely phonological concerns than the structure of syntactic constituents is—a point which I will return to in section 1.2 (page 36).

parsings of the same English sentence taken from Hayes (1990:86). The parsing in (19) marks the syntactic constituency of the sentence while the parsing in (20) represents a phonological parsing.¹⁴ (The labels in (20) stand for the following prosodic constituent types: W = word, C = clitic group, P = phonological phrase, I = intonational phrase, U = utterance.)

(19)

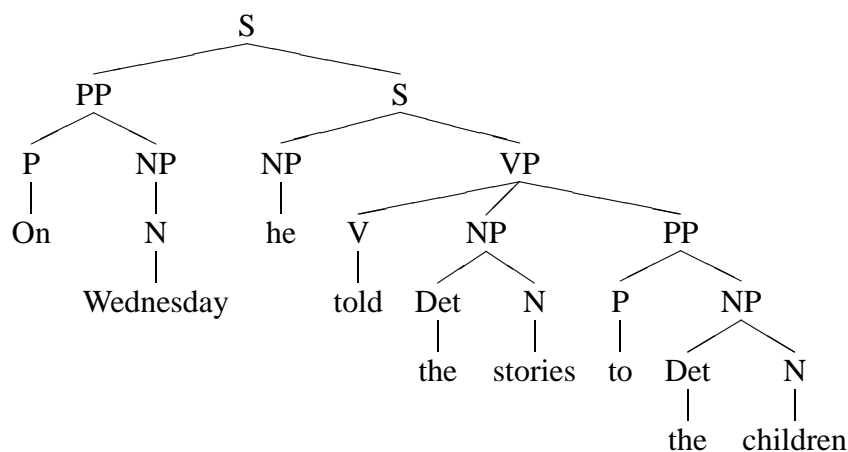

(20)

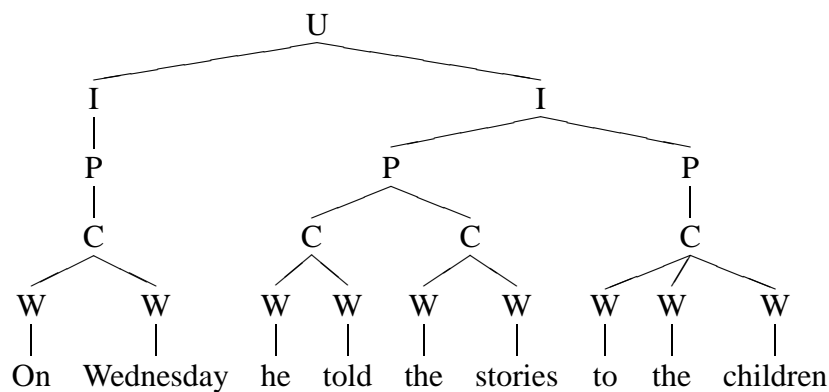

A cursory examination of the structures in (19) and (20) reveals that they have fairly different constituency from each other. The most striking difference is that the subject and the verb form a prosodic constituent even though they are not a syntactic constituent.

¹⁴ As with other examples I will use, I am not necessarily endorsing the constituency relations given by Hayes (1990). I use his examples simply by way of illustration.

There are at least as many linearity domains in the sentence *On Wednesday, he told the stories to the children* as there are non-overlapping syntactic and prosodic constituents. The fact that each syntactic constituent is a linearity domain derives directly from the fact that there are well-defined linear relations between the subconstituents of each constituent. Insofar as these linear relations are completely predictable given knowledge of English syntax, these are all weak linearity domains.

Each of the prosodic constituents also is a linearity domain, although this point might be a bit more subtle. While, in English at least, rules of syntactic and morphological realization define the linear order of words and morphemes—the most conspicuous linear properties of an utterance—various other linearity effects are the domain of prosodic constituents, for example, certain stress effects, intonational contours, and the domain of some phonological rules. Since these sorts of phonological effects are sensitive to linear positions in their prosodic constituent (like “beginning”, “end”, “leftmost”, “rightmost”, or “adjacent to”), such prosodic constituents form a linearity domain. So, for example, the simple fact that the left and right edges of an intonational phrase, like *On Wednesday* in (20), are the left and right anchors of an intonational contour makes it a linearity domain.

In addition, the prosodic constituents in the English sentence above are all weak linearity domains, like their syntactic counterparts. This is because it is possible to develop some general algorithm which could predict the prosodic structure of the sentence by referring to its hierarchical syntactic structure. Consider, for example, the set of rules for English given in (21) which predict the set of prosodic constituents above the word seen in (20).

- (21) a. Adjunct prepositional phrases and sentences form their own intonational phrase.
- b. A prepositional phrase as well as a verb and its core arguments form a phonological phrase
- c. A verbal object forms its own clitic group. Any other material not in a clitic group forms a clitic group with adjacent elements in its phonological phrase.

The algorithm in (21) should not be taken as a serious analysis of the relationship between a hierarchical structure and prosodic structure in English sentence (see Inkelas and Zec (1995) for an overview of proposals of permissible properties of prosodic constituency algorithms). Its role, here, is simply to illustrate that we can predict the prosodic constituency algorithmically (here, based on syntactic relations)—thus, the prosodic constituents in (20) are weak linearity domains.

In the subsequent chapters and in section 1.3.2 (page 65) and section 1.3.3 (page 71) below, we will see some clear cases of strong linearity domains. However, here, by way of illustration, I offer a potential analysis of English wherein the structure in (20) does contain a strong linearity domain and does not completely consist of weak linearity domains.

There is a well-known fact of English that verbs in the language require subjects—even if, semantically, a subject seems to be superfluous. The standard way of thinking of this requirement is that it is solely syntactically driven—this is almost certainly how Hayes (1990:85) would understand it, though the matter does not come up explicitly. However, Bobaljik (2002:39–41) takes a different approach. On the basis of subtle data involving

there-existentials in English, within a wider-ranging discussion of “movement” operations, Bobaljik analyzes the word *there* in these sentences as “having no syntactic role but being instead inserted (at P[honological] F[orm]) only to fill some phonological requirement having to do with the left edge of the clause. . . (Bobaljik 2002:41).”

With respect to the terminology being developed here, Bobaljik would appear to be claiming that the clause in English is a strong linearity domain.¹⁵ Specifically, there is a requirement in the language about what can appear at the left edge (a linearly specified position) of a clause which forces the insertion of a dummy subject. This is taken to be a “phonological” restriction not predictable from any aspect of the hierarchical structure of the clause. The position taken in Bobaljik (2002) for English clauses is certainly a minority one, but it, nevertheless, here serves as an illustration of the concept of strong linearity domain.

In addition to serving as an example of a description of a strong linearity domain, another important point emerges from Bobaljik’s (2002) discussion: a given strong linearity domain can only be well-defined within the scope of a particular analysis. In the case of the English clause, one could produce an analysis where it is a strong or a weak linearity domain, there is nothing intrinsic to any one piece of data making it an example of either type of linearity domain.

If strong linearity domains only exist within a given analysis, this raises the issue that

¹⁵ It might be possible to understand Bobaljik’s (2002) analysis as making use of weak linearity domain if a theory were developed that could predict the existence of the relevant “phonological requirement having to do with the left edge of the clause”. However, to the extent that Bobaljik does not treat this as predictable—by an appeal to something like prosodic structure, for example—his analysis, as it stands, is most straightforwardly interpreted as one involving a strong linearity domain.

they might generally be nothing other than artifacts of a particular way of looking at grammar and might not be present in grammar at all. Depending on one's theoretical bias, it might be desirable to assume that there are no strong linearity domains in morphology and syntax—and, thus, claim that all morphological and syntactic linearity domains are weak, and, therefore, predictable.¹⁶ This would run contrary to one of the major aims of this work.

My first comment on this is that I will devote the bulk of this work to three case studies which, I believe, when taken together, present a compelling case for the existence of strong linearity domains in morphology and syntax.

My second comment, however, is that I have no doubt that, if it were crucial for there to be a claim in some research agenda that there are no strong linearity domains in morphology and syntax, a method of description could be developed which would not require their invocation. My hope is that, after looking at the case studies I will provide, no one will want to do this since they will see that the behavior of certain phenomena can be most straightforwardly understood if a strong linearity domain is used to describe their properties and that any analysis involving only weak linearity domains would be very difficult, if even possible, to develop in a principled way.

My third (and final) comment is that, I do not believe strong linearity domains can take on just any arbitrary form and, to this end, I will offer a restrictive theory of strong linearity domains in section 1.2 (page 36). They are clearly a powerful device, and their power

¹⁶ I suspect, however, it would be impossible to fully eliminate strong linearity domains in the lexicon. This is because of the existence of lexical “linear minimal pairs”, like *tip* and *pit* in English, as discussed above in section 1.1.2.6 (page 22). Thus, strong linearity domains would seem to have to exist in grammar, no matter what theoretical framework one is working in.

might, at first, appear to be stronger than is warranted. So, while I will be arguing they exist, I will simultaneously argue that they can only have certain, limited properties. This should make the idea that they exist more acceptable to many researchers than if I were to propose that they could take on any number of arbitrary forms.¹⁷

1.1.3.3 Strong linearity domains and templates

In the rest of this work, I will use the term *template* fairly freely, following the way it has generally been used—that is, I take it to be a useful atheoretical taxonomic term for a set of phenomena which is salient, if not well-defined, to most linguists. I have developed the idea of a linearity domain for use in contexts when there is a need to be more technically specific. It would be useful, however, to explicitly contrast the term *template* with the term *strong linearity domain*.

As discussed above, I take *template* to be a term which evaluates the linear relations of a linguistic unit against some set of expectations. Based on this sense of the term, we can quickly characterize the most important difference between templates and strong linearity domains. The way in which “expectations” are determined when choosing to apply the term “templatic” to some grammatical phenomena is essentially impressionistic, while the comparable “expectations” of what makes something a strong linearity domain are well-defined—namely when we can’t completely predict linearity relations of some linguistic constituent from hierarchical structure, it should be taken to exhibit strong linearity.

¹⁷ In section 1.3.4 (page 77) I will take up the issue as to whether or not Bobaljik’s (2002) strong linearity domain for English, just discussed above, is consistent with the restrictive theory I will propose and conclude that it is not.

In the next section, I will develop the Strong Linearity Domain Hypothesis—the restrictive hypothesis concerning the form of strong linearity domains which will be employed in this work.

1.2 TOWARDS A RESTRICTIVE THEORY OF STRONG LINEARITY DOMAINS

1.2.1 Introduction

In this section I develop the notion of the Strong Linearity Domain Hypothesis. I gave this in (5), and I repeat it in (22).

(22) **Strong Linearity Domain Hypothesis:** The boundaries of any strong linearity domain must be coextensive with a prosodic constituent, and its non-predictable linearity restrictions must be consistent with the characteristic phonology of that prosodic constituent.

The Strong Linearity Domain Hypothesis employs two distinct subtheories of grammar, each of which needs to be explicated before the general hypothesis can be fully understood. The first of these, a theory prosodic constituency, is the easier to deal with since I will be adapting earlier proposals from work in prosodic phonology. Therefore, I will not be developing any particularly novel theory of prosody. Rather, I will, more or less, be applying existing theories in a new way.

The second subtheory encompassed by the Strong Linearity Domain Hypothesis is a theory of characteristic phonology, which can usefully be thought of as the prototypical phonology of a prosodic constituent. The theory of this I will be developing here is, as far

as I know, novel. However, it will borrow from some previously developed concepts, for example, that of the cophonology (Orgun (1996:101–50), Inkelas and Orgun (1998:365)).

In section 1.2.2 (page 37), I discuss the theory of prosodic phonology to be employed in this work, and, in section 1.2.3 (page 44), I discuss the notion of characteristic phonology. In section 1.2.4 (page 54), I give the rationale behind the Strong Linearity Domain Hypothesis, and, in section 1.3 (page 64), I apply the Strong Linearity Domain Hypothesis to some test cases.

1.2.2 Subtheory I: Prosodic constituency

1.2.2.1 The prosodic hierarchy

Broadly speaking, prosodic phonology is a theory of phonological constituency. Specifically, it posits a prosodic hierarchy which specifies possible phonological constituents and how those constituents are built up to form larger phonological constituents. In (23) I give a sample hierarchy of prosodic categories consistent with the assumptions being made here to be discussed below. This hierarchy is adapted from Inkelas (1993:89) and Downing (1999:73).

(23) PROSODIC HIERARCHY

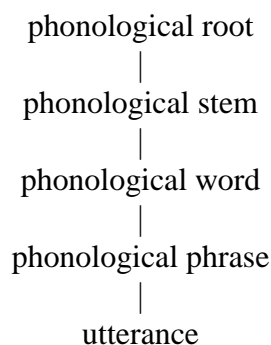

The prosodic hierarchy in (23) deviates from more frequently found versions, like that of Nespor and Vogel (1986) and Selkirk (1986) (or, more recently, (McCarthy and Prince 1995) and (Inkelas and Zec 1995)), in its specification of lexically-oriented prosodic constituents below the level of the word: the phonological stem and phonological root. Other versions of the prosodic hierarchy make use of the two purely phonological categories below this level: the foot and the syllable.

Importantly, the hierarchy I have given in (23) is meant to be illustrative rather than absolute. That is, unlike most phonologically-oriented proposals of the prosodic hierarchy, I do not take the categories in (23) to be universal. I do assume that all languages have some hierarchy of prosodic constituents. Furthermore, a hierarchy along the lines of (23) is sufficient for many languages. It is primarily for this reason that I gave a hierarchy making use of categories like phonological root and stem in (23) instead of a hierarchy containing categories like syllable and foot. These categories are universal types of phonological organization, but following Inkelas (1990), Inkelas (1993), and Downing (1999), I do not take them to be the only constituents over which phonological generalizations should be

stated at levels below that of the phonological word.

Rather, here, determining the nature of the prosodic hierarchy for a given language is understood to be an empirical matter relating to environments over which phonological generalizations can be stated. So, to the extent that the roots of a language show phonological behavior which is consistently different from stems in that language, there would be good evidence for specifying prosodic categories phonological root and phonological stem in that language. On the other hand, a different language might not show markedly different phonological behavior for those categories, in which case only one prosodic category for roots and stems would be proposed.

Consistent with these ideas, when proposing that a prosodic category exists in a language within this work, I will give specific justification for that category in the language. Justification will come in the form of phonological generalizations which hold over a particular, identifiable phonological domain.

1.2.2.2 The Strict Layering Hypothesis and types of weak linearity domains

In addition to postulating the prosodic hierarchy itself, theories of the prosodic phonology typically add three stipulations to phonological structures. The first is that a given phonological constituent's immediate subconstituents must be of the category immediately "preceding" it in the hierarchy—with the exception of the smallest prosodic unit in the hierarchy (Nespor and Vogel 1986:7). The second stipulation is that any subconstituents of a given constituent are completely contained within that constituent—that is, overlapping prosodic constituents are not permitted (Nespor and Vogel 1986:7). The final stipulation

is simply that a phonological string be exhaustively parsed at every level (Hayes 1990:86). A quick glance at the structure in (20) shows that it meets this conditions—Hayes (1990) was working within a standard version of prosodic phonology. I adopt these stipulations here. Taken together, these stipulations are sometimes referred to as the Strict Layering Hypothesis (Selkirk 1984:26–7). I will refer to the combination of these stipulations with this label at various points below.

As mentioned in section 1.1.3.1 (page 26), for the sake of expediency, I am sidestepping debates on the nature of hierarchical relations here in two ways. First, I am, in general, only considering phonological, morphological, and syntactic hierarchical relations (as opposed to say, pragmatic). Second, I am assuming a fairly simple representation of morphological and syntactic hierarchical relations as labelled trees. Morphological and syntactic structures can clearly be associated with weak linearity domains to the extent that the morphology and the syntax impose ordering restrictions on morphemes in a predictable fashion. Furthermore, these morphologically and syntactically defined linearity domains can operate without reference to phonology.

Similarly, prosodic constituents clearly constitute weak linearity domains, insofar as they are the domain over which phonological rules, which relate to the pronunciation of (necessarily) linearized linguistic elements, are stated.

For the phenomena which will be of primary interest here in following chapters, which are morphosyntactic in nature, the Strict Layering Hypothesis has the important effect of ensuring that all weak linearity domains are either the result of linearization of morphemes

and words based on morphological and syntactic hierarchical structure respectively or are prosodic constituents. Morphological and syntactic structures govern most of the basic ordering relationships among morphemes and words.¹⁸ Prosodic constituents are then the domains over which the ordered string is completely parsed phonologically and are responsible for all other linearity domain effects (stress, intonation, sandhi effects, etc.).

Further research might prove this view to be too simplistic—that is, there might be some other source for linearity domains. However, this view will be sufficient for the case studies to appear in subsequent chapters, and it is adopted here. I suspect it shouldn't be considered particularly controversial since it essentially boils down to a statement that predictable linear relations (here, weak linearity domains) derive from morphological, syntactic, and phonological structure—a statement which is not at all out of line with many proposed models of grammar.

The obvious objection to this is the simplistic nature of the hierarchical structures I am assuming. As mentioned above, this is merely for expediency, and I readily concede that a more complete theory of linear relations will need to take a more richly articulated of hierarchical relations into account. However, for the purposes of examining strong linearity domains in morphology and syntax (the primary focus of this work) this simplistic view of hierarchical structure will be seen to be generally sufficient.

¹⁸ Though some of these ordering relationships might be partially determined by the phonology. I have in mind here phenomena like infixes (analyzed by some authors, e.g., McCarthy and Prince (1993, section 4.1), as having partially phonologically conditioned placement) and second-position clitics (some aspects of which will be discussed in section 1.3.2 (page 65)) and in section 3.0 (page 275) in chapter 3.

1.2.2.3 On the predictability of prosodic domains

I do not assume here that the domains of weak linearization phenomena are completely predictable from the hierarchical representations of morphological and syntactic structure. That is, I assume that there can be multiple sources for weak linearity domains—and, specifically, that prosodic constituency can be formed independently from morphological and syntactic constituency. This assumption is relevant here in light of certain theories of the phonology-syntax “interface”.

Within morphophonology, this assumption does not appear to be divergent from what is generally assumed. The tradition of Lexical Phonology (Kiparsky (1982), Mohanan (1986), Kenstowicz (1994:195–243)), for example, commonly assumes the possibility of a number of morphologically-defined domains of phonological rule application in a given language. However, at the same time, metrical phonology (Lieberman (1979), Hayes (1985), Kenstowicz (1994:548–614)) posits that a range of phonological phenomena are sensitive to purely phonological domains like the syllable and foot.

The sum effect of these two different subtheories of phonology theory is that, for word-based phonological effects, there are at least two independent sources of weak linearity domains, one related to morphological structure and the other related to more purely phonological structure. I will not be adopting any particular theory of Lexical Phonology and metrical phonology here—I bring up these two subtheories of phonology, here, just to illustrate that previous researchers have not assumed that domains of phonological rules are completely predictable from non-phonological structure.

However, within the literature on the interaction between phonology and syntax, proposals have been made that the structure of phonological constituents above the word is completely algorithmically predictable from syntactic structure. Furthermore, “[t]he most restrictive proposals limit algorithms to information about the configurationality of syntactic structure . . . (Inkelas 1993:77)” If such proposals are correct, then this would imply that, in syntax, there is only one ultimate source of weak linearity domains—syntactic structure—and prosodic constituency falls out predictably from it.

There is not universal agreement that these restrictive proposals are correct. Hayes (1990) and Odden (1990), for example, both reject them in their strongest form. In different ways, each argues for a division of rules of the phrasal phonology which parallels the division posited between Lexical Phonology and metrical phonology for phonological phenomena whose domain is the word and units smaller than the word.

While I include this discussion to situate the present framework within previous frameworks of linearity effects, my assumption that there can be multiple sources of weak linearity domains will not critically effect any of the analyses to be provided in the case studies. In the case study on Saramaccan in chapter 4, for example, I will have recourse to a particular theory of the phonology-syntax interface which conforms to the strong hypothesis about the predictability of prosodic structure from syntactic structure. This will be primarily for expository purposes, however, and should not be taken as an acceptance of such a view.

1.2.2.4 Local conclusion

This concludes the discussion of the first subtheory assumed by the Strong Linearity Domain Hypothesis: a theory of prosodic constituency. I have more or less adapted this theory from previous work, but I deviate from some previous work in assuming a less restrictive theory than found in some well-known proposals (Nespor and Vogel (1986), for example). In particular, while I assume that every language has some hierarchy of prosodic categories, I do not assume that the set of such categories is universal.

In the next section, I will develop the second subtheory assumed by the Strong Linearity Domain Hypothesis, the notion of characteristic phonology.

1.2.3 Subtheory II: The notion of characteristic phonology

1.2.3.1 The characteristic phonology of a prosodic constituent

The second subtheory assumed by the Strong Linearity Domain Hypothesis, given in (22), is that of the characteristic phonology. Conceptually, it is fairly easy to understand what is meant by this term: a given prosodic constituent should have a definable set of phonological characteristics and the characteristic phonology is simply a term encompassing those characteristics.

As an example, consider the phonological word in Turkish. The phonological generalizations in (24) can be taken to apply to this prosodic constituent in Turkish.

- (24) a. The Turkish phonological word is a vowel harmony domain. (Lewis 1967:15–20)
- b. It receives final stress. (Lewis 1967:21–24)

c. It is minimally bimoraic. (Inkelas and Orgun 1995:773)

We can, thus, say that the characteristic phonology of the Turkish phonological word is at least the sum of the three characteristics given in (24).

There are several points to be made about the characteristics given in (24). First, none of them are exceptionless. There are native words, compound words, suffixes, and borrowed words which do not follow the standard harmony rules in Turkish. In addition, there are some semi-regular epenthesis rules in the languages which regularly violate vowel harmony (Lewis 1967:9). There are numerous exceptions to final stress, as well (Lewis 1967:21–24), including a fairly productive pattern found in place names (Sezer (1981) and Inkelas and Orgun (1998:372–7)). Finally, there is also a limited class of words with monomoraic roots, which for some speakers, can surface without being lengthened (Inkelas and Orgun 1995:774).

Violability is, in fact, central to the notion of characteristic phonology. The characteristic phonology represents a prototype that a given prosodic constituent can deviate from. This is not to say that a given characteristic in a given language cannot be strictly enforced and, therefore, be exceptionless. It is just to say that a violable characteristic is still perfectly valid as part of a prosodic constituent's characteristic phonology.

Another important point about the characteristic phonology is that I do not assume that it must derive directly from a constraint/rule that manifests itself within the domain of the relevant prosodic constituent. For example, there is a good case to be made that the constraint that words in Turkish be minimally bimoraic is not active at the level of the

prosodic word, but, instead, the prosodic root (Inkelas and Orgun 1995:773–81). However, if a root must be minimally bimoraic, then a word must necessarily also be minimally bimoraic. Bimoraicity can, then, become part of the characteristic phonology of the word even if it is not a “word-level” restriction.

In two sample case studies, given in section 1.3.2 (page 65) and in section 1.3.3 (page 71), and in three proper case studies in chapter 2, chapter 3, and chapter 4, which make up the bulk of this work, there will be further examples of characteristic phonologies.

From a theoretical standpoint, there is one crucial aspect of the characteristic phonology that I assume which would not necessarily be assumed by other researchers. I take it not to simply be a descriptive cover term, but a grammatical object in its own right. That is, the sum of the characteristics of a given prosodic constituent is taken to be an active part of linguistic representation. This assumption is important in light of the idea of strong linearity restrictions being “consistent” with the characteristic phonology of a prosodic constituent, to be discussed in section 1.2.3.2 (page 47). If the characteristic phonology were not a proper linguistic object, it would be hard to make sense of the claim that the properties of some other linguistic object must be consistent with it.

The closest thing to a characteristic phonology that has been proposed, which I am aware of, is a cophonology (Orgun (1996:101–50), Inkelas and Orgun (1998:365)). A cophonology is a phonological “mapping function” (Orgun 1996:102) which can be associated with a particular morphological construction or set of morphological constructions. In the terminology being developed here, a cophonology, then, is the set of phonological

effects associated with some morphologically-defined weak linearity domain.

Clearly, a cophonology is not the same as a characteristic phonology, since the latter is defined over prosodic, and the former over morphological, constituents. What they both have in common is the idea that one can classify sets of phonological generalizations into “bundled” categories. The characteristic phonology is the set of phonological generalizations that can be made over a prosodic constituent. A cophonology is the set of phonological generalizations that can be made over a morphological constituent (as defined by Orgun—but the idea of cophonology could easily be extended to syntactic constituents as well).

1.2.3.2 Consistency and the characteristic phonology

Having developed the notion of the characteristic phonology, it is possible to see more clearly the role it plays in the Strong Linearity Domain Hypothesis. Specifically, the Strong Linearity Domain Hypothesis stipulates that strong linearity restrictions must be consistent with the characteristic phonology of the relevant prosodic constituent. This notion of consistency is the aspect of the Strong Linearity Domain Hypothesis I am able to define least specifically. To a large extent this is because, while the basic idea of the characteristic phonology should not be particularly difficult to grasp, developing a well-defined notion of consistency, as the term will be understood here, would seemingly require a theory of the “structure” of a characteristic phonology. Consistency could then be defined by isolating particular, relevant structural aspects of the characteristic phonology as being the characteristic which we can use to determine whether or not the condition on “consistency” is met.

Developing a theory of the structure of the characteristic phonology of a prosodic constituent, would clearly be a large-scale undertaking. In all likelihood, it would be comparable to developing a theory of the structure of the segment (something which is still not well-agreed upon). Therefore, I will not work out any such theory here.

In general, then, I will have to rely instead on arguments tailored to a specific set of data each time I want to claim that some set of strong linearity restrictions is consistent with a characteristic phonology. This sort of argument is inherently less persuasive than one falling out of a carefully articulated theory. However, I will try to make each of the arguments relating to consistency as detailed as possible and rely on criteria which I do not believe will be obviously controversial.

However, despite this area of difficulty, it is possible for me to expand upon the notion of consistency in an informal way to make it clearer what I mean by it. In addition to the discussion here, there will be discussion of it in two sample case studies to be provided in section 1.3.2 (page 65) and section 1.3.3 (page 71) which should serve as preparation for the notion of consistency with some characteristic phonology will be applied to the proper case studies in subsequent chapters.

It is worth pointing out here, though, that there is a way in which I consider strong linearity restrictions to trivially satisfy the conditions on phonological consistency. Following the Strict Layering Hypothesis (discussed in section 1.2.2.2 (page 39)), every prosodic constituent fully consists of a set of prosodic constituents immediately below it in a language's prosodic hierarchy. Thus, we can give a schematic representation of, say, a phonological

phrase for some language as consisting of some number of phonological words, say two or three. Such a schema is represented in (25).

(25) [[]_{phon word} []_{phon word} ([]_{phon word})]_{phon phrase}

The schema in (25) implies a minimal characteristic phonology for a phonological phrase of two to three *ordered* phonological words. In principle, every prosodic constituent, except for the smallest one, will have some similar minimal characteristic phonology of some (fairly small) number of ordered prosodic subconstituents.

Given this, I assume a template that specifies an ordering relationship between the particular subconstituents of a given prosodic constituent to trivially satisfy the condition on consistency—this assumption will be put to direct use in the sample case study in section 1.3.2 (page 65) as well as the case studies in chapter 3 and chapter 4.

To make this discussion more concrete, consider the data in (26) from English.

- (26) a. I picked *up* the ball which was rolling towards me.
- b. ??I picked the ball which was rolling towards me *up*.
- c. I picked *up* the ball.
- d. I picked the ball *up*.

The sentences in (26) illustrate a well-known type of alternation found in English whereby a verb+particle combination can be separated by a light noun phrase (though this

is not obligatory), like one consisting of just a noun and a determiner but not by a heavy noun phrase.

Purely for illustrative purposes, let's assume the facts about English in (27).

- (27) a. The independent elements of a verb particle combination must be part of the same phonological phrase.
- b. A noun modified by a relative clause (i.e. a “heavy noun phrase”) forms its own phonological phrase, whereas other nouns (i.e. “light noun phrases”) can form phonological phrases with their preceding verb.
- c. Particles, verbs, and “light” noun phrases are phonological words.

Under this analysis, the verb+particle in English combination is a strong linearity domain. In particular, the statement in (27a) encodes the relevant strong linearity domain restriction—two constituents must appear in the same phonological phrase together. We can schematize a “template” encoding this restriction along the lines of (28) where two arbitrary phonological words are specified as being within the same phonological phrase with optional material intervening between them or following the second word (to account for the variation in (26c) and (26d) above). The template in (28) could be understood in various ways—one useful way is as a lexically specified subcategorization frame associated with all verb+particle combinations. Similar types of subcategorization frames will be seen in section 1.3.2 (page 65) and section 1.3.3 (page 71) below.

(28) [[. . .]_{phon word} . . . [. . .]_{phon word} . . .]_{particle template}

Assuming that verb+particle combinations are subject to the schematized template in (28), then, within the confines of the simplistic analysis sketched in (27), it is impossible for a “heavy” noun phrase to fulfill the template since it will form its own phonological phrase and not be able to enter into the construction in (28). A “light” noun phrase, on the other hand, can appear before or after the particle without affecting whether or not the template can be fulfilled.

The templatic restrictions of this construction, as stated in (28), are that one particular phonological word must be in the same phonological phrase as another phonological word. The aspect of the analysis stated in (27c) means that, by assumption, this is a case where the two relevant syntactic constituents for the template are coextensive with the immediate prosodic sub-constituents of the phrase they are a part of.

Under the view taken here, the templatic restriction in (28) can, thus, be understood to be trivially consistent with the characteristic phonology of the prosodic domain of the phonological phrase because it is a statement only on the basic ordering relations between two linguistic constituents which happen to be immediate subconstituents of their prosodic constituent.¹⁹ In order for it to be consistent in this way, it was important to state the template very generally, without reference to the morphosyntactic categories of the various elements involved for example. As will be discussed again below, this is because there is no way for a morphosyntactic category to be directly consistent with the characteristic *phonology* of some constituent.

¹⁹ Incidentally, it is not a coincidence that I characterized the boundaries of the templatic construction in (28) as coinciding with the prosodic constituent of a phonological phrase. This was to ensure that the strong linearity domain in (28) matched the first restriction of the Strong Linearity Domain Hypothesis.

This brings up an issue, of a sort that will be recurring throughout the case studies, that this templatic analysis does not specify all aspects of the ordering of the verb+particle combination—specifically it does not specify that the verb must precede the particle. We will, therefore, need another analysis of that fact. Various analyses of this ordering fact are possible—an obvious one would be to say that the particle must follow the verb because of a syntactic restriction that only subjects precede the verb in English. The fact that the particle must follow the verb would then be a (syntactically-conditioned) weak linearity domain restriction of English which would complement the strong linearity domain restriction that both the phonological words of the verb+particle combination be contained within the same phonological phrase.

As mentioned, this analysis of the English facts given in (26) is simplistic. Its purpose is simply to illustrate the most trivial way the condition of consistency between strong linearity restrictions and characteristic phonology can be met. In section 1.3.2 (page 65) I will give a similar, where the condition of consistency is trivially satisfied. The case study of Saramaccan serial verb phrases in chapter 4 will also make use of this notion.

Beyond trivial satisfaction of the consistency condition, the other major tool I will use in establishing that the condition is met is by relating it as closely as possible to documentable phonological effects. For example, if a templatic phenomenon appears to have the effect of limiting the size of some constituent, then I will try to show that the characteristic phonology of that constituent includes the fact that the relevant prosodic constituent is limited in size—this kind of reasoning will be applied in chapter 2, a case study on the

Bantu verb stem.

Similarly, when, in chapter 3, a case study on the Chechen verb phrase, I propose a templatic restriction saying that some constituent needs to be of some minimal size, I will relate it to comparable minimality restrictions found in the phonology of other languages (like the bimoraic minimal size restriction for Turkish mentioned in (24)). So, while I might not be able to give a technical definition of “consistency”, I will try to tie together data in a way which makes the relevant argument as strong as possible.

1.2.3.3 Local conclusion

In this section, the second subtheory of the Strong Linearity Domain Hypothesis was reviewed—the notion of the characteristic phonology of a prosodic constituent. The idea of a prosodic constituent having a characteristic phonology is not striking in and of itself. However, an important aspect of this work is the assumption that that the characteristic phonology is a grammatical object in its own right—an idea which does not fall out immediately from easily observable facts.

Furthermore, the characteristic phonology plays a central role in the Strong Linearity Domain Hypothesis because it is a limiting factor on the form of strong linearity domains since strong linearity restrictions must be consistent with the characteristic phonology of the prosodic constituent they are coextensive with. Unfortunately the idea of “consistency”, as used here, is not well-defined. So, establishing that the consistency condition of the Strong Linearity Domain Hypothesis is met will require arguments tailored to specific invocations of strong linearity domains.

1.2.4 The Strong Linearity Domain Hypothesis

1.2.4.1 The intuition behind the Strong Linearity Domain Hypothesis

Having discussed the two subtheories assumed by the Strong Linearity Domain Hypothesis (given above in (22)), that of the prosodic hierarchy and the notion of characteristic phonology, it is now possible to fully develop this hypothesis.

I would like to begin here by discussing the intuition behind the Strong Linearity Domain Hypothesis. This intuition derives in large part from the rough model of grammar given in (29).²⁰

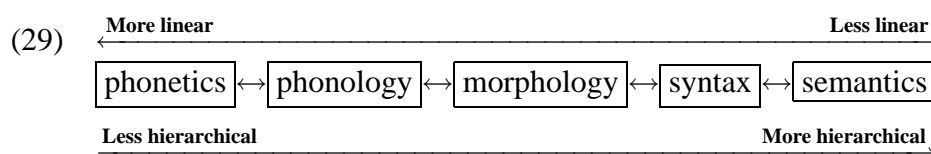

While I have not seen any particular formalization of grammar explicitly following the model in (29), I doubt there should be anything inherently controversial about it. The basic idea behind it is quite simple: phonetics is essentially linear, semantics is essentially hierarchical, and everything else lies in between.²¹ Furthermore, syntax, an area of grammar typically understood to be closely aligned with semantics, is more hierarchical than linear; phonology, an area of grammar typically understood to be closely aligned with phonetics, is more linear than hierarchical; morphology (as always) lies somewhere in the middle.

Given the model of grammar in (29), the intuition behind the Strong Linearity Domain

²⁰ Comparable discussion on the model of grammar depicted in (29) can be found in Sadock (1991:164–5).

²¹ By claiming that phonetics is essentially linear, I do not mean to ignore the fact that a phonetic representation could consist of multiple, linearized levels (take for example, F_0 structure and formant structure). Rather, I mean to say because a phonetic representation necessarily describes an uttered linguistic constituent, it must be linearized in some way.

Hypothesis, then, is this: if strong linearity domains represent unpredictably linear relations in some constituent, they should pattern, in some way, with the aspects of grammar already understood to be “linear”. The Strong Linearity Domain Hypothesis is, then, as a result, a statement about the relationship between strong linearity domains and phonological domains.

The two subtheories of the Strong Linearity Domain Hypothesis are designed to parallel two different ideas encoded by (29). The first subtheory, the prosodic hierarchy, models the way in which the linearity of phonology “creeps” upward into larger and larger constituents—some of which are clearly governed more by syntactic considerations than phonological ones. So, while the model of a prosodic hierarchy was adopted for phonological theory, and not linearity theory, it has been co-opted here as a general model for the organization of smaller linearized structures into larger ones. That is, it is taken to be apply not just to the weak linearity domains of prosodic constituents but also for strong linearity domains.

The second subtheory, the notion of characteristic phonology, is intended to be a model for the changing nature of linear relations as one moves upward along the prosodic hierarchy. Again, while this, in and of itself, is a model of phonological representations, not linear representations, I am co-opting it as a general model for the nature of linear relations at different levels of linguistic constituency. The idea here is, as before, that there should be a relationship between strong linearity and the most linear “component” of grammar, phonology. So, if, at some level of linguistic constituency, the phonological relations “look

one way”, then strong linearity restrictions at that level should “look the same way”.

Within this model, one way of looking at the two subtheories of the Strong Linearity Domain Hypothesis is that together they model a *cline of linearity*. *Prosodic constituency demarcates relevant grammaticalized points along the cline* that will be the locus of linearity generalizations for a given language. *The characteristic phonology delineates the prototypical linear relations on each point of the cline*. The Strong Linearity Domain Hypothesis, then, is designed us to tell us two important things: (i) where to look for strong linearity and (ii) what it should look like once we find it. As such, it is stated as a well-formedness generalization on strong linearity domains.²² In section 1.4 (page 84), I will briefly take up how this well-formedness model of linear relations compares to previous models of linearity, which can roughly be characterized as concatenation models (and, as such, are more derivationally oriented than surface oriented).

In the concluding chapter of this work, I will discuss possible explanations and formalizations of the Strong Linearity Domain Hypothesis. In section 5.2.3 (page 508) of chapter 5, I will offer an evolutionary explanation for it which will fit in with idea of using phonological tools in order to understand of strong linearity.

Before moving on, it is important to explicitly point out an important aspect of the

²² I wish to remain agnostic throughout the bulk of this work as to how we might want to account for the Strong Linearity Domain Hypothesis generally. In chapter 5, I will offer my own preferred explanation for it as well as sketch how we might account for it within two other popular grammatical frameworks. However, since the validity of the Strong Linearity Domain Hypothesis is independent from any explanation of its properties, I generally take the route here of highlighting its general feasibility as a restrictive statement of well-formedness conditions on strong linearity domains rather than trying to explain why it might be true in the first place. A consequence of this is that, throughout the work, I will speak of particular grammatical constructions as being “consistent with” the Strong Linearity Domain Hypothesis as opposed to using such vocabulary as “obeying” or “explained by” since I don’t want to presuppose any particular model of grammar within which the Strong Linearity Domain Hypothesis could be taken to be explanatory in one way or another.

Strong Linearity Domain Hypothesis—it is a theory of the form of strong linearity domains, not the semantic content. The importance of this point will become clear at the end of the Bantu case study in chapter 2 (though a less important application of it was seen above in section 1.2.3.2 (page 47) and one will be seen below section 1.3.4 (page 77)). Because of this, there will be cases when a given construction may be consistent with the Strong Linearity Domain Hypothesis but, at the same time, some other unattested logical variant of that construction will also be consistent with it. In such a case, the Strong Linearity Domain Hypothesis will simply not offer an explanation for why one pattern is attested while the other is not and some auxiliary explanation will be required to account for such a fact. This should not be construed a weakness of the Strong Linearity Domain Hypothesis. Rather, it simply reflects the fact that it is a hypothesis about form and not meaning. If the grammar of a language assigns elements with different meanings very similar forms, an explanation for their relative order may simply lie outside the purview of the Strong Linearity Domain Hypothesis.

1.2.4.2 The Strong Linearity Domain Hypothesis and the Prosodic Morphology Hypothesis

While many of the ideas behind the Strong Linearity Domain Hypothesis are new, there is precedent for something very much like it. McCarthy and Prince (1995), in a summary of earlier work, state a restrictive theory for *templatic* morphology, a theory on the nature of certain purely morphological phenomena like Semitic root-and-pattern morphology (morphology of the sort seen in (8) and (9)), reduplication, and truncative morphology (seen in

(10)), among other things. This restrictive theory, the Prosodic Morphology Hypothesis, “requires that templatic restrictions be defined in terms of prosodic units (McCarthy and Prince 1995:320).” Their use of the term *template* is roughly equivalent to a strong linearity domain insofar as it is a phonologically unpredictable imposed pattern on morphological structure.

Unlike the present work, McCarthy and Prince are focused only on the role of of prosodic constituency up to the level of the word, as indicated by their use of the word *morphology* in the quotation. Furthermore, they are mostly concerned with morphophonological templates of the type described in section 1.1.2.2 (page 8). Their different focus resulted in the creation of a more restrictive theory of templatic phenomena than the Strong Linearity Domain Hypothesis—which is consistent with, but less restrictive than, the Prosodic Morphology Hypothesis. Like the Strong Linearity Domain Hypothesis, the Prosodic Morphology Hypothesis puts the locus of templatic restrictions within prosodic constituents. However, where the Prosodic Morphology Hypothesis enforces that “templatic” (i.e. strong linearity) restrictions be defined “in terms of prosodic units”, the Strong Linearity Domain Hypothesis makes the less restrictive stipulation that strong linearity restrictions “be consistent with” the characteristic phonology of the relevant prosodic constituent.

While the Strong Linearity Domain Hypothesis is less restrictive than the Prosodic Morphology Hypothesis, it is, at the same time, more encompassing since it seeks to constrain templatic phenomena throughout grammar. Nevertheless, the parallels between the Prosodic Morphology Hypothesis and the Strong Linearity Domain Hypothesis are noteworthy

and point to the fact, eventually, it might be possible to rectify the differences between them.

An open and interesting question is whether the two different hypotheses reflect something fundamentally different about morphophonological templates, on the one hand, and templatic phenomena generally, on the other. Though I will not be able to answer that question fully here, I will address some aspects of it in the next section.

1.2.4.3 The cline in templatic restrictions

An important aspect of the Strong Linearity Domain Hypothesis, which will be explored in three case studies to be presented in subsequent chapters, is that it predicts an aspect of templatic phenomena which we can impressionistically describe as follows: the smaller a given templatic construction the more specific the phonological aspects of its templatic restrictions can be.

For example, CV templates, of the sort described for Sierra Miwok in section 1.1.2.2 (page 8) appear to be possible at the level of the word, but not the level of the sentence. That is, no language is attested as having a series of CV templates which govern the shape of its sentences even though various (non-related) languages are attesting of having such templates at the level of the word.

We can imagine a language with sentential CV templates, but it is hard to believe that it would ever be a possible language. For example, in (30a) I give a mini-lexicon in a hypothetical language, and, in (30b), I give two sentences from that language. In this language, all nouns consist of three consonants, intransitive verbs consist of two vowels, and transi-

tive verbs consist of four vowels. Intransitive sentences in such a language would then have a CVCVC template, where the nominal consonants and the verbal vowels could be interspersed. Transitive sentences would consist of two CVCVC words, the first word would contain the “subject” consonants, the second word would contain the “object” consonants, with the verbal vowels interspersed throughout both words.

(30) a.

LEXICAL ITEM	MEANING
<i>tgr</i>	‘tiger’
<i>rkn</i>	‘raccoon’
<i>ao</i>	‘sleep’
<i>uioe</i>	‘see’
CVCVC	intransitive sentence template
CVCVC CVCVC	transitive sentence template

b.

SENTENCE	MEANING
<i>Tagor.</i>	‘the tiger sleeps’
<i>Tugir roken.</i>	‘the tiger sees the raccoon’

There are numerous reasons we might want to exclude a language like that depicted in (30)—not the least of which is that it might not be possible for it have a lexicon large enough for basic communicative needs unless it had a particularly extensive segmental inventory. Whatever the reasons may be why such a language is not attested, however, it is clear that one problem with it is that CV templates are simply not found as sentence-level phenomena—they are only word-level phenomena. The sort of interdigitation of morphemes seen in a language like Arabic does not appear to be possible across syntactic constituents.

The fact that we don’t find languages like the one exemplified in (30) is not because it is inherently implausible to have templates at the level of the sentence, however. Simpson and

Withgott (1986), for example, specifically analyze clitic pronouns in French as exhibiting templatic properties. For example, first and second person clitic can only precede other pronominal clitics if they denote indirect, and not direct, objects, as seen in (31). Thus, “double” indirect object are possible.

- (31) a. *Je te lui ai écrit une note.*
 I 2s.OBJ 3s.DAT have.1s written a.FEM note
 “I tell ya, I wrote him a note.” (Simpson and Withgott 1986:160)
- b.**Je te lui présenterai.*
 I 2s.OBJ 3s.DAT present.FUT.1s
 “I shall present you to him.” (Simpson and Withgott 1986:160)

While the exact morphosyntactic status of clitic pronouns in French is unclear (see, e.g., Miller and Sag (1997)), the combination of a verb with its clitics clearly produces a sentence. Simpson and Withgott (1986:173) analyze the facts for French illustrated in (31) via a templatic restriction against that particular order of clitics.

What Simpson and Withgott’s analysis tells us is that it is reasonable to propose a template at the sentential level.²³ However, the templatic restrictions are less specific in their linearization requirements than a CV template. Their proposed French template is one where two lexical items cannot appear in some relative order—and, as such, it is clearly less phonologically articulated than the word-level CV templates of Sierra Miwok.

In general, to the extent that we expect to find templatic restrictions at all, we would intuitively expect them to behave this way—the larger the linguistic constituent, the less spe-

²³ I will not discuss in detail at this point whether or not Simpson and Withgott’s (1986) are consistent with the Strong Linearity Domain Hypothesis, though I will take up the issue in section 3.0 (page 275), in chapter 3. My primary reason for avoiding this issue relates to the idea of the “templatic residue” to be discussed in section 1.5.4 (page 104).

cific the possible strong linearity restrictions. For example, a phrase-level strong-linearity domain specifying how many syllables a phrase should have seems highly unlikely to be attested, even though root-level restrictions along those lines are attested. This expectation derives naturally from the conception of grammar schematized in (29)—and is also encoded in the Strong Linearity Domain Hypothesis by its appeal to the characteristic phonology of a prosodic constituent. Prosodic constituents, as observed, exhibit the property of having less specific phonological restrictions as one goes further up the hierarchy—the phonotactics of word-level units are much more richly articulated than the phonotactics of phrases, which are, in turn, more richly articulated than the phonotactics of utterances, etc.

A similar idea to this is expressed in the Prosodic Morphology Hypothesis, which was just discussed in section 1.2.4.2 (page 57). If all templatic restrictions must be expressed in terms of prosodic units, this predetermines a cline of templatic restrictions. As I mentioned above, the Prosodic Morphology Hypothesis is a stronger claim than the Strong Linearity Domain Hypothesis. One of the reasons for this is, I believe, that by focusing only on word-level phenomena, the Prosodic Morphology encompasses templates which tend to impose more specific strong linearity restrictions than templates in larger domains. These more specific restrictions allowed for the reasonable formulation of a more restrictive hypothesis at the word-level than the Strong Linearity Domain Hypothesis, which is designed to account for templatic phenomena at all levels.

The main reason why I discuss clines and the Strong Linearity Domain Hypothesis explicitly at this point is that the three case studies to be examined in subsequent chapters, are

ordered in a way which is designed illustrate a how the Strong Linearity Domain Hypothesis implies a cline of strong linearity restrictions from smaller morphosyntactic domains to larger ones. The templatic restrictions to be examined will be more specific in the first case study (the Bantu *verb stem*) than the last one (the Saramaccan *serial verb phrase*), with the second case study (the Chechen *verb phrase*) falling somewhere between the other two. In my view, one of the strengths of the Strong Linearity Domain Hypothesis is its ability to predict and model this cline.

Having properly developed the Strong Linearity Domain Hypothesis, in the next section, I give two sample case studies where the Strong Linearity Domain Hypothesis is applied to templatic phenomena. These will serve to prepare us for the proper case studies to be found in subsequent chapters. The first case sample study will be on Serbo-Croatian second-position clitics, and the second will be on *IV*-prefix nouns in Leggbó.

The fact that the first of these case studies involves clitics is indicative of a general point regarding clitics and other unaccented syntactic units, like particles, with respect to the existence of templatic structures. Such linguistic elements represent a divergence from a general prosodic pattern in language that syntactic constituents are phonologically independent. Because of this, it should not be surprising to see that clitics, and similar elements, often play a role in strong linearity domains, given the nature of the Strong Linearity Domain Hypothesis. Specifically, the fact that they must always form a prosodic constituent with some syntactic host, means that host+clitic structures always fulfill the first condition of the Strong Linearity Domain Hypothesis. Few other syntactic structures that

I am aware of have such a property (though one other example, that of serial verb phrases, will be discussed in chapter 4). An effect of this would seem to be that such structures have a greater tendency to take on templatic properties than comparable syntactic structures which do not necessarily form prosodic constituents.

1.3 APPLYING THE STRONG LINEARITY DOMAIN HYPOTHESIS

1.3.1 Introduction

The bulk of this work will be an examination of three case studies of templatic constructions, with a focus on how they are consistent with the Strong Linearity Domain Hypothesis. However, some of these case studies will represent fairly complicated interactions of morphology and syntax with strong linearity domains. Furthermore, many aspects of the analyses I am presenting will be new to this work. In order to make the understanding of the major case studies easier, here, I present two “mini” case studies of templatic constructions in order to illustrate how arguments involving the Strong Linearity Domain Hypothesis can be made.

The first example case study, in section 1.3.2 (page 65), is on second-position clitics in Serbo-Croatian, and the second, in section 1.3.3 (page 71), is on *IV*- prefix nouns in Leggbó. In addition, in section 1.3.4 (page 77), I will re-examine the strong linearity domain analysis of English *there*-existentials given by Bobaljik (2002), as discussed in section 1.1.3 (page 26). Unlike the sample case studies, I am not as convinced that the relevant phenomena are templatic. However, I will offer a reformulation of Bobaljik’s analysis to show how it could be made consistent with the Strong Linearity Domain Hypothesis. In so doing, I will be

able to illustrate how, in some cases, while the Strong Linearity Domain Hypothesis may be able to account for the relevant properties of a strong linearity domain, there may be other aspects of a templatic construction, which fall outside of the purview of the Strong Linearity Domain Hypothesis and, will, therefore, require some other explanation. This will be a recurring point in the main case studies.

1.3.2 Example case study I: Serbo-Croatian second-position clitics

Serbo-Croatian second-position clitics have received a good deal of attention in the literature, Franks and King (2000) offers an up-to-date synopsis of the various analyses which have been made of them.²⁴ Here, I will examine the analysis of Zec and Inkelas (1990), which is an analysis making use of a strong linearity domain.²⁵ I will argue that their analysis is consistent with the Strong Linearity Domain Hypothesis.

Zec and Inkelas observe that, while, generally, second-position clitics in Serbo-Croatian can follow the first word in a sentence, they cannot follow “function” words consisting of a single, unstressed light syllable (Zec and Inkelas 1990:367–9). The data in (32) illustrates this. (The relevant clitic *je* is bolded in the examples.)

²⁴ Franks and King (2000:17–31) is a summary of the major descriptive facts and Franks and King (2000:287–310) offers a survey of much of the theoretical work.

²⁵ As mentioned in section 1.1.3 (page 26), strong linearity domains are always products of a particular analysis. This analysis is chosen because it is illustrative, not necessarily because I believe it is correct (though I do happen to believe that it is). My discussion of this analysis diverges slightly from that found in Zec and Inkelas (1990) since they consider the data here to be an instance where phonology constrains syntax. Within the terminology being developed here, their analysis, however, is not categorized quite that way. Rather, I take their analysis to be one where a strong linearity domain constrains syntax. However, since they were operating from the view point that phonology could only constrain syntax in a way which was mediated by prosodic constituency, the restrictions they put on such phenomena bear obvious similarities to the restrictions of the Strong Linearity Domain Hypothesis, and I take the recasting of their analysis given below to be a relatively trivial divergence from their original formulation.

- (32) a. *Petar=je u kući.*
 Peter=AUX in house
 “Peter is in the house.”
- b. *U kući=je Petar.*
 in house=AUX Peter
 “Peter is in the house.”
- c. **U=je kući Petar.*
 in=AUX house Peter (Zec and Inkelas 1990:367)

Zec and Inkelas analyze the restrictions on the placement of these clitics with the prosodic “subcategorization frame” given in (33) specifically applied to the auxiliary clitic *je* (Zec and Inkelas 1990:369).

- (33) *je*: [[]_{phon word} ___]_{phon word}

The subcategorization frame in (33) specifies that the second-position clitic *je* can only appear after a phonological word (and forms a larger phonological word with its host). This accounts for the fact that *je* cannot appear after the preposition *u*, as seen in (32c). Though *u* may be a syntactic word, phonologically it is not. The subcategorization frame in (33) is not a full characterization of the clitic *je* because it does not specify that *je* must occur in the “second-position” of its clause. It is not clear specifically how Zec and Inkelas (1990) would choose to formalize this (see Bošković (2001) for extensive discussion of various possibilities).

The work of Zec and Inkelas (1990) is focused on how phonology can constrain syntax, and they propose that it can do so via prosodically-defined constraints like the one in (33). This implies a view that sentential linear relations can not always be predicted directly from

syntactic hierarchical structure. Since the relevant relations encoded by (33) also cannot be predicted by a general algorithm creating prosodic structure—which could bundle together linearized constituents but could not enforce that some lexically-specified element *must* always be associated with particular prosodic characteristics—they are describing what, here, is being referred to as a strong linearity domain. The particular way they encode this strong linearity domain is with the lexically-specified subcategorization frame given for the clitic in (33).

Importantly, for our purposes, the characterization of Serbo-Croatian second-position clitics schematized in (33) is consistent with the Strong Linearity Domain Hypothesis. First, the strong linearity domain is coextensive with a prosodic constituent, namely a phonological word. Second, the characterization of that strong linearity domain is another instance, in addition to the type of case discussed in section 1.2.3.2 (page 47), where the strong linearity restrictions are trivially consistent with the characteristic phonology of their strong linearity domain.

Since the clitic itself is not specified as belonging to any particular prosodic category, the strong linearity restriction is quite simple: a string lacking prosodic structure, but which must be part of a phonological word, attaches to a constituent which is a prosodic word. The characteristic phonology of a phonological word can be straightforwardly taken to include the fact that it is, in fact, a phonological word. So, a strong linearity domain restriction requiring that a string lacking in prosodic structure must stand in a well-defined linear relation to a word in order to become a word is, therefore, a trivial satisfaction of the

consistency condition.

To help make it clearer how the analysis in Zec and Inkelas (1990) satisfies the consistency condition of the Strong Linearity Domain Hypothesis, it would be helpful to show an analysis which would work for the facts presented in (32) but not make use of strong linearity conditions consistent with the characteristic phonology of the phonological word. Consider the subcategorization frame in (34) which could account for the data in (32) but would violate the Strong Linearity Domain Hypothesis.

(34) *je*: [[*content word*] ___]_{phon word}

The subcategorization frame in (34) specifies that the clitic *je* must attach to a content word, instead of a function word.

Such a subcategorization frame violates the consistency condition of the Strong Linearity Domain Hypothesis because it is not possible to rectify the characteristic phonology of the phonological word with a strong linearity restriction that makes reference to a morphosyntactic property of that word. As Zec and Inkelas (1990:368) point out, there are important phonological generalizations that distinguish function words from content words—appealing to these restrictions directly is consistent with the Strong Linearity Domain Hypothesis. However, appealing directly to their morphosyntactic status would not

be.²⁶

²⁶ This point is relevant for some of the more elaborate templates proposed with reference to morphosyntactic categories for languages with rich morphology, like Athabaskan languages as described in Kari (1989). Without reanalysis, such analyses would violate the Strong Linearity Domain Hypothesis. I will take up aspects of this issue for Athabaskan languages in section 2.0 (page 107), in chapter 2.

Since this sample case study and the one that follows it are both intended to illustrate the general approach being taken here, it would be useful to give a case of a potential templatic construction very similar to the one just described here for Serbo-Croatian but which would not be consistent with the Strong Linearity Domain Hypothesis. While the subcategorization frame in (34) gave an example of a recharacterization of some data in a way which not be consistent with the Strong Linearity Domain Hypothesis, the data itself was still consistent with the Strong Linearity Domain Hypothesis, given the right analysis. At this point, I want to give an example of hypothetical data that would generally be excluded by the Strong Linearity Domain Hypothesis—but, at the same time, unlike the hypothetical language depicted in (30), I want this hypothetical language to be considerably more plausible.

For the Serbo-Croatian data just seen here, a small change in the data—namely that the second-position clitic be a proclitic instead of an enclitic—would be sufficient to make the data very problematic for the Strong Linearity Domain Hypothesis. If *je* were a proclitic, it would have a subcategorization frame along the lines of the one in (35).

(35) *je*: []_{phon word} [[___]_{phon word} []_{phon word}]

The subcategorization frame in (35) is meant to schematize two important aspects of the linearity behavior of *je*—if it were a second-position proclitic. It must appear in second position (here, described as after a phonological word), but it must lean on the word which follows it. At face value, the subcategorization frame violates the Strong Linearity Domain Hypothesis because the relevant strong linearity domain is not a prosodic constituent. This

seems to be a reasonable prediction since there is no well-attested example of a second-position proclitic (see Sadock (1991:72).

If it turned out that, on independent grounds, we could show that the strong linearity domain schematized in (35) were a prosodic constituent, then it might be consistent with the Strong Linearity Domain Hypothesis. It would still be necessary to make sure that the relevant strong linearity restrictions did not violate the consistency condition. However, such a structure would not automatically violate the first condition of the Strong Linearity Domain Hypothesis the way the one in (35) does.

As we will see in chapter 3, a case study of the templatic behavior of the Chechen verb phrase, this discussion is not purely academic. There, I will argue that, in fact, there is a template very much like the one in (35). However, rather than involving a second-position proclitic, it will involve the mirror-image situation of a penultimate-position enclitic. That is, it could be schematized along the lines of the schema given in (36). The form of the clitic is given as 'a, since that it is the form of the relevant Chechen enclitic.

(36) 'a: [[[]_{phon word} ___]_{phon word} []_{phon word}]??

The schema in (36) is meant to illustrate the relevant clitic, with the form 'a is enclitic to the word preceding it but must appear before some other word (i.e. be in penultimate position). This schema would violate the first condition of the Strong Linearity Domain Hypothesis automatically, unless it could be shown that the bracketed material labelled “??” was a prosodic constituent. In chapter 3 I will argue that the relevant bracketed material is,

in fact, a prosodic constituent. However, if I were not able to do so, the Strong Linearity Domain Hypothesis predicts that a template of the sort in (36) would be unattested.

Having covered various aspects of second-position cliticization, with specific reference to Serbo-Croatian, I turn now to the next case study concerning the structure of *IV*-prefix nouns in Leggbó.

1.3.3 Example case study II: Leggbó *IV*- prefix nouns

The second example case study is of *IV*- prefix nouns in Leggbó, an Upper Cross language of Nigeria. This case study covers a morphological rather than syntactic domain. Most nouns in Leggbó are marked with a noun class prefix. These prefixes come in several phonological shapes. Examples are given in (37).²⁷ Capital “E” represents a tense/lax harmonizing vowel and capital “N” represents a nasal consonant assimilating for place.

(37)

PREFIX	EXAMPLES
<i>li-</i>	<i>litól</i> ‘ear’, <i>livɔl</i> ‘belly’, <i>lidèèl</i> ‘name’, <i>linyumìl</i> ‘thorn’
<i>lE-</i>	<i>lèbàl</i> ‘axe’, <i>lèzàṅàl</i> ‘river’, <i>lèttol</i> ‘head’, <i>lèbèl</i> ‘beard’
<i>gi-</i>	<i>gìtáá</i> ‘witchcraft’, <i>gìvála</i> ‘guilt’, <i>gittù</i> ‘life’, <i>gìbáà</i> ‘marriage’
<i>gE-</i>	<i>gèbɔ</i> ‘arm, hand’, <i>gèvè</i> ‘foot’, <i>gètti</i> ‘tree’, <i>gèkù</i> ‘hoe’
<i>i-</i>	<i>ìwà</i> ‘spirit’, <i>ìzù</i> ‘gourd’, <i>ìtobo</i> ‘monkey’, <i>ìzòòm</i> ‘knife’
<i>E-</i>	<i>ènòn</i> ‘person’, <i>ètεεm</i> ‘meat, animal’, <i>èbbi</i> ‘goat’, <i>ènùṅ</i> ‘salt’
<i>a-</i>	<i>àzì</i> ‘blood’, <i>àsi</i> ‘water’, <i>ànààn</i> ‘oil’, <i>aggbà</i> ‘chin’, <i>àji</i> ‘feast’
<i>N-</i>	<i>m̩bom</i> ‘cheek’, <i>ṅzùṅ</i> ‘nose’, <i>ṅnyóṅ</i> ‘maggot’, <i>ṅkɔ</i> ‘nut’

The prefixes of interest here are *li-* and *lE-*. Nouns marked with these prefixes typically end with a coda *l*. (For most nouns with the prefix, the final *l* is obligatory, and for a few it is optional.)

²⁷ All Leggbó noun data is taken from Hyman (2002).

This restriction on the coda of nouns beginning with an *IV*- prefix means that such nouns can never have a final consonant other than *l*, even if this might be expected. So, for example, the verb *dum* ‘bite’ is associated with the noun *lé-dul* ‘bite’ and the verb *nòm* ‘copulate’ is associated with the noun *lènɔl* ‘penis’. Furthermore, it is clear that the final *l* is not part of the noun root based on the examination of noun pairs like the ones given in (38) where the same root appears with two different prefixes, one of which is an *IV*-prefix.

(38)

WORD	GLOSS	WORD	GLOSS
<i>lèbɔl</i>	‘handle’	<i>gèbɔ</i>	‘hand’
<i>lèdil</i>	‘palm seed’	<i>èdi</i>	‘palm (tree)’
<i>lèdzil</i>	‘day’	<i>èdzì</i>	‘sunshine’
<i>lèkàalal</i>	‘English’	<i>èkaala</i>	‘European’
<i>lèmmàl</i>	‘door’	<i>gèmmà</i>	‘mouth’

Various synchronic analyses could be made for the structure of Leggbó *l*-prefix nouns—we could say they are marked with an *l*-suffix, some sort of circumfix, or that they are affected by some sort of templatic override. However, whatever analysis is chosen, the restrictions on these nouns point to the idea that they are part of a strong linearity domain. No general principle of Leggbó grammar could predict this pairing of a “prefix” with a “suffix” for the simple reason that there are no other such constructions found in the language.

We can schematize the relevant strong linearity domain restriction for Leggbó *IV*-prefix nouns with a subcategorization frame like the one in (39).

(39) *IV*: [__ [. . .]_{stem}]_{word}

The subcategorization frame in (39) is essentially the same as a circumfixal analysis of Leggbó nouns. However, I do not mean to claim here that all circumfixes are part of strong

linearity domains. I make this claim only for Leggbó since the circumfixal characteristics of *l*-prefix nouns cannot be predicted on independent grounds.

It becomes important here to be clear on what exactly the strong linearity domain in question is—since it may not be completely clear from the schema in (39). In (39) the aspect of the frame which encodes that *lV-* is a prefix is not part of any strong linearity domain—this is because nominal prefixes are a general characteristic of the language. The strong linearity domain itself is limited to the *l*-final restriction on the stem since this is the aspect of the subcategorization frame which is both linear (it makes reference to final-position) and unpredictable (the final *l* cannot be related to any other aspect of Leggbó grammar that I am aware of).²⁸

Given this, to show that the Leggbó data fits into the restrictions of the Strong Linearity Domain Hypothesis, it is first necessary to establish that the strong linearity domain described by (39) is coextensive with a prosodic constituent. This in fact does seem to be the case, namely it is part of a constituent which I will label the phonological stem. The schema in (39) refers to the category of stem, a morphological category which does not necessarily correspond to a prosodic category in the language. Because of this, it is necessary to establish that there are morphophonological rules corresponding to this morphological category.

²⁸ With respect to a morphological analysis of the data, we can think of the Leggbó case as a subcategorization restriction. All noun prefixes, for example, subcategorize for a nominal stem. In addition, *lV-* prefix nouns subcategorize for stems with a particular phonological shape. Since this subcategorization restriction is also a strong linearity restriction, it falls under the purview of the Strong Linearity Domain Hypothesis—in addition to whatever restriction morphological theories might also put on its form.

The relevant arguments for establishing this here come from the fact that there is a range of Leggbó-internal evidence which distinguishes stems from the prefix+stem combination. Since some of this is phonological, we can use it to argue that the stem is associated with its own prosodic category. The strongest evidence of this sort comes from the formation of diminutive nouns which reduplicates the first CV of the stem and then suffixes *-wé* ‘child’ to it in the singular and *-bé* ‘child.PL’ in the plural. Examples are given in (40).²⁹

(40)

NOUN	GLOSS		DIM. SG.	DIM. PL.
<i>lìtól</i>	‘ear’	→	<i>lì-tó-tó-wé</i>	<i>lì-tó-tól-bé</i>
<i>lèttol</i>	‘head’	→	<i>lè-tto-tto-wé</i>	<i>lè-tto-ttol-bé</i>
<i>gizù</i>	‘game’	→	<i>gi-zù-zù-wé</i>	<i>gi-zu-zu-bé</i>
<i>gèkumì</i>	‘fever’	→	<i>gè-ku-kumì-wé</i>	<i>gè-ku-kumì-bé</i>
<i>itóbo</i>	‘monkey’	→	<i>ì-tó-tóbo-wé</i>	<i>ì-tó-tóbo-wé</i>
<i>èmùma</i>	‘seed’	→	<i>è-mù-mùma-wé</i>	<i>è-mù-mùma-bé</i>
<i>àwìlì</i>	‘gown’	→	<i>à-wì-wìlì-wé</i>	<i>à-wì-wìlì-bé</i>
<i>nzú</i>	‘nose’	→	<i>ñ-zú-zú-wé</i>	<i>ñ-zú-zúm-bé</i>

I take the fact that reduplication targets the noun stem as strong evidence that the stem is a prosodic constituent in Leggbó, which means that stating a strong linearity domain restriction at the level of the stem is consistent with the first condition of the Strong Linearity Domain Hypothesis. This takes us to the second condition of the Strong Linearity Domain Hypothesis—that strong linearity restrictions be consistent with the characteristic phonology of the relevant prosodic constituent.

In the Serbo-Croatian example, the only specifications of the subcategorization frame were on the prosodic category for the host of the second position clitic, meaning the condition on consistency could be trivially satisfied. For Leggbó, however, the restrictions are

²⁹ In the singular forms of the *l*-prefix nouns, the stem-final *l* is lost due to a restriction against the cluster **lw*.

much more particular. Specifically, there is a restriction that the stem of an *IV*-prefix noun must end in *l*.

Showing that the consistency condition is satisfied requires an examination of the general restrictions on stem-final consonants in the language. These are, generally, highly restricted—specifically only nasals and *l* appear in this position. This means that we can consider final consonant restrictions part of the characteristic phonology of the phonological stem in Leggbó. Importantly, there are *l*-final stems which do not appear with an *IV*-prefix. The prefixless noun *kkwàl* ‘boat’ is an example.

Since the strong linearity restriction on a coda consonant has such a strong parallel in phonological restrictions on the relevant prosodic constituent, I take the consistency condition to be satisfied. A reinforcing factor for this conclusion is that the consonant involved in the strong linearity restriction is one of the few consonants generally found in final position—the case for consistency would be weaker if final *l* was only found with *IV*-prefix nouns.

Again, so that the way in which I am applying the consistency condition can be made clearer, let me give an example of a subcategorization frame which, though similar to the one given in (39) would violate it.

(41) $[[IV \dots l]_{\text{phon word}} \dots]_{\text{phon phrase}}$

Leggbó noun phrases are head initial. The subcategorization frame in (41) puts a restriction on the segmental content of the first phonological word of a phrase beginning with *IV*-. This frame would deal with the data presented here. However, the word-level pho-

nology of Leggbó doesn't have any segmental restrictions on the shape of words—these restrictions are at prosodic categories below the word.³⁰ Thus, this subcategorization frame would violate the consistency condition of the Strong Linearity Domain Hypothesis.

As with the Serbo-Croatian case, it would be worthwhile here to examine a hypothetical case where we altered the Leggbó situation in some minimal way to give an example of data itself which would be predicted by Strong Linearity Domain Hypothesis not to be possible (as opposed to just giving an analysis of data which is inconsistent with the Strong Linearity Domain Hypothesis). In the Serbo-Croatian case, I presented a hypothetical strong linearity domain which was not coextensive with a prosodic constituent. Here, I will briefly discuss a case where the Leggbó *IV*-prefix noun strong linearity domain (including its characterization in (39)) would violate the consistency condition if the general phonology of the language were slightly different.

Suppose that Leggbó had no coda consonants other than this templatic final *l* found in *IV*-prefix nouns. The Strong Linearity Domain Hypothesis would automatically predict we could not find the strong linearity domain schematized in (39) in such a language, since there would be no way to rectify a strong linearity restriction for a coda consonant on stems in a language which otherwise never have coda consonants.

This is not to say, that some other very similar set of surface facts in this hypothetical language could not be consistent with the Strong Linearity Domain Hypothesis. Suppose, for example, it could be shown conclusively that the final *l* in *IV*-prefix nouns was a clitic.

³⁰ Leggbó may actually have a level of the prosodic hierarchy below that of the prosodic stem, namely the prosodic root, which is the locus of some segmental restrictions. For simplicity, I am passing over that possibility here.

It would then not be a stem-level restriction but would be at some higher prosodic level. In such a case, the relevant facts might then be consistent with the Strong Linearity Domain Hypothesis.

1.3.4 Another look at Bobaljik (2002)

It would be worthwhile now to revisit the templatic analysis of the requirement that English sentences always have a subject, found in Bobaljik (2002) and discussed in section 1.1.3 (page 26). Recall that Bobaljik analyzed the expletive *there* in English existentials as “having no syntactic role but being instead inserted (at PF) only to fill some phonological requirement having to do with the left edge of the clause... (Bobaljik 2002:41).” Here, I will sketch out a reformulation of this analysis which is consistent with the Strong Linearity Domain Hypothesis.

Unlike the earlier two case studies, I am not convinced that the relevant aspect of English syntax is templatic. Nevertheless, I take this as a further useful example to illustrate the sorts of structures the Strong Linearity Domain Hypothesis predicts are possible—and I discuss it here for two reasons. The first is because it represents a strong linearity domain analysis previously proposed in the literature.

The second reason for reexamining Bobaljik’s analysis here is that, unlike the two sample case studies just discussed, the strong linearity domain analysis which will be developed will raise the important point that not all the properties of a given templatic construction are necessarily strong linearity restrictions. Because of this, even if a given templatic construction is consistent with the Strong Linearity Domain Hypothesis, some of aspects of

it might require an auxiliary explanation—we saw one example of this above in section 1.2.3.2 (page 47) in the discussion of verb+particle combinations in English. In particular, in this case, I will argue that a strong linearity restriction requiring that some element precede the form of the verb *be* in *there*-existentials is consistent with the Strong Linearity Domain Hypothesis. However, the Strong Linearity Domain Hypothesis, on its own, cannot account for why this element should be *there*, as opposed to any other word in English. Importantly, for reasons to be discussed below, I do not believe this limitation of the Strong Linearity Domain Hypothesis is undesirable.

As it is stated, Bobaljik’s formulation of the rule involving the presence of *there* in English *there*-existentials violates the Strong Linearity Domain Hypothesis since the relevant strong linearity domain he gives is not a prosodic constituent—instead it is a syntactic constituent, the clause. Furthermore, it is not at all clear, given the way he states the rule, how it could satisfy the consistency condition of the Strong Linearity Domain Hypothesis. However, we can straightforwardly reformulate Bobaljik’s rule in a way which would satisfy the Strong Linearity Domain Hypothesis and which I believe would still be consistent with his basic intuition. Recall from the tree in (20) that, in English, an unstressed pronominal subject and following finite verb are taken to form a prosodic unit (for Hayes it is a clitic group).

We could, therefore, as an approximation, restate Bobaljik’s analysis along the following lines: the first clitic group (following Hayes’ designation) in an English phonological phrase must be branching and the insertion of expletive *there* allows that restriction to be

filled.³¹ This version of the rule, I believe, is more or less consistent with Bobaljik's formulation since it refers to the left-edge of the clause and it attributes no particular syntax to the word *there*.

Such an analysis would straightforwardly fulfill the first condition of the Strong Linearity Domain Hypothesis as long as it could be made clear that the *there*+verb combination in English was always a prosodic unit.³² This seems to be the case. For example, the sentence in (42) shows that the combination pronoun+verb need not always be a prosodic unit, though it often is, because, when the pronoun is stressed, material can intervene between the pronoun and the verb.

(42) *We*, the undersigned, *certify* that we have read this project and approve it as adequate in scope and quality for the Master's Degree in Studies of the Future.

(Source: <http://www.richardb.us/signature%20page.pdf>)

However, comparable sentences involving *there*-existentials are not possible. It is possible to find examples of sentences making use of *there* as a subject when not immediately adjacent to the verb. However, such cases cause *there* to get a referential reading, referring to a particular location. An example of such a use is given in (43a). It is opposed to a comparable sentence, in (43b), where *there* is adjacent to the verb and where it can not take a referential reading.

³¹ See Zec and Inkelas (1990:372–7) for discussion of branching restrictions in prosodic phonology.

³² I don't intend commit myself to the idea that this prosodic unit should be labeled a clitic group here. Rather, I'll just try to show that there is evidence that *there*+verb forms some prosodic unit and uncritically adopt the term of Hayes (1990).

- (43) a. She walked over to the window and looked outside. There, in the garden, was a shiny ball about the size of a large shed.

(Source: <http://www.mud.co.uk/richard/alien.htm>)

- b. *There is* a unicorn in the garden.

I take the opposition between sentences like those in (43) to show that the combination *there+verb* in *there*-existentials is necessarily a prosodic unit because, when the two words are not adjacent, the existential reading is not available. This means that we can develop an analysis comparable to that of Bobaljik (2002) which satisfies the first condition of the Strong Linearity Domain Hypothesis.

As for the second condition of the Strong Linearity Domain Hypothesis, as mentioned above, one way to understand the relevant strong linearity restriction would be to say that the first clitic group in an English sentence must be branching—and the insertion of *there* allows this restriction to be filled. While it is not completely clear what the characteristic phonology of the Hayes's clitic group should be, it is fairly clear that it should consist of multiple phonological words since it is the domain immediately above the phonological word (the tree in (20) is consistent with this idea). Since a restriction Hayes's clitic group that it must be "branching" is essentially a restriction that it must consist of more than one phonological word, the reformulation of Bobaljik's strong linearity domain restriction given here, trivially satisfies the second condition of the Strong Linearity Domain Hypothesis.

We can, thus, restate aspects of Bobaljik’s analysis in a way consistent with the Strong Linearity Domain Hypothesis. There is one aspect of this construction which is outside of the explanatory purview of the Strong Linearity Domain Hypothesis under this analysis, however. The strong linearity restriction given above merely says that the first clitic group of an English sentence must be branching—it does not say that *there* should be the material used to enforce this restriction if it would not otherwise be fulfilled. We will, therefore, need some other account for why the “filler” material is *there*, and not something else.

The Strong Linearity Domain Hypothesis forces an explicit statement as to what properties are, and are not, strong linearity restrictions for a given construction. For the analysis of English *there*-existentials seen here, the appearance of the word *there*, as opposed to some other word, is simply not taken to be a strong linearity restriction.

Evidence that this aspect of the analysis is correct is that there are at least two syntactic “filler” subjects in English, *there*, as we have seen, and *it*, in expressions like *It’s raining*. The principles governing the choice between these two elements are clearly not templatic, but rather are tied to the syntax of the sentences in which they appear. Therefore, encoding one or the other of them directly into a strong linearity restriction would overlook the fact that their distribution could be predicted by other means.

We will see comparable phenomena in each of the case studies to be presented—that is, there will be aspects of each of the templatic constructions to be analyzed which are outside of the purview of the Strong Linearity Domain Hypothesis since they will not be analyzed as strong linearity restrictions. While, here, I did not offer any particular explanation for

the use of *there* as “filler” for the relevant templatic construction, in the real case studies, I will sketch out auxiliary explanations for aspects of the template which are not strong linearity restrictions.

The analysis in this section serves as an illustration of how the Strong Linearity Domain Hypothesis could apply to a previously proposed strong linearity domain and shows that, although the properties of this strong linearity domain, as originally proposed, are not consistent with it, we can recast them fairly straightforwardly in a way which satisfies its conditions. Furthermore, this analysis also provided us an example of something which will come up in the case studies below—specifically, the Strong Linearity Domain Hypothesis will not always be able to account for all properties of a given templatic construction since some of them might not properly be strong linearity restrictions but arise from some other aspect of grammar.

1.3.5 Local conclusion

We have seen here several small-scale applications of the Strong Linearity Domain Hypothesis which foreshadow the larger case studies which make up the bulk of this work. The full case studies will differ from the sample case studies mostly in the fact that I will spend a great deal of time justifying a templatic analysis for them in the first place—something which I did not do here.

I would like to close the section on applications of the Strong Linearity Domain Hypothesis by discussing a well-known straw man from the literature on phonosyntax which describes a rule which most linguists believe should generally be excluded by linguistic theory.

This is a rule which, “obligatorily moves to the beginning of the sentence the highest constituent that begins *phonetically* with a bilabial consonant (Zwicky and Pullum 1986:75).”

This rule, as stated, could be analyzed as a reflex of some strong linearity domain, since it relates the linearization of a sentence to phonetic properties of words in the sentence. This is something which could not be predicted from any model of hierarchical structure of phonology, morphology, or syntax that I am aware of.

What I would like to point out here is that the Strong Linearity Domain Hypothesis predicts that such a rule should not be found in language on two counts. First, the strong linearity restrictions are described in terms of a syntactic, not a prosodic, constituent, violating the first condition of the Strong Linearity Domain Hypothesis.

Second, any restriction on words beginning with a particular consonant should only be consistent with a small domain of prosodic constituency (almost certainly nothing larger than the phonological word) which implies that, even if we were to recast Zwicky’s statement with reference to a prosodic constituent (presumably, the utterance), it would be hard to imagine—let alone find—any language where such a movement rule would be consistent with the characteristic phonology of the utterance.

The fact that Zwicky’s rule is considered generally undesirable and that it violates both conditions of the Strong Linearity Domain Hypothesis is a good thing, since the Strong Linearity Domain Hypothesis would be suspect if it did not unequivocally exclude such a rule as being a possible strong linearity domain. There might be other theoretical reasons why we might want to exclude such a rule. Here, what we see though, is the present theory

excludes it as well. This is important since it means that, even though this work accepts that strong linearity domains exist in syntax, it does not allow for at least this one type of strong linearity domain which has long been considered particularly undesirable.

1.4 A BRIEF DISCUSSION OF PREVIOUS ACCOUNTS OF LINEARITY RELATIONS IN MORPHOLOGY AND SYNTAX

1.4.1 Introduction

While it is not hard to find statements on linearity in morphology and syntax, it is somewhat difficult to find statements which attempt to describe it in the way the Strong Linearity Domain Hypothesis does. In particular, all discussions of it that I am aware of operate more or less within a concatenation model of linearity. That is, they try to explain how the “pieces” of morphology and syntax are assembled. The Strong Linearity Domain Hypothesis, on the other hand, is a general well-formedness relation on a particular subclass of linear relations.³³ Here, I will discuss three different concatenation approaches so that we can see how previous researchers have looked at the issue of linearity in morphology and syntax.³⁴ Where necessary, in the case studies I will discuss some approaches like these in detail since they will be relevant to the strong linearity analyses I will be proposing.

The first is that of Baker (1988), which popularized the notion of the Mirror Principle,

³³ In this way, it resembles the Prosodic Morphology Hypothesis, discussed in section 1.2.4.2 (page 57)—a statement on well-formedness in morphophonological relations.

³⁴ I will not discuss here, the model of linearity envisioned by prosodic phonology, which was discussed in detail in section 1.2.2 (page 37), since it has already been covered and since it is not specific to morphology and syntax. This theory of linearity is open to being construed as following a concatenation or a well-formedness model depending on how one implements both the prosodic hierarchy and the Strict Layering Hypothesis. Another model which I will not cover here, since it is generally used to deal only with morphology, is Lexical Phonology (see Kiparsky (1982)). This is a concatenation model of linearity used to account for the relationship between morphological and phonological structure.

a statement on the relationship between morphological and syntactic structure. The second is that of Embick and Noyer (2001) within Distributed Morphology, an example of an approach which makes a tight distinction between morphological and syntactic constituents. The final approach is that of Bybee (1985) which I take as representative of diachronically-oriented approaches to the issue.

1.4.2 Baker (1988) and the Mirror Principle

Baker (1988) is a noteworthy attempt to deal with a fairly well-known observation that the order of morphological elements often parallels their semantic scope in a regular way. For example, Baker (1988:14) offers the following sentences from Chichewa to illustrate this idea.

- (44) *Mtsikana a-na-perek-er-edw-a mpiringidzo ndi mbidzi*
 girl 3S-PST-hand-APPL-PASS-FV crowbar with zebra
 “The girl was handed the crowbar by the zebras.”

In (44) the applicative suffix *-er-* introduces the benefactive argument *mtsikana* ‘girl’. Since this is the passivized argument, applicativization must have, in some sense, logically “preceded” passivization—otherwise the benefactive argument would not be available for passivization. This is correlated with the fact that the passive suffix *-edw-* follows the applicative suffix on the verb *-perek-* ‘hand’.

Baker (1985:4) labels this type of observable correlation between morpheme order and syntactic derivations the “Mirror Principle” which he defines as follows, “Morphological derivations must directly reflect syntactic derivations (and vice versa).” In order to explain the Mirror Principle, Baker (1988) goes on to develop a comprehensive theory of “incorpo-

ration”. This is a model of morphosyntax where both morphology and syntax are governed by a common set of semantic well-formedness principles and the difference between the two is primarily related to the fact that, in some languages, certain morphemes must “incorporate” into stems—thus appearing as affixes—while, in other languages, comparable morphemes can stand as free words.

For Baker, a sentence like the one in (44) would have a structure schematized in (45). (This structure is an adaptation of one found in Baker (1988:401) following comments made in Baker (1988:405).)³⁵

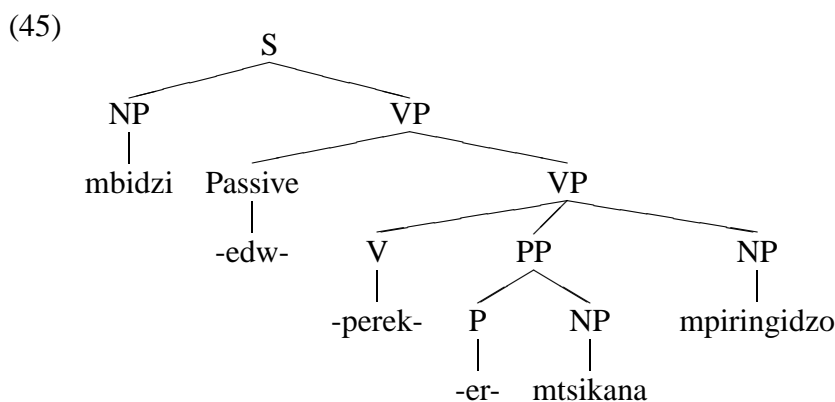

In (44) the passive *-edw-* and the applicative *-er-* are both morphologically dependent and need to incorporate onto the verb *-perek-* in order to be realized—incorporation, in Baker’s model, is a effectively type of movement where one syntactic element affixes to another syntactic element. Baker (1988) holds a common assumption that movement must affect lower elements of the syntactic tree before higher elements. Thus, the applicative

³⁵ In the the tree in (45), I follow a convention, adopted throughout the work, of attempting to standardize the labelling of syntactic trees by renaming certain theoretically-defined node labels in favor of more commonly known ones. My general tactic in relabeling has been to follow ideas explicitly endorsed by, or adapted from, McCawley (1998).

-er-, which is low in the tree, will attach to *perek-* before the passive morpheme *-edw-*, which is high in the tree. The order of attachment is taken to be reflected by the linear order of morphemes on the verb in (44).

Critically, this order of attachment is explained via syntactic mechanisms. Thus, a language which lacked applicative and passive morphology and relied on more properly syntactic structures to express comparable semantics could be given the same basic syntactic representation as Chichewa. The difference between the two languages, in Baker's view, would be relatively superficial aspects of morphological exponence rather than fundamentally different syntax.

There's a lot to be said about Baker's (1988) proposal. For our purposes, the most satisfying aspect of it is its ability to explain the correlation between morpheme order and certain syntactic structures—an important accomplishment.

What is decidedly unsatisfactory, however, for the purposes of the present work, is this fact: Having explained the correlation between morphology and syntax by analyzing some morphology syntactically, he is left with no explanation as to why languages should have “morphology” and “syntax” in the first place. In fact, as a default, his theory would seem to predict that language's shouldn't have morphology at all (or shouldn't have syntax at all).

Baker (1988) does address this issue, however, he does not offer a full explanation. “I claim that morphology is in effect another subtheory, roughly on a par with the established subtheories of principles of government-binding theory... As such, ‘morphology theory’ (as we may call it) can be characterized as the theory of what happens when a complex

structure of the form [$_{Z^0}$ X + Y] is created” (Baker 1988:68).

This existence of this assumed, but undeveloped, theory of Baker’s is problematic because, barring stipulation, there is no obvious reason why such a theory should order elements in words in any way which correlates with the syntactic structure. Since Baker (1988) operates within a concatenation model of linearity, we can assume that morphology and syntax both exhibit concatenative effects—this might explain why they are similar, but this still leaves us with the question of why they are different.³⁶

Any researcher with a serious interest in studying linear relations needs to pay attention to Baker’s key insight that, in fact, syntax and morphology are not totally divergent from each other with respect to the linearization of elements. However, at the same time, such a researcher is still left with the considerable task of explaining why there should be a distinction between morphology and syntax in the first place.

It is worth noting in this context, that, while Baker (1988) works in a transformationalist framework, it is not hard to find principles comparable to Baker’s Mirror Principle in other models of morphology and syntax—that is, a range of theories operating under the concatenative model of linearity, employ some device like the Mirror Principle to predict correlation between morphological linearization and syntactic structure.

Nordlinger (1998:102), for example, working within Lexical Functional Grammar, a lexicalist theory, proposes the Principle of Morphological Composition, which, as she

³⁶ Some authors, like Noyer (1991) and Rose (1996), have assumed the Mirror Principle to be more or less accurate and have proposed special morphological constructions and operations to account for languages which exhibit surface violations of the Mirror Principle. Though these proposals do not completely explain the difference between morphology and syntax, they represent attempts to do so that were specifically designed to be compatible with Baker (1988).

points out, shares various affinities with the Mirror Principle. In chapter 2 we will closely examine another work within Lexical Functional Grammar, Alsina (1999), which makes similar assumptions. Sadock (1991:163–5) also constructs a principle comparable to the Mirror Principle. Notably, with respect to present work, though he does not formalize it fully, he discussed some ways in which the differences between linearization in morphology and linearization in syntax, along with their similarities, can be modeled.

1.4.3 Embick and Noyer (2001)

Work like that of Embick and Noyer (2001), and other work in Distributed Morphology (e.g. Halle and Marantz (1993), Noyer (1997)), deals with some of the problems of Baker (1988) with respect to the distinction between morphology and syntax. This work is also done within transformationalist framework and is worth mentioning here. The most important difference between Embick and Noyer (2001) and Baker (1988) is that the former makes a strong distinction between words and other syntactic elements, which is intended to partially account for properties which appear to be found in words but not phrases.

Embick and Noyer (2001) assume that, in the derivation of sentences, initially the only elements that are manipulated are syntactic features. At a particular point in the derivation a process called *Vocabulary* insertion (Embick and Noyer 2001:558) takes place which replaces feature bundles with actual pronounceable morphemes. Critical, for our purposes, is the following fact: “linear order is imposed on a string only at Vocabulary Insertion. . . (Embick and Noyer 2001:565).” Before Vocabulary insertion, the only way that linearization can be affected is by placing feature bundles in particular hierarchical positions—this is

because Embick and Noyer (2001) only allow a limited range of “movements” to occur after Vocabulary insertion. Thus, the hierarchical relationship between any two features limits their possible linear realization.

Work like that of Embick and Noyer (2001) is noteworthy for seriously considering at all when linearization takes place in grammar. Like Baker (1988), they explicitly adopt a version of grammar with a separate component that can roughly be described as the morphological component (Embick and Noyer 2001:560). Importantly, they capture Mirror Principle effects by stating, “In the default case the structure interpreted in Morphology will simply be the output of the syntactic derivation,” In this view, Mirror Principle effects are part of a sort of “elsewhere” condition through which morphology looks like syntax unless some other process comes into play.

Within the framework of Embick and Noyer (2001), an important feature is what operations can affect linear order after syntax. Some have been proposed, but as they point out, “The status of such operations, and the conditions on their application, is the subject of an ongoing research program (Embick and Noyer 2001:560).” Exactly how work within Distributed Morphology will deal with all aspects of linearization, thus, has not yet been worked out. However, it is a promising framework for current research with respect to the present work for the simple reason that linearization is an active concern within it.

Nevertheless, Embick and Noyer (2001) still operate more or less within a concatenation model of linearization—and concatenation is, indeed, their default operation for linearization. In their morphological component, however, it is the case that simple concatena-

tion can specifically be overridden, meaning that do not strictly adhere to the concatenation model. Even so, the model they adopt is still very different from the well-formedness model of the Strong Linearity Domain Hypothesis since it represents an emendation of the concatenation model, rather than a different model in its own right.

1.4.4 Bybee (1985)

Bybee (1985) takes a rather different approach in explaining the linear order of elements in morphology and syntax. First and foremost, unlike work like Baker (1988) and Embick and Noyer (2001), she explicitly adopts the idea that a diachronic model which correctly predicts a particular order of elements at some level of grammatical structure can constitute an explanation for that ordering.³⁷

Following Givón (1971a), Bybee makes the claim that the order of morphemes within a word reflects an earlier ordering of words within a sentence (Bybee 1985:38). “Thus, the high frequency of, for example, inflection marking aspectual categories, and their proximity to the verb stem, could be traceable solely to the occurrence in earlier times of words expressing aspectual notions in positions contiguous to the main verb (Bybee 1985:28).” Thus, the historical source of morphology can be used to account for general principles of morpheme order—specifically for the fact that morpheme order seems to reflect order of syntactic operations. Bybee (1985), thus, presents an alternative account to Baker’s (1985) Mirror Principle.

However, as Bybee points out, such an explanation for the order of morphemes leaves

³⁷ Though I single out Bybee (1985) here, Bybee et al. (1994) also makes a number of similar points.

open the question of why words are ordered in the syntax in a particular way. To explain this, she invokes the *relevance* principle which, within syntax, states, “that words that function together in the sentence tend to occur together in the sentence (Bybee 1985:39).” The relevance principle appears to be considered an unexplained primitive of grammar. Nevertheless, it does not need to be applied to both morphology and syntax—accepting its existence at the level of syntax implies that it will hold in morphology in Bybee’s (1985) view.

Additionally, Bybee (1985) believes that morphology is not merely “fossilized” syntax, but that this is just a sort of default. Once elements become morphologized, independent developments within the morphology can create innovations not predictable from the earlier syntax of the language (Bybee 1985:39–41). This view bears some similarities to the view of Embick and Noyer (2001)—that is, morphology will, for the most part, look like syntax, but various word-level effects can interfere with this basic situation. Bybee (1985) diverges strongly from Embick and Noyer (2001), however, by having a diachronic explanation for this relationship rather than a synchronic one.

Bybee (1985) still operates within a concatenation model. However, her model bears a much closer affinity to the one implied by the Strong Linearity Domain Hypothesis than those of Baker (1988) and Embick and Noyer (2001). This is because Bybee does not assume some syntactically privileged morphological level. Rather, “morphology” represents one position in a cline of linearity relations where they are fairly fixed and “syntax” represents a position where they are relatively free.

In her view, the difference between these two types of linguistic phenomena are not due as much to the architecture of grammar but to the nature of the diachronic change that produces morphology, which is a mixture of phonological and semantic reduction. The linear reflex of this reduction is more fixed order of elements, more specific phonological restrictions on linearization, and “smaller” phonological structures. In this way, the claims of Bybee (1985) are similar to the aspect of the Strong Linearity Domain Hypothesis which tries to model the cline of more specific to less specific templatic restrictions from smaller to larger linearity domains.

1.4.5 Local conclusion

The three summaries provided here are merely meant to exemplify some earlier approaches to linearity in morphology and syntax and are not intended to be an exhaustive survey of the literature. The three approaches seen here have in common that they operate primarily within a concatenation model of linearization, while this work operates more or less within a well-formedness model.

The principle reason for this divergence is that the works on linearity just described have focused on the interaction between syntactic/semantic structure and morphological structure, an aspect of grammar inherently well-suited to a model where words and phrases are “constructed” from constituent pieces.

This work, on the other hand, is focused on templatic constructions—constructions where linear order cannot be predicted, and must be stipulated. Such constructions do not lend themselves well to the concatenation model since there is no obvious principle to be

invoked to govern the concatenation.

Because of the different phenomena under investigation, the model of linearization implied by the Strong Linearity Domain Hypothesis does not necessarily clash with the concatenation model.³⁸ While I will not address how the differences between the two different models can be rectified to create one general model for the description of linearization, this would clearly be a relevant area for future work.

1.5 THE THREE CASE STUDIES

1.5.1 The role of the case study in the present work

As mentioned in section 1.0 (page 1), there are three strains of argument I am pursuing, in different ways, in this work. The narrowest argument is one which supports the Strong Linearity Domain Hypothesis. More broadly, I want to argue that templatic constructions can exist in morphology and syntax—but they are constrained to only appearing in certain environments and having certain forms. Finally, I want to use this work as part of the foundation for general theory of linearity.

Given that the Strong Linearity Domain Hypothesis is a well-formedness generalization that is intended to hold cross-linguistically, one obvious way for me to achieve my aims would be a broad study of all purported morphological and syntactic templates.

I'm not going to take this route, however, for several reasons. The first is that the Strong Linearity Domain Hypothesis is a fairly abstract claim about grammar incorporating three

³⁸ This is similar to the fact that the well-formedness model of linearity implied by the Prosodic Morphology Hypothesis, discussed in section 1.2.4.2 (page 57), does not necessarily clash with the concatenation model employed by Lexical Phonology (Kiparsky 1982).

somewhat “big” concepts: strong linearity domains, prosodic constituents, and the notion of characteristic phonology. This means that, at this point, it seems more appropriate to focus on a few detailed case studies, so that the nature of the Strong Linearity Domain Hypothesis will become as clear as possible. Once several such examples of the type of argument needed to support the Strong Linearity Domain Hypothesis have been established, it might then be appropriate to engage in a more properly typological study of the relevant phenomena.

Another reason I am making use of case studies is related to an aim of this work to show that there are, in fact, templatic constructions in the morphology and syntax. Arguing for a strong linearity analysis for a morphosyntactic or syntactic construction is generally an involved enterprise since it requires “factoring out” the hierarchical (weak linearity) effects from the strong linearity effects. This, thus, is another reason for focusing on case studies instead of a large typological survey at this point.

A final reason why I am making use of case studies is mostly aesthetic—they are the type of linguistic analysis I am most comfortable with and feel are best suited to making the sort of points I wish to make here. I should point out here, then, what I think the primary use of the case study is in this work. While many linguists use case studies to argue for a particular, restricted view of the possibilities of grammar, I instead will be using them to argue that a particular typological possibility can be instantiated in grammar—the morphological and syntactic template. A well-known example of the former use of case studies, parts of which were just discussed in section 1.4.2 (page 85), is found in Baker (1988)

where he uses detailed analyses of a few languages to argue for a very specific architecture for the relationship between morphology and syntax. An excellent recent example of the latter use of case studies is Harris (2002) which uses detailed data from one language to argue for the existence of endoclitics in language, a phenomenon previously believed not to be possible.

Because I envision the case studies as having this latter role of showing that some possibility is instantiated in in grammar, even though I will be arguing that templatic constructions must be consistent with the Strong Linearity Domain Hypothesis, it is more the case that I am trying to use this hypothesis to help us understand templatic constructions generally than to propose a strict, universal restriction on grammar. The Strong Linearity Domain Hypothesis, here, is, therefore, not considered to be so much a restrictive theory on some aspect of grammar as it is considered to be an investigative tool to help us understand a particular class of observable phenomena.

1.5.2 The three case studies

1.5.2.1 Introduction

The choice of the three case studies, not surprisingly, in large part reflects languages which I am reasonably familiar with—this is a necessity given the fact that the Strong Linearity Domain Hypothesis encompasses morphology, syntax, and phonology. Fortunately, I have been able to make use of languages which are typologically fairly diverse: the well-known Bantu languages, Chechen, a Nakh-Daghestanian language spoken in the Caucasus, and Saramaccan, an Atlantic creole spoken in Suriname. Also, the particular phenomena

I will examine in each of three case studies are fairly distinct as are some of the methods I will need to employ to analyze them. So, a potential limiting factor, has not necessarily resulted case studies of a limited range of phenomena.

The order of the three case studies reflects an ordering from smaller to larger linguistic constituency of the phenomena under examination. For the Bantu case study, in chapter 2, I will be looking at a subset of templatic restrictions which have been document in the verb stem. For the Chechen case study, in chapter 3, I will be looking at an interesting position class phenomenon in verb phrases in the language. Finally, for the Saramaccan case study, in chapter 4, I will be looking at serial verb phrases—structures where multiple “small” verb phrases are combined into a single predicate.

In addition to being arranged from smallest to largest, these three case studies all deal with verbal argument structure in one way or another. Therefore, there is a morphosyntactic unity to the three of them—in addition to the unity that results in the idea that each represents a templatic construction.

Finally, there is a way in which each of the three case studies can be taken to exemplify a major type of morphological and syntactic templatic constructions that can be found in the literature. The Bantu case study focuses on affixes marking a verb root and, therefore, bears some resemblance to the morphosyntactic position class templates of the sort discussed in section 1.1.2.3 (page 12). An important aspect of the Chechen case study is that it involves the positional restrictions of a clitic. Since the work of Simpson and Withgott (1986), the templatic properties of clitics have been of theoretical interest—and we’ve already looked

closely at the potentially templatic properties of second-position clitics in section 1.3.2 (page 65), the sample case study on Serbo-Croatian. Lastly, the case study of Saramaccan serial verb phrases is an instance where a well-defined set of syntactic structures appear to have “slots” where designated syntactic material is placed. They, thus, exemplify a class of template-like syntactic phenomena commonly termed “constructions” and gives them a good degree of similarity to the structure of the German sentence implied by the topological fields analysis discussed in section 1.1.2.5 (page 18).

At the beginning of each of the case studies, I will situate the phenomena to be analyzed within the broader category of templatic constructions they are taken to exemplify. Below, I give a brief summary of the three case studies in their order of presentation.

1.5.2.2 Causativization and applicativization of the Bantu verb stem: A case study of a morphosyntactic template

The first case study will be a detailed examination of the morphemic exponence of causativization and applicativization within languages of the Bantu family. Three different verbal suffixes are widely attested in the family as marking causative and applicative semantics. Chichewa shows two suffixes used for marking such semantics—a “long” causative with the form *-its-* and an applicative with form *-ir-*. These two suffixes can combine in the order *-its-ir-* but not *-ir-its-* as seen in (46).

(46)

STEM	GLOSS	TRANSLATION
<i>-mang-its-</i>	‘tie-CAUS’	“cause to tie”
<i>-mang-ir-</i>	‘tie-APP’	“tie for”
<i>-mang-its-ir-</i>	‘tie-CAUS-APP’	“cause to tie for”
* <i>-mang-ir-its-</i>	‘tie-APP-CAUS’	

In Kinande, on the other hand, causativization is marked with the “short” causative, here called the transitive, with form *-j-*. Applicativization is also marked with *-ir-*, like in Chichewa. Whereas in Chichewa the suffix marking causativization obligatorily preceded the applicative if both were present on the same verb, in Kinande, as illustrated in (47), the transitive must follow the applicative—even though the Chichewa causative and Kinande transitive have the same semantics.

(47)

STEM	GLOSS	TRANSLATION
<i>-tsap-</i>	‘wet’	“wet (intr.)”
<i>-tsap-ir-</i>	‘wet-APP’	“wet for”
<i>-tsap-j</i>	‘wet-TRANS’	“make wet”
* <i>-tsap-j-ir</i>	‘wet-TRANS-APP’	
<i>-tsap-ir-j</i>	‘wet-APP-TRANS’	“make wet for”

In chapter 2, based on a cross-linguistic study of over thirty Bantu languages, I will argue that the ordering restrictions exemplified in (46) and (47) are instantiating a strong linearity restriction found throughout the family where these three verbal suffixes must surface in causative-applicative-transitive (CAT) order. I will then describe how this ordering restriction is consistent with the Strong Linearity Domain Hypothesis.

Unlike the other case studies, there has been previous work on verbal suffix ordering specifically within Bantu. So, it will serve as the case study where competing analyses can most easily be compared with the analysis to be presented here.

1.5.2.3 The preverbal enclitic *'a* and the Chechen verb phrase template: A case study of a templatically-positioned clitic

The second case study will be on a strong linearity domain in Chechen, which I will refer to as the “core” verb phrase, and which instantiates a position-class template. Specifically, in a definable set of environments in the language, the verb must be preceded by a word in the core verb phrase. The syntactic environment which demonstrates the existence of this template is somewhat complex. The sentences in (48) begin to illustrate where it is found.

- (48) a. *Cicko*, [*ch'aara 'a goj*,] *'i bu'u*.
 cat.ERG fish & see.CVPAN 3S.ABS B.eat.PRS
 ‘The cat sees a fish and eats it.’
- b. [*Ga 'a goj ch'aara*,] *iza bu'u cicko*.
 see & see CVPAN fish 3s ABS B eat PRS cat ERG
 “Having seen the fish, the cat eats it.”

Chechen makes extensive use of clause-chaining constructions where non-finite clauses are embedded within a finite matrix clause to express narrative semantics. In the non-finite clauses which are part of the chain, an enclitic with the form *'a* obligatorily appears before the main verb of the clause. This enclitic must itself be preceded by an element within the core verb phrase headed by this non-finite verb.

In (48a) the bracketed non-finite clause in a chained construction shows standard OV order for the language, and the object of the verb *ga* ‘see’ serves as the host for the enclitic *'a*. However, in (48b) the object of *ga* appears in non-standard post-verbal position. As a result, there is no “natural” host for *'a* and a semantically empty copy infinitive is added to

the clause to serve as its host—thus, showing that the preverbal position class is active in the language.

There are two broad goals to the Chechen case study. The first is that Chechen offers the best example that I am aware of a clearly syntactic position-class template. To the extent that such a phenomenon can be detected at all, this provides general support to the idea that templates do occur in morphology and syntax. It also provides more specific support to the Strong Linearity Domain Hypothesis which predicts that templates should be found at all levels of morphological and syntactic constituency, provided particular conditions are met.

The second goal of the Chechen case study is to serve as a bridge between the clearly morphosyntactic Bantu case study and the clearly syntactic Saramaccan case study (to be described immediately below). The Chechen core verb phrase is a strong linearity domain intermediate in size between the word and the sentence—allowing it to serve as a conceptual stepping stone in an illustration of how the Strong Linearity Domain Hypothesis models a cline for templatic constructions.

Unlike the Bantu case, there are no previous analyses of the Chechen data to contrast with the analysis to be presented here. However, the enclitic *'a* seen in the examples in (48) will be argued to be of a typologically rare type excluded by some theories of clitic typology, and its status as a rare clitic will be implicated in some aspects of the templatic behavior of the Chechen core verb phrase. So, while the comparisons will not be direct, the Chechen case study will have some relevance to earlier theoretical literature.

1.5.2.4 Saramaccan serial verb phrases and uniformity in serial verb ordering: A case study of a constructional template in the syntax

The final case study will be of serial verb phrases in Saramaccan. Serial verb phrases are constructions found where a series of “small” verb phrases form one complex predicate. Unlike the Bantu and Chechen cases, there is nothing particularly interesting about Saramaccan serial verb phrases insofar as they follow a typical Atlantic creole/West African model of serialization in SVO languages. I have chosen Saramaccan in particular here because I am very familiar with its prosodic phonology allowing me to thoroughly test the Strong Linearity Domain Hypothesis against the relevant phenomena.

The aspect of serial verb phrases which will be the focus of the present work is the order of elements in the serial verb phrase—which, it will be argued, is templatically governed. Evidence for this comes from the fact that, in languages which otherwise show different basic word order order, the verbs in serial verb phrases show the same order. This can be seen in the data in (49) where Sranan, an SVO language, and Izon, an SOV language, both order the verbs in the semantically similar serial verb phrases the same way.

- (49) a. *Kofi teki a aksi fala a bon.*
 Kofi take the axe fell the tree
 “Kofi felled the tree with the axe.” SRANAN (Sebba 1987:132)
- b. *áràú, zu ye àkì, buru teri-mí*
 she basket take yam cover-SIMPLE_PAST
 “She used a basket to cover a yam.” IZON (Williamson 1965:53)

While I will not be able to argue that all serializing languages follow the Strong Linearity Domain Hypothesis, for the simple reason that I lack enough data on them, I will argue

that the Strong Linearity Domain Hypothesis holds for a templatic analysis of Saramaccan.

The serial verb phrase template will be the least phonologically specific of the three, consistent with the cline of strong linearity restrictions implied by the Strong Linearity Domain Hypothesis. The clearly syntactic serialization phenomena of Saramaccan will, thus, finish the progression from smaller to larger domains of linguistic constituency which the Strong Linearity Domain Hypothesis is designed to be able to describe.

1.5.3 On the bipartite structure of the case studies

It is worth making a point here that the case studies will have a structure which will sometimes result in a fairly abrupt transition between morphosyntactic/syntactic discussion and more phonologically-oriented discussion. This is because, before examining whether or not the Strong Linearity Domain Hypothesis is consistent with some set of strong linearity restrictions, it is first necessary to establish that we are dealing with a strong linearity domain in the first place.

Establishing the existence of a strong linearity domain requires fairly extensive discussion as to why a weak linearity account is not available for some set of data. Since the case studies all focus on morphosyntactic and syntactic phenomena, instead of morphophonological phenomena, the tools to use to develop a weak linearity account of them would most naturally come from morphosyntactic and syntactic theory.

However, once it is established that there is a strong linearity domain in some language, the Strong Linearity Domain Hypothesis takes over as the guiding principle. To the extent that the Strong Linearity Domain Hypothesis establishes a correlation between phonologi-

cal phenomena in a given language and strong linearity domains in that language, the mode of discussion will then rapidly shift from what is typically associated with morphosyntactic and syntactic theory to phonological theory—giving the case studies, in some sense, a bipartite structure.

1.5.4 The Strong Linearity Domain Hypothesis and “templatic residue”

A final point that will emerge from the case studies is that, in addition to being a restrictive theory of templatic constructions in morphology and syntax, maintaining consistency with the Strong Linearity Domain Hypothesis in descriptions of templates will often force us to look deeply for the “templatic residue” of a given templatic construction.

What I mean by this is that, for any given template, there are different, descriptively adequate, possible ways to characterize it. However, not all of these will be consistent with the Strong Linearity Domain Hypothesis. This will result in my choosing a characterization which will often be fairly simplistic with respect to other possible characterizations.

In some sense, this is definitely a positive outcome of working with the Strong Linearity Domain Hypothesis. This is because it will force us, for each case study, to clearly define the nature of the construction being analyzed and to clearly articulate what is and what isn't templatic about it. It will, thus, produce a more accurate description of the phenomenon in question—which can generally be considered a good thing.

Finding the templatic residue of a given construction will, in some cases, also force us to see that the Strong Linearity Domain Hypothesis has limitations in what it can explain, and in some cases it will not be able to fully characterize what might seem to superficially

be the templatic properties of the construction in question. For example, in the Bantu case study, I will argue that the Strong Linearity Domain Hypothesis predicts the basic form of the CAT template but that it cannot tell us, in any way, why the template is CAT instead of ACT (though it will limit us to one of those two possibilities).

This will not be taken to be a weakness of the Strong Linearity Domain Hypothesis as a restrictive theory about templatic constructions. Rather, it simply serves to make us carefully consider the exact nature of the strong linearity restrictions of each templatic construction we wish to examine. In cases where the Strong Linearity Domain Hypothesis cannot explain all the aspects of some “template”, I will offer alternative suggestions as to what could be the governing force behind them.

These suggestions will mostly be diachronic in nature. That is, given multiple logical possibilities for a particular template, I will argue that the attested form is the one for which there is a more plausible scenario for its historical development. In each case study, I will make it clear what aspects of the templatic construction, I am explaining via the Strong Linearity Domain Hypothesis and what aspects require an auxiliary explanation.

1.6 CONCLUSION

In this chapter, I have laid out the general taxonomic and theoretical framework I will be employing in the three case studies to follow. The core hypothesis of this work is the Strong Linearity Domain Hypothesis, given in (22).

In its most basic interpretation, the Strong Linearity Domain Hypothesis is a statement of the relationship between strong linearity restrictions and phonological constituency.

More broadly speaking, it constitutes a theory of templatic constructions which attempts to model them via a cline from more specific linear ordering restrictions in smaller linguistic constituents to less specific linear ordering restrictions in larger constituents.

Having explicated and given the rationale behind the Strong Linearity Domain Hypothesis, we are now in a position to apply it to the three case studies which comprise the bulk of the present work. I turn then to chapter 2, a case study of causativization and applicativization in the Bantu verb stem. After that, I will cover templatic phenomena in Chechen and Saramaccan. In chapter 5, I will offer a concluding chapter where I consider general explanations as to why the Strong Linearity Domain Hypothesis might be true at all.

2 Causativization and applicativization of the Bantu verb stem: A case study of a morphosyntactic template

2.0 BACKGROUND: MORPHOSYNTACTIC TEMPLATES

The focus of this case study will be a morphosyntactic template found within the Bantu verb stem. As discussed in section 1.1.2.3 (page 12) in chapter 1, morphosyntactic templates are an important class of proposed templates and have had a place in both the descriptive and theoretical literature. While no one that I am aware of has argued against their utility as simple descriptive devices, their theoretical status as valid grammatical objects has been questioned. For example, the Athabaskan verb is often considered to be extreme in its templatic behavior. However, work like that of Rice (1993, 2000), Speas (1984, 1990:240–280), and McDonough (1990, 2000) on its structure, has suggested that alternative non-templatic analyses are not only possible but preferable to templatic analyses.

At the same time, however, it is not difficult to find work, which does assume that morphosyntactic templates are theoretically valid devices. Examples of such work include Simpson and Withgott (1986), Stump (1992), Stump (1993), Anderson (1992:128–35), Inkelas (1993), and Halpern (1995:191–222). These works are accompanied by a long tradition of descriptive work employing morphosyntactic templates including Hoiijer (1971), Kari (1989), and Young (2000) for Athabaskan; McLendon (1975) for Pomo (a language of the Hokan stock); Kimball (1991) for Koasati (a Muskogean language); and Bloomfield (1962) for Menomini (an Algonquian language)—among many others.

Since the Athabaskan verb represents the most well-studied potential case of a morpho-syntactic template, I will often use it in illustrative examples here. All of the most elaborate morphosyntactic templates that I am aware of are verbal rather than nominal—allowing the Athabaskan languages to reasonably stand in for many others.

The basic structure of proposed morphosyntactic templates makes use of a series of position classes or “slots” in some morphological constituent which specify the order in which the various morphemes associated with that constituent appear. For example, Hoijer (1971:125) gives the pan-Athabaskan template seen in (50) for verbs in that family. The template schematizes the verb as consisting of a stem (the final element in the verb) preceded by a series of nine prefixal slots. Hoijer categorizes these prefixes semantically.

- (50) 1. Zero, one or more adverbial prefixes.
2. The prefix for the iterative paradigm (lacking in some languages).
 3. A pluralizing prefix.
 4. An object pronoun prefix, found only in transitive verbs and some passives.
 5. A deictic subject prefix.
 6. Zero, one or two adverbial prefixes.
 7. A prefix marking mode, tense, or aspect.
 8. A subject pronoun prefix.

9. A classifier prefix.

10. A stem.

While, in some templatic systems, like the one schematized for Athabaskan in (50), it is possible to give a semantic classification for the various proposed positions, there are languages where the position classes have been described as being potentially arbitrary. Inkelas's (1993) discussion of Nimboran, for example, argues that position classes in that language cannot be associated with coherent semantics and, thus, must be given essentially arbitrary labels.

Nimboran has also been analyzed as showing a striking type of position-class effect worth mentioning here, which has not been frequently attested. Some morphemes may occupy a set of adjacent positions, rather than just occupying a single one. Such morphemes cannot cooccur with any morphemes which would otherwise be expected to appear in any of the positions they occupy (Inkelas 1990:586–90).

In addition to morphological position classes, another notable feature of languages that have been attributed to languages employing morphosyntactic templates is complex morphophonology. Rice (1993:146), for example, marks three different kinds of phonological boundaries appearing between elements in the ten position classes she gives for the verb of the Athabaskan language Slave. Her schema is given in (51). (Rice (1993:146–9) discusses the meaning of the various categories in (51).)

(51) preverb # distributive # iterative # incorporate # direct object % deictic subject %
 theme-derivation-aspect + conjugation/mode + subject = voice + stem

The three different boundary symbols in (51) are used to indicate the degree to which the various verbal prefixes are bound to the stem, with “#” used to mark the least bound, “+” the most bound, and “%” something in between the two extremes. Comparable boundaries are found throughout Athabaskan (Rice 2000:34)—with the most common division being made between the disjunct boundaries (marked with a “#” in (51)) and conjunct boundaries (marked with a “%” or a “+” in (51)). Hargus (1988) also documents the complex nature of the Athabaskan verb in her study of the lexical phonology of Sekani, another language in that family.

Complex morphophonological structure in morphosyntactic templates is not isolated to Athabaskan. Inkelas’s (1993) description of Nimboran, for example, suggests levels of phonological structure for verbs in the language which imply that they have comparable structure to Athabaskan verbs as schematized in (51).

Given that the Strong Linearity Domain Hypothesis specifically relates the properties of templatic constructions to their phonology, the fact that morphosyntactic templates can be associated with multiple levels of phonological structure is of obvious interest here. This means that, if these languages can be conclusively shown to employ morphosyntactic templates, there is reason to believe that the characteristic phonology of their verbs exhibits sufficient complexity to make those templates consistent with the second condition of the Strong Linearity Domain Hypothesis.

However, the central issue, for the present work, with respect to the morphosyntactic templates proposed for languages like Athabaskan is not whether or not they are consistent with the Strong Linearity Domain Hypothesis. More important is whether or not they truly contain the strong linearity domains implied by position-class analyses. This is where the Athabaskan case is particularly relevant since the structure of the verb in those languages has been so well studied.

Unfortunately, I have little to say about how the Strong Linearity Domain Hypothesis relates to Athabaskan at present. The crucial information which I lack is how we could precisely determine what the templatic “residue” (a concept discussed in section 1.5.4 (page 104)) is of the Athabaskan verb generally—or within any one Athabaskan language specifically. Without knowing what this residue is, it is not possible to clearly isolate any strong linearity domains which might be found within the verbs of these languages, and doing this, of course, would be a prerequisite to determining whether or not these verbs are consistent with the Strong Linearity Domain Hypothesis.

However, we are not at a complete loss in trying to deal with this issue. Rice (2000) is an important recent work on comparative Athabaskan which begins the process of determining the templatic residue in the verbal system of that family. In that work, she argues that many aspects of the prefixal ordering schematized in (50) constitute what, here, would be termed weak linearity restrictions because they can be generally predicted by virtue of their relative semantic scope or, in more particular cases, by their phonological properties. At the same time, certain prefixes do not interact with each other semantically or phonologically

in obvious ways, but still have strict ordering relationships with respect to each other—for these Rice (2000:394) suggests language-specific statements may be necessary. She summarizes her position as follows:

Any model [of the Athabaskan verb] must account for several things: the scopal principle is an overarching principle that consists of interacting subprinciples. Syntactic, morphological, and phonological principles also play a role in determining morpheme order. In addition, mechanisms are required to situate non-interacting material and to account for the variability associated with it. The best model for capturing all of this is the topic of another piece of work. (Rice 2000:395)

Even though the general argument of Rice (2000) is that the Athabaskan verb is not templatic, it is clear from the quote that there might be templatic “corners” of it. The main thesis of the present work suggests that, after morphosyntactic and phonological aspects of ordering are taken into account, any ordering restrictions still not accounted for should be consistent with the Strong Linearity Domain Hypothesis. Whether or not this is true is a matter for future research.

A confounding factor in detecting strong linearity domains in morphosyntactic templates is that it is generally not at all clear how much of their formation should be considered “morphological” as opposed to “syntactic”. Again, using the Athabaskan case for illustration, Rice (2000) takes an approach where its structure is determined mostly in the syntax. McDonough (1990, 2000) and Halpern (1995:194–211), on the other hand, suggest a mixed account where some elements are added morphologically and others syntactically. Choosing one of these analyses over another could have important affects on where strong linearity domains are found in the Athabaskan verb. Aspects of this issue will come up

again in section 3.0 (page 275) in chapter 3, when I discuss phenomena often referred to as *clitic* clusters which have many similarities with traditional morphosyntactic templates as noted in Simpson and Withgott (1986).

With respect to many previously proposed morphosyntactic templates, like those argued for in Athabaskan languages, we are left, then, with an issue, that will come up again in the introductions to the other two case studies: the complexity involved in determining the templatic residue of a potentially templatic construction makes it impossible to come to any quick judgement as to whether or not its properties are consistent with the Strong Linearity Domain Hypothesis. For each possible template, detailed research and analysis is required.

The particular templatic construction which will be focused on in this case study is found within the Bantu verb stem. This template is considered morphosyntactic since it involves argument-structure changing morphology marked on the verb. It will involve the relative ordering restrictions of three verbal suffixes—a far cry from the ten prefix slots of Athabaskan. However, while the Bantu verb does not show the same degree of complexity as the Athabaskan verb, it shows a number of interesting morphosyntactic and phonological characteristics which makes it a reasonable testing ground for the Strong Linearity Domain Hypothesis. Within the general scope of this work, my intention is for the Bantu case study to strike a balance between complexity and simplicity where it is complex enough to clearly illustrate how we can apply the Strong Linearity Domain Hypothesis to a morphosyntactic template but not so complex that it fails to serve as a good general example.

The particular template I will be focusing on comes out of work done by Larry Hyman,

culminating in Hyman (2003a), on the order of derivational suffixes marking the verb stem. However, this work is not the first to propose that there is a template in the Bantu verb. Stump (1992, 1993), has argued that some of the inflectional material found on the Bantu verb should be described as being within a position-class system (this material is not of the argument-structure changing type which is the focus of the present case study).

In particular, Stump is interested in things like the order of the bolded morphemes in the verb form in (52), which are from Swahili.

(52) ***tu-li-wa-on-a***
 1p-PST-2p-see-FV
 “We saw you.”

(Ashton 1947:42)

The verb in (52) shows a prefix order of subject marker, tense marker, and object marker before the verb stem. This basic prefix order can be found throughout Bantu. Stump (1993) presents arguments for a position-class analysis of the prefix order found in verb forms like the one in (52), as well as for other inflectional affixes found on the Bantu verb, and he also gives a detailed formalization of his analysis. Because of this, his work can be understood a strong argument for a position-class approach to Bantu inflectional affixes. However, alternative analyses of some of the same basic facts exist which treat the ordering of these affixes as, at least partially, determined by syntactic considerations. Barrett-Keach (1986), for example, argues that some of the Swahili verb prefixes are syntactically independent from the stem. Such an argument is obviously incompatible with treating all of the verbal prefixes in the language as being realized in morphological position classes. Myers (1987:32–49) makes similar arguments for Shona, another Bantu language.

In large part, these differing treatments fall out from fundamentally different approaches to the problem. Stump (1992, 1993) seems to work under the assumption that the Bantu verb is a purely morphological construct and, as such, requires a purely morphological analysis. Stump (1993), in particular, is especially considered with the paradigmatic aspects of the Bantu verb, as opposed to its syntagmatic aspects. Barrett-Keach (1986) and Myers (1987), on the other hand, work within models where the Bantu verb need not necessarily be treated as a single syntactic constituent and, thereby, utilize non-morphological tools to explain its form. In this way, they anticipate some of the ideas found in Baker (1988) which will be discussed in detail below.

These differing approaches lead us to a similar problem for a templatic treatment of Bantu inflectional prefixes as one noted for Athabaskan above—it is not clear what the templatic residue is of the relevant constructions, if, in fact, there is any at all. And, without knowing this, it is impossible to determine the properties of any strong linearity domains which might be found within them. As with the Athabaskan case, I leave open the question as to whether or not the Bantu inflectional prefixes are truly templatic in their ordering.

With respect to whether or not the Bantu verb shows any phonological properties which could be relevant to a templatic account of the ordering of inflectional affixes, we will see in section 2.7 (page 229) below that there have been proposals treating the inflectional prefix material as prosodically separate from the verb stem. In addition to this, with specific reference to the Swahili verb, Barrett-Keach (1986:562–3) points out that it shows a multi-layered phonological structure which appears comparable to that seen of the disjunct-

conjunct structure seen for the Athabaskan verb in (51) above. This suggests that, if the prefixal material of the Bantu verb is ultimately determined to contain a strong linearity domain, its phonological structure may be sufficiently complex to allow any strong linearity restrictions within it to be consistent with the Strong Linearity Domain Hypothesis.

Having gone over some relevant background of morphosyntactic templates in this section, we can move onto the case study of causativization and applicativization in Bantu. As mentioned above, an important role of this case study within the present work is to exemplify how the Strong Linearity Domain Hypothesis can be applied to a templatic construction in a morphosyntactically complex form.

2.1 INTRODUCTION TO BANTU CASE STUDY

2.1.1 Causativization and applicativization in Bantu

The focus of this chapter is on the morphophonology and morphosyntax of causativization and applicativization in Bantu, with an emphasis on the templatic effects found in the morphological exponents of these two processes. In Bantu languages, causativization and applicativization are typically marked by particular verbal suffixes, most of which are members of a class given the traditional label *extensions*. The Bantu linguistic tradition generally recognizes a number of these extensions, some examples being the causative, the applicative, the reciprocal, the passive, and the stative. While the extensions are primarily defined by their morphological properties, most of them share the common syntactic property that they alter the argument structure of the verb which they are suffixed to.

The data in this chapter comes from a wide variety of published and unpublished

sources. As a result, it can take on very different forms—from fully tone-marked sentences to only verb stems. As a general rule, the examples here follow whatever was given in the published sources, in some cases with minor alterations were made in the interests of expositional clarity. The glossing abbreviations used for the Bantu examples in this chapter as follows:

VERBS		OTHER	
APP	applicative	1...12	noun class
CAUS	(long) causative	1s,2s,3s	singular person
TRANS	transitive (a.k.a. short causative)	1p,2p,3p	plural person
FV	final vowel	SUBJ	subject
PERF	perfect	OBJ	object
PST	past	INS	instrumental
TNS	tense		
REC	reciprocal		
PASS	passive		

In (54) and (53), basic examples are given illustrating the nature of causativization and applicativization in Bantu. These examples come from Chichewa.¹

(53) CHICHEWA (N.31b) (Baker 1988:10)

a. *Mtsuko u-na-gw-a.*
3.waterpot 3-PST-FALL-FV
“The waterpot fell.”

b. *Mtsikana u-na-gw-ets-a mtsuko.*
1.girl 3-PST-FALL-CAUS-FV 3.waterpot
“The girl made the waterpot fall.”

(54) CHICHEWA (N.31b) (Alsina and Mchombo 1993:18)

a. *Chitsîru chi-na-gúl-á mphátso.*
7.fool 7S-PST-buy-FV 9.gift
“The fool bought a gift.”

¹ Following convention, I give the Guthrie numbers (Guthrie 1948) which are customarily used designations for Bantu languages.

- b. *Chitsîru chi-na-gúl-ír-á atsíkána mphátso.*
 7.fool 7S-PST-buy-APP-FV 2.girls 9.gift
 “The fool bought a gift for the girls.”

The sentences in (53) give a basic example of causativization marked with the causative extension. The verb *-gw-* ‘fall’ is intransitive, as seen in (53a). When the causative extension is added to it forming the stem *-gwets-*, the verb becomes transitive and takes on causative semantics. The syntactic and semantic effects of causativization are discussed in more depth in section 2.3 (page 127). An important fact discussed in that section is the existence of a second suffix found in some Bantu languages giving causative semantics to verbs which will be given the label *transitive*—an example of the transitive will be seen below in (57).

The sentence in (54b) illustrates one of the more common types of applicativization found in Bantu. A verb based on the stem *-gul-* ‘buy’ takes only one non-oblique object, as seen in (54a). When the applicative extension is added to that verb, forming the stem *-gulir-*, as seen in (54b), the verb takes an extra non-oblique argument. The syntactic and semantic effects of the applicative are discussed in more depth in section 2.2 (page 126).

The basic examples in (53) and (54) actually mask quite a bit of complexity in the morphophonology and morphosyntax of these two Bantu extensions and of causativization and applicativization generally. The primary area of interest of this chapter will be the varied interactions among the morphological exponents of applicativization and causativization when they appear on the same verb.

The sentences in (55) and (56) give some sense of the sort of issues that can arise.

The data in (55) shows that in Ndebele the causative and the applicative can only occur in the order causative-applicative—the other order is ungrammatical. In the sentences in (56) from the Korekore dialect of Shona, on the other hand, we see that this language does allow the order applicative-causative, as well as causative-applicative. However, the use of the applicative-causative order is fairly restricted, occurring “mostly in possessively inflected infinitive inflections” (Dembetembe 1987:78).

(55) NDEBELE (S.44) (Sibanda 2000:18)

a. *-sik-is-el-*
cut-CAUS-APP
'W make X cut Y for Z'

b.**-sik-el-is-*
cut-APP-CAUS
'W make X for Y cut Z'

(56) KOREKORE (S.11) (Dembetembe 1987:79–83)

a. *Hón-a, wa-ndí-tem-es-er-a mbúdzí chíjá*
see-FV 2S-1S-cut-CAUS-APP-FV 9.goat 7.thigh
“Look, you were responsible for the cut my goat got in its thigh.”

b. *Tém-a mazání e-kú-sos-er-es-a nzira iyi*
cut-FV 6.branch 6-INF-block-APP-CAUS-FV 9.path 9.this
“Cut branches with which to block this path.”

Ndebele represents one logical type of language insofar as it allows only the order causative-applicative. Korekore represents another type, allowing both orders. Significantly, a language allowing only applicative-causative order is unattested, to the best of my knowledge. As we shall see, there does not appear to be a straightforward explanation to account for possible orders of the causative and applicative, and the restrictions appear to be templatic.

An further complication with respect to causativization and applicativization in Bantu is that, in some languages, like Kinande, a suffix sometimes referred to as the “short causative” but which here will be labelled the transitive, is sometimes used to mark causativization. This suffix is etymologically distinct from the causative suffix seen in an example like (53), but, in many languages, it has taken on the same basic meaning as the causative. Unlike the causative, the transitive generally appears *after* the applicative when the two suffixes are combined. The data in (57) illustrates this.

(57) KINANDE (D.42)

(Hyman 2001:9)

STEM	GLOSS
<i>-tsap-</i>	‘get wet (intr.)’
<i>-tsap-ĩ</i>	‘wet-TRANS’
<i>-tsap-ir-ĩ</i>	‘wet-APP-TRANS’

These examples illustrate that understanding the nature of the morphological exponence of causativization and applicativization in Bantu goes beyond an examination of basic cases like (53) and (54).

As mentioned above, there are a wide range of verbal suffixes in Bantu and, as we shall see below, these are not the only suffixes described as exhibiting templatic behavior. The suffixes marking causativization and applicativization have been singled out here for various reasons. The first is simply practical. Working out the morphophonological and morphosyntactic details of the behavior of just two of these processes is a large enough task that it was considered worthwhile not to attempt to work out an analysis of the behavior of more than two of them.

Given that general restriction, causativization was chosen since it shows interesting

morphological properties in many Bantu languages and since it has been, both in Bantu and cross-linguistically, the subject of extensive work attempting to explain the relationship between the morphology and syntax of the process. This latter fact will be important in illustrating how the general approach to linear relations espoused here is better-equipped to deal with the full range of facts found in Bantu than previous approaches.

Applicativization was chosen for similar reasons. It also shows interesting morphological properties within Bantu, and a great deal of work has been done on its morphosyntactic properties cross-linguistically. Furthermore, the nature of the semantics of causativization and applicativization allows there to be a potentially rich interaction between them, allowing for more hypotheses to be examined than if, for example, causativization and reciprocalization were chosen. This is because applicativization and causativization are both valence-increasing processes, where the other suffixes found on the Bantu verb, more or less, mark valence decreasing operations.

Before moving further into the discussion some remarks on terminology are in order. I will use the terms *causativization* and *applicativization* to refer to abstract sets of morphological strategies which encode the particular semantics associated with those terms. I will restrict my use of the terms *causative*, *applicative*, and *transitive* to refer to the various etymological reflexes of three particular suffixes reconstructed for Proto-Bantu which have important roles in causativization and applicativization. This distinction is necessary since it will allow us to refer to these suffixes with common labels even if they show importantly different behavior in the various Bantu daughter languages.

2.1.2 The role of this case study in the general analysis

Of the case studies to be presented in this work, the Bantu verb stem is being examined first for two reasons. First, in terms of linearity, this is the smallest of three domains which will be studied—the other two being the verb phrase (in Chechen) and multiple verb phrases (in Saramaccan). Second, though some Bantu data will be presented here which has not yet been thoroughly examined in the theoretical literature, this is the only one of the case studies where the basic data has already featured in the theoretical literature, making it easier to show how the current approach to linearity compares with previous approaches.

Of the three case studies presented here, this study is the only one which is comparative. This study, therefore, is meant to be an illustration of how the Strong Linearity Domain Hypothesis can be used to account for templatic behavior found in a whole family—thus, in some ways, this case study can serve as a model for how one might want to deal with the much more complicated family-level template found in Athabaskan. The comparative nature of this case study means that it will be the longest of the three.

2.1.3 The structure of the analysis

The discussion to follow will be divided into several parts. First, in section 2.2 (page 126) the properties of applicativization will be discussed in more detail, and in section 2.3 (page 127) the properties of causativization in Bantu will be discussed in more detail.²

In section 2.4 (page 131), the Proto-Bantu verb stem will be discussed. This discussion

² This case study is focused more on the morphology than the syntax of the causativization and applicativization. Baker (1988) gives what is probably the most detailed syntactic discussion of these processes in Bantu. Discussion in this area can also be found in Pytkäinen (2002).

will help frame the data to be presented which will come from a range of languages all of which take Proto-Bantu as their starting point. Section 2.5 (142) will summarize the findings of a survey of thirty languages as to how verbal suffixes marking causativization and applicativization are ordered with respect to each other. Section 2.6 (page 181) will discuss some previous analyses of the behavior of these two processes with a focus on how it would be difficult for them to accommodate a wider range of Bantu data than they were able to consider. Section 2.7 (page 229) will analyze the Bantu data with respect to the Strong Linearity Domain Hypothesis. Finally, section 2.8 (page 273) will include some concluding remarks on causativization and applicativization in Bantu and serve to link this case study to the other two.

It will be useful here to summarize the general nature of the argument which will be presented in the chapter. On a descriptive level, I will follow Hyman (2003a) in arguing for the existence of a template in the Bantu verb which accounts for a strong tendency for the three suffixes to be discussed here, the causative, applicative, and transitive, to appear in that order—which I will typically abbreviate as CAT. While the facts are somewhat more complicated than the basic CAT-template implies, that restriction is the most important one.

On a theoretical level, I will then discuss how approaches which try to account for affix order via a mechanism where affix order is transparently related to semantic scope fail to account for the full range of Bantu facts. These approaches, which I will generally refer to as “Mirror Principle” approaches (see Baker (1985:4)), take as their basic assumption that affixes with more narrow scope will appear in linear order closer to a root than affixes with

a less narrow scope.³

The Bantu verbal suffixes have generally been held to follow the Mirror Principle and, in fact, have been taken to be parade examples of Mirror Principle effects (Baker (1988), Alsina (1999), Pytkänen (2002)). This means that the data presented here does not only present evidence for templates in its basic descriptive content, but it also “removes” the Bantu verb stem from its original position of offering strong support to Mirror Principle approaches. Within the terminology developed here, the primary reason to go through these previous analyses is to show how analyses assuming that the Bantu verb constitutes a weak linearity domain are insufficient to analyze the full range of data found in Bantu. This implies that the Bantu verb stem is a strong linearity domain and should, therefore, be consistent with the Strong Linearity Domain Hypothesis.

At the end of chapter, I will discuss how the Bantu data relates to the Strong Linearity Domain Hypothesis. This will involve a discussion of the phonology of the Bantu verb stem, which, importantly, has been argued to be a prosodic unit (Downing 1999). This discussion will serve to map out the “characteristic phonology” of the Bantu stem, which is central to the Strong Linearity Domain Hypothesis, and I will then relate this phonology to the CAT-template of the Bantu verbal stem, arguing that it is “consistent” with that phonology.

³ Baker’s particular formulation of the Mirror Principle is, “Morphological derivations must directly reflect syntactic derivations (and vice versa) (Baker 1985:4).” While this is a syntactic definition, other authors, like Hyman (2003a), have understood the Mirror Principle to as a statement about the relationship between morphological exponence and semantic scope. This is presumable because, in the syntactic framework Baker adopts, many aspects of syntax and semantics, including scopal relations, are conflated making a semantically oriented statement of the Mirror Principle trivially different from Baker’s syntactic formulation.

An important aspect of the analysis to be presented here, which will have analogs in the two other case studies, relates to the idea of templatic residue discussed in section 1.5.4 (page 104). Specifically, in analyzing the templatic properties of the Bantu verb stem, we will be forced to describe the form of the template itself in a very restricted way in order to establish that it is consistent with the Strong Linearity Domain Hypothesis. This will have the consequence that the Strong Linearity Domain Hypothesis on its own will not be able to explain all aspects of the template.

I do not view this as a weakness of the model developed here. Rather, it falls out from one of its strengths: The Strong Linearity Domain Hypothesis forces us to be very specific about the form of any proposed template. However, this will mean that it will sometimes be necessary to develop auxiliary explanations for aspects of any templatic construction which fall outside of the explanatory ability of the Strong Linearity Domain Hypothesis.

In the Bantu case specifically, I will argue that the Strong Linearity Domain Hypothesis can properly explain why the Bantu verb stem is a candidate for showing templatic phenomena of the sort that it does, and why, given a templatic relationship between the causative, applicative, and transitive suffixes in Bantu, the transitive should be final in a relative-order template. However, we will need to invoke a separate explanation to explain why a CAT, but not an ACT, template is found. I will sketch out an auxiliary explanation for this aspect of the template in section 2.7.5 (page 262).

2.2 APPLICATIVIZATION

In his discussion of Bantu applicativization, Peterson (1999:120) characterizes the original use of the Bantu applicative as follows, “[I]t made intransitive verbs transitive and transitive verbs ‘supertransitive’ in that they had two direct objects.” The transitivizing function of applicativization is very different from that of causativization, however. Applicatives add “object” arguments to verbs whereas causatives add “subject” arguments. One of the more interesting features of Bantu applicativizes is the range of semantic functions that these objects can take on. The following sentences, taken from Kichaga, illustrate uses of the applicative which promote noun phrases to direct objects which fill the following with the following roles: beneficiary/maleficiary (58a), instrumental (58b), locative (58c), and cause (58d). In addition, sentence (59), from Chichewa, shows the applicative being used in a possessor-raising construction.

(58) KICHAGA (E.62) (Bresnan and Moshi 1993:49)

- a. *N-ǎ-í-lyì-í-à* *m̀kà* *kélyà*.
 FOC-3S-PR-eat-APP-FV **1.wife** 7.food
 “He is eating food for/on (his) **wife**.”
- b. *N-ǎ-í-lyì-í-à* *m̀awòkó* *kélyà*.
 FOC-3S-PR-eat-APP-FV **6.hand** 7.food
 “He is eating food with **his hands**.”
- c. *N-ǎ-í-lyì-í-à* *m̀r̀nyì* *kélyà*.
 FOC-3S-PR-eat-APP-FV **7.homestead**.LOC 7.food
 “He is eating food at **the homestead**.”
- d. *N-ǎ-í-lyì-í-à* *nj́áá* *kélyà*.
 FOC-3S-PR-eat-APP-FV **9.hunger** 7.food
 “He is eating food because of **hunger**.”

(59) CHICHEWA (N.31b)

(Baker 1988:271)

Fisi a-na-dy-er-a kalulu nsomba.

1.hyena 1-PST-eat-APP-FV 1.hare 9.fish

“The hyena ate the **hare**’s fish.”

The bolded words in (58) and (59) are the applied objects which have been “promoted” to act as direct objects of their governing verb. Among other things, one of the indications that they are acting as direct objects is their immediate postverbal position.⁴

Of course, not every Bantu language has the full range of uses of the applicative. Furthermore, it is well-documented that the syntax of applied objects can be significantly different from that of “natural” objects. (See Peterson (1999:117–124) for some discussion from a diachronic and synchronic perspective.)

From a morphological perspective, the marking of applicativization is usually fairly straightforward, either *-il-* or *-ir-* (from Proto-Bantu **-id-*). Although, in some cases, especially in combination with causativization, the suffix associated with applicativization appears to be etymologically from a reduplicated applicative suffix.

2.3 CAUSATIVIZATION

The uses of causativization in Bantu are rather less exotic than those of the applicative. It typically adds standard causative semantics to the verb which, among other things, includes adding an causer subject argument to the verb.⁵ The subject of the non-causativized version of the verb then becomes realized as an object. (More rarely, in some languages

⁴ Possessed nouns generally precede their possessor and are marked with a preposition (in a construction analogous to English *X of Y*), making the sentence in (59) a clear example of applicativization of a possessive.

⁵ For further discussion of the syntax and semantics of causativization, see Shibatani (1976), a collection of articles, two of which, Cooper (1976) and Givón (1976), focus specifically on Bantu. For more recent discussion, see Shibatani (2002).

(e.g., Kinyarwanda (Kimenyi 1980)) the causative is also observed to promote instruments to objects or to introduce an instrument, much like an applicative.) An example from Chichewa, repeated from (53), is given in (60). The sentence in (60a) contains a non-causativized verb and the one in (60a) contains its causativized variant.

- (60) CHICHEWA (N.31b) (Baker 1988:10)
- a. *Mtsuko u-na-gw-a.*
 3.waterpot 3-PST-FALL-FV
 “The waterpot fell.”
- b. *Mtsikana u-na-gw-ets-a mtsuko.*
 1.girl 3-PST-FALL-CAUS-FV 3.waterpot
 “The girl made the waterpot fall.”

Some of the Bantu languages formally distinguish direct and indirect causativization, as can be seen in (61). The paradigm in (61a) illustrates this for Nkore, and the one in (61b) illustrates it for Nyoro. The first causativized verb in each paradigm is marked with the transitive suffix and conveys a type of causative semantics where in the causer of an action is also the agent of that action—hence, it marks direct causativization. The second causativized verb in each paradigm is marked with the causative extension and conveys a type of causative semantics where the causer of an action is not necessarily the agent of that action—hence, it marks indirect causativization. In these languages, the causative extension has the additional effect of giving the verb root a transitive interpretation, similar to the interpretation of the verb root when it is suffixed with the transitive.

(61) a. NKORE (J.31)

(Bastin 1986:116)

STEM	GLOSS	TRANSLATION
<i>-ham-a</i>	'be_assured-FV'	'be assured'
<i>-ham-y-a</i>	'be_assured-TRANS-FV'	'confirm'
<i>-ham-is-a</i>	'be_assured-CAUS-FV'	'make confirm'

b. NYORO (J.11)

(Bastin 1986:116)

STEM	GLOSS	TRANSLATION
<i>-og-a</i>	'bathe-FV'	'bathe'
<i>-og-y-a</i>	'bathe-TRANS-FV'	'wash'
<i>-og-is-a</i>	'bathe-CAUS-FV'	'make wash'

Languages making the overt morphological distinction seen in (61) do not appear to be very common. The more common case is for a language to show no productive formal marking for the semantic distinction between direct and indirect causativization. Multiple morphological markers of causativization, derived respectively from the causative extension **-ic-*, the transitive suffix **-j-*, or some combination of the two, are common both across the Bantu languages and within particular languages. However, when a language shows different productive morphological markers of causativization, they typically do not correlate with different semantics and are probably best considered allomorphs of each other.

In one commonly found pattern, the exponent of causativization for some verbs is the simultaneous appearance of both the causative and the transitive in that order—that is, of the combination **-ic-j-* (as will be discussed in section 2.4 (page 131)) the transitive shows a very strong tendency to appear after the causative across Bantu and the cooccurrence of the transitive with the causative has been reconstructed for Proto-Bantu). Languages marking causativization this way often show interesting morphological behavior when verbs are

marked simultaneously for applicativization and causativization wherein the applicative can intervene between the causative and the transitive.

As mentioned in section 2.1 (page 116), there is a strong tendency in Bantu towards a causative-applicative-transitive (CAT) template. In some languages, innovations in the marking of causativization have taken place, making it hard to see clear traces of an original **-ic-i-* as marking causativization. However, reflexes of this original construction becomes apparent when the verb is marked for causativization and applicativization. This is illustrated in (62) from Mwera, a language mutually intelligible with Ciyao.

(62) MWERA (P.22) (Harries 1950:68)

a. Applicative only

STEM	GLOSS	APP	GLOSS
<i>-am-</i>	'move_away'	<i>-am-il-</i>	'move_away-APP'
<i>-ugul-</i>	'unfasten'	<i>-ugul-il-</i>	'unfasten-APP'
<i>-tend-</i>	'do'	<i>-tend-el-</i>	'do-APP'

b. Applicative and causative

CAUS	GLOSS	CAUS-APP	GLOSS
<i>-gwi-y-</i>	'fall-CAUS'	<i>-gwi-c-iy-</i>	'fall-CAUS-APP'
<i>-jogo-y-</i>	'be_afraid-CAUS'	<i>-jogo-c-ey-</i>	'be_afraid-CAUS-APP'
<i>-gumba-y-</i>	'be_full-CAUSE'	<i>-gumba-c-iy-</i>	'be_full-CAUSE-APP'

The data in (62a) shows that the general form of the applicative in Mwera is *-il-*.⁶ However, in the verbs marked for causativization and applicativization in (62b), the applicative has the shape *-iy-*. Note also that, in this context, the causative ending shifts from *-y-* to *-c-*.⁷

This alternation can be straightforwardly explained if we assume that Mwera verbs marked for causativization and applicativization show an ending etymologically derived from the

⁶ It is common to find vowel harmony processes in Bantu wherein *i* alternates with *e* in various phonological contexts. An *i* will be used throughout as the citation form of such a vowel.

⁷ The causatives in (62) though all having the synchronic shape *y* likely represent several distinct etymologies.

Proto-Bantu sequence **-ic-id-j-* ‘CAUS-APP-TRANS’. The etymological **-j-* would have triggered palatalization, perhaps more than once during the history of Mwera, of a consonant immediately preceding it, accounting for the present pattern.⁸ Alternations of the type seen in (62) involving applicativization and causativization are quite common and give important evidence that the transitive suffix historically was restricted to a position after the extensions.

The example in (62) illustrates a further general complication of the morphological reflexes of causativization. The fact that the transitive historically consisted of a super-high *j* has resulted in its reflexes often being not any particular segment but, instead, palatalization of a segment. This fact can be implicated in many interesting developments in the morphological exponence of causativization and applicativization in Bantu. It will be further discussed in section 2.4 (page 131).

2.4 PROTO-BANTU

2.4.1 The structure of the Proto-Bantu verb stem

The first step in situating the present work within a general analysis of causative, applicative, and transitive ordering restrictions in Bantu is to examine the status of these suffixes in Proto-Bantu. Adapting the ideas in Meeussen (1967) and Hyman (2001) as well as con-

⁸ I do not have any direct evidence of this palatalization in Mwera. However, in Ciyao, which is mutually intelligible with Mwera, there is a comparable alternation which provides us with some evidence for this sound change. Ngunga (2000:153) reports that *l* alternates with *s* before etymological transitive *-j-*, which surfaces as a *y* after *s*. Furthermore, Ciyao (Ngunga 2000:235) shows a similar alternation where a *c* appears on verbs marked for applicativization and causativization when it is not found on verbs marked only for causativization. Mwera and Ciyao, thus, seem to be very similar except that in Mwera the palatalization has gone one step further resulting in *y* where Ciyao shows *sy*.

tributing some new ones, I propose the structure in (63) for the Proto-Bantu verb stem. In addition to the stem, Bantu verbs are typically marked by a number of prefixes marking subject agreement, pronominal objects, and a range of tense, mood, and aspect markers. There are some other suffixes commonly found in Bantu, not given here since they do not figure prominently in the analysis. One of these, the perfective marker *-jde-*, will appear in some examples.⁹

(63)

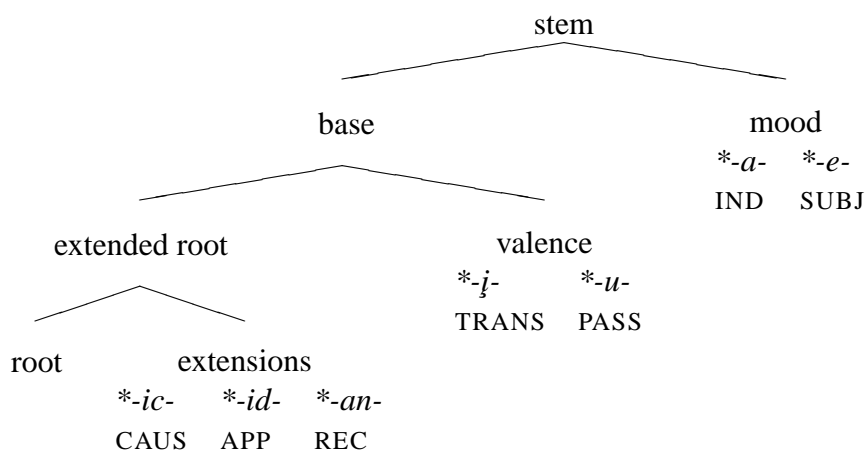

As the tree (63) indicates, the Proto-Bantu verb stem structure, consisted of a verb root potentially followed by a number of suffixes. Of the layers of suffixal structure in (63), only one, the mood marker, is obligatory. The mood vowel is typically referred to as the *final vowel* in Bantu description, and since it plays no crucial role in the data to be presented here, it will simply be glossed FV. The three -VC- suffixes given in (63) which come immediately after the root are traditionally referred to as *extensions*, a term which I make use of here.¹⁰ As mentioned above, the suffixes which are the primary concern of this paper

⁹ If we were to put *-jde-* into the tree in (63) it would follow the extensions and precede the valence markers.

¹⁰ There are other reconstructed extensions not given in the tree in (63) but which would belong in the same

are the causative extension **-ic-*, the applicative extension **-id-*, and the transitive suffix **-j-*.¹¹ The symbol *j* represents a front unrounded vowel higher than *i*. The exact quality of *i* and *j* in Proto-Bantu is not well-established. However, it is generally agreed upon that there were two degrees of front and back high vowels in Proto-Bantu.

The tree in (63) makes a distinction between “extensions” and “valence” markers which departs from traditional descriptions. However, this extra level of structure encodes an idea first mentioned by Meeussen (1967) that the two suffixes which I have labelled “valence” were obligatorily positioned after all other extensions in Proto-Bantu. Furthermore, considering these two suffixes to be valence markers is in line with a suggestion in Hyman (2001) that they were originally part of a voice marking system.¹² I should make it clear, in this context, that the sense in which I use the label *transitive* for the suffix with the form *-j-* is a sense where it is taken to transitivize an inherently intransitive verb rather than one where it is taken to mark all transitive verbs.

A final note about the tree in (63) is that the order given for the extensions and the valence markers was, almost certainly, the most natural for Proto-Bantu given what we find in the daughter languages. In section 2.4.3 (page 138), I will go into more detail on the nature of Proto-Bantu ordering restrictions for the causative and applicative extensions—

position as the others, for example the *-ik-* stative extension. Furthermore, there are some extensions found throughout Bantu which appear to be less than fully productive in Proto-Bantu, like the reversives *-uk-* and *-ud-*. Meeussen (1967:92) offers relevant discussion. It is not clear where these would belong in the tree. They could have their own position before the productive extensions or be grouped directly with those extensions.

¹¹ There is some debate as to whether or not the initial vowel of the causative extension is *i* or *j* (see Bastin (1986:89–90)). Here, I follow of Guthrie (1970:219) in writing the proto-form as **-ic-*.

¹² Further evidence for grouping these two suffixes together separately from the other extensions is that their phonological shape is simply *-V-* whereas all other extensions (including ones not described here) are of shape *-VC-*.

which I reconstruct as being fixed in causative-applicative order. However, whether or not the analysis of their being fixed in Proto-Bantu is completely correct, it is almost certain that there was some aspect of the proto language which favored causative-applicative order over applicative-causative order. Towards the end of this chapter in, section 2.7.5 (page 262), I will discuss some cross-linguistic data which is consistent with this fact—that is, it appears to be the case that the preference for this order in Proto-Bantu is, in one way or another, a reflex of a more general typological fact.

The transitive suffix, by virtue of being a valence marker, is taken to be necessarily ordered as occurring after the extensions in Proto-Bantu. I consider reconstructing this latter ordering restriction to be uncontroversial since no one appears to have taken issue with since it was first suggested by Meeussen (1967:92) in a very well-known article. The only novel aspect of my reconstruction is explicitly distinguishing between extensions and valence markers in a structural way. Finally, the relative order of the transitive and the passive, when they cooccur is as indicated in the tree—transitive-passive. This has been analyzed as a strict restriction in Proto-Bantu (Meeussen 1967:92).

In the following two sections, the Proto-Bantu transitive suffix **-j-*, causative suffix **-ic-*, and the applicative suffix **-id-* will be discussed in more detail since each will be central to the later discussion. Throughout the paper, the labels in (63) will be used to refer to the reflexes of the suffixes in the Bantu daughter languages—even when the semantics of the suffixes may have shifted.

2.4.2 The transitive suffix **-j-*

Whatever the precise story is behind the split between the extensions and the valence markers, some of the details of the transitive marker **-j-* will be very important in the analysis to be given. So, it will be important to describe its behavior, particularly with respect to how it interacts with the causative suffix **-ic-*.¹³

First, the phonological reflexes of **-j-* are typically *-y-* or some sort of phonological process affecting the consonant which **-j-* is reconstructed as directly following. The data in (64) from Kinyamwezi shows both reflexes occurring in the same language.

- (64) KINYAMWEZI (F.22) (Maganga and Schadeberg 1992:151–2)
- a. *kʊ-fuup-a* → *kʊ-fuup-y-a*
 INF-sprinkle-FV INF-sprinkle-TRANS-FV
- b. *koo-g-á* → *koo-j-á*
 INF-bathe-FV INF-bathe-TRANS-FV

In (64a), the labial-final stem is suffixed with a *y* to produce a causativized form. In (64b), the velar-final stem is palatalized to mark for causativization—there is no overt segmental reflex of **-j-*. This reflex of **-j-* is predictable in Kinyamwezi, and it is not uncommon for there to be no productive reflex **-j-* in a language. Importantly, in some of the Bantu languages, the reflex of **-j-* has lost its restrictive final positioning and can be followed by verbal extensions as the example in (65) from the Korekore dialect of Shona shows.

¹³ In fact, the uses of the reflexives of **-ic-* and **-j-* in the various Bantu languages have such great overlap that they are often both taken to synchronically be variants of each other. See Bastin (1986) for the most extensive discussion available of the causative extension and transitive suffix across the Bantu languages.

(65) KOREKORE (S.11)

(Dembetembe 1987:80)

Ndi-sákusúmúts-ír-a zvinhu zvakó.
 1.S.rise.TRANS-APP-FV 8.THING 8.your
 “I shall lift up your things for you.”

The extended root *-samuts-* ‘raise’ is the causative of *-samuk-*. Most languages with a productive reflex of the transitive, however, maintain strong final-positioning restriction for the transitive suffix **-j-*, as will be discussed in section 2.5 (page 142). Examples of verbs marked with an etymological transitive by followed by other extensions, like *-samuts-* seen in (65), have only been observed to occur in cases which can straightforwardly be analyzed as involving the transitive suffix having been lexicalized on to a particular reconstructible verb stem—a phenomenon will be discussed in more detail in section 2.5.2 (page 150).

As mentioned above, the occurrence of the transitive **-j-* in Proto-Bantu does not seem to have been quite as simple as the name I have given it suggests. First, it could not appear directly suffixed to a CV verbs (Bastin 1986:130), which are reconstructed for Proto-Bantu. Rather, such verbs had to be extended in some way, before appearing with the transitive suffix. Such a requirement would have allowed roots marked with the causative to more closely conform to the typical *-CVC-* pattern for roots reconstructed for Bantu (this fact about the root in Bantu be discussed in detail in section 2.7.3.2 (page 235)).

Second, it did not simply appear on all transitive verbs. Rather, it seemed to have a transitivizing function and turned inherently intransitive verbs into transitive ones. Because of the inherent overlap in transitivizing and causativizing semantics, it is easiest to see difference between transitive **-j-* and causative **-ic-* by looking at languages which employ both to mark different semantics. Bastin (1986), reconstructs the transitive **-j-* as a marker

of direct causation and **-ic-* as a marker indirect causation. He gives examples from Nkore and Nyoro, seen in (66), repeated from (61).

(66) a. NKORE (J.31) (Bastin 1986:116)

STEM	GLOSS	TRANSLATION
<i>-ham-a</i>	'be_assured-FV'	'be assured'
<i>-ham-y-a</i>	'be_assured-TRANS-FV'	'confirm'
<i>-ham-is-a</i>	'be_assured-CAUS-FV'	'make confirm'

b. NYORO (J.11) (Bastin 1986:116)

STEM	GLOSS	TRANSLATION
<i>-og-a</i>	'bathe-FV'	'bathe'
<i>-og-y-a</i>	'bathe-TRANS-FV'	'wash'
<i>-og-is-a</i>	'bathe-CAUS-FV'	'make wash'

As mentioned above, the first causativized verb in each of paradigms given in (66) is marked with the transitive suffix and conveys a type of causative semantics where in the causer of an action is also the agent of that action—hence, it marks direct causativization. The second causativized verb in each paradigm is marked with the causative extension and conveys a type of causative semantics where the causer of an action is not necessarily the agent of that action—hence, it marks indirect causativization. In addition, the causative extension in these languages has the additional effect of giving the verb root a transitive interpretation instead of its default intransitive interpretation.

Another relevant fact about transitive **-j-* is that there is good evidence that it obligatorily marked any verb which contained a causative extension in Proto-Bantu (see Bastin (1986)). Because of this, in some languages, it is probably the case that what is described here as a synchronic causative extension is diachronically a fusion of the causative and the transitive—the evidence to discern between an etymological causative versus a fusion of

the causative and the transitive is generally not available.

However, in some languages, in what might otherwise appear to be a single causative suffix, a fusion between the causative and the transitive can be “undone” in the right morphological contexts, as briefly discussed in section 2.3 (page 127). The examples in (67) show this as well. In these examples, when the reciprocal extension appears in the Kinande verb, it intervenes between the causative and the transitive—thus, clearly showing that there are two distinct suffixes marking causativization in Kinande.

(67) KINANDE (D.42) (Hyman 1993:13)

a.	STEM	GLOSS
	<i>-h_ym-</i>	‘move (intr.)’
	<i>-h_ym-is-<i>j</i>-</i>	‘move-CAUS-TRANS’
	<i>-h_ym-is-an-<i>j</i>-</i>	‘move-CAUS-REC-TRANS’
b.	STEM	GLOSS
	<i>-lim-</i>	‘cultivate (intr.)’
	<i>-lim-is-<i>j</i>-</i>	‘cultivate-CAUS-TRANS’
	<i>-lim-is-an-<i>j</i>-</i>	‘cultivate-CAUS-REC-TRANS’

Finally, as discussed above in section 2.3 (page 127), in most Bantu languages, any semantic distinction which was found in Proto-Bantu between the causative extension and the transitive suffix has been lost—either because a given language only has one causative/transitivizing suffix or simply because the semantics of the two suffixes have effectively merged.

2.4.3 The causative extension **-ic-* and the applicative extension **-id-*

The reflexes of the causative extension and the applicative extension in the Bantu daughter languages, are generally more straightforward than those of the transitive. The causative

typically has a reflex of the form *-is-*, *-its-*, or *-ish-* (or something very similar). And the reflex of the applicative is typically *-il-* or *-ir-*. However, there are some complications worth noting.

First, we saw above in section 2.4.2 (page 135) how the causative extension **-ic-* contrasts with the transitive suffix. It was also mentioned that it often fuses with the transitive suffix **-j-*. This means that it is not always possible to straightforwardly tell when a causative suffix of the form *-VC-* is a reflex of simply the causative of the causative plus the transitive suffix (except in those cases when such fusion can be “undone” as exemplified in (67)).

Outside of the sort of alternation seen in (62), the applicative extension **-id-* shows an additional relevant historical complication. As seen below, in examples like (68) from Luvale, the applicative can be reduplicated in many Bantu languages. In an interesting set of cases, a frozen reduplicated applicative has become obligatory in several languages. In some cases, multiple applicative suffixes are reported as introducing multiple applicativized arguments (see, e.g., Bentley (1967:631)), while in the case of Luvale, multiple suffixes do not add multiple arguments but, instead, add only one.

- (68) LUVALE (K.21) (Horton 1949:94)
- a. *Kuze ngw-a-semuw-il-il-ile*
 there 1s-PERF-be_born-APP-APP-PERF
 “there where I was born”
 - b. *Haze a-y-il-il-il-ile*
 that 3s-go-APP-APP-APP-PERF
 “that whereon he went”

2.4.4 Causative and applicative ordering restrictions in Proto-Bantu

A final and important issue which needs to be addressed regarding Proto-Bantu is what ordering restrictions, if any, can be reconstructed between the applicative and the causative extensions. (Recall, from above, that the transitive is reconstructed as having to appear after the the causative and the applicative.) As we will see below, in section 2.5 (page 142), there is certainly a very strong preference across the daughter languages for the order causative-applicative (i.e. **-ic-id-*). I believe that this order was actually fixed in Proto-Bantu for several reasons.

The first is, quite simply, that the tendency to prefer **-ic-id-* causative-applicative order is pervasive, as will be shown in section 2.5 (page 142). Furthermore, every language I have encountered which is described as allowing a single root to be affixed with both the causative and the applicative allows the causative-applicative order and only a few allow applicative-causative order. I have yet to encounter a language which allows only applicative-causative order.

Furthermore, in all but one of the languages I have found which do allow applicative-causative order, there is something “funny” about the combination. The one exception to this generalization is Xhosa. In some cases, applicative-causative order has a strange morphophonological distribution, and, in others, it does not mark canonical causativization or applicativization semantics. These issues will be discussed in more detail in section 2.5.7 (page 171). So, even where applicative-causative order is found, it only very rarely seems to be transparently productive in the way that the causative-application combination

is in language after language.

This assumption, however, is not critical to an analysis of the templatic restrictions to be discussed here. The goal of this chapter will be to argue that the restrictions found in present-day Bantu languages are consistent with the Strong Linearity Domain Hypothesis, which is not crucially related to whether or not these restrictions are inherited.

Given the present-day distribution of ordering restrictions, the only viable alternative to the hypothesis that the causative and applicative appeared in a fixed order in Proto-Bantu is that their order was free but that there was some aspect of the language which overwhelmingly biased its daughter languages towards fixing the order of the two extensions as causative-applicative. Under such a scenario, Xhosa would represent the most conservative of the Bantu languages looked at here with respect to the ordering of the extensions and the handful of other languages allowing applicative-causative order would represent the retention of archaisms.

Given these two alternative analyses, I have decided that an analysis where the order was fixed in Proto-Bantu is more likely for the simple reason that any other analysis would force us to posit the same morphological change taking place multiple times independently in the various daughter languages. Such a scenario is not impossible, of course, and, in reality, determining what the situation was in Proto-Bantu will require a more thorough study than that provided here.

2.4.5 Local conclusion

In this section, I have presented an overview of the situation in Proto-Bantu with respect to applicativization and causativization. The critical morphological exponents of these processes which are found in Proto-Bantu are the applicative extension, **-id-*, the causative extension, **-ic-* and the transitive suffix **-j*. It was suggested that, in Proto-Bantu, the order of these suffixes was fixed in the order causative-applicative-transitive (CAT). While the idea that the transitive suffix appeared after the other two is not new to this work, the proposal that the causative and applicative were fixed in CA order is new. The basic evidence for this proposal is given in the next section which presents the data on affix ordering restrictions based on a survey of thirty Bantu languages.

2.5 THE RELATIVE ORDER OF THE CAUSATIVE, APPLICATIVE, AND TRANSITIVE:

A SURVEY

2.5.1 Basic results

As will be discussed in section 2.6 (page 181) there have been various claims as to principles of suffix ordering in Bantu. These analyses (with the notable exception of various works by Hyman, culminating in Hyman (2003a)) have generally been based on a detailed examination of one or two languages. In this section, I seek to extend the basic database of languages under examination in order to provide support for an important generalization about the marking of causativization and applicativization in Bantu. Specifically, there is a very strong bias favoring the morpheme order: causative-applicative-transitive (CAT). This bias is the first step in understanding the nature of the templatic effects found in the Bantu

verb stem.

I should be quick to point out that arriving at the basic generalizations discussed in this section required relying on existing grammatical descriptions, some of which are almost certainly incomplete. However, while the details may be amended, I suspect the broad patterns uncovered by this survey do give a reasonably accurate reflection of the ordering restrictions of the causative, applicative, and transitive in Bantu since not only has a fairly large number of languages been looked at, these languages cover a wide range of the Bantu-speaking area, as can be seen in the map given in (71). The nature of this study has meant that it is biased towards morphological generalizations over syntactic ones since few thorough syntactic treatments of Bantu languages are available. This is a weakness inherent in trying to take a broad, comparative approach to Bantu given the current state of available descriptions.

From a methodological standpoint, I took a language to allow a particular set of morpheme orders for the causative, applicative, and transitive (i) if the source either explicitly stated that some order was possible or (ii) if an example could be found showing a given order. Similarly, I took a language to disallow a set of morpheme orders (i) if there was an explicit statement that some order was not possible or (ii) if the description of possible orders was reasonably thorough and no mention was made of that order being possible. The languages reported on here are those for which at least one of the two criteria for possible orders and one of the two criteria for impossible orders was met. In some cases, usually supported directly by the grammatical description, I took a language not to allow a

particular morpheme order, even if there were some examples, because this order was not productive. In section 2.5.2 (page 150) I discuss the nature of such cases—which, generally, various authors of the grammatical descriptions, as well as myself, attribute to suffixes being lexicalized onto particular verb stems.

The languages listed in (69) were examined in bringing together the generalizations described in this section.¹⁴ The choice of these languages simply reflects those for which I could find enough data to determine what ordering restrictions held between the causative, applicative, and transitive.¹⁵

The table in (70) gives an overview of the relative surface morpheme orders found for the causative extension (C), the applicative extension (A), and the transitive suffix (T) for all the above languages. In addition, it gives the form of the various endings for each

¹⁴ In addition, I examined the following sources and languages: Bafia (A.53) (Guarisma 2000), Bakweri (A.22) (Henson 2001), Bushonga (C.84) (Edmiston 1932), Cibemba (M.42) (Givón (1976), Hyman and Katamba (1991), Hyman (1994)), Duala (A.24) (Ittmann 1978), Ewondo (A.72) (Abéga (1976), Essono (2000)), Gitonga (S.62) (Lanham 1955), Haya (E.20) (Rubanza 1988), Lebéo (C.51) (Gérard 1924), Lega (D.25) (Meeussen 1971), Lingala (C.36) (Guthrie (1935), Motingea (1987)), Nkore-Nkiga (E.13) (Taylor 1985), Oshiwambo (R.21) (Viljoen and Amakali 1978), Punu (B.43) (Bonneau 1956), Zulu (S.42) (Taljaard and Bosch 1988). However, these either did not have sufficient data to determine what ordering restrictions held between the causative, applicative, and transitive or innovations in the languages no longer made this a relevant question. Importantly, none of these languages contains data which contradicts the generalizations made in section 2.5 (page 142).

One of these languages, Bushonga, has an interesting development in which the causative and the applicative both have the same shape, *-ish-* (Edmiston 1932:153–158). My suspicion is that this overlap is due to accidental convergence via sound change. However, I have not investigated this thoroughly. In any event, with a few exceptions, one does not find two occurrences of the *-ish-* extension on one stem, and where this is found there is not enough data to determine which instantiation of *-ish-* corresponds to which extension.

For another language, Cibemba, I have not found enough data to be certain, but a combination of some of the data in Givón (1976), Hyman and Katamba (1991), and Hyman (1994) suggests that Cibemba may be like Shona. That is, it shows reflexes of a causative and an applicative and applicativization and causativization on the same verb is marked with an etymologically derived from an applicative+transitive combination. In any case, the limited data from Bemba shows it to be consistent with the CAT template.

¹⁵ Of these languages, the data I have available for Bukusu is more limited than the others. I include because I have specific information on a limited context where applicative-causative (AC) order is possible.

(69)	LANGUAGE	SOURCE(S)
	Basaa (A.43)	Hyman (2003b)
	Bukusu (J.31)	(D. Peterson, personal communication)
	Ciyao (P.21)	Ngunga (2000)
	Chichewa (N.31b)	Baker (1988), Alsina and Mchombo (1993), Alsina (1999), Hyman (2001)
	Chimwi:ni (G.41)	Abasheikh (1978)
	Emakhuwa (P.31)	Kathupa (1983), Kathupa (1991)
	Ganda (J.15)	Hyman (2003a)
	Holoholo (D.28)	Coupez (1955)
	Ikalanga (S.16)	Mathangwane (2000)
	Isangu (B.42)	Idiata (1998)
	Kinande (D.43)	Hyman (1993)
	Kinyarwanda (D.62)	Kimenyi (1980), Coupez (1980)
	Kinyamwezi (F.25)	Maganga and Schadeberg (1992)
	Kirundi (D.62)	Meeussen (1959)
	Kitalinga (J.25)	Paluku (1998)
	Kongo (H.16)	Bentley (1967)
	Korekore (S.11)	Dembetembe (1987)
	Lingala (C.36)	Institut National de Recherche et d' Action Pédagogiques (1982)
	Lomongo (C.61a)	de Rop (1958), Hulstaert (1965)
	Luvale (K.21)	Horton (1949)
	Mwera (P.22)	Harries (1950)
	Ndebele (S.44)	Sibanda (2000)
	Nugunu (A.62)	Orwig (1989)
	Nyakyusa (M.31)	Schumann (1899), Meinhof (1932)
	Runyambo (E.21)	Rugemalira (1993)
	Sesotho (S.32)	Jacottet (1927), Machobane (1989)
	Shi (D.53)	Polak-Bynon (1975)
	Shona (S.12)	Fortune (1955)
	Swahili (G.40)	Baker (1988)
	Swazi (S.43)	Ziervogel (1952)
	Xhosa (S.41)	Satyo (1985)

language.¹⁶ A “—” in the table means that no productive reflex of that suffix was reported as existing in the language.¹⁷ In languages indicated as having a segmental reflex of **-j-*, it usually does not appear in all phonological environments, and when it does it typically is realized as a *y* or as palatalization—therefore the form *j* in the table should be understood liberally. In many cases, the form in the **-ic-* column may not properly be the reflex of only the causative extension but the reflex of the causative followed by the transitive. When this was able to be discerned clearly (because of the possibility of the reflexes becoming separated in the right morphological environment), a two-part reflex appears under the **-ic-* column.¹⁸

In the column entitled “productive combinations”, I give the phonological form and the morpheme order of the combinations found to be productive in the various languages. Importantly, the form of the combined suffixes is not always trivially related to the form of the suffixes in isolation. These special combined forms will be discussed in section 2.5.3 (page 159) below.

¹⁶ For one of the languages in the table, Shona, I have encountered one form, given below which shows an order not mentioned in (70) and which I have no reason to believe (or disbelieve) represents a lexicalized stem.

SHONA (S.10) (Hawkinson and Hyman 1974:157)
múdzídzísi á-kà-nyór-ér-és-à m̀̀r̀̀úmé yé múkàdzí
 teacher 3s-PST-write-APP-CAUS-FV man for woman

“The teacher made the man write for the woman.”

The description of Shona in (70) follows what is found in Fortune (1955:211). As the above example was one sentence in an article not focused on ordering restrictions of the extensions, I am not sure if the way it differs with the description of Fortune is significant.

¹⁷ It is often the case, especially with the transitive, however, that traces of such suffixes remain in particular lexical items. Sometimes I had to make my own judgement regarding the productivity of a suffix. However, when possible, I took the lead of the various sources in deciding if a suffix was productive.

¹⁸ In one language, Ciyao (Ngunga 2000:162–8), an innovative causative suffix has developed with the form *-aas-y-* which has not been included in this study, and which has ordering restrictions different from the causative deriving from the Proto-Bantu etymological causative.

(70)

LANGUAGE	*-ic-	*-id-	*-j-	PRODUCTIVE COMBINATIONS
Basaa (A.43)	-is-	-il-	—	-h- <i>en</i> - (CA)
Bukusu (J.31)	-isy-	-il-	—	-is-il- (CA), -isy-il- (AC)
Ciyao (P.21)	-is-j-	-il-	-j-	-ic-is-j- (CAT), -is-j- (AT)
Chichewa (N.31b)	-its-	-ir-	—	-its-ir- (CA)
Chimwi:ni (G.41)	-ish-j-	-it-	-j-	-ish-itiz- (CAT), -itiz- (AT)
Emakhuwa (P.31)	-ih-	-el-	—	-ih-el- (CA), -el-ih- (AC)
Ganda (J.15)	-is-j-	-ir-	-j-	-is-iz- (CAT), -iz- (AT)
Holoholo (D.28)	-isy-	-il-	-y-	-is-y- (AT)
Isangu (B.42)	-is-	-il-	—	-is-il- (CA)
Ikalanga (S.16)	-is-	-il-	—	-is-il- (CA)
Kinande (D.42)	-is-j-	-ir-	-j-	-is-ir-j- (CAT), -ir-j- (AT)
Kinyarwanda (D.61)	-ish-j-	-ir-	-j-	-ish-ir-iz- (CAT), -ir-iz- (AT)
Kinyamwezi (F.22)	-iish-j-	-il-	-i-	-is-ij- (CAT), -ij- (AT)
Kirundi (D.62)	-iish-	-ir-	-j-	(-ir)-iz- (AT)
Kitalinga (J.20)	-is-	-il-	-i-	-is-il-i- (CAT), -il-i- (AT)
Kongo (H.16)	-is-	-il-	—	-is-il- (CA)
Korekore (S.11)	-is-	-ir-	—	-is-ir- (CA), -ir-is- (AC), -idz- (AT)
Lingala (C.36)	-is-	-el-	—	-is-el- (CA)
Lomongo (C.61a)	-ey-	-el-	-j-	-ey-el- (CA), -ej- (AT)
Luvale (K.14)	-is-	-il-	—	-ish-il- (CA)
Mwera (P.22)	-ic-j-	-il-	—	-c-ey- (CAT)
Ndebele (S.44)	-is-	-el-	—	-is-el- (CA), -el-is- (AC)
Nugunu (A.62)	—	-en-	-i-	<i>en-i</i> (AT)
Nyakyusa (M.31)	—	-il-	-j-	-(i)k-is- (AT)
Runyambo (E.21)	-is-	-ir-	-j-	-is-iz- (CAT), -iz- (AT)
Sesotho (S.33)	-is-	-el-	—	-is-ets- (CAT)
Shi (D.53)	-iis-j-	-ir-	-j-	-iis-iiz-i- (CAT), -iz-i- (AT)
Shona (S.12)	-is-	-ir-	—	-idz- (AT)
Swahili (G.40)	-ish-	-i-	—	-ish-i- (CA)
Swazi (S.43)	-is-	-el-	—	-is-el- (CA)
Xhosa (S.41)	-is-	-el-	—	-is-el- (CA), -el-is- (AC)

In (71) below, I give a map of the Bantu-speaking area, created with Bantu MapMaker (Lowe and Schadeberg 1996), on which either a black dot or a white star marks the central area where the languages in (70) are spoken. A star indicates a language where applicative-causative (AC) order is attested. As can be seen, this selection of languages covers a fairly large extent of the Bantu-speaking area, which includes most of the area of southern Africa given on the map, except for the southwest and northeast corners where languages from other families are spoken. There is no striking geographical generalization to be made about all the languages showing AC order. However, it does seem to be more prevalent in the south of the Bantu-speaking area than the north.¹⁹

¹⁹ Importantly, in this context, the sources for both Xhosa, Satyo (1985), and Sesotho, Machobane (1989), are fairly thorough on the subject of causative and applicative combinations. These languages are both spoken in the south. The lack of attested applicative-causative order in some of the southern languages other than Sesotho may, however, be the result of sources which did not consider such combinations in detail.

(71)

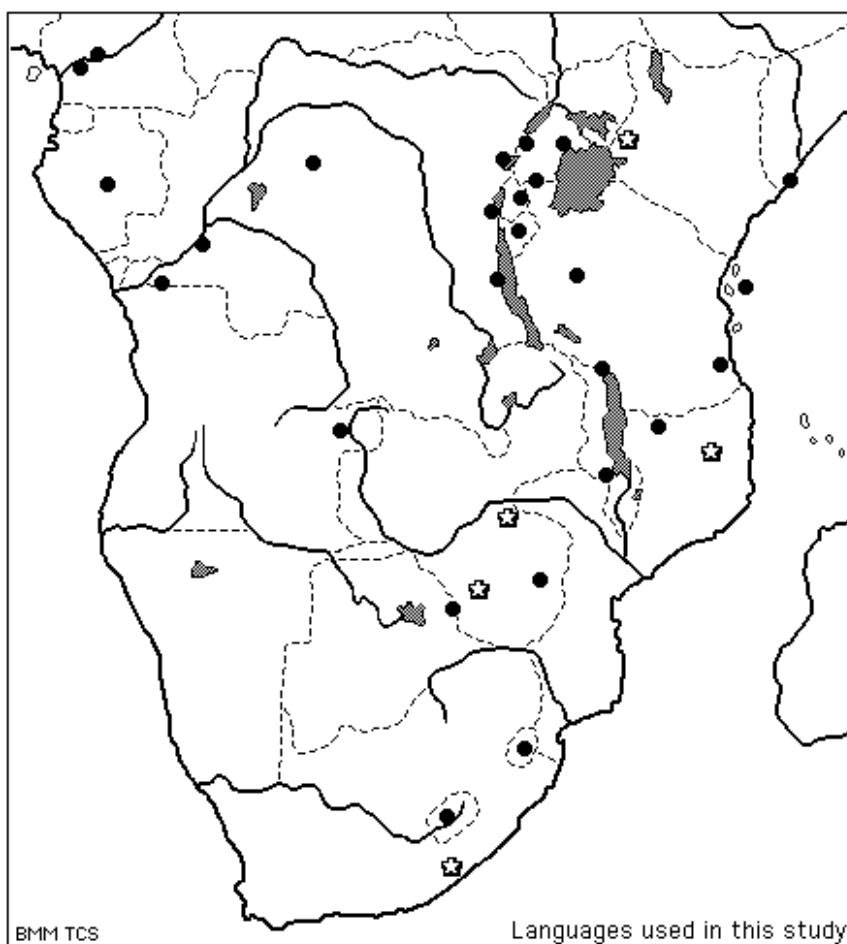

According to my interpretation of the sources, five languages in the table allowed applicative-causative (AC) ordering in contexts other than cases where the applicative was lexicalized onto a verb root: Emakhuwa, Korekore, Ndebele, and Xhosa.²⁰ The characteristics of AC ordering, which only has been reported to be both productive and fully semantically transparent in one of these languages, Xhosa, will be discussed in section

²⁰ There are some indications that Ikalanga also allows AC order (Mathangwane 2000:16). However, the examples and conditioning environment were somewhat unclear. So, I have not included them here. If it is the case that Ikalanga allows this order, it would only allow it in restricted contexts, and Xhosa would remain, by far, the most clearly attested case of a language with productive, semantically transparent applicative-causative ordering.

2.5.7 (page 171). Some of the languages showed forms with transitive-applicative or transitive causative order. I take these to be instances where the transitive has been lexicalized onto a verb root and I discuss this phenomenon in section 2.5.2 (page 150).

Beyond the appearance of a minority of languages showing AC order, there are various other complications with respect to the morphemic exponence of causativization and applicativization in Bantu which could not be easily conveyed in the table. These are (i) special forms of the applicative when combined with the causative, discussed in section 2.5.3 (page 159), (ii) the effect of complex suffix combinations involving extensions other than the applicative, causative, and transitive, discussed in section 2.5.4 (page 164), (iii) ambiguity of semantic scope for some orders, discussed in section 2.5.5 (page 165), and (iv) suffix doubling resulting in different semantics, discussed in section 2.5.6 (page 168). At the end of this section, in section 2.5.7 (page 171), I will discuss the languages found showing productive applicative-causative order. First, in section 2.5.2 (page 150) I will discuss the existence of verb stems with lexicalized extensions sometimes creating the appearance of non-CAT morpheme orders.

2.5.2 Lexicalized suffixes

An important aspect of the data given in (70) is that the possible combinations of suffixes do not include instances where an order is only instantiated because an extension has been lexicalized onto a particular stem. This particular situation is fairly frequent in Bantu, and I'll give a few examples here to illustrate the general phenomenon.

Korekore is described as showing some verb forms which could potentially be ana-

lyzed as having transitive-causative (TC) or transitive-applicative (TA) order. These are given in (72) and (73) respectively.²¹ This situation is likely found in more languages than it is reported in—Dembetembe (1987) was particularly thorough in documenting all suffix combinations, even those other authors more or less automatically attribute to lexicalization.

(72) KOREKORE (S.11) (Dembetembe 1987:82)

- a. *Va-ndí-gadz-ís-a* *hári pachotó.*
3p-1s-sit.**TRANS-CAUS-FV** 9.pot on.7.fire
“She made me place the pot on the fire.”
- b. *Nd-a-mú-tambidz-is-a* *mvúrá négaba iro.*
1s-PERF-3s-receive.**TRANS-CAUS-FV** 9.water 5.tin 5.that
“I offered him some water in that tin.”

(73) KOREKORE (S.11) (Dembetembe 1987:80)

- a. *Chando chá-ndi-múts-ír-a* *chihwéré chíye.*
7.cold 7-1s-wake.**TRANS-APP-FV** 7.sickness 7.that
“The cold spell has revived that illness in me.”
- b. *Nd-a-mú-pedz-er-a* *hwawhá hwáké.*
1s-PERF-3s-end.**TRANS-APP-FV** 14.beer 14.poss
“I finished his beer.”
- c. *Ndi-sákusúmúts-ír-a* *zvinhu zvakó*
1s.rise.**TRANS-APP-FV** 8.THING 8.your
“I shall lift up your things for you.”

The facts exemplified in (72) and (73) are almost certainly explained by the fact that the transitive suffix is no longer productive in Korekore and has been lexicalized onto certain stems. Where the transitive **-j-* has a reflex in Korekore, it never appears as a segment,

²¹ The bolded root-final consonants in (72) and (73) show mutations from non-causativized forms attributed to the etymological presence of transitive.

but only as palatalization of the consonant which would have etymologically preceded it. Furthermore, this palatalization is synchronically observed with only a small number of consonants—namely, *k*, *r*, *nd*, *mb*, *t*, *p*, or *ng* (Dembetembe 1987:56). Examples are given in (74).

(74) KOREKORE (S.11)

(Dembetembe 1987:58)

STEM	GLOSS	→	CAUS. STEM	GLOSS
<i>-svik-</i>	‘arrive’	→	<i>-svits</i>	‘make arrive, help to arrive’
<i>-rir-</i>	‘sound, ring’	→	<i>-ridz</i>	‘cause to sound, ring’
<i>-wand-</i>	‘be plentiful’	→	<i>-wanz-</i>	‘increase’
<i>-net-</i>	‘get tired’	→	<i>-nets-</i>	‘cause trouble, be troublesome’
<i>-ymb-</i>	‘rely on’	→	<i>-yinzv-</i>	‘cause to rely on’
<i>-rep-</i>	‘be long’	→	<i>-redzv-</i>	‘make long, lengthen’
<i>-péng’</i>	‘be insane’	→	<i>-péngv’</i>	‘madden’

The use of this suffix is even further restricted than the table in (74) indicates since the last three verbs, the ones ending in *mb*, *p*, and *ng* are the only known instances of the transitive **-j-* being used with verbs ending in those consonants (Dembetembe 1987:57).

I believe that the limited realization of the reflex of the transitive suffix in Korekore, where it was no longer expressed via an overt segment but was also limited to occurring with a small range of consonants, has caused it to be effectively lost in the language as a productive *suffix*. Rather, I analyze the language as containing a set of non-causative and causative stem pairs which can be related to each other by predictable consonant mutation—but not by the presence or absence of any particular suffix. Under such an analysis, the lexicalization of the transitive suffix as a consonant mutation on some stems would then have resulted in its losing its original ordering constraints which was tied to its suffixal status.

An aspect of Korekore which favors such an analysis is that, unlike some other languages where the transitive can be realized as a consonant mutation, there is no set of forms where the transitive ever has an obvious segmental reflex. For example, we saw in (64) that, in Kinyamwezi, the transitive is realized as *-y-* after labials and as a consonant mutation in other cases. There is no such segmental reflex for any stem in Korekore. Therefore, while it would be possible to analyze the consonant mutations in Korekore as some sort of abstract suffix, unlike some other Bantu languages, this suffix would have to always be abstract.

Korekore is a particularly well-documented case of lexicalization of the transitive suffix onto a verb root, which is why I've singled it out here. Such roots can be found throughout Bantu, and I excluded them from showing examples of transitive-applicative (TA) order when putting together the table in (70). I have found no language which clearly shows productive TA order.

However, one language Lomongo, as cited in de Rop (1958:92), stands out as being the most likely candidate for showing such order—although even it is not a clear candidate. Two forms are cited by deRop as showing transitive-applicative (TA) order. These are given in (75).

(75) LOMONGO (C.61a)

(de Rop 1958:92)

STEM	GLOSS	TRANSLATION
<i>-jwê-y-</i>	'vomit-TRANS'	'make vomit'
<i>-jwê-y-el-</i>	'vomit-TRANS-APP'	'make vomit on'
<i>-kitan-y-</i>	'follow-TRANS'	'make follow'
<i>-kitan-y-el-</i>	'follow-TRANS-APP'	'replace for'

He also says the expected applicative-transitive order can occur and gives the examples in (76). The applicative generally has the form *-il-* in Lomongo. In this causativized form it shows a palatalized form *-ij-*, the reflex of Proto-Bantu **-id-j-*. (I have not given morpheme glosses for the non-causativized stems since this is not given in de Rop (1958).)

(76) LOMONGO (C.61a)

(de Rop 1958:92)

STEM-T	GLOSS	STEM-AT	GLOSS
<i>-ám̄b-y-</i>	‘lay_down’	<i>-ám̄b-ej-</i>	‘lay_down-APP.TRANS’
<i>-af-y-</i>	‘add’	<i>-af-ej-</i>	‘add-APP.TRANS’
<i>-lang-y-</i>	‘permit’	<i>-lang-ej-</i>	‘permit-APP.TRANS’
<i>-fuj-</i>	‘increase’	<i>-ful-ej-</i>	‘increase-APP.TRANS’
<i>-túng-y-</i>	‘chain_up’	<i>-túng-ej-</i>	‘chain_up-APP.TRANS’
<i>-ó̄j-</i>	‘make_leave’	<i>-ó̄j-ej-</i>	‘make_leave-APP.TRANS’

There is no clear statement in de Rop (1958) about whether one of the two patterns exemplified in (75) and (76) is more productive than the other. However, I take the fact that only two forms are given for the transitive applicative order and six forms for the applicative-transitive order to be significant that the latter should be taken as more productive within the scope of the description by de Rop (1958).

Beyond this, there are specific reasons for excluding Lomongo as showing productive TA order. The first is that, one of the two forms in (75), *-jwê-y-ɛl-*, could plausibly be understood to etymologically causative-applicative. This falls out of a general consideration of causativization in Proto-Bantu. de Rop (1958) specifically gives the causative forms for two vowel-final verbs reconstructed as monosyllabic in Proto-Bantu, ‘eat’ and ‘die’, which have causative forms *-lê-y-* and *-wê-y-* respectively. As argued for by Bastin (1986:130), there is good evidence that Proto-Bantu should be reconstructed as requiring monosyllabic

vowel-final roots to appear with the **-ic-* causative extension when causativized (in addition to appearing with the *-j-* transitive).

The causativized forms of the roots for ‘eat’ and ‘die’ in Proto-Bantu would, then, be typically reconstructed as, *-dj-ic-j-* and *-ku-ic-j-* respectively. If the forms *-lê-y-* and *-wê-y-* are the regular reflexes of those Proto-Bantu forms, the verb form *-jwê-y-* could be understood to be a reflex of a comparable form containing the causative extension, implying that an apparent instance of TA order might actually be etymological CTA order for a monosyllabic vowel-final verb stem where the causative and transitive have become fused—contrary to de Rop’s (1958) analysis of the form as showing TA order. This then means that we are left with only one clear instance of a verb showing TA order in Lomongo, *-kitan-y-el-*.

An additional point worth making is that, despite the examples in (75), Hulstaert’s (1965) description of Lomongo, which is generally more thorough than de Rop’s (1958), does not admit transitive-applicative (TA) as a possible order. In fact, of the combination *-y-el-* ‘TRANS-APP’, Hulstaert (1965:300) explicitly states that it is always reversed, giving the form *-ej-*, with the expected applicative-transitive (AT) order.

These two facts lead me to believe that the form *-kitan-y-el-* in (75) is an instance of a stem with a lexicalized transitive suffix which has lost its ordering restrictions of the sort described for the Korekore transitive suffix above. A factor making this analysis especially plausible is that de Rop (1958:92) gave the applicativized form of the verb a less transparent translation than the other applicative forms, which is reflected in the translation I have given in (75), my own translation of deRop’s French. Whereas deRop translated the first

verb forms in (75), *faire vomir* and *faire vomir sur qq. ch.* in a way which transparently shows the effects of applicativization, he gave the less transparently related translations *faire succéder* and *remplacer pour qqn.* for the second verb.

As we have seen, the transitive suffix is particularly susceptible to being lexicalized since its phonological reflex is often non-segmental. While I only specifically discuss Korekore and Lomongo here, with respect to reorderings this can cause, comparable examples can be found in many other languages. Korekore and Lomongo were singled out because they are languages which were some of the best potential cases of having productive derivation where the transitive suffix does not obligatorily follow an extension. However, they are far from clear cases of this and can readily be analyzed in different ways as having this order because of the loss of the transitive as a suffix. I expect that this type of argument will hold up generally to account for cases where the transitive precedes the causative and applicative, even if the database of Bantu languages examined for verbal suffix ordering were to be greatly expanded.

Outside of the transitive, there are other instances, however, where lexicalization of suffixes has taken place which has resulted in languages showing applicative-causative (AC) order. This is distinct from languages which show productive AC order which I will discuss below in section 2.5.7 (page 171).

Horton (1949:87) for example gives the productive order of suffixes in Luvale which includes, as a subset, the order causative-applicative in Luvale and then comments, “That order may be ignored when a derived form has largely lost its derivative significance. He

cites the verb forms given in (77).

(77) LUVALE (K.21)

(Horton 1949:87)

STEM	GLOSS	TRANSLATION
<i>-lw-a-</i>	'fight-FV'	'fight'
<i>-lw-il-a-</i>	'fight-APP-FV'	'save'
<i>-lw-il-is-a</i>	'fight-APP-CAUS-FV'	'cause to save'
<i>-lw-ish-il-a</i>	'fight-CAUS-APP-FV'	'cause to fight for'

As can be seen in (77) the verb stem *-lw-il-* has been lexicalized to mean 'save'. This frozen stem can then be causativized showing etymological applicative-causative (AC) order. However, since the meaning 'save' is unpredictable, Horton does not consider this to be a productive case of suffixation. By contrast, he gives the form *-lw-ish-il-a* to show that the productive causative-applicative (CA) order has a predictable meaning. As mentioned above, I generally followed the guidance of a given source in determining if an order was productive or not.

Within the wider scope of the study of the Bantu extensions, I am not the first researcher to leave lexicalized forms out of consideration when analyzing ordering restrictions in Bantu suffixes. Baker (1988:255–6), for example, considers the use of the applicative on intransitive verbs in Chichewa to be derivational morphemes, while the applicative attached to a transitive verbs is considered to be an instance of an inflectional morpheme. Based on this logic, which is very similar to the idea that some instances of the extensions are lexicalized, he excludes applicativized intransitive verbs from his general analysis of applicativization in Chichewa. Cooper (1976), though not interested in suffix ordering, also distinguishes between lexicalized and non-lexicalized causative in Bantu.

Somewhat interestingly, in light of the general importance of morpheme ordering relations to the present study, it is not uniformly the case that lexicalized suffixes lose their basic CAT templatic ordering restrictions. In Kinande, for example, Hyman (1993:13) reports the existence of “pseudocausative” verbs which are lexicalized with the transitive suffix but for which there is not a corresponding root in the language without the transitive suffix. An example is given in (78). Such verbs can be classified as exhibiting a more general phenomena termed *deponence* which occurs when a word lacks the usual forms associated a particular morphological class (here, underived verb stems) and instead takes the forms of another (here, transitivized verb stems) (Bickel and Nichols to appear).

(78) KINANDE (D.42)

(Hyman 1993:13)

STEM	GLOSS	TRANSLATION
*- <i>song</i> -	‘SONG’	no meaning
- <i>song-i</i> -	‘SONG-TRANS	‘gather’
- <i>song-an-i</i> -	‘SONG-REC-TRANS’	‘gather each other’

In (78) the basic form of the verb for ‘gather’ is given, *-song-i-*. This verb is suffixed with the transitive, but, unexpectedly, there is no verb *-song-* in Kinande. Thus, *-song-i-* must be considered a lexicalized combination. Despite this, when the reciprocal suffix is added to the verb it appears before the transitive, consistent with the fact that the transitive is specified to occur after the extensions across Bantu.

Similarly, Hyman and Mchombo (1992:359) report that, in Chichewa, when a lexicalized root-applicative combination is causativized, the causative is placed in before the applicative reflecting the basic CAT order. An example is given in (79).

(79) CHICHEWA (N.31b)

(Hyman and Mchombo 1992:359)

STEM	GLOSS	TRANSLATION
<i>-uk-a</i>	'wake_up-FV'	'wake up'
<i>-uk-ir-a</i>	'wake_up-APP-FV'	'rebel against'
* <i>-uk-ir-its-a</i>	'wake_up-APP-CAUS-FV'	
<i>-uk-its-ir-a</i>	'wake_up-CAUS-APP-FV'	'cause to rebel against'

Despite the fact that the stem *-uk-ir-a* has a lexicalized sense meaning 'rebel against', when it is causativized, the causative appears between the stem and the applicative.

What data like that in (78) and (79) shows is that, while in some languages lexicalized suffixes cause them to lose their templatic ordering restrictions, this is not universally the case. To the extent that there is normally an expectation that lexicalization will result in the fixing of the order of morphemes which make up the lexical item, the fact that, in some languages, suffixes can be clearly semantically lexicalized with verb stems but still retain the templatic ordering restrictions is, I believe, evidence for the synchronic reality of the CAT template in those languages.²²

2.5.3 Special forms of the causative, applicative, and transitive when combined

In several of the languages described in (70), there are special forms of the applicative when it is used with a verb stem marked for causativization.²³ That is, the form of a

²² It might be the case that it is too simplistic to consider these suffixes "lexicalized" just because the meaning of the stems they appear on is not transparently derived from the meaning of the root plus the meaning of the suffix (either because the root cannot exist without the suffix, as in (78), or because a particular stem+suffix has acquired a specialized meaning, as in (79)). The relevant suffixes could still be, then, marking their typical meaning on some sort of defective stem. I have no strong argument against this view. However, even if we were to adopt it, the general point would hold that even when the stem+suffix combination does not have completely transparent semantics, the templatic ordering restrictions can hold. This would be weaker than saying that *lexicalized* stem+suffix combinations still exhibit such ordering restrictions, but it still supports the general argument.

²³ An examination of the table in (70) makes it appear that Basaa has a special form of the causative-applicative combination. This form turns out to be phonologically predictable (Hyman 2003b).

verb marked for causativization and applicativization is not completely predictable from the form of the causative and applicative suffixes in the language. The data in (80) from Kinyarwanda gives an example of this.²⁴

(80) KINYARWANDA (D.62)

- a. *Úmwáalímu a-ra-andik-iisha-a íbárúwa íkárámu.*
 teacher 3S-PRS-write-CAUS-FV letter pen
 “The teacher is writing a letter with the pen.” (Kimenyi 1980:79)
- b. *U-ra-andik-ir-a íbárúwa íki.*
 2S-PRS-write-APP-FV letter what
 “Why are you writing the letter?” (Kimenyi 1980:109)
- c. *U-ra-andik-iish-ir-iz-a iyo kárámu íki.*
 2S-PRS-write-CAUS-APP-APP.TRANS-FV that pen what
 “Why are you writing with that pen?” (Kimenyi 1980:109)

Sentences (80a) and (80b) show the causative and applicative when not in combination. The expected combination of the causative and applicative would be something like *-ish-ir*. However, as Kimenyi (1980) states, “Whenever both instrumental and applicative morphemes occur in the same verb, an extra suffix *-iz-* appears on the verb (234).” Furthermore, data in Coupez (1980:363–70) indicates that, at least for some verbs, an *-ir-iz-* variant exists to mark a verb for causativization and applicativization, even when the *-ish-* causative suffix is not present.

The *-iz-* form is glossed as *app.trans* since I take it to be the reflex of a fusion of the applicative and transitive (**-id-j*) which was reanalyzed as marking causativization and applicativization on a single verb. A comparable proposal is made for Kinyamwezi (Maganga

²⁴ The sentences in (80b) and (80c) are both examples of causatives which promote an instrument to object position. Despite this innovative use of the causative, the suffix *-ish-* is clearly etymologically derived from the causative extension **-ic-*.

and Schadeberg 1992:168) to account for a class of verbs which are marked for causativization and applicativization with a form of the shape *-ilij-*. Such an analysis implies that verbs marked for causativization and applicativization in Kinyarwanda show a reduplicated applicative since, in addition to surfacing with a form corresponding to a fusion of the applicative and the transitive, there is also a more recognizable applicative prefix preceding the fused element.

It is worth mentioning that, as pointed out in section 2.4.3 (page 138), reduplicated applicatives are found in various Bantu languages (one example, from Luvale, was seen in (68)). Hulstaert (1965:289) also reports this as a (somewhat marginal) possibility in Lomongo in the particular context where the second applicative has been palatalized due to the presence of an etymological transitive suffix—which closely parallels the Kinyarwanda case. In light of these facts, the special forms marking the combination of causativization and applicativization involving etymologically reduplicated applicatives are not necessarily surprising in its form. What is somewhat surprising is that, in some languages, they have developed to obligatorily mark the particular semantic combination of causativization and applicativization.

Special forms of verbs marked for applicativization and causativization are not unique to Kinyarwanda, something very similar is also seen in Kirundi (not surprising since Kinyarwanda and Kirundi are mutually intelligible), with some interesting differences to be described below in section 2.5.6 (page 168). Comparable forms are also seen in Chimwi:ni (Abasheikh 1978:65–9) and Shona (Fortune 1955:211). The Shona case is noteworthy in-

so far as a special combined form, *-idz-* ‘APP.TRANS’, is the only suffix found on verbs productively marked for causativization and applicativization even though the language generally otherwise marks causativization using a reflex of the causative (Fortune 1955:212–16). In addition, Shona represents a case where the special suffix is not etymologically from a reduplicated applicative but simply a single instance of the applicative—otherwise, it is similar to Kinyarwanda and Kinyamwezi discussed above.

Special forms of the combined suffixes, of the type seen in (80) should not be confused with data like that in (62) where the shape of the suffix combination can be predicted by assuming the causative suffix in these languages is a fusion of the causative extension **-ic-* and the transitive **-j-* which is split apart by an intervening applicative extension. A form is labelled “special” here only when it is not predictable on the basis of other aspects of the language’s morphology.

A different kind of special combined form of the causative, applicative, and transitive from those just discussed is illustrated by the data in (81) taken from Hyman (2003a) and originally reported on by Schumann (1899) and Meinhof (1932).²⁵

(81) NYAKYUSA (M.31) (Hyman 2003a)

a.	STEM	GLOSS	APP	GLOSS
	<i>-sat-</i>	‘be_in_pain’	<i>-sat-il-</i>	‘be_in_pain-APP’
	<i>-sas-j-</i>	‘be_in_pain-TRANS’	<i>-sak-is-j-</i>	‘be_in_pain-APP-TRANS’
b.	STEM	GLOSS	APP	GLOSS
	<i>-tup-</i>	‘thicken’	<i>-tup-il-</i>	‘thicken-APP’
	<i>-tuf-j-</i>	‘thicken-TRANS’	<i>-tuk-if-j-</i>	‘thicken-APP-TRANS’

²⁵ The causativized form of *-sat-* is interpreted with the meaning ‘give pain’(whether or not it is also applicativized).

c.

STEM	GLOSS	APP	GLOSS
<i>-lim-</i>	‘cultivate’	<i>-lim-il-</i>	‘cultivate-APP’
<i>-lim-j-</i>	‘cultivate-TRANS’	<i>-lim-ik-is-j</i>	‘cultivate- IK -APP-TRANS’

The forms in (81a) and (81b) illustrate that the reflex of the transitive in Nyakyusa, which marks causativization, fricates certain consonants. The consonants *t*, *l*, *j*, and *g*, palatalize to *s* as exemplified for *t* in (81a), and the consonants *p* and *b* fricate to *f* as exemplified for *p* in (81b). Interestingly, the frication is “undone” for roots marked for applicativization and causativization. However, frication is undone not to the consonant found in the bare stem, but instead uniformly becomes *k*. Thus, the stem *-sat-* ‘be_in_pain’ becomes *-sak-* when marked for applicativization and causativization.

A further complication is that the transitive suffix triggers a kind of “frication” on the *l* of the applicative. This frication is not purely phonological, however. If the unmarked verb root ends in a *t*, *l*, *j*, and *g*, the applicative is realized as *-is-*, showing the same consonant that the causativized root ends with. If the unmarked verb root ends in a *p* or *b*, on the other hand, the applicative is realized as *-if-*, again showing the same consonant that the causativized root ends with.

The basic facts illustrated in (81a) and (81b) are fairly interesting in and of themselves. However, roots ending in *m*, which does not fricate, show an extra, intriguing complication. A formative *-ik-* appears on these roots when they marked for applicativization and causativization directly after the verb root. This formative does not correspond to any particular morpheme in Nyakyusa. Rather, it appears to be satisfying some condition that markers of causativization and applicativization contain the sequence *-kiS-* (where *S* is a cover symbol

for *s* or *f*). This condition, which Hyman (2003a) refers to as the KIS requirement, is the most striking restriction on the form of combined suffixes that I am aware of.

With respect to the general CAT ordering restriction found in Bantu, it is worth noting that none of the special forms discussed here appear to have resulted from a diachronic situation violating this basic restriction. In a case like that of Kinyarwanda, we do need to posit that the present reflex of applicativization and causativization arises from two instances of the applicative. However, even in such cases, the multiple applicatives maintain their ordering restriction after the causative and before the transitive.

2.5.4 The effect of complex suffix combinations

A striking fact in some languages is that, even though they do not allow the suffix order applicative-causative (AC), they do allow the applicative extension to precede the causative if another extension intervenes. This has been noted, for example, as occurring with the reciprocal as seen in the data in (82) from Chichewa.

(82) CHICHEWA (N.31b)

(Hyman and Mchombo 1992:354)

STEM	GLOSS	TRANSLATION
<i>-mang-ir-an-</i>	‘tie-APP-REC’	“tie for each other”
<i>-mang-ir-an-its-</i>	‘tie-APP-REC-CAUS’	“cause to tie for each other”
* <i>-mang-ir-its-</i>	‘tie-APP-CAUS’	

This exact sort of phenomenon is seen in Ikalanga (Mathangwane 2000:14) and also in Ciyao (Ngunga 2000:250).

Data like that seen in (82) has rarely been looked for explicitly. So, it is hard to say how widespread a phenomenon it is. It will come up again in section 2.7.4.3 (page 259).

2.5.5 Ambiguity of semantic scope for some orders

It is often the case that scope relations are predictable from the order of suffixes on verbs in Bantu. The effects of morpheme order on scope have been reported to be clearly observed with respect to the interpretation of the semantics of the reciprocal extension as seen in the data from Chichewa in (83), as reported in Alsina (1999).²⁶

(83) CHICHEWA (N.31b) (Alsina 1999:7)

- a. *Alēnje a-na-mény-án-its-á mbûzi.*
 2.hunter 3P-PST-HIT-REC-CAUS-FV 10.goat
 “The hunters made the goats hit each other.”
- b. *Alēnje a-na-mény-éts-an-á mbûzi.*
 2.hunter 3P-PST-HIT-CAUS-REC-FV 10.goat
 “The hunters made each other hit the goats.”

In (83a), the reciprocal suffix *-an-* has scope over the main verb *-mény-* ‘hit’, whereas in (83b) the reciprocal has scope over the causativized verb *-mény-éts-*—resulting in different coreference relations in the two sentences.

However, it is not uncommon to find cases in Bantu languages where a combination of two suffixes is ambiguous in scope. One such case is found the applicative-reciprocal combination in Chichewa (Hyman and Mchombo 1992:356) and Kinande (Hyman 1993:8). Such ambiguity can also be found for the combinations of the causative, applicative, and transitive as seen in the data from Runyambo in (84).

²⁶ While the gloss in (83b) is that reported in Alsina (1999) and is certainly that of the most salient reading for the sentence, data discussed in Hyman and Mchombo (1992:356) indicates that it may in fact be ambiguous for reciprocalization on either argument.

(84) RUNYAMBO (E.21) (Rugemalira 1993:189)

- a. *a-ka-mu-kor-ez-á* *egári*
 3S-PST-3S-repair-APP.TRANS-FV bicycle
 “She had the bicycle repaired for him.”
- b. *a-ka-tu-son-es-ez-á* *emyênda*
 3S-PST-1S-sew-CAUS-APP.TRANS-FV dresses
 “She had dresses made for us.”

The sentence in (84a) is an example of an etymological applicative-transitive (AT) combination which marks for causativization and applicativization in Runyambo. The sentence in (84b) is a case where Runyambo uses the etymological causative-applicative-transitive (CAT) combination to mark causativization and applicativization. On the subject of the scope relations of the applied argument in the sentences (in both cases the applied argument, a beneficiary, is realized as a prefixed pronominal object), Rugemalira (1993) writes, “The glosses in [(84)] contain two scope interpretations: ‘cause to V-for’ (causative of applicative) and ‘on behalf of, cause to V’ (applicative of causative) (189).” Thus the semantics encoded by these suffixes in Runyambo is ambiguous for scope. The same sort of phenomena for the causative, applicative, and transitive suffixes is reported for Chimwi:ni (Abasheikh 1978:209–227), Kinyamwezi (Maganga and Schadeberg 1992:156), Ikalanga (Mathangwane 2000:13), Ndebele (Sibanda 2000:17–18), and Chichewa (Hyman 2001:3) (as will be seen in (118)).

Since these are among the most thorough descriptions of the semantics of different suffix orders I had access to, it is very likely that this type of ambiguity is significantly underreported. If it is indeed more common than this survey indicates, then this would support the general arguments to be made here that the ordering is templatic and not governed

by something like the Mirror Principle. Any principle relating the order of morphemes to a specific scopal interpretation of those morphemes will necessarily have trouble dealing with cases where a given order is ambiguous for scope. However, such ambiguity is not problematic for an analysis where the ordering of a set of morphemes is templatically governed. If some morpheme must be stipulated to occur in a fixed with respect to some other morpheme, then there is simply no prediction as to how the semantics of those two morphemes should be related to each other unlike under a Mirror Principle approach.

It is important to note that where ambiguity for scope is reported for certain order of causative, applicative, and transitive, it is only reported for the templatic order. So, for example, none of the five languages given in (70) as exhibiting applicative-causative (AC) are reported as showing scopal ambiguity for that order of suffixes. This relationship between templatic order and scopal ambiguity has been explored in depth by Hyman (2003a) and will be discussed in more detail in section 2.6.4 (page 218).

To close this section, I would like to point out that, outside of Bantu, I am aware of one typologically comparable language which shows ambiguity for certain suffix orders which could logically have well-defined scope relations. This is Quechua, as described by Muysken (1988a). Ambiguity of the sort just described for Bantu is limited in Quechua, and Muysken only describes it for one combination of suffixes (out of a number suffix combinations discussed generally). In Quechua, the cislative *-mu-* (abbreviated ‘CIS’) must follow the causative *-chi-*. However, scope readings are available where the causative has scope over the cislative and vice versa, as seen in (85a).

The data in (85b), in contrast, shows a verb being suffixed with an “auxiliary” meaning ‘help’, *-schi-*, which like *-chi-* must also precede the cislative but does not produce a verb with ambiguous scopal semantics. The scope reading for the verb in (85b) follows the basic predictions of the Mirror Principle, discussed in section 1.4.2 (page 85) in chapter 1.

- (85) a. *apa-chi-mu-n*
 take-CAUS-CIS-3s
 “He causes to bring” or “He goes and causes to take”
- b. *apa-schi-mu-n*
 take-help-CIS-3s
 “He goes and helps take.” (Not: “He helps bring”) (Muysken 1988a:271)

The Quechua data in (85) indicates that ambiguity of the sort seen in Bantu might be a more general cross-linguistic phenomenon which runs counter to the predictions Mirror Principle. The fact that it is found in Bantu and Quechua suggests that it might be typologically correlated with extensive, morphosyntactic derivational verbal suffixing. Of course, with the current level of evidence, this is only speculative, but it points to a direction of possible future research for the relationship between semantic interpretation of affixes and their linear order outside of Bantu.

2.5.6 Suffix doubling resulting in different semantics

Data presented in section 2.5.3 (page 159) showed that combinations of the applicative and causative may result in special forms of one of the suffixes. In (80), for example, from Kinyarwanda, the special form of the applicative was *-iriz-*, which was used instead of the regular applicative *-ir* in a verb marked for causativization and applicativization. This form is probably based on a reduplicated form of the applicative, with shape *-irir-*, where the

second *r* surfaces as a *z* as a reflex of palatalization triggered by an etymological transitive suffix **-j-*. (A similar effect on the final consonant of the applicative was seen in (62) where it surfaced as a *y* instead of an *l*.)

Kirundi presents a rather striking use of this reduplicated applicative. This reduplication also has the form *-iriz-*, like Kinyarwanda. However, it is not employed in every combination of the causative and the applicative. Rather, it is employed only when the semantics of the combination is such that the applicative has scope over the causative. Despite this scope relation and the different realization of the applicative suffix, the causative-applicative-transitive (CAT) order of the suffixes is maintained. This is illustrated in (86). The English translations, taken from Hyman (1993:10) are given followed in parentheses by Meeussen's (1959:59) original French translations.²⁷

(86) KIRUNDI (D.62)

(Meeussen 1959:59)

STEM	GLOSS	TRANSLATION
<i>-gum-</i>	'firm'	"be firm" ("être ferme")
<i>-gum-y-</i>	'firm-CAUS'	"hold" ("tenir")
<i>-gum-ir-</i>	'firm-APP'	"hold fast at" ("tenir quelque part (intr.)")
<i>-gum-iz-</i>	'firm-APP.TRANS'	"make hold fast at" ("tenir quelque part")
<i>-gum-ir-iz</i>	'firm-APP-APP.TRANS'	"hold for" ("tenir pour")

The idea that forms like *-gum-ir-iz-* 'be_firm-APP-APP.TRANS' contain a doubled applicative was originally put forth by Meeussen (1959:58). Though he did not give examples of the verbs in (86) in sentences, he made it clear that he interpreted forms with the doubled applicative to represent the applicativization having scope over the causativization whereas

²⁷ The English translations in (86) are adapted from Hyman (1993:10).

the forms with just a single applicative followed by a transitive represented the case where causativization had scope over the applicativization (Meeussen 1959:58–9).

As indicated in the table in (70), Kirundi also makes use of a reflex of the causative **-ic-*. Words using this causative suffix, do not use it when they are also marked for applicativization which has scope over the causativization. In such instances, the *-ir-iz-* suffix seen in (86)—this is comparable to what was seen for Shona, as discussed in section 2.5.3 (page 159). Examples of this from Kirundi are given in (87).

(87) KIRUNDI (D.62)

(Meeussen 1959:59)

STEM	GLOSS	TRANSLATION
<i>-moot-</i>	‘smell_good’	“smell good” (“sentir bon”)
<i>-moot-eesh-</i>	‘smell_good-CAUS’	“perfume” (“parfumer”)
<i>-moot-er-ez-</i>	‘smell_good-APP-APP.TRANS’	“make breathe a scent” (“faire respirer une odeur”)

As with the verb *-gum-ir-iz-* in (86), Meeussen (1959:59) indicates that, in the verb *-moot-er-ez-* ‘smell_good-APP-APP.TRANS’, where the causativization has scope over the applicativization. Since, as (87) indicates, even verbs taking the **-ic-* causative form use the *-ir-iz-* ‘APP-APP.TRANS’ form for the applicativized causative, it appears that *-ir-iz-* has become the fixed marker for these semantics.

Kirundi is the only language I have found exhibiting causativization and applicativization data like that seen in (86). However, suffix doubling associated with different semantics is found elsewhere in Bantu for combinations of suffixes other than the causative, applicative and transitive, and some other cases are documented in Hyman and Katamba (1991).

The developments exemplified in (86) within Kirundi are certainly noteworthy. Importantly, for the general question here about the relative order of the causative, applicative, and the transitive, they did not result in innovative orders, just forms with innovative semantics maintaining the overall causative-applicative-transitive (CAT) order. I am hesitant to make strong inferences based on the few forms Meeussen gives in (86). However, it is worth pointing a Mirror Principle approach would predict that such innovative forms should result in a different morpheme order—which is precisely what we don't see.

2.5.7 Languages showing productive AC order

One of the main points of this chapter is to show that there is a strong tendency towards causative-applicative-transitive (CAT) order in Bantu—strong enough that the ordering can be described as templatic. As summarized in (70), however, several languages were found to allow productive applicative-causative order in certain contexts. These languages are Korekore, Ndebele, Emakhuwa, Bukusu, and Xhosa. In this section, I will describe how AC order works in each of these languages in turn. Importantly, only Xhosa allows completely productive order with clear “scopal” semantics. In the other languages, there are restrictions on applicative-causative order, not found for causative-applicative order, which indicate that it is not fully morphologically or semantically productive.

In (88) I give all the examples of AC order given by Dembetembe (1987) for the Korekore dialect of Shona.

- (88) KOREKORE (S.11) (Dembetembe 1987:78–79)
- a. *Ndinedá bhásikoro re-kú-dzok-er-es-a kumushá.*
 1s.PRS.want.FV 5.bicycle 5-INF-return-APP-CAUS-FV to.3.home
 “I want a bicycle to get me back home.”
- b. *Endá katórá mapango é-ku-vák-ír-ís-a munda.*
 go.FV CONS.fetch.DV 6.pole 6-INF-build-APP-CAUS-FV 3.field
 “Go and bring some poles to fence the field with.”
- c. *Nd-a-mú-reg-er-es-a basa ráké.*
 1s-PERF-3s-allow-APP-CAUS-FV 5.work 5.3s.POSS
 “I made him leave his work.”
- d. *Tém-a mazání e-kú-sos-er-es-a nzira iyi*
 cut-FV 6.branch 6-INF-block-APP-CAUS-FV 9.path 9.this
 “Cut branches with which to block this path.”

Dembetembe (1987:78) specifically says about AC order that, “It occurs mostly in possessively inflected infinitive inflections.” This is the use in three of the four examples he gives, (88a), (88b), and (88d). In the one case where it is not used in this construction, the sentence in (88c), the semantics of the combination are fairly opaque. Dembetembe does not offer discussion of this, but from the translations he gives, the verb root meaning “allow” seems to have come to mean something like “get_off (work)” when applicativized. This verb is then causativized. Since this is not a transparent derivation from the root *-reg* ‘allow’, my conclusion from this is that the verb in (88c) has a lexicalized applicative suffix, accounting for AC order in that case, and that, in the other instances, while AC order is productive, it no longer productively marks causativization and applicativization, but has a specialized morphosyntactic function. This semantic shift appears to have been accompanied by a loss of templatic ordering restrictions. Because of the semantic shift is involved, Korekore is not a clear case of the CAT template being violated.

The Ndebele case, like the Korekore case, is highly restricted, though not semantically but phonologically, and its source clearly lies in these phonological restrictions. Applicative-causative order is excluded generally but permitted with a class of roots which Sibanda (2000:52) gives the label “subminimal”—a term often used in Bantu linguistics. These are roots which do not have canonical -CVC- shape and Sibanda (2000) use the non-canonical root *-dl-* ‘eat’ to illustrate the data. In (89) I repeat the example from (55) showing the behavior of the non-subminimal root *-sik-* ‘cut’. In (90) I give examples of the interesting behavior of the root *-dl-* ‘eat’.

(89) NDEBELE (S.44) (Sibanda 2000:18)

- a. *-sik-is-el-*
cut-CAUS-APP
‘W make X cut Y for Z’
- b.**-sik-el-is-*
cut-APP-CAUS
‘W make X for Y cut Z’

(90) NDEBELE (S.44) (Sibanda 2000:57–58)

- a. *-dl-is-el-*
eat-CAUS-APP
‘feed (or make eat) for/at’
- b. *dl-el-is-*
eat-APP-CAUS
‘make eat at’
- c. *dl-el-is-el-*
eat-APP-CAUS-APP
‘make eat for/at (but not feed)’

As can be seen in (89), non-subminimal roots in Ndebele do not allow the applicative-causative order. Subminimal roots not only allow this order, as seen in (90b), they also allow applicative-causative-applicative order, as seen in (90c). However, this applicative-causative order is more semantically restricted than causative-applicative order insofar as only a locative applicative object can be used with this verb as indicated by the translation. Somewhat strikingly, when the applicative is repeated to make a verb with applicative-causative-applicative order, full applicative semantics are found. Finally, it is worth noting that only the causative-applicative combination in the examples in (90) allows the verb to be interpreted with the lexicalized meaning ‘feed’ as opposed to the compositional meaning ‘make eat’.

Sibanda (2000:58) suggests an explanation for the behavior of subminimal roots: “The acceptability of [applicative-causative] can be due to the fact that /-el-/ is treated like a non-productive suffix in the verb, that is, C-VC- is taken to be CVC-.” The semantics of the verbs in (90) supports this idea of reanalysis insofar as the root+causative allows the lexicalized reading of ‘feed’ and the root+applicative reading does not allow for the full range of applicative objects.

Thus the applicative-causative order in Ndebele appears to be a special case of lexicalization of a stem-affix combination along the lines discussed in section 2.5.2 (page 150). It is, in some sense, more productive than the typical lexicalization pattern which involves individual roots, and not a phonologically defined subclass of roots. However, this is not surprising given the subminimal phonological shape of this particular class. What we see,

then, is that AC ordering in Ndebele, is also not a strong counterexample to the CAT template.

AC order in Emakhuwa (Kathupa 1991) is less clearly aberrant than it was in Korekore and Ndebele. However, the facts for Emakhuwa are complex and the translations of the relevant verbs are difficult to interpret. Examples of the causative-applicative ordering alternating with the applicative-causative ordering are given in (91).

(91) EMAKHUWA (P.31)

(Kathupa 1991:307)

VERB	GLOSS	TRANSLATION
<i>o-cis-er-ih-a</i>	INF-take-APP-CAUS-FV	“cause to take for somebody”
<i>o-cis-ih-er-a</i>	INF-take-CAUS-APP-FV	“put on top of”/ “cause to take for some reason”/ ? “cause to take for somebody”
<i>o-lip-el-ih-a</i>	INF-hard-APP-CAUS-FV	“cause to get hard for somebody”
<i>o-lip-ih-er-a</i>	INF-hard-CAUS-APP-FV	“harden towards something”/
<i>o-we-el-ih-a</i>	INF-come-APP-CAUS-FV	“cause to come for something”
<i>o-wi-ih-er-a</i>	INF-come-CAUS-APP-FV	“bring something for somebody”/ “bring for some reason”/
<i>o-tek-el-ih-a</i>	INF-build-APP-CAUS-FV	“cause to build on behalf of”
<i>o-tek-ih-er-a</i>	INF-build-CAUS-APP-FV	‘cause to build for some reason’/ ? “cause to build on behalf of”
<i>wa-akuv-el-ih-a</i>	INF-hurry-APP-CAUS-FV	“cause to hurry up on behalf of”
<i>wa-akuv-ih-er-a</i>	INF-hurry-CAUS-APP-FV	“cause to hurry up towards/for something”/ ? “cause to hurry up on behalf of”

The somewhat idiosyncratic translations given in (91) are taken directly from Kathupa (1991:307). Kathupa (1991:307–310) discusses the distinction between the verb pairs in (91) and gives examples of these verbs in main clauses. After analyzing the meaning of these verbs, he comes to the conclusion, “[I]t may be said that the order between the applicative and the causative does not reflect the Mirror Principle in any straightforward manner

(Kathupa 1991:310).”

What this means is that, even if AC order is morphologically productive in Emakhuwa, it does not appear to be semantically compositional. Emakhuwa, thus, appears to be similar to the Korekore case, except that it allows AC order in a wider range of contexts. In this sense, it is not the strongest counterexample to the CAT since it is possible that it involves lexicalization of particular suffixes onto verb stems. I would treat it in more detail here except for that fact that I have found other languages where the order appears to be more semantically transparent which shed more clear light on the general issue of AC order in Bantu.

The first of these is Bukusu, which I only have limited data on. However, this data is interesting in that there is a clear difference in what semantic readings for the applicativized object are available for non-templatic applicative-causative order over templatic causative-applicative order.

David Peterson (personal communication) has observed that it is possible in Bukusu, though somewhat marginal, to mark a verb with applicative-causative order if the applicative is introducing an instrumental object. The data in (92a) illustrates a case where Bukusu shows AC order. The sentence in (92b) gives the preferred variant where the instrumental object is marked with a preposition rather than being applicativized. The sentence in (93) gives a minimal pair for (92a) with the verb showing CA order.

(92) BUKUSU (J.31)

- a. *a-mu-lim-il-isy-a* *em-bako*
 3s.SUBJ-3s.OBJ-cultivate-APP-CAUS-FV 9-hoe
 “He made him cultivate with a hoe (i.e., he used a hoe to make him cultivate).”
- b. *a-mu-lim-isy-a* *n-em-bako*
 3s.SUBJ-3s.OBJ-cultivate-CAUS-FV INS-9-hoe
 “He made him cultivate with a hoe.” (preferred variant of (92a))

(93) BUKUSU (J.31)

- a-mu-lim-is-il-a* *em-bako*
 3s.SUBJ-3s.OBJ-cultivate-CAUS-APP-FV 9-hoe
 “He made him cultivate with a hoe (i.e. he caused him to use a hoe to cultivate)”

It is not clear whether or not Bukusu would allow AC order for a benefactive applicativized objects. However, to the extent that it might be possible, it appears that AC order would be more marginal with benefactive applicative semantics than instrumental applicative semantics (David Peterson, personal communication). Bukusu, therefore, even with limited data, represents an important instance where AC order can be associated, in some cases, with transparent semantics but where the semantics of applicativization is more limited than with templatic causative-applicative order. Bukusu represents an intermediate case between Korekore and Emakhuwa discussed above, which allowed AC order morphologically but without semantics reflecting that order in a transparent way, and Xhosa, which shows productive AC order without any reported restrictions on the semantics of applicativization for that order.

Following the general pattern, Xhosa productively allows CA order as exemplified in the forms in (94).

(94) XHOSA (S.41) (Satyo 1985:244)

STEM	GLOSS	TRANSLATION
<i>-qhum-is-el-</i>	‘emit-CAUS-APP’	‘puff at/for’
<i>-sebenz-is-el-</i>	‘work-CAUS-APP’	‘cause to work at/for’
<i>-thenth-is-el-</i>	‘speak-CAUS-APP’	‘make to speak at/for’

The forms in (95) illustrate the additional fact, just mentioned above, that Xhosa also productively allows semantically transparent AC order.

(95) XHOSA (S.41) (Satyo 1985:239)

STEM	GLOSS	TRANSLATION
<i>-bhal-él-is-</i>	‘write-APP-CAUS’	‘cause to write to’
<i>-qumb-él-is-</i>	‘be_angry-APP-CAUS’	‘cause to be angry with’
<i>-coth-él-is-</i>	‘approach-APP-CAUS’	‘make someone/something approach’

The sentence in (96) clearly shows that a verb marked with an applicative followed by a causative shows the syntax of a verb which is first applicativized then causativized. The semantics of the applicativized object are those of a benefactive.

(96) XHOSA (S.41) (Satyo 1985:296–7)

Utiitshala u-bhal-él-is-a inqúnunu ileta ngábafúndi
 teacher 1-write-APP-CAUS-FV principal letter student
 “The teacher makes the students write a letter to the principal.”

In (96) the benefactive object *inqúnunu* ‘principle’ appears close to the verb and the agent of the caused action *ngábafúndi* ‘students’ appears further from it. This can be taken to reflect the narrow scope of the applicative suffix over the verb root, which it is adjacent to, as opposed to the wide scope of the causative suffix over the applied verb.²⁸ The semantics

²⁸ Given data regarding the ambiguity of order causative-applicative (CA) with respect to scope, as discussed in section 2.5.5 (page 165), I should point out here that Satyo (1985) does not address whether or not any of the combinations of suffixes he gives as possible are ambiguous for scope. The study is fairly thorough. So, to the extent that no mention is made of ambiguity, I believe the default assumption should be that it is not found.

of this sentence clearly illustrate that the causative has scope over the applicative since the students are being caused to perform the whole action of writing a letter to the principle—they are not simply writing a letter.

Xhosa represents the one case where the templatic CA ordering restrictions appear not to hold and the ordering between the causative and the applicative is apparently determined by semantics in the way predicted by the Mirror Principle. Because of this, it is an important language insofar as it shows that the logically possible AC order is indeed attested, although it is rare. The fact that Xhosa exists does not contradict the idea that a CAT template is active in Bantu. Rather it tells us that it is a very strong tendency in Bantu which can be violated. Languages like Korekore or Emakhuwa also indicate this, though not as clearly.

At first glance, the existence of a language like Xhosa would appear to support Mirror Principle approaches to affix ordering in Bantu. At least, it could be taken to show that, in addition to templatic ordering, other principles of ordering were attested. And, indeed, if we understand the Mirror Principle merely as a statement on the relationship between morpheme ordering and semantic scope, Xhosa would seem to support it. However, we shall see in section 2.6 (page 181) that, while Xhosa might offer general support of Mirror Principle approaches, particular formalisms of the Mirror Principle for Bantu have actually ruled out a language like Xhosa on independent grounds. Specifically, they argue that there are general reasons to rule out applicative-causative order based on the syntax and semantics of the extensions.

2.5.8 Local conclusion

In this section, I presented the results of a survey of thirty geographically dispersed Bantu languages with respect to the morphemic exponence of causativization and applicativization on the verbs of those languages as derived from the etymological causative, applicative, and transitive suffixes.

The most striking result of the survey was the overwhelming tendency for languages to show causative-applicative-transitive (CAT) morpheme order, even when this order did not reflect “scopal” semantics. Various cases where this order is violated in present-day languages have been found. Many of these cases are simply understood as suffixes having been lexicalized onto particular verb roots, as discussed in section 2.5.2 (page 150). Other cases where it is violated were discussed in section 2.5.7 (page 171), where languages showing productive or semi-productive AC order were discussed. In all but one case, that of Xhosa, languages allowing this order productively, showed phonologically-based or semantically-based restrictions. Xhosa does allow semantically transparent AC order and constitutes the only clear exception to the CAT template.

There were additional complications in the morphemic exponence of causativization and applicativization discussed in sections 2.5.3–2.5.6, but none of these phenomena violated the CAT template.

The main point I would like to take from this comparative survey is that a restriction favoring CAT order is generally active in Bantu. I understand this restriction to be templatic—that is, it must be independently stipulated. This is not necessarily obvious

since there might also be syntactic/semantic explanations for it. In fact, various such explanations have been proposed for suffix ordering restrictions in Bantu.

In the next section, I will closely examine three previous analyses (Baker (1988), Alsina (1999), and Hyman (2003a)) of suffix ordering in Bantu with a focus on the analysis of ordering restrictions in morphemes expressing applicativization and causativization. A third kind of analysis (Hyman and Mchombo (1992) and Hyman (1993)) will also be looked at in order to provide a foundation for understanding some aspects of the others.

Two of these analyses, Baker (1988), Alsina (1999), propose non-templatic explanations for suffix ordering in Bantu and explicitly include at least two of the three CAT suffixes in their discussion. I intend to show that these analyses make incorrect predictions with respect to the mechanisms which would ensure a CAT order. The third analysis, Hyman (2003a), does propose a templatic analysis for the CAT ordering restriction, and I will follow the basic insights of that work here and also attempt to extend them in some new directions in later sections.

In section 2.7 (page 229) I will argue that the CAT ordering restriction in Bantu is consistent with the Strong Linearity Domain Hypothesis.

2.6 PREVIOUS ANALYSES OF THE RELATIVE ORDERING OF THE VERBAL SUFFIXES

2.6.1 Introduction

In this section, three previous analyses of Bantu suffix ordering will be examined. All of these analyses make use of the Mirror Principle in one way or another. The first one, that

of Baker (1988), is representative of syntactic analyses of the extensions—specifically, the extensions are treated as syntactic words which combine with a verb root morphophonologically in order to be realized. The second analysis, that of Alsina (1999), is similar to Baker’s insofar as it accepts the Mirror Principle as a valid grammatical universal. It diverges from Baker, however, in being a lexical analysis of the extensions—in effect treating them as derivational morphemes which produce new verb stems which then enter into syntactic constructions.

Finally, the analysis of Hyman (2003a) offers an important contrast to these two. Hyman suggests that there is a template operating in Bantu morphology governing some aspects suffix ordering. In addition to this, like Baker (1988) and Alsina (1999), Hyman also assumes that some form of the Mirror Principle is operating in Bantu.

Hyman examined a wider range of data than Baker or Alsina. In particular, his basic data set, though smaller than the data set used here, exhibited all the major features of Bantu suffix ordering discussed in section 2.5 (page 142). Largely because of this, his analysis is most closely aligned with the approach taken in the present work. In section 2.7 (page 229) I will present my own analysis for the CAT template found in the Bantu verb stem. This analysis will be largely complementary to Hyman’s analysis insofar as each is focused on accounting for different aspects of templatic suffix ordering in Bantu. Hyman’s work, as we will see, focuses on the relationship between suffix ordering and semantic interpretation. This work is focused on trying to understand whether or not the template found in the Bantu verb can be understood to be consistent with a restrictive theory of the form of templates,

namely the Strong Linearity Domain Hypothesis.

It should already be apparent that the survey of causativization and applicativization in Bantu discussed in section 2.5 (page 142) runs counter to the idea that the Mirror Principle is the primary determiner of the ordering of the morphemes marking causativization and applicativization. Nevertheless, it is useful to understand how previous researchers have explained morpheme ordering in Bantu to get the proper sense for the facts the present analysis is trying to explain.

2.6.2 Baker (1988)

2.6.2.1 A sketch of Baker's analysis

Baker (1988) is concerned with a general class of phenomena which he calls examples of “incorporation” and which he analyzes within a transformationalist framework. Though the standard version of transformationalist frameworks has changed significantly since his original work, the core of his analysis has been retained by many authors (see, e.g., Pylkkänen (2002) who uses aspects of Baker's approach in a recent Minimalist analysis of Bantu causatives and applicatives). Baker's work is of direct interest to the present discussion since, among other types of incorporation phenomena, he analyzed causativization and applicativization in Chichewa and Swahili.

The heart of Baker's analysis is that he treats the Bantu verbal extensions as independent units in the syntax which have the morphological requirement of attaching to a verb stem. Such an approach allows the deep structure of Bantu sentences headed by verbs suffixed with applicative and causative extensions to resemble the surface structures of sentences

in languages which express applicative and causative semantics periphrastically as will be seen below.²⁹

The primary difference between Bantu languages and languages like English, in his framework, is the fact that, in some instances, Bantu verbs and extensions must “move” during the course of derivation so that the extensions can attach to the main verb root of the sentence in order to satisfy their morphological requirements.³⁰ English causativization and applicativization constructions are taken to require no such movement and words used to express causative and applicative ideas, thus, remain closer to their deep structure locations. This powerful unification of morphology and syntax allows Baker to formulate an elegant explanation for the Mirror Principle: Morpheme order reflects syntactic/semantic scope not because of any external mechanism enforcing some sort of homogeneity between morphology and syntax. Rather, morphology *is* syntax (and vice versa). The only difference between them is the morphological dependency (or lack thereof) of the relevant syntactic elements.

Like Hyman (2003a), Baker (1988:68–74) explicitly claims that there is a morphological component in grammar (though their views on the exact nature of this component may be very different). For Baker, this morphological component in grammar is responsible for affixation, among other things. While he does not describe the properties of this component in detail, it would seem necessary to assume that he envisions its default operation as being some simple type of concatenation. That is, the basic process bringing morphemes

²⁹ Myers (1987) presents an analysis of the Shona verb which anticipates many aspects of Baker’s (1988) analysis of other Bantu languages.

³⁰ Baker (1988) does not examine any Bantu language making use of the transitive suffix productively.

together into words would have to be the same as the basic process bringing words together into phrases. If morphological concatenation operated on fundamentally different principles than syntactic concatenation, Baker's explanation of the Mirror Principle would cease to be valuable—linear order in syntax should only represent linear order in morphology if the basic linearization operations of the two components are the same.

This assumption is certainly reasonable, and it is very similar to that of Embick and Noyer (2001) discussed in section 1.4.3 (page 89). However, a consequence of that assumption will be that some of the data presented here will cause problems for his analysis of the relationship between morphology and syntax/semantics.

Among a wide range of things, Baker (1985) discusses causative and applicative constructions in Bantu. Within his typology of incorporation phenomena, Bantu causativization is considered to be verb incorporation and applicativization is considered to be preposition incorporation. These two types of incorporation are structurally very different, as illustrated by the tree (98), which gives the deep structure for a verb marked with causative followed by the applicative. This tree is based on Baker's tree for the Swahili sentence given in (97).

(97) SWAHILI (G.40)

(Baker 1988:394)

A-li-ni-fung-ish-i-a *mtoto wangu mlanga.*
 3S-PAST-1S-close-CAUS-APP-FV child my door
 "He had my child close the door for me."

(98)

(based on Baker (1988:398))

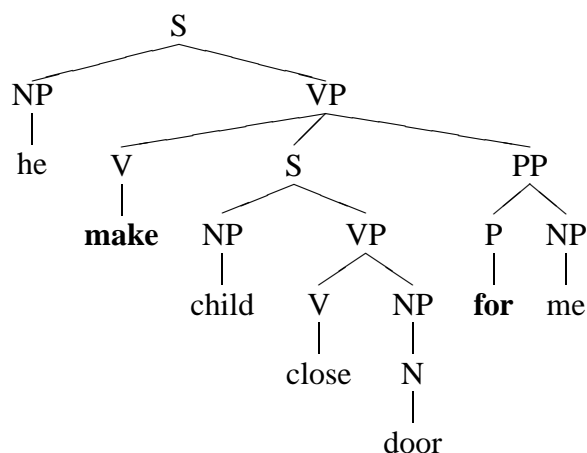

The bolded words in (98), *make* and *for* correspond to the causative extension *-ish-* and the applicative extension *-i-* in (97) respectively. The causative is treated as a separate predicate entirely which means, like a regular verb, it has the ability to subcategorize for its own verbal arguments. Since the causative verb *make* actually governs the complement phrase containing the verb *close*, the verb *close* will have to move upwards to join with *make* in order to make the complex verb stem *-fung-ish-* ‘close-CAUSE’. The applicative, on the other hand, is treated as being part of an adjoined prepositional phrase. The applicative marker *for* does not move “upwards” to attach to the main verb—it simply moves “leftwards”. Making use of this basic distinction, Baker gives a surface structure for the sentence diagrammed in (98) like the one in in (99).

(99)

(based on Baker (1988:398))

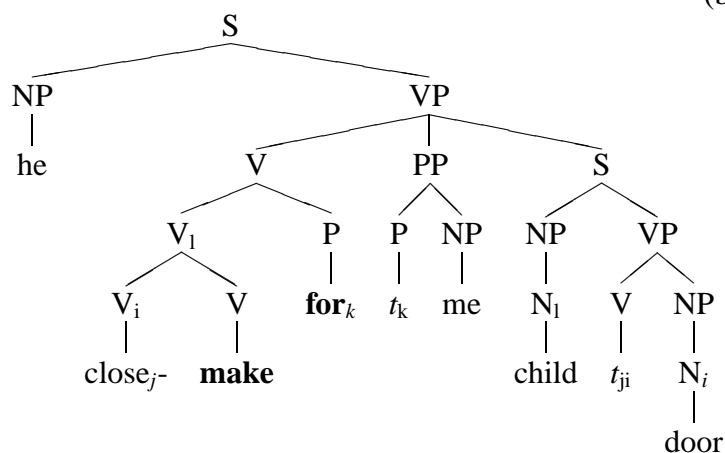

The example in (99) illustrates how Baker analyzes causativization as a multi-step movement of the main verb to the higher position of the causative verb. Applicativization, as mentioned above, involves only one-step movement of a preposition to the main verb of the sentence.

An additional fact about the structure in (99) is that the verb complex under the node V_I specifically subcategorizes for the applicativized object *me*. This fact is meant to explain various asymmetries between objects introduced via applicativization and those which are part of the lexical subcategorization of the verb root. (These asymmetries have been of much theoretical interest in the literature on Bantu; see, e.g., Alsina and Mchombo (1993), Bresnan and Moshi (1993), Marantz (1993) and Alsina (1999), McGinnis (2001), Seidl (2001), Pylkkänen (2002)).

To help compare Baker's approach with that of Alsina (1999), which will be discussed in section 2.6.3 (page 204), it will be useful to try to describe Baker's analysis of applicativization and causativization in more atheoretical terms than given above. I believe that Baker's division between the causative and the applicative is reminiscent of the traditional

distinction between derivational morphology and cliticization. Causativization, under his analysis, parallels derivational morphology insofar as it makes a fairly radical alteration to the syntactic properties of the causativized verb—adding a whole extra layer of predication to the sentence. The degree of this alteration is roughly correlated with the amount of “movement” required in the derivation. Applicativization, on the other hand, closely resembles cliticization insofar as it is the result of a low-level syntactic operation that occurs between words which are, roughly speaking, syntactically adjacent. This requires movement only in one step without not vastly altering the syntactic structure of the sentence, much as cliticization does not typically vastly alter the syntax of a sentence.³¹

Another parallel between cliticization and applicativization is that, under Baker’s treatment, applicativization is predicted to block later causativization—much in the way we expect derivational morphology to occur “inside” any cliticization processes. This is taken as a good result since the languages Baker examined did not allow AC order (and, as we saw in section 2.5 (page 142), the applicative-causative (AC) order is very restricted across Bantu). To see how a derivation involving applicativization followed by causativization is blocked in Baker’s framework, it is first useful to see the basic type of deep structure Baker assigns to sentences which would express such semantics (100). This structure parallels the one given for CA order in (98).

³¹ I do not mean to say, of course, that Baker treats causativization as derivation and applicativization as cliticization. I simply believe that the parallels between Baker’s account and these two traditional terms of grammatical description will be helpful in comparing his analysis to Alsina’s (1999).

(100)

(based on Baker (1988:395))

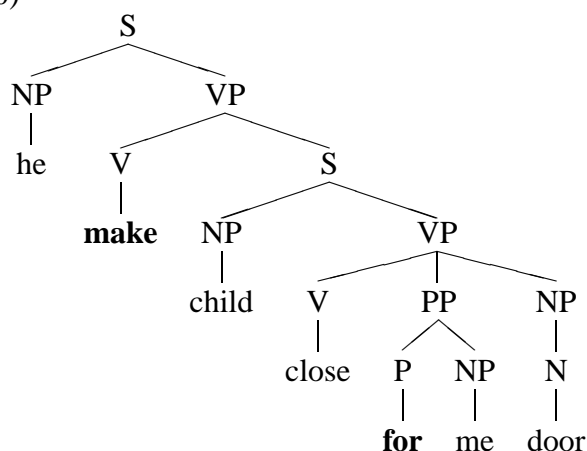

Recall that the words *for* and *make* in the tree in (100) represent morphological affixes—the applicative and causative extensions respectively. Again, under Baker’s analysis, these must be joined with the main verb *close* in order to create a well-formed sentence. Baker (1988:395–397) describes how it is impossible to derive a well-formed surface structure from the deep structure in (100) within his framework. No matter which order you incorporate *make* and *for*, key syntactic constraints are violated. If the applicative *for* is incorporated to *close* first, and then the verb complex *close-for* is moved upward along the tree to join with *make*, then, under Baker’s theory, no verb in the sentence can properly subcategorize for the argument *me*. On the other hand, if *close* moves up the tree and incorporates *make*, *for* cannot move up the tree to incorporate with the verb complex *make-close* since movement of a lower item in the tree is not permitted to follow movement of a higher item.

This analysis of Baker’s predicts two related things: stems showing AC morpheme should not occur and that stems with a meaning where causativization has scope over applicativization also should not occur. The first prediction falls out of the basic insight of the

Mirror Principle that morpheme order is correlated with syntactic/semantic scope. If the syntax rules out a derivation where causativization has scope over applicativization, then we should not see morphology corresponding to such a derivation. The second prediction falls out from Baker's general analysis of the syntax of causativization and applicativization. If a deep structure like the one in (100) cannot correspond to any grammatical surface structure, we should not expect any surface verb to surface with a meaning corresponding to the scope relations of that deep structure.

Given the survey of Bantu languages discussed in section 2.5 (page 142), there appear to be four classes of data which are problematic Baker's claim that applicativization cannot be followed by causativization. The first of these is the existence of languages which allow both causative-applicative (CA) and applicative-causative (AC) orders. The second of these is the effect of complex suffix combinations as described in section 2.5.4 (page 164), which is similarly be problematic for Baker since this can also produce cases where a causative extension follows an applicative extension. The third class of problematic data is ambiguous scope readings for certain affix orders, as described in section 2.5.5 (page 165). The final class of data deals with the some of the complicated morphological effects of suffix combinations as described in section 2.5.3 (page 159) and section 2.5.6 (page 168).

Each of these four areas will be taken up in turn in the following sections.

2.6.2.2 Languages allowing applicative-causative (AC) order

The first potential complication for Baker's claim to be discussed here comes most clearly from the language Xhosa, which, as discussed in section 2.5.7 (page 171) was

the one language which allowed for semantically transparent applicative-causative (AC) order and less clearly from the other languages exhibiting AC order. It might be possible for Xhosa to be consistent with the basic proposal in Baker (1988) regarding the nature of applicativization and causativization if it could be shown that applicativization in that language is syntactically different, in some way, from Chichewa and Swahili, and if such a difference could be argued to correlate with possible AC morpheme order.

One possible avenue to explore in this arena is whether or not the different morpheme ordering restrictions reflect, in some coherent way, the opposition between so-called symmetric and asymmetric object languages in Bantu (see Bresnan and Moshi (1993) for some discussion). This division of Bantu languages refers to how the two objects of ditransitive verbs behave with respect to various morphosyntactic parameters—the two most important being object marking/agreement in the prefixal area of the Bantu verb and passivization. Languages where the two objects behave the same way under those parameters are considered to be symmetric object languages, and languages where the two objects behave differently are considered to be asymmetric.

Developing how an argument relating object asymmetries to morpheme order would take some time, and I won't pursue it here. However, I will point out that Machobane (1989:208–26) has, broadly speaking, made the claim that symmetric object languages should allow AC order and asymmetric languages should not. Her discussion was specifically geared to account for the fact that Sesotho did not allow AC order and was an asymmetric object language while Xhosa did allow such order and was a symmetric object lan-

guage.

Machobane (1989) did not have access to all the data seen here. She knew, for example, that Kinyarwanda was a symmetric object language (Machobane (1989:221) citing Kimenyi (1980)) but was explicit in that she did not know what the allowable morpheme orders of the language were. While I have not been able to find an explicit statement saying that AC is not possible in Kinyarwanda (as is often the case in descriptions of Bantu language), the discussion of Coupez (1980:263–70) very clearly points to the idea that Kinyarwanda maintains CAT order but does not allow AC order in any verbal construction. Since it is not at all clear how the transitive suffix would fit into Machobane’s analysis, it is difficult to say, either way, how such data from Kinyarwanda would fit into her proposal, and I leave the issue open what the relationship might be (if any) between AC order and being a symmetric object language.

For now, then, it would seem to be an open question whether or not languages with AC order can be accommodated within Baker’s (1988) framework (or some more modern variant of it). In more recent transformationalist developments, comments found in Pylkkänen (2002:115–6) combined with the work of McGinnis (2001) suggest some syntactic criteria to examine in order to account for suffix ordering possibilities in Bantu which were not carefully considered by Baker (1988) and which could be relevant in developing a transformationalist account of AC order. These specifically relate to a distinction made between “high” and “low” applicatives (Pylkkänen 2002:17–43).

However, even if there is some way to syntactically deal with AC order in Xhosa, all

such proposals that I am aware of crucially would make use of cross-linguistic variation in applicativization and causativization constructions and designate that a given language will have one of a well-defined subset of applicative types and another of a well-defined subset of causative types. What this means is that such proposals can deal with cross-linguistic variation of morpheme-ordering restrictions, but not intralinguistic ones. Important intralinguistic morpheme-ordering variation has been discovered, which is the topic of the next section and which poses much greater problems for Baker's approach than the fact that Xhosa exhibits AC order.

Importantly, under the approach to be developed here, the fact that Xhosa shows AC order, with transparent semantics, poses no particular issue. The Strong Linearity Domain Hypothesis is intended to explain where and how templates can occur in grammar. The fact that some language, in this case Xhosa, does not make use of a template simply means that that language does not fall under the explanatory rubric of the Strong Linearity Domain Hypothesis. In this sense, until a satisfactory syntactic account of AC order in Xhosa can be developed, it indirectly supports the Strong Linearity Domain Hypothesis insofar as Baker's approach excludes AC order while the Strong Linearity Domain Hypothesis, by being silent on such an issue, implicitly includes it as a possible order (in a weak linearity domain).

Baker's approach, however, does have the advantage that, by excluding AC order generally, it implicitly predicts the weaker generalization that if it can occur at all, it should be rare—and, we see this is the case. The Strong Linearity Domain Hypothesis does not

make any such prediction. I don't take the rarity of AC order to necessarily be an argument against the Strong Linearity Domain Hypothesis. However, it certainly does require an explanation. In section 2.7.5 (page 262) I will present some data which suggests that, on grounds independent from the Strong Linearity Domain Hypothesis, CA order should be expected over AC order cross-linguistically. To the extent that such an auxiliary explanation can be justified, it allows the general analysis being developed here to go beyond the explanatory coverage found in Baker (1988) by dealing with the facts he presents as well as some of the facts uncovered by the survey discussed in section 2.5 (page 142).

2.6.2.3 Complex suffix combinations

The second potential area of data conflicting with Baker's analysis is of the type seen in (82). It is repeated below in (101). Verb forms like those in (101) constitute some of the strongest evidence against Baker's (1988) approach to the lack of AC order in Bantu languages.

(101) CHICHEWA (N.31b)

(Hyman and Mchombo 1992:354)

STEM	GLOSS	TRANSLATIOON
<i>-mang-ir-an-</i>	'tie-APP-REC'	"tie for each other"
<i>-mang-ir-an-its-</i>	'tie-APP-REC-CAUS'	"cause to tie for each other"
* <i>-mang-ir-its-</i>	'tie-APP-CAUS'	

As can be seen from (101), Chichewa disallows adjacent combinations of the applicative followed by the causative, but allows the applicative to precede the causative when the reciprocal extension intervenes. Though Baker (1988) does not discuss the Bantu reciprocal extension, he would probably classify it as an instance of noun incorporation in his

typology. The reciprocal extension certainly resembles nouns in that it fills an argument role of the verb it affixes to. His analysis of the reciprocal could, then, presumably be similar to his analysis of antipassive morphemes (Baker 1988:129–146), with some additional elements to deal with its coreferential properties.

Upon first examination, it might seem that Baker could allow for structures like the one in (101) by saying that moving the applied reciprocal “object” into the verb would allow it to be properly subcategorized for, thereby avoiding the derivational problems in a structure like (100). However, Baker’s particular formulation of preposition incorporation does not allow the preposition and its object to join together and then incorporate into the verb. Rather, the preposition must incorporate into the verb on its own. As Baker points out, if the promoted, applied object were then incorporated into the verb, “this [would be] an acyclic combination. . . (1988:389).” Since acyclic combinations are never allowed in Baker’s theory, he thus excludes verbs like those in (101) on independent grounds from the general restriction on causativized applicatives. The fact that such verbs can exist, therefore, presents a fairly deep problem for his analysis because they contradict it on two levels.

As mentioned in section 2.6.2.2 (page 190) more recent versions of transformational grammar offer some potential solutions to the Xhosa case where AC order does seem to be allowed with transparent semantics. Specifically, work like that of Pytkäinen (2002) claims that there are two types of applicatives, with each different scope over the verb phrase, and three types of causatives, also with each having different scope over the verb

phrase. Pylkkänen discusses a number of Bantu cases but, crucially, in her framework, she assumes that, for a given causative or applicative suffix on the Bantu verb, it can only be one type of applicative or causative. This means that, while she might be able to deal with cross-linguistic variation, there would be no straightforward way for her to deal with language-internal variation of the sort seen in (101).

Below, it will be argued that data like that in (101) argues for an account where the restriction on AC order is essentially templatic and, in Chichewa, the restriction is only local. So, an intervening suffix allows the applicative to precede the causative. This can be understood as a morphotactic explanation. Such an explanation cannot naturally fall out of Baker’s framework where morphology and syntax are so closely allied.

2.6.2.4 Ambiguity of scope for certain orders

A third type of data which complicates Baker’s analysis is that of the sort seen in (84), repeated in (102). These are sentences where one morpheme order is ambiguous for scope.

(102) RUNYAMBO (E.21) (Rugemalira 1993:189)

- a. *a-ka-mu-kor-ez-á* *egári*
 3S-PST-3S-repair-APP.TRANS-FV bicycle
 “She had the bicycle repaired for him.”
- b. *a-ka-tu-son-es-ez-á* *emyênda*
 3S-PST-1S-sew-CAUS-APP.TRANS-FV dresses
 “She had dresses made for us.”

Data of this type led to the observation in section 2.5.5 (page 165) that, in some cases CAT morpheme order can have two different readings. In the case of the data in (102), the two interpretations which are available for each sentence are one where the *for*-clauses

are roughly equivalent to “on behalf of” and one where the *for*-clauses have a beneficiary reading.

I take the existence of the narrow-scope, benefactive reading in sentences like (102) to indicate that languages with ambiguous interpretation of fixed causative-applicative-transitive order, like Runyambo, would have to allow deep structures of the sort given (100) within Baker’s framework. Otherwise, it is unclear how the surface ambiguity could be generated in such a theory. The fact that he completely disallows such deep structures implies that his theory is too restrictive.

The data in (102) offers another, more superficial, problem for Baker’s analysis, which is worth taking up briefly here. Runyambo is one of the languages which uses the transitive suffix to mark causatives. In (102a), the combination applicative-transitive (AT) marks applicativization and causativization, while in (102a) the combination causative-applicative-transitive (CAT) marks those semantics. The Mirror Principle cannot account for the “ambifixal” causativization marking C-T in (102a), and it also would have problems accounting for the typological difference between languages like Swahili, which use CA to mark causativization and applicativization, as seen in (97), and languages like Runyambo which can use AT to mark such semantics. Any analysis claiming there is a relationship between morpheme order and scope necessarily has trouble dealing with morpheme orders like these which appear to be arbitrary with respect to scope.

However, since Baker allows for a morphological component to account for affixal phenomena, nothing in his theory would necessarily prevent morphophonological rules con-

spiring to produce morpheme orders which do not, on the surface, obey the Mirror Principle. While this might violate the spirit of his analysis and, therefore, should not be passed over lightly, this sort of variation in affix order is not nearly as problematic as the narrow scope readings for the sentences in (102), which Baker rules out on syntactic/semantic grounds—and, thus, should never be allowed in a model where morphology and syntax are as deeply connected as the one he proposes.

We should ask, then, whether or not the data in (102) could be accounted for without altering the foundational elements of Baker’s framework. There is an obvious alternative analysis to the Bantu applicative which would allow the formalization of some of the data like that in both (101), described in section 2.6.2.3 (page 194) above, and (102)—namely, to treat the applicative as an example of verb incorporation. Such an analysis would be consistent with Givón (1971b) who proposed that the diachronic source of the applicative was verbal. One potential complication for a verb incorporation analysis is data like the following, where an applicative suffix “alternates” with a preposition in minimal pair sentence. Examples like those in (103) are what motivated the preposition incorporation analysis of the Bantu applicative in the first place.

(103) CHICHEWA (N.31b) (Baker 1988:229)

- a. *Mbidzi zi-na-perek-a msampha kwa nkhandwe*
10.zebra 6-PST-hand-FV 3.trap to 9.fox
“The zebras handed the trap to the fox.”
- b. *Mbidzi zi-na-perek-er-a nkhandwe msampha*
10.zebra 6-PST-hand-APP-FV 9.fox 3.trap
“The zebras handed the trap to the fox.”

Putting aside this issue, treating applicatives as incorporated verbs would allow them to combine more freely with the causative. Under Baker's analysis this is effectively because verbs can subcategorize for surface arguments at a greater distance than prepositions can—thereby avoiding the problems found in structures like (100). Cross-linguistically, Baker rules out causativized applicatives where preposition incorporation feeds verb incorporation (Baker 1988:395–400) whereas he allows for multiple verb incorporations in a word (Baker 1988:370–373). Thus, incorporation of a verbal applicative followed by a verbal causative should be permissible.³²

However, treating the applicative extension as an incorporated verb would come at a cost. Whereas it would allow Baker to predict and formalize data like that in (102), it would only be able to take care of some of the data in (101). It would predict that both *-mang-ir-an-its-* 'tie-APP-REC-CAUS' and **-mang-ir-its-* 'tie-APP-CAUS' would be grammatical. In other words, a too restrictive explanation would be replaced with a too permissive one.

It's hard to say exactly what the appropriate way to "fix" Baker's analysis of the Bantu applicative and causative in light of data like that in (101) and (102). The simplest explanation would be to add a purely morphotactic restriction against **-ir-its-* in the grammar. Data like that in (102) involving scope ambiguity of affix combinations could be treated either via some sort of morphemic metathesis or infixation, and data like that in (101) would fall out straightforwardly. (See Hyman and Mchombo (1992) for an implementa-

³² Though she does not explicitly use such language, Pykkänen (2002) analysis of applicatives bears more affinity to a verb-incorporation analysis than to a preposition-incorporation one. This is because she treats the applicative as a separate predicate, initially located at a structural position above the verb root. The root then moves upward to incorporate the applicative. This is in opposition to Baker (1988) who specifically treats the applicative more as a preposition which itself moves rightward to incorporate with the verb.

tion of such an analysis.) Appealing to this type of solution where the problematic data is explained within some morphophonological component to the grammar, however, as mentioned above, would violate the spirit of the Mirror Principle, if not the letter of it.

It could well be that a more nuanced analysis of the facts presented here would allow data like that in (101) and (102) to be analyzed within Baker’s framework. However, as the facts stand, they serve as a strong challenge to it. On the one hand, it might seem that this challenge is minor insofar as it deals with only two suffixes within one group of languages—whereas Baker (1988) covers an impressive range of facts across a wide number of languages. However, these two particular affixes and this particular language group were central in the development of his incorporation framework in the first place. So, the problematic data of the sort seen here cannot be dismissed lightly.

2.6.2.5 Special forms for combined suffixes

There are two categories of special forms of combined suffixes. The first is exemplified by languages like (104), repeated from (80). Recall that in (104c) an extra suffix *-iz-* appears on verbs marked for causativization and applicativization.

(104) KINYARWANDA (D.62) (Kimenyi 1980)

- a. *Úmwáalímu a-ra-andik-iisha-a ibáruwa ikáramu*
 teacher 3S-PRS-write-CAUS-FV letter pen
 “The teacher is writing a letter with the pen.” (Kimenyi 1980:79)
- b. *U-ra-andik-ir-a ibáruwa íki*
 2S-PRS-write-APP-FV letter what
 “Why are you writing the letter?” (Kimenyi 1980:109)

- c. *U-ra-andik-iish-ir-iz-a* *ikárámu iyo iki*
 2S-PRS-write-CAUS-APP-APP.TRANS-FV that pen what
 “Why are you writing the letter with that pen?” (Kimenyi 1980:109)

The sort of special form seen in (104) is apparently obligatory and conveys no particular semantics. The Kinyarwanda case can be contrasted with the Kirundi case, repeated from (86), in (105).³³

(105) KIRUNDI (D.62)

(Meeussen 1959:59)

STEM	GLOSS	TRANSLATION
<i>-gum-</i>	‘firm’	“be firm” (“être ferme”)
<i>-gum-y-</i>	‘firm-CAUS’	“hold” (“tenir”)
<i>-gum-ir-</i>	‘firm-APP’	“hold fast at” (“tenir quelque part (intr.)”)
<i>-gum-iz-</i>	‘firm-APP.TRANS’	“make hold fast at” (“tenir quelque part”)
<i>-gum-ir-iz-</i>	‘firm-APP-APP.TRANS’	“hold for” (“tenir pour”)

In the Kirundi forms in (105), a suffix of the form *-iz-* also appears in Kirundi when a verb is marked both for causativization and applicativization. However, Kirundi has two different forms of the verb depending on the scope of applicativization with respect to causativization. Wide-scope applicativization are marked with an *-ir-* and an *-iz-* suffix whereas narrow scope applicatives are marked only with the *-iz-* suffix.

The Kinyarwanda case causes a relatively minor problem for Baker’s analysis already discussed—the obvious way to account for the data is to appeal to some sort of morphological restriction. As with comparable cases, while appealing to a morphological restriction is not impermissible under Baker’s approach, it deprives it of much of its elegance.

The Kirundi case is more problematic since it allows allow a narrow-scope applicativization reading that is specifically excluded syntactically by Baker and, therefore, poses the

³³ As mentioned above, the English translations in (86) are adapted from Hyman (1993:10).

same problem as seen in sentences like (102).

Beyond this, it is also worthwhile to examine the particular morphology for the wide-scope and narrow-scope applicatives in Kirundi. The *-iz-* suffix, which is a fusion of the etymological applicative and transitive (**-id-j-*), marks the narrow scope applicative when it appears on its own, according to Meeussen. This form can be schematized as AT and would appear to be the form predicted by the mirror principle—the suffix with narrower scope appears closer to the verb stem than the suffix with the wider scope.

The wide scope applicative, on the other hand, has the form *-ir-iz-*, which etymologically corresponds to **-id-id-j-*, or schematically, A-AT. This morpheme order is the exact opposite of what would be predicted by the Mirror Principle. We've seen cases comparable to this where a morpheme order can be associated with a semantic reading which is opposite of expectations, but those all involved instances where some order of morphemes was ambiguous for scope. However, in Kirundi, the order is opposite of what we might expect from the Mirror Principle but not ambiguous in scope. Kirundi is the only language which I am aware of that employs a special morphological sequence to mark wide-scope applicative. It is striking that in the one case we find such a sequence, it fails to obey the default assumptions of the Mirror Principle.

As with some of the other cases of surprising orderings, the Kirundi case is not incontrovertible evidence against the Mirror Principle—re-orderings could happen in the morphology regardless of syntactic operations. However, as such cases multiply, whatever the general validity of Mirror Principle may be cross-linguistically, the case that the Bantu

verbal extensions support it becomes weaker and weaker.

2.6.2.6 Local conclusion

The general conclusion reached in this section is that, when a wide range of Bantu data is examined, Baker's analysis is not able to explain the patterns found in the verbal extensions of the languages in the family. In some cases, the analysis incorrectly rules out narrow-scope applicativization readings for verbs marked for causativization and applicativization. In other cases, it predicts different facts for the order of extensions than is actually attested.

It is worthwhile to point out here that Baker's analysis is largely adequate for the not insubstantial data he examined. Especially important, with respect to this fact, is that the two Bantu languages Baker examined, Chichewa and Swahili, lack any productive formations involving the transitive suffix. As seen in section 2.5 (page 142), many of the complications which are hard to explain under Baker's theory are in some way connected to the strange morphophonology of that suffix. So, while it's clearly appropriate to test Baker's claims across all Bantu languages, it is important to realize that Baker designed his framework using test cases from Bantu languages which happened to lack a complication found in many of the others.

I take Baker's approach to be representative of Mirror-Principle based transformationalist approaches generally. One of the main reasons for this has been that Baker offered an explicit treatment of applicative and causative order in two Bantu languages.

As mentioned in some of the sections above, more recent transformationalist analy-

ses of the Bantu extensions exist (McGinnis (2001), Pytkänen (2002)). These are not as detailed as Baker, which is why they were given less attention here. In terms of the relationship between morphology and syntax, they build on the basic insights of Baker's approach with the inclusion of certain types of syntactic analyses which were not available to him. As I suggested in section 2.6.2.2 (page 190), this newer work might help explain the case of semantically-transparent, productive AC order in Xhosa. However, the extra tools they introduce would not be able to deal with the other problematic areas of Bantu morpheme ordering uncovered in this survey.

The next analysis to be discussed is that of Alsina (1999). Like Baker's analysis, one encounters two basic sorts of problems with Alsina's analysis. The first is the basic problem that one of the main principles behind suffix ordering in Bantu appears to be the templatic specification of CAT, while Alsina assumes the Mirror Principle is the main conditioning factor. The second problem is that, in the formal details, Alsina's analysis also makes some incorrect predictions about the various possible suffix combinations.

2.6.3 Alsina (1999)

2.6.3.1 The basic analysis

Alsina (1999) operates under the assumption that the Mirror Principle is exceptionless (Alsina 1999:6) and, therefore, believes it needs to be incorporated into any grammatical framework. Alsina, thus, takes a stronger stance than Baker (1985:400–3) who allows for the possibility that certain kinds of morphological systems (like Semitic templates) may not obey the Mirror Principle).

While Baker (1988) exemplifies a transformationalist analysis of Bantu suffix ordering, Alsina represents a lexicalist one since he worked within Lexical Functional Grammar. Alsina's explanation for the Mirror Principle is that some syntactic and semantic information is part of the lexical entries for verbal affixes, and that this information governs in what order they can be affixed to a verb which, thus, in turn, predicts the actual linear order they should appear in.

The affixes Alsina focuses on are the Chichewa causative, applicative, reciprocal, and passive extensions—therefore his work is directly relevant to this case study. Unfortunately, he did not explicitly deal with the causative and applicative in combination; so, it will be necessary to derive the analysis of that combination from the rest of his framework.

The driving idea behind Alsina's analysis is that, since the Bantu verb behaves like a word, it must be derived in the lexicon and not the syntax. Thus, an incorporation analysis of the Bantu verb extensions, like that of Baker (1988) is not a possibility for Alsina. As we will see, his explanation for the Mirror Principle is, at heart, a morphosemantic one, since the order in which affixes are attached to a verb determines by the particular semantic roles which the elements of its argument structure take on. This differs from Baker's more properly syntactic approach.

The most relevant parts of Alsina's analysis for the present work are given in (106). These are his definitions of the lexical entries for the Chichewa causative and applicative, respectively.

(106) a. Chichewa causative: [its]]_v____ <ag pt <... θ ...>>

b. Chichewa applicative: [ir]]_v____ << θ ... θ ...> pt >

(Alsina 1999:26)

The first thing to note about the formalizations in (106) is that both the causative and the applicative are treated as embedding an input argument structure (the argument structures containing the θ 's in both definitions) within a predefined higher argument structure. The higher argument structure contains specific thematic roles which must link to other thematic roles in the lower argument structure. The roles seen in (106) are agent (ag) and patient (pt). Although the contents of the relevant argument structures are different for the causative definition in (106a) and the applicative definition in (106b), the basic tool employed is the same. This is a notable difference from Baker who gave the causative and applicative extensions radically different syntax.

In Baker's system, the causative and applicative definitions in (106) would both count as instances of verb incorporation since they add an extra layer of predication (here, an extra layer in the argument structure) to a verb. In more traditional terms, then, Alsina treats the causative and the applicative as derivational morphemes—there is no derivation/cliticization asymmetry for him as I claimed was implicit in Baker's analysis due to his treatment of causativization as verb incorporation and applicativization as preposition incorporation.

Moving onto the particulars, the causative definition in (106) basically says that a verb

which is causativized subcategorizes for three arguments: an agent, a patient, and an argument structure (i.e., a predicate). The contents of this argument structure are left mostly underspecified—the only restriction is that it must contain at least one argument. In addition, the patient argument in the higher argument structure must be linked to an argument in the lower argument structure—meaning that the two arguments must be the same. Descriptively, the definition in (106a) describes the causative basically as a raising-to-object verb.

The definition of the applicative in (106b) adds less overall syntax and semantics than the causative definition. An applicativized verb subcategorizes for two arguments: a patient and an argument structure. This patient argument can be linked to any non-initial argument in the lower argument structure (effectively preventing subjects from being affected by the applicative). Crucially, the applicative actually introduces this argument to the lower argument structure. The linking of the patient to an argument in the lower argument structure means the applicative, like the causative, is treated very much as a raising verb. However, it does not resemble a raising-to-object verb, but rather it resembles a raising-to-subject verb because the linked (i.e. raised) argument is identified with the one argument of an intransitive predicate.

In addition to placing some syntactic information in the lexical entries of the Bantu extension, Alsina also makes use of a range of formal tools, which are treated as representing universal constraints in language, to restrict how argument structures can combine and what semantic roles can be expressed with various combinations. Among the more

important of these is the decomposition of grammatical functions, like subject and object, into two binary features $[\pm r]$ (restrictedness) and $[\pm o]$ (objectiveness) (Alsina 1999:27). Roughly speaking, restrictedness refers to whether or not a particular grammatical function can take on a range of semantic roles, and objectiveness refers to whether or not a grammatical function is the object of a transitive verb or adposition.

Another formal tool of Alsina's is the thematic hierarchy, given in (107).

(107) *agent > beneficiary > goal > instrument > patient > locative* (Alsina 1999:23)

For our purposes, the only important fact about his hierarchy is that nothing higher than an instrument can be specified $[+o]$ (Alsina 1999:29). Three final relevant aspects of the analysis are that (i) all arguments initially receive specification for either $[\pm o]$ or $[\pm r]$ and the other role is filled in by various default rules, (ii) patients must be initially specified for either $[-r]$ or $[+o]$, and (iii) $[-r]$ can only be initially specified once for a given argument structure (this restriction does not apply when $[-r]$ is filled in as a default and is specific to Chichewa) (Alsina 1999:27–32).

Taken together, the definitions of the applicative and the causative, the thematic hierarchy, and restrictions on feature composition of grammatical function are designed to constrain, among other things, the possible interaction between the Bantu verbal extensions. Alsina's focus in the article was explaining various interactions between the causative and reciprocal, the applicative and the passive, and the passive and the reciprocal. So, although he built up a formal architecture for dealing with the causative and the applicative, he did not explicitly analyze it. Unfortunately, his definitions of the causative and applicative ex-

tensions, seen in (106), are inadequate to deal with all the facts of even Chichewa—let alone Bantu in general, as we shall see in the next section.

2.6.3.2 Applying Alsina (1999)

The case of applicativizing a verb already marked for causativization causes some analytical problems in Alsina’s framework. In Chichewa, such a form is *-mang-its-ir-* ‘tie-CAUSE-APP’. In (108), I give a “derivation” of this verb by starting with its basic argument structure, then causativizing, and finally applicativizing. In the case of ‘tie’, its basic argument structure contains simply an agent and a patient. Causativization chooses the agent of the simple verb as the causee of causativized verb.

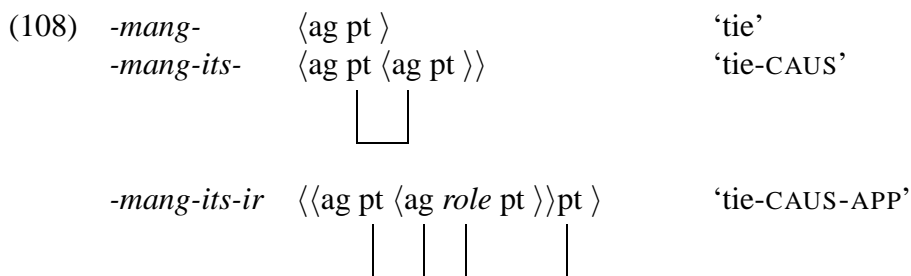

The term *role* in the final argument structure in (108) stands for anyone of the several roles the applicative morpheme can introduce (these were described in section 2.2 (page 126)).

Recall that in Alsina’s theory, patients must be assigned, initially, either [-r] or [+o]. The fact that two arguments in the final structure in (108) are linked to patient arguments means that those two arguments also, effectively, share that restriction. Since the leftmost link in that structure is between an agent and a patient—only one feature, [-r], can be assigned to those linked arguments because agents cannot be specified as [+o] due to their

location above instruments in the thematic hierarchy in (107). In more descriptive terms, this basically says that any grammatical function which must serve as both a patient and an agent needs to be able to take on multiple grammatical functions since both agents and patients can appear in a range of grammatical positions—take unergative and unaccusative verbs, for example, which show that both agents and patients can be subjects.

Now, focusing on the second pair of linked arguments in (108), we mentioned above that one of the linked arguments is also a patient. Since the feature [-r] can only be assigned once in the creation of an initial argument structure (as mentioned above this is a Chichewa-specific constraint to handle asymmetries in its double object constructions), then the paired arguments must be assigned [+o], since it is the only other feature specification available for a patient. We saw above that, in Alsina's framework, no semantic role higher than an instrument can be assigned [+o]. Among other things, this means that beneficiaries cannot be assigned [+o] per the thematic hierarchy in (107). Alsina's framework, then, makes a straightforwardly testable prediction: An applicativization of a causativized verb should not allow the thematic role of the applicativized object to be a beneficiary.

We saw above in (84a) (repeated in (102a)) that Runyambo clearly allows the applicativized objects in applicativized causatives to be beneficiaries. As implied by the glosses in Hyman and Mchombo (1992:354) and the data in (109), this is also possible in Chichewa.³⁴

³⁴ All uncited Chichewa data comes from Sam Mchombo (personal communication).

(109) CHICHEWA (N.31b)



Ti-na-mang-its-ir-a atsikana alenje mbuzi.
 1p-PST-tie-CAUS-APP-FV 2.girl 2.hunter 10.goats
 “We made the hunters tie the goats for the women.”

Data like that in (109) is clearly a major problem for Alsina’s general analysis. His motivation for the restriction of the [+o] to only certain semantic roles was motivated by the restrictions on the combination of the passive and the applicative. While his analysis was insightful for these forms, it turns out that the interaction of the causative and the applicative, the two extensions which he defines as adding patient roles to a verb’s argument structure, shows his analysis to be too restrictive.

Moving on, Alsina’s analysis also suffers very similar problems to that of Baker (1985) when one uses it to analyze causativized applicatives like **-mang-ir-its-* ‘tie-APP-CAUS’ which, as we saw in (82) (repeated in (101)), was ungrammatical. It would be analyzed along the lines of the derivation in (110).

(110)	<i>-mang-</i>	$\langle \text{ag pt} \rangle$		‘tie’
	<i>-mang-ir-</i>	$\langle \langle \text{ag role pt} \rangle \text{pt} \rangle$		‘tie-APP’
		┌ ┐ └ ┘		
	<i>*-mang-ir-its-</i>	$\langle \text{ag pt} \langle \langle \text{ag role pt} \rangle \text{pt} \rangle \rangle$		‘tie-APP-CAUS’
		┌ ┐ └ ┘ * ┌ ┐		

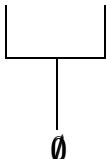
Alsina’s analysis correctly predicts that **-mang-ir-its-* is ungrammatical because, as indicated by the “crossed out” link in the final stage in (110), the causative extension cannot “peek in” to the embedded argument structure and link to the agent of the argument structure of *-mang-* ‘tie’. Within Baker’s (1988) framework this would amount to a (stipulated)

(112)	<i>-mang-</i> <i>-mang-ir-</i>	$\langle \text{ag pt} \rangle$ $\langle \langle \text{ag role pt} \rangle \text{pt} \rangle$	‘tie’ ‘tie-APP’
			
	<i>-mang-ir-an-</i>	$\langle \langle \text{ag}_i \text{ role pt} \rangle \text{pt}_i \rangle$	‘tie-APP-REC’
			
	<i>-mang-ir-an-its-</i>	$\langle \text{ag pt} \langle \langle \text{ag}_i \text{ pt} \rangle \rangle \rangle$	‘tie-APP-REC-CAUS’
			

The basic idea behind the definition of the reciprocal in (111) is that the reciprocal deletes a patient argument from an argument structure when that argument is coreferential with an earlier argument in the argument structure (not dealt with in (111) but also needed is a semantic restriction that the relevant arguments must refer to more than one individual).

In the derivation in (112), as seen, even when the reciprocal is added in between the addition of the applicative and the causative, the embeddedness of the argument structure of *-mang-* still prevents the causative from applying. It is not at all clear to me how Alsina’s analysis could be “fixed” to deal with forms like *-mang-ir-an-its-* ‘tie-APP-REC-CAUS’. It would seem to either require the restructuring of argument structures by the reciprocal morpheme or a new definition of the causative extension.

So, we have seen that Alsina’s analysis, like Baker’s, is too restrictive. The nature of the restrictions are different but they both have problems dealing with the same types of data: extension orders which are ambiguous in scope (as discussed in section 2.5.5 (page 165) above) and the effects of intervening suffixes (as discussed in section 2.5.4 (page 164)

above). The essential problem with Alsina’s analysis is that his argument-structure based definitions of the various extensions are too simple—the facts from Chichewa, and Bantu in general, indicate a more subtle interaction between the extensions than his relatively simple definitions would allow.

2.6.3.3 Cyclic phonology and order of suffix application

There seems to be a more fundamental problem in Alsina’s approach, however, than not correctly predicting the grammaticality of some kinds of subtle data. Alsina (1999:4–5) makes use of data regarding cyclic application of morphology as evidence for the universality of the Mirror Principle. The data in (113), taken from Hyman (2001), is an example of the sort of case Alsina employs to make this argument.

(113) KINYAMWEZI (F.22)

(Hyman 2001:12)

STEM	GLOSS	TRANSLATION
<i>-sul-</i>	‘forge’	“forge”
<i>-suj-<i>j</i></i>	‘forge-TRANS’	“make forge”
<i>-sug-ij-<i>j</i></i>	‘forge-APP-TRANS’	“make [X forge with Y]” or “make with Y [X forge]”

The data in (113) shows a sort of consonant alternation very similar to that seen in (81). The verb stem *-sul-* is palatalized to *-suj-* when causativized (this being the reflex of the transitive suffix), and this palatalization is partially “undone” when the applicative intervenes between the stem and the etymological transitive suffix, causing the stem to surface as *-sug-*. Similar data was seen in (81).

If morphophonological derivation correlated with the Mirror Principle, we would expect the verb *-sug-ij-*j** ‘forge-APP-TRANS’ to have only the reading of an applicativized

causative since the stem shows the effects of having been directly followed by the etymological transitive suffix, as indicated in (113), however, that form is ambiguous in scope. Furthermore, any analysis following the basic idea behind the Mirror Principle would then predict the derivation in (114) for the causativized applicative where only the applicative *l* undergoes phonological effect triggered by the transitive *-j-*.³⁵

(114) KINYAMWEZI (F.22) (Hyman 2001:12)

-sul- → *-sul-il* → **-sul-ij-i*
 ‘forge’ ‘forge-APP’ ‘forge-APP-TRANS’

As can be seen by the ambiguity of the form in (113) and the fact that the derivation in (114) does not occur, if Bantu morphology is taken to be cyclic (as Hyman and Mchombo (1992) claim), it is cyclic independent from semantic scope.

Without being able to use evidence from cyclic morphology to justify the existence of the Mirror Principle, the power of Alsina’s explanation for the Mirror Principle is weakened considerably. Within Alsina’s framework, the Mirror Principle is explained by the idea that, “[t]he morphological and syntactic aspects of a ‘grammatical function changing rule’ are seen not as two independent phenomena which happen to take place simultaneously in two different domains by virtue of stipulation, but rather as two phenomena which are intimately related to each other by virtue of being part of the same lexical entry (Alsina 1999:25).” Since Alsina is working within LFG, a lexicalist framework, this means that the Mirror Principle applies within the lexical derivation of a word.

³⁵ Chichewa does not provide the same sort of evidence as Kinyamwezi for cyclic morphology. However, since Alsina uses cyclic morphology from other Bantu languages to make his general argument (Alsina 1999:4–5), it seems perfectly appropriate to bring up the Kinyamwezi data here.

Assuming that morphophonology, also, occurs in the lexicon, then Alsina would clearly predict that a form like that in (114) should occur. As each extension is added, the relevant morphological alternations could occur and a new extension would be added. As stated above, the fact that a form like that in (114) cannot be derived, means that the morphophonology and the morphosyntax must be independent of each other. However, as seen in the quotation above, Alsina's explanation is totally reliant on syntactic "grammatical function changing" being intimately tied to "morphology" (i.e., the phonology of the morphological affix). If these two aspects of morphological derivation are divorced from each other, then Alsina's analysis of Chichewa might still work, but his general explanation of the Mirror Principle no longer holds.

Tying together the lexical entry for a morpheme with syntactic information still remains a potentially valid explanation for the Mirror Principle. And, indeed, Alsina has shown that the Mirror Principle can be explained within a lexicalist framework (excepting, for the moment, the problems with his particular analysis of Chichewa). What he hasn't shown is that his explanation offers any special insight beyond the basic insight of the Mirror Principle into the nature of the relationship between morphology and syntax, since without being able to rely on morphophonological data, he cannot show that morphology and syntax are related in any non-abstract, testable way.

The approach to be taken here, has little to say directly about data like that in (113) or (114). Phonological effects of the sort typically associated with cyclicity have an available weak linearity domain analysis and, thus, do not directly tie into the Strong Linearity

Domain Hypothesis. Furthermore, the Strong Linearity Domain Hypothesis, as a well-formedness generalization over linearized constituents, has nothing in particular to say about what the interaction should be between phonology, morphology, and syntax. As such, it makes no predictions about whether or not cyclic effects should correlate with scope readings unlike Alsina (1999).

2.6.3.4 Local conclusion

Alsina (1999) offers a lexicalist alternative to Baker (1988). On the whole, it would appear to be a weaker analysis since it correctly formalizes less of the data than Baker's. For example, while Baker can account for applicativized causatives, Alsina can not. In addition, Alsina suffers from the same problem as Baker: The Mirror Principle, in its most basic interpretation, does not hold across Bantu. Any analysis using that as a starting point will run into immediate difficulty. Specifically, such an analysis will not be able to deal with the array of effects which can be attributed to a CAT template.

A question raised by this is whether or not a lexicalist framework generally could handle the Bantu facts. The answer to this would seem to be that it could, assuming such a framework allowed for a sufficiently rich word-formation component. My primary reason for believing this is because of the success of the next analysis to be discussed that of Hyman (2003a). Hyman, unlike Baker or Alsina, assumes a fairly rich morphological component to grammar. If Alsina were to adopt such a component as part of lexical word formation, then it would seem that he could explain the Bantu facts more precisely.

2.6.4 Hyman (2003a)

A large body of work, beginning in Hyman and Mchombo (1992) and culminating in Hyman (2003a) is the immediate inspiration for this particular case study. The core insight of this work rests on the observation that a morphological template governs important aspects of the realization and interpretations of the verbal suffixes throughout Bantu. Hyman's abbreviation for the template is CARP: causative, applicative, reciprocal, passive. I will refer to this template as CARTP to keep it in line with the CAT subset of the template which is the focus of this chapter.

Though fully aware of the different behavior of the causative extension and the transitive suffix, Hyman does not encode this in the name of his template (though he does discuss it as part of the template). In general, therefore, Hyman's CARP template and the CAT described here are compatible—the different templatic abbreviations are mostly indicative of different focuses for research. In (115) I schematize the form of Hyman's template using the reconstructed forms of the Proto-Bantu verbal suffixes. In this work, it has been argued that one subset of these suffixes, CAT, exhibited templatic behavior in Proto-Bantu. The schema in (115) is not intended to imply that all of these suffixes were rigidly ordered in Proto-Bantu, and it is likely that at least one of these suffixes, the reciprocal, had some freedom in its positioning in the proto language.

(115) **-ic-* > **-id-* > **-an-* > **-j-* > **-u-*
 CAUS APP REC TRANS PASS

Hyman's analysis of the Bantu verbal suffixes goes beyond the simple statement of a template along the lines of the one in (115). He makes an additional, important observation,

that I summarize in (116) and label Hyman’s Law for Bantu.

(116) **Hyman’s Law for Bantu:** Unmarked morphological ordering in Bantu is correlated with unmarked semantics and marked morphological ordering is correlated with marked semantics.

“Unmarked morphological order” in (116) refers to the order given in (115)—marked morphological order, then, refers to an order which does not follow the template. “Unmarked semantics” refers to semantic scope of the suffixes not being encoded—that is, it refers to morpheme orders, like those exemplified in (84) which are ambiguous for scope. When the template is overridden, and scope is unambiguously marked, Hyman observes that scope is determined in a way that accords well with the Mirror Principle.

Hyman’s Law, as far as I am aware, refers to a type of templatic behavior which was previously unrecognized. While templates are generally described via obligatorily fixed positions in a morphological structure. Hyman’s Law allows for the possibility that a template can be overridden for semantic reasons.³⁶

Hyman’s Law, therefore, implies something very important: that the template is a grammatical object in its own right. Specifically, rather than being simply a cover term for a set of adjacent “slots” in the structure of Bantu verb stem, adherence (or lack thereof) to the

³⁶ The closest statement describing a similar effect to Hyman’s Law in Bantu, which I’m aware of, is a comment made about Quechua by Muysken (1988a). Describing the various possibilities for verbal suffix ordering in Quechua, Muysken (1988a:279) writes, “The only thing we do not find is a situation where the order of affixes is not restricted, but the interpretation of each pair is contrary to what compositionality would predict.” Bringing this in line with the terminology being used here, Muysken’s observation comes down to the idea that, in Quechua, suffix ordering is determined by only one of two mechanisms: semantic scope, in a way consistent with the Mirror Principle, or a template. This is not exactly like the idea encoded in (116). However, it is similar to it insofar as it recognizes a connection between possible semantic interpretation of morpheme orders and templatic effects.

template has predictable semantic consequences. If the template were only a “side-effect” of morphological organization, then it would not make sense to refer to how “unmarked morphological order” is related to “unmarked semantics” since the unmarked morphological order would not itself be properly a part of the grammar of any Bantu languages.

To understand this another way, without referring to the Bantu template, it would not be possible state Hyman’s Law in any straightforward way. Any restatement of it will require, in one way or another, reference to some notion of a default CARTP order to the Bantu verbal extensions, which, in essence, would be a reference to a template.

Hyman’s Law, importantly, is a generalization over Bantu. Different Bantu languages show different behavior with respect to this pan-Bantu template. However, it is striking that it holds over so many Bantu languages. None of the languages in section 2.5 (page 142) were directly observed to disobey it with respect to the behavior of the causative, applicative, and transitive suffixes (though Xhosa represents an unclear case depending on whether or not CA order is ambiguous). Furthermore, for that minority of languages where data was available, the templatic order of the suffixes (CAT) was unmarked for semantic scope.

Hyman (2003a) chooses to formalize Hyman’s Law within Optimality Theory since it is well designed for dealing with the fact that the Bantu template can be overridden for semantic reasons in some Bantu languages. The two basic pieces of Hyman’s analysis are a TEMPLATE constraint, found in individual Bantu languages, favoring the CARTP order over other orders, and a family of MIRROR constraints favoring a Mirror Principle order—

that is an order where the order of morphemes is consistent with their semantic scope.

Hyman's understanding of the TEMPLATE constraint, importantly, is that it is a morphotactic constraint. In understanding the constraint this way, Hyman is, in some sense, rejecting the syntactically driven account of morpheme ordering favored by Baker (1988) and the lexico-semantically driven account of Alsina (1999). For Hyman, it is permissible to capture certain morpheme ordering generalizations within an independent morphological "module" of grammar.

Hyman's conception of the MIRROR constraints is closer to Alsina's than Baker's conception of the Mirror Principle since for Hyman these constraints are principally semantic, not syntactic, in nature—enforcing predictable scope relations based on a general notion of semantic compositionality.

Hyman (2003a) surveys a number of Bantu languages and uncovers a range of interesting phenomena many of which have been discussed here. He does not provide a full formal analysis of all the facts he presents. However, he gives some tableaux which can be taken as indicative of his formalization of Hyman's Law.

The tableaux in (117), for example, are intended to formalize the fact that a verb stem like *-mang-its-ir-* 'tie-CAUS-APP' in Chichewa is ambiguous for scope, allowing readings where the causative has scope over the applicative and where the applicative has scope over the causative.

(117) CHICHEWA (N.31b) (Hyman 2001:3) TEMPLATE \gg MIRROR(C(aus), A(pp))

a. Applicativized Causative

	[[[mang] CAUS] APP]	TEMPLATE	MIRROR(C,A)
→	<i>-mang-its-ir-</i>		
	<i>-mang-ir-its-</i>	*!	*

b. Causativized Applicative

	[[[mang] APP] CAUS]	TEMPLATE	MIRROR(C,A)
→	<i>-mang-its-ir-</i>		*
	<i>-mang-ir-its-</i>	*!	

The basic idea illustrated by the tableaux in (117) is that the higher-ranked morphological TEMPLATE constraint overrides the morphosemantic constraint MIRROR. This means that, regardless of semantics, causativization and applicativization marked on the same verb root in Chichewa must always be realized as *-root-its-ir-*.

The sentences in (118) give examples as to how verbs suffixed with *-its-ir-* are ambiguous for scope of applicativization and causativization in Chichewa, as predicted by the tableaux in (117). Comparable data was seen in (84) in section 2.5.5 (page 165). These examples simply show that the same basic facts hold in Chichewa. (The glosses for the extensions are abbreviated A for applicative, R for reciprocal, and P for passive in the interests of presentation.)

(118) CHICHEWA (N.31b) (Hyman 2001)

- a. *Abúsa a-ku-thámáng-its-ir-a ndodo mbúzi.*
 2.shepherd 3s-PRS-run-CAUS-APP-FV 10.stick 10.goat
 “The shepherds are chasing the goats with sticks.”
 (Applicativization has scope over causativization.)
- b. *Alenjé a-ku-tákás-its-ir-a akázi mthiko.*
 2.hunters 3s-PRS-stir-CAUS-APP-FV 2.women 9.spoon
 “The hunters are making the women stir with a spoon.”
 (Causativization has scope over applicativization.)

In (118a) the sticks are the instruments used in order to make the goats run, thus the applicativized instrumental object is associated with the causativized predicate, meaning applicativization has scope over causativization. In (118b), on the other hand, the sticks are being used to stir the soup. The hunters are causing this action but are not stirring the soup themselves. Thus, causativization has scope over applicativization in this sentence.

The tableaux in (117) only illustrate the first half of Hyman’s Generalization—the TEM-PLATE constraint means that unmarked morphological ordering leads to unmarked semantics. The second half of the principle is illustrated by the Chichewa data seen in (119).

(119) CHICHEWA (N.31b)

(Hyman and Mchombo 1992:350–3)

STEM	GLOSS	TRANSLATION
<i>-mang-ir-an-</i>	‘tie-A-R’	“tie for each other/tie each for”
* <i>-mang-an-ir-</i>	‘tie-R-A’	
<i>-mang-an-ir-an-</i>	‘tie-R-A-R’	“tie each other for”
<i>-mang-an-its-idw-ir-an-</i>	‘tie-R-C-P-A-R’	“be caused to to tie each other at”

The ambiguity of scope for the form *-mang-ir-an-* again illustrates that unmarked morpheme order leads to unmarked semantics. The form **-mang-an-ir-* in (119) shows another way in which the template in (115) is operative in Chichewa since simple RA order is ungrammatical. However, we see that the form *-mang-an-ir-an-* is grammatical, and it is also unambiguous for scope only allowing a reading where applicativization has scope over reciprocalization. This form contains an interesting instance of suffix doubling of the reciprocal but is not semantically interpreted as containing two reciprocals—instead, it is interpreted as though there were only one reciprocal extension on the verb. In addition to having a doubled reciprocal, the form contains an instance of reciprocal-applicative order

which we saw was ungrammatical in the form without reciprocal doubling.

Hyman (2003a) treats the form *-mang-an-ir-an-* as arising as a direct result of two constraints in Bantu—one favoring the CARTP template and one favoring the Mirror Principle. This is a form which satisfies both constraints, in some ways. The *-an-ir-* (AR) part of the sequence is predicted by the template while the *-ir-an-* part is predicted by the Mirror Principle. Because the form contains the marked *-an-ir-* morpheme order, it is unambiguous for semantic scope illustrating how Hyman’s Law applies to such forms.

Unlike Baker (1988) and Alsina (1999), Hyman (2003a) specifically notes many of the complications discussed in section 2.5 (page 142). Even though he does not present formal analyses for all of them, he does lay down a templatic analysis, which, in principle, can account for those aspects of Bantu which most blatantly violate the Mirror Principle. Because of the templatic aspects of Hyman’s analysis, it is closely aligned with the treatment of the Bantu verb stem adopted by this work which will be presented in section 2.7 (page 229) below.

Importantly for the present work, Hyman’s Law implies the existence of a strong linearity domain to the right of the root in the Bantu verb stem—the CARTP template. In the next section, I will build upon the basic insight of Hyman’s Law and attempt to show that the CAT subset of the CARTP template is consistent with the predictions of the Strong Linearity Domain Hypothesis.

Hyman’s analysis of Bantu and the one here are largely complementary. Hyman focused on the relationship between the semantics and morphemic exponence of the Bantu

verbal suffixes. This work assumes his analysis to be largely correct and attempts to build upon it by claiming that the CAT subset of the CARP template is consistent with the Strong Linearity Domain Hypothesis. To the extent that Hyman's proposed template fits in within this restrictive theory of templates, this would seem to support his general analysis.

2.6.5 Local conclusion

We have seen three previous approaches to suffix ordering in the Bantu verb stem. Since the analysis to be developed here in the next section more or less assumes Hyman's (2003) templatic analysis as opposed to the Mirror-Principle oriented analyses of Baker (1988) and Alsina (1999) it would be worthwhile to briefly contrast how the different styles of analysis fare against the range of data discussed in section 2.5 (page 142).

First, to the extent that the table in (70) indicates an overwhelming tendency towards causative-applicative-transitive (CAT) order, this clearly favors the templatic approach of Hyman (2003a), also adopted here.

Furthermore, no language shows a productive order where the transitive preceded an extension. Since the transitive, when used alone, has similar semantic effects to the causative extension, this would add further support to the templatic analysis over a Mirror Principle analysis which would generally predict that suffixes with similar meaning should be able to appear in similar positions. So, since the applicative can follow the causative, we would, under a basic interpretation of the Mirror Principle approach, expect the applicative to be able to follow the transitive as well. To the extent that we don't find language showing productive TA order, we have further evidence in favor of the analysis being adopted here.

We did see that some languages allow templatic causative-applicative order as well as non-templatic applicative-causative order. We might, at first, expect a language like Xhosa, which had semantically transparent applicative-causative order to support a Mirror-Principle style approach, since, at face value, an approach linking suffix order to semantic interpretation would predict a language like Xhosa to exist.

However, the two specific formal analyses employing the Mirror Principle discussed above, as we have seen, rule out AC order for reasons having to do with the general architecture of their analysis. These approaches, furthermore, do not merely rule out a language like Xhosa, they generally predict that there should not be languages where causativization has scope over applicativization—however, such languages exist as discussed in section 2.5.5 (page 165) and section 2.5.6 (page 168). They are just hard to detect because they don't exhibit AC order to express such semantics. I leave it as an open question whether some Mirror-Principle oriented proposal could use Xhosa data to support its analysis as well as be able to deal with languages allowing causativization to have semantic scope over applicativization generally. The ones so far proposed cannot.

For the proposal here, even though a language like Xhosa does not support a templatic approach, it does not strongly argue against it—Xhosa might not exhibit templatic behavior, but the vast majority of languages examined do, and we will still need to account for them somehow. Furthermore, unlike the Mirror-Principle approaches seen here, the templatic approach makes no prediction that causativization cannot generally have scope over applicativization. Therefore, languages exhibiting such semantic possibilities, do not argue

against it in any way. At present, this all suggests the templatic approach is favorable to the Mirror-Principle approaches.

A final fact to note along these lines is that a Mirror-Principle approach cannot account for data like that seen in section 2.5.4 (page 164) where intervening suffixes made it acceptable for the applicative to precede the causative, as long as it did not immediately precede the causative. In the analysis to be presented below, we will see that there is an explanation for this under the templatic analysis. As we saw in the discussion above, however, these facts are highly problematic for the Mirror Principle analyses. They, therefore, lend further support to the templatic approach.

Given this background, it would be useful to “sum up” the languages in the table in (70) to see how many languages can be seen to be consistent with the different analyses. As discussed above, five languages allow AC order. We can consider these languages to support neither a templatic analysis nor either of the Mirror Principle approaches seen here. Nine languages allow only CA order. These languages, at first, might seem to be predicted both by the templatic approach and the Mirror Principle approaches examined here. However, two of these languages, Ikalanga and Chichewa, are reported to exhibit ambiguity of scope for CA order—which, as discussed above, is problematic for Mirror-Principle approaches for various reasons. Therefore, only seven of the CA languages are equally well predicted by both analyses.

This leaves us with seventeen languages showing either CAT or AT order, but not showing AC order. These I take to support the templatic approach for the reason discussed, just

above, that the overlap in meaning between the causative and the transitive in attested languages suggest that it should have the same ordering restrictions as the causative. When adding the other two languages showing CA order with ambiguous scope just mentioned above, this gives us nineteen languages supporting the templatic approach. Twelve languages support neither type of approach over the other. And no language supports only the Mirror-Principle approaches.

This numerical comparison is not a proper statistical analysis, of course, and I present it as a summary of the basic facts. This summary would appear to support the templatic approach over the Mirror Principle approach generally for Bantu for the simple reason that it accounts for more languages and no language contradicts it.

As we move onto the analysis of suffix ordering to be developed here, we therefore see that there is good empirical reason to favor the templatic approach. The next section is designed to show that there is theoretical support to it as well insofar as the CAT template can be shown to be consistent with the Strong Linearity Domain Hypothesis. The templatic approach is clearly syntactically less restrictive than the Mirror-Principle approaches. Fortunately, however, we will see that the form of the template matches the restrictions imposed by the Strong Linearity Domain Hypothesis. So, we can make up for lack of restrictiveness in one area by showing there is restrictiveness in another.

2.7 THE CAT TEMPLATE AND THE STRONG LINEARITY DOMAIN HYPOTHESIS

2.7.1 Overview of argument

The goal of this section is to show how a templatic analysis of the morphemic realization of causativization and applicativization in Bantu is consistent with the Strong Linearity Domain Hypothesis, repeated below in (120) for convenience.

(120) **Strong Linearity Domain Hypothesis:** The boundaries of any strong linearity domain must be coextensive with a prosodic constituent, and its non-predictable linearity restrictions must be consistent with the characteristic phonology of that prosodic constituent.

I will be specifically arguing the a causative-applicative-transitive (CAT) template is consistent with the Strong Linearity Domain Hypothesis. This will require first establishing that the Bantu verb stem is a prosodic domain and then showing that a CAT affix-ordering restriction is consistent with the phonological restrictions of the Bantu verb stem. The first task, not surprisingly, will be easier than the second since it merely requires showing something exists. The second task, on the other hand, will require building a general picture of the phonology of the Bantu verb stem.

Since the Strong Linearity Domain Hypothesis is an idea new to this work, it will be easy to lose sight of how the analysis of the Bantu data seen here fits in with the analyses examined in the previous section. Broadly speaking, I will be accepting the basic analysis of Hyman (2003a) over the analyses of Baker (1988) and Alsina (1999). That is, given the

present state of the evidence, I believe that a template is present in Bantu verb stems which is responsible for many aspects of the order of suffixes found in them.

However, I want to take a step beyond Hyman (2003a) and, having established that there is a template, try to explain why this particular template exists. Such explanations represent the primary motivation behind the Strong Linearity Domain Hypothesis, which is meant to be the foundation of a restrictive theory of templates. So, any time a template is proposed, it becomes necessary to see whether or not it matches the predictions of the Strong Linearity Domain Hypothesis.

Hyman (2003a) also sought to restrict the Bantu template by proposing two competing constraints for the Bantu verb stem: *TEMPLATE* and *MIRROR*, each of which was involved with the relative order of the verbal suffixes. His focus was on understanding the relationship between the “morphocentric” order dictated by the template and the semantically-centered order dictated by the Mirror Principle.

While this work will have occasion to discuss the interaction between templatic constraints and the Mirror Principle, it will focus on a different aspect of restricting the Bantu template—namely, why does it have the *CAT* form that it does instead of any number of other imaginable forms. By this question, I am not referring to simple permutations of *CAT* (like *ACT*, *TCA*, etc.). Rather, I mean to explore why the template takes the form as a restriction of the relative order of particular morphemes, of the shape *-VC-* and *-V-*, with respect to each other as opposed to, for example, a restriction where there are three obligatory “slots” after the verb root each possibly containing one, and only one, member

from the class of morphemes assigned to each slot.³⁷ Furthermore, I will also explore how some of the more idiosyncratic aspects of the morphemic realization of causativization and applicativization, as described in section 2.5 (page 142), are consistent with the Strong Linearity Domain Hypothesis.

The rest of this section will be structured as follows. In section 2.7.2 (page 231) I present evidence that the verb stem in Bantu is a prosodic unit. In section 2.7.3 (page 234) I will present data which will allow us to get a sense for the characteristic phonology of the Bantu verb stem. In section 2.7.4 (page 250) I will argue that the templatic behavior of the Bantu verb stem is consistent with the Strong Linearity Domain Hypothesis. However, as we shall see, on its own, the Strong Linearity Domain Hypothesis cannot explain why the Bantu template has the form CAT instead of ACT. Because of this, in section 2.7.5 (page 262) I will offer an auxiliary explanation for that particular aspect of the Bantu verb stem template. Finally, section 2.7.6 (page 272) will offer some brief concluding remarks on the analysis.

2.7.2 The Bantu verb stem as a prosodic unit

In his survey of the Bantu verb stem, Hyman (1993:25) has written, "... apparently all Bantuists agree that the verb stem is distinguished by phonological characteristics...". He then gives a number of its phonological characteristics, some of which are paraphrased in

³⁷ While no one has ever suggested that the Bantu verb stem contains such slots for its derivational suffixes, Athabaskan languages are often described as having derivational slot-filler morphology (see, e.g., Young and Morgan (1980:101)). While the semantics of this derivational morphology in Athabaskan is highly varied and is not limited to narrow valence-changing categories like causativization and applicativization, this shows that it is not unheard of to have slot-filler derivational morphology. Aspects of this issue were discussed in section 2.0 (page 107)

(121). He also notes that the basic generalizations for the verb stem hold for the noun stem in Bantu (Hyman and Mchombo 1992:25). While this work has been focusing on constituents consisting of root+extensions, the prosodic verb stem is generally taken to include the inflectional final vowel found in Bantu languages, and this will be the prosodic constituent I will employ in the analysis to follow.

- (121) a. The full seven vowels reconstructed for Proto-Bantu only occur in the first position of the verb stem (and, therefore, in the root).
- b. Vowel height harmony is observed in some Bantu languages within (but not outside of) the verb stem.³⁸
- c. Vowel coalescence often applies differently within the verb stem than it does elsewhere.
- d. Meinhof's Rule applies only to NC sequences within the verb stem.³⁹
- e. All vowels between the initial vowel of the verb stem and the FV (obligatory final vowel) are underlyingly toneless.
- f. In most Bantu languages only the verb stem is available for reduplication.

Hyman (2003a:26–8) further notes that there are cases in individual languages where not all the criteria in (121) hold. However, such cases usually involve well-defined classes of exceptions.

³⁸ See Hyman (1999) for a detailed discussion of vowel harmony in Bantu.

³⁹ Meinhof's Rule (Meinhof 1932:183–4) is a rule affecting nasal-voiced oral stop clusters. Meeussen (1967:85) suggest that it may have been operative in Proto-Bantu.

The set of criteria in (121) comprise compelling evidence that the verb stem in Bantu is a prosodic constituent in Bantu since it is clearly the locus of a number of phonological effects. Characteristic (121f) is especially noteworthy in light of the fact that reduplication is often taken to refer to prosodic constituents (see, e.g., McCarthy and Prince (1995)).

Using facts like those in (121) as evidence specifically for positing that the verb stem in Bantu is a prosodic unit is not at all new to this work. It has also been proposed by Downing (1999:73), and is implied in other work (see, e.g. Ngunga (2000:87)). Downing (1999:75) gives the structure adapted in (122) for the Bantu verb, which includes the constituent *Inflected Stem*, which corresponds to what is being referred to as the verb stem here. (For a comparable structure see Myers (1987:32–40).)

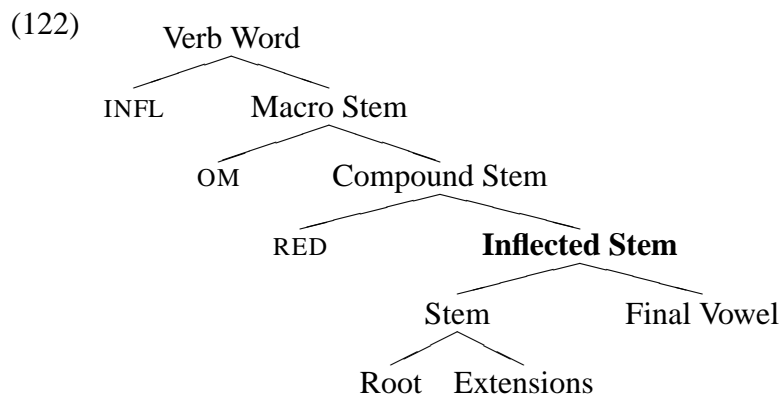

The levels of structure above the compound stem in (122) refer to prefixal material on the Bantu verb. The compound stem is a label for a reduplicant-stem combination. It is above the inflected stem in the tree since it is the inflected stem which is copied in reduplication constructions.

Comparable to the view taken in this work as discussed in section 1.2.2 (page 37), Downing (1999) adopts the view that, while the constituents in the prosodic hierarchy are

not necessarily coincident with morphological structure, the prosodic hierarchy in a language, at level below the word, is based on morphological, instead of metrical, structure. Because of this, there is a default expectation in her proposal that there will be a prosodic constituent corresponding to each of the morphological constituents given in (122). Importantly, for our purposes, Downing (1999) specifically employs the category of prosodic stem in her analysis of certain aspects of the Bantu verb. This prosodic category's morphological analog is the verb stem (or Downing's inflected stem), and we, therefore, see that the view adopted here has been explicitly adopted previously. In fact, it would appear to be a more or less uncontroversial idea within Bantu linguistics.

Having established that the verb stem in Bantu is a prosodic constituent allows the first condition of the Strong Linearity Domain Hypothesis to be satisfied. In the next section, I will present data which has bearing on establishing the characteristic phonology of the Bantu verb stem.

2.7.3 The characteristic phonology of the Bantu verb stem

2.7.3.1 The basic shape of the Bantu verb stem

A number of characteristics of the Bantu verb stem were given in (121). These can be taken to justify the treatment of the verb stem as a prosodic constituent. There is another important aspect to the phonology of the verb stem which, its general phonological shape, which is schematized in (123).

- (123) -CVC- -VC-* -W-* V
 root extensions valence FV

As indicated in (123), the Bantu verb typically consists of a CVC root followed optionally by some number of extensions, followed by the valence markers (i.e., transitive or passive) followed by the final vowel. The structure in (123) is only schematic, and there are various ways in which actual verb stems deviate from it. The -W- abbreviation for the valence markers in (123) is meant to indicate that they do not usually have a vocalic reflex despite their reconstruction as vowels, as discussed in section 2.7.3.4 (page 242).

In the following sections, I will discuss various aspects of the structure of roots, extensions, and valence markers, and then return to the overall shape of the verb stem.

2.7.3.2 The root

The dominant pattern for verb roots in Bantu is -CVC- where the vowel may be long or short. As mentioned in (121), only the first vowel of the root in the verb stem shows the full contrast between the seven vowels of the Proto-Bantu system (*a, e, i, o, u*, and “super-high” *i* and *ɥ*). However, there are a number of ways in which Proto-Bantu roots and roots in the daughter languages deviate from the basic -CVC- pattern.

For example, it is very common to find roots beginning with vowels and, therefore, taking the form -VC- in modern-day Bantu languages. This is generally understood to be an innovation triggered by loss of the initial consonant of the stem found in Proto-Bantu. Thus, for example, the root for ‘see’ in Chichewa is *-on-*. This root is reconstructed as **-bon-* in Proto-Bantu. The justification for such a reconstruction is straightforward since the same root in other languages where the root for ‘see’ begins with a labial consonant, like in Kinyamwezi where it is *-βon-*. Other instances -VC- in Bantu languages are generally

amenable to this type of analysis. The most common path triggering the development of -VC- roots is where roots of the form -jVC- have lost the initial *j* (Meeussen 1967:86).

In addition to the existence of -VC- roots, “subminimal” -CV- roots are also well-attested in Bantu. Such roots are reconstructed for Proto-Bantu, but only in limited numbers. Meeussen (1967:87) lists about twenty, some of which are given in (124).

(124)

PB FORM	GLOSS
*-pá-	‘give to’
*-ké-	‘dawn’
*-dí-	‘eat’
*-mo-	‘cut hair’
*-du-	‘fight’
*-kú-	‘die’

In modern Bantu languages, the fact that subminimal roots do not match the typical -CVC- pattern has meant that, in some cases, they trigger phonological effects which cause their size to be increased to something closer to the normal pattern. Downing (1999), for example, gives relevant examples from Swazi.

(125) SWAZI (S.43)

(Downing 1999:80)

	INFINITIVE	PASSIVE	GLOSS
	<i>kú-bón-a</i>	<i>kú-bon-w-a</i>	‘see’
-CVC-	<i>kú-val-a</i>	<i>kú-val-a</i>	‘close’
	<i>kú-jiktjel-a</i>	<i>kú-jiktjel-w-a</i>	‘throw’
	<i>kû-dl-á</i>	<i>kû-dl-íw-a</i>	‘eat’
-C-	<i>kû-ph-á</i>	<i>kû-ph-íw-a</i>	‘give’
	<i>kú-mb-a</i>	<i>kú-mb-iw-a</i>	‘dig’
	<i>kw-áb-a</i>	<i>kw-áb-iw-a</i>	‘share’
-VC-	<i>kw-ént-a</i>	<i>kw-ént-iw-a</i>	‘do’
	<i>k-ókh-a</i>	<i>k-ókh-íw-a</i>	‘light’

As Downing describes, roots that are of the canonical CVC form or longer take *-w-* as the passive marker (etymologically **-y-*). Roots that are “smaller” take *-iw-* as the passive marker. Some of these small roots fall into the CV class found in Proto-Bantu, though due to changes in Swazi, these roots are just C.⁴⁰ Additionally, in Swazi, *-VC-* roots also take the long *-iw-* passive. This sort of allomorphy is not uncommon and comparable effects are reported by Sibanda (2000) for Ndebele and by Maganga and Schadeberg (1992:147–8) for Nyamwezi, for example.

The C roots of Swazi trigger show at least one additional type of phonological behavior which distinguishes them both from *-CVC-* and *-VC-* roots. In (126), taken from Downing (1999), a *-C-* root, *-dl-* ‘eat’ contrasts with a *-CVC-* and a *-VC-* root with respect to reduplication.

(126) SWAZI (S.43)

(Downing 1999:84)

	INFINITIVE	REDUPLICATION	GLOSS
<i>-CVC-</i>	<i>kú-bóna</i>	<i>kú-boná-bona</i>	‘see’
<i>-VC-</i>	<i>kw-ába</i>	<i>kw-abá-yaba</i>	‘share’
<i>-C-</i>	<i>kû-dlá</i>	<i>kû-dlayí-dla</i>	‘eat’

In (126) the *-CVC-* root is reduplicated with the final vowel. The *-VC-* root is reduplicated with an epenthetic *y* appearing between the final vowel of the first half of the reduplication construction and the initial vowel of the root in the second half of the construction. This epenthesized *y* is not particularly striking given that it appears between two vowels.⁴¹

⁴⁰ Two of the three C roots in (125) are among Meeussen’s (1967) examples of CV roots in Proto-Bantu and are given in (124).

⁴¹ Reduplicated forms like *-enyá-yenya*, based on the root *-ény* ‘soak’ (Downing 1999:86), indicate that the

More surprising is the appearance of the syllable *yí* in the reduplicated form of *-dl-* ‘eat’. This epenthetic syllable causes the first half of the reduplication construction of a verb like *-dl-* to more closely resemble the reduplication pattern for *-CVC-* verbs by giving it the form *-CVCV-*, which they typically show by virtue of appearing with the final vowel. Effects like this have been generally attributed to some sort of minimality requirement on stems dictating that they be at least two syllables (cf., e.g. Downing’s STEM MINIMALITY constraint for Swazi, “PStems can be no smaller than two syllables (1999:81)”).

The effects of such apparent minimality restrictions are not limited to Swazi. Chichewa, Shona and Ndebele show very similar behavior to Swazi, for example, and Ciyao and Kinande also show the effects of apparent minimality restrictions (Ngunga (2000:117), Hyman et al. (1998)). Epenthetic segments do not appear in these latter two languages, though. Rather, a sort of “double” reduplication takes place. The examples in (127) from Ciyao are taken for illustration from Ngunga (2000) (see also Mutaka and Hyman (1990)).

(127) CIYAO (P.21)

(Ngunga 2000:117)

	STEM	REDUPLICATION	GLOSS
	<i>-dya-</i>	<i>-dyaa-dyaa-dya-</i>	‘eat’
cf.	<i>-diile-</i>	<i>-diile-diile-</i>	‘eat.PERF
	<i>-wa-</i>	<i>-waa-waa-wa-</i>	‘die’
cf.	<i>-wiile-</i>	<i>-wiile-wiile-</i>	‘die.PERF
	<i>-ta-</i>	<i>-taa-taa-ta-</i>	‘name’
cf.	<i>-teele-</i>	<i>-teele-teele-</i>	‘name.PERF

The first member of each pair of stems in (127) represents the *-CV-* basic form of the verb. These subminimal forms are reduplicated twice, creating a stem with three parts. The epenthetic *y* in the reduplicated *-VC-* root in (126) is not solely conditioned by its size but, instead, by the fact that it begins with a vowel.

perfective stem of these verbs, as can be seen in the table, fits the shows a -CVCV- pattern, and these stems only reduplicate once following the normal pattern for Ciyao. Ngunga (2000:117) takes the double reduplication to result from a similar restriction to Downing's STEM MINIMALITY constraint. "By doubling the reduplicant, the Ciyao -CV stems satisfy the minimal two syllable size of the reduplicant in total reduplication (2001:117)."

Ciyao -CV- stems show another type of alternation, not dissimilar from the data seen in (125), where an "intermorph" *-il-* appears on -CV- roots when they take the transitive or passive valence markers. This intermorph "extends" the root to a more canonical shape. Thus, for example, the passive of the root *-so-* 'grow dark' is *-sw-eel-w-*. The *-w-* is the passive suffix and *-eel-* is this intermorph. Comparable phenomena have been described by Polak-Bynon (1975:176–7) for Shi and Bastin (1983:154-65) for a number of languages.

A final way in which roots can deviate from the -CVC- pattern is that in addition to long vowels being possible in the root, there are some roots reconstructed in Proto-Bantu as being -CVVC- with two distinct vowels. Some examples include **-byim-* 'chase' and **-pɿang-* 'sweep' Meeussen (1967:87). These roots are fairly close to the basic -CVC- pattern, especially since long vowels are possible in the root, and I don't consider them to be major deviations from the general pattern.

My conclusion from this discussion that the characteristic phonology of the verb root is -CVC- where the vowel can be long. This is not a strict requirement but certainly a strong tendency. Roots with the shape -VC- are not uncommon and are, in some sense, closer to the -CVC- pattern because, when the final vowel is added to them, they consist of two

syllables. Roots of the form -CV- deviate more greatly from the -CVC- pattern because, even when the final vowel is added to them, they remain one syllable. It is not clear if this led to any peculiar phonological effects in Proto-Bantu, but it has in various daughter languages as seen in the data from Swazi and Ciyao. These phonological effects result in the -CV- stems behaving more similarly to -CVC- stems than they would otherwise.

The fact that -CV- stems show this exceptional phonological behavior is some of the best evidence that the characteristic phonology of the verb stem is -CVC-. These phonological effects demonstrate that there are active processes in the language to make non-canonical stems behave more canonically and, thereby, demonstrate that there is some linguistic reality to this characteristic phonology. Such effects, which are one type of a class of phenomena sometimes given the label “the emergence of the unmarked,” where irregular forms become more regular in derived environments, are generally good indicators of what the characteristic phonology of a given prosodic unit is.⁴²

2.7.3.3 The extensions

The extensions, being the focus of this chapter, have already been fairly thoroughly covered. However, there are a few points to make regarding their characteristic phonology.

First and foremost, the core extensions in Proto-Bantu all had the shape -VC-. However, some languages have innovated other shapes. For example, the shape of the applicative in Swahili is simply -i-. This is the result of a simple sound change.

⁴² It would have been possible for me to adopt the notion of “unmarked phonology” instead of “characteristic phonology” here. However, I have not done so, because I do not want to make any claims about markedness—rather, I sought a more purely descriptive notion.

Other languages have innovated extensions which do not adhere to the Proto-Bantu -VC- form. For example, the passive marker in Chichewa is *-idw-*. This extension has the form -VCW-, and the *w* in the form is almost certainly the reflex of the Proto-Bantu passive valence marker *u*. Similarly, the reciprocal marker in Luganda is *-agan-* where the Proto-Bantu reciprocal is **-an-*.

In this study, I have generally ignored innovative extensions like *-idw-* in Chichewa and *-agan-* in Kinande and, instead, focused on combinations with a more clear lineage from the Proto-Bantu system. At least for the case of Chichewa *-idw-*, Hyman (2003a) points out that this innovative extension shows unexpected ordering behavior. Specifically, it can appear productively before the applicative extension in Chichewa, violating his CARP (causative, applicative, reciprocal, passive) template. Generally, these innovative extensions are the exceptions, not the rule, within Bantu.

Other than their basic -VC- shape, there are two other notable characteristics of the extensions. First, they do not show the full range of seven vowels in the initial V position. Furthermore, in many cases, especially for the causative and the applicative, the extensions exhibit a height harmony where the vowel of the extension alternates between *i* and *e*. This results in a further neutralization of possible vowel contrasts in the extensions. Second, as mentioned in (121), the extensions are underlyingly toneless.

The basic phonological characteristics of the extensions then, are their -VC- shape and that they show neutralization of distinctions (both tonal and vocalic) present elsewhere in the language.

2.7.3.4 The valence markers

As with the extensions, we have already had occasion to examine many aspects of the valence markers. There are only two of them, the transitive **-j-* and the passive **-u-*, each having the basic form *-V-*. As mentioned in (2.5), the reflex of the transitive is often not a segment at all—rather, it appears in the daughter languages as palatalization of a preceding consonant. The passive **-u-* is also known to trigger palatalization (in particular, in the Nguni languages and Sesotho and Tswana, spoken in the south of the Bantu-speaking area). Examples of the transitive triggering palatalization were seen in (62) and (113). Examples of **-u-* causing palatalization are given in (128) which gives data from Swazi.

(128) SWAZI (S.43)

(Ziervogel 1952:79)

ACTIVE	PASSIVE	GLOSS
<i>-khiph-a</i>	<i>-khish-w-a</i>	‘take out’
<i>-gub-a</i>	<i>-guj-w-a</i>	‘dig out’
<i>-vum-a</i>	<i>-vuny-w-a</i>	‘consent’
<i>-bamb-a</i>	<i>-banj-w-a</i>	‘catch’
<i>-landz-a</i>	<i>-landv-w-a</i>	‘fetch’

We saw in (113) for palatalization associated with the etymological transitive suffix can show apparent cyclic effects in the phonology of some languages. Palatalization triggered by the passive can also do this as the data in (129) shows.

(129) SWAZI (S.43)

(Ziervogel 1952:79)

ACTIVE	PASSIVE	GLOSS
<i>-khiph-el-a</i>	<i>-khish-el-w-a</i>	‘take out for’
<i>-gub-el-a</i>	<i>-guj-el-w-a</i>	‘dig out for’
<i>-bamb-elel-a</i>	<i>-banj-elel-w-a</i>	‘hold up’

As can be seen in (129), even when the *-w-* marking the passive does not appear immediately adjacent to the verb root, its appearance still can trigger palatalization on the final consonant of the root. This is comparable to the “cyclic” effects found with the transitive suffix exemplified above in (113).

The examples in (128) and (129) illustrate another important aspect about the voice extensions, that has been mentioned above—despite the fact that they are reconstructed as vowels, their segmental reflexes are typically glides. Thus, passive **-u-* typically appears as *w*, as seen in (128) and (129) and **-j-* typically appears as *y*, when it has a segmental reflex, as seen in (130), which gives the form and conditioning environment of the exponents of causativization in Lòmɔ̀ngɔ̀ which are most clearly derived from the transitive.

(130) LÒMƆ̀NGƆ̀ (C.61a)

(de Rop 1958:89–90)

ENVIRONMENT	EXAMPLES	GLOSS
“default” allomorph <i>-y-</i>	<i>-somb-y-</i>	‘buy-TRANS’
	<i>-if-y-</i>	‘stuff-TRANS’
	<i>-lang-y-</i>	‘want-TRANS’
	<i>-àm-y-</i>	‘inflate-TRANS’
	<i>-fen-y-</i>	‘be_profane-TRANS’
	<i>-kis-y-</i>	‘be_seated-TRANS’
coronal-final stems (palatalization)	<i>-mit-</i> → <i>-mits-</i>	‘pinch.TRANS’
	<i>-tend-</i> → <i>-tenj-</i>	‘rebound.TRANS’
	<i>-kel-</i> → <i>-kej-</i>	‘do.TRANS’

The data in (130) shows two different realizations of the transitive in Lòmɔ̀ngɔ̀ causativized verbs. As can be seen, the “default” exponent of causativization is *-y-*. Lòmɔ̀ngɔ̀ also show various other reflexives of the transitive, including palatalization for some forms as indicated in the table.

What we see then is that the overall characteristic phonology of the valence markers is one where, while they are reconstructed as vowels, they are either glides, a phonological process, or some combination of the two.

2.7.3.5 The entire verb stem

We are now in a position to discuss the characteristic phonology of the entire Bantu verb stem. I repeat the schematization of it given in (123) in (131).

(131)	-CVC-	-VC-*	-W-*	V
	root	extensions	valence	FV

The most notable aspect of the characteristic phonology of the verb stem is its basic CV* structure. Various aspects of the verb stem's structure "conspire" to keep this basic syllable structure. One is the fact that the extensions have -VC- shape. Thus, their addition to the verb root does not create consonant clusters. Also, the obligatory final vowel crucially plays into the creation of a consistent CV* pattern. Additionally, the fact that the valence markers often appear as phonological processes further helps to keep the basic CV* structure intact. In this sense, some of the daughter languages are more faithful to this structure than Proto-Bantu was.

There are some deviations from the basic structure. The most common of these is for the initial "vowel" of the stem to either be of the form CVV, where the two vowels are not the same (as opposed to a long vowel) or for it to be CWV where the first segment is a glide. Thus, for example, as mentioned in section 2.7.3.2 (page 235), the root **-pjang-* 'sweep' is reconstructed for Proto-Bantu with a CVV sequence. This root then appear in various

daughter languages as a CWV sequence, *-pyang-* in Bemba, for example. Obviously the phonetic difference between such a CVV sequence and its corresponding CWV one is slight. But, whether such sequences are viewed as CVV or CWV, they still represent a deviation from the basic CV* pattern of the verb stem.

This deviation in the first vowel can be echoed by the same kind of deviation in the last vowel when the valence markers surface as vowels or a glide before the final vowel. Thus, for example, in Chichewa, the passive suffix has innovated to *-idw-*, where the *w* is a reflex of the passive valence marker. The use of this suffix consistently produces a final CWV sequence in passivized verbs in Chichewa as seen in the examples in (132).

(132) CHICHEWA (N.31b)

STEM	GLOSS
<i>-pats-idw-a</i>	‘give-PASS-FV’
<i>-nen-edw-a</i>	‘tell-PASS-FV’

In the case of Chichewa, the fact that the innovation of the passive suffix to the form *-idw-* has meant that all productive passives in the language contain a CWV sequence. Other languages show comparable patterns, but in some cases the CWV sequences are restricted to particular environments. For example, the data in (130) shows that only the “default” realization of the transitive suffix would result in a CWV sequence for a causativized verbs in Lomongo. Similarly, as seen in (133), the passive form in Kinyamwezi shows an alternation which produces a CWV sequences in certain environment but a CVWV sequence in others.

(133) KINYAMWEZI (F.22)

Maganga and Schadeberg (1992:148)

ACTIVE	PASSIVE	GLOSS
<i>-gop-a</i>	<i>-gop-w-a</i>	'borrow'
<i>-it-a</i>	<i>-it-w-a</i>	'pour away'
<i>-bad-á</i>	<i>-bad-w-á</i>	'catch'
<i>-soómb-á</i>	<i>-soómb-w-a</i>	'carry'
<i>-shoosh-a</i>	<i>-shoosh-iw-a</i>	'answer'
<i>-laan-j-a</i>	<i>-laanz-iw-a</i>	'teach'
<i>-ogóh-a</i>	<i>-ogóh-iw-a</i>	'fear'
<i>-jaan-a</i>	<i>-jaan-iw-a</i>	'take along'
<i>-p-aá-</i>	<i>-p-íw-a</i>	'give'

As can be seen (133), the passive in Kinyamwezi has two allomorphs, one of which is *-w-* and the other which is *-iw-*. The *-iw-* allomorph appears after *-C-* verbs, similar to the Swazi pattern seen in (125). Additionally, the *-iw-* form appears after *-CVC-* verbs ending with certain consonants, palatalized consonants and β , n , h , mh , and η , while the *-w-* stem appears after the other consonants. The second allomorph *-iw-* has a shape such that, when it appears, the verb stem maintains the canonical CV* pattern. So, even though the *-w-* allomorph causes the stem to show a non-canonical CWV sequence, its environment is restricted. Notably, the *-iw-* allomorph is the innovative member of the pair.

We see, with data like that in (133), a comparable pattern to what was seen in section 2.7.3.2 (page 235). Specifically, various phonological effects can be found that conspire the characteristic phonology of the verb stem to be maintained when it might otherwise not be—this is some of the most important evidence in arguing that any particular feature is part of the characteristic phonology of a prosodic constituent. The particular alternation in (133) helps further make the case that the characteristic phonology of the Bantu verb stem is that it have a CV* shape.

With respect to the formation of non-canonical syllables as the result of suffixation to the verb root, a final area worth examining is the typical behavior of the combination of the transitive and passive. As discussed in section 2.4 (page 131), they can cooccur, but when they do so, their relative order is strictly transitive-passive (Meeussen 1967:92). As the two suffixes are generally reconstructed as the vowels **-j-* and *-u-*, their cooccurrence could cause deviation from the canonical CV* structure.

However, alternations are found in Bantu which conspire to keep an **-j-u-* combination from creating non-canonical syllables—in languages where this might occur. The primary sort of alternation is one noted by Meeussen (1967:92), “The sequence **-V-ú* is manifested as */-Vbú/*, dial. */-Vgú/*.”⁴³ In more concrete terms, because of the generally restrictive shape of the extensions, this means that the potential sequence **-j-u-* is realized as **-j-bu-*. The derivations in (134) given by Polak-Bynon (1975) from Shi illustrate this. Kinande also offers a good example of this phenomenon (Hyman 1993:3).

(134) SHI (D.53)

(Polak-Bynon 1975:169)

BASIC FORM		<i>b</i> -INSERTION	INFINITIVE
<i>súnik-iikI-u-á</i>	→	<i>súnik-iikI-bu-á</i>	cf. <i>óokusunikiisibwaa</i>
push-CAUS.TRANS-PASS-FV			
<i>súnik-I-u-á</i>	→	<i>súnik-I-bu-á</i>	cf. <i>óokusunisibwaa</i>
push-TRANS-PASS-FV			

Polak-Bynon’s (1975) treatment of causativization in Shi sets up two suffixes for causativization. Her *-iikI-* suffix corresponds to **-ic-j-* here. The *k* is always palatalized to *s*

⁴³ Meeussen (1967:92) tentatively reconstructs the transitive and passive with high tones—hence the tone marks in the quote. This aspect of the reconstruction is less clear than the segmental reconstruction. See Hyman and Katamba (1990) for discussion of the issue.

over the course of the derivations she give. The other suffix she proposes marking causativization is *I* which is her notation for the reflex of **-j-* in Shi.⁴⁴

As can be seen in (134), this alternation of the passive between *-u-* and *-bu-* does not completely eliminate non-canonical syllables—the example verb forms end in *-bwa*. However, the *-bu-* form of the passive does allow a potential **-j-u-* combination to be realized more closely to a canonical syllable structure than would otherwise occur.

The overall picture, then, that we get of the Bantu verb stem is that it follows a basic CV* pattern. There are some deviations from the pattern, but, in some cases, the deviations are minimized by morphophonological alternations found in particular languages. Since the extensions, and, to a lesser extent, the valence markers, allow the verb stem to maintain the basic CV* pattern found in the root+FV combination, I believe we can safely consider part of the characteristic phonology of the verb stem.

Under this description, the term *extension*, as found in traditional Bantu linguistics, remains appropriate as a description of their phonological effect. They do not fundamentally alter the structure of the verb root, rather they simply “extend” the root without affecting its core phonological structure. And, while there are some complications, there is a sense that a verb marked with extensions and other verbal suffixes is, phonologically, simply an extended root.

Based on this idea, I further propose that the characteristic phonology of the Bantu verb stem is not simply CV* but specifically CVCV. By giving it this particular pattern I mean

⁴⁴ As indicated in the table in (70), this palatalization of *k* to *s* also occurs when an applicative suffix follows the causative. As far as I can tell, the underlying *k* in the causative is posited mostly to conform to a particular phonological analysis and not because it is ever attested on the surface.

to encode two aspects of its characteristic phonology. First, that its syllable structure is generally CV. Second that the verb stem is characteristically fairly small—having the basic size of root+FV. Clearly, all extensions cause the stem to deviate from the basic CVCV shape. I propose this as the basic shape to reflect the idea that extensions do, in fact, *extend* the root, and, in this sense, a verb stem suffixed with an extension *is* deviating from the canonical stem structure.

Thus, we can state the characteristic phonology of the verb stem as in (135).

(135) **Characteristic phonology of Bantu verb stem:** The characteristic phonology of the Bantu verb stem can be schematized as CVCV. This schema encodes two key features: (i) its basic syllable structure is CV and (ii) its basic length is two syllables.

The statement in (135) may seem a bit anticlimactic. The basic syllable structure in Bantu is CV, and verb roots are generally -CVC-. These two generalizations are well-known and brought together would predict something along the lines of (135)—and such an observation is far from new in Bantu linguistics. The discussion in this section was developed for several reasons of different kinds.

First, and most importantly, I wanted to justify the idea that the term *extension* is indeed appropriate and that the extensions build on a root to create something phonologically that still looks like a root. This is because in section 2.7.4 (page 250), where I discuss the Bantu case with respect to the Strong Linearity Domain Hypothesis, the idea that the Bantu verb stem should be characteristically “small” in size—that is CVCV—will be important

in understanding how the Bantu template is consistent with the Strong Linearity Domain Hypothesis.

Another reason for spending time to develop the idea in (135) is that I wanted to show that the basic CV structure is not simply an epiphenomena of a -CVC- root plus a final vowel. Rather, although the basic CV* pattern can be violated, we see alternations in present-day Bantu languages which actively maintain that pattern, suggesting that CV* is, indeed, part of the characteristic phonology of the verb stem.

A final reason for this detailed discussion is that, since the notion of characteristic phonology is new to this work, it is important to walk through all uses of it carefully so that it is completely clear what I mean by it for each case study.

2.7.4 Applying the Strong Linearity Domain Hypothesis to the Bantu data

2.7.4.1 Towards a proper description of the CAT template

Having established that the Bantu verb stem forms a prosodic domain and the characteristic phonology of the verb stem as CVCV, the next step in examining how the Bantu template with respect to the Strong Linearity Domain Hypothesis is showing how its restrictions are consistent with the characteristic CVCV phonology. While I have been generally been describing the Bantu verb stem as “templatic”, it will now be necessary to appeal more frequently to the technical term strong linearity domain so that we can properly apply the Strong Linearity Domain Hypothesis to the Bantu case.

The first step in doing this is to come up with a proper description of the CAT template, or to use the technical terms developed for this work, to understand the precise nature of

the strong linearity domain involving the causative, applicative, and transitive suffixes in Bantu. Naively, we could imagine the CAT template being set up along the lines depicted in (136).

(136) [[[root] [(*caus*)] [(*app*)] [(*trans*)]]_{ext. root} [FV]_{verb stem}

The schema in (136) is a “slot-filler” analysis of the CAT template. It basically sets up three slots after the verb root where the various suffixes would “fit in”. I have put parentheses around each of them to indicate these slots would have to be optional since verb roots can grammatically surface without any of the parenthesized suffixes (but they generally do require a final vowel, hence no parentheses around that position).

The structure in (136) presents various problems. With respect to this work, an important problem is that I can think of no way to rectify such a structure with the Strong Linearity Domain Hypothesis. Specifically, I can think of no way to make the slots in in (136) consistent with the characteristic phonology of the Bantu verb stem. However, more problematic is the fact that the sort of slot-filler analysis seen in (136) isn’t descriptively ideal. While it manages to capture the most basic ordering facts, it fails to capture various other aspects of the Bantu template.

First and foremost, there is no evidence that the optional “slots” in (136) are grammatically active when empty. This is because there’s no sense in which the lack of, for example, a causative suffix lends any particular extra meaning to the verb. In some languages, the absence of an overt morpheme is taken to signal particular semantics. This is

common in agreement systems, for example, where one member of an agreement paradigm is phonologically null—frequently the third person singular.

Since no such meaning can be associated with the lack of a causative, applicative, or transitive suffix on the Bantu verb, a slot-filler analysis doesn't seem appropriate for the Bantu extensions. Analyses along those lines have been proposed for other aspects of Bantu phonology, for example, the Bantu verbal prefix system (see, e.g., Stump (1993)), but would not be appropriate for its suffixal morphology (and, perhaps, also, not for its prefixal morphology as briefly discussed in section 2.0 (page 107)—though I do not take up that issue here).

As discussed earlier in section 2.0 (page 107), positing a series of slots is the most extreme form of a morphological template and has not been proposed for many languages. Athabaskan languages probably offer the most prominent cases where slot-filler templates have been proposed (see, e.g., Young (2000) and Kari (1989))—and their morphology is significantly more complex than that found in the Bantu verb stem.

The Bantu CAT template, on the other hand, can actually be described fairly simply since so few suffixes are involved. While various imaginable parameters could be given, I will operate with the characterization of the CAT template given in (137).

(137) **Parameters of the CAT template**

- a. The transitive cannot precede the extensions.
- b. The causative extension cannot directly follow the applicative extension.

The sort of template described by the statements in (137) can be understood as a relative template, as opposed to the schema in (136) which would be an absolute template. The statement in (137) describes a relative template since they do not assign specific positions for the various affixes. Rather, they state restrictions on their relative order of combination.

In the only other work I am aware of making use of a templatic analysis of the Bantu suffixes, that found in Hyman (2003a), something along the lines of a relative template is also assumed. Hyman assumes a *TEMPLATE* constraint in Bantu which is violated by any stem not adhering to his *CARP* template, discussed in section 2.6.4 (page 218). By treating the *CARP* template as a violable constraint on the Bantu verb stem, rather than a rigid forced order, he effectively adopts a relative template as opposed to a slot-filler one. His template, like the restrictions in (137), describes an ideal, but not obligatory, set of ordering relations among various morphological elements—an inherently relative kind of description. Therefore, the restrictions described in (137) and Hyman's template are similarly-aligned descriptions for the Bantu data seen here.

The restrictions in (137) are descriptively adequate for the basic data involving just the causative, applicative, and transitive. Data like that in (82), involving the effects of intervening extensions, is also intended to be covered by it—and how I see that data fitting into the general analysis will be discussed in section 2.7.4.3 (page 259). First, however, in the next section, I will describe how the restrictions in (137) are consistent with the characteristic phonology of the verb stem.

2.7.4.2 The CAT restrictions and the characteristic phonology of the verb stem

Recall from section 2.7.3.5 (page 244) that the characteristic phonology of the Bantu verb stem is taken to be CVCV—that is it has CV* structure and is bounded in its size, ideally two syllables.

From these two core properties, I believe, it can be shown that the restrictions in (137) are consistent with the phonology of the Bantu verb stem. While we've seen, throughout this chapter, that particular Bantu languages might have other aspects of their characteristic phonology—like cyclicity effects, for example—it is important for the general argument to limit the discussion to these two very general phonological characteristics. These two characteristics are pan-Bantu and the template is pan-Bantu—thus, the two can be linked in this evaluation of Bantu against the Strong Linearity Domain Hypothesis. In section 2.7.4.3 (page 259) I will discuss how the data seen in (2.5.4) fits in with the Strong Linearity Domain Hypothesis.

Restriction (137a), that the transitive cannot precede the other extension, is consistent with the Strong Linearity Domain Hypothesis for the crucial reason that the transitive is the only one of the three suffixes which, when it has a segmental reflex at all, does not follow the -VC- pattern, and, it, therefore, cannot “extend” the root phonologically in the way the true extensions can.⁴⁵ Its appearance necessarily marks a deviation from the basic root shape, thus making it impossible for any extension following the root to attach to the stem without violating the CV phonology of the stem. Thus, rather than “extending” the

⁴⁵ In the Proto-Bantu case, where the transitive is reconstructed as a vowel, we can consider its final position to also be consistent with the characteristic phonology of the verb stem for similar reasons.

stem, the phonological shape of the transitive can be thought of as “finishing” the stem by virtue of its creating a stem of phonologically deviant form which cannot be extended in the normal way.

Importantly, in those cases where an etymological transitive does precede the extensions, as discussed in section 2.5.2 (page 150), the transitive typically has a reflex consisting only of a consonant mutation—and, thus, it can be followed by an extension without violating the CV pattern. Similarly, in cases where we see cyclicity effects which appear to correspond to multiple instances of the transitive, as in the example in (113), the transitive also has a consonant mutation reflex, and the basic CV pattern of the verb stem is maintained. This lends general support to the idea that the transitive is final because its segmental reflex is typically a glide. When its reflex ceases to be a glide, but is only a phonological effect on a consonant, it can lose this positioning restriction.

There’s a potentially subtle distinction to be made here. I take the restriction that the transitive must follow the other suffixes to be a strong linearity domain restriction. That is, it cannot be explained as a predictable position of the suffix given its syntactic, semantic, or phonological characteristics. It is an independently specified restriction on linear order.

In appealing to the special shape of the transitive suffix in showing how its positioning is consistent with the Strong Linearity Domain Hypothesis, I do not mean to imply any phonological analysis where the transitive follows the other suffixes *because* it does not have -VC- shape. This does not seem to be the case. As discussed in section 2.7.3.2 (page 235), CWV sequences are well attested in Bantu verb roots and a glide reflex of the

transitive suffix necessarily produces such a sequence at the end of the stem once the final vowel is added. Thus, it is not the case that CWV sequences are ruled out phonologically. Rather, I am arguing that, because CWV sequences diverge from the characteristic phonology of the verb stem, a strong linearity domain restriction preventing -VC- extensions from being added to a verb stem, which would create such a sequence, is consistent with its characteristic phonology.

Therefore, I explicitly do not take there to be a phonological restriction explaining the position of the transitive in the template—its position results from an independent stipulation in the grammar. The claim I am making is somewhat different: Given the general phonological characteristics of the Bantu verb stem, a restriction specifying that a suffix which violates that phonology cannot appear before VC suffixes is consistent with those characteristics. Since the Bantu verb stem is a prosodic constituent, this implies that the strong linear position of the transitive is consistent with the Strong Linearity Domain Hypothesis.

This takes us to the restriction that the causative cannot immediately follow the applicative. Since the causative and the applicative both have the same basic phonological shape, -VC-, we cannot appeal to the same kind of argument just used to explain why the position of the transitive is consistent with the Strong Linearity Domain Hypothesis. Rather, we will have to appeal to the second aspect of the characteristic phonology of the stem, its limited CVCV size.

The core idea which will be made use of here is that, since the Bantu verb stem, has

a limited size, strong linearity restrictions limiting its size are consistent with its basic phonology. This basically, then, makes it easy to understand how the restriction in (137b), which effectively rules out the the *AC combination, is consistent with the characteristic phonology of the Bantu verb stem. Generally, given the restricted size of the characteristic phonology of the verb stem, any strong linearity restriction which, in one way or another, prevents that verb stem from being extended is consistent with the phonology of the stem.

On this view, then, both the causative and the applicative violate the characteristic phonology of the verb stem, by extending it. The applicative, by restricting which affixes can come after partially maintains a basic size restriction to the verb stem. The applicative doesn't completely obstruct other extensions from being added to the stem—the reciprocal can follow it as seen in (82), for example. But the *AC restriction, when stated along the lines of a selectivity restriction as in (137b), becomes consistent with the “limited size” aspect of the characteristic phonology of the verb stem.

Again, as with the explanation of the positioning of the transitive suffix, the *AC restriction is taken to be a strong linearity restriction. So, there is no explanation for it outside of its being a stipulation on linear order. However, this stipulation matches the predictions of the Strong Linearity Domain Hypothesis and, therefore, is taken to support the general argument of this work.

However, having said this, it is important to reiterate the point that the Strong Linearity Domain Hypothesis, on its own, cannot account for why the attested template is CAT versus ACT. The causative and the applicative are both extensions with a -VC- shape, and there

is no way to distinguish between them (or, at least, no way I am aware of) with respect to the characteristic phonology of the verb stem. A proximate explanation of this ordering restriction, which follows from some of the discussion in section 2.4 (page 131) is that the template is inherited from Proto-Bantu. However, even if we accept that explanation, this just raises the question as to why Proto-Bantu should have preferred the CA order in the first place. Though I will not address the issue fully, I will suggest some reasons in section 2.7.5 (page 262) why CA might be preferred to AC typologically and, thereby, assume the Bantu template is an instantiation of a cross-linguistically more general phenomenon.

In the next section, I will discuss show the data regarding complex suffix combinations seen in section 2.5.4 (page 164) fits in with the Strong Linearity Domain Hypothesis. Before I do that, however, I would like to make an important point about the analysis just presented. Critical to the argument is describing the template in the right way. The naive template given in (136) is so generally articulated as to make it impossible to connect to the basic phonology of the verb stem. Adopting the more limited description of the “template”, in terms of two strong linearity effects, in (137), on the other hand, allowed an analysis where the Strong Linearity Domain Hypothesis could be satisfied.

In this way, in addition to becoming a restrictive theory of strong linearity phenomena, the Strong Linearity Domain Hypothesis has a side effect of forcing carefully articulated descriptions of strong linearity effects. To the extent that these descriptions are insightful, this could be considered a positive aspect of it. To the extent that these descriptions are not insightful, this could be a negative thing. The “insight” of these descriptions will have

to be looked at on a case by case basis. In the next section, some positive aspects of the description of the CAT template given in (137) will be seen—thus, demonstrating that this narrow description of the template imposed by the Strong Linearity Domain Hypothesis, in fact, may help us understand other aspects of the Bantu verb stem.

2.7.4.3 The effects of an intervening reciprocal on the verb stem

As summarized in section 2.5 (page 142) there are various complications found in the morphological exponence of applicativization and causativization in various Bantu languages. Most of them are not of interest to the presence of strong linearity domains with respect to suffix ordering. For example, there are various special forms of the applicative when causativized, as seen, for example, in Chimwi:ni in (70) where the applicative surfaces as *-it-iz-* instead of the form *-it-*, which it takes on in non-causativized contexts. This is an interesting phenomenon but not a templatic phenomenon, since it is probably best analyzed as morphological allomorphy. Similarly, the Strong Linearity Domain Hypothesis makes no predictions relating to the existence suffix orders which are ambiguous for scope, as discussed in section 2.5.5 (page 165). So, I have little to say about this at this point in the case study (though, of course, the existence of such ambiguity is important evidence against a Mirror Principle analysis and for a strong linearity domain).

One of the more interesting complications for suffix ordering with respect to the template came from the effects of the reciprocal allowable orders as discussed in (2.5.4). The relevant effects were seen for Chichewa in (82) and has also been reported for Ikalanga as seen in the data in (138). As discussed in section 2.6.2 (page 183) and section 2.6.3 (page

204), data like this raises important problems for Mirror Principle analyses of Bantu morpheme order. To the extent that the approach here can deal with these facts, it represents an advantage it has over previous analyses.

(138) IKALANGA (S.16)

(Mathangwane 2000)

STEM	GLOSS	TRANSLATION
<i>-lób-el-an-</i>	‘hit-APP-REC’	“hit for each other”
<i>-lób-el-an-es-</i>	‘hit-APP-REC-CAUS’	“cause to hit for each other”
* <i>-lób-el-es-</i>	‘tie-APP-CAUS’	

As mentioned in section 2.5.4 (page 164), few linguists seem to have tested for this phenomenon so it is, in all likelihood, underreported. What’s striking about data like that in (82) and (138) is that the intervening reciprocal allows an applicative to precede a causative. Thus, it seems to be the case that it is not that the applicative can’t precede the causative. Rather, the applicative can’t *immediately* precede the causative.

Given the way the CAT template was formulated in (137), the facts regarding the intervening reciprocal can be incorporated naturally into the general analysis, which is another reason motivating the relative ordering version of the template generally. Essentially, while the applicative specifies that it can’t be followed by the causative, there is no comparable restriction preventing the applicative from being followed by the reciprocal. In fact, the work of Hyman (2003a) indicates that, if anything, the most templatically natural position for the reciprocal in Bantu is following the applicative.

What seems to be going on, then, with respect to data like that in (138) is that the essence of the Bantu template is local restrictions on which affixes can follow a given affix. Since the applicative can be followed by the reciprocal and the reciprocal can, in turn, be

followed by the causative, forms ending in **-id-an-ic-* are well-formed, even if **-id-ic-* is not well formed. In this sense, Ikalanga and Chichewa morphology is not completely templatic since, if the combination **-id-an-ic-* were ungrammatical, then there would be a non-local dependency between two morphemes which, as pointed out in (11), is considered to be a feature of templatic systems.

At least one language has been explicitly reported not to allow the **-id-an-ic-* combination. That is Ndebele (Sibanda 2000). The **AC* restriction in Ndebele is apparently non-local. Ndebele is reported as having ambiguity of templatic suffix ordering of the sort described in section 2.5.5 (page 165). So this restriction appears to be purely templatic and is not related to semantic restrictions. Specifically, the lack of a **-id-an-ic-* does not correspond to a lack of the semantics expected of that order.

Ndebele, then, is somewhat more templatic than Ikalanga or Chichewa. Furthermore, it allows both **-an-ic-* and **-ic-an-* orders of the causative and the reciprocal. So, the ungrammaticality of **-id-an-ic-* is not due to a restriction against the causative following the reciprocal. Rather, it seems to be, as Sibanda (2000) notes, the case that the **AC* restriction is simply not local in Ndebele.

This means that the description of the CAT template in (137) is not sufficient for Ndebele and the (137b) condition should be generalized by removing the qualification that the causative cannot *directly* follow the applicative. This difference between Ndebele, on the one hand, and Ikalanga, on the other, does not affect whether or not the Strong Linearity Domain Hypothesis applies to the Bantu case. Though the **AC* constraint is non-local, it

still serves to keep the verb stem small and is, thus, in line with the *CVCV phonology of the verb stem. It is simply the case the Ndebele is more “templatic” than Ikalanga.

2.7.5 Some notes on why CA is attested instead of AC

Before concluding this section, the final issue I would like to address is why the Bantu template enforces causative-applicative order instead of applicative-causative order. As mentioned above, the Strong Linearity Domain Hypothesis cannot account for this particular aspect of the template since the causative and applicative are both -VC- extensions, and, because of this, there is no obvious reason why CA order should more closely match the characteristic phonology of the verb stem than AC order.

As discussed in section 2.6.2 (page 183) and section 2.6.3 (page 204), summaries of the formal analyses of Baker (1988) and Alsina (1999) respectively, previous authors have excluded, using various formal tools, AC order. This exclusion, in some sense, gives their analyses an advantage over the present one which cannot distinguish between CA and AC orders. However, we have also seen that, since a language with productive AC order, Xhosa, is attested, there is reason to believe that we do not want to exclude AC order across the board and a different type of analysis is called for.

In this section, I would like to sketch my own explanation for the fact that CA order is favored over AC order. Unlike the explanations of Baker and Alsina, it will not be a formal account rejecting AC order for all languages. Rather, it will be a diachronically-oriented explanation which will suggest that there is reason to believe that causativization should generally be marked more closely to a verb root than applicativization. Such an

explanation has the advantage of predicting the general pattern in Bantu without outright excluding the possibility of a language like Xhosa.

The central aspect of my explanation for the CA aspect of the CAT template rests with the idea that causativization is more “relevant” (in the sense of Bybee (1985:13)) to the verb than applicativization, and, therefore, all things being equal, the exponence of causativization is likely to be closer to the verb stem than the exponence of applicativization. Bybee (1985:13) defines relevance as follows: “A meaning element is *relevant* to another meaning element if the semantic content of the first directly affects or modifies the semantic content of the second.” Bybee (1985:33–6) then makes the general observation that the degree of relevance of a derivational morpheme to a root is one of the factors determining how close it is to the root, where a more relevant derivational morpheme tends to occur closer to the root than a less relevant derivational morpheme.

In the rest of this section, I will present cross-linguistic data to support the general claim that causativization is more relevant to the verb root than applicativization. The particular data I will examine relates to how common causatives and applicatives are in the world’s languages as well as how often the two are found in the same language. As we will see, causatives are much more common than applicatives, and there is an asymmetry where languages with applicatives are more likely to have causatives than languages with causatives are to have applicatives. These facts, which are independent from any morpheme ordering facts, will be taken to indicate that causativization is more relevant to the verb stem than applicativization. Therefore, following Bybee’s (1985) observations, they predict that

there should be a bias towards causative-applicative suffix order over applicative-causative order—which is precisely what we find in Bantu.

First and foremost, I should point out that it is fairly clear that causativization and applicativization are both highly relevant to the basic meaning of a verb since, as we have seen, both causativized and applicativized verb forms can become lexicalized with particular meanings. In fact, Bybee (1985:18) singles out causativization as an example of a sort of meaning which is highly relevant to verbs and supports this view using evidence from Ganda, a Bantu language.

Second, before I present the data which supports my general view, I should also mention that I take relevance to be a deciding factor in the case of the order of the causative and the applicative in Bantu only because, generally, all other morphological factors between them are equal. Specifically, they are both -VC- extensions. Clearly the transitive should have similar relevance to the causative. But, it has a different morphological status than the causative and the applicative—and its different status appears to be the major factor determining its position in the template.

Nichols (1992:153–9) contains data, coming out of a sophisticated cross-linguistic survey, on the correlation between different kinds of valence-affecting operations, including operations which could be labelled causativization and applicativization. She does not explicitly categorize languages with respect to whether or not they have productive causatives or applicatives. However, she makes use of the largely overlapping categories of agent-introducing marking appearing on verbs and object-introducing marking appear-

ing on verbs.⁴⁶ Agent-introducing verbal marking can be associated with the traditional term causative and object-introducing verbal marking can be associated with the term applicative (Nichols 1992:154). Though Nichols' category of agent-introducing and object-introducing do not precisely overlap with these traditional terms, I assume them to be more or less comparable here.

The first point to be made about the data found in Nichols (1992) is that it suggests that a language with an applicative is likely to have a causative—an important result for the present argument. Nichols (1992:155) identifies thirty-eight languages in her survey with both agent-introducing and object-introducing verbal marking versus only four languages which have object-introducing verbal marking but not agent-introducing verbal marking. These stand in marked contrast to languages which have agent-introducing verbal marking but not object-introducing verbal marking, of which there are seventy two in Nichols' survey.⁴⁷

These differences would appear to validate the general point being made here. However, they do not all hold up as significant under statistical testing. In the table in (139) I give the number of languages in Nichols' sample broken down by whether or not they show agent-introducing verbal marking and whether or not they show object-introducing verbal marking. These numbers exhibit no clear statistical bias which could be used to argue

⁴⁶ Though she recognizes the distinction between direct-object introducing verb marking and indirect-object introducing verb marking (a.k.a. applicativization), she treats both as one, general object-introducing category.

⁴⁷ With respect to Nichols (1992) general characterization, most Bantu languages are “±A” “+O”. That is, they have agent-introducing verbal marking (causative), agent-removing verbal marking (passive), and object-introducing verbal marking (applicative).

that applicativization tends to occur with causativization. The abbreviation “+A” for agent-introducing, and “+O” is an abbreviation for patient-introducing.

(139)

	+A	NON +A	TOTAL	
+O	38	4	42	
NON +O	72	16	88	
TOTAL	110	20	130	$\chi^2=1.637$ $p \leq 1$

There is an important fact about Nichols’ data which is worth mentioning in this context. In her survey of valence-affecting verbal marking for around 170 languages, for forty three of those languages (Nichols 1992:155), there was not enough information to make a determination as to what verbal marking was present in them. If that set of languages is skewed in any way towards a certain kind of valence-affecting verbal marking (or lack thereof), it could greatly affect the results presented in (139).

While Nichols’ data can only be taken to be suggestive, there is other data, from a study specifically focused on applicative constructions which indicates that there is, in fact, a correlation where languages having applicatives tend to have causatives. The relevant data comes from Peterson (2003). Peterson’s sample of languages is biased towards those for which good descriptions were available and, as a result, his data set may not be as generally representative of the world’s languages as that of Nichols (1992). However, to the extent that it is most detailed study of the typology of languages with applicatives, it is of great value to us here.

Peterson (2003) makes use of two sample sets of languages, fifty languages which he determined made use of applicative constructions and fifty which did not. In addition, he

tried to ensure, as much as possible, that his samples were areally and genetically diverse. His findings with respect to causative marking found in these sample sets is given in (140).

(140)

	APPLICATIVE	NO APPLICATIVE	TOTAL	
CAUSATIVE	44	34	78	
NO CAUSATIVE	6	16	22	
TOTAL	50	50	100	$\chi^2=5.886$ $p \leq .025$

As can be seen from the data in (140), a language with an applicative is more likely to have a causative than a language without one. Eighty-eight percent of languages in his applicative sample had causatives, while only sixty-eight percent in his general sample did, and this difference is statistically significant. Peterson's results would appear, then, to statistically verify a bias that was suggested by in Nichols' data.

The results from Peterson (2003), however, only tell us half of the story needed to support the general argument here: languages with applicatives tend to have causatives. Knowing if there is a reverse correlation is also important—that is, whether or not languages with causatives tend to have applicatives. We already saw data above which indicates that, even if there is some correlation along these lines, it is probably much weaker than the correlation justified by the data in (140)—recall that only four languages from Nichols' survey were categorized as having object-introducing verbal marking but not agent-introducing verbal marking, but seventy-two languages were categorized as having agent-introducing verbal marking without patient-introducing verbal marking.

These facts reflect a more general trend that Nichols (1992:154) found, namely that agent-effecting verbal markers (like causatives and passives) are cross-linguistically much

more common than object-affecting verbal marking. In addition to this general fact, causatives specifically were found to be more common than passives.

Nichols' data further indicates that the cross-linguistic bias towards agent-introducing verbal marking over object-introducing verbal marking is, in fact, highly significant. The relevant figures are given in (141).

(141)

	+A	+O	TOTAL	
YES	110	42	152	
NO	20	88	108	
TOTAL	130	130	260	$\chi^2=73.2358$ $p \leq .001$

I take the data in (141), together with the data in (140), to tell us, that languages with causatives (i.e. agent-introducing verbal marking) are not as likely to have applicatives (i.e. object-introducing marking) as languages with applicatives are to have causatives. That is there is an asymmetry between causatives and applicatives where the latter tends to imply the former but not vice versa. The logic behind this view is, if causatives were comparably common in languages with applicatives as applicatives are in languages with causatives, the disparity between agent-introducing and object-introducing verbal marking, as found in Nichols' survey should not be found (or should, at least, not be as marked as the figures in (141) indicate).

As mentioned above, in terms of the general argument being made here, I take these cross-linguistic biases to indicate that causativization is more relevant to the meaning of a verb than applicativization. Since relevance, in Bybee's (1985) view, is understood to be a factor in grammaticalization, the fact that causatives grammaticalize more often than

applicatives can be taken as initial evidence that causative semantics are more relevant to the verb than applicative semantics.

Furthermore, the fact that languages with applicatives tend to have causatives, but not vice versa, is a further indication, in my view, that causative semantics is more relevant to the verb than applicative semantics. The logic behind this being that whatever factors bias a language towards grammaticalizing applicatives seem to also bias it towards grammaticalizing causatives. This fact falls out more or less naturally if we were to take a view that applicativization and causativization were related to each other by both being valence-increasing processes. If the structural factors of a language led it down a path where it grammaticalized less relevant applicative verbal marking, presumably those biases would also be such that the language would tend to grammaticalize more relevant causative verbal marking.

It would be ideal, here, of course to be able to develop a complete theory of causative and applicative semantics so that we could define the notion of relevance more concretely with respect to these categories. While I will not attempt to do this, I would like to point out that Baker's (1988) syntactic analysis of causatives and applicatives can be understood as encoding the idea that causativization is more relevant to the the verb than causativization—and, thus, there is at least one formal analysis which takes on the general view being espoused here.

In section 2.6.2 (page 183), I discussed that Baker (1988) analyzed the causative extension in Bantu as a predicate in its own right, and, in the formation of a causative verb,

a verb stem moved upward in a syntactic tree, in multiple stages, to incorporate with it. This movement altered the basic structure of the sentence fairly drastically. The applicative extension, on the other, hand was analyzed as a type of preposition. This underlying preposition moved in one step attaching to the verb in a process not dissimilar to cliticization, as I discussed in section 2.6.2 (page 183), and did not greatly alter the basic structure of the sentence. This dichotomy between the structural effects of causativization and applicativization could be understood as a formal way of expressing that causativization is more relevant—insofar as it has a greater effect on the verb’s syntax—to the verb than applicativization, and I, thus, understand Baker’s analysis to corroborate the general view being taken here.

Regardless of how we might formalize the notions of applicativization and causativization, however, the general point has been made here that there is good reason to believe that causativization is more relevant to the verb than applicativization. The particular evidence used to make this claim come from the general distribution of causatives and applicatives. Importantly, the relative order in which causative morphemes and applicative morphemes tend to appear on the verb with respect to each other was not one of the criteria.

As mentioned above, Bybee (1985:33–6) discusses the relationship of relevance to morpheme ordering generally. For our purposes, an important aspect of her discussion is that the more relevant an affix to its host the closer it tends to be to its host. This means that, based on the evidence gathered from the cross-linguistic distribution of causatives and applicatives just discussed above, the more relevant causative suffix would be generally pre-

dicted to appear closer to the verb than the less relevant applicative suffix. This is, of course, precisely what we see, again and again, in Bantu languages.

These facts, on their own, are far from constituting a full analysis of why causative-applicative order is so predominant in Bantu. However, I believe they indicate that this tendency in so many Bantu languages is not due to some Bantu-internal factor but, rather, is related to general linguistic patterns regarding causatives and applicatives. The reflex of these patterns within Bantu is the CA portion of the CAT template—and the fact that AC order is very rare. That is, Bantu represents one way in which the fact that causativization is more relevant to a verb than applicativization becomes grammaticalized.

With respect to the general arguments regarding the Bantu verb stem template, we have, then, two complementary explanations for different aspects of it. The Strong Linearity Domain Hypothesis was able to explain, in general, why the template has the form it does, and, more particularly, it was able to predict that a template among the causative, applicative, and transitive suffixes should have the form CAT or ACT. However, it did not favor one of those orders over another.

Here, we have seen that an independent factor, namely the role of relevance in morpheme ordering, would have generally favored CAT order over ACT order—and CAT is the attested order. Bybee's (1985) notion of relevance has nothing to say directly about the possible forms of templates, and the Strong Linearity Domain Hypothesis has nothing to say about the semantic content of elements which have templatic relations with each other. However, when brought together, each has a role to play in explaining the presence of a

CAT template.⁴⁸

2.7.6 Local conclusion

We've seen in this section, that, if the characteristic phonology of the Bantu verb stem is understood as CVCV, then the CAT template can be understood to be in line with the Strong Linearity Domain Hypothesis. Specifically, the fact that the Bantu template does not need to be described through a set of position classes, but rather can be understood as a set of constraints which serve to limit the overall size of the stem is what makes the Bantu case consistent with the Strong Linearity Domain Hypothesis. This fact leads to a secondary point to be taken from the analysis: understanding the form templates can take on requires careful characterization of their properties.

In addition, we saw that, even though the Strong Linearity Domain Hypothesis cannot account for the fact that the Bantu template has the form CAT instead of ACT that there appears to be another cross-linguistic principle which can be used to account for this, namely Bybee's (1985) notion of relevance. Given such a notion, there is evidence that causativization is generally more relevant to the meaning of a verb than applicativization. The reflex of this general fact in Bantu has been taken to be the fact that the templatic order of the causative and applicative is CA instead of AC.

The interplay, here, between the Strong Linearity Domain Hypothesis and the notion

⁴⁸ There is, of course, an important question lurking within this explanation: if there are multiple possible factors which play a role in morpheme ordering, what are the critical factors which cause some languages to be templatic in the first place? Unfortunately, I have no answer to such a question. At this point, I am focusing only on devising a restrictive theory on the possible form of templates, and I simply do not know why only certain constructions in certain languages become templatic in the first place.

of relevance is important since each has its own role to play in the account of the CAT template. The Strong Linearity Domain Hypothesis is able to account for many aspects of the form of the template, but it makes no predictions about how semantic relationships may be represented within that form. To deal with this issue, the relevance principle, which makes specific predictions about the relationship between semantics and morpheme order, was then brought in to help account for the semantic content template.

In the subsequent case studies, we will see a similar interplay between the Strong Linearity Domain Hypothesis and external principles in accounting for templatic phenomena not covered by it.

2.8 CONCLUSION

This case study attempted to establish several related points. The first is that the existence of restrictions on the order of verbal suffixes in Bantu favoring the order causative-applicative-transitive (CAT) is pervasive in Bantu. The second point was that this ordering restriction does not appear to be purely semantically motivated, as argued for in work like that of Baker (1988) and Alsina (1999), but rather seems to be templatically motivated as argued for by Hyman (2003a).

Given these facts, an account of the characteristic phonology of the Bantu verb stem was developed, and it was argued that the templatic CAT restriction was consistent with the Strong Linearity Domain Hypothesis. To the extent that the Strong Linearity Domain Hypothesis is a restrictive theory of templatic constructions, the fact that the Bantu data is consistent with it can be taken to support a templatic analysis of the facts for the verb stem

in Bantu languages. This account was not able to completely ignore the semantics of the template—since, it was argued, Bybee’s (1985) notion of relevance was needed to explain why the template took the form CAT instead of ACT. However, invoking this principle did not obviate the need for a templatic characterization of suffix ordering. Rather, it served to deal with an aspect of the template that was outside the explanatory purview of the Strong Linearity Domain Hypothesis.

In the next case study, that of the Chechen verb phrase, we move from the prototypically morphological domain of the verb to a larger, more prototypically syntactic domain. The Chechen template will, therefore, have less specific restriction than the Bantu template, as predicted by the consistency condition of the Strong Linearity Domain Hypothesis, but we will see that many of the same principles will apply to its description.

3 The preverbal enclitic *'a* and the Chechen verb phrase template: A case study of a templatically-positioned clitic

3.0 BACKGROUND: CLITICS AND TEMPLATES

We already saw in section 1.3.2 (page 65) in chapter 1, that clitics can play an important role in templatic constructions. In particular, we examined one analysis of second-position clitics in Serbo-Croatian (that of Zec and Inkelas (1990)) which made use of a strong linearity domain. Within the scope of the present work, it should not be surprising that clitics would have a role in templatic phenomena. In the traditional view, clitics represent a mismatch between syntax and phonology—they are elements which are phonologically dependent but syntactically independent. Their phonological dependence means they necessarily form a prosodic constituent with their host. Since the Strong Linearity Domain Hypothesis links strong linearity domains to prosodic constituents, this means that the clitic-host combination is predicted to be a possible locus of templatic restrictions, in general, and it seems to be the case that it often is.

This second case study, on the templatic aspects of the Chechen verb phrase, involves the templatic positioning of a syntactically penultimate-position enclitic. I use the term “penultimate-position clitic”, here, by analogy to the well-known term “second-position clitic”. In situating it within other work on templatic phenomena, it will, therefore, be useful to take a closer look at the sorts of templatic phenomena attributed to clitics generally.

The first point to be made regarding potential clitic-conditioned templates is that, in trying to analyze them, we run into the immediate problem that it is often not clear if a given

morpheme should be considered a clitic or an affix (Pullum and Zwicky (1983) offers a now classic treatment of this question which includes several basic tests to distinguish between the two). That is, given an element which is phonologically dependent on a host (i.e. it cannot be alone in an utterance but must occur adjacent to some other element), one must determine if its phonological dependence derives from the fact that it is also morphologically dependent and must occur with some root (an affix) or if it is an independent syntactic constituent which, for whatever reason, is not phonologically independent, as would otherwise be expected (a clitic).

This problem is especially acute in the case of “clitic clusters”—phenomena where multiple clitics appear adjacent to each other and which all share the same host. When encountering such clusters, we are not only presented with the binary opposition between clitic and affix, we must also consider the relationship between elements within the cluster itself.

French is a good example of a language exhibiting this kind of phenomenon—in particular, it is typically described as having clitic clusters containing pronominal arguments. At one end of the analytical spectrum of French, Miller and Sag (1997:575–9) completely abandon the traditional treatment of the elements in these clusters and present arguments that these “clitics”, examples of which are bolded in (142), are, in fact, best analyzed as affixes to the verb instead of syntactically free elements.¹

¹ Miller and Sag’s (1997) justification for this claim comes out of applications of the basic tests for clitichood given by Pullum and Zwicky (1983). While they exemplify ways in which French pronominal clitics violate the basic tests put forth by Pullum and Zwicky (1983), they do not systematically argue that each of the so-called clitics violates each test. Therefore, it remains an open question the extent to which every one of the pronominal elements behaves like a clitic as opposed to an affix.

(142) *Marie le lui donne.*

Marie 3s.ACC 3s.DAT give.PRS.3S

“Marie gives it to her.”

(Miller and Sag 1997:574)

Simpson and Withgott (1986) similarly do not treat these pronominal elements individually as clitics and analyze the whole clitic cluster in French, as well as some other languages, as an instance of a morphosyntactic template, of the sort described in section 2.0 (page 107) in chapter 2. However, they do not go as far as Miller and Sag (1997) in an affixal analysis since they analyze the cluster itself as a kind of complex clitic rather than treating each of the elements in the cluster as a verbal affix.

Halpern (1995:191–222) takes a somewhat different approach from these other two and suggests that there is a general phenomenon of a cluster which can be composed of clitics (to produce a clitic cluster) or affixes (forming an affixal cluster within a larger morphological unit). Such clusters, no matter what their constituent pieces, are taken to be essentially templatic in their ordering. Halpern (1995:194–211) exemplifies affix clusters with the conjunct set of prefixes in the Athabaskan language of Sekani—these were discussed in section 2.0 (page 107) in chapter 2. He, therefore, makes an explicit connection between morphosyntactic templates and clitic cluster templates.

Given these varying kinds of analyses for clitic clusters, it should be clear that they present us with the major analytical complication that it is difficult to know just what aspects of them should be understood as syntactic and what aspects should be understood as morphological. A well-agreed upon resolution of this issue is simply not available at present.

With respect to the phonological characteristics of clitic clusters, Simpson and Withgott (1986:167–70) is useful in this regard. They present evidence for lexical phonological effects within clitic clusters that are not found between clitic clusters and their hosts. This implies that clitic clusters can be coextensive with a prosodic domain—meaning that, if they turn out to be truly templatic, they would immediately be consistent with the first condition Strong Linearity Domain Hypothesis. At this point, it is hard for me to say anything more definitive than this about how clitic clusters relate to the Strong Linearity Domain Hypothesis because, as with some of the cases discussed in section 2.0 (page 107) in chapter 2, without further analysis, it is not possible to know precisely what the templatic residue is of the various proposed clitic clusters.

An interesting question, with respect to the present work, is the extent to which clitic clusters should be modeled with the same sort of tools one might use to analyze complex verbal templates of the sort seen in the Athabaskan verb. Simpson and Withgott (1986) and Halpern (1995), discussed above, certainly indicate this might be desirable. However, outside of these works, I am not aware of any further debate on the issue of explicitly bringing together the two types of phenomena. The works being discussed in this introduction to the Chechen case study have been grouped together because they involve the analysis of elements given the common label “clitic”. However, it might be the case that a more apt categorization would separate clitic cluster effects from more general cliticization effects and classify clusters with more prototypical morphosyntactic templates.

As with the case study of the Bantu verb stem, which exemplified a morphosyntactic

template, but was less complicated than many better known cases, the Chechen case study deals with a template partially conditioned by a clitic which is intended to strike an appropriate balance between complexity and simplicity so that it can meet its intended goal as a useful illustration of an application of the Strong Linearity Domain Hypothesis. One result of this is the fact that the Chechen case will not require us to delve too deeply into the issue of how to deal with clitic clusters.²

Outside of work on clitic clusters, one type of clitic, the second-position clitic, stands out as being the most typically associated with some sort of template. The clitic to be focused on below, as we will see, is not a second position clitic but, rather, a penultimate position clitic. However, to the extent that second-position clitics may be templatic in their ordering, it is worth exploring them here—and, as we will see in the case study below, some of the tools developed for analyzing second-position clitics will be relevant to understanding the Chechen case.

While many clitics (English *'ll*, for example) show the position expected by syntactic elements with their semantics, second-position clitics, as the name implies, appear in a fixed position within some constituent—typically, the clause.³ An example of a typical second-position clitic are given in (143), where sentences from Halpern (1995:15) are seen which contain the Serbo-Croatian second-position auxiliary clitic *je*. There are a number of second-position clitics in Serbo-Croatian, including clitic forms for pronominal objects,

² The point at which a clitic cluster will come up within this case study is in section 3.7.4.2 (page 363). However, this cluster is very simple consisting simply of one proclitic followed by one enclitic.

³ The papers in Halpern and Zwicky (1996) comprise a wide range of data and treatments of second-position clitics.

and they all have roughly the same positional requirements.

- (143) a. *Čovek je voleo Mariju.*
 man.NOM AUX loved Mary.ACC
 “The man loved Mary.”
- b. *Čovek je Mariju voleo.*
- c. *Voleo je Mariju čovek.*
- d. *Voleo je čovek Mariju.*
- e. *Mariju je čovek voleo.*
- f. *Mariju je voleo čovek.*

As can be seen in (143) regardless of the order of the other elements in the sentence, second-position clitics in Serbo-Croatian, here exemplified by *je*, have a constant linear position.

The meaning of “second position” with respect to these clitics is not entirely well-defined since it can be understood syntactically (e.g., after the first major constituent of a clause) or prosodically (e.g., after the first prosodic word of a clause) depending both on the data being examined and the particular analysis being provided. Halpern (1996:x–xv) contains a useful summary of the issues raised in trying to define the term. We saw, in section 1.3.2 (page 65), that, for Serbo-Croatian, there is reason to believe that the best characterization of second position as after the first prosodic, not syntactic, word.

Related to the issue of what is meant by “second position” is, of course, the more general issue discussed above as to whether or not some second-position element truly

is a clitic or an affix. Specifically, some element may be an affix but always appear in second-position by virtue of other aspects of a language's grammar. Person agreement on the verb in a VSO language, for example, may always appear in second position after the verb but not be a true second-position clitic. Such cases must be distinguished from true second-position clitics which require a syntactic analysis for their position.

Assuming that it is clear that a given element which consistently appears in second-position is a clitic as opposed to an affix (see Garrett (1996), however, where such a choice is difficult), an important question raised with respect to this work is whether or not the second-position status of such a clitic is predictable on syntactic grounds or needs to be stipulated. If it is completely predictable, its positioning constitutes a weak linearity domain and is not of particular interest here. If any aspect of its placement is unpredictable, however, it constitutes a strong linearity domain and falls within the class of phenomena which are supposed to be consistent with the Strong Linearity Domain Hypothesis.

Not surprisingly, both strong linearity domain and weak linearity domain analyses exist of various second-position clitic phenomena. In the present context, Bošković (2001:8–96) presents useful discussion since he reviews the different kinds of analyses which have been proposed for the second-position clitics of the same language, Serbo-Croatian. (Examples of a second-position clitic in Serbo-Croatian were just seen in (143).)

Bošković (2001) classifies treatments of second-position clitics in Serbo-Croatian into four different classes: strong syntactic, weak syntactic, strong phonological, and weak phonological. The first three of these are weak linearity accounts. The two syntactic ac-

counts assume that the second-position status of the relevant clitics is determined on syntactic grounds—and, therefore, by definition, these are weak linearity domain analyses since the position of the clitic is taken to be predictable by some aspect of hierarchical (here, syntactic) structure.⁴ We will have occasion to specifically discuss an analysis which Bošković (2001) classifies as a strong phonological account, that of Halpern (1995), in section 3.6.3 (page 342). As we will see, this is also a weak linearity domain account because it is based on the idea that second-position clitics move *in order to* have a host. Since this movement is motivated by the phonological requirements of the clitic, it can be taken to be predictable from prosodic structure, and, therefore, is not part of a strong linearity domain.

The last of the four types of accounts found in the literature, as classified by Bošković (2001), the weak phonological account, is essentially the same type of analysis as that discussed in section 1.3.2 (page 65) and, thus, would be classified, here, as a strong linearity domain analysis—just as the analysis in section 1.3.2 (page 65) was. I will, therefore, discuss this type of approach in more detail here. Roughly speaking, weak phonological accounts can be understood as involving subcategorization requirements where second-position clitics are lexically specified as having some set of positional restrictions, such that the sum of these restrictions forces them to appear in “second-position”. Bošković (2001) himself adopts such an account and gives various ways of stating the relevant po-

⁴ Strong syntactic approaches, as exemplified by Radanović-Kocić (1996), for example, can bear similarities to strong linearity domain analyses. In that particular analysis, second-position clitics are assigned a feature indicating their special positioning and they move, via a process called Clitic Movement (Radanović-Kocić 1996:441), to a prosodically defined position in the sentence. Depending on whether or not this special-positioning feature can be independently predicted, this could constitute a strong linearity domain analysis. However, since this feature is taken to be syntactic under this type of approach, as a default, I assume it constitutes a weak linearity domain analysis predictable, in some way, from syntactic considerations.

sitional requirements of second-position clitics in Serbo-Croatian, one of which, adapted from Bošković (2001:82), is given in (144).

- (144) a. The domain of clitic placement is the intonational phrase.
- b. The clitic is initial in its phrase.
- c. The clitic is an enclitic.

The category of “intonational phrase” in (144a) should, here, be taken to include the sentence. The characterization of Serbo-Croatian second-position clitic placement in (144) is used by Bošković (2001) to partially account for placement facts like those just seen above in (143) and is very similar to the one seen in (33).

Bošković (2001:83) adopts a variant of a principle termed Morphological Merger, proposed by Marantz (1988), which will be discussed in section 3.6.2 (page 333) below. This principle allows an enclitic suffixed to the first word of its domain to be treated as initial in its domain. By means of this principle, a second-position clitic can both fulfill the requirement of being initial in its phrase and of being an enclitic. This allows Bošković’s analysis to partially account for the position of *je* and other second position clitics in Serbo-Croatian. However, the characterization in (144) alone does not explain how these clitics get to be in second position in the first place.

While Bošković works in a transformationalist framework, he explicitly rules out an approach where the clitic “moves” to second position just in order to fulfill its requirements. Rather, he treats the conditions in (144) as a filter on grammatical utterances. He, thus,

analyzes the clitics as having to appear in second-position either “naturally” or by virtue of some independently motivated movement—any sentence where the clitic is not placed in second-position will be judged ungrammatical. Since the “filtering” requirements of the second-position clitic are not independently predicted in his analysis, they constitute strong linearity domain restrictions.

While the facts for each potential case of a second-position clitic will be different, we see here that it is possible to analyze them by means of a strong linearity domain. Furthermore, we already saw in section 1.3.2 (page 65) that strong linearity analyses of second-position clitics can be consistent with the Strong Linearity Domain Hypothesis.

In the Chechen case to be examined below, we will not be dealing with a second-position clitic but, rather, a penultimate-position clitic. Despite this difference, the data will indicate that penultimate-position clitics can show similar templatic properties to those proposed for second-position clitics. However, they will also require the development of additional analytical techniques not needed in the analysis of second-position clitics.

Crucially, I will argue that the properties of the relevant penultimate-position clitic in Chechen will make some of the weak linearity domain approaches available for the analysis of Serbo-Croatian clitics, and comparable second-position clitics, unavailable in the Chechen case. This will strengthen the case that a strong linearity domain analysis is required for it and will help to establish that strong linearity domains can exist in syntactic constructions—as implied by analyses of second-position clitics like the one just discussed.

What we’ve seen in this section, generally, is that there are phenomena relating to clitic

placement which have previously been analyzed as templatic. The case study in this chapter, therefore, can be taken to exemplify how the Strong Linearity Domain Hypothesis can apply to such clitic templates. As with all potential templates, a range of complications can arise in detecting any strong linearity domains in clitic constructions. First among these is understanding the morphological status of a potential “clitic”—that is, whether it is an affix or a true clitic and what its relationship might be to a larger clitic cluster. Furthermore, even with relatively simple cases, like single second-position clitics, both strong and weak linearity domain analyses may be available—determining the best analysis is, of course, an empirical matter and is crucial for determining the templatic residue of a given construction, if, in fact, there is any. Based on what accounts are available, it appears as though clitic clusters are promising candidates for being consistent with the Strong Linearity Domain Hypothesis, and we have already seen above that second-position clitics can be analyzed in a way which is consistent with it.

I turn, then, to the Chechen case study which focuses on the templatic properties of a penultimate-position clitic and is, here, taken to exemplify clitic templates generally.

3.1 INTRODUCTION TO CHECHEN CASE STUDY

The focus of this chapter is on the templatic properties of the “core” verb phrase of Chechen. Chechen is spoken in the north central Caucasus and belongs to the Nakh branch of the Nakh-Daghestanian family. Typologically it is head-final, suffixing, ergative, case-using, and dependent-marking.

The orthography in this chapter was developed for Ingush and Chechen by Johanna

Nichols as part of the UCB Ingush project. In the chart below, I give the IPA equivalent for those consonants whose value may be unclear and for all the vowels.

CONSONANTS	
p', t', k', q', ch'	ejective consonants
ch	[tʃ]
gh	[ɣ]
sh	[ʃ]
w	[ʁ]
hw	[ħ]
x	[x]
cch, ggh, ssh, ”	geminate for ch, gh, sh and ’

VOWELS					
ii	[i:]	yy	[y:]	uu	[u:]
i	[ɪ]	y	[y]	u	[ʊ]
ie	[i:ɛ]	ue	[y:ʌ]	uo	[u:ʌ]
ia	[iɛ]	oe	[yʌ]		
e	[ɛ]	a	[ʌ]	o	[wʌ]
ea	[ɛæ:]	aa	[a:]	oa	[ɔa:]
ei	[ej]				
ai	[ʌj]	oi	[oj]	ou	[ʌw]
~	nasalization on the preceding vowel				

The glossing abbreviations which will be used in this chapter are given in the table below. The abbreviation “CV”, for converb, is prefixed to a descriptive name for various converbal suffixes found in Chechen.⁵ A “@” (for “attested”) before a sentence means that it was not elicited but taken from an unpublished text.

⁵ Converbs are non-finite verb forms which form clauses which can be combined with other clauses. Following Haspelmath (1995:4) converbs can be considered a sort of verbal adverb, contrasting with participles (verbal adjectives) and gerunds (verbal nouns).

VERBAL		OTHER	
DX	Deictic proclitic	ABS	Absolutive
IMP	Imperative	ERG	Ergative
PRS	Present	DAT	Dative
INF	Infinitive	CSN	Comparative
RP	Recent Past	ALL	Allative
WP	Witnessed Past	LAT	Lative
NW	Non-witnessed Past	1,2,3	1st, 2nd, 3rd person
IMPF	Imperfect	S,P	singular, plural
FUT	Future	E,I	exclusive, inclusive
GEM	Focus gemination	&	Preverbal conjunctive 'a
CS	Causative	&NEG	Negative imperative proclitic
INGR	Ingressive	&SIM	Simultaneous proclitic
INT	Interrogative	FOC	Focus marker
CVANT	Anterior	PTC	Particle
CVPAN	Present Anterior	NEG	Negation
CVSIM	Simultaneous	QUOT	Quotative marker
CVTEMP	Temporal		
NZ	Nominalizer		
MAS	Masdar (verbal noun)		
B,D,J,V	Gender prefixes		

There are several basic types of verb phrases in Chechen. Some of the most common types, which will serve as prototypes for much of the discussion in this chapter, are exemplified by the sentences in (145).

- (145) a. *So voelu.*
 1s v.laugh.PRS
 "I am laughing."
- b. *Malika dwa-jedira.*
 Malika DX-J.run.WP
 "Malika ran away."
- c. *Ahwmad oeghaz-vaghara.*
 Ahmed anger-V.go.WP
 "Ahmed got angry."
- d. *Ahwmadna Maliika gira.*
 Ahmed.DAT Malika see.WP
 "Ahmed saw Malika."

The sentence in (145a) is headed by a simplex intransitive verb. Though verbs like this are not especially uncommon in Chechen, they are also not particularly common. Sentence (145b) contains a motion verb preceded by a deictic element—this is a common complex verb construction in the language. Sentence (145c) shows a structure where a “light” verb is preceded by a nominal preverb. Complex verbs like these occur frequently in the language. Finally, sentence (145d) shows a simplex two-argument verb preceded by an absolutive direct object.

Though it is a simplification, for our purposes, we will be able to classify most verb phrases in Chechen with respect to one of the prototypes in (145). That is, they will be simplex intransitive, verb preceded by deictic element, light verb preceded by preverb, or transitive. Of these four prototypes, the simplex intransitive will be of particular interest since it is the only one which does not consist of two syntactic units—a fact which will be highly relevant to the templatic properties of the core verb phrase in Chechen.

In particular, it will be argued over the course of this chapter that the basic verb phrase in Chechen should be at least two phonological words and that simplex intransitive verb phrases of the type exemplified in (145a) are, in some sense, “subminimal”. Furthermore, data will be presented indicating that this restriction can lead to the characteristically templatic effect of the insertion of a “dummy” slot-filling element.

The examples in (146) will serve to give a basic idea of this dummy-element insertion. The two sentences in (146) contain coordinated verb phrases. The preverbal enclitic *'a* (glossed with an ampersand) serves as an overt marker of the coordination. This clitic

comes immediately before the conjugated verb. Because of this, it intervenes between the verb and a deictic element preceding the verb in the verb phrases with motion verbs seen in (146a).

The coordinated verb phrases in (146b), on the other hand, are intransitive and simplex. Thus, they would be expected to consist only of the verb preceded by the enclitic *'a*. However, what we see in (146b) is that copy infinitives appear immediately before the enclitic, expanding the verb phrase. As seen in (145a) these copy infinitives are not generally obligatory, since one is not found in that sentence which contains the simplex intransitive verb *diela* ‘laugh’—a verb which is also seen in (146b). They are, however, obligatory in (146b).

- (146) a. *Maliika loomax hwal 'a jeelara ohwa 'a joessara.*
 Malika mountain.LAT up & J.ascend.WP down & J.descend.WP
 “Malika climbed up and down the mountain.”
- b. *Maalik viela 'a viilara vialxa 'a vilxara.*
 Malik V.laugh.INF & V.laugh.WP V.cry.INF & V.cry.WP
 “Malik laughed and cried.”

Roughly speaking, what seems to be going on in (146b) is that the presence of the enclitic *'a* forces the instantiation of a basic two-element verb phrase template in Chechen. When a verb phrase is naturally two elements, as is the case with the verb phrases (146a), then the template is fulfilled automatically. In sentences containing simplex intransitive verbs, the template is not naturally fulfilled and a dummy element appears—specifically a copy infinitive.

The data in (146) is somewhat complex and will be described in more detail below. For

now it is simply given so that some of the core data for the general argument to be presented can be seen from the outset.

In addition to exemplifying a clitic template, the role of this case study, within the present work, is twofold. First, it serves as a bridge between the first case study, which focuses on the verb, and the second case study which focuses on serial verb phrases. The focus of this case study is on the verb phrase, which is at a level intermediate between those two.

The second role this case study serves is to give data showing the most compelling case I am aware of a templatic construction in the syntax.⁶ Thus, to the extent that the interpretation of the data to be presented here is correct, it serves as an exemplar case for syntactic templates. Since templates are most typically understood to be morphophonological and

⁶ There certainly have been other syntactic analyses making use of something like a template, Kathol's (2000) analysis of German sentence structure being the most well-articulated case I am aware of. Another good example of a template-like syntactic analysis is found in Kay and Fillmore's (1999) analysis of the *What's X doing Y?* construction in English. To the extent that numerous non-templatic analyses of the facts that Kathol (2000) discusses exist, I take his work to make the valuable point that a templatic analysis is possible for German. However, it is not entirely clear how compelling a case it is for templates generally because it is clear that non-templatic analyses are possible. Work like that of Kay and Fillmore (1999) within Construction Grammar (see Goldberg (1995) for more general discussion of this approach to syntactic analysis) certainly has a templatic "feel. However, it is not focused on demonstrating the existence of any template in particular, and it is unclear to me the extent to which constructional analyses at present can be used to offer strong support for templatic phenomena generally—though I think such a line of research is a promising one with respect to the discovery of templates. I will take up Kathol (2000) and work within Construction Grammar in more detail in section 4.0 (page 379) in chapter 4. One way in which the Chechen data can be set apart from these other cases is simply that I will be specifically arguing for a templatic analysis of a phenomenon for which no other analysis has been proposed. However, in addition, I will be arguing that Chechen makes use of a construction where the insertion of a "dummy element" is required to "fill out" a template. (An earlier example of such a dummy element attributed to a template was seen in Sierra Miwok in section 1.1.2.2 (page 8).) I take true dummy elements (i.e. dummy elements whose presence cannot be predicted via a weak linearity domain restriction) to be some of the best indicators of the presence of a template since they clearly mark the existence of a linearly-defined position which needs to be fulfilled even if there is no element which fulfills it "naturally". In chapter 4, I will discuss another instance of what I believe to be a syntactic template, serial verb phrases in Saramaccan. However, this will be a case of a relative ordering template and, thus, its templatic behavior will be less striking than that found in the Chechen constructions focused on in this chapter.

morphosyntactic phenomena, the arguments to be seen here will try to establish that they are more general in grammar. This will lend general support to one of the core ideas behind the Strong Linearity Domain Hypothesis—that templatic phenomena are tied to the existence of prosodic constituents. So, to the extent that prosodic constituents exist in syntactic structures, templates should also be found in syntactic structures.

The structure of this chapter is as follows. Section 3.2 (page 291) goes over some important aspects of Chechen grammar which will make it easier to interpret the data in the rest of the chapter. Section 3.3 (page 295) will go over the structure of the Chechen verb phrase in more detail. Section 3.4 (page 297) discusses the properties of the preverbal clitics in Chechen. Section 3.5 (page 315) discusses the appearance of copy infinitives in Chechen. Since one use of the copy infinitive is crucial to demonstrating the presence of the verb phrase template, the basic parameters of the Chechen verb phrase template will also be discussed in that section. Since a typologically rare clitic plays a role in the verb phrase template, in section 3.6 (page 332) I discuss some relevant previous analyses of clitics and situate the properties of the Chechen preverbal enclitic *'a* within earlier work. Section 3.7 (page 346) discusses how the Chechen template is consistent with the Strong Linearity Domain Hypothesis, and section 3.8 (page 377) offers a brief conclusion.

3.2 OVERVIEW OF PERTINENT ASPECTS OF CHECHEN GRAMMAR

3.2.1 Nominal inflection and gender classes

Chechen makes use of an extensive ergative case system. The morphology of nominal inflection is far from regular, and it will not be possible to give a proper description of

it here. However, all nouns do mark for case, making it useful in determining syntactic relationships. For ease in interpreting the example sentences, in (147), I give the declension for the word *ch'aara* 'fish'. The absolutive case is morphologically unmarked. Therefore, absolutive nouns are not explicitly glossed as such.

(147)

CASE	SINGULAR	PLURAL
Absolutive	<i>ch'aara</i>	<i>ch'eerii</i>
Genitive	<i>ch'era~</i>	<i>ch'erii~</i>
Dative	<i>ch'eerana</i>	<i>ch'eerashna</i>
Ergative	<i>ch'eeruo</i>	<i>ch'eerash</i>
Allative	<i>ch'eerie</i>	<i>ch'eerashka</i>
Instrumental	<i>ch'eeraca</i>	<i>ch'eerashca</i>
Lative	<i>ch'eerax</i>	<i>ch'eeriax</i>
Comparative	<i>ch'eeral</i>	<i>ch'eerial</i>

In addition to being marked for case, each noun in Chechen has an inherent gender, coming from one of four more or less arbitrary noun classes, which may be different for plural and singular forms of the noun. Of relevance to this chapter is the fact that many verbs in Chechen show gender agreement with their absolutive argument. While the majority of verbs do not agree with their subject, a number of the most frequently used verbs do agree, meaning that agreement is prevalent in the examples in this chapter.

The morphological realization of gender agreement on verbs in Chechen is somewhat idiosyncratic. The first consonant of a verb showing agreement alternates between one of four consonants *b*, *d*, *j*, and *v* depending on the gender class of its absolutive argument. Taking the present tense stem of the verb meaning 'come' as an example, gender agreement will cause it to alternate between the forms *booghu*, *dooghu*, *jooghu*, and *vooghu*.⁷

⁷ Since it is not of direct relevance aside, I put aside a formal analysis of this agreement system here. One possible analysis which has been suggested to me, and which might at first appear feasible, is that all vowel-

Since there are no coherent semantics to the four gender classes, agreement on the verb is simply glossed with capital letters corresponding to one of the four alternating consonants. However, there is at least one important correlation between semantics and gender which will be useful in interpreting the examples below. Singular human male referents are classified in the V gender and human female referents are classified in the J gender. The closest thing to a default gender is the D gender, and citation forms are given that gender marking.

3.2.2 Clause chaining

A particularly striking feature of Chechen is its use of clause chaining. Clause chaining can be approximately understood as linking together clauses which have a narrative relationship into a syntactic structure consisting of any number of non-finite clauses embedded in a finite matrix clause. An example is given in (148).

- (148) *Maliika, tykana 'a jaghna, zheina 'a iacna, c'a je'ara.*
 Malika store.DAT & J.go.CVANT book & buy.CVANT home J.come.WP
 “Malika went to the store, bought a book, and came back home.”

In (148) the two clauses set off by commas are non-finite and the final clause contains the finite verb. Chaining constructions overwhelmingly tend to have a shared subject across the clauses, as seen here where each clause has the subject, *Maliika*. The case of the shared subject is governed by the finite verb of the clause. Thus, the subject of the sentence in (148) is absolutive because the finite verb ‘je’ara’ ‘J.come.WP’ is intransitive, even though initial verb stems are marked with a gender prefix. Such an analysis turns out to be inadequate, however, since there are numerous vowel-initial stems in the language which do not receive gender marking, an example being the verb *ooxu* ‘plow’.

one of the clauses in the chaining construction, ‘iacna’ ‘take.WP’, is transitive.

In the discussion below, the term *chained clause* will be used exclusively to refer to a non-finite clause in a chaining construction. For our purposes, the most important fact about chained clauses is that preverbal *'a* obligatorily appears in them. This preverbal enclitic plays a critical role in the Chechen verb phrase template. For more discussion of clause chaining see Good (2003a).

3.2.3 Word order

As mentioned above, basic word order in Chechen is SOV, but other word orders are possible. Since some of the templatic phenomena to be discussed will be sensitive to word order (specifically what elements appear before the verb), the topic is worth bringing up here. In (149) the same basic sentence is given involving a coordination structure. As can be seen the various conjuncts instantiate SOV, SVO, and OVS orders.

- (149) a. *Ahwmada iicara ch'aara, t'q'a Mariamas doexkira cicig.*
 Ahmed.ERG buy.WP fish and Mary.ERG sell.WP cat
 “Ahmed bought a fish, and Mary sold a cat.”
- b. *Ahwmad ch'aara iicara, t'q'a cicig doexkira Mariamas.*
 Ahmed.ERG fish buy.WP and cat D.sell.WP Mary.ERG
 “Ahmed bought a fish, and Mary sold a cat.”

Some non-SOV orders are more common than others. The chaining structure in (150) shows a very common variant order where the subject *Malika* appears at the very end of the sentence.

- (150) *Doogha toexna aara 'a jialla, tykana 'a jaghna,*
 lock hit.CVANT DX & J.go.CVANT store.DAT & J.come.CVANT

c'a je'ara Maliika.

home J.go.WP Malika

“Having locked the door and gone out, Malika went to the store, and came home.”

Less common are orders where the object does not appear immediately before the verb. The sentence in (151) gives an example (as did the sentence in (149a)). In this sentence, containing a pair of coordinated verb phrases, the shared object and subject of the two verb phrases appear at the end of the sentence. Since coordinated verb phrases always contain preverbal *'a*, copy infinitives appear to serve as hosts for the clitic in each conjoined verb phrase. (This is described in more detail in section 3.4 (page 297).)

(151) *Ieca 'a iecara doexka 'a doexkira ch'eeri Maliikas.*

buy & buy.WP sell & D.sell.WP fish.PL Malika.ERG

“Malika bought and sold some fish.”

For our purposes, what is most important about word order in Chechen is that, except for simplex intransitive verbs, generally some element of the verb phrase (an object, deictic element, or preverb) will appear immediately before the verb.

3.3 THE BASIC STRUCTURE OF THE CHECHEN VERB PHRASE

To get an understanding of the basic structure of the Chechen verb phrase, I give a schema for it in the table in (152). The schema describes the verb phrase as a series of five “position classes”, though this is just for descriptive ease. As we will see, there is strong evidence for the existence for something like a position class in the interaction between the columns labelled “4” and “3”, but, generally speaking, a pure position class analysis would ignore the fact that most of the elements of the verb phrase have syntactically expected positions for an SOV language. It would also ignore the fact that, in some case, multiple

elements in slot “4” can be instantiated. When multiple elements are found in slot “4”, their relative order is fairly rigid. Our concern here will be whether there is *some* element in that slot, not how elements within it are ordered. So, this fact is not crucial for later analysis.

(152)

CHECHEN VERB PHRASE STRUCTURE				
5	CORE VERB PHRASE			
	4	3	2	1
Adjuncts	Objects/Goals Deictic Proclitics Preverbs Copy Infinitives	'a	Negative	Inflected Verb

The third position in the table contains only the preverbal enclitic 'a. This will be discussed in more detail in section 3.4 (page 297).

The sentence in (153) contains a clause in which all five positions in (152) are instantiated. For a given position, the element filling it is labelled.

(153) *Maliika* [*loomax*]₅ [*hwal*]₄ [*'a*]₃ [*ca*]₂ [*jeelara*]₁ *ohwa 'a ca joessara.*
 Malika mountain.LAT DX & not J.go.WP down & not J.descend.WP
 ‘Malika didn’t climb up and down the mountain.’

The expression for ‘ascend’ is a complex verb consisting of the deictic element *hwal* and a form of the verb *doolu* ‘go’. Often, the deictic element and the preverb are adjacent, but in (153) two other elements, the preverbal enclitic 'a and the negative marker *ca* intervene between the two. Finally, the argument *loomax*, the word for mountain in the lative case, fills the adjunct position of the verb phrase and means something like, “along the mountain”.⁸

⁸ Lative case is used to mark certain oblique objects in Chechen.

Among the elements specified in (152) as occurring in the fourth position are objects and goals. Two examples of goals in that position were seen in (150) with the words *tykana* ‘store.DAT’ and *c’a* ‘home’. Goal arguments need to be distinguished from elements in the lative case like *loomax* ‘mountain.LAT’ in (153) which also express the location where an action takes place but are not part of the core verb phrase and are adjuncts syntactically. The sentence in (148) contains a clause with an object in the fourth slot—the word *zheina* ‘book’.

The table in (152) makes the distinction between the verb phrase and the core verb phrase. The importance of this distinction will be made clear in section 3.5 (page 315). The core verb phrase is intended to encompass the verb, its obligatory “arguments” and everything in between, but it excludes adjuncts. As we will see, the preverbal clitic *'a* must be preceded by an element of the core verb phrase or a verb phrase containing it will be ungrammatical. This restriction on the placement of *'a* is the critical factor triggering templatic behavior in Chechen.

3.4 THE CLITICS FOUND IN THE CHECHEN VERB PHRASE

3.4.1 Introduction

In this section, the behavior of three Chechen clitics found in the verb phrase will be discussed. The first two of these, *ma* ‘&NEG’ and *ca* ‘NEG’ are proclitics leaning on the verb, and the last of these *'a* is an enclitic which appears before the verb but leans on the word preceding it. Of these three clitics *'a* will be of the most interest since it triggers the appearance of an obligatory copy infinitive. As we will see, there are two distinct uses of

'a in Chechen and, generally, I will treat the uses as more or less unrelated. Only one of these uses triggers the appearance of the copy infinitive.

In the following sections, each of the three clitics is discussed in turn.

3.4.2 The negative proclitic *ca*

The standard marker of negation in Chechen is the negative proclitic *ca* which appears immediately before the verb. Examples are given in (154).

- (154) a. *Ahwmad shkolie ca vaxara, Maliika comgush jolu deela.*
 Ahmed school.DAT not V.go.WP Malika ill J.be.PPL.PRS because
 "Ahmed didn't go to school because Malika was sick."
- b. *Suuna Ahwmad ca gira, Aadam gira.*
 1S.DAT Ahmed NEG see.WP Adam see.WP
 "I didn't see Ahmed, I saw Adam."

As seen in (155) the negative proclitic intervenes between the verb and a deictic element or preverb. Specifically, in (155a) *ca* appears between the deictic element *ohwa* and the verb *dussu* 'descend', and in (155b) *ca* appears between the preverb *tiargal* 'attend' and the verb *do* 'do'.

- (155) a. *Maliika loomax hwal jeelira, amma (iza) ohwa ca joessara.*
 Malika mountain.LAT DX J.go.WP but 3S.ABS down not J.descend.WP
 'Malika climbed up the mountain but (she) didn't climb down.'
- b. *Ahwmada aarz tiargal ca dira.*
 Ahmed.ERG complaint attend NEG D.do.WP
 "Ahmed didn't pay attention to the complaint"

Finally, as seen in (153) above, the negative proclitic follows the preverbal enclitic 'a.

3.4.3 The proclitic *ma*

A proclitic with the shape *ma* has several different uses. The first is in negative imperatives, as seen in the examples in (156). The simple imperative form seen in these examples is homophonous with the infinitive form of the verb.

- (156) a. *Chu ma vuola*
 DX &NEG V.come.IMP
 “Don’t come in!”
- b. *Ma diica suega*
 &neg D.tell.INF 1s.DAT
 “Don’t tell me!”
- c. *Ga ma go*
 see.INF &NEG see.IMP
 “Don’t look!”
- d. *Byrka qossa ’a ma qossa suega.*
 ball throw.INF FOC &neg throw.IMP 1s.DAT
 “Don’t ever throw me the ball”

In (156a) the negative imperative proclitic *ma* appears between the verb and a deictic element. In (156b) it occurs at the beginning of its sentence, before a simplex verb. In (156c) it is also in a clause containing a simplex verb, but it is preceded by a copy infinitive. Such copy infinitives are often found in negative imperatives and, in such constructions, they are a type of focus marking for the verb, as discussed in section 3.5 (page 315). Finally, in (156d) we see *ma* preceded by *’a* and a copy infinitive. As we will see in section 3.4.4 (page 301), *’a* is, in some cases a focus marker. So, a sentence like (156d) we are seeing double focus marking. The exact conditions under which the different types of focus marking occur have not yet been thoroughly examined.

There is another use of a preverbal clitic of the shape *ma* in “as soon as...” constructions. As seen in the examples in (156c) and (156d), the negative imperative use of *ma* is often accompanied by focus marking formally marked by copy infinitives. This second use of *ma* is also accompanied by focus marking—but of a different sort. In this use, the verb *ma* precedes is obligatorily marked with focus gemination, a process through which a consonant in the verb is geminated.

In (157) *ma* appears just before the verb *dooghu* ‘come’ in the first clause, the one with the “as soon as...” semantics. The verb is in the recent past tense which would, typically, have the form *je’i* (with J gender agreement for the female human subject).⁹ As a result of focus gemination, it has the form *je”i* with a geminate glottal stop.

- (157) *C’a ma je”i, Ahwmad gira Maliikina.*
 home &SIM J.come.GEM.RP Ahmed see.WP Malika.DAT
 “As soon as she came home, Malika saw Ahmed.”

The use of *ma* exemplified in (157) has the same positioning properties as the negative imperative use. In (157), for example, it intervenes between the verb and a deictic used for motion towards home.

A final use of *ma* is that it can be a marker of general emphasis, as in (158).

- (158) @ *Deeladahw vai shinna juoxa taruo ’a ma jaacar.*
 of_course 1pi two.NZ.GEN J.break.INF & FOC &neg J.be.NEG.IMP
 “Of course, there’s no way we could break off our marriages.”

In this sentence, *ma* is not the sole marker of negation since negation is already marked on the main verb, and it has an emphatic function.¹⁰ This emphatic use of *ma* shows the

⁹ The verb *dooghu* ‘come’ is irregular, exhibiting a suppletive stem alternation between the infinitive and past stems.

¹⁰ The verb ‘be’, exceptionally, is marked for negation with suffix with the form *c*.

same positional properties as the other uses.

3.4.4 The enclitic *'a*

3.4.4.1 Introduction

In this section, I will discuss in some detail two distinct uses of an enclitic with the form *'a*. The first of these, preverbal *'a*, plays a central role in the verb phrase template in Chechen. The second use of *'a* is as a focus marker. These two uses of *'a* are treated as synchronically distinct here but there may be a diachronic connection between them (as will be suggested in section 3.7.4.5 (page 371)). There is certainly a close relationship between the two uses of *'a*, as will be seen in the discussion connected to the examples to appear below in (166), (167), and (168), and I do not mean to suggest otherwise by separating them here. However, they do show sufficiently different behavior to justify positing at least two distinct uses of the clitic, if not two different clitics entirely. Furthermore, the preverbal use of *'a* is central to the Chechen verb phrase template to be analyzed below. Therefore, it makes good sense to treat it separately from the focal use for explanatory convenience, if nothing else.

The discussion of preverbal below will take some time because, in addition to describing its basic properties, I will argue that it is an example of a poorly attested type of clitic. Making this point will require reference to previous authors who have predicted that clitics like *'a* should not be found generally.

3.4.4.2 Preverbal 'a

Enclitic particles with the form 'a are ubiquitous in Chechen grammar. There are two very distinct uses of them. Central to this work is the preverbal use of 'a, which is found in clause chaining constructions and verb phrase coordination.¹¹ Preverbal 'a is exemplified below in sentence (159a), repeated from (148), which is a chaining construction, and (159b), repeated from (146a), which is an example of verb phrase coordination.

- (159) a. *Maliika, tykana 'a jaghna, zheina 'a iacna, c'a je'ara.*
 Malika store.DAT & J.go.CVANT book & buy.CVANT home J.come.WP
 “Malika went to the store, bought a book, and came back home.”
- b. *Maliika loomax hwal 'a jeelara ohwa 'a joessara.*
 Malika mountain.LAT up & J.ascend.WP down & J.descend.WP
 “Malika climbed up and down the mountain.”

Preverbal 'a is glossed with a “&” as a mnemonic for the fact that it plays a role in “conjoining” verb phrases together.

The primary evidence that 'a is enclitic is that it phrases prosodically with the word that precedes it. Other evidence that is enclitic is that fact that, in some instances, it is reduced to a glottal stop which is pronounced in the coda of the final syllable of the word it attaches to. Perceptually, this often sounds like a pause immediately following 'a's host where a pause would not otherwise be expected. An additional piece of evidence supporting its enclitic status is that 'a is associated with a high pitch and, when reduced to a glottal stop in the manner just described, the high pitch shifts to the end of the word preceding it, suggesting a close phonological affinity between 'a and this word.

¹¹ In Good (2003a) I argue that preverbal 'a is a marker of cosubordination in the sense of Foley and Van Valin (1984:239–44) which accounts for its appearance in these two specific constructions.

The status of 'a as an enclitic, instead of a suffix, is clear since it passes all the tests for cliticness outlined in Pullum and Zwicky (1983). It shows a lack of host sensitivity (as will be seen in (161), attaching to nouns, deictic elements, and preverbs). There are no documented arbitrary host-clitic gaps, morphophonological or semantic idiosyncrasies, or syntactic rules treating the host and clitic as a single unit.

Peterson (2001) gives a thorough discussion of the enclitic 'a in Ingush, a close relative of Chechen, which is cognate with the Chechen enclitic. Ingush 'a and Chechen 'a behave in almost exactly the same way.¹² Preverbal 'a is important in apparently being, to date, the best example of what would be classified as a type 5 clitic according to Klavans' (1985) well-known typology of clitic types.

Klavans (1985) classifies clitics across three parameters. The first is whether they are *initial* or *final* in the syntactic domain they are placed with respect to. The second is whether they are placed *before* or *after* the element at the edge of the domain where they are placed. Klavans' final parameter is the traditional distinction between *proclitic* and *enclitic*. These three parameters predict a total of eight different clitic types. Peterson (2001:153–4) makes the claim, which is adopted by this work and will be justified below, that preverbal 'a can be classified with the three parameters: final, before, enclitic, which is Klavans' type 5.

To make the following discussion clearer, the tree in (160) schematizes Klavans' typology of clitic placement. A number is used for each of the eight types. An “=” sign before the number indicates it is an enclitic, and one after the number indicates it is proclitic. The

¹² The only major difference between Chechen and Ingush with respect to 'a is that 'a in Ingush can optionally have the negative marker *ca* as its host (creating strings of the form *c'a 'a*) while 'a in Chechen cannot (and the relative order of the two elements is thus always *'a ca*).

clitic positions are defined with respect to a some syntactic constituent which I label “XP” and which I make sufficiently large to ensure the eight types can be clearly distinguished. I don’t intend this structure to necessarily represent any actual syntactic phrase—it shape is determined purely for expository purposes. Importantly, Klavans’ typology predicts that clitics always appear near the edges of some syntactic domain they are positioned with respect to—either at the edges themselves, or in second or penultimate position.

(160)

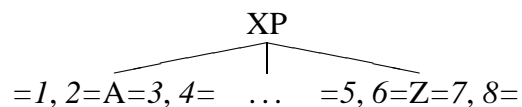

As Klavans (1985:103) points, four of her eight clitic types represent mismatches between the syntax and the phonology where the phonological host of the clitic is not the word it is syntactically positioned with respect to. These are types 1, 4, 5, and 8. The traditional notion of second-position clitic is classified in her typology as type 3. A type 4 clitic is exactly the same as a second-position clitic except it is proclitic instead of enclitic. The clitic type of interest to us here, type 5, is a “mirror-image” of a type 4 clitic—a penultimate position enclitic. While Klavans (1985) presents examples which she takes to exemplify each of the eight types, various authors have question the validity of those examples. We will examine some aspects the arguments of two of those, Marantz (1988) and Halpern (1995), in some detail below, with respect to type 5 clitics.

In the rest of this section, I will go through the evidence that preverbal *'a* is, in fact, a type 5 clitic. Much of the evidence will parallel Peterson’s (2001) evidence for Ingush, but some of it will be new. Some of the new evidence will be directed towards Marantz

(1988) and Halpern (1995), two works which propose formal systems which predict that type 5 clitics should not occur. Neither Marantz (1988) nor Halpern (1995) were aware of the Chechen/Ingush case. However, they were aware of other purported instances of type 5 clitics, which they argue were misanalyzed and were clitics of different, more common types. What I specifically will attempt to show is that the criticisms made against other potential instances of type 5 clitics do not hold in the Chechen case.¹³ The purpose of this discussion will become clearer in subsequent sections, when the odd typological status of 'a will be implicated in its templatic behavior.

In (161) I give example sentences of the four prototypical types of verb phrases described in (145) in syntactic environments where they contain preverbal 'a. Examples of preverbal 'a in some of these environments have already been given—these examples are given for ease of comparison. All of the sentences in (161) are cases where preverbal 'a is used as a marker of chaining constructions.

- (161) a. *Ahwmad, wa 'a wiina, dwa-vaghara.*
 Ahmed stay.INF & stay.CVANT DX-V.go.WP
 ‘Ahmad stayed (for a while) and left.’
- b. *Maliikas Ahwmadna zheina dwa 'a della, dwa-jaghara.*
 Malika.ERG Ahmed.DAT book DX & D.give.WP DX-J.go.WP
 ‘Malika gave the book back to Ahmed and left.’
- c. *Ahwmada, kiexat jaaz 'a dina, zheina dueshu.*
 Ahmed.ERG letter write & D.do.CVANT book D.read.PRS
 ‘Ahmad, having written a letter, reads a book.’

¹³ In all likelihood, the points made here hold for Ingush as well. However, I do not have access to enough data for Ingush to argue the case as strongly as I can for Chechen.

- d. *Ahwmad, zhwala 'a iacna, vilxira.*
 Ahmed dog & buy.CVANT V.cry.WP
 “Ahmed bought a dog and cried.”

In (161a) preverbal *'a* appears in a simplex intransitive predicate, and is preceded by an obligatory copy infinitive (which will be discussed in more detail in section 3.5 (page 315)). In (161b) the bolded instance of *'a* is a case where it appears before a verb which normally is immediately preceded by a deictic element. Importantly, since this sentence involves the verb *dala* ‘give’ which takes a direct object (*zheina* ‘book’) and an indirect object (*Ahwmadna* ‘Ahmed.DAT’), as well as a deictic element, this sentence clearly shows that *'a* appears in penultimate and not second position of the verb phrase—its position is ambiguous in many other cases. Sentence (161c) is a case where *'a* intervenes between a transitive verb with an obligatory preverb. Such a sentence also exhibits the penultimate position of *'a*. The word *kiexat* ‘letter’ is the direct object of the preverb-light verb combination meaning ‘write’. Finally, sentence (161d) shows an example of *'a* intervening between a verb and a direct object.

The sentences in (161) establish the basic penultimate position of *'a* in the verb phrase and comprise the basic type of evidence made use of by Peterson (2001) in arguing that *'a* in Ingush was a type 5 clitic (that is, he made use of comparable sentences in Ingush to the Chechen ones in (161)). There appear to be only two other purported cases of type 5 clitics in the literature. One of these, discussed by Klavans (1985:104–5), is the case of dative clitics in Nghanhcara, and the other is the case of Modern Greek possessive pronouns, as described by Sadock (1991:71). Arguments have been presented by Marantz (1988:267–

8) and Halpern (1995:34–6) respectively that these are, in fact, not type 5 clitics but are instead clitics of typologically better-attested types in Klavans' typology.

Both Marantz (1988) and Halpern (1995) make the same basic kind of argument about the other reported cases of type 5 clitics. They do not disagree with their basic status as enclitics but claim that the domain these clitics attach to is a word-level domain, instead of a phrase-level domain. This change in the analysis results in a change of the typological classification of the relevant enclitics.

I am not necessarily convinced by the arguments of Marantz (1988) or Halpern (1995), which will be presented in detail below, and it may, in fact, be the case the dative clitics in Nghanhcara and possessive clitics in Modern Greek should be considered to be of type 5.¹⁴ Importantly, however, the two basic types of arguments used to argue against those two potential cases of type 5 clitics do not hold for Chechen, as will be seen. I take this as evidence corroborating Peterson's (2001) claim that 'a is a type 5 clitic.

Basic data for dative clitics in Nghanhcara is given in (162). The relevant clitic in these examples is *ngu* '3s.DAT'. This enclitic can either appear after the verb, as in (162a), in which case it is not considered by Klavans to exhibit type 5 behavior, or it can appear before the verb, as in all the other examples, where Klavans does take it to exhibit type 5 behavior.

- (162) a. *nhila pama-ng nhingu pukpe-wu ku?a wa:=ngu.*
 he.NOM man-ERG him.DAT child-DAT dog give=3S.DAT
- b. *nhila pama-ng nhingu pukpe-wu ku?a=ngu wa:.*

¹⁴ Marantz's arguments are, in general, more convincing than Halpern's because Marantz gives a plausible reinterpretation of the facts presented by Klavans (1985), whereas Halpern introduces data which is not consistent with the data presented by Sadock. All that Halpern conclusively shows is that for some speakers, the relevant clitic may not be of type 5.

c. *nhila pama-ng kuʔa nhingu pukpe-wu=ngu wa:.*

d. *nhila pama-ng kuʔa pukpe-wu nhingu=ngu wa:.*

e. *kuʔa nhingu pukpe-wu nhila pama-ng=ngu wa:.*

f. *kuʔa nhingu pukpe-wu pama-ng nhila=ngu wa:.* (Klavans 1985:104)

In all the examples Klavans gives from Nghancara the verb is final.¹⁵ The clitic *ngu* (and other dative clitics), when appearing before the verb, do, then, always appear in penultimate position of the sentence.

However, as Marantz (1988:268) points out that, while on the surface, *ngu* appears in penultimate position in the sentence and the verb phrase, this does not necessarily mean that its domain of placement should be considered to be one of those two constituents. It would instead be possible to treat the domain of this clitic as a level just above the verb. If one were to adopt such an analysis, then the clitic would not be penultimate in its domain—rather it would be initial. Because the verb is final, the fact the the clitic would precede the verb means it will always surface in penultimate position, but this does not mean it is specified to appear in such a position.

Given the apparent restricted syntax of Nghancara, it is impossible, on the basis of linear position alone, to distinguish between penultimate placement in the sentence and initial placement before the verb for the dative clitics in the language. In order to counter the

¹⁵ Klavans (1985:104) is non-committal as to whether or not the verb must always be final in Nghancara since she writes, “Since the verb appears always to be final. . .”. However, it does seem to be the case that this is true for all the data she had access to.

idea that these dative clitics are of type 5, Marantz (1988:268) appeals to general syntactic arguments, writing, “[T]he dative is either an indirect object agreement marker, with the verb as its domain, or a pronominal argument of the verb, which may ‘double’ a full dative [noun phrase] argument in the sentence in the familiar situation of clitic doubling.”

This is a reasonable argument insofar as dative agreement or dative pronouns very often are considered to be attached at a low-level verb phrase, and it does cast doubt on Nghanhcara dative clitics as being examples of type 5 clitics. In principle, on the basis of just linear position, a similar argument kind of argument could be extended to preverbal *'a* in Chechen. It, too, could be taken to be positioned with respect to the verb and appear before it rather than being penultimate in the whole verb phrase. In Klavans' terminology, it would then be a type 1 clitic with the verb (or some small phrase containing only the verb) as its domain.

However, unlike the Nghanhcara case, there is no obvious syntactic argument in favor of an analysis where the verb is the relevant domain for *'a*. The clitic is, roughly speaking, a marker of coordination. It either marks that a clause is a chained clause or is a conjunct in a verb phrase coordination structure. Syntactically, *'a* “coordinates” clauses, not verbs, which is an important reason to believe that its domain is a larger constituent than just the verb.

It would, of course, be possible to claim that preverbal *'a* is positioned before the verb instead of being positioned in penultimate position of the phrase. What I'd like to claim here is that the basic logic used by Marantz to support his analysis of Nghanhcara can't

be applied to the Chechen case. The essence of this claim is that, since the “scope” of preverbal *'a* is the verb phrase, then it should be understood to be positioned with respect to the verb phrase not the verb. This is unlike the Nghanhcara case which was straightforwardly amenable to an analysis where the potential type 5 clitic was placed with respect to the verb itself. This fact can be taken to strengthen the case that preverbal *'a* is, in fact, a type 5 clitic.

Halpern (1995) accepted Marantz’s arguments against the Nghanhcara case and then presented arguments against Sadock’s (1991) claim Modern Greek possessive clitics were of type 5. Sadock’s basic data is given in (163).

- (163) a. *o-filos-mu*
the.MASC-friend-my
- b. *o-kalos-mu* *filos* / *o-kalos filos-mu*
the.MASC-dear-my friend
- c. *o-kalos* *palyos-mu filos* / *o-kalos palyos filos-mu*
the.MASC-dearest old-my friend
- d. **o-kalos-mu palyos filos* (Sadock 1991:71)

In (163) examples are given with the first person possessive pronoun *mu* which can either follow the head noun of the noun phrase or an adjective in the noun phrase. The examples in (163c) and (163d) are intended to contrast by showing that the possessive pronoun can appear on the adjective immediately preceding the noun but not on any other adjective. This data supports the idea that the clitic can appear in penultimate position.

The data that Sadock gives would indicate that *mu* can be a type 5 clitic. Halpern (1995) counters Sadock’s claims with two types of data. First, he claims that there are

some speakers who will accept the noun phrase in (163d) and other noun phrases like it (Halpern 1995:35–6). Relevant examples are given in (164). The sentence in (164b) is comparable to the sentence in (163d)—but it is reported as grammatical.

- (164) a. *to mikro palyo-mu spiti*
 the.NEUT little old-my house
 “my little old house”
- b. *to mikro-mu palyo spiti*
 the.NEUT little-my old house
 “my little old house”

Halpern also presents a second kind of data which argues against Sadock’s analysis. For some speakers, it is possible to have *mu* repeated multiple times in the noun phrase after each adjective as in (165).

- (165) *to palyo-mu kokino-mu mikro-mu spiti*
 the.NEUT old-my red-my little-my house
 “my little old red house” (Halpern 1995:36)

Halpern takes data like that in (165) and (164) as evidence for the claim that the domain of attachment for the possessive clitic is not the noun phrase but some smaller constituent which it follows and to which it is enclitic.

There is data in Chechen which, at first, could be used to make a comparable argument to Halpern’s that preverbal *’a* in Chechen is syntactically placed with respect to the word it is enclitic to. In (166) *’a* appears after the word *sialxana* ‘yesterday’ in the chained clause.

- (166) *Ahwmad, sialxana ’a wiina, dwa-vaghara.*
 Ahmed yesterday FOC stay.CVANT DX-V.go.WP
 “Ahmed stayed yesterday (too) and left.”

While the position of *'a* in (166) is “preverbal”, it is not an example of preverbal *'a* since adjuncts cannot serve as hosts to preverbal *'a*—as mentioned in table (152). Rather, it is an example of focal *'a* (to be discussed in section 3.4.4.3 (page 313)) which happens to be preverbal. While (166) is possible, the normal variant of the sentence is given in (167) where *'a* is preceded by a copy infinitive.

(167) *Ahwmad, sialxana wa 'a wiina, dwa-vaghara.*
 Ahmed yesterday stay.INF & stay.CVANT DX-V.go.WP
 “Ahmed stayed yesterday and left.”

A sentence like the one in (166) could be taken as evidence that like *mu* in Halpern’s data, *'a* can actually follow any constituent in the verb phrase. However, the consultant reported that the sentence in (166) is semantically marked with emphasis on the word *sialxana* (this focal use of *'a* will be discussed in more detail in section 3.4.4.3 (page 313) below). The sentence in (167), on the other hand, is semantically unmarked for this sort of emphasis and is solely a marker of chaining. Thus, while it might appear that *'a* has variable position the verb phrase, akin to that of *mu*, these different positions reflect different uses of the enclitic, and this is not counterevidence for the penultimate position of preverbal *'a*.

Despite the different semantics of *'a* in the two positions, *'a* can only grammatically appear once in a chained clause as the data in (168) indicates.

(168)**Ahwmad, sialxana 'a wa 'a wiina, dwa-vaghara.*
 Ahmed yesterday FOC stay.INF & stay.PP DX-V-go.WP

The restriction exemplified in (168) is important since it means that there is no data in Chechen along the lines of the Modern Greek data seen in (165) which could argue for an

analysis of Chechen along the lines of Halpern’s proposed analysis for Greek, and it adds to the argument that the two positions of *'a* in chained clauses reveal a genuine semantic alternation, not an ability of the clitic to appear on different hosts in the clause.

What we’ve seen, then, is the basic position of *'a* supports the fact that it is a type 5 clitic and that the arguments that have been used against the other possible instances of such clitics do not hold in the Chechen case. While this does not mean that an analysis treating preverbal *'a* as something other than a type 5 clitic is impossible, it does mean that there is no strong evidence against it. There is one other fact that supports the analysis of *'a* as a type 5 clitic, the appearance of the obligatory copy infinitive in some verb phrases, which will be discussed in section 3.5 (page 315).

3.4.4.3 Focal *'a*

In contrast to preverbal *'a*, there is also a focus use of *'a*. When used in this way, *'a* appears immediately after the focused constituent. This use of *'a* is not central to the chapter, but it has appeared in various examples and is worth mentioning briefly. To avoid confusion between this use and the preverbal use of *'a*, focal *'a* has been glossed as FOC.

We’ve seen examples of focal *'a* at this point in sentences (156d), (158), and (166). Another instance of focal *'a* can be seen in (169) where it marks that the subject of the second clause of the coordination structure contrasts with the subject of the first clause.

- (169) *Ahwmada ch'aara iicara, t'q'a Mariamas 'a iicara izza.*
 Ahmed.ERG fish buy.WP and Mary.ERG FOC buy.WP 3S.FOC.ABS
 “Ahmed bought a fish, and Mary bought one, too.”

Focal *'a* can follow a range of different syntactic categories. In (166) it follows an

adverb, in (169) it follows a noun, and in (170) it follows a finite verb (in a sentence-focus construction).

(170) *Mosazza oexu 'a masitta ch'eerii loocu as.*
 each time go.PRS & several fish.PL catch.PRS 1S.ERG
 “Each time I go, I catch several fish.”

While focal *'a* appears in coordinate structures in the two examples just given, the example of a focus-marked imperative in (156d) shows that this is not a requirement for the appearance of the clitic.

The focal use of *'a* is optional in the sense that it does not have to appear in every sentence—thus, it might be better labelled as an emphatic focus marker. Peterson (2001:146) reflects this sentiment by remarking that the various non-chaining uses of *'a* in Ingush (what here would correspond with the non-preverbal uses for Chechen) could be broadly characterized as marking “emphasis”.

3.4.4.4 Local conclusion to discussion of clitics with the form *'a*

In this section, I discussed two distinct uses of enclitics with the form *'a* in Chechen. The first of these was the preverbal use. I argued in section 3.4.4.2 (page 302) that the preverbal use of *'a* shows the behavior associated with a type 5 clitic, according to the typology found in Klavans (1985). Type 5 clitics are not well-attested and, because of this, I attempted to strengthen the case for this classification building on arguments first presented in Peterson (2001) for the cognate clitic in Ingush.

The second part of this section discussed the focal use of *'a*, which is a separate use of the clitic, and is not central to the arguments being made here.

3.5 THE COPY INFINITIVE AND THE VERB PHRASE TEMPLATE

3.5.1 Introduction

Before moving onto the more theoretical part of this chapter, there is one more descriptive aspect of Chechen grammar to cover—the copy infinitive. In so doing, I will be able to give a description of the Chechen verb phrase template itself since the copy infinitive plays a crucial role in demonstrating its existence.

We've already seen various examples of the copy infinitive. In (146b) an example was given where it was obligatory and (156c) gave an example where it was optional. The copy infinitive is always followed by either the enclitic *'a* or the proclitic *ma*. In section 3.5.2 (page 315), I will discuss the non-obligatory focal use of the copy infinitive. In section 3.5.3 (page 317), I will discuss its obligatory templatic use in clauses containing preverbal *'a* and, thereby, establish the basic parameters of the Chechen verb phrase template. In section 3.5.4 (page 321), I will briefly discuss other uses of the infinitive to make it clear how the copy infinitive differs from how the infinitive is used more generally. In section 3.5.5 (page 327), I will discuss why the copy infinitive does not appear to be an “object” of its verb and merits special analysis.

3.5.2 The focal use of the copy infinitive

Broadly speaking, there are two uses of the copy infinitive. The first, and simpler, use is to mark a verb phrase for focus. Contrasting examples are given in (171) and (172).

- (171) a. *Ma aala.*
 &neg say.IMP
 “Don’t tell!”
- b. *Aala ma aala.*
 say.INF &neg say.IMP
 “Don’t even tell!”

- (172) a. *Ma lie.*
 &neg die.IMP
 “Don’t die!”
- b. *Vala ma lie.*
 V.die.INF &neg die.IMP
 “Don’t die!”

As can be seen in (171a) and (172a), a negative infinitive can be formed by putting the negative imperative clitic *ma* before the verb. This imperative can be made emphatic, as seen in (171b), by being preceded by an infinitive copy of the main verb. This strategy of verb phrase focus is not limited to negative imperatives. A copy infinitive can also be found as a host for preverbal *'a* with a focus use. In (173) the copy infinitive appears in two verb phrases marking how they contrast with one another.

- (173) *Maliikina Ahwmad ga 'a gira Mariam xaza 'a xezara.*
 Malika.DAT Ahmed see.INF & see.WP Mary hear.INF & hear.WP
 “Malika saw Ahmed and heard Mary.”

Finally, it is not uncommon for a verb phrase containing *ma* to be given extra emphasis by including both a copy infinitive and the enclitic *'a* as in (174), which contrasts with (156c).

- (174) *Ga 'a ma guo*
 see.INF & &NEG see.IMP
 “Don’t even look!”

3.5.3 The obligatory copy infinitive and core the verb phrase template

I consider the focus use of the copy infinitive to be less complicated than the second use of it since it is associated with semantics which, though not completely predictable, are roughly in line with the form of the construction. The second use of the copy infinitive, on the other hand, is associated with no particular semantics. Rather, it is a “slot-filler” employed to serve as a host for preverbal *'a*.

As schematized in the table in (152), the enclitic particle *'a* is placed before the verb but after an object, a deictic element, or a preverb. Additionally, there is a positional restriction on *'a* that its host must be in the core verb phrase. Of the four basic types of verb phrases in Chechen exemplified in (145) all but one, the simplex intransitive verb phrase, naturally fulfill this restriction on *'a*. Any complex verb can fulfill the restriction on *'a* because the preverb or deictic element can serve as its host. A transitive verb can also fulfill the restriction since its object can serve as a host.

The single argument of simplex intransitive verbs, on the other hand, an absolutive subject, is not within the core verb phrase and cannot, therefore, serve as a host for preverbal *'a*. In cases like this, the copy infinitive is employed to “fill out” the verb phrase. Importantly, when it is used in this way, it has no focus semantics—or any detectable semantics at all, for that matter. An example of this use of the copy infinitive is given in (175) repeated from (146b).

- (175) *Maalik viela 'a viilara vialxa 'a vilxara.*
 Malik V.laugh.INF & V.laugh.WP V.cry.INF & V.cry.WP
 “Malik laughed and cried.”

The example in (175) shows a use of the copy infinitive in a verb phrase coordination construction. It is also common in chaining constructions where one of the chained clauses contains a simplex intransitive verb. The sentence in (176) illustrates this where the chained clause is headed by the intransitive verb *daat'a* 'tear'.

- (176) *Kiexat, daat'a 'a daett'a, telxara.*
 paper tear.INF & tear.CVANT spoil.WP
 "The paper ripped and was spoiled."

As mentioned above, in the examples in (175) and (176) no particular semantics is associated with the copy infinitive.

Even in verb phrases which would normally have elements allowing *'a* to fulfill its positional requirements, an obligatory copy infinitive can appear if that element does not appear in its standard preverbal position as illustrated in (177) and (178).

- (177) a. *Maliikas ch'aara 'a iecara, cicig 'a doexkira.*
 Malika.ERG fish & buy.WP cat & D.sell.WP
 "Malika bought a fish and sold a cat."
 b. *Ieca 'a iecara doexka 'a doexkira ch'eri Maliikas.*
 buy & buy.WP sell & D.sell.WP fish.PL Malika.ERG
 "Malika bought and sold some fish."

- (178) a. *Cicko, ch'aara 'a goj, 'i bu'u.*
 cat.ERG fish & see.CVPAN 3S.ABS B.eat.PRS
 'The cat sees a fish and eats it.'
 b. *Ga 'a goj ch'aara, iza bu'u cicko.*
 see & see.CVPAN fish 3s.ABS B.eat.PRS cat.ERG
 "Having seen the fish, the cat eats it."

The sentence in (177a) contains two conjoined verb phrases showing unmarked OV order. The bolded objects serve as hosts for the enclitic *'a* and no copy infinitive is needed.

In (177b), repeated from (151), on the other hand, the shared object of the two conjoined verb phrases is postposed after the second verb phrase. As a result of this, there is no “natural” host for *'a* in those verb phrases, and the obligatory copy infinitive appears.

Similarly, in (178a), in the chained clause headed by the present anterior converb form of the verb meaning ‘see’, *goj*, the object *ch'aara* ‘fish’ serves as a host for *'a*. In (178b), on the other hand, *ch'aara* has been postposed to the end of the clause and a copy infinitive is employed to serve as a host to *'a*.

While the copy infinitives in (177b) and (178b) are obligatory for syntactic reasons, unlike the cases in (175) and (176), it isn't completely clear that they are not marking any particular semantics. The word order in both those sentences is marked. Therefore, the pragmatics of the sentences are marked, and the copy infinitives may be contributing to those pragmatics in some regular way. However, I lack a detailed enough description of how (177b) and (178b) to be able to say anything more specific than this at this point.

I have labelled this slot filling verb form the copy *infinitive* for the simple reason that it generally takes the form of the infinitive of the head verb of its phrase. However, as reported in Conathan and Good (2001), while the copy verb is always the same as the infinitive for regular verbs, for irregular verbs, there is some variation in the form of the copy verb, with the infinitive form being the preferred variant for at least one consultant.

In (179) I give the form of the infinitive, the present stem, and the copy verb form for various suppletive verbs forms in Chechen where the relationship between the infinitive and present stem is not predictable. As can be seen, for some (but not all) of the verbs,

the copy verb can either be the true infinitive or an “fake” infinitive formed on the basis of what the predicted infinitive form would be based on the present stem.

(179)

INFINITIVE	PRESENT	COPY VERB	GLOSS
<i>dala</i>	<i>lo</i>	<i>dala</i> or <i>la</i>	‘give’
<i>da~</i>	<i>dahwa</i>	<i>da~</i> or <i>dahwa</i>	‘bring’
<i>dagha</i>	<i>duedu</i>	<i>dagha</i> or <i>duoda</i>	‘go’
<i>daa~</i>	<i>dooghu</i>	<i>daa~</i>	‘come’

The alternate form for the copy verb of *dagha* ‘go’ is particularly instructive since the vowel change in it from *ue* to *uo* represents an “undoing” of morphophonological ablaut found in present stems. Thus, the form *duoda* would be the predicted infinitive based on the present stem *duedu*. The alternate copy verb can only be used in verb phrases whose head verb is based on the present stem. This situation in Chechen where, for suppletive verbs, it is possible to have a variant of the copy verb which is more “faithful” in form to the head verb of the clause is comparable to the situation in Ingush, discussed by Peterson (2001) and Conathan and Good (2001), where the form of the copy verb is always based on the stem of the head verb—even if that would imply that the copy verb does not have the same form as the infinitive.

A final descriptive note about the copy infinitive is, as discussed in section 3.4.4 (page 301), and exemplified in (166), when an enclitic with the form *'a* is used to mark focus in a chained clause, it is not necessarily positioned preverbally, in which case the copy infinitive no longer appears.

In (180) I schematize the Chechen core verb phrase template. The schema is fairly simple and, to some extent, can be understood as a phrasal subcategorization frame for

preverbal *'a*. Specifically, it says that preverbal *'a* must be preceded by some element in the core verb phrase. The unspecified syntactic status of this element is indicated by “...” in (180). Critically, the appearance of the copy infinitive shows us that some element must precede *'a*—and, thus, gives us crucial evidence for the presence of the template.

(180) [[... =*'a*]_{Word} []_{Core VP}]

I don't intend (180) to serve as an analysis for the template—rather, it is a convenient schematization. In section 3.7 (page 346), I will give an analysis of it trying to show how it is similar to minimality templates reported to exist in smaller domains, like the word and the root.

In the next section, I will discuss other uses of the infinitive in Chechen in order to establish that the copy infinitive constitutes a different use of the infinitive from its other uses. In section 3.6 (page 332), I will discuss previous analyses of type 5 clitics since I believe these will help us to understand part of the reason why preverbal *'a* exhibits templatic behavior. Though I do not consider it a central concern of the general analysis to be provided here, in section 3.7.4.5 (page 371), I will suggest some reasons why the “filler” element for the template, when one is needed, is a copy infinitive and not some other dummy element.

3.5.4 Other uses of the infinitive

Since the obligatory appearance of the copy infinitive in verb phrases headed by simplex intransitive verbs containing preverbal *'a* constitutes crucial evidence for the template, in

this section I will briefly discuss other uses of Chechen infinitives to establish that the presence of the copy infinitive should not be taken to be an instantiation of some general pattern involving infinitives in the languages.¹⁶ This is not to exclude a connection between the focal use of the copy infinitive and its “slot-filler” use—rather, I mean only to separate the general copy infinitive construction from other infinitival constructions.¹⁷

Not surprisingly, one of the most common uses of the infinitive is as the head of complement-clauses which share a subject with the verb of the main clause. Some examples of this use are given, for sentences headed by the verb *lae’ a* ‘want’, in (181), where the infinitives are bolded. The infinitives in these complements are typically immediately preverbal, lending them some similarity to the copy infinitive construction.

- (181) a. *Ocu naaxana zudchynga **hwousa** lae’ a.*
 this people:DAT women:ALL look-at:INF want:PRS
 “The people want to look at the women.”
- b. *Zheina **jaazda** ’a surt **dilla** ’a lae’ ara zudchunna*
 book write:D:DO:INF & picture D:paint:INF & want:WP woman:DAT
 “The woman wanted to write a book and paint a picture.”

The sentence in (181b) contains an instance of the coordinative use of the enclitic *’a* almost certainly related to its use as noun phrase coordination, an example of which is given in (182). Outside of this coordinating construction, *’a* does not mark infinitival complements—which is an important difference between them and the copy infinitive construction.

¹⁶ The discussion in this section and the following one owes a debt to a number of insightful comments made by Andrew Garrett.

¹⁷ In section 3.7.4.5 (page 371), I will, in fact, argue that there is a connection between the focal use and slot-filler use of the copy infinitive.

- (182) *Stol 'a c'oga 'a deexa du.*
 table & tail & D.long D.be.PRS
 “The table and the tail are long.”

I include the sentence in (181b) here as a case, outside of the copy infinitive construction, where an infinitive is followed by a clitic with the form *'a*. This might, at first, appear to be a comparable construction to the copy infinitive one. However, despite the superficial similarity, there are two important ways in which this use of *'a* shows itself to be clearly different from its preverbal use. The first is that coordinative *'a* appears final in the clauses it coordinates (both in coordinated noun phrases and infinitive phrases) and not in penultimate position. It, therefore, can be understood as appearing after the infinitive because OV word order is standard in infinitive phrases and not because of some special infinitive+*'a* construction.

The second difference between the use of *'a* in (181b) and its preverbal use is that, though there is some sense in which both uses are “coordinating”, it does not, in fact, appear that preverbal *'a* is precisely a marker of coordination. In Good (2003a) as mentioned above, evidence is given that preverbal *'a* is best characterized as a marker of cosubordination, in the sense of Foley and Van Valin (1984:239–44), a category intermediate between the traditional categories of coordination and subordination. The use of *'a* in (181b), on the other hand, is properly coordinating. Thus, despite their similar form, these two uses of *'a* appear to be clearly separate from one another.

Furthermore, the infinitival clauses in (181b) are occupying the same structural position as the one infinitive clause in (181a) and are, thus, clearly serving as complements to the

verb *lae'a* ‘want’. Therefore, we can straightforwardly understand the infinitives in (181b) to be “licensed” by the main verb of the sentence. However, there is no obvious way to analyze copy infinitives as being licensed by the main verb of their clause since they appear with verbs which do not, outside of the copy infinitive construction, appear with infinitives. This gives us further cause to distinguish between these two cases where the combination infinitive+’*a* is found, since, in the one case, its appearance is correlated with more general syntactic patterns, while, in the other case, it is not.

Having discussed why the infinitive-phrase coordination construction in (181b) is different from the copy infinitive construction, we should consider if there is any obvious relationship between infinitival complements and copy infinitive more generally. Further examples of verbs taking infinitival complements in Chechen are given in (183), (184), and (185).

(183) *Zudchuo hwiizuo juoliira 'i.*
 woman:ERG torment:INF J:begin:WP 3S:ABS
 “The woman began to torment him.”

(184) *Kibarchk jotta ca xae'a suuna.*
 brick J:stack:INF not know:PRS 1S:DAT
 “I don’t know how to lay bricks.”

(185)@ *Irs, jukha daa~ diezara hwo.*
 happiness back D.come.INF D.should.IMPF 2s
 “Happiness, please come back.”

The sentence in (183) shows that the verb *duola* ‘begin’ takes an infinitival complement, the sentence in (184) shows that the verb *xae'a* ‘know’ (in the sense of German *wissen*) also takes an infinitival complement. Finally, the sentence in (185) is an instance where a modal, *dieza* ‘should’, takes an infinitival complement.

The semantics of these verbs, as well as the verb *lae'a* ‘want’ seen in (181), is such that there is an obvious interpretation for their infinitive phrases as same-subject clausal complements. We can contrast them with, for example, verbs like *diela* ‘laugh’ and *dialxa* ‘cry’ seen in (146b), whose semantics are not obviously consistent with them taking any object—let alone an infinitival object—but which are seen to appear with copy infinitives. My conclusion from this is that the copy infinitive construction is not generally related to cases of infinitival complements like those just seen. The conditions governing the use of infinitival complements are straightforwardly related to the semantics of the head verb of their clause, while the conditions governing the use of the copy infinitive cannot be readily explained in the same way.

Outside of verbs taking infinitival complements, the only other major syntactic use of the infinitive that I am aware of is as the head of purpose clauses.¹⁸ Examples are given in (186).

- (186) a. *Ooxa dyesha zheina iicara.*
 IPE:ERG D:read:INF book buy:WP
 “We bought a book to read.”
- b. @*Ishta cq'a wyyrana bezhnash dwalaaxka juedash cwana*
 thus once morning:ADV cattle DX:drive:INF J:go:CVSIM one:OBL
nesana gira eesana t'e 'a xi'ana bezhnash liallana
 dtr-in-law:DAT see:WP calf:DAT on & sit:CVANT cattle drive:CVANT

¹⁸ The infinitive stem is used in some derivational processes. For example, verbs with inceptive meaning can be formed via a combination of the infinitive stem with the verb *lo* ‘give’, and causative verbs can be formed with a combination of the infinitive and the verb *do* ‘do’. I do not consider such processes in detail here since these processes are lexical, while the copy infinitive is a syntactic phenomenon.

jooghu *jow.*
 J:come:PRS:PART girl

“One morning one of the daughters-in-law was going to take the cattle to pasture when she saw a girl sitting on a calf driving cattle.”

c. @'I *ghullaq q'aastuo* *juxa 'a voerzii,* *massuo 'a*
 that matter investigate:INF back & V:turn:CVPAN all &
chuenashka chiaq-voorii *hozhu iza.*
 room:PL:ALL completely-V:go:CVPAN look:PRS 3S:ABS

“He goes back to investigate and goes through all the rooms and checks.”

The purposive infinitive clauses seen in (186) are all in a position before the verb (though not immediately before it). This gives them some affinity to copy infinitives. However, no consultant has ever reported purposive semantics to copy infinitives, purposive infinitives are not obligatorily followed by preverbal *'a* (like infinitival complements), and they do not have to be immediately preverbal (as seen in (186a) and (186c)). So, while there are some similarities between purposive infinitives and copy infinitives, there is no evidence that copy infinitives should be considered special cases of purpose infinitives.

What we've seen, then, is that there is no clear way in which other infinitive constructions could be taken to be closely related the copy infinitive construction. Rather, it appears to be its own construction, involving an independent use of the infinitive from other uses. This fact is somewhat important for clearly establishing that the appearance of the copy infinitive, in its non-focal use, is templatically governed due to some restriction on the placement of preverbal *'a* along the lines of the schema given in (180).

In the next section, I will present evidence that the Chechen copy infinitive should not be considered an “object” of the head verb of its clause (specifically, along the lines of a cognate object).

3.5.5 Why the copy infinitive does not appear to be an object

If the Chechen copy infinitive appears to be separate from other infinitival constructions, given its obligatory appearance only with (simplex) intransitive verbs, another question that might be raised is whether or not it could be some special nominal-like form—that is, whether or not it might be a special type of object. In some languages, prototypically intransitive verbs are sometimes observed to exceptionally take objects and often these objects bear what could be described as a “copying” relation with the main verb. A good example of this is the cognate object construction in English, instances of which are given in the italicized phrases in (187).

(187) Shield us under your patronage,

that following your example and strengthened by your help,

we may *live a holy life, die a happy death,*

and attain to everlasting happiness in heaven.

(Source: <http://www.op-stjoseph.org/sacredheart/pages/novenas.htm>)

The examples of the cognate object construction in English seen in (187) establish its basic properties. A prototypically intransitive verb appears with an object that is closely semantically related to that verb. Critically, it is clear that the relevant post-verbal element is nominal in this construction.

There are several reasons to believe that the copy infinitive in Chechen is not a cognate object, or, more generally, any sort of object. The first is that a default expectation for

the part of speech of such an element is that it would be nominal. Chechen possesses two completely productive nominalization strategies, a nominalizer form and a masdar form (which creates a nominal form with the semantics of a headless relative)—but the copy infinitive construction does not use either of these. Each of these two forms is seen in the examples in (188). The sentence in (188a) contains a (bolded) nominalized verb, and the sentence in (188b) contains a (bolded) masdar. Like true nouns in the language, these nominal forms are marked for case.

(188) a. *K'antuo **booxurg** ca do deela, daa cynga*
 boy:ERG speak:NZ not D:do:PRS because father 3s:ALL
gooma-hwoezhush vu.
 frown:CVSIM V:be:PRS
 “Because the boy did not do what he said, the father is frowning.”

b. *Hwaina milla-'a **garx** q'amial ma*
 2S:RFL:DAT who-& see:MAS:LAT conversation NEG:IMP
deelahw cynca.
 D:make:IMP:POL 3S:INST
 “Whoever you see, don’t talk to them.” (“Don’t talk to whoever you see.”)

If the copy infinitive were filling a role similar to an object construction in English, we would have to explain why an infinitive, instead of a nominalized verb form, is chosen as the “object” when two different nominalized forms are available.

A second reason why the copy infinitive does not seem to be readily analyzable as an object is related to the data presented in (179), with respect to the form of the copy infinitive for suppletive verbs. As was seen in (179), a copy infinitive could have the form of a true infinitive, but it could also, for suppletive verbs, take on the form of a “fake” infinitive, formed by analogy to the stem of the head verb of the relevant clause. This suggests that

the copy infinitive is, in fact, a copy of the head of the clause and not some object-like form participating in a transitivizing construction for intransitives. A “filler” object, as a default, would not be expected to create new forms to fill the object slot. Rather, as is found in the English example in (187), the default expectation would be that the object would be an element clearly part of the language’s lexicon. This is further evidence, then, that the copy infinitive is in fact something separate from an object.

A third reason to believe that the copy infinitive is not syntactically treated like an object involves case marking. Given that Chechen is an ergative language, if the copy infinitive were an object, we would expect it to be marked in the absolutive case, and the subject of the lexically intransitive verb would be expected to receive ergative case marking. While the absolutive case is unmarked, it would, therefore, not necessarily be unreasonable to say the copy infinitive is in the absolutive case. However, an example like the one in (175) shows that the subject of a clause containing a copy verb retains its absolutive case marking. Thus, an object analysis of the copy infinitive would require us to assume that there are two absolutive arguments in a sentence like the one in (175). While this is not completely implausible, it adds a further complication.

A final reason why the copy infinitive does not appear to be an object relates to the opposition of the sentences seen in (177) and (178). As we saw in those sentences, even transitive verbs required the presence of a copy infinitive when their clauses contained preverbal *'a* and their objects appeared in a non-canonical post-verbal position. These verbs clearly have objects—they just don’t have any element in the core verb phrase preceding

'*a*. If we were to analyze the copy infinitive as some type of object, we would then have to devise a separate analysis for the appearance of the “other” object in such sentences.

Taken together, I believe these facts argue strongly against an analysis where the copy infinitive is taken to be some sort of object. The fact that it obligatorily appears in chained constructions containing simplex intransitive verb phrase, at first, may make such an analysis seem promising. However, the morphosyntactic evidence which can be brought to bear on the issue indicates that copy infinitives do not behave like objects. Furthermore, their appearance can be triggered in certain phrasal configurations in clauses headed by transitive verbs.

To the extent that the copy infinitive can be associated with any of the slot “4” elements, it might be reasonable to suggest that it is a preverb. The term preverb, as used here, refers to a heterogeneous category of elements occurring before light verbs. While the copy infinitive need not appear before light verbs, it shares a quality with many preverbs that its place in the syntax of the verb phrase is not readily apparent. If we were to accept this view, however, we still would not have explained why the copy infinitive appears—we would just be able to simplify the view of the relationship between the copy infinitive and other slot “4” elements.

3.5.6 Local conclusion

In this section, I discussed the existence of the slot-filling copy infinitive in Chechen. As seen in section 3.5.3 (page 317), the copy infinitive becomes obligatory in a particular context—when preverbal '*a* would not otherwise have a host in the core verb phrase.

The appearance of the copy infinitive, therefore, gives us important justification for the core verb phrase template, which I schematized in (180) and repeat below in (189).

(189) [[... = 'a]_{Word} []_v]_{Core VP}

The schema in (189) is intended to illustrate that there is a restriction on preverbal 'a' wherein it must be preceded by some element (whose content is left unspecified) within the core verb phrase. When the syntax of the clause does not naturally provide such a host for 'a', the copy infinitive appears and does not add any particular semantics to the clause.

In this section, I also described other uses of the infinitive and presented evidence that the copy infinitive should not be considered a cognate object. This discussion was intended to demonstrate that the copy infinitive is part of a special construction in its own right, and its properties are not generally derivable from other aspects of Chechen grammar.

Before moving onto the analysis of the template schematized in (189) to be given here, in the next section, I will discuss previous analyses of type 5 clitics. Two analyses have predicted that they should be unattested. While the data from Chechen indicates that such conclusions are too strong, they will still be valuable to look at here since one of the core aspects of the analysis of the Chechen template will be that the interesting properties of the type 5 clitic are crucial to the existence of the template.

3.6 PREVIOUS ANALYSES INVOLVING TYPE 5 CLITICS

3.6.1 Introduction

With the exception of Peterson's (2001) descriptive study of the cognate enclitic to *'a* in Ingush, no analysis has been provided for its behavior. Conathan and Good (2001) discuss the morphosyntactic relationship between the copy infinitive and the main verb in constructions involving *'a* and the obligatory copy infinitive. However, they do not analyze *'a* specifically.

In the next section, I will develop a treatment of the relationship between *'a*, the copy infinitive, and a verb phrase template in Chechen. Unlike the Bantu case discussed in chapter 2, no previous analysis exists of this relationship—so, there are no previous analyses to discuss en route to the analysis to be presented below.

However, notably, at least two analyses of clitics in general have been developed which specifically predict that type 5 clitics should be unattested. These two analyses, Marantz (1988) and Halpern (1995), were referred to above in section 3.4.4 (page 301) in arguing that preverbal *'a* is, in fact, a type 5 clitic. This is because both of those works, in trying to support their general analysis of clitics, offered reanalyses of previous reported cases of type 5 clitics suggesting they are better characterized as word-domain final enclitics (type 7) as opposed to phrase-domain penultimate enclitics.

As discussed in section 3.4.4, the objections raised against the previous purported type 5 clitics cases do not hold for the case of Chechen (and Ingush) preverbal *'a*. Because of this, *'a* appears to be the best case reported so far of a type 5 clitic. However, even if

preverbal *'a* is of type 5, it is clear that such clitics are not particularly common.

In the next two sections, I will explore how type 5 clitics are excluded from the formal mechanisms of Marantz (1988) and Halpern (1995). While I do believe that preverbal *'a* is a type 5 clitic, I also believe that there may be a connection between the templatic requirements of preverbal *'a* and its type 5 status. To understand that connection, it is worthwhile to understand why previous authors have wanted to rule out type 5 clitics entirely. In section 3.6.4 (page 344), I will discuss how the analysis to be presented here will, in some sense, indicate that preverbal *'a* has affinities to second position clitics—this will further tie in my analysis with previous ones.

3.6.2 Marantz (1988)

Marantz (1988) makes use of two principles in developing a general theory of clitics which predicts the non-existence of type 5 clitics. The first of these relates to the way “adjacency” requirements of linguistic elements can be realized (Marantz 1988:259), and the second of these is the principle of “morphological merger” (Marantz 1988:261).

Marantz’s notion of how morphemes fulfill their adjacency requirements is developed both to deal with various possibilities for clitic positioning as well as so-called “bracketing paradoxes” (Pesetsky 1985). For Marantz, the linear relations of elements in a linguistic constituent are partially mediated by adjacency relationships dictating which elements must precede and follow a given element.

Marantz gives the schema in (190) to illustrate how this adjacency relationship works. He uses the notational device of a “*” for the adjacency relation which should be understood

as “is left adjacent to”. Thus, “X * Y” is short hand for “X is left adjacent to Y”—that is, X must appear immediately to the left of Y (Marantz 1988:259).

(190) a. X * [_Y Z * W * ...]

b. [[X Z] W ...]

The schema in (190a) represents some syntactic structure with specified adjacency relations. The schema in (190b) represents the constituency of a linearized structure which fulfills the adjacency restrictions requires by (190a). Importantly, this phonological structure does not show the same phonological constituency as (190a). However, this is a permissible realization of the adjacency relations given in (190a) because, regardless of the constituency, the relevant adjacency requirements are fulfilled. (Or, in Marantz’s terminology, (190b) is a valid phonological structure for (190a) because adjacency is an “associative” relation (Marantz 1988:259).)

To make the discussion less abstract, it is instructive to look at the example in (191) adapted from Marantz (1988:259) of the adjacency relations and phonological constituency of the English sentence *I’ll go to Milwaukee*.

(191) a. [I * [’ll * [go to Milwaukee]]]

b. [[I’ll] [go to Milwaukee]]

Marantz (1988) gives an example like (191a) as a description of the syntactic structure and adjacency relationships of the sentence *I’ll go to Milwaukee*. In (191b) the clitic *’ll*

has grouped phonologically with the subject of the sentence, thereby not showing a direct correspondence with the syntactic constituency of the sentence. However, the clitic still fulfills its adjacency requirements, making the structure in (191b) acceptable.

Examples like (191) illustrate one type of mismatch between phonological and syntactic structure—specifically where phonological constituency does not trivially correspond to syntactic constituency. Within Marantz’s theory such structures are generally acceptable because because the mismatch does not result in a violation of adjacency requirements.

A second type of mismatch in Marantz’s theory can result from the process of “morphological merger”. This process is analogous to the process of incorporation as formalized by Baker (1988). Essentially, the head of one syntactic constituent can affix to the head of another syntactic constituent with which it has some well-defined relationship. Once a constituent affixes in this way, it can behave like any other affix and be prefixing or suffixing (or, presumably, infixing). If an adjacency requirement holds between two merged elements, it is automatically satisfied by the merger. In addition, the constituent created by the merger has the same adjacency requirements as the element which is merged with.

Again, in order to make the discussion more concrete, in (192) I give an example from Marantz (1988:262) involving a Tohono O’odham (formerly known as Papago) clitic.

(192) a. Syntactic structure

[_s =’*o* [_v *pi iam-hu cikpan*] [_g *Huan*]]
 AUX NEG there work ART John
 “John is not working there.”

b. Adjacency constraints

[=’*o* * [[*pi * iam-hu * cikpan*], [_g * *Huan*]]]

c. Phonological structure consistent with the constraints

[[[=’*o* * *pi*] * *iam-hu * cikpan*] * [_g * *Huan*]]

d. Phonological structure after merger

[[[*pi + o*] * *iam-hu * cikpan*] * [_g * *Huan*]]

The examples in (192) are to be interpreted as follows. The structure in (192a) represents the syntactic structure of a Tohono O’odham sentence in which the enclitic auxiliary *’o* appears. Syntactically, Marantz posits that it is initial in the sentence. This syntactic structure has the adjacency requirements given in (192b). Notably, the auxiliary is ordered with respect to the verb phrase. The comma after the verb phrase (192b) indicates that the syntax does not place strict adjacency requirements between the verb phrase and the subject noun phrase.

The structure in (192c) indicates one acceptable structure with the adjacency requirements fully specified. In this case, the subject is specified as being right adjacent to the verb phrase—other orders are possible, and this structure represents just one possible relative order between the verb phrase and the subject. Notably, in this structure, the auxiliary *’o* and the negative marker *pi* have been phonologically bracketed together. These are both

the heads of their respective phrases. Importantly, it will be 'o that will merge (or incorporate) with *pi*, not the other way around, as indicated in the structure where 'o appears in the constituent headed by *pi*.

Finally, the structure in (192d) schematizes merger between the enclitic auxiliary and the negative element. These have now fused into one word. Since 'o is enclitic, it suffixes to the negative element *pi*. As indicated in (192b), there is an adjacency requirement between 'o and *pi*—this is automatically satisfied via the merger. The structure in (192b) also indicates that *pi* must be left adjacent to *iam-hu*. This requirement is fulfilled because the structure formed by the merger between 'o and *pi* is left adjacent to *iam-hu* even if the phonological string *pi* is no longer immediately adjacent to it.

Marantz (1988:262) points out that, for the structure in (192d) to be grammatical, it is important that 'o is, at first, initial in its sentence. Because of this there was only a left-adjacent requirement, and not a right-adjacent requirement for 'o. Once 'o merges with the element to its left, it can no longer satisfy any right-adjacent requirements it might have. Thus, if 'o did have any right-adjacent requirements, a structure like (192d) would be ungrammatical.

The example in (192) exemplifies Marantz's general account of second-position clitics. Specifically, Marantz claims that second-position enclitics can become suffixes to what surfaces as the first-position element in order to satisfy their positional requirements. Critically, his theory predicts that second position elements must be enclitics and not proclitics since, if they "moved inward" to prefix to the second-position element, they could

not merge with the first element of the sentence and satisfy their adjacency requirements. In (193) I illustrate how such a derivation would take place and be ungrammatical for a language just like Tohono O’odham as exemplified in (192) except where *'o* is a proclitic.

(193) a. Syntactic structure

[s *'o*= [v *pi iam-hu cikpan*] [g *Huan*]]
 AUX NEG there work ART John

b. Adjacency constraints

[*'o*= * [[*pi * iam-hu * cikpan*], [g * *Huan*]]]

c. “Second-position” phonological structures

[* [*pi * ['o= iam-hu * cikpan] * [g * *Huan*]]]*

The syntactic structure and adjacency requirements of the proclitic-Tohono O’odham language would be the same as the syntactic structure for the real language, as given in (193a) and (193b). In (193c), the proclitic version of *'o* has been “moved” to second position into a constituent with *iam-hu* which, could, presumably host a proclitic. However, this movement would not allow the proclitic version of *'o* to satisfy its adjacency requirements with the negative marker *pi*. The proclitic version of *'o* neither satisfies its positional requirements naturally, nor can it satisfy them with merger since it would merge with *iam-hu* not with *pi*. Thus, no possible derivation of a second-position proclitic is possible under Marantz’s theory and he predicts they could not exist.¹⁹

¹⁹ This is not to say that no proclitic could appear in second position in a given language. This analysis simply says that a proclitic which is analyzed as syntactically sentence-initial cannot appear in second-position. However, a proclitic analyzed as syntactically second-position and appearing second-position in the phonological structure would be predicted to be perfectly grammatical in Marantz’s (1988) framework.

The main reason I have gone through both the grammatical “enclitic” second-position derivation in (192) and an ungrammatical “proclitic” second-position derivation in (193) is *'a*'s penultimate position makes it the “mirror-image” of the second-position case. Therefore, discussing second-position proclitics in Marantz’s theory leads naturally into a discussion of penultimate-position enclitics.

Marantz’s theory, in a similar fashion to Halpern (1995) as we will see below, essentially predicts that second position enclitics and penultimate position proclitics are grammatical but that second-position proclitics and penultimate position enclitics are not. One way of stating these restrictions is that if a clitic appears in a syntactically unexpected position before or after a given word, that word should be its host.

Since preverbal *'a* in Chechen is a penultimate *enclitic*, it is, therefore, ruled out by Marantz’s theory. In order to see why this is the case, we need to make the assumption, that, since preverbal *'a* takes scope over the whole clause it appears in, it is syntactically positioned at its periphery. This assumption is in line with the discussion in Marantz (1988:265–6) concerning the Latin conjunctive enclitic *-que* and, therefore, seems reasonable here. Given *'a*'s positioning towards the right edge of the clause, I will make the further assumption that *'a*'s adjacency relation is to the right of the constituent in its scope. This is consistent with the fact that Marantz formalized Latin *-que* as having an adjacency relationship to the left of the constituent in its scope because it is positioned towards the left edge of that constituent, in second position (it is also consistent with his analysis of Tohono O’odham *'o* seen above).

In (194) I give the syntactic and phonological structures for preverbal *'a* in Chechen which would exist under an analysis along the lines of Marantz (1988). These structures are the mirror image of those in (193), and, under Marantz's theory, are predicted to be ungrammatical. The verb phrase in (194) is taken from (161d)

(194) a. Syntactic structure

[[_{VP} *zhwala iacna*] *'a*]
 dog take &

b. Adjacency constraints

[[*zhwala * iacna*] * *'a*]

c. "Penultimate-position" phonological structure

[[_{VP} [*zhwala 'a*] * *iacna*] *]

As seen in (194c), when the enclitic *'a* is moved into penultimate position there is no way for it to fulfill its adjacency requirements. If *'a* were a proclitic, on the other hand, it could fulfill them via merger, along the lines of the second-position enclitic *'o* in Tohono O'odham, seen in (192).

Since the data available to Marantz indicated that type 5 clitics were non-existent, he viewed the fact that his theory excluded them as favorable. Furthermore, he explicitly discussed that his theory predicts they should not occur (Marantz 1988:267–8). Thus, while I am devising my own analysis of how preverbal *'a* would be analyzed in Marantz's framework, I am not coming to any new conclusions about how his theory excludes type 5 clitics.

If the present interpretation of the positioning behavior of *'a* is correct, then, clearly, Marantz's theory is too strong insofar as it excludes a linguistically possible clitic.

However, I am sympathetic to Marantz's claims because, while I do interpret preverbal *'a* as being a type 5 clitic, I find the templatic restriction—that *'a*'s host be within the core verb phrase—to follow the spirit of Marantz's theory. Specifically, Marantz's theory allows for a particular, well-defined class of mismatches between the linear phonological realization of an utterance and the syntactic relationships of the utterance. While preverbal *'a* shows a mismatch which violates his prediction, Chechen grammar is set up in a way which minimizes the mismatch.

Specifically, while *'a* can be in penultimate position without being proclitic to the verb it precedes, it, at least, always has a host within the core constituent that that verb heads. This means that there are some restrictions on its host which are, at least, related to the verb it precedes. One way to interpret this fact is that Marantz's research strategy of limiting the mismatches between phonological and syntactic structure is not necessarily incorrect even if the particular set of mismatches he proposes should be allowed is too narrow.

In the analysis of the placement of *'a* which I will adopt here, I will make no claims as to what should or shouldn't be possible clitic positions, since the central concern of this work is templatic restrictions and not clitics. However, I will be tying in the templatic restriction on *'a* to its type 5 status. Because of this, it is worthwhile to note that a previous researcher have decided that there's something "funny" about type 5 clitics, since, as we've seen, even though it does appear that a type 5 clitic is linguistically possible given the

Chechen and Ingush data, there is something funny about it—namely that it is associated with a template.

3.6.3 Halpern (1995)

Halpern's (1995) analysis of clitics bears some similarity to Marantz's. So, it will not be necessary to go into it in great detail here. In essence, Halpern (1995) motivates second-position and penultimate clitics the same way—by invoking a linguistic principle which is termed Prosodic Inversion.

Halpern (1995:63) offers a somewhat complex definition of Prosodic Inversion, but, for our purposes, Prosodic Inversion can be understood as a process whereby (i) an enclitic placed at the left edge of a constituent such that there is no phonological material to its left to lean on will appear after the first word which would otherwise be expected to follow it or (ii) a proclitic placed at the right edge of a constituent such that there is no phonological material to its right to lean on will appear before the first word which would otherwise be expected to precede it.

Halpern (1995:64) offers the schematic representations in (195) to illustrate how the process of prosodic inversion operates to create a “second-position” clitic.

(195)

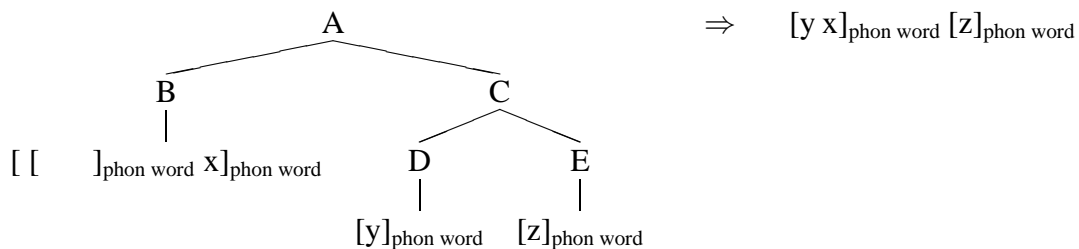

In the tree in (195) the element given the phonological form *x* is a second position clitic. It has a subcategorization frame, comparable to the one seen in (33) (page 66), which indicates it is phonologically dependent and can only surface if it has a phonological word to its left as a host. Since this element is syntactically initial in the structure, and there is, therefore, no “natural” host for it, the process of Prosodic Inversion applies. This causes the clitic and the first phonological word of the sentence to appear in inverted order. The first phonological word of the constituent can then serve as the host for the clitic as indicated by the “output” structure to the left of the tree.

In Halpern’s theory, the surface position of second-position clitics is, thus, prosodically motivated.²⁰ Because of this Halpern predicts, as Marantz also does, that there can be penultimate position proclitics—but not penultimate position enclitics.²¹ This latter claim falls out from the fact that an enclitic placed finally in some syntactic domain will always be preceded by some phonological material which could serve as its host, rendering Prosodic Inversion unnecessary.

As with the claims of Marantz (1988), I believe that Halpern’s analysis is too strong, excluding a type of clitic which is, in fact, attested in Chechen, but I am sympathetic to it. In the next section, I will briefly discuss how the analysis of preverbal *'a* to be given

²⁰ Because of the prosodic motivation taken to determine the position of second-position enclitics, in addition to predict that type 5 clitics should be unattested, Halpern (1995) also predicts type 4 clitics—second-position proclitics—should be unattested, which is reasonable since no good example of one has been found. Halpern also predicts that type 6 clitics—penultimate position proclitics—should be attested, since they are “mirror-images” of second-position enclitics and should, therefore, be able to undergo Prosodic Inversion. However, as Halpern (1995:33–4) points out, clear cases of type 6 clitics have not yet been reported. Halpern does not offer a full explanation for this but links it to a cross-linguistic tendency wherein enclitics are more common than proclitics.

²¹ Again, as with the discussion of Marantz, this is not to say that a enclitic could not appear in penultimate position. It is simply the case that it cannot appear there as the result of Prosodic Inversion.

below partially supports their analyses because, while I do believe it to be a true type 5 clitic, my own analysis will show it have important affinities with (type 3) second-position enclitics, lending validity to their idea that second-position enclitics are somehow “good” clitics while penultimate-position enclitics are somehow “bad”.

3.6.4 Preverbal 'a as a second-position enclitic in its prosodic phrase

Halpern and Marantz both invoke somewhat different mechanisms to rule out type 5 clitics. For Marantz, the problem with them is that they cannot fulfill their adjacency requirements. For Halpern, there is no reason, given their prosodic structure, for them to appear in that position. As mentioned above, even though I believe both theories are too restrictive, I am sympathetic to them. This is because, in developing my own account of preverbal 'a in Chechen, I will crucially invoke aspect of its prosodic “deviancy”.

Anticipating much of the discussion in the next section, it is worth pointing out here that an important aspect of my analysis of preverbal 'a will be treating it as a second-position enclitic in its prosodic domain. Specifically, I will argue that the template schematized in (180) is coextensive with a two-word prosodic constituent. If we, thus, recast the schema in (180) along the lines of what is given in (196), it becomes clear that preverbal 'a appears in second-position in such a prosodic phrase (simply labeled *phon phrase* in (196)).

(196) 'a: [[[] ___]_{phon word} [*verb*]]_{phon phrase}

The typology found in Klavans (1985), as well as the analyses in Marantz (1988) and Halpern (1995), deal with the syntactic placement of clitics—not the prosodic placement.

So, the fact that preverbal *'a* appears in second-position in a prosodic constituent does not alter its type 5 status. Preverbal *'a* is syntactically penultimate in its phrase, even if it is prosodically in second position.

In the analysis to be given below, I will not only claim that *'a* is in second-position of its prosodic domain, but I will further argue that the existence of the Chechen verb phrase template is, in fact, related to its prosodic second-position placement. It will, therefore, be treated in a way similar to the templatic analysis of Serbo-Croatian second-position clitics discussed in section 1.3.2 (page 65). The copy infinitive, in such an analysis, becomes one of the mechanisms which ensures preverbal *'a*'s second-position status.

What we see, here, is that a syntactically deviant clitic is not deviant prosodically. This, in some sense, can be taken to support the prosodic approach to clitics espoused by Zec and Inkelas (1990) since such an analysis for Chechen would allow us to subsume preverbal *'a* into a well-attested clitic type. It also suggests that, consistent with Marantz (1988) and Halpern (1995), there is something “bad” about type 5 clitics. Even in the most well-attested case of a type 5 clitic to date, the overall grammar of the language is such that the clitic is part of a template which ensures that it has prosodic second-position placement. In section 3.7.4.4 (page 370), this aspect of the template will come up again when I briefly discuss the idea that the Chechen verb phrase template represents, potentially, a “conspiracy” to keep the phonology and the syntax from deviating too strongly.

In the next section, I will develop my analysis of the Chechen verb phrase template and will show that it is consistent with the Strong Linearity Domain Hypothesis.

3.7 THE CHECHEN VERB PHRASE TEMPLATE AND THE STRONG LINEARITY DOMAIN HYPOTHESIS

3.7.1 Overview of argument

The purpose of this section is to show that the templatic properties of the Chechen verb phrase are consistent with the Strong Linearity Domain Hypothesis. The basic structure of the argument will be similar to the one presented in section 120 (page 229) where I analyzed the Bantu CAT template with respect to the Strong Linearity Domain Hypothesis. For convenience, I repeat the Strong Linearity Domain Hypothesis below in (197).

(197) **Strong Linearity Domain Hypothesis:** The boundaries of any strong linearity domain must be coextensive with a prosodic constituent, and its non-predictable linearity restrictions must be consistent with the characteristic phonology of that prosodic constituent.

As with the Bantu CAT case, there are several pieces to the argument that the Chechen verb phrase template is consistent with the Strong Linearity Domain Hypothesis. The first is establishing that the Chechen verb phrase does constitute a prosodic constituent. This is crucial in showing that the Chechen verb phrase template is consistent with the first restriction of the Strong Linearity Domain Hypothesis. This will be discussed in section 3.7.2 (page 347).

The next step in the argument will be a discussion as to what the characteristic phonology of the Chechen verb phrase is, which will be done in section 3.7.3 (page 351). Having

done those two things, in section 3.7.4 (page 360), it will be possible to show how the Chechen verb phrase template is consistent with the Strong Linearity Domain Hypothesis.

As with the Bantu case, it is important to make clear that the intention of this section is not to offer an account of all the properties of the Chechen verb phrase. Rather, the goal here is to account for its templatic properties—specifically the requirement that the host of preverbal *'a* be within the core verb phrase. Critically, as will be discussed in more detail in section 3.7.4 (page 360), the Strong Linearity Domain Hypothesis has nothing to say about why the “default” host is a copy infinitive, as opposed to some other dummy element, the form of the dummy element is not a strong linearity restriction—only its obligatory presence is. (However in section 3.7.4.5 (page 371) I will suggest a reason as to why the filler element is a copy infinitive.)

Generally speaking, the argument in this section will be less complicated than the argument for the Bantu template in section 2.7 (page 229). The main reason for this is fairly simple—the Chechen verb phrase is, comparatively speaking, a larger prosodic unit than the Bantu verb stem. Consistent with the Strong Linearity Domain Hypothesis, this means that it should have less complicated templatic restrictions since the characteristic phonology of larger prosodic units will always be less specific than that of smaller prosodic units, as discussed in section 1.2.4.3 (page 59).

3.7.2 The Chechen verb phrase as a prosodic constituent

In sentences showing basic SOV order, the verb and the word preceding it in Chechen certainly form a prosodic constituent on an impressionistic level. No thorough study has

been done of Chechen prosody generally. However, it is known that Chechen's prosody closely resembles that of Ingush and that at least one phonological rule affects the verb and immediately preceding constituent in standard, declarative sentences. Importantly, while I am only discussing here the prosodic constituency of the core verb phrase, I do not mean to imply that this stress pattern is only found in such constituents. Rather, I simply am discussing the evidence showing that the core verb phrase itself is, in fact, a prosodic constituent.²²

There is rule in Chechen which assigns a particular stress pattern to the verb and the preceding element. Specifically, the stressed syllable of the word preceding the verb is marked with a high pitch and the stressed syllable of the verb itself is marked with a low pitch.²³ Stress in Chechen is always assigned to first syllable of word. I will refer to the unit marked with these stresses as the core verb phrase prosodic constituent.

In (198) I give two examples of Chechen verb phrases where the verb and preceding element are marked for stress. An acute accent marks the occurrence of the high-pitch stress and a grave a low-pitch stress.

- (198) a. *Malika* [*dwá-jèdira*].
 Malika DX-J.run.WP
 "Malika ran away."
- b. *Ahwmad* [*óeghaz-vàghara*].
 Ahmed anger-V.go.WP
 "Ahmed got angry."

²² I am thankful to Johanna Nichols for providing most of the information found in this section.

²³ As will be mentioned below, an especially high pitch is marked on any element hosting 'a. The high pitch discussed here should not be conflated with this other focal high pitch.

One way to understand this pattern is that the verb and preceding element in sentences like those in (198) form a phonological phrase wherein the element preceding the verb receives a phrasal primary stress, marked with stress and a high pitch, and the verb itself receives a phrasal secondary stress, marked with stress and a low pitch. Relying on such an analysis isn't crucial—what's important to note from data like that in (198) is simply that the core verb phrase is part of a prosodic constituent in standard, declarative sentences.

The addition of other elements to the core verb phrase can affect the prosodic constituency of the verb phrase in various ways. For example, the preverbal enclitic *'a* causes the vowel preceding it to be realized with a high tone. This is marked in (199) on the two preverbal deictic elements. This high tone is similar to the high stress, but perceptually somewhat higher, and it can appear on a non-stressed syllable. No detailed study has been made of this high tone (though it is reported for Ingush in Peterson (2001:144))—which is found in some other cases, notably before the proclitic *ma*.

- (199) *Maliika loomax* [hwál 'a jèelara] [óhwa 'a jòessara].
 Malika mountain.LAT up & J.ascend.WP down & J.descend.WP
 “Malika climbed up and down the mountain.”

Clearly the *'a* in an example like that in (199) affects the prosodic structure of the core verb phrase in Chechen. However, perceptually the *X'a V* unit is still set off from the other elements in the sentence and, something similar to the high-low stress pattern can be observed. Thus, while the internal prosody of a verb phrase containing preverbal *'a* may be somewhat different from a verb phrase without it, the host of *'a* and the following verb still form a prosodic constituent.

Importantly, this core verb phrase prosodic constituent is always “small” insofar as expanding the verb phrase does not expand the constituent—which always consists of the verb and the element directly preceding it. Thus, for example, in a sentence like (173), repeated below in (200), the prosodic constituent described above consists only of the copy infinitive and following verb.

(200) *Maliikina Ahwmad [ga 'a gira] Mariam [xaza 'a xezara].*
 Malika.DAT Ahmed see.INF & see.WP Mary hear.INF & hear.WP
 “Malika saw Ahmed and heard Mary.”

The copy infinitives in (200) are not obligatory insofar as both the verb phrases containing preverbal *'a* have objects which could serve as host. However, the inclusion of the copy infinitive changes the prosodic structure of the verb phrase, and it then serves as the first element in the core verb phrase prosodic constituent.

In (152) a characterization of the core verb phrase was given along syntactic lines. In this section, we have seen that it can also be characterized along prosodic lines. Critically, when we characterize it this way, the word immediately preceding the verb is part of the core verb phrase—this is exactly the syntactic unit which is a host for *'a*.

The data in this section shows that the Chechen verb phrase template is coextensive with a prosodic constituent which means that it satisfies the first condition of the Strong Linearity Domain Hypothesis.

3.7.3 The characteristic phonology of the Chechen verb phrase

3.7.3.1 The basic schema

Having established the existence of a core verb phrase prosodic constituent in Chechen, the next step in showing that the Chechen verb phrase template is consistent with the Strong Linearity Domain Hypothesis is to establish the characteristic phonology of this prosodic constituent, which I take to follow the schema given in (201).

(201) $[[w\acute{o}rd][w\grave{o}rd]]$

The schema in (201) is intended to encode the fact that the characteristic phonology of the Chechen verb phrase is that it is two words, the first with a high pitch and the second one with a low pitch. As an abbreviation in this section, I will refer to this schema as “2W” (for two words) since, under the present analysis, the two-word restriction is the important aspect of the characteristic phonology, and I won’t be relying on the aspects of the pitch of the prosodic constituent in any way.

The schema in (201) corresponds to the prosodic unit for the verb phrase described in section 3.7.2 (page 347). Like the Bantu case where certain verb stems could be well-formed, but still violate the characteristic phonology of the Bantu verb stem as described, not all Chechen verb phrases will perfectly match the 2W schema.

Importantly, the 2W schema is for a prosodic “core verb phrase” constituent, and not for any syntactic constituent. Elements of the syntactic verb phrase other than the verb and the constituent preceding it are not part of this constituent and will form separate phonological constituents. These might, in fact, take on the same form as the 2W schema. However, for

our purposes, the most important fact is that the verb and the word immediately preceding it generally form a 2W prosodic constituent. This constituent is the locus of the Chechen verb phrase template.

3.7.3.2 The basic schema and verb phrase types

In (202) I repeat the examples given in (145) illustrating the four verb phrase prototypes discussed earlier for Chechen. The verb phrases are bolded in the examples.

- (202) a. *So voelu.*
 1s V.laugh.PRS
 “I am laughing.”
- b. *Malika dwa-jedira.*
 Malika DX-J.run.WP
 “Malika ran away.”
- c. *Ahwmad oeghaz-vaghara.*
 Ahmed anger-V.go.WP
 “Ahmed got angry.”
- d. *Ahwmadna Maliika gira.*
 Ahmed.DAT Malika see.WP
 “Ahmed saw Malika.”

Of the four verb types exemplified in (202), the first case, that of the simplex intransitive verb phrase, as exemplified in (202a), strongly violates the 2W schema for the core verb phrase prosodic constituent. This is because it consists of just one word—the verb—when I’ve claimed that the characteristic phonology of the Chechen verb phrase is two words. This is not to say that the sentence in (202a) cannot be parsed prosodically. In fact, it can show the same high-low stress pattern associated with the core verb phrase with high pitch on the subject and low pitch on the verb. What is important here, however, is the fact that

the sentence violates the characteristic phonology of the prosodic constituent prototypically associated with the core verb phrase. Because of this, later on in this section, I will characterize the verb phrase in sentences like the one in (202) as subminimal.

The sentence in (202b) also violates the characteristic phonology of the core verb phrase prosodic constituent, since the verb phrase does not clearly consist of two words, but it is less deviant than (202a) since the verb does consist of two elements—though the first is probably better characterized as a proclitic than a proper phonological word since impressionistically it forms a tighter phonological unit with the verb than a full object does.

In the case of (202c), the verb phrase doesn't contain what might be clearly considered to be two syntactic words, since the element *oeghaz* isn't observed to stand on its own in any context and only occurs in collocation with the verb 'go'. However, *oeghaz* is not a clitic and, thus, the verb phrase *oeghaz-vaghara* can be easily understood as consisting of two phonological words.

Finally, of the four sentences, (202d) most clearly conforms to the 2W schema.

There's an obvious issue here that there are many verb phrases which, to a lesser or greater extent, do not conform to the characteristic phonology of the Chechen verb stem as described. As mentioned above, something like this was seen in chapter 2 insofar as there are subminimal CV roots in many Bantu languages when the characteristic phonology of the verb root was taken to be CVC. There are various ways to understand what a characteristic phonology is. Two useful ones are that it is a prototypical phonology or an unmarked phonology. Importantly, since the notion of characteristic phonology is in-

tended to be constraint-like, rather than rule-like, it should be violable. Therefore, the idea that some constituents in a language violate their characteristic phonology is not inherently problematic.

In the following discussion, first I will point out that verb phrases deviating from the 2W schema are less common than they might seem to be at first, due to the nature of the Chechen verbal paradigm and of verbal derivation. Then, in section 3.7.3.3 (page 356), I will discuss how the exceptional cases fit into the broader picture of the Chechen verb phrase.

The examples given to this point have contained verbs in non-periphrastic tenses. It is important to note, however, that periphrastic progressive and perfect tenses are quite common in Chechen and take the form of a simultaneous or past participle followed by an inflected form of the verb *du* ‘to be’. Examples are given in (203).

- (203) a. *Ahwmad ch'aara uecush vu, t'q'a Mariam cicig uecush ju.*
 Ahmed fish buy:CVSIM V:be:PRS and Mary:ERG cat buy:CVSIM J:be:PRS
 “Ahmed is buying a fish, and Mary is buying a cat.”
- b. *Ahwmad c'a vallalie, irs dolush vara.*
 Ahmed house V.come.CVPOST happiness D.be:CVSIM V.be.WP
 “Before Ahmed got home, he was happy.”
- c. *Mariam cicigash iacna ju.*
 Mary cat.PL buy.CVANT J.be.PRS
 “Mary has bought cats.”

In (203a) two examples of the periphrastic present progressive verb forms are given, in (203b) a past progressive tense is given, and in (203c) an example of the perfect is given. These periphrastic tenses automatically match the 2W schema by virtue of their *participle+verb* syntax.

Similarly, it is worthwhile to point out that some of the most productive processes of verbal derivation in Chechen create verb phrases which will match the 2W schema. Verbal compounding where any one of a number of auxiliary verbs is preceded by a non-verbal element is common and examples are given in (204).

(204)

VERB	GLOSS	TRANSLATION
<i>maaxa tuuxu</i>	'needle hit'	"inject"
<i>doogha tuuxu</i>	'lock hit'	"lock"
<i>dog dooghu</i>	'heart come'	"be inclined"
<i>mohw hwoqu</i>	'cry smear'	"cry, shout"
<i>kyygie doedu</i>	'hand.ALL go'	"make peace"

Compounding of the sort exemplified in (204) always produces verb forms which follow the 2W schema.

In addition to compounds, there are at least two productive derivational processes in Chechen which make use of auxiliary verbs following other verbs. These involve *lo* 'give' and *do* 'do' which can be used to form inceptive and causative verbs respectively. Similar to periphrastic tenses/aspects, derived verbs marked with these auxiliaries will always be consistent with the 2W schema.

What these facts show is that, while there certainly are exceptions to the schema given for the characteristic phonology of the Chechen verb phrase, there are productive aspects of verb/verb-phrase derivation create verb phrases which do match the schema. On the whole, then, a listing of the prototypical types of verb phrases in Chechen, as seen in (202), is somewhat misleading with respect to gaining an understanding of how often the characteristic 2W phonology of the verb stem is violated. The periphrastic tenses/aspects

associated with the paradigms of every verb always match the 2W schema, and some very common strategies for producing new verbs create forms which also obey it.

3.7.3.3 Verb-phrase minimality and the exceptional cases

While it may be the case that most verb phrases in Chechen fit, more or less, into the schema in (201), it is still important to understand how the exceptional verb phrases fit into the general analysis. Though the structure of the verb phrase is generally considered to be the domain of syntactic analysis, I would like to suggest that the best way to understand these verb phrases is to appeal to devices developed to deal with phonological exceptional-ity at the level of the stem/root. In particular, I will draw parallels with the notion of stem minimality effects.

We already encountered certain types of minimality effects in the discussion of the Bantu verb stem in chapter 2, specifically in section 2.7.3.2 (page 235). A more general discussion of minimality constraints can be found in McCarthy and Prince (1993:45–8). In the Bantu case, we observed an overwhelming tendency for roots to be of the form CVC, which in turn implied that stems would be of the form CVCV, but there are some roots reconstructed for the family of form CV, and some roots in the present-day languages of form C. These exhibit various effects which have been attributed to their “subminimal” size.

For example, Hyman et al. (1998:10) report that in Ndebele the imperative form of the verb is typically just the bare verb stem. However, subminimal C roots are prefixed with *yi-* in the imperative as seen in the data in (205). (Just as in chapter 2, the glossing abbreviation

FV stands for final vowel in (205); the parenthesized letters after some of the verb forms refer to their tone class.)

(205)	IMPERATIVE	GLOSS	TRANSLATION
	<i>lim-a</i>	'cultivate-FV	'cultivate!'
	<i>bamb-a</i>	'catch-FV	'catch!'
	<i>thum-a</i> (H)	'send-FV	'send!'
	<i>nambith-a</i> (H)	'taste-FV'	'taste!'
	<i>yi-dl-a</i> (H) (* <i>dl-a</i>)	'YI-eat-FV'	'eat!'
	<i>yi-lw-a</i> (H/L) (* <i>lw-a</i>)	'YI-fight-FV'	'fight!'
	<i>yi-m-a</i> (H) (* <i>m-a</i>)	'YI-stand-FV'	'stand!'
	<i>yi-z-a</i> (H/L) (* <i>z-a</i>)	'YI-come-FV'	'come!'

In (205) the forms in the first half of the table all have at least CVC roots and show regular imperative formation. The forms in the lower half of the table are all C roots and form their imperative with the addition of the regular final vowel and a *yi-* prefix which is not associated with any particular meaning but which does help enforce a disyllabic minimal size constraint on surfacing Bantu verb forms. The forms in (205) are similar to those seen for Swazi reduplication in (126), and, in fact, Ndebele shows similar effects in reduplication.

Hyman et al. (1998) formalize this prosodic restriction on Ndebele imperatives via a templatic constraint on the prosodic word in Ndebele as seen in (206). (The “ σ ” in (206) is an abbreviation for ‘syllable’.)

(206) Minimal Prosodic word = [σ σ]_{foot}

As mentioned above, minimality restrictions like the one schematized in (206) are not uncommon. We can imagine various ways in which they could be reflected in surface forms

of a given language. In the Ndebele case, apparently “dummy” phonological material is affixed to the verb root. In Turkish, Inkelas and Orgun (1995:769–73) have observed that a comparable disyllabic restriction can result in certain morphological forms simply being impossible to produce in any grammatical way.

The Turkish case, furthermore, illustrates an important phenomenon not seen in the Ndebele. In Ndebele the C stems simply never surface without being in forms at least two syllables long. In Turkish, on the other hand, monosyllabic forms can surface in isolation but cannot surface when a suffix appears on them for at least one dialect of speakers from Istanbul. The data in (207), taken from Inkelas and Orgun (1995), illustrates this restriction.

(207)

WORD	GLOSS	TRANSLATION
<i>fa</i>	‘fa_note’	‘fa note’
<i>be</i>	‘b_letter’	‘letter B’
* <i>fa-m</i>	‘fa_note-1SG.POSS’	intended: ‘my fa’
* <i>be-m</i>	‘b_letter-1SG.POSS’	intended: ‘my be’
<i>fa-mız</i>	‘fa_note-1PL.POSS’	‘our fa’
<i>be-ler</i>	‘b_letter-PL’	‘B’s’

The data in (207) shows that, for some speakers, CV roots with a short vowel can grammatically surface in isolation in Turkish. These same speakers, however, judge as ungrammatical forms suffixed with just a consonant suffix which are not two syllables. However, this is clearly not a semantic restriction since forms with very similar meaning are judged grammatical when the suffix consists of a whole syllable and the surfacing form has, therefore, two syllables.

Inkelas and Orgun (1998) analyze the data in (207) by assuming that non-derived forms in Turkish can violate minimality constraints but derived forms cannot. Therefore, it’s

ungrammatical to suffix just a consonantal suffix to a CV root even though that root can surface in isolation.

In the next section, I will suggest that the Chechen template is analogous to the Bantu and Turkish minimality restrictions just described. Like Turkish and Bantu, there is a minimality restriction in Chechen—though at the level of the phrase, not the word. Furthermore, it's a two-unit restriction, though a two-word restriction, not a two-syllable one. Like Bantu, Chechen exhibits a repair strategy—in the form of the appearance of copy infinitives—for subminimal verb phrases. However, like Turkish, the minimality restriction is only imposed for derived environments—verb phrases containing preverbal *'a*.

This is merely a sketch of an appropriate analysis of the Chechen verb phrase template which I will pursue in more detail shortly. At this point, the main idea to be taken from this discussion of minimality restrictions is that it is not unprecedented for the characteristic phonology of a constituent to be a violable feature of that constituent. Furthermore, making the sensible assumption that the minimality restrictions of Bantu and Turkish verb roots are part of their characteristic phonology, we specifically see that both languages contain “subminimal” roots which don't meet the restrictions of their characteristic phonology.

In phonology the existence of such roots has not been taken to invalidate the general phonological template proposed for roots in Bantu or Turkish. Similarly, even though in Chechen there are verb phrases not meeting the 2W restriction, this does not immediately imply there is something infelicitous about positing the 2W restriction for the characteristic phonology of the verb phrase.

For the Bantu and Turkish cases, there was morphophonological evidence that the minimality restrictions were active in those languages. In the Chechen case, I will argue in the next section that copy infinitive are parallel evidence for minimality restrictions in the verb phrase.

3.7.4 Applying the Strong Linearity Domain Hypothesis to the Chechen verb phrase template

3.7.4.1 The description of the verb phrase template

In (180) I gave an initial schema for the core verb phrase template in Chechen. In (208) I give the one that I will be assuming in the analysis below. Since preverbal *'a* triggers the templatic effect, it is incorporated directly into the schema.

(208) [[... = 'a]_{Word} []_{Word}]

Since the template consists just of the word following *'a* and the word before it, it is coextensive with the core verb phrase prosodic constituent described in section 3.7.2 (page 347)—thus, this template is consistent with the first stipulation of the Strong Linearity Domain Hypothesis. As with the other templates being proposed here, this one leaves out information which is relevant for the construction but not needed as part of the template. In this case, the template does not encode that *'a* appears in a verb phrase, as opposed to some other two-word unit, for example. This is taken to be a predictable aspect of the syntax of the clitic and is, thus, not encoded in the template.

In a way similar to Zec and Inkelas's (1990) analysis of Serbo-Croatian clitics discussed in section 1.3.2 (page 65), this template can be understood, in some sense, as a particular subcategorization frame for preverbal *'a*. This subcategorization frame constitutes a strong linearity domain since it requires that the "slot" before preverbal *'a* be filled. That is, it stipulates an unpredictable linearity relation with respect to some linguistic constituent. I refer to the schema in (208) as a template generally, rather than a subcategorization frame, since, as we shall see, I shall suggest that some of its features derive from *'a*'s status as a type 5 clitic. As such, I take some of the aspects of the template not to be associated specifically with *'a*, but rather its prosodic status, even though this is not clearly encoded in the schema. The obvious prediction of such an analysis is that, if there were any other type 5 clitics in Chechen, they would show similar behavior to preverbal *'a*. This prediction is, of course, not testable since preverbal *'a* is the only known type 5 clitic in the language. Because of this, little rests on my choice to characterize the schema in (208) as a template rather than the more narrow idea of a subcategorization frame.

The template in (208) is deliberately non-specific about how it is fulfilled. Preverbal *'a* needs to be preceded by some element in the verb phrase such that the prosodic constituent of it with its host is a phonological word. Exactly what is meant by this will be discussed in more detail below. First, I want to point out that most of the template is straightforwardly consistent with the characteristic phonology of the core verb phrase prosodic constituent. As discussed in section 3.7.3 (page 351), its characteristic phonology was taken to be "2W", that is two phonological words. The aspect of the template in (208) which strictly enforces

a two-word requirement on Chechen verb phrases containing 'a is, thus, trivially consistent with the second condition of the Strong Linearity Domain Hypothesis.²⁴

For the Chechen template to be consistent with the Strong Linearity Domain Hypothesis, it is important that there is very little restriction on the host of 'a. The only restriction put on it is that it must be within a particular syntactic constituent—a stipulation on its constituency, not its form. If there were any additional phonological restrictions on the host of 'a (for example, that it had to be, say, two syllables) this would almost certainly violate the second stipulation of the Strong Linearity Domain Hypothesis, depending on the precise nature of the restrictions. Furthermore, any restriction on the “internal” morphosyntactic features (like its part of speech, for example) of 'a's host would certainly violate the Strong Linearity Domain Hypothesis since there is no way for a morphosyntactic feature to be part of some prosodic constituent's characteristic *phonology*.

A final point with respect to (208) is that, while 'a is placed directly within the template for expository purposes, if we understood its phonological content to be part of the templatic restriction, it would clearly violate the Strong Linearity Domain Hypothesis. There is no obvious way that specifying the necessity of a formative with such a particular phonological shape would be consistent with the characteristic phonology of the core verb phrase

²⁴ In the case study of Saramaccan serial verb phrases in chapter 4, we will see that all aspects of the template trivially satisfy the consistency condition of the Strong Linearity Domain Hypothesis. Recall that, as discussed in section 1.2.3.2 (page 47) in chapter 1, the core idea of trivially satisfying the consistency condition is that the templatic requirements of some construction only refer to the basic prosodic subconstituents of the prosodic constituent coextensive with the relevant strong linearity domain. In this way, trivial satisfaction of the consistency condition is very similar to the restriction of the Prosodic Morphology Hypothesis, discussed in section 1.2.4.2 (page 57) in chapter 1, that all morphophonological restrictions be directly stated in terms of the prosodic hierarchy. This suggests that there might be some general tendency for templatic restrictions to refer only generally to elements of a language's prosodic hierarchy and that, perhaps, more elaborate templatic restrictions, like those discussed for Bantu in chapter 2 are fairly rare.

prosodic constituent.

In section 3.7.4.3 (page 366), I will discuss the specific role that 'a has in the template. In particular, as mentioned above, its status as an enclitic will be taken to be its critical role in the template here—not its segmental form. In that section, I will discuss how referring only to this property of 'a alone allows the Chechen template to satisfy the consistency condition of the Strong Linearity Domain Hypothesis. In the next section, I will discuss the status of the proclitic+'a combination for the analysis given here.

3.7.4.2 The proclitic+'a combination

While the template in (208) is clearly broadly consistent with the Strong Linearity Domain Hypothesis, there are still some details that need to be worked out. One of these relates to how structures like the one in (209a), repeated from (161b), fit into the template when compared to ones like those in (209b), repeated from (161d).

- (209) a. *Maliikas Ahwmadna zheina* [[*dwa 'a*] *della,*] *dwa-jaghara.*
 Malika.ERG Ahmed.DAT book DX & D.give.WP DX-J.go.WP
 “Malika gave the book back to Ahmed and left.”
- b. *Ahwmad,* [[*zhwala 'a*] *iacna,*] *vilxira.*
 Ahmed dog & buy.CVANT V.cry.WP
 “Ahmed bought a dog and cried.”

In the sentences in (209), I have bracketed the elements which fill out the template schematized in (208). While I have not discussed it in much detail, the deictic element which is the host for 'a in sentences like those in (209a) is impressionistically proclitic to the verb. To fulfill the template, it is necessary to understand the proclitic+'a combination as a phonological word. In a sentence like (209b), on the other hand, the combination

object+'*a* is straightforwardly considered a phonological word since the host of '*a* is an independent word in its own right.

Fortunately, it is not particularly problematic to consider the combination proclitic+'*a* a phonological word. Prosodically it is clearly perceived as independent from the following verb, unlike the combination of deictic element+verb without '*a*, which is impressionistically one unit. This fact is reflected in the orthography where deictic proclitic and the following verb are typically written as one word. However, when '*a* intervenes between the proclitic and the word there are three orthographic words—the proclitic, '*a*, and the verb.

This can be seen in the sentences in (210) which were taken from a fragment of a text found online given in (210a) in the original Cyrillic transcription.²⁵ In this excerpt, two sentences, both italicized and in close proximity to each other, illustrate this orthographic convention. The first sentence contains the bolded orthographic form which, here, would be transcribed as *dwa 'a vaxana* 'DX & V.go.CVANT', where the deictic prefix is written as a separate word. The second sentence contains the orthographic form *dwavaxcha* 'DX.V.go.CVTEMP' which is a temporal converb form of the first verb. Preverbal '*a* does not appear in this clause and the form is written as one word. The glosses for the two relevant sentences appear in (210b) and (210c) following the text excerpt.

²⁵ The fragment, from a short text entitled "Doxk" (which means 'fog'), was found at:
<http://orga.narod.ru/folklor/c502.htm>
 Johanna Nichols assisted in the analysis of these sentences.

- (210) a. *Чечанхоcho дийцина: лаха д1а а вaxана, аьрру аг1ор д1а ма-хъевзинна*
бу а хьуна и некъ аьлла Г1ойт1апхоcho шена и карор бац, ван а болий
айхъара и некъ аьлла дехна цуьнга. “Доккха х1ума ду-кх шега
дуйцучух ца хетап” —бохуш, г1ам-г1ам а деш, хьалха а ваьлла, некъ
гайта веана чечанхо.
- Жимма д1аваxча, юха а вирзина, чечанихоcho шаьттина, вайциъ*
мичахъ ву аьлла.

- b. *Cheechanxuochuo diicina: laqa dwa 'a vaxana*
 Cheechan_man.ERG Dsay.CVANT up DX & V.go.CVANT
aerru aaghuor dwa ma-hweuzzina bu hwuuna
 left crooked DX &sim-turn.GEM.CVANT B.be.PRS 2s.DAT
niaq' aella.
 road QUOT
 “The man from Cheechan said, ‘When you get up there, the road turns off to the left.’”
- c. *Zhimma dwavaxcha, juxa 'a virzina,*
 little_bit DX.V.go.CVTEMP back & V.turn.CVANT.
cheechanxuochuo xaettina, vaishi' michahw vu aella.
 Cheechan_man.ERG ask.CVANT Ipi.two at_where V.be.PRS QUOT
 “The man from Cheechan went a bit further, then turned around and said, ‘Where are we?’” (Or: “They went a bit further, and then the man from Cheechan turned around and said, ‘Where are we?’”

This general orthographic convention has been partially followed in the examples here, and I take it as fairly good evidence that there is a prosodic difference between the proclitics followed by 'a which gives them the characteristics of phonological words.

Deictic proclitics, like *dwa*, are the preverbal elements which are the least word-like in their phonology. To the extent that, when followed by 'a, the combination has the prosody

of a phonological word, it should not be surprising that when the other preverbal elements, such as incorporated nouns, are followed by 'a, they also take on the prosodic characteristics of phonological words. What this means then is that, even in the potentially marginal cases where the host of 'a is a proclitic or some other partially dependent element, the template is fulfilled.

3.7.4.3 Subminimal verb phrases and the template

The final area to cover, with respect to the Chechen template and the Strong Linearity Domain Hypothesis is the fact that the template is conditioned by preverbal 'a. As mentioned above, in section 3.7.3.3 (page 356), I take the template in (208) to be akin to a minimality restriction at the phrasal level which is only obligatorily enforced in a derived environment.

The inspiration for this analysis is from analyses of minimality restriction in Bantu and Turkish verb roots. Bantu data, like that in (205) shows the use of phonological “filler” material so that a verb stem can meet its minimality requirements, and the Turkish data shows that minimality requirements are, in some cases, only enforced in derived environments.

To understand the analysis I give for Chechen, it is instructive to look at the schematization in (211) of the role of minimality in deciding the grammaticality of Turkish forms, adapted from Inkelas and Orgun (1998:366).

(211)

MORPH	PHON	'unripe'	'fa-1SG.POSS'	'1PL.POSS'
UR	—	<i>ham</i>	<i>fa-m</i>	<i>fa-mız</i>
Poss.	$[\sigma\sigma]$	—	<i>*fam</i>	<i>famız</i>
Word	stress	<i>hám</i>		<i>famíz</i>

The basic idea expressed by the table in (211) is that there is a discernible morphological constituent consisting of a word and the possessive suffix and that this constituent is subject to a two-syllable minimality restriction (abbreviated with sigma’s in the column labeled “phonology”). A monomorphemic word like *ham* ‘unripe’, despite being segmentally very similar to **fam* ‘fa-1SG.POSS’ is not subject to this restriction since it is not a constituent marked with a possessive suffix. The form *fa-muz* ‘fa-1PL.POSS’ is grammatical since it meets the two-syllable requirement.

If we apply this idea to Chechen, we could schematize Chechen verb phrases along the lines seen in the table in (212).

(212)

MORPH	PHON	‘laugh.PRS’	‘& laugh.WP’	‘laugh.INF & laugh.WP’
UR	—	<i>voelu</i>	<i>’a viilara</i>	<i>viela ’a viilara</i>
Core VP	[WW]	—	*[[=’a] [viilara]]	[[viela=’a] [viilara]]
Phrase	pitch	[vòelu]		[[v’iela=’a] [viilara]]

In (212) I give three “derivations” for verb phrases headed by a form of the verb *diela* ‘laugh’. The first verb phrase, simply consisting of one word *voelu* ‘v.laugh.PRS’, is taken from sentence (202a). While it does not meet the 2W restriction of the core verb phrase, it is taken not subject to this requirement, being an “underived” verb phrase, and it is grammatical.²⁶ The second verb phrase is ungrammatical since it is a subminimal verb phrase without a host for *’a* but containing *’a*. The final verb phrase *viela ’a viilara* ‘laugh.INF & laugh.WP’, seen in (175), contains a copy infinitive which allows it to both contain *’a* and fulfill the two-word prosodic requirement, and it is, thus, grammatical.

²⁶ Allowing such prosodically underived verb phrases to be subminimal in this way is taken to be specific to Chechen. Should comparable restrictions in other languages be found, various other patterns are imaginable. For example, one could imagine a language where some dummy element would be generally inserted in all subminimal phrases not just prosodically derived ones.

Under this analysis, the Chechen verb phrase is showing something which can essentially be labeled a Non-derived Environment Blocking (NDEB) Effect (Kiparsky (1993), Inkelas (2000)). That is, a non-derived form is not subject to restrictions which a derived form is subject to. The existence of such effects has been already noted in small phonological domains. The main innovation here is to invoke their existence at the level of the phonological phrase. If this is a valid application of this theoretical notion, it raises a question as to how to formalize NDEB effects generally. Work in this area has focused on word-level effects, not phrase-level effects (see Inkelas (2000) for a recent overview). And, from an analytical perspective, it has often made critical use of how structure is specified in lexical items. It is not immediately clear whether such analyses could be extended to the specification of phrasal structure given the traditional lexical/phrasal distinction often exploited in phonological theory. However, there has been work (Hayes (1990), Odden (1990)) which has questioned this division, and, for now, it would seem to be an open question as to whether or not the proposed NDEB effect seen here could be easily integrated into more general theories of such effects.

Given my invocation of NDEB effects, a natural question that arises from this analysis is whether or not there is a good account for the exactly how *'a* makes the verb phrase environment “derived”. There is no predetermined response to this since the arguments presented here are the first that I am aware of to invoke the notion of Non-derived Environment Blocking in the syntax. However, I believe the answer to this lies in the enclitic nature of preverbal *'a*.

Here, the contrast between the proclitic *ma* which does not force its verb phrase to be subject to the 2W restriction (by not forcing the appearance of a copy infinitive as illustrated in (171)) and preverbal *'a* is instructive. The proclitic status of *ma* is such that its host is the main verb of the verb phrase. In this sense, it extends the phonological structure of the head word of the phrase. The enclitic status of *'a*, on the other hand, means that it phonologically must be part of the word which precedes the head verb and, thereby, implies the existence of such a word.

In this sense, at the level of the core verb phrase prosodic constituent, enclitic *'a* adds prosodic structure to the verb phrase while proclitic *ma* merely extends preexisting prosodic structure. I take *'a*'s extension of the prosodic structure to create the relevant derived environment—which thereby makes a verb phrase containing it subject to the 2W restriction. A verb phrase containing *ma*, on the other hand, does not create any new prosodic structure, and the core verb phrase prosodic constituent retains its original form, with subsequent Non-derived Environment Blocking.

Importantly, this phonologically-driven explanation for the templatic effect is not a complete explanation for the template. Its purpose here is to support the idea that the template is consistent with the characteristic phonology of the core verb phrase prosodic constituent by pointing out a parallel between minimality effects within it and comparable phonological effects found elsewhere.

No matter how much phonology can be used to help explain features of the template, there is no way to escape the fact that only an element in the core verb phrase can serve

as the host for *'a*. However, given this, we can see that this template follows the Strong Linearity Domain Hypothesis insofar as it is coextensive with a prosodic constituent and its restrictions can be argued to be consistent with the characteristic phonology of that constituent—even given the fact that some verb phrases in Chechen are subminimal.

A final point to be made about subminimal verb phrases is that it is not the domain of the Strong Linearity Domain Hypothesis to explain why a copy infinitive is the chosen element to fill out the template. This is because the infinitive shows a morphosyntactic correspondence with the head of the verb phrase and not a phonological correspondence (as discussed in Conathan and Good (2001)). If the correspondence were phonological, we might need to deem it part of the strong linearity restrictions of the constructions and explain it as an aspect of the characteristic phonology of the construction. However, since the correspondence is morphosyntactic, we will need to appeal to a different device to explain its form. In the section 3.7.4.5 (page 371), however, I will suggest a possible reason, outside of the Strong Linearity Domain Hypothesis, as to why the filler element is an infinitive. In the next section, I will discuss the idea that there is a “conspiracy” in Chechen to keep the type 5 clitic from being too deviant syntactically.

3.7.4.4 A potential conspiracy

As mentioned in section 3.6 (page 332), it has not escaped my attention that the precise place where we, somewhat surprisingly, find a syntactic position-class template is also where we find a typologically deviant clitic.

Within the scope of the present work, Chechen verb phrases containing *'a* are strong

linearity domains insofar as they are marked for having to have material preceding 'a within the core verb phrase. This strong linearity domain, however, could be understood as being part of a “conspiracy” to keep the type 5 clitic from showing phonological behavior which deviates too strongly from its syntactic behavior. Specifically, its templatic requirements ensure that its phonological host is as close to its syntactic host as possible given its positional restrictions. Additionally, as discussed in section 3.6 (page 332), the preverbal 'a appears in second position of its prosodic phrase. So, the template also has a role in creating an environment where 'a behaves like clitics of a well-attested type.

The template for preverbal 'a, therefore, suggests some principle wherein a template can be employed to minimize clashes between phonology and syntax. I will not explore this idea here since developing a theory as to how such a principle would operate is well beyond the scope of this work. However, such a principle, if it were generally true, would be an interesting complementary generalization about templates in order to further refine the theory of templates encoded in the Strong Linearity Domain Hypothesis.

3.7.4.5 Why a copy *infinitive*

A final issue I would like to take up here is a possible explanation as to why the filler element is a infinitive instead of some other syntactic element. I won't address this issue in detail. However, I would like to suggest that it is not coincidental that copy infinitives are not only filler elements but are also found in focus constructions.

For example, in (213), repeated from (173), we see a focal use of the copy infinitive. The absolutive objects of the two conjoined verb phrases could host preverbal 'a. However,

instead, copy infinitives are used to contrast the verbs in the two conjoined verb phrases.²⁷

- (213) *Maliikina Ahwmad ga 'a gira Mariam xaza 'a xezara.*
 Malika.DAT Ahmed see.INF & see.WP Mary hear.INF & hear.WP
 “Malika saw Ahmed and heard Mary.”

On a purely synchronic level, I'd like to propose an analysis where the copy infinitive is employed as a filler element because a copy infinitive construction is already available in the grammar. It is difficult to imagine the precise nature of the grammatical principles which would need to be invoked to explain this sort of constructional borrowing. However, they could be related to a principle, suggested by Polinsky (1998) to explain a similar fact in English grammar.²⁸

The data in (214) and (215), taken from Polinsky (1998:408), illustrates some parallel facts regarding object asymmetries in English *wh*-questions and relative clauses.

- (214) a. What did John give Mary?

²⁷ Another possible analysis that *Ahwmad* and *Mariam* are contrastively focused, thereby altering the prosodic constituency of (213) in a way which forces the appearance of the copy infinitive because those two natural objects are not available to fulfill the template. I reject this analysis because, under such a reading, I would expect focal *'a* to mark the objects directly. Such a sentence would be (at least in print) indistinguishable from one containing preverbal *'a*. However, consultants have reported that, in sentences containing preverbal *'a*, the focal reading of *'a* is also available, although not the default reading.

²⁸ A similar line of reasoning, within a different area of grammar, could treat the copy infinitive as a phrasally reduplicated form. Such a treatment is implied in Peterson (2001) who uses the term “reduplicant” to describe Ingush’s version of the copy infinitive. This is more warranted for Ingush than Chechen where the copy verb is actually a copy of the stem of the head verb of the phrase and not necessarily an infinitive stem. Such an analysis for Chechen wouldn’t involve *constructional* “borrowing” but, instead, morphological “borrowing”. That is, the filler material would be “copied” from some other prominent material in the verb phrase—in this case, the verbal head of the phrase. Such a line of reasoning is pursued in Conathan and Good (2001). (Conathan and Good (2001) give arguments as to why a reduplication for the Chechen copy infinitive is better understood via morphological over phonological correspondence between the copy infinitive and the head verb.) Both the constructional borrowing and reduplication analyses suggest that the copy infinitive is somehow derivative of some other aspect of Chechen grammar, either an independently motivated construction or copying of material from the head of the verb phrase to the empty slot in the verb phrase. In fact, both analyses are largely compatible. If we understood the focal use of the copy infinitive to be an instance of (pragmatically) meaningful reduplication, then its extension, via constructional borrowing, as a filler element could also be considered a case of reduplication—the difference being that the reduplicant would no longer be associated with any particular meaning.

b. ?/*Who did John give a book?

(215) a. the candy that John gave the little girl

b. ?/*the little girl that John gave (the) candy

The data in (214) and (215) is intended to illustrate that, in English double object constructions, there is a preference both for *wh*-questions and relativization on the patient as opposed to the recipient. While some speakers might accept all the structures in (214) and (215), Polinsky (1998) claims that no speaker who accepts questions and relatives formed on the recipient will not also accept questions and relatives formed on the patient.

Polinsky (1998:416) explains the data in (214) by invoking the fact that *wh*-questions are focus constructions and that, generally, in double object constructions, “the patient is superior to the recipient in focusing . . .”.²⁹ Thus, a *wh*-question on the patient is expected to be better than one on the recipient.

For our purposes, the exact nature of Polinsky’s account of these English phenomena is not critical—the main point to take from it is that she invokes a more general principle (focus effects) to account for it. What is of interest here is how she accounts for the comparable effects found in relative clauses. According to Polinsky (1998:416) relativization, “is patterned after Wh-word licensing for a purely formal reason—most relative pronouns in English are related to Wh-words.”

²⁹ This generalization is related to the fact that the recipient tends to be a human and the patient non-human. Since humans are generally likely to be topics and inanimates are generally likely to be in focus, an asymmetry where patients are more easily focused than recipients, along the lines of that suggested by the data in (214) and (215) is not unexpected.

The principle Polinsky invokes, then, to account for the relativization facts in (215) is, roughly speaking, one of synchronic constructional analogy: Formally similar constructions in the same language will show similar behavior.

While the case of the Chechen copy infinitive is not precisely the same as the English double object construction, we could invoke the notion of synchronic constructional analogy there as well. Specifically, the copy-infinitive focus construction employs focal *'a*, and, while preverbal *'a* is not the same as focal *'a*, it is formally similar. Chechen, thus, employs a construction associated with focal *'a* to fill out the template required by preverbal *'a*.

The above argument is a sketch of a synchronic way of understanding why the copy infinitive is employed. There is also a diachronic scenario which could have produced the same pattern. (By invoking diachrony, I do not mean to exclude the synchronic account above, since it is completely possible they could both reinforce each other.) When we examine the two major contexts where we see preverbal *'a*—chaining and verb phrase coordination—we see that such constructions put inherent focus on the verb phrase. This is because, roughly speaking, each sets up a common topic, the subject of the sentence, and then introduces a series of predicates containing new information relating to that topic.

If the copy infinitive focus construction were used in chaining or verb phrase coordination constructions, its focal semantics would have been redundant, allowing it to be reanalyzed as being templatically licensed. Such a reanalysis could also have resulted in a focal use of *'a*, occurring within the construction, being interpreted as a preverbal marker of chaining or verb phrase coordination. Thus, this scenario can tie in the rise of the copy

infinitive with the rise of preverbal *'a* as distinct from focal *'a* and suggests a diachronic connection between the two attested uses of the enclitic.

This is obviously only a rough sketch of a possible diachronic scenario. I include to show that there are both possible synchronic and diachronic analyses as to the origin of a copy infinitive as a filler to the template. Therefore, even if the Strong Linearity Domain Hypothesis cannot account for the specific presence of a copy infinitive, there is reason to believe that other principles could account for its observed use.

3.7.4.6 Local conclusion

In this section, it was shown that the Chechen verb phrase template, as described, is consistent with the Strong Linearity Domain Hypothesis. Borrowing from tools developed to analyze minimality restrictions in smaller domains, I further analyzed the Chechen verb phrase as showing a minimality effect in a derived environment.

I believe that invoking the notion of a Non-derived Environment Blocking to help account for facts relating to phrases and not words is new to this work. It is consistent with a general bias of this work in treating templatic effects as occurring, in different guises, at all levels of linguistic constituency. Specifically, to the extent that minimality restrictions have been proposed to account for idiosyncrasies involving prosodic templates for small constituents (like roots), such effects should be visible in larger domains—with the restriction that such effects should reflect the prosodic restrictions in those larger domains.

In the case of a subminimal phrase, which is certainly a less familiar notion than a subminimal root, we saw that a variety of factors had to come together in Chechen in order

to see the effects of phrasal subminimality. We needed a preponderance of complex verbs, in order for the characteristic phonology of the verb phrase to be 2W, and we also needed a typologically unusual clitic which, in some cases, would disrupt the typical phonology of the verb phrase. To the extent that few languages show such properties, any analysis making use of those properties predicts that their effects should be uncommon.

A positive aspect of the present analysis is that it serves as the foundation for a model of an otherwise deviant aspect of Chechen grammar. Chechen does not have free word order. However, word order within the core verb phrase is more restricted than word order outside of it. Thus, as discussed in section 3.2.3 (page 294), it is not uncommon for subjects to appear sentence-finally, but it is uncommon for objects to appear after the verb, and it is especially rare for preverbal deictic elements and preverbs to not appear immediately before the verb (except for the case when other strictly ordered verbal elements, like preverbal 'a, intervene).

If we were to describe, in broad terms, the surface domains in Chechen syntax where linear ordering is restricted, we would certainly want to refer to the word and the sentence.³⁰ In addition, however, we would want to refer to this special syntactic unit of the core verb phrase which has some phrasal properties but also exhibits more strict ordering relationships than the other elements of the sentence do. In the discussion above, we were able to model the templatic properties of the core verb phrase by appealing to its phonology. The implication of this is that this particular syntactic domain is subject to greater phonological

³⁰ We would probably also want to refer to the chained clause which shows more rigid order than finite clauses, almost always being SOV.

restrictions than other syntactic domains.

Therefore, while we focused on the core verb phrase's templatic properties here, we could extend this idea to its general ordering restrictions. I won't develop such an analysis here. However, it appears that the basic apparatus implied by the Strong Linearity Domain Hypothesis of isolating a particular prosodic constituent and its characteristic phonology could be extended to less linearization phenomena, a fact which argues that it might have utility beyond the core purpose of its design, to account specifically for templatic constructions.

3.8 CONCLUSION

This second case study focused on a larger domain and a different kind of template than the first one. Specifically, the domain was the verb phrase and the template was of the position-class variety. One reason why this particular case study was relevant was that it established the presence of a template in a syntactic domain, thus showing templates are not purely morphological phenomena. But, at the same time, the template was less specific in its ordering restrictions than the Bantu template. This is consistent with the Strong Linearity Domain Hypothesis which predicts that the larger the unit, the less specific the templatic restrictions.

An additional aspect of this case study was that it strengthened the case that preverbal 'a is a type 5 clitic, as originally proposed by Peterson (2001). Specifically, it was shown that arguments made against previous purported type 5 clitics do not apply to preverbal 'a.

Consistent with the structure of the order of the case studies, this case study serves as

a bridge between the small domain of the template in the Bantu case study and the larger domain of the next case study—serial verb phrases. I turn to these in the next chapter which covers such constructions in Saramaccan.

4 Saramaccan serial verb phrases and uniformity in serial verb ordering: A case study of a constructional template in the syntax

4.0 BACKGROUND: TOPOLOGICAL FIELDS AND CONSTRUCTIONS

As discussed in section 1.1.2.5 (page 18) in chapter 1, the term “template” has not been explicitly used in syntactic analyses in the way it has been in morphophonological and morphosyntactic analyses. Nevertheless, there are syntactic analyses which make use of devices not dissimilar to the templates proposed in other areas of grammar. That is, there are syntactic analyses where the linear ordering of elements in some linguistic constituent must be stipulated, contrary to general expectations.

One term which is often applied to template-like phenomena in syntax is that of the “construction”. This chapter will focus on syntactic phenomena in Saramaccan which I will generally call serial verb *phrases*. However, conspicuously in this regard, many authors refer to them as serial verb constructions. Hence, a recent article on serial verb phrases by Baker and Stewart (2002) is entitled: “A serial verb construction without constructions”. I will have more to say about this article in section 4.4 (page 492). However, for now, its title is indicative of the fact that many authors have made use of the notion of a “construction” in analyzing serial verb phrases and, thereby, adopted a template-like analysis of them. (This particular article’s title is indicative of the fact that Baker and Stewart (2002) do not adopt such an analysis.)

In this introduction, I will focus on two potential instances of templates in the syntax other than serial verb phrases. First, I will discuss the traditional analysis of the German

clause as consisting of a set of topological fields. Höhle (1986) contains a general overview of this model of German syntax, and, here, I will be mostly borrowing from the work of Kathol (2000) who presents a thorough formalization of it which represents the most detailed strong-linearity domain analysis of a language's syntax that I am aware of. I will then discuss Kay and Fillmore's (1999) Construction Grammar analysis of *What's X doing Y?* sentences in English, to exemplify how "constructions" fit into the general framework being developed here. While it is not difficult to find works making use of the term *construction*, Kay and Fillmore (1999) is noteworthy for working in a theoretical framework where constructions are considered a fundamental aspect of grammatical structure.

Beginning with a discussion of the topological field analysis of the German sentence, the basic idea behind this theory of the language's syntax is, "...leaving considerations of constituency and dependency completely aside, the sentence patterns of German can be described in terms of particular classes of linear occurrence (Kathol 2000:47)." Following this view, topological fields show obvious similarities to morphosyntactic position-class templates discussed of the sort discussed in section 2.0 (page 107) in chapter 2. And, in fact, Kathol (2000:87) even uses terms like "positional class" in discussing aspect of his topological field analysis.

This approach first recognizes that German clauses can be divided into three broad categories, based on the linear order of the elements within them. These categories can be usefully labelled *verb-final*, *verb-initial*, and *verb-second*, based on the position of the finite verb in the clause. I give examples of each in (216), repeated from (14) in section

1.1.2.5 (page 18). The relevant verbs are bolded in each example. In some instances, the examples contain multiple clauses, in which case I have bracketed the relevant clause.

- (216) a. *Ich weiß [daß Otto das Buch **liest**].*
 I know that Otto the book reads
 “I know that Otto is reading the book.” (Kathol 2000:53)
- b. [***Hätte** sie später die Blume gegossen] dann wäre das Büro schöner.*
 had she later the flower water then were the office nicer
 “If she had watered the flower later, the office would look nicer.” (Kathol 2000:49)
- c. *Peter **wird** Paul sprechen wollen.*
 Peter will Paul speak want
 “Peter will want to speak to Paul.” (Kathol 2000:59)

The bracketed clause in (14a) is an example of one where the verb appears finally, the one in (14b) is an example of one where the verb appears initially, and the sentence in (14c) is a case where the verb is in second position. There are various ways in which the word order differences in (14) could be analyzed, and Kathol (2000) discusses a range of analyses—in some of these the different order classes of German sentences are treated as secondary effects of other aspects of German syntax. However, in a topological fields approach, like that espoused by Kathol, these order classes are treated as resulting from the division of the German sentence into a series of well-defined position classes where different syntactic elements can be placed. The elements which can appear in a given position class are not necessarily a syntactic natural class—and, thus, the position classes are taken to be grammatical objects in their own right.

Kathol’s (2000) formalization of topological fields is of interest here since aspects of it appear to constitute a strong linearity domain. Kathol (2000:78) first designates five

large complements, like clauses. Of the various position classes the *cf* position (*linke Satzklammer*) is notable for containing either a finite verb, as in (219b) and (219c) or a complementizer, as in (219a). This topological field, therefore, exhibits a prototypically position-class behavior of containing elements which do not bear an obvious syntactic or semantic relationship to one another.

As should be clear from the examples in (219), it is not the case that all position classes need to be instantiated in every German sentence. Thus, for example, only one of the labelled clauses in (219), the main clause in (219c), contains material in the *vf* (*Vorfeld*) position. Also, it is not the case that only one constituent can occupy a given position class. The *mf* (*Mittelfeld*) position in sentences (219a) and (219b), for example, contains multiple syntactic constituents.

Making use of these position classes, Kathol (2000) gives an analysis of German syntax which associates particular syntactic elements with particular position classes based on the type of clause they appear in. So, for example, in declarative root clauses, of the sort exemplified in (219c), the finite verb gets assigned to the *cf* position. Furthermore, such clauses are also specified as having a *vf* positions—while subordinate clauses are not. Thus, only that clause, of the three labeled clauses, contains an element in that position.

If it were possible to predict, on broader principles, what the content was of the various position classes, the statement in (218) would be considered a useful schematization of a weak linearity domain. However, to the extent that Kathol (2000) presents them as unpredictable grammatical primitives, that ordering statement constitutes a strong linearity

domain analysis for all German clauses.

In addition to this broad strong linearity domain analysis, there are also more particular strong linearity domain analyses that Kathol proposes for specific syntactic constructions in German. For example, there is an idiomatic use of an expletive, of the form *es* found in German (roughly similar to the English expletive *it*), which Kathol (2000:149–50) analyzes as having very specific linear properties. He gives the sentences in (220) to illustrate the basic behavior of this element, which is bolded in the two examples where it occurs.

- (220) a. *Jemand sah die Blume.*
 someone saw the flower
 “Someone saw the flower.”
- b. ***Es*** sah jemand die Blume.
 ES saw someone the flower
 “Someone saw the flower.”
- c. *daß (*es) jemand die Blume sah*
 that ES someone the flower saw
 “that someone saw the flower”
- (Kathol 2000:149–50)

As seen in the opposition between (220a) and (220b), in root clauses in German an expletive *es* can appear before the finite verb. However, in subordinate clauses, as seen in (220c), this element cannot appear. Kathol (2000:150) analyzes this by giving this particular use of *es* a special lexical entry, seen in (221), wherein the position class of *es* is specified as *vf*. Since subordinate clauses do not contain such a position, they cannot contain this particular instantiation of *es* in his analysis, accounting for the difference between (220b) and (220c).

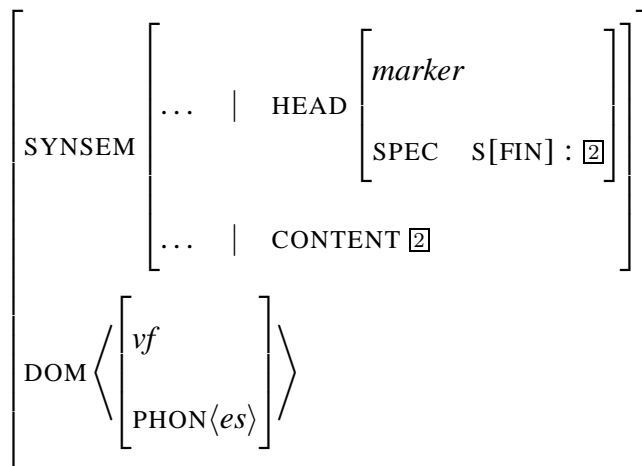
(221) *es*

The part of the lexical entry for this use of *es* in (221) labelled SYNSEM is not directly relevant to us here. Its intent is to give *es* properties similar to those of a complementizer which takes a finite clause complement. The part of the entry labelled DOM for “domain” is what specifies that this use of *es* can only appear in the *vf* topological field. No particular principle is taken to produce this restrictions—it is, instead, a direct stipulation on the linear properties of this word. It, therefore, bears some resemblance to the schematization of the Chechen enclitic *'a* given in (208) in section 3.7.4 (page 360) of chapter 3. (Although, in that case, in order to present an analysis of *'a*’s behavior which was consistent with the Strong Linearity Domain Hypothesis, I motivated some aspects of its positional restrictions on independent grounds.)

Another important specific strong linearity domain proposed by Kathol, some aspects of which were just discussed above, is one which covers all declarative root clauses. These are defined as specifying that their finite verb must appear in the *cf* position Kathol (2000:148–9). This accounts for the phenomena generally termed as verb-second (or “V2”) positioning

in German declarative root clauses.

Given this background, we are led to the question as to whether or not these proposed strong linearity domains for German are consistent with the Strong Linearity Domain Hypothesis. On the surface, at least, it should be fairly clear that they are not. The lexical entry in (221), for example, associates a strong linearity domain with a particular word. While this is not, in principle, ruled out by the Strong Linearity Domain Hypothesis, to be consistent with it, the prosody of such a word must be tied into its strong linearity restrictions—prosody does not factor at all in the formalization (221). Thus, we can contrast the analysis of *es* seen here with the analysis of the Serbo-Croatian element *je* seen in section 1.3.2 (page 65) in chapter 1 or of Chechen *'a* in the last chapter. In these cases, particular lexical items were also isolated as exhibiting strong linearity restrictions, but these restrictions were explicitly tied into the prosody of the lexical items involved, making the relevant analyses consistent with the Strong Linearity Domain Hypothesis.

This is not to say, of course, that there might not be some set of prosodic properties associated with *es* which could bring the analysis of Kathol (2000) in line with the Strong Linearity Domain Hypothesis. However, the analysis of *es* as given is not consistent with it. Similarly, Kathol's analysis of verbs appearing in the *cf* topological field of declarative root clauses in German is also inconsistent with the Strong Linearity Domain Hypothesis by specifying that an element with particular morphosyntactic characteristics—a finite verb—must appear in a particular position. Unless it is possible to devise a prosodic characterization that uniquely encompasses finite verbs and any other elements that appear in

the *cf* topological field (like complementizers), such a characterization of verb placement would violate the Strong Linearity Domain Hypothesis. This same basic logic holds for all of the positions proposed for the German sentence in (217).

Unlike the present work, Kathol (2000) is not interested in developing a theory restricting the form of unpredictable linearity. Instead its primary concern is developing a way to model a dissociation between linearity and constituency. As such, there is nothing inherently incompatible with the general arguments of the two works, even if the particular analyses of Kathol (2000) may be incompatible with the Strong Linearity Domain Hypothesis. Rather, it becomes necessary to see if it is possible to recast Kathol's analyses in a way that retains their general spirit but does not violate the Strong Linearity Domain Hypothesis. However, as with some other previously proposed strong linearity domains, as discussed in section 2.0 (page 107) and section 3.0 (page 275), it is not, in fact, completely clear to me to what extent the topological fields analysis of German syntax can be rectified with the Strong Linearity Domain Hypothesis. So, I will not present a complete discussion of this issue here but will instead bring up some relevant aspects of the problem.

As we have seen, the primary question to be addressed when looking at a potentially templatic construction, with respect to the present work, is not so much whether it should be analyzed templatically at all. Rather, it is more important to establish exactly what the templatic residue of such a templatic construction might be.

In the case of German second-position verbs, for example, we could retain the spirit of Kathol's (2000) analysis and have it be consistent with the Strong Linearity Domain Hy-

pothesis, if it could be shown that some general principle not related to constituent structure predicted that finite verbs in main clauses should appear in the *cf* slot. Anderson (1993), for example, develops a model for second-position verbs in German which attributes some aspects of their position to a cross-linguistic tendency for inflectional features to be realized in prominent “anchor” positions of a linguistic constituent. If we were to adopt Anderson’s general notion of an anchor and account for verb-second position by reference to it, we could, presumably, retain the core of Kathol’s analysis while reformulating the position of the verb in declarative root clauses as a weak linearity restriction—thus taking second-position verbs in German outside of the explanatory rubric of the Strong Linearity Domain Hypothesis and, therefore, making their linearization inherently consistent with it.¹

Putting aside verb-second phenomena, it is fairly clear that there are, in some areas, general principles at work governing aspects of word order in German sentences which are not directly related to constituent structure but would create weak linearity domains. Such principles, would be compatible with Kathol (2000) and could also help us to characterize the topological fields analysis in a way compatible with the Strong Linearity Domain Hy-

¹ In this context, it is worth reiterating a point made earlier in section 1.1.3.1 (page 26) in chapter 1. The Strong Linearity Domain Hypothesis specifies that a strong linearity domain is a domain where linear relations cannot be determined from hierarchical relations. However, the restriction to hierarchical relations, as opposed to some other principled sort of relationship between elements, was made for simplicity due to the nature of the phenomena being focused on here. It is not immediately clear whether or not “anchors”, in the sense of Anderson (1993), should be represented in a hierarchical structure or some other kind of structure. Either way, however, if the existence of such anchors could be independently motivated in grammar and if they affect linear relations, we would want to include them as contributing to the structure of weak linearity domains and not treat their effects as creating strong linearity domains. The basic idea behind strong linearity is that it is unpredictable—so, any ordering which could be predicted by some principle of grammar, hierarchical or otherwise, should be excluded from contributing to it. In section 4.2.5.4 (page 442) below, I will consider another principle, that of temporal iconicity, which is a good example of a clearly non-hierarchical principle which has been used to account for weak linear relations.

pothesis. Uszkoreit (1987:9-30) discusses various factors affecting word order in German clauses, and he determines that the principles in (222) (adapted from Uszkoreit (1987:24)) are at work in the language.

- (222) a. Focused constituents follow non-focused constituents.
- b. The unmarked order is subject, indirect object, direct object.
- c. Personal pronouns precede other noun phrases.
- d. Definite noun phrases precede indefinite noun phrases.
- e. Light constituents precede heavy constituents.

As can be seen in (222), many of the principles that he proposes affect German word order are clearly pragmatic in nature.² If pragmatic principles, of the sort outlined in (222) are, indeed, a factor in the order of elements in the German clause, then it would become necessary to factor them out of any potentially templatic aspects of it.

We are left, then, in a similar position to some other possible templatic constructions—a strong linearity domain may be involved, though its exact properties are not immediately apparent. I will not attempt to analyze the German case any further here, and it remains an open question as to whether or not the templatic aspects of the German sentence will turn out to be consistent with the Strong Linearity Domain Hypothesis.

² One of his principles, that of (222e), is phonologically oriented and is similar to a restriction on English verb-particle combinations which was discussed in section 1.2.3.2 (page 47) in chapter 1 and which was shown there to be characterizable as a strong linearity domain in a way which was compatible with the Strong Linearity Domain Hypothesis.

Some of the issues that have come up in looking at the case of the German clause underscore a general problem with understanding the linear properties of sentence-level phenomena—with larger constituents, we must consider potential factors which may affect linear order which we do not have to consider for smaller constituents. For example, while pragmatics does not appear to generally play a role in morpheme order, it clearly can affect word order. Furthermore, consistent with the general model of grammar, given in (29) in section 1.2.4 (page 54), assumed in this work, we expect larger linguistic constituents to have weaker strong linearity restrictions than smaller ones. As a result of this, the templatic residue of a syntactic construction, to the extent that there is any, will generally be relatively small and hard to accurately detect.

With respect to this issue, a relevant work is that of Kay and Fillmore (1999), which gives an analysis of the *What's X doing Y?* (WXDY) construction in English exemplified by such sentences as *What is this scratch doing on the table?*. Kay and Fillmore (1999) present arguments for treating such sentences as a special construction in English which expresses an incongruity judgment—such an analysis implies that the properties of these sentences are not completely determined by the general syntactic and semantic rules of English. Their abbreviation of the construction, WXDY, appears somewhat templatic, insofar as it implies something like a position-class analysis wherein some material is plugged into an X “slot” and other material into a Y “slot”. Because of this, it will be interesting to examine it in more detail here. Moreover, Kay and Fillmore (1999) work within the framework of Construction Grammar, which, as its name indicates, gives a central role to constructions

in the analysis of syntactic phenomena. Therefore, an examination of this work will also be valuable in exemplifying how constructions fit into the general framework being developed here.

Central to Kay and Fillmore (1999) is the idea that, in order to give a proper analysis of any construction, it is necessary to isolate the precise properties of that construction which are unique to it and, where possible, attribute its other properties to independently motivated generalizations which can be made about a language's grammar. So, they seek to find what, here, might be called the constructional residue of any structure they examine. This is very much in the same spirit as the present work with its focus on isolating the templatic residue of a given structure.

In their analysis of the WXDY construction, Kay and Fillmore (1999), have few specific remarks about the linear relations of the elements in the construction. However, in large part, this is because they take these relations to be predictable on the basis of general facts of English. To understand how their analysis works, it will be useful to refer to the sentences in (223).

- (223) a. What is this scratch doing on the table?
- b. What are these scratches doing on the table?
- c. What's this fly doing in my soup?
- d. The fly is doing the backstroke in your soup.

The alternation between *is* and *are* in the sentences in (223a) and (223b) establishes that the *X* in the *WXDY* construction is the subject of the form of the verb *to be* following *what*. Because of this, the order of the *what*, the form of *to be*, and *X* can be described as an instantiation of the more general subject-auxiliary inversion construction found in all main-clause English *wh*-questions.

Furthermore, while the sentence in (223d) is not a felicitous response to the incongruity-judgement reading of the question in (223c), it establishes that there is a general pattern in English which allows the *what* of the *WXDY* construction to be considered an object of *doing*. The appearance of *what* at the beginning of the sentence can, therefore, be attributed to “Wh-movement” of the standard variety that results when a question is formed on the object of a verb.

In fact, even though Kay and Fillmore’s (1999) analysis of the *WXDY* is clearly constructional, insofar as one specialized meaning of an incongruity judgement must be overlaid on the semantics specified by its *X* and *Y* elements, it does not appear to be templatic. This is because, as just discussed, they can account for the linear order of the elements by appealing to general aspects of English syntax.

In this regard, it is worth mentioning that they explicitly point out that, “The relative position of *be* and *X* cannot be specified for the construction since *WXDY* appears in both inverted and non-inverted (main-clause) forms (Kay and Fillmore 1999:19).” What they have in mind with this statement are sentences oppositions like the one in (224) where subject-auxiliary inversion does not occur when a *WXDY* clause is embedded within a

larger clause. This alternation reflects the general properties of direct versus indirect questions in English. This aspect of their analysis underscores the fact that this “construction” does not seem to be templatic—despite initial appearances that it might be.

(224) a. What is this scratch doing on the table?

b. I wonder what this scratch is doing on the table.

What we can conclude then is that the WXDY construction does not contain a strong linearity domain even though its slot-filler type of abbreviation made it appear as though it would require such a characterization. While it might seem odd to include such an example here, it serves to make the important point that, when we examine large structures, it becomes especially important to carefully isolate the templatic residue. Even constructions which appear templatic at first might instead be the result of a complex interaction of principles related to the hierarchical relations of a language’s grammar. As we will see, however, it does not appear to be the case that phenomena given the label “construction” can never contain strong linearity domains. I will argue that we do find strong linearity domains in serial verb phrases, which, as mentioned above, have traditionally been classified as a type of construction.

In this context, it is worth pointing out that I am not aware of any analysis of serial verb phrases within Construction Grammar itself or, more generally, of a formal analysis which I would label “constructional” for serial verb phrases. The closest thing to such an analysis would probably be Sebba’s (1987) analysis of serial verbs phrases within Gener-

alized Phrase Structure Grammar (GPSG), which will be discussed below. While GPSG is not explicitly a construction-oriented approach to grammar, it does bear some affinities with Construction Grammar in that it is non-transformational. It would seem that, while the term “construction” has been used as a descriptive label with respect to serial verb phenomena, the notion has yet to be applied in a formal way to their analysis. I do not believe that this is because serial verb phrases will be any less amenable to a constructional analysis than other structures which have been analyzed this way. Rather, it more likely results from the fact that most researchers studying serial verb phrases have come from formal traditions which do not favor constructional analyses. In section 4.4 (page 492), I will offer some brief remarks as to what the constructional nature of serial verb phrases might be, in a formal sense.

We have seen in this introduction that, while templates are not typically associated with large constituents, like sentences, they have not been completely excluded from them. Kathol (2000) was taken as representative of a long tradition in German grammar where clauses in the language are analyzed as templatic. Furthermore, there is a general class of syntactic structures, often called “constructions”, which lend themselves to templatic description. Here, a particular construction, the WXDY construction was examined, and it turned out that despite its abbreviation, which implies a slot-filler structure, it does not appear to contain a strong linearity domain. It serves as a good example, nonetheless, of how “constructions” can fit into the framework being developed here. The particular point to be taken from the discussion of the WXDY construction is that apparently templatic

effects in the syntax might really result from complex hierarchical considerations. This makes it particularly difficult to isolate the templatic residue of a given syntactic construction and determine, with certainty, whether a strong linearity domain governs any aspects of its structure.

This takes us to the last case study, on serial verb phrases, with a particular focus on Saramaccan. I will argue that serial verb phrases are an example of syntactic “constructions” which do, in fact, contain a strong linearity domain—unlike the WXDY construction. However, they will be analyzed as having the most minimal strong linearity domain possible, simple extrinsic ordering of the prosodic subconstituents of a larger prosodic constituent.

4.1 INTRODUCTION TO SARAMACCAN CASE STUDY

The final case study of this work focuses on serial verb phrases in Saramaccan. In section 4.2 (page 402) the properties of these constructions will be described in some detail. However, for now, as a first approximation, we can describe serial verb phrases as a consisting of a series of verb phrases joined together into one larger verb phrase to create a complex predicate. An example from Saramaccan is given in (225).³

³ All uncited examples come from consultant work. The cited examples from Saramaccan have, in some cases, been normalized for consistency. Surface tone marking is only given for sentences which I have either directly elicited or which are fully transcribed for tone in the cited source. Tone marking follows the usual conventions with an acute accent (´) for high tones and a grave (`) for low tones. Vowels unmarked for tone may surface with either high or low tones depending on their phonosyntactic environment as described in section 4.3.2 (page 447). The orthography used for Saramaccan here is largely self-explanatory except for the fact that “coda” nasals signify nasalization on the preceding vowel instead of nasal segments. Further discussion of the tone system of Saramaccan can be found in Voorhoeve (1961), Rountree (1972), and Good (in press).

(225) *Mi téi dí búku léi dí wómi.*

I take the book show the man

“I showed the book to the man.”

(Veenstra 1996:85)

In (225) there are two “small” verb phrases in the sentence: *téi dí búku* ‘take the book’ and *léi dí wómi* ‘show the man’. These two verb phrases are interpreted as being part of the same event and the meaning of the sentence is best rendered in English as a sentence with a single verb phrase.

Importantly, for our purposes, the order of elements within a serial verb phrase for a particular semantic reading is almost always very rigid. Thus, for example, the reordering of (225) given in (226) is ungrammatical for the reading *I showed the book to the man*.

(226)**Mi léi dí wómi téi dí búku.*

I show the man take the book

At first glance, serial verb phrases seem like good candidates for exhibiting templatic phenomena. In his description of serial verb phrases, Veenstra (1996:78), for example, offers, among other criteria, that they have a structure along the lines schematized in (227).

(227) NP₁ V₁ NP₂ V₂ (XP₃)

(X = N, P)

Taken at face value, the schema in (227) resembles a position-class template. There are particular slots for particular syntactic constituents and these slots are ordered. Veenstra did not intend the schema in (227) to be an analysis of serial verb phrases. Rather, it is simply a useful descriptive device. Nevertheless, it highlights the fact that serial verb phrases are conducive to being described with template-like schemas.

Templatic approaches to serial verb phrases, however, are not limited to atheoretical descriptive schema. Sebba's (1987) constructional approach to serial verb phrases within Gazdar and Pullum's (1982) version of Generalized Phrase Structure Grammar has some templatic properties by proposing phrase structure rules which can specifically refer to lexical categories of verbs appearing in particular positions of the phrase structure (Sebba 1987:112–40).

Furthermore, the work of Awóyalé (1988) (based on some ideas originally found in Ekundayo and Akinnaso (1983)) proposes a “semantic template” to account for the possible combinations of predicates. The template used by Awóyalé (1988:9) is given in (228).

(228)

MODALITY	↔	EVENT	↔	STATE
	relational rules		relational rules	

As discussed in more detail in section 1.1.2.5 (page 18) in chapter 1, the template in (228) is intended to schematize the order of different sorts of predicates with respect to each other in serial verb phrases—with special relational rules serving as devices to semantically link the individual verb phrases into one larger predicate. In this sense, though Awóyalé (1988) labels it a semantic template, it is probably more readily understood as a syntactic template since the form of the template is a restriction on syntactic, not semantic, structures.

As Veenstra (1996:90) points out, Awóyalé's template cannot be considered a full analysis of serial verb phrases, since it leaves open the nature of the syntactic relationships between the predicates. (Awóyalé (1988:28–31) does sketch his own a syntactic analysis making use of the template, but the template itself does not fully account for their syntactic structure.) For present purposes, the existence of an analysis like that of Veenstra (1996:90)

simply underscores the fact that there appears to be something templatic about the ordering of element within them.

The Strong Linearity Domain Hypothesis rules out purely syntactic templates like (227) or syntactic/semantic ones like (228) for the simple reason that they lack any reference to the prosodic properties of serial verb phrases in their formulation. However, at the same time, the fact that templates have been proposed for serial verb phrases at all makes them promising as an area of study within this work. While this particular case study will focus on Saramaccan serial verb phrases, data from other languages will be used on occasion. The reason for the focus on Saramaccan serial verb phrases is because it is the language for which I have the most data on both the syntax and prosodic constituency of the constructions. Veenstra (1996) is a thorough study of their syntax, and Good (2003b, *In press*), building on work of Voorhoeve (1961) and Rountree (1972), offers a reasonably thorough examination of the phrase-level prosody of the language.

Other than the apparent templatic features of serial verb phrases, as just outlined above, there is a more particular reason why I discuss serial verb phrases here. A recent article, Carstens (2002), to be discussed in section 4.2.3 (page 416), has used some of the templatic properties of serial verb phrases noted by other authors to argue that, in fact, serial verb phrases do not offer evidence for templates. Rather, according to Carstens, they offer evidence for Kayne's (1994) theory that syntax is "antisymmetric". There are various ways to characterize Kayne's claim—a useful simplification here is that all syntactic structures exhibit specifier-head-complement order and that apparent instances of other orders

attested in language are, in some sense, “derived”.

The particular generalization which was of interest to Carstens (2002) and which will be of interest here is what Carsten’s terms Muysken’s Anomaly, a version of which I give in (229) and which I label the Serial Verb Construction (SVC) Uniformity Generalization.⁴

(229) **SVC Uniformity Generalization:** The order of the verb phrases in serial verb constructions is not sensitive to whether or not the language generally shows VO or OV word order.

The basic sort of fact described by the SVC Uniformity Generalization is illustrated by the data in (230) which gives two semantically comparable sentences containing serial verb phrases from Sranan, in (230a), and Izon (also known as Ijò), (230b). Sranan has basic SVO word order while Izon has basic SOV order. Sranan is very closely related to Saramaccan.

- (230) a. *Kofi teki a aksi fala a bon.*
 Kofi take the axe fell the tree
 “Kofi felled the tree with the axe.” SRANAN (Sebba 1987:132)
- b. *áràú, zu ye àkì, buru teri-mí*
 she basket take yam cover-SIMPLE_PAST
 “She used a basket to cover a yam.” IZON (Williamson 1965:53)

⁴ There are two reasons for not using Carstens’ term. The first is that she cites it as being made in a paper by Muysken (1988b) while Sebba (1987:144–5) makes a comparable observation—so, it is not clear to whom the generalization should be attributed. Further complicating matters is the fact that I cannot locate a copy of Muysken (1988b) which is cited in at least four different ways in various sources I have looked at (those sources being: Veenstra (1996), Schiller (1991), Stewart (2001), and Carstens (2002)). The reference here follows Carstens. The second reason I do not adopt Carstens’ term is that I follow most authors in not viewing the statement in (229) as anomalous. Rather, I take it as a basic typological property of serial verb phrases which is neither straightforwardly viewed as anomalous or expected.

Both the sentences in (230) make use of instrumental ‘take’-serials where a verb meaning ‘take’ (or something similar like ‘use’ or ‘carry’) introduces an instrumental argument for the action described by another verb phrase. In (230a) the verb *teki* ‘take’ introduces the instrument *aksi* ‘axe’, and in (230b), the verb *àkì* ‘take’ introduces the instrument *zu ye* ‘basket’.

The SVC Uniformity Generalization is meant to describe the fact that in both sentences in (230) the verb phrase headed by ‘take’ is the first verb phrase in the construction and the “action” verb phrase is second in the construction, even though Sranan has VO verb phrases and Izon has OV verb phrases. In other words, the relative order of the verb phrases within the serial verb construction is constant regardless of the position of the head of the verb phrase in a given language.⁵

⁵ It is not clear how typologically robust the SVC Uniformity Generalization is. Carstens (2002:31–2) cites four SOV languages, in addition to Izon, in support of it: Yi (Tibeto-Burman), Kalam (Papuan), and Korean. Only the data from Yi clearly instantiates the SVC Uniformity Generalization by showing SOVOV word orders. The Kalam and Korean examples show SOVV order, where the two verbs share an object. Without more detailed syntactic argumentation, which Carstens does not give, it is not clear that such structures are proper instances of serialization rather than verb concatenation. Schiller (1991:149) cites another SOV Papuan language, Barai, with an $SO_1O_2V_2V_1$ structure, which is hard to rectify with the SVC Uniformity Generalization. Aghem offers another variation on the general theme since it allows certain complex SV...VO sequences wherein multiple verbs appear adjacent followed by an object which can be construed with more than one of the verbs (Larry Hyman, personal communication). A further type of complication for the SVC Uniformity Generalization comes from languages in West Africa which exhibit word order alternations such that the objects of verbs in serial verb phrases do not always consistently show the same order. For example, in Leggbó, as reported on in Good (to appear), affirmative clauses are fairly rigidly SVO but negative clauses are SOV. This alternation can affect objects of serial-verb phrases in various ways producing both SOVVO structures and $SO_1O_2V_2V_1$ structures. The sum total of these facts calls into question the robustness of the SVC Uniformity Generalization. Therefore, I don’t necessarily assume it to be true. However, I will refer to it in order to contrast the approach taken by this work with the approach of Carstens (2002). The explanation for the SVC Uniformity Generalization, which I will give in section 4.3.5 (page 486), will be one where it can be understood via a natural path of diachronic change. Since such an explanation is not grounded in some synchronic analysis, it automatically predicts languages violating the SVC Uniformity Generalization are possible as long as a diachronic pathway is open to their evolution. Thus, languages violating the SVC Uniformity Generalization do not, in general, contradict the analysis here.

Under the view to be espoused here, the SVC Uniformity Generalization is taken to imply that hierarchical relations (like those involved in determining if a language is SVO or SOV) cannot predict the order of the verb phrases within a serial verb construction, which, in turn, means that they constitute a strong linearity domain. Their properties, thus, should be consistent with the Strong Linearity Domain Hypothesis. Carstens, on the other hand, made use of a different kind of logic and determined that the SVC Uniformity Generalization implied that there could be no “head”-parameter generally in language and all languages, therefore, underlyingly, necessarily show the same basic order of syntactic constituents (which, following Kayne (1994), is, for sentences, SVO).

One of the goals of this chapter will be to point out problems with Carsten’s approach. More importantly, though, I will try to show that, at least for Saramaccan, the order of the “small” verb phrases within the larger verb phrase can be shown to be consistent with the Strong Linearity Domain Hypothesis. The clearly syntactic status of serial verb phrases will, then, give us more evidence for templates in syntax and allow us to apply the Strong Linearity Domain Hypothesis to a fairly large syntactic structure—namely, the concatenation of verb phrases.

In section 4.2 (page 402), I will give a more detailed description of serial verb phrases including their basic descriptive properties as well as some formal analyses of them, including detailed discussion of Carstens (2002) and Veenstra (1996), the latter of which I will adopt as a general analysis for the syntax of Saramaccan serial verb phrases. In section 4.3 (page 445), I will relate Saramaccan serial verb phrases to the Strong Linearity Domain

Hypothesis, and section 4.4 (page 492) will offer a brief conclusion.

4.2 SERIAL VERB PHRASES

4.2.1 Their descriptive properties

It is not difficult to find overviews of the properties of serial verb constructions in the literature. The set of criteria in (231) are adapted from Muysken and Veenstra (1995:290).

- (231) a. Serial verb phrases contain at least two verbs.
- b. There is only one expressed subject in the sentence containing the serial verb phrase.
- c. Each verb has at most one expressed object.
- d. Each verb must have the same specification for tense/aspect (though this specification might be coded in different ways).
- e. The verbs cannot be independently negated.
- f. No coordinating conjunction is found within the serial verb phrase.
- g. No subordinating conjunction is found within the serial verb phrase.
- h. No intervening pause is possible within the serial verb phrase.

It is important to note that different authors describe serial verb phrases differently (and often use the terms “serial verbs” or “serial verb construction” where I generally use “serial verb phrase”). Sebba (1987:1–37), Schiller (1991:27–65), and Stewart (2001:3–18) each

provide fairly thorough discussions of different senses of the notion of serial verb phrase and, thus, serve as useful general introductions. Within the literature on serial verb phrases, the criteria in (231) are not particularly controversial as general descriptive characteristics of serial verb phrases. What is controversial is how these properties fit into particular syntactic descriptions.

From the perspective of this work, the criterion in (231h) is particularly noteworthy since it establishes that, among the more properly syntactic characteristics of serial verb phrases, there is also a unifying prosodic characteristic. The idea that serial verb phrases form a prosodic unit, often described as their consisting of one intonational unit, has been taken to be “uncontroversial and accurate (Schiller 1991:29)”, though it has generally not been discussed in detail. A notable exception which has focused on how serial verb phrases are realized intonationally is Givón (1991), who presents the results of an empirical investigation which found, based on a study several Papuan languages, that there are far fewer pauses within serial verb phrases than other clausal constructions.

While the criteria in (231) list a set of properties that serial verb phrases are often considered to have in common, most authors subdivide serial verb phrases into different classes along one set of criteria or another. Here, I will discuss Veenstra’s (1996) division of Saramaccan serial verb phrases into four semantically and syntactically defined classes. This choice was made since he offers the most thorough description of Saramaccan serial verb phrases. While I ultimately will adopt many aspects of Veenstra’s analysis of Saramaccan, I do not intend to make any theoretical claims about the status of these classes at this point.

Rather, this discussion will allow us to outline general properties of serial verb phrases while getting more acquainted with such constructions in Saramaccan.

In his first class, Veenstra (1996:92–99) puts four types of serial verb constructions: directional, argument-introducing, aspectual, and degree-marking. This class is syntactically characterized by making use of a non-initial verb from a lexically restricted set which serves to mark a sentence for one of the four syntactic/semantic properties just listed. Additionally, these serial verb phrases have the semantic characteristic that they clearly denote one event.

Examples of the four types of serial verb phrases in Veenstra’s first class are given in (232). Comparable constructions can be found in many other serializing languages.

- (232) a. *A wáka kó à mi písi.*
 he walk come at my yard
 “He walked to my yard.” (Veenstra 1996:93)
- b. *De maá dí fáka dá mi.*
 they sharpen the knife give me
 “They sharpened the knife for me.” (Veenstra 1996:95)
- c. *Mi jabí dí dóo kabá.*
 I open the door finish
 “I have finished opening the door.” (Veenstra 1996:97)
- d. *A fátu pása mi.*
 he fat pass me
 “He is fatter than me.” (Veenstra 1996:98)

The sentence in (232a) is an example of a directional serial verb phrase construction, the sentence in (232b) is an example of an argument-introducing construction (in this case introducing a benefactive), the sentence in (232c) is an aspectual construction, and the sentence in (232d) is a degree construction (in particular, a comparative).

The second class of serial verb phrases designated by Veenstra (1996:99–102) is similar to the first type insofar as it involves a limited set of verbs in a particular position. However, unlike the first class of serial verb phrases, these constructions don't as clearly denote one event. Veenstra's gives two types of serial verb phrases in this second class, causative and argument-introducing (of a different sort than the argument-introducing predicates of the first class). Examples are given in (233).

- (233) a. *Dí tjúba tá kái mbéi hen uwíi munjá tooná kó bè.*
 the rain PROG fall make he.EMPH hair wet turn come red
 "It is raining so that her hair becomes wet and turns red." (Veenstra 1996:101)
- b. *A téi fáka kóti dí béeé.*
 he take knife cut the bread
 "He cut the bread with a knife." (Veenstra 1996:10)

The sentence in (233a) is an example of a causative construction. While causative serials are found in other serializing languages, this sort of causative, where an event, rather than an agent, is the cause is not a prototypical serial verb phrase construction—though Veenstra does give it as a basic type for Saramaccan.

The sentence in (233b) is an example of an argument-introducing serial verb phrase construction in Veenstra's second class—in particular an example of an instrumental 'take'-serial. Such serial verb constructions which use a verb like 'take' to introduce an instrumental argument will feature prominently in some aspects of the discussion below. One thing that distinguishes the sentence in (233b) from the sentence in (232b), which was also an argument introducing serial verb phrase, is the fact that (233b) can be understood as referring to two different events. Also, the argument-introducing verb is initial and de-

scribes a real-world action. The serialized use of *da* ‘give’ in (232b), on the other hand, is not initial and does not imply a second “giving” event—and need not even imply physical transfer, as indicated by the translation of (232b).

The third class of serial verb phrases which Veenstra (1996:102) discusses are resultatives. This class is different from the first two insofar as it involves two verbs, each of which comes from a relatively open class. The most salient restriction on this construction is that both verbs must be transitive and “share” a direct object. An example is given in (234).

- (234) *De sikópu hen kii.*
 they kick he.EMPH kill
 “They kicked him dead.” (Veenstra 1996:102)

In (234) the two verbs *sikópu* ‘kick’ and *kii* ‘kill’ are transitive, and both have *hen* ‘he.EMPH’ as an understood argument (although the exact syntax of this object—that is, what its structural position is—is unclear). Resultative serials of this sort are quite common and, depending on the language, can involve a wide range of verb types.

The final class of serial verb phrases in Saramaccan, according to the classification of Veenstra (1996:103), are narrative constructions wherein there is little restriction on the combination of verb phrases in a serial verb phrase other than semantic or pragmatic factors. An example is given in (235).

- (235) *A kisi dí fóu nakí kii limbó bóí njan.*
 he catch the bird hit kill clean cook eat
 “He caught the bird, struck it dead, cleaned, cooked, and ate it.” (Veenstra 1996:103)

Of the various types, this narrative construction has been the least thoroughly analyzed in the literature. While this particular example involves object sharing, Veenstra (1996:103) points out that, at least in Saramaccan, this is not obligatory.

The goal of this section has been simply to give a broad overview of some of the properties of serial verb phrases and to go over some of the common Saramaccan serial verb constructions. As such, it is neither intended to be descriptively complete nor grounded theoretically. As we will see, at least in Saramaccan, while the syntax and semantics of serial verb phrases can be fairly heterogenous, their prosody is much less so. So, for our purposes, the range of distinctions for serial verb phrases that has been made in the syntactic and semantic literature will not always be relevant.

In the next sections, I will review some analyses of serial verb phrases that have been proposed in order to properly situate the templatic analysis to be given in section 4.3 (page 445) within earlier work. In section 4.2.2 (page 408) I will give a general summary of previous analyses. In section 4.2.3 (page 416) I will present a detailed discussion of the analysis in Carstens (2002) which, as mentioned in section 4.1 (page 395), pointedly ruled out a templatic analysis of any ordering properties of serial verb phrases. In section 4.2.4 (page 428) I will go over some aspects of Veenstra's (1996) analysis of serial verb phrases in Saramaccan, which I will adopt here. I will specifically focus on aspects of Veenstra's analysis which argue against Carstens analysis. Finally, in section 4.2.5 (page 434) I will take up the issue of the role that temporal iconicity and argument hierarchies may play in the ordering of elements in serial verb phrases.

4.2.2 A general review of some syntactic analyses of serial verb phrases

In section 4.2.3 (page 416) and section 4.2.4 (page 428) I will give a review of two specific analyses of serial verb phrases, those of Carstens (2002) and Veenstra (1996) respectively. First, in this section, I will summarize three broad approaches to the analysis of the structure of serial verb phrases which can roughly be characterized along the lines of complementation, coordination, and adjunction structures.⁶ The focus here will be on the syntactic structure the various analyses choose, rather than semantic details, since the syntactic structures tie in more directly to questions of constituent order in serial verb phrases, which is the focus of this chapter—this being the locus of the templatic aspect of serial verb phrases.

The three relevant kinds of structures are respectively schematized in (236), (237), and (238). Not all authors use precisely these configurations for these basic types of syntactic union. In particular, the structures in (236) and (237) are not consistently binary branching, which is required by some syntactic frameworks. In the case of the complementation structure, such frameworks adopt a similar structure for (236) as they would for double-object constructions—whatever that happens to be. In the case of (237) the structure could be “repaired” by positing a null conjunction which forms a constituent with its conjunct, thus maintaining binary-branching.

Finally, the complementation structure in (236) is representative of an SVO language for the simple reason that most analyses (with the notable exception of Carstens (2002) to

⁶ While the structures given here are representative, not all authors employ the same labels for them as I do here. For example, Sebba (1987) refers to the complementation structure as a “subordinating” structure.

be discussed in section 4.2.3 (page 416)) have primarily analyzed languages with that basic word order.

(236) COMPLEMENTATION

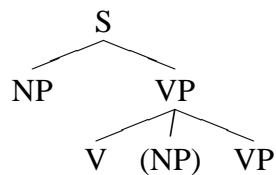

(237) COORDINATION

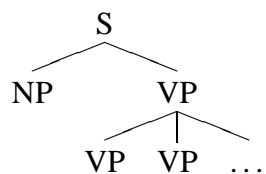

(238) ADJUNCTION

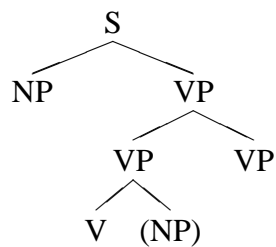

The fact that three structures of such differing types have been proposed for serial verb phrases reflects how little consensus there is in the literature on their constituency. Furthermore, in some cases, authors do not assign the same structure to each type of serial verb phrase. Therefore, if I cite a particular author as employing a particular structural analysis,

it is not necessarily the case that that author employed only that type of analysis.⁷ In the

⁷ Stewart (2001), for example, argues in detail for a complementation structure for resultative constructions (like the example given in (234)) (Stewart 2001:28) and an adjunction structure for consequential constructions (like the example in (235)) (Stewart 2001:38). Something comparable can be found in Foley and Van Valin (1984:188–97) who distinguish between serial verb phrases where the verbs share an object argument and those which share only a subject argument, the former being examples of nuclear juncture and the latter of core juncture, in their terminology. Similarly, Li and Thompson (1973) suggest an adjunction analysis for some instances of serialization in Mandarin and a coordination one for others. In another variant, Bamgboṣe (1974) argues that there are coordinate serials and modificational serials, the latter of which have a complementation structure.

rest of this section, I will discuss each of these three types of analyses in more detail.

Examples of the complementation analysis are fairly well-represented in the literature. Variants of it can be found in Sebba (1987), Baker (1989), Baker (1991), Larson (1991), Lefebvre (1991), and Collins (1993), for example. As we will see in section 4.2.3 (page 416), Carstens (2002) also would be classified as a complementation analysis.

The basic features of these analyses is that there is something special about serializing languages which allows their verbs to take on an extra verb phrase object. Sebba (1987:112-33), for example, states a series of phrasal expansion rules for Sranan which allow this sort of structure. Two of these are given in (239). In Sebba's analysis, the presence rules like this are the special feature that makes a language serializing.

(239) a. IVP → V[3] IVP[DIR]

V[3] → {*dansa, waka, lon*} (Sebba 1987:120)

b. TVP → V[7] NP IVP[DIR]

V[7] → {*tyari, fringi, yagi*} (Sebba 1987:121)

The rule in (239a) is one of the ways an intransitive verb phrase can be realized in Sebba's framework. A verb of arbitrarily marked class "3", some instances of which are exemplified under the rule, can be followed by a directional intransitive verb phrase. Similarly, a transitive verb of class "7" can consist of a verb, followed by a noun phrase, followed by a directional intransitive verb phrase.

While (239) can be taken as representative of the various accounts which make use of something like complementation syntactically, many of these accounts differ in they understand the semantics of these constructions to be interpreted. Lefebvre (1991), for example, views the semantic effects of serialization as resulting from an alteration of a verb's lexical-conceptual structure and further proposes that serial verb phrases are headed by multiple verbs, not just one. Baker (1991), similarly proposes that serial verb phrases are syntactically double-headed, but does not see serialization as a process involving changes to verbs lexical structure. Larson (1991:201–2) views serialization as a type of secondary predication, equating it with English sentences like *Carol rubbed her fingers raw*.

Because of these different interpretations of the semantics of serial verb structures, the arguments used to support the presence of complementation structures in serial verb phrases can be varied. For Lefebvre (1991:66), for example, a complementation structure is a concomitant of the fact that serial verbs are joined lexically, not syntactically—and only in a complementation could such verbs properly subcategorize for their arguments. Baker (1991) offers a parametric analysis and argues that serializing languages are different from non-serializing languages in allowing double-headed verb phrases. A structure like the one in (236) fairly clearly encodes this idea insofar as there is no clearly privileged syntactic head verb in it. In Sebba's (1987) view the initial verb in a serial verb phrase actually subcategorizes for the following verb—thus, implying that the non-initial verb is similar to a true complement. We will see another justification for a complementation structure in the discussion of Carstens (2002) below. The differing stances taken by these authors should

make it clear that similar syntactic structures do not necessarily suggest similar overall analyses.

Coordination analyses of serial verb phrases along the lines of the structure in (237) have been argued for by Boadi (1968:87), Awobuluyi (1973), Schiller (1991:47–61), and Déchaine (1993:201), for example. These proposals take the structure of serial verb phrases to be analogous to coordination structures in non-serializing languages, the main difference between them being there are overt conjunctions in non-serializing languages but not in serializing languages.

As with complementation analyses, authors employing coordination analyses understand the semantic relationship between the predicates in different ways. Schiller, for example, does not directly relate any semantic asymmetries between the verbs of the serial verb phrase to syntactic principles. Dechaine, on the other hand, does stipulate that one of the verbs in the serial verb phrase is the head of the whole structure (which verb is the head depends on the semantics of the particular sentence being analyzed)—thus, giving syntax a role in the semantic interpretation.

Related to this fact is that, similar to analyses involving complementation structures noted above, there is not one single leading idea behind the use of complementation structures. Schiller (1991) works within the framework of Autolexical syntax (see Sadock (1991)) which allows for the dissociation of syntactic from semantic structure. Because of this, he does not need to represent any lexical or semantic relationship between serial verbs within his syntactic structure. Thus, since he knew of “no *syntactic* arguments against the

simple concatenation of [verb phrases],” he adopted a structure along the lines of the one in (237) (Schiller 1991:60, emphasis added). Déchaine (1993), on the other hand, adopts the coordination structure, in large part, because of larger theoretical questions she raises about permissible predicate structures in language. Again we see that a unified structural analysis is not necessarily related to a unified general analysis.

The final major type of syntactic structure proposed for serial verb phrases is the adjunction structure diagrammed in (238). Structures along such lines can be found in Schachter (1974), Stahlke (1974), Li (1991), Law and Veenstra (1992), and Muysken and Veenstra (1995). Veenstra (1996), as we shall see in section 4.2.4 (page 428), also argues for an adjunction structure. Importantly, as represented in the tree in (238), the adjunction structures proposed have all involved right-adjunction of the second verb or verb phrase to the first.

Like with the complementation and coordination structures, authors arguing for adjunction structures have had differing proposals for aspects of the semantic interpretation of such structures. Li (1991) takes the interpretation of verbal arguments in serial verb phrases to follow from similar conventions to what would be needed for sentences without serial verb phrases, for example. Law and Veenstra (1992), on the other hand, propose that the arguments of non-initial verbs in serial verb phrases are phonologically null, but syntactically present, and their reference is determined by principles comparable to the ones governing the interpretation of overt pronouns.

Furthermore, as with complementation and coordination analyses, the adoption of the same structural analysis need not correspond to similar analyses generally. Li (1991), for

example, is more concerned with determining the differences between serializing and non-serializing than trying to definitively argue for one structure over another. He appeals to different principles, but a similar basic type of argument as Déchaine (1993), in suggesting an adjunction structure—specifically, he appeals to the fact that such an analysis fits in well with larger theoretical considerations of phrase structure. Muysken and Veenstra (1995), on the other hand, is similar to Veenstra (1996), to be discussed below, in adopting an adjunction structure on the basis of surface constituency tests.

With respect to the focus of the present work, it is important to note how each of these broad types of analysis understands how the order of elements of the serial verb phrase is determined. There is not complete consistency in this across the different types of structural analyses. However, broad trends can be identified.

Analyses treating serial verb phrases as having a complementation structure generally treat the order of elements to be predictable in some way that is related to a more general analysis of the relationship between a predicate and its arguments. Thus, for example, Baker (1991:85) proposes general principles of word order in a sentence and then argues that those principles only allow particular orders of elements within the serial verb phrase.

Analyses making use of coordinate structures typically invoke some notion of semantic well-formedness to account for the order of elements within a serial verb phrase. Schiller (1991:142–155) discusses the issue of linear order and adopts a temporal iconicity approach which is taken to operate on principles independent from the syntax and orders the verbal predicates in serial verb phrases in a way which is iconic with the progression of real-

world events. Déchaine (1993:210) takes a comparable approach insofar as she makes use of Awóyalé's (1988) semantic template, given in (228). This is a restriction of different permissible orderings of different semantic types, specifically modality, event, and state. Thus, she, too, invokes an external semantic explanation for the order of elements within serial verb phrases.

Adjunction analyses have also made use of some notion along the lines of temporal iconicity for the ordering of the elements (Stewart 2001:14). In addition, however, they have, to some extent, left the issue unanalyzed. Li (1991:110), for example, has taken aspects of rigid element order in serial verb phrases as an argument for the autonomy of syntax—something which I take to mean he understood their order as either stipulated or, at least, not predictable from semantic considerations. Some aspects of Li's analysis resemble Baker (1991) insofar as certain principles governing the relationship between a verb and its arguments are taken to hold for sentences both with and without serial verb phrases (Li 1991:113–4). These principles would disallow certain orders without a need to appeal to iconicity. However, they are not, on their own, a full account of element order since they only restrict the ordering relationship between verbs with shared arguments.

The adjunction analysis of Law and Veenstra (1992) makes use of null pronominal-like elements to account for the semantics of serial verb phrases. These elements are placed within the adjoined structures and, insofar as they refer to an argument in an earlier part of the sentence, one could argue they have to appear after the overt occurrence of this argument. This could thereby predict their position in the sentence and, therefore, the

position of the verb phrase they are part of. However, I am not aware of any author claiming that ordering relationships fall out from the position of these null elements. Rather, they argue for the adjunction structure on other grounds and then propose these elements to account for how semantic interpretation of the whole serial-verb phrase is possible at all. As such, these pronominal elements probably should not be considered as devices which dictate the order of the “small” verb phrases in the larger serial predicate.

In section 4.2.4 (page 428) I will discuss more specifically, for the analysis of Veenstra (1996), which makes use of such null elements in adjunction structures, the extent to which they can predict the order of elements in the serial verb phrase.

Having given a broad characterization of analyses of the structure of serial verb phrases, I move on to a more detailed discussion of two analyses. First, I will discuss that of Carstens (2002), and then I will move on to that of Veenstra (1996).

4.2.3 Carstens (2002)

Of the categories for analyses of serial verb phrases given in section 4.2.2 (page 408), Carstens (2002) would be categorized as a complementation analysis. Her analysis is relevant to the present work since she explicitly makes the strong claim that the ordering relationship between verbs in the serial verb phrase is syntactically predictable, regardless of other typological ordering characteristics of a given language. A crucial aspect of her argument is reliance on the antisymmetry theory of Kayne (1994) which generally predicts that there is no such thing as a “head”-parameter in language. For Kayne surface patterns, like the fact that some languages are SVO and others are SOV, are secondary in nature and

all languages show the same underlying order of constituents (which, for a sentence, would be SVO).

Within the terminology being employed here, this would mean that, for Carstens, serial verb phrases always constitute weak linearity domains. Since I will be claiming that they constitute a strong linearity domain, it is, therefore, important that I address her work closely.

Carsten's analysis starts with what she terms Muysken's anomaly but which is, here, called the SVC Uniformity Generalization, given in (229) and repeated in (240).

(240) **SVC Uniformity Generalization:** The order of the verb phrases in serial verb constructions is not sensitive to whether or not the language generally shows VO or OV word order.

Most authors, including Veenstra (1996), to be discussed in section 4.2.4 (page 428), have taken this generalization to mean that serial verb phrase order operates on different principles than basic word order type and have treated it, more or less, extra-syntactically. Carstens (2002:18), on the other hand, takes the SVC Uniformity Generalization as an extremely significant syntactic generalization which indicates that all serial verb phrases must exhibit a right-branching complementation structure.

Specifically, Carstens takes the SVC Uniformity Generalization to indicate the inadequacy of a parametric analysis which, "would have us identify a single hierarchical representation determined by the principles of U[niversal] G[rammar], and explain the VO/OV difference in terms of the head-parameter (Carstens 2002:18)." Such an approach, if strictly

followed, would not predict the data found in (230), repeated in (241), and would instead predict that the sentence in (241b) should surface along the lines of the sentence in (242).

- (241) a. *Kofi teki a aksi fala a bon.*
 Kofi take the axe fell the tree
 “Kofi felled the tree with the axe.” SRANAN (Sebba 1987:132)
- b. *áràú, zu ye àkì, buru teri-mí*
 she basket take yam cover-SIMPLE_PAST
 “She used a basket to cover a yam.” IZON (Williamson 1965:53)
- (242) * *áràú, buru teri-mí, zu ye àkì*
 * she basket cover-SIMPLE_PAST take yam

The sentence in (242) is the mirror-image of (241a). Such a sentence is certainly not predicted by all analyses of serial verb phrase structure, but it is predicted by a complementation analysis if one assumes head-placement is strictly parametric and strict binary-branching syntactic constituency. This latter restriction is assumed by Carstens. The trees in (243) and (244) help illustrate how such an analysis would work.⁸ The tree in (243) is taken to represent an SVO language and the tree in (244) is taken to represent an “ideal” SOV language.

⁸ In (243) and (244) I don’t use the same node labels as Carstens, since that would force discussion of certain non-crucial theoretical considerations. In particular, Carstens (2002) employs syntactically null “light verbs” (see Hale and Keyser (1993)) in her trees. However, I retain the basic spirit of her node labels insofar as they are consistent with Kayne’s (1994) antisymmetry principle, which she adopts.

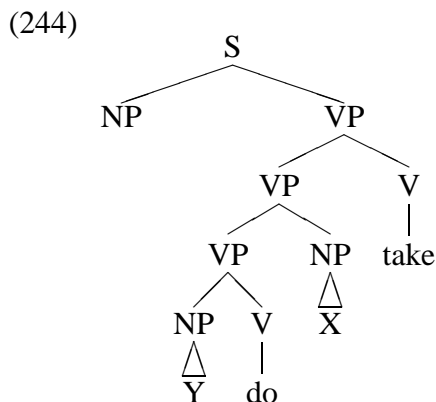
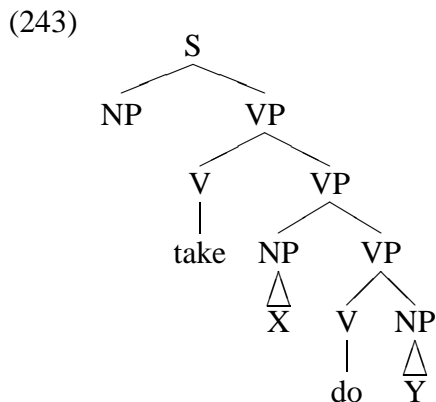

As should be clear, the tree in (244) is consistent with the non-existent sentence in (242) but is not consistent with the attested pattern in (241b). This illustrates the fact that the strictly parametric analysis is inconsistent with the SVC Uniformity Generalization.

Word order would not appear to be the only effect of the SVC Uniformity Generalization, since there is at least one other notable which can be understood as related to it. In a serial verb phrase containing two verbs each of which has an overt object, the linearly first object can bind a pronoun in the second object but not vice versa for both SVO and SOV languages. The sentences in (245) illustrate this for the SVO language Yoruba, and the data in (246) illustrates this for the SOV language Izon.⁹

⁹ The differing glosses for *olùkòwé* 'author/teacher' are found in Carstens (2002:15). No mention is made of why the glosses differ. The gloss PART is for 'particle'.

- (245) a. *Mo mú ìwé_i kòòkan fún olùkòwé_j rẹ̀_j* OK $i = j$
 I take book each give author 3SG.GEN
 “I took each book_i for/to its_j author.” YORUBA (Carstens 2002:15)
- b. *Mo mú ìwé_i rẹ̀_i fún olùkòwé_j kòòkan *i = j*
 I take book 3SG.GEN give teacher each
 “I took his_i book for/to each teacher_j.” YORUBA (Carstens 2002:15)
- (246) a. *Arí keni tóbọ̀u kẹ-ni tóbọ̀u_i akí-ni wo_i yengi píri-mí*
 I one child one child take-PART his mother give-PAST
 “I gave each child_i to his_i mother.” IZON (Carstens 2002:16)
- b. *Arí wó fún-bí akí gẹ̀gẹ̀bo-gegẹ̀bo píri-mí*
 I gave book-the take author-author give-PAST
 “I gave his_i book to each author_j.” IZON (Carstens 2002:17)

The sentence in (245a) shows that in Yoruba, the noun *ìwé* ‘book’, which is the first object in the serial verb phrase, can bind a possessive pronoun in the second object. The sentence in (245b) shows, however, that a possessive pronoun which is part of the first object of the serial verb phrase cannot be coreferential with a noun which is part of the second object. The same basic facts are replicated in the SOV language Izon.¹⁰

Carstens takes data like that in (245) and (246) to support the idea that the first object in all serial verb phrases must be structurally “higher” than the second object regardless of a language’s basic word order. This fact, combined with the lack of any attested languages showing “mirror” serial verb phrases of the sort depicted in (244) leads Carstens (2002:19) to propose that serial verb phrases in all languages have the same underlying structure, and she proposes the one in (247). (The tree in (247) represents only the verb phrase and not the whole sentence.)

¹⁰ The different nature of the coreferentiality judgements—that is, the fact the coreferential reading is explicitly ruled out in (245b) but not in (246b) reflects a gap in the data that was available to Carstens. She explicitly notes, however, that she expects Izon to show comparable ungrammaticality judgements to Yoruba (Carstens 2002:16, footnote).

(247)

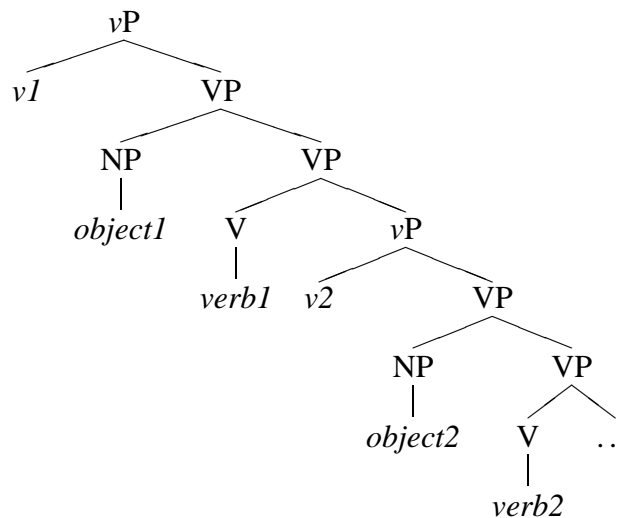

The *vP*'s in (247) represent a null “light verb” (see Hale and Keyser (1993)) which is assumed by Carstens license the arguments of a verb. These light verbs take whole verb phrases as their complement. This is why Carstens (2002) can be classified as a complementation approach to the structure of serial verb phrases. One of the primary elements distinguishing a serial verb phrase structure from a non-serial verb phrase structure in her analysis is that the former contains multiple light verbs within the main clause whereas the latter would not.

In the structure in (247), verbal complements do not appear in the typical position as sisters to the verb. Rather, they appear in “specifier” position adjoined above the verb phrase (I assume this structural relation is adjunction since specifiers are structurally indistinct from adjuncts within the antisymmetry theory of Kayne (1994:23) which Carstens adopts.) As is clear from the structure in (247), Carstens claims the underlying order of sentences containing serial verb phrases is for objects to precede their verbs.

A language like Izon, more or less, is then taken to show a surface order which faith-

fully represents the underlying order. A language like Yoruba or Saramaccan, on the other hand, is taken to exhibit movement of the main verbs to the position of the light verbs, a phenomenon which is akin to incorporation as discussed in section 2.6.2 (page 183) in chapter 2. Thus, Carstens (2002:19) represents the surface structure of a serial verb phrase in an SVO language along the lines of the structure in (248).

(248)

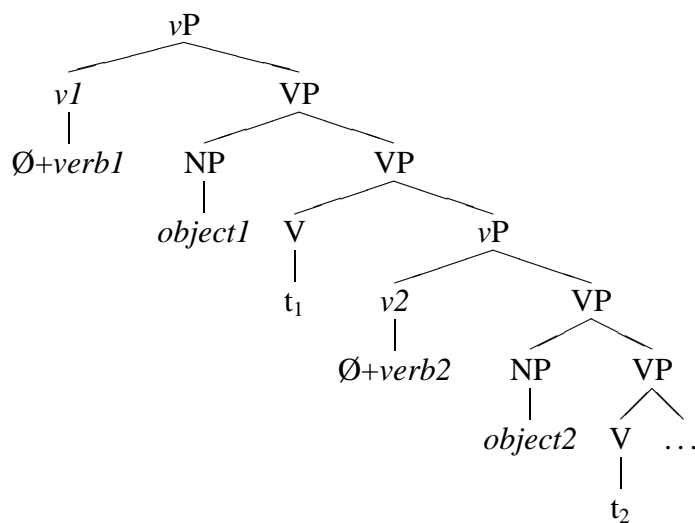

This discussion should largely suffice as an outline of Carstens' analysis of serial verb phrases, and I should point out that I am glossing over many details from Carstens (2002) here. The crucial feature of her analysis, for the present purposes, has been discussed, however: one of the driving forces behind the SVC Uniformity Generalization is that a "head"-parameter plays no role in the structure of serial verb phrases and their order can be explained by an appear to antisymmetry theory.

Carstens' proposal, if correct, would serve as a strong argument against any templatic approach the ordering of elements in serial verb phrases since it is an account which predicts the order using a purely hierarchical structure. In the rest of this section, I will focus

on criticizing one aspect of her approach: the evidence she uses to reject an adjunction analysis of serial verb phrases since that is, ultimately, the sort of analysis I will adopt. Other arguments against her approach will appear in section 4.2.4 (page 428), when I cover the analysis of Veenstra (1996) since he explicitly rejects a structural analysis for serial verb phrases along the lines of Carstens (2002) citing evidence from basic constituency tests, and in section 4.2.5 (page 434), when I will critique Carstens' appeal to the thematic hierarchy to account for certain ordering facts.

As just mentioned, the central question which I want to address at this point, with respect to Carstens' proposal, is whether or not it should be considered superior to the one schematized by the trees given in (249) and (250).¹¹

(249)

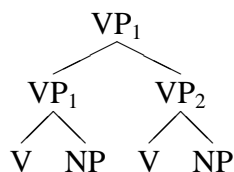

(250)

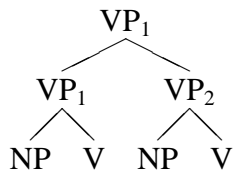

The two trees in (249) and (250) are meant to illustrate how an adjunction analysis for serial verb phrases could account for the SVC Uniformity Generalization. Such an analysis

¹¹ In the discussion to follow, I will focus on an adjunction analysis of the structure of serial verb phrases, though many of the arguments would hold for coordination analyses. In section 4.2.4 (page 428) I will outline arguments as to why an analysis of structural adjunction would be favorable to a coordination analysis. In general, however, the distinction is not particularly important here since, unlike a complementation analysis, adjunction and coordination analyses will require some independent principles accounting for the order of elements in serial verb phrases. The need for such a principle is what is important here—not the particular structure it applies to.

(as well as a coordination analysis) would do this by setting up the “small” verb phrases in the serial verb phrase, each having its own domain for head-parametrization. These small verb phrases could then be ordered with respect to each other by the same principles for both VO and OV languages, thus predicting the SVC Uniformity Generalization. Carstens (2002:32) is aware of the possibility of such an analysis.

However, Carstens (2002:32–4) raises several objections to adjunction structures along the lines of (249) and (250), most of which, I will argue, are weak. The first, and strongest, is that an adjunction analysis requires an independent stipulation of verb phrase order—specifically, the fact that the adjoined verb phrase follows, rather than precedes, the verb phrase it is adjoined to is not automatically predicted. While there are problems with Carstens’ analysis, as we will see, one of its strengths is that the SVC Uniformity Generalization falls out more or less automatically.

The claim made in this work will be that the verb phrase order in serial verb phrases is not, in fact, predictable from hierarchical structure and should be considered templatic. That is, I will argue that an independent stipulation of verb phrase order is necessary and can be made consistent with the Strong Linearity Domain Hypothesis. Since I accept this objection of Carstens’ as being one of the primary features of my own analysis, I will not counter it directly here. In this section, I will argue that her other objections are not particularly problematic. In subsequent sections, I will give more general reasons why the order of the verb phrases cannot be predicted in the way she proposes.

Carstens raises several other objections to structures like those in (249) and (250). The

first of these is that, given facts like the pronominal binding ones illustrated by (245) and (246), Carstens (2002:33) writes “these adjunction analyses force abandonment of the classical first branching node definition of c-command (Reinhart 1979).” As stated, I believe this objection is essentially groundless. This is because, as Carstens (2002:33, footnote) points out, Kayne (1994) also abandons the first-branching node definition of c-command, and she bases her most important conclusions on Kayne’s theory of antisymmetry. Carstens treats this as incidental. However, for Kayne (1994:15–32), a different definition of c-command is a central part of his theory.

The revised definition of c-command found in Kayne (1994:16), in fact, would not predict that the first object in a structure like (249) or (250) would c-command the second object (though Carstens does not point this out). So, perhaps Carstens’ objection could be salvaged pending a more thorough analysis of the nature of c-command in Kayne’s framework. As it stands, however, it can not be considered a strong argument against an analysis making use of an adjunction structures.¹²

Carstens (2002:33) raises another object to the structures in (249) and (250), “The loosening required to accommodate [an adjunction structure] seems to permit complements to c-command material inside specifiers, a move without independent support.” I am not precisely sure how to interpret this objection. Given that there is no adjunct/specifier distinction in antisymmetry theory, my best guess is that she is reinterpreting the adjunction structures along the lines given in (251) which is a reconception of (249).

¹² For a definition of c-command consistent with an adjunction analysis of serial verb phrases see McCawley (1998:353).

(251)

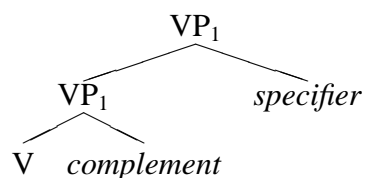

Following the tree in (251), I believe Carstens is labelling the right-adjunct in structures like the one in (249) as a specifier. If this interpretation is correct, how this second objection of hers is substantially different from the earlier objection about revising the first-branching node definition of *c-command* is not at all clear to me. Because of this, I set this objection aside.

Another objection raised by Carstens (2002:33) is that movement out of adjuncts is, “a potential problem for movement-theoretic reasons.” Beyond being a theory-internal objection, this problem is addressed by Veenstra (1996:121–2) working within a comparable framework. I take this to mean that this “potential problem” is not intractable, and therefore not a strong counterargument to an adjunction analysis.

Carsten’s final objection to the adjunction analysis is, “A further drawback is the incompatibility of right-adjunction with the antisymmetry framework Carstens (2002:34).” Considering that Carstens is using the facts from serial verb phrases to argue that the antisymmetry framework is correct, this argument would appear to be circular and I, thus, also consider it not to be a proper counterargument to the adjunction analysis.

To this point, all I have attempted to show is that Carstens’ objections to an adjunction analysis are by no means strong enough to rule one out. In the next section, I will present arguments from Veenstra (1996) that, in general, a complementation analysis for serial verb

phrases is not tenable and an adjunction analysis is preferable on empirical grounds. Since I will largely adopt Veenstra's analysis, it was important for me to address Carstens' specific objections to an adjunction analysis here.

There is an additional aspect of Carstens' analysis which needs to be covered, though I will do so later on in section 4.2.5 (page 434) when I discuss approaches which invoke temporal iconicity and the thematic hierarchy to account for the order of elements within serial verb phrases. Specifically, while Carstens' analysis predicts that verb order should be the same in languages regardless of the order that holds between a verb and its object, it does not, on its own, explain why one verb should appear before another more generally. To explain this, Carstens (2002:36–8), invokes the thematic hierarchy, in a way similar to Baker (1989) and Baker (1991). These types of proposals encounters general problems, as will be discussed in section 4.2.5 (page 434).

What we have seen in this section is that, while there is an articulated analysis of serial verb phrases which treats the order of the elements in them as completely predictable, there is no solid evidence to favor it over an adjunction analysis. Carstens' argument is essentially based on two ideas: (i) that the SVC Uniformity Generalization means that a head-parameter is not involved in serial-verb constructions and (ii) that there must be an account of the SVC Uniformity Generalization by appealing only to hierarchical structure. From these ideas she develops a complementation account for serialization. Based on the work of Veenstra (1996), in the next section, I will reject such an analysis. In section 4.2.5 (page 434) I will also argue against the thematic-hierarchy analysis she gives to account for

the order of verbs in serial verb phrases generally. I will take the sum of the arguments to mean that Carstens' analysis should be abandoned generally, and we will, therefore, need a non-antisymmetry-based account of the order of elements within serial verb phrases. The account I will ultimately provide is a templatic one.

4.2.4 Veenstra (1996)

While Carstens (2002) only examines two properties of serial verb phrases in depth, the SVC Uniformity Generalization and the binding facts for objects, Veenstra (1996) analyzes a much wider range of properties—including those two—and, based on his study, concludes that serial verb phrases are examples of adjunction structures (Veenstra 1996:151).¹³ As mentioned above, Veenstra's focus is on Saramaccan, which makes his work particularly relevant here.

For our purposes, the most important aspect of Veenstra (1996) is the evidence he provides against a complementation analysis.¹⁴ Interestingly, in light of arguments made by Carstens (2002), the first reason Veenstra gives against a complementation analysis is, “if

¹³ There is an inconsistency in Veenstra (1996), which explicitly favors in the text an adjunction structure for serial verb phrases in multiple places but gives various structures in examples which are not obviously adjunction structures. For example, he gives the following structure in his analysis of *take*-serials (Veenstra 1996:140).

[_{IP} NP₁ [_{VP} t₁ [_{V'} v [_{VP} NP₂ [_{V'} V [_{AspP} [_{VP} PRO₁ [_{V'} V pro₂ PP]]]]]]]]]]

This structure is certainly not a typical adjunction structure, if it can be considered one at all. However, Veenstra (1996) does not give many examples of the structures he envisions in his analysis and never gives trees—instead, he always uses bracketed forms, which are, of course, harder to inspect for accuracy than trees. Since his prose is completely clear in advocating an adjunction structure, I suspect that the structures he gives like the one above are not precisely what was intended, and I follow the prose analysis he gives throughout this case study.

¹⁴ Veenstra (1996:116–8) applies the term “subordination” to what is, here, called complementation.

[complementation] were a guiding principle for the arrangement of verbs, then we would expect this arrangement to be determined by verb-complement order (i.e. directionality of government).” Then, specifically on the basis of the SVC Uniformity Generalization, he concludes, “the arrangement of the elements in serial verb constructions is independent of the directionality of government and, as such, militates against an analysis in terms of [complementation] (Veenstra 1996:116).”

We have seen, of course, from Carstens (2002), that it is possible to devise an analysis of serial verb phrases in terms of complementation which follows the SVC Uniformity Generalization. So, Veenstra’s inference, on its own, cannot argue against a complementation analysis. However, he presents several other arguments against one.

His second argument against a complementation analysis runs as follows:

In addition, in a [complementation] type-analysis [sic] the first verb would select the second VP. Thus a semantic relationship should hold between V_1 and VP_2 . But with respect to resultative serial verb constructions, it is not at all clear how the first verb in any relevant way would select the second VP...

Veenstra then gives the data in (252).

- (252) a. *Mí nakí hén kíi.*
 I hit he.EMPH kill
 “I struck him dead.” (Veenstra 1996:117)
- b. *Mí sáka dí láí butá àlá.*
 I lower the load put there
 “I have put the load over there.” (Veenstra 1996:117)

Veenstra’s objection to the complementation analysis is simply that it is hard to understand how a verb like *náki* ‘hit’, in (252a), could assign a semantic role to *kíi*, in any typical

fashion. It is similarly difficult to understand what the semantic relationship between *sáka* ‘lower’ and *butá àlá* ‘put there’ would be in (252b). If constructions like those in (252) were limited to a few verbs, a complementation analysis might be conceivable. However, serial verb phrases constructions are productively derived. Thus, a complementation analysis, “would mean that practically all verbs in Saramaccan (or any other serializing language for that matter) have the ability to select a predicate in addition to a nominal argument, presumably an unwarranted complication of the lexicon (and the grammar) of serializing languages (Veenstra 1996:117).”

I agree with this objection to a complementation raised by Veenstra. It would be useful to know what the position of Carstens (2002) would be to this problem. She does not discuss this issue raised by a complementation analysis, and it is not clear to me how she would react to it. This issue is not clearly addressed by some of the other authors who make use of a complementation analysis. However, this is not necessarily problematic for their analyses. Sebba (1987) does not assume the same restrictive theory of phrase structure assumed by Carstens (2002) or Veenstra (1996)—so, it is not surprising that he does not comment on this potential problem. Baker (1991) employs a complementation *structure*, but he assumes that serial verb phrases can have multiple heads. So, for him, one verb is not a complement of another verb in any semantic sense. It is clear that Carstens (2002) is not adopting such an analysis, however. As matters stand, I take this object of Veenstra’s to be a valid one—at least for a Carstens-style approach.

A related objection to the complementation analysis of serial verb phrases relates to

constituency if one assumes strict binary branching. Such a complementation analysis, which is assumed by Carstens (2002), implies that the bracketed material in (253) is a constituent.

(253) *A téi [dí bεέε kóti].*
 he take the bread cut
 “He cut the bread.” (Veenstra 1996:117)

Some complementation analyses, like that of Baker (1989), do not take the bracketed material in (253) to be a constituent and, thus, consider the object to be in a position similar to where it would appear in non-serial verb phrase construction.¹⁵ However, those analyses which do predict that the bracketed material in (253) is a constituent must treat a verb like *téi* ‘take’ as being able to take a proposition. For Saramaccan, this is an awkward side-effect of a complementation analysis since the verb *téi* is able to be used in sentences where its complement is clearly not a proposition, as seen in (254).

(254) *A téi dí fáka.*
 he take the knife
 “He took the knife” (Veenstra 1996:117)

Another objection Veenstra (1996) raises in this regard relates to ellipsis facts for Haitian reported in Law and Veenstra (1992:194–5). The relevant data is given in (255).

¹⁵ In two papers, Baker (1989) and Baker (1991), Baker suggests that certain kinds of serial verb phrases have the structure [V NP VP]_{VP}. I do not consider this approach in detail in this discussion of complementation analyses since no one seems to have accepted Baker’s proposal that serial verb phrases can be double-headed (in a recent paper, Baker and Stewart (2002), he too, rejects this) and because Baker was examining only a subset of serial verb phrase types, making it hard to compare it with broader analyses. As Baker (1989:525–7) points out, a double-headed approach can be made consistent with aspects of the SVC Uniformity Generalization. His account for the SVC Uniformity Generalization relates to the thematic hierarchy and will be discussed in section 4.2.5 (page 434).

- (255) a. *Jan pran foto montre Mari e Pol pran *(tablo a).*
 Jan take picture show Mari and Paul take painting the
 “Jan showed Mari a picture and Pol showed Mari a painting” HAITIAN
 (Veenstra 1996:118)
- b. *Jan pran machet koupe pye-bwa e Mari pran *(rach).*
 Jan take machete cut tree and Mari take axe
 “Jan cut the tree with a machete and Mari cut the tree with an axe.” HAITIAN
 (Veenstra 1996:118)

The sentences in (255) show that, when sentences containing serial verb phrases are conjoined in Haitian, the second “small” verb phrase of the serial verb phrase in the second conjunct can be elided and that conjunct is interpreted as though it contained the second “small” verb phrase of the serial verb phrase in the first conjunct. However, in this construction, the object of the first verb cannot also be elided. Veenstra (1996:18) takes this as further evidence against an object-VP constituent of the kind bracketed in (253).

What we have, then, is several coherent, fairly theory non-specific arguments against a complementation analysis. While Carstens (2002) offered arguments against an adjunction analysis, we saw that all but one of those were theory-internal and, even within the relevant theory, they were not particularly strong. The one non-theory internal objection, that an adjunction analysis requires the stipulation of some of the ordering relationships within the serial verb phrase, is precisely the position that will be argued for here, and, for that reason, was set aside. My conclusion from this is that Veenstra’s analysis is the more plausible of the two analyses.

Further support for Veenstra’s rejection of a complementation analysis, comes from the fact that, working within a radically different framework, Foley and Van Valin (1984:263) devise an approach which also would argue against one. In particular, they analyze verb

serialization as nuclear coordinate nexus, nuclear cosubordinate nexus, or core cosubordinate nexus. None of these types of “nexus”, or clause union, involves embedding of one clause into another—thus, they could not be classified as complementation analyses. Nexus at the core level implies that two verbs share a subject and nexus at the nuclear level implies that two verbs share a subject and an object. This sharing can be taken to have the same role in an analysis of serialization Veenstra’s null syntactic elements, which will be briefly discussed below. Thus, we see that both Veenstra (1996) and Foley and Van Valin (1984) came to similar conclusions despite operating within different frameworks (and, in some cases, looking at different languages).

What we have seen, in this section, is that there is empirical evidence against a complementation analysis for serial verb phrases while there is empirical support for an adjunction analysis. The syntax of serial verb phrases is clearly very complex. However, it is also clear that, given our present state of knowledge, an adjunction-type analysis is favorable over a complementation one.

Before moving on, I would like to point out that Veenstra (1996) is silent on the issue as to what principle (if any) dictates the order of the order of the verb phrases as well as which one is adjoined versus which one is the main verb phrase of the sentence. He does propose that there are phonologically null, but syntactically present, “empty categories” in the adjunct phrases which play a role in the interpretation of the arguments of the verbs in those phrases. It is possible that these null arguments could be taken to somehow enforce a restriction that adjuncts must follow the main clause—so that they could be interpreted.

However, while such an analysis would predict that the adjunct phrase has to follow the main verb phrase, it cannot predict which verb will appear in the adjunct position and which will be the main verb.

For example, if we take a sentence like (253) which means *he cut the bread* and can be glossed as *he take bread cut*, an adjunct analysis, on its own, cannot predict why it is not expressed as *he cut bread take*. It could predict that the expressed object follows the first verb and not the second verb—this would ensure that the null pronominal element follows the expressed object. But it cannot predict the order of the verbs themselves on its own. The solution that will be proposed here is that the ordering relations between the verbs are determined (partially) templatically.

However, two other types of proposals have been made for external principles which govern the ordering of verbs in the serial verb phrase: temporal iconicity and the thematic hierarchy. I take each of these in turn in the next section, and discuss why they also cannot account for all the ordering facts in serial verb phrases.

4.2.5 Other explanations for ordering effects: Temporal iconicity and the thematic hierarchy

4.2.5.1 Introduction

In this section, I will discuss two external principles which have been invoked to account for the order of verbs in serial verb phrases. These are temporal iconicity and the thematic hierarchy. The former of these can account for many aspect of ordering, but not ordering in serial verb phrases involving highly grammaticalized verbs. There are various

incarnations of the latter approach, but they also are not fully adequate for dealing with all the relevant facts.

4.2.5.2 Temporal iconicity

One principle sometimes taken to govern the ordering of elements within serial verb phrases is that of temporal iconicity. For example, when we examine serial verb phrases like the one in (256), repeated from (235), it is tempting to say that the ordering of verbs reflects, in some way, the real-world ordering of events described by the verbs. We could, therefore, say that the ordering is determined by some sort of temporal iconicity.

(256) *A ḱisi dí f́ou nakí ḱi limbó bói njan.*
 he catch the bird kill hit kill clean cook eat
 “He caught the bird, struck it dead, cleaned, cooked, and ate it.” (Veenstra 1996:103)

While temporal iconicity may play some role in long serial verb phrases of the sort in (256), just as it might play a role in the English translation of that sentence, there is reason to believe that it cannot, on its own, account for the ordering of elements in serial verb phrases.

One of the major problems with such an account results from grammaticalization of certain verbs. For example, it is common for a verb meaning ‘give’ to be used in contexts which would be translated in English as a prepositional benefactive/recipient, as seen in (257), repeated from (232b).

(257) *De maá dí fáka dá mi.*
 they sharpen the knife give mi
 “They sharpened the knife for me.” (Veenstra 1996:95)

While it is possible to conceive of a temporal iconicity explanation for the order of predicates in the particular sentence in (257), this becomes difficult in other cases, like the sentence in (258). (This sentence is taken from de Groot (1977). I give his original Dutch translation after the English translation, which is taken from Veenstra (1996:99).)

- (258) *A fón wójo dá dí taánga u dí sónu.*
 he beat eye give the strength for the sun
 “He blinked his eyes against the strong sunlight.”
 (“Hij knippert met de ogen tegen het sterke zonlicht.”) (de Groot 1977:156)

The relationship between the object of the verb *dá* ‘give’ and the main verb *fón* ‘beat’ is not immediately clear and is probably best classified as a cause. The whole serial verb phrase in (258) certainly can sensibly encode one event. However, to the extent that temporal iconicity would predict an order of the two constituent verb phrases at all, it would probably predict the reverse order since the sun is causing the subject to blink—and, therefore, presumably is shining in his eyes before he blinks. Baker (1989:526) presents similar arguments to this against a temporal iconicity approach.

Further examples which can serve argue against a temporal iconicity approach are found in Law and Veenstra (1992) and are given in (259). This data is from Haitian.

- (259) a. *Jan pran liv la montre Mari.*
 Jan take book the show Mari
 “Jan showed the book to Mari.”
 b. *Jan pran Mari montre liv la.*
 Jan take Mary show book the
 “Jan showed Mari the book.” HAITIAN (Law and Veenstra 1992:190)

The pair of sentences in (259) both express essentially the same event and are not reported to have any fundamentally different meaning, and the translations given by Law and

Veenstra (1992) in no way indicate any effects of temporal iconicity. Unlike the data in (258), devising an analysis in which the sentences in (259) can be consistent with temporal iconicity is possible. However, such data is probably more indicative of the general fact that serial verb phrases are prone to a type of grammaticalization which renders temporal iconicity irrelevant.¹⁶

My conclusion is that, while temporal iconicity can probably play some role in ordering the predicates of serial verb phrases, it cannot account for all the ordering facts. Rather, there are instances where the order is fairly clearly grammaticalized in a way which can render their ordering non-iconic. These instances indicate that a templatic account of the ordering of elements in serial verb phrases is required to account for the full range of facts.

4.2.5.3 The thematic hierarchy

Another principle that has been invoked as governing the order of elements in serial verb phrases is the thematic hierarchy. Baker (1989) and Carstens (2002) both suggest that predicate order in serial verb phrases reflects a thematic hierarchy of argument types. Baker (1989:544) for example proposes that the thematic hierarchy given in (260) predicts which verb will come first in a serial verb phrase—specifically, a verb assigning its object a role in a higher position of the hierarchy will proceed one assigning its object a lower role in the hierarchy.

(260) Agent > Instrument > Patient/Theme > Goal/Location

¹⁶ The sentences in (259) further suggest that direct and indirect objects in Haitian are symmetrical—that is, they do not show different syntactic behavior (at least in this construction).

As pointed out by Law and Veenstra (1992), the data seen above in (259), where their appears to be free variation in the ordering of objects with different thematic roles, immediately presents a problem for Baker's analysis of predicate order, and it is difficult to see how to rectify it with a thematic hierarchy analysis.

A related problem with a thematic hierarchy analysis is that it is not clear what the proper thematic hierarchy should be at all. In chapter 2, for example, a standard thematic hierarchy within LFG was given which Alsina (1999) used to examine certain Bantu data. I repeat it below in (261).

(261) *agent > beneficiary > goal > instrument > patient > locative* (Alsina 1999:23)

Aside from the obvious difference between the number of categories assumed by Baker (1989) and Alsina (1999), it is important to point out that Alsina's beneficiary would be categorized as a goal/location by Baker—a major difference in position.

Carstens (2002:36) assumes a simple thematic hierarchy of nontheme > theme. This represents a third variant of the thematic hierarchy, and also one not without problems. Carstens (2002:38–47) addresses a number of “exceptions” to her thematic hierarchy.

It will not be worthwhile to repeat her analysis of the “exceptional cases” in detail here for the simple reason that, despite her claim that the non-theme > theme hierarchy is well-motivated for many serial verb phrases (Carstens 2002:44), this is not at all clear. Her basis for this claim appears to be that, “We've seen that in [serial verb phrases] instruments, locations, and adverbial elements like ‘new way’ and ‘cleverness’ are to the left of and thus higher than themes as this hierarchy predicts. . . Carstens (2002:36).”

As far as I can tell, Carstens' claim does not hold, except for instrumental serial verb phrases, and, it is not even completely adequate for those. A further problem is that her “three” categories of serial verb phrases which she uses to support her case, may really only be two—instrumentals and locatives. I discuss this issue first.

Specifically, with respect to her category of “adverbial elements”, the cases she cites are both instances of ‘take’-type serials with instrumental core uses. For example, in (262a), from Yoruba, the core use of the verb *fi* ‘take’ is to introduce an instrumental object. In (262b) the exact same construction is used with a nominal “adverbial element”.

- (262) a. *Mo fi ibon pa ekun.*
 I FI gun kill leopard
 “I killed a leopard with the gun.” YORUBA (Carstens 2002:11)
- b. *Mo fi ogbon ge igi.*
 I use cleverness cut tree
 “I cut down the tree with cleverness” YORUBA (Stahlke 1970:62)

It is not completely clear if the sentences in (262) represent two distinct syntactic classes of serial verb phrases since they both make use of the same initial verb with two clearly related uses. That is, the distinction between an instrumental argument and an adverbial made by Carstens does not immediately mean her hierarchy accounts for two different classes of sentences. Rather, these two types of sentences can easily be considered to be of the same class with moderately differing semantics.

However, even to the extent that syntactic evidence can be found to distinguish between the two classes, it actually demonstrates that the non-theme > theme is not sufficient to explain the full range of the data—at least for Yoruba. With reference to the sentence

in (262b), Stahlke (1970:62) notes, “There does seem to be an order constraint, however, requiring that when both an instrumental and a manner adverbial occur in one sentence, the manner adverb comes first.” As it stands, Carstens’ analysis predicts free variation in the order of the two since both instances of *fi* ‘use’ introduce non-themes.

Thus, even though it’s not completely clear if serial verb phrases containing manner adverb phrases should be considered a separate category from instrumental serials, if we were to do this we’d have to alter her hierarchy to take into account the strict ordering relationship between the two uses of *fi*. While this is a problem for Carstens’ analysis, it is, however, a relatively small one since it could be fixed simply by expanding on her thematic hierarchy.

A more critical problem for Carstens’, however, is the second class of verb phrases she gives as obeying her hierarchy: locatives. Her justification for this comes from the following sentences from Izon, given in (263).

- (263) a. *erí amá dùo yọu bo-mi*
 he town go_through paddle come-PAST
 “He came paddling from the town.” IZON (Williamson 1965:49)
- b. *erí bení dùo yọu-mi*
 he water go_through paddle-PAST
 “He paddled through the water.” IZON (Williamson 1965:49)

The sentences in (263) do not, in any straightforward way, illustrate a nontheme > theme hierarchy since there is only one nominal argument in them, and it is not clear to me how Carstens’ intended them to be understood in light of her general argument.

Furthermore, to the extent that a generalization can be made, locatives would seem to be more likely to follow themes than precede them. When serial verb phrases containing locatives have two objects, there is a common pattern where the locative expression is predicated on an object introduced as the theme of an earlier verb—as in the example in (264) from Saramaccan. Sentences like (264) were probably what Baker (1989) had in mind when proposing his thematic hierarchy in (260).

(264) *À féní wátà bà bütá à wósù.*
 he find water carry put in house
 “He finds water and brings it to the house.”

I am not aware of anyone having studied the general placement of locative expression in serial verb phrases. However, my sense from the literature is that sentences like the one in (264) are quite common and, therefore, constitute major counterexamples to Carstens’ nontheme>theme hierarchy.

When looked at more closely, then, the claim the non-themes precede themes is only valid for one broad class of serial verb constructions—instrumental serials. As Carstens (2002:39–44) herself is aware, it makes exactly the wrong prediction for benefactive serials (an example of which was seen in (232b) where a verb with the core meaning ‘give’ follows the verb introducing the theme and introduces a benefactive argument).¹⁷

The general conclusion that we can arrive at is that neither of the two thematic hierarchies proposed in the literature to account for the ordering facts of serial verb phrases,

¹⁷ Carstens (2002:38–47) does provide analyses to deal with some counterexamples. I do not consider them in depth because of the general problems with her claim about the explanatory adequacy of a nontheme>theme hierarchy for verb order in serial verb phrases.

those of Baker (1989) and Carstens (2002), is adequate. An additional problem with analyses making use of thematic hierarchies is disagreement as to what an appropriate thematic hierarchy should be.

4.2.5.4 Refining aspects of the Strong Linearity Domain Hypothesis

We have seen, here, that neither temporal iconicity nor the thematic hierarchy can fully explain the order of verbs within serial verb phrases. Before continuing, I would like to discuss how these principles, if it turns out that they might be valid as explanatory devices for the ordering relations of some grammatical phenomena, relate to the notion of a strong linearity domain.

In section 1.1.3.1 (page 26), I defined strong linearity domains in (18) as linearity domains “in which some aspects of the linear relations among constituents must be specified independently of their hierarchical relations”. It is not clear how temporal iconicity and the thematic hierarchy relate to the idea of “hierarchical relations” which was intended to refer to the traditional sort of hierarchical relations encoded in labelled constituency trees.

With respect to the thematic hierarchy, we could conceivably extend the notion of “hierarchical relations” to include hierarchies like the thematic hierarchy (in addition to comparable proposed grammatical hierarchies like the animacy hierarchy and sonority hierarchy). Such hierarchies can’t be encoded via trees and represent a different sense of the idea “hierarchical relations” from those which were originally at the core of the definition of a strong linearity domain. However, for the theory of linear relations being developed here extending the sense of the term “hierarchy” would follow the original spirit of the definition of

a strong linearity domain which was essentially understood as a domain where linear relations were generally unpredictable. If some set of linear relations can be predicted via a thematic “hierarchy”, then we wouldn’t want to consider them examples of strong linearity.

The notion of temporal iconicity is not obviously “hierarchical” in any sense. However, ordering relations based on temporal iconicity would be predictable. And, so, if temporal iconicity turns out to be a factor in linear relations, we would want to further add to the definition of strong linearity domain that linear relations be unpredictable both from hierarchical and from such iconic relations.

While it might be the case that a specific definition assigned to the term “strong linearity domain” might leave out some factor which predicts some linear relations, the guiding principle behind the notion should be that all linearity domains which are synchronically predictable via some outside principle (hierarchical constituency relations, various grammatical hierarchies, iconic relations, etc.) do not constitute strong linear relations. So, as such principles are discovered they should be added to the list of linear relations excluded from possible strong linearity restrictions. Determining what those principles might be is, here, considered to be essentially an empirical endeavor.

The potential role of a factor like temporal iconicity further relates to a different point, discussed, to some extent, in the earlier case studies, which is worth bringing up again here. As a well-formedness constraint, the Strong Linearity Domain Hypothesis has little to say about why the precise linear order of elements within a strong linearity domain is what it is. Rather, it is merely a restriction on what kinds of ordering relations generally can be

specified within strong linearity domains. So, for example, in the Bantu case I argued that a CAT template was consistent with the Strong Linearity Domain Hypothesis but further discussed the need for a separate explanation for CA versus AC order being found.

We will, therefore, generally need separate theories for how the order of elements within a strong linearity is explained, once the existence of one is proposed. So, while I have claimed here, that the order of elements within a serial verb phrase cannot be explained solely via temporal iconicity, I will suggest in section 4.3.5 (page 486) that it has a role in their historical development and, therefore, does explain many aspects of their order diachronically, if not synchronically. Such an explanation constitutes a separate subtheory of ordering relations which is directly related to the linear order of particular elements within a strong linearity domain and covers a very different territory from the well-formedness statement of the Strong Linearity Domain Hypothesis.

In the larger picture, what this means is that, as we uncover principles which predict the linear order of elements within a linearity domain, this does not necessarily mean they will “chip away” at the phenomena which are intended to be constrained by the Strong Linearity Domain Hypothesis. Rather, one must also consider the possibility that they will allow us to explain aspects of strong linearity domains not encompassed by the Strong Linearity Domain Hypothesis.

4.2.6 Local conclusion

In this section, I outlined some descriptive properties and previous analyses of serial verb phrases. I have largely adopted the analysis of Veenstra (1996) which treats serial

verb phrases as consisting of a core initial verb phrase to which other verb phrases are adjoined. I rejected analyses making use of complementation structures—with a particular focus on Carstens (2002). Within the larger scope of the overall argument, these arguments were taken to imply that the order of elements in serial verb phrases was not syntactically predictable.

In addition two principles designed to explain the order of the verbs in serial verb phrases were discussed: temporal iconicity and the thematic hierarchy. The general conclusion was that, although such principles might be used to explain some aspects of the ordering of the verbs in serial verb phrases, they cannot fully account for it.

The sum of these facts is taken to mean that serial verb phrases constitute a strong linearity domain—that is, their order must be independently stipulated. In the next section, I will develop an account for this which is consistent with the Strong Linearity Domain Hypothesis. Such an account will require that the “templatic residue” of serial verb phrases be simple enough as to avoid detailed reference to their syntactic structure.

4.3 SARAMACCAN SERIAL VERB PHRASE ORDERING AND THE STRONG LINEARITY DOMAIN HYPOTHESIS

4.3.1 Overview of argument

In this section I will attempt to establish the parameters of a strong linearity domain for Saramaccan serial verb phrases. As mentioned above, one of the reasons for choosing Saramaccan serial verb phrases in particular is that their prosodic phonology is fairly well-studied, and relevant aspects of the prosodic phonology of Saramaccan will be discussed

in section 4.3.2 (page 447). This discussion will establish that serial verb phrases in Saramaccan are, in fact, prosodic constituents. This allows them to fulfill the first condition of the Strong Linearity Domain Hypothesis.

In section 4.3.3 (page 473), I will establish the characteristic phonology of the Saramaccan serial verb phrase, and in section 4.3.4 (page 477), I will show how the templatic properties of serial verb phrases in the language are consistent with the Strong Linearity Domain Hypothesis. Finally, section 4.3.5 (page 486) offers a discussion of aspects of the serial verb phrase ordering which cannot be accounted for by the Strong Linearity Domain Hypothesis.

Consistent with the model of linearity on which the Strong Linearity Domain Hypothesis is based, since Saramaccan serial verb phrases are the largest of the linguistic constituents being discussed here, they have the least specific templatic requirements of the three phenomena being examined. In fact, I will argue that the serial verb phrase ordering template is simple enough that it trivially satisfies the consistency condition of the Strong Linearity Domain Hypothesis, as described in section 1.2.3.2 (page 47). While serial verb phrases are clearly fairly complex structures, the template which governs them is simple since most of their complexity will be taken to be syntactic—the template will only be used to account for some of the basic ordering of these structures.

4.3.2 Saramaccan phrasal prosody

4.3.2.1 Introduction

In this section, I will present an overview of aspects of Saramaccan phrasal prosody which will be relevant to establishing that serial verb phrases in the language are consistent with the Strong Linearity Domain Hypothesis. This discussion will be complicated by the fact that, while the prosody of Saramaccan serial verb phrases is well documented, the facts which have so far been uncovered do not lend themselves to a straightforward analysis. Nevertheless, a clear argument can be made that the serial verb phrase in Saramaccan acts as a prosodic domain—even if it is not possible to give a detailed formal analysis of its behavior.

There are two main aspects of Saramaccan phrasal phonology to be covered. The first is a process of tonal plateauing found within phonological phrases in the language. While this process does not present direct evidence for a prosodic constituent contiguous with the serial verb phrase in Saramaccan, it will be important to understand its behavior for two reasons. The first is that this process can act within serial verb phrases, and, therefore, to understand the prosodic effects which are peculiar to them, it will be necessary to see the role plateauing independently plays within them. The second reason why plateauing needs to be discussed is that the domains of plateauing will have a role in describing the characteristic phonology of serial verb phrases. So, in order to establish that Saramaccan serial verb phrases are consistent with the Strong Linearity Domain Hypothesis, we will need an understanding of the shape of these domains.

In section 4.3.2.2 (page 448), I discuss tonal plateauing, and, in section 4.3.2.3 (page 459), I discuss the evidence for a prosodic constituent associated specifically with the serial verb phrase.

4.3.2.2 Tonal plateauing

The most conspicuous phenomenon in Saramaccan phrasal phonology is tonal plateauing. This is a process wherein tone bearing units (TBU's) in the language unspecified for tone surface with high tones when flanked by high tones in a well-defined set of syntactic environments. It will turn out that the prosodic unit associated with serial verb phrase is not a plateauing environment. However, in order to understand what the evidence is for the this prosodic constituent and the nature of its characteristic phonology, it will be important to understand how plateauing interacts with it. So, it merits a summary here.

A basic example of tonal plateauing is given in (265). In this section, I only give a sketch of the process. A much more detailed discussion can be found in Good (2003b), and much of the discussion in this section is taken more or less directly from there.

(265) *Dí wómi kulé àlá.* → *Dí wómí kúlé àlá.*
 the man run there
 “The man runs there.”

The citation form of the word meaning ‘man’ is *wómì* and the citation form of ‘run’ is *kùlé*. However, in (265), the two forms respectively surface as *wómí* and *kúlé*, with all high tones, as result of plateauing. This example shows that plateauing can affect more than one TBU—which is generally true in Saramaccan, though in most of the examples given here only one TBU is affected.

In Saramaccan, tone-bearing units can be unspecified for tone (and thus be subject to plateauing), or they can be specified for a high tone or a low tone. Lexically-specified high tones are critical triggers for plateauing. Lexically-specified low tones block plateauing. TBU's unspecified for tone surface with low tones as a default and surface with high tones in plateauing environments and, in some cases, in serial verb phrases, as will be discussed in section 4.3.2.3 (page 459).

The example in (265) illustrates one syntactic environment where plateauing is found: between the last word of a subject noun phrase and the first word of the verb phrase. The table in (266) schematizes, for a range syntactic environments, where plateauing does and does not occur. A “|” indicates that plateauing does not occur and a “ \frown ” that plateauing does occur. Basic word order in Saramaccan noun phrases is Det-Adj-Noun, and basic sentence word order is SVO.

(266)	PLATEAUING	NO PLATEAUING
<i>Noun phrases</i>	Det \frown Noun Adj \frown Noun	Det Adj Adj Adj
<i>Verb phrases</i>		Verb NP
<i>Prep. phrases</i>		Prep NP
<i>Sentences</i>	NP \frown VP	

The examples in (267)–(269) illustrate the three syntactic environments where plateauing is found. In (267) it is shown that nouns and a preceding determiner form a plateauing environment. In (268) we see that nouns and a preceding adjective also form a plateauing environment. Finally, in (269) we see that a verb and the last word of its subject noun phrase form a plateauing environment.

- (267) *dí mujéε* → *dí mújéè*
 the woman
 “the woman” (Rountree 1972:318)
- (268) a. *dí hánso wómi* → *dí hánsó wómi*
 the handsome man
 “the handsome man”
- b. *dí lánɡa hánso mujéε* → *dí lánɡà hánsó mújéè*
 the tall handsome woman
 “the tall handsome woman” (Rountree 1972:321)
- (269) a. *Dí mujéε tá=wáka.* → *Dí mújéé tá=wákà.*
 the woman PROG=walk
 “The woman walks.” (Rountree 1972:324)
- b. *Dí wómi hén kulé=dé.* → *Dí wómi hén kúlé=dè.*
 the man he.EMPH run=there
 “The man, he runs there.” (Rountree 1972:324)
- c. *Dí goón à Saamáka héi.* → *Dí góón à Sàámáká héi.*
 the ground in Saramacca high
 “The ground in Saramacca is high.”

The example in (268b) further illustrates that adjacent adjectives do not form a plateauing environment—the final TBU of *lánɡa* ‘tall’ surfaces with a low tone despite being flanked by two high tones. The example seen in (270) shows that a determiner and a following adjective do not form a plateauing environment since the first TBU of *taánɡa* ‘strong’ surfaces with a low tone.

- (270) *dí taánɡa wómi* → *dí tàánɡá wómi*
 the strong man
 “the strong man”

The examples in (271) show that a verb and a following object noun phrase do not form a plateauing environment—this is the most notable environment where plateauing

is blocked since it shows a basic asymmetry between noun phrases before verbs (seen in (269)) and noun phrases after verbs. This asymmetry will play an important role in some later discussion regarding the characteristic phonology of the serial verb phrase.

- (271) a. *Mi lápu koósu.* → *Mì lápù kòósù.*
 I mend clothes
 “I mend clothes.”
- b. *A náki dí tatái.* → *À nákì dí tátâi.*
 he hit the rope
 “He hit the rope.”

Saramaccan has very few prepositions marked with high tones which could participate in plateauing. Furthermore, since no phrasal tonal process has been observed to affect the surface tones of a preposition, it is impossible to conclusively determine if a given polysyllabic preposition is marked fully or partially for tone. In any case, prepositions are never observed to raise with a following noun phrase. An example is given in (272).

- (272) *boíti koósu* → *bòitù kòósù*
 except clothes
 “except clothes” (Rountree 1972:321)

The example in (273) shows that words marked with specified low tones block high-tone plateauing, as would be expected. In (273) the use of low-tone verb *lègèdè* ‘lie’ prevents any plateauing from occurring with the preceding subject.

- (273) *Páúlu lègèdè.* → *Páúlù lègèdè.*
 Paul lie
 “Paul lies.”

A final important point about the plateauing process is how it interacts with an intonational rule lowering the final tone of an utterance. When this rule lowers one of the

high-tone triggers for plateauing, the plateauing is not observed to take place. Examples are given in (274) and (275).

- (274) a. *Dí bóto kó.* → *Dí bótò kò.*
 the boat come * *dí bótó kò*
 “The boat came.” (Rountree 1972:325)
- b. *Dí bóto kó ésidè.* → *Dí bótó kó ésidè.*
 the boat come yesterday
 “The boat came yesterday.”
- (275) a. *Dí wómi kulé.* → *Dí wómì kùlè.*
 the man run
 “The man runs.”
- b. *Dí wómi kulé àlá.* → *Dí wómí kùlé àlá.*
 the man run there
 “The man runs there.”

The interaction between plateauing and intonational lowering can be clearly seen in the opposition between the sentences in (274a) and (275a) and those in (274b) and (275b). In the first pair, intonational lowering targets a potential high-tone trigger and plateauing is not observed. In the second pair, when an extra word is added to the end of the sentence, protecting the high-tone trigger from being lowered, plateauing is observed, as expected.

Within certain theories of the phonology-syntax interface, it is fairly easy to describe the environments for plateauing and non-plateauing in (266). Chen (1987), Hale and Selkirk (1987), and Selkirk and Shen (1990), among others, have proposed that the necessary level of syntactic sensitivity needed to describe the interaction between phonology and syntax can be achieved via an “end-based mapping” approach. Under this approach, “mapping

algorithms impose phonological phrase junctures at the designated edge (either left or right) of syntactic constituents of a selected rank (Inkelas and Zec 1995:540).”¹⁸

In order to see how we can apply an end-based mapping approach to Saramaccan tonal plateauing, we will need to specify two things: a phonological form of the plateauing rule and a specification of where phonological phrase junctures are placed in the sentence. A proper specification of the form of the rule will allow us to ensure that we have the right characterization of how the tones interact, and specifying where the junctures are placed will define the environments (i.e. specific phonological phrases) in which the plateauing occurs.

Consistent with an end-based mapping approach, if we take the left edge of any “maximal projection” (i.e., noun phrase, adjective phrase, prepositional phrase, or sentence) to be the position where a phrasal juncture is added in Saramaccan, we can quickly account for the syntactic environments where plateauing is found. The statement in (276) specifies this aspect of the analysis.

(276) Saramaccan juncture placement

Place a phrasal juncture at the left edge of every maximal projects (noun phrase, adjective phrase, prepositional phrase, and sentence).

Based on the statement in (276), a simple Saramaccan sentence will have the phrasing junctures indicated with brackets in (277).

¹⁸ The fact that I develop an end-based analysis for Saramaccan is not intended to be an endorsement of that general approach to the syntax-phonology interface. Rather, it is being used to help make more explicit the nature of tonal plateauing in Saramaccan so that it can be compared to phonological effects found in serial verb phrases to be discussed in section 4.3.2.3 (page 459).

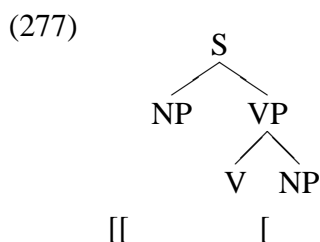

Under this end-based analysis, the only major sentence-level phrasal juncture is between the verb and a following noun phrase. As a phrasal process, plateauing should then be predicted to occur whenever it is not blocked by a juncture. As can be seen in the sentence schematized in (277), this approach readily accounts for the fact that subject noun phrases do plateau with a following verb while object noun phrases do not. The left-edge juncture of the subject noun phrase corresponds with the juncture at the left edge of the sentence, having no effect on the sentence's internal phonological structure, while the left-edge juncture of the object noun phrase effectively divides the sentence into two phonological phrases. The point at which this juncture divides the sentence in two is the exact same point where plateauing is not observed to occur.¹⁹

Assuming that single adjectives each form their own adjective phrase, the end-based mapping approach also accounts for why adjectives do not plateau with each other. Given two adjacent adjectives, a phrasing juncture will be placed at the left edge of the second adjective. The existence of such a juncture would similarly account for why a determiner and a following adjective do not form a plateauing environment. Thus, this end-based approach straightforwardly accounts for the asymmetric behavior of determiners when they

¹⁹ The fact that there is a boundary at the left edge of a noun phrase can also be used to account for the fact that a preposition and a following noun phrase are not observed to form a plateauing environment, although, as mentioned above, there might be other explanations for this.

precede adjectives versus when they precede nouns.

So, placing a juncture at the left edge of a maximal projection can account for the environment of high-tone plateauing. We can then account for the form of the plateauing using the algorithm in (278).

(278) SARAMACCAN PHRASING ALGORITHM

- a. Attach a low tone to any open TBU at the edge of a phrase.
- b. Spread a high tone leftward across unspecified TBU's to any other high tone in the phrase.
- c. Spread a low tone left or right across any unspecified TBU's.

A diagrammatic representation of the algorithm in (278) is given in (279).

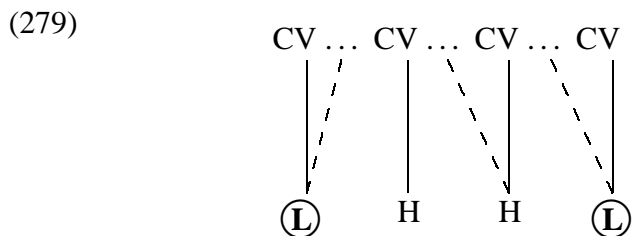

The low tones inserted at the edges of phonological phrases can be understood as simple boundary tones (see Ladd (1996:79–112) for general discussion). They don't appear in many of the examples because they only are found when the edge TBU's of a phrase are open. We see examples of both left-edge and right-edge boundary tones in the sentence in (271a). Since there is a juncture between the verb *lápu* 'mend' and *koósu* 'clothes', the

right-edge of *lápu* surfaces with one of these boundary low tones as does the left edge of *koósu*.

The algorithm in (278) and the diagram in (279) both formalize the fact that high-tone plateauing creates (L)H(L) contours in most Saramaccan phrases. The only cases where such a contour is not seen is where words fully specified for tone interfere with the plateauing rule. For example, the word *tótómbòtí* ‘woodpecker’, having a lexical HHLH contour, will always cause its phrase to deviate from the typical (L)H(L) contour.

I have illustrated here that an end-based mapping approach can work for Saramaccan for two reasons. The first is that it implies that there is nothing particularly striking about the environments wherein plateauing takes place. Specifically, they can be very easily accommodated within a fairly restrictive theory of the phonology-syntax interface. The second reason is that, in the discussion to follow, it will be convenient to refer to the boundaries of the different phrases predicted by the end-based mapping approach as delimiting prosodic constituents. So, while other characterizations of plateauing domains are possible, this particular one will help make some aspects of subsequent arguments more clear. On a descriptive level, however, the end-based mapping approach obscures certain generalizations which can be made regarding where plateauing applies, which would be worthwhile to point out here.

The end-based mapping approach operates in terms of a “blocking” juncture insofar as it describes where boundary junctures across which plateauing is not found are placed. A different, fairly succinct, characterization could be made instead by describing those

junctures across which plateauing does occur. Specifically, plateauing occurs between the head of a phrase and the word preceding it, but not elsewhere. We could schematize this relationship as in (280) where a “ $\widehat{}$ ” is used to indicate plateauing occurring between two constituents.²⁰

(280) [... Y \widehat{X}]_{XP}

Following this schema, we then straightforwardly capture the fact that, for example, plateauing occurs between a noun and the word preceding it regardless of the syntactic category of that word but does not occur between other elements of the noun phrase—that is, between adjectives or a determiner and an adjective. Such a schema also succinctly characterizes the fact that the primary plateauing environment within the sentence is between the verb and the last word in the noun phrase.

The fact that plateauing can so accurately be characterized by reference to the position of the head suggests that such information might be relevant to phonosyntactic generalizations. This is not universally admitted as a type of syntactic information which is “available” to phonological rules and, as we have seen, Saramaccan can be characterized without direct reference to the head of the phrase. However, research on the phonology-syntax interface has not yet arrived at one well-agreed upon model, and proposals exist in which a rule referring to a head like the one schematized in (280) would not necessarily be disallowed. Selkirk (1984:284–96), for example, suggests that the head-argument and

²⁰ With respect to earlier discussion, the environment in (280) could also describe where the high-low pitch sequence is found in Chechen (and Ingush).

head-modifier relation can play a role in the formation intonation phrases. Furthermore, Hale and Selkirk (1987) suggest that the syntactic notion of government can be a factor in the application of phonological rules—government is a relation sensitive to the syntactic notion of head. Also, Chen (1990) proposes, within a set of more general arguments, that phonological rules can be sensitive to the argument/adjunct distinction—another case where the head of a phrase is relevant. Finally, Odden (1990:261) specifically formalizes a rule in Kimatuumbi which, like the rule schematized in (280), refers to the head and some other element in the same phrase in the environment of application for the rule.

Since the primary goal of this section is not to advocate one version of the phonology-syntax interface over another one but, rather, to give a thorough characterization of plateauing, which specific analysis one adopts for Saramaccan will not affect the rest of the argument here in any critical way. What is important is that there is a well-defined set of plateauing domains and that we will be able to use these to understand the characteristic phonology of the serial verb phrase once we establish that it is a prosodic constituent. Saramaccan does not offer definitive support for an end-based model over one which makes direct reference to the head of the phrase. Both types of analyses can be given, and each lends a different set of insights into the structure of Saramaccan phrases. The end-based approach allows us to characterize them in terms of their boundaries, while the head-based approach allows a succinct characterization of the triggers of plateauing within them. As mentioned above, for the arguments to be made below, the end-based approach is more useful since I will be more concerned with the boundaries of plateauing phrases than their

internal structure—though it is likely that other discussions of Saramaccan phrasal phonology would be interested in this.

Having discussed various aspect of high-tone plateauing in in Saramaccan, we can now move on to the phonology of the serial verb phrase. In some cases, plateauing environments are nested within serial verb phrases, which is the primary reason why it was necessary to cover them here.

4.3.2.3 The prosody of serial verb phrases

In this section, I will discuss the prosody of serial verb phrases in Saramaccan. In Good (2003b), I argued that some tonal effects in Saramaccan serial verb phrases were instances of tonal morphology, while, in Good (in press), I classified a similar set of tonal effects as intonational phenomena. Since Good (in press) is based on a larger data set, I will generally follow the conclusions found there. While these tonal effects are taken as evidence that the Saramaccan serial verb phrase is a prosodic constituent, it is difficult to give a detailed formal characterization of all of their properties. Nevertheless, they will show that there is good reason to believe that serial verb phrases in Saramaccan are associated with a prosodic constituent, which will allow them to satisfy the first condition of the Strong Linearity Domain Hypothesis in the templatic analysis to follow.

The evidence for a particular prosodic constituent associated with serial verb phrases—often referred to, here, as the serial verb phrase prosodic constituent—suggests that it is not necessarily the entire serial verb phrase which is a prosodic constituent. Rather, serial verb phrases show similar structure to other sentences in the language wherein there is a prosodic

break before an object.²¹ This gives Saramaccan sentences a basic prosodic structure of the sort schematized in (281) wherein a nominal object (or prepositional phrase), if present, forms a separate plateauing domain from the subject and following verb.

(281) [NP V] [(XP)]

The serial verb phrase prosodic constituent will be argued to impose a comparable structure onto serial verb phrases, along the lines schematized in (282). The serial verb prosodic constituent is labelled “svcp” in (282). Note that, in this structure, the only major prosodic break is before the last object in the sentence—there is not one before every object.

(282) [NP V (NP) V]_{svcp} [(XP)]

The bracketed material in (282) labelled as the serial verb phrase prosodic constituent is not a plateauing domain. However, we will see that it is the domain for special high tones which are only found in serial verb phrases. These high tones are the primary evidence for a serial verb prosodic constituent. Consistent with the analysis given in section 4.3.2.2 (page 448), there are also two plateauing domains within the serial verb phrase prosodic constituent: between two verbs and between noun phrases and following verbs. A feature of the serial verb phrase prosodic constituent which will prove to be very important to later aspects of the argument is the clash between syntactic and phonological constituency wherein the final verb of the serial verb phrase groups more closely together with the other verbs in the serial verb phrase than it does with its object, if it has an object.

²¹ We saw in sentences like those in (271), a verb and its object do not form a plateauing domain, and the sentence in (283) shows that a verb and a following prepositional phrase “object” also do not form a plateauing domain.

Before introducing the relevant data to establish the existence of a serial verb phrase prosodic constituent, I should make one point clear: I have not found any differences in the prosodic behavior of different types of serial verb phrases which cannot be attributed to the principles guiding phonological phrasing environments for plateauing discussed in section 4.3.2.2 (page 448) above. Specifically, the exact syntax of serial verb phrases does not seem to affect their prosody—what’s important is that there is some serial verb phrase, not its type.

Having made this general point, the first fact to cover about serial verb phrases is, as mentioned above, that there are two cases where a plateauing domain can be found within them—these plateauing domains are those predicted by the end-based mapping analysis given just above and which is employed here for purposes of explication. Thus, their existence is not surprising. The first of these plateauing domains is two adjacent verbs in a serial verb phrase, as illustrated by (283).

- (283) *Mì hópo kumútu à dí wósu.* → *Mì hópó kúmútù à dí wósù.*
 I go_up go_out of the house
 “I get up and go out of the house.” (Rountree 1972:324)

As can be seen, consistent with their being part of a plateauing domain, the last TBU of *hópo* ‘go_up’ and the first TBU of *kumútu* ‘go_out’ surface with high tones.

In addition, the environment NP-V in a serial verb phrase forms a plateauing domain in sentences where an object intervenes between two verbs in the phrase.²² An example is given in (284).²³

²² Throughout the discussion the word *object* should be broadly construed to include both nominal objects and locative prepositional phrases which follow verbs of motion.

²³ The fact that that plateauing is found between an object and following verb in a serial verb phrase is pre-

- (284) *A bà wáta bɛbɛ́ ɛ́side.* → *À bà wátá bɛ́bɛ́ ɛ́sidè.*
 he carry water drink yesterday
 “He carried water and drank it yesterday.”

The sentence in (285) illustrates an odd tonal property of serial verb phrases when the serial verbs are adjacent. In (285) the final TBU of *wáka* surfaces with a high tone even though it directly precedes the low-tone verb *bà*. This high tone cannot be attributed to plateauing. As we will see, high tones like this are found in various environments within serial verb phrase and constitute the primary evidence for a serial verb phrase prosodic constituent schematized in (282). Such high tones are only ever found in medial positions of the serial verb phrase. As such, they do not appear on subject noun phrases, the right edge of final verbs, on the objects of final verbs. A number of examples below will exemplify the various medial positions wherein they have been found.

- (285) *A wáka bà wáta gó à wósu.* → *À wáká bà wátá gó à wósù.*
 he walk carry water go in house
 “He carries water into the house.”

Odd tonal effects in serial verb phrases were first noted by Rountree (1972) who used the sentence in (286) to justify an analysis where serial verbs could plateau with each other even if an object intervened between them.

- (286) *Mì ó=náki dí lógòsò kulé gó à mì wósu.* →
Mì ó=nákí dí lógòsò kúlé gó à mì wósù.
 I FUT=hit the turtle run go to my house
 “I will hit the turtle and run to my house.” (Rountree 1972:325)

dicted by the end-based mapping analysis given in section 4.3.2.2 (page 448) above. It might not necessarily be immediately accounted for in the alternate analysis schematized in (280). However, it is broadly consistent with the idea that heads plateau with the words that precede them since, semantically at least, intervening objects are always associated in some way with the verb they precede.

object is *káìmà* ‘alligator’, a noun fully specified for tone with a mixed HLL tone contour. In (288b) the intervening object is the low-tone noun *lògòsò* ‘turtle’. This minimal change of the tonal structure of the object results in different tone markings on the verbs in the serial verb phrase. In (288a) two serial-verb high tones are found, one on the last TBU of *féni* ‘find’ and another on the first TBU of *butá* ‘put’, while in (288b) no serial-verb high tones are found.

Importantly, the serial-verb high tones in (288a) are not always consistently realized by my informants. However, in that sentence, and phonosyntactically similar sentences, the high tone at the right edge of the first verb (*féni* in (288a)) is more consistently found than the high tone at the left edge of the second verb (*butá* in (288a)).

As mentioned above, Good (2003b) adopts a morphemic analysis of serial-verb high tones where they are treated as morphemes marking that a verb or noun was part of a serial verb construction. That work, however, does not discuss data like that in (288) which indicates that the appearance of the high tones was variable and affected by the phonology of the intervening object. This is most clear when comparing the sentences in (288) where the objects are essentially the same from a syntactic perspective and only differ in their phonology. It can also be seen by comparing (286) and (288b), where the objects differ both phonologically and syntactically (the object in (286) contains a definite article whereas the object in (288b) has the same head noun but no definite article). A serial-verb high tone precedes the object in (286) but not (288b). This fact might be attributed to the different syntax of the objects. However, data like that in (288), where such a syntactic analysis is

not available, suggests instead that it is instead conditioned by the presence of the high tone in the definite article in the object in (286). The lack of any obvious syntactic correlation between the appearance and non-appearance of serial-verb high tones makes a morphemic analysis difficult since it is unclear what the relevant conditioning environment might be.

Further problems for a morphemic account comes from data like that seen in (289) where a serial-verb high tone targets an adjective in an intervening object in a serial verb phrase, as seen in (289b) on the adjective *lánga* ‘tall’.

- (289) a. *Dè súti dí lánga sèmbè.* → *Dè súti dí lángà sèmbè.*
 they shoot the tall person
 “They shot the man.”
- b. *Dè súti dí lánga sèmbè kú.* → *Dè súti dí lángá sèmbè kú.*
 they shoot the tall person kill
 “They shot the man dead.”

The data in (289b) indicates that serial-verb high tones do not affect just the edge of a verbs or noun phrases but can also affect other medial TBU’s. The morphemic analysis in Good (2003b) assumed that the high tones in serial verb phrases were morphemes appearing at the edge of verbs or noun phrases marking their participation in a serial verb construction. Clearly, data like that in (289b) renders important aspects of that assumption invalid and an alternative analysis is needed.

Good (in press) addresses the data in (288) and (289) above and adopts an intonational analysis of serial verb high tones and takes them as an indication there is a tension in Saramaccan between treating a serial verb phrase as a single intonational unit and dividing it up into several units on the basis of the “small” verb phrases found within the larger serial

predicate.

If it were consistent with tonal plateauing rules, a verb phrase should always show a juncture between the verb and an object—a juncture which could have low tones on either side of it. However, as mentioned in section 4.3.2.2 (page 448), one effect of plateauing is that it implies that the vast majority of phrases in Saramaccan will show an (L)H(L) contour. If serial verb phrases were treated as one “phrase”, then serial-verb high tones could be understood as an attempt to impose the (L)H(L) contour on them.²⁴

Good (in press) sketched out the parameters of this opposition in parsing serial verb phrases by giving two phonological phrase parsings to the sentence in (288a), as seen in (290). The first represents the parsing predicted from the data and analysis in section 4.3.2.2. The second would be the parsing if a serial verb phrase were treated as one intonational unit (i.e. one phonological phrase).

(290) a. [dè féni] [káimà butá] [à téla]

b. [dè féni káimà butá] [à téla]

The difference between (290a) and (290b) is that a new phrase which is typically taken to start at the left edge of a noun phrase is not found before *káima* in (290b). Instead, the sentence in (290b) contains only one major phrasal juncture at the level of the sentence—before the final verbal object, which is the pattern found in sentences in Saramaccan headed

²⁴ It is worth noting here that such a contour could only act to change the tones of unspecified TBU's—it would have no effect on TBU's already specified for tone. This is consistent with the general phonology of the language as discussed in Good (in press) which shows that no phrase-level process affects TBU's lexically specified as surfacing with tone.

by single transitive verbs as schematized in (281). Thus, the restructuring depicted in (290b) is one which only affects the medial portion of the serial verb phrase in a way which allows a sentence containing a serial verb phrase to more closely follow the pattern of a sentence not containing one.

An analysis which implies some sort of phrasal restructuring, as suggested by Good (in press), can nicely account for the difference between the two sentences in (288) by implying that there is no juncture between *féni* ‘find’ and its following object. This would imply that there is a plateauing domain between it and its object. Thus a high tone would be expected before *káìma* ‘alligator’, but not before *lògòsò* ‘turtle’, since the former has an initial high-tone TBU while the latter does not.

However, such an analysis cannot account for the high tone found at the left edge of *butá* in (288a). Nor can it account generally for any serial-verb high tone adjacent to a low tone, as seen in (285), for example. At best, as discussed in Good (in press), an analysis of a serial-verb phrase as a phrase with an (L)H(L) intonation contour imposed on it is suggestive of a possible formal analysis. The exact details as to how we could analyze such an (L)H(L) contour as being realized within a serial verb phrase have yet to be established. However, minimally, based on the facts seen here, it could be understood to have the effect of causing unspecified TBU’s in medial positions—but not edge positions—of a serial verb phrase to surface unexpectedly with high tones, which is precisely what is observed.

The lack of a detailed formal analysis, fortunately, does not prevent us from establishing that serial-verb phrases are a prosodic unit, which is all that is needed for the first condi-

tion of the Strong Linearity Domain Hypothesis to be satisfied.²⁵ Serial-verb high tones, however we may analyze them, only appear within serial verb phrases. Furthermore, there is no purely morphological or syntactic way to predict their placement since it is not the case that they uniformly appear in a fixed position on, for example, nouns or verbs. Rather, they can appear on phrase-medial open TBU's, as most clearly seen in (289b), where they appear on an adjective preceding a low-tone noun object.

What this all means is that there is a phonological generalization about Saramaccan which can be stated along the following lines: the only environment in which high tones are found which cannot be attributed to lexical specification or tonal plateauing is the serial verb phrase wherein high tones can variably appear on open TBU's in medial positions of the phrase. They never appear on the right edge of the final verb or anywhere on a final object which clearly indicates that there is a break between the two and establishes

²⁵ Ideally, of course, we could devise a more precise analysis for the facts surrounding serial-verb high tones. Unfortunately, the current state of the data makes coming to a precise analysis impossible. The next stage in the investigation of Saramaccan serial verb phrases surely requires instrumental analysis of the pitch fluctuations throughout the sentence. It is important to note, in this context, that researchers of Saramaccan have generally operated within a "two-tone" paradigm, wherein each surfacing TBU is taken to receive a high tone or a low tone. Voorhoeve (1961) seems to be the first person to adopt this paradigm, which is also adopted by Rountree (1972). Ham (1999) and Veenstra (1996) follow Rountree (1972), as does Good (2003b). Good (in press) adopts some ideas (anticipated by Devonish (1989:48–55)) which begin to depart from this paradigm. In particular, an argument is put forth that most of the Saramaccan lexicon is marked for pitch accent, not tone. If this research is on the right track, it calls the two-tone paradigm into question. In particular, it suggests that consultants' inconsistent realization of serial-verb high tones, discussed above, could be because they are not proper tones at all, but are, more properly, an intonational effect and, thus, are less perfectly aligned to particular tone-bearing units than true tones would be.

What this would mean, then, in the larger picture, is that some of the transcriptions given above may appropriately represent the forced choice of a transcriber working within a two-tone model, but they do not necessarily best represent the best possible transcription for Saramaccan. Many, but not all, of the serial-verb transcriptions in this chapter resemble the best judgements of multiple linguists listening to the same utterances—however, often, the judgments took considerable discussion.

Barring instrumental analysis which would establish norms for high tones and low tones outside of serial verb phrases and comparing them with serial-verb high tones, I doubt a satisfactory analysis of serial-verb high tones will be forthcoming.

the final verb as the right boundary of the prosodic constituent—giving sentences containing serial verb phrases a similar structure to sentences in Saramaccan containing just one verb.²⁶ Some of these medial tones may be the result of phrasal restructuring but others are not straightforwardly amenable to such an explanation but still can be understood as realizations of the high-tone portion of an (L)H(L) contour. Under the view of the prosodic hierarchy being adopted here, as discussed in section 1.2.2 (page 37), the existence of these tones implies that the serial verb phrase constitutes a prosodic constituent since it is the domain over which we can make a phonological generalization. An initial schematization of this constituent was given in (282). I will discuss this schematization in more detail in section 4.3.3 (page 473) below in establishing the characteristic phonology of the serial verb phrase prosodic constituent.

It must be admitted, at this point, that, in an ideal world, a case study of serial verb phrases—or some “construction” in general—would involve a language where an analysis of the relevant prosodic domain is more clear than what has been given here. Fortunately, as we will see in the next section, I am using the diagnostic of serial-verb high tones only to detect the presence of a prosodic constituent, and they will not factor into the relevant part of the characteristic phonology of the serial verb phrase which I will exploit in the templatic analysis to be given. So, whatever the correct analysis of serial-verb high tones may be, one only need accept here that the environment in which they are found is a prosodic constituent in order for them to be used to support the general arguments.

²⁶ In the next section, I will discuss the status of the subject noun phrase in the serial verb phrase constituent and will assume that it is part of it.

A further point worth making, in this context, is that, with respect to languages which make use of serial verb phrases, Saramaccan is the language where their prosody has been most thoroughly described, to the best of my knowledge. So, while choosing another language might make for a somewhat easier prosodic description, this would be at the expense of making use of a language for which there is less empirical coverage.

A final point to make in this regard is that, as mentioned in (231), an uncontroversial property of serial verb phrases is the fact that no pause is possible within them. This is an indication that serial verb phrases generally form some sort of prosodic constituent since it is a phonological generalization which can be made about them. Saramaccan, apparently like all other serializing languages, exhibits this property, which gives us a second, more general criterion for establishing the existence of a serial verb prosodic constituent. In fact, the phrasal restructuring analysis schematized in (290) suggests that the lack of a pause in serial verb phrases might be related to the presence of serial verb high tones, and some of them could, thus, be taken as a Saramaccan-specific reflex of this generally property of serial verb phrases.

I would like to conclude this section with an analysis of serial-verb high tones, which represents a compromise position between the morphemic analysis of Good (2003b) and the restructuring analysis of Good (in press) and which is also consistent with the idea that serial verb phrases are characterized by the lack of a pause within them. Following ideas which can be found in Pierrehumbert (1987) and discussed in a more typologically oriented way in Ladd (1996), intonational contours can be analyzed as a specialized type

of tonal *morpheme* with a phonological domain of attachment larger than the word. If the serial-verb high tones are considered to be the reflex, not of individual morphemes, but of one (L)H(L) tonal contour morpheme, applied at the level of some prosodic constituent associated with the serial verb phrase, we immediately have an account as to why they appear on such a diverse range of constituents. This analysis is both morphemic, marking only serial verb phrases, in the spirit of Good (2003b), and also intonational, in the spirit of Good (in press). Furthermore, it suggests serial verb phrases are associated with a single intonational phrase, consistent with the idea that no pause is allowed to occur within them.

Such an analysis runs into an immediate problem insofar as, in its simplest form, it would seem to predict that all unspecified TBU's in serial verb phrases would surface as high. This is clearly not the case as an example like the one in (288b) shows, where the last TBU of *féni* 'find' and the first TBU of *butá* 'put' surface with low tones. These facts suggest that the surfacing of such a (L)H(L) morpheme can be overridden by local considerations—in the case of *féni* and *butá* in (288b), the fact that they are adjacent to a fully low-toned object (*lògòsò* 'turtle') seems to force the appearance of low tones instead of high tones.

I don't take effects like these as an argument against the (L)H(L)-morpheme analysis. Rather, it seems that the complex syntactic structure of serial verb phrases results in comparably complex phonological effects. In this sense, the phonology of Saramaccan serial verb phrases, which does not clearly pattern any one way, parallels the syntax of serial verb phrases generally, which have proven problematic for syntacticians seeking a straightfor-

ward analysis to account for all their properties.

Having established that there is a prosodic constituent associated with the serial verb phrase (even though it is still not well understood) and discussed some possible analyses for its properties, I will describe its structure and characteristics in more detail in the next section.

4.3.3 The characteristic phonology of the Saramaccan serial verb phrase

As seen in the above section, there are some aspects of the characteristic phonology of the Saramaccan serial verb phrase which are very obscure—in particular, the precise characterization of serial-verb high tones. However, there are other aspects of it which are less obscure, namely the basic constituents which comprise it. Fortunately, for the arguments below, the critical aspect of the characteristic phonology of the serial verb phrase will not involve reference to its tonal properties. Rather, it will focus on its subconstituents.

As discussed in the last section, the primary diagnostic for whether or not an element is part of the serial verb phrase prosodic constituent is whether or not it is marked with serial-verb high tones. These high tones are found in a part of the syntactic serial verb phrase which could roughly be termed “medial”. They can mark the right-edge of the first verb in the serial verb phrase (as in (287b)), the left-edge of the final verb (as in (288a)), and various constituents in between (such as open TBU’s in adjectives of nominal objects, as seen in (289b)).

The location of these serial-verb high tones, then, allows us to delimit the boundaries of the prosodic constituent associated with the serial verb phrase, which, as mentioned above,

is generally referred to, here, as the serial verb phrase prosodic constituent. The serial verb phrase prosodic constituent need not necessarily be coextensive with the syntactic serial verb phrase. However, the two are closely related. Based on the appearance of serial-verb high tones, this constituent minimally includes the first verb in the serial verb phrase, the last verb, and all intervening material.

This part of the sentence encompasses most of its constituents, with the most conspicuous exceptions being the subject noun phrase and an object of the final verb, if there is one, and it is necessary to determine whether or not either of these constituents is part of the serial verb phrase prosodic constituent. Following the Strict Layering Hypothesis, discussed in section 1.2.2.2 (page 39) in chapter 1 and adopted here, overlapping prosodic constituents are not permitted. Given this, because the subject forms a plateauing domain with the first verb of the serial verb phrase, we will need to assume that it is part of the serial verb phrase prosodic constituent—or else the plateauing domain of the subject and verb will overlap with the serial-verb phrase prosodic constituent which extends beyond that verb. A final object noun phrase, however, does not form a plateauing environment with the final verb of the serial verb phrase. This implies that, since it also has never been observed to surface with serial-verb high tones, it is not part of the serial verb phrase prosodic constituent.

Based on these arguments, the bracketed material in the sentence schematized in (291) is what the serial verb phrase prosodic constituent is taken to consist of here. This encompasses all words which have been observed to be marked with serial-verb high tones plus

the subject of the sentence.

(291) [NP V (NP) V]_{svcp} (XP)

While I assume the Strict Layering Hypothesis in giving the schematization of serial verb phrase prosodic constituent in (291), it will actually not be crucially relevant here since the characteristics of the serial verb phrase prosodic constituent which will be focused on in later arguments all involve the properties of its right edge, not its left edge.

Based on the schema in (291), there are two major types of serial verb phrase prosodic constituents. They are schematized in (292). These correspond to whether or not an object intervenes between two serial verbs. In (292) I mark relevant plateauing domains (with a subscript “plat”) and serial verb phrase prosodic constituent domains (with a subscript “svcp”). The plateauing domains are consistent those predicted by the end-based mapping analysis in section 4.3.2.2 (page 448). I leave out marking the plateauing domains within the noun phrase since they will not factor into the analysis.

(292) a. [[NP V]_{plat} [NP V]_{plat}]_{svcp} (XP)

b. [[NP V V]_{plat}]_{svcp} (XP)

The schemas in (292) represent just sentences with two verbs in the serial verb phrase. More complex types are possible as seen in, for example, (285). I repeat this sentence below in (293) and schematize it prosodically, again marking plateauing domains as consistent with the analysis in section 4.3.2.2 (page 448), in (294).

(293) *A wáka bà wáta gó à wósu.* → *À wáká bà wátá gó à wósù.*
 he walk carry water go in house
 “He carries water into the house.”

(294) [[NP V V]_{plat} [NP V]_{plat}]_{svcp} (XP)

What we can see from these schemas is that the general pattern for the serial verb phrase prosodic constituent is that it will consist of one or more plateauing domains. Multiple adjacent verbs are in the same plateauing domain with a preceding noun phrase, and noun phrases begin a new plateauing domain.

A crucial fact, for our purposes, given the adoption of an adjunction analysis for serial verb phrases, is a clash between the prosodic and syntactic constituency of the serial verb phrase in Saramaccan. In (295) I give some relevant syntactic constituency overlaid on the prosodic constituency, with the syntactic constituents marked with large bold brackets and the prosodic constituents marked with normal brackets. For the sake of simplicity, I use the two structures in (292) as illustrative for all serial verb phrases.

(295) a. [[NP [V]_{plat} [NP]**VP** [V]_{plat}]_{svcp} (XP)]**VP**

b. [[NP V [V]_{plat}]_{svcp} (XP)]**VP**

What’s critical to note is that the plateauing domains straddle the various syntactic constituents—this clash will be crucial to my analysis serial verb phrase template, as will be seen in section 4.3.4 (page 477) where it will be discussed in more detail.

First, however, we need to establish the characteristic phonology of the Saramaccan serial verb phrase. In this case, the facts indicate there are two characteristic phonologies to

take into account. These are the two represented by (292). The first, schematized in (292a), consists of two plateauing domains, and will henceforth be abbreviated as PP (for “two plateauing domains”). The second, in (292b), consists of one “extended” plateauing domain—insofar as it contains three constituents which can plateau with each other, when only two words are required in a plateauing domain. This type will henceforth be abbreviated as P+ (for “extended plateauing”).

More complicated serial verb phrases can be understood as combinations of the two basic types. So, for example, the sentence in (293) and schematized by (294) can be abbreviated P+P. Similarly, the complex sentence seen in (235), repeated below in (296) can be abbreviated PP++++.

(296) *A kisi dí fóu nakí kú limbó bóí njan.*
 he catch the bird hit kill clean cook eat
 “He caught the bird, struck it dead, cleaned, cooked, and ate it.” (Veenstra 1996:103)

In the next section, I will discuss how these two characteristic phonologies relate to a serial verb phrase template and the Strong Linearity Domain Hypothesis.

4.3.4 Applying the Strong Linearity Domain Hypothesis to Saramaccan serial verb phrases

In the previous two sections, we established that the serial verb phrase is a prosodic domain and that it can consist of a characteristic phonology of two plateauing domains (PP), an extended plateauing domain (P+), or combinations of the two. In this section, it will be argued that the templatic aspects of serial verb phrases in Saramaccan are consistent

with the Strong Linearity Domain Hypothesis.

The first step in making this argument is devising the exact nature of the strong linearity domain associated with the templatic aspects of the serial verb phrase. The core aspect of these restrictions is quite simple: the order of verb phrases in a serial verb phrase is not intrinsically predictable—as argued earlier in section 4.2 (page 402).

However, we will run into an immediate problem if we directly characterize the strong linearity domain for serial verb phrases via stipulation of the ordering of verb phrases. The verb phrase is not a prosodic constituent in Saramaccan since there is a juncture between verbs and object constituents as exemplified in the data in (271)—thus a statement of ordering of verb phrases would be hard to rectify in terms of the Strong Linearity Domain Hypothesis which relates templates to prosodic constituents.

It may be the case that in other serializing languages, there is a definable verb phrase constituent. However, we do not have that option here. Furthermore, while the focus of this chapter is on Saramaccan, there is a sense in which the solution developed for Saramaccan should be more or less applicable to other serializing languages since the SVC Uniformity Generalization is a templatic generalization across a number of them. Because of this, the ideal analysis for the Saramaccan facts would be based, as much as possible, on criterion (231h) from the general criteria given in (231)—namely that, there is no pause between the verb phrases in a serial verb phrase. This is a prosodic characteristic generally described for serial verb phrases, and a templatic analysis based on it should be more or less applicable

to all serializing languages.²⁷

Therefore, I will focus on an aspect of serial-verb phrasal phonology in Saramaccan which can readily be taken to be one of the reflexes of the criterion (231h) in the language. This is the fact, as schematized in (295), that there is a mismatch between syntactic and prosodic constituents in Saramaccan serial verb phrases which causes words in two different “small” verb phrases to be combined into one plateauing domain. This combination results in, among other things, the lack of a pause between the various verb phrases in the Saramaccan serial verb phrases.

As schematized in (295), there are two environments where this prosodic/syntactic mismatch occurs under the adjunction analysis of serial verb phrases adopted here: between an object noun phrase and following verb and between two verbs, each found in the PP and P+ characteristic phonologies respectively.²⁸ In (297) I mark these critical domains for a PP and P+ serial verb phrase with an “”.

(297) a. [[NP V]_{plat} [ NP V]_{plat}]_{svcp} (XP)

b. [[NP  V V]_{plat}]_{svcp} (XP)

What I would like to suggest is that the strong linearity domain restrictions for a serial verb phrase in Saramaccan represent an example of the trivial case discussed in section 1.2.3.2 (page 47): they consist of a simple ordering relationship between two elements in the serial verb phrase prosodic constituent. For a PP serial verb phrase, this is the ordering

²⁷ For ease of discussion, I will restrict myself to the SVO patterns of Saramaccan here, though the basic argument could be readily altered to deal with an SOV language like Izon.

²⁸ These mismatches here would also be found in a coordination analysis of serial verb phrase structure.

of the first plateauing domain followed by the second one, and for a P+ serial verb phrase, this is the ordering of the two verbs.

So, if the characteristic phonology of the prosodic constituent is simply PP, we could label the templatic restriction as P_1P_2 —that is the two plateauing domains are critically ordered. Since linear ordering is taken to be one of the fundamental aspects of any prosodic constituent, such a strong linearity restriction trivially satisfies the consistency condition.

Similarly, for a P+ serial verb phrase, the strong linearity domain restriction would be an ordering of the second verb with respect to the first. Since a P+ serial verb phrase consists of three basic constituents, a noun phrase followed by two verbs, specifying an ordering relationship among the constituents is also consistent with the characteristic phonology of that domain. We can thus abbreviate the template associated with a P+ constituent as P_{1+2} —that is, the “extra” verb is crucially ordered with respect to the first.

At this point, it becomes crucial to invoke the mismatch between syntax and prosody and the role of syntax in defining many of the overall properties of the template. The prosodic constituency of the serial verb phrase allows us to propose that there is a templatic ordering relationship between two elements. That on its own cannot account for the syntax of serial verb phrase constructions generally or for the SVC Uniformity Generalization in particular. However, once an ordering relationship is established between two plateauing domains, as found in the P_1P_2 , or between two verbs, as in a P_{1+2} domain, the general syntactic principles of the language will severely limit the possible grammatical structures satisfying the template.

To make this more clear, it is useful to walk through some basic examples. The first sort of template I will deal with is the P_1P_2 —that is, the ordering of two plateauing domains in a serial verb prosodic constituent. From a prosodic perspective, it might be possible for any number of syntactic configurations to match a P_1P_2 template. We can imagine any one of the combinations in (298) doing this, for example.

(298) a. [NP V]_{plat} [NP V]_{plat}

b. [NP V]_{plat} [NP]_{plat}

c. [NP]_{plat} [NP]_{plat}

d. [AP]_{plat} [AP]_{plat}

Of the various combinations in (298), only (298a) would constitute a permissible form for a serial verb phrase prosodic unit. The structure in (298b) is syntactically well-formed, and would correspond to a simple transitive sentence. However, no serial-verb high tones have been observed in such a structure—so, it cannot comprise a serial verb phrase prosodic constituent. The other structures can be ruled out on the syntactic grounds that they do not even approximate a structure required for a grammatical serial verb phrase.

The general claim is, then, that the strong linearity restrictions for a P_1P_2 template are that two [NP V] plateauing domains are extrinsically ordered. There's slightly more to the story, however. For some sentences, like (287b), repeated below in (299), the schema in (298a) will be sufficient to explain the ordering relationships among the verbs. This

Hypothesis, the overall behavior associated with the template might still be fairly complex. In the larger picture, we can take such interaction between a specific strong linearity domain and the general rules of a language's syntax to be an important possible characteristic of a syntactic "construction"—this point will come up again later, with specific reference to serial verb phrases, in section 4.4 (page 492).²⁹

Having discussed the P_1P_2 template, we can move on to the P_{1+2} template. This has the form of an extended plateauing domain. As with the P_1P_2 domain, we can imagine various syntactic elements which could fulfill the prosodic requirements for a P+ domain but which would not form the right sort of syntactic constituent. For example, while [NP V N] would be predicted to form a P+ domain, from a phonological perspective, to the extent that it could correspond to a grammatical structure, we would probably want to suggest that the verb followed immediately by a noun, instead of an NP, would correspond to a verb-noun compound.³⁰ However, such a structure would not receive serial-verb high tones and, therefore, not be part of a serial verb phrase prosodic constituent. Thus, it could not be part of an instantiation of a serial verb phrase template.

Therefore, as with the P_1P_2 template, we have only one sensible structure for the P_{1+2} template, [NP V V], and this corresponds to one possible syntactic structure of a serial verb phrase. Just as with the P_1P_2 template, there will be some serial verb phrases containing the P_{1+2} template which also contain verbal objects which lie outside of the serial verb phrase

²⁹ As we saw in section 4.0 (page 379), however, not all constructions need contain strong linearity domains.

³⁰ There are reasonable candidates in Saramaccan for such structures. One of which would be the idiomatic *mbéi fà* 'ridicule' (presumably related in some way to the English phrase 'make fun') as listed Rountree et al. (2000).

prosodic constituent. The sentence in (283), repeated from (301) is an example.

- (301) [[*Mì hópó kúmútù*]_{plat}]_{svep} *à dí wósù.*
 I go_up go_out of the house
 “I get up and go out of the house.” (Rountree 1972:324)

A sentence like the one in (301) containing a P_{1+2} template is amenable to the same sort of explanation given for (300). The template orders the relevant verbs—specifically by ordering the “extending” verb after the first verb—the syntax then requires there to be a final object after the second verb.

There is an important point to be made here—a large number of semantic and syntactic principles are at play in the construction of serial verb phrases. In fact, these syntactic principles, most of which relating to argument realization and interpretation, are the primary determinant of most aspects of serial verb phrase structure. This includes, among other things, rules governing what combinations of predicates are semantically allowable.

However, as indicated by the SVC Uniformity Generalization, the order of the elements in serial verb phrases does not appear to be completely determined by the syntax. Carstens (2002) has a syntactic analysis of their order, which has been rejected here for two reasons. The first is that there are a series of syntactic arguments against it, as seen in section 4.2.4 (page 428)—including the fact that the most sensible structure for serial verb phrases seems to be one of adjunction rather than complementation as suggested by Carstens (2002).

Another reason why it has been rejected is that Carstens assumed that that the only way to explain the SVC Uniformity Generalization was by an appeal to hierarchical structure. Here, however, we have seen that for Saramaccan, a templatic account can be developed for

the order of elements in serial verb phrases which is consistent with the Strong Linearity Domain Hypothesis. Importantly, this account essentially relied on a phonological diagnostic typically given as common to all serial verb phrases—the lack of a pause between the verb phrases in the serial verb phrase. The phonological details of various serializing languages may be different from Saramaccan, but they should all have something corresponding to the mismatch of phonological and syntactic domains as depicted in (297).

Since the templatic account of serial verb phrase ordering is consistent with the Strong Linearity Domain Hypothesis, it allows us to account for part of the SVC Uniformity Generalization—namely that a headedness parameter does not automatically result in a change of the order of elements of serial verb phrases. The elements can be templatically ordered, and their order is, thus, not predictable from hierarchical structure.

However, as with the Bantu case, where there was an explanation for the form of the template within the rubric of the Strong Linearity Domain Hypothesis but not an explanation for the semantic content of the form, we will need a separate account as to why serializing languages show the same basic order for semantically similar constructions. For example, why do seemingly all serializing languages with instrumental ‘take’-serials grammaticalize the order *take X do Y* as opposed to *do Y take X*. While this question is not directly related to the main goal of the present work, I take it up briefly in the next section. Developing such an account allows the account given here to have the same level of explanatory ability as the account in Carstens (2002).

In conclusion, then, we’ve seen here that the templatic analysis allows us to develop

an account wherein the linear order of “small” verb phrases within the serial verb phrase can be stipulated. What it can not tell us is why, given such stipulation, one logical order is attested but another is not. For that we need an auxiliary explanation, much like the auxiliary explanation given for CA over AC order in the Bantu template discussed in section 2.7.5 (page 262). This is the subject of the next section.

4.3.5 Comments on the attested verb orders in serial verb phrases

What we have seen above is that there is evidence for a serial verb phrase prosodic constituent in Saramaccan and that its characteristic phonology is such that it permits the ordering of elements in the serial verb to be externally stipulated as part of a strong linearity domain. This allows us to explain some aspects of the SVC Uniformity Generalization without appealing to a purely syntactic explanation, like that of Carstens (2002).

However, the Strong Linearity Domain Hypothesis has nothing to say about the semantic content of the structures which go into the formulation of such generalizations like the SVC Uniformity Generalization. For example, as just mentioned above, the Strong Linearity Domain Hypothesis in no way predicts that *take X do Y* should be more common than *do Y take X*—it merely predicts that languages could choose a particular way, independent of the syntax, to order those two predicates.

There seems to be a fairly clear explanation for this second aspect of the SVC Uniformity Generalization which relates to a synchronic explanation for the order of elements in serial verb phrases which I rejected in section 4.2.5 (page 434): namely one which makes

use of temporal iconicity.

In section 4.2.5 (page 434) I acknowledged that temporal iconicity may play some role in the ordering of elements in serial verb phrases, particularly for long narrative serial verb phrases. However, I also pointed out that serial verb phrases can become grammaticalized in a way which renders temporal iconicity explanations unsatisfactory. Thus, for example, the sentence in (302), repeated from (258), does not seem amenable to a temporal iconicity analysis.

(302) *A fón wójo dá dí taánga u dí sónu.*
 he beat eye give the strength for the sun
 “He blinked his eyes against the strong sunlight.”
 (“Hij knippert met de ogen tegen het sterke zonlicht.”) (de Groot 1977:156)

To the extent that any temporal relation can be clearly ascertained between the two verb phrases comprising the larger serial verb phrase in (302), it would appear that such a sentence would run directly counter to a temporal iconicity approach since, presumably, the sunlight would hit someone’s eyes before it made them blink.

Sentences like the one in (302), where there seems to be an anti-iconic temporal relationship between the two parts of the serial verb phrase are certainly not prototypical. In the case of (302) specifically, it is probably related to the extent to which the meaning of *da* ‘give’ has become grammaticalized in serial verb phrases in Saramaccan.

Furthermore, while there are many instances where there is a fairly straightforward temporally iconic relationship between the first and second predicate in a ‘take’-serial (as in (230a), for example), there are also plenty of cases where the temporal relationship is simply not obvious, as in the example from Yoruba in (303) repeated from (262b)—that

is, where the temporal relationship is not iconic or anti-iconic but, rather, appears to be more or less unspecified. (The sentence in (262b) was used by Carstens (2002) who uses it to make essentially the same point.) Unlike anti-iconic sentences, like the one in (302), temporally unspecified sentences are not at all marginal in serializing languages.

(303) *Mo fi ogbòn gé igi*
 I use cleverness cut tree
 “I cut down the tree with cleverness” (Stahlke 1970:62)

I do not think that sentences like (302) or (262b) should be taken as evidence that there is no temporally iconic aspect to the structure of serial verb phrases. Rather, it would appear to be the case that temporal iconicity plays a crucial role in the historical development in serial verb phrases—even though it cannot be invoked to explain all of their synchronic properties.³¹

For example, while the sentence in (302) appears to be anti-iconic, its source is almost certainly a much more iconic construction involving the core meaning of the verb *dá* ‘give’. The sentence in (304), from Saramaccan, gives a less grammaticalized use of this verb which retains some degree of temporal iconicity.³²

(304) *A tá tendé sondí dá déé penáma*
 he PROG reach_out thing give the poor.AGT
 “He is giving something to the poor.” (Veenstra 1996:164)

³¹ For a similar view, see Lord (1993:237–40).

³² Though, to the best of my knowledge, no thorough study has been done, there is a general sense in the literature on serial verb phrases that they originally derived from some sort of coordinate structure (see, e.g., Hyman (1971:30–31), Hyman (1975:136–9), Schachter (1974:264–7), Givón (1975), and Lord (1993:101–111)). If this is true, then temporal iconicity in serial verbs could be understood to have the same source as temporal iconicity in coordinated structures generally.

In (304) a temporally iconic relationship still holds between the two verb phrases insofar as the motion of reaching out precedes the giving.³³

Similarly, a sentence like the one in (303) is clearly related to a temporally iconic construction reflecting the fact that real-world instruments are typically taken before they are used. In this sense, the sentence in (262a) reflects the core use of the ‘take’-construction, while the sentence in (303) is a secondary development.

I have couched this discussion in terms of diachronic development from a core iconic use to non-core non-iconic uses, the major point being that serial verb phrases can become sufficiently grammaticalized to lose any trace of temporal iconicity. However, I should make the caveat that, while I believe there is some validity to this story in terms of the general development of serial verb phrases cross-linguistically, when we look at a creole like Saramaccan or even an area like West Africa, there might be individual languages which have non-iconic serial verb phrases as the result of transfer/borrowing. In such cases, though, I assume that the non-iconic constructions can generally be traced to iconic constructions in some language.

Like the Bantu case, then, we see that the Strong Linearity Domain Hypothesis can help us understand the form of a templatic construction. However, often, another mode of explanation will be required to explain the semantic content of that form—in this instance, I believe that there is truth to the idea that temporal iconicity plays a role in serial verb constructions, thus accounting for some aspects of the SVC Uniformity Generalization.

³³ Veenstra (1996:163–72) gives further discussion of the different uses of *dá* in Saramaccan.

However, its role is diachronically, not synchronically, oriented.

Such a diachronically-oriented analysis allows for a wider variety of possible synchronic serial verb phrases than other, more restrictive, analyses might—like those of Carstens (2002) or Baker (1989), for example. This is consistent with the adoption of the adjunction analysis of Veenstra (1996) which did not place any restrictions specific to serial verb phrases in Saramaccan on what was a permissible set of verb phrases comprising the adjunction structure.³⁴ Since, as we saw in (4.2.5), the two types explanations employed in the literature for the order of serial verb phrases to this point, those appealing to temporal iconicity and the thematic hierarchy, fail to account for the synchronic facts, it seems reasonable to adopt a non-restrictive analysis for serial verb phrase ordering at this point. If a more restrictive theory than the present one, that can account for all the observed facts should be developed, the diachronic account of ordering suggested here would need to be reevaluated.

I leave open the question as to how the semantic ordering of elements within the serial verb phrases should be synchronically analyzed other than that it partially involves an independent linear stipulation of verb phrase order in the grammar, consistent with templatic analysis of the last section. One imaginable approach would be a “constructional” one which would involve positing a number of lexical constructions—that is, lexical items con-

³⁴ As discussed above, Veenstra (1996) did propose specific devices to handle argument interpretation in serial verb phrases. However, these were not used to restrict adjunction possibilities. Rather, they were simply employed to account for the interpretations which were observed. This is not to say that Veenstra’s analysis is completely unconstrained. He does suggest that the difference between serializing and non-serializing languages is tied to the presence/absence of tense morphology on the verb (Veenstra 1996:145–51). This makes important, restrictive predictions—however, these predictions do not restrict the possible combinations of verb phrases as other analyses do.

taining syntactic structure—to account for the presence of various different types of serial verb phrases. For example, a *take*-serial could be analyzed as being associated with a constructional subcategorization frame like *take X do Y* similar to Kay and Fillmore's (1999) analysis of the WXDY construction discussed in section 4.0 (page 379) above. Unlike the WXDY constructions such a construction would, of course, require a strong linearity domain which would stipulate the order *take X do Y* over *do Y take X*. However, all other aspects of the construction could be analyzed via syntactic or semantic relations.

In any event, the exact nature of such a synchronic analysis of the syntax and semantics of serial verb phrases would require an auxiliary theory to the Strong Linearity Domain Hypothesis. The critical argument here does not rest on the nature of such an auxiliary theory. Rather, it rests on the fact that an ordering restriction of the type required for serial verb phrases is consistent with the Strong Linearity Domain Hypothesis. The Strong Linearity Domain Hypothesis is a restrictive theory on the form of templatic constructions—it has nothing to say about their semantic content. However, to the extent that I was able to present a reasonable diachronic scenario for the attested syntactic/semantic orders of verbs in serial verb phrase here, it gives my own account comparable explanatory ability to other accounts of their order, like that of Carstens (2002).

4.3.6 Local conclusion

In this section, I discussed the evidence for a serial verb phrase prosodic constituent in Saramaccan and showed that its characteristic phonology allowed us to account for a strong linearity domain associated with serial verb phrases in the language. Specifically,

an account where the verb phrases must have their order stipulated independent of their syntax or semantics is consistent with the Strong Linearity Domain Hypothesis. The nature of the strong linearity restrictions is quite simple: an ordering relation between prosodic constituents which are the immediate subconstituents of the serial verb phrase prosodic constituent. However, this ordering restriction interacts with various aspects of the syntax and semantics of Saramaccan to produce a fairly rich “construction”.

The Strong Linearity Domain Hypothesis on its own could not account for all aspects of the SVC Uniformity Generalization. Specifically, it could account for the fact that a “head”-parameter did not seem to interact with the ordering of the “small” verb phrases within the serial verb phrases, but it could not account for the fact that serializing languages showed the same order of those verb phrases within larger serial verb phrase structures generally. To account for this, I invoked a diachronic scenario wherein temporally iconic structures became grammaticalized into serial verb phrase structures which were no longer necessarily temporally iconic.

4.4 CONCLUSION

We have seen in this chapter a further application of the Strong Linearity Domain Hypothesis to a phenomenon which has some templatic properties—namely serial verb phrases. An adjunction analysis of serial verb phrases was adopted, and it was argued that such an analysis, while an adequate characterization of the constituency of such structures did not, on its own, predict the order of elements in serial verb phrases.

It was established that serial verb phrases in Saramaccan constitute a prosodic domain

and that the characteristic phonology of this domain was such that a serial verb phrase template could be understood to be consistent with the Strong Linearity Domain Hypothesis. This, on its own, could not explain all aspects of ordering in serial verb phrases, so an account involving the grammaticalization of temporally iconic constructions was invoked.

Within the larger argument being developed here, there are two important points to be taken from this case study. The first is that templaticity can be found at fairly large levels of syntactic structure—here, in constituents as large as serial verb phrases. At the same time, of the three templatic constructions examined, the ones examined here had the least specific strong linearity restrictions. Specifically, the crucial part of the strong linearity domain within serial verb phrases was that prosodic units were specifically ordered, the most basic type of linear relation imaginable.

Such externally-defined ordering, of course, could not determine all the properties of serial verb phrases on its own. Here, it was taken to just have a role in the ordering of the relevant “small” verb phrases in a larger serial verb phrase. Syntax and semantics, however, were taken to have a more crucial role in determining grammaticality for serial verb phrases. The serial verb phrase template was only employed to deal with the “templatic residue” of the construction, and, importantly, that residue was consistent with the Strong Linearity Domain Hypothesis.

I would like to close this chapter, then, with some final remarks on the notion of the serial verb *construction* and how the analysis here relates generally to other analyses of serial verb phrases. In a recent manuscript Baker and Stewart (2002) attempt to analyze

serial verb constructions “without constructions”. The manuscript argues that there are not serial verb constructions, *per se*. Rather, phenomena typically given that label bear no deep underlying relationship to each other and, in fact, their properties are predictable from independently-motivated syntactic principles.

There are some cogent arguments in Baker and Stewart (2002). However, I hesitate to accept that a category like “serial verb construction” that has proven descriptively useful for quite a long period of time has no linguistic validity. The results of this chapter offer a compromise: that phenomena typically categorized as serial verb phrases might be syntactically distinct but they are templatically similar. That is, all serial verb phrases in a language will have the same basic type prosodic constituency regardless of their syntax and the order of elements within serial verb phrase will be determined templatically within the bounds of the Strong Linearity Domain Hypothesis.

The “constructional” aspect of serial verb phrases, then, would refer only to ordering relationships, and the syntactic relationships could then be independently motivated and be heterogeneous among the different serial verb constructions. At this point, this is merely a suggestion. A fact which is in line with this is that, for the Saramaccan data discussed in section 4.3.2.3 (page 459), no prosodic distinction was found among the various types of serial verb phrases. They seem to be a phonological class, if not a syntactic one.

A consequence of this is that, whatever syntactic analysis one may adopt for serial verb phrases, one thing that separates serializing languages from non-serializing languages is the presence of a templatic construction governing the order verb phrases in serializing

languages which is not found in other languages. In fact, the analysis given here more or less implies that this template is one of the defining analytical characteristics of serializing languages, and it is directly related to one of the descriptive properties typically associated with them—that no pause is allowed within them (as given in (231h)). The conclusions of this case study, therefore, have relevance outside of the narrow issue of how ordering relationships work within serial verb phrases. They are also relevant to establishing just what makes a language “serializing” in the first place.

5 Conclusion: Towards an explanation for the Strong Linearity Domain Hypothesis

5.1 INTRODUCTION

In chapter 1, I outlined the basic principle for analyzing templates that was to be employed in the present work: the Strong Linearity Domain Hypothesis. I repeat it below in (305).

(305) **Strong Linearity Domain Hypothesis:** The boundaries of any strong linearity domain must be coextensive with a prosodic constituent, and its non-predictable linearity restrictions must be consistent with the characteristic phonology of that prosodic constituent.

In chapter 2, chapter 3, and chapter 4, I then applied the Strong Linearity Domain Hypothesis in three detailed case studies of templatic phenomena from Bantu, Chechen, and Saramaccan respectively. These case studies were chosen to represent a cline from smaller to larger templates.

In section 1.0 (page 1), I gave the three broad aims of this work: (i) to defend Strong Linearity Domain Hypothesis, (ii) to present clear instances of templatic constructions in morphology and syntax and, thereby, to show that they do exist, and (iii) to lay some of the foundations for a general theory of linearity.

At this point, I have laid out the core arguments which I intended to allow me to achieve those three aims. The introductory chapter provided a general framework for the three

case studies, individually the case studies provided thorough examples of the application of the Strong Linearity Domain Hypothesis, and taken together, they demonstrated how the Strong Linearity Domain Hypothesis modeled the nature of templatic relations within a cline of smaller-to-larger linguistic constituents. These aspects of this work, I believe, achieved the first aim.

In addition, each of the case studies provided what I believe to be a good example of a morphological or syntactic templatic construction, thus helping me achieve my second aim. Finally, to the extent that this work represents a coherent discourse on the nature of strong linearity domains, it will have achieved my third aim since a subtheory of strong linearity domains will be an important part of any general theory of linearity.

In this closing chapter, then, I would like to take a somewhat different direction and attempt to explain why the Strong Linearity Domain Hypothesis could be true. Throughout the work, I have assumed it as a hypothesis and then given arguments for its validity. However, if it is a statement that faithfully represents some aspect of grammar, then there must be some explanation for why grammar is that way.

The closest I have come to explaining why the the Strong Linearity Domain Hypothesis might be true was in section 1.2.4 (page 54), where I discussed the intuition behind the Strong Linearity Domain Hypothesis and how it related to a conception of grammar where phonology is considered to be very “linear” while syntax is considered to be very “hierarchical”, with morphology falling between the two. While such a model contains the seeds of an explanation, I seek a something more concrete here.

The sort of explanation which I will suggest here is the most likely to be valid is an evolutionary one which understands the Strong Linearity Domain Hypothesis as the product of a natural course of diachronic change which produces the restrictions associated with templates.¹ I will develop such an account, in some detail, in section 5.2 (page 499). In addition, I will sketch out how we might explain the Strong Linearity Domain Hypothesis in two other types of approaches to grammar. The first sketch will be one making use of the basic architecture of Optimality Theory, given in section 5.3.2 (page 531), and the second one will follow the basic architecture of PF/LF approaches to grammar (e.g., Government and Binding Theory, Principles and Parameters, Minimalism) in section 5.3.3 (page 538).

These latter two accounts will only be sketches, and they are primarily intended to illustrate that the Strong Linearity Domain Hypothesis is not inherently incompatible with other popular approaches to grammar. That is, even though I adopt an evolutionary account, this does not mean that there are not other possible accounts.

¹ Though I have not pointed it out explicitly, these restrictions can be synchronically understood as subcategorization restrictions that a language imposes on particular morphological and syntactic constructions. This was seen most clearly in the case study of Chechen in chapter 3. However, this could also be applied to the Bantu case, where the verb root could be understood subcategorizing for extensions appearing in particular orders. And, in the Saramaccan case, the serial verb phrase could subcategorize for the fact that it must contain several “small” verb phrases, which are subject syntactic and semantic restrictions associated with the template but which are independent from it.

5.2 AN EVOLUTIONARY ACCOUNT OF THE STRONG LINEARITY DOMAIN HYPOTHESIS

5.2.1 Introduction

In this section, I will develop an evolutionary account of the Strong Linearity Domain Hypothesis. This will consist of two separate tasks. The first will be to outline the general nature of an evolutionary approach to the explanation of grammatical phenomena. This is will be done in section 5.2.2 (page 499). Then, I will situate the Strong Linearity Domain Hypothesis within this mode of explanation in section 5.2.3 (page 508)

5.2.2 A sketch of an evolutionary approach to grammar

5.2.2.1 Introduction

The grammatical framework which will be employed to offer my own explanation of the Strong Linearity Domain Hypothesis can usefully be called *evolutionary grammar*. The term is analogized from the notion of *Evolutionary Phonology* first proposed by Juliette Blevins and discussed in Blevins (in press). The central premise of Evolutionary Phonology is given in (306).

(306) Central Premise of Evolutionary Phonology

Principled diachronic explanations for sound patterns have priority over competing synchronic explanations unless independent evidence demonstrates, beyond reasonable doubt, that a synchronic account is warranted.

While the above premise only refers to phonological systems, its reasoning can be extended to all aspects of grammar. In (307), I outline what the basic premises are for the evolutionary approach to grammar which will be taken here.

- (307) a. **The bipartite origin of grammar:** The shape of a given grammar is determined *both* by universal constraints on grammar in general and by the diachronic processes which have acted on that grammar in particular.
- b. **The bipartite structure of grammatical explanation:** Therefore, *explanations* for the patterns found in a given grammar properly reside in both the synchronic and the diachronic domains of linguistic theory.
- c. **The preference for diachronic explanation:** When a principled diachronic explanation for a grammatical pattern can be determined, it is to be preferred over a synchronic explanation since this would result in fewer stipulations on synchronic grammars, and therefore permit simpler grammatical models.

Of the three premises in (307), the first should be completely uncontroversial. However, assumptions (307b) and (307c) both require further explanation and justification, which I provide in section 5.2.2.2 (page 501) and section 5.2.2.3 (page 504) below.

I should be quick to point out that no one aspect of or evolutionary grammar is particularly novel. The only innovation of evolutionary approaches to grammar is the explicit integration of the three premises in (307), along with the use of well-defined diachronic models (see section 5.2.3 (page 508)), in order to create a coherent historically-inclined re-

search program for the explanation of linguistic typology. This is not to say that there is not earlier work which, explicitly or implicitly, adopts an evolutionary model of grammatical explanation. Examples of such work include Greenberg et al. (1963), Greenberg (1966), Anderson (1977), and Garrett (1990)—and I will discuss another case, that of Spencer (1997) below. It is just that works like these did not explicitly develop a coherent evolutionary research program opposed to other research programs, in the way that can be seen in, for example, Blevins (in press).²

5.2.2.2 The bipartite structure of grammatical explanation

The second premise in (307) is that grammatical explanation must take on a bipartite structure including both synchronic and diachronic explanations for the shape of a given grammar. The word *explanation* is used deliberately here and should not be confused with terms like *account* or *description*. Though the development of formal models which predict the same set grammaticality judgements as produced by native speakers has a place within linguistics, this is not the goal of evolutionary models which seek to truly explain why grammars look the way they do.

Probably the best way to illustrate the distinction between synchronic and diachronic explanation in grammar is by example.³ A recent paper on agreement (Wechsler and Zlatić

² In this context, it is worthwhile to note that Greenberg et al. (1963) comes very close to outlining something like an evolutionary research program—however, they give it no particular name and do not adopt a specific diachronic model.

³ In addition to the work of Blevins (in press), other examples of work making use of an evolutionary approach to grammatical explanation can be found in Kavitskaya (2001) and Barnes (2002), among others. Here, I choose to specifically not use such works in my examples in order to illustrate that the key principles behind evolutionary approaches to grammar are not limited to linguists working within such a research program.

2000) will serve well. The basic premise of the paper is that agreement systems, across languages, must always follow the network of relationships given in (308), taken from Wechsler and Zlatić (2000:800).

(308) declension ⇔ concord ⇔ index ⇔ semantics

The network in (308) is intended to describe how closely declension, concord, index, and semantics should correlate with each other in agreement systems. It predicts, for example, that clashes between declension and semantics should be more common in language than clashes between declension and concord. Wechsler and Zlatić (2000) use detailed data from Serbo-Croatian to show that the agreement clashes found in the language are precisely those predicted to occur as the result of breaking one link the network in (308).

The network in (308) is, thus, a statement of a constraint on grammar predicting a particular typology of agreement clashes. An example of the type of data used to justify the claim is given in (309).

(309) *Vratio mi je ovaj ludi Steva*
 returned.1S me AUX.3S this.NOM.MASC.SG crazy.NOM.MASC.SG Steve.NOM
violinu koju sam mu pozajmio.
 violin.ACC which AUX.1S 3.DAT.MASC.SG loaned
 “This (M) crazy (M) Steve returned to me the violin which I loaned him (M).”
 (Wechsler and Zlatić 2000:812)

There is a set of *a*-final nouns in Serbo-Croatian, of which the name *Steva* is one, which are in a declension whose nouns are predominantly of feminine gender but which take masculine concord and index values and which are semantically male. The network in (308) explains one aspect of this agreement clash: that a split between declension and

the other three features should be possible. It has nothing to say about the agreement specifications of the split—for example, whether masculine/feminine clashes should be more common than masculine/neuter clashes.

Presumably, the omission of particular genders from (308) is deliberate, and Wechsler and Zlatić (2000) simply don't believe that any particular genders have special behavior with respect to the typology of agreement clashes cross-linguistically.

And, at least for the case of non-feminine *a*-stems, this is probably a good thing. Stems of this sort, belonging to a declension whose nouns are predominantly of feminine gender, are found throughout Indo-European and are reconstructed in Proto-Indo-European (Meillet [1909]1964:318), where declension class and gender were less closely aligned. Thus, the existence of that particular masculine/feminine clash in Serbo-Croatian should, in all likelihood, be ultimately explained as the result of historical inheritance. Clearly, the exact nature of the clash may have undergone various shifts in the development of the Indo-European daughter languages. The claim here is simply that only some aspects of Serbo-Croatian agreement are the result of general cross-linguistic principles of agreement. Others, like this particular stem clash, are the result of inheritance. This is reflected in the fact that Wechsler and Zlatić (2000) only choose to include some aspects of agreement clashes found in Serbo-Croatian in their universal schema in (308).

The data in (309), thus, requires a synchronic and diachronic analysis. The synchronic restriction on agreement networks in (308) explains why declension patterns one way while concord, index, and semantics pattern another way, while the particular genders involved

in the agreement clash need to be explained diachronically.

The basic point to be taken from this example, then, is that explanations for grammatical patterns can come either from claims about restrictions on synchronic grammars themselves or by tracing the historical origins of a pattern. It is a matter of research to determine which is the better source for an explanation of a given generalization.

5.2.2.3 The preference for diachronic explanation

Of the three premises of evolutionary grammar, the one in (307c), the preference for diachronic explanation, will likely be by far the most controversial and the one which most distinguishes evolutionary approaches from other approaches to grammar. To explain the reasoning behind it, it is instructive to examine a statement found in Blevins and Garrett (to appear) regarding the appropriateness of synchronic versus diachronic explanations: “Which explanation will emerge in any case is a matter to be resolved based on the evidence, but since historical accounts permit simpler grammatical models they are preferable wherever possible.”

If it is the case that historical accounts permit a “simpler” model of grammar, then, indeed, they should be preferable to other accounts. However, it is important to specify precisely what makes a grammar simple in evolutionary terms. In the evolutionary approach as adopted here, a grammatical model will be taken to be simpler when it requires the stipulation of fewer constraints on the shape of synchronic grammar than another model.

The reasoning behind the preference for diachronic accounts is straightforward. Diachronic change is an observable, independently motivated factor in the shaping of gram-

mars. If a well-constructed model of diachronic change predicts that grammars will naturally evolve to match some cross-linguistically common pattern A but not some cross-linguistically rare pattern B, then specifying a synchronic constraint favoring pattern A over pattern B would be a redundant form of explanation.

A recent example of an argument which seems to be based on the basic premise of the preference for diachronic explanation can be found in Spencer (1997). Broadly speaking, Spencer is concerned with the relationship between the historical development of morphology and what he terms the “functional head” approach to morphology developed by Baker (1988) and discussed in section 1.4.2 (page 85) in chapter 1. Among other problematic cases, he presents the data in (310) from the Daghestanian language Xinalug. (Some of the glosses taken from (Kibrik 1972:123).) The strange glosses for the verbs reflect the multiple positions of agreement in a morphological unit which, as a whole, has the meaning “forgot”.

- (310) a. *jae buuj k'ur-Ø-qXin-Ø-k^hu-d-mæ*
 I father (I) forget.**I**.PST
- b. *jae dædæ k'ur-s-qXin-s-k^hu-dæ-mæ*
 I mother (II) forget.**II**.PST
- c. *jae p^hsi k'ur-p^h-qXin-Ø-k^hu-dæ-mæ*
 I horse (III) forget.**III**.PST
- d. *jae k'ats'uun k'ur-Ø-qXin-Ø-k^hu-ʒ-mæ*
 I stone (IV) forget.**IV**.PST (Spencer 1997:40)

The basic issue illustrated by this data is the multiple exponence of agreement morphology seen in the complex verb ‘forgot’. There are four gender classes in Xinalug (marked (I–IV) in (310)) and, as can be seen, agreement appears in three different positions on the

verb. Spencer gives a historical analysis of Xinalug whereby there was a stage of the language, exemplified in (311), when the complex Xinalug verb actually was a syntactic unit of a main verb and a series of auxiliaries. The tree in (311) is based on sentence (310b).

(311)

(Spencer 1997:41)

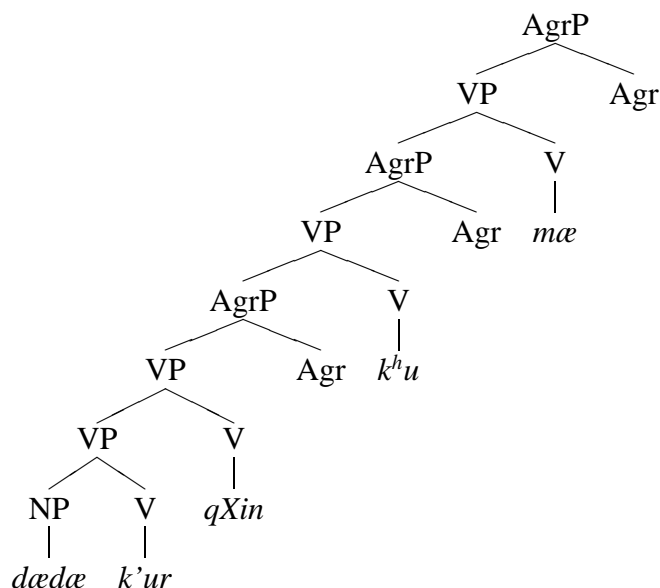

In this stage of the language, “the noun which conditions agreement [here: *dædæ*] moves successively through the specifier position of a series of AgrP nodes, triggering agreement with the auxiliaries found there...(42)”. So, just like in the present language, there is multiple agreement. However, the agreement markers each appear on independent units of the syntax, posing no particular analytical problems for a theory like Baker’s.

In the attested language, Spencer (1997:43) claims that, if auxiliaries are treated as being incorporated as part of an inflectional system under the sort of analysis proposed by Baker (1988), the only way to achieve the right ordering among the lowest verbal head (*k'ur* in the examples), the first auxiliary (*qXin* in the examples), and an agreement marker (*s* in sentence (310b)) is via “acyclic combination” (Baker 1988:363–370) creating the

subtree in (312) which in turn ultimately derives the subtree in (313). The tree, however, in (313) would be illicit within Baker's style of analysis since it violates restrictions on the placement of traces with respect to their antecedents—in particular, the V could act as a governor for the auxiliary trace t_i , but does not, leading to a violation of proper government (Baker 1988:367). (Baker's theory rules out acyclic combination in general.)

(312)

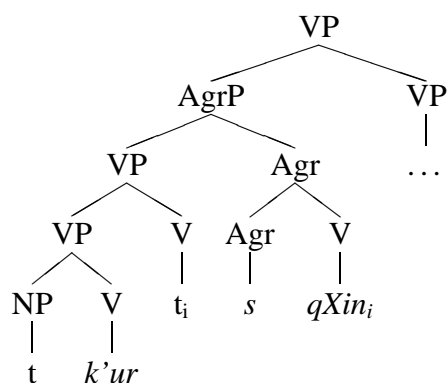

(Spencer 1997:43)

(313)

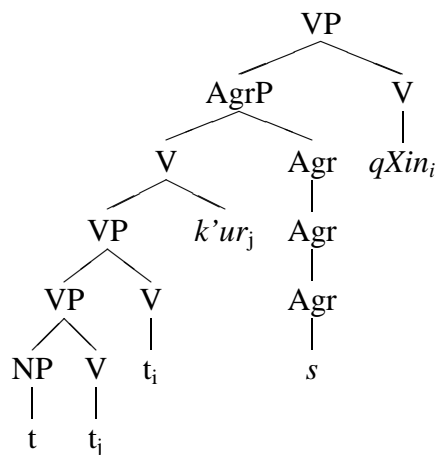

(Spencer 1997:43)

How, then, does Spencer choose to analyze the Xinalug agreement pattern having concluded that Baker's style of analysis will run into intractable difficulties? "... [I]f we assume that the process is essentially one of cliticization to an already inflected form, with the recurrent inflectional becoming 'locked' into the final word form, there is no difficulty,

in principle, at least, in seeing how such a word-structure could arise (43).” He implicitly makes use of the premise of the preference for diachronic explanation: Since this structure can be seen to have arisen from a well-attested sort of diachronic development, its synchronic existence shouldn’t be particularly surprising.

Having gone over the basic aspects and rationale of an evolutionary approach to grammar in general, in the next section, I will develop an evolutionary account of the Strong Linearity Domain Hypothesis in particular

5.2.3 An evolutionary explanation for the Strong Linearity Domain Hypothesis

5.2.3.1 The foundation of the explanation: Templatic reanalysis

In this section, I will attempt to provide an evolutionary explanation for the Strong Linearity Domain Hypothesis, given in (22) (page 36).

The essence of my evolutionary explanation of the Strong Linearity Domain Hypothesis lies with the conception of grammar, given in section 1.2.4 (page 54), which I repeat below in (314). This conception of grammar guided my intuitions in devising the Strong Linearity Domain Hypothesis, and it will also guide the evolutionary account of it.

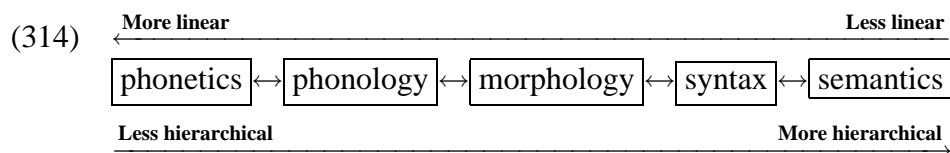

As discussed section 1.2.4 (page 54), the conception of grammar depicted in (314) implies the existence of a tension in the various grammatical “components” between linear and hierarchical relations. Phonetics, due to the fact it describes physically produced

sound, is inherently linear. Semantics, due to the fact that it describes abstract relationships between the meanings of various elements, is inherently hierarchical. Phonology, morphology, and syntax show both linear and hierarchical properties—but phonology is very linear, being closely allied with phonetics, syntax is very hierarchical, being closely allied with semantics. And, as always, morphology lies right in the middle strongly subject both to linearity and to hierarchical effects.

The intuition behind the Strong Linearity Domain Hypothesis, based on this conception of grammar, was that phonological tools could be used to explain strong linearity because phonology is highly linear. The Strong Linearity Domain Hypothesis, therefore, specifically limited strong linearity domains to prosodic constituents since the “unexpected” linearity of templates was expected to correlate with highly-linear phonological constituents instead of highly-hierarchical syntactic constituents.

The evolutionary account of the Strong Linearity Domain Hypothesis draws on an idea related to this intuition: the phonological nature of prosodic constituents should make them the crucial channel for unexpected linearity effects to “leak” into structures which are typically hierarchical.

By definition, the linear relations in strong linearity domains are unpredictable. This implies, in turn, that they are a type of lexical object, and lexical objects have etymologies (if we understand this term to apply to all lexical objects and not just words). The general goal, then, becomes to understand how an evolutionary model can predict that the etymologies of strong linearity domains are restricted to those predicted by the Strong Linearity

Domain Hypothesis. The proposal here, relating to the conception of grammar depicted in (314), will be that prosodic constituents are the critical etymological source of strong linearity domains.

The most basic strong linearity domain is the lexically specified phonological string, which is part of the representation of a morpheme. Such strings aren't typically considered to be "templatic" for the precise reason that we expect them to be subject to strong linearity restrictions—nevertheless, they share an important feature with templates: their linear relations are unpredictable. There's not much we can say generally about the etymology of lexically specified strings without speculating about the prehistory of language. What we can say is that, in the theory of the prosodic hierarchy adopted here in section 1.2.2 (page 37) which included categories like prosodic root and prosodic stem, lexically specified strings can straightforwardly be made consistent with the first condition of the Strong Linearity Domain Hypothesis. Furthermore, though we would need to examine this on a language-by-language basis, the phonotactic constraints at such low levels of the prosodic hierarchy should make lexical strings consistent with the second condition of the Strong Linearity Domain Hypothesis.

For our purposes, though, what is most interesting is how the evolutionary approach can explain how the Strong Linearity Domain Hypothesis relates to morphological and syntactic templates. It will be useful here to make use of the term *templatic reanalysis* which I define in (315).

(315) **Templatic reanalysis:** The reanalysis of linear relations predictable from hierarchi-

cal structure (i.e. a weak linearity restrictions) as strong linearity restrictions.

With respect to the terminology developed here for discussing linear relations developed here, templatic reanalysis can be understood as a label for the reanalysis of a weak linearity domain as a strong one. The task of devising an evolutionary explanation for the Strong Linearity Domain Hypothesis can now be restated as devising a model of templatic reanalysis which predicts the Strong Linearity Domain Hypothesis. As mentioned above, the first part of this explanation lies with the idea that prosodic constituents are the etymological source of strong linearity domains.

Before going into this explanation in more depth, in the next section I will give an example of templatic reanalysis taken from Udi as described by Harris (2002) in order to make the discussion more concrete.

5.2.3.2 An example of templatic reanalysis: Udi endoclitics

This example of templatic reanalysis draws on a recent analysis of the development of endoclitics in Udi by Harris (2002).

Harris (2000, 2002) presents convincing evidence for the presence of endoclitics (infixing clitics) in Udi. Since the typical description of clitics is that they are placed via syntactic principles, and should, thus, appear at word boundaries, the existence of this type of clitic is surprising. As Harris (2000:145) points out, the existence of this type of clitic has been ruled out by many syntactic theories.

In Udi, a particular class of clitics, person markers which attach to the focused element

of a sentence, often appear inside verb stems. I will not take the time to repeat Harris’s arguments as to why these person markers are clitics, and not affixes—the case is made clearly in Harris (2002), a monograph devoted to the subject, and Harris (2000), a short article covering all the major points of the argument. Instead, I will discuss the positioning of these clitics, focusing on their infixing properties, and discuss Harris’s diachronic analysis of their placement which involves templatic reanalysis.

The structure of the Udi verb is somewhat complicated. Verbs can be classified as complex or simplex. Complex verbs consist of a preverbal element followed by an inflecting root. The preverbal elements can be a range of things, incorporated nouns, adjectives, and adverbs or locative morphemes, for example Harris (2002:64–72). Simplex verbs consist solely of an inflecting verb root Harris (2002:72–6). (Harris 2002:77–87) further provides extensive evidence that complex verbs are a single (multi-morphemic) word.

Given this background, I give the data in (316) which shows the endoclititic placement of personal markers in verbs. The endoclititics are bolded. (The complete facts of the placement of these clitics are complex, and they are not always endoclititics. For a full discussion, I refer the reader to Harris (2002:116–131).)

- (316) a. *zavod-a aš-**ne**-b-sa*
 factory-DAT work-3SG-do-PRES
 “She works in a factory.” (Harris 2002:122)
- b. *kaγuz-ax a-z-**q**’-e*
 letter-DAT receive₁-1SG-receive₂-AORII
 “I received the letter.” (Harris 2002:125)

- c. *q'ačarγ-γ-on bez tänginax baš-q'un-q'-e*
 thief-pl-erg my money.DAT steal₁-3PL-steal₂-AORII
 “Thieves stole my money.” (Harris 2002:125)

Harris gives two different endoclititic placement rules to account for data like that in (316). She takes the placement of the endoclititic in (316a) to be morphologically governed. Specifically, the endoclititic appears between an incorporated element (a noun in (316a)) and a following light verb (*b-* ‘do’ in (316a)) (Harris 2002:122).

Such a morphological treatment cannot apply in (316b) and (316c), however, since the verbs in those sentences are simplex. The fact that the endoclititics are appearing within a monomorphemic verb stem is indicated by the glosses in (316b) and (316c), where the split halves of the verb stems are marked by the full gloss of the verb plus a subscript number. The rule which governs the placement of endoclititics in these verbs is that it appears before the final consonant of the verb root (Harris 2002:125).

Assuming Harris’s analysis, since the placement of the endoclititic in a sentence like that in (316a) can be characterized in terms of morphological structure, the clitic-verb combination probably does not necessarily constitute a strong linearity domain. I say “probably” because it would be possible to say something like, “the endoclititic follows the *first* morpheme of the complex verb”, and such a characterization would imply the existence of a strong linearity domain. However, we can imagine other ways of characterizing the placement like, simply, “the endoclititic follows the preverb” which would not imply the existence of a strong linearity domain.

However, the placement of the endoclititic in (316b) and (316c) does constitute a strong

linearity domain under Harris’s analysis since it is characterized with respect to a linear position in the verb root (namely “before the last consonant”).⁴ Below, I will take up the issues as to whether or not this strong linearity domain is consistent with the Strong Linearity Domain Hypothesis. First, I will discuss Harris’ diachronic analysis of the rise of endoclitics in Udi.

One reason why I chose Udi as an example of templatic reanalysis is because of the way Harris (2002) analyzes the emergence of the phonologically conditioned endoclitic pattern exemplified in (316b) and (316c). She makes use of three hypotheses about the development of Ude from pre-Udi. I will only discuss two of them here since the third, though partially relevant, is not needed to make the general point and would lead us into further complications of Udi morphology.

The first of the relevant hypotheses is the Univerbation Hypothesis. This hypothesis suggests that complex verbs were originally not one word, but two, and they became lexicalized as one verb over time. When they were still two words, the person marker clitics preceded the inflecting verb root and, after lexicalization the clitic became “trapped” inside the new word, rather than moving outward to the periphery (Harris 2002:212).

The second hypothesis is the Simple Movement Hypothesis. This hypothesis suggests that after univerbation had created a large number of verb stems showing the endoclitic pattern, the pattern was extended, by phonological analogy, to the simplex verb stems,

⁴ Since templatic properties of the Bantu verb stem have played an important role in this work, it is worth pointing out that one suffix found on the verb stem in some Bantu languages, the imperfective *-ag-*, appears to have undergone a similar templatic reanalysis—developing a requirement that it be placed *after* the last consonant of the verb stem Hyman (1993:14–17)

where, formerly, the person marker clitics are taken to have simply followed the verb. The reason for the appearance of the endoclitics specifically before the last consonant of the simplex verb stem is that all light verbs in Udi, except one, *bak-* ‘be, become’, consist of a single consonant (see, for example, the light verb *b-* ‘do’ in (316a) above). Since these light auxiliary verbs follow the preverb, this means that an endoclititic positioned before a light verb will also precede the last consonant of the verb (Harris 2002:212–213).

The Simple Movement Hypothesis implies the occurrence of a stage of templatic re-analysis in Udi. Specifically, the morphological positioning of the endoclitics, which is straightforwardly understood as being conditioned by hierarchical structure within the complex verb, was reanalyzed as being phonologically conditioned by the linear order phonemes in the verb stem. We can schematize this shift as in (317) (PM stands for “person marker” in (317) and C is any consonant).

(317) [[]_{preverb} PM []_{root}]_{complex verb} > [... PM C]_{complex verb}

The relevant data on the prosodic phonology of Udi is lacking to determine if the re-analysis described by Harris and schematized in (317) is fully consistent with the Strong Linearity Domain Hypothesis. However, Harris does offer various relevant observations which indicate that this change in Udi is consistent with it. In light of the general focus of this work, I will briefly discuss these here.

First, with respect to whether or not the verb is a prosodic domain: “Complex verbs have the stress characteristic of words, not that of syntactic phrases (Harris 2002:76).” This indicates that the idea that a complex verb is a “word” is not simply based on syntactic

considerations, but that it is also a prosodic constituent, in line with the first condition of the Strong Linearity Domain Hypothesis. Furthermore, though it is not explicitly stated, since there clearly is a category of word, it is probably safe to assume that non-complex verbs (i.e. the simplex verb roots which are of interest to us here) are also words subject to the same word-level restrictions as complex verbs. Thus, the verb generally would appear to form a prosodic word.

There is also evidence that the consistency condition of the Strong Linearity Domain Hypothesis is met—though such a conclusion is necessarily tentative. First, as mentioned above, light auxiliary verbs typically consist of single consonants. Furthermore, most monomorphemic verb stems are of the form (C)VC(C) (Harris 2002:213). This indicates that, generally, there are restrictions on the segmental structure of verbs—making a strong linearity restriction sensitive to a particular segment roughly consistent with the phonological restrictions of that prosodic constituent.

We have seen here an interesting example of templatic reanalysis. Specifically a system of positioning for a clitic, which was once sensitive to morphological structure has become, instead, sensitive to phonological structure creating a strong linearity domain. In the next section, I go back to the idea of how an evolutionary model of grammar can explain the Strong Linearity Domain Hypothesis.

5.2.3.3 Strong linearity domains as reanalyzed prosodic domains

Returning to the broader topic of an evolutionary explanation of the Strong Linearity Domain Hypothesis, I take Harris's analysis of Udi as an example of the general way strong

linearity restrictions come about in language. Specifically, within a well-defined prosodic domain, the principle(s) affecting the position of some element in that domain are reinterpreted as linear instead of being sensitive to hierarchical constituency.

Ideally, we will be able to point to “conspiring” factors whenever proposing templatic reanalysis—in the Udi case it is that most light auxiliaries consist of a single consonant and that complex verbs outnumber simplex verbs making the endoclititic pattern very common after univerbation had spread through the language (Harris 2002:213).

This model of the development of strong linearity domains can account for both major conditions of the Strong Linearity Domain Hypothesis. If templatic restrictions come from the reanalysis of predictable linearity restrictions, coinciding with prosodic constituents, being reanalyzed as strong linearity restrictions, this means that the rise of such restrictions will always follow a path which makes them consistent with the first condition of the Strong Linearity Domain Hypothesis.

Furthermore, if strong linearity restrictions arise via the reanalysis of a prosodic constituent, the reanalysis will be constrained to properties that are consistently found within that prosodic constituent. Therefore, strong linearity restrictions should have similar characteristics to the prosodic constituents they derive from. This evolutionary account of strong linearity domains can also explain, then, the consistency condition of the Strong Linearity Domain Hypothesis.

This evolutionary explanation of the Strong Linearity Domain Hypothesis can basically be understood as a theory of the etymology of templatic restrictions—that is, that they arise

as the result of the lexicalization of linear relations within prosodic constituents. In sum, this means that not only are they coincident with prosodic constituents but also that they will show comparable phonological properties to the prosodic constituent they coincide with.

As it stands, this account of the evolution of strong linearity domains leaves open a very important question, however. While it can predict a path through which strong linearity domains consistent with the Strong Linearity Domain Hypothesis may come about, on its own, it does not predict that this is the only path through which they can come about. I discuss this issue in the next section.

5.2.4 Why only reanalyzed prosodic domains can become strong linearity domains

In the last section, I outlined a diachronic path through which strong linearity domains would be created which were consistent with the Strong Linearity Domain Hypothesis—and this scenario constituted the core of an evolutionary account of it. However, in establishing that this is the correct account, it is important to explain why strong linearity domains could only be the result of reanalyzed prosodic domains and not arise from some other path. This is the topic of the present section.

I will not be able to completely defend this aspect of my proposal here. However, I will be able to outline an explanation for it as an extension of listener-oriented views of sound change, which can be found in the work of various authors, including Hyman (1977), Ohala (1981), Hajek (1997), and Blevins (in press). Though these authors differ in the details of the models they adopt, they all have in common the belief that the parsing

of the speech signal by the listener is the critical factor in linguistic change. Blevins (in press), for example, outlines three ways, labelled *change*, *chance*, and *choice*, given in (318), which she believes are the major paths through which sound change is effected by the listener. The examples in (318) are those given by Blevins.

(318) a. CHANGE: The phonetic signal is *misheard* by the listener due to perceptual similarities of the actual utterance with the perceived utterance.

Example: Speaker says [anpa]
Listener hears [ampa]

b. CHANCE: The phonetic signal is accurately perceived by the listener but is intrinsically phonologically ambiguous, and the listener associates a phonological form with the utterance which differs from the phonological form in the speaker's grammar.

Example: Speaker says [ʔaʔ] for /aʔ/
Listener hears [ʔaʔ] and assumes /ʔa/

c. CHOICE: Multiple phonetic signals representing variants of a single phonological form are accurately perceived by the listener, and, due to this variation, the listener (i) acquires a prototype or best exemplar of a phonetic category which differs from that of the speaker and/or (ii) associates a phonological form with a set of variants which differs from the phonological form in the speaker's grammar.

Example: Speaker says [kakáta], [kǎkáta], [kkáta] for /kakata/
Listener hears [kkáta], [kakáta], [kǎkáta] and assumes /kakata/

Central to these listener-oriented approaches of sound change is the idea that the only type of linguistic change taking place in the reanalysis is a change in how the listener assigns an underlying representation to a sound or set of sounds. If this were not the case, one would not have sound change in the language but, rather, a general misperception of an utterance.

While the works taking on a listener-oriented view of change cited above all focus on sound change, there are enough similarities between sound change and templatic reanalysis, as defined in (315), that we can readily adopt such an approach to the phenomena which are of interest to us here. Essentially, what we need to say is that templatic reanalysis occurs when a listener correctly deduces the semantics of a given utterance but incorrectly parses a weak linearity domain in an utterance as a strong linearity domain.⁵

Working within this model, to show that the evolutionary explanation sketched above of the Strong Linearity Domain Hypothesis is correct, we will need to establish that, of the two major types of weak linearity domains focused on here, prosodic constituents and morphological/syntactic constituents, only prosodic constituents should be subject to listener-oriented misparsing of the sort that would result in templatic reanalysis. My argument for this will rely on a similar idea to the one found in the listener-oriented views of sound change that change takes place when the semantics of an utterance are properly understood but some aspect of its linguistic structure is reanalyzed.

To make the discussion concrete, I will first refer to some possibilities for templatic

⁵ I assume here that strong linearity restrictions arise between two constituents only if they already bear some linearity relations with respect to each other and hence limit them to arising from weak linearity domains as opposed to an arbitrary linguistic domain.

reanalysis of the structure of the English sentence, following some of the discussion in chapter 1. First, I repeat the syntactic and prosodic structure of the English example sentence given in Hayes (1990), discussed in section 1.1.3.2 (page 29), in (319) and (320) below.

(319)

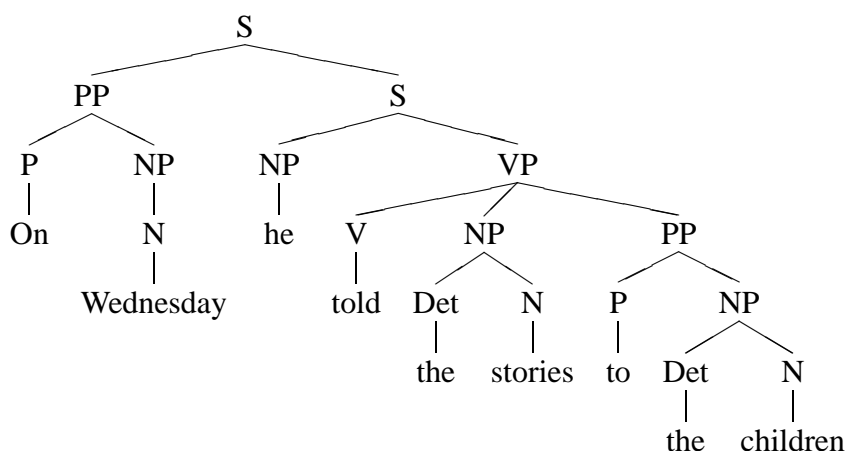

(320)

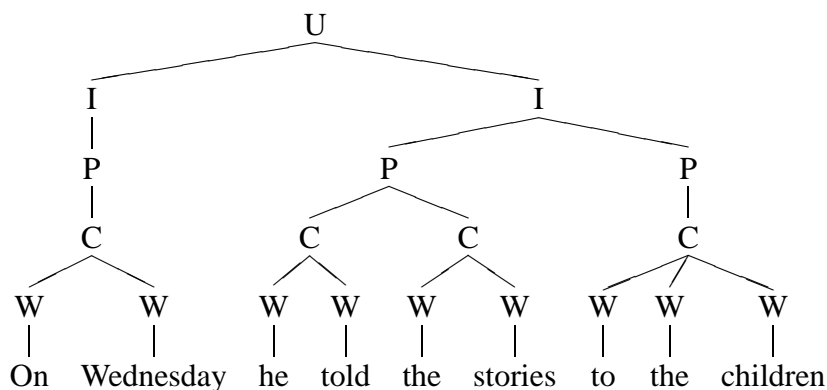

I will focus on, here, an aspect of the relationship between these two structures which was of interest earlier—namely, the fact that the subject and the verb form a close prosodic constituent, despite not forming a close syntactic constituent, and the fact that the verb and its objects form a close syntactic constituent but not a close prosodic constituent.

It was discussed in section 1.3.4 (page 77), in reference to Bobaljik's (2002) analysis of *there*-existentials, that a possible characterization of English sentence structure could center on an analysis with a strong linearity domain coextensive with the prosodic constituent formed by the subject and the verb which would be consistent with the Strong Linearity Domain Hypothesis. As mentioned in that discussion, I do not necessarily wish to adopt such an analysis for English, but we can use it as a good jumping off point here. Suppose that at some stage of English, the prosodic analysis given in (20) were completely correct for an English sentence. For illustrative purposes, further suppose that the subject-verb (henceforth SV) prosodic constituent was reanalyzed as a strong linearity domain which required that the SV prosodic constituent be branching, as discussed in section 1.3.4. Such a strong linearity restriction could be taken, for example, to account for the fact that (non-imperative) English sentences typically require a subject.

Adopting the view, as discussed above, that templatic reanalysis only occurs when the semantics of the relevant utterance are properly comprehended, an important aspect of this hypothetical case of the development of a strong linearity domain is that it involves the reanalysis of one type of linearity domain with no particular semantic content as another type of linearity domain with no particular semantic content. This is not to say that there is no semantic relationship between a subject and a verb—and even their order with respect to each other. Rather, there is no particular semantic content to the SV prosodic constituent. It is a linearity domain imposed by phonological requirements not syntactic/semantic requirements associated with the meaning of the sentence—therefore, a speaker who fails

to parse some prosodic constituent as a weak linearity domain will not necessarily fail to properly understand a given utterance.

It is useful, then, to contrast this hypothetical reanalysis with another hypothetical one, which this explanation of the Strong Linearity Domain Hypothesis suggests should not occur, namely that the VO syntactic constituent should be reanalyzed as a strong linearity domain along comparable lines to the SV prosodic constituent. While the ordering relationship between a verb and its object(s) is reasonably fixed, as pointed out above, there is no prosodic constituent corresponding to this syntactic constituent. If the meaning of a sentence, like the one in (319), is correctly apprehended, then the syntactic/semantic relationship between the verb and its objects will also necessarily be apprehended.

Since the VO syntactic constituent can be readily associated with some meaning necessary for the comprehension of the sentence, the listener will always be presented with an obvious weak linearity domain analysis of such a constituent, namely that objects follow their verbs. I take the fact that such an alternative weak linearity analysis will always exist for the linearity domain of the VO syntactic constituent to block a strong linearity analysis of it. Again, the core idea here is that if the syntax and semantics of a sentence have been correctly apprehended, linearity domains readily associated with syntactic or semantic meaning will not be prone to being reanalyzed as strong linearity domains since a weak linearity domain analysis will necessarily be available for them.

There is a potentially subtle point here to be made regarding the difference between the VO syntactic constituent and the SV prosodic constituent. There is clearly a syntactic rela-

tionship between a subject and a verb, and I do not mean to suggest otherwise. However, unlike the VO constituent, there is both a syntactic and a prosodic constituent associated with the subject and the verb of the sentence. The meaningful syntactic relationship between the two is not what is reanalyzed in the creation of a strong linearity domain, under the present proposal. Rather, the “meaningless” SV prosodic constituent is reanalyzed.⁶

I will not claim to have definitively argued for this claim. However, I believe I have set out a reasonable explanation as to why only prosodic constituents, but not morphological or syntactic constituents, can be reanalyzed as strong linearity domains even though both can constitute weak linearity domains. Essentially, if we assume a listener-oriented model of change for templatic reanalysis, meaningful morphological and syntactic weak linearity domains are not reanalyzed as strong linearity domains because, if the utterance is correctly apprehended, an alternative analysis, not making use of a strong linearity domain will always be available to the listener. Since prosodic constituents, on the other hand, are not directly associated with any particular meaning, a misperception of them as strong lin-

⁶ There is an issue here that comes up whenever one claims some linguistic feature is “meaningless”, as I have just done for the SV prosodic constituent. Clearly, it would be dangerous to suggest that it could never help the listener determine the meaning of a sentence. So, I should qualify my use of “meaningless” here to refer to structures that, even if they could potentially convey some meaning, have a form which is predictable but not “predicting”. So, while the SV prosodic constituent might help a speaker isolate the subject and verb of a sentence, such a prosodic constituent does not uniquely correspond to a subject and a verb. This follows from the fact that SV prosodic constituent is really just a special case of the Hayes’s clitic group (both before and after any hypothetical reanalysis of it as a strong linearity domain), which can encompass syntactic elements other than an SV combination. Following the structure in (320), this same prosodic constituent can consist of a prepositional phrase, a noun phrase, or an SV unit—a syntactically heterogeneous set. Thus, even if the word “meaningless” might be too strong an adjective for a prosodic constituent, it is clearly the case that they do not carry critical meaning in the way syntactic constituents can. This idea is clearly instantiated in many formal theories of prosodic constituency, like that of end-based mapping, for example, discussed in section 4.3.2.2 (page 448), where it is assumed that prosodic structure above the word is determined by syntactic structure and that the phonology only has access to a very limited amount of information encoded in syntactic structures—making the prosodic form of a sentence a semantically “impoverished” reflection of its syntactic form.

earity domains does not necessarily correspond with any loss of the semantic content of an utterance—thus, opening the door to templatic reanalysis.

The general question remains open as to how we might explain why only some prosodic domains ever undergo reanalysis wherein they become strong linearity domains. As mentioned above in section 5.2.3.3 (page 516), hopefully one would be able to isolate various conspiring factors in every given instance of templatic reanalysis which would help to explain why it took place. For now, the nature of the relevant conspiring factors has yet to be determined.

Underlying this whole discussion, is the idea that, even if they do not strongly encode any meaning, prosodic constituents still play a role in how the listener parses an utterance. That is, there must be some general psychological reality to them if they are to be reanalyzed as strong linearity domains in the first place. There is not a particularly large body of research in the area of prosody and parsing (see Warren (1996) and Cutler et al. (1997) for overviews of research up to the time those articles were written), and what has been done has not been focused on the question which would be of most interest here: whether or not there is any connection between prosodic constituency and the storage of unpredictable linear relations.

The focus of most of the psycholinguistic work in this area has been on the role of prosodic boundary markers in sentence parsing—a topic not directly related to the analyses found in the case studies here which all focused on the internal structure of prosodic constituents. Furthermore, even within the study of the effect of boundary markers on per-

ception, experiments have not produced clear results. In their review of the experimental literature on the relationship between syntax and prosody, Cutler et al. (1997:169) summarize their findings as follows:

The conclusion warranted by the studies we have reviewed here is that the presence of prosodic information cueing a boundary, or of a sentence accent, can have an effect on syntactic analysis; it can lead the listener to prefer analyses that are consistent with the prosodic information provided. However, these effects are far from robust, and there is little evidence for early exploitation of prosodic information in parsing.

From the perspective of the present work, these results neither seem to support the claims being made here nor do they argue against them. Determining how prosodic constituents relates to the storage of linearized sequences will have to await experimental work on prosody which allows firmer conclusions than those outlined above.

However, while the general literature may not be able to offer much support for the account of the Strong Linearity Domain Hypothesis being developed here, this may be due to the fact that prosody is more important in language acquisition than in the use of language by adult speakers. This has been suggested by Morgan (1996), and, if it is true, it would imply that the roots of the Strong Linearity Domain Hypothesis do not lie in language change triggered by adults but, rather, by children.

In this regard, Read and Schreiber (1982) present some results which are highly relevant to the hypothetical reanalysis of the English SV prosodic constituent as a strong linearity domain given above. They performed an experiment involving the ability of seven-year-old children to identify the subject of a sentence. The ability of children to succeed at this task increased with the length of the subject. Short subjects, consisting of just one word, were

found to be harder to identify than multi-word subjects. Pronominal subjects, in particular, proved exceptionally difficult for children to identify.

When asked to identify the subject of a sentence containing a pronominal subject, a typical response from the children studied, “was to repeat the first few words of the sentence, usually ending at a phrase boundary . . . (Read and Schreiber 1982:86)” For example, given the sentence, *He could not answer all my questions*, common answers for the subject were *He could not* or *He could not answer*.

The conclusion reached by Read and Schreiber (1982), based on various experiments, is that prosody is a critical factor for children’s ability to parse the phrase structure of sentences. There was a lack of a strong prosodic boundary between single-word subjects and the verb in the sentences used in the experiment, and pronouns, in particular, consistently formed a close prosodic unit with the following verb because they were not stressed.⁷ These phonological facts seemed to render the task of subject identification very difficult for single-word subjects (and nearly impossible for pronominal subjects). Adults did not show the same difficulties as children, although, as Read and Schreiber (1982:81) point out, it is hard to conclude anything too strong from this because the adults participating in the experiment were all university undergraduates and, therefore, might have represented a demographic significantly different from the children in ways other than age.

Nevertheless, Read and Schreiber (1982) and Morgan (1996) indicate that the most

⁷ This is not to say that subject pronouns can never be stressed, of course, as we saw in section 1.3.4 (page 77) in chapter 1. However, Read and Schreiber (1982:87) explicitly mention, “the complete absence of suprasegmental marking on pronominal subjects.” I take this to mean that none of the pronominal subjects in the set of sentences used in the experiment were stressed.

fruitful avenue of exploration, with respect to verifying the evolutionary explanation for the Strong Linearity Domain Hypothesis given here, would be studies on how children use prosody in determining the weak linear relations of their language. If it is true that they rely on prosody more than adults, templatic reanalysis may be an artifact of an inability of children, during language acquisition, to correctly uncover all potential weak linearity domains in a given utterance, and their strong reliance on prosodic constituents to assist in parsing would, then, bias them towards reanalyzing weak linearity relations of elements within those constituents as strong linearity relations. Again, using the SV prosodic constituent in English as an example, the fact that the subject precedes the verb is typically analyzed as a weak linearity relationship between the subject and the verb phrase. However, children who have not fully internalized such a relationship might, instead, analyze this as a strong linearity relationship within the salient prosodic constituent of the subject and the verb.

A factor which might be preventing such an analysis from generally taking hold in English is suggested by Read and Schreiber's (1982) study—multi-word subjects may be followed by a prosodic break and only single-word subjects formed the tightest SV prosodic constituents in their experiment sentences. This fact might be preventing a strong linearity analysis of English sentence structure from completely winning out, even if, as the results of Read and Schreiber (1982) suggest, children as old as seven are not able to consistently parse single-word subjects away from the verb.

Clearly, the arguments presented here should only be considered suggestive, rather

than conclusive. I have intended outline an explanation as to why templatic reanalysis should only exist within prosodic constituents and not other weak linearity domains. A central premise of the explanation is that since prosodic constituents are not associated with any particular semantics, the linear relations within them are prone to being reanalyzed as strong linear relations since it is not necessary to correctly analyze the prosodic constituency of an utterance in order to determine its semantics. Since morphological and syntactic constituents do need to be correctly analyzed in order to determine the meaning of an utterance, a weak linearity analysis is always available for them which prevents them from being analyzed as strong linearity domains. While, at present, there is only limited experimental evidence to verify this hypothesis, there are some experimental results which suggest that templatic reanalysis is more likely to occur with children than adults. With respect to the main concerns of the present work, however, I should stress that most of the necessary experimental work has yet to be done.

5.2.5 Local conclusion

In this section, I first outlined an evolutionary approach to grammatical explanation. This includes an acknowledgement that there is both a synchronic and a diachronic aspect to an explanation for grammatical phenomena accompanied by a bias towards diachronic explanations.

Within such a model of grammar, I then developed an account for the Strong Linearity Domain Hypothesis which essentially can be understood as a theory of etymology for strong linearity domains. In particular, it was proposed that strong linearity domains arise

from templatic reanalysis of the linear relations of prosodic constituents as strong linearity restrictions. This both accounts for the fact that strong linearity domains should be coextensive with prosodic constituents and for the fact that strong linearity restrictions should be consistent with the characteristic phonology of these constituents. This latter point is true since the reanalysis of linear relations of a prosodic constituent as strong linearity relations will necessarily mean that those strong linearity relations resemble the basic phonological characteristics of the constituent since it is the features of that prosodic constituent which would be subject to reanalysis in the first place.

I further suggested an explanation as to why only prosodic constituents, and not other constituents whose elements bear linear relations with respect to one another, should undergo templatic reanalysis. This explanation rested on the idea that prosodic constituents are essentially “meaningless” while other constituents are “meaningful”. Finally, it was pointed out that there is some experimental evidence that indicates templatic reanalysis is more likely to occur during child language acquisition than in adult language.

5.3 TOWARDS A NON-EVOLUTIONARY ACCOUNT OF THE STRONG LINEARITY DOMAIN HYPOTHESIS

5.3.1 Introduction

While an evolutionary interpretation of the Strong Linearity Domain Hypothesis is the one assumed here, it is possible to imagine explanations of the Strong Linearity Domain Hypothesis within other models of grammar. I choose to discuss two here for illustrative purposes.

In section 5.3.2 (page 531), I will discuss how we might account for it within Optimality Theory, and in section 5.3.3 (page 538), I will discuss how we might do so in models of grammar making a distinction between PF (Phonological Form) and LF (Logical Form).

5.3.2 Optimality Theory

In this section, I will show how a system of plausible constraints and a default constraint ranking can predict a typology of languages where strong linearity domain effects consistent with the Strong Linearity Domain Hypothesis. Under this formalization, following the basic ideas behind Optimality Theory, the Strong Linearity Domain Hypothesis does not become an inviolable universal but rather will be formalized as a violable tendency in language. Crucially, however, I will attempt to formalize a cline where more flagrant violations of the Strong Linearity Domain Hypothesis are predicted to be less likely than less flagrant ones.

The first step in creating an Optimality Theory formulation of the Strong Linearity Domain Hypothesis is to establish some prosodic phonological primitives which can be used to build up underlying representations to serve as the input to constraint evaluation metrics. For the purposes of illustration, I assume the set of prosodic constituents in (321) as basic prosodic constituents in an Optimality Theory grammar. As basic constituents, I put them on par with elements like features and segments—meaning that they can appear in input representations for constraint evaluation. These constituents are the ones assumed in the model of the prosodic hierarchy adopted in section 1.2.2 (page 37).

- (321) a. **PRoot**: The phonological root
- b. **PStem**: The phonological stem
- c. **PWord**: The phonological word
- d. **PPhrase**: The phonological phrase
- e. **Utt**: The utterance

While the hierarchy in (321) reflects the one adopted here generally, we could easily imagine recasting it in terms of prosodic hierarchies which employ the syllable and the foot (like the ones in Nespor and Vogel (1986) and Selkirk (1986)).

In addition to some notion of basic prosodic constituents, it will also be necessary to specify some categories of phonological phenomena—for example segment-based phenomena, accentual phenomena, etc. These categories will allow us to formalize the notion of the characteristic phonology of a prosodic constituent. In (322) I give a list of five broad categories of such phenomena.

- (322) a. **C&V**: Segmental phenomena
- b. $\acute{\text{}}$: Primary accent phenomena
- c. ˘ : Secondary accent phenomena
- d. * : Phrasal accent phenomena
- e. ~ : Intonational phenomena

I have limited the categories in (322) to five in order to simplify the discussion by having a simple one-to-one matching of phonological category to prosodic constituent—as mentioned above, the Optimality Theory formalization developed here is merely meant to be a sketch of how the Strong Linearity Domain Hypothesis can be formalized. It is not meant to be a fully developed formal treatment.

The next step here is to propose a pairing, along the lines of that diagrammed in (323) which relates each prosodic constituent to the prototypical type of phonological phenomena associated with that prosodic constituent.

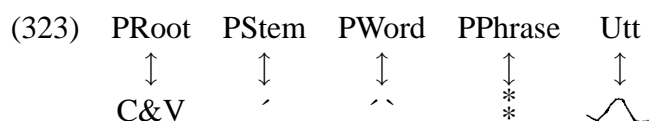

The pairing in (323) can essentially be understood as a schematization of the notion of the characteristic phonology of a prosodic constituent. So, for example, the diagram is meant to convey the idea that we expect statements referring directly to the consonant and vowel patterns in a language’s phonology to appear in descriptions of phonological roots, and we expect statements about the nature of intonational phrases in a language to appear in descriptions of utterances. The diagram (323) is only meant to be a general typological statement, of course, and we would expect a more complicated sort of pairing if we were describing real phonological phenomena in a particular language.

In Optimality Theory, we can express the basic idea schematized behind the diagram in (323) as a series of constraint rankings penalizing the association of phonological patterns with particular phonological constituents. The “natural” pairings will be lower-ranked

than the “unnatural” ones. I give the relevant constraint rankings in (324). There is a series of five separate rankings, one for each prosodic constituent in (321). The constraints are abbreviated, in somewhat typical fashion, using the format “*Prosodic constituent/Phonological class” to mean “disprefer phonological phenomena of the specified phonological class within that prosodic constituent”.

- (324) a. *PRoot/ \sim \gg *PRoot/* \gg *PRoot/'` \gg *PRoot/' \gg *PRoot/C&V
- b. *PStem/ \sim \gg *PStem/* \gg *PStem/'`, *PStem/C&V \gg *PStem/'
- c. *PWord/ \sim \gg , *PWord/C&V \gg *PWord/*, *PWord/' \gg *PWord/'`
- d. *PPhrase/C&V \gg *PPhrase/' \gg *PPhrase/ \sim , *PPhrase/'` \gg *PPhrase/*
- e. *Utt/C&V \gg *Utt/' \gg *Utt/'` \gg *Utt/* \gg *Utt/ \sim

Taken as a whole, constraint rankings like those in (324) predict the second part of the Strong Linearity Domain Hypothesis—namely, that the phonological restrictions on strong linearity domains should be consistent with the phonology of a given domain. This is because any strong linearity restriction which is not consistent with the characteristic phonology of a domain will incur a higher penalty in evaluation than one which is consistent.

Thus, for example, a strong linearity domain restriction at the level of the syllable which restricts consonants and vowels in syllables will incur a relatively low penalty compared to one which makes statements about the intonation of syllables. Similarly, a strong linearity domain restriction at the level of the phonological phrase which makes restrictions on con-

sonants and vowels will incur a higher penalty than one which makes restrictions on the intonational properties of such a phrase.

While I have given an Optimality Theory formalization, here, this aspect of the Strong Linearity Domain Hypothesis would likely also be predicted by many other theories of phonology since the association of the right type of rule or constraint with the right type of phonological constituent is a general problem in phonological theory. The primary goal of the formalization in (324) is simply to show that the consistency condition of the Strong Linearity Domain Hypothesis can be modeled in Optimality Theory without any alterations to its general formal architecture.

While it is fairly easy to formalize the consistency condition of the Strong Linearity Domain Hypothesis using constraint rankings, formalizing the first condition of it—that all strong linearity domains be coextensive with prosodic constituents—is not as straightforward. However, I will make some suggestions as to how we might do this here.⁸

The first element in understanding how an implementation of the first condition of the Strong Linearity Domain Hypothesis would work in Optimality Theory is to decide exactly how templatic restrictions are represented. Consistent with the discussion in section 5.2 (page 499), I take strong linearity restrictions to be represented as lexical objects.

Such an idea is not new to this work, we saw it above in section 1.3.2 (page 65) in example (33), in the discussion of second-position clitics in Serbo-Croatian. Once we take

⁸ The proposal below is not consistent with the only implementation of the phonology-syntax interface within Optimality Theory that I am aware of, Truckenbrodt (1999). This is because, in the discussion to follow, I assume that both prosodic and syntactic structure are present in an input to be evaluated. The tableaux in Truckenbrodt (1999), on the other hand, imply that he assumes only syntactic structure is in the input and prosodic structure is assigned to a form based on its syntactic structure.

strong linearity effects to be a type of lexical object, they would simply appear in the underlying representation of a phonological form—and their realization (or lack thereof) would be governed by the interaction of faithfulness constraints with markedness constraints, in the normal Optimality Theory fashion.

The next element in implementing the first restriction of the Strong Linearity Domain Hypothesis in Optimality Theory would be to posit that constraints dealing with the linearization of *morphological and syntactic* hierarchical structures in input forms would have to follow something like the Mirror Principle. Or, keeping more in line with the architecture of Optimality Theory, constraints relating morphological and syntactic hierarchical structures to their linearization would uniformly penalize surface forms which did not obey the Mirror Principle.

This restriction would mean that, if any lexical object containing a strong linearity domain was coextensive with a morphological or syntactic structure, it would be uniformly penalized by Mirror Principle constraints. Such constraints could then be assumed to generally override any faithfulness constraints which would favor the realization of such a strong linearity domain over a surface form obeying the Mirror Principle.

Constraints on the realization of prosodic structure, on the other hand, would make no such reference to the Mirror Principle. This would mean that forms conforming to faithfulness constraints within lexically specified prosodic structure for strong linearity domains would not automatically be penalized—they might be penalized by various other constraints for any number of reasons, though, of course. However, unlike strong linearity

restrictions associated with morphological or syntactic constituents, the penalty would not follow from the fundamental architecture of grammar.

Strong linearity domains within prosodic constituents would, thus, be favored over strong linearity domains in morphological and syntactic constituents and, thus, be more likely to surface. For all the pieces to fit together, we would need to make sure that the constraints were ranked and defined to make sure that strong linearity domains over morphological and syntactic constituents were very strongly disfavored. There is some degree of stipulation in this formalization, as I have outlined it, since there is no specific aspect of the architecture which directly predicts that Mirror Principle constraints should be linked to morphological and syntactic structures but not prosodic ones. However, to the extent that the association of a constraint referring to scope could not have any straightforward interpretation with respect to a prosodic constituent, it is likely that such a stipulation could be derived from more general principles relating to how semantic constraints should be interpreted with respect to phonological structures on the one hand and morphological and syntactic structures on the other.⁹

As mentioned already, the proposal here about how to implement the Strong Linearity Domain Hypothesis within Optimality Theory is intended only as a sketch to show that this could be done without any significant alteration to theory. Thus, in some sense, the arguments presented in this section could simply be taken as showing that there is nothing

⁹ A third possibility for a strong linearity domain would be that it would be coextensive with neither a morphological/syntactic constituent nor a prosodic constituent. I assume we could rule out an underlying representation containing such a strong linearity domain via a set of constraints which would penalize lexical objects not associated with some linguistic constituent.

intrinsically radical about the Strong Linearity Domain Hypothesis with respect to Optimality Theory. I doubt every detail of the formalization presented here would survive under extensive empirical application. Nevertheless, I believe it offers a promising start.

5.3.3 PF/LF approaches to grammar

In this section, I will discuss how the Strong Linearity Domain Hypothesis can be related to approaches to grammar which take a basic division between Phonological Form (PF) and Logical Form (LF) to be an essential part of grammatical structure. The particular approaches I have in mind are Government and Binding Theory, Principles and Parameters, and Minimalism, each of which maintains this basic PF/LF distinction.

It should be fairly clear, I hope, that strong linearity effects within such an approach should be understood as PF-effects. LF is a level of syntactic representation which encodes relationships which we can say are roughly related to the notion of scope. PF, on the other hand, is where all linearity relationships are encoded. (These aspects of the division between LF and PF are made explicit in Marantz (1988:256–7).)

In these PF/LF theories, there is not yet widespread consensus as to what operations are permissible at the PF level of representation. Of particular interest to this work is the possibility of PF-movement. That is, the movement of elements at the level of phonological, but not “logical”, representation. PF-movement, if it exists in one form or another, could be a very powerful process. If unconstrained, it could be used to describe a range of templatic effects far beyond those predicted by the Strong Linearity Domain Hypothesis. This is due to the fact that PF-movement would not have any semantic effects, allowing it to rearrange

the linear order of elements without affecting the interpretation of a constituent. However, as we will see below, researchers who have proposed PF-movement have proposed that it is highly constrained in ways which are in line with the Strong Linearity Domain Hypothesis.

In addition to PF-movement, another general sort of PF-effect of interest to the present work is the idea of a PF-filter. PF-filters are restrictions on allowable PF representations. As such, they don't have the ability to "move" any elements in PF. However, they can mark PF structures as ungrammatical, effectively forcing something that looks like movement to take place on the surface. The effects of such filters are not understood as movement, *per se*, of course, but rather they are taken to force alternative derivations of syntactic structures which allow their restrictions to be met, resulting in something that has the surface appearance of PF-movement.

A useful overview of contrasting approaches to PF-effects, both PF-movement and PF-filters, can be found in Bošković (2001:7–96), which provides a discussion comparing and contrasting various approaches to second-position clitics in Serbo-Croatian categorized by the way they appeal to PF-effects.

For the sake of illustration I will discuss four specific analyses involving PF-effects which have been proposed in the literature—each of these will help us get some sense of how the Strong Linearity Domain Hypothesis could be implemented in a PF/LF model of grammar. The first of these is Bošković's (2001) version of the prosodic filter (for a comparable version see Zec and Inkelas (1990)). The second is prosodic hopping from in Halpern (1995) (Marantz (1988) allows something comparable). The third is prosodic

movement approach found in Radanović-Kocić (1996). The final is PF-insertion found in Bobaljik (2002). The labels for these four PF-effects are my own. I consider the last three of these to all fall under the rubric of PF-movement approaches.

Bošković (2001) and Zec and Inkelas (1990) have essentially the same analysis of prosodic filters (despite claims by Bošković (2001:86) to the contrary, in my opinion). While Zec and Inkelas's (1990) model is more carefully worked out, I will discuss Bošković's (2001) analysis here since he works explicitly in a PF/LF model of grammar whereas Zec and Inkelas (1990) do not. Bošković (2001:83) analyzes second-position clitics in Serbo-Croatian and gives the formalization in (325), which was first developed in Bošković (1995:263).

(325) a. #_ (where # is an intonational phrase boundary)

b. Suffix

The formulation in (325) borrows heavily from the work of Klavans (1985) on the typological classification of clitics, which was discussed in section 3.4.4 (page 301) in chapter 3. The restriction in (325a) is meant to formalize the fact that Serbo-Croatian second position clitics must appear at the left edge of an intonational phrase while (325b) says that they must be suffixing. These requirements are in conflict, but Bošković (2001), following Marantz (1988), allows the conflict to be resolved by saying that if a clitic attaches to the word at the left edge of the intonational phrase, then its left-edge requirement is met.

Under Bošković's (2001) view, however, the clitic does not appear at the right-edge of

the first word in the intonation phrase by PF-movement. Rather, it must be placed there via properly syntactic movement. Critically, however, any syntactic derivation which does not place a second position clitic in a “good” position will be ungrammatical. Therefore, statements like those in (325) technically only act as filters on syntactic representations. This is a highly restricted view of PF-effects.

Halpern (1995) takes an approach which assumes something very much like a PF/LF model of grammar, though he does not explicitly adopt one of the standard versions of those models. Like Bošković (2001) his approach makes use of a very restricted set of PF-effects. He adds a possibility, however, that Bošković (2001) does not allow for, a type of prosodic “hopping” (Halpern calls this Prosodic Inversion (Halpern 1995:62–5)). In Halpern’s view, a clitic is allowed to “hop” one word into a phrase to meet its prosodic requirements. Under such an analysis, second-position effects are not caused solely by rejecting syntactic derivations which do not place clitics in second position. Rather, they can also be the result of a clitic moving one word inward from the periphery of a phrase and then prefixing or suffixing to that word in order to meet its dependency requirements.

In Radanović-Kocić (1996) full PF-movement is considered a possibility in grammar. Second-position clitics, for example, are assigned a feature indicating their special positioning and they move, via a process called Clitic Movement (Radanović-Kocić 1996:441), to a prosodically defined position in the sentence. This powerful approach to PF effects would allow for a wide-range of “templatic” behavior to be formalized since it allows the use of arbitrary features whose sole effects are to trigger particular positional shifts of ele-

ments in a sentence.

The final approach, that of Bobaljik (2002), was already discussed above in section 1.1.3 (page 26) and section 1.3 (page 64). Recall that Bobaljik analyzed the expletive *there* in English existentials as “having no syntactic role but being instead inserted (at PF) only to fill some phonological requirement having to do with the left edge of the clause. . . (Bobaljik 2002:41).” Bobaljik (2002) was not all that concerned with the precise nature of this insertion process. So, it is not quite clear what the nature of this “requirement” about the left edge of the clause might be. Nevertheless, he points out at least one other possible sort of PF-effect—insertion/pronunciation of a “dummy” lexical item (which I classify here with the movement approaches since it involves actually changing a structure rather than simply marking it as ungrammatical).

Taken together, these four approaches to PF offer a blueprint as to how one might implement the Strong Linearity Domain Hypothesis in PF/LF approaches to grammar. Interestingly, for the present purposes, three of the four approaches are already in line with the first condition of the Strong Linearity Domain Hypothesis because they characterize PF-effects with respect to prosody. These approaches to PF do not explicitly limit PF-effects to prosodic constituents, but the fact that they refer to prosodic constituency in their analyses is promising with respect to rectifying them with the Strong Linearity Domain Hypothesis. As for the one approach which doesn’t explicitly invoke prosody, Bobaljik (2002), such a possibility isn’t specifically excluded, it just isn’t mentioned at all.

Thus, to fully bring the first restriction of the Strong Linearity Domain Hypothesis

into PF/LF approaches to grammar, we would simply have to more fully articulate the prosodic aspect of PF-effects. Specifically, any domain of PF-movement or of a PF-filter would have to be defined in terms of prosodic categories—in a way similar to the definition of the Serbo-Croatian clitic *je* found in Zec and Inkelas (1990) as discussed in section 1.3.2 (page 65). Adopting such a proposal, notably, would have effects for some analyses making use of PF-movement for effects which have no obvious prosodic conditioning. For example, Baunaz (2002), building on earlier work, has suggested that some of the verb-second effects found in Scandinavian languages (which are comparable to the verb-second effects of German discussed in section 4.0 (page 379) in chapter 4) are attributable to PF-movement. I am not aware of any evidence which would suggest that such movement is prosodically-driven in the way second-position clitic placement has been analyzed (as discussed in section 3.0 (page 275) in chapter 3). Therefore, the proposal seen here would seem to disallow such an analysis and, in general, would place strong limitations on the possibilities of PF-movement which could be incompatible with previous work.¹⁰

While stating restrictions on PF-effects in terms of prosodic constituents would allow the us to formalize of the first condition of the Strong Linearity Domain Hypothesis within PF/LF approaches to grammar, none of these four approaches ties in directly with the second condition of the Strong Linearity Domain Hypothesis—the requirement that strong

¹⁰ With respect to verb-second positioning in Germanic languages specifically, analyses not attributing the placement of the verb to PF-movement have been proposed. In this context, Anderson (1993, 2000) is noteworthy. In these works, he incorporates many of the insights of prosodically-oriented analysis of second-position clitic placement into an analysis of verb-second placement without specifically attributing the position of the verb to PF-movement. This suggests that, even if one were to adopt the proposal suggested here, it would not be necessary to completely abandon any of the leading ideas behind a PF-movement approach to verb-second phenomena.

linearity restrictions show consistency with the phonology of a given prosodic constituent. This is not surprising since most of the work on PF-effects in these frameworks has been limited clitics whose phonological properties are fairly restricted.

There would be many details to work out, but it seems to me that the most straightforward way to bring the consistency condition of the Strong Linearity Domain Hypothesis into such an approach to grammar would be to enforce very strong restrictions on the relationship between PF-effects and prosodic constituents. While this was not done explicitly in any of the approaches, it would not be inconsistent with them.

For example, under an approach which allowed PF-movement, a prosodic constituent could be considered a “barrier” to movement. So, an immediate sub-constituent of a prosodic constituent could move within its constituent but not outside of it. Such a restriction would prevent undesirable effects, like rearranging segments in a phonological phrase, but, at the same time, allow words to be rearranged within such phrases. Similarly, under approaches which made use of PF-filters, filters could be constrained to referring only to prosodic constituents and the possible formal content of the filters could be constrained in a way which would allow them to obey the consistency condition of the Strong Linearity Domain Hypothesis.

Importantly, one of the guiding principles of PF/LF approaches to grammar is to propose formal mechanisms which constrain the range of grammars which can be formally described. Trying to incorporate the Strong Linearity Domain Hypothesis in the way I sketched would produce a formal system which would be more restrictive than other ap-

proaches to PF, which leave many aspects of PF-effects unconstrained. As a result of this, I believe that altering such frameworks to be consistent with the Strong Linearity Domain Hypothesis would, if anything, be considering a favorable addition to them.

5.4 CONCLUSION

In this chapter, I developed an account of the Strong Linearity Domain Hypothesis within an evolutionary approach to grammar and sketched how we might account for it within Optimality Theory and within PF/LF approaches to grammar. These accounts filled a gap in the rest of this work—namely, while earlier chapters attempted to justify the Strong Linearity Domain Hypothesis as a valid and meaningful constraint on grammatical systems, I had given no specific explanation as to why such a constraint might exist in the first place.

The explanation for the Strong Linearity Domain Hypothesis which I espouse is the evolutionary one discussed in section 5.2 (page 499). However, I also outlined how we might be able to account for it within other approaches to grammar as just seen above. My primary reason for this was to show that that Strong Linearity Domain Hypothesis is not inherently problematic to other theories of grammar—which means that, to the extent that it is empirically valid, it could be readily understood as a theory which is complementary to various other proposals made about the nature of linguistic constituents instead of one which is contradictory to them.

Bibliography

- Abasheikh, Mohammed. 1978. *The grammar of Chimwi:ni causatives*. University of Illinois Ph.D. Dissertation.
- Abéga, P. 1976. *L'organisation du verbe ewondo: Suivie de quelques textes*. Yaoundé: Département des langues africaines et linguistique, Section de linguistique appliquée.
- Alsina, Alex. 1999. Where's the mirror principle? *The Linguistic Review* 16:1–42.
- Alsina, Alex, and Sam A. Mchombo. 1993. Object asymmetries and the Chichewa applicative construction. In S. A. Mchombo (Ed.), *Theoretical aspects of Bantu grammar*, 17–45. Stanford: CSLI.
- Anderson, Stephen. 1993. Wackernagel's revenge: Clitics, morphology, and the syntax of second position. *Language* 69:68–98.
- Anderson, Stephen R. 1977. On mechanisms by which languages become ergative. In C. N. Li (Ed.), *Mechanisms of syntactic change*, 317–63. Austin: University of Texas.
- Anderson, Stephen R. 1992. *A-morphous morphology*. Cambridge: Cambridge University.
- Anderson, Stephen R. 2000. Toward an optimal account of second position phenomena. In J. Dekkers, F. v. d. Leeuw, and J. v. d. Weijer (Eds.), *Optimality Theory: Phonology, syntax, and acquisition*. Oxford: Oxford University.
- Ashton, E. O. 1947. *Swahili grammar (with intonation)* (second edition). London: Longmans.

- Awobuluyi, Oladele. 1973. The modifying serial construction: A critique. *Studies in African Linguistics* 4:87–111.
- Awóyalé, Yíwolá. 1988. *Complex predicates and verb serialization*. Cambridge, Mass.: Lexicon Project, Center for Cognitive Science, MIT.
- Baker, Mark. 1985. The mirror principle and morphosyntactic explanation. *Linguistic Inquiry* 16:373–415.
- Baker, Mark. 1988. *Incorporation: A theory of grammatical function changing*. Chicago: University of Chicago.
- Baker, Mark. 1989. Object sharing and projections in serial verb constructions. *Linguistic Inquiry* 20:513–53.
- Baker, Mark. 1991. On the relation of serialization to verb extensions. In C. Lefebvre (Ed.), *Serial verbs: Grammatical, comparative, and cognitive approaches*, Studies in the sciences of languages series, 79–102. Amsterdam: Benjamins.
- Baker, Mark, and Osamuyimen T. Stewart. 2002. A serial verb construction without constructions. New Brunswick, New Jersey: Rutgers University (ms.).
- Bamgboṣe, Ayo. 1974. On serial verbs and verbal status. *The Journal of West African Languages* 9:17–48.
- Barnes, Jonathan. 2002. *Positional neutralization: A phonologization approach to typological patterns*. Berkeley: UC Berkeley Ph.D. Dissertation.

- Barrett-Keach, Camillia N. 1986. Word-internal evidence from Swahili for AUX/INFL. *Linguistic Inquiry* 17:559–664.
- Bastin, Yvonne. 1983. La finale *ide* et l'imbrication en bantou. In *Annales du Musée Royal de l'Afrique Centrale*, Série IN-8°, Sciences Humaines, No. 114. Tervuren: Musée Royal de l'Afrique Centrale.
- Bastin, Yvonne. 1986. Les suffixes causatifs dans les langues bantoues. *Africana Linguistica* 10:55–145.
- Baunaz, Léna. 2002. On Scandinavian PF-verb movement. *Generative Grammar in Geneva (GG@G)* 3:37–66.
- Bentley, W. Holman. 1967. *Dictionary and grammar of the Kongo language as spoken at San Salvador, the ancient capital of the Kongo Empire, West Africa*. Farnborough: Gregg.
- Bickel, Balthasar, and Johanna Nichols. To appear. Inflectional morphology. In T. Shopen (Ed.), *Language typology and syntactic description*, (second edition). Cambridge: Cambridge University.
- Blevins, Juliette. In press. *Evolutionary phonology: The emergence of sound patterns*. Cambridge: Cambridge University.

- Blevins, Juliette, and Andrew Garrett. To appear. The evolution of metathesis. In B. Hayes, R. Kirchner, and D. Steriade (Eds.), *The phonetic basis of phonology*. Cambridge: Cambridge University.
- Bloomfield, Leonard. 1962. *The Menomini language*. New Haven: Yale University.
- Boadi, L. A. 1968. Some aspects of Akan deep syntax. *The Journal of West African Languages* 5:83–90.
- Bobaljik, Jonathan David. 2002. A-chains at the PF-interface: Copies and covert movement. *Natural Language and Linguistic Theory* 20:197–267.
- Bonneau, J. 1956. *Grammaire pounoue et lexique pounou-francais*. Montpellier: Imprimerie Charité.
- Bošković, Željko. 1995. Participle movement and second position cliticization in Serbo-Croatian. *Lingua* 245–66.
- Bošković, Željko. 2001. *On the nature of the syntax-phonology interface*. Amsterdam: Elsevier.
- Bresnan, Joan, and Lioba Moshi. 1993. Object asymmetries in comparative Bantu syntax. In S. A. Mchombo (Ed.), *Theoretical aspects of Bantu grammar*, 47–91. Stanford: CSLI.
- Broselow, Ellen. 1995. Skeletal positions and moras. In J. A. Goldsmith (Ed.), *The handbook of phonological theory*, 175–205. Oxford: Blackwell.

- Bybee, Joan. 1985. *Morphology: A study of the relation between meaning and form*. Amsterdam: Benjamins.
- Bybee, Joan, William Pagliuca, and Revere Perkins. 1994. *The evolution of grammar: Tense, aspect, and modality in the languages of the world*. Chicago: University of Chicago.
- Carstens, Vicki. 2002. Antisymmetry and word order in serial constructions. *Language* 78:3–50.
- Chen, Matthew Y. 1987. The syntax of Xiamen tone sandhi. *Phonology Yearbook* 4:109–50.
- Chen, Matthew Y. 1990. What must phonology know about syntax? In S. Inkelas and D. Zec (Eds.), *The phonology-syntax connection*, 19–46. Stanford: CSLI.
- Collins, Christopher Thad. 1993. *Topics in Ewe syntax*. Cambridge, Mass.: M.I.T. Ph.D. Dissertation (distributed by MIT Working Papers in Linguistics).
- Conathan, Lisa, and Jeff Good. 2001. Morphosyntactic reduplication in Chechen and Ingush. In A. Okrent and J. Boyle (Eds.), *The Proceedings from the Panels of the Chicago Linguistic Society's Thirty-Sixth Meeting*, 49–61. Chicago: Chicago Linguistic Society.

- Cooper, Robin. 1976. Lexical and nonlexical causatives in Bantu. In M. Shibatani (Ed.), *Syntax and Semantics, Volume 6: The Grammar of Causative Constructions*, 313–24. New York: Academic Press.
- Coupez, André. 1955. *Esquisse de la langue holoholo*. Tervuren: Tervuren.
- Coupez, André. 1980. *Abrège de grammaire rwanda*. Butare, Rwanda: Institut national de recherche scientifique.
- Croft, William, and Marilyn Vihman. 2003. Radical templatic phonology and phonological development. Manchester: University of Manchester (ms.).
- Cutler, Anne, Delphine Dahan, and Wilma van Donselaar. 1997. Prosody in the comprehension of spoken language: A literature review. *Language and Speech* 40:141–201.
- de Groot, A., C.S.R. 1977. *Woordregister Nederlands-Saramakaans*. [Paramaribo?]: A. de Groot.
- de Rop, Albert. 1958. *Grammaire du Lomongo: Phonologie et morphologie*. Léopoldville: Éditions de l'université.
- Déchaine, Rose-Marie. 1993. *Predicates across categories*. Amherst, Mass.: University of Massachusetts, Ph.D. Dissertation. (Distributed by the Graduate Linguistic Student Association.).
- Dembetembe, N.C. 1987. *A linguistic study of the verb in Korekore*. Harare: University of Zimbabwe.

- Devonish, Hubert. 1989. *Talking in tones*. London: Karia.
- Downing, Laura J. 1999. Prosodic stem \neq prosodic word in Bantu. In T. A. Hall and U. Kleinhenz (Eds.), *Studies on the phonological word*. Amsterdam: Benjamins.
- Edmiston, Althea Brown. 1932. *Grammar and dictionary of the Bushonga or Bukuba language as spoken by the Bushonga or Bukuba tribe who dwell in the Upper Kasai District, Belgian Congo, Central Africa*. Belgian Congo: American Presbyterian Congo Mission.
- Ekundayo, S. Ayotunde, and F. Niyi Akinnaso. 1983. Yoruba serial verb string commutability constraints. *Lingua* 60:115–33.
- Embick, David, and Rolf Noyer. 2001. Movement operations after syntax. *Linguistic Inquiry* 555–95.
- Essono, Jean-J. Marie. 2000. *L'Ewondo: Langue bantu du Cameroun: Phonologie–morphologie-syntaxe*. Yaoundé, Cameroun: Presses de l'Université Catholique d'Afrique Centrale.
- Foley, William A., and Robert D. Jr. Van Valin. 1984. *Functional syntax and universal grammar*. Cambridge: Cambridge University.
- Fortune, George. 1955. *An analytical grammar of Shona*. London: Longmans.
- Franks, Steven, and Tracy Holloway King. 2000. *A handbook of Slavic Clitics*. Oxford: Oxford University.

- Freeland, L.S. 1951. *Language of the Sierra Miwok*. Baltimore: Waverly.
- Garrett, Andrew. 1990. The origin of NP split ergativity. *Language* 66:261–96.
- Garrett, Andrew. 1996. Wackernagel's law and unaccusativity in Hittite. In A. L. Halpern and A. M. Zwicky (Eds.), *Approaching second: Second position clitics and related phenomena*, 85–133. Stanford: CSLI.
- Gazdar, Gerald E., and G.K. Pullum. 1982. *Generalized Phrase Structure Grammar: A theoretical synopsis*. Bloomington: Indiana University Linguistics Club.
- Gérard, Reverend P. 1924. *La langue lebéo: Grammaire et vocabulaire*. Brussels: Vromant and Co.
- Givón, Talmy. 1971a. Historical syntax and synchronic morphology: An archaeologist's fieldtrip. In *Papers from the Seventh Regional Meeting of the Chicago Linguistic Society*, 394–415. Chicago: Chicago Linguistic Society.
- Givón, Talmy. 1971b. On the verbal origin of Bantu verb affixes. *Studies in African linguistics* 2:145–164.
- Givón, Talmy. 1975. Serial verbs and syntactic change: Niger-Congo. In N. Li, Charles (Ed.), *Word order and word order change*, 47–112. Austin: University of Texas.
- Givón, Talmy. 1976. Some constraints on Bantu causativization. In M. Shibatani (Ed.), *Syntax and Semantics 6: The grammar of causative constructions*, 325–351. New York: Academic Press.

- Givón, Talmy. 1991. Some substantive issues concerning verb serialization: Grammatical versus cognitive packaging. In C. Lefebvre (Ed.), *Serial verbs: Grammatical, comparative, and cognitive approaches*, Studies in the sciences of languages series, 137–84. Benjamins: Amsterdam.
- Goldberg, Adele E. 1995. *A construction grammar approach to argument structure*. Chicago: University of Chicago.
- Good, Jeff. 2003a. Clause combining in Chechen. *Studies in Language* 27:113–70.
- Good, Jeff. 2003b. Tonal morphology in a creole: High-tone raising in Saramaccan serial verb constructions. In G. Booij and J. van Marle (Eds.), *Yearbook of morphology 2002*, 105–134. Dordrecht: Kluwer.
- Good, Jeff. In press. Tone and accent in Saramaccan: Charting a deep split in the phonology of a language. *Lingua*.
- Good, Jeff. To appear. When arguments become adjuncts: Split configurationality in Leggbó. In *The Proceedings from the General Session of the Chicago Linguistic Society's Thirty-Ninth Meeting*. Chicago: Chicago Linguistic Society.
- Greenberg, Joseph H. 1966. Synchronic and diachronic universals in phonology. *Language* 42:508–17.

- Greenberg, Joseph H., Charles Osgood, and James Jenkins. 1963. Memorandum concerning language universals. In J. H. Greenberg (Ed.), *Universals of language*, 255–64. Cambridge, Mass.: MIT.
- Guarisma, Gladys. 2000. *Complexité morphologique simplicité syntaxique: Le cas du bafia*. Paris: Peeters.
- Guthrie, Malcolm. 1935. *Lingala grammar and dictionary*. Leopoldville-ouest, Congo Belge: Conseil protestant du Congo.
- Guthrie, Malcolm. 1948. *The classification of the Bantu languages*. Oxford: Oxford.
- Guthrie, Malcolm. 1970. *Comparative Bantu: An introduction to the comparative linguistics and prehistory of the Bantu languages, Volume 4*. Farnborough: Gregg.
- Hajek, John. 1997. *Universals of sound change in nasalization*. Oxford: Blackwell.
- Hale, Ken, and Jay Keyser. 1993. On argument structure and the lexical expression of syntactic relations. In K. Hale and J. Keyser (Eds.), *The view from building 20: A festschrift for Sylvain Bromberger*, 53–108. Cambridge, Mass.: MIT.
- Hale, Ken, and Elisabeth Selkirk. 1987. Government and tonal phrasing in Papago. *Phonology Yearbook* 4:151–83.
- Halle, Morris, and Alec Marantz. 1993. Distributed morphology and the pieces of inflection. In S. J. Keyser and K. Hale (Eds.), *The view from Building 20*, 111–76. Cambridge, Mass.: MIT.

- Halpern, Aaron. 1995. *On the placement and morphology of clitics*. Stanford: CSLI.
- Halpern, Aaron L. 1996. Introduction. In A. L. Halpern and A. M. Zwicky (Eds.), *Approaching second: Second position clitics and related phenomena*, ix–xxiii. Stanford: CSLI.
- Halpern, Aaron L., and Arnold M. Zwicky (Eds.). 1996. *Approaching second: Second position clitics and related phenomena*. Stanford: CSLI.
- Ham, William. 1999. Tone sandhi in Saramaccan: A case of substrate transfer? *Journal of Pidgin and Creole Linguistics* 14:45–92.
- Hargus, Sharon. 1988. *The lexical phonology of Sekani*. New York: Garland.
- Harries, Lyndon. 1950. *A grammar of Mwera*. Johannesburg: Witwatersrand University.
- Harris, Alice. 2000. Where in the word is the Udi clitic? *Language* 593–616.
- Harris, Alice. 2002. *Endoclitics and the origins of Udi morphosyntax*. Oxford: Oxford University.
- Haspelmath, Martin. 1995. The growth of affixes in morphological reanalysis. In G. Booij and J. van Marle (Eds.), *Yearbook of morphology 1994*, 1–29. Dordrecht: Kluwer.
- Hawkinson, Annie K, and Larry M. Hyman. 1974. Hierarchies of natural topic in Shona. *Studies in African Linguistics* 5:147–170.
- Hayes, Bruce. 1985. *A metrical theory of stress rules*. New York: Garland.

- Hayes, Bruce. 1990. Precompiled phrasal phonology. In S. Inkelas and D. Zec (Eds.), *The phonology-syntax connection*, 85–108. Stanford: CSLI.
- Henson, Bonnie. 2001. The *-an* extension in Mòkpè. Berkeley: University of California, Berkeley, Department of Linguistics and SIL International (ms.).
- Hojjer, Harry. 1971. Athapaskan morphology. In J. Sawyer (Ed.), *Studies in American Indian languages*, 113–47. Berkeley: University of California.
- Horton, A. E. 1949. *A grammar of Luvale*. Johannesburg: Witwatersand Press.
- Hulstaert, G. 1965. Grammaire du lomongo: Deuxième partie, Morphologie. *Annales du Musée Royale de l’Afrique Centrale, Série 8, Sciences Humaines* 57:1–679.
- Höhle, Tilman. 1986. Der Begriff “Mittelfeld”, anmerkungen über die theorie der topologischen felder. In A. Schöne (Ed.), *Kontroversen alte und neue: Akten des 7. Internationalen Germanisten-Kongresses, Göttingen 1985, Band 3*, 329–40. Tübingen: Niemeyer.
- Hyman, Larry. 2002. The noun and noun phrase [in Leggbó]. Berkeley: University of California, Berkeley (ms.).
- Hyman, Larry M. 1971. Consecutivization in Feʔfeʔ. *Journal of African languages* 10:29–43.

- Hyman, Larry M. 1975. On the change from SOV to SVO: Evidence from Niger-Congo. In N. Li, Charles (Ed.), *Word order and word order change*, 113–47. Austin: University of Texas.
- Hyman, Larry M. 1977. Phonologization. In A. G. Juillard (Ed.), *Linguistic studies offered to Joseph Greenberg on the occasion of his sixtieth birthday*, 407–18. Saratoga, Calif.: Anna Libri.
- Hyman, Larry M. 1993. Conceptual issues in the comparative study of the Bantu verb stem. In S. S. Mufwene and L. Moshi (Eds.), *Topics in African linguistics*, 3–34. Amsterdam: Benjamins.
- Hyman, Larry M. 1994. Cyclic phonology and morphology in Cibemba. In J. Cole and K. Charles (Eds.), *Perspectives in Phonology*, 81–112. Stanford: CSLI.
- Hyman, Larry M. 1999. The historical interpretation of vowel harmony in Bantu. In J.-M. Hombert and L. Hyman (Eds.), *Bantu historical linguistics: Theoretical and empirical perspectives*, 235–295. CSLI: Stanford.
- Hyman, Larry M. 2001. Templatic and/or compositional morphology: Suffix ordering in Bantu. Talk given at the Workshop on Linguistic Typology, Berkeley, California, March 17, 2001.
- Hyman, Larry M. 2003a. Suffix ordering in Bantu: A morphocentric approach. In G. Booij and J. van Marle (Eds.), *Yearbook of morphology 2002*, 245–281. Dordrecht: Kluwer.

- Hyman, Larry M. 2003b. Basaá. In D. Nurse and G. Phillipson (Eds.), *The Bantu languages*, 257–82. London: Curzon Press.
- Hyman, Larry M., Sharon Inkelas, and Galen Sibanda. 1998. Morphosyntactic correspondence in Bantu reduplication. In Paper presented at the Trilateral Phonology Weekend (TREND), UC Berkeley, April 25, 1998. Available as ROA 437-0601: Rutgers Optimality Archive.
- Hyman, Larry M., and F. X. Katamba. 1991. Cyclicity and suffix doubling in the Bantu verb stem. In K. Hubbard (Ed.), *Proceedings of the Seventeenth Annual Meeting of the Berkeley Linguistics Society, Special session on African Language Structures*, 133–44. Berkeley: Berkeley Linguistics Society.
- Hyman, Larry M., and Francis X. Katamba. 1990. Spurious high-tone extensions in Luganda. *South African Journal of African Languages* 10:142–58.
- Hyman, Larry M., and Sam A. Mchombo. 1992. Morphotactic constraints in the Chichewa verb stem. In L. Buszard-Welcher, L. Wee, and W. Weigel (Eds.), *Proceedings of the Eighteenth Meeting of the Berkeley Linguistics Society, General Session and Parassession*, 350–363. Berkeley: Berkeley Linguistics Society.
- Idiata, Daniel Franck. 1998. *Aperçu sur la morphosyntaxe de la langue isangu (Bantou, B42)*. München: Lincom Europa.
- Inkelas, Sharon. 1990. *Prosodic constituency in the lexicon*. New York: Garland.

- Inkelas, Sharon. 1993. Nimboran position class morphology. *Natural Language and Linguistic Theory* 11:559–624.
- Inkelas, Sharon. 2000. Phonotactic blocking through structural immunity. In B. Stiebels and D. Wunderlich (Eds.), *Lexicon in Focus*, *Studia Grammatica* 45, 7–40. Berlin: Akademie Verlag.
- Inkelas, Sharon, and Orhan Orgun. 1995. Level ordering and economy in the lexical phonology of Turkish. *Language* 71:763–93.
- Inkelas, Sharon, and Orhan Orgun. 1998. Level (non)ordering in recursive morphology. In S. G. Lapointe, D. K. Brentari, and P. M. Farrell (Eds.), *Morphology and its relation to phonology and syntax*, 360–92. Stanford: CSLI.
- Inkelas, Sharon, and Draga Zec. 1995. Syntax-phonology interface. In J. A. Goldsmith (Ed.), *The handbook of phonological theory*, 535–49. Oxford: Blackwell.
- Institut National de Recherche et d'Action Pédagogiques. 1982. *Éléments de grammaire lingala*. Paris: Nathan Afrique.
- Ittmann, Johannes. 1978. *Grammaire de Duala*. Translated by L.A. Boumard. Douala, Cameroun: Collège Libermann. First published 1939.
- Jacottet, Edouard. 1927. *A grammar of the Sesuto language*. Johannesburg: University of Witwatersrand.

- Kari, James. 1989. Affix positions and zones in the Athapaskan verb. *International Journal of American Linguistics* 55:424–55.
- Kathol, Andreas. 2000. *Linear syntax*. Oxford: Oxford University.
- Kathupa, José Mateus Muária. 1983. *A preliminary description of sentence structures in the E-sáaka dialect of E-mákhwa*. School of Oriental and African Studies, University of London.
- Kathupa, José Mateus Muária. 1991. *The grammar of Emakhuwa verbal extensions*. School of Oriental and African Studies, University of London.
- Kavitskaya, Darya. 2001. *Compensatory lengthening: Phonetics, phonology, diachrony*. Berkeley: UC Berkeley Ph.D. Dissertation.
- Kay, Paul, and Charles J. Fillmore. 1999. Grammatical constructions and linguistic generalizations: The what's X doing Y? construction. *Language* 75:1–33.
- Kayne, Richard. 1994. *The antisymmetry of syntax*. Cambridge, Mass.: MIT.
- Kenstowicz, Michael. 1994. *Phonology in Generative Grammar*. Oxford: Blackwell.
- Kibrik, A.E. 1972. *Fragmenty grammatiki khinalugskogo iazyka*. Moscow: Moscow University Press.
- Kimball, Geoffrey D. 1991. *Koasati grammar*. Lincoln: University of Nebraska.

- Kimenyi, Alexandre. 1980. *A relational grammar of Kinyarwanda*. Berkeley: University of California.
- Kiparsky, Paul. 1982. Lexical morphology and phonology. In I. Yang (Ed.), *Linguistics in the morning calm*, 3–91. Seoul: Hanshin.
- Kiparsky, Paul. 1993. Blocking in non-derived environments. In S. Hargus and E. M. Kaisse (Eds.), *Phonetics and phonology 4: Studies in lexical phonology*. New York: Academic Press.
- Klavans, Judith. 1985. The independence of syntax and phonology in cliticization. *Language* 61:95–120.
- Ladd, Robert D. 1996. *Intonational phonology*. Cambridge: Cambridge University.
- Lanham, L.W. 1955. *A study of giTonga of Inhmabane*. Johannesburg: Witwatersrand University Press.
- Larson, Richard K. 1991. Some issues in verb serialization. In C. Lefebvre (Ed.), *Serial verbs: Grammatical, comparative, and cognitive approaches*, Studies in the sciences of languages series, 185–210. Benjamins: Amsterdam.
- Law, Paul, and Tonjes Veenstra. 1992. On the structure of serial verb constructions. *Linguistic Analysis* 22:185–217.

- Lefebvre, Claire. 1991. *Take* serial verb constructions in Fon. In C. Lefebvre (Ed.), *Serial verbs: Grammatical, comparative, and cognitive approaches*, Studies in the sciences of languages series, 37–78. Amsterdam: Benjamins.
- Lewis, Geoffrey L. 1967. *Turkish grammar*. Oxford: Oxford University.
- Li, Charles, and Sandra Thompson. 1973. Serial verb constructions in Mandarin Chinese: Subordination or co-ordination? In C. Corum, C. T. Smith-Stark, and W. Ann (Eds.), *You take the high node and I'll take the low node: Papers from the comparative syntax festival*, 96–103. Chicago: Chicago Linguistic Society.
- Li, Yafei. 1991. On deriving serial verb constructions. In C. Lefebvre (Ed.), *Serial verbs: Grammatical, comparative, and cognitive approaches*, Studies in the sciences of languages series, 103–35. Benjamins: Amsterdam.
- Liberman, Mark. 1979. *The intonational system of English*. New York: Garland.
- Lord, Carol. 1993. *Historical change in serial verb constructions*. Amsterdam: Benjamins.
- Lounsbury, Floyd G. 1953. *Oneida verb morphology*. New Haven: Yale University.
- Lowe, John, and Thilo Schadeberg. 1996. *Bantu Mapmaker* (computer program). Berkeley and Leiden: CBOLD and Department of African Linguistics, University of Leiden.
- Machobane, Malilo. 1989. *Some restrictions on the Sesotho transitivity morphemes*. McGill University Ph.D. thesis.

- Maganga, Clement, and Thilo Schadeberg. 1992. *Kinyamwezi: Grammar, texts, vocabulary*. Cologne: Rüdiger, Köpper Verlag.
- Marantz, Alec. 1988. Clitics, morphological merger, and the mapping to phonological structure. In M. Hammond and M. Noonan (Eds.), *Theoretical morphology: Approaches in modern linguistics*, 253–70. San Diego: Academic Press.
- Marantz, Alec. 1993. Implications of asymmetries in double object constructions. In S. A. Mchombo (Ed.), *Theoretical aspects of Bantu grammar*, 113–150. Stanford: CSLI.
- Mathangwane, Joyce T. 2000. Suffix ordering in the Ikalanga verb stem: A case against the repeated morph constraint. Gaborone: Department of English, University of Botswana (ms.).
- McCarthy, John, and Alan Prince. 1990. Foot and Word in prosodic morphology: The Arabic broken plural. *Natural Language and Linguistic Theory* 8:209–82.
- McCarthy, John, and Alan Prince. 1993. *Prosodic morphology: Constraint interaction and satisfaction*. New Brunswick, New Jersey: Rutgers University Center for Cognitive Science.
- McCarthy, John, and Alan Prince. 1995. Prosodic morphology. In J. A. Goldsmith (Ed.), *The handbook of phonological theory*, 318–66. Oxford: Blackwell.
- McCawley, James D. 1998. *The syntactic phenomena of English*, (second edition). Chicago: University of Chicago.

- McDonough, Joyce. 2000. On a bipartite model of the Athabaskan verb. In T. B. Fernald and P. R. Platero (Eds.), *The Athabaskan languages: Perspectives on a Native American language family*, 139–66. Oxford: Oxford University.
- McDonough, Joyce M. 1990. *Topics in the phonology and morphology of Navajo verbs*. Amherst, Mass.: University of Massachusetts, Ph.D. Dissertation. (Distributed by the Graduate Linguistic Student Association.).
- McGinnis, Martha. 2001. Variation in the phase structure of applicatives. In J. Rooryck and P. Pica (Eds.), *Linguistic variations yearbook*. Amsterdam: Benjamins. (To appear.).
- McLendon, Sally. 1975. *A grammar of Eastern Pomo*. Berkeley: University of California.
- Meeussen, A. E. 1959. *Essai de grammaire rundi*. Tervuren: Tervuren.
- Meeussen, A.E. 1967. *Bantu grammatical reconstructions*. Tervuren: Tervuren.
- Meeussen, A.E. 1971. *Elements de grammaire Lega*. Tervuren: Musée Royale de l’Afrique Centrale.
- Meillet, Antoine. [1909]1964. *Introduction à l’étude comparative des langues indo-européennes*. University, Alabama: University of Alabama.
- Meinhof, Carl. 1932. *Introduction to the phonology of the Bantu languages*. Translated by N.J. van Warmelo. Berlin: Dietrich Reimer. First published 1910.
- Miller, Philip, and Ivan Sag. 1997. French clitic movement without clitics or movement. *Natural Language and Linguistic Theory* 15:573–639.

- Mohanan, K. P. 1986. *The theory of lexical phonology*. Dordrecht: Reidel.
- Morgan, James L. 1996. Prosody and the roots of parsing. *Language and cognitive processes* 11:69–106.
- Motingea, Mangulu. 1987. Élargissement du radical en lingala. *Annales Aequitoria* 8:355–64.
- Mutaka, Ngessimo, and Larry Hyman. 1990. Syllables and morpheme integrity in Kinande reduplication. *Phonology* 7:73–119.
- Muysken, Pieter. 1988a. Affix order and interpretation: Quechua. In M. Everaet, A. Evers, R. Huybregts, and M. Trommelen (Eds.), *Morphology and modularity*, Publications in language sciences, 259–279. Dordrecht: Foris.
- Muysken, Pieter. 1988b. Parameters for serial verbs. *Niger-Congo syntax and semantics* 1:65–75.
- Muysken, Pieter, and Tonjes Veenstra. 1995. Serial verbs. In J. Arends, P. Muysken, and N. Smith (Eds.), *Pidgins and creoles: An introduction*, 289–301. Amsterdam: Benjamins.
- Myers, Scott P. 1987. *Tone and the structure of words in Shona*. University of Massachusetts, Amherst.
- Nespor, Marina, and Irene Vogel. 1986. *Prosodic phonology*. Dordrecht: Foris.

- Ngunga, Armindo. 2000. *Lexical phonology and morphology of Ciyao*. Stanford: CSLI.
- Nichols, Johanna. 1992. *Linguistic diversity in space and time*. Chicago: University of Chicago.
- Nordlinger, Rachel. 1998. *Constructive case: Evidence from Australian languages*. Stanford: CSLI.
- Noyer, Rolf. 1991. The mirror principle revisited: Verbal morphology in Maung and Nunggubuyu. *MIT Working Papers in Linguistics* 14:195–209.
- Noyer, Rolf. 1997. *Features, positions, and affixes in autonomous morphological structure*. New York: Garland.
- Odden, David. 1990. Syntax, lexical rules, and postlexical rules in Kimatuumbi. In S. Inkelas and D. Zec (Eds.), *The phonology-syntax connection*, 259–77. Stanford: CSLI.
- Ohalo, John J. 1981. The listener as a source of sound change. In C. S. Masek, R. A. Hendrick, and M. F. Miller (Eds.), *Papers from the Parasession on Language and Behavior*, 178–203. Chicago: Chicago Linguistic Society.
- Orgun, Orhan. 1996. *Sign-based morphology and phonology*. Berkeley: UC Berkeley Ph.D. Dissertation.
- Orwig, Carol. 1989. Les extensions verbales en nugunu. In *Descriptions de langues camerounaises*, 283–314. Paris: ORSTOM.

- Paluku, André Mbula. 1998. *Description grammaticale du Kitalinga (Langue bantu du Nord-Est du Zaïre)*. München: Lincom Europa.
- Pesetsky, David. 1985. Morphology and logical form. *Linguistic Inquiry* 16:193–246.
- Peterson, David. 1999. *Discourse-functional, historical, and typological aspects of applicative constructions*. Berkeley: UC Berkeley Ph.D. Dissertation.
- Peterson, David. 2001. Ingush 'a: The elusive type 5 clitic? *Language* 77:144–55.
- Peterson, David. 2003. Structural correlates of applicative constructions. Hanover, New Hampshire: Dartmouth College, Department of Linguistics (ms.).
- Pierrehumbert, Janet. 1987. *The phonology and phonetics of intonation*. Bloomington: Indiana University Linguistics Club.
- Polak-Bynon, Louise. 1975. *A Shi grammar: Surface structures and generative phonology of a Bantu language*. Tervuren: Tervuren.
- Polinsky, Mariya. 1998. A non-syntactic account of some asymmetries in the double object construction. In J.-P. Koenig (Ed.), *Discourse and cognition: Bridging the gap*, 403–22. Stanford: CSLI.
- Poser, William. 1990. Evidence for foot structure in Japanese. *Language* 66:78–105.
- Pullum, Geoffrey K., and Arnold M. Zwicky. 1983. Cliticization vs. inflection: English *n't*. *Language* 59:502–13.

- Pylkkänen, Liina. 2002. *Introducing arguments*. Cambridge, Mass.: M.I.T. Ph.D. Dissertation (distributed by MIT Working Papers in Linguistics).
- Radanović-Kocić, Vesna. 1996. The placement of Serbo-Croatian clitics: A prosodic approach. In A. Halpern and A. Zwicky (Eds.), *Approaching second: Second position clitics and related phenomena*, 429–445. Stanford: CSLI.
- Raimy, Eric. 2000. *The phonology and morphology of reduplication*. Berlin: Mouton.
- Read, Charles, and Peter Schreiber. 1982. Why short subjects are harder to find than long ones. In E. Wanner and L. R. Gleitman (Eds.), *Language acquisition: The state of the art*, 78–101. Cambridge: Cambridge University.
- Reinhart, Tanya. 1979. The syntactic domain for semantic rules. In F. Guenther and S. J. Schmidt (Eds.), *Formal semantics and pragmatic for natural languages*, 107–30. Dordrecht: Reidel.
- Rice, Keren. 1993. The structure of the Slave (northern Athabaskan) verb. In S. Hargus and E. M. Kaisse (Eds.), *Phonetics and phonology 4: Studies in lexical phonology*. San Diego: Academic Press.
- Rice, Keren. 2000. *Morpheme order and semantic scope: Word formation in the Athabaskan verb*. Cambridge: Cambridge University.
- Rose, Sharon. 1996. Inflectional affix order in Ethio-Semitic. In J. Lecarme, J. Lowenstamm, and U. Shlonsky (Eds.), *Studies in Afroasiatic grammar: Papers from the*

- second conference on Afroasiatic languages Sophia Antipolis, 1994*, 337–359. The Hague: Holland Academic Graphics.
- Rountree, S. Catherine. 1972. Saramaccan tone in relation to intonation and grammar. *Lingua* 29:308–25.
- Rountree, S. Catherine, J. Asodanoe, and Naomi Glock. 2000. *Saramaccan word list (with idioms)*. Paramaribo: Instituut voor Taalwetenschap (SIL).
- Rubanza, Yunus Ismail. 1988. *Linear order in Haya verbal morphology: Theoretical implications*. Michigan State University Ph.D. dissertation.
- Rugemalira, Josephat. 1993. *Runyambo verb extensions and constraints on predicate structure*. Berkeley: UC Berkeley Ph.D. Dissertation.
- Sadock, Jerrold M. 1991. *Autolexical syntax: A theory of parallel grammatical representations*. Chicago: University of Chicago.
- Satyo, Sizwe Churchill. 1985. *Topics in Xhosa verbal extension*. Pretoria: University of South Africa, Ph.D. dissertation.
- Schachter, Paul. 1974. A non-transformational account of serial verbs. *Studies in African Linguistics Supplement* 5:253–70.
- Schiller, Eric. 1991. *An autolexical account of subordinating serial verb constructions*. Chicago: University of Chicago, Ph.D. Dissertation.

- Schumann, C. 1899. Grundriss einer Grammatik der Kodesprache. *Mitteilungen des Orientalische Seminars zu Berlin* 2.3:1–86.
- Sebba, Mark. 1987. *The syntax of serial verbs*. Amsterdam: Benjamins.
- Seidl, Amanda. 2001. *Minimal indirect reference: A theory of the syntax-phonology interface*. New York: Routledge.
- Selkirk, Elisabeth. 1984. *Phonology and syntax: The relation between sound and structure*. Cambridge, Mass.: MIT.
- Selkirk, Elisabeth. 1986. On derived domains in sentence phonology. *Phonology Yearbook* 3:371–405.
- Selkirk, Elisabeth, and Tong Shen. 1990. Prosodic domains in Shanghai Chinese. In S. Inkelas and D. Zec (Eds.), *The phonology-syntax connection*, 313–38. Stanford: CSLI.
- Sezer, Engin. 1981. On non-final stress in Turkish. *Journal of Turkish Studies* 5:61–9.
- Shibatani, Masayoshi. 1976. *Syntax and Semantics, Volume 6: The Grammar of Causative Constructions*. New York: Academic Press.
- Shibatani, Masayoshi. 2002. Introduction: Some basic issues in the grammar of causation. In M. Shibatani (Ed.), *The grammar of causation and interpersonal manipulation*, 1–22. Amsterdam: Benjamins.

- Sibanda, Galen. 2000. Constraints in Ndebele suffix ordering. Berkeley: Department of Linguistics, University of California, Berkeley (ms.).
- Simpson, Jane, and M. Withgott. 1986. Pronominal clitic clusters and templates. In H. Borer (Ed.), *Syntax and semantics 19: The syntax of pronominal clitics*, 149–174. New York: Academic Press.
- Speas, Margaret. 1984. Navajo prefixes and word structure typology. In M. Speas and R. Sproat (Eds.), *MIT Working Papers in Linguistics 7*, 86–109. Cambridge, Mass.: MIT Working Papers in Linguistics.
- Speas, Margaret. 1990. *Phrase structure in natural language*. Dordrecht: Kluwer.
- Spencer, Andrew. 1991. *Morphological theory: An introduction to word structure in generative grammar*. Oxford: Blackwell.
- Spencer, Andrew. 1997. Inflectional morphology and functional heads. In W. U. Dressler, M. Prinzhorn, and J. R. Rennison (Eds.), *Advances in morphology*. Berlin: Mouton.
- Stahlke, Herbert F. W. 1970. Serial verbs. *Studies in African Linguistics* 1:69–99.
- Stahlke, Herbert F. W. 1974. Serial verbs as adverbs: A reply to Paul Schachter. *Studies in African Linguistics Supplement* 5:271–7.
- Stewart, Osamuyimen Thompson. 2001. *The serial verb construction parameter*. New York: Garland.

- Stump, Gregory T. 1992. On the theoretical status of position class restrictions on inflectional affixes. In G. Booij and J. van Marle (Eds.), *Yearbook of Morphology 1991*, 211–41. Dordrecht: Kluwer.
- Stump, Gregory T. 1993. Position classes and morphological theory. In G. Booij and J. van Marle (Eds.), *Yearbook of Morphology 1992*, 129–80. Dordrecht: Kluwer.
- Taljaard, P.C., and S.E. Bosch. 1988. *Handbook of Isizulu*. Pretoria: J.L. van Schaik,.
- Taylor, Charles. 1985. *Nkore-Kiga*. London: Croom Helm.
- Truckenbrodt, Hubert. 1999. On the relation between syntactic phrases and phonological phrases. *Linguistic Inquiry* 30:219–55.
- Uszkoreit, Hans. 1987. *Word order and constituent structure in German*. Stanford: CSLI.
- Veenstra, Tonjes. 1996. *Serial verbs in Saramaccan: Predication and creole genesis*. The Hague: Holland Academic Graphics.
- Viljoen, J. J., and P. Amakali. 1978. *A handbook of Oshiwambo*. Pretoria: University of South Africa.
- Voorhoeve, Jan. 1961. Le ton et la grammaire dans le saramaccan. *Word* 17:146–63.
- Warren, Paul. 1996. Prosody and parsing: An introduction. *Language and Cognitive Processes* 11:1–16.

- Wechsler, Stephen, and Larisa Zlatić. 2000. A theory of agreement and its application to Serbo-Croatian. *Language* 76:799–832.
- Williamson, Kay. 1965. *A grammar of the Kolokuma dialect of Ijò*. London: Cambridge University.
- Yip, Moira. 1989. Cantonese morpheme structure and linear ordering. In E. J. Fee and K. Hunt (Eds.), *Proceedings of the eighth West Coast Conference on Formal Linguistics*, 445–56. Stanford: CSLI.
- Young, Robert W. 2000. *The Navajo verb system: An overview*. Albuquerque: University of New Mexico.
- Young, Robert W., and William Morgan. 1980. *The Navajo language: A grammar and colloquial dictionary*. Albuquerque: University of New Mexico.
- Zec, Draga, and Sharon Inkelas. 1990. Prosodically constrained syntax. In S. Inkelas and D. Zec (Eds.), *The phonology-syntax connection*, 365–78. Stanford: CSLI.
- Ziervogel, D. 1952. *A grammar of Swazi*. Johannesburg: Witwatersrand University Press.
- Zwicky, Arnold M., and Geoffrey K. Pullum. 1986. The principle of phonology-free syntax: Introductory remarks. *Ohio State University Working Papers in Linguistics* 32:63–91.