

# UC San Diego

## Scripps Institution of Oceanography Technical Report

### Title

Calibration Methodology for the Scripps  $^{13}\text{C}/^{12}\text{C}$  and  $^{18}\text{O}/^{16}\text{O}$  stable Isotope program  
1992-2018

### Permalink

<https://escholarship.org/uc/item/4n93p288>

### Authors

Lueker, Timothy  
Keeling, Ralph  
Bollenbacher, Allane  
et al.

### Publication Date

2020-01-22

**Calibration Methodology for the Scripps  $^{13}\text{C}/^{12}\text{C}$  and  $^{18}\text{O}/^{16}\text{O}$  stable isotope program  
1992-2018.**

**Timothy Lueker, Ralph Keeling, Alane Bollenbacher, Stephen Walker, Eric Morgan,  
Mariela Brooks**

**Scripps Institution of Oceanography, La Jolla, CA 92024**

**Published January 22, 2020**

**Table of Contents**

<b>Abstract</b>	<b>page 3</b>
<b>1. Introduction</b>	<b>3</b>
<b>2. METHODS</b>	<b>5</b>
<b>2.1 Machine standards</b>	<b>5</b>
<b>2.2 Secondary standards</b>	<b>6</b>
<b>2.3 Seawater secondary standards</b>	<b>7</b>
<b>2.4 CO<sub>2</sub> extraction method</b>	<b>7</b>
<b>2.5 Data reduction</b>	<b>8</b>
<b>2.6. Assignment of secondary standards</b>	<b>10</b>
<b>2.7 Assignment methodology</b>	<b>12</b>
<b>2.7.1 Set 1</b>	<b>12</b>
<b>2.7.2 Preliminary assignment of Set 2 and Set 3</b>	<b>14</b>
<b>2.7.3 Revised assignments for Set 2, Set 3, and JRAC2 including             drift corrections</b>	<b>14</b>
<b>3. RESULTS AND DISCUSSION</b>	<b>16</b>
<b>3.1 Summary of daily terms</b>	<b>16</b>

3.2 Impact of new secondary standard assignments on isotopic data	17
3.3 Comparison of SIO and JRAS WMO calibration scales	17
3.4 Precision for Prism and Optima	18
3.5 Estimate of Optima Span stability	19
3.6 Data continuity during Prism to Optima transition in 2000	19
3.7 N <sub>2</sub> O corrections	20
3.8 Discussion of daily term drift in relation to scale contraction and N <sub>2</sub> O effects	23
<b>REFERENCES</b>	<b>24</b>
<b>Appendix A. Mass spectrometer operation</b>	<b>25</b>
A.1 Introduction of machine standards and zero enrichment analysis	25
A.2 Analysis of samples or secondary standards	25
A.3 Freeze-Back Method for capturing residual CO <sub>2</sub> for future <sup>14</sup> C analyses	27
<b>Appendix B. Supplemental Tables and Figures</b>	<b>29-39</b>

**Calibration Methodology for the Scripps  $^{13}\text{C}/^{12}\text{C}$  and  $^{18}\text{O}/^{16}\text{O}$  stable isotope program  
1992-2018.**

**Tim Lueker, Ralph Keeling, Alane Bollenbacher, Stephen Walker, Eric Morgan,  
Mariela Brooks**

**Scripps Institution of Oceanography, La Jolla, CA 92024**

**Abstract**

This report details calibration method for measurements of  $^{13}\text{C}/^{12}\text{C}$  and  $^{18}\text{O}/^{16}\text{O}$  ratios of atmospheric  $\text{CO}_2$  by the Scripps  $\text{CO}_2$  program from 1992-2018. The method depends principally on repeat analysis of  $\text{CO}_2$  derived from a suite of high-pressure gas cylinders filled with compressed natural air pumped at La Jolla. The first set of three cylinders were given isotopic assignments in 1994 based on comparisons with material artifacts NBS16, NBS17, and NBS19. Six cylinders subsequently brought into service were assigned values by comparing directly or indirectly with this first set. A tenth cylinder with natural  $\text{CO}_2$  in air was obtained from MPI Jena. Aliquots of  $\text{CO}_2$  from these cylinders, which serve as secondary standards, were extracted into heat-sealed glass ampoules (“flame-off tubes”) before introduction into the mass spectrometer. Some of these ampoules have been stored for many years before analysis, allowing long-term isotopic drift of the cylinders to be quantified. All secondary standards contain natural levels of  $\text{N}_2\text{O}$ . The method corrects for any detected drift, while also applying corrections for  $\text{N}_2\text{O}$  interference, for isobaric interferences (“Craig correction”) and for an inter-lab offset identified in early comparisons with the isotope lab at the University of Groningen. The Jena cylinder was found to be drifting upwards in  $\delta^{18}\text{O}$  at a rate of +0.10 ‰ per decade. Five of the other nine cylinders were found to be drifting downwards in  $\delta^{18}\text{O}$ ,  $\delta^{13}\text{C}$ , or both, at rates of up to -0.11 ‰ per decade. The secondary standards were applied uniformly across a transition to a new mass spectrometer in 2000, thereby establishing continuity across this transition. Results are presented also for instrumental precision based on replicate analyses of standards. Drift-corrected analyses of the Jena cylinder establishes offsets of +0.037 ‰ in  $\delta^{13}\text{C}$  and +0.041 ‰ in  $\delta^{18}\text{O}$  between the Scripps and JRAS isotopic scales (Scripps more positive).

**1. Introduction**

The Scripps  $\text{CO}_2$  program sustains time-series that began in 1978 of the  $^{13}\text{C}/^{12}\text{C}$  and  $^{18}\text{O}/^{16}\text{O}$  ratios in atmospheric  $\text{CO}_2$  from flasks collected at a global array of sampling sites. These isotopic data complement time-series measurements of atmospheric  $\text{CO}_2$  mole fraction initiated by C.D. Keeling in 1958.

From 1978 till 1992 the isotopic measurements were made on a VG Sira mass spectrometer at the Centrum voor Isotopen Onderzoek (CIO) at the University of Groningen, where  $\text{CO}_2$  extracted from

the Scripps flasks was sent for analysis. From 1992 to 2000 the isotopic measurements were made on a Prism mass spectrometer in the lab of Professor Martin Wahlen at Scripps. From 2000 onwards the measurements have been made on an Optima mass spectrometer operated by the Scripps CO<sub>2</sub> program, formerly called the Carbon Dioxide Research Group.

The calibration methodology for stable isotopic measurements of <sup>13</sup>C/<sup>12</sup>C and <sup>18</sup>O/<sup>16</sup>O expressed as δ<sup>13</sup>C and δ<sup>18</sup>O in per mil (‰) (see box) by the Keeling laboratory has been described by Bollenbacher et.al. [2000] and Guenther et al. [2001]. These isotopic reports describe materials and methods used on the Prism mass spectrometer (1992-2000) and methods used to merge these measurements with the previous measurements (1978-1992) made in Groningen.

This report provides an update through July 2018. The methodology depends on nine secondary standards that consist of CO<sub>2</sub> in compressed natural air stored in high-pressure gas cylinders pumped at La Jolla. This report reviews the assignments of isotopic composition to these cylinders, including assignments for six cylinders brought into service after 2000. These assignments now allow for linear drift over time in the isotopic composition of the CO<sub>2</sub> from these cylinders. A smooth transition from the Prism to the Optima was achieved by using the same secondary standards on both instruments.

**Delta notation:**

The symbol δ<sup>13</sup>C is used to refer to the "reduced isotopic ratio," the relative variation in <sup>13</sup>C/<sup>12</sup>C isotopic ratio from that of the carbonate standard "PDB", as given by the formula:

$$\delta^{13}\text{C} = (R / R_s - 1) * 1000$$

where R denotes the <sup>13</sup>C/<sup>12</sup>C of the sample, and R<sub>s</sub> the <sup>13</sup>C/<sup>12</sup>C of the standard, assigned as 0.0112372 [Craig, 1957]. The δ<sup>13</sup>C is expressed in "per mil PDB" (symbol, ‰ PDB).

The symbol δ<sup>18</sup>O in the same way is used to refer to the relative variation in <sup>18</sup>O/<sup>16</sup>O isotopic ratio from that of the standard "PDB."

Isotopic measurements on the Optima have been used in prior publications [C.D. Keeling et al., 2011; Welp et al., 2011; R. Keeling et al., 2017] based on previous assignments of the secondary standards. This report describes an update to these assignments, which impacts all atmospheric samples analyzed since 2000. The changes are typically on the order of a few hundredths per mil (‰) or less (Figure 1).

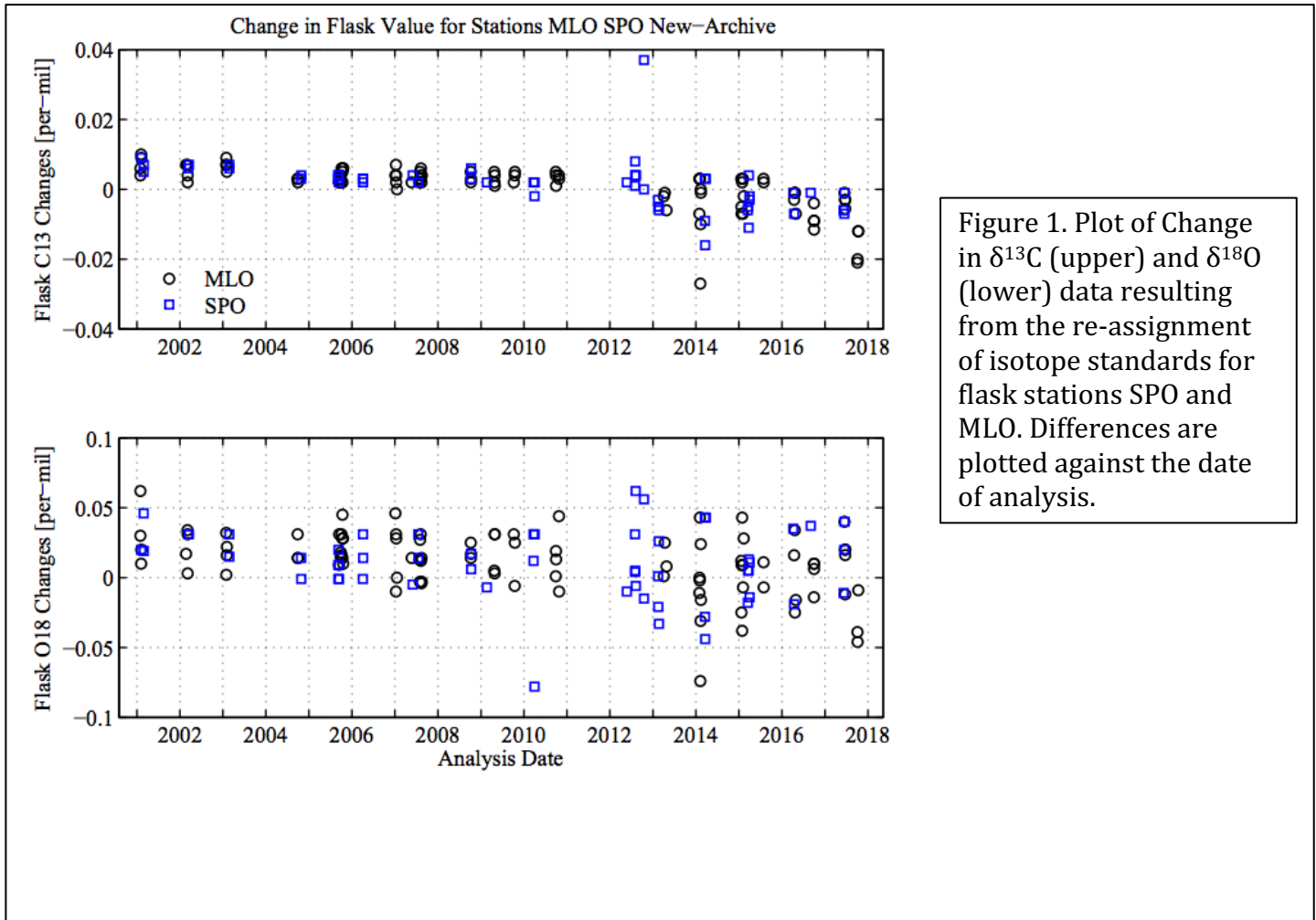

## 2. METHODS

### 2.1 Machine standards

The Prism and Optima are both dual-inlet systems in which unknown samples are run against a reference or “machine standard” with an assigned isotopic composition. The machine standard used in the Prism, designated MW1, consisted of pure  $\text{CO}_2$  derived from a high pressure gas cylinder. MW1 was introduced into the Prism by first transferring to a 1.5 liter glass flask, which was then used for introducing the sample into the mass spectrometer. The machine standard used on the Optima was based on  $\text{CO}_2$  derived from a suite of nominally identical steel tanks (cans) filled initially to 25 PSIG, which were purchased from a vendor at Southern Methodist University (SMU).

The assigned values of machine standards (Table 1) are entered manually into the mass spectrometer computer program to generate preliminary results for unknown samples (see below). These assignments are not critical because of the subsequent corrections based on secondary standards (see below). MW1 was assigned by Martin Wahlen [Bollenbacher et al.

2000]. SMU was assigned based on comparisons with several NBS standards (NBS18, NBS19, NBS20) in June 2003. The standards included NBS18, NBS19, and NBS20, where NBS18 and NBS20 were obtained from M. Whalen’s lab. The SMU assignment used is slightly different than the nominal values printed on the cans by the vendor.

**Table 1. Machine standards used on Prism and Optima instruments**

Instrument	Standard	Source	$\delta^{13}\text{C}$ ‰	$\delta^{18}\text{O}$ ‰
Prism	MW1	Compressed CO <sub>2</sub>	-42.2	-27.8
Optima	SMU	Compressed CO <sub>2</sub>	-3.964	-15.696

## 2.2 Secondary standards

The long-term stability of the isotopic measurements at Scripps is based on secondary standards consisting of compressed natural air stored in high pressure cylinders, which were pumped under unpolluted (i.e. near background) conditions. Periodically, these cylinders are used to produce glass “flame-off” tubes containing CO<sub>2</sub> and N<sub>2</sub>O in roughly the same proportions as natural air samples, as described further below. The flame-off tubes are also potentially stored for long periods of time, allowing the buildup of an “archive” for future analyses.

Over the 27 years of mass spectrometer analyses at Scripps, we have utilized three “sets” of 3 cylinders for secondary standards, as well as an additional cylinder from the Max Planck Institute for Biogeochemistry in Jena. The number of extractions obtained for each cylinder and the number of extracted samples remaining (as of May 2018) are listed in Appendix B, Table B1.

**Set 1: Cylinder I.D.s 39382, 75635, and 75859.** These cylinders were pumped at La Jolla in 1991 (Table 2, tank characteristics in Appendix B, Table B2). Flame-off tubes were routinely generated from these cylinders on approximately a monthly basis from March 1991 to March 2000, and these flame-off tubes were used as the main secondary standards for the full history of the Prism measurements from 1992 to 2000. After 2000, Set 1 standards were extracted annually until March 2005, and occasionally analyzed as an overlap comparison with Set 2. CO<sub>2</sub> extracts from Set 1 cylinders were also sent to CIO starting in June 1991 for the purpose of inter-calibration. (See figure B1a in Appendix A).

**Set 2: 2407, 39414, 96364.** These cylinders were fill at La Jolla between 1990 and 1996, and routinely used as secondary standards on the Optima from 2000 until 2017. These cylinders were selected for this function in 1999 from already existing full cylinders in the Scripps laboratory. CO<sub>2</sub> was first extracted from these cylinders in 1999 and extractions continued, typically on a monthly basis, until 2016, and were stored in flame off tubes. Set 2 standards were mainly run on the Optima, although a few comparisons with set one were conducted on the VG Prism in early 2000.

**Set 3: 7362, 6081, 1008.** These cylinders were filled at La Jolla in 1999, and have been routinely used for calibration standards from 2013 to present. These cylinders were extracted periodically (typically monthly) beginning in September 1999. Prior to 2013, a number of Set 3 extractions

were analyzed on the same days as Sets 1 and 2 to provide data for assignment of Set 3  $\delta^{13}\text{C}$  and  $\delta^{18}\text{O}$  values.

**JRAC2.** This aluminum cylinder (ID 769224) was obtained from the Max Planck Institute for Biogeochemistry in Jena, Germany to help assist in cross calibration with other labs making  $\delta^{13}\text{C}$  and  $\delta^{18}\text{O}$  measurements. We began extracting and analyzing this cylinder in 2013 as an additional secondary standard, assigning  $\delta^{13}\text{C}$  and  $\delta^{18}\text{O}$  values on the Scripps scale by comparisons with our secondary standards in sets 2 and 3 (as described below).

### 2.3 Seawater secondary standards

Separate standards were created for seawater isotopic analyses, which did not include  $\text{N}_2\text{O}$ . The assignment of these standards through 2000 was described in Bollenbacher et al. [2000] and Guenther et al. [2001]. Assignments of seawater standards brought into use since then will be described elsewhere.

### 2.4 $\text{CO}_2$ extraction method

The system used to extract  $\text{CO}_2$  (and  $\text{N}_2\text{O}$ ) from air samples and gas cylinders is shown in Figure 2. The air stream from the cylinder (or flask) passes through two preliminary cold traps for removal of water vapor, and then a “cryo” trap, cooled to  $-180^\circ\text{C}$  to capture the  $\text{CO}_2$ . The temperature of the cryotrap is controlled by throttling a flow liquid  $\text{N}_2$  in a feedback loop. The quantity of  $\text{CO}_2$  captured from an air sample or cylinder is controlled by adjusting the duration of the extraction, and hence the volume of air passing through the trap. The air pressure in the line is set to 1.1 kPa (8 torr) with the MKS flow control valve. Upon completion of the extraction the residual air is evacuated from the line and then the cryo trap is warmed to  $-100^\circ\text{C}$  to release the  $\text{CO}_2$ . The  $\text{CO}_2$  gas is transferred to one of 6 glass flame off tubes immersed in liquid nitrogen. After the  $\text{CO}_2$  is fully transferred to the tube a quartz heater fuses the glass tube, trapping the  $\text{CO}_2$  inside.

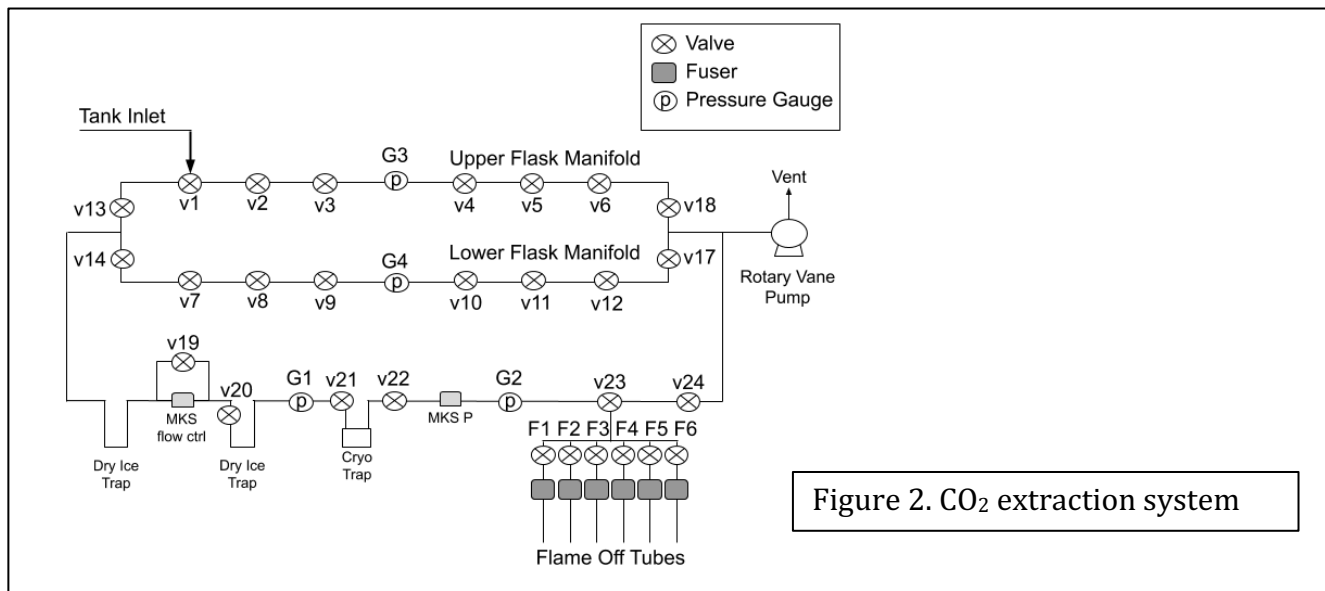



## 2.5 Data reduction

The instruments measure relative differences in the 45/44 and 46/44 ion current ratios of the unknown sample relative to the machine standard to compute sample  $\delta$  values, designated here as  $\delta^{13}\text{C}_{\text{MS}}$  and  $\delta^{18}\text{O}_{\text{MS}}$ . This instrument algorithm, which was identical for the Prism and Optima machines, includes the standard “Craig correction” for the interference of  $^{12}\text{C}^{17}\text{O}^{18}\text{O}$  on mass 45 [Craig, 1957; Brand et al., 2010].

Using the outputted  $\delta^{13}\text{C}_{\text{MS}}$  and  $\delta^{18}\text{O}_{\text{MS}}$  values, we apply a 6 step procedure to compute final  $\delta$  values. The same data reduction procedure has been applied to both the Prism and Optima data.

**Step 1:** Undo the instrument-generated Craig correction to yield  $\delta$  values based on original ion currents [Bollenbacher et al, 2000, eqn. 1 p. 3].

$$\delta(45/44) = (\delta^{13}\text{C}_{\text{MS}} + 0.0338 \cdot \delta^{18}\text{O}_{\text{MS}})/1.0676 \quad (1)$$

$$\delta(46/44) = (\delta^{18}\text{O}_{\text{MS}} + 0.0021 \cdot \delta^{13}\text{C}_{\text{MS}})/1.0010 \quad (2)$$

where  $\delta^{18}\text{O}_{\text{MS}}$  and  $\delta^{13}\text{C}_{\text{MS}}$  are the delta values reported by the instrument software.

**Step 2:** Apply the NBS correction determined in 1994 [Bollenbacher et al 2000, P.3, Eqn. 2] or, for analysis dates after 1 Oct. 1996, the NBS correction of 1997 [Guenther et al 2001, p. 5]. These corrections are

$$\delta(45/44)' = (0.995034 \cdot \delta(45/44)) + 0.05901 \quad (3)$$

$$\delta(46/44)' = (1.00758 \cdot \delta(46/44)) + 0.21137 \quad (4)$$

$$\delta(45/44)' = (0.994228 \cdot \delta(45/44)) + 0.017353 \quad (3)'$$

$$\delta(46/44)' = (1.00487 \cdot \delta(46/44)) + 0.007153 \quad (4)'$$

where Eq. (3) and (4) are 1994 corrections and (3)' and (4)' are the 1997 corrections [Guenther et al., 2001, p. 5]. The change in NBS correction has essentially no impact on the final numbers, because it is corrected for through the use of the daily terms (Step 4 below).

**Step 3:** Reapply the ion (Craig) correction [Bollenbacher et al, 2000, p. 5, eqn. 3]

$$\delta^{13}\text{C}_{\text{nbscorr}} = ((1.0676 \cdot \delta(45/44)') - (0.0338338 \cdot \delta(46/44)'))/0.99992902 \quad (5)$$

$$\delta^{18}\text{O}_{\text{nbscorr}} = ((1.0010 \cdot \delta(46/44)') - (0.00224196 \cdot \delta(45/44)'))/0.99992902 \quad (6)$$

**Step 4:** Results from analyses of secondary standards are averaged to obtain values of the “daily terms”, which serve the purpose of removing the influence of day-to-day drift in instrument performance. The daily terms are assessed based on the differences between assigned and measured values of secondary standards

$$^{13}\text{D}_i = (\delta^{13}\text{C}_{\text{assigned}, i} - \delta^{13}\text{C}_{\text{nbscorr}, i}) \quad (7)$$

$$^{18}\text{D}_i = (\delta^{18}\text{O}_{\text{assigned}, i} - \delta^{18}\text{O}_{\text{nbscorr}, i}) \quad (8)$$

where  $\delta^{13}\text{C}_{\text{nbcorr},i}$  is the  $\delta^{13}\text{C}_{\text{nbcorr}}$  value measured for a particular standard  $i$  on the relevant analysis date, and  $\delta^{13}\text{C}_{\text{assigned},i}$  is the assigned value of this standard, determined as described further below. Typically, several standards are run on a particular day, and the average of daily terms for each of these is used for the defined daily term on that day, e.g.

$${}^{13}\text{D}_{\text{term}} = \langle {}^{13}\text{D}_i \rangle. \quad (8a)$$

$${}^{18}\text{D}_{\text{term}} = \langle {}^{18}\text{D}_i \rangle. \quad (8b)$$

The standard deviation of the individual differences, e.g.  ${}^{13}\text{D}_i$  is also computed. The standards are recursively filtered, rejecting outliers until all remaining individual terms lie within  $\pm 0.04\text{‰}$  in  $\delta^{13}\text{C}$  or  $\pm 0.08\text{‰}$  for  $\delta^{18}\text{O}$  from the mean. If no points satisfy this criterion then the points are manually flagged.

Daily terms are defined separately for seawater samples because they sometimes exhibit different day-to-day drift, possibly due to the lack of  $\text{N}_2\text{O}$  in the samples and standards.

The daily terms are added to the  $\delta^{13}\text{C}_{\text{nbcorr}}$  and  $\delta^{18}\text{O}_{\text{nbcorr}}$  values to compute corrected delta values:

$$\delta^{13}\text{C}_{\text{termcorr}} = \delta^{13}\text{C}_{\text{nbcorr}} + {}^{13}\text{D}_{\text{term}} \quad (9)$$

$$\delta^{18}\text{O}_{\text{termcorr}} = \delta^{18}\text{O}_{\text{nbcorr}} + {}^{18}\text{D}_{\text{term}} \quad (10)$$

**Step 5:** A CIO/SIO offset correction (“Mook correction”) is added to bring the air sample values into agreement with the early isotope data provided by CIO

$${}^{13}\text{D}_{\text{mook}} = -0.112 \text{‰} \quad \text{and} \quad {}^{18}\text{D}_{\text{mook}} = -0.109 \text{‰} \quad [\text{Bollenbacher et al. 2000, p. 31 and p. 37}].$$

**Step 6:** A correction for  $\text{N}_2\text{O}$  is added, based on determinations by Dr. Wahlen on the Prism (see equations on page 34 of Bollenbacher et al. [2000]).

$${}^{13}\text{D}_{\text{N}_2\text{O}} = (2.24 \cdot I(44) + 221) \cdot \rho \quad (11)$$

$${}^{18}\text{D}_{\text{N}_2\text{O}} = (3.46 \cdot I(44) + 331) \cdot \rho \quad (12)$$

Where  $I(44)$  = mass 44 beam current in nanoamperes (nA) (typically chosen to be 9.2 nA on the Optima) and where  $\rho$  is molar abundance ratio  $\text{N}_2\text{O}/\text{CO}_2$  of the air sample. These corrections based on  $I(44)$  were developed in the 1990s in the laboratory of Martin Wahlen. The sensitivity to  $I(44)$  is quite small. For example, a run at 6 nA compared to 9.2 nA changes the  $\text{N}_2\text{O}$  corrections (for  $\rho = 0.81$ ) by 0.006 ‰ for  $\delta^{13}\text{C}$  and 0.009 ‰ for  $\delta^{18}\text{O}$ . The corrections depend on the absolute ratios  $\rho$ , rather than ratio differences, because the assigned values of the secondary standards ( $\delta^{13}\text{C}_{\text{assigned}}$  and  $\delta^{18}\text{O}_{\text{assigned}}$ ) are not  $\text{N}_2\text{O}$  corrected.

$\text{N}_2\text{O}$  concentrations have not been routinely measured on air samples. Prior to the update documented in this report,  $\text{N}_2\text{O}$  was estimated (Bollenbacher et al., 2000, p. 35] assuming a linear trend

$$\text{N}_2\text{O}(\text{ppm}) = (-889.8725 + 0.60204083 \cdot t) / 1000 \quad (13)$$

where  $t$  is in decimal year (e.g. 2009.3).

With this report, we instead calculate a time dependent global average for N<sub>2</sub>O based averaging separate Northern and Southern Hemispheric annual averages from HATS global N<sub>2</sub>O webarchive from NOAA (<https://www.esrl.noaa.gov/gmd/hats/combined/N2O.html>). This global average is shown in Figure 3, along with the previously used linear relation.

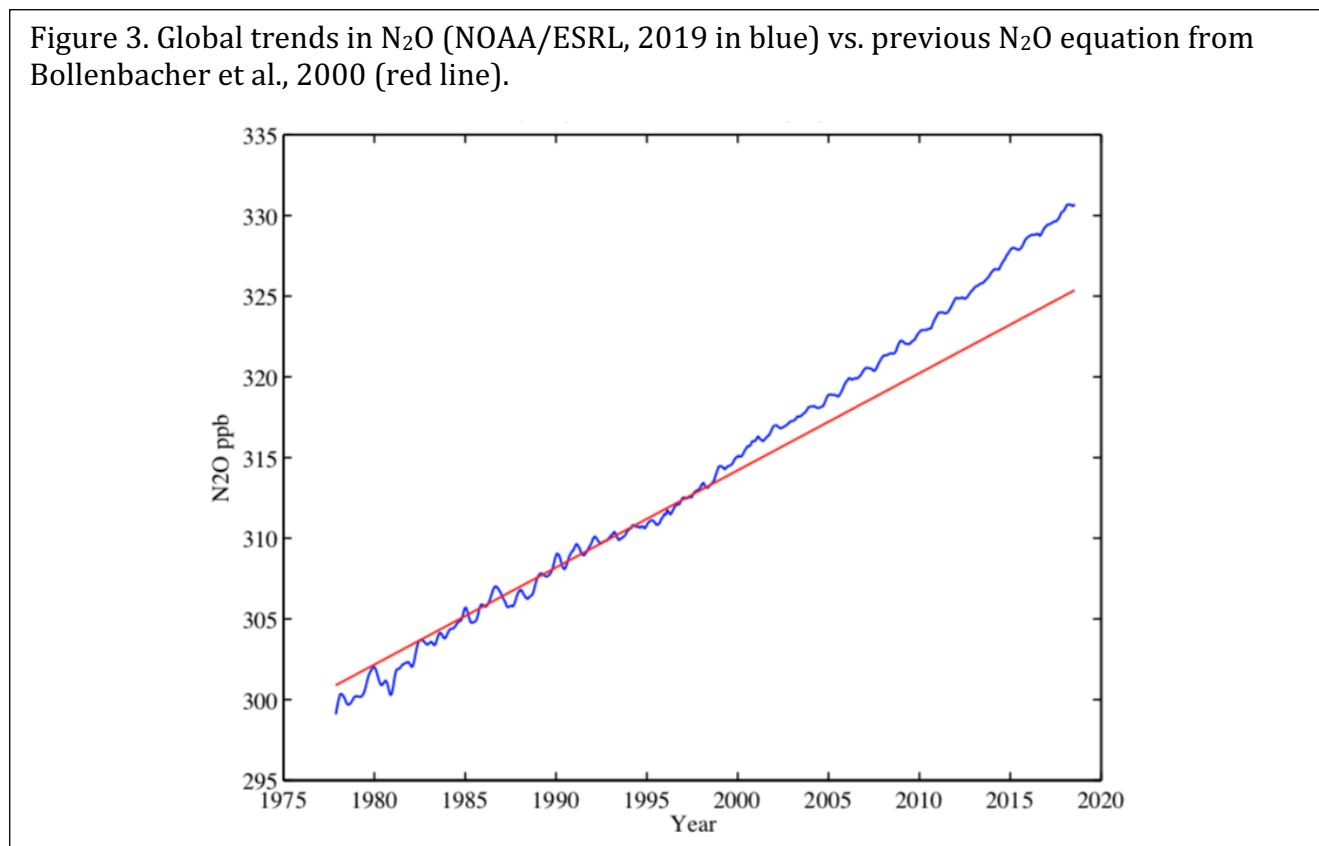

We combine this with measurements of CO<sub>2</sub> mole fraction made on the same flask to compute  $\rho$ . Additional information on N<sub>2</sub>O corrections is provide below and in Bollenbacher et al [2000], page 36.

**Overall formula:** Combining Steps (5), and (6), the final reported delta values are computed according to

$$\delta^{13}\text{C} = \delta^{13}\text{C}_{\text{termcorr}} + {}^{13}\text{D}_{\text{mook}} + {}^{13}\text{D}_{\text{N2O}} \quad (14)$$

$$\delta^{18}\text{O} = \delta^{18}\text{O}_{\text{termcorr}} + {}^{18}\text{D}_{\text{mook}} + {}^{18}\text{D}_{\text{N2O}} \quad (15)$$

## 2.6 Assignment of secondary standards

The secondary standards are assigned values based on a formula that allows for linear drift

$$\delta^{13}\text{C}_{\text{assigned}} = \delta^{13}\text{C}_{\text{assigned}}(t_0) + {}^{13}\text{Drift} \cdot (t-t_0) \quad (16)$$

where  $\delta^{13}\text{C}_{\text{assigned}}$  is the assigned value at date  $t$ ,  $\delta^{13}\text{C}_{\text{assigned}}(t_0)$  is the constant reference value at  $t_0$ ,  ${}^{13}\text{Drift}$  is a linear drift rate,  $t$  (in years, e.g. 2008.5) is the date at which the  $\text{CO}_2$  was extracted from the cylinder, and  $t_0$  is a reference extraction date. A similar formula is used for  $\delta^{18}\text{O}$ .

The linear drift rates,  ${}^{13}\text{Drift}$ , were determined using so-called “archive studies”. An archive study involves analyzing multiple flame-off tubes of a given secondary standard. These analyses are all carried out on one date, using flame-off tubes derived from different extraction dates. Using archives extracted over many years, we obtain an estimate of cylinder drift that is independent of day-to-day variations in instrument performance. Furthermore, as we can carry out repeated stability checks on the same cylinder, we obtain multiple independent estimates of the drift in the standard. The method relies on the seemingly well-justified assumption that the isotopic composition of  $\text{CO}_2$  flame-off tubes is stable over time. Figure 4 illustrates this process for cylinder 96364. Four different archive studies performed from January 2002 to December 2017 characterize the rate of drift.

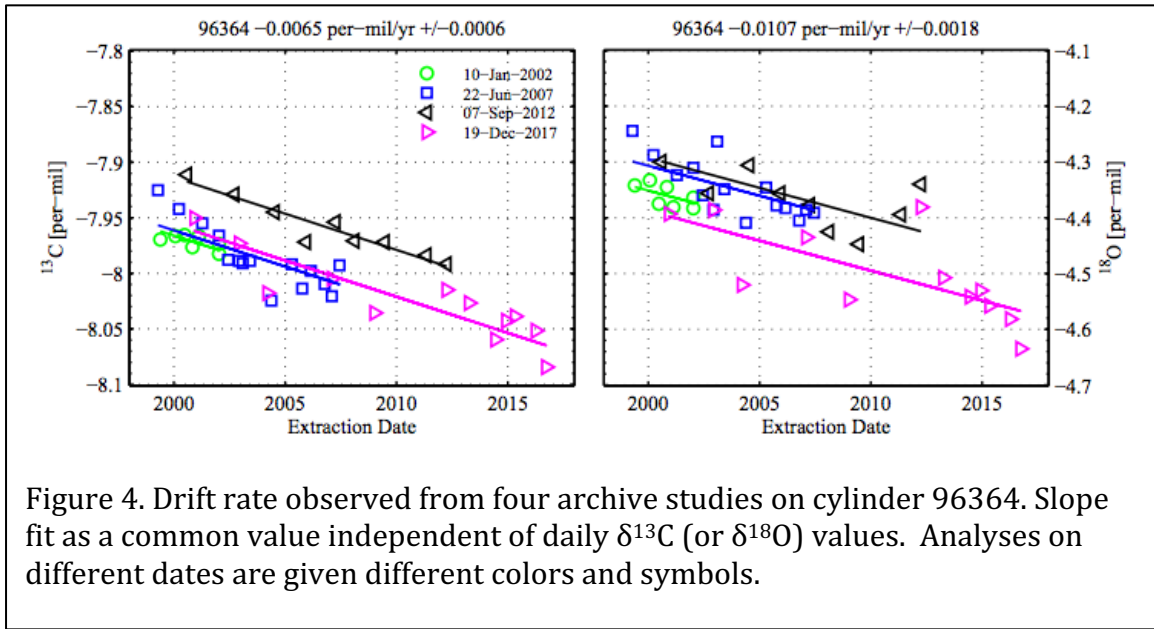

Figure 4. Drift rate observed from four archive studies on cylinder 96364. Slope fit as a common value independent of daily  $\delta^{13}\text{C}$  (or  $\delta^{18}\text{O}$ ) values. Analyses on different dates are given different colors and symbols.

The archive studies were then used to estimate linear drift rates for each cylinder using a linear least squares fit that includes a separate additive constant for each analysis date but a common drift rate (slope) versus extraction date. Archive study results for all cylinders can be found in Appendix B, Figures B2 a-c. Parameter values are summarized in Table 2.

Standard	Ref date, to	$\delta^{13}\text{C}_{\text{assigned}}$ (‰)	$\delta^{18}\text{O}_{\text{assigned}}$ (‰)	$^{13}\text{C}$ Drift ‰/yr	$^{18}\text{O}$ Drift ‰/yr	Cylinder Fill Date
Set 1						
39382	N/A	-8.281	-0.418	*	*	16-Mar-91
75635	N/A	-8.388	-0.425	*	*	16-Mar-91
75859	N/A	-8.282	-0.266	*	*	16-Mar-91
Set 2						
2407	1-Jan-08	-7.753	-2.818	-0.0024	-0.0060	27-Jun-96
39414	1-Jan-08	-8.356	-5.182	0.0004**	-0.0003**	23-Nov-90
96364	1-Jan-08	-8.014	-4.444	-0.0065	-0.0107	5-Sep-96
Set 3						
7362	1-Jan-08	-8.37	-2.743	-0.0020	-0.0104	9-Sep-99
6081	1-Jan-08	-8.333	-3.03	-0.0013	-0.0005**	9-Sep-99
1008	1-Jan-08	-8.343	-2.897	-0.0032	-0.0104	9-Sep-99
JRAC2	1-Jan-08	-7.945	-3.197	0.0007**	0.0102	9-Dec-10

<sup>1</sup>The values assigned are prior to applying the CIO offset correction and the N<sub>2</sub>O correction.

\* Set 1 values were assigned without drift correction (see main text).

\*\* Values deemed insignificant – zero drift rate assigned to standard.

## 2.7 Assignment methodology

**2.7.1 Set 1** The assignment of the Set 1 values was described in Bollenbacher et al. [2000] and is summarized only briefly here. This assignment involved comparisons with NBS standards in Jan. and Feb. 1994. An archive study in Jan. 2000 of the Set 1 standards extracted over a 6 year period [Bollenbacher et al., 2000, p. 33-34] indicated insignificant drift (less than +/- 0.002 ‰ yr<sup>-1</sup> in  $\delta^{13}\text{C}$  and -0.007 ‰ yr<sup>-1</sup> in  $\delta^{18}\text{O}$ ), so the assignment of Set 1 was entirely based on the 1994 comparison with NBS standards without drift correction.

Three NBS standards were used: NBS16 and NBS17 in the form of pure CO<sub>2</sub> gas, and NBS19 in the form of limestone carbonate, which was reacted with phosphoric acid to produce CO<sub>2</sub> gas. Figure 5, which repeats Figure 1 from Bollenbacher et al [2000], shows the  $\delta(45/44)$  and  $\delta(46/44)$  values of these standards, calculated from measurements on the Prism via Eqs. (1) and (2), plotted against the NBS assigned values. Here the NBS values have had the Craig correction removed, via the equivalent of Eqs. (1) and (2). The assigned values used for NBS16, NBS17, and NBS19 are

presented in Bollenbacher et al., [2000, Table A(1)], with  $\delta$  values ranging from roughly -41‰ to +1‰ for  $\delta(45/44)$  and -37‰ to -3 ‰ for  $\delta(46/44)$ . The assigned value for NBS19 used acid-corrected values as documented in Bollenbacher et al [2000, Table E]. The measured minus assigned  $\delta(45/45)$  and  $\delta(46/44)$  values are consistent with a linear relationship against measured values to within the measurement uncertainties. The linear fit is reflected in Eqs. (3) and (4).

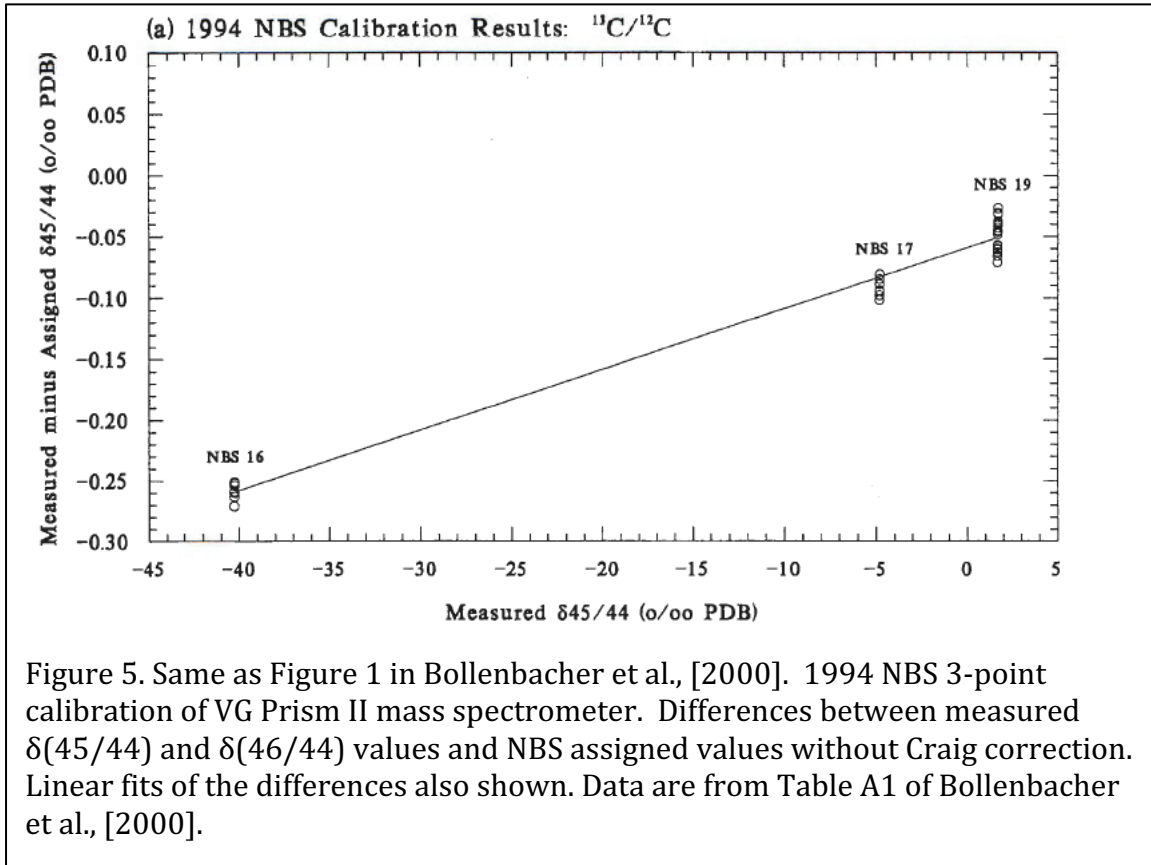

Figure 5. Same as Figure 1 in Bollenbacher et al., [2000]. 1994 NBS 3-point calibration of VG Prism II mass spectrometer. Differences between measured  $\delta(45/44)$  and  $\delta(46/44)$  values and NBS assigned values without Craig correction. Linear fits of the differences also shown. Data are from Table A1 of Bollenbacher et al., [2000].

The Set 1 assignments were carried out using measurements of two pure CO<sub>2</sub> (seawater) standards (GS19 and GEA4), which were also analyzed in early 1994, overlapping with the measurements of the NBS standards. The offsets between these pure CO<sub>2</sub> standards and the Set 1 standards measured on other dates were then used to assign the Set 1 standards, accounting for offset drift over time to align the assignments with the 1994 NBS calibrations. The assignments are NBS- and Craig-corrected using the equivalent of Eqs. (3) to (6), but not N<sub>2</sub>O corrected. These values were reported in Table E with supporting calculations in Table I of Bollenbacher et al., [2000]. The Set 1 assigned values are reproduced here in Table 2.

The three NBS standards were again run in 1996-1997, including repeating the evolution of CO<sub>2</sub> gas from NBS19 [Guenther et al., 2001]. These analyses were sufficiently consistent with the earlier analyses that they were not used to update the Set 1 assignments. (These repeat analyses were used to produce updated linear fits for the NBS corrections via Eqs. (3)' and (4)', a change which is anyway compensated by daily term corrections in Eqs. (7) and (8).)

### 2.7.2 Preliminary assignment of Set 2 and Set 3

Initial assessments of the Set 2 standards were made on the VG Prism through measurements of samples from both Set 1 and Set 2 on the same analysis date. The Set 2 gases were treated as unknowns to determine values of  $\delta^{13}\text{C}_{\text{termcorr}}$  and  $\delta^{18}\text{O}_{\text{termcorr}}$ . The initial assigned value of the Set 2 standards were effectively based on the average of multiple measurements of  $\delta^{13}\text{C}_{\text{termcorr}}$  against standards from Set 1.

In September 2012 we conducted an archive study of the standards in Set 2. The results indicated a significant drift in cylinder 2407 ( $\delta^{13}\text{C}$  of -0.0021 per mil/yr,  $\delta^{18}\text{O}$  of -0.0056 per mil/yr), and 96364 ( $\delta^{13}\text{C}$  of -0.0060 per mil/yr,  $\delta^{18}\text{O}$  of -0.0074 per mil/yr). Cylinder 39414 showed negligible drift (Table 2). Based on these results we re-evaluated daily term calculations, correcting for the linear drift observed in cylinders 2407 and 96364.

In November 2012, cylinders from Set 3 were assigned  $\delta$  values based on 47 to 50 analyses as unknowns on days when either Set 1 and/or Set 2 standards were used for the daily terms. From then until April 2018, the calibrations allowed for continued drift in 2407, and 96364, but not in the Set 3 standards.

### 2.7.3 Revised assignments for Set 2, Set 3, and JRAC2 including drift corrections

Effective April 1, 2018, a revised set of assignments was made for both the Set 2 and Set 3 standards. These assignments were made as follows:

Set 2 standards were treated as unknowns to compute  $\delta^{13}\text{C}_{\text{termcorr}}$ , using the Set 1 standards to define the daily term. The measurements were then corrected for the known drift in the secondary standards (see above) relative to Jan 1, 2008

$$\delta^{13}\text{C}_{\text{driftcorr},i} = \delta^{13}\text{C}_{\text{termcorr},i}(2008) - {}^{13}\text{Drift}_i \cdot (t - 2008) \quad (17)$$

where  ${}^{13}\text{Drift}_i$  is the linear drift rate computed from the fitting procedure and listed in Table 2, and  $t$  is the extraction date.

The average of multiple measurements of  $\delta^{13}\text{C}_{\text{driftcorr}}$  for secondary standard  $i$  were then averaged to yield assigned values for the Set 2 standards, effective Jan, 2008.

$$\delta^{13}\text{C}_{\text{assigned},i}(2008) = \langle \delta^{13}\text{C}_{\text{driftcorr},i} \rangle \quad (18)$$

which is then combined with the known drift rate to allow time-dependent assignment:

$$\delta^{13}\text{C}_{\text{assigned},i} = \delta^{13}\text{C}_{\text{assigned},i}(2008) + {}^{13}\text{Drift}_i \cdot (t - 2008.00) \quad (19)$$

The same procedure was applied for determining  $\delta^{18}\text{O}_{\text{assigned},i}$  values.

Figure 6 illustrates the resulting drift-corrected  $\delta^{13}\text{C}$  values for standard Set 2.

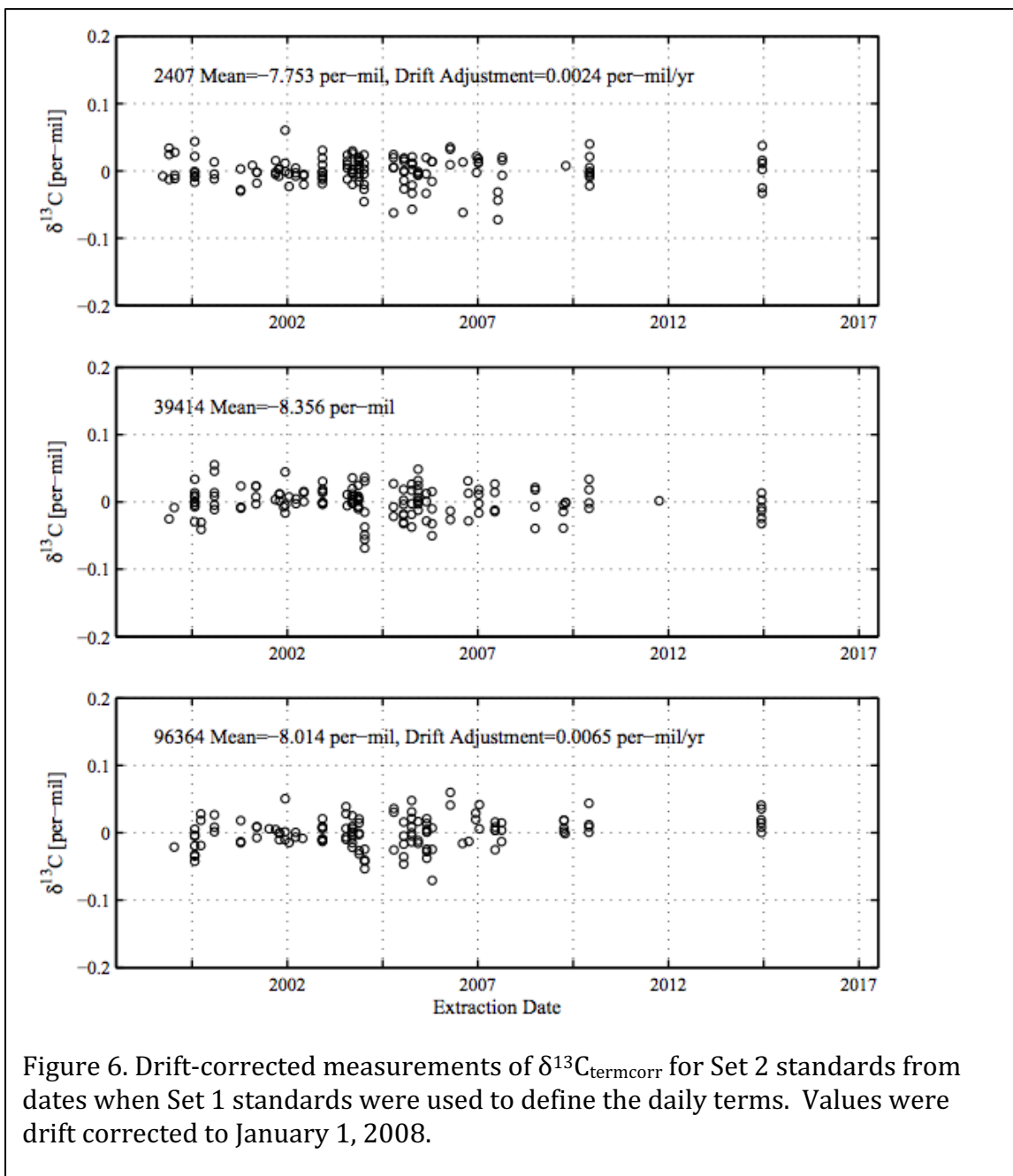

Set 3 and JRAC2 standards were assigned in the same manner as Set 2, also using drift rates in Table 2 to correct to the Jan. 1, 2008 reference date. The method relied on analyses from dates when Set 3 standards were measured as unknowns using Set 1 and/or Set 2 standards to define the daily terms. See Appendix B, Figures B3 a-e for drift-corrected  $\delta^{13}\text{C}_{\text{termcorr}}$  and  $\delta^{18}\text{C}_{\text{termcorr}}$  measurements of Set 2, Set 3, and JRAC2.



### 3. RESULTS AND DISCUSSION

#### 3.1 Summary of daily terms

Figures 7a and 7b show the daily terms for the VG Prism documented in Bollenbacher et al., [2000, p. 27] along with daily terms for the Optima. Also indicated are known “milestone” events with potential to influence these terms.

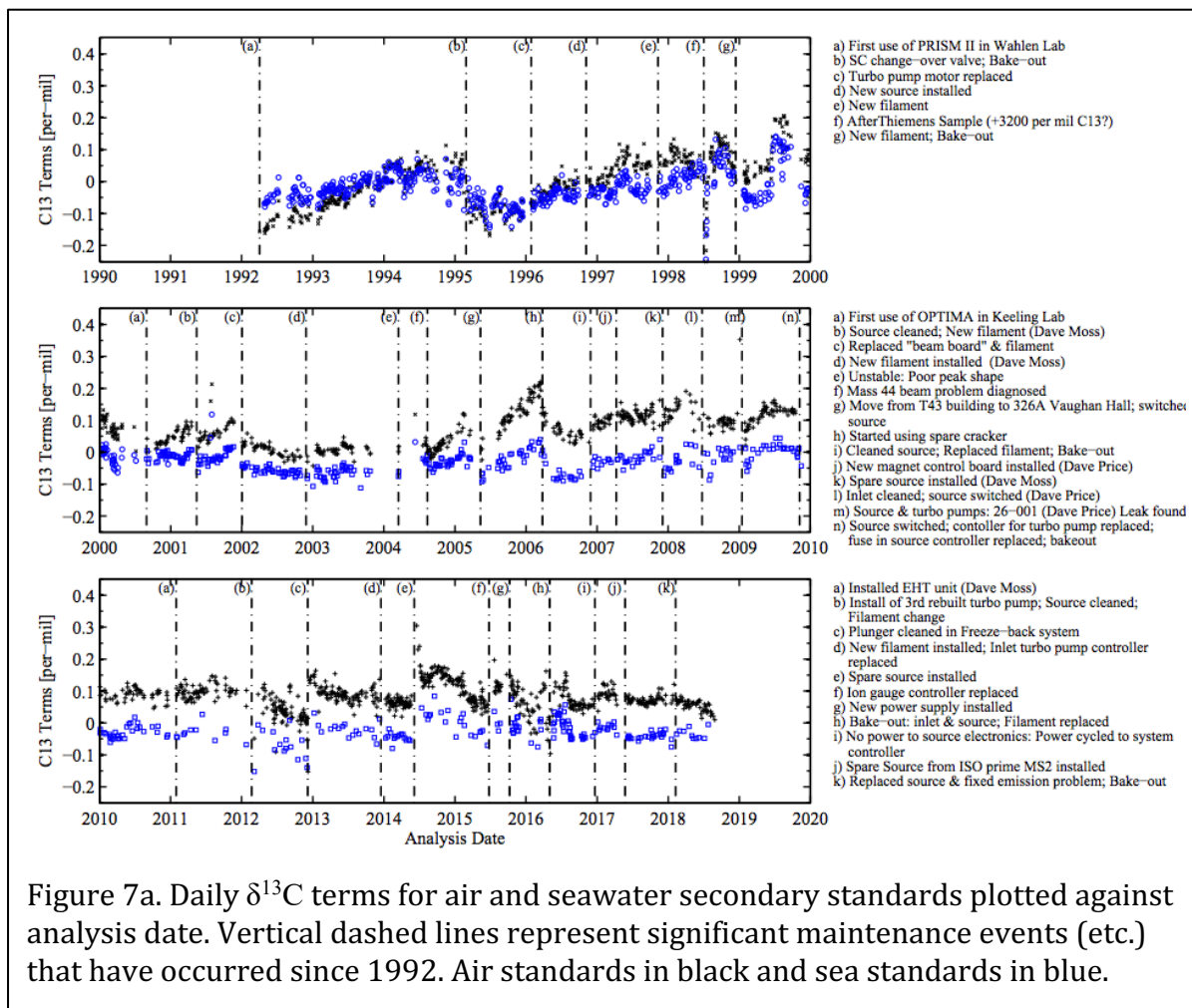

Figure 7a. Daily  $\delta^{13}\text{C}$  terms for air and seawater secondary standards plotted against analysis date. Vertical dashed lines represent significant maintenance events (etc.) that have occurred since 1992. Air standards in black and sea standards in blue.

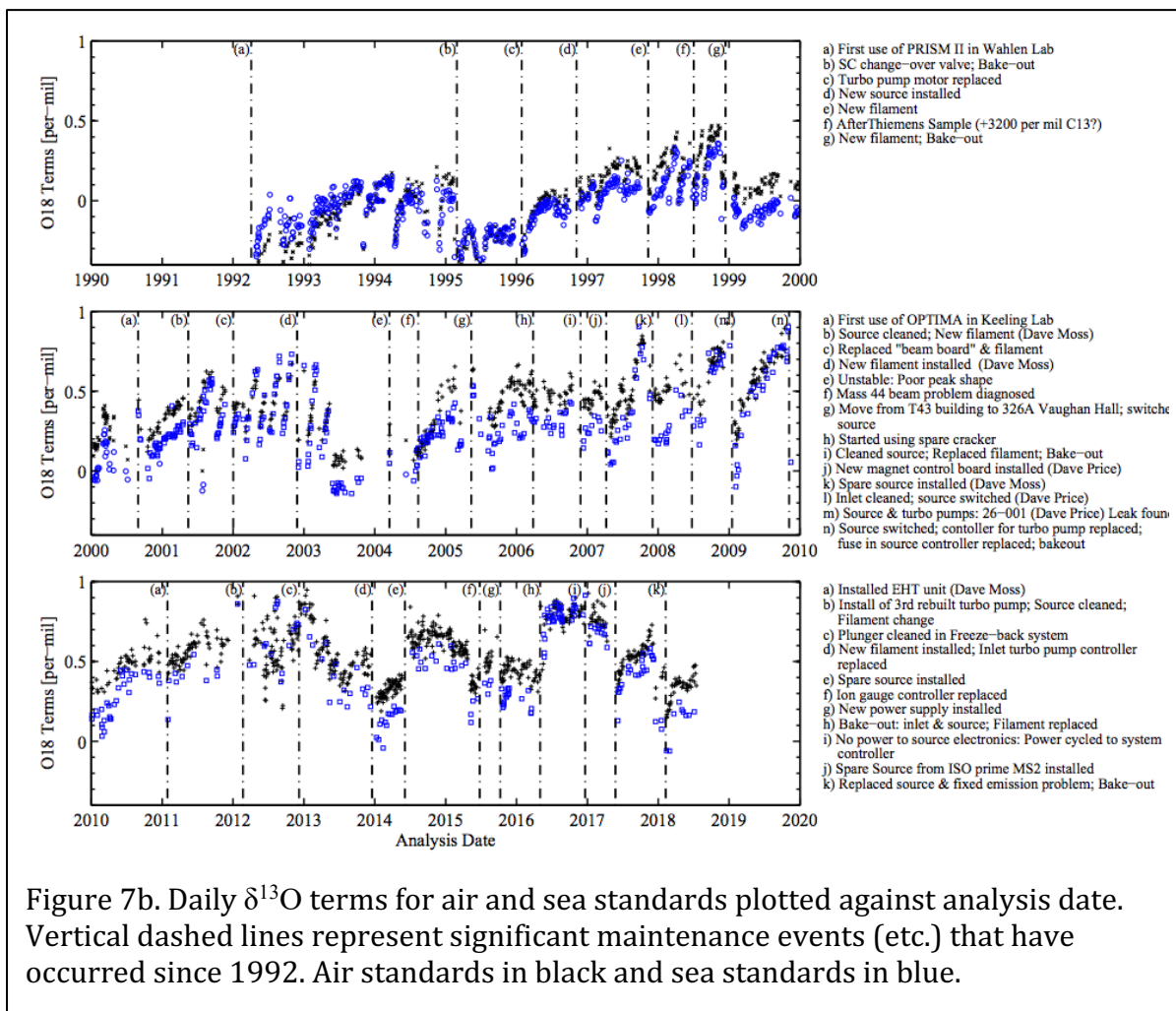

Figure 7b. Daily  $\delta^{13}\text{O}$  terms for air and sea standards plotted against analysis date. Vertical dashed lines represent significant maintenance events (etc.) that have occurred since 1992. Air standards in black and sea standards in blue.

### 3.2 Impact of new secondary standard assignments on isotopic data

Based on the revised assignments of the Set 2 and Set 3 standards, the daily terms for all analyses on the Optima were recalculated. The revised daily terms were then compared to the previously calculated terms, yielding differences on the order of 0.01 to 0.02 ‰. The impact of the revision on isotopic records from Mauna Loa and the South Pole is shown in Figure 1.

### 3.3 Comparison of SIO and JRAS WMO calibration scales

Our analysis of the JRAC2 (769224) cylinder provides a basis for comparing the SIO scale with the JRAS WMO scale [Wendeburg et al., 2013]. This cylinder was determined to have values of  $\delta^{13}\text{C} = -7.887\text{‰}$  and  $\delta^{18}\text{O} = -3.003\text{‰}$  on the JRAS scale at the stable Isotope Laboratory at MPI Jena based on analysis on 9 Dec 2010. Our assigned values, based on treating it as new unknown standard, and after applying the CIO offset and  $\text{N}_2\text{O}$  corrections, are  $-7.850\text{‰}$  and  $-2.962\text{‰}$ . The  $\text{N}_2\text{O}$  correction at SIO was based on a measurement of  $\text{N}_2\text{O}$  in the Weiss lab of 324.2 ppb. The  $\delta^{18}\text{O}$  value of  $-2.962\text{‰}$  refers to an extrapolated value on 9 Dec 2010, using the non-zero drift rate established from archive studies of this cylinder (see Table 2). The differences between the SIO

and JRAS scales are +0.037‰ in  $\delta^{13}\text{C}$  and +0.041‰ in  $\delta^{18}\text{O}$ , the SIO scale being more positive than Jena in both cases.

### 3.4 Precision for Prism and Optima.

We estimated the precision of daily analysis on the VG Prism and Optima by comparing results of daily replicate analyses of standards (Figures 8a, 8b). We grouped the results into 3 periods corresponding to the use of the VG Prism, initial use of the Optima, and later use of the Optima after a noticeable change in precision beginning in early 2005. The sigma values listed in the figures reflect the pooled precision of multiple daily analyses of different aliquots (flame off tubes) of the same standards. We were not able to identify a physical cause or other reason for the change in precision of the Optima in 2005. The precision reported here includes imprecision from both the extraction and analyses.

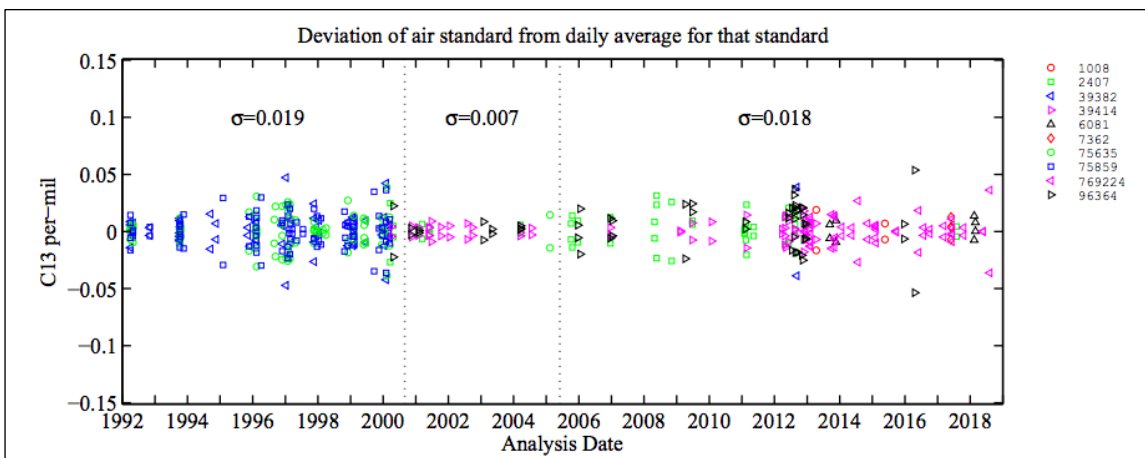

Figure 8a.  $\delta^{13}\text{C}_{\text{nbscorr}}$  precision evaluated from daily replicates of std. cylinder analyses. Three distinct regions have different precision as noted in text.

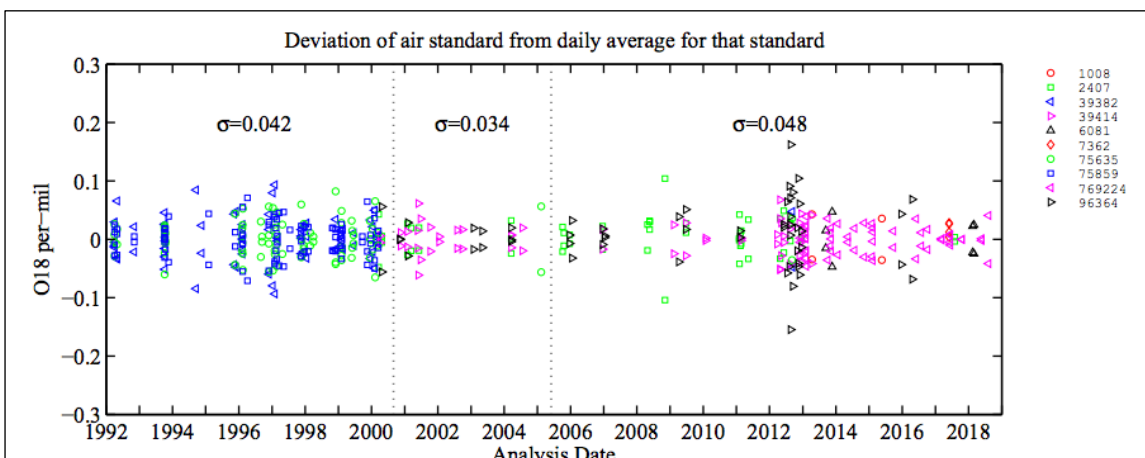

Figure 8b.  $\delta^{18}\text{O}_{\text{nbscorr}}$  precision evaluated from daily replicates of std. cylinder analyses. Three distinct regions have different precision as noted in text.

### 3.5 Estimate of Optima Span stability

To assess the stability of the  $\delta^{13}\text{C}$  instrument span (i.e. accounting for scale contraction) we examined the stability of the differences in two secondary standards used for seawater calibration, GEA4 with  $\delta^{13}\text{C} \sim -7.5\text{‰}$  and GES1 with  $\delta^{13}\text{C} \sim +1.9\text{‰}$ . Results (Figure 9) show no significant long-term trend with a standard deviation in the difference of  $\pm 0.019\text{‰}$ , corresponding to 0.2% of the difference in  $\delta^{13}\text{C}$  between GEA4 and GES1. The results suggest that the instrument span for both the Prism and Optima was stable to this level.

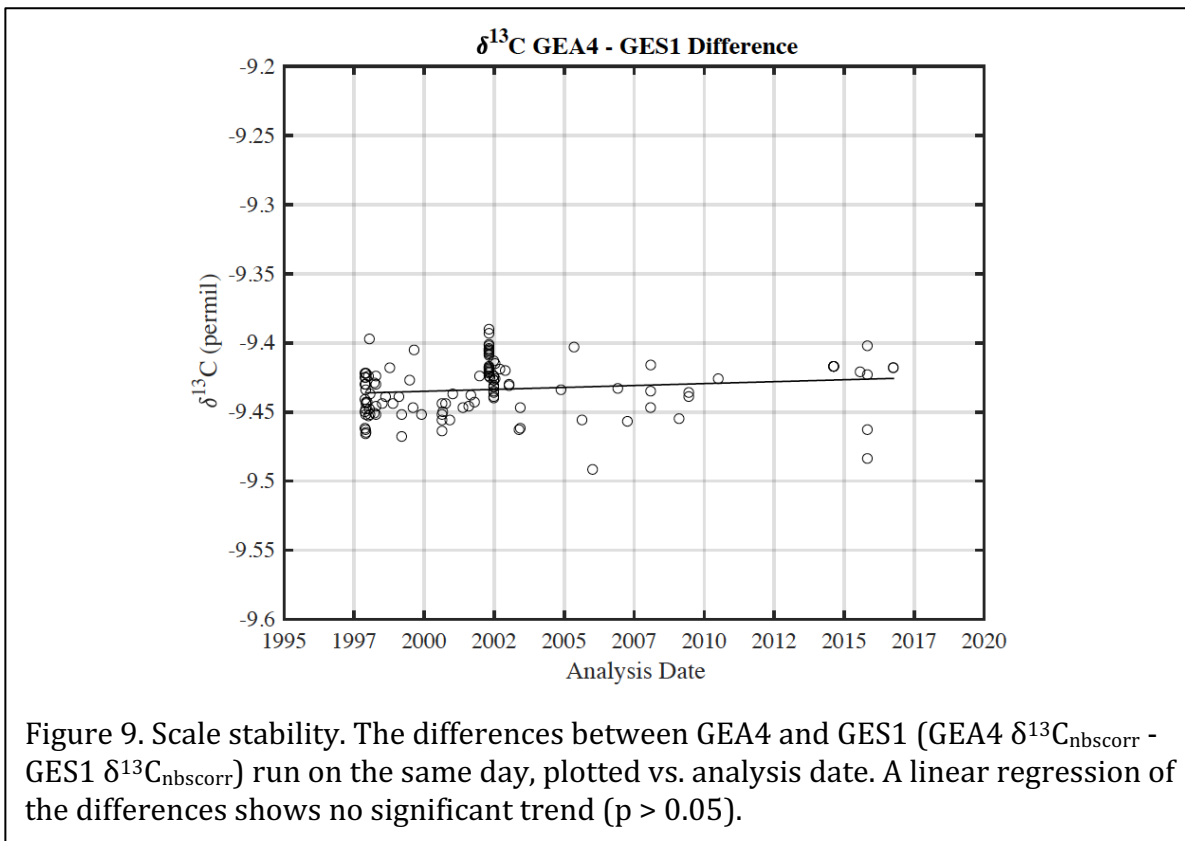
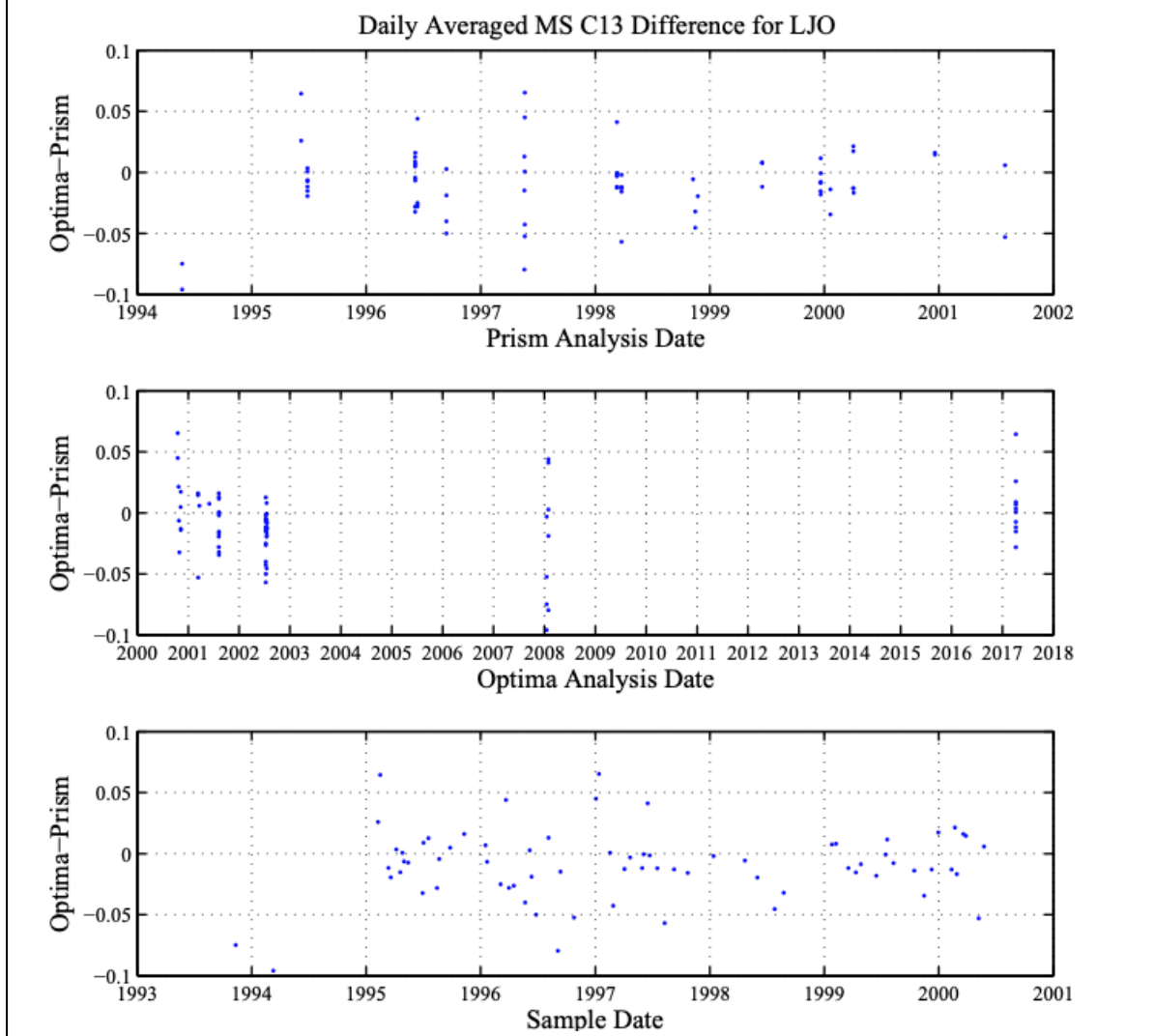

Figure 9. Scale stability. The differences between GEA4 and GES1 ( $\text{GEA4 } \delta^{13}\text{C}_{\text{nbscorr}} - \text{GES1 } \delta^{13}\text{C}_{\text{nbscorr}}$ ) run on the same day, plotted vs. analysis date. A linear regression of the differences shows no significant trend ( $p > 0.05$ ).

### 3.6 Data continuity during Prism to Optima transition in 2000

During the period of transition from the VG Prism to the Optima in year 2000, multiple air samples collected at La Jolla (up to 6 at a time) were archived for analyses (on either the Prism or the Optima). A summary of the duplicates analyzed on both instruments is shown in Figure 10.

Figure 10. Differences between  $\delta^{13}\text{C}$  results on duplicate air samples analyzed on the VG Prism before and Optima after the transition period (Sept. 2000) The mean difference (Optima -Prism) is  $-0.009 \pm 0.029$  (1 sigma). Air samples were collected in La Jolla CA.



### 3.7 N<sub>2</sub>O corrections

The presence of N<sub>2</sub>O in air samples and standards requires a correction that depends on both the abundance of N<sub>2</sub>O in the sample and standard and the ionization conditions of the Mass Spectrometer (see for example Craig and Keeling, [1963], Freidli and Seigenthaler, [1988]).

During ionization in the Mass Spectrometer, the N<sub>2</sub>O yields less mass 44 ions than an equivalent amount of CO<sub>2</sub>, due to the different fragmentation patterns in the ion source [Freidli and Seigenthaler, 1988]. The ratio of ionization efficiency, E in the source, is defined as

$$E = {}^{44}\text{I}(\text{N}_2\text{O})/{}^{44}\text{I}(\text{CO}_2) / \rho \quad (20)$$

where  $\rho$  = abundance ratio  $\text{N}_2\text{O}/\text{CO}_2$  of the sample

When pure  $\text{N}_2\text{O}$  gas is introduced as a sample and measured against pure  $\text{CO}_2$  as a reference in an IRMS, E values in a range of 0.73 to 0.75 are typically found on a variety of instruments (MAT 250, VG Micromass 903, VG SIRA 9, Micromass 603D) [Mook and Van der Hoek, 1983; Freidli and Seigenthaler, 1988, etc.].

The correction required to remove the effects of the  $\text{N}_2\text{O}$  varies with the abundance of  $\text{N}_2\text{O}$  in the sample. Empirical formulae for the  $\text{N}_2\text{O}$  correction have been presented in Mook and Van der Hoek [1983] and Bollenbacher et al., [2000]. In both studies,  $\text{CO}_2$  with varying amounts of  $\text{N}_2\text{O}$  was used to establish the relationship. The resulting equations gave nearly identical corrections [Bollenbacher et al., 2000, p. 35] and are duplicated here (Equations 11 and 12). Independently, Freidli and Seigenthaler [1988] also derived corrections based on  $\text{N}_2\text{O}-\text{CO}_2$  mixtures, finding nearly identical results as Mook and Van der Hoek, and Wahlen [Freidli and Seigenthaler, 1988, p. 131, equations 9a and 9b]. The consistent results of these independent studies support use of the  $\text{N}_2\text{O}$  correction equations developed for the VG Prism on samples measured on the Optima.

In April 2019 we obtained further evidence in support for use of the  $\text{N}_2\text{O}$  correction equations derived by M. Wahlen (eqns. 11 and 12) by analyzing mixtures of  $\text{N}_2\text{O}$  and  $\text{CO}_2$  on the Optima. High purity  $\text{N}_2\text{O}$  and  $\text{CO}_2$  with nominal  $\rho$  values of 0.0005, 0.0010, and 0.0015 were prepared (by G. Emanuel in 2006) to bracket the natural levels of  $\text{N}_2\text{O}$  and  $\text{CO}_2$  in air ( $\sim 0.00085$ ). We also analyzed aliquots of pure  $\text{CO}_2$  from the same source (also extracted in 2006-2007). Figure 11 illustrates the effect of increasing  $\text{N}_2\text{O}$  on the  $\delta^{13}\text{C}_{\text{MS}}$  values (red symbols) and the same values after adding the  $\text{N}_2\text{O}$  correction from eqn. 11 (green symbols). Values for  $\delta^{18}\text{O}_{\text{MS}}$  are shown in Figure 12, with the  $\text{N}_2\text{O}$  corrections from eqn. 12.

The relationship between ionization efficiency and source behavior may help explain some of the variations seen in our long records of daily terms (Figures 7a, 7b). Note the variations over time between the air terms, and the sea terms, which have no  $\text{N}_2\text{O}$  in the samples or standards. Dates when instrument maintenance could have influenced source ionization characteristics, such as filament changes, are indicated in the notes.

Figure 11.  $\delta^{13}\text{C}_{\text{MS}}$  of the optima readings (red symbols) indicate the expected shift to more negative values as the amount of  $\text{N}_2\text{O}$  increases. Correcting the data using the equations derived by M. Wahlen (plus symbols) (eqn. 11) results in fairly constant values that bracket  $\text{N}_2\text{O}$  values in  $\text{CO}_2$  extracted from air samples.

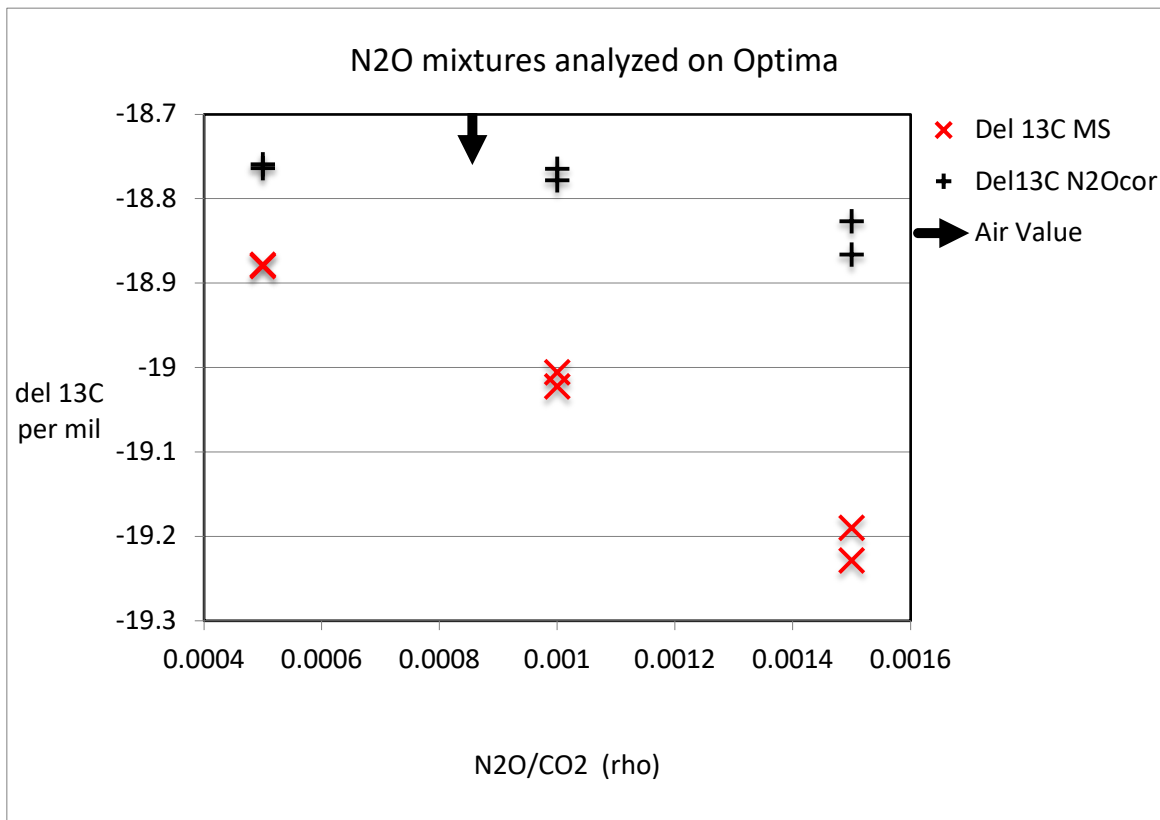
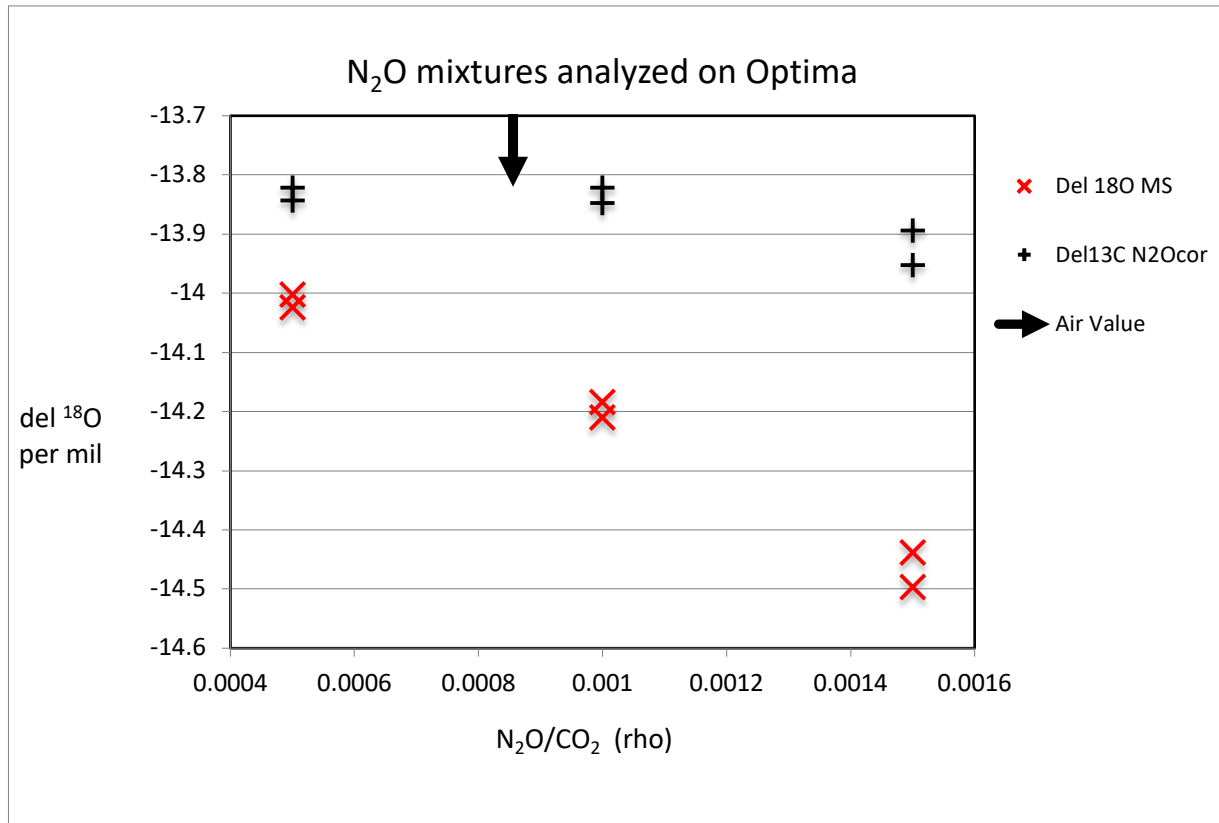

Figure 12. Same as Figure 11 except results for  $\delta^{18}\text{O}_{\text{MS}}$ .



### 3.8 Discussion of daily term drift in relation to scale contraction and N<sub>2</sub>O effects

The drift in the daily terms, shown above in Figure 7a and 7b, reflects processes that impact the apparent differences between the isotopic composition of the secondary standards and the machine standards. This drift follows similar patterns for both the seawater and air standards, but close examination of Figure 7a and 7b shows systematic variations that are different between these two categories of standards. The drift in the daily terms, whether matched or unmatched, does not directly impact measurements on air samples, because these measurements are tied on a daily basis to the secondary air standards through the use of these daily terms. Nevertheless, the origin of this differential drift between seawater and air standards, which can be as large as ~0.1 ‰ for  $\delta^{13}\text{C}$  and 0.2 ‰ for  $\delta^{18}\text{O}$ , merits further investigation, and will be addressed in a future report.



## REFERENCES

- Bollenbacher, A. F., Guenther, P. R., Keeling, C. D., Stewart, E. F., Wahlen, M. and Whorf, T. P. (2000). Calibration methodology for the Scripps  $^{13}\text{C}/^{12}\text{C}$  and  $^{18}\text{O}/^{16}\text{O}$  stable isotope program, 1992-1996. *SIO Reference Series*, No. 01-2, 2001.
- Brand, W. A., Assonov, S. S., and Coplen, T. B. Correction for the  $^{17}\text{O}$  interference in  $\delta(^{13}\text{C})$  measurements when analysing  $\text{CO}_2$  with stable isotope mass spectroscopy (IUPAC Technical Report), *Pure Appl. Chem.*, 82, 1719–1733, 2010.
- Craig, H. Isotopic standards for carbon and oxygen and correction factors for mass spectrometric analysis of carbon dioxide, *Geochim. Cosmochim. Ac.*, 12, 133–149, 1957.
- Friedli H., and Siegenthaler, U. Influence of  $\text{N}_2\text{O}$  on isotope analyses in  $\text{CO}_2$  and mass-spectrometric determination of  $\text{N}_2\text{O}$  in air samples. *Tellus*, 1988 40B, 129-133.
- Guenther, P. R., Bollenbacher, A. F., Keeling, C. D., Stewart, E. F. and Wahlen, M. Calibration methodology for the Scripps  $^{13}\text{C}/^{12}\text{C}$  and  $^{18}\text{O}/^{16}\text{O}$  stable isotope program, 1996-2000. *SIO Reference Series*, No. 01-2, 2001.
- Keeling, C. D., Piper, S.C., Whorf, T and Keeling, R.F. Evolution of natural and anthropogenic fluxes of atmospheric  $\text{CO}_2$  from 1957 to 2003. *Tellus B: Chemical and Physical Meteorology*, Volume 63, 2011 - Issue 1.
- Keeling, Ralph F., Heather D. Graven, Lisa R. Welp, Laure Resplandy, Jian Bi, Stephen C. Piper, Ying Sun, Alane Bollenbacher, and Harro A. J. Meijer. Atmospheric evidence for a global secular increase in carbon isotopic discrimination of land photosynthesis. *Proceedings of the National Academy of Sciences of the United States of America*, September 26, 2017 114 (39) 10361-10366
- Wendeberg, M., J. M. Richter, M. Rothe and W. A. Brand (2013). "Jena Reference Air Set (JRAS): a multi-point scale anchor for isotope measurements of  $\text{CO}_2$  in air." *Atmospheric Measurement Techniques*, 6(3): 817-822.
- Mook, W. G. and van der Hoek, S. 1983. The  $\text{N}_2\text{O}$  correction in the carbon and oxygen isotopic analysis of atmospheric  $\text{CO}_2$ . *Isot. Geosci.* 1. 237-242.
- Francey, R. J. and Goodman, H. S. 1986. Systematic error in, and selection of, in situ  $\delta^{13}\text{C}$ . *Baseline Atmospheric Program (Australia) 1983-1984* (eds. R. J. Francey and B. W. Forgan), Australian Department of Science, 27-36.
- Craig, H. and Keeling, C. D., 1963. The effects of atmospheric  $\text{N}_2\text{O}$  on the measured isotopic composition of atmospheric  $\text{CO}_2$ . *Geochim. Cosmochim. Acta* 27, 549-551.
- Mook, W. G. and Jongsma, J. 1987. Measurement of the  $\text{N}_2\text{O}$  correction for  $^{13}\text{C}/^{12}\text{C}$  ratios of atmospheric  $\text{CO}_2$  by the removal of  $\text{N}_2\text{O}$ . *Tellus* 39B. 9699.
- Hall, B.D., G.S. Dutton, and J.W. Elkins (2007), **The NOAA nitrous oxide standard scale for atmospheric observations**, *J. Geophys. Res.*, 112, D09305, doi:10.1029/2006JD007954.

## **Appendix A. Mass spectrometer operation**

### **A.1 Introduction of machine standards and zero enrichment analysis.**

Figure A1 shows a diagram of the Optima inlet system, which is essentially identical to the Prism inlet system. Controlled amounts of the machine standards are introduced into the mass spectrometer using sequential opening and closing of valves or stopcocks, first allowing CO<sub>2</sub> to expand from the source container into a (evacuated) intermediate volume, and then from the intermediate volume into the mass spectrometer bellows. Several minutes are allowed after each expansion for the gas to “equilibrate”. During the transfer, the sample and reference sides of the mass spectrometer are left open to each other. After the transfer the bellows are alternately expanded and compressed three times to mix the gas thoroughly and then parked (fully expanded).

Sample and reference differences are then analyzed on the mass spectrometer, thus establishing the “zero enrichment”. These analyses are typically performed after closing the bellows to each other, adjusting each to obtain a current of ~10 nA on mass 44, and then closing valves RV and SV (Figure A1). This zero enrichment result is not used for data reduction, but simply as a diagnostic to assure that the mass spectrometer is operating properly.

After the zero enrichment measurements, the reference side is closed off, and the sample side evacuated. The reference bellows is refilled (as above) at least once a month, or at the point where 25% of the gas is remaining. Otherwise the gas in the reference bellows is reused from one analysis day to the next.

### **A.2 Analysis of samples or secondary standards**

Flame-off tubes containing samples or standards are inserted into a “cracker” which is mounted to the sample inlet at SI. The cracker consists of a ½” bendable metal bellows which is connected to inlet SI through a fitting containing a metal frit, which prevents glass fragments from entering the mass spectrometer. After evacuating the cracker, the flame-off tube is broken, allowing the CO<sub>2</sub> to expand into the fully expanded sample bellows through SI. The sample bellows is then contracted and expanded once to mix the gas. The changeover valve is then toggled to allow gas from each side into the source, and both bellows adjusted to achieve ~10nA at mass 44 for both sample and reference. Once balanced this way, valves RV and SV are closed and the run is initiated. After the run is completed (and results printed out) a second run can be made, again balancing and closing RV and SV. All samples and standards are typically run twice this way. These second runs are known as “reruns”. To reduce run time, single runs are sometimes performed when the previous fill of the sample bellows involved a nominally identical sample, thus reducing potential for memory artifacts.

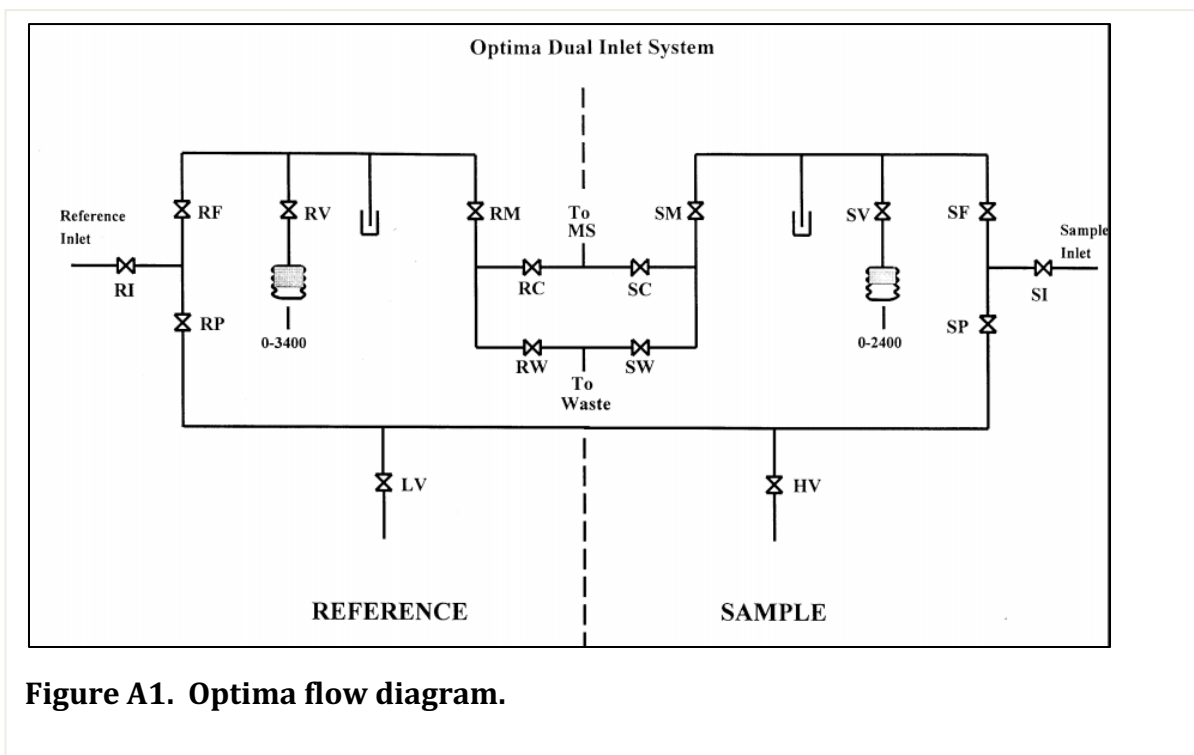

**Figure A1. Optima flow diagram.**

The CO<sub>2</sub> Data Acquisition Control Parameter file is typically set up with the number of comparisons between reference and sample equal to 12, a changeover delay of 15 seconds, and an integration time of 20 seconds. The total analysis time for an unknown (or standard) is about 7 minutes. This same configuration was used on both the Prism and Optima.

The daily analysis sequence for atmospheric samples typically starts with running one of ten secondary air standards. Atmospheric samples are then run, and the daily sequence ends with a second standard. The choice of standards is arbitrary but typically follows a pattern to progressively cycle through all ten secondary standards over sequential analysis days.

The mass spec output is manually transcribed to data table (MS Access). The Craig-corrected values of all runs (including repeats) are transcribed. If a rerun is performed, the first run is flagged such that only the second run (i.e. the rerun) is accepted. This method was adopted out of concern that the first run might be biased due to memory effects from the previous sample. The rerun information is available as a diagnostic of performance. This transcription method has been applied uniformly since 1992 on both the Prism and Optima, and applies to both samples and standards.

The residual CO<sub>2</sub> in the bellows is typically discarded after analysis. An exception has been for samples from special campaigns (e.g. HIPPO, ATOM) for which the residual sample was recovered by freezing back into flame-off tubes. This method, which also entails replacing the sample bellows with a custom piston system, is described below (Appendix A.3).

The procedure of closing RV and SV during the run is somewhat unconventional and bears comment. This method was established by Prof. M. Wahlen for the operation on the Prism and has been used uniformly also on the Optima. The method isolates the CO<sub>2</sub> in the bellows from the impact of fractionation by the inlet capillary, thus enabling a rerun with a nominally identical

starting point. The method also reduces the impact of unequal reservoir volumes on the extent of fractionation.

### A.3 Freeze-Back Method for capturing residual CO<sub>2</sub> for future <sup>14</sup>C analyses

In order to preserve CO<sub>2</sub> samples for follow-on analysis (e.g. <sup>14</sup>C), we implemented a procedure for freezing back samples after analysis on the Optima. This method was particularly used for aircraft or specialized research campaigns (HIPPO, ORCAS, ATOM, CMS, etc.) where the volume of CO<sub>2</sub> was also smaller than that obtained from the normal 5-liter flasks.

An important test for this method is the ability to freeze back a sample and then reintroduce it into the mass spectrometer without significant isotopic offsets. Early work showed that this was not possible using the normal sample bellows. This difficulty was overcome using a custom inlet system, detailed in Figure A2. The resulting method is called the “Freeze-Back” method.

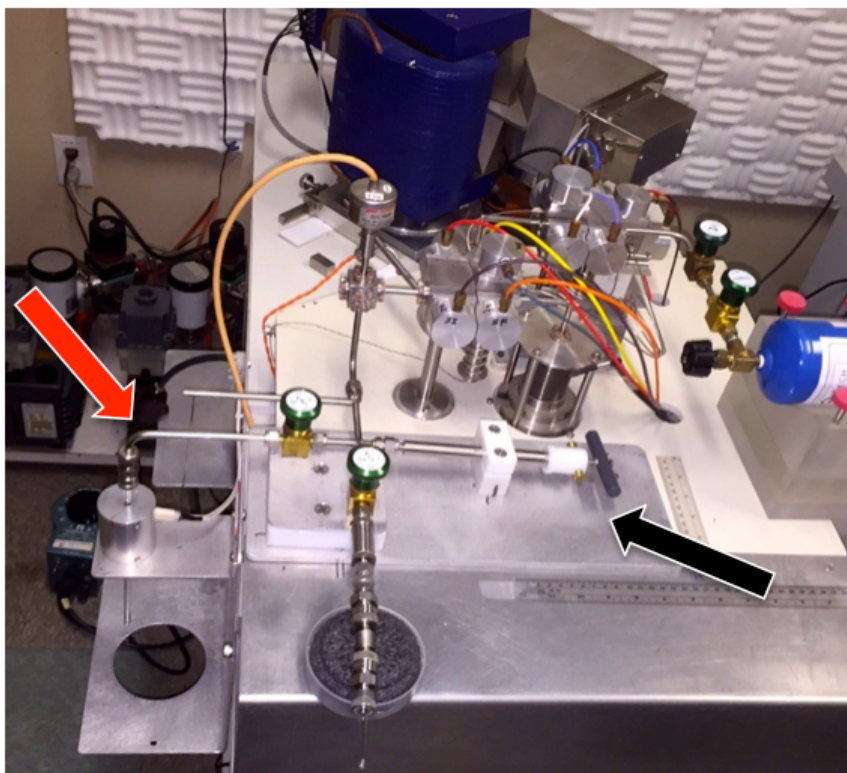

Figure A2. Photograph of Optima with “freeze-back” plumbing. The plunger that serves to adjust the pressure of the sample in place of the bellows is indicated by the black arrow. The connection to the “freeze back” tube is indicated by the red arrow.

After the sample flame-off tube is cracked, the sample is introduced into a cold finger immersed in liquid nitrogen at -198 °C for 90 sec. to completely collect the CO<sub>2</sub> in the finger. The valve to the cracker is then closed and the finger is warmed, allowing the CO<sub>2</sub> to expand into a chamber affixed with a piston plunger. After allowing the CO<sub>2</sub> to equilibrate in the chamber for 150 sec., the plunger is pushed in until the sample pressure gives a response which matches the reference

bellows pressure, typically 10 nA, but sometimes less depending on the sample size. If necessary the reference bellows is adjusted downwards to match the sample pressure. Valves SF and SI are closed, isolating the remaining CO<sub>2</sub> in the chamber from the mass spectrometer, and the sample gas is analyzed in the usual fashion. While the mass spectrometer run is progressing, the remaining CO<sub>2</sub> in the chamber is collected into a new glass tube (Figure A2, red arrow) by immersing the tube in liquid N<sub>2</sub> and opening the FOT valve. After allowing 90 seconds for the transfer, a quartz heater is activated to seal the sample into the tube.

The “freeze-back” method was tested for fractionation by re-analyzing the  $\delta^{13}\text{C}$ , and  $\delta^{18}\text{O}$  of the recovered samples at a later date on the Optima. The results of 118 freeze-back tests (Table A2) are consistent with minimal fractionation during the transfer process.

**Table A2.** Freeze Back method statistics

	$\delta^{13}\text{C} \text{ ‰}$	$\delta^{18}\text{O} \text{ ‰}$
n (tests)	118	118
Average	-0.005	-0.036
Std. deviation	0.031	0.137

## Appendix B. Supplemental Tables and Figures

**Table B1.** Secondary standard cylinder extractions and remaining archived samples (as of May 2018).

Cylinder Set	Cylinder I.D.	# of extractions as of May2018	# remaining to analyze as of May2018
Set 1	39382	539	41
Set 1	75635	535	40
Set 1	75859	531	32
Set 2	2407	727	83
Set 2	39414	727	92
Set 2	96364	722	71
Set 3	7362	353	131
Set 3	6081	352	133
Set 3	1008	355	128
JRAC2	769224	642	86

**Table B2.** Standard cylinder characteristics

Tank ID#	Manu- facturer	Cyl. Mat.	Vol. (l)	Capacity (SCF)	Valve	Valve connection	Fill Date
Set 1							
39382	COYNE	Steel	43	200	Brass	Pipe	16-Mar-91
75635	COYNE	Steel	43	200	Brass	Pipe	16-Mar-91
75859	COYNE	Steel	43	200	Brass	Pipe	16-Mar-91
Set 2							
2407	COYNE	Steel	43	200	Brass	Pipe	27-Jun-96
39414	COYNE	Steel	43	200	Brass	Pipe	23-Nov-90
96364	COYNE	Steel	43	200	Brass	Pipe	5-Sep-96
Set 3							
7362	COYNE	Steel	43	200	Brass	Pipe	9-Sep-99
6081	COYNE	Steel	43	200	Brass	Pipe	9-Sep-99
1008	COYNE	Steel	43	200	Brass	Pipe	9-Sep-99
JRAC							
769224	Luxfor	Al	50	300	Brass	Pipe	9-Dec-10

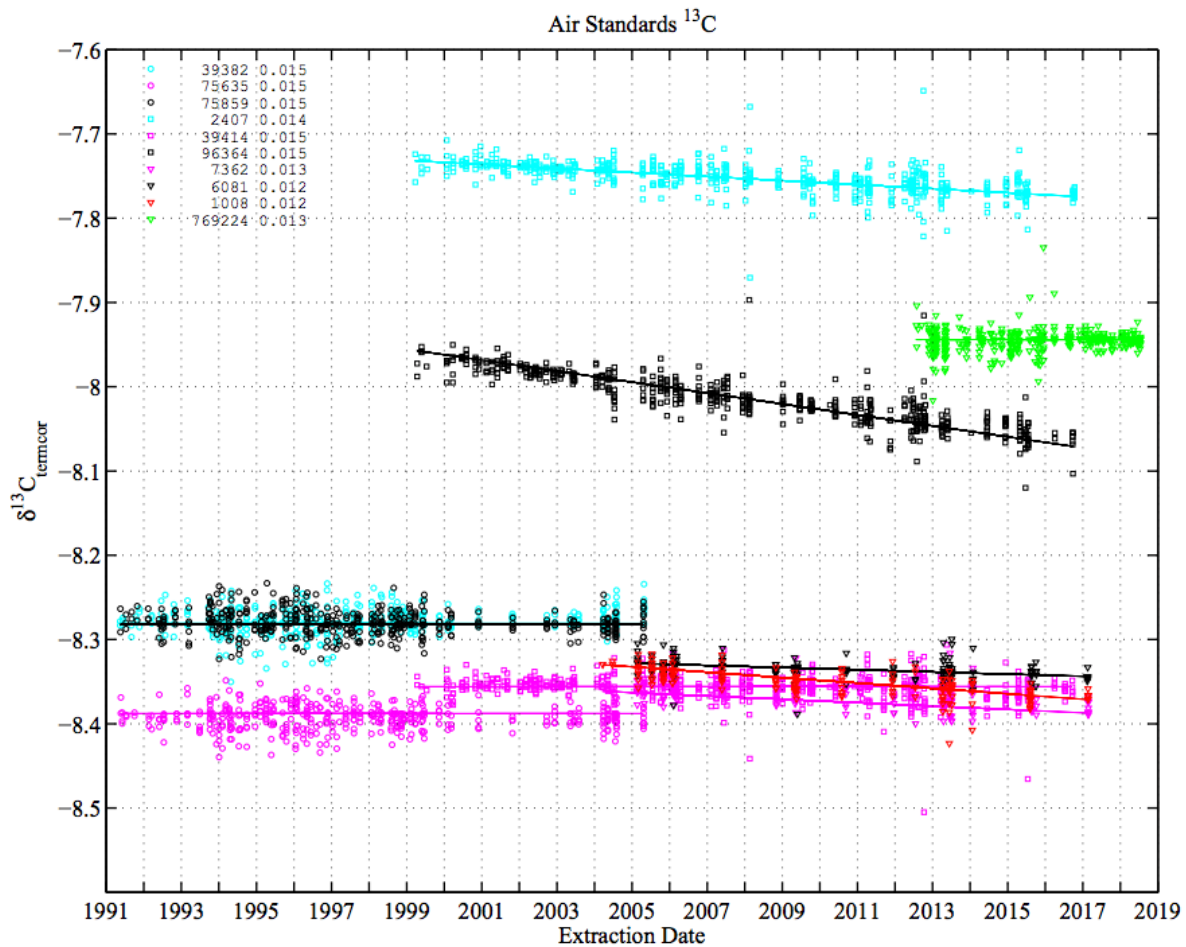

Figure B1a. Plot showing every analysis of the atmospheric standards indicating the individual  $\delta^{13}\text{C}_{\text{termincor}}$  values for each standard (eqn. 9 in text), as well as the time frame of their usage. The figure indicates how well the daily standard results track the assigned values based on the linear fits, with the drift rates indicated by the lines. The original 3 standards (Set #1, circles) were used on the Prism, and then were overlapped with the new Set #2 standards (squares) upon switching to the Optima in August 2000. Use of Set #3 standards, as well as the Jena JRAC2 standard (triangles) began in early 2013. Values shown are NBS-corrected  $\delta^{13}\text{C}$  measurements of natural-air (“atmospheric”) secondary standards stored in high-pressure gas cylinders.  $\text{N}_2\text{O}$  correction and CIO/SIO offset have not been applied to this data. The table (top left) indicates the precision of analyses, in per mil, for each standard. (1 sigma).

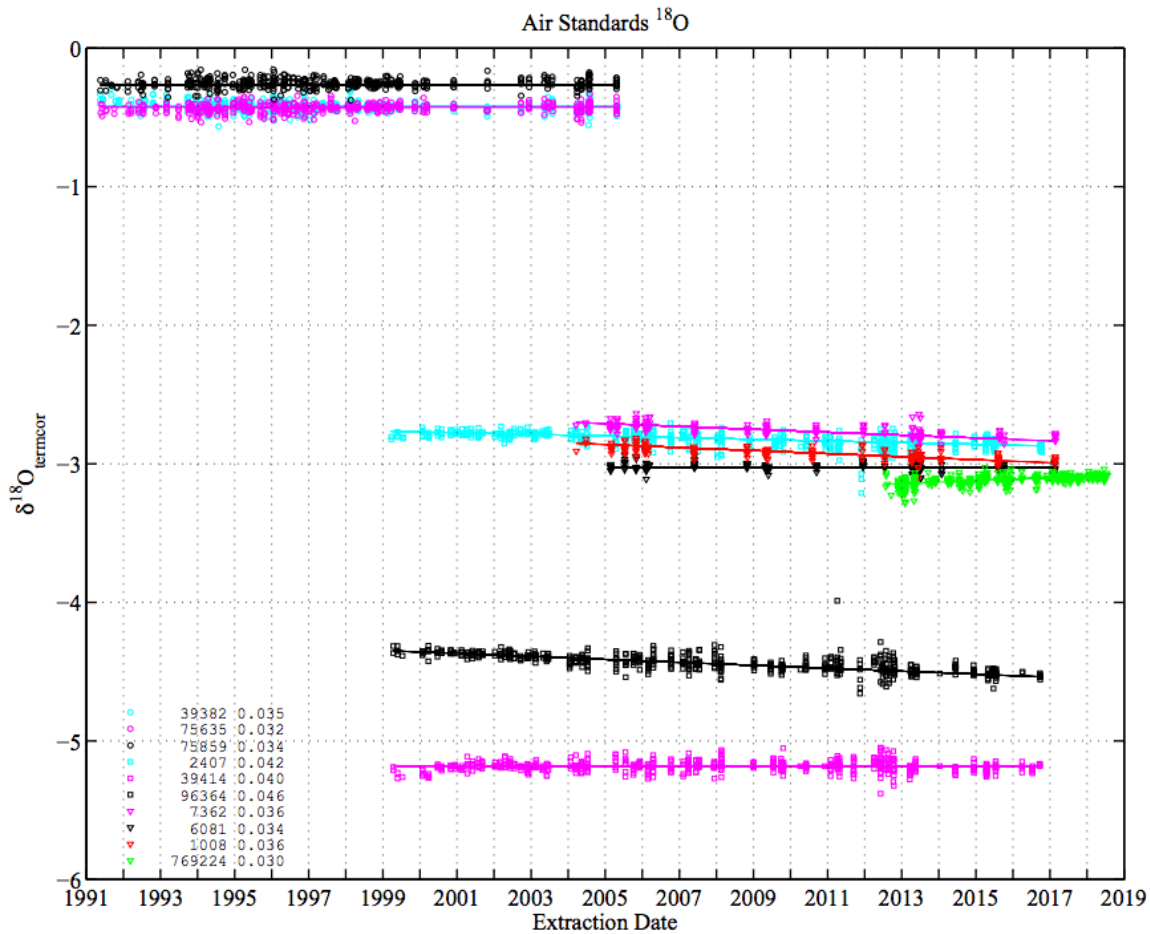

Figure B1b. Plot showing every analysis of the atmospheric standards indicating the individual  $\delta^{18}\text{O}_{\text{termincor}}$  values for each standard (eqn. 10 in text), as well as the time frame of their usage. The figure indicates how well the daily standard results track the assigned values based on the linear fits, with the drift rates indicated by the lines. The original 3 standards (Set #1, circles) were used on the Prism, and then were overlapped with the new Set #2 standards (squares) upon switching to the Optima in August 2000. Use of Set #3 standards, as well as the Jena JRAC2 standard (triangles) began in early 2013. NBS-corrected  $\delta^{18}\text{O}$  measurements of natural-air (“atmospheric”) secondary standards stored in high-pressure gas cylinders.  $\text{N}_2\text{O}$  correction and  $\text{ClO}/\text{SiO}$  offset have not been applied to this data. The table (bottom left) indicates the precision of analyses, in per mil, for each standard. (1 sigma).



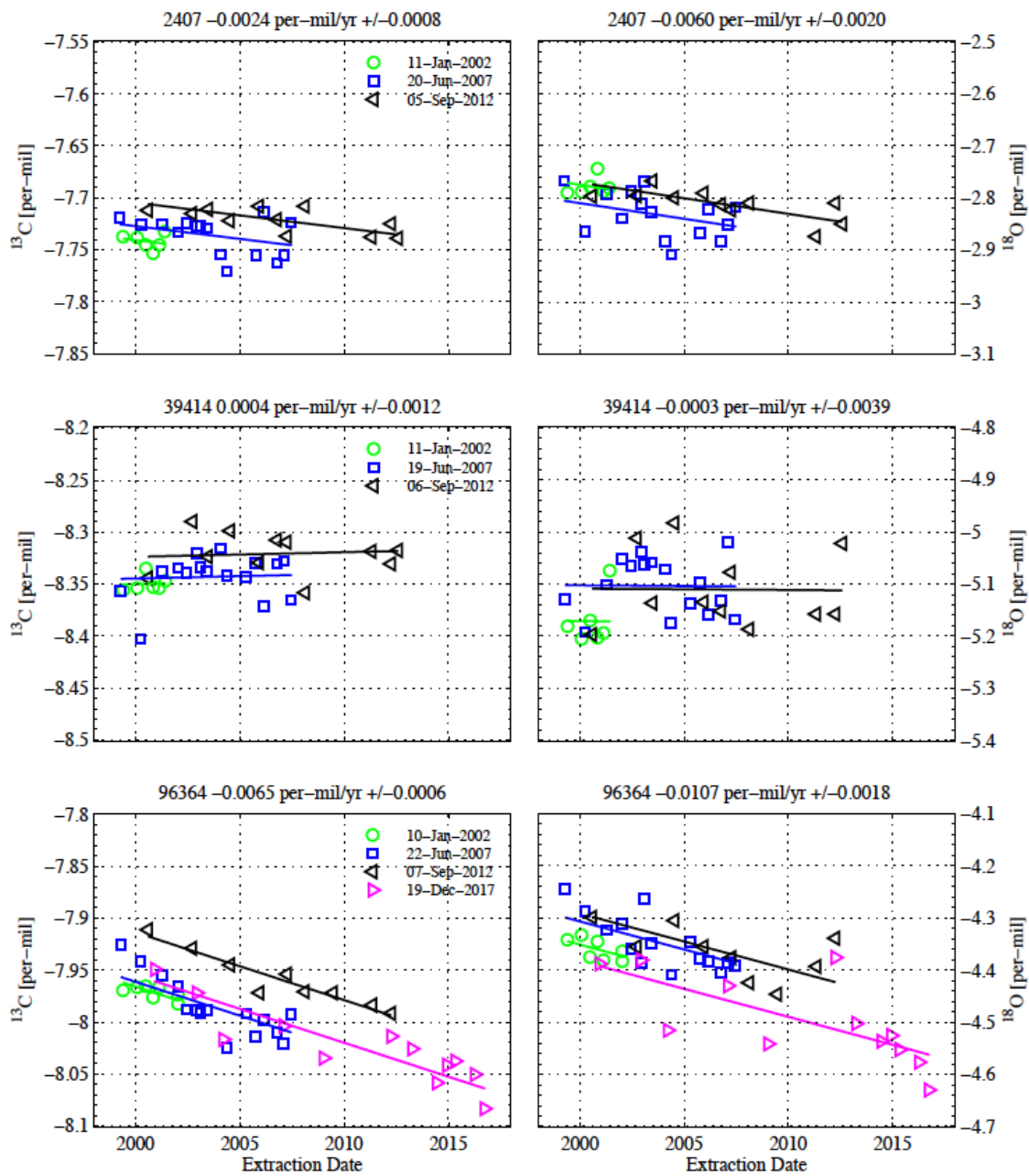

Figure B2a. Drift rates observed from archive studies on Set 2 cylinders. Slopes fit as a common value independent of daily  $\delta^{13}\text{C}$  (or  $\delta^{18}\text{O}$ ) values. Values shown are for  $\delta^{13}\text{C}_{\text{termcorr}}$  and  $\delta^{18}\text{O}_{\text{termcorr}}$ . Results for 96364 are also shown in Figure 4 of the text.

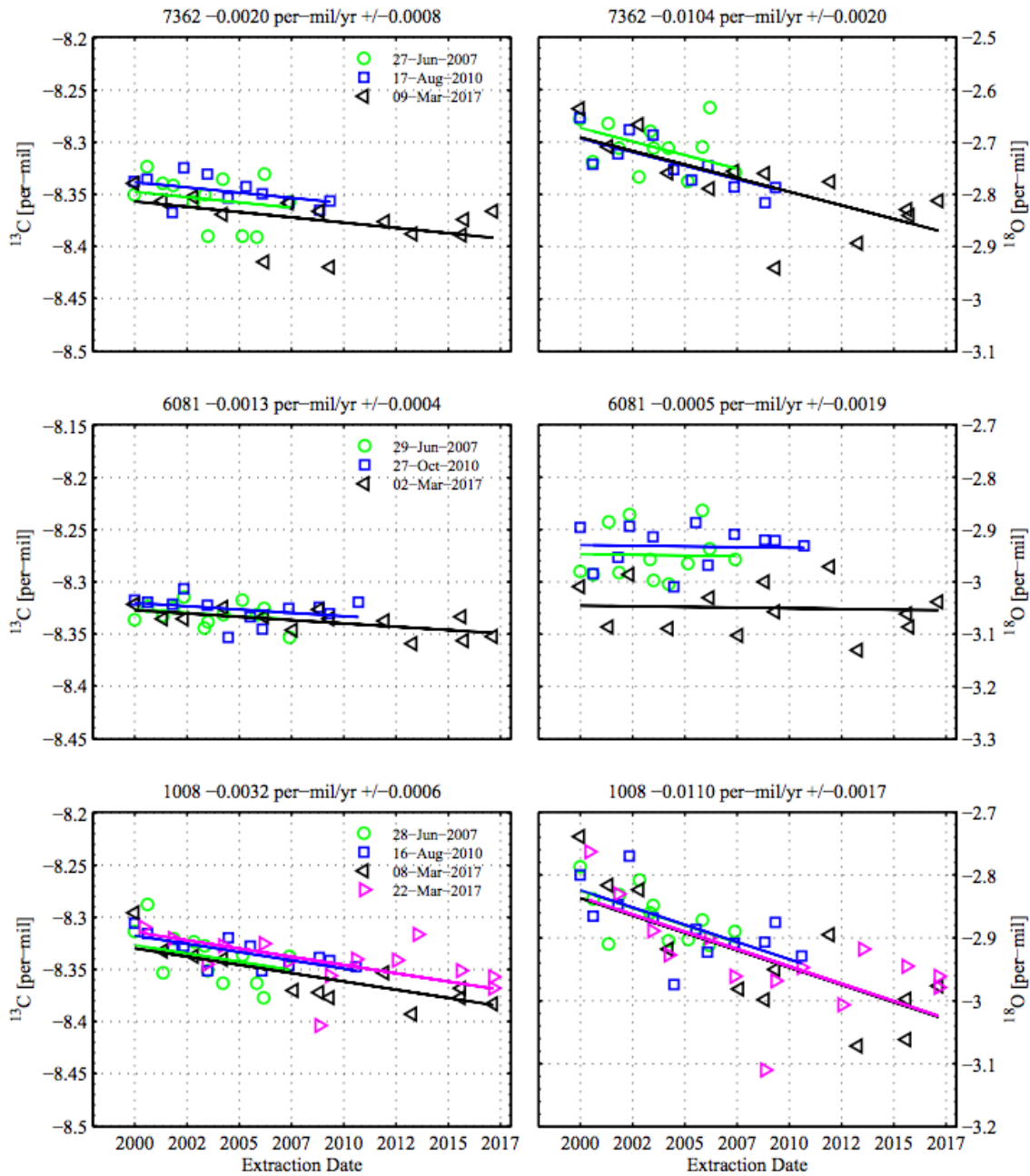

Figure B2b. Drift rates observed from archive studies on Set 3 cylinders. Slopes fit as a common value independent of daily  $\delta^{13}\text{C}$  (or  $\delta^{18}\text{O}$ ) values. Values shows are for  $\delta^{13}\text{C}_{\text{termcorr}}$  and  $\delta^{18}\text{O}_{\text{termcorr}}$ .

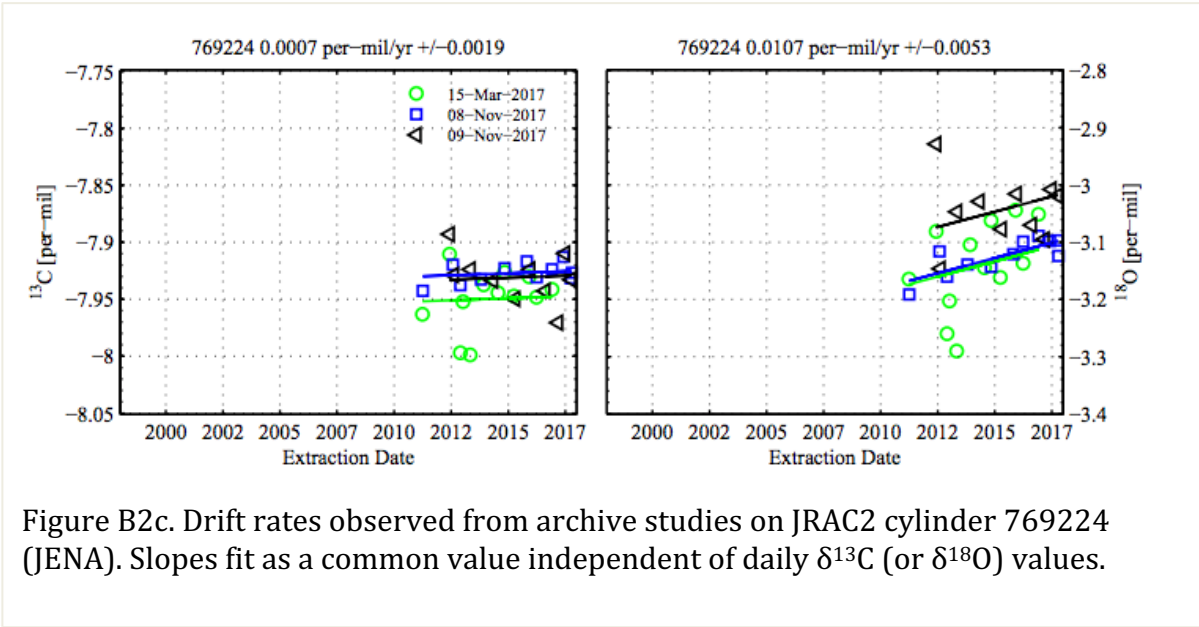

Figure B2c. Drift rates observed from archive studies on JRAC2 cylinder 769224 (JENA). Slopes fit as a common value independent of daily  $\delta^{13}\text{C}$  (or  $\delta^{18}\text{O}$ ) values.

Assigned using: 75635 75859 39382

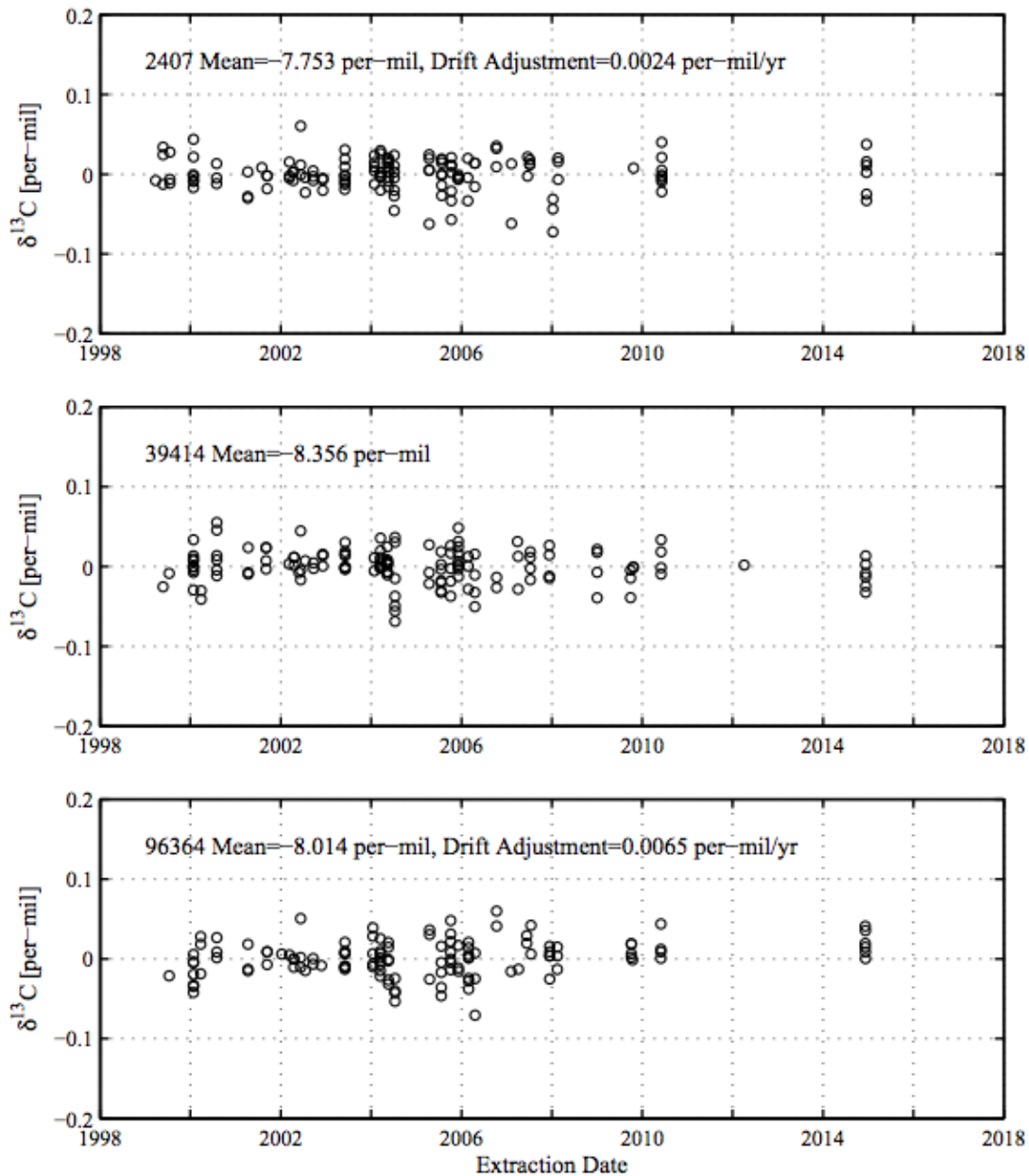

Figure B3a. Drift-corrected measurements of  $\delta^{13}\text{C}_{\text{termcorr}}$  for Set 2 standards from dates when Set 1 standards were used to define the daily terms. Individual values are drift-corrected to January 1, 2008.

Assigned using: 75635 75859 39382

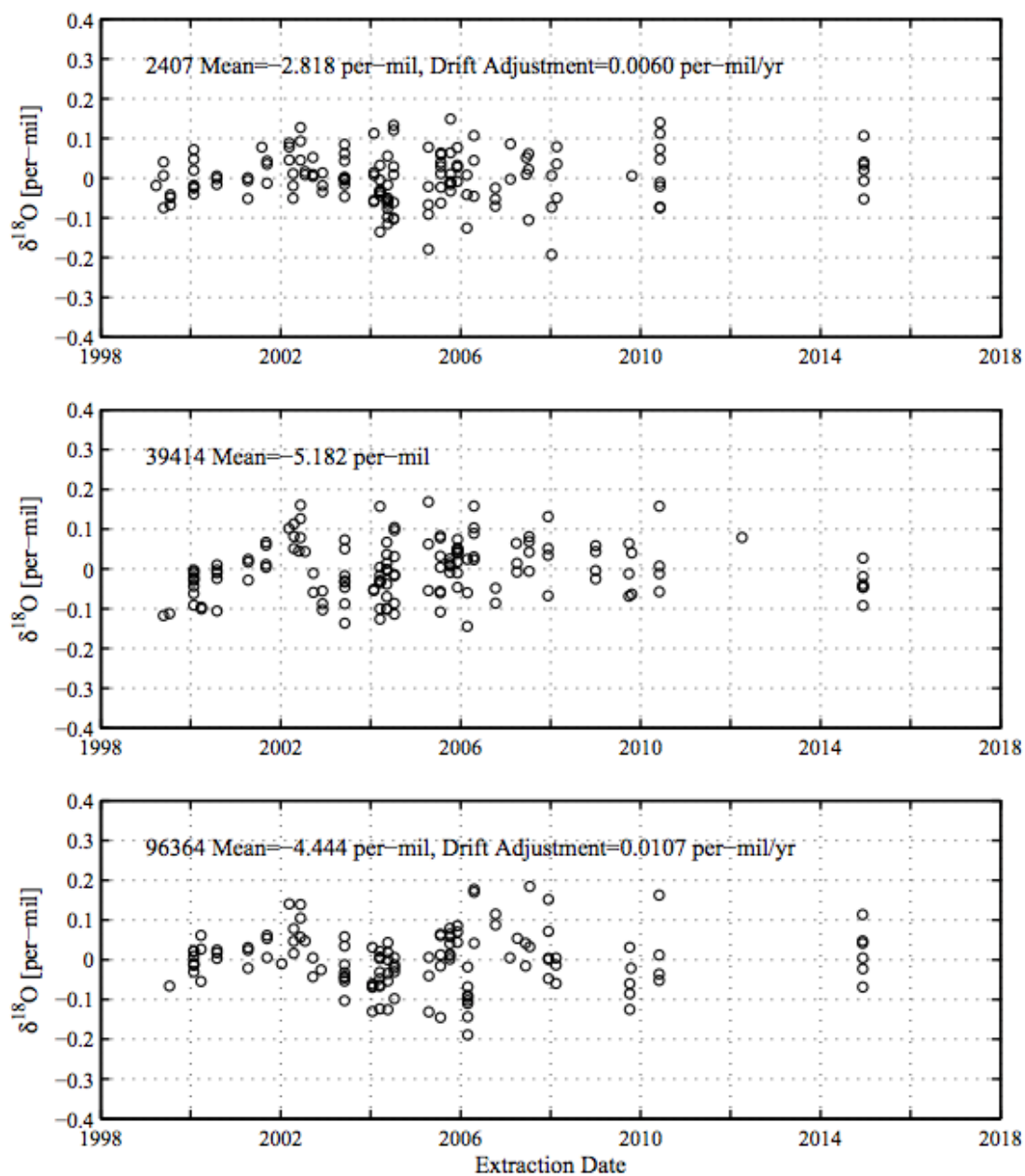

Figure B3b. Drift-corrected measurements of  $\delta^{18}\text{O}_{\text{termcorr}}$  for Set 2 standards from dates when Set 1 standards were used to define the daily terms. Individual values are drift-corrected to January 1, 2008.

Assigned using: 75635 75859 39382 2407 39414 96364

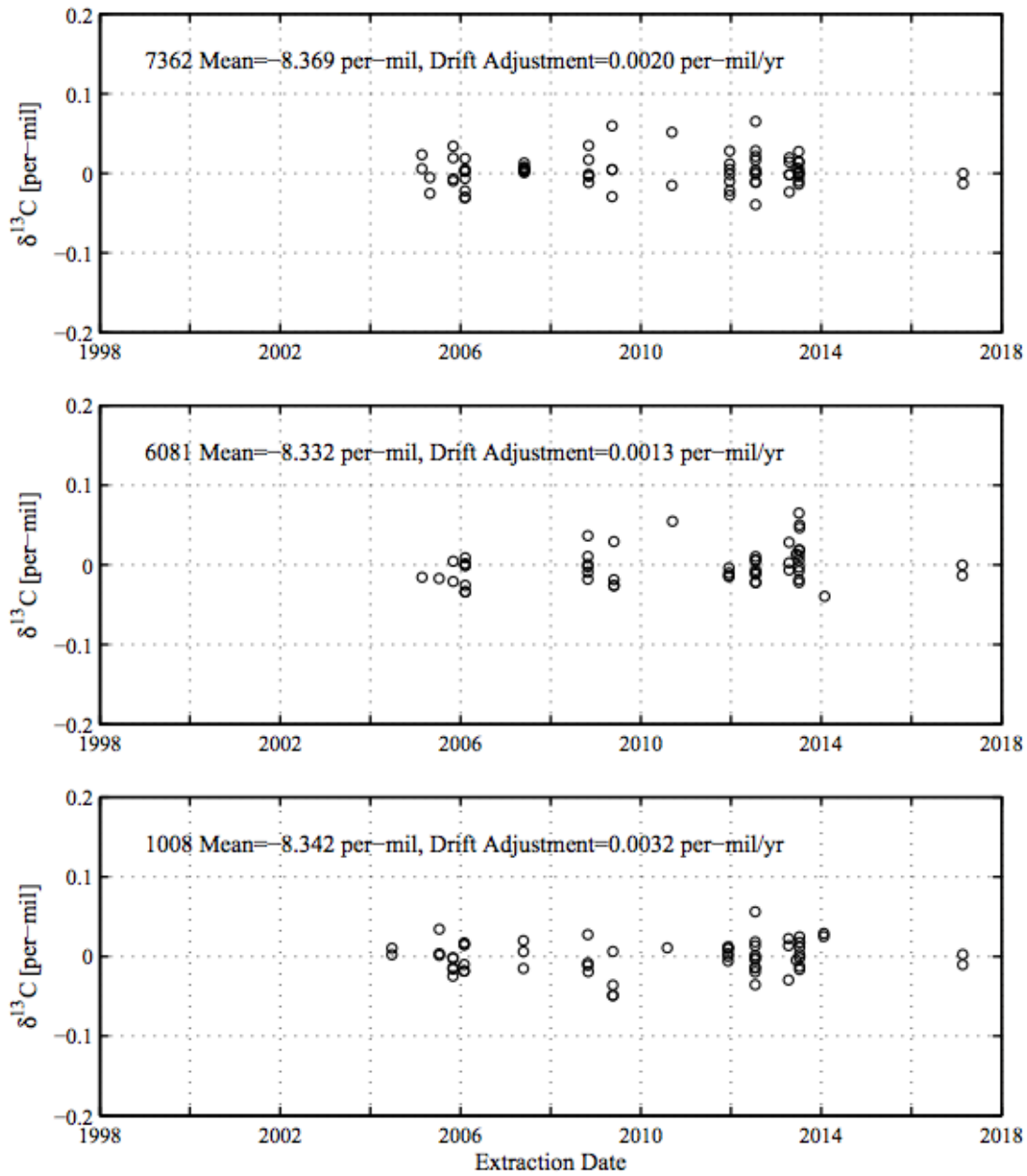

Figure B3c. Drift-corrected measurements of  $\delta^{13}\text{C}_{\text{termcorr}}$  for Set 3 standards from dates when Set 1 standards were used to define the daily terms. Individual values are drift-corrected to January 1, 2008.

Assigned using: 75635 75859 39382 2407 39414 96364

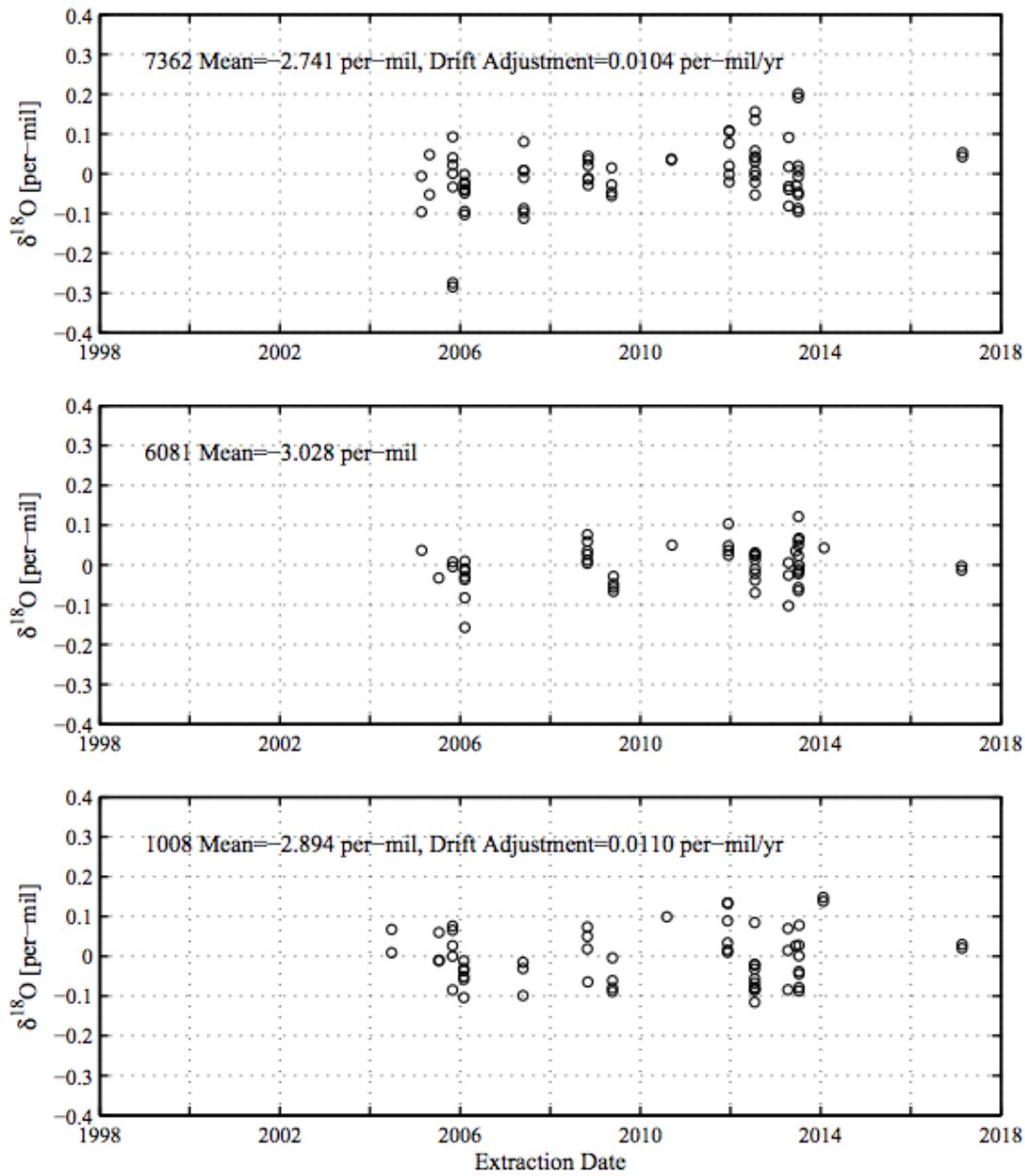

Figure B3d. Drift-corrected measurements of  $\delta^{18}\text{O}_{\text{termcorr}}$  for Set 3 standards from dates when Set 1 standards were used to define the daily terms. Individual values are drift-corrected to January 1, 2008.

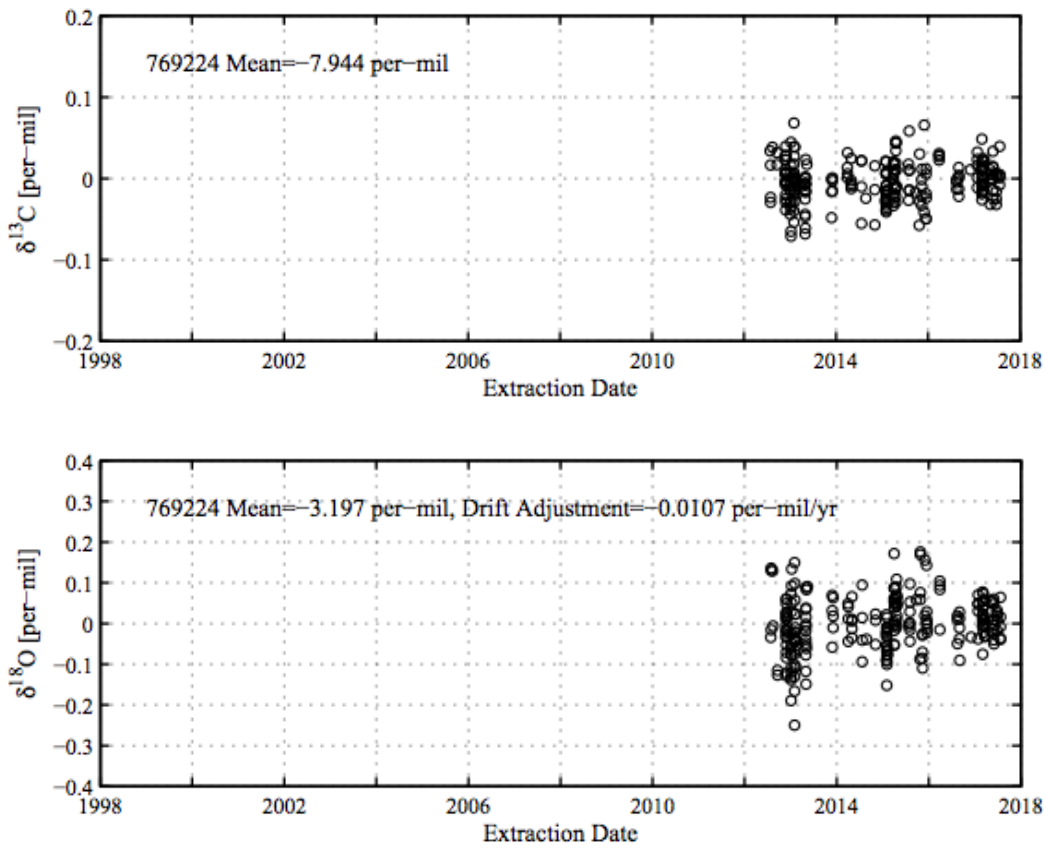

Figure B3e. Drift-corrected measurements of  $\delta^{13}\text{C}_{\text{termcorr}}$  and  $\delta^{18}\text{O}_{\text{termcorr}}$  for JRAC2 cylinder (ID 769224) from dates when Set 2 and/or Set 3 standards were used to define the daily terms. Individual values are drift-corrected to January 1, 2008.