



**CALIFORNIA  
ENERGY COMMISSION**



**CALIFORNIA  
natural  
resources  
AGENCY**

Energy Research and Development Division

## **FINAL PROJECT REPORT**

# **Open-Source, Open- Architecture Software Platform for Plug-In Electric Vehicle Smart Charging in California**

**Gavin Newsom, Governor  
March 2020 | CEC-500-2020-005**

**PREPARED BY:**

**Primary Authors:**

Timothy Lipman, PhD (PI)  
Duncan Callaway, PhD (Co-PI)  
Gabriel Fierro  
Mahdi Ghamkhari, PhD  
Mingxi Liu, PhD  
Alexandra von Meier, PhD

Scott Moura, PhD  
Therese Peffer, PhD  
Phillippe Phanivong  
Elizabeth Ratnam, PhD  
Julia Szinai

University of California – Berkeley, Transportation Sustainability Research Center  
2150 Allston Way, #280  
Berkeley, CA 94704  
510-642-4501  
tsrc.berkeley.edu

**Contract Number:** EPC-15-013

**PREPARED FOR:**

California Energy Commission

Matthew Fung, P.E.

**Project Manager**

Jonah Steinbuck, Ph.D.

**Office Manager**

**ENERGY GENERATION RESEARCH OFFICE**

Laurie ten Hope

**Deputy Director**

**ENERGY RESEARCH AND DEVELOPMENT DIVISION**

Drew Bohan

**Executive Director**

**DISCLAIMER**

This report was prepared as the result of work sponsored by the California Energy Commission. It does not necessarily represent the views of the Energy Commission, its employees or the State of California. The Energy Commission, the State of California, its employees, contractors and subcontractors make no warranty, express or implied, and assume no legal liability for the information in this report; nor does any party represent that the uses of this information will not infringe upon privately owned rights. This report has not been approved or disapproved by the California Energy Commission nor has the California Energy Commission passed upon the accuracy or adequacy of the information in this report.

## **ACKNOWLEDGEMENTS**

The XBOS-V project team thanks Matthew Fung for serving as Commission Agreement Manager for this project. The team also thanks BMW North America LLC and specifically Adam Langton, Alissa Harrington, and Michelle Bogen for their partnership in the project. The project team additionally thanks the project Technical Advisory Committee members who were very helpful in providing advice and helping disseminate project outcomes during the project.

## PREFACE

The California Energy Commission's Energy Research and Development Division supports energy research and development programs to spur innovation in energy efficiency, renewable energy and advanced clean generation, energy-related environmental protection, energy transmission and distribution and transportation.

In 2012, the Electric Program Investment Charge (EPIC) was established by the California Public Utilities Commission to fund public investments in research to create and advance new energy solutions, foster regional innovation and bring ideas from the lab to the marketplace. The California Energy Commission and the state's three largest investor-owned utilities—Pacific Gas and Electric Company, San Diego Gas & Electric Company and Southern California Edison Company—were selected to administer the EPIC funds and advance novel technologies, tools, and strategies that provide benefits to their electric ratepayers.

The Energy Commission is committed to ensuring public participation in its research and development programs that promote greater reliability, lower costs, and increase safety for the California electric ratepayer and include:

- Providing societal benefits.
- Reducing greenhouse gas emission in the electricity sector at the lowest possible cost.
- Supporting California's loading order to meet energy needs first with energy efficiency and demand response, next with renewable energy (distributed generation and utility scale), and finally with clean, conventional electricity supply.
- Supporting low-emission vehicles and transportation.
- Providing economic development.
- Using ratepayer funds efficiently.

*Open-Source, Open-Architecture Software Platform for Plug-In Electric Vehicle Smart Charging in California* is the final report for the Open-Source, Open-Architecture Software Platform For Plug-In Electric Vehicle Smart Charging in California Residential and Small Commercial Settings (XBOS-V) project (Contract Number EPC-15-013) conducted by the Transportation Sustainability Research Center at the University of California, Berkeley. The information from this project contributes to the Energy Research and Development Division's EPIC Program.

For more information about the Energy Research and Development Division, please visit the [Energy Commission's research website](http://www.energy.ca.gov/research/) (www.energy.ca.gov/research/) or contact the Energy Commission at 916-327-1551.

## ABSTRACT

This interdisciplinary eXtensible Building Operating System–Vehicles project focuses on controlling plug-in electric vehicle charging at residential and small commercial settings using a novel and flexible open-source, open-architecture charge communication and control platform. The platform provides smart charging functionalities and benefits to the utility, homes, and businesses.

This project investigates four important areas of vehicle-grid integration research, integrating technical as well as social and behavioral dimensions: smart charging user needs assessment, advanced load control platform development and testing, smart charging impacts, benefits to the power grid, and smart charging ratepayer benefits.

The key results of the project include developing a better understanding of the vehicle-grid integration adoption barriers among two key stakeholder groups: plug-in electric vehicle drivers and building energy managers. The project team developed a novel, open-source hardware and software integration solution for power level control of Level 1 and Level 2 plug-in electric vehicle chargers, along with algorithms for managing plug-in electric vehicle charging in response to changes in local building loads. The project team demonstrated that vehicle-grid integration offers the potential to alleviate congestion at the utility grid distribution level, helping reduce the potential for voltage excursions (voltage levels outside of specified limits) when many plug-in electric vehicles are charging on the same utility distribution feeder.

The project team analyzed the California grid in 2024 and 2030 and found that vehicle-grid integration can enable better use of renewable energy in California. Vehicle-grid integration, enabled through systems such as the platform developed in this project, can potentially mitigate up to 500 gigawatt hours of renewable electricity curtailment in 2024 and about 2 terawatt-hours by 2030, offering overall grid operation and electricity ratepayer benefits as well as reductions in greenhouse gas and air pollutant emissions.

**Keywords:** electric vehicle, vehicle-grid integration, battery storage, utility grid, customer acceptance

Please use the following citation for this report:

Lipman, Timothy (TSRC, University of California, Berkeley). 2020. *Open-Source, Open-Architecture Software Platform for Plug-In Electric Vehicle Smart Charging in California*. California Energy Commission. Publication number: CEC-500-2020-005.

# TABLE OF CONTENTS

	Page
ACKNOWLEDGEMENTS.....	i
PREFACE .....	ii
ABSTRACT .....	iii
EXECUTIVE SUMMARY .....	1
Introduction .....	1
Project Purpose .....	2
Project Approach .....	2
Project Results .....	3
Sharing Technology and Information .....	5
Benefits to California .....	6
CHAPTER 1: Introduction .....	9
Introduction and Background .....	9
Project Background .....	11
Project Technical Tasks and Goals .....	12
CHAPTER 2: Project Approach .....	13
Task 2: PEV Smart Charging User Needs Assessment .....	14
Focus Groups – Phase I Logistics.....	14
Focus Groups – Phase II Logistics .....	15
Focus Groups – Execution and Follow Up .....	15
Building Energy Manager Interviews .....	15
Task 3: XBOS-V Module Scoping, Development, and Testing.....	15
BOSSWAVE – The Communication Channel .....	16
Current State of XBOS-V Implementation .....	17
Approach for XBOS-V Development and Implementation .....	18
Task 4: Distribution-Level Utility Power Grid Impacts and Benefits Analysis of PEV Smart Charging Using XBOS-V .....	20
Task Overview .....	20
Overview of PEV Power Quality and Delivery Issues for Utility Grid Systems Management.....	20

Transmission System Impacts .....	20
Distribution Level Power Quality Impacts of PEVs .....	21
PEV Effects on Voltage Profiles .....	21
PEVs and Overcurrent Conditions .....	22
PEV Effects on Power Quality .....	23
Volt-VAR Optimization.....	23
Future Charging Technology .....	24
Strategies for Addressing PEV Power Quality/Delivery Issues for Utility Grid Management.....	24
Vehicle to Grid Integration Communication Standards.....	25
Functional Specifications for PEV Charge Management for Grid Distribution System Level Impact Mitigation: Data Needs .....	26
Thermal Limit Constraints .....	27
Voltage Magnitude Constraints .....	28
Power Quality Constraints .....	29
Data Needs and Control Paradigms.....	30
Distribution Level Power Flow Algorithms.....	31
Task 5 Project Activity Approach: Analysis and Forecast of Ratepayer Benefits of PEV Smart Charging in California .....	32
CHAPTER 3: Project Results.....	34
Task 2 Project Activity Results: VGI User-Needs Assessment.....	34
Focus Group Findings .....	34
Focus Groups - Summary of Findings.....	41
Building Energy Manager Interview Findings .....	42
Task 2 - Conclusions.....	43
Task 3 Project Activity Results: XBOS-V Module Scoping, Development, and Testing 43	
VGI Test-Bed and XBOS Platform Installation at the Berkeley Global Campus .....	44
Implementation of XBOS and XBOS-V Capability at the UC Berkeley Global Campus .....	45
Software Beta Testing and Drivers for Electric Vehicle Service Equipment (EVSE) ..	46
Coordinated Building Load Control Including EVSE with XBOS .....	48
Task 3 - Conclusions.....	50

Task 4 Project Activity Results: Distribution-Level Utility Power Grid Impacts and Benefits Analysis of PEV Smart Charging Using XBOS-V .....	51
Feeder Voltage Analysis .....	55
Task 4 - Conclusions.....	58
Task 5 Project Activity Results: Analysis and Forecast of Ratepayer Benefits of PEV Smart Charging in California .....	59
VGI Opportunities at the Electric Power Transmission Level .....	59
Grid Curtailment and Opportunities for VGI in 2024 .....	67
Grid Curtailment and Opportunities for VGI in 2030 .....	74
Task 5 - Conclusions.....	79
CHAPTER 4: Technology/Knowledge/Market Transfer Activities.....	80
Technology and Knowledge Transfer Activities .....	80
XBOS-V Project Professional Presentations and Publications .....	81
Market Transfer Activities .....	81
Online Resources.....	81
Technical Advisory Committee.....	82
Summary.....	82
CHAPTER 5: Conclusions/Recommendations .....	84
Summary of Key Project Conclusions .....	84
PEV Smart Charging User Needs Assessment .....	84
XBOS-V Module Scoping, Development, and Testing.....	84
Distribution-Level Utility Power Grid Impacts and Benefits Analysis of PEV Smart Charging Using XBOS-V .....	85
Analysis and Forecast of Ratepayer Benefits of PEV Smart Charging in California...	85
Project Recommendations .....	86
CHAPTER 6: Benefits to Ratepayers .....	87
Ratepayer Benefits of VGI and the XBOS-V Project.....	87
XBOS-V Implementation Potential.....	87
Potential Monetary and Emissions Savings .....	88
Human Resources Development .....	89
Groundwork for Other Studies.....	89
LIST OF ACRONYMS.....	90
REFERENCES .....	94



APPENDIX A: Smart Charging User Needs Assessment – Approval of the UC Berkeley Office of the Protection of Human Subjects.....	A-1
APPENDIX B: Smart Charging User Needs Assessment – Focus Group Script .....	B-1
APPENDIX C: Details of Plug-In Electric Vehicle Smart Charging User Needs Assessment .....	C-1
APPENDIX D: Further Details of XBOS-V Software Module Development and Application .....	D-1
APPENDIX E: Further Details of Development and Application of Distribution Grid Stabilization Algorithms through PEV Flexible Load.....	E-1
APPENDIX F: PEVs in California – Recent History and Current Status.....	F-1
APPENDIX G: XBOS-V Project Technology Transfer Activity Details .....	G-1

## **LIST OF FIGURES**

	Page
Figure 1: Plug-in Electric Vehicle Charge Control with Open-Source and Architecture Platform .....	10
Figure 2: Research Vehicle Undergoing Testing at UC Berkeley Global Campus Vehicle-Grid Integration Testbed .....	10
Figure 3: Inter-Relationship of XBOS-V Technical Tasks and Activities .....	13
Figure 4: High-Level Depiction of XBOS System Architecture .....	16
Figure 5: High-Level Depiction of XBOS-V System Architecture .....	19
Figure 6: Potential Communication Protocols for Vehicle-Grid Integration Systems.....	25
Figure 7: Focus Group Participant Response to New Technology Purchase .....	35
Figure 8: Focus Group Participant Response to Frequency of Weekly PEV Charging.....	36
Figure 9: Focus Group Participant Response to PEV Charging Location .....	37
Figure 10: Focus Group Participant Response to PEV Charging Time of Day.....	38
Figure 11: Focus Group Participant Response to Climate Change Importance .....	39
Figure 12: Focus Group Participant Response to VGI Managed Charging .....	40
Figure 13: Focus Group Participant Response to VGI Managed Charging Entities.....	41
Figure 14: Aerovironment Level 2 Charger.....	44
Figure 15: NHR “Grid Simulator” Power Supply and Power Quality Testing Device.....	45
Figure 16: Installation of XBOS and Associated Devices for Building Energy Control and Management for XBOS-V Development and Testing .....	45
Figure 17: eMotorWerks “JuicePlug” Level 1 Smart PEV Charging Device .....	46

Figure 18: Aerovironment Level 2 Smart PEV Charging Device .....	47
Figure 19: The XBOS-V Controller Demonstrating the Coordinated Control of Berkeley Global Campus Bldg. 190 Loads and a Level 2 PEV Charger .....	49
Figure 20: LMP in Davis, California on July 10th, 2017.....	52
Figure 21: LMP vs Current Commercial TOU Hours July 10th, 2017 .....	53
Figure 22: LMP vs Proposed Commercial TOU Hours July 10th, 2017 .....	53
Figure 23: Voltage Profile of the Most Remote Node on the MIP Feeder Without PEVs	55
Figure 24: Voltage Profile of the Most Remote Node on the MIP Feeder With 2,000 PEVs Optimizing Towards the LMP .....	56
Figure 25: Voltage Profile of the Most Remote Node on the MIP Feeder With 2,000 PEVs Optimizing Towards the LMP With Constraints .....	57
Figure 26: Voltage Profile of the Most Remote Node on the MIP Feeder with 2000 PEVs Optimizing Towards the Current A10 Rate .....	58
Figure 27: Voltage Profile of the Most Remote Node on the MIP Feeder With 2000 PEVs Optimizing Towards the Proposed A10 Rate.....	58
Figure 28: DLap (left) and Sublap (right) Zones in California.....	66
Figure 29: Negative Pricing Hours With and Without Managed PEV Charging .....	69
Figure 30: Annual Renewable Curtailment Decreases with Managed Charging .....	70
Figure 31: Monthly Renewable Generation and Curtailment, All Cases .....	71
Figure 32: The California Net Load “Duck Curve” (2012-2020).....	72
Figure 33: Net Load Flattened Out with Managed Charging and Less Curtailment .....	73
Figure 34: Statewide Baseline Annual Electricity Consumption .....	75
Figure 35: Curtailment Effects with CPUC RPS Calculator Projections – 2030 Case .....	77
Figure 36: Curtailment Effects With NREL ReEDS Model Projections .....	79
Figure C-1: Survey Responses on Typical Charging Location and Time of Day (Phase I, n=28) .....	C-9
Figure C-2: Survey response of climate change attitudes (Phase I, n=28) .....	C-12
Figure C-3: Survey Ranking of Top 10 Federal Priorities to Address (Phase I, n=28)	C-13
Figure C-4: Survey Ranking of PEV Purchase/Lease Motivations (Phase I, n=28) .....	C-15
Figure C-5: Survey Ranking of PEV Adoption Reasons (Phase I, n=28).....	C-16
Figure C-6: Survey response on comfort with managed charging (Phase I, n=28)....	C-21
Figure 43: Survey Responses Ranking Trust in Various Institutions (Phase I, n=28).	C-22
Figure C-7: Survey Responses on Typical Charging Location and Time of Day (Phase II, n=22) .....	C-25
Figure C-8: Survey Responses on Typical Charging Weekly Frequency (Phase II, n=22) .....	C-26
Figure C-9: Survey Response of Climate Change Attitudes (Phase II, n=22) .....	C-28

Figure C-10: Survey Response of External Charge Management Attitudes (Phase II, n=22) .....	C-30
Figure C-11: Survey Response of External Charge Management Institutions (Phase II, n=22) .....	C-30
Figure C-12: Focus Group Participant Response to New Technology Purchase .....	C-34
Figure C-13: Focus Group Participant Response to Frequency of Weekly PEV Charging C-35	
Figure C-14: Focus Group Participant Response to PEV Charging Location .....	C-35
Figure C-15: Focus Group Participant Response to PEV Charging Time of Day .....	C-36
Figure C-16: Focus Group Participant Response to Climate Change Importance .....	C-37
Figure C-17: Focus Group Participant Response to VGI Managed Charging .....	C-37
Figure C-18: Focus Group Participant Response to VGI Managed Charging Entities ..	C-38
Figure D-1: VGI Test-Bed With Wi-Fi Enabled Charger at UC Berkeley Global Campus	D-2
Figure D-2: XBOS-V System (left) and TED Energy Monitor (right) at UC Berkeley Global Campus.....	D-3
Figure D-3: Potential Communication Protocols for VGI System.....	D-5
Figure D-4: High Level Depiction of XBOS System Architecture .....	D-6
Figure D-5: EVSEs subscribe to URIs that Users publish on.....	D-8
Figure D-6: Access over XBOS-V URIs is fine grained .....	D-8
Figure E-1: SPDS Algorithm .....	E-3
Figure E-2: Convergence of Valley-Filling.....	E-5
Figure E-3: Nodal Voltage Magnitudes .....	E-5
Figure E-4: Energy Requirement Evolutions .....	E-5
Figure E-5: Charging Profiles of PEVs .....	E-6
Figure E-6: An Example Daily Load Curve for a Residential Distribution Feeder .....	E-6
Figure E-7: An Example Daily Load Curve for a Distribution Feeder, and Changes Observed When PV Generators are Connected Downstream .....	E-7
Figure E-8: An Example Daily Load Curve for a Distribution Feeder with PV Generators, and Changes Observed when PEVs Charge During the Evening Peak.....	E-8
Figure E-9: Baseline load and total load (three-phase sum) .....	E-21
Figure E-10: Nodal Voltage Magnitudes at Phase a.....	E-23
Figure E-11: Nodal Voltage Magnitudes at Phase b.....	E-23
Figure E-12: Nodal Voltage Magnitudes at Phase c.....	E-24
Figure E-13: LMP in Davis, CA on April 14th, 2017 .....	E-25
Figure E-14: Current Winter Weekday Commercial TOU Hours.....	E-25
Figure E-15: Proposed Spring Day Commercial TOU Hours .....	E-26
Figure E-16: LMP in Davis, CA on July 10th, 2017 .....	E-27

Figure E-17: LMP vs Current Commercial TOU hours July 10th, 2017 .....	E-28
Figure E-18: LMP vs Proposed Commercial TOU Hours July 10th, 2017 .....	E-28
Figure E-19: Voltage Profile of the Most Remote Node on the MIP Feeder without PEVs .....	E-30
Figure E-20: Voltage Profile of the Most Remote Node on the MIP Feeder with 2000 PEVs Optimizing Towards the LMP .....	E-31
Figure E-21: Voltage Profile of the Most Remote Node on the MIP Feeder with 2000 PEVs Optimizing Towards the LMP with Constraints.....	E-32
Figure E-22: Voltage Profile of the Most Remote Node on the MIP Feeder with 2000 PEVs Optimizing Towards the Current A10 Rate.....	E-33
Figure E-23: Voltage Profile of the Most Remote Node on the MIP Feeder with 2000 PEVs Optimizing Towards the Proposed A10 Rate .....	E-33
Figure F-1: Cumulative U.S. PEV Sales – 2011-2014.....	F-3
Figure F-2: Forecasts of California's BEV Population .....	F-9
Figure F-3: Forecasts of California's PHEV Population, 2012-2030 .....	F-10
Figure F-4: Forecasts of California's BEV and PHEV Combined Population .....	F-11

## **LIST OF TABLES**

	Page
Table 1: Cost of Charging PEVs at One Building on April 14 <sup>th</sup> , 2017.....	51
Table 2: kWh of PEVs Charging Between 9am and 4pm at One Building on April 14 <sup>th</sup> , 2017 .....	52
Table 3: Cost of Charging PEVs at One Building on July 10 <sup>th</sup> , 2017.....	54
Table 4: kWh of PEVs Charging Between 9am and 4pm at One Building on July 10 <sup>th</sup> , 2017 .....	54
Table 5: Various VGI Services and Approximate Values .....	60
Table 6: Curtailment Capacity of Energy Commission PEV Forecast .....	76
Table 7: Curtailment Effects on CPUC RPS Calculator Projections – 2030 Case .....	77
Table 8: Curtailment Effects on NREL ReEDS Standard Scenarios Projections – 2030 Case.....	78
Table D-1: Standard Interface for EVSE.....	D-10
Table E-1: PG&E Feeder D0001 .....	E-13
Table E-2: DOE Building Model Types used in MIP Feeder .....	E-14
Table E-3: Cost of Charging PEVs at One Building on April 14 <sup>th</sup> , 2017.....	E-26
Table E-4: kWh of PEVs Charging Between 9am and 4pm at One Building on April 14 <sup>th</sup> , 2017 .....	E-27

Table E-5: Cost of Charging PEVs at One Building on July 10<sup>th</sup>, 2017.....E-29

Table E-6: kWh of PEVs Charging Between 9am and 4pm at One Building on July 10<sup>th</sup>, 2017 .....E-29

Table F-1: Forecasted BEV, PHV, and Total PEV Populations In Line with Current Adoption Scenario .....F-5

Table F-2: Forecasted BEV, PHV, and Total PEV Populations In Between Scenario .....F-5

Table F-3: Forecasted BEV, PHV, and Total PEV Populations Aggressive Scenario .....F-6

Table F-4: California Energy Demand Forecasted BEV, PHV, and Total PEV Populations Through 2024 – Low Case .....F-7

Table F-5: California Energy Demand Forecasted BEV, PHV, and Total PEV Populations Through 2024 – Mid Case.....F-7

Table F-6: California Energy Demand Forecasted BEV, PHV, and Total PEV Populations Through 2024 – High Case .....F-7

Table F-7: California Energy Demand Forecasted BEV, PHV, and Total PEV Populations Through 2026.....F-8

Table G-1: XBOS-V Project Presentations..... G-1



# EXECUTIVE SUMMARY

## Introduction

California is the largest U.S. car market with about 20 percent of all new cars in the country and accounting for almost half of all plug-in electric vehicles (PEVs) sold since 2011. The state is moving toward the goal of launching 5 million zero-emission vehicles on the road by 2030. Since most of these vehicles will rely on charging batteries, increasing the number of PEVs also increases electricity demand. This uneven demand at specific times and locations can be burdensome for the local electric utilities. Managing and spreading the electrical load across different locales, infrastructures, and periods using vehicle-grid integration strategies and technologies (which help align electric vehicle charging with the needs of the electric grid) could prevent costly infrastructure upgrades and decrease costly grid balancing.

Vehicle-grid integration takes advantage of the significant capacity of PEV onboard batteries that can be charged (and potentially discharged) at times that are beneficial for local and regional utility grid operations. The concept of vehicle-grid integration has been around since the 1990s but has grown in interest and importance in recent years with the growing PEV adoption in California and around the world.

The eXtensible Building Operation System—Vehicles (XBOS-V) project focused on controlling PEV charging at homes and small businesses using a novel and flexible open-source platform that gives users the rights to use or modify the software code. The research team designed the XBOS-V software-based platform to integrate into residential/business electrical and building automation systems..

This project also focused on the key issues associated with open-source platform development, including assessment of user needs, grid operation and ratepayer benefits, grid security considerations, and the potential for PEV charge control to help integrate intermittent renewable energy into California's electrical grid by providing a place to store overgeneration. The platform was built as a flexible open-source and open-architecture system that can (depending on site requirements and hardware solutions) integrate with established vehicle-grid integration protocols and standards. This project addressed a key gap where some industry groups are proposing vehicle-grid integration solutions that are inherently proprietary and "closed" to other developers (such as communicating thermostats and smart assistant-systems that integrate with PEV chargers). This effort was open to all developers and intended for further flexible development by interested stakeholders. It attempted to simplify and clarify the technical operation of vehicle-grid integration systems, as well as integrate vehicle-grid integration with other local building load controls in an area that had not yet been significantly researched and developed.

## **Project Purpose**

This project combined an interdisciplinary team of researchers, engineers, software developers, and social scientists to address key aspects of vehicle-grid integration concept development. These aspects included:

- Better understanding user needs and requirements for vehicle-grid integration.
- Developing an open-source software code platform for controlling PEV charging at a local level (by communicating directly with PEV chargers using on-site building automation software) in conjunction with other loads.
- Identifying opportunities for vehicle-grid integration to improve grid operations at the distribution level and potentially provide additional value for at the transmission level.

The project intended to 1) develop vehicle-grid integration concepts to improve the local and regional operations of utility grids by developing the XBOS-V software module for the established XBOS platform (an open-source, open-architecture building automation system originally developed at the University of California [UC] - Berkeley); 2) understand the vehicle-grid integration potential to improve integration of intermittent renewable resources on the California grid; and 3) better understand the interest level and concerns of key stakeholder groups for vehicle-grid integration concepts including PEV drivers and building energy managers.

## **Project Approach**

The project involved four key technical areas:

- PEV user needs assessment: Conduct focus groups with 50 participants in the BMW ChargeForward vehicle-grid integration project.
- Software development: Develop XBOS device drivers (that tell the hardware what to do) for Level 1 (120 volt) and Level 2 (240 volt) PEV chargers using Wi-Fi communication, test and validate the computer drivers and XBOS-V code, and develop and implement building automation system controls.
- Utility distribution grid Impacts and opportunities: Examine potential distribution system impacts of future PEV penetration on example feeder networks, develop and test algorithms to address adverse impacts.
- Larger utility grid operation impacts and opportunities: Examine the market potential for PEVs to participate in utility and wholesale electricity market programs, and analyze the potential for PEVs to reduce curtailment of intermittent renewable energy (solar and wind) through control of charging times and rates in example years 2024 and 2030 in California.

For the primary XBOS-V development and implementation task, the project team installed Wi-Fi based load control devices on three baseboard heaters, selected lighting fixtures, and several plug loads. The team monitored consumption at the building



electrical panel. The team used a “grid simulator” with power-flow visualization to provide additional power monitoring for the PEV charging loads at the UC Berkeley vehicle-grid integration test-bed. The project team then controlled these loads in coordination using project-developed algorithms to manage the building loads to meet potential control criteria, which includes evening demand peak periods, valleys in demand, and the adjustment of building loads to avoid the peak pricing times in time-of-use electricity rates.

A key challenge to overcome was to develop an open-source code solution for electric vehicle supply equipment (EVSE) that is free from proprietary concerns of industry and that is available for wide dissemination. Addressing this challenge required considerable work to understand the functional requirements needed, and develop a PEV charging control solution in concert with control of other local home and small business loads.

In another project effort, the project team studied the potential negative consequences of uncontrolled PEV charging and the potential PEV charging management benefits to the system. In addition, the project team proposed control algorithms designed to be functional with any of the proposed vehicle-grid integration communication protocols. These proposed vehicle-grid integration communication protocols include Smart Energy Profile (SEP) 2.0, Open Automated Demand Response (OpenADR), Open Charge Point Protocol (OCPP), Institute for Electrical and Electronics Engineers (IEEE) 2030.5, and International Standards Organization 15118, among others.

Finally, a key project effort involved using sophisticated grid models, such as PLEXOS and SWITCH, to analyze the potential for PEVs to reduce curtailment of intermittent renewables through managed charging. The model shifted PEV charging loads from high and increasing “ramping” periods to times of low and decreasing grid loads. The analysis focused on example years 2024 and 2030 in California (by which times the energy supplying the California grid is expected to be 40 percent renewable and 50-60 percent renewable, respectively), with PEV market penetration scenarios.

Details of the project approach for each primary technical task are in the body of this report.

## **Project Results**

The ChargeForward participant focus group and building energy manager interviews provided a valuable opportunity to learn from real-world settings and concerns related to vehicle-grid integration and PEV charge management. The focus group findings helped inform current project and potential future efforts including:

- Understanding what can motivate PEV drivers to participate in vehicle-grid integration programs.
- The participant desired level of user complexity/information.
- Concerns about vehicle-grid integration use in specific settings.

- Insight into potential vehicle-grid integration application at a wide range of homes and businesses.

The overall response to vehicle-grid integration was generally positive in the PEV driver focus groups and the building energy manager interviews, but with many nuances and some specific concerns as noted. These included the level of information and engagement desired by drivers related to their vehicle-grid integration program participation, their relative levels of flexibility in their charging behavior to adapt to charge management, and for building energy managers concerns about potential data security related to extension of their building energy management systems to include PEV charger control.

The XBOS-V software development to extend the capabilities of the platform demonstrated the ability of the system to control Level 1 and Level 2 charging systems for PEVs, along with other local building loads.

This type of dynamic PEV charging rate control can be used to keep a building or office complex under a physical power limit because of transformer or electrical panel capacity constraints, or economic limits to manage facility demand charges. It can also be used to respond to scheduled or more dynamic 15-minute ahead calls for demand response or power acceptance. Readily extensible platforms such as XBOS can be scaled to medium and large fleets with the appropriate communication infrastructure at the project scale.

All software and device drivers were released on a fully open-source basis for the project team and other stakeholders to develop and implement. The software and device drivers developed in the project are available through the following links:

- [XBOS platform documentation](https://docs.xbos.io/): <https://docs.xbos.io/>
- [XBOS platform code](https://github.com/softwaredefinedbuildings/xbos): <https://github.com/softwaredefinedbuildings/xbos>
- [OCPP 2.0 Implementation](https://github.com/gtfierro/ocpp-2.0): <https://github.com/gtfierro/ocpp-2.0>
- [Juiceplug driver implementation \(XBOS-V\)](https://github.com/SoftwareDefinedBuildings/bw2-contrib/tree/master/driver/juiceplug): <https://github.com/SoftwareDefinedBuildings/bw2-contrib/tree/master/driver/juiceplug>
- [Aerovironment driver implementation \(XBOS-V\)](https://github.com/SoftwareDefinedBuildings/bw2-contrib/tree/master/driver/aerovironment): <https://github.com/SoftwareDefinedBuildings/bw2-contrib/tree/master/driver/aerovironment>
- [Brick Schema documentation](http://brickschema.org/): <http://brickschema.org/>
- [Brick database code](https://github.com/gtfierro/hod): <https://github.com/gtfierro/hod>

Next, the project team studied the potential negative consequences of uncontrolled PEV charging and the potential PEV charging management benefits to the system. The research team proved the potential for signals such as nodal grid prices to interact with PEV load control on standard recognized test feeders and a real-world-sized model feeder. The project team also compared the distribution feeder capacity for charging

infrastructure under home and workplace charging. . Key findings include the effects of current and proposed utility rates on PEV charging behavior, the potential to use locational marginal pricing signals for grid control, and additional distribution grid impacts. Locational marginal pricing is the cost to buy and sell power at different locations. The project team found that locational marginal pricing signals are not adequate for maintaining grid reliability and stability through voltage correction on distribution feeders.

Vehicle-grid integration-enabled PEVs can play important roles in the wholesale power market and the grid at the transmission and distribution levels. The analysis shows that PEV-managed charging has the potential to reduce renewable electricity generation curtailment by up to 500 gigawatt-hours (GWh) in 2024 and about 2 terawatt-hours (TWh) in 2030, helping bring more low-cost and low-carbon resources onto California's utility grid. This mitigated power curtailment amounts to about \$5 million–\$15 million per year in avoided electricity costs in 2024 and \$20 million–\$60 million per year in 2030 (at avoided generation costs of \$10–\$30 per megawatt-hour [MWh]), as well as nearly 72,500 tons (2024) and 290,000 tons (2030) of avoided greenhouse gas (GHG) emissions.

There are potentially significant values for PEV drivers, workplace charging locations, and PEV fleets that can be accrued through provision of wholesale grid services, but they vary geographically and temporally as markets evolve, creating issues with identifying dependable long-term revenue streams. It is important to consider the net value of vehicle-grid integration participation in larger grid operations, as any net values are affected by key stakeholder needs to participate in vehicle-grid integration services.

## **Sharing Technology and Information**

The XBOS-V project provided an open source, easily implementable solution for electric vehicle service equipment power management for building energy management systems. The team widely disseminated the key findings from four main technical tasks, while making widely available the open source code and energy management algorithms developed in the project. The project team continues to pursue activities related to technology transfer, as the XBOS platform and XBOS-V electric vehicle service equipment modules continue to develop through project follow-on activities. The project has already resulted in a significant number of professional presentations, research and conference papers, and additional market transfer activities conducted during the project. These technology and knowledge transfer activities included 27 professional presentations, 6 research papers, and XBOS-V open-source software code release efforts. Additional professional and academic technology transfer activities are anticipated well beyond the end of the project term, with submission of journal publications and additional conference and meeting presentations.

## **Benefits to California**

This project generated information that helps identify the opportunities and obstacles to vehicle-grid integration use, and provided a flexible, open-source platform for vehicle-grid integration development. The project contributes to larger efforts by electric utilities and grid operators to provide ratepayer benefits with greater electricity reliability and lower energy costs. The ratepayers will realize the benefits by advanced vehicle-grid integration technologies that can reduce grid strain at the distribution level, better coordinate PEV loads to improve reliability at existing power grid nodes, and allow PEV load management to help address issues associated with intermittent renewable power generation.

Potential ratepayer benefits from greater vehicle-grid integration use, in part enabled by developments from this project, include greater electrical grid reliability, reduction in electricity costs by allowing low cost renewable energy resources to be more effectively used, increased acceptance of renewable electricity on the grid, and reduced emissions of GHGs and criteria air pollutants.

The XBOS platform is easily implemented and tailored for individual sites based on their electricity loads and objectives for power use management. It is a low-cost computing platform (less than \$200 for a basic system and then relatively inexpensive add-ons for Wi-Fi control of groups of devices, such as thermostats, lighting, and plug loads). A goal of XBOS is to demystify some key aspects of controlling electrical loads in coordination, using secure communication and device drivers for many types of devices.

XBOS operates at about 20 sites in the San Francisco Bay Area, with additional inquiries for additional installations being received regularly and efforts underway to develop additional “instances” of the control system in new locations. Existing and future XBOS installations can easily integrate the XBOS-V module.

## **Potential Monetary and Emissions Savings**

Based on analyses and calculations conducted by the project team, the potential monetary and emissions impacts and benefits of vehicle-grid integration systems, including further implementation of XBOS-V-based installations, include:

- Greater reliability of the electric distribution grid, reducing frequency of outages in residential areas.
- Annual reductions in electricity costs for ratepayers derived from lower electric distribution system upgrade and operating costs, increased electric distribution system energy efficiency, increased PEV charging energy efficiency, and lower electricity generation costs through better acceptance of low-cost renewables.
- Potentially hundreds of megawatts of avoided peak electric demand at the electric distribution system level by 2025.
- An estimated 73,000 metric tons of carbon dioxide (CO<sub>2</sub>e) emissions per year avoided in 2024 and 290,000 metric tons in 2030 from increasing the fraction of

intermittent operationally GHG-free renewable electricity generation (and decreased need for GHG-intensive supplemental peaking generation), along with additional potential reductions from increased electric distribution system and PEV charging efficiency.

- Significant amounts of oxides of nitrogen (NO<sub>x</sub>) emissions per year avoided by 2025 from increased electric distribution system energy efficiency, increased PEV charging efficiency, increased fraction of intermittent operationally NO<sub>x</sub>-free renewable electricity generation (with decreased need for NO<sub>x</sub>-intensive supplemental peaker plant generation).

The project team did not focus on the details of the direct benefits to PEV drivers and fleet owners to a significant degree in this project, but this is a clear additional area of private benefit in addition to the broader social benefits listed above.



# CHAPTER 1:

## Introduction

---

This report provides the final findings for the open-source open-architecture software platform for plug-in electric vehicle (PEV) smart charging in California residential and small commercial settings (Open XBOS-V) project. The Transportation Sustainability Research Center at the University of California (UC) Berkeley led the project, along with contributions from the Berkeley Energy and Climate Institute, the Energy and Resources Group, and BMW North America LLC.

### Introduction and Background

This interdisciplinary XBOS-V project focuses on controlling the charging of PEVs at residential and small commercial settings using a novel and flexible open-source, open-architecture charge communication and control platform. This software-based platform known as eXtensible Building Operation System - Vehicles (XBOS-V) is embedded in the context of overall utility and residential/business electrical and building automation systems, lending itself to potential broad implementation by commercial interests.

This project also focuses on the key issues associated with the development of the open-source platform, including assessment of user needs and grid operation and ratepayer benefits, grid security considerations, and the potential for PEV charge control to lead to increased ability to accept intermittent renewable energy for California's electrical grid. The platform is being built as a flexible open-source and open-architecture system that can (depending on site requirements and hardware solutions) integrate with established protocols and standards for vehicle-grid integration (VGI), such as OpenADR, Institute of Electrical and Electronics Engineers (IEEE) 2030.5/Smart Energy Profile (SEP) 2.0, Zigbee, Society of Automotive Engineers J1772, Open Charge Point Protocol (OCPP), and International Standards Organization (ISO) 15118.

Figure 1 shows a generalized scheme for using a low-cost computing platform coupled with Wi-Fi enabled devices for control of local building loads including PEV chargers. The system is readily extensible to many devices in a given location, with the necessary communications bandwidth considerations for nodes on the network.

**Figure 1: Plug-in Electric Vehicle Charge Control with Open-Source and Architecture Platform**

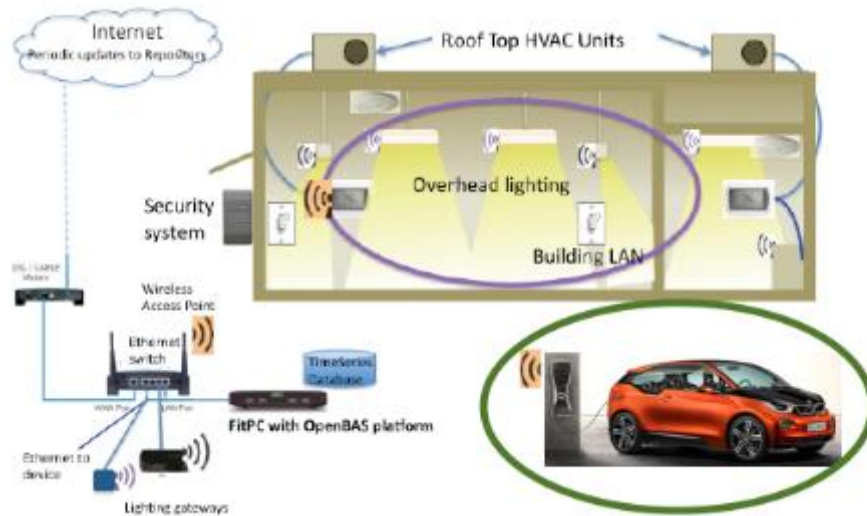

Source: UC Berkeley

The project brings together a group of researchers from the University of California – Berkeley and BMW North America LLC to conduct an in-depth study that will gather key information learned from the “ChargeForward” project by Pacific Gas and Electric Co. and BMW. The project uses key insights and observations from the pilot project to inform the development of the Open XBOS-V platform and associated grid and user benefits analysis. Approximately 100 participants took part in the Phase I ChargeForward program for BMW i3 drivers, culminating in late 2016, and now in the ongoing Phase II approximately 400 drivers are participating with i3 vehicles as well as newer BMW PEV models (Figure 2).

**Figure 2: Research Vehicle Undergoing Testing at UC Berkeley Global Campus Vehicle-Grid Integration Testbed**



Source: UC Berkeley



## **Project Background**

The concept of VGI has been around for many years, even before the proliferation of modern PEVs. However, these concepts are now being explored more extensively with the recent availability of large numbers of models of PEVs and market development where cumulative PEV sales are now approximately 1 million in the United States and 500,000 in California. Various types of VGI development and demonstration projects are examining ways of managing PEV charging onsite at workplaces to provide as much charging as possible within site power constraints, and managing charging power levels and charge timing to minimize utility demand charges (or residential time-of-use or TOU charges). Other VGI projects are examining mechanisms for PEVs to participate in power markets and receive compensation through third-party aggregation services, and examining concepts for vehicle-grid and vehicle-charger-grid communication schemes using vehicle telematics or local Wi-Fi based (or other) communication protocols.

While simple in some instances (for example simple PEV charging timing at the local level to adapt to grid conditions), vehicle-to-grid (V2G) power and interfacing with the wholesale level power market and transmission level of the grid are much more complex, requiring the alignment of interest and efforts of a number of actors along the value chain. These include (at a minimum) the vehicle driver or fleet operator, the services aggregator and grid scheduler, the local utility, and the wholesale market entity or "independent system operator" such as the California Independent System Operator in California. There are many potential use-cases for VGI in California and other markets; understanding these use cases in larger and more real-world types of settings is a key area of ongoing and future research.

With regard to the types of integrated VGI solutions that combine control of PEV loads with other local building loads, a few efforts have been publicly announced by electric vehicle supply equipment (EVSE) manufacturers and automakers. These have been targeted at residential charging locations (e.g. combining a ChargePoint charger with a Nest thermostat) or at workplace sites where PEV loads are controlled to help manage overall building and site power usage. Additional "microgrid" demonstrations have taken place that also integrate local generation of power such as through solar photovoltaics and energy storage through batteries or flywheels, along with traditional building loads and PEV charging. However, these efforts are mostly industry-driven and tend to be proprietary rather than open-source code development efforts, with regard to the hardware and software integration aspects.

It is also worth noting that there currently is a somewhat fluid situation with sets of international and United States-based standards for communication between PEVs and the grid, with various models that either connect vehicles to the grid directly with vehicle telematics, or that instead use "smart" EVSE with communication capability. Various approaches are being investigated using IEEE and ISO based standards and other approaches (e.g., OpenADR, OCPP, IEEE/SEP 2.0, Zigbee, etc.) but without consensus yet on any preferred solution for a wide range of use cases. There is thus a

need for flexible approaches with ability to adapt to different communication standards, something readily accomplished with the flexible design and architecture of the XBOS platform.

## **Project Technical Tasks and Goals**

The goals of this project are to explore four key areas of VGI implementation in California, and to conduct additional technology transfer and outreach activities. The four key project areas and tasks are:

- PEV Smart Charging User Needs Assessment
- XBOS-V Module Scoping, Development, and Testing
- Distribution-Level Utility Power Grid Impacts and Benefits Analysis of PEV Smart Charging
- Analysis and Forecast of Ratepayer Benefits of Open Source PEV Smart Charging in California

Key goals for the project include: 1) conducting a series of VGI pilot-project participant focus groups and building energy manager interviews (Task 2); 2) developing and testing an open-source and open-architecture VGI module for the XBOS platform known as XBOS-V; 3) analyzing distribution system level impacts of PEV charging scenarios and developing impact control strategies and algorithms using detailed grid modeling tools; and 4) assessing larger utility grid impacts and opportunities from PEV charging and VGI including potential benefits to vehicle drivers and utility ratepayers. Another project goal is to conduct additional technology transfer activities through technical briefings, conference presentations, conference papers, and journal articles.

This report documents: 1) an open source platform and architecture called XBOS-V for managing the operation of PEV charging in the context of feeder-level utility grid operations; 2) the expected benefits in California IOU service territory of such a system; 3) and key commercialization and “market lead in” concepts. The focus of the project is analyzing systems for control of PEV charging through both “connected vehicle” communication interfaces to the vehicle directly, and through the control of communication-enabled EVSE.

# CHAPTER 2:

## Project Approach

---

This project consists of a suite of technical tasks that interrelate but that also represent relatively distinct project efforts. The main thrusts of the project are to:

- 1) Better understand issues and opportunities for PEV drivers to respond to VGI type programs for grid support.
- 2) Develop a set of open-source, open-architecture software code for power control of Level 2 AC PEV chargers for providing load flexibility for utility grids, in conjunction with control of other local building loads.
- 3) Understand potential utility distribution-level impacts of PEV charging loads as the PEV market develops, along with development of potential algorithms to reduce these impacts.
- 4) Better understand the larger grid system-wide (distribution and transmission level) issues and opportunities for VGI, including ability of PEV flexible loads to reduce the level of curtailment of renewable energy in California.

The four main technical tasks are identified as Tasks 2 through 5 in Figure 3.

**Figure 3: Inter-Relationship of XBOS-V Technical Tasks and Activities**

**UC Berkeley XBOS-V Project – Cyber-Physical Space**

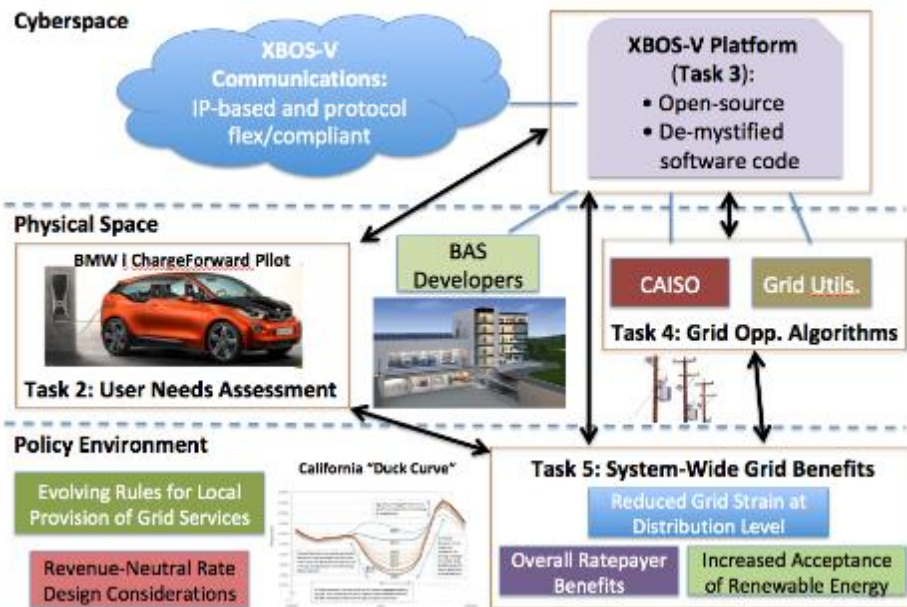

Source: UC Berkeley

As shown, the Task 2 “User Needs Assessment” has connections with Task 3 “XBOS-V Platform” and Task 5 “System-Wide Grid Benefits,” while Task 4 “Grid Operation Algorithms” interrelates with Tasks 3 and 5, and Tasks 3 and 5 also interrelate directly.

## **Task 2: PEV Smart Charging User Needs Assessment**

The goal of this task was to conduct two key activities to better understand market and human behavior aspects of VGI and managed PEV charging, to better understand PEV driver / consumer attitudes toward the concept of managed PEV charging, as well as those of building energy managers to understand their interest, ideas for, and potential concerns with the concept of connecting managed PEV charging to management of larger residential and commercial building loads. The two key activities of this task are:

- 1) A series of two rounds of focus groups around the Bay Area with BMW ChargeForward program participants, with an overall total of 50 participants.
- 2) A set of building energy manager interviews with 12 different building sites examined.

The overall approach to this task was to work closely with BMW North America LLC on the recruitment, design, and conduct of the focus groups and separately to recruit and conduct interviews with the group of building energy managers. Following are further details about the approach and planning for the task.

### **Focus Groups – Phase I Logistics**

The focus group plan and protocol developed in late 2016/early 2017 included the following key elements:

- Prior approval by the UC Berkeley campus Office for the Protection of Human Subjects (OPHS)
- Selection of focus group meeting space in the Mountain View/Sunnyvale area.
- Preparation of the focus group interview “protocol” script.
- Recruitment of focus group participants with the aid of project partner BMW North America.
- Execution of the focus groups.
- Follow-up activities including awarding of participant incentives.
- Analysis of focus group surveys and audio recordings.
- Summary of focus group findings.

In preparation for the Phase I focus groups, meeting space was reserved at the Bay Area Cultural Connections at 1257 Tasman Drive Suite B in Sunnyvale, California. The OPHS approval, this was granted on February 10, 2017 under UC Berkeley Protocol ID: 2016-10-9220. The formal approval letter from the OPHS is provided in Appendix A. The focus group interview script can be found in Appendix B.

## **Focus Groups – Phase II Logistics**

For the Phase II set of focus groups, a protocol amendment to Protocol ID: 2016-10-9220 was requested in from OPHS in May 2017 to allow for additional sites beyond the Phase I Sunnyvale location. This also required minor revision to the focus group participant consent form. The campus approval for the amendment request was granted on June 22, 2017.

Based on the formal campus approval, the project team proceeded with planning for the Phase II round of focus groups. Two locations were selected for this Phase II round of focus groups: 1) Oakland and 2) San Mateo. Four additional focus group sessions were held in July 2017 with a total of 28 additional participants. Thus, between Phase I and Phase II, a total of 50 participants were included in the focus group research.

## **Focus Groups – Execution and Follow Up**

Following the completion of each round of focus groups, subsequent activities included incentive payments to the participants (\$100 each in the form of an online gift card, plus a random drawing of one winner from each round for an Apple iPad) and preparation of summaries of the focus group and initial survey findings. Chapter 3 contains a general summary of the focus group findings with further details, including separate sets of findings for each of the two focus group rounds, presented in Appendix C.

## **Building Energy Manager Interviews**

The second key activity from project Task 2 consisted of a series of 12 interviews conducted with building energy managers from a wide array of building types, from residential “smart homes” to large commercial compounds consisting of several buildings. The interviews followed a prescribed list of questions asked over approximately 45 minutes per interview.

The building types covered in the research interviews included a wide range of buildings from a residential household, to large office buildings, to a multi-building complex. Included were mostly office buildings, but also including offices with laboratories, a grocery store chain, a museum, university buildings, and county municipal buildings. Among the 12 interviews, 225 buildings were included at the various sites discussed. The total combined buildings square footage is approximately 16.3 million square feet.

The project team summarized each of the interviews and used these notes to provide a summary of findings. This summary is provided in Chapter 3 of this report.

## **Task 3: XBOS-V Module Scoping, Development, and Testing**

The approach to this key project “Task 3: XBOS-V Module Scoping, Development, and Testing” was to embark on an ambitious plan that consisted of integration of several hardware and software development efforts. The status of underlying components needed for development and implementation of XBOS-V into the larger XBOS

framework are discussed briefly below, followed by the general approach for XBOS-V development and testing. The key results of this task are discussed in the following chapter.

### BOSSWAVE – The Communication Channel

One of the key components in managed charging of electric loads is the communication channel for delivering control commands from aggregators to the electric loads and the measurements data from electric loads to the aggregator. The communication channel in XBOS-V is called BOSSWAVE (Building Operating System Services Wide Area Verified Exchange) (“BOSSWAVE,” n.d.), which is a secure, distributed *publish-subscribe* (Anderson, Fierro, & Culler, 2017), bus message. XBOS uses a *publish-subscribe* (or *pub-sub*) communication pattern as opposed to a *point-to-point* or *client/server* architecture. Instead of messages being sent directly from data producers to data consumers, messages are sent to an intermediary called a *broker*. Publishers describe each message with an identifying topic, i.e. a URI, when sending a message to the broker. Subscribers tell the broker the topics they are interested in, and the broker forwards the relevant messages to the subscribers. The project team have chosen this architecture because the load of scaling is placed on capable servers acting as brokers, rather than on the data producers that are typically constrained and behind NATs (meaning they are not publicly addressable). A high-level depiction of the architecture is shown in Figure 4.

**Figure 4: High-Level Depiction of XBOS System Architecture**

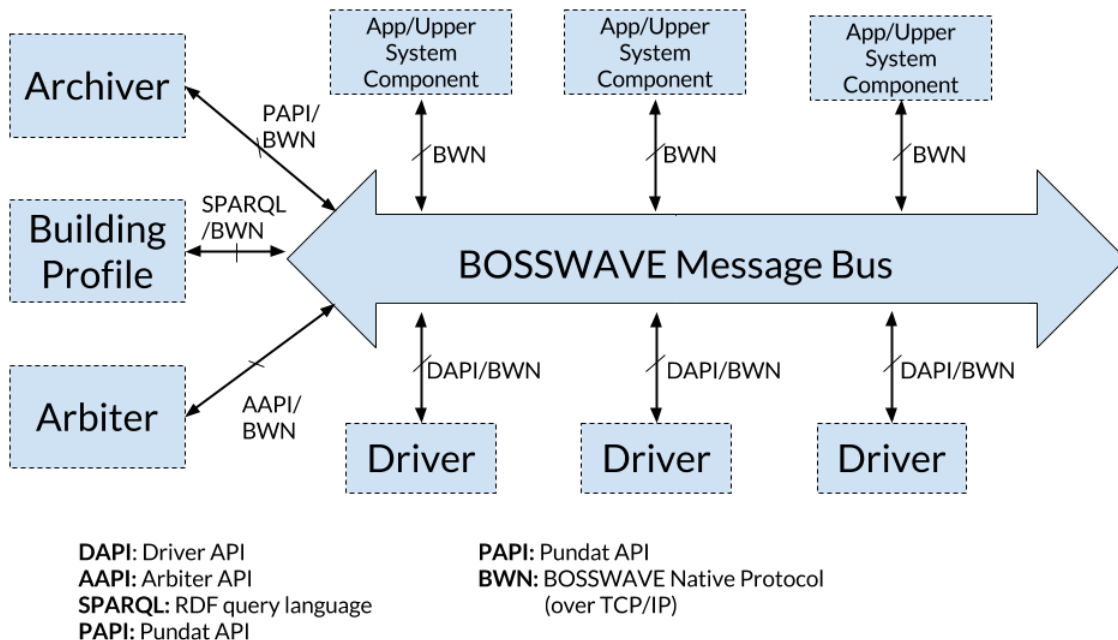

Source: UC Berkeley

## **Current State of XBOS-V Implementation**

Several core services required for implementation of XBOS-V, i.e., BOSSWAVE, the archiver, the Building Profile database and Spawnpoint, are all the subject of dedicated development efforts and are at different levels of maturity. The project tracker for XBOS organizes and details the necessary development tasks for XBOS (and thus XBOS-V) and is publicly accessible ("XBOS-V Software Development," n.d.).

The maturity of the XBOS-V metadata solution can be broken down into several components: the Building Profile database, the metadata models, and the client libraries for interfacing with the database. The Building Profile database ("HodDB," n.d.) is almost feature-completed with current efforts focusing on stability and reliability to ensure reasonable behavior in a production environment. As for the metadata models, the project team now have initial versions ("Meta Data Models," n.d.) of the models for several deployment sites containing references to deployed devices and drivers. The content and evolution of these models is driven by the needs of the applications developed on top of XBOS-V.

Additional key features of the underlying software code needed to implement XBOS-V include the following elements. First, the BOSSWAVE message bus is mature where an instance of the BOSSWAVE message bus has been running for over 400 days across around 30 servers and has routed hundreds of thousands of messages. The routing infrastructure has been shown to handle message rates of up to 1,600 messages per second on a single resource. This communication rate is more than enough for XBOS-V platform, as the project team does not expect the XBOS-V resources to emit more than two messages per second each.

The Berkeley Tree Database (BTrDB) timeseries store, which has been deployed in production for more than two years and is quite mature, backs the PunDat. The project team have had a production instance of the PunDat archiver running for six months over a two-node, 96 TB capacity BTrDB cluster. Also, client libraries are an important development point because they allow application developers to interact natively with the XBOS-V metadata model in the programming language of their choice. The project team have authored a fairly complete Python module for interacting with XBOS services ("XBOS Python Module," n.d.). Similar modules for other languages are under development. Additionally, development of Spawnpoint is complete. The project team have had several production deployments of Spawnpoint running for several months, and all existing XBOS-V drivers and services are deployed and actively monitored using Spawnpoint. Further development on Spawnpoint will concentrate on stability and bug fixes, but the project team do not anticipate any substantial changes.

The project team have already developed a library ("XBOS-V Drivers, n.d.) of several services and drivers, which are ready to be deployed in an XBOS-V site. Below is a list of devices and services for which the project team have developed a driver:

1. Electric meters (Rainforest Eagle, The Energy Detective, Rainforest EMU-2)

2. Photovoltaics (Enphase Energy, California ISO)
3. Thermostats (Venstar, Pelican, and Proliphix manufacturers)
4. Networked plug strips (Echola and TP-Link manufacturers)
5. Weather forecasting (WeatherUnderground) Networked lighting (LIFX, Enlighted)
6. Virtual Drivers for testing

The project team developed the drivers for two different EVSEs: The JuicePlug from eMotorWerks (Level 1) and the Aerovironment EVSE (Level 2). These drivers allow the remote control of the charging session for electric vehicles by controlling charge status and current limit parameters of the EVSE. The drivers also read the charging measurements data from the EVSE and make these data available in the XBOS-V platform. These drivers make the rest of the XBOS-V platform agnostic to the particular protocols and APIs of the PEV and EVSE by exposing a standard interface for the interaction between XBOS-V and the EVSE. Further details of the XBOS-V architecture and development effort are provided in Appendix D.

### **Approach for XBOS-V Development and Implementation**

The general approach for this project task is to develop a new module for XBOS that is designed to interface with a wide array of potential EVSE at Level 1 (1.6 kW) and Level 2 (7.7 kW and higher). The module is then to be tested with both Level 1 and Level 2 hardware, with the subsequent power control capability to control these loads in conjunction with local residential and commercial building loads for heating, ventilating, and air conditioning (HVAC), lighting, refrigeration, plug-loads, etc. This will add a set of EVSE drivers to the current capabilities of XBOS, depicted in Figure 5.



**Figure 5: High-Level Depiction of XBOS-V System Architecture**

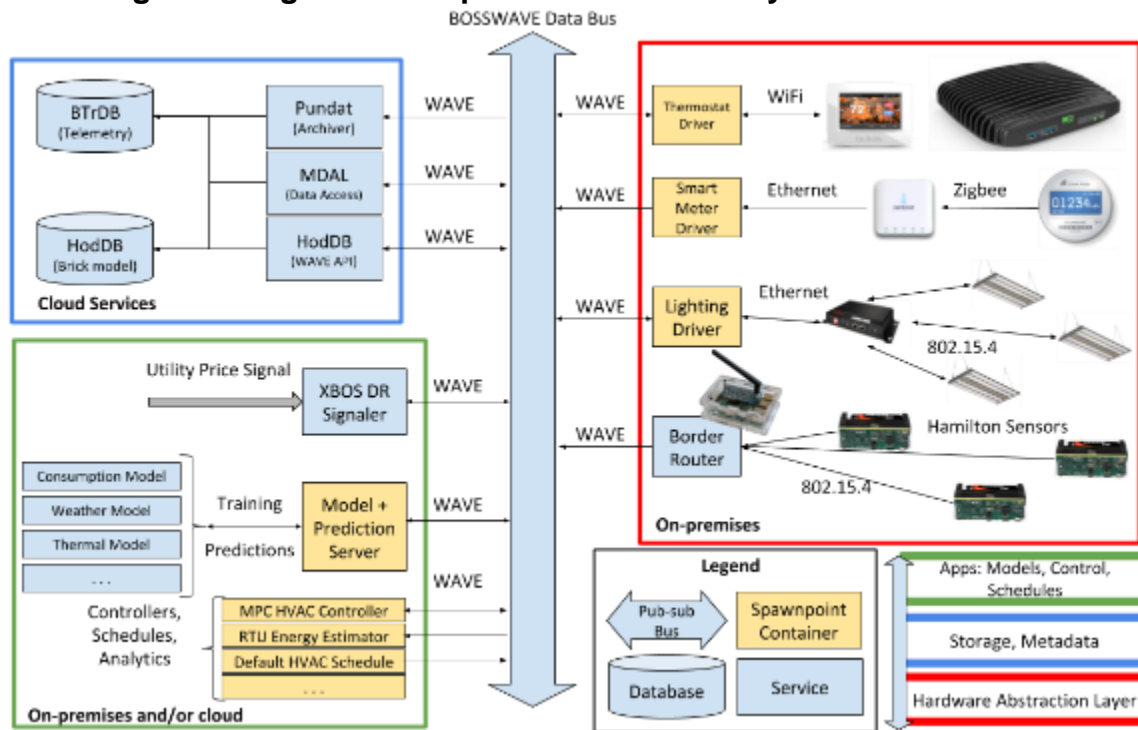

Source: UC Berkeley

The steps taken for implementation include:

- Developing a physical VGI test-bed at the UC Berkeley Global Campus (BGC) in Richmond.
- Developing an instance of XBOS at BGC.
- Creating a network of test Wi-Fi enabled building loads for testing of coordinated load management and grid signal response.
- Developing open-source XBOS-V code for EVSE charge management through Wi-Fi.
- Creating interface and testing a Level 1 AC power Wi-Fi controlled charger with XBOS.
- Creating interface and testing a Level 2 AC power Wi-Fi controlled charger with XBOS.
- Exploring managed charging of PEVs with XBOS-V in the context of residential and small commercial building loads.
- Releasing open-source XBOS-V code for use by the PEV industry and for further development.

The results and findings of the project team efforts for these project Task 3 goals are discussed in the following chapter.

## **Task 4: Distribution-Level Utility Power Grid Impacts and Benefits Analysis of PEV Smart Charging Using XBOS-V**

The approach to this project Task 4 “Distribution-Level Utility Power Grid Impacts and Benefits Analysis of PEV Smart Charging Using XBOS-V” is discussed in this section. Analysis results are presented in the following Chapter 4, and more details of the analysis can be found in Appendix E.

### **Task Overview**

The objective of this task is to examine the impacts of potential scenarios of PEV charging on distribution-level utility grid infrastructure. Examined are the potential impacts on distribution grids in California of unmanaged PEV charging, as well as opportunities to mitigate these impacts through coordinated charge management algorithms.

### **Overview of PEV Power Quality and Delivery Issues for Utility Grid Systems Management**

As discussed in Chapter 1 of this report, California is projected to have more than one million PEVs in the year 2024 (“California Transportation Electrification Assessment Phase 2,” 2014). Unfortunately, the power grid was not designed to support the charging of all these vehicles. There could be negative grid impacts if a large portion of PEVs were to charge at the same time. To avoid these impacts and take advantage of possible benefits, it is important to integrate vehicle-charging management into current power grid management systems.

Technical approaches to analyzing PEV integration in detail were first taken around the early 1980s. One of the first issues discovered was the impact of PEV chargers on system power quality (Orr, Emanuel, & Oberg, 1982). This same work was extended to measure the voltage distortion and current harmonics at the substation transformer (Orr, Emanuel, & Pileggi, 1984). This opened a new area of research into the negative impacts of PEV charging. Numerous papers since that time have explored grid impacts of uncontrolled PEV charging with differing impacts for the transmission system and the distribution system. For the transmission system, most of the concern comes from generation source selection. While on the distribution system, the concerns can be divided into three major categories—effects on feeder voltage profiles, overcurrent conditions and power quality issues stemming from the power electronics. Also, two emerging areas of research are PEV charging with volt-VAR control schemes and new charger technologies. The following section is a brief overview of these issues as they apply to Level 1 and Level 2 EVSE (“SAE Electric Vehicle,” n.d.).

### **Transmission System Impacts**

Although it may be possible that aggregate PEV charging could lead to unbalance at the transmission level, generation sources have been the primary concern with PEV penetration because of the increase in electricity demand outside of the solar day.

Specifically, life cycle CO<sub>2</sub> emissions may be higher for a PEV in certain regions compared to a hybrid vehicle due to the use of coal as a generation source (Tamayao et al., 2015). For example, on the PJM Interconnection PEVs cause a negative net social benefit (Weis et al, 2015). However, this is not the case for California and it is predicted that PEVs will reduce CO<sub>2</sub> emissions (Tamayao et al., 2015).

### **Distribution Level Power Quality Impacts of PEVs**

For distribution system effects, there has been a significant amount of work modeling and analyzing different potential scenarios of both uncontrolled and controlled PEV charging. One of the most impactful survey of the research in this area identified the main problems as: “phase imbalance,” “power quality issues,” “transformer degradation and failure,” and “circuit breaker and fuse blowout” (R. Liu, Dow, & E. Liu, 2011). Meanwhile, a very comprehensive EPRI effort modeled and analyzed feeders from several different utilities. The purpose of the project was to measure the distribution system attributes that were most affected by PEV integration. These attributes were: thermal overloads, steady-state voltage, power quality, system losses and voltage imbalance (EPRI, 2012). While all of these problems can arise, they are symptoms that arise from PEV effects on voltage profiles, overcurrent conditions and power quality issues. It is through the lens of these three effects that the project team will examine the results of these reports and other research in the area of PEV integration.

### **PEV Effects on Voltage Profiles**

PEV effects on voltage profiles can be divided into phase imbalance and feeder under-voltage conditions. R. Liu, Dow, & E. Liu (2011) identifies the concern of PEVs causing phase imbalances. This imbalance is due to PEVs on three phase residential circuits being large single-phase loads. PEVs can contribute to voltage drops in feeders as well. If voltage is low in the acceptable range, then it may drop out of range with excessive concurrent vehicle charging. Clement, Haesen, & Driesen (2008) modeled the charging of plug-in hybrid electric vehicles (PHEVs) in a European distribution system. Single phase, 4-kW chargers were modeled at 10 percent, 20 percent and 30 percent penetration with both coordinated and uncoordinated charging schemes. In uncoordinated charging scenarios, voltage drops out of acceptable range on the feeders and current exceeds transformer ratings.

Since the publishing of studies by R. Liu, Dow & E. Liue (2011) and Clement, Haesen, & Driesen (2008), additional work has been done to model the effects on voltage profiles. In 2015, SDG&E and Quanta Technology developed lab tests for PEVs based on a circuit of SDG&E in a Real Time Digital Simulator to perform hardware in the loop testing (Montes & Katiraei, 2015). The results showed that PEVs could cause overloads in service transformers because of their high current draw. Additionally, the increased demand from PEVs caused an increase in voltage drop in secondary circuits. This led to voltage dropping out of the acceptable range if the voltage of the system was already

low in the acceptable range. However, voltage drops on the primary circuits were less of concern and did not cause voltage to go out of range.

### **PEVs and Overcurrent Conditions**

The increased load demand from PEV charging increases the current flow in the system. This can lead not only to higher losses (Gerkenmeyer, Kintner-Meyer, & DeSteeze, 2010) but can also lead to overcurrent conditions. Depending on the current rating of equipment, several negative outcomes can occur. If the current rating of protective equipment, like fuses or circuit breakers, are exceeded then the protective equipment will falsely detect a fault and isolate the circuit. In 2010, a Pacific Northwest National Laboratory (PNNL) modeled the potential effects of high penetrations of PHEVs on three different utility systems. Fuse failures were found to be the most common device failures in two of the different utilities (Gerkenmeyer, Kintner-Meyer, & DeSteeze, 2010). While the third utility saw overloading affect its service transformers. However, these studies showed significant penetration was required for these overcurrent conditions to occur. PNNL also acknowledged that the modeling was performed with PHEVs which typically consume less power when charging and overall consume less energy than the other type of PEV, the battery electric vehicle (BEV). With the expected increase in sales of BEVs, these problems are expected to get worse.

Several other research groups also explored overcurrent effects on service transformers. While transformers can be operated beyond their rated capacity, it can lead to advanced transformer aging. The IEEE provides guidance and calculations to determine the amount of loss of life for transformer winding insulation due to the thermal effects of increased load. These effects are exacerbated by both maximum temperature-reached and the length of time at this higher temperature. One study examined the effects on transformer aging with PHEVs exceeding the kVA rating of the service transformer (Rutherford & Yousefzadeh, 2011). It was found that several vehicles charging from the same service transformer can quickly exceed the rated capacity of that transformer. This led to an increased in aging of the transformer.

In a different study, the rating of the transformer was not exceeded but the PHEVs shortened the late night/early morning low load period when the transformer would be cooler (Roe et al., 2009). This was also shown to significantly shorten the life of transformer winding insulation. However, it was also noted in this study ambient temperature had a significant effect as well.

In 2013, Southern California Edison (SCE) released a white paper of their key findings about electric vehicles (SCE, 2013). SCE customers at the time had more than 12,000 PEVs or 10 percent of United States PEV sales. SCE found that only about one percent of the 400 system upgrades that were performed since 2010 were needed because of the increase in demand brought by PEVs. This is in contrast to EPRI's report that showed many circuits being affected by overcurrent. EPRI found that even at low

penetrations nearly 60 percent of the circuits they examined would have some level of overload risk (EPRI, 2012).

### **PEV Effects on Power Quality**

Harmonics in the 1980's were the primary power quality concern of PEVs. Harmonics can be a problem for both loads and power system equipment. Some electronic loads are sensitive to harmonics and can shut-down if the power quality is poor. For power system equipment, transformer heating increases with the increase of harmonics in the system and protective equipment may also be affected by harmonics (R. Liu, Dow, & E. Liu, 2011).

More recent studies of harmonics have shown they still may be a concern with PEVs. In Gómez & Morcos (2003), models were developed to analyze the effects of harmonics on service transformers. It was found that to limit transformer aging, THD should be limited to 25-30 percent. While "Wrapping C++ in Cgo" proposed a deterministic assessment methodology to examine the harmonics from PEVs in a distribution system. Their results show that in the near-term, harmonics will not be a major concern. However, this was due to low penetration of PEVs and could be a concern as more EVSEs are connected to the grid.

In one of the few examples of real world system testing of harmonics from PEVs, researchers from Portland State University in 2013 measured the effects of five level two chargers and a level three DC fast charger with respect to power quality (Bass & Zimmerman, 2013). It was found that with both types of chargers there were high levels of THD (greater than 15 percent). Also, these higher levels of THD occurred in later in the charging period when the PEVs were slowing down their charging rate as they approached full charge. As such, the authors noted that the measured total demand distortion (TDD) would be a better measure of the effect of PEVs since TDD measures the impact of harmonic distortion over a feeder.

### **Volt-VAR Optimization**

PEVs may affect the ability to perform volt-VAR optimization (VVO) on distribution systems (Manbachi et al., 2016). A study from 2016 proposed a decentralized VVO scheme with PEVs in the system to model the effects of PEVs on conservation voltage reduction (CVR). This scheme relied on automated metering infrastructure (AMI) to achieve energy conservation through CVR. It was found that depending on the ZIP model of the PEVs and the number of PEVs in the system, the VVO scheme gave different results. If vehicles had high constant-power charging characteristics, then the VVO performed less CVR. While vehicles that were constant current or constant impedance allowed for more CVR. The authors stressed that it was important that as new distribution system control techniques are incorporated in the grid such as VVO, it is important to model the new loads on the grid as well to see how these techniques respond.

## **Future Charging Technology**

There are two technologies that could significantly change PEV charging equipment in the future—wireless charging and high-powered DC fast charging. For residential and small businesses, the most common service connection to the power grid is a split-phase 120/240V connection from a single-phase service transformer. With this type of connection, high powered DC fast charging is not likely since all current designs require a three phase, 480V connection. However, wireless charging is a technology that has come to market for several level one chargers and soon level two chargers as well (“Meet Plugless,” n.d.). These chargers will charge a vehicle at the same charging levels as a plug-in EVSE but have much greater impacts on the power grid. When INL measured the charging of an electric vehicle with a PLUGLESS level two charging system, they measured 134 percent current THD, a 0.60 power factor, and 82.5 percent maximum efficiency (“Plugless Level 2 PEV Charging System,” 2015). This same electric vehicle when plugged into a level two EVSE had a current THD of 6.04 percent, 0.998 power factor, and an efficiency of 88.5 percent during the max charge rate (“Steady State Vehicle Charging Fact Sheet,” 2015). At 10-20 times the THD of a plug-in EVSE, wireless charging THD is much more likely to be a concern. It is also interesting that the wireless charger had comparable efficiency to the plug-in EVSE while having a significantly worse power factor.

## **Strategies for Addressing PEV Power Quality/Delivery Issues for Utility Grid Management**

There are several challenges in managing PEV charging—specifically grid awareness, communication and selecting an optimizing strategy. A VGI management system will need to be aware of grid conditions. This may require addition sensors in the system, communication with the distribution control center or at least communication with the smart meter. Communications between the PEV and the charger is based on several different competing standards. While some standards are being explored to allow better communication between the charger and vehicle, none of the currently implemented standards share the status of the vehicle’s state of charge with the charger and level all charging control decisions are left to the vehicle itself (Schwarzer & Ghorbani, 2015). Communications between different chargers will also be required for aggregate benefits. This may be wireless, powerline carrier or Ethernet connected.

Selecting the correct optimization strategy may be the most difficult challenge in VGI. Many of the charging strategies explored in the literature assume that the chargers will know the state of charge of vehicle batteries and can modify the vehicle charging rate (Callaway & Hiskens, 2013; Ma, Callaway & Hiskens, 2013; Gan, Topcu, & Low, 2013). However, as described above, the state of charge and charging rate are only known to the vehicle by design of current standards. This severely limits the options for coordinated charging. In addition, decision for centralized or decentralized control for aggregate charging control still needs to be made. The following section is a summary of VGI Communication Standards and data requirements for VGI control strategies.

## Vehicle to Grid Integration Communication Standards

PEV charging communication standards have been a contentious topic in the State of California. In a ruling on the implementation of SB 350 by the IOUs, the California Public Utilities Commission directed the utilities to look at the issue of choosing a standard ("Assigned Commissioner's Ruling," 2018). The CPUC's recommendation was for the utilities to adopt ISO/IEC 15118 standard. This led to several comments from parties both in support and against this position. To further the discussion, the Energy Commission and CPUC established a VGI communication protocol working group ("Assigned Commissioner's Ruling," 2018). The following is a summary of the various communication standards discussed by the working group and their final recommendations for the CPUC. Also presented in Figure 6 is a graphical depiction of some of the main standards and protocols.

**Figure 6: Potential Communication Protocols for Vehicle-Grid Integration Systems**

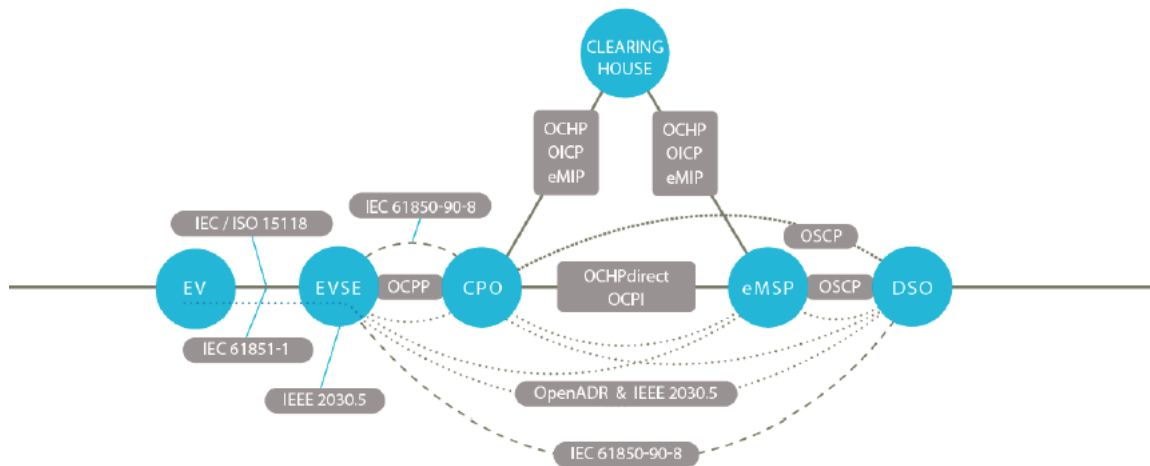

Source: ElaadNL, 2016

### ISO/IEC 15118

The ISO/IEC 15118 control paradigm depends on a powerline carrier (PLC) connection between the PEV and the EVSE. The communication between the two leads to an agreed-upon charging profile that does not exceed the limits of the charger and provides the required energy needed by the PEV for the required payment given. ISO/IEC 15118 has provision for both AC and DC charging.

ISO/IEC 15118 is being implemented in a ChargePoint pilot project with LBNL (Quattrini & Patadia, 2016). In this pilot, a utility would communicate using OpenADR 2.0b to ChargePoint network operating system. Then ChargePoint would communicate with the EVSE with an unidentified technology. Then the EVSE would communicate with the PEV using ISO/IEC 15118.

### **SAE Standards (SAE J2847, J2836 and IEEE 2030.5)**

The Society of Automotive Engineers created a suite of standards to identify use case and communication protocols for VGI (Scholer, 2016). The suite maps the use cases of IEEE 2030.5 standard, also known as SEP 2.0, to PEVs. This allows more than one communication protocol to communicate between the vehicle and the utility such as SEP 2.0 allows PLC, Wi-Fi or Zigbee. The SAE Standards are being implemented in an EPRI pilot project to explore V2G (Chhaya, 2016).

### **Direct Telematics Control of PEVs by OEMs**

Direct control of PEV charging by OEMs has been an approach used by BMW in their Chargeforward pilot with PG&E (Almeida, 2016). PG&E would request DR events by sending a signal over OpenADR 2.0b to BMW. BMW, in turn, would send signals directly to customer's smartphone apps identifying the time when their vehicle would not be charging and the money saved by participating. The customers could at this point opt out of the event and not receive the cash incentive. If the customer lets the event occur, BMW would remotely contact the vehicles over cellular signals to stop charging over the time of the event.

### **Future of PEV VGI Standards in California**

The task group established by the CPUC and Energy Commission provided a space for stakeholders to discuss options for communication protocols in California. The group's final report included matrices of use cases for each protocol and hardware requirements ("Assigned Commissioner's Rulings," 2018). However, the report's recommendation was not for a specific protocol. Instead, the report advised against requiring IOUs to use a single protocol. While this guidance provides flexibility, it also adds uncertainty to the industry. This was voiced by some stakeholders during the process. However, a consensus protocol was never reached and control strategies and optimal charge management schemes must be designed to be executed with the set of protocols that provides a good (if not the best) end-to-end solution for communications and control.

### **Functional Specifications for PEV Charge Management for Grid Distribution System Level Impact Mitigation: Data Needs**

As noted above, widespread adoption of PEVs is expected to have significant impacts on electric distribution grids, especially if their charging is not controlled. Any PEV charge control algorithm should identify when there is a high risk of a problem occurring and adjust the charging appropriately to avoid a violation. For example, if a load spike occurs or is expected to occur, charging rates should be reduced during that time period to avoid overloading. Furthermore, the algorithm could not only avoid PEV-induced network constraint violations but also leverage the PEVs to mitigate existing problems on the network. For example, PEVs could charge preferentially during hours of peak solar generation to avoid overvoltage conditions on feeders with high solar penetration. To accomplish these goals, multiple inputs must be aggregated and



delivered to the controller, including some measure of the present and predicted states of the network, the constraints that are in danger of being violated, the amount of controllable PEV resource available to remediate the problem, and a model to predict the results of the control actions. This section will outline the inputs that may be valuable for each of the use cases of PEV charge control. The primary focus will be on the use cases of satisfying line and transformer thermal limit constraints and satisfying voltage magnitude constraints. The locations or levels of control at which these various inputs may be used will be discussed at the end of this section.

### **Thermal Limit Constraints**

The increased current flow in a system due to uncontrolled PEV charging may lead to overcurrent conditions, which have several potential negative impacts. Current exceeding the rating of a protective device, such as a fuse or circuit breaker, will cause the device to operate and isolate the circuit. Even if the overcurrent is not sufficient to cause protective device operation, it will still increase the loading on equipment such as conductors and service transformers. High peak current may exceed the thermal ampacity ratings of lines and transformers (Clement, Haesen, & Driesen, 2008; Montes & Katiraei, 2015; Rutherford & Yousefzadeh, 2011), and increased current during off-peak times may reduce the ability of the equipment to cool (Roe et al., 2009). While these issues do not tend to lead to immediate failure (since most equipment can be operated beyond its rated capacity on an emergency basis for short periods of time), accelerated equipment aging can result. Therefore, an important function of the PEV charge control algorithm is to ensure thermal limit constraints are not violated. The following inputs are desirable for this purpose.

First, the thermal ratings of lines and transformers are needed. These should be specified per phase and may be either a current rating in amps (closely related to the kVA power rating) or a thermal rating in degrees Celsius. If only a temperature rating is available, a thermal model of the device and ambient temperature measurements are required to convert from measured current to temperature rise. If the current rating is available, this will serve as the explicit constraint. It is worth noting two sources of imprecision in thermal ratings. First, the time dependence of the current rating is important, since devices can withstand higher currents if the duration of the current peak is not long enough to cause substantial heating. Second, the relationship between current and actual conductor temperature naturally depends upon the ambient conditions, including air temperature and wind speed. These factors are rarely accounted for in practice, especially in the context of routine distribution operations, because there are simply too many variables. Instead, it would be typical to include some margin for uncertainty, e.g. by using the current rating appropriate for a hot summer day throughout the year. If one intends to operate electric grid components very close to their actual thermal capacity in real-time, much more than static ratings are needed.

In addition to the equipment ratings, some measure of the present and predicted states of the system is required in order to determine whether a constraint will be violated. This may be a direct measurement of the current per phase at the location of interest on the network (e.g. a transformer at risk of overloading). Alternatively, the current can be calculated from a measurement of real and/or reactive power per phase, coupled with a measurement or estimate of voltage. Another alternative is to measure the temperature of the equipment directly in real-time with a thermosensor. This is far from common practice in today's distribution systems, although the rapidly declining costs of such sensors, along with growing ease of telecommunications and data integration from sensor networks, could make this a realistic option in the near future (ARUP, 2014).

The information is necessary to determine whether thermal constraints are currently being violated. To resolve the violation, it is important to understand the impact of PEV charging on equipment loading. In this way, the algorithm can select an appropriate combination of vehicles for which modifying the charge rate is most likely to be effective at relieving the overload.

### **Voltage Magnitude Constraints**

In addition to equipment overloading, the extra current flow associated with uncoordinated PEV charging also poses a concern for voltage magnitude. The increase in voltage drop due to this additional current can cause the voltage to go out of the acceptable range, especially for feeders whose voltage is already low in the range (EPRI, 2012; Clement, Haesen, & Driesen, 2008; Montes & Katiraei, 2015). This type of violation is particularly likely for secondary circuits with large penetration of PEVs, where the charging current is significant compared to the other loads on the circuit (EPRI, 2012; Montes & Katiraei, 2015). Under-voltage conditions due to PEV charging may also increase the number of tap change operations (EPRI, 2012). Furthermore, since PEVs are large single-phase loads that are not necessarily connected to each phase in equal numbers, phase imbalances can occur (R. Liu, Dow, & E. Liu, 2011). Therefore, managing voltage profile is also an important use case for charge control algorithms. The information requirements for this use case are similar to the case of thermal limits, but here the most important variable to measure and model is voltage, rather than current.

Analogous to equipment thermal ratings in the previous use case, voltage constraints are a critical input here. First, there are standards that specify the allowable voltage range on distribution networks. For example, the ANSI standard C84.1 requires the voltage on secondary circuits in the United States to be within five percent of the nominal value, or between 114 and 126 V. Excursions from this range are allowed only if they are short in duration. Second, individual devices on the network, such as customer appliances, may have their own voltage ratings, independent of the standards. The performance of these appliances can be compromised if they are provided with a voltage outside of the specified range. For example, refrigerators often fail during sustained under-voltage conditions. PEV charging should, therefore, be

controlled so that neither these equipment voltage constraints nor the general voltage standards are violated.

Voltage measurements are the most direct means of determining whether a voltage constraint is being violated. In particular, if voltage measurements at each customer's service entrance or point of common coupling are provided to the controller, the controller can work to maintain all of these voltages within the desired range. However, distribution networks rarely have voltage measurements with adequate resolution in time and space to detect and respond to localized under-voltage events. While customer smart meters do sense voltage, the existing AMI communications and data handling infrastructure typically does not provide for these measurements to be used for system operations. A likely worthwhile area of investigation is whether and how AMI voltage data could be made available for circuit monitoring and operational purposes under high PEV penetration, at a reasonable cost. For this purpose, it would not be necessary to query every single customer meter; rather, a limited number of voltage reference points (say, on the order of tens, depending on the length and topology of the circuit) could suffice.

### **Power Quality Constraints**

A third potential negative impact of PEV charging is the introduction of harmonics onto the grid. Electronic power converters such as vehicle chargers are known as "nonlinear loads" because they draw current not in direct proportion to the voltage, but in a sometimes peculiar manner over the course of the AC cycle, depending on the internal process of the electronic device. These peculiar current profiles are characterized in terms of harmonics, or mathematical components of the waveform at higher frequencies than the 60-Hz fundamental. Current harmonics do not contribute to real power transfer, but they circulate in the utility equipment and thereby add to heating. Consequently, significant current harmonics can cause equipment such as transformers to overheat, shortening the equipment lifetime (R. Liu, Dow, & E. Liu, 2011; Gómez & Marcos, 2003). Very large current harmonics on a circuit can also translate into noticeable voltage harmonics (just as the voltage generally declines with high load current, but here on a much faster timescale), which can potentially impact the power quality for other customers nearby, but these problems tend to be rare compared to the heating issue with current harmonics.

Current or voltage harmonics are quantified in terms of the percentage of power contained in all frequencies other than the fundamental, or total harmonic distortion (THD). If the controller is provided with information about current THD, it could control charging so that the THD does not exceed a given maximum value. To do this, power quality sensors with sufficient sampling rate to detect higher-order harmonics would need to be present on the grid. The controller would also need some measure of each vehicle's contribution to the THD at the present moment. Since THD is known to change over the charging period (Bass & Zimmerman, 2013), this could comprise a model of

the THD as a function of charging rate or state of charge, coupled with knowledge of the current charging rate or state of charge.

### **Data Needs and Control Paradigms**

Various paradigms of control, from more centralized to more decentralized are possible. For more centralized entities such as utilities or third-party aggregators, knowledge of the constraints, conditions on the network, locations and EVSE characteristics of PEVs currently on the network, and models for the impact of charging on the network conditions are all valuable inputs. With these inputs, the controller can make the most informed decision about what control signals to send to which PEVs.

In cases where the centralized controller is computationally complex, one or more simpler decentralized controller/s are potentially sufficient. For example, inputs required for a decentralized controller designed to coordinate PEV charging to address the problem of overloading a service transformer may include the: (1) transformer rating; (2) current and future constraints and conditions of a secondary network; (3) the amount of downstream controllable PEV resource available to remediate the problem; and (4) a model to predict the results of the control actions.

In this example, reducing the charge rate of PEVs connected downstream of the service transformer will potentially resolve the overload problem. In contrast, a centralized controller would require the constraints and conditions of the entire distribution network and charging constraints and preferences for all grid-connected PEVs before arriving at the same control action. Another potential benefit of a decentralized control scheme is a reduction in the distances required for communicating measurements and information associated with PEV charging. In the example mentioned above, the project team would anticipate the PEVs to be communicating to a decentralized controller located less than a one mile away, whereas the communication of PEV states and preferences to a centralized controller could require signals to travel over hundreds of miles.

The proposed simpler decentralized architecture, however, may lead to PEV charging that is suboptimal. For example, in cases where under-voltages occur in multiple locations across a distribution feeder, a centralized controller could curb PEV charging for a small subset of devices. In contrast, multiple independent, decentralized controllers located across the feeder that are designed to control PEV charging downstream of a service transformer would act independently, potentially leading to many more PEVs commanded to reduce charging. That is, the decentralized controllers would not be aware of how widespread the problem is, with each acting independently to rectify the under-voltage condition.

An alternate control architecture that potentially balances the optimality of the central controller with the simplicity of a decentralized controller is often referred to as a hierarchical controller. This hierarchical control architecture could be envisioned in a number of different ways. For example, information downstream of each service transformer could be aggregated and communicated back to a central (or supervisory)

controller system. This central controller would then send commands to decentralized controllers co-located at each service transformer, tasked with deciding how to allocate PEV resources downstream to meet the central controller command (for example a load reduction).

Under all of these control paradigms, the project team envision larger XBOS deployments to operate in a similar fashion. Specifically, XBOS would pass through PEV charging signals or enact a subset of loads to achieve a given power reduction as specified by a central controller, decentralized controller, or a controller in the hierarchical paradigm. In cases where a distributed control architecture is possible, XBOS could additionally host control algorithms that coordinate PEV charging to alleviate network constraints. Such a distributed control paradigm requires XBOS systems to communicate to other XBOS systems additionally, a concept that is out of scope for this project but a potential subject of future investigation.

### **Distribution Level Power Flow Algorithms**

The optimal charging sequences for all grid-connected PEVs providing a feeder-level, valley-filling service can be obtained by solving a formula that includes information about PEV charging power levels and nodal voltage constraints. The formulation of this optimization problem or “Lagrangian” is described in detail in Appendix E.

A central entity could solve this constrained optimization problem using a quadratic program. To have the control sequences properly solved, the central entity needs to:

- be equipped with appropriate hardware and software to execute quadratic programming.
- know the distribution network topology and its associated impedance matrix which are used for constructing the LinDistFlow model (described in Appendix E).
- determine the base load forecast with an acceptable accuracy.
- identify the nominal network voltage and the lower bound of nodal voltage magnitudes.
- gather the charging requirements of all feeder-connected PEVs, including the individual maximum charging rates, individual charging efficiencies, and individual charging deadlines.

In the process of solving the constrained optimization problem, the central entity informs each PEV of the charge rate to apply at each time-step in the control horizon.

### **Decentralized Controller and Algorithm Design**

The centralized controller described above relies on a secure communication channel between each XBOS-V installation and a central entity, so that private individual PEV charging information can be exchanged. Private information exchanged includes individual PEV charging constraints and the control action to take (i.e., charge rate to apply) at each time step. The project team proposed a decentralized, valley-filling

algorithm where the individual PEV charging constraints remain with the XBOS-V, and instead, each XBOS-V collects a universal coordination signal from the central entity before deciding upon the control action to take. In this way, the project team moves the significant computational burden from the central entity to the XBOS-Vs, while improving the security of individual PEV parameters like the battery efficiency and the energy needed to be fully charged.

The control architecture developed for the decentralized, valley-filling algorithm is hierarchical. The central entity iteratively dispatches high-level universal coordination signals to and receives updated information from all XBOS-Vs. Having received coordination signals from the control center, each XBOS-V solves an optimization problem according to its local PEV constraints and then updates its charging strategy. At the same time, the central entity also solves an optimization problem and updates the coordination signals sent to each XBOS-V. The central entity monitors the convergence of all PEV charging strategies to be implemented. Specifically, the above procedure does not stop until either a maximum number of iterations is reached or the charging strategies for each PEV converges to an acceptable range. A detailed mathematical description of the decentralized, valley-filling control problem is provided in Appendix E.

The analysis results of employing PEV charge control algorithms with the issues and requirements discussed above for grid management are discussed in the following Chapter 4. Further technical details from this project Task 4 activity including the functional specifications for the tested algorithms are also included in Appendix E.

## **Task 5 Project Activity Approach: Analysis and Forecast of Ratepayer Benefits of PEV Smart Charging in California**

The goal of this project Task 5 is to examine key issues related to the larger utility grid picture with regard to VGI in California through 2030, and potential ratepayer opportunities for VGI programs for grid support. Examined are forecasts of utility grid evolution in the context of California's RPS program, now targeted to achieve 100 percent zero-carbon electricity by 2045 (Senate Bill No. 100, 2018) and the ability of smart charging of PEVs to effectively provide a substitute for some amount of dedicated grid storage through their flexible load potential.

Potential ratepayer opportunities and benefits through improved grid operations are examined, with a focus on detailed estimates of future renewable power curtailment in California and the ability of PEVs to mitigate this through managed charging. Example years 2024 and 2030 are presented below, by which times the energy supplying the California grid is expected to be 40 percent renewable and 50-60 percent renewable, respectively.

The approach to this task involved: 1) researching utility and grid operator (California ISO) opportunities for general public and fleet manager participation in VGI; and 2)

conducting detailed analysis of the opportunity of flexible load from PEVs to potentially shift (with driver behavior modification) to store and use renewable power that might otherwise be curtailed. The first objective was accomplished through a literature review and analysis of utility and California ISO programs, with key findings documented in the next chapter.

With regard to the detailed grid modeling for California in 2024 and 2030, a combination of grid modeling using PLEXOS (for the 2024 case) and examination of other models including PLEXOS but also including SWITCH (a UC Berkeley model) were then synthesized and adjusted to develop a 2030 grid snapshot, where a level of 50 percent renewable electricity is projected. This compares with an expected 40 percent in 2024, increasing from about 33 percent in 2018.

The general approach to conducting this modeling work was to: 1) develop data input files for PLEXOS (or examining other model assumptions for the 2030 case); 2) operate the models to generate results for grid curtailment and opportunities to mitigate this through PEV flexible load; 3) interpreting and analyzing the results; and 4) documenting the findings. Key results from this modeling work is presented in the following chapter, and further details of the approach and methods for this work is provided in Appendix F and in Szinai (2017).

## **CHAPTER 3:**

# **Project Results**

---

The results of the XBOS-V project technical tasks are presented in this chapter. These tasks are numbered Task 2 through Task 5 and the key findings are summarized by Task number because while inter-related, the tasks also have somewhat distinct objectives, research and analysis methods, software code development efforts, and key findings.

### **Task 2 Project Activity Results: VGI User-Needs Assessment**

The project Task 2 consisted of two activities: 1) a series of focus groups with 50 participants in the BMW ChargeForward VGI pilot program; and 2) a series of interviews with building energy managers for various types of buildings with their interest in VGI concepts. Presented below are the primary findings from this task activity, with additional details presented in Appendix C including detailed results for each round of the focus groups (Phase 1 with 28 and Phase 2 with 22 participants).

#### **Focus Group Findings**

The overall survey findings of the full set of focus groups are presented next, complementing the detailed summaries of the Phase I and Phase II focus-group sessions presented above. These findings below represent the overall results of the full group of “n=50” respondents.

Some general characteristics of the focus group study population, shown in Figure 7, indicates that this participant group is a relatively “early adopter” sample with over half of the respondents saying they wait to read a review before purchasing new technology items. A significant amount of (about one-third) the population saying they are among the first to purchase. Only a few respondents say they wait until someone they know purchases the item first, or rarely purchase new technology.



**Figure 7: Focus Group Participant Response to New Technology Purchase**

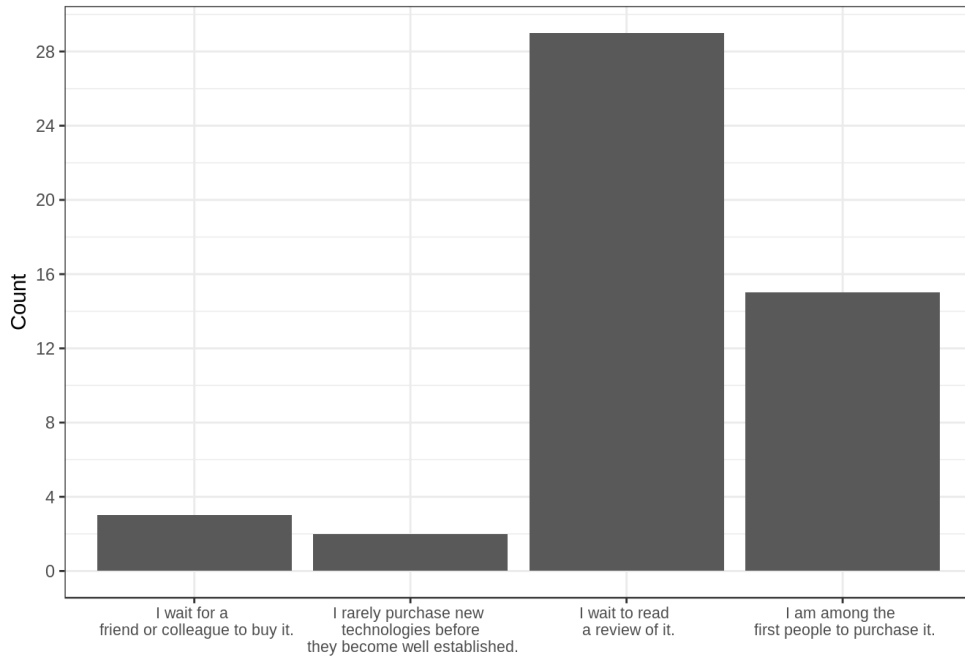

**Participants were asked, “When a new technology that I am interested in becomes available for purchase”**

Source: UC Berkeley

Figure 8 shows responses to the question of how often during the week PEV drivers charge their vehicles. A large group of about one-third of drivers charge five to six times per week, with about 25 percent charging seven to eight times, about 20 percent charging three to four times per week, and fewer percentages charging either more or less frequently. The project team expects these patterns to change over time as PEV OEMs introduce larger battery capacity PEVs, leading to more flexibility with regard to charge timing and frequency.

**Figure 8: Focus Group Participant Response to Frequency of Weekly PEV Charging**

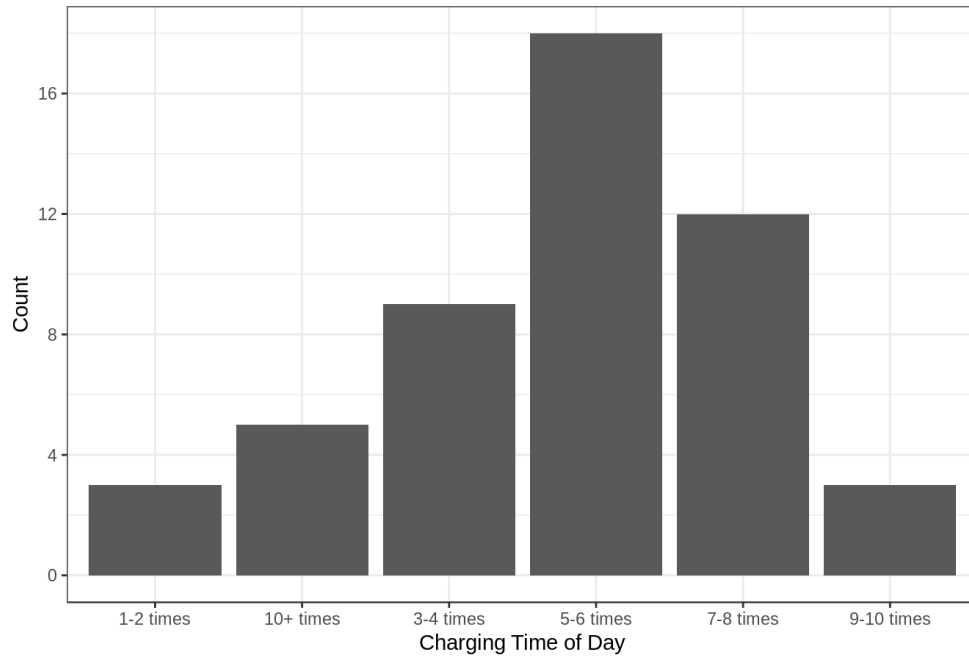

**Participants were asked, “How often do you charge your PEV during a typical week?”**

Source: UC Berkeley

With regard to the location of PEV charging, Figure 9 shows that focus group participants overall indicated home Level 2 charging as their most typical weekday charging type, with a much lower level of home Level 1 and workplace charging. A predominant use of public charging was indicated in only about eight percent of respondents.

**Figure 9: Focus Group Participant Response to PEV Charging Location**

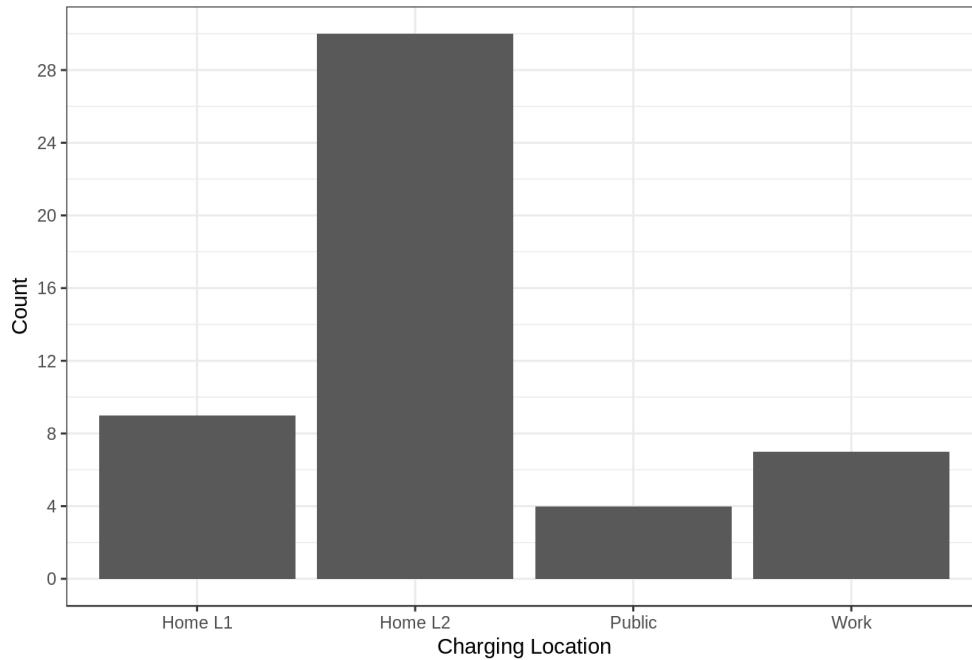

**Participants were asked, “Where do you charge your PEV most often on a typical weekday?”**

Source: UC Berkeley

As for the time of day of charging, Figure 10 shows the Phase I and Phase II groups were fairly consistent with most charging being done overnight (consistent with the heavy reliance on home charging). The next largest time block in terms of frequency was in the late evening, followed by late afternoon and early evening. Some of the program participants are likely on TOU rates because of either separate PEV meters or solar PV in the household, where in PG&E territory the rates are currently the highest from 3-8pm with the TOU rate schedules. Thus, participants are probably aware of this in those cases and arranging for charging to occur after 8pm even if they arrive home earlier.

**Figure 10: Focus Group Participant Response to PEV Charging Time of Day**

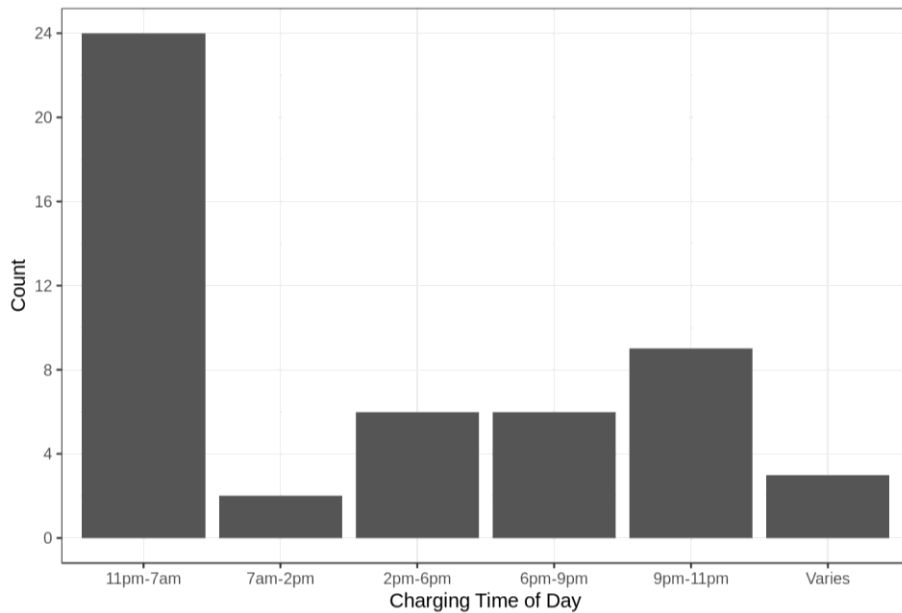

**Participants were asked, “What time of day do you most often charge your PEV on a weekday?”**

Source: UC Berkeley

With regard to motivations for PEV purchase, as noted above this is a highly environmentally concerned group of participants. Out of 50 participants, 28 (56 percent) of them indicated that climate change was extremely important and an additional 30 percent indicated it was very important, as shown in Figure 11. None of the participants reported that it was either not at all important or even only somewhat important.

**Figure 11: Focus Group Participant Response to Climate Change Importance**

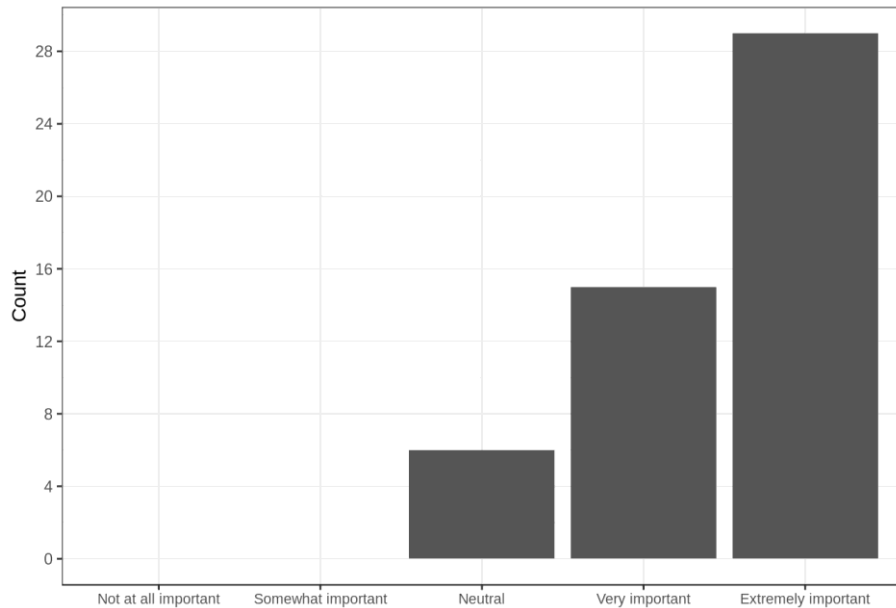

**Participants were asked, “How important is the issue of climate change to you personally?”**

Source: UC Berkeley

Figure 12 shows with regard to comfort with managed charging, 21 participants (42 percent) said that they were comfortable with this concept, 42 percent said that it would depend on the entity involved in managing the program, 14 percent said they had some reservations (“maybe”) and one participant (two percent) said they would not be interested at all.

**Figure 12: Focus Group Participant Response to VGI Managed Charging**

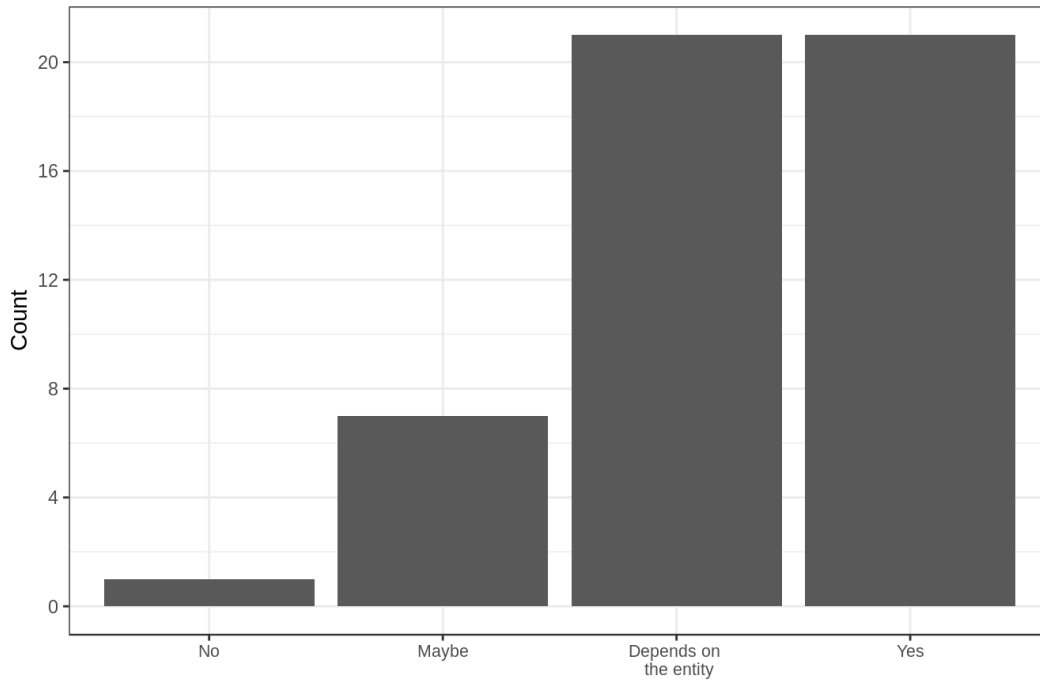

**Participants were asked, “Are you comfortable with an external entity’s involvement in managing your electric vehicle charging, with consideration of your driving needs?”**

Source: UC Berkeley

Finally, with regard to which entities participants would trust to be involved in managed PEV charging, the most trusted entities are car companies, large private companies, and government entities, followed by public and private utilities. In terms of the “somewhat trust” response, it is interesting that all of these entities are very closely grouped with a similar level of trust, as shown in Figure 13.

**Figure 13: Focus Group Participant Response to VGI Managed Charging Entities**

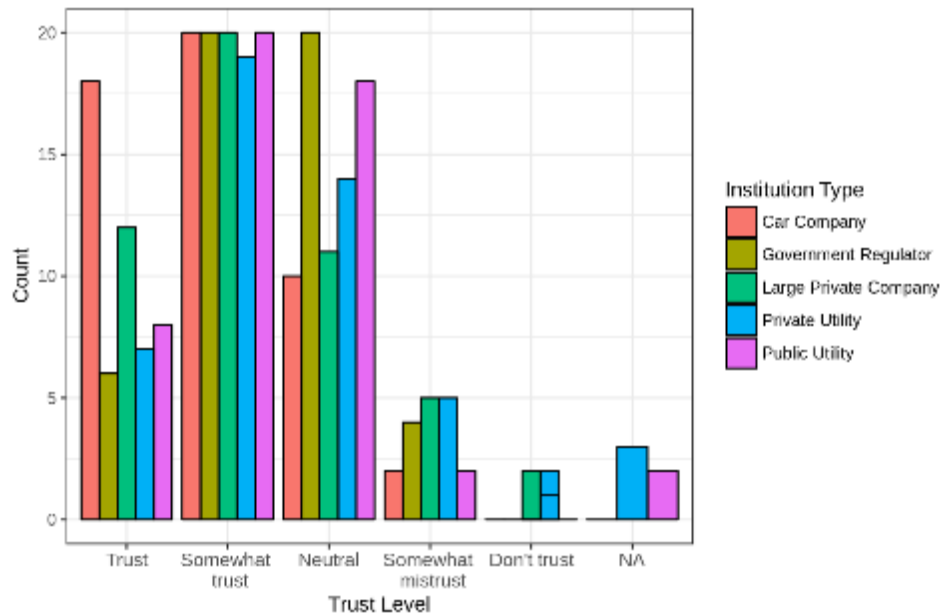

Participants were asked to, “Rate the following types of institutions based on your comfort with their involvement in the managing of your electric vehicle charging.”

Source: UC Berkeley

### Focus Group Study Limitations

The focus group study is limited by a relatively small sample size (n=50 participants) and a few biases that could arise from self-reporting charging and driving behavior, group dynamics in the focus group, among others. Some of the “group dynamic” biases inherent in focus groups were offset by having a second method of data collection through the survey instrument to validate responses. The sample size was also not randomly selected, and is not a representative sample of typical California drivers. Given the location in the San Francisco Bay Area, the sample is even a subset of PEV drivers, who in general are relatively high-income, well educated, male, and primarily in “STEM” (science, technology, engineering, and math) fields. However, the sample is perhaps well representative of early PEV adopters, who are typically enthusiastic about trying new technologies and programs; therefore, any concerns about managed charging or PEV driving experience should be heeded when considering future managed program design. Given time and resource limitations, the project team were not able to correlate individual answers from the survey to the same individual’s answers in the focus group, but this is an aspect that could be explored further.

### Focus Groups - Summary of Findings

The two rounds of focus groups revealed generally similar findings. There was a somewhat more diverse set of findings from the second round of focus groups that were conducted over a wider area of the SF Bay Area, and with a somewhat broader cross-section of participants based on their demographics.

Key overall findings from the focus groups include the following points:

- Participants were very interested in the ChargeForward program and found it to be fairly transparent and not disruptive to their travel needs.
- Most participants in this study charge heavily from the household and use limited workplace and public charging.
- Participants were interested in the concept of PEV charge management in the context of overall household energy management.
- Some data security and privacy concerns were raised but most participants were willing to share basic “charging and travel plan” type data with a trusted organization.
- Involvement of a major OEM (BMW in this case) was important to the participation of many of the focus group participants, but they wanted more information about program benefits and a better iOS type interface to the program.
- Participants were split over what actors would best serve as integrators for management of grid services from PEVs, with some favoring solutions by large but relatively trusted companies, and others preferring smaller company or even individually configured and managed systems.

Overall, the focus group sessions provided a valuable opportunity to learn from PEV drivers who actually participated in a “managed charging” program. The key features for future VGI type systems such as those that could be developed as extensions of XBOS-V include a simple and easy to understand user interface for smart phone applications, the ability to readily opt-out of any expected events if PEV charging is needed without interruption, and a sense for participants of how their individual actions are contributing to a significant overall effect in benefitting utility grids.

### **Building Energy Manager Interview Findings**

As discussed in the previous chapter, a second Task 2 activity consisted of conducting a series of 12 interviews with building energy managers regarding their thoughts on VGI in the context of their buildings.

The key findings from the building energy manager interviews include:

- The studied buildings ranged from single-family homes to large commercial office buildings and commercial/industrial building complexes.
- The building energy managers at all of these sites exhibited a high degree of knowledge with regard to building energy management concepts.
- Many of the buildings have established advanced energy management systems that are potentially able to integrate with PEV charge management systems.



- Building energy managers were generally either participating in or aware of and interested in energy load demand-response type programs, and interested in how PEV charge management could be coordinated to manage overall site loads.
- However, some buildings especially involving specialized laboratories have some data security concerns with combining overall building energy systems with PEV charge management.
- Building energy managers were generally interested in the idea of PEVs providing emergency backup power to buildings during times of high occupancy, potentially supplementing additional emergency backup systems.
- Building energy managers cited a high level of power reliability as being an important concern of building occupant/renters, especially for high technology and mixed office/laboratory companies such as Samsung and Genentech.

## **Task 2 - Conclusions**

In conclusion, these ChargeForward participant focus group and building energy manager interviews provided a valuable opportunity to learn from real world settings and concerns related to PEV charge management. Findings from the Task helped to inform current project and potential future efforts including: 1) understanding what can motivate PEV drivers to participate in VGI programs; 2) the participant desired level of user complexity/information; 3) concerns about use of VGI in specific settings; and 4) insight into potential VGI application at a wide range of commercial locations as well as residential sites. The overall response to the concept of VGI was generally positive in both the PEV driver focus groups and the building energy manager interviews, but with many nuances and some specific concerns as noted in the summary above.

## **Task 3 Project Activity Results: XBOS-V Module Scoping, Development, and Testing**

Completing Task 3 of this project required a series of hardware and software integration steps in order to allow for the development of the XBOS-V software module and subsequent testing at this "VGI testbed," along with documentation of task findings. Task goals included: 1) installing a Level 2 PEV charger with Wi-Fi communications capability at the Berkeley Global Campus in Richmond; 2) establishing an instance of XBOS at the location using a low-cost computing platform; 3) developing an open-source set of software drivers to integrate smart PEV charging with XBOS in the XBOS-V module; 4) demonstrating Level 1 (1.6 kW) binary on/off control using the XBOS-V module; 5) demonstrating Level 2 (7.7 kW) variable power control using the XBOS-V module; and 6) documenting task software code development (with open source release) and overall task results.

## **VGI Test-Bed and XBOS Platform Installation at the Berkeley Global Campus**

The Aerovironment Level 2 charger installation for project testing at the UC Berkeley Global Campus in Richmond was performed easily once the University of California approved the site plans for installing the charger. Once the charger unit and support pedestal were ordered and delivered, the charger was installed by a qualified campus electrician, and the full set of electrical inspections were conducted. The installation was completed and the “VGI testbed” was ready for use in September 2017 (Figure 14 and Figure 15).

Aiding the rapid installation of the unit, the site had been prepared for the installation of an EVSE from a previous project that also included the installation of an NHR 9410 “Grid Simulator” power management device. The NHR device, in Figure 15, can be configured to provide different levels of AC and DC power output from a 480 Volt, three-phase input. For this project, the device was configured to provide single phase 220 Volt output to the Aerovironment EVSE. Hence, the project leveraged previous efforts to install the NHR power unit and the conduit run and wiring to the EVSE location, then needing only to install and test the Wi-Fi enabled EVSE unit itself.

**Figure 14: Aerovironment Level 2 Charger**



Source: UC Berkeley

**Figure 15: NHR “Grid Simulator” Power Supply and Power Quality Testing Device**



*Model 9410 single Power Module front panel view*

Source: UC Berkeley

### **Implementation of XBOS and XBOS-V Capability at the UC Berkeley Global Campus**

In parallel with installing the EVSE unit for testing, the project team implemented an instance of XBOS at the site, along with some additional Wi-Fi enabled controllable building loads and building energy-use measurement telemetry. Shown in Figure 16 on the left is the collection of devices for XBOS implementation at the site, including a low-cost FitPC micro-computer (\$100), an internet switch (\$40), and interface devices for control of the Level 2 EVSE, a set of three baseboard heaters using a Pelican system, Phillips LED light bulbs, and several 110V plug-load controllers. Also included is an interface device for communication with a TED electrical panel power monitoring system that is connected to the three-phase power panel shown in the right figure, to measure the power use in the building. The TED device was needed because Bldg. 190 is not separately metered from other nearby buildings.

**Figure 16: Installation of XBOS and Associated Devices for Building Energy Control and Management for XBOS-V Development and Testing**



Source: UC Berkeley

## Software Beta Testing and Drivers for Electric Vehicle Service Equipment (EVSE)

With regard to the XBOS-V software development and software-hardware integration efforts, the team overcame several implementation challenges regarding integration of current EVSE technologies. In this section, the project team discuss those challenges and the solutions that were used for tackling them.

### eMotorWerks JuicePlug

The JuicePlug EVSE from eMotorWerks manufacturer attaches to an existing Level 1 charge cable and connects to a local WiFi network. The plug is only powered and connected to the WiFi network when the PEV is present and plugged in, so it is infeasible to have a XBOS-V driver communicating with the plug over the local network. In XBOS-V, the project team would like to be able to read the plug's states and set charging schedules even when the PEV is not present. To work around this issue, eMotorWerks provides a simple cloud-based API for reading and writing the plug's states; however, this API uses an HTTP connection instead of an HTTPS connection, meaning that XBOS-V has very little control over the privacy of the EVSE and PEV state.

The project successfully demonstrated the ability of the XBOS platform to provide binary (on/off) control of the eMotorWerks smart plug, using both example plug-in hybrid and battery PEVs (Figure 17). This fulfilled one goal of this project task to integrate a Level 1 charging system with that basic remote power switching capability in XBOS-V. The larger power levels for Level 2 charging at 220 Volts (7.7kW and higher) provide the opportunity for adjusting power levels over a fairly wide range of current (from about 6 Amps to 32 Amps), for a power range of 1.4 kW to 7.7 kW with the Aerovironment charger used in the project. For future implementation (beyond this project) for Level 1 solutions, the project team are now discussing with eMotorWerks if they can migrate their API to HTTPS for better data security.

**Figure 17: eMotorWerks “JuicePlug” Level 1 Smart PEV Charging Device**



**Charger Rating: 120V/15A/1.6 kW**

Source: eMoterWerks

## **Aerovironment EVSE**

The Aerovironment Level 2 EVSE was fully installed, tested, and inspected and cleared for use in September 2017. The project installation during vehicle testing is shown in Figure 18. This section discusses the EVSE API from the manufacturer and the software implementation for the driver.

**Figure 18: Aerovironment Level 2 Smart PEV Charging Device**



**Charger Rating: 220V/32A/7.7 kW**

Source: UC Berkeley

The Aerovironment Level 2 EVSE comes with a Raspberry Pi board (Raspberry Pi A+) that is connected to the EVSE hardware through a serial communication port, and a C++ library for interfacing with the EVSE over that serial link. The C++ library defines an API for reading the state of the EVSE and sending control commands to the EVSE.

For initial work on this project task, the project team wrapped the provided C++ library using cgo ("Wrapping C++ in Cgo, n.d.") so that the project team could use our existing BOSSWAVE client bindings written in the Go programming language. These client bindings have been used in production for over a year and are stable. Because interacting with BOSSWAVE involves performing computationally expensive cryptographic operations that can cause problems on older platforms (such as the first-generation Raspberry Pi board provided with the Aerovironment charger), the project team have implemented a "remote" BOSSWAVE agent ("Ragant," n.d.) for use in such constrained environments, which outsources the expensive cryptographic operations to an external, capable and trusted server. The Aerovironment driver interacts with this remote agent in order to publish data and receive messages from subscriptions.

## **Initial Open Charge Point Protocol 2.0 Implementation**

As a next step with regard to charge control of Level 2 AC EVSE, the project team has developed an initial open-source XBOS-V driver using the Open Charge Point Protocol

(OCPP) 2.0 international standard. OCPP was originally largely designed to facilitate inter-operability of EVSE with regard to secure customer payment and billing, but in the new 2.0 version offers additional features including better capabilities for integrated load control (needed for XBOS-V implementation) and additional features including support for ISO 15118. More details on OCPP can be found in the link below:

<https://www.openchargealliance.org/protocols/ocpp-20/>

The project team has developed an initial OCPP 2.0 implementation that can be readily adapted to further development for interfacing with any Level 2 OCPP compliant EVSE. This offers the potential to have a simple interface for controlling multiple EVSE in the same location made by different manufacturers as long as they can respond to OCPP 2.0 signals.

### **Coordinated Building Load Control Including EVSE with XBOS**

In this section, the project team present our preliminary results on using XBOS-V to automate and coordinate the control of building loads with PEV charging. In particular, the project team developed a controller that maintains the overall power consumption below a predefined threshold. The controller implements a “0-1 Knapsack-based algorithm”<sup>1</sup> to achieve this goal. The source code for the controller is open sourced and released as part of the XBOS-V platform.

The project team deployed the controller in Bldg. 190 and used it to coordinate the A/V Level 2 charger, three baseboard heaters, and five representative plug loads of residential settings (e.g., a fridge, a microwave, a water boiler, a space heater, and a fan). The inputs to the controller are: 1) the maximum power threshold, 2) the priority of loads (which load has higher priority), and 3) an optional minimum charge rate for the EVSE. The controller continuously obtains the: 1) overall power consumption of the building, 2) current state and power consumption of the EVSE, and 3) current state and power consumption of all controllable loads. If the total consumption is above the predefined threshold, the controller selects the loads that should remain on (based on the predefined priorities), turns off other loads, and adjusts the charging rate for the EVSE (if needed).

As shown in Figure 19, using the XBOS platform the EVSE current limit in Amps can be readily adjusted in an automated fashion to compensate for changes in local building loads. As the building electricity load sensor detects changes in building electrical loads, it can adjust rapidly to stay under a maximum building load set point or other constraints related to such as minimizing electricity consumption due to higher priced time periods in TOU rate schedules.

---

<sup>1</sup> The knapsack problem or rucksack problem is a problem in combinatorial optimization: Given a set of items, each with a weight and a value, determine the number of each item to include in a collection so that the total weight is less than or equal to a given limit and the total value is as large as possible.

**Figure 19: The XBOS-V Controller Demonstrating the Coordinated Control of Berkeley Global Campus Bldg. 190 Loads and a Level 2 PEV Charger**

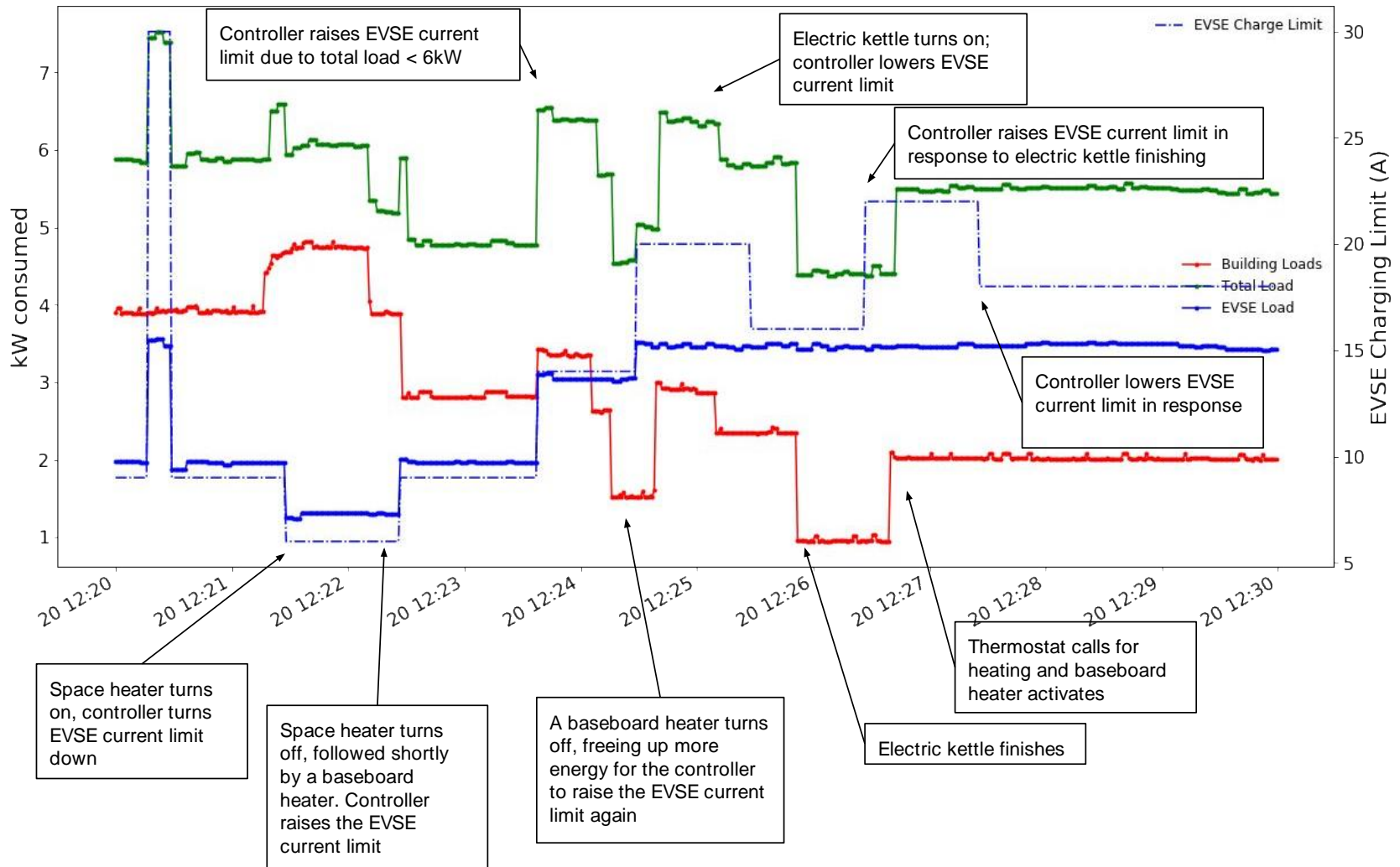

Source: UC Berkeley

### Task 3 - Conclusions

In conclusion, this task achieved all of the key technical objectives of developing the VGI testbed at UC Berkeley Global Campus, creating an instance of XBOS as a platform for XBOS-V development, instrumenting a test building with Wi-Fi load control devices and a power flow metering device, developing open-source, Wi-Fi compliant drivers for Level 1 and Level 2 EVSE, demonstrating coordinated load control of building and EVSE loads using the XBOS platform, and documenting key findings and releasing the open-source code.

The open-source driver code and details of the tasks in the software development plan are available at the following "github" locations:

- XBOS platform documentation: <https://docs.xbos.io/>
- XBOS platform code: <https://github.com/softwaredefinedbuildings/xbos>
- OCPP 2.0 Implementation: <https://github.com/gtfierro/ocpp-2.0>
- Juiceplug driver implementation (XBOS):  
<https://github.com/SoftwareDefinedBuildings/bw2-contrib/tree/master/driver/juiceplug>
- Aerovironment driver implementation (XBOS):  
<https://github.com/SoftwareDefinedBuildings/bw2-contrib/tree/master/driver/aerovironment>
- Brick Schema documentation: <http://brickschema.org/>
- Brick database code: <https://github.com/gtfierro/hod>

Supporting XBOS code including for BOSSWAVE, SPAWNPOINT, PunDat, Ragent, etc. is available at additional "github" locations as indicated in the References section.

In summary, the XBOS-V architecture is designed to easily integrate with new technologies, applications, control schemes, and protocols. It does so using a modular architecture built around a secure, distributed message bus (BOSSWAVE) that enables easy scaling of the system while maintaining a fine-grained and auditable permissions model. Development of the new EVSE drivers in XBOS-V is complete, along with integration into the larger XBOS platform. Additional development efforts for XBOS-V are expected in the future to integrate more versions of the driver to interface with the API of more types of especially Level 2 EVSE, working with additional EVSE suppliers. Finally, further technical details on the XBOS platform and XBOS-V module are available in Appendix D of this report.



## Task 4 Project Activity Results: Distribution-Level Utility Power Grid Impacts and Benefits Analysis of PEV Smart Charging Using XBOS-V

Discussed below are the results of the project Task 4 activity to help understand distribution-level power grid impacts and potential benefits of PEV smart charging using power control systems such as those provided by XBOS and the XBOS-V module developed in this project. An example case of 2,000 PEVs on a representative feeder near Davis, California are discussed below, with further details available in Appendix E.

The PEVs were modeled to follow a charging schedule based on the minimal cost of the LMP and the A-10, and E-19V. Table 1 shows the resulting cost of charging the PEVs at one building for each of the different price signals. The first column is the rate the PEVs were optimized against. The other columns are the costs in each rate for following the price signal. Table 2 shows the amount of energy consumed by PEVs charging between 9am and 4pm. Here the project team see that following the LMP causes a 36 percent increase in energy consumed during peak solar production compared to the next highest price signal. However, the costs the building owner would see based on their retail rate is significantly higher if they follow the LMP compared to a retail rate price signal.

**Table 1: Cost of Charging PEVs at One Building on April 14<sup>th</sup>, 2017**

Price Signal	LMP	Current A-10	Proposed A-10	Current E-19V	Proposed E-19V
LMP	\$ 0.019	\$ 1465.15	\$ 1495.01	\$ 2286.26	\$ 2488.95
Current A-10	\$ 8.86	\$ 99.16	\$ 100.78	\$ 77.92	\$ 93.14
Proposed A-10	\$ 7.90	\$ 99.16	\$ 98.93	\$ 77.92	\$ 91.52
Current E-19V	\$ 8.40	\$ 99.16	\$ 103.37	\$ 77.92	\$ 95.39
Proposed E-19V	\$ 6.21	\$ 99.16	\$ 98.93	\$ 77.92	\$ 68.78

Source: UC Berkeley

**Table 2: kWh of PEVs Charging Between 9am and 4pm at One Building on April 14<sup>th</sup>, 2017**

Price Signal	kWh
LMP	750.0
Current A-10	402.2
Proposed A-10	428.0
Current E-19V	436.3
Proposed E-19V	482.7

Source: UC Berkeley

July 10<sup>th</sup>, 2017 was a hot summer day with high LMP prices that peaked late in the evening (Figure 20). It was also the day the DOE building model for the medium office building had its annual peak load. For comparing retail rates, July 10<sup>th</sup> highlighted the disparity between the current TOU hours for commercial customers and the LMP on the wholesale market (Source: "Day-ahead Market LMP for Davis\_1\_PNode, July 10, 2017).

Figure 21 shows how the current peak TOU hours do not capture the peak costs at the wholesale level. In PG&E's motion for new commercial rates, the TOU hours are shifted later and better capture the price on the wholesale market (Figure 22).

**Figure 20: LMP in Davis, California on July 10th, 2017**

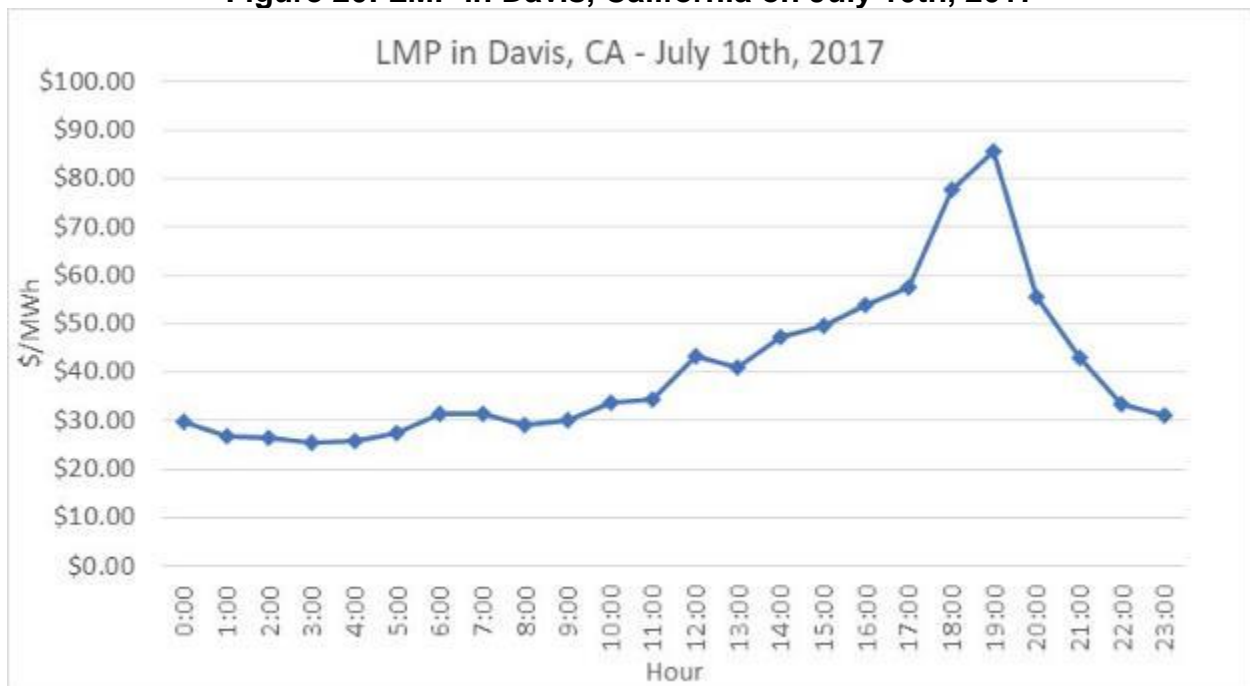

Source: "Day-ahead Market LMP for Davis\_1\_PNode (July 10, 2017)

**Figure 21: LMP vs Current Commercial TOU Hours July 10th, 2017**

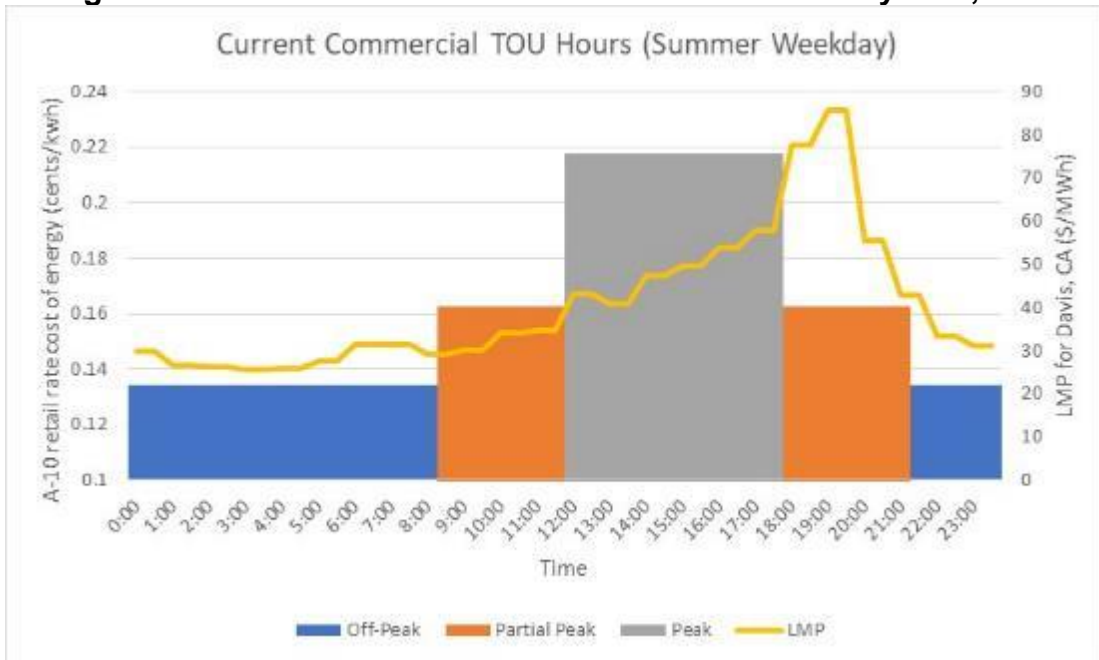

Source: UC Berkeley

**Figure 22: LMP vs Proposed Commercial TOU Hours July 10th, 2017**

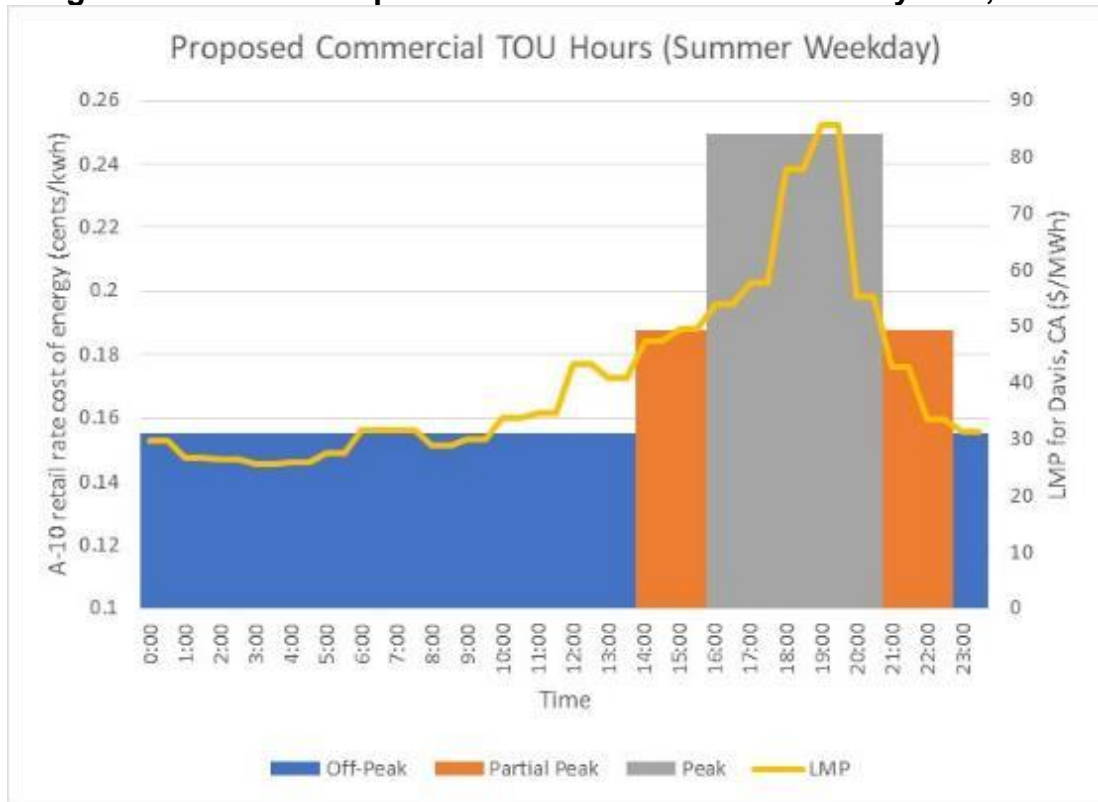

Source: UC Berkeley

For July 10<sup>th</sup>, the project team modeled the PEVs again to follow a charging schedule based on the minimal cost of the LMP, A-10, and E-19V. Table 3 shows the resulting cost of charging the PEVs at one building for each of the different price signals. The first column is the rate the PEVs were optimized against. The other columns are the costs in each rate for following the price signal. Table 4 shows the amount of energy consumed by charging PEVs between 9am and 4pm. Although this is not when the LMP is cheapest, it is when there is peak solar output and would be where future solar production would be expected. The resulting energy consumption shows that the LMP and Proposed E-19V rates only account for a nine percent difference in consumption during peak solar output. However, the cost to a building owner if they were on the Proposed E-19V rate would be almost twice as high if the PEVs at their building were following the LMP as a control signal.

**Table 3: Cost of Charging PEVs at One Building on July 10<sup>th</sup>, 2017**

Price Signal	LMP	Current A-10	Proposed A-10	Current E-19V	Proposed E-19V
<b>LMP</b>	\$ 24.76	\$ 1436.51	\$ 927.20	\$ 3288.39	\$ 1475.20
<b>Current A-10</b>	\$ 33.01	\$ 514.22	\$ 373.57	\$ 1182.44	\$ 1091.17
<b>Proposed A-10</b>	\$ 33.01	\$ 514.22	\$373.57	\$ 1182.44	\$ 1091.17
<b>Current E-19V</b>	\$ 33.01	\$ 514.22	\$ 373.57	\$ 1182.44	\$ 1091.17
<b>Proposed E-19V</b>	\$ 30.78	\$ 691.93	\$ 476.39	\$ 1587.36	\$ 766.36

Source: UC Berkeley

**Table 4: kWh of PEVs Charging Between 9am and 4pm at One Building on July 10<sup>th</sup>, 2017**

Price Signal	kWh
<b>LMP</b>	470.7
<b>Current A-10</b>	389.6
<b>Proposed A-10</b>	389.6
<b>Current E-19V</b>	389.6
<b>Proposed E-19V</b>	428.9

Source: UC Berkeley

## Feeder Voltage Analysis

In addition to analyzing the effects of workplace PEV charging, the project team examined the effects of a reasonable penetration of controlled workplace charging on voltage of the MIP (mixed-integer programming) Feeder. The project team found experimentally that 2,000 PEVs were feasibly supplied if each medium office building had 309 PEVs and each warehouse building had five PEVs. Figure 23 shows the voltage profile of one of the most remote node on the MIP Feeder without PEVs. This node is the node most susceptible to voltage excursions beyond the allowed limits (1.05 and 0.95 per unit) per ANSI C84.1 ("American National Standards for Electric Power Systems Equipment," 2016). Spikes in voltage below or above the limit (such as at 2pm or 11pm) were found to be momentary and corrected by capacitor banks per the requirements of ANSCI C84.1. As such, the voltage of the MIP feeder is considered acceptable without PEVs.

**Figure 23: Voltage Profile of the Most Remote Node on the MIP Feeder Without PEVs**

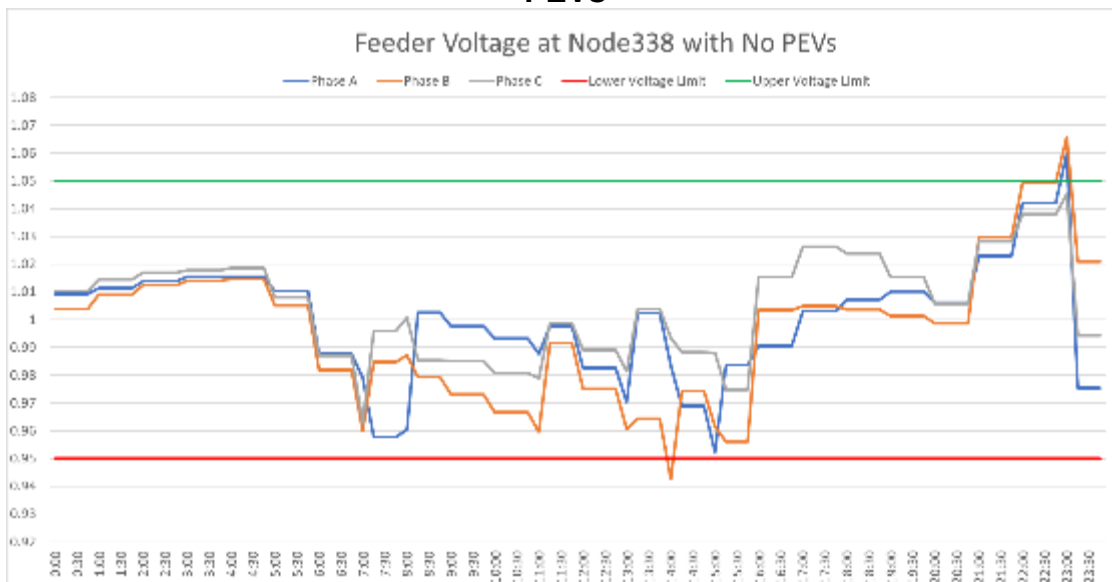

Source: UC Berkeley

PEVs were then added to the MIP Feeder and were modeled to follow the LMP for the feeder. Figure 24 shows voltage on the feeder when PEVs were following the LMP as a price signal. In this scenario, voltage drops below the Lower Voltage Limit at 8am and 3:30pm. Due to these low voltage conditions, it was determined that LMP would not be a sufficient control signal for PEV charging.

**Figure 24: Voltage Profile of the Most Remote Node on the MIP Feeder With 2,000 PEVs Optimizing Towards the LMP**

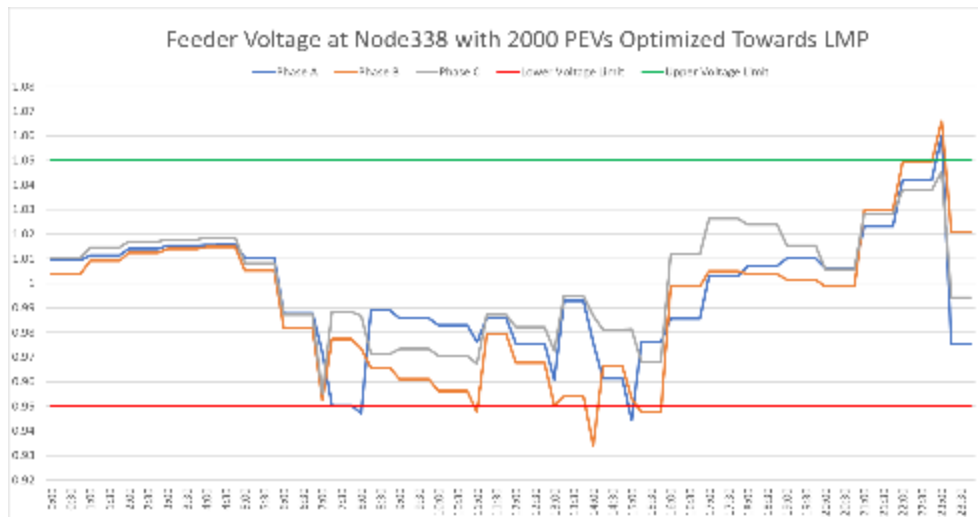

Source: UC Berkeley

To improve the control signal, a lower voltage limit was added as constraints to the optimization function. Voltage at every node was limited to lowest voltage in the system prior to PEVs being added to the feeder (0.96pu). Figure 25 shows the voltage results at the most susceptible node of the MIP feeder with this control signal. The voltage excursion previously seen at 8am is corrected, but the 3:30pm voltage drop is not. In further investigation, the project team found that the voltage at 3:30pm at this node in the non-linear Gridlab-D was lower than the linearized optimization model. Thus, although the linear optimization included voltage limits in the constraints, the resulting charging profile caused the non-linear model to still go out of range.

**Figure 25: Voltage Profile of the Most Remote Node on the MIP Feeder With 2,000 PEVs Optimizing Towards the LMP With Constraints**

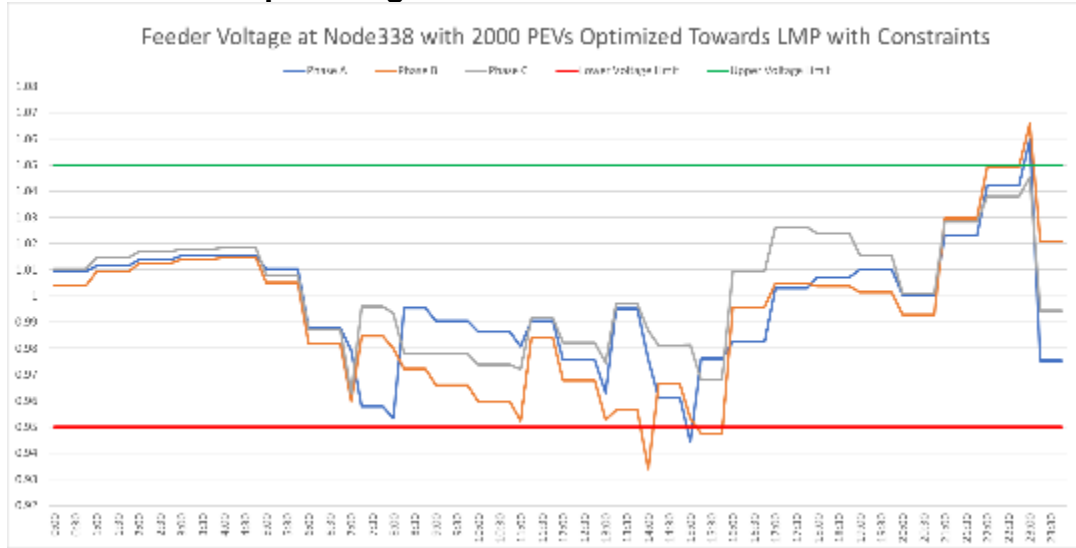

Source: UC Berkeley

As an alternative to the LMP, the current A-10 rate was used as a control signal for PEV charging. Since the E-19V rate is similar in design to the A-10 rate, only the A-10 rate was modeled here. The current A-10 rate corrected the voltage excursions at both 8 am and 3:30 pm without adding the voltage to the constraints of the optimization (Figure 26). The prospective A-10 rate was also tested as a control signal (Figure 26). Again, the A-10 rate corrected all voltage excursions. The reason both A-10 rates kept voltage in range was because of the demand charge. Since the demand charge limits the load at all hours, the PEV charging is reduced because of the cost of charging and the system voltage is kept in range.

**Figure 26: Voltage Profile of the Most Remote Node on the MIP Feeder with 2000 PEVs Optimizing Towards the Current A10 Rate**

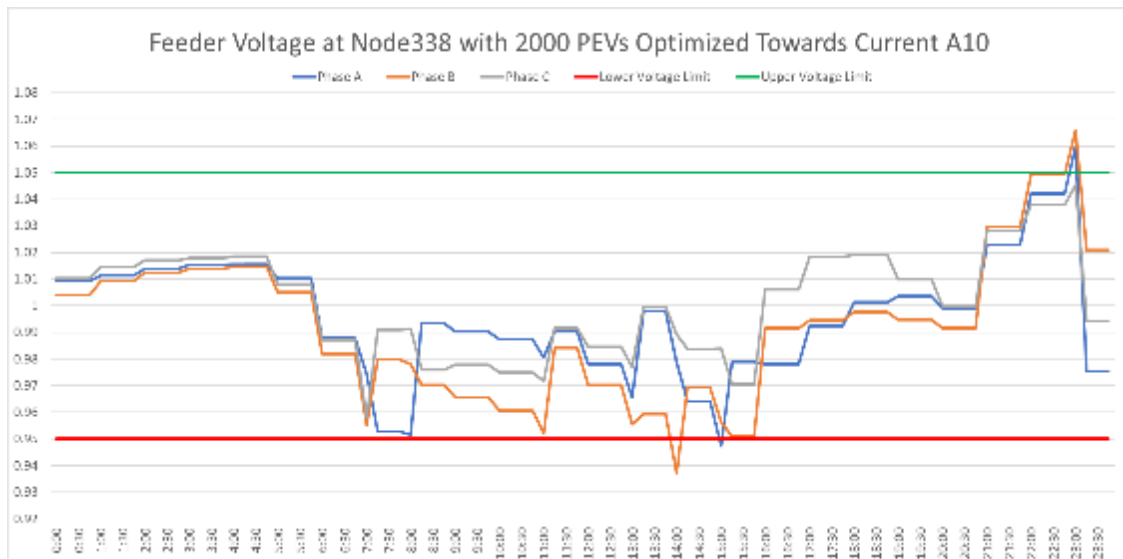

Source: UC Berkeley

**Figure 27: Voltage Profile of the Most Remote Node on the MIP Feeder With 2000 PEVs Optimizing Towards the Proposed A10 Rate**

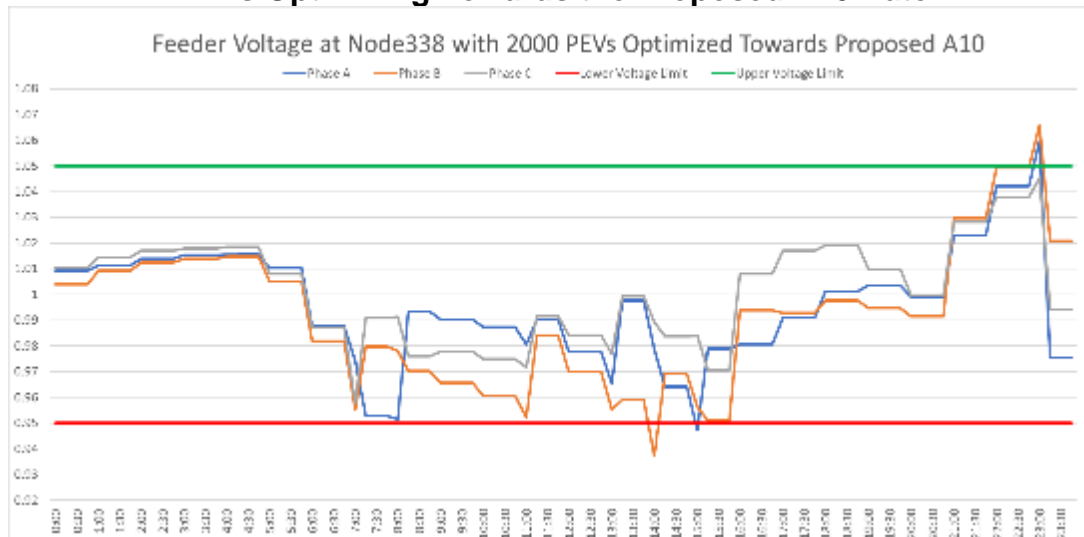

Source: UC Berkeley

### Task 4 - Conclusions

This task analyzed the potential negative consequences of uncontrolled PEV charging and the potential system-wide benefits that could be gained from PEV charging management. In addition, the project team propose control algorithms designed to be functional with any of the proposed VGI communication protocols. The project team prove this on standard recognized test feeders and a real-world sized model feeder. By examining home versus workplace charging separately, the project team also compared



the hosting capacity of the distribution feeder for charging infrastructure under either paradigm. Key findings include examination of current and proposed utility rates and their impacts on PEV charging behavior, the potential to use LMP signals for grid control, and additional distribution grid impacts. It seems that LMP signals alone are not adequate for voltage correction on distribution feeders, and this is being explored further in the context of specific feeders with and without solar generation and other features.

## **Task 5 Project Activity Results: Analysis and Forecast of Ratepayer Benefits of PEV Smart Charging in California**

As discussed, this project Task 5 examined key issues related to the larger utility grid picture with regard to VGI in California through 2030, and potential ratepayer benefits of VGI programs for grid support. Examined are forecasts of utility grid evolution in the context of California's RPS program, now targeted to achieve 100 percent zero-carbon electricity by 2045 (Senate Bill No. 100, 2018) and the ability of smart charging of PEVs to effectively provide a substitute for some amount of dedicated grid storage through their flexible load potential.

Potential ratepayer benefits through improved grid operations are discussed below, followed by forecasts of the potential of one key opportunity – the potential for flexible load from PEVs to mitigate curtailed renewable power (renewable power that is not accepted onto the grid for technical or economic reasons) as more and more renewables are introduced to the California grid. Detailed estimates of future curtailment and the ability of PEVs to mitigate this through managed charging for example years 2024 and 2030 by which times the energy supplying the California grid is expected to be 40 percent renewable and 50-60 percent renewable, respectively (Table 5). The background for PEV adoption in California and estimates for future PEV market penetration through 2030 are provided in Appendix F.

### **VGI Opportunities at the Electric Power Transmission Level**

Many years of research have identified the potential for PEVs to provide various types of grid services while they are plugged in to charge. The potential values of VGI is summarized in the table below, where each row shows a type of service that PEVs can offer to the power grid and the corresponding value to this type of service (Markel, et al. 2015).

**Table 5: Various VGI Services and Approximate Values**

<b>Type of Service</b>	<b>Potential Value (\$)</b>	<b>Unit</b>
Real-time frequency regulation	30 to 45	/MWh
Real-time frequency regulation	150	/Month
Spinning reserves	10	/MWh
Dual use (frequency regulation and Peak Reduction)	2,200 to 2,500	/Year
Voltage support	5 to 50	/Year
Demand response	50	/(kW * Year)
Transmission and distribution deferral costs	Depends on Location	
Emergency backup	950 to 1,000 (California ISO, 2015, p. 99)	/MW

Source: UC Berkeley

### **Demand Response Programs in California ISO**

California has clear objectives to produce considerable portion of the State’s energy demand from renewables. However, using renewable energy is challenging mostly because of the uncertainty in the amount of energy that renewable generators produce. In fact, renewable generation is not typically dispatchable, i.e., unpredictable fluctuations in the output of renewable generations make it a difficult task for the California ISO to keep a balance between supply and demand of energy in the real-time operation of power grid. Demand Response is shown to be an effective mechanism to mitigate this obstacle, without having a need for more ancillary services from fossil fuel generators. Specially, California ISO designed four demand response programs for the flexible loads to participate in wholesale electricity markets:

- Participating Load
- Proxy Demand Resource (PDR)
- Reliability Demand Response Resource (RDRR)
- Non-Generator Resource

A load with flexible demand can participate in any one of the above programs, if it satisfies the corresponding requirements associated with the specific program. The project team discusses each program and its associated requirements, and indicate which programs are applicable to PEVs.

## **Participating Load**

Participating Load is an entity providing Curtailable Demand. The demand from a Participating Load that can be curtailed at the direction of California ISO in the real - time dispatch. Participating Loads must be scheduled within a unique Custom Load Aggregation Point (California ISO, 2016); therefore, Participating Load is not an option for the aggregation of PEVs at different locations.

## **Proxy Demand Resource (PDR)**

The Proxy Demand Resource (PDR), introduced in 2010, is a participation model for load curtailment used to increase demand response participation in the California ISO's wholesale Energy and Ancillary Services markets. PDR helps in facilitating the participation of existing retail demand response into these markets (California ISO, 2016). As the aggregation of small flexible loads is available under this program, PDR is an option for PEVs.

A PDR can bid to the following markets as a supplier (California ISO, 2015):

- Day Ahead Energy Market
- Real Time Market (RTM)
- Ancillary Service (AS) Non-Spinning Market
- Ancillary Service (AS) Spinning Market
- Residual Unit Commitment
- Self-Provide Ancillary Services

Correspondingly, the PDR is dispatched in Economic Day Ahead and Real Time market (California ISO, 2015). A PDR can participate in wholesale markets all hours and all days of the year (California ISO, 2015). A PDR must be capable of providing measurable and verifiable load curtailment with the following characteristics (California ISO, 2015):

- Minimum Load Curtailment for Energy: 100 KW.
- Minimum Load Curtailment for Ancillary Service: 500KW.
- Minimum Bid Segment in the Price-Energy Curve: 10KW.
- A PDR may not be self-scheduled and must bid a non-zero price.

Of course, many flexible loads do not have the above minimum required capacities, however, the capacities of such small loads can be aggregated to achieve the minimum requirements. The aggregation process is discussed in a later section of this report.

## **Reliability Demand Response Resource**

Reliability Demand Response Resource (RDRR) is a product created to further increase demand response participation in the California ISO markets by facilitating the integration of existing emergency - triggered retail demand response programs and newly configured demand response resources that have reliability triggers and desire to be dispatched only under certain system conditions (California ISO, 2016). As the

aggregation of retail demand response is available under this program, RDRR is an option for PEVs.

A RDRR can bid to the following markets as a supplier (California ISO, 2015):

- Day Ahead Energy market.
- Real Time Market (RTM).
- Fifteen Minute Market (FMM).
- Offer uncommitted capacity and respond to a reliability event for the delivery of “reliability energy” in real-time.

A RDRR must be capable of providing measurable and verifiable load curtailment with the following characteristics (California ISO, 2015):

- Minimum Load Curtailment: 500 KW.
- In delivering reliability Energy in real time, must reach full curtailment within 40 minutes.
- Minimum run time cannot be greater than one hour.
- Must have sustained response period or maximum run time of least four hours.
- Must be available for up to 15 events and 48 hours run time per a six-month period.

Small loads can be aggregated to achieve the minimum requirements above, where the aggregation process is discussed below. The California ISO may use the RDRR resources in real-time for system emergencies, e.g., in transmission emergencies or imminent operating reserve deficiencies. California ISO uses the RDRR resources only when all the energy, spinning reserve, and non-spinning reserve resources are exhausted (California ISO, 2015).

### **Non-Generator Resource**

A Non-Generator Resource (NGR) has the capability to serve as both generators and loads, and can be dispatched to any operating level within their entire capacity range. In the other words, an NGR is a resource that can operate continuously between generation and consumption modes. As NGR is available for aggregation of small resources, NGR is an option for PEVs.

NGRs are modeled as a generator with positive and negative energy, and are constrained by energy (MWh) and capacity (MW) limits to inject or withdraw energy at a set of nodes in power grid. Specifically, the maximum and minimum capacities for an NGR represent the maximum and minimum rates that the resource can inject or withdraw energy at a sustainable rate (MW) (California ISO, 2015).

NGRs should be dispatchable seamlessly within their entire capacity range and may be made up of aggregated physical resources. An important term in the context of NGRs is

the State of Charge (SOC), which is the amount of energy (MWh) remaining in the resource and is available for California ISO's use (California ISO, 2015).

The California ISO collects the energy limits, capacity limits and SOC values from NGRs and co-optimizes the participation of NGR resources in the ancillary service markets, along with optimizing participation of other resources in these markets. In fact, the California ISO determines the best use of NGR resources based on all the submitted energy and ancillary services bids. Particularly, the California ISO will use SOC values to prevent infeasible dispatches or infeasible control signals (California ISO, 2015).

An NGR must meet the below minimum capacity and continuous energy requirements (California ISO, 2015)

- Minimum Capacity: 0.5 MW.
- Minimum Duration for Spinning and Non-Spinning Reserve: 60 minutes.
- Minimum Duration for Frequency Regulation in Day Ahead Market: 60 minutes; and,
- Minimum Duration for Frequency Regulation in Real Time Market: 30 minutes.

An NGR can opt to participate in ancillary service market either with or without Regulation Energy Management (REM) option. The REM option was implemented to remove barriers that limit the full participation of limited energy resources in the California ISO's regulation markets. The REM option lets an NGR to bid in ancillary service market with an energy bid that is lower than the minimum required energy bid for normal generators. However, an NGR that opts to use REM option can only offer frequency regulation to the power grid (California ISO, 2015).

For an NGR with REM option, the regulation capacity awarded in the day-ahead market is evaluated as 4 times the regulation energy it can provide within 15 minutes. An NGR with REM option must meet the below minimum requirements (California ISO, 2015):

- Minimum Capacity for Frequency Regulation in Day Ahead Market: 0.125 MW.
- Minimum Capacity for Frequency Regulation in Real Time Market: 0.5 MW.
- Minimum Duration for Frequency Regulation in Day Ahead Market: 15 minutes.
- Minimum Duration for Frequency Regulation in Real Time Market: 30 minutes.

### **Mechanisms for VGI Participation in Local Utility Program Markets**

Currently, the market mechanisms that are being practiced in utility companies are mostly in the form of special time-of-use (TOU) rates that are dedicated to PEVs' electricity consumption. PG&E, SCE, SDG&E and Liberty each offer electric vehicle "time-of-use" energy rates for residential customers. Time-of-use rates encourage customers to charge during "off-peak" hours, and help minimize the impact of the energy demand from electric vehicles on the electric grid (CPUC). For instance, SCE offers TOU-EV-1 (Edison) program to its customers, where the customers are billed based on the seasonal off-peak and on-peak hours for their PEVs' electricity

consumption. In TOU-EV-1 program, on-peak hours are 12:00 p.m. to 9:00 p.m. and off-peak hours are the rest of day. Also, two distinguished seasons in TOU-EV-1 program are summer and winter seasons (Edison).

Of course, for fully deriving the potential values of VGI, there is a need for more comprehensive mechanisms that aligns electric vehicle charging with the needs of the electric grid, by two-way interaction between vehicles and the grid in managed charging sessions. To achieve this goal, the California Public Utilities Commission has established a significant funding resource, specifically the Electric Program Investment Charge (EPIC), to support clean energy use within the State (CPUC, 2012). EPIC promotes public interest investments in research and development of clean energy technologies for the benefit of electricity ratepayers of the three large investor-owned utilities (IOUs), PG&E, SDG&E and SCE. As a mandated requirement set by the utilities commission, an activity might be eligible for EPIC funding support, if the activity can be mapped to the elements of the electricity system "value chain" consisting of: 1) Grid operations and market design; 2) Generation; 3) Transmission; 4) Distribution and 5) Demand side management (CPUC, 2012).

SCE has an ongoing effort to absorb financial support from EPIC for their VGI development. Specially, in their recent proposal for the 2018-2020 period, SCE proposes to consider the above value chain in their VGI technology development (Vyas & Matthews, 2017). One can see that, even utility companies would have to link the VGI to the wholesale markets, as the last piece of the chain depicted by the utilities commission. Therefore, importance of the wholesale level mechanisms for VGI is evident, and utility companies will end up using the market mechanism introduced in this report for aggregated participation of VGI in wholesale markets.

As another evidence for this conclusion, the project team discuss the final outcomes of Open Vehicle Grid Integration Platform (OVGIP) project. OVGIP is a pioneer project proceeded by EPRI to evaluate the potential of electric vehicles for participation in DR programs via an aggregator (Vyas & Matthews, 2017). In this project, the SCE dispatches DR events to OVGIP as a platform that provides single interface to receive OpenADR signals from utilities and translates into proprietary automaker's software platforms. The automaker platform will dispatch vehicles with available capacity to provide the demand reduction (Vyas & Matthews, 2017). However, the final report of the project indicates that project provides only empirical test and demonstration data on the viability and value of VGI to assist California ISO in identifying the basis of revenues streams for OVGIP. In the other words, OVGIP lends itself to the programs available in California ISO for VGI participation (Chhaya, 2016).

The project team conclude that, whether directly through an aggregator or indirectly through a utility company, electric vehicles are becoming able to participate in wholesale markets for offering services to the power grid and benefiting from values of VGI. If the later path is taken, the utility company effectively serves as the aggregator for participation of PEVs in wholesale markets.

## **Mechanisms for VGI Participation in Wholesale Markets**

The energy storage (MWh) and capacity (MW) of a single PEV is not enough to directly participate in electricity wholesale markets. The key to overcome this obstacle is to aggregate the energy storage and capacity of PEVs through an aggregator that represents the PEVs in wholesale markets. In this section, the project team explains the network model in California ISO, then describes the aggregation mechanism that California ISO has developed for its various demand response programs. In the final section of the report, the project team discusses how the California ISO's aggregation mechanism is tailored for PEVs.

### **The Network Model in California ISO**

The power network in California is divided into eight areas, namely, balancing authority areas. In the seven smaller balancing areas, public power companies manage their own transmission systems. However, in the largest balancing area that constitutes 80 percent of California, California ISO manages the flow of electricity in the transmission system (California ISO, 2015). This report focuses on the California ISO balancing authority area.

California ISO constitutes three Default Load Aggregation Points (DLAPs). Each DLAP is constituted of several Sub-Load Aggregation Points (SubLAPs) (Figure 28). There are 24 SubLAPs in California ISO. Each SubLAP constitutes several Aggregated Pricing Nodes (APnodes), where each APnode either corresponds to a single Pricing node (Pnode) or represents a set of Pnodes (California ISO, 2004).

Pnodes are the physical nodes of the power grid that are considered in the California ISO Full Network Model (FNM). The FNM is a computer-based model that includes all transmission network, loads, generating units, buses and transmission constraints in California ISO ("Glossary of terms and acronyms). As a part of clearing the wholesale electricity markets, California ISO derives Locational Marginal Price (LMP) and power dispatch for the Pnodes that are corresponding to a source or sink of energy in the California ISO's grid. For those Pnodes that are within a particular APnode, the LMP and power dispatch are mapped to the individual Pnodes using a set of Allocation Factors (AFs) (California ISO, 2004). The LMPs show the location-dependent value of electricity for the supply and demand of electricity in Energy and Ancillary Service markets.

**Figure 28: DLap (left) and Sublap (right) Zones in California**

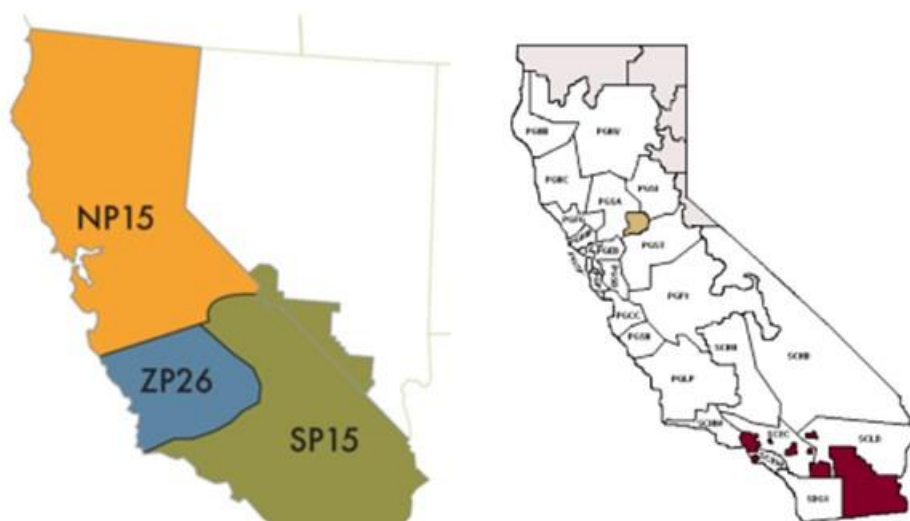

Sources: Vyas & Matthews, 2017; Chhaya, 2016; California ISO, 2004

### **Power Procurement for the Loads that Participate in Demand Response Programs**

Various designs are possible for the participation of a flexible load in Energy and Ancillary Services markets as a supplier. A flexible load is not a physical generator, but rather is a load that may behave like a pseudo generator by reducing its power consumption. However, before participating in wholesale markets as a supplier, a PDR needs to produce the energy demand for its load behavior. The energy demand of a flexible load belonging to a PDR, RDRR or NGR, is produced through a Load Servicing Entity (LSE) in a process similar to the procurement of energy demand for normal unflexible loads (California ISO, 2015).

The LSE forecasts the power consumption of all loads under its territory, including the power consumption of loads participating in Demand Response programs, and bid for the aggregated power consumption of loads at the specific DLAP that encompasses LSE's loads (California ISO, 2015). The electricity price for all the loads within a DLAP is the same and is the average of LMPs at all the Pnodes that are corresponding to power sinks, i.e., power consumers of the DLAP. The LSE charges the flexible loads with the DLAP's electricity price for the flexible load power consumption. The project team note that the LSE and the DRP could be the same or two separate entities (California ISO, 2015).

### **Aggregation of Demand Response**

The capacities of many flexible loads are not high enough to meet the minimum requirements of Demand Response programs. Fortunately, this obstacle can be tackled by aggregating the small flexible resources toward creating a larger resource. PDR and



RDRR have the same aggregation process and policies, which is slightly different from the aggregation process and policies for NGR. In this section, our focus is on the aggregation process and policies for PDR.

As for the PDR/RDRR, the sub-resources within an aggregation can be distributed geographically, such as distributed over different Pnodes, but must be located within a single Sub-LAP (California ISO, Energy Storage and Aggregated Distributed Energy Resource Education Forum, 2015). The power consumption of all the sub-resources within a PDR is metered by a utility company. However, the metered power consumptions of individual sub-resources are not reported to California ISO directly. In fact, a PDR is obligated to make a contract with a Demand Response Provider (DRP), which, in turn, is obligated to make a contract with a Scheduling Coordinator (SC). The SC is responsible to report the power consumptions of individual sub-resources of a PDR to ISO (California ISO, 2015).

In general, the California ISO requires any entity to use a certified SC to transact business. A DRP could endeavor to become a certified SC or use an existing certified SC (California ISO, 2009). Although telemetry with the California ISO is not required for the sub-resources within a PDR, all the sub-resources with a capacity of higher than 10 MW should have telemetry with California ISO if the PDR provides Ancillary Services to the power grid (California ISO, 2015).

A PDR may participate in the wholesale markets on behalf of all its sub-resources. In the California ISO territory, the PDR is assigned a resource identification (ID) and behaves as a single demand response unit in the ISO markets (California ISO, 2009). The PDR resource ID will be used to bid, schedule, receive an award, and be settled on in the ISO market.

There are certain steps that must be accomplished by the DRP, LSE, Utility Distribution Company (UDC) and the ISO before the PDR can be assigned a resource ID by ISO (California ISO, 2009). For instance, any sub-resource in a PDR should be associated with the specific Pnode that is the physical location of that sub-resource in the power grid. The reason is that the aggregation of sub-resources is just to pass the minimum energy and capacity requirements set by the ISO, however individual sub-resources are taken into account separately in the California ISO's Full Network Model (FNM) (California ISO, 2009).

## **Grid Curtailment and Opportunities for VGI in 2024**

California's utility grid is evolving rapidly with a steady transition toward a larger share of renewable resources (some of which are variable during the day) and away from a more traditional paradigm using fully dispatchable resources. On the load side of the grid, changes are also occurring rapidly due to the proliferation of more efficient lighting and other energy-efficient devices (reducing load), overall population growth and development (increasing load), and the steady proliferation of PEVs (increasing load).

The project team noted that PEVs can be charged under several different charging plans, which are charging paradigms distinguished by their level of external, non-driver, control. Following are the five common types of charging plans, each with different implications for the grid.

- 1. Unmanaged or “Dumb Charging”: The vehicle starts charging right as it is plugged in.
- 2. Delayed Charging: Even if the vehicle is plugged in, vehicle charging is delayed until a pre-set time, such as during off-peak hours in the middle of the night when prices for electricity are the lowest. The charging time can often be set on the charger or through the vehicle software.
- 3. Managed Charging or “Smart Charging” (often referred to as V1G because of one-directional power flow and control from grid to vehicle): Smart charging generally involves some degree of control over the charging of the vehicle by the utility, system operator, aggregator or some other entity. The goal is to charge the vehicle when it provides the most societal/grid benefit, such as when electricity is cheapest (off-peak times), when demand is otherwise low, when there is some excess generation, or when some other threshold is met.
- 4. Vehicle-to-grid (V2G referring to bi-directional power flow between grid and vehicle): PEVs act like storage to the grid by charging over some hours, storing the energy in the car battery, and then discharging some energy back to the grid. Under V2G, PEVs could also provide some ancillary services to the grid, such as regulation, load following, and spinning reserves. Some of these additional services may also be possible with V1G (option 3).
- 5. Vehicle-to-building (V2B): V2B is a variant of V2G but instead of responding to broader grid needs, the PEV would help manage an individual buildings’ load in coordination with the building’s energy management system (as in XBOS-V).

In this investigation, the project team focus on comparing unmanaged charging (option 1) with managed charging (option 3) because unmanaged charging is the default for most drivers, and the value from load shifting that could be achieved from managed charging has the most easily accessible value. Task 3 (Chapter 3) of this report investigated V2B type concepts but with benefits that accrue in conjunction with the host site in a highly variable way depending on site conditions (“peakiness” of loads, utility service territory, etc.)

### **VGI Modeling Results and Discussion**

After running the three cases, the project team analyzed several outcomes using the PLEXOS modeling framework. The results of these outcomes across the cases are described in the following section. Results are produced for all of the Western Electricity Coordinating Council region, but the discussion of results focuses on the California case.

## Price Regimes

PLEXOS produces zonal prices in this analysis. To calculate a statewide CA price, the project team calculates a load weighted average price, using the load for each utility planning area and the price for that utility planning area. In all three cases, there are significant instances of negative prices (29), particularly in the spring months (Szinai, 2017). These negative prices are primarily due to excess renewable energy supply. Our analysis shows that when negative hourly prices reach as low as  $-\$300/\text{MWh}$ , renewable curtailment is triggered. However, it is likely that in real California ISO operations, renewable generators may restrict their output before the prices reach levels as low as the  $-\$300$  price floor. Because of the additional  $\sim 4,000$  GWh of load from PEVs, the number of hours with negative prices and the number of hours with curtailment both decrease as unmanaged PEVs are added in Case 1, and decrease further with managed PEVs in Case 2, when charging shifts load from high price to low price times (Szinai, 2017).

**Figure 29: Negative Pricing Hours With and Without Managed PEV Charging**

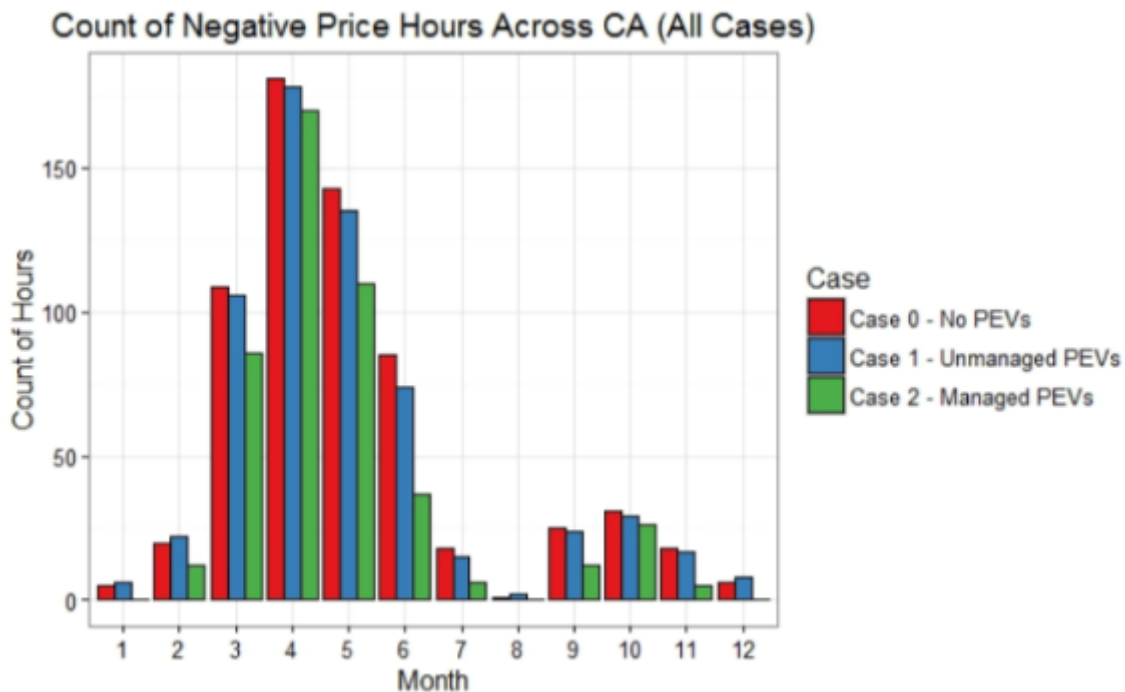

Source: UC Berkeley

## Renewable Curtailment and Renewable Generation

At a 40 percent RPS in 2024 with no PEVs in Case 0, there are significant hours of renewable curtailment, and as PEVs are added, curtailment decreases (Figure 30). Reduced curtailment is expected with the added 4,000 GWh of PEV load that absorbs renewable generation, even with unmanaged charging. However, the level of

curtailment decreases significantly more under the Case 2 scenario because the charging shifts to times with more (zero or negatively priced) renewable generation.

A key finding is that managed charging lowers annual curtailment by about 500 GWh, or 32 percent, compared to unmanaged PEVs (Figure 30). As mentioned, this reduction of curtailment likely understates the impact of managed PEVs, because in reality renewable generators reduce their production before the prices reach such negative levels and managed charging could help avoid this voluntary reduction by shifting to those times; curtailment by the system operator is usually the last step in a series of actions to maintain reliability (John, 2017).

**Figure 30: Annual Renewable Curtailment Decreases with Managed Charging**

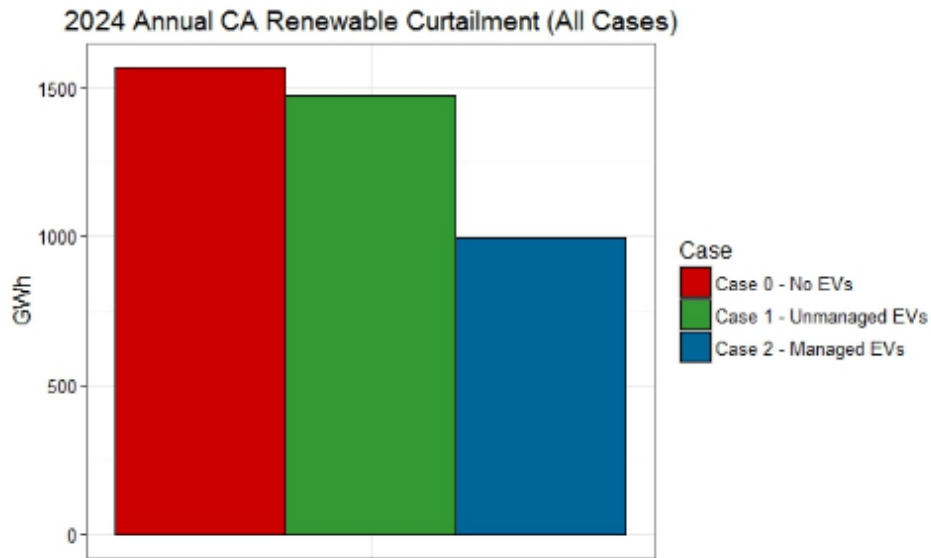

Source: UC Berkeley

Figure 31 shows monthly renewable curtailment and generation, and their sources. In Case 0, during spring months, curtailment can be close to 10 percent of renewable generation, when solar production is high, load is low, and hydro generation is high from snowmelt. The majority of curtailment comes from solar and decreases most in April between Case 2 and Case 0.

**Figure 31: Monthly Renewable Generation and Curtailment, All Cases**

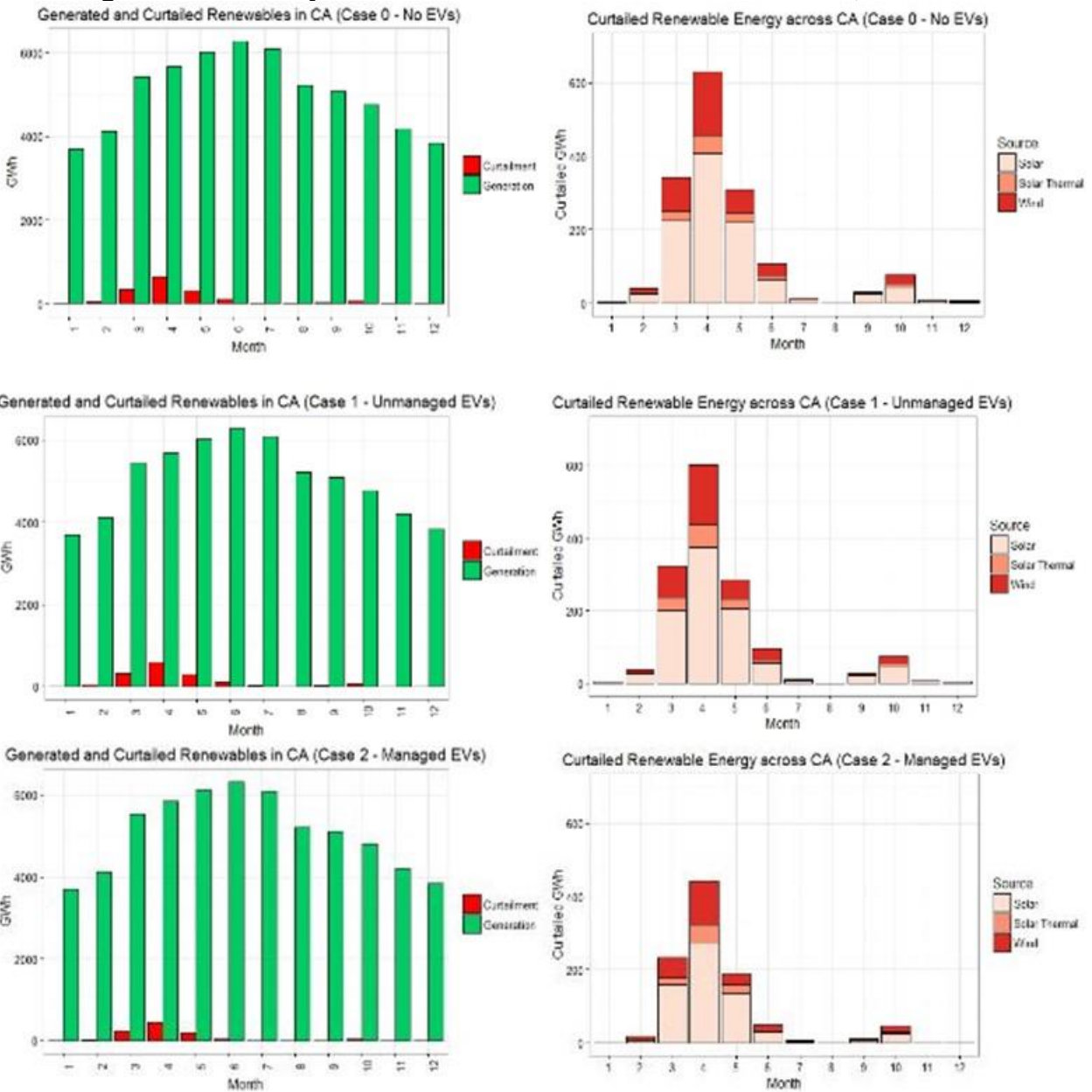

Source: UC Berkeley

In addition to the annual and monthly views of curtailment, the curtailment for March 31, is analyzed, in the context of California ISO's net load "duck curve" for 2024. The duck curve gets its name from the shape of net load over time, as shown in Figure 32. Net load is the remaining load on the grid after some demands have been supplied with "must take" renewables such as solar, wind, and small hydropower. For an example Spring day, the figure shows how the "belly" of the duck is growing over time, creating over-generation risk, and evening ramp rate is increasing. This changing shape of the curve is causing generation difficulties to match the supply needs of the grid at each

instant in time, in order to balance bulk power needs as well as maintain grid frequency at 60 Hertz.

**Figure 32: The California Net Load “Duck Curve” (2012-2020)**

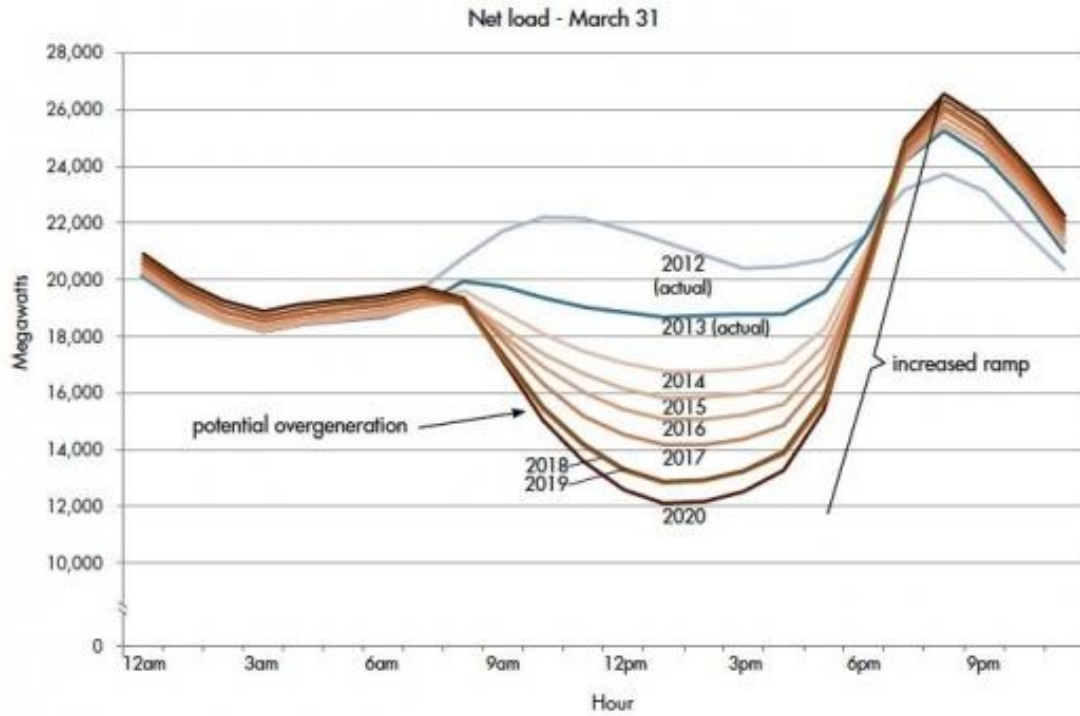
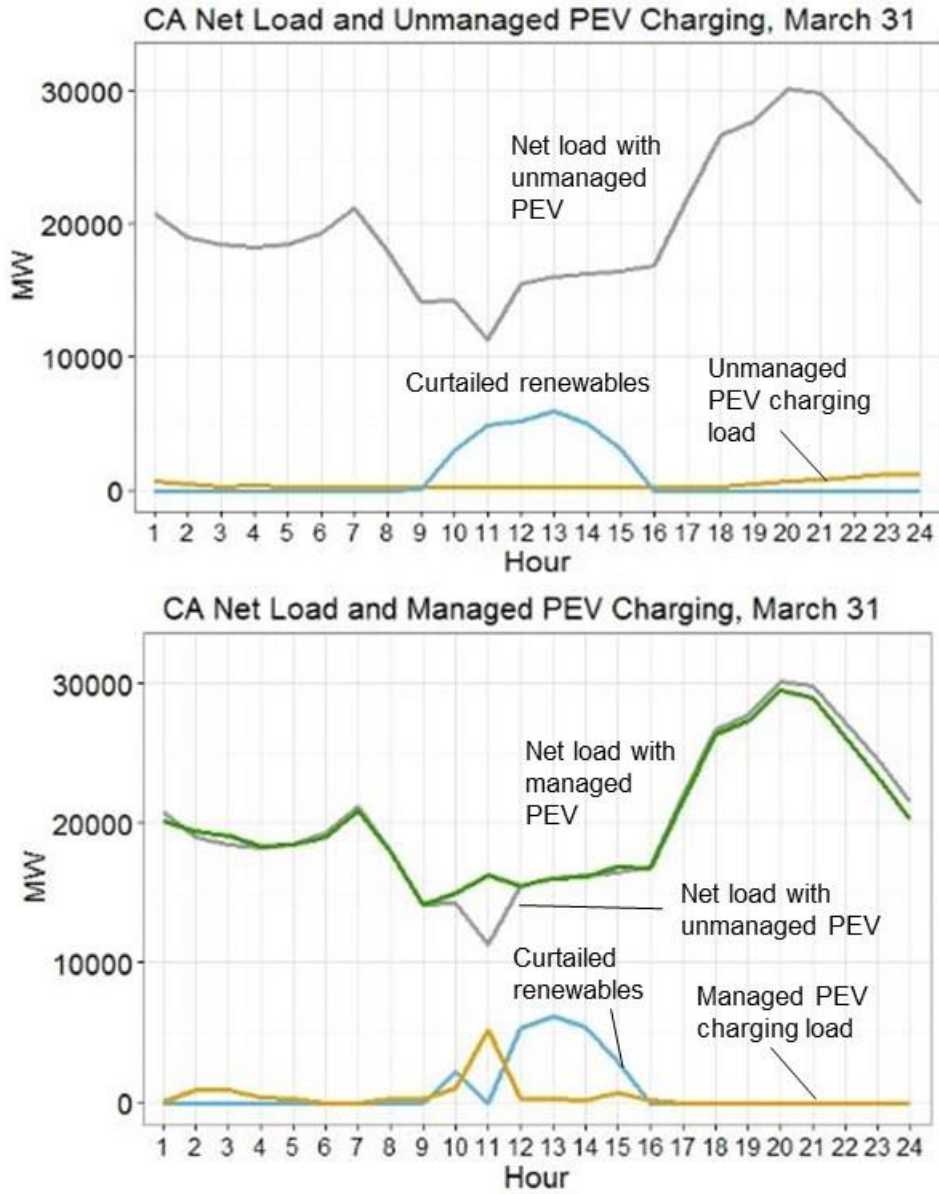

Figure 33 shows the net load curves for Case 1 and 2 (load minus solar and wind generation) for the same example day of the year. March 31 is a weekend day in 2024, which exacerbates the duck curve because loads tend to be lower than weekdays, but renewable generation is still high.

**Figure 33: Net Load Flattened Out with Managed Charging and Less Curtailment**



Source: UC Berkeley

When unmanaged PEVs are added in Case 1, there is a large amount of curtailment (blue line) between 9 am and 4 pm, the PEVs charge (yellow line) primarily in the evening starting at 5pm (coincident with net load peak and adding to ramping needs), and there is a sharp dip in net load around 11 am. However, when PEVs are managed in Case 2, the PEV charging shifts to spiking in the middle of the day (yellow line) to avoid curtailment. The net load (green line) is much smoother, and the curtailment (blue line) is reduced by the same portion as the PEV managed load. It is clear from this one day’s example that the ability to absorb renewable generation and alleviate renewable curtailment depends greatly on the time of the day that the “flexibility” from managed PEVs is available.

## **Grid Curtailment and Opportunities for VGI in 2030**

In 2017, the California Energy Commission (Energy Commission) published an updated version of the *Integrated Energy Policy Report (IEPR)*. The *IEPR* provides estimations of PEV market penetration for 2030. While Governor Edmund G. Brown's executive order goal considers all zero-emission vehicles (ZEVs), the *IEPR* considers specifically PEVs. However, even high estimates for PEV 2030 penetration in the *IEPR* are lower than would be necessary to meet Governor Brown's updated goal of 5 million ZEVs in California by 2030. While it is possible that Governor Brown's announcement will cause a more rigorous increase in ZEVs, the *IEPR* estimates may provide more realistic 2030 PEV market penetration. Estimates for 'low,' 'mid,' and 'high' scenarios, along with their assumptions, are given below.

The increasing number of PEVs on the roads of California will have an impact on the hourly and total electricity demand in the state. The variety of PEV models in the future is increasing and forces the state and its regulatory and planning entities to incorporate versatile future electricity demand scenarios. The demand forecast by the Energy Commission has recently been revised due to higher PEV projections, derived from wider acceptance of PEVs, bigger varieties of electrified car models in the future and advancements in battery technologies that are promising higher ranges (Bailey, 2018; Energy Commission, 2018).

The revised demand forecast of the Energy Commission projects three different demand scenarios for 2030 that include different vehicle adoption rates, behind-the-meter solar build-out scenarios, energy efficiency improvements and many more factors. This projection results in so-called 'low-demand,' 'mid-demand' and 'high-demand' scenarios that are visualized in Figure 34 (Energy Commission, 2018).



**Figure 34: Statewide Baseline Annual Electricity Consumption**

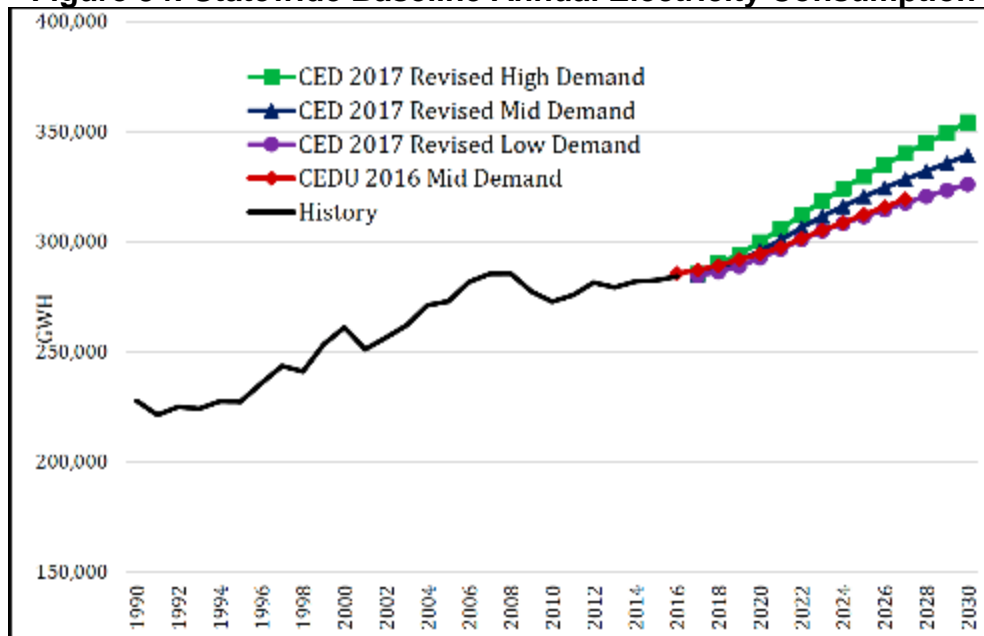

Source: "California Energy Demand 2018-2030 Revised Forecast," 2018

Even though the rising numbers of PEVs will have an impact on increasing electricity demand in the future, their integration and charging patterns can have positive impacts on the shape of the hourly demand in the state. PEVs have the potential to mitigate curtailment of excess renewable electricity or help flatten the shape of the California ISO 'duck-curve' to alleviate ramping requirements to meet dropping load demands in the morning and increasing load demands in the evening. The study from Szinai (2017) that was discussed in the 2024 California Grid section above showed that unmanaged and especially managed charging will have a positive impact on decreasing curtailment.

The study from Szinai (2017) was used to create extrapolated estimates for the influence of PEV charging and its effect on curtailment mitigation for the projected 2030 scenarios from the Energy Commission. The project team assumed that the share of battery electric vehicles (BEVs) and plug-in hybrid electric vehicles (PHEVs) will remain the same as in Szinai's study (BEV: 14 percent/PHEV: 86 percent) (2017). Furthermore, the project team does not assume a change in the available charging infrastructure and mobility behaviors of people in the state. This extrapolation provides rough estimates of curtailment mitigation with the projected loads from the Energy Commission forecasts.

The following section describes the extrapolation method and input assumptions that have been made. First, important inputs from the Szinai study (2017) include:

- 2.4 million PEVs in 2024:
  - 14 percent BEV / 86 percent PHEV
- 4.1 TWh charging load annually through mobility behavior analysis and results charging demand:

- 0.39 TWh curtailment mitigation with unmanaged charging (9.4 percent of total PEV load)
- 1.64 TWh curtailment mitigation with managed charging (40 percent of total PEV load)
- 40 percent RPS in 2024

The Energy Commission Demand Forecast and Transportation Demand Forecast project the following penetration rates of PEVs in 2030 (*California Energy Demand 2018-2030 Revised Forecast, 2018; Transportation Energy Demand Forecast, 2017*):

- Low-Demand: 2.6 million PEVs
- Mid-Demand: 3.3 million PEVs
- High-Demand: 3.9 million PEVs

Table 6 shows the derived input assumptions for mitigating curtailment through PEV charging.

**Table 6: Curtailment Capacity of Energy Commission PEV Forecast**

<b>Energy Commission Scenario</b>	<b>Number of PEVs</b>	<b>Unmanaged Charging – Curtailment Mitigation</b>	<b>Managed Charging – Curtailment Mitigation</b>
<b>Low-Demand</b>	2.6 million	0.417 TWh	1.776 TWh
<b>Mid-Demand</b>	3.3 million	0.529 TWh	2.255 TWh
<b>High-Demand</b>	3.9 million	0.626 TWh	2.665 TWh

Source: UC Berkeley

To align with the input assumptions from the Energy Commission, the overall electric energy consumption in the three demand scenarios has been used to estimate curtailment on the projected overall system demand. Furthermore, two different models have been used that are predicting the energy mix in California for 2030 and its derivations on curtailment for the state.

The first model that has been used was the CPUC RPS calculator created by the California Public Utilities Commission (CPUC). With a given input of a 50 percent RPS goal in 2030, the CPUC RPS Calculator projects a high percentage of 5.8 percent curtailment. This model is using relatively conservative input assumptions on the build-out of storage that will most likely be a key-technology for dealing with the mismatch of supply and demand in the future (“CPUC RPS Calculator,” 2016).

Given the model inputs and the Energy Commission demand forecast, numbers for possible curtailment mitigation can be calculated. Table 7 shows an overview of these results.

**Table 7: Curtailment Effects on CPUC RPS Calculator Projections – 2030 Case**

<b>Energy Commission Scenario</b>	<b>Number of PEVs</b>	<b>Curtailment [TWh]</b>	<b>Curtailment Mitigation Unmanaged Charging</b>	<b>Curtailment Mitigation Managed Charging</b>
<b>Low-Demand</b>	2.6 million	9.454	4.41 percent	18.79 percent
<b>Mid-Demand</b>	3.3 million	9.831	5.39 percent	22.93 percent
<b>High-Demand</b>	3.9 million	10.266	6.1 percent	25.96 percent

Source: UC Berkeley

Managed charging with high PEV penetration rates can have a very positive impact on mitigating curtailment by nearly 26 percent. Figure 35 visualizes these mitigation scenarios with the Energy Commission and CPUC inputs.

**Figure 35: Curtailment Effects with CPUC RPS Calculator Projections – 2030 Case**

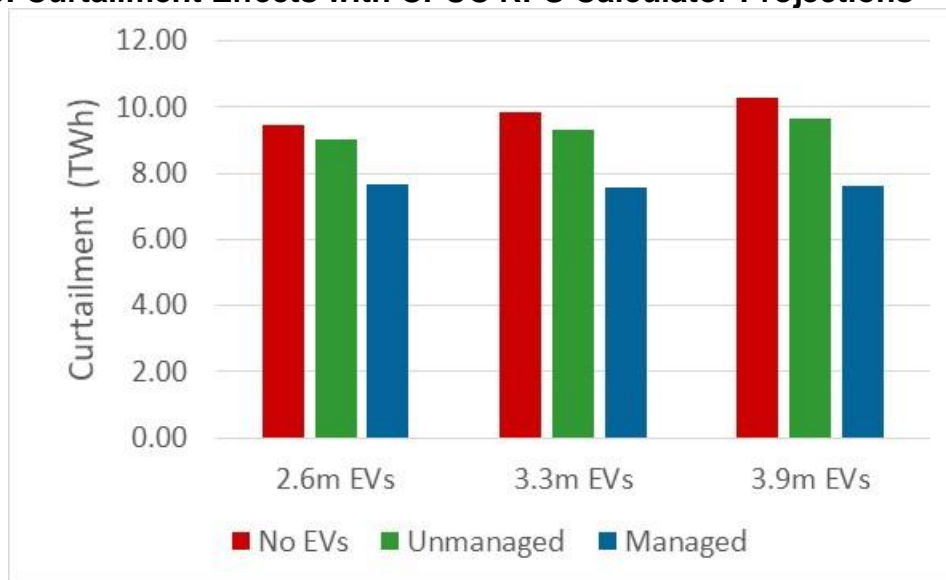

Source: UC Berkeley

The second model that has been used to extrapolate curtailment influences of PEVs in 2030 is the NREL ReEDS Standard Scenarios Viewer by the National Renewable Energy Laboratory (NREL). The NREL model projects that California reaches a renewable RPS mix of roughly 58 percent in 2030. Curtailment in the model is relatively low with 1.47 percent, which is likely derived from higher build-outs of stationary storage components. Furthermore, the NREL model predicts more wind and less solar energy than the CPUC RPS calculator, which will have an impact on curtailment as well the load inputs for each model (Chaurey et al., 2018; Eureka et al., 2016).

Given these inputs, the following estimates (Table 8) are projected for mitigating curtailment with the PEV forecast scenarios from the Energy Commission.

**Table 8: Curtailment Effects on NREL ReEDS Standard Scenarios Projections – 2030 Case**

<b>Energy Commission Scenario</b>	<b>Number of PEVs in 2030</b>	<b>Curtailment [TWh]</b>	<b>Curtailment Mitigation - Unmanaged Charging</b>	<b>Curtailment Mitigation - Managed Charging</b>
<b>Low-Demand</b>	2.6 million	2.779	15.02 percent	63.92 percent
<b>Mid-Demand</b>	3.3 million	2.890	18.33 percent	78.02 percent
<b>High-Demand</b>	3.9 million	3.018	20.74 percent	88.29 percent

Source: UC Berkeley

With lower curtailment predictions as the one from the ReEDS model, it can be seen that PEVs can have a significant impact on mitigating curtailment, especially with managed charging. In the 'High-Demand' scenario (Energy Commission, 2018) with extrapolated assumptions from the 2024 study that was conducted by Szinai (2017), the maximum of mitigating curtailment is close to 90 percent of excess renewable generated electricity. Figure 36 visualizes these figures from Table 8 to give a better understanding of the potential impacts of PEVs.

**Figure 36: Curtailment Effects With NREL ReEDS Model Projections**

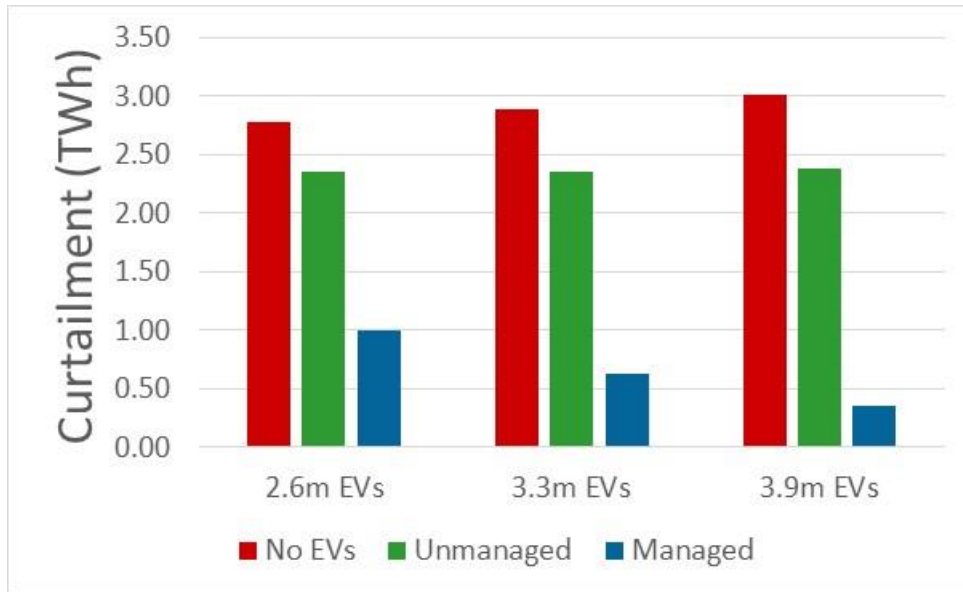

Source: UC Berkeley

### **Task 5 - Conclusions**

In conclusion, PEVs through VGI can potentially play important roles in the wholesale power market and at the transmission level as well as at the distribution level as examined in project Task 4. This analysis shows that managed charging of PEVs has the potential to mitigate curtailment of renewable electricity generation by up to 500 GWh in 2024 and about 2 TWh in 2030, helping to bring an increasing amount of low-cost and low-carbon resources onto California’s utility grid.

There are potentially significant values that can be accrued by providing wholesale grid services, but they are variable geographically and temporally as markets evolve over time, and create issues with identifying dependable long-term revenue streams. It is important to consider the net value of VGI participation in larger grid operations, as any gross values are eroded by involving key stakeholders in the value chain, including load aggregation services, grid scheduling coordinator and accounting services, and mechanisms for enrolling participating customers or fleets in the first place.

# CHAPTER 4:

## Technology/Knowledge/Market Transfer Activities

---

The important project activity includes a range of efforts that help to describe the scope and key outcomes of the project, as well as additional activities to increase project impact including documenting and posting the XBOS-V software code in a public repository (such as GitHub), and publicizing the project in various ways especially through professional presentations and research papers. The project team has also been using the project technical advisory committee members and other key resources to widely disseminate project results, and encourage PEV smart charging and building-automation system developers to use the software framework for ease of implementation.

### Technology and Knowledge Transfer Activities

The key activities of this project Task 7 include preparing:

- An *Initial Fact Sheet* at start of the project that describes the project.
- A *Final Project Fact Sheet* at the project's conclusion that discusses results.
- A *Technology/Knowledge Transfer Plan and Report* that includes:
  - An explanation of how the knowledge gained from the project will be made available to the public, including the targeted market sector and potential outreach to end users, utilities, regulatory agencies, and others.
  - A description of the intended use(s) for and users of the project results.
  - Published documents, including date, title, and periodical name.
  - Copies of documents, fact sheets, journal articles, press releases, and other documents prepared for public dissemination.
  - A discussion of policy development impacts.
  - The number of website downloads or public requests for project results.

The project technology transfer activities consist of the following elements:

- Presentations at professional conferences.
- Presentations at meetings and executive briefings.
- Peer reviewed journal articles.
- Conference papers.
- Release of open-source software code through GitHub.

- Magazine articles and other avenues to disseminate the availability of project findings.

These activities are targeted at the following groups:

- The general public including California electricity ratepayers.
- Electric utility representatives and trade groups.
- EVSE manufacturers and PEV industry groups.
- Policymakers and regulators;
- NGOs and advocacy groups.
- Academic researchers.

The professional presentations, research and conference papers, and additional market transfer activities conducted during the project are summarized and include 27 professional presentations, six research papers, and additional XBOS-V open-source software code release efforts. Additional professional and academic technology transfer activities are anticipated beyond the end of the project, with journal publications and additional conference and meeting presentations.

### **XBOS-V Project Professional Presentations and Publications**

Included in Appendix G is a list of professional presentations either focused on or directly related to the XBOS-V project. The presentations addressed various audiences and took place in venues ranging from meetings to executive briefings to large audiences at professional conference. Also listed are several submitted and in-progress research papers resulting from the project, including conference papers and peer-reviewed journal articles.

### **Market Transfer Activities**

A key goal of the XBOS-V project is to continue to be a platform for further open-source VGI code development, beyond the end of the initial EPIC project. As described above, the open-source and open-architecture nature of XBOS is designed to accommodate a continually growing set of device drivers to interface a wide range of load control for buildings, including traditional building electricity loads along with emerging new loads and sources of generation and storage, including EVSE as well as stationary storage and solar photovoltaics.

Market transfer activities include formally releasing project software

### **Online Resources**

The project team has released the following XBOS-V project technical documents and software code packages through the following links:

- XBOS platform documentation: <https://docs.xbos.io/>
- XBOS platform code: <https://github.com/softwaredefinedbuildings/xbos>

- OCPP 2.0 Implementation: <https://github.com/gtfierro/ocpp-2.0>
- Juiceplug driver implementation (XBOS): <https://github.com/SoftwareDefinedBuildings/bw2-contrib/tree/master/driver/juiceplug>
- Aerovironment driver implementation (XBOS): <https://github.com/SoftwareDefinedBuildings/bw2-contrib/tree/master/driver/aerovironment>
- Brick Schema documentation: <http://brickschema.org/>
- Brick database code: <https://github.com/gtfierro/hod>

The release of the code and the web locations will be publicized on campus partner group websites and in future publications and presentations moving forward.

### **Technical Advisory Committee**

The project engaged a formal technical advisory committee (TAC) for the project with the following members:

- Abigail Tinker, Pacific Gas and Electric Company
- Dr. Brett Williams, Center for Sustainable Energy
- Charlie Botsford, Aerovironment
- Dr. Willett Kempton, University of Delaware
- Dr. Doug Black, Lawrence Berkeley National Laboratory
- Dr. Sunil Chhaya, Electric Power Research Institute
- Florian Michahelles, Siemens
- Craig Rodine, ChargePoint
- Alec Brooks, eMotorWerks
- Steve Davis, Oxygen Initiative

As project follow-up activities, the project team will continue to inform the TAC about the results from the culmination of the initial EPIC project as well as significant developments moving forward through follow-on projects, as additional market transfer activities.

### **Summary**

The XBOS-V project is intended to provide an open source, easily implementable solution for EVSE power management in the context of building energy management systems. A key aspect of the project is widely disseminating the key findings from the study across four main technical tasks, along with making widely available the open source code and energy management algorithms developed in the project. The project team has been and expects to continue to pursue a vigorous set of activities related to



Technology Transfer (Task 7) of the project, as the XBOS platform and XBOS-V EVSE modules continue to develop further through project follow-on activities.

# CHAPTER 5:

## Conclusions/Recommendations

---

### Summary of Key Project Conclusions

The key conclusions from the various primary project technical tasks are summarized briefly. These are organized by the four primary project tasks because while interrelated, they also represent somewhat distinct efforts with individual insights and conclusions.

### PEV Smart Charging User Needs Assessment

The ChargeForward participant focus group and building energy manager interviews provided a valuable opportunity to learn from real world settings and concerns related to PEV charge management. Findings helped to inform current project and potential future efforts including: 1) understanding what can motivate PEV drivers to participate in VGI programs; 2) the participant desired level of user complexity/information; 3) concerns about use of VGI in specific settings; and 4) insight into potential VGI application at a wide range of commercial locations as well as residential sites. The overall response to the concept of VGI was generally positive in the PEV driver focus groups and the building energy manager interviews, but with many nuances and some specific concerns as noted.

### XBOS-V Module Scoping, Development, and Testing

In conclusion, this task achieved all of the key technical objectives of developing the VGI testbed at UC Berkeley Global Campus, creating an instance of XBOS as a platform for XBOS-V development, instrumenting a test building with Wi-Fi load control devices and a power flow metering device, developing open-source Wi-Fi compliant drivers for Level 1 and Level 2 EVSE, demonstrating coordinated load control of building and EVSE loads using the XBOS platform, documenting key findings and releasing the open-source code.

The open-source driver code and details of the tasks in the software development plan are available at the following "github" locations:

- XBOS platform documentation: <https://docs.xbos.io/>
- XBOS platform code: <https://github.com/softwaredefinedbuildings/xbos>
- OCPP 2.0 Implementation: <https://github.com/gtfierro/ocpp-2.0>
- Juiceplug driver implementation (XBOS):  
<https://github.com/SoftwareDefinedBuildings/bw2-contrib/tree/master/driver/juiceplug>

- Aerovironment driver implementation (XBOS): <https://github.com/SoftwareDefinedBuildings/bw2-contrib/tree/master/driver/aerovironment>
- Brick Schema documentation: <http://brickschema.org/>
- Brick database code: <https://github.com/gtfierro/hod>

Supporting XBOS code including for BOSSWAVE, SPAWNPOINT, PunDat, Ragent, etc. is available at additional “github” locations as indicated in the References section.

In summary, the XBOS-V architecture is designed to easily integrate with new technologies, applications, control schemes, and protocols. It does so using a modular architecture built around a secure, distributed message bus (BOSSWAVE) that enables easy scaling of the system while maintaining a fine-grained and auditable permissions model. Development of the new EVSE drivers in XBOS-V is complete, with integration into the larger XBOS platform. Additional development efforts for XBOS-V are expected in the future to integrate more versions of the driver to interface with the API of more types of especially Level 2 EVSE, working with additional EVSE suppliers. Finally, further technical details on the XBOS platform and XBOS-V module are available in Appendix D of this report.

### **Distribution-Level Utility Power Grid Impacts and Benefits Analysis of PEV Smart Charging Using XBOS-V**

This task analyzes the potential negative consequences of uncontrolled PEV charging and the potential system-wide benefits that could be gained from PEV charging management. In addition, the project team propose control algorithms designed to be functional with any of the proposed VGI communication protocols. The project team prove this on both standard recognized test feeders and a real-world sized model feeder. By examining home vs. workplace charging separately, the project team also compared the hosting capacity of the distribution feeder for charging infrastructure under either paradigm. Key findings include examination of current and proposed utility rates and their impacts on PEV charging behavior, the potential to use LMP signals for grid control, and additional distribution grid impacts. It seems that LMP signals alone are not adequate for voltage correction on distribution feeders, and this is being explored further in the context of specific feeders with and without solar generation and other features.

### **Analysis and Forecast of Ratepayer Benefits of PEV Smart Charging in California**

In conclusion, PEVs through VGI can potentially play important roles in the wholesale power market and at the transmission level as well as at the distribution level as examined in project Task 4. There are potentially significant values that can be accrued through provision of these services, but they are variable geographically and temporally as markets evolve over time, creating issues with identifying dependable long-term revenue streams. It is important to consider the net value of VGI participation in larger

grid operations, as any gross values are eroded by the needs to involve key stakeholders in the value chain, including load aggregation services, grid scheduling coordinator and accounting services, and mechanisms for enrolling participating customers or fleets in the first place.

## **Project Recommendations**

VGI development in California is an active state, enabled by the recent proliferation of PEVs (about 500,000) in the state and concurrent developments with VGI codes and standards and growing understanding of VGI value streams, use cases, and potential business cases. After more than 20 years of discussion, initially hypothetically with few PEVs on the road, VGI is now becoming a reality in various forms through the development of utility pilot rate programs for VGI, larger-scale demonstration and pilot projects, and increasing interest among California state agencies and stakeholder groups.

Recommendations for further development of VGI based on findings and learnings from this XBOS-V project include:

- Further development of understanding of potential value streams from various VGI use cases in different settings (residential, workplace, etc.) is important, particularly on a net-value basis where implementation costs are carefully considered along with potential gross revenue value streams.
- Further efforts are needed to better understand what motivates PEV drivers to participate in VGI programs, what functionality and level of control and information they would like, and what concerns would prevent them from participating, especially as the market moves from “early adopters” of PEVs to the “early mainstream;”
- Communications protocols have been the subject of much discussion for VGI with some calling for standardization on a subset of standards, but this seems somewhat premature and unnecessary at this time; flexible frameworks like XBOS-V can operate with various protocols depending on site needs;
- PEVs can clearly offer the potential to help stabilize (or at least avoid further destabilizing) utility grids at the distribution level, and application of the types of algorithms developed in this project should be further investigated for practical application.
- Inter-agency working groups such as the California VGI Working Group are of critical importance to align state agency efforts to help provide consistent signals to the marketplace.

## **CHAPTER 6:**

# **Benefits to Ratepayers**

---

As discussed in Chapter 4 on Technology and Market Transfer activities, the project team has been engaged in an effort to disseminate project findings and encourage use of the project's open-source resources. These efforts are targeted at various stakeholder groups especially including EVSE manufacturers, integrators, and system solution providers, and also for other academic and research groups for further collaborative development. These efforts will be continued as the XBOS platform is undergoing continual development through various funding sources, including state and federal grants and private sector participation.

This project used the information generated to assist public and private organizations to better identify the opportunities and obstacles to VGI use, and to provide a flexible, open-source platform for further development, and increase the use of VGI energy technologies. The project contributes to larger efforts by electric utilities and grid operators to provide ratepayer benefits of greater electricity reliability and lower costs by reducing potentially strained transformers and feeder circuits at the distribution level. This project demonstrated providing better potential throughput through existing power grid nodes by allowing for better coordination of PEV loads, and allowing PEV loads to be used to help manage the issues created by the increasing level of intermittent power generation through California's RPS program.

### **Ratepayer Benefits of VGI and the XBOS-V Project**

Potential ratepayer benefits from greater use of VGI, in part enabled by developments from this project, include greater electrical grid reliability, reduction in electricity costs by allowing low cost renewables to be more effectively used, increased acceptance of renewable electricity on the grid, and reduced emissions of GHGs and criteria air pollutants.

### **XBOS-V Implementation Potential**

The XBOS platform is designed to be easily implemented and tailored for individual sites based on their electricity loads and objectives for power use management. It is based on a very low-cost computing platform (less than \$200 for a basic system and then relatively inexpensive add-ons for Wi-Fi control of groups of devices, such as thermostats, lighting, plug loads.). A goal of XBOS is to "demystify" some key aspects of controlling electrical loads in coordination, using the BOSSWAVE framework for secure communication and device drivers for many different types of devices that the project team is putting in the public domain.

XBOS is currently operational at about 20 sites in the San Francisco Bay Area, with additional inquiries for additional installations being received on a regular basis and

efforts underway to develop additional “instances” of the control system in new locations.

### **Potential Monetary and Emissions Savings**

Based on analysis and calculations conducted by the project team, the potential monetary and emissions impacts and benefits of VGI systems, including further implementation of XBOS-V based installations, include:

- Greater reliability of the electric distribution grid, reducing frequency of outages in residential areas.
- Annual reductions in electricity costs for ratepayers derived from lower electric distribution system upgrade and operating costs, increased electric distribution system energy efficiency, increased PEV charging energy efficiency, and lower electricity generation costs through better acceptance of low-cost renewables.
- Potentially hundreds of MW of avoided peak electric demand at the electric distribution system level by 2025 timeframe.
- Hundreds of thousands of metric tons of carbon dioxide (CO<sub>2</sub>e) emissions per year avoided in 2024 from: increased electric distribution system energy efficiency, increased PEV charging efficiency, increased fraction of intermittent operationally GHG-free renewable electricity generation (and decreased need for GHG-intensive supplemental peaking generation).
- Significant amounts of oxides of nitrogen (NO<sub>x</sub>) emissions per year avoided by 2025 from increased electric distribution system energy efficiency, increased PEV charging efficiency, increased fraction of intermittent operationally NO<sub>x</sub>-free renewable electricity generation (with decreased need for NO<sub>x</sub>-intensive supplemental peaking generation).

In an overall sense, increased market penetration of smart PEV charging will enable increased management of electric load at the distribution system level, reducing peak demand. This will reduce electric distribution system failures due to peak loads. Both increased reliability (decreased number of outages) and lower distribution system upgrade and operational costs should result. In addition, distribution system energy efficiency will increase due to the leveling of load and reduced sizing of transformers while maintaining appropriate margins of safety.

Importantly, managing electric load and using flexible PEV loads will allow easier integration of intermittent low-cost renewable (operationally GHG and NO<sub>x</sub>-free) generation into the portfolio. With output dependent on availability of solar input or wind, this generation capacity will have higher usefulness with the ability to manage electric demand to match supply. Integrating these resources will be accomplished with less need for expensive spinning reserve, storage, or supplemental peaking generation.

## **Human Resources Development**

An additional benefit for California of the current project is that it provided an excellent opportunity for post-doctoral, graduate student, visiting scholar, and undergraduate student learning and information exchange. Approximately 20 post-doctoral scholars and students at UC Berkeley have been involved in the project in at least some meaningful (and often central) ways, providing both immediate training opportunities for future leaders in VGI research as well as longer term potential through their future efforts. Additional training opportunities have been afforded through the partnership on the project with BMW North America LLC, where extensive exchanges have taken place between BMW staff and interns and the UC Berkeley project staff.

## **Groundwork for Other Studies**

Finally, the XBOS platform and XBOS-V module are specifically designed to be continually expanding sets of device drivers and translators, control and optimization algorithms, and functional capabilities as needed for specific sites (number of devices to be controlled, type of functionality, etc.), all provided on a completely free and open-source basis through GitHub. The project team encourages other groups to study and adopt the XBOS system and whatever elements it would like, assist with developing and publishing additional drivers and functionality, and help to further disseminate the platform for future use either as a simple open-source solution or part of a more complicated service that provides greater utility to host sites on a commercial basis.

Individuals, companies, public agencies, and other stakeholders wishing to learn more about the XBOS effort and its current status are welcome to contact the lead authors of this report. The project team hope that many further developments occur that are facilitated by the project team and can be conducted independently around the world, leading to benefits within California and also in other regions, where especially GHG reduction benefits accrue to everyone regardless of where the reductions occur.

## LIST OF ACRONYMS

Term/Acronym	Definition
\$	U.S. dollar(s)
A	Amperes
AC	alternating current
ADR	automated demand response
AF	allocation factors
AMI	advanced metering infrastructure
APnodes	aggregated pricing nodes
AS	ancillary service
BEV	battery electric vehicle
BGC	Berkeley Global Campus
California ISO	California Independent System Operator
CalETC	California Electric Transportation Coalition
CARB	California Air Resources Board
CO <sub>2</sub> e	carbon dioxide equivalent
CPUC	California Public Utilities Commission
CVR	conservation voltage reduction
DC	direct current
DLAP	default load aggregation points
DR	demand response
DRP	demand response provider
E3	Energy and Environmental Economics, Inc.
Energy Commission	California Energy Commission
EPIC	Electric Program Investment Charge
EV	electric vehicle (specifically electrically powered; when used alone it is usually in reference to an all-battery electric vehicle)



<b>Term/Acronym</b>	<b>Definition</b>
EVSE	electric vehicle service equipment
FCEV	Hydrogen fuel cell vehicle
FCV	fuel cell vehicle
FNM	full network model
GDF	generation distribution factor
GHG	greenhouse gas
HVAC	heating, ventilating, and air conditioning
IEEE	Institute of Electrical and Electronics Engineers
IEPR	Integrated Energy Policy Report
IOU	investor-owned utility
ISO	International Standards Organization
km	kilometer(s)
kW	kilowatt(s)
kWh	kilowatt-hour(s)
LMP	locational marginal pricing
LSE	load-serving entity
mi	mile(s)
MIP	mixed-integer programming
MW	megawatt(s)
MW	megawatt
MWh	megawatt hours
NGR	non-generator resource
NOx	Oxides of nitrogen
NREL	National Renewable Energy Laboratory
OVGIP	Open Vehicle Grid Integration Platform
OCPP	Open Charge Point Protocol
PEV	plug-in electric vehicle

<b>Term/Acronym</b>	<b>Definition</b>
PG&E	Pacific Gas & Electric Co.
PHEV	plug-in hybrid electric vehicle
PNNL	Pacific Northwest National Laboratory
Pnode	pricing node
PTC	Production Tax Credit
REC	Renewable Energy Credit
REM	Regulation Energy Management
RPS	Renewable Portfolio Standard
SC	scheduling coordinator
SCE	Southern California Edison
SDG&E	San Diego Gas & Electric
SEP	Smart Energy Profile
SMUD	Sacramento Municipal Utility District
SOC	state of charge
SPDS	Shrunken-Primal-Dual-Subgradient
SubLAP	sub-load aggregation points
TAC	Technical Advisory Committee
TAM	technology acceptance model
THD	total harmonic distortion
TOU	time of use
TSRC	UC Berkeley's Transportation Sustainability Research Center
UC	University of California
UCS	Union of Concerned Scientists
UDC	utility distribution company
V	volt(s)
V1G	managed or smart charging
V2B	vehicle-to-building

<b>Term/Acronym</b>	<b>Definition</b>
V2G	vehicle-to-grid, or bi-directional power flow between the grid and vehicle
VGI	vehicle-grid integration
WECC	Western Electricity Coordinating Council
XBOS	eXtensible Building Operating System
XBOS-V	eXtensible Building Operating System - Vehicles
y	year(s)
ZEV	zero-emission vehicle

## REFERENCES

- "Advanced Clean Cars - Introduction Page." California Air Resources Board. Accessed November 14, 2016.  
[https://www.arb.ca.gov/msprog/consumer\\_info/advanced\\_clean\\_cars/consumer\\_acc.htm](https://www.arb.ca.gov/msprog/consumer_info/advanced_clean_cars/consumer_acc.htm).
- Almeida, D. "PG&E and Vehicle Grid Integration: BMW ChargeForward Pilot Program Presentation." Third Annual California Multi-Agency Update on Vehicle-Grid Integration Research, California Energy Commission, December 12, 2016.
- Alstone, P. et al. "Interim Report on Phase 1 Results, 2015 California Demand Response Potential Study: Charting California's Demand Response Future." Lawrence Berkeley National Laboratory, 2016.
- "American National Standard for Electric Power Systems and Equipment — Voltage Ratings (60 Hertz)." ANSI C84.1-2016, National Electrical Manufacturers Association, American National Standard Institute, Inc. June 9, 2016.
- Andersen, M. P. et al. "Democratizing Authority in the Built Environment." Proceedings of the ACM International Conference on Systems for Energy-Efficient Built Environments, 2017.
- Andersen, M. P., G. Fierro and D. E. Culler. "Enabling synergy in IoT: Platform to service and beyond." Journal of Network and Computer Applications, vol. 81, pp. 96-110, March 2017.  
<http://www.sciencedirect.com/science/article/pii/S1084804516302521>.
- "Assigned Commissioner's Ruling Regarding the Filing of the Transportation Electrification Applications Pursuant To Senate Bill 350." R.13-11-007, Public Utilities Commission of the State of California, September 14, 2016.
- "Assigned Commissioner's Ruling Seeking Comment on Vehicle-Grid Integration Communication Protocol Working Group Energy Division Staff Report." R.13-11-007, Public Utilities Commission of the State of California, February 23, 2018.
- Background Information Regarding the Zero-Emission Vehicle and Plug-In Hybrid Light-Duty Vehicle Rebate Project." California Air Resources Board, May 23, 2018. Accessed November 15, 2016. <https://www.arb.ca.gov/msprog/aqip/cvrp.htm>.
- Bailey, Joseph and Jonn Axsen. "Anticipating PEV Buyers' Acceptance of Utility Controlled Charging." Transportation Research Part A: Policy and Practice 82, pp. 29-46, December 2015, doi:10.1016/j.tra.2015.09.004.

- Balaji, B. et al. "Brick: Towards a unified metadata schema for buildings." Proceedings of the ACM International Conference on Systems for Energy-Efficient Built Environments, pp. 41-50, 2016.
- Bansal, S., M. N. Zeilinger, and C. J. Tomlin. "Plug-and-play model predictive control for electric vehicle charging and voltage control in smart grids." 53rd IEEE Conference on Decision and Control, pp. 5894–5900, December 15-17, 2014.
- Baran, M. and F. Wu. "Optimal sizing of capacitors placed on a radial distribution network." IEEE Transactions on Power Delivery, vol. 4, no. 1, pp. 735-743, 1989.
- Barnes, E. Gregory. "Electric Vehicle-Grid Integration Pilot Program ("Power Your Drive") Third Semi-Annual Report of San Diego Gas & Electric Company." San Diego Gas & Electric Company, September 19, 2017.  
[https://www.sdge.com/sites/default/files/documents/PYD\\_Semi-Annual\\_Rpt\\_with\\_attchmnt.pdf](https://www.sdge.com/sites/default/files/documents/PYD_Semi-Annual_Rpt_with_attchmnt.pdf).
- Bass, R. and N. Zimmerman. "Impacts of Electric Vehicle Charging on Electric Power Distribution Systems." OTREC-SS-731 Oregon Transportation Research and Education Consortium, 2013.
- "Berkeley Tree Database." University of California, Berkeley. <http://btrdb.io/>.
- "BMW and PG&E for iChargeForward." Fleets and Fuels.  
<http://www.fleetsandfuels.com/fuels/evs/2015/01/bmw-and-pge-for-ichargeforward-evs/>.
- "BMW i3 Model Overview - BMW North America." BMW. Accessed April 16, 2017.  
<https://www.bmwusa.com/vehicles/bmwi/i3.html>.
- "BMW Initiates Next Phase of Its BMW ChargeForward Program." BMW BLOG, BMW. November 14, 2016. <http://www.bmwblog.com/2016/11/14/bmw-initiates-next-phase-bmw-chargeforward-program/>.
- "Bodge." University of California, Berkeley. <https://github.com/gtfierro/bodge>.
- "BOSSWAVE." University of California, Berkeley. <https://github.com/immesys/bw2>.
- "Brick." University of California, Berkeley. <http://brickschema.org/>.
- California ISO. "California ISO Proxy Demand Resource Project Implementation Plan." 2009.
- California ISO. "Demand Response Frequently Asked Questions." February 2016.  
<https://www.caiso.com/Documents/DemandResponseandProxyDemandResourcesFrequentlyAskedQuestions.pdf>.

- California ISO. "Energy Storage and Aggregated Distributed Energy Resource Education Forum." April 2015. <http://www.caiso.com/Documents/Presentation-EnergyStorageandAggregatedDistributedEnergyResource-EducationalForum.pdf>.
- California ISO. "Glossary of terms and acronyms." <https://www.caiso.com/Pages/glossary.aspx>.
- California ISO. "Pricing Nodes, Aggregated Pricing Nodes, and Hubs." September 20, 2004. <https://www.caiso.com/Documents/2004092011062529290.pdf>.
- California ISO. "Storage Technologies Provide Flexible Resources in the Market." <https://www.caiso.com/participate/Pages/Storage/Default.aspx>.
- "California's Advanced Clean Cars Midterm Review Summary Report for the Technical Analysis of the Light Duty Vehicle Standards." California Air Resources Board, 2017. Accessed October 9, 2018. [https://www.arb.ca.gov/msprog/acc/mtr/acc\\_mtr\\_summaryreport.pdf?\\_ga=2.95058076.1057667072.1545249310-1223654290.1536080993](https://www.arb.ca.gov/msprog/acc/mtr/acc_mtr_summaryreport.pdf?_ga=2.95058076.1057667072.1545249310-1223654290.1536080993).
- "California Energy Demand 2014 - 2024 Final Forecast Volume 1: Statewide Electricity Demand, End - User Natural Gas Demand, and Energy Efficiency." California Energy Commission, 2014.
- "California Energy Demand 2016-2026, Revised Electricity Forecast, Volume 1: Statewide Electricity Demand and Energy Efficiency." California Energy Commission, 2016.
- "California ISO market data, Day-ahead Market LMP for Davis\_1\_N001 PNode, April 14, 2017." Accessed January 18th, 2018. <http://oasis.caiso.com/mrioasis/logon.do>.
- "California ISO market data, Day-ahead Market LMP for Davis\_1\_N001 PNode, July 10, 2017." Accessed January 18th, 2018. <http://oasis.caiso.com/mrioasis/logon.do>.
- "California Transportation Electrification Assessment: Phase 1: Final Report." ICF International and E3, September 2014. [http://www.caletc.com/wp-content/uploads/2016/08/CalETC\\_TEA\\_Phase\\_1-FINAL\\_Updated\\_092014.pdf](http://www.caletc.com/wp-content/uploads/2016/08/CalETC_TEA_Phase_1-FINAL_Updated_092014.pdf).
- "California Transportation Electrification Assessment Phase 2: Impacts." Energy and Environmental Economics, 2014.
- Callaway, D. S. and I. A. Hiskens. "Achieving Controllability of Electric Loads." Proc. IEEE, vol. 99, no. 1, 2010.
- Chang, T.-H., A. Nedic, and A. Scaglione. "Distributed constrained optimization by consensus-based primal-dual perturbation method." IEEE Transactions on Automatic Control, vol. 59, no. 6, pp. 1524-1538, 2014.

- Chen, C. et al. "Extended ADMM and BCD for nonseparable convex minimization models with quadratic coupling terms: Convergence analysis and insights." arXiv preprint arXiv: 1508.00193v3 [math.OC], pp. 1-21, 2016.
- Chhaya, S. "Energy Commission Project 14-086 'Distribution System Aware Vehicle to Grid Services for Improved Grid Stability and Reliability' Presentation." Third Annual California Multi-Agency Update on Vehicle-Grid Integration Research, California Energy Commission, December 12, 2016.
- Chhaya, S. "Open Vehicle-Grid Integration Platform." Electric Power Research Institute. July 2016.  
<https://publicdownload.epri.com/PublicDownload.svc/product=000000003002008705/type=Product>.
- "Clean Vehicle Rebate Project: Final Report Fiscal Year 2013-2014." Center for Sustainable Energy, Prepared under Grant G13 - AQIP - 01 for the California Air Resources Board, 2015.  
<https://cleanvehiclerebate.org/sites/default/files/attachments/CVRPpercent20Finalpercent20Reportpercent20FYpercent202013-14.pdf>.
- Clement, K., E. Haesen, and J. Driesen. "The Impact of Charging Plug-in Hybrid Electric Vehicles on the Distribution Grid." Proc. 2008-4th IEEE BeNeLux Young Res. Symp. Electr. Power Eng., vol. 25, no. 1, pp. 1-6, 2008.
- "Commercial and Residential Hourly Load Profiles for all TMY3 Locations in the United States." OpenEI. Accessed August 7, 2017.  
<https://openei.org/datasets/dataset/commercial-and-residential-hourly-load-profiles-for-all-tmy3-locations-in-the-united-states>.
- Cui, Y. et al. "On the convergence properties of a majorized ADMM for linearly constrained convex optimization problems with coupled objective functions." arXiv preprint arXiv: 1502.00098v1 [math.OC], pp. 1-26, 2015.
- Culnan, Mary J. and Pamela K. Armstrong. "Information Privacy Concerns, Procedural Fairness, and Impersonal Trust: An Empirical Investigation." *Organization Science* 10, no. 1 (1999): 104-15. <http://www.jstor.org/stable/2640390>.
- Denholm, P. and W. Short. "An Evaluation of Utility System Impacts and Benefits of Optimally Dispatched Plug-In Hybrid Electric Vehicles." NREL Rep. noTP-620, p. 41, October 2006.
- Doney, Patricia M. and Joseph P. Cannon. "An Examination of the Nature of Trust in Buyer-Seller Relationships." *Journal of Marketing* 61, no. 2, pp. 35-51, 1997, doi:10.2307/1251829.

- Dunlap, Riley E. et al. "New Trends in Measuring Environmental Attitudes: Measuring Endorsement of the New Ecological Paradigm: A Revised NEP Scale." *Journal of Social Issues* 56, no. 3, pp. 425-442, January 1, 2000, doi:10.1111/0022-4537.00176.
- "Electric Schedule A-10 Medium General Demand-Metered TOU Service." Pacific Gas and Electric Company. Accessed January 7, 2018. [https://www.pge.com/tariffs/assets/pdf/tariffbook/ELEC\\_SCHEDS\\_A-10.pdf](https://www.pge.com/tariffs/assets/pdf/tariffbook/ELEC_SCHEDS_A-10.pdf).
- "Electric Schedule E-19 Medium General Demand-Metered TOU Service." Pacific Gas and Electric Company. Accessed January 8, 2018. [https://www.pge.com/tariffs/assets/pdf/tariffbook/ELEC\\_SCHEDS\\_E-19.pdf](https://www.pge.com/tariffs/assets/pdf/tariffbook/ELEC_SCHEDS_E-19.pdf).
- "Electric Transportation and Goods Movement Technologies in California: Technical Brief." TIAX LLC, October 2005, updated September 2008.
- "EV Market Share by State." EVAdoption, 2018. Accessed December 19, 2018. <http://evadoption.com/ev-market-share/ev-market-share-state/>.
- "EV Related Protocol Study." ElaadNL. 2016.
- "Executive Order B-16-2012." Office of Governor Edmund G. Brown Jr., March 23, 2012. Accessed September 23, 2016. <http://gov.ca.gov/news.php?id=17472>.
- Farivar, M., L. Chen, and S. Low. "Equilibrium and dynamics of local voltage control in distribution systems." *Proceedings of IEEE Conference on Decision and Control*, Florence, Italy, pp. 4329-4334, December 10-13, 2013.
- "Fiber Optic Module for Direct Transformer Winding Hotspot Measurement." *Dynamic Ratings*, 2017. <http://www.dynamicratings.com/dr-products/transformer-monitors/>.
- Fierro, G. and D. E. Culler. "Design and Analysis of a Query Processor for Brick." *Proceedings of the ACM International Conference on Systems for Energy-Efficient Built Environments*, 2017.
- Franke, Thomas et al. "Enhancing Sustainability of Electric Vehicles: A Field Study Approach to Understanding User Acceptance and Behavior." *Advances in Traffic Psychology*, 2012.
- Gan, L., U. Topcu, and S. H. Low. "Optimal Decentralized Protocols for Electric Vehicle Charging." *IEEE Transactions on Power Systems*, vol. 28, no. 2, pp. 940-951, 2013.



- Gao, X. and S. Zhang. "First-order algorithms for convex optimization with non-separable objective and coupled constraints." arXiv preprint arXiv:1605.05969v1 [math.OC], pp. 1-39, 2016.
- Gefen, David and Elena Karahanna, and Detmar W. Straub. "Trust and TAM in Online Shopping: An Integrated Model." MIS Q. 27, no. 1, pp. 51-90, March 2003. <http://dl.acm.org/citation.cfm?id=2017181.2017185>.
- Gerkenmeyer, C., M. C. W. Kintner-Meyer, and J. G. DeSteese. "Technical Challenges of Plug-In Hybrid Electric Vehicles and Impacts to the US Power System: Distribution System Analysis." PNNL-19165, 2010.
- Geth, F. et al. "Voltage droop charging of electric vehicles in a residential distribution feeder." IEEE PES Innovative Smart Grid Technologies Europe (ISGT Europe), pp. 1–8, 2012.
- "Global PEV Outlook 2016: Beyond one million electric cars." International Energy Agency, 2016.
- Golden, Rachel and Bentham Paulos. "Curtailment of Renewable Energy in California and Beyond." The Electricity Journal, Elsevier Inc., 2015. <https://pdfs.semanticscholar.org/0af3/9008296cbc2f0e21700f4b6d66f65cfd5ee5.pdf>.
- Gómez, J. C. and M. M. Morcos. "Impact of PEV battery chargers on the power quality of distribution systems." IEEE Trans. Power Deliv., vol. 18, no. 3, pp. 975–981, 2003.
- "Gridlab-D PG&E D0001 Model Feeder." Pacific Northwest National Laboratory. Accessed April 10, 2017. [https://github.com/gridlab-d/Taxonomy\\_Feeders/tree/master/PGE\\_Models/GLD\\_percent20Simulation\\_percent20Primary/GLD\\_percent20Simulation\\_percent20Primary/D0001](https://github.com/gridlab-d/Taxonomy_Feeders/tree/master/PGE_Models/GLD_percent20Simulation_percent20Primary/GLD_percent20Simulation_percent20Primary/D0001).
- "HodDB." University of California, Berkeley. <http://hoddb.org/>.
- Hu, J. et al. "Coordinated Charging of Electric Vehicles for Congestion Prevention in the Distribution Grid." IEEE Trans. Smart Grid, vol. 5, no. 2, pp. 703–711, March 2014.
- Hunt, T. "Can PEVs Pay Their Fueling Costs Entirely With Grid Support Services?" May 2015. <https://www.greentechmedia.com/articles/read/can-evs-pay-their-fueling-costs-entirely-with-grid-support-services>.
- Jia, D. and B. H. Krogh. "Distributed model predictive control." Proceedings of American Control Conference, Arlington, VA, USA, pp. 2767-2772, June 25-27, 2001.

- Jiang, C. et al. "Method to assess the power-quality impact of plug-in electric vehicles." IEEE Trans. Power Deliv., vol. 29, no. 2, pp. 958–965, 2014.
- John, J. S. "California's Flood of Green Energy Could Drive a Record 8GW of Curtailment This Spring." GTM, Greentech Media, March 21, 2017. [https://www.greentechmedia.com/articles/read/californias-flood-of-green-energy-could-drive-a-record-6-to-8-gigawatts-of#gs.L\\_s9gfM](https://www.greentechmedia.com/articles/read/californias-flood-of-green-energy-could-drive-a-record-6-to-8-gigawatts-of#gs.L_s9gfM).
- John, J. S. "California's Plan to Turn Distributed Energy Resources Into Grid Market Players," GTM, Greentech Media, June 12, 2015. <https://www.greentechmedia.com/articles/read/californias-plan-to-turn-distributed-energy-resources-into-grid-market-play>.
- Kidd, Pamela S. and Mark B. Parshall. "Getting the Focus and the Group: Enhancing Analytical Rigor in Focus Group Research." Qualitative Health Research 10, no. 3, pp. 293-308, May 1, 2000, doi:10.1177/104973200129118453.
- Koshal, J., A. Nedic, U. Shanbhag. "Multiuser optimization: Distributed algorithms and error analysis." SIAM Journal on Optimization, vol. 21, no. 3, pp. 1046-1081, 2011.
- Kundu, S. and I. A. Hiskens. "Hysteresis-based charging control of plug-in electric vehicles." 2012 IEEE 51st IEEE Conference on Decision and Control (CDC), pp. 5598–5604, 2012.
- Leiserowitz, Anthony, Edward Maibach, and Connie Roser-Renouf. "Global Warming's Six Americas 2009." Yale Program on Climate Change Communication. May 20, 2009. <https://trid.trb.org/view.aspx?id=889822>.
- Li, N. and J. Marden. "Decoupling coupled constraints through utility design." IEEE Transactions on Automatic Control, vol. 59, no. 8, pp. 2289-2294, 2014.
- Liu, M. et al. "Decentralized charging control of electric vehicles in residential distribution networks." IEEE Transactions on Control Systems Technology, pp. 1-15, April 2017.
- Liu, R., L. Dow, and E. Liu, "A survey of PEV impacts on electric utilities," IEEE PES Innov. Smart Grid Technol. Conf. Eur. ISGT Eur., 2011.
- Liu, M., Y. Shi, and X. Liu. "Distributed MPC of aggregated heterogeneous thermostatically controlled loads in smart grid." IEEE Transactions on Industrial Electronics, vol. 63, no. 2, pp. 1120-1129, 2016.
- Luo, X. and K. W. Chan. "Real-time scheduling of electric vehicles charging in low-voltage residential distribution systems to minimise power losses and improve

- voltage profile." IET Gener. Transm. Distrib., vol. 8, no. 3, pp. 516–529. March 2014.
- Ma, Z. J., D. S. Callaway, and I. A. Hiskens. "Decentralized Charging Control of Large Populations of Plug-in Electric Vehicles." IEEE Trans. Control Syst. Technol., vol. 21, no. 1, pp. 67–78, 2013.
- Ma, Z., S. Zou, and X. Liu. "A distributed charging coordination for large-scale plug-in electric vehicles considering battery degradation cost." IEEE Transactions on Control System Technology, vol. 23, no. 5, pp. 2044-2052, 2015.
- "Making Sense of the Rates." PG&E. Accessed April 16, 2017.  
[https://www.pge.com/en\\_US/residential/rate-plans/rate-plan-options/electric-vehicle-base-plan/electric-vehicle-base-plan.page](https://www.pge.com/en_US/residential/rate-plans/rate-plan-options/electric-vehicle-base-plan/electric-vehicle-base-plan.page).
- Manbachi, M. et al. "Impact of PEV penetration on Volt-VAR Optimization of distribution networks using real-time co-simulation monitoring platform." Appl. Energy, vol. 169, pp. 28–39, 2016.
- Markel, T. et al. "Study, Multi-Lab PEV Smart Grid Integration Requirements." NREL, May 2015.
- Mead, John, Vaibhav Donde, and John Garnett. "Advanced Control Technologies for Distribution Grid Voltage and Stability with Electric Vehicles and Distributed Generation." Pacific Gas and Electric Company, California Energy Commission. Publication number: Energy Commission-500-2015-046, 2014.
- "Meet Plugless | The Wireless PEV Charging Station." Accessed December 1, 2016.  
<https://www.pluglesspower.com/>.
- Merkel, D. "Docker: lightweight Linux containers for consistent development and deployment." Linux Journal 2014, vol. 239, no. 2, 2014.
- "Meta Data Models." University of California, Berkeley.  
<https://github.com/SoftwareDefinedBuildings/BrickModels>.
- Montes, G. and F. Katiraei. "Laboratory Testing and Field Measurement of Plug-in Electric Vehicle Grid Impacts." California Energy Commission: Publication number: Energy Commission-500-2015-093, 2015.
- "Motion of Pacific Gas and Electric Company for Adoption of the Standby and Medium and Large Light and Power Rate Design Supplemental Settlement Agreement." Pacific Gas and Electric Company, Application No. 16-06-013, Submitted to the California Public Utilities Commission on January 31, 2018.

- Nelson, J. et al. "High-resolution modeling of western North American power system demonstrates low-cost and low-GHG futures." *Energy Policy*, no. 43, pp. 436-447, 2012.
- Nelson, James H. and Laura M. Wisland, "Achieving 50 Percent Renewable Electricity in California: The Role of Non-Fossil Flexibility in a Cleaner Electricity Grid." Union of Concerned Scientists, August 2015.  
<https://www.ucsusa.org/sites/default/files/attach/2015/08/Achieving-50-Percent-Renewable-Electricity-In-California.pdf>.
- "NREL: Transportation Research - Data, Models, and Tools." NREL. Accessed November 13, 2016.  
[http://www.nrel.gov/transportation/data\\_resources.html](http://www.nrel.gov/transportation/data_resources.html).
- Orr, J. A., A. E. Emanuel, and K. W. Oberg. "Current Harmonics Generated by a Cluster of Electric Vehicle Battery Chargers." *IEEE Trans. Power Appar. Syst.*, vol. PAS-101, no. 3, pp. 691–700, 1982.
- Orr, J. A., A. E. Emanuel, and D. J. Pileggi. "Current Harmonics, Voltage Distortion, and Powers Associated with Electric Vehicle Battery Chargers Distributed on the Residential Power System." *IEEE Trans. Ind. Appl.*, vol. IA-20, no. 4, pp. 727–734, Jul. 1984.
- "Phase 2 decision establishing purposes and governance for electric program investment charge and establishing funding collections for 2013-2020." May 31, 2012. [http://docs.cpuc.ca.gov/word\\_pdf/FINAL\\_DECISION/167664.pdf](http://docs.cpuc.ca.gov/word_pdf/FINAL_DECISION/167664.pdf).
- "Plugless Level 2 PEV Charging System (3.3 kW) by Evatran Group Inc." Activity Advanced Vehicle Testing, INL/MIS - 14 - 33980 Idaho National Laboratory, 2015.
- "PunDat." University of California, Berkeley. <https://github.com/gtfierro/PunDat>.
- "PunDat Client for Python 2 Programming Language." University of California, Berkeley. <https://github.com/gtfierro/pybw2dataclient>.
- "PunDat Client for Go Programming Language." University of California, Berkeley. <https://github.com/gtfierro/pundat/tree/master/client>.
- Quattrini, R. and S. Patadia. "Next-Generation Grid Communication for Residential PEV (EPC-14-078) Project Update Presentation." Third Annual California Multi-Agency Update on Vehicle-Grid Integration Research, California Energy Commission. December 12, 2016.

- Quiros-Tortos, J. et al. "Control of PEV charging points for thermal and voltage management of LV networks." IEEE Power and Energy Society General Meeting (PESGM), p. 1. 2016.
- "Ragent." University of California, Berkeley. <https://github.com/immesys/ragent>.
- Reichheld, Frederick F. and Phil Schefter. "E-Loyalty: Your Secret Weapon on the Web." Harvard Business Review. July 2000. <https://hbr.org/2000/07/e-loyalty-your-secret-weapon-on-the-web>.
- Richardson, P., D. Flynn, and A. Keane. "Optimal Charging of Electric Vehicles in Low-Voltage Distribution Systems." IEEE Trans. Power Syst., vol. 27, no. 1, pp. 268–279, February 2012.
- Rivera, J. et al. "Alternating direction method of multipliers for decentralized electric vehicle charging control." Proceedings of IEEE Conference on Decision and Control, Florence, Italy, pp. 6960-6965, December 10-13, 2013.
- Roe, C. et al. "Power system level impacts of PHEVs." Proc. 42nd Annu. Hawaii Int. Conf. Syst. Sci. HICSS, pp. 1–10, 2009.
- Rutherford, M. J. and V. Yousefzadeh. "The impact of Electric Vehicle battery charging on distribution transformers." 2011 Twenty-Sixth Annu. IEEE Appl. Power Electron. Conf. Expo., pp. 396–400, 2011.
- "SAE Electric Vehicle and Plug in Hybrid Electric Vehicle Conductive Charge Coupler." SAE Surface Vehicle Standard J1772, SAE. October 13, 2017.
- "Sales Dashboard." Veloz. Accessed October 15, 2018. <http://www.veloz.org/sales-dashboard/>.
- Salihi, J.T. "Energy requirements for electric cars and their impact on electric power generation and distribution systems." IEEE Trans. Ind. Appl., vol. IA-9, no. 5, pp. 516–532, 1973.
- Saunders, Carol and Paul Hart. "Power and Trust: Critical Factors in the Adoption and Use of Electronic Data Interchange." Organization Science - ORGAN SCI 8, no. 1 (1997): 23–42, doi:10.1287/orsc.8.1.23.
- "Schedule TOU-EV-1 domestice time of use electric vehicle charging." S.C. Edison. <https://www.sce.com/NR/sc3/tm2/pdf/ce114-12.pdf>.
- Schmalfuß, Franziska et al. "User Responses to a Smart Charging System in Germany: Battery Electric Vehicle Driver Motivation, Attitudes and Acceptance." Energy Research & Social Science, Special Issue on Smart Grids and the Social Sciences, pp. 60-71, September 9, 2015, doi:10.1016/j.erss.2015.08.019.

- Scholer, R. "CPUC Meeting VGI Standards Summary Presentation." Vehicle-Grid Integration Communications Standards Workshop, California Energy Commission, December 7, 2016.
- Schwarzer, V. and R. Ghorbani. "Current State-of-the-Art of PEV Chargers." Hawaii Natural Energy Institute, Honolulu, HI, HNEI-01-15, 2015.
- "Senate Bill No. 100." California Legislative Information. September 10, 2018.  
[https://leginfo.legislature.ca.gov/faces/billTextClient.xhtml?bill\\_id=201720180SB100](https://leginfo.legislature.ca.gov/faces/billTextClient.xhtml?bill_id=201720180SB100).
- Sharma, I., C. Canizares, and K. Bhattacharya. "Smart charging of PEVs penetrating into residential distribution systems." 2015 IEEE Power Energy Society General Meeting, p. 1., 2015.
- Singer, M. "Consumer Views on Plug-in Electric Vehicles – National Benchmark Report." National Renewable Energy Laboratory, 2016.
- "Smart Grid, Smart City: Shaping Australia's Energy Future." Ausgrid, Arup. Executive Report. July 2014.
- "Southern California Edison's key learnings about electric vehicles, customers, and grid reliability." Southern California Edison, pp. 1–6, August 6, 2013.
- "Spawnpoint." University of California, Berkeley.  
<https://github.com/SoftwareDefinedBuildings/spawnpoint>.
- "Steady State Vehicle Charging Fact Sheet : 2012 Chevrolet Volt." Advanced Vehicle Testing Activity, INL/EXT-15-34055 Idaho National Laboratory, 2015.
- Szinai, J. "Charging Ahead – Assessing Impacts and User Acceptance of Managed Charging of Electric Vehicles in California." University of California, Berkeley. 2017.
- Tamayao, M. A. M., J. J. Michalek, C. Hendrickson, and I. M. L. Azevedo. "Regional variability and uncertainty of electric vehicle life cycle CO<sub>2</sub> emissions across the United States." Environ. Sci. Technol., vol. 49, no. 14, pp. 8844–8855, 2015.
- "Transitions to Alternative Vehicles and Fuels." National Research Council of the National Academy of Sciences, 2013.
- "Understanding Electric Vehicle Charging." Plug In America. Jan. 31, 2011.  
<https://pluginamerica.org/understanding-electric-vehicle-charging/>.
- "Understanding the Grid Impacts of Plug-In Electric Vehicles (PEV): Phase 1 Study -- Distribution Impact Case Studies." EPRI, 2012.

- Van Derbeken, Jaxon. "CPUC Commissioner Tied to E-Mail Saying He'd Help PG&E." SFGate, December 15, 2014. <http://www.sfgate.com/bayarea/article/CPUC-commissioner-tied-to-e-mail-saying-he-d-5959190.php>.
- "VGI Communications Protocols Working Group." California Public Utility Commission. December 15, 2017. <http://www.cpuc.ca.gov/WorkArea/DownloadAsset.aspx?id=6442455746>.
- Vyas, K. G. and W. A. Matthews. "Application of Southern California Edison company for approval of its 2018-2020 triennial investment plan for the electric program investment charge." May 1, 2017. [http://www3.sce.com/sscc/law/dis/dbattach5e.nsf/0/8AF1792A8CF877098825811300790FE5/\\$FILE/A1705XXX-SCE percent20Application percent20for percent20Approval percent20of percent202018-2020 percent20EPIC.pdf](http://www3.sce.com/sscc/law/dis/dbattach5e.nsf/0/8AF1792A8CF877098825811300790FE5/$FILE/A1705XXX-SCE%20percent20Application%20for%20Approval%20of%202018-2020%20EPIC.pdf).
- Weis, A. et al. "Emissions and cost implications of controlled electric vehicle charging in the U.S. PJM interconnection." Environ. Sci. Technol., vol. 49, no. 9, pp. 5813–5819, 2015.
- Will, Christian & Alexander Schuller. "Understanding user acceptance factors of electric vehicle smart charging." Transportation Research Part C: Emerging Technologies, Elsevier (October 2016): 198-214, doi:10.1016/j.trc.2016.09.006.
- Williams, B. et al. "Clean Vehicle Rebate Project Participation Rates: The First Five Years (March 2010 – March 2015)." Center for Sustainable Energy, October 2015. [https://cleanvehiclerebate.org/sites/default/files/attachments/2015-10 percent20CVRP percent20Participation.pdf](https://cleanvehiclerebate.org/sites/default/files/attachments/2015-10%20CVRP%20Participation.pdf).
- "Wind and Solar Curtailment April 14, 2017", California ISO. Accessed April 3rd, 2018. [http://www.caiso.com/Documents/Wind\\_SolarReal-TimeDispatchCurtailementReportApr14\\_2018.pdf](http://www.caiso.com/Documents/Wind_SolarReal-TimeDispatchCurtailementReportApr14_2018.pdf).
- "Wrapping C++ in Cgo." University of California, Berkeley. <https://coderwall.com/p/5sxsog/wrapping-c-with-go>.
- "XBOS-V Drivers." University of California, Berkeley. <https://github.com/SoftwareDefinedBuildings/bw2-contrib/>.
- "XBOS-V Software Development Tasks." University of California, Berkeley. <https://github.com/SoftwareDefinedBuildings/xbos/projects/1>.
- "XBOS Python module." University of California, Berkeley. [https://docs.xbos.io/xbos\\_python.html](https://docs.xbos.io/xbos_python.html).

"Zero-Emission Vehicle Legal and Regulatory Activities." California Air Resources Board, October 27, 2014. Accessed: November 14, 2016.  
<https://www.arb.ca.gov/msprog/zevprog/zevregs/zevregs.htm>.

"Zero Emission Vehicles." CPUC. <http://www.cpuc.ca.gov/zev/>.

"ZEV Action Plan: A roadmap toward 1.5 million zero-emission vehicles on California roadways by 2025." Governor's Interagency Working Group on Zero-emission Vehicles, February 2013.  
[http://opr.ca.gov/docs/Governors\\_Office\\_ZEV\\_Action\\_Plan\\_\(02-13\).pdf](http://opr.ca.gov/docs/Governors_Office_ZEV_Action_Plan_(02-13).pdf).



# APPENDIX A: Smart Charging User Needs Assessment – Approval of the UC Berkeley Office of the Protection of Human Subjects

---

UNIVERSITY OF CALIFORNIA AT BERKELEY

BERKELEY • DAVIS • IRVINE • LOS ANGELES • MERCED • RIVERSIDE • SAN DIEGO

COMMITTEE FOR PROTECTION OF HUMAN SUBJECTS  
OFFICE FOR THE PROTECTION OF HUMAN SUBJECTS  
University of California, Berkeley  
2150 Shattuck Avenue, Suite 313  
Berkeley, CA 94704 -5940



SAN FRANCISCO • SANTA BARBARA • SANTA CRUZ

(510) 642-7461  
Fax: (510) 643-6272  
Website: <http://ophs.berkeley.edu>  
FWA#00006252

## NOTICE OF APPROVAL FOR HUMAN RESEARCH

**DATE:** February 10, 2017  
**TO:** Timothy LIPMAN, ITS  
Julia Szinai, Energy & Resources Group ERG, Michael Dysart, ITS  
**CPHS PROTOCOL NUMBER:** 2016-10-9220  
**CPHS PROTOCOL TITLE:** Utility-Controlled Electric Vehicle Charging Focus Groups  
**FUNDING SOURCE(S):** SPO ID# 040303-002

A(n) *new* application was submitted for the above-referenced protocol. The Committee for Protection of Human Subjects (CPHS) has reviewed and approved the application on an expedited basis, under Category 6,7 of the federal regulations.

Effective Date: February 10, 2017  
Expiration Date: February 09, 2027

**Continuation/Renewal:** Applications for continuation review should be submitted no later than 6 weeks prior to the expiration date of the current approval. *Note: It is the responsibility of the Principal Investigator to submit for renewed approval in a timely manner. If approval expires, all research activity (including data analysis) must cease until re-approval from CPHS has been received.* See [Renew \(Continue\) an Approved Protocol](#).

**Amendments/Modifications:** Any change in the design, conduct, or key personnel of this research must be approved by the CPHS **prior** to implementation. For more information, see [Amend/Modify an Approved Protocol](#).

**Ten-year approvals:** Minimal risk, non-federally funded protocols that are not subject to federal oversight may now be given a ten-year approval period. Please see [Ten Year Approvals](#) for information about which protocols can qualify for ten-year approvals.

The addition of federal funding or certain modifications that increase the level of risk may require a continuing review form to be submitted and approved in order for the protocol to continue. If one or more of the following changes occur, a Continuing Review application must be submitted and approved in order for the protocol to continue.

- Changes in study procedures that increase risk;
- Addition of federal funds.

**Unanticipated Problems and Adverse Events:** If any study subject experiences an unanticipated problem involving risks to subjects or others, and/or a serious adverse event, the CPHS must be informed **promptly**. For more information on definitions and reporting requirements related to this topic, see [Adverse Event and Unanticipated Problem Reporting](#).

This approval is issued under University of California, Berkeley Federalwide Assurance #00006252.

If you have any questions about this matter, please contact the OPHS staff at 642-7461 or email [ophs@berkeley.edu](mailto:ophs@berkeley.edu).

UNIVERSITY OF CALIFORNIA AT BERKELEY

BERKELEY • DAVIS • IRVINE • LOS ANGELES • MERCED • RIVERSIDE • SAN DIEGO



SAN FRANCISCO • SANTA BARBARA • SANTA CRUZ

**COMMITTEE FOR PROTECTION OF HUMAN SUBJECTS**  
**OFFICE FOR THE PROTECTION OF HUMAN SUBJECTS**  
University of California, Berkeley  
2150 Shattuck Avenue, Suite 313  
Berkeley, CA 94704 -5940

**(510) 642-7461**  
Fax: (510) 643-6272  
Website: <http://cphs.berkeley.edu>  
FWA#00006252

Sincerely,

A handwritten signature in cursive script that reads "Jane Mauldon".

Jane MAULDON  
Committee for Protection of Human Subjects

# APPENDIX B:

## Smart Charging User Needs Assessment – Focus Group Script

---

Contact: Tim Lipman ([telipman@berkeley.edu](mailto:telipman@berkeley.edu))

### FOCUS GROUP PROTOCOL

~~ChargeForward~~ Vehicle-Grid Integration Participants

UC Berkeley XBOS-V Project (CEC PON 14-310)

- 7:00 – 7:30 Pre-Focus Group with Participants:**
- Consent form
  - Intake questionnaire
- 7:30 – 7:40 Introduction:**
- Moderator introduction and focus group purpose/overview. Moderator will remind focus group participants that to maintain confidentiality, they are not to disclose anything discussed during the focus group with anyone outside of the focus group.
  - Participant introductions: brief introductions
- 7:40 – 7:55 EV Driving and Charging Patterns and Habits:**
- Where do you mainly charge?
  - Is plugging in easy for you or somewhat inconvenient?
  - Do you have range anxiety and if so how do you manage it?
  - How do you think about range: is it a state of charge? Miles to 'empty'?
- 7:55 – 8:10 Attitudes and Motivations:**
- What are your main reasons for driving an EV? (economics, environmental aspects, "new technology," carpool lane access, etc.)
  - Does it matter to you that managed charging of EVs could help to balance the grid and allow more renewable energy in the future?
  - In order to help accept more renewable energy, would you be willing to provide more information to the program such as what time you would be leaving on your next trip? How far you need to travel before your next charge?
- 8:10 – 8:15 Smart Charging/Managed Charging:**
- Do you have concerns / issues with the concept of utility incentives for smart charging, within the constraints of driver preferences?
  - Please elaborate on these concerns if you have them?
  - Are there options or features that could be added that would help to mitigate these concerns?
  - How do you feel about plugging in even if you don't really need a charge?
  - How valuable is it to you to have your automaker playing a role in managing your charging?
  - How much communication would you like about what the program benefits are? How often?
- 8:15 – 8:30 Managed EV Charging and Building Automation:**
- What do you think of the idea of linking vehicle charging with residential or small commercial building automation systems to manage electrical power at a local level? Any additional security concerns?
  - Has anyone experienced this, for example through a Nest thermostat connected to an EV charger?
  - What questions or concerns would you have with this type of arrangement, other than it being simple to use?
  - Would this type of concept affect how you would think about "habitually" plugging in, even if you don't need a charge?
  - In linking vehicle charging to a building automation system, what role do you think the automaker can play in supporting this concept? What is the most logical entity to operate the overall building energy controls?
- 8:30 Adjourn**

# APPENDIX C:

## Details of Plug-In Electric Vehicle Smart Charging User Needs Assessment

---

As described in the body of this Final Project Report, the goal of this project Task 2 has been to conduct two key activities to better understand market and human behavior aspects of VGI and managed PEV charging, to better understand PEV driver / consumer attitudes toward the concept of managed PEV charging, as well as those of building energy managers to understand their interest, ideas for, and potential concerns with the concept of connecting managed PEV charging to management of larger residential and commercial building loads. The two key activities of this task are:

- A series of two rounds of focus groups around the Bay Area with BMW ChargeForward program participants, including an overall total of 50 participants.
- A set of building energy manager interviews with 12 different building sites examined.

Additional details of the procedures and key findings for these investigations are described in the sections below.

### **Focus Group Study Background**

A series of focus groups was planned and implemented for this project to supplement initial focus groups conducted by BMW on the ChargeForward pilot project. The goal of the task was to attract a total of 50-60 program participants to share their experiences and additional thoughts related to the concept of “utility managed charging” of PEVs to help balance both night-time and day-time electricity loads on local and regional utility grids.

For additional background, below is a program summary of the BMW ChargeForward program as reported by “Fleets and Fuels” (“BMW and PG&E for iChargeForward,” n.d.):

#### ***Pilot Program Is to Show How PEVs Can Improve Power Grid Efficiency: EV Owners Will Be Paid to Defer Their Charging When Grid Is Stressed***

BMW and northern California’s Pacific Gas & Electric utility are promoting BMW ChargeForward, a two-part pilot program that aims to reduce the cost of electric vehicle ownership while demonstrating the ability to integrate renewable energy into the power grid.

Select drivers of BMW's battery electric i3 vehicles will receive \$1,000 initially, and an additional reward of up to \$540 at the conclusion of the 18-month program, based on their level of participation.

The goal is to provide PG&E with 100 kilowatts of capacity at any given time, regardless of how many BMW electric vehicles are charging, as part of a voluntary load-reduction program known as "Demand Response."

### **Please Give Us an Hour**

"In the managed charge pilot program," explains a release "select BMW i3 owners will allow PG&E to request a delay in the charging of their vehicles by up to an hour, when grid loads are at their peak."

Participants whose vehicles are selected for delayed charging will receive a text message notifying them that their vehicle will stop charging for up to one hour, thereby temporarily reducing the load on the power grid. Using the BMW ChargeForward smartphone app, participants can opt out of any request based on their driving needs, and their vehicle charging will continue uninterrupted.

BMW begins accepting applications via the [www.bmwchargeforward.com](http://www.bmwchargeforward.com) website this month. The program will kick off in July.

### **EV Batteries to Enable Solar for the Grid**

The program also includes a "second life" for used Mini E batteries, by "repurposing" the batteries into a stationary solar-powered electric storage facility at the BMW Technology Office in Mountain View, Calif.

Such batteries have at least 70 percent of their original storage capacity available, making them suitable for re-use, PG&E and BMW note. "By removing them from the vehicle and installing them in a stationary storage system with integrated solar power generation, new renewable capacity can be added to the grid – supported by resources that once took energy from it.

The XBOS-V project focus groups reported in this Energy Commission EPIC project report complement previous focus groups conducted by BMW and PG&E to probe initial participant reactions in more detail, and to explore concepts linking managed PEV charging to larger building energy management systems at residential and commercial settings.

### **Overview of Existing Managed Charging User Acceptance Literature**

There is limited literature available on the user acceptance of managed charging. Much of the literature has studied the acceptance factors of PEVs more broadly, or of managed charging specifically, by evaluating financial incentives, environmental motivations, and barriers such as range anxiety. Drivers' motivations to participate in managed charging to aid with grid stability, and any barriers due to mistrust in the

system are less understood. I summarize the top four relevant studies below, which serve as the basis for the qualitative analysis of this paper.

Will and Schuller (2016) used a survey of early PEV adopters in Germany to test the following: 1) benefits such as financial incentives and integration of renewables; 2) disadvantages such as loss of flexibility, lack of customization, data privacy; and 3) general attitudes to PEVs as early adopters of the technology (Will & Schuller, 2016). 237 responses were used in the final model. The results showed that the majority of respondents preferred an option to enter a minimum range and to override the system (Will & Schuller, 2016). The average bill and per kWh discount percent requested was around 20 percent. In terms of acceptance, the survey results indicated that smart charging is seen as an accepted and valid concept but so far lacks optimal implementation (low scores in "satisfaction") (Will & Schuller, 2016). The study found statistically significant reasons for smart charging acceptance of grid stability and renewable energy integration, while a desire for flexibility with mobility is a statistical barrier to smart charging acceptance (Will & Schuller, 2016). Even with the requested high discount, the analysis does not show the discount to be a statistically significant factor supporting the acceptance of the concept of smart charging. Overall this study shows that non-monetary aspects of smart charging should be used by policymakers/program designers to promote smart charging, and the fear of losing flexibility should be addressed (Will & Schuller, 2016).

Schmalfuß et al. conducted a 5-month pilot in 2015 with BMW BEV drivers comparing traditional charging to smart charging (2015). Schmalfuß et al.'s literature review shows that trust in the system, in the owners and developers (including BEV manufacturer, utility, aggregator) and in the technology itself, was found to also be very important with the acceptance of smart grid technologies (2015). Schmalfuß et al. looked at: how users experience a charging system with a rather high need for user involvement and how they integrate it in daily routine; users' motivation to use the system; perceived benefits and costs, fairness, and trust in the system; and general acceptability and willingness to use such a system (Schmalfuß et al. 2015). Actual controlled charging usage behavior was also investigated to check for any deviations between intentions and actual behavior. The first 10 weeks comprised the baseline (uncontrolled charging) and concluded with a survey and interview with the researcher. For the remaining time the users could participate in smart charging whereby the car was programmed to charge during off-peak times and when the need for regulation power was high. This schedule was set based on user-specified (through a phone app) departure time, minimum state of charge and a minimum state of charge that had to be reached as fast as possible ("safety buffer"). The participants were rewarded with monetary incentives for keeping their car plugged-in longer, and specifying small safety buffers and a low minimum state of charge (SOC). The research questions were tested through structured interviews and surveys.

The study results showed a range of experiences: half favored the controlled charging, the other half found it needed more development/had technical difficulties/didn't find the financial benefits to be worth the hassle (Schmalfuß et al. 2015). Most participants integrated the controlled charging into their routine. Most participants were motivated by "doing something good" for the environment (Schmalfuß et al. 2015). In terms of costs, most drivers reported less flexibility and spontaneity (Schmalfuß et al. 2015). A total of 7 of the 10 drivers reported after the controlled charging portion that the benefits balanced the costs. Overall the paper showed that drivers can integrate controlled charging into their daily routine as long as they can predict when and where they will have to be the next day and therefore how much range they need (Schmalfuß et al. 2015). The participants also indicated that it was relatively easy to understand the charging system, but had to learn how to plan ahead and understand the mobility and financial incentive tradeoffs (Schmalfuß et al. 2015).

A 2015 study by Bailey & Axsen investigated the case of a nightly charging program where the electric utility can control home PEV charging, through a web survey of a sample of 1470 new car buyers (purchased a car in the last 5 years and use it regularly) in Canada. The study was interested in "early mainstream" car buyers who are a larger segment than early adopters and are more aligned with average consumer preferences (Bailey & Axsen 2015). The focus was on using controlled charging to integrate wind and solar generation and run-of-river hydropower. The survey first tested consumer interest in PEVs generally. The survey then explained utility-controlled charging and elicited openness to controlled charging through attitudinal questions and a stated choice experiment to assess the tradeoffs between different attributes of utility controlled charging program (Bailey & Axsen 2015). The alternatives were the percentage of renewable energy, source of renewable energy, guaranteed minimum charge, monthly electric bill (Bailey & Axsen 2015).

Across various scenarios, the survey found support for managed charging among one-half to two thirds of respondents interested in purchasing a PEV (Bailey & Axsen 2015). However, some respondents expressed concerns with lack of privacy and less control, possibly due to lack of trust or understanding of utility controlled charging (Bailey & Axsen 2015). The paper identified four distinct categories of respondents that vary in their acceptance of managed charging, benefits of renewable electricity, electricity bill savings, and undergoing charging inconvenience. The classes are: renewable-focused, cost-sensitive, charge-focused, and anti-utility controlled charging customers. Survey respondents in their attitudes toward managed charging programs were more sensitive to cost rather than to renewable incentives.

Franke et al. in 2012 conducted a multi-method study in Germany (including interviews, surveys, diary methods, experimentally oriented methods, and continuous data logging of the PEVs) to understand the user acceptance of the "Electric Mobility System," which include a controlled charging scheme, and asked questions related to attitudes on using excess renewable energy and lowering minimum charging buffers (Franke et al., 2012).

Results showed stronger preferences for renewable energy sources, but high range preferences (Franke et al., 2012). Despite wanting to increase environmental benefits, the users prioritized their mobility desires and reserved a substantial buffer in the range that they were willing to use (usually only comfortable using up to 82 percent of the range they had on their cars) (Franke et al., 2012).

### **Focus Group Report – Phase I Logistics**

The focus group plan and protocol developed in late 2016/early 2017 included the following key elements:

- Prior approval by the UC Berkeley campus Office for the Protection of Human Subjects.
- Selection of focus group meeting space in the Mountain View/Sunnyvale area.
- Preparation of the focus group interview “protocol” script.
- Recruitment of focus group participants with the aid of project partner BMW North America.
- Execution of the focus groups.
- Follow-up activities including awarding of participant incentives.
- Analysis of focus group surveys and audio recordings.
- Summary of focus group findings.

In preparation for the Phase I focus groups, meeting space was been reserved at the Bay Area Cultural Connections at 1257 Tasman Drive Suite B in Sunnyvale, California. The OPHS approval for the focus groups was granted on February 10, 2017 under UC Berkeley Protocol ID: 2016-10-9220. The formal approval letter from the OPHS is provided in Appendix A. The focus group interview script can be found in Appendix B.

### **Focus Group Report – Phase II Logistics**

For the Phase II set of focus groups, a protocol amendment to Protocol ID: 2016-10-9220 was requested in May 2017 to allow for additional sites beyond the Phase I Sunnyvale location. This also required minor revision to the focus group participant consent form. The campus approval for the amendment request was granted on June 22, 2017.

Based on the formal campus approval, the project team proceeded with planning for the Phase II round of focus groups. Two locations were selected for this Phase II round of focus groups: 1) Oakland and 2) San Mateo. A total of four additional focus group sessions were held in July 2017 with a total of 28 additional participants. Thus, between Phase I and Phase II, a total of 50 participants were included in the focus group research.



## **Focus Group Report – Phase I Background and Findings**

The Phase I focus groups held in March 2017 in Sunnyvale, California took place over three days and with a total of 28 participants. Key findings are described below.

### **Focus Group Recruitment and Facilitation**

The sample consists of 28 of the 94 BMW i3 drivers who had participated in the ChargeForward managed charging pilot program administered by BMW in partnership with PG&E. The pilot was conducted July 2015 through December 2016 and offered BMW i3 drivers a monetary incentive for allowing their PEV to have its charge delayed up to one hour during times when PG&E sent a demand response (DR) signal to BMW (“BMW Initiates Next Phase of Its BMW ChargeForward Program”, 2016). The DR signal would be a request for BMW to select vehicles to collectively drop up to 100 kW of load, and drivers could opt-out if they needed to use their car immediately (“BMW Initiates Next Phase of Its BMW ChargeForward Program”, 2016). According to BMW’s blog, the pilot program had 192 DR events between July 2015 and Oct. 2016, with 19,000 kWh of load shifted as a result of the program by August 2016 (“BMW Initiates Next Phase of Its BMW ChargeForward Program”, 2016). The BMW i3 is a plug-in BEV, with a range of approximately 80 to 114 miles. The i3 also has a Range Extender plug-in hybrid model, which has a small gasoline motor to lengthen the range offered by the pure battery vehicle to 180 (“BMW i3 Model Overview”, n.d.).

### **Focus Group and Survey Goals and Methods**

In order to recruit participants to the focus groups UC Berkeley TSRC staff worked with the Charge Forward program managers at the Technology Office of BMW in Mountain View. BMW sent out a recruitment email to the participants of the Charge Forward program, and the project team managed the responses and scheduling, moderated the groups, and administered the \$100 Amazon gift card incentive for participation (there was also a drawing for a free iPad for one randomly selected participant).

The focus groups and survey were conducted in Sunnyvale, CA (in Silicon Valley) over 3 days and 5 sessions in March 2017.<sup>2</sup> Each focus group session had 5 to 8 participants. Prior to the start of the group discussion, participants filled out a consent form and an intake survey of questions to collect information on their driving behavior, charging behavior, vehicle purchase motivation, technology adoption, environmental attitudes, trust, and demographics. After the approximately 15-minute survey, Dr. Timothy Lipman and Julia Szinai facilitated a group discussion for 60-70 minutes to cover some

---

<sup>2</sup> Prior to helping to facilitate the focus groups (including administering the consent forms), I completed the Collaborative Institutional Training Initiative (CITI) online training in Human Subjects Research for Social and Behavioral Research Investigators. I assisted in filing and responding to comments the project’s CPHS protocol (2016-10-9220), which was approved in its final form on March 15, 2017. The approval is included in the report Appendix A.

of the same topics, and also additional areas of interest related to managed charging. The discussion was recorded for audio only.

TSRC staff administered the survey prior to conducting the focus groups to assess attitudes and responses from individual perspectives. By having the survey instrument cover some of the same topic areas as the questions from the focus group protocol, the project team account for some of the inevitable focus group bias that arises because individuals in groups do not respond the same way as they do in other settings (Kidd & Parshall, 2000). Participants in a focus group often relate their answers to those of the other participants, comment on each other's responses, and may challenge each other's answers (Kidd & Parshall, 2000). Agreements or disagreements within the group discussion can strongly influence the results, and participants may modify their responses based on the reaction from others in the group (Kidd & Parshall, 2000). Despite potential biases, focus groups are a more practical way to reach a larger sample while still allowing for a more freeform discussion. Focus groups can elicit a broader set of perspectives than individual responses (from an interview or survey), and may collectively uncover some information that may otherwise not be revealed (Kidd & Parshall, 2000).

Based on user acceptance literature described above, drivers' general motivations for purchasing PEVs, environmental awareness, and sensitivity to financial incentives are key parameters for user acceptance of managed charging. Additionally, trust in a managed charging program is little understood. Therefore, the goal of the focus groups and the survey together is to assess participants' motivations of purchasing a PEV broadly, probe their attitudes toward participating in a managed charging program, gauge their trust in potential institutions involved in a managed charging program, and evaluate how knowing that the program may aid in the integration of renewable energy would impact their participation, if at all.

Across all the attitudinal questions in the survey, the project team use a 5-point Likert-type scale and offer a "don't know" or "prefer not to state" option for any potentially controversial questions. Because the survey is meant to be short and to supplement the focus group responses, each section evaluating these topics is not a complete scale to capture all aspects of a construct. Nonetheless, the responses are helpful as a first order analysis to narrow areas for future research.

### **Broad Environmental Attitudes and Toward Renewable Integration**

In order to develop environmental related questions for the survey, the project team reference literature on scales gauging environmental perspectives and attitudes specifically about climate change (such as the Global Warming 6 Americas survey (Maibach, Roser-Renouf, & Leiserowitz, 2009) and the broader scale of the New Ecological Paradigm (Dunlap et al., 2000)). The project team also include a question to place environment in the context of the respondents' broader political priorities (similar to the Global Warming 6 Americas survey) (Maibach, Roser-Renouf, & Leiserowitz, 2009) In addition, in the survey and in the group discussion the project team

specifically probe the respondents' willingness to participate in a managed charging program and possibly adjust their charging behavior, if they knew it could help balance renewable generation on the grid. The goal is to see how consistent a pro-environmental attitude and awareness of climate change would be with actual action or intent (i.e., would a person "put their money where their mouth is?").

### **Trust in Managing Charging Institutions**

When considering how trust may influence a consumer's decision to opt-in to a managed charging program, there are many parallels to online transactional experiences because managed charging involves an electronic interaction with no face to face human interaction, which is how trust is usually established (Reichheld & Scheffer, 2000). Especially in this more abstracted interaction, "trust mitigates the extent of the uncertainty that exists between organizations which cannot control one another's actions" (Saunders & Hart, 1997). In their study of online shopping Gefen, Karahanna, and Straub identify two schools of thought regarding how trust affects technology adoption, 1) trust in the technology and 2) trust in the vendor (Gefen, Karahanna, & Straub, 2003).

The first, trust in the technology, is from the theory of the Technology Acceptance Model (TAM) which is that the acceptance by a consumer of a technology is based on perceived usefulness and ease of its use (Gefen, Karahanna, & Straub, 2003). For the second, trust in the vendor, this is a good parallel to customer trust in the institution administering the managed charging program. Particularly for electronic sales, trust in the vendor was found to dominate other effects, including price, and is a key determinant when customers choose which sites/vendors to purchase from (Reichheld & Scheffer, 2000). There is also literature in this area showing the relationship between privacy concerns and trust, and that "developing information practices that address this perceived risk results in positive experiences with a firm over time, increasing the customer's perceptions that the firm can be trusted" (Culnan & Armstrong, 1999). In addition to privacy concerns, reputation of a firm could also affect trust from consumers (Doney & Cannon, 1997). With recent news of corruption within PG&E and the CPUC, and gas leaks of the storage facility run by SCE, public opinion of utilities is low and could influence customer adoption of utility-run programs (Derbeken, 2014). Therefore, the survey asks respondents to rank their trust in the top five likely entities who could be involved in managing charging.

### **Early Technology Adoption**

The user acceptance literature mentions that likely managed charging participants are early adopters of technology. A question on typical motivations for technology adoption is included in the survey.

### **Findings and Key Themes: Phase I Focus Groups**

To analyze the focus group results, the project team collect the key responses and code the emergent themes from each session individually, and then aggregate them up to

the unit of analysis of the whole sample, because most themes are repeated across sessions. If only one or two people across all the sessions had a certain answer, it is noted below. Answers from the survey are interspersed with the focus group responses to corroborate the themes and point out any inconsistencies between the themes emerging from the group discussion and those from the individual survey answers.

The following section describes the key themes and findings across four main areas covered by the focus groups: 1) PEV Driving and Charging Patterns and Habits, 2) General Attitudes and Motivations for Adopting a PEV, 3) Experience and Concerns with Managed Charging, and 4) Managed PEV Charging and Building Automation.

### EV Driving and Charging Patterns and Habits

In the focus groups, most respondents said that they do “about 99 percent” of their charging at home; almost everyone had a Level 2 charger at home (Level 2 chargers supply power at 240 V, and typically can charge at a rate of 7 kW or 26 miles of range per hour) (“Understanding Electric Vehicle Charging, 2011). Inconsistent and unreliable operation of the public charging networks were cited by participants as reasons for their heavy reliance on home charging. As shown in Figure C-1 below, most charging is done at home at Level 2 for this group of participants, and most charging is done overnight after 11pm.

**Figure C-1: Survey Responses on Typical Charging Location and Time of Day (Phase I, n=28)**

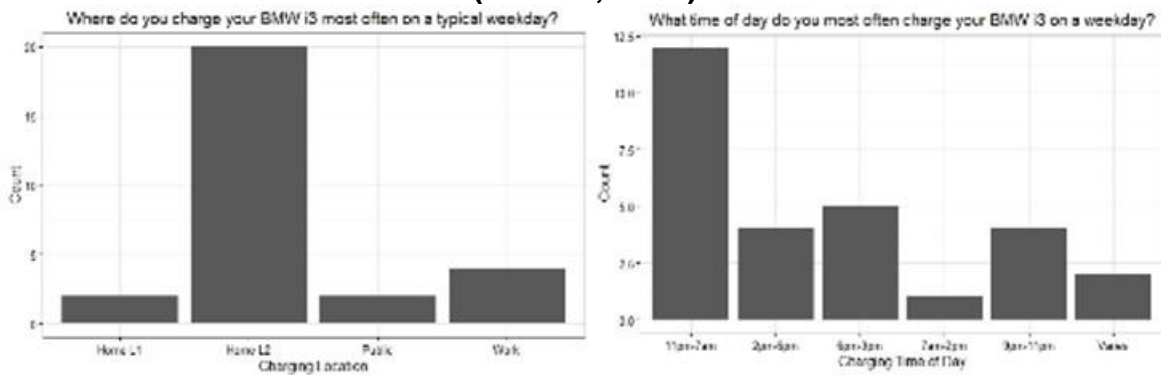

Source: UC Berkeley

While charging at home was also encouraged by the pilot program to be available to participate in a DR event, most people found home charging to be most convenient overall, and part of their daily routine, just like charging their phone overnight. Several people mentioned favorable electricity rates, such as PG&E PEV A or another time-of-use rate, which motivates them to charge overnight at home. Under the PG&E EV-A rate (for accounts with a single meter for the PEV and home), electricity is cheapest from 11 pm to 7 am, and most expensive during peak times 2 p.m. to 9 p.m. (“Making Sense of the Rates,” n.d.).

In terms of other charging locations, participants mentioned a range of challenges with cost, limited availability, and charging etiquette. Overall, workplace charging was not a realistic option for most people, because of logistical challenges and general shortage of chargers. A couple, but very few, respondents mentioned that they have included public chargers as part of their charging routine. However, the vast majority said in the focus groups, and in the survey, that they do not typically use public chargers because they are often out of order, occupied, expensive, inaccurately indicated on phone applications, or inconvenient due to incompatibility between various charging networks.

#### Typical Charging Locations and Habits

##### **Routine Overnight Charging:**

*"Charging is a non-issue, it's like charging your phone."*

##### **Work charging can often be a hassle:**

*"5 years ago, I got a parking spot at work and free charging. Now it's the other way around, finding a spot is very difficult. You try to be courteous to your fellow PEV drivers. But now I'm afraid to leave that spot to be courteous to the next driver because where am I going to park my car?"*

##### **A couple of respondents have included public chargers as part of their charging routine:**

*"Charging is convenient for me, I've worked public charging in my daily life. Most of my sessions are 30 minutes, and for the regular places I go to, I figure out what the main peak times are. Usually I figure out something to do while charging."*

##### **Majority does not rely on public charging:**

*"With public charging situations, I find it more often than not I found chargers unavailable, either broken or full."*

*"It's often down so have quit using it – I would never plan a trip with having to charge with it. They are down more often than not."*

*"When I'm traveling, public charging is badly done, there are different networks, or your spots been taken, or have to drive around to find the charger hidden in the parking lot."*

*"I modify my driving habits so that I eliminate the need to rely on the public infrastructure. That is why I like the REX (Range Extender)."*

Overall, most respondents found the range of the vehicle sufficient for their needs, but because of the unreliability of public chargers, and logistical hassle many found with workplace chargers, many respondents experienced range anxiety for any trips out of the routine. In order to cope with this anxiety, another key theme that emerged was the importance of planning ahead. Many respondents mentioned using a second car (often gasoline powered) for any non-routine trips or destinations further away. A couple of respondents who had purchased the Range Extender model because of range anxiety changed their perspective once they developed a regular charging routine.

#### Range Anxiety and Trip Planning

##### **Planning and knowing travel schedule for the day alleviates range anxiety:**

*"It was a fear before getting the car, but because you usually leave home or work with a full charge, as long as you know how you are going to use the car and live within its range, I don't mind."*

##### **Using a different car to cope with range anxiety:**

*"When you are outside the routine, I find it very difficult. When in doubt take the other car."*

*"I'm conservative in my planning, anything that is farther than 60-70 miles I don't go with this car."*

*"The project team think of the car in a limited sense, this car goes this far, because the project team are going to charge at home, the project team don't often think about longer trips to bridge to another charger like going touring or something."*

Opinions differed on the accuracy of the car's software in predicting remaining range, especially because respondents found that ambient air temperature, past driving behavior, auxiliary features such as heating or radio, and speed were major determinants of state of charge. Responses were split down the middle as to whether miles-to-empty on the "guess 'o-meter" (coined by one respondent), or the "bars of battery" left, were more accurate measures to help with managing range.

#### **Overall PEV Adoption Motivations and Environmental Attitudes**

The importance of environmental reasons (usually described in terms of mitigating climate change by lowering emissions) differed between the survey and the group discussion, and depending on if asked to prioritize options or state attitudes about the environment in isolation. Overall, the environment was a relatively high priority, but not the only high priority, for respondents.

For example, in isolation, the survey results showed that climate change was very important or extremely important to all but one respondent who was neutral on the topic (Figure C-2).

**Figure C-2: Survey response of climate change attitudes (Phase I, n=28)**

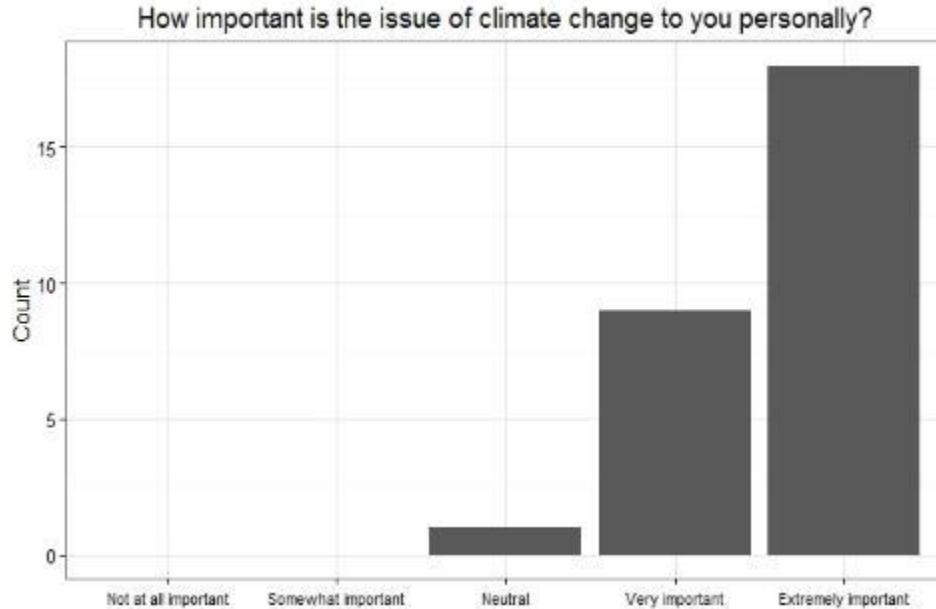

Source: UC Berkeley

When asked to rank the top 10 domestic (non-military) federal priorities in order of most important to least important to address (with 1 being most important and 10 being least important) in the survey, the top choice—people chose it as either 1, 2 or 3 most important— was “Maintaining economic growth and stability.” “Slowing US contributions to global warming” was fourth highest ranked priority. As shown in Figure C-3, relative to other priorities, the environment was ranked relatively high, but not the only important area for respondents. Green indicates the share of respondents who marked that reason as a top priority, blue as middle priority, and yellow as lower priority.

**Figure C-3: Survey Ranking of Top 10 Federal Priorities to Address (Phase I, n=28)**

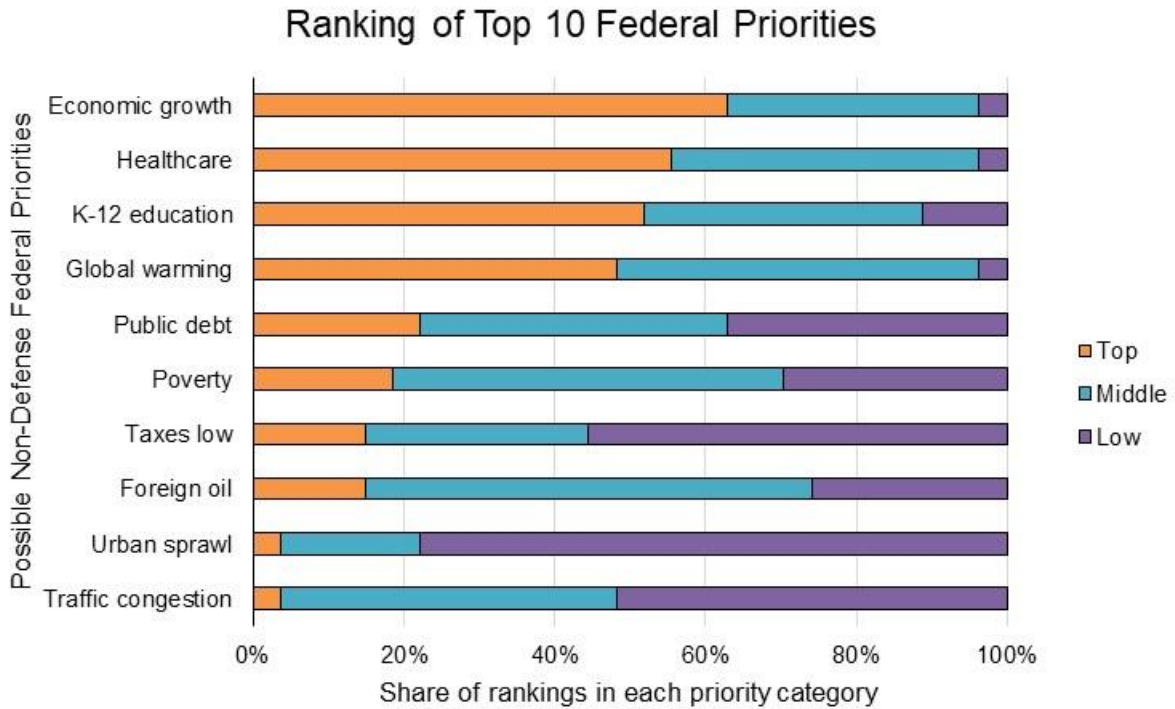

Source: UC Berkeley

When asked during the discussion about their motivation for driving the BMW i3, environmental reasons were not the primary motivator for many respondents, although it may have been a secondary or tertiary reason to get a PEV. Many people mentioned several other factors or a confluence of reasons including: design, torque/driving experience, carpool lane access, or trying a new technology.



## PEV Adoption for a Variety of Reasons

### **Some people cared about the new technology:**

*"I really wanted to try the technology. There is a lot of good reasons for cars to go electric, but if you just talk and read about it but that's not the real thing. I wanted to experience it."*

*"It's a technology thing. The federal tax credit, etc. makes it sweeter."*

### **Others were primarily concerned about emissions and the environment:**

*"I'm totally a tech nerd but for me it was environmental, really concerned about emissions."*

*"Environmental reasons foremost. I feel better driving in it."*

*"I can't get myself to buy another car that is not electric or not hybrid. It doesn't seem right. I always think of the earth as a balloon and if you stick a car inside the balloon and it has all the exhaust, where do you think it's going?"*

### **Others mentioned a convergence of several aspects:**

*"Torque. I like the performance aspect very much, but can't say which is more important: performance, emissions free, or that it's powered at my home off of solar PV. My carbon footprint is really small, love the cutting-edge technology. And getting rid of dependence on foreign oil. It's a convergence of lots of things I find important."*

*"Pollution, not supporting the Middle East. It's the future, it's quiet, it's got a lot of things going for it. I hate gas companies."*

From the survey results, the top three reasons respondents ranked as most important motivations for driving a PEV were environmental reasons, access to the carpool lane, and trying a new technology. For the middle-ranked priorities, responses were also high for environmental, vehicle brand and design, and incentives.

**Figure C-4: Survey Ranking of PEV Purchase/Lease Motivations (Phase I, n=28)**

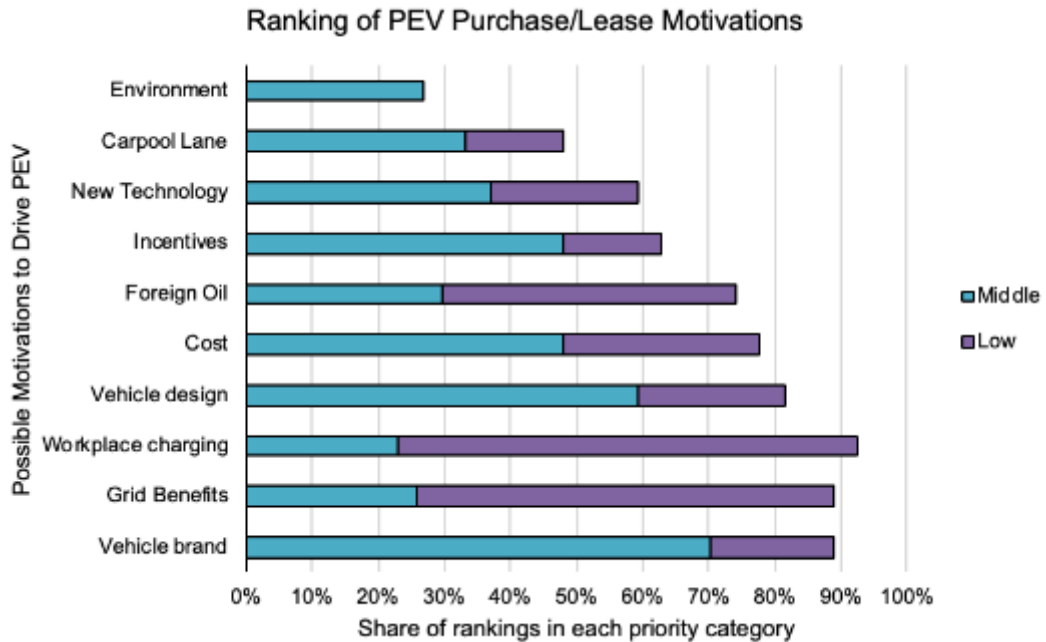

Source: UC Berkeley

Figure C-5 below shows the survey results for this question, with orange marking the share of respondents who marked that reason as a top priority, blue as middle priority, and purple as lower priority. Access to workplace charging (likely due the barriers of workplace charging described above) was by far the lowest ranked reason for adopted the PEV.

**Figure C-5: Survey Ranking of PEV Adoption Reasons (Phase I, n=28)**

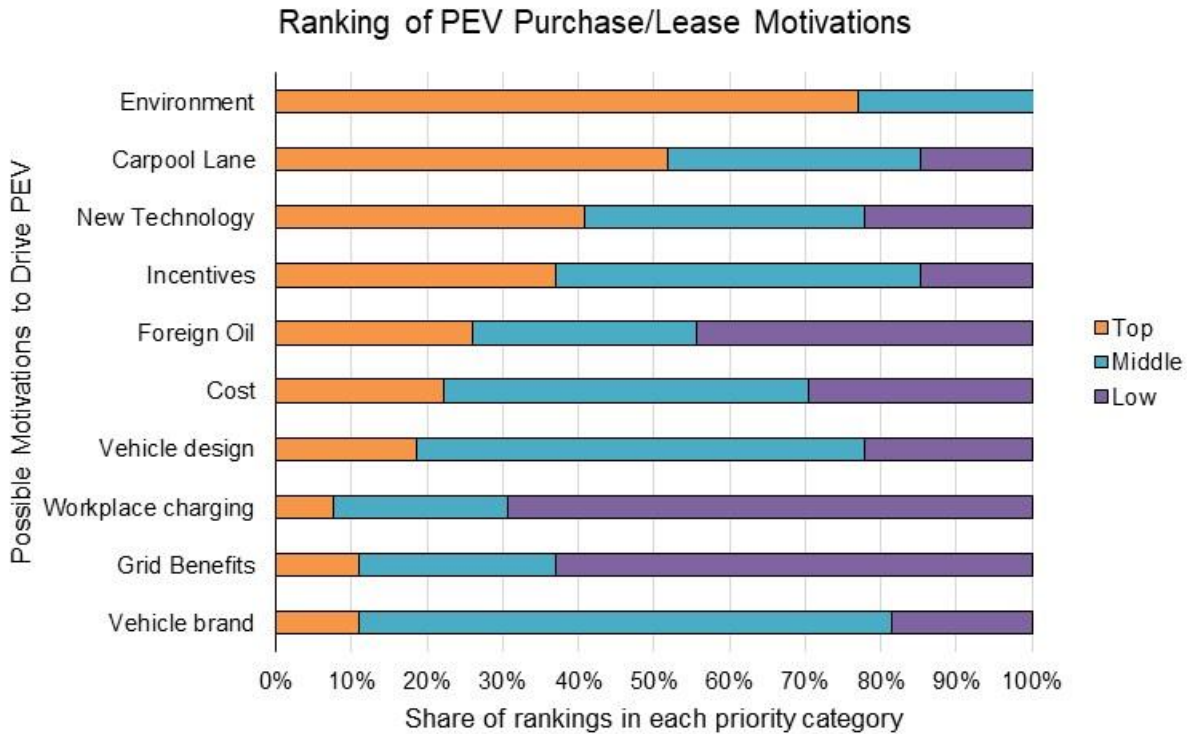

Source: UC Berkeley

Surprisingly, providing grid benefits to balance renewables was also among the lowest ranked reason for purchasing the EV, despite the high value placed on emissions and environmental benefits overall, and importance of climate change across the responses. This contradiction of wanting to eliminate emissions from the transportation sector by using a PEV, but not being as motivated to help eliminate emissions from the power sector, may be due to limited understanding of the role of PEVs to balance renewables for managed charging. Despite having participated in the pilot program of managed charging, most of the DR events the drivers participated in were during peak times, and were not focused on shifting charging to help with balancing renewable generation. Therefore, pilot participants may not be as well informed about these additional potential benefits.

It was revealed in the focus group discussion, that many of the drivers had solar panels on their own roofs. Solar customers took advantage of the net metering options to arbitrage price differences, getting credit for solar production fed back to the grid during the day at a high price, and charging their PEV at a lower rate at night. From the discussion, most respondents were more interested in helping contribute renewable generation locally, than use their PEV to balance intermittent wholesale renewables. This may be for financial reasons (arbitraging with Net Metering rates as described above), desire for energy independence, or simply because their environmental contribution felt more direct.

Overall during the focus group discussion when the project team explained how a managed charging program could shift charging to times of day when solar and wind generators were generating, there were varying degrees of awareness of the concept, but the majority of respondents were cautiously enthusiastic about the idea. When asked if they were willing to change the times that they charge, and possibly plug-in when they did not necessarily need a charge, some said that if the program required charging at work in the middle of the day, the logistics and infrastructure limitations (limited parking, time limits, etc.) would be too high of a barrier to participate. Others mentioned they already habitually plug-in and it would not be an inconvenience, at least at home. One person mentioned that time-of-use rates should already incorporate times when charging is more valuable or detrimental for the grid, highlighting the lower-cost tariff option to help balancing the grid versus the direct control of managed charging. There was some concern about losing independence and control over mobility without the option of an override during a charging event.

**Most were open to the idea of managed charging to help shift load for renewable balancing:**

*"When I found out about the program, I thought personally to me it has no direct benefit, but I thought it was pretty cool. I could definitely see the potential in how as PEVs expand and become more common. This could be really a good thing, not just for utilities, but if they have to fire up an extra power plant or draw energy from other sources on hot summer days and if that this can mitigate that, it's a good thing."*

*"When I was thinking of an PEV 10 years ago, this wasn't on my mind. It is now, and I'm much more willing to engage in programs because I think it matters. The project team have an opportunity to help shape these things."*

**When asked if willing to plug-in even if they didn't need to charge, most were open to the idea because they already habitually plug-in (at least at home):**

*"My rule is ABC: always be charging, even if have 25 percent remaining to charge plug in anyway."*

*"It's a good habit, you just tether your car to the grid and forget it."*

*"I don't drive that much and I don't plug in all the time, but wouldn't mind plugging in more if it's convenient for everybody as long as I can drive my 10 miles that I do a day."*

**Some said if required to charge at work or elsewhere in the middle of the day, the logistics were too high of a barrier:**

*"I'm afraid I wouldn't charge during the middle of the day to take renewables. During the day, I'm at work, and in my current work environment there is just no opportunity for me to plug in. If every stall had a plug available, then yes. The infrastructure has got to meet the potential."*

**Several people prioritized their own rooftop solar rather than using a vehicle to balance utility-scale renewables:**

*"If you are talking about centralized generation, I don't think the car buyer of electric cars really care about that. I think people would be more likely to put solar on their own roofs."*

## **Experience and Concerns with Managed Charging**

The focus group discussion included a section to talk about the experience of the drivers with the pilot managed charging program. The vast majority of respondents in the focus groups and in the free-response answer on the survey found the ChargeForward pilot program to be completely non-intrusive, or a “total non-event.” A major theme was the prioritization of mobility needs; as long as drivers had a full charge when they needed it, they didn’t (or wouldn’t) mind participating in a managed charge program. Many people also expressed the desire for an override or opt-out feature for the rare occasion that the DR event occurs when they need to drive. When asked if willing to accept a less than full charge (such as pre-specified minimum charge), some said that the range of the BMWi3 was not big enough not to have not to have a full charge for the long commutes of the Bay Area.

Opinions differed as to how actively drivers should be involved in the day-to-day management of the charging. Almost everyone wanted to be informed (through email, website or an app notification) about the results of the program, and the benefit the managed charging was having, while a handful of respondents appreciated that the program was running in the background.

## Experience and Concerns with Managed Charging

### **Willing to participate as long as mobility needs are met:**

*"What really interested me in the program was having a full battery when I need it. I don't really care how it gets done as long as I have a full charge."*

*"During the whole program, during the first phase, my charging was never interrupted, and it's good because if I need to go I need to go. It's imperative that I have the charge. It's more about what I need than the whole grid because I otherwise I get stuck."*

*"I'm a big believer in using the electric cars, there are going to be a big load on the grid, and they need to be managed somehow. I'm even happy to share my driving patterns with whomever needs it, PG&E, BMW, whomever I don't care. I just don't want to get in my garage in the morning and have an empty battery."*

### **One person suggested that a closer-to-real-time option to decide on opt-in or opt-out of an event would be helpful because sometimes it is hard to plan driving a day-ahead:**

*"The cycle time is currently 24 hours. If you reduce that decision to one minute like Uber that would make it easier."*

### **Many people wanted to be notified during an event, or wanted more information on the results afterwards:**

*"I was super disappointed that we didn't get the data. The ones and zeros I mainline. I'm a data junkie."*

*"I would like to see a picture of how this is operating. And if I happen to get interrupted I would be more tolerant of it."*

### **Others appreciated that the program was running in the background:**

*"I like the fact that its lights out and no communication. Set it and forget it."*

From both the survey and the discussion it was clear that choice of entity running the managed charging program was important. In the survey prior to the discussion, about one third of respondents marked that their willingness to participate in a managed charging program depended on the entity involved.

**Figure C-6: Survey response on comfort with managed charging (Phase I, n=28)**

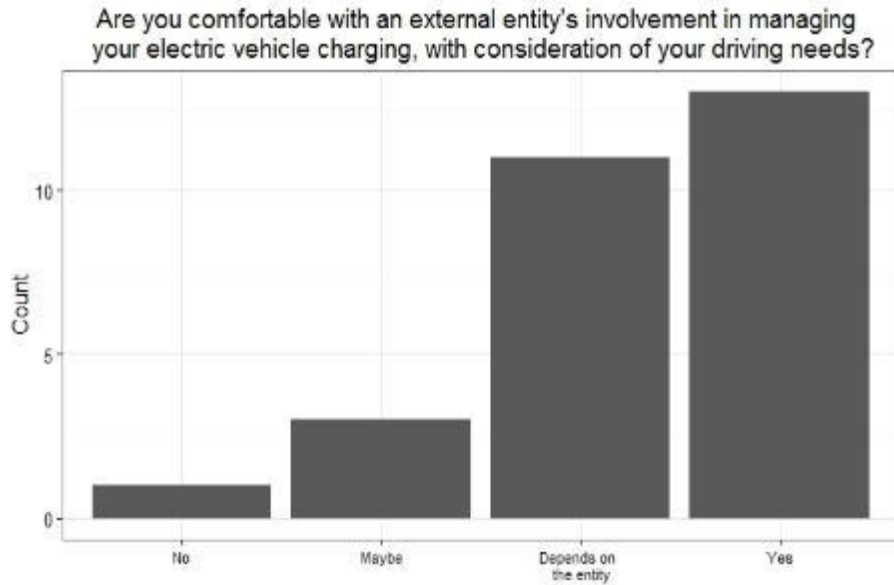

Source: UC Berkeley

When looking at the trust ratings of various types of institutions in the survey, the majority of respondents trusted or somewhat trusted large private companies, and a car company. The majority of responses were neutral or somewhat trusting of the government regulator. The majority of responses were somewhat trusting or neutral on the public utility. The private utility had the most divisive responses, and had the only “don’t trust” and highest “somewhat mistrust” rating, though most people were either somewhat trusting or neutral. These varied attitudes also emerged from the focus group discussion, with a couple of vocal participants mistrusting PG&E specifically, because of recent corruption scandals or the natural gas pipeline explosion in San Bruno, California.

It was unclear if participants would feel similarly about other utilities more broadly. Since many of the focus group participants came from Silicon Valley, and technology companies in particular, many of them had strong opinions of large private companies such as Google being involved in managing their charge. Most mentioned that they were glad to have the car company involved with the pilot program since it is the most familiar with the software of the vehicle and has strong brand loyalty.



**Figure 43: Survey Responses Ranking Trust in Various Institutions (Phase I, n=28)**

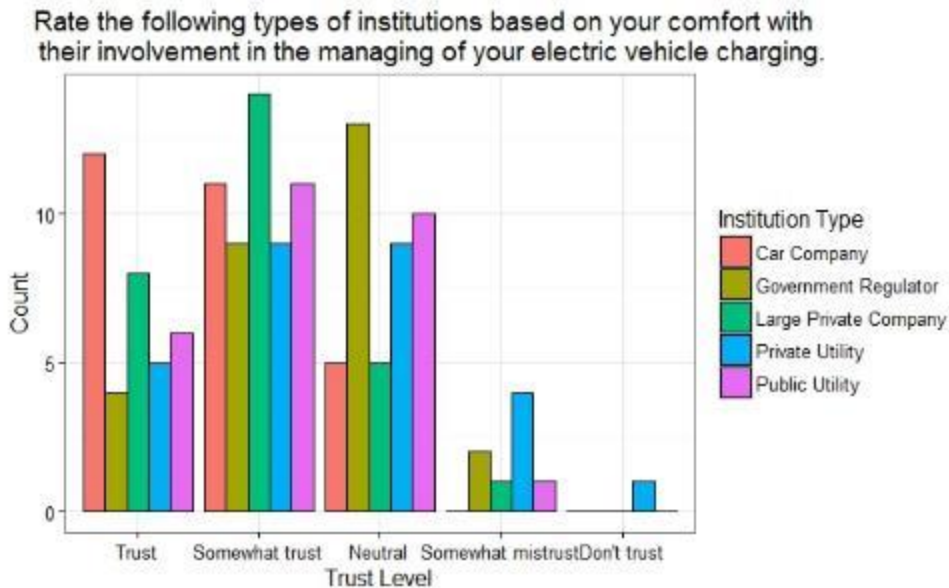

Source: UC Berkeley

### Home Automation and Managing Charging

Some respondents, particularly self-described early technology adopters, were intrigued and interested in the idea of linking their home energy management with the electric vehicle charging. However, themes of privacy concerns, and data security also emerged in the discussion of entities managing charging, especially when the project team asked about linking the charging with a home energy management system. In addition to privacy and security, the discussion also focused on who would determine the hierarchy of control, standards between managed devices, and the overall complexity of such as system. Many people were wary of ceding control of their entire house and vehicle charging to an algorithm. Several people wanted to make sure that the reliability and quality of energy services would not go down if participating or enabling such a smart-house and PEV managed charging program. One person speculated that automation and car sharing would change the picture of an individual household owning a PEV that could be used for grid services.

**Many were intrigued by the idea, especially those people who were heavily into technology.**

*"We definitely need this. We are working on this, soon enough this is going to be the standard. If we are not in control of the loads, we will never have an efficient energy system. Just like renewable balancing of loads."*

*"I would even go a step forward, all the dryers in my neighborhood should talk to each other. If that helps to reduce the consumption or grid utilization that would be helpful."*

**Privacy and security concerns:**

*"My first thing is security...I wouldn't want Ukraine to turn on my washing machine."*

*"I don't trust Nest or anyone to control the car. Unless I get the keys to the server, I wouldn't want to give up control. I think it would be naïve that this wouldn't get attacked."*

**Questions about who will be the "master controller"**

*"Who's the boss on all this? Anytime a system makes a decision on all this, there always a chance there is a wrong decision."*

*"It would need to be some neutral platform, car neutral. Possibly a military grade security company. It wouldn't be a car manufacturer's core competency."*

*"One thing is that there should be universal standard. It's one of the most frustrating things about technology. I would want portability if we want to switch."*

**Others were concerned about the complexity of the system:**

*"I think it's too far off, too difficult to explain to my mom. It's very Star Trek territory, very far off. But it's a nice concept."*

*"It has got to be invisible to the user. Don't ask me to figure out yet another system... I'm topped out... Who benefits? None of this helps me. I have no interest in adding complexity to my home. Has to be dirt simple to retrofit."*

**Role of automation and car sharing affecting PEV ownership:**

*"This picture suggests a point of view where people own cars. I think that's not going to be the future. I think that the future will be shared. My kids are not interested in getting a driver's license...The idea that a car is connected to one house is fundamentally flawed from my perspective."*

## **Demographics**

Of the 28 respondents:

- 43 percent indicated they are usually among the first people to purchase a new technology, while 58 percent wait to read a review before purchasing.
- 93 percent identified as male and 7 percent as female
- 86 percent of respondents were married
- The average age of participants was 52
- 38 percent had a household income \$300K or more, 29 percent had a household income \$200K to \$300K, and 29 percent had a household income of \$120K – \$200K.
- The sample was also highly educated; 63 percent had a Masters or Doctorate degree, with the remaining participants with Bachelor degrees.

## **Focus Groups – Phase II Findings**

As described above, the Phase II focus groups were held in July 2017 in Oakland and San Mateo, California. The focus groups took place over two days and with a total of 22 participants in four sessions. The findings of the second round of focus groups were similar to the first, with some differences probably due to the somewhat wider demographics of the Phase II focus groups being held in a wider part of the Bay Area than Silicon Valley. A few features of the Phase II results are discussed below, followed by discussion of the full set of “n=50” results.

## **Focus Group Recruitment and Facilitation**

The Phase II sample consists of 22 of the approximately 300 BMW i3 and other BMW PEV drivers who were currently participating in the second of two ChargeForward managed charging pilot programs administered by BMW in partnership with PG&E. The second phase pilot was initiated in 2016 and is being continued through late 2018. The program offers BMW PEV drivers a monetary incentive for allowing their PEV to have its charge delayed up to one hour during times when PG&E sent a DR signal to BMW, and to participate in other trials such as instructions to perform workplace charging at certain times when they are able.

The focus groups and survey were conducted in Oakland, CA (East Bay area) and San Mateo, CA (SF peninsula) over two days and four sessions in July 2017. Each focus group session had five to seven participants. Prior to the start of the group discussion, participants filled out a consent form and an intake survey of questions to collect information on their driving behavior, charging behavior, vehicle purchase motivation, technology adoption, environmental attitudes, trust, and demographics. After the

approximately 15-minute survey, Dr. Timothy Lipman and Dr. Mahdi Ghamkhari facilitated a group discussion for 60-70 minutes to cover some of the same topics, and also additional areas of interest related to managed charging. The discussion was recorded for audio only.

TSRC staff administered the survey prior to conducting the focus groups to assess attitudes and responses from individual perspectives. Presented below are the key findings from the Phase II focus group activity, including both survey responses and highlights from the focus group sessions. These cover the key themes and findings across the four main areas covered by the focus groups: 1) PEV Driving and Charging Patterns and Habits, 2) General Attitudes and Motivations for Adopting a PEV, 3) Experience and Concerns with Managed Charging, and 4) Managed PEV Charging and Building Automation.

### EV Charging Patterns and Habits

A similar pattern is seen in the Phase II focus groups as in the Phase I, where weekday charging is mostly done at home and with Level 2 charging, with a somewhat higher percentage of households reporting Level 1 charging at home in the Phase II set of groups. Only about 10 percent of respondents report mostly using workplace charging and about five percent mainly using public charging. In the focus groups, most respondents said they had a Level 2 charger at home. Also, once again, inconsistent and unreliable operation of public charging networks were cited by participants as reasons for their heavy reliance on home and in some cases workplace charging.

**Figure C-7: Survey Responses on Typical Charging Location and Time of Day (Phase II, n=22)**

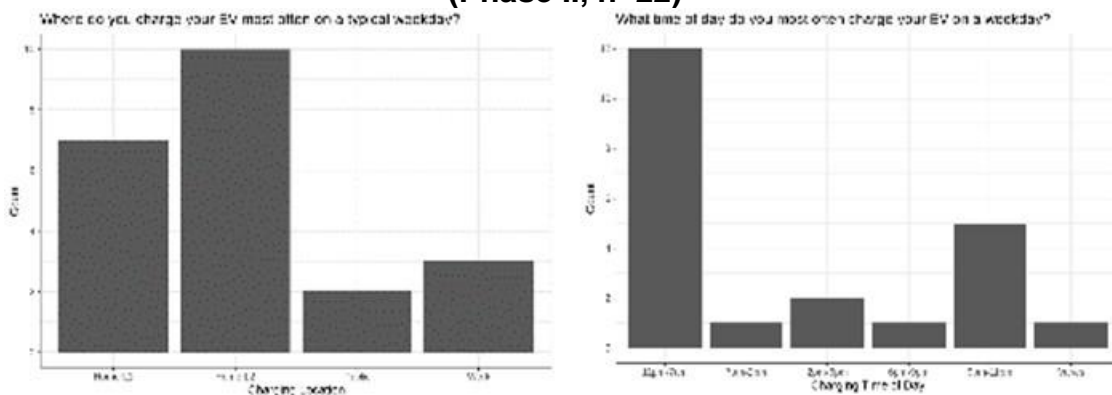

Source: UC Berkeley

As shown below in Figure C-8, the greatest grouping of participants by weekly charging frequency charge five to six times per week, followed by seven to eight times, 10+ times, three to four times, and nine to 10 times. Thus, participants charge on average pretty close to once per day with these relatively short range PEVs (about 90 miles electric range with the i3 vehicles and less for the PHEVs). As battery capacity improves

in the future, one would expect less charging frequency per week and more flexibility about when and where those charging events can occur.

**Figure C-8: Survey Responses on Typical Charging Weekly Frequency (Phase II, n=22)**

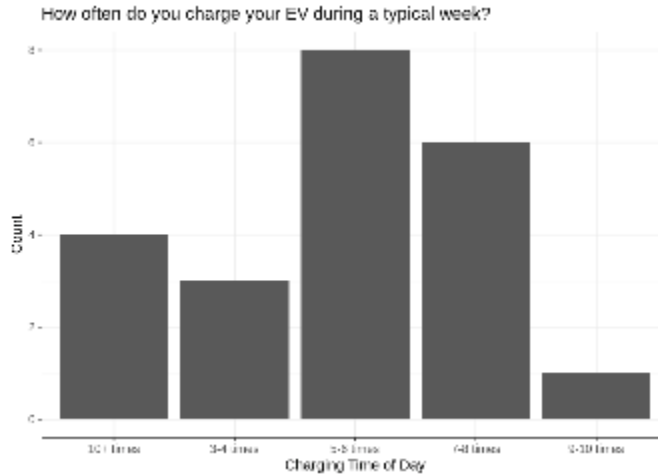

Source: UC Berkeley

The following quotes help to add some nuances to drivers responses related to charging location and habits. The themes were similar to the Phase I focus groups but with a somewhat wider range of charging behavior, including a few participants that drove low miles per week and weren't very concerned about charging, to one participant who relies almost entirely on public charging, but again with the majority focused on home Level 1 and Level 2 charging.

## Typical Charging Locations and Habits

### **Routine Overnight Charging:**

*"I do it pretty much every night, it's what you do, you come in, close the garage door, plug in the car"*

### **Leaving car at public transit stations instead of workplaces during the day:**

*"I live in Pacifica, so I commute via Bart to the city, so most days I'm driving from home to Daly City Bart and back home in the evenings, so I charge at home every night... very rarely I charge somewhere else"*

*"In the beginning, we charged at the Cal train because it was fairly easy to find parking but it got too difficult so we started charging at home"*

### **Preferences for high levels of charge:**

*"Right now, I'm always at full charge because you never know when you're going to need it"*

*"I like topping off everyday, I think if I had a long range car, I'd be willing to wait [to charge]"*

### **Some expressed more expensive electricity rates as current inhibitors to charging during the day:**

*"My wife and I both pretty much work from home and I would love to be able to charge during the day, but right now, [PG&E] is still charging me at a high rate so if PG&E said look, if you have an PEV and you want to charge it all 24 hours of the day and it's going to be \$0.11 if you sign up for this program, I'd say great, I would like to participate"*

### **Lack of employer incentives for work charging can be a barrier to work charging:**

*"I charge at home because there's no charger at work. If there was some sort of incentive for me or my employer to get a charger at work and where [my EV] is parked when it's sunny... it sounds like a good idea. I don't know how to get my employer to get a charger"*

### **Desire for greater reliability and availability with public charging:**

*"Public charging stations, I've had some sort of hit or miss experiences"*

*"I feel like there should be some kind of system that puts you in line... like a reservation... that puts you in line [to charge]... [the current apps] doesn't tell you right away if a charger is not available"*

*"Issues with charging where people are inconsiderate"*

*"I only charged once outside my house... I wish there was more easily available public charging. One time I went to Whole Foods and then there were no available spaces, I didn't want to hang out there for the next hour"*

## Overall PEV Adoption Motivations and Environmental Attitudes

With regard to PEV adoption motivations, the Phase II focus groups showed similarly to the Phase I group that climate change was very important or extremely important. A somewhat higher percentage of about 20 percent were “neutral” in this Phase II grouping but close to 80 percent said that the issue was very or extremely important to them.

**Figure C-9: Survey Response of Climate Change Attitudes (Phase II, n=22)**

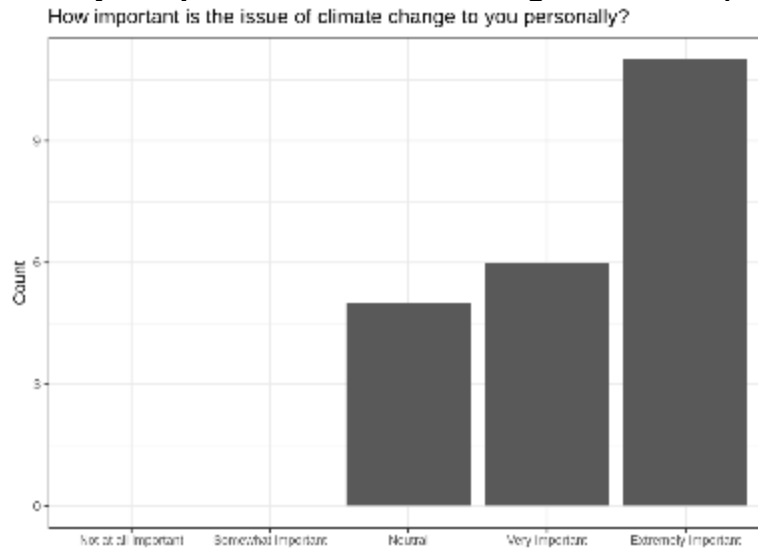

Source: UC Berkeley

The following excerpts from the focus group interviews help to provide more information about participant motivations for PEV adoption. The Phase II respondents reported similar themes as the Phase I respondents but with somewhat more discussion of fuel cost savings compared to the Phase I groups.

## PEV Adoption for a Variety of Reasons

### **Some people expressed wanting to be a part of an advancing technology:**

*"Just to be cutting edge... someone has to be buying the electric cars before they get better"*

### **Others were primarily concerned about emissions and the environment:**

*"I really care about the environment, so having an electric vehicle helps me reduce my personal environmental footprint"*

### **The car itself was important to some:**

*"I think it's a cool car, I like the way it looks, I like the way it handles"*

### **Access to the HOV lane was a big reason for some:**

*"The HOV was a definite consideration for me, I commute and I have to go on 80 sometimes and it's horrible"*

### **One or two mentioned other government incentives:**

*"The state and federal government incentives were big"*

## **Experience and Concerns with Managed Charging**

The focus group discussion sessions included a section to talk about the experience of the drivers with the BMW ChargeForward pilot program. A key question was the extent to which participants were comfortable with an external entity being involved in managing the charging of their vehicle. As shown in Figure C-10, about 35 percent of the participants were comfortable, about 20 percent were perhaps comfortable, and nearly half the participants said it would depend on the entity involved. As shown in the figure further below, participants were more likely to trust car companies and government regulators with this responsibility, followed by electric utilities and then "large private companies" but with some subtleties in the relative Likert-scale responses.



**Figure C-10: Survey Response of External Charge Management Attitudes (Phase II, n=22)**

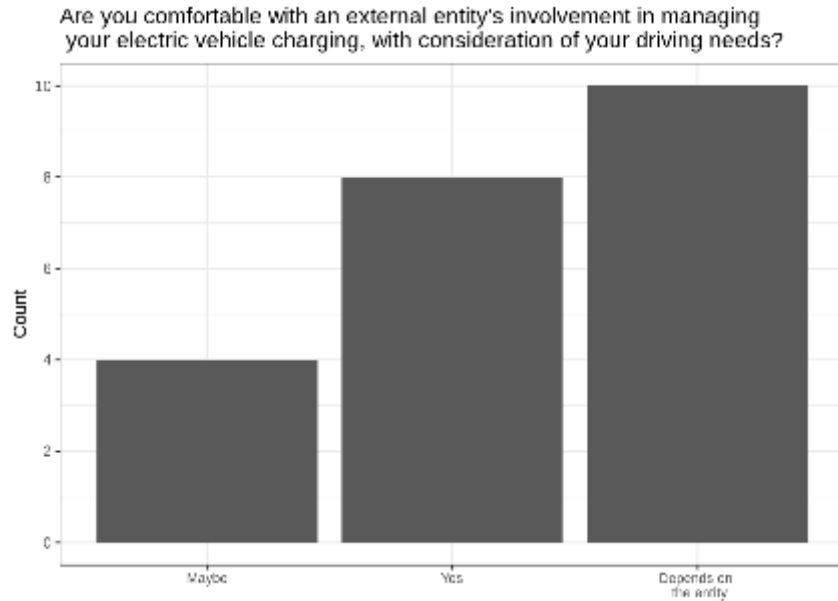

Source: UC Berkeley

**Figure C-11: Survey Response of External Charge Management Institutions (Phase II, n=22)**

Rate the following types of institutions based on your comfort with their involvement in the managing of your electric vehicle charging.

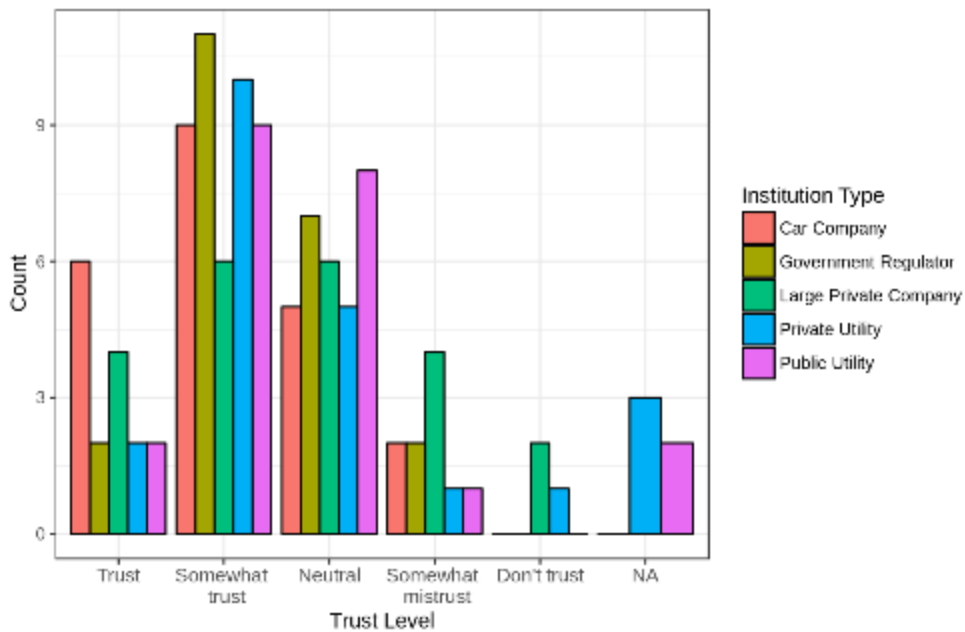

Source: UC Berkeley

The following quotes from the Phase II focus groups help to nuance these findings, with key themes expressed in the selected quotes summary.

## Experience and Concerns with Managed Charging

### **Overall, most people thought, at least in theory, it was a good idea:**

*"I like the idea of using the car as a sponge to absorb up any excess renewable energy that's generated"*

*"I have the philosophy you can never have too much charge, so if I could get charge at a lower rate, I would keep it plugged in"*

### **Some had concerns over the potential amount of user involvement:**

*"I wouldn't want to have to spend a lot of time looking at the price forecast"*

### **Many people wanted at least some information on the operation of their charging and their contribution to charge management:**

*"I wanted to know... how many times they were calling demand response signal or changing my patterns or something"*

*"More visibility on what it's doing, it's a complete mystery to me, I'm not sure if it's even working or if it's making a difference"*

*"It would be interesting to know more how a power grid is managed, most of us just flip on a switch and don't know"*

### **It was important to some, though, that these notifications were not too frequent:**

*"It's not like I'm dying to see what's going on, but once in a blue moon, maybe once a year a letter or an email"*

### **Several people wanted the notification to be directly on the charger or car, as opposed to an app, for greater convenience:**

*"If I plug in my charger and it doesn't turn blue, I don't want to have to pull out my phone and find an app, I'd want a smart charger [to tell me]"*

### **Some expressed concerns for the battery in being plugged in more:**

*"I'm leasing the car, but if I were owning it, I might have more concerns with degradation of the battery... I hear that that can do that"*

### **Some users trusted BMW to manage charging:**

*"There's a lot of electronics going on there, so there's some peace of mind that [BMW] knows what's going on"*

*"BMW wants to keep me happier than PG&E does"*

*"I wouldn't have done it if it weren't BMW"*

### **While others were more open to allowing PG&E or other entities manage their charging:**

*"I do my electric rate with PG&E so I'd be happy to do it directly with them"*

*"Whoever asked me [to join the program], I would have said yes unless it was someone I couldn't recognize"*

## Home Automation and Managing Charging

As in the Phase I focus groups, some respondents, particularly self-described early technology adopters, were intrigued and interested in the idea of linking their home energy management with the electric vehicle charging. Once again, however, themes of privacy concerns, and data security also emerged in the discussion of entities managing charging, especially when participants were asked about linking the charging with a home energy management system. In addition to privacy and security, the discussion also focused on who would determine the hierarchy of control, standards between managed devices, and the overall complexity of such a system. Concerns were again raised to make sure that the reliability and quality of energy services would not go down if participating or enabling such a smart-house and PEV managed charging program.

### Attitudes Toward Linked PEV Charging and Home Energy Management

#### **Many had generally positive attitudes towards the idea, with some reservations about the current capacity of technology:**

*"Yeah I like the idea of [home energy management] but there are a lot of complexities so I'd wanna make sure it's robust"*

*"I think we're gonna have to move from smart homes to smart streets to smart towns, it's all going to continue to expand"*

*"It's a good concept, I don't think it's there yet"*

#### **Many specified the condition of their energy needs working normally as agreement to having their home energy managed:**

*"As long as... I turn on my lights and they turn on and there are no interruptions... I'm okay with it"*

*"As long as the end product works then it's fine"*

#### **Some expressed not wanting to be the first ones to test out implementation:**

*"I don't want to be the beta tester on this"*

*"I don't want to be the first one they have problems with, but if it's working fine, I'm all for it"*

#### **Some concerns about the amount of user involvement:**

*"I wouldn't want to be a building manager for my house as my second job"*

#### **Some expressed concerns with having a for-profit company operate the energy management:**

*"PG&E but not a tech company that's for profit, I don't trust for profit"*

#### **Others thought that having a for-profit company operate their management would improve their customer service:**

*"I would trust a large company or maybe PG&E, someone with a market incentive for customer service"*

*"I think I would trust the large tech companies more than the others... but it would come down to communication... about what exactly they're tracking and that it's an opt in, then I'd be a lot more willing, knowing what I'm getting into"*

**Others were open to any recognizable entity managing their energy:**

*"PG&E or some large tech company"*

**Some had privacy concerns:**

*"I do have some privacy concerns as to who has access to information about when the car is being charged and not being charged, you could read that as I'm in the house versus not in the house or I'm on vacation they haven't charged the car in 2 weeks... that information would tell you other things about the house"*

**While others were less concerned about privacy:**

*"They can see everything that I'm doing, but they're gonna get pretty bored of that pretty quickly, so I'm not concerned about that part"*

**Demographics – Phase II Focus Groups**

Of the 22 Phase II focus group respondents:

- 18 percent indicated they are usually among the first people to purchase a new technology, while a majority group of 59 percent wait to read a review before purchasing.
- 82 percent identified as male and 18 percent as female.
- 82 percent of respondents were married.
- The average age of participants was 43.
- 18 percent had a household income \$300K or more, 36 percent had a household income \$200K to \$300K, and 27 percent had a household income of \$120K – \$200K, and 18 percent had a household income of \$50K-\$120K.
- The sample was also highly educated; 41 percent had a Masters or Doctorate degree, with the remaining participants with Bachelor degrees except for one participant with a high-school education.

**Focus Group Study – Overall Findings**

The overall survey findings of the full set of focus groups are presented next, complementing the detailed summaries of the Phase I and Phase II focus-group sessions presented above. These findings below represent the overall results of the full group of "n=50" respondents.

First, with regard with some general characteristics of the focus group study population, shown below in Figure C-12 indicates that this is a relatively "early adopter" sample

with most respondents saying they wait to read a review before purchasing new technology items (but clearly are interested) and a significant amount of about one-third of the population saying they are among the first to purchase. Only a few respondents say they wait until someone they know purchases the item first, or rarely purchase new technology.

**Figure C-12: Focus Group Participant Response to New Technology Purchase**

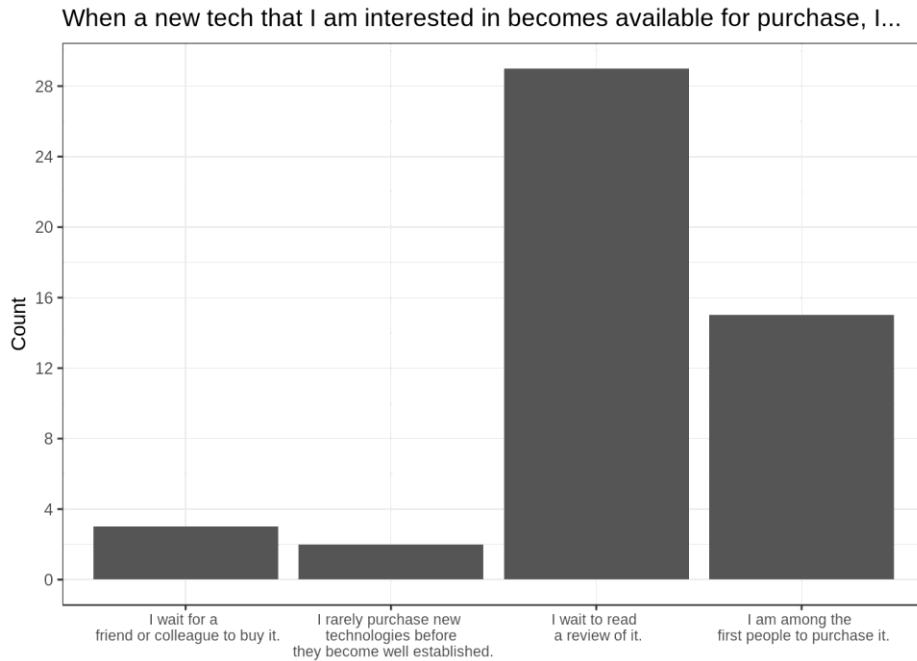

Source: UC Berkeley

Next, for response to the question of how often during the week PEV drivers charge their vehicles, a large group of about one-third of drivers charge five to six times per week, with about 25 percent charging seven to eight times, about 20 percent charging three to four times per week, and fewer percentages charging either more or less frequently. The project team expects these patterns to change over time as larger batter capacity PEVs are introduced, leading to more flexibility with regard to charge timing and frequency.

**Figure C-13: Focus Group Participant Response to Frequency of Weekly PEV Charging**

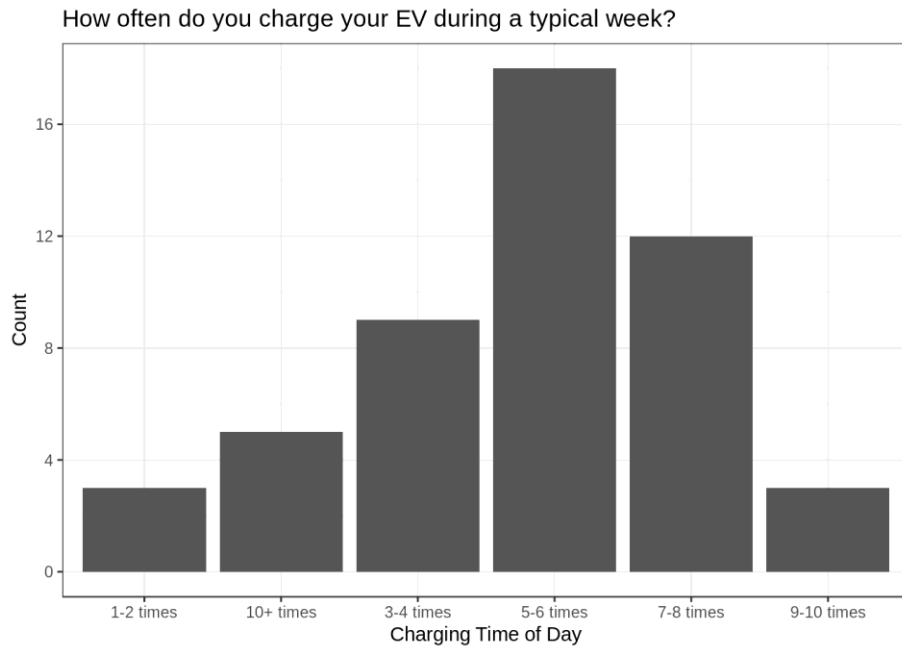

Source: UC Berkeley

With regard to the location of PEV charging, focus group participants overall indicated home Level 2 charging as their most typical weekday charging type, with a much lower level of home Level 1 and workplace charging. A predominant use of public charging was indicated in only about eight percent of respondents.

**Figure C-14: Focus Group Participant Response to PEV Charging Location**

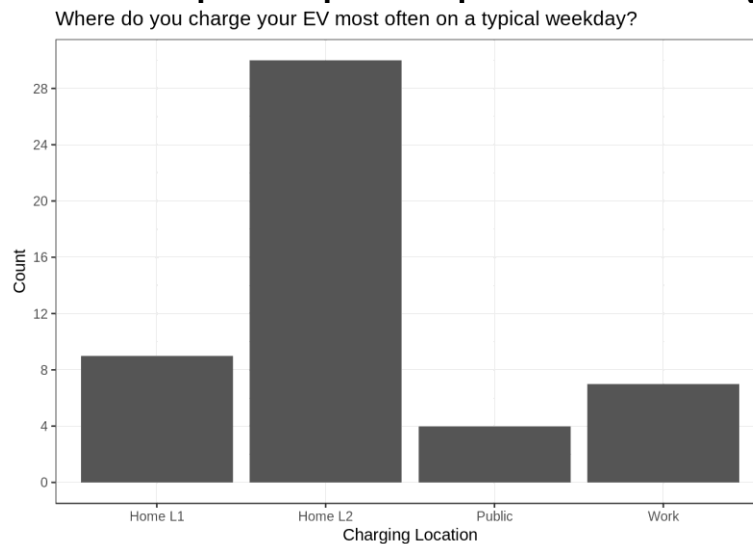

Source: UC Berkeley

As for the time of day of charging, the Phase I and Phase II groups were fairly consistent with most charging being done overnight (consistent with the heavy reliance on home charging). The next largest time block in terms of frequency was in the late evening, followed by late afternoon and early evening. Some of the program participants are likely on TOU rates because of either separate PEV meters or solar PV in the household, where in PG&E territory the rates are currently the highest from 3-8pm with the TOU rate schedules. Thus, participants are probably aware of this in those cases and arranging for charging to occur after 8pm even if they arrive home earlier.

**Figure C-15: Focus Group Participant Response to PEV Charging Time of Day**

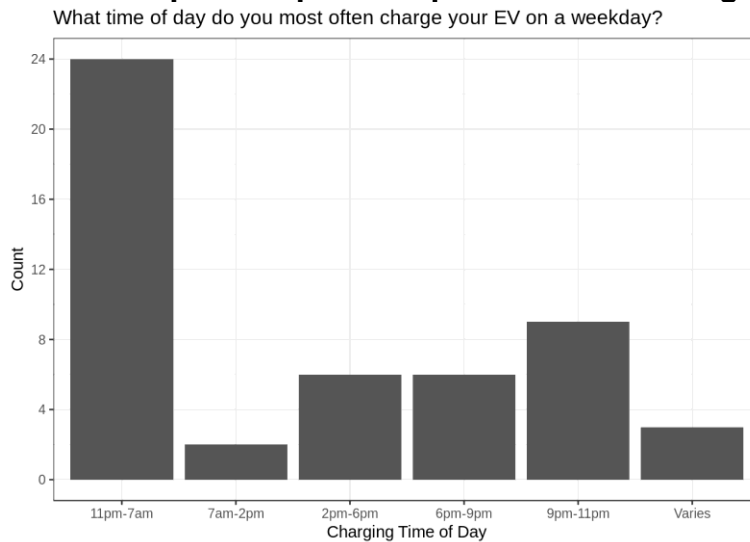

Source: UC Berkeley

With regard to motivations for PEV purchase, as noted above this is a highly environmentally concerned group of participants. Out of 50 participants, 28 (56 percent) of them indicated that climate change was extremely important and an additional 30 percent indicated it was very important. None of the participants reported that it was either not at all important or even only somewhat important.

**Figure C-16: Focus Group Participant Response to Climate Change Importance**

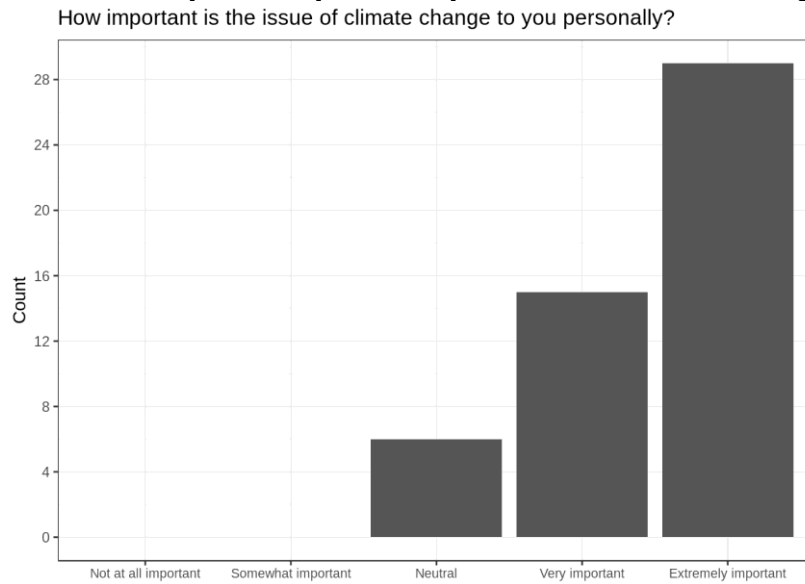

Source: UC Berkeley

Next, with regard to comfort with managed charging, 21 participants (42 percent) said that they were comfortable with this concept, 42 percent said that it would depend on the entity involved in managing the program, 14 percent said they had some reservations (“maybe”) and one participant (2 percent) said they would not be interested at all.

**Figure C-17: Focus Group Participant Response to VGI Managed Charging**

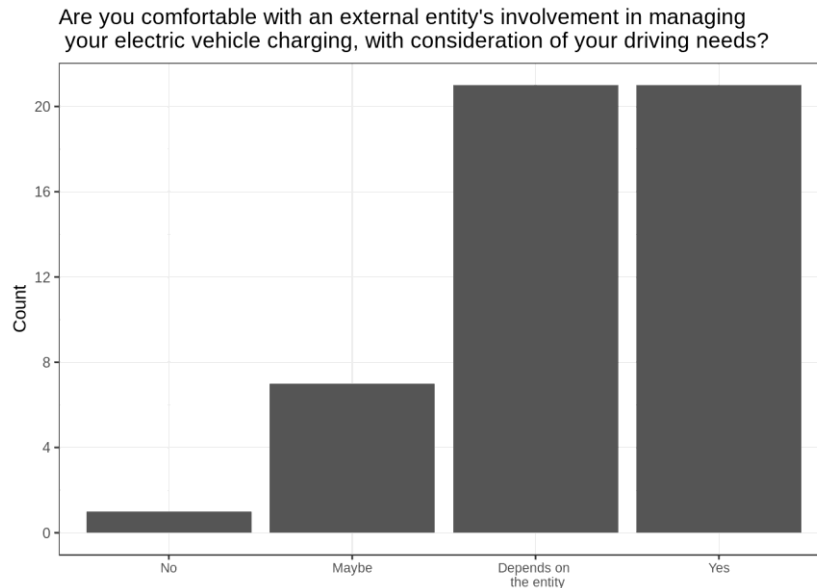

Source: UC Berkeley



Finally, with regard to which entities participants would trust to be involved in managed PEV charging, the most trusted entities are car companies, large private companies, and government entities, followed by public and private utilities. In terms of the “somewhat trust” response, it is interesting that all of these entities are very closely grouped with a similar level of trust.

**Figure C-18: Focus Group Participant Response to VGI Managed Charging Entities**

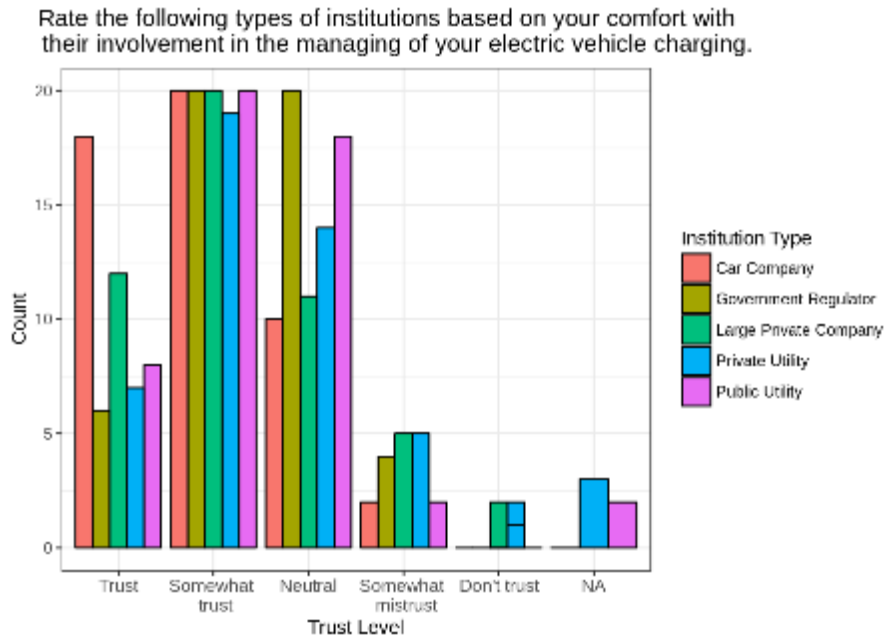

Source: UC Berkeley

### Focus Group Study Limitations

The focus group study is limited by a relatively small sample size (n=50 participants) and a few biases that could arise from self-reporting charging and driving behavior, group dynamics in the focus group, among others. Some of the “group dynamic” biases inherent in focus groups were offset by having a second method of data collection through the survey instrument to validate responses. The sample size was also not randomly selected, and is not a representative sample of California drivers. Given the location in the San Francisco Bay Area, the sample is even a subset of PEV drivers, who in general are relatively high-income, well educated, male, and primarily in “STEM” (science, engineering, technology, and medicine) fields. However, the sample is perhaps well representative of early PEV adopters, who are typically enthusiastic about trying new technologies and programs; therefore, any concerns about managed charging or PEV driving experience should be heeded when considering future managed program design. Given time and resource limitations, the project team were not able to correlate individual answers from the survey to the same individual’s answers in the focus group, but this is an aspect that could be explored further.

## **Building Energy Manager Interview Background**

As part of the XBOS-V project Task 2, a series of building energy manager interviews were conducted with a goal of interviewing at least 12 California building energy managers with regard to their views of integrating smart PEV charging with broader building energy management strategies. A series of locations and building types were considered and ultimately included in the interviews, targeting organizations located in California investor-owned utility territories. Summarized below is the list of organizations included in the interview research.

### **Interviews Conducted:**

1. University of California – Berkeley Sutardja Dai Hall
2. San Francisco Commercial Building Owner
3. Whole Foods stores
4. Smart Homeowner
5. Contra Costa County buildings
6. University of California – San Diego medical complex
7. David Brower Center
8. Pacific Gas and Electric Company building
9. Samsung building
10. Alameda County buildings
11. Genentech
12. San Francisco Exploratorium

## **Building Energy Manager Interview Findings**

A diverse array of building energy managers was interviewed for this task activity, with 12 total interviews conducted. They ranged from an individual “smart home” owner to a manager of a large and elaborate corporate office and laboratory complex. Also included were commercial building owner/manager settings, grocery stores, high technology firms, a museum, and municipal and university buildings. Sites were targeted where PEV charging is either currently available or planned in the near term.

Overall, the building energy managers were receptive to the idea of PEV charge management in conjunction with management of overall site building loads. Some of the sites are already pursuing these concepts and others are interested as described below.

Key findings of this study include the following:

- The studied buildings ranged from single-family homes to large commercial office buildings and commercial/industrial building complexes.

- The building energy managers at all of these sites exhibited a high degree of knowledge with regard to building energy management concepts.
- Many of the buildings have established advanced energy management systems that are potentially able to integrate with PEV charge management systems.
- Building energy managers were generally either participating in or aware of and interested in energy load demand-response type programs, and interested in how PEV charge management could be coordinated to manage overall site loads.
- However, some buildings especially involving specialized laboratories have some data security concerns with combining overall building energy systems with PEV charge management.
- Building energy managers were generally interested in the idea of PEVs providing emergency backup power to buildings during times of high occupancy, potentially supplementing additional emergency backup systems.
- Building energy managers cited a high level of power reliability as being an important concern of building occupant/renters, especially for high technology and mixed office/laboratory companies such as Samsung and Genentech.

These findings are discussed in more detail in the following report sections. Summaries of the individual interviews can be found in the report Appendix E.

### **Building Types Examined**

The building types covered in the research interviews included a wide range of buildings from a residential household, to large office buildings, to a multi-building complex. Included were mostly office buildings, but also including offices with laboratories, a grocery store chain, a museum, university buildings, and county municipal buildings. Among the 12 interviews, a total of 225 buildings were included at the various sites discussed. The total square footage of these buildings all together is approximately 16.3 million square feet.

### **Installed Building Automation Systems**

Of the twelve sites surveyed, ten of them had installed building automation systems at least at most site buildings (for organizations with multiple buildings) and two did not. These systems included several manufacturers at the various sites, including BAS, Siemens, Advanced Logic Control, Apogee, Alerton, Johnson Controls, and Wattstopper (for lighting). Some of the interview subjects indicated that plans were either underway or being considered to update and/or expand these systems, in part to help to explore building electricity demand-response opportunities.

### **Installed PEV Charging Systems**

Most of the building sites indicated that they had EVSE systems installed, either connected to individual buildings or adjacent but separately metered, typically in parking garages. Ten of the organizations interviewed had PEV chargers installed, and

two did not. In one case this is because there is no associated parking with the facility (the museum site in San Francisco), and in one case it is because PEV charging is being planned but not yet installed.

The majority of the sites indicated that they had ChargePoint systems installed, with most sites using 100 percent ChargePoint and a few using a mix of types. Additional types mentioned included Clipper Creek and PEV Go.

### **Concept of Building Automation Systems Linked to PEV Charge Management**

The concept of linking building automation systems with PEV charging and charge management was appealing to the majority of the subjects interviewed. Eight of the subjects interviewed were interested in the concepts, two were somewhat interested with some reservations, and two sites indicated that this did not make sense in their location. In the cases of the sites with concerns, in one case the issue is that the building parking lot where the PEV chargers are located is owned by the City of Berkeley and separately metered, while the building is privately owned, so it is hard to integrate those systems. In the cases of the two sites that weren't interested in this concept, in one case the site was a transportation dispatch facility with minimal loads that could be managed. However, the site has dozens of PEV chargers and is interested in smart energy management of those, just not in conjunction with the (minimal and hard to curtail) stationary building loads. In the other case of the San Francisco museum, there are various building energy systems installed but no adjacent PEV charging spaces so no opportunities for coordinated control.

### **EV Charge Management – Data Security Concerns**

The concept of data security and potential additional vulnerabilities to host sites through the inclusion of PEV charge management is a somewhat sensitive topic, and one that seems to be of highly variable concern by site.

One site, the San Francisco museum, indicated that its building had already been hacked, making this a significant concern. They have documented the incident through a link included in the Site 12 interview write-up in Appendix A.

### **PEVs for Emergency Backup Power**

One concept for PEVs to provide grid services includes emergency backup power. This would involve bi-directional flow of power, something that concerns automakers because of battery warranty issues. However, this is being explored and several of the host sites indicated interest in the concept.

Of the twelve sites interviewed, seven of the sites were interested in the concept of PEV backup power for their locations. Five of the sites expressed little interest in this concept, either because they had minimal needs for emergency backup power or limited opportunities for this concept based on physical site constraints.

## **Additional Comments**

Several of the building managers interviewed had further comments regarding these concepts. These are summarized in the interview details included in the report Appendix D. Concepts included extension ideas for VGI, ideas for reverse flow of electricity for building backup systems, and indications of further expansion of PEV charging facilities with potential grid-integration aspects.

## **Study Limitations**

The study sampled a somewhat random group of building energy managers who consented to an interview for the project. The participants were all from the San Francisco Bay Area, but did represent a fairly broad array of applications and locations for PEV charging. The goal of this project task activity was to be exploratory rather than comprehensive or generalizable, with a fairly small sample of “n=12” building energy managers interviewed.

## **Project Task 2 Activity Conclusions**

This appendix provides further details of the findings for the ChargeForward driver focus groups and building energy manager interview activity of this EPIC 15-013 project Task 2. The activity consisted of conducting two phases of driver focus groups with a total of 50 participants, related to their experiences with the ChargeForward program, and interviewing 12 building energy managers. The interviews explored the building energy setting, availability of advanced building energy control systems, installation of PEV chargers, and perceptions and thoughts about advanced building/EV charge management coordination concepts. The key findings from these two investigations are summarized below.

As discussed above, the project focus groups were conducted in two rounds, one in March and one in July 2017, with a total of 50 ChargeForward program participants in various locations around the San Francisco Bay Area.

Key overall findings include the following points:

- Participants were very interested in the program and found it to be fairly transparent and not disruptive to their travel needs.
- Most participants in this study charge heavily from the household and use limited workplace and public charging.
- Participants were interested in the concept of PEV charge management in the context of overall household energy management.
- Some data security and privacy concerns were raised but most participants were willing to share basic “charging and travel plan” type data with a trusted organization.
- Involvement of a major OEM (BMW in this case) was important to the participation of many of the focus group participants, but they wanted more

information about program benefits and a better iOS type interface to the program.

- Participants were split over what actors would best serve as integrators for management of grid services from PEVs, with some favoring solutions by large but relatively trusted companies, and others preferring smaller company or even individually configured and managed systems.

Overall, the focus group sessions provided a valuable opportunity to learn from PEV drivers who actually participated in a “managed charging” program. The project team will continue to monitor and learn from this real-world experiment over the course of the project, working closely with BMW ChargeForward program.

Next, key findings from the building energy manager interviews include:

- The studied buildings ranged from single-family homes to large commercial office buildings and commercial/industrial building complexes.
- The building energy managers at all of these sites exhibited a high degree of knowledge with regard to building energy management concepts.
- Many of the buildings have established advanced energy management systems that are potentially able to integrate with PEV charge management systems.
- Building energy managers were generally either participating in or aware of and interested in energy load demand-response type programs, and interested in how PEV charge management could be coordinated to manage overall site loads.
- However, some buildings especially involving specialized laboratories have some data security concerns with combining overall building energy systems with PEV charge management.
- Building energy managers were generally interested in the idea of PEVs providing emergency backup power to buildings during times of high occupancy, potentially supplementing additional emergency backup systems.
- Building energy managers cited a high level of power reliability as being an important concern of building occupant/renters, especially for high technology and mixed office/laboratory companies such as Samsung and Genentech.

In conclusion, these ChargeForward participant focus group and building energy manager interviews provided a valuable opportunity to learn from real world settings and concerns

# **APPENDIX D:**

## **Further Details of XBOS-V Software Module Development and Application**

---

This key project task consists of extending the XBOS platform to include an “XBOS-V” module that controls and manages charging for Level 1 and Level 2 AC chargers for PEVs. Key elements of the task include:

- Developing a physical VGI test-bed at the UC Berkeley Global Campus (BGC) in Richmond.
- Developing an instance of XBOS at BGC.
- Creating a network of test Wi-Fi enabled building loads for testing of coordinated load management and grid signal response.
- Developing open-source XBOS-V code for EVSE charge management through Wi-Fi.
- Creating interface and testing a Level 1 AC power Wi-Fi controlled charger with XBOS.
- Creating interface and testing a Level 2 AC power Wi-Fi controlled charger with XBOS.
- Exploring managed charging of PEVs with XBOS-V in the context of residential and small commercial building loads.
- Releasing open-source XBOS-V code for use by the PEV industry and for further development.

The outcomes of these task activities are described below.

### **XBOS-V Implementation for Project Development and Testing**

A key initial aspect of this task was to develop the infrastructure needed to perform the project hardware and software integration and testing. This includes developing the VGI test-bed at RFS as well as the instance of XBOS as the backbone, as well as advanced building energy load measurement and load control devices.

As shown below, the project VGI test-bed was installed and became powered for testing in August 2017. The site includes an Aerovironment Level 2 charger equipped with a Wi-Fi communication board. In the nearby test building Bldg-190 the team installed an “Energy Detective” or “TED” device for the three-phase electrical panel to visualize power flows through the building. A basic suite of baseboard heater, lighting, and plug load controllers were installed for testing of coordinated load control between building and EVSE. Also included at the site (previously installed) are an NHR Systems

power delivery and visualization device (providing 220V AC power to the Level 2 charger) and power transformer and emergency shut off devices.

Figure D-1 and Figure D-2 show the details of the installations. The XBOS installation requires only a simple "FitPC" micro-computer at a cost of approximately \$100, a Wi-Fi router (\$40), an additional Ethernet switch (\$25), and then whatever end-use HVAC, lighting, and plug-load controllers attached as Ethernet "dongles" to the system, with the appropriate Wi-Fi based, end-use load control or "smart bulb and appliance" type devices.

**Figure D-1: VGI Test-Bed With Wi-Fi Enabled Charger at UC Berkeley Global Campus**



Source: UC Berkeley



**Figure D-2: XBOS-V System (left) and TED Energy Monitor (right) at UC Berkeley Global Campus**



Source: UC Berkeley

### **VGI Software Implementation in XBOS**

The following sections of this chapter describe implementation of VGI implementation in XBOS through the XBOS-V module and software code. First included is an overall description of the XBOS-V effort and context followed by details of the task accomplishments.

### **XBOS-V: A Platform for Energy Management of Electric Vehicles**

Managed charging of PEVs through the “smart grid” provides potentially prosperous opportunities for both the industrial and residential sections of the country by advancing programs for better energy management of electric vehicles. These types of programs also help power grid operators enhance the reliability and efficiency of the power grid. Below, some of these programs along with their benefits to the power consumers are discussed:

- Demand Response Programs: Time-of-Use electricity prices let home-owners schedule the power consumption of their electric vehicles according to the price of electricity, to avoid the risk of high electricity costs.
- Ancillary Service Programs: Electric vehicle owners can bid in the ancillary service markets as a supplier of energy indirectly through an aggregator. Electric vehicle owners that offer ancillary services to the power grid commit to lowering the power consumption of their vehicles by certain amounts upon receiving a request from the power grid operator.
- Energy Storage: Electric vehicles can act as batteries themselves by consuming and storing electricity when the price of electricity is low and injecting the stored electricity back into the power grid when the price of electricity is high. Arbitraging electricity exploits the differences between the price of energy

purchase and energy sale, and can bring considerable monetary profits to the electric vehicle owners.

There are major obstacles facing the power consumers of the power grid for taking advantage of the above programs. For instance, participating in demand response programs requires the electricity prices to be communicated to the electric vehicle owners or their representatives in a seamless manner. Also, an electric load must have a minimum capacity of 500 kWh to be eligible for offering ancillary services to the power grid, at present in California. Since the power capacity of an electric vehicle is considerably less than 500 kWh, electric vehicles are not eligible to individually offer ancillary services to the power grid. To become eligible, electric vehicles can synchronize their operation so that the aggregate power reduction is greater than 500 kWh. This requires the implementation of an aggregator, which controls the PEVs for simultaneous power reductions.

To address the above obstacles, the project team have developed an open source distributed operating system, XBOS-V, to act as a platform for managing, auditing, modeling and coordinating the charging of PEVs in California and other regions.

### **Flexibility in Choice of Underlying Communication Protocols**

Regional and local power grids, electricity markets, and EVSE networks are among the entities that are involved in managed charging of electric vehicles. Depending on the region and location of practice, there could be many other stakeholder groups that play a role in energy management of electric vehicles. Accordingly, the method for exchanging information between all these stakeholders usually consists of a complex array of communication protocols. For instance, Figure D-3 shows a set of communication protocols proposed by ElaadNL for vehicle grid integration. Although the figure may not include the most updated efforts by Society of Automotive Engineers (SAE), it still servers as a good example of the complexities involved in communication part.

**Figure D-3: Potential Communication Protocols for VGI System**

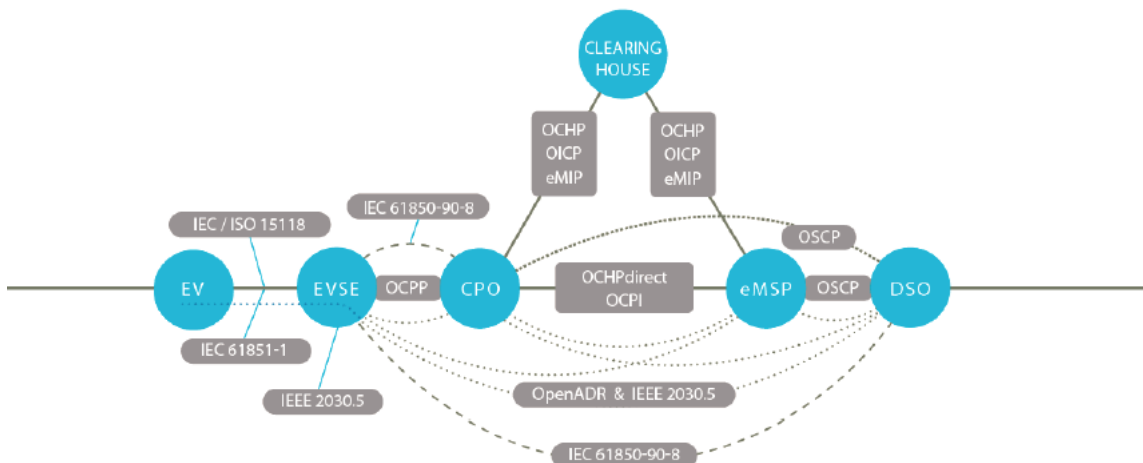

Source: ElaadNL, 2016

The XBOS-V team has been studying development of relevant standards and protocols by participating in the California Public Utility Commission “VGI working groups” on an academic basis without any attachment or stake in the development of these standards. The VGI working group considered a diverse set of use cases for managed charging of electric vehicles, where each use case is a combination of various attributes during the charging session, e.g., location of charging session, the entities that are involved in the session, the type of service that PEV offers to the grid and the price of electricity during the session. For each use case, the working group identified possible combinations of the existing protocols that can be used for proper deployment of the use case. After a period of six-month study, the working group concluded that no combination of protocols can be designated as the most suitable array of protocols even for a single use case (“VGI Communications Protocols Working Group,” 2017). The working group further explained that, because of the rapid development of markets, protocols, and technology, no protocol should be precluded in delivering VGI values (“VGI Communications Protocols Working Group,” 2017).

The above discussion indicates that a unified platform for managing such resources should remain agnostic to the exact protocols used. XBOS-V enforces an architectural separation between the “low-level” read/write access to PEVs and EVSEs and the policy, controls, and auditing executed against them. XBOS-V can similarly interface with different communication standards used by grid operators, smart meters, building automation systems, off-the-shelf “Internet of Things” devices such as thermostats and lights as well as external services such as weather and renewable energy forecasting. The intent of this design is for XBOS-V to act as an independent core that can easily integrate with both existing and emerging services and devices.

In the rest of this chapter, the general software approach in XBOS-V development is described along with key task outcomes.

## Architecture of XBOS-V

The XBOS platform is an open-source, secure, distributed operating system realized on top of a family of technologies developed by the SDB (Software Defined Buildings group) at UC Berkeley, with a high level depiction shown in Figure D-4. XBOS-V is an extension of the XBOS platform with a focus on integrating building management with grid operators and electric vehicles. In this section, the project team describe the architecture and components of XBOS-V. The project team also explain how these components interact with each other to facilitate the monitoring and control of real-world resources.

**Figure D-4: High Level Depiction of XBOS System Architecture**

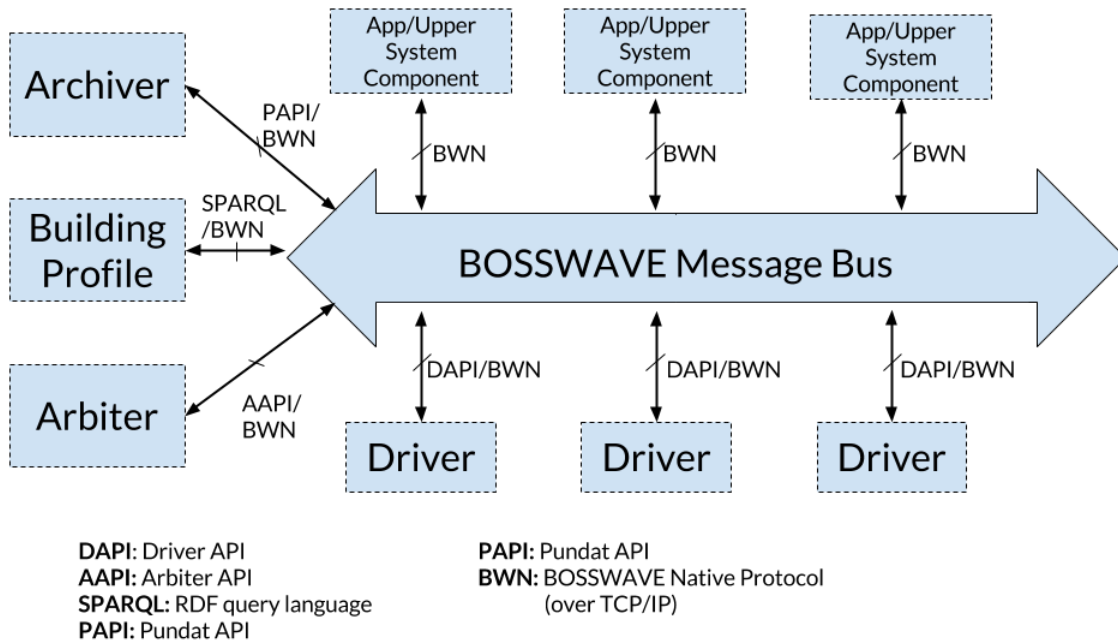

Source: UC Berkeley

## BOSSWAVE: The Communication Channel

One of the key components in managed charging of electric loads is the communication channel for delivering control commands from aggregators to the electric loads and the measurements data from electric loads to the aggregator. The communication channel in XBOS-V is called BOSSWAVE (Building Operating System Services Wide Area Verified Exchange) ("BOSSWAVE," n.d.), which is a secure, distributed *publish-subscribe* (Anderson, Fierro, & Culler, 2017), bus message. XBOS uses a *publish-subscribe* (or *pub-sub*) communication pattern as opposed to a *point-to-point* or *client/server* architecture. Instead of messages being sent directly from data producers to data consumers, messages are sent to an intermediary called a *broker*. Publishers describe each message with an identifying topic, i.e. a uniform resource identifier (URI), when sending a message to the broker. Subscribers tell the broker the topics they are interested in, and the broker forwards the relevant messages to the subscribers. The

project team have chosen this architecture because the load of scaling is placed on capable servers acting as brokers, rather than on the data producers that are typically constrained and behind NATs (meaning they are not publicly addressable).

All resources (drivers, services, etc) are represented in BOSSWAVE as a collection of one or more URIs. A resource reports its status by publishing on its own URIs and receives commands by subscribing on its URIs. Resources implement control of other resources by publishing on the URIs of those other resources.

BOSSWAVE enforces guarantees not offered by existing pub-sub systems, namely the ability to enforce fine-grained permissions on resources (logically represented by one or more topics) at global scale without relying on a centralized or trusted infrastructure (Andersen et al., 2017). Each resource in BOSSWAVE (such as an instance of a driver representing an EVSE or an archival data service) has an *entity* represented by a public/private Ed25519 key pair. This key pair is used for granting and revoking permissions on resources.

As an example, the project team examine the BOSSWAVE URIs used for a particular EVSE station. The “base” URI for the station is:

```
rfs/drivers/s.aerovironment/evse1/i.xbos.evse
```

In XBOS, URIs follow a certain convention. *rfs* represents the *namespace*, which is a logical grouping of URIs administered by a single key. *s.aerovironment* is the *service name* and indicates which driver the project team are using and what equipment the project team are interfacing with. *i.xbos.evse* is an *interface name* and dictates the fields and URIs used by the driver. *evse1* is the *instance name* and serves to disambiguate between different devices exposed by the same driver (future EVSE drivers may expose more than one EVSE station). The definition of the *i.xbos.evse* interface means that the driver will be listening on the URI as follows for control input:

```
rfs/drivers/s.aerovironment/evse1/i.xbos.evse/slot/state
```

It will then be publishing its current state on the following resource:

```
rfs/drivers/s.aerovironment/evse1/i.xbos.evse/signal/info
```

The content and format of the messages published on those URIs is also defined by the *i.xbos.evse* interface and will be described in the next section.

For better explaining the communication channel in XBOS-V, the project team provide an example. Figure D-5 shows a scenario where there are two Users and three EVSEs. The EVSE 1 and EVSE 2 have subscribed on URI 1, and EVSE 3 has subscribed on URI 3. The User 1 and User 2 are publishing on URI 1 and URI 2, respectively. Therefore, the messages that are sent by User 1 are received by EVSE 1 and EVSE 2, and the messages that are sent by User 2 are received by EVSE 3 only.

**Figure D-5: EVSEs subscribe to URIs that Users publish on**

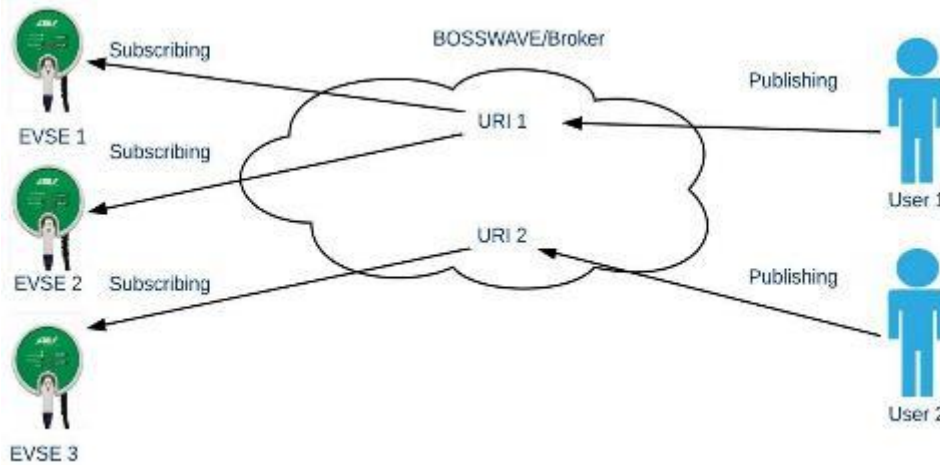

Source: UC Berkeley

Access over resources in BOSSWAVE is fine grained, which means an entity has specific permissions over specific URIs. More precisely, an entity can have “publishing” and/or “subscribing” permissions over certain URIs. For instance, in **Error! Reference source not found.** below, EVSE 1 has subscribing access over URI 1, but cannot publish on this URI. Also, User 2 has publishing access over URI 1, but User 2 cannot publish on this URI. An entity with a certain type of permission over a URI can grant that type of permission to another entity. For instance, in Figure D-6, User 1 has granted publishing access over URI 1 to User 3, so that User 3 can also publish on URI 1.

**Figure D-6: Access over XBOS-V URIs is fine grained**

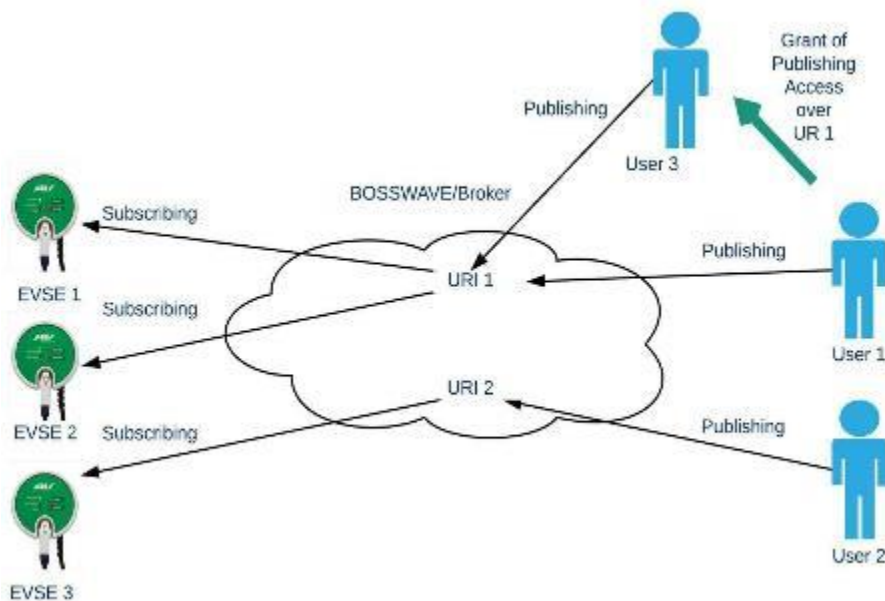

Source: UC Berkeley

In summary, BOSSWAVE is a secure, distributed message that provides low-latency connections between components of XBOS-V with a fine-grained permissions model. BOSSWAVE offers various important features germane to the implementation of a secure, distributed system, among which three of them were discussed in this section:

1. BOSSWAVE's *publish-subscribe* communication model decouples the producers and consumers of data, which permits the scaling of popular data sources and facilitates the discovery of distributed resources.
2. BOSSWAVE integrates a strong notion of identity with a fine-grained permission model; data, services, applications and devices can only interact if allowed.
3. BOSSWAVE allows distributed administration of these entities; rather than a single bottle-necked individual managing permission for all entities, administration and auditing roles can be designated to other individuals in a hierarchical manner.

### **Drivers: Exposition of Devices to XBOS-V Platform**

In XBOS-V, every type of electric load accepts certain inputs, and produces certain outputs. These inputs and outputs constitute the "standard interface" for a specific type of load. For instance, XBOS defines the following standard interface for an EVSE:

**Table D-1: Standard Interface for EVSE**

<b>Property Name</b>	<b>Data Type</b>	<b>Description</b>	<b>Units</b>	<b>Required</b>	<b>Writable</b>
charging_time_left	int64	Seconds left until car is fully charged	second	false	No
current	float64	Active charge current	Ampere	true	No
current_limit	float64	Maximum allowed charge current	Ampere	true	Yes
state	boolean	Charging state of EVSE	on/off	true	Yes
voltage	float64	Active charge voltage	Volt	true	No
time	int64	Time of reading in nanoseconds since Unix epoch	nano seconds	true	No

Source: UC Berkeley

Having standard interfaces for various type of electric loads allows XBOS-V to be extended easily by interfacing with new resources. For instance, consider a new EVSE purchased from an EVSE manufacturer and installed at a local site. A local XBOS-V server is already running on the local site and the project team want to add the new installed EVSE as a new resource. The installed EVSE comes with remote control capabilities through an API that is designed by the EVSE manufacturer, which takes certain inputs as the commands and gives certain outputs as measurement data. To include the EVSE as a resource within the local XBOS-V instance, the project team prepare a program that converts inputs and outputs in the API format to inputs and outputs in the XBOS-V format and emulates the expected operational semantics on top of the EVSE API. This program is called a driver.

The project team note that a driver may expose either a device or a service to XBOS-V platform. More details about the definition and role of services in XBOS-V will be provided in the next sections. Also, a set of drivers ("XBOS-V Drivers, n.d.)\_have already been prepared for exposing standard interfaces from devices (such as networked charge plugs) and services (such as a weather forecasting API). These interfaces provide read and write functionality.



## **Metadata: Context for Data**

Metadata is an essential part of XBOS-V architecture because it provides the context necessary for the discovery and interpretation of data sources and control points in a deployment. XBOS-V uses the Brick metadata schema ("Brick, n.d. and Balaji et al., 2016) to describe the set of components in a deployment (devices, objects, spaces, subsystems, sensors, meters, etc.) and the relationships between them.

A *Brick model* is a representation of a building in the Brick schema, exposed through a Building Profile service, which executes queries against the Brick model. These queries come from drivers, dashboards, services, alarms, EVSEs and other resources and processes in and around the built environment. In this way, the Building Profile acts as a discovery service that allows these resources and processes to configure themselves to a particular site.

The upshot of having this sort of configuration is it becomes possible to author *generic* services whose implementation is not tied to the details of any single deployment. This stands in contrast to the current state-of-the-art in which control algorithms and analytics programs have a hardcoded set of resources they can access (which need to be duplicated across all programs).

For example, consider a simple alarm service that notifies an administrator when the total power consumed by all EVSEs at a site exceeds some threshold. One approach for configuring this service is to hardcode the BOSSWAVE resource URIs for all EVSEs at a site; however, this manual effort needs to be redone for each site where the service is deployed and needs to be updated whenever the set of EVSEs at a site changes. If instead the project team capture the existence of all EVSEs in a Brick model, then the project team can write a single alarm service that simply queries the Building Profile at a deployment site for the local EVSEs and adapts its operation to those resources. In this way, the Building Profile becomes a "single point of truth" for a deployment: any changes to the resources at a deployment only need to be committed in a single place to have those changes automatically reflected to all other resources in that deployment.

Having the Building Profile be a rendezvous point for configuration of all services and resources in a deployment places certain requirements on its implementation. Among these are the need for access control and the need for fast response to queries (the project team use the general interactive threshold of 100ms as a baseline). To this end the project team have implemented HodDB, a fast query processor for the Brick schema ("HodDB," n.d. and Fierro & Culler, 2017). HodDB provides a BOSSWAVE interface, and thus integrates with the BOSSWAVE permission model. Many of the currently implemented services (alarms, schedulers and the like) all leverage Brick queries and Brick models for their operation.

## **Archiver: Recording Telemetry**

The storage and retrieval of time-series data is paramount for any intelligent analysis or control in the built environment. XBOS drivers generate new data at variable rates

(from 10Hz all the way through .00001 Hz). Resources and services can consume that data in real time for analysis and control (provided they have permission to in BOSSWAVE), but cannot commit to long-term storage of that data. For this reason, the project team have developed a BOSSWAVE-integrated archival service named PunDat ("Pundat," n.d.). PunDat stores streams of timeseries data produced by XBOS drivers and provides protected access to this data using the BOSSWAVE permission model. This means that PunDat can provide expirable and rescindable access to arbitrary collections of data streams over arbitrary historical and future periods. For example, PunDat can lease access to a month of building meter data to an analysis script for a duration of a couple hours -- just enough time for the analysis to complete.

The PunDat archiver uses the BTrDB timeseries database ("Berkeley Tree Database," n.d.) for fast, durable, large-scale storage.

### **Arbiter: Conflict Management**

In the XBOS-V platform, an arbiter service is included for performing conflict management and maintaining invariants for XBOS-V drivers. The project team are actively investigating the proper implementation for the XBOS arbiter. At this point, not enough applications and controllers have been written to inform the specific features the arbiter needs to implement. The project team have implemented a simple rule engine ("Bodge," n.d.) as a prototype for the arbiter's behavior. The rule engine integrates with BOSSWAVE and enables simple expressions of arbitration logic such as schedules, rate limiting, priorities and bounds-checking on published values.

### **Container: Managing Services**

In an XBOS-V local site many services and drivers may need to be running simultaneously, e.g., EVSEs and plug load drivers. The local XBOS-V server should have the full control over starting and stopping of these services. Further, these services should be *persistent* -- that is, they should automatically restart in the presence of failure and maintain logs of their operation for the purpose of debugging. Most XBOS-V drivers execute in *containers*, which are lightweight, dependency-free, executable packages of software and configuration similar to a virtual machine image. Spawnpoint ("Spawnpoint," n.d.) is the secure execution container framework developed for XBOS-V, implemented on top of Docker (Merkel, 2014). To deploy an XBOS-V driver, an administrator or administrative process installs a Spawnpoint daemon on the local XBOS-V server, and then hands this daemon a deploy file (a descr of the driver running in the container) and a params file (configuration parameters for this particular invocation of a driver). The Spawnpoint daemon creates and manages the container, reports its status over BOSSWAVE, and restarts the container in the presence of crashes or network outages. Administration of containers and the Spawnpoint daemon can be performed remotely over BOSSWAVE.

## Logically and Physically Distributed Components

The main function of XBOS-V is to manage energy consumptions of appliances within and around a building. This functionality is accomplished with the aid of various components that are included in XBOS-V architecture (see the previous section for more details). However, XBOS-V doesn't include any control algorithm or specific plan for managing the power consumption of appliances; rather, XBOS-V serves as a platform for implementing applications, schedulers, analytics, and controllers that are developed by other research efforts. For enhancing the capability of XBOS-V in performing energy management, the components of XBOS-V are logically and physically distributed. This has several advantages that are discussed below:

- The architecture can support the addition of new services and applications without needing to refactor or recompile the whole operating system. For instance, drivers implement a well-defined protocol for reading and writing states, which is general enough to be integrated in any real-time analytics or controller application.
- The BOSSWAVE pub-sub message bus facilitates the scaling of the system, so that new applications can subscribe to any data stream they have permission to without the data publisher needing to be notified. This is helpful in cases such as when many services and applications want to interact with a single device.
- Finally, physically distributing the components of XBOS-V facilitates deployment and administration while also only requiring minimal resources at deployment sites. Core XBOS-V services can be hosted "in the cloud" (using a service such as Amazon EC2) or on other capable servers. A deployment site only needs a cheap server (such as a Raspberry Pi or FitPC) to run the BOSSWAVE agent gateway process and any drivers that require access to the local network (such as those accessing charge station API or networked thermostat). BOSSWAVE ensures that each site of an XBOS-V deployment can communicate securely with remote services and other sites without having to be aware of where those resources are physically located.

# **APPENDIX E:**

## **Further Details of Development and Application of Distribution Grid Stabilization Algorithms through PEV Flexible Load**

---

### **Functional Specifications Applied to a Decentralized Algorithm**

As stated in previous sections, controlling PEVs in the context of distribution network constraints is potentially important for local grid stability and to minimize transformer stress. Recently, more literature has been devoted to this problem. In Geth et al. (2012), the authors developed a voltage droop charging control to maintain the nodal voltage level. Quiros-Tortos et al. (2016) studied a centralized algorithm, currently being trailed in the UK, to mitigate voltage drop and transformer overloading in a low-voltage distribution network. In Bansal, Zeilinger, & Tomlin (2014), the authors developed a centralized model predictive control (MPC) scheme to maintain the voltage profile while satisfying the charging requirements. Although the above-mentioned results can help alleviate the impacts, they were designed for meeting the network constraints only, thus not being able to be generalized for grid benefits. Up to now, only a few works have addressed this type of problem.

Considering the network impacts, Richardson, Flynn, & Keane (2012) optimized the PEV charging profiles to minimize the total power consumption. Luo and Chan (2014) studied a real-time control design based on the voltage profile leveling to minimize the power losses. Among all types of grid services, studies in a large amount of literature indicate that one of the best ways PEVs could serve the grid is to fill the overnight load valley, where the non-EV electricity is at its lowest (Ma, Callaway, & Hiskens, 2013; Kunda & Hiskens, 2012). By filling the valley, on the one hand, PEVs could be charged during the night without causing any inconvenience; on the other hand, the daily operations of power plants and associated cost could be reduced (Denholm & Short, 2006). In this research, the project team target at establishing a framework for the provision of valley-filling while satisfying both local charging needs and distribution network constraints. Such a framework can be readily extended to facilitate other grid services, such as power trajectory tracking, and include more network constraints, like transformer thermal limits.

The core of establishing such a framework lies in the control algorithm design. Most literature addressing the charging control problem under the network constraints utilized the centralized control scheme (Clement, Haesen, & Driesen, 2008; Quiros-Tortos et al., 2016; Bansal, Zeilinger, & Tomlin, 2014; Richardson, Flynn, & Keane, 2012; Luo & Chan, 2014; Sharma, Canizares, Bhattacharya, 2015; Hu et al., 2014).

Though the centralized scheme is easy to realize in algorithm design, it requires a powerful centralized controller that can handle the heavy computational duty when the number of PEVs increases, thus being not scalable. In contrast, decentralized control distributes the heavy computing load to individual agents. Each agent only needs to solve its own problem of small size without communicating with others. Such a control scheme can decouple the computing time from the number of PEVs, thus being scalable. In addition, the emerging bidirectional communication protocol defined in ISO 15118 allows and suggests an active direct charging control from charging points. To achieve the scalability and fit into ISO 15118, our objective in this research is to design a decentralized optimal controller that can be embedded into XBOS-V and does not require a communication network among PEVs.

### **Control Architecture and Infrastructure Requirements**

The developed decentralized control architecture is hierarchical. A control center or aggregator needs to be in place to iteratively dispatch high-level universal coordination signals to and receive updated information from all XBOS-Vs. XBOS-V needs to be equipped with computing units for the purpose of solving optimal charging control sequences according to the universal coordination signals and local charging dynamics. Once the grid service is started, the aggregator and XBOS-Vs keep exchanging information till all control sequences and coordination signals are converged. Since this control architecture is realized in a decentralized fashion, no communication network is required among XBOS-Vs. A direct communication channel between each XBOS-V and the aggregator is needed.

### **Input Requirements and Information Flow**

This decentralized control architecture is built upon local charging dynamics and the distribution network model. Specifically, each XBOS-V collects the plug-in time, designated charging deadline, and battery capacity from the connected EV. The collected information will not be exchanged with the aggregator, instead, only serves as constraints for solving local control sequences. Additionally, each XBOS-V receives a dual variable value  $\lambda$  and the aggregated power signal from the aggregator. The dual variable  $\lambda$  can be interpreted in many ways, for example, the cost of violating network constraints. Our proposed algorithm embedded in XBOS-V utilizes the information from both the PEV and the aggregator to solve for its optimization problem to obtain a local charging control sequence. This temporary control sequence needs to be sent to the aggregator for the exchange of new coordination signals. It is worth mentioning that XBOS-V does not need to know the distribution network model and associated constraints, for this information has been inherently included in the dual variable  $\lambda$  which is used by XBOS-V in computing control sequences. Thus, once converged, the network constraints are automatically satisfied. The converged control sequence will be translated by XBOS-V into a maximum current limitation and sent to the PEV to adjust the charging power at each time instant.

## Algorithm Specifications

The control problem is formulated as an optimization problem, consisting of a non-separable objective function (for the valley-filling purpose), heterogeneous local constraints (individual charging requirements), and cooperative constraints (network constraints). Currently, there is no decentralized algorithm that can handle this type of problem without any convergence error. In our research, the project team tackled this problem by developing a Shrunken-Primal-Dual-Subgradient (SPDS) algorithm as shown in Figure E-1. The SPDS can solve the formulated optimization problem in a decentralized way with no convergence error or regularization error.

**Figure E-1: SPDS Algorithm**

Algorithm 1 SPDS Algorithm	
1:	Iteration number $\ell = 0$ ; EVs initialize $\mathcal{U}_i^{(0)}$ ; Operator initializes $\lambda^{(0)}$ ; Tolerance $\tau_\epsilon$ ; Initial error $\epsilon = 10^9$ ; Maximum iteration $\ell_{max}$ ;
2:	<b>procedure</b>
3:	<b>while</b> $\epsilon > \tau_\epsilon$ and $\ell \leq \ell_{max}$ <b>do</b>
4:	Each EV charger transmits its own $\mathcal{U}_i^{(\ell)}$ to the operator.
5:	Operator computes the Lagrangian gradient and broadcasts it together with $\lambda^{(\ell)}$ to all chargers.
6:	All connected chargers perform
	$\mathcal{U}_i^{(\ell+1)} = \Pi_{\mathcal{U}_i} \left( \frac{1}{\tau_{\mathcal{U}}} \Pi_{\mathcal{U}_i} \left( \tau_{\mathcal{U}} \mathcal{U}_i^{(\ell)} - \alpha_{(i,\ell)} \nabla_{\mathcal{U}_i} \mathcal{L}(\mathcal{U}^{(\ell)}, \lambda^{(\ell)}) \right) \right)$
7:	The operator performs
	$\lambda^{(\ell+1)} = \Pi_{\mathcal{D}} \left( \frac{1}{\tau_\lambda} \Pi_{\mathcal{D}} \left( \tau_\lambda \lambda^{(\ell)} + \beta_\ell \nabla_\lambda \mathcal{L}(\mathcal{U}^{(\ell)}, \lambda^{(\ell)}) \right) \right).$
8:	$\epsilon = \ \mathcal{U}^{(\ell+1)} - \mathcal{U}^{(\ell)}\ _2.$
9:	$\ell = \ell + 1.$
10:	<b>end while</b>
11:	<b>end procedure</b>

Source: UC Berkeley

Specifically, before the valley-filling starts, SPDS requires all participants including XBOS-Vs and the aggregator to initialize the iteration number; each XBOS-V initializes its control sequence; the aggregator initializes the dual variable  $\lambda$  and the convergence error  $\epsilon$ . All XBOS-Vs firstly send their initial control sequences to the aggregator; the aggregator computes the gradient of the associated Lagrangian function of the centralized valley-filling optimization problem then dispatches it together with the initial  $\lambda$  value to all XBOS-Vs. Having the information received from the aggregator, each XBOS-V performs a two-tier projection according to its local constraints to update its control sequences. At the same time, the aggregator also performs a two-tier projection on a specific convex set to update the dual variable  $\lambda$ . The aggregator is also

in charge of monitoring the convergence of all control sequences together with the dual variable  $\lambda$ . The above procedure does not stop until either the maximum number of iterations is reached, or the primal-dual sequences converge to an acceptable range.

It is worth mentioning that the developed SPDS guarantees the convergence of both the control sequence and the dual variable by the two-tier projection, given that the updating step sizes and dual variable bound are carefully chosen. Compared to the conventional approach that utilizes a regularized Lagrangian function, SPDS has no convergence error. In addition, since information coming out of PEVs only stays in XBOS-Vs and XBOS-Vs do not send any of this information to the aggregator, customers' privacy is not threatened.

### **Performance of the Identified Algorithm**

The SPDS algorithm was tested via simulations in which 700 heterogeneous PEVs are involved. The distribution network inherits the single-phase IEEE-13 test feeder and is modeled in a LinDistFlow form. LinDistFlow refers to a set of linearized equations that relate voltages to real and reactive power flows along a radial distribution feeder. Linearization means replacing exact mathematical expressions with carefully chosen approximations that are more easily manipulated for fast computation. More details of the simulation can be referred to our working papers.

Figure E-2 shows the comparisons between the total load under the control of SPDS with the baseline load. It can be seen that, as the iteration goes, aggregated charging power fills the overnight load valley. Figure E-3 presents the nodal voltage magnitudes of 13 nodes based on the baseline load (solid lines), total controlled load at the 1st iteration (dashed lines) and the total controlled load at the 25th iteration (diamond marked lines). It readily reveals that the SPDS-based decentralized controller can well maintain the voltage level above 0.954 per-unit (p.u.) and at the same time providing valley-filling service. Per-unit electrical quantities are decimal ratios with respect to reference quantities (such as nominal voltage or rated power) so as to be comparable across different situations (for example, two sides of a transformer). Additionally, Figure E-4 clearly shows that heterogeneous battery energy requirements of all PEVs can be met at the end of the valley-filling. Charging profiles of all 700 PEVs can be found in Figure E-5.

**Figure E-2: Convergence of Valley-Filling**

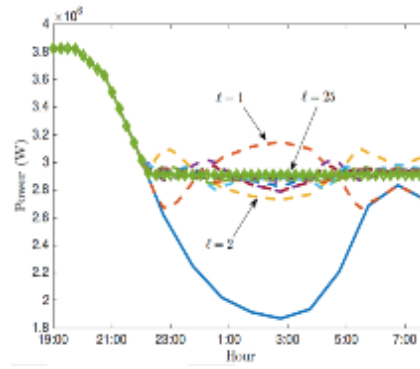

Source: UC Berkeley

**Figure E-3: Nodal Voltage Magnitudes**

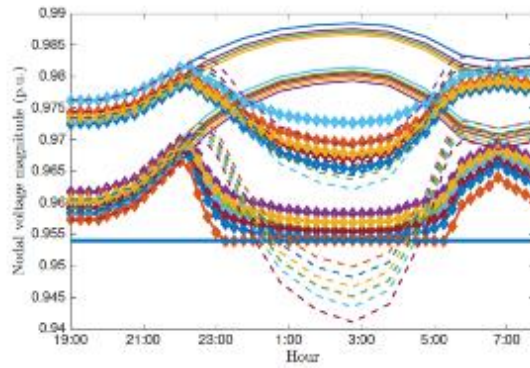

Source: UC Berkeley

**Figure E-4: Energy Requirement Evolutions**

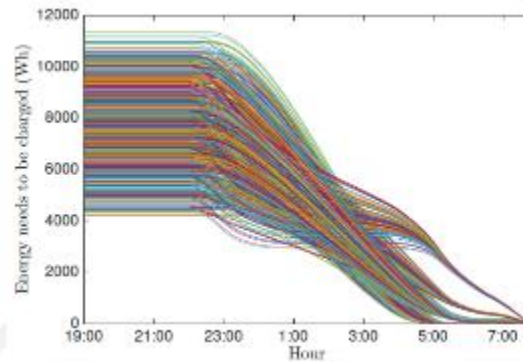

Source: UC Berkeley



**Figure E-5: Charging Profiles of PEVs**

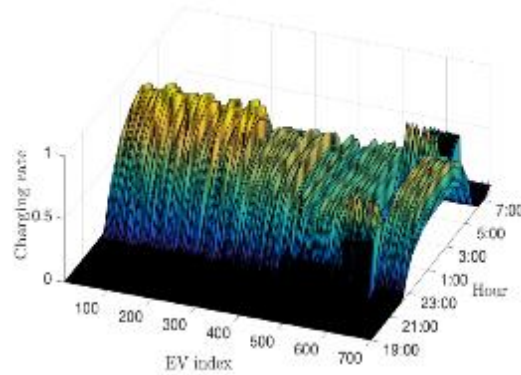

Source: UC Berkeley

### **Opportunities for Improved Grid Performance**

In this section, the project team outline four scenarios for improved grid performance by way of “valley filling” through control PEV charging. The mentioned four scenarios motivate our approach to designing a decentralized controller.

#### **Base Scenario 1 – Mitigate voltage rise during “no load” periods**

To describe the first opportunity for improved grid performance by way of coordinated PEV charging, the project team consider the situation where a distribution feeder serves mostly residential loads and has no distributed generation. In this scenario, the daily load-curve for the feeder as observed at a distribution substation would typically have an overnight valley from about midnight till approximately 9am, as illustrated in Figure E-6. The overnight valley might lead to cases of “voltage rise” at the end of longer (or shorter underground) distribution feeders. That is, voltage regulation equipment in the distribution grid may not be able to correct for voltage rise that results from the physics of the conductors, their spacing and length.

Coordinated PEV charging thereby creates an opportunity to correct for voltage rise that occurs during the overnight valley, otherwise known as the “no load” period.

**Figure E-6: An Example Daily Load Curve for a Residential Distribution Feeder**

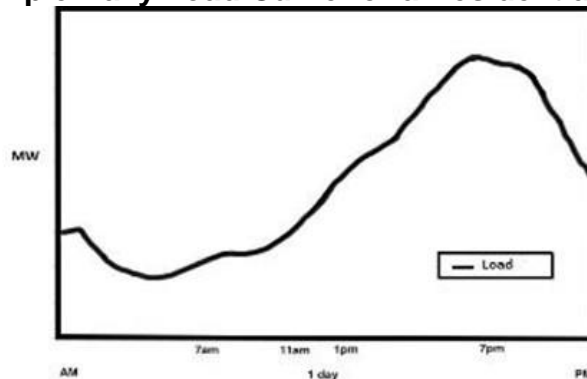

Source: UC Berkeley

## Scenario 2 – Mitigate voltage rise during periods of excess PV generation

The second opportunity for coordinated PEV charging aligns with the situation where a distribution feeder accommodates significant PV generation from residential rooftops. In particular, situations where excess PV generation results in bi-directional power flows along a feeder that serves mostly residential loads. In such scenarios, the feeder-level load curve would typically have a valley around midday when PV production peaks, as illustrated in Figure E-7. This midday valley typically aligns with cases of “voltage rise” at the PV sites along the feeder, a consequence of the grid physics in accommodating the excess PV generation.

Coordinated PEV charging during periods of excess PV generation thereby creates an opportunity to correct for voltage rise that potentially occurs during a midday valley. Moreover, such a strategy could enable greater levels of PV integration into the grid.

**Figure E-7: An Example Daily Load Curve for a Distribution Feeder, and Changes Observed When PV Generators are Connected Downstream**

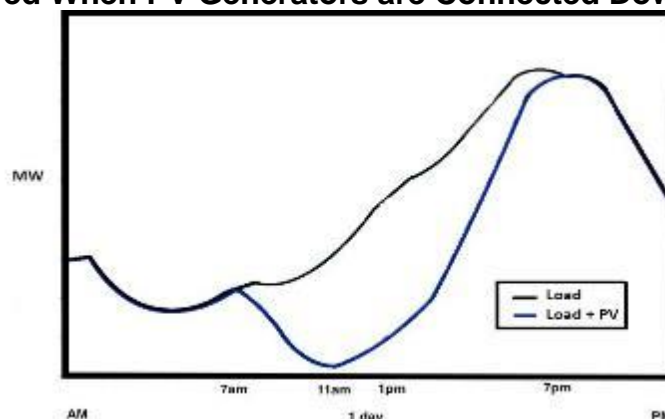

Source: UC Berkeley

## Scenario 3 – Mitigate peak loads exacerbated by uncoordinated PEV charging when such loads create voltage dips and/or exceed thermal limits on infrastructure

Situations that allow uncoordinated PEV charging, especially during the evening peak periods, could result in new problems for a distribution grid. Specifically, uncoordinated PEV charging during the evening may grow the load curve peak of a distribution feeder, as illustrated in Figure E-8. Increases in peak loads as a consequence of PEV charging potentially create issues such as the thermal limits of lines or transformers to be exceeded. Further, supply voltages could potentially fall below thresholds set to maintain the power quality during a peak load event.

Another situation where uncoordinated PEV charging potentially exacerbates problems in the distribution grid is related to daytime PEV charging on distribution feeders serving mostly commercial loads. In this scenario, each commercial load (not shown here) increases steadily in the morning, levels off with a peak during the work day (from 8am till 6pm), and steadily decreases in the evening. Here, PEV charging during business

hours could potentially exacerbate the existing feeder peak, thus increasing the risk of a network state approaching the thermal limits of lines or transformers. Moreover, PEV charging during business hours could potentially reduce the quality of the power delivered.

Coordinated PEV charging to reduce peak loads and potentially fill a load-curve valley would thus improve the grid performance. Moreover, such a control strategy could enable greater levels of PEV integration into the grid.

**Figure E-8: An Example Daily Load Curve for a Distribution Feeder with PV Generators, and Changes Observed when PEVs Charge During the Evening Peak**

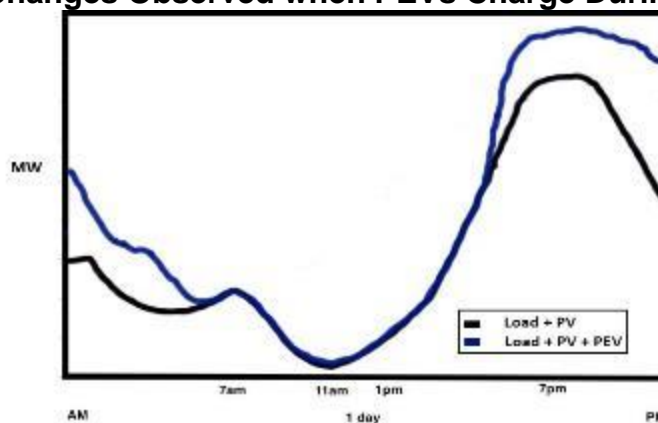

Source: UC Berkeley

#### **Scenario 4 – Mitigate problems that manifest in the distribution grid when coordinating PEV charging for upstream (or transmission-level) services**

Situations of coordinated PEV charging for upstream services could also result in new problems for the distribution grid. For example, coordinated PEV charging on a distribution feeder to fill the midday valley observed on the primary side of the upstream distribution substation could create a new feeder peak. In this example, the midday valley in the load curve at the upstream substation (that is not shown here) occurs when there is excess PV generation on the other respective downstream feeders. The potential consequence of a control strategy that coordinates PEV charging for upstream services without consideration for downstream constraints includes situations where the thermal limits along distribution feeders are exceeded and/or supply voltages fall above or below power quality thresholds.

Strategies for coordinated PEV charging that include constraints in the downstream distribution grid potentially improve the grid performance. Moreover, such control strategies could enable greater levels of PEV integration into the grid.

#### **Controlled PEV Charging**

For the rest of this task's report, the project team apply the theoretical aspects of VGI to two different charging strategies. First, the project team apply the SPDS algorithm on charging PEVs on a realistic distribution feeder to control the night-time charging

thousands of residential customers. Our results show significant benefits in terms of hosting capacity of PEVs on the feeder when charging is controlled.

Second, the project team look at workplace charging of PEVs as a grid asset to absorb previously curtailed solar energy from the transmission system. Our analysis focused on the effects of controlled charging on workplace site owner's electricity bills. Our results highlight a significant disparity between the wholesale cost of charging PEVs and the retail rate cost seen by the customer.

The four scenarios for improved grid performance by way of "valley filling" as outlined above motivate our PEV charging controller algorithms. That is, our overarching objective is to flatten feeder-level load curves to reduce peak loads and fill overnight (and in cases of high PV penetration, midday) valleys. Given that the grid operator must ensure that the power received by customers is of a high-quality, the PEV charging control algorithms will also be designed in a way to help mitigate sustained voltage violations (above a minute) at downstream locations.

Before introducing our PEV charging control algorithms the project team first provide a mathematical description of the PEV charging dynamics, and the associated modeling constraints, and the specific distribution system feeder model used in our simulations.

### **PEV Charging Dynamics and Constraints**

Here the project team introduce individual PEV battery charging dynamics and PEV charging constraints. That is, our objective of flattening a distribution feeder load curve is constrained by the battery physics of each PEV in addition to a customer-negotiated or a regulated timeframe for fully charging each battery.

Included in the battery charging dynamics is the charging efficiency of each PEV, an adjustable charge rate capped at a maximum PEV-specific limit, and the energy required by each PEV to reach a fully charged state. A mathematical description of the charging dynamics for each individual PEV battery follows. The project team will pick up with a general discussion on the distribution network model and constraints in the next section.

In our control algorithm the system state for each individual PEV is chosen to be the "energy remained to be charged" instead of the conventional battery state-of-charge (SOC). The motivation is twofold, (1) so that the project team might force the system state to zero at the end of the planning horizon, and (2) accurate SOC models are not always provided by the original equipment manufacturer. Let  $\eta_i$  denote the charging efficiency (as a percent),  $\Delta t$  denote the sampling time (in sec), and  $\bar{P}_i$  denote the maximum charging power of the  $i$ th PEV (in kW). The 1<sup>st</sup>-order charging dynamics for the  $i$ th PEV is represented as:

$$x_i(k + 1) = x_i(k) + B_i u_i(k)$$

where  $x_i(k)$  is the energy remained to be charged at time  $k$  (in kWh),  $B_i = -\eta_i \Delta t \bar{P}_i$ , and  $u_i(k)$  is the charging rate or control signal. Note that the charging rate  $u_i(k)$  can be continuously adjusted within the range of  $[0,1]$ .

Suppose the valley-filling period is from time  $k + 1$  to time  $k + K$ . By augmenting the control signal along the valley-filling period, the control sequence of the  $i$ th PEV is represented as:

$$\mathcal{U}_i(k) = \begin{bmatrix} u_i(k|k) \\ u_i(k+1|k) \\ \vdots \\ u_i(k+K-1|k) \end{bmatrix} \in \mathbb{R}^K.$$

In the proposed PEV charging controller design, the project team incorporate constraints on the charging rate of each PEV. For the  $i$ th PEV, its charging rate should satisfy:

$$\mathcal{U}_i \in \mathbb{U}_i,$$

Where:

$$\mathbb{U}_i := \{\mathcal{U}_i \mid \mathbf{0} \leq \mathcal{U}_i \leq \mathbf{1}, x_i(k) + \mathfrak{B}_{i,l} \mathcal{U}_i = 0\}.$$

The second condition in  $\mathbb{U}_i$  ensures that the energy remained to be charged at the end of valley-filling timeframe, i.e., at time  $k + K$ , must be 0. That is, the project team guarantee individual mobility requirements by the end of the planning horizon. Note that the local constraint set  $\mathbb{U}_i$  is convex.

## Distribution System Constraints

Here the project team include a mathematical description of a radial distribution network topology, in which supply voltage thresholds are captured as constraints. That is, the power received by customers must be of a high quality, and as such distribution supply voltages and associated constraints are incorporated into the PEV charging controller design.

To mathematically describe a radial distribution network some assumptions and simplifications are made to improve the performance (e.g., speed and stability) of the proposed PEV charging algorithms. Specifically, a linear model enables a relatively easier controller design, and such controllers are often supported with proofs of convergence needed to ensure the robustness of the design in application. Accordingly, the project team linearize the real DistFlow model (Baran & Wu, 1989) to a linear LinDistFlow model, characterizing a linear relationship between bus power or PEV charging power and nodal voltages. A mathematical description of the distribution network model and constraints follows. The project team will pick up with a general discussion on the control problem in the next section.

Let  $\mathbb{H} = [l \mid l = 1, \dots, h]$  denote the set of nodes of this distribution feeder and let  $\mathbb{E}$  denote the set of all downstream segments. Node 0 is the feeder head, decoupling

interactions in the downstream distribution system from the rest of the grid and maintaining its own voltage magnitude  $|V_0|$ .

At time  $k$ , let  $|V_i(k)|$  denote the voltage magnitude at Node  $i$ ; let  $p_i(k)$  and  $q_i(k)$  denote the real and reactive power consumption at Node  $i$ ; and let  $r_{i\delta}(k)$  and  $x_{i\delta}(k)$  denote the resistance and reactance of the line segment  $(i, \delta)$ . According to Baran & Wu (1989), Bansal, Zeilinger, & Tomlin (2014), and Farivar, Chen, & Low (2013), by omitting the line losses in DistFlow equations, the LinDistFlow model of this distribution network can be written as:

$$\mathbf{V}(k) = \mathbf{V}_0 - 2\mathbf{R}p(k) - 2\mathbf{X}q(k),$$

where

$$\mathbf{V}(k) = \begin{bmatrix} |V_1(k)|^2 \\ |V_2(k)|^2 \\ \vdots \\ |V_h(k)|^2 \end{bmatrix} \in \mathbb{R}^h, \mathbf{V}_0 = \begin{bmatrix} |V_0|^2 \\ |V_0|^2 \\ \vdots \\ |V_0|^2 \end{bmatrix} \in \mathbb{R}^h,$$

$$p(k) = \begin{bmatrix} p_1(k) \\ p_2(k) \\ \vdots \\ p_h(k) \end{bmatrix} \in \mathbb{R}^h, q(k) = \begin{bmatrix} q_1(k) \\ q_2(k) \\ \vdots \\ q_h(k) \end{bmatrix} \in \mathbb{R}^h,$$

and

$$\mathbf{R} \in \mathbb{R}^{h \times h}, \mathbf{R}_{i\delta} = \sum_{(\hat{i}, \hat{\delta}) \in \mathbb{E}_i \cap \mathbb{E}_\delta} r_{i\delta},$$

$$\mathbf{X} \in \mathbb{R}^{h \times h}, \mathbf{X}_{i\delta} = \sum_{(\hat{i}, \hat{\delta}) \in \mathbb{E}_i \cap \mathbb{E}_\delta} x_{i\delta},$$

where  $\mathbb{E}_i$  and  $\mathbb{E}_\delta$  are the sets containing downstream line segments connecting Node 0 and Node  $i$  and connecting Node 0 and Node  $\delta$ , respectively Baran & Wu (1989), Farivar, Chen, & Low (2013).

Assuming that the PEVs consume real power only, the project team construct

$$\mathbf{V}(k) = \mathbf{V}_0 - \mathbf{V}_b(k) - \mathbf{D}u(k),$$

where  $\mathbf{V}_b(k)$  is the nodal voltage drops caused by loads other than PEVs,  $\mathbf{D}u(k)$  models the nodal voltage drops cause by PEV charging, and  $u(k)$  contains the charging rates of all PEVs at time  $k$ . Detailed definitions of the matrices can be found in the submitted paper (M. Liu et al., 2017).

Let  $y_d(k)$  denote  $\mathbf{V}_0 - \mathbf{V}_b(k)$ , and  $y(k)$  denote  $\mathbf{V}(k)$ , the project team have

$$y(k) = y_d(k) + \mathbf{D}u(k).$$

For a valley-filling period from time  $k + 1$  to time  $k + K$ , the project team augment the system output  $y(k)$  along the valley-filling period. Accordingly, the system output sequence is represented as the LinDistFlow model:

$$\mathcal{Y}_k = \mathcal{Y}_{dk} + \sum_{i=1}^n \mathcal{D}_i \mathcal{U}_i,$$

where

$$\mathcal{D}_i = \bigoplus_{k=1}^K \mathcal{D}_i \in \mathbb{R}^{hK \times K},$$

$$D = [D_1 \ D_2 \ \dots \ D_n].$$

In order to maintain the power quality along the distribution feeder, nodal voltage magnitude should be kept within the service range, i.e.,  $[\underline{v}|V_0|, \bar{v}|V_0|]$ , around the nominal voltage magnitude  $|V_0|$ . Since no generation or reactive power supply is considered in this network, the project team consider only the lower-bound constraint on nodal voltage magnitude as follows:

$$\mathcal{Y}_k = \mathcal{Y}_{dk} + \sum_{i=1}^n \mathcal{D}_i \mathcal{U}_i$$

$$\geq \underline{v}^2 \mathbf{V}_0.$$

Let  $\mathcal{Y}_b$  denote  $\underline{v}^2 \mathbf{V}_0 - \mathcal{Y}_{dk}$ , the project team define the distribution network constraints by:

$$\mathcal{Y}_b - \sum_{i=1}^n \mathcal{D}_i \mathcal{U}_i \leq \mathbf{0}.$$

### **Distribution system feeder model**

To perform a more accurate assessment of our algorithms than in our previous reports, a large, more detailed distribution system feeder model was needed. Preliminary investigations identified a GridLAB-D model of the PG&E circuit labelled D0001 that is presently available through Pacific Northwest National Laboratories ("Gridlab-D PG&E D0001 Model Feeder," n.d.). This feeder is one of 12 circuit models for Northern California that were identified in a PG&E report prepared for the Energy Commission (Mead, Donde, & Garnett, 2014). A summary of circuit model D0001 is presented below.

**Table E-1: PG&E Feeder D0001**

<b>Item</b>	<b>Characteristic</b>
Feeder Code	D0001
Zone	Interior
Total Circuit Length	17.11 miles
Number of Switches	6
Primary Voltage	12 kV
Number of Residential Customers	2894
Number of Commercial Customers	270
Number of Agricultural Customers	0
Number of Industrial Customers	91
Number of Voltage Regulators	0

Source: Pacific Gas and Electric Company Energy Commission Report

Unfortunately, the load modeling approach used in the original D0001 Feeder was not adequate for PEV charging coordination modeling. The D0001 Feeder used a weighted scale of feeder head loading at all load nodes in the system. While this approach leads to an accurate load profile as measured at the feeder substation, it masks the feeder imbalances and load diversity from different customer classes. In addition, the modeling approach to underground line models had changed in Gridlab-D since the D0001 Feeder model was developed. Considering these issues, the project team decided to modify the D0001 Feeder model to meet the demands of our analysis. The modified feeder model was named the MIP Feeder due to the process described below to assign building models to the feeder.

To create realistic load diversity on the MIP Feeder, the project team examined the customer types as described in the Energy Commission report and found suitable models of individual buildings created by DOE for different climate zones ("Commercial and Residential Hourly Load Profiles," n.d.). Each building was modeled in Energy+ to have hourly load profiles for an entire year. When compared to recent calendar years, these models matched the year 2017 in terms of weekends and holidays. The project



team used the Sacramento Metro climate zone and selected 10 different building models that would provide load diversity for our three customer classes. Table E-2 lists the different building types and the number used in the MIP Feeder.

**Table E-2: DOE Building Model Types used in MIP Feeder**

Building Type	Customer Class	Phases	Number of Buildings
Low Residential	Residential	Single Phase	960
Mid Residential	Residential	Single Phase	1005
High Residential	Residential	Single Phase	919
Midrise Apartment	Residential	Three Phase	10
Small Office	Commercial	Single Phase	248
Medium Office	Commercial	Three Phase	5
Stand-alone Retail	Commercial	Three Phase	10
Quick Service Restaurant	Commercial	Three Phase	5
Small Hotel	Commercial	Three Phase	2
Warehouse	Industrial	Three Phase	91

Source: UC Berkeley

Once the building models were selected, the project team measured the peak load at each load node in the original D0001 Feeder. Then the project team formulated a mixed integer program least squares problem to assign buildings to load nodes based on the peak load from the D0001 feeder and the number of phases available at each node. The problem formulation was as follows

$$\begin{aligned}
 \min_{\substack{\text{buildings}_{3\phi} \in \mathbb{Z}^{164 \times 10}, \text{buildings}_{1\phi} \in \mathbb{Z}^{171 \times 10}}} C = & \left\| \text{buildings}_{1\phi} \cdot \text{building\_loading}_{1\phi} \right. \\
 & \left. - \text{single\_phase\_loading} \right\|_2^2 \\
 & + \left\| \text{buildings}_{3\phi} \cdot \text{building\_loading}_{3\phi} - \text{three\_phase\_loading} \right\|_2^2 \\
 \text{s.t. } & \sum_{i=1}^{164} \text{buildings}_{3\phi} + \sum_{i=1}^{171} \text{buildings}_{1\phi} = \text{building\_count}
 \end{aligned}$$

In addition to disaggregating the load, the MIP Feeder's underground lines were replaced with updated 12 kV concentric neutral underground lines as modeled in the IEEE 13 Node feeder. Finally, to ensure consistent results between simulations, all event driven capacitors in the D0001 feeder were converted to schedules operating as they would have been before the PEVs were placed onto the feeder. This was to ensure

that the controllable PEV charging would be able to correct for any voltage issues instead of relying on the installed capacitor banks. Once the controlled charging profile was established, capacitors were converted back to event driven devices to validate the PEVs did not cause excessive capacitor switching.

## **Control Problems**

Different approaches were taking for the residential versus the workplace charging. The residential charging control problem was formulated as a decentralized optimization problem focused on coordinating between a central host and thousands of decentralized controllers with data privacy and security as a primary requirement. The workplace charging focused on a centralized cost-based optimization problem modeling how rational customers would charge vehicles based on the price signals they received—either their retail rate or the LMP for their location.

## **Residential Decentralized Charging**

Here the project team provide a mathematical description of a centralized controller for coordinated PEV charging, followed by the formulation of a novel decentralized optimization problem. In our problem formulations the project team consider the scenario where a radial distribution feeder has no controllable distributed generation. Extensions to cases where a distribution feeder accommodates significant controllable distributed generation (e.g., smart inverter solar PV) could be considered in future work. Accordingly, our PEV charging controllers are designed to:

1. Steer the aggregated PEV charging power to fill the overnight valley,
2. Guarantee all PEVs are charged to their designated State of Charge (SOC), and
3. Maintain the nodal voltage profiles within the service range.

## **Centralized Controller and Problem Formulation**

The project team first present a centralized PEV charging control problem that serves as a basis for the later decentralized control algorithm. Loads other than PEVs are assumed to be uncontrollable and are distributed along a radial distribution feeder. The aggregate value of all uncontrollable loads across a full day results in a load curve with an overnight valley. The centralized controller is designed to fill the overnight valley by way of coordinated PEV charging. A mathematical description of the approach to valley-filling the daily load curve is described in what follows. At the end of the section a summary of the inputs needed to solve the control problem are listed.

Let  $P_b \in \mathbb{R}^K$  denote the aggregated value of all distributed uncontrollable loads, located at nodes along a radial feeder, during the control period. The process of valley-filling is the process of flattening the total load profile. That is, the total load profile is the result of the aggregate value of controllable and uncontrollable loads, during a control period. Our approach to valley-filling is to minimize the variance of the total load profile (Gan, Topcu, & Low, 2013). This implies that the control objective function can be written as:

$$\mathcal{F}(\mathcal{U}) = \frac{1}{2} \|P_b + \tilde{P}\mathcal{U}\|_2^2 + \frac{\rho}{2} \|\mathcal{U}\|_2^2,$$

where  $\mathcal{U} = [u_1^\top \ u_1^\top \ \dots \ u_1^\top]^\top$  represents the collection of all PEVs' charge rates (or control sequences) and  $\tilde{P}$  is the power aggregation matrix. Detailed definitions can be referred to in (M. Liu et al. 2017). Note that the second term in the objective function is a proxy for battery degradation cost (Ma, Zou, & X. Liu, 2015).

In this optimal PEV charging control problem there are two types of constraints: (1) individual PEV charging constraints, and (2) distribution network constraints. Recall, for the  $i$ th PEV, its charging rate must satisfy:

$$\mathcal{U}_i \in \mathbb{U}_i,$$

where

$$\mathbb{U}_i := \{\mathcal{U}_i \mid \mathbf{0} \leq \mathcal{U}_i \leq \mathbf{1}, x_i(k) + \mathfrak{B}_{i,i}\mathcal{U}_i = 0\}.$$

Further recall that the distribution network constraints were designed to limit sustained under-voltages in the nodal voltage magnitude that would otherwise result from PEV charging. Assuming that no distributed generation or reactive power supply is located along the distribution feeder, the constraint on the nodal voltage magnitude is represented by:

$$y_b - \sum_{i=1}^n \mathcal{D}_i \mathcal{U}_i \leq \mathbf{0}.$$

In summary, the optimal charging sequences for all grid-connected PEVs providing a feeder-level valley-filling service can be obtained by solving:

$$\begin{aligned} & \min_{\mathcal{U}} \mathcal{F}(\mathcal{U}) \\ & \text{s.t. } \mathcal{U}_i \in \mathbb{U}_i, \forall i = 1, \dots, n, \\ & y_b - \sum_{i=1}^n \mathcal{D}_i \mathcal{U}_i \leq \mathbf{0}. \end{aligned}$$

A central entity could solve this constrained optimization problem using a quadratic program. To have the control sequences properly solved, the central entity needs to:

1. Be equipped with appropriate hardware and software to execute quadratic programming.
2. Know the distribution network topology and its associated impedance matrix which are used for constructing the LinDistFlow model.
3. Determine the base load forecast with an acceptable accuracy.
4. Identify the nominal network voltage and the lower bound of nodal voltage magnitudes.

5. Gather the charging requirements of all feeder-connected PEVs, including the individual maximum charging rates, individual charging efficiencies, and individual charging deadlines.

In the process of solving the constrained optimization problem, the central entity informs each PEV of the charge rate to apply at each time-step in the control horizon.

### **Decentralized Controller and Algorithm Design**

The centralized controller described above relies on a secure communication channel between each XBOS-Vs and a central entity, so that private individual PEV charging information can be exchanged. Private information exchanged includes individual PEV charging constraints and the control action to take (i.e., charge rate to apply) at each time step. In what follows the project team propose a decentralized valley-filling algorithm where the individual PEV charging constraints remain with the XBOS-V, and instead, each XBOS-V collects a universal coordination signal from the central entity before deciding upon the control action to take. In this way, the project team move a significant computational burden from the central entity to the XBOS-Vs, while improving the security of individual PEV parameters like the battery efficiency and the energy needed to be fully charged.

The control architecture developed for the decentralized valley-filling algorithm is hierarchical. Here the central entity iteratively dispatches high-level universal coordination signals to and receives updated information from all XBOS-Vs. Having received coordination signals from the control center, each XBOS-V solves an optimization problem according to its local PEV constraints and then updates its charging strategy. At the same time, the central entity also solves an optimization problem and updates the coordination signals sent to each XBOS-V. The central entity monitors the convergence of all PEV charging strategies to be implemented. Specifically, the above procedure does not stop until either a maximum number of iterations is reached or the charging strategies for each PEV converges to an acceptable range. A detailed mathematical description of the decentralized valley-filling control problem follows. At the end of the section a summary of the inputs needed to solve the control problem are listed.

In the centralized optimization problem, the individual decision variables  $u_i$ 's in the objective function are coupled in the 2-norm and are thus non-separable, and the decision variables in the distribution network constraint are also coupled. This coupling poses significant challenges in designing a decentralized algorithm. Specifically, if the project team could separate the decision variables in both the objective function and constraints the project team could readily distribute the optimization problem to be solved amongst the XBOS-Vs.

Of the considerable literature targeting the developing decentralized/distributed algorithms (Jia & Krogh, 2011; M. Liu, Shi, & X. Liu, 2016; Rivera et al., 2013; Chen et al. 2016, Gao & Zhang, 2016; Cui et al., 2015; Li & Marden, 2014; Chang *et al.*, 2014;

Koshal, Nedic, & Shanbhag, 2011), only a few publications consider our aforementioned problem. Specifically, Chang et al. (2014) proposed a consensus-based primal-dual perturbation algorithm for a distributed consensus problem. Koshal, Nedic, & Shanbhag (2011) developed a regularized primal-dual subgradient (PDS) algorithm via regularizing both primal and dual variables in the Lagrangian. The regularized PDS guarantees convergence, however introduces relative errors to the optimal solution. To eliminate unnecessary errors, in what follows the project team propose a novel decentralized algorithm that manages the coupling of individual decision variables without regularizing the Lagrangian. First the project team define the Lagrangian of the centralized optimization problem as:

$$\mathcal{L}(\mathbf{u}, \lambda) = \mathcal{F}(\mathbf{u}) + \lambda^\top d(\mathbf{u}),$$

where  $d(\mathbf{u}) = \mathbf{y}_b - \sum_{i=1}^n \mathcal{D}_i \mathbf{u}_i$ . The developed shrunken-primal-dual subgradient (SPDS) is presented as follows: the primal variables and the dual variable update by following:

$$\begin{aligned} \mathbf{u}_i^{(\ell+1)} &= \Pi_{\mathbb{U}_i} \left( \frac{1}{\tau_u} \Pi_{\mathbb{U}_i} \left( \tau_u \mathbf{u}_i^{(\ell)} - \alpha_{(i,\ell)} \nabla_{\mathbf{u}_i} \mathcal{L}(\mathbf{u}^{(\ell)}, \lambda^{(\ell)}) \right) \right), \\ \lambda^{(\ell+1)} &= \Pi_{\mathbb{D}} \left( \frac{1}{\tau_\lambda} \Pi_{\mathbb{D}} \left( \tau_\lambda \lambda^{(\ell)} + \beta_\ell \nabla_\lambda \mathcal{L}(\mathbf{u}^{(\ell)}, \lambda^{(\ell)}) \right) \right), \end{aligned}$$

where

$$\mathbb{D} := \{\lambda | \lambda \geq \mathbf{0}, \|\lambda\|_2 \leq d_\lambda\},$$

and  $0 < \tau_u, \tau_\lambda < 1$  are the shrinking parameters. Herein, the projection  $\Pi_{\mathbb{X}} \tilde{x}$  represents the following quadratic programming:

$$\Pi_{\mathbb{X}} \tilde{x} \triangleq \begin{array}{l} \arg \min \|x - \tilde{x}\|_2 \\ \text{s.t. } x \in \mathbb{X} \end{array}$$

The corresponding SPDS algorithm that performs valley filling by way of PEV charging is presented in Figure 57. Note that convergence analyses and associated proofs are omitted in this report but can be referred to in our submitted paper (M. Liu et al., 2017).

To have the proposed decentralized control algorithm successfully implemented, the central entity and individual EVSEs must:

#### Central Entity

- know the distribution network topology and its associated impedance matrix which are used for constructing the LinDistFlow model.
- be equipped with appropriate hardware and software to execute quadratic programming.
- know the base load forecast;
- identify nominal nodal voltages and a lower bound on nodal voltage magnitudes.

- receive updated control sequences and the associated ID number of all EVSEs.

#### Individual EVSE

- be equipped with appropriate hardware and software to execute quadratic programming.
- receive updated dual variable sequences sent by the central entity.
- acquire information of local charging requirements, maximum charging rate, charging efficiency, and charging deadline.

### **Workplace Cost-Optimized Charging**

The workplace charging optimization was built on linear programs based on minimizing cost either with retail rates or with LMP. The LMP used was for the City of Davis, while the retail rates used were the PG&E commercial Time of Use (TOU) rates for medium size businesses, specifically A-10 TOU ("Electric Schedule A-10 Medium General Demand-Metered TOU Service," 2018) and E-19V ("Electric Schedule E-19 Medium General Demand-Metered TOU Service," 2018). Each optimization had the following general formulation:

$$\min_{EV\_load} \text{Cost} = \sum_{\text{Number\_of\_Buildings}} \left( \sum_{\text{billing\_hour}=1}^{24} (\text{Hourly\_building\_load} + \text{EV\_load}) \cdot \text{Electricity\_rate} \right)$$

$$\text{where } EV\_load = \sum_{\text{number of EVs}} \text{individual\_EV\_load}$$

$$\text{s. t. } \text{building\_transformer\_limit} \geq \max(\text{Hourly\_building\_load}) + \max(\text{EV\_load})/4$$

$$\text{max\_charging\_rate} \geq \text{individual\_EV\_load} \geq 0 \text{ kW}$$

$$\sum_{\text{billing\_hour}=1}^{24} \text{individual\_EV\_load} = \text{EV\_full\_charge}$$

In this formulation the DOE building model hourly load was used as the Hourly\_building\_load and assumed to not be price responsive. Thus, only buildings with workplace charging PEVs were modeled. Each building with PEVs was modeled as the sum of all PEVs charging at the building and the existing building load for each hour of the day. Those buildings had a transformer limit modeled as the sum of the peak load of the building and 25 percent of the PEVs charging at their max rate. This limit was used as a reasonable assumption of transformer capacity. For each PEV, limits were placed on the maximum charging rate to be equivalent to a Level 2 EVSE and each PEV was expected to be fully charged by the end of the work day.

The *Electricity\_rate* used in the above formulation was dependent on the types of rates used in the model. For the wholesale market, LMP was used directly. For the retail market, both the volumetric TOU energy charge and the demand charge were used. Fixed daily charges, Peak Day Pricing rates, Standby rates, and Power Factor Adjustment rates were all ignored in this formulation. Retail rate objective functions were formulated as follows:

$$\min_{EV\_load} \text{Cost} = \sum_{\text{Number\_of\_Buildings}} \left[ \left( \sum_{\text{billing\_hour}=1}^{24} (\text{Hourly\_building\_load} + \text{EV\_load}) \cdot \text{TOU\_energy\_charge} \right) + \max \left( \sum_{\text{billing\_hour}=1}^{24} (\text{Hourly\_building\_load} + \text{EV\_load}) \right) \cdot \text{demand\_charge} \right]$$

During the development of this model, PG&E was working through their 2017 General Rate Case Phase II proceeding (GRC A.16-06-013). Through this process, PG&E and stakeholder parties work with the California Public Utilities Commission (CPUC) to determine rates for all PG&E customers for the 2017-2020 rate cycle. Since this was occurring, the project team examined the potential changes to the retail rates the project team were modeling.

Significant changes were proposed for the TOU hours for medium and large commercial customers. First, weekends and holidays would no longer be off-peak days. In the proposed rates, the TOU hours apply to all days of the year. Second, the months of May and October would be part of the winter pricing season instead of the summer. This leads to a four-month summer and an eight-month winter. Third, peak hours would be shifted later in the day<sup>3</sup>. Partial-peak hours in the summer would also shift to later in the day as well. Finally, for the months of March, April, and May, a new super-off-peak time period would be introduced in the morning. This additional time period turns these three months into three-period days similar to the summer months.

While the proposed changes are not fully approved, PG&E submitted a final motion for approval for new medium sized customer rates ("Motion of PG&E Company for Adoption," 2018). Considering these changes, the project team modeled both the current TOU rates and the proposed TOU rates to see their effects. For consistency with

---

<sup>3</sup> Winter season days previously did not have peak hours, only partial-peak and off-peak hours. Now they only have peak and off-peak hours, unless it is March, April, or May.

the final motion, both current and proposed rates from the final motion were in all calculations.

## **Simulations on the MIP Feeder**

The following sections describe the simulations applied to the MIP Feeder for both residential and workplace charging. The residential charging focuses on the decentralized optimization of PEVs charging at night. While the workplace charging focuses on the costs of PEVs charging during the day and how PEVs following price signals can affect feeder voltages. Finally, a comparison is made between hosting capacity for PEVs using strictly residential or workplace charging.

### **Residential Charging**

In this section, the project team applied SPDS to control PEV charging in the three-phase PG&E test feeder. The control objective is to use the aggregated PEV charging power to fill the three-phase baseline load valley during the night meanwhile maintaining the nodal voltage level. To have a clear view of the impacts on nodal voltage, the project team assumed a very high level of PEV penetration – 2 PEVs at each residential site or 200 percent PEV penetration. Consequently, there will be 5758 PEVs charging during the night. Each PEV is charged by a level-2 EVSE with continuous power adjustment. Battery capacities are uniformly distributed over the range of 18 kWh to 20 kWh. Initial and designated SOCs are uniformly distributed over the range of 20 percent to 40 percent, and the range from 70 percent to 90 percent, respectively. The nodal voltage magnitude bound is set to 0.95 p.u. The baseline load is the sum of loads on all three phases and it is obtained from PG&E.

Parameters for the SDPS algorithm are carefully chosen: the primal step size is  $5.6 \times 10^{-17}$ , the dual step size is 5, and the dual variable bound  $d_\lambda$  of  $1 \times 10^9$ . Both primal and dual shrinking parameters are set to 0.974. The maximum iteration number is 150 and the convergence error tolerance is  $1 \times 10^{-4}$ . The maximum iteration number in the PG&E test is slightly higher than that of the IEEE-13 test as significantly larger number of decentralized residential sites are involved. This maximum iteration number can be further reduced with more tuning. The valley-filling service period is set from 19:00 to 7:00 next day. All simulations are conducted in MATLAB+Gurobi on a MacBook Pro with 2.8 GHz Intel Core i7 and 16 GB memory.

The valley-filling performance of the proposed SPDS-based decentralized controller is shown in Figure E-9. Herein, the project team only show the performance when the system is operating with the converged PEV charging schedules. It can be clearly observed that the aggregated controlled charging does fill the overnight valley, flatten the total load profile, and without elevating the existing demand peak at 20:00.

**Figure E-9: Baseline load and total load (three-phase sum)**



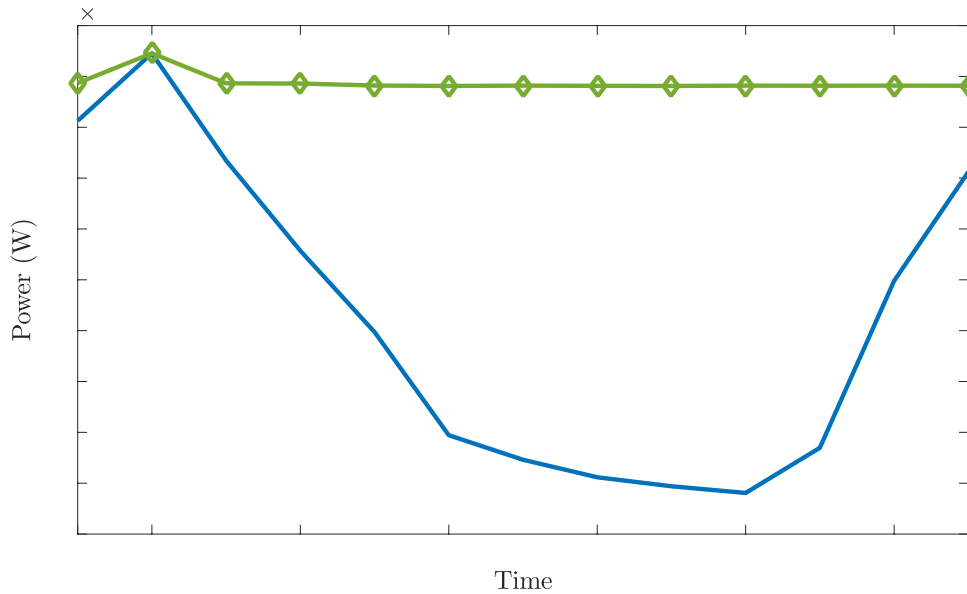

Voltage magnitudes at all nodes on three phases in both baseline and PEV charging cases are shown in Figure E-10, Figure E-11, and Figure E-12. Voltage magnitude at the swing bus is raised by 1.05 to ensure all voltage magnitudes under baseline loads are above 0.95 p.u. From upper plots of Figure E-10, Figure E-11, and Figure E-12, the project team can see the voltage magnitudes on Phase a are significantly lower than those of Phase b and Phase c. This is because the test feeder is severely unbalanced as the residential sites are unevenly distributed across three phases, i.e., 1132, 1099 and 648 sites on Phases a, b and c, respectively. Lower plots of Figure E-10, Figure E-11, and Figure E-12 show the voltage magnitudes on three phases when all PEVs follow the optimized charging schedules. It is obvious that, with such a high penetration of PEVs, voltage magnitudes severely drop when PEVs start charging during the night. However, the SPDS-optimized charging schedules can well maintain the nodal voltage magnitudes above the 0.95 p.u. Therefore, in terms of voltage drop, the SPDS can guarantee no impacts on the PG&E distribution feeder even with 200 percent level of PEV penetration.

There are two interesting observations in the controlled charging simulations: (1) Though Phase a and Phase b have similar number of residential sites, the 0.95 p.u. voltage constraint is only binding on Phase a and voltage magnitudes are slightly affected on Phase b. (2) Comparing with the baseline case, voltage magnitudes under PEV charging at Phase b and Phase c are much higher at about 22:00.

**Figure E-10: Nodal Voltage Magnitudes at Phase a**

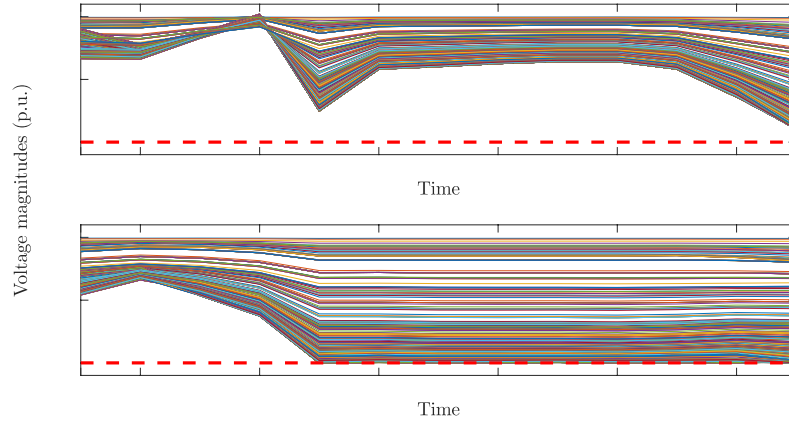

Source: UC Berkeley

**Figure E-11: Nodal Voltage Magnitudes at Phase b**

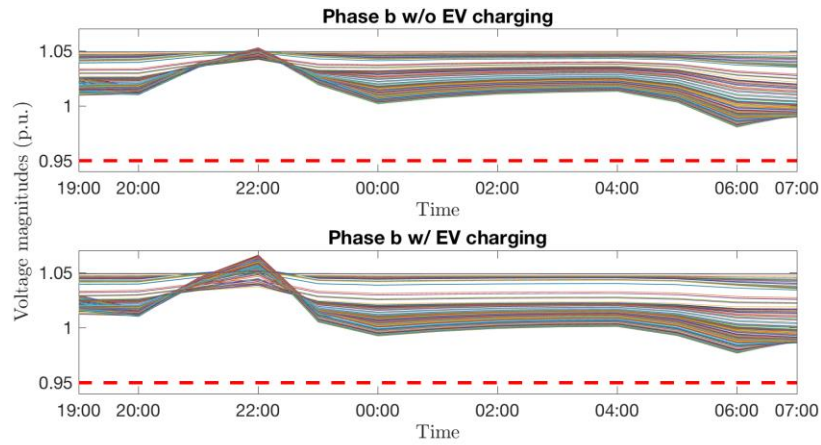

Source: UC Berkeley

**Figure E-12: Nodal Voltage Magnitudes at Phase c**

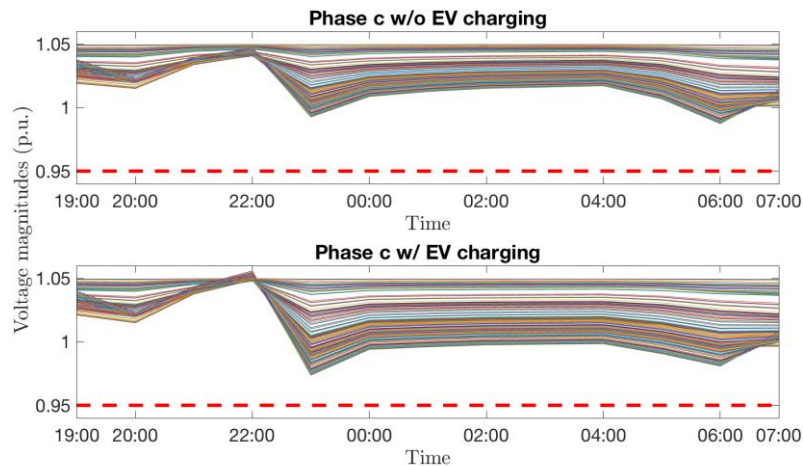

Source: UC Berkeley

### **Workplace Charging**

For each building with workplace charging, each PEV was assumed to charge at a maximum of 7.2 kWh and required a 15kW charge. Two separate analyses were performed, the first a simple cost optimization at a single medium size office build and the second was a feeder voltage analysis to determine the effects these rates had on higher penetrations of PEVs on the MIP Feeder.

### **Single Building Cost Optimization**

At each medium size office building there were 50 PEVs from 7:00 am to 6:00 pm needing to be charged. Two days were analyzed for different cost optimizations, one in the Spring during low LMP prices and one during the Summer on the peak DOE building model load day. The Spring day was April 14<sup>th</sup>, 2017. The Summer day was July 10<sup>th</sup>, 2017.

April 14<sup>th</sup>, 2017 was a day with an LMP that reached \$0/MWh during day due to excess solar on the transmission system (Figure E-13). During that day 8,046 MWh were curtailed on the wholesale market ("Wind and Solar Curtailment," 2017). This day was an ideal day to show how PEVs would charge if they were to follow the LMP to encourage PEV charging to absorb excess solar on the wholesale market.

**Figure E-13: LMP in Davis, CA on April 14th, 2017**

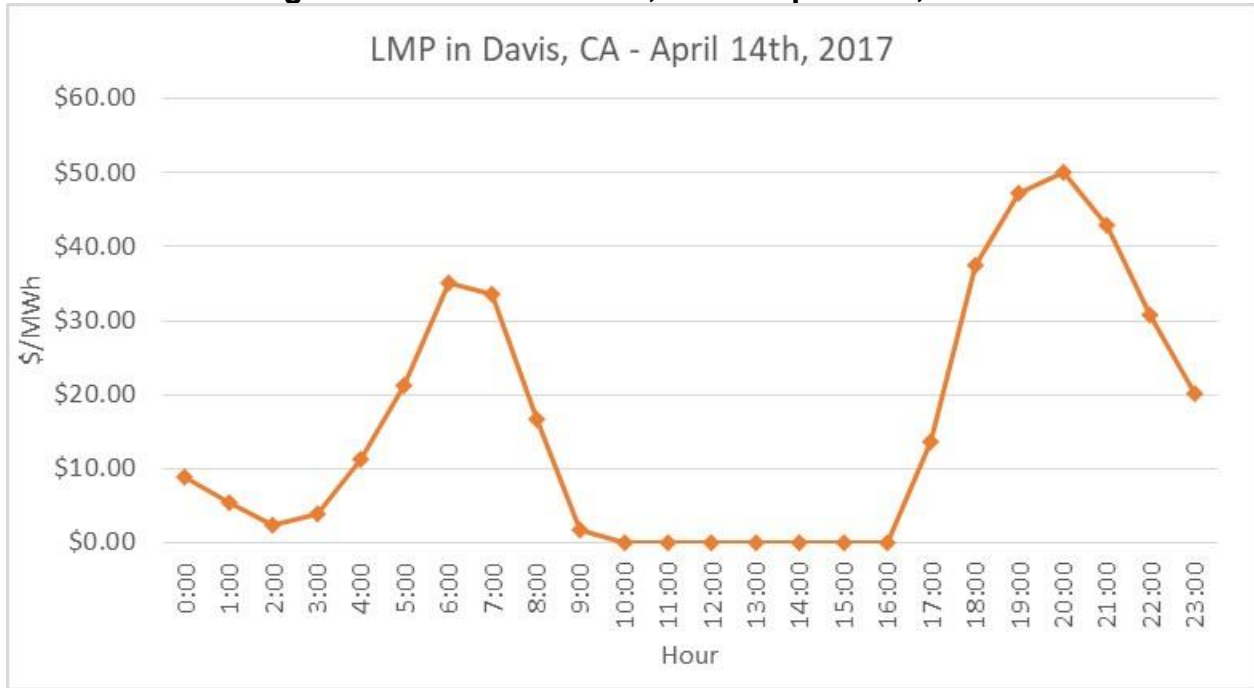

Source: "Day-ahead Market LMP for Davis\_1\_N001 PNode" (April 14, 2017)

April 14<sup>th</sup> also was a workday, this allowed for comparing the current and proposed retail rates. With the current rates, April 14<sup>th</sup> had normal Winter weekday TOU hours (Figure E-14). However, with the proposed rates April 14<sup>th</sup> would become a Spring day with a super-off peak low TOU rate in the morning (Figure E-15).

**Figure E-14: Current Winter Weekday Commercial TOU Hours**

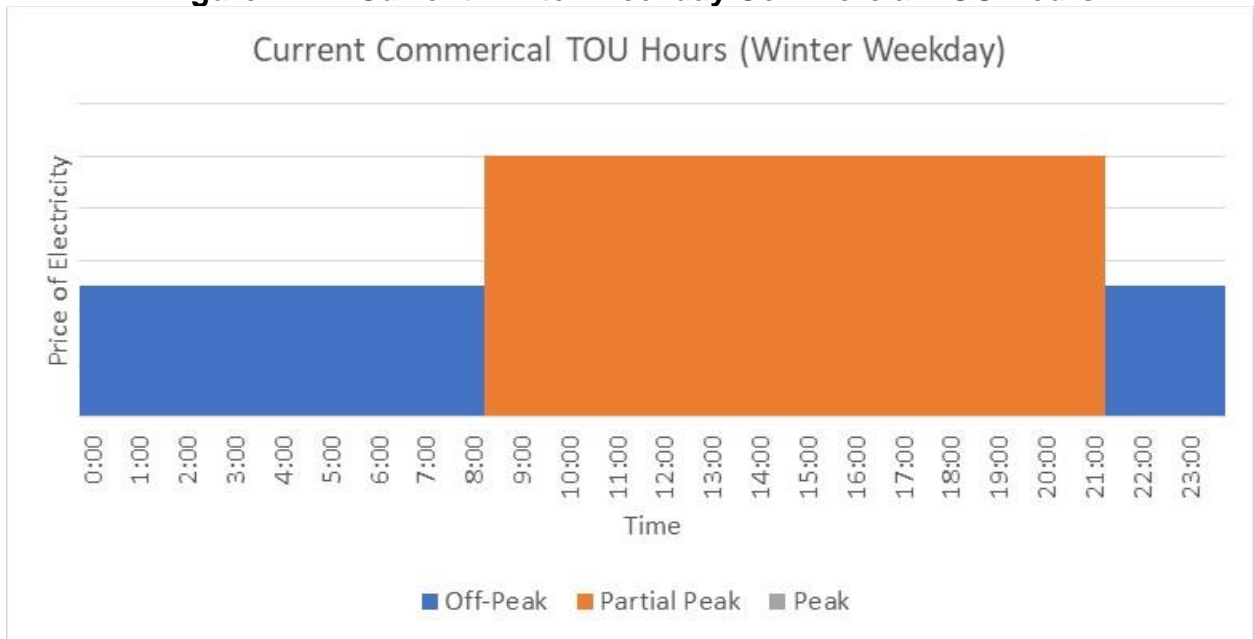

Source: UC Berkeley

**Figure E-15: Proposed Spring Day Commercial TOU Hours**

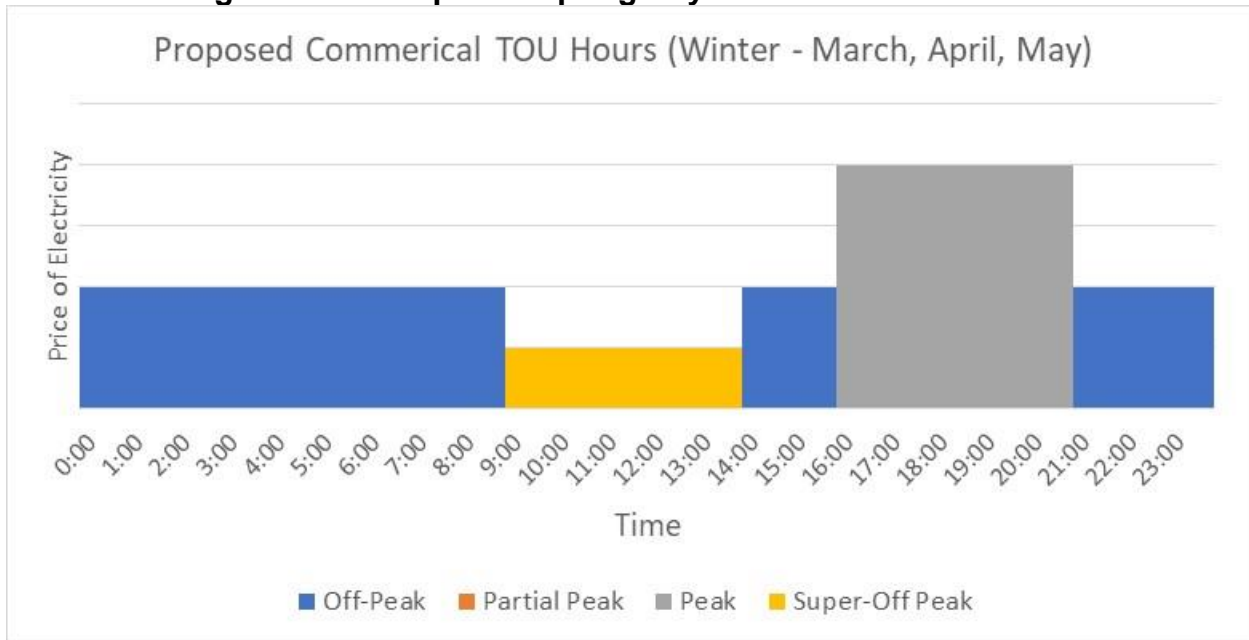

Source: UC Berkeley

The PEVs were modeled to follow a charging schedule based on the minimal cost of the LMP, A-10, and E-19V. Table E-3 shows the resulting cost of charging the PEVs at one building for each of the different price signals. The first column is the rate the PEVs were optimized against. The other columns are the costs in each rate for following the price signal. Table E-4 shows the amount of energy consumed by PEVs charging between 9am and 4pm. Here the project team see that following the LMP causes a 36 percent increase in energy consumed during peak solar production compared to the next highest price signal. However, the costs the building owner would see based on their retail rate is significantly higher if they follow the LMP compared to a retail rate price signal.

**Table E-3: Cost of Charging PEVs at One Building on April 14<sup>th</sup>, 2017**

Price Signal	LMP	Current A-10	Proposed A-10	Current E-19V	Proposed E-19V
<b>LMP</b>	\$ 0.019	\$ 1465.15	\$ 1495.01	\$ 2286.26	\$ 2488.95
<b>Current A-10</b>	\$ 8.86	\$ 99.16	\$ 100.78	\$ 77.92	\$ 93.14
<b>Proposed A-10</b>	\$ 7.90	\$ 99.16	\$ 98.93	\$ 77.92	\$ 91.52
<b>Current E-19V</b>	\$ 8.40	\$ 99.16	\$ 103.37	\$ 77.92	\$ 95.39
<b>Proposed E-19V</b>	\$ 6.21	\$ 99.16	\$ 98.93	\$ 77.92	\$ 68.78

Source: UC Berkeley

**Table E-4: kWh of PEVs Charging Between 9am and 4pm at One Building on April 14<sup>th</sup>, 2017**

Price Signal	kWh
LMP	750.0
Current A-10	402.2
Proposed A-10	428.0
Current E-19V	436.3
Proposed E-19V	482.7

Source: UC Berkeley

July 10<sup>th</sup>, 2017 was a hot summer day with high LMP prices that peaked late in the evening (Figure E-16).

**Figure E-16: LMP in Davis, CA on July 10th, 2017**

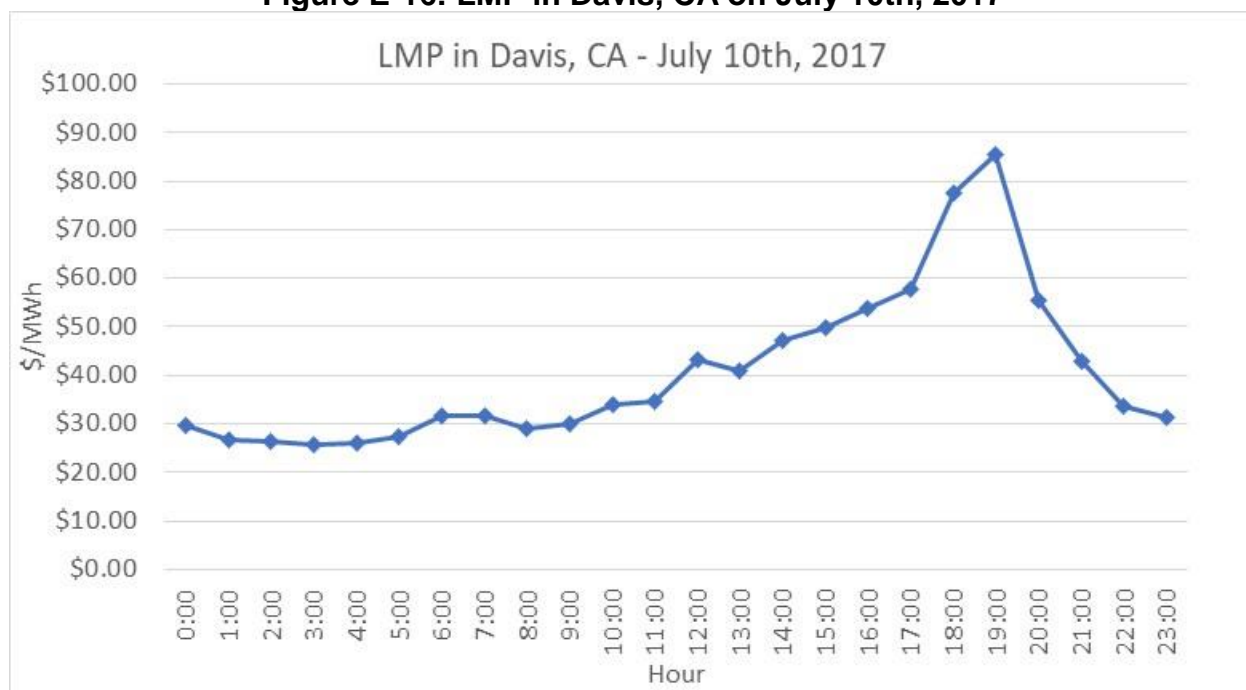

Source: "Day-ahead Market LMP for Davis\_1\_PNode (July 10, 2017)"

It was also the day the DOE building model for the medium office building had its annual peak load. For comparing retail rates, July 10<sup>th</sup> highlighted the disparity between the current TOU hours for commercial customers and the LMP on the wholesale market. Figure E-17 shows how the current peak TOU hours do not capture the peak costs at the wholesale level. In PG&E's motion for new commercial rates, the TOU hours are shifted later and better capture the price on the wholesale market (Figure E-18).

**Figure E-17: LMP vs Current Commercial TOU hours July 10th, 2017**

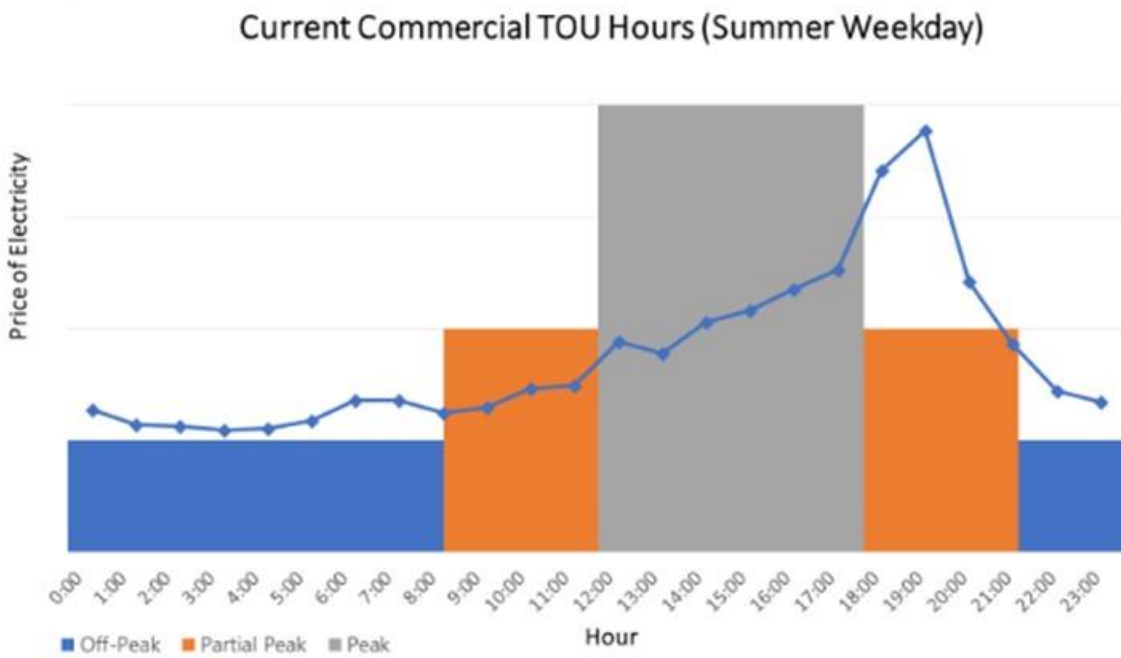

Source: UC Berkeley

**Figure E-18: LMP vs Proposed Commercial TOU Hours July 10th, 2017**

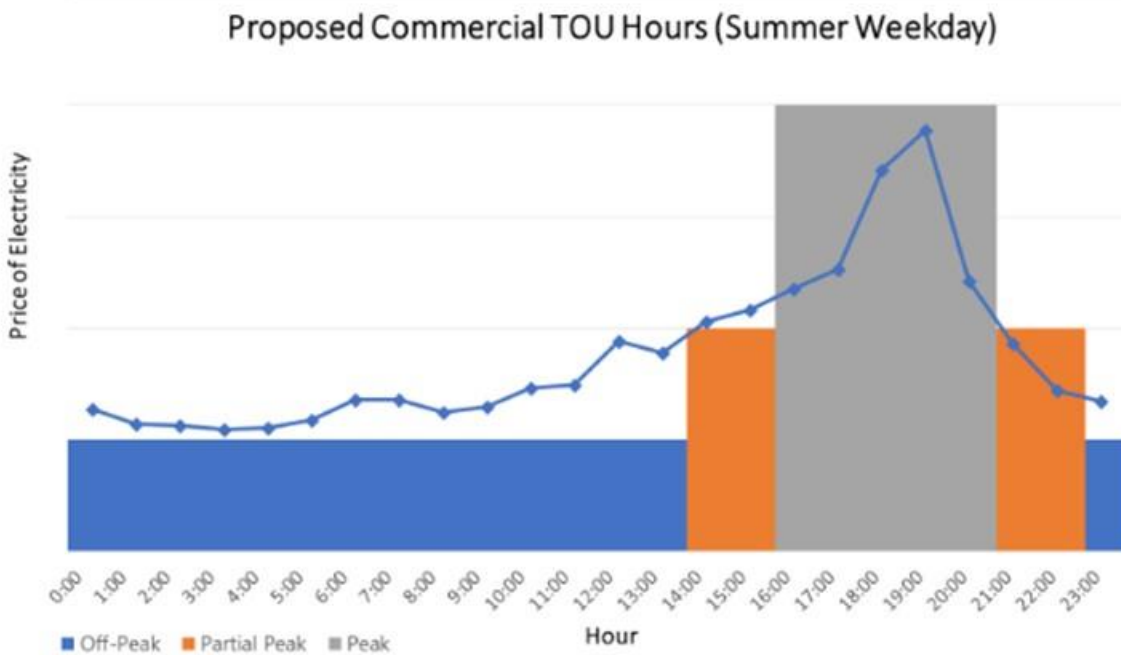

Source: UC Berkeley

For July 10<sup>th</sup>, the PEVs were again modeled to follow a charging schedule based on the minimal cost of the LMP, A-10, and E-19V. Table E-5 shows the resulting cost of

charging the PEVs at one building for each of the different price signals. The first column is the rate the PEVs were optimized against. The other columns are the costs in each rate for following the price signal. Table E-6 shows the amount of energy consumed by charging PEVs between 9am and 4pm. Although this is not when the LMP is cheapest, it is when there is peak solar output and would be where future solar production would be expected. The resulting energy consumption shows that the LMP and Proposed E-19V rates only account for a 9 percent difference in consumption during peak solar output. However, the cost to a building owner if they were on the Proposed E-19V rate would be almost twice as high if the PEVs at their building were following the LMP as a control signal.

**Table E-5: Cost of Charging PEVs at One Building on July 10<sup>th</sup>, 2017**

Price Signal	LMP	Current A-10	Proposed A-10	Current E-19V	Proposed E-19V
<b>LMP</b>	\$ 24.76	\$ 1436.51	\$ 927.20	\$ 3288.39	\$ 1475.20
<b>Current A-10</b>	\$ 33.01	\$ 514.22	\$ 373.57	\$ 1182.44	\$ 1091.17
<b>Proposed A-10</b>	\$ 33.01	\$ 514.22	\$373.57	\$ 1182.44	\$ 1091.17
<b>Current E-19V</b>	\$ 33.01	\$ 514.22	\$ 373.57	\$ 1182.44	\$ 1091.17
<b>Proposed E-19V</b>	\$ 30.78	\$ 691.93	\$ 476.39	\$ 1587.36	\$ 766.36

Source: UC Berkeley

**Table E-6: kWh of PEVs Charging Between 9am and 4pm at One Building on July 10<sup>th</sup>, 2017**

Price Signal	kWh
<b>LMP</b>	470.7
<b>Current A-10</b>	389.6
<b>Proposed A-10</b>	389.6
<b>Current E-19V</b>	389.6
<b>Proposed E-19V</b>	428.9

Source: UC Berkeley

### **Feeder Voltage Analysis**

In addition to analyzing the effects of workplace PEV charging, the project team examined the effects of a reasonable penetration of controlled workplace charging on voltage of the MIP Feeder. The project team found experimentally that 2000 PEVs were feasibly supplied if each medium office building had 309 PEVs and each warehouse building had 5 PEVs. Figure E-19 shows the voltage profile of one of the most remote



node on the MIP Feeder without PEVs. This node is the node most susceptible to voltage excursions beyond the allowed limits (1.05 and 0.95 pu) per ANSI C84.1 (“American National Standards for Electric Power Systems Equipment,” 2016). Spikes in voltage below or above the limit (such as at 2pm or 11pm) were found to be momentary and corrected by capacitor banks per the requirements of ANSCI C84.1. As such, the voltage of the MIP feeder is considered acceptable without PEVs.

**Figure E-19: Voltage Profile of the Most Remote Node on the MIP Feeder without PEVs**

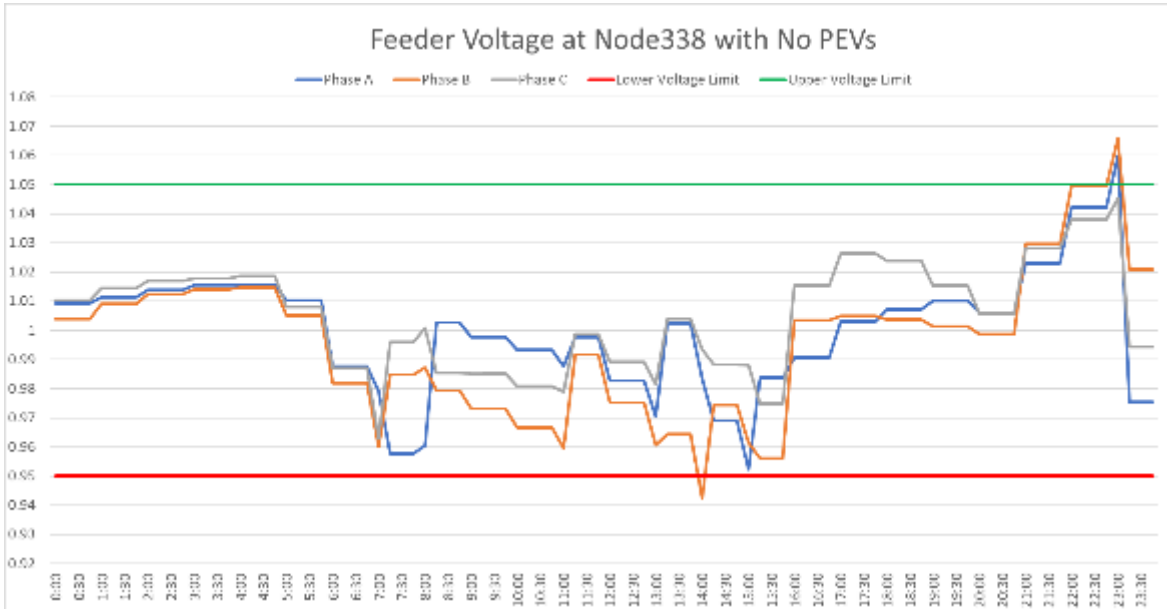

Source: UC Berkeley

PEVs were then added to the MIP Feeder and were modeled to follow the LMP for the feeder. Figure E-20 shows voltage on the feeder when PEVs were following the LMP as a price signal. In this scenario, voltage drops below the Lower Voltage Limit at 8am and 330pm. Due to these low voltage conditions, it was determined that LMP would not be a sufficient control signal for PEV charging.

**Figure E-20: Voltage Profile of the Most Remote Node on the MIP Feeder with 2000 PEVs Optimizing Towards the LMP**

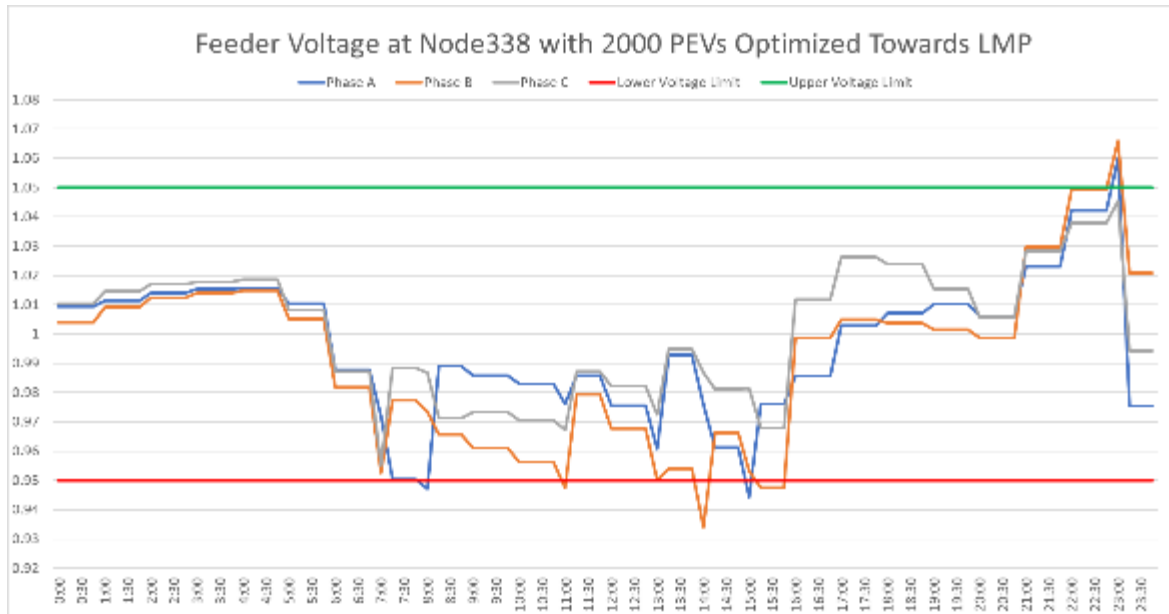

Source: UC Berkeley

To improve the control signal, a lower voltage limit was added as constraints to the optimization function. Voltage at every node was limited to lowest voltage in the system prior to PEVs being added to the feeder (0.96pu). Figure E-21 shows the voltage results at the most susceptible node of the MIP feeder with this control signal. The voltage excursion previously seen at 8am is corrected but the 330pm voltage drop is not. In further investigation, it was found that the voltage at 330pm at this node in the non-linear Gridlab-D was lower than the linearized optimization model. Thus, although the linear optimization included voltage limits in the constraints, the resulting charging profile caused the non-linear model to still go out of range.

**Figure E-21: Voltage Profile of the Most Remote Node on the MIP Feeder with 2000 PEVs Optimizing Towards the LMP with Constraints**

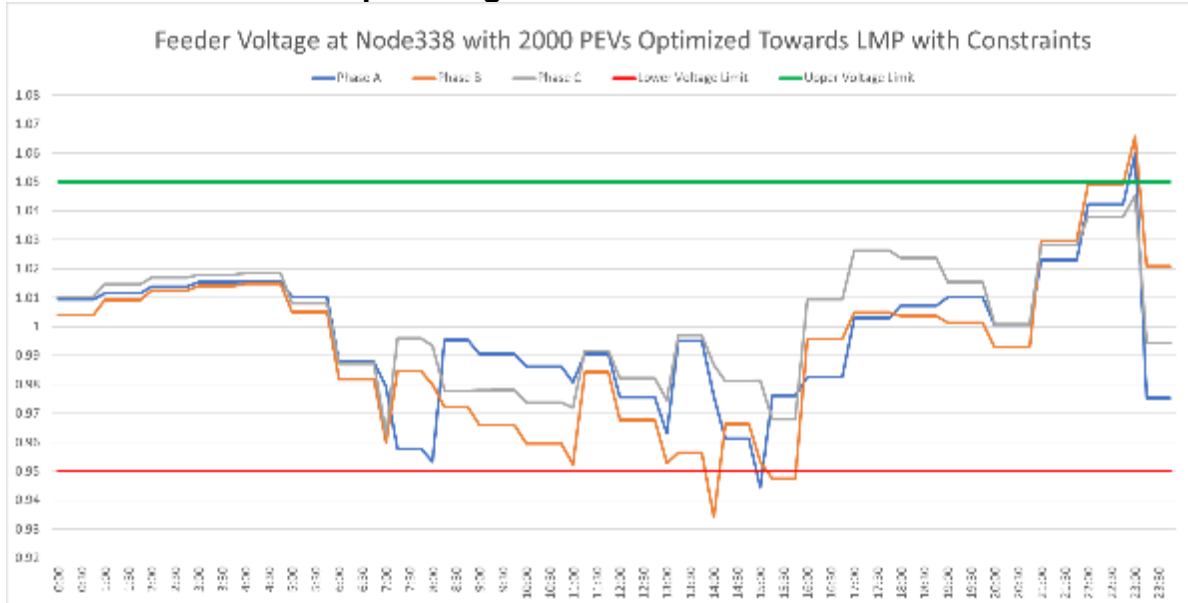

Source: UC Berkeley

As an alternative to the LMP, the current A-10 rate was used as a control signal for PEV charging (Figure E-22). Since the E-19V rate is similar in design to the A-10 rate, only the A-10 rate was modeled here. The current A-10 rate corrected the voltage excursions at both 8am and 330pm without adding the voltage to the constraints of the optimization. The prospective A-10 rate was also tested as a control signal (Figure E-23). Again, the A-10 rate corrected all voltage excursions. The reason both A-10 rates kept voltage in range was because of the demand charge. Since the demand charge limits the load at all hours, the PEV charging is reduced because of the cost of charging and the system voltage is kept in range.

**Figure E-22: Voltage Profile of the Most Remote Node on the MIP Feeder with 2000 PEVs Optimizing Towards the Current A10 Rate**

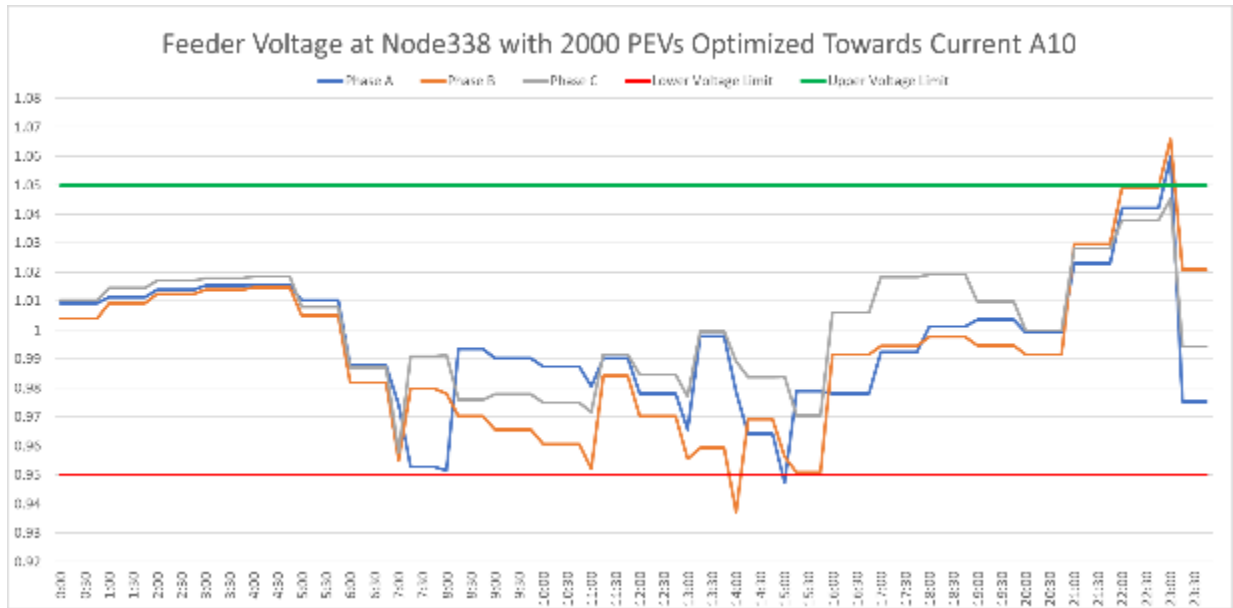

Source: UC Berkeley

**Figure E-23: Voltage Profile of the Most Remote Node on the MIP Feeder with 2000 PEVs Optimizing Towards the Proposed A10 Rate**

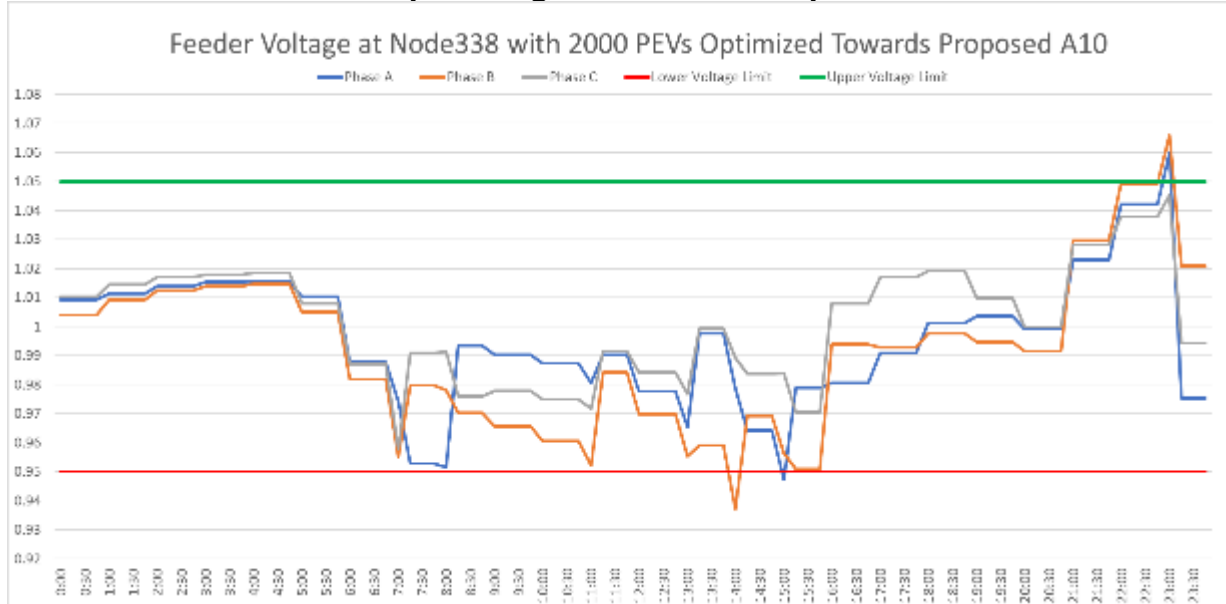

Source: UC Berkeley

## **Hosting Capacity**

Hosting capacity was compared between the controlled charging at workplaces versus controlled home charging. Although in the future it is predicted that both home and workplace charging will occur, it is important for determining policy implications to see what type of charging promotes the most PEVs on a feeder. While workplace charging was able to support up to 2,000 PEVs under certain conditions, the home charging system was simulated at over 5,000 PEVs on the MIP feeder. The advantage home charging sees over workplace charging is due to the reduction of non-PEVs load on the feeder. Regardless of the solar generation available, there is more capacity on a feeder at night than during the day.

# **APPENDIX F:**

## **PEVs in California – Recent History and Current Status**

---

California leads the United States (U.S.) in sales of PEVs, with about half of U.S. PEV sales in the state. After an unsuccessful attempt to introduce PEVs in California in the 1990s, sales are finally starting to become significant and PEVs are becoming commonly seen on California roadways. The early introduction of PEVs faltered based on battery technology that did not provide attractive enough attributes for consumers, especially with regard to limited driving range. But the latest generation of PEV battery technology using lithium-based technologies has offered much improved performance. Modern fully battery electric cars (BEVs) are capable of going well over 100 miles on a charge, and plug-in hybrid PEVs (PHEVs) can offer 20-100 miles of “all electric” range followed by further range based on range-extending engine-generators.

### **Policy History**

California — whose transportation sector is the largest relative greenhouse gas (GHG) emitter, comprising 40 percent of total state emissions — has long been a leader in supporting clean vehicle policies to reduce greenhouse gas emissions and localized pollution (Office of the Governor, 2012). These policies largely started with the California Air Resources Board (CARB)'s Zero-emission Vehicle mandate in 1990, which required that by 1998, 2 percent of vehicles sold by the major car manufacturers would be zero-emission vehicles (ZEVs), ratcheting that goal up to 10 percent by 2003 (CARB, 2011). That ZEV mandate was modified in the intervening years — due to legal challenges and constraints in vehicle costs, battery technology status, and other technical problems. Subsequent changes include allowing for partial ZEV (PZEV) credits, to update for later model years, and to combine the control and standards of air pollutants and GHGs in the Advanced Clean Cars Standards (CARB, 2017).

In 2012, the governor issued Executive Order B-16-2012 setting a state target of 1.5 million ZEVs (which include hydrogen fuel cell vehicles (FCEVs) and BEVs) on the road by 2025, and ordering the state agencies and stakeholders to work together to integrate electric vehicle charging into the electric grid (Office of the Governor, 2012). The order also targets lowering transportation-related GHG emissions by 80 percent below 1990 by 2050. Following the executive order, the ZEV Action Plan was developed in 2013 to lay out strategies for addressing the intermediate milestones and final goals of planning and completing infrastructure, expanding consumer awareness and demand, transforming fleets, and increasing jobs and private investment through deployment of ZEVs. At the time, in 2013, 40 percent of the U.S. market for PEV was in California (Interagency Working Group, 2013).

Alongside the ZEV mandate and executive order, the state's AB 118 program, consisting of the Alternative and Renewable Fuel and Vehicle Technology Program and Air Quality Improvement Program founded in 2007, has supported clean vehicles by provided funding for various initiatives, such as hydrogen infrastructure station development, state-wide vehicle rebates, medium and heavy-duty bus and truck demonstrations, alternative vehicle manufacturing, and workforce training (Interagency Working Group, 2013).

Additional funding and research by the California State Legislature, US Department of Energy, local governments, and investor-owned utilities have also promoted the development of vehicles, charging infrastructure and business models to encourage increased adoption (Interagency Working Group, 2013). Notably, the Clean Vehicle Rebate Project (funded by a combination of revenues from the state's cap-and-trade program, Air Quality Improvement Program, and AB 118 revenues), promotes the purchase or lease of BEVs, PHEVs, and FCEVs with rebates up to \$7,000 per light-duty vehicle (Center for Sustainable Energy, 2015). In the first five years of the Clean Vehicle Rebate Project, from March 2010 – March 2015, about three-fourths of eligible vehicles received rebates, and about 67 percent of PHEV customers and 81 percent of BEV customers participated in the program (Williams et al., 2015).

### **Current Status of PEV Sales**

The focus of this assessment for use in the XBOS-V project is on the sale of PEVs, both hybrid and fully electric. Since the governor's target, and with the help of federal and state vehicle incentives, the number of PEVs on the road has been increasing. It is estimated that cumulatively 512,717 PEVs have been sold in California from October 2011 through November 2018 (Veloz, 2018). Compared with about 74,000 PEV sales in California in 2016, almost 95,000 were sold in 2017 (EVAoption, 2018).

Figure F-1 shows the variety of PEV vehicles that are available on the market as of a few years ago, and the evolution of the market since the initial electric vehicles were commercially available in the 1990s. In 2018, there are now over 40 available PEV models for sale in the U.S. with more being introduced in each new model year.

**Figure F-1: Cumulative U.S. PEV Sales – 2011-2014**

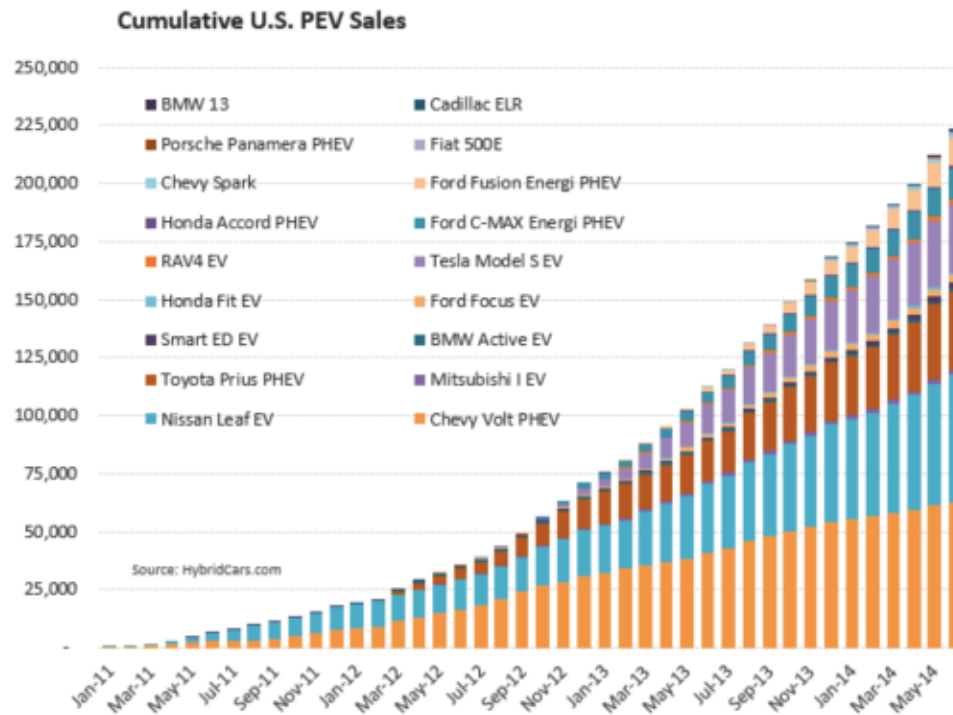

Source: Hybridcars.com

### Remaining Barriers to Adoption

Despite the progress that has been made to-date toward the state’s PEV goals, there still remain several barriers to widespread adoption of PEVs. First, the upfront cost of PEVs relative to conventional vehicles is still relatively high, despite state and federal incentives. According to customer surveys, the majority of car buyers are looking to purchase a car under \$30,000, and have a PEV cost-competitive with gasoline models (ICF and E3, 2014). The price differential between the price of gasoline compared to electricity is also a major driver of PEV sales, and customer awareness about the benefits of PEVs is limited, including availability of chargers, electric rate structures for home charging, and accessible public charging (Interagency Working Group, 2013). It seems that many customers are not willing to pay the higher upfront PEV cost because they undervalue the fuel cost savings from PEVs (ICF and E3, 2014).

Second, PEVs require the build out of charging infrastructure—in homes, public places, and workplaces (Interagency Working Group, 2013). There is a particular gap in deploying charging infrastructure at multi-family housing units, and workplace chargers have also not been deployed as much as in public locations with shorter parking limits (ICF and E3, 2014). Charging infrastructure build out also requires the development of business models for managing and deploying PEV chargers across the state to meet drivers’ needs in a way that integrates PEVs efficiently into the grid (ICF and E3, 2014). A Level 2 residential charger including installation can cost up to about \$2,000, but



surveys show that most consumers are only willing to pay up to \$500 for this capability. Level 1 chargers are more easily available and are inexpensive, but require longer charging times and do not have the same controllability (ICF and E3, 2014). Third, some customers have not purchased PEVs because of concerns about limitations on their range and locations of chargers (Singer, 2016).

### **Summary of PEV Market Forecasts for California**

There are a range of California-specific market forecasts that have been conducted in the last 3-4 years across government agencies, consulting firms, and industry trade groups, each with different scenarios and assumptions. There have been several recent national or even global PEV forecasts (e.g., International Energy Agency, 2016 and National Research Council 2013). However, forecasts were only included in this report if they were specific to California and publicly available (not including reports for-purchase). The majority of the forecasts differ as to how quickly California will meet its ZEV mandate, the distribution of BEV to PHEVs among future vehicle sales, the stock turnover, and availability and response to future vehicle rebates.

The forecasts of four recent studies of PEV adoption were assessed:

- California Transportation Electrification Assessment, ICF International and E3 (2014)
- California Energy Commission, California Energy Demand Forecast 2013 (2014)
- California Energy Commission, Revised California Energy Demand Forecast 2015 (2016)
- NREL, ADOPT Model (2016)

The results of these forecasts are summarized below, along with some details of the methodology and modeling assumptions for each forecast.

### **California Transportation Electrification Assessment, ICF International and E3**

This study updates a previous California Electric Transportation Coalition (CalETC) Study ("Electric Transportation and Goods Movement Technologies in California: Technical Brief," 2008) with new market sizing, forecasts and societal benefits of electrified transportation in California. The study contains forecasts for three cases through 2030 for PEV: a case called "In Line with Current Adoption," based on anticipated market growth, incentive programs and existing regulations; a case called "Aggressive Adoption" based on new incentive programs and regulations; and an "In Between" case that lands between the current and aggressive trajectories.

For PEVs, the study aligns its three scenarios with specific regulations and incentives. Under the "In Line with Current Adoption" scenario, the study assumes a California Zero Emission Vehicle (ZEV) compliance with a 50/50 split of PEVs and fuel cell vehicles

(FCVs).<sup>4</sup> The “In Between” scenario for ZEVs is the “likely” compliance per the California Air Resources Board. The “Aggressive Adoption” scenario has three times the ZEV as the “likely” compliance of the “In Between” scenario.

Table F-1, Table F-2, and Table F-3 show the forecasted numbers for 2020, 2025 and 2030 across the three scenarios. As shown, the estimates for 2030 range from 605 thousand to 6.65 million for a factor of 10 variation. Estimates for BEVs alone range from 60,000 in the Current Adoption scenario to over 2.2 million in the Aggressive scenario by 2030.

**Table F-1: Forecasted BEV, PHV, and Total PEV Populations  
In Line with Current Adoption Scenario**

<b>In Line with Current Adoption</b>	<b>2020</b>	<b>2025</b>	<b>2030</b>
Light-duty BEV population (thousands)	27.4	38.4	60.4
Light-duty PHEV10 pop. (thousands)	42.2	92.5	136.2
Light-duty PHEV20 pop. (thousands)	40.1	91.1	135.3
Light-duty PHEV40 pop. (thousands)	85.5	185.9	272.8
Total PEV population (thousands)	195.1	408.0	604.7

Source: CalETC

**Table F-2: Forecasted BEV, PHV, and Total PEV Populations  
In Between Scenario**

<b>In Between</b>	<b>2020</b>	<b>2025</b>	<b>2030</b>
Light-duty BEV population (thousands)	147.1	428.1	734.2
Light-duty PHEV10 pop. (thousands)	62.1	201.1	395.7
Light-duty PHEV20 pop. (thousands)	62.1	201.1	395.7
Light-duty PHEV40 pop. (thousands)	124.3	402.2	791.4
Total PEV population (thousands)	395.7	1,232.5	2,317.0

Source: CalETC

---

<sup>4</sup> The ZEV regulation requires about 4.2 million ZEV credits, rather than specifying a set number of ZEVs. Different vehicle types earn different quantities of ZEV credits per vehicle in 2030 (e.g. 0.5 for some types of PHEVs and 4.0 for fuel cell PEVs). Therefore, there are various possible compliance pathways from fewer than 1 million cumulative PEVs in 2030 to more than 3 million (“Electric Transportation and Goods Movement Technologies in California,” 2008).

**Table F-3: Forecasted BEV, PHV, and Total PEV Populations  
Aggressive Scenario**

<b>Aggressive</b>	<b>2020</b>	<b>2025</b>	<b>2030</b>
Light-duty BEV population (thousands)	441.2	1,284.2	2,202.5
Light-duty PHEV10 pop. (thousands)	186.4	603.3	1,187.1
Light-duty PHEV20 pop. (thousands)	186.4	603.3	1,187.1
Light-duty PHEV40 pop. (thousands)	372.9	1,206.7	2,374.3
Total PEV population (thousands)	1,187.0	3,697.5	6,951.1

Source: CalETC

**California Energy Commission, California Energy Demand 2014—2024 Final Forecast (CED 2013)**

This 2014 — 2024 forecast supports the recommendations of the 2012 and 2013 Integrated Energy Policy Reports. The forecast is based on data from the Energy Commission’s Transportation Energy Office from 2012, and was updated with the latest data on PEV sales and credits from the CARB ZEV mandate (CARB, 2014). The forecast has three scenarios: the “low” scenario is based on CARB’s “most-likely” case of just meeting the ZEV mandates as they relate to PEV sales; the “high” scenario is a downscaled forecast to match 2012 PEV totals in combination with 2013 sales data from the state rebate program; and the mid scenario assumes an average of the high and low scenarios. The Energy Commission allocated the forecasts across the state’s 8 electricity-planning areas by county, based on the PEV rebate program’s data. The growth of sales for each county was based on expectations of county-level population growth.

Table F-4, Table F-5, and Table F-6 show the forecasted numbers for 2018, 2020, 2024 across the three scenarios. For the farthest out year of 2024, the estimates are about 1 million total PEVs in the Low scenario and about 3.7 million in the High scenario.

**Table F-4: California Energy Demand Forecasted BEV, PHV, and Total PEV Populations Through 2024 – Low Case**

Low	2018	2020	2024
Light-duty BEV population (thousands)	58.7	112.6	335.5
Light-duty PHV population (thousands)	151.2	262.5	688.6
Total PEV population (thousands)	210.0	375.1	1,024.1

Source: California Energy Commission

**Table F-5: California Energy Demand Forecasted BEV, PHV, and Total PEV Populations Through 2024 – Mid Case**

Mid	2018	2020	2024
Light-duty BEV population (thousands)	60.9	119.9	340.0
Light-duty PHV population (thousands)	774.4	1,198.9	2,009.7
Total PEV population (thousands)	835.3	1,318.8	2,349.7

Source: California Energy Commission

**Table F-6: California Energy Demand Forecasted BEV, PHV, and Total PEV Populations Through 2024 – High Case**

High	2018	2020	2024
Light-duty BEV population (thousands)	63.1	127.3	344.5
Light-duty PHV population (thousands)	1,397.6	2,135.3	3,330.8
Total PEV population (thousands)	1,460.7	2,262.6	3,675.3

Source: California Energy Commission

These vehicle forecast numbers were also used by Lawrence Berkeley National Laboratory (LBNL) as the basis of a projection of the number of PEVs on the road for the 2016 CPUC California Demand Response Potential Study (CPUC, 2016).

**California Energy Commission, California Energy Demand 2016—2026, Revised Electricity Forecast (CED 2015 Revised)**

This forecast (used to support the 2014 IEPR) uses scenarios for fuel consumption by BEVs and PHEVs provided by the Energy Commission’s Transportation Energy Forecasting Unit (“California Energy Demand 2016-2026,” 2016). For its vehicle adoption levels, the mid case represents the “most-likely” scenario for compliance with the ZEV mandate, and was provided by CARB staff. To reach the compliance levels of purchases with their vehicle choice model, the staff modeled lower prices for PEVs and increased an PEV preference parameter relative to gasoline vehicles. The high scenario also has this high PEV preference parameter, and lower prices around the levels of gasoline vehicles by 2030. The low case assumes business as usual with existing and constant consumer preferences toward PEVs, and higher PEV prices relative to gasoline vehicles. The mid case scenario reaches around 2.5 million by 2026.

The final statewide PEV numbers were distributed to the utility planning areas and climate zones based on the results of regression analysis, with PEV ownership as a function of per capita income in that county. Disaggregated PEV forecasts between BEVs and PHEVs were not available.

**Table F-7: California Energy Demand Forecasted BEV, PHV, and Total PEV Populations Through 2026**

Scenario	2018	2020	2026
Low: Total PEV population (thousands)	600.0	900.0	2,900.0
Mid: Total PEV population (thousands)	500.0	750.0	2,400.0
High: Total PEV population (thousands)	350.0	600.0	1000.0

Source: California Energy Commission

**National Renewable Energy Lab (NREL) Automotive Deployment Options Projection Tool (ADOPT)**

NREL has developed a light-duty vehicle consumer choice and stock model to estimate detailed, high geographic resolution vehicle stocks, based on income and other demographic data. The results are validated with historical sales data. The data is not yet available for download, but will be public soon, according to the NREL website (“NREL: Transportation Research,” n.d.).

**Bounded Market Forecast for PEVs for 2015-2030**

The following figures show the range of the market forecasts, both across the forecast sources as well as across the low to high scenarios within each forecast.

**Figure F-2: Forecasts of California's BEV Population**

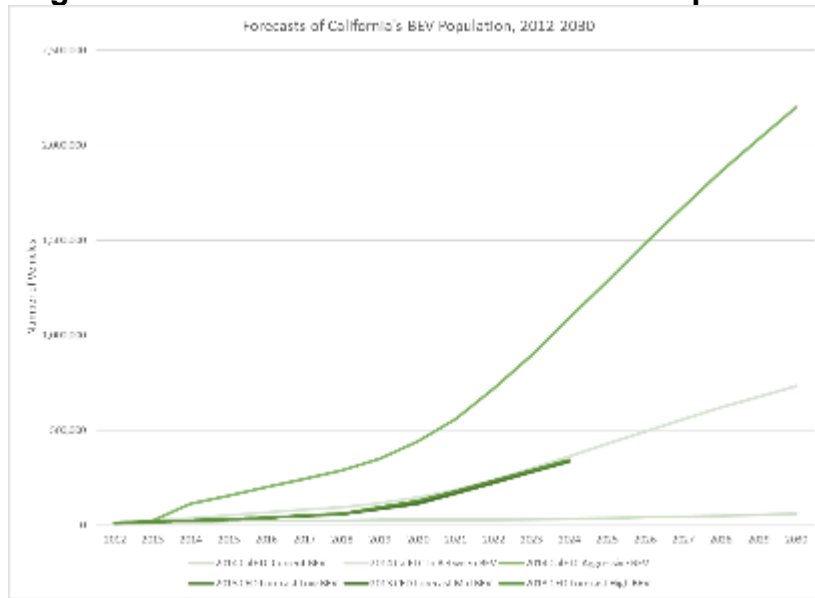

Source: UC Berkeley

Figure F-2 compares the forecasts of BEV population across the three sources, and the low, mid and high scenarios for each. The California Energy Demand 2015 forecast does not have disaggregated BEV predictions. The highest BEV forecast is the aggressive scenario for the CalEVC 2014 forecast, and the lowest projections are from the low scenario of the CalEVC 2014 forecast. The high scenario for the Energy Commission forecast is around the level of the mid case for CalEVC.

**Figure F-3: Forecasts of California’s PHEV Population, 2012-2030**

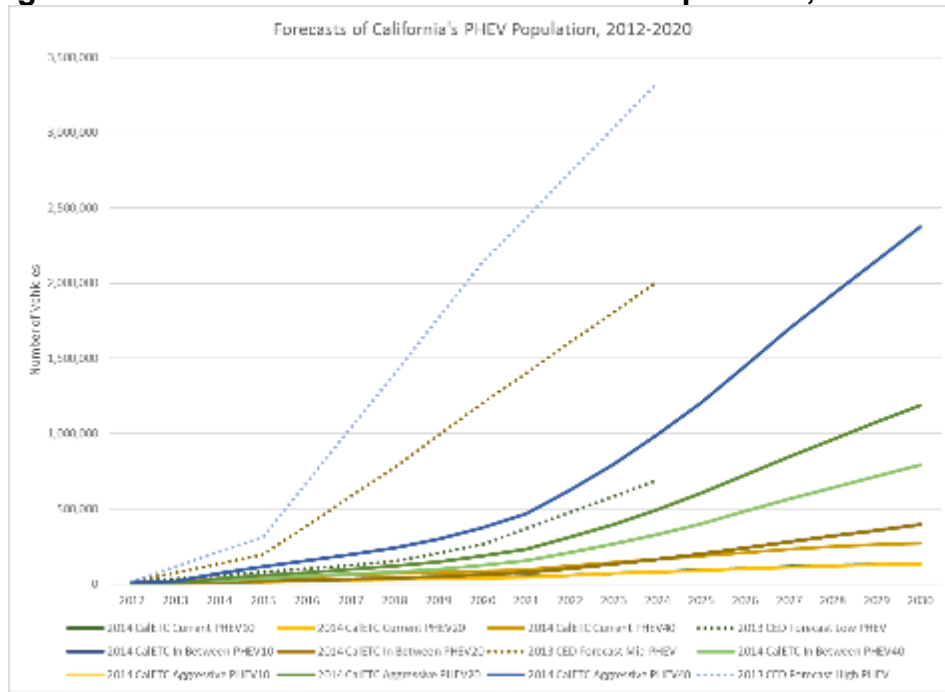

Source: UC Berkeley

Figure F-3 compares the forecasts of PHEV population across the three sources, and the low, mid and high scenarios for each. The Cal ETC forecast also has separated values for the PHEV of different electric ranges (PHEV10, PHEV20 and PHEV40). The Energy Commission California Energy Demand 2015 forecast does not have disaggregated PHEV predications. The dotted lines in the figure are from the Energy Commission forecast, and the solid lines are from the Cal ETC forecast.

The trajectory of the high scenario (over 3 million PHEVs by 2024) from the Energy Commission forecast is the upper bound for the PHEV population projections, and the lower bound (about 80,000 vehicles) is the current Cal ETC forecast for the lowest range PHEV 10 and PHEV 20. The total population across all PHEV models for the Cal ETC forecast low scenario (about 330,000 vehicles in 2024) is less than that of the Energy Commission as well.

Figure F-4 compares the forecasts of combined BEV and PHEV population across the three forecasts (both vintages from the Energy Commission and the Cal ETC forecast), and the low, mid and high scenarios for each. The dotted lines in the figure are from the Energy Commission’s 2013 CED forecast, the dashed lines are for the Energy Commission’s 2015 CED forecast, and the solid lines are from the Cal ETC forecast. The highest forecast trajectory is that of Cal ETC’s aggressive scenario, reaching about 7 million combined PEVs by 2030. The lowest is the same forecast’s low/current scenario, with about 600,000 PEVs by 2030. In 2024, the last year overlapping all the forecasts, Cal ETC’s aggressive scenario is a bit over the high and mid cases from the Energy

Commission’s 2015 CED forecast, around 2 million PEVs. The mid case for the Cal ETC forecast is similar to the low 2015 Energy Commission and low 2013 CED cases in 2024.

**Figure F-4: Forecasts of California's BEV and PHEV Combined Population**

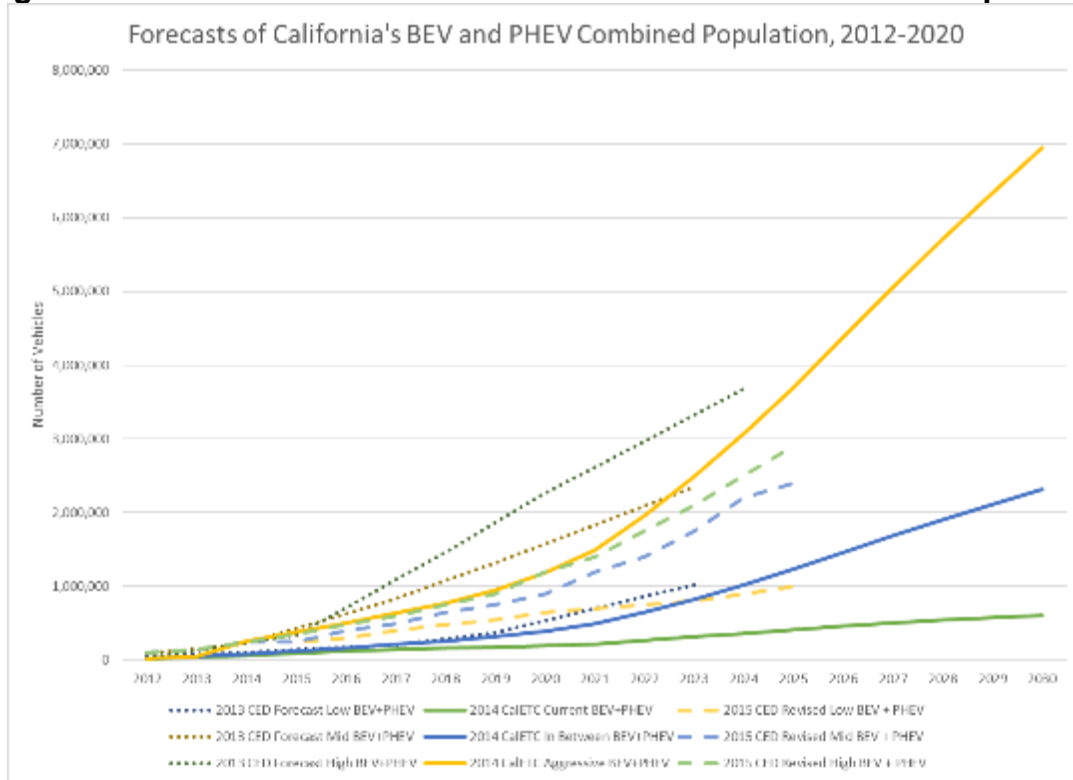

Source: UC Berkeley

### Summary

As a basic underlying analysis, in order to estimate the future potential impact of PEV charge control at a large scale on California’s electrical grid, it is necessary to forecast the number of PEVs that will be on the road in the project analysis period through 2030, and what types in terms of BEV vs. PHEV and battery size they may be. Using publicly available forecasts for this time period, specific to California, this chapter summarizes and provides a bounded market forecasts for the range of PEVs that can be expected by 2030. According to these forecasts, under the most aggressive case, California could have almost 7 million PEVs on the road by 2030. Under the lowest scenario, there could be closer to 600,000 PEVs.

The range of forecasts in this report are then used as inputs to the Task 5 of this study to estimate the range of potential system-wide benefits of PEV controlled charging in California. PEV market penetration levels in 2020, 2025, and 2030 are examined based on higher and lower expectations of PEV sales. These future expectations are inherently uncertain due to market and consumer response variables, as well as the type and extent of the development of supportive public policies.



# APPENDIX G: XBOS-V Project Technology Transfer Activity Details

---

## XBOS-V Project Professional Presentations

Shown in Table G-1 are the professional presentations either focused on or directly related to the XBOS-V project. The presentations addressed various audiences and took place in venues ranging from meetings to executive briefings to large audiences at professional conference.

**Table G-1: XBOS-V Project Presentations**

Team members	Event	Presentation Type	Location and Date	Audience
Timothy Lipman (PI)	Transportation Research Board Conference	Conference podium presentation	Washington, DC January 8, 2017	Approx. 300 professional attendees
Timothy Lipman (PI) and Phillippe Phanivong	PUC Briefing	Meeting presentation	S.F., CA May 12, 2017	CA PUC staff
Timothy Lipman (PI)	Asilomar Biennial Transportation and Energy Conference	Conference podium presentation	Asilomar, CA August 24, 2017	Approx. 300 professional attendees
Timothy Lipman (PI)	California Multi-Agency Update on Vehicle-Grid Integration Research	Symposium podium presentation	Sacramento, CA December 5, 2017	Approx. 100 professional attendees
Timothy Lipman (PI)	TRB Executive Committee Meeting	Podium presentation	Cape Cod, MA June 13, 2018	Executive Committee of the Transp. Research Board
Timothy Lipman (PI)	International Scholar Briefing	Meeting presentation	Berkeley, CA August 23, 2018	Visiting delegation from Japan

<b>Team members</b>	<b>Event</b>	<b>Presentation Type</b>	<b>Location and Date</b>	<b>Audience</b>
Timothy Lipman (PI)	International Scholar Briefing	Meeting presentation	Berkeley, CA October 4, 2018	Visiting delegation from Malta
Duncan Callaway (Co-PI)	Oxford University Control Group Weekly Colloquium	Colloquium presentation	Oxford, England April 30, 2018	Oxford University faculty and students
Duncan Callaway (Co-PI)	ETH Zurich Power Systems Laboratory Special Colloquium	Colloquium presentation	Zurich, Switzerland May 16, 2018	ETH Zurich faculty and students
Duncan Callaway (Co-PI)	University of Minnesota ECE weekly colloquium	Colloquium presentation	Minneapolis, MN November 29, 2018	University of Minnesota ECE faculty and students
Duncan Callaway (Co-PI)	Stanford Smart Grid Seminar	Colloquium presentation	Stanford, CA December 6, 2018	Stanford faculty and students
Duncan Callaway (Co-PI)	Stem Data Science seminar series	Colloquium presentation	December 10, 2018 Berkeley, CA	Stem (battery integrator) data science employees
Mingxi Liu	IEEE Conference on Decision and Control	Conference presentation	Melbourne, Australia Dec. 12, 2017	Approximately 100 professional attendees
Mingxi Liu	Power Systems Computation Conference	Conference presentation	Dublin, Ireland Jun. 11, 2018	Approximately 150 professional attendees
Mingxi Liu	University of Utah ECE weekly colloquium	Colloquium presentation	Salt Lake City, UT Sept. 28, 2018	University of Utah ECE faculty and students

<b>Team members</b>	<b>Event</b>	<b>Presentation Type</b>	<b>Location and Date</b>	<b>Audience</b>
Mingxi Liu	Beihang University Transportation Science and Engineering Department weekly colloquium	Colloquium presentation	Beijing, China May. 21, 2018	Beihang University Transportation Science and Engineering Department faculty and students
Mingxi Liu	China State Key Laboratory of Alternate Electrical Power System with Renewable Energy Sources invited talk	Podium presentation	Beijing, China May. 23, 2018	Approximately 200 professional attendees
Mingxi Liu	Shanghai Jiaotong University, Department of Automation weekly colloquium	Colloquium presentation	Shanghai, China May. 6, 2018	Shanghai Jiaotong University Department of Automation faculty and students
Gabe Fierro	BuildSys Conference 2018	Podium presentation	Shenzhen, China, November 8, 2018	Approx 60 international faculty, students, industry attendees
Gabe Fierro	WeWork Presentation	Meeting presentation	San Francisco, CA Sept 4, 2018	Approx 10 WeWork employees
Gabe Fierro	Smart Citites Week Silicon Valley	Podium presentation	Santa Clara, CA, May 9, 2018	Approx 50 attendees (mostly industry)

<b>Team members</b>	<b>Event</b>	<b>Presentation Type</b>	<b>Location and Date</b>	<b>Audience</b>
Therese Peffer, Sascha von Meier, David Culler	Software Defined Buildings End of Project Retreat	Podium presentation	Berkeley, CA February 6, 2017	30 Industry partners, researchers
Therese Peffer	Consortium for Energy Efficiency Winter Conference	Podium presentation	San Francisco, CA January 17, 2018	250 members of utilities, manufacturers, government, and research
Therese Peffer	Presentation at Mexico Smart Grid Workshop	Podium presentation	Cuernavaca, Mexico September 19 2018	50 researchers, utility members
Therese Peffer	Various presentations to visiting organization to CITRIS (Energy Foundation, Jiangsu, EPRI, Leuven, ICDK)	Meeting presentation	Berkeley, CA 2017-2018	5-10 researchers per meeting
Phillippe Phanivong	Presentation at CCST Climate Science Translators Showcase	Meeting Presentation	San Francisco, CA September 11, 2018	Approx 250 professional attendees
Phillippe Phanivong	Presentation at Stem	Podium Presentation	Oakland, CA September 17, 2018	5 researchers and professionals

Source: UC Berkeley

**Project Research Papers (accepted and in progress):**

M. Ghamkhari, G. Fiero, M. AbdelBaky, and T.E. Lipman, "Implementation of Open Source Code for Vehicle Grid Integration with Building Automation Systems" (2019, in progress)

- M. Liu, P. K. Phanivong, Y. Shi, and D. S. Callaway, "Decentralized charging control of electric vehicles in residential distribution networks," *IEEE Transactions on Control Systems Technology*, vol. 27, no. 1, pp. 266-281, 2019.
- M. Liu, P. K. Phanivong, and D. S. Callaway, "Customer- and network-aware decentralized PEV charging control," in *Proceedings of Power Systems Computation Conference*, Dublin, Ireland, Jun. 11-15, 2018, pp. 1-7.
- G. Fierro, M. Pritoni, M. AbdelBaky, P. Raftery, T. Peffer, G. Thomson, and D.E. Culler, "Mortar: An Open Testbed for Portable Building Analytics," *5th ACM International Conference on Systems for Energy-Efficient Built Environments (BuildSys)*, Shenzhen, China, November 2018.
- G. Fierro and D.E. Culler, "Design and Analysis of a Query Processor for Brick (Journal Extension)," *ACM Transactions on Sensor Networks*, January 2018.
- M.P. Andersen, J. Kolb, K. Chen, G. Fierro, D. E. Culler and R.A. Popa, "WAVE: A Decentralized Authorization System for IoT via Blockchain Smart Contracts," *Technical Report No. UCB/EECS-2017-234*, December 2017.
- M. Liu, P. K. Phanivong, and D. S. Callaway, "Electric vehicle charging control in residential distribution network: A decentralized event-driven realization," in *Proceedings of IEEE Conference on Decision and Control*, Melbourne, VIC, Australia, Dec. 12-15, 2017, pp. 214-219.