

# UC Berkeley

## Envelope Systems

### Title

High-performance facades design strategies and applications in North America and Northern Europe

### Permalink

<https://escholarship.org/uc/item/4vq936rc>

### Authors

Zelenay, Krystyna  
Perepelitza, Mark  
Lehrer, David

### Publication Date

2011

Peer reviewed

**Public Interest Energy Research (PIER) Program**  
**DRAFT PROJECT REPORT**

# **High-Performance Facades**

## **Design Strategies and Applications in North America and Northern Europe**

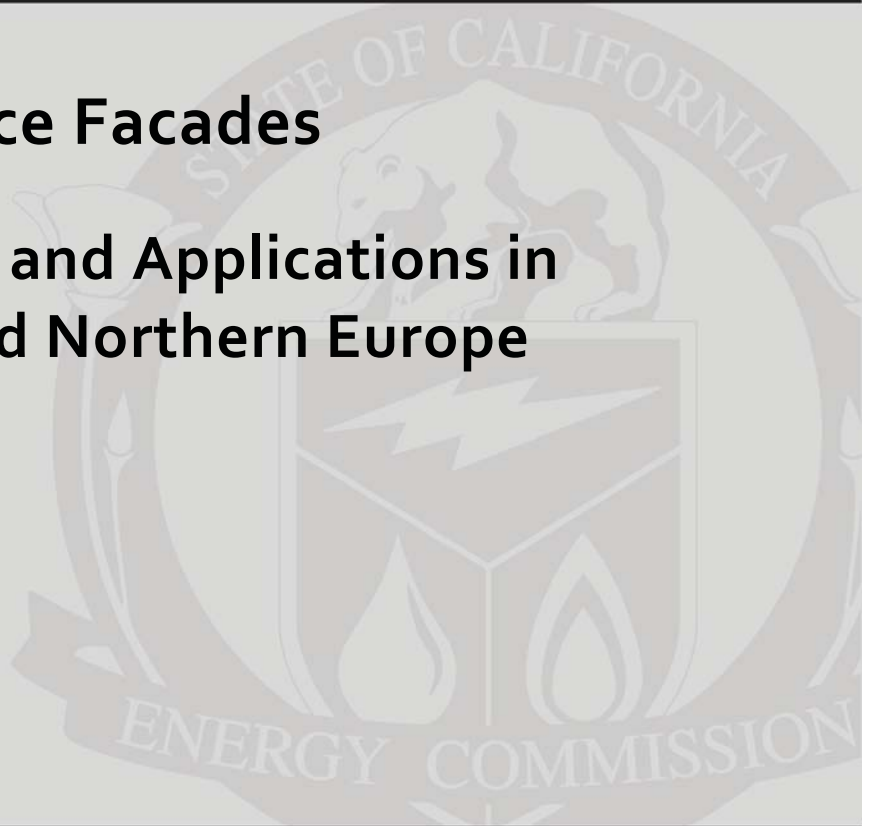

Prepared for: California Energy Commission

Prepared by: Center for the Built Environment (CBE)



FEBRUARY 2011

CEC-500-99-013

**Prepared by:**

**Primary Authors:**

Krystyna Zelenay

Mark Perepelitza

David Lehrer

Center for the Built Environment  
University of California, 390 Wurster Hall #1839  
Berkeley, CA 94720-1839  
(510) 642-4950 (voice)  
(510) 643-5571 (fax)  
[www.cbe.berkeley.edu/](http://www.cbe.berkeley.edu/)



**Contract Number: CEC-500-99-013**

**Prepared for:**

**California Energy Commission**

Chris Scruton

**Contract Manager**

Fred Bauman

**Project Manager**

**DISCLAIMER**

This report was prepared as the result of work sponsored by the California Energy Commission. It does not necessarily represent the views of the Energy Commission, its employees or the State of California. The Energy Commission, the State of California, its employees, contractors and subcontractors make no warrant, express or implied, and assume no legal liability for the information in this report; nor does any party represent that the uses of this information will not infringe upon privately owned rights. This report has not been approved or disapproved by the California Energy Commission nor has the California Energy Commission passed upon the accuracy or adequacy of the information in this report.

# ACKNOWLEDGEMENTS

The authors would like to thank the California Energy Commission for funding this study through the Public Interest Energy Research (PIER) program. We also wish to acknowledge the Architecture Foundation of Oregon, for their support for background research and travel in northern and central Europe. We also thank the Center for the Built Environment's Industry Partners for their continued support and feedback related to industry needs.

Much of the information presented in this report was influenced by the insights of a number of building construction professionals with experience in the design and construction of high performance facades. The authors would like to extend a special thanks to all of those who agreed to be interviewed:

Martin Haas, Behnisch Architekten	Gabe Hanson, formerly with Weber Thompson
Christoph Ingenhoven, Ingenhoven Architects	Myer Harrell, Weber Thompson
Heiko Weissbach, Sauerbruch Hutton	Scott Thompson, Weber Thompson
Peter Clegg, Feilden Clegg Bradley	Brett Terpeluk, Studio Terpeluk
Bill Gething, Feilden Clegg Bradley	Steve DeIraio, LMN Architects
Andrew Clifford, Shepherd Robson Architects	Shani Krevsky, formerly with EHDD Architecture
Andrew Hall, Arup	Don Young, D. R. Young Associates
Mikkel Kragh, Arup	Tyler Bradshaw, Integral Group
Peter Thompson, Buro Happold	Michele Sagehorn, Integral Group
Thomas Auer, Transsolar	Karl Lyndon, Arup
William Bordass, Usable Building Trust	John Paul Peterson, Sherwood Design Engineers
Peter Langenmayr, Josef Gartner Facades	George Loisos, Loisos + Ubbelohde
Patrick Briem, Josef Gartner Facades	Susan Ubbelohde, Loisos + Ubbelohde
Winfried Heusler, Schüco Window Systems	Roddy Wykes, Arup
Tillmann Klein, Facade Research Group at Delft University of Technology	Alex Goehring, Arup
Marcel Bilow, Facade Research Group at Delft University of Technology	Claire Johnson, Atelier Ten
Stephen Ledbetter, Center for Cladding and Window Technology	Ari Harding, California Academy of Sciences
Petra Scheerer, Deutsche Post Tower	Don Carlson, Marin Country Day School
Mareike Rößmann, Behnisch Architekten	Mark Grey, Stephen C. Grey and Associates
Claus Marquart, Sauerbruch Hutton	Eleanor Lee, Lawrence Berkeley National Laboratory
Birgitt Heinicke, Umweltbundesamt (UBA),	Jerry Ingwalson, CTG Energetics, Inc.
Liz Adams, Heelis – National Trust Headquarters,	Michael Donn, of Centre of Building Performance Research at Victoria University of Wellington
Mike Caple, Wessex Water Facilities	Mudit Saxena, Heschong Mahone Group
Malcolm Harris, Solomon WRT	Matthew Craven, Nysan Solar Control
	Bernie Grosse, T&T Shading

# PREFACE

The California Energy Commission Public Interest Energy Research (PIER) Program supports public interest energy research and development that will help improve the quality of life in California by bringing environmentally safe, affordable, and reliable energy services and products to the marketplace.

The PIER Program conducts public interest research, development, and demonstration (RD&D) projects to benefit California.

The PIER Program strives to conduct the most promising public interest energy research by partnering with RD&D entities, including individuals, businesses, utilities, and public or private research institutions.

PIER funding efforts are focused on the following RD&D program areas:

- Buildings End-Use Energy Efficiency
- Energy Innovations Small Grants
- Energy-Related Environmental Research
- Energy Systems Integration
- Environmentally Preferred Advanced Generation
- Industrial/Agricultural/Water End-Use Energy Efficiency
- Renewable Energy Technologies
- Transportation

The Center for the Built Environment (CBE) was established in May 1997 at the University of California, Berkeley, to provide timely and unbiased information on promising new building technologies and design strategies. The center's work is supported by CBE's industry partners, a consortium of corporations and organizations committed to improving the design and operation of commercial buildings.

*High-Performance Facades: Design Strategies and Applications in North America and Northern Europe* is the final report for Task #4 (Facade Design and Performance) of the Advanced Integrated Systems Tools Development and Performance Testing project (contract number CEC-500-99-013) conducted by the Center for the Built Environment (CBE). The information from this project contributes to PIER's Buildings End-Use Energy Efficiency Program.

For more information about the PIER Program, please visit the Energy Commission's website at [www.energy.ca.gov/research/](http://www.energy.ca.gov/research/) or contact the Energy Commission at 916-654-4878.



## ABSTRACT

A number of buildings built in central and northern Europe over the course of the last two decades utilize a range of more advanced facade design solutions than those typically implemented on U.S. buildings – a trend that has been driven in part by higher energy prices, stricter building codes, and higher expectations regarding the quality of the built environment. Through a critical analysis of select North American buildings and interviews with building professionals in northern Europe and North America, this report identifies both simple and advanced facade technologies that enable the development of commercial buildings that minimize the need for HVAC and lighting energy use, while enhancing occupant well-being. Challenges and lessons learned from detailed North American case study buildings are discussed in the hope that these can serve as a guide for the successful implementation and accelerate the adoption of advanced facade design solutions in the U.S. building stock. Findings from discussions with design teams and building managers reveal that many of the fundamental principles driving facade design in European buildings can and are already being applied in North American buildings. One exception to this trend is that automated facade technologies are only slowly beginning to penetrate the market, accompanied by a moderate learning curve on the projects on which they have been installed. Regular system maintenance, occupant education, and assessment of occupant satisfaction during the building operation phase are critical for ensuring that facade systems are meeting energy and occupant comfort requirements.

**Keywords:** High-performance facades, advanced, envelope, shading, occupant comfort, thermal, visual, COMFEN, DIVA-for-Rhino, DAYSIM, motorized, automated systems, dynamic, operable windows, trickle vents, louvers, venetian blinds, roller shades, design practice

Please use the following citation for this report:

Zelenay, Krystyna, Mark Perepelitza, David Lehrer. (Center for the Built Environment, University of California, Berkeley). 2011. ***High-Performance Facades: Design Strategies and Applications in North America and Northern Europe.*** California Energy Commission. Publication number: CEC-500-99-013.

# TABLE OF CONTENTS

<b>ACKNOWLEDGEMENTS</b> .....	<b>I</b>
<b>PREFACE</b> .....	<b>II</b>
<b>ABSTRACT</b> .....	<b>IV</b>
<b>TABLE OF CONTENTS</b> .....	<b>V</b>
<b>EXECUTIVE SUMMARY</b> .....	<b>1</b>
1. INTRODUCTION .....	1
2. PURPOSE .....	1
3. CONCLUSION .....	2
<b>1. BACKGROUND</b> .....	<b>5</b>
1.1. FACADE IMPACT ON ENERGY USE: A BRIEF OVERVIEW .....	5
1.2. HUMAN FACTORS .....	7
1.2.1. DAYLIGHT AND VISUAL COMFORT .....	7
1.2.2. THERMAL COMFORT .....	9
1.3. ENERGY CODES AND RATING SYSTEMS .....	10
1.3.1. MEASURING BUILDING ENERGY USE .....	10
1.3.2. CURRENT TRENDS IN THE U.S. ....	11
1.3.3. CURRENT TRENDS IN EUROPE .....	12
<b>2. PURPOSE</b> .....	<b>14</b>
<b>3. APPROACH</b> .....	<b>15</b>
3.1. INTERVIEWS .....	15
3.2. CASE STUDIES .....	15
<b>4. CASE STUDIES: FUNDAMENTAL DESIGN STRATEGIES</b> .....	<b>16</b>
4.1. MASSING AND ORIENTATION .....	17
4.2. TRANSPARENCY .....	18
4.3. SOLAR CONTROL .....	20
4.3.1. SPECTRALLY-SELECTIVE GLAZING COATINGS .....	20
4.3.2. SCREENS AND FRITS .....	21
4.3.3. FIXED EXTERIOR SHADING .....	23
4.3.4. AUTOMATED EXTERIOR SHADING .....	23
4.4. NATURAL VENTILATION .....	24
4.5. DOUBLE-SKIN FACADE .....	25
4.6. SEMI-CONDITIONED ATRIA .....	26
4.7. INTEGRATED LIGHTING AND HVAC CONTROLS .....	27



<b>5. CASE STUDIES: PRACTICAL CONSIDERATIONS.....</b>	<b>28</b>
5.1. DESIGN PHASE .....	28
5.1.1. FACADE AND COOLING SYSTEM INTEGRATION .....	28
5.1.2. COST .....	29
5.2. CONSTRUCTION PHASE.....	31
5.3. OPERATION AND MAINTENANCE PHASE.....	34
5.3.1. BUILDING USERS .....	35
5.3.2. AUTOMATED EXTERIOR SHADING.....	37
5.3.3. AUTOMATED WINDOWS AND TRICKLE VENTS .....	39
5.3.4. OPERABLE WINDOWS .....	40
<b>6. CASE STUDIES: INTRODUCTION.....</b>	<b>42</b>
<b>7. TERRY THOMAS OFFICE BUILDING.....</b>	<b>42</b>
<b>8. MARIN COUNTY DAY SCHOOL.....</b>	<b>53</b>
<b>9. CALIFORNIA ACADEMY OF SCIENCES.....</b>	<b>60</b>
<b>10. DAVID BROWER CENTER.....</b>	<b>69</b>
<b>REFERENCES.....</b>	<b>78</b>
<b>APPENDIX A: INTERVIEWEES .....</b>	<b>82</b>
<b>APPENDIX B: DESIGN RESOURCES .....</b>	<b>84</b>

# EXECUTIVE SUMMARY

## 1. INTRODUCTION

The combined crises of energy source depletion and significant climate change are generating a sense of urgency and fundamental changes in many industries including the construction industry. About 40% of energy use and carbon emissions in the U.S. are associated with buildings (U.S. Department of Energy, 2007). In response, the American Institute of Architects (AIA), American Society of Heating, Refrigerating and Air-Conditioning Engineers (ASHRAE), and the Department of Energy (DOE) have begun programs that seek to incrementally reduce building energy use to net-zero over the next 15 to 20 years. But despite this interest and ambitious goals, the rate of adoption of low-energy buildings in professional practice in the U.S. is disappointing. Progress has been slow, and even the U.S. Green Building Council's Leadership in Energy and Environmental Design (LEED) rating program has failed to adequately prioritize energy efficiency (Turner & Frankel, 2008).

One of the essential considerations in the design, engineering and operation of ultra-low energy buildings is the building envelope. Rather than serving as a static enclosure, the building skin has the potential to redirect and filter daylight, provide natural ventilation, manage heat transfer, enhance occupant well-being, and create visual and physical connections between inside and outside. Over the past 20 years, a number of buildings have been built in Central and Northern Europe that utilize a range of more advanced facade technologies than those typically implemented on U.S. buildings. This trend has been driven in part by higher energy prices, stricter building codes, and higher expectations regarding the quality of the working environment and construction (Yudelson, 2009). Since European commercial buildings use air conditioning very selectively, and it is expected that daylight, views, and natural ventilation be provided to all occupants – far more attention is paid to the design and construction of the building envelope. As the building industry pushes for improved performance in buildings, there is much value to be gained by exchanging conceptual and technical knowledge between North American and European professionals.

## 2. PURPOSE

The two primary objectives of this research are to identify effective design strategies that minimize building energy use while simultaneously enhancing the comfort and well-being of the building's occupants; and second, to identify some of the practical considerations related to the successful design and implementation of advanced facade solutions on projects. Through a critical analysis of North American case study buildings and interviews with building professionals in Northern Europe and North America, this report identifies effective facade design strategies as

well as some of the benefits and barriers to the implementation of select solutions. What are the benefits of simple facade design solutions compared to advanced facade systems and components? How are European buildings striving for high performance, and what can be learned from them? What are the barriers preventing the adoption of advanced facade solutions in the U.S.? What are some of the issues that arise in the design, construction, and operation of projects with advanced facade systems?

### **3. CONCLUSION**

As discussed in the introduction, there is a growing recognition of the need to significantly improve the performance of North American buildings. Many of the fundamental principles driving facade design in European buildings can be applied in North American buildings. While highly complex solutions may be applicable for only high-profile demonstration projects, simpler, low-tech strategies can go a long way in terms of reducing building energy use and meeting occupant comfort needs. Reviews of case study buildings and discussions with design teams and building managers reveal that in order to ensure proper operation of operable and automated facade systems appropriate follow-through is needed, not only in terms of system commissioning prior to occupancy, but also in terms of ongoing re-evaluation of system performance after occupancy. Regular system maintenance, occupant education, and assessment of occupant satisfaction are critical for ensuring that operable and automated systems are meeting energy and occupant comfort requirements. It is clear from interviews conducted for this report that facility managers and building occupants play an essential role in meeting performance goals. Below are a few points summarizing key case study and interview findings:

1. Integration of facade systems with other building systems provides an opportunity to maximize performance benefits and cost savings. For example, a high-performance facade can allow for a reduction in peak cooling loads and thus provide the opportunity to implement a smaller HVAC system and/or a low-energy alternative, which can translate into increased energy savings, reduced initial costs, and HVAC system operation and maintenance savings. Facade and HVAC system integration is especially advantageous in temperate climates such as that of Coastal California or the Pacific Northwest, where the relatively mild climate provides an opportunity to eliminate the need for cooling altogether.
2. Simple design strategies (proper building massing and orientation, moderate window-to-wall ratio, high-performance glazing, fixed exterior shading, etc.) are relatively robust design solutions and have a generally predictable impact on energy use, so these should be pursued whenever possible. As one of interview subject stated, “the most intelligent facade is as passive as possible.” Operable and automated facade system operation is more complex – optimizing performance requires regular maintenance, occupant education and ongoing re-evaluation of system performance over a building’s life. With operable and automated facade elements, the facility manager and building users become important players in realizing the performance potential of the facade.

3. When considering the implementation of a complex facade system, the design team should consider both first cost as well as the operation and maintenance (O&M) cost of the system, especially when considering an automated exterior system. O&M requirements are higher for exterior systems because they are exposed to the elements and more likely to get damaged (e.g., certain exterior shading devices may be prone to wind damage).
4. The project team should pursue a maintenance contract for complex facade systems during the design phase. Having a maintenance contract in place provides a way of ensuring that the system continues to operate properly after initial commissioning.
5. Design of trickle vents and automated windows for natural ventilation should be carefully evaluated with respect to occupant thermal comfort. Climate, operational design and control, occupant location, and activity level should all be taken into account during the design process in order to eliminate the risk of drafts. Deflecting/diffusing elements incorporated within the window opening or pre-heating air within a window cavity can help ensure that cool outside air mixes adequately with the indoor air before reaching the occupant. While the California Academy of Science case study reveals that the risk of drafts may be lower in circulation areas and other spaces in which occupants are moving around and have a higher metabolic rate, proper air mixing is critical in ensuring comfort among more sedentary office space occupants.
6. Implementation of operable windows should be accompanied by user education in order to ensure that window operation does not contribute to excessive heat losses and gains.
7. Complex facade systems require ongoing monitoring in order to ensure that they are performing as designed. While post-occupancy monitoring is typically outside of the scope of design services for most projects, ideally designers should coordinate with contractors, commissioning agents, building owners, and/or facility managers during the first year or longer to ensure that facade systems are properly commissioned and operating, and that building operators and occupants understand how to operate facade components. The design team's involvement during this time would provide the team with the opportunity to learn about how specific systems are operating in practice and develop ways to improve system design on future projects.
8. Post-occupancy occupant comfort surveys may be a useful means of assessing whether the facade is meeting occupant expectations. Additional operation and maintenance surveys and more-focused interviews with building managers may be especially useful for buildings with operable facade components.<sup>1</sup>

---

<sup>1</sup> The Center of the Built Environment has developed an occupant comfort and a facade operation and maintenance (O&M) survey focusing specifically on facade systems. For more information visit <http://www.cbe.berkeley.edu/research/survey.htm>

9. Survey and interview findings provide a useful source of information on critical design aspects, O&M requirements, and actual performance of complex facade systems. Since many architects and engineers are not able to follow-through to the occupancy phase of a project to see how systems are operating in practice, the development of a comprehensive database containing documented case study buildings and unbiased information could provide a very useful resource for design professionals and facility managers alike.

# 1. BACKGROUND

Window systems are critical to occupant comfort and well-being, but frequently bring a high level of complexity to the design process due to the inherent difficulty of striking a balance between occupant comfort needs, building energy use, project budget and a range of other considerations. While windows provide a way to introduce daylight and views, fenestration design must be carefully assessed in terms of visual comfort and solar heat gain in order to ensure occupant comfort and minimize energy use. Similarly, operable window openings can provide a way to cool and bring fresh air into a space, however, if not properly operated by occupants, can lead to an increase in building cooling and/or heating loads. Automated controls provide a way to control facade systems, as is the case with automated shading, openings and louvers, however they provide their own set of challenges – added operational complexity and cost, and the need for maintaining additional controls and components.

The following sections discuss some of the main challenges and research areas in facade performance. An exhaustive overview of all facade performance-related research (e.g., facade durability, moisture control, etc.) is beyond the scope of this paper – the primary focus of this work is the impact of the facade on: (1) energy use; (2) occupant comfort and occupant interaction with the facade; and (3) operation and maintenance considerations for complex facade systems.

## 1.1. FACADE IMPACT ON ENERGY USE: A BRIEF OVERVIEW

The impact of fundamental design strategies such as building orientation, climate, window-to-wall ratio (WWR), glazing type, fixed exterior shading on annual energy use and peak cooling loads has been thoroughly analyzed in a number of studies conducted over the past several decades. The impact of select design strategies, including window-to-wall ratio (WWR), glazing type, and fixed exterior shading on energy use and peak loads is assessed through a series of parametric studies in the book *Window Systems for High-Performance Buildings* (Carmody et al., 2004). The effect of the facade on energy use is also a consistent thread in the book *ClimateSkin* (Hausladen et al., 2008), and a major element in the book, *PlusMinus 20°/40° Latitude* (Hindrichs and Daniels, 2007). The premise of the latter book is based on the fact that most of the global population lives in the region from 20° north to 40° south latitude, and therefore this is a region on which design teams and manufacturers should focus attention for building performance. A majority of sources on this topic stress the potential of the building envelope in reducing energy use through the use of daylighting, solar heat gain control strategies, natural ventilation, and integration with HVAC and lighting systems.

As part of a multi-year project focusing on the performance of advanced glazing systems, LBNL has been conducting on-going testing of more advanced facade design strategies, including automated exterior and interior systems, under real sun and sky conditions (**Figure 1**). These

laboratory studies serve as the basis for the development of models describing the optical and thermal properties for shading systems, including automated venetian blinds and roller shades. Preliminary results of LBNL's studies of several shading systems, including venetian blinds and roller shades, have been implemented in LBNL's WINDOW software, a public software tool used for window energy efficiency labeling and rating, available for free from LBNL's website.<sup>2</sup> The software is widely used by the building industry to show glazing assembly compliance with building energy codes. The extensive WINDOW glazing library incorporates optical and thermal performance characteristics for the majority of commercially-available glazing, coating, interlayer and film products, and can be used to easily calculate the performance characteristics (e.g. U-value, solar heat gain coefficient, shading coefficient, and visible transmittance) for commercially available as well as custom glazing make-ups.



**Figure 1: Lawrence Berkeley National Laboratory windows testing facility**

*Photo Credit: Krystyna Zelenay*

In addition to expanding on the capabilities of WINDOW, LBNL has supported development of COMFEN (Commercial Fenestration) tool, a user-friendly simulation software tool for evaluating alternative facade configurations in the early design phase. The software uses Energy Plus as the underlying simulation engine, however due to its limited inputs, it can be used to quickly and efficiently compare the performance of alternative facade configurations, including automated roller shades and venetian blinds. Software outputs include annual energy use by end use (heating, cooling, fans, or lighting), peak energy use, average annual daylight illuminance and

---

<sup>2</sup> <http://windows.lbl.gov/software/window/6/index.html>

glare, and average annual thermal comfort. The program may be downloaded for free from LBNL's website.<sup>3</sup>

Research staff at LBNL was also involved as the daylighting consultant on the New York Times building. They have generated a series of reports discussing practical considerations in the design and installation of automated interior roller shades in combination with a daylight dimming system. All of these reports are available from their website.<sup>4</sup>

## 1.2. HUMAN FACTORS

Some of the factors contributing to occupant satisfaction in buildings include visual connections to the outside, thermal comfort, air quality, acoustics, access to daylight, and visual comfort. Numerous studies have explored the advantages that view and natural light provide for mental health, learning, and productivity (Heschong Mahone Group, 1999; 2001; and 2003) – a few are listed in the following sub-sections. In addition, recent studies on human thermal adaptation have shaped new standards for naturally-ventilated spaces that allow for broader temperature ranges (Brager and de Dear, 2001). Moreover, studies show that when ventilation, temperature, and daylighting are provided through the building envelope, and when users have the ability to control these elements, studies have shown a positive effect on occupant comfort, productivity and energy use (Leaman and Bordass, 1999; Brager et al., 2004). In addition to the thermal comfort and energy savings potential of operable windows (Daly, 2002; Emmerich and Crum, 2005), naturally-ventilated buildings are characterized by improved air quality and fewer sick building syndrome symptoms (Hedge et al., 1989; Seppänen and Fisk, 2001).

### 1.2.1. DAYLIGHT AND VISUAL COMFORT

Daylighting has a significant impact on buildings and occupants – it is essential to human health and well-being and productivity and a fundamental design element, which can offset a significant portion of a building's electricity use. William Lam's classic book on daylight and architecture, *Perception and Lighting as Formgivers for Architecture*, begins with the sentence, "light has always been recognized as one of the most powerful form-givers available to the designer, and great architects have always understood its importance as the principal medium which puts man in touch with his environment" (Lam, 1977). While attaining a well daylit space is clearly an important design objective, predicting the impact of facade design on occupant visual comfort and lighting energy use is challenging due to variation in occupant preferences and interior shade operation.

Whereas daylight can be used to offset electrical lighting use and have a positive impact on occupant productivity and mood, a number of studies suggest that without proper solar control, occupants are likely to draw blinds when visual or thermal comfort thresholds are exceeded and

---

<sup>3</sup> <http://windows.lbl.gov/software/comfen/comfen.html>

<sup>4</sup> [http://windows.lbl.gov/comm\\_perf/newyorktimes.htm](http://windows.lbl.gov/comm_perf/newyorktimes.htm)



that these blinds are likely to remain closed for some time, negating the potential benefits of having the window in the first place (Galasiu and Veitch, 2006; Inkarojrit, 2008). As a result, the impact of daylighting on visual comfort in office spaces has been an area of much study in recent years. A number of visual comfort field studies have been conducted in an effort to develop occupant behavioral models for blind and shade operation and glare metrics for assessing the quality of the visual environment and determining thresholds when occupant will open or close blinds or shades (Galasiu and Veitch, 2006; Wienold and Christoffersen, 2006; Inkarojrit 2008; Sutter, Y. et al, 2006; Tuaycharoen and Tregenza, 2007). Since visual discomfort leads to deployment of blinds or shades and an accompanying decrease in available daylight, a number of these studies have focused on the development of occupant behavioral models that could be applied in building simulation software to predict the effect of occupant blind and shade control on lighting energy use. Moreover, the development of more accurate algorithms for blind and shade operation would allow for an improved understanding of energy savings afforded by automated shading systems, and could also provide insight as to how to improve existing control algorithms for automated shading to achieve greater occupant comfort (Inkarojrit 2008).

The characterization of occupant visual comfort metrics is a complex area of study, and while several methods for the prediction of glare discomfort have been developed, they do not account for the effect of variability in individual response to glare (Galasiu and Veitch, 2006) and the complexity and variability of environmental conditions from office to office. A number of studies suggest that there is relatively low correlation between the various glare indices developed to date (e.g. daylight glare index (DGI), daylight glare probability (DGP), luminance contrast ratios) and occupant response (Wienold and Christoffersen, 2006). While none of the aforementioned metrics can be used to consistently predict occupant response in a particular environment, many of these metrics, such as luminance contrast ratios prescribed by IESNA (IESNA Lighting Handbook, 2000), can serve as useful design guidelines for comparing different facade configurations.

In addition to understanding occupant visual comfort preferences, another area of current research interest involves dynamic daylight performance metrics. While the widely-used daylight factor (DF) is calculated based on the ratio of the internal illuminance at a given point to the unshaded external horizontal illuminance under a CIE overcast sky, the dynamic daylight metrics are calculated based on annual climate data, and thus account for variations in both climate and solar position (Reinhart et al., 2006; Nabil and Mardaljevic, 2006). The calculation of these metrics is more complicated than the daylight factor method, and requires the use of special software such as DAYSIM, a Radiance-based annual daylight simulation software.<sup>5</sup> However the dynamic daylight method provides more detailed information on the quality of daylighting in the space throughout the year. An alternative to DAYSIM is using Rhinoceros 3-d modeling design software in combination with DIVA-for-Rhino – a sustainable design plug-in for Rhino.<sup>5</sup> The

---

<sup>5</sup> Please refer to Design Resources in the appendix for a more detailed description of Radiance - based software, including DAYSIM and the DIVA-for-Rhino plug-in.

research report, “Dynamic Daylight Performance Metrics for Sustainable Building Design” provides a more detailed discussion of the advantages of dynamic daylight metrics (Reinhart et al., 2006). It reviews several metrics, including *daylight autonomy* (DA), an index which represents the percentage of time during which the target illuminance is met during occupied hours for a particular point in space, and *useful daylight illuminance* (UDI).

### 1.2.2. THERMAL COMFORT

A fundamental aspect of buildings and the building enclosure is to provide a thermal environment which supports occupant comfort, productivity, and well-being. The basics of thermal comfort are covered in a number of sources including the *ASHRAE Handbook of Fundamentals* (ASHRAE, 2009) and ASHRAE Standard 55-2004, “Thermal Environmental Conditions for Human Occupancy,” which discusses factors affecting both overall thermal comfort and local thermal discomfort.

Thermal comfort is affected by the occupant’s metabolic rate, clothing insulation, and by four environmental factors: air temperature, radiant temperature, air speed, and humidity. It should be noted that ASHRAE Standard 55 only addresses thermal comfort under steady-state conditions, not the effect of temporal variation in environmental conditions on comfort. The ASHRAE Thermal Comfort Tool software can be used for calculating overall thermal comfort in accordance with the PMV (Predicted Mean Vote) model. PMV is an index corresponding to the occupant’s assessment of thermal conditions in an environment, where indices of -3 (cold) and +3 (hot) are the extremes of the seven-point scale. The standard recommends that PMV values for a particular space be within a -0.5 to +0.5 range – values which correspond to a 10% PPD (Predicted Percentage of Dissatisfied). While PMV is the most widely used comfort model, it is based on uniform thermal environments that are significantly different than those often experienced in the perimeter zones of buildings. In contrast to the ASHRAE tool, the UC Berkeley Advanced Thermal Comfort Model<sup>6</sup> can be used to simulate local perception and comfort of individual body parts, making it particularly appropriate for evaluating comfort in asymmetric thermal environments, such as those in building perimeter zones, and can simulate comfort under both steady-state and transient environmental conditions. A procedure for assessing the thermal comfort impact of fenestration on occupant comfort is described in a 2006 report developed by the Center for the Built Environment (CBE) for the National Fenestration Rating Council (Huizenga, 2006). The report includes a detailed overview of relevant prior studies, a description of the UCB’s Advanced Thermal Comfort Model, and a discussion of Fanger’s development of PMV and PPD models. The issue of local thermal discomfort is discussed in detail in the two-part CBE report “Partial- and Whole-Body Thermal Sensation and Comfort.” Part I of the report addresses “Uniform environmental conditions,” and Part II discusses “Non-uniform environmental conditions” (Arens et al., 2006).

---

<sup>6</sup> <http://www.cbe.berkeley.edu/research/briefs-thermmodel.htm>

Research focusing on thermal comfort expectations and perceptions has shown that occupants who can manage their environment through personal operation of windows are comfortable over a wider range of indoor temperatures than occupants in air-conditioned buildings. These studies led to the development of an “adaptive” thermal comfort model, which was adopted in the 2004 revision to ASHRAE Standard 55. The standard stipulates that the allowable PPD value can be increased to 20% in naturally-ventilated buildings (Brager and de Dear, 2001). In more recent studies conducted at the Center for the Built Environment (CBE), and verified by other research, researchers found that in both air-conditioned and naturally-ventilated buildings, most occupants prefer to have more air movement, and very few want less (Arens et al., 2009; Hoyt et. al., 2009). This was found to be true for a range of temperatures, even in many cases with slightly cool temperatures. Consequently, ASHRAE Standard 55 was again modified in 2009 to expand the allowable airspeed range in neutral to warm conditions. This revision now allows building designers to use air movement to improve both energy and comfort performance, and provides opportunities for implementing energy-efficient systems which have cooling capacity limitations, or that are inherently slow-acting such as radiant floors and ceilings.

### **1.3. ENERGY CODES AND RATING SYSTEMS**

#### **1.3.1. MEASURING BUILDING ENERGY USE**

Benchmarking building energy use presents a number of challenges. In North America, Energy Use Intensity (EUI) is a standard measure of all energy used by a building, as measured at the site. Source energy use takes into account the losses due to generation and transmission to the site. The average source energy for electricity in the U.S. is approximately three times the site energy. In some countries the equivalent carbon emissions are seen as the most accurate complete measure of energy impacts. But impacts of nuclear waste disposal are not well-represented by carbon equivalents. An additional factor complicating building energy use benchmarking is the appropriate definition of gross or net floor area measured. For example, are vertical openings such as shafts, elevators, and atria, included? What defines the perimeter of the building—inside surface of glass, outside face of exterior finish? Are semi-conditioned or un-conditioned spaces included? Exceptional uses such as commercial kitchens and computer server centers are also difficult to characterize when they are included within buildings. All of the metrics typically used show energy used per unit of floor area, but do not take into account occupant density. Obviously buildings that are sparsely populated may use more energy per unit area, but they can use less energy per person. Moreover, building populations often vary and it is difficult to capture this impact. In Europe, a significant effort has gone into finding standardized definitions to provide accurate comparisons between buildings within the EU.

### 1.3.2. CURRENT TRENDS IN THE U.S.

Energy use in U.S. buildings is documented by the Commercial Building Energy Consumption Survey (CBECS) which is conducted every three to four years by the Department of Energy (DOE) through the Energy Information Administration (EIA). Energy codes are typically administered on a state-wide basis and many states either adopt the ASHRAE 90.1 standard directly, or base their code in some way on it. Along with other organizations, ASHRAE is moving incrementally toward the goal of net-zero energy buildings. The 2030 Challenge<sup>7</sup> which seeks net-zero buildings by the year 2030 has had a significant impact, and has been adopted by the American Institute of Architects (AIA) nationally. Many firms have also signed on to the 2030 Challenge directly. These energy goals and energy use through 2003 documented by CBECS are shown in **Figure 2**. The graph shows the wavering downward trends from the 1980s through 2003 for actual building energy use data from CBECS, and the targeted energy use reductions for the next 20 years. Similar to many of the zero-energy initiatives, the graph does not differentiate between building energy use and on-site renewable energy generation.

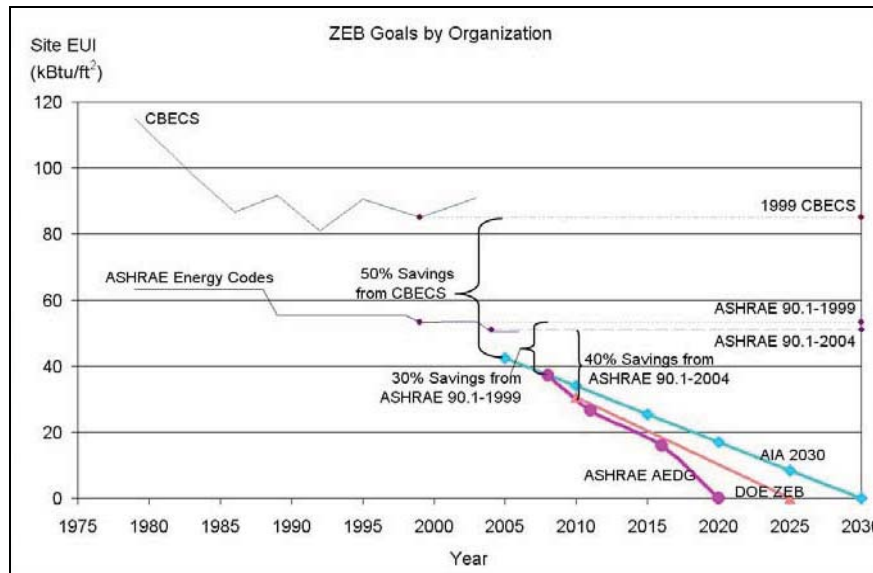

**Figure 2: U.S. Zero Energy Building Goals by Organization**

Source: Paul Torcellini, NREL, presentation slide, 2007

Many research and education programs are beginning to take on this topic to better understand the issues of net-zero energy buildings. The U.S. Department of Energy (DOE) Zero Energy Building website contains case studies of several net-zero energy buildings.<sup>8</sup> The 2030 Challenge focuses on incremental reductions in building energy consumption over the next two decades. The AIA Committee on the Environment (COTE) runs a program to select the “Top Ten”

<sup>7</sup> [http://www.architecture2030.org/2030\\_challenge/index.html](http://www.architecture2030.org/2030_challenge/index.html)

<sup>8</sup> [http://www.nrel.gov/buildings/comm\\_building\\_design.html#case\\_studies](http://www.nrel.gov/buildings/comm_building_design.html#case_studies)

sustainable projects annually.<sup>9</sup> Their submission requirements include detailed simulated and actual energy use data as well as other performance metrics. The Whole Building Design Guide is a website sponsored by the National Institute of Building Science (NIBS) with information on high-performance buildings, including sustainability, energy, and occupant comfort and well-being.<sup>10</sup> As discussed in the Introduction, USGBC's LEED program has come under scrutiny for not prioritizing energy-use in its credit structure.<sup>11</sup> Over the past year, the USGBC has been investigating their credit structure and seeking input for raising the performance requirements. The Cascadia Green Building Council has developed their own rating system for going beyond LEED, called the Living Building Challenge.<sup>12</sup> For this program, net-zero energy use is a prerequisite for certification. Although the actual adoption of the goals of the various organizations may be slow, there is clearly a strong interest in increasing the performance of buildings.

### 1.3.3. CURRENT TRENDS IN EUROPE

Similar to the U.S., several programs are in place in Europe to set standards for energy codes, develop energy certificates, and to rate the sustainability of buildings. The European Directive for Energy Performance of Building (EPBD) was established by the European Parliament and Council in 2002 in order to unify the diverse national regulations and calculation standards (Eicker 2009). The standard was adopted in Germany as the Energy Savings Ordinance – Energieeinsparverordnung (EnEV) 2007. One feature of the EPBD and EnEV is the establishment of a standardized system to measure and document building energy use through energy certificates. Energy certificates were to be posted at all buildings over 1000 m<sup>2</sup> by October 2008, however actual adoption has been much slower. Two types of certificates are required – an asset rating, also known as an Energy Performance Certificate (EPC) which determines the intrinsic efficiency of a building assuming standard use, and an operational rating, also known as a Display Energy Certificate (DEC), which is based on the actual total energy used by a building over a year (**Figure 3**). Benchmarks are established by building use type and adjustments are also made based on climate.

A voluntary UK program, Carbonbuzz, evaluates the total greenhouse gases emitted in the operation of buildings.<sup>13</sup> Germany has also established Forschung für Energieoptimiertes Bauen (EnOB), a program to promote building energy optimization.<sup>14</sup> German worker health and safety regulations require direct access to fresh air and natural light which limits room depths.<sup>15</sup> Overall sustainability rating programs similar to USGBC's LEED program have also been established –

---

<sup>9</sup> AIA COTE Top Ten website: <http://www.aiatopten.org/hpb/>

<sup>10</sup> Whole Building Design Guide website: <http://www.wbdg.org/>

<sup>11</sup> USGBC website: <http://www.usgbc.org/>

<sup>12</sup> International Living Building Institute website: <http://ilbi.org/>

<sup>13</sup> RIBA CIBSE Carbonbuzz website: <http://www.bre.co.uk/carbonbuzz/>

<sup>14</sup> Forschung für Energieoptimiertes Bauen (EnOB) website: <http://www.enob.info/>

<sup>15</sup> The Association of German Engineers website: <http://www.vdi.eu/>



# ENERGIEPASS

Projektbezeichnung Bürogebäude Münchner Tor

Erstellt am 24. Januar 2005

## Gesamtbewertung Primärenergiebedarf

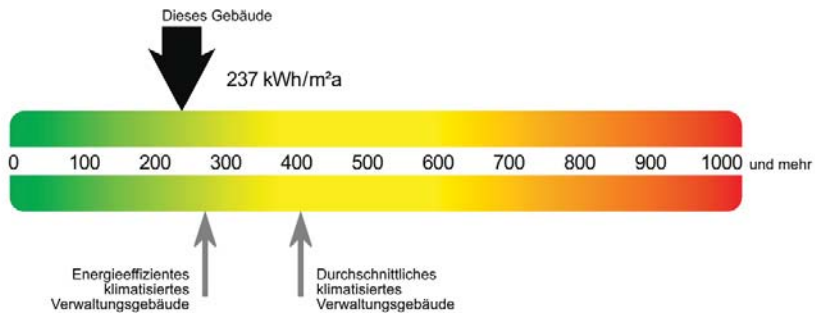

Gebäudetyp / Nutzungsart	Klimatisiertes Verwaltungsgebäude
Adresse	Schlüterstraße 6-10, 80805 München
Nutzer	Münchener Rückversicherung
Baujahr Gebäude	2003
Baujahr Anlagentechnik	2003
Bruttogrundfläche	49.258 m²
Energiepass erstellt mit	DIN V 18599



Nutzer  
Münchener Rückversicherungs-Gesellschaft AG  
Königinstraße 107  
80802 München

Aussteller  
Fraunhofer-Institut für Bauphysik  
Nobelstraße 12  
D-70569 Stuttgart



## Detailanalyse

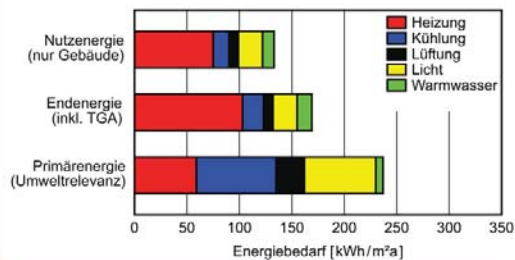

Figure 3: Münchner Tor Energy certificate

Source: Munich RE website

BRE Environmental Assessment Method (BREEAM) in the UK.<sup>16</sup> and the Deutsche Gesellschaft für Nachhaltiges Bauen (DGNB) in Germany.<sup>17</sup> As in the U.S., numerous efforts are underway in Europe to promote sustainable buildings and highly energy-efficient buildings through regulation and voluntary standards.

Among the standards that must be met by European buildings is a restriction on overall energy consumption outlined by the EPBD. In Germany section 8 of DIN 4108-2 – *Thermal protection and energy economy in buildings: Minimum requirements to thermal insulation*, regulates the allowable maximum summer room temperature. Building envelope strategies are a primary means of balancing these requirements. The pertinent section of the standard, “Mindestanforderungen an den sommerlichen Wärmeschutz” (Minimum Requirements for Summer Heat Protection) prescribes minimum envelope shading requirements for preventing summer overheating and providing a comfortable environment in each occupied zone. The *incoming solar energy factor* – a function of window-to-floor ratio, glazing solar transmittance, and shading type; is compared to the *maximum allowable incoming solar energy factor*. The latter is determined based on climate region, interior construction type, night ventilation strategy, glazing orientation and glazing inclination for a particular space.

## 2. PURPOSE

Through a critical analysis of case study buildings in North America and interviews with building professionals in both northern Europe and North America, this report identifies facade design solutions that enable the development of spaces that minimize the need for HVAC and lighting energy use, while maximizing occupant well-being and connection to the outdoors. The goal of this research is to answer questions related to the benefits and barriers to the implementation of advanced facade design strategies and to accelerate the adoption of both simple and advanced facade technologies in the U.S. building stock. How are European buildings striving for high performance, and what can be learned from them? What are the benefits of simple facade design solutions compared to advanced facade systems and components? What are the barriers preventing the adoption of advanced facade solutions in the U.S.? What are some of the issues that arise in the design, construction, and operation of projects with advanced facade systems?

---

<sup>16</sup> BRE Environmental Assessment Method (BREEAM) website: <http://www.breeam.org/>

<sup>17</sup> Deutsche Gesellschaft für Nachhaltiges Bauen website: <http://www.dgnb.de/en/index.php>

## **3. APPROACH**

### **3.1. INTERVIEWS**

U.S. and Northern European professionals with substantial experience in the design and construction of building envelopes were sought out in order to obtain their perspective on the design and construction of high-performance facades, as well as the benefits and barriers to the adoption of advanced facade systems.

Interviews with German, British and Dutch design professionals, researchers, and building managers were conducted during the summer of 2008. This initial phase of the study encompassing background research and travel in central and northern Europe was funded by a fellowship from the Architecture Foundation of Oregon (AFO).<sup>18</sup> Interviews with design professionals, researchers, and building managers in the U.S. were conducted between February 2009 and July 2010. The professionals were selected based on their level of involvement in the design, construction, or operation and maintenance of case study buildings presented in this paper and/or their expertise with respect to energy-efficient building envelope design. A complete list of interviewees is included in Appendix A.

The interviews focused on design intentions, performance objectives, design process and tools, promising new technologies, and lessons learned. The architects interviewed are partners or senior staff from firms that are highly-regarded for design and their emphasis on sustainability and energy efficiency. Among window manufacturers, those interviewed included Josef Gartner Facades and Schüco Window Systems, two companies that offer both standard as well as custom window system products, including framing with excellent thermal performance, operable windows, and integrated shading and daylight-redirecting systems. Most of the researchers interviewed offered broad perspectives regarding facades and building performance; researchers at the Usable Building Trust focus on post-occupancy evaluations of buildings in terms of operation, performance and occupant comfort.

### **3.2. CASE STUDIES**

Four North American buildings were selected for facade case studies. These buildings demonstrate envelope strategies ranging from simple yet effective designs to advanced dynamic facade systems. The case studies illustrate the benefits as well as the challenges seen in specific solutions with respect to energy use, comfort, and operation and maintenance. Detailed information on the following four case study buildings can be found in 6. *Case studies*:

---

<sup>18</sup> The Van Evera Bailey Fellowship is awarded annually to mid-career professionals by The Van Evera and Janet M. Bailey Fund of the Oregon Community Foundation in collaboration with the Architecture Foundation of Oregon.



1. Terry Thomas Office Building– Seattle, Washington
2. Marin Country Day School – Corte Madera, California
3. California Academy of Sciences – San Francisco, California
4. David Brower Center – Berkeley, California

Information on case study buildings was gathered through a review of existing literature (online electronic sources, published journal articles), interviews with design team members (architect, mechanical engineer and/or energy or daylighting consultant) and, in some instances, building managers. The authors were particularly interested in finding buildings with automated facade systems in order to identify practical considerations in the design and operation of these systems. These complex facade design solutions are complemented by additional case studies incorporating simpler facade configurations. Regardless of the level of facade complexity, all of the included case studies incorporate fundamental design strategies (proper building orientation, shallow floor plan, moderate window-to-wall ratio, etc.); a prerequisite for attaining optimal facade performance. In all four case studies, the elimination of the cooling system or the incorporation of a low-energy cooling alternative placed particular demands on the design of the facade – these projects required a particularly careful assessment of the impact of facade design and operation on occupant summer comfort and peak cooling loads.

While the case studies in this paper focus on North American buildings, case studies of Northern European buildings with advanced facade design strategies are available at the Better Bricks website.<sup>19</sup>

## **4. CASE STUDIES: FUNDAMENTAL DESIGN STRATEGIES**

The case studies reviewed for this report, as well as high-performance European buildings identified in interviews with European design professionals, revealed a number of common design strategies. This section serves as a summary of these key design strategies, including building massing and orientation, fenestration layout, and natural ventilation. Effective facade strategies can range from simple passive solutions with low or moderate window-to-wall ratio and fixed exterior shading to highly complex design solutions with automated shading and ventilation elements, which can further improve performance, but require additional operation and maintenance. The incorporation of these strategies provides the opportunity to minimize the need for electric lighting, cooling, and heating energy and enhance occupant well-being and productivity. Since occupant interaction with the facade can greatly affect building energy use, facade performance cannot be understood in isolation, but rather as a building component whose

---

<sup>19</sup> Integrated Facades: High-Performance Innovations from Northern Europe. *Better Bricks website*. <http://betterbricks.com/design-construction/tools-resources/integrated-facades>

performance is interconnected not only with building systems, but also with occupant thermal and visual comfort.

To maintain a comfortable indoor climate, fixed and operable shading systems are used in northern Europe to limit solar heat gain, and operable windows are implemented to allow for natural ventilation. European buildings typically have a narrow floor plate which enhances the effectiveness of natural ventilation and daylighting, and reduces the need for cooling and electrical lighting. The prevalence of narrow floorplates among European office buildings can be explained by a combination of factors: working condition standards, economics, and cultural expectations in terms of access to daylight and operable windows. Natural ventilation enables the elimination of expensive ventilation and cooling systems.<sup>20</sup> In fact, air-conditioning is used very selectively – typical office spaces in northern Europe are not air-conditioned, with the exception of conference and other meeting rooms which are often subject to higher internal loads and thus more likely to need mechanical cooling. In contrast, typical U.S. office buildings, especially those constructed in the last three decades of the 20th century, have sealed envelopes and rely on mechanical heating and cooling to maintain a uniform interior temperature conditions.

#### **4.1. MASSING AND ORIENTATION**

Building massing and orientation drive fenestration layout and design and have a significant impact on building performance. Orienting the building so that its long elevations face north and south while minimizing facade exposure on the east and west elevations is advantageous in that it allows for easier control of solar heat gain through the implementation of exterior shading (see discussion in section 4.3. *Solar control*). Moreover, effective distribution of daylight in a space also requires careful consideration of floor plate depth as well as the layout of service and core spaces.

Floor plates in Germany and central Northern Europe are typically quite shallow, especially when compared with U.S. buildings. Thomas Auer of Transsolar KlimaEngineering – a German consulting firm, explains the relationship between floor plate depth, facade, and mechanical system design: spaces with a floor depth greater than 40 feet have an internal zone with very limited access to the facade and consequently require mechanical ventilation. It makes economic sense (in terms of energy use) to minimize the floor plate depth and thus eliminate the need for mechanical air supply, however greater attention must in turn be paid to the design and performance of the facade. A shallow floor plate, combined with a well-shaded facade with

---

<sup>20</sup> Auer, Thomas (2008, July 7). Personal interview with managing director at Transsolar KlimaEngineering.

operable windows and exposed thermal mass, provides the opportunity to eliminate air-conditioning in mild climates, e.g., Central Europe, Northwestern U.S., etc.<sup>21</sup>

Having a fundamental understanding of the potential benefits of massing and orientation allows the design teams to capitalize on these strategies when possible, or seek other strategies if necessary. For example, site constraints may require a less-than-optimal building orientation or footprint and require alternative design solutions, as is seen in the case of the Terry Thomas Office Building in Seattle. The square-shaped lot and an adjacent building on the south side of the lot, which precluded the incorporation of south-facing windows, led the design team to incorporate a central courtyard, by which they were able to minimize the depth of the floor plate and bring in additional light through courtyard windows. For the design of the David Brower Center in Berkeley, vertical height restrictions forced the design team to vary the height of each floor based on programmatic requirements and daylight availability. Moreover, by incorporating roof skylights the design team was able to reduce the height of the top floor, and thereby increase the height of the bottom retail floor.<sup>22</sup> Since some strategies, such as automated exterior shading for solar control, are likely to be more complex and expensive, maximizing the benefits of massing and orientation in the earliest stages of design can have a significant impact on building performance and cost.

## 4.2. TRANSPARENCY

While window systems play a critical role in providing daylight and as well as a visual – and often physical, connection to the outside, they introduce significant complexity in terms of managing thermal transfer and daylight control. In spite of these challenges, the design trend towards highly-glazed facades has held steady for several decades and many clients and occupants have come to expect that the modern building will afford them with ample daylight, views and a sense of connection to the outside. Over the course of the last decade there has been a fair amount of controversy and discussion about the performance of highly transparent buildings. In November 2004 the German political and cultural magazine *Der Spiegel* published an article titled “Life in a Sweat Box” (Schulz, 2004), which took a rather brash swipe at highly-glazed buildings, including the Commerzbank in Frankfurt and the Swiss Re tower in London. The article refers to a study of twenty-four glass towers conducted by the Darmstadt Institute for Housing and Environment which found that the towers consume 95 to 220 kBtu/ft<sup>2</sup>-yr (300 to 700 kWh/m<sup>2</sup>-yr) as primary energy. While this is considered poor performance for conventional buildings, the data behind the study was not publicly released.

Many European buildings, including projects by the European design teams interviewed for this report, also demonstrate the trend towards highly transparent facades. However many European

---

<sup>21</sup> Auer, Thomas (2008, July 7). Personal interview with managing director at Transsolar KlimaEngineering.

<sup>22</sup> Loisos, George (2010, July 6). Personal interview with principal at Loisos + Ubbelohde.

interviewees expressed mixed attitudes about such high levels of transparency. A senior architect at Foster and Partners noted that clients typically associate the firm’s work with highly transparent buildings with floor-to-ceiling glass. But he noted that the office is losing interest in the all-glass building and highly elaborate custom curtain wall assemblies for environmental and economic reasons. Although London City Hall and Swiss Re, were completed relatively recently (in 2002 and 2004, respectively), they were started over ten years ago. The office has since moved on with their intentions, priorities, and approach to building design, and is now exploring ways “to make beautiful, more solid buildings.”

While one approach for managing solar heat gain and loss is to use transparency in a limited and strategic fashion, in cases where there is a higher area of glazing, a carefully engineered multi-layered assembly can help control light and heat exchange. Russell Fortmeyer describes this approach in the article “Transparency: Literal and Sustainable” (Fortmeyer, 2009). The North American case study buildings included with this paper are a good example of this approach – while all of the case studies incorporate moderate to high window-to-wall ratios, all glazing is shaded through the use of either fixed or automated exterior shading.

Ken Shuttleworth – a former Foster partner and lead designer of London City Hall and 30 St. Mary Axe (Swiss Re), has formed the architectural firm MAKE and become an outspoken critic of highly transparent buildings. In his presentation paper for the CTBUH 8<sup>th</sup> World Congress, “Form and Skin: Antidotes to Transparency in High Rise Buildings” CTBUH 8<sup>th</sup> World Congress, March 2008, he states:

“The design of the tall building facade is at the forefront of a change. The fully glazed, totally transparent office block is dead, a thing from the past when regulations were more lenient and our attitude to the environment more naive. The design of the tall building facade needs to incorporate more opacity, more solidity and more insulation, with windows strategically located where natural light penetration is actually required, as opposed to simply wrapping every inch of the building skin in glazing.”<sup>23</sup>

A fully-glazed facade constructed using present off-the-shelf technologies is not environmentally sustainable. While some highly-glazed facades with advanced systems for controlling heat gains and losses may be an exception, they are likely to bring their own set of challenges in the form of increased cost, additional operation and maintenance requirements, and/or possibility of not performing as designed. Rather than solely relying on highly experimental and expensive facade solutions as a means for mitigating heat gains and losses in highly-glazed facades, it may be worthwhile to consider simpler strategies, mainly more moderate window-to-wall ratios and high-performance glazing as the first step in meeting building energy use and occupant comfort requirements, and then

---

<sup>23</sup> Ken Shuttleworth presentation paper:  
[http://www.ctbuh.org/Portals/0/Repository/T13\\_Shuttleworth.ef1f055c-cd18-46c9-b72f-fa7e8c3009bb.pdf](http://www.ctbuh.org/Portals/0/Repository/T13_Shuttleworth.ef1f055c-cd18-46c9-b72f-fa7e8c3009bb.pdf)

selectively incorporating more complex automated systems in order to further improve performance.

### 4.3. SOLAR CONTROL

While some direct sunlight may be desirable at certain times or in certain spaces, direct beam radiation can significantly increase energy use and peak cooling load, and result in visual and thermal discomfort. From an occupant comfort standpoint, the use of a high-performance low-e coating alone is generally not a sufficient solar control strategy, since it does little in terms of controlling direct sun which can negatively impact both thermal and visual comfort. Moreover, high-performance glazing does not effectively block direct beam radiation coming from low altitude sun angles (e.g., east and west elevations), which can lead to a significant increase in peak cooling loads. Thus, additional solar control strategies in the form of interior shading, special glazing treatments, scrims, screens and/or fixed or operable exterior shading are generally needed in addition to high-performance glazing. The selection of a particular strategy will depend on project needs and site conditions. All of the case study buildings incorporate some form of exterior shading, and, in all cases, the primary factors driving the implementation of shading was the need to minimize solar gain in order to eliminate the need for cooling and to meet occupant thermal comfort needs.

#### 4.3.1. SPECTRALLY-SELECTIVE GLAZING COATINGS

Perhaps the most common window solar control strategy are spectrally-selective glazing coatings – coatings that transmit some wavelengths of energy but reflect others. While glazing with a quality spectrally-selective coating can go a long ways in terms of reducing solar heat gain, a reduction in the *solar heat gain coefficient* (SHGC) is typically accompanied by a corresponding reduction in the *visible light transmittance* (VT) of the glazing. The *light-to-solar-heat-gain ratio* (LSR) is one good indicator of glazing performance and can be easily calculated by dividing glazing VT by the SHGC. For projects seeking to minimize external solar gains (e.g. most office buildings in cooling-dominated climates) while maximizing daylight, glazing with a high LSR is preferred, provided that the glazing SHGC meets the project glazing requirements. However, projects seeking some solar heat gain, e.g. many buildings in cooling-dominated climates, will use glazing with a higher SHGC, and the LSR in these cases will be lower. Presently, the best-performing coatings have an LSR just over 2 and a glazing VT. A similar LSR can be attained through the use of a moderately well-performing coating on surface #2 in conjunction with a tinted outboard lite. While using a tinted rather than clear outboard lite can provide a marked decrease in the solar heat gain coefficient, a tinted inboard lite will provide little benefit in terms of SHGC reduction but still reduces the unit's VT. The inboard lite will thus typically be clear if a high VT is desired.

#### 4.3.2. SCREENS AND FRITS

Screens and frits can work with changing exterior and interior light conditions to create a dynamic and sometimes diaphanous effect. By reducing solar heat gain through transparent facade elements, and in some case reducing glare, these elements can benefit facade performance. Ceramic frits are applied to one or more glass surfaces, typically on an inner face to avoid damage to the frit pattern. A more unusual application of fritted glazing is installed at the Salvation Army Headquarters in London, where the fritted glass panels are mounted in front of the facade.

Screens can be installed inside insulated glass units, but are typically supported by metal framing and installed on the exterior side of the glazing, as for example, on the south elevation of the San Francisco Federal building. While dark screens can be used to reduce visual discomfort, light-colored translucent frits can become very bright surfaces and lead to glare discomfort. Since these treatments are static, glare control may only be effective during certain times of day during a part of the year. It is most effective to use these devices as a screening layer to reduce solar heat gain, with a separate element – an operable interior window covering – for managing glare.

A unique screen design which effectively balances the need for solar control with visual comfort and view was developed for the Seattle Central Library. While the design team had looked into several options for solar heat gain control, including tinted glazing and frits, in the end they settled on an expanded aluminum mesh material suspended between two sheets of glazing that took advantage of the three-dimensional quality of the mesh. When expanded, the metal mesh creates a diamond-shaped opening and a series of mini “louvers” above the opening which act as micro-shading (**Figure 4** and **Figure 5**). While this custom solution was quite expensive and required third party testing for solar performance, the areas of the curtain wall which incorporated the aluminum mesh provide very good performance both in terms of view to the outside and the SHGC; in fact, the curtain wall SHGC for glazing with the mesh is 0.16 – this includes the contribution of the 4”-wide glazing framing. The diamond shape of the mesh complemented the project design aesthetic by mimicking the larger diamond-shaped structural grid, and the diamond-shaped glazing on the project.<sup>24</sup> It should be noted that the mesh was only used at exterior surfaces receiving the highest solar heat gain (approximately 50 percent of the curtain wall) in order to minimize cost and increase visible light transmittance at all non-mesh surfaces.

---

<sup>24</sup> DelFraino, Steve (2008, April 19). Telephone interview with architect at LMN Architects.



**Figure 4: Seattle Central Library glazing**

*Photo Credit: Mark Perepelitza*



**Figure 5: Detail of expanded aluminum mesh at Seattle Central Library**

*Photo Credit: Mark Perepelitza*

### 4.3.3. FIXED EXTERIOR SHADING

Fixed horizontal and vertical elements can provide visual texture and enrich the architectural aesthetics of the facade, as well as create shading effects inside that vary throughout the day and throughout seasons. Fixed horizontal elements are common on south elevations, because they are particularly effective in blocking undesirable direct solar gain during the cooling season while allowing low-angle direct sunlight to enter the building during winter months, which can be advantageous in buildings that have a demand for heating during the cooler season.

While the use of shading for solar control can be effective in terms of managing energy use and peak loads, direct sunlight penetration with low-altitude sun is problematic – apart from resulting in potential thermal discomfort, bright patches of sunlight on the work surface and reflections on the computer screen contribute to visual discomfort. One effective shading combination includes fixed exterior devices for managing solar heat gain, and operable interior systems for managing glare, such as those seen at the David Brower Center (see case studies in *6 Case studies*). Exterior shading with a light-colored and reflective surface, such as an exterior lightshelf, can serve a dual purpose of shading and redirecting daylight deeper into the space, but typically works best above eye level – outside the occupant’s field of view, so that it does not become a source of glare. Depending on the position of the shading with respect to the occupant’s field of view, one side of the shading device may need to be less reflective so that it does not become a source of glare.

While fixed exterior overhangs can be quite effective on the south elevation, their impact is limited on the east and west elevations where low sun angles in the morning and afternoon are somewhat better controlled through vertical shading. However, even with vertical shading, solar gain on east and west elevations is very difficult to manage without obstructing the view out, so automated exterior shading may be a good alternative for projects with large glazing areas on the east and west elevations (see following section).

### 4.3.4. AUTOMATED EXTERIOR SHADING

The inherent limitations of fixed shading systems in terms of controlling for variable sun angles can be addressed through automating shading systems. Automated shading systems are especially well-suited for east and west orientations, where the systems can be effective in the morning and afternoon to block low-altitude direct sun and reduce solar heat gain when needed without sacrificing views at other times. Automated venetian blinds or louvers can be used to block direct sun, but by remaining at least partially open they can still redirect and admit some daylight into the space. Exterior roller shades can also be used to manage heat gain and glare, however the selection of a material with a low openness factor is critical. Dividing the window into a lower view area and an upper daylighting portion allows the utilization of shading systems with different control sequences in order to maximize the daylight benefit provided by the upper portion of the window. While performance benefits of automated exterior shading systems can be significant if systems are operating as designed (Lee and Selkowitz, 2009) high wind loads often



preclude the implementation of these systems on high-rise buildings. As a result, some high-rise buildings incorporate a double-skin envelope, which provides a means of protecting the shading systems from wind (see 4.5 *Double-skin facade*).

In Europe, automated exterior shading systems have been in use for several decades. Manually-controlled exterior shading systems can be effective for small buildings and/or trained and committed building users, but automated systems are generally required for larger buildings. In contrast to manually-operated exterior systems, automated systems offer more reliable control of solar heat gain while maximizing daylight. However, a careful design and maintenance plan are needed to ensure system durability and proper operation (see 5.3.2. *Automated exterior shading* for a more detailed discussion of operation and maintenance considerations). While relatively common in Europe, automated exterior shading is not as common in the U.S. due to different expectations in terms of building performance and quality, cost and concerns about system operation and maintenance (Lee et al., 2002; Southern California Edison, 2008). A lack of awareness of the benefit of these systems in terms of peak cooling load reductions may also be a contributing factor, however there are at least two documented projects – the Terry Thomas Office Building and Marin Country Day School administrative building, that have implemented these systems in an effort to reduce peak cooling loads and eliminate the need for mechanical cooling (see case studies).

#### **4.4. NATURAL VENTILATION**

Natural ventilation can be used to enhance building conditioning in four ways:

- a. Providing fresh air (indoor air quality)
- b. Providing air movement to increase comfort at higher temperatures
- c. Removal of overheated air from interior spaces
- d. Cooling of thermal mass

In relatively mild climates such as portions of Northern Europe, the Pacific Northwest, Coastal California, and some U.S. Mountain States, natural ventilation can be used in conjunction with thermal mass for much of the year to provide fresh air and help maintain comfortable indoor temperatures, reducing or in some cases eliminating the need for mechanical ventilation and compressor-based cooling.

Operable windows, included in all of the case study buildings described in this report, are a direct and effective means of providing natural ventilation and are standard in European buildings. The ubiquity of this feature in high-performance facade projects in Europe is evidence of the high level of importance attributed to operable windows by society. One interview subject noted that it would be difficult to find a tenant for a building in Germany without operable windows.<sup>25</sup> In addition to

---

<sup>25</sup> Auer, Thomas (2008, July 7). Personal interview with managing director at Transsolar KlimaEngineering.

providing occupants with a sensation of good air quality and thermal control, natural ventilation provides building users with a tangible, sensual connection to the outside. The number of viable hours for natural ventilation varies by climate—in Winnipeg it is “about 30 percent of the year, in Stuttgart it’s 50 percent of year, perhaps 80 percent of the year in Oregon.”<sup>25</sup>

The effectiveness of operable windows is not driven solely by design decisions such as window size and layout. Occupant operation of windows can also have a large impact on performance, so steps should be taken to influence occupants to operate windows in a manner that will enhance building performance (e.g., opening windows for cooling in summer months but keeping them closed during the heating season if it is more efficient to mechanically ventilate the space). See additional information on this topic in section 5.3.4. *Operable windows*.

## 4.5. DOUBLE-SKIN FACADE

While exterior shading can be effective for controlling solar heat gain and filtering daylight, it may be difficult to implement on the upper portions of tall buildings due to higher wind loads. The double-skin envelope is an expensive albeit effective means for dealing with adverse environmental conditions, and while its application is limited in the U.S., this strategy has been implemented on a number of European high-rises.<sup>26</sup> This solution can provide additional benefits when outdoor air quality or noise is a concern, for example, in buildings near busy highways, airports or other sources of noise and airborne contaminants, or where the use of operable windows for natural ventilation would otherwise not be possible.

While this strategy was first explored over one hundred years ago, contemporary configurations were developed more recently, in the 1990s, in an attempt to accommodate exterior shading and operable windows on European high-rise buildings. The effectiveness of double-skin facades has been somewhat controversial, perhaps because their benefits may have been overstated, some were not well-designed, and in a number of cases performance expectations were not realized. Nonetheless, a new generation of double-skin facades installed on several new buildings hold promise for improved performance. While it is an expensive and not a common strategy even by European standards, the additional cost may be justified on some projects, depending on project requirements and site constraints. However, as one interview subject pointed out, the double-skin is likely to be economically feasible only in Northern Europe, and is typically out of the question for U.S. speculative projects.<sup>27</sup>

Double-skin facades can be an effective way of managing solar heat gain and daylighting through an operable blind system in the cavity, as well as ventilation through the cavity configuration. A double-skin facade can also be used to minimize drafts in naturally-ventilated spaces when cool

---

<sup>26</sup> Perepelitza, M. (2009). Integrated Facades: Case Studies. In *BetterBricks.com*. Retrieved August 15, 2010, from <http://www.betterbricks.com/CaseStudies.aspx?ID=1136>.

<sup>27</sup> Kragh, Mikkel (2008, June 17). Personal interview with Arup.

outdoor conditions would otherwise prohibit the use of operable windows by moderating air velocity and by preheating air in the cavity.

One interviewee noted that double-skin facades typically provide high shading values via operable shading in the cavity.<sup>28</sup> The U-value is also somewhat better compared to a standard curtain wall system with operable windows. While motorized exterior flaps can further improve the U-value of the double-skin, cost and maintenance for the flaps generally make this option not cost effective. The interviewee estimated that the cost of a double-skin was typically one-and-one-half times that of a standard wall, and perhaps double the cost when operable exterior flaps are included.

#### **4.6. SEMI-CONDITIONED ATRIA**

One strategy to increase access to daylighting and natural ventilation without a significant increase in exterior skin area is to incorporate semi-conditioned atria. Daylight from the atrium is introduced to occupied spaces at its perimeter. To minimize energy use, atria can be designed to use natural ventilation with minimal need for additional conditioning. The Umweltbundesamt in Dessau, Germany is a good example of this strategy; the semi-conditioned atrium space provides an opportunity to incorporate a narrow floorplate while minimizing the skin exposed to the exterior (**Figure 6** and **Figure 7**). Natural ventilation is provided directly to the offices through operable windows and automated vent panels, and warm air is passively exhausted through the atrium roof (Perepelitza, 2009). Additional examples and a discussion of this strategy are included in *PlusMinus 20°/40° Latitude* (Hindrichs and Daniels, 2007) in a chapter called, “Climatic Envelopes,” which outlines major design considerations and graphs heating and cooling implications for a reference building.

A central outdoor courtyard is an alternative to a semi-conditioned atrium in that it also provides an opportunity to improve daylighting by reducing the effective depth of the floor plate. While the incorporation of a courtyard increases the exterior wall area, additional benefits in terms of enhanced cross-ventilation may be gained. For example, at the Terry Thomas building a central courtyard allowed the design team to limit the depth of the floor plate to 38 feet in order to take advantage of daylighting and cross-ventilation throughout all of the occupied spaces (see case study in *6 Case studies*).<sup>29</sup>

---

<sup>28</sup> Briem, Patrick. (2008, July 9). Personal interview with Josef Gartner Facades.

<sup>29</sup> Hanson, Gabe (2009, July 31). Telephone interview with former associate architect at Weber Thompson.

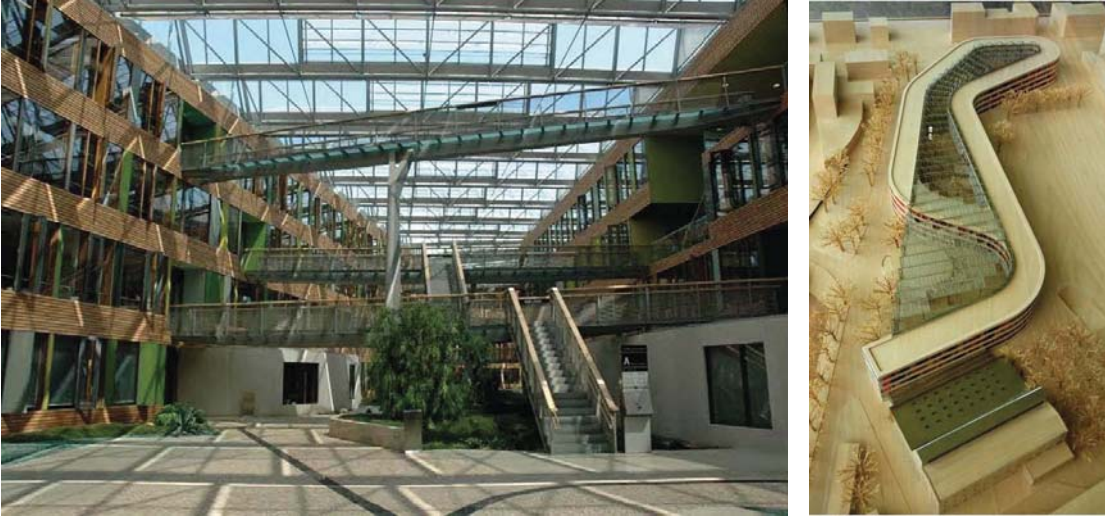

**Figure 6: (left) Glazed atrium at Umweltbundesamt**

*Photo Credit: Mark Perepelitza*

**Figure 7: (right) Model of Umweltbundesamt showing massing and atrium**

*Photo Credit: Mark Perepelitza*

#### **4.7. INTEGRATED LIGHTING AND HVAC CONTROLS**

Building performance can be optimized by integrating the daylighting, shading, and natural ventilation systems with the electrical lighting system and HVAC controls. Occupant-controlled windows and lighting can be effective for individual offices or other spaces where occupants have a sense of ownership and control, but for shared and larger spaces automated systems provide more reliable performance. Commissioning of all systems and controls is critical to proper operation, and periodic or ongoing refinement and adjustment can assure that the systems provide the desired performance. Previous research has documented the complexities of developing effective control strategies for mixed mode buildings (Brager, Borgeson and Lee, 2007).

## 5. CASE STUDIES: PRACTICAL CONSIDERATIONS

Facade performance is contingent on operation and maintenance (O&M), thus O&M requirements should be explicitly addressed during the design process. Ideally, aesthetic, cost and performance objectives are well-integrated in building and system design, but typically difficult trade-offs must be made. While operable and automated facade systems can enhance performance, the case studies in this report illustrate that these systems require special consideration during commissioning and throughout the life of the building. For example, case study interviews revealed the operation of automated window vents at the California Academy of Sciences had to be adjusted during the first year to meet occupant thermal comfort needs, while the automated exterior shading systems in three of the case study projects require regular maintenance. Also, occupant education with respect to automated shade and operable window operation was found to be important in ensuring that the occupants are both comfortable operating the systems, and that they understand how the systems should be operated to maintain comfort and minimize energy use.

### 5.1. DESIGN PHASE

#### 5.1.1. FACADE AND COOLING SYSTEM INTEGRATION

In many climates high-performance facades provide an opportunity to use low-energy alternatives to compressor-based cooling, including displacement ventilation, underfloor air distribution, evaporative cooling, chilled beams, and activated slabs. Such is the case at the David Brower Center, where fixed exterior shading on the south elevation of the building contributes significantly to building cooling load reduction. This strategy, in conjunction with other fundamental design strategies, allowed the design team to minimize peak cooling loads and implement a low-energy radiant cooling system (see case study).<sup>30</sup> Similarly, the complete elimination of compressor-based cooling systems at the Marin Country Day School and the Terry Thomas Office Building would not have been possible without fixed and automated exterior shading, which ensure that external loads do not increase the temperatures beyond the already relaxed temperature limits.<sup>31,32</sup>

While such integration provides opportunities to implement low-energy cooling systems, this approach may require the mechanical engineer to take on additional risk in ensuring that the building meets occupant comfort needs. Unfortunately U.S. engineers tend to be very

---

<sup>30</sup> Bradshaw, Tyler (2010, July 12). Green building design team manager at Integral Group. Telephone interview.

<sup>31</sup> Hanson, Gabe (2009, July 31). Telephone interview with former associate architect at Weber Thompson.

<sup>32</sup> Krevsky, Shani (2010, April 23). Telephone interview with former architect at EHDD Architecture.

conservative in their design assumptions.<sup>33</sup> An engineer that does agree to exploring a new technology will likely need to spend more time on analysis to ensure that the system is designed correctly, possibly requiring higher design fees.<sup>34</sup> Not surprisingly, engineering professionals have found that clients, may resist the higher fees, as they are not convinced that higher than typical fees will indeed benefit the project.<sup>34</sup> Consequently, innovative engineers are faced with a challenge – how can they convince the client that they will in fact be getting a better-quality building?

Passive low-energy cooling approaches may require that clients accept more flexible thermal comfort requirements. In such cases, the decision of whether or not to pursue a more aggressive approach is also contingent on how open the building owner is to such an approach. In the case of the David Brower Center, the client was indeed open to a low-energy cooling alternative and agreed to accept relaxed thermal comfort requirements and a range of passive design strategies from the project start (see case study).<sup>33</sup>

### 5.1.2. COST

Higher design fees and construction costs present barriers to the widespread adoption of advanced technological solutions in buildings, and this is especially apparent with building facades. Due to lower energy costs and different cultural expectations in terms of construction quality in the U.S. (Yudelson, 2009), U.S. developers and building owners may have little incentive to invest in the development of high-performance envelopes. From their experience with the Harvard Allston Science Complex, Behnisch and Transsolar found that the costs of window systems are about one-third higher in the U.S. than in Germany.<sup>35,36</sup> A study of dynamic shading products conducted by the Heschong Mahone Group, identified commercially available dynamic shading products, as well barriers to the implementation of dynamic shading in the U.S. The study found that cost is one of the main barriers impeding the widespread adoption of automated shading systems (Southern California Edison, 2008). A summary of product cost data included in the report reveals that the costs of a automated shading systems (interior or exterior venetian blinds and shades, integral blinds, etc.) varies widely between manufacturers. Given that some cost data were provided on a per-square-foot basis while other were provided per unit or item making it difficult to distill precise per-square-foot numbers for dynamic shading systems. The paper cites the high cost of controllers as a major factor contributing to the high cost of automated shading systems. Additional barriers to implementation identified by manufacturers include lack of consumer awareness of benefits; a complex, multi-disciplinary design process; and owner and facility manager concerns with operation and maintenance (Southern California Edison, 2008).

---

<sup>33</sup> Loisos, George (2010, July 6). Personal interview with principal at Loisos + Ubbelohde.

<sup>34</sup> Bradshaw, Tyler (2010, July 12). Telephone interview with green building design team manager at Integral Group.

<sup>35</sup> Haas, Martin (2008, 2008, July 7). Personal interview with architect at Behnisch Architekten.

<sup>36</sup> Auer, Thomas (2008, July 7). Personal interview with managing director at Transsolar KlimaEngineering.

Discussions with design professionals revealed that, on projects on which exterior shading was implemented, the decision to implement shading was not the subject of normative payback calculations. The need for exterior shading was not questioned on a number of projects, including the David Brower Center, Terry Thomas, and the Marin Country Day School.; rather it was implemented to minimize peak cooling loads and enable the implementation of a low-energy cooling strategy. Similarly, the shading system at Sidwell Friends School Washington, D.C was never thought of the design team or client as a separate "added" cost:

“[The shading system] was conceived as an integral component of many passive and active systems dedicated to reducing the energy use and operating costs of the building. These components, with only a few exceptions, were never separated from each other and analyzed in terms of life cycle costs on a separate, case-by-case basis. They were analyzed and presented to the client holistically as a total, integrated system.”<sup>37</sup>

While the design team on the Terry Thomas building in Seattle had calculated the payback on energy conserving features, the combined impact of all of these features was included in the payback calculation (see Terry Thomas case study).<sup>38</sup>

By following fundamental design strategies of massing and orientation, and careful consideration of the facade design, the implementation of shading may allow the design team to eliminate mechanical cooling. Such a decision can be a significant source of not only first-cost savings but also energy and operational savings over the building's life. This approach is more likely to succeed in milder U.S. climates such as Northern California and the Pacific Northwest. The Terry Thomas design team was able to limit mechanical costs to \$16/ft<sup>2</sup> (\$172/m<sup>2</sup>) by using natural ventilation in place of a traditional mechanical system to cool the building (ASHRAE's Best, 2010). While a range of design strategies was used on the project to minimize loads, the automated exterior shading played a central role in minimizing solar gains and ensuring that the office space temperatures would not exceed specific thresholds.<sup>39</sup>

George Loisos from Loisos + Ubbelohde, a California-based firm specializing in building energy efficiency and daylighting analysis, says that based on his firm's experience with past projects, if a discussion “revolves around a normal air-based cooling system, and one performs simple payback calculations based on annual energy savings, the payback periods are never short enough to satisfy the average developer. One needs to change the conversation to a system choice discussion, and a thermal and visual comfort discussion.” He points out that many clients

---

<sup>37</sup> Whitney, Carin (2009, August 18). Personal correspondence with communications director, at KieranTimberlake .

<sup>38</sup> Hanson, Gabe (2009, July 31). Telephone interview with former associate architect at Weber Thompson.

<sup>39</sup> Hanson, Gabe (2009, July 31). Telephone interview with former associate architect at Weber Thompson.

do not understand the benefits associated with such approaches, but are also unwilling to pay the additional design fees to carry out studies that would illustrate these benefits.<sup>40</sup>

## 5.2. CONSTRUCTION PHASE

In order to ensure optimal performance of complex facade systems, properly trained installers and robust commissioning processes are needed. Design professionals interviewed for this report advise that when working with subcontractors unfamiliar with a particular system, greater oversight and guidance is needed from the design team.<sup>41</sup> Interviewees involved in the design or operation of case study buildings with automated exterior shading noted several specific installation issues. For example, undersizing of the hembar – a weight at the bottom of roller shades, resulted in faulty shade tracking at Marin Country Day School (MCDS) administrative buildings.<sup>42</sup> Subcontractors should ensure that the hembar is heavy enough to prevent the shade fabric from ripping due to excessive movement, however it should not be so heavy as to limit the motor operation.<sup>43</sup> In addition, the shades at MCDS were not retracting when needed because the exterior wind sensors had been installed in an area sheltered from the wind.<sup>44</sup> In order to ensure that exterior shading retracts for the specified wind speeds, sensors should be placed as close as possible to the roller shades to accommodate building micro-climates. Thus, different orientations and elevations may require separate sensors.<sup>43</sup> Both of the aforementioned issues were corrected by the installer, and management has received no complaints regarding the operation of the roller shades at MCDS since.<sup>42</sup>

While such installation and operation problems are generally covered by the initial warranty, extended commissioning of complex systems is often beneficial. Interviews revealed that a number of projects included a facade commissioning period of one year or longer. Several months were needed to fine-tune the facade systems in the offices at the California Academy of Sciences, especially the automated openings for ventilation, where drafts caused by cool incoming air led to occupant thermal discomfort during the first few months of occupancy (see case study).<sup>45</sup>

---

<sup>40</sup> Loisos, George (2009, August 18). Personal correspondence with principal at Loisos + Ubbelohde.

<sup>41</sup> Krevsky, Shani (2010, April 23). Telephone interview with former architect at EHDD Architecture.

<sup>42</sup> Carlson, Don (2010, June 22). Telephone interview with director of facilities at Marin Country Day School.

<sup>43</sup> Terpeluk, Brett. (2009, November 16). Telephone interview with former architect at Renzo Piano Building Workshop.

<sup>44</sup> Krevsky, Shani (2010, April 23). Telephone interview with former architect at EHDD Architecture.

<sup>45</sup> Harding, Ari (2010, May 13). Personal interview with director of building systems at California Academy of Sciences.



Installation and commissioning concerns and trends were also noted in our interviews with building managers and engineers in Northern Europe. The facility manager at Wessex Water Headquarters (**Figure 8**), a two-story office building in Bath, U.K., noted that commissioning was very important to getting the building running properly. Buro Happold, the mechanical engineering firm, was contracted to monitor and report on the building's energy consumption over a three-year period.<sup>46</sup> The building is organized as a series of three south-facing office wings off a central



**Figure 8: Wessex Water Headquarters**

*Photo Credit: Mark Perepelitza*

'street' containing shared and social functions. Each southern facade has a steel and aluminum brise-soleil for shading and daylight redirection. The office spaces are naturally ventilated via operable windows and use exposed thermal mass to help moderate the interior temperature. During summer months the thermal mass is naturally ventilated at night to remove excess heat and passively cool the building. The building's energy and comfort performance is fine-tuned through commissioning and on-going monitoring (Perepelitza, 2009).

Similarly, the building manager at Heelis National Trust Headquarters, a two-story office building in Swindon, U.K. (**Figure 9**), noted that it took three years to fully commission the building, in part due to its non-standard systems, such automated wall openings used for natural ventilation.<sup>47</sup>

---

<sup>46</sup> Caple, Mike (2010, July 17). Personal interview with facility manager at Wessex Water Facilities.

<sup>47</sup> Adams, Liz (2008, July 17). Personal interview with building manager at Heelis National Trust Headquarters.

While at 108 kWh/m<sup>2</sup>/year, the building doesn't quite achieve its ambitious performance goals (75 kWh/m<sup>2</sup>/year),<sup>48</sup> Heelis is one of the more energy-efficient office buildings in the U.K.

While performance monitoring and commissioning is generally not included in the scope of engineering services, some firms report increased interest in post-occupancy monitoring on the part of a few clients. The German consulting firm Transsolar has been contracted to review the performance of projects on which they were involved during the design phase in an effort to understand whether the buildings are performing as designed. For example, the firm had been hired to evaluate performance at the Manitoba Hydro Headquarters in Winnipeg, Canada for the first two years of operation. For the new KfW Banking Group headquarters in Frankfurt, Germany (**Figure 10**), Transsolar is collaborating with the University of Karlsruhe for independent third-party monitoring on a floor-by-floor basis. In spite of these contracts, Transsolar managers stress that owners must take primary responsibility for ensuring that buildings perform as intended.<sup>49</sup>



**Figure 9: Heelis National Trust Headquarters**

*Photo Credit: Mark Perepelitza*

---

<sup>48</sup> RIBA CIBSE Carbonbuzz website: <http://www.bre.co.uk/carbonbuzz/>

<sup>49</sup> Auer, Thomas (2008, July 7). Personal interview with managing director at Transsolar KlimaEngineering.



**Figure 10: KfW banking group headquarters**

*Photo Credit: Mark Perepelitza*

### **5.3. OPERATION AND MAINTENANCE PHASE**

Design professionals interviewed for the report noted that clients desire assurance that innovative facade systems will perform as intended and will be reasonably cost-effective to maintain. They state that many U.S. professionals are unfamiliar with automated exterior systems, as they are relatively new to the U.S. market. Moreover, very little third party information on the actual performance, operation and maintenance of these systems is available. Findings from interviews with design team members and building managers in this report are intended as a first step in providing guidance and insight into how to design and operate these systems for optimal performance. In addition, the Center of the Built Environment's facade operation and maintenance survey<sup>50</sup> could be used as a tool to study the subject in more detail. The questionnaire, geared towards building managers and operators, includes a number of questions related to the performance and maintenance of facade components (fixed, movable non-

---

<sup>50</sup> The Center of the Built Environment has developed an occupant comfort and an operation and maintenance (O&M) survey focusing specifically on facade systems. For more information visit <http://www.cbe.berkeley.edu/research/survey.htm>

motorized, motorized, and automated) including an assessment of system performance, frequency of component repair and replacement, ease of component sourcing, and availability of operation and maintenance documentation.

### 5.3.1. BUILDING USERS

The interviews conducted for this report reveal an increasing interest in occupant education, as performance of buildings with dynamic facade components can be dependent on actual component operation and/or switch override use by users. Education can also serve to alleviate occupants' concerns about system operation. For example, while some occupants at the California Academy of Sciences feel comfortable utilizing the overrides for the automated shading, others appear to be intimidated by the system.<sup>51</sup>

At the Marin Country Day School administrative building, it was important to educate users that the shades should remain lowered in the afternoon during warm weather to prevent overheating. Building managers at the California Academy of Sciences conduct periodic educational sessions with building occupant in which they stress the importance of proper window operation.<sup>51</sup> Occupants are asked to close windows on warm days to ensure that outside air infiltration does not increase the temperature inside the offices. Although a red/green light indicator system was installed at the Academy as a means of prompting occupants to open or close windows, it is not presently being used.<sup>52</sup>

Similarly, aggressive building sustainability goals were explained to the occupants of the Heelis National Trust Headquarters in Swindon, U.K during the design process. Occupants were instructed that the indoor environment would change slightly with the seasons and that their building would mitigate the climate, rather than create constant interior conditions regardless of exterior conditions. The employees learned to stay comfortable by dressing for the season, and making small adjustments to keep comfortable.<sup>53</sup> The naturally-ventilated building incorporates a series of BMS-controlled motorized windows with supply and exhaust ventilators, referred to locally as "snouts." Occupants at perimeter desks can override the automatic settings for 60 minutes by the use of switches located by the windows (BSRIA, 2007). According to a 2006 occupant survey, the building is relatively comfortable overall, but can be too cold in winter and too hot in summer. Some respondents reported that the automated ventilators opened at odd times (Ibid.).

---

<sup>51</sup> Harding, Ari (2010, May 13). Personal interview with director of building systems at California Academy of Sciences.

<sup>52</sup> Young, Don (2010, May 5). Telephone interview with principal at D.R. Young Associates; owner's representative.

<sup>53</sup> Adams, Liz (2008, July 17). Personal interview with building manager at Heelis National Trust Headquarters.



**Figure 11: Automated openings for natural ventilation at Heelis National Trust**

*Photo Credit: Mark Perepelitza*

While energy performance is one broad indicator of building performance, occupant comfort should not be overlooked in any facade O&M program. Post-occupancy surveys such as the Center for the Built Environment's Occupant Indoor Environmental Quality (IEQ) Survey can serve as a useful tool for understanding whether occupant comfort needs are met. A specially developed facade module can be administered in conjunction with the general survey to obtain more detailed information on the impact of facade systems specifically on occupant comfort and to understand whether systems are operating properly.<sup>54</sup>

CBE has implemented the facade occupant comfort survey at Alley 24, a six-story Seattle office building with automated exterior venetian blinds (**Figure 12**). Survey results suggest that while three-quarters of the respondents are satisfied with the amount of daylight and visual comfort in their space, close to half of the occupants sitting near automated exterior shading are either slightly or moderately dissatisfied with the automated control of the shading. A third of the dissatisfied respondents stated that they have no control over the shading, however the primary source of occupant dissatisfaction with shading operation is that the shades close even when it is cloudy outside. Several of the respondents commented that the system appears to be running on a time clock rather than responding to outdoor sky conditions. These survey results suggest that

---

<sup>54</sup> Information on CBE's Occupant Indoor Environmental Quality (IEQ) is at <http://www.cbe.berkeley.edu/research/survey.htm>.

the automated venetian blinds should be sufficiently sensitive to sky conditions to maximize daylighting in the space on overcast days, and/or occupants should be provided with an option to override the system.



**Figure 12: Alley 24 Office Building**

*Photo Credit: Nysan*

### 5.3.2. AUTOMATED EXTERIOR SHADING

Despite concerns about operation and maintenance, projects with automated exterior shading are gradually appearing on the U.S. market. Three of the case studies included in this report incorporate automated exterior shading systems: (1) venetian blinds at the Terry Thomas Office Building; (2) roller shades at the California Academy of Sciences (CAS); and (3) roller shades the Marin Country Day School (MCDS) administrative building. Due to concerns about operation and maintenance, administrators at MCDS were initially hesitant to implement automated exterior shading, recommended by the architect in order to minimize solar gain on the west elevation and ensure that the building could operate without mechanical cooling. However the client's concerns were alleviated once they learned that the system had been installed on another local project.<sup>55</sup>

With automated shading systems, special provisions should be made for systems installed where pedestrians may inadvertently (or intentionally) damage the shades. Keeping shades clean and free of debris is important in preventing dirt build-up which can lead to asymmetrical tension and

---

<sup>55</sup> Krevsky, Shani (2010, April 23). Telephone interview with formerly architect at EHDD Architecture.

binding up of the shades. Horizontal roller shades can also be especially prone to dirt build up.<sup>56</sup> An industry professional who engineers such systems advises that exterior venetian blinds can be washed at the same time as the windows with a low-pressure washer. Blinds need to be fully extended, rinsed, then reversed and extended again, rinsed again, and finally retracted so that the windows can be rinsed.<sup>57</sup>

At MCDS, an extended warranty was negotiated with the system manufacturer, under the condition that the school conducts regular cleaning and maintenance of the shades. Consequently MCDS plans a regular wash-down of the shades to make sure that the system is free of debris, as well as annual servicing (through a maintenance contract with the installer), during which the shades are checked to ensure that they are calibrated and running properly.<sup>58</sup>

While no maintenance contract was established at the Terry Thomas building, both CAS and MCDS were in the process of developing maintenance contracts for the exterior shading at the time of the interviews (during the summer of 2010).<sup>58, 59, 60</sup> Although adjustments to the shading systems at Terry Thomas and MCDS were required early on, and some replacements and repairs at Terry Thomas were needed, the building managers report that they are quite satisfied with the operation of the systems. The automated exterior shading at CAS however, has required considerably more maintenance, including replacement of ripped fabrics and broken cables on several occasions. Since no maintenance contract for the shades was developed during the design phase, the Academy has had to manage the repairs on their own – an expensive and time-consuming endeavor. While the roller shades are programmed to retract under high wind loads, there is no way to prevent occasional damage resulting from a strong initial wind gust. Roller shades at the public level were prone to additional damage due to visitors pulling on the shades. For this reason, the Academy has opted to keep exterior shades at the public level in the exhibit spaces retracted during visiting hours. At the time of the interview, the Academy was contemplating a maintenance contract with the installer. Due to the large number of roller shades, a maintenance contract in this case would be costly – approximately \$20,000 to \$30,000 per year to operate and maintain all of the shades.<sup>61</sup>

---

<sup>56</sup> Terpeluk, Brett. (2009, November 16). Telephone interview with former architect at Renzo Piano Building Workshop. Telephone interview.

<sup>57</sup> Gross, Bernie (2009, June 23). Telephone interview with T&T Shading.

<sup>58</sup> Carlson, Don (2010, June 22). Telephone interview with director of facilities at Marin Country Day School.

<sup>59</sup> Grey, Mark (2010, July 10). Telephone interview with property manager at Stephen C. Grey & Associates.

<sup>60</sup> Harding, Ari (2010, May 13). Personal interview with director of building systems at California Academy of Sciences.

<sup>61</sup> Harding, Ari (2010, May 13). Personal interview with director of building systems at California Academy of Sciences.

### 5.3.3. AUTOMATED WINDOWS AND TRICKLE VENTS

Trickle vents – small openings incorporated within the facade for ventilation, are quite widely used in housing in the UK, and in small non-domestic buildings, including small offices.<sup>62</sup> They are typically located at the window head and incorporate a diffusing or damping element which allows the air to be deflected and diffused.<sup>63</sup> This allows for the introduction of relatively cool air, as low as 40°F (5°C), without running the risk of draft-related occupant discomfort. If the outside air is close to freezing point, radiators and convectors below windows (conventional practice in the U.K.) can be used to temper drafts, providing improved mixing with the rising air plume from the radiator. An alternative solution for buildings without perimeter heating is pre-heating the incoming air by bringing it in between the panes of a double- or triple-glazed window (hence preheating from heat that would otherwise be lost from the building).<sup>64</sup>

The Barclaycard Headquarters building, an office building in Northampton, U.K., incorporated a series of trickle vents above the windows without diffusers. Due to the lack of diffusers, the cold incoming air led to discomfort among occupants (Probe, 2000).

This is similar to the issue that was encountered in the office spaces at the California Academy of Sciences, where the temperature- and CO<sub>2</sub>-controlled motorized awning windows lead to drafts and subsequent complaints among office occupants.<sup>65</sup> Due to the absence of any deflecting or diffusing elements at the high-level openings, the incoming outside air was not diffused sufficiently, resulting in thermal discomfort among office occupants even with the relatively small 15°F (7 to 8°C) differences between inside and outside temperature typical for the building. The building manager pointed out however, that the same type of system is working fairly well in the Academy's exhibit spaces, most likely due to the fact that occupants are moving around and have a higher metabolic rate. Visitors are presumably also dressed more warmly, and unlike most office occupants, have the option to move to a different part of the space. In response to occupant complaints, the window control sequence in the office spaces was modified so that the awnings now only open when the outside temperature is within +/- 2°F of interior temperature during occupied periods.

Finally, it is worth noting that not only perimeter office space occupants may be affected by drafts. Those sitting further towards the center of a space can be affected as well, since air coming through a high-level opening will flow some distance along the ceiling before “sinking” into the space. Such were the findings of a study of environmental conditions and occupant satisfaction at the Open University's administrative offices at Walton Hall in Milton Keynes, UK. The 40-foot (13-

---

<sup>62</sup> Bordass, William (2010, August 16). Personal communication.

<sup>63</sup> For an example of typical trickle vent designs see [www.titon.co.uk/pages/products/ventilators/slot-vents.php](http://www.titon.co.uk/pages/products/ventilators/slot-vents.php)

<sup>64</sup> Bordass, William (2010, August 16). Personal communication.

<sup>65</sup> Harding, Ari (2010, May 13). Personal interview with director of building systems at California Academy of Sciences.



m) deep naturally-ventilated open office space has high-level hopper windows. Field measurements found higher air velocity at the center of the space than at the perimeter, and responses from an occupant comfort survey indicated that occupants near the center of the space felt cold and drafty more often. In addition, the study found that occupants near the windows felt that they were in much more control of their environment, whereas those in the middle of the room more likely to report lack of control, low daylight levels, and visual and thermal discomfort (Energy Efficiency Best Practice Programme, 1998).

These case studies illustrate that proper air mixing is critical in ensuring comfort among relatively sedentary office occupants when using trickle vents. Caution should be exerted when designing more substantial automated facade openings. A conservative approach would be to limit the application of these systems for night ventilation only or to incorporate manual occupant overrides.

#### 5.3.4. OPERABLE WINDOWS

Operable windows are standard in northern European commercial buildings. One German interview subject noted that “you wouldn’t be able to find a tenant if you didn’t have operable windows” and that operable windows for natural ventilation are a “must for the quality of the space.”<sup>66</sup>

While operable windows can have a positive impact on occupant comfort and satisfaction, steps need to be taken to ensure that the windows are closed during warm weather to prevent an increase in the cooling load. A number of strategies can be used to address issues of misuse by occupants, including occupant education, systems for communicating when window operation is beneficial, and using automated openings operated according to outdoor environmental conditions and interlocks connected to HVAC controls. However, as discussed above, poorly designed, automated systems can lead to drafts and discomfort, especially among sedentary occupants.

Greater awareness related to window and other facade system operation can be achieved through occupant education, however steps should be taken to periodically remind occupants about how systems should be operated. The building manager at the California Academy of Sciences noted that while office space occupants are quite satisfied with the operable windows, it has been challenging to ensure that occupant-operated windows are closed on warm days. Thus, during periodic occupant training sessions, building managers stress the importance of proper window operation and ask occupants to close windows on warm days in order to ensure that outside air infiltration does not contribute to an increase in the temperature inside the offices.<sup>67</sup>

---

<sup>66</sup> Auer, Thomas (2008, July 7). Personal interview with managing director at Transsolar KlimaEngineering.

<sup>67</sup> Harding, Ari (2010, May 13). Personal interview with director of building systems at California Academy of Sciences.

In combination with occupant education, red/green light indicator systems for encouraging occupants to open or close windows based on outdoor conditions have also been implemented on a number of projects, for example at Alley 24 in Seattle, and the Orinda City Hall in Orinda, Calif. While red/green light systems are intended to improve building performance through influencing occupant behavior, presently there is limited literature available on the effectiveness of these systems. Researchers at the Center for the Built Environment at UC Berkeley are investigating the effectiveness of these systems in 15 U.S. commercial buildings. Preliminary findings suggest that occupants typically do not pay attention to the signals unless the purpose of the system relates to something of personal benefit and the meaning of the signals is well-communicated by management. However, people are more likely to respond and much more likely to follow directions in open office environments. The completion date for this study is set for spring 2011.<sup>68</sup>

---

<sup>68</sup> Ackerly, Katie (July 11, 2010). Personal correspondence with Graduate Student Researcher at the Center for the Built Environment.

## 6. CASE STUDIES: INTRODUCTION

Four North American buildings were selected for facade case studies. Information on case study buildings was gathered through a review of existing literature (online electronic sources, published journal articles), interviews with design team members (architects, mechanical engineers and/or energy or daylighting consultants) and, in some instances, building managers. In all four case studies, the elimination of the cooling system or the incorporation of a low-energy cooling alternative placed particular demands on the design and performance of the facade in terms of occupant summer comfort and peak cooling load reduction. Facade design strategies, ranging from simple yet effective designs to advanced dynamic facade systems, are discussed in terms of their benefits as well as the challenges with respect to energy use, comfort, and operation and maintenance. Regardless of the facade solution however, all of the included case studies incorporate a series of fundamental design strategies (proper building orientation, shallow floor plan, moderate window-to-wall ratio, etc.); a prerequisite for attaining optimal facade performance. The four case study buildings include:

1. Terry Thomas Office Building – Seattle, Washington
2. Marin Country Day School – Corte Madera, California
3. California Academy of Sciences – San Francisco, California
4. David Brower Center – Berkeley, California

## 7. TERRY THOMAS OFFICE BUILDING

Seattle, Washington



**Figure 13: South courtyard elevation**

*Image credit: Weber Thompson*

The Terry Thomas building is one of the few modern Class A office buildings to be built in the Seattle and the greater Puget Sound region without air conditioning in decades. Since the architects, Weber Thompson, are also tenants in the building, they had multiple incentives to create a comfortable, environmentally-friendly and beautiful building. A triple net lease – an agreement in which the tenant is required to cover a share of the cost of building operation and maintenance, provided the financial incentive for the architect to reduce energy use and operational costs.<sup>69</sup>

---

<sup>69</sup> Brown, Nathan (2009). *Performance by Design: An Energy Analysis of AIA/COTE Top Ten Projects*. Retrieved from <http://www.aia.org/aiaucmp/groups/aia/documents/pdf/aiab081492.pdf>



**Figure 14: Second floor plan, typical**  
 Image credit: Weber Thompson

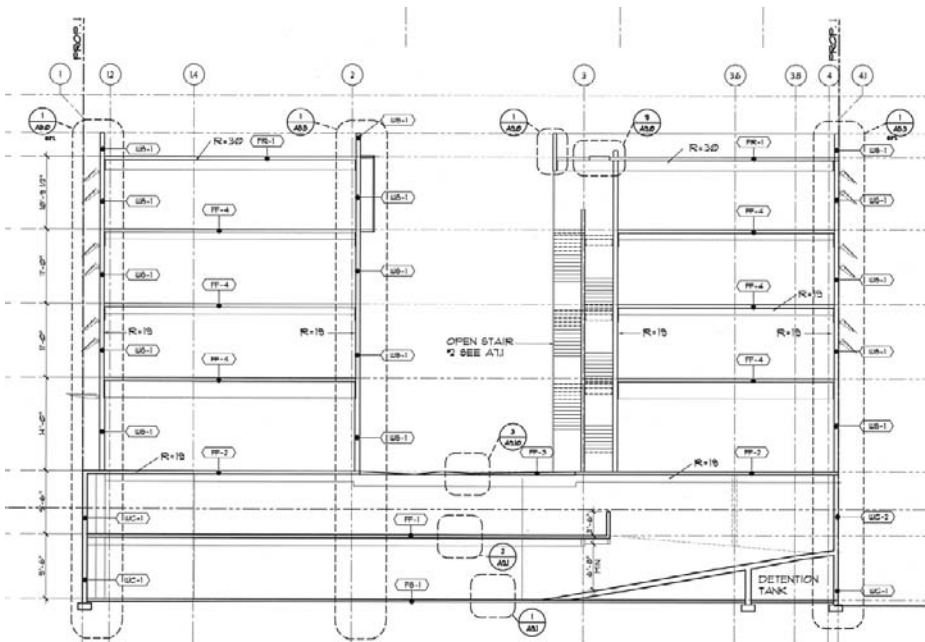

**Figure 15: Building section**  
 Image credit: Weber Thompson

## 7.1 THE BUILDING

Several site considerations were driving factors for the building massing and eventual facade design. An existing building immediately to the south of the site was a major constraint, as it precluded any glazing on the south elevation. The shape of the lot also required the development a plan with a relatively square footprint. The design team's solution to addressing these site limitations was a central courtyard (**Figure 13**), which allowed them to limit the depth of the floor plate to 38 ft and thus take advantage of daylighting and cross-ventilation throughout all of the occupied spaces (**Figure 14** and **Figure 15**). To eliminate the need for mechanical cooling, a range of strategies were used to prevent the office spaces from overheating, including automated exterior venetian blinds, fixed exterior shading, passive night cooling with thermal mass, and lighting controls.<sup>70</sup> The mechanical engineer conducted a detailed energy simulation using TAS (Thermal Analysis Simulation) software to simulate and calculate natural airflow patterns produced by stack effect and wind, and confirm that the indoor temperatures would not exceed prescribed limits. The internal temperature profiles of the spaces were studied to determine the number of hours when spaces may drift above design comfort conditions in a typical year. Using the bounding comfort parameters from LEED-NC 2.1 as a guide (**Table 1**), the design team limited the number of hours during which the indoor temperatures were outside of the 75°F upper temperature limit. Based on the simulation for a typical meteorological year, it was predicted that temperatures exceeding 75°F and 80°F would occur for only 140 and 60 hours, respectively, during working hours (8 am to 6 pm).<sup>71</sup>

**Table 1: LEED bounding comfort parameters**

75-80°F < 150 hours
80-85°F < 50 hours
85°F + < 20 hours

The design team predicted that the use of passive design strategies in combination with a hydronic heating system would provide a 40 percent reduction in building energy use relative to the 2003 EIA Commercial Building Energy Consumption Survey (CBECS).<sup>72,73</sup> Both energy and water use for the building are being carefully monitored. The measured site energy use intensity (EUI) for the year 2009 (20 months into occupancy) exceeded the design team's expectations: 46.2 kBtu/ft<sup>2</sup>/yr (145.7 kWh/m<sup>2</sup>/yr) excluding parking, and 34.1 kBtu/ft<sup>2</sup>/yr (107.6 kWh/m<sup>2</sup>/yr) with parking, the latter EUI corresponding to a 57 percent reduction relative to CBECS.<sup>74</sup> More recently, due to the economic downturn, some tenants were forced to move out, and as of summer 2010 the building is no longer fully occupied, making it difficult to analyze energy use for the second year.

<sup>70</sup> Hanson, Gabe (2009, July 31). Tekephone interview with former associate at Weber Thompson.

<sup>71</sup> Sethi, Amarpreet. (2010) Old Concepts, New Tools: The Terry Thomas. High Performing Buildings, 3(3): 26-37. Retrieved from [http://www.nxtbook.com/nxtbooks/ashrae/hpb\\_2010summer/#/28](http://www.nxtbook.com/nxtbooks/ashrae/hpb_2010summer/#/28)

<sup>72</sup> Based on the predicted EUI of 47.3 kBtu/ft<sup>2</sup>/yr (149.1 kWh/m<sup>2</sup>/yr) calculated according to LEED-NC Energy and Atmosphere credit 1, using performance based method, ASHRAE 90.1.

<sup>73</sup> Calculated EUI includes enclosed parking.

<sup>74</sup> While the building was only 90 percent occupied during the first year, the design team extrapolated energy use for unoccupied spaces to determine what the energy intensity would have been with the building fully occupied.



**Figure 16: Building section**

*Image credit: Weber Thompson*



**Figure 17: North elevation**

*Image credit: Weber Thompson*

The owner Thomas & Terry LLC and Weber Thompson estimated that spending 3 percent of the total project cost (approx. \$300,000) on the facade and other energy-efficient strategies would yield an acceptable rate of return on the investment. The added cost of additional facade area required for the central courtyard, hydronic heating, automated louvers, operable windows and exterior shading were partially offset by \$760,000 estimated first-cost savings from the elimination of air-conditioning and a forced-air distribution system.<sup>75</sup> The end result was a mechanical system that cost approximately \$16/ft<sup>2</sup> (\$172/m<sup>2</sup>).<sup>76</sup> The design team predicted that the added features would pay for themselves within 25 years assuming 30 percent annual energy savings. Furthermore, if these features were to contribute to only a 1 percent reduction in employee cost (e.g. through reduced absenteeism), this would result in only a 3-year payback period.<sup>75</sup>

## 7.2 THE FACADE

In addition to developing a building section and window configuration that would promote cross-ventilation, the design team sought to provide daylight in all of the occupied spaces. To maximize views and daylighting while minimizing solar gain, a range of shading strategies were used, including fixed exterior tinted glass overhangs on the east and west elevations (**Figure 18** and **Figure 19**) and automated exterior venetian blinds (**Figure 20** and **Figure 21**) on the northeast street elevation, and several of the courtyard elevations (south, east, and west). A unique attachment structure was designed to offset the blinds from the facade in order to accommodate the outward-opening operable windows. The venetian blinds retract according to sun intensity and wind speed – they retract automatically if the wind speed exceeds 28 mph to prevent damage to the system.

A solar shading analysis was done early in the design to determine which elevations required shading. The Integrated Design Lab in Seattle, a research group affiliated with the University of Washington's College of Built Environments, helped with the daylighting and shading analysis on the Terry Thomas. A number of daylighting models were tested to ensure that adequate daylighting levels (2 percent daylight factor) were met.

A unique feature of the facade is a series of automated louvers which together with operable windows are used for natural ventilation (**Figure 22**), ensuring that indoor air requirements and temperature setpoints are met. During the heating season, louvers are operated during occupied hours to not exceed maximum allowable CO<sub>2</sub> levels in the space, while during the cooling season, louvers are controlled by a thermostat and open when the outside air temperature is less than 78°F and at least 2°F cooler than a floor's average common office temperature. An additional application of the louvers – night-purging in select spaces during unoccupied hours, helps reduce temperatures in the building to the operator-defined setpoint.

---

<sup>75</sup> Hanson, Gabe (2009, July 31). Telephone interview with formerly an associate at Weber Thompson.

<sup>76</sup> ASHRAE. (2010) ASHRAE's Best: 2010 Technology Awards. *ASHRAE Journal*, 52(3): 56-63.



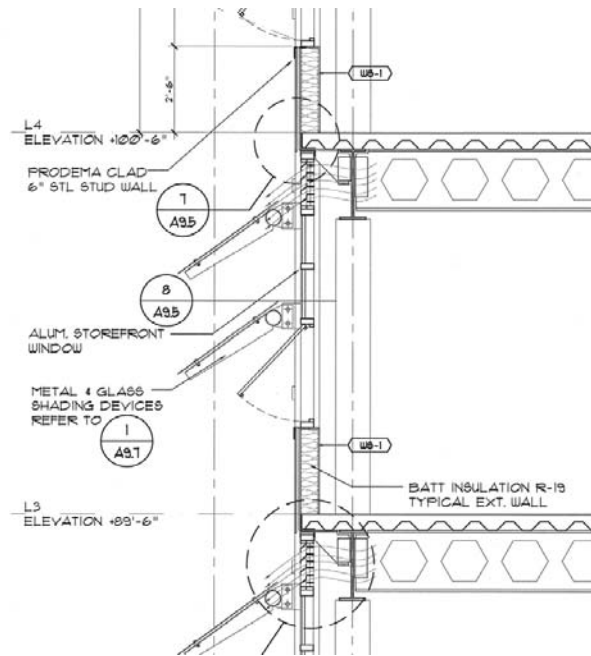

**Figure 18: Section showing fixed exterior overhangs**

*Image credit: Weber Thompson*

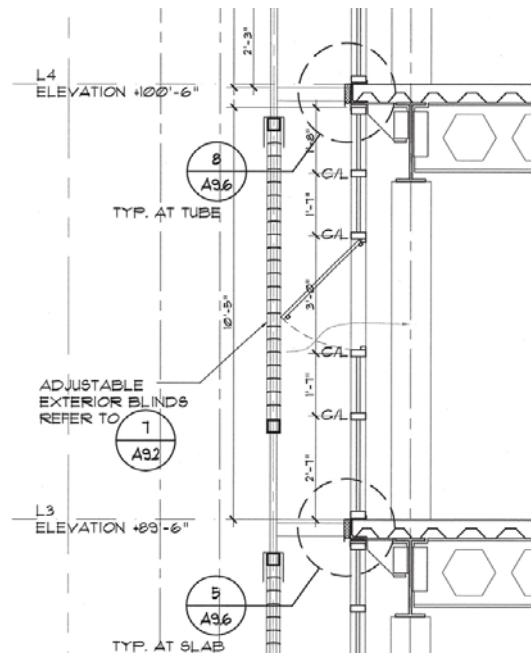

**Figure 20: Section showing automated exterior venetian blinds**

*Image credit: Weber Thompson*



**Figure 19: Fixed exterior overhangs**

*Image credit: Weber Thompson*



**Figure 21: Automated exterior venetian blinds**

*Image credit: Weber Thompson*



**Figure 22: Detail of operable windows and automated louvers (left)**

*Image credit: Weber Thompson*



**Figure 23: View of interior (right)**

*Image credit: UW Integrated Design Lab*

### 7.3 CHALLENGES

Due to the relatively low floor-to-ceiling height, care had to be taken in ensuring that the interior design would not inhibit natural ventilation and daylighting. Consequently, Weber Thompson sought to minimize the use of full-height partitions and opted for the use of castellated steel beams throughout the structure to maximize air movement. The owner also developed a tenant manual with specific recommendations for maintaining a comfortable indoor environment, such as reducing heat generated by office equipment and lighting, locating computer servers in enclosed and separately exhausted spaces, maximizing daylight and cross-ventilation effectiveness by avoiding full-height partitions, especially those parallel to the facade. The manual also advises that full-height partitions perpendicular to the window terminate below the castellated steel beams and incorporate automated dampers or other openings to provide cross ventilation whenever possible. If a fit-out does include enclosed spaces these should not be located along the west building perimeter, where they would be likely to overheat. While the open floor plan brings many advantages in terms of daylighting and natural ventilation, it also brings challenges, related to acoustic privacy, so specific recommendations are provided when acoustic privacy is required. In cases where an enclosed space is required, full-height partitions perpendicular to the building facade should incorporate operable openings (automated or manual dampers or windows) to ensure that cross ventilation is not disrupted. Acoustical treatments such as carpet and/or acoustic panels, either suspended from the ceiling or placed directly on the walls or ceiling, can be used in both open and enclosed spaces for sound attenuation.

During the spring and fall, building management monitors the automated louver system operation especially closely as outside temperatures can dip into the 45°F to 55°F range and excessive ventilation can result in

occupant thermal discomfort. Weber Thompson and other tenants continually monitor the system, check weather forecasts, and communicate with building management to ensure that occupant comfort needs are met. While the system has required a learning curve for the building management crew, it is reported to be working as designed when managed correctly.<sup>77</sup> During the two years since building occupancy, the automated facade components have required some repairs – the automated venetian blinds were damaged by wind on a few occasions, and motors had failed on a few individual units. One of the motors for the automated louvers had to be replaced as well.<sup>77</sup>

## 7.4 LESSONS LEARNED

The design of Terry Thomas illustrates that a synergistic approach to building design can offer considerable benefit in terms of maximizing building performance while minimizing cost. By implementing an inner courtyard as the central design feature, the design team was able to meet its objective of eliminating the need for mechanical cooling, while maximizing daylight and views to the outside. Moreover, an integrated design approach made it more difficult to “value engineer” or otherwise eliminate a particular building feature; for example, the elimination of exterior shading would have increased internal loads and required the implementation of mechanical cooling. When confronted with a high price for the exterior shading from the contractor, who was unfamiliar with the system, it took multiple rounds of negotiation to come to an agreement regarding the cost of shading.<sup>78</sup> Moreover, the project illustrates the importance of ongoing oversight from building management in terms of ensuring optimal building operation, and highlights the role of tenant manuals in ensuring that office fit-out schemes follow the design intent, in this case, maintaining a relatively open floor plan to maximize daylighting and natural ventilation.

---

<sup>77</sup> Thompson, Scott (2010, July 28). Personal correspondence with senior principal at Weber Thompson.

<sup>78</sup> Brown, Nathan (2009). *Performance by Design: An Energy Analysis of AIA/COTE Top Ten Projects*. Retrieved from <http://www.aia.org/aiaucmp/groups/aia/documents/pdf/aiab081492.pdf>

## 7.5 KEY PROJECT FEATURES

<b>Location</b>	Seattle, WA
<b>Date of completion</b>	2008
<b>Architect</b>	Weber Thompson
<b>Mechanical Engineer</b>	Stantec, Inc.
<b>Building type</b>	4-story mixed-use office and retail building
<b>Project size</b>	40,460 ft <sup>2</sup> (3,760 m <sup>2</sup> ), excluding enclosed parking <sup>79</sup> 65,060 ft <sup>2</sup> (6,040 m <sup>2</sup> ), including enclosed parking
<b>Passive design strategies</b>	Building massing, operable windows in all spaces, exterior shading, natural ventilation, thermal mass and night-time purging, daylight controls
<b>Mechanical system</b>	No air conditioning or forced-air distribution system, CO <sub>2</sub> -sensor-controlled automated louvers, hydronic heating, convection heaters at perimeter
<b>Window-to-Wall Ratio (exterior)</b>	45% (including shared south wall) <sup>15</sup>
<b>Floor depth</b>	38 feet (11.5 m), typical
<b>Glazing specifications</b>	PPG Solarban 60 or equivalent, typical
<b>Exterior shading type</b>	Automated exterior venetian blinds and fixed exterior glass overhangs
<b>Other dynamic facade elements</b>	CO <sub>2</sub> -sensor-controlled automated dampers in common areas
<b>Predicted annual energy use <sup>80</sup></b>	47.3 kBtu/ft <sup>2</sup> /yr (149.1 kWh/m <sup>2</sup> ), <sup>81</sup> without parking
<b>Actual energy use <sup>82</sup></b>	34.1 kBtu/ft <sup>2</sup> /yr (107.6 kWh/m <sup>2</sup> ), with parking 57% below CBECS national average
	46.2 kBtu/ft <sup>2</sup> /yr (145.7 kWh/m <sup>2</sup> /yr), without parking
<b>Ratings</b>	LEED-CS v. 2.0 Gold (building) LEED-CI v. 2 Platinum (Weber Thompson offices on floors 2 and 3) Energy Star rating = 84 <sup>83</sup>

<sup>79</sup> Includes 37,430 ft<sup>2</sup> of office space and 3,030 ft<sup>2</sup> of retail and restaurant space.

<sup>80</sup> Harrell, Myer (2010, September 3). Architect at Weber Thompson. Personal correspondence.

<sup>81</sup> Calculated based on LEED-NC Energy and Atmosphere credit 1, using performance based method, ASHRAE 90.1.

<sup>82</sup> Based on 2009 building utility bills.

<sup>83</sup> Sethi, Amarpreet. (2010) Old Concepts, New Tools: The Terry Thomas. *High Performing Buildings*, 3(3): 26-37. Retrieved from [http://www.nxtbook.com/nxtbooks/ashrae/hpb\\_2010summer/#/28](http://www.nxtbook.com/nxtbooks/ashrae/hpb_2010summer/#/28)

## 7.6 REFERENCES

1. ASHRAE. (2010) ASHRAE's Best: 2010 Technology Awards. *ASHRAE Journal*, 52(3): 56-63.
2. Brown, Nathan (2009). *Performance by Design: An Energy Analysis of AIA/COTE Top Ten Projects*. Retrieved from <http://www.aia.org/aiaucmp/groups/aia/documents/pdf/aia081492.pdf>
3. Building Green official website (2009, 13 April). *The Terry Thomas*. Retrieved from <http://www.buildinggreen.com/hpb/overview.cfm?projectid=1292>
4. Hanson, Gabe (2009, July 31). Telephone interview with former associate at Weber Thompson.
5. Harrell, Myer (2010, September 3). Telephone interview with associate at Weber Thompson.
6. Thompson, Scott (2010, July 28). Personal correspondence with senior principal at Weber Thompson.
7. Sethi, Amarpreet. (2010) Old Concepts, New Tools: The Terry Thomas. *High Performing Buildings*, 3(3): 26-37. Retrieved from [http://www.nxtbook.com/nxtbooks/ashrae/hpb\\_2010summer/#/28](http://www.nxtbook.com/nxtbooks/ashrae/hpb_2010summer/#/28)

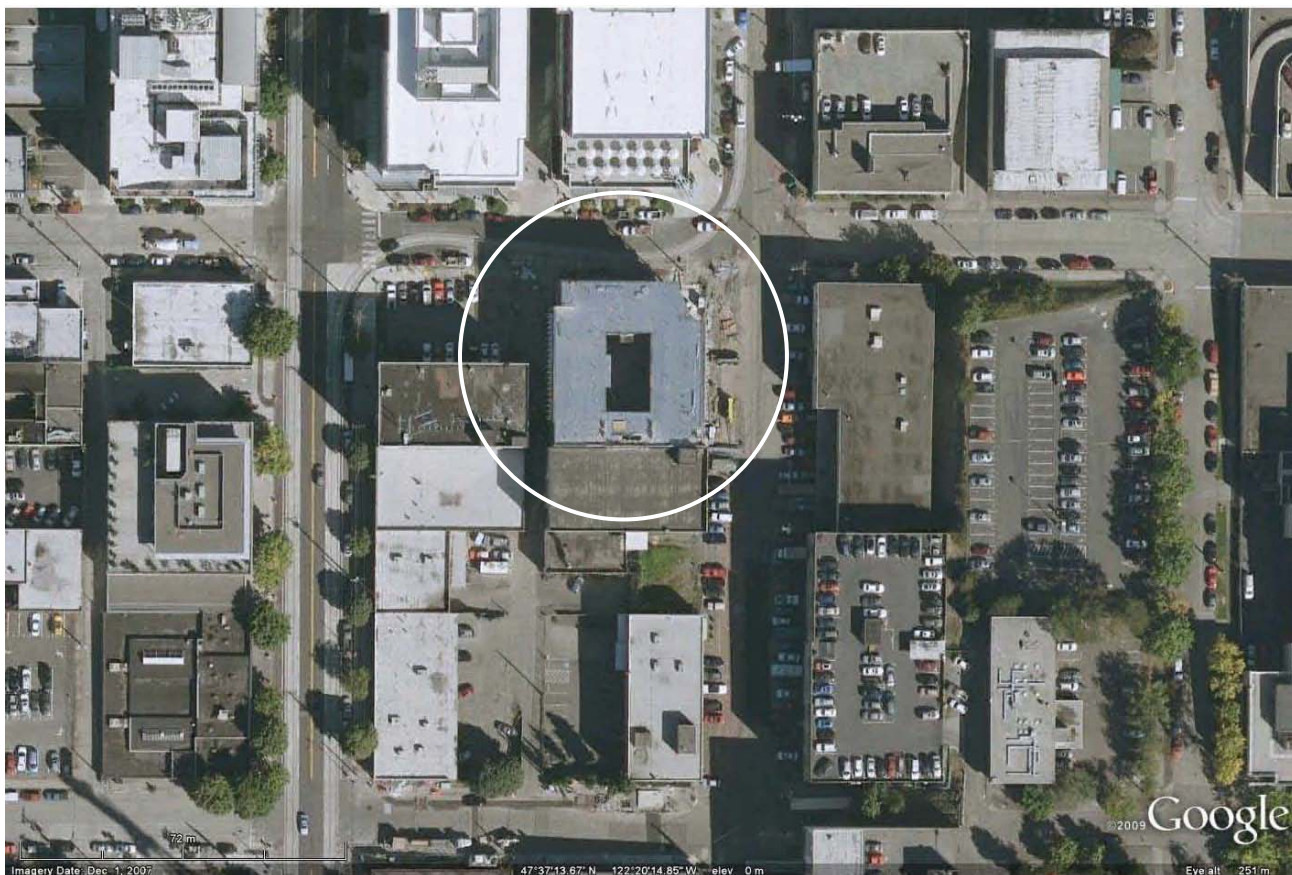

**Figure 24: Site plan**

Source: Google Maps

## 8. MARIN COUNTY DAY SCHOOL ADMINISTRATIVE BUILDING

Corte Madera, California



**Figure 25: North elevation**

*Image credit: Mark Luthringer*

Marin County Day School constructed its administrative building in 2007 as part of a redevelopment project targeting the expansion of student learning facilities at the K-8 independent day school. In order to preserve the surrounding natural site, an underutilized patio area within the campus footprint adjacent to an existing classroom building was selected as the site for the administrative building. Due to site limitations, the building was oriented with the long facades facing east and west, challenging the design team to utilize a range of passive design strategies that would help mitigate solar gains from the west elevation and meet the design goal of eliminating the need for mechanical cooling.

## 8.1 THE BUILDING

The design of the single-story administrative building was largely driven by the owner's desire to use sustainable design strategies that aligned with the school's teaching principles. Although the building is heated through hydronic in-slab radiant heating, the need for mechanical cooling was eliminated by employing a series of passive design strategies, including building massing, natural ventilation, thermal mass and exterior shading. By limiting the depth of the floor plate to 30 feet, the design team was able to effectively optimize the building for daylighting and natural ventilation. The significant amount of exposed thermal mass in combination with moderate diurnal temperature swings (up to 30°F in the summer)<sup>84</sup> allowed for a significant reduction in peak cooling loads. According to the building manager, the building does not overheat so long as the windows remain open throughout the night to ensure pre-cooling of the floor slab and walls.<sup>85</sup>

## 8.2 THE FACADE

The narrow building footprint and window configuration were driven both by site limitations and by the desire to utilize night-time cooling through implementing windows that would encourage cross-ventilation. Due to site limitations, the building was oriented with the long facades facing east and west. While the east building elevation is shaded by the adjacent Classroom Building, the unshaded west facade (**Figure 26**) was subjected to significant solar gains in the afternoon. In order to ensure that solar gains on the west elevation were minimized, automated exterior roller shades (**Figure 31**), which deploy automatically when direct sun hits the facade, were implemented. Had the shading not been implemented, temperatures in some spaces could have easily reached 100°F, well beyond the simulated maximum of 82°F.<sup>3</sup> Although the exterior roller shades are automated, occupants have access to overrides.

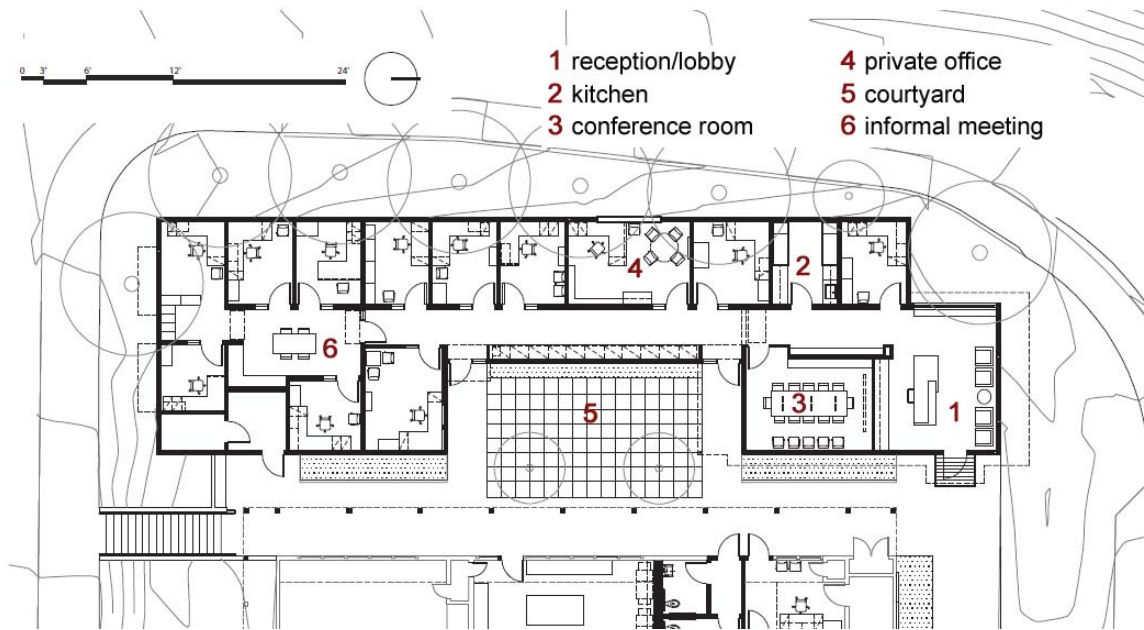

**Figure 26: West elevation**

*Image credit: Mark Luthringer*

<sup>84</sup> Peterson, John Paul (2009, August 12). Telephone interview with former principal at Stantec.

<sup>85</sup> Carlson, Don (2010, June 22). Telephone interview with director of facilities at Marin Country Day School.

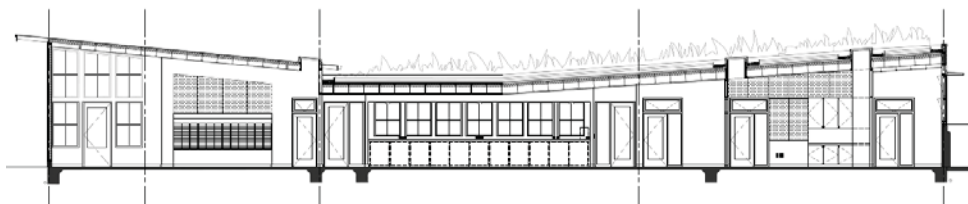

**Figure 27: Floor plan**

*Image credits (this page): EHDD Architecture*



**Figure 28: Long section looking west**



**Figure 29: Long section looking east**

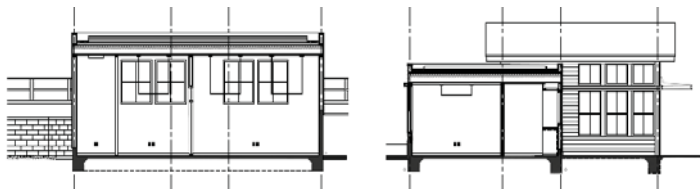

**Figure 30: Cross sections**



### 8.3 CHALLENGES

Design team members noted that it was challenging to persuade the client that the building could be comfortable without mechanical cooling. Since the building is occupied year-round, there was concern that spaces would overheat on hot summer days. A study was conducted using IES thermal modeling software to explore the feasibility of natural ventilation. The results indicated that the temperatures would remain below 82°F, and eventually the client agreed to the possibility of slightly higher summer indoor temperatures than those generally accepted in an air-conditioned building.<sup>86</sup>

Furthermore, the client had expressed concern about operation and maintenance of the automated exterior shades, however these were partially alleviated when the design team obtained information from the manufacturer's local representative about other institutional installations; the client found it encouraging that the same type of system had already been installed on another project locally.<sup>87</sup> The design included an occupant override in the form of a wall switch next to the light switch, consequently it was important to educate the users that the shades should remain down in the afternoon when direct sun is present to ensure that the space does not overheat on warmer days.<sup>88</sup>

The installers experienced difficulty with the installation and initial operation of the system, resulting from their lack of familiarity with the system. For example, the exterior wind sensors had been installed in an area sheltered from the wind, and as a result the shades were not retracting when needed. Also, the guide wires that keep the fabric taught (**Figure 31**) had not been anchored at the correct point.<sup>87</sup>

In addition to installation issues, the undersizing of the hembar – a weight at the bottom of the shade, resulted in faulty shade tracking. It turned out that the hembar which in conjunction with the cables on either side of the shade helps keep the shade in place, was not heavy enough for the 15-foot-long shades, resulting in uneven retraction and consequent binding of the shade. The problem was resolved once the hembar was replaced with a heavier bar. Once these initial problems had been corrected, the system operated as needed, and there have been no complaints from the occupants regarding the operation of the shading.<sup>88</sup>

The aforementioned adjustments to the system were covered by the initial warranty for the system. An additional extended warranty was negotiated with the system manufacturer, under the condition that Marin Country Day School conduct regular cleaning and maintenance of the shades. Hence, MCDS is planning on a regular wash-down of the shades to make sure that the system is free of debris. The scheduled annual servicing, in which the shades will be checked to ensure that they are calibrated and running properly, will be provided through a maintenance contract with the installer.<sup>89</sup>

---

<sup>86</sup> Peterson, John Paul (2009, August 12). Telephone interview with former principal at Stantec.

<sup>87</sup> Krevsky, Shani (2010, April 23). Telephone interview with former architect at EHDD Architecture.

<sup>88</sup> Carlson, Don (2010, June 22). Telephone interview with director of facilities at Marin Country Day School.

<sup>89</sup> Carlson, Don (2010, June 22). Telephone interview with director of facilities at Marin Country Day School.

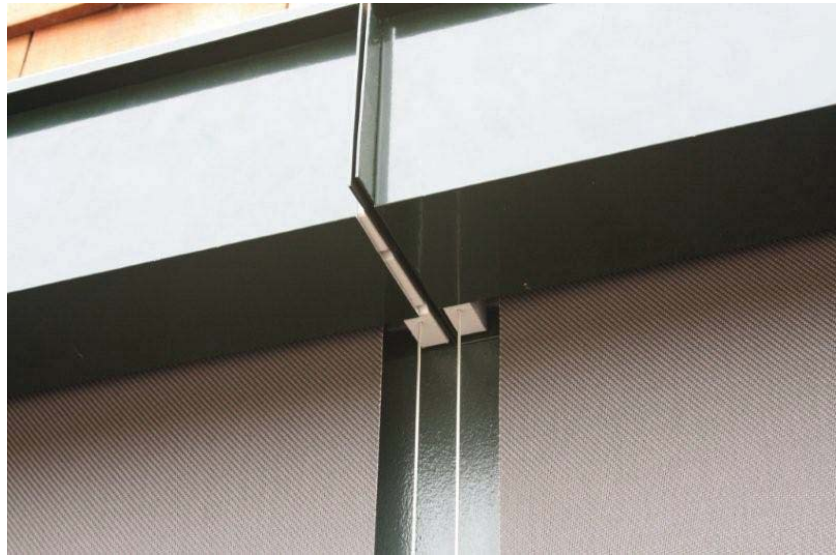

**Figure 2: Automated exterior roller shades on west elevation (left) and shade detail (right)**

*Image credit: EHDD Architecture*

## **8.4 LESSONS LEARNED**

The design of this low-energy building required that the owner be open to relaxed temperature design criteria. The use of thermal modeling tools to understand design implications on occupant comfort was a critical aspect of the design process.

When working with subcontractors who may not be familiar with a particular type of system, greater guidance is needed from the design team with respect to understanding how the system should be installed. The architect should coordinate with the manufacturer of the system to correctly specify the details of the system. Finally, work that interfaces with the shading system should be reviewed carefully to ensure that appropriate elements are incorporated in their design and construction drawings (e.g. electrical wiring in electrical drawings).

## 8.5 KEY PROJECT FEATURES

<b>Location</b>	Corte Madera, CA
<b>Date of completion</b>	2007
<b>Architect</b>	EHDD Architecture
<b>Mechanical Engineer</b>	Stantec, Inc.
<b>Building type</b>	Single-story office building
<b>Project size</b>	82,000 ft <sup>2</sup> (7,620 m <sup>2</sup> ), campus 36,780 ft <sup>2</sup> (3,417 m <sup>2</sup> ), campus expansion 900 ft <sup>2</sup> (84 m <sup>2</sup> ), administrative wing only
<b>Passive design strategies</b>	Narrow building footprint, moderate WWR, exterior shading, natural ventilation, thermal mass and night-time purging, daylight controls, green roof
<b>HVAC system</b>	No mechanical cooling, hydronic in-slab radiant heating
<b>Window-to-wall ratio</b>	27% (South), 66% (North), 24% (East), 24% (West)
<b>Floor depth</b>	18 ft (5.5 m), typical
<b>Glazing specifications</b>	PPG Solarban-60 or equivalent
<b>Exterior shading type</b>	Automated exterior roller shades and fixed exterior overhangs
<b>Predicted EUI</b> <sup>90, 91</sup>	2.8 kBtu/ft <sup>2</sup> /yr (8.8 kWh/m <sup>2</sup> /yr), campus 6.1 kBtu/ft <sup>2</sup> /yr (1.9 kWh/m <sup>2</sup> /yr), Step I <sup>92</sup> and II <sup>93</sup> expansion
<b>Estimated renewable energy</b> <sup>90, 94</sup>	0.7 kBtu/ft <sup>2</sup> /yr (2.1 kWh/m <sup>2</sup> /yr), campus 1.5 kBtu/ft <sup>2</sup> /yr (4.6 kWh/m <sup>2</sup> /yr), Step I and II expansion
<b>Ratings</b>	LEED for Schools v. 2.0 Gold (Step I expansion) LEED for Schools v. 2.0 Platinum (Step II expansion)

<sup>90</sup> Peterson, John Paul (2009, 29 March). *Marin Country Day School (Steps I & II)*. Poster session presented at the ASHRAE conference "Countdown to a Sustainable Energy Future...Net-Zero and Beyond," San Francisco, CA. Retrieved from <http://www.ashrae.org/events/page/2094>.

<sup>91</sup> Excludes renewable energy production

<sup>92</sup> Includes a new administrative wing, music building and multi-purpose space, library

<sup>93</sup> Includes IT services, private office spaces, and relocation of a number of teaching spaces and classrooms

<sup>94</sup> Includes photovoltaics and solar hot water heating

## 8.6 REFERENCES

1. Carlson, Don (2010, June 22). Telephone interview with director of facilities at Marin Country Day School.
2. Krevsky, Shani (2010, April 23). Telephone interview with former architect at EHDD Architecture.
3. Peterson, John Paul (2009, August 12). Telephone interview with former principal at Stantec.
4. Peterson, John Paul (2009, March 29). *Marin Country Day School (Steps I & II)*. Poster session presented at the ASHRAE conference "Countdown to a Sustainable Energy Future...Net-Zero and Beyond," San Francisco, CA. Retrieved from <http://www.ashrae.org/events/page/2094>.



**Figure 32: Site plan**

Source: Google Maps

## 9. CALIFORNIA ACADEMY OF SCIENCES

San Francisco, California



**Figure 33: Southeast elevation**

*Image credit: Krystyna Zelenay*

The California Academy of Sciences museum of natural history accommodates open exhibit spaces, a planetarium, aquarium, laboratories, collection storage spaces, and offices. The predicted energy use of 103 KBTu/sf/yr (12 percent below ASHRAE 90.1-1999)<sup>95</sup> was driven in part by the fairly stringent relative humidity and temperature requirements in the rainforest (79° to 84°F with 50 to 70 percent relative humidity), planetarium, aquariums, laboratory and collection storage spaces. The building code also required that the collection areas containing specimens preserved in a highly combustible solution, be continuously mechanically ventilated.<sup>96</sup> Nevertheless, San Francisco's mild climate provided the opportunity to utilize natural ventilation and eliminate the need for cooling in the open exhibit spaces. The design team also sought to maximize natural ventilation in the 30-foot-deep open office spaces spanning all five floors on the southeast side of the building, and, despite the limitations associated with ventilating a space with operable windows on only one side, they were able to rely on natural ventilation for cooling in the outermost 20-foot perimeter zone of the office space.

---

<sup>95</sup> Gonchar, Joann. (2009) Case Study: California Academy of Sciences. *Green Source*, March/April: 68-75.  
[http://greensource.construction.com/projects/2009/03\\_California-Academy-of-Sciences.asp](http://greensource.construction.com/projects/2009/03_California-Academy-of-Sciences.asp)

<sup>96</sup> Lyndon, Karl (2010, May 14). Telephone interview with mechanical engineer.

## 9.1 THE BUILDING (FACULTY OFFICES)

The office spaces are located along the building's southeast elevation (the building is rotated 45° from the cardinal directions). In an effort to minimize the need for cooling in the open office space, computational fluid dynamics (CFD) simulations were conducted in conjunction with a thermal analysis using ROOM, Arup's in-house thermal analysis software, to determine the effect of natural ventilation on occupant thermal comfort in the 30-foot-deep open office space. According to the CFD analysis, 20 feet was the approximate limit for a single-sided naturally-ventilated space. However, getting the outermost 20 feet of the 30-foot-deep open office plan to work with single-sided ventilation was a challenge, requiring a very high free area on the facade. Supplemental mechanical ventilation was required for the inner third of the open office space (**Figure 35** and **Figure 36**). In the end, the results of the simulation showed that the temperature inside the space could reach 79°F at certain times of the year, corresponding to 20 percent PPD (Predicted Percentage of Dissatisfied) – an upper limit that was acceptable to the owner. The enclosed office spaces located between the open office and collection areas are mechanically ventilated and cooled (**Figure 36**). The exhibit spaces are entirely naturally-ventilated and conditioned through the radiant slab, which is cooled at night through night-purging and, if required, by the hydronic cooling system during the day.<sup>97</sup>

Since the completion of the initial measurement and verification phase during the first year of building occupancy, the Academy has been closely monitoring building performance. They plan to publish a detailed energy breakdown and analysis as part of their LEED operation and maintenance certification in early 2011.<sup>98</sup>

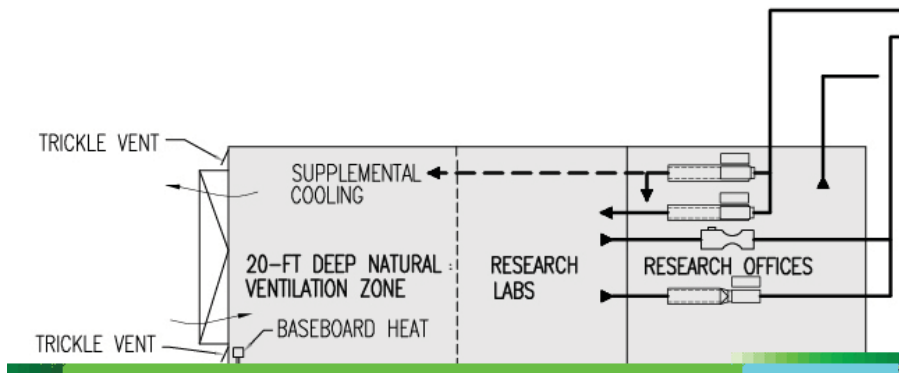
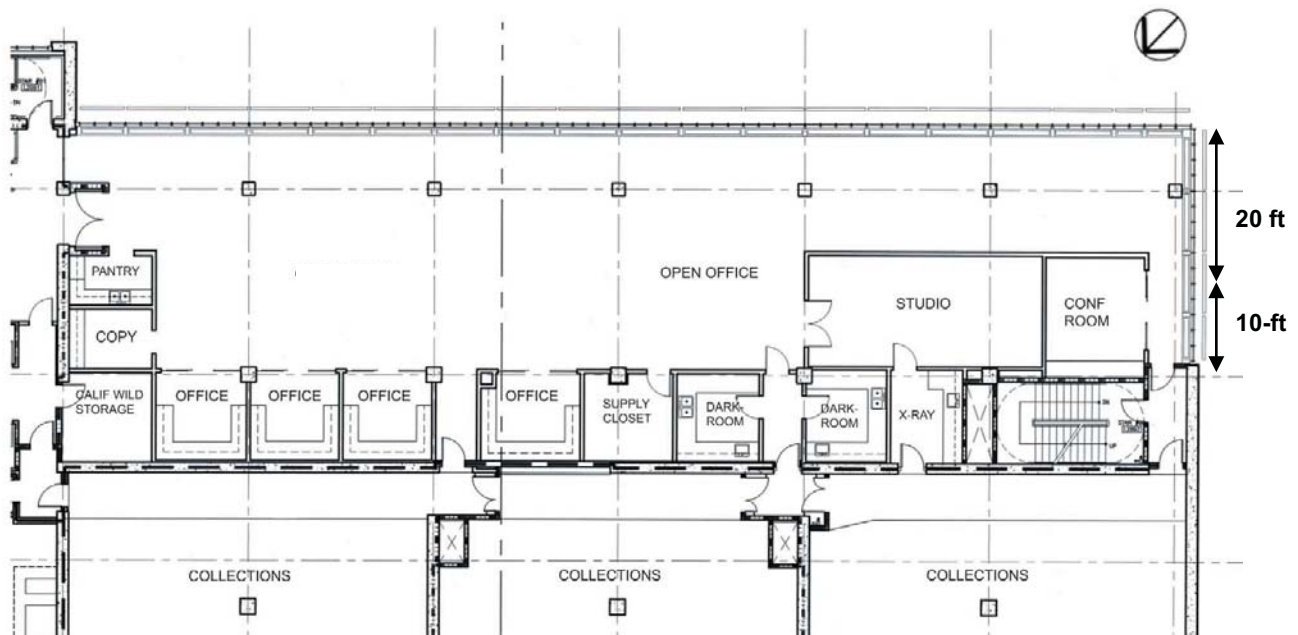

**Figure 34: Office air schematic**

*Image credit:* California Academy of Sciences

<sup>97</sup> Lyndon, Karl (2010, May 14). Telephone interview with mechanical engineer at Arup.

<sup>98</sup> Harding, Ari (2010, May 13). Personal interview with director of building systems at California Academy of Sciences.



**Figure 35: Partial second floor plan**

*Image credit: California Academy of Sciences*

## 9.2 THE FACADE

The design team utilized several facade design strategies to minimize the cooling load in the offices, including exterior roller shades for minimizing solar heat gain and operable windows to promote natural ventilation. The shades are automatically controlled to block direct sunlight based on a time schedule, however building management is contemplating adjusting the control type to solar intensity. Occupants have access to manual overrides which control a third of the shades in each wing of the building.

Operable casement windows, 10 feet tall by 2 feet wide, assist with natural ventilation and provide occupants with the means to control the environment. During warmer months, building management urges occupants to close their windows when the temperature approaches 79°F. In addition to the manually-operated casement windows, small automated awning windows at the head and sill of the window are incorporated on each floor. The windows were implemented for night purging of offices as well as meeting code-mandated temperature and ventilation requirements in the perimeter office area. However, as discussed in the following section, the control sequence for the vents was adjusted during the first year of occupancy due to occupant thermal comfort complaints.

In the first few months of occupancy, per specifications, the windows were automatically controlled by the BAS in groups of two bays, with six upper-level and six lower-level windows per bay. Multiple combination sensors (temperature, CO<sub>2</sub> and relative humidity) at every other structural column controlled the operation of the windows. With building in occupied mode, the bottom glazing unit would first open in stages, and if after some time, CO<sub>2</sub> and/or temperature limits were exceeded, the top unit would open in stages as well. If the indoor temperature, measured at the structural columns just inboard of the facade, fell below the operator-defined setpoint, the finned tube perimeter heaters at the base of the facade would be activated to preheat incoming outside air.



**Figure 36: Detail of exterior roller shades and trickle vents**

*Image credit: Krystyna Zelenay*

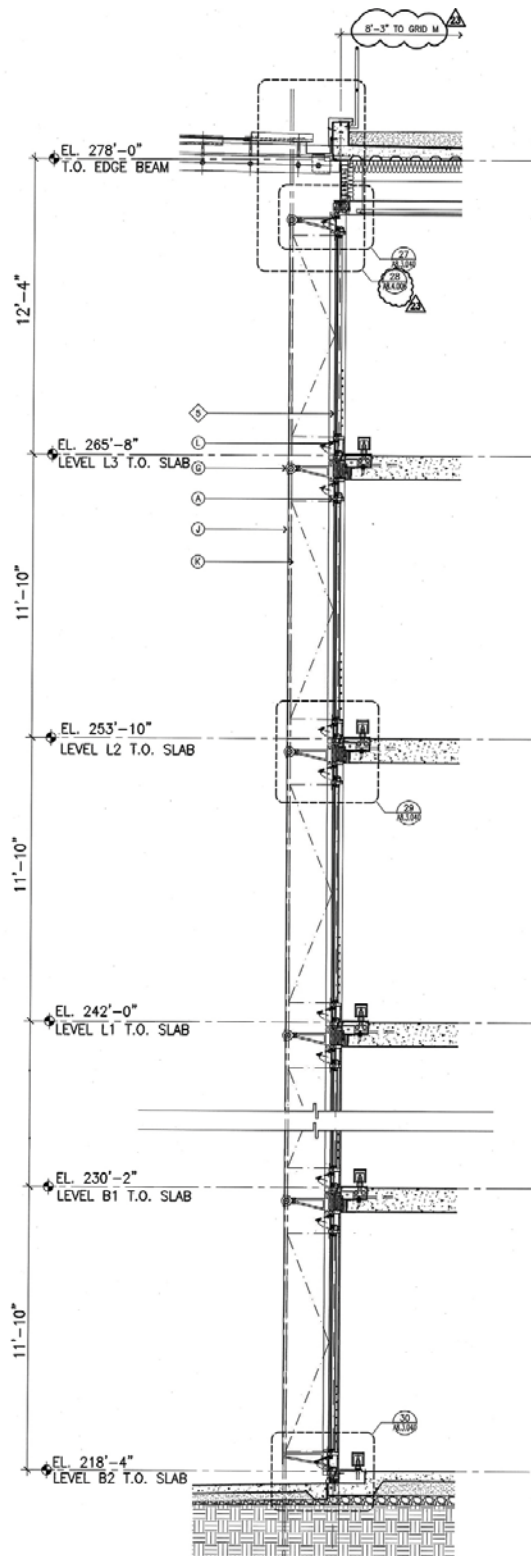

**Figure 37: Section through southeast facade**

*Image credit: California Academy of Sciences*



### 9.3 CHALLENGES

It took several months to fine-tune the facade systems in the offices, especially the small automated awnings at the head and sill of each open office space. Drafts caused by cool incoming air, 60°F to 65°F, led to occupant thermal discomfort during the first few months of occupancy. Consequently the window control sequence (discussed above) was modified so that the awnings only open when the outside temperature is within +/- 2°F of interior temperature during occupied periods.<sup>99</sup> An additional source of complaints related to the automated awnings was the loudness of operation; the sound of the actuators opening and closing the glazing units was noticeable to the occupants. Thermal comfort complaints have not been common in public areas, possibly because people are dressed more warmly and have an increased activity level as they move through the exhibit spaces or, as transient occupants, they may be less likely to complain.

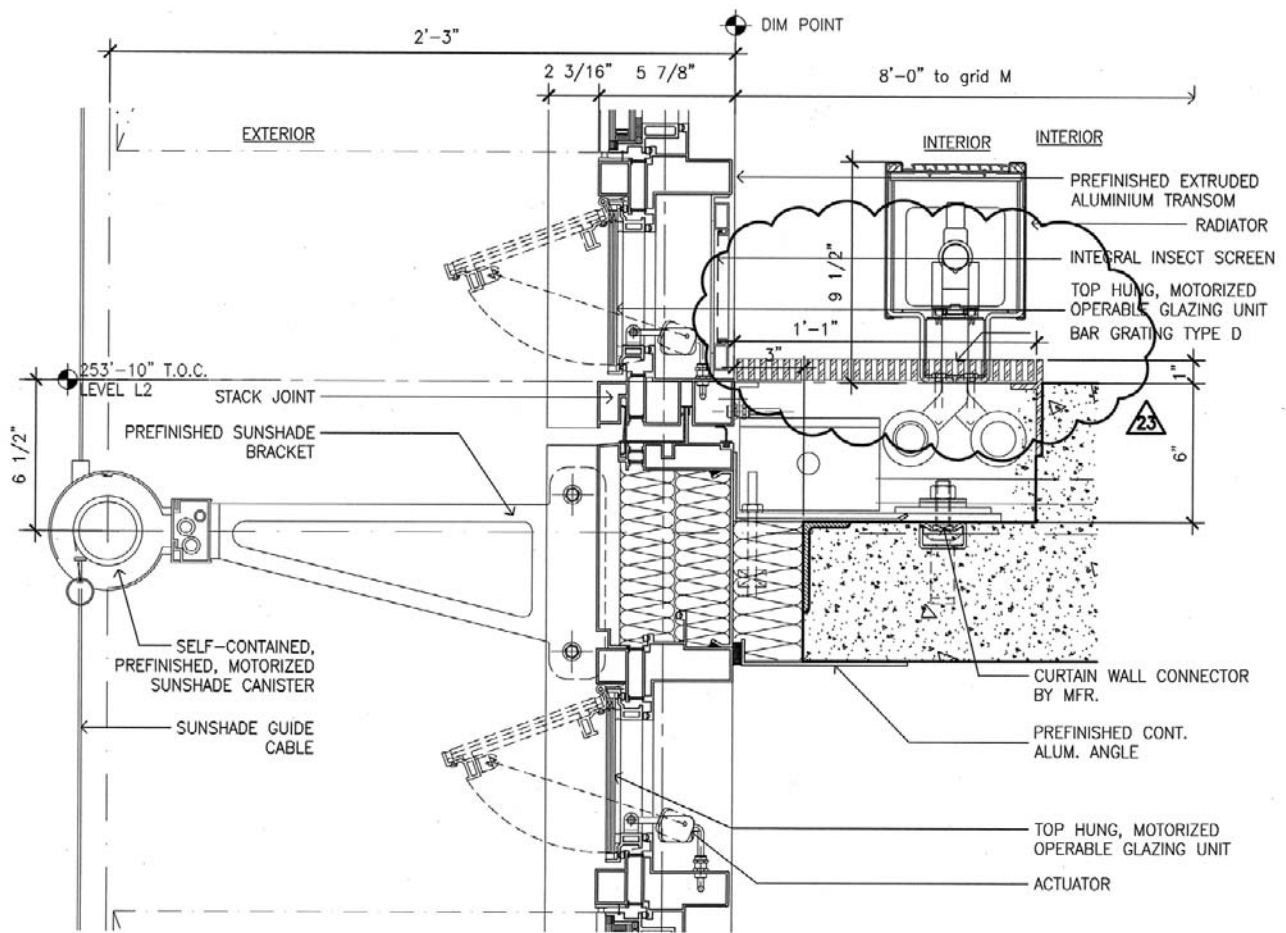

**Figure 38: Detail section at slab**

Image credit: California Academy of Sciences

<sup>99</sup> Harding, Ari (2010, May 13). Personal interview with director of building systems at California Academy of Sciences.

Another challenge has been the operation and maintenance of the automated exterior roller shades, many of which have required replacement since building occupancy.<sup>100</sup> While the shades are programmed to retract under high wind loads, there is no way to prevent the occasional damage resulting from a strong initial wind gust. The Academy has had to replace ripped fabrics and broken cables on several occasions. Roller shades at the public level were prone to additional damage due to visitors pulling on the shades. For this reason, the Academy has opted to keep exterior shades at the public level at the exhibit spaces retracted during visiting hours. Since no maintenance contract for the shades had been developed during the design phase, the Academy has had to manage the repairs on their own – an expensive and time-consuming endeavor. At the time of this study, the owners were contemplating a maintenance contract with the installer of the shading. The contract would likely consist of quarterly check-ups during which the system will be checked, calibrated, lubricated, and straightened. The cost of the maintenance contract had been estimated at approximately \$20,000 to \$30,000 per year for all of the roller shades at the Academy.<sup>100</sup>



**Figure 39: View of office interior**

*Image credit: Nic Lehoux*

---

<sup>100</sup> Harding, Ari (2010, May 13). Personal interview with director of building systems at California Academy of Sciences.



**Figure 40: Northeast elevation**

*Image credit: Krystyna Zelenay*

## **9.4 LESSONS LEARNED**

Following several improvements to the office facade and daylighting dimming systems made by facilities staff, it appears that the occupants are presently quite satisfied with the space. They appreciate having access to operable windows, as well as the abundant views and good daylighting. While some occupants feel comfortable utilizing the overrides for the automated shading, others appear to be intimidated by the system and prefer to leave it alone.<sup>101</sup> Periodic training sessions on building operation have been conducted in order to alleviate the confusion with respect to how the systems are operated.<sup>101</sup> Moreover, building management stresses the importance of proper window operation and asks occupants to close windows on warm days in order not to increase the temperature inside the offices. A red/green light system was installed to prompt occupants to open or close windows, however it is not presently being used.<sup>102</sup>

---

<sup>101</sup> Harding, Ari (2010, May 13). Personal interview with director of building management systems at California Academy of Sciences.

<sup>102</sup> Young, Don (2010, May 5). Telephone interview with principal at D.R. Young Associates; owner's representative.

## 9.5 KEY PROJECT FEATURES

<b>Location</b>	San Francisco, CA
<b>Date of completion</b>	2008
<b>Architect</b>	Renzo Piano Building Workshop and Stantec Architecture (formerly Chong Partners)
<b>Mechanical Engineer</b>	Arup
<b>Building type</b>	5-story natural history museum
<b>Project size</b>	400,000 ft <sup>2</sup> (37,161 m <sup>2</sup> ), <i>entire museum</i>
<b>Passive design strategies</b>	Operable windows, external shading, BAS-controlled trickle vents and roof vents to enhance natural ventilation, thermal mass and night-time purging, daylight controls, green roof
<b>HVAC system</b>	Cooling tower with radiant slab hydronic heating and cooling, low pressure ventilation via under floor air distribution system
<b>Window-to-wall ratio</b>	Greater than 75%
<b>Floor depth</b>	30 ft (9 m)-deep open office space, enclosed office spaces beyond
<b>Glazing specifications</b>	VE 1-2M or equivalent
<b>Exterior shading type</b>	Nysan automated exterior roller shades, PV canopy at south and north elevations
<b>Other dynamic facade elements</b>	Automated trickle vents in office and public spaces, Nysan automated interior sunshades, interior acoustic shades, and exterior rainscreen over piazza
<b>Predicted EUI</b>	103 kBtu/ft <sup>2</sup> /yr (324.9 kWh/m <sup>2</sup> ) - 12% below ASHRAE 90.1-1999 <sup>103</sup>
<b>Actual EUI</b>	151.4 kBtu/ft <sup>2</sup> /yr (477.6 kWh/m <sup>2</sup> ) <sup>104</sup>
<b>Ratings</b>	LEED-NC v. 2.1 Platinum

<sup>103</sup> Gonchar, Joann. (2009) Case Study: California Academy of Sciences. *Green Source*, March/April: 68-75. [http://greensource.construction.com/projects/2009/03\\_California-Academy-of-Sciences.asp](http://greensource.construction.com/projects/2009/03_California-Academy-of-Sciences.asp)

<sup>104</sup> Based on utility data from July 2009 through June 2010. Includes electricity generated by photovoltaic array. The Academy will be publishing a more detailed energy breakdown and analysis as part of their LEED Operation and Maintenance certification in early 2011.

## 9.6 REFERENCES

1. Harding, Ari (2010, May 13). Personal interview with director of building management systems at California Academy of Sciences.
2. Lyndon, Karl (2010, May 14). Telephone interview with mechanical engineer at Arup.
3. Terpeluk, Brett (2009, Nov. 16). Telephone interview with former architect at Renzo Piano Building Workshop.
4. Young, Don (2010, May 5). Telephone interview with principal at D.R. Young Associates; owner's representative.
5. Gonchar, Joann. (2009) Case Study: California Academy of Sciences. *Green Source*, March/April: 68-75. [http://greensource.construction.com/projects/2009/03\\_California-Academy-of-Sciences.asp](http://greensource.construction.com/projects/2009/03_California-Academy-of-Sciences.asp)

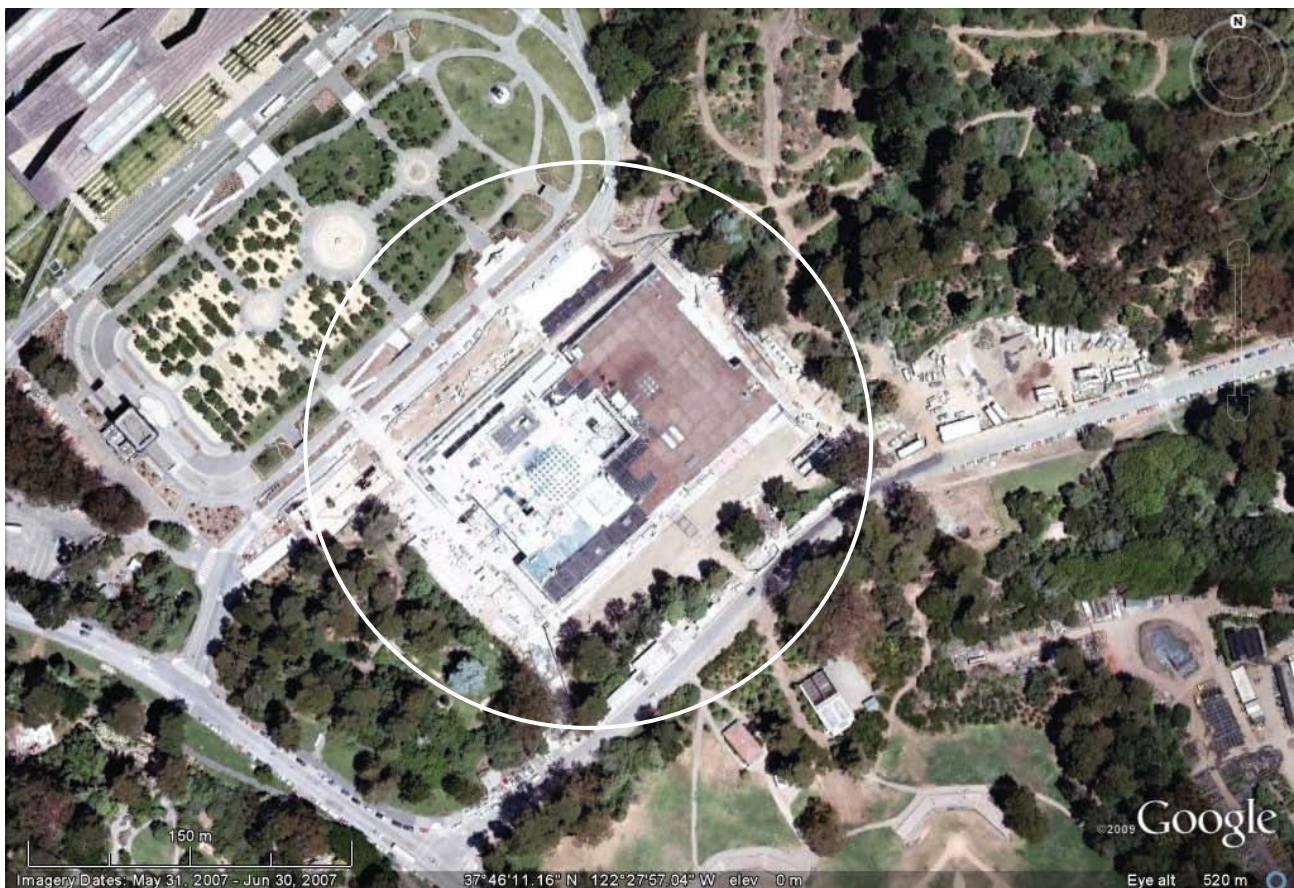

**Figure 41: Site plan**

Source: Google Maps

|

# 10. DAVID BROWER CENTER

Berkeley, California



**Figure 42: Northwest elevation**

*Image credit: Krystyna Zelenay*

The main performance objective for the design of the David Brower Center was the development of an environmentally-friendly office building with a high-quality indoor environment, created to house environmental non-profit organizations. The design team pursued a narrow building footprint, which allowed them to maximize performance in terms of energy efficiency and daylighting, and despite a value-engineering phase during which several facade elements were eliminated, the project clearly illustrates the benefits associated with proper building massing, orientation and a thoughtfully designed building envelope.

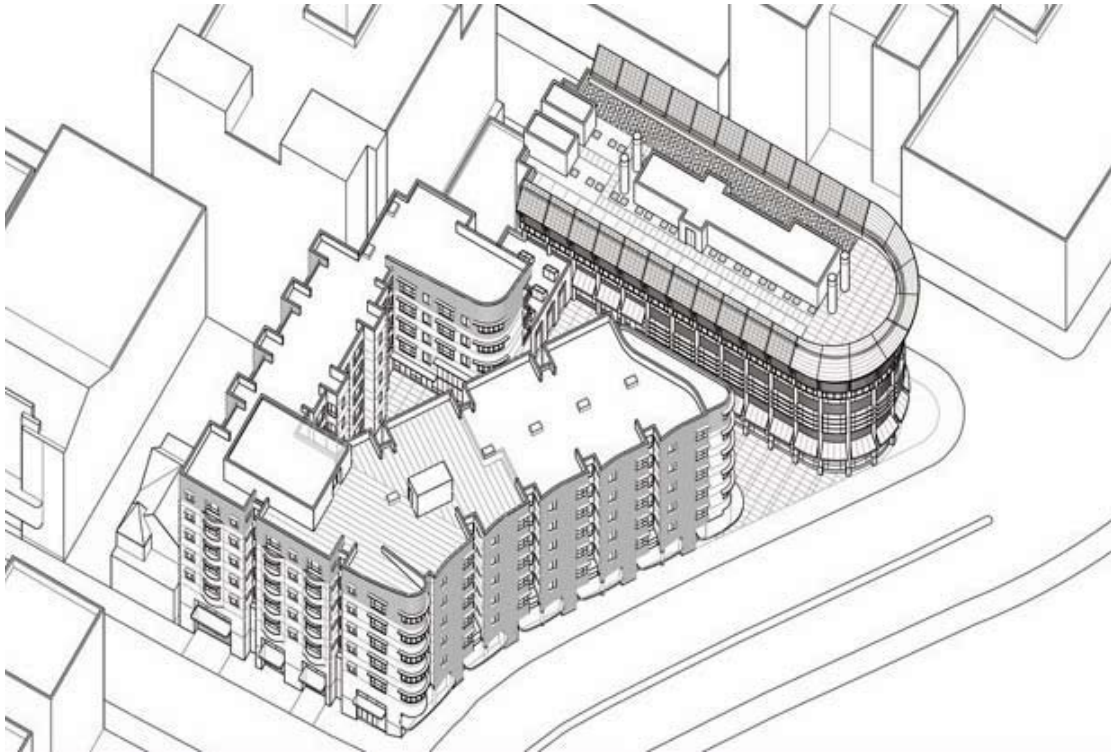

**Figure 43: Axonometric view of David Brower Center (right) and adjacent condominiums**  
*Image credit: Solomon WRT*

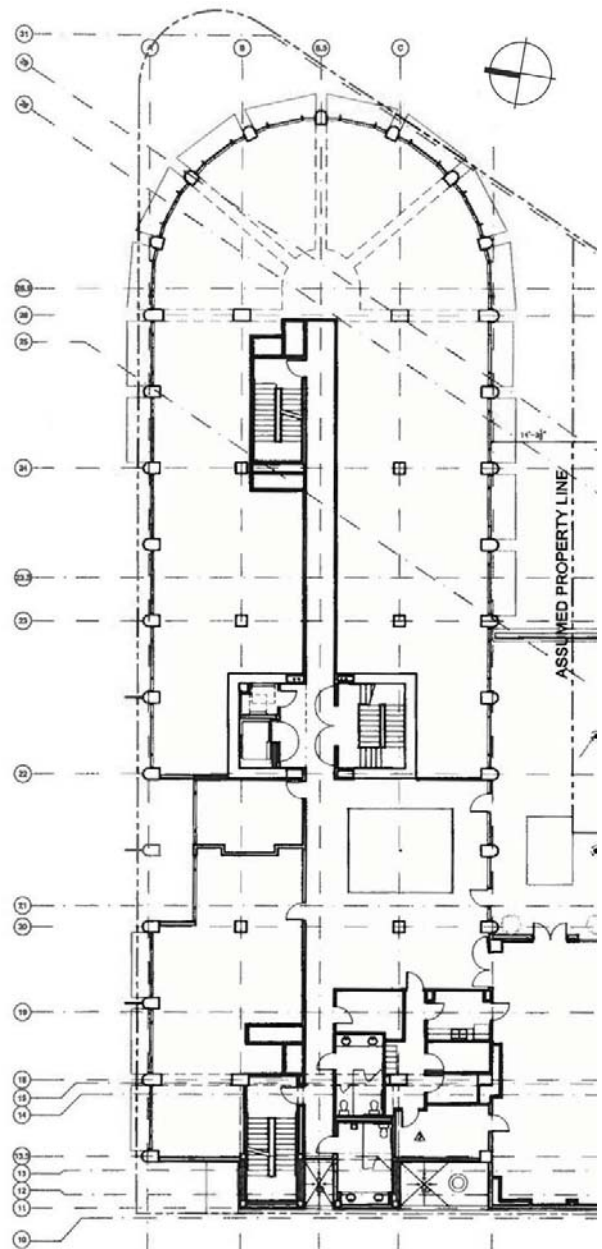

**Figure 44: South elevation**  
*Image credit: Krystyna Zelenay*



**Figure 45: West elevation**

*Image credit: Solomon WRT*



**Figure 47: Third floor plan**

*Image credit: Solomon WRT*

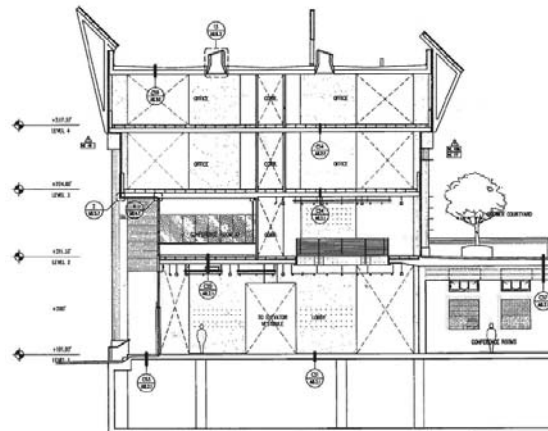

**Figure 46: Cross section**

*Image credit: Solomon WRT*

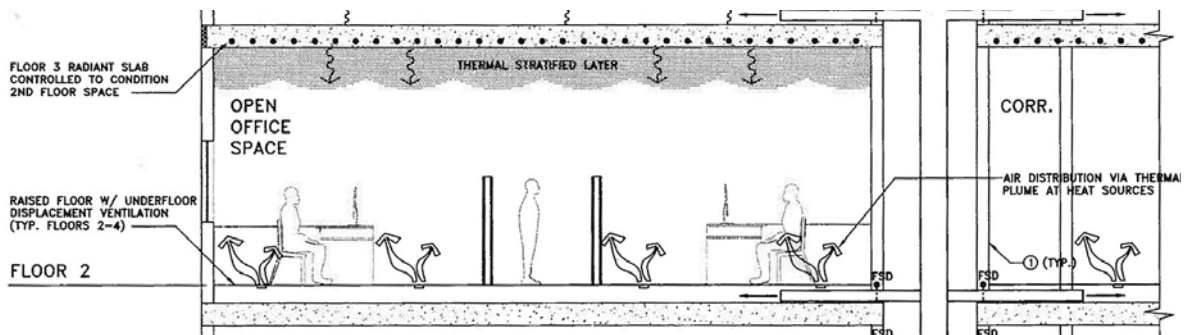

**Figure 48: Section through office space showing mechanical system**

*Image credit: Solomon WRT*



## 10.1 THE BUILDING

The David Brower Center incorporates a number of passive design strategies, including building massing and orientation, moderate window-to-wall ratio, thermal mass, natural ventilation, high-performance glazing and fixed exterior shading. Between these passive design strategies and careful control of internal loads, the design team was able to reduce peak cooling loads enough to enable the implementation of a cooling tower in combination with a hydronic in-slab radiant cooling system – a more efficient alternative to standard VAV systems and compressor-based cooling.

Due to local ordinances which imposed a maximum allowable volume for the development, the height of the building was fixed, limiting the floor-to-ceiling heights. The heights of individual floors was driven by daylight availability and programmatic requirements. For example, the ground floor with retail occupancy has a higher floor-to-floor height than the remaining floors (**Figure 51**). The top floor has the lowest height since daylight requirements are partially met through top lighting provided by a series of roof-level skylights, while the 2<sup>nd</sup> floor has a higher floor-to-floor height in order to compensate for reduced daylight availability at the lower floors resulting from surrounding site obstructions.<sup>105</sup>

The primary space conditioning subsystem is hydronic in-slab radiant cooling and heating, which is installed in the exposed ceiling slabs over the second, third and fourth floors of the building. Due to their large surface area and high thermal mass, slab-integrated radiant systems use relatively warm chilled water temperatures, making them well-matched with non-compressor-based cooling such as cooling towers. In addition to the improved efficiency of transporting thermal energy with water rather than air, the building cooling energy savings are attained through the utilization of a cooling tower, which uses about one-tenth of the energy of a chiller for one ton of cooling to make chilled water.<sup>106</sup> While more efficient than a chiller, the main limitation of the cooling tower is that it can only cool water to a certain temperature, generally a few degrees above the outside wet-bulb temperature, so its application is limited to projects with low cooling loads.

Since radiant surfaces cannot be cooled below the dewpoint temperature of the space due to risk of surface condensation, they have a relatively low cooling capacity, and 99 W/m<sup>2</sup> (31.4 Btu/hr/ft<sup>2</sup>) is generally regarded as the cooling capacity for radiant ceilings.<sup>107</sup> Therefore the project design team aimed to reduce building loads as much as possible. An underfloor air distribution (UFAD) system was implemented to provide ventilation and additional cooling, however the cooling load handled by the UFAD system is reduced because the radiant slab system handles most of the cooling load. Since building loads are low on account of the envelope performance and the incorporation of thermal mass, a fixed lower limit for the surface temperature of the ceiling was assumed. While this calculation is somewhat conservative in that the temperature of the radiant cooling ceiling may be well above the actual dewpoint temperature of the room throughout much of the year, the project's mechanical engineer finds that this is a simple and reliable approach to controlling the system. The alternative would have been to continuously track the room dewpoint temperature through the use of humidity sensors, which can be highly inaccurate when brand new (approximately +/-2 percent RH for a quality sensor) and have a lot of drift over time, up to +/-5 percent RH after five years without calibration. While assuming a fixed lower temperature for the radiant surface is an appropriate solution for projects with low internal loads, humidity sensors may be

---

<sup>105</sup> Loisos, George (2010, July 6). Personal interview with principal at Loisos + Ubbelohde..

<sup>106</sup> Bradshaw, Tyler (2010, July 12). Telephone interview with green building design team manager at Integral Group.

<sup>107</sup> Olesen, Bjarne. (2008) Radiant Floor Cooling Systems. *ASHRAE Journal*, 50(9): 16-22.

needed in cases where high loads are anticipated. If implemented, at least two or three sensors should be installed and calibrated against each other regularly to minimize the risk of failure.<sup>108</sup>

## 10.2 THE FACADE

The key objectives in the design of the facade were limiting conductive and radiant heat losses and gains, maximizing daylight, and controlling direct sun. The implementation of simple fixed exterior aluminum louvers (**Figure 50**) allowed the design team to greatly decrease the peak cooling load, and improve occupant visual and thermal comfort by blocking direct sun throughout much of the year. Manually-operated interior roller fabric shades, a medium gray color with a 3 percent openness factor and 15 percent visible transmittance, allow the occupants to make further adjustments to their environment.<sup>109</sup> Fabric shades rather than venetian blinds were selected because even when lowered, they provide some daylight and view to the outside.

Facade strategies for improving light uniformity in the office spaces were proposed early in the design, including an exterior lightshelf with an Alanod<sup>110</sup> reflector (a highly reflective metal finish) on the south facade, and a Serraglaze light-redirecting film<sup>111</sup> (a thin film that allows diffuse light to penetrate deeper into a room) for the glazing on the north facade. However these features, along with the automated roller shades and many of the roof skylights, were eliminated during subsequent design iterations and value engineering. While all of the occupied spaces in the building are well daylit, the third floor appears somewhat darker due to a lower floor-to-ceiling height and the elimination of the light-redirecting elements.<sup>109</sup> According to a recent Center for the Built Environment (CBE) occupant IEQ survey, the majority of occupants are very satisfied with the daylighting and visual comfort in the space. Seventy-five percent of occupants in south-facing office spaces are either satisfied or very satisfied with the daylighting in the space. The people who were dissatisfied with daylighting cited lack of direct sunlight as the main reason for their dissatisfaction.

---

<sup>108</sup> Bradshaw, Tyler (2010, July 12). Telephone interview with green building design team manager at Integral Group.

<sup>109</sup> Loisos, George (2010, July 6). Personal interview with principal at Loisos + Ubbelohde.

<sup>110</sup> See Alanod-Solar website for more information: <http://alanod-solar.com/opencms/opencms/Reflexion/index.html>

<sup>111</sup> See Bending Light website for more information: [http://www.bendinglight.co.uk/building\\_home.asp](http://www.bendinglight.co.uk/building_home.asp)



**Figure 49: South elevation**

*Image credit: Krystyna Zelenay*



**Figure 50: Detail of aluminum louvers**

*Image credit: Krystyna Zelenay*

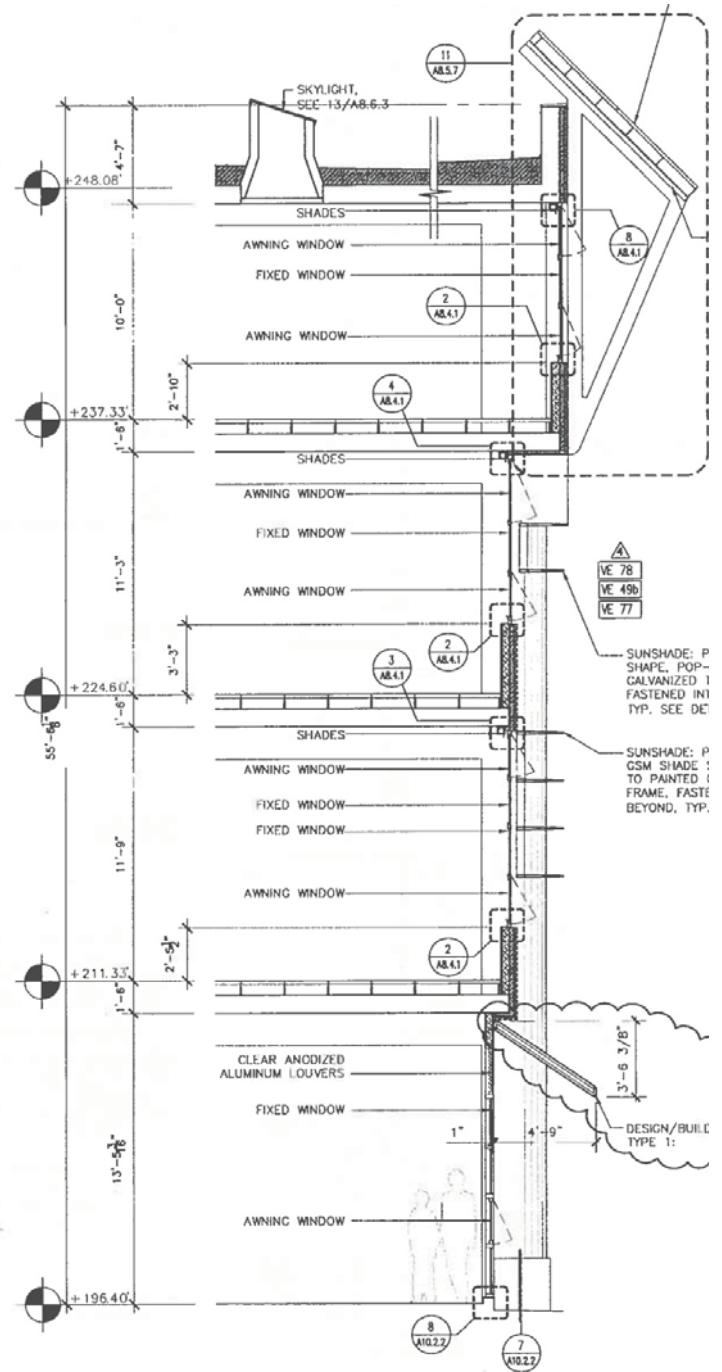

**Figure 51: Section through south facade**

*Image credit: Solomon WRT*

### 10.3 LESSONS LEARNED

The design approach clearly illustrates how to attain a well-daylit building by relying on a combination of fundamental design strategies. Important starting points include building massing by which the floor plate depth is minimized, alignment of the main axis north-south, maximization of the floor-to-floor heights and window head heights. The project is successful despite value-engineering during which some proposed facade features were eliminated. While the added cost of light-redirecting elements may be difficult to justify, they can play an important role in improving daylight uniformity, especially in spaces with low floor-to-ceiling heights.

Finally, a somewhat conservative approach to facade design, in which reliance on automated controls and sensors is minimized can be highly successful. The main benefit of such an approach is the elimination of potential risks associated with controls and operation. However this requires a rigorous approach optimizing fixed rather than operable elements, and emphasizing the fundamental design strategies, such as building massing and orientation, moderate WWR, and solar control.



**Figure 52: View of 4th floor skylights**

*Image credit: David Lehrer*



**Figure 53: View of interior**

*Image credit: Krystyna Zelenay*

## 10.4 KEY PROJECT FEATURES

<b>Location</b>	Berkeley, CA
<b>Date of completion</b>	2009
<b>Architect</b>	Solomon WRT
<b>Mechanical Engineer</b>	Rumsey Engineers
<b>Daylighting consultant</b>	Loisos + Ubbelohde
<b>Building type</b>	4-story commercial and office building
<b>Project size</b>	38,500 ft <sup>2</sup>
<b>Passive design strategies</b>	Building massing and orientation, moderate WWR with exterior shading, operable windows, thermal mass and night-time purging, daylight controls
<b>HVAC system</b>	Cooling tower with radiant slab hydronic heating and cooling, low pressure ventilation via under floor air distribution (UFAD) system
<b>Window-to-wall ratio</b>	41% (South), 54% (North), 51% (East), 6% (West), 2% (roof)
<b>Floor depth</b>	60 ft
<b>Glazing specifications</b>	PPG Solarban 60 or equivalent, typical
<b>Exterior shading type</b>	Fixed exterior white-painted aluminum louvers on 2nd and 3rd floors, awning at ground floor, photovoltaic canopy at 4th floor
<b>Occupancy</b>	150 people, 40 hr/person/week
<b>Predicted EUI</b> <sup>112, 113</sup>	38.4 kBtu/ft <sup>2</sup> /yr (121.1 kWh/m <sup>2</sup> /yr) – 54% savings over Title 24-2005
<b>Actual EUI</b> <sup>9, 114</sup>	47.3 kBtu/ft <sup>2</sup> /yr (149.2 kWh/m <sup>2</sup> /yr) – 44% savings over Title 24-2005
<b>PV production</b> <sup>115</sup>	8.92 kBtu/ft <sup>2</sup> /yr (28.1 kWh/m <sup>2</sup> /yr)
<b>Purchased energy</b> <sup>116</sup>	38.4 kBtu/ft <sup>2</sup> /yr (121.1 kWh/m <sup>2</sup> /yr)
<b>Ratings</b>	LEED-NC v. 2.2 Platinum, <i>pending</i> Energy Star rating = 100, <i>pending</i>

<sup>112</sup> Sagehorn, Michele (2010, September 2). Personal correspondence with commissioning engineer at Integral Group.

<sup>113</sup> Excludes restaurant energy use. Includes the following end uses (in kBtu/ft<sup>2</sup>/yr): cooling (2.23), heating (13.26), indoor fans (1.73), lighting (9.23), heat rejection (0.48), pumps (1.51), DHW (3.39), and receptacle energy use (6.56).

<sup>114</sup> Excludes restaurant energy use. Calculated based on utility bills for the first year of occupancy (July 2009 to June 2010). While most of the restaurant systems and equipment is separately submetered, minor adjustments to the utility bill numbers were made by the mechanical engineer in order to exclude the portion of energy used by restaurant for systems shared by the base building and restaurant (e.g. condenser water from base building for heat pumps). Does not include contribution of photovoltaic array.

<sup>115</sup> Based on photovoltaic array electricity generation data obtained from the building dashboard (<http://buildingdashboard.com/clients/brower/>) for the first year of occupancy (July 2009 to June 2010). The electricity generated by the array offset approximately 50% of the building's electricity demand during this period.

<sup>116</sup> Purchased energy = Actual EUI – PV production

## 10.5 REFERENCES

1. Bradshaw, Tyler (2010, July 12). Telephone interview with green building design team manager at Integral Group.
2. Harris, Malcolm (2010, June 30). Telephone interview with senior associate at Solomon WRT.
3. Loisos, George (2010, July 6). Personal interview with principal at Loisos + Ubbelohde.
4. Olesen, Bjarne. (2008) Radiant Floor Cooling Systems. *ASHRAE Journal*, 50(9): 16-22.
5. Sagehorn, Michele (2010, September 2). Personal correspondence with commissioning engineer at Integral Group.

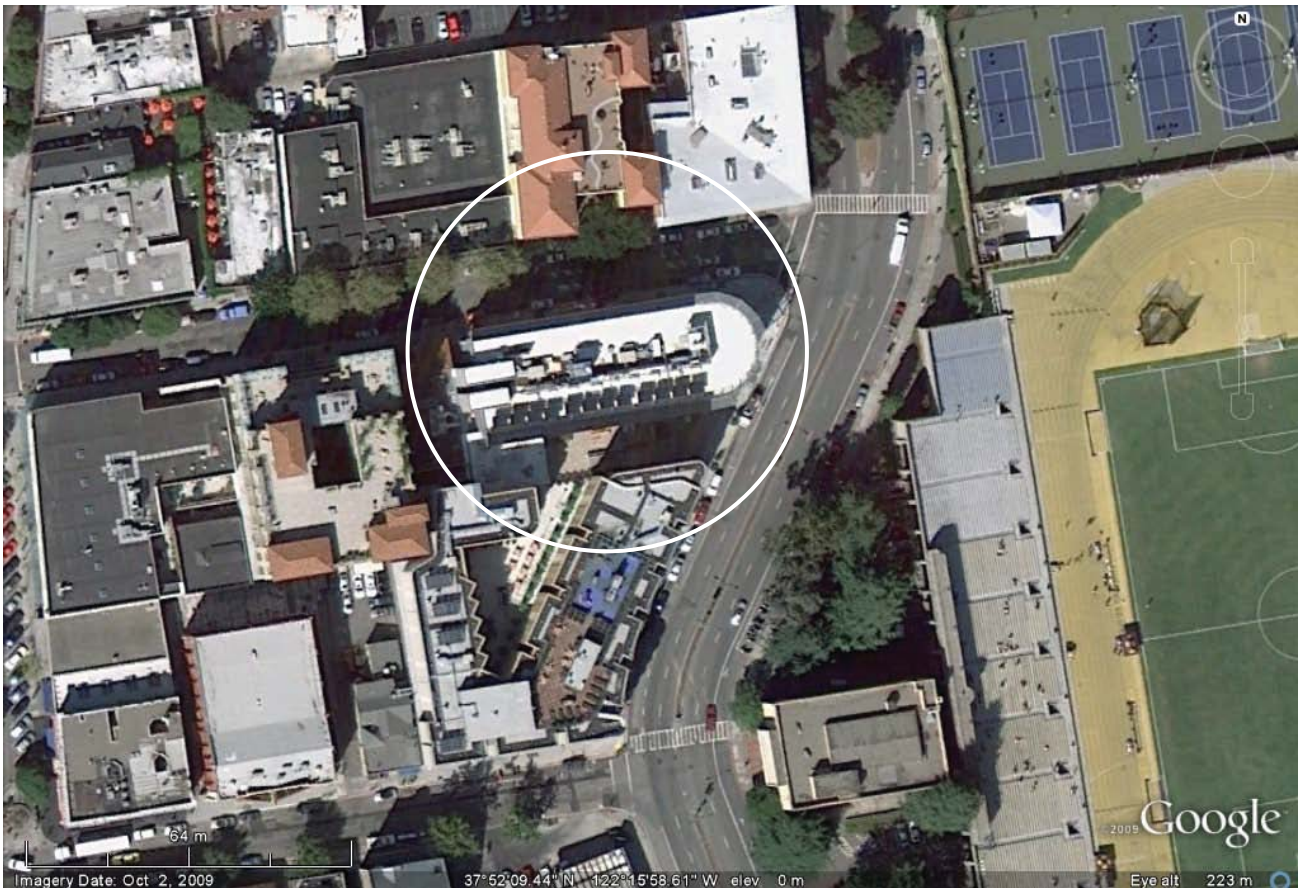

**Figure 54: Site plan**

Source: Google Maps

## REFERENCES

1. *Advanced Thermal Comfort Model website*. (n.d.). Retrieved from Center for the Built Environment, University of California, Berkeley: <http://cbe.berkeley.edu/research/briefs-thermmodel.htm>.
2. Arens, E., Turner, S., Zhang, H., and Paliaga, G.. (2009). *Moving Air for Comfort*. UC Berkeley: Center for the Built Environment. Retrieved from: <http://escholarship.org/uc/item/6d94f90b>
3. Arens, E., Zhang, H., & Huizenga, C. (2006). *Partial- and whole-body thermal sensation and comfort, Part I: Uniform environmental conditions, Part II: Non-uniform environmental conditions*. Center for the Built Environment, University of California, Berkeley.
4. *ASHRAE Handbook – Fundamentals*. (2009). ASHRAE.
5. ASHRAE Standard 55-2004. “Thermal Environmental Conditions for Human Occupancy.”
6. ASHRAE. (2010) ASHRAE’s Best: 2010 Technology Awards. *ASHRAE Journal*, 52(3): 56–63.
7. Brager, G. and R. de Dear (2001). Climate, Comfort & Natural Ventilation: A new adaptive comfort standard for ASHRAE Standard 55. *Proceedings, Moving Thermal Comfort Standards into the 21st Century*, Windsor, UK, April 2001.
8. Brager, G., S. Borgeson, and E. Lee (2007). *Control Strategies for Mixed-Mode Buildings*. CBE Summary Report. Center for the Built Environment, University of California, Berkeley.
9. Brager, G., G. Paliaga, and R. de Dear (2004). Operable Windows, Personal Control and Occupant Comfort. *ASHRAE Transactions*.
10. Brown, Nathan (2009). *Performance by Design: An Energy Analysis of AIA/COTE Top Ten Projects*. Retrieved from <http://www.aia.org/aiaucmp/groups/aia/documents/pdf/aiab081492.pdf>
11. Building Services Research and Information Association. (2007, June). *Trust in Construction: Heelis post-occupancy report*. Retrieved from BSRIA: <http://www.bsria.co.uk/news/1936/>
12. Carmody, J., S. Selkowitz, E. S. Lee, D. Arasteh, T. Willmert (2004). *Window Systems for High-Performance Buildings*. New York: W.W. Norton.
13. Carmody, John and Bruce Haglund (2006). *External Shading Devices in Commercial Buildings: The Impact on Energy Use, Peak Demand and Glare Control*. Center for Sustainable Building Research, University of Minnesota.
14. Daly, A. (2002). Operable windows and HVAC systems. *Heating/Piping/Air Conditioning Engineering (HPAC)*.
15. “Electricity Consumption (kWh) Intensities by End Use for All Buildings, 2003.” *Energy Information Administration*. 2008. 3. Nov. 2008. [http://www.eia.doe.gov/emeu/cbecs/cbecs2003/detailed\\_tables\\_2003/2003set19/2003html/e06a.html](http://www.eia.doe.gov/emeu/cbecs/cbecs2003/detailed_tables_2003/2003set19/2003html/e06a.html)

16. Emmerich, S.J. and J. Crum (2005). Simulated Performance of Natural and Hybrid Ventilation Systems in an Office Building. Final Report, *Air-Conditioning and Refrigeration Technology Institute*, ARTI-21CR/611-40076-01.
17. Fanger, P. O. (1973). *Thermal Comfort*. McGraw-Hill.
18. Fortmeyer, R. (2009, July). Transparency: Literal and Sustainable. *Architectural Record*, p. 101.
19. Galasiu, A. D. and J. A. Veitch (2006). "Occupant Preferences and Satisfaction with the Luminous Environment and Control Systems in Daylit Offices: A Literature Review." *Energy and Buildings*. 38: 728–742.
20. Energy Efficiency Best Practice Programme (1998). *General Information Report 48: Passive Refurbishment at the Open University – Achieving Staff Comfort through Improved Natural Ventilation*, March 1998, available free from Brecsu.
21. Gertis, K. (1999). "Sind Neuere Fassadenentwicklungen Bauphysikalisch Sinnvoll? Teil 2: Glas-Doppelfassaden (GDF)." *Bauphysik*, 21 (2), 54–66.
22. Hausladen, G., de Saldanha, M., & Liedl, P. (2008). *ClimateSkin, Building-Skin Concepts that Can Do More with Less Energy*. Basel: Birkhäuser.
23. Hedge, A., P.S. Burge, A.S. Wilson, J. Harris-Bass (1989). Work-related illness in office workers: A proposed model of the sick-building syndrome. *Environment International*, 15, 143–58.
24. Heschong Mahone Group (2003). *Windows and offices: a study of office workers performance and the indoor environment*. Prepared for California Energy Commission: Fair Oaks, CA.
25. Heschong Mahone Group (1999). *Daylighting in schools: an investigation into the relationship between daylighting and human performance, detailed report*. Fair Oaks, CA.
26. Heschong Mahone Group (2001). *Re-Analysis Report, Daylighting in Schools*, for the California Energy Commission, published by New Buildings Institute, [www.newbuildings.org](http://www.newbuildings.org).
27. Heschong Mahone Group (2003). *Windows and classrooms: a study of student performance and the indoor environment*. Prepared for California Energy Commission: Sacramento, CA.
28. Hindrichs, D. U., & Daniels, K. (2007). *PlusMinus 20°/40° Latitude*. Edition Axel Menges.
29. Hopkinson, R.G. (1972). "Glare from Daylighting in Buildings." *Applied Ergonomics*, 3: 206–215.
30. Hoyt, T., Zhang, H., and E. Arens (2009). *Draft or Breeze? Preferences for air movement in office buildings and schools from the ASHRAE database*. UC Berkeley: Center for the Built Environment. Retrieved from: <http://escholarship.org/uc/item/99q2f4cf>
31. Huizenga, C., H. Zhang, Mattelaer, P., T. Yu and E. Arens (2006). *Window Performance for Human Thermal Comfort—Final Report to the National Fenestration Ratings Council*. Center for the Built Environment, University of California, Berkeley.
32. Illuminating Engineering Society of North America (IESNA) (2000). *Lighting Handbook 9th Edition*, New York, NY.



33. Inanici, Mehlika (2006). "Evaluation of high Dynamic Range Photography as a Luminance Data Acquisition System." *Lighting Research and Technology*, 38: 123–136.
34. Inkarojrit, Vorapat (2008). "Monitoring and Modeling of Manually-Controlled Venetian Blinds in Private Offices." *Journal of Building Performance Simulation*, 1: 75–89.
35. Jones, W. (2008, February). "Bennetts Associates Architects' Wessex Water HQ reviewed." Retrieved from *BD Magazine*: <http://www.bdonline.co.uk/>
36. Lam, W. M. (1977). *Perception and Lighting as Formgivers for Architecture*. McGraw-Hill.
37. Lee, E. et al. (2002). *High-Performance Commercial Building Facades*, LBNL 50502. Berkeley: Ernest Orlando Lawrence Berkeley National Laboratory.
38. Lee, E. S., S. Selkowitz, M. Levi, S. Blanc, M. McConahey, M. McClintock (2002). *Active Load Management with Advanced Wall Systems: Research and Industry Perspectives*. LBNL.
39. Lee, Eleanor S. and Stephen E. Selkowitz. (Lawrence Berkeley National Laboratory). 2009. *High-Performance Building Facade Solutions*. California Energy Commission. Publication number: CEC-500-06-041.
40. Leaman, A. and B. Bordass (1999). 'Productivity in Buildings: the 'Killer' Variables', *Building Research & Information*, 27: 1, 4–19.
41. Nabil, A. and J. Mardaljevic (2006). "Useful Daylight Illuminances: A Replacement for Daylight Factors." *Energy and Buildings*, 38: 905–913.
42. Reinhart, C.F. (2004). Lightswitch- 2002: A Model for Manual and Automated Control of Electric Lighting and Blinds. *Solar Energy*, 77(1) pp. 15–28.
43. Reinhart, C., J. Mardaljevic, and Z. Rogers (2006). *Dynamic Daylight Performance Metrics for Sustainable Building Design*. National Research Council Canada.
44. Oesterle, E., R. Lieb, M. Lutz, and W. Heusler (2001). *Double-Skin Facades: Integrated Planning*. Presetel Verlag.
45. Pasquay, T. (2004). Natural Ventilation in High-Rise Buildings with Double Facades, Saving or Waste of Energy. *Energy and Buildings*, 36(4), 381–389.
46. Perepelitza, M. (2010). *Integrated Building Facades – Performance Potential and Effective Applications*. Masters thesis. University of California Berkeley.
47. Perepelitza, Mark. (2010). Integrated Facades: High-Performance Innovations from Northern Europe. *Better Bricks website*. <http://betterbricks.com/design-construction/tools-resources/integrated-facades>
48. Poirazis, H. (2006). *Double Skin Facades – A Literature Review*. IEA SHC Task 34 Annex 43 report.
49. Poirazis, H., and M. Kragh (2009). "Establishing a Simplified Correlation Between a Proposed Double Skin Facade and a Thermally Equivalent Single Skin Facade for Dynamic Building Energy Modeling." *IBPSA Building Simulation Conference*. Glasgow, Scotland.
50. Probe. 2000. "Barclaycard Headquarters." *Building Services Journal*. March: 37–42.

51. Seppänen, O. and W. Fisk (2001). "Association of Ventilation System Type with Sick Building Symptoms in Office Workers", *Indoor Air*, 2001, pp. 98–112.
52. Schulz, M. (2004, November 15). Leben im Switzenkasten. *Der Spiegel*. 47/2004 - 15. November 2004. <http://www.spiegel.de/spiegel/print/d-36625924.html>
53. Southern California Edison. *Dynamic Window Shading Systems Technology Overview and Product Assessment*. Design & Engineering Services, 2008.
54. Torcellini, P., Pless, S., Deru, M., & Crawley, D. (2006). *Zero Energy Buildings: A Critical Look at the Definition*. National Renewable Energy Laboratory and U.S. Department of Energy.
55. Tuaycharoen, N. and P.R. Tregenza (2007). "View and Discomfort Glare from Windows." *Lighting Research and Technology*, 39: 185–200.
56. Turner, C., & Frankel, M. (2008). *Energy Performance of LEED® for New Construction of Buildings*. New Building Institute.
57. Ubbelohde, S. (2006). Occupant Thermal Comfort in Curtain Wall Selection. *Journal of Building Enclosure Design*.
58. Sutter, Y. et al. "The Use of Shading Systems in VDU Task Offices: A Pilot Study." *Energy and Buildings*. 38 (2006): 780–789.
59. Wienold, J. and J. Christoffersen (2006). "Evaluation Methods and Development of a New Glare Prediction Model for Daylight Environments with the Use of CCD Cameras." *Energy and Buildings*, 38: 743–757.
60. U.S. Department of Energy (2007). Energy Flow Diagram. Retrieved from Annual Energy Review: <http://www.eia.doe.gov/emeu/aer/diagram1.html/>
61. Yudelson, Jerry (2009). *Green Building Trends: Europe*. Washington, DC: Island Press.

# APPENDIX A: INTERVIEWEES

## NORTHERN EUROPEAN INTERVIEWEES

### Architects:

- Martin Haas, Behnisch Architekten (Stuttgart, Germany)
- Christoph Ingenhoven, Ingenhoven Architects (Düsseldorf, Germany)
- Heiko Weissbach, Sauerbruch Hutton
- Peter Clegg, Feilden Clegg Bradley (Bath, UK)
- Bill Gething, Feilden Clegg Bradley (Bath, UK)
- Andrew Clifford, Sheppard Robson (tour of Arup Fitzrovia)

### Facade and energy consultants:

- Andrew Hall, Arup facade engineering (London, UK)
- Mikkel Kragh, Arup facade engineering (London, UK)
- Peter Thompson, Buro Happold facade engineering (London, UK)
- Thomas Auer, Transsolar (Stuttgart, Germany)

### Window system manufacturers:

- Peter Langenmayr, Josef Gartner Facades (Gundelfingen, Germany)
- Patrick Briem, Josef Gartner Facades (Gundelfingen, Germany)
- Winfried Heusler, Schüco Window Systems (Bielefeld, Germany)

### Building researchers and academics:

- William Bordass, Usable Building Trust (UK)
- Tillmann Klein, Facade Research Group at Delft University of Technology
- Marcel Bilow, Facade Research Group at Delft University of Technology
- Stephen Ledbetter, Director of the Center for Cladding and Window Technology, University of Bath

### Building tours:

- Petra Scheerer, public relations – Deutsche Post Tower, Bonn, Germany
- Mareike Rößmann, Behnisch Architekten – Nord/LB, Hannover, Germany
- Claus Marquart, Sauerbruch Hutton – GSW, Berlin, Germany
- Birgitt Heinicke, office of president – Umweltbundesamt (UBA), Dessau, Germany
- Liz Adams, building manager – Heelis – National Trust Headquarters, Swindon, UK
- Mike Caple, building manager – Wessex Water Facilities, Bath, UK
- Andrew Clifford, project architect, Shepherd Robson Architects – Arup Fitzrovia, London, UK

## **NORTH AMERICAN INTERVIEWEES**

### Architects and owner representatives:

- Malcolm Harris, Solomon WRT (San Francisco, CA)
- Gabe Hanson, formerly an architect at Weber Thompson (Seattle, WA)
- Myer Harrell, Weber Thompson (Seattle, WA)
- Scott Thompson, Weber Thompson (Seattle, WA)
- Brett Terpeluk, Studio Terpeluk, formerly an architect at RPBW (San Francisco, CA)
- Steve DelFraino, LMN Architects (Seattle, WA)
- Shani Krevsky, formerly and architect at EHDD Architecture (San Francisco, CA)
- Don Young, D. R. Young Associates (San Rafael, CA)

### Mechanical engineers:

- Tyler Bradshaw, Integral Group (Oakland, CA)
- Michele Sagehorn, Integral Group (Oakland, CA)
- Karl Lyndon, Arup (London, UK)
- John Paul Peterson, Sherwood Design Engineers, formerly a mechanical engineer at Stantec (San Francisco, CA)

### Facade and energy consultants:

- George Loisos, Loisos + Ubbelohde (Alameda, CA)
- Susan Ubbelohde, Loisos + Ubbelohde (Alameda, CA)
- Roddy Wykes, Arup (San Francisco, CA)
- Alex Goehring, Arup (San Francisco, CA)
- Claire Johnson, Atelier Ten (San Francisco, CA)

### Building managers:

- Ari Harding, Director of Building Managements Systems, California Academy of Sciences (San Francisco, CA)
- Don Carlson, Director of Facilities at Marin Country Day School (Corte Madera, CA)
- Mark Grey, Stephen C. Grey and Associates, Terry Thomas property manager (Seattle, WA)

### Building researchers and academics:

- Eleanor Lee, Staff Scientist at Lawrence Berkeley National Laboratory Environmental Energy Technologies Division (Berkeley, CA)
- Michael Donn, Director of Centre of Building Performance Research at Victoria University of Wellington (Wellington, New Zealand)
- Mudit Saxena, Senior Project Manager Heschong Mahone Group (Sacramento, CA)

### Manufacturers:

- Matthew Craven, Nysan Solar Control
- Bernie Grosse, T&T Shading

# APPENDIX B: DESIGN RESOURCES

## SOFTWARE

### **DAYSIM (Dynamic Daylight Simulations) software**

*National Research Council Canada*

[www.nrc-cnrc.gc.ca/eng/projects/irc/daysim.html](http://www.nrc-cnrc.gc.ca/eng/projects/irc/daysim.html)

[www.daysim.com](http://www.daysim.com)

DAYSIM is an annual daylight availability simulation software which uses Radiance, developed by Lawrence Berkeley National Laboratory, as the underlying simulation engine. DAYSIM can be used to calculate both annual daylight availability and lighting energy based on on/off switches and automated lighting controls (occupancy sensors, photocells). The underlying “Lightswitch” manual lighting control model is based on monitored occupancy behavior from several field studies (Reinhart, 2004). Among the dynamic daylight performance metrics calculated by DAYSIM are daylight autonomy (DA) and useful daylight index (UDI). DAYSIM has been linked to several other design software, including Ecotect and Rhinoceros.

### **DIVA-for-Rhino**

*Harvard Graduate School of Design*

<http://www.gsd.harvard.edu/research/gdsdsquare/ABPS.html>

<http://www.diva-for-rhino.com/>

DIVA-for-Rhino is a design plug-in for the Rhinoceros - NURBS modeling for Windows application. The plug-in, developed by Christoph Reinhart, Alstan Jakubiec, Kera Lagios and Jeff Niemasz as part of the G(SD)<sup>2</sup> research initiative at Harvard University, can be used to evaluate building performance in terms of radiation maps, visualizations, climate-based metrics, glare analysis and LEED IEQ Credit 8.1.

### **COMFEN (Commercial Fenestration) Tool**

*Buildings Technology Department, Environmental Energy Technologies Division, Lawrence Berkeley National Laboratory*

<http://windows.lbl.gov/software/comfen/comfen.html>

COMFEN is a simplified computer simulation tool for evaluating alternative facade configurations early in the design process. The software uses Energy Plus as the underlying simulation engine, however due to its largely simplified inputs it can be used to quickly and efficiently compare the performance of alternative facade configurations, including automated roller shades and venetian blinds. Software outputs include annual energy use by end use (heating, cooling, fans, or lighting), peak energy use, average annual daylight illuminance, visual discomfort and thermal comfort.

### **WINDOW**

*Buildings Technology Department, Environmental Energy Technologies Division, Lawrence Berkeley National Laboratory*

<http://windows.lbl.gov/software/window/6/index.html>

WINDOW software, a public software used for window energy efficiency labeling and rating, is available for download from LBNL. The software is widely used by the building industry to show glazing assembly compliance with building energy codes. The extensive WINDOW material library incorporates optical and thermal performance characteristics for the majority of commercially-available glazing, coating, interlayer and film products, and can be used to easily calculate the performance characteristics (e.g. U-value, solar heat gain coefficient, shading coefficient, and visible transmittance) for custom glazing make-ups.