

UC Davis

UC Davis Electronic Theses and Dissertations

Title

The Risk and Resilience of Plug-in Vehicles in the Presence of an Imperfect Charging Network

Permalink

<https://escholarship.org/uc/item/5ft8m45f>

Author

Karanam, Vaishnavi

Publication Date

2023

Peer reviewed|Thesis/dissertation

The Risk and Resilience of Plug-in Vehicles in the Presence of an Imperfect Charging Network

By

VAISHNAVI KARANAM
DISSERTATION

Submitted in partial satisfaction of the requirements for the degree of

DOCTOR OF PHILOSOPHY

In

Transportation, Technology, and Policy

in the

OFFICE OF GRADUATE STUDIES

of the

UNIVERSITY OF CALIFORNIA

DAVIS

Approved:

Gil Tal, Chair

Christopher Nitta

Alan Jenn

Committee in Charge

2023

Acknowledgements

I would like to extend my thanks to the members of my committee, Dr. Gil Tal, Dr. Christopher Nitta, and Dr. Alan Jenn, for their invaluable guidance, feedback, and contributions to my research.

I would especially like to thank Christopher Nitta for his role as my advisor and mentor throughout my time at UC Davis. This work would not have been possible without your patience and guidance.

Thank you to Claire Sugihara, Katrina Sutton, and Adam Davis for their significant contributions to the research design and analysis for Chapter 3. Claire Sugihara's insights were particularly pivotal in shaping the outcomes of this chapter.

Finally, I wish to acknowledge the Electric Vehicle (EV) Research Center at UC Davis for fostering a collaborative and supportive environment that enabled me to pursue this research.

Special thanks go to Dahlia Garas, Gil Tal, Matthew Favetti, and Scott Hardman for their unwavering support to the graduate students at the EV Center.

Funding for the collection of data used in this research came from the California Air Resources Board; thank you for your support.

Abstract

This dissertation aims to explore some of the key barriers to realizing the full emission reduction potential of Plug-in Electric Vehicles (PEVs). Specifically, it explores the tradeoffs between Battery Electric Vehicles (BEVs) and Plug-in Hybrid Electric Vehicles (PHEVs) at reducing tailpipe emissions in the presence of an imperfect Electric Vehicle (EV) charging network.

BEVs are true Zero Emission Vehicles (ZEVs) since they rely solely on energy from a battery (i.e., a rechargeable energy storage system) for propulsion, emitting no tailpipe emissions. In contrast, PHEVs can propel themselves using a combination of battery and internal combustion engine (ICE) energy. As such, driver behavior that determine the extent to which PHEVs' electric range is used, have a strong influence on their energy use and emission potential. The first few chapters of this dissertation specifically explore the impact of the interaction between driver behavior and technical vehicle parameters on the energy consumption and Green House Gas (GHG) emissions of PHEVs in order to inform policy about the true emission potential of these low emission vehicles.

Chapter 2 presents a study that aims to characterize the engine start activity profiles and emission potential of various PHEV models by examining the characteristics associated with engine starts, identifying the travel conditions that trigger engine starts, and determining the frequency of different types of starts. The study ultimately finds that long range PHEVs with high battery capacity such as the Chevrolet Volt are ideal for both curbing start emissions via initializing few engine starts and maximizing fuel displacement.

Chapter 3 presents two studies that aim to understand the motivations and implications of driver mode, user-selectable drivetrain configuration setting, usage in PHEVs. In addition to

comprehensively defining and classifying various drive modes, the first study examines the motivations for drive mode usage using a survey of over 26,000 PEV drivers in California. The second study quantifies the energy use and emission impacts of drive mode usage using on-road vehicle data from 81 Chevy Volts driven in California.

Since BEVs aren't equipped with ICEs, they are far superior to PHEVs at curbing tailpipe emissions. However, given the vehicles are solely powered by electricity, the adoption and acceptance of BEVs is tightly coupled with the quality of the EV charging infrastructure. As such, the scarcity of reliable and functional EV charging stations presents a significant barrier to the widespread adoption of BEVs. This dissertation aims to complement and expand the limited literature on EV charging reliability by examining the impact of EV charger reliability on BEV driver experience and developing a tool to help charging networks effectively meet impending reliability standards.

Chapter 4 presents a study that focuses on understanding the impact of EV charger reliability on driver experience. It uses real-world EV charging data to simulate the level of disruption that would've occurred to EV drivers had their successful charging sessions been unsuccessful. Additionally, it quantifies how many charging sessions were actually unsuccessful and qualifies how disruptive those unsuccessful charging sessions were to drivers. By quantifying and qualifying the level of disruption associated with both real and hypothetical charge failures, it finds that EV chargers are not all equally important to EV drivers, highlighting the need for more nuanced charging reliability standards to more effectively meet consumer charging needs.

Chapter 5 develops a tool enabling EV charging service providers to swiftly detect charge failures that cannot be detected by standard monitoring protocols. By analyzing habitual charging patterns of EV drivers, the tool identifies unexpected gaps in charger usage, indicating potential

charger faults. The tool incorporates two anomaly detection models: a naive probability distribution-based technique and a LSTM for complex pattern modeling. Depending on the tool's preferred confidence level, CPOs could've detected potential charging faults 1.5 to 3 times faster with the naive method and 1.5 to 2.4 times faster with the LSTM method.

Table of Contents

Acknowledgements	ii
Abstract	iii
Table of Contents	vi
List of Tables	ix
List of Figures	x
List of Abbreviations	xii
Chapter 1: Introduction and Motivation	1
1.1 Policy Environment	1
1.2 The Energy Inefficiencies Linked to Plug-in Hybrid Electric Vehicles	4
1.3 The Charging Anxiety Linked to Battery Electric Vehicles	6
1.4 Dissertation Outline	8
Chapter 2: An Empirical Exploration of Plug-in Hybrid Electric Vehicle Engine Starts	10
2.1 Introduction	10
2.2 Literature Review	11
2.3 Methods	14
2.3.1 Data Collection and Processing Overview	14
2.3.2 Analyzing Engine Start Triggers and Emission Potential of PHEVs	18
2.4 Results	19
2.4.1 Travel Conditions at Engine Start	19
2.4.2 Potential Emission Impacts of Engine Starts	31
2.5 Discussion	34
2.6 Conclusion & Future Direction	36
Chapter 3: From Shifting Gears to Changing Modes: The impact of user-induced drive modes on Plug-in Hybrid Vehicle Energy Efficiency	39
3.1 Introduction	39
3.2 Literature Review	41
3.2.1 Previous Studies on Eco-Driving Behaviors	41
3.2.2 Factors Affecting Driver Behavior	43
3.2.3 Factors Affecting Driver Interaction with PHEV Technology	44
3.2.4 Plug-in Hybrid Drive Modes Overview	45
3.3 The Motivations of Drive Mode Usage in Plug-in Hybrid Electric Vehicles	49
3.3.1 Introduction	49
3.3.2 Methods	50

3.3.3 Results	56
3.3.4 Discussion	64
3.4 <i>The Implication of Drive Mode Usage in a Chevrolet Volt</i>	68
3.4.1 Introduction	68
3.4.2 Methods	68
3.4.3 Results	78
3.4.4 Discussion	87
3.5 <i>Conclusion and Future Direction</i>	90
Chapter 4: BEV Charging Insecurity: How Disruptive are Unreliable Electric Vehicle Chargers?	94
4.1 <i>Introduction</i>	94
4.2 <i>Literature Review</i>	95
Electric Vehicle Supply Equipment	95
Electric Vehicle Charging Activities & Locations	97
Public Charging Infrastructure Anatomy	98
Charging Ecosystem	99
Charging Infrastructure Points of Failure	100
Charging Infrastructure Reliability Metrics	102
Consequences of Unreliable Charging Infrastructure	104
4.3 <i>Methods</i>	105
Data Overview	105
Analytical Methods	108
4.4 <i>Results</i>	111
Level of Disruption from Simulated Charge Failure	111
Quantifying and Qualifying Observed Unsuccessful Charging Sessions	117
4.5 <i>Discussion</i>	120
4.6 <i>Conclusion & Future Direction</i>	124
Chapter 5: BEV Charging Insecurity: How to Detect Charging Failures standard reliability protocols cannot detect?	125
5.1 <i>Introduction</i>	125
5.2 <i>Types of Charging Failures</i>	125
5.3 <i>Time Series Anomaly Detection Literature Review</i>	130
Forecasting Methods	130
Reconstruction Methods	131
Encoding Methods	131
Distribution Methods	132
Distance Methods	132
Isolation Trees	133
5.4 <i>Methods</i>	137

Methodology Intuition	137
Methodology Framework	138
Data Overview & Preparation	139
Naïve Probability Distribution for Anomaly Detection	140
LSTM Autoencoder for Anomaly Detection	142
<i>5.5 Results</i>	<i>147</i>
Detected Charging Usage Gaps	147
Potential Benefits of using Tool	153
<i>5.6 Discussion</i>	<i>156</i>
<i>5.7 Conclusion & Future Direction</i>	<i>159</i>
Chapter 6: Conclusion	161
References	166

List of Tables

<i>Table 1 Vehicle Specifications</i>	15
<i>Table 2 Mode type descriptions and potential efficiency impact</i>	48
<i>Table 3 Example of Modes by Mode Type Category</i>	49
<i>Table 4 PHEV Mode Type Categories</i>	52
<i>Table 5 Percentage of All Observations for Each Categorical Variable</i>	54
<i>Table 6 Summary Statistics of Continuous Variables</i>	54
<i>Table 7 Overview of Modes by Frequency of Use. For each mode type the use case with the smallest percentage of respondents is denoted in red while the largest response category is denoted in green.</i>	55
<i>Table 8 Results of The Seven Regression Mode Type Models</i>	57
<i>Table 9 Average Marginal Effect for all Mode Type Models (95% Confidence Interval)</i>	58
<i>Table 10 Summary of Variable Effects on Mode Use by Type and Efficiency</i>	67
<i>Table 11 Trip Descriptive Statistics (The shaded cells mark trip types that were analyzed in this study)</i>	70
<i>Table 12 Travel Conditions analyzed for trips that contain a drive mode</i>	73
<i>Table 13 Regression Model Descriptive Statistics</i>	77
<i>Table 14 Median values of Travel Conditions Indicating Mode Change</i>	78
<i>Table 15 Trip-Level Net Energy Usage Regression Results</i>	83
<i>Table 16 EV Charging Ecosystem Stakeholder Descriptions</i>	99
<i>Table 17 EV Data Overview</i>	106
<i>Table 18 Share of Successful Charging Sessions that are Trip, Charge and Day Disruptive</i>	111
<i>Table 19 Travel Conditions affecting Level of Disruption Means and Kruskal-Wallis Test Results</i>	115
<i>Table 20 Common EV Charger Failures</i>	126
<i>Table 21 Advantages & Disadvantages of Anomaly Detection Methods</i>	134
<i>Table 22 Charging Data Overview</i>	140

List of Figures

<i>Figure 1 Data Acquiring and Processing Pipeline.....</i>	<i>15</i>
<i>Figure 2 Engine-on Time Trace</i>	<i>17</i>
<i>Figure 3 SOC at First Engine Start.....</i>	<i>20</i>
<i>Figure 4 Maximum Estimated Power Requirement 5 Seconds before Engine Start.....</i>	<i>22</i>
<i>Figure 5 Catalyst Temperature at Engine Start (first engine starts in blue and all subsequent engine starts in red) 23</i>	
<i>Figure 6 Prius Soak Time by SOC at Engine Start.....</i>	<i>24</i>
<i>Figure 7 C-Max-Fusion Soak Time by SOC at Engine Start.....</i>	<i>25</i>
<i>Figure 8 Prius Prime Soak Time by SOC at Engine Start.....</i>	<i>25</i>
<i>Figure 9 Pacifica Soak Time by SOC at Engine Start</i>	<i>26</i>
<i>Figure 10 Volt 16 Soak Time by SOC at Engine Start</i>	<i>26</i>
<i>Figure 11 Volt 18 Soak Time by SOC at Engine Start</i>	<i>27</i>
<i>Figure 12 Distance from Start of Day to First Engine Start of Day for all PHEVs</i>	<i>29</i>
<i>Figure 13 Distance from Start of Trip to First Engine Start of Trip for all PHEVs</i>	<i>30</i>
<i>Figure 14 Probability of Engine Start per Vehicle Model (Derived from Annualized Engine Start Days)</i>	<i>31</i>
<i>Figure 15 Average Daily Cold Starts</i>	<i>32</i>
<i>Figure 16 Ratio of Electric Miles to Total Miles</i>	<i>33</i>
<i>Figure 17 PHEV Propulsion Power Sources</i>	<i>45</i>
<i>Figure 18 Mode Utilization by Vehicles</i>	<i>70</i>
<i>Figure 19 Additional energy use from time spent in Mountain and Hold Mode</i>	<i>85</i>
<i>Figure 20 Probability of Engine Start by Mode Type</i>	<i>86</i>
<i>Figure 21 Level 2 EVSE Anatomy.....</i>	<i>99</i>
<i>Figure 22 Charging Infrastructure Points of Failure.....</i>	<i>102</i>
<i>Figure 23 Share of Public Charging Sessions by Charging Level and EV Type.....</i>	<i>106</i>
<i>Figure 24 Share of Public EV Charging by Charging Network.....</i>	<i>107</i>
<i>Figure 25 Charging Session Disruption Level Criteria</i>	<i>109</i>
<i>Figure 26 Charging Reliability Scenario Analysis Charger Level Shares.....</i>	<i>112</i>
<i>Figure 27 vehicle-level distribution of the proportion of disruptive level 2 and DCFC charges=.....</i>	<i>113</i>
<i>Figure 28 Share of vehicles miles traveled on long distance travel days (over 50 miles) as a percentage of total VMT</i>	<i>113</i>
<i>Figure 29 Map of Location Critical Charging Sessions</i>	<i>116</i>
<i>Figure 30 Total Day Distance Distributions of Location Critical Charging Sessions</i>	<i>117</i>
<i>Figure 31 Duration to beginning of next trip by level of disruption (slightly, moderately).....</i>	<i>118</i>
<i>Figure 32 Share of unsuccessful charging sessions by vehicle model</i>	<i>119</i>
<i>Figure 33 Share of unsuccessful charges by charging network</i>	<i>120</i>
<i>Figure 34 Consumer Uptime vs. CPO Uptime</i>	<i>127</i>
<i>Figure 35 EV Charging Timeline and associated Failures</i>	<i>130</i>
<i>Figure 36 Charging Anomaly Detection Intuition</i>	<i>138</i>
<i>Figure 37 Charging Anomaly Detection Methodology Framework</i>	<i>139</i>
<i>Figure 38 LSTM Autoencoder Architecture</i>	<i>143</i>

<i>Figure 39 LSTM Architecture</i>	<i>143</i>
<i>Figure 40 LSTM-AD Encoding Layer</i>	<i>145</i>
<i>Figure 41 LSTM-AD Decoding Layer.....</i>	<i>146</i>
<i>Figure 42 Residential Charging Usage Gaps.....</i>	<i>149</i>
<i>Figure 43 Commercial Charging Usage Gaps</i>	<i>150</i>
<i>Figure 44 Workplace Charging Usage Gaps</i>	<i>151</i>
<i>Figure 45 Corridor DC Fast Charging Usage Gaps</i>	<i>152</i>
<i>Figure 46 Charger Repair Time Savings with Tool Use</i>	<i>154</i>
<i>Figure 47 Total Detected Gap Hours with and without Tool Use</i>	<i>155</i>
<i>Figure 48 Average Gap Duration with and without Tool Use.....</i>	<i>156</i>

List of Abbreviations

AE	all-electric (a PHEV mode)
AER	all-electric range
BEV	battery electric vehicle
CARB	California Air Resources Board
CDB	charge depleting blend
CEC	California Energy Commission
CHO	clearing house operator
CO	carbon monoxide
CO ₂	carbon dioxide
CPO	charge point operator
CS	charge sustaining
CVRP	Clean Vehicle Rebate Project
DCFC	DC fast charger
DSO	Distribution system operator
EPA	Environmental Protection Agency
EV	electric vehicle
eVMT	electric vehicle miles traveled
EVSE	electric vehicle supply equipment
EVSP	electric vehicle service provider
FTP	federal test procedure
GHG	greenhouse gas
gVMT	gasoline vehicle miles traveled
HC	Hydrocarbons
HDD	habitual driving distance
HEV	Hybrid electric vehicle
HH	household
NO _x	oxides of nitrogen
NSP	navigation service provider
ICE	internal combustion engine
L1	Level 1 charger
L2	Level 2 charger
LDT	long distance travel
LSTM	long short-term memory
MPG	miles per gallon
MSE	mean squared error
MY	model year
PEV	plug-in electric vehicle

PHEV	plug-in hybrid electric vehicle
PM	particulate matter
SOC	state of charge
UF	utility factor
VMT	vehicle miles traveled
ZEV	zero emission vehicle
zVMT	Zero tailpipe emission trip

Chapter 1: Introduction and Motivation

1.1 Policy Environment

Transportation is a major source of global Green House Gas (GHG) emissions with around 24% of direct CO₂ emissions being attributable to fuel combustion from the transportation sector in 2020 [1]. Road vehicles, in particular, account for three-quarters of these CO₂ emissions [1]. The transition from internal combustion engine (ICE) vehicles to plug-in electric vehicles (PEVs) is considered one of the most promising pathways for reducing GHG emissions and improving local air quality from the road transportation sector [2]. PEV is an umbrella term for battery electric vehicles (BEVs) and plug-in hybrid electric vehicles (PHEVs); these vehicles either wholly (BEVs) or partially (PHEVs) eliminate tailpipe emissions as they rely on an internal battery and an electric motor to power themselves, as opposed to just an internal combustion engine. Several countries have developed official targets to attain a specific number of PEV sales in the near future, along with detailed measures to meet the targets. According to a 2014 study on global PEV incentives, these targets add up to cumulative PEV sales of 20 million units by 2020 [3]. In order to successfully meet set targets, many governments are supporting research to advance PEV battery technology, providing incentives to consumers by lowering PEV purchase and operation costs, and investing in PEV charging infrastructure, the lack of which is a major barrier to PEV adoption.

Despite all the global efforts, the net environmental footprint of certain PEVs, especially PHEVs, heavily depends on a factor of technical parameters and driver behavior; this includes metrics such as the drivetrain configuration, distance traveled, charging behavior, the usage of driver-selectable modes, etc. BEVs are true Zero Emission Vehicles (ZEVs) since they rely solely on energy from a battery (i.e., a rechargeable energy storage system) for propulsion, emitting no tailpipe emissions. In contrast, PHEVs can propel themselves using a combination of battery and

ICE energy. As such, driver behavior that determine the extent to which PHEVs' electric range is used, have a strong influence on their energy use and emission potential. Many recent studies have revealed that some drivers frequently fail to charge their PHEVs consistently, essentially treating them as heavy gasoline cars [4] [5]. The U.S. Environmental Protection Agency (EPA) plans to address this issue by revising its assumptions about PHEV electric drive share [5]. The existing approach has led to an overestimation of the emissions reduction impact of PHEVs, as drivers often rely more on gasoline. While EPA's proposed changes, like categorizing a PHEV with a 35-mile electric range as 45% zero-carbon instead of 57%, represent a significant step towards matching real-world usage patterns, there remains room for further alignment with real-world usage [5]. Alternative datasets, like California Bureau of Automotive Repair data, demonstrate lower electric drive shares and higher gasoline consumption, prompting further research into the true emission potential of PHEVs [5]. The next two chapters of this dissertation specifically explore the impact of the interaction between driver behavior and technical vehicle parameters, on the energy consumption and GHG emissions of PHEVs in order to inform policy about the true emission potential of these low emission vehicles.

Since BEVs aren't equipped with ICEs, they are far superior to PHEVs at curbing tailpipe emissions. However, given the vehicles are solely powered by electricity, the adoption and acceptance of BEVs is tightly coupled with the quality of the EV charging infrastructure. The scarcity of reliable and functional EV charging stations presents a significant barrier to the widespread adoption of BEVs. EV advocates argue that for drivers to embrace BEVs, public charging must be as convenient as refueling at a gas station. However, according to Atlas Public Policy, as of 2023, there are approximately 145,000 places to refuel an ICE vehicle compared to just 11,600 non-tesla fast charging stations that can be used by any EV driver [6]. Additionally,

the 2022 U.S. Electric Vehicle Experience Public Charging survey by J.D. Power revealed that one in five survey respondents encountered difficulties charging their EVs at public charging stations [7]. This lack of reliable and functional charging stations can be attributed to the absence of clear long-term incentives for stakeholders to install and maintain them. EV charging stations involve substantial fixed costs, often requiring real estate retrofitting to integrate with the electrical grid. Consequently, charging stations do not provide immediate profitability, discouraging stakeholders from investing in nascent EV markets. Although government incentives, such as those from the bipartisan infrastructure law and federal tax credits under the Inflation Reduction Act, improve the viability of charging station projects, it will likely take considerable time to effectively develop a sufficient and reliable EV charging network [6]. In the interim, PHEVs may still be the most viable low carbon transportation option for some individuals.

While much research has focused on the importance of and challenges to increasing the quantity of EV chargers worldwide, less has been devoted to assessing the quality of existing EV chargers. It is crucial to not only add more EV chargers to the map, but also ensure that the installed chargers are functional for BEVs to be considered a viable transportation option. According to the 2022 U.S. Electric Vehicle Experience Public Charging survey by J.D. Power, despite the growth of public EV charging infrastructure, one out of every five respondents couldn't charge their EVs due to charger malfunction or being out of service [8]. In response, various jurisdictions, including California, Canada, the European Union, and others, are advocating for stricter EV charger reliability requirements. The U.S. Department of Transportation and the Federal Highway Administration released national standards in February 2023, setting a minimum average annual uptime requirement of 97% for federally funded electric vehicle chargers [9]. Simultaneously, the California Energy Commission (CEC) is developing uptime recordkeeping and reporting standards

for EV charging stations that received public funding, considering a 97% uptime requirement for public chargers for 5 years from commissioning, with different requirements for Level 2 and DC fast chargers [9]. The final two chapters of this dissertation aim to complement and expand the limited literature on EV charging reliability by examining the impact of EV charger reliability on BEV driver experience and developing a tool to help charging networks effectively meet impending reliability standards.

1.2 The Energy Inefficiencies Linked to Plug-in Hybrid Electric Vehicles

Since PHEVs can use energy from a battery, an ICE or a combination of the two to attain propulsion power (enabling them to invoke the engine at any moment within a given trip), the tailpipe emissions of PHEVs can differ dramatically from the emissions of traditional ICE vehicles. Numerous studies have found that engine starts at suboptimal travel conditions, such as low engine block and/or catalytic converter temperatures, are major sources of harmful environmental air pollutants in conventional ICE vehicles. These emission-heavy engine starts are typically referred to as cold starts given their direct link to low engine operation temperatures. When a PHEV's power requirement exceeds the power that can be provided by its all-electric propulsion system, it can invoke the ICE to assist the vehicle to meet this requirement. PHEV engine cold starts that occur during a trip (not the start), as a result of high-power requirements have been shown to emit even more pollutants than regular cold starts given the engine must quickly rev itself up to support the vehicle's high operating speed and torque. Cold starts and high-power cold starts can negate the environmental benefits of PHEVs that are designed to reduce fuel use by maximizing the dwell time or "engine cooling period" between engine starts.

While most PHEVs are engineered to maximize miles traveled on electricity and minimize ICE starts, many of them are equipped with user-selectable drivetrain configuration settings, more

commonly known as drive modes, that let drivers alter vehicle performance to best suit their needs. Some drive modes are designed to improve vehicle energy efficiency while others are meant to enhance driver experience. Despite the innocuous intentions behind the inclusion of user-selectable drive modes, drivers can misuse these modes to the detriment of their vehicles' environmental footprint. Efficiency-based mode buttons in PHEVs can directly alter the main power source of the vehicles and the improper usage of these modes can lead to inefficient energy use, more engine starts and higher overall GHG emissions.

Despite the fact that cold starts and drive mode use can exacerbate the environmental footprint of PHEVs, their impacts aren't assessed in standard vehicle performance and certification tests; this can significantly hinder their ability to meet state and federal emission targets. One of the major reasons for the negligence of these key operational factors is the relative scarcity of actual PEV usage data. For the most part, researchers and policymakers have been creating scenarios by combining various sources of travel data and superimposing a set of preconceived expectations about PEV driving and charging needs. They often assume perfect substitution between ICEs and PHEVs, assume homogeneity in PHEV usage irrespective of technology, and ignore the relationship between driving and charging behavior [10]. These unrealistic assumptions are used as benchmark to estimate PEV usage metrics such as energy and emissions, making it critical to gain a better understanding of the dynamics of PEV usage in the real world. The next two chapters of this dissertation leverage real-world PHEV data to empirically assess key areas of energy inefficiencies within PHEVs attributable to driver behavior, namely cold starts and drive mode misuse.

1.3 The Charging Anxiety Linked to Battery Electric Vehicles

Given that BEVs lack an alternative propulsion source, the consequences of encountering an unexpectedly inoperable EV charger are typically more significant for BEVs compared to PHEVs, as PHEVs can rely on their gasoline engine for backup propulsion if their battery is fully depleted. For BEVs, The consequences of an unsuccessful public charging session varies depending on how quickly the charge failure is discovered by the BEV driver and how easy it is for the BEV driver to locate and reach the nearest operational public charging station. An unsuccessful public charging session isn't very inconvenient/disruptive for a BEV driver who immediately detects the charge failure and has sufficient electric range in their BEV to reach an operation charging station nearby. On the other hand, an unsuccessful public charging session can be very inconvenient/disruptive for a BEV driver who does not immediately detect the charge failure (detects it a few hours or more after plugging in) and/or doesn't have sufficient electric range to reach the nearest operational charging station. The latter scenario is especially prevalent during long-distance travel (LDT) within low-charger density regions.

Before embarking on a LDT/a road trip, most EV drivers meticulously plan their travel route based on their BEV's estimated electric range and scope out compatible charging stations in order to sufficiently meet their perceived charging needs. However, in many cases, BEV drivers' perceived charging needs may not reflect their actual charging needs. The EPA determines a BEV's estimated electric range based on a number of test procedures which mostly cover warm-weather, a mix of speeds, multiple trips, HVAC needs, and some starts and stops. However, this estimated range can be inaccurate and volatile in certain driving scenarios that were not accounted for. In general, the efficiency of a vehicle depends on its aerodynamic drag or its opposing air flow, its rolling resistance or the effort required to keep the tires moving, its mass, its speed, and

the grade of the road it's on. A miscalculation of any of these factors or an unexpected environmental change that shifts the magnitude of these factors can drastically alter the vehicle's electric range. In addition to these factors, cold weather can dwindle the efficiency of a BEV at an alarming rate as it slows down the chemical reactions within the battery pack, necessary to supply and receive energy. According to the American Automobile Association (AAA), BEVs lose around 12% of their range in cold weather, but this goes up to 41% if the heater is on full blast [11]. According to the Department of Energy, the total number of public charging stations in the U.S. as of 2022 is around 55,000; this may seem like a lot, but less than 8,000 of these chargers are DC Fast chargers and there are few charging ports at these stations [12]. Non-DC Fast EV charging times are much higher than ICE refueling times, so congestion at these sparsely distributed stations is a major concern for LDT travelers. The often unpredictable internal and external driving conditions coupled with the sparse availability of reliable public charging stations along large highway segments, make it extremely difficult to carve out a successful BEV charging route.

In fact, using a BEV for LDT/road trips is often framed as a challenge over just a means to an end. There are numerous blogs on the internet charting BEV road trips that vary in levels of enthusiasm for the technology but all share the same general theme of “it was a struggle, but we made it!” [13]–[20]. In some cases, an unpleasant BEV road trip experience deterred drivers from ever using BEVs for LDT in the future; Rachel Wolfe took a Kia EV6 (EPA-rated range of 232 miles) on a 4-day road trip between New Orleans and Chicago and said “the experience made her thankful for her gas-powered 2008 Volkswagen Jetta” [17]. She said a lack of efficient charging infrastructure caused her and a passenger to miss a dinner reservation and led to a nail-biting return trip that left them with only four hours of sleep in their haste to return home on time” [17].

Moreover, a handful of blogs document instances of BEV drivers being stranded in the midst of long-distance trips due to faulty chargers [13], [14]. To further understand the extent of charging insecurity caused by unreliable EV chargers, the final two chapters of this dissertation empirically explore the impact of charger reliability on BEV driver experience.

1.4 Dissertation Outline

This dissertation aims to explore some of the key barriers to realizing the full emission reduction potential of PEVs. Chapters 2 and 3 focus on the driver driven energy inefficiencies of PHEVs while chapters 4 and 5 examine and aims to mitigate the charging anxiety associated with BEVs. More specifically:

Chapter 2 presents a study that aims to characterize the engine start activity profiles and emission potential of various PHEV models by examining the characteristics associated with engine starts, identifying the travel conditions that trigger engine starts and determining the frequency of different types of starts. The study ultimately found that long range PHEVs with high battery capacity such as the Chevrolet Volt are ideal for both curbing start emissions via logging very few engine starts and maximizing fuel displacement.

Chapter 3 presents two studies that aim to understand the motivations and implications of driver mode, user-selectable drivetrain configuration setting, usage in PHEVs. In addition to comprehensively defining and classifying various drive modes, the first study examines the motivations for drive mode usage using a survey of over 26,000 PEV drivers in California. The second study quantified the energy use and emission impacts of drive mode usage using on-road vehicle data from 81 Chevy Volts driven in California.

Chapter 4 presents a study that focuses on understanding the impact of EV charger reliability on driver experience. It uses real-world EV charging data to simulate the level of

disruption that would've occurred to EV drivers had their successful charging sessions been unsuccessful. Additionally, it quantifies how many charging sessions were actually unsuccessful and qualifies how disruptive those unsuccessful charging sessions were to drivers. By quantifying and qualifying the level of disruption associated with both real and hypothetical charge failures, it finds that EV chargers are not all equally important to EV drivers, highlighting the need for more nuanced charging reliability standards to meet consumer charging needs more effectively.

Chapter 5 aims to develop a tool enabling EV charging service providers to swiftly detect charge failures that cannot be detected by standard monitoring protocols. By analyzing habitual charging patterns of EV drivers, the tool identifies unexpected gaps in charger usage, indicating potential charger faults. The tool incorporates two anomaly detection models: a naive probability distribution-based technique and a Long Short-Term Memory Network (LSTM) for complex pattern modeling. Depending on the tool's preferred confidence level, charging service providers could've detected potential charging faults 1.5 to 3 times faster with the naive method and 1.5 to 2.4 times faster with the LSTM method.

Chapter 2: An Empirical Exploration of Plug-in Hybrid Electric Vehicle Engine Starts

2.1 Introduction

Numerous studies have found that engine starts at suboptimal travel conditions, such as low engine block and/or catalytic converter temperatures, are major sources of harmful environmental air pollutants in conventional ICE vehicles. These emission-heavy engine starts are typically referred to as cold starts given their direct link to low engine operation temperatures. The engine start emissions of PHEVs can differ dramatically from the emissions of traditional ICE vehicles since unlike ICE vehicles, PHEVs can use energy from a battery, an ICE or a combination of the two to attain propulsion power, enabling them to invoke the engine at any moment within a given trip. PHEVs can even potentially finish a trip or a travel day without a single engine start, emitting zero tailpipe emissions. When a PHEV's power requirement exceeds the power that can be provided by its all-electric propulsion system, it can invoke the ICE to assist the vehicle to meet this requirement. PHEV engine cold starts that occur during a trip (not the start), as a result of high-power requirements have been shown to emit even more pollutants than regular cold starts given the engine must quickly rev itself up to support the vehicle's high operating speed and torque. Cold starts and high-power cold starts can negate the environmental benefits of PHEVs that are designed to reduce fuel use by maximizing the dwell time or "engine cooling period" between engine starts.

Given there is very little empirical research on the tailpipe emissions associated with PHEVs, this study seeks to characterize the engine start activity profiles and emission potential of various PHEV models by defining the characteristics associated with engine starts, identifying the travel conditions that trigger engine starts and determining the frequency of different types of starts. We examine on-road vehicle data from six PHEV models: Toyota Prius Plug-in, Ford C-

Max Energi and Fusion, Toyota Prius Prime, Chrysler Pacifica, and Chevrolet Volt. These models account for around 67% of PHEV sales in California to this date and cover a wide range of vehicle specifications; this allows for the comprehensive analysis of the impact of these specifications, including battery capacity and drivetrain configuration, on the engine start emission potential of PHEVs [21].

2.2 Literature Review

ICE cold starts are a critical source of many environmentally detrimental air pollutants; these pollutants include hydrocarbons (HC), carbon monoxide (CO), oxides of nitrogen (NO_x) and particulate matter (PM) – all of which pose a serious threat to the health and well-being of the environment in which they permeate [22]. When an engine's block and coolant temperatures are especially low, typically when it is turned on after a long period of time, incomplete combustion can result in higher emissions than during normal operating temperatures, particularly if the catalytic converter has not reached the high temperature necessary to convert engine out pollutants efficiently [22]. Since catalytic converters filter out a significant amount of primary pollutants while operating in high temperatures, engine start emissions from when the operating temperatures were much lower make up a large share of the total vehicle emissions. According to the California Air Resources Board (CARB), an engine start is classified as a cold start when it occurs after the vehicle's engine hasn't been activated in 12 or more hours with this off period being referred to as a 'soak period' [23]. On the other hand, a hot start describes a start that occurs after an extremely short soak period such as five minutes. All starts that aren't cold or hot starts are referred to as warm starts.

Unlike an ICE vehicle cold start that can exclusively occur during the beginning of a trip, a PHEV cold start can occur during any point of a trip given the appropriate travel conditions. A

PHEV differs from an ICE vehicle in that it can draw propulsion energy from both a fuel source and a rechargeable energy storage system that can be recharged by an external electric energy source. The type of drivetrain architecture a PHEV possess dictates its possible propulsion energy sources. PHEV drivetrains can typically be classified as either series systems, parallel systems, or series-parallel hybrid systems [24]. For series systems, the drive wheels will solely receive mechanical power from the electric motor while for the parallel systems, the drive wheels are powered by the electric motor and the internal combustion engine together [24]. In series-parallel hybrid systems, the wheels can be powered by any combination of the aforementioned modes. The propensity for an ICE start in PHEVs is dependent on many factors, including the available battery energy or state of charge (SOC), the available electric motor torque to propel the drive wheels, the mechanical limits of the powertrain, and the vehicle road load [24].

A PHEV can operate in two different modes based on the energy source that is being used to propel its drive wheels. In the charge sustaining (CS) mode, the SOC level of the vehicle's energy storage system is maintained at a certain level while the vehicle is driven. In the charge depleting (CD) mode, the SOC of the vehicle decreases while the vehicle is in motion. The CD mode can further be broken down into all-electric CD and blended CD. In all-electric CD mode, the wheels are solely powered by electricity supplied by the battery and in blended CD mode battery energy and fuel energy are both simultaneously used to propel the vehicle. Typically, when the vehicle's power demand exceeds the power that can be provided by the electric propulsion system, the ICE is invoked to provide the additional power needed to meet the required demand, instantiating the blended CD mode. Since this blended CD mode immediately proceeds an ICE start triggered by a high-power demand, regardless of the battery SOC, it introduces high-power cold starts which are linked to even higher emissions than regular cold starts. Researchers at CARB

devised a methodology to compare the start emissions from high-power cold start acceleration cycles to emissions from regulated emission certification test cycles and found that high-power cold starts could be producing significantly higher exhaust emissions than those observed during regulated emission test cycles [24]. For instance, for the 2016 Hyundai Sonata blended test PHEV used in their study, three acceleration cycles had NO_x emissions that were 5 to 7 times higher than the Federal Test Procedure (FTP) test cycle [24].

A study from Argonne National Laboratory examining data from multiple low volume aftermarket PHEVs found that the key to successful emission control, for PHEVs, is how the engine is operated during initial start, warm-up and restart [25]. The study found that there was a fundamental tradeoff between keeping the engine off as much as possible and running the engine at lower power levels early in a drive schedule; the former approach would be best for reducing fuel use while the latter may potentially lead to lower emissions given there would likely be fewer instances of cold starts [25]. If a PHEV has limited electric capabilities, it may be beneficial to invoke the engine early into a trip to pre-heat its engine and catalyst for the likely high-power requirements that can only be met with the combined power of the electric propulsion system and the engine, in order to minimize engine start emissions. On the other hand, if a PHEV has higher electric capabilities that can handle high-power requirements without the engine's assistance, it would be more optimal to keep the engine off during a trip to reduce fuel use. However, if the distance traveled between the charging sessions of these PHEVs with higher electric capabilities is greater than the vehicles' all electric range, depletion rates should be optimized in order to truly minimize overall fuel use [25].

The aforementioned studies rely on test cycles conducted under controlled laboratory conditions to gauge engine start triggers and emission potentials of a few PHEV and HEV models.

This paper seeks to determine those same metrics using empirical on-road measurements of a relatively large number of individual PHEV vehicles driven under real-world operating conditions, to confirm or expand on the findings from laboratory tests.

2.3 Methods

This study's methodology consists of the data collection/processing section, followed by the engine start analysis section. The first section provides a detailed overview of how the on-road data was collected from the PHEVs in question and the second section describes the steps taken to analyze the engine starts and the emission potential of the PHEVs.

2.3.1 Data Collection and Processing Overview

The data analyzed in this study is a small subset from the *Advanced PEV Driving and Charging Behavior* project, a California-wide study spanning five years (2015-2019) that aims to understand the driving and charging behavior of PEVs [26]. This PEV study collected on-road data from around 400 households and 800 vehicles (400 PEVs). Households selected for the study that contained at least one PEV had a data logger installed in each of their vehicles for roughly 12 months. The logger captured key driving and charging attributes such as speed and GPS coordinates on a second-by-second basis.

Figure 1 visualizes the process of transforming raw data collected from the data loggers into meaningful trip summaries or events, containing key vehicle metrics. The loggers transmit the data they collect to a third-party vendor who then relays that data via a file transfer protocol. The received raw data is fed into a data processing pipeline that cleans, standardizes and transforms it into trip summaries associated with a set of key vehicle metrics. The data processing pipeline can be divided into three stages: pre-processing, event generation, and metrics generation. The pre-processing stage involves resolving and/or marking any data inconsistencies before storing the

data in a time series database. In the event generation stage, the time series database is queried based on a given temporal and behavioral criteria to generate vehicle events such as trips that are written to a relational database. In the metrics generation stage, a series of analyses are performed on the data captured within each vehicle event in order to generate a set of metrics (such as distance, energy/fuel consumed, etc.) that is stored in the relational database with its associated event.

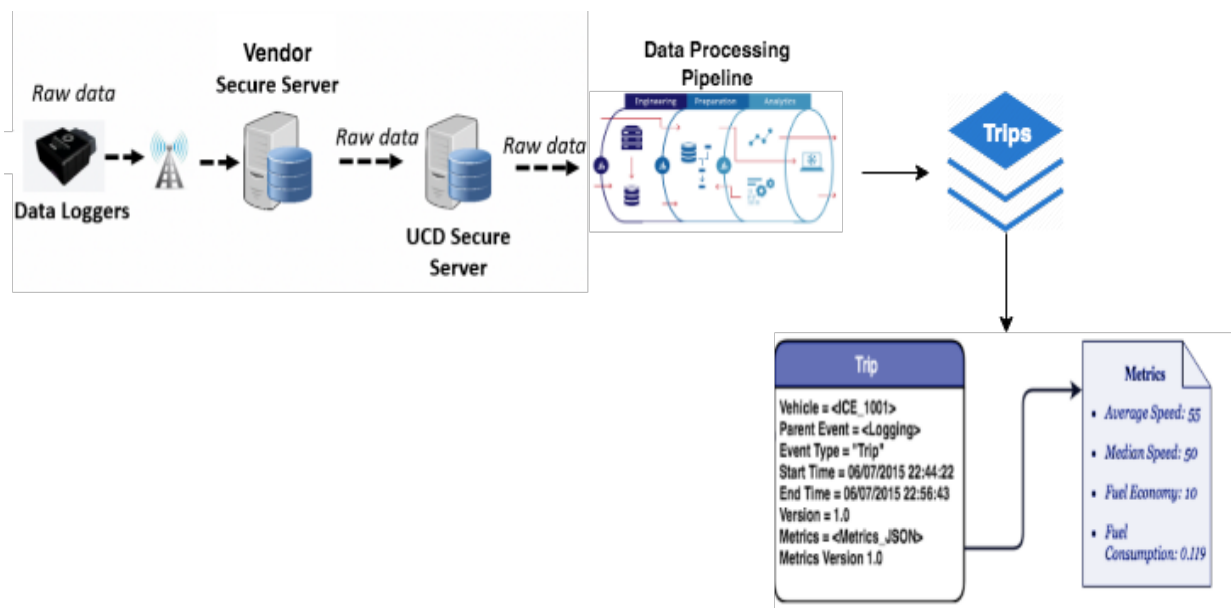

Figure 1 Data Acquiring and Processing Pipeline

Table 1 Vehicle Specifications

Vehicle Model	Model Years	Battery Capacity (kWh)	EPA AER (mi)	Electric Motor Power (kW)	Curb Weight (lbs.)
Prius Plug-in	2012-2014	4.4	11	18	3,165
C-Max-Fusion	2013-2017	7.6	20	68	3,859-3,899
Prius Prime	2017	8.8	25	16 & 37 kW AC Induction	3,365-3,375
Pacifica	2017-2018	16	33	89	4,330
Volt 16	2011-2015	16	38	111	3,781-3,786
Volt 18	2016-2017	18	53	48 and 87 kW 3-Phase AC	3,519-3,543

Vehicle Descriptive Statistics

While over 15 different PEV models were included in the study, this paper specifically focuses on the PHEV models: Toyota Prius Plug-in, Ford C-Max Energi/Fusion, Toyota Prius Prime, Chrysler Pacifica, and Chevrolet Volt. The specifications for the models analyzed in this project can be found in **Table 1**. Since both the Ford C-Max Energi and Fusion have fairly similar specifications, they are considered as one model in this analysis, under the name C-Max-Fusion. On the other hand, since the 2016-2017 Chevrolet Volts have a significantly larger battery capacity than earlier Volts, they are analyzed separately; a 2011-2015 Volt is classified as a Volt 16 while a 2016-2017 Volt is referred to as a Volt 18.

Trip Descriptive Statistics

The dataset used in this paper consists of trip summaries logged from 2015-2019, from the PHEV models described in the above section. Error! Reference source not found. summarizes the PHEV trips that were generated from the data collected from the loggers, broken down by vehicle model. The trip summaries capture key metrics such as average speed and total distance traveled within time frames in which the vehicle is driven. Trips with distances below 1 km (0.621 miles) were marked invalid and were excluded from this study as they tend to contain extremely noisy data. This criteria is based on the rule of thumb values for acceptable walking distances [29], [30]. A combination of the RPM data and fuel data reported by the loggers was used to gauge if an engine start occurred within a trip. In case the engine was invoked within a trip, an engine start child event was generated for that trip to capture critical engine start metrics such as power requirement and battery SOC at ICE initiation. If the engine is invoked multiple times within a single trip, an engine start event will be generated for each of the ICE invocations within that trip i.e., an engine may be started several times within a given trip.

Engine Start Event Description

An engine start event captures key metrics such as travel time and SOC within the timeframe of a trip wherein the RPM is greater than zero for more than 10 seconds. **Figure 2** provides a snapshot of the raw time trace of a valid engine start event. In this instance, the engine turns on when the battery SOC reaches nearly 0% and provides all the traction power to the vehicle for about 10 minutes. After 10 minutes some of the energy produced by the engine is used to recharge the battery. This analysis used 2.6 million engine start events over roughly 128,000 trips with engine start events from 221 PHEVs that were each tracked for approximately one year.

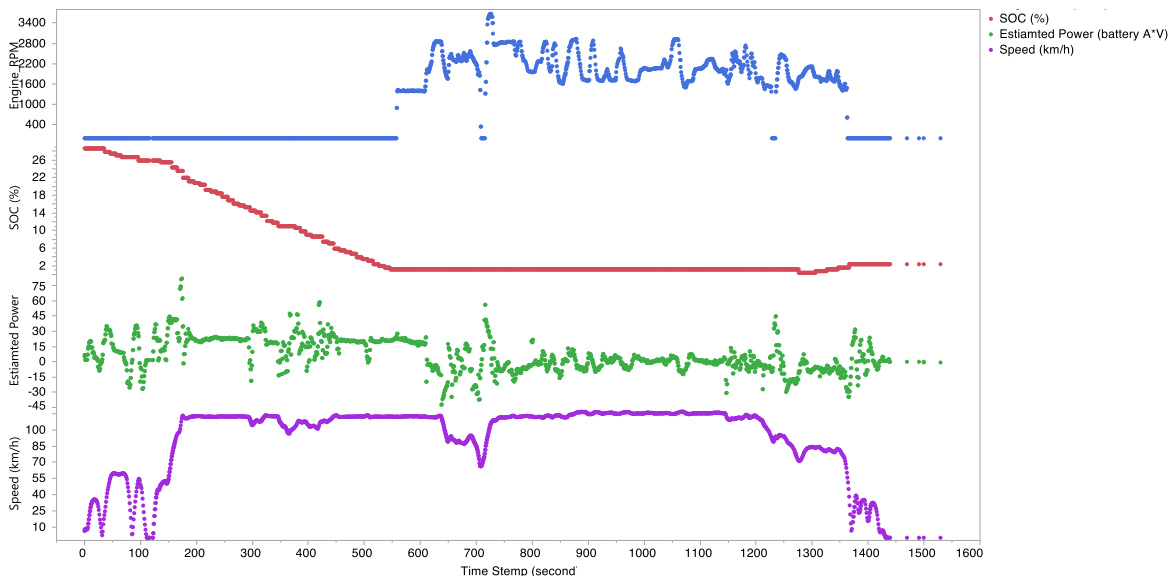

Figure 2 Engine-on Time Trace

It is critical to note that the sample frequencies of the collected data attributes weren't always consistent. For instance, some attributes were collected every few seconds while other parameters were recorded only when a change in value was detected; in such cases, a distinction could not be made between parameters that had been updated but remained constant over several seconds versus those that had not been updated and are simply duplicated from the previous measurement. This

lack of synchronicity makes it extremely challenging to analyze the relationship between certain attributes.

2.3.2 Analyzing Engine Start Triggers and Emission Potential of PHEVs

Since this study has two distinct objectives, the analysis was divided into two stages. In the first stage, the travel conditions immediately preceding the engine starts are explored, and in the second stage, the potential emission impacts of the observed engine starts are evaluated.

Travel Conditions at Engine Start

We first isolated and analyzed the following metrics, recorded at or prior to engine start events: SOC, maximum power requirement (calculated based on battery current and voltage), and catalytic converter temperature when available. We then analyzed the engine soak time (i.e., time elapsed between two consecutive engine start events) and two distance metrics: the distance traveled from the beginning of a day to the first engine start of the day and the distance traveled from the beginning of a trip to the first engine start of the trip. Although we aimed to explore the relationship of vehicle power requirements with road grade, we couldn't do so due to differing data sample rates and imprecise data values.

Potential Emission Impacts of Engine Starts

In this stage, we analyzed the proportion of days in a year with cold starts and/or high-power cold starts in order to get a rough estimate of the engine start emission potential of each vehicle model. We initially aimed to quantify the emissions associated with the engine starts but couldn't do so because the HC and NO_x in-use emission factors (such as those used within the EMFAC or MOVES models) for most of the vehicle models (classified as LEV III SULEV30) in this study haven't been published so far [27].

2.4 Results

In this section, we present the results of our engine start analysis. Section 2.4.1 reveals the travel conditions that potentially trigger PHEV engine starts and Section 2.4.2 quantifies the emission impacts of PHEV engine starts.

2.4.1 Travel Conditions at Engine Start

SOC at First Engine Start

One of the major causes for engine starts is the inability of the electric motor to adequately propel the vehicle due to a low battery SOC. We, therefore, explored the distribution of battery SOC when the engine is first turned-on within trips for all PHEV models in the study. **Figure 3** illustrates this SOC distribution and highlights the fact that, for all vehicle models, most engine starts are invoked at a near-zero usable SOC (reported by the vehicle). Nearly 70% of C-Max-Fusion, Prius Prime and Volt engine starts occurred at SOC below 5% while over 50% of Prius Plug-in and Pacifica engine starts occurred at SOC under 5%. The Prius Plug-in vehicles are more likely than the other vehicles to start their engine at high SOC due to their relatively low battery capacity while the Volts are least likely to start their engine at high SOC since they are non-blended PHEVs with significantly higher battery capacity. The Pacificas are more likely to start their engine than other vehicles with similar battery capacity because they are heavy minivans, leading to potentially higher overall power demand.

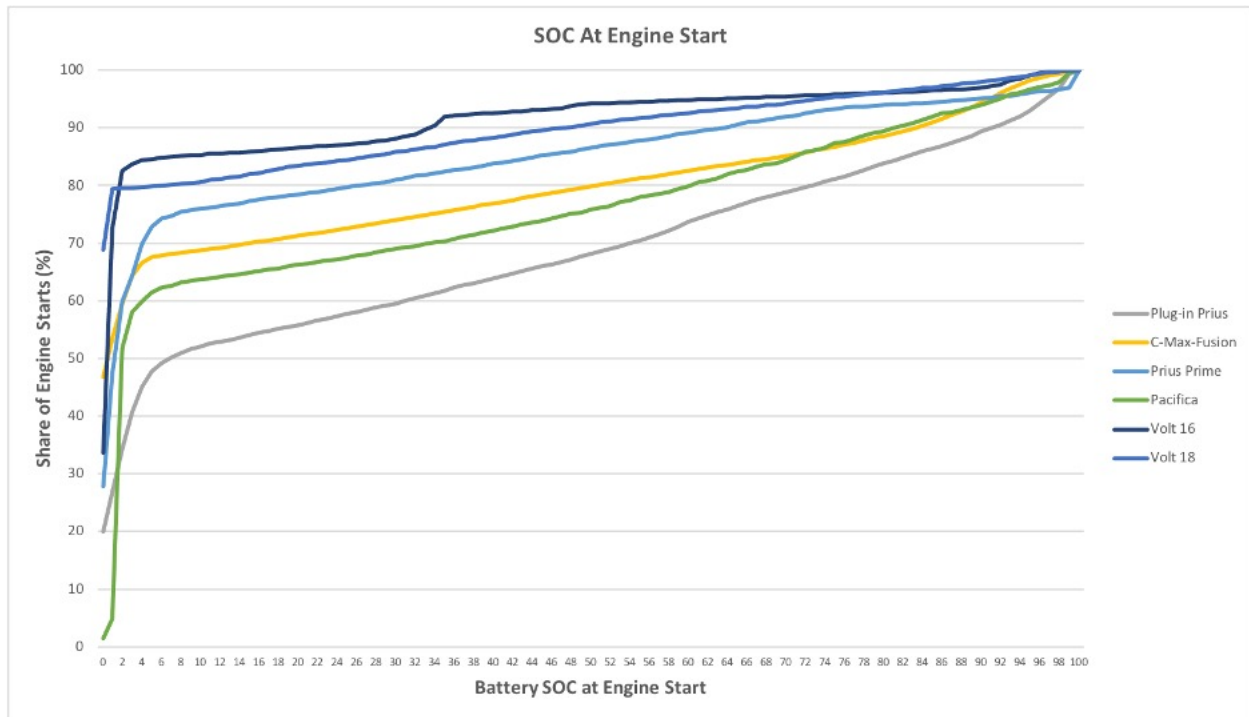

Figure 3 SOC at First Engine Start

Maximum Estimated Power Requirement before First Engine Start

As discussed earlier, in certain driving situations such as traveling at high speeds or climbing a steep incline, a PHEV’s power requirement may exceed the power that can effectively be provided by its electric motor, regardless of the vehicle’s battery SOC; these situations can force the ICE to start up in order to provide the additional power required to propel the vehicle at an appropriate speed. Therefore, in order to decouple the effect of vehicle SOC and power demand, we developed three SOC classifications for engine starts. For all vehicle models, low or Empty (E) SOC is between 0% to 1%, medium (M) SOC is between 1% to 10%, and High (H) SOC is over 10%.

We explored the distribution of the estimated maximum power requirement 5 seconds before the first engine start within trips, acknowledging the potential error due to time reporting gaps between the parameters, broken down by the mentioned SOC classifications, for each vehicle

model (**Figure 4**). For the PHEVs with relatively lower battery capacities such as the Prius Plug-in and the C-Max-Fusion vehicles, most low SOC engine starts correlate with lower power requirements (0-12 kW) while majority of high SOC engine starts correlate with relatively higher power requirements (25-42 kW). However, while the medium SOC engine starts for the Prius Plug-in vehicles are correlated with low power requirements (0 kW), the medium SOC engine starts for the C-Max-Fusion vehicles are correlated with medium power requirements (30 kW). Most of the high SOC starts are associated with high power requirements (30 kW for the Prius Plug in, and 60 kW for the Fusion), but some are associated with low power requirements (0 kW for Prius Plug in, 20 kW for the Fusion). On the other hand, the engine starts of PHEVs with relatively high battery capacities, such as the Volts, don't seem to correlate strongly with power requirements; these vehicles are least likely of the models to invoke an engine start in the incidence of high-power requirements, regardless of their SOC. However, the Pacificas, despite having a battery capacity close to that of the Volts, seem to invoke the engine at medium SOC's under a wide range of power requirements and, at high SOC's at high power requirements (90 kW). In fact, the Prius Prime vehicles, which only boast a little over half the battery capacity of the Pacificas, behave more like the Volts given most of their engine starts occur at near zero SOC's. This is because the Pacifica minivans are much larger and heavier than the other PHEVs in this study, potentially leading to a higher incidence of greater power requirements due to larger road loads. Overall, the Prius Plug-in and C-Max-Fusion vehicles, having relatively smaller battery capacities, are more likely to turn on their engine to meet high power requirements while the Volts, being non-blended PHEVs and having a larger battery capacity, are least likely to start their engine in the presence of high-power requirements.

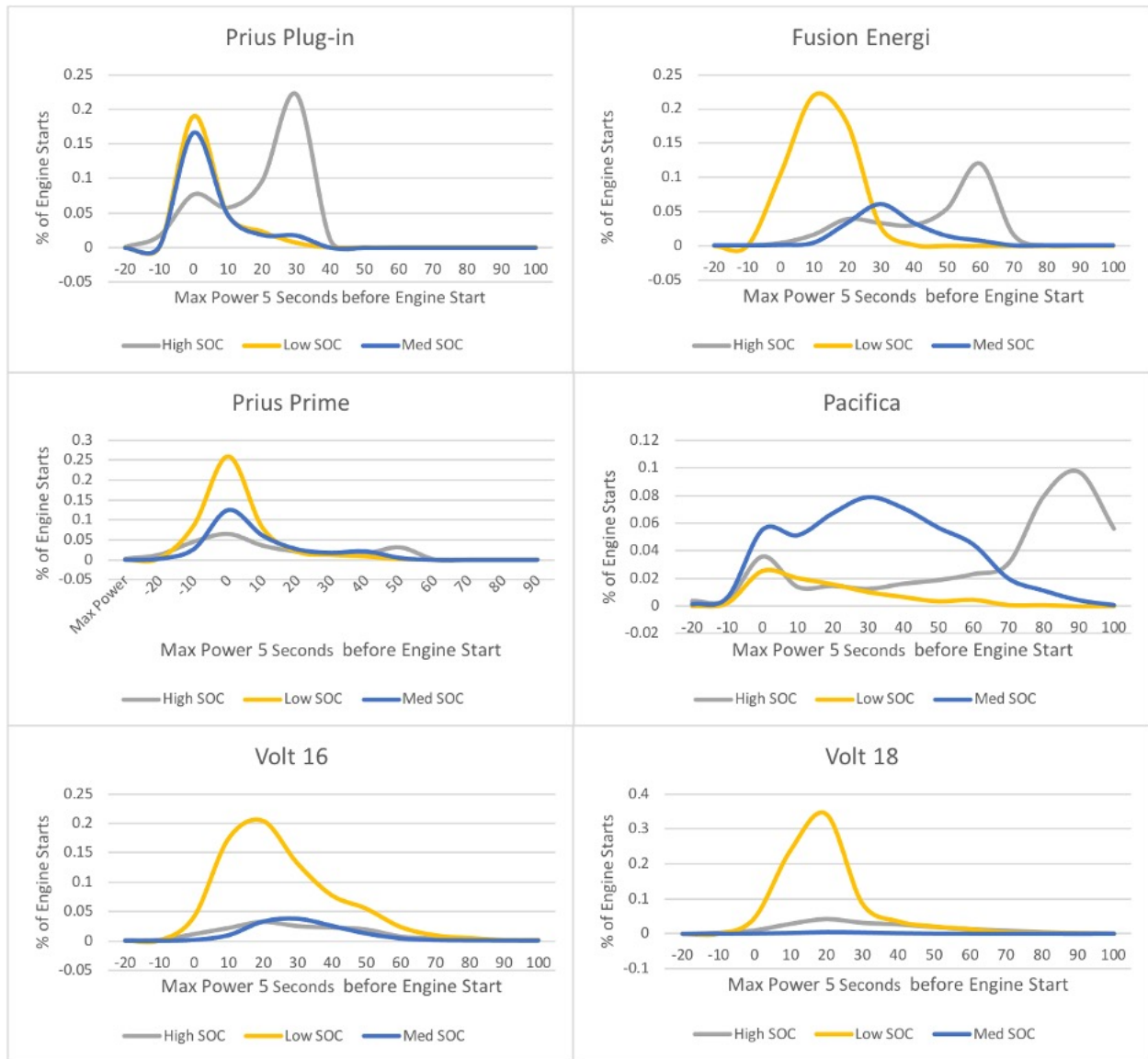

Figure 4 Maximum Estimated Power Requirement 5 Seconds before Engine Start

Catalyst Temperature before Engine Start

Our loggers captured modeled catalyst temperature data for only the C-Max-Fusion and Volt vehicles. For all engine start trips of these two PHEV models, we analyzed the distribution of catalyst temperature for the first engine starts and all subsequent engine starts within trips separately, assuming that the first starts would include a mixture of cold and hot starts and that subsequent starts would predominantly include warm/hot starts. **Figure 5** depicts the distribution of catalyst temperature of first engine starts in blue and all subsequent engine starts in red. For

both vehicle models, around half of the first engine starts occurred at temperatures above ambient temperatures. We didn't observe any cold starts after the first start for all trips even though 0.4%

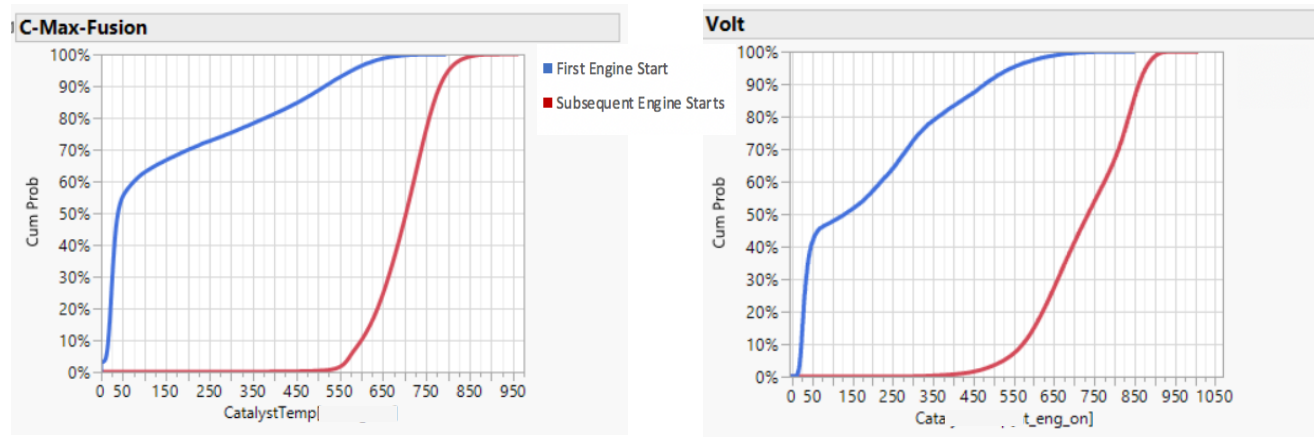

Figure 5 Catalyst Temperature at Engine Start (first engine starts in blue and all subsequent engine starts in red)

of the starts may not be fully warmed up to 425°C. The lack of cold restarts could be because the vehicles are keeping the engine on for enough time to ensure that the first engine start adequately warms up the catalyst for any potential subsequent starts within the same trip. In addition, the time elapsed between consecutive engine starts within trips is fairly small; among all the PHEV trips, the longest time elapsed between the first engine start and its successive start was 245 seconds which isn't enough time for the catalyst to completely cool off.

Engine Soak Time

For all engine start trips, we analyzed the time elapsed between two consecutive engine starts (soak time). Engine starts that weren't the first engine start of trips were filtered out; we solely studied the soak time of the first engine start of every trip. The soak time of each engine start was calculated by measuring the duration between it and the engine start preceding it. The SOC classification criteria from the previous sections was again used to categorize the engine starts. **Figure 6 to Figure 11** present the soak time distribution of all the PHEVs in this study.

For all vehicles, there seems to be an inverse relationship between soak times and engine start shares; the proportion of engine start events decay as soak time increases. For all PHEV starts, high SOC starts seems to be more prevalent with longer soak times. Engine starts with higher soak times may be more likely to have higher SOC than engine starts with lower soak times because vehicle charging sessions are more likely to have occurred between trips that result in a high soak times given there is a relatively larger potential charging window.

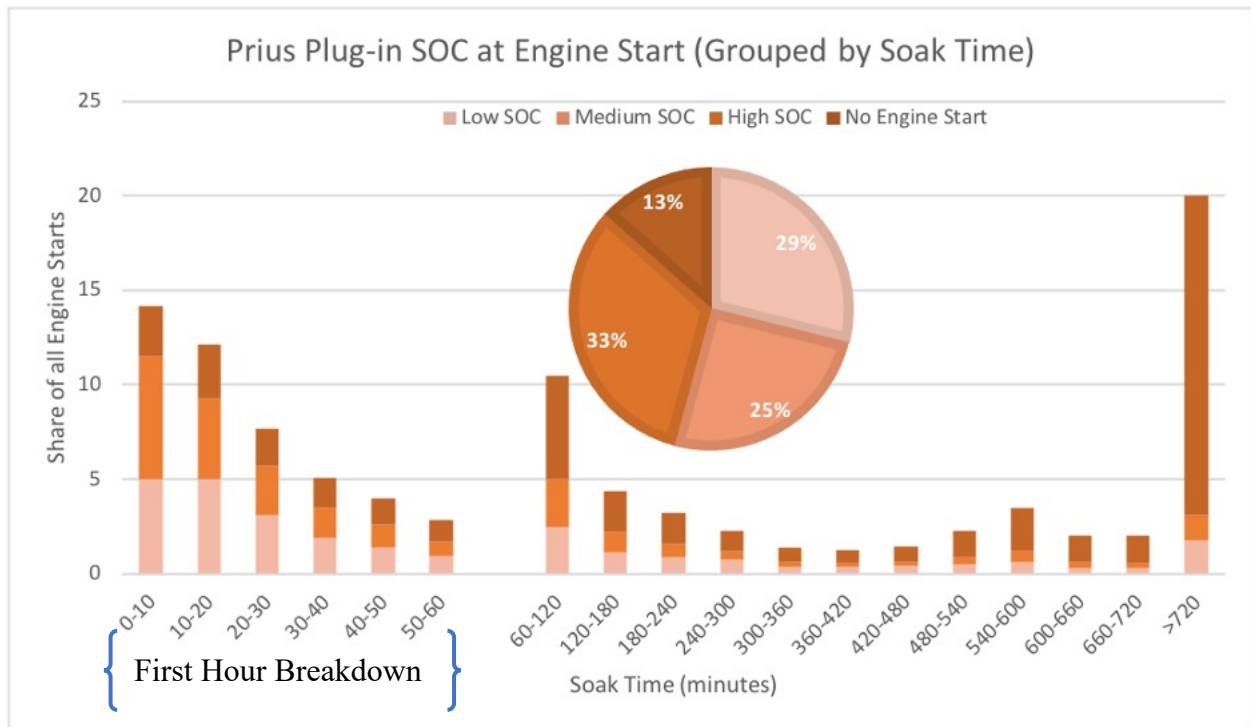

Figure 6 Prius Soak Time by SOC at Engine Start

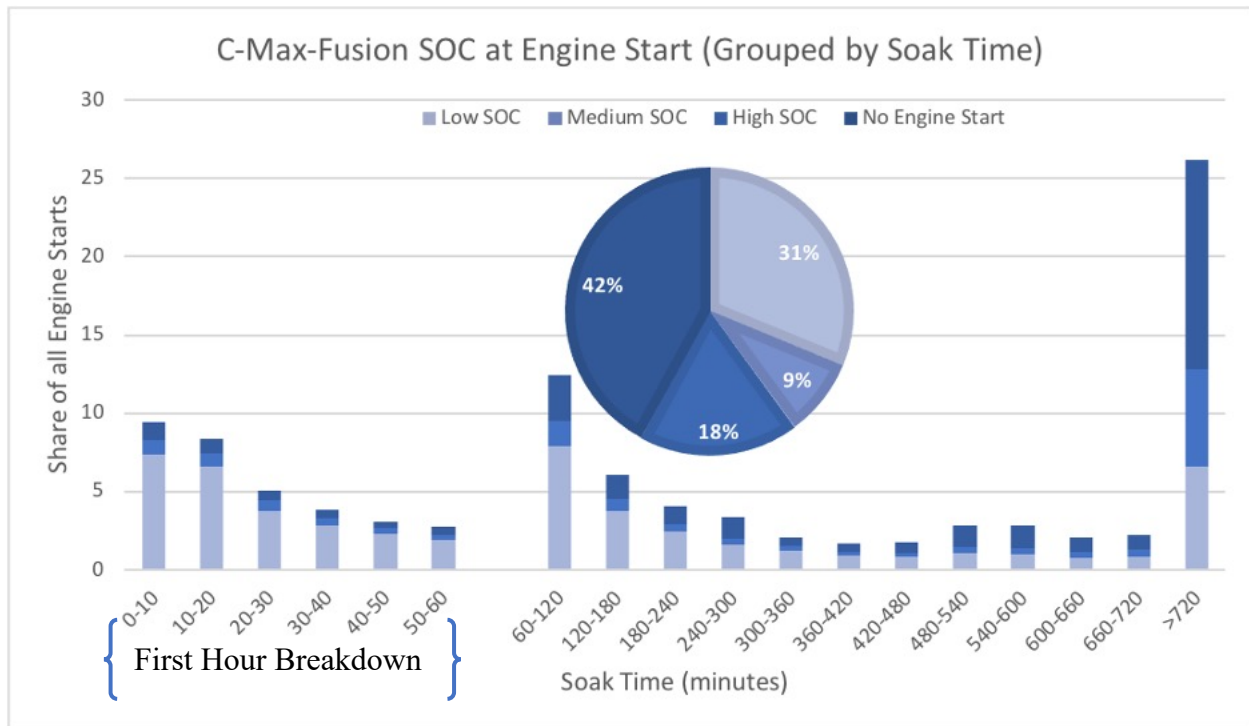

Figure 7 C-Max-Fusion Soak Time by SOC at Engine Start

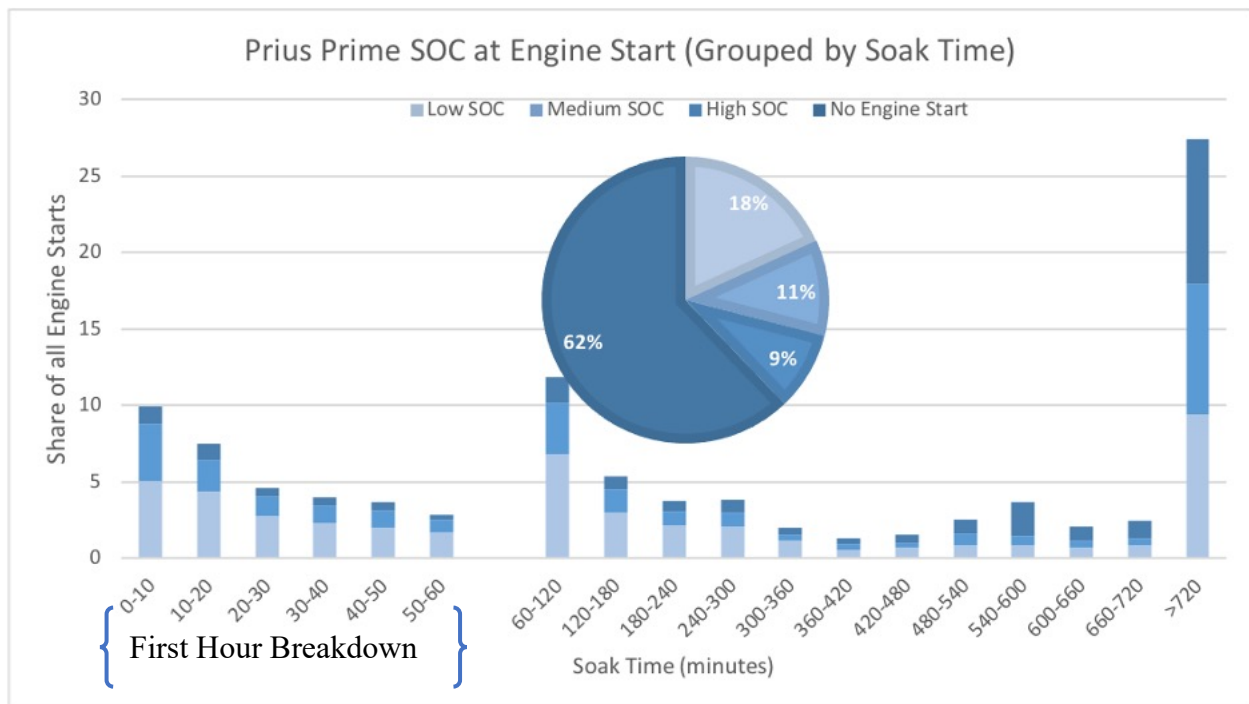

Figure 8 Prius Prime Soak Time by SOC at Engine Start

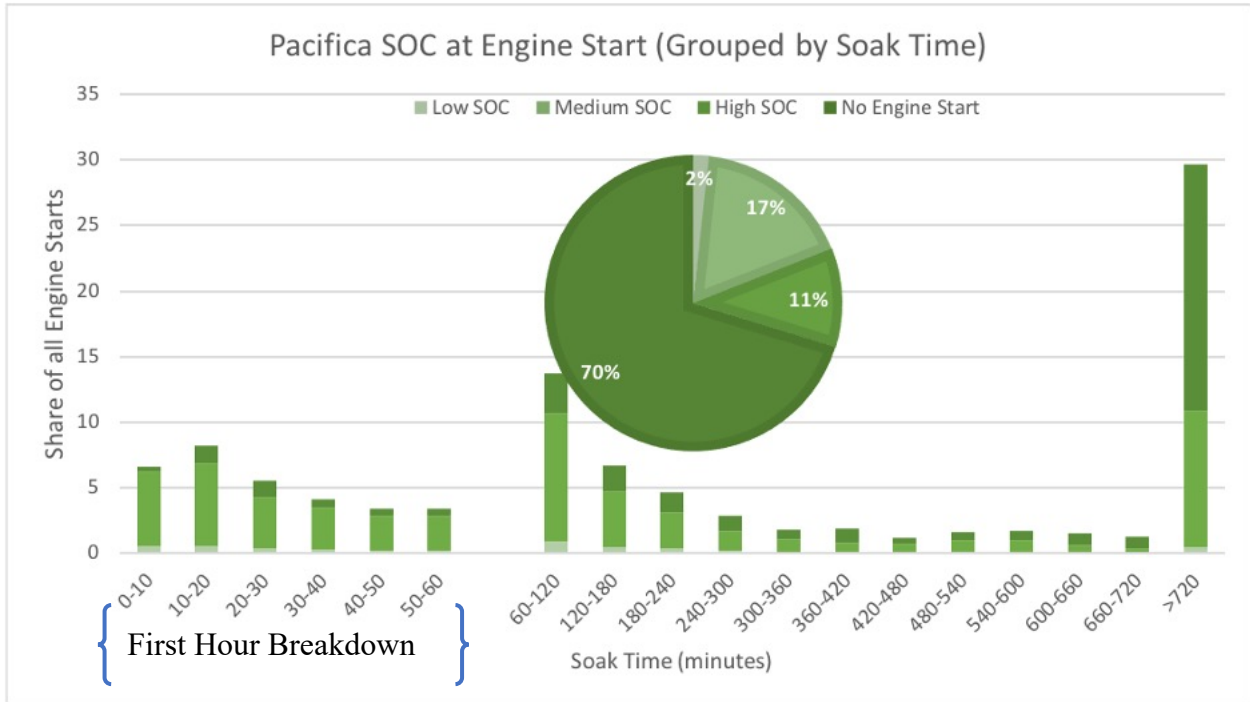

Figure 9 Pacifica Soak Time by SOC at Engine Start

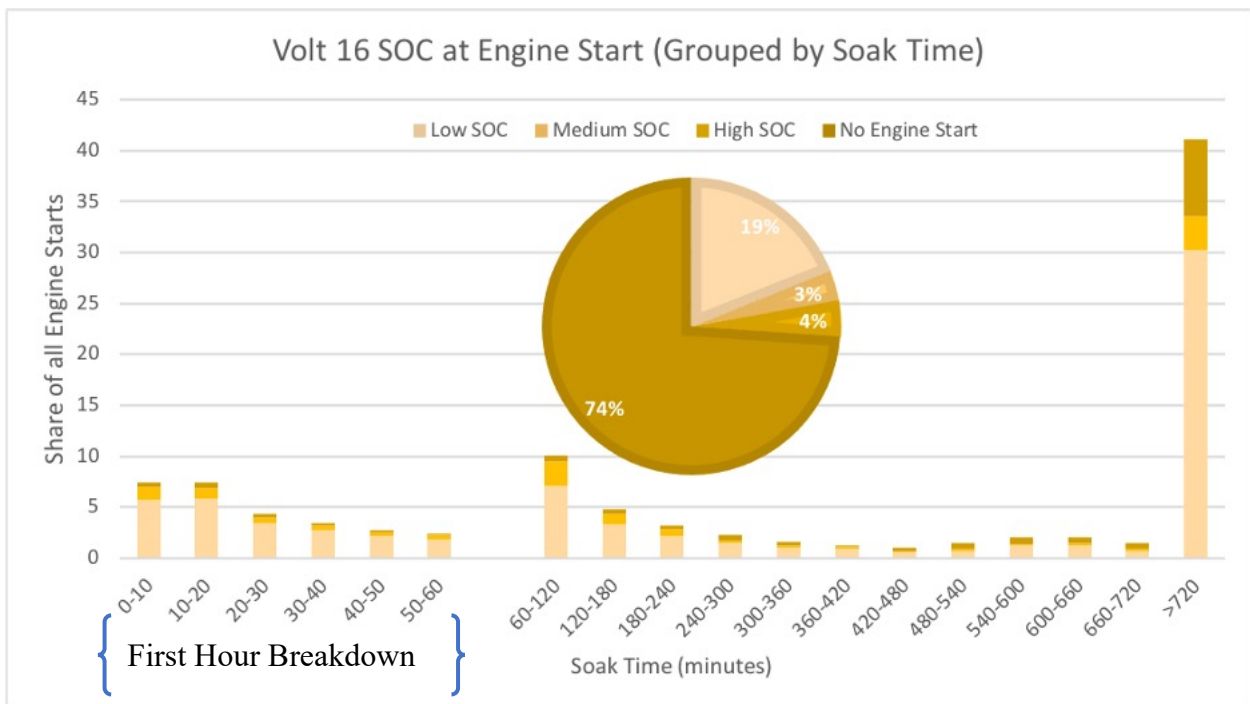

Figure 10 Volt 16 Soak Time by SOC at Engine Start

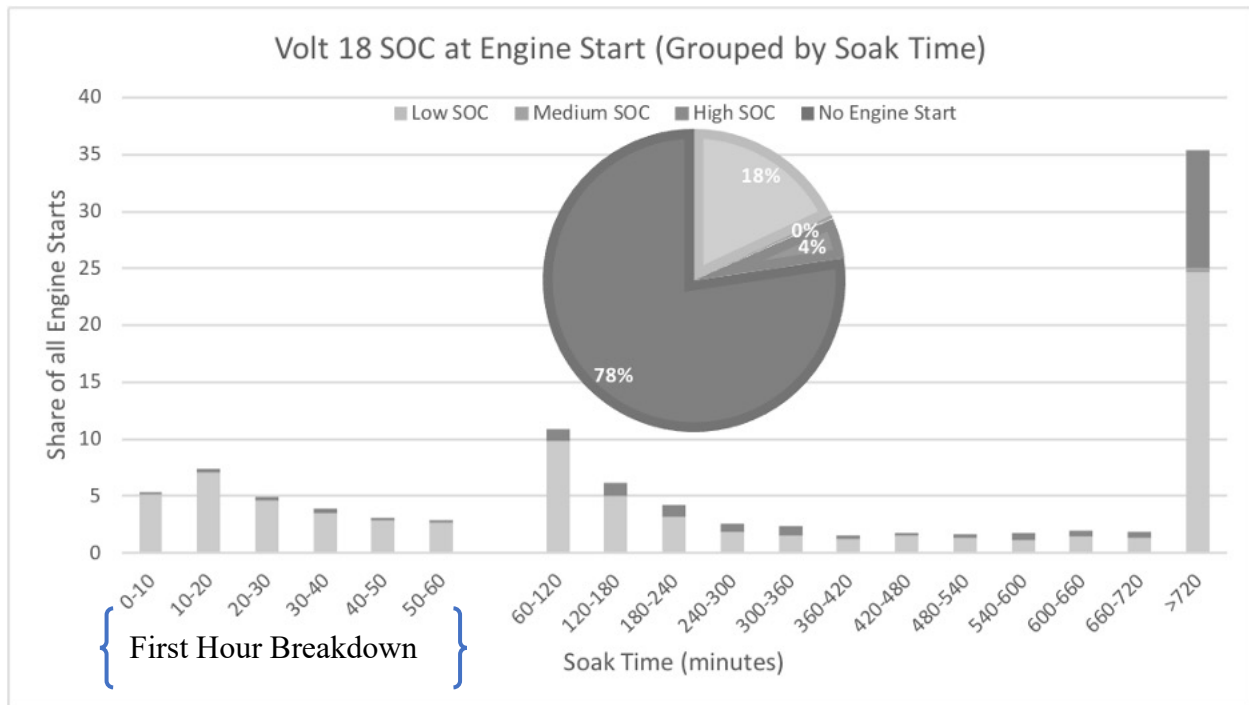

Figure 11 Volt 18 Soak Time by SOC at Engine Start

Distance between Engine Starts

For each engine start trip, we analyzed two key distance metrics: the distance traveled from the beginning of a day to the first engine start of the day and the distance traveled from the beginning of a trip to the first engine start of the trip. To derive the first distance metric, we first grouped trips into days with a 3AM cutoff rather than the standard 12AM cutoff and then aggregated the distance of all trips that took place between the start of a day and the first engine start of the day for all days with an engine start. We chose a 3AM cutoff as it is the hour with the lowest trip frequency for all vehicle trips in our dataset. For the second distance metric, we simply calculated the distance from the start of a trip to the point at which the engine is first initiated for all engine start trips. For the first metric, we only considered the first engine start of each day with an engine start while for the second metric, we considered the first engine start of every trip. **Figure 12** and **Figure 13** depict the distribution of these two distance metrics for all PHEV vehicles.

Over 80% of the Prius Plug-in vehicles' first engine starts occurred after less than 5 miles of travel from the beginning of the day; most of these starts were happening at medium to high SOCs. On the other hand, less than around 40% of the Prius Prime, Pacifica and Volt first engine starts occurred after less than 5 miles of travel from the beginning of the day. While most of the Volts' starts occurred at low SOCs, the Pacifica's starts occurred at mostly medium to high SOCs. The Volts are also more likely to have engine starts after longer distances of travel from the start of the day than other PHEVs. The C-Max-Fusion vehicles have a lower proportion of engine starts than the Prius Plug-in and a greater proportion of engine starts than the Volts after less than 5 miles of travel from the beginning of the day. These observations are in line with previous sections which found that PHEVs with relatively small battery capacities such as the Prius Plug-in and the C-Max-Fusion vehicles are more susceptible to engine starts at medium and high SOCs than PHEVs with larger battery capacities such as the Volts, to meet high power demands. Overall, the occurrence of engine starts is more correlated to power demand than SOC for small battery PHEVs than it is for large battery PHEVs. For all PHEVs, over 50% of engine starts occurred after less than 5 miles of travel from the start of the trip; most of these starts happened at low to medium SOCs, suggesting that a sizable proportion of engine start trips begin with lower SOCs.

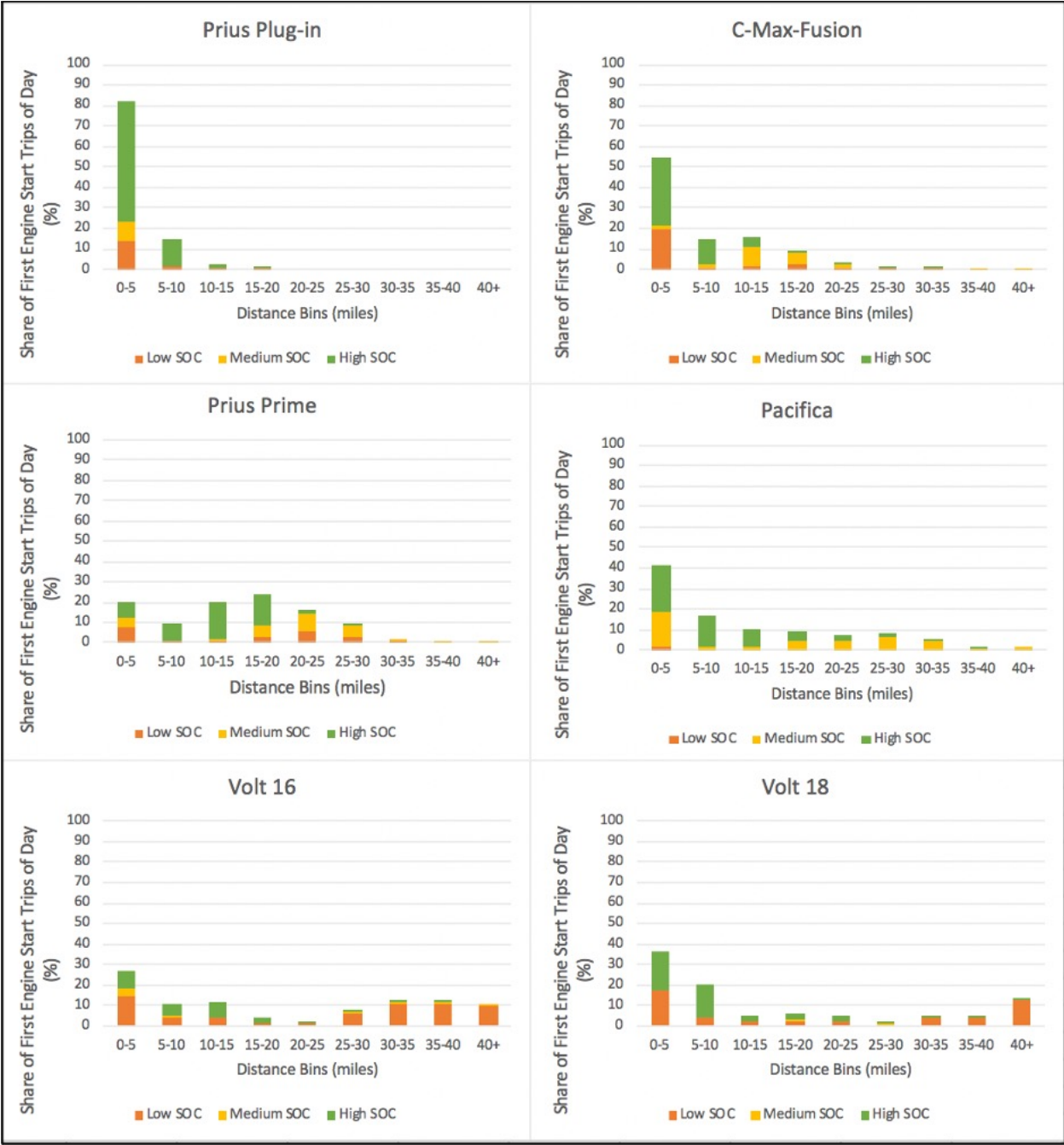

Figure 12 Distance from Start of Day to First Engine Start of Day for all PHEVs

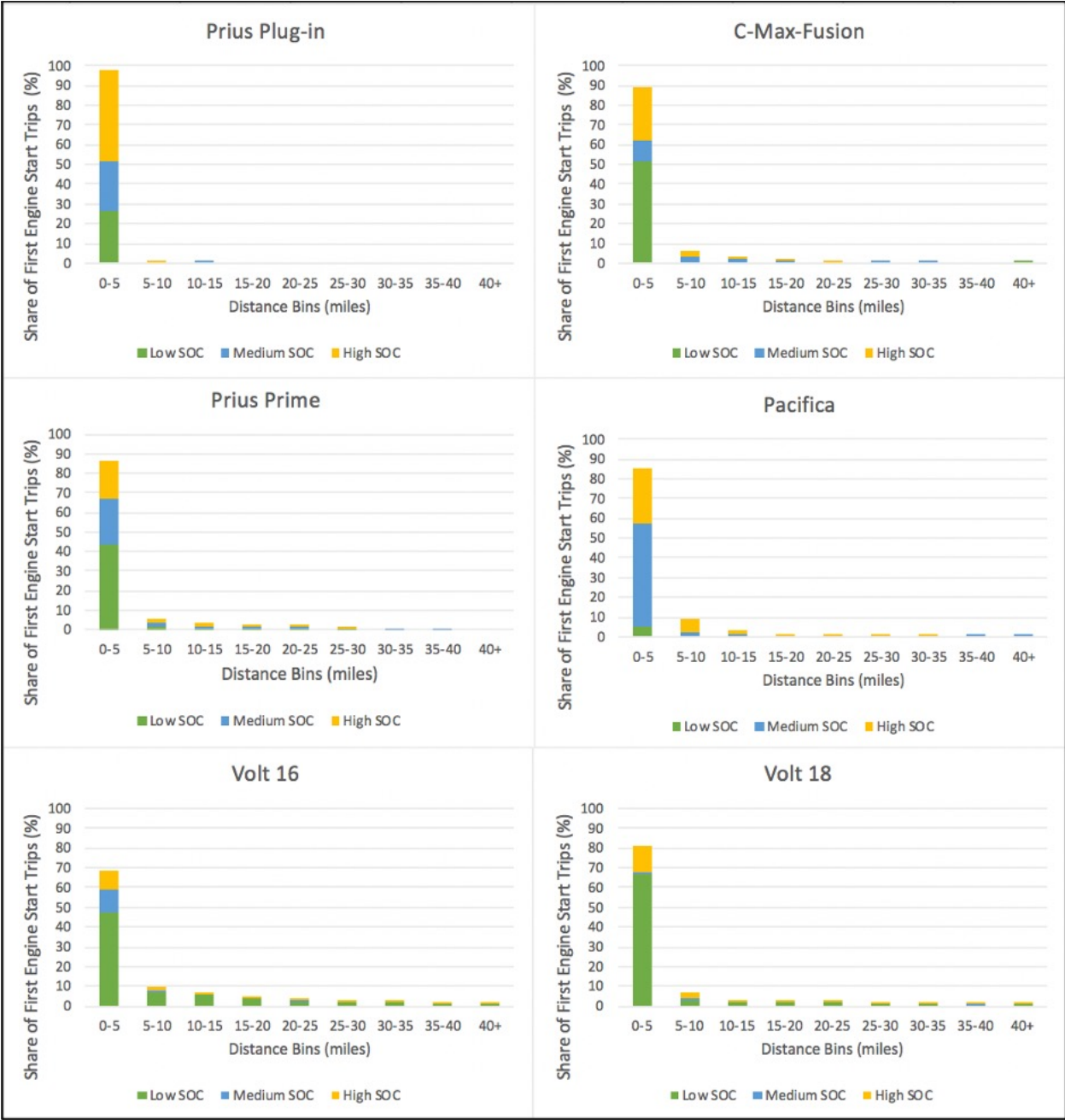

Figure 13 Distance from Start of Trip to First Engine Start of Trip for all PHEVs

2.4.2 Potential Emission Impacts of Engine Starts

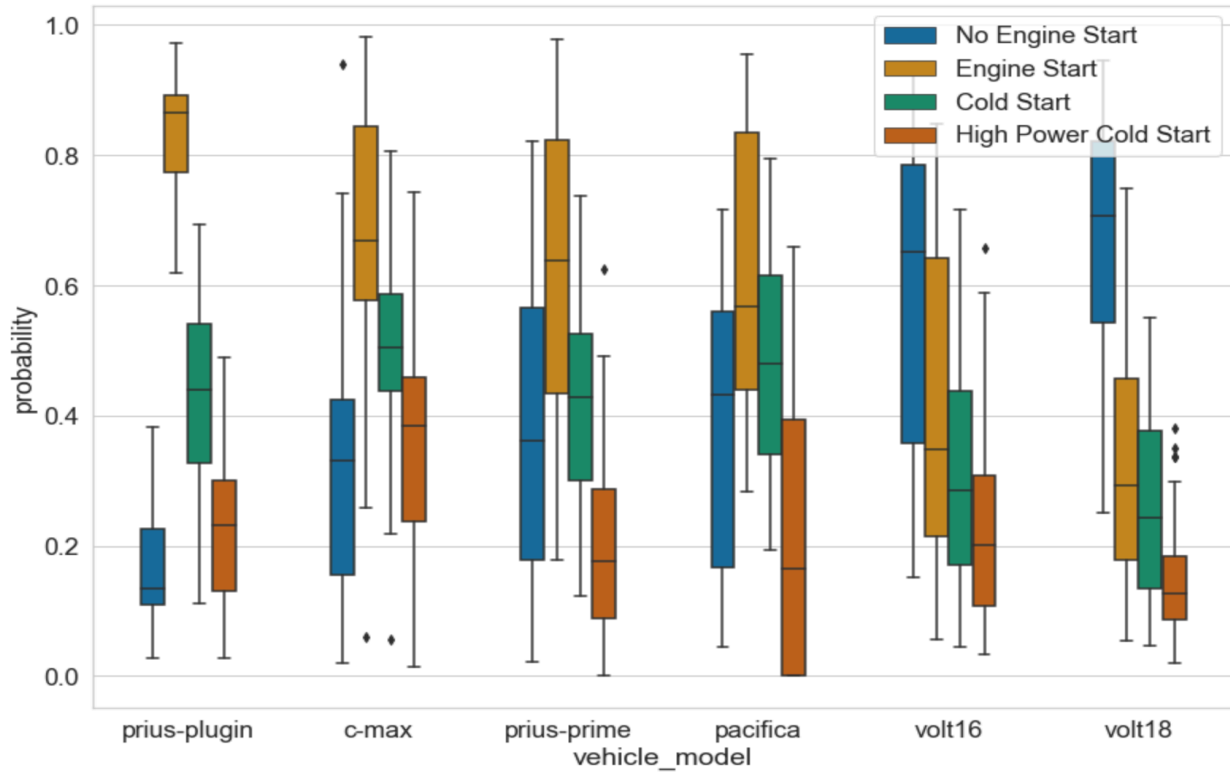

Figure 14 Probability of Engine Start per Vehicle Model (Derived from Annualized Engine Start Days)

Figure 14 illustrates the probability of various engine starts to occur on a given day for each vehicle model. The probabilities were derived from the annualized engine start days for each vehicle in the study. For this analysis, a cold start is an engine start with a soak time greater than 12 hours and a high-power cold start is a cold start with a maximum power requirement 5 seconds before the start of over 25 kW. For the most part, there is an inverse correlation between vehicle battery capacity and the probability of an engine start with the Prius Plug-in vehicles having far more engine start days than the Volt vehicles. However, this isn't the case for cold starts and high-power cold starts. There are much smaller differences in cold start proportions than engine start proportions across all PHEV models other than the Volts. The Prius Prime vehicles recorded nearly as many cold starts as the Prius Plug-in vehicles, despite having nearly twice the battery capacity

as the Prius Plug-in cars; this is probably because the Prius Plug-in starts its engine more frequently, resulting in relatively shorter engine cool down periods than the other vehicles. The C-Max-Fusion cars and the Pacificas, on average, have slightly higher proportions of cold start days than the other vehicles. The C-Max-Fusion cars have low electric motor power capabilities than the other vehicles, owing to its large proportion of high-power cold starts. The Pacificas, being minivans, are far heavier than the other models and so are more likely to have high power demand instances, resulting in a fairly high frequency of cold starts despite their high battery capacity. The Volts, as expected, have much fewer cold starts than the other vehicles given their high battery capacity and electric range.

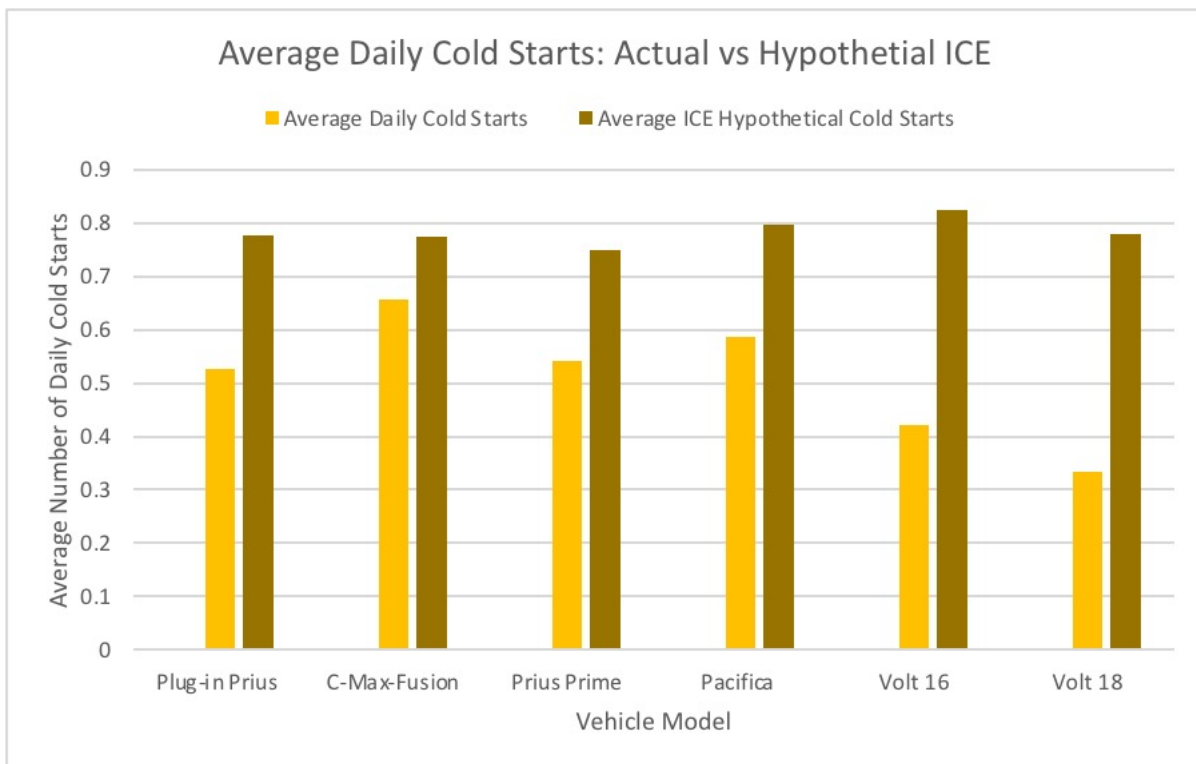

Figure 15 Average Daily Cold Starts

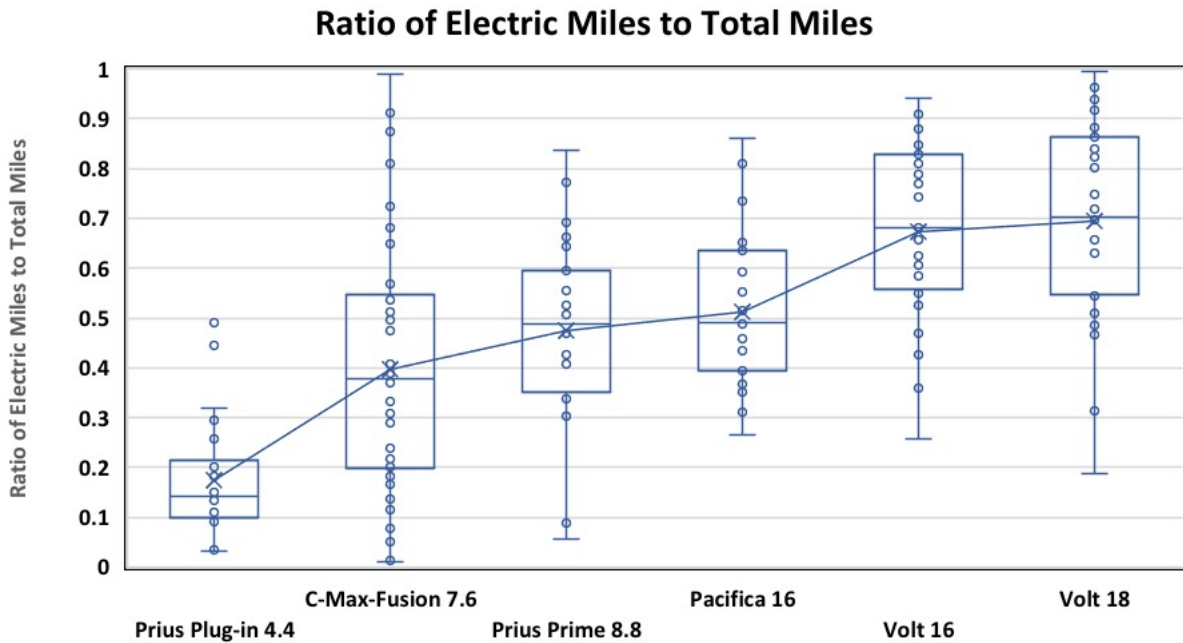

Figure 16 Ratio of Electric Miles to Total Miles

Figure 15 depicts the average number of daily cold starts that occur for each vehicle model juxtaposed with the average number of daily cold starts if the models behaved like conventional ICE vehicles with the engine being invoked at the beginning of every trip. As expected, the Volts have far fewer real cold starts than their hypothetical ICE cold starts given that their larger battery capacity and drivetrain design seek to reduce engine starts in order to reduce fuel use. The Plug-in Prius, Prius Prime and Pacifica vehicles also had fairly few real cold starts compared to their hypothetical ICE vehicle performance. On the other hand, the C-Max-Fusion vehicles, despite having a battery capacity close to that of the Prius Prime vehicles, don't seem to have a huge difference between actual cold starts and Hypothetical ICE cold starts; this is most likely due to the combination of their relatively medium battery capacity and low electric power capabilities. The C-Max-Fusion vehicles are less likely than the Prius Plug-in cars to have engine starts as they have the relatively larger battery capacity and more likely than the Prius Prime to have high-power cold starts due to their lower electric power capabilities, resulting in more engine starts with long

soak periods than the other cars. Overall, the Volts do a much better job than the other PHEVs at both curbing start emissions via logging very few engine starts and reducing fuel use. **Figure 16** plots the distributions of the ratio of electric miles to total miles for all PHEV models and demonstrates how the Volts are far better than the other vehicle models at displacing gasoline.

2.5 Discussion

In this study, we found that PHEVs tend to log fewer cold starts than comparable ICE vehicles, performing the same trips. For all PHEV models analyzed, most of the trips' first engine starts occurred due to low battery SOC. Depending on the model, around 50% to 85% of first engine starts occurred at SOCs below 5%. The remaining starts may have been invoked for reasons ranging from having to meet high power requirements to maintaining an appropriate cabin temperature. For the two PHEV models that recorded catalyst temperature, we found that most engine starts after the first engine start, within a given trip, were warm/hot starts, indicating that the engine was on for long enough the first time to keep the catalyst warm for subsequent starts. Soak time distributions for individual PHEV models showed that most trips' first engine starts were invoked before a 12-hour soak period, suggesting that most PHEV engine starts are warm starts. The distributions also revealed that PHEVs with larger battery capacities are more likely than those with smaller battery capacities to have longer soak periods with 40% of the Volt 18 starts having a soak period over 12 hours compared to just 20% of the Prius Plug-in starts. Analysis of the distance traveled from the beginning of the day to the first engine start revealed that local emissions may be at a location away from home for long-range PHEVs such as the Volts given around 60% of Volt engine starts occurred over 5 miles away from start day location; the inverse is observed for the Prius Plug-in starts with over 80% of starts having occurred under 5 miles from

the start day location. We focused on identifying and analyzing high power cold starts, in addition to cold starts, for the remainder of the study given their high emission potential.

An analysis of the maximum power requirement prior to the trips' first engine starts revealed that PHEVs with higher all-electric range such as the Volts are least likely to invoke the ICE in the presence of a high-power requirement while those with low all-electric range such as the Prius Plug-in cars are most likely to invoke the ICE to meet a high-power requirement, regardless of battery SOC. Mid-range PHEVs with relatively low electric motor peak power (C-Max-Fusion) or higher than average road load due to high curb weight (Pacifica) tend to invoke the engine over a wide range of power requirements given there could be many factors driving engine invocation for these cars.

The probability of an engine start to occur in a day, for each model, can be explained by the models' individual specifications. In general, there is an inverse correlation between vehicle battery capacity and the probability of an engine start with the Prius Plug-in vehicles having logged far more engine start days than the Volt vehicles. However, this trend doesn't hold for cold starts and high-power cold starts. The Prius Plug-in vehicles recorded nearly as many cold starts as the Prius Prime vehicles, given they start their engine more frequently, resulting in relatively shorter engine cool down periods than the other vehicles. The C-Max-Fusion and the Pacifica vehicles incurred the highest number of cold starts most likely due to design specifications, ranging from low peak electric motor power to high curb weight. On the other hand, the Volts logged far fewer cold starts than all other PHEV models in the study.

Comparing the average daily cold starts for each PHEV model to the average daily cold starts if the model vehicles behaved like conventional ICE vehicles showed that all models would've logged more cold starts if they behaved as ICE vehicles, suggesting that they all incur

start emission savings functioning as PHEVs. The Prius Plug-in vehicles show just as much cold start emission savings as the Prius Prime vehicles and far more savings than the C-Max-Fusion vehicles, despite having a much smaller battery capacity; this is again most likely due to their relatively shorter engine cool down periods between starts. The C-Max-Fusion vehicles show meager cold start emission savings compared to all other studied PHEVs, owing to their relatively medium battery capacity and low electric motor power. There was a 136% increase in cold starts for the Volt 18 vehicles and a 47% increase in cold starts for Prius Plug-in vehicles if they behaved as ICE vehicles, compared to just 11% increase in cold starts for the C-Max-Fusion cars. Ultimately, the Volts, the PHEVs with the highest electric range, do a much better job than the other vehicles at both curbing start emissions via logging very few engine starts and reducing fuel use as suggested by their relatively high electric miles to total miles ratio of roughly 0.7, on average.

2.6 Conclusion & Future Direction

This study explored the characteristics, triggers and frequencies of various types of PHEV engine starts in order to gauge the emission potential of multiple PHEV models, spanning a wide range of specifications and drivetrain configurations. The engine starts that were not linked to low battery SOC were typically invoked by high power requirements that the vehicles' all-electric propulsion systems could not meet. Vehicles with low all-electric range and battery capacity were more likely than vehicles with high all-electric range and battery capacity to instantiate the engine during a high-power demand. Vehicles with mid-range capabilities started the engine over a wide range of power requirements given there could be many factors driving engine invocation for these cars.

While there is a fairly strong correlation between battery capacity and the probability of avoiding an engine start on a given day, this relationship doesn't hold true for cold and high-power cold starts. The low battery capacity vehicles recorded nearly as many cold starts as the mid-battery capacity vehicles given they have a shorter cool down window between starts due to their engine being invoked more frequently. Mid-sized battery vehicles display wide variation in cold start probabilities since there are several factors, ranging from low peak electric motor power to high curb weight, that determine when the engine is invoked for these cars. Ultimately, we found that long range PHEVs with high battery capacity, such as the Chevrolet Volt, are ideal for both curbing start emissions via logging very few engine starts and reducing fuel use. The analysis on distance from the beginning of the first trip also suggests that PHEVs shift location of cold starts and the derived local emissions from around home to a further away destination. In case of long-range PHEVs, the first engine start may occur during the afternoon commute, in a different urban setting than the home location. Based on these findings, it is recommended that researchers and policymakers devise a more rigorous emission testing framework for PHEVs, rooted in realistic driving scenarios to truly capture their emission potentials; they should update any current local emissions forecasting tools to reflect this change. Policymakers should also consider providing more incentives for purchasing PHEVs with high battery capacities and electric ranges, such as the Volt, given they are far better at minimizing cold starts and fuel use than PHEVs with lower capacities. Furthermore, auto manufacturers should try to optimize the drivetrain configuration of PHEVs based on vehicle specifications and trip route details (distance, SOC remaining, etc.) to simultaneously minimize cold starts and fuel use. Additional analysis should be conducted to quantify the emissions associated with the engine starts identified in this study to reinforce our conclusions. Future studies should consider exploring the charging behavior between trips, in

addition to driving behavior, to figure out the ideal engine start time to minimize both fuel use and engine starts along with their associated emissions. The spatial distribution of emissions from PHEVs are also an important topic for future study.

Chapter 3: From Shifting Gears to Changing Modes: The impact of user-induced drive modes on Plug-in Hybrid Vehicle Energy Efficiency

3.1 Introduction

The transition from ICE vehicles to PEVs is considered one of the most promising pathways for reducing GHG emissions and improving local air quality from the on-road transportation sector. Here, PEVs include both BEVs and PHEVs, which are powered by an externally-charged battery and propelled by an electric motor. BEVs are powered solely by energy from the battery, making them full zero emission vehicles. PHEVs, however, use energy from both a battery and a liquid fuel. The proportion of power drawn from each respective source determines the emissions produced by a PHEV.

There are four main factors that contribute to the overall fuel efficiency of a given PEV. First, the vehicle's technologies and components have the strongest effect and work together to affect its estimated efficiency. Next, this baseline efficiency rating is influenced by the driving conditions such as the ambient temperature, topography, and wind speeds. From here, driver inputs including accelerator pedal position, breaking, and cabin comfort controls can further alter the efficiency from the baseline estimates. The fourth determinant of vehicle efficiency utilizes drive modes to give the driver the option to alter the vehicle technology to fit their driving needs. These first three factors have been examined extensively in the literature (Shams-Zahraei and Kouzani, 2010; Smart et al., 2010; Ma and Ming, 2013; Smart, Powell and Schey, 2013; Plötz, Funke and Jochem, 2015). While the emissions and efficiency impact of drive modes have been examined in a few recent studies (Karanam et al. 2022; Chau, Elbassioni and Tseng, 2017; Watanabe et al., 2020), the impact of a driver's choice of drive modes has been examined in only one study (Arend and Franke, 2021).

While drive modes are available in both PHEVs and conventionally fueled vehicles, the two studies presented in this chapter examine drive modes only in PHEVs due to their potential to significantly affect the vehicle's energy use and emissions. PHEVs allow the driver to change the way the vehicle performs and override the default powertrain management system by selecting from a series of preset drive modes. These are user-selected drivetrain configurations that can affect several aspects of the vehicle's performance. For PHEVs, the primary feature of drive modes is shifting the propulsion power source between electricity and gasoline, thus altering the vehicle's energy consumption. This can significantly impact the energy use and expected emissions of these vehicles from traditional estimates. Some drive modes are designed to improve efficiency, such as the Toyota Prius Prime's *Eco mode*, which reduces the climate control power and throttle response to maximize efficiency. Others are meant to enhance driver experience through changes to vehicle characteristics such as steering responsiveness, acceleration responsiveness, suspension stiffness, and regenerative braking strength. For example, the Chevrolet Volt's *Sport Mode* increases the throttle response for quick acceleration. These types of drive modes generally enhance driver experience but may negatively impact emissions rates.

By changing the drive mode, the driver can impact the efficiency and emissions of the vehicle, however, these changes may not be the intended use of the vehicle leading to unexpected emissions. Watanabe *et al.* [31] found average fuel savings of approximately 15% can be achieved by optimizing drive mode use in a Prius PHEV for maximum efficiency. Under everyday conditions, drivers are generally not concerned with maximizing efficiency, leading to differences in driver behaviors including charging behavior, daily miles traveled, and annual miles traveled. This variation in driving behavior leads to efficiency differences within the same vehicle [32]. Despite the potential impact drive modes can have on energy use and emissions, they are not

currently assessed in standard vehicle performance and certification tests. To address this gap, the two studies presented in this chapter aim to understand the motivations and implications of driver mode usage in PHEVs. In addition to comprehensively defining and classifying various drive modes, the first study examines the motivations for drive mode usage using a survey of over 26,000 PEV drivers in California. The second study quantifies the energy use and emission impacts of drive mode usage using on-road vehicle data from 81 Chevy Volts driven in California.

3.2 Literature Review

Given the ability of drive modes to alter the efficiency and emissions potential of PHEVs, mode choice can be seen as a type of eco-driving. To understand the choice of drive mode, previous literature on the motivations and intentions for eco-driving is explored. This is followed by a review of the potential factors influencing mode choice that has been identified in previous literature. Given the relative novelty of drive modes, variables with the potential to impact driver behavior of all types (e.g., eco-driving, aggressive driving, etc.) are identified to test the greatest number of relationships. Finally, variables related specifically to the interaction between drivers and PHEVs are identified.

3.2.1 Previous Studies on Eco-Driving Behaviors

There have been many studies examining the motivations for eco-driving [33]–[36]. While each study had their own definition of eco-driving, Franke et al. [37] defines it as, “driving behaviors performed in order to increase real-world energy efficiency of a road vehicle.” Cristea, Paran, and Delhomme [38] note that eco-driving includes changes in driver behavior that work to reduce emissions, increase safety, or save fuel. They conducted a survey of 1,243 drivers aged 18–75, finding that safety was the biggest motivation for eco-driving. Ünal, Steg, and Gorsira [39] studied eco-driving in the Netherlands, finding that the driver’s values were more important than

their knowledge of eco-driving in predicting their intentions to eco-drive so teaching them how to drive more efficiently was insufficient. Just two of these studies examined the effects of eco-driving in Plug-in Electric Vehicles (PEVs). Günther, Kacperski, and Krems [40] examined the impacts of feedback, gamification, and financial rewards on persuading BEV drivers to eco-drive. They looked at the impacts of these strategies on 108 staff members at a German university, finding that participant's attitudes towards, and use of, eco-driving were not affected by these interventions. Stillwater and Kurani [41] conducted interviews with 46 PHEV drivers who were given access to an in-vehicle eco-driving interface. They found that having a personal efficiency goal paired with instantaneous efficiency feedback helped motivate participants to eco-drive.

While drive modes can be used for eco-driving, there have been relatively few studies that have looked at the impacts of drive modes on vehicle efficiency. The first papers were published by Chau, Elbassioni, and Tseng [42], [43], who developed an algorithm to enable drivers to select the drive mode that maximizes fuel efficiency based on their trip route. Another study by Watanabe *et al.* [31] similarly sought to optimize the use of drive modes in Prius PHEVs to optimize fuel and electricity demand based on driving routes. These simulations suggest that average fuel savings of approximately 15% can be achieved by optimizing drive mode use for maximum efficiency. To date, just one study has examined the interaction between drivers and mode choice [44]. This study examined the use of eco modes by 121 HEV drivers to understand how drivers interacted with the modes.

Given their ability to utilize gasoline, electricity, or a combination of the two to propel the vehicle, the energy and environmental impacts of drive mode choice in PHEVs is significant and requires further evaluation. This paper seeks to fill this gap by extending the field of eco-driving

to drive modes, establishing a foundation for future research into this subject, which had thus far been understudied.

3.2.2 Factors Affecting Driver Behavior

The regression model used in this study uses a number of input factors taken from the existing literature as having a potential impact on driving behavior. As this is an exploratory study that seeks to understand the factors associated with drive mode use, variables were chosen by examining factors that were identified as impacting driver behaviors. Although the use of drive modes is most similar to eco-driving behaviors, we use factors that have been identified as affecting driving behaviors of all types (e.g., eco-driving, aggressive driving) as drive mode use is a new field of study and the behaviors associated with its use are currently unclear.

Both gender and age were often found as influencing driver behavior [38], [45], [46]. Younger drivers and males were found to be more reckless in their driving than older drivers [47], [48]. A study by Shinar, Schechtman, and Compton [49] found that demographic factors affect driver behavior, stating that drivers with higher income and education levels were more likely to violate speed limits. Lower income drivers may additionally be more inclined to participate in eco-driving due to the fuel-savings potential [50]. Given that these factors have been shown to influence driver's willingness to take risks and experiment with the vehicles, their potential to influence the decisions to utilize drive modes is examined.

This study additionally examines the impact of make and the frequency of long-distance trips on the use of drive modes. Vehicles differ significantly in how they display drive mode options. Displays of vehicle characteristics such as those that report the energy savings from eco-driving have been found to influence the choice to eco-drive [41], [51]. Franke *et al.* [37] found

that drivers reported taking long-distance trips as being a hinderance to their eco-driving as they wished to save time by driving at higher speeds.

3.2.3 Factors Affecting Driver Interaction with PHEV Technology

In addition to the factors that impact driver behavior in all vehicles, variables specific to driver interactions with PHEVs were identified. Lee, Hardman, and Tal [52] examined the characteristics of PEV households, finding that early-adopters tended to have a higher income, level of education, and number of vehicles than the average driver. A study by Jakobsson *et al.* [53] examined the effects of having a BEV in a multi-car household compared to a single-car household, finding that having additional vehicles in the household impacts the use of the BEVs as drivers can choose to use them on trips that maximize their range and forgo using them on longer trips. The number of vehicles in the household is thus included as a variable in the model.

The type of home and whether it is rented or owned also has a specific relationship with PEVs. A study by Axsen and Kurani [54] discussed the difference in access to home-charging based on home type, with those in single-family homes more likely to have access to dedicated home-charging than those who live in an apartment. The study notes that drivers who rent their home may have more difficulty installing a home-charging station as they would need to gain permission from the property-owner. This lack of access to charging can therefore influence the importance of preserving the electric range of the vehicle by using the drive modes.

Finally, electric range and the frequency of plugging in the vehicle were identified as variables that can impact drive mode use. Jensen and Mabit [55] conducted a study of BEV trials in households, finding that factors such as the vehicle's range limited which types of trips participants used them for. Given the impact of drive modes on the range of the vehicle, it is anticipated that the use of certain modes will depend on the electric range of the vehicle. Similarly,

the charging behavior of drivers is studied. Drivers who report plugging their vehicle in less than four times a month are differentiated as are less able to realize the benefits of the electric range [32]. This may affect their interaction with drive modes as they could be using them to preserve range as a substitute charging or may show less concern for utilizing their electric range.

3.2.4 Plug-in Hybrid Drive Modes Overview

PHEVs are unique in that the propulsion power is split between the electric motor and the gasoline engine. As shown in **Figure 17**, the drivetrain configuration influences the degree to which the gasoline engine or electric motor is more actively used. In general, the propulsion status of PHEVs alternates between a zero emission (ZE), a charge depleted blended (CDB), and a charge sustaining (CS) state. The ZE state is when the battery is used as the primary source of power for the vehicle, while CDB drives the vehicle with a combination of the electric motor and gasoline engine. This is necessary for quick acceleration or operating at high speeds. The CS state occurs when the battery is fully depleted and only the engine is used to propel the vehicle. Drive modes allow drivers to manually alter the vehicle's propulsion status, steering responsiveness, suspension stiffness, and regenerative braking strength.

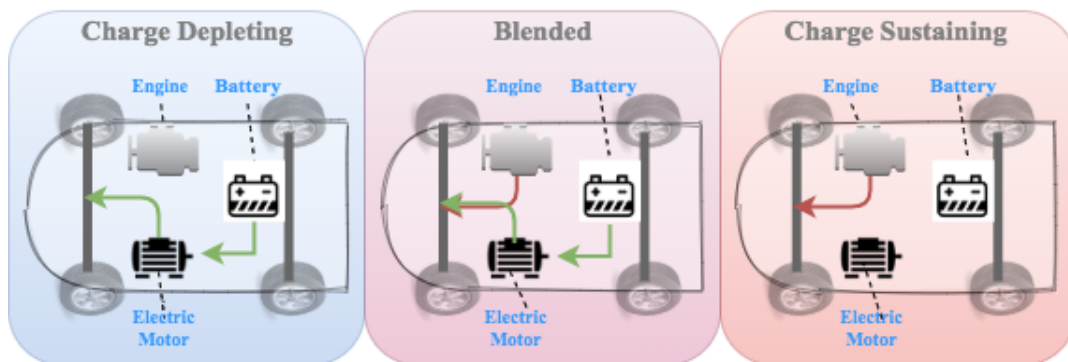

Figure 17 PHEV Propulsion Power Sources

Drive modes are subdivided into two categories: driver-induced and default. Driver-induced modes are those which must be selected by the user to transition the vehicle from the

default configuration into another state. Default drive modes are defined as the drivetrain configuration the vehicle starts in when initially turned on. Depending on the vehicle, the default drive mode can propel the vehicle in a CDB, CD, or CS state. In most cases, this is a specific drive mode chosen by the manufacturer that the vehicle reverts to when turned on. For example, the Chevrolet Volt has a *speedy mode* (sport mode), but when the vehicle is turned off in that mode, it will start again in default mode. In some vehicles, the default mode is the drive mode that the vehicle was last in before being turned off, in which case, the vehicle does not have a default mode. Two PHEVs (Toyota Prius Prime and Honda Clarity) have a user-selectable default mode, while the remaining 21 vehicles examined start in the same mode regardless of the active mode when the vehicle was turned off.

While drive modes are broadly defined as pre-made configurations that give drivers the option to change the configuration of their vehicle, the actual impacts of these modes vary significantly. These modes fall into two main categories (Propulsion Adjustment and Driver Experience Adjustment), each of which contains various mode types. Propulsion Adjustment Modes include *engine recharge*, *hybrid*, *hold*, *efficiency*, and *all electric* mode types. These are defined as drive modes that impact how the vehicle is propelled, such as allowing the driver to force the vehicle into CDB, CS, or ZE propulsion statuses. Driver Experience Adjustment Modes include the *speedy* and *rugged* mode types, which affect how the vehicle responds to the driver's steering and pedal usage. These can perform functions such as adjusting the accelerator pedal responsiveness, steering tightness, regenerative braking, and suspension height and strength.

In addition to these two main categories of drive mode types, some vehicles contain modes that do not fit into any of these predefined modes. For example, *Individual mode* allows Volvo drivers to personalize driver display, steering force, powertrain, brakes, suspension, and climate.

While these drive modes allow the driver increased customization and freedom with their vehicle, the differing and unintuitive names can create issues for users as they may be using a mode incorrectly, or not using the offered modes, affecting their vehicle's efficiency.

While not all drive modes were directly designed to effect vehicle emissions, each of these modes has the potential to alter energy use, and thus emissions output. Three mode types (*all-electric, efficiency, and hybrid*) are designed to reduce emissions by prioritizing use of the electric motor, while three are designed for purposes such as increasing power or altering driving experience (*engine recharge, speedy, and rugged*), resulting in an increased emissions potential. The *hold mode* type is designed to enable the user to toggle between gasoline and electric propulsion, making the emissions impact of this mode type highly dependent on usage, thus no generalization on the emissions impact can be made. The potential emissions changes are based on efficiency impacts as described in the owner's manuals, however, the actual impacts will depend greatly on how the mode is deployed.

Table 2 provides examples of the various drive mode options that are available in current market PHEVs, sub-categorized into mode types based on their intended purpose. While Tesla does not make PHEVs, the drive modes of the four Tesla models (Model S, Model X, Model 3, and Model Y) were included for reference as they are widely known among electric vehicles consumers. Each of these PHEVs were available in California and had publicly accessible owner's manuals online. The average number of drive modes in these PHEVs is 4.9, with one vehicle (Chrysler Pacifica) having just the default drive mode, and three vehicles (Toyota Prius Prime, Volvo XC60, and Volvo XC90) having the greatest number of modes with 8 each. **Table 3** classifies these modes into Propulsion Adjustment or Driver Experience Modes, providing examples of drive modes which fall into each category. In some cases (Mitsubishi Outlander

PHEV’s *Eco Lock*, Subaru Crosstrek PHEV’s *Intelligent*, and Volvo XC60 & XC90’s *Individual*), a mode can affect both the propulsion and throttle mapping of the vehicles, in which case, the mode is classified by its primary purpose, as described by the vehicle’s owner’s manual.

Table 2 Mode type descriptions and potential efficiency impact

Mode Category	Mode Type	Description	Efficiency Potential
Propulsion Adjustment	All-Electric	Exclusively uses the battery to power the vehicle <ul style="list-style-type: none"> Gasoline is used only when the battery is depleted 	Positive
	Efficiency	Makes the vehicle more efficient by adjusting one or more of the following: <ul style="list-style-type: none"> Decreasing the accelerator pedal responsiveness Increasing the regenerative braking Adjusting climate control settings 	Positive
	Hybrid	Prioritizes the vehicle’s battery power <ul style="list-style-type: none"> High power demand (e.g. fast acceleration, steep incline, etc.) can still turn on the engine 	Positive
	Hold	Prioritizes the engine’s power to drive the vehicle <ul style="list-style-type: none"> Recharges the battery from braking Occasional battery use in slow driving conditions 	Case Specific
	Engine Recharge	Gasoline engine recharges the traction battery <ul style="list-style-type: none"> Decreases the vehicle’s fuel economy (charging the battery while propelling the vehicle) Many vehicles will not charge the battery to full 	Negative
Driver Experience	Speedy	Enhance driver experience by increasing the responsiveness of the accelerator pedal <ul style="list-style-type: none"> Some models restrict the mode to be used only in CDB or CS propulsion statuses 	Negative
	Rugged	Intended to be used for off-road or adverse conditions <ul style="list-style-type: none"> May raise the suspension Only available at lower speeds (<20 MPH) Activates AWD 	Negative
Other		Various additional modes, including customizable drive modes.	Case Specific

Some mode names are intuitive (e.g., *sport*, *electric*), while others have uses that are unidentifiable unless the user looks further into them. The same vehicle can also have a different number of drive modes depending on the model year and options selected (particularly for Tesla vehicles and Chevrolet Volts), which can add confusion for the drivers. Many drive modes are

standardized within a manufacturer (e.g. all Subaru models offer *X-mode*) but not between them (e.g. Subaru *X-Mode* functions similar to the Volvo *Off-Road* mode, but with a different name).

Table 3 Example of Modes by Mode Type Category

Driver Experience		Propulsion Adjustment					Other
Rugged	Speedy	Engine Recharge	Hold (Forced CS)	Hybrid (Forced CDB)	Efficiency	All Electric (Forced ZE)	
<ul style="list-style-type: none"> •Off Road (Volvo) •4WD (Mitsubishi) •X-Mode (Subaru) 	<ul style="list-style-type: none"> •Sport (Chevy, Hyundai, Honda) •Power (Toyota, Volvo) •Insane (Tesla) •Track (Tesla) •Ludicrous (Tesla) 	<ul style="list-style-type: none"> •Mountain (Chevy) •Charge (Toyota, Volvo) •Hybrid Battery Charge (Subaru) •HV Charge (Honda) •Battery Charge (Hyundai, Mitsubishi) 	<ul style="list-style-type: none"> •Hold (Audi, Chevy, Volvo) •CS (Kia, Hyundai) •EV Later (Ford) •Battery Save (Mitsubishi) •Hybrid Battery Save (Subaru) 	<ul style="list-style-type: none"> •Hybrid (Audi, Kia, Volvo) •HV (Toyota, Honda) 	<ul style="list-style-type: none"> •Eco (Honda, Hyundai, Kia, Mitsubshi, Toyota) •Eco Lock (Mitsubishi) •Green (Mini Cooper) •EcoPro (BMW) •EcoPro+ (BMW) •Intelligent (Subaru) 	<ul style="list-style-type: none"> •EV (Audi, Kia, Kia, Mitsubshi) •Max eDRIVE (Mini Cooper) •Pure Now (Volvo) •EV Auto (Ford) •EV Auto (Toyota) •CD (Hyundai, Kia) 	<ul style="list-style-type: none"> •Individual (Volvo) •Mid (Mini Cooper) •Intelligent (Subaru)

3.3 The Motivations of Drive Mode Usage in Plug-in Hybrid Electric Vehicles

3.3.1 Introduction

To understand how drive modes are used, the study presented in this chapter seeks to understand the factors associated with a driver’s decision to use drive modes, and the potential impact that these decisions have on emissions. The study begins by providing an overview of PHEV drive modes, defining, grouping, and characterizing them according to their potential emissions impacts. This is followed by an analysis of the indicators for mode usage using logistic regression to analyze data from a survey of over 3,600 PHEV-owning households in California. These predictors help explore drivers’ motivations for using these drive modes, providing insights into their level of understanding for how the modes are used. This allows for a comparison between

drivers who use drive modes in a manner that improves the environmental performance of their vehicle with those who use modes that negatively impact emissions rates.

3.3.2 Methods

Data Overview

This study investigates PHEV driver mode usage quantitatively using a set of logistic regression models to identify the relationships between driver and vehicle attributes, and the use of specific drive modes. The data for this analysis comes from the *Advanced PEV Driving and Charging Behavior* project, a California-wide study spanning five years (2015-2019) that aims to understand the driving and charging behavior of PEVs (Tal *et al.*, 2020). This study includes a survey which collected responses from over 26,000 PEV drivers in California who were invited to participate after applying for the Clean Vehicle Rebate Program (CVRP) each year over this timeframe. Each iteration of the survey asked drivers about characteristics of their new vehicle, characteristics of the other vehicles in their household, travel patterns, sociodemographic information, access to charging stations, etc.

All PEV owners who applied for the CVRP were asked if they were willing to participate in the survey, regardless of whether they received funding through the program, so all applicants were given an equal chance to participate, but biases may still arise due to self-selection. Given that modern PEVs are still relatively new, having only come onto the market in 2010, the difference between those applying for the rebate when the survey began in 2015 are likely to be different than those applying in the later years, although all are considered early adopters [52]. Rebate amounts and qualifications have changed several times over the sample years, which may cause some difference in who is applying for them, but this is unlikely to have a significant effect on their likelihood of using drive modes.

This paper focuses only on the impact of these modes in PHEVs, so a subset of approximately 13,600 responses from the survey was used (BEV driver responses were removed). From this sample, only drivers of five PHEV models (Ford C-max, Ford Fusion, Chevrolet Volt, Toyota Prius Prime, and BMW i3 REx) were asked about their drive mode use. This reduced the sample size to roughly 4,522 responses. Due to the importance of the household characteristic variables, observations with missing data for age, gender, education, and home type were additionally excluded, removing about 25% of the remaining sample. This full sample was used as the basis for the regression models presented in this study.

Modeling Overview

Seven binomial logistic regression models were performed using the `{stats}` package in R. The first six were used to identify factors of the driver and vehicle that are linked to the usage of each mode. The last model was estimated to identify factors linked to the use of at least one mode, regardless of type. This question asked respondents to identify how often they used each of the drive modes available in their vehicle, providing a description of the mode's function. Response options included "Nearly every day," "About once a week," "About once a month," "A few times a year", and "Never". This study examines the factors correlated with the use of modes so these responses were consolidated into a binary "yes" or "no" use case where "Never" responses were assigned "no" and all other responses were assigned to "yes".

Drive modes were grouped into the mode types outlined in the PHEV Drive Mode Overview section, and individual models were estimated for each mode type except *rugged*, which was excluded for lack of data. Five different PHEV models (Ford C-max, Ford Fusion, Chevrolet Volt, Toyota Prius Prime, and BMW i3 REx) were included in this survey, and each driver was asked about how often they use each of the drive modes that are available in the model of PHEV that

they own. A summary of the vehicles and modes discussed in this analysis are displayed in **Table 4**, showing that sample size varies considerably across mode type. This variation is due to the differing number of vehicles that offer each mode (e.g., *Hold modes* are included in the C-max, Fusion, and Volt while *engine recharge modes* are included only in the Volt) as well as differences in response rate between vehicles. *Hybrid modes* are only present in one model and have the smallest total number of survey responses (n = 1,095), while *hold modes* are present in three models and have the highest number responses (n = 3,231). The *all modes* analysis includes all survey responses from the full sample.

Table 4 PHEV Mode Type Categories

Mode Type	Mode	Models		Survey Responses
Hold	EV Later	Cmax	Fusion	n=3,231
	Hold	Volt		
All Electric	EV Now	Cmax	Fusion	n=2,359
	EV Auto	Prius		
Efficiency	EcoPro	i3		n=1,291
	Eco	Prius		
Engine Recharge	Mountain	Volt		n=1,967
Speedy	Sport	Volt		n=3,062
	Power	Prius		
Hybrid	HV	Prius		n=1,095
All Modes	All Modes			n=3,625

The study sample is shown in **Table 5** and **Table 6**. This shows a significant skew towards male respondents which made up roughly 72% of the sample. The average age and income of the sample are just over 50 years and \$174,000. This is consistent with prior studies on early electric vehicle consumers which find that they are more frequently middle aged, high-income males (Tal *et al.*, 2020). All regression results were carefully analyzed in the context of the current state of technology. This limits the generalizability of the results and caution should be taken in

extrapolating findings to the wider population of drivers and in future scenarios with more mature technologies.

This work draws from a section of the survey which asks PHEV drivers about their knowledge of the availability of drive modes in their vehicle, and how often they are used. Eleven different variables were tested to try to understand mode usage. These factors were chosen because of their potential to impact mode usage, as discussed in the literature review section. Each of these characteristics were categorized into three different groups of variables to guide interpretation: household characteristics, vehicle characteristics, and travel behaviors. A series of data cleaning steps were taken to ensure variables performed correctly in the model and make results easier to interpret. Vehicle makes and models were standardized to prevent vehicles from being classified incorrectly due to spelling or capitalization errors. Observations with missing data in these groups were distributed randomly between vehicle types, so they are not anticipated to have any significant effect on the model outcomes. Observations with outliers in the number of trips over 200 miles in a year were removed to prevent them having a significant influence on the model. After this was done, the number of household vehicles and number of trips over 200 miles were grouped into categorical variables to account for lack of data at extreme values, which could cause them to have unequal influence on the model. The final groupings of these variables are shown in **Table 5** and **Table 6**. All variables were tested in the original model formulation, and insignificant variables were removed in a stepwise fashion. Each model was carefully checked to ensure it met the assumptions of logistic regression including checks for linearity amongst the categorical variables, extreme values, and multicollinearity.

Table 5 Percentage of All Observations for Each Categorical Variable

Categorical Variables					
Variable Type	Variable	Category 1 (%)	Category 2 (%)	Category 3 (%)	Category 4 (%)
Household Characteristics (HC)	Gender- Male	Male (72%)	Female (28%)		
	Home Type	Apartment (8%)	Detached House (78%)	Attached House (13%)	
	Education Level	High School Diploma or less (16%)	College Degree (43%)	Graduate Degree (41%)	
	# of household vehicles	1 (17%)	2 (49%)	3 or more (34%)	
	Rent or Own Home	Rent (19%)	Own (81%)		
Vehicle Characteristics (VC)	Make	Ford (27%)	Chevrolet (44%)	Toyota (24%)	BMW (4%)
Travel Behavior (TB)	# of trips over 200 miles	0 (36%)	1 (18%)	2 to 3 (22%)	4 and up (24%)
Other	Plugging in the vehicle	Doesn't plug in (8%)	Plugs in (92%)		

Table 6 Summary Statistics of Continuous Variables

Continuous Variables					
Variable Type	Variable	Minimum	Maximum	Mean	Standard Deviation
Household Characteristics	Age	17	85	50.6	13.6
	Income	\$25,000	\$550,000	\$174,145	\$104,394
Vehicle Characteristics	Electric Range	11 miles	72 miles	35.8 miles	17.9

Table 7 Overview of Modes by Frequency of Use. For each mode type the use case with the smallest percentage of respondents is denoted in red while the largest response category is denoted in green.

Model	Mode	Mode Type	Nearly every day	About once a week	About once a month	A few times a year	Never
Cmax	EV Later	Hold	17.4%	9.8%	7.7%	11.0%	54.1%
	EV Now	All Electric	22.7%	7.0%	3.8%	8.8%	57.7%
Fusion	EV Later	Hold	21.9%	13.3%	8.2%	11.9%	44.6%
	EV Now	All Electric	26.6%	9.9%	3.5%	11.2%	48.9%
Volt	EV Hold	Hold	9.6%	11.7%	14.2%	19.2%	45.3%
	Mountain Mode	Engine Recharge	1.6%	2.7%	7.6%	26.4%	61.8%
	Sport Mode	Speedy	7.0%	8.9%	10.0%	19.2%	55.0%
Prius	HV Mode	Hybrid	31.1%	12.1%	6.8%	8.7%	41.3%
	Eco Mode*	Efficiency	65.4%	4.8%	3.9%	5.7%	20.3%
	PWR Mode*	Speedy	7.1%	10.8%	11.7%	20.7%	49.7%
i3 REX	Comfort Mode*	Default	52.0%	13.3%	9.2%	7.7%	17.8%
	Eco Pro or Eco Pro+	Efficiency	52.6%	13.3%	12.2%	10.2%	11.7%
Total	All	All	18.6%	8.8%	8.7%	16.2%	47.7%

* denotes default drive mode for that vehicle

To provide a foundation for mode use, a summary of the percentage of responses on reported mode use is presented in **Table 7**. Respondents were prompted with the specific list of modes available on their vehicle. Here, it is interesting to note the differences between vehicle models. Most drivers of Ford, Chevrolet, and Toyota PHEVs report utilizing user-selectable drive modes “very rarely” or “never”, but over 50% of drivers of the range extended BMW i3 report using both the default *comfort* and driver-induced *eco pro* modes nearly every day. Additionally, in the Prius, the default *eco mode* was reported as being used nearly every day by over 65% of drivers while 7% of these drivers reported that they always use *power mode*.

These differences in mode use between different vehicle models may be attributable to differing amounts of education provided by the manufacturers or dealers about the modes. The differences in mode usage within a vehicle model may be more attributable to differences in what the mode is used for. For example, in the Prius, *HV* and *eco mode* are both *propulsion adjustment modes* that are used to help improve the overall fuel economy of the vehicle and have high reported usage rates while *power mode* is a *driver experience mode* and has a lower reported usage rate.

3.3.3 Results

Table 8 shows the results of the individual mode type models, which are presented in three main categories: household characteristics, vehicle characteristics, and behavioral factors. **Table 9** provides the average marginal effects on the probability of mode usage from a one-unit change in continuous variables or a change from the reference level to each other level of the categorical variables. Average marginal effects were computed from model results using the {margins} package in R [57]. The results of each of these mode type models is presented below

Table 8 Results of The Seven Regression Mode Type Models

Mode Type Model Results: estimate (standard error)								
Parameter Type	Parameter	Efficiency					Driver Experience	Any Mode
		All Electric (Positive)	Efficiency (Positive)	Hybrid (Positive)	Hold (Case Specific)	Engine Recharge (Negative)	Speedy (Negative)	
	Intercept	0.0813 (0.261)	1.51 (0.321)	-0.0366 (0.121)	0.363 (0.202)	-1.66 (0.190)	0.724 (0.308)	2.57 (0.340)
HC	Gender: Male	0.506 (0.115)***	0.341 (0.169)*	0.549 (0.147)***	0.0672 (0.099)***	0.697 (0.147)***	0.790 (0.102)***	0.840 (0.0954)***
	Age	-0.0210 (0.00413)***			-0.0156 (0.00324)***		-0.0324 (0.00343)***	-0.0229 (0.00333)***
	# of household vehicles: 2	0.395 (0.148)**					0.306 (0.129)*	0.444 (0.124)***
	# of household vehicles: 3+	0.456 (0.158)**					0.414 (0.140)**	0.491 (0.134)***
	Income (per thousand dollars)				-0.00107 (0.000430)*	-0.00142 (0.000573)*		-0.00134 (0.000437)**
	Education Level: College Degree						-0.245 (0.132)	
	Education Level: Graduate Degree						-0.522 (0.132)***	
	Home Type: Detached House						0.287 (0.187)	
	Home Type: Attached House						0.405 (0.201)*	
	Rent or Own Home: Rent						0.413 (0.141)**	
VC	Make: Ford	Reference	Not in vehicle	Not in vehicle	-0.306 (0.0903)***	Not in vehicle	Not in vehicle	-2.30 (0.286)***
	Make: Chevrolet	Not in vehicle	Not in vehicle	Not in vehicle	Reference	Only in this vehicle		-1.48 (0.282)***
	Make: Toyota	0.790 (0.118)***		Only in this vehicle	Not in vehicle	Not in vehicle		0.163 (0.308)
	Make: BMW	Not in vehicle		Not in vehicle	Not in vehicle	Not in vehicle	Not in vehicle	Reference
	Electric Range		0.0130 (0.00453)**				-0.00991 (0.00265)***	
TB	# of trips over 200 miles: 1	0.236 (0.149)			0.468 (0.124)***	0.995 (0.165)***	0.198 (0.122)	0.343 (0.125)**
	# of trips over 200 miles: 2 or 3	0.139 (0.149)			0.513 (0.117)***	1.25 (0.159)***	0.450 (0.115)***	0.513 (0.120)***
	# of trips over 200 miles: 4+	0.439 (0.148)**			0.705 (0.117)***	1.57 (0.160)***	0.615 (0.116)***	0.635 (0.120)***
	Plugging in the vehicle: Yes		-0.655 (0.312)*					
Stats	Sample Size	2,359	1,291	1,095	3,231	1,967	3,062	3,195
	AIC	1,936	1,002	1,194	3,044	1,729	3,159	3,205
	Log Likelihood	-959	-497	-595	-1,514	-859	-1,564	-1,590

Significance codes: 0.001 **** 0.01 *** 0.05 ** 0.05 Significance cutoff level was used to remove parameters from models

Note: For mode type, the reference category varied between mode types

Reference categories: number of household vehicles (1), education level (High School Diploma or Less), home type (apartment), number of trips over 200 miles (0)

4Table 9 Average Marginal Effect for all Mode Type Models (95% Confidence Interval)

Average Marginal Effect (95% Confidence Interval)								
Parameter Type	Parameter	Efficiency					Driver Experience	Any Mode
		All Electric (Positive)	Efficiency (Positive)	Hybrid (Positive)	Hold (Case Specific)	Engine Recharge (Negative)	Speedy (Negative)	
HC	Gender: Male	11.9% (6.61%, 17.1%)	5.27% (-0.01%, 10.6%)	13.5% (6.40%, 20.5%)	16.1% (11.5%, 20.6%)	14.2% (9.70%, 19.6%)	17.6% (13.3%, 21.8%)	14.9% (11.5%, 18.3%)
	Age	-0.48% (-0.67%, -0.30%)			-0.37% (-0.51%, -0.22%)		-0.73% (-0.87%, -0.58%)	-0.38% (-0.48%, -0.27%)
	# of household vehicles: 2	9.21% (2.49%, 15.9%)					6.78% (1.25%, 12.3%)	7.71% (3.40%, 12.0%)
	# of household vehicles: 3+	10.6% (3.45%, 17.8%)					9.21% (3.18%, 15.2%)	8.46% (3.87%, 13.1%)
	Income (per thousand dollars)				-0.03% (-0.04%, -0.01%)	-0.03% (-0.05%, -0.01%)		-0.02% (-0.04%, -0.01%)
	Education Level: College Degree						-5.57% (-11.4%, 0.30%)	
	Education Level: Graduate Degree						-11.8% (-17.7%, -6.00%)	
	Home Type: Detached House						6.37% (-1.61%, 14.35%)	
	Home Type: Attached House						9.01% (0.36%, 17.7%)	
	Rent or Own Home: Rent						9.37% (3.09%, 15.7%)	
VC	Make: Ford	Reference	Not in vehicle	Not in vehicle	-7.26% (-11.4%, -3.07%)	Not in vehicle	Not in vehicle	-36.5% (-41.7%, -31.3%)
	Make: Chevrolet	Not in vehicle	Not in vehicle	Not in vehicle	Reference	Only in this vehicle		-19.1% (-23.7%, -14.4%)
	Make: Toyota	18.4% (13.2%, 23.5%)		Only in this vehicle	Not in vehicle	Not in vehicle		1.16% (-3.30%, 5.61%)
	Make: BMW	Not in vehicle		Not in vehicle	Not in vehicle	Not in vehicle	Not in vehicle	Reference
	Electric Range		0.19% (0.06%, 0.32%)				-0.22% (-0.34%, -0.11%)	
TB	# of trips over 200 miles: 1	5.50% (-1.60%, 12.6%)			11.2% (5.46%, 16.7%)	20.3% (13.6%, 27.0%)	4.42% (-0.92%, 9.76%)	5.95% (1.80%, 10.1%)
	# of trips over 200 miles: 2 or 3	3.23% (-3.55%, 10.0%)			12.3% (7.86%, 17.7%)	26.5% (20.0%, 33.0%)	10.2% (5.08%, 15.2%)	8.65% (4.80%, 12.5%)
	# of trips over 200 miles: 4+	10.2% (3.52%, 16.8%)			16.7% (11.4%, 22.0%)	34.3% (27.8%, 40.9%)	13.9% (8.83%, 19.0%)	10.5% (6.74%, 14.2%)

	Plugging in the vehicle: Yes		-8.20% (-14.5%, -1.89%)				
<p>Note: For mode type, the reference category varied between mode types</p> <p>Reference categories: number of household vehicles (1), education level (High School Diploma or Less), home type (apartment), number of trips over 200 miles (0)</p>							

Any Mode

For the *any mode* model, if drivers in any vehicle reported using any of the modes, they were classified as using drive modes, thus testing the relationship between knowing and activating the modes to see if these were different than those of using the individual mode types. Six variables were found to be significant in the model for any mode use: gender, age, number of household vehicles, income, make, and number of long-distance trips. Each of these showed the same general trend as the individual mode types. For gender, men had a positive relationship with mode use compared to women, increasing the likelihood of using them by 14.9 percentage points, on average. Increasing age showed a negative relationship with mode use, and a larger number of household vehicles showed a positive relationship with mode usage.

Income was found to have a negative trend consistent across models for all the individual mode types. On average, for each additional thousand dollars in annual income that the household makes, the likelihood of using any mode decreases by 0.02 percentage points. This can have a significant effect on the likelihood of using the modes between high- and low-income drivers.

Toyota drivers were found to be the most likely to use a drive mode and were, on average, 1.2 percentage points more likely to use it than BMW drivers. Chevrolet drivers were the next most likely to use the mode and were found to be, on average, 19.1 percentage points less likely to use them while Ford drivers were the least likely to report using the modes and were, on average, 36.5 percentage points less likely than BMW drivers to use them. These trends could be attributed to factors such as differences in the functionality of the modes, advertising, user interfaces, user knowledge, interest in mode types, etc.

Speedy

In addition to comparing the use of any drive modes, models were estimated for whether a driver used individual mode types. Of these, *speedy* was found to be influenced by the highest number of variables: age, gender, number of household vehicles, education level, home type, renting vs owning a home, electric range, and number of long-distance trips in a year. **4Table 9** shows that the most significant effect came from gender with male drivers being 17.6 percentage points more likely to use *speedy mode types* on average. Education level was inversely related with use of *speedy mode types*. Drivers with a college degree or a graduate degree were respectively 5.6 and 11.8 percentage points less likely to use the mode, on average, than those with a high school diploma or less. While the reason for this trend is unclear, this shows a clear differentiation between these groups. *Speedy mode types* were also found to be the only type with a significant correlation to home type. Compared to drivers living in an apartment, drivers living in an attached house were found to be, on average, 9 percentage points more likely to use these modes while drivers living in a detached house were 6.4 percentage points more likely. The difference between drivers living in apartments and those in attached or detached houses may be attributable to differences in access to charging infrastructure. *Speedy modes* are generally less efficient than *propulsion adjustment mode types*, meaning the battery is depleted more rapidly. There is a relationship between using *speedy modes* and renting their home, which was found to increase a driver's likelihood of using these modes by 9.4 percentage points, on average, as compared to drivers who own their homes. This appears to be counterintuitive because drivers are less likely to have access to home based charging when they are renting [58]. This may indicate that these drivers are less concerned with preserving the electric range of the vehicle.

The number of long-distance trips made in a year was also found to be strongly influential with drivers who take only one trip over 200 miles in a year being, on average, 4.4 percentage points more likely to use these modes and those who take four or more being 13.9 percentage points more likely to use it. This may be due to these drivers spending more time in their vehicle, thus giving them more opportunity to experiment with mode use.

Efficiency

Efficiency mode types were found to be significantly influenced by three different variables: gender, number of household vehicles, make, electric range, and whether they plug in the vehicle. While men were found to be more likely to use all modes, the difference for efficiency modes was considerably smaller than it was on other mode types, increasing the likelihood of using the mode by 5.3 percentage points on average. This may indicate either that women are more likely to use efficiency modes than other mode types or that men are less likely to use efficiency modes than they are other modes. This could be due to differences in the perception of the mode, since these modes are given environmentally conscious names like “*EcoPro*” and “*Green Mode*”. These may be preferred by women who are more environmentally conscious or avoided by men who see this as less technology focused.

Notably, drivers who reported plugging their vehicles in more than four times a month, were, on average, 8.2 percentage points less likely to use these modes than people who drive the vehicle primarily on gasoline. This may imply that drivers who use this mode are less concerned with maximizing their electric mileage or that they lack reliable access to a charging station, so they rely on these modes to extend the range of the battery.

Hold

Hold modes prioritize the engine's power to drive the vehicle, overriding the default use of the electric motor, using the battery in occasional slow driving conditions. Five variables were found to significantly affect a driver's likelihood of using a *hold mode type*: gender, age, income, make, and number of long-distance trips. In addition to men being more likely to use the mode, younger people are more likely to use hold mode types than older drivers. On average, each additional year older the driver is, the likelihood of them using these modes decreases by 0.37 percentage points; for example, a 35-year age gap between two respondents would represent a nearly 13 percentage point difference in the probability of using *hold mode*.

This model also indicates that Ford drivers are 7.3 percentage points less likely to use these modes than Chevrolet drivers. The rationale for this difference may be the same as discussed in the *any mode* analysis.

Engine Recharge

Engine recharge modes were significantly influenced by three variables: gender, income, and the number of long-distance trips taken in a year. The relationship between this mode type and the number of long distance trips taken in a year shows that compared to households that take no long distance trips in a year, households that take just one long distance trip were, on average, 20.3 percentage points more likely to use the mode while those that take 2 or 3 long distance trips increased the likelihood of mode usage by 26.5 percentage points and those that took 4 more long distance trips in a year were 34.3 percentage points more likely to use these modes. These modes use the gasoline engine to recharge the battery. While the Engine Recharge mode is intended to extend the vehicle's electric range, doing so will significantly impact the vehicle's efficiency [59].

The strong positive relationship between these modes and the number of long-distance trips indicates that drivers may be using it for this purpose.

All-Electric

Five different variables were found to have a significant relationship with the use of *all-electric mode types*. These include gender, age, number of household vehicles, make, and number of long-distance trips. On average, households with two vehicles were 9.2 percentage points more likely, and households with three or more vehicles were 10.6 percentage points more likely than those with only one household vehicle to use all-electric drive modes. This may be due to households with more vehicles knowing more about the vehicles and making them more likely to try the modes.

These modes also showed differences between makes with Toyota drivers, on average, 18.4 percentage points more likely to use the mode than Ford drivers. The relatively short electric range of the Prius limits its ability to drive for long distances in *all-electric modes*, however, the driver may know that they are going only a short distance and try to use the mode to maximize their electric driving and prevent the gasoline engine from starting unnecessarily for these trips.

Hybrid

Use of *hybrid mode types* was only significantly related to one variable, gender, which is the fewest of any model. Like the other models, men were found to be more likely to use the modes and were, on average, 14.1 percentage points more likely to use *hybrid modes* than females.

3.3.4 Discussion

Table 10 provides a summary of the results of the models for mode type use, as discussed in the results section of this paper. This shows that gender and the number of long-distance trips

(over 200 miles) were the variables that were most commonly associated mode usage. The increasing number of long-distance trips either had no significant trend or a positive correlation with mode use. For *hold modes*, this may indicate that they are being used as intended to preserve electric range for lower speed, stop and go driving. While not the intended use, drivers may be applying this concept to *engine recharge modes* by using them to help preserve the vehicle's electric range throughout the trip or for increased power in mountainous areas. Longer trips were also linked with the *speedy* and *any mode type*, which may be attributable to people who drive more being more willing to experiment with their vehicle's capabilities.

Men were more likely than women to use all mode types, which is consistent with previously reported trends for new technologies [60]. Similarly, younger drivers were found to be more likely to use the modes than older drivers. This is also constant with the previous trends in technology. Education levels were only related to the use of *speedy mode types* which showed a negative correlation with education levels where those with a high school degree or less were most likely to use the modes while those with a graduate degree were the least likely to use them. The *speedy mode type* was more often used by drivers who rent their homes than those who own them and those living in attached homes were the most likely to use them while those in apartments were the least likely.

All electric and *speedy mode types*, as well as the use of *any mode type* were linked with a higher number of household vehicles. The last household characteristic that was tested was income, which was found to be negatively correlated with the use of *engine recharge*, *hold*, and *any mode types*. This may be attributable to lower income drivers using these modes to preserve their electric range and increase the time between charging events.

Next, the vehicle characteristics were studied including vehicle make and electric range. Here, the Toyota drivers were found to be the most strongly linked to use of the modes, followed by BMW drivers, Chevrolet drivers, then the Ford drivers. The differences in mode use between makes may be attributable to differences in advertising, education, ease of use, user interface, etc. Electric range showed mixed results with a positive correlation with the use of *efficiency modes* and a negative correlation with the use of *speedy mode types*.

The last variable examined was whether the drivers plug their vehicles in regularly or not. This was measured by asking PHEV survey participants how often they plugged their vehicle in. If they charged the vehicle more than four times a month, this was considered plugging in the vehicle and driving it as a PHEV. If they reported never plugging in their vehicle or plugging it in between one and four times a month, they were categorized as not plugging the vehicle in, and driving the vehicle primarily as a conventional HEV. For the most part, there was no correlation between mode type and plugging in the vehicle. *Efficiency mode types* were found to have a negative correlation with plugging in the vehicle, which may be attributable to them using the mode to maximize the efficiency of the vehicle as a substitute for plugging it in.

It is also important to examine the difference between *driver experience mode types* and *propulsion adjustment mode types*. For *driver experience mode types*, the survey only included questions on the *speedy modes*, which was found to have the highest number of variable correlations. This was the only mode type to have a significant correlation with education level and home type. While there is not enough data to draw significant conclusions from this, it may indicate that *driver experience modes* have different user groups than the *propulsion adjustment modes*.

These findings also show that drive modes with a negative or case-specific emissions impact were more likely to be used by drivers who take a higher number of long-distance trips each year and those with lower incomes. This implies that these drivers are less likely to achieve the emissions reduction potential that PHEVs offer.

Table 10 Summary of Variable Effects on Mode Use by Type and Efficiency

Summary of Parameter Effects on Mode Use by Type								
Parameter Type	Parameter	Efficiency					Driver Experience	Any Mode
		All Electric (Positive)	Efficiency (Positive)	Hybrid (Positive)	Hold (Case Specific)	Engine Recharge (Negative)	Speedy (Negative)	
HC	Gender: Male	+	+	+	+	+	+	+
	Age	-			-		-	-
	# of household vehicles	+					+	+
	Income (per thousand dollars)				-	-		-
	Education Level						-	
	Home Type: Detached House						Detached > Attached > Apartment	
	Rent or Own Home: Rent						+	
VC	Make: Ford	Toyota > Ford		NA	Chevrolet > Ford	NA		Toyota > BMW > Chevrolet > Ford
	Electric Range		+				-	
TB	# of trips over 200 miles	~			+	+	+	+
	Plugging in the vehicle: Yes		-					

Note: For mode type, the reference category varied between mode types
Reference categories: number of household vehicles (1), education level (High School Diploma or Less), home type (apartment), number of trips over 200 miles (0)

3.4 The Implication of Drive Mode Usage in a Chevrolet Volt

3.4.1 Introduction

The study presented in this chapter empirically examines on-road, second-by-second data from 81 Chevrolet Volt PHEVs collected over 5 years. It investigates whether Volt drivers use drive modes for their intended purpose and quantifies the energy and GHG emission impacts resulting from the use of these modes. The study first explores several key travel conditions to gauge if drivers are using modes as intended in the owners' manual. It then presents the results of a regression model quantifying the impact of drive mode usage on overall trip-level energy efficiency. Finally, the probability of ICE starts associated with the use of drive modes is presented to show the effects of these modes on PHEVs' local emissions.

3.4.2 Methods

Data Overview

This paper utilizes a subset of data from the *Advanced PEV Driving and Charging Behavior* project which collected data from over 400 households and 800 vehicles (400 PEVs) throughout California. For a 12-month period, households with at least one PEV had a data logger installed into each of their vehicles in order to capture key driving and charging attributes on a second-by-second basis. Although over nine different PEV models were included in the study, this paper uses data only from 2012-2017 model year Chevrolet Volts. The 2011 Volt is excluded from this study due to the lack of the Hold Mode option. The 2012-2015 Volts, known as generation one (Gen 1) have an EPA estimated electric range of 38 miles, and an average fuel economy of 37 miles per gallon (mpg). Starting in 2016, the second generation (Gen 2) Volts arrived with a 53-mile electric range and an EPA estimated 42 mpg [61], [62].

While the data loggers provide most of the information needed for this study such as speed, drive mode data, etc., altitude information in the GPS traces is too noisy to be useful in analysis. This study instead links GPS traces to a US Geological Survey digital elevation model using a spatial resolution of 1 arc second (approximately 30 meters north-south and 24 meters east-west at California’s latitude). Elevation change is then calculated by subtracting the elevation at each point in the trace from the elevation at the previous point, which is generally ten seconds prior. This provides more accurate elevation information than could be obtained from the logger data alone.

In addition to quantitative on-road data, the *Advanced PEV Driving and Charging Behavior* study also conducted 38 interviews in 2018 with a subset of its participants. In order to help gain a deeper understanding of the motivations for drive mode use, the interviews with Volt drivers, were analyzed alongside the trip data.

Vehicle Descriptive Statistics

This study contains 81 Chevrolet Volts, of which 40 are Gen 1 and 41 are Gen 2. **Figure 18** illustrates the utilization of the modes by the vehicles from each generation. At least one mode was activated for at least 2 minutes (to exclude instances where modes were briefly activated for no rational reason) at some point in the logging period for 77% of Gen 1 vehicles and 81% of Gen 2

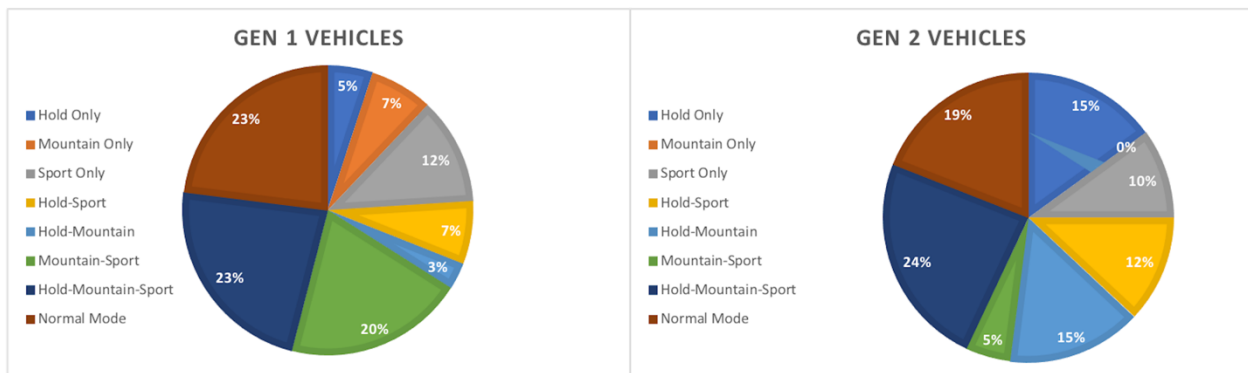

vehicles, and all modes were activated in the logging period for 23% of Gen 1 vehicles and 24% of the Gen 2 vehicles.

Figure 18 Mode Utilization by Vehicles

Trip Descriptive Statistics

The dataset analyzed in this paper contains trip summaries logged from 2015 through 2018 from the 81 Chevrolet Volts described in the above section. Trip summaries capture key metrics such as average speed and total distance traveled on the trip. Trips with distances below 1 km (0.621 miles) were excluded from this study as they tend to contain extremely noisy data. Each of the remaining valid trips was assigned one of eight mode type categories based on the combination of modes that were activated during its time frame, and the number of times the mode button was pushed in the trip was also recorded. For instance, if Hold Mode was activated once and Mountain Mode was activated twice in a given trip, that trip would be classified as a Hold-Mountain trip with a push count of three.

Table 11 Trip Descriptive Statistics (The shaded cells mark trip types that were analyzed in this study)

		Mode Type								
		Hold Only	Mtn Only	Sport Only	Hold-Mtn	Hold-Sport	Mtn-Sport	All Drive Modes	Normal Mode	Total
Gen 1	<i>N Trips (Pushes = 1)</i>	1,004	907	2,311						4,222
	<i>VMT (Pushes = 1)</i>	33,483	30,998	26,472						90,953
	<i>N Trips (Pushes > 1)</i>	81	108	37	26	12	36	2		302

	<i>VMT (Pushes > 1)</i>	3,428	5,299	1,233	1,327	577	3,283	99		15,246
	<i>Total Trips</i>	1,085	1,015	2348	26	12	36	2	42,696	47,220
	<i>Total VMT</i>	36,911	36,297	27,705	1,327	577	3,283	99	397,781	106,199
Gen 2	<i>N Trips (Pushes = 1)</i>	1,668	112	1,974						3,754
	<i>VMT (Pushes = 1)</i>	47,217	3,655	9,199						60,071
	<i>N Trips (Pushes > 1)</i>	418	5	94	30	102	16	4		669
	<i>VMT (Pushes > 1)</i>	18,947	307	727	2,274	3,532	272	195		26,254
	<i>Total Trips</i>	2,086	117	2,068	30	102	16	4	47,806	52,229
	<i>Total VMT</i>	66,164	3,962	9,926	2,274	3,532	272	195	383,827	86,325

Table 11 summarizes the trip counts and total distance traveled (in miles) for each possible mode type category per Volt generation. The trip counts and distances are also broken down by the number of times the mode button was pushed (activated) in a trip. The “Pushes=1” qualifier shows that the button was only pushed once in the entire trip, while the “Pushes>1” qualifier means that the button was pushed more than once in the trip.

The mode button was activated at least once during 9.6% of the 47,220 Gen 1 trips and 8.5% of the 52,229 Gen 2 trips. Since this paper seeks to understand the travel conditions and efficiency impacts associated with each mode independently, the 1.7% of Gen 1 mode trips and 3.4% of Gen 2 mode trips that use multiple modes were excluded from this analysis. The 5% of Gen 1 mode trips and 11.7% of Gen 2 mode trips that use the same mode multiple times were also filtered out as they tend to contain a lot of noise. The shaded cells in **Table 11** mark trip types that

were analyzed in this study which include 2672 trips that use Hold Mode exactly once, 1019 trips that use Mountain Mode exactly once, and 4285 trips that use Sport Mode exactly once. The 90,502 of the trips that use none of the drive modes (i.e., the Normal Mode trips) were used as a baseline in the study to quantify the extent to which drive mode usage impacts vehicle energy use and emissions.

Analytical methods

This study has two main aims: understanding whether drive modes use is consistent with their intended purpose and understanding how drive mode usage influences vehicles' energy use and emissions. It is critical to examine both of these components to understand why and to what degree drive mode usage impacts PHEV energy use and emissions. To achieve this, the study first gauges whether drivers are using these modes as intended by exploring travel conditions prior to, during, and after drive mode usage. It then assesses the impact of modes on vehicle energy and emissions. This includes the results of a regression model developed to quantify the impact of drive mode usage on overall trip-level energy efficiency and the associated probability of ICE starts.

Are Drive Mode Being Used as Intended by Vehicle Manufacturers?

According to the Chevrolet Volt Owner's Manual, each mode is designed for a distinct purpose and should be used in a specific manner to either optimize vehicle efficiency or enhance user experience. Hold and Mountain Mode are *propulsion adjustment* modes, since they can directly shift the Volts' propulsion energy sources between gas and electricity. Sport Mode is a *driver experience* mode since it increases the responsiveness of the accelerator pedal.

Hold Mode should be used during high-speed driving, within trips where the battery is expected to be fully depleted. Mountain Mode should be used 20 minutes before climbing a mountain or steep incline in order to maintain speed while climbing. While there is no explicit

driving recommendation for the Sport Mode, it is mentioned that this mode can reduce efficiency, therefore, possibly motivating drivers to use it for shorter distances. This section aims to gauge whether the modes are used for the reasons indicated in the manual. **Table 12** summarizes the key travel conditions that were analyzed for trips that contain a drive mode.

Table 12 Travel Conditions analyzed for trips that contain a drive mode

Travel Condition	Significance	Criteria
<i>Speed</i>	To check if Hold Mode is activated during high-speed trip segments and deactivated during low-speed trip segments	Average speed from the start of a trip to the point at which a mode was activated
		Speed when the mode is initiated
		Average speed from the point in a trip when a mode is initiated to the point when it is deactivated
		Average speed from the point in a trip when a mode is deactivated to the end of the trip
<i>Battery SOC</i>	To check if Hold Mode is being used within trips that are expected to use up the vehicle's SOC	SOC at the start of the trip
		SOC when the mode is initiated
		SOC when the mode is deactivated
		SOC at the end of the trip
<i>Distance</i>	To understand how much distance is covered by each drive mode	Distance traveled before the mode is initiated
		Distance traveled while the mode is active
		Distance traveled after the mode is active to the end of the trip

<i>Elevation</i>	To check if Mountain Mode is being used 20 minutes prior to climbing and deactivated when beginning to climb	Elevation when the mode is initiated
		Elevation when the mode is deactivated
<i>Gross Elevation</i>	To check if Mountain Mode is being used for trips that involve significant elevation change	Gross elevation increase while the mode is active
		Gross elevation decrease while the mode is active

The quantitative, on-road vehicle data used to gauge proper drive mode usage is supplemented with qualitative data from interviews with Volt drivers in the study in order to see if drivers' motivations for using drive modes aligns with the vehicle manufacturers motivations for including drive modes.

Effects of Drive Mode Usage on Trip-level Energy Use

This stage of the analysis seeks to quantify the impact of mode changes on overall energy usage of trips that contain those modes. This analysis was performed by regressing trip-level combined energy consumed on the trip duration spent in Mountain, Hold, and Sport Modes, as well as several covariates likely to impact vehicle efficiency. Trip-level net energy (in kWh) is chosen as the unit of analysis because PHEVs adjust their propulsion power split between gas and electricity over the course of the trip in response to driving conditions and state of charge. As a result, mode use at one point in a trip can impact vehicle efficiency of the rest of the trip. For example, Hold Mode is designed to improve the vehicle's overall efficiency by switching the vehicle from CD to CS mode at high speeds where the internal combustion engine is most efficient in order to leave more battery power available for low-speed driving after Hold Mode is

deactivated. For this analysis, trip-level net energy use was computed converting the total volume of fuel consumed from gallons to kWh using the EPA standard conversion factor of 33.7 kWh per gallon of gasoline and adding this to the total electrical energy consumed [62]. The following equation shows how trip level net energy is computed. In this equation, $Energy_{trip}$ (kWh) is the net energy used on a trip, $Battery_{depletion}$ (kWh) is the total amount of energy drawn from the battery over the course of the trip, $Battery_{charging}$ (kWh) is the total amount of energy supplied to the battery over the course of the trip, and $Fuel$ (gal) is the total amount of gasoline consumed by the internal combustion engine over the course of the trip.

$$Energy_{trip} = Battery_{depletion} - Battery_{charging} + 33.7 * Fuel$$

Trip-level vehicle efficiency depends on the speed, slope, and acceleration of travel, and in PHEVs it also depends on the mix of power drawn from the battery and internal combustion engine. Hold and Mountain Modes are designed to control this mix in a way that improves vehicle efficiency and performance, but since these modes may not be used optimally, their overall effect is in question. Since the user-selectable drive modes are intended for use under specific driving conditions that do not occur in all trips, it is necessary to control for covariates that may affect vehicle efficiency to extract an accurate estimate of the effect.

The main variables of interest in the regression model are the total duration spent in each mode, measured in minutes. Covariates controlled for are distance traveled in a range of speed bins (0-25, 25-45, 45-60, 60-80, and 80+ miles per hour), the net elevation gain on the trip in meters, and battery state of charge at trip start. The irregular speed bins are meant to separate low-speed, city driving from high-speed, highway driving scenarios. Elevation change is calculated by subtracting the elevation at end of the trip from the elevation at the start of the trip. Trip-level efficiency can vary widely for short trips, so this analysis is restricted to trips of at least 10 minutes

duration in which the vehicle traveled at least one kilometer, and in which the average speed of travel was at least 5mph. Mean values for the variables used in the model for all trips and for trips that used each mode in **Table 13**.

Table 13 Regression Model Descriptive Statistics

	Normal mode used	Hold Mode	Mountain Mode	Sport Mode
<i>Minutes spent in mode</i>	0.00	22.81	31.59	18.55
<i>Total Net Energy, kWh</i>	5.51	22.64	31.11	4.98
<i>SOC at start of trip (%)</i>	60.03	65.06	47.67	72.68
<i>Miles traveled at 0-25 mph</i>	1.52	2.20	1.86	1.43
<i>Miles traveled at 25-45 mph</i>	3.11	4.62	4.83	3.40
<i>Miles traveled at 45-60 mph</i>	2.70	5.56	10.03	3.26
<i>Miles traveled at 60-80 mph</i>	4.13	19.44	20.47	3.77
<i>Miles traveled above 80 mph</i>	0.14	1.59	1.91	0.18
<i>Net elevation gain, m</i>	3.70	0.03	24.33	-11.01

Potential Emission Impacts of Drive Mode Trips' Engine Starts

Since certain drive modes give drivers the power to start the engine at any point in the trip, they could also have a significant influence on the engine start frequency and local emission potential of PHEVs [63]. Activating the internal combustion engine at high power demand can greatly increase the vehicle's emissions of air pollutants, particularly through cold starts. Engine starts are classified as cold starts when they occur after the vehicle's engine hasn't been activated in 12 or more hours with this off period being referred to as a 'soak period' [23]. During cold starts, low engine block and coolant temperatures can result in incomplete combustion, resulting in higher emissions of hydrocarbons (HC), carbon monoxide (CO), oxides of nitrogen (NOx) and particulate matter (PM); these emissions cannot effectively be filtered by a catalytic converter that likely hasn't reached its optimal operating temperature [22]. Cold starts that occur immediately after a high-power demand are linked to even higher emissions than regular cold starts [24].

For a given trip in the Volt dataset, the time segments wherein engine RPM is continually greater than zero for more than 10 seconds are considered engine starts. An engine start is classified as a cold start if the time elapsed between that engine start and the previous engine start (soak time) is greater than 12 hours. A cold start is classified as a high-power cold start if the maximum

power before the start of over 25 kW. In order to estimate the engine start emission potential of each drive mode, the proportion of cold starts and high-power cold starts within each Volt drive mode’s trips were analyzed in this stage of the analysis.

3.4.3 Results

Are Drive Modes Being Used as Intended by Vehicle Manufacturers?

Table 14 illustrates the median value of each of the 11 travel conditions that were analyzed for the mode trips for both Volt generations. Here, the median values were chosen as they are more representative of the sample than the mean values, given the high instances of outliers. The following three sections summarize key travel condition statistics for each mode and gauge if the modes are being used as intended by the manufacturer.

Table 14 Median values of Travel Conditions Indicating Mode Change

	Condition (units)	Hold	Mountain	Sport
Gen 1	Average Speed before Initiation (mph)	24.81	19.32	6.93
	Speed at Initiation (mph)	65.80	44.66	17.30
	Average Speed during Activation (mph)	54.45	41.22	24.18
	Average Speed after Activation (mph)	22.25	0.88	0.09
	Trip Start SOC (%)	98.43	37.65	83.53
	Trip End SOC (%)	52.94	32.55	48.24
	Mode Start SOC (%)	63.92	63.92	74.51
	Mode End SOC (%)	65.49	33.33	50.20
	Distance before Initiation (mi)	3.26	2.20	0.22
	Distance during Activation (mi)	20.50	15.46	5.46
	Distance after Activation	7.21	0.04	0.00
	Elevation at Initiation (m)	41.76	61.90	40.24
	Elevation at Deactivation (m)	71.70	77.93	35.61
	Gross Elevation Gain during Activation (m)	172.32	161.50	37.49
	Gross Elevation Loss during Activation (m)	123.32	144.47	51.15

Gen 2	Average Speed before Initiation (mph)	22.00	17.84	10.85
	Speed at Initiation (mph)	63.40	38.17	0.78
	Average Speed during Activation (mph)	58.99	48.39	23.62
	Average Speed after Activation (mph)	11.11	5.73	0.27
	Trip Start SOC (%)	54.51	16.86	86.27
	Trip End SOC (%)	34.51	12.94	80.39
	Mode Start SOC (%)	41.18	11.76	84.31
	Mode End SOC (%)	40.78	15.29	77.25
	Distance before Initiation (mi)	3.43	2.16	0.29
	Distance during Activation (mi)	11.38	17.91	2.71
	Distance after Activation	1.52	0.36	0.01
	Elevation at Initiation (m)	80.61	182.10	76.75
	Elevation at Deactivation (m)	77.82	286.75	83.09
	Gross Elevation Gain during Activation (m)	102.18	130.47	13.99
	Gross Elevation Loss during Activation (m)	96.02	156.54	15.62

Hold Mode

Hold Mode is generally initiated at high speeds during trips with a median speed of around 64 mph for both Gen 1 and Gen 2 trips. The average speeds before and after the mode is activated are low for both Gen 1 and Gen 2 trips with median speeds between 10 and 24 mph. The median SOC at which Hold Mode is initiated is 64% for Gen 1 trips and 40% for Gen 2 trips. The end SOC of Hold Mode trips is relatively high with median SOC of 53% and 35% for Gen 1 and Gen 2 trips respectively. The electric range remaining at the end of the trips given these SOC is approximately 19 to 20 miles for both generation vehicles. For Hold Mode trips, the median user-selectable mode to normal mode driving ratio is over two-thirds for both generations. The high activation speeds and mode distance ratios indicate that the drivers use the modes on the highways, as recommended. This is consistent with the driver's own statements about how they use the mode, as indicated by the interview findings.

“I try to take advantage of the electric charge by, umm, turning it off when I’m on a highway. So, because highway or high speed driving, it really depletes the charge so. So, on the Volt there’s the option to turn off the, the electric charge or the electric consumption and just restrict it to only gas consumption. So that’s how I try to, to maximize the charge as much as possible.” (Interview 01, Chevrolet Volt)

“When I drove to Coachella and I was, I don’t know, going 70 plus miles per hour, on the freeway? That’s when I would kick it in. I would kick in the engine because the battery like drainage was way too fast.” (interview 19, Chevrolet Volt)

While drivers of both vehicle generations seem to initiate Hold Mode at relatively high speeds, they end up with a significant amount of unused electric charge at the end of their trips, suggesting that they may not be taking advantage of the full capacity of their electric range. This excess range remaining could be due to delayed mode deactivation, poor trip planning, or range preservation for future use. This underutilization prevents the mode from creating a net benefit, therefore, leading to an increased need for automation.

Mountain Mode

Mountain Mode is initiated at a median speed of 45 mph for Gen 1 trips and 38 mph for Gen 2 trips with a median absolute deviation of over 22 mph for both generations. Additionally, for both generations, the median of the average is around 20 mph before the mode is active and between 40 mph and 50 mph while the mode is active. However, half the trips have an average speed less than 6 mph after the mode is deactivated. The median change in SOC over the active mode period for trips in both generations vehicles is below 1% with a median absolute deviation of less than 6%. The median SOC for Gen 1 trips is roughly 33% when the mode is initiated and when it is deactivated. Similarly, for Gen 2 trips, the median SOC is roughly 13% when the mode

is initiated and when it is deactivated. The electric range remaining given those SOCs is around 12 miles for Gen 1 vehicles and 7 miles for Gen 2 vehicles. For half of the trips, over 70% of the trip distance is driven while the mode is active for both generations.

There is large variability in the trips' speed and SOC metrics, and analysis of elevation change on these trips suggests that there are wide differences in mode usage patterns. Mountain Mode is used at slightly higher elevations and for hillier segments than Sport Mode but has similar elevation values to Hold Mode. While most uses of Mountain Mode appear to be for similar types of driving to the uses of Hold Mode, we found some cases of drivers using Mountain Mode while traveling through high-elevation areas or areas of significant elevation change, both uphill and downhill. Mountain Mode was activated in a way that matched the user's manual recommendation (turned on at least 20 minutes before a steep ascent) in less than 1% of Mountain Mode trips.

The interview results for this mode are also consistent with these findings and show that while some drivers use the mode, some drivers are unaware of what the mode does, and are just assuming its usage based on the name, while others think they know what the mode does, but are incorrect.

"Uh just cause I just figure- I don't even know. I just thought it was like, I'm in the mountains... I should use Mountain mode. That makes sense." (Interview 26, Chevrolet Volt)

"I mean, I was mostly like 'oh, I'm driving in the mountains, I guess I should try this mountain mode.' I don't notice it having made a huge difference." (Interview 13, Chevrolet Volt)

“Yeah, so there’s the Mountain mode which I think provides additional acceleration when you’re on a steep cliff or a steep hill. I haven’t really taken advantage of that; I personally didn’t find the value in it.” (Interview 01, Chevrolet Volt)

Sport Mode

For both generations, the median of the average speed before Sport Mode activation is less than 10 miles. The median of the average speed while the mode is active is around 25 mph while the median of the average speed after the mode is active is less than 1 mph. The SOC at the start of the trip and at mode initiation are high with a median SOC of over 70% for Gen 1 trips and 87% for Gen 2 trips. The end SOC of the trips is also high with a median of about 50% for Gen 1 trips and 80% for Gen 2 trips. The electric range remaining at the end of these trips is around 19 miles for Gen 1 vehicles and 42 miles for Gen 2 vehicles based on the remaining battery capacity. For half of the trips, over 90% of the distance was covered while the mode was active for both generations of Volts.

The data shows that drivers use Sport Mode for short-distance, city trips rather than long-distance, highway trips given the relatively low overall speed and distance metrics. The mode is initiated at fairly high SOC, suggesting that drivers may be aware of the inefficiency of high acceleration. As intended by the manufacturers, Sport Mode drivers seem to be using the mode to enhance their travel experience, not to optimize the efficiency of their vehicles. The interviewees reported using this mode for a variety of reasons, all of which were to enhance their driving experience rather than for increasing efficiency.

“The only one I’ve used more than once or twice is the Sport Mode, and that’s mainly just if I’m feeling like I just wanna accelerate quickly for whatever reason. I mean just for fun

or um, or um, if I have friends in the car and I'm like 'this car is actually pretty fast.'"
 (Interview 14, Chevrolet Volt)

"If I'm sitting next to somebody at a light and they're totally douche and I know that they're gonna try to race me but I know that my power mode sport mode will go faster than their car." (Interview 20, Chevrolet Volt)

Effects of Drive Mode Usage on Trip-level Energy Use

The regression model for trip-level net energy shows that the use of Mountain Mode and Hold Mode is linked to substantially higher energy usage, even after controlling for other variables that strongly impact energy use. **Table 15** presents the results of a regression model for trip-level net energy usage on distance traveled in various speed bins, elevation change, mode usage, and state of charge at trip start. Since there is minimal variation between Gen 1 and Gen 2 mode trip variables, they are not separately examined in this analysis. All variables have a highly significant relationship to trip-level net energy usage, and the model explains 91.5% of the variation in trip-level energy usage. Variables were checked for multicollinearity and all had Variance Inflation Factor values of less than 2, well below the threshold of concern.

Table 15 Trip-Level Net Energy Usage Regression Results

Independent Variable	Coefficient	Std. Error	t-statistic	p-value
Constant	3.213	0.033		
Minutes Spent in Hold Mode	0.128	0.002	55.12	< 0.0001
Minutes Spent in Mountain Mode	0.165	0.003	59.07	< 0.0001
Minutes Spent in Sport Mode	0.022	0.003	7.50	< 0.0001
Start State of Charge (0-1)	-0.073	0.000	-181.91	< 0.0001

Miles traveled below 25 mph	0.250	0.012	20.36	< 0.0001
Miles traveled between 25 - 45 mph	0.466	0.008	61.58	< 0.0001
Miles traveled between 45 - 60 mph	0.531	0.004	133.40	< 0.0001
Miles traveled between 60 - 80 mph	0.755	0.002	484.51	< 0.0001
Miles traveled above 80 mph	1.234	0.007	167.29	< 0.0001
Net elevation gain (m)	0.013	0.000	122.19	< 0.0001
R-squared	0.915			
F-Ratio	78,390			
P-value	< 0.0001			
n	72,472			

These model results show that trips where Mountain Mode and Hold Mode are used for significant stretches of time have higher energy use than similar trips where these modes are used less or not at all. Use of Sport Mode is linked to a small but significant increase in energy use, possibly because it may correspond to more aggressive acceleration behavior. The coefficients for control variables are largely as expected. Trips that start with the battery in a higher SOC use less energy because the electric motor is more efficient than the internal combustion engine. Travel speed and elevation change were included primarily as control variables and all have predictable effects, with energy use increasing at higher speeds and in cases of elevation gain. **Figure 19** shows that there is a significant amount of additional energy use resulting from Hold and Mountain Mode use compared to driving in Normal Mode. This figure was produced by converting the coefficients

for Mountain Mode and Hold Mode from per minute to per mile values at various speeds and combining these with the coefficients on distance traveled in each speed bin.

Average net energy usage per mile with Mountain / Hold Modes

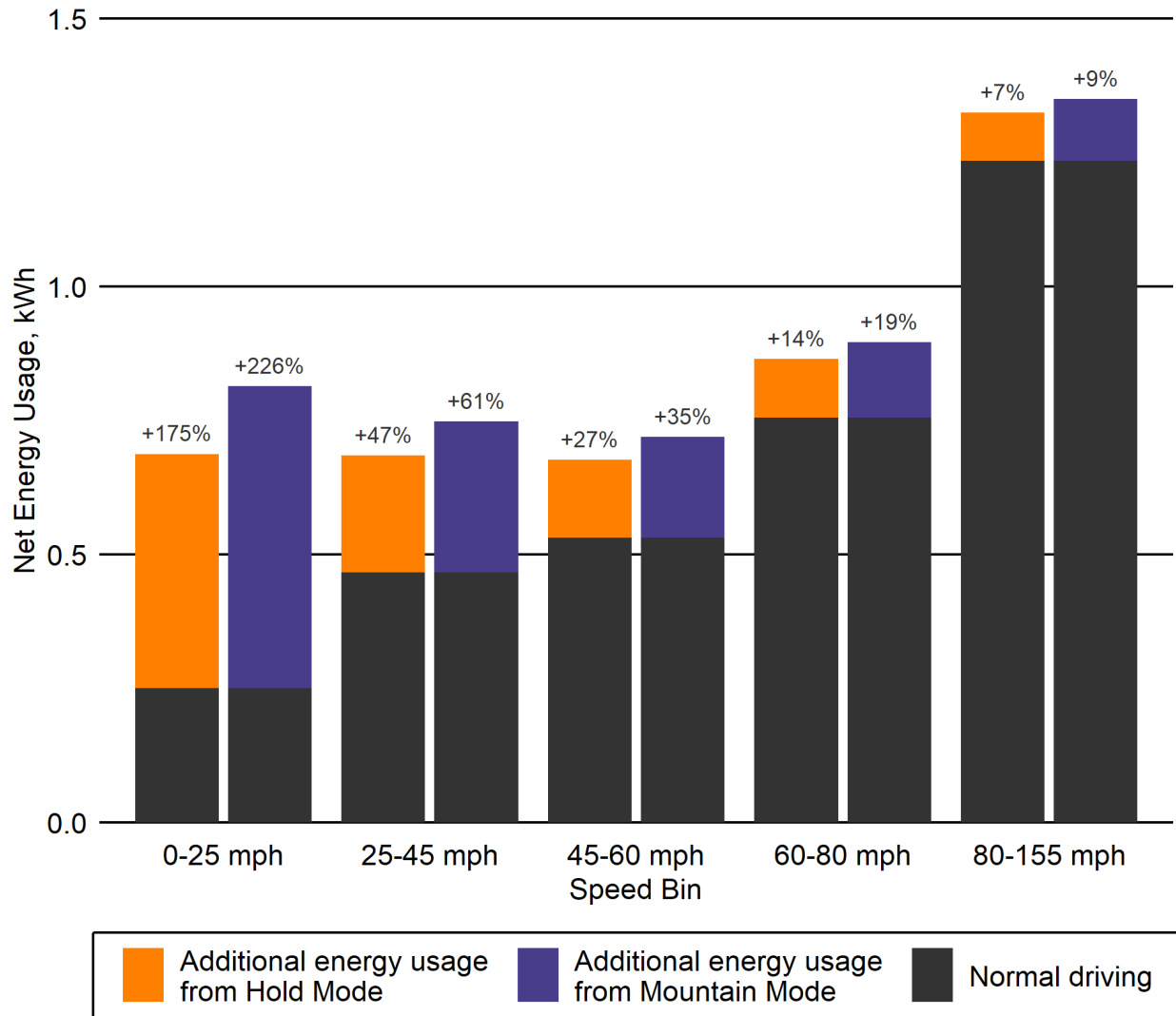

Figure 19 Additional energy use from time spent in Mountain and Hold Mode

Potential Emission Impacts of Drive Mode Trips' Engine Starts

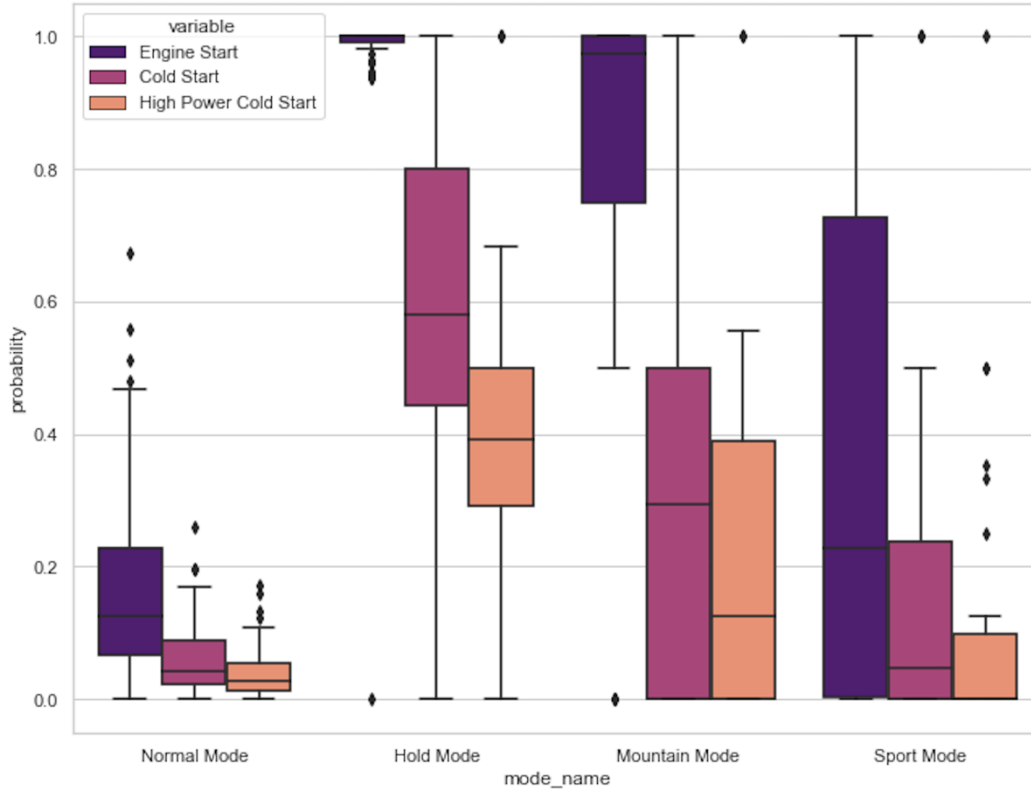

Figure 20 Probability of Engine Start by Mode Type

Figure 20 illustrates the probability of various engine starts to occur for Hold Mode, Mountain Mode, Sport Mode, and Normal Mode trips. The probabilities show the proportion of trips for each Volt drive mode that contain cold starts and high-power cold starts. There is minimal variation between Gen 1 and Gen 2 engine start probabilities, so they are not separately examined in this analysis. For this analysis, a cold start is an engine start with a soak time greater than 12 hours and a high-power cold start is a cold start with a maximum power requirement before the engine start of over 25 kW. Cold starts were more prevalent in Hold Mode trips with around 40%

of Hold Mode uses resulting in a high-power cold start; this aligns with the fact that activating the mode directly triggers an engine start. There is a wide variation in engine start probabilities for Mountain Mode and Sport Mode since the activation of the mode in combination with internal factors such as SOC level and external factors such as road load/grade ultimately determine if the engine is invoked. Mountain Mode has the widest variation in high power cold starts. Correct use of Mountain Mode (20 minutes before ascending a steep hill) is unlikely to induce a high-power cold start, but as observed in the conditions indicating drive mode use analysis, many drivers do not use Mountain Mode correctly, sometimes using it on trips that don't contain any significant grade changes, leading to the large variation in high power cold start probabilities. Overall, most driver-induced mode trips recorded more engine starts (including cold and high-power cold starts) than trips that used Normal Mode. Improper drive mode usage, especially unnecessary Hold Mode usage, could lead to higher local emissions from an increased frequency of engine starts, hindering the PHEVs capacity to minimize engine starts and their associated local emissions.

3.4.4 Discussion

This paper reveals that Chevrolet Volt drivers do not use their vehicles' drive modes as intended by the manufacturers, and that misuse of Mountain Mode and Hold Mode (the *propulsion adjustment* modes) substantially diminishes the potential GHG emission benefits of these vehicles.

Sport mode is the most commonly used mode in this sample, with 62% of Gen 1 drivers and 51% of Gen 2 drivers using Sport Mode at least once during the course of the study. Trips with this mode account for 4.2% of the total trips taken by all vehicles in the sample. Sport Mode is used most often at low speeds, possibly for the enjoyment of high torque and quicker acceleration performance. We didn't analyze the impact of Sport Mode usage on vehicle energy use and emissions because we expect Sport Mode to have much less impact on these metrics than

either Hold Mode or Mountain Mode given it is most often used in the all-electric charge depleting configuration.

While drivers appear to initiate Hold Mode at high speeds as advised in the owner's manual, trips in which the mode is activated often end with high levels of SOC remaining, indicating an underutilization of the vehicle's electric range. This is shown by the average of 35.6% battery capacity remaining for Gen 1 trips and an average of 26.5% SOC remaining for Gen 2 trips. Unsurprisingly, regression analysis of trip-level net energy indicated that trips with more time spent in Hold Mode have substantially higher energy use than similar trips where Hold Mode was not used, even after controlling for other variables that strongly impact energy use. Moreover, Hold Mode use is far more likely to result in cold starts compared to other modes with almost 60% of Hold Mode uses leading to a cold start. The frequency of cold starts, increased energy usage, and presence of excess battery capacity at the end of Hold Mode trips suggests that this mode's usage leads to significantly higher point-source and local emissions. Driving in Normal Mode (no drive modes engaged) was found to be more efficient than Hold Mode, so it is advantageous to use Hold Mode on long trips to reserve SOC for lower speeds or future use. Under these scenarios, the inefficiencies associated with Hold Mode may be offset by higher efficiencies on successive trips, however, this relationship is outside the scope of this study.

Given its unintuitive name and complex usage criterium, it isn't surprising that Mountain Mode is rarely, if ever, used correctly. Mountain Mode was activated in a way that matched the owner's manual recommendation (turned on at least 20 minutes before a steep ascent) in less than 1% of Mountain Mode trips. While this mode is intended to be used around 20 minutes before climbing steep inclines, drivers instead often use the mode for the majority of the trip, including before, during and after the climb. Using the mode in this way may negate the benefits of having

additional battery charge to use for a climb, and regression model results suggest that trips with more time spent in Mountain Mode tend to have substantially higher net energy use, even after controlling for elevation change and travel speed. Moreover, when Mountain Mode is used within trips with no substantial elevation change, the engine is unnecessarily invoked to charge the battery, resulting in excess local GHG emissions.

In the light of limited charging infrastructure and other short-term technological constraints, PHEVs play a vital role in the global transition to zero emission mobility. While the results of this study are limited to drive modes in the Chevrolet Volt, this study's findings suggests that the misuse of user-selectable drive modes within these vehicles can significantly hinder their emissions reduction potential and thereby, their ability to support emissions reduction goals. It is critical to test the worst-case emissions scenario of PHEV drive mode usage in order to get a valid upper-bound of these vehicles' true emission potential. Moreover, in order for the emission savings potential of PHEVs to be fully realized, steps must be taken to ensure that drive mode usage is consistent with its intended purpose. Based on these findings, policymakers and vehicle manufacturers should work together to foster education and awareness of these modes through solutions such as on-board information systems. These efforts should include information on how the modes are used and how the impacts of their use can improve the on-road performance of PHEVs. This will help to ensure that these modes are used more optimally and with drivers understanding the full impacts of their decisions. In a study of PEV drive modes, Sugihara *et al.* (2021) states that standardizing the capabilities and names of basic drive modes across all PHEVs would help reduce driver confusion and improve their understanding of the impacts of these modes.

Since the correct use of efficiency-based drive modes can potentially result in substantial energy savings, vehicle manufacturers should consider incorporating on-board technology systems that use key trip metrics (destination, SOC, etc.) to automatically optimize drive mode usage; this would diminish energy losses from driver ignorance or negligence. This study showed that drivers often neglect to turn off Hold Mode after a high-speed road segment or not read the user manual thoroughly enough to know when to turn on and turn off Mountain Mode. This shows the need for mode choices to be integrated into the vehicle in a way that is semi- or fully-automated. Some vehicle manufacturers are actively working on automating drive mode selection to optimize vehicle efficiencies and reduce GHG emissions. For example, the automaker BMW has announced that, starting in 2020, its PHEVs will automatically switch their propulsion from hybrid mode to pure electric when they enter certain geofenced areas, typically in urban centers [64]. The impact of geofencing may result in increased GHG emissions as drivers may use a lower portion of the battery while saving it for the fenced area. This effect may be alleviated by using automated or semi-automated “Hold” mode during the high-speed portion of the trip.

Finally, if the decreased efficiency that results from the use of these modes becomes too widespread of an issue, then policymakers may find it necessary to ban the inclusion of drive modes that have been found to increase emissions in PHEVs. According to the findings in this paper, driving without using Hold and Mountain Modes results in higher energy savings and lower GHG emissions than incorrectly using drive modes.

3.5 Conclusion and Future Direction

PHEVs allow drivers to override their vehicle’s default powertrain management system by selecting from a variety of preset drivetrain configurations known as drive modes. Drive modes enable drivers to adjust the vehicle's operating characteristics and fall into two main categories

(Propulsion Adjustment and Driver Experience Adjustment) and eight mode types. Propulsion Adjustment Modes impact how the vehicle is propelled, such as allowing the driver to force the vehicle into different propulsion statuses. Propulsion Adjustment Modes include *engine recharge*, *hybrid*, *hold*, *efficiency*, and *all electric* mode types. Driver Experience Adjustment Modes affect how the vehicle responds to the driver's steering and pedal usage and include *speedy* and *rugged* mode types. Driver Experience Adjustment Modes can adjust accelerator pedal responsiveness, steering tightness, regenerative braking, and suspension height and strength. While not all drive modes are directly designed to affect vehicle emissions, each mode has the potential to alter energy use and emissions output of PHEVs depending on the driver's behavior.

Despite the potential impact drive modes can have on energy use and emissions, they are not currently assessed in standard vehicle performance and certification tests. To address this gap, this chapter presents two studies that aim to understand the motivations and implications of driver mode usage in PHEVs. In addition to comprehensively defining and classifying various drive modes, the first study examines the motivations for drive mode usage using a survey of over 26,000 PEV drivers in California. The second study quantifies the energy use and emission impacts of drive mode usage using on-road vehicle data from 81 Chevy Volts driven in California.

The first study finds that not all drive modes were directly designed to affect vehicle emissions, however, each mode has the potential to alter energy use and emissions output. Three mode types (*all-electric*, *efficiency*, and *hybrid*) prioritize the use of the electric motor, resulting in an expected positive impact on vehicle efficiency. Three mode types are designed to increase power or alter driving experience (*engine recharge*, *speedy*, and *rugged*). Use of these modes is expected to result in decreased vehicle efficiency. Drive modes categorized as *hold* or *other* have case specific efficiency potentials as their impacts are highly dependent on driver behavior.

Moreover, Gender, age, and the number of long-distance trips are the variables most commonly associated with mode usage. Across all mode types, men are found to be more likely than women to have used drive modes. Age was a significant indicator of mode use for *all electric, hold, speedy*, and any modes, with younger drivers found to be more likely to use modes than older drivers. For *hold, engine recharge, speedy*, and any modes, the likelihood of using modes increased as the number of trips over 200 miles per year increased. For the use of any mode type, Toyota drivers were found to be the most strongly linked to use of the modes, followed by BMW drivers, Chevrolet drivers, then the Ford drivers. Differences in mode use between makes may be attributable to variations in factors such as advertising, education, ease of use, or user interfaces.

The second study finds that Chevrolet Volt drivers do not use their vehicles' propulsion adjustment drive modes (Hold and Mountain Mode) as intended by the manufacturers. Hold Mode maintains the battery's charge level while using the gasoline engine for propulsion. It is intended to be used during high-speed driving on long trips where the battery is expected to be fully depleted. Its use often results in an underutilization of the vehicle's electric range, suggesting improper use. Mountain Mode uses the gasoline engine to maintain battery state of charge. It is intended to be used briefly before steep inclines; however, it is rarely used correctly, with less than 1% of users activating it 20 minutes before steep climbs as recommended. The misuse of drive modes in Chevrolet Volt vehicles leads to a 15-30% increase in energy usage and higher engine start emissions. Results from a regression model for trip-level net energy revealed the use of Mountain Mode and Hold Mode is linked to substantially higher energy usage, even after controlling for other variables that strongly impact energy use. **Figure 19** Additional energy use from time spent in Mountain and Hold Mode illustrates the impact of Hold and Mountain Mode use on energy consumption per mile at various driving speeds. It shows that, in comparison to

driving in the vehicle's default configuration, Hold Mode increases energy consumption by 175% at 0-25 mph, while Mountain Mode increases energy consumption by over 200%. Moreover, most driver-induced mode trips recorded more engine starts than trips that used normal mode. Improper drive mode usage, especially unnecessary Hold Mode usage, could lead to higher local emissions from an increased frequency of engine starts.

Drawing from the insights discussed in this chapter, we can formulate several policy recommendations aimed at mitigating the adverse effects of drive mode usage in PHEVs. Standardizing drive modes across PHEV models has the potential to reduce driver confusion regarding mode functionality and promote appropriate mode selections. Designing PHEVs with clear and intuitive in-vehicle indicators that display the active drive mode and its impact on vehicle efficiency can empower drivers to comprehend the consequences of their choices. Implementing educational campaigns, delivered through avenues such as car dealerships and social media, can educate drivers on how to maximize efficiency through drive modes. The integration of predictive analytics into PHEVs can offer personalized recommendations for the most efficient drive mode based on a driver's typical usage patterns and upcoming trip destination. Additionally, the establishment of standards for drive mode testing and certification can ensure that reported efficiency and emissions data for PHEVs accurately reflect their real-world performance. Pending further investigation into the impacts of drive modes on PHEV emissions, banning certain mode types from inclusion in PHEVs may be warranted.

Chapter 4: BEV Charging Insecurity: How Disruptive are Unreliable Electric Vehicle Chargers?

4.1 Introduction

The shift from conventional ICE vehicles to EVs hinges on both the quantity and quality of EV charging infrastructure. While much research has focused on the importance of and challenges to increasing the quantity of EV chargers worldwide, less has been devoted to assessing the quality of existing EV chargers. It is crucial to not only add more EV chargers to the map, but also ensure that the installed chargers are functional. According to the 2022 U.S. Electric Vehicle Experience Public Charging survey by J.D. Power, despite the growth of public EV charging infrastructure, one out of every five respondents couldn't charge their EVs due to charger malfunction or being out of service [7]. In response, various jurisdictions, including California, Canada, the European Union, and others, are advocating for stricter EV charger reliability requirements. The U.S. Department of Transportation and the Federal Highway Administration released national standards in February 2023, setting a minimum average annual uptime requirement of 97% for federally funded electric vehicle chargers [65]. Simultaneously, the California Energy Commission (CEC) is developing uptime recordkeeping and reporting standards for EV charging stations that received public funding, considering a 97% uptime requirement for public chargers for 5 years from commissioning, with different requirements for Level 2 and DC fast chargers.

Within an electrical system, reliability is a measure of how effectively the system transfers electricity to the consumer in the amount desired. From the perspective of an EV driver, a reliable charger charges their vehicle at an expected rate for the expected duration and accepts the appropriate payment method. Whereas from the perspective of a charging service provider, a reliable charger is one that meets the minimum uptime requirement of its jurisdiction. Uptime

represents the portion of time a charging port's hardware and software are both online and available to use [65]. This metric fails to consider all the technological and logistical challenges within the charging ecosystem that ultimately determine the true reliability of chargers, as perceived by consumers. Given the stark difference in the definition of reliability between charging consumers and providers, it is no surprise that there is a contradiction between the high average uptime reported by charging providers and the low user satisfaction scores reported by consumers. In 2022, CARB conducted a survey of 11 charging service providers, with four respondents claiming a national uptime of 95-98% [66]. This finding directly conflicts with a simultaneous survey of EV drivers in California, who reported mixed experiences with existing EV chargers, including broken plugs (9%), unexpected shut-off during charging (6%), charging station malfunctions (22%), payment issues (18%), and the need to contact customer service (53%) [67]. CARB's findings are consistent with a study by Rempel et al. that evaluated the functionality of all open, public Direct Current Fast Charging (DCFC) stations in the Greater Bay Area, revealing that around a quarter of surveyed plugs were unreliable or had design failures [67].

This study aims to understand the impact of public EV charger reliability on driver experience. To accomplish this, we use real-world EV charging data, collected in California, to simulate the level of disruption that would've occurred to EV drivers had their successful charging sessions been unsuccessful. Additionally, we quantify how many charging sessions were actually unsuccessful and qualify how disruptive those unsuccessful charging sessions were to drivers.

4.2 Literature Review

Electric Vehicle Supply Equipment

According to the National Electronics Manufacturers Association, EVSEs, more commonly referred to as EV chargers, are devices that “provide electric power to the vehicle and

use that to recharge the vehicle's batteries. EVSE systems include the electrical conductors, related equipment, software, and communications protocols that deliver energy efficiently and safely to the vehicle” [68]. EVSEs can be characterized by three different descriptors: mode, type and level. The mode defines how the EVSE connects to the electrical grid. In mode 1 charging, the EVs plug into a household AC socket; this mode is typically not allowed in most regions because it lacks safety electronics [69]. In mode 2 charging, the EVs still plug into a standard household AC outlet but the charging is controlled via an in-cable control box to ensure safety. In mode 3 charging, a dedicated charging station or a home mounted wall box with built-in control electronics is used for AC charging [69]. In the case of mode 1-3, the EVSE delivers AC to the EV’s built-in battery which then converts the AC to DC for consumption. But mode 4 charging involves a charger/converter in a dedicated charging station that converts AC to DC and directly provides DC to the EV’s battery [69]. The level specifies the amount of electric power that is delivered from the EVSE to the EV battery. Level 1 charging uses standard plug sockets limited to 120V and 1.8 kW; it provides the slowest charge with 100 miles of range in 24 hours; it’s typically used for overnight charging at home [70]. Level 2 charging has a wide range of charging speeds based on the charging equipment and the EV’s capability. Level 2 charging uses an outlet at 208 or 240 volts and can provide 100 miles of range in 4-12 hours; Level 2 charging stations are commonly found in workplaces and public locations such as shopping centers, downtown communities, multifamily housing and workplaces - places where people are likely to be parked for a few hours [70]. Level 1 and level 2 chargers supply AC current to the EVs’ onboard chargers which converts the power from AC to DC. On the other hand, DC Fast chargers convert power from AC to DC inside the charger itself and then supply DC power directly to the EVs’ batteries [70]. Therefore, DC Fast charging provides the fastest charge using an outlet at 400 or 800 volts

and adds around 60 to 80 miles in 20 minutes; DC fast chargers are usually located in high-traffic public locations and along highway corridors. The type refers to the interface between the EV and EVSE. There is no global standard for EVSE type. North America uses J1772 Type 1 for AC charging and CCS1 for DC charging [69]. Europe uses IEC Type 2 for AC and CCS2 for DC charging [69]. China used the GB/T interface for AC and a unique DC interface. Japan used J1772 Type 1 for AC and CHAdeMO for DC charging [69].

Electric Vehicle Charging Activities & Locations

EV charging can broadly occur in four different locations: at or near home, at a workplace or commute destination, at a public location other than work, or on travel corridors along a trip/tour. These location categories are more so based on the activity and location of the EV driver than on the location of the EVSE. For instance, a charging session that occurs at a publicly available charging station would still be considered home charging if the EV driver was at their home nearby during the charging session. Most EV charging (50-80%) occurs at home [54], [71]–[74]. Outside of home, workplace charging is the most common charging location (15-20%), followed by public and corridor charging [71]–[80]. It is important to note that these shares may not accurately reflect future charging trends as EV adoption rates increase among households without direct access to EV charging such as MUDs or households with multiple vehicles. Despite their small current share, public and corridor EV charging infrastructure is paramount to encourage new buyers to purchase EVs and old buyers to retain their EVs. Several studies have discovered and reinforced the importance of public EV charging; they find that developing more public EV charging infrastructure will alleviate buyer concerns about EV driving ranges [81]–[85] and potentially increase the share of electric vehicles miles traveled by encouraging EV owners to use their EVs more often than their ICEVs [73], [80], [86]–[92]. Public and corridor EV charging is

especially critical for long distance trips. While these charging sessions are only needed for 3.4–8.3% of EV journeys, these shares represent between 30% and 45% of total vehicle miles traveled, primarily from long distance trips [93].

Public Charging Infrastructure Anatomy

According to the Northeast States for Coordinated Air Use Management (NESCAUM), a public EVSE is an EVSE that is located at a publicly available parking space i.e a parking space that has been designated by a property owners to be available to and accessible by the public [94]. Parking spaces that are reserved for exclusive use for an individual driver or a group of drivers are not considered publicly available. Most public charging locations have a few kiosks, each placed adjacent to parking spaces. Each kiosk has one or more EVSEs. As illustrated in **Figure 21**, each EVSE consists of a vehicle coupler connector to establish the connection between the EV and the EVSE, a grid cord to transfer electricity from the grid to the EVSE, an in-cable control box (ICCB) to ensure safe charging by relaying information between the EVSE and the EV, and one or more cables to transfer electricity from the EVSE to the EV [95]. The EVSE can only provide power to one vehicle at a time even if it has multiple cables. EVSEs rely on software, networks and communication protocols to effectively exchange information with plugged in EVs and charging management systems to monitor and regulate the amount of current supplied to the EV. In addition to the above components, DC Fast chargers also contain a converter and additional circuitry to convert alternating current to direct current [95]. The charging kiosks can also be equipped with payment systems that accept payments from credit cards, debit cards, membership cards or smart phone applications [66]. Based on the payment method, the transaction may be a tap, insert, swipe, or near field detection. Plug and charge is another payment method for which the EV is

automatically identified and linked to a previously established payment method after it is plugged in.

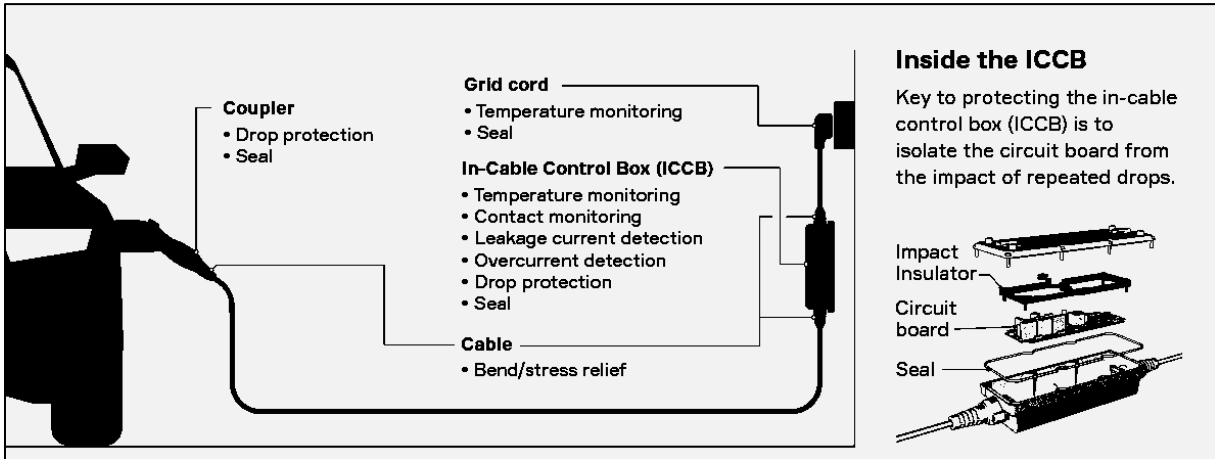

Figure 21 Level 2 EVSE Anatomy

Charging Ecosystem

The current charging ecosystem consists of eight stakeholders, whose descriptions and roles are summarized in **Table 16** [96]. Information must smoothly be exchanged between these stakeholders in order for a charging session to be successful. A communication failure between any two stakeholders in the ecosystem can compromise the reliability of their charging stations.

Table 16 EV Charging Ecosystem Stakeholder Descriptions

Charging Stakeholder	Description
<i>EV user</i>	A person who owns/drives an EV. In order to charge their EVs at a public charging station, the EV user typically must be subscribed to a CSO via their eMSP.
<i>E-Mobility Service Provider (eMSP) or the Electric vehicle Service Provider (EVSP)</i>	The eMSP or EVSP is a company that offers EV charging services to EV users. The eMSP is responsible for all communication and billing processes involving the EV users. They grant EV users access to charging infrastructure by issuing UIDs.
<i>Navigation Service Provider (NSP)</i>	The NSP aids EV users to locate and/or reserve public charging stations. The NSP usually belongs to the eMSP.

<i>Charging Station or EVSE</i>	A device equipped with charging connectors to supply energy to EVs from the electrical grid.
<i>Charging Station Operator (CSO)</i>	CSOs are responsible for installing and operating charging stations that they own. They can also maintain charging stations owned by eMSPs. CSOs typically manage charging stations remotely using communication protocols such as Open Charge Point Protocol.
<i>Clearing House Operator (CHO)</i>	The CHO enables roaming services i.e., they allow EV users to charge at CSO that they aren't subscribed to via the eMSP. They run a software platform to facilitate the exchange of information between eMSPs, NSPs and CSOs.
<i>Energy Supplier</i>	The energy supplier is contracted by the CSO to deliver electricity to charging stations, according to contracted tariffs.
<i>Distribution System Operator (DSO)</i>	The DSO provides the connection to the distribution power grid and provides the CSO with key information about the grid status.

Charging Infrastructure Points of Failure

There are electrical, mechanical, software/communication and logistical factors within the EV charging ecosystem that influence the reliability of public EV chargers.

On the electrical side, the components within an EVSE’s ICCB are responsible for temperature monitoring, contact monitoring, leakage current detection, and overcurrent detection - all to ensure safe supply of power to the EV. A failure within even one of these components can make the EVSE unreliable and potentially unsafe. For instance, if the thermal management system malfunctions, overheating can cause damage to the circuit components and potentially cause a fire/explosion. The ICCB needs to have redundant features built into its design so a component failure does not lead to a reliability or safety issue [95].

On the mechanical side, the external components of the EVSEs are prone to damage from various environmental factors. Consumers tend to drop EV chargers repeatedly, wrap and drive over cables, as well as leave them out in the rain. Animals may chew on the cables. EVSE design must account for these mechanical challenges. They should construct cables with stress reducers

and proper strain relief to prevent copper strands from breaking [95]. The ICCB should be properly sealed to protect it from the elements. The vehicle coupler connector should be built to withstand frequent drops and misalignment when being plugged in [69].

On the communication side, configuration errors, line damage, power loss or traffic spikes, and hardware failure anywhere along the communication network within the charging ecosystem may cause reliability issues as it can interrupt the flow of information between the various actors in the EV charging ecosystem. Using diverse linkages can make EVSE network communication more robust as failure of a single link wouldn't bring down the entire connection.

On the logistical side, membership requirements, payment issues, complicated EVSE instructions/operations, difficulty locating EVSEs, lack of EVSE availability, and poor cell service/Wi-Fi availability make EV charging daunting to current and prospective EV drivers. According to a recent CARB survey of EV owners, membership requirements are a major barrier to public EV charging [66]. Most Electric Vehicle Service Providers (EVSPs) require EV drivers to obtain a membership or pay a subscription fee to use their stations. Membership requirements are tightly coupled with EVSE payment systems. EV drivers typically have a credit card on hold the EVSP and pay for charging via the EVSP-issued radio frequency identification card or the EVSP app on their smartphone. In many cases, the location and operating status of a particular EVSE can only be found in the membership app of the network that that EVSE belongs to, and depending on the app, this crucial information can often be outdated. EVSE payment and locating methods heavily rely on smartphones with internet connectivity - this can be a huge concern when charging in locations with poor network connectivity. Since public EV charging stations are currently fairly sparse, membership requirements force EV drivers to purchase and keep track of multiple memberships in order to adequately meet their public charging needs. This complex EV

driver-EVSP dynamic is a significant barrier to the transition from gas stations to EV chargers. The CARB enacted the Electric Vehicle Charging Stations Open Access Act to eliminate membership barriers and developed the EVSE Standards Regulation to establish more streamlined and diverse EVSP payment systems [66].

Figure 22 extends these technical and logistical factors to all stakeholders in the charging ecosystem where each stakeholder is color-coded with the potential factors that can compromise EVSE reliability.

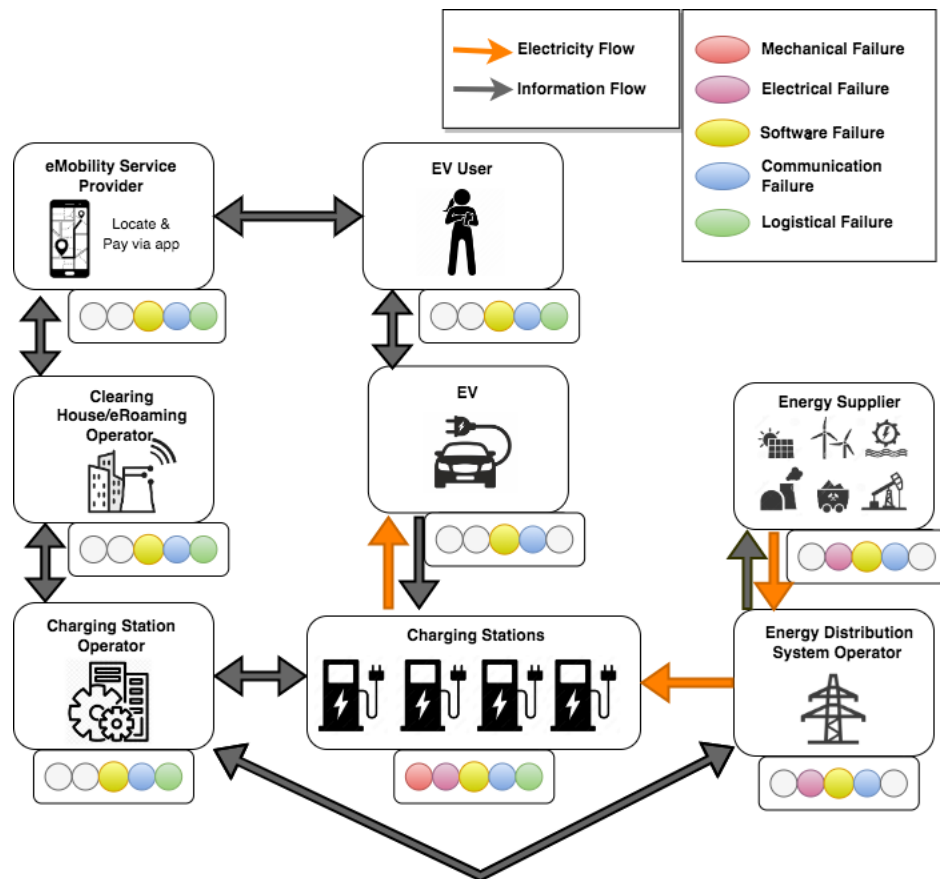

Figure 22 Charging Infrastructure Points of Failure

Charging Infrastructure Reliability Metrics

The most common EVSE reliability measure is uptime i.e., the time during which a machine is in operation. However, until recently, there had been no standard method to measure

uptime across EVSPs and no standard minimum uptime requirement across jurisdictions. For instance, the Northeast states required a 99% charging uptime for their DC fast chargers which they define as each station being operational for at least 99% of the time based on a 24 hour and 7-day week [67]. On the other hand, California required their DC fast chargers to be operational for at least 97% of standard operating hours over a period of five years [67]. On June 22, 2022, the Federal Highway Administration published a Notice of Rulemaking that defines regulations for projects funded under the National Electric Vehicle Infrastructure (NEVI) Formula Program and other Title 23, US Code programs. The regulations propose a minimum average annual charging port uptime requirement of 97%. The uptime percentage calculation for a given charging port, captures the percentage of time that the port's hardware and software are both online and available to use. The calculation excludes the hours of outage caused by reasons outside the control of the charging station operator such as electric utility service interruptions and internet service provider interruptions. While NEVI's proposed uptime calculation and requirement is a step in the right direction, it still may not sufficiently account for all the technical and logistical failures outlined in the previous section. If CSOs monitor their EVSEs using Open Charge Point Protocol, they can effectively detect most of the electrical and software failures given an operational communication network. However, they may be in the dark when it comes to failures caused by mechanical, communication and logistical factors. For instance, they may be unable to detect a physically damaged charging cable if the EVSE is otherwise operational and detected as so via their communication network. Or communication lags may cause charging station operators to be unaware of inoperable charging ports for substantial periods of time, resulting in inaccurate uptime calculations. Moreover, the stakeholders that are responsible for maintaining uptime have still not been standardized across jurisdictions - the responsibility can be with the local electric utility, the

installer, the site host, the charge point operator, or the servicing company. These stakeholders will likely have different levels of visibility over the system, making it especially challenging to maintain high uptime [67]. Overall, the complex dynamics within the EVSE ecosystem make it especially challenging to accurately measure and maintain this uptime.

Consequences of Unreliable Charging Infrastructure

The consequences of an unsuccessful charging session varies depending on how quickly the charge failure is discovered by the EV driver and how easy it is for the EV driver to locate and reach the next nearest operational charging station. The consequences of an unsuccessful charging sessions can be especially dire during long-distance travel (LDT) within low-charger density regions. Many EV drivers meticulously plan their LDT route based on their EV's estimated electric range and scope out compatible charging stations in order to sufficiently meet their perceived charging needs. However, in many cases, drivers' perceived charging needs may not reflect their actual charging needs. The EPA determines an EV's estimated electric range based on a number of test protocols which mostly cover warm-weather, a mix of speeds, multiple trips, HVAC needs, and some starts and stops [15], [97]. However, this estimated range can be inaccurate and volatile in driving scenarios that were not accounted for. In general, the efficiency of a vehicle depends on its aerodynamic drag or its opposing air flow, its rolling resistance or the effort required to keep the tires moving, its mass, its speed, and the grade of the road it's on. An unexpected environmental change that shifts the magnitude of these factors can drastically alter the vehicle's electric range. In addition to these factors, cold weather can dwindle the efficiency of an EV. According to the AAA, EVs lose around 12% of their range in cold weather, but this goes up to 41% if the heater is on full blast [11].

Since actual EV charging needs can deviate from drivers' perceived EV charging needs due to the aforementioned factors, using an EV for LDT is often framed as a challenge over just a means to an end. There are numerous blogs on the internet charting EV road trips that vary in levels of enthusiasm for the technology but all share the same general theme of "it was a struggle, but we made it!" [13]–[18]. In some cases, an unpleasant EV road trip experience deterred drivers from ever using EVs for LDT in the future. Moreover, a handful of blogs document instances of EV drivers being stranded in the midst of LDT due to faulty chargers [13], [14].

4.3 Methods

Data Overview

Our study uses real-world EV charging session data from 132 EVs driven in California, over a one year period. This charging session dataset was geographically merged with the U.S. Department of Energy's Alternative Fueling Stations Dataset to get more robust charging station information.

Charging Sessions

The charging sessions analyzed in this study is a subset of the data from the *Advanced PEV Driving and Charging Behavior* project, a California-wide study spanning five years (2015-2020) that aims to understand the driving and charging behavior of EVs [98]. This EV study collected on-road data from around 400 households and 800 vehicles (400 EVs). **Table 17** provides an overview of the data analyzed in this study. We are focusing on charging session data, collected over a one year period for 132 EVs, spanning three popular EV models: the Nissan Leaf (Model Years 2011-2017, 24-30 kWh battery capacity), the Chevrolet Bolt (Model Year 2017, 66 kWh battery capacity), and the Tesla model S (Model Years 2012-2017, 60-100 kWh battery capacity). We are only interested in evaluating non-home charging sessions in this study, so we only focus

on sessions that are shaded in grey within **Table 17**. **Figure 23** presents the percent share of non-home charging sessions by charger level.

Table 17 EV Data Overview

EV Type	Number of Vehicles	Number of Trips	Total Miles Traveled (mi)	Number of Charging Sessions	Number of Non-home Charging Sessions	Total kWh Charged
Nissan Leaf	57	79,202	5,32,425	16,091	5,415	1,20,575
Chevrolet Bolt	27	47,760	3,82,603	9,434	1,137	1,00,612
Tesla Model S	48	46,361	6,60,619	12,073	3,671	2,46,597

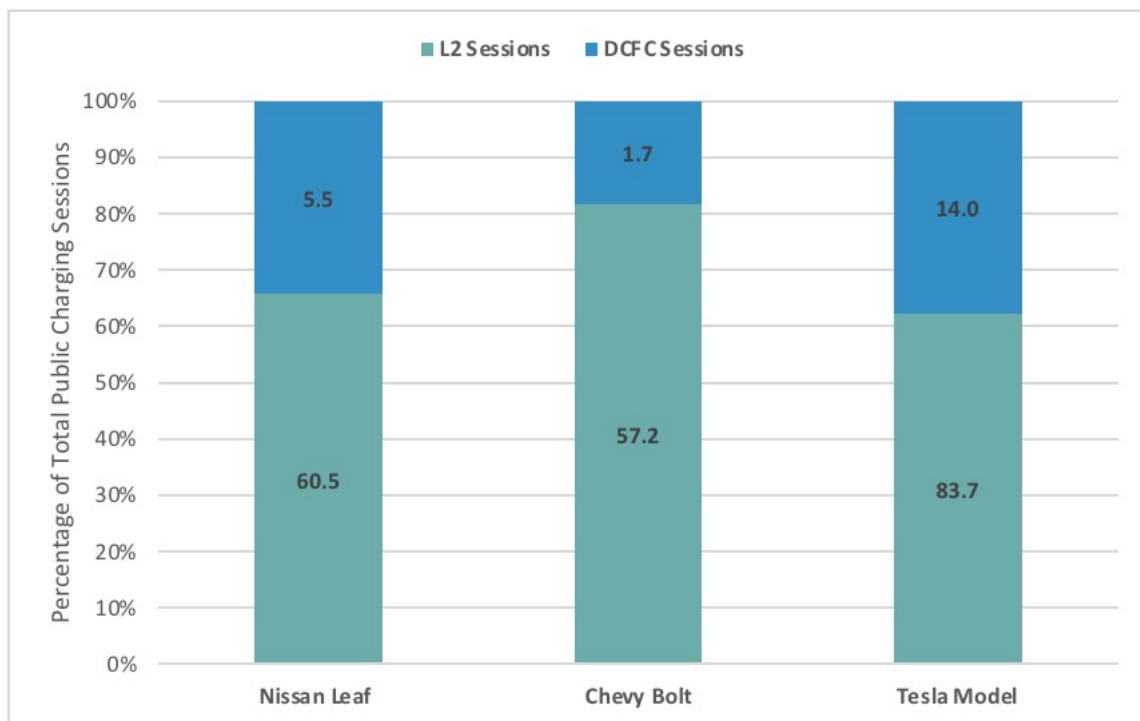

Figure 23 Share of Public Charging Sessions by Charging Level and EV Type

Charging Stations

We used the U.S. Department of Energy’s Alternative Fueling Stations Dataset to get more robust charging station information. This dataset contains comprehensive charging station metrics such as location, charger/connector types etc., for most existing public charging networks in the

U.S. Based on a study by Xu et al. (2021), that successfully combined charging station datasets, we used DBSCAN clustering to match charging station locations to charging session locations [99]. DBSCAN typically has two parameters: minPts is the minimum number of neighbors a point must have to be within a cluster and epsilon is the search radius used to figure out if two points are neighbors. The magnitude of these two parameters were based on findings in the study by Xu et al., who determined that an appropriate search radius for DBSCAN for charging station matching should be in the range of 50 to 200 meters. The minPts was set to 2 as we intended to match a charging session to a charging station and epsilon was set to 50 meters, the lower end of the recommended range as this led to the most robust matches. The Alternative Fueling Stations Dataset’s coverage isn’t perfect so we could only identify accurate charging station information for roughly 67% of charging sessions in our dataset. **Figure 24** shows the charging network share of the successfully matched charging sessions.

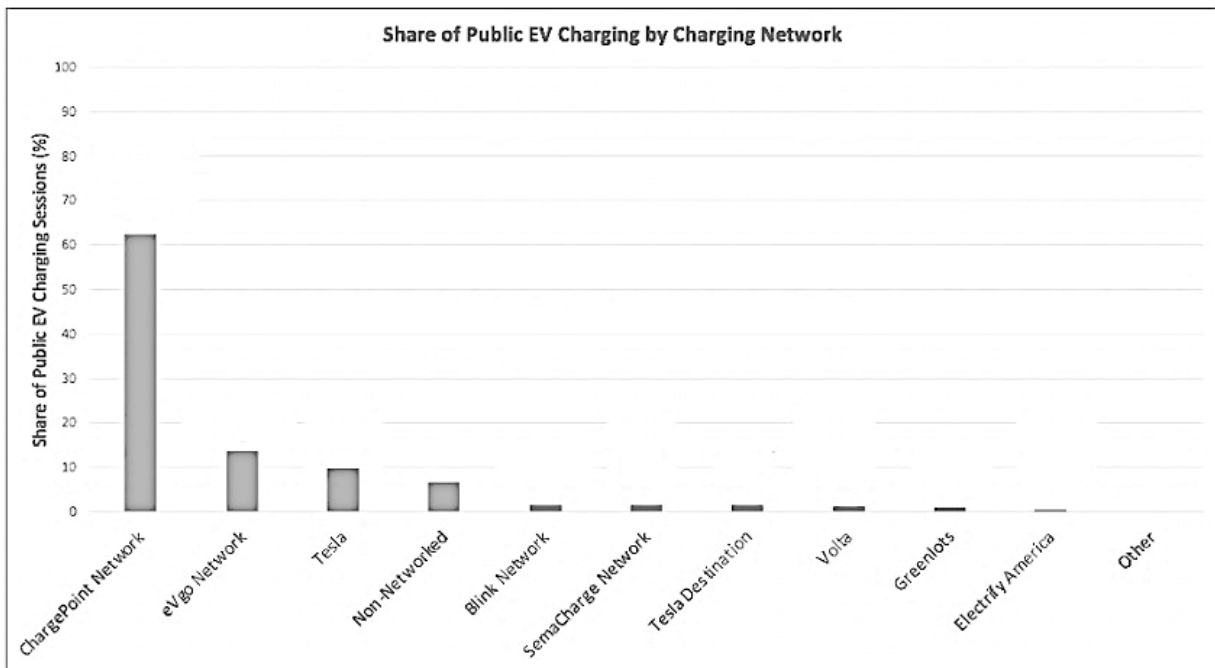

Figure 24 Share of Public EV Charging by Charging Network

Analytical Methods

In the first part of this analysis, we simulate the level of disruption that would've occurred to EV drivers had their successful charging sessions been unsuccessful. In the second part of this analysis, we quantify how many charging sessions were actually unsuccessful and qualify how disruptive those unsuccessful charging sessions were to drivers.

Level of Disruption from Simulated Charge Failure

We define three levels of disruption, as follows, in order to qualify how much of a hassle driver would've faced had a successful charging session failed.

Trip Disruptive: We consider a charging session to be trip disruptive if the next trip cannot be completed had that charging session failed. In this case, the electric range remaining prior to the charging session isn't sufficient to cover the next trip.

Charge Disruptive: We consider a charging session to be charge disruptive if the next charging location cannot be reached had the charging session failed.

Day Disruptive: We consider a charging session to be day disruptive if all the trips that occur after the charging session on that day cannot be completed had the charging session failed. In this case, the electric range remaining prior to the charging session isn't sufficient to cover all remaining trips within that day, even after accounting for other successful charging sessions within that day.

Figure 25 illustrates the aforementioned levels of disruption. In the case of the trip disruptive charging session, the EV cannot reach the next trip destination, in this case the supermarket, had the charging session in the beginning of the timeline failed. In the case of the charge disruptive charging session, the EV cannot reach the next charging location on the timeline had the charging session in the beginning of the timeline failed. In the case of the day disruptive charging session,

the EV cannot complete all trips before the end of the day and reach home, had the charging session in the beginning of the timeline failed. It is important to note that all the charging sessions used in this part of the analysis were successful - we're just simulating how much disruption the EV driver would face had those successful charging sessions failed.

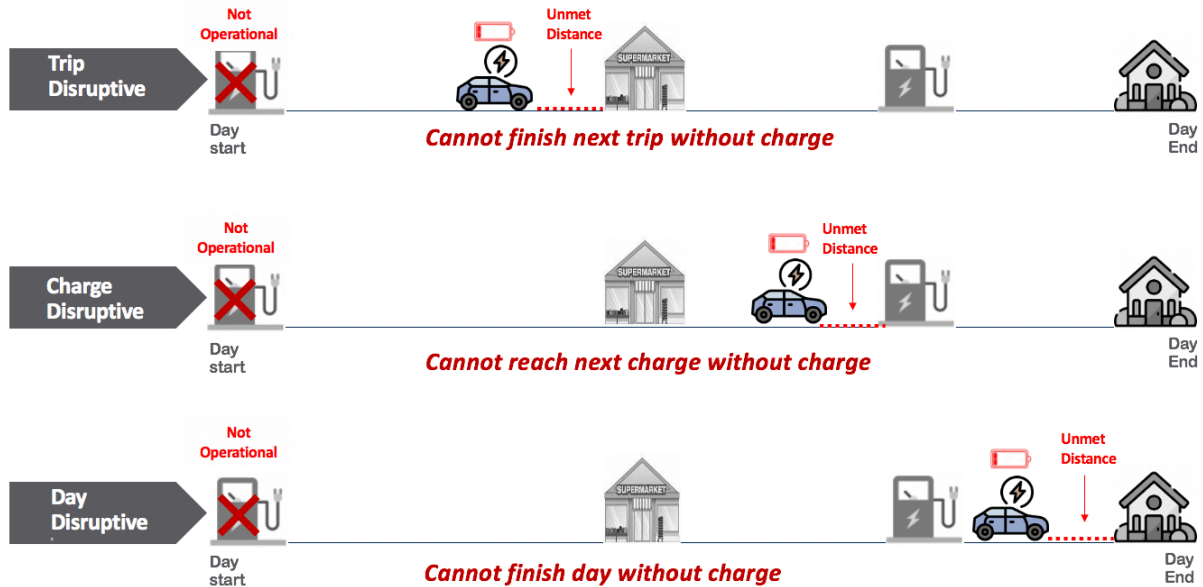

Figure 25 Charging Session Disruption Level Criteria

In addition to classifying the charging sessions by level of disruption, we also analyze five travel behavioral conditions to better understand why some successful charging sessions were more prone to be disruptive upon failure than others. We compared the following travel conditions between disruptive and non-disruptive charging sessions:

- Vehicle battery capacity
- Total distance travelled in the day in which the charging session occurred
- Number of charging sessions in the day in which the charging session occurred
- Starting battery state of charge prior to the charging session

- Distance between the charging session location and the driver's home

Since none of the mentioned travel conditions met the normality assumption of the ANOVA test, we opted to use the Kruskal-Wallis test, the non-parametric equivalent of the ANOVA test, to analyze the difference between the means of disruptive and non-disruptive charging sessions. The Kruskal-Wallis test is a rank-based non-parametric test that can deduce if there are statistically significant differences between two or more groups of an independent variable on a continuous or ordinal dependent variable.

Location Critical Charging Sessions

The trip, charge and day disruptive charging session criteria don't necessarily imply that an EV driver would be stranded at some point in a day if those charging sessions had failed. For instance, if a trip disruptive charging session had failed, the EV driver could find an alternative operational charger along their route and finish their next trip; in this case, finding another charging location may be very inconvenient to the EV driver, but this isn't the worst-case scenario. This is why we also identified location critical charging sessions without which EV drivers may potentially end up being stranded. A charging session is considered location critical if the EV doesn't have enough electric range remaining to reach the next nearest charging location had the charging session failed.

Quantifying and Qualifying Observed Unsuccessful Charging Sessions

In this part of the analysis, we quantify unsuccessful charging sessions from our dataset and then qualify how much of a hassle these unsuccessful charging sessions were to the EV drivers.

In this study, we identify an unsuccessful charge based on the following conditions:

- There is no or very little energy (less than 0.5 kWh) delivered to the EV's battery by the end of the charging session.

- The charging session immediately following that charging session is at a different charging station (at least 50 meters away from the current charging station).

4.4 Results

Level of Disruption from Simulated Charge Failure

Out of the roughly 10,200 successful non-home charging events, around 9% of the sessions are trip disruptive and over 35% are charge or day disruptive. This implies that, in 9% of charging sessions, if those charging sessions were unsuccessful, EV drivers would not be able to complete subsequent trips as planned, without locating and using another functional EVSE within the electrical range remaining of their EVs. And in 35% of charging sessions, if those charging sessions were unsuccessful, EV drivers would need to alter their habitual/planned charging behavior and charge their EV sooner than initially intended in order to successfully complete all trips within the day. **Table 18** provides the proportion of successful charging sessions that were classified as trip, charge, and day disruptive for each of the three vehicle models in this study. **Figure 26** illustrates that there is a higher proportion of disruptive charging sessions among successful DCFC sessions over successful level 2 charging sessions. This observation especially holds true for charge and day disruptive charging sessions; over 55% of successful DCFC sessions are charge and day disruptive while only around 27% of successful level 2 charging sessions are charge and day disruptive.

Table 18 Share of Successful Charging Sessions that are Trip, Charge and Day Disruptive

BEV Type	Number of Successful Charging Sessions		Share of Trip Disruptive Charging Sessions (%)		Share of Charge Disruptive Charging Sessions (%)		Share of Day Disruptive Charging Sessions (%)	
	Level 2	DCFC	Level 2	DCFC	Level 2	DCFC	Level 2	DCFC

Nissan Leaf	3,130	1,754	3.03	3.56	13.65	14.06	14.30	14.46
Chevrolet Bolt	888	207	0.13	0.01	1.24	0.64	1.27	0.67
Tesla Model S	2,220	1,347	1.13	2.12	2.94	4.55	3.14	4.72
All BEVs	6,238	3,308	4.28	5.69	17.83	19.24	18.71	19.85

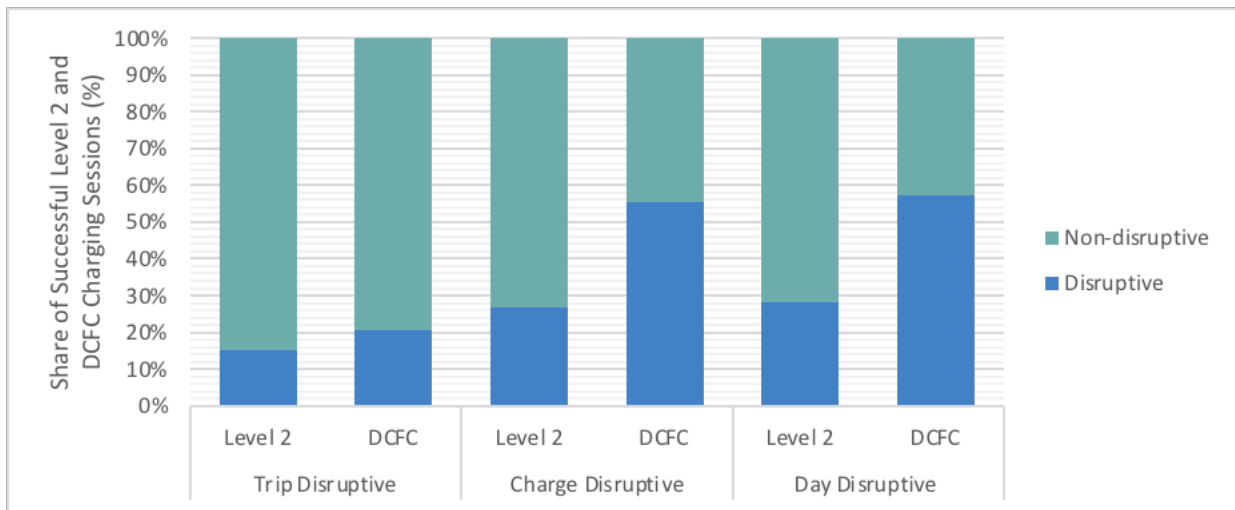

Figure 26 Charging Reliability Scenario Analysis Charger Level Shares

Figure 27 shows the vehicle-level distribution of the proportion of disruptive level 2 and DCFC charging sessions, respectively. Each point overlaid on the boxplots represents the proportion of disruptive charging sessions for a single car. There seems to be a negative correlation between electric range and rate of disruptive for level 2 charging sessions, but the same trend doesn't hold for DCFC sessions. There are more disruptive DCFC sessions than Level 2 charging sessions for all car models and this observation is especially pronounced for the Tesla Model S vehicles. The Model S vehicles records a higher proportion of disruptive DCFC charging sessions than the Chevy Bolt vehicles which have a lower battery capacity, on average, than the Model S vehicles. For the Model S vehicles, the average proportion of charge/day-disruptive charging sessions is around 7% for Level 2 charging sessions but is over 30% for DCFC sessions. Higher

electric range and the access to a robust fast charging network (Tesla Supercharging Network) make Model S vehicles more likely to be used for LDT than the other two vehicle models, rendering these vehicles to be more dependent on public DCFC chargers along highway corridors.

Figure 28 shows the share of vehicles miles traveled on LDT days (over 50 miles) as a percentage of total VMT and confirms the fact that the Model S vehicles are more likely to be used for LDT.

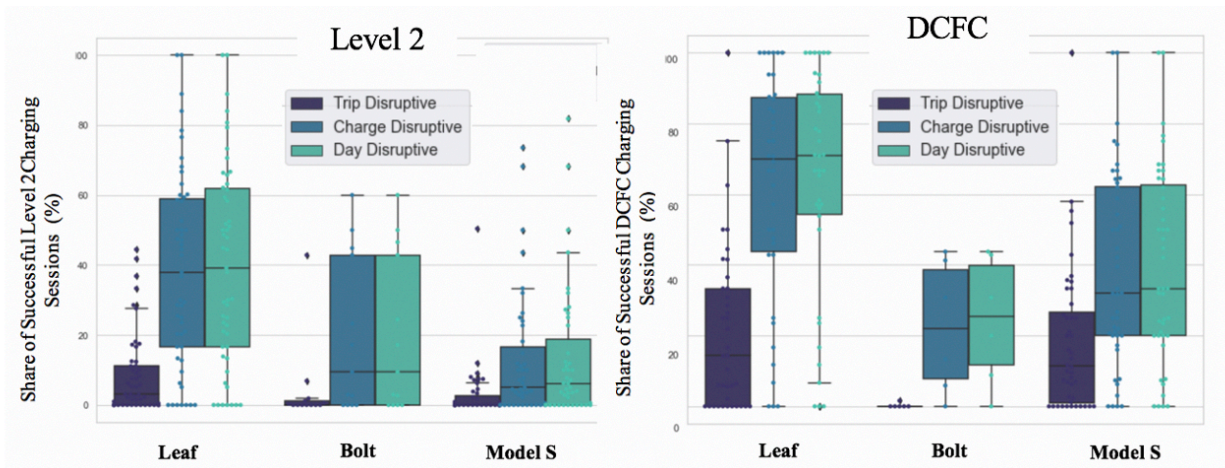

Figure 27 vehicle-level distribution of the proportion of disruptive level 2 and DCFC charges=

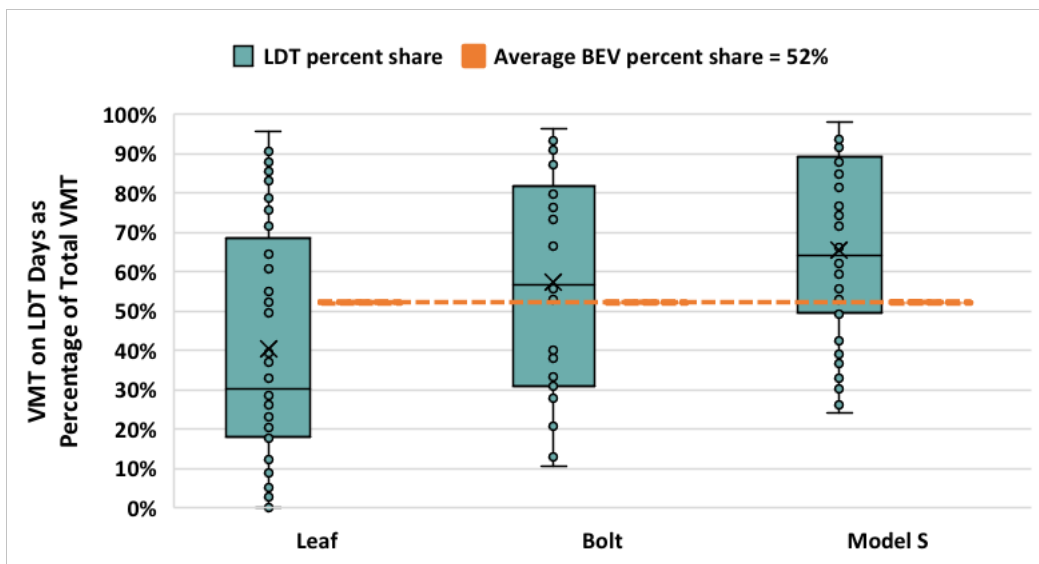

Figure 28 Share of vehicles miles traveled on long distance travel days (over 50 miles) as a percentage of total VMT

We analyzed five travel behavioral conditions to better understand why certain successful charging sessions were more prone to be disruptive upon failure than others. **Table 19** provides the means of each travel condition for disruptive and non-disruptive charging sessions, along with the results of the Kruskal-Wallis test. The difference in means between trip disruptive and trip non-disruptive charging sessions is very significant for most analyzed travel conditions. All disruptive charging sessions are associated with higher distance traveled in the day and lower starting battery state of charge compared to their non-disruptive counterparts. The average distance traveled in day among trip disruptive charging sessions is around 30% higher than the average distance travelled by charge and day disruptive charging sessions. Since higher battery capacity vehicles, such as the Model S, are more likely to be used for LDT, trip disruptive charging sessions are associated with higher battery capacity whereas charge and day disruptive charging sessions are associated with lower battery capacity, compared to their non-disruptive counterparts. In addition to the five travel behavioral conditions, we also analyzed how access to home charging impacted charge disruption levels. We found that drivers who did not have access to home charging are 9% more likely to experience charge and day disruptive charging sessions than drivers with access to home charging; this is likely because drivers without access to home charging primarily rely on workplace or public charging to meet their daily charging needs whereas drivers with access to home charging primarily rely on home charging and are not as dependent on outside charging sources.

Table 19 Travel Conditions affecting Level of Disruption Means and Kruskal-Wallis Test Results

Travel Condition	Disruption Level	Disruptive Mean	Non-disruptive Mean	Kruskal Wallis Test
Vehicle Battery Capacity (kWh)	Trip	53.71	49.67	F Statistic = 80.41 $p = 3.040e-19$ ****
	Charge	39.33	56.14	F Statistic = 727.91 $p = 2.552e-160$ ****
	Day	39.35	56.53	F Statistic = 777.94 $p = 3.383e-171$ ****
Distance Travelled in Day (miles)	Trip	115.33	70.37	F Statistic = 363.96 $p = 3.865e-81$ ****
	Charge	89.11	72.35	F Statistic = 207.25 $p = 5.462e-47$ ****
	Day	90.85	70.97	F Statistic = 294.62 $p = 4.891e-66$ ****
Number of Charges in Day (#)	Trip	2.23	1.71	F Statistic = 323.64 $p = 2.332e-72$ ****
	Charge	1.70	1.85	F Statistic = 81.97 $p = 1.380e-19$ ****
	Day	1.75	1.82	F Statistic = 33.15 $p = 8.522e-09$ ****
Starting Battery State of Charge (%)	Trip	38.40	51.74	F Statistic = 503.13 $p = 1.985e-111$ ****
	Charge	32.43	58.36	F Statistic = 3245.24 $p = 0.0$ ****
	Day	32.73	58.81	F Statistic = 3350.37 $p = 0.0$ ****
Distance from Home (miles)	Trip	49.15	31.41	F Statistic = 201.73 $p = 8.767e-46$ ****
	Charge	32.34	35.70	F Statistic = 1.09 $p = 0.296$
	Day	32.79	35.52	F Statistic = 0.04 $p = 0.851$

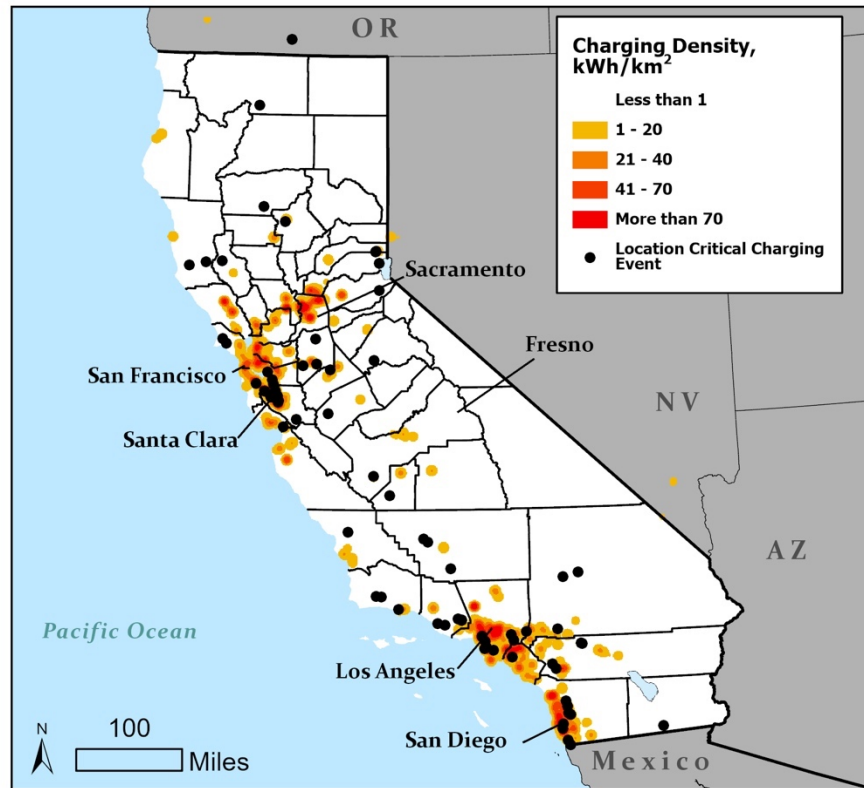

Figure 29 Map of Location Critical Charging Sessions

We found that in around 2.87% of successful charging sessions, drivers were one unsuccessful charging sessions away from being stranded. The locations of these critical charging sessions are plotted on the map in **Figure 29**. In these cases, the EVs did not have sufficient range remaining to get to the next nearest charging station. Many of these critical charging sessions occurred in relatively low charging station density areas within the central valley and rural northern California as illustrated in **Figure 29**. Moreover, these critical charging sessions were more likely to occur during LDT days, as suggested by the total day distance distributions in **Figure 30**.

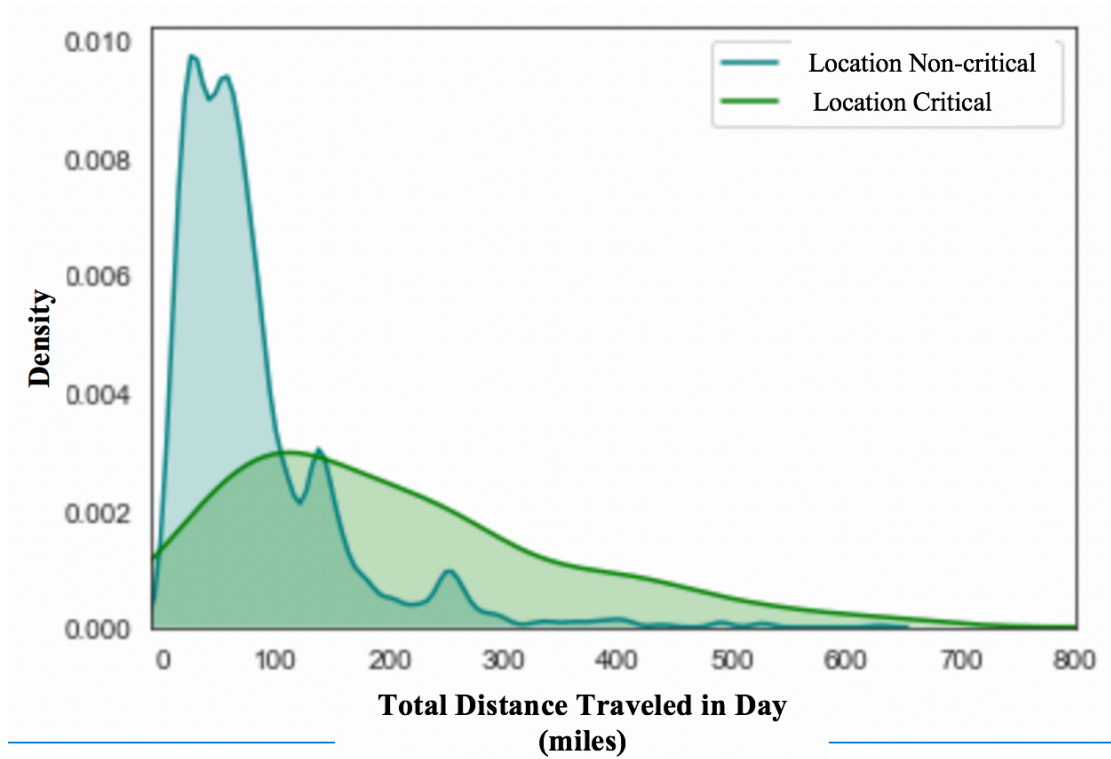

Figure 30 Total Day Distance Distributions of Location Critical Charging Sessions

Quantifying and Qualifying Observed Unsuccessful Charging Sessions

We found that around 7% of all logged charging sessions were unsuccessful as in no energy or very little energy was transferred from the charger to the cars' batteries. The stated 7% is an underestimate of the true charge failure rate as it doesn't include charge failures wherein EV drivers realized a charger was broken before plugging in their EVs. Since unsuccessful charging sessions were logged for a very short duration, we could not effectively extrapolate the charger level for most of these charges. The identified unsuccessful charging sessions are broken down into categories based on how disruptive they were to the EV drivers. Around 96% of unsuccessful charging sessions were 'Slightly disruptive' as EV drivers quickly discovered the charging failure

and drove to a different charging location immediately. In these cases, the time elapsed between the beginning of an unsuccessful charging session and the beginning of the trip immediately following that charging session is very small, less than 10 minutes with an average of roughly 3 mins. 4% of unsuccessful charging sessions were ‘Moderately disruptive’ as the EV driver discovered the charge failure several minutes or hours after the beginning of the charge attempt. In these cases, the time elapsed between the beginning of an unsuccessful charging session and the beginning of the trip immediately following that charging session is roughly 3 hours on average. **Figure 31** illustrates the distribution of the time elapsed between the beginning of an unsuccessful charging session and the beginning of the next trip for slightly disruptive and moderately disruptive unsuccessful charging sessions.

In the previous cases, EV drivers had enough range to complete the next trip despite the failed charge, but 2 unsuccessful charging sessions were “very disruptive” as in the EV did not have enough electric range remaining to complete the next trip. In these two cases, the EV drivers were basically stranded and their EVs needed to be towed to reach the next charging location. Both these charging sessions had a starting battery state of charge of under 7% and occurred in locations with relatively lower charging station densities.

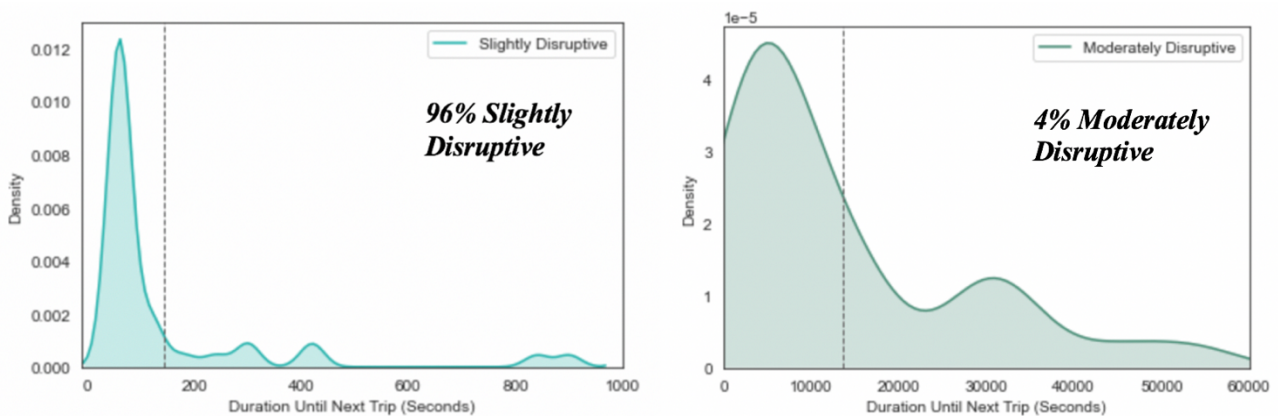

Figure 31 Duration to beginning of next trip by level of disruption (slightly, moderately)

Figure 32 shows the car-level distribution of the proportion of unsuccessful charging sessions and **Figure 33** shows the proportion of unsuccessful charging sessions by EV charging network. Both Tesla’s cars and charging stations recorded the lowest number of unsuccessful charging sessions.

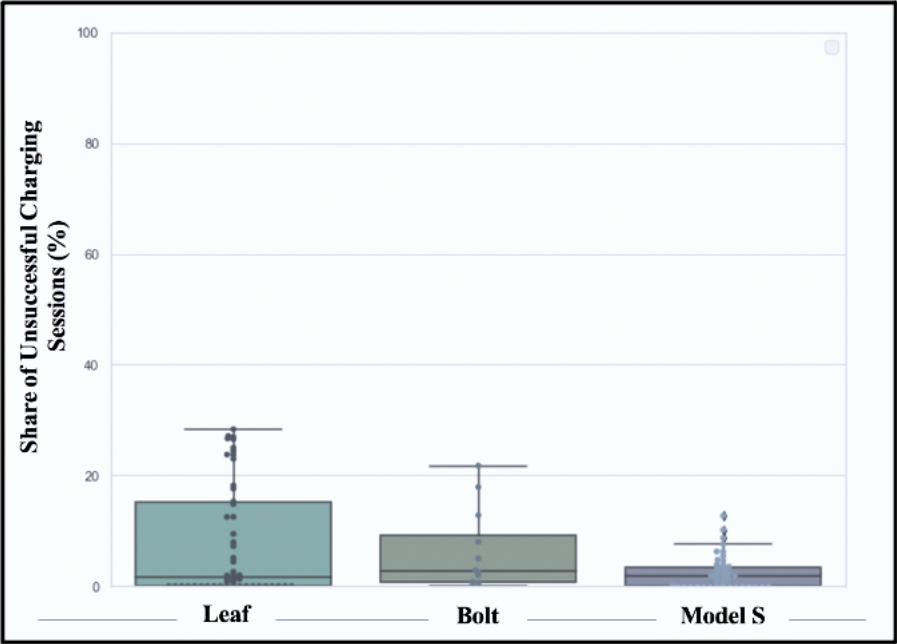

Figure 32 Share of unsuccessful charging sessions by vehicle model

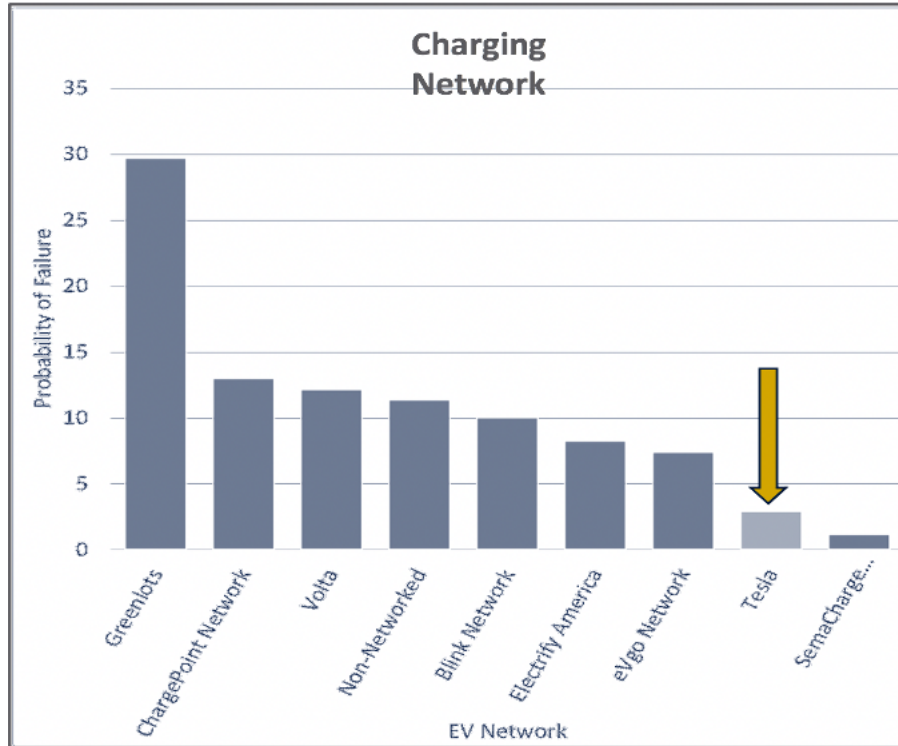

Figure 33 Share of unsuccessful charges by charging network

4.5 Discussion

This study reveals that EV charging sessions are not all equally important. A charging session is more important to an EV with a low state of charge in a low charging station density location compared to an EV with a high state of charge in a high charging density location. We simulated the level of disruption that would've occurred to the drivers had their charging sessions failed. In 9% of charging sessions, if those charging sessions were unsuccessful, EV drivers would not be able to complete subsequent trips as planned, without locating and using another functional EVSE within the electrical range remaining of their EVs. And in 35% of charging sessions, if those charging sessions were unsuccessful, EV drivers would need to alter their habitual/planned charging behavior and charge their EV sooner than initially intended in order to successfully complete all trips within the day. There is a higher proportion of potentially disruptive charging

sessions among DCFC charging sessions over level 2 charging sessions, especially for the Model S vehicles which are more likely to be used for LDT. All potentially disruptive charging sessions are associated with higher LDT and lower starting battery state of charge compared to non-disruptive charging sessions. In around 3% of charging sessions, the EVs were one unsuccessful charging sessions away from being stranded; most of these location critical charging sessions occurred during LDT, in low charging station density areas.

This study also finds that 7% of recorded charging sessions were unsuccessful. Based on how quickly drivers discovered these charge failures, we reasoned that over 95% of them were only slightly disruptive to the EV drivers but in a small number (2) of cases EV drivers did end up being stranded. Both Tesla's cars and charging stations recorded the lowest proportion of unsuccessful charging sessions. Our loggers only recorded 'plug-in' events as charging sessions, so the stated 7% is an underestimate of the true charge failure rate as it doesn't include charge failures wherein EV drivers realized a charger was broken before plugging in their EVs. Moreover, we cannot extrapolate exactly why these charging sessions were unsuccessful. Rempel et al. (2022) found that unresponsive/unavailable screens, payment system failures, network failure, or damaged connectors were major contributing factors to the charge failures in their study.

Current EVSP charging reliability standards do not consider the nuances in consumer charging needs. While not all EV charging sessions are equally important to drivers, all EV chargers are essentially held to the same reliability standards by stakeholders. A charger in a low charging density area along a LDT route is held to the same uptime requirement as a charger in a high charging density urban area. This is a problem because the consequences for a charge failure in low charging density areas can be more dire than the consequences for a charge failure in high charging density areas. It's the difference between being stranded in the middle of nowhere and

being a little annoyed about driving less than a mile away to the next functional charger. Moreover, chargers along LDT routes or in low charging density areas may be more prone to technical, communication and logistical failures due to weak network connectivity. These concerns could dissuade EV drivers from using their EVs for LDT which accounts for around 30% to 45% of total vehicle miles traveled [93]. Or in the worst case, motivate EV owners to give up their EVs and return to gas vehicles [100]. Stakeholders should have higher reliability standards for chargers that are deemed to be more critical for consumers; this can be in the form of a higher uptime or the instillation of more chargers in locations with those critical chargers so that if one charger goes down, there will be an alternative. In general, charging reliability standards for EVSEs in a given location should take into account that location's charging station density and the stations' associated utilization rates. In a location with a relatively high density of EVSEs, the reliability of each charging port does not need to be very high as if one port is inoperable, EV drivers can easily locate and access another port nearby. On the other hand, in a location with a relatively low density of EVSEs, the reliability of each charging port should be high as if one port is inoperable, EV drivers are less likely to have enough electric range remaining to reach the next nearest charging port. This recommendation can lower the costs associate with maintaining EVSE reliability as chargers in the presence of high charging station redundancy need not be held to very high reliability standards. To reflect this spatial nuance in EVSE reliability, EVSE signage should include instructions to locate the next nearest charging port in case of a charge failure. If reliability standards are lower in locations with high charging station redundancy, signage to locate the next nearest charging point more easily could lower the level of driver disruption associated with more frequently encountering inoperable charging ports in those locations.

Uptime, in general, may be an insufficient metric to measure EV charging reliability. There are numerous electrical, mechanical, software, communication and logistical factors within the EV charging ecosystem that ultimately determine the operational status of an EV charger. The calculation for uptime doesn't seem to adequately incorporate all these technical and logistical factors. Moreover, there is currently no standard method to measure uptime across EVSPs and no standard minimum uptime requirement across jurisdictions. It is critical to have a common definition and standard for uptime so EV drivers aren't blindsided by a slew of unreliable chargers from EVSPs claiming high uptimes. In addition to standardizing and increasing uptime requirements across EVSPs and jurisdictions, frequent maintenance and servicing of EVSE stations would increase charging reliability from a consumer perspective. Maintenance could include repairing damaged EVSE parts, removing garbage/obstacles surrounding the EVSE, and ensuring that the software and communication protocols are functional. These routine checks would lower the probability of a charge failure and ensure that any faults within the EVSEs are quickly resolved. Accurate, real-time data on EVSE status should also be made available to consumers so they can better understand the actual reliability of EV infrastructure and adjust their expectations accordingly. In addition to monitoring the operational status of EVSEs, CSOs should also monitor the usage patterns of EVSEs as any detected usage gaps may uncover a reliability issue. EV drivers are likely to habitually charge their EVs in the same public charging locations along their daily travel routes. Therefore, any sudden gaps within the usage pattern of a given EVSE could reveal a technical or logistic failure that standard reliability monitoring protocols failed to capture. The next chapter of this dissertation leverages this idea to develop a tool that detects EVSE usage gaps that could indicate charger faults in real-time.

4.6 Conclusion & Future Direction

This study evaluates the impact of public charger reliability on EV driver experience. It uses real-world EV charging data to simulate the level of disruption that would've occurred to EV drivers had their successful charging sessions been unsuccessful. Additionally, it quantifies how many charging sessions were actually unsuccessful and qualifies how disruptive those unsuccessful charging sessions were to drivers. The study finds that EV charging sessions are not all equally important as the level of disruption associated with each simulated and actual unsuccessful charge substantially varies. In around 65% of charging sessions, a hypothetical charge failure results in very little disruption. In the remaining 35% of charging sessions, a hypothetical charge failure can force drivers to completely alter their habitual/planned charging behavior. Moreover, in around 3% of charging sessions, drivers were one unsuccessful charging session away from being stranded. 7% of all logged charging sessions were actually unsuccessful. Most of these unsuccessful charging sessions led to low levels of disruption but in 2 sessions, drivers ended up being stranded. Charging sessions linked to high levels of potential disruption were associated with LDT, low battery state of charge and lack of access to home charging.

Since our results suggest that EV charging sessions are not all equally important, we recommend stakeholders to have more nuanced charging reliability standards to meet actual consumer charging needs more effectively. They need to enforce more stringent reliability standards for critical chargers i.e., chargers that are associated with high charge failure rates and/or high levels of potential disruption from charge failures. The findings in this paper can assist stakeholders to identify critical chargers – we found that chargers along LDT routes and within low charger density regions were especially linked to reliability issues and high levels of potential disruption.

Chapter 5: BEV Charging Insecurity: How to Detect Charging Failures

standard reliability protocols cannot detect?

5.1 Introduction

The transition to electric EVs hinges on the quantity and quality of the EV charging infrastructure. However, current reliability metrics do not fully account for crucial technological and logistical challenges in the charging ecosystem, which significantly influence the actual consumer-facing reliability of chargers. While Charge Point Operators (CPOs) can effectively monitor most electrical and software failures using standard monitoring protocols, they may overlook mechanical, communication, and logistical failures. These hidden issues can persist until encountered by an EV driver, leading to delayed fault resolution. To address this, our study aims to develop a tool enabling CPOs to swiftly detect charge failures that cannot be detected by standard monitoring protocols. By analyzing habitual charging patterns of EV drivers, the tool identifies unexpected gaps in charger usage, indicating potential charger faults. The tool incorporates two anomaly detection models: a naive probability distribution-based technique and a LSTM for complex pattern modeling.

5.2 Types of Charging Failures

In their study on the reliability of open DCFC chargers within the California bay area, Rempel et al. revealed six types of charge failures that they encounter in their study: broken connectors, non-responsive screens, error message on screens, connection error, payment system failure, and charge initiation failure. **Table 20** abstracts these six failures to more comprehensively capture the most common obstacles consumer encounter while attempting to charge their EVs [101], [102].

Table 20 Common EV Charger Failures

	Failure	Description
<i>Remotely Observable</i>	Charger to Vehicle Communication Failure	Malfunction in the EV's charging port or the charging station's connector, issue with the communication protocol used by the EV and the charging station
	Connector/cable Issue	Charger cable improperly placed into vehicle charging port, poor conductivity due to corrosion
	Electrical Insulation / Safety Issue	Electrical system of charger may be overheating, insulation may need to be inspected
	Payment Errors	Technical issues with the payment system, compatibility issues with the payment method used, or user error during the payment process
	Vehicle Errors	Software or hardware malfunctions, charging port incompatibility, or battery issues.
	Charger Equipment Errors	Software or hardware malfunctions, power supply issues
	Power Outage	Power outage can cause EV charger to shut-down or interrupt an on-going charging process
<i>Remotely Unobservable</i>	Blocked Access to station	Access to chargers could be physically blocked by gas cars, other non-charging EVs, fences, snow, flood water, etc.
	Physically Damaged Equipment	External components of the EVSEs are prone to damage from various environmental factors.
	Logistical and interoperability Issues	Membership requirements, payment incompatibility, equipment incompatibility, complicated EVSE instructions/operations, difficulty locating EVSEs, lack of EVSE availability, and poor cell service/Wi-Fi availability make EV charging daunting to current and prospective EV drivers.
	Network Communication Failure	Configuration errors, line damage, power loss or traffic spikes, and hardware failure anywhere along the communication network

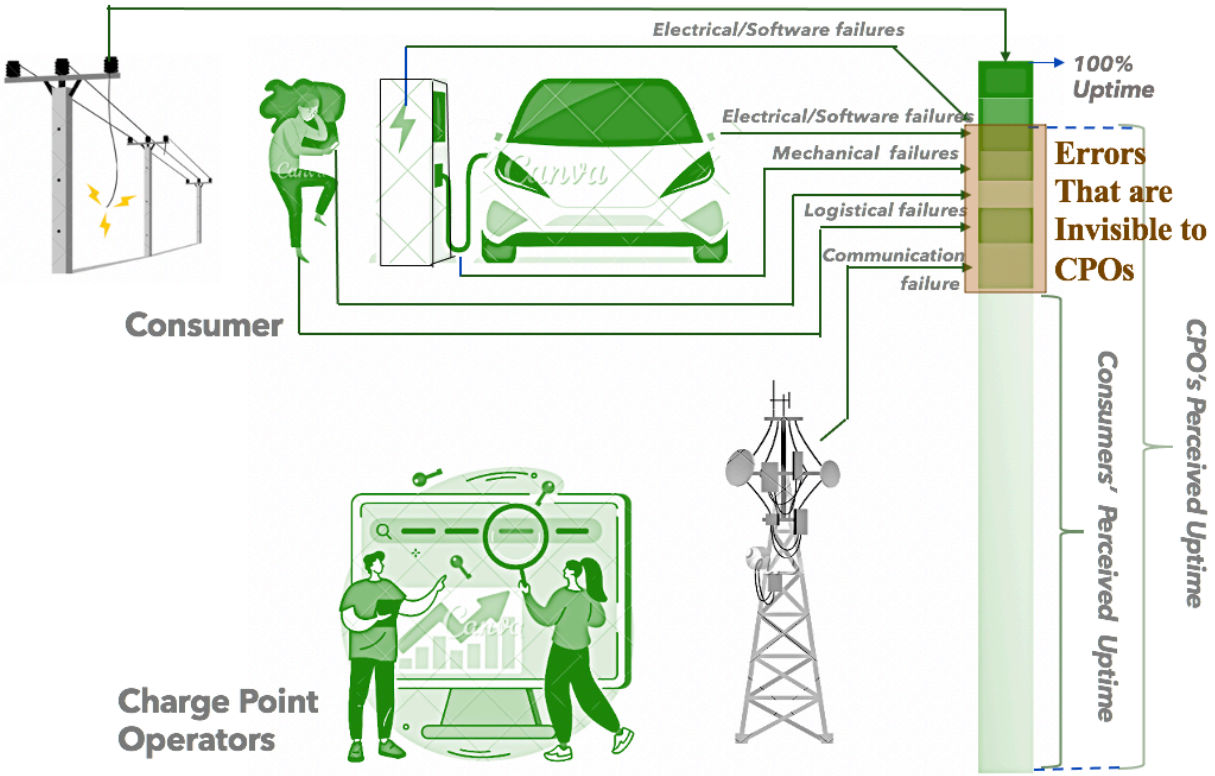

Figure 34 Consumer Uptime vs. CPO Uptime

A CPO is typically the stakeholder that is responsible for ensuring optimal ongoing operations of EV charging infrastructure. This includes managing the backend technologies as well as the communications between the backend system and the chargers. The CPO needs to ensure that all chargers under their control are operational enough to at least meet the uptime requirement of their jurisdiction. As such, they need to have systems in place to notify them of any problems with the chargers. Ideally, the CPO should monitor its chargers' operational statuses in real-time to discover and fix issues before the customer is aware of them. If CPOs effectively monitor their chargers using Open Charge Point Protocol (OCPP), they can effectively detect most of the electrical and software failures given an operational communication network. However, they may be in the dark when it comes to failures caused by mechanical, communication, and logistical factors. For instance, they may be unable to detect a physically damaged charging cable if the EVSE is otherwise operational and detected as so via their communication network. Or

communication lags may cause charging station operators to be unaware of inoperable charging ports for substantial periods of time, resulting in inaccurate uptime calculations. **Figure 34** illustrates the dichotomy between the uptime measured by CPOs and the uptime experienced by consumers due to the varying levels of visibility of certain charge failures. **Figure 35** enumerates the timeline of a charging attempt, accompanied by the possible charge failures that could occur at each stage of the attempt, separated by their level of visibility to CPOs.

A failure that is invisible to CPOs may persist until an unlucky EV driver encounters a charger with the failure and reports it to the CPO. As such, these invisible failures exacerbate the EV charger reliability issue. This study aims to develop a tool to help CPOs quickly detect these invisible charge failures. In this study, our goal is to develop a tool capable of detecting charger faults that standard reliability protocols might overlook. To achieve this, we explore the utilization of two anomaly detection models as the foundation of our tool. The first model is a naive probability distribution-based technique, which effectively identifies anomalies occurring outside the normal charging behavior probability distribution of chargers. The second model is a Long LSTM Network, a deep learning technique known for its ability to model and comprehend complex patterns in sequential data. We demonstrate the use of the developed tool by detecting anomalous charging usage gaps from real-world charging data collected from 12 chargers in California.

CPO Invisible Failures



Electric Vehicle Public Charging Timeline

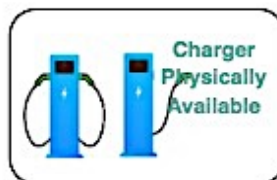
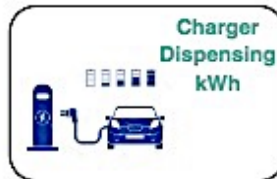

CPO Visible Failures



5.3 Time Series Anomaly Detection Literature Review

Time series anomaly detection is a process of identifying abnormal patterns within a sequence of data points collected over time. There are various techniques that can be employed for time series anomaly detection, including traditional statistics methods, machine learning algorithms, deep learning algorithms, data mining techniques, and signal analysis [103]. These techniques span across six categories of general approaches, including forecasting, reconstruction, encoding, distribution, distance and isolation tree approaches. We considered techniques from all these classes to isolate and develop the optimal technique to detect anomalous usage patterns and thereby CPO invisible charger faults within EV charging time series traces.

Forecasting Methods

Time series anomaly detection using forecasting methods involves using a learned model to predict future values based on a current window of data. The predicted values are then compared to the actual values to determine the extent of anomalous behavior. Forecasting models are typically trained in a semi-supervised manner on normal data, and any deviations from the expected behavior in the test dataset are identified as anomalous. The traditional statistical methods used for forecasting time series anomalies include Autoregressive Integrated Moving Average (ARIMA), Seasonal Autoregressive Integrated Moving Average (SARIMA), the median method, and Triple Exponential Smoothing (Triple ES) [104][105]–[107]. Forecasting methods that use deep learning include Long-Short Term Memory Autoencoders, Convolutional Neural Networks, Graph Attention Networks, and Echo State Networks [108]–[112]. These models are trained in a

semi-supervised manner, where the training data without anomalies is used to learn the normal model of the data, which is then used to identify anomalies in the test dataset.

Reconstruction Methods

Reconstruction methods for time series anomaly detection techniques create a model of normal behavior by encoding subsequences of a normal training dataset into a low-dimensional data space. This model is then used to reconstruct subsequences from a test dataset, and the difference between the original and the reconstructed time sequences is used to calculate an anomaly score. Traditional statistical approaches to reconstruction include Principle Component Isolation (PCI) [113]. Machine learning techniques include Principle Component Analysis (PCA) and Principle Component Classifier (PCC) [114], [115]. Deep learning approaches include autoencoders, variational autoencoders, LSTM-based variational autoencoders, Recurrent Neural Networks (RNN), Spectral Residual, and Generative Adversarial Networks (GAN) [116]–[124]. Most of these methods are semi-supervised, meaning they are trained on normal data and use this to identify anomalies in the test dataset.

Encoding Methods

Encoding methods for time series anomaly detection utilize techniques to encode subsequences into a low-dimensional latent space and compute anomaly scores directly from the representations of the encoded subsequences. These techniques employ a range of methods to encode subsequences and calculate anomaly scores, such as inferring hierarchical grammar rules, using bitmaps, constructing probabilistic models, and building directed cyclic graphs. Anomaly scores are attributed to the points corresponding to the encoded subsequences in the latent space, and subsequences that are difficult to compress or have low frequency are considered anomalous. Stochastic learning techniques are used in encoding methods such as Hidden Markov Models

(HMMs) and Dynamic Bayesian Networks (DBNs) [125], [126]. Meanwhile, data mining techniques employed in encoding methods include grammar-based compression, graph-based compression, suffix trees, and time series bitmaps.

Distribution Methods

Distribution methods for time series anomaly detection involve estimating the distribution of the data or fitting a distribution model to the data, and then using probabilities, likelihoods, or distances to calculate anomaly scores for points or subsequences with respect to the prior calculated distributions. In contrast to other methods, the anomalous points or subsequences are judged by their frequency rather than their distance. To estimate Gaussian distributions or generic probability distributions of subsequences, various techniques such as histograms, copulas, and wavelet transforms are utilized. The anomaly scores are calculated based on the distance or likelihood of the points or subsequences with respect to the estimated distributions. Some of these methods assume a normal training time series for semi-supervised anomaly detection, while others are unsupervised and can detect anomalies in the tails of the distributions. Traditional statistical methods for distribution-based anomaly detection include extreme value theory and copula-based outlier detection [127], [128]. In the field of signal analysis, discrete wavelength transforms and maximum likelihood estimation are often employed [129]. Machine learning techniques, on the other hand, use Histogram-based Outlier Scores (HBOS) to identify anomalies [130]. Deep learning techniques for distribution-based anomaly detection use Normalizing Flows (NF) to model the data distribution and identify anomalies based on the estimated density values [131].

Distance Methods

Distance-based methods for time series anomaly detection involve comparing points or subsequences of a time series using specialized distance metrics. These methods assume that

anomalous subsequences will have larger distances to other subsequences than those with normal behavior. For the distance calculations, these algorithms may use either all other subsequences, some nearest neighbors, or certain cluster centroids as distance reference points. Some methods also perform a mapping of the subsequences into a multidimensional space before computing the distances. Distance-based methods are usually unsupervised and do not require training data. Nearest neighbor methods are a common example, where anomaly scores are determined by computing the distance of points or subsequences to their nearest neighbors. Infrequent or uncommon subsequences have large distances to their neighbors and are, therefore, scored as anomalous. Distance-based methods using traditional statistics involve identifying density- or cluster-based local outliers [132]–[134]. Machine learning methods using distance methods include k-means, K-nearest neighbors (KNNs), and Support Vector Machines (SVMs) [135]–[137]. Deep learning methods using distance methods include hybrid KNNs [138].

Isolation Trees

Isolation tree methods for time series anomaly detection involve building a collection of random trees that partition test time series samples (points or subsequences). Anomalous samples are closer to the root of the tree and have shorter path lengths than normal samples, so their reciprocal values can be used as anomaly scores. Representative algorithms use traditional statistics and include Isolation Forest (iForest), Extended Isolation Forest (EIF), Hybrid Isolation Forest (HIF), Sub-IF, and Isolation Forest - Local Outlier Factor (IF-LOF) [139]–[142]. The iForest algorithm is the basis for all algorithms in this category, and supervised variants include EIF and HIF. IF-LOF combines iForest and LOF.

Table 21 presents the advantages and disadvantages of various anomaly detection techniques considered for the development of our tool.

Table 21 Advantages & Disadvantages of Anomaly Detection Methods

<i>Method Family</i>	<i>Method Class</i>	<i>Methods(s)</i>	<i>Advantages</i>	<i>Disadvantages</i>
Forecasting	<i>Deep Learning</i>	AD-LTI, DeepAnt, DeepNap, HealthESN, LSTM-AD, MTAD-GAT, Telemanom, Torsk	automated feature learning, ability to capture non-linear relationships, consideration of temporal context, and adaptability to changing data distributions	data requirements, computational complexity, black-box nature, susceptibility to overfitting, and the need for careful hyperparameter tuning, which can limit their interpretability and performance in scenarios with limited labeled data
	<i>Traditional Statistics</i>	ARIMA, MedianMethod, SARIMA, Triple ES	interpretability, less data requirements, computational efficiency, and robustness to outliers	assuming linearity in data, limited temporal context, manual feature engineering, limited adaptability to changing data distributions, and sensitivity to certain data patterns, which may hinder their performance in complex and dynamic anomaly detection scenarios
Reconstruction	<i>Deep Learning</i>	Autoencoder, Bagel, Donut, EncDec-AD, LSTM-VAE, MSCRED, OmniAnomaly, Spectral Residual, TAnoGAN	unsupervised learning, feature learning, and the ability to capture non-linear relationships and temporal context	data requirements, computational intensity, hyperparameter tuning, reconstruction ambiguity, limited interpretability, and susceptibility to overfitting
	<i>Machine Learning</i>	PCC, RobustPCA	interpretability, computational efficiency, and robustness to outliers	assuming linearity in data, limited feature learning capabilities, reduced consideration of temporal context, and the lack of detailed anomaly localization compared to deep learning reconstruction methods
	<i>Traditional Statistics</i>	PCI	interpretability, computational efficiency, and dimensionality reduction	assuming linearity in data, limited feature learning capabilities, sensitivity to data distribution, challenges in selecting an appropriate anomaly detection

				threshold, and limited adaptability to complex and dynamic anomaly detection scenarios.
Encoding	<i>Data Mining</i>	Ensemble GrammarViz, Series2Graph, TARZAN, TSBitmap	GI, PST, graph representation, data abstraction, flexibility, and temporal context	complexity, hyperparameter tuning, interpretability, data transformation, data requirements
	<i>Stochastic Learning</i>	LazerDBN, MultiHMM	probabilistic modeling, sequential data handling, representation learning, scalability, and adaptability	complexity, data requirements, hyperparameter tuning, interpretability, initialization sensitivity, and data distribution assumptions
Distance	<i>Data Mining</i>	HOT SAX, NormA-SJ, SSA	computational efficiency, interpretability, and scalability	parameter sensitivity, feature engineering requirements, lack of full temporal context consideration, sensitivity to data scaling, limited representation learning, and dependence on data distribution
	<i>Deep Learning</i>	Hybrid KNN	feature learning, modeling non-linear relationships, data abstraction, and adaptability.	computational intensity, data requirements, hyperparameter tuning, interpretability, overfitting, and sensitivity to data characteristics
	<i>Machine Learning</i>	k-means, KNN, PS-SVM	interpretability, simplicity, scalability, and parameter tuning	limitations in feature learning capabilities, sensitivity to data scaling, curse of dimensionality, data requirements, computation time, and hyperparameter tuning
	<i>Traditional Statistics</i>	CBLOF, COF, LOF	interpretability, scalability (CBLOF), and robustness to noise (COF and LOF)	limitations in feature learning capabilities, sensitivity to data scaling, data distribution, curse of dimensionality (LOF), computation time (COF and LOF), data requirements, and hyperparameter tuning

Distribution	<i>Deep Learning</i>	Normaizing Flows (NF)	flexible distribution modeling, generative capabilities, scalability, and non-linear relationship modeling	computational intensity, data requirements, hyperparameter tuning, data distribution assumptions, interpretability, and data scaling
	<i>Machine Learning</i>	HBOS	computational efficiency, interpretability, scalability, and non-linear relationship modeling	limitations in feature learning capabilities, sensitivity to data distribution assumptions, data scaling, data requirements, anomaly localization, and susceptibility to overfitting
	<i>Signal Analysis</i>	DWT-MLEAD	signal processing expertise, noise robustness, multiscale analysis, and non-linear relationship modeling	limitations in data requirements, interpretability, parameter tuning, computation time, feature learning capabilities, and sensitivity to data scaling
	<i>Traditional Statistics</i>	COPOD, S-H-ESD, DSPOT	interpretability, robustness to outliers (S-H-ESD), data distribution modeling, and anomaly localization (DSPOT)	limitations in data scaling, data requirements, computation time, data distribution assumptions, hyperparameter tuning, feature learning capabilities, and non-linear relationship modeling
Isolation Trees	<i>Traditional Statistics</i>	EIF, HIF, Isolation Forest - Local Outlier Factor (IF-LOF), iForest	outlier-focused design, model simplicity, scalability, and non-linear relationship modeling	data scaling, data requirements, hyperparameter tuning (IF-LOF), anomaly localization, feature learning capabilities, curse of dimensionality, and data distribution assumptions

In general, the tradeoff between employing deep learning and traditional statistical techniques for anomaly detection revolves around considerations of complexity, interpretability, feature learning, data requirements, and computational resources. Deep learning exhibits the capability to discern intricate patterns from raw data; however, it necessitates a substantial amount

of labeled data and computational resources. On the other hand, traditional statistical methods are often more interpretable, demand fewer labeled data points, and are computationally efficient but may lack the ability to learn features automatically. To harness the advantages of both techniques, we opted to implement both a traditional statistical anomaly detection method and a deep learning anomaly detection technique. Specifically, we employed a traditional statistical approach based on a naiver probability distribution anomaly detection technique, as well as a deep learning method utilizing LSTM networks.

5.4 Methods

Methodology Intuition

EV drivers are likely to charge their EVs in the same public charging locations along travel routes. Therefore, any sudden gaps within the usage pattern of a given EVSE location could reveal a technical or logistical failure that standard reliability monitoring protocols fail to capture. **Figure 36** illustrates an intuitive demonstration of how our tool uncovers unexpected charging usage gaps that may indicate a reliability issue. Let's say we have a charger with a broken plug. This heatmap on the top defines the hourly probabilities of charging at this charger on a typical summer Saturday. At hour T_0 , an EV that usually charges at the station around that time attempts to charge but fails to do so since it has a broken plug. The probability of no charge occurring in this hour is 89%, which is pretty high. At hour T_1 , another EV similarly attempts to charge but fails. No charge in this hour has a probability of 78%. Two more cars attempt to charge at hour T_2 and T_3 and fail with probabilities of 67% and 58%. So individually, the probability of not charging at those hours is pretty high - all above 50%. But the probability of the entire 4-hour sequence of no charging sessions is pretty low, 26%, potentially raising a red flag about the state of the charger.

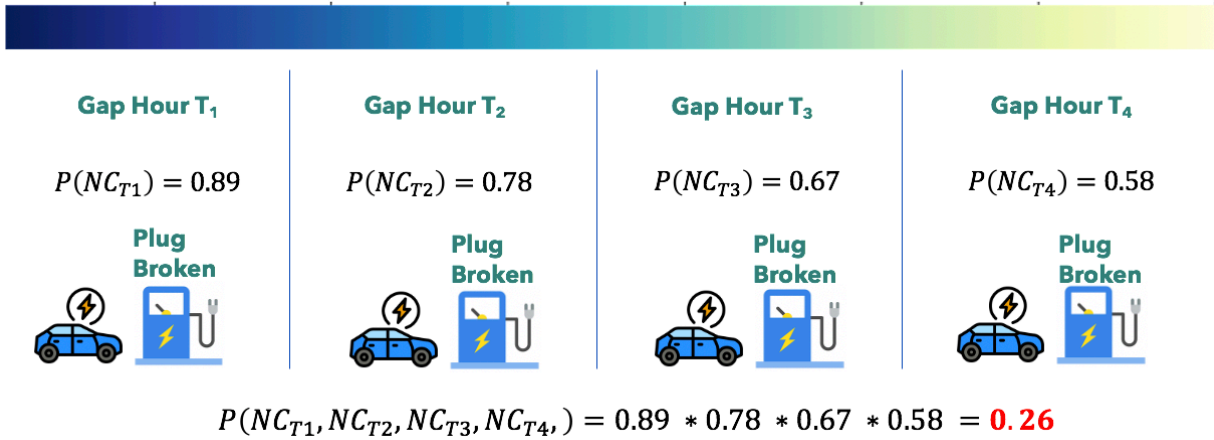

Figure 36 Charging Anomaly Detection Intuition

Methodology Framework

Our methodology framework consists of three major steps illustrated in **Figure 37**. In the first step, we collect EVSE charging session data and ensure its quality through thorough cleaning. Then, we transform the data into hourly time traces to accurately capture temporal patterns. Additionally, we partition the time traces into separate training and testing datasets. In the second step, we focus on implementing anomaly detection models. These models undergo training using the cleaned dataset to understand the regular charging patterns exhibited by EV chargers. By learning these patterns, the models become capable of discerning anomalies from normal charging behavior during the testing phase. In the third step, we apply the trained anomaly detection models to the testing dataset to identify potential anomalies. The models analyze charging behavior in the testing data and flag instances that significantly deviate from the learned normal patterns.

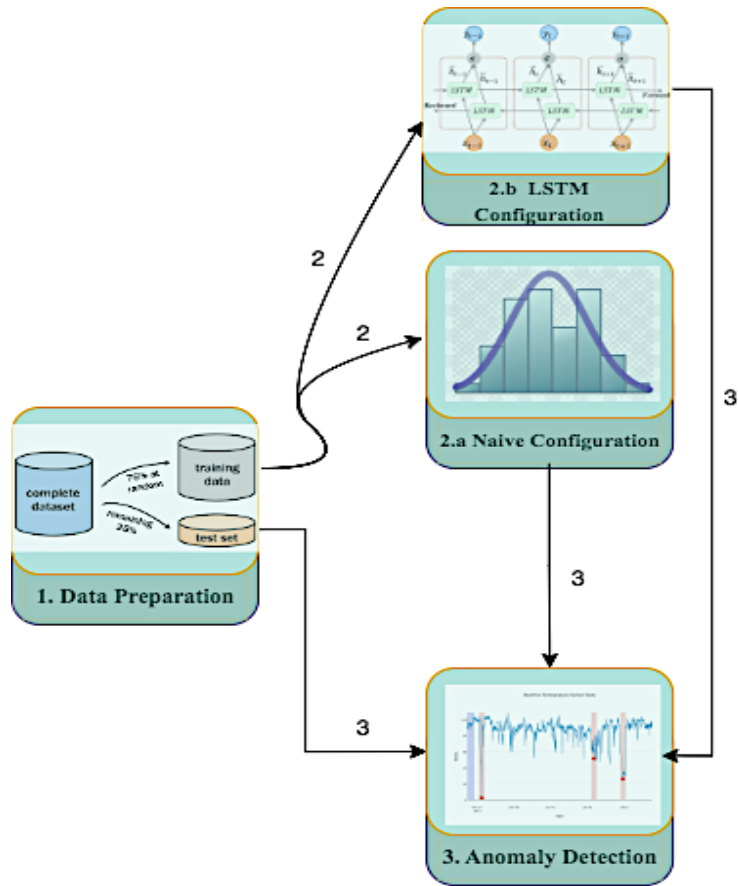

Figure 37 Charging Anomaly Detection Methodology Framework

Data Overview & Preparation

We use charging session data from EV chargers in four locations in California to demonstrate the tool developed in this study. The dataset consists of two public residential level 2 chargers (for apartments) from the Oakland, three public commercial level 2 chargers from San Francisco, four level two workplace chargers from San Diego and 4 DC Fast chargers from a highway corridor in Northern California. The session details for the chargers were obtained from their corresponding installation companies. However, to safeguard their identity and confidentiality, we have anonymized the name of the installation companies. **Table 22** summarizes

the charging session information for the DCFC, and level 2 chargers analysed in this study. There are a total of 12,006 level 2 charging sessions logged for over 700 days between April 2021 and January 2023 and 2341 DC Fast charging sessions logged for over 263 days between January 2021 and October 2021.

Table 22 Charging Data Overview

<i>Charger Type</i>	<i>Charger ID</i>	<i>Number of Charging Sessions</i>	<i>Total kWh Charged</i>	<i>Days Logged</i>	<i>Utilization Rate</i>
<i>Residential Level 2</i>	1	1742	34466	1055	0.3288
	2	1786	36577	1055	0.3864
<i>Commercial Level 2</i>	1	2841	18729	731	0.3031
	2	1098	12672	731	0.1466
	3	2079	29703	731	0.4205
<i>Workplace Level 2</i>	1	592	4529	575	0.2890
	2	717	2744	575	0.3491
	3	772	3293	575	0.3451
	4	479	3078	575	0.2531
<i>Corridor DCFC</i>	1	736	9959	263	0.0446
	2	396	6790	263	0.0295
	3	627	12684	263	0.0521
	4	582	6407	263	0.1639

To pre-process the charging session data in our dataset and transform it into time series traces, we conducted hourly iterations throughout the entire logging period of each charger. During this process, we allocated the respective energy consumption and number of charging sessions that occurred within each specific hour to the corresponding entry in the time series trace. For training the models, we utilized one full year of charging data for each charger in the dataset. Subsequently, we designated the 1-month period immediately following that year as the testing dataset.

Naïve Probability Distribution for Anomaly Detection

In the case of the Naïve probability distribution anomaly detection method, charging usage gaps or anomalies are detected using the following algorithm:

Input: Charging behavior data for EV chargers, including hourly time traces of charging sessions, day type (weekday or weekend), and holiday information.

Algorithm Steps:

1. Calculate Daily Charging Probability Distribution:

- a. For each charger, calculate the daily charging probability distribution considering the time of day, day type (weekday or weekend), and holiday status.
- b. This step models the expected charging behavior for each day and time slot.

2. Iterate through Time Traces by the hour:

- a. For each charger's time trace, traverse through the data one hour at a time.

3. Detect No Charging Sessions in an Hour:

- a. If no charging sessions are detected in an hour, proceed to calculate the probability of no charging in that hour.

4. Calculate Joint Probability of No Charging Sessions:

- a. Using the daily charging probability distribution calculated in Step 1, compute the joint probability of no charging sessions for a sequence of no charge hours.
- b. Calculate the joint probability of no charging for consecutive hours by considering the charging patterns before the current hour. For example, if there was no charging in the previous hour, compute the joint probability of no charging for both hours by multiplying the static calculated daily probability of not charging during those two hours. Repeat this process for longer intervals of no charging as needed.

5. Identify Anomalies:

- a. If the joint probability of no charging sessions is less than a set threshold (for now 0.5) mark that window as an anomaly.

- b. A joint probability of no charging sessions lower than the set threshold suggests an unexpected deviation from the expected charging behavior.

Output: identified anomalies, including the charger ID, joint probability and the corresponding time window(s) where the charging behavior deviates from the expected distribution.

LSTM Autoencoder for Anomaly Detection

LSTM Autoencoder is a deep learning-based approach that can be used to detect and classify anomalous events within time series data. The method is based on the LSTM network, which is a type of a RNN that is well-suited for modelling sequential data. We designed an LSTM autoencoder architecture in Keras. The autoencoder consists of two LSTM layers, one for encoding and one for decoding. The encoding LSTM layer takes the input sequence and reduces its dimensionality by encoding it into a smaller representation. The decoding LSTM layer then takes this encoded sequence and decodes it back to the original input sequence. The output of the decoding layer is compared to the original input sequence using mean squared error (MSE) loss function.

LSTM Autoencoder Architecture Overview

In Keras, we implemented the LSTM autoencoder using the Sequential model class. The encoder part of the network was defined using the LSTM layer, while the decoder can be defined using the RepeatVector and LSTM layers. **Figure 38** and **Figure 39** illustrates our model architecture for one of the Level 2 chargers in our study.

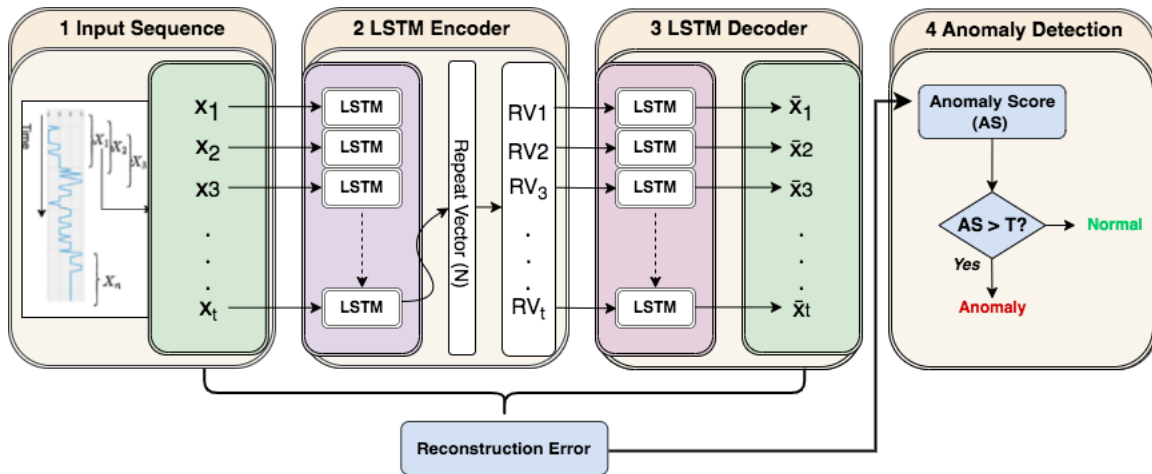

Figure 38 LSTM Autoencoder Architecture

```

Training shape: (4151, 42, 1)
Testing shape: (145, 42, 1)
Model: "sequential_3"

```

Layer (type)	Output Shape	Param #
lstm_6 (LSTM)	(None, 128)	66560
dropout_6 (Dropout)	(None, 128)	0
repeat_vector_3 (RepeatVecto	(None, 42, 128)	0
lstm_7 (LSTM)	(None, 42, 128)	131584
dropout_7 (Dropout)	(None, 42, 128)	0
time_distributed_3 (TimeDist	(None, 42, 1)	129
=====		
Total params:	198,273	
Trainable params:	198,273	
Non-trainable params:	0	

Figure 39 LSTM Architecture

Input Data Sequence

The initial dataset is structured as a succession of time sequences $[X_1, X_2, X_3, \dots, X_n]$. Each sequence X consists of a consistent time window with T -length data $[x_1, x_2, x_3, \dots, x_t]$, where $x_t \in$

R^m signifies an input of m features at time point t . This configuration is subsequently transformed into a two-dimensional (2D) array, depicting both samples and time steps. The initial input data in our case is an hourly time trace of a charger's energy output. This input energy data is converted into a 2D array wherein each dimension represents a collection of samples across 42-time steps.

LSTM Encoder

The LSTM encoder functions as a sequential folding layer, transforming features into batches of time-dependent feature sequences. It resembles independent convolution operations applied to time step-based feature sequences. **Figure 40** delineates how the encoder of the Autoencoder (AE) interacts with LSTM unit cells that are trained to discern the most pertinent features within the input sequence. Each X_i time series comprises 42 samples collected across 42-time steps. This one-dimensional dataset assumes a two-dimensional form for encoder input. Specifically, the dataset is unrolled based on time steps, configuring the input as a 2D vector. This vector comprises one dimension encompassing the 42-time steps and another dimension containing the feature (charger energy output samples) presented as a 42x1 vector. This transformed input is then directed to the encoder. Layer 1 of the encoder integrates a LSTM network housing 42 LSTM cells. These cells sequentially process individual samples. The LSTM cells collaborate in sequence; the output from the first LSTM unit is passed to the second, which decides whether to retain or discard the preceding sample's information. If retained, this information is stored in the long-term memory. The second LSTM unit then passes its output, combined with the processed feature information from the current sample, to the third LSTM unit, and so forth. The final LSTM cell (42nd in our model) accumulates all the pertinent samples processed by the preceding 41 LSTM cells. The outcome is the collective relevant sample information, which is presented as the output from the last LSTM cell—a 1x128 encoded features

vector. Layer 2, a RepeatVector, is introduced to replicate the 1x128 vector to match the number of time steps. For instance, in our model with 42 time steps, Layer 2 generates 42 replicas of the encoded features vector.

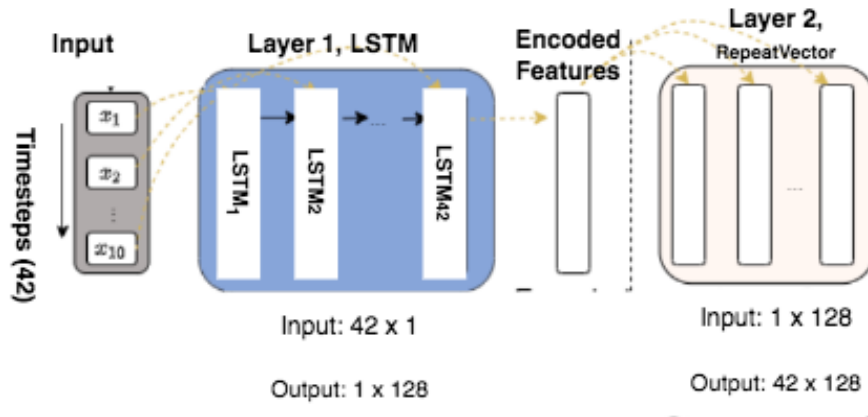

Figure 40 LSTM-AD Encoding Layer

LSTM Decoder

The core aim of the LSTM decoder is to operate as a sequential unfolding layer, reinstating the original sequence arrangement of the input data following the previous folding operation on time steps. As outlined in **Figure 41**, the decoder interacts with LSTM cells to achieve output reconstruction. Each 1x128 dataset is channelled into the decoder. This triggers the creation of Layer 3, encompassing a network with 42 LSTM cell units. Each LSTM unit processes a 1x128 encoded feature set. The output from each LSTM unit signifies the assimilated knowledge from the encoded feature set. The output from each LSTM unit signifies the assimilated knowledge from the encoded feature; this output is combined with the 1x128 vector originating from an additional TimeDistribution layer, effectively forming a multiplied output. Concurrently, every LSTM cell unit generates a secondary output containing the processed state, which is conveyed to the subsequent LSTM cell, excluding the final one. It's important to note that the matrix multiplication

linking the output from each LSTM layer (L) (42x128) with the TimeDistribution layer (128x1) yields a vector sized 42x1, mirroring the input size.

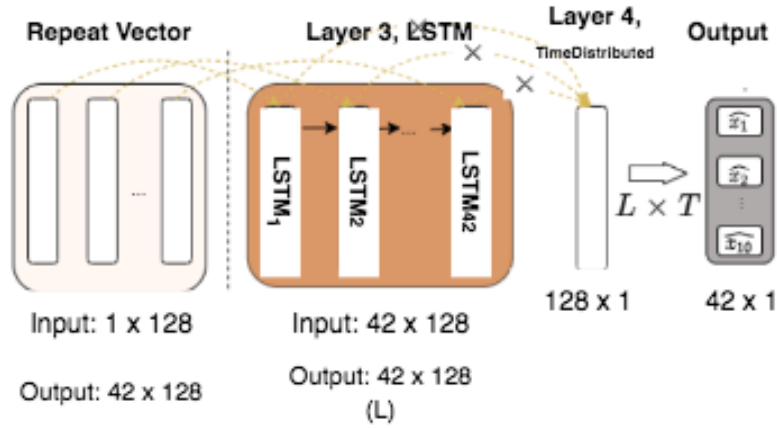

Figure 41 LSTM-AD Decoding Layer

Anomaly Detection

Using this threshold-based approach, our model is trained on a large dataset which theoretically captures the habitual energy output values of chargers. This helps compute reconstruction error rates for normal energy output data points. After training and calculating reconstruction errors across all training samples, the reconstruction error at the 90th percentile is set as the threshold. Once the threshold is set, the testing dataset, encompassing a wide range of energy readings, is fed into the trained model. Each data point's reconstruction error rate is computed across all testing samples. If the error rate goes over the threshold, the sample is flagged as an anomaly.

Training & Testing

Our model training dataset consisted of all hourly energy output data points excluding the last month of the data logging period for each charger. While our testing dataset consisted of all hourly energy output data points in the last month of the logging period for each charger. We

trained the LSTM autoencoder on the training set for each charger separately using backpropagation algorithm with the ADAM optimizer. We trained the model for 100 epochs and a batch size of 32 for each charger. We used early stopping to prevent overfitting. Once the LSTM autoencoder was trained, we used it to detect anomalous usage patterns in the testing set. We fed the testing set to the LSTM autoencoder and calculated the reconstruction error (based on the mean squared error formula shown in **Equation 1**) between the original sequence and the reconstructed sequence. We then defined a threshold based on the reconstruction error, above which a sequence is considered anomalous. The anomaly threshold for each charger was set to the 90th percentile value of the MSE of that charger's training data. We evaluated the performance of our LSTM autoencoder model using various metrics such as precision, recall, F1-score, and area under the receiver operating characteristic curve (AUC-ROC).

Equation 1 Mean Squared Error

$$MSE = \frac{1}{N} \sum_{i=1}^N \left(|\widehat{Y}_i - Y_i| \right)^2$$

Where N is the total number of observations, i is the index of output layer sample, \widehat{Y}_i desired vector of sample i Y_i output vector of sample i .

5.5 Results

Detected Charging Usage Gaps

Figure 42-Figure 45 present the detected charging usage gaps or anomalous hours using both the naive probability distribution method and the LSTM method for the testing dataset of all chargers in each charging location. The base time series represent the hourly energy usage of each charger. The colored markers in the figures represent the charging usage gaps for the chargers

detected by either the naive probability distribution method or the LSTM-autoencoder, assuming both methods effectively learned the usage patterns of the chargers from the previous one year of data. The color of the markers indicates the probability that the detected usage gap is an actual usage gap. Gaps colored in darker pink/red shades are more likely to be actual usage gaps, while gaps colored in lighter yellow shades are less likely to be usage gaps. This color-coding provides a visual representation of the confidence level associated with each detected usage gap, aiding in the interpretation and understanding of the results.

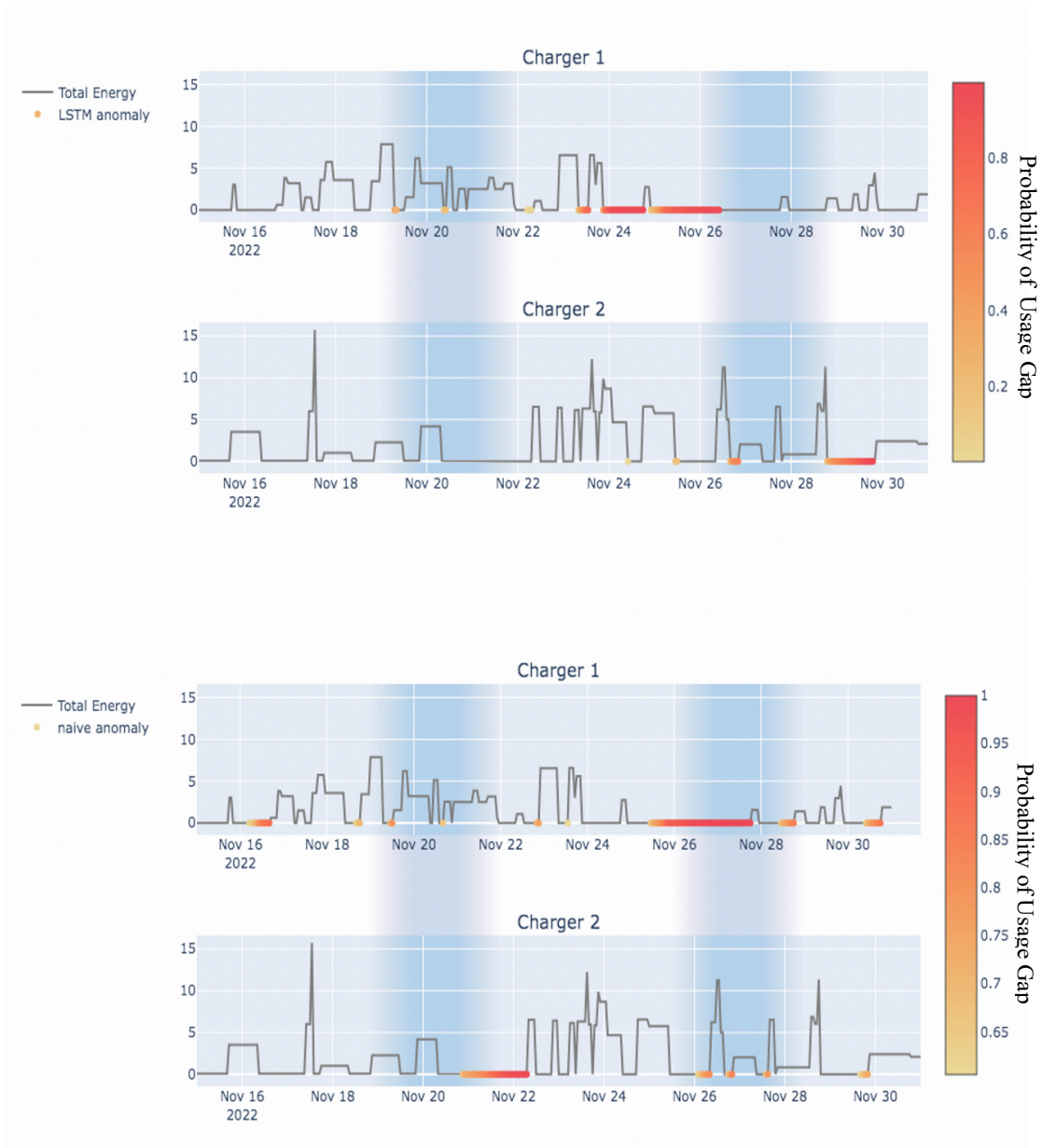

Figure 42 Residential Charging Usage Gaps

Figure 42 illustrates the detected charging gaps for the residential charging location. Charger 1 exhibited 94 hours of charging gaps, resulting in a 13.6% reduction in uptime. On the other hand, Charger 2 experienced 52 hours of charging gaps, leading to a 7.2% reduction in uptime. The average length of the detected gaps for both chargers was approximately 10 hours.

Moreover, both chargers encountered a maximum gap exceeding 30 hours.

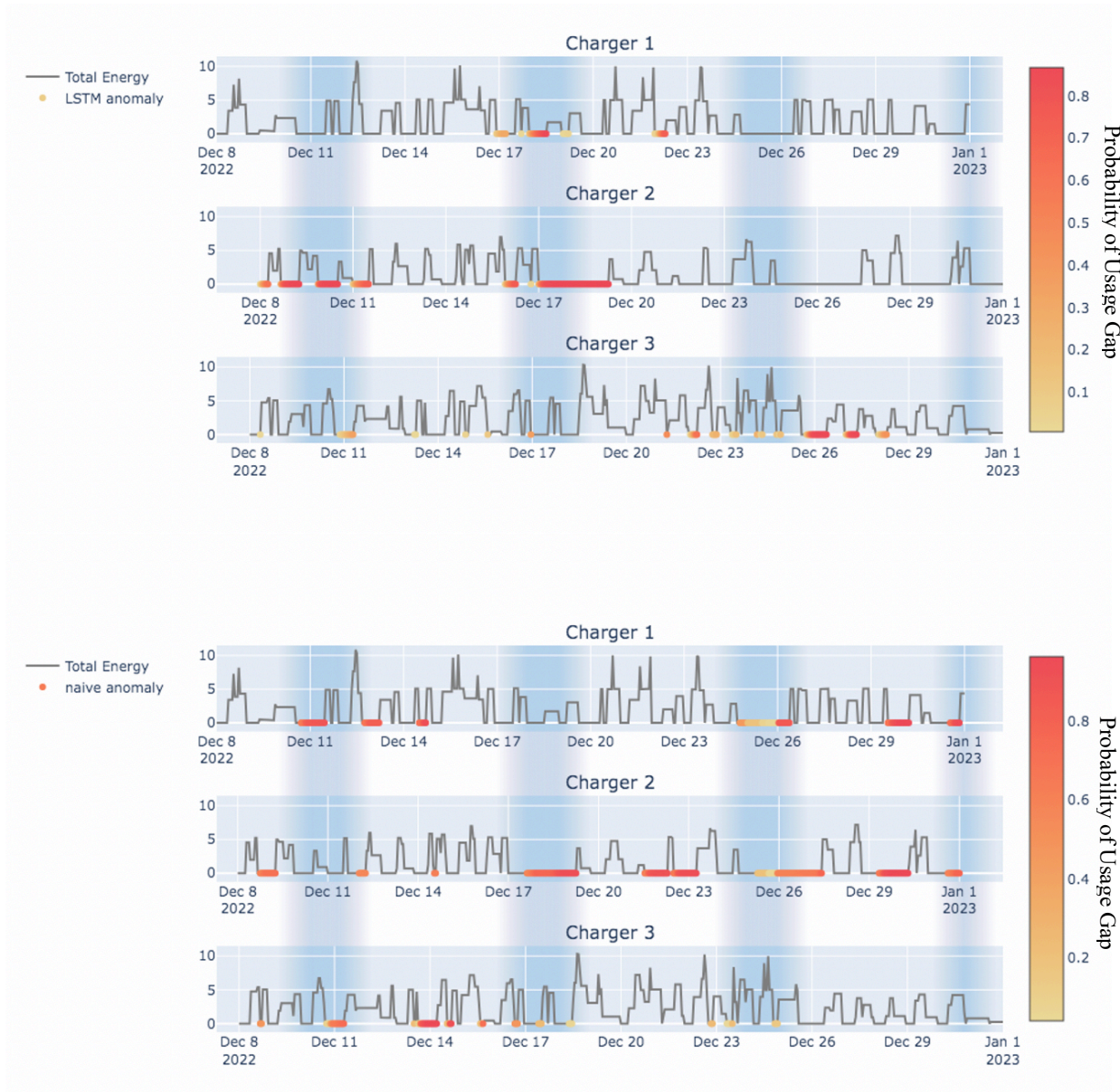

Figure 43 Commercial Charging Usage Gaps

Figure 43 depicts the detected charging gaps for the commercial charging location. Charger 1 had 101 hours of charging gaps, resulting in a 13.58% reduction in uptime. Charger 2 and Charger 3 experienced 185 hours and 57 hours of charging gaps, leading to 25% and 7.66%

reductions in uptime, respectively. The average length of the detected gaps for Charger 1 and Charger 2 was over 15 hours, while for Charger 3, it was approximately 4 hours. Additionally, both Charger 1 and Charger 2 encountered maximum gaps exceeding 30 hours.

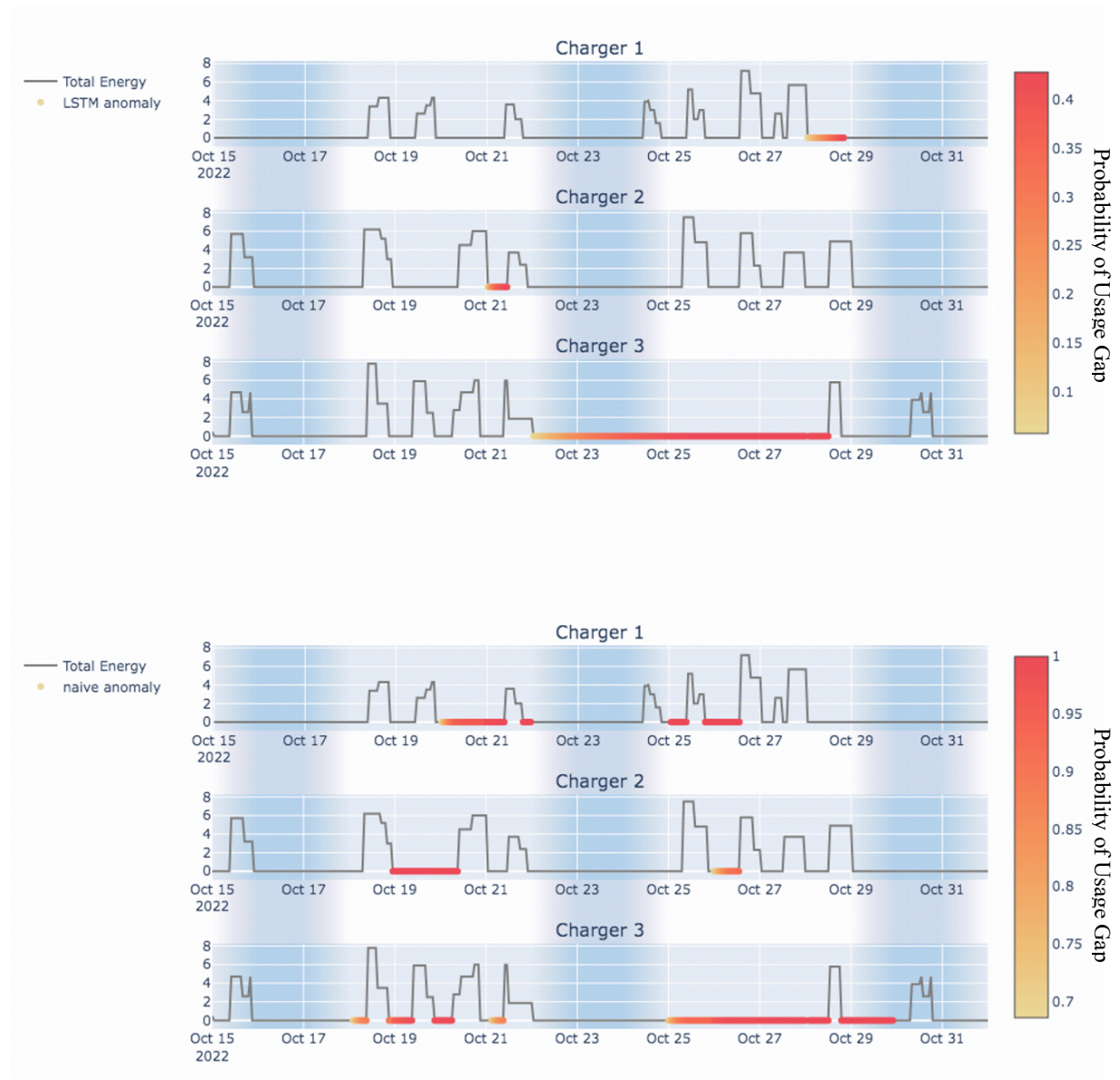

Figure 44 Workplace Charging Usage Gaps

Figure 44 illustrates the detected charging gaps for the workplace charging location. Charger 1 exhibited 67 hours of charging gaps, resulting in a 9% reduction in uptime. For Charger 2 and Charger 3, the detected charging gaps were 49 hours and 159 hours, leading to 6.59% and 29% reductions in uptime, respectively. The average length of the detected gaps for Charger 2 and Charger 3 was over 20 hours, while for Charger 1, it was closer to 15 hours. Moreover, all three chargers experienced maximum gaps exceeding 30 hours.

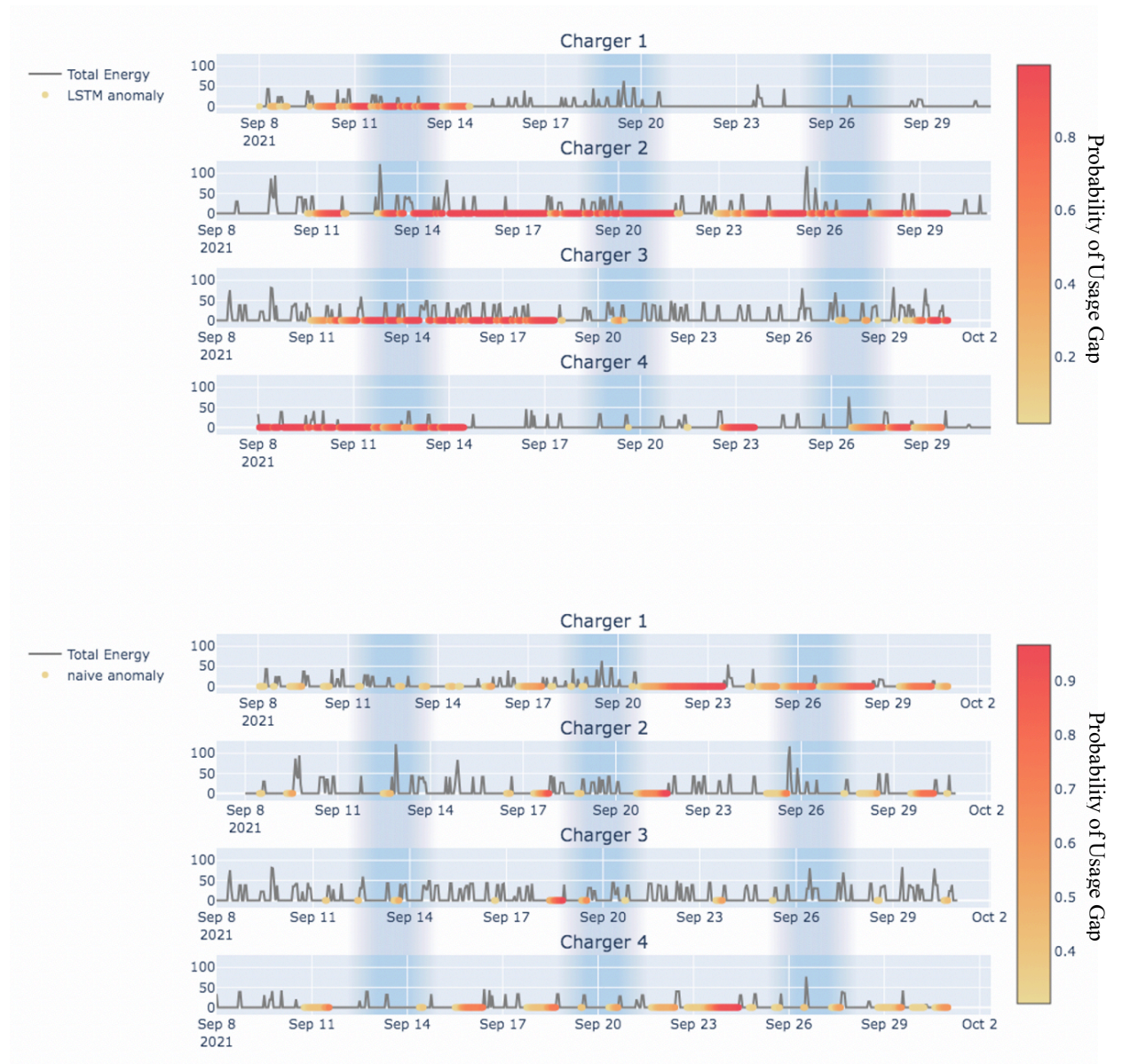

Figure 45 Corridor DC Fast Charging Usage Gaps

Figure 45 depicts the detected charging gaps for the DC Fast corridor charging location. Charger 1, charger 2, and charger 4 exhibited charging gaps exceeding 100 hours, resulting in uptime reductions ranging from 16% to 38%. Notably, the average length of the detected gaps for all chargers remained under 15 hours. However, the maximum gap length varied significantly, ranging from 11 hours to 68 hours.

Potential Benefits of using Tool

In this section, we estimate the potential time savings for repairs at various confidence intervals, determined by the usage gap probabilities of detected gaps, if CPOs deploy this tool in real-time. **Figure 46** illustrates a detected charging gap for a residential charger in our study. The green line represents the hourly probability distribution of charging on a weekday for the charger, while the brown line represents the energy dispensed by the charger on a specific weekday.

For this charger, a gap was detected between hours 5 PM and 11 PM. At 6:40 PM, the probability of an anomalous usage gap between 5 PM to 6:40 PM (for the past hour and 40 minutes) is over 0.5. So, if we translate the 0.5 gap probability to a 50% confidence level, we can estimate that the tool will notify the CPO of the gap within an hour and 40 minutes, potentially reducing the gap's length by 4 hours and 20 minutes or 72% with a 50% confidence level. Similarly, at 7:55 PM, the probability of an anomalous usage gap between 5 PM to 7:55 PM (for the past two hours and 55 minutes) is over 0.75. So, if we translate the 0.75 gap probability to a 75% confidence level, we can estimate that the tool will notify the CPO of the gap within two hours and 55 minutes, potentially reducing the gap's length by 3 hours and 5 minutes or 51%. the tool will notify the CPO of the gap within two hours and 55 minutes, potentially reducing the gap's length by 3 hours and 5 minutes or 51% with a 75% confidence level. And at 9:22 PM, , the probability of an anomalous usage gap between 5 PM to 9:22 PM (for the past four hours and 22 minutes) is over 0.90. So, if

we translate the 0.90 gap probability to a 90% confidence level, we can estimate that the tool will notify the CPO of the gap within four hours and 22 minutes, potentially reducing the gap's length by 1 hour and 38 minutes or 27%.

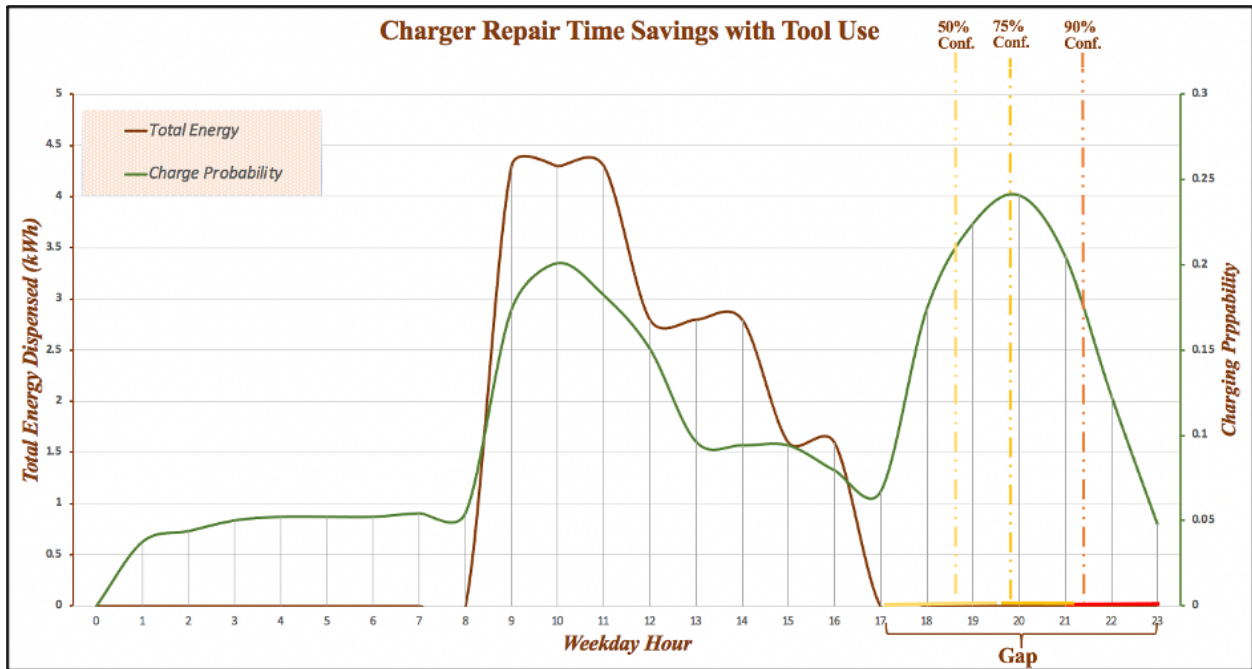

Figure 46 Charger Repair Time Savings with Tool Use

Figure 47 depicts the total gap hours for all chargers in each charging location by default and with the use of the tool at various confidence intervals. The gap hour estimation with tool use assumes that the potentially faulty charger will be fixed by the CPO within an hour of detection. As expected, the lower the confidence level, the greater the reduction in gap hours. For all chargers, at 50% confidence level, the naïve gaps hours were reduced by 62% and the LSTM gaps by 68%. At 75% confidence level, the naïve gaps hours were reduced by 43% and the LSTM gaps by 50%. At 90% confidence level, the naïve gaps hours were reduced by 28% and the LSTM gaps by 46%.



Figure 47 Total Detected Gap Hours with and without Tool Use

Figure 48 depicts the average gap duration for all chargers in each charging location by default and with the use of the tool at various confidence intervals. The average gap duration estimation with tool use assumes that the potentially faulty charger will be fixed by the CPO within an hour of detection. As expected, the lower the confidence level, the greater the reduction in gap length. For all chargers, at 50% confidence level, on average, the average gap length for gaps detected by the naïve method was reduced by 66% and the equivalent reduction for gaps detected by the LSTM method was 59%. For all chargers, at 75% confidence level, on average, the average gap length for gaps detected by the naïve method was reduced by 50% and the equivalent reduction for gaps detected by the LSTM method was 45%. For all chargers, at 90% confidence level, on

average, the average gap length for gaps detected by the naïve method was reduced by 35% and the equivalent reduction for gaps detected by the LSTM method was 34%.

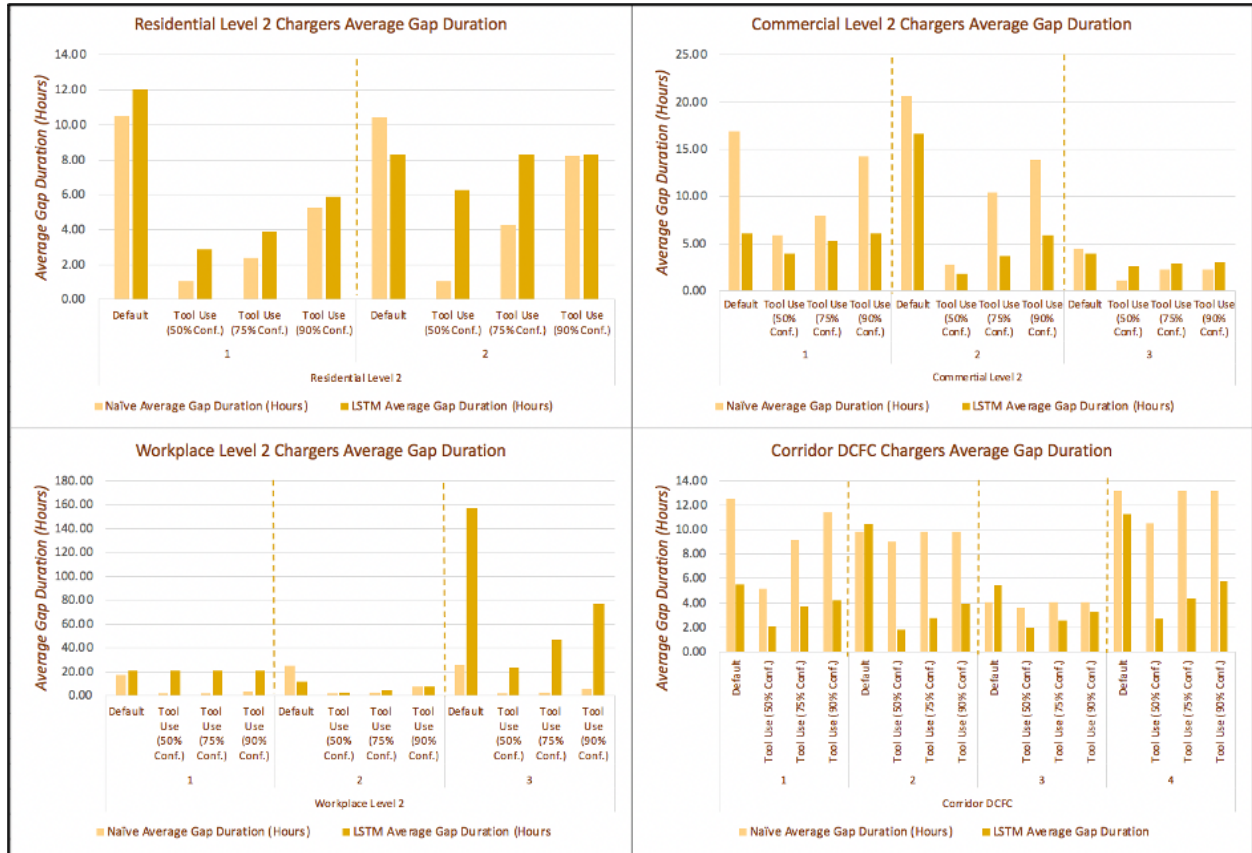

Figure 48 Average Gap Duration with and without Tool Use

5.6 Discussion

The goal of this study was to develop a tool that leverages the routine usage patterns of EV chargers to effectively identify charging faults that may not be captured by traditional reliability measures. To achieve this, we explore the utilization of two anomaly detection models as the foundation of our tool. The first tool model is a naïve probability distribution-based technique, which effectively identifies anomalies occurring outside the normal charging behavior probability

distribution of chargers. The second model is an LSTM autoencoder, a deep learning technique known for its ability to model and comprehend complex patterns in sequential data.

We demonstrated the use of our tool by detecting anomalous charging usage gaps from real-world charging data collected from 12 chargers in California. The reduction in uptime resulting from detected anomalies ranges between 6% and 38%, with a mean reduction of 16% for the naïve method. For the LSTM method, the reduction ranges from 1.5% to 49%, with a mean reduction of 16%. By utilizing the tool to detect charging gaps in real-time and promptly responding to potential charging faults, CPOs could effectively reduce both uptime losses and charger fault resolution times to different extents, depending on their preferred gap confidence level of the tool. With a 50% confidence level, CPOs could detect gaps, on average, three times faster using the naïve method and 2.4 times faster using the LSTM method. With a 75% confidence level, CPOs could detect gaps, on average, 2 times faster using the naïve method and 1.8 times faster using the LSTM method. At a 90% confidence level, CPOs would detect gaps, on average, 1.5 times faster using both the naïve and LSTM methods. These findings indicate that the tool can provide valuable insights to improve the operation and maintenance of chargers.

The CEC is developing uptime recordkeeping and reporting standards for electric vehicle charging stations that received public funding [143]. The standards will address charger interoperability and payment system failures prior to installation, while charger and network failures and internal payment system failures will be addressed through performance standards and monitoring [143]. Remote and physical monitoring options are being considered, such as implementing an operative status of charge, conducting random field inspections, and requiring preventive maintenance. The tool developed in this study could aid CPOs to effectively meet these impending reliability standards.

CPOs can use the tool to monitor their charging infrastructure in real-time and detect any charge failures that may not have been captured via their internal fault detection protocols. Charge failures that are technically invisible to CPOs include network communication failures, blocked access, physically broken cable/equipment, and other unknown failures that cannot be captured via remote monitoring systems. By using this tool, CPOs can quickly detect these invisible charge failures and take the necessary actions to fix them before an EV driver encounters the same issue and reports it. The CPO can set up alerts and notifications to be sent out when an anomaly is detected, allowing them to take immediate action. Additionally, the tool can provide insights into the usage patterns of the charging infrastructure, allowing the CPO to make informed decisions about where to add more charging stations or when to perform maintenance on existing ones.

It's important to note that fault detection isn't enough to thwart all charging infrastructure reliability concerns. Lack of stakeholder profit incentives, unclear division of responsibilities, lack of accountability, and lack of performance monitoring can significantly delay or impede fault resolution [144]. As such, measures should be taken to better define business models, operational structures, and incentives that can enable the reliable operation of EV charging infrastructure. Governments should encourage CPOs to provide access to data for hosts and third-party service providers to facilitate fault diagnostic and performance monitoring platforms. CPOs should make the charging process frictionless by eliminating the need for initiating a charge or logging in using apps or RFID cards [145]. All charge points should be mandated to have roaming SIM network providers and standardized communication restoration and synchronization processes to reduce the frequency and duration of lost communication [145]. The business models of charger ownership and operation should be carefully considered, particularly around public EV charging tariffs to provide sufficient revenue for maintenance and servicing [145]. Stakeholders should

Increase training and recruitment of accredited EV charging repair workforce to avoid increased times to repair charge points.

5.7 Conclusion & Future Direction

Reliable and functional electric vehicle chargers are crucial for the widespread adoption of EVs. By proactively advocating for stricter EV charger reliability requirements, jurisdictions can ensure that the installed chargers are functional and meet the expectations of EV drivers, ultimately facilitating the global transition to EVs. While uptime is the most commonly used metric to measure the reliability of EV chargers, it fails to capture all the technological and logistical challenges within the charging ecosystem that ultimately determine the true reliability of chargers as perceived by consumers. In this study, we develop a tool that leverages the habitual usage patterns of EV chargers to effectively identify potential charger faults that may not be captured by traditional reliability measures. We explore using two anomaly detection models as the foundation of the tool: a naive probability distribution-based technique and a LSTM autoencoder, known for modelling complex patterns in sequential data. We demonstrated the use of our tool by detecting anomalous charging usage gaps from real-world charging data collected from a dozen chargers in California.

The reduction in uptime resulting from detected anomalies ranges between 6% and 38%, with a mean of 16% for the naïve method, and between 1.5% and 49%, with a mean of 16% for the LSTM method. Depending on the preferred confidence level of the tool, using the naïve method, CPOs could have detected charging faults 1.5 to 3 times faster, and using the LSTM method, they could have detected charging faults 1.5 to 2.4 times faster. These findings indicate that the tool can provide valuable insights to improve the operation and maintenance of chargers. There are various ways to enhance the capability of our tool. One possible method is to include

supplementary data sources beyond habitual charging patterns, such as weather forecasts, traffic patterns, and power outage maps. This proactive approach may help identify potential charger failures caused by external factors before they occur rather than retrospectively. Additionally, a closer integration of the tool with the charging infrastructure may be beneficial. If charging stations were equipped with sensors capable of detecting cable damage or port malfunction, this information could be fed directly into the tool, resulting in quicker identification of potential failures. Furthermore, if the tool were able to communicate directly with the charging infrastructure, it could trigger automated maintenance or repair processes to resolve issues more efficiently. Despite the significant progress made by our tool in identifying EV charger reliability issues, further improvement could be achieved by incorporating more data sources and seamlessly integrating with the charging infrastructure. While our tool has made significant progress in identifying EV charger reliability issues., we can further improve its capabilities by incorporating additional data sources and integrating it seamlessly with the charging infrastructure.

While the developed tool uses two anomaly detection models to identify charging usage gaps, the thresholds used to classify these gaps as anomalies are initially set intuitively, without empirical evidence. This may cause the tool to detect either too many or too few gaps, affecting its reliability in identifying actual charger faults. To enhance the tool's effectiveness, it needs calibration using real-world charging data. During future phases of this project, the tool will be deployed in various charging infrastructure environments, continuously collecting data on charging patterns and charger performance. The tool's algorithms and thresholds will be fine-tuned based on continuous evaluation during this calibration phase. Data from this process will be used to validate the tool's detections and improve its accuracy in identifying genuine charge failures while reducing false positives.

Chapter 6: Conclusion

This dissertation aims to explore some of the key barriers to realizing the full emission reduction potential of PEVs. Specifically, it explores the tradeoffs between BEVs and PHEVs at reducing tailpipe emissions in the presence of an imperfect EV charging infrastructure. BEVs have the greatest potential for emission reduction due to their exclusive reliance on a battery and electric motor for propulsion power, regardless of interactions between driver inputs and technical parameters. However, their adoption relies on the state of the EV charging infrastructure, which is currently inadequate to fully support them. Conversely, PHEVs provide drivers with flexibility, particularly in areas lacking in comprehensive charging networks, as they possess a backup gas engine. However, the emission reduction capability of PHEVs hinges heavily on the interaction between technical parameters and driver behavior with several studies revealing that drivers aren't leveraging PHEV technology in a manner that maximizes the utilization of their electric range.

Chapter 2 explores the characteristics, triggers, and frequencies of various types of PHEV engine starts in order to gauge the emission potential of multiple PHEV models, spanning a wide range of specifications and drivetrain configurations. For the most part, engine starts are invoked due to low battery SOC for all PHEV vehicle models analyzed. The engine starts that were not linked to low battery SOC were typically invoked by high power requirements that the vehicles' all-electric propulsion systems could not meet. Vehicles with low all-electric range and battery capacity (such as the Prius Plug-in) were more likely than vehicles with high all-electric range and battery capacity (such as the Volt) to instantiate the engine during a high power demand. Ultimately, the study found that long range PHEVs with high battery capacity such as the Chevrolet Volt are ideal for both curbing start emissions via logging very few engine starts and maximizing fuel displacement. Additional analysis should be conducted to quantify the emissions

associated with the engine starts identified in this study to reinforce our conclusions. Future studies should consider exploring the charging behavior between trips, in addition to driving behavior, to figure out the ideal engine start time to maximize fuel displacement and minimize engine start emissions.

Chapter 3 introduces two studies that aim to understand the motivations and implications of driver mode usage in PHEVs. In addition to comprehensively defining and classifying various drive modes, the study presented in chapter 3.3 examines the motivations for drive mode usage using a survey of over 26,000 PEV drivers in California. The study presented in chapter 3.4 quantifies the energy use and emission impacts of drive mode usage using on-road vehicle data from 81 Chevy Volts driven in California.

Chapter 3.3 finds that not all drive modes were directly designed to affect vehicle emissions, however, each mode has the potential to alter energy use and emissions output. Three mode types (*all-electric*, *efficiency*, and *hybrid*) prioritize the use of the electric motor, resulting in an expected positive impact on vehicle efficiency. Three mode types are designed to increase power or alter driving experience (*engine recharge*, *speedy*, and *rugged*). Use of these modes is expected to result in decreased vehicle efficiency. Drive modes categorized as *hold* or *other* have case specific efficiency potentials as their impacts are highly dependent on driver behavior. Gender, age, and the number of long-distance trips are the variables most commonly associated with mode usage. Across all mode types, men are found to be more likely than women to have used drive modes. Age was a significant indicator of mode use for *all electric*, *hold*, *speedy*, and any modes, with younger drivers found to be more likely to use modes than older drivers. For *hold*, *engine recharge*, *speedy*, and any modes, the likelihood of using modes increased as the number of trips over 200 miles per year increased. For the use of any mode type, Toyota drivers were found

to be the most strongly linked to use of the modes, followed by BMW drivers, Chevrolet drivers, then the Ford drivers. Differences in mode use between makes may be attributable to variations in factors such as advertising, education, ease of use, or user interfaces.

Chapter 3.4 reveals that Chevrolet Volt drivers do not use their vehicles' propulsion adjustment drive modes (Hold and Mountain Mode) as intended by the manufacturers. Hold Mode maintains the battery's charge level while using the gasoline engine for propulsion. It is intended to be used during high-speed driving on long trips where the battery is expected to be fully depleted. Its use often results in an underutilization of the vehicle's electric range, suggesting improper use. Mountain Mode uses the gasoline engine to maintain battery state of charge. It is intended to be used briefly before steep inclines; however, it is rarely used correctly, with less than 1% of users activating it 20 minutes before steep climbs as recommended. The misuse of drive modes in Chevrolet Volt vehicles leads to a 15-30% increase in energy usage and higher engine start emissions. Results from a regression model for trip-level net energy revealed the use of Mountain Mode and Hold Mode is linked to substantially higher energy usage, even after controlling for other variables that strongly impact energy use. **Figure 19** Additional energy use from time spent in Mountain and Hold Mode illustrates the impact of Hold and Mountain Mode use on energy consumption per mile at various driving speeds. It shows that, in comparison to driving in the vehicle's default configuration, Hold Mode increases energy consumption by 175% at 0-25 mph, while Mountain Mode increases energy consumption by over 200%. Moreover, most driver-induced mode trips recorded more engine starts than trips that used normal mode. Improper drive mode usage, especially unnecessary Hold Mode usage, could lead to higher local emissions from an increased frequency of engine starts.

Chapter 4 presents a study that evaluates the impact of public charger reliability on EV driver experience. It uses real-world EV charging data to simulate the level of disruption that would've occurred to EV drivers had their successful charging sessions been unsuccessful. Additionally, it quantifies how many charging sessions were actually unsuccessful and qualifies how disruptive those unsuccessful charging sessions were to drivers. The study finds that EV charging sessions are not all equally important as the level of disruption associated with each simulated and actual unsuccessful charge substantially varies. In around 65% of charging sessions, a hypothetical charge failure results in very little disruption. In the remaining 35% of charging sessions, a hypothetical charge failure can force drivers to completely alter their habitual/planned charging behavior. Moreover, in around 3% of charging sessions, drivers were one unsuccessful charging session away from being stranded. 7% of all logged charging sessions were actually unsuccessful. Most of these unsuccessful charging sessions led to low levels of disruption but in 2 sessions, drivers ended up being stranded. Charging sessions linked to high levels of potential disruption were associated with LDT, low battery state of charge and lack of access to home charging. The study suggests that stakeholders should have more nuanced charging reliability standards to more effectively meet actual consumer charging needs. They need to enforce more stringent reliability standards for critical chargers i.e., chargers that are associated with high charge failure rates and/or high levels of potential disruption from charge failures.

Chapter 5 introduces a tool that leverages the habitual usage patterns of EV chargers to effectively identify potential charger faults that may not be captured by traditional reliability measures. The chapter explores using two anomaly detection models as the foundation of the tool: a naive probability distribution-based technique and a Long Short-Term Memory Network (LSTM), known for modelling complex patterns in sequential data. The use of the tool is

demonstrated by detecting anomalous charging usage gaps from real-world charging data collected from a dozen chargers in California. The reduction in uptime resulting from detected anomalies ranges between 6% and 38%, with a mean of 16% for the naïve method, and between 1.5% and 49%, with a mean of 16% for the LSTM method. Depending on the preferred confidence level of the tool, using the naïve method, CPOs could have detected charging faults 1.5 to 3 times faster, and using the LSTM method, they could have detected charging faults 1.5 to 2.4 times faster. These findings indicate that the tool can provide valuable insights to improve the operation and maintenance of chargers. While our tool has made significant progress in identifying EV charger reliability issues., we can further improve its capabilities by incorporating additional data sources and integrating it seamlessly with the charging infrastructure. While the developed tool uses two anomaly detection models to identify charging usage gaps, the thresholds used to classify these gaps as anomalies are initially set intuitively, without empirical evidence. This may cause the tool to detect either too many or too few gaps, affecting its reliability in identifying actual charger faults. To enhance the tool's effectiveness, it needs to be calibrated using real-world charging data.

References

- [1] IEA, “Transport – Topics - IEA,” 2020. [Online]. Available: <https://www.iea.org/topics/transport>. [Accessed: 13-Jul-2021].
- [2] CARB, “Zero-Emission Vehicle Program | California Air Resources Board.” [Online]. Available: <https://ww2.arb.ca.gov/our-work/programs/zero-emission-vehicle-program>. [Accessed: 25-Feb-2021].
- [3] Y. Zhou, M. Wang, H. Hao, L. Johnson, H. Wang, and H. Hao, “Plug-in electric vehicle market penetration and incentives: a global review,” *Mitig. Adapt. Strateg. Glob. Chang.*, vol. 20, no. 5, pp. 777–795, 2015.
- [4] S. Srinivasa Raghavan and G. Tal, “Influence of User Preferences on the Revealed Utility Factor of Plug-In Hybrid Electric Vehicles,” *World Electr. Veh. J.*, vol. 11, no. 1, p. 6, Dec. 2019.
- [5] A. Searle, Stephanie; Isenstadt, “DON’T PLUG IN YOUR PLUG-IN HYBRID? EPA WILL NOW HOLD AUTOMAKERS RESPONSIBLE.,” *International Council on Clean Transportation*, 2023. .
- [6] J. Hiller, “Why America Doesn’t Have Enough EV Charging Stations - WSJ,” *The Wall Street Journal*, 2022.
- [7] J.D. Power, “2022 U.S. Electric Vehicle Experience (EVX) Public Charging Study | J.D. Power.” [Online]. Available: <https://www.jdpower.com/business/press-releases/2022-us-electric-vehicle-experience-evx-public-charging-study>. [Accessed: 09-Feb-2023].
- [8] J.D. Power, “Public Charging Experience for Electric Vehicle Owners Can Get Much Better, J.D. Power Finds,” 18-Aug-2021. [Online]. Available: <https://www.jdpower.com/business/press-releases/2021-us-electric-vehicle-experience-evx-public-charging-study>. [Accessed: 21-Dec-2021].
- [9] M. R. Bernard, “Improving public charging infrastructure reliability,” *International Council on Clean Transportation*, 2023. [Online]. Available: <https://theicct.org/wp-content/uploads/2023/03/public-charging-reliability-mar23.pdf>. [Accessed: 14-Apr-2023].
- [10] J. Davies and K. S. Kurani, “Moving from assumption to observation: Implications for energy and emissions impacts of plug-in hybrid electric vehicles,” *Energy Policy*, vol. 62,

pp. 550–560, Nov. 2013.

- [11] R. Suarez-Bertoa *et al.*, “Effect of Low Ambient Temperature on Emissions and Electric Range of Plug-In Hybrid Electric Vehicles,” 2019.
- [12] “How GM, Ford, Tesla are tackling the national EV charging challenge.” [Online]. Available: <https://www.cnbc.com/2022/06/20/how-gm-ford-tesla-are-tackling-the-national-ev-charging-challenge.html>. [Accessed: 26-Jul-2022].
- [13] Tim Levin, “How my first road trip in an electric car almost ended in disaster,” *Business Insider*, 23-Nov-2021. [Online]. Available: <https://www.businessinsider.com/ev-electric-car-ford-mustang-mach-e-road-trip-charging-2021-8>. [Accessed: 21-Dec-2021].
- [14] Jennifer Sensiba, “Charger Reliability Is The Next Challenge For The EV Industry,” *CleanTechnica*, 21-Apr-2021. [Online]. Available: <https://cleantechnica.com/2021/04/21/charger-reliability-is-the-next-challenge-for-the-ev-industry/>. [Accessed: 21-Dec-2021].
- [15] “5 Reasons Battery-Electric Vehicle Road Trip Range Stinks | Torque News.” [Online]. Available: <https://www.torquenews.com/1083/5-reasons-ev-road-trip-range-60-or-less-maximum-range-possible>. [Accessed: 26-Jul-2022].
- [16] “I rented an electric car for a 4-day road trip. I spent more time charging it than I did sleeping. | Fox Business.” [Online]. Available: <https://www.foxbusiness.com/lifestyle/electric-car-four-day-trip-more-time-charging-sleeping>. [Accessed: 26-Jul-2022].
- [17] “Woman’s Road Trip Highlights Issues Taking EV Cross-Country.” [Online]. Available: <https://www.businessinsider.com/electric-car-road-trip-highlights-issues-driving-cross-country-charging-2022-6>. [Accessed: 26-Jul-2022].
- [18] “Can a Big Western Road Trip Be Done in an Electric Car? - Outside Online.” [Online]. Available: <https://www.outsideonline.com/adventure-travel/essays/tesla-electric-car-road-trip-test/>. [Accessed: 26-Jul-2022].
- [19] “Lessons from an Electric Vehicle Road Trip - ZETA.” [Online]. Available: <https://www.zeta2030.org/insights/joes-electric-road-trip-across-america>. [Accessed: 26-Jul-2022].

- [20] “‘We ruined the weekend!’ Electric car owners share their stories about EV road trips.” [Online]. Available: <https://thedriven.io/2021/12/23/i-ruined-the-weekend-electric-cars-owners-share-their-stories-about-ev-road-trips/>. [Accessed: 26-Jul-2022].
- [21] California Energy Commission, “California Energy Commission Zero Emission Vehicle Infrastructure Statistics,” 2020. [Online]. Available: https://tableau.cnra.ca.gov/t/CNRA_CEC/views/DMVDataPortal_15986380698710/STOCK_Dashboard?:showAppBanner=false&:display_count=n&:showVizHome=n&:origin=viz_share_link&:isGuestRedirectFromVizportal=y&:embed=y. [Accessed: 25-Nov-2020].
- [22] M. S. Reiter and K. M. Kockelman, “The problem of cold starts: A closer look at mobile source emissions levels,” *Transp. Res. Part D Transp. Environ.*, vol. 43, pp. 123–132, Mar. 2016.
- [23] California Air Resources Board, “Volume III - Technical Documentation,” 2018.
- [24] A. Pham and M. Jeftic, “Characterization of Gaseous Emissions from Blended Plug-In Hybrid Electric Vehicles during High-Power Cold-Starts,” *SAE Tech. Pap.*, vol. 2018-April, pp. 1–9, 2018.
- [25] M. Duoba, H. Lohse-Busch, and E. Rask, “PHEV engine operational considerations for criteria emissions control and low fuel consumption,” in *2011 IEEE Vehicle Power and Propulsion Conference, VPPC 2011*, 2011.
- [26] G. Tal *et al.*, “Advanced Plug-in Electric Vehicle Travel and Charging Behavior Final Report,” 2020.
- [27] United States, “Www.fueleconomy.gov,” *U.S. Dept. of Energy, Energy Efficiency and Renewable Energy*, 2000. [Online]. Available: <http://www.fueleconomy.gov/>.
- [28] “<https://www.edmunds.com/>,” *Edmunds.com, Inc.* [Online]. Available: <https://www.edmunds.com/>.
- [29] M. S. Smith and T. A. Butcher, “How Far Should Parkers Have to Walk?,” *Parking* 47, 2008. [Online]. Available: https://www.gsweventcenter.com/GSW_RTC_References/2008_05_Smith-Butcher.pdf. [Accessed: 24-Jul-2020].
- [30] Y. Yang and A. V. Diez-Roux, “Walking distance by trip purpose and population

- subgroups,” *Am. J. Prev. Med.*, vol. 43, no. 1, pp. 11–19, Jul. 2012.
- [31] R. Watanabe, S. Hirate, T. Ibuki, Y. Sakayanagi, and M. Sampei, “Route-optimized drive mode switching control for plug-in hybrid vehicles: Controller design and experimental validation,” in *CCTA 2020 - 4th IEEE Conference on Control Technology and Applications*, 2020, pp. 207–212.
- [32] S. S. Raghavan and G. Tal, “Plug-in hybrid electric vehicle observed utility factor: Why the observed electrification performance differ from expectations,” *International Journal of Sustainable Transportation*. 2020.
- [33] M. S. Alam and A. McNabola, “A critical review and assessment of Eco-Driving policy & technology: Benefits & limitations,” *Transp. Policy*, vol. 35, pp. 42–49, Sep. 2014.
- [34] T. Bouman and L. Steg, “Motivating Society-wide Pro-environmental Change,” *One Earth*, vol. 1, no. 1, pp. 27–30, Sep. 2019.
- [35] W. T. Lai, “The effects of eco-driving motivation, knowledge and reward intervention on fuel efficiency,” *Transp. Res. Part D Transp. Environ.*, vol. 34, pp. 155–160, Jan. 2015.
- [36] C. Andrieu and G. Saint Pierre, “Using statistical models to characterize eco-driving style with an aggregated indicator,” in *IEEE Intelligent Vehicles Symposium, Proceedings*, 2012, pp. 63–68.
- [37] T. Franke, M. G. Arend, R. C. McIlroy, and N. A. Stanton, “What drives ecodriving? Hybrid electric vehicle drivers’ goals and motivations to perform energy efficient driving behaviors,” in *Advances in Intelligent Systems and Computing*, 2017, vol. 484, pp. 451–461.
- [38] M. Cristea, F. Paran, and P. Delhomme, “The Role of Motivations for Eco-driving and Social Norms on Behavioural Intentions Regarding Speed Limits and Time Headway,” *World Acad. Sci. Eng. Technol. Int. J. Econ. Manag. Eng.*, 2007.
- [39] A. B. Ünal, L. Steg, and M. Gorsira, “Values Versus Environmental Knowledge as Triggers of a Process of Activation of Personal Norms for Eco-Driving,” *Environ. Behav.*, vol. 50, no. 10, pp. 1092–1118, Dec. 2018.
- [40] M. Günther, C. Kacperski, and J. F. Krems, “Can electric vehicle drivers be persuaded to eco-drive? A field study of feedback, gamification and financial rewards in Germany,”

Energy Res. Soc. Sci., vol. 63, p. 101407, May 2020.

- [41] T. Stillwater and K. S. Kurani, “Drivers discuss ecodriving feedback: Goal setting, framing, and anchoring motivate new behaviors,” *Transp. Res. Part F Traffic Psychol. Behav.*, vol. 19, pp. 85–96, Jul. 2013.
- [42] C. K. Chau, K. Elbassioni, and C. M. Tseng, “Drive Mode Optimization and Path Planning for Plug-In Hybrid Electric Vehicles,” *IEEE Trans. Intell. Transp. Syst.*, vol. 18, no. 12, pp. 3421–3432, Dec. 2017.
- [43] C. K. Chau, K. Elbassioni, and C. M. Tseng, “Fuel minimization of plug-in hybrid electric vehicles by optimizing drive mode selection,” in *Proceedings of the 7th International Conference on Future Energy Systems, e-Energy 2016*, 2016, pp. 1–11.
- [44] M. G. Arend and T. Franke, “Eco-Drivers and Eco-Automation: A Case Study with Hybrid Electric Vehicle Drivers,” 2021.
- [45] B. Krahé and I. Fenske, “Predicting Aggressive Driving Behavior: The Role of Macho Personality, Age, and Power of Car,” *Aggress. Behav.*, vol. 28, no. 1, pp. 21–29, 2001.
- [46] A. Ingale, P. Sahu, R. Bajpai, A. Maji, and A. Sarkar, “Understanding Driver Behavior at Intersection for Mixed Traffic Conditions Using Questionnaire Survey,” *Transp. Res.*, vol. 45, pp. 647–661, 2020.
- [47] R. Fernandes, R. F. S. Job, and J. Hatfield, “A challenge to the assumed generalizability of prediction and countermeasure for risky driving: Different factors predict different risky driving behaviors,” *J. Safety Res.*, vol. 38, no. 1, pp. 59–70, Jan. 2007.
- [48] J. Cestac, F. Paran, and P. Delhomme, “Young drivers’ sensation seeking, subjective norms, and perceived behavioral control and their roles in predicting speeding intention: How risk-taking motivations evolve with gender and driving experience,” *Saf. Sci.*, vol. 49, no. 3, pp. 424–432, Mar. 2011.
- [49] D. Shinar, E. Schechtman, and R. Compton, “Self-reports of safe driving behaviors in relationship to sex, age, education and income in the US adult driving population,” *Accid. Anal. Prev.*, vol. 33, no. 1, pp. 111–116, Jan. 2001.
- [50] P. Barla, M. Gilbert-Gonthier, M. A. Lopez Castro, and L. Miranda-Moreno, “Eco-driving training and fuel consumption: Impact, heterogeneity and sustainability,” *Energy Econ.*,

- vol. 62, pp. 187–194, Feb. 2017.
- [51] T. Franke, M. G. Arend, R. C. McIlroy, and N. A. Stanton, “Ecodriving in hybrid electric vehicles - Exploring challenges for user-energy interaction,” *Appl. Ergon.*, vol. 55, pp. 33–45, Jul. 2016.
- [52] J. H. Lee, S. J. Hardman, and G. Tal, “Who is buying electric vehicles in California? Characterising early adopter heterogeneity and forecasting market diffusion,” *Energy Res. Soc. Sci.*, vol. 55, pp. 218–226, Sep. 2019.
- [53] N. Jakobsson, T. Gnann, P. Plötz, F. Sprei, and S. Karlsson, “Are multi-car households better suited for battery electric vehicles? – Driving patterns and economics in Sweden and Germany,” *Transp. Res. Part C Emerg. Technol.*, vol. 65, pp. 1–15, Apr. 2016.
- [54] J. Axsen and K. S. Kurani, “Who can recharge a plug-in electric vehicle at home?,” *Transp. Res. Part D Transp. Environ.*, vol. 17, no. 5, pp. 349–353, Jul. 2012.
- [55] A. F. Jensen and S. L. Mabit, “The use of electric vehicles: A case study on adding an electric car to a household,” *Transp. Res. Part A Policy Pract.*, vol. 106, pp. 89–99, Dec. 2017.
- [56] G. Tal, K. Kurani, A. Jenn, D. Chakraborty, S. Hardman, and D. Garas, “Electric Cars in California: Policy and Behavior Perspectives,” 2020. .
- [57] T. Leeper, J. Arnold, V. Arel-Bundock, and J. Long, “margins: Marginal Effects for Model Objects.,” 2021. .
- [58] M. Nicholas, “Estimating electric vehicle charging infrastructure costs across major U.S. metropolitan areas,” 2019.
- [59] Chevrolet, “VOLT Owner’s Manual,” 2019. .
- [60] S. Li, R. Glass, and H. Records, “The Influence of Gender on New Technology Adoption and Use-Mobile Commerce,” *J. Internet Commer.*, vol. 7, no. 2, pp. 270–289, 2008.
- [61] O. US EPA, “Dynamometer Drive Schedules.”
- [62] U.S. EPA, “Fuel Economy Data.” [Online]. Available: <https://www.fueleconomy.gov/feg/download.shtml>. [Accessed: 22-Apr-2021].
- [63] V. Chaitanya Karanam and G. Tal, “Emission Implications of Plug-in Hybrid Electric Vehicles Through an Empirical Exploration of Engine Starts,” *Transp. Res. Rec. J. Transp.*

Res. Board, p. 036119812110038, Mar. 2021.

- [64] P. Dzikiy, “BMW PHEVs will have forced geofenced EV mode in emission-free zones, rewards,” *Electrek*, 2019. [Online]. Available: <https://electrek.co/2019/06/25/bmw-phev-ev-mode/>. [Accessed: 22-Apr-2021].
- [65] Federal Highway Administration, “Federal Register :: National Electric Vehicle Infrastructure Standards and Requirements,” 2023. [Online]. Available: <https://www.federalregister.gov/documents/2023/02/28/2023-03500/national-electric-vehicle-infrastructure-standards-and-requirements>. [Accessed: 14-Apr-2023].
- [66] E. Standards Staff, “ELECTRIC VEHICLE SUPPLY EQUIPMENT STANDARDS TECHNOLOGY REVIEW,” 2022.
- [67] D. Rempel, C. Cullen, M. Matteson Bryan, and G. Vianna Cezar, “Reliability of EV Direct Current Fast Chargers Reliability of Open Public Electric Vehicle Direct Current Fast Chargers.”
- [68] “Electric Vehicle Supply Equipment/System.” [Online]. Available: <https://www.nema.org/membership/products/view/electric-vehicle-supply-equipment-system>. [Accessed: 07-Sep-2023].
- [69] “What Are EV Charger Types, Levels and Modes?” [Online]. Available: <https://www.aptiv.com/en/insights/article/what-are-ev-charger-types-levels-and-modes>. [Accessed: 26-Jul-2022].
- [70] S. Hardman *et al.*, “A review of consumer preferences of and interactions with electric vehicle charging infrastructure,” *Transp. Res. Part D Transp. Environ.*, vol. 62, pp. 508–523, Jul. 2018.
- [71] “2017 Midterm Review Report | California Air Resources Board.” [Online]. Available: <https://ww2.arb.ca.gov/resources/documents/2017-midterm-review-report>. [Accessed: 26-Jul-2022].
- [72] E. Figenbaum, “Perspectives on Norway’s supercharged electric vehicle policy,” *Environ. Innov. Soc. Transitions*, vol. 25, pp. 14–34, Dec. 2017.
- [73] J. G. Smart and S. D. Salisbury, “Plugged In: How Americans Charge Their Electric Vehicles,” Jul. 2015.

- [74] P. Morrissey, P. Weldon, and M. O'Mahony, "Future standard and fast charging infrastructure planning: An analysis of electric vehicle charging behaviour," *Energy Policy*, vol. 89, pp. 257–270, Feb. 2016.
- [75] L. H. Björnsson and S. Karlsson, "Plug-in hybrid electric vehicles: How individual movement patterns affect battery requirements, the potential to replace conventional fuels, and economic viability," *Appl. Energy*, vol. 143, pp. 336–347, Apr. 2015.
- [76] T. Franke and J. F. Krems, "Understanding charging behaviour of electric vehicle users," *Transp. Res. Part F Traffic Psychol. Behav.*, vol. 21, pp. 75–89, Nov. 2013.
- [77] "Charging for Charging at Work: Increasing the Availability of Charging Through Pricing." [Online]. Available: <https://trid.trb.org/view/1339540>. [Accessed: 26-Jul-2022].
- [78] "Daytime Charging: What Is the Hierarchy of Opportunities and Customer Needs? Case Study Based on Atlanta Commute Data." [Online]. Available: <https://trid.trb.org/view/1289891>. [Accessed: 26-Jul-2022].
- [79] J. Stark *et al.*, "Electric Vehicles with Range Extenders: Evaluating the Contribution to the Sustainable Development of Metropolitan Regions," *J. Urban Plan. Dev.*, vol. 144, no. 1, p. 04017023, Nov. 2017.
- [80] G. Tal, M. A. Nicholas, J. Davies, and J. Woodjack, "Charging Behavior Impacts on Electric Vehicle Miles Traveled: Who is Not Plugging In?," <https://doi.org/10.3141/2454-07>, vol. 2454, pp. 53–60, Jan. 2014.
- [81] J. Axsen and K. S. Kurani, "Hybrid, plug-in hybrid, or electric—What do car buyers want?," *Energy Policy*, vol. 61, pp. 532–543, Oct. 2013.
- [82] J. Bailey, A. Miele, and J. Axsen, "Is awareness of public charging associated with consumer interest in plug-in electric vehicles?," *Transp. Res. Part D Transp. Environ.*, vol. 36, pp. 1–9, May 2015.
- [83] "I am not an environmental wacko! Getting from early plug-in vehicle owners to potential later buyers." [Online]. Available: <https://trid.trb.org/view/1339003>. [Accessed: 26-Jul-2022].
- [84] E. Graham-Rowe *et al.*, "Mainstream consumers driving plug-in battery-electric and plug-in hybrid electric cars: A qualitative analysis of responses and evaluations," *Transp. Res.*

- Part A Policy Pract.*, vol. 46, no. 1, pp. 140–153, Jan. 2012.
- [85] S. Skippon and M. Garwood, “Responses to battery electric vehicles: UK consumer attitudes and attributions of symbolic meaning following direct experience to reduce psychological distance,” *Transp. Res. Part D Transp. Environ.*, vol. 16, no. 7, pp. 525–531, Oct. 2011.
- [86] J. Dong, C. Liu, and Z. Lin, “Charging infrastructure planning for promoting battery electric vehicles: An activity-based approach using multiday travel data,” *Transp. Res. Part C Emerg. Technol.*, vol. 38, pp. 44–55, Jan. 2014.
- [87] “Learning from Norwegian Battery Electric and Plug-in Hybrid Vehicle users – Results from a survey of vehicle owners - Transportøkonomisk institutt.” [Online]. Available: <https://www.toi.no/publications/learning-from-norwegian-battery-electric-and-plug-in-hybrid-vehicle-users-results-from-a-survey-of-vehicle-owners-article33869-29.html>. [Accessed: 26-Jul-2022].
- [88] M. Neaimeh, S. D. Salisbury, G. A. Hill, P. T. Blythe, D. R. Scoffield, and J. E. Francfort, “Analysing the usage and evidencing the importance of fast chargers for the adoption of battery electric vehicles,” *Energy Policy*, vol. 108, pp. 474–486, Sep. 2017.
- [89] “California Statewide Charging Assessment Model for Plug-in Electric Vehicles: Learning from Statewide Travel Surveys.” [Online]. Available: <https://escholarship.org/uc/item/3qz440nr>. [Accessed: 26-Jul-2022].
- [90] P. Plötz and S. A. Funke, “Mileage electrification potential of different electric vehicles in Germany,” 2017.
- [91] N. Shahraki, H. Cai, M. Turkay, and M. Xu, “Optimal locations of electric public charging stations using real world vehicle travel patterns,” *Transp. Res. Part D Transp. Environ.*, vol. 41, pp. 165–176, Dec. 2015.
- [92] C. Weiller, “Plug-in hybrid electric vehicle impacts on hourly electricity demand in the United States,” *Energy Policy*, vol. 39, no. 6, pp. 3766–3778, Jun. 2011.
- [93] “DC Fast as the Only Public Charging Option? Scenario Testing from GPS-Tracked Vehicles.” [Online]. Available: <https://trid.trb.org/view/1130070>. [Accessed: 26-Jul-2022].
- [94] K. Kinsey, E. O’grady, and J. Way, “BUILDING RELIABLE EV CHARGING

NETWORKS: MODEL STATE GRANT AND PROCUREMENT CONTRACT PROVISIONS FOR PUBLIC EV CHARGING.”

- [95] “Quality and Reliability Matter When It Comes to EV Chargers.” [Online]. Available: <https://www.aptiv.com/en/insights/article/quality-and-reliability-matter-when-it-comes-to-ev-chargers>. [Accessed: 26-Jul-2022].
- [96] A. Unterweger, F. Knirsch, D. Engel, D. Musikhina, A. Alyousef, and H. de Meer, “An analysis of privacy preservation in electric vehicle charging,” *Energy Informatics*, vol. 5, no. 1, pp. 1–27, Dec. 2022.
- [97] “What to Do When Your Electric Car Runs Out of Power - Bloomberg.” [Online]. Available: <https://www.bloomberg.com/news/articles/2022-05-21/what-to-do-when-your-electric-car-runs-out-of-power>. [Accessed: 26-Jul-2022].
- [98] G. Tal *et al.*, “Emerging Technology Zero Emission Vehicle Household Travel and Refueling Behavior (CARB Contract 16RD009),” 2021.
- [99] B. Xu, A. W. Davis, and G. Tal, “Estimating the Total Number of Workplace and Public Electric Vehicle Chargers in California:,” <https://doi.org/10.1177/03611981211031214>, vol. 2675, no. 12, pp. 759–770, Aug. 2021.
- [100] S. Hardman and G. Tal, “Understanding discontinuance among California’s electric vehicle owners,” *Nat. Energy*, vol. 6, no. 5, pp. 538–545, May 2021.
- [101] “Common Error Codes for EV Stations - Santella Electric.” [Online]. Available: <https://santellaelectricinc.com/common-error-codes-for-ev-stations/>. [Accessed: 14-Apr-2023].
- [102] “IC/RC/ICL Series Faults and Error Codes – Delta-Q Technologies Corp.” [Online]. Available: <https://support.delta-q.com/hc/en-us/articles/360044018472-IC-RC-ICL-Series-Faults-and-Error-Codes>. [Accessed: 14-Apr-2023].
- [103] S. Schmidl, P. Wenig, T. Papenbrock, and T. Papenbrock Anomaly, “Anomaly Detection in Time Series: A Comprehensive Evaluation,” vol. 15, no. 9, pp. 2150–8097, 2022.
- [104] P. Arumugam and R. Saranya, “Outlier Detection and Missing Value in Seasonal ARIMA Model Using Rainfall Data,” *Mater. Today Proc.*, vol. 5, no. 1, pp. 1791–1799, 2018.
- [105] S. Basu and M. Meckesheimer, “Knowledge and Information Systems Automatic outlier

- detection for time series: an application to sensor data,” *Knowl Inf Syst*, vol. 11, no. 2, pp. 137–154, 2007.
- [106] A. Hanbanchong and K. Piromsopa, “SARIMA based network bandwidth anomaly detection,” *JCSSE 2012 - 9th Int. Jt. Conf. Comput. Sci. Softw. Eng.*, pp. 104–108, 2012.
- [107] A. Aboode, “Anomaly Detection in Time Series Data Based on Holt-Winters Method,” *DEGREE Proj. Comput. Sci. Eng.*, 2018.
- [108] Q. Chen, A. Zhang, • Tingwen Huang, Q. He, and Y. Song, “Imbalanced dataset-based echo state networks for anomaly detection.”
- [109] “Proceedings: ESANN 2015 - Google Books.” [Online]. Available: https://books.google.com/books?hl=en&lr=&id=USGLCgAAQBAJ&oi=fnd&pg=PA89&dq=Pankaj+Malhotra,+Lovekesh+Vig,+Gautam+Shroff,+and+Puneet+Agarwal.+2015.+Long+Short+Term+Memory+Networks+for+Anomaly+Detection+in+Time+Series&ots=FtjhhvE_UK&sig=xFVwb_uHGVz-LbXb85maMIthbOk#v=onepage&q&f=false. [Accessed: 18-Mar-2023].
- [110] H. Zhao *et al.*, “Multivariate Time-series Anomaly Detection via Graph Attention Network.”
- [111] K. Hundman, V. Constantinou, C. Laporte, I. Colwell, and T. Soderstrom, “Detecting Spacecraft Anomalies Using LSTMs and Nonparametric Dynamic Thresholding,” *KDD*, vol. 18.
- [112] N. Heim and J. E. Avery, “ADAPTIVE ANOMALY DETECTION IN CHAOTIC TIME SERIES WITH A SPATIALLY AWARE ECHO STATE NETWORK A PREPRINT,” 2019.
- [113] Y. Yu, Y. Zhu, S. Li, and D. Wan, “Time series outlier detection based on sliding window prediction,” *Math. Probl. Eng.*, vol. 2014, 2014.
- [114] R. Paffenroth, K. Kay, and L. Servi, “Robust PCA for Anomaly Detection in Cyber Networks.”
- [115] M. Shyu, S. Chen, K. Sarinnapakorn, and L. Chang, “A Novel Anomaly Detection Scheme Based on Principal Component Classifier,” 2003.
- [116] M. Sakurada and T. Yairi, “Anomaly Detection Using Autoencoders with Nonlinear

- Dimensionality Reduction,” 2014.
- [117] Z. Li, W. Chen, and D. Pei, “Robust and Unsupervised KPI Anomaly Detection Based on Conditional Variational Autoencoder,” *2018 IEEE 37th Int. Perform. Comput. Commun. Conf. IPCCC 2018*, Jul. 2018.
- [118] H. Xu *et al.*, “Unsupervised Anomaly Detection via Variational Auto-Encoder for Seasonal KPIs in Web Applications,” p. 12, 2018.
- [119] P. Malhotra, A. Ramakrishnan, G. Anand, L. Vig, P. Agarwal, and G. Shroff, “LSTM-based Encoder-Decoder for Multi-sensor Anomaly Detection.”
- [120] D. Park, Y. Hoshi, and C. C. Kemp, “A Multimodal Anomaly Detector for Robot-Assisted Feeding Using an LSTM-based Variational Autoencoder.”
- [121] C. Zhang *et al.*, “A Deep Neural Network for Unsupervised Anomaly Detection and Diagnosis in Multivariate Time Series Data,” *Proc. AAAI Conf. Artif. Intell.*, vol. 33, no. 01, pp. 1409–1416, Jul. 2019.
- [122] Y. Su, Y. Zhao, C. Niu, R. Liu, W. Sun, and D. Pei, “Robust Anomaly Detection for Multivariate Time Series through Stochastic Recurrent Neural Network.”
- [123] H. Ren *et al.*, “Time-Series Anomaly Detection Service at Microsoft,” vol. 19, 2019.
- [124] A. Bashar and R. Nayak, “TAnoGAN: Time Series Anomaly Detection with Generative Adversarial Networks.”
- [125] A. Ogbechie, J. Díaz-Rozo, P. Larrañaga, and C. Bielza, “Dynamic Bayesian Network-Based Anomaly Detection for In-Process Visual Inspection of Laser Surface Heat Treatment,” *Mach. Learn. Cyber Phys. Syst.*, pp. 17–24, 2017.
- [126] J. Li, W. Pedrycz, and I. Jamal, “Multivariate time series anomaly detection: A framework of Hidden Markov Models,” *Appl. Soft Comput. J.*, vol. 60, pp. 229–240, Nov. 2017.
- [127] A. Siffer, P. A. Fouque, A. Termier, and C. Largouet, “Anomaly detection in streams with extreme value theory,” *Proc. ACM SIGKDD Int. Conf. Knowl. Discov. Data Min.*, vol. Part F129685, pp. 1067–1075, Aug. 2017.
- [128] Z. Li, Y. Zhao, N. Botta, C. Ionescu, and X. Hu, “COPOD: Copula-Based Outlier Detection.”
- [129] M. Thill, W. Konen, and T. Bäck, “Time Series Anomaly Detection with Discrete Wavelet

Transforms and Maximum Likelihood Estimation.”

- [130] M. Goldstein and A. Dengel, “Histogram-based Outlier Score (HBOS): A fast Unsupervised Anomaly Detection Algorithm.”
- [131] A. Ryzhikov, M. Borisyak, A. Ustyuzhanin, and D. Derkach, “NFAD: fixing anomaly detection using normalizing flows.”
- [132] M. M. Breunig, H. P. Kriegel, R. T. Ng, and J. Sander, “LOF: Identifying Density-Based Local Outliers,” *SIGMOD 2000 - Proc. 2000 ACM SIGMOD Int. Conf. Manag. Data*, pp. 93–104, 2000.
- [133] J. Tang, Z. Chen, A. W. C. Fu, and D. W. Cheung, “Enhancing Effectiveness of Outlier Detections for Low Density Patterns,” *Lect. Notes Comput. Sci. (including Subser. Lect. Notes Artif. Intell. Lect. Notes Bioinformatics)*, vol. 2336, pp. 535–548, 2002.
- [134] Z. He, X. Xu, and S. Deng, “Discovering cluster-based local outliers,” *Pattern Recognit. Lett.*, vol. 24, no. 9–10, pp. 1641–1650, 2003.
- [135] T. Yairi, Y. Kato, and K. Hori, “Fault Detection by Mining Association Rules from House-keeping Data,” *Can. Sp. Agency*, 2001.
- [136] S. Ramaswamy, R. Rastogi, and K. Shim, “Efficient algorithms for mining outliers from large data sets,” *SIGMOD Rec. (ACM Spec. Interes. Gr. Manag. Data)*, vol. 29, no. 2, pp. 427–438, 2000.
- [137] J. Ma and S. Perkins, “Time-series Novelty Detection Using One-class Support Vector Machines,” *IEEE*, 2003. [Online]. Available: https://ieeexplore.ieee.org/stamp/stamp.jsp?arnumber=1223670&casa_token=QTrjE_M6cMIAAAAA:UicmkT0Xznq0VMTMNybx_Nqz6W_y9CyjmRTK_7cKfOR4tG3LCs_1gVXT_gZtx6WwV-wWnz-WNznU. [Accessed: 19-Mar-2023].
- [138] H. Song, Z. Jiang, A. Men, and B. Yang, “A hybrid semi-supervised anomaly detection model for high-dimensional data,” *Comput. Intell. Neurosci.*, vol. 2017, 2017.
- [139] S. Hariri, M. C. Kind, and R. J. Brunner, “Extended Isolation Forest,” *IEEE Trans. Knowl. Data Eng.*, vol. 33, no. 4, pp. 1479–1489, Nov. 2018.
- [140] P.-F. Marteau, “Hybrid Isolation Forest-Application to Intrusion Detection,” 2017.
- [141] Z. Cheng, C. Zou, and J. Dong, “Outlier detection using isolation forest and local outlier,”

- Proc. 2019 Res. Adapt. Converg. Syst. RACS 2019*, pp. 161–168, Sep. 2019.
- [142] F. T. Liu, K. M. Ting, and Z. H. Zhou, “Isolation forest,” *Proc. - IEEE Int. Conf. Data Mining, ICDM*, pp. 413–422, 2008.
- [143] B. Fauble *et al.*, “California’s Deployment Plan for the National Electric Vehicle Infrastructure Program,” 2022.
- [144] “EV charger reliability could threaten adoption if maintenance challenges aren’t tackled - Current News.” [Online]. Available: <https://www.current-news.co.uk/ev-charger-reliability-could-threaten-adoption-if-maintenance-challenges-arent-tackled/>. [Accessed: 14-Apr-2023].
- [145] R. Sims and C. Edmunds, “Assure charge: a data driven approach to servicing and maintaining EV charge points,” pp. 888–892, Jul. 2022.