

Lawrence Berkeley National Laboratory

Lawrence Berkeley National Laboratory

Title

The Effect of Coenzyme A on the Metabolic Oxidation of Labeled Fatty Acids: Rate Studies, Instrumentation, and Liver Fractionation

Permalink

<https://escholarship.org/uc/item/5hv2s8r5>

Authors

Tolbert, B.M.
Hughes, Ann M.
Kirk, Martha R.
et al.

Publication Date

1955-04-18

UNIVERSITY OF CALIFORNIA

Radiation Laboratory
Berkeley, California

Contract No. W-7405-eng-48

EFFECT OF COENZYME A ON
THE METABOLIC OXIDATION OF LABELED FATTY ACIDS:
Rate Studies, Instrumentation, and Liver Fractionation
B. M. Tolbert, Ann M. Hughes, Martha R. Kirk, and M. Calvin

April 18, 1955

METABOLISM OF LABELED FATTY ACIDS

Contents

Abstract	3
Introduction	4
Materials and Methods	
Animals	5
Compounds	7
Radioactivity Determination	7
The Ionization Chamber	9
Electronic Equipment	9
The Gas Flow System	12
Calculations - Precision of Method	13
Results	17
Discussion	25
Fatty Acid Synthesis in the Liver	27
Experimental	27
Results	28
Conclusions	30
References	31

EFFECT OF COENZYME A ON
THE METABOLIC OXIDATION OF LABELED FATTY ACIDS:
Rate Studies, Instrumentation, and Liver Fractionation

B. M. Tolbert, Ann M. Hughes, Martha R. Kirk, and M. Calvin

Radiation Laboratory and Department of Chemistry,
University of California, Berkeley, California

April 18, 1955

ABSTRACT

The effect of pantothenic acid deficiency on the rate of $C^{14}O_2$ excretion and on distribution of radioactivity in liver fractions has been studied in rats given sodium acetate-2- C^{14} and sodium heptanoate-7- C^{14} . The rate of excretion of breath $C^{14}O_2$ has been measured by use of a method in which a sensitive ionization chamber and electrometer directly and continuously record carbon-14 excretion. The labeled fatty acids are more rapidly metabolized to $C^{14}O_2$ in PAD rats than in normal rats. CoA depresses the $C^{14}O_2$ excretion in both normal and PAD rats in experiments with either labeled acid. There are differences in the oxidation of these two fatty acids, and the differences are consistent with postulated metabolic schemes. CoA increases radioactivity deposited in the fat of the liver, but does not appreciably change the radioactivity incorporated in the protein and nonsaponifiable lipid fractions.

EFFECT OF COENZYME A ON
THE METABOLIC OXIDATION OF LABELED FATTY ACIDS:
Rate Studies, Instrumentation, and Liver Fractionation*

B. M. Tolbert, Ann M. Hughes, Martha R. Kirk, and M. Calvin

Radiation Laboratory and Department of Chemistry
University of California, Berkeley, California

April 18, 1955

INTRODUCTION

Of the several catabolic fates of carbon in animal systems, quantitatively the most important is breath excretion as carbon dioxide. While the excretion of carbon via this method serves as an excellent index of over-all metabolic level, it fails to give any information on the oxidative metabolism to CO_2 of specific compounds. This lack of specificity is overcome by the use of labeled compounds; the excretion of labeled carbon dioxide from specifically labeled metabolites is potentially one of the most important nondestructive tests that can be made in metabolic studies in living organisms.

The excretion of labeled carbon dioxide after administration of labeled compounds has been measured by many investigators. In general, the animal is placed in a closed cage, from which the air can be swept through a dilute sodium hydroxide solution. These solutions are periodically changed and the collected CO_2 precipitated--usually as the insoluble barium carbonate--filtered, dried, weighed, and analyzed for radioactivity. The method is time-consuming and only a limited number of samples may be taken. In order to simplify this procedure, the authors have devised an apparatus that, with a minimum of effort, will continuously measure and record C^{14} pulmonary excretion vs time. Equipment of the proper size for rats and mice is described in this paper. The equipment is simple and is basically capable of such expansion or contraction as to permit studies on very large animals, on one hand, or on individual insects, on the other.

The applications of such an instrument to an important biochemical problem are manifold. In order to investigate the possibilities of this technique, the authors have made a study of the catabolic oxidation of fatty acids. Acetic acid, in particular, has been used, as it is one of the most extensively studied

*The work described in this paper was sponsored by the U. S. Atomic Energy Commission.

compounds in biochemistry.^{1,2,3} A schematic diagram for the metabolism of the two-carbon moiety of acetic acid is given in Fig. 1. As indicated in this figure, Coenzyme A (CoA) is an important substrate in the metabolism of acetic acid or of fats in general. Since CoA is commercially available and rats may be made deficient in this coenzyme by feeding pantothenic-acid-free diets, all the needed tools are available for a biological rate study of the influence of Coenzyme A on the catabolic metabolism of $C^{14}O_2$ of labeled fatty acids in normal and pantothenic-acid-deficient (PAD) rats.

MATERIALS AND METHODS

Animals

Long-Evans rats, both male and female, were made pantothenic-acid-deficient by the method of Hurley and Morgan.⁴ The basic diet is a vitamin-free test diet,* supplemented by the oil-soluble and crystalline B vitamins, except pantothenic acid. Control animals were given the same diet plus calcium pantothenate. Experimental work started when the rats were five weeks old.

The livers from three groups of rats were assayed for CoA colorimetrically by arsenolysis of acetyl phosphate.⁵ Rats with and without CoA injected one hour previously were sacrificed by decapitation and allowed to bleed freely. The livers were removed and homogenized at 0°C. The homogenates were boiled in a water bath for five minutes and centrifuged. The supernatant was poured off, and stored as a frozen solution until just prior to assay. The results are shown in Table I.

The range of values for a normal animal is given by Olson and Kaplan⁶ as 135 to 205 units CoA/g wet liver, and for PAD rats the range is given as 55 to 135 units. The spread of our results is consistent with data of previous investigators and agrees with our observation that it was hard to define the degree of pantothenic acid deficiency in the experimental animals. It was also difficult to maintain this deficiency; two injections of 4 mg each of CoA in any deficient animal was sufficient to change permanently the respiratory metabolism patterns discussed later in this paper to a pattern characteristic of a normal animal.

* Vitamin B-Complex Test Diet (modified salts), General Biochemicals, Inc., Chagrin Falls, Ohio.

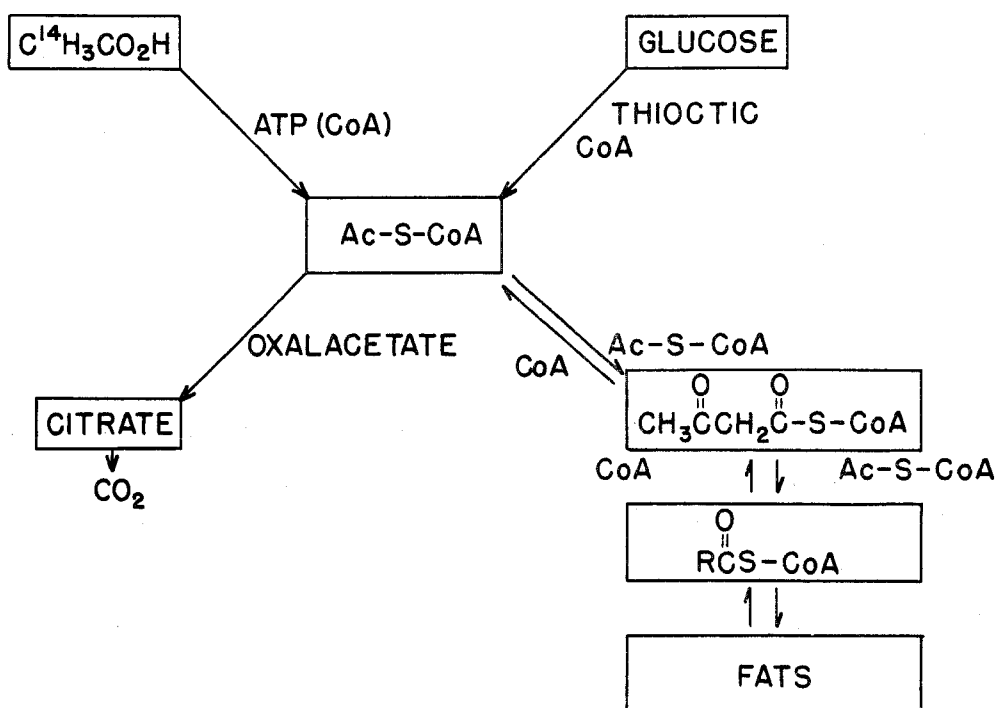

MU-6652

Fig. 1. Schematic diagram for the role of the two-carbon moiety in fatty acid metabolism.

Table I

Assay of CoA in Normal and PAD Rats

(Units CoA/g wet liver)

Normal Rats	PAD Rats	PAD Rats + 6 mg CoA
221	140	119
197	75	158
173	71	162
164	122	180
<hr/>	<hr/>	<hr/>
Average 189	102	155

Compounds

The two labeled fatty acids studied were sodium acetate-2-C¹⁴ (5.85 μ c/mg)⁷ and sodium heptanoate-7-C¹⁴ (4.8 μ c/mg).⁸ The compounds were checked for purity by paper chromatography in propanol-ammonia-water and gave only one radioactive spot, thus indicating a radiochemical purity of 99%. Equivalent-weight determination and C and H analyses confirmed the macropurity of these salts.

The Coenzyme A, a commercial preparation,* was about 65% active material. The same sample of CoA was used for each series of experiments in order to eliminate dose variations arising from variation in CoA purity.

Radioactivity Determination

The total activity of C¹⁴ in the breath per unit of time was measured by means of an ionization chamber assay unit and plotted directly on a recorder chart. The area under the curve was integrated with a polar planimeter and the total C¹⁴ for any desired interval of time was determined.

The equipment needed for this measurement is diagrammatically represented in Fig. 2 and consists of a flow system, an ionization chamber, a

*Pabst Laboratories, Milwaukee, Wisconsin.

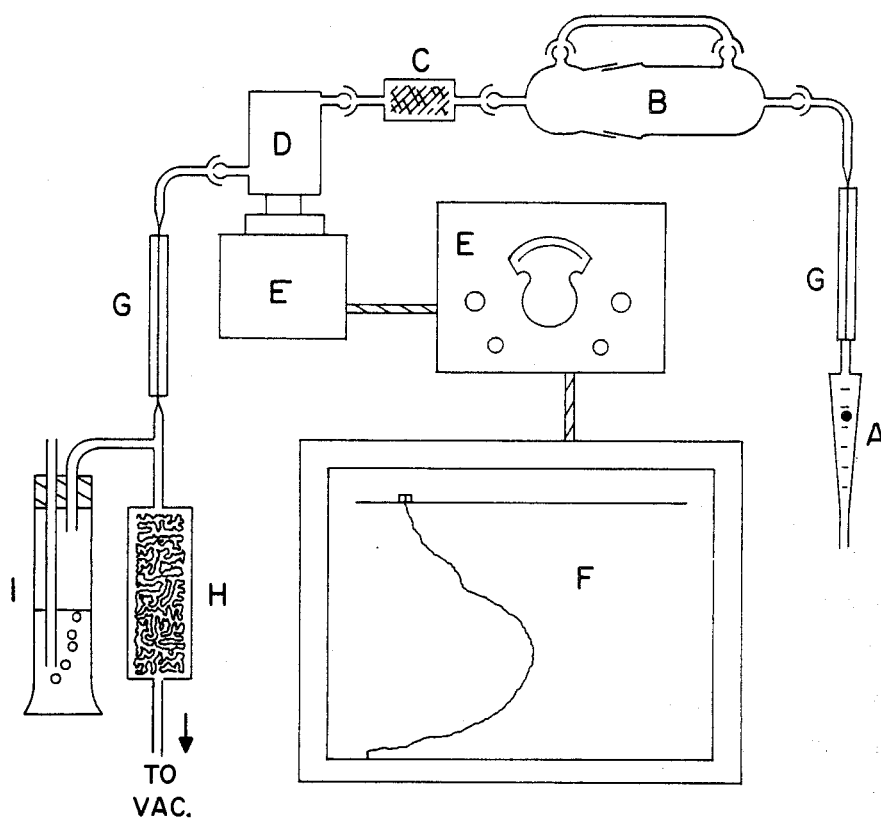

MU-8955

Fig. 2. Apparatus used to measure and record breath $C^{14}O_2$ activity

- | | |
|-------------------------------|---------------------------------|
| A - gas flowmeter | E - vibrating-reed electrometer |
| B - mouse or rat cage | F - recorder |
| C - $Mg(ClO_4)_2$ dryer | G - capillary tubing |
| D - ionization chamber | H - soda lime CO_2 absorber |
| I - constant-pressure bubbler | |

vibrating-reed electrometer, * and a potentiometer recorder. **

The Ionization Chamber

The design of the ionization chamber was derived from that of equipment in current use for low-level assay of carbon,^{9,10,11} and uses a sapphire insulator base manufactured by the Applied Physics Corp. * The chamber is sketched in Fig. 3 and is constructed of stainless steel because of this metal's low alpha-contamination and corrosion-resistance characteristics.

The volume of the chambers (115 to 125 cc) was measured gasometrically as well as by weight of water. An electron collection potential of 90 volts was used, although 5 to 10 volts was sufficient to collect all the electron charges. The radioactivity calibration of the chamber was done empirically under conditions designed to reproduce the gas conditions during an experiment as closely as possible. For this procedure, a tank of 2% CO₂-in-air was prepared with a specific activity of 1.75×10^{-4} $\mu\text{c/cc}$. The activity of this tank gas was carefully determined by use of ion chambers calibrated against National Bureau of Standards sodium carbonate-C¹⁴. This gas was used to determine a chamber-calibration constant that included all the fixed variables in the system.

Electronic Equipment

The ionization chamber is mounted on a vibrating-reed electrometer equipped with a grounding resistor of 10^{12} ohms. † The electrometer is connected to a recording potentiometer ** reading from 0 to 100 with the chart set to move six inches per hour.

In operation, the electrons produced in the ionization chamber by the β -particles (approximately 1,000 to 1,500 per average carbon-14 β -particle) are collected on the center electrode (see Fig. 4). This flow of electrons acts as a current source and creates an equilibrium potential for the center electrode that is proportional to the value of the grounding resistor and the rate of electron production. This equilibrium value is measured by the electrometer and plotted by the recorder.

The rate at which this electrical equilibrium value is reached is directly proportional to the grounding resistance and the effective capacity of the

* Model 30, Applied Physics Corp., Pasadena, California.
** Brown "Elektronik" potentiometer recorder, Brown Instrument Division, Minneapolis-Honeywell Regulator Company, Philadelphia, Pennsylvania.
† Victoreen hi-megohm resistors. Victoreen Company, Cleveland, Ohio.

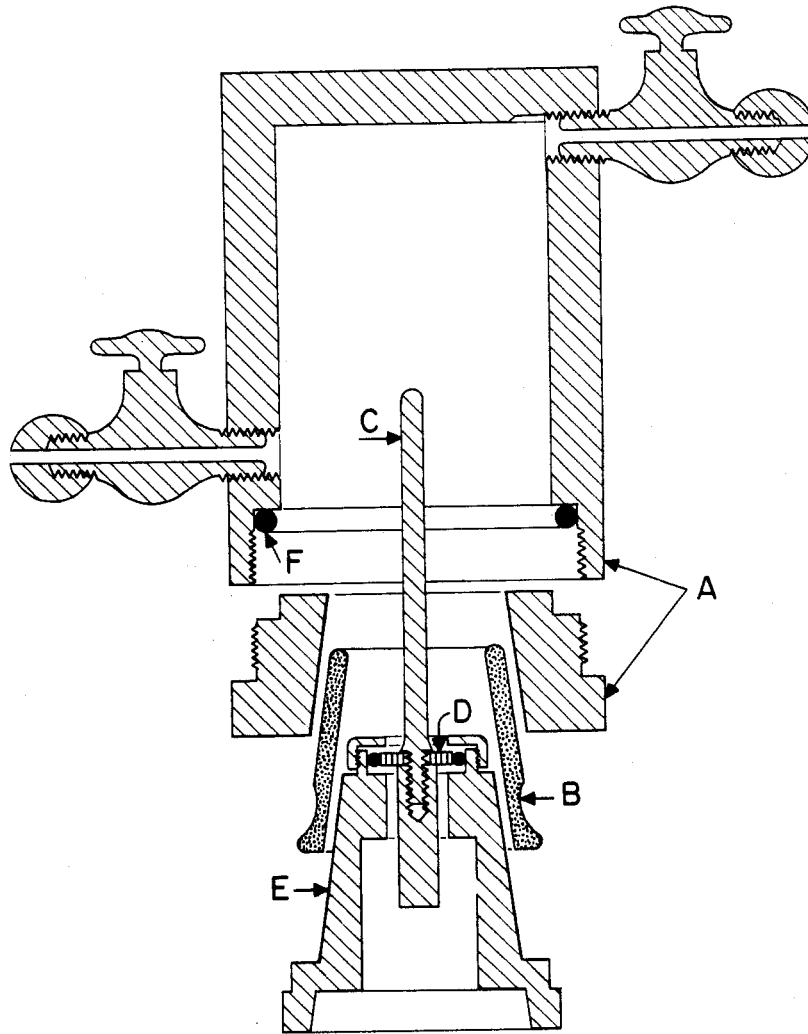

MU-8956

Fig. 3. Ionization chamber

- A - stainless steel body with connecting valves and 18/9 spherical joints
- B - glass inner-outer S adapter
- C - center probe
- D - sapphire insulator
- E - brass base
- F - O-ring seal

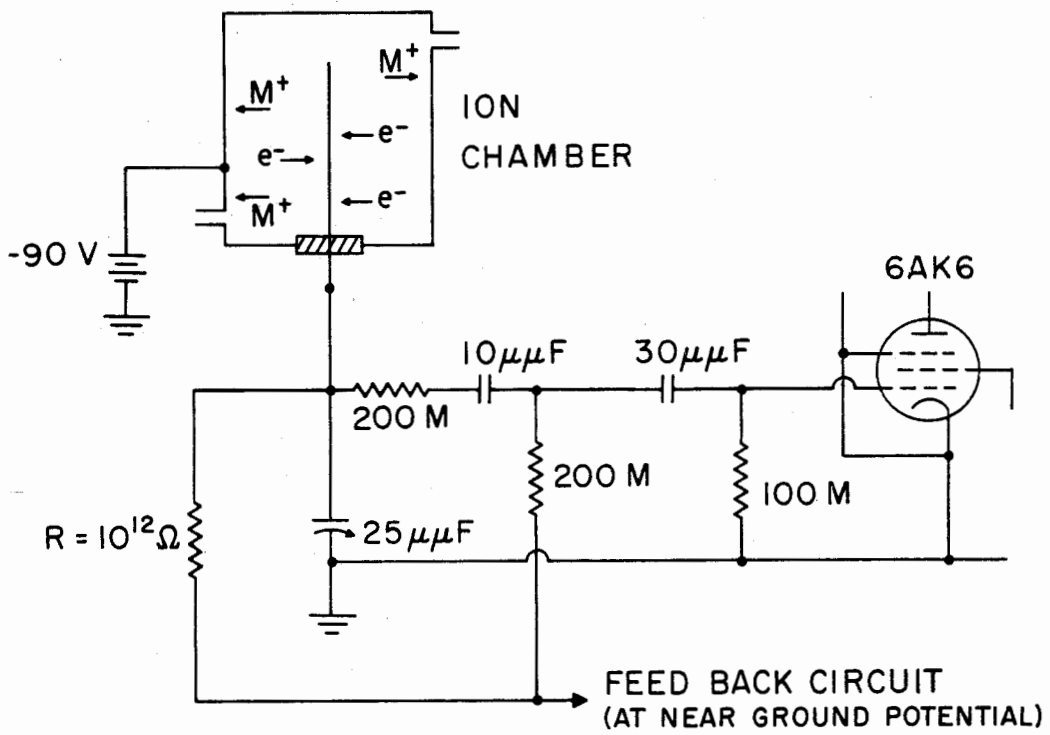

MU-8957

Fig. 4. Simplified schematic diagram of first-stage circuit of electrometer and ionization chamber.

electrometer head:

$$t = RC,$$

where t = seconds for condenser to reach 63% of equilibrium voltage

C = capacitance in farads

R = grounding resistance in ohms

The time for the system to reach 99% of equilibrium value is given by $t = 4.60 RC$. * Since the electrometer head has an effective capacity of about 10 micromicro-farads (10^{-11} farads), three-quarters of a minute is needed to reach 99% of equilibrium value when the grounding resistance is 10^{12} ohms.

In the equipment used for this study it was desired to obtain a good instrument sensitivity so that a minimal amount of C^{14} could be used in a single experiment, and yet to have a system with reasonably rapid response to the breath radioactivity. A rat has ample oxygen with an air flow rate of 100 cc/min, and when the gas is passed through an ionization chamber of about 100 cc volume, gas replacement times of one minute are realized. The electrical system should also have a similar time constant, and this is true for the 10^{12} -ohm resistor. Although 10^{13} -ohm resistors are available, their time constant, which is of the order of magnitude of 5 to 10 minutes, is too slow for good response in the early stages of the breath carbon dioxide elimination curves for this size of animal and for rapidly metabolized compounds.

The Gas Flow System

Since the precision of the radioactivity assay is directly proportional to the gas flow rate, it is necessary to control this factor carefully. Constant flow rate over a long period of time is hampered by (1) changes in the pressure of the air source; (2) movement of the animal in the system; (3) effect of minute dust particles in orifices, such as needle valves; and (4) variation in atmospheric pressure. Most of these factors are compensated for in the

$$* \quad Q = CE \left(1 - e^{-\frac{t}{RC}} \right),$$

where Q = charge,
 C = capacitance,
 t = time,
 R = resistance.

If $Q = 0.99 CE$

$$\text{then } 0.99 = 1 - e^{-\frac{t}{RC}},$$

$$0.01 = e^{-\frac{t}{RC}}$$

Therefore $t = 4.60 RC$.

system shown in Fig. 2. Room air is pulled by a vacuum pump through a flowmeter, * through 25 cm of 1-mm i. d. capillary tubing, through the rat cage, through a tube containing "Anhydrone" ** to remove moisture, through the ionization chamber, through 25 cm more of 1-mm i. d. capillary tubing and, finally, through a soda lime tube (20 mm x 20 cm) to remove $C^{14}O_2$, before the gas is exhausted into the room by the vacuum pump. An oil bubbler stabilizes the low-pressure vacuum system, and the capillary tubing smoothes out short-term pressure variations from animal movement.

The rat cage itself, made from a shortened 60/50 standard tapered glass joint, is about 5 cm in diameter by 20 cm long. It is held in a slightly slanting position so that urine and feces will collect in the screened-off lower end. A bypass provides an alternate flow route so the animal may not stop air flow in the system, and also decreases the effect of the animal's movement on the gas flow rate. Indentations around the tubulations at the head of the cage prevent the rat from stopping the gas flow with his snout. In practice neither food nor water is provided during a normal seven-hour run, since they are usually shunned by the rat in his cramped cage during this period of time.

Calculations - Precision of Method

In a typical experiment a rat is injected intraperitoneally with 8 to 10 μ c of the labeled fatty acid and is immediately placed in the cage. The measurements are recorded continuously for the next seven hours. A number of irregularities in the curve are observed, and these can be easily correlated with sporadic animal activity.

The total carbon-14 evolved can be determined from this curve by several methods. If a smooth line is drawn through the curve, the data can be transferred to regular graph paper and the resulting curve integrated by weighing the paper under the curve. A much faster and more accurate method is to use a polar planimeter. *** With this instrument the area under either the smoothed curve or the original tracing for any time interval may be quickly determined and multiplied by a constant to give a cumulative radioactivity excretion. Table II compares the results obtained by these three methods.

* Tri-Flat Flowrator, Fisher and Porter Company, Hatboro, Pennsylvania. The calibration of this flowmeter was checked, as the absolute value is important.

** Magnesium perchlorate drying agent.

*** Model 123-A, Lasico Compensating Polar Planimeter, Los Angeles Scientific Company, Los Angeles, California.

Table II

Comparison of Percent of Injected Activity Eliminated as $C^{14}O_2$
Using Various Integration Methods

Time after Injection (Min)	By Weighing Paper	By Planimeter	
	Smoothed Curve	Smoothed Curve	Original Tracing
0-90	51.03	49.99	50.25
90-120	5.00	4.96	5.00
120-200	6.01	6.05	6.17
200-300	3.35	3.39	3.52
300-420	2.43	2.39	2.69
Total	67.82	66.78	67.63

In order to check further the accuracy of the entire apparatus a sodium hydroxide bubbler was substituted for the soda lime tube in three experiments. The activity absorbed was precipitated and counted as barium carbonate. The activity so determined and the activity calculated from tracings by use of the polar planimeter were well within the experimental error.

A number of procedural variations which might affect the rate of oxidation to $C^{14}O_2$ of the labeled atoms in these compounds were investigated. The mode of administration of CoA could easily affect the rate of its absorption, and thus, the rate of metabolism of the labeled compounds. Figures 5 and 6 show the changes produced by intraperitoneal (i. p.), intravenous (i. v.), and subcutaneous (s. c.) injections on $C^{14}O_2$ excretion from sodium heptanoate-7- C^{14} by PAD rats. Intraperitoneal and subcutaneous CoA depress $C^{14}O_2$ excretion more than intravenous injections. Somewhat more consistent results from intraperitoneal injection make this procedure the method of choice.

Carbon dioxide concentrations* of air from the animals varied from

*Measured using a Liston-Becker infrared gas analyzer. Liston-Becker Instrument Co., Inc., Stamford, Connecticut.

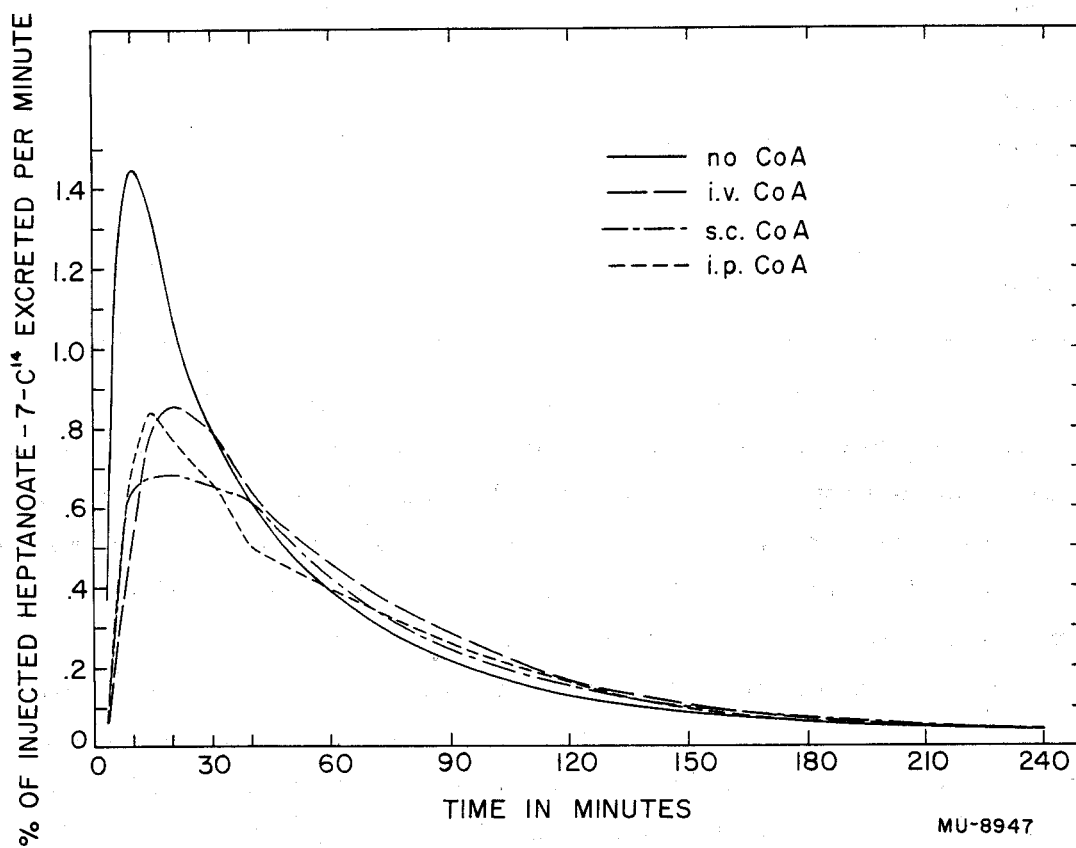

Fig. 5. Effect of mode of administration of 4 mg CoA on rate of oxidation of heptanoate-7-C¹⁴ in PAD rats.

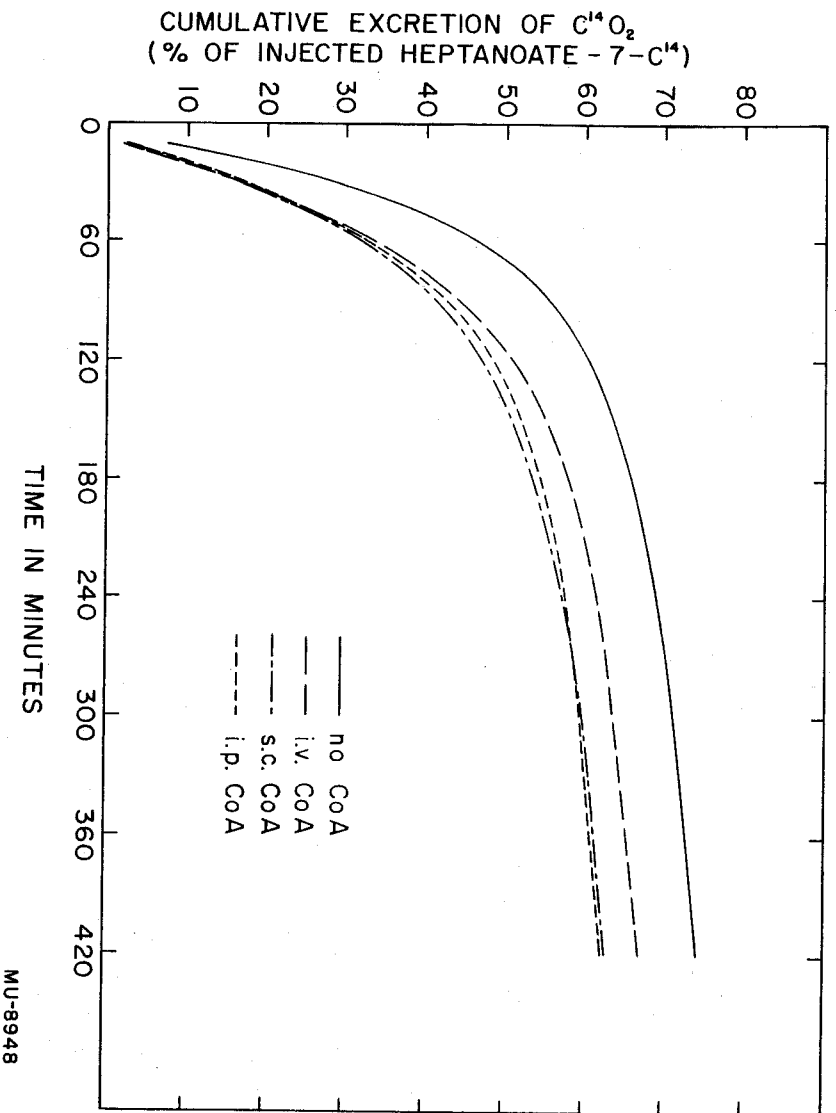

Fig. 6. Effect of mode of administration of 4 mg CoA on cumulative excretion of $C^{14}O_2$ after injecting heptanoate-7- C^{14} in PAD rats.

MU-8948

1% to 4% for a 100-cc flow rate and depended on the weight of the animal used. To check whether the air flow rate was critical, a six-animal series of PAD rats was run at an air flow of 200 cc/min, which would produce one-half the former CO_2 percent value. No significant difference in C^{14}O_2 excretion pattern was observed; therefore, a 100-cc flow rate was used.

The amount of sodium acetate and the size of the body pool of acetate in the animal can be a critical factor in a rate study such as is described here. The pool size of total acetate in the rat is quite large and has been measured by other investigators^{12,13} and shown to vary from 12 to 25 mg per 100 g rat per day. Thus the equivalent of 1.6 to 3.2 mg sodium acetate is produced per minute per 100 g rat body weight. The 2-mg sodium acetate dose used should not produce any long-term flooding effect. However, the uncombined or "free" acetate pool may be quite small in rats, and the handling of excess free acetate could be a critical function of CoA availability. Therefore, we have determined the C^{14}O_2 excretion rates for a series of sodium acetate-2- C^{14} doses (0.2, 2, 20, 100 mg), using the same amount of radioactivity for each injection. The results are shown in Figs. 7 and 8. Each curve represents the average of at least seven animals. There is no consistent significant difference in the total excretion of C^{14}O_2 from 0.2, 2, or 20 mg of acetate-2- C^{14} . However, the recovery of C^{14}O_2 from 100 mg is markedly depressed. Apparently the 2-mg dose does not produce any flooding of the animal system. Therefore, 2 mg has been used as the standard dose.

A series of PAD rats were given 2, 4, and 8 mg of CoA, respectively, together with the labeled heptanoate. In these animals the excretion rate for C^{14}O_2 was increasingly depressed with increasing doses of CoA. A value of 4 mg CoA was chosen for this study as the minimum amount needed to produce a consistent effect on C^{14}O_2 metabolism.

RESULTS

Figures 9 and 10 show the rate of excretion and the cumulative excretion curves for C^{14}O_2 after administration of sodium acetate-2- C^{14} ($\text{C}^{14}\text{H}_3\text{CO}_2\text{Na}$) under the various nutritional states of the rats. Figures 11 and 12 present the same data for the metabolism of sodium heptanoate-7- C^{14} ($\text{C}^{14}\text{H}_3(\text{CH}_2)_5\text{CO}_2\text{Na}$). Each of these curves represents the mean value for at least twelve animals and, in some cases, for as many as twenty animals. The standard

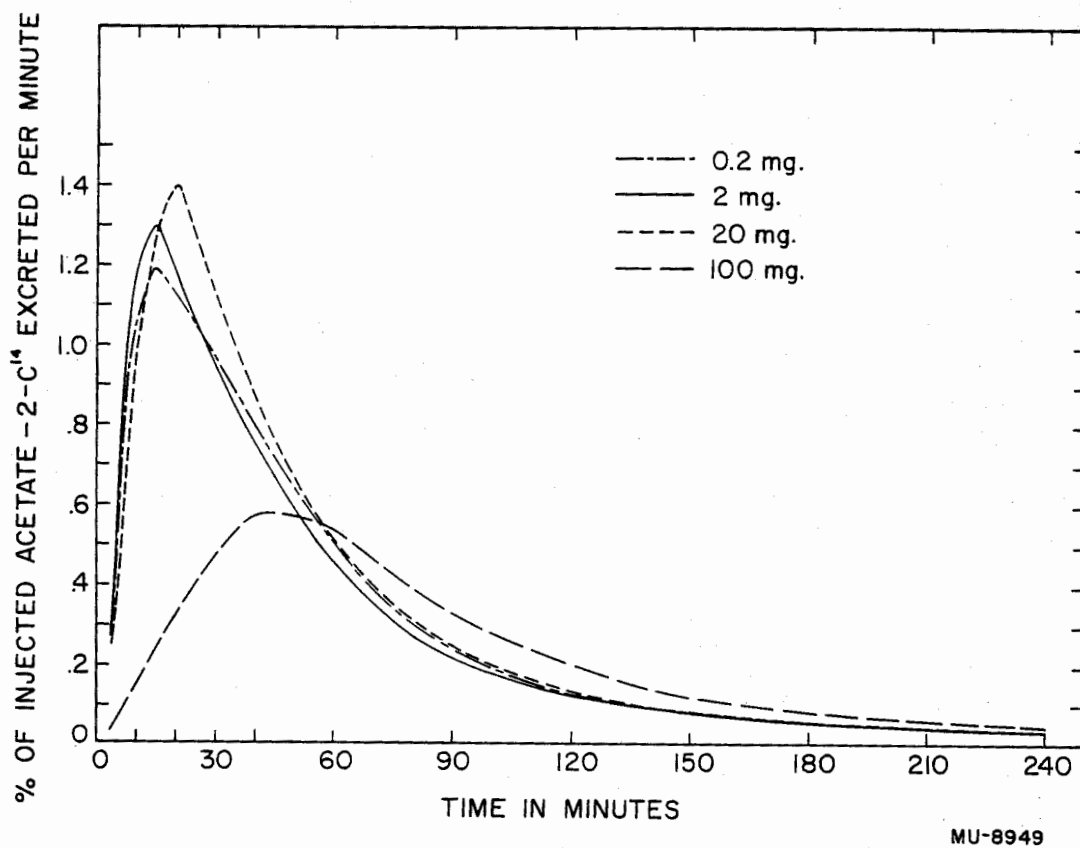

Fig. 7. Effect of substrate concentration on the rate of excretion of C¹⁴O₂ following administration of sodium acetate-2-C¹⁴ in normal rats.

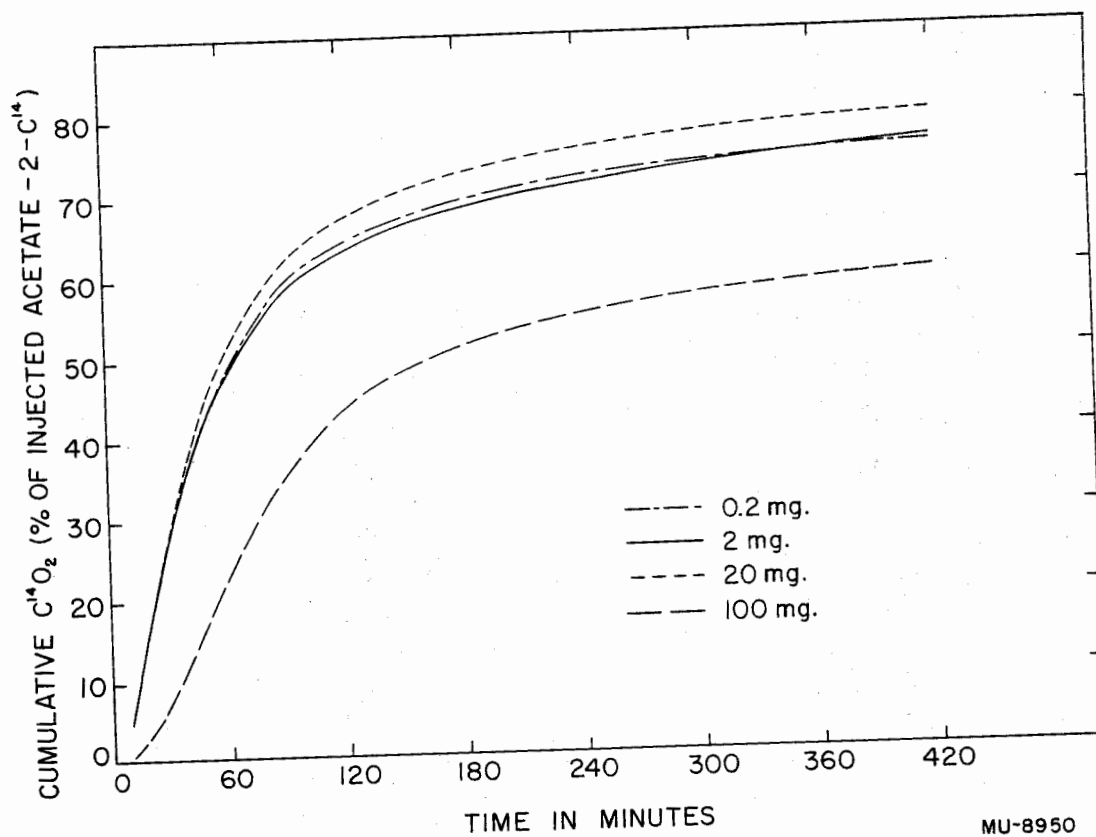

Fig. 8. Effect of substrate concentration on the cumulative excretion of C¹⁴O₂ following administration of sodium acetate-2-C¹⁴ in normal rats.

MU-8950

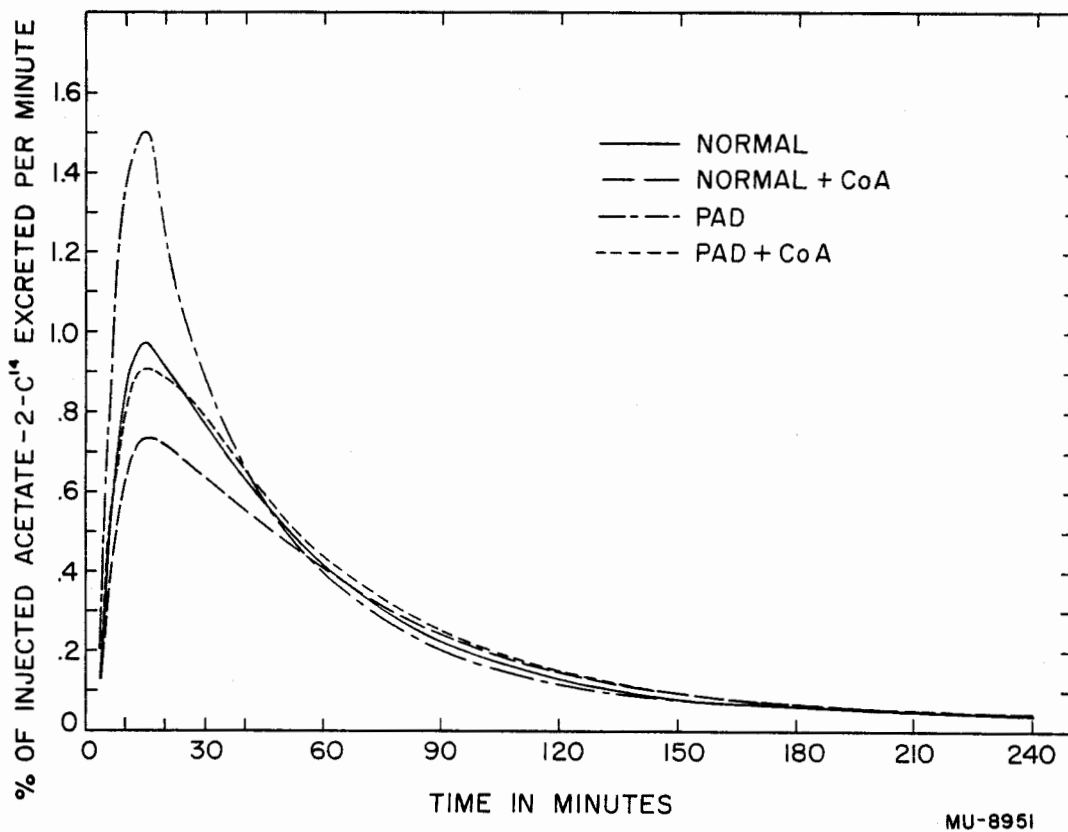

Fig. 9. Rate of excretion of C¹⁴O₂ in normal and PAD rats following administration of sodium acetate-2-C¹⁴.

MU-8951

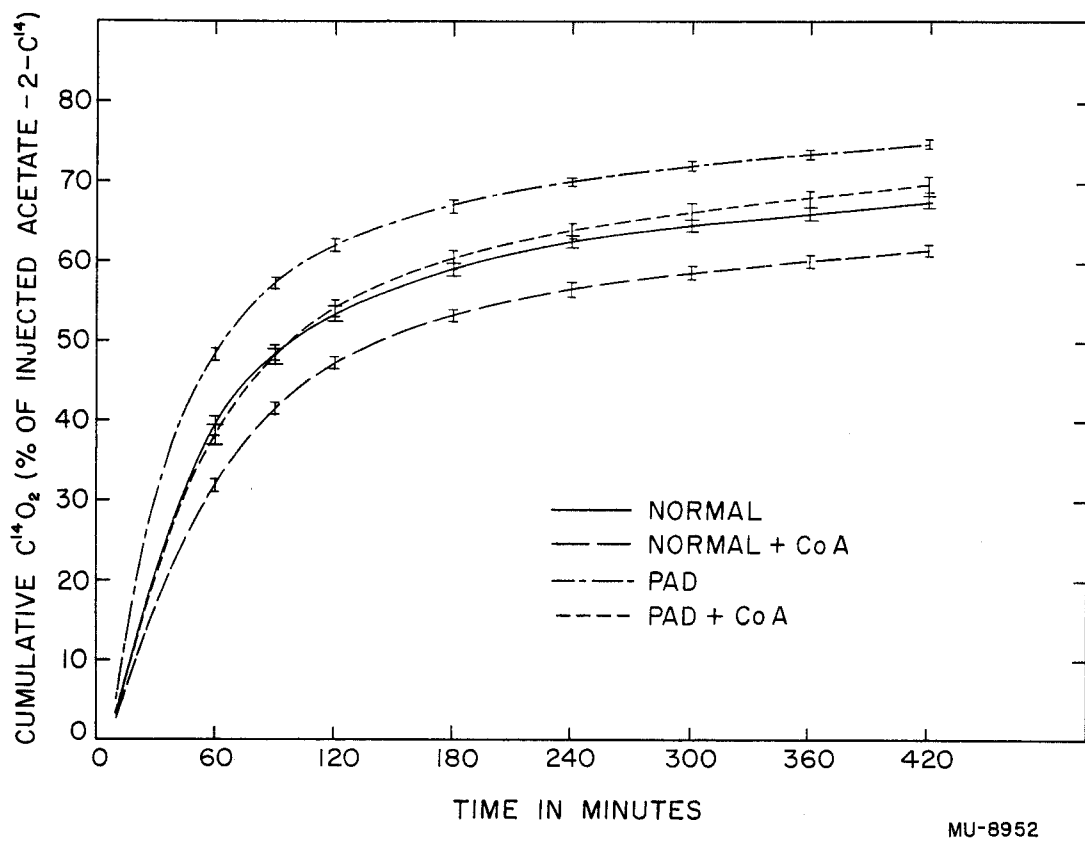

Fig. 10. Cumulative excretion of $C^{14}O_2$ in normal and PAD rats following administration of sodium acetate-2- C^{14} .

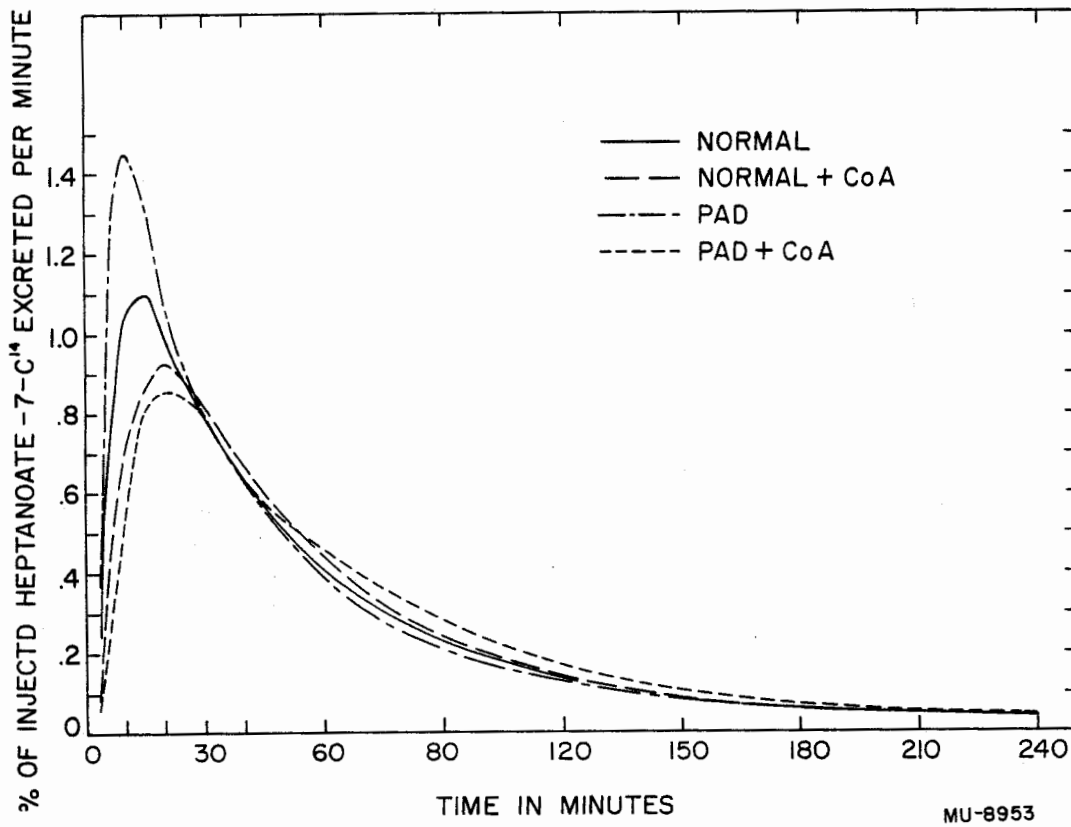

Fig. 11. Rate of excretion of C¹⁴O₂ in normal and PAD rats following administration of sodium heptanoate-7-C¹⁴.

MU-8953

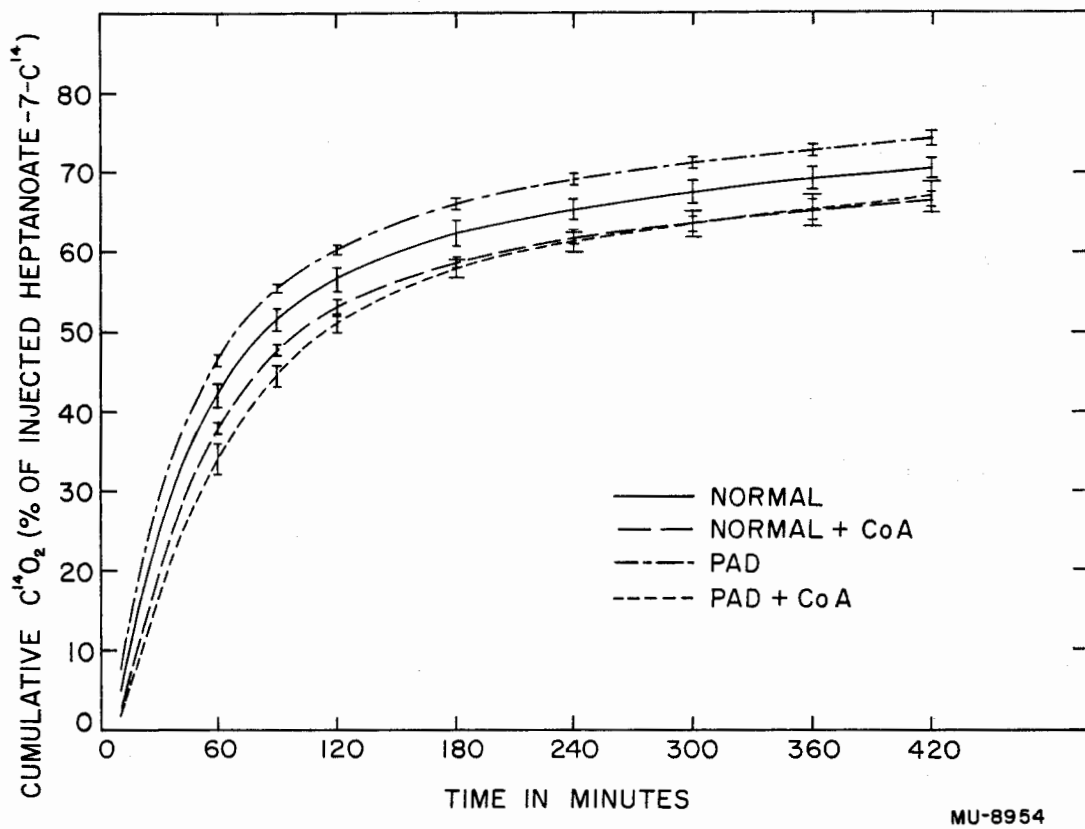

Fig. 12. Cumulative excretion of $C^{14}O_2$ in normal and PAD rats following administration of sodium heptanoate-7- C^{14} .

error of the mean* is indicated by a short vertical line for each point on the cumulative curve.

The problem of presentation of $C^{14}O_2$ excretion curves is complicated by the fact that there is no simple way to compare all the effects observed. It is possible to make a semilog plot of the data and determine a series of first-order "half times" for the elimination of the C^{14} . A first-order reaction for this excretion process can be fully justified on a theoretical basis, but the determination of a discrete series of reproducible rate constants by a graphic method is very difficult and lacks, at present, a clear physiological basis. Therefore, we have chosen to present rate of excretion and cumulative excretion curves to be visually compared as the simplest way to interpret the results of what must be a very complicated series of biological processes. In addition, equivalent numerical values of the cumulative excretion of $C^{14}O_2$ as a function of time are given in Table III.

A very interesting fact easily seen in Figs. 9 and 11 is that the labeled fatty acids are more rapidly metabolized to $C^{14}O_2$ in PAD rats than in normals. This effect is seen in the rate of excretion curves for both fatty acids studied, and reaches a maximum differential about twenty minutes after injection. Although the cumulative $C^{14}O_2$ excretion from the sodium acetate is greater in PAD than normal rats, the cumulative excretion of radioactivity from the labeled heptanoate is essentially the same in normal and PAD rats after the first few hours.

The other clear-cut effect shown in Figs. 9 through 12 is that CoA depresses the $C^{14}O_2$ excretion in both normal and PAD rats in experiments with either labeled acid. Acetate metabolism in both the normal and PAD animals is depressed in comparable amounts by CoA. In heptanoate oxidation, however, CoA depresses the $C^{14}O_2$ excretion far more in the PAD animal than in the normal.

* Standard error of the mean = $\sqrt{\frac{(X-X')^2}{n(n-1)}}$

After "Isotopic Carbon," M. Calvin et al., John Wiley and Sons, Inc., New York, N. Y., 1949.

Table III
 Cumulative Excretion of $C^{14}O_2$ after Administration
 of Two Labeled Fatty Acids

Time (min)	% of Injected Dose				% of Injected Dose			
	Sodium Acetate-2- C^{14}				Sodium Heptanoate-7- C^{14}			
	Normal Rats		PAD Rats		Normal Rats		PAD Rats	
	No CoA	+CoA	No CoA	+CoA	No CoA	+CoA	No CoA	+CoA
10	3.45	2.80	5.64	3.52	5.13	2.88	7.62	1.93
20	12.50	9.70	19.38	12.07	15.98	10.90	19.95	8.47
40	28.27	22.42	37.89	27.03	31.91	26.86	36.47	23.39
60	39.15	31.99	48.56	38.03	42.17	37.88	46.63	33.80
90	48.49	41.58	57.28	48.17	51.42	47.66	55.43	44.44
120	53.67	47.29	61.98	54.03	56.63	53.23	60.44	51.19
180	59.18	53.38	67.14	60.44	62.34	58.78	66.04	58.04
240	62.54	56.52	70.16	63.99	65.34	61.68	69.06	61.49
300	64.62	58.62	72.18	66.39	67.26	63.68	71.15	63.71
360	66.20	60.21	73.70	68.26	68.24	65.26	72.79	65.47
420	67.51	61.60	74.94	69.83	70.51	66.51	74.21	67.05
No. of rats	12	13	26	18	13	9	18	7

DISCUSSION

Coenzyme A is known to be necessary for the activation of the acetate (or two-carbon) fragment in biological oxidations.¹⁴⁻¹⁷ Since pantothenic acid is a necessary precursor of CoA, it is postulated that animals deficient in pantothenic acid should not be able to metabolize fatty acids in a normal manner. The dynamics of the steady state shown in Fig. 1 will be changed. It would be expected that the PAD rats should have a smaller acetyl-S-CoA pool than the normal rats. Thus after administration of acetate-2- C^{14} a higher specific activity should be observed in the products directly derived from this intermediate, such as $C^{14}O_2$ formed via the citric acid cycle. This

is a short-term rate effect; it is observed in the high-specific-activity $C^{14}O_2$ from PAD rats, but the effect is not seen in the cumulative $C^{14}O_2$ excretion curves.

One effect of added CoA on the dynamics should be through an increase in the size of the pool of acetyl-S-CoA and higher acyl-CoA intermediates to provide more "active acetate" as a fundamental building block for fat synthesis. As a result the amount of carbon from the acetate excreted as CO_2 should be decreased, both in rate and in total amount. In the experimental results injected CoA reduces both the rate and the cumulative excretion of $C^{14}O_2$ from acetate-2- C^{14} , in agreement with the postulated scheme in Fig. 1. While this is not a unique scheme and is, of course, based upon the separately demonstrated enzymatic reactions, the present observations on the intact animals do provide new information on the possible quantitative interrelationships between the various reactions. It suggests, for example, that the enzyme systems involved in fatty acid synthesis and breakdown are far more sensitive to pantothenic acid deficiency and hence a shortage of the necessary CoA than are some of the other enzyme systems using CoA, such as the citric acid-forming enzyme.

Sodium heptanoate-7- C^{14} is an unnatural fatty acid, but this compound was used because it represented a fatty acid labeled in such a position that a multistep enzymatic process would be required to catabolize the label to $C^{14}O_2$. We are assuming that two β -carbon cleavages take place to produce a labeled three-carbon fragment and that omega-oxidation of the heptanoate does not occur. This three-carbon fragment should be oxidized to CO_2 in a different manner than the acetate fragment.

Some of these differences can be seen in Figs. 9 through 11 and are summarized in Table IV. The effect of injected CoA is to depress heptanoate-7- C^{14} oxidation to $C^{14}O_2$. The seven-hour cumulative effect is twice as large in PAD rats as in normal rats. The peak excretion rate for $C^{14}O_2$ is depressed by CoA three times as much in PAD rats as in normal rats. In acetate-2- C^{14} metabolism the depression in $C^{14}O_2$ cumulative excretion is the same in normal and PAD rats; the peak excretion rate is depressed by a factor of about 2.

These differences between the acetate and heptanoate oxidation are fairly distinct and are probably due to two factors: the difference in the animals' handling of the three-carbon vs the two-carbon fragment; and the possibilities for the seven-, five- and three-carbon fragments to be incorpor-

ated into larger fat moieties before the omega-carbon can be oxidized to $C^{14}O_2$.

Table IV

Depression in $C^{14}O_2$ Excretion by CoA in Normal and PAD Rats

	Difference between 7-hr cumulative % excretions caused by the CoA	Difference between peak %/min excretions caused by the CoA
Acetate-2- C^{14}		
Normal rats	5.9	0.24
PAD rats	5.1	0.60
Heptanoate-7- C^{14}		
Normal rats	4.1	0.17
PAD rats	7.2	0.61

FATTY ACID SYNTHESIS IN THE LIVER

The dynamic effects of CoA on the metabolism of acetate in normal and PAD rats as postulated in the previous paragraphs can be further tested by studying the distribution of radioactivity in the liver.

Experimental

Normal and PAD rats were given 0.1 ml (2 mg, 10 μ c) of sodium acetate-2- C^{14} solution intraperitoneally with and without ten-second prior intravenous injection of 6 mg CoA. One hour later the animals were sacrificed. The livers were removed, washed in isotonic saline and lyophilized. A portion of the dried livers was analyzed for total radioactivity by the Folch-Van Slyke wet combustion method and barium carbonate plate counting.¹⁸

Approximately half of each liver was extracted with acetone for 24 hours in a Soxhlet extractor; the residue, mostly protein, was rinsed with ether, dried in vacuo, and counted. The acetone-soluble fraction, mostly lipid material, was saponified by refluxing in 10 ml of 10% alcoholic potassium hydroxide for eight hours. The resulting mixture was extracted with petroleum

ether, and the ether extract, which contained the nonsaponifiable material such as steroids, was counted. The aqueous fraction was acidified with 5 N sulfuric acid and ether-extracted. The ether fraction, which contained the fatty acids, was also counted, as was the aqueous raffinate, representing the glyceride fraction.

Results

The distribution of radioactivity in the livers of PAD and normal rats after administration of sodium acetate-2-C¹⁴ with and without CoA is summarized in Table V. Feeding CoA to a PAD rat makes available the necessary enzymatic material for greatly increased fatty acid synthesis. This effect is probably accentuated by the fat-deficient state of the liver and entire body of the PAD rat. It is also seen, on the basis of this limited series, that there are no gross differences or changes in the rate of protein, steroid, or glyceride synthesis in any of these animals. This is in agreement with the data of other workers on this subject,¹⁹ and indicates that protein synthesis in severe pantothenic acid deficiency has priority over fatty acid synthesis. There are insufficient numbers of animals in these series to draw valid conclusions on the small difference between the normal and PAD rats given acetate only, or between normal rats with and without CoA.

The radioactive compounds in several of these liver fractions were investigated by paper chromatography. The acid-aqueous (glyceride) fraction remaining from the final ether extraction described above was neutralized and dried, and the acetone-soluble material (90% of the radioactivity) was separated by two-dimensional paper chromatography (phenol-water and butanol-propionic acid-water).²⁰ Radioautographs of the paper chromatograms showed two to five well-defined spots, but these were not identified.

Several of the fatty acid fractions were chromatographed by use of a propanol-ammonia-water (60:30:10) system.²⁰ The radioautographs showed that the labeled compounds from the rats given CoA moved farther from the origin than the labeled compounds from those without CoA. The effect was seen in both normal and PAD animals, but was greater and more clearly defined in the PAD rats. This indicates that after administration of CoA relatively less radioactivity is present in short-chain and oxygenated fatty acids. Thus the synthesis of fatty acids in PAD rats given CoA continues at an accelerated pace over a period of time, so that in these animals in one hour much of the radioactivity administered as acetate is converted to longer-chain fatty acids.

Table V

Influence of CoA on the Distribution of Radioactivity in the Livers of
Normal and PAD Rats after Injection of Sodium Acetate-2-C¹⁴

	<u>C¹⁴H₃CO₂Na Only</u>		<u>C¹⁴H₃CO₂Na + 6 mg CoA</u>	
	% Liver Act.	% Inj. Dose*	% Liver Act.	% Inj. Dose*
<u>PAD Rats</u>	(Av. of 2)		(Av. of 4)	
Liver	100	3.78	100	7.96
1. Protein	68.8	2.60	32.6	2.60
2. Lipid	30.9	1.17	65.1	5.19
a. Nonsapon.	4.5	0.17	3.6	0.29
b. Fatty acid	17.5	0.66	57.1	4.55
c. Aqueous	8.7	0.33	4.9	0.39
<u>Normal Rats</u>	(Av. of 3)		(Av. of 2)	
Liver	100	3.68	100	3.01
1. Protein	67.1	2.47	59.0	1.78
2. Lipid	35.8	1.32	38.2	1.15
a. Nonsapon.	6.5	1.24	3.7	0.11
b. Fatty acid	23.1	0.85	30.2	0.91
c. Aqueous	6.0	0.22	4.3	0.13

* Data are expressed as percent of injected dose/gram of liver/100 grams body weight.

Chromatograms were made from the water-soluble extracts of livers from all the above fractionations, and the following radioactive amino acids (in approximate order of decreasing radioactivity) were identified by ninhydrin sprays and radioautographs: glutamic acid, glutamine, glycine, alanine, and valine. Also present, but not radioactive enough to produce a radioautograph, were aspartic acid, cystine, and phenylalanine. Four other radioactive spots, one of which was ninhydrin-positive, were not identified. The uniformity of the chromatograms from all these varying nutritional states gives further evidence that amino acid metabolism is not seriously affected by pantothenic acid deficiency.

CONCLUSIONS

The effect of pantothenic acid deficiency in rats given sodium acetate-2-C¹⁴ or sodium heptanoate-7-C¹⁴ has been studied. The rate of excretion of breath C¹⁴O₂ has been measured by a method, not previously described, in which a sensitive ionization chamber and electrometer directly and continuously record carbon-14 excretion.

The effect of Coenzyme A on the oxidative metabolism of normal and pantothenic-acid-deficient rats was measured. The differences in the rate of excretion of C¹⁴O₂ show that the methyl carbon of acetate is oxidized faster and in greater amount in PAD than in normal rats, but is slower in animals given CoA than in animals not given CoA. These results are consistent with previous data on fatty acid metabolism. The oxidation of the methyl (omega) carbon of heptanoic acid to C¹⁴O₂ is much more depressed by CoA than is the oxidation of the methyl carbon of acetic acid. In a confirmatory series of experiments, normal and PAD rats, with and without CoA injection, were given sodium acetate-2-C¹⁴. Fractionation, paper chromatography, and radioautography of the livers from these rats showed that more activity was incorporated in liver--and especially the liver fats--in PAD rats given CoA than in either normal rats or PAD rats without CoA. Incorporation of radioactivity into amino acids was similar in all cases.

REFERENCES

1. K. Bloch, *Physiol. Rev.* 27, 574 (1947).
2. H. A. Barker, in "Phosphorus Metabolism," Vol. I, Johns Hopkins University Press, Baltimore, Maryland (1951), p. 204-241.
3. A. D. Welch, and C. A. Nichol, *Ann. Rev. Biochem.* 21, 669-275 (1952).
4. L. S. Hurley and A. F. Morgan, *J. Biol. Chem.* 195, 583 (1952).
5. E. R. Stadtman, L. Novelli, and F. Lipmann, *J. Biol. Chem.* 191, 365 (1951).
6. R. E. Olson and N. O. Kaplan, *J. Biol. Chem.* 175, 515 (1948).
7. B. M. Tolbert, *J. Biol. Chem.* 173, 205 (1948).
8. R. M. Noller, Preparation of Sodium Heptanoate-7-C¹⁴, University of California Radiation Laboratory Report No. UCRL-2677.
9. B. M. Tolbert and E. M. Baker, *Proc. Soc. Exptl. Biol. Med.* in press.
10. N. I. Berlin, B. M. Tolbert, and J. H. Lawrence, *J. Clin. Invest.* 30, 73 (1951).
11. N. I. Berlin, B. M. Tolbert, and C. Lotz, *J. Clin. Invest.* 31, 335 (1952).
12. K. Bloch and D. Rittenberg, *J. Biol. Chem.* 159, 45 (1945).
13. H. S. Anker, *J. Biol. Chem.* 176, 1343 (1948).
14. Lipmann, *Bact. Rev.* 17, 1 (1953).
15. F. Lipmann, "Biosynthetic Mechanisms," Harvey Lectures, Ser. 44, 99-123 (1948-1949).
16. G. D. Novelli and F. Lipmann, *J. Biol. Chem.* 171, 833 (1947).
17. E. R. Stadtman, *Federation Proc.* 9, 233 (1950).
18. M. Calvin et al., "Isotopic Carbon," John Wiley and Sons, Inc., New York, N. Y. (1949).
19. H. Klein and Lipmann, *J. Biol. Chem.* 203, 101 (1953).
20. A. A. Benson et al., *J. Am. Chem. Soc.* 72, 1710 (1950).