

# Lawrence Berkeley National Laboratory

LBL Publications

Title

Design Options for the JLEIC Large Aperture IR Quadrupoles

Permalink

<https://escholarship.org/uc/item/5kh5388q>

Author

Sabbi, GianLuca

Publication Date

2023-12-13

Peer reviewed

*JLEIC Spring Collaboration Meeting 2019*  
*April 1-3, 2019*

# Design Options for the JLEIC Large Aperture IR Quadrupoles

**GianLuca Sabbi**  
**Lawrence Berkeley National Laboratory**



# Layout and Parameters (V. Morozov)

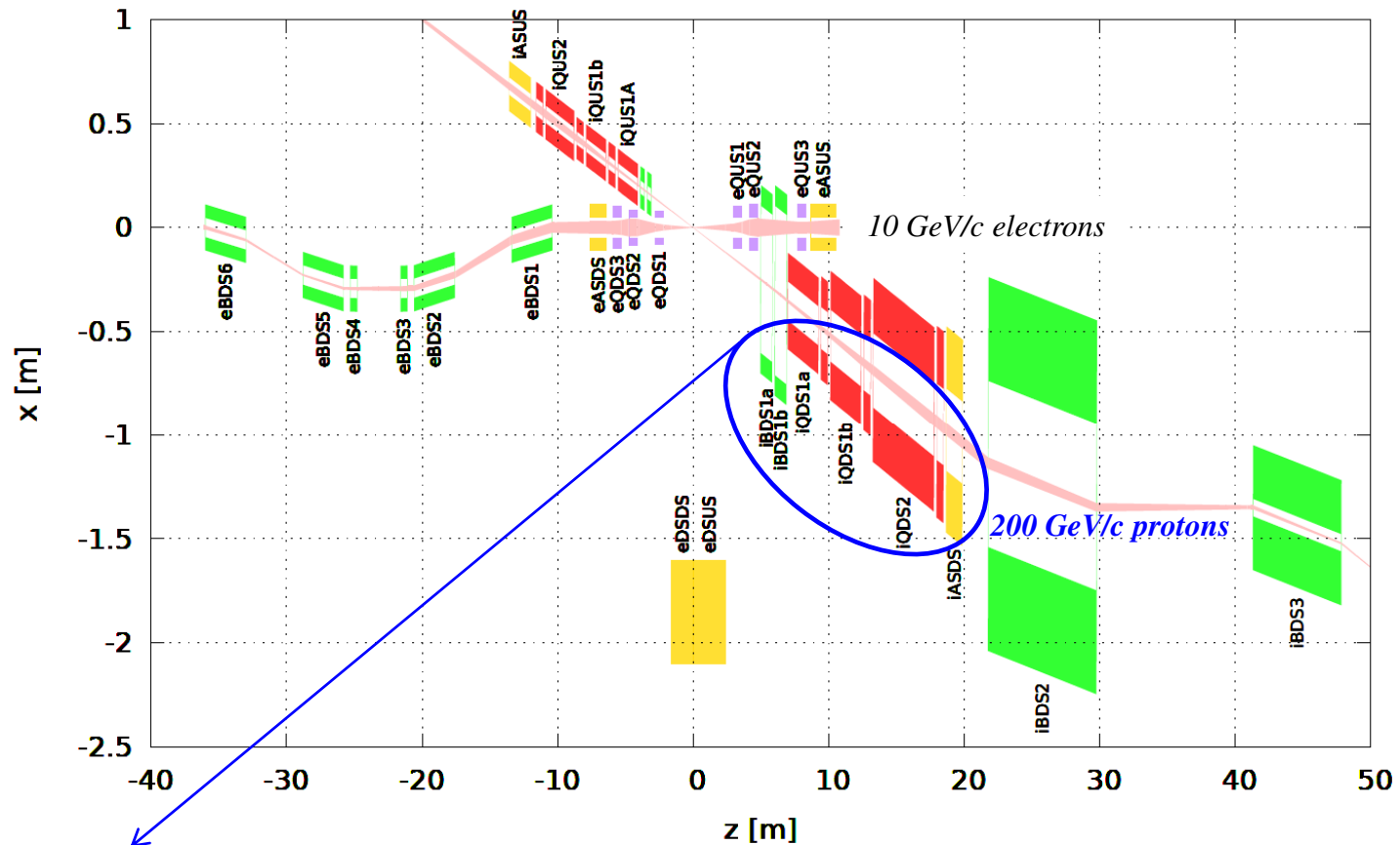

Quadrupole Element	Magnetic length [m]	Inner radius [cm]	Outer Radius [cm]	Good Field Radius [cm]	Field Gradient Normal / Skew [T/m]	$G \times R_{\text{inner}}$ [T]
iQDS1a	2.25	9.2	23.1	4	-37.2 / -1.23	3.4
iQDS1b	2.25	12.3	31.0	4	-37.2 / 0.0	4.6
iQDS2	4.5	17.7	44.4	4	26.0 / 0.0	4.6

# IR Quadrupole Design References

RHIC (130 mm, 48 T/m, 4.5K)

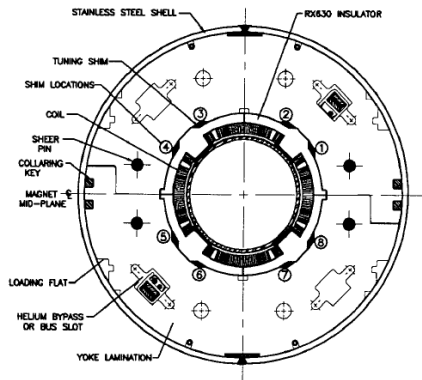

LHC MQXC (120 mm, 118 T/m, 1.9K)

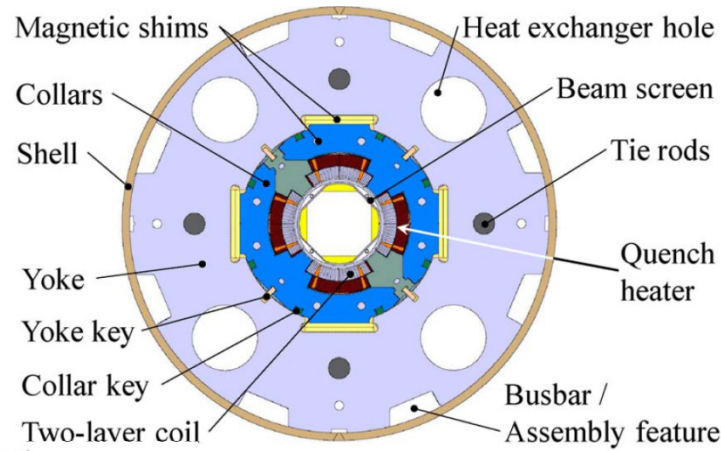

AHF-2 (634 mm, 10.1 T/m, 1.9K)

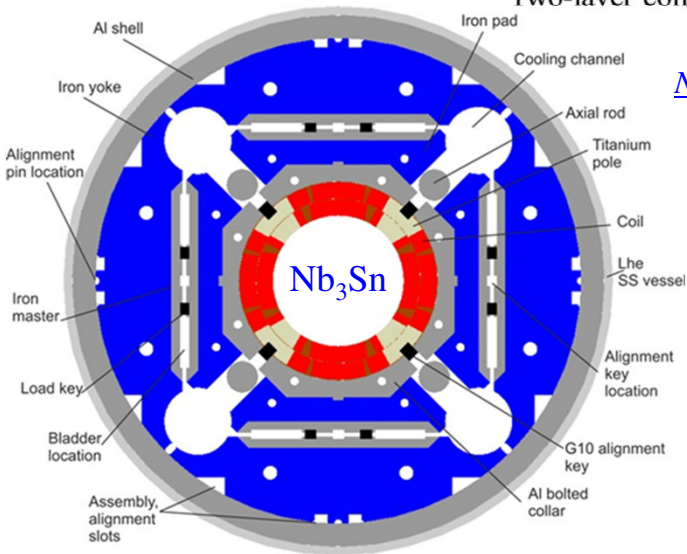
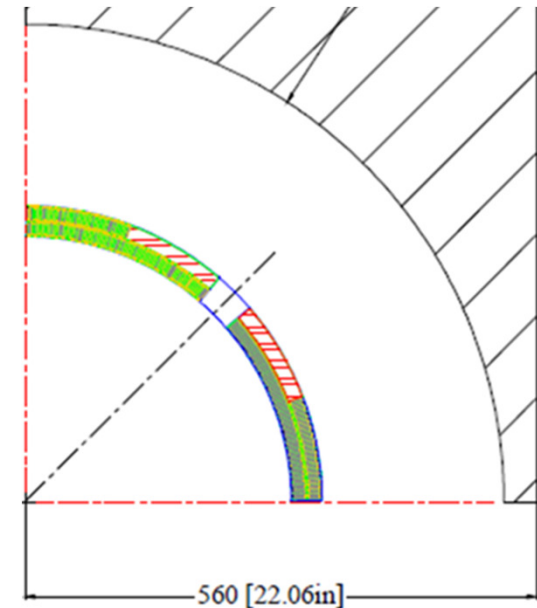

*Note: diameters refer to the coil winding*

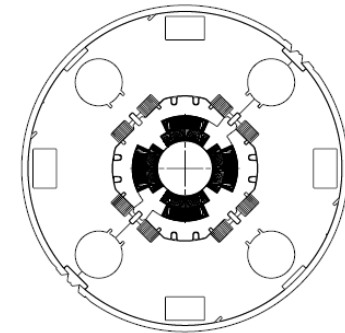
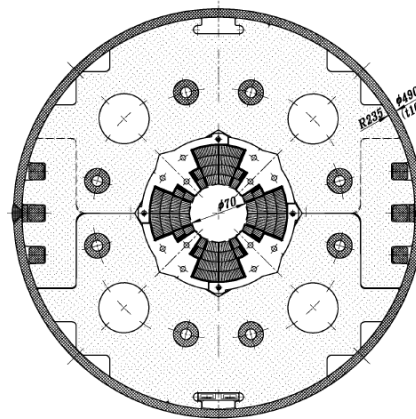

HL-LHC MQXF (150 mm, 143 T/m, 1.9K)

LHC MQXA (70 mm, 205 T/m, 1.9K)

LHC MQXB (70 mm, 205 T/m, 1.9K)

# Cos( $n\theta$ ) Coil Layout

- The cos( $n\theta$ ) coil layout with keystone Rutherford cable has dominated the accelerator applications to date

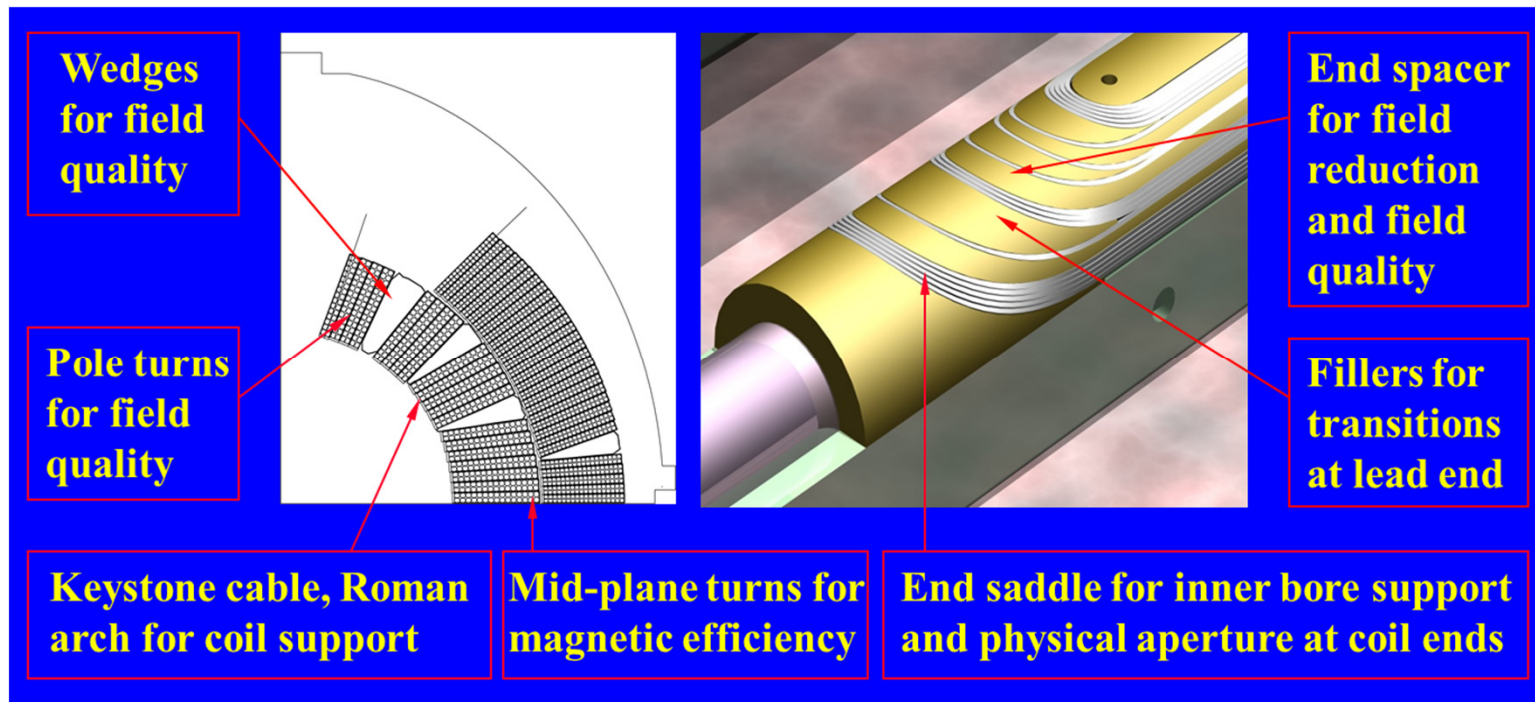

- The extension to iQDS1a appears to be relatively straightforward (although aperture is significantly larger than in design references)
- Combination of very large aperture, gradient, and limited radial/axial space budget in iQDS1b/2 may require a modified approach

# A Preliminary Design for iQDS1a

## Goals:

- Perform a first-pass magnetic analysis and optimization
- Obtain a preliminary design and performance parameters: **cable and coil geometry, operating current, margin to quench, fringe field, magnetic length and field quality**
- Iterate as needed, get feedback to/from AP

## Coil and yoke geometry:

- **Single layer coil with 15 mm width**
- Two coil blocks (one wedge) for control of geometric harmonics
- Inner coil radius at 9.19 cm (increase ~8 mm for inner vessel)
- Radial space reserved for collars: 23 mm
- Outer yoke radius 23.1 cm (decrease ~6 mm for outer vessel)

## Superconductor and cable:

- **NbTi superconductor at 4.5K**
- MQXC inner cable (same as LHC dipole inner cable)
- Alternative options: MQXC outer cable (same as LHC dipole outer cable, LHC arc quadrupole); MQXB inner cable

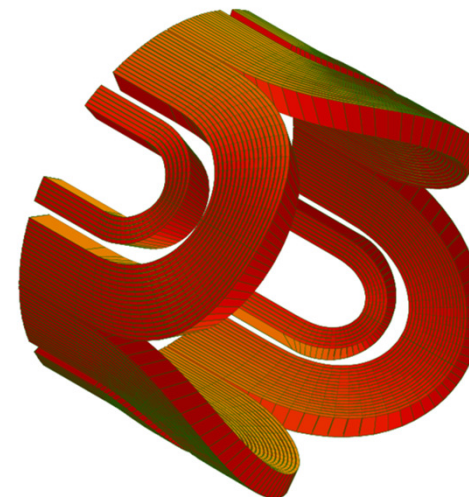
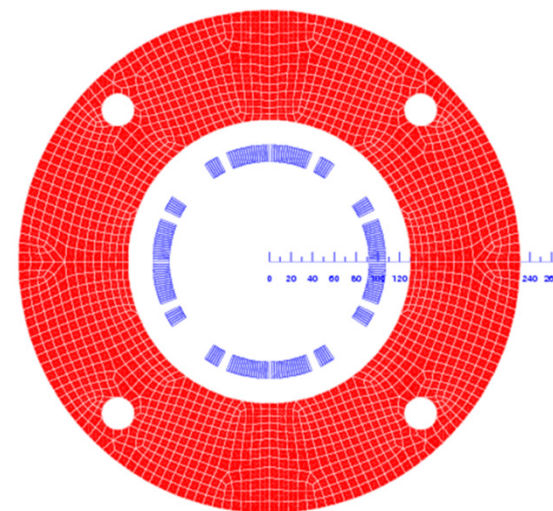

# Design and Performance Parameters

Superconducting strand	Unit	Value
Strand diameter	mm	1.065
Critical current density (*)	kA/mm <sup>2</sup>	2.85
Copper/non-copper ratio		1.65

(\*) 5T, 4.2K

Cable and coil geometry	Unit	Value
Number of strands		28
Cable width	mm	15.1
Cable thickness (min)	mm	1.736
Cable thickness (max)	mm	2.064
Number of turns (B1+B2)		17+6

Operating Parameters (2D)	Unit	Value
Current	kA	9.5
Field Gradient	T/m	38.0
Peak field in the coil (*)	T	4.3
Lorentz force (azimuthal)	MN	0.38
Coil stress (azimuthal)	MPa	25

(\*) Includes strand self-field

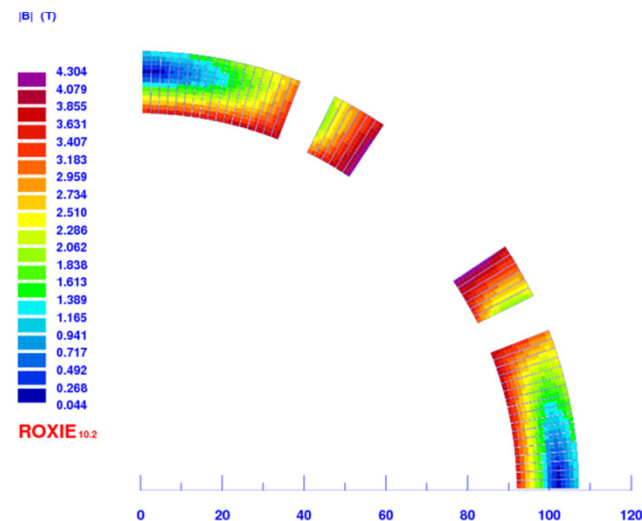
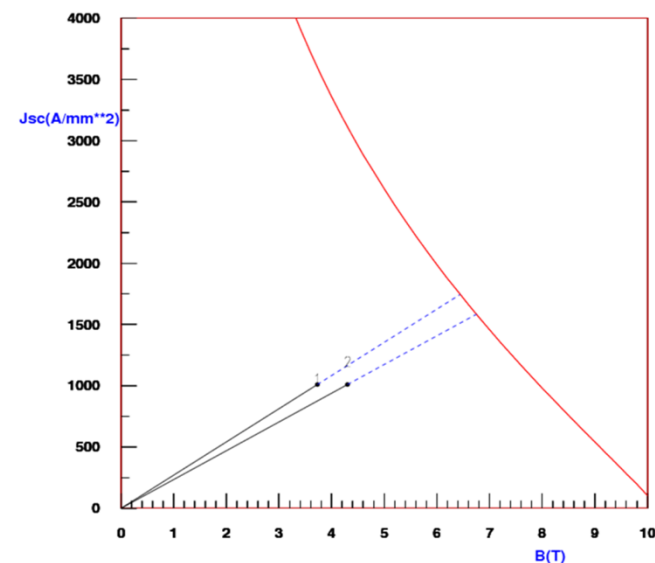



# Short Sample and Margin to Quench

Short sample parameters (*)	Unit	Value
Current	kA	14.9
Peak field	T	6.75
Gradient	T/m	59.6

Margins to quench (*)	Unit	Value
Operating point on the load line	%	63.7
Fraction of critical current at $I_{op}$	%	32.4
Temperature margin at $I_{op}$	K	1.85

(\*) based on a linear extrapolation of the peak field load line

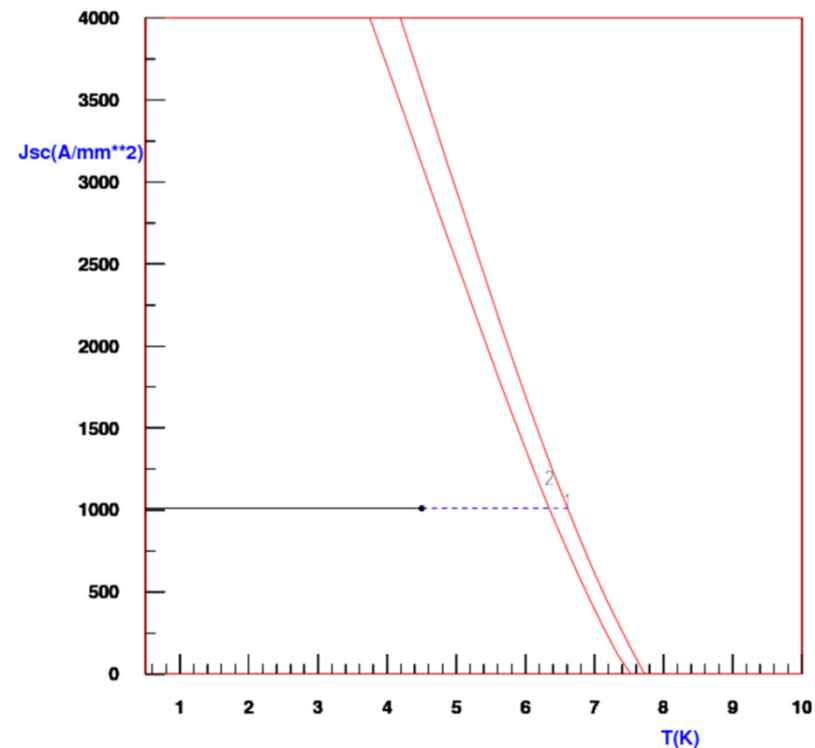
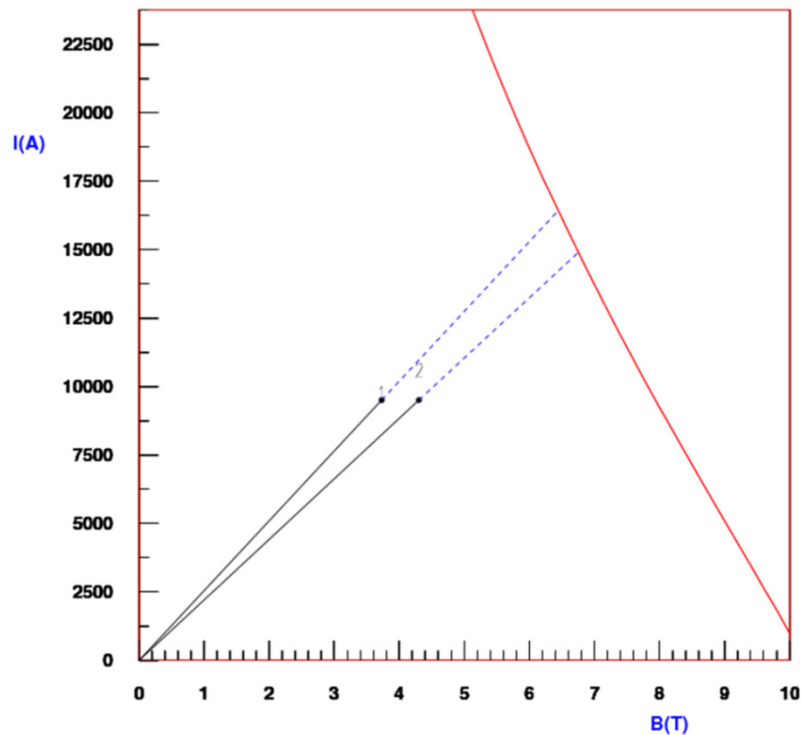



# Fringe Field at the electron beamline

- At the operating gradient, the iron yoke thickness at the magnetic mid-plane is sufficient to return all the magnetic flux
- Fringe field outside yoke is below 0.002 T at the magnetic mid-plane, and further decreasing to < 0.001 T at the pole
- Note however that this case does not include radial space for He vessel/beam pipe and yoke geometry optimization to control saturation

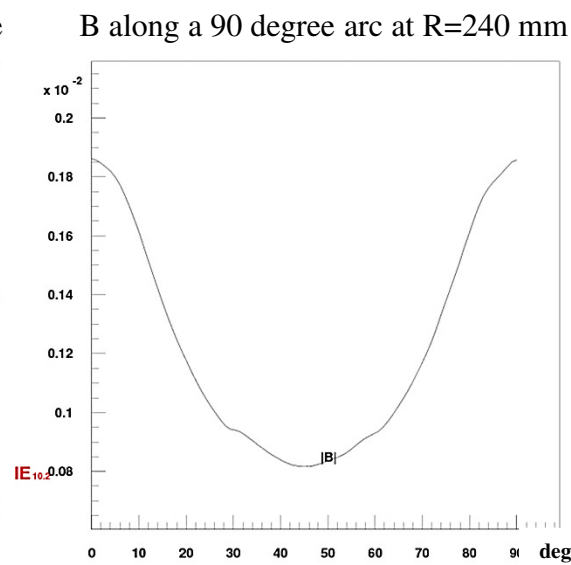
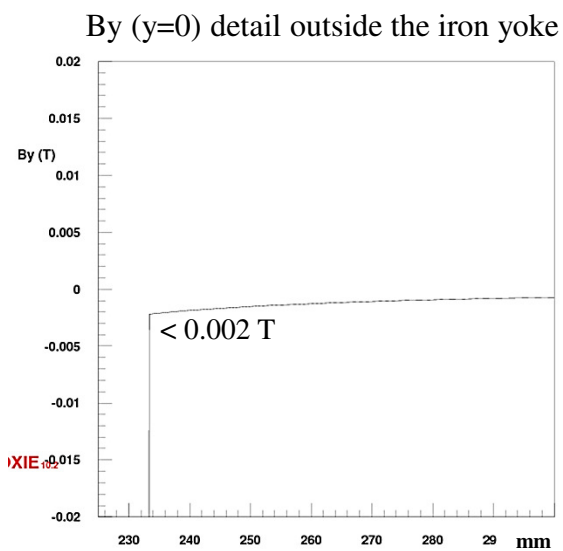
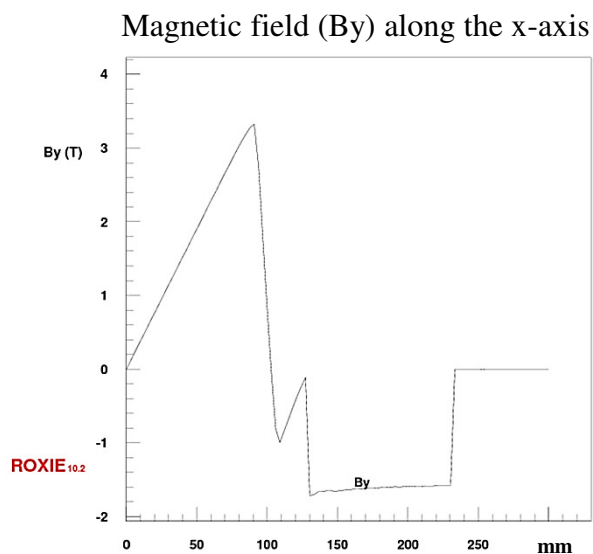
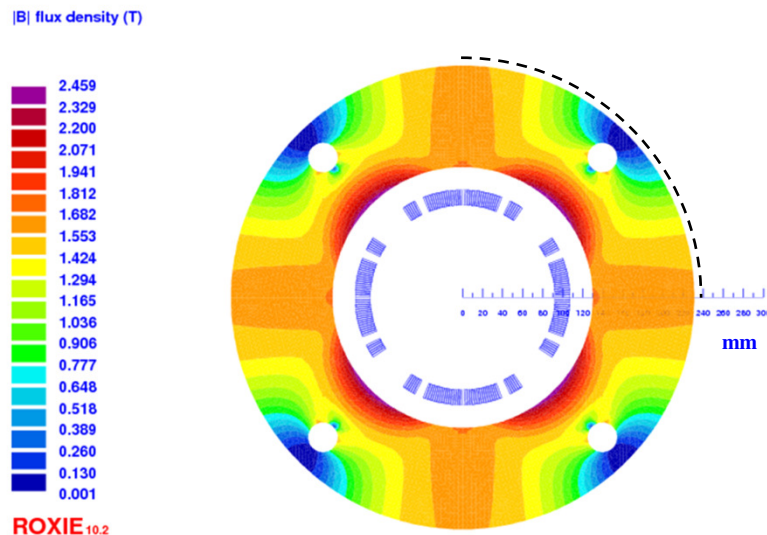

# Field Quality (2D)

- Field quality optimization carried out and reported at 60 mm radius (~2/3 of aperture)
- Good field radius required by beam is 40 mm: significant benefit for higher orders
- Harmonics at nominal current can be optimized to  $\ll 1$  “unit” ( $10^{-4}$  of quadrupole)
- However,  $b_6$  saturation is several units (R=60 mm) in the absence of yoke optimization
- Yoke optimization for saturation control will increase the fringe field: is it needed?
- Random errors calculated for radial/azimuthal block displacements with  $\pm 100 \mu\text{m}$  range
- Persistent current and ramp rate effects not yet analyzed – generally dominated by dipoles

Random errors (1 sigma) for 100  $\mu\text{m}$  block displacements

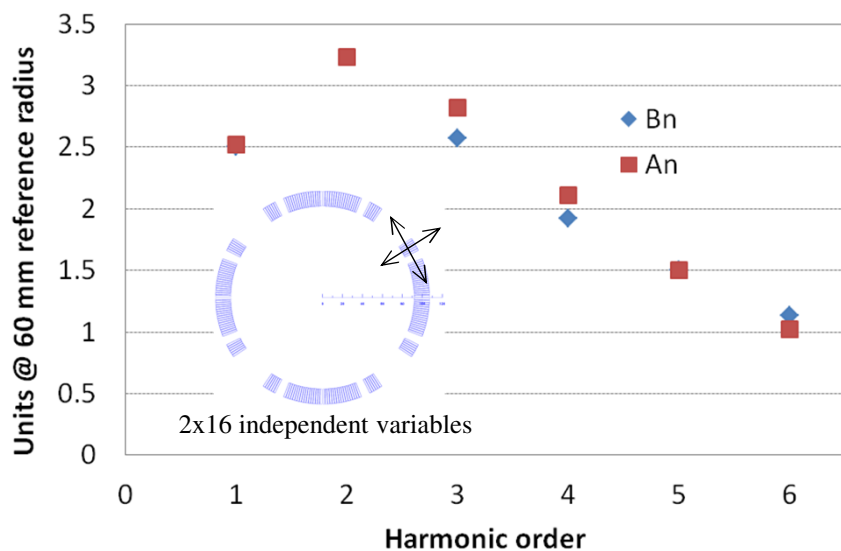

Saturation effect on  $b_6$  (R=60 mm)

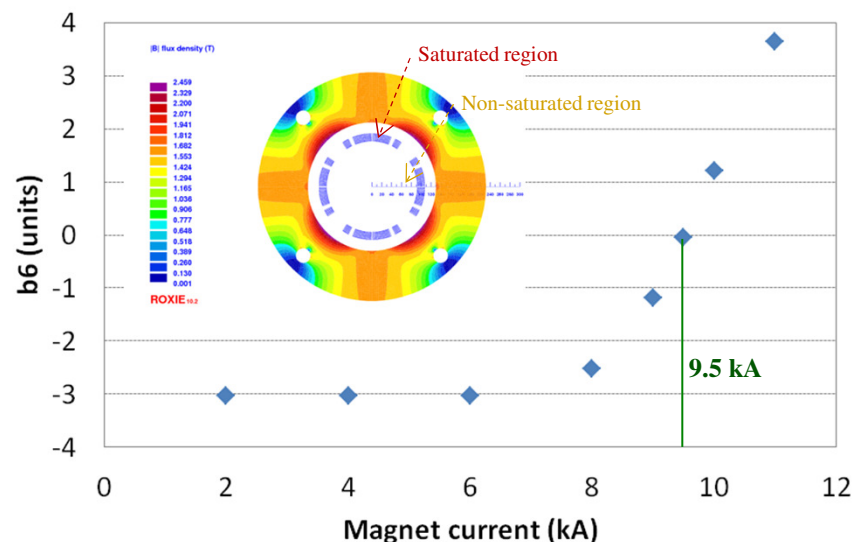

# Field Quality (3D)

- Large negative contribution to  $b_6$ ,  $b_{10}$  in the ends
  - Due to conductor blocks lifting away from the mid-plane as they turn around the pole
- $b_6$ : -280 units peak, or -43.3 units integrated over a magnetic length (straight section equivalent) of 406.3 mm
- $b_{10}$ : -30 units peak, or -3.1 units integrated over 406.3 mm
- Integral can be corrected by body-end compensation or by end optimization – with different advantages and disadvantages
- Need AP evaluation and feedback for different options

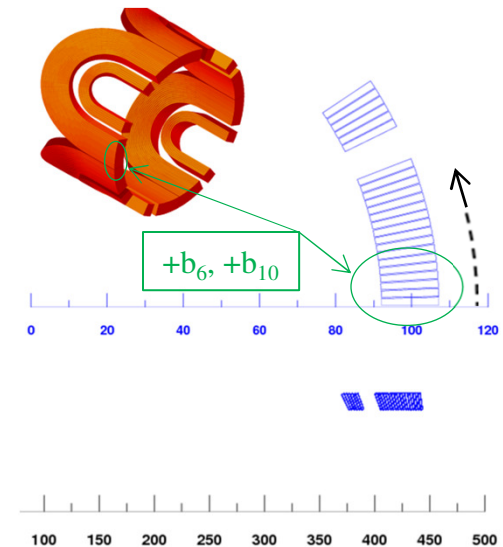
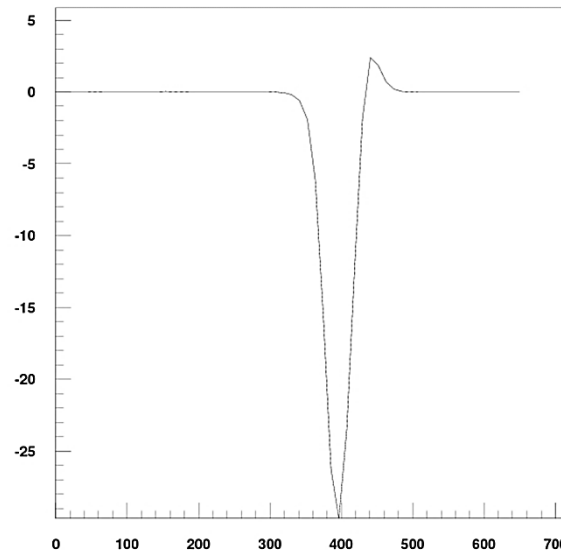
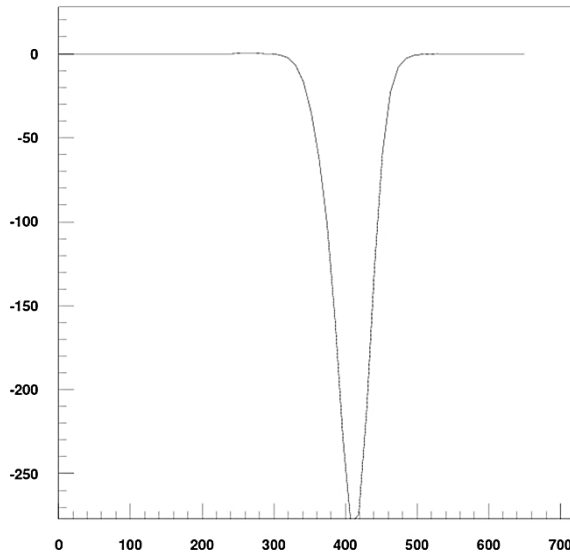
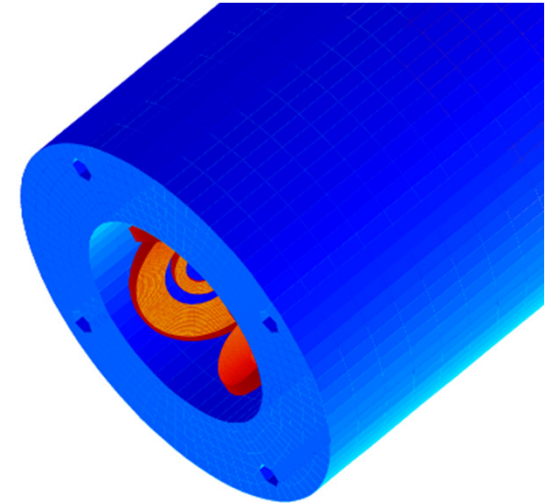

# Coil End Optimization

- Negative  $b_6$ ,  $b_{10}$  due to turns lifting away from the mid-plane can be compensated by **increasing the length of straight section** for these turns. Here we increase the straight section length of the **entire lower block** to avoid introducing additional spacers
- $b_6$ :  $\Delta z$  (B1)= 53 mm results in two peaks of  $\pm 250$  units which integrate to essentially zero
- Additional spacers would be required to compensate  $b_{10}$ , or to further lower the  $b_6/b_{10}$  peaks
- **Spacers are also effective to control the peak field in the ends** (iron needs to cover entire length to avoid a large fringe field) **but will increase the magnet length requirements**

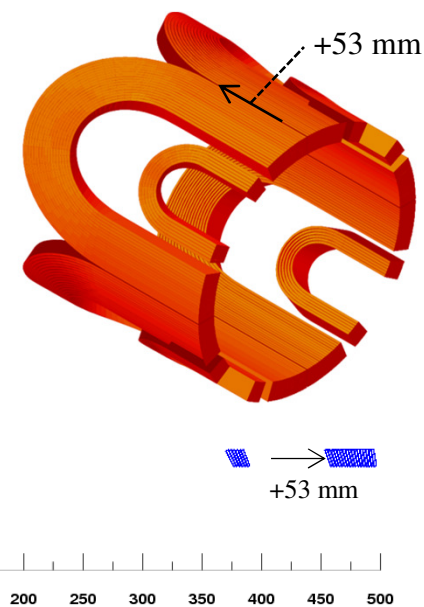
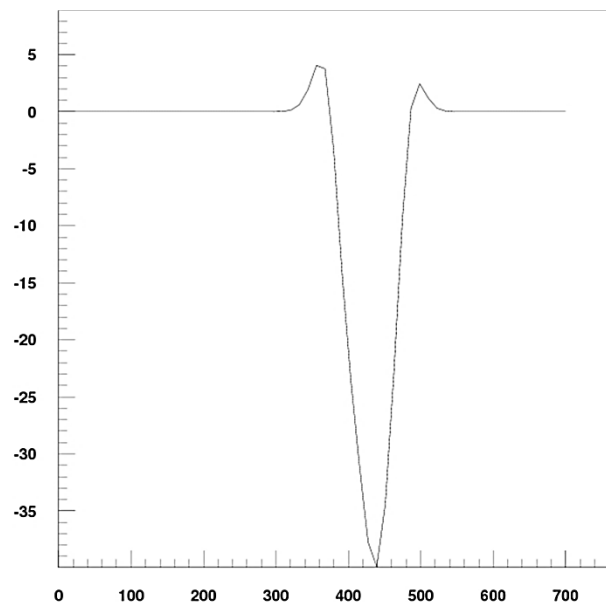
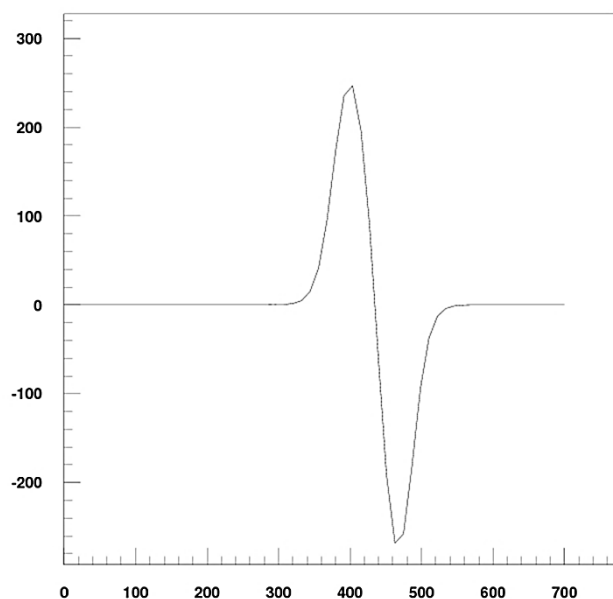

# Magnet Length Requirements

- Longitudinal space budget is one of the main challenges for the JLEIC IRs
- Requires a global optimization to meet both AP requirements and technology constraints:
  - Selection of operating parameters, coil design, acceptable fringe field, field quality (with implications on corrector needs), end mechanical support, leads and splices, integration of cold mass in cryostat and integration of different magnets/beamlines
- A first-pass evaluation of the preliminary design will be useful to determine next steps
  - Main question: **do we need to increase the central gradient** (with potential implications for coil design, operating temperature/margins, fringe field, forces etc.) **to decrease length**

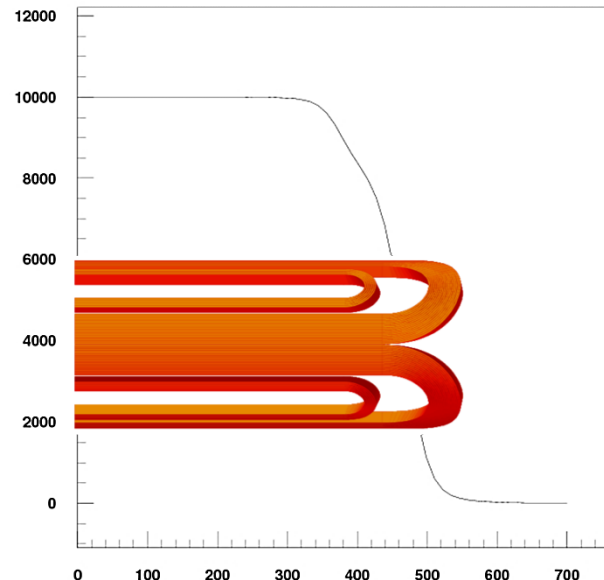
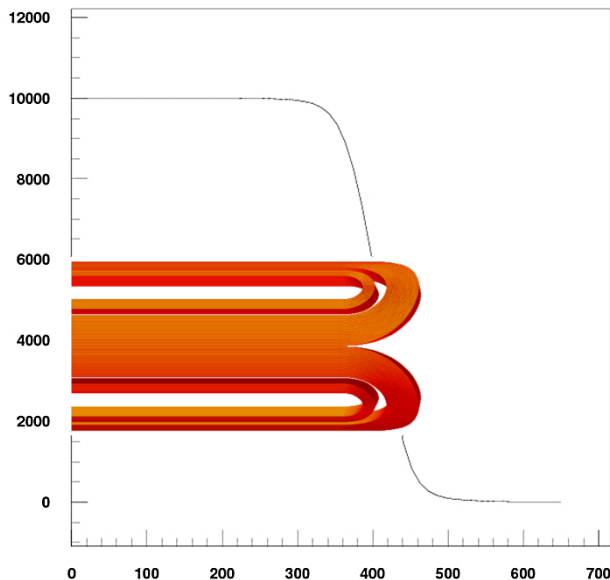

Longitudinal efficiency:

Baseline (compact) end:

- Coil half-length in the model: 450 mm
- Magnetic length: 406.3 mm

With additional spacer:

- Physical length +53 mm
- Magnetic length + 44.6 mm
- Requires a 17 mm increase of total coil length (both ends) to achieve the same magnetic length

# iQDS1b preliminary analysis

## Main features:

- Same gradient with increase aperture
- Double-layer coil with 30 mm total width
- MQXC cable with lower (1/2) keystone angle
- One wedge in each layer (probably not required)
- Radial space for “collars”: 25 mm
- Radial space for He vessel: 8mm + 8 mm

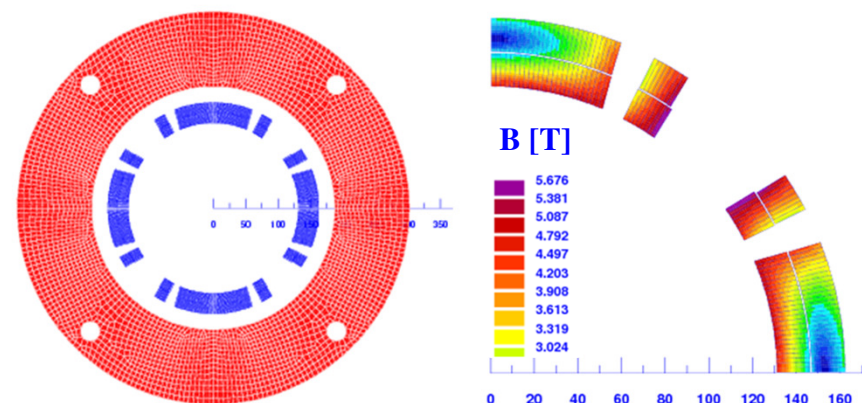

Coil and iron yoke geometry	Unit	Value
Inner coil radius	cm	13.1
Outer yoke radius	cm	30.2
Number of turns (L1, L2)		33, 35

Operating Parameters (2D)	Unit	Value
Current	kA	7.1
Copper current density	kA/mm <sup>2</sup>	0.46
Field Gradient	T/m	36.7
Field at coil radius ( $G \times R_{in}$ )	T	4.9
Peak field in the coil (2D) (*)	T	5.67
Lorentz force ( $F_{\theta}$ 1 octant)	MN/m	1.12

(\*) Includes strand self-field

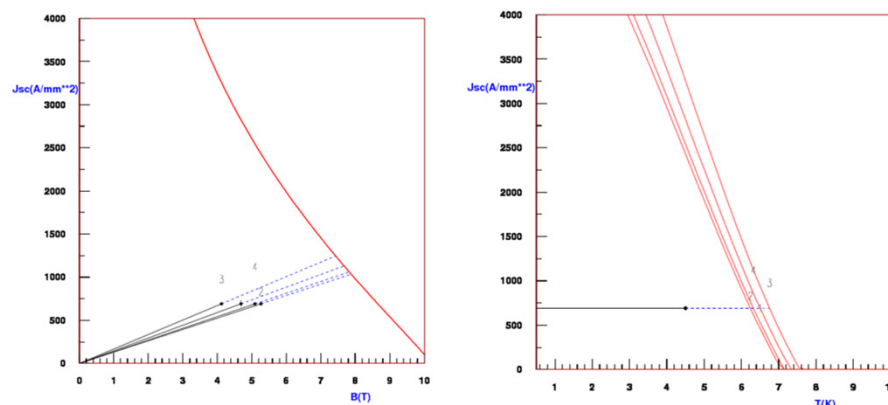

Margins to quench (*)	Unit	Value
Operating point on the load line	%	72.2
Temperature margin at $I_{op}$	K	1.48

(\*) based on 2D peak field

# iQDS2 preliminary analysis

## Main features:

- Double-layer coil with 30 mm total width
- MQXC cable with lower (1/2) keystone angle
- One wedge in each layer (probably not required)
- Radial space for “collars”: 30 mm
- Radial space for He vessel: 8mm + 10 mm

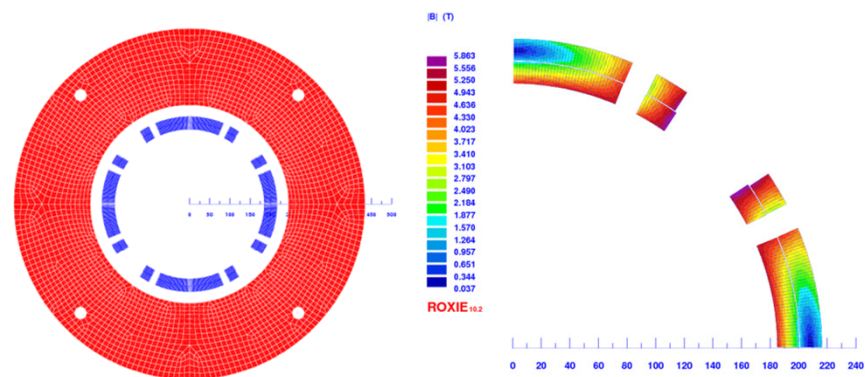

Coil and iron yoke geometry	Unit	Value
Inner coil radius	cm	18.5
Inner yoke radius	cm	24.5
Outer yoke radius	cm	43.4
Number of turns (L1, L2)		46, 49

Operating Parameters (2D)	Unit	Value
Current	kA	6.5
Copper current density	kA/mm <sup>2</sup>	0.42
Field Gradient	T/m	26.2
Field at coil radius ( $G \times R_{in}$ )	T	4.85
Peak (2D) coil field (*)	T	5.86
Lorentz force ( $F_{\theta}$ 1 octant)	MN/m	1.49

(\*) Includes strand self-field

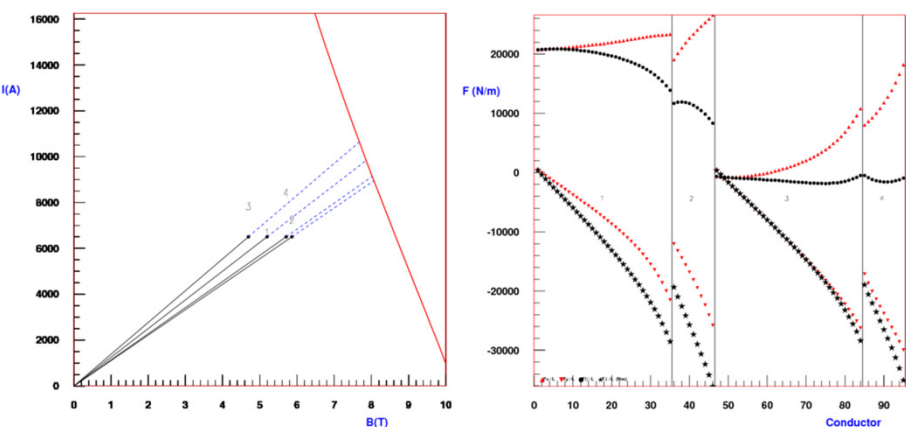

Margins to quench (*)	Unit	Value
Operating point on the load line	%	72.7
Temperature margin at $I_{op}$	K	1.46

(\*) based on 2D peak field

# Advanced Hydrotest Facility at LANL

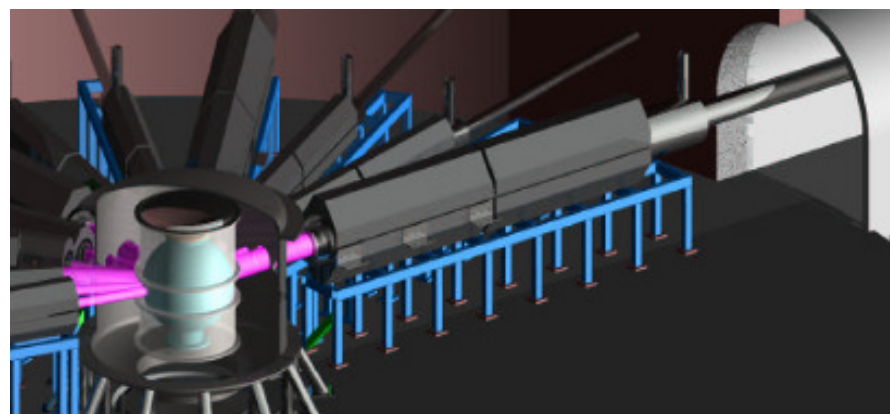
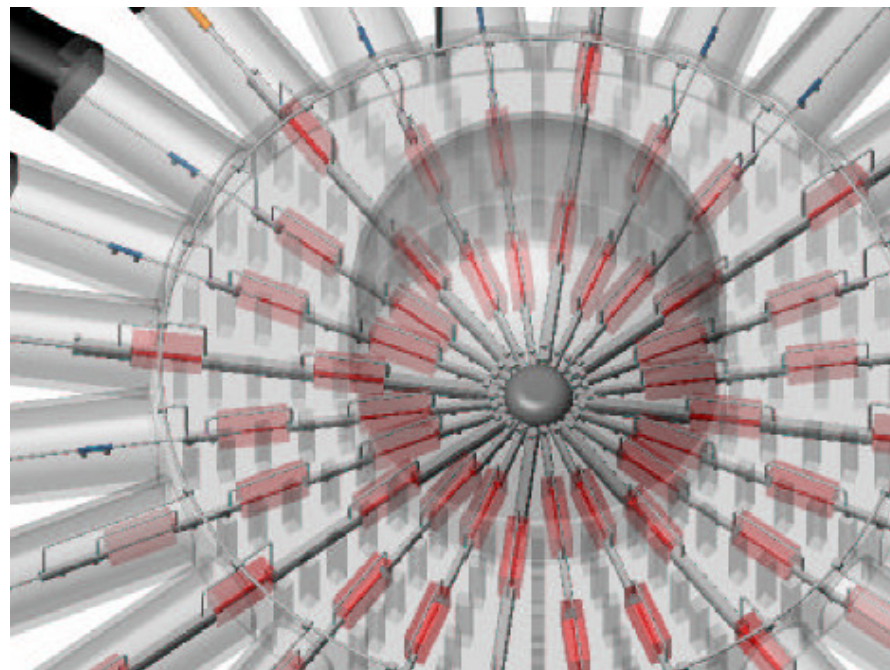
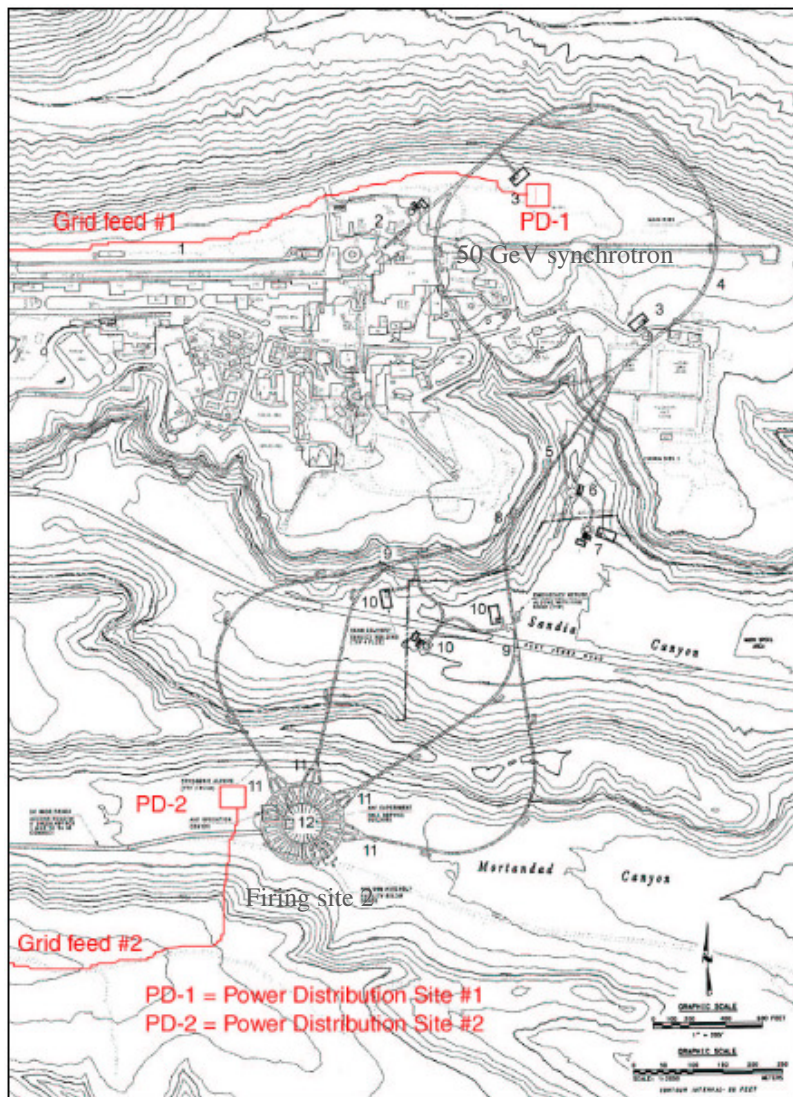





# AHF Final Focus System Parameters

## AHF Large Bore Quadrupole Focusing System Parameters

Parameter	Case I (Small Lens)	Case II (Large Lens)
No. upstream (illuminator/monitor) lines	8	4
No. downstream (imaging) lines	8	4
No. quadrupoles/doublet	2	2
No. quadrupoles/imaging lens	4	4
No. imaging lenses/line	2	2
No. quadrupoles/ upstream line	5	5
No. quadrupoles/imaging line	8	8
Total singlets, system	8	4
Total doublets, system	48	24
Total quadrupoles, system	104	52

## Case 1 and Case 2 Quadrupole Requirements

Parameter	Units	Case I (Small Lens)	Case II (Large Lens)
FOV radius	(mm)	60	150
R <sub>inner, beam pipe</sub>	(mm)	114	241
R <sub>inner, winding</sub>	(mm)	182	330
L <sub>quad</sub>	(m)	3.1	4.25
Hard-edge equivalent quadrupole gradient	(T/m)	18.4	10.4
Winding average quadrupole gradient*	(T/m)	17.13	9.75
Total lens length	(m)	25.4	33.8

Reference: *J. Schultz et al., IEEE TASC Vol. 13, No. 2, June 2013, pp.1343*

IEEE TRANSACTIONS ON APPLIED SUPERCONDUCTIVITY, VOL. 13, NO. 2, JUNE 2003

1343

The Advanced Hydrotest Facility (AHF) Large Bore Quadrupole Focusing Magnet System

Joel H. Schultz, Member, IEEE, T. Antaya, J. V. Minervini, A. L. Radovinsky, B. A. Smith, R. J. Camille, R. L. Myatt, A. Jason, P. Walstrom, and J. A. Waynert

## Case 2 coil geometry and operating field

Parameter	Units	Value
Rinner + gndwrap	(mm)	317.7
Router + gndwrap	(mm)	351.5
tgndwrap	(mm)	0.5
tins, turn	(mm)	0.2
tins, interlayer	(mm)	0.4
nturns, inner		69
nturns, outer		37
θ <sub>1</sub> (pole to inner layer)	(degrees)	7.7
θ <sub>2</sub> (pole to outer layer)	(degrees)	25.5
NIquad	(MAT)	3.4
B <sub>max, center</sub>	(T)	4.28
B <sub>max, end turns</sub>	(T)	5.01
W <sub>m, quadrupole</sub>	(MJ)	5.85
L <sub>coil</sub>	(m)	4.46
L <sub>magnetic</sub>	(m)	4.25

$$G \times R_{\text{pipe}} = 2.5 \text{ T} ; G \times R_{\text{coil}} = 3.3 \text{ T}$$

# AHF-2 Cable and Coil Design at MIT

2-layer cos(2θ) layout

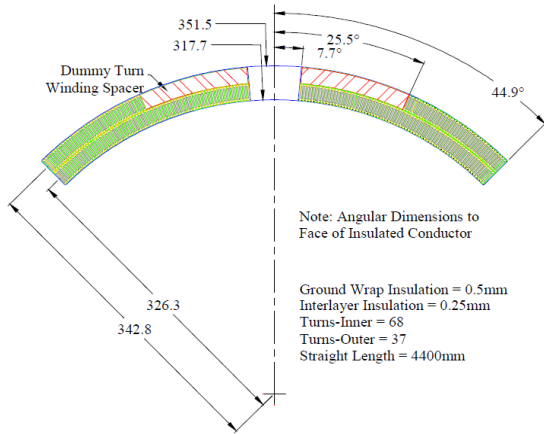

Rutherford cable in Cu channel

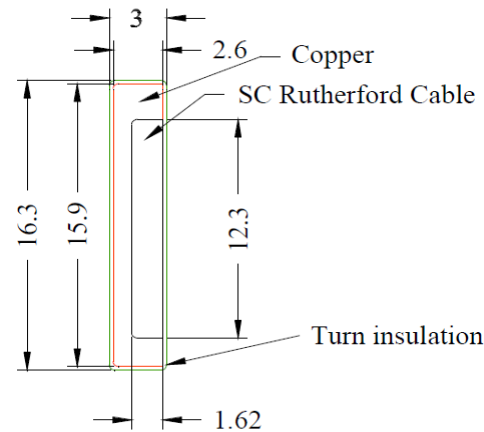

Raised saddle end

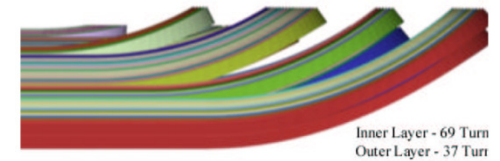

3 spacers in each layer

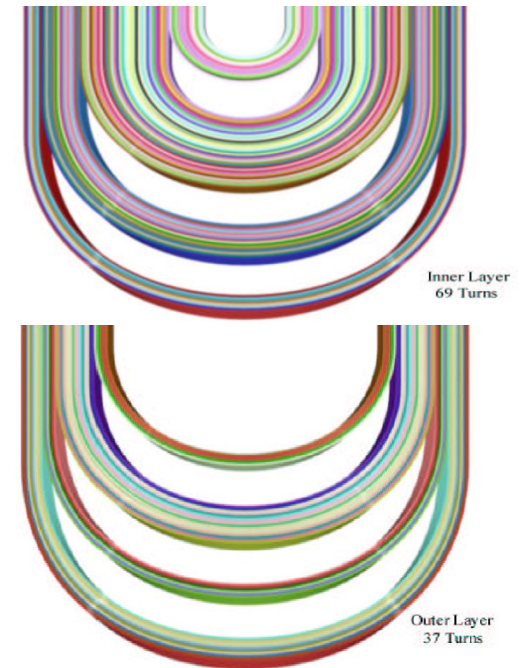

Dummy turns in outer layer

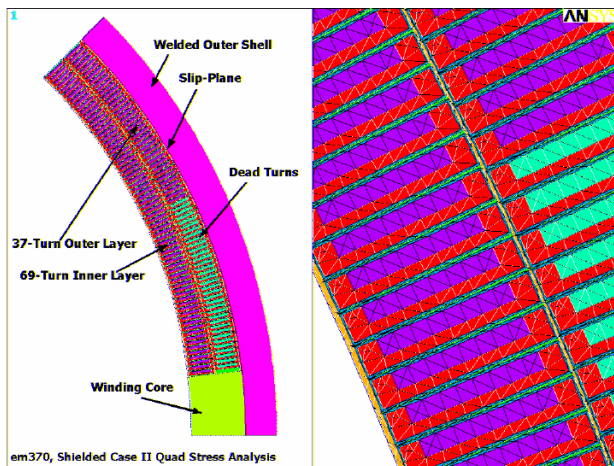

SSC strand and cable

Parameter	Units	Value
henv	(mm)	16.3
wenv	(mm)	3.0
hchannel	(mm)	15.9
wchannel	(mm)	2.6
hcablespace	(mm)	12.3
wcablespace	(mm)	1.623
Dstrand	(mm)	0.808
nstrands		30
Cu/Noncu		1.3
tins	(mm)	0.2



# AHF-2 Mechanical Design at MIT

## Design approach and main components:

- The mechanical design is based on a **30 mm thick welded stainless steel shell directly surrounding the coil** which provides preload and support against the Lorentz forces
- The (warm) iron yoke is not part of the mechanical support structure
- The pre-load level is selected **to prevent separation at the coil-pole interface** up to full field
- A **Titanium pole** is required to increase pre-load at cool-down and **decrease the warm pre-load**
- **Cable is encased in a copper channel** is to cope with the high pre-load and Lorentz forces/stresses

## Results of mechanical analysis:

- Stresses for Ti pole are **within material limits**
- **Warm pre-loaded stage is the most critical**

## Comments/next steps:

- New approach to address the specific design challenges, but outside established experience
- Many questions: need to study in more detail, and discuss with MIT colleagues who may provide additional insights or experimental information

Compute stress in cable conduit after pre-load (with Ti pole)

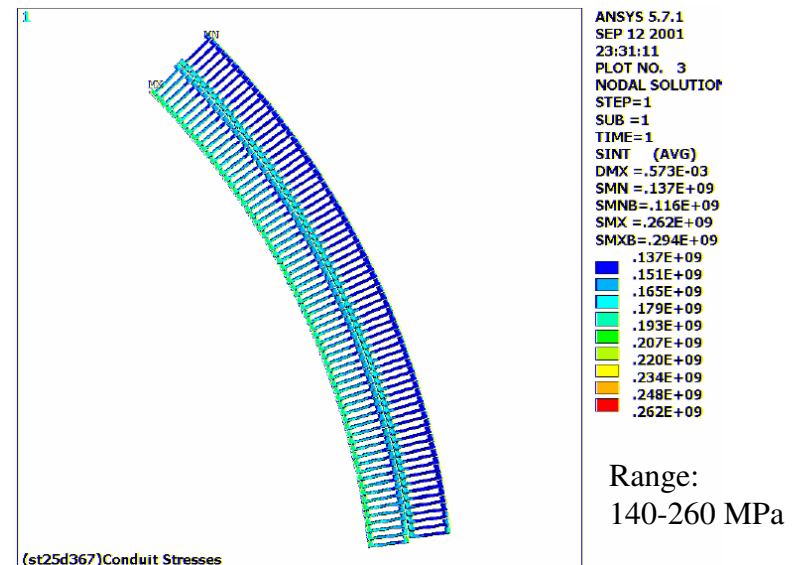

# Shell-based structure option

- The LBNL shell-based structure has replaced the traditional collars in high field/force/stress magnets
- Based on an aluminum shell over iron yoke
- Assembly preload provided by water-pressurized bladders and interference keys
- Significant pre-load increase at cool-down due to differential thermal contraction

## HL-LHC (MQXF) IR Quadrupole

### Main elements of the mechanical structure:

- Shell-Yoke sub-assembly
  - Aluminum shell
  - Iron yoke
- Coil-pack subassembly
  - Nb<sub>3</sub>Sn Coils
  - Aluminum Collars
  - Load pads
- Master Key assembly
  - Slots for pressurized bladders
  - Load keys, alignment keys
- Axial rods for longitudinal pre-load

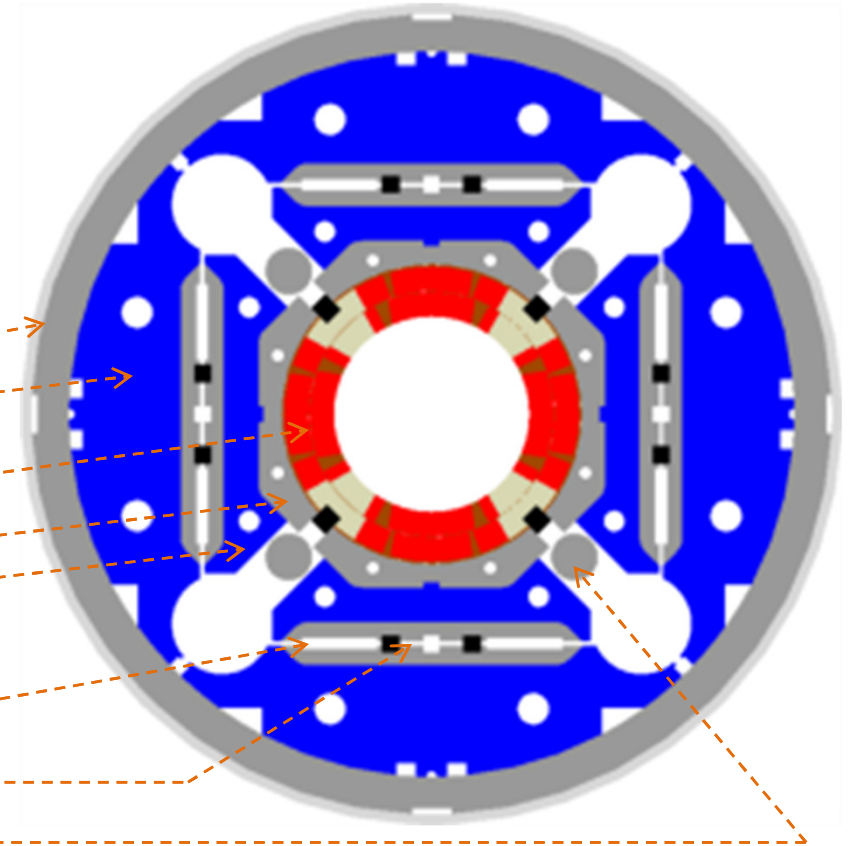

*Note however that radial space requirements for shell and bladder assembly features will further constrain the yoke optimization relative to a traditional collar-based structure*

# Shell structure test results

Demonstrated performance in the range of interest: force and stress levels, fine control of pre-load, low pre-load at warm, large diameter (fabrication and test)

TQS quadrupole (LBNL/LARP)

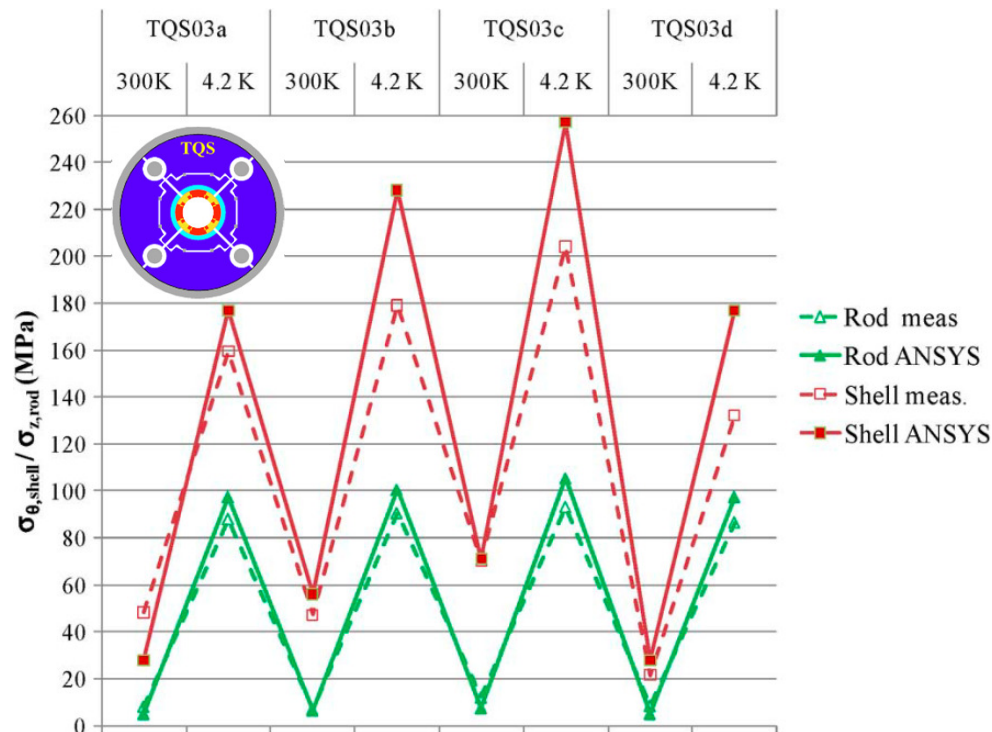

FRESCA2 dipole (CERN)

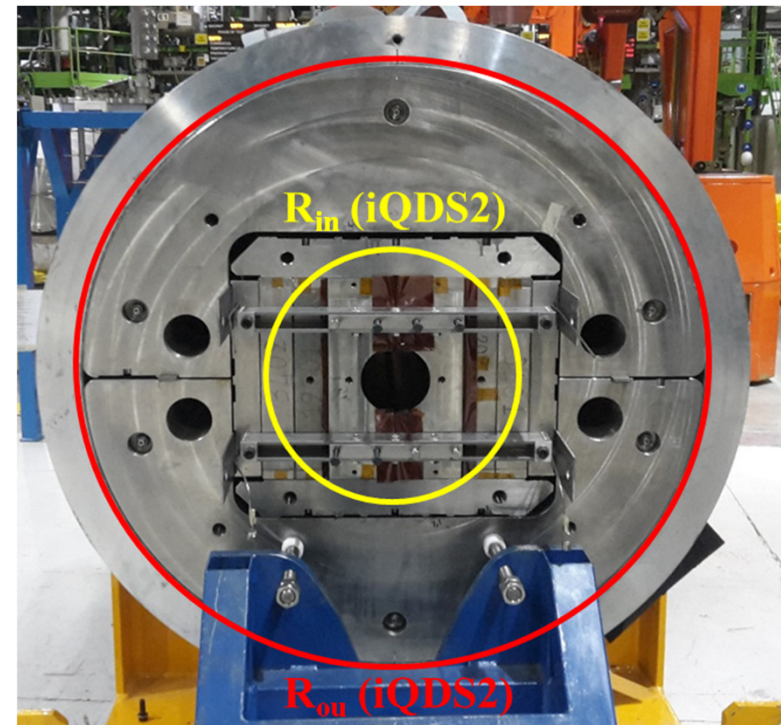

# AHF-2 Design Study at Fermilab

## Design drivers and approach:

- Traditional shell type coil will **suffer from stress accumulation at the mid-plane** and conductor displacements during excitation
- **Split in mechanically decoupled blocks**, for stress management and individual positioning and support
- NbTi and Nb<sub>3</sub>Sn options considered
- **Active shielding of fringe field**
- Reference: V. Kashikhin et al., PAC 2003

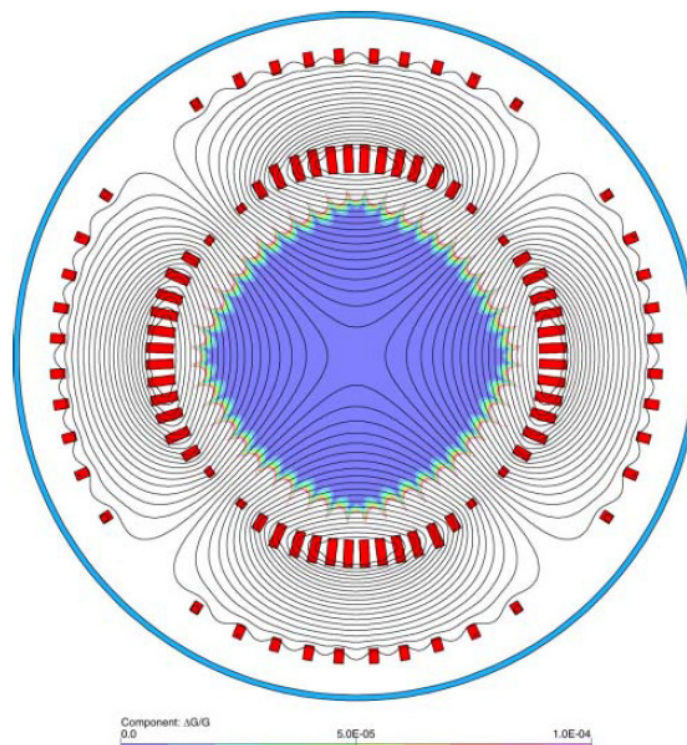

Parameter	NbTi	Nb <sub>3</sub> Sn
Strand diameter, mm	1.000	
Number of strands	32	
Cable bare width, mm	16.214	
Cable bare thickness, mm	1.772	
Number of SC strands	32	8
Number of Cu strands	0	24
Copper to non-copper ratio	1.6	0.85
$J_c(5T, 4.2 K)$ , A/mm <sup>2</sup>	3000	-
$J_c(12T, 4.2 K)$ , A/mm <sup>2</sup>	-	2200

Parameter	Small-bore	Large-bore
Operating gradient, T/m	24.15	13.18
Magnetic length, m	3.0	4.3
Reference radius $R_{ref}$ , mm	113.4	241.3
Field quality at $R_{ref}$	$<10^{-4}$	$<10^{-4}$
Main coil inner radius, mm	170.0	322.0

# iQDS1b fringe field

- Fringe field is  $\sim 0.25$  T
- Evaluate correction options
- Integrate the design of electron and ion quadrupoles and beamlines

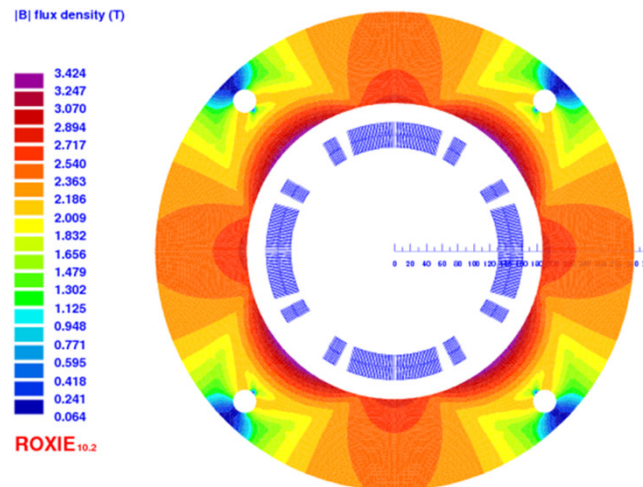

Magnetic field ( $B_y$ ) [T] along the x-axis

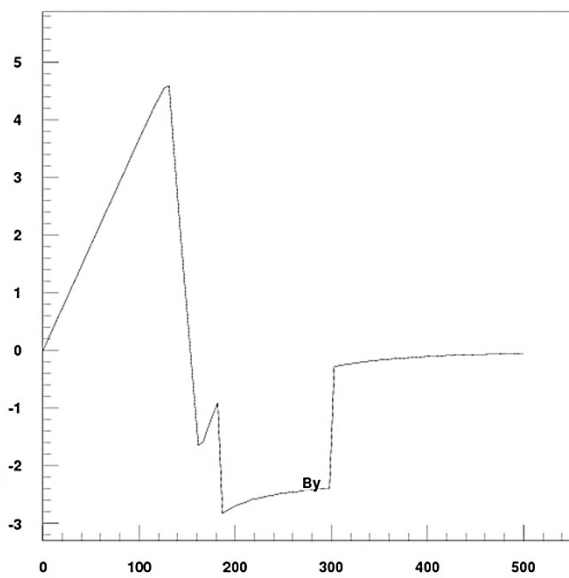

$B_y$  ( $y=0$ ) detail outside the iron yoke

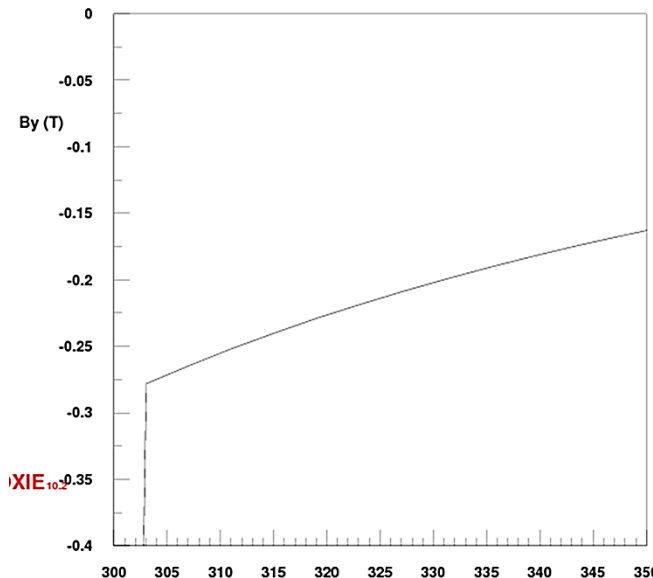

B along a 90 degree arc at  $R=310$  mm

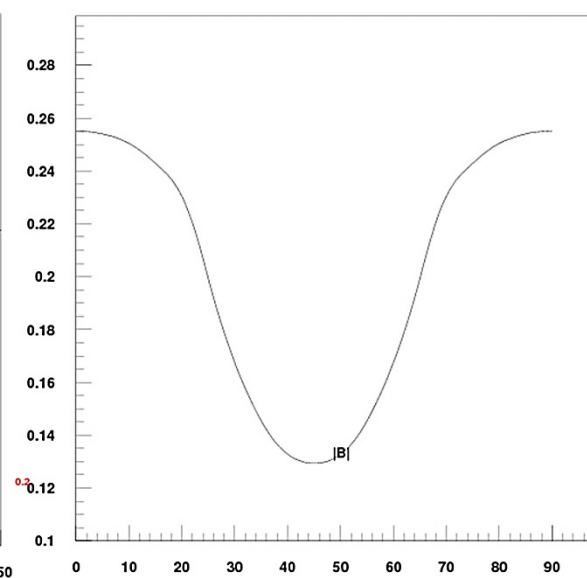

# iQDS2 Fringe Field

- Fringe field is 0.1-0.15 T
- Evaluate correction options
- Integrate the design of electron and ion quadrupoles and beamlines

|B| flux density (T)



ROXIE<sub>10.2</sub>

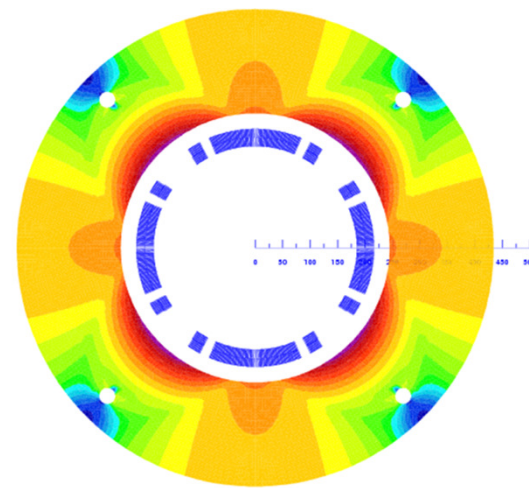

Magnetic field ( $B_y$ ) along the x-axis

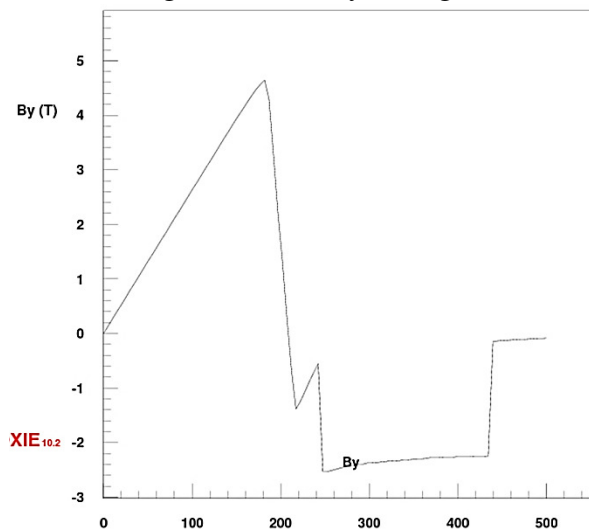

$B_y$  ( $y=0$ ) detail outside the iron yoke

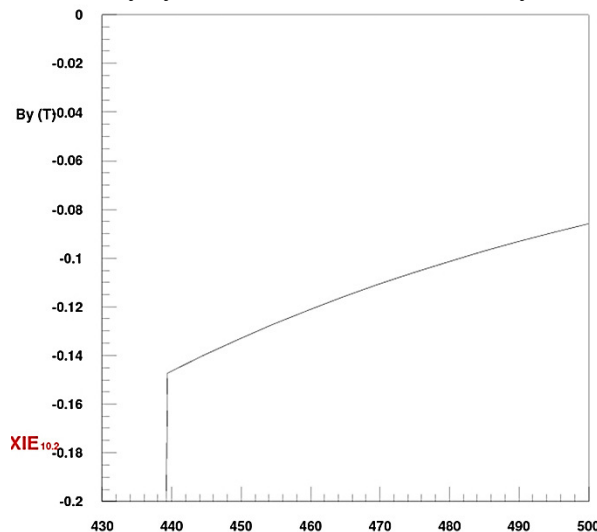

B along a 90 degree arc at R=240 mm

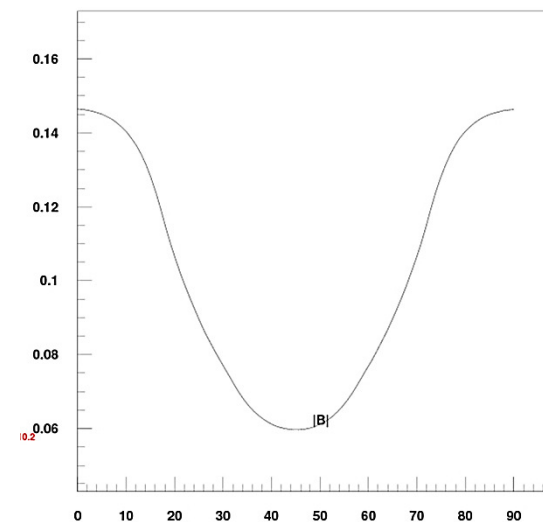





# Summary

- A preliminary analysis of the JELIC large aperture IR quadrupoles was performed
- Parameters of first quadrupole (iQDS1a) are within established technology envelopes
  - Design can be based on traditional  $\cos 2\theta$  approach: superconducting wire and cable, NbTi coil fabrication and collar-based mechanical support
  - Initial parameters were provided and can be used as a starting point for further optimization (e.g. cable dimensions, operating current, collar thickness etc.)
  - Field quality estimates were provided including 2D random errors, saturation effects, 3D end harmonics, and correction options
  - Main issue is longitudinal space budget and optimization
  - iQDS1a would be a good candidate for preliminary AP feedback on field quality and a detailed engineering exercise to establish longitudinal requirements for coil ends/transitions, current leads and splices, axial mechanical support, cooling, He containment and cryostat design. Results will be also useful for other magnets
- The second and third quadrupoles (iQDS1b and iQDS2) require a significant extrapolation from past experience due to a combination of aperture, field gradient, radial and longitudinal space constraints
  - Initial work should focus on conceptual design studies and selection of promising approach for conductor, cable, coil fabrication and mechanical structure
  - Prototype fabrication and test will be required to validate the proposed design
- Current radial allowances do not include any radiation shielding in the bore



# Additional slides

# iQDS1a with reduced radial envelope

- In order to provide radial space for the inner and outer LHe containment and beam pipe, the inner coil radius is increased by 8 mm and the outer yoke radius is decreased by 6 mm
- No change in cable parameters (15.1 mm width)
- Added two turns in B1 and adjusted angles
- Radial space for collars: 20 mm (-3 mm)
- Margin on the load line decreases by 4.2%
- Lorentz force and stress increases by ~24%

Coil and iron yoke geometry	Unit	Value
Inner coil radius	cm	10.0
Outer yoke radius	cm	22.5
Number of turns (B1+B2)		19+6

Operating Parameters (2D)	Unit	Value
Current	kA	9.9
Field Gradient	T/m	37.6
Peak field in the coil (*)	T	4.63
Lorentz force (azimuthal)	MN	0.47
Coil stress (azimuthal)	MPa	31.1

(\*) Includes strand self-field

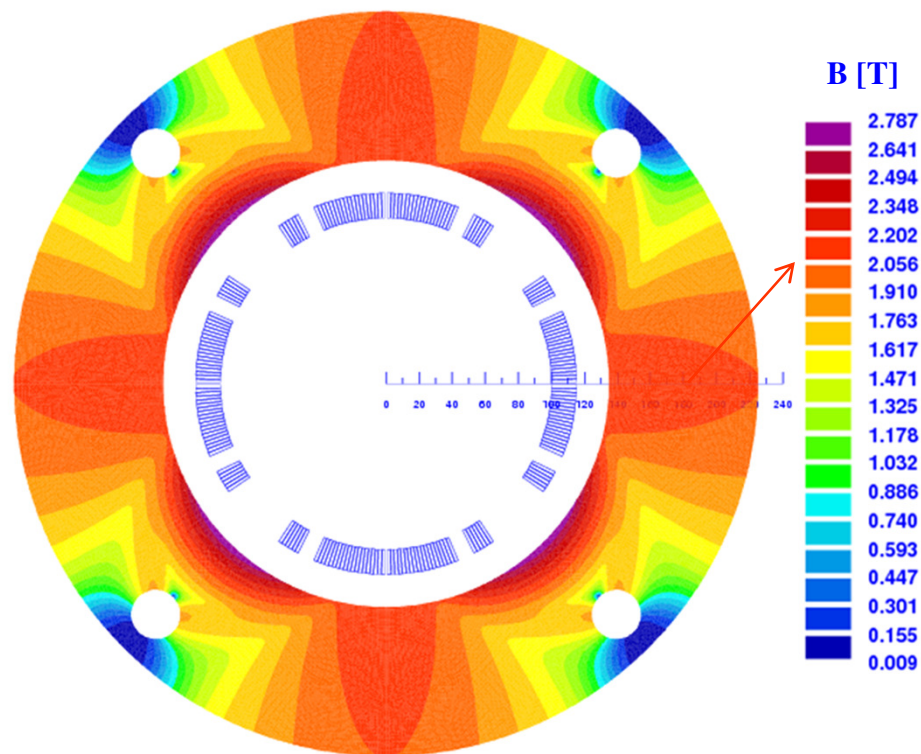

Margins to quench (*)	Unit	Value
Operating point on the load line	%	67.9
Fraction of critical current at $I_{op}$	%	36.7
Temperature margin at $I_{op}$	K	1.65

(\*) based on a linear extrapolation of the peak field load line

# Fringe field at the electron beamline

- Fringe field is 0.02-0.04 T
- Expect further increase if yoke is optimized for low saturation
- Evaluate correction needs and options:
- Passive correction e.g. with iron surrounding the electron beamline
- Active correction by tuning the design of the electron quadrupoles, or with a small dipole coil

