

# Lawrence Berkeley National Laboratory

## LBL Publications

### Title

Heat Transfer in Forced Convection Film Boiling

### Permalink

<https://escholarship.org/uc/item/5mz6f6jb>

### Authors

Bromley, LeRoy A

LeRoy, Norman R

Robbers, James A

### Publication Date

1952-08-01

UCRL-1894  
UNCLASSIFIED

UNIVERSITY OF CALIFORNIA - BERKELEY

**TWO-WEEK LOAN COPY**

*This is a Library Circulating Copy  
which may be borrowed for two weeks.  
For a personal retention copy, call  
Tech. Info. Division, Ext. 5545*

**RADIATION LABORATORY**

## **DISCLAIMER**

This document was prepared as an account of work sponsored by the United States Government. While this document is believed to contain correct information, neither the United States Government nor any agency thereof, nor the Regents of the University of California, nor any of their employees, makes any warranty, express or implied, or assumes any legal responsibility for the accuracy, completeness, or usefulness of any information, apparatus, product, or process disclosed, or represents that its use would not infringe privately owned rights. Reference herein to any specific commercial product, process, or service by its trade name, trademark, manufacturer, or otherwise, does not necessarily constitute or imply its endorsement, recommendation, or favoring by the United States Government or any agency thereof, or the Regents of the University of California. The views and opinions of authors expressed herein do not necessarily state or reflect those of the United States Government or any agency thereof or the Regents of the University of California.

UNIVERSITY OF CALIFORNIA

Radiation Laboratory

Contract No. W-7405-eng-48B

HEAT TRANSFER IN FORCED CONVECTION FILM BOILING

LeRoy A. Bromley, Norman R. LeRoy<sup>a</sup> and James A. Robbers<sup>b</sup>

August 1, 1952

Present address

<sup>a</sup>California Research and Development Co., Livermore, California

<sup>b</sup>California Research Corporation, Richmond, California

HEAT TRANSFER IN FORCED CONVECTION FILM BOILING

LeRoy A. Bromley, Norman R. LeRoy and James A. Robbers

Radiation Laboratory, Department of Chemistry  
University of California, Berkeley, California

August 1, 1952

Abstract

Heat transfer coefficients in upward flow forced convection film boiling (liquid at b.p.) from a horizontal tube, have been measured and a theory developed. Based on the theory and the data, simple expressions (equations 26-29) are developed by which it is possible to calculate heat transfer coefficients for this type of boiling.

## Introduction

There are two distinct types of boiling phenomena for the boiling of liquids from heated surfaces depending upon the heat input to the system. The first type, and that most generally preferred because of the fairly large heat transfer coefficients encountered, is nucleate boiling where the vapor originates from individual points on the hot surface. The second type of boiling phenomena is that of film boiling where there is a continuous vapor film between the boiling liquid and the heated surface. Film boiling is generally distinguished by low values of the heat transfer coefficient and high values of the temperature of the heated surface compared to nucleate boiling. A discussion of the occurrence of film boiling has been given by one of the authors<sup>1</sup>.

Natural convection film boiling has been studied by Bromley<sup>1</sup> and is that form of film boiling in which the liquid motion past the heated surface is caused ~~by changes in the density of the liquid with temperature, and~~ by viscous drag forces of the rising vapor acting on the liquid. Forced convection film boiling is that type of film boiling where the liquid is forced past the heated surface. As would be expected, the heat transfer coefficients increase with increasing liquid flow rates past the heated surface, because of the decrease in the vapor film thickness.

It is the purpose of this study to develop a theory for predicting heat transfer coefficients to be expected in forced convection film boiling from a horizontal tube, and to verify by experiment the resulting expressions.

### Film Boiling Theory

Mathematical relationships will be developed which will enable one to calculate the coefficients of heat transfer to be expected in upward flow forced convection film boiling from the outside of a horizontal tube. The vapor film is in dynamic equilibrium, for as it rises under the action of buoyant and drag forces, vapor is added to it from the boiling liquid. The heat required to vaporize the liquid and heat the vapor is supplied by radiation and conduction through the film. This mechanism appears to be the situation on about the lower half of the tube where from visual observation there appears to be a smooth continuous vapor film. The situation is very complicated on the upper half of the tube, for in this region the bubbles form before rising. The point on the tube at which the thickness of the vapor film approaches infinity (compared to the normal thickness) will be called the separation point. Since most of the heat is transferred on the bottom section of the tube up to the separation point, it would seem most important to have the theory fit the mechanism on this part of the tube.

The concept is represented graphically in Fig. 1. The tube is immersed in a body of fluid which is moving upward at a uniform velocity equal to  $U$ . If  $P$  represents the pressure at a point in the film, it has been shown<sup>6</sup> that,

$$P = P_0 + \frac{\rho_l}{\rho_v} R \cos \theta + \frac{\rho_l}{2g_c} U^2 (1 - 4 \sin^2 \theta) \quad (1)$$

A heat balance may be written for the element of vapor in the film enclosed by  $d\theta$  for a tube of length  $L$ .

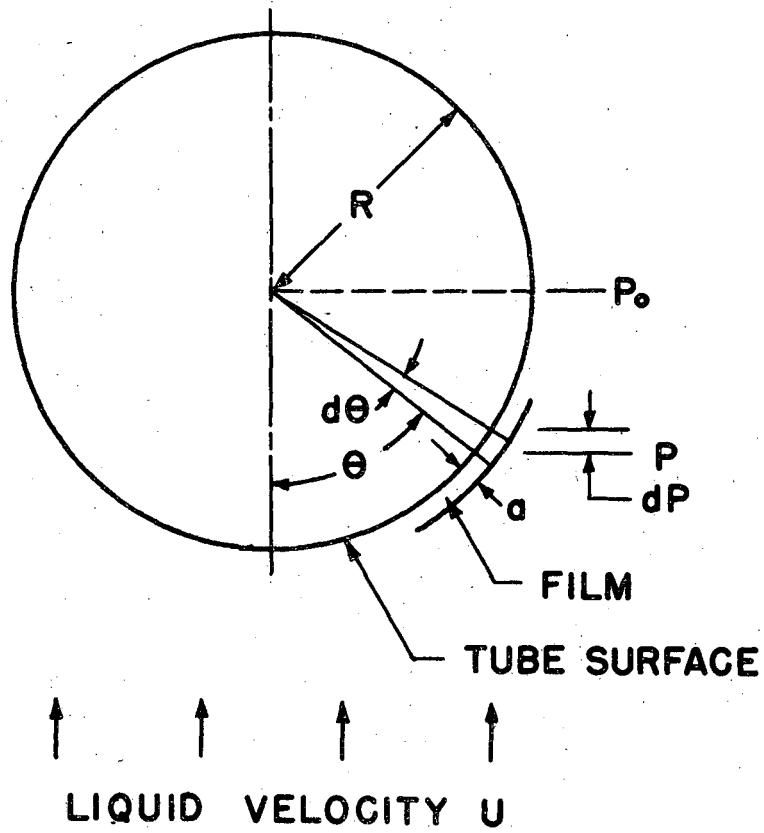

MU 2661

Fig. 1



$$dq = h_{co} \Delta t dA = h_{co} R L d\theta \Delta t = \lambda' dw \quad (2)$$

where  $\lambda'$  represents the effective heat content of the vapor film in excess of the heat content of the liquid.

We will consider that the vapor film is in laminar flow such that heat travels through the vapor film by conduction only. If "a" represents the average thickness of the vapor film at any angle  $\theta$ , then

$$h_{co} = \frac{k}{a} \quad (3)$$

In this case  $h_{co}$  represents the heat transfer coefficient due to convection when  $h_r$ , the coefficient due to radiation, equals zero. All of the heat does not pass clear through the vapor film as some of the heat is required to heat the film itself. Therefore, the above expression can not be exact but should give a fairly good approximation, as long as the latent heat is the major item in  $\lambda'$ . The correct  $\lambda'$  to be used has been derived elsewhere<sup>2</sup>.

Let us apply Bernoulli's theorem to the element  $d\theta$ , neglecting the kinetic energy of the vapor in the film<sup>1</sup>. Consider a unit mass of vapor entering this differential element in viscous flow.

$$-\frac{dp}{\rho} = dx \frac{f}{R_c} + dF \quad (4)$$

From the application of a material balance we obtain,

$$w = \rho v a L \quad (5)$$

From the geometry of the system we obtain,

$$dx = R \sin \theta d\theta \quad (6)$$

It is necessary to restrict ourselves to a tube of such diameter

-7-

that the film thickness is a negligible quantity compared to the radius of curvature of the film. The vapor film can be considered as in viscous flow between two parallel plates, one of which is stationary while the other is moving at a velocity of  $2U \sin \theta$ . The frictional drag force has been shown<sup>3</sup> to be represented by

$$\frac{dF}{Rd\theta} = \frac{12\mu V}{\rho g_c a^2} - \frac{12\mu U}{\rho g_c a^2} \sin \theta \quad (7)$$

The use of the numerical value of twelve implies that the velocity distribution in the liquid at the liquid-vapor interface is unaffected by the vapor drag.

Substituting the values of  $dF$  from equation (4),  $dp$  from the differentiation of equation (1), and  $dx$  from equation (6), and substituting the value of  $V$  from equation (5), the value of "a" from equations (2) and (3), and  $1/2 \sin 2\theta$  for  $\sin \theta \cos \theta$ , we obtain the following equation

$$\frac{12\mu\lambda^3 w}{\rho^2 g_c k^3 R^2 L^4 \Delta t^3} \left(\frac{dw}{d\theta}\right)^3 = \frac{g}{g_c} R \left(\frac{\rho}{\rho'} - 1\right) \sin \theta + \frac{4 \rho' U^2}{\rho g_c} \frac{\sin 2\theta}{2} + \frac{12\mu\lambda^2 U \sin \theta}{\rho g_c k^2 R L^2 \Delta t^2} \left(\frac{dw}{d\theta}\right)^2 \quad (8)$$

The terms in equation (8) may be designated as the static drag effect, the gravity pressure effect, the velocity pressure effect, and the velocity drag effect respectively.

Since we have not been able to derive an exact solution to equation (8), let us derive an approximate solution from which we may predict the coefficients of heat transfer due to convection. The term  $\theta'$  will be defined as the separation point for the flow upward across the tube.

Let us restrict ourselves to the consideration of the heat transfer from the region of 0 to  $\theta'$ , since from visual observation it is from this lower section of the tube that the major portion of the heat transfer takes place. The value of  $\theta'$  will depend upon the velocity of the liquid impinging upon the tube. For high flows  $\theta'$  approaches 90 degrees, while for low values  $\theta'$  tends toward a value of 180 degrees and equals 180 degrees at sufficiently low values.

An analysis of the no flow case<sup>1</sup> indicates that  $\frac{dw}{d\theta}$  does not vary greatly over a large section of the tube and hence it is possible to substitute  $\frac{W}{\theta}$  for  $\frac{dw}{d\theta}$  in the least significant term, the velocity drag term, in equation (8). Thus

$$\frac{12\mu\lambda^3 w}{\rho^2 g_c k^3 R^2 L^4 \Delta t^3} \left(\frac{dw}{d\theta}\right)^3 = \frac{gR(\rho_l - \rho) \sin \theta}{\rho g_c} + \quad (9)$$

$$\frac{2\rho_l U^2 \sin 2\theta}{\rho g_c} + \frac{12\mu\lambda^2 U \sin \theta}{\rho g_c k^2 R L^2 \Delta t^2} \left(\frac{W}{\theta}\right)^2$$

Multiply the above equation by  $\frac{\rho g_c}{2\rho_l U^2}$ , take the cube root, and separate the variables; also let us integrate from 0 to  $\theta'$  and rearrange.

$$\left[ \frac{12\mu\lambda^3}{\rho g_c k^3 D^2 L^4 \Delta t^3 U^2} \right]^{1/4} W = \left(\frac{4}{3}\right)^{3/4} \left(\frac{1}{2}\right)^{1/4} \left[ \int_0^{\theta'} \frac{gD(\rho_l - \rho)}{4\rho_l U^2} + \frac{12\mu\lambda^2 W^2}{\rho_l U k^2 D L^2 \Delta t^2 \theta^2} \sin \theta + \sin 2\theta \right]^{1/3} d\theta \quad (10)$$

The weight of liquid vaporized per unit time on one half the tube,  $W$ , can also be evaluated from the integrated form of equation (2).

$$W = \frac{h_{co}(0-\theta')DL\theta'\Delta t}{2\lambda'} \quad (11)$$

In this equation  $h_{co}(0-\theta')$  is the value of the heat transfer coefficient for convection averaged over the portion of the tube from zero to  $\theta'$ . This equation, as stated previously, neglects the heat transferred by radiation from the specified portion of the tube.

Let us substitute the value of  $W$  from equation (11) into equation (10); also let us neglect for the present the heat transferred above  $\theta'$ , hence

$$h_{co} = h_{co}(0-\theta') \cdot \frac{\theta'}{\pi} \quad (12)$$

The following equation results:

$$h_{co} \left[ \frac{D^2 \Delta t \mu}{U^2 k^3 \rho e \lambda} \right]^{1/4} = \frac{2}{3\pi} \int_0^{\theta'} \left\{ \left( \frac{gD(\rho_2 - \rho)}{4U^2 \rho_2} + \frac{3D\mu^2 h_{co}^2}{Uk^2 \rho_2 \theta'^2} \right) \sin \theta + \sin 2\theta \right\}^{1/3} d\theta \quad (13)$$

This equation has been evaluated numerically in Table I. A more complete derivation is given by Robbers<sup>7</sup>.

It will be noted in Fig. 8 that the experimental data lie approximately in a straight line somewhat above the predicted curve. Or

$$h_{co} \left[ \frac{D^2 \Delta t \mu}{U^2 k^3 \rho e \lambda} \right]^{1/4} = 0.88 \left[ \frac{gD(\rho_2 - \rho)}{4U^2 \rho_2} + \frac{3D\mu h_{co}^2}{Uk^2 \rho_2} \left( \frac{\pi}{\theta'} \right)^2 \right]^{1/4} \quad (14)$$

At very low flows this equation reduces

$$h_{co} \sqrt[4]{\frac{D \Delta t \mu}{k^3 (\rho_2 - \rho) \rho_2 g \lambda}} = 0.62 \quad (15)$$

which checks the natural convection work<sup>1</sup>. At very high flows ( $\theta' \rightarrow \frac{\pi}{2}$ ) and equation (14) becomes

$$h_{co} \sqrt{\frac{D \Delta t}{Uk \rho \lambda}} = 2.7 \quad (16)$$

TABLE 1

Numerical Evaluation of Integral for Equation (13)

$$F = \frac{gD(e_2 - e_1)}{4U^2 e_1} + \frac{3D\mu\pi^2 h_{co}^2}{Uk^2 e_1 e_2^2}$$

for  $F > 2$ ;  $\theta' = \pi$

for  $F < 2$ ;  $F = -2 \cos \theta'$

$$B = \frac{7}{3\pi} \left[ \int_{\theta}^{\theta'} (F \sin \theta + \sin 2\theta)^{\frac{1}{3}} d\theta \right]^{\frac{3}{4}}$$

<u>F</u>	<u>B</u>	<u>θ'</u>
0	0.429	90°
0.01	0.435	90° 17'
0.10	0.451	92° 52'
0.50	0.521	104° 29'
1.00	0.608	120°
2.00	0.814	180°
10.00	1.293	180°
∞	0.721 $F^{\frac{1}{4}}$	180°

This is plotted as the solid curve in Fig. 8a.

It will be shown later that with equation (15) or (16) the coefficient of heat transfer may be calculated for almost the entire range of velocity.

If one adopts equations (15) and (16) as two dimensionless groups, one must add a third group to correlate all of the variables. Such groups as  $\left(\frac{U}{GD}\right)$ ,  $\left(\frac{\Delta t k_e}{e \lambda \mu}\right)$  or combinations with the above might be used.

### Effect of Radiation

For the case of natural convection film boiling the following equation has been used<sup>1</sup>:

$$h = h_{CO} + 3/4 h_r \quad (17)$$

This equation is accurate within five per cent for cases where the value of  $h_r$  is small compared to the value of  $h_{CO}$ .

A similar development assuming that all heat transferred above  $\theta'$  is by radiation results<sup>7</sup> in the expression

$$h = h_{CO} + h_r \left(1 - \frac{\theta'}{4\pi}\right) \quad (18)$$

at high velocities  $\theta' \rightarrow \frac{\pi}{2}$  and

$$h = h_{CO} + \frac{7}{8} h_r \quad (19)$$

The term  $h_r$  may be calculated by the following equation for parallel plates;

$$h_r = \frac{\sigma}{\frac{1}{\epsilon} + \frac{1}{\alpha} - 1} \left[ \frac{T_T^4 - T_L^4}{\Delta t} \right] \quad (20)$$

where:  $T_L$  is the temperature of the boiling liquid in degrees R

$T_T$  is the temperature of the hot tube in degrees R

$\epsilon$  is the emissivity of the hot tube

$\alpha$  is the absorptivity of the liquid

$\sigma$  is the Stefan-Boltzman constant,  $0.1713 \times 10^{-8}$   
 Btu/(hr)(ft<sup>2</sup>)(°R<sup>4</sup>)

For the graphite tube  $\epsilon$  was taken = 0.8 and for the liquids used  
 $\alpha$  was taken = 1.0.

### Film Properties

It is necessary to know the correct average values of the physical properties of the vapor film in order to evaluate the dimensionless groups utilized in the theory. A general procedure for evaluating the film properties is to determine the values at the arithmetic average temperature. This approach, although usually adequate, is not very exact. Therefore, expressions are developed for evaluating the best average value of each physical property individually. In order to simplify the derivation, other properties were assumed constant when considering any single property.

Thermal Conductivity.--The thermal conductivity of most vapors vary with temperature in such a manner that a plot of the logarithm of the thermal conductivity,  $k$ , versus the logarithm of the temperature,  $T$ , is approximately a straight line with a slope equal to  $n$ . We can write the equation of the straight line as

$$k = CT^n, \quad (21)$$

where  $C$  is a constant. With this it may be derived<sup>7</sup> that

$$k_{ave} = \frac{\frac{k_T T_T}{n+1} - \frac{k_L T_L}{n+1}}{(T_T - T_L)} \quad (22)$$

We now have an expression for the average value of the thermal conductivity that involves a knowledge of the values of the thermal conductivity at the temperature at the tube surface and at the temperature of the boiling liquid. Equation (83) can be reduced to a simpler form since for any given liquid at its boiling point the value of  $\frac{k_L T_L}{n+1}$  is a constant.

Density of Vapor.--Assuming ideal gas it may be derived<sup>7</sup> that

$$\rho_{ave} = \frac{2\rho_L T_L}{\Delta T} - \frac{4.606\rho_L T_L^2}{\Delta T^2} \log\left(\frac{T_T}{T_L}\right) \quad (23)$$

where  $\rho_L$  = density of the vapor at the liquid boiling temperature.

Viscosity.--The average viscosity of the vapor film was determined from an analogy to an expression given by McAdams<sup>8</sup>. McAdams evaluates the average viscosity of the liquid film produced by film condensation at a temperature that is lower than the average film temperature. The viscosity for the vapor film also should be evaluated at a temperature closer to the tube temperature than to the liquid temperature. The temperature at which the viscosity should be evaluated is denoted by  $T_{\mu}$ . If the fluidity is assumed linear with temperature, then,

$$T_{\mu} = T_L + 0.75\Delta t \quad (24)$$



Heat Content -  $\lambda'$ .-- The "effective" latent heat of vaporization in the case of condensation has been derived<sup>2</sup>. A consideration of the equations indicate that for natural convection film boiling that the same type of equation is involved, however although it may be slightly in error for forced convection film boiling the error should not be serious.

$$\lambda' = \lambda \left[ 1 + \frac{0.4\Delta t C_p}{\lambda} \right]^2 \quad (25)$$

Average Temperature Method.--The only physical property for which the error in the calculated coefficient is serious (> 5%) is that for  $\lambda'$ . Accordingly it is recommended that all physical properties except  $\lambda'$  be evaluated at the average temperature of the vapor film for simplicity.

#### Description of the Apparatus

Figure 2 is a diagram of the forced convection film boiler.

The film boiling apparatus was used for continuously circulating a liquid at its boiling temperature past a graphite heating element where the liquid underwent film boiling and subsequently for condensing the resulting vapors for recirculation. The heat input to the heating element was controlled by means of a voltage regulator and current transformer. Instruments were provided for measuring the amperage, voltage, temperature, and liquid velocity. Auxiliary equipment was included for pumping the liquids to storage and for filling the film boiler. Safety measures have been devised for protection against the toxic vapors and the fire hazards resulting from the liquids to be studied in the apparatus. A more complete description has been given

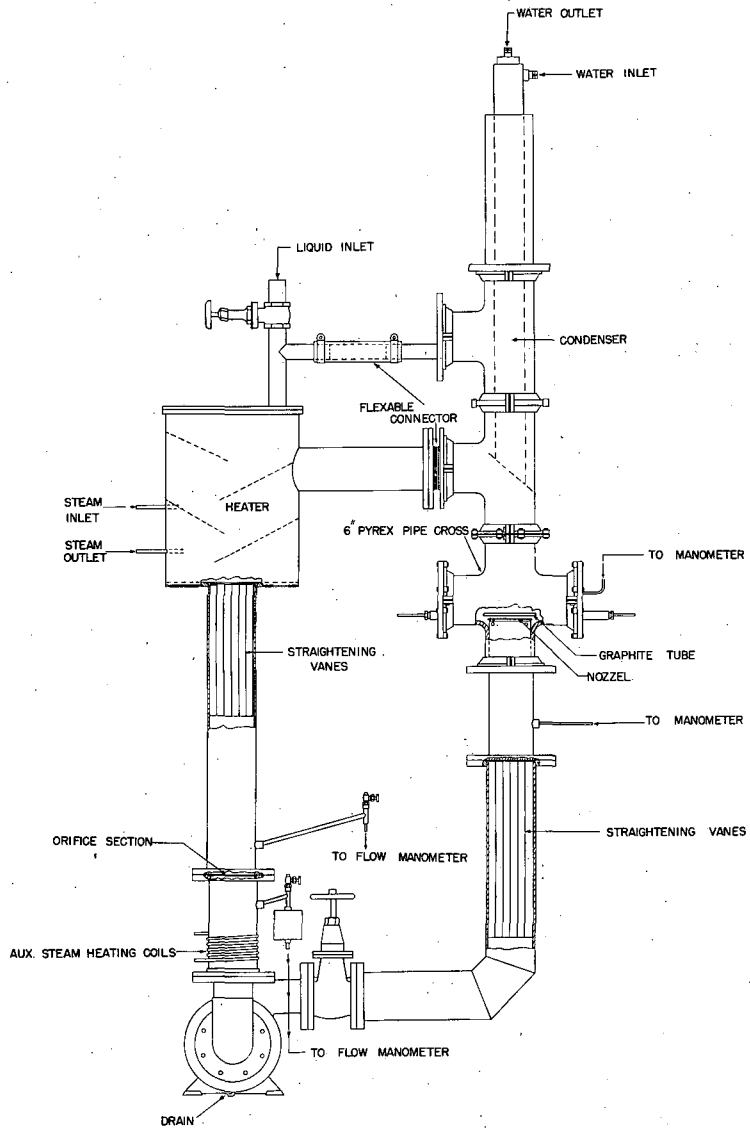

FIG. — FORCED CONVECTION FILM BOILER

Fig. 2

by LeRoy<sup>4</sup> and Robbers<sup>7</sup>.

### Experimental Procedure

The graphite heating tube to be used in a series of runs was carefully polished with crocus cloth before being installed in the test section. The outside diameter of the graphite tube was determined with a micrometer and recorded. The copper sleeves which fitted the graphite tube were polished to provide a good electrical contact surface with the tapered end of the graphite tube as well as to help prevent leakage during the run. The apparatus was then assembled.

After charging the apparatus with the desired liquid, and preheating to the boiling point, the heat input to the graphite tube was increased until the boiling from the tube changed from nucleate to film boiling. The flow rate was adjusted to the desired value and the flow manometer reading was recorded. Three sets of data were determined for each flow reading. These corresponded to a low, high and an intermediate value of the heat input to the graphite tube.

A chromel versus alumel thermocouple was inserted through the copper supporting tubes and was used to determine the average temperature at the center of the graphite tube. Consecutive temperature readings were determined until the stable film boiling attained steady state conditions. After recording the average temperature at the center of the tube, the thermocouple was moved specified distances across the tube so as to attain a temperature profile with distance. The temperature profile was determined in order to calculate the heat conducted longitudinally away from the center of the graphite tube.

The thermocouple was removed and the voltage probe was inserted. The leads from the voltmeter were connected to the voltage probe and to the electrical connector on the right hand supporting tube. The voltage was determined at points 2.5 inches on either side of the center of the graphite tube and the difference between the two values was recorded as the voltage drop across the 5.0 inch test section. The current flowing through the graphite tube during each run was measured with the ammeter and recorded.

The three inch and the one inch orifice sections were calibrated by means of a movable pitot tube which could be mounted in the left hand end plate when the graphite heating tube was removed. A static pressure tap was mounted on the upper side of the nozzle. The static tap and the pitot tube were connected to two vertical glass tubes which were open to the atmosphere. The difference in the hydrostatic heads developed at each flow rate was used as a basis for calibrating the orifice manometer.

The velocity profile was determined at different heights above the nozzle section. The velocity distribution was fairly constant up to about one and one-fourth inches above the nozzle section. The vertical distance between the center of the graphite tube and the nozzle plate was determined from a consideration of the uniform flow profile and the established flow distribution around a cylinder in a uniform flow.

The visual characteristics of the stable film boiling phenomenon were recorded as an important part of the present investigation.

### Description of the Vapor Film

The use of pyrex glass piping for the test section made possible the visual observation of the liquid boiling from the graphite tube. The change from nucleate boiling into film boiling and the reverse was clearly distinguishable. The effect of changing the liquid flow rate or the heat flux generated within the graphite tube was noted by a corresponding change in the vapor film surrounding the tube. The bubbles formed at the graphite tube surface during the preheating of the liquid to its boiling point were observed and their resulting change in size as they flowed to the condensing section was used as a measure of the liquid temperature.

In film boiling the vapor film surrounding the tube was very smooth at low tube surface temperatures with only natural convective forces acting in the liquid. As the tube temperature or heat flux was increased, a corresponding increase in the film thickness was noted. The roughness or irregularities at the vapor and liquid interface increased noticeably with the increased heat flux. The separation point for the vapor leaving the tube surface was at the top of the tube and the tube appeared to be completely surrounded by the vapor film. As the liquid flow rate was increased, the vapor film thickness decreased, and the separation point moved down to approximately the middle of the tube as predicted by the theory.

In some trial runs made with a carbon tube it was observed that at high velocities with film boiling that the bottom of the tube was from 100° to 200° colder than the top half of the tube, indicating

that by far the largest percentage of the heat is transferred on the lower half of the tube, especially at high flow rates.

### Experimental Data

Experimental data were taken on the following liquids: absolute ethyl alcohol, benzene, carbon tetrachloride, and n-hexane. The data and calculated quantities appear in Tables 2 to 19. The values for ethyl alcohol are listed in Tables 2 to 7 for benzene, Tables 8 to 13 for carbon tetrachloride, Tables 14 to 16, and for n-hexane, Tables 17 to 19.

To study the effect of tube diameter, three different tube sizes were used. The approximate outside diameters were  $3/8$ ,  $1/2$ , and  $5/8$  inches. More accurate measurement of each are listed in the headings of each table. The tube material in all three cases was graphite, and all three sizes were used for each liquid.

Since the primary problem was to study the effect of forced convection on the heat transfer coefficient, liquid velocities were varied from zero flow to approximately 14 feet per second depending on the particular liquid. Extensive studies were made on alcohol and benzene in the region from zero flow to 2 feet per second. These data are listed as low flows in the heading as distinguished from high flows, which covers the entire range. The general practice was to record three pieces of data, covering a range of temperatures for each velocity setting.

A sample calculation and values of the physical properties of the

liquids used in computation have been recorded<sup>4,7</sup>.

Included in the tables are the following quantities:

1. The run number is taken from the laboratory notebook and is used only as a means of listing the data in the correct columns. In some cases the data were taken at different times and therefore the run numbers may not be concurrent with each other.

2. "Volts" refers to the voltage drop across a five inch section on the center portion of each tube. The values represent the difference of two readings as read from a current flux voltmeter.

3. "Amp" refers to the total current flowing in the tube. The values being read for an alternating current ammeter.

4. The " $t_i$ " is the recorded inside temperature of the tube at the center point. The values were measured in millivolts by a chromel vs. alumel thermocouple and converted to degrees Fahrenheit.

5. The " $\Delta t$ " is the temperature difference between the outside surface of the tube and the boiling liquid. The tube surface temperature is calculated from a knowledge of  $t_i$  and the thermal conductivity of graphite<sup>4</sup>. A correction<sup>7</sup> is made for longitudinal heat conduction.

6. "U" is the velocity of liquid at the slot opening as measured by a calibrated sharp edged orifice.

7. The "h" is the calculated overall coefficient of heat transfer of the vapor film.

8. The " $h_{co}$ " is the calculated value of the coefficient of heat transfer due to convective heat transfer if there were no radiation.

The rest of the calculated quantities are dimensionless groups based on the theory and useful in the correlations.

TABLE 2

Experimental and Calculated Data on the Film Boiling of Ethyl Alcohol  
at Low Flows from a 0.387-Inch Outside Diameter Tube.

Run No.	Volts	Amps	$t_i$ °F	$\Delta t$ °F	$U$ $\frac{ft}{sec}$	$h$ $\frac{Btu}{(hr)(sq. ft)(°F)}$	$h_{co}$ $(°F)$
342	3.09	158.0	1017	838	0	45.2	39.6
343	3.43	175.0	1146	966	0	48.2	41.4
344	3.68	190.0	1326	1145	0	47.2	38.3
345	2.98	153.5	946	768	0	46.2	41.2
346	3.37	173.5	1132	953	0	47.5	40.8
347	3.69	187.5	1256	1075	0	49.9	41.9
348	2.83	144.0	853	675	0.37	47.1	42.9
349	3.29	170.5	1092	913	0.37	47.9	41.6
350	3.72	193.5	1283	1102	0.37	50.9	42.6
351	2.57	140.5	815	638	0.55	44.2	39.9
352	3.28	181.5	1132	952	0.55	48.8	41.6
353	3.76	200.0	1263	1082	0.55	54.3	45.5
354	2.93	148.5	864	686	0.78	49.7	44.9
355	3.42	175.0	1105	925	0.78	50.7	43.5
356	3.70	191.5	1249	1068	0.78	52.0	43.1
357	2.71	149.0	799	621	1.00	51.2	46.8
358	3.25	180.0	1013	834	1.00	55.1	48.8
359	3.82	209.5	1269	1088	1.00	57.9	48.5
360	3.08	156.0	842	664	1.31	57.0	52.2
361	3.47	180.0	1063	883	1.31	56.7	49.8
362	3.83	200.0	1211	1030	1.31	58.7	51.1
363	2.93	160.0	829	651	1.61	57.1	52.4
364	3.32	186.5	1024	844	1.61	58.1	51.6
365	3.84	211.5	1229	1048	1.61	61.5	52.5



TABLE 2 (Cont.)

Run No.	$\frac{U}{\sqrt{gD}}$	$h_{co} \left[ \frac{D^2 \Delta t \mu}{U^2 k^3 e e \lambda'} \right]^{1/4}$	F	$h_{co} \left[ \frac{D \Delta t \mu}{k^3 e (e - e_g \lambda')} \right]^{1/4}$	$h_{co} \sqrt{\frac{D \Delta t}{U k e \lambda'}}$	$\frac{\Delta t e k}{\mu e \lambda'}$
342	0	0		0.65		
343	"			0.66		
344	"			0.58		
345	"			0.69		
346	"			0.65		
347	"			0.65		
348	0.358	1.21	2.20	0.72	5.08	310
349	"	1.12	2.13	0.67	5.08	420
350	"	1.10	2.12	0.66	5.13	470
351	0.536	0.94	1.18	0.69	3.91	300
352	"	0.90	1.12	0.66	4.09	430
353	"	0.96	1.13	0.70	4.57	520
354	0.765	0.85	0.75	0.75	3.59	320
355	"	0.80	0.68	0.70	3.54	430
356	"	0.76	0.64	0.67	3.54	470
357	0.978	0.82	0.59	0.81	3.40	300
358	"	0.81	0.55	0.80	3.60	390
359	"	0.76	0.50	0.75	3.55	480
360	1.288	0.79	0.47	0.90	3.34	320
361	"	0.71	0.39	0.81	3.24	410
362	"	0.70	0.37	0.80	3.24	460
363	1.584	0.70	0.36	0.88	2.94	310
364	"	0.67	0.32	0.84	2.99	400
365	"	0.65	0.30	0.81	3.01	460

TABLE 3

Experimental and Calculated Data on the Film Boiling of Ethyl Alcohol  
at High Flows from a 0.387-Inch Outside Diameter Tube.

Run No.	Volts	Amps	$t_s$ °F	$\Delta t$ °F	U ft sec	h (hr)(sq. ft)	$h_{co}$ (°F)
257	2.70	150.5	703	526	2.32	62.4	58.6
258	3.41	201.0	1017	838	2.32	66.1	59.6
259	4.23	246.5	1335	1153	2.32	73.1	62.6
260	2.90	164.0	685	508	3.97	75.7	72.0
261	2.57	214.0	972	793	3.97	77.9	71.8
262	4.43	261.0	1274	1092	3.97	85.6	76.0
263	3.45	201.0	790	611	6.02	91.6	87.2
264	4.12	243.0	1029	848	6.02	95.5	88.9
265	4.84	285.5	1292	1108	6.02	100.8	91.0
266	3.87	225.5	811	631	7.92	111.8	107.2
267	4.54	267.0	1062	880	7.92	111.4	104.4
268	5.28	312.0	1346	1160	7.92	114.6	104.1
269	4.34	254.0	896	715	10.03	124.7	119.4
270	4.83	288.5	1087	906	10.03	124.3	117.1
271	5.54	325.0	1314	1127	10.03	129.2	119.2
272	4.76	280.5	982	800	12.01	134.8	128.7
273	5.15	306.0	1105	921	12.01	138.4	131.0
274	5.58	331.0	1249	1062	12.01	140.7	131.5
275	4.80	282.5	991	808	12.01	135.5	129.4
276	5.15	306.5	1128	943	12.01	135.4	127.7
277	5.56	331.0	1274	1087	12.01	137.1	127.6
278	4.94	294.0	1018	835	14.55	140.5	134.1
279	5.23	315.5	1117	932	14.55	142.1	134.5
280	5.74	340.0	1267	1080	14.55	146.0	136.6

TABLE 3 (Cont.)

Run No.	$\frac{U}{\sqrt{gD}}$	$h_{co} \left[ \frac{D^2 \Delta t \mu}{U^2 k^3 e e \lambda^3} \right]^{1/4}$	F	$h_{co} \left[ \frac{D \Delta t \mu}{k^3 e (e_l - \theta) g \lambda^3} \right]^{1/4}$	$h_{co} \sqrt{\frac{D \Delta t}{U k \theta}}$	$\frac{\Delta t e k}{\mu e \lambda^3}$
257	2.277	0.69	.34	1.04	2.77	260
258	"	0.65	.26	0.98	2.90	400
259	"	0.63	.23	0.95	2.94	510
260	3.897	0.65	.28	1.28	2.59	250
261	"	0.60	.21	1.19	2.65	380
262	"	0.59	.25	1.17	2.35	250
263	5.909	0.62	.23	1.51	2.60	310
264	"	0.60	.20	1.46	2.70	410
265	"	0.58	.17	1.41	2.75	520
266	7.771	0.67	.26	1.86	2.84	320
267	"	0.61	.20	1.70	2.77	430
268	"	0.56	.15	1.57	2.65	520
269	9.844	0.64	.23	2.02	2.81	370
270	"	0.60	.19	1.89	2.75	440
271	"	0.58	.16	1.81	2.76	520
272	11.79	0.62	(.22)	2.14	2.79	410
273	"	0.61	.19	2.11	2.62	340
274	"	0.59	.17	2.03	2.77	490
275	"	0.63	.21	2.16	2.82	400
276	"	0.59	(.19)	2.04	2.71	450
277	"	0.57	.16	1.97	2.70	510
278	14.26	0.59	.18	2.21	2.67	420
279	"	0.57	(.17)	2.17	2.61	440
280	"	0.55	.15	2.09	2.62	520

TABLE 4.1

Experimental and Calculated Data on the Film Boiling of Ethyl Alcohol  
at Low Flows from a 0.497-Inch Outside Diameter Tube.

Run No.	Volts	Amps	$t_i$ °F	$\Delta t$ °F	$U$ $\frac{\text{ft}}{\text{sec}}$	$h$ $\frac{\text{Btu}}{(\text{hr})(\text{sq. ft})(\text{°F})}$	$h_{co}$
319	2.62	180.0	844	666	0	41.0	36.9
320	2.95	207.5	1026	846	0	41.9	36.2
321	3.28	236.5	1202	1021	0	44.1	36.6
322	2.78	189.5	923	744	0	41.0	36.2
323	3.12	223.0	1121	941	0	42.8	36.3
324	2.78	189.5	914	735	0.34	41.9	37.2
325	3.08	216.0	1071	891	0.34	43.6	37.6
326	3.45	244.0	1252	1070	0.34	46.0	38.0
327	2.47	183.5	822	644	0.55	41.4	37.0
328	2.95	227.0	1072	892	0.55	44.1	37.5
329	3.33	256.5	1233	1051	0.55	47.8	39.4
330	2.91	199.5	957	778	0.77	44.1	38.5
331	3.17	224.0	1108	928	0.77	45.1	38.0
332	3.53	247.5	1245	1063	0.77	48.5	39.8
333	2.63	199.0	847	668	1.00	46.5	41.8
334	3.05	230.5	1015	835	1.00	50.1	43.8
335	3.44	265.5	1224	1042	1.00	52.0	43.4
336	3.02	210.0	943	763	1.29	49.7	44.0
337	3.33	236.0	1101	920	1.29	51.1	43.8
338	3.60	256.0	1225	1043	1.29	52.8	43.7
339	2.77	211.0	862	683	1.63	51.5	46.6
340	3.13	242.0	1026	845	1.63	54.0	47.5
341	3.67	278.5	1247	1064	1.63	57.9	48.7

TABLE 4 (Cont.)

Run No.	$\frac{U}{\sqrt{GD}}$	$h_{co} \left[ \frac{D^2 \Delta t \mu}{U^2 k^3 e e \lambda'} \right]^{1/4}$	F	$h_{co} \left[ \frac{D \Delta t \mu}{k^3 e (e \lambda - e) g \lambda'} \right]^{1/4}$	$h_{co} \sqrt{\frac{D \Delta t}{U k e \lambda'}}$	$\frac{\Delta t e k}{\mu e \lambda'}$
319	0			0.67		
320	"			0.63		
321	"			0.61		
322	"			0.65		
323	"			0.62		
324	0.297	1.22	3.09	0.66	5.13	310
325	"	1.17	3.05	0.64	5.23	400
326	"	1.14	3.02	0.62	5.28	460
327	0.473	0.98	1.41	0.67	4.11	310
328	"	0.94	1.36	0.65	4.20	400
329	"	0.95	1.35	0.65	4.40	460
330	0.665	0.84	0.85	0.68	3.55	320
331	"	0.80	0.80	0.65	3.62	420
332	"	0.80	0.79	0.66	3.73	470
333	0.864	0.82	0.64	0.76	3.46	320
334	"	0.83	0.62	0.77	3.69	390
335	"	0.77	0.57	0.72	3.57	460
336	1.118	0.74	0.46	0.79	3.23	360
337	"	0.71	0.43	0.75	3.23	430
338	"	0.69	0.40	0.73	3.21	470
339	1.413	0.71	0.39	0.85	3.03	330
340	"	0.70	0.36	0.83	3.13	400
341	"	0.68	0.33	0.80	3.17	470

TABLE 15

Experimental and Calculated Data on the Film Boiling of Ethyl Alcohol  
at High Flows from a 0.496-Inch Outside Diameter Tube.

Run No.	Volts	Amps	$t_i$ °F	$\Delta t$ °F	$U$ $\frac{\text{ft}}{\text{sec}}$	$h$ $\frac{\text{Btu}}{(\text{hr})(\text{sq. ft})(\text{°F})}$	$h_{co}$
287	3.77	239.5	763	584	4.02	71.5	67.3
288	3.13	279.0	937	756	4.02	72.8	67.2
289	3.80	334.0	1180	995	4.02	80.4	72.1
290	3.06	270.0	788	608	6.00	85.7	81.4
291	3.61	319.5	995	812	6.00	89.6	83.3
292	4.12	368.0	1202	1015	6.00	94.4	85.8
293	3.63	320.0	892	709	8.00	103.3	98.0
294	4.02	357.0	1042	856	8.00	105.7	99.1
295	4.54	398.5	1294	1104	8.00	103.5	93.7
296	4.21	370.0	1072	885	9.99	111.0	104.0
297	4.48	395.5	1168	979	9.99	118.4	110.3
298	4.79	419.5	1283	1092	9.99	116.0	106.4
299	4.71	414.5	1184	994	12.03	123.8	115.6
300	4.90	427.0	1238	1046	12.03	126.3	117.3
301	5.11	447.5	1339	1145	12.03	126.0	117.2
302	5.16	450.0	1270	1077	14.55	136.0	126.6
303	5.28	462.0	1319	1124	14.55	137.0	127.0
304	4.97	435.0	1213	1021	14.55	133.4	124.7

TABLE 5 (Cont.)

UCRL-1894

Run No.	$\frac{U}{\sqrt{gD}}$	$h_{co} \left[ \frac{D^2 \Delta t \mu}{U^2 k^3 e e \lambda^3} \right]^{1/4} F$	$h_{co} \left[ \frac{D \Delta t \mu}{k^3 e (e_1 - e) g \lambda^3} \right]^{1/4}$	$h_{co} \sqrt{\frac{D \Delta t}{U k e \lambda^3}}$	$\frac{\Delta t e k}{\mu e \lambda}$
287	3.186	0.67	.29	1.20	2.76 290
288	"	0.64	.24	1.14	2.81 370
289	"	0.65	.22	1.15	3.01 460
290	5.205	0.67	.26	1.52	2.85 320
291	"	0.64	.22	1.46	2.86 400
292	"	0.63	.20	1.43	2.94 470
293	6.940	0.67	.25	1.77	2.92 360
294	"	0.65	.22	1.71	2.94 420
295	"	0.59	.17	1.54	2.79 500
296	8.665	0.61	.19	1.80	2.79 440
297	"	0.63	.20	1.87	2.94 470
298	"	0.59	.17	1.75	2.80 510
299	10.430	0.60	.18	1.94	2.79 470
300	"	0.60	.18	1.94	2.83 500
301	"	0.58	.16	1.87	2.77 530
302	12.620	0.58	.16	2.07	2.75 510
303	"	0.58	.16	2.07	2.76 520
304	"	0.58	.17	2.07	2.72 490

TABLE 6

Experimental and Calculated Data on the Film Boiling of Ethyl Alcohol at  
Low Flows from a 0.638-Inch Outside Diameter Tube.

Run No.	Volts	Amps.	$t_i$ °F	$\Delta t$ °F	$U$ $\frac{\text{ft}}{\text{sec}}$	$h$ $\frac{\text{Btu}}{(\text{hr})(\text{sq. ft})(\text{°F})}$	$h_{co}$
366	2.10	270.0	792	613	0	40.9	36.5
367	2.26	289.5	874	695	0	41.8	36.7
368	2.42	316.0	979	799	0	42.5	36.4
369	2.18	274.5	808	629	0.54	42.7	38.8
370	2.48	324.5	1002	821	0.54	43.9	38.3
371	2.88	376.0	1225	1042	0.54	46.7	39.0
372	2.30	294.5	869	690	1.00	44.4	39.5
373	2.63	339.0	1042	861	1.00	46.9	40.3
374	3.01	389.0	1243	1059	1.00	50.2	40.8
375	2.51	327.0	941	760	1.62	49.5	43.9
376	2.71	357.5	1067	885	1.62	50.2	43.3
377	3.12	402.0	1238	1053	1.62	54.8	45.9



TABLE 6 (Cont.)

Run No.	$\frac{U}{\sqrt{gD}}$	$h_{co} \left[ \frac{D^2 \Delta t \mu}{U^2 k^3 e e \lambda'} \right]^{1/4} F$	$h_{co} \left[ \frac{D \Delta t \mu}{k^3 e (e_l - e) g \lambda'} \right]^{1/4}$	$h_{co} \sqrt{\frac{D \Delta t}{U k e \lambda'}}$	$\frac{\Delta t e k}{\mu e \lambda'}$
366	0		0.73		
367	"		0.70		
368	"		0.69		
369	0.416	1.18	1.79	0.76	4.78 270
370	"	1.11	1.72	0.72	4.87 370
371	"	1.07	1.68	0.69	4.91 450
372	0.764	0.87	.76	0.77	3.68 320
373	"	0.86	.72	0.75	3.81 390
374	"	0.83	.68	0.73	3.88 480
375	1.241	0.75	.44	0.84	3.25 350
376	"	0.72	.40	0.80	3.22 400
377	"	0.72	.39	0.81	3.33 460

TABLE 7

Experimental and Calculated Data on the Film Boiling of Ethyl Alcohol  
at High Flows from a 0.638-Inch Outside Diameter Tube.

Run No.	Volts	Amps	$t_i$ °F	$\Delta t$ °F	$U$ $\frac{\text{ft}}{\text{sec}}$	$h$ $\frac{\text{Btu}}{(\text{hr})(\text{sq. ft})(\text{°F})}$	$h_{co}$ $(\text{°F})$
305	2.34	294.5	802	623	2.47	51.7	47.2
306	2.64	339.5	970	789	2.47	53.1	47.2
307	2.96	390.0	1162	979	2.47	55.2	47.1
308	2.59	335.0	783	603	4.06	69.6	65.3
309	2.85	372.0	909	727	4.06	70.6	65.2
310	3.10	411.0	1044	860	4.06	71.8	65.1
311	2.92	384.0	914	732	5.52	75.2	69.8
312	3.15	412.5	1009	825	5.52	77.3	70.9
313	3.36	443.5	1098	912	5.52	80.3	73.0
314	3.08	409.5	943	759	7.00	81.8	76.1
315	3.29	435.5	1024	839	7.00	83.9	77.4
316	3.49	457.0	1083	897	7.00	87.0	79.8
317	3.31	440.0	959	774	8.53	92.5	86.7
318	3.53	465.0	1031	845	8.53	95.4	88.8
319	3.15	415.0	873	689	8.53	93.1	88.1

TABLE 7 (Cont.)

Run No.	$\frac{U}{\sqrt{gD}}$	$h_{co} \left[ \frac{D^2 \Delta t \mu}{U^2 k^3 e e \lambda'} \right]^{1/4} F$	$h_{co} \left[ \frac{D \Delta t \mu}{k^3 e (e_e - e_g \lambda')} \right]^{1/4}$	$h_{co} \sqrt{\frac{D \Delta t}{U k e \lambda'}}$	$\frac{\Delta t e_e k}{\mu e \lambda'}$	
305	1.890	0.68	.33	0.93	2.83	300
306	"	0.65	.29	0.89	2.85	370
307	"	0.64	.26	0.88	3.03	510
308	3.107	0.73	.33	1.29	3.04	300
309	"	0.71	.29	1.25	3.07	350
310	"	0.68	.26	1.21	3.06	410
311	4.224	0.65	.25	1.34	2.83	360
312	"	0.65	.23	1.34	2.90	400
313	"	0.65	.27	1.34	2.96	430
314	5.357	0.62	.22	1.45	2.72	370
315	"	0.62	.21	1.44	2.79	410
316	"	0.63	.21	1.46	2.87	430
317	6.526	0.64	.23	1.64	2.84	390
318	"	0.65	.22	1.65	2.94	420
319	"	0.67	.25	1.70	2.90	350

TABLE 8

Experimental and Calculated Data on the Film Boiling of Benzene at Low  
Flows from a 0.387-Inch Outside Diameter Tube.

Run No.	Volts	Amps	$t_i$ °F	$\Delta t$ °F	U ft sec	$\frac{h}{h_{co}}$ Btu (hr)(sq. ft)(°F)
378	2.72	137.0	865	685	0	42.2 37.9
379	3.03	155.0	1017	837	0	43.5 37.9
380	3.42	175.5	1195	1014	0	45.9 38.5
381	2.85	145.5	932	752	0.40	43.1 36.5
382	3.18	163.5	1083	902	0.40	45.0 36.5
383	3.46	177.0	1193	1011	0.40	47.3 37.3
384	3.02	154.0	970	790	0.80	46.3 40.1
385	3.26	169.0	1099	918	0.80	47.1 39.2
386	3.54	182.0	1209	1027	0.80	49.3 40.2
387	3.13	160.5	955	775	1.30	51.3 45.3
388	3.33	173.0	1044	863	1.30	52.8 45.9
389	3.58	185.0	1146	964	1.30	54.3 46.2
390	3.20	164.5	961	780	1.58	53.6 47.6
391	3.38	176.0	1045	864	1.58	54.7 47.9
392	3.62	189.0	1162	980	1.58	55.4 47.3

TABLE 8 (Cont.)

Run No.	$\frac{U}{\sqrt{gD}}$	$h_{co} \left[ \frac{D^2 \Delta t u}{U^2 k^3 \rho e \lambda} \right]^{1/4}$	F	$h_{co} \left[ \frac{D \Delta t u}{k^3 (\rho e - e) g \lambda} \right]^{1/4}$	$h_{co} \sqrt{\frac{D \Delta t}{U k e \lambda}}$	$\frac{\Delta t e k}{\mu e \lambda}$
378	0			0.62		
379	"			0.57		
380	"			0.52		
381	0.395	0.92	1.77	0.58	3.98	350
382	"	0.86	1.76	0.54	3.77	370
383	"	0.82	1.74	0.51	3.64	390
384	0.787	0.70	0.62	0.62	3.05	360
385	"	0.64	0.58	0.57	2.82	380
386	"	0.62	0.57	0.55	2.75	390
387	1.280	0.62	0.35	0.71	2.70	360
388	"	0.61	0.34	0.68	2.67	370
389	"	0.58	0.32	0.65	2.57	390
390	1.550	0.60	0.29	0.74	2.61	360
391	"	0.57	0.28	0.72	2.51	380
392	"	0.53	0.25	0.66	2.35	390

TABLE 9

Experimental and Calculated Data on the Film Boiling of Benzene at High  
Flows from a 0.387-Inch Outside Diameter Tube.

Run No.	Volts	Amps	$t_i$ °F	$\Delta t$ °F	$U$ $\frac{\text{ft}}{\text{sec}}$	$h$ $\frac{\text{Btu}}{(\text{hr})(\text{sq. ft})(\text{°F})}$	$h_{co}$
423	3.10	159.5	874	694	2.44	57.6	52.5
424	3.47	179.0	1008	827	2.44	60.6	54.3
425	3.86	198.0	1159	976	2.44	63.3	55.2
426	3.50	180.0	811	630	5.03	81.4	76.9
427	3.95	205.0	948	765	5.03	86.2	80.4
428	4.47	230.5	1141	957	5.03	87.7	79.8
429	3.96	205.5	793	611	8.01	108.5	104.1
430	4.45	231.0	923	739	8.01	113.3	107.8
431	4.90	256.0	1072	886	8.01	115.3	108.3
432	4.49	233.0	856	673	11.03	126.6	121.7
433	4.97	260.0	991	805	11.03	130.7	124.5
434	5.45	284.5	1128	940	11.03	134.4	126.7
435	4.88	254.5	957	772	11.72	131.1	125.2
436	5.28	277.0	1072	885	11.72	134.8	127.8
437	5.66	294.5	1180	1001	11.72	135.9	127.5

TABLE 9 (Cont.)

UCRL-1894

Run No.	$\frac{U}{\sqrt{gD}}$	$h_{co} \left[ \frac{D^2 \Delta t \mu}{U^2 k^3 e (\alpha - \theta g) \lambda} \right]^{1/4}$	F	$h_{co} \left[ \frac{D \Delta t \mu}{k^3 e (\alpha - \theta g) \lambda} \right]^{1/4}$	$h_{co} \sqrt{\frac{D \Delta t}{U k e \lambda}}$	$\frac{\Delta t e k}{\mu e \lambda}$
423	2.406	0.55	.22	0.85	2.38	350
424	"	0.53	.20	0.82	2.33	370
425	"	0.50	.18	0.78	2.23	400
426	4.953	0.58	.21	1.30	2.47	330
427	"	0.57	.19	1.26	2.50	370
428	"	0.51	.15	1.13	2.29	410
429	7.896	0.63	.23	1.77	2.69	330
430	"	0.61	.21	1.71	2.67	370
431	"	0.56	.17	1.58	2.52	410
432	10.890	0.61	.21	2.01	2.64	350
433	"	0.58	.18	1.90	2.56	380
434	"	0.55	.12	1.81	2.57	480
435	11.560	0.58	.19	1.96	2.54	370
436	"	0.56	.16	1.89	2.55	430
437	"	0.52	.14	1.75	2.37	430

TABLE 10

Experimental and Calculated Data on the Film Boiling of Benzene at  
Low Flows from a 0.496-Inch Outside Diameter Tube.

Run No.	Volts	Amps	$t_i$ °F	$\Delta t$ °F	$U$ $\frac{\text{ft}}{\text{sec}}$	$h$ $\frac{\text{Btu}}{(\text{hr})(\text{sq. ft})(\text{°F})}$	$h_{co}$ $(\text{°F})$
393	2.01	162.5	671	492	0	38.4	35.4
394	2.11	175.0	732	553	0	38.7	35.3
395	2.37	197.0	865	685	0	39.5	35.1
396	2.08	172.5	738	559	0.39	37.6	34.1
397	2.28	187.0	817	637	0.39	39.2	35.2
398	2.50	206.5	986	805	0.39	37.5	32.2
399	2.26	184.5	784	604	0.77	40.8	36.6
400	2.37	197.0	847	667	0.77	41.3	36.6
401	2.65	218.0	982	801	0.77	42.7	36.8
402	2.34	192.5	779	599	1.27	45.0	40.7
403	2.49	207.0	853	673	1.27	46.0	41.1
404	2.75	230.5	984	803	1.27	47.2	41.2
405	2.43	204.0	804	624	1.58	47.9	43.4
406	2.66	221.0	905	724	1.58	49.0	43.6
407	2.93	244.0	1029	847	1.58	50.9	44.3



TABLE 10 (Cont.)

Run No.	$\frac{U}{\sqrt{gD}}$	$h_{co} \left[ \frac{D^2 \Delta t \mu}{U^2 k^3 e e \lambda'} \right]^{1/4}$	F	$h_{co} \left[ \frac{D \Delta t \mu}{k^3 e (e_2 - e) g \lambda'} \right]^{1/4}$	$h_{co} \sqrt{\frac{D \Delta t}{U k e \lambda'}}$	$\frac{\Delta t e k}{\mu e \lambda'}$
393	0			0.67		
394	"			0.65		
395	"			0.61		
396	0.334	1.10	2.46	0.63	4.53	290
397	"	1.09	2.45	0.63	4.58	310
398	"	0.91	2.38	0.53	3.94	350
399	0.668	0.82	0.85	0.76	3.41	300
400	"	0.79	0.82	0.65	3.36	320
401	"	0.74	0.78	0.60	3.20	350
402	1.102	0.71	0.47	0.75	2.98	310
403	"	0.69	0.45	0.72	2.92	320
404	"	0.64	0.41	0.67	2.77	350
405	1.371	0.67	0.37	0.79	2.84	320
406	"	0.64	0.35	0.75	2.74	340
407	"	0.61	0.32	0.72	2.66	360

TABLE 11

Experimental and Calculated Data on the Film Boiling of Benzene at High  
Flows from a 0.496-Inch Outside Diameter Tube.

Run No.	Volts	Amps	$t_i$ °F	$\Delta t$ °F	U ft sec	$h$ $\frac{\text{Btu}}{(\text{hr})(\text{sq. ft})(\text{°F})}$	$h_{co}$ °F
438	2.31	185.0	673	493	2.44	54.7	51.2
439	2.48	206.5	774	594	2.44	54.5	50.2
440	2.85	237.0	912	731	2.44	58.4	53.0
441	2.55	208.0	649	469	5.09	71.4	68.0
442	2.91	241.5	774	593	5.09	74.8	70.6
443	3.21	271.5	912	729	5.09	75.6	70.2
444	3.52	249.5	777	595	7.46	93.0	88.7
445	3.94	276.0	898	714	7.46	96.2	90.9
446	4.46	316.5	1096	909	7.46	98.2	90.9
447	3.91	275.0	900	716	9.49	94.9	89.6
448	4.27	303.0	1022	836	9.49	98.3	91.8
449	4.75	335.0	1168	979	9.49	102.7	94.5
450	4.28	300.0	954	768	11.72	105.7	99.9
451	4.60	325.5	1054	867	11.72	109.0	101.9
452	4.90	351.0	1166	977	11.72	111.3	103.2

TABLE 11 (Cont.)

UCRL-1894

Run No.	$\frac{U}{\sqrt{gD}}$	$h_{co} \left[ \frac{D^2 \Delta t \mu}{U^2 k^3 \rho (e_1 \lambda)^2} \right]^{1/4}$	F	$h_{co} \left[ \frac{D \Delta t \mu}{k^3 \rho (e_1 - e) g \lambda^2} \right]^{1/4}$	$h_{co} \sqrt{\frac{D \Delta t}{U k e \lambda}}$	$\frac{\Delta t e k}{\mu e \lambda}$
438	2.119	0.67	.33	0.98	2.71	270
439	"	0.63	.28	0.92	2.62	300
440	"	0.62	.26	0.90	2.68	350
441	4.418	0.62	.26	1.31	2.49	260
442	"	0.62	.24	1.29	2.60	310
443	"	0.57	.19	1.19	2.48	360
444	6.477	0.64	.24	1.63	2.73	330
445	"	0.62	.21	1.57	2.72	370
446	"	0.56	.17	1.43	2.54	420
447	8.639	0.57	.16	1.67	2.64	460
448	"	0.55	.15	1.61	2.59	500
449	"	0.52	.13	1.53	2.49	530
450	10.180	0.52	.16	1.68	2.29	380
451	"	0.50	.14	1.61	2.25	410
452	"	0.48	.13	1.53	2.16	410

TABLE 12

Experimental and Calculated Data on the Film Boiling of Benzene at  
Low Flows from a 0.638-Inch Outside Diameter Tube.

Run No.	Volts	Amps	$t_i$ °F	$\Delta t$ °F	$U$ $\frac{\text{ft}}{\text{sec}}$	$h$ $\frac{\text{Btu}}{(\text{hr})(\text{sq. ft})(\text{°F})}$	$h_{co}$
408	1.80	234.5	630	451	0	41.5	38.7
409	1.94	259.5	734	554	0	40.4	36.9
410	2.14	285.0	822	641	0	42.2	38.2
411	1.88	246.0	694	514	0.39	40.2	37.0
412	2.01	268.0	777	597	0.39	40.4	36.7
413	2.19	292.5	867	686	0.39	41.8	37.5
414	1.93	257.5	738	558	0.77	40.0	36.2
415	2.05	278.0	808	627	0.77	40.9	36.6
416	2.27	300.0	887	705	0.77	43.5	38.6
417	2.03	269.0	734	554	1.27	44.8	40.9
418	2.18	290.0	811	630	1.27	45.7	41.2
419	2.32	312.0	878	696	1.27	47.3	42.2
420	2.13	283.5	757	576	1.58	48.0	43.9
421	2.26	300.5	815	633	1.58	49.2	44.5
422	2.36	320.5	885	702	1.58	49.4	44.3

TABLE 12 (Cont.)

Run No.	$\frac{U}{\sqrt{gD}}$	$h_{co} \left[ \frac{D^2 \Delta t \mu}{U^2 k^3 e e \lambda'} \right]^{1/4}$	F	$h_{co} \left[ \frac{D \Delta t \mu}{k^3 e (e_2 - e_1 \lambda')} \right]^{1/4}$	$h_{co} \sqrt{\frac{D \Delta t}{U k e \lambda'}}$	$\frac{\Delta t e_2 k}{\mu e \lambda'}$
408	0			0.80		
409	"			0.73		
410	"			0.72		
411	0.298	1.36	3.15	0.74	5.51	270
412	"	1.30	3.10	0.71	5.35	290
413	"	1.26	3.07	0.69	5.40	340
414	0.589	0.93	1.06	0.71	3.80	280
415	"	0.90	1.03	0.69	3.74	300
416	"	0.92	1.03	0.71	3.92	330
417	0.974	0.82	0.60	0.81	3.35	280
418	"	0.79	0.57	0.78	3.32	310
419	"	0.79	0.56	0.78	3.37	330
420	1.209	0.78	0.50	0.79	3.21	290
421	"	0.77	0.48	0.78	3.23	310
422	"	0.74	0.45	0.75	3.15	330

TABLE 13

Experimental and Calculated Data on the Film Boiling of Benzene at High  
Flows from a 0.638-Inch Outside Diameter Tube.

Run No.	Volts	Amps.	$t_i$ °F	$\Delta t$ °F	$U$ $\frac{\text{ft}}{\text{sec}}$	$h$ $\frac{\text{Btu}}{(\text{hr})(\text{sq. ft})(\text{°F})}$	$h_{co}$ °F
453	2.30	295.5	761	580	2.52	54.8	50.6
454	2.43	318.5	829	647	2.52	56.0	51.3
455	2.65	347.0	930	747	2.52	57.6	52.0
456	2.40	310.0	727	546	3.96	65.8	61.8
457	2.60	335.5	804	622	3.96	67.8	63.3
458	2.70	358.0	878	695	3.96	67.2	62.1
459	2.47	319.5	698	517	5.50	74.9	71.2
460	2.64	345.0	777	595	5.50	75.1	70.8
461	2.74	368.0	849	666	5.50	74.4	69.5
462	2.67	350.0	763	580	7.00	79.0	74.9
463	2.73	368.0	817	634	7.00	77.8	73.1
464	2.96	396.0	900	716	7.00	80.4	75.0
465	2.85	385.5	810	627	8.51	86.1	81.6
466	3.01	410.0	885	700	8.51	86.7	81.5
467	3.31	451.0	997	810	8.51	90.5	84.3

TABLE 13 (Cont.)

Run No.	$\frac{U}{\sqrt{gD}}$	$h_{co} \left[ \frac{D^2 \Delta t \mu}{U^2 k^3 \rho \epsilon \lambda'} \right]^{1/4} F$	$h_{co} \left[ \frac{\Delta t \mu}{k^3 \rho (\epsilon \rho - \rho) g \lambda'} \right]^{1/4}$	$h_{co} \sqrt{\frac{DA\epsilon}{U k \rho \lambda'}} \frac{\Delta t \rho_{ak}}{\mu \epsilon \lambda'}$		
453	1.925	0.72	.36	1.00	2.97	290
454	"	0.70	.34	0.97	2.96	320
455	"	0.67	.31	0.93	2.90	350
456	3.033	0.70	.31	1.22	2.89	290
457	"	0.70	.30	1.22	2.96	320
458	"	0.66	.27	1.15	2.83	340
459	4.207	0.70	.31	1.44	2.86	280
460	"	0.67	.28	1.37	2.79	300
461	"	0.64	.24	1.30	2.72	330
462	5.357	0.63	.24	1.47	2.65	310
463	"	0.60	.22	1.39	2.54	320
464	"	0.59	.21	1.37	2.55	350
465	6.509	0.61	.22	1.56	2.58	320
466	"	0.59	.20	1.50	2.55	350
467	"	0.57	.19	1.46	2.52	380

TABLE 14

Experimental and Calculated Data on the Film Boiling of Carbon Tetrachloride at High Flows from a 0.387-Inch Outside Diameter Tube.

Run No.	Volts	Amps	$t_i$ °F	$\Delta t$ °F	$U$ $\frac{\text{ft}}{\text{sec}}$	$h$ $\frac{\text{Btu}}{(\text{hr})(\text{sq. ft})(\text{°F})}$	$h_{co}$
522	1.99	110.8	770	598	0	27.7	24.1
523	2.38	133.3	1015	842	0	28.3	22.8
524	2.71	155.4	1240	1066	0	29.7	21.8
525	2.37	132.1	828	655	2.48	37.1	32.4
526	2.61	147.3	963	789	2.48	37.9	32.0
527	2.93	166.0	1132	957	2.48	39.5	31.7
528	2.72	154.0	867	693	5.00	48.6	44.2
529	3.02	173.7	1038	863	5.00	48.9	42.2
530	3.33	187.5	1153	977	5.00	51.4	43.4
531	3.07	174.5	874	700	7.01	61.9	56.8
532	3.45	196.5	1063	887	7.01	61.7	54.8
533	3.90	222.0	1261	1084	7.01	64.6	55.2
534	4.18	238.5	1242	1064	9.49	75.8	66.6
535	3.98	226.0	1144	967	9.49	75.2	67.3
536	4.19	239.0	1153	975	13.37	83.0	75.1
537	4.43	251.5	1252	1073	13.37	83.9	74.7



TABLE 14 (Cont.)

Run No.	$\frac{U}{\sqrt{gD}}$	$h_{co} \left[ \frac{D^2 \Delta t \mu}{U^2 k^3 e e \lambda'} \right]^{1/4}$	F	$h_{co} \left[ \frac{D \Delta t \mu}{k^3 e (e_2 - e) g \lambda'} \right]^{1/4}$	$h_{co} \sqrt{\frac{D \Delta t}{U k e \lambda'}}$	$\frac{\Delta t e k}{\mu e \lambda'}$
522	0			0.83		
523	"			0.77		
524	"			0.70		
525	2.429	0.71	.36	1.11	2.80	240
526	"	0.69	.33	1.08	2.79	270
527	"	0.67	.29	1.04	2.81	310
528	4.912	0.68	.30	1.51	2.70	250
529	"	0.64	.25	1.41	2.77	350
530	"	0.64	.25	1.42	2.71	320
531	6.881	0.75	.34	1.98	3.07	280
532	"	0.71	.29	1.87	3.03	330
533	"	0.69	.26	1.82	3.04	380
534	9.317	0.70	(.40)	2.15	3.03	350
535	"	0.72	.27	2.22	3.07	330
536	13.130	0.68	.29	2.46	2.90	330
537	"	0.66	.26	2.41	2.86	350

TABLE 15

Experimental and Calculated Data on the Film Boiling of Carbon Tetrachloride at High Flows from a 0.496-Inch Outside Diameter Tube.

Run No.	Volts	Amps	$t_i$ °F	$\Delta t$ °F	$U$ $\frac{ft}{sec}$	$h$ $\frac{Btu}{(hr)(sq. ft)(°F)}$	$h_{co}$ (°F)
540	1.42	134.0	599	427	0	25.8	23.2
541	1.79	160.6	820	647	0	25.5	21.5
542	2.02	184.3	1008	834	0	25.6	20.1
543	1.76	155.4	718	545	2.52	29.8	26.0
544	2.00	178.0	869	696	2.52	30.4	25.3
545	2.22	197.7	1009	835	2.52	31.2	24.8
546	2.05	183.2	653	480	5.01	48.3	44.9
547	2.30	204.5	801	627	5.01	46.3	41.9
548	2.54	229.4	955	780	5.01	46.1	40.3
549	2.37	209.5	702	528	7.00	59.3	55.5
550	2.65	237.5	880	705	7.00	56.3	51.2
551	2.89	266.0	1051	875	7.00	55.4	48.6
552	2.79	253.5	840	665	9.50	67.0	62.2
553	3.03	279.5	943	766	9.50	69.7	64.0
554	3.35	306.0	1137	959	9.50	67.3	59.5

TABLE 15 (Cont.)

Run No.	$\frac{U}{\sqrt{gD}}$	$h_{co} \left[ \frac{D^2 \Delta t \mu}{U^2 k^3 \rho e \lambda'} \right]^{1/4} F$	$h_{co} \left[ \frac{D \Delta t \mu}{k^3 \rho e \lambda'} \right]^{1/4}$	$h_{co} \sqrt{\frac{D \Delta t}{U k \rho \lambda'}}$	$\frac{\Delta t \rho k}{\mu \lambda'}$
540	0		0.87		
541	"		0.80		
542	"		0.74		
543	2.187	0.65 .35	0.96	2.42	190
544	"	0.62 .30	0.92	2.42	230
545	"	0.60 .28	0.89	2.41	260
546	4.341	0.80 .46	1.67	2.97	190
547	"	0.74 .36	1.54	2.85	220
548	"	0.70 .31	1.46	2.83	270
549	6.072	0.83 .45	2.04	3.11	200
550	"	0.75 .36	1.86	2.98	250
551	"	0.69 .29	1.71	2.82	280
552	8.242	0.79 .39	2.28	3.11	240
553	"	0.83 .39	2.37	3.42	290
554	"	0.72 .30	2.08	3.05	320

TABLE 16

Experimental and Calculated Data on the Film Boiling of Carbon Tetrachloride at High Flows from a 0.638-Inch Outside Diameter Tube.

Run No.	Volts	Amps	$t_i$ °F	$\Delta t$ °F	$U$ $\frac{\text{ft}}{\text{sec}}$	$h$ $\frac{\text{Btu}}{(\text{hr})(\text{sq. ft})(^\circ\text{F})}$	$h_{\text{calc}}$ $\frac{\text{Btu}}{(\text{hr})(\text{sq. ft})(^\circ\text{F})}$
558	1.47	183.0	561	389	0	29.8	27.4
559	1.86	229.5	817	643	0	28.6	24.6
560	2.12	272.0	1096	921	0	27.0	20.7
561	1.84	225.0	631	458	2.48	40.3	37.1
562	2.00	255.0	781	607	2.48	37.6	33.3
563	2.21	285.5	981	806	2.48	35.0	28.9
564	2.13	270.5	772	598	5.01	44.6	40.4
565	2.31	297.0	914	739	5.01	42.9	37.4
566	2.50	323.5	1076	899	5.01	41.8	34.7
567	2.46	314.5	853	677	7.00	54.9	50.0
568	2.60	348.0	1015	838	7.00	52.0	45.5
569	2.93	389.0	1222	1043	7.00	52.6	43.8
570	2.78	362.5	871	694	9.50	71.3	66.2
571	2.94	393.0	1054	875	9.50	64.9	58.1
572	3.17	418.0	1173	993	9.50	65.6	57.4
573	3.08	409.0	997	817	13.37	75.8	69.6
574	3.29	435.5	1092	911	13.37	77.3	70.1
575	3.63	467.0	1249	1066	13.37	78.1	69.0

TABLE 16 (Cont.)

Run No.	$\frac{U}{\sqrt{gD}}$	$h_{co} \left[ \frac{D^2 \Delta t u}{U^2 k^3 \rho e \lambda} \right]^{1/4}$	F	$h_{co} \left[ \frac{D \Delta t u}{k^3 (\rho - \rho_g) \lambda} \right]^{1/4}$	$h_{co} \frac{\sqrt{D \Delta t}}{U k e \lambda}$	$\frac{\Delta t e k}{\rho e \lambda}$
558	0			1.07		
559	"			0.96		
560	"			0.77		
561	1.893	1.06	.74	1.46	3.83	170
562	"	0.94	.59	1.30	3.57	210
563	"	0.81	.44	1.11	3.25	260
564	3.830	0.77	.43	1.51	2.82	180
565	"	0.76	.36	1.44	3.02	250
566	"	0.67	.28	1.31	2.76	290
567	5.357	0.84	.44	1.96	3.31	240
568	"	0.75	.34	1.74	3.07	280
569	"	0.70	.28	1.61	2.96	320
570	7.270	0.95	.51	2.56	3.78	250
571	"	0.80	.38	2.17	3.27	280
572	"	0.79	.34	2.14	3.38	340
573	10.227	0.83	.39	2.66	3.42	290
574	"	0.82	.37	2.62	3.44	310
575	"	0.79	.33	2.52	3.42	350

TABLE 17

Experimental and Calculated Data on the Film Boiling of n-Hexane from a  
0.387 Inch Outside Diameter Tube

Run No.	Volts	Amps	$t_i$ °F	$\Delta t$ °F	U $\frac{\text{ft}}{\text{sec}}$	$h$ $\frac{\text{Btu}}{(\text{hr})(\text{sq ft})(\text{°F})}$	$h_{co}$
468	2.15	111.5	581	424	0	43.8	41.3
469	2.46	138.0	766	608	0	43.2	39.7
470	2.80	158.0	907	748	0	45.9	41.3
471	2.80	156.5	729	569	2.46	62.0	58.2
472	3.21	186.0	912	751	2.46	63.9	58.6
473	3.65	211.0	1069	907	2.46	68.3	61.4
474	3.20	181.0	682	523	5.03	89.4	85.9
475	3.60	205.0	799	639	5.03	93.3	89.0
476	4.09	233.0	930	768	5.03	100.3	94.8
477	3.68	209.0	729	569	7.56	109.4	105.6
478	4.16	235.0	844	682	7.56	115.9	111.2
479	4.70	263.5	982	818	7.56	121.8	115.9
480	4.08	234.5	761	598	10.01	129.3	125.2
481	4.55	263.0	887	722	10.01	133.4	128.3
482	4.97	288.5	1013	846	10.01	136.1	129.8
483	4.67	268.0	914	749	12.37	134.5	129.1
484	5.10	301.0	1053	885	12.37	139.4	132.7
485	5.63	327.5	1166	996	12.37	148.9	141.0

TABLE 17 (Cont.)

Run No.	$\frac{U}{\sqrt{gD}}$	$h_{co} \left[ \frac{D^2 \Delta t \mu}{U^2 k^3 e e_g \lambda'} \right]^{1/4}$	F	$h_{co} \left[ \frac{D \Delta t \mu}{k^3 e (e_g - e) g \lambda'} \right]^{1/4}$	$h_{co} \sqrt{\frac{D \Delta t}{U k e \lambda'}}$	$\frac{\Delta t \theta k}{\mu e \lambda'}$
468	0	1.36		0.69		
469	0			0.66		
470	0	1.11		0.58		
471	2.411	0.59	.29	0.89	2.21	200
472	2.411	0.54	.24	0.84	2.10	230
473	2.411	0.51	.22	0.80	2.01	240
474	4.944	0.62	.28	1.38	2.32	200
475	4.944	0.60	.26	1.34	2.31	220
476	4.944	0.60	.25	1.33	2.37	240
477	7.421	0.61	.26	1.67	2.35	220
478	7.421	0.60	.25	1.65	2.34	230
479	7.421	0.58	.23	1.59	2.29	240
480	9.825	0.63	.26	1.97	2.48	240
481	9.825	0.59	.24	1.85	2.33	240
482	9.825	0.56	.21	1.75	2.23	250
483	12.126	0.53	.19	1.84	2.09	240
484	12.126	0.50	.17	1.75	1.99	250
485	12.126	0.50	.17	1.74	2.01	260

TABLE 18

Experimental and Calculated Data on the Film Boiling of n-Hexane from a  
0.496 Inch Outside Diameter Tube

Run No.	Volts	Amps	$t_i$ °F	$\Delta t$ °F	U $\frac{\text{ft}}{\text{sec}}$	$\frac{h}{h_{co}}$	
						$\frac{\text{Btu}}{(\text{hr})(\text{sq ft})(\text{°F})}$	$\frac{\text{Btu}}{(\text{hr})(\text{sq ft})(\text{°F})}$
486	1.75	155.0	550	390	0	41.1	38.8
487	2.07	185.0	700	540	0	41.8	38.6
488	2.40	214.0	833	672	0	45.0	41.0
489	1.99	173.0	543	383	2.46	55.8	53.2
490	2.21	192.0	633	473	2.46	55.7	52.5
491	2.51	226.5	747	586	2.46	60.2	56.3
492	2.30	201.0	538	377	5.00	77.3	74.7
493	2.65	230.5	640	478	5.00	80.6	77.5
494	2.91	261.0	736	574	5.00	83.5	79.6
495	2.55	221.0	532	371	7.51	95.8	93.1
496	2.81	249.5	619	457	7.51	96.7	93.6
497	3.10	282.5	720	557	7.51	99.2	95.4
498	2.83	251.5	615	453	10.01	99.1	96.0
499	3.11	283.5	705	542	10.01	102.6	98.9
500	3.40	314.0	797	633	10.01	106.3	102.4
501	3.10	285.0	680	517	12.37	107.8	104.3
502	3.40	314.5	766	602	12.37	112.0	107.9
503	2.72	345.0	865	699	12.37	115.8	110.9



TABLE 18 (Cont.)

Run No.	$\frac{U}{\sqrt{gD}}$	$h_{co} \left[ \frac{D^2 \Delta t u}{U^2 k^3 e \rho \lambda'} \right]^{1/4}$	F	$h_{co} \left[ \frac{D \Delta t u}{k^3 e (\rho_2 - \rho) g \lambda'} \right]^{1/4}$	$h_{co} \sqrt{\frac{D \Delta t}{U k e \lambda'}}$	$\frac{\Delta t e k}{\mu e \lambda'}$
486	0	1.11		0.74		
487	"	1.11		0.67		
488	"	1.11		0.66		
489	2.130	0.66	.38	0.97	2.38	170
490	"	0.63	.34	0.91	2.34	190
491	"	0.64	.33	0.93	2.43	210
492	4.332	0.66	.34	1.36	2.38	170
493	"	0.65	.31	1.34	2.41	190
494	"	0.64	.29	1.32	2.46	220
495	6.509	0.67	.34	1.71	2.42	170
496	"	0.65	.31	1.65	2.41	190
497	"	0.63	.28	1.61	2.39	210
498	8.678	0.58	.25	1.70	2.15	190
499	"	0.57	.24	1.68	2.17	210
500	"	0.56	.22	1.65	2.18	230
501	10.730	0.54	.22	1.79	2.05	210
502	"	0.54	.21	1.78	2.08	220
503	"	0.53	.20	1.73	2.07	230

TABLE 19

Experimental and Calculated Data on the Film Boiling of n-Hexane from a  
0.638 Inch Outside Diameter Tube

Run No.	Volts	Amps	$t_i$ °F	$\Delta t$ °F	$U$ $\frac{\text{ft}}{\text{sec}}$	$h$ $\frac{\text{Btu}}{(\text{hr})(\text{sq ft})(\text{°F})}$	$h_{co}$
504	1.52	187.0	462	303	0	41.4	39.5
505	1.78	220.5	565	406	0	42.8	40.4
506	1.99	249.0	678	518	0	42.4	39.4
507	1.68	209.0	451	292	2.54	55.3	53.1
508	1.91	238.0	532	373	2.54	56.0	53.4
509	2.11	264.0	610	450	2.54	56.7	53.7
510	1.95	240.5	486	326	5.00	70.0	67.6
511	2.17	271.5	563	403	5.00	71.0	68.2
512	2.39	302.5	651	490	5.00	71.7	68.4
513	2.29	283.0	518	358	7.53	88.9	86.3
514	2.47	313.0	594	433	7.53	87.7	84.7
515	2.66	341.0	664	502	7.53	88.6	85.3
516	2.58	324.0	561	400	10.01	102.7	99.9
517	2.73	354.5	630	468	10.01	101.6	98.4
518	2.95	384.5	705	541	10.01	103.0	99.4
519	2.73	353.5	590	428	12.37	110.8	107.8
520	2.96	384.5	657	494	12.37	113.2	109.9
521	3.12	416.0	738	573	12.37	111.6	107.7

TABLE 19 (Cont.)

Run No.	$\frac{U}{\sqrt{gD}}$	$h_{co} \left[ \frac{D^2 \Delta t \mu}{U^2 k^3 e e \lambda'} \right]^{1/4}$	F	$h_{co} \left[ \frac{D \Delta t \mu}{k^3 e (e_L - e) g \lambda'} \right]^{1/4}$	$h_{co} \sqrt{\frac{D \Delta t}{U k e \lambda'}}$	$\frac{\Delta t e k}{\mu e \lambda'}$
504	0			0.78		
505	"			0.77		
506	"			0.72		
507	1.948	0.71	.50	0.99	2.30	110
508	"	0.74	.46	1.04	2.63	160
509	"	0.73	.43	1.02	2.67	180
510	3.822	0.68	.38	1.32	2.36	140
511	"	0.67	.35	1.31	2.42	170
512	"	0.65	.31	1.27	2.41	190
513	5.762	0.70	.38	1.68	2.49	160
514	"	0.67	.34	1.61	2.45	180
515	"	0.66	.32	1.59	2.47	200
516	7.661	0.70	.36	1.93	2.56	180
517	"	0.66	.32	1.82	2.45	190
518	"	0.67	.32	1.85	2.51	200
519	9.466	0.66	.32	2.00	2.47	190
520	"	0.66	.31	2.03	2.48	200
521	"	0.62	.27	1.90	2.40	220

### Results

The measured heat transfer coefficients have been plotted in Figs. 3 through 6. From equations (15) and (16) it would be predicted that if  $h_{co} \times D^{1/4}$  were plotted against  $\frac{U}{\sqrt{gD}}$  for any given liquid (at same  $\Delta t$ ) that a single curve would result. Fig. 7 indicates that this is approximately correct. Indeed it appears that benzene, ethyl alcohol and n-hexane are nearly on the same curve. Fig. 8 which is a plot of

$$h_{co} \left[ \frac{D^2 \Delta t \mu}{U^2 k^3 \rho \epsilon \lambda'} \right]^{1/4} \quad \text{vs.} \quad \left[ \frac{gD}{4U^2} + \frac{3D\pi^2 h_{co}^2}{Uk^2 \rho \epsilon'^2} \right]$$

indicates that in absolute magnitude the experimental data about 20 to 40% above the theoretical and that indeed they lie on an approximate straight line as given by equation (14).

The deviation of the experimental data from the theory may be explained as follows. Heat transferred above  $\theta'$  was neglected; although small it is appreciable. Indeed the higher the velocity (low F) the better is the agreement between theory and experiment, as would be expected. It is fortunate that the low velocity limit corresponds to the natural convection equation (15). This should be expected though. The assumption that  $\frac{dw}{d\theta} = \frac{W}{\theta}$  in the velocity drag term undoubtedly introduced some error also.

Figure 9 is a plot of

$$h_{co} \sqrt[4]{\frac{D \Delta t \mu}{k^3 \rho \epsilon \lambda'}} \quad \text{or} \quad h_{co} \sqrt[4]{\frac{D \Delta t Pr}{k^2 \rho \epsilon \lambda' C_p}}$$

vs.  $\frac{U}{\sqrt{gD}}$ . It will be noted that for  $\frac{U}{\sqrt{gD}} < 1$  that the quantity above is essentially constant at 0.62.

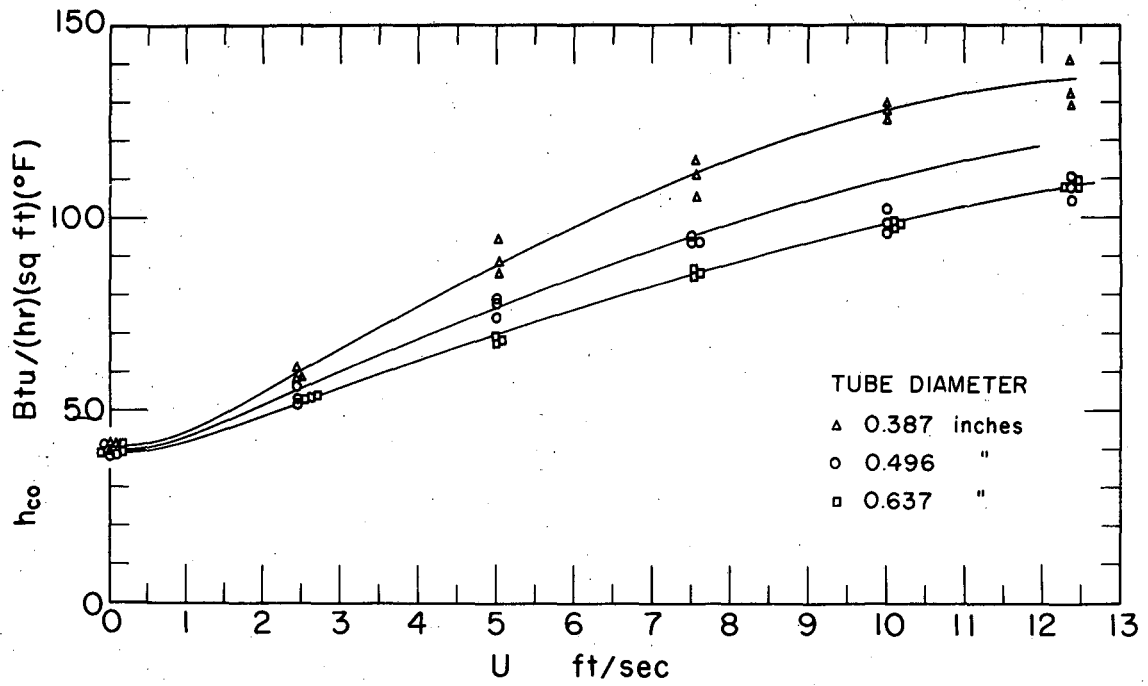

### FILM BOILING OF n-HEXANE

MU 2654

Fig. 3

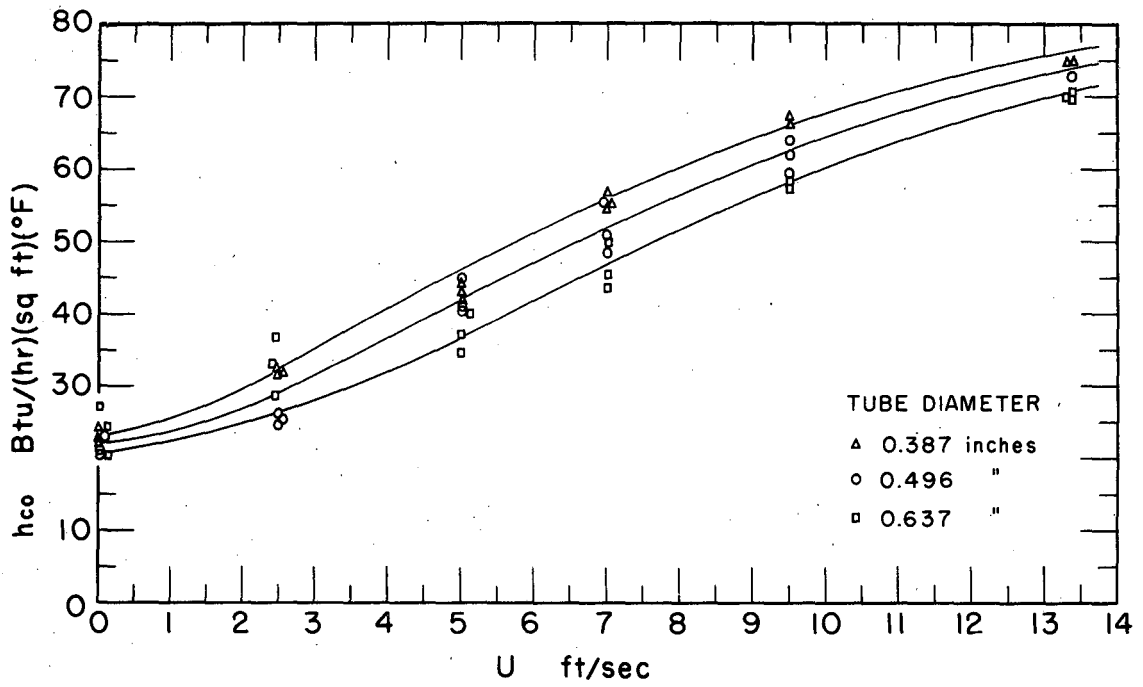

### FILM BOILING OF CARBON TETRACHLORIDE

MU 2652

Fig. 4

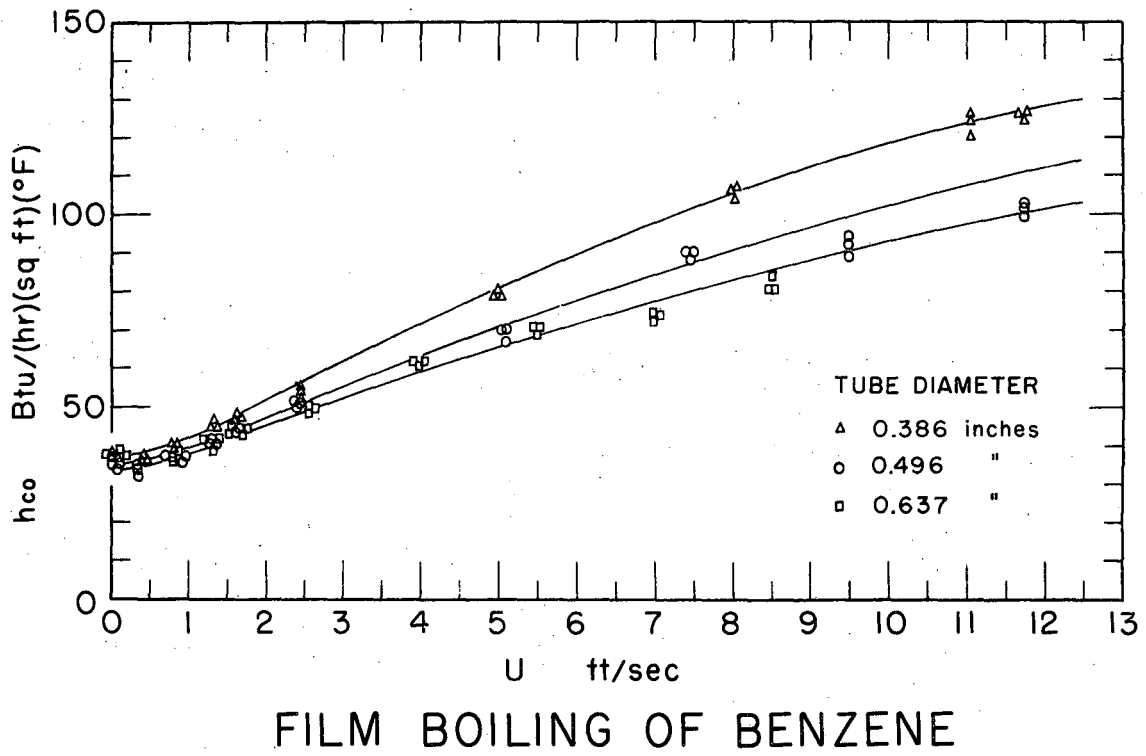

MU 2653

Fig. 5

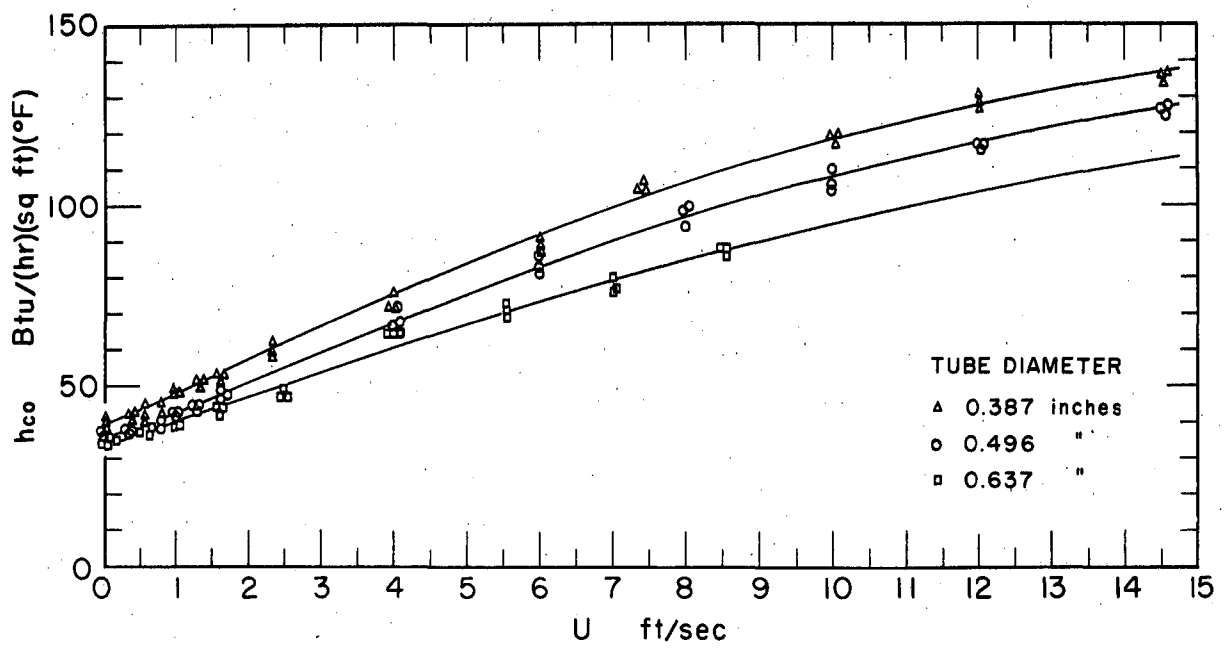

### FILM BOILING OF ETHYL ALCOHOL

MU 2658

Fig. 6



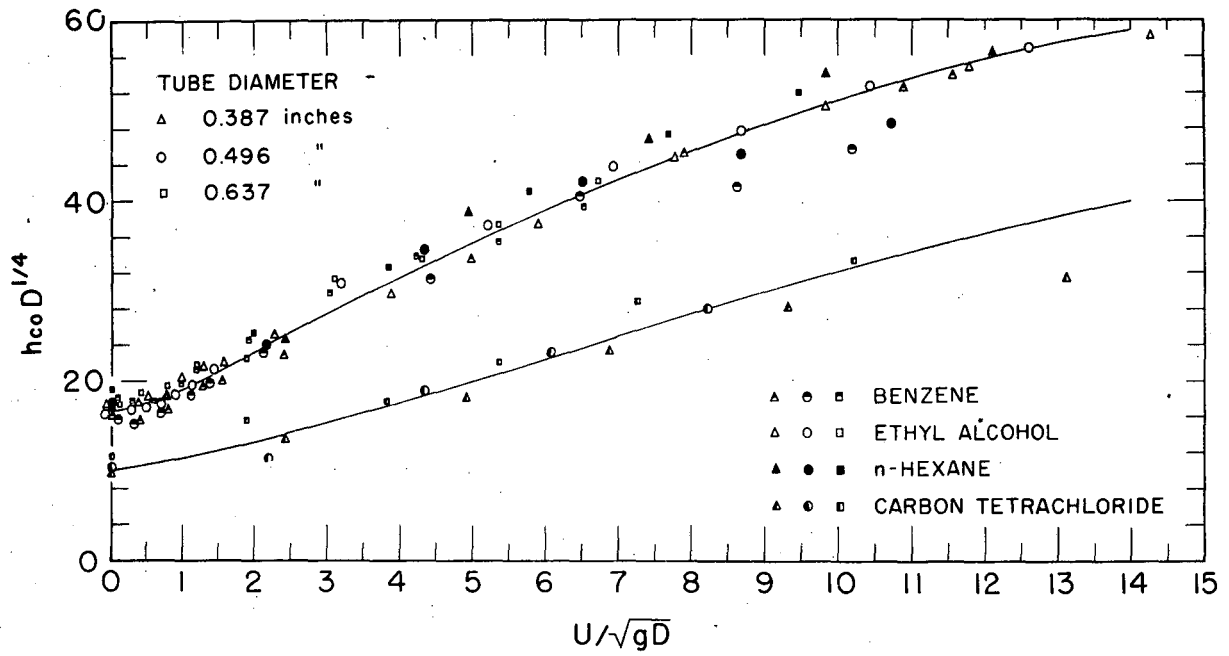

EFFECT OF VELOCITY AND DIAMETER  
ON HEAT TRANSFER COEFFICIENTS

MU 2659

Fig. 7

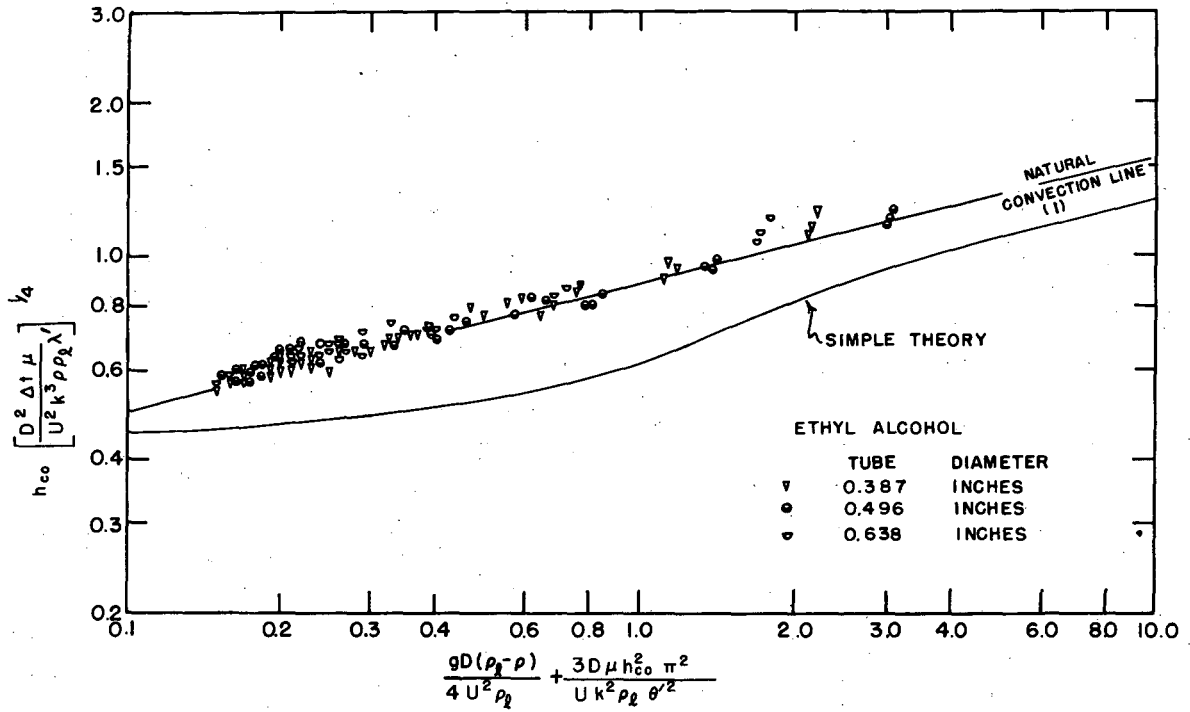

FIG. 8a

FORCED CONVECTION FILM BOILING OF ETHYL ALCOHOL

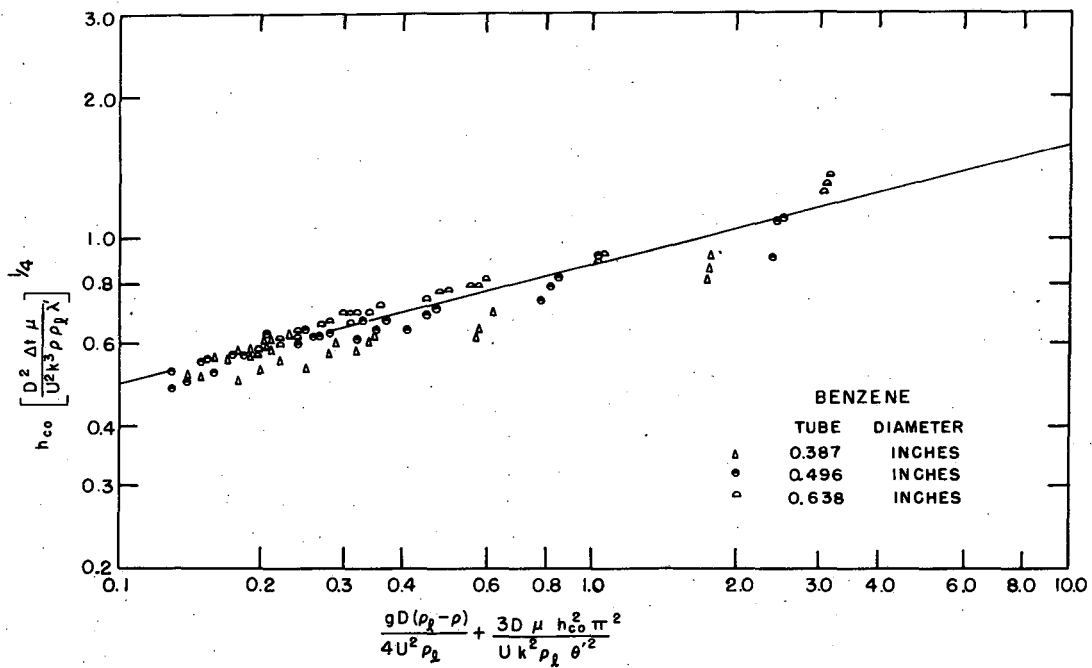

FIG. 8b  
FORCED CONVECTION FILM BOILING OF BENZENE

MU4104

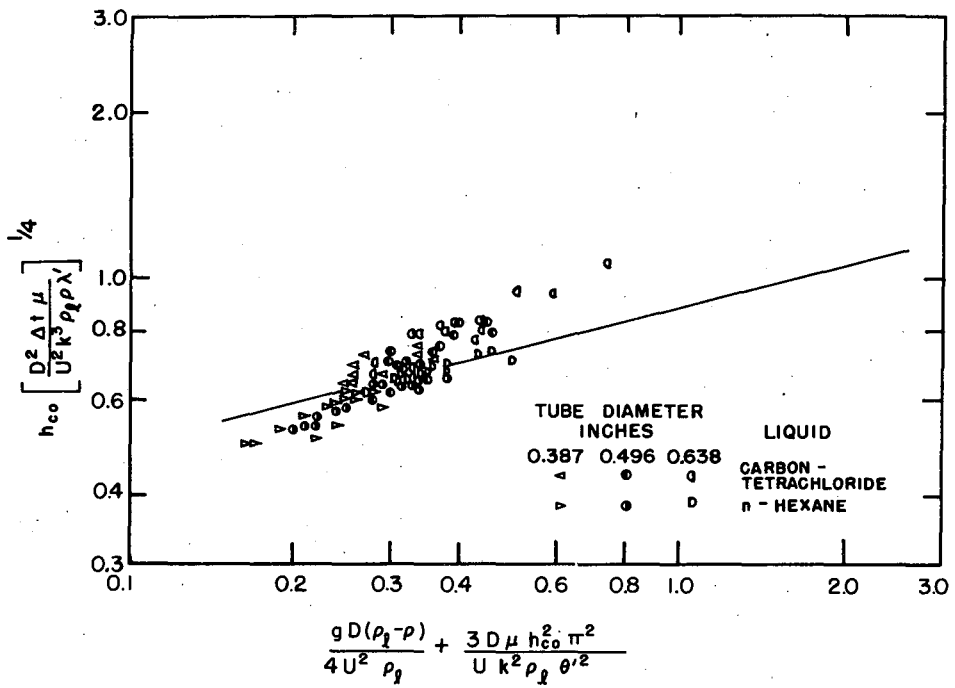

FIG. 8c  
 FORCED CONVECTION FILM BOILING OF n-HEXANE AND  
 CARBON TETRACHLORIDE

MU 4105

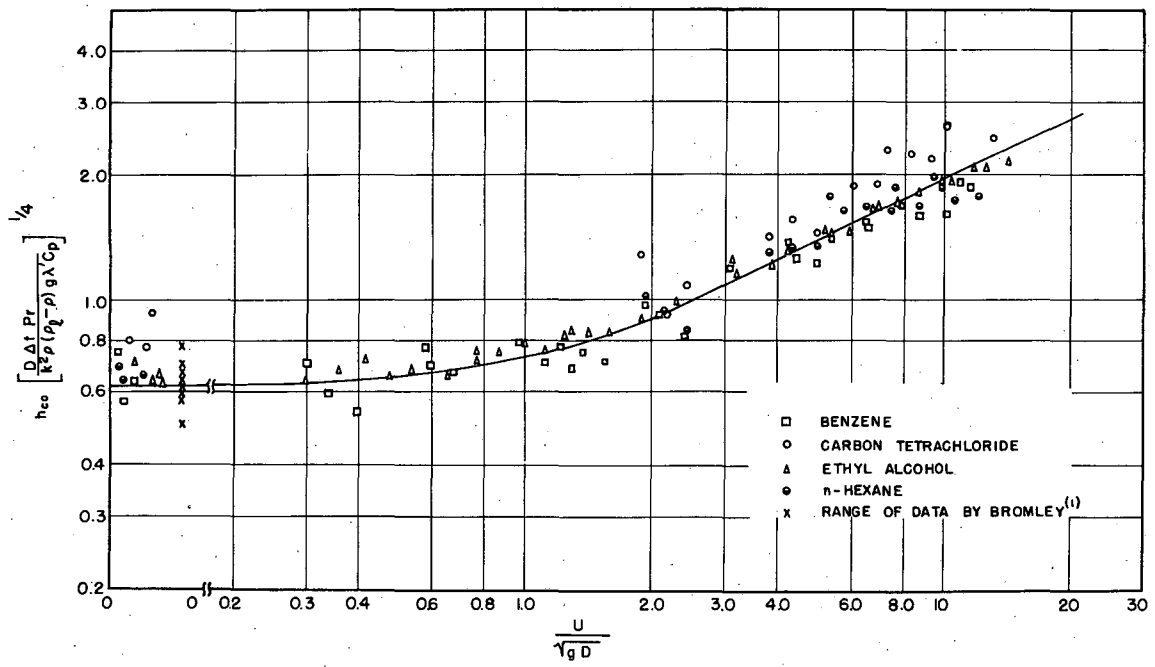

FIG. 9

NATURAL AND FORCED CONVECTION FILM BOILING

MU 4106

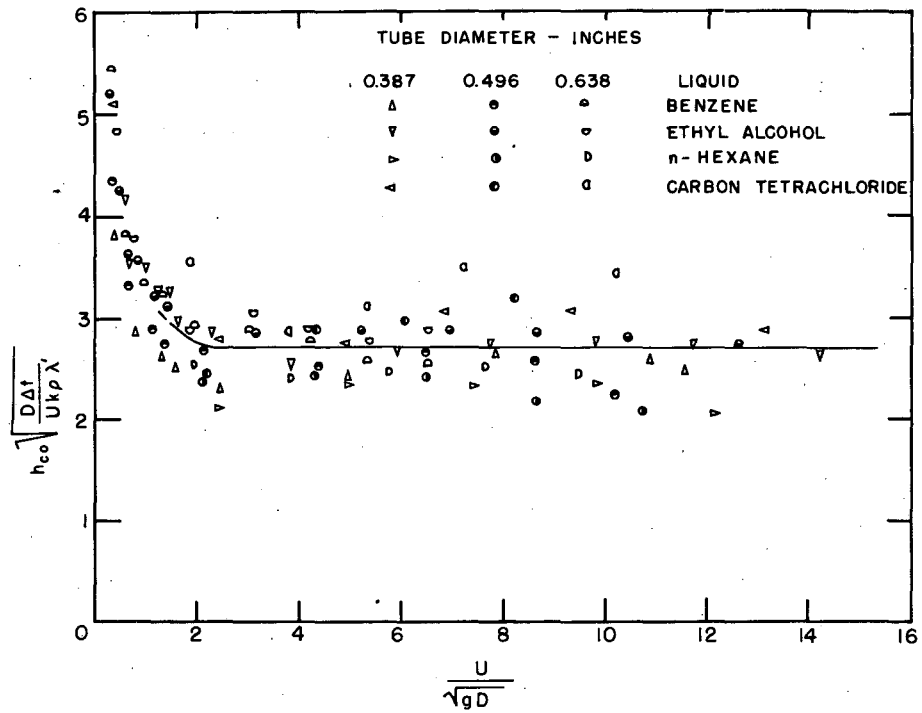

FIG. 10

FORCED CONVECTION FILM BOILING

MU 4107

Figure 10 is a plot of  $h_{co} \sqrt{\frac{D\Delta t}{Uk\rho\lambda'}}$  vs.  $\frac{U}{\sqrt{gD}}$ . It is to be noted that for  $\frac{U}{\sqrt{gD}} > 2$  that this group has the value of  $\sim 2.7$  as given in equation (16).

### Conclusions

A sound theory has been advanced which explains almost quantitatively the observed heat transfer coefficients in forced convection film boiling for upward flow over a horizontal tube. The equations may be simplified as follows:

$$\text{for } \frac{U}{\sqrt{gD}} < 1.0$$

$$h_{co} = 0.62 \sqrt[4]{\frac{D\Delta t Pr}{k^2(\rho_l - \rho)\rho g \lambda' C_p}} = 0.62 \sqrt[4]{\frac{D\Delta t \mu}{k^3(\rho_l - \rho)\rho g \lambda'}} \quad (26,15)$$

$$\text{and } h = h_{co} + \frac{3}{4} h_r \quad (27,17)$$

or the same as for natural convection.

$$\text{for } \frac{U}{\sqrt{gD}} > 2.0$$

$$h_{co} = 2.7 \sqrt{\frac{D\Delta t}{Uk\rho\lambda'}} \quad (28,16)$$

$$\text{and } h = h_{co} + \frac{7}{8} h_r \quad (29,19)$$

$$\text{where } \lambda' = \lambda \left[ 1 + \frac{0.4 \Delta t C_p}{\lambda} \right]^2 \quad (25)$$

For intermediate values one may use Figs. 8 or 9.

Nomenclature

<u>Symbol</u>	<u>Definition</u>	<u>Suggested Units</u>
a	thickness of vapor film	ft
A	heat transfer area	ft <sup>2</sup>
C <sub>p</sub>	specific heat at constant pressure	$\frac{\text{Btu}}{\text{lb } ^\circ\text{F}}$
D	outside diameter of tube	ft
F	friction loss, also see Table 1.	$\frac{(\text{ft})(\text{lb force})}{\text{lb mass}}$
g	acceleration of gravity	
g <sub>c</sub>	gravitational constant = $4.17 \times 10^8$	$\frac{(\text{lb mass})(\text{ft})}{(\text{lb force})(\text{hr}^2)}$
h	film coefficient of heat transfer	$\frac{\text{Btu}}{(\text{hr})(\text{ft}^2)(^\circ\text{F})}$
h <sub>co</sub>	film coefficient of heat transfer if there were no radiation	$\frac{\text{Btu}}{(\text{hr})(\text{ft}^2)(^\circ\text{F})}$
h <sub>r</sub>	radiation coefficient of heat transfer, see equation (20)	$\frac{\text{Btu}}{(\text{hr})(\text{ft}^2)(^\circ\text{F})}$
k	thermal conductivity	$\frac{\text{Btu}}{(\text{hr})(\text{ft}^2)(^\circ\text{F}/\text{ft})}$
l	subscript denoting liquid	
L	length of tube	ft
P	pressure	$\frac{\text{lb force}}{\text{ft}^2}$
P <sub>o</sub>	pressure at $\theta = 90^\circ$	
Pr	Prandtl number = $\frac{\mu C_p}{k}$	
q	heat flow	$\frac{\text{Btu}}{\text{hr}}$
t	temperature	$^\circ\text{F}$
T	absolute temperature	$^\circ\text{R}$
Δt	temperature difference between tube surface and liquid at its boiling point	$^\circ\text{F}$



Nomenclature (Concluded)

<u>Symbol</u>	<u>Definition</u>	<u>Suggested Units</u>
$t_i$	temperature inside the tube	$^{\circ}\text{F}$
$t_L$	boiling point of the liquid	$^{\circ}\text{F}$
$t_T$	temperature of the outside of the tube	$^{\circ}\text{F}$
$U$	velocity of the liquid	$\frac{\text{ft}}{\text{hr}}$
$V$	velocity of the vapor in the film	$\frac{\text{ft}}{\text{hr}}$
$w$	weight evaporated up to any angle $\theta$	$\frac{\text{lb mass}}{\text{hr}}$
$W$	weight evaporated on entire tube	$\frac{\text{lb mass}}{\text{hr}}$
$x$	height above datum plane	ft
$a$	absorptivity of the cold liquid	
$\epsilon$	emissivity of hot tube	
$\theta$	angle measured from bottom of the tube	
$\theta'$	separation point, see after eq. (8) and Table 1	
$\lambda$	latent heat of vaporization	$\frac{\text{Btu}}{\text{lb mass}}$
$\lambda'$	effective difference in heat content between vapor at its average temperature and the liquid at its boiling point, see eq. (25)	$\frac{\text{Btu}}{\text{lb mass}}$
$\mu$	viscosity of vapor	$\frac{\text{lb mass}}{(\text{hr})(\text{ft})}$
$\rho$	density of vapor	$\frac{\text{lb}}{\text{ft}^3}$
$\rho_l$	density of liquid	$\frac{\text{lb}}{\text{ft}^3}$
$\sigma$	Stefan-Boltzman Constant $0.1713 \times 10^{-8}$	$\frac{\text{Btu}}{(\text{hr})(\text{ft}^2)(^{\circ}\text{R}^4)}$

Bibliography

1. Bromley, L. A., Ph.D. Thesis, "Heat Transfer in Stable Film Boiling", University of California, Berkeley (1948); also Chem. Eng. Prog. 46, 221-7 (1950).
2. Bromley, L. A., Ind. Eng. Chem., "Effect of Heat Capacity of Condensation on Heat Transfer Coefficient in Condensation", to be published in September 1952.
3. Jameson, A. H., "Introduction to Fluid Mechanics", 2nd Ed., Longmans, Green and Co., New York (1942).
4. LeRoy, N. R., M. S. Thesis, "Heat Transfer in Forced Convection Film Boiling; Effect of Physical Variables", University of California, Berkeley (1952).
5. McAdams, W. H., "Heat Transmission", 2nd Edition, McGraw-Hill, New York (1942).
6. Milne-Thompson, "Theoretical Hydrodynamics", 2nd Edition, Macmillan, New York (1949).
7. Robbers, J. A., M. S. Thesis, "Heat Transfer in Forced Convection Film Boiling; Effect of Geometric Variables", University of California, Berkeley (1952).