

# Lawrence Berkeley National Laboratory

## Lawrence Berkeley National Laboratory

### **Title**

Fluence to Dose Equivalent Conversion Coefficients for Evaluation of Accelerator Radiation Environments

### **Permalink**

<https://escholarship.org/uc/item/5pd0x47s>

### **Authors**

Thomas, Ralph H.  
Zeman, Gary H.

### **Publication Date**

2001-03-01

Fluence to Dose Equivalent Conversion Coefficients for Evaluation of Accelerator Radiation Environments

Ralph H. Thomas  
Gary H. Zeman

Ernest Orlando Lawrence Berkeley National Laboratory  
Berkeley, California 94720

February 2001

**Abstract**

The derivation of a set of conversion functions for the expression of neutron fluence measurements in terms of Effective Dose,  $E$ , is described. Four functions in analytical form are presented, covering the neutron energy range from  $2.5 \cdot 10^{-8}$  to  $10^4$  MeV, for the interpretation of fluence measurements in the typical irradiation conditions experienced around high-energy proton accelerators such as the Bevatron<sup>1</sup>. For neutron energies below 200 MeV the analytical functions were modeled after the ISO and ROT conversion coefficients in ICRU 57. For neutron energies above 200 MeV, the analytical function was derived from an analysis of recent published data. Sample calculations using either the analytical expressions or the tabulated conversion coefficients from which the analytical expressions are derived show agreement to better than  $\pm 5\%$ .

This work was supported by the Director, Office of Science, Office of Basic Energy Sciences, Materials Sciences Division of the U.S. Department of Energy, under Contract No. DE-AC03-76SF00098

---

<sup>1</sup> The Bevatron was a weak-focusing proton synchrotron that accelerated protons to an energy of 6.2 GeV and first operated in 1954.

*“Our ideas are intellectual instruments which we use to break into phenomena; we must change them when they have served their purpose, as we change a blunt lancet that we have used long enough”*  
Claude Bernard<sup>(1)</sup>

## Introduction

Measurements of neutron fields made in the late 1950's and early 1960's, and their interpretation for the purposes of radiation protection, around the Bevatron of the University of California Radiation Laboratory<sup>2</sup> have recently been reviewed<sup>(2)</sup>.

Simply stated, measurements of total neutron fluence made in known energy-spectra may be related to dose equivalent quantities,  $H^3$ , by a spectrum-averaged fluence-to-dose-equivalent conversion coefficient<sup>4</sup>,  $\langle g \rangle$  by the equation:

$$H = \langle g \rangle \Phi \quad (1)$$

[see references (3-5)].

The spectrum-averaged conversion coefficient  $\langle g \rangle$  which is applied to the total neutron fluence is an intricate function of neutron energy spectrum, neutron angular distribution, irradiation geometry and the phantom used to represent the human body. Values of  $\langle g \rangle$  may only be determined if a comprehensive fluence to dose equivalent conversion function is available. Radiation protection concepts and data developed during the last thirty years now make it necessary to revise the conversion function that was used in the late 1950's and early 1960's<sup>(6,7)</sup>. This paper describes the derivation of a set of conversion functions for neutrons in the energy range from  $2.5 \cdot 10^{-8}$  to  $10^4$  MeV which has been used in the reappraisal of the early Bevatron measurements and may be of more general application to other accelerator radiation environments<sup>(2)</sup>.

## Neutron Fields at Proton Accelerators

Neutrons dominated the radiation field around the Bevatron<sup>(8)</sup>. In the early days of its operation only limited information on the energy spectrum of neutrons outside shielding was available. In the late fifties it was reasoned that the neutron energy spectrum around the Bevatron would be very similar to the equilibrium neutron spectrum generated by the interaction of primary cosmic rays in the Earth's atmosphere<sup>(8-10)</sup>. In the early 1960's analysis of measurements of accelerator radiation fields and of the Hess Cosmic-Ray Neutron spectrum, and the use of conversion coefficient data then available<sup>5</sup>, it was concluded that:

*Fast neutrons between 50 keV and 20 MeV contribute 80% of (the total) exposure. Neutrons of energy greater than 50 MeV, slow neutrons, and gamma rays contribute a few percent each.* [Patterson<sup>(8)</sup>]<sup>(11, 12, 13)</sup>.

Figure 1 shows the cosmic ray neutron energy spectrum in air measured by Hess *et al.*<sup>(9)</sup> plotted in two ways. Fig. 1a plots the neutron differential energy spectrum,  $d\phi/dE$ , as function of neutron energy in log-

---

<sup>2</sup> The University of California Radiation Laboratory has also been known as the Lawrence Berkeley Laboratory, the Lawrence Berkeley National Laboratory and is currently known as the Ernest Orlando Lawrence Berkeley National Laboratory. For brevity it is referred to as the Berkeley Laboratory for the remainder of this paper.

<sup>3</sup> Throughout this paper a special font designates Dose Equivalent Quantities, H. It was necessary to distinguish between the symbol  $E$  used for the quantity Effective Dose and the symbol E that represents energy. To be consistent the symbols  $H_E$  &  $M$  are used for the Effective Dose Equivalent and Maximum Dose Equivalent respectively.

<sup>4</sup> Now referred to in what follows as a “conversion coefficient”.

<sup>5</sup> The information contained in ICRP Publication 4 was generally available to the accelerator community well before its publication in 1960.

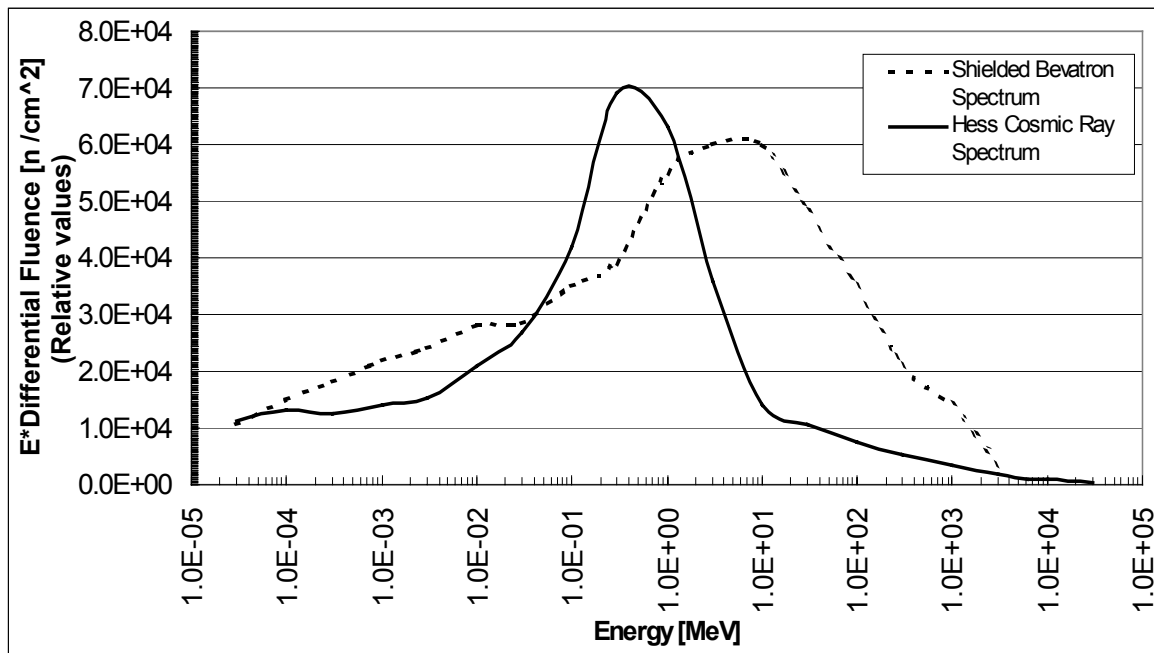
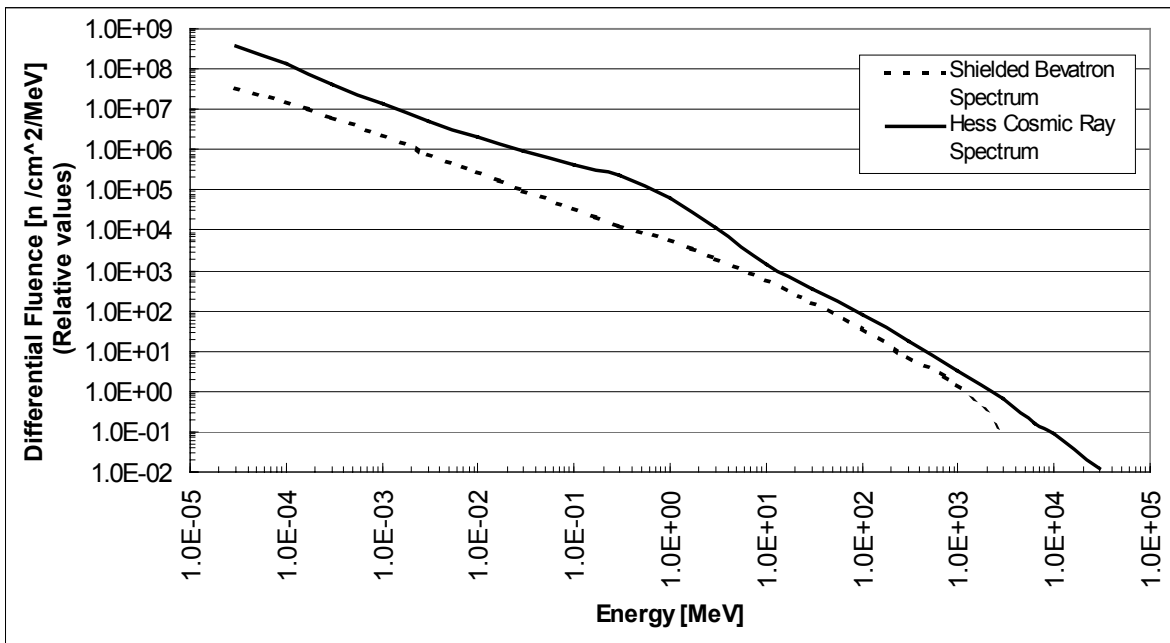

Figure 1.

The spectrum of neutrons in the Earth's atmosphere produced by cosmic-ray interactions (Hess Cosmic ray spectrum) compared with the spectrum outside the concrete shielding of the Bevatron (Shielded Bevatron spectrum). Figures 1a and 1b present  $d\phi/dE$  and  $E*d\phi/dE$ , as function of neutron energy respectively.

log manner while Fig. 1b presents a lethargy plot  $E \cdot d\phi/dE$ , as function of neutron energy in linear-log fashion. For comparison the neutron energy spectrum outside the concrete shielding of the Bevatron, which was determined some years after the work of Hess *et al.*, is also shown in both figures. The general similarity between the two spectra is evident from figure 1a but figure 1b reveals differences in structure in the few hundred keV-few tens of MeV energy region. It is most likely that in the early days of Bevatron operation the neutron spectrum more closely resembled the cosmic-ray spectrum than the shielded Bevatron spectrum.

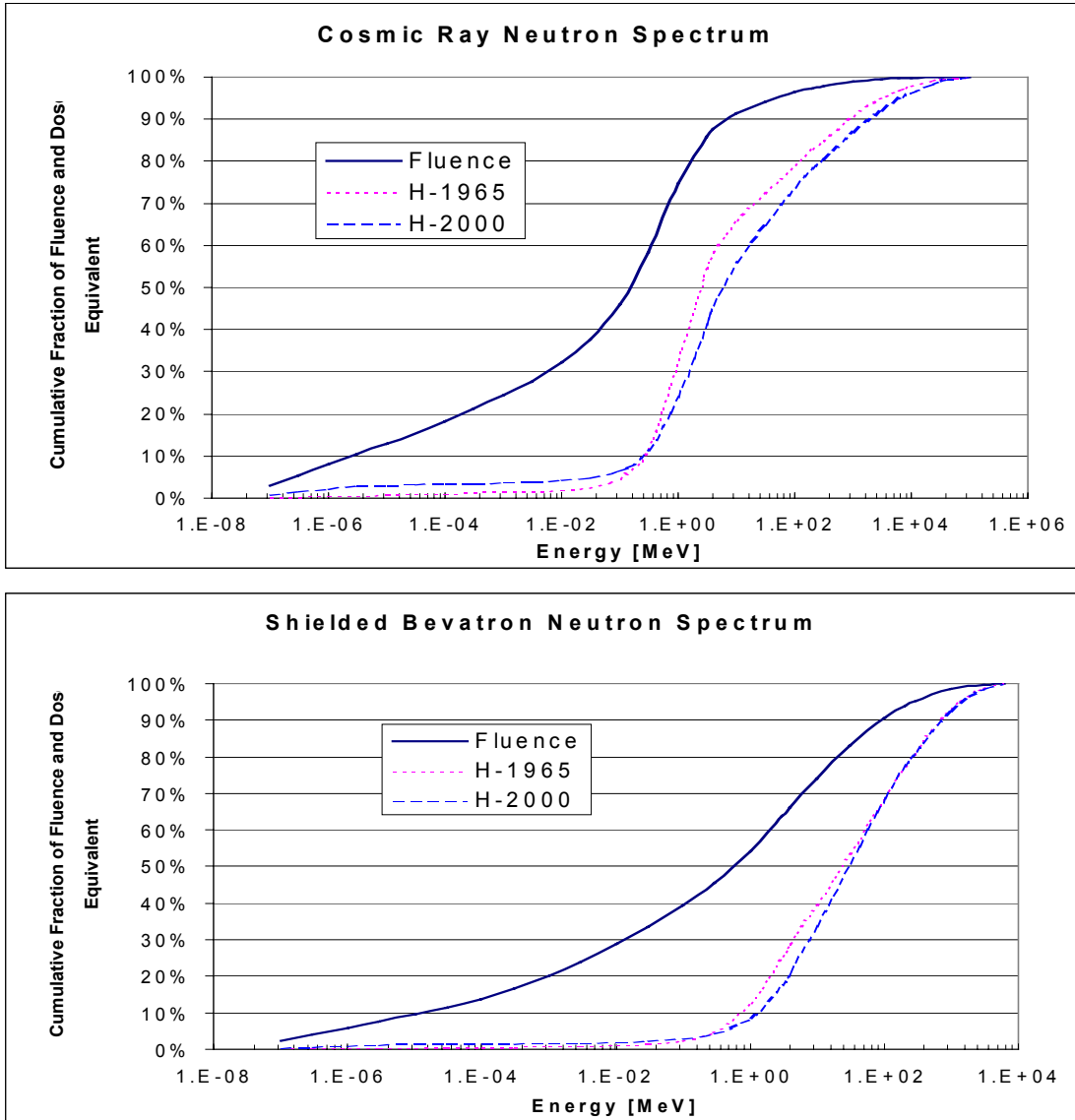

Figure 2.

Percentage of fractions of both the total neutron fluence and dose equivalent contributed up to a given energy,  $E$  for the Hess Cosmic-Ray and Shielded Bevatron neutron spectra. Two conversion coefficient functions were used, the first developed in 1965<sup>(6)</sup> and the second described in this paper.

Figure 2 shows the fractions of the total neutron fluence and dose equivalent contributed up to a given energy,  $E$ , for both spectra. The figure shows that neutrons below 30 MeV contribute 91% and 74% of the integral fluence for the cosmic ray and shielded Bevatron spectrum respectively. At the same energy cut-off about 70% and 40% of the dose equivalent are contributed. Evidently, the dose equivalent curves are not strongly dependent upon the conversion function. It was fortunate both that the neutrons that contributed to

the preponderance of the dose equivalent lay in an energy region where measurement was feasible and that, furthermore, some conversion coefficient data were available<sup>(6,13)</sup>.

Direct measurements of angular distribution of neutrons in the radiation field are rarely made for the purposes of radiation protection but are nevertheless necessary to reach reasonable conclusions about the irradiation geometry of people moving through accelerator radiation fields. Typically the neutron fields at a large accelerator are produced by many diffuse sources. The preponderance of the dose is deposited by neutrons having energies much smaller than the primary proton beam and which are scattered by the air, and by surrounding structures. Furthermore, the nature of the random movement of people in these fields (walking, sitting, sleeping) leads to the conclusion that their exposure will be isotropic in character.

### **Dose Equivalent Quantities and Field Quantities.**

Many accelerator laboratories make direct measurements to use field-quantities for radiation protection purposes. However, in accordance with the recommendations of advisory bodies such as the ICRP<sup>6</sup>, ICRU<sup>7</sup> and NCRP<sup>8</sup>, radiological protection standards for administrative, legislative and regulatory purposes are expressed in dose equivalent quantities. It therefore important to provide a link between these two types of quantity.

Dose Equivalent Quantities  $H_E$ . A dose equivalent quantity is defined to be a construct of weighted absorbed-doses (see ICRU Report 57<sup>(15, 16)</sup>)<sup>9</sup>. Space limitations prevent the detailed description here of the evolution, over the past fifty years, of the concept of dose equivalent quantities, from their origin as RBE-dose to those currently in use. The interested reader can find a discussion in ICRU Report 57. The principal quantities of interest for this paper are the Maximum Dose Equivalent<sup>(17)</sup>,  $M$ , Effective Dose Equivalent,  $H_E$ <sup>(18,19)</sup> and Effective Dose  $E$ <sup>(20)</sup>.

Maximum Dose Equivalent, (MADE).  $M$  is the operational expression of the “critical organ” system of protection. By this scheme any “critical organ” could be protected provided it was ensured that the maximum dose equivalent in the body did not exceed the critical organ dose limit. For relatively low energy neutrons this maximum occurred at depths less than 1 cm. in soft tissue<sup>(12)</sup>. The conversion coefficients recommended by the ICRP in Publication 21 convert neutron fluence to  $M$ . and remain to this day the basis of neutron exposure limits in regulations in the United States<sup>(21-23)</sup>. Because it takes no account the dose equivalent distribution within the human body  $M$  is generally a conservative protection quantity.

Effective Dose Equivalent,  $H_E$ . First defined to be used for internal dosimetry, Effective Dose Equivalent was later recommended for use in external dosimetry<sup>(18,19)</sup>. It is the sum of weighted<sup>10</sup> absorbed doses for several specified human organs and was an attempt to take account of the dose distribution though the human body. ICRP Publication 51 provides fluence to  $H_E$  conversion coefficients up to 14 MeV<sup>(24)</sup>. In AP irradiation geometry these coefficients are a factor of about 3 lower than corresponding values for  $M$  at energies up to 1 MeV but above this energy the coefficients increase and at 14 MeV are roughly equal to those for  $M$ <sup>11</sup>. While Publication 51 was in the process of publication the ICRP recommended the coefficients for  $H_E$  be doubled<sup>(25)</sup>. Conversion coefficients for  $H_E$  were not adopted into regulations in the United States.

Effective Dose,  $E$ . In 1990 the ICRP revised its definition of  $H_E$  and in particular the method by which it was to be calculated. This revision was defined to be a new protection quantity and named Effective Dose<sup>(20)</sup>. For neutrons the most significant change was in the method of radiation weighting. ICRP Publication 74 and ICRU Report 57 provide conversion coefficients from fluence to Effective Dose for neutron energies up to 200 MeV for the standard ICRP irradiation geometries.

---

<sup>6</sup> ICRP- International Commission on Radiological Protection.

<sup>7</sup> ICRU-International Commission on Radiation Units and Measurements.

<sup>8</sup> NCRP-National Council on Radiation Protection and Measurements.

<sup>9</sup> ICRU Report 57 and ICRP 74 were intended to be identical. The later (ICRU) version is more carefully edited and will be referred to for the remainder of this paper.

<sup>10</sup> This weighting has two components- one for tissue radiosensitivity and the other for radiation quality factor.

<sup>11</sup> These comments do not include the effects of the “Paris Statement” of the ICRP, issued 1985<sup>(25)</sup>

McDonald *et al.* have commented on the, perhaps rather surprisingly, fair agreement between the coefficients for  $E$  and  $M^{(26)}$ . Figure 3 shows the ratio of the values of the conversion coefficients of  $M$  to  $E$  calculated in AP irradiation geometry. For much of the energy region of interest the two coefficients agree within  $\pm 20\%$  but with a notable difference of about a factor of 2 at 100 keV. For typical accelerator neutron spectra, when the dose equivalent must be obtained by integration over a wide energy region, the MADE and Effective Dose agree to better than  $\pm 20\%$ .

One of the principal purposes of this paper is to provide a convenient set of analytical expressions that represent the conversion coefficients from fluence to Effective Dose with accuracy sufficient for radiation protection purposes.

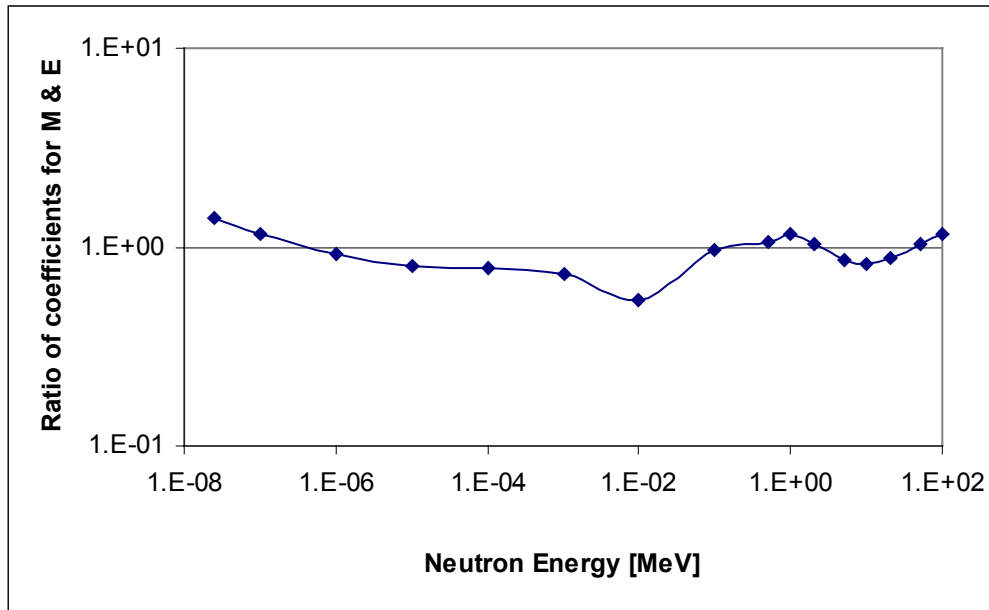

**Figure 3.**

**A Comparison between the values of the conversion coefficients for the MADE and for Effective Dose recommended by the ICRP in 1973 and 1997 respectively (AP Irradiation geometry)<sup>(17,21)</sup>.**

Field Quantities. In the fifties Moyer anticipated the evolution of dose equivalent quantities just described and elected a more stable basis for radiation protection measurements at the Berkeley accelerators<sup>(3,4)</sup>. His approach to radiation dosimetry was to eschew any attempts to directly “measure” dose equivalent quantities but rather systematically identify the components and characteristics of the “high-energy” radiation fields. This approach required the measurement of integrated particle fluence and energy spectra. Such a procedure had (and has) the advantage that the physical data may, at any time, be interpreted in terms of the current ICRP and ICRU dose equivalent quantities.

Differential energy spectrum,  $(d\phi/dE)$ . Neutron energy spectra outside shields, which contain even rather small quantities of hydrogen (usually in the form of water or waters of crystallization), approach a dominant “ $1/E$ ” shape in the intermediate neutron energy region. This shape of the spectrum gradually steepens at higher energies with the slope approaching  $1/E^2$  in the hundreds of MeV region (see Fig 1). The techniques of radiation measurement that are made to determine neutron spectra are described in the basic texts (see, for example, reference 11).

Neutron Fluence,  $\Phi$ . The principal field quantity of interest in accelerator radiation protection is the total neutron fluence:

$$\Phi = \int_{E_{\min}}^{E_{\max}} \frac{d\phi}{dE} dE \quad (2)$$

where:

$E_{\min}$  and  $E_{\max}$  are the minimum and maximum energies bounding the spectrum  
 $d\phi/dE$  is the neutron differential energy spectrum

In the case of proton accelerators it is usual to consider the minimum energy to be that of thermal neutrons ( $\sim 2.5 \cdot 10^{-8}$  MeV) and the maximum energy to be that of the primary protons. These assumptions are generously conservative because it is most improbable that neutrons with energy as high as that of the primary protons will penetrate the accelerator shielding. Techniques of neutron fluence measurement are described in the basic texts (see, for example, reference (11)).

Angular Distribution,  $(d\phi/d\Omega)$  and Irradiation Geometry. Two factors determine the distribution of neutrons over an individual's body: the angular distribution of the neutrons in the field (a receptor-free condition) and the orientation of the body in the field (a receptor condition)<sup>(27)</sup>. Consideration of both factors leads to the conclusion that the irradiation of people in accelerator neutron fields outside shielding is best represented by isotropic (ISO) irradiation geometry.

**Angular Distribution:** Direct measurements of angular distribution of neutrons in the radiation field of particle accelerators are rarely made for the purposes of radiation protection. However, the radiation field outside accelerator shielding is typically produced by many diffuse sources. Furthermore, the preponderance of the dose is deposited by relatively low-energy neutrons, which are scattered approximately by the air, and by surrounding structures

**Irradiation (Receptor) Geometry:** Persons present in the radiation field are typically randomly oriented with respect to the incident radiation (walking, sitting, sleeping) and leads to the conclusion that their exposure will be isotropic in character. The ICRU have adopted the conventions of expansion and alignment with which it is possible to calculate conversion coefficients appropriate to broad neutron radiation fields such as these around particle accelerators<sup>(28,29)</sup>. Calculations of weighted absorbed dose in the organs in an anthropomorphic phantom is usually performed in five standard geometries, G:

AP (antero-posterior): phantom irradiated from front to back.

PA (postero-anterior): phantom irradiated from back to front.

LAT (laterally): phantom irradiated from the side.

ROT (rotationally): phantom irradiated while rotating about its longitudinal axis in the field

ISO (isotropically) phantom irradiated isotropically

These standard irradiation geometries are illustrated in figure 4. More precise definitions may be found in ICRU Report 57<sup>(15)</sup>.

Practical considerations of potential exposures of persons moving around the accelerator and at random orientations in highly-scattered neutron radiation fields therefore lead to the conclusion that the ISO irradiation geometry is the most appropriate for calculations of Effective Dose in areas surrounding particle accelerator facilities.



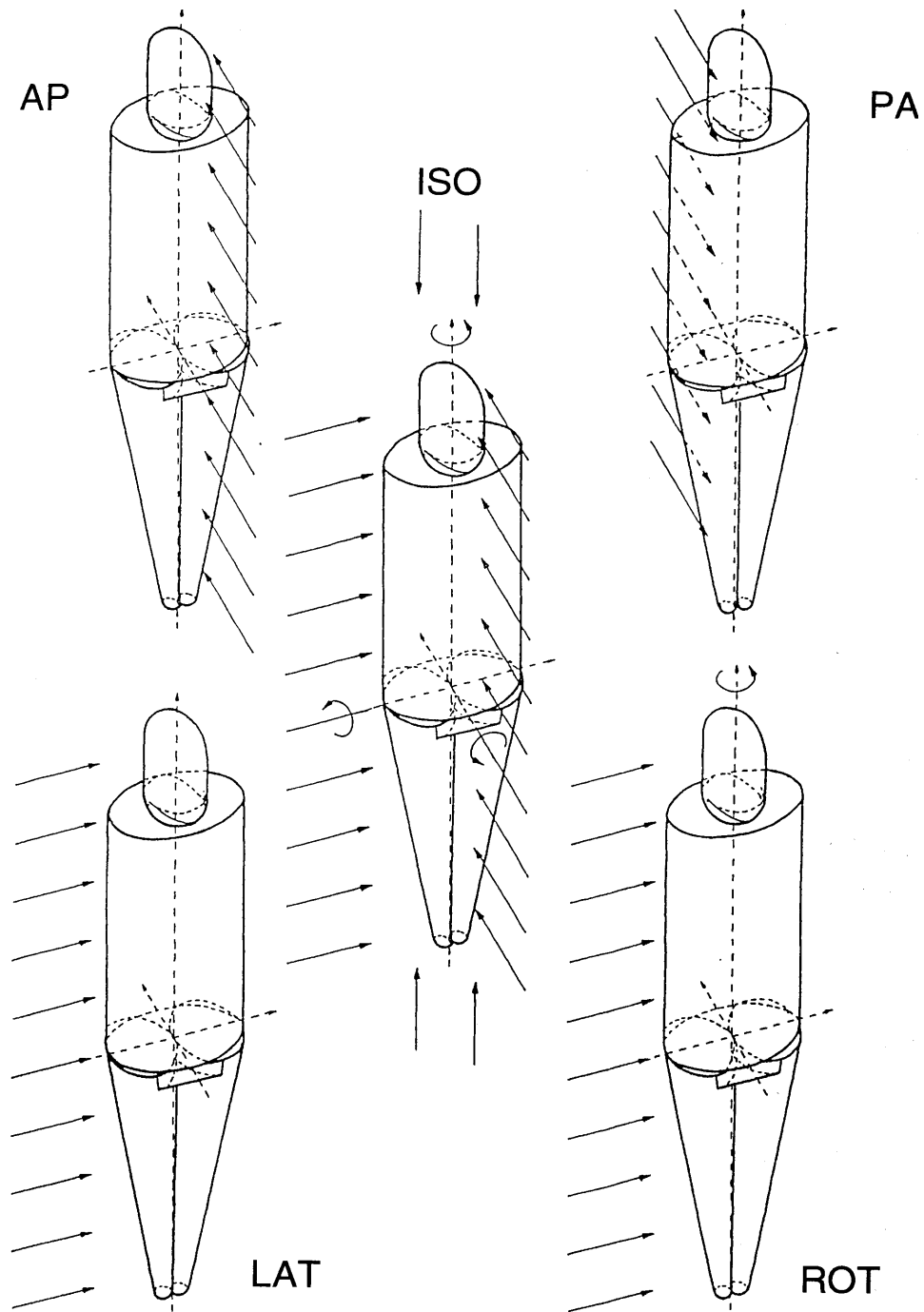

Figure 4.  
 A Diagrammatic Representation of the Five Standard Irradiation Geometries selected by the ICRP and ICRU for the calculation of Conversion Coefficients in ICRU Report 57 (from ICRP Publication 74 and ICRU Report 57).

**Accuracy and Precision.**

The field quantities used in accelerator radiation protection may be determined with good accuracy and excellent precision. The total neutron fluence may be measured to an accuracy of about ±20% or better.

The conversion of physical quantities to dose equivalent quantities by an accepted convention should, in principle, incur no loss of accuracy. However, there will be no loss in accuracy if, and only if, consistent conventions are accepted and followed. Unfortunately there is some internal inconsistency in ICRP Publications on this issue, which seem to suggest that ICRP considers factors of 2-3 to be of no consequence in the estimation of dose equivalent and this has resulted in some confusion (for example see references 30, 31)

The American National Standard for Dosimetry – Personnel Dosimetry <sup>(32)</sup> provides one example of consistent practices. This standard cites both ICRP Publication 35 and NCRP Report 57 <sup>(33,34)</sup>.

ICRP Publication 35 (1982) states: "If these quantities (shallow and deep dose equivalent indices) are of the order of the relevant annual limits, the uncertainties should not exceed a factor of 1.5 at the 95% confidence level. Where they amount to less than 10 mSv an uncertainty factor of 2 at the 95% confidence level is acceptable."

NCRP 57 states: For personal monitoring..."The desirable precision of measurements is ±10%." and, later:-  
----- "At the level of the MPD a measurement accuracy of ±30% *should* (NCRP italics) be achieved. If the dose equivalent to critical organs is less than ¼ of the MPD, personnel monitoring is not required and a lower level of accuracy (e.g., a factor of 2) is acceptable. On the other hand, at higher doses such as may occur during emergency procedures or accidents, determination with an accuracy better than 20% is desirable."

However, it is worth commenting that in some countries regulatory authorities appear on occasion to have, in some cases, required more stringent standards than those just suggested.

**Conversion Coefficients**

It is, in principle, a relatively simple matter to use conversion coefficients to determine the values of dose equivalents required by regulatory agencies. In practice the neutrons are distributed over a wide range of energy and a conversion coefficient averaged over the energy spectrum is required and denoted by  $\langle g_{HG} \rangle$  where H and G specify the dose equivalent and irradiation geometry respectively. Thus, for example, equation (1) may be modified as needed to equations of the type:

$$H_G = \langle g_{HG} \rangle \Phi \tag{3a}$$

$$M_G = \langle g_{MG} \rangle \Phi \tag{3b}$$

$$E_G = \langle g_{EG} \rangle \Phi \tag{3c}$$

*et cetera.*

Values for  $\langle g_{HG} \rangle$  may be determined using a set of conversion coefficients, g(E), defined as the ratio of the dose equivalent to the fluence of neutrons at the specific energy E, for the appropriate geometries and dose equivalent quantities (see the following section on the determination of spectrum-averaged conversion coefficients from conversion functions).

Sets of fluence to Effective Dose conversion coefficients over a range of neutron energies and for the standard ICRP/ICRU geometries specified irradiation geometry is defined to be a "conversion function". Specific values of the conversion function for neutrons of energy up to 180 MeV have been tabulated in ICRU Report 57<sup>(15)</sup>. These ICRP/ICRU recommendations are based on a literature-wide review and incorporate seven independent studies (see figure 5).

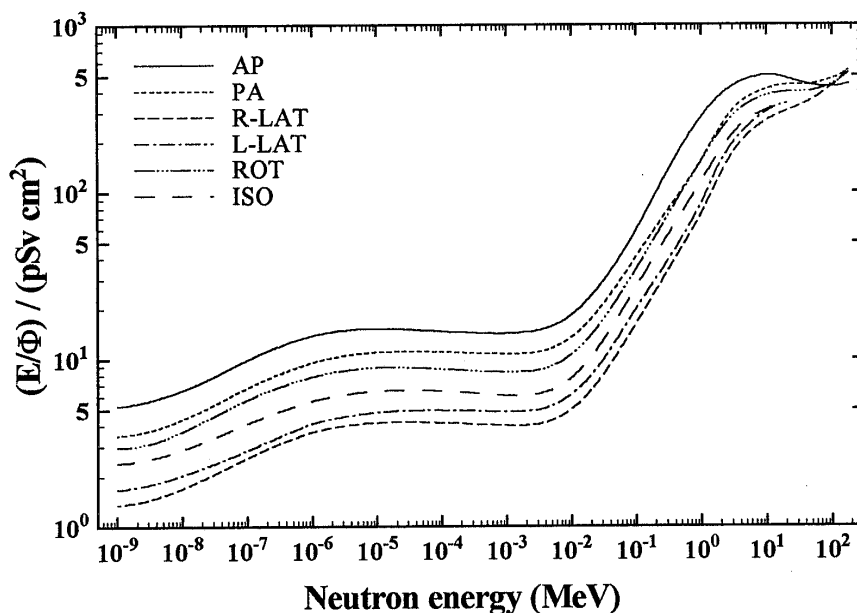

**Figure 5.**

**Values of Neutron Fluence to Effective Dose Conversion Coefficients recommended by the ICRP and ICRU. Curves are shown for the standard ICRP/ICRU irradiation geometries over the energy range from thermal to 200MeV<sup>(15,16)</sup>.**

Inspection of figure 5 reveals the important dependence of the value of the Effective Dose on irradiation geometry. In the eV and keV energy region the values for AP geometry are always at least twice as large as those for ISO geometry and can be as much as three times larger. Between about 1 MeV and 20 MeV this ratio declines from 2.4 to 1.4. Above 20 MeV the curves for all geometries converge to nearly equal values at 200 MeV. This convergence may be understood by noting that the ionization range of a 200 MeV proton is roughly equal to the thickness of the human trunk. Thus, as the incident neutron energy increases, secondary charged particles penetrate deeper into the trunk, tending to produce a uniform illumination, which is only weakly dependent on the direction of the incident neutrons. This interpretation is supported by calculations of conversion coefficients above 200 MeV (see below).

Ferrari *et al.*<sup>(35)</sup> and Yoshizawa *et al.*<sup>(31)</sup> have published other data, not available to the joint ICRP/ICRU Task Group that prepared ICRU Report 57. Ferrari *et al.* give data for PA, AP, LAT and ISO irradiation geometries. Their work is primarily devoted to the extension of conversion coefficients to high-energies (in the GeV region and above). Yoshizawa *et al.* give data only for AP and PA irradiation geometries.

For energies below 200 MeV the analytic conversion functions reported here were directly derived from the ICRP/ICRU coefficients. This was primarily done because the ICRP/ICRU coefficients are based on seven sets of calculations, but also because only limited data for ISO irradiation geometry are provided by Ferrari *et al.* in this energy region. In the discussion of the conversion coefficients, which follows, the Ferrari *et al.* data are shown on figures 6a-6d for information.

Above 200 MeV the coefficients reported here were primarily derived from the data of Ferrari *et al.* and Yoshizawa *et al.* (for detailed discussion see the section entitled Analytical Representations which follows).

#### **Analytical Representations of Conversion Functions.**

Analytical forms for conversion functions facilitate the solution in closed form of many integrals, which must be solved in radiation protection. Such closed form solutions are amenable to numerical manipulation (see Appendix).

Following the earlier examples of Thomas and Rindi<sup>(6)</sup> a convenient analytical representation of the conversion function,  $g(E)$ , shown in figures 5 and 6, may be derived by considering it to be composed of  $k$  energy regions in each of which  $g(E)$  may be expressed by the exponential form  $aE^m$ . Thus in the  $j$ th energy region, bounded by the energies  $E_j$  and  $E_{j+1}$ :

$$g_j(E) = a_j E^{m_j} \quad E_j < E \leq E_{j+1} \quad (4)$$

thus the complete function may be expressed by the sum of all such  $g_j$ s:

$$g(E) = \sum_{j=1}^{j=k} a_j E^{m_j} \quad (5)$$

Inspection of the conversion coefficients for ISO and ROT geometries shown figures 5 and 6 suggest that the energy range from  $2.5 \times 10^{-8}$  to  $6 \times 10^3$  MeV may be conveniently divided into five discrete energy regions. Values of the coefficients  $a_j$  and  $m_j$  were determined so as to replicate the primary data as closely as possible, while avoiding serious discontinuities at the boundaries. The values of the coefficients  $a_j$  and  $m_j$  and the region energy limits  $E_j$  and  $E_{j+1}$  are summarized in Table 1.

**Table 1**  
**Analytic Conversion Functions<sup>12</sup>**

Region	$E_j$ (MeV)	$E_{j+1}$ (MeV)	$a_j$	$m_j$
Region 1	$2.5 \times 10^{-8}$	$3.0 \times 10^{-6}$	29.0	0.121
Region 2	$3.0 \times 10^{-6}$	$1.0 \times 10^{-2}$	6.44	0
Region 3	$1.0 \times 10^{-2}$	$4.0 \times 10^0$	116	0.623
Region 4	$4.0 \times 10^0$	$2.0 \times 10^{+2}$	197.	0.187
Region 5	$2.0 \times 10^{+2}$	$1.0 \times 10^{+4}$	70.8	0.379

Region 1:  $2.5 \times 10^{-8}$  to  $3 \times 10^{-6}$  MeV. Figure 6a shows that the ICRU Report 57 ISO conversion coefficients over this energy range are well represented by:

$$g_1(E) = 29.0E^{0.121} \quad (6)$$

Equation (6) yields the values of the ICRP/ICRU coefficients with a standard deviation of  $\pm 3\%$  and an extreme deviation of 7%. Figure 6(a) compares the analytical representation, together with the ICRP/ICRU ISO data points. The ROT conversion coefficients are also shown for comparison and are seen to be consistently higher the ISO coefficients. Also shown is the ISO coefficient at thermal energy ( $2.5 \times 10^{-8}$  MeV) reported by Ferrari *et al.* which is 9% greater than the corresponding ICRU value.

Region 2:  $3 \times 10^{-6}$  to  $10^{-2}$  MeV. Figure 6b shows that the ICRU Report 57 ISO conversion coefficients over this energy range are well represented by the constant value  $6.44 \text{ pSv cm}^2$ .

$$g_2(E) = 6.44E^0 \quad (7)$$

Equation (7) yields the values of the ICRP/ICRU coefficients with a mean standard deviation of  $\pm 3\%$  over the greater part of the region but with decreasing accuracy at the highest energy, where the deviation is as much as 20%. Figure 6(b) compares the analytical representation with the ICRP/ICRU ISO and ROT data points. As before the ROT conversion coefficients are consistently higher the ISO coefficients. The Ferrari *et al.* ISO coefficients at  $10^{-4}$  and  $10^{-2}$  MeV are 14% and 94% greater than the corresponding ICRU values.

<sup>12</sup> The number of significant figures given is for the convenience of arithmetical manipulations only and does not indicate the accuracy with which these values are known.

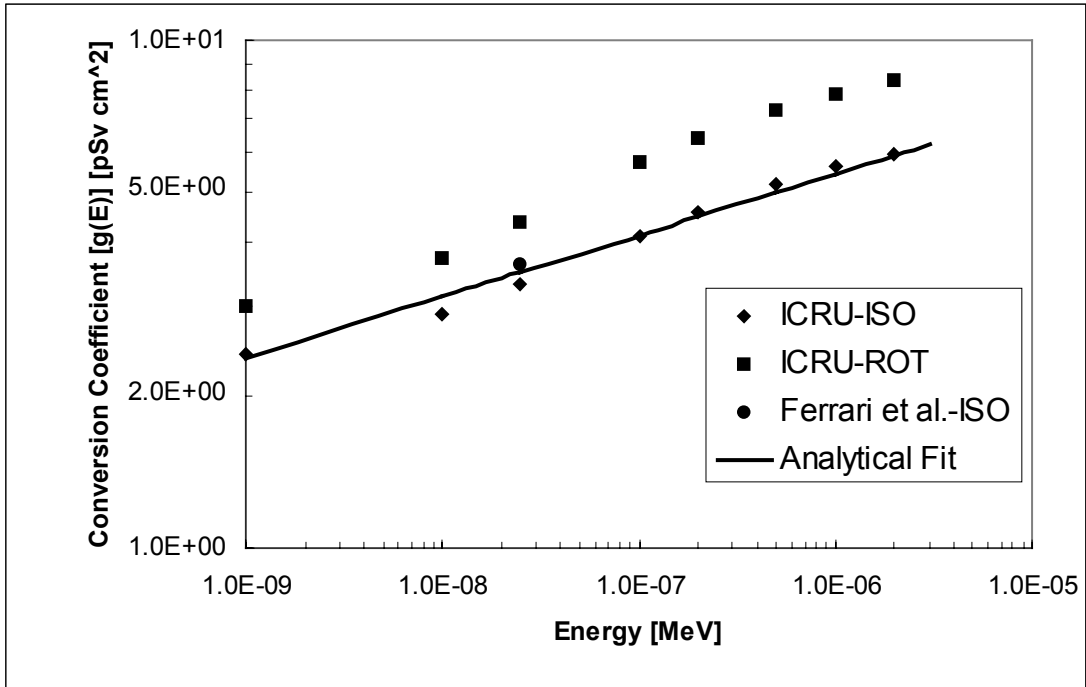

Figure 6a

Comparison of the analytical conversion function for the energy range  $2.5 \cdot 10^{-8}$  to  $3 \cdot 10^{-6}$  MeV with the ICRU-ISO, ICRU-ROT and the Ferrari *et al.*-ISO data point at  $2.5 \cdot 10^{-8}$  MeV.

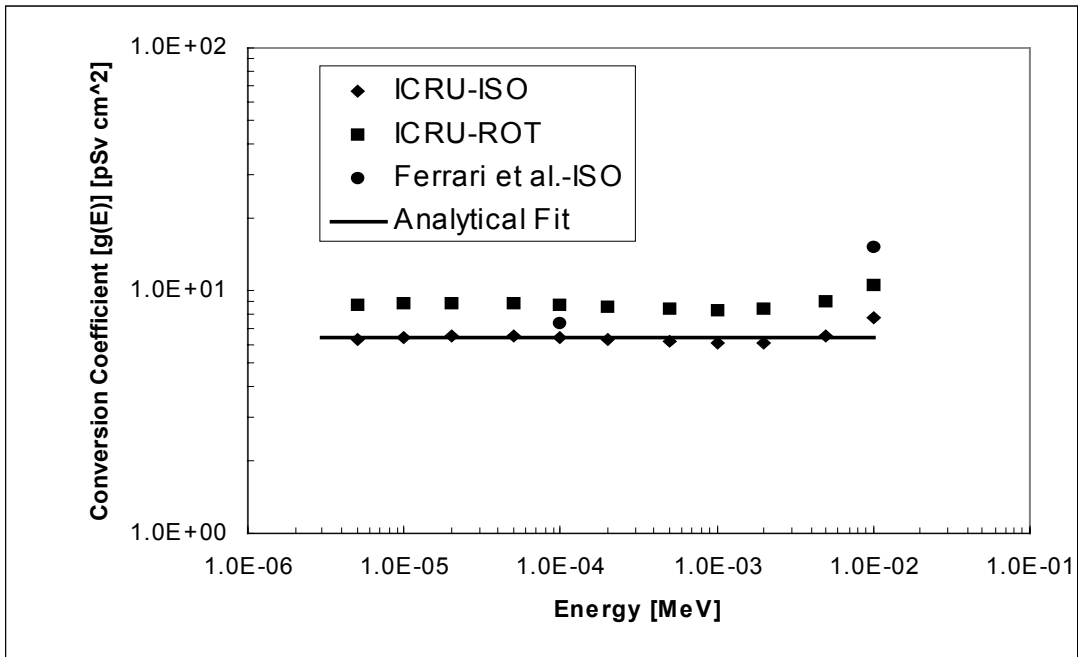

Figure 6b

Comparison of the analytical conversion function for the energy range  $3 \cdot 10^{-6}$  to  $10^{-2}$  MeV with the ICRU-ISO, ICRU-ROT and the Ferrari *et al.*-ISO data points.

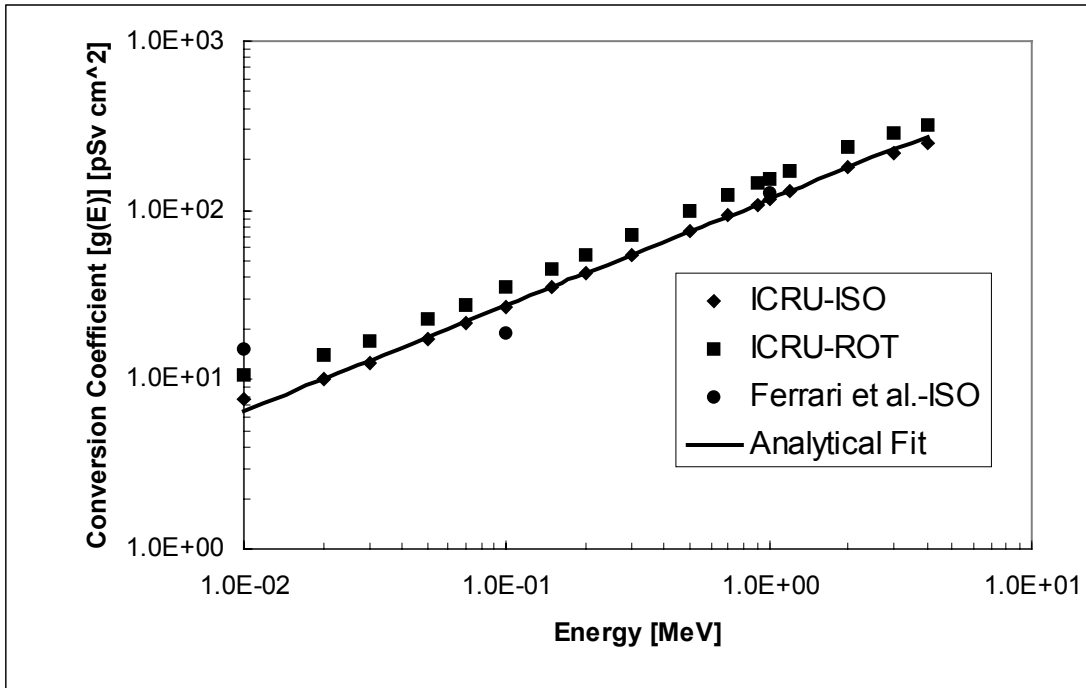

Figure 6c

Comparison of the analytical conversion function for the energy range  $10^{-2}$  to  $4 \cdot 10^0$  MeV with the ICRU-ISO, ICRU-ROT and the Ferrari *et al.*-ISO data points.

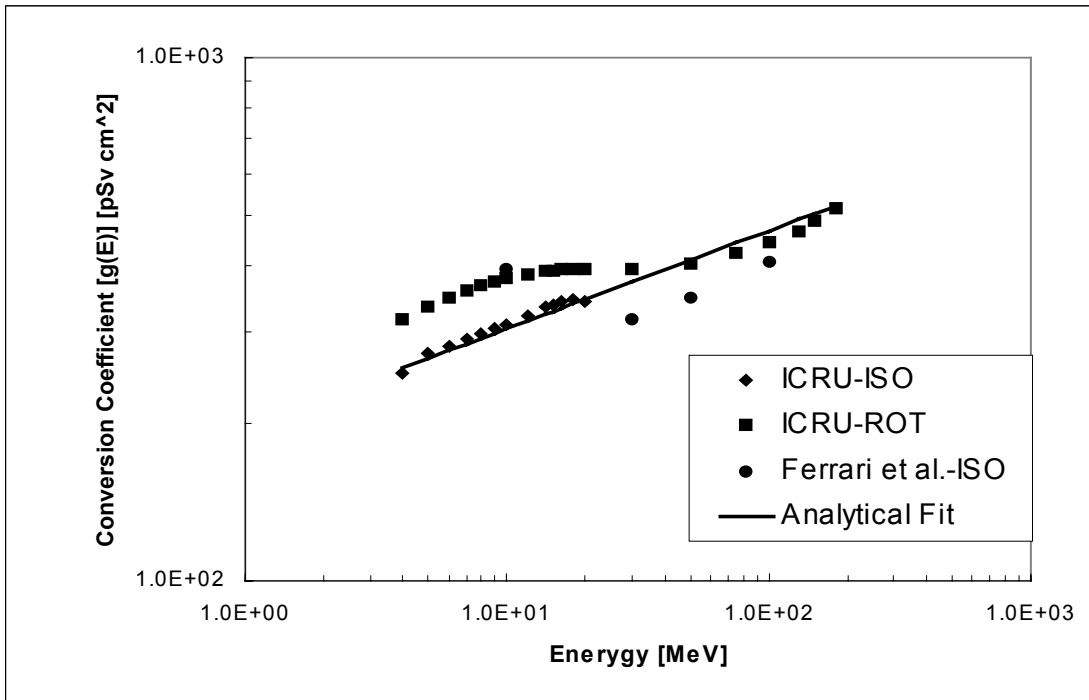

Figure 6d

Comparison of the analytical conversion function for the energy range 4-200 MeV with the ICRU-ISO, ICRU-ROT and the Ferrari *et al.*-ISO data points.

Region 3:  $10^{-2}$  to  $4 \cdot 10^0$  MeV: Figure 6c shows that the ICRU Report 57 ISO conversion coefficients over this energy range are well represented by the equation:

$$g_3(E) = 116E^{+0.623} \quad (8)$$

Equation (8) yields the values of the ICRP/ICRU coefficients with a mean standard deviation of better  $\pm 2\%$  over the greater part of the region except at the extremes of the energy range where the deviation is about 10%. Figure 6(c) compares the analytical representation with the ICRP/ICRU ISO and ROT data points. As before the ROT conversion coefficients are consistently higher the ISO coefficients. The deviations of the Ferrari *et al.* ISO coefficients from than the corresponding ICRU values at  $10^{-2}$ ,  $10^{-1}$  and  $10^0$  MeV are +94%, -33% and +8% respectively.

Region 4:  $4 \cdot 10^0$  to  $2 \cdot 10^{+2}$  MeV: ICRU Report 57 does not provide values for conversion coefficients in ISO geometry beyond an energy of 20 MeV but values of ROT coefficients are given up to 180 MeV. The section on conversion coefficients has previously described how, at energies above about 50 MeV, the coefficients for different irradiation geometries converge (see also figure 5). This confluence makes it possible to achieve a smooth transition between regions 3 and 4 with the exponential relationship:

$$g_4(E) = 197E^{+0.187} \quad (9)$$

Figure 6d compares the analytical representation with the ICRU-ISO (up to 20 MeV only), ICRU-ROT and Ferrari *et al.* data points at  $10^1$ ,  $2 \cdot 10^1$ ,  $5 \cdot 10^1$  and  $10^2$  MeV. As before the ROT conversion coefficients are consistently higher the ISO coefficients. The deviation of the Ferrari *et al.* coefficient from the corresponding ICRU-ISO coefficient at 10 MeV is +27% and the deviations at 20, 50 and MeV from the ICRU-ROT coefficients is about -15%

Region 5:  $2 \cdot 10^{+2}$  to  $10^4$  MeV: The derivation of a conversion function in this energy region depends on the basic data of Ferrari *et al.* and Yoshizawa *et al.* Of these two data sets only Ferrari *et al.* provide calculations in ISO geometry. Figure 6e summarizes the data of both sets of authors. Significant differences are evident. These differences between the data are much larger than either the statistical precision of the calculations or differences in method would predict<sup>13</sup>. The possibility of some systematic error needs to be examined but is beyond the scope of this paper. In the absence of a complete understanding of these variations between the data and of any clear and obvious pattern the data were pooled to give analytic form:

$$g_5(E) = 70.8E^{+0.379} \quad (10)$$

One would wish for more precise data but it is fortunate that the impact of any uncertainty in the conversion coefficients in this energy range is lessened by the relatively small contribution to the dose equivalent ( $\sim 20\%$ ). Thus, for example, a 10% error in the coefficients will be reflected as an uncertainty of 2%-3% in the computed dose equivalent.

---

<sup>13</sup> The statistical precision was about  $\pm 4\%$  or less in these calculations. Ferrari *et al.* state "----differences of 5% can be expected among the results of proven codes"<sup>(32)</sup> (see also Pelliccioni and Pillon<sup>(36)</sup>).

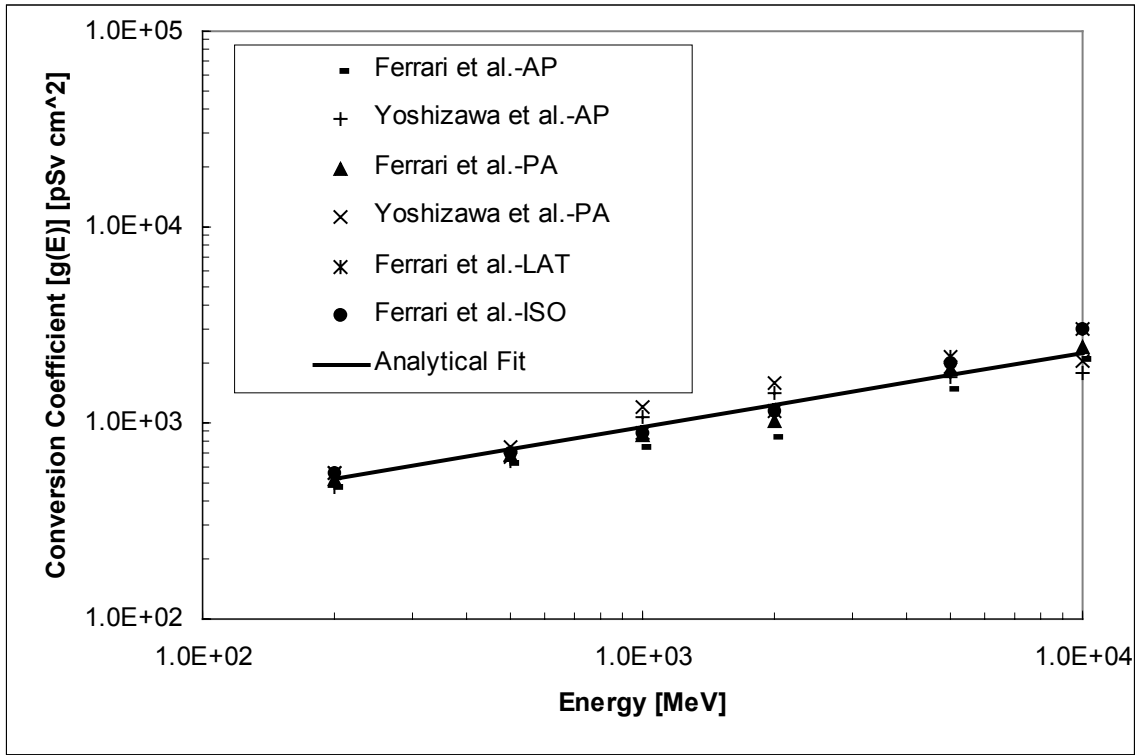

Figure 6e

Comparison of the analytical conversion function for the energy range  $2.10^2$  to  $10^4$  MeV with the data from which it is derived (Ferrari *et al.* and Yoshizawa *et al.*).

#### The Determination of Spectrum-averaged Conversion Coefficients from Conversion Functions

One of the principal purposes of this paper is provide a convenient set of analytical expressions that represent  $g(E)$  with accuracy sufficient for radiation protection purposes to calculate values of  $\langle g \rangle$  in "Bevatron-like" neutron spectra.

Values for  $\langle g \rangle$  may be determined in two ways, both of which require a set of conversion coefficients,  $g(E)$ , defined as the ratio of the dose equivalent to the fluence of neutrons at the specific energy  $E$ , for the appropriate geometries and dose equivalent quantities.

In the late fifties, when only limited conversion functions were available, values of  $\langle g \rangle$  were obtained by estimating a value of the effective energy of the spectrum,  $E_{\text{eff}}$  from:

$$\langle g \rangle = g(E_{\text{eff}}) \quad (11)$$

$E_{\text{eff}}$  is trivially defined by:

$$E_{\text{eff}} = g^{-1}\{g(E_{\text{eff}})\} \quad (12)$$

where  $g$  and  $g^{-1}$  are the respective conversion and inverse conversion functions.



To evade the circular logic of equation (12) the Berkeley Health Physics Group measured the average energy of the neutron spectrum and determined a value for  $\langle g \rangle$  by assuming the effective energy to be equal to the average energy<sup>(8)</sup>:

$$E_{eff} \approx \bar{E} = \frac{\int_{E_{min}}^{E_{max}} E \frac{d\phi}{dE} dE}{\int_{E_{min}}^{E_{max}} \frac{d\phi}{dE} dE} \quad (13)$$

This assumption, while not strictly valid is supported by experience that in accelerator neutron spectra in the energy range of consequence (0.1 MeV- 20 MeV) the increasing tendency of  $g(E)$  is roughly compensated by the declining tendency of  $(d\phi/dE)$  so that  $\bar{E}$  and  $E_{eff}$  have approximately the same value. The values of  $\langle g \rangle$  reported by the Berkeley Group have been shown to be appropriately conservative<sup>(2)</sup>.

More precisely  $\langle g \rangle$  is defined by:

$$\langle g_G \rangle = \frac{\int_{E_{min}}^{E_{max}} g_G(E) \left( \frac{d\phi}{dE} \right) dE}{\int_{E_{min}}^{E_{max}} \left( \frac{d\phi}{dE} \right) dE} \quad (14)$$

where the usual symbols apply:

- $E_{min}$  and  $E_{max}$  are the minimum and maximum energies of the spectrum
- $g(E)$  is the fluence to dose equivalent conversion coefficient function for monoenergetic neutrons
- $d\phi/dE$  is the neutron differential energy spectrum
- $G$  is the irradiation geometry (AP, PA, LAT, ROT, and ISO<sup>14</sup>)

### Summary and Conclusions

A set of functions for the conversion of neutron fluence measurements to Effective Dose,  $E$ , has been derived. The complete conversion function consists of a set of four functions in analytical form covering the neutron energy range from  $2.5 \cdot 10^{-8}$  to  $10^4$  MeV. The conversion function was derived for typical irradiation conditions experienced around high-energy proton accelerators such as the Bevatron. For neutron energies below 200 MeV the analytical functions were modeled after the ISO and ROT conversion coefficients in ICRU 57. For neutron energies above 200 MeV, the analytical function was derived from an analysis of recent published data. Sample calculations with the Hess Spectrum and the Shielded Bevatron Spectrum show agreement to better than  $\pm 5\%$  using either the analytical expressions or the tabulated conversion coefficients from which the analytical expressions are derived.

**Acknowledgments.** The wish to thank J. C. McDonald (Pacific Northwest National Laboratory) for helpful discussions, Alan Smith for providing the neutron spectra data, Henry Tran & Steven Wyrick for crucial assistance with the preparation of the figures and Ron Pauer for support on this project. This work was supported by the Director, Office of Science, Office of Basic Energy Sciences, of the U.S. Department of Energy, under Contract No. DE-AC03-76SF00098.

### References

1. Bernard, C. *Introduction à l'Étude de la Médecine Expérimentale* (1863).
2. Thomas R. H, Smith, A. R. and Zeman, G. H. *A Reappraisal of the Reported DoseEquivalents at the Boundary of the University of California Radiation Laboratory during the early Days of Bevatron Operation*. Ernest Orlando Lawrence Berkeley National Laboratory Internal Report LBNL-45224 (2000).
3. Moyer, B. J. *Survey Methods for Fast- and High-Energy Neutrons*, *Nucleonics* **10(5)**, 14–19, (1952).

<sup>14</sup> For definitions of the irradiation geometries designated by AP, PA, LAT, ROT & see either ICRP Publication 74 or ICRU Report 57.

4. Moyer, B. J. *Neutron Physics of Concern to the Biologist*. Radiation Research. **1**, 10–22, (1954).
5. Patterson, H. W., and Thomas, R. H. *Accelerator Health Physics*. New York: Academic Press (1973).
6. Thomas, R. H. *The Radiation Field Observed around High-Energy Nuclear Accelerators*. In Proceedings of the XI International Congress on Radiology, Rome, September 1965. (Amsterdam: Excerpta Medica Foundation) pp. 1849–1856 (1967). See also Rindi, A. *An Analytical Expression for the Flux to Absorbed Dose Conversion Factor*. Health Physics **33**, 264 (1977).
7. Gilbert, W. S., et al. 1966 *CERN-LRL-RHEL Shielding Experiment at the CERN Proton Synchrotron*. Lawrence Radiation Laboratory, University of California, Report UCRL-17941 (1968).
8. Patterson, H. W. *The Effect of Shielding on Radiation Produced by the 730 MeV Synchrocyclotron and the 6.3 GeV Proton Synchrotron at the Lawrence Radiation Laboratory*. In. Premier Colloque International sur la Protection auprès des Grands Accélérateurs. Eds. Bonet-Maury, P., Duhamel, M. and Perrin, M. F. Paris: Presses Universitaires de France, pp. 95–99 (1962).
9. Hess, W. N., Patterson, H. W., Wallace, R. W., and Chupp, E. L. *Cosmic Ray Produced Neutron Spectrum*. Phys. Rev. **116**(2) 445–457 (1959).
10. Patterson, H. W., Hess, W. N., Moyer, B. J. and Wallace, R. W. *The Flux and Spectrum of Cosmic Ray Produced Neutrons as a Function of Altitude*. Health Physics **2**, 69 (1959).
- 11: International Atomic Energy Agency *Radiological Safety Aspects of the Operation of Proton Accelerators*. Technical Report No. 283. Vienna: International Atomic Energy Agency (1988). 12. National Council on Radiation Protection and Measurements. *Protection Against Neutron Radiation up to 30 MeV*, NBS Handbook 72 . National Bureau of Standards, U.S. Dept. of Commerce, Washington D. C. (1957).
13. International Commission on Radiological Protection. *Report of Committee IV on Protection Against Electromagnetic Radiation above 3 MeV and Electrons, Neutrons and Protons*, ICRP Publication 4, (Oxford: Pergamon Press) (1964).
14. Patterson H. W. and Thomas, R. H. (Eds.). *A History of Accelerator Radiation Protection*. Ashford, Kent: Nuclear Technology Publishing (1994).
15. International Commission on Radiation Units and Measurements. *Conversion Coefficients for use in Radiological Protection against External Radiation*. ICRU Report 57. Bethesda, Maryland; ICRU (1998).
16. International Commission on Radiological Protection. *Conversion Coefficients for Use in Radiological Protection against External Radiation*, Publication 74. Annals of the ICRP, **26** (3/4). Oxford: Pergamon Press (1997).
17. International Commission on Radiation Units and Measurements. *Conceptual Basis for the Determination of Dose Equivalent* , Report 25. Bethesda, Maryland: ICRU (1976).
18. International Commission on Radiological Protection. *Recommendations of the International Commission on Radiological Protection*, Publication 26. Annals of the ICRP, **1**(3). Oxford: Pergamon Press. (1977, reprinted with revisions, 1981).
19. International Commission on Radiological Protection. *Statement and Recommendations of the International Commission on Radiological Protection from Its 1980 Stockholm Meeting*, Publication 30, Part 2. Annals of the ICRP, **4**(3/4). Oxford: Pergamon Press (1980).
20. International Commission on Radiological Protection. *Recommendations of the International Commission on Radiological Protection*, Publication 60, Annals of the ICRP **21**(1–3). (Oxford: Pergamon Press) (1991).
21. International Commission on Radiological Protection. *Data for Protection Against Ionizing Radiation from External Sources*, ICRP Publication 21, Oxford: Pergamon Press (1973).
22. Nuclear Regulatory Commission, *Part 20-Standards for Protection Against Radiation*, In Title 10 of Code of Federal Regulations, U.S. Government Printing Office, Washington, D.C. (1996).
23. U.S. Department of Energy, *Part 835-Occupational Radiation Protection*, In: Title 10 of Code of Federal Regulations, U.S. Government Printing Office, Washington, D.C. (1993).

24. International Commission on Radiological Protection. *Data for Protection Against Ionizing Radiation from External Sources*, ICRP Publication 51, Annals of the ICRP, **17(2/3)**, Oxford; Pergamon Press, (1987).
25. International Commission on Radiological Protection. *Statement from the Paris Meeting of the International Commission on Radiological Protection*. Annals of the ICRP, **15(2/3)**, Oxford: Pergamon Press (1985).
26. McDonald, J. C., Schwartz, R. B., and Thomas, R. H. *Neutron Dose Equivalent Conversion Coefficients Have Changed in the Last Forty Years—Haven't They?* Radiation Protection Dosimetry **78(2)**, 147–149. (1998).
27. International Commission on Radiation Units and Measurements. *Conceptual Basis for the Determination of Dose Equivalent*. Report 25. ICRU: Bethesda, Maryland. (1976).
28. International Commission on Radiation Units and Measurements. *Determination of Dose Equivalents resulting from External Radiation Sources*, Report 39. ICRU: Bethesda, Maryland (1985).
29. International Commission on Radiation Units and Measurements. *Determination of Dose Equivalents resulting from External Radiation Sources-Parts*, Report 43. ICRU: Bethesda, Maryland. (1988).
30. International Commission on Radiation Units and Measurements. *The Quality Factor in Radiation Protection*, Report 40. ICRU: Bethesda, Maryland (1986).
31. Yoshizawa, N., Sato, O., Takagi, S., Furihata, S, Iwai, S., Takashi, U., Tanaka, S. and Sakamoto, Y. *External Radiation Conversion Coefficients using Radiation Weighting Factors and Quality factors for Neutrons and Protons from 20 MeV to 10 GeV*. Journal of Nuclear Science and Technology **35(12)**, 928-942 (1998).
32. American National Standards Institute / Health Physics Society. *American National Standard for Dosimetry – Personnel Dosimetry Performance – Criteria for Testing*, ANSI/HPS N13.11-1993: McClean, VA (1993).
33. International Commission on Radiological Protection. *General Principles of Monitoring for Radiation Protection of Workers*. ICRP Report 35. Annals of the ICRP, **9(4)**, Oxford: Pergamon Press (1982).
34. National Council on Radiation Protection and Measurements. *Instrumentation and Monitoring Methods for Radiation Protection*. **NCRP Report 57 : Bethesda, MD (1978)**
35. Ferrari, A., Pelliccioni, M., and Pillon, M. *Fluence to Effective Dose Conversion Coefficients for Neutrons up to 10 TeV*. Radiation Protection Dosimetry **71(3)**, 165-173 (1997).
36. Pelliccioni, M., and Pillon, M. *Comparison between Anthropomorphic Mathematical phantoms using MCNP and FLUKA Codes*. Radiation Protection Dosimetry **67**, 253-256 (1996).

## Appendix

### Analytical Approximations for the Conversion Functions and Energy Spectra

If we assume that over an energy region  $E_j$  to  $E_{j+1}$  the fluence to dose equivalent conversion function may be expressed in the form:

$$g_j(E) = a_j E^{m_j} \quad E_j < E \leq E_{j+1} \quad (A1)$$

and that, similarly, over the same energy region the neutron differential energy spectrum may be expressed in the form:

$$\left( \frac{d\phi}{dE} \right)_j = b_j E^{n_j} \quad E_j < E \leq E_{j+1} \quad (A2)$$

Then dose equivalent, total fluence spectrum averaged equivalent conversion coefficient may be determined in closed form suitable for calculation by a desktop computer.

For example, the dose equivalent,  $H_j$ , is then given by:

$$H_j = \frac{a_j b_j}{m_j + n_j + 1} \left[ E^{m+n+1} \right]_{E_j}^{E_{j+1}} \text{ when } m_j + n_j + 1 \neq 0 \quad (\text{A3a})$$

$$H_j = a_j b_j \ln \left( \frac{E_{j+1}}{E_j} \right) \text{ when } m_j + n_j + 1 = 0 \quad (\text{A3b})$$

and the total dose equivalent over the entire spectrum is then:

$$H = \sum_{j=1}^{j=k} H_j \quad (\text{A4})$$

The total fluence may be similarly calculate , and hence the value of the spectrum averaged conversion coefficient with the use of equation (14) of the main text.