

Available online at [www.sciencedirect.com](http://www.sciencedirect.com)

ScienceDirect

[www.elsevier.com/locate/jes](http://www.elsevier.com/locate/jes)**JES**  
JOURNAL OF  
ENVIRONMENTAL  
SCIENCES  
[www.jesc.ac.cn](http://www.jesc.ac.cn)

# Particulate matter emissions and gaseous air toxic pollutants from commercial meat cooking operations

Nicholas Gysel, William A. Welch, Chia-Li Chen, Poornima Dixit,  
David R. Cocker III, Georgios Karavalakis\*

Department of Chemical and Environmental Engineering, University of California, Riverside, CA 92521, USA  
Center for Environmental Research and Technology, University of California, Riverside, CA 92507, USA

## ARTICLE INFO

### Article history:

Received 22 November 2016

Revised 15 March 2017

Accepted 16 March 2017

Available online xxx

### Keywords:

Charbroiled meat cooking

Particulate emissions

Particle number

Carbonyl compounds

VOCs

## ABSTRACT

This study assessed the effectiveness of three novel control technologies for particulate matter (PM) and volatile organic compound (VOC) removal from commercial meat cooking operations. All experiments were conducted using standardized procedures at University of California, Riverside's commercial test cooking facility. PM mass emissions collected using South Coast Air Quality Management District (SCAQMD) Method 5.1, as well as a dilution tunnel-based PM method showed statistically significant reductions for each control technology when compared to baseline testing (*i.e.*, without a catalyst). Overall, particle number emissions decreased with the use of control technologies, with the exception of control technology 2 (CT2), which is a grease removal technology based on boundary layer momentum transfer (BLMT) theory. Particle size distributions were unimodal with CT2 resulting in higher particle number populations at lower particle diameters. Organic carbon was the dominant PM component (>99%) for all experiments. Formaldehyde and acetaldehyde were the most abundant carbonyl compounds and showed reductions with the application of the control technologies. Some reductions in mono-aromatic VOCs were also observed with CT2 and the electrostatic precipitator (ESP) CT3 compared to the baseline testing.

© 2017 The Research Center for Eco-Environmental Sciences, Chinese Academy of Sciences.

Published by Elsevier B.V.

## Introduction

Commercial cooking has been shown to be an important contributor to ambient particle emissions (with particulate matter less than 2.5  $\mu\text{m}$  in size,  $\text{PM}_{2.5}$ ) in urban environments and megacities (Allan et al., 2010; Schauer et al., 1999, 2002; Sun et al., 2011; Zhao et al., 2015). Emission inventory data showed that  $\text{PM}_{2.5}$  emissions from restaurant operations in the Los Angeles Basin contributed approximately 9.15 tons per annual average day for 2014, with an estimate to exceed 10 tons per annual average day for 2023 (AQMP, 2012). In the greater Los Angeles Basin, restaurant operations including

charbroilers (chain-driven and under-fired) are responsible for about 84% of the  $\text{PM}_{2.5}$  emissions from this source category (AQMP, 2012). With an environmental problem of this magnitude, the South Coast Air Quality Management District (SCAQMD) was forced to implement rules as part of the Air Quality Management Plan for reducing 7 tons per day of  $\text{PM}_{10}$  from charbroilers. At present time, SCAQMD evaluates rule development efforts for restaurants including under-fired charbroilers to install control devices with at least 85% reduction in  $\text{PM}_{2.5}$  emissions.

Recently, there is an intense research activity within the scientific community for the understanding of cooking organic

\* Corresponding author. E-mail: [gkaraval@cert.ucr.edu](mailto:gkaraval@cert.ucr.edu) (Georgios Karavalakis).

aerosol contribution to total organic aerosol in urban settings due to the importance of airborne particulate emissions and negative effects on human health (Mohr et al., 2012; Li et al., 2014; Robinson et al., 2006; Schauer et al., 1999). Numerous studies have found associations between particulate air pollution with asthma exacerbations, increased respiratory symptoms, decreased lung function, increased medication use, and increased hospital admissions (BeruBe et al., 2007; Kreyling et al., 2006; Utell and Frampton, 2000). Epidemiological studies have shown that exposure to particulate air pollution is associated with increased cardiovascular and respiratory morbidity and mortality (Pope, 2000; Sioutas et al., 2005). Oberdorster et al. (2005) have shown that ultrafine particles are more biologically active than larger particles due to their greater surface area per mass. It was also found that the small size facilitates uptake into cells and transcytosis across epithelial cells into the blood circulation to reach potentially sensitive areas, as well as penetrating the skin distribute via uptake into lymphatic channels.

Commercial cooking can generate particulate emissions, volatile organic compounds (VOCs), heterocyclic aromatic amines, and polycyclic aromatic hydrocarbons with the quantities of these pollutants strongly dependent on cooking procedures, such as cooking temperature, ingredients, duration, and other factors (Lewtas, 2007; McDonald et al., 2003; Nolte et al., 1999; Saito et al., 2014). Many studies have evaluated the effects of different cooking styles on PM and VOC emissions (Abdullahi et al., 2013; Cheng et al., 2016; He et al., 2004). Western cooking operations involve the consumption of beef and chicken, whereas Chinese cooking mainly involves frying with pork, poultry, beef, seafood, and vegetables. Zhao et al. (2007) showed a dominant presence of  $\beta$ -sitosterol and levoglucosan in  $PM_{2.5}$  confirming that vegetable oils are consumed during Chinese cooking operations. Huang et al. (2011) reported a significant production of formaldehyde, acetaldehyde, and benzene during residential cooking activities in Hong Kong. Mugica et al. (2001) reported the non-methane organic compounds, including some monoaromatic hydrocarbons, of cooking emissions from tortillerias, restaurants, rotisseries, and fried food places in Mexico. They found that food cooking can be an important source of these species. Schauer et al. (1999) showed that formaldehyde and acetaldehyde were the predominant aldehydes from commercial charbroiling meat cooking operations. Buonanno et al. (2009) conducted a study to characterize particle emissions during grilling and frying and they found higher emission factors at higher food temperatures, as well as higher particle emissions as a function of the oil used. Rogge et al. (1991) reported increasing organic acids and higher PM emissions for meats with higher fat contents. McDonald et al. (2003) compared cooking methods and identified under-fired charbroiling meat cooking emitted the highest amount of  $PM_{2.5}$  per pound of meat cooked. They also found that charbroiling emissions were almost exclusively composed of organic carbon (OC) in nature with almost no elements or inorganic ions. Hildemann et al. (1991) estimated that approximately 21% of all organic  $PM_{2.5}$  in Los Angeles was from meat cooking, while Schauer et al. (2002) estimated that 23% of the  $PM_{2.5}$  organic carbon mass emitted in Los Angeles was contributed from meat cooking activities.

Although previous studies have provided substantial data about indoor and outdoor cooking emissions, there is very limited data on the effects of aftertreatment control technologies on emissions from commercial cooking operations. In California, and most of the United States, smaller restaurant chains operating with under-fired charbroilers are not required to control their PM emissions, which are an environmental burden and also complicates the human risk assessment on cooking emissions. Thus, it is necessary to study emissions from under-fired charbroiled meat cooking operations with and without aftertreatment control technologies. This work examines the physical and chemical characteristics of  $PM_{2.5}$ , particle number emissions and gaseous toxic pollutants from meat cooking processes.

## 1. Materials and methods

### 1.1. Test facility and protocol

The meat cooking experiments were conducted at the University of California Riverside, Center for Environmental Research and Technology (CE-CERT) commercial cooking facility. The facility was equipped with a Nieco Model 9025 conveyerized charbroiler fired with natural gas. Total emissions were captured by a 48-inch by 48-inch Captive-Aire stainless steel hood and ducted to the second level of the facility with an upblast blower. The blower had a variable speed drive and controller, which was used to adjust the velocity and flow rates through the stack to meet the Uniform Mechanical Code (UMC) and National Fire Protection Association (NFPA).

Prior to testing, the hamburger patties were prepared by loading them onto sheet pans lined with freezer paper. The 1/3-pound meat patties used in this study were finished grind, pure beef hamburger, 21% fat by weight, 58%–62% moisture, 3/8-inch-thick, and 5 in. in diameter. The fat and moisture content of the patties were verified in accordance with recognized laboratory procedures (Association of Official Analytical Chemists, AOAC, Official Actions 960.39 and 950.46, respectively). Patties were cooked to an average internal temperature of  $175 \pm 5$  °F, to confirm a medium-well condition. Internal meat temperature was determined with a stack of hamburger patties placed in a temperature measurement system.

Cooking cycles were developed in conjunction with the California and National cooking restaurant associations and private entities to best mimic commercial cooking processes and were six minutes in duration.

### 1.2. Sampling and analysis

A sampling system (Fig. 1) was devised to simultaneously collect multiple filter and gas samples. A sample was isokinetically withdrawn from the stack at a fixed flow rate and diluted with VOC and particle-free air using a partial flow venturi dilution system. The dilution system included quartz filters (Q1–Q3), Teflon filters (T1–T4), equipped with orifices to control flow rate through the filters and differential pressure (P1–P7) to measure filter loading. The total PM mass was determined by gravimetric analysis of 47 mm (Teflo®, Pall Gelman, USA) filters. The filters were conditioned and

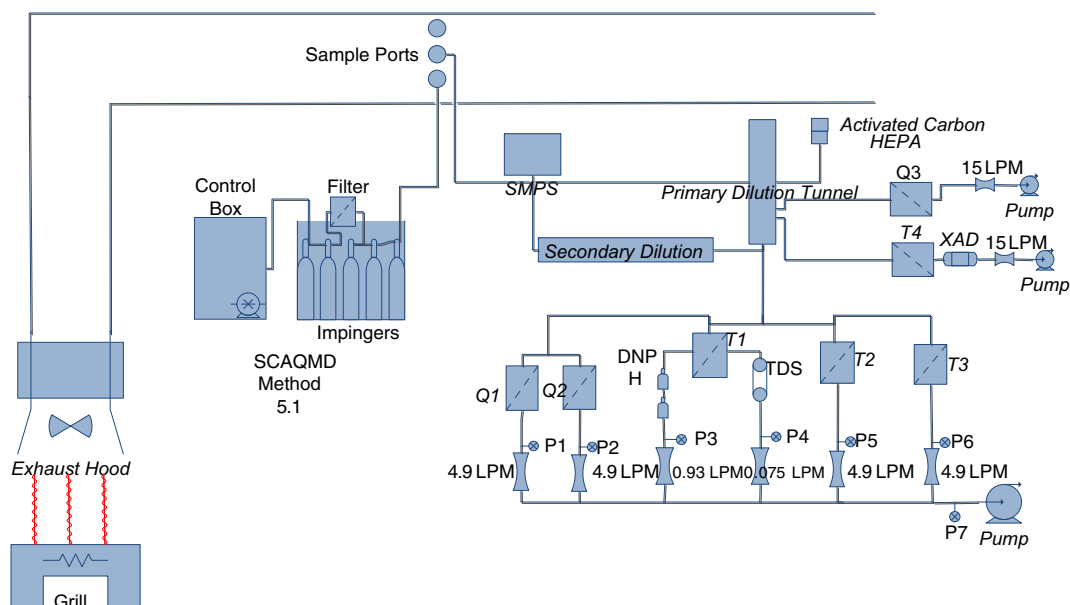

**Fig. 1 – Schematic of sampling system for measurement of particle phase and gas phase compounds. SMPS: Scanning Mobility Particle Spectrometer; DNP H: Dinitrophenylhydrazine; XAD: Polyaromatic absorbent resin; LPM: liters per minute; TDS: thermal desorption tubes; Q1: quartz filter #1; Q2: quartz filter #2; Q3: quartz filter #3; T1: teflon filter #1; T2: teflon filter #2; T3: teflon filter #3; T4: teflon filter #4; P1: pressure 1; P2: pressure 2; P3: pressure 3; P4: pressure 4; P5: pressure 5; P6: pressure 6; P7: pressure 7; HEPA: high-efficiency particulate arrestance.**

weighed with a Mettler Toledo UMX2 microbalance according to the Code of Federal Regulations. Elemental and organic carbon (EC/OC) fractions were collected on 2500 QAT-UP Tissuquartz (2500 QAT-UP Tissuquartz, Pall Gelman, USA) filters. Quartz fiber filters were pre-cleaned to remove carbonaceous contaminants by firing at 600°C for 5 hr. A thermal/optical carbon aerosol analyzer (Sunset Laboratory, USA) operating using the NIOSH (National Institute of Occupational Safety and Health) Method 5040 was used to analyze the organic carbon (OC) and elemental carbon (EC) fractions. In addition, South Coast Air Quality Management District (SCAQMD) Method 5.1 was used for PM mass sampling as this is the known protocol method for stationary source PM emissions (SCAQMD, 1989). Real-time particle number emissions were monitored by a 3776 (TSI, USA) ultrafine condensation particle counter (CPC) with a 2.5 nm cut-point. Particle size distributions were collected using a TSI scanning mobility particle spectrometer (SMPS) (TSI 3081 long column, TSI 3772 CPC, 7–200 nm) and a custom built SMPS (TSI 3081 long column, TSI 3776 CPC, 27–696 nm).

Samples for carbonyl analysis were collected through a heated line onto 2,4-dinitrophenylhydrazine (DNPH) coated silica cartridges (Waters Corp., USA). Sampled cartridges were extracted using 5 mL of acetonitrile and injected into a high performance liquid chromatograph (Agilent 1200 series, Agilent, USA) equipped with a variable wavelength detector. The column used was a 5  $\mu\text{m}$  Deltabond AK resolution (200 cm  $\times$  4.6 mm inner diameter) with upstream guard column. The high performance liquid chromatography (HPLC) sample injection and operating conditions were set up according to the specifications of the SEA (Society of Automotive Engineers) 930142HP protocol. Samples for 1,3-butadiene, benzene, toluene, ethylbenzene, and xylenes were collected using Carbotrap

adsorption tubes consisting of multi-beds, including a molecular sieve, activated charcoal, and carbotrap resin. A gas chromatograph (GC) with a Flame Ionization Detector (FID) maintained at 300°C was used to measure volatile organic compounds (6890, Agilent, USA). A Gerstel thermal desorption tube (TDS) thermal adsorption unit was used for sample injection. This unit ramps the temperature from 30 to 380°C at a rate of 6°C per minute to desorb the sample from the tubes. A 60 m  $\times$  0.32 mm HP-1 column was used. For these analyses, the GC column and operating conditions were set up according to the specifications of SAE 930142HP Method-2 for C<sub>4</sub>–C<sub>12</sub> hydrocarbons. Ion chromatography (IC) was performed on a Dionex ICS-3000 (ICS-3000, Dionex, USA) instrument equipped with an autosampler. Soluble ions (NH<sub>4</sub><sup>+</sup>, NO<sub>3</sub><sup>-</sup>, SO<sub>4</sub><sup>2-</sup>, Cl<sup>-</sup>) were extracted from filter substrates by immersion in 10.0 mL of deionized water. Extraction was conducted for 60 min with sonication. For Teflo® filters, 0.5 mL of 95% ethanol was first placed on the filter surface as a wetting agent.

### 1.3. Description of the aftertreatment control technologies

The first control device (hereinafter denoted as control technology 1 (CT1)) was an in-hood dual stage filtration system with a primary steel cartridge filter followed by a fabric filter. CT1 was located directly above the grill surface near the grease baffles. The primary stage of filtration was manufactured from stainless steel and can be readily washed with water or common dish wash detergents. The secondary fabric filter was biodegradable and can be disposed with other restaurant waste.

The second control device (hereinafter denoted as control technology 2 (CT2)) was an aerosol grease removal prototype based on a patented technology for particle (solid or liquid)

separation from an incoming flow stream via boundary layer momentum transfer (BLMT) theory. The baseline unit was equipped with enhanced evaporative cooling and electrostatic ionization to condition the effluent prior to entry into the device. As the device was designed for a flow rate of 550 cubic feet per minute (CFM), a duct was installed in the cooking ventilation system to extract a side stream for testing.

The third technology (hereinafter denoted as CT3) was an electrostatic precipitator (ESP). ESPs are proven technologies used to clean the effluents by using high voltage to ionize air molecules and having followed by both negative and positive charged collector plates to remove charged particles from the air. Subsequently, VOCs are removed by adsorption into an activated carbon bed. The activated charcoal bed is comprised of eight 24 in. × 24 in. × 2 in. panels configured in a 'V' bank to allow for a dwell time > 0.10 sec ensuring efficient VOC removal.

## 2. Results and discussion

Triplicate samples were taken for each control technology and the baseline testing. Statistical significance between baseline and the control technology experiments was determined by a two-tailed, paired, equal variance t-test where  $p \leq 0.05$ . Emission factors of all measured pollutants in this study are presented in mass of emitted pollutant per kilograms of meat cooked.

### 2.1. PM mass and EC/OC emissions

PM mass emissions as a function of dilution method (gravimetric PM) and protocol method are shown in Fig. 2. The dilution method draws the sample from the stack at a fixed flowrate and mixes the sample stream with particle free and scrubbed dilution air, which effectively cools the PM sample to <52°C, as specified in the ISO-8178 sampling protocol. Method 5.1 isokineticly withdraws the PM sample from the source through the stack and condenses the PM in impingers containing deionized water and on a backup filter. The impingers are contained in an ice bath to maintain the sample gas temperature

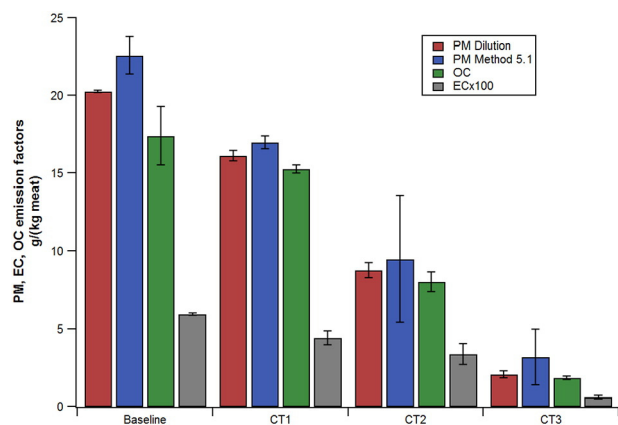

Fig. 2 – Elemental and organic carbon (EC/OC) fractions and particulate matter (PM) emission factors. CT1, CT2, and CT3 are described in Section 1.3. CT: control technology.

at 15°C or less. The lower temperature of the Method 5.1 sample stream leads to greater semi-volatile condensation compared to the dilution method. Specifically, a higher quench rate with Method 5.1 compared to the dilution method may account for increased condensable PM and therefore higher total PM mass.)

Overall, all control technologies reduced PM mass emissions compared to the baseline testing (See Fig. 3. CT3 showed the largest reductions in PM mass emissions for Method 5.1 and the dilution method at 86% and 90%, followed by 58% and 57% for CT2, and 25% and 21% for CT1, respectively. CT1 resulted in the lowest removal efficiency of PM<sub>2.5</sub> as this technology was more effective in removing the solid particles, but not the gaseous oil and mist vapors, which were abundant in the sample effluent. This may be attributed to the gases not condensing before the filter, but rather after the filter as CT1 was installed directly above the grease baffles and very close to the source of emissions. CT2 also proved to be effective in removing PM<sub>2.5</sub> emissions, primarily due to the condensation of the hot grease vapor onto small particles, which then grew to larger sizes and subsequently removed by inertial separation. CT3 showed the highest removal efficiency of PM<sub>2.5</sub> emissions due to this technology ability to effectively remove the smaller particles. CT3 incorporated negatively charged plates, which gave the oily particles a negative charge. The particles were then routed past positively charged collector plates, which attracted the negatively-charged oily particles. Similar PM<sub>2.5</sub> removal efficiencies have been reported by other studies utilizing electrostatic precipitators during meat cooking processes (Lee et al., 2011). Theoretically, the removal efficiency of an electrostatic precipitator unit can be >99% for PM<sub>2.5</sub> emissions. The lower observed removal efficiency of 86% with the ESP used in this study may be attributed to the abundance of organic vapors accumulated throughout the ESP. Oil mist and vapors that adhere to the walls of the precipitators may reduce the electrical resistivity of the particles resulting in an insufficient electrical charge to adhere the particles to the collector plates and therefore cause a lower removal efficiency.

The composition of PM mass was predominantly comprised of carbonaceous particles, particularly organic carbon, with little elemental carbon present in the samples, as shown

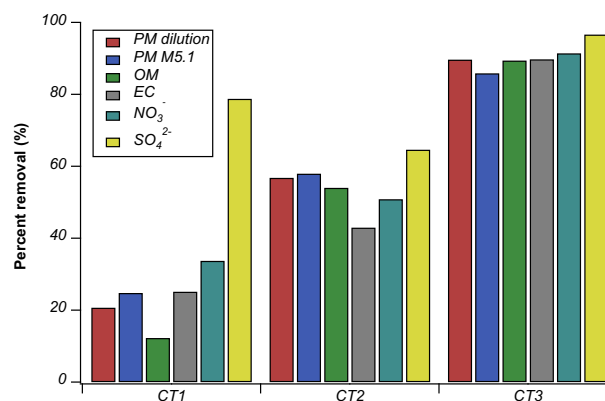

Fig. 3 – Percent removal (%) for PM mass emissions and ionic species for each control technology. OM: organic matter; M5.1: Method 5.1. PM: particulate matter.

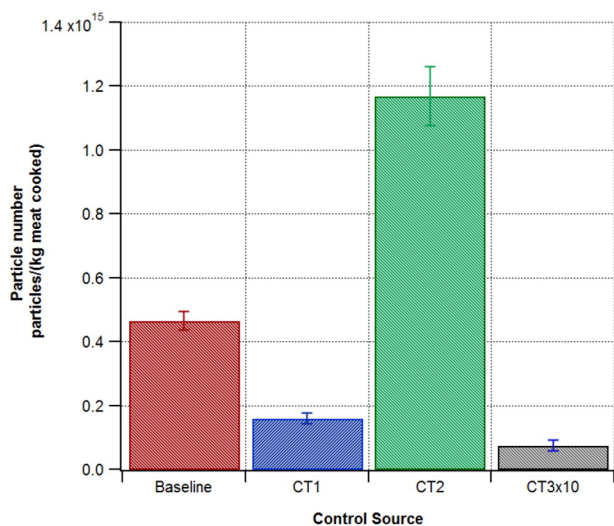

Fig. 4 – Total particle number emission factors.

in Fig. 2. Our results are in line with previous studies showing that PM emissions from cooking operations were primarily organic in nature (Li et al., 2015; Rogge et al., 1991; Watson and Chow, 2001). Rogge et al. (1991) showed the predominance of organic compounds in charbroiled meat cooking, which are released through oxidation, decarboxylation, rearrangement, and cyclization reactions from the meat components. McDonald et al. (2003) reported that OC comprised approximately 96% of total carbon for under-fired charbroiling, similar to the findings of this study. See and Balasubramanian (2008) also reported that the majority of PM emissions from different cooking processes were composed of OC. The high OC content was as expected due to the nature of the cooking process, which emits very little soot or EC. The organic mass was determined by multiplying the OC by 1.2 (Shah et al., 2004) to account for

the bound oxygen and hydrogen to the carbon. Organic matter (OM) was greater than  $PM_{2.5}$  measured gravimetrically due to sorption filter artifacts.

## 2.2. Particle number emissions and particle size distributions

Particle number emissions for the baseline testing and the control technologies are shown in Fig. 4. The results for particle number emissions did not necessarily corroborate the gravimetric PM mass. Particle number emissions showed the greatest reduction of 98% for CT3 compared to the baseline testing, followed by a 66% reduction for CT1. An increase in particle number emissions of 152% for CT2 compared to the baseline testing was observed, however. This increase in particle number emissions could be attributed to residual particle formation from the nebulizing unit used for evaporative cooling and secondary particle bursts.

The average particle size distributions for the baseline testing and the aftertreatment technologies are illustrated in Fig. 5. Error bars represent the standard deviation of the scans during each test. All distributions were unimodal in nature with accumulation mode peaks ranging from 118 nm to 150 nm in diameter. Hildemann et al. (1991) measured size distributions with a long residence time sampler from meat charbroiling and found peak mass concentrations at approximately 200 nm, slightly higher than those found in this study. The peak mode diameters for baseline, CT1, and CT3 were at 150 nm compared to CT2 at 118 nm in diameter. Both CT1 and CT3 resulted in significantly lower concentrations of accumulation mode particles compared to the baseline testing. CT2 was more efficient at removing the larger particles, but showed higher populations of accumulation mode particles compared to the baseline and the other control technologies. The nebulizing unit was not fully able to grow the smaller particles to a large enough size that could be fully removed by the inertial separation device. This may be due

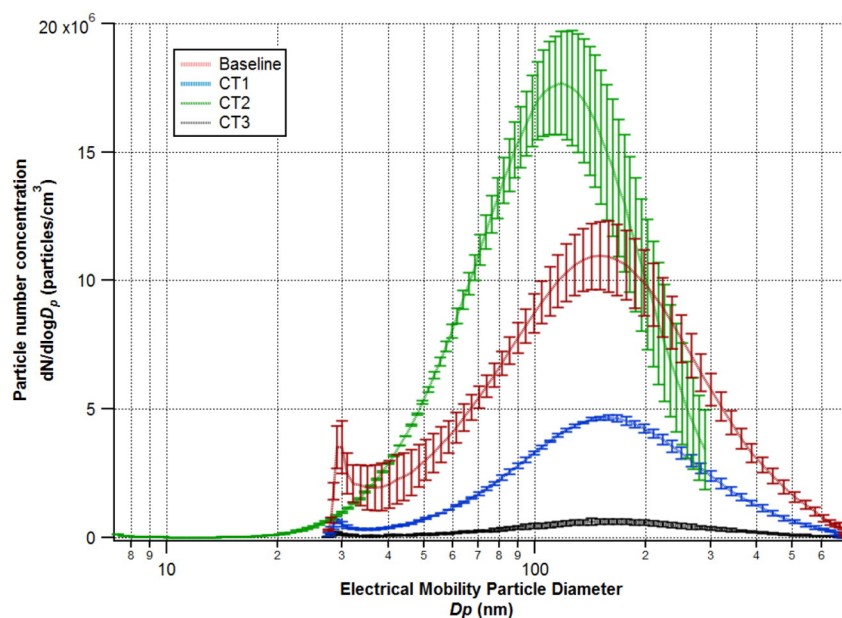

Fig. 5 – Average particle size distribution profiles for baseline testing and the control technologies.

to the short residence times of the sample effluent in the nebulizer. Consistent with the PM mass and particle number emissions in this study, CT3 showed the greatest reduction in particle population. This was expected as the mean diameter of the cooking emissions were approximately 0.15  $\mu\text{m}$ , well within the 0.01 to 10  $\mu\text{m}$  particle size removal operating range of the ESP.

### 2.3. Inorganic ions

Sulfate ( $\text{SO}_4^{2-}$ ), nitrate ( $\text{NO}_3^-$ ) and chloride ( $\text{Cl}^-$ ) were among the dominant inorganic ions of the PM mass emissions, with their emissions being at  $17.1 \pm 14.3$ ,  $7.9 \pm 0.05$ , and  $2.6 \text{ mg/kg}$ , respectively (Table 1). The dominance of nitrate and sulfate ions from cooking aerosol emissions has been also previously shown by Schauer et al. (2002) and McDonald et al. (2003). Schauer et al. (2002) showed that the most abundant ions were potassium, sulfur and chloride ( $340 \pm 3$ ,  $190 \pm 1.2$ ,  $160 \pm 3 \text{ mg/kg}$ ) for under-fired charbroiling with 25% fat meat patties. Similarly, McDonald et al. (2003) showed that under-fired charbroiling of 25% fat meat patties produced potassium, sulfate, chloride, and nitrate emissions at  $60.14 \pm 3.29$ ,  $17.01 \pm 5.16$ ,  $14.23 \pm 5.10$ , and  $7.15 \pm 5.54 \text{ mg/kg}$ , respectively. The emission rates measured in this study are considerably lower than those reported by Schauer et al. (2002), but similar to those of McDonald et al. (2003). Differences between the results reported here and other studies may be attributed to differences in cooking conditions, including the duration of the cooking cycle and the state of the meat (thawed or frozen).

Overall, the use of control technologies resulted in reductions in inorganic ions compared to the baseline testing, with CT3 showing greater reductions in ionic species than CT2 and CT1. These reductions are in line with those observed for the PM mass emissions where CT3 showed higher reductions in PM mass emissions compared to CT1 and CT2. The reductions in sulfate and nitrate ions were higher than reductions seen with PM mass emissions for CT1, CT2, and CT3 except for nitrate with CT2. This suggests that OM was condensing after the ions onto the solid particles. This can be observed with CT1, which has the lowest percent reduction with OM compared to CT2 and CT3 as OM was condensing downstream of the filter. CT3 showed consistently higher reductions in ionic species because it was proved effective in removing the solid particles as well as the condensing OM.

**Table 1 – Emissions of inorganic ionic species expressed in mg/(kg meat cooked).**

	Baseline	CT1	CT2	CT3
Chloride	2.64	BDL	$0.48 \pm 0.064$	$0.079 \pm 0.011$
Nitrate	$7.89 \pm 0.053$	$5.23 \pm 0.043$	$3.88 \pm 0.177$	$0.68 \pm 0.15$
Sulfate	$17.1 \pm 14.3$	$3.64 \pm 0.139$	$6.10 \pm 0.417$	$0.58 \pm 0.050$
Phosphate	BDL	0.777	0.295	$0.21 \pm 0.002$
Sodium	BDL	BDL	$3.20 \pm 0.41$	$0.25 \pm 0.052$
Ammonium	BDL	$0.36 \pm 0.000$	BDL	$0.073 \pm 0.002$

BDL: Below the detection limit; CT: control technology.

### 2.4. Carbonyl emissions

Carbonyls (aldehydes and ketones) are known toxic compounds formed from incomplete combustion. Carbonyl compounds play an important role in atmospheric chemistry and urban air quality because they are precursors to free radicals, ozone, and peroxyacyl nitrates (PANs) (Bakeas et al., 2003). The United States Environmental Protection Agency (US EPA) lists acetaldehyde, acrolein, methyl ethyl ketone (MEK), formaldehyde, and propionaldehyde as hazardous air pollutants (HAPs). According to the International Agency for Research on Cancer (IARC), formaldehyde is considered as human carcinogen, acetaldehyde is classified as a suspected carcinogen, while both acrolein and crotonaldehyde are classified as highly toxic compounds (IARC, 2006). As shown in Fig. 6, under-fired charbroiling is a significant source of carbonyl emissions, expressed in g/kg of meat cooked. Overall, twelve carbonyl compounds were identified and quantified for all experiments including formaldehyde, acetaldehyde, acrolein, crotonaldehyde, propionaldehyde, methacrolein, butyraldehyde, methyl ethyl ketone (MEK), benzaldehyde, valeraldehyde, tolualdehyde, and hexanaldehyde. Consistent with previous studies, low molecular weight aldehydes, such as formaldehyde and acetaldehyde, were the most abundant carbonyls from the cooking processes, followed by hexanaldehyde, butyraldehyde, propionaldehyde, and acrolein (Cheng et al., 2016; Ho et al., 2006; Huang et al., 2011; Kabir et al., 2010; Schauer et al., 2002). Formation of these species could be attributed either to the meat that was being charbroiled leading to lipid oxidation or from the natural gas combustion used in the cooking appliance. It is hypothesized, however, that aldehyde formation was favored by the high temperatures used for charbroiling through the rapid oxidation of unsaturated and polyunsaturated lipids and the increase of the number of free radicals in the middle. These radicals attack other, less susceptible lipids, favoring the formation of aldehydes and ketones (Elmore et al., 1999).

The baseline testing showed significantly higher carbonyl emission rates compared to all three control technologies. For the uncontrolled and the three controlled cooking processes, both MEK and tolualdehyde were practically undetectable. For formaldehyde emissions, CT2 and CT3 showed statistically

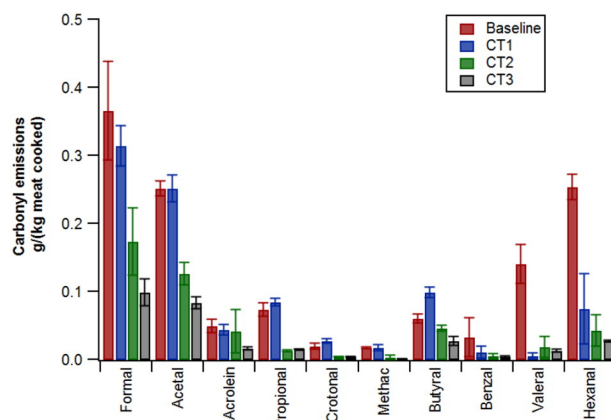

**Fig. 6 – Carbonyl emission factors.**

significant decreases of 52% and 73%, respectively, compared to the baseline testing. For acetaldehyde emissions, CT2, and CT3 showed statistically significant decreases of 60%, and 74%, respectively, relatively to the baseline testing, whereas CT1 showed indistinguishable differences for acetaldehyde emissions. While acrolein emissions trended lower for all three control technologies compared to the baseline testing, the only statistically significant reduction (67%) was observed for CT3 compared to the baseline testing. Propionaldehyde, crotonaldehyde, and methacrolein emissions showed statistically significant reductions for CT2 and CT3 compared to the baseline testing. The reductions for propionaldehyde were 81% and 79%, for crotonaldehyde were 78% and 77%, and for methacrolein were 80% and 95% for CT2 and CT3, respectively, compared to the baseline testing. Butyraldehyde, valeraldehyde, and hexanaldehyde emissions showed statistically significant decreases for all three control technologies relative to baseline testing, with some exceptions. For CT1, butyraldehyde emissions showed a statistically significant increase of 63% relative to the baseline testing. For CT2 and CT3 testing, the reductions for butyraldehyde emissions were 23% and 55%, respectively, compared to the baseline testing. The reductions for valeraldehyde emissions were 96%, 87%, and 90%, and for hexanaldehyde were 70%, 83%, and 89%, respectively, for CT1, CT2, and CT3 compared to the baseline testing. Comparing the control technologies, CT1 was the least effective catalyst unit in removing carbonyl emissions, whereas CT3 the most effective in reducing carbonyl emissions most likely due to the adsorption of the unburned hydrocarbons onto the activated carbon beds after the collector plates.

### 2.5. Benzene, toluene, ethylbenzene, and xylenes (BTEX) emissions

BTEX and 1,3-butadiene emissions for the baseline testing and the three control technologies are shown in Fig. 7. BTEX species and 1,3-butadiene are classified by US EPA as HAPs. Specifically, 1,3-butadiene is classified as a group B2 human carcinogen by the US EPA. Huang et al. (2011) found BTEX levels above the World Health Organization (WHO) limits for indoor dwellings during commercial cooking practices. Further, Mugica et al. (2001) found significant levels of

benzene, toluene and ethylbenzene in restaurant emissions. Similar to the findings reported here, Schauer et al. (1999) determined that benzene and toluene were among the most abundant aromatic VOCs from cooking operations at 0.083 and 0.040 g/kg, respectively.

Overall, CT1 showed higher 1,3-butadiene, benzene and toluene emissions than the baseline testing. These increases were statistically significant at 69%, 71% and 35%, respectively. CT2 and CT3 showed marked reductions in BTEX and 1,3-butadiene emissions compared to the baseline testing, with CT3 showing the lowest emission levels for BTEX and 1,3-butadiene. The larger reductions in aromatic VOCs and 1,3-butadiene for CT2 and CT3 relative to CT1 can be attributed to the catalysts ability to remove the VOCs. The inertial separation device or CT2, was equipped with a nebulizer or mist system which was implemented to cool the sample effluent and condense existing volatile compounds onto the solid particles, thereby growing them to a large enough diameter to be separated by the inertial separation portion of the device. For CT2, aromatic VOCs and 1,3-butadiene reduced compared to the baseline testing. Toluene, ethylbenzene, and *o*-xylene showed statistically significant reductions of 41%, 52%, and 77%, respectively. The ESP or CT3 showed the highest reductions in aromatic VOC emissions compared to the baseline testing. CT3 showed statistically significant reductions for 1,3-butadiene, benzene, toluene, ethylbenzene, *m/p* xylene, and *o*-xylene of 97%, 90%, 70%, 61%, 67%, and 68%, respectively. Similar to the carbonyl emissions, the very low VOC emissions for CT3 can be attributed to the activated carbon bed. As the collector plates were able to collect the majority of the particles, the remaining gas phase VOCs were absorbed on the activated carbon bed panels which were configured to allow for a long residence time for a high collection efficiency of the VOCs.

## 3. Conclusions

Impacts of control technologies on commercial cooking emissions were investigated in this study. Commercial cooking emissions reported here were comparable to those found in literature. PM composition consisted mainly of OM with very little soot particles present. The ESP (CT3) resulted in the highest PM reductions, while the activated carbon beds after the ESP were shown to significantly reduce VOC emissions. CT2 was effective in removing the larger diameter particles (>120 nm) and VOCs, although reductions were not as profound as the ESP and activated carbon bed combination (CT3). The filtration device (CT1) was only effective in removing PM emissions after condensation; condensation of semi-volatile organic compounds after the filter resulted in reduced PM removal efficiency. This study showed that commercial kitchens produce significant amounts of PM and toxic VOC emissions, which may pose serious environmental and occupational health issues. The implementation of strict rules for the application of control technologies for PM emissions removal from underfired charbroiled meat cooking is currently a necessity for the protection of human health and urban air quality improvements.

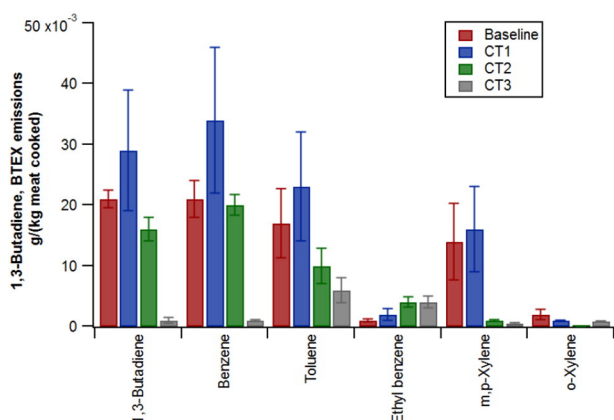

Fig. 7 – 1,3-Butadiene and benzene, toluene, ethylbenzene and xylenes (BTEX) emission factors.

## Acknowledgments

This study was supported by the South Coast Air Quality Management District (SCAQMD) under contract 12174. The authors thank Mr. Kurt Bumiller of the University of California, Riverside for helping with the test preparations and setup.

## REFERENCES

- Abdullahi, K., Delgado-Saborit, J.M., Harrison, R.M., 2013. Emissions and indoor concentration of particulate matter and its specific chemical components from cooking: a review. *Atmos. Environ.* 71, 260–294.
- Allan, J.D., Williams, P.I., Morgan, W.T., Martin, C.L., Flynn, M.J., Lee, J., Nemitz, E., Phillips, G.J., Gallagher, M.W., Coe, H., 2010. Contributions from transport, solid fuel burning and cooking to primary organic aerosols in two UK cities. *Atmos. Chem. Phys.* 10, 647–668.
- AQMP, 2012. Appendix IV-A. [http://www.aqmd.gov/docs/default-source/clean-air-plans/air-quality-management-plans/2012-air-quality-management-plan/final-2012-aqmp-\(february-2013\)/appendix-iv-\(a\)-final-2012.pdf](http://www.aqmd.gov/docs/default-source/clean-air-plans/air-quality-management-plans/2012-air-quality-management-plan/final-2012-aqmp-(february-2013)/appendix-iv-(a)-final-2012.pdf).
- Bakeas, E.B., Argyris, D.I., Siskos, P.A., 2003. Carbonyl compounds in the urban environment of Athens, Greece. *Chemosphere* 52, 805–813.
- Berube, K., Balharry, D., Sexton, K., Koshy, L., Jones, T., 2007. Combustion-derived nanoparticles: mechanisms of pulmonary toxicity. *Clin. Exp. Pharmacol. Physiol.* 34, 1044–1050.
- Buonanno, G., Morawska, L., Stabile, L., 2009. Particle emission factors during cooking activities. *Atmos. Environ.* 43, 3235–3242.
- Cheng, S., Wang, G., Lang, J., Wen, W., Wang, X., Yao, S., 2016. Characterization of volatile organic compounds from different cooking emissions. *Atmos. Environ.* 145, 299–307.
- Elmore, J.D., Mottram, D.S., Enser, M., Wood, J.D., 1999. Effect of polyunsaturated fatty acid composition of beef muscle on the profile of aroma volatiles. *J. Agric. Food Chem.* 47, 1619–1625.
- He, L.Y., Hu, M., Huang, X.F., Yu, B.D., Zhang, Y.H., Liu, D.Q., 2004. Measurement of emissions of fine particulate organic matter from Chinese cooking. *Atmos. Environ.* 38, 6557–6564.
- Hildemann, L.M., Markwski, G.R., Cass, G.R., 1991. Chemical composition of emissions from urban sources of fine organic aerosol. *Environ. Sci. Technol.* 25, 744–759.
- Ho, S.S.H., Yu, J.Z., Chu, K.W., Yeung, L.L., 2006. Carbonyl emissions from commercial cooking sources in Hong Kong. *J. Air Waste Manage. Assoc.* 56, 1091–1098.
- Huang, Y., Ho, S.S.H., Ho, K.F., Lee, S.C., Yu, J.Z., Louie, P.K.K., 2011. Characteristics and health impacts of VOCs and carbonyls associated with residential cooking activities in Hong Kong. *J. Hazard. Mater.* 186, 344–351.
- IARC, 2006. Overall Evaluation of Carcinogenicity to Human, Formaldehyde [50-00-0]. Monograph Series International Agency for Research on Cancer, Lyon, France.
- Kabir, E., Kim, K.H., Ahn, J.W., Hong, O.F., Ryeul Sohn, J., 2010. Barbecue charcoal combustion as a potential source of aromatic volatile organic compounds and carbonyls. *J. Hazard. Mater.* 174, 492–499.
- Kreyling, W.G., Semmler-Behnke, M., Moller, W., 2006. Health implications of nanoparticles. *J. Nanopart. Res.* 8, 543–562.
- Lee, J.B., Kim, K.H., Kim, H.J., Cho, S.J., Jung, K., Kim, S.D., 2011. Emission rate of particulate matter and its removal efficiency by precipitators in under-fired charbroiling restaurants. *Sci. World J. Environ.* 11, 1077–1088.
- Lewtas, J., 2007. Air pollution combustion emissions: characterization of causative agents and mechanisms associated with cancer, reproductive, and cardiovascular effects. *Mutat. Res.* 636, 95–133.
- Li, N., Bhattacharya, P., Karavalakis, G., Williams, K., Gysel, N., Rivera-Rios, N., 2014. Emissions from commercial-grade charbroiling meat operations induce oxidative stress and inflammatory responses in human bronchial epithelial cells. *Toxicol. Rep.* 1, 802–811.
- Li, Y.C., Shu, M., Ho, S.S.H., Wang, C., Cao, J.J., Wang, G.H., Wang, X.X., Wang, K., Zhao, X.Q., 2015. Characteristics of PM<sub>2.5</sub> emitted from different cooking activities in China. *Atmos. Res.* 166, 83–91.
- McDonald, J.D., Zielinska, B., Fujita, E.M., Sagebiel, J.C., Chow, J.C., Watson, J.G., 2003. Emissions from charbroiling and grilling of chicken and beef. *J. Air Waste Manage. Assoc.* 53, 185–194.
- Mohr, C., DeCarlo, P.F., Heringa, M.F., Chirico, R., Slowik, J.G., Richter, R., Reche, C., Alastuey, A., Querol, X., Seco, R., Penuelas, J., Jimenez, J.L., Crippa, M., Zimmermann, R., Baltensperger, U., Prevot, A.S.H., 2012. Identification and quantification of organic aerosol from cooking and other sources in Barcelona using aerosol mass spectrometer data. *Atmos. Chem. Phys.* 12, 1649–1665.
- Mugica, V., Vega, E., Chow, J., Reyes, E., Sanchez, G., Arriaga, J., Egami, R., Watson, J., 2001. Speciated non-methane organic compounds emissions from food cooking in Mexico. *Atmos. Environ.* 35, 1729–1734.
- Nolte, C.G., Schauer, J.J., Cass, G.R., Simoneit, B.R.T., 1999. Highly polar organic compounds present in meat smoke. *Environ. Sci. Technol.* 33, 3313–3316.
- Oberdorster, G., Oberdorster, E., Oberdorster, J., 2005. Nanotoxicology: an emerging discipline evolving from studies of ultrafine particles. *Environ. Health Perspect.* 113, 823–839.
- Pope, C.A., 2000. What do epidemiologic findings tell us about health effects of environmental aerosols. *J. Aerosol Med.* 13, 335–354.
- Robinson, A.L., Subramanian, R., Donahue, N.M., Bernardo-Bricker, A., Rogge, W.F., 2006. Source apportionment of molecular markers and organic aerosol. 3. Food cooking emissions. *Environ. Sci. Technol.* 40, 7820–7827.
- Rogge, W.F., Hildemann, L.M., Mazurek, M.A., Cass, G.R., 1991. Sources of fine organic aerosol. 1. Charbroilers and meat cooking operations. *Environ. Sci. Technol.* 25, 1112–1125.
- Saito, E., Tanaka, N., Miyazaki, A., Tsuzaki, M., 2014. Concentration and particle size distribution of polycyclic aromatic hydrocarbons formed by thermal cooking. *Food Chem.* 153, 285–291.
- Schauer, J.J., Kleeman, M.J., Cass, G.R., Simoneit, B.R.T., 1999. Measurement of emissions from air pollution sources. 1. C1 through C29 organic compounds from meat charbroiling. *Environ. Sci. Technol.* 33, 1566–1577.
- Schauer, J.J., Kleeman, M.J., Cass, G.R., Simoneit, B.R.T., 2002. Measurement of emissions from air pollution sources. 4. C1-C29 organic compounds from cooking with seed oils. *Environ. Sci. Technol.* 36, 567–575.
- See, S.W., Balasubramanian, R., 2008. Chemical characteristics of fine particles emitted from different gas cooking methods. *Atmos. Environ.* 42, 8852–8862.
- Shah, S.D., Cocker III, D.R., Miller, J.W., Norbeck, J.M., 2004. Emission rates of particulate matter and elemental and organic carbon from in-use diesel engines. *Environ. Sci. Technol.* 38, 2544–2550.
- Sioutas, C., Delfino, R.J., Singh, M., 2005. Exposure assessment for atmospheric ultrafine particles (UFPs) and implications in epidemiologic research. *Environ. Health Perspect.* 113, 947–955.
- South Coast Air Quality Management District (SCAQMD), 1989. Method 5.1. Determination of particulate matter emissions from stationary sources using a wet impinger train.



- <http://www.aqmd.gov/docs/default-source/laboratory-procedures/methods-procedures/stm-005-1.pdf?sfvrsn=2> (March).
- Sun, Y.L., Zhang, Q., Schwab, J.J., Demerjian, K.L., Chen, W.N., Bae, M.S., Hung, H.M., Hogrefe, O., Frank, B., Rattigan, O.V., Lin, Y.-C., 2011. Characterization of the sources and processes of organic and inorganic aerosols in New York City with a high-resolution time-of-flight aerosol mass spectrometer. *Atmos. Chem. Phys.* 11, 1581–1602.
- Utell, M.J., Frampton, M.W., 2000. Acute health effects of ambient air pollution: the ultrafine particle hypothesis. *J. Aerosol Med.* 13, 355–359.
- Watson, J.G., Chow, J.C., 2001. Source characterization of major emission sources in the imperial and Mexicali Valleys along the US/Mexico border. *Sci. Total Environ.* 276, 33–47.
- Zhao, Y., Hu, M., Slanina, S., Zhang, Y., 2007. Chemical compositions of fine particulate organic matter emitted from Chinese cooking. *Environ. Sci. Technol.* 41, 99–105.
- Zhao, X., Hu, Q., Wang, X., Ding, X., He, Q., Zhang, Z., Shen, R., Lu, S., Liu, T., Fu, X., Chen, L., 2015. Composition profiles of organic aerosol from Chinese residential cooking: case study in urban Guangzhou south China. *J. Atmos. Chem.* 72, 1–18.