

UC Office of the President

Human Memory and the Learning Process

Title

Human Memory and the Learning Process (Entire Collection)

Permalink

<https://escholarship.org/uc/item/5sw5x88c>

Author

Atkinson, Richard C.

Publication Date

1980

Peer reviewed

HUMAN
MEMORY
and the
LEARNING
PROCESS

Selected Papers of
Richard C. Atkinson

The attached papers are a collection of research articles assembled by Russian colleagues translated into Russian and published by the USSR Academy of Sciences. The reference is Human Memory and the Learning Process: Selected Papers of Richard C. Atkinson, edited by Y. Zabrodin and B.F. Lomov. Moscow: Progress Publishing House, 1980.

Preface

The papers in this volume deal with fundamental research on human memory, perception and cognition as well as more applied work on school learning and the instructional process. A theme running through all of these papers is a close interplay between theory and experimentation. Whenever possible, the theory is stated in formal terms either as a mathematical model or as a computer program; predictions are then derived from the theory; the predictions are used to design an appropriate experiment; the experiment is conducted and data collected; discrepancies are identified between theoretical predictions and experimental outcomes; the theory is revised to take account of the discrepancies; and the cycle of events is repeated. This cycle characterizes the scientific method whether in psychology or any other field of science. The interplay between theory and experiment is strengthened to the extent that the theory is stated in formal terms and can be used to identify differences between observed and predicted behavior.

It is a great honor and a pleasure for me to have some of my papers translated into Russian and published in the Soviet Union. I have been in close contact with psychologists and mathematicians in the Soviet Union since my first visit there in 1960 and these exchanges have proved to be invaluable. Discussions in the 1960's with Soviet scientists were influential in my use of control theory as a method for optimizing the instructional process, and the first public lecture that I gave on my theory of long- and short-term memory was in Moscow at the 1968 meetings of the International Congress of Psychology. In recent years, I have maintained close relations with Professor Lomov and other members of the Institute of Psychology of the U.S.S.R. Academy of Sciences in Moscow; members of the institute have been in my laboratory at Stanford University several times and I have been a visitor at the Institute on at least four occasions. The understanding and collegueship between American psychologists and their Soviet counterparts is as close as that of any two nations. Both the science of psychology and relations between our two countries benefit by this close interchange. I hope that the Soviet readers of this volume will share with me my excitement for research in psychology and that together we can expand the frontiers of the psychological sciences.

Richard C. Atkinson
Washington, D.C.
February 22, 1979



TABLE OF CONTENTS

SECTION I:	<u>Human memory and its control processes</u>	
1	The control of short-term memory (with R.M. Shiffrin)	3
2	Human Memory: A proposed system and its control processes (with R. M. Shiffrin)	13
3	Human memory and the concept of reinforcement (with T. D. Wickens)	121
4	Some remarks on a theory of memory (with K. T. Wescourt).	177
SECTION II:	<u>Search and decision processes in recognition memory</u>	
5	Search processes in recognition memory (with D.J. Herrmann and K. T. Wescourt)	193
6	Search and decision processes in recognition memory (with J. F. Juola)	239
SECTION III:	<u>Signal detection and recognition as influenced by memory and learning processes</u>	
7	A learning model for forced-choice detection experiments (with R. A. Kinchla)	293
8	Signal recognition as influenced by information feedback (with T. A. Tanner, Jr., and J. A. Rauk)	317
SECTION IV:	<u>Optimizing the learning process</u>	
9	Adaptive instructional systems: Some attempts to optimize the learning process	335
10	Computerized instruction and the learning process.	363
11	Ingredients for a theory of instruction	379
12	Mnemotechnics in second-language learning.	391

SECTION I:

HUMAN MEMORY AND ITS CONTROL PROCESSES

- 1 The control of short-term memory. Scientific American, 1971, 224, 82-90 (with R. M. Shiffrin)..... 3
- 2 Human memory: A proposed system and its control processes. In The Psychology of Learning and Motivation: Advances in Research and Theory, Vol. 2, edited by K. W. Spence and J. T. Spence, New York: Academic Press, 1968, 89-195 (with R. M. Shiffrin)..... 13
- 3 Human memory and the concept of reinforcement. In The Nature of Reinforcement, edited by R. Glazer, New York: Academic Press, 1971, 66-120 (with T. D. Wickens)..... 121
- 4 Some remarks on a theory of memory. In Attention and Performance V, edited by P.M.A. Rabbitt and S. Dornic, London: Academic Press, 1975, 485-498 (with K. T. Wescourt)..... 177

The Control of Short-Term Memory

Memory has two components: short-term and long-term. Control processes such as “rehearsal” are essential to the transfer of information from the short-term store to the long-term one

by Richard C. Atkinson and Richard M. Shiffrin

The notion that the system by which information is stored in memory and retrieved from it can be divided into two components dates back to the 19th century. Theories distinguishing between two different kinds of memory were proposed by the English associationists James Mill and John Stuart Mill and by such early experimental psychologists as Wilhelm Wundt and Ernst Meumann in Germany and William James in the U.S. Reflecting on their own mental processes, they discerned a clear difference between thoughts currently in consciousness and thoughts that could be brought to consciousness only after a search of memory that was often laborious. (For example, the sentence you are reading is in your current awareness; the name of the baseball team that won the 1968

World Series may be in your memory, but to retrieve it takes some effort, and you may not be able to retrieve it at all.)

The two-component concept of memory was intuitively attractive, and yet it was largely discarded when psychology turned to behaviorism, which emphasized research on animals rather than humans. The distinction between short-term memory and long-term memory received little further consideration until the 1950's, when such psychologists as Donald E. Broadbent in England, D. O. Hebb in Canada and George A. Miller in the U.S. reintroduced it [see “Information and Memory,” by George A. Miller; SCIENTIFIC AMERICAN, August, 1956]. The concurrent development of computer models of behavior and of mathematical psychology accelerated

the growth of interest in the two-process viewpoint, which is now undergoing considerable theoretical development and is the subject of a large research effort. In particular, the short-term memory system, or short-term store (STS), has been given a position of pivotal importance. That is because the processes carried out in the short-term store are under the immediate control of the subject and govern the flow of information in the memory system; they can be called into play at the subject's discretion, with enormous consequences for performance.

Some control processes are used in many situations by everyone and others are used only in special circumstances. “Rehearsal” is an overt or covert repetition of information—as in remembering a telephone number until it can be writ-

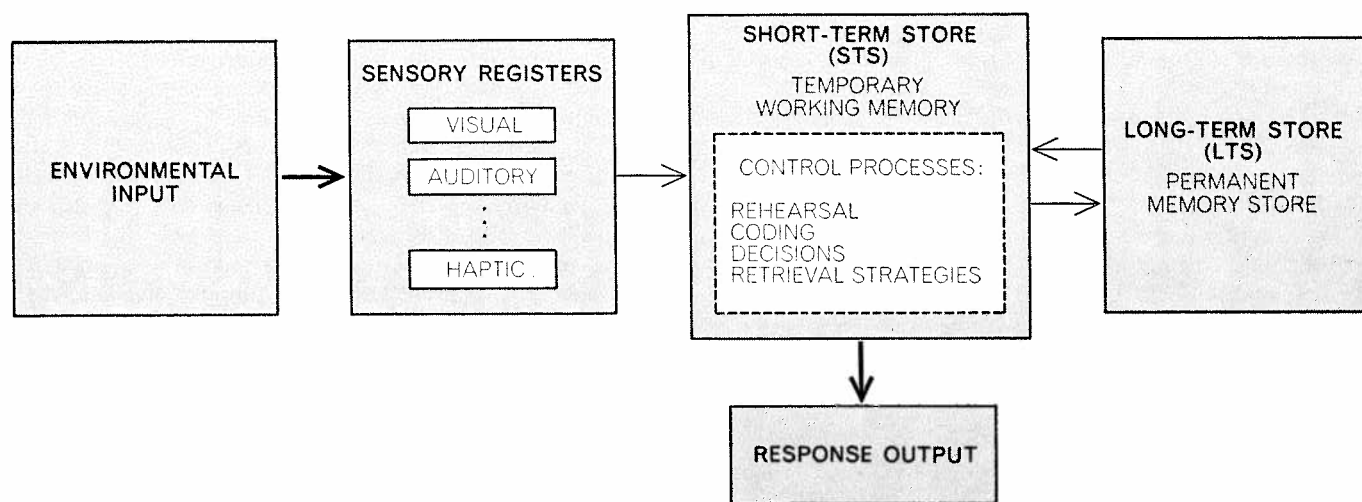

INFORMATION FLOW through the memory system is conceived of as beginning with the processing of environmental inputs in sensory registers (receptors plus internal elements) and entry into the short-term store (STS). While it remains there the information may be copied into the long-term store (LTS), and associated in-

formation that is in the long-term store may be activated and entered into the short-term store. If a triangle is seen, for example, the name “triangle” may be called up. Control processes in the short-term store affect these transfers into and out of the long-term store and govern learning, retrieval of information and forgetting.

ten down, remembering the names of a group of people to whom one has just been introduced or copying a passage from a book. "Coding" refers to a class of control processes in which the information to be remembered is put in a context of additional, easily retrievable information, such as a mnemonic phrase or sentence. "Imaging" is a control process in which verbal information is remembered through visual images; for example, Cicero suggested learning long lists (or speeches) by placing each member of the list in a visual representation of successive rooms of a well-known building. There are other control processes, including decision rules, organizational schemes, retrieval strategies and problem-solving techniques; some of them will be encountered in this article. The point to keep in mind is the optional nature of control processes. In contrast to permanent structural components of the memory system, the control processes are selected at the subject's discretion; they may vary not only with different tasks but also from one encounter with the same task to the next.

We believe that the overall memory system is best described in terms of the flow of information into and out of short-term storage and the subject's control of that flow, and this conception has been central to our experimental and theoretical investigation of memory. All phases of memory are assumed to consist of small units of information that are associatively related. A set of closely interrelated information units is termed an image or a trace. Note that "image" does not necessarily imply a visual representation; if the letter-number pair *TKM-4* is presented for memory, the image that is stored might include the size of the card on which the pair is printed, the type of print, the sound of the various symbols, the semantic codes and numerous other units of information.

Information from the environment is accepted and processed by the various sensory systems and is entered into the short-term store, where it remains for a period of time that is usually under the control of the subject. By rehearsing one or more items the subject can keep them in the short-term store, but the number that can be maintained in this way is strictly limited; most people can maintain seven to nine digits, for example. Once an image is lost from the short-term store it cannot thereafter be recovered from it. While information resides in short-term storage it may be copied into

the long-term store (LTS), which is assumed to be a relatively permanent memory from which information is not lost. While an image is in short-term storage, closely related information in the long-term store is activated and entered in the short-term store too. Information entering the short-term store from the sensory systems comes from a specific modality—visual, auditory or whatever—but associations from the long-term store in all modalities are activated to join it. For instance, an item may be presented visually, but immediately after input its verbal "name" and associated meanings will be activated from the long-term store and placed in the short-term one [*see illustration on opposite page*].

Our account of short-term and long-term storage does not require that the two stores necessarily be in different parts of the brain or involve different physiological structures. One might consider the short-term store simply as being a temporary activation of some portion of the long-term store. In our thinking we tend to equate the short-term store with "consciousness," that is, the thoughts and information of which we are currently aware can be considered part of the contents of the short-term store. (Such a statement lies in the realm of phenomenology and cannot be verified scientifically, but thinking of the short-term store in this way may help the reader to conceptualize the system.) Because consciousness is equated with the short-term store and because control processes are centered in and act through it, the short-term store is considered a working memory: a system in which decisions are made, problems are solved and information flow is directed. Retrieval of information from short-term storage is quite fast and accurate. Experiments by Saul Sternberg of the Bell Telephone Laboratories and by others have shown that the retrieval time for information in short-term storage such as letters and numbers ranges from 10 to 30 milliseconds per character.

The retrieval of information from long-term storage is considerably more complicated. So much information is contained in the long-term store that the major problem is finding access to some small subset of the information that contains the desired image, just as one must find a particular book in a library before it can be scanned for the desired information. We propose that the subject activates a likely subset of information, places it in the short-term store and then scans that store for the desired image. The image may not be present in the

current subset, and so the retrieval process becomes a search in which various subsets are successively activated and scanned [*see illustration below*]. On the basis of the information presented to him the subject selects the appropriate "probe information" and places it in the short-term store. A "search set," or subset of information in the long-term store closely associated with the probe, is then activated and put in the short-term store. The subject selects from the search set some image, which is then examined. The information extracted from the selected image is utilized for a decision: has the desired information

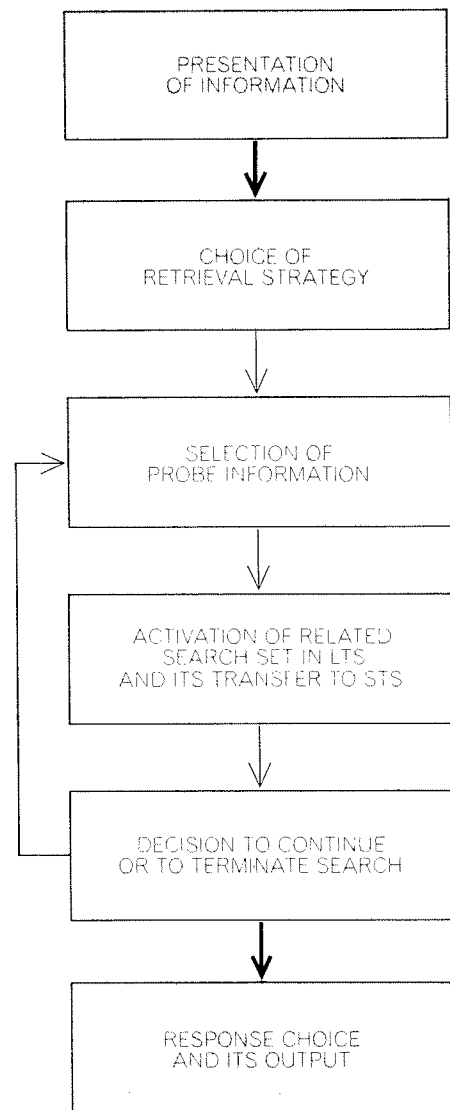

RETRIEVAL from the long-term store requires a choice of strategy and selection of certain information as a "probe" that is placed in the short-term store. The probe activates a "search set" of information in the long-term store. The search set is placed in the short-term store and is examined for the desired information. If it is not found, search is halted or recycled with new probe.

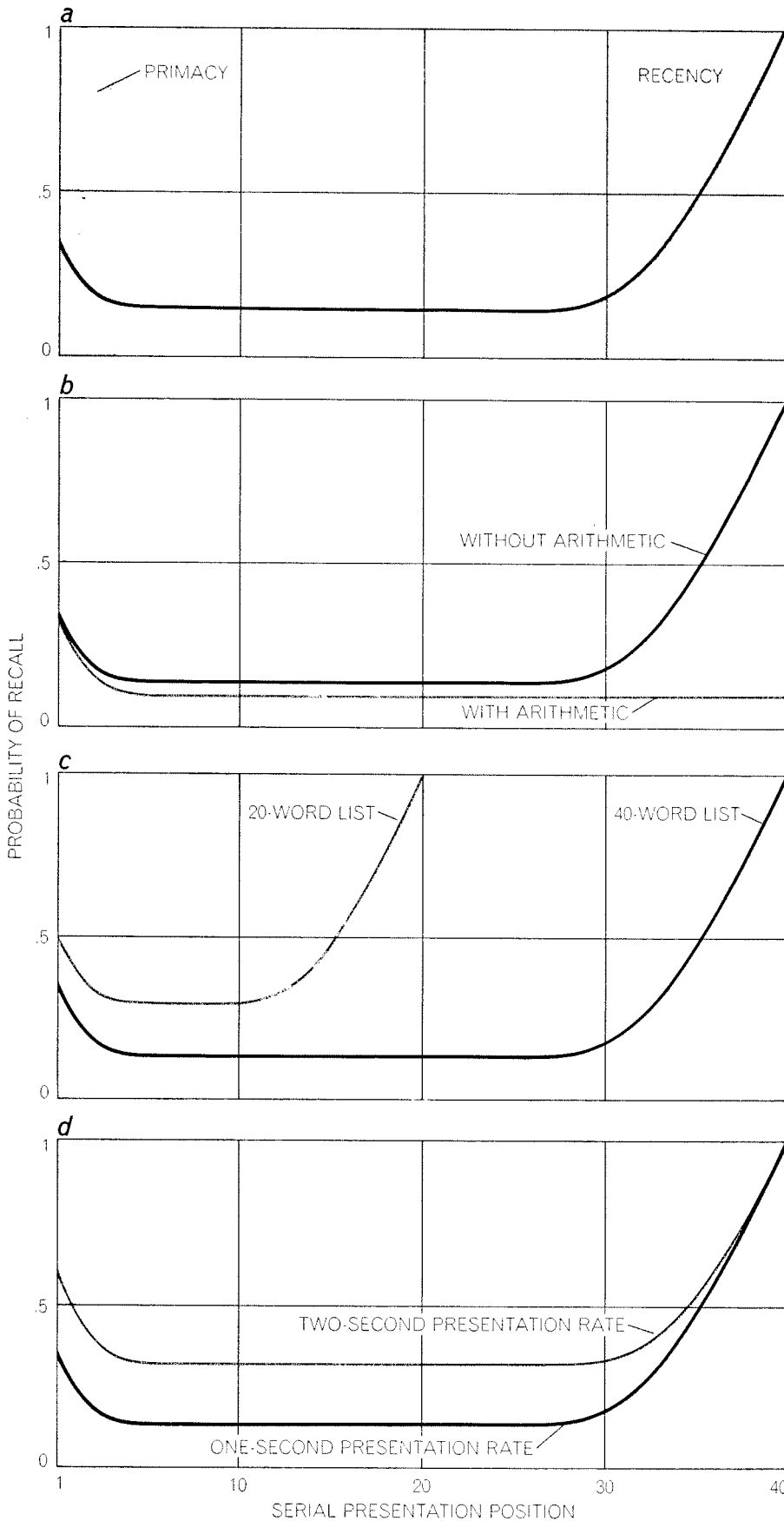

PROBABILITY OF RECALL in free-recall experiments varies in a characteristic way with an item's serial position in a list: a "primacy effect" and a "recency effect" are apparent (a). If an arithmetic task is interpolated between presentation and recall, the recency effect disappears (b). Words in long lists are recalled less well than words in short lists (c). Slower presentation also results in better recall (d). The curves are idealized ones based on experiments by James W. Dees, Bennet Murdock, Leo Postman and Murray Glanzer.

been found? If so, the search is terminated.

If the information has not been found, the subject may decide that continuation is unlikely to be productive or he may decide to continue. If he does, he begins the next cycle of the search by again selecting a probe, which may or may not be the same probe used in the preceding cycle depending on the subject's strategy. For example, a subject asked to search for states of the U.S. starting with the letter *M* may do so by generating states at random and checking their first letter (in which case the same probe information can be used in each search cycle), or he may generate successive states in a regular geographic order (in which case the probe information is systematically changed from one cycle to the next). It can be shown that strategies in which the probe information is systematically changed will result more often in successful retrieval but will take longer than alternative "random" strategies. (Note that the Freudian concept of repressed memories can be considered as being an inability of the subject to generate an appropriate probe.)

This portrayal of the memory system almost entirely in terms of the operations of the short-term store is quite intentional. In our view information storage and retrieval are best described in terms of the flow of information through the short-term store and in terms of the subject's control of the flow. One of the most important of these control processes is rehearsal. Through overt or covert repetition of information, rehearsal either increases the momentary strength of information in the short-term store or otherwise delays its loss. Rehearsal can be shown not only to maintain information in short-term storage but also to control transfer from the short-term store to the long-term one. We shall present several experiments concerned with an analysis of the rehearsal process.

The research in question involves a memory paradigm known as "free recall," which is similar to the task you face when you are asked to name the people present at the last large party you went to. In the typical experimental procedure a list of random items, usually common English words, is presented to the subject one at a time. Later the subject attempts to recall as many words as possible in any order. Many psychologists have worked on free recall, with major research efforts carried out by

Bennet Murdock of the University of Toronto, Endel Tulving of Yale University and Murray Glanzer of New York University. The result of principal interest is the probability of recalling each item in a list as a function of its place in the list, or "serial-position position." Plotting this function yields a U-shaped curve [see "a" in illustration on opposite page]. The increased probability of recall for the first few words in the list is called the primacy effect; the large increase for the last eight to 12 words is called the recency effect. There is considerable evidence that the recency effect is due to retrieval from short-term storage and that the earlier portions of the serial-position curve reflect retrieval from long-term storage only. In one experimental procedure the subject is required to carry out a difficult arithmetic task for 30 seconds immediately following presentation of the list and then is asked to recall. One can assume that the arithmetic task causes the loss of all the words in short-term storage, so that recall reflects retrieval from long-term storage only. The recency effect is eliminated when this experiment is performed; the earlier portions of the serial-position curve are unaffected [b]. If variables that influence the long-term store but not the short term one are manipulated, the recency portion of the serial position curve should be relatively unaffected, whereas the earlier portions of the curve should show changes. One such variable is the number of words in the presented list. A word in a longer list is less likely to be recalled, but the recency effect is quite unaffected by list length [c]. Similarly, increases in the rate of presentation decrease the likelihood of recalling words preceding the recency region but leave the recency effect largely unchanged [d].

In free recall experiments many lists are usually presented in a session. If the subject is asked at the end of the session to recall all the words presented during the session, we would expect his recall to reflect retrieval from long-term storage only. The probability of recalling words as a function of their serial position within each list can be plotted for end-of-session recall and compared with the serial-position curve for recall immediately following presentation [see illustration on this page]. For the delayed-recall curve the primacy effect remains, but the recency effect is eliminated, as predicted. In summary, the recency region appears to reflect retrieval from both short-term and long-term storage whereas the serial-position curve preced-

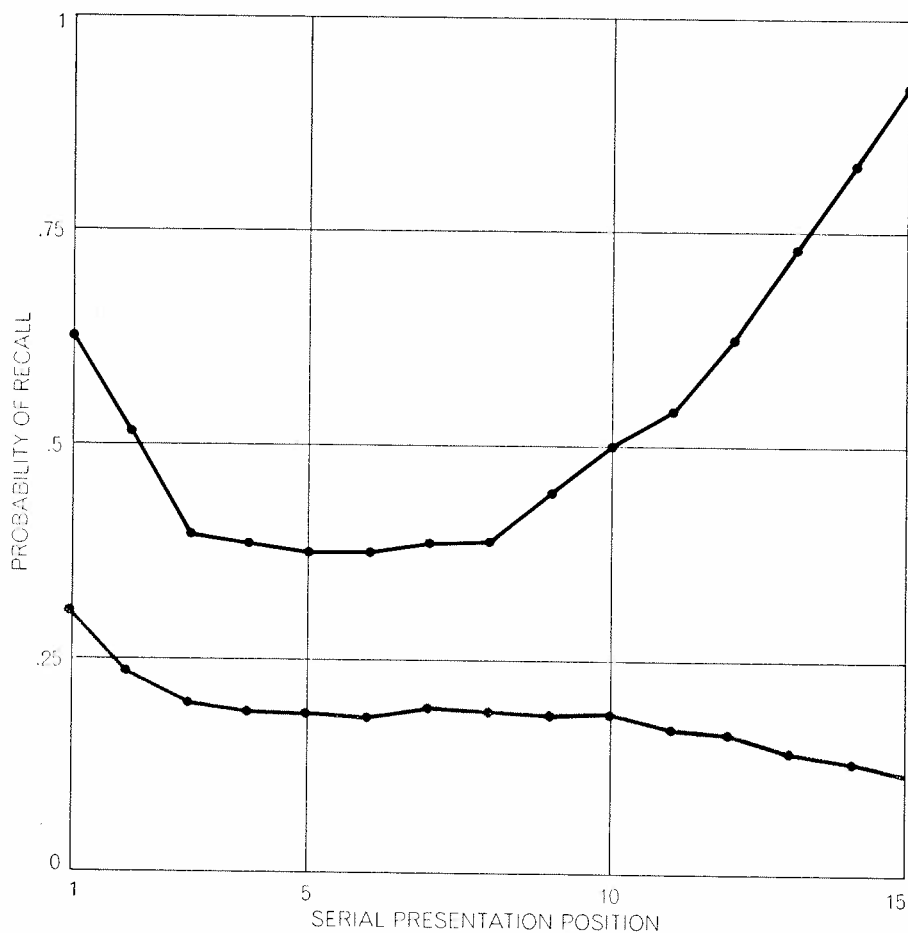

EFFECT OF DELAY is tested by asking subjects to recall at the end of a session all words from the entire session, and then plotting probability of recall against serial position within each list. An experiment by Fergus Craik compares immediate recall (*black*) with delayed recall (*color*). The delayed-recall curve emphasizes transitory nature of recency effect.

ing the recency region reflects retrieval from long-term storage only.

In 1965, at a conference sponsored by the New York Academy of Sciences, we put forward a mathematical model explaining these and other effects in terms of a rehearsal process. The model assumed that in a free-recall task the subject sets up a rehearsal buffer in the short-term store that can hold only a fixed number of items. At the start of the presentation of a list the buffer is empty; successive items are entered until the buffer is filled. Thereafter, as each new item enters the rehearsal buffer it replaces one of the items already there. (Which item is replaced depends on a number of psychological factors, but in the model the decision is approximated by a random process.) The items that are still being rehearsed in the short-term store when the last item is presented are the ones that are immediately recalled by the subject, giving rise to the recency effect. The transfer of information from the short-term to the long-term store is

postulated to be a function of the length of time an item resides in the rehearsal buffer; the longer the time period, the more rehearsal the item receives and therefore the greater the transfer of information to long-term storage. Since items presented first in a list enter an empty or partly empty rehearsal buffer, they remain longer than later items and consequently receive additional rehearsal. This extra rehearsal causes more transfer of information to long-term storage for the first items, giving rise to the primacy effect.

This rehearsal model was given a formal mathematical statement and was fitted to a wide array of experiments, and it provided an excellent quantitative account of a great many results in free recall, including those discussed in this article. A more direct confirmation of the model has recently been provided by Dewey Rundus of Stanford University. He carried out free-recall experiments in which subjects rehearsed aloud during list presentation. This overt rehearsal was tape-recorded and was com-

pared with the recall results. The number of different words contained in the "rehearsal set" (the items overtly rehearsed between successive presentations) was one after the first word was presented and then rose until the fourth word; from the fourth word on the number of different words in the rehearsal set remained fairly constant (averaging about 3.3) until the end of the list. The subjects almost always reported the members of the most recent rehearsal set when the list ended and recall began. A close correspondence is evident between the number of rehearsals and the recall probability for words preceding the recency effect; in the recency region, however, a sharp disparity occurs [see illustrations below]. The hypothesis that

long-term storage is a function of the number of rehearsals can be checked in other ways. The recall probability for a word preceding the recency region was plotted as a function of the number of rehearsals received by that word; the result was an almost linear, sharply increasing function. And words presented in the middle of the list given the same number of rehearsals as the first item presented had the same recall probability as that first item.

With efficacy of rehearsal established both for storing information in the long-term store and for maintaining information in the short-term store, we did an experiment in which the subjects' rehearsal was manipulated directly. Our subjects were trained to engage in one

of two types of rehearsal. In the first (a one-item rehearsal set) the most recently presented item was rehearsed exactly three times before presentation of the next item; no other items were rehearsed. In the second (a three-item rehearsal set) the subject rehearsed the three most recently presented items once each before presentation of the next item, so that the first rehearsal set contained three rehearsals of the first word, the second rehearsal set contained two rehearsals of the second word and one rehearsal of the first word, and all subsequent sets contained one rehearsal of each of the three most recent items [see illustrations on opposite page].

When only one item is rehearsed at a time, each item receives an identical number of rehearsals and the primacy effect disappears, as predicted. Note that the recency effect appears for items preceding the last item even though the last item is the only one in the last rehearsal set. This indicates that even when items are dropped from rehearsal, it takes an additional period of time for them to be completely lost from short-term storage. The curve for the three-item rehearsal condition shows the effect also. The last rehearsal set contains the last three items presented and these are recalled perfectly, but a recency effect is still seen for items preceding these three. It should also be noted that a primacy effect occurs in the three-rehearsal condition. This was predicted because the first item received a total of five rehearsals rather than three. A delayed-recall test for all words was given at the end of the experimental session. The data confirmed that long-term-store retrieval closely parallels the number of rehearsals given an item during presentation, for both rehearsal schemes.

These results strongly implicate rehearsal in the maintenance of information in the short-term store and the transfer of that information to the long-term system. The question then arises: What are the forgetting and transfer characteristics of the short-term store in the absence of rehearsal? One can control rehearsal experimentally by blocking it with a difficult verbal task such as arithmetic. For example, Lloyd R. Peterson and Margaret Peterson of Indiana University [see "Short-Term Memory," by Lloyd R. Peterson; SCIENTIFIC AMERICAN, July, 1966] presented a set of three letters (a trigram) to be remembered; the subject next engaged in a period of arithmetic and then was asked to recall as many letters of the trigram

ITEM PRESENTED	ITEMS REHEARSED (REHEARSAL SET)
1 REACTION	REACTION, REACTION, REACTION, REACTION
2 HOOF	HOOF, REACTION, HOOF, REACTION
3 BLESSING	BLESSING, HOOF, REACTION
4 RESEARCH	RESEARCH, REACTION, HOOF, RESEARCH
5 CANDY	CANDY, HOOF, RESEARCH, REACTION
6 HARDSHIP	HARDSHIP, HOOF, HARDSHIP, HOOF
7 KINDNESS	KINDNESS, CANDY, HARDSHIP, HOOF
8 NONSENSE	NONSENSE, KINDNESS, CANDY, HARDSHIP
⋮	⋮
20 CELLAR	CELLAR, ALCOHOL, MISERY, CELLAR

OVERT-REHEARSAL experiment by Dewey Rundus shows the effect of rehearsal on transfer into long-term storage. The subject rehearses aloud. A partial listing of items rehearsed in one instance shows typical result: early items receive more rehearsals than later items.

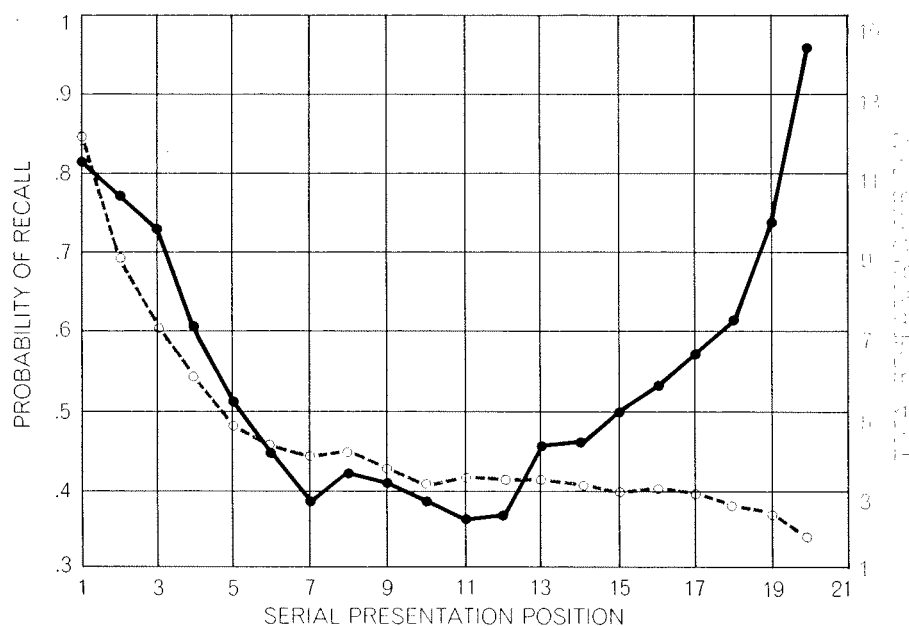

EFFECT OF REHEARSAL is demonstrated by comparison of an item's probability of recall (black) with the total number of rehearsals item receives (color). The two are related in regions reflecting retrieval from long-term storage (preceding recency region). That is, long-term storage efficacy depends on number of rehearsals and is reflected in retrieval.

as possible. When the probability of recall is plotted as a function of the duration of the arithmetic task, the loss observed over time is similar to that of the recency effect in free recall [see top illustration on next page]. Short-term-store loss caused by an arithmetic task, then, is similar to loss from short-term storage caused by a series of intervening words to be remembered. The flat portion of the curve reflects the retrieval of the trigram from long-term storage alone and the earlier portions of the curve represent retrieval from both short-term and long-term storage; the loss of the trigram from short-term storage is represented by the decreasing probability of recall prior to the asymptote.

Does the forgetting observed during arithmetic reflect an automatic decay of short-term storage that occurs inevitably in the absence of rehearsal or is the intervening activity the cause of the loss? There is evidence that the amount of new material introduced between presentation and test is a much more important determinant of loss from short-term storage than simply the elapsed time between presentation and test. This finding is subject to at least two explanations. The first holds that the activity intervening between presentation and test is the *direct* cause of an item's loss from short-term storage. The second explanation proposes that the rate of intervening activity merely affects the number of rehearsals that can be given the item to be remembered and thus *indirectly* determines the rate of loss.

It has recently become possible to choose between these two explanations of loss from the short-term store. Judith Reitman of the University of Michigan substituted a signal-detection task for the arithmetic task in the Peterson's procedure. The task consisted in responding whenever a weak tone was heard against a continuous background of "white" noise. Surprisingly, no loss from short-term storage was observed after 15 seconds of the task, even though subjects reported no rehearsal during the signal detection. This suggests that loss from the short-term store is due to the type of interference during the intervening interval: signal detection does not cause loss but verbal arithmetic does. Another important issue that could potentially be resolved with the Reitman procedure concerns the transfer of information from the short-term to the long-term store: Does transfer occur only at initial presentation and at subsequent rehearsals, or does it occur throughout the pe-

ONE-ITEM REHEARSAL SCHEME

SERIAL POSITION	ITEM PRESENTED	ITEMS REHEARSED	TOTAL REHEARSALS PER ITEM
1	A	AAA	3
2	B	BBB	3
3	C	CCC	3
4	D	DDD	3
5	E	EEE	3
6	F	FFF	3
.	.	.	.
.	.	.	.
14	N	NNN	3
15	O	OOO	3
16	P	PPP	3

THREE-ITEM REHEARSAL SCHEME

SERIAL POSITION	ITEM PRESENTED	ITEMS REHEARSED	TOTAL REHEARSALS PER ITEM
1	A	AAA	5
2	B	BBA	4
3	C	CBA	3
4	D	DCB	3
5	E	EDC	3
6	F	FED	3
.	.	.	.
.	.	.	.
14	N	NML	3
15	O	ONM	2
16	P	PON	1

NUMBER OF REHEARSALS is controlled with two schemes. In one (*top*) only the current item is rehearsed and all items have three rehearsals. In the other (*bottom*) the latest three items are rehearsed; early ones have extra rehearsals. (Letters represent words.)

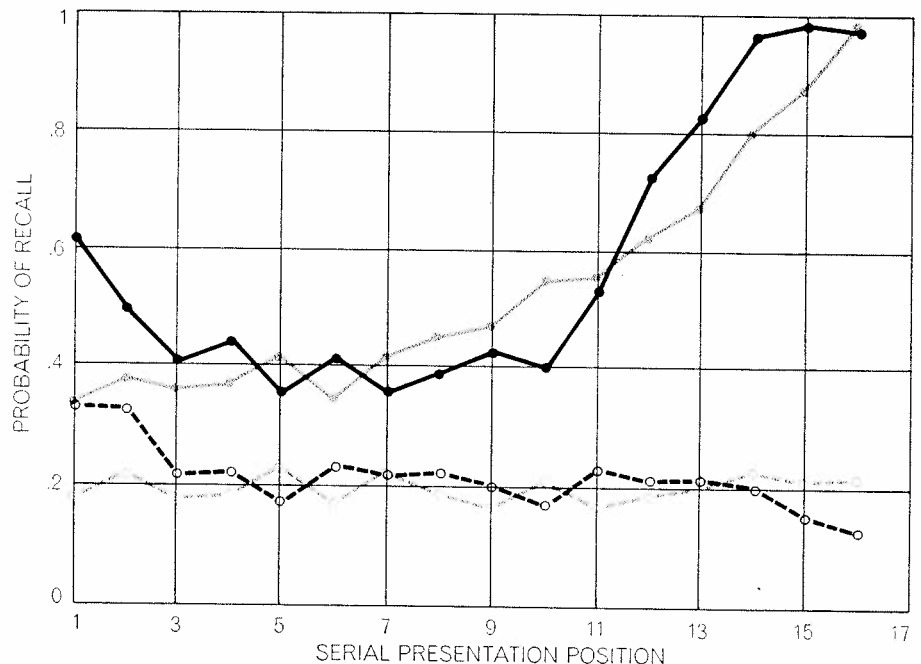

PRIMACY EFFECT disappears with one-item rehearsal (*color*), in which all items have equal rehearsal, but remains with three-item rehearsal (*black*). Recency effect is pronounced for both schemes in immediate recall (*solid lines*). Curves for delayed recall (*broken lines*), which reflect only retrieval from long-term storage, parallel the number of rehearsals.

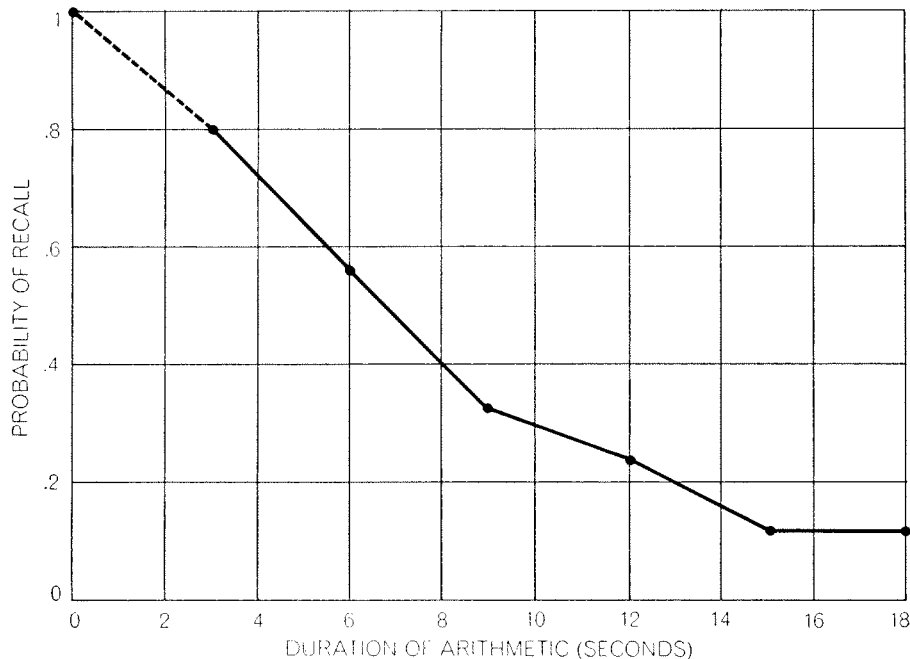

ARITHMETIC TASK before recall reduces the probability of recall. Lloyd R. Peterson and Margaret Peterson charted recall probability against duration of arithmetic. The probability falls off with duration until it levels off when recall reflects retrieval from long-term storage alone. Does curve reflect only lack of rehearsal or also nature of intervening task?

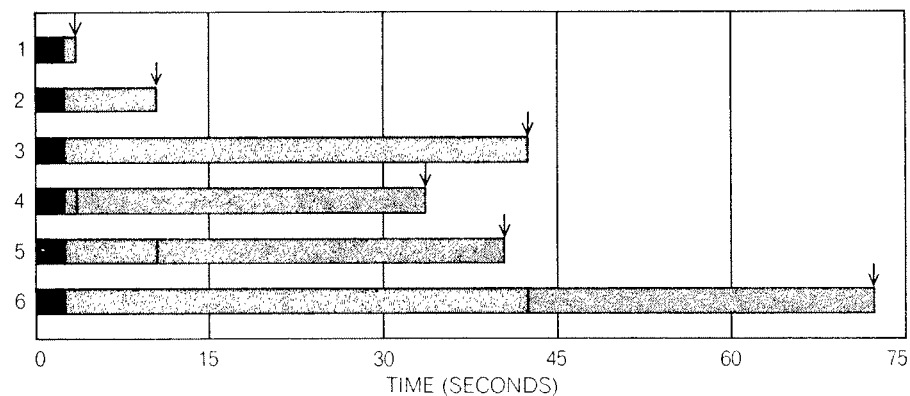

TWO TASKS were combined in an experiment with these six conditions. Five consonants were presented for 2.5 seconds (dark gray), followed by a signal-detection task for one second, eight seconds or 40 seconds (color), followed in three cases by arithmetic (light gray). Then came the test (arrows). Rehearsal during detection was included in a control version.

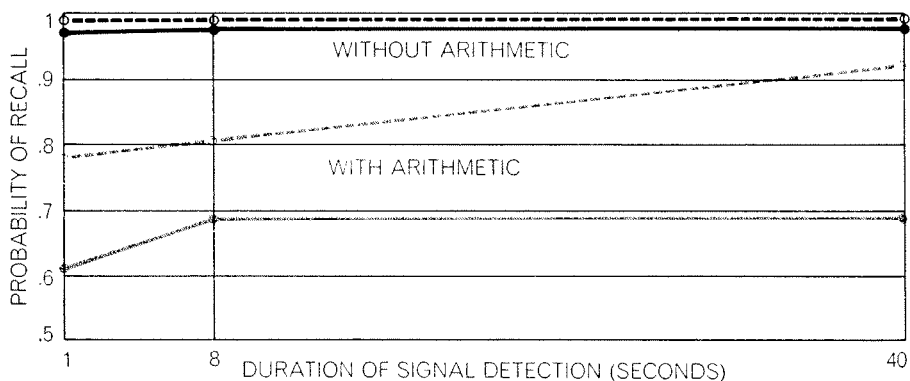

NATURE OF TASKS is seen to have an effect. In the absence of arithmetic, signal detection leaves the short-term store virtually unaffected, with rehearsal (broken black curve) or without (solid black). Arithmetic, however, causes loss from the short-term store (color); decreased recall shown reflects retrieval from long-term store only. Retrieval improves with duration of signal detection if there is rehearsal, which increases transfer to the long-term store (broken colored curve) but not in the absence of rehearsal (solid color).

riod during which the information resides in the short-term store, regardless of rehearsals?

To answer these questions, the following experiment was carried out. A consonant pentagram (a set of five consonants, such as *QJXFK*) was presented for 2.5 seconds for the subject to memorize. This was followed by a signal-detection task in which pure tones were presented at random intervals against a continuous background of white noise. The subjects pressed a key whenever they thought they detected a tone. (The task proved to be difficult; only about three-fourths of the tones presented were correctly detected.) The signal-detection period lasted for either one second, eight seconds or 40 seconds, with tones sounded on the average every 2.5 seconds. In conditions 1, 2 and 3 the subjects were tested on the consonant pentagram immediately after the signal detection; in conditions 4, 5 and 6, however, they were required to carry out 30 seconds of difficult arithmetic following the signal detection before being tested [see middle illustration at left]. In order to increase the likelihood that rehearsal would not occur, we paid the subjects for performing well on signal detection and for doing their arithmetic accurately but not for their success in remembering letters. In addition they were instructed not to rehearse letters during signal detection or arithmetic. They reported afterward that they were not consciously aware of rehearsing. Because the question of rehearsal is quite important, we nevertheless went on to do an additional control experiment in which all the same conditions applied but the subjects were told to rehearse the pentagram aloud following each detection of a tone.

The results indicate that arithmetic causes the pentagram information to be lost from the short-term store but that in the absence of the arithmetic the signal-detection task alone causes no loss [see bottom illustration at left]. What then does produce forgetting from the short-term store? It is not just the analysis of any information input, since signal detection is a difficult information-processing task but causes no forgetting. And time alone causes no noticeable forgetting. Yet verbal information (arithmetic) does cause a large loss. Mrs. Reitman's conclusion appears to be correct: forgetting is caused by the entry into the short-term store of other, similar information.

What about the effect of rehearsal? In the arithmetic situation performance improves if subjects rehearse overtly

during the signal-detection period. Presumably the rehearsal transfers information about the pentagram to the long-term store; the additional transfer during the long signal-detection period is reflected in the retrieval scores, and the rehearsal curve rises. The no-rehearsal curve is horizontal over the last 32 seconds of signal detection, however, confirming that no rehearsal was occurring during that period. The fact that the lowest curve is flat over the last 32 seconds has important implications for transfer from the short-term store to the long-term. It indicates that essentially no transfer occurred during this period even though, as the results in the absence of arithmetic show, the trace remained in the short-term store. Hence the presence of a trace in the short-term store is alone not enough to result in transfer to the long-term store. Apparently transfer to the long-term system occurs primarily during or shortly after rehearsals. (The rise in the lowest curve over the first eight seconds may indicate that the transfer effects of a presentation or rehearsal take at least a few seconds to reach completion.)

The emphasis we have given to rote rehearsal should not imply that other control processes are of lesser importance. Although much evidence indicates that transfer from short-term storage to long-term is strongly dependent on rehearsals, effective later retrieval from long-term storage can be shown to be highly dependent on the type of information rehearsed. Coding is really the choosing of particular information to be rehearsed in the short-term store. In general, coding strategies consist in adding appropriately chosen information from long-term storage to a trace to be remembered and then rehearsing the entire complex in the short-term store. Suppose you are given (as is typical in memory experiments) the stimulus-response pair *HRM-4*; later *HRM* will be presented alone and you will be expected to respond "4." If you simply rehearse *HRM-4* several times, your ability to respond correctly later will probably not be high. Suppose, however, *HRM* reminds you of "homeroom" and you think of various aspects of your fourth-grade classroom. Your retrieval performance will be greatly enhanced. Why? First of all, the amount and range of information stored appears to be greater with coding than with rote rehearsal. Moreover, the coding operation provides a straightforward means by which you can gain access to an appropriate and small region of memory

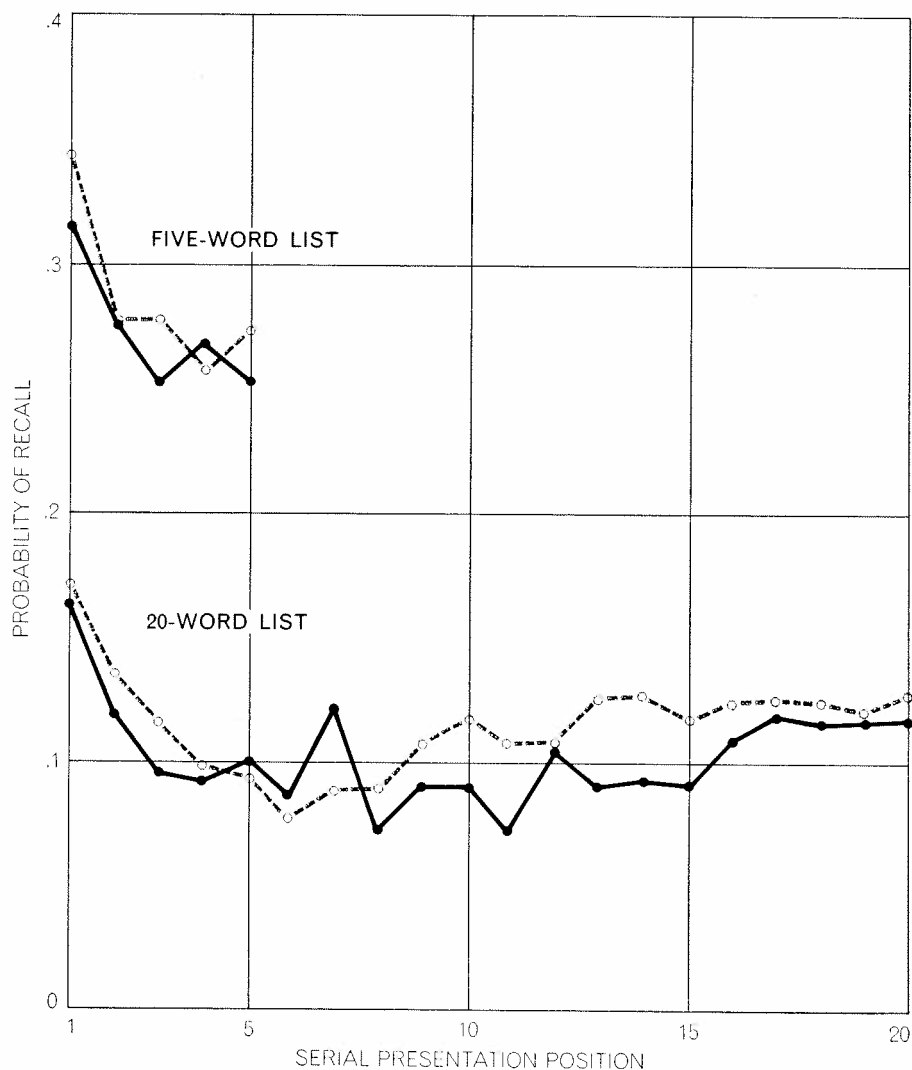

LENGTH OF LIST rather than amount of "interference" governs recall probability. Subjects were asked to recall the list before the one just studied. Five-word lists (*top*) were recalled better than 20-word lists (*bottom*) whether they were followed by intervening lists of five words (*black*) or of 20 words (*color*). The data are averages from three experiments.

during retrieval. In the above example, when *HRM* is presented at the moment of test, you are likely to notice, just as during the initial presentation, that *IIRM* is similar to "homeroom." You can then use "homeroom" (and the current temporal context) as a further probe and would almost certainly access "fourth grade" and so generate the correct response.

As the discussion of coding suggests, the key to retrieval is the selection of probe information that will activate an appropriate search set from the long-term store. Since in our view the long-term store is a relatively permanent repository, forgetting is assumed to result from an inadequate selection of probe information and a consequent failure of the retrieval process. There are two basic ways in which the probe selection

may prove inadequate. First, the wrong probe may be selected. For instance, you might be asked to name the star of a particular motion picture. The name actually begins with *T* but you decide that it begins with *A* and include *A* in the probe information used to access the long-term store. As a result the correct name may not be included in the search set that is drawn into the short-term store and retrieval will not succeed.

Second, if the probe is such that an extremely large region of memory is accessed, then retrieval may fail even though the desired trace is included in the search set. For example, if you are asked to name a fruit that sounds like a word meaning "to look at," you might say "pear." If you are asked to name a living thing that sounds like a word meaning "to look at," the probability of your coming up with "pear" will be

greatly reduced. Again, you are more likely to remember a "John Smith" if you met him at a party with five other people than if there had been 20 people at the party. This effect can be explained on grounds other than a failure of memory search, however. It could be argued that more attention was given to "John Smith" at the smaller party. Or if the permanence of long-term storage is not accepted, it could be argued that the names of the many other people met at the larger party erode or destroy the memory trace for "John Smith." Are these objections reasonable? The John Smith example is analogous to the situation in free recall where words in long lists are less well recalled from long-term storage than words in short lists.

The problem, then, is to show that the list-length effect in free recall is dependent on the choice of probe information rather than on either the number of words intervening between presentation and recall or the differential storage given words in lists of different size. The second issue is disposed of rather easily: in many free-recall experiments that vary list length, the subjects do not know at the beginning of the list what the length of the list will be. It is therefore unlikely that they store different amounts of information for the first several words in lists of differing length. Nevertheless, as we pointed out, the first several words are recalled at different levels.

To dispose of the "interference" explanation, which implicates the number of words between presentation and recall, is more difficult. Until fairly recently, as a matter of fact, interference theories of forgetting have been predominant [see "Forgetting," by Benton J. Underwood, *SCIENTIFIC AMERICAN*, March, 1964, and "The Interference Theory of Forgetting," by John Ceraso, October, 1967]. In these theories forgetting has often been seen as a matter of erosion of the memory trace, usually by items presented following the item to be remembered but also by items preceding the item to be remembered. (The list-length effect might be explained in these terms, since the average item in a long list is preceded and followed by more items than the average item in a short list.) On the other hand, the retrieval model presented in this article assumes long-term storage to be permanent; it maintains that the strength of long-term traces is independent of list length and that forgetting results from the fact that the temporal-contextual probe cues used to access any given list tend to elicit a larger search set for longer lists, thereby producing less efficient retrieval.

In order to distinguish between the retrieval and the interference explanations, we presented lists of varying lengths and had the subject attempt to recall not the list just studied (as in the typical free-recall procedure) but the list before the last. This procedure makes it possible to separate the effect of the size of the list being recalled from the effect of the number of words intervening between presentation and recall. A large or a small list to be recalled can be followed by either a large or a small intervening list. The retrieval model predicts that recall probability will be dependent on the size of the list being recalled. The interference model predicts that performance will be largely determined by the number of words in the intervening list.

We used lists of five and of 20 words and presented them in four combinations: 5-5, 5-20, 20-5, 20-20; the first number gives the size of the list being recalled and the second number the size of the intervening list. One result is that there is no recency effect [see *illustration on preceding page*]. This would be expected since there is another list and another recall intervening between presentation and recall; the intervening activity causes the words in the tested list to be lost from short-term storage and so the curves represent retrieval from long-term storage only. The significant finding is that words in lists five words long are recalled much better than words in lists 20 words long, and the length of the intervening list has little, if any, effect. The retrieval model can predict these results only if a probe is available to access the requested list. It seems likely in this experiment that the subject has available at test appropriate cues (probably temporal in nature) to enable him to select probe information pertaining to the desired list. If the experimental procedure were changed so that the subject was asked to recall the 10th preceding list, then selection of an adequate probe would no longer be possible. The results demonstrate the importance of probe selection, a control process of the short-term store.

The model of memory we have described, which integrates the system around the operations of the short-term store, is not in any sense a final theory. As experimental techniques and mathematical models have become increasingly sophisticated, memory theory has undergone progressive changes, and there is no doubt that this trend will continue. We nevertheless think it is likely that the short-term store and its control processes will be found to be central.

HUMAN MEMORY: A PROPOSED SYSTEM AND ITS CONTROL PROCESSES¹

R. C. Atkinson and R. M. Shiffrin

STANFORD UNIVERSITY
STANFORD, CALIFORNIA

I. Introduction.....	90
II. Structural Features of the Memory System.....	92
A. Sensory Register.....	94
B. Short-Term Store.....	96
C. Long-Term Store.....	103
III. Control Processes in Memory.....	106
A. Control Processes in the Sensory Register.....	107
B. Control Processes in Short-Term Store.....	108
C. Control Processes in Long-Term Store.....	117
IV. Experiments Concerned with Short-Term Processes.....	123
A. A Continuous Paired-Associate Memory Task (Experiment 1).....	123
B. The "All-Different" Stimulus Procedure (Experiment 2).....	135
C. A Continuous Paired-Associate Memory Task with Multiple Reinforcements (Experiment 3).....	141
D. Overt versus Covert Study Procedures (Experiment 4).....	153
E. Additional Variables Related to the Rehearsal Buffer (Experiments 5, 6, and 7).....	158
V. Experiments Concerned with Long-Term Search and Retrieval.....	164
A. A Serial Display Procedure Involving Single Tests (Experiment 8).....	165
B. Free-Verbal Recall Experiments.....	174
C. Further Considerations Involving LTS.....	183
VI. Concluding Remarks.....	190
References.....	191

¹This research was supported by the National Aeronautics and Space Administration, Grant No. NGR-05-020-036. The authors are indebted to W. K. Estes and G. H. Bower who provided many valuable suggestions and comments at various stages of the work. Special credit is due J. W. Brelsford who was instrumental in carrying out the research discussed in Section IV and whose overall contributions are too numerous to report in detail. We should also like to thank those co-workers who carried out a number of the experiments discussed in the latter half of the paper; rather than list them here, each will be acknowledged at the appropriate place.

I. Introduction

This paper is divided into two major portions; the first outlines a general theoretical framework in which to view human memory, and the second describes the results of a number of experiments designed to test specific models that can be derived from the overall theory.

The general theoretical framework, set forth in Sections II and III, categorizes the memory system along two major dimensions. One categorization distinguishes permanent, structural features of the system from control processes that can be readily modified or reprogrammed at the will of the subject. Because we feel that this distinction helps clarify a number of results, we will take time to elaborate it at the outset. The permanent features of memory, which will be referred to as the memory structure, include both the physical system and the built-in processes that are unvarying and fixed from one situation to another. Control processes, on the other hand, are selected, constructed, and used at the option of the subject and may vary dramatically from one task to another even though superficially the tasks may appear very similar. The use of a particular control process in a given situation will depend upon such factors as the nature of the instructions, the meaningfulness of the material, and the individual subject's history.

A computer analogy might help illustrate the distinction between memory structure and control processes. If the memory system is viewed as a computer under the direction of a programmer at a remote console, then both the computer hardware and those programs built into the system that cannot be modified by the programmer are analogous to our structural features; those programs and instruction sequences which the programmer can write at his console and which determine the operation of the computer, are analogous to our control processes. In the sense that the computer's method of processing a given batch of data depends on the operating program, so the way a stimulus input is processed depends on the particular control processes the subject brings into play. The structural components include the basic memory stores; examples of control processes are coding procedures, rehearsal operations, and search strategies.

Our second categorization divides memory into three structural components: the sensory register, the short-term store, and the long-term store. Incoming sensory information first enters the sensory register, where it resides for a very brief period of time, then decays and is lost. The short-term store is the subject's working memory; it receives selected inputs from the sensory register and also from long-term store. Information in the short-term store decays completely and is lost within a period of about 30 seconds, but a control process called rehearsal can

maintain a limited amount of information in this store as long as the subject desires. The long-term store is a fairly permanent repository for information, information which is transferred from the short-term store. Note that "transfer" is not meant to imply that information is removed from one store and placed in the next; we use transfer to mean the copying of selected information from one store into the next without removing this information from the original store.

In presenting our theoretical framework we will consider first the structural features of the system (Section II) and then some of the more generally used control processes (Section III). In both of these sections the discussion is organized first around the sensory register, then the short-term store, and finally the long-term store. Thus, the outline of Sections II and III can be represented as follows:

	Sensory register	Short-term store	Long-term store
Structure	Sec. II,A	Sec. II,B	Sec. II,C
Control processes	Sec. III,A	Sec. III,B	Sec. III,C

These first sections of the paper do not present a finished theory; instead they set forth a general framework within which specific models can be formulated. We attempt to demonstrate that a large number of results may be handled parsimoniously within this framework, even without coming to final decisions at many of the choice points that occur. At some of the choice points several hypotheses will be presented, and the evidence that is available to help make the choice will be reviewed. The primary goal of Sections II and III is to justify our theoretical framework and to demonstrate that it is a useful way of viewing a wide variety of memory phenomena.

The remaining sections of the paper present a number of precise models that satisfy the conditions imposed by our general theoretical framework. These sections also present data from a series of experiments designed to evaluate the models. Section IV is concerned with an analysis of short-term memory; the model used to analyze the data emphasizes a control process based in the short-term store which we designate a rehearsal buffer. Section V presents several experiments that shed some light upon processes in the long-term store, especially subject-controlled search processes. Some of the experiments in Sections IV and V have been reported by us and our co-workers in previous publications, but the earlier treatments were primarily mathematical whereas the present emphasis is upon discussion and overall synthesis.

If the reader is willing to accept our overall framework on a provisional

basis and wishes to proceed at once to the specific models and experiments, then he may begin with Section IV and as a prerequisite need only read that portion of Section III,B concerned with the rehearsal buffer.

II. Structural Features of the Memory System

This section of the paper will describe the permanent, structural features of the memory system. The basic structural division is into the three components diagrammed in Fig. 1: the sensory register, the short-term store, and the long-term store.

When a stimulus is presented there is an immediate registration of that stimulus within the appropriate sensory dimensions. The form of this registration is fairly well understood in the case of the visual system (Sperling, 1960); in fact, the particular features of visual registration (including a several hundred millisecond decay of an initially accurate visual image) allow us positively to identify this system as a distinct component of memory. It is obvious that incoming information in other sense modalities also receives an initial registration, but it is not clear whether these other registrations have an appreciable decay period or any other features which would enable us to refer to them as components of memory.

The second basic component of our system is the short-term store. This store may be regarded as the subject's "working memory." Information entering the short-term store is assumed to decay and disappear completely, but the time required for the information to be lost is considerably longer than for the sensory register. The character of the information in the short-term store does not depend necessarily upon the form of the sensory input. For example, a word presented visually may be encoded from the visual sensory register into an auditory short-term store. Since the auditory short-term system will play a major role in subsequent discussions, we shall use the abbreviation a-v-l to stand for auditory-verbal-linguistic store. The triple term is used because, as we shall see, it is not easy to separate these three functions.

The exact rate of decay of information in the short-term store is difficult to estimate because it is greatly influenced by subject-controlled processes. In the a-v-l mode, for example, the subject can invoke rehearsal mechanisms that maintain the information in STS and thereby complicate the problem of measuring the structural characteristics of the decay process. However, the available evidence suggests that information represented in the a-v-l mode decays and is lost within a period of about 15-30 seconds. Storage of information in other modalities

is less well understood and, for reasons to be discussed later, it is difficult to assign values to their decay rates.

The last major component of our system is the long-term store. This store differs from the preceding ones in that information stored here does not decay and become lost in the same manner. All information eventually is completely lost from the sensory register and the short-term store,

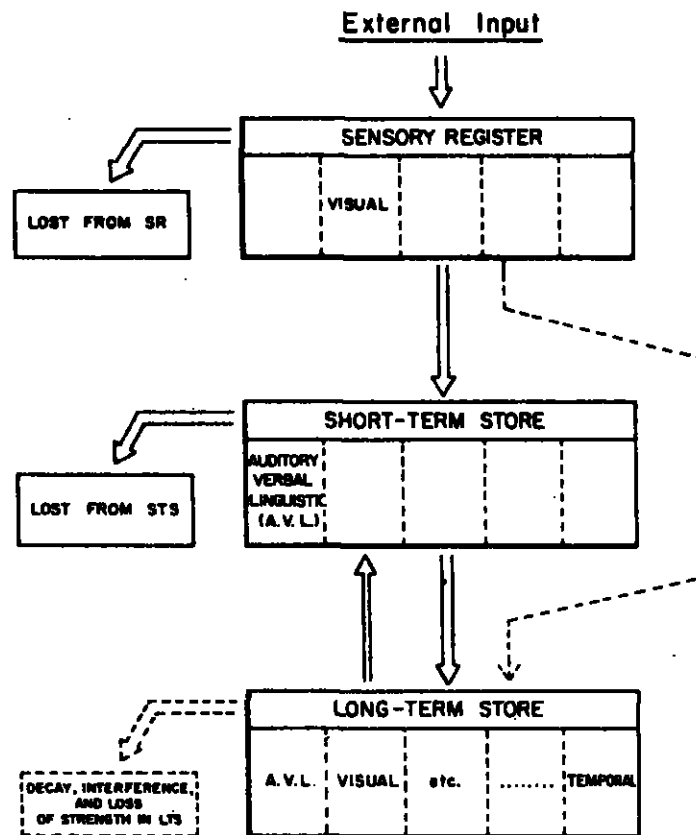

FIG. 1. Structure of the memory system.

whereas information in the long-term store is relatively permanent (although it may be modified or rendered temporarily irretrievable, as the result of other incoming information). Most experiments in the literature dealing with long-term store have been concerned with storage in the a-v-l mode, but it is clear that there is long-term memory in each of the other sensory modalities, as demonstrated by an ability to recognize stimuli presented to these senses. There may even be information

in the long-term store which is not classifiable into any of the sensory modalities, the prime example being temporal memory.

The flow of information among the three systems is to a large degree under the control of the subject. Note that by information flow and transfer between stores we refer to the same process: the copying of selected information from one store into the next. This copying takes place without the transferred information being removed from its original store. The information remains in the store from which it is transferred and decays according to the decay characteristics of that store. In considering information flow in the system, we start with its initial input into the sensory register. The next step is a subject-controlled scan of the information in the register; as a result of this scan and an associated search of long-term store, selected information is introduced into short-term store. We assume that transfer to the long-term store takes place throughout the period that information resides in the short-term store, although the amount and form of the transferred information is markedly influenced by control processes. The possibility that there may be direct transfer to the long-term store from the sensory register is represented by the dashed line in Fig. 1; we do not know whether such transfer occurs. Finally, there is transfer from the long-term store to the short-term store, mostly under the control of the subject; such transfer occurs, for example, in problem solving, hypothesis testing, and "thinking" in general.

This brief encapsulation of the system raises more questions than it answers. Not yet mentioned are such features as the cause of the decay in each memory store and the form of the transfer functions between the stores. In an attempt to specify these aspects of the system, we now turn to a more detailed outline, including a review of some relevant literature.

A. SENSORY REGISTER

The prime example of a sensory register is the short-term visual image investigated by Sperling (1960, 1963), Averbach and Coriell (1961), Estes and Taylor (1964, 1966), and others. As reported by Sperling (1967), if an array of letters is presented tachistoscopically and the subject is instructed to write out as many letters as possible, usually about six letters are reported. Further, a 30-second delay between presentation and report does not cause a decrement in performance. This fact (plus the facts that confusions tend to be based on auditory rather than visual similarities, and that subjects report rehearsing and subvocalizing the letters) indicates that the process being examined is in the a-v-l short-term store; i.e., subjects scan the visual image and transfer a number of letters to the a-v-l short-term store for rehearsal and output.

In order to study the registered visual image itself, partial-report procedures (Averbach & Coriell, 1961; Averbach & Sperling, 1961; Sperling, 1960, 1963) and forced-choice detection procedures (Estes, 1965; Estes & Taylor, 1964, 1966; Estes & Wessel, 1966) have been employed. The partial-report method typically involves presenting a display (usually a 3×4 matrix of letters and numbers) tachistoscopically for a very brief period. After the presentation the subject is given a signal that tells him which row to report. If the signal is given almost immediately after stimulus offset, the requested information is reported with good precision, otherwise considerable loss occurs. Thus we infer that a highly accurate visual image lasts for a short period of time and then decays. It has also been established that succeeding visual stimulation can modify or possibly even erase prior stimulation. By using a number of different methods, the decay period of the image has been estimated to take several hundred milliseconds, or a little more, depending on experimental conditions; that is, information cannot be recovered from this store after a period of several hundred milliseconds.

Using the detection method, in which the subject must report which of two critical letters was presented in a display, Estes and Taylor (1964, 1966) and Estes and Wessel (1966) have examined some models for the scanning process. Although no completely satisfactory models have yet been proposed, it seems reasonably certain that the letters are scanned serially (which letters are scanned seems to be a momentary decision of the subject), and a figure of about 10 msec to scan one letter seems generally satisfactory.

Thus it appears fairly well established that a visual stimulus leaves a more or less photographic trace which decays during a period of several hundred milliseconds and is subject to masking and replacement by succeeding stimulation. Not known at present is the form of the decay, that is, whether letters in a display decay together or individually, probabilistically or temporally, all-or-none, or continuously. The reader may ask whether these results are specific to extremely brief visual presentations; although presentations of long duration complicate analysis (because of eye movements and physical scanning of the stimulus), there is no reason to believe that the basic fact of a highly veridical image quickly decaying after stimulus offset does not hold also for longer visual presentations. It is interesting that the stimulation seems to be transferred from the visual image to the a-v-l short-term store, rather than to a visual short-term store. The fact that a written report was requested may provide the explanation, or it may be that the visual short-term store lacks rehearsal capacity.

There is not much one can say about registers in sensory modalities other than the visual. A fair amount of work has been carried out on the

auditory system without isolating a registration mechanism comparable to the visual one. On the other hand, the widely differing structures of the different sensory systems makes it questionable whether we should expect similar systems for registration.

Before leaving the sensory register, it is worth adding a few comments about the transfer to higher order systems. In the case of the transfer from the visual image to the a-v-l short-term store, it seems likely that a selective scan is made at the discretion of the subject.³ As each element in the register is scanned, a matching program of some sort is carried out against information in long-term store and the verbal "name" of the element is recovered from long-term memory and fed into the short-term store. Other information might also be recovered in the long-term search; for example, if the scanned element was a pineapple, the word, its associates, the taste, smell, and feel of a pineapple might all be recovered and transferred to various short-term stores. This communication between the sensory register and long-term store does not, however, permit us to infer that information is transferred directly to long-term store from the register. Another interesting theoretical question is whether the search into long-term store is necessary to transfer information from the sensory register to the short-term store within a modality. We see no a priori theoretical reason to exclude nonmediated transfer. (For example, why should a scan or match be necessary to transfer a spoken word to the a-v-l short-term store?) For lack of evidence, we leave these matters unspecified.

B. SHORT-TERM STORE

The first point to be examined in this section is the validity of the division of memory into short- and long-term stores. Workers of a traditional bent have argued against dichotomizing memory (e.g., Melton, 1963; Postman, 1964). However, we feel there is much evidence indicating the parsimony and usefulness of such a division. The argument is often given that one memory is somehow "simpler" than two; but quite the opposite is usually the case. A good example may be found in a comparison of the model for free recall presented in this paper and the model proposed by Postman and Phillips (1965). Any single-process system making a fair attempt to explain the mass of data currently available must, of necessity, be sufficiently complex that the term *single process* becomes a misnomer. We do not wish, however, to engage in the controversy here. We ask the reader to accept our model provisionally until its power to deal with data becomes clear. Still, some justification

³ Sperling (1960) has presented evidence relating the type of scan used to the subject's performance level.

of our decision would seem indicated at this point. For this reason, we turn to what is perhaps the single most convincing demonstration of a dichotomy in the memory system: the effects of hippocampal lesions reported by Milner (1959, 1966, 1968). In her words:

"Bilateral surgical lesions in the hippocampal region, on the mesial aspect of the temporal lobes, produce a remarkably severe and persistent memory disorder in human patients, the pattern of breakdown providing valuable clues to the cerebral organization of memory. Patients with these lesions show no loss of pre-operatively acquired skills, and intelligence as measured by formal tests is unimpaired, but, with the possible exception of acquiring motor skill, they seem largely incapable of adding new information to the long-term store. This is true whether acquisition is measured by free recall, recognition, or learning with savings. Nevertheless, the immediate registration of new input (as measured, for example, by digit span and dichotic listening tests) appears to take place normally and material which can be encompassed by verbal rehearsal is held for many minutes without further loss than that entailed in the initial verbalization. Interruption of rehearsal, regardless of the nature of the distracting task, produces immediate forgetting of what went before, and some quite simple material which cannot be categorized in verbal terms decays in 30 seconds or so, even without an interpolated distraction. Material already in long-term store is unaffected by the lesion, except for a certain amount of retrograde amnesia for preoperative events" (Milner, 1966).

Apparently, a short-term store remains to the patients, but the lesions have produced a breakdown either in the ability to store new information in long-term store or to retrieve new information from it. These patients appear to be incapable of retaining new material on a long-term basis.³

As with most clinical research, however, there are several problems that should be considered. First, the patients were in a general sense abnormal to begin with; second, once the memory defect had been discovered, the operations were discontinued, leaving only a few subjects for observation; third, the results of the lesions seem to be somewhat variable, depending for one thing upon the size of the lesion, the larger lesions giving rise to the full syndrome. Thus there are only a few patients who exhibit the deficit described above in full detail. As startling as these patients are, there might be a temptation to discount them as anomalies but for the following additional findings. Patients who had

³ A related defect, called Korsakoff's syndrome, has been known for many years. Patients suffering from this abnormal condition are unable to retain new events for longer than a few seconds or minutes (e.g., they cannot recall the meal they have just eaten or recognize the face of the doctor who treated them a few minutes earlier), but their memory for events and people prior to their illness remains largely unimpaired and they can perform adequately on tests of immediate memory span. Recent evidence suggests that Korsakoff's syndrome is related to damage of brain tissue, frequently as the result of chronic alcoholism, in the hippocampal region and the mammillary body. (Barbizot, 1963).

known damage to the hippocampal area in one hemisphere were tested for memory deficit after an intracarotid injection of sodium amygdal temporarily inactivated the other hemisphere. Controls were patients without known damage, and patients who received injections inactivating their damaged side. A number of memory tests were used as a criterion for memory deficit; the easiest consisted of presenting four pictures, distracting the patient, and then presenting nine pictures containing the original four. If the patient cannot identify the critical four pictures then evidence of memory deficit is assumed. The results showed that in almost all cases memory deficit occurs only after bilateral damage; if side A is damaged and side B inactivated, memory deficit appears, but if the inactivated side is the damaged side, no deficit occurs. These results suggest that the patients described above by Milner were not anomalous cases and their memory deficits therefore give strong support to the hypothesis of distinct short- and long-term memory stores.

1. *Mechanisms Involved in Short-Term Store*

We now turn to a discussion of some of the mechanisms involved in the short-term store. The purpose of this section is not to review the extensive literature on short-term memory, but rather to describe a few experiments which have been important in providing a basis for our model. The first study in this category is that of Peterson and Peterson (1959). In their experiment subjects attempted to recall a single trigram of three consonants after intervals of 3, 6, 9, 12, 15, and 18 seconds. The trigram, presented auditorily, was followed immediately by a number, and the subject was instructed to count backward by three's from that number until he received a cue to recall the trigram. The probability of a correct answer was nearly perfect at 3 seconds, then dropped off rapidly and seemed to reach an asymptote of about .08 at 15-18 seconds. Under the assumption that the arithmetic task played the role of preventing rehearsal and had no direct interfering effect, it may be concluded that a consonant trigram decays from short-term store within a period of about 15 seconds. In terms of the model, the following events are assumed to occur in this situation: the consonant trigram enters the visual register and is at once transferred to the a-v-l short-term store where an attempt is made to code or otherwise "memorize" the item. Such attempts terminate when attention is given to the task of counting backward. In this initial period a trace of some sort is built up in long-term store and it is this long-term trace which accounts for the .08 probability correct at long intervals. Although discussion of the long-term system will come later, one point should be noted in this context; namely, that the long-term trace should be more powerful the more

repetitions of the trigram before arithmetic, or the longer the time before arithmetic. These effects were found by Hellyer (1962); that is, the model predicts the probability correct curve will reach an asymptote that reflects long-term strength, and in the aforementioned experiment, the more repetitions before arithmetic, the higher the asymptote.

It should be noted that these findings tie in nicely with the results from a similar experiment that Milner (1968) carried out on her patients. Stimuli that could not be easily coded verbally were used; for example, clicks, light flashes, and nonsense figures. Five values were assigned to each stimulus; a test consisted of presenting a particular value of one stimulus, followed by a distracting task, followed by another value of the stimulus. The subject was required to state whether the two stimuli were the same or different. The patient with the most complete memory deficit was performing at a chance level after 60 seconds, whether or not a distracting task was given. In terms of the model, the reduction to chance level is due to the lack of a long-term store. That the reduction occurred even without a distracting task indicates that the patient could not readily verbalize the stimuli, and that rehearsal in modes other than the verbal one was either not possible or of no value. From this view, the better asymptotic performance demonstrated by normal subjects on the same tasks (with or without distraction) would be attributed to a long-term trace. At the moment, however, the conclusion that rehearsal is lacking in nonverbal modes can only be considered a highly tentative hypothesis.

We next ask whether or not there are short-term stores other than in the a-v-l mode, and if so, whether they have a comparable structure. A natural approach to this problem would use stimuli in different sense modalities and compare the decay curves found with or without a distracting task. If there was reason to believe that the subjects were not verbally encoding the stimuli, and if a relatively fast decay curve was found, then there would be evidence for a short-term memory in that modality. Furthermore, any difference between the control group and the group with a distracting task should indicate the existence of a rehearsal mechanism. Posner (1966) has undertaken several experiments of this sort. In one experiment the subject saw the position of a circle on a 180-mm line and later had to reproduce it; in another the subject moved a lever in a covered box a certain distance with only kinesthetic feedback and later tried to reproduce it. In both cases, testing was performed at 0, 5, 10, and 20 seconds; the interval was filled with either rest, or one of three intervening tasks of varying difficulty. These tasks, in order of increasing difficulty, consisted of reading numbers, adding numbers, and classifying numbers into categories. For the kinesthetic task there was a decline in performance over 30 seconds,

but with no obvious differences among the different intervening conditions. This could be taken as evidence for a short-term kinesthetic memory without a rehearsal capability. For the visual task, on the other hand, there was a decline in performance over the 30 seconds only for the two most difficult intervening tasks; performance was essentially constant over time for the other conditions. One possibility, difficult to rule out, is that the subjects' performance was based on a verbal encoding of the visual stimulus. Posner tends to doubt this possibility for reasons that include the accuracy of the performance. Another possibility is that there is a short-term visual memory with a rehearsal component; this hypothesis seems somewhat at variance with the results from Milner's patient who performed at chance level in the experiment cited above. Inasmuch as the data reported by Posner (1966) seem to be rather variable, it would probably be best to hold off a decision on the question of rehearsal capability until further evidence is in.

2. Characteristics of the a-v-l Short-Term Store

We restrict ourselves in the remainder of this section to a discussion of the characteristics of the a-v-l short-term store. Work by Conrad (1964) is particularly interesting in this regard. He showed that confusions among visually presented letters in a short-term memory task are correlated with the confusions that subjects make when the same letters are read aloud in a noise background; that is, the letters most confused are those sounding alike. This might suggest an auditory short-term store, essentially the auditory portion of what has been called to this point an a-v-l store. In fact, it is very difficult to separate the verbal and linguistic aspects from the auditory ones. Hintzman (1965, 1967) has argued that the confusions are based upon similar kinesthetic feedback patterns during subvocal rehearsal. When subjects were given white noise on certain trials, several could be heard rehearsing the items aloud, suggesting subvocal rehearsal as the usual process. In addition, Hintzman found that confusions were based upon both the voicing qualities of the letters and the place of articulation. The place-of-articulation errors indicate confusion in kinesthetic feedback, rather than in hearing. Nevertheless, the errors found cannot be definitely assigned to a verbal rather than an auditory cause until the range of auditory confusions is examined more thoroughly. This discussion should make it clear that it is difficult to distinguish between the verbal, auditory, and linguistic aspects of short-term memory; for the purposes of this paper, then, we group the three together into one short-term memory, which we have called the a-v-l short-term store. This store will henceforth be labeled STS. (Restricting the term STS to the a-v-l mode

does not imply that there are not other short-term memories with similar properties.)

The notation system should be made clear at this point. As just noted, STS refers to the auditory-verbal-linguistic short-term store. LTS will refer to the comparable memory in long-term store. It is important not to confuse our theoretical constructs STS and LTS (or the more general terms short-term store and long-term store) with the terms short-term memory (STM) and long-term memory (LTM) used in much of the psychological literature. These latter terms have come to take on an operational definition in the literature; STM refers to the memory examined in experiments with short durations or single trials, and LTM to the memory examined in long-duration experiments, typically list learning, or multiple-list learning experiments. According to our general theory, both STS and LTS are active in both STM and LTM experiments. It is important to keep these terms clear lest confusion results. For example, the Keppel and Underwood (1962) finding that performance in the Peterson situation is better on the first trials of a session has been appropriately interpreted as evidence for proactive interference in short-term memory (STM). The model we propose, however, attributes the effect to changes in the long-term store over the session, hence placing the cause in LTS and not STS.

At this point a finished model would set forth the structural characteristics of STS. Unfortunately, despite a large and growing body of experiments concerned with short-term memory, our knowledge about its structure is very limited. Control processes and structural features are so complexly interrelated that it is difficult to isolate those aspects of the data that are due solely to the structure of the memory system. Consequently, this paper presumes only a minimal structure for STS; we assume a trace in STS with auditory or verbal components which decays fairly rapidly in the absence of rehearsal, perhaps within 30 seconds. A few of the more promising possibilities concerning the precise nature of the trace will be considered next. Because most workers in this area make no particular distinction between traces in the two systems, the comments to follow are relevant to the memory trace in the long-term as well as the short-term store.

Bower (1967a) has made a significant exploration of the nature of the trace. In his paper, he has demonstrated the usefulness of models based on the assumption that the memory trace consists of a number of pieces of information (possibly redundant, correlated, or in error, as the case may be), and that the information ensemble may be construed as a multicomponent vector. While Bower makes a strong case for such a viewpoint, the details are too lengthy to review here. A somewhat different approach has been proposed by Wickelgron and Norman (1966)

who view the trace as a unidimensional strength measure varying over time. They demonstrate that such a model fits the results of certain types of recognition-memory experiments if the appropriate decay and retrieval assumptions are made. A third approach is based upon a phenomenon reported by Murdock (1966), which has been given a theoretical analysis by Bernbach (1967). Using methods derived from the theory of signal detectability, Bernbach found that there was an all-or-none aspect to the confidence ratings that subjects gave regarding the correctness of their response. The confidence ratings indicated that an answer was either "correct" or "in error" as far as the subject could tell; if intermediate trace strengths existed, the subject was not able to distinguish between them. The locus of this all-or-none feature, however, may lie in the retrieval process rather than in the trace; that is, even if trace strengths vary, the result of a retrieval attempt might always be one of two distinct outcomes: a success or a failure. Thus, one cannot rule out models that assume varying trace strengths. Our preference is to consider the trace as a multicomponent array of information (which we shall often represent in experimental models by a unidimensional strength measure), and reserve judgment on the locus of the all-or-none aspect revealed by an analysis of confidence ratings.

There are two experimental procedures which might be expected to shed some light on the decay characteristics of STS and both depend upon controlling rehearsal; one is similar to the Peterson paradigm in which rehearsal is controlled by an intervening activity and the other involves a very rapid presentation of items followed by an immediate test. An example of the former procedure is Posner's (1966) experiment in which the difficulty of the intervening activity was varied. He found that as the difficulty of an intervening task increased, accuracy of recall decreased.

Although this result might be regarded as evidence that decay from STS is affected by the kind of intervening activity, an alternative hypothesis would ascribe the result to a reduction in rehearsal with more difficult intervening tasks. It would be desirable to measure STS decay when rehearsal is completely eliminated, but it has proved difficult to establish how much rehearsal takes place during various intervening tasks.

Similar problems arise when attempts are made to control rehearsal by increasing presentation rates. Even at the fastest conceivable presentation rates subjects can rehearse during presentation if they attend to only a portion of the incoming items. In general, experiments manipulating presentation rate have not proved of value in determining decay characteristics for STS, primarily because of the control processes the subject brings into play. Thus Waugh and Norman (1965) found no

difference between 1-second and 4-second rates in their probe digit experiment; Conrad and Hille (1958) found improvement with faster rates; and Buschke and Lim (1967) found increases in the amount of primacy in their missing-span serial position curves as input rate increased from one item per second to four items per second. Complex results of this sort make it difficult to determine the structural decay characteristics of STS. Eventually, models that include the control processes involved in these situations should help clarify the STS structure.

3. *Transfer from STS to LTS*

The amount and form of information transferred from STS to LTS is primarily a function of control processes. We will assume, however, that transfer itself is an unvarying feature of the system; throughout the period that information resides in the short-term store, transfer takes place to long-term store. Support for such an assumption is given by studies on incidental learning which indicate that learning takes place even when the subject is not trying to store material in the long-term store. Better examples may be the experiments reported by Hebb (1961) and Melton (1963). In these experiments subjects had to repeat sequences of digits. If a particular sequence was presented every several trials, it was gradually learned. It may be assumed that subjects in this situation attempt to perform solely by rehearsal of the sequence within STS; nevertheless, transfer to LTS clearly takes place. This Hebb-Melton procedure is currently being used to explore transfer characteristics in some detail. R. L. Cohen and Johansson (1967), for example, have found that an overt response to the repeated sequence was necessary for improvement in performance to occur in this situation; thus information transfer is accentuated by overt responses and appears to be quite weak if no response is demanded.

The form of the STS-LTS transfer may be probabilistic, continuous, or some combination; neither the literature nor our own data provide a firm basis for making a decision. Often the form of the information to be remembered and the type of test used may dictate a particular transfer process, as for example in Bower's (1961) research on an all-or-none paired-associate learning model, but the issue is nevertheless far from settled. In fact, the changes in the transfer process induced by the subject effectively alter the transfer function form experiment to experiment, making a search for a universal, unchanging process unproductive.

C. LONG-TERM STORE

Because it is easiest to test for recall in the a-v-l mode, this part of long-term store has been the most extensively studied. It is clear, how-

ever, that long-term memory exists in each of the sensory modalities; this is shown by subjects' recognition capability for smells, taste, and so on. Other long-term information may be stored which is not necessarily related to any of the sensory modalities. Yntema and Trask (1963), for example, have proposed that temporal memory is stored in the form of "time-tags." Once again, however, lack of data forces us to restrict our attention primarily to the a-v-l mode, which we have designated LTS.

First a number of possible formulations of the LTS trace will be considered. The simplest hypothesis is to assume that the trace is all-or-none; if a trace is placed in memory, then a correct retrieval and response will occur. Second-guessing experiments provide evidence concerning an hypothesis of this sort.

Binford and Gettys (1965) presented the subject with a number of alternatives, one of which was the correct answer. If his first response is incorrect, he picks again from the remaining alternatives. The results indicate that second guesses are correct well above the chance level to be expected if the subject were guessing randomly from the remaining alternatives. This result rules out the simple trace model described above because an all-or-none trace would predict second guesses to be at the chance level. Actually, the above model was a model of both the form of the trace and the type of retrieval. We can expand the retrieval hypothesis and still leave open the possibility of an all-or-none trace. For example, in searching for a correct all-or-none trace in LTS, the subject might find a similar but different trace and mistakenly terminate the search and generate an answer; upon being told that the answer is wrong the subject renews the search and may find the correct trace the next time. Given this hypothesis, it would be instructive to know whether the results differ if the subject must rank the response alternatives without being given feedback after each choice. In this case all the alternatives would be ranked on the basis of the same search of LTS; if the response ranked second was still above chance, then it would become difficult to defend an all-or-none trace.

A second source of information about the nature of the trace comes from the tip-of-the-tongue phenomenon examined by Hart (1965), R. Brown and McNeill (1966), and Freedman and Landauer (1966). This phenomenon refers to a person's ability to predict accurately that he will be able to recognize a correct answer even though he cannot recall it at the moment. He feels as if the correct answer were on the "tip of the tongue." Experiments have shown that if subjects who cannot recall an answer are asked to estimate whether they will be able to choose the correct answer from a set of alternatives, they often show good accuracy in predicting their success in recognition. One explanation might be that the subject recalls some information, but not enough to generate an

answer and feels that this partial information is likely to be sufficient to choose among a set of alternatives. Indeed, Brown and McNeill found that the initial sound of the word to be retrieved was often correctly recalled in cases where a correct identification was later made. On the other hand, the subject often is absolutely certain upon seeing the correct response that it is indeed correct. This might indicate that some new, relevant information has become available after recognition. In any case, a simple trace model can probably not handle these results. A class of models for the trace which can explain the tip-of-the-tongue phenomenon are the multiple-copy models suggested by Atkinson and Shiffrin (1965). In these schemes there are many traces or copies of information laid in long-term store, each of which may be either partial or complete. In a particular search of LTS perhaps only a small number or just one of these copies is retrieved, none complete enough to generate the correct answer; upon recognition, however, access is gained to the other copies, presumably through some associative process. Some of these other copies contain enough information to make the subject certain of his choice. These multiple-copy memory models are described more fully in Atkinson and Shiffrin (1965).

The decay and/or interference characteristics of LTS have been studied more intensively over the past 50 years than any other aspect of memory. Partly for this reason a considerable body of theory has been advanced known as interference theory.⁴ We tend to regard this theory as descriptive rather than explanatory; this statement is not meant to detract from the value of the theory as a whole, but to indicate that a search for mechanisms at a deeper level might prove to be of value. Thus, for example, if the interfering effect of a previously learned list upon recall of a second list increases over time until the second list is retested, it is not enough to accept "proactive interference increasing over time" as an explanation of the effect; rather one should look for the underlying search, storage, and retrieval mechanisms responsible.

We are going to use a very restricted definition of interference in the rest of this paper; interference will be considered a structural feature of memory not under the control of the subject. It will refer to such possibilities as disruption and loss of information. On the other hand, there are search mechanisms which generate effects like those of structural interference, but which are control processes. Interference theory, of course, includes both types of possibilities, but we prefer to break down interference effects into those which are structurally based, and those under the control of the subject. Therefore the term *interference* is used henceforth to designate a structural feature of the long-term system.

⁴ For an overview of interference theory see Postman (1961).

It is important to realize that often it is possible to explain a given phenomenon with either interference or search notions. Although both factors will usually be present, the experimental situation sometimes indicates which is more important. For example, as we shall see in Section V, the decrease in the percentage of words recalled in a free verbal-recall experiment with increases in list length could be due either to interference between items or to a search of decreasing effectiveness as the number of items increase. The typical free recall situation, however, forces the subject to engage in a search of memory at test and indicates to us that the search process is the major factor. Finally, note that the interference effect itself may take many forms and arise in a number of ways. Information within a trace may be destroyed, replaced, or lessened in value by subsequent information. Alternatively, information may never be destroyed but may become irretrievable, temporarily or permanently.

In this section an attempt has been made to establish a reasonable basis for at least three systems—the sensory register, the short-term store, and the long-term store; to indicate the transfer characteristics between the various stores; and to consider possible decay and interference functions within each store.

III. Control Processes in Memory

The term *control process* refers to those processes that are not permanent features of memory, but are instead transient phenomena under the control of the subject; their appearance depends on such factors as instructional set, the experimental task, and the past history of the subject. A simple example of a control process can be demonstrated in a paired-associate learning task involving a list of stimuli each paired with either an A or B response (Bower, 1961). The subject may try to learn each stimulus-response pair as a separate, integral unit or he may adopt the more efficient strategy of answering B to any item not remembered and attempting to remember only the stimuli paired with the A response. This latter scheme will yield a radically different pattern of performance than the former; it exemplifies one rather limited control process. The various rehearsal strategies, on the other hand, are examples of control processes with almost universal applicability.

Since subject-controlled memory processes include any schemes, coding techniques, or mnemonics used by the subject in his effort to remember, their variety is virtually unlimited and classification becomes difficult. Such classification as is possible arises because these processes, while under the voluntary control of the subject, are nevertheless dependent upon the permanent memory structures described in the

previous section. This section therefore will follow the format of Section II, organizing the control processes into those primarily associated with the sensory register, SRS, and LTS. Apart from this, the presentation will be somewhat fragmentary, drawing upon examples from many disparate experiments in an attempt to emphasize the variety, pervasiveness, and importance of the subject-controlled processes.

A. CONTROL PROCESSES IN THE SENSORY REGISTER

Because a large amount of information enters the sensory register and then decays very quickly, the primary function of control processes at this level is the selection of particular portions of this information for transfer to the short-term store. The first decision the subject must make concerns which sensory register to attend to. Thus, in experiments with simultaneous inputs from several sensory channels, the subject can readily report information from a given sense modality if so instructed in advance, but his accuracy is greatly reduced if instructions are delayed until after presentation. A related attention process is the transfer to SRS of a selected portion of a large information display within a sensory modality. An example to keep in mind here is the scanning process in the visual registration system. Letters in a tachistoscopically presented display may be scanned at a rate of about 10 msec a letter, the form of the scan being under the control of the subject. Sperling (1960) found the following result. When the signal identifying which row to report from a matrix of letters was delayed for an interval of time following stimulus offset, the subjects developed two observing strategies. One strategy consisted of obeying the experimenter's instructions to pay equal attention to all rows; this strategy resulted in evenly distributed errors and quite poor performance at long delays. The other strategy consisted of anticipating which row would be tested and attending to only that row; in this case the error variance is increased but performance is better at longer delay intervals than for the other strategy. The subjects were aware of and reported using these strategies. For example, one experienced subject reported switching from the first to the second strategy in an effort to maximize performance when the delay between presentation and report rose above .15 seconds. The graph of his probability of a correct response plotted against delay interval, while generally decreasing with delay, showed a dip at about .15 seconds, indicating that he did not switch strategies soon enough for optimal performance.

The decisions as to which sensory register to attend to, and where and what to scan within the system, are not the only choices that must be made at this level. There are a number of strategies available to the subject for matching information in the register against the long-term

store and thereby identifying the input. In an experiment by Estes and Taylor (1966) for example, the subject had to decide whether an F or B was embedded in a matrix display of letters. One strategy would have the subject scan the letters in order, generating the "name" of each letter and checking to see whether it is a B or an F. If the scan ends before all letters are processed, and no B or F has been found, the subject would presumably guess according to some bias. Another strategy might have the subject do a features match on each letter against B and then F, moving on as soon as a difference is found; in this strategy it would not be necessary to scan all features of each letter (i.e., it would not be necessary to generate the name of each letter). A third strategy might have the subject compare with only one of the crucial letters, guessing the other if a match is not found by the time the scan terminates.

B. CONTROL PROCESSES IN SHORT-TERM STORE

1. *Storage, Search, and Retrieval Strategies*

Search processes in STS, while not as elaborate as those in LTS because of the smaller amount of information in STS through which the search must take place, are nevertheless important. Since information in STS in excess of the rehearsal capability is decaying at a rapid rate, a search for a particular datum must be performed quickly and efficiently. One indirect method of examining the search process consists of comparing the results of recognition and recall experiments in which STS plays the major role. Presumably there is a search component in the recall situation that is absent in the recognition situation. It is difficult to come to strong conclusions on this basis, but recognition studies such as Wickelgren and Norman (1966) have usually given rise to less complicated models than comparable recall experiments, indicating that the search component in STS might be playing a large role.

One result indicating that the STS search occurs along ordered dimensions is based upon binaural stimulus presentation (Broadbent, 1954, 1956, 1958). A pair of items is presented, one to each ear simultaneously. Three such pairs are given, one every half second. Subjects perform best if asked to report the items first from one ear and then the other, rather than, say, in pairs. While Broadbent interprets these results in terms of a postulated time needed to switch attention from one ear to the other (a control process in itself), other interpretations are possible. In particular, part of the information stored with each item might include which ear was used for input. This information might then provide a simple dimension along which to search STS and report during recall. Another related possibility would have the subject group the

items along this dimension during presentation. In any case we would expect similar results if another dimension other than "sides" (which ear) were provided. Yntema and Trask (1963) used three word-number pairs presented sequentially, one every half second; one member of a pair was presented to one ear and the other member to the other ear. There were three conditions: the first in which three words were presented consecutively on one side (and therefore the three numbers on the other), the second in which two words and one number were presented consecutively on one side, the third in which a number separated the two words on one side. Three test conditions were used: the subject was asked to report words, the numbers (types); or to report one ear followed by the other (sides); or the simultaneous pairs in order (pairs). The results are easy to describe. In terms of probability correct, presentation condition one was best, condition two next, and condition three worst. For the test conditions, "types" yielded the highest probability of correct response, followed by "sides" and then "pairs." "Sides" being better than "pairs" was one of the results found by Broadbent, but "types" being even better than "sides" suggests that the organization along available dimensions, with the concomitant increase of efficiency in the search process, is the dominant factor in the situation.

One difficulty in studying the search process in STS is the fact that the subject will perform perfectly if the number of items presented is within his rehearsal span. Sternberg (1966) has overcome this difficulty by examining the latency of responses within the rehearsal span. His typical experiment consists of presenting from one to six digits to the subject at the rate of 1.2 seconds each. Following a 2-second delay, a single digit is presented and the subjects must respond "yes" or "no" depending on whether or not the test digit was a member of the set just presented. Following this response the subject is required to recall the complete set in order. Since the subjects were 98.7% correct on the recognition test and 98.6% correct on the recall test, it may be assumed that the task was within their rehearsal span. Interesting results were found in the latencies of the recognition responses: there was a linear increase in latency as the set size increased from one to six digits. The fact that there was no difference in latencies for "yes" versus "no" responses indicates that the search process in this situation is exhaustive and does not terminate the moment a match is found. Sternberg concludes that the subject engages in an exhaustive serial comparison process which evaluates elements at the rate of 25 to 30 per second. The high processing rate makes it seem likely that the rehearsal the subjects report is not an integral part of the scanning process, but instead maintains the image in STS so that it may be scanned at the time of the test. This conclusion depends upon accepting as a reasonable rehearsal rate

for digits the values reported by Landauer (1962) which were never higher than six per second.

Buschke's (1963) missing-span method provides additional insight into search and retrieval processes in STS. The missing-span procedure consists of presenting in a random order all but one of a previously specified set of digits; the subject is then asked to report the missing digit. This technique eliminates the output interference associated with the usual digit-span studies in which the entire presented set must be reported. Buschke found that subjects had superior performance on a missing-span task as compared with an identical digit-span task in which all of the presented items were to be reported in any order. A natural hypothesis would explain the difference in performance as being caused by output interference; that is, the multiple recalls in the digit-span procedure produce interference not seen in the single test procedure of the missing span. An alternative explanation would hold that different storage and search strategies were being employed in the two situations. Madsen and Drucker (1966) examined this question by comparing test instructions given just prior to or immediately following each presentation sequence; the instructions specify whether the subject is to report the set of presented digits or simply to report the missing digit. Output interference would imply that the difference between missing-span and digit-span would hold up in both cases. The results showed that the missing-span procedure with prior instructions was superior to both missing-span and digit-span with instructions following presentation; the latter two conditions produced equal results and were superior to digit-span with prior instructions. It seems clear, then, that two storage and search strategies are being used: a missing-span type, and a digit-span type. Prior instructions (specifying the form of the subject's report) lead the subject to use one or the other of these strategies, but instructions following presentation are associated with a mixture of the two strategies. It appeared in this case that the strategies differed in terms of the type of storage during presentation; the digit-span group with prior instructions tended to report their digits in their presentation order, while the digit-span group with instructions after presentation more often reported the digits in their numerical order. This indicates that the missing-span strategy involved checking off the numbers as they were presented against a fixed, numerically ordered list, while the digit-span strategy involved rehearsing the items in their presented order. It is interesting to note that if the subjects had been aware of the superiority of the missing-span strategy, they could have used it in the digit-span task also, since the two types of tests called for the same information.

It should be noted that retrieval from STS depends upon a number of factors, some under the control of the subject and some depending upon

the decay characteristics of STS. If the decay is partial in some sense, so that the trace contains only part of the information necessary for direct output, then the problem arises of how the partial information should be used to generate a response. In this case, it would be expected that the subject would then engage in a search of LTS in an effort to match or recognize the partial information. On the other hand, even though traces may decay in a partial manner, the rehearsal capability can hold a select set of items in a state of immediate recall availability and thereby impart to these items what is essentially an all-or-none status. It is to this rehearsal process that we now turn.

2. Rehearsal Processes

Rehearsal is one of the most important factors in experiments on human memory. This is particularly true in the laboratory because the concentrated, often meaningless, memory tasks used increase the relative efficacy of rehearsal as compared with the longer term coding and associative processes. Rehearsal may be less pervasive in everyday memory, but nevertheless has many uses, as Broadbent (1958) and others have pointed out. Such examples as remembering a telephone number or table-tennis score serve to illustrate the primary purpose of rehearsal, the lengthening of the time period information stays in the short-term store. A second purpose of rehearsal is illustrated by the fact that even if one wishes to remember a telephone number permanently, one will often rehearse the number several times. This rehearsal serves the purpose of increasing the strength built up in a long-term store, both by increasing the length of stay in STS (during which time a trace is built up in LTS) and by giving coding and other storage processes time to operate. Indeed, almost any kind of operation on an array of information (such as coding) can be viewed as a form of rehearsal, but this paper reserves the term only for the duration-lengthening repetition process.

In terms of STS structure, we can imagine that each rehearsal regenerates the STS trace and thereby prolongs the decay. This does not imply that the entire information ensemble available in STS immediately after presentation is regenerated and maintained at each rehearsal. Only that information selected by the subject, often a small proportion of the initial ensemble, is maintained. If the word "cow" is presented, for example, the sound of the word cow will enter STS; in addition, associates of cow, like milk, may be retrieved from LTS and also entered in STS; furthermore, an image of a cow may be entered into a short-term visual store. In succeeding rehearsals, however, the subject may rehearse only the word "cow" and the initial associates will decay and be lost. The process may be similar to the loss of meaningfulness that occurs when a word is repeated over and over (Lambert & Jakobovitz, 1960).

An interesting question concerns the maximum number of items that can be maintained via rehearsal. This number will depend upon the rate of STS decay and the form of the trace regenerated in STS by rehearsal. With almost any reasonable assumptions about either of these processes, however, an ordered rehearsal will allow the greatest number of items to be maintained. To give a simple example, suppose that individual items take 1.1 seconds to decay and may be restarted if rehearsal begins before decay is complete. Suppose further that each rehearsal takes .25 seconds. It is then clear that five items may be maintained indefinitely if they are rehearsed in a fixed order over and over. On the other hand, a rehearsal scheme in which items are chosen for rehearsal on a random basis will quickly result in one or more items decaying and becoming lost. It would be expected, therefore, that in situations where subjects are relying primarily upon their rehearsal capability in STS, rehearsal will take place in an ordered fashion. One such situation, from which we can derive an estimate of rehearsal capability, is the digit-span task. A series of numbers is read to the subject who is then required to recall them, usually in the forward or backward order. Because the subject has a long-term store which sometimes can be used to supplement the short-term rehearsal memory, the length of a series which can be correctly recalled may exceed the rehearsal capacity. A lower limit on this capacity can be found by identifying the series length at which a subject never errs; this series length is usually in the range of five to eight numbers.⁵

The above estimates of rehearsal capability are obtained in a discrete-trial situation where the requirement is to remember every item of a small input. A very similar rehearsal strategy can be employed, however, in situations such as free recall where a much greater number of items is input than rehearsal can possibly encompass. One strategy in this case would be to replace one of the items currently being rehearsed by each new item input. In this case every item would receive at least some rehearsal. Because of input and reorganization factors, which undoubtedly consume some time, the rehearsal capacity would probably be reduced. It should be clear that under this scheme a constant number of items will be undergoing rehearsal at any one moment. As an analogy, one might think of a bin always containing exactly n items; each new item enters the bin and knocks out an item already there. This process has been called in earlier reports a "rehearsal buffer," or simply a "buffer," and we will use this terminology here (Atkinson & Shiffrin, 1965).

⁵ Wickelgren (1965) has examined rehearsal in the digit-span task in greater detail and found that rehearsal capacity is a function of the groupings engaged in by the subject; in particular, rehearsal in distinct groups of three was superior to rehearsal in four's and five's.

In our view, the maintenance and use of the buffer is a process entirely under the control of the subject. Presumably a buffer is set up and used in an attempt to maximize performance in certain situations. In setting up a maximal-sized buffer, however, the subject is devoting all his effort to rehearsal and not engaging in other processes such as coding and hypothesis testing. In situations, therefore, where coding, long-term search, hypothesis testing, and other mechanisms appreciably improve performance, it is likely that a trade-off will occur in which the buffer size will be reduced and rehearsal may even become somewhat random while coding and other strategies increase.

At this point we want to discuss various buffer operations in greater detail. Figure 2 illustrates a fixed-size buffer and its relation to the rest

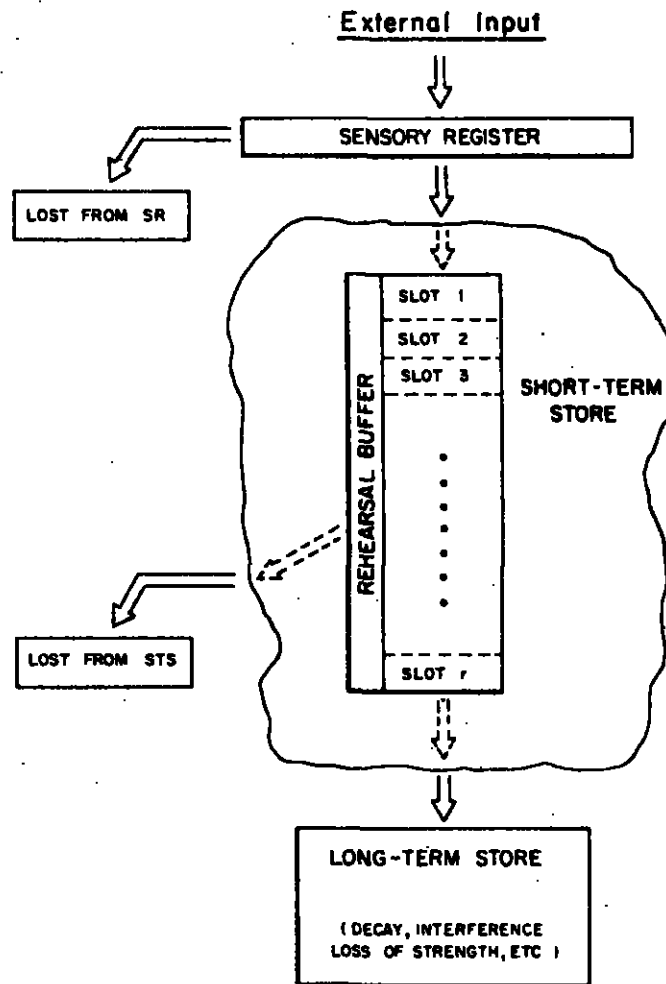

FIG. 2. The rehearsal buffer and its relation to the memory system.

of the memory system. The content of the buffer is constructed from items that have entered STS, items which have been input from the sensory register or from LTS. The arrow going toward LTS indicates that some long-term trace is being built up during an item's stay in the buffer. The other arrow from the buffer indicates that the input of a new item into the buffer causes an item currently in the buffer to be bumped out; this item then decays from STS and is lost (except for any trace which has accumulated in LTS during its stay). An item dropped from the buffer is likely to decay more quickly in STS than a newly presented item which has just entered STS. There are several reasons for this. For one thing, the item is probably already in some state of partial decay when dropped; in addition, the information making up an item in the buffer is likely to be only a partial copy of the ensemble present immediately following stimulus input.

There are two additional processes not shown in Fig. 2 that the subject can use on appropriate occasions. First, the subject may decide not to enter every item into the buffer; the reasons are manifold. For example, the items may be presented at a very fast rate so that input and reorganization time encroach too far upon rehearsal time. Another possibility is that some combinations of items are particularly easy to rehearse, making the subject loath to break up the combination. In fact, the work involved in introducing a new item into the buffer and deleting an old one may alone give the subject incentive to keep the buffer unchanged. Judging from these remarks, the choice of which items to enter into the buffer is based on momentary characteristics of the current string of input items and may appear at times to be essentially random.

The second process not diagrammed in Fig. 2 is the choice of which item to eliminate from the buffer when a new item is entered. There are several possibilities. The choice could be random; it could be based upon the state of decay of the current items; it could depend upon the ease of rehearsing the various items; most important, it could be based upon the length of time the various items have resided in the buffer. It is not unreasonable that the subject knows which items he has been rehearsing the longest, as he might if rehearsal takes place in a fixed order. It is for this reason that the slots or positions of the buffer have been numbered consecutively in Fig. 2; that is, to indicate that the subject might have some notion of the relative recency of the various items in the buffer.

The experimental justification for these various buffer mechanisms will be presented in Section IV. It should be emphasized that the subject will use a fixed-size buffer of the sort described here only in select situations, primarily those in which he feels that trading off rehearsal time for coding and other longer term control processes would not be fruitful. To the extent that long-term storage operations prove to be successful

as compared with rehearsal, the structure of the rehearsal mechanism will tend to become impoverished. One other point concerning the buffer should be noted. While this paper consistently considers a fixed-size short-term buffer as a rehearsal strategy of the subject, it is possible to apply a fixed-size model of a similar kind to the structure of the short-term system as a whole, that is, to consider a short-term buffer as a permanent feature of memory. Waugh and Norman (1965), for example, have done this in their paper on primary memory. The data on the structure of STS is currently so nebulous that such an hypothesis can be neither firmly supported nor rejected.

3. Coding Processes and Transfer between Short- and Long-Term Store

It should be evident that there is a close relationship between the short- and long-term store. In general, information entering STS comes directly from LTS and only indirectly from the sensory register. For example, a visually presented word cannot be entered into STS as an auditory-verbal unit until a long-term search and match has identified the verbal representation of the visual image. For words, letters, and highly familiar stimuli, this long-term search and match process may be executed very quickly, but one can imagine unfamiliar stimuli, such as, say, a nonsense scribble, where considerable search might be necessary before a suitable verbal representation is found to enter into STS. In such cases, the subject might enter the visual image directly into his short-term visual memory and not attempt a verbal coding operation.

Transfer from STS to LTS may be considered a permanent feature of memory; any information in STS is transferred to LTS to some degree throughout its stay in the short-term store. The important aspect of this transfer, however, is the wide variance in the amount and form of the transferred information that may be induced by control processes. When the subject is concentrating upon rehearsal, the information transferred would be in a relatively weak state and easily subject to interference. On the other hand, the subject may divert his effort from rehearsal to various coding operations which will increase the strength of the stored information. In answer to the question of what is a coding process, we can most generally state that a coding process is a select alteration and/or addition to the information in the short-term store as the result of a search of the long-term store. This change may take a number of forms, often using strong preexisting associations already in long-term store. A number of these coding possibilities will be considered later.

Experiments may be roughly classified in terms of the control operations the subject will be led to use. Concept formation problems or tasks where there is a clear solution will lead the subject to strategy selection and hypothesis-testing procedures (Restle, 1964). Experiments which

do not involve problem solving, where there are a large number of easily coded items, and where there is a long period between presentation and test, will prompt the subject to expend his efforts on long-term coding operations. Finally, experiments in which memory is required, but long-term memory is not efficacious, will lead the subject to adopt rehearsal strategies that maintain the information the limited period needed for the task. Several examples of the latter experiment will be examined in this paper; they are characterized by the fact that the responses assigned to particular stimuli are continually changing, so that coding of a specific stimulus-response pair will prove harmful to succeeding pairs using the same stimulus. There are experiments, of course, for which it will not be possible to decide on a priori grounds which control processes are being used. In these cases the usual identification procedures must be used, including model fits and careful questioning of the subjects.

There are other short-term processes that do not fit easily into the above classification. They include grouping, organizing, and chunking strategies. One form that organizing may take is the selection of a subset of presented items for special attention, coding and/or rehearsal. This selection process is clearly illustrated in a series of studies on magnitude of reward by Harley (1965a, 1965b). Items in a paired-associate list were given two monetary incentives, one high and one low. In one experiment the subjects learned two paired-associate lists, one consisting of all high incentive items, the other consisting of all low incentive items; there were no differences in the learning rates for these lists. In a second experiment, subjects learned a list which included both high and low incentive items; in this case learning was faster for the high than the low incentive items. However, the overall rate of learning for the mixed list was about the same as for the two previous lists. It seems clear that when the high and low incentive items are mixed, the subject selectively attends to, codes, and rehearses those items with the higher payoffs. A second kind of organizing that occurs is the grouping of items into small sets, often with the object of memorizing the set as a whole, rather than as individual items. Typically in this case the grouped items will have some common factor. A good example may be found in the series of studies by Battig (1966) and his colleagues. He found a tendency to group items according to difficulty and according to degree of prior learning; this tendency was found even in paired-associate tasks where an extensive effort had been made to eliminate any basis for such grouping. A third type of information organization is found in the "chunking" process suggested by Miller (1956). In his view there is some optimal size that a set of information should have in order to best facilitate remembering. The incoming information is therefore organized into chunks of the desired magnitude.

C. CONTROL PROCESSES IN LONG-TERM STORE

Control processes to be considered in this section fall roughly into two categories: those concerned with transfer between short-term and long-term store and those concerned with search for and retrieval of information from LTS.

1. *Storage in Long-Term Store*

It was stated earlier that some information is transferred to LTS throughout an item's stay in STS, but that its amount and form is determined by control processes. This proposition will now be examined in greater detail. First of all, it would be helpful to consider a few simple examples where long-term storage is differentially affected by the coding strategy adopted. One example is found in a study on mediators performed by Montague, Adams, and Kiess (1966). Pairs of nonsense syllables were presented to the subject who had to write down any natural language mediator (word, phrase, or sentence associated with a pair) which occurred to him. At test 24 hours later the subject attempted to give the response member of each pair and the natural language mediator (NLM) that had been used in acquisition. Proportion correct for items on which the NLM was retained was 70%, while the proportion correct was negligible for items where the NLM was forgotten or significantly changed. Taken in conjunction with earlier studies showing that a group using NLMs was superior to a group learning by rote (Runquist & Farley, 1964), this result indicates a strong dependence of recall upon natural language mediators. A somewhat different encoding technique has been examined by Clark and Bower (personal communication). Subjects were required to learn several lists of paired-associate items, in which each item was a pair of familiar words. Two groups of subjects were given identical instructions, except for an extra section read to the experimental group explaining that the best method of learning the pairs was to form an elaborate visual image containing the objects designated by the two words. This experimental group was then given a few examples of the technique. There was a marked difference in performance between the groups on both immediate and delayed tests, the experimental group outperforming the control group by better than 40% in terms of probability correct. In fact, postexperimental questioning of the subjects revealed that the occasional high performers in the control group were often using the experimental technique even in the absence of instructions to do so. This technique of associating through the use of visual images is a very old one; it has been described in considerable detail, for example, by Cicero in *De Oratore* when he discusses memory as one of the five parts of rhetoric, and is clearly very effective.

We now consider the question of how these encoding techniques improve performance. The answer depends to a degree upon the fine structure of long-term store, and therefore cannot be stated precisely. Nevertheless, a number of possibilities should be mentioned. First, the encoding may make use of strong preexisting associations, eliminating the necessity of making new ones. Thus in mediating a word pair in a paired-associate task, word *A* might elicit word *A'* which in turn elicits the response. This merely moves the question back a level: how does the subject know which associates are the correct ones? It may be that the appropriate associations are identified by temporal position; that is, the subject may search through the associations looking for one which has been elicited recently. Alternatively, information could be stored with the appropriate association identifying it as having been used in the current paired-associates task. Second, the encoding might greatly decrease the effective area of memory which must be searched at the time of test. A response word not encoded must be in the set of all English words, or perhaps in the set of all words presented "recently," while a code may allow a smaller search through the associates of one or two items. One could use further search-limiting techniques such as restricting the mediator to the same first letter as the stimulus. A third possibility, related to the second, is that encoding might give some order to an otherwise random search. Fourth, encoding might greatly increase the amount of information stored. Finally, and perhaps most important, the encoding might protect a fledgling association from interference by succeeding items. Thus if one encodes a particular pair through an image of, say, a specific room in one's home, it is unlikely that future inputs will have any relation to that image; hence they will not interfere with it. In most cases coding probably works well for all of the above reasons.

There is another possible set of effects of the coding process which should be mentioned here. As background, we need to consider the results of several recent experiments which examine the effect of spacing between study and test in paired-associate learning (Bjork, 1966; Young, 1966). The result of primary interest to us is the decrease in probability correct as the number of other paired-associate items presented between study and test increases. This decrease seems to reach asymptote only after a fairly large number (e.g., 20) of intervening items. There are several possible explanations for this "short-term" effect. Although the effect probably occurs over too great an interval to consider direct decay from STS as an explanation, any of several rehearsal strategies could give rise to an appropriate-looking curve. Since a paired-associate task usually requires coding, a fixed-size rehearsal buffer may not be a reasonable hypothesis, unless the buffer size is fairly small; on the other hand, a variable rehearsal set with semirandomly spaced

rehearsals may be both reasonable and accurate. If, on the other hand, one decides that almost no continuing rehearsal occurs in this task, what other hypotheses are available? One could appeal to retroactive interference but this does little more than name the phenomenon. Greeno (1967) has proposed a coding model which can explain the effect. In his view, the subject may select one of several possible codes at the time of study. In particular, he might select a "permanent" code, which will not be disturbed by any other items or codes in the experiment; if this occurs, the item is said to be learned. On the other hand, a "transitory" code might be selected, one which is disturbed or eliminated as succeeding items are presented. This transitory code will last for a probabilistically determined number of trials before becoming useless or lost. The important point to note here is the fact that a decreasing "short-term" effect can occur as a result of solely long-term operations. In experiments emphasizing long-term coding, therefore, the decision concerning which decay process, or combination of decay processes, is operative will not be easy to make in an a priori manner; rather the decision would have to be based upon such a posteriori grounds as goodness-of-fit results for a particular model and introspective reports from the subject.

2. Long-Term Search Processes

One of the most fascinating features of memory is the long-term search process. We have all, at one time or another, been asked for information which we once knew, but which is momentarily unavailable, and we are aware of the ensuing period (often lasting for hours) during which memory was searched, occasionally resulting in the correct answer. Nevertheless, there has been a marked lack of experimental work dealing with this rather common phenomenon. For this reason, our discussion of search processes will be primarily theoretical, but the absence of a large experimental literature should not lead us to underestimate the importance of the search mechanism.

The primary component of the search process is locating the sought-for trace (or one of the traces) in long-term store. This process is seen in operation via several examples. The occasionally very long latencies prior to a correct response for well-known information indicates a non-perfect search. A subject reporting that he will think "of it the moment he thinks about something else" indicates a prior fixation on an unsuccessful search procedure. Similarly, the tip-of-the-tongue phenomenon mentioned earlier indicates a failure to find an otherwise very strong trace. We have also observed the following while quizzing a graduate

student on the names of state capitals. The student gave up trying to remember the capital of the state of Washington after pondering for a long time. Later this student quickly identified the capital of Oregon as Salem and then said at once that the capital of Washington was Olympia. When asked how he suddenly remembered, he replied that he had learned the two capitals together. Presumably this information would have been available during the first search if the student had known where to look: namely in conjunction with the capital of Oregon. Such descriptive examples are numerous and serve to indicate that a search can sometimes fail to uncover a very strong trace. One of the decisions the subject must make is when to terminate an unsuccessful search. An important determiner of the length of search is the amount of order imposed during the search; if one is asked to name all the states and does so strictly geographically, one is likely to do better than someone who spews out names in a haphazard fashion. The person naming states in a haphazard fashion will presently encounter in his search for new names those which he has already given; if this occurs repeatedly, the search will be terminated as being unfruitful. The problem of terminating the search is especially acute in the case of recalling a set of items without a good natural ordering. Such a case is found in free-verbal-recall experiments in which a list of words is presented to the subject who must then recall as many as possible. The subject presumably searches along some sort of temporal dimension, a dimension which lets the subject know when he finds a word whether or not it was on the list presented most recently. The temporal ordering is by no means perfect, however, and the search must therefore be carried out with a degree of randomness. This procedure may lead to missing an item which has a fairly strong trace. It has been found in free-verbal-recall experiments, for example, that repeated recall tests on a given list sometimes result in the inclusion on the second test of items left out on the first test. In our own experiments we have even observed intrusions from an earlier list that had not been recalled during the test of that list.

It would be illustrative at this point to consider an experiment carried out by Norma Graham at Stanford University. Subjects were asked to name the capitals of the states. If a correct answer was not given within 5 seconds following presentation of the state name, the subjects were then given a hint and allowed 30 seconds more to search their memory. The hint consisted of either 1, 2, 4, 12, or 24 consecutive letters of the alphabet, one of which was the first letter in the name of the state capital. The probability correct dropped steadily as the hint size increased from 1 to 24 letters. The average response latencies for correct answers, however, showed a different effect; the 1-letter hint was associated with the fastest response time, the 2-letter hint was slower, the 4-letter hint

was slower yet, but the 12- and 24-letter hints were faster than the 4-letter hint. One simple hypothesis that can explain why latencies were slower after the 4-letter hint than after the 12- and 24-letter hints depends upon differing search processes. Suppose the subject in the absence of a hint engages in "normal" search, or N search. When given the first letter, however, we will assume the subject switches to a first letter search, or L search, consisting of a deeper exploration of memory based upon the first letter. This L search might consist of forming possible sounds beginning with the appropriate letter, and matching them against possible city names. When the size of the hint increases, the subject must apply the L search to each of the letters in turn, obviously a time-consuming procedure. In fact, for 12- or 24-letter hints the probability is high that the subject would use up the entire 30-second search period without carrying out an L search on the correct first letter. Clearly a stage is reached, in terms of hint size, where the subject will switch from an L search to N search in order to maximize performance. In the present experiment it seems clear that the switch in strategy occurred between the 4- and 12-letter hints.

In the above experiment there were two search-stopping events, one subject-controlled and the other determined by the 30-second time limit. It is instructive to consider some of the possible subject-controlled stopping rules. One possibility is simply an internal time limit, beyond which the subject decides further search is useless. Related to this would be an event-counter stopping rule that would halt the subject when a fixed number of prespecified events had occurred. The events could be total number of distinct "searches," total number of incorrect traces found, and so on. A third possibility is dependent on a consecutive-events counter. For example, search could be stopped whenever x consecutive searches recovered traces that had been found in previous searches.

It was noted earlier that searches may vary in their apparent orderliness. Since long-term memory is extremely large, any truly random search would invariably be doomed to failure. The search must always be made along some dimension, or on the basis of some available cues. Nevertheless, searches do vary in their degree of order; a letter-by-letter search is highly structured, whereas a free associative search that proceeds from point to point in a seemingly arbitrary manner will be considerably less restrained, even to the point where the same ground may be covered many times. One other possible feature of the search process is not as desirable as the ones previously mentioned. The search itself might prove destructive to the sought-after trace. That is, just as new information transferred to the long-term store might interfere with previous material stored there, the generation of traces during the search might prove to have a similar interfering effect.

A somewhat different perspective on search procedures is obtained by considering the types of experimental tests that typically are used. Sometimes the very nature of the task presumes a specific search procedure. An example is found in the free-verbal-recall task in which the subject must identify a subset of a larger well-learned group of words. A search of smaller scope is made in a paired-associate task; when the set of possible responses is large, the search for the answer is similar to that made in free recall, with a search component and a recognition component to identify the recovered trace as the appropriate one. When the set of responses in a paired-associate task is quite small, the task becomes one of recognition alone: the subject can generate each possible response in order and perform a recognition test on each. The recognition test presumably probes the trace for information identifying it as being from the correct list and being associated with the correct stimulus.

It was said that the primary component of the search process is locating the desired memory trace in LTS. The secondary component is the recovery of the trace once found. It has been more or less assumed for simplicity in the above discussions that the trace is all-or-none. This may not be the case, and the result of a search might be the recovery of a partial trace. Retrieval would then depend either upon correctly guessing the missing information or performing a further search to match the partial trace with known responses. It is possible, therefore, to divide the recovery processes into a search component and retrieval component, both of which must be successfully concluded in order to output the correct response. The two components undoubtedly are correlated in the sense that stronger, more complete traces will both be easier to find and easier to retrieve, having been found.

One final problem of some importance should be mentioned at this time. The effects of trace interference may be quite difficult to separate from those of search failure. Trace interference here refers either to loss of information in the trace due to succeeding inputs or to confusions caused by competition among multiple traces at the moment of test. Search failure refers to an inability to find the trace at all. Thus a decrease in the probability of a correct response as the number of items intervening between study and test increases could be due to trace interference generated by those items. It could also be due to an increased likelihood of failing to find the trace because of the increasing number of items that have to be searched in memory. One way these processes might be separated experimentally would be in a comparison of recognition and recall measures, assuming that a failure to find the trace is less likely in the case of recognition than in the case of recall. At the present, research along these lines has not given us a definitive answer to this question.

IV. Experiments Concerned with Short-Term Processes

Sections II and III of this paper have outlined a theoretical framework for human memory. As we have seen, the framework is extremely general, and there are many alternative choices that can be made in formulating models for particular experimental situations. The many choice points make it impossible for us to examine each process experimentally. Instead we shall devote our attention to a number of processes universally agreed to occur in experiments on memory, namely rehearsal and search processes. In Section V the LTS search processes will be examined in detail; in the present section the major emphasis will be on STS mechanisms, particularly the control process designated as the rehearsal buffer. The sensory registration system is not an important factor in these models; the experiments are designed so that all items enter the sensory register and then are transferred to STS. The long-term store will be presented in the models of this section but only in the simplest possible manner. We now turn to a series of experiments designed to establish in some detail the workings of the buffer mechanism.

A. A CONTINUOUS PAIRED-ASSOCIATE MEMORY TASK (EXPERIMENT 1)

This study is the prototype for a series of experiments reported in this section designed specifically to study buffer processes. The buffer is a fixed-size rehearsal scheme in STS; conditions which prompt the subject to make use of a buffer include difficulty in using long-term store, a large number of short study-test intervals, and a presentation rate slow enough that cognitive manipulations in STS are not excessively rushed. The task that was developed to establish these conditions is described below.⁶

The subject was required to keep track of constantly changing responses associated with a fixed set of stimuli.⁷ The stimuli were 2-digit numbers chosen from the set 00-99; the responses were letters of the alphabet. At the start of a particular subject-session a set of s stimuli was chosen randomly from the numbers 00 to 99; these stimuli were not changed over the course of that day's session. To begin the session each stimulus was paired with a letter chosen randomly from the alphabet. Following this initial period, a continuous sequence of trials made up the rest of the session, each trial consisting of a test phase followed by a

⁶ The reader may consult Atkinson, Brelsford, and Shiffrin (1967) for details of the experimental procedure and theoretical analyses that are not covered in the present discussion. Also presented there is an account of the mathematics of the model.

⁷ The task is similar to those used by Yntema and Mueser (1960, 1962), Brelsford *et al.* (1966), and Katz (1966).

study phase. During the test phase, one of the s stimuli was randomly selected and presented alone for test. The subject was required to respond with the most recent response paired with that stimulus. No feedback was given to the subject. Following his response the study portion of the trial began. During the study portion the stimulus just presented for test was paired with a new response selected randomly from the alphabet; the only restriction was that the previous response (the correct response during the immediately preceding test phase) was not used during the study phase of the same trial. The subject was instructed to forget the previous pairing and try to remember the new pairing currently being presented for study. Following the study period, a stimulus was again selected randomly from the set of s stimuli and the test portion of the next trial began.

The result of this procedure is as follows: a particular stimulus-response pair is presented for study, followed by a randomly determined number of trials involving other stimuli, and then tested. Having been tested, the pair is broken up and the stimulus is paired with a different response; in other words, no stimulus-response pair is presented for study twice in succession. It is easy to imagine the effects of this procedure on the subject's long-term memory processes. If any particular pair is strongly stored in long-term memory, it will interfere with subsequent pairings involving that same stimulus. In addition, the nature of the stimuli and responses used makes coding a difficult task. For these reasons, the subject soon learns that the usual long-term storage operations, such as coding, are not particularly useful; in fact, the subject is forced to rely heavily on his short-term store and his rehearsal capacity. The experimental procedure also was designed so that it would be possible to carry out extensive parametric analyses on data from individual subjects. This was accomplished by running each subject for 12 or more days and collecting the data on a system under the control of a time-sharing computer, a procedure which made the precise sequence of events during each session available for analysis.

1. *Method*

The subjects were nine students from Stanford University who received \$2 per experimental session. This experiment, and most of the others reported in this paper, was conducted in the Computer-Based Learning Laboratory at Stanford University. The control functions were performed by computer programs run on a modified PDP-1 computer manufactured by the Digital Equipment Corp., and under control of a time-sharing system. The subject was seated at a cathode-ray-tube display terminal; there were six terminals, each located in a separate 7 x 8 foot sound-shielded room. Stimuli were displayed on the face of

the cathode ray tube (CRT); responses were made on an electric typewriter keyboard located immediately below the lower edge of the CRT.

For each session the subject was assigned to one of the three experimental conditions. The three conditions were defined in terms of s , the size of the set of stimuli to be remembered, which took on the values 4, 6, or 8. An attempt was made to assign subjects to each condition once in consecutive three-session blocks. Every session began with a series of study trials: one study trial for each stimulus to be used in the session. On a study trial the word "study" appeared on the upper face of the CRT. Beneath the word "study" one of the stimuli (a 2-digit number) appeared along with a randomly selected letter from the alphabet. Subjects were instructed to try to remember the stimulus-response pairs. Each of these initial study trials lasted for 3 seconds with a 3-second intertrial interval. As soon as there had been an initial study trial for each stimulus to be used in the session, the session proper began.

Each subsequent trial involved a fixed series of events. (1) The word "test" appeared on the upper face of the CRT. Beneath the word "test" a randomly selected member of the stimulus set appeared. Subjects were instructed that when the word "test" and a stimulus appeared on the CRT, they were to respond with the last response that had been associated with that stimulus, guessing if necessary. This test portion of a trial lasted for 3 seconds. (2) The CRT was blacked out for 2 seconds. (3) The word "study" appeared on the upper face of the CRT for 3 seconds. Below the word "study" a stimulus-response pair appeared. The stimulus was the same one used in the preceding test portion of the trial. The response was randomly selected from the letters of the alphabet, with the stipulation that it be different from the immediately preceding response assigned to that stimulus. (4) There was a 3-second intertrial interval before the next trial. Thus a complete trial (test plus study) took 11 seconds. A subject was run for 220 such trials during each experimental session.

2. Theoretical Analysis

In order that the reader may visualize the sequence of events which occurs in this situation, a sample sequence of 18 trials is illustrated in Fig. 3. Within the boxes are the displays seen on the CRT screen. In this session the stimulus set includes the four stimuli 20, 31, 42, and 53 (i.e., $s = 4$). On trial n , item 31-Q is presented for study. On trial $n + 1$, 42 is tested and 42-B presented for study. Then on trial $n + 2$, 31 is tested; the correct answer is Q as is seen by referring to trial n . After the subject answers he is given 31-S to study. He is instructed to forget the previous pair, 31-Q, and remember only the new pair, 31-S. The response letter S was selected randomly from the alphabet, with the restriction that the

previous response, Q, could not be used. A previously used response may through chance, however, be chosen again later in the session; for example, on trial $n + 7$, 31-Q is again presented for study. It is also possible that two or more stimuli might be paired with the same response concurrently; as an example, on trial $n + 15$, 20 is paired with C and on trial $n + 16$, 42 also is paired with C. The stimulus presented on each trial is chosen randomly; for this reason the number of trials intervening

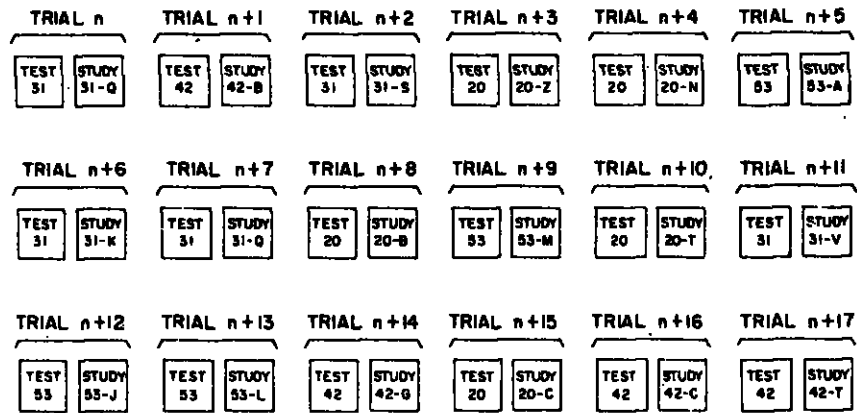

FIG. 3. A sample sequence of trials for Experiment 1.

between study and test is a random variable distributed geometrically. In the analysis of the results, a very important variable is the number of trials intervening between study and test on a particular stimulus-response pair; this variable is called the *lag*. Thus 20 is tested on trial $n + 4$ at a lag of 0 because it was studied on trial $n + 3$. On the other hand, 42 is tested on trial $n + 14$ at a lag of 12, because it was last studied on trial $n + 1$.

Consider now the processes the subject will tend to adopt in this situation. The obvious difficulties involved in the use of LTS force the subject to rely heavily upon rehearsal mechanisms in STS for optimal performance.⁶ A strategy making effective use of STS is an ordered rehearsal scheme of fixed size called the buffer in Section III,B. The fixed-size requirement may not be necessary for maximal utilization of

⁶ The usual examples given for the usefulness of a distinct short-term store do not stress the positive benefits of a memory decaying quickly and completely. Without such a memory, many minor tasks such as adding a long column of numbers might become far more difficult. The current experiment, in which associative bonds are frequently broken and re-formed, is an example of a class of operations for which a short-term store is almost essential.

STS, but is indicated by the following considerations. Keeping the size of the rehearsal set constant gives the subject a great deal of control over the situation; each rehearsal cycle will take about the same amount of time, and it is easier to reorganize the buffer when a new item is introduced. Furthermore, an attempt to stretch the rehearsal capacity to its limit may result in confusion which causes the entire rehearsal set to be disrupted; the confusion results from the variable time that must be allowed for operations such as responding at the keyboard and processing the new incoming items. The hypothesis of an ordered fixed-size buffer is given support by the subjects' reports and the authors' observations while acting as subjects. The reader is not asked, however, to take our word on this matter; the analysis of the results will provide the strongest support for the hypothesis.

It must be decided next just what is being rehearsed. The obvious candidate, and the one reported by subjects, is the stimulus-response pair to be remembered. That is, the unit of rehearsal is the two-digit stimulus number plus the associated response letter. Under certain conditions, however, the subject may adopt a more optimal strategy in which only the responses are rehearsed. This strategy will clearly be more effective because many more items may be encompassed with the same rehearsal effort. The strategy depends upon ordering the stimuli (usually in numerical order in the present case) and rehearsing the responses in an order corresponding to the stimulus order; in this way the subject may keep track of which response goes with which stimulus. For a number of reasons, the scheme is most effective when the size of the stimulus set is small; for a large-set the subject may have difficulty ordering the stimuli, and difficulty reorganizing the rehearsal as each new item is presented. When the number of stimulus-response pairs to be remembered is large, the subject may alter this scheme in order to make it feasible. The alteration might consist of rehearsing only the responses associated with a portion of the ordered stimuli. In a previous experiment (Brelsford *et al.*, 1966) with a similar design, several subjects reported using such a strategy when the stimulus set size was four, and an examination of their results showed better performance than the other subjects. Subject reports lead us to believe that this strategy is used infrequently in the present experiment; consequently, our model assumes that the unit of rehearsal is the stimulus-response pair, henceforth called an "item."

Figure 2 outlines the structure of the model to be applied to the data. Despite the emphasis on rehearsal, a small amount of long-term storage occurs during the period that an item resides in the buffer. The information stored in LTS is comparatively weak and decays rapidly as succeeding items are presented. In accord with the argument that the long-term

process is uncomplicated, we assume here that information stored in LTS increases linearly with the time an item resides in the buffer. Once an item leaves the buffer, the LTS trace is assumed to decrease as each succeeding item is presented for study.

Every item is assumed to enter first the sensory register and then STS. At that point the subject must decide whether or not to place the new item in the rehearsal buffer. There are a number of reasons why every incoming item may not be placed in the buffer. For one thing, the effort involved in reorganizing the buffer on every trial may not always appear worthwhile, especially when the gains from doing so are not immediately evident; for another, the buffer at some particular time may consist of a combination of items especially easy to rehearse and the subject may not wish to destroy the combination. In order to be more specific about which items enter the buffer and which do not, two kinds of items must be distinguished. An O item is an incoming stimulus-response pair whose stimulus is currently in the buffer. Thus if 52-L is currently in the buffer, 52 is tested, and 52-G is presented for study, then 52-G is said to be an O item. Whenever an O item is presented it is automatically entered into the buffer; this entry, of course, involves replacing the old response by the appropriate new response. Indeed, if an O item did not enter the buffer, the subject would be forced to rehearse the now incorrect previous response, or to leave a useless blank spot in the buffer; for these reasons, the assumption that O items are always entered into the buffer seems reasonable. The other kind of item that may be presented is an N item. An N item is a stimulus-response pair whose stimulus currently is not in the buffer. Whenever an N item is entered into the buffer, one item currently in the buffer must be removed to make room the new item (i.e., the buffer is assumed to be of fixed size, r , meaning that the number of items being rehearsed at any one time is constant). The assumption is made that an N item enters into the buffer with probability α ; whenever an N item is entered, one of the items currently in the buffer is randomly selected and removed to make room for it.

The model used to describe the present experiment is now almost complete. A factor still not specified is the response rule. At the moment of test any item which is in the buffer is responded to correctly. If the stimulus tested is not in the buffer, a search is carried out in LTS with the hope of finding the trace. The probability of retrieving the correct response from LTS depends upon the current trace strength, which in turn, depends on the amount of information transferred to LTS. Specifically we assume that information is transferred to LTS at a constant rate θ during the entire period an item resides in the buffer; θ is the transfer rate per trial. Thus, if an item remains in the rehearsal

buffer for exactly j trials, then that item accumulated an amount of information equal to $j\theta$. We also assume that each trial following the trial on which an item is knocked out of the buffer causes the information stored in LTS for that item to decrease by a constant proportion τ . Thus, if an item were knocked out of the buffer at trial j , and i trials intervened between the original study and test on that item, then the amount of information in LTS at the time of the test would be $j\theta\tau^{i-j}$. We now want to specify the probability of a correct retrieval of an item from LTS. If the amount of information in LTS at the moment of test is zero, then the probability of a correct retrieval should be at the guessing level. As the amount of information increases, the probability of a correct retrieval should increase toward unity. We define ρ_{ij} as the probability of a correct response from LTS for an item that was tested at lag i , and resided in the buffer for exactly j trials. Considering the above specifications on the retrieval process,

$$\rho_{ij} = 1 - (1 - g) \exp[-j\theta(\tau^{i-j})]$$

where g is the guessing probability, which is $1/26$ since there were 26 response alternatives.⁹

The basic dependent variable in the present experiment is the probability of a correct response at the time of a test, given lag i . In order to derive this probability we need to know the length of time that an item resides in the memory buffer. Therefore, define β_j = probability that an item resides in the buffer for exactly j trials, given that it is tested at a lag greater than j . The probability of a correct response to an item tested at lag i can now be written in terms of the β_j 's. Let " C_i " represent the occurrence of a correct response to an item tested at lag i . Then

$$\Pr(C_i) = \left[1 - \sum_{k=0}^i \beta_k \right] + \left[\sum_{k=0}^i \beta_k \rho_{ik} \right]$$

The first bracketed term is the probability that the item is in the buffer at the time of the test. The second bracket contains a sum of probabilities, each term representing the probability of a correct retrieval

⁹ Lest the use of an exponential function seem entirely arbitrary, it should be noted that this function bears a close relation to the familiar linear model of learning theory. If we ignore for the moment the decay feature, then

$$\rho_{ij} = 1 - (1 - g) \exp(-j\theta).$$

It is easily seen that this is the linear model expression for the probability of a correct response after j reinforcements with parameter $e^{-\theta}$. Thus, the retrieval function ρ_{ij} can be viewed as a linear model with time in the buffer as the independent variable. To be sure, the decay process complicates matters, but the reason for choosing the exponential function becomes somewhat less arbitrary. A decay process is needed so that the probability of a correct retrieval from LTS will approach chance as the lag tends toward infinity.

from LTS of an item which remained in the buffer for exactly k trials and was then lost.¹⁰ There are four parameters in the model: r , the buffer size which must be an integer; α , the probability of entering an N item into the buffer; θ , the transfer rate of information to LTS; and τ , the decay rate of information from LTS after an item has left the buffer.

One final process must be considered before the model is complete. This process is the recovery of information from STS which is not in the buffer. It will be assumed that the decay of an item which has entered and then left the buffer is very rapid, so rapid that an item which has left the buffer cannot be recovered from STS on the succeeding test.¹¹ The only time in which a recovery is made from STS, apart from the buffer, occurs if an item is tested immediately following its study (i.e., at a lag of 0). In this case there is virtually no time between study and test and it is assumed therefore that the recovery probability is one, regardless of whether the item was entered into the buffer or not. In other words, the probability correct is one when the lag is zero.

3. Data Analysis

Figure 4 presents the probability of a correct response as a function of lag for each of the three stimulus set sizes examined. It can be seen that the smaller the stimulus set size, the better the overall performance. It is important to note that the theory predicts such a difference on the following basis: the larger the size of the stimulus set, the more often an N item will be presented; and the more often N items will be presented, the more often items in the buffer will be knocked out. Recall that only N items can knock items from the buffer; O items merely replace themselves.

It can be seen that performance is almost perfect for lag 0 in all three conditions. This was expected because lag 0 means that the item was tested immediately following its study, and was therefore available in STS. The curves drop sharply at first and slowly thereafter, but have not yet reached the chance level at lag 17, the largest lag plotted. The chance level should be $1/26$ since there were 26 response alternatives.

The four parameters of the model were estimated by fitting the model to the lag curves in Fig. 4 using a minimum chi-square as a best fit

¹⁰ One factor which the model as outlined ignores is the probability of recovering from LTS an old, incorrect trace. In the interest of simplicity this process has not been introduced into the model, although it could be appended with no major changes.

¹¹ Clearly this assumption depends on the time intervals involved. In the present experiment the trials were quite slow; in experiments where a faster presentation rate is used, the model probably would need to be modified slightly to allow a nonzero probability of recovery of an item from STS on the test following its removal from the buffer.

criterion.¹² The solid lines in Fig. 5 give the best fit of the model, which occurred when the parameter values were: $r = 2$, $\alpha = .39$, $\theta = .40$, and $\tau = .93$. It can be seen that the observed data and the predictions from the model are in close agreement. It should be emphasized that the three curves are fit simultaneously using the same parameter values, and the differences between the curves depend only on the value of s (the stimulus

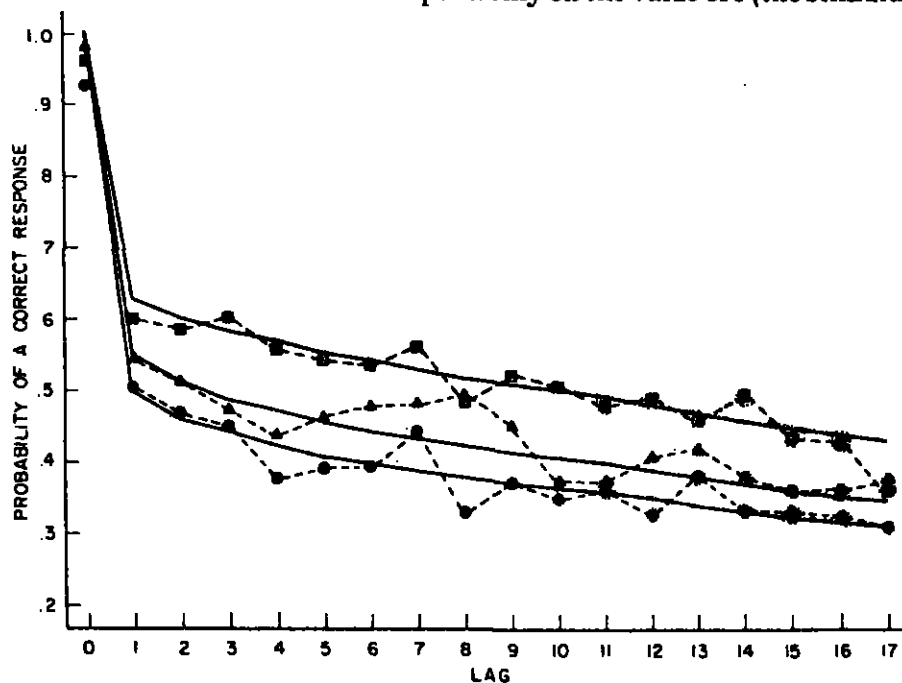

FIG. 4. Observed and theoretical probabilities of a correct response as a function of lag (Experiment 1). --■-- $s = 4$; --▲-- $s = 6$; --●-- $s = 8$; —theory.

set size) which, of course, is determined by the experimenter. The predicted probabilities of a correct response weighted and summed over all lag positions are .562, .469, and .426 for s equal to 4, 6, and 8, respectively; the observed values are .548, .472, and .421.

The estimated value of r might seem surprising at first glance; two items appear to be a rather small buffer capacity. But there are a number of considerations that render this estimate reasonable. It seems clear that the capacity estimated in a task where the subject is constantly interrupted for tests must be lower than the capacity estimated, for example, in a typical digit-span task. This is so because part of the attention time that would be otherwise allotted to rehearsal must be used to search memory in order to respond to the continuous sequence

¹² See Atkinson, Brelsford, and Shiffrin (1967) for details of the estimation procedure and a statistical evaluation of the goodness-of-fit.

of tests. Considering that two items in this situation consist of four numbers and two letters, an estimate of r equal to two is not particularly surprising. The estimated value of α indicates that only 39% of the N items actually enter the buffer (remember that O items always enter the buffer). This low value may indicate that a good deal of mental effort is involved in keeping an item in the buffer via rehearsal, leading to a reluctance to discard an item from the buffer that has not yet been tested. A similar reluctance to discard items would be found if certain

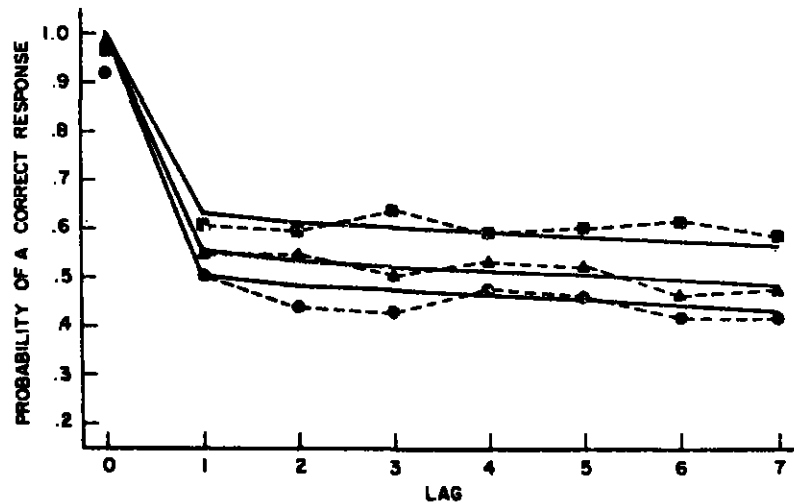

FIG. 5. Observed and theoretical probabilities of a correct response as a function of lag when every intervening item uses the same stimulus (Experiment 1). —■— $s = 4$; —▲— $s = 6$; —●— $s = 8$; — theory.

combinations of items were particularly easy to rehearse. Finally, note that the theory predicts that, if there were no long-term storage, the subject's overall probability of a correct response would be independent of α . Thus it might be expected that α would be higher the greater the effectiveness of long-term storage. In accord with this reasoning, the low value of α found would result from the weak long-term storage associated with the present situation.

In addition to the lag curves in Fig. 4, there are a number of other predictions that can be examined. One aspect of the theory maintains that O items always enter the buffer and replace themselves, while N items enter the buffer with probability α and knock an item out of the buffer whenever they do so. The effects of different stimulus-set sizes displayed in Fig. 5 are due to this assumption. The assumption, however, may be examined in other ways; if it is true, then an item's probability of being correct will be affected by the specific items that intervene

between its initial study and its later test. If every intervening trial uses the same stimulus, then the probability of knocking the item of interest from the buffer is minimized. This is so because once any intervening item enters the buffer, every succeeding intervening item is an O item (since it uses the same stimulus), and hence also enters the buffer. Indeed, if α were one, then every intervening item after the first would be an O

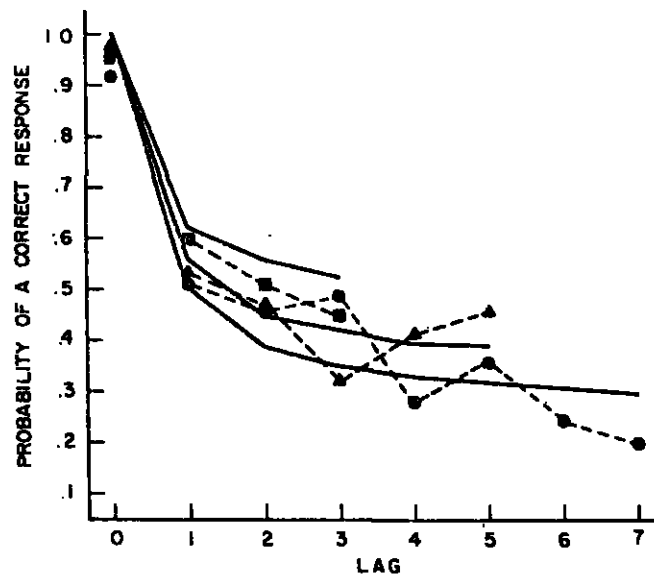

FIG. 6. Observed and theoretical probabilities of a correct response as a function of lag when every intervening item uses a different stimulus (Experiment 1). ---■--- $s = 4$; ---▲--- $s = 6$; ---●--- $s = 8$; — theory.

item, and hence only the first intervening item would have a chance of knocking the item of interest from the buffer; if $\alpha = 1$ and there were no long-term decay, then the lag curve for this condition would be flat from lag 1 onward. In this case, however, α is not equal to one and there is long-term decay; hence the lag curve will decrease somewhat when the intervening items all have the same stimulus, but not to the extent found in Fig. 4. This lag curve, called the "all-same" curve, is shown in Fig. 5; it plots the probability of a correct response as a function of lag, when all the intervening trials between study and test involve the same stimulus. The parameters previously estimated were used to generate predictions for these curves and they are displayed as solid lines. It seems clear that the predictions are highly accurate.

A converse result, called the "all-different" lag curve, is shown in Fig. 6. In this condition, every intervening item has a different stimulus,

and therefore the probability of knocking the item of interest from the buffer is maximized. The lag curves for this condition, therefore, should drop faster than the unconditional lag curves of Fig. 4. Predictions were again generated using the previous parameter values and are represented by the solid lines in Fig. 6. Relatively few observations were available in this condition; considering the instability of the data the predictions seem reasonable.

The procedure used in this experiment is an excellent example of what has been traditionally called a negative transfer paradigm. The problems inherent in such a paradigm were mentioned earlier as contributing to the subjects' heavy reliance upon the short-term store. To the extent that there is any use of LTS, however, we would expect intrusion errors from previously correct responses. The model could be extended in several obvious ways to predict the occurrence of such intrusions. For example, the subject could, upon failing to recover the most recent trace from LTS, continue his search and find the remains of the previous, now incorrect, trace. In order to examine intrusion errors, the proportion of errors which were the correct response for the previous presentation of the stimulus in question were calculated for each lag and each condition. The proportions were quite stable over lags with mean values of .065, .068, and .073 for the 4, 6, and 8 stimulus conditions, respectively. If the previously correct response to an item is generated randomly for any given error, these values should not differ significantly from $1/25 = .04$. In both the $s = 4$ and $s = 6$ conditions seven of the nine subjects had mean values above chance; in the $s = 8$ condition eight of the nine subjects were above chance. Intrusion errors may therefore be considered a reliable phenomenon in this situation; on the other hand, the relatively low frequency with which they occur indicates a rather weak and quickly decaying long-term trace.

A second error category of interest includes those responses that are members of the current set of responses to be remembered but are not the correct responses. This set, of course, includes the set of responses in the buffer at any one time; if the subject tends to give as a guess a response currently in the buffer (and therefore highly available), then the probability of giving as an error a response in the current to-be-remembered set will be higher than chance. Since responses may be assigned to more than one stimulus simultaneously, the number of responses in the to-be-remembered set is bound by, but may be less than, the size of the stimulus set, s . Thus, on the basis of chance the error probabilities would be bounded below .12, .20, and .28 for $s = 4, 6,$ and $8,$ respectively. The actual values found were .23, .28, and .35, respectively. This finding suggests that when the subject cannot retrieve the response from his buffer or LTS and is forced to guess, he has a somewhat greater

than chance likelihood of giving a response currently in the rehearsal set but assigned to another stimulus. It is not surprising that a subject will give as a guess one of the responses in his buffer since they are immediately available.

Other analyses have been performed on the data of this experiment, but the results will not be presented until a second experiment has been described. Before considering the second experiment, however, a few words should be said about individual differences. One of the reasons for running a single subject for many sessions was the expectation that the model could be applied to each subject's data separately. Such analyses have been made and are reported elsewhere (Atkinson, Brelsford & Shiffrin, 1967). The results are too complex to go into here, but they establish that individual subjects by and large conform to the predictions of the model quite well. Since our aim in this paper is to present a nontechnical discussion of the model, to simplify matters we will make most of our analyses on group data.

B. THE "ALL-DIFFERENT" STIMULUS PROCEDURE (EXPERIMENT 2)

In the preceding experiment, the number of stimuli used in a given experimental session and the size of the to-be-remembered set were identical. These two factors, however, can be made independent. Specifically, a set of all-different stimuli could be used while keeping the size of the to-be-remembered set constant. The name, all-different, for this experiment results from the use of all-different stimuli, i.e., once a given stimulus-response pair is presented for test, that stimulus is not used again. In other respects the experiment is identical to Experiment 1.

One reason for carrying out an experiment of this type is to gain some information about the replacement hypothesis for O items. In Experiment 1 we assumed that a new item with a stimulus the same as an item currently in the buffer automatically replaced that item in the buffer; that is, the response switched from old to new. In the all-different experiment subjects are instructed, as in Experiment 1, to forget each item once it has been tested. If an item currently in the buffer is tested (say, 52-G) and a new item is then presented for study (say, 65-Q), we might ask whether the tested item will be automatically replaced by the new item (whether 65-Q will replace 52-G in the buffer). This replacement strategy is clearly optimal for it does no good to retain an item in the buffer that already has been tested. Nevertheless, if the reorganization of the buffer is difficult and time consuming, then the replacement of a tested item currently in the buffer might not be carried out. One simple assumption along these lines would postulate that every item has an independent probability α of entering the buffer.

The all-different experiment was identical to Experiment 1 in all

respects except the following. In Experiment 1 the s stimuli were the same throughout an experimental session, with only the associated responses being changed on each trial, whereas in the all-different experiment 100 stimuli were available for use in each session. In fact, every stimulus was effectively new since the stimulus for each study trial was selected randomly from the set of all 100 stimuli under the restriction that no stimulus could be used if it had been tested or studied in the previous 50 trials. There were still three experimental conditions with s equal to 4, 6, or 8 denoting the number of items that the subject was required to try to remember at any point in time. Thus a session began with either 4, 6, or 8 study trials on different randomly selected stimuli, each of which was paired with a randomly selected response (from the 26 letters). On each trial a stimulus in the current to-be-remembered set was presented for test. After the subject made his response he was instructed to forget the item he had just been tested on, since he would not be tested on it again. Following the test a new stimulus was selected (one that had not appeared for at least 50 trials) and randomly paired with a response for the subject to study. Thus the number of items to be remembered at any one time stays constant throughout the session. However, the procedure is quite different from Experiment 1 where the study stimulus was always the one just tested.

Denote an item presented for study on a trial as an O item (old item) if the item just tested was in the buffer. Denote an item presented for study as an N item (new item) if the item just tested was not in the buffer. This terminology conforms precisely to that used to describe Experiment 1. If an O item is presented there will be at least one spot in the buffer occupied by a useless item (the one just tested). If an N item is presented, the buffer will be filled with information of the same value as that before the test. If we assume that an N item has probability α of entering the buffer, and that an O item will always enter the buffer and knock out the item just made useless, then the model for Experiment 1 will apply here with no change whatsoever. In this case we again expect that the lag curves for $s = 4, 6,$ and 8 would be separated. In fact, given the same parameter values, exactly the same curves would be predicted for the all-different experiment as for Experiment 1.

As noted earlier, however, there is some doubt that the assumptions regarding N items and O items will still hold for the all-different experiment. In Experiment 1 the stimulus just tested was re-paired with a new response, virtually forcing the subject to replace the old response with a new one if the item was in the buffer. Put another way, if an item is in the buffer when tested, only a minor change need be made in the buffer to enter the succeeding study item: a single response is replaced by another. In the all-different experiment, however, a greater change

needs to be made in order to enter an O item; both a stimulus and a response member have to be replaced. Thus an alternative hypothesis might maintain that every entering item (whether an N item or an O item) has the same probability α of entering the buffer, and will knock out any item currently in the buffer with equal likelihood. In this case we predict no differences among the lag curves for the $s = 4, 6,$ and 8 conditions.

1. Results

The observed lag curves for Experiment 2 are displayed in Fig. 7. It should be emphasized that, except for the procedural changes described

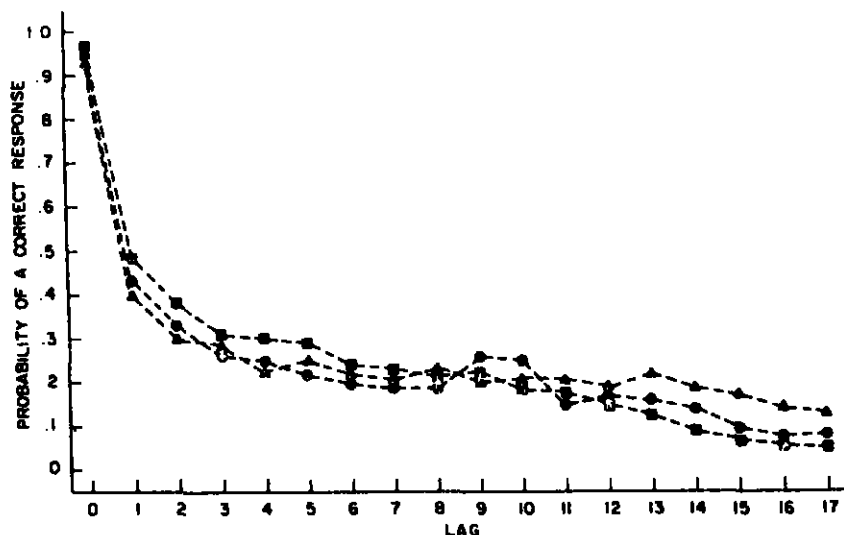

FIG. 7. Observed and theoretical probabilities of a correct response as a function of lag (Experiment 2). --■-- $s = 4$; --▲-- $s = 6$; --●-- $s = 8$.

above and the fact that a new sample of subjects was used, the experimental conditions and operations were identical in Experiments 1 and 2. The important point about this data is that the lag curves for the three conditions appear to overlap.¹³ For this reason we lump the three curves to form the single lag curve displayed in Fig. 8.

Because the three curves overlap, it is apparent that the theory used in Experiment 1 needs modification. The hypothesis suggested above

¹³ To determine whether the three curves in Fig. 7 differ reliably, the proportions correct for each subject and condition were calculated and then ranked. An analysis of variance for correlated means did not yield significant effects ($F = 2.67$, $df = 2/16$, $p > .05$).

will be used: every item enters the buffer with probability α . If an item enters the buffer it knocks out an item already there on a random basis. This model implies that useless items are being rehearsed on occasion, and subjects reported doing just that despite instructions to forget each item once tested.

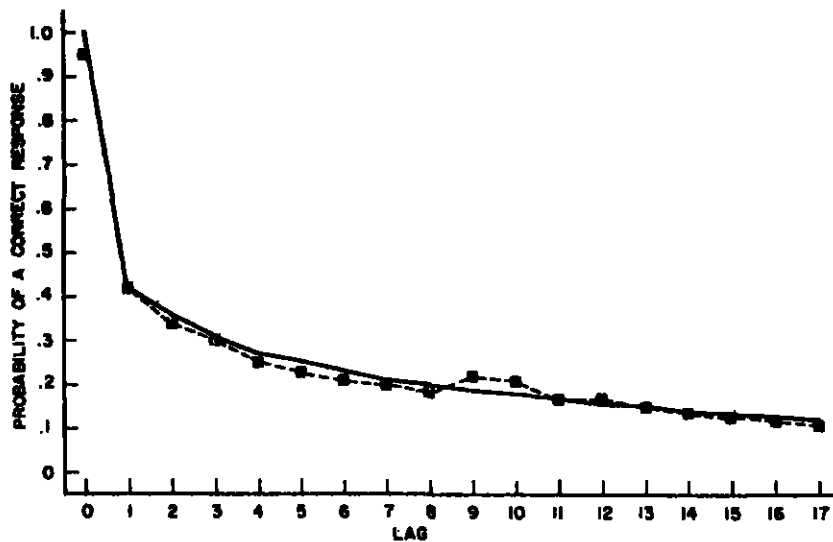

FIG. 8. Observed and theoretical probabilities of a correct response as a function of lag. Data from the $s = 4, 6,$ and 8 conditions have been pooled (Experiment 2). ---■--- Data;—theory.

The curve in Fig. 8 was fit using a minimum χ^2 procedure; the parameter estimates were $r = 2$, $\alpha = .52$, $\theta = .17$, and $\tau = .90$. It can be seen that the fit is excellent. Except for r , the parameters differ somewhat from those found in Experiment 1, primarily in a slower transfer rate, θ . In Experiment 1 the estimate of θ was .40. This reduction in long-term storage is not too surprising since the subjects were on occasion rehearsing useless information. It could have been argued in advance of the data that the change away from a strong "negative-transfer" paradigm in Experiment 2 would lead to increased use of LTS; that this did not occur is indicated not only by the low θ value, but also by the low probability of a correct response at long lags. One outcome of this result is the possibility that the all-different procedure would give superior long-term memory in situations where subjects could be induced to attempt coding or other long-term storage strategies. It seems apparent that LTS was comparatively useless in the present situation.

2. *Some Statistics Comparing Experiments 1 and 2*

In terms of the model, the only difference between Experiments 1 and 2 lies in the replacement assumption governing the buffer. In Experiment 1, an item in the buffer when tested is automatically replaced by the immediately succeeding study item; if the tested item is not in the buffer, the succeeding study item enters the buffer with probability α , randomly displacing an item already there. In Experiment 2, every study item, independent of the contents of the buffer, enters the buffer with probability α , randomly displacing an item already there. While these assumptions are given credence by the predictions of the various lag curves of Figs. 4 and 8, there are other statistics that can be examined to evaluate their adequacy. These statistics depend upon the fact that items vary in their probability of entering the buffer. Since items which enter the buffer will have a higher probability correct than items which do not, it is relatively easy to check the veracity of the replacement assumptions in the two experiments.

In Experiment 1, the probability that an item will be in the buffer at test is higher the greater the number of consecutive preceding trials that involve the same stimulus. Thus if the study of 42-B is preceded, for example, by six consecutive trials using stimulus 42, there is a very high probability that 42-B will enter the buffer. This occurs because there is a high probability that the stimulus 42 already will be in the buffer when 42-B is presented, and if so, then 42-B will automatically enter the buffer. In any series of consecutive trials all with the same stimulus, once any item in the series enters the buffer, every succeeding item will enter the buffer. Hence, the longer the series of items with the same stimulus, the higher the probability that that stimulus will be in the buffer. Figure 9 graphs the probability of a correct response to the last stimulus-response pair studied in a series of consecutive trials involving the same stimulus; the probability correct is lumped over all possible lags at which that stimulus-response pair is subsequently tested. This probability is graphed as a function of the length of the consecutive run of trials with the same stimulus and is the line labeled Experiment 1. These curves are combined over the three experimental conditions (i.e., $s = 4, 6, 8$). We see that the probability of a correct response to the last item studied in a series of trials all involving the same stimulus increases as the length of that series increases, as predicted by the theory.

In Experiment 2 stimuli are not repeated, so the above statistic cannot be examined. A comparable statistic exists, however, if we consider a sequence of items all of which are tested at zero lag (i.e., tested immediately after presentation). One could hypothesize that the effect displayed in Fig. 9 for Experiment 1 was due to a consecutive sequence of zero-lag tests, or due to factors related to the sequence of

correct answers (at zero-lag an item is always correct). These same arguments would apply, however, to the sequence of zero-lag items in Experiment 2. In Fig. 9, the line labeled Experiment 2 represents a probability measure comparable to the one displayed for Experiment 1. Specifically, it is the probability of a correct response on the eventual test of the last S-R pair studied in a consecutive sequence of trials all involving S-R pairs tested at lag zero, as a function of the length of the

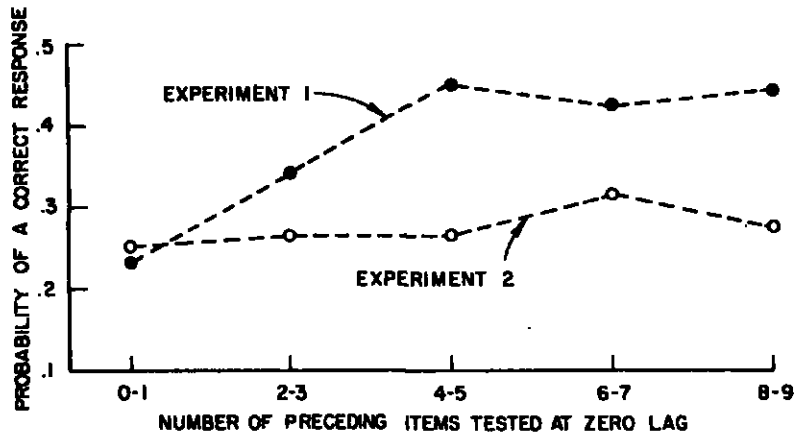

FIG. 9. Probability of a correct response as a function of the number of consecutive preceding items tested at zero lag (Experiment 1 and Experiment 2).

sequence. The model for Experiment 2 with its scheme for entering items in the buffer predicts that this curve should be flat; the data seem to bear out this prediction.

The close correspondence between the predicted and observed results in Experiments 1 and 2 provides strong support for the theory. The assumptions justified most strongly appear to be the fixed-size rehearsal buffer containing number-letter pairs as units, and the replacement assumptions governing O and N items. It is difficult to imagine a consistent system without these assumptions that would give rise to similar effects. Some of the predictions supported by the data are not at all intuitive. For example, the phenomenon displayed in Fig. 9 seems to be contrary to predictions based upon considerations of negative transfer. Negative transfer would seem to predict that a sequence of items having the same stimulus but different responses would lead to large amounts of interference and hence reduce the probability correct of the last item in the sequence; however, just the opposite effect was found. Furthermore, the lack of an effect in Experiment 2 seems to rule out explanations based on successive correct responses or successive zero-lag tests. Intuition notwithstanding, this effect was predicted by the model.

C. A CONTINUOUS PAIRED-ASSOCIATE MEMORY TASK WITH MULTIPLE REINFORCEMENTS (EXPERIMENT 3)

In contrast to a typical short-term memory task, the subjects' strategy in paired-associate learning shifts from a reliance on rehearsal processes to a heavy emphasis on coding schemes and related processes that facilitate long-term storage. There are many factors, however, that contribute to such a shift, and the fact that items are reinforced more than once in a paired-associate learning task is only one of these. In the present experiment, all factors are kept the same as in Experiment 1, except for the number of reinforcements. It is not surprising, then, that subjects use essentially the same rehearsal strategy found in Experiment 1. It is therefore of considerable interest to examine the effects associated with repeated reinforcements of the same item.

In Experiment 3 only one stimulus set size, $s = 8$, was used. Each session began with eight study trials on which the eight stimuli were each randomly paired with a response. The stimuli and responses were two-digit numbers and letters, respectively. After the initial study trials, the session involved a series of consecutive trials each consisting of a test phase followed by a study phase. On each trial a stimulus was randomly selected for testing and the same stimulus was then presented for study on the latter portion of the trial. Whereas in Experiment 1, during the study phase of a trial, the stimulus was always re-paired with a new response, in the present experiment the stimulus was sometimes left paired with the old response. To be precise, when a particular S-R pair was presented for study the first time, a decision was made as to how many reinforcements (study periods) it would be given; it was given either 1, 2, 3, or 4 reinforcements with probabilities .30, .20, .40, and .10 respectively. When a particular S-R pair had received its assigned number of reinforcements, its stimulus was then re-paired with a new response on the next study trial, and this new item was assigned a number of reinforcements using the probability distribution specified above. In order to clarify the procedure, a sample sequence from trials n to $n + 19$ is shown in Fig. 10. On trial $n + 2$ stimulus 22 is given a new response, L , and assigned three reinforcements, the first occurring on trial $n + 2$. The second reinforcement occurs on trial $n + 3$ after a lag of zero. After a lag of 6, the third reinforcement is presented on trial $n + 10$. After a lag of 8, stimulus 22 is re-paired with a new response on trial $n + 19$. Stimulus 33 is sampled for test on trial $n + 6$ and during the study phase is assigned the new response, B , which is to receive two reinforcements, the second on trial $n + 9$. Stimulus 44 is tested on trial $n + 4$, assigned the new response X which is to receive only one reinforcement; thus when 44 is presented again on trial $n + 16$ it is assigned another response which by chance also is to receive only one reinforce-

ment, for on the next trial 44 is studied with response Q. The subject is instructed, as in Experiments 1 and 2, to respond on the test phase of each trial with the letter that was *last* studied with the stimulus being tested.

The same display devices, control equipment, and timing relations used in Experiment 1 were used in this study. There were 20 subjects, each run for 10 or more sessions; a session consisted of 220 trials. Details of the experimental procedure, and a more extensive account of the data

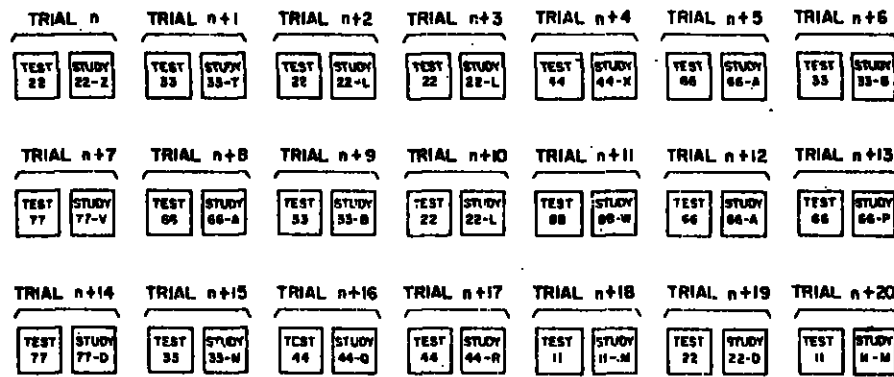

FIG. 10. A sample sequence of trials for Experiment 3.

analysis, including a fit of the model to response protocols of individual subjects, can be found in Brelsford, Shiffrin, and Atkinson (1968).

The model for Experiment 1 may be used without change in the present situation. There is some question, however, whether it is reasonable to do so. The assumptions concerning LTS storage and decay may be applied to items which are given multiple reinforcements: information is transferred to LTS at a rate θ whenever the item resides in the buffer, and decays from LTS by the proportion τ on each trial that the item is not present in the buffer. The assumption regarding O items also may be applied: since the stimulus already is in the buffer, the new response replaces the old one, thereby entering the item in the buffer (if, as is the case in this experiment, the old response is given yet another study, then nothing changes in the buffer). N items, however, are not so easily dealt with. N items, remember, are items whose stimuli are not currently represented in the buffer. In Experiment 1, the stimulus of every N item also was being paired with a new response. In the current experiment this is not always the case; some N items, although not in the buffer, will be receiving their second, third, or fourth reinforcement when presented for study. That is, some N items in this experiment will

already have a substantial amount of information stored on them in LTS. It seems reasonable that subjects may not rehearse an item which has just been retrieved correctly from LTS. The assumption regarding N items is therefore modified for purposes of the present experiment as follows. If a stimulus is tested and is not in the buffer, then a search of LTS is made. If the response is correctly retrieved from LTS, and if that stimulus-response pair is repeated for study, then that item will not be entered into the buffer (since the subject "knows" it already). If a new item is presented for study (i.e., the response to that stimulus is changed), or if the correct response is not retrieved from LTS (even though the subject may have made the correct response by guessing), then the study item enters the buffer with probability α . This slight adjustment of the replacement assumption allows for the fact that some items presented for study may already be known and will not enter the rehearsal buffer. This version of the model is the one used later to generate predictions for the data.

1. Results

Figure 11 presents the probability of a correct response as a function of lag for items tested after their first, second, and third reinforcements. The number of observations is weighted not only toward the short lags,

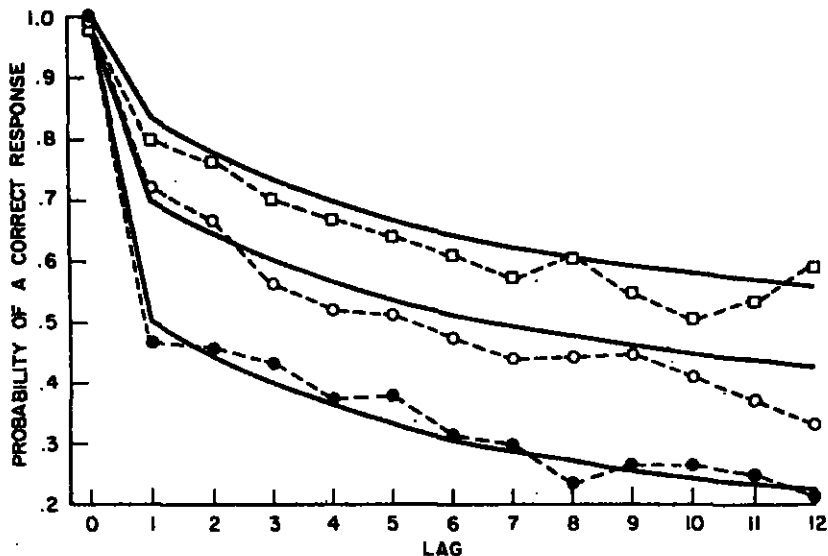
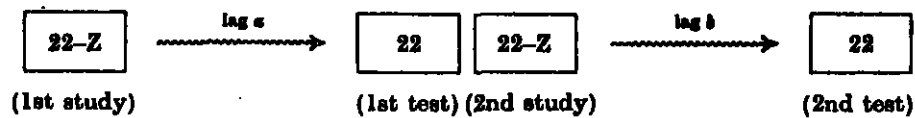

FIG. 11. Observed and theoretical probabilities of a correct response as a function of lag for items tested following their first, second, or third reinforcement (Experiment 3). --□-- Three reinforcements; --○-- two reinforcements; --●-- one reinforcement; — theory.

but also toward the smaller numbers of reinforcements. This occurs because the one-reinforcement lag curve contains not only the data from the items given just one reinforcement, but also the data from the first reinforcement of items given two, three, and four reinforcements. Similarly, the lag curve following two reinforcements contains the data from the second reinforcement of items given two, three, and four reinforcements, and the three-reinforcement curve contains data from the third reinforcement of items given three and four reinforcements. The lag curves in Fig. 11 are comparable to those presented elsewhere in this paper. What is graphed is the probability of a correct response to an item that received its j th reinforcement, and was then tested after a lag of n trials. The graph presents data for n ranging from 0 to 15 and for j equal to 1, 2, and 3. Inspecting the figure, we see that an item which received its first reinforcement and was then tested at a lag of 8 trials gave a correct response about 23% of the time; an item that received its second reinforcement and was then tested at lag 8 had about 44% correct responses; and an item that received its third reinforcement and was then tested at lag 8 had about 61% correct.

The curves in Fig. 11 exhibit a consistent pattern. The probability correct decreases regularly with lag, starting at a higher value on lag 1 the greater the number of prior reinforcements. Although these curves are quite regular, there are a number of dependencies masked by them. For example, the probability of a correct response to an item that received its second reinforcement and was then tested at some later trial will depend on the number of trials that intervened between the first and second reinforcements. To clarify this point consider the following diagram



Item 22-Z is given its first reinforcement, tested at lag a and given a second reinforcement, and then given a second test at lag b . For a fixed lag b , the probability of a correct response on the second test will depend on lag a . In terms of the model it is easy to see why this is so. The probability correct for an item on the second test will depend upon the amount of information about it in LTS. If lag a is extremely short, then there will have been very little time for LTS strength to build up. Conversely, a very long lag a will result in any LTS strength decaying and disappearing. Hence the probability of a correct response on the second test will be maximal at some intermediate value of lag a ; namely, at a

lag which will give time for LTS strength to build up, but not so much time that excessive decay will occur. For this reason a plot of probability correct on the second test as a function of the lag between the first and second reinforcement should exhibit an inverted U-shape. Figure 12 is such a plot. The probability correct on the second test is graphed as a function of lag a . Four curves are shown for different values of lag b . The

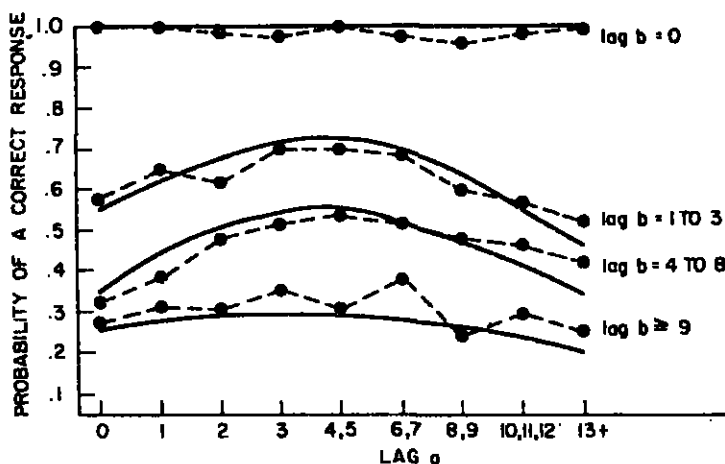

FIG. 12. Observed and theoretical probabilities of a correct response as a function of lag a (the spacing between the first and second reinforcement) (Experiment 3).

four curves have not been lumped over all values of lag b because we wish to indicate how the U-shaped effect changes with changes in lag b . Clearly, when lag b is zero, the probability correct is one and there is no U-shaped effect. Conversely, when lag b is very large, the probability correct will tend toward chance regardless of lag a , and again the U-shaped effect will disappear. The functions shown in Fig. 12 give support to the assumption that information is being transferred to LTS during the entire period an item resides in the buffer. If information is transferred, for example, only when an item first enters the buffer, then our model will not predict the rise in the functions of Fig. 12 for lag a going from zero to about five. The rise is due to the additional information transferred to LTS as lag a increases.

2. Theoretical Analysis

A brief review of the model is in order. O items (whose stimulus is currently in the buffer) always enter the buffer. N items (whose stimulus is not currently in the buffer) enter the buffer with probability α if they

are also new items (i.e., receiving their first reinforcement). However, N items do not enter the buffer if they are repeat items and were correctly retrieved from LTS on the immediately preceding test; if they are repeat items and a retrieval was not made, then they enter the buffer with probability α . An O item entering the buffer occupies the position of the item already there with the same stimulus; an entering N item randomly replaces one of the items currently in the buffer. During the period an item resides in the buffer, information is transferred to LTS at a rate θ per trial. This information decays by a proportion τ on each trial after an item has left the buffer.¹⁴ The subject is always correct at a lag of zero, or if the item is currently in the buffer. If the item is not in the buffer a search of LTS is made, and the correct response is retrieved with a probability that is an exponential function of the amount of information currently in LTS (i.e., the same function specified for Experiments 1 and 2). If the subject fails to retrieve from LTS, then he guesses. There are four parameters for this model: r , the buffer size; α , the buffer entry probability; θ , the transfer rate of information to LTS; and τ , the parameter characterizing the LTS decay rate once an item has left the buffer.

Estimates of r , α , θ , and τ were made using the data presented in Figs. 11 and 12. We shall not go into the estimation procedures here, for they are fairly complex; in essence they involve a modified minimum χ^2 procedure where the theoretical values are based on Monte Carlo runs. The parameter estimates that gave the best fit to the data displayed in Figs. 11 and 12 were as follows: $r = 3$; $\alpha = .65$; $\theta = 1.24$; and $\tau = .82$. Once these estimates had been obtained they were then used to generate a large-scale Monte Carlo run of 12,500 trials. The Monte Carlo procedure involved generating pseudo-data following precisely the rules specified by the model and consulting a random number generator whenever an event occurred in the model that was probabilistically determined. Thus the pseudo-data from a Monte Carlo run is an example of how real data would look if the model was correct, and the parameters had the values used in the Monte Carlo computation. In all subsequent discussions of Experiment 3, the predicted values are based on the output of the Monte Carlo run. The run was very long so that in all cases the theoretical curves are quite smooth, and we doubt if they reflect fluctuations due to sampling error. A detailed account of the estimation and prediction procedures for this experiment is given in Brelsford, Shiffrin, and Atkinson (1968).

The predictions from the theory are shown as the smooth curves in

¹⁴ In this experiment an item receiving x reinforcements may enter the buffer as many as x times. When the item is in the buffer the θ -process is activated, and when not in the buffer the τ -process takes over.

Figs. 11 and 12. It should be evident that the predicted values are quite close to the observed ones. Note also that the seven curves in the two figures are fit simultaneously with the same four parameter values; the fact that the spacing of the curves is accurately predicted is particularly interesting.

We now examine a number of statistics that were not used in making parameter estimates. First consider the all-same and all-different curves shown in Fig. 13; these are the same functions displayed in Figs. 5 and 6

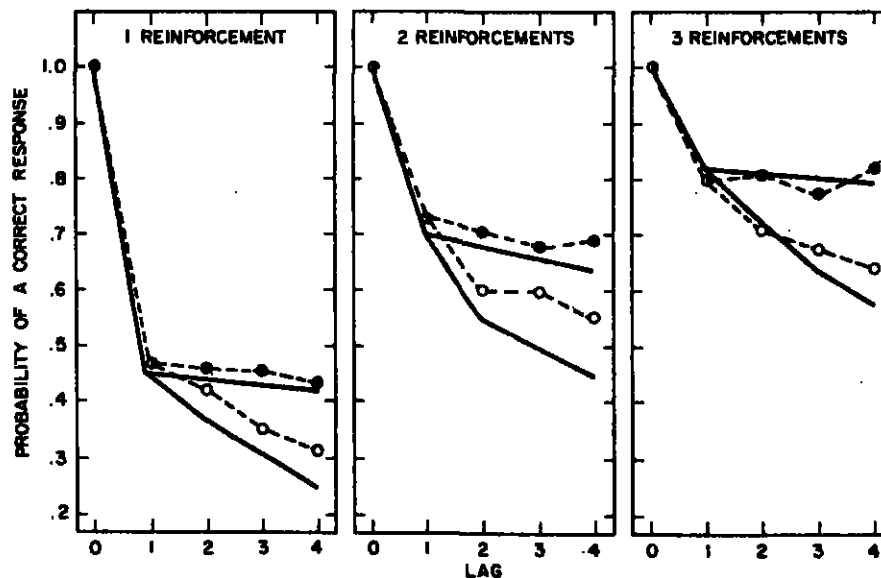

FIG. 13. Observed and theoretical probabilities of a correct response as a function of lag for the "all-same" and "all-different" conditions (Experiment 3). --●-- all-same; --○-- all-different; — theory.

for Experiment 1. For the all-same curve, we compute the probability of a correct response as a function of the lag, when all the intervening items between study and test involve the same stimulus. There are three such curves, depending on whether the study was the first, second, or third reinforcement of the particular S-R pair. The model predicts that once the intervening stimulus enters the buffer, there will be no further chance of any other item being knocked out of the buffer. Hence these curves should drop at a much slower rate than the unconditional lag curves in Fig. 11. The all-different curve plots the probability of a correct response as a function of lag, when the intervening items between study and test all involve different stimuli. Again there are three curves depending on whether the study was the first, second, or third reinforcement of the S-R pair. The all-different sequence maximizes the expected

number of intervening N items and therefore the curve should have a much faster drop than the unconditional lag curves in Fig. 11. The predictions are shown in the figure as solid lines. The correspondence between predicted and observed values is reasonably good. It is particularly impressive when it is noted that the parameter values used in making the predictions were estimated from the previous data.

We next examine the data displayed in Fig. 14. Consider a sequence of consecutive trials all involving the same stimulus, but where the

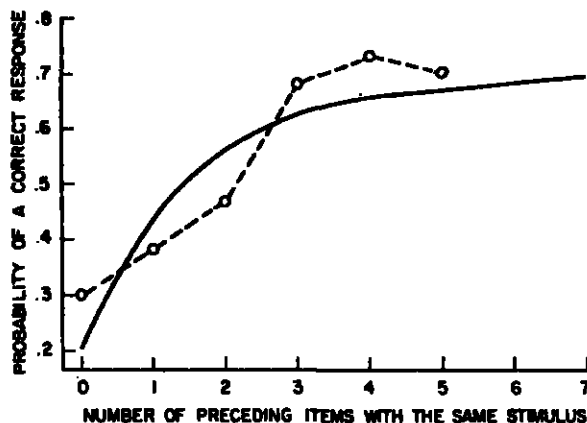
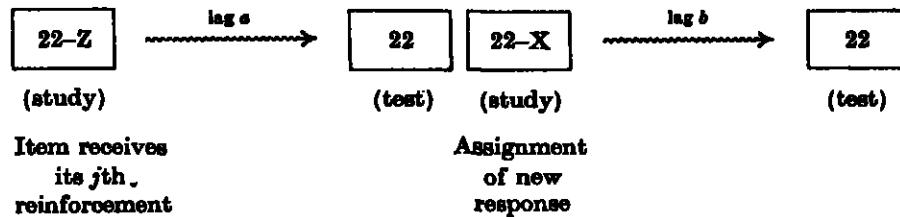

FIG. 14. Observed and theoretical probabilities of a correct response as a function of the number of consecutive preceding items using the same stimulus (Experiment 3).

response paired with the stimulus on the study phase of the last trial in the sequence is different from the response on the immediately preceding trial. Then, the theory predicts that the longer this sequence of consecutive trials, the higher will be the probability of a correct response when the last item studied in the sequence is eventually tested. This is so because the probability of the last item entering the buffer increases as the length of the sequence increases: once any item in the sequence enters the buffer, every succeeding one will. The data is shown in Fig. 14. What is graphed is the length of the sequence of trials all involving the same stimulus versus the probability of a correct response when the last item studied in the sequence is eventually tested. In this graph we have lumped over all lags at which the eventual test of the last item is made. The predictions generated from the previously estimated parameter values are shown as the smooth line. The predicted values, though not perfect, are surprisingly close to the observed proportions correct. It is worth reemphasizing that considerations of negative transfer make this result somewhat unexpected (see p. 140).

We next examine another prediction of the theory that ran counter to our initial intuitions. To make matters clear, consider the following diagram:



Item 22-Z is studied for the j th time and then tested at lag a ; on this trial 22 is paired with a new response X , and tested next at lag b . According to the theory, the shorter lag a , the better performance should be when the item is tested after lag b . This prediction is based on the fact that the more recently a stimulus had appeared, the more likely that it was still in the buffer when the next item using it was presented for study; if the stimulus was in the buffer, then the item using it would automatically enter the buffer. In the present analysis, we examine this effect for three conditions: the preceding item using the stimulus in question could have just received its first, second, or third reinforcement. Figure 15 presents the appropriate data. In terms of the above diagram, what is plotted is the value of lag a on the abscissa versus the probability of a correct response lumped over all values of lag b on the ordinate; there is a separate curve for $j = 1, 2, \text{ and } 3$.

The predicted curves are based upon the previous parameter estimates. The predictions and observations coincide fairly well, but the effect is not as dramatic as one might hope.¹⁵ One problem is that the predicted decrease is not very large. Considerably stronger effects may be expected if each curve is separated into two components: one where the preceding item was correct at test and the other where the preceding item was not correct. In theory the decrease predicted in Fig. 15 is due to a lessened probability of the relevant stimulus being in the buffer as lag a increases. Since an item in the buffer is always responded to correctly, conditionalizing upon correct responses or errors (the center test in the above diagram) should magnify the effect. To be precise, the decrease will be accentuated for the curve conditional upon correct responses, whereas no decrease at all is predicted for the curve conditional upon errors. If an error is made, the relevant stimulus cannot be in the buffer and hence the new item enters the buffer with probability α

¹⁵ A curve comparable to the one displayed in Fig. 15 for the one-reinforcement condition was obtained from the data of Experiment 1. This curve showed a similar but more pronounced drop and was well predicted by the model.

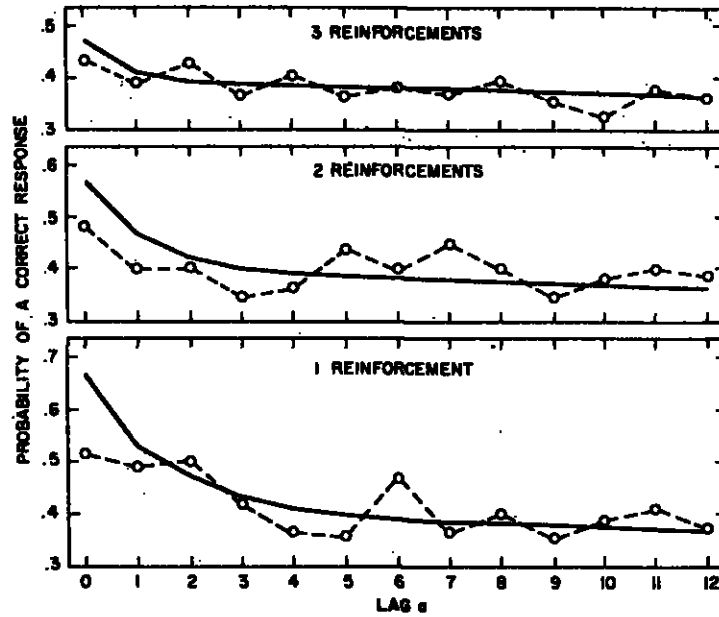

FIG. 15. Observed and theoretical probabilities of a correct response as a function of lag α (the lag of the item preceding the item tested, but using the same stimulus) (Experiment 3). --o-- Data; ---theory.

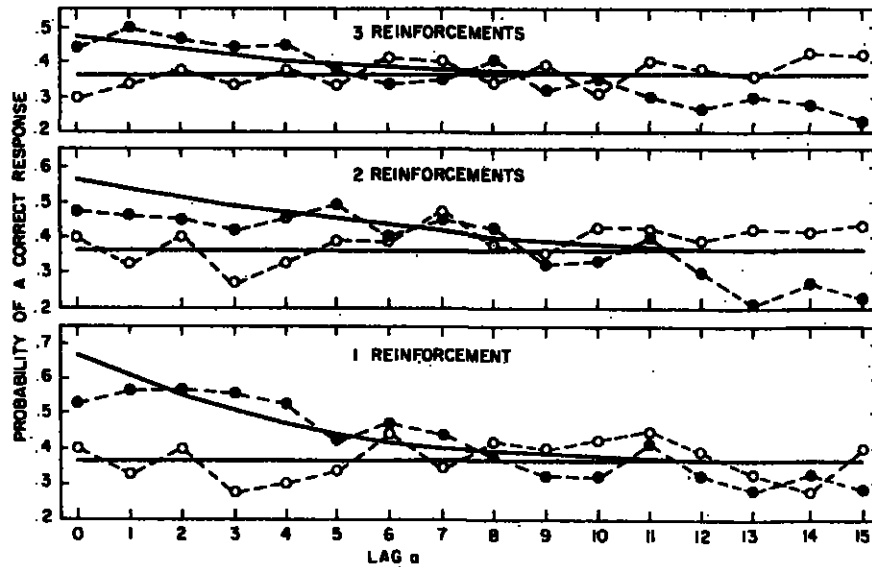

FIG. 16. Observed and theoretical probabilities of a correct response as a function of lag α conditionalized on errors or successes on the test at lag α (Experiment 3). --●-- Correct data; --o-- error data; ---theory.

Item 22-Z is studied for the j th time and then tested at lag a ; on this trial 22 is paired with a new response X and next tested at lag b . By an intrusion error we mean the occurrence of response Z when 22 is tested at the far right of the diagram. The model predicts that these intrusion errors will be at chance level ($1/25$), independent of lag and number of reinforcements. In fact, these predictions fail. Figure 17 presents the

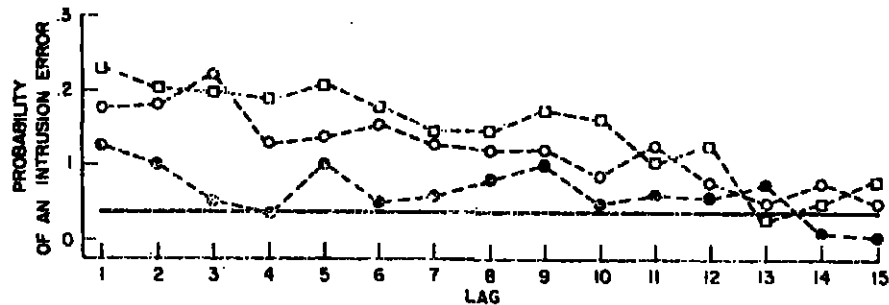

FIG. 17. Probability that the correct response for the preceding item using the same stimulus will be given in error to the present item (Experiment 3). --□-- Three reinforcements; --○-- two reinforcements; --●-- one reinforcement; —chance.

probability of intrusion errors as a function of lag b ; where the data have been lumped over all values of lag a , three curves are plotted for $j = 1, 2$, and 3. This failure of the model is not very distressing because it was expected: the model could be extended in a number of obvious ways to take account of competing LTS traces without appreciably changing any of the predictions so far presented. The extension has not been made because our interest in this study is centered upon short-term effects.

Judging by the agreement between theory and data for each of the effects examined, the accuracy of the model is extremely good. It is interesting to note that the multiple-reinforcement procedure is not sufficient by itself to cause the subjects to switch their strategies from rehearsal to coding. The major emphasis still appears to be on rehearsal manipulations in STS, a not entirely surprising result since the situation is identical to that used in Experiment 1 except for the number of reinforcements given. The comments previously made concerning the difficulty associated with LTS storage in Experiment 1 apply here also. Because the emphasis is upon short-term mechanisms, this experiment is not to be considered in any strong sense as a bridge to the usual paired-associate learning situation. Nevertheless, a number of long-term effects, such as intrusion errors and interference caused by previously learned items on new items with the same stimulus, demonstrate that LTS mechanisms cannot be ignored in the theory. In Section V we consider

experiments that are designed to provide a sharper picture of the workings of LTS; experimentally this is accomplished by systematically varying the number of items in LTS through which searches must be made. Before considering this problem, however, there are other features of the STS rehearsal strategy to be explored. We turn next to an experiment in which the probability of entering an item into the buffer is manipulated experimentally.

D. OVERT VERSUS COVERT STUDY PROCEDURES (EXPERIMENT 4)

The statistics considered in the previous section leave little doubt about the role of O items, N items, and the buffer entry parameter α . But one question we have not considered is whether α is amenable to experimental manipulation; if the process is really under the control of the subject, such manipulation would be expected. We now turn to a study by Brelsford and Atkinson (1968) which was designed to answer this question.

In Experiment 1, the proportions of O items and N items were varied by changing the size of the stimulus set, and the predicted differences were found. Manipulating α , however, is a somewhat more subtle task since it is the subject's strategy that must be affected. One experimental device which seems likely to increase the probability of an item's entering the buffer is to have the subject recite the item aloud as it is presented for study; this will be referred to as the "overt" study procedure. The "covert" study procedure is simply a replication of the procedure used in Experiment 1 where the subject was not required to recite the item aloud when it was presented for study, but simply told to study it.

1. *Method*

The method was identical to that used in Experiment 1 except for the following changes. The size of the stimulus set was fixed at six for all subjects and sessions. Each session consisted of 200 trials divided into four 50-trial blocks alternating between the overt and covert conditions. The initial 50-trial block was randomly chosen to be either an overt or a covert condition. The covert condition was identical in all respects to Experiment 1; when the word "study" and an S-R pair appeared on the CRT (the display screen) the subjects were told to silently study the item being presented. In the overt blocks, instead of the word "study" appearing on the CRT during the study portion of a trial, the word "rehearse" appeared. This was a signal for the subject to recite aloud twice the item then being presented for study. This was the only difference from the procedure used during the covert trials. It was hoped that the act of repeating the items aloud would raise the subject's probability of entering the item into his rehearsal buffer.

2. Results

In order to allow for the subject's acclimation to a change in study conditions, the first 15 trials of each 50-trial block are not included in the data analysis. Figure 18 presents the lag curves for the overt and covert conditions. It is evident that performance is superior in the overt condition. Furthermore, the overt lag curve is S-shaped in form, an

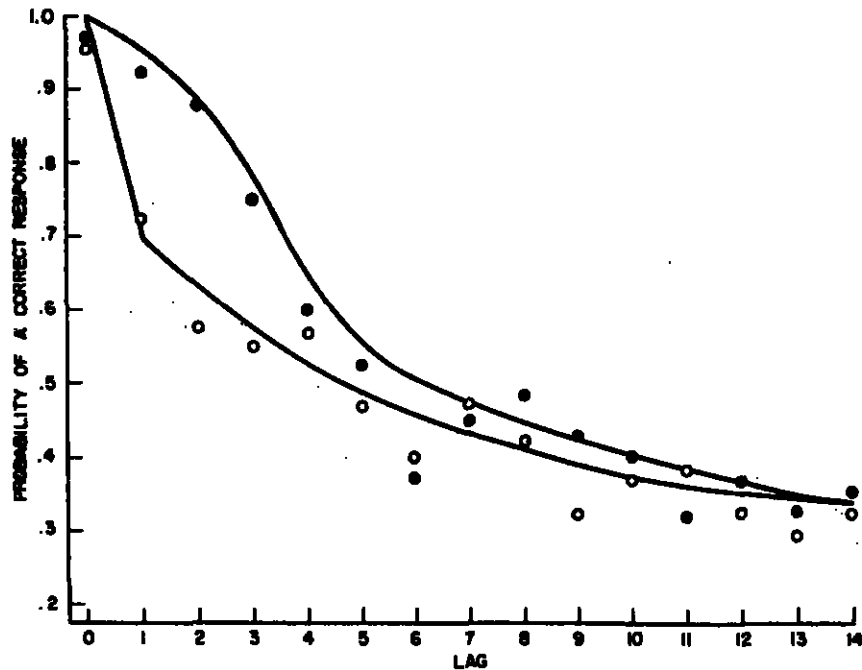

FIG. 18. Observed and theoretical probabilities of a correct response as a function of lag (Experiment 4). ● Overt; ○ covert; — theory.

effect not observed in earlier curves. Since the parameters of the models will be estimated from these curves, the model is presented before considering additional data.

The model for the covert condition is, of course, identical to that used in the analysis of Experiment 1. It has the four parameters r , α , θ , and τ . Since it was hypothesized that α would be raised in the overt condition, we might try estimating α separately for that condition. This version of the model will not fit the overt data, however, because of the pronounced S-shaped form of the lag curve. Although setting α equal to 1.0 will predict better performance in the overt condition, the lag curve will have the form of an exponentially decreasing function, which is clearly not found in the data. In order to account for the S-shaped curve, we

need to assume that in the overt condition the subject tends to knock the oldest items out of the buffer first. In the model for the covert case, an entering N item is said to knock out at random any item currently in the buffer. It will be assumed for the overt case that an entering N item tends to replace the oldest item in the buffer; remember O items are items whose stimulus is currently in the buffer and they automatically replace the item with that stimulus. This probability of knocking the oldest items from the buffer first is specified as follows: if there are r items in the buffer and they are numbered so that item 1 is the oldest and item r is the newest, then the probability that an entering N item will knock the j th item from the buffer is

$$\frac{\delta(1 - \delta)^{j-1}}{1 - (1 - \delta)^r}$$

This equation is derived from the following scheme. The oldest item is knocked out with probability δ . If it is not knocked out, then the next oldest is knocked out with probability δ . The process continues cyclically until an item is finally selected to be knocked out. When δ approaches zero, the knockout probabilities are random, as in the covert case. When δ is greater than zero there will be a tendency for the oldest items to be knocked out of the buffer first; in fact if δ equals one, the oldest item will always be the one knocked out. It should be clear that the higher the value of δ , the greater the S-shaped effect predicted for the lag curve.

The model for the curves in Fig. 18 is therefore structured as follows. The parameters r , θ , and τ will be assumed to be the same for the two conditions; the parameters α and δ will be assumed to be affected by the experimental manipulation. To be precise, in the covert case α will be estimated freely and δ will be set equal to zero, which is precisely the model used in Experiment 1. In the overt case, α will be set equal to 1.0, which means that every item enters the buffer, and δ will be estimated freely. The parameter values that provided the best χ^2 fit to the data in Fig. 30 were $r = 3$, $\theta = .97$, $\tau = .90$; for the covert condition the estimate of α was .58 (with δ equal to zero) and for the overt condition the estimate of δ was .63 (with α equal to one). The predictions for this set of parameter values are shown in Fig. 18 as smooth curves. The improvement in performance from the covert to overt conditions is well predicted; actually it is not obvious that variations in either α or δ should affect the overall level of performance. The principal reason for the improvement is due to the value of α ; placing every item into the buffer means that an item entering the buffer will be expected to stay there for a shorter period than if some items did not enter the buffer. This shorter period in the buffer, however, is outweighed by the advantages resulting from the entry of every item in the first place. It is not

easy to find statistics, other than the gross form of the lag curve, which reflect changes in δ ; thus the assumption that the oldest items are lost first is not easy to verify in a direct way. Nevertheless, it is quite common to find experiments that yield S-shaped recency curves and these results can be fit by assuming that the oldest items in the buffer tend to be knocked out first. Other examples will be presented in Section V.

A number of additional aspects of the data will now be examined. First we consider the "all-same" and "all-different" lag curves. Figure 19

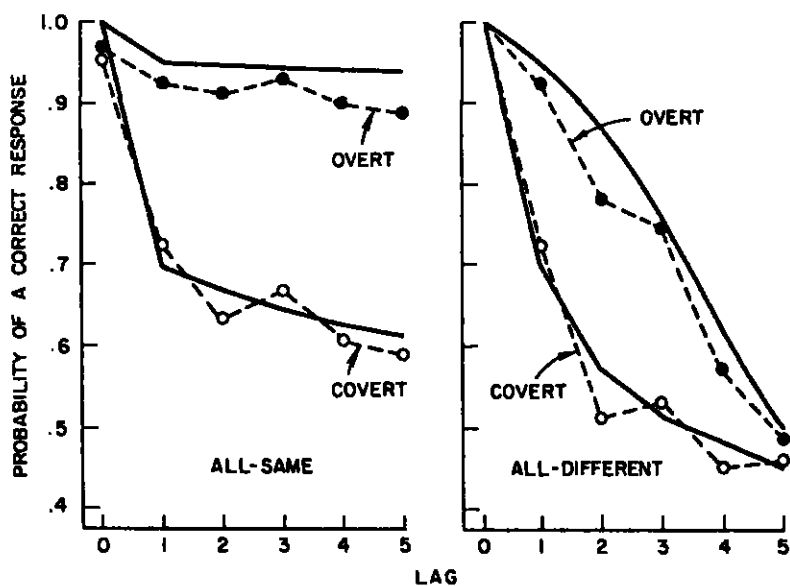

Fig. 19. Observed and theoretical probabilities of a correct response as a function of lag for the "all-same" and "all-different" conditions (Experiment 4).

gives the "all-same" lag curves for the overt and covert conditions. This curve gives the probability of a correct response for an item when all of the intervening items (between its study and test) have the same stimulus. This curve will be quite flat because the items following the first intervening item tend to be O items which will not knock other items from the buffer (for the overt case, every item following the first intervening item is an O item, since all items enter the buffer). Figure 19 also presents the "all-different" lag curves. This curve is the probability of making a correct response to a given item when the other items intervening between its study and test all involve different stimuli. The

predictions generated by the previous parameter values are given by the smooth curves; they appear to be quite accurate.

We now look for an effect that will be sharply dependent upon the value of α and hence differ for the overt and covert conditions. Such an effect is given in Fig. 20; graphed there is the probability of a correct response as a function of the number of immediately preceding items having the same stimulus as the item in question. This is the same

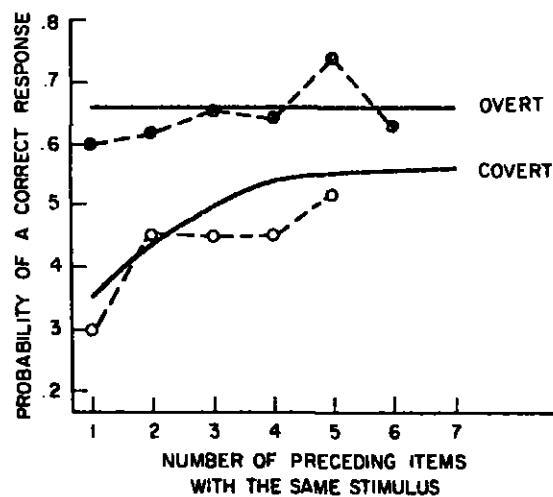

FIG. 20. Observed and theoretical probabilities of a correct response as a function of the number of consecutive preceding items all using the same stimulus (Experiment 4).

statistic that is plotted in Figs. 9 and 14; it is not a lag curve because the probability correct is given as an average over all possible lags at which the item was tested. If α is less than 1, then the length of the preceding sequence of items with the same stimulus will be an important variable; since any item in the sequence which enters the buffer will cause every succeeding item in the sequence to enter the buffer, the probability that the item in question enters the buffer will approach one as the length of the preceding sequence of items all using the same stimulus increases. For α equal to 1 (overt condition), every item enters the buffer and therefore no change would be expected. As indicated in Fig. 20, the data and theory are in good agreement. The slight rise in the data points for the overt condition may indicate that an estimate of α a little below 1.0 would improve the predictions, but the fit as it stands seems adequate.

**E. ADDITIONAL VARIABLES RELATED TO THE REHEARSAL BUFFER
(EXPERIMENTS 5, 6, AND 7)**

1. *Known Items and the Buffer (Experiment 5)*

In this section we shall consider briefly a number of other variables that relate to the rehearsal buffer. The overt manipulation in the preceding section succeeded in raising to near 1.0 the probability of entering an item in the buffer. As an alternative, one would like an experimental manipulation which would cause the entry probability to drop to near zero for some items. W. Thomson at Stanford University has performed an experiment that satisfies this requirement. The experimental manipulation involves interspersing some extremely well-known items among a series of items never seen before. The assumption is that a well-known item will not enter the rehearsal buffer. The experiment was performed using a modification of the "all-different" stimulus procedure employed in Experiment 2. The stimuli were consonant-vowel-consonant trigrams and the responses were the digits 0-9. For each subject two stimuli were chosen at the start of the first session and assigned responses. These S-R pairs never changed throughout the series of sessions. Except for these two items all other items were presented just once. The size of the to-be-remembered set(s) was six which included the two "known" items. The presentation schedule was as follows: on each trial with probability .5 one of the two known items would be presented for test and then given yet another study period; otherwise one of the four items in the current to-be-remembered set would be tested and a new stimulus-response pair then presented for study. Thus, the task was like that used in Experiment 2, except that on half the trials the subject was tested on, and then permitted to study, an S-R pair which was thoroughly known. The data from the first session in which the known items were being learned will not be considered.

The simplest assumption regarding the two known items is that their probability of entering the buffer is zero. This assumption is the one used in the multiple-reinforcement study (Experiment 3); namely, that an item successfully recovered from LTS is not entered into the buffer.¹⁸ In contrast to Experiment 3, in this study it is easy to identify the items that are known since they are experimentally controlled; for this reason we can look at a number of statistics depending upon the likelihood of entering known items into the buffer. The one of particular interest is presented in Fig. 21. Graphed there is the unconditional lag curve, the

¹⁸ Underwood and Ekstrand (1967) have found that insertion of known items from a previously learned list into a succeeding list improves performance on the learning of unknown items on the second list, although list length was a confounded variable.

"all-known-intervening" lag curve and the "all-unknown-intervening" lag curve. By known items we mean the two S-R pairs that repeatedly are being studied and tested; by unknown items we mean those pairs that are studied and tested only once. The unconditional lag curve gives the probability correct for unknown items as a function of lag, independent of the type of items intervening between study and test; of

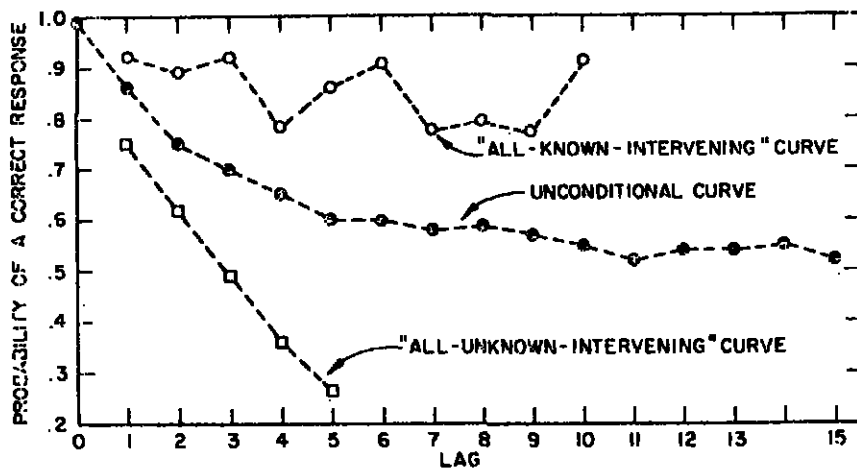

FIG. 21. Observed and theoretical probabilities of a correct response as a function of lag, for the overall condition and for the "all-known-intervening" and "all-unknown-intervening" conditions (Experiment 5).

course, the corresponding curve for known items would be perfect at all lags since subjects never make errors on them. The all-known-intervening curve gives the probability correct as a function of lag, when all of the items intervening between study and test are known items. If none of the known items enter the buffer, this curve should be level from lag 1 on and equal to α , the probability that the item entered the buffer when presented for study. At the opposite extreme is the all-unknown-intervening curve; when all the intervening items are new, the probability of knocking the item of interest from the buffer increases with lag and therefore the curve should decay at a rapid rate. It may be seen that this curve indeed drops at a more rapid rate than the unconditional lag curves. The marked difference between the all-known and all-unknown curves in Fig. 21 leads us to conclude that known and unknown items clearly have different probabilities for entering the rehearsal buffer. If the all-known curve were flat after lag 1, then the probability for entering a known item into the buffer would be zero. Another possibility is that

α is indeed zero for known items, but that the subject occasionally picks an item from LTS for additional rehearsal when a known item is presented.

2. Response Time Measures (Experiment 6)

We now turn to a consideration of some latency results. Potentially, latencies offer an avenue of analysis that could be more fruitful than the

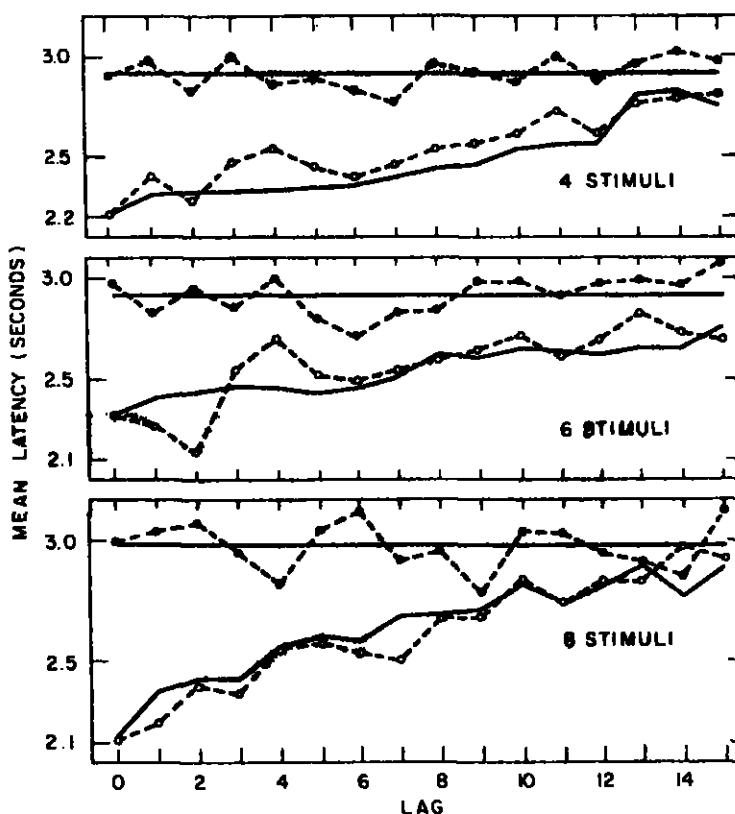

FIG. 22. Observed and theoretical mean latencies as a function of lag for correct and incorrect responses (Experiment 6). --●-- Error latencies; --○-- correct latencies;—predicted latencies.

analysis of choice response data; we say this because the latencies should reflect search and retrieval times from both STS and LTS. A detailed latency analysis is beyond the scope of this paper, but one simple result will be considered. Figure 22 presents the average latencies as a function of lag for correct and incorrect responses in a study by Brelsford *et al.* (1966). This experiment employed the same procedure described earlier

in our discussion of Experiment 1 except that only 6 rather than 26 responses were used. As in Experiment 1, this study used three different stimulus-set sizes; i.e., s equalled 4, 6, or 8. For each stimulus set in Fig. 22 it may be seen that the correct and incorrect latency curves converge at long lags. This convergence would be expected since the probability of a correct response is dropping toward chance at long lags. The theoretical curves are based on an extremely simple latency model which assumes that latencies for responses correctly retrieved from either LTS or STS have a fixed mean value λ , whereas a failure to retrieve and a subsequent guess has a fixed mean value of λ' . Thus error responses always have a mean latency λ' ; however, a correct response may occur as a result of a retrieval from memory or a correct guess, and consequently its latency is a weighted average of λ and λ' . We can estimate λ' as the average of the points on the latency lag curve for errors, and λ can be set equal to the latency of a correct response at lag zero since all responses are due to retrievals from memory at this lag. In order to predict the remaining latency data, we make use of the observed probability of a correct response as a function of lag; these values are reported in Brelsford *et al.* (1966). If p_i is the observed probability of a correct response at lag i , then

$$p_i = x_i + (1 - x_i)\frac{\lambda'}{\lambda}$$

where x_i is the probability of retrieving the response from memory and $(1 - x_i)\frac{\lambda'}{\lambda}$ is the probability of making a correct response by guessing. Estimating x_i in this way, we predict that the mean latency of a correct response at lag i is simply $x_i\lambda + (1 - x_i)\lambda'$. Using this equation and estimating λ and λ' as indicated above, leads to the theoretical curves displayed in Fig. 22. The error latency curve is predicted to be equal to λ' for all lags, whereas the correct latency curve is λ at lag 0 and approaches λ' over lags as the estimate of x_i goes to zero. This latency model is of course oversimplified, and fails to take into account differences in latencies due to retrieval from STS as compared to retrieval from LTS; the results nevertheless indicate that further analyses along these lines may prove fruitful.

3. Time Estimation (Experiment 7)

One factor related to our model that has not been discussed is temporal memory. It seems clear that there is some form of long-term temporal memory; in a negative transfer paradigm, for example, there must be some mechanism by which the subject can distinguish between the most recent response paired with a stimulus versus some other response paired with that stimulus at an earlier time. This temporal memory undoubtedly involves the long-term store; somehow when an

event is stored in LTS it also must be given a time tag or stored in such a way that the subject can date the event (albeit imperfectly) at the time of retrieval. In addition to long-term temporal storage, there is evidence that a subject's estimate of elapsed time depends upon an item's length of residence in the buffer. An experiment by R. Freund and D. Rundis at Stanford University serves to illustrate the dependence of temporal memory upon the buffer.¹⁹ The study employed essentially

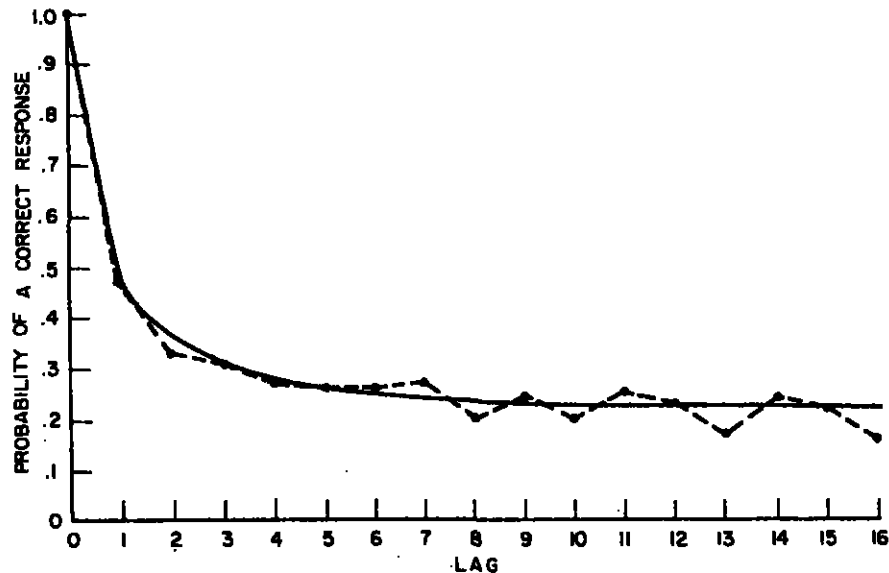

FIG. 23. Observed and theoretical probabilities of a correct response as a function of lag (Experiment 7). --- Observed;—predicted.

the same procedure used in Experiment 2. There was a continuous sequence of test-plus-study trials and the stimuli kept changing throughout each session; each stimulus appeared only once for study and test. The stimuli were consonant-vowel-consonant trigrams and the responses were the 26 letters of the alphabet; the size of the to-be-remembered set of items was fixed at eight. When a stimulus was tested the subject first gave his best guess of the response that had been previously studied with the stimulus and then gave an estimate of the number of trials that intervened between the item's initial study and final test; this estimate could range from 0 to 13; if the subject felt the lag was greater than 13 he responded by pressing a key labeled 14+.

The unconditional lag curve for the probability of a correct response is presented in Fig. 23. The solid line represents the predictions that were

¹⁹ This study employs a time-estimation procedure similar to one developed by L. R. Peterson (personal communication).

generated by the model used to fit Experiment 2. The parameter values providing the best fit to the lag curve were $r = 2$, $\alpha = .57$, $\theta = .13$, $\tau = 1.0$. The data of interest is presented in Fig. 24. The average lag judgment is plotted as a function of the actual lag. The solid dots are the average lag judgments for those items to which a correct response was given; the open circles are the average lag judgments for those items to which an incorrect response was given. If lag judgments were perfect,

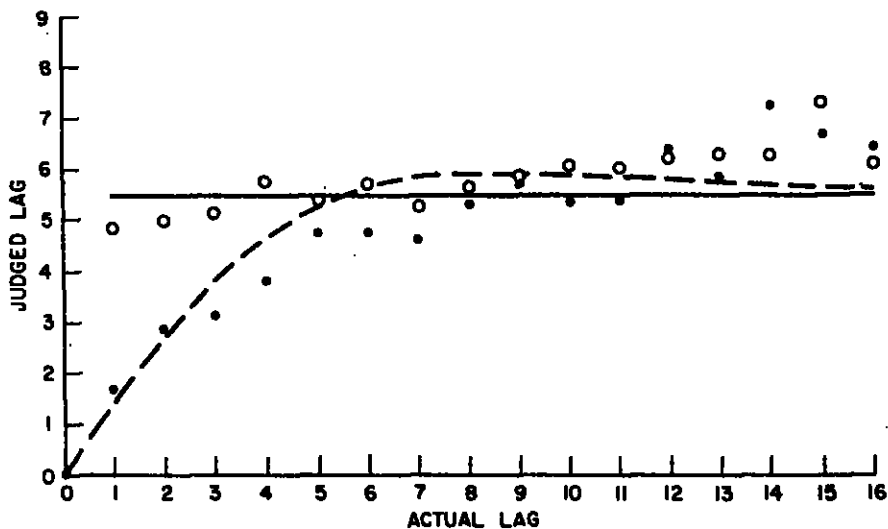

FIG. 24. Observed and theoretical mean lag judgments as a function of the actual lag (Experiment 7). \circ Error data; — error theory; \bullet correct data; -- correct theory.

they would fall on the 45° diagonal; it may be seen that the correct curve is fairly accurate to about lag 5 and then tails off. The lag judgments associated with incorrect responses seem to be virtually unrelated to the actual lag. This indicates that the retrieval of a correct response and temporal estimation are closely related. An extremely simple model for this data assumes that the mean lag judgment for an item in the buffer is the true lag value; any item not in the buffer is given a lag judgment at random from a distribution that is unrelated to the true lag. The predictions using the above parameter estimates are shown in Fig. 24. Freund and Rundis have developed more elaborate models which include both a long- and short-term temporal memory and have obtained quite accurate predictions; but these models will not be examined here. The point we want to make by introducing these data is that temporal memory may be tied to the short-term system even more strongly than to the long-term system.

V. Experiments Concerned with Long-Term Search and Retrieval

The major purpose of this section is to examine a series of experiments concerned with search and retrieval processes in LTS. These experiments differ from those of the preceding section in that the memory tasks are not continuous; rather, they involve a series of discrete trials which are meant to be relatively independent from one to the next. On each trial a new list of items is presented sequentially to the subject for study; following the presentation a test is made on some aspect of the list. Using this procedure, the size of the list, d , can be systematically manipulated. Variations in list size affect the size of the memory set through which the subject must search when tested, and consequently search and retrieval processes can be examined in more detail than was previously possible. The title of this section is not meant to imply, however, that the short-term processes involved in these experiments are different from those appearing in the continuous-presentation situations; in fact, the models used to describe the experiments of this section will be based upon the same STS rehearsal buffer introduced earlier. The difference is one of emphasis; the long-term processes will be elaborated and explored in greater depth in this section. This exploration of long-term models will by no means be exhaustive, and will be less extensive than that carried out for the short-term processes.

Prior to an examination of particular experiments, a few remarks need to be made about the separability of lists. In any experiment in which a series of different lists is presented, we may ask just what information in LTS the subject is searching through at test. The same problem arises, though less seriously, in experiments where the subject is tested on only one list. Clearly the information relevant to the current list of items being tested must be kept separate from the great mass of other information in LTS. This problem is accentuated when individual lists within a session must be kept separated. How this is managed is somewhat of a mystery. One possible explanation would call for a search along a temporal memory dimension: the individual items could be assumed to be temporally ordered, or to have "time tags." It is not enough to propose that search is made through all items indiscriminately and that items recovered from previous lists are recognized as such and not reported; if this were true, the duration and difficulty of the search would increase dramatically over the session. In fact, the usual result is that there is little change in performance over a session except for effects concentrated at the very start. On the other hand, judging from such factors as intrusion errors from previous lists, the subject is not able to restrict his search solely to the current list. In the experiments to follow, we will make the simplifying assumption, without real justification, that the

lists are entirely separated in LTS, and that the subject searches only through information relevant to the list currently being tested.

**A. A SERIAL DISPLAY PROCEDURE INVOLVING SINGLE TESTS
(EXPERIMENT 8)**

This experiment involved a long series of discrete trials. On each trial a new display of items was presented to the subject. A display consisted of a random sequence of playing cards; the cards varied only in the

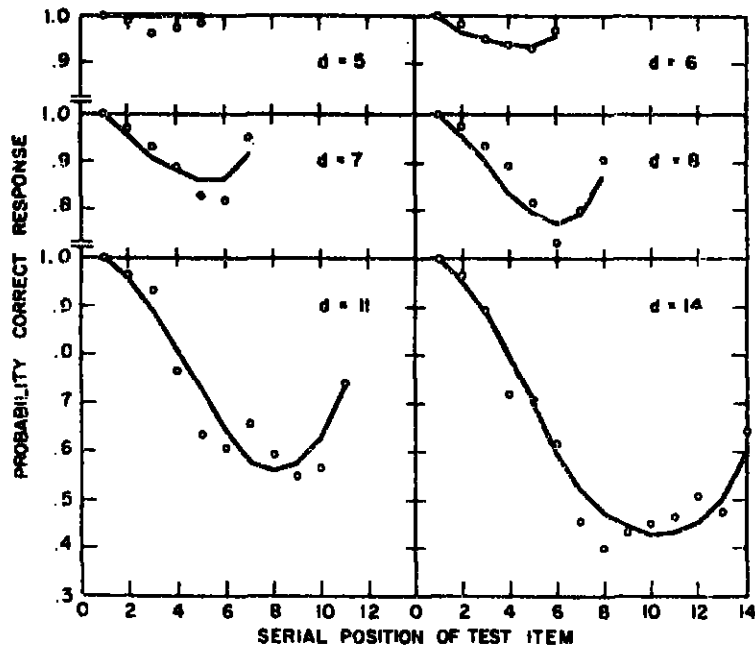

FIG. 25. Observed and theoretical probabilities of a correct response as a function of serial position (Experiment 8).

color of a small patch on one side; four colors (black, white, blue, and green) were used. The cards were presented to the subject at a rate of one card every 2 seconds. The subject named the color of each card as it was presented; once the color of the card had been named it was turned face down on a table so that the color was no longer visible, and the next card was presented. After presentation of the last card in a display, the cards were in a straight row on the table; the card presented first was to the subject's left and the most recently presented card to the right. The trial terminated when the experimenter pointed to one of the cards on the table and the subject attempted to recall the color of that card. The subject was instructed to guess the color if uncertain and to

qualify the response with a confidence rating. The confidence ratings were the numerals 1 through 4. The subjects were told to say 1 if they were positive; 2 if they were able to eliminate two of the four possible colors as being incorrect; 3 if one of the four colors could be eliminated as incorrect; and 4 if they had no idea at all as to the correct response.

It is important to note that only one position is tested in a display on each trial. The experiment involved 20 female subjects who participated in five daily sessions, each lasting for approximately 1 hour. Over the course of the five sessions, a subject was given approximately 400 trials. The display size, d , was varied from trial to trial and took on the following values: $d = 3, 4, 5, 6, 7, 8, 11$, and 14. Details of the experimental procedure are presented in Phillips, Shiffrin, and Atkinson (1967).

Figure 25 presents the probability of a correct response at each serial position for displays of size 5, 6, 7, 8, 11, and 14. For displays of sizes 3 and 4, the probability correct was 1.0 at all positions. The circles in the figure are the observed points; the solid lines are predicted curves which will be explained shortly. The serial positions are numbered so that item 1 designates the last item presented (the newest item), and item d designates the first item presented (the oldest item). The most apparent features of the curves are a fairly marked S-shaped recency portion and a smaller, quite steep primacy portion. For all display sizes, the probability of a correct response is 1.0 at serial position 1.

1. Theory

We must first decide whether a subject will set up and use a rehearsal buffer in this situation. Despite the fact that the continuous procedure has been dropped, it is still unlikely that the subject will engage in a significant amount of long-term coding. This is true because the task is still one of high "negative transfer"; the stimuli, which are the positions in the display, are constantly being re-paired with new responses as a session continues. Too much LTS encoding would undoubtedly lead to a high degree of interference among lists. It is only for a relatively weak and decaying LTS trace that a temporal search of long-term memory may be expected to keep the various lists separate. This difficulty in LTS transfer leads to the adoption of short-term strategies. Another reason for using a rehearsal buffer in this task depends upon the small list lengths employed; for small list lengths, there is a high probability that the item will be in the buffer at the moment of test. Thus the adoption of a rehearsal buffer is an efficient strategy. There is some question concerning just what the unit of rehearsal is in this situation. For example, the subject could assign numbers to positions in the display and then rehearse the number-color pairs. Most likely, however, the subject uses the fact that the stimuli always remain before her to

combine STS rehearsal with some form of visual mnemonic. That is, the unit of rehearsal is the response alone; as the subject rehearses the responses, she "mentally" places each response upon the appropriate card before her. This might therefore be a situation where the a-v-l and visual short-term stores are used in conjunction with each other. In any case, it seems reasonable that the units of rehearsal are the names (or perhaps the abbreviations) of the colors.

We might ask how the buffer will act in this situation. As noted earlier, in reference to the "overt-covert" experiment, the fact that items are read aloud as they are presented will tend to cause the subject to enter each item into the buffer. Furthermore, an S-shaped recency effect would not be unexpected. Indeed, if the units of rehearsal are the responses themselves, then the subject might tend to keep them in consecutive order to ease the visual memory task; if all items enter the buffer and are kept in consecutive order, then the oldest items will tend to be deleted first. That is, when a new item enters the buffer there will be a tendency to eliminate the oldest item from the buffer to make room for it. One other question that should be considered is the size of the buffer the subject would be expected to use in this task. There are a number of reasons why the buffer size should be larger here than in the continuous tasks of Section IV. First, the subject is not continually being interrupted for tests as in the previous studies; more of the subject's attention may therefore be allotted to rehearsal. Second, rehearsal of color names (or their abbreviations) is considerably easier than number-letter combinations. Equivalent to rehearsing "32-G, 45-Q" might be "Black, White, Black, Green" (or even a larger set if abbreviations are used). The magnitude of the difference may not be quite as large as this argument would lead us to expect because undoubtedly some time must be allotted to keeping track of which response goes on which position, but the estimate of the buffer size nevertheless should be larger in this situation than in the continuous tasks.

The STS part of the model for this experiment is similar to that used in the "overt" experiment in Section IV,D in that every item is entered in the buffer when it is presented. There is one new factor, however, that must be considered. Since each trial starts with the buffer empty, it will be assumed that the first items presented enter the buffer in succession, without knocking any item out, until the buffer is filled. Once the buffer is filled, each item enters the buffer and knocks out one of the items currently there. If the most recently presented item is in slot r of the buffer, and the oldest item is in slot 1, then the probability that the item in slot i of the buffer will be the one eliminated is

$$\frac{\delta(1 - \delta)^{i-1}}{1 - (1 - \delta)^r}$$

This is the same equation that was used to describe the knock-out process for the overt-covert study (Experiment 4). The larger δ , the greater the tendency to delete the oldest item in the buffer when making room for a new one.

The first set of long-term storage and retrieval assumptions that will be considered are essentially identical to those used in the previous sections. Information will be assumed to enter LTS during the entire period an item resides in the buffer at a rate θ per inter-item interval. This process must be qualified with regard to the first few items presented on each trial before the buffer is filled; it is assumed that the subjects divide their attention equally among the items in the buffer. Thus, if the rate of transfer is θ when there is only one item in the buffer, and the buffer size is r , then the rate of transfer will be θ/r when the buffer is filled. That is, since attention must be divided among r items when the buffer is full, each item receives only $1/r$ th as much transfer as when the buffer only holds a single item. In general, information on each item will be transferred to LTS at rate θ/j during the interval in which there are j items in the buffer. The effect of this assumption is that more information is transferred to LTS about the items first presented in a list than about later items that are presented once the buffer is full.

The LTS decay and retrieval processes must now be examined. In earlier experiments we assumed that information decayed solely as a result of the number of items intervening between study and test; in other words, only the retroactive interference effect was considered. Because the previous tasks were continuous, the number of items preceding an item's presentation was effectively infinite in all cases. For this reason the proactive effects were assumed to be constant over conditions and did not need explicit inclusion in the model. In the present experiment the variation in list size makes it clear that proactive interference effects within a trial will be an important variable. The assumption that will be used is perhaps the simplest version of interference theory possible: each preceding and each succeeding item has an equal interfering effect. To be precise, if an amount of information I has been transferred to LTS for a given item, then every other item in the list will interfere with this information to the extent of reducing it by a proportion τ . Thus, if there were d items in the list, the item of interest would have an amount of information in LTS at the time of test equal to $I(\tau^{d-1})$. Clearly, the longer the list the greater the interference effect.

The model can now be completed by specifying the response process which works as follows. An item in the buffer at the time of test is responded to correctly. If the item is not in the buffer, then a search is made in LTS. The probability of retrieving the appropriate response is,

as in our other models, an exponential function of this information and equals $1 - \exp[-I(\tau^d - 1)]$; if a retrieval is not made, then the subject guesses.

2. Data Analysis

The parameter values that gave the best fit to the data of Fig. 25 using a minimum χ^2 criterion were as follows: $r = 5$, $\delta = .38$, $\theta = 2.0$, and $\tau = .85$.²⁰ Remember that r is the buffer size, δ determines the probability of deleting the oldest item in the buffer, θ is the transfer rate to LTS, and τ is the proportional loss of information caused by other items in the list. The theoretical curves generated by these parameter estimates are shown in Fig. 30 as solid lines. The predictions are quite accurate as indicated by a χ^2 value of 44.3 based on 42 degrees of freedom. It should be emphasized that the curves in the figure were all fit simultaneously with the same parameter values.

The primacy effect in the curves of Fig. 25 is predicted because more information is transferred to LTS for the first items presented on each trial. There are two reasons for this. First, the transfer rate on any given item is higher the fewer items there are in the buffer; thus the initial items, which enter the buffer before it is filled, accumulate more information in LTS. Second, the initial items cannot be knocked out of the buffer until the buffer is filled; thus the time period that initial items reside in the buffer is longer on the average than the time for later items. The recency effect is predicted because the last items presented in a list tend to be still in the buffer at the time of test; the S-shape arises because the estimate of δ indicates a fairly strong tendency for the oldest items in the rehearsal buffer to be eliminated first when making room for a new item.

Having estimated a set of parameter values that characterizes the data in Fig. 25, we now use these estimates to predict the confidence rating data. Actually, it is beyond the scope of this paper to analyze the confidence ratings in detail, but some of these data will be considered in order to illustrate the generality of the model and the stability of the parameter estimates. The data that will be considered are presented in Fig. 26; graphed is the probability of giving confidence rating R_1 (most confident) for each list size and each serial position. The observed data is represented by the open circles. It is clear that these results are similar in form to the probability correct curves of Fig. 25. The model used to fit these data is quite simple. Any item in the buffer is given an R_1 . If the item is not in the buffer, then a search is made of LTS. If the amount of information in LTS on the item is $I(\tau^d - 1)$ then the probability of giving R_1 is an exponential function of that information: namely the

²⁰ For details on the method of parameter estimation see Phillips, Shiffrin, and Atkinson (1967).

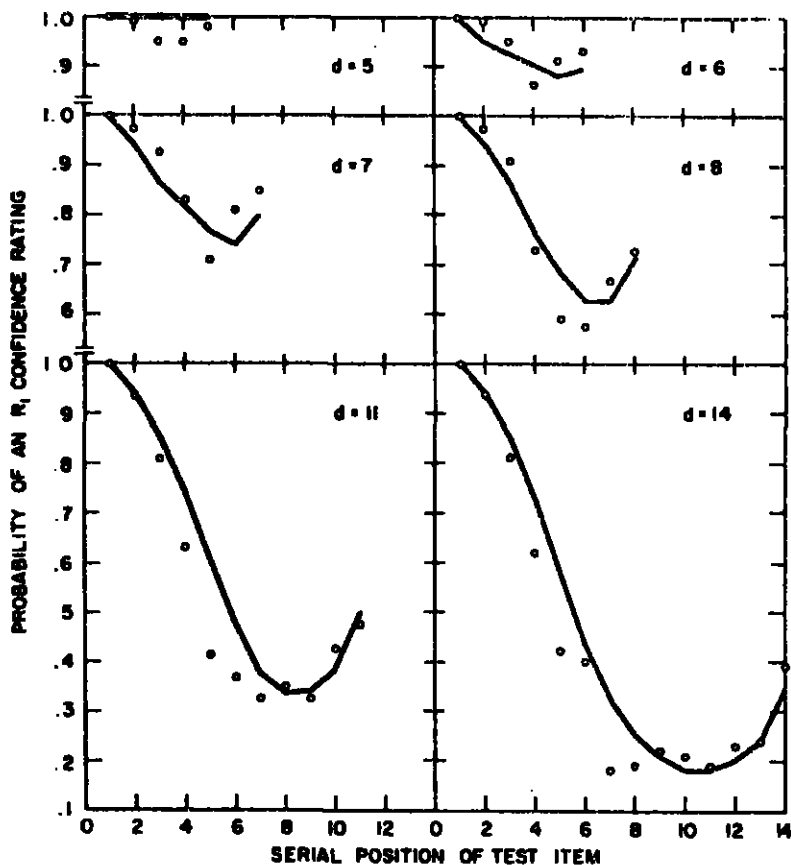

FIG. 26. Observed and predicted probabilities of confidence rating R_1 as a function of serial position (Experiment 8).

function $1 - \exp[-c_1 I(\tau^{d-1})]$, where c_1 is a parameter determining the subject's tendency to give confidence rating R_1 . This assumption is consistent with a number of different viewpoints concerning the subject's generation of confidence ratings. It could be interpreted equally well as an assignment of ratings to the actually perceived amount of information in LTS, or as a proportion of the items that are recovered in an all-or-none fashion.²¹ In any event, the predictions were generated using the previous parameter values plus an estimate of c_1 . The predicted curves, with c_1 equal to .66, are shown in Fig. 26. The predictions are not as accurate as those in Fig. 25; but, considering that only one new parameter was estimated, they are quite good.

²¹ The various possibilities may be differentiated through an analysis of conditional probabilities of the ratings given correct and incorrect responses, and through ROC curve (Type II) analyses (Bornbach, 1967, Murdock, 1966) but this will not be done here.

3. Discussion

In developing this model a number of decisions were made somewhat arbitrarily. The choice points involved will now be considered in greater detail. The assumption that the amount of transfer to LTS is dependent upon the number of items currently in the buffer needs elaboration. Certainly if the subject is engaged in coding or other active transfer strategies, the time spent in attending to an item should be directly related to the amount of transfer to LTS. On the other hand, the passive type of transfer which we assume can occur in situations where the subject makes use of a rehearsal buffer may not be related to the time spent in rehearsing an item per se, but rather to the total period the item resides in the buffer. That is, direct attention to an item in STS may not be necessary for some transfer to take place; rather a passive form of transfer may occur as long as the item remains in STS. Thus in situations where the rehearsal buffer is used and active transfer strategies such as coding do not occur, it could reasonably be expected that the amount of information transferred to LTS would be related solely to the total time spent in the buffer, and not to the number of items in the buffer at the time. In practice, of course, the actual transfer process may lie somewhere between these two extremes. Note that even if the transfer rate for an item is assumed to be a constant (unrelated to the number of items currently in the buffer) the first items presented for study still would have more information transferred to LTS than later items; this occurs because the items at the start of a list will not be knocked out of the buffer until it is filled and hence will reside in the buffer for a longer time on the average than later items. For this reason, the primacy effect could still be explained. On the other hand, the primacy effect will be reduced by the constant transfer assumption; in order to fit the data from the current experiment with this assumption, for example, it would be necessary to adjust the retrieval scheme accordingly. In modeling the free verbal-recall data that follows, a constant transfer assumption is used and accordingly a retrieval scheme is adopted which amplifies more strongly than the present one small differences in LTS strength.

We now consider the decay assumption in greater detail. The assumption is that the information transferred to LTS for a particular item is reduced by a proportion τ for every other item in the list. There are a number of possibilities for the form of this reduction. It could be actual physical interference with the trace, or it could be a reduction in the value of the current information as a result of subsequent incoming information. An example of this latter kind of interference will be helpful. Suppose, in a memory experiment the first item is GEX-5, and the subject stores "G_-5" in LTS. If tested now on GEX, the subject

would give the correct response 5. Suppose a second item GOZ.3 is presented and the subject stores "G__-3" in LTS. If he is now tested on either GEX or GOZ his probability of a correct response will drop to .5. Thus the actual information stored is not affected, but its value is markedly changed.

The assumption that every other item in a list interferes equally is open to question on two counts. First of all, it would be expected that an item about which a large amount of information is transferred would interfere more strongly with other items in LTS than an item about which little information is transferred. Certainly when no transfer occurs for an item, that item cannot interfere with other LTS traces. However, the equal interference assumption used in our analysis may not be a bad approximation. The second failing of the equal interference assumption has to do with separation of items. If the list lengths were very long, it might be expected that the number of items separating any two items would affect their mutual interference; the greater the separation, the less the interference. The list lengths are short enough in the present experiment, however, that the separation is probably not an important factor.

4. *Some Alternative Models*

It is worth considering some alternatives to the interference process of the model just presented, henceforth referred to as Model I in this subsection. In particular it is important to demonstrate that the effects of the interference-decay assumption, which could be viewed as a *structural feature of memory*, can be duplicated by simple search processes. For example, any limited search through the information in LTS will give poorer performance as the amount of that information increases. In order to make the concept of the search process clear, Model II will adopt an all-or-none transfer scheme. That is, a single copy of each item may be transferred to LTS on a probabilistic basis. If a copy is transferred, it is a perfect copy to the extent that it always produces a correct response if it is retrieved from LTS. The short-term features of the model are identical to those of Model I: each item enters the buffer; when the buffer is filled each succeeding item enters the buffer and knocks out an item already there according to the δ -process described earlier.

The transfer assumption for Model II is as follows. If an item is one of the j items in the buffer, then the probability that a copy of that item will be placed in LTS between one item's presentation and the next is θ/j . Therefore, the transfer depends, as in Model I, upon the number of other items currently in the buffer. No more than one copy may be placed in LTS for any one item. The retrieval assumptions are the

following. A correct response is given if the item is in the buffer when tested. If it is not in the buffer, then a search is made in LTS. If a copy of the item exists in LTS and is found, then a correct response is given; otherwise a random guess is made. As before, we assume that the information pertinent to the current list is distinguishable from that of earlier lists; thus, the search is made only among those copies of items in the current list. The central assumption of Model II is that exactly R selections are made (with replacement) from the copies in LTS; if the tested item has not been found by then, the search ends. The restriction to a fixed number of searches, R , is perhaps too strong, but can be justified if there is a fixed time period allotted to the subject for responding. It should be clear that for R fixed, the probability of retrieval decreases as the list length increases; the longer the list the more copies in LTS, and the more copies the less the probability of finding a particular copy in R selections. Model II was fit to the data in the same fashion as Model I. The parameter values that gave the best predictions were $r = 5$, $\delta = .39$, $\theta = .72$, and $R = 3.15$. The theoretical curves generated by these parameters are so similar to those for Model I that Fig. 25 adequately represents them, and they will not be presented separately. Whereas the χ^2 was 44.3 for Model I, the χ^2 value for Model II was 46.2, both based on 42 degrees of freedom. The similarity of the predictions serves to illustrate the primary point of introducing Model II: effects predicted by search processes and by interference processes are quite similar and consequently are difficult to separate experimentally.

The search process described above is just one of a variety of such mechanisms. In general there will be a group of possible search mechanisms associated with each transfer and storage assumption; a few of these processes will be examined in the next section on free-verbal-recall. Before moving on to these experiments, however, we should like to present briefly a decay and retrieval process combining some of the features of interference and search mechanisms. In this process the interference does not occur until the search begins and is then caused by the search process itself. The model (designated as Model III) is identical in all respects to Model II until the point where the subject begins the search of LTS for the correct copy. The assumption is that the subject samples copies with replacement, as before, but each unsuccessful search may disrupt the sought-after copy with probability R' . The search does not end until the appropriate copy is found or until all copies in LTS have been examined. If the copy does exist in LTS, but is disrupted at any time during the search process, then when the item is finally retrieved, the stored information will be such that the subject will not be able to recall at better than the chance level. The parameter values giving the best fit for this model were $r = 5$, $\delta = .38$, $\theta = .80$, and

$R' = .25$. The predicted curves are again quite similar to those in Fig. 25 and will not be presented. The predictions are not quite as accurate, however, as those of Models I and II, the χ^2 value being 55.0.²²

B. FREE-VERBAL-RECALL EXPERIMENTS

The free-verbal-recall situation offers an excellent opportunity for examining retrieval processes, because the nature of the task forces the subject to engage in a lengthy search of LTS. The typical free-verbal-recall experiment involves reading a list of high-frequency English words to the subject (Deese & Kaufman, 1957; Murdock, 1962). Following the reading, the subject is asked to recall as many of the words as possible. Quite often list length has been a variable, and occasionally the presentation time per item has been varied. Deese and Kaufman, for example, used lists of 10 and 32 items at 1 second per item. Murdock ran groups of 10, 15, and 20 items at 2 seconds per item, and groups of 20, 30, and 40 items at 1 second per item. The results are typically presented in the form of serial position curves: the probability of recall is plotted against the item's position in the list. The Murdock (1962) results are representative and are shown in Fig. 27. It should be made clear that the numbering of serial positions for these curves is opposite from the scheme used in the previous section; that is, the first item presented (the oldest item at the time of test) is labeled serial position 1. This numbering procedure will be used throughout this section to conform with the literature on free-verbal-recall; the reader should keep this in mind when comparing results here with those presented elsewhere in the paper. The primacy effect in Fig. 27 is the rise on the left-hand portions of the curves and the recency effect is the larger rise on the right-hand portions of the curves. The curves are labeled with the list length and the presentation rate per item. Note that the curves are quite similar to those found in Experiment 8 of the previous section; an effect not seen in Experiment 8 (because of the short list lengths used) is the level asymptotic portions of the curves which appear between the primacy and recency effects for the longer lists.

The form of the curves suggests that a buffer process could explain the results, with the words themselves being the units of rehearsal. The recency effect would be due to the probability that an item is still in the buffer at test; this probability goes to near zero after 15 items or so and the recency effect accordingly extends no further than this. The primacy effect would arise because more information accrued in LTS for the first few items presented in the list. Whether a buffer strategy is reasonable in the free-recall situation, however, is worth further discussion. It can hardly be maintained that high-frequency English words are difficult to

²² For a more detailed account of Models I, II, and III, and a comparison among models, see Atkinson and Shiffrin (1965).

code; on the other hand, the task is not a paired-associate one and cues must be found with which to connect the words. One possibility is that upon seeing each word the subject generates a number of associates (from LTS) and tries to store the group of words; later during testing a search which retrieves any of the associates might in turn retrieve the desired word. We tend to doubt that this strategy, used by itself, will greatly improve performance.²³ To the extent that coding occurs, it

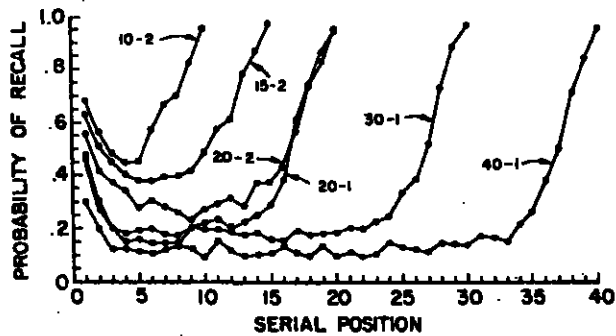

FIG. 27. Probability of correct recall as a function of serial position for free verbal recall. After Murdock (1962).

probably involves connecting words within the presented list to each other. This technique would of course require the consideration of a number of words *simultaneously in STS and therefore might be characterized reasonably well by a buffer process*. Whether or not coding occurs in the free-recall situation, there are other reasons for expecting the subjects to adopt a buffer strategy. The most important reason is undoubtedly the improvement in performance that a rehearsal buffer will engender. If the capacity of the buffer is, say, 4 or 5 words, then the use of a buffer will assure the subjects of a minimum of four or five items correct on each list (assuming that all of the items may be read out of the buffer correctly). Considering that subjects report on the average only about 8 or 9 items, even for long lists, the items stored in the buffer are an important component of performance.

It will be assumed, then, that the subjects do adopt a rehearsal strategy. The comparability of the curves in Fig. 25 to those in Fig. 27

²³ B. H. Cohen (1963) has presented free-recall lists containing closely related categories of words, e.g., north, east, south, west. Indeed, the recovery of one member of a category usually led to the recovery of other members, but the total number of categories recalled did not exceed the number of separate words recalled from noncategorized lists.

might indicate that a model similar to any of the models presented in the previous section could be applied to the current data. There are, however, important differences between the two experimental paradigms which must be considered: the free-recall situation does not involve pairing a response with a stimulus for each list position, and has the requirement of multiple recall at the time of test. The fact that explicit stimulus cues are not provided for each of the responses desired would be expected to affect the form of the search process. The multiple-response requirement raises more serious problems. In particular, it is possible that each response that is output may interfere with other items not yet recalled. The problem may be most acute for the case of items still in the buffer; Waugh and Norman (1965) have proposed that each response output at the time of test has the same disrupting effect upon other items in the buffer as the arrival of a new item during study. On the other hand, it is not clear whether a response emitted during test disrupts items in LTS. It might be expected that the act of recalling an item from LTS would raise that item's strength in LTS; this increase in strength is probably not associated, however, with the transfer of any new information to LTS. For this reason, other traces will most likely not be interfered with, and it shall be assumed that retrieval of an item from LTS has no effect upon other items in LTS.

Because there is some question concerning the effects of multiple recall upon the contents of the buffer, and because this section is primarily aimed at LTS processes, the part of the free-recall curves that arise from the buffer will not be considered in further analyses. This means that the models in this section will not be concerned with the part of the curve making up the recency effect; since the data in Fig. 27 indicate that the recency effect is contained in the last 15 items (to the right in the figure) of each list, these points will be eliminated from the analyses. Unfortunately, the elimination of the last 15 items means that the short list lengths are eliminated entirely. The problem of obtaining data for short list lengths not contaminated by items in the buffer at the time of test has been circumvented experimentally by a variation of the counting-backward technique. That is, the contents of the buffer can be eliminated experimentally by using an interfering task inserted between the end of the list and the start of recall. We now turn to a consideration of these experiments.

A representative experiment is that by Postman and Phillips (1965). Words were presented at a rate of one per second in all conditions. In one set of conditions three list lengths (10, 20, and 30) were used and recall was tested immediately following presentation. This, of course, is the usual free recall procedure. The serial position curves are shown in the top panel of Fig. 28 in the box labeled "0 second." The same list lengths

were used for those conditions employing an intervening task; immediately following presentation of the list the subjects were required to count backwards by three's and four's for 30 seconds. Following this intervening task, they were asked to recall the list. The results are shown in the lower panel in Fig. 28. If the intervening task did not affect the contents of LTS but did wipe out all items in the buffer, then the recency

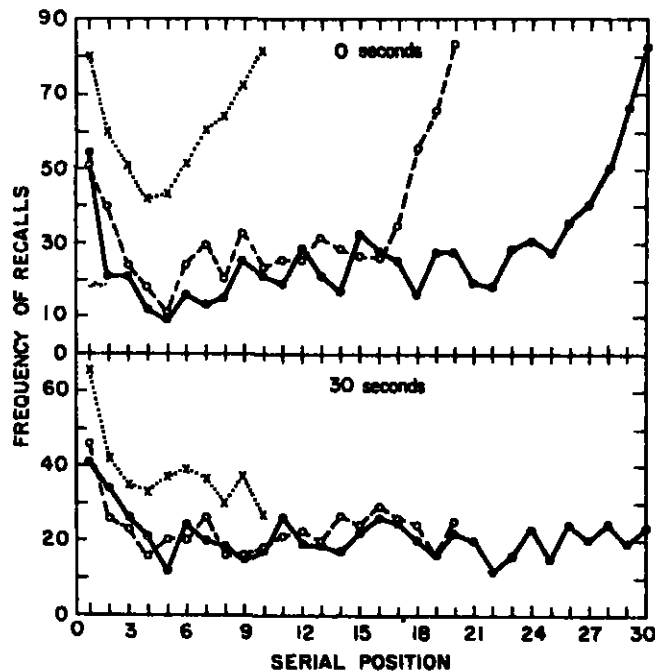

FIG. 28. Probability of correct recall as a function of serial position for free verbal recall with test following 0 seconds and 30 seconds of intervening arithmetic. After Postman & Phillips (1965).

effects would be expected to disappear with the curves otherwise unchanged. This is exactly what was found. The primacy effects and asymptotic levels remain unchanged while the recency effect disappears. It is clear, then, that normal free-recall curves (without intervening arithmetic) from which the last 15 points have been deleted should be identical to curves from experiments using intervening arithmetic. The following data have therefore been accumulated: Murdock's data with the last 15 points of each list deleted; data reported by Deese and Kaufman (1957) using a free-recall paradigm, but again with the last 15 points of each list deleted; the data reported by Postman and Phillips (1965); and some data collected by Shiffrin in which an intervening task

was used to eliminate the contents of the buffer.²⁴ All of these serial position curves have the same form; they show a primacy effect followed by a level asymptote. For this reason the results have been presented in Table I. The first three points of each curve, which make up the primacy

TABLE I
OBSERVED AND PREDICTED SERIAL POSITION CURVES FOR VARIOUS
FREE-VERBAL-RECALL EXPERIMENTS

List	Point 1		Point 2		Point 3		Asymptote		Number of points
	Obs.	Pred.	Obs.	Pred.	Obs.	Pred.	Obs.	Pred.	
M-20-1	.46	.45	.27	.37	.20	.29	.18	.22	2
M-30-1	.38	.35	.30	.28	.21	.22	.19	.17	12
M-20-2	.55	.61	.42	.51	.37	.41	.31	.32	2
M-40-1	.30	.29	.20	.23	.13	.18	.12	.14	22
M-25-1	.38	.39	.23	.32	.21	.25	.15	.19	7
M-20-2.5	.72	.66	.61	.56	.45	.46	.37	.35	2
D-32-1	.46	.33	.34	.27	.27	.21	.16	.16	14
P-10-1	.66	.62	.42	.52	.35	.42	.34	.32	7
P-20-1	.47	.45	.27	.37	.23	.29	.22	.22	17
P-30-1	.41	.35	.34	.28	.27	.22	.20	.17	27
S-6-1	.71	.74	.50	.64	.57	.52	.42	.40	3
S-6-2	.82	.88	.82	.79	.65	.66	.66	.52	3
S-11-1	.48	.60	.43	.50	.27	.40	.31	.31	8
S-11-2	.72	.76	.55	.66	.52	.54	.47	.42	8
S-17-1	.55	.49	.33	.40	.26	.32	.22	.24	14
S-17-2	.68	.66	.65	.56	.67	.45	.43	.35	14

effect, are given in the table. The level portions of the curves are then averaged and the average shown in the column labeled "asymptote." The column labeled "number of points" is the number of points which have been averaged to arrive at the asymptotic level.²⁵ The column labeled "list" gives the abbreviation of the experimenter, the list length, and the presentation rate for each of the serial position curves. (M = Murdock, 1962; D = Deese and Kaufman, 1957; P = Postman and Phillips, 1965; S = Shiffrin.)

²⁴ The Shiffrin data are reported in more detail in Atkinson and Shiffrin (1965).

²⁵ For the Postman-Phillips and Shiffrin lists the number of points at asymptote are simply list length, d , minus 3. For the Murdock and the Deese-Kaufman lists the number of points is $d - 15 - 3$ because the last 15 points in these lists have been eliminated.

1. *Theoretical Analysis*

Having accumulated a fair amount of parametric data in Table I, we should now like to predict the results. The first model to be considered is extremely simple. Every item presented enters the subject's rehearsal buffer. One by one the initial items fill up the buffer, and thereafter each succeeding item knocks out of the buffer a randomly chosen item. In conditions where arithmetic is used following presentation, it is assumed that the arithmetic operations knock items from the buffer at the same rate as new incoming items. This is only an approximation, but probably not too inaccurate. Information is assumed to be transferred to LTS as long as an item remains in the buffer, in fact as a linear function of the total time spent in the buffer (regardless of the number of other items concurrently in the buffer). If an item remains in the buffer for j seconds, an amount of information equal to θ times j is transferred to LTS. Call the amount of information transferred to LTS for an item its *strength*. When the subject engages in a search of LTS during recall it is assumed that he makes exactly R searches into LTS and then stops his search (the number of searches made might, for example, be determined by the time allowed for recall). On each search into LTS the probability that information concerning a particular item will be found is just the ratio of that item's strength to the sum of the strengths of all items in the list. Thus, items which have a greater LTS strength will be more likely to be found on any one search. The probability that the information in LTS will produce a correct recall, once that information has been found in a search, is assumed to be an exponential function of the strength for that item.

There are just three parameters for this model: r , the buffer size; θ , the parameter determining the rate per second at which information on a given item is transferred to LTS while the item resides in the rehearsal buffer; and R the number of searches made.²⁶ The probability of a correct response from the buffer is zero for the results in Table I because the contents of the buffer have been emptied experimentally by intervening arithmetic, or because the recency data (which represents recovery from the buffer) has been omitted. The parameters giving the best fit to the data were as follows: $r = 4$, $\theta = .04$, and $R = 34$. The predictions also are presented in Table I. The predictions are rather remarkable considering that just three parameters have been used to predict the results from

²⁶ It is important to remember that θ for this model is defined as the *rate per second* of information transfer, and thus the time measures listed in Table I need to be taken into account when applying the model. For example, an item that resides in the buffer for three item presentations will have 3θ amount of information in LTS if the presentation rate is one item per second, and 7.5θ if the presentation rate is 2.5 seconds per item.

four different experiments employing different list lengths and different presentation rates. Some of the points are not predicted exactly but this is largely due to the fact that the data tends to be somewhat erratic; the predictions of the asymptotic values (where a larger amount of data is averaged) are especially accurate.

2. *Some Alternative Models*

A number of decisions were made in formulating the free-recall model that need to be examined in greater detail. First consider the effect of an arithmetic task upon items undergoing rehearsal. If the arithmetic caused all rehearsal and long-term storage operations to cease immediately, then the probability of recalling the last item presented should decrease toward chance (since its LTS strength will be negligible, having had no opportunity to accumulate). The serial position curve, however, remains level and does not drop toward the end of the list. One possible explanation is that all transfer to LTS takes place when the item first enters the buffer, rather than over the period the item remains in the buffer; in this case the onset of arithmetic would not affect the formation of traces in LTS. While this assumption could handle the phenomenon under discussion, we prefer to consider the LTS trace as building up during the period the item remains in the buffer. Recall that this latter assumption is borne out by the accuracy of the earlier models and, in particular, the U-shaped functions presented in Fig. 12 for the multiple-reinforcement experiment. The explanation of the level serial position curve implied by our model is that the arithmetic operations remove items from the buffer in a manner similar to that of new entering items. Two sources give this assumption credibility. First, Postman and Phillips (1965) found that short periods of arithmetic (15 seconds) would leave some of the recency effect in the serial position curve, suggesting that some items remained in the buffer after brief periods of arithmetic. Second, the data of Waugh and Norman (1965) suggest that output operations during tasks such as arithmetic act upon the short-term store in the same manner as new incoming items.

Another choice point in formulating the model occurred with regard to the amount of LTS transfer for the first items in the list. The assumption used in an earlier model let the amount of transfer depend upon the number of other items concurrently undergoing rehearsal, as if the attention allotted to any given item determines the amount of transfer. An alternative possibility is that the amount of transfer is determined solely by the length of stay in the buffer and is therefore independent of the number of items currently in the buffer. Another assumption resulting in this same independence effect is that the subject allots to items in the buffer only enough attention to keep them "alive"; when

the number of items in the buffer is small, the subject presumably uses his spare time for other matters. A free-verbal-recall experiment by Murdock (1965) seems to support a variant of this latter assumption. He had subjects perform a rather easy card-sorting task during the presentation of the list. The serial position curve seemed unaffected except for a slight drop in the primacy effect. This would be understandable if the card-sorting task was easy enough that the buffer was unaffected, but distracting enough that extra attention normally allotted to the first few items in the list (before the buffer is filled) is instead allotted to the card-sorting task. In any case, it is not clear whether the transfer rate should or should not be tied to the number of items concurrently in the buffer. The model that we have proposed for free-recall (henceforth referred to as Model I in this subsection) assumed a constant transfer process; a model using a variable transfer assumption will be considered in a moment.

The search process used in Model I is only one of many possibilities. Suppose, for example, that the strength value for an item represents the number of bits of information stored about that item (where the term "bits" is used in a nontechnical sense). A search might then be construed as a random choice of one bit from all those bits stored for all the items in the list. The bits of information stored for each item, however, are associated to some degree, so that the choice of one bit results in the uncovering of a proportion of the rest of the information stored for that item. If this proportion is small, then different searches finding bits associated with a particular item will result in essentially independent probabilities of retrieval. This independent retrieval assumption was used in the construction of Model I. On the other hand, finding one bit in a search might result in all the bits stored for that item becoming available at once; a reasonable assumption would be that this information is either sufficient to allow retrieval or not, and a particular item is retrieved the first time it is picked in a search or is never retrieved. This will be called the dependent retrieval assumption.

It is interesting to see how well the alternate assumptions regarding transfer and search discussed in the preceding paragraphs are able to fit the data. For this reason, the following four models are compared:²⁷

Model I: Transfer to LTS is at a constant rate θ regardless of the number of other items concurrently in the buffer, and independent retrieval.

Model II: Transfer to LTS is at a variable rate θ/j where j is the number of other items currently in the buffer, and independent retrieval.

Model III: Constant LTS transfer rate, and dependent retrieval.

²⁷ These models and the related mathematics are developed in Atkinson and Shiffrin (1965).

Model IV: Variable LTS transfer rate, and dependent retrieval. Model I, of course, is the model already presented for free-verbal-recall. The four models were all fit to the free-verbal-recall data presented in Table I, and the best fits, in terms of the sums of the squared deviations, were as follows: Model I: .814; Model II: 2.000; Model III: .925; Model IV: 1.602 (the lowest sum meaning the best predictions). These results are of interest because they demonstrate once again the close interdependence of the search and transfer processes. Neither model employing a variable transfer assumption is a good predictor of the data and it seems clear that a model employing this assumption would require a retrieval process quite different from those already considered in order to fit the data reasonably well.

Perhaps the most interesting facet of Model I is its ability to predict performance as the presentation rate varies. A very simple assumption, that transfer to LTS is a linear function of time spent in the buffer, seems to work quite well. Waugh (1967) has reported a series of studies which casts some light on this assumption; in these studies items were repeated a variable number of times within a single free-recall list. The probability of recall was approximately a linear function of the number of repetitions; this effect is roughly consonant with an assumption of LTS transfer which is linear with time. It should be noted that the presentation rates in the experiments we analyzed do not vary too widely: from 1 to 2.5 second per item. The assumption that the subject will adopt a buffer strategy undoubtedly breaks down if a wide enough range in presentation rates is considered. In particular, it can be expected that the subject will make increasing use of coding strategies as the presentation rate decreases. M. Clark and G. Bower (personal communication) for example, have shown that subjects proceeding at their own pace (about 6-12 seconds a word) can learn a list of 10 words almost perfectly. This memorization is accomplished by having the subject make up and visualize a story including the words that are presented. It would be expected that very slow presentation rates in free-recall experiments would lead to coding strategies similar to the one above.

One last feature of the models in this section needs further examination. Contrary to our assumption, it is not true that successive lists can be kept completely isolated from each other at the time of test. The demonstration of this fact is the common finding of intrusion errors: items reported during recall which had been presented on a list previous to the one being tested. Occasionally an intrusion error is even reported which had not been reported correctly during the test of its own list. Over a session using many lists, it might be expected that the interference from previous lists would stay at a more or less constant level after the presentation of the first few lists of the session. Nevertheless,

the primacy and asymptotic levels of the free-recall serial position curves should drop somewhat over the first few lists. An effect of this sort is reported by Wing and Thomson (1965) who examined serial position curves for the first, second, and third presented lists of a session. This effect is undoubtedly similar to the one reported by Keppel and Underwood (1962); namely, that performance on the task used by Peterson and Peterson (1959) drops over the first few trials of a session. The effects in both of these experiments may be caused by the increasing difficulty of the search process during test.

C. FURTHER CONSIDERATIONS INVOLVING LTS

The models presented in the last section, while concerned with search and retrieval processes, were nevertheless based primarily upon the concept of a rehearsal buffer. This should not be taken as an indication that rehearsal processes are universally encountered in all memory experiments; to the contrary, a number of conditions must exist before they will be brought into play. It would be desirable at this point then to examine some of the factors that cause a subject to use a rehearsal buffer. In addition, we want to consider a number of points of theoretical interest that arise naturally from the framework developed here. These points include possible extensions of the search mechanisms, relationships between search and interference processes, the usefulness of mnemonics, the relationships between recognition and recall, and coding processes that the subject can use as alternatives to rehearsal schemes.

Consider first the possible forms of search mechanisms and the factors affecting them. Before beginning the discussion two components of the search process should be emphasized: the first component involves locating information about an item in LTS, called the "hit" probability; the second component is the retrieval of a correct response once information has been located. The factor determining the form of the search is the nature of the trace in long-term store. The models considered thus far have postulated two different types of traces. One is an all-or-none trace which allows perfect recall following a hit; the other is an unspecified trace which varies in strength. The strength notion has been used most often because it is amenable to a number of possible interpretations: the strength could represent the "force" with which a particular bond has been formed, the number of bits of information which have been stored, or the number of copies of an item placed in memory. It should be emphasized that these different possibilities imply search processes with different properties. For example, if the strength represents the force of a connection, then it might be assumed that there is an equal chance of hitting any particular item in a search, but the

probability of giving a correct answer following a hit would depend upon the strength. On the other hand, the strength might represent the number of all-or-none copies stored in LTS for an item, each copy resulting in a correct response if hit. In this case, the probability of a hit would depend upon the strength (the number of copies) but any hit would automatically result in a correct answer. A possibility intermediate to these two extremes is that partial copies of information are stored for each item, any one partial copy allowing a correct response with an intermediate probability. In this case, the probability of a hit will depend on the number of partial copies, and the probability of a correct response following a hit will depend on the particular copy that has been found. A different version of this model would assume that all the partial copies for an item become available whenever any one copy is hit; in this version the probability of a correct answer after a hit would depend on the full array of copies stored for that item. In all the search processes where the retrieval probability following a hit is at an intermediate level, one must decide whether successive hits of that item will result in independent retrieval probabilities. It could be assumed, for example, that failure to uncover a correct response the first time an item is hit in the search would mean that the correct response could not be recovered on subsequent hits of that item.²⁸ This outline of some selected search processes indicates the variety of possibilities; a variety which makes it extremely difficult to isolate effects due to search processes from those attributable to interference mechanisms.

Other factors affecting the form of the search are at least partially controlled by the subject; a possible example concerns whether or not the searches are made with replacement. Questions of this sort are based upon the fact that all searches are made in a more or less ordered fashion; memory is much too large for a completely random search to be feasible. One ordering which is commonly used involves associations: each item recovered leads to an associate which in turn leads to another associate. The subject presumably exercises control over which associates are chosen at each stage of the search and also injects a new starting item whenever a particular sequence is not proving successful.²⁹ An alternative to the associate method is a search along some partially ordered dimension. Examples are easy to find; the subject could generate letters of the

²⁸ For a discussion of partial and multiple copy models, see Atkinson and Shiffrin (1965).

²⁹ Associative search schemes have been examined rather extensively using free-recall methods. Clustering has been examined by Doese (1959), Rousfield (1953), Cofer (1966), Tulving (1962), and others; the usual technique is to determine whether or not closely associated words tend to be reported together. The effect certainly exists, but a lack of parametric data makes it difficult to specify the actual search process involved.

alphabet, considering each in turn as a possible first letter of the desired response. A more general ordered search is one that is made along a temporal dimension; items may be time-tagged or otherwise temporally ordered, and the subject searches only among those items that fall within a particular time span. This hypothesis would explain the fact that performance does not markedly deteriorate even at the end of memory experiments employing many different lists, such as in the free-verbal-recall paradigm. In these cases, the subject is required to respond only with members of the most recent list; if performance is not to degenerate as successive lists are presented, the memory search must be restricted along the temporal dimension to those items recently stored in LTS. Yntema and Trask (1963) have demonstrated that temporal information is available over relatively long time periods (in the form of "time-tags" in their formulation) but the storage of such information is not well understood.

We now turn to a brief discussion of some issues related to interference effects. It is difficult to determine whether time alone can result in long-term interference. Nevertheless, to the extent that subjects engage in a search based upon the temporal order of items, interference due to the passage of time should be expected. Interference due to intervening material may take several forms. First, there may be a reduction in the value of certain information already in LTS as a result of the entry of new information; the loss in this case does not depend on making any previous information less accessible. An example would be if a subject first stores "the stimulus beginning with D has response 3" and later when another stimulus beginning with D is presented, he stores "the stimulus beginning with D has response 1." The probability of a correct response will clearly drop following storage of the second trace even though access to both traces may occur at test. Alternatively, interference effects may involve destruction of particular information through interaction with succeeding input. This possibility is often examined experimentally using a paired-associate paradigm where the same stimulus is assigned different responses at different times. DaPolito (1966) has analyzed performance in such a situation. A stimulus was presented with two different responses at different times, and at test the subject was asked to recall both responses. The results indicated that the probability of recalling the first response, multiplied by the probability of recalling the second response, equals the joint probability that both responses will be given correctly. This result would be expected if there was no interaction of the two traces; it indicates that high strengths of one trace will not automatically result in low strengths on the other. The lack of an interaction in DaPolito's experiment may be due to the fact that subjects knew they would be tested on both responses. It is

interesting to note that there are search mechanisms that can explain this independence effect and at the same time interference effects. For example, storage for the two items might be completely independent as suggested by DaPolito's data; however, in the typical recall task the subject may occasionally terminate his search for information about the second response prematurely as a result of finding information on the first response.

Within the context of interference and search processes, it is interesting to speculate about the efficacy of mnemonics and special coding techniques. It was reported, for example, that forming a visual image of the two words in a paired-associate item is a highly effective memory device; that is, one envisages a situation involving the two words. Such a mnemonic gains an immediate advantage through the use of two long-term systems, visual and auditory, rather than one. However, this cannot be the whole explanation. Another possibility is that the image performs the function of a mediator, thereby reducing the set of items to be searched; that is, the stimulus word when presented for test leads naturally to the image which in turn leads to the response. This explanation is probably not relevant in the case of the visual-image mnemonic for the following reason: the technique usually works best if the image is a very strange one. For example, "dog-concrete" could be imaged as a dog buried to the neck in concrete; when "dog" is tested, there is no previously well-learned association that would lead to this image. Another explanation involves the protection of the stored information over time; as opposed to the original word pairs, each image may be stored in LTS as a highly distinct entity. A last possibility is that the amount of information stored is greatly increased through the use of imagery—many more details exist in the image than in the word pair. Since the image is highly cohesive, the recovery of any information relevant to it would lead to the recovery of the whole image. These hypotheses are of course only speculations. At the present time the relation of the various search schemes and interference processes to mnemonic devices is not well understood. This state of affairs hopefully will change in the near future since more research is being directed toward these areas; mediation, in particular, has been receiving extensive consideration (e.g., Bugelski, 1962; Runquist & Farley, 1964).

Search processes seem at first glance to offer an easy means for the analysis of differences between recognition and recall. One could assume, for example, that in recall the search component which attempts to locate information on a given item in LTS is not part of the recognition process; that is, one might assume that in recognition the relevant information in LTS is always found and retrieval depends solely on matching the stored information against the item presented for test.

Our analysis of free-verbal recall depended in part upon the search component to explain the drop in performance as list length increased. Thus if the free recall task were modified so that recognition tests were used, the decrement in performance with list length might not occur. That this will not be the case is indicated by the position-to-color memory study (Experiment 8) in which the number of responses was small enough that the task was essentially one of recognition; despite this fact, the performance dropped as list length increased. One possible explanation would be that search is necessary even for recognition tasks; i.e., if the word "clown" is presented, all previous times that that word had been stored in LTS do not immediately spring to mind. To put this another way, one may be asked if a clown was a character in a particular book and it is necessary to search for the appropriate information, even though the question is one of recognition. On the other hand, we cannot rule out the possibility that part of the decrement in performance in free recall with the increase of list length may be due to search changes, and part to other interference mechanisms. Obviously a great deal of extra information is given to the subject in a recognition test, but the effect of this information upon search and interference mechanisms is not yet clear.

We now turn to a consideration of LTS as it is affected by short-term processes other than the rehearsal buffer. It has been pointed out that the extent and structure of rehearsal depends upon a large number of factors such as the immediacy of test and difficulty of long-term storage. When rehearsal schemes are not used in certain tasks, often it is because long-term coding operations are more efficacious. These coding processes are presumably found in most paired-associate learning paradigms; depending upon conditions, however, the subject will probably divide *his attention between coding and rehearsal*. Atkinson and Shiffrin (1965) have presented a paired-associate learning model based upon a rehearsal-buffer. Whether a rehearsal strategy would be adopted by the subject in a given paired-associate learning experiment needs to be determined in each case. The answer is probably no for the typical fixed-list learning experiment, because the items are usually amenable to coding, because the test procedure emphasizes the importance of LTS storage, and because short study-test intervals are so infrequent that maintenance of an item in STS is not a particularly effective device. If these conditions are changed, however, then a paired-associate model based upon a rehearsal buffer might prove applicable.

It is important to note the distinction between coding models and rehearsal models. Rehearsal models actually encompass, in a rough sense, virtually all short-term processes. Coding, for example, may be considered as a type of rehearsal involving a single item. The buffer

process is a special type of rehearsal in which a fixed number of items are rehearsed for the primary purpose of maintaining them in STS. A pure coding process is one in which only a single item is considered at a time and in which the primary purpose is the generation of a strong LTS trace; almost incidentally, the item being coded will be maintained in STS through the duration of the coding period, but this is not a primary purpose of the process. These various processes, it should be emphasized, are under subject control and are brought into play as he sees fit; consequently there are many variations that the subject can employ under appropriate conditions. One could have a coding model, for example, in which more than one item is being coded at a time, or a combination model in which several items are maintained via rehearsal while one of the items is selected for special coding.

At the other extreme from the buffer strategy, it might be instructive to consider a coding process that acts upon one item at a time. Although such a process can be viewed as a buffer model with a buffer containing only one item, the emphasis will be upon LTS storage rather than upon the maintenance of the item in STS. The simplest case occurs when the presentation rate is fairly slow and the subject attempts to code each item as it is presented for study. However, the case that seems most likely for the typical paired-associate experiment, is that in which not every item is coded, or in which it takes several presentation periods to code a single item. The first case above could be conceptualized as follows: each item is given a coding attempt during its presentation interval, but the probability of finding a code is ξ . The second case is a bit more complex. One version would have a single item maintained in STS over trials until a code is found. It could be supposed that the probability of a code being found during a single presentation interval is ξ ; having once coded an item, coding attempts are focused on the next presented item. This model has something in common with the buffer models in that some items will remain in STS over a period of several trials. This will produce a short-term decay effect as the interval between presentation and test is increased.

It is worth considering the form of the usual short-term effects that are found in a paired-associate learning. Figure 29 presents data from a paired-associate experiment by Bjork (1966). Graphed is the probability of a correct response for an item prior to its last error, as a function of the number of other items intervening between its study and subsequent test. The number of intervening items that must occur before this curve reaches the chance level can be taken as a measure of the extent of the short-term effect. It can be seen that the curve does not reach chance level until after about 20 items have been presented. If the coding model mentioned above were applied to this data, a short-term effect would be

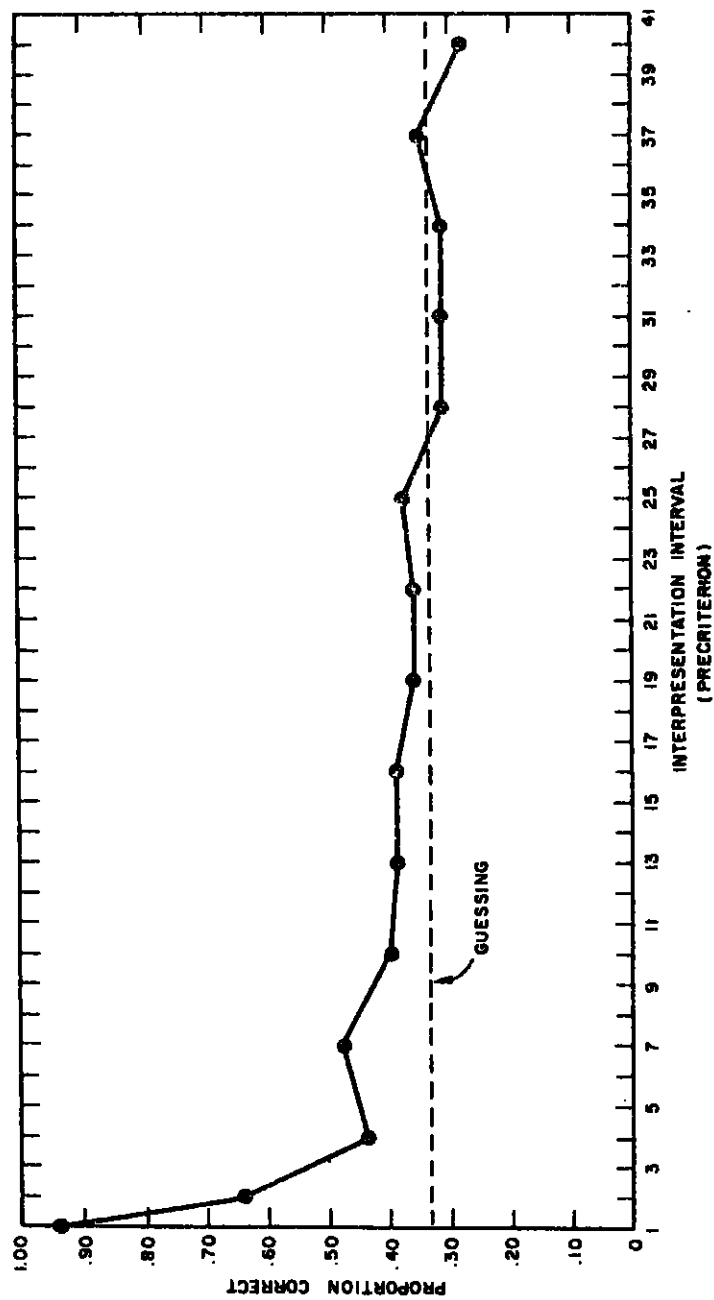

FIG. 29. Probability of a correct response prior to the last error as a function of leg. After Bjork (1968).

predicted due to the fact that some items are kept in STS for more than one trial for coding. It hardly seems likely, however, that any item will be kept in STS for 20 trials in an attempt to code it. Considerations of this sort have led a number of workers to consider other sources for the "short-term" effect. One possibility would be that the effect is based in LTS and is due to retroactive interference. A model in which this notion has been formalized was set forth by Restle (1964) and subsequently developed by Greeno (1967). For our purposes Greeno's presentation is more appropriate. He proposes that a particular code may be categorized as "good" or "bad." A good code is permanent and will not be interfered with by the other materials presented in the experiment. A bad code will be retrievable from LTS for a time, but will be subject to interference from succeeding items and will eventually be useless. Employing this model, the short-term effects displayed in Fig. 29 are due to those items that were assigned bad codes (i.e., codes that were effective for only a short period of time). The interesting feature of this model is its inclusion of a short-term memory effect based not upon features of STS, but upon processes in LTS.³⁰ One other useful way in which this LTS interference process has been viewed employs Estes' stimulus fluctuation theory (Estes, 1955a, 1955b). In this view, elements of information in LTS sometimes become unavailable; it differs from the above models in that an unavailable element may become available again at a later time. In this sense, fluctuation theory parallels a number of the processes that are expected from search considerations. In any case, the theory has been successfully applied in a variety of situations (Izawa, 1966). There is a great deal more that can be said about paired-associate learning and long-term processes in general, but it is beyond the scope of this paper to enter into these matters. We should like to reemphasize, however, the point that has just been made; namely, that short-term decay effects may arise from processes based in LTS as well as mechanisms in STS; considerable care must be taken in the analysis of each experimental situation in order to make a correct identification of the processes at play.

VI. Concluding Remarks

The first three sections of this paper outlined a fairly comprehensive theoretical framework for memory which emphasized the role of control processes—processes under the voluntary control of the subject such as

³⁰ It is this short-term effect that is probably captured by the intermediate state in various Markov models for paired-associate learning (Atkinson & Crothers, 1964; Bernbach, 1965; Bjork, 1966; Calfee & Atkinson, 1965; Kintsch, 1965, 1967; Young, 1966). Theorists using these models have been somewhat non-committal regarding the psychological rationale for this intermediate state, but the estimated transition probabilities to and from the state suggest to us that it represents effects taking place in LTS.

rehearsal, coding, and search strategies. It was argued that these control processes are such a pervasive and integral component of human memory that a theory which hopes to achieve any degree of generality must take them into account. Our theoretical system has proved productive of experimental ideas. In Sections IV and V a particular realization of the general system involving a rehearsal buffer was applied to data from a variety of experiments. The theoretical predictions were, for the most part, quite accurate, proving satisfactory even when based upon previously estimated parameter values. It was possible to predict data over a range of experimental tasks and a wide variety of independent variables such as stimulus-set size, number of reinforcements, rehearsal procedures, list length, and presentation rate. Perhaps even more impressive are the number of predictions generated by the theory which ran counter to our initial intuitions but were subsequently verified.

It should be emphasized that the specific experimental models we have considered do not represent a general theory of the memory system but rather a subclass of possible models that can be generated by the framework proposed in the first half of the paper. Paired-associate learning, for example, might best be described by models emphasizing control processes other than rehearsal. These models could be formulated in directions suggested by stimulus sampling theory (Estes, 1955a, 1955b, 1968), models stressing cue selection and coding (Greeno, 1967; Restle, 1964), or queuing models (Bower, 1967b).

Finally, it should be noted that most of the ideas in this paper date back many years to an array of investigators: Broadbent (1957, 1958) and Estes (1955a, 1968) in particular have influenced the development of our models. The major contribution of this paper probably lies in the organization of results and the analysis of data; in fact, theoretical research could not have been carried out in the manner reported here as little as 12 years ago. Although conceptually the theory is not very difficult to understand, many of our analyses would have proved too complex to investigate without the use of modern, high-speed computers.

REFERENCES

- Atkinson, R. C., Brelsford, J. W., Jr., & Shiffrin, R. M. Multi-process models for memory with applications to a continuous presentation task. *Journal of Mathematical Psychology*, 1967, 4, 277-300.
- Atkinson, R. C., & Crothers, E. J. A comparison of paired-associate learning models having different acquisition and retention axioms. *Journal of Mathematical Psychology*, 1964, 1, 285-315.
- Atkinson, R. C., & Shiffrin, R. M. Mathematical models for memory and learning. Technical Report No. 79, Institute for Mathematical Studies in the Social Sciences, Stanford University, 1965. (To be published in D. P. Kimble (Ed.), *Proceedings of the third conference on learning, remembering and forgetting*, New York: New York Academy of Sciences.)

- Averbach, E., & Coriell, A. S. Short-term memory in vision. *Bell System Technical Journal*, 1961, 40, 309-328.
- Averbach, E., & Sperling, G. Short-term storage of information in vision. In C. Cherry (Ed.), *Information theory*. London and Washington, D.C.: Butterworth, 1961. Pp. 196-211.
- Barbizet, J. Defect of memorizing of hippocampal-mammillary origin: A review. *Journal of Neurology, Neurosurgery, and Psychiatry*, 1963, 26, 127-135.
- Battig, W. F. Evidence for coding processes in "rote" paired-associate learning. *Journal of Verbal Learning and Verbal Behavior*, 1966, 5, 171-181.
- Bernbach, H. A. A forgetting model for paired-associate learning. *Journal of Mathematical Psychology*, 1965, 2, 128-144.
- Bernbach, H. A. Decision processes in memory. *Psychological Review*, 1967, 74, 462-480.
- Binford, J. R., & Gettys, C. Nonstationarity in paired-associate learning as indicated by a second guess procedure. *Journal of Mathematical Psychology*, 1965, 2, 190-195.
- Bjork, R. A. Learning and short-term retention of paired-associates in relation to specific sequences of interpresentation intervals. Technical Report No. 106, Institute for Mathematical Studies in the Social Sciences, Stanford University, 1966.
- Bousfield, W. A. The occurrence of clustering in the recall of randomly arranged associates. *Journal of General Psychology*, 1953, 49, 229-240.
- Bower, G. H. Application of a model to paired-associate learning. *Psychometrika*, 1961, 26, 255-280.
- Bower, G. H. A multicomponent theory of the memory trace. In K. W. Spence and J. T. Spence (Eds.), *The psychology of learning and motivation: Advances in research and theory*, Vol. I. New York: Academic Press, 1967. Pp. 229-325. (a)
- Bower, G. H. A descriptive theory of memory. In D. P. Kimble (Ed.), *Proceedings of the second conference on learning, remembering and forgetting*. New York: New York Academy of Sciences, 1967. Pp. 112-185. (b)
- Brelsford, J. W., Jr., Shiffrin, R. M., & Atkinson, R. C. Multiple reinforcement effects in short-term memory. *British Journal of Mathematical and Statistical Psychology*, 1968, in press. 21, 1-19.
- Brelsford, J. W., Jr., & Atkinson, R. C. Short-term memory as a function of rehearsal procedures. *Journal of Verbal Learning and Verbal Behavior*, 1968, in press.
- Brelsford, J. W., Jr., Keller, L., Shiffrin, R. M., & Atkinson, R. C. Short-term recall of paired-associates as a function of the number of interpolated pairs. *Psychonomic Science*, 1966, 4, 73-74.
- Broadbent, D. E. The role of auditory localization in attention and memory span. *Journal of Experimental Psychology*, 1954, 47, 191-196.
- Broadbent, D. E. Successive responses to simultaneous stimuli. *Quarterly Journal of Experimental Psychology*, 1956, 8, 145-152.
- Broadbent, D. E. A mechanical model for human attention and immediate memory. *Psychological Review*, 1957, 64, 205-215.
- Broadbent, D. E. *Perception and communication*. Oxford: Pergamon Press, 1958.
- Broadbent, D. E. Flow of information within the organism. *Journal of Verbal Learning and Verbal Behavior*, 1963, 4, 34-39.
- Brown, J. Some tests of decay theory of immediate memory. *Quarterly Journal of Experimental Psychology*, 1958, 10, 12-21.
- Brown, R., & McNeill, D. The "tip of the tongue" phenomenon. *Journal of Verbal Learning and Verbal Behavior*, 1966, 5, 325-337.

- Bugelski, B. R. Presentation time, total time, and mediation in paired-associate learning. *Journal of Experimental Psychology*, 1962, **63**, 409-412.
- Buschke, H. Retention in immediate memory estimated without retrieval. *Science*, 1963, **140**, 56-57.
- Buschke, H., & Lim, H. Temporal and interactional effects in short-term storage. *Perception and Psychophysics*, 1967, **2**, 107-114.
- Calfée, R. C., & Atkinson, R. C. Paired-associate models and the effects of list length. *Journal of Mathematical Psychology*, 1965, **2**, 254-265.
- Cofer, C. N. Some evidence for coding processes derived from clustering in free recall. *Journal of Verbal Learning and Verbal Behavior*, 1966, **5**, 188-192.
- Cohen, B.-H. Recall of categorized word lists. *Journal of Experimental Psychology*, 1963, **66**, 227-234.
- Cohen, R. L., & Johansson, B. S. The activity trace in immediate memory; a reevaluation. *Journal of Verbal Learning and Verbal Behavior*, 1967, **6**, 139-143.
- Conrad, R. Acoustic confusions in immediate memory. *British Journal of Psychology*, 1964, **55**, 1, 75-84.
- Conrad, R., & Hille, B. A. The decay theory of immediate memory and paced recall. *Canadian Journal of Psychology*, 1958, **12**, 1-6.
- DaPolito, F. J. Proactive effects with independent retrieval of competing responses. Unpublished doctoral dissertation, Indiana University, 1966.
- Deese, J. Influence of inter-item associative strength upon immediate free recall. *Psychological Reports*, 1959, **5**, 305-312.
- Deese, J., & Kaufman, R. A. Serial effects in recall of unorganized and sequentially organized verbal material. *Journal of Experimental Psychology*, 1967, **54**, 180-187.
- Estes, W. K. Statistical theory of distributional phenomena in learning. *Psychological Review*, 1955, **62**, 369-377. (a)
- Estes, W. K. Statistical theory of spontaneous recovery and regression. *Psychological Review*, 1955, **62**, 145-154. (b)
- Estes, W. K. A technique for assessing variability of perceptual span. *Proceedings of the National Academy of Sciences of the U.S.*, 1965, **4**, 403-407.
- Estes, W. K. Reinforcement in human learning. In J. Tapp (Ed.), *Current problems in reinforcement*. New York: Academic Press, 1968, in press.
- Estes, W. K., & Taylor, H. A. A detection method and probabilistic models for assessing information processing from brief visual displays. *Proceedings of the National Academy of Sciences of the U.S.*, 1964, **52**, No. 2, 446-454.
- Estes, W. K., & Taylor, H. A. Visual detection in relation to display size and redundancy of critical elements. *Perception and Psychophysics*, 1966, **1**, 9-16.
- Estes, W. K., & Wessel, D. L. Reaction time in relation to display size and correctness of response in forced-choice visual signal detection. *Perception and Psychophysics*, 1966, **1**, 369-373.
- Freedman, J. L., & Landauer, T. K. Retrieval of long-term memory: "Tip-of-the-tongue" phenomenon. *Psychonomic Science*, 1966, **4**, 309-310.
- Greeno, J. G. Paired-associate learning with short-term retention: Mathematical analysis and data regarding identification of parameters. *Journal of Mathematical Psychology*, 1967, **4**, 430-472.
- Harley, W. F., Jr. The effect of monetary incentive in paired-associate learning using a differential method. *Psychonomic Science*, 1965, **2**, 377-378. (a)
- Harley, W. F., Jr. The effect of monetary incentive in paired-associate learning using an absolute method. *Psychonomic Science*, 1965, **3**, 141-142. (b)
- Hart, J. T., Jr. Recall, recognition, and the memory-monitoring process. Unpublished doctoral dissertation, Stanford University, 1965.

- Hebb, D. O. Distinctive features of learning in the higher animal. In J. F. Delafresnaye (Ed.), *Brain mechanisms and learning*. London and New York: Oxford University Press, 1961. Pp. 37-46.
- Hellyer, S. Supplementary report: Frequency of stimulus presentation and short-term decrement in recall. *Journal of Experimental Psychology*, 1962, **64**, 650-651.
- Hintzman, D. L. Classification and aural coding in short-term memory. *Psychonomic Science*, 1965, **3**, 161-162.
- Hintzman, D. L. Articulatory coding in short-term memory. *Journal of Verbal Learning and Verbal Behavior*, 1967, **6**, 312-316.
- Izawa, C. Reinforcement-test sequences in paired-associate learning. *Psychological Reports*, Monograph Supplement, 3-V18, 1966, 879-919.
- Katz, L. A technique for the study of steady-state short-term memory. *Psychonomic Science*, 1966, **4**, 361-362.
- Keppel, G., & Underwood, B. J. Proactive inhibition in short-term retention of single items. *Journal of Verbal Learning and Verbal Behavior*, 1962, **1**, 153-161.
- Kintsch, W. Habituation of the GSR component of the orienting reflex during paired-associate learning before and after learning has taken place. *Journal of Mathematical Psychology*, 1965, **2**, 330-341.
- Kintsch, W. Memory and decision aspects of recognition learning. *Psychological Review*, 1967, **74**, 496-504.
- Lambert, W. E., & Jakobovitz, L. A. Verbal satiation and changes in the intensity of meaning. *Journal of Experimental Psychology*, 1960, **60**, 376-383.
- Landauer, T. K. Rate of implicit speech. *Perceptual and Motor Skills*, 1962, **15**, 646-647.
- Madsen, M. E., & Drucker, J. M. Immediate memory by missing scan and modified digit span. *Psychonomic Science*, 1966, **6**, 283-284.
- Melton, A. W. Implications of short-term memory for a general theory of memory. *Journal of Verbal Learning and Verbal Behavior*, 1963, **2**, 1-21.
- Miller, G. A. The magical number seven, plus or minus two: Some limits on our capacity for processing information. *Psychological Review*, 1956, **63**, 81-97.
- Milner, B. The memory defect in bilateral hippocampal lesions. *Psychiatric Research Reports*, 1959, **11**, 43-58.
- Milner, B. Neuropsychological evidence for differing memory processes. Abstract for the symposium on short-term and long-term memory. *Proceedings of the 18th international congress of psychology, Moscow, 1966*. Amsterdam: North-Holland Publ., 1968, in press.
- Milner, B. Amnesia following operation on the temporal lobes. In O. L. Zangwill and C. W. M. Whitty (Eds.), *Amnesia*. London and Washington, D.C.: Butterworth, 1967. Pp. 109-133.
- Montague, W. E., Adams, J. A., & Kiess, H. O. Forgetting and natural language mediation. *Journal of Experimental Psychology*, 1966, **72**, 829-833.
- Murdock, B. B., Jr. The serial position effect of free recall. *Journal of Experimental Psychology*, 1962, **64**, 482-488.
- Murdock, B. B., Jr. Effects of a subsidiary task on short-term memory. *British Journal of Psychology*, 1965, **56**, 413-419.
- Murdock, B. B., Jr. The criterion problem in short-term memory. *Journal of Experimental Psychology*, 1966, **72**, 317-324.
- Peterson, L. R. Short-term verbal memory and learning. *Psychological Review*, 1966, **73**, 193-207. (a)
- Peterson, L. R. Short-term memory. *Scientific American*, 1966, **215**, 90-95. (b)
- Peterson, L. R., & Peterson, M. Short-term retention of individual verbal items. *Journal of Experimental Psychology*, 1959, **58**, 193-198.

- Peterson, L. R., Wampler, R., Kirkpatrick, M., & Saltzman, D. Effect of spacing presentations on retention of a paired-associate over short intervals. *Journal of Experimental Psychology*, 1963, **66**, 206-209.
- Phillips, J. L., Shiffrin, R. M., & Atkinson, R. C. The effects of list length on short-term memory. *Journal of Verbal Learning and Verbal Behavior*, 1967, **6**, 303-311.
- Posner, M. I. Components of skilled performance. *Science*, 1966, **152**, 1712-1718.
- Postman, L. The present status of interference theory. In C. N. Cofer (Ed.), *Verbal learning and verbal behavior*. New York: McGraw-Hill, 1961. Pp. 152-170.
- Postman, L. Does interference theory predict too much forgetting? *Journal of Verbal Learning and Verbal Behavior*, 1963, **2**, 40-48.
- Postman, L. Short-term memory and incidental learning. In A. W. Melton (Ed.), *Categories of human learning*. New York: Academic Press, 1964. Pp. 145-201.
- Postman, L., & Phillips, L. W. Short-term temporal changes in free recall. *Quarterly Journal of Experimental Psychology*, 1965, **17**, 132-138.
- Restle, F. Sources of difficulty in learning paired associates. In R. C. Atkinson (Ed.), *Studies in mathematical psychology*. Stanford, Calif.: Stanford University Press, 1964. Pp. 116-172.
- Rumquist, W. N., & Farley, F. H. The use of mediators in the learning of verbal paired associates. *Journal of Verbal Learning and Verbal Behavior*, 1964, **3**, 280-285.
- Sperling, G. The information available in brief visual presentations. *Psychology Monographs*, 1960, **74** (Whole No. 498).
- Sperling, G. A model for visual memory tasks. *Human Factors*, 1963, **5**, 19-31.
- Sperling, G. Successive approximations to a model for short-term memory. *Acta Psychologica*, 1967, **27**, 285-292.
- Sternberg, S. High speed scanning in human memory. *Science*, 1966, **153**, 652-654.
- Tulving, E. Subjective organization in free recall of "unrelated" words. *Psychological Review*, 1962, **69**, 344-354.
- Underwood, B. J., & Ekstrand, B. R. Studies of distributed practice: XXIV. Differentiation and proactive inhibition. *Journal of Experimental Psychology*, 1967, **74**, 574-580.
- Waugh, N. C. Presentation time and free recall. *Journal of Experimental Psychology*, 1967, **73**, 39-44.
- Waugh, N. C., & Norman, D. A. Primary memory. *Psychological Review*, 1965, **72**, 89-104.
- Wickelgren, W. A. Size of rehearsal group and short-term memory. *Journal of Experimental Psychology*, 1965, **68**, 413-419.
- Wickelgren, W. A., & Norman, D. A. Strength models and serial position in short-term recognition memory. *Journal of Mathematical Psychology*, 1966, **3**, 316-347.
- Wing, J. F., & Thomson, B. P. Primacy-recency effects in free recall. *Proceedings of the 1965 annual convention of the American Psychological Association*. Pp. 57-58.
- Yntema, D. B., & Mueser, G. E. Remembering the present state of a number of variables. *Journal of Experimental Psychology*, 1960, **60**, 18-22.
- Yntema, D. B., & Mueser, G. E. Keeping track of variables that have few or many states. *Journal of Experimental Psychology*, 1962, **63**, 391-395.
- Yntema, D. B., & Trask, F. P. Recall as a search process. *Journal of Verbal Learning and Verbal Behavior*, 1963, **2**, 65-74.
- Young, J. L. Effects of intervals between reinforcements and test trials in paired-associate learning. Technical Report No. 101, Institute for Mathematical Studies in the Social Sciences, Stanford University, 1966.

3 | HUMAN MEMORY AND THE CONCEPT OF REINFORCEMENT¹

RICHARD C. ATKINSON and THOMAS D. WICKENS²
Stanford University

The purpose of this paper is to offer a theory about the role of reinforcement in human learning and to evaluate the theory against data from several different types of experiments. It should be emphasized that this analysis is restricted to human learning. Our discussion of reinforcement will be based on a more general theory of memory (Atkinson and Shiffrin, 1968a) that has been derived primarily from results of verbal-learning experiments. The remarks that we shall make about reinforcement have not been applied outside of this context, and accordingly we

¹Preparation of this paper was supported by the National Aeronautics and Space Administration, Grant NGR-05-020-036, and by a fellowship from the National Institutes of Health to the second author. The authors would like to thank several of their co-workers who carried out experiments reported here; each will be acknowledged at the appropriate point in the paper. Thanks are also due to William Cook, Geoffrey Loftus, and John Schnorr for a critical reading of an earlier draft of this paper.

²Now at the University of California, Los Angeles.

are unwilling at this time to extrapolate the analysis to animal learning.

In his discussion of the law of effect, Thorndike (1931) proposed two alternative views regarding the nature of reinforcement. One view, which he favored, assumed that the action of a reinforcement produced a direct and automatic strengthening of stimulus-response associations. The other view, which Thorndike considered and rejected, postulated that reinforcement did not affect learning *per se*, but rather determined the choice of a response once the subject recalled the relevant events that had occurred on preceding trials of the experiment. These two alternative views have been maintained in the literature since that time, and much research has been done in an attempt to determine which is the true state of affairs (for an excellent review of this research see Postman, 1962). This distinction may be useful in a general way to categorize theories of reinforcement, but it is becoming increasingly clear that the set of theories qualifying in each category is so large and variegated that it is not possible to formulate experimental tests which meaningfully differentiate between them. With this reservation in mind, it still seems worth noting that we regard our discussion of reinforcement as most closely allied to the second of the two views. Thus our analysis is in general accord with the theorizing of Tolman (1932) and with the more recent analyses offered by Estes (1969) and by Buchwald (1969).

Our discussion of learning and memory is in terms of information-processing concepts (Broadbent, 1963; Simon and Newell, 1964). Accordingly, we view the processes involved in learning as an exchange and transfer of information between a number of memory storage units. The nature of these transfers and the properties of the storage units will be specified in some detail, but we offer no speculations about their inner structure or possible physiological representations. In our view, learning involves the transfer of information generated by sources both external and internal to the organism into some form of memory store that can hold it until it is needed later. Reinforcement is a modulation of this information flow. A reinforcing event, in this sense, serves two functions: first, to set in motion the processes that cause the transfer to take place, and second, to select what information is to be transferred. When the study of some item occurs in an experiment, information associated with it is coded and transferred to the subject's memory. In order to produce a response at a later point in time, this information must be retrieved by a process which involves a more or less active search of memory. Thus, the operations involved in a typical learning situation can be divided into two classes, one associated with storage and the other with retrieval of information from memory. In many experiments this distinction is reflected in the study and test phases of a trial. The distinction between storage

and retrieval is fundamental to the system and is reflected in our analysis of reinforcement.

Reinforcement manipulations that affect the storage process are the ones most commonly studied. Indeed, typically when the term reinforcement is used, it refers to operations that cause information about events which have taken place (including, perhaps, the reinforcing event itself) to be stored. To understand how transfer is effected, it is necessary to realize that a reinforcing event plays two separate and distinct roles in determining the storage of information: an informational role and an attentional role.

The first concerns the knowledge that is provided by giving feedback to the subject about whether or not his response to a particular stimulus was correct. When a subject is told that his response was, for example, correct, this provides the information that he must store to assure correct performance on subsequent trials. The quality of this feedback can be varied in a number of ways, most obviously by varying the amount of information provided to the subject after an error. The use of a correction procedure, in which the subject is told the response that should have been made after an error, makes more information available than does a partial correction or a noncorrection procedure in which the correct response is not completely specified (Bower, 1962; Keller, Cole, Burke, and Estes, 1965; Millward, 1964). The quality of information provided by the feedback also can be manipulated by introducing a delay between the subject's response and this feedback. Under these conditions, some information about the situation may be lost or confused, so that the feedback information, when presented, is of less value.

The attentional component of reinforcement in the storage process is closely related to conventional ideas of reward. Reinforcement, in this sense, acts to direct the subject's attention to one aspect of the situation and not to others. Thus, when a reward is associated with certain items presented for learning and not with others, more study may be given to the rewarded items and consequently they may be learned more rapidly (Harley, 1965a). Indeed, we postulate that this is the principal role of incentives when presented at the time of study: to cause the subject to attend to certain items or aspects of the situation more intensely than to others.

The storage aspects of reinforcement have received a good deal of study. The same cannot be said about the role of reinforcement in the retrieval of information and the production of a response. Again, we believe that these effects can take at least two forms. On the one hand, when the payoff value associated with a particular item is presented at the time of study, it may become part of the information complex placed in mem-

ory and may even determine where in memory it is stored. If this is the case, storage for an item with a high payoff value, for example, will be different in some way from storage of an item with low payoff. Knowledge given at the time of test regarding the payoff value assigned to the item, therefore, can aid the subject by indicating where in memory to look and hence cause him to set up a more effective search. The other effect that reinforcement may have on retrieval is to dictate the effort and time the subject is willing to spend in searching memory. It often happens that the information necessary to produce a response may be available in memory, but for various reasons cannot be recovered without an extended search. Presumably, when items are presented for test which have been assigned high payoff values, the subject will engage in a more extensive search and hence will be more likely to retrieve the appropriate information. Unfortunately, these two effects are largely speculative and have not been carefully documented experimentally. We have, however, undertaken some preliminary studies, which will be described later, on reinforcement effects during retrieval.

The main body of this paper is divided into two sections. The first develops the theoretical system, and the second deals with applications of the theory to a number of experimental situations. The theoretical section begins with a fairly extensive discussion of the structure of human memory. Although this discussion will not explicitly consider the question of reinforcement, the nature of the reinforcing process is so much determined by how the subject uses his memory that it cannot be analyzed without first considering these more basic processes. As we have noted above, the action of reinforcement may be thought of, in part, as an attentional process. Accordingly, the second step in our analysis specifies more exactly the ways in which attention acts within the framework of the theory. This consideration brings us in turn to a discussion of reinforcement.

In the second section the theory is applied to a number of experiments involving the manipulation of reinforcement variables. The first of these demonstrates the workings of the memory system when items are given varying numbers of reinforcements under different presentation schedules. This example will also illustrate a number of the complexities that can plague an analysis of reinforcement: in particular, the ways in which the short- and long-term properties of memory can lead to apparently contradictory effects. The second application examines delay of reinforcement and illustrates how this variable can have many different effects depending on the precise conditions of learning. The role of feedback in learning will be examined in another way as part of a third experiment, using a concept-identification paradigm. One of the primary purposes of this discussion is to demonstrate that the actual responses made by a

subject frequently fail to provide an adequate indicator of the reinforcing processes involved. The experiment will also show how superficially similar reinforcements can have markedly different effects, depending upon the strategy used by the subject. Finally, the last set of experiments considers the ways in which reward magnitude can lead to selective study of certain items and, in turn, affect both the storage and retrieval of information.

Before starting our discussion, a warning should be added. We view reinforcement as a complex process and one which is derived from other, more fundamental aspects of the learning situation. Because of this fact, the effects of reinforcement are often quite varied, both in their appearance and in the manner by which they are produced. Our discussion, therefore, may well prove unsatisfactory to someone who is looking for a single, unified law to explain all reinforcement phenomena. Such a law, we feel, does not exist.

Theoretical System

The memory system. Although the theory on which our discussion of reinforcement will be based has been described in other papers (Atkinson and Shiffrin, 1965, 1968a,b; Shiffrin and Atkinson, 1969), a brief review will provide a starting point for the work to be presented. This discussion will not present the theory in its full detail. In particular, no attempt will be made to consider all of the possible variants of the memory system, nor will explicit mathematical predictions of the theory be derived. For these matters, and for a description of the evidence which supports this formulation, the reader is referred to the previously cited *theoretical papers and to reports of related experimental work* (Atkinson, 1969; Atkinson, Brelsford, and Shiffrin, 1967; Brelsford and Atkinson, 1968; Brelsford, Shiffrin, and Atkinson, 1968; Freund, Loftus, and Atkinson, 1969; Phillips, Shiffrin, and Atkinson, 1967; Rundus, 1970; Rundus and Atkinson, 1970; Shiffrin, 1968; Thomson, 1967).

In what follows, the memory system will be assumed to be divided into three components: a sensory register (SR) which receives information from the sense organs; a short-term store (STS) which may temporarily hold information that has been passed to it, either from the SR or from the third component of the system, the long-term store (LTS). The LTS represents permanent memory, and it is only here that information³

³In this paper the term "information" is used to refer to codes, mnemonics, images, or other material that the subject places in memory and that can help him to generate a response; we will not use the term in its formal information-theoretic sense.

may be retained for an extended period of time. All three of these stores are capable of retaining information received from any of the sense modalities. Since the experiments that will be discussed in this paper have used verbal material exclusively, no attempt will be made to consider memory other than of a linguistic nature. This restriction does not represent a limitation of the theory, since the system can accommodate other sorts of material (see Atkinson and Shiffrin, 1968a, for a more complete discussion).

At the outset, it is important to make a distinction between two aspects of the proposed memory system. On the one hand, there are certain fixed structural features of the system that are invariant and cannot be modified by the subject. On the other hand, the operation of the system is determined by a set of control processes that may change from one point in time to another. Thus, for example, information that is transferred from the SR to LTS must pass through STS since the functional connections between the three states are structural aspects of the system. The way in which STS is used to make this transfer, however, is a control process selected by the subject that can be quite different in nature from one task to the next. In one task the subject may use STS to rehearse several items simultaneously in order to maintain them over a short retention interval, whereas in another task each item may be studied and coded individually in an attempt to form a mental image for longterm storage. We shall return to an example in which different uses of STS are illustrated after a brief description of the components and control processes of the system.

The interconnections between the three stores are illustrated in Fig. 4-1. New information can enter the system only via the SR. In order to be retained, it must be passed from there to STS. It is in this store that most processing of information takes place. The STS, therefore, receives input not only from the SR but also from LTS. Information may be transferred from LTS to STS, for example, during recall, during the formation of associations while coding an item, or during the comparisons of one event with the memory of another. Finally, information which is to be permanently stored in LTS is "copied" into it from STS. Notice that the transfer of information from one store to another is a nondestructive process; that is, the information in the original store is not lost as a result of a transfer per se.

In the case of visual input⁴, the information entered into the SR usually takes the form of a fairly complete image of the observed scene which will decay in a matter of a few hundred milliseconds. The control processes at this level are concerned primarily with the selection of ma-

⁴The properties of the SR are best known for visual input; for some information on other modalities, however, see Crowder and Morton, 1969; Hill and Bliss, 1968.

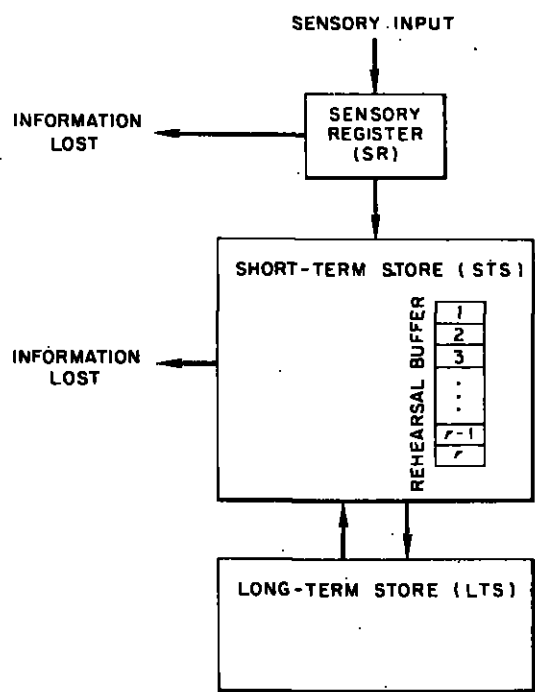

FIGURE 4-1. Structure of the memory system.

material for transfer to STS. Much more information is present in the SR than it is possible to transfer to STS. For example, partial report studies of visual memory (Sperling, 1960) show that subjects are able to recall correctly one line of a tachistoscopically presented 3×4 array of letters if they are instructed which line to remember immediately after presentation. If the recall instruction is delayed by more than a tenth of a second, the number of letters that are correctly recalled drops sharply, indicating that information originally present in the SR was lost before it could be transferred to STS.

Information entered in STS will also decay, but at a slower rate than in the SR. The measurement of this decay is complicated by the fact that the subject is able to retain information in STS almost indefinitely by rehearsal. Experiments (e.g., Peterson and Peterson, 1959) which attempt to prevent rehearsal have generally indicated that, without rehearsal, information in STS decays with a half-life on the order of ten to fifteen

seconds, the exact rate being highly dependent on the interpolated activity (Spring, 1968).

Control processes associated with STS may be grouped into three classes. The first of these classes is associated with the search for information in STS and its retrieval. There is evidence that the storage of information in STS is structured, hence that the use of a particular search strategy may lead to more or less rapid recovery of certain aspects of the data (Murdock, 1967; Sternberg, 1966). These search processes do not play an important role in experiments of the type that we shall be considering in this paper, so will not concern us further.

The second class of control processes in STS is far more important in the typical learning experiment. Processes of this type involve the rehearsal of items in STS in order to circumvent their decay. As long as information is rehearsed in STS it is preserved, but it begins to decay as soon as rehearsal ceases. In order to formalize this rehearsal process, it is assumed that the subject sets up a buffer in STS that can hold a fixed number, r , of items (see Fig. 4-1). This buffer is not a structural feature of the system, but is set up by the subject when required. The size of this buffer, when it exists, will depend both on the nature of the material that is being rehearsed and on the learning strategy that the subject is currently employing. It is not necessary that every item which enters STS be incorporated into the rehearsal buffer. The decision as to whether an item is to be entered into the buffer is another control process and depends on, among other things, the nature of the item and on the current contents of the buffer. Since the buffer is of fixed capacity, when an item is entered another must be deleted. The probability that a particular item in the buffer is forced out depends on such factors as the age of the item, the ease with which it can be rehearsed, and so forth (Brelsford and Atkinson, 1968). Once an item has been deleted from the buffer it undergoes rapid decay in STS.

The third important class of STS control processes are those associated with the transfer of information to LTS. In general, whenever information is in STS, some of it will be transferred to LTS. What is transferred, however, may vary greatly, both in the quantity and the quality of the resultant representation in LTS. If the major portion of the subject's effort is devoted to rehearsal in STS, relatively little information will be transferred to LTS, whereas if he attempts to develop appropriate ways of organizing and encoding the material, a great deal may be transferred. For example, in the learning of paired-associates, long-term performance is greatly improved if the subject searches for some word or phrase that will mediate between the stimulus and the response rather than simply rehearsing the item (Montague, Adams, and Kiess, 1966). Of course, the reduced

rate of transfer to LTS as the result of the generation of a rehearsal buffer is frequently offset by the greater length of time which the information will reside in STS and hence be available for transfer to LTS. The size of the buffer can also affect the rate at which information is transferred in another way. All of the items in STS at any one time are, in a sense, competing for transfer to LTS. Thus, when the buffer is large, the amount of information transferred to LTS about each item is proportionally smaller.

In the view of this theory, information that is stored in LTS is not subject to decay. Information, once stored, remains in LTS indefinitely. This does not imply, however, that this information will always be immediately available for recall. It is essential here to distinguish between the storage of information in LTS and its retrieval. Information which has been stored at one time may fail to be retrieved at a later time either because the strategy which the subject employed to locate the information is inadequate, or because later learning may have resulted in the storage of additional information that was sufficiently similar to that stored about the item in question as to render the original information, when recovered, insufficient for the generation of a correct response. In general, the control processes which are associated with LTS are involved with storage and with the determination of appropriate search routines. These will not be important in the discussion of reinforcement to follow, so the reader is again referred to the papers by Atkinson and Shiffrin (1968a,b) and Shiffrin and Atkinson (1969).

In the remainder of this section, an unpublished study run by Geoffrey Loftus at Stanford University will be described. We have three reasons for presenting this experiment. First, it will illustrate the continuous paired-associate task that has been used in much of the experimental work to be considered later in this paper. Second, it will extend our discussion of the memory system, in particular indicating how it can be given an explicit quantitative formulation. Finally, the experiment will provide an illustration of the way in which control processes in STS are affected by the nature of the task.

In this experiment, subjects were required to keep track of a randomly changing response paired with each of nine different stimuli. To be more specific, the task proceeded as follows: At the start of the experiment each of the nine stimuli (which were the digits 1 through 9) was paired with a randomly selected letter from the alphabet. After these initial presentations the experiment proper began. At the start of each trial a randomly chosen stimulus was presented to the subject, and he was required to make a response indicating which letter had last been paired with it. As soon as the response had been made, the same stimulus was presented for study paired with a new response chosen at random from the twenty-five

letters not just paired with the stimulus. The subject had been instructed to forget the old stimulus-response pairing and to remember only the new one. After a brief study period this pair disappeared and the next trial was started. In this manner three hundred trials could be presented during a session lasting about an hour.

The motivation for Loftus' experiment was to examine how the type of test employed to measure retention would affect the strategy used by the subject to store information. In particular, strategies were to be examined when the subject knew that he was to be tested using a recognition procedure, when he knew that a recall procedure was to be used, and when he had no information about the type of test. There were, thus, three experimental conditions, only one of which was used during a single session: (1) Items were tested by a recognition procedure; that is, at test a stimulus was presented along with a letter that was either the correct response or another randomly chosen from the remainder of the alphabet. The subject made his choice by striking either a key marked "YES" or a key marked "NO" to indicate whether or not he thought that the letter was indeed the one last paired with the stimulus. This condition will be referred to as the *recognition* condition. (2) Items were tested by a recall procedure; that is, a stimulus was presented alone for test and the subject was instructed to strike a key indicating which of the twenty-six letters of the alphabet he thought was correct. This condition will be referred to as the *recall* condition. (3) On each trial the choice of whether to use a recognition or a recall test was made randomly with equal probability. The data from this *mixed* condition must, therefore, be analyzed in two parts, according to which type of retention test was used. Unlike the other two conditions, when subjects were serving in the mixed condition, they were unable to tell at the time of study how that item would be tested.

Eight college students served in this experiment, each running for a total of sixteen daily sessions. In each session one of the three conditions was used. In order to allow subjects to become familiar with the apparatus and with the nature of the test procedures, the first session was run in the mixed condition and the data collected were excluded from analysis. During the remainder of the experiment each subject served in each condition for a total of five sessions. To avoid warmup effects during the later sessions, the first twenty-five trials of each session were also eliminated. The resulting data consists of 1,375 trials for each condition and each subject. The experiment was controlled by a modified PDP-1 computer which was operated on a time-sharing basis to drive eight KSR-33 teletypes, one for each of the subjects. These teletypes were used to present the material and to receive responses. The output from each teletype was masked so that only a single line of typed material was visible to the subject. This allowed

control of the duration of the exposure and prevented the subject from looking back to the results of earlier trials.

Since the stimulus that was presented on a trial was chosen randomly, the number of trials that intervened between the study of a particular stimulus-response pair and its subsequent test was given by a geometric distribution with parameter equal to the reciprocal of the number of stimuli, in this case $1/9$. The data which were collected, therefore, can be summarized by plotting the proportion of correct responses as a function of the number of trials that intervened between study and test. We shall refer to the number of intervening trials as the *lag* of the test for that item. In Fig. 4-2 the proportion of correct responses at a given lag is plotted for each of the conditions. There are over one thousand observations at lag zero for the recall and recognition groups and about half that many for the two curves from the mixed condition. The number of observations falls with increasing lag according to the geometric distribution mentioned above; thus there were only about two hundred observations for each condition by lag 14. Beyond this lag, therefore, the lag curves begin to show considerable instability and have not been plotted. The recognition data

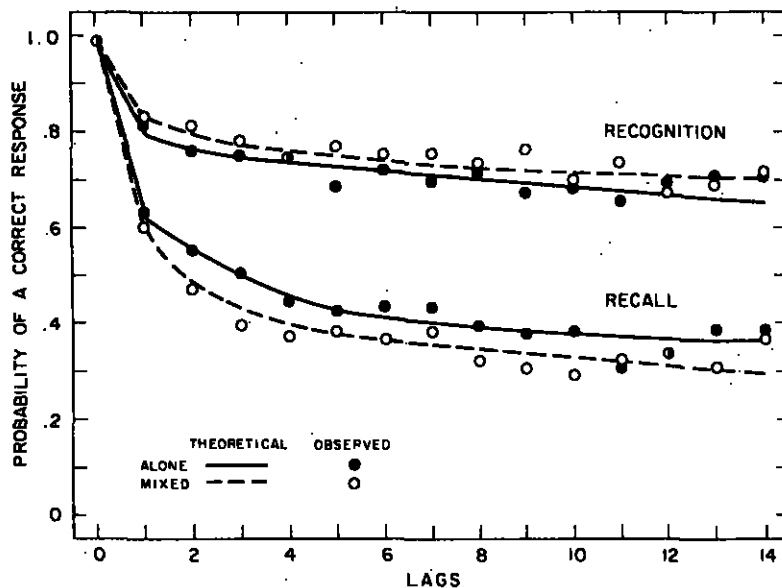

FIGURE 4-2. Probability of a correct response as a function of the lag between study and test for different retention-test conditions.

may be separated into two subsets, depending upon whether the pair presented to the subject for identification was actually correct or incorrect. In Fig. 4-3 lag curves reflecting this distinction are plotted: The upper curves show the probability of a hit (i.e., of a correct identification of a true pair) while the lower curves show the false alarms (i.e., the incorrect designation of a false pair as correct). These two functions were used in the analysis of the recognition data rather than the probability of a correct response.

The lag curves of Figs. 4-2 and 4-3 show a consistent difference between the mixed condition and the two homogeneous conditions. When serving in the recall condition, subjects were able to perform better than in the mixed condition. On the other hand, a greater proportion of the items were correctly recognized in the mixed condition than in the recognition condition. This result is also apparent in the proportion of hits and, to a lesser extent, of false alarms.

In order to interpret these results in terms of the memory system previously discussed, the assumptions of the theory must be given in a more explicit form (for a more detailed discussion of these assumptions and their implications, see Freund, Loftus, and Atkinson, 1969). The first step

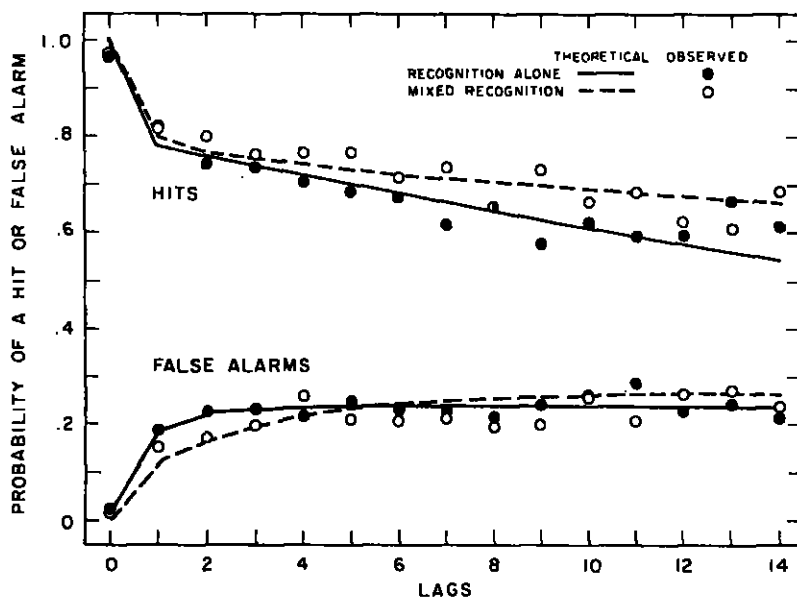

FIGURE 4-3. Probability of a hit and false alarm as a function of the lag between study and test.

is to clarify the conditions under which a new stimulus-response pair will enter a rehearsal buffer in STS. Whenever a stimulus is presented for study, there is a possibility that it will already be in the buffer, although the response that is paired with it will now be incorrect. If this happens, it is assumed that the new pairing invariably replaces the old pairing in the buffer. In the case where the stimulus that is presented for study is not represented in the buffer, we assume that entry is not assured, but takes place with probability α . The value of the parameter α is not known in advance and will need to be estimated from the data. If the new item enters the buffer, another item must be removed so that the buffer size remains constant at r items. As mentioned above, the choice of which item to delete from the buffer depends on many factors, but for this analysis it is sufficient to assume that it is random, with each item having the same probability of being knocked out.

The second set of assumptions that are required to make explicit predictions from the theory involves the transfer of information from STS to LTS. Since every item that is presented enters STS (although it does not necessarily enter the buffer), there will be some minimum amount of information about it transferred to LTS. This quantity of information will be denoted by θ' . If the item is also included in the buffer, it will reside in STS for a longer period of time, and hence more information about it will be transferred. In particular, it will be assumed that for each trial that passes, an additional amount of information, θ , will be transferred.⁵ Thus, for an item which enters the buffer and resides in it for j trials, the amount of information in LTS will be $\theta' + j\theta$. For simplicity we identify the two transfer parameters θ' and θ so that the information transferred will be $(j + 1)\theta$.

Information once stored in LTS is postulated to remain there indefinitely. Nevertheless, with the passage of time, other information may also be transferred to LTS which makes the original information less easy to

⁵The model that is represented by this assumption may be contrasted with a "single pulse" model in which rehearsal in STS does not induce additional information to be transferred to LTS, that is, in which $\theta = 0$ but $\theta' > 0$ (Atkinson, Brelford, and Shiffrin, 1967, Appendix). Evidence for the continual transfer assumption that we have used is provided by a free-recall experiment run by Dewey Rundus at Stanford University (Rundus and Atkinson, 1969). In learning the list of items to be recalled, subjects were instructed to rehearse out loud as the study list was being presented by the experimenter. This rehearsal was tape-recorded, and the set under rehearsal after the presentation of each new item could be precisely determined. Under these conditions the probability of correctly recalling an item when tested was a sharply increasing function of the number of times that it was in the rehearsal buffer: items that were in the buffer for a single time period were correctly recalled only 12 per cent of the time, while items that were rehearsed for nine or more times were almost always given correctly.

retrieve or which renders it ambiguous once retrieved. To quantify this decrement we assume that *retrievable* information decreases by a proportion $1 - \tau$ for every trial which passes after the item has left STS ($0 < \tau \leq 1$).⁶ In summary, the amount of information which will be retrievable from LTS for an item that remained in the buffer for j trials and was tested at a lag of i trials ($i \geq j$) is $(j + 1) \Theta \tau^{i-j}$.

The final class of assumptions specifies the relationship between information in LTS and the production of an appropriate response. There are three cases to consider here, depending on the disposition of the item in STS. The first of these is the case where the test is at a lag of zero. It is assumed here that the correct response is always available in STS regardless of whether the item was entered into the rehearsal buffer or not. No error is made. Similarly, when the lag is greater than zero but the item has been entered into the buffer and is still resident in it, a correct response will be made with probability one. Only in the third case, when the item is not in STS and must be retrieved from LTS, is an error possible. The probability that a correct response is produced here will depend upon the amount of information transferred to LTS. There are a number of ways in which this correspondence can be made; in the analysis of the experiment considered here, a postulate based on signal-detection theory was used. This equated the sensitivity parameter, d' , with the amount of retrievable information, i.e.,

$$d'_{ij} = (j + 1) \Theta \tau^{i-j}.$$

For the recall data, this value can be converted to the probability of an incorrect response (Elliot, 1964) which we shall denote by η_{ij} . For the recognition data, the results must be analyzed in terms of hits and false alarms, requiring the introduction of a bias parameter, c , associated with the subject's tendency to respond "YES."

⁶In a more precise model of memory the decay of information in STS would be represented by the same sort of exponential process that we have used here to describe the deterioration of information in LTS. This loss of information would be through actual decay, however, rather than through problems of retrieval that have been postulated for LTS. Formally, parameters θ'' and τ'' would be required, the first representing the amount of information available in STS at the time when an item is knocked out of the buffer, the second representing the rate of decay of this information in STS. The amount of information retrievable from both STS and LTS would, therefore, be $(\theta' + j\theta) \tau^{i-j} + \theta'' \tau''^{i-j}$. The original amount of information in STS would be greater than that in LTS ($\theta'' > \theta$ or θ'), but its rate of decay would be more rapid ($\tau'' > \tau$) so that the short-term contribution would become negligible while the contribution of LTS was still large. For the purposes of the analysis at hand, however, we can assume that information in LTS becomes unavailable so much more slowly than in STS, that the short-term decay factors may be ignored without changing the quality of the predictions.

The final step in the analysis involves the calculation of the actual probabilities of correct or error responses. From the assumptions about the probability that an item enters the buffer and that it is later forced out, we can calculate the probability that an item resides in the buffer for exactly j trials given that it is tested at a lag greater than j . This probability will be denoted as β_j . Since errors may occur only when the item is not in the buffer (i.e., only when it has resided in the buffer for a number of trials less than the lag), the net probability of an error is equal to the probability that an item remains in the buffer j trials multiplied by the probability of an error given this number of trials in the buffer, these terms summed over values of j less than or equal to i . Hence, the probability of an error at lag i is

$$P(E_i) = \sum_{j=0}^i \beta_j \eta_{ij},$$

where the case of $j = 0$ is used to indicate that the item did not enter the buffer. The derivation of the hit and false-alarm functions follow very much the same pattern.

The predictions of the theory, therefore, depend on the integer-valued parameter r and on the four real-valued parameters α , θ , τ , and c . In order to estimate these parameters, a minimum chi-square procedure was used. For the recall condition, the observed frequencies of correct responses and of errors were compared to their predicted values with a standard Pearson chi-square. Because the probabilities of correct responses are not independent at different lags, the result of this calculation is not assured of being distributed as a true chi-square. Nevertheless, it should be approximately correct and in any case should be nearly monotone in goodness of fit. The set of parameters that minimize the chi-square will, therefore, be a good estimate of the true parameter values. In order to evaluate approximately how well a particular parameter set fits the data, the resultant "chi-square" can be compared with a true chi-square distribution. For this comparison, each of the fourteen points on the lag curve will contribute a single degree of freedom to the chi-square. Subtracting one degree of freedom for each of the four parameters estimated (performance in the recall conditions does not depend upon c) the total number of degrees of freedom is $14 - 4 = 10$. In the case of the recognition condition, the data consist of two functions, the hits and the false alarms. By fitting both of these functions simultaneously, the number of degrees of freedom in the initial sum is doubled. Since in this case five parameters are to be estimated, a total of $2 \times 14 - 5 = 23$ degrees of freedom are available. Finally, for the mixed condition, minimization must be carried out simul-

taneously over the hits and false alarms for the recognition data and the number of correct responses for the recall data. There are, then, thirty-seven degrees of freedom in this chi-square.

TABLE 4-1
ESTIMATES OF MODEL PARAMETERS FOR PAIRED-ASSOCIATE
ITEMS TESTED BY A RECOGNITION, A RECALL, OR A MIXED
PROCEDURE

	<i>Experimental condition</i>		
	<i>Recognition</i>	<i>Mixed</i>	<i>Recall</i>
<i>r</i>	1	2	3
<i>α</i>	0.79	0.73	0.53
<i>θ</i>	0.79	0.52	0.30
<i>τ</i>	0.95	0.97	0.99
<i>c</i>	0.71	0.62	*
χ^2	22.3	29.3	11.3
<i>df</i>	23	37	10

*The parameter *c* was not required for this group.

The results of these estimations are shown in Table 4-1. It is first worth noting that the chi-squares are roughly on the same order as the number of degrees of freedom, and so in every case the fit is satisfactory. However, because the assumptions of the Pearson chi-square are not satisfied here, a comparison of the relative goodness of fit between the groups may not be made.

The values taken by the five parameters indicate the nature of the differences between conditions. The changes in all of the parameters are monotonic across the three conditions, with the mixed condition showing estimated parameters between those of the two unmixed conditions. The parameter *c* is not too useful here since it was estimated for only two of the conditions and since it does not differ much between them. The parameter that changes most dramatically is the size of the buffer, *r*. This parameter is estimated at 1 for the recognition condition, at 2 for the mixed condition, and at 3 for the recall condition. At the same time the probability that a new item enters the buffer, *α*, drops from 0.79 in the recognition condition to 0.53 in the recall condition. This difference in parameters implies that in the recognition condition subjects enter most items into the buffer, but hold them there for little more than a single trial, whereas in the recall condition almost half of the items fail to enter the buffer at all, although when they do enter, they tend to stay for a fairly long time. The mean number of trials that an item stays in the buffer, given that

it is entered, is r/α , which is 1.3 trials for the recognition condition and 5.7 trials for the recall condition. At the same time, the amount of information about each item that is transferred into LTS on each trial, indicated by the value of Θ , is much larger for the recognition condition than for the recall condition.

These results may be interpreted as characterizing two alternative strategies that the subject can adopt to deal with the two testing procedures. When the recognition test is used, the quality of the information required to produce a correct response is fairly low. It would, for example, frequently be sufficient to code the response letter E simply as an early letter in the alphabet or as a vowel. In this condition the parameter estimates suggest that the subject chose to concentrate on each item when it was presented and to transfer as much information about it as possible to LTS. Although the quality of this representation was probably poor and became largely unavailable at long lags ($\tau = 0.95$, but, e.g., $\tau^4 = 0.66$), it was frequently sufficient to determine a correct response. On the other hand, the recall condition required much more complete information. Apparently, in this condition the subjects tried to maintain some items in STS for a longer time, at the expense of other items. A strategy similar to that used for the recognition condition apparently transferred so little information to LTS as to be unable to support recall. The strategy employed, therefore, seems to be to use STS as much as possible for information storage (remember that more short lags are present than longer lags), even though this allowed information about each item to accumulate in LTS only slowly ($\Theta = 0.30$ compared to 0.79 for the recognition group). In order to do this, some incoming items had to be skipped almost entirely. In the mixed condition, subjects apparently were forced into an intermediate strategy, retaining items in STS for longer than they had in the *recognition condition*, but not for as long as in the *recall condition*. It is interesting to note that fewer errors were made on the recognition task in the mixed condition than in the recognition condition. Apparently, the strategy selected for the mixed condition actually was better on recognition tests than the strategy selected when the recognition task only was present. It seems that subjects do not always choose the set of control processes which produce the best performance.⁷

⁷The interpretation given to the above experiment is based in part on the parameter estimates presented in Table 4-1. It should be noted that the interpretation also depends on a detailed analysis of the sequential properties of the data that have not been described here. The reason is that such analyses are complex and require a lengthy description; further, analyses of this sort will be considered later in treating a similar experiment (pp 88-97).

Attention. It is difficult to consider the concept of reinforcement without at least attempting to relate it to attention.⁸ The extent to which a particular event modifies a subject's later behavior is influenced by the attention he gives to that event as much as by any reward or punishment associated with it. Accordingly, before reinforcement is considered, we shall examine the ways in which attentional variables can be incorporated into the framework of our memory system. We assume that attentional variables affect this system in three different ways, associated with the input of information into the SR, STS, and LTS. In the next section, when considering reinforcement, our interpretation of it will be very similar to the third of these attentional processes: that associated with entry of information to LTS.

The first place where attention can affect information transfer is at the very outset, by selecting information for entry into the SR. The processes which determine this selection are, in general, gross behavioral ones, primarily involving the orientation of the subject toward sources of stimulation so that the appropriate sense organs are stimulated. Once the sense organs have been activated, however, we assume that the incident information will be transferred to the SR.

The attentional processes involved in the transfer of this information to STS are more complex. This transfer results in a great reduction in the amount of information that is processed, since only information of importance to the subject is entered into STS. Such information may roughly be grouped into three classes which we associate with three different types of transfer control processes. The first class of information transferred to STS relates directly to the task with which the subject is currently involved. Thus, for example, in reading this text, one more or less automatically transfers information about the next words into STS (note, however, that the eye-movements involved in scanning the page are an attentional process of the first type). To account for this transfer, it will be assumed that the presence of information of a particular sort in STS will induce transfer of any similar information in the SR to take place. It is immaterial whether the control processes involved here are thought of as comparing the contents of the SR to STS; or as reaching out from STS and tracking a particular part of the SR. In any case, these control processes allow the system to track activity in the environment as long as information about it is maintained in STS. The second class of information transferred requires a somewhat more elaborate set of control processes. It is postulated that all information entered into the SR is rapidly analyzed

⁸ See Guthrie (1959) for an interesting discussion of this point.

and, as part of this analysis, a reference is made to LTS. At this stage, the primary result of this reference is the retrieval of a quantity, the *pertinence* associated with the information (Norman, 1968). For the purposes of this discussion, the pertinence may be thought of as a scalar quantity, with the property that information which has a high pertinence is likely to be selected for transfer to STS and information which has a low pertinence is likely to be allowed to decay without attention. The value that is taken by the pertinence function will depend on many different variables. The recency of a reference to the information in LTS and the frequency with which the information has been referenced, for example, are two such variables. The reference to LTS and the transfer to STS take place only after the information in the SR has been analyzed at a fairly high level. If anything is entered into STS as a result of these attentional processes, it will be far more complicated than a sensory image and will include some of the information recovered from LTS, for example, its context and several associations to it. The last class of information which may be transferred from the SR to STS concerns sudden changes in the environment. It is postulated that whenever there is a sharp discontinuity in the contents of the SR that is not correlated with an observing response or other subject-induced activity, there is a tendency for the new material in the SR to be transferred to STS. It is worth noting that these three classes of processes are competing with each other for the limited processing capacity available in STS, as well as with information that is being transferred from LTS and information that is being maintained in STS. What actually will be entered depends on the relative demands of all these sources of input, rather than on the magnitude of any one request.

The third place where attention influences the transfer of information is in the link between STS and LTS. It is clear that we remember a great deal about some aspects of the environment and very little about others, even when we have "attended" to all of them. In interpreting such effects it is not necessary to add anything to the collection of control processes that have already been introduced. In the previous section we noted that the transfer to LTS was influenced by any of a number of control processes acting on STS. The number of items in STS, the formation of a rehearsal buffer, or the retrieval of information from LTS to form mnemonics are examples of these processes. We shall not dwell on these attentional processes here, since they will be discussed in the next section.

The concept of reinforcement. In the preceding two sections a theory of memory and attention has been outlined that we believe can account for most of the results from simple verbal-learning experiments. In this section an attempt will be made to discuss reinforcement in the framework of this

system. We do not think that a single formulation can explain the variety of reinforcement effects that have been demonstrated with human subjects. Rather, it appears that the major determinants of learning are the memory and attention processes, and that the concept of reinforcement may best be understood in terms of their action. In several of the applications to be discussed in the second part of this report, results will be presented where the reinforcement effects appear at first glance to be quite complicated. When these effects are analyzed in terms of the theory, however, their basis will be seen to be relatively simple. The memory and attentional processes available to the subject provide bounds, often quite strict, that limit the set of control processes that can be used, and thereby constrain the action of reinforcement.

In many ways our interpretation of reinforcement is quite similar to the ideas of attention that were discussed in the preceding section. Transfer of information to LTS takes place only while that information is resident in STS. Thus, if learning is to take place, the appropriate information must be maintained in STS for some period of time. As indicated before, however, STS is a system of limited capacity, and many potential sources of information are competing for access to it. At the same time that an item is being studied for later recall, processing space in STS is also demanded by incoming stimuli and by other items already in STS. The extent to which information about the item is successfully processed depends on the limitations imposed by the task and on the strategy selected by the subject.

The data collected in an experiment may appear to be unduly complicated for another reason. The system of memory has two distinct ways in which information about an item may be stored. An improvement in performance as a result of a study trial may be brought about either because information is temporarily maintained in STS or because it is permanently stored in LTS. The relative importance of these two stores will depend on many factors, such as the nature of the task, the presence or absence of competing stimulation, and the length of time between study and test. The operation of reinforcement will have an effect on both of these processes; that is, feedback or payoff may lead the subject both to retain information in STS and to try to transfer it efficiently to LTS. Although the term reinforcement typically is used to refer to processes that have an effect on the permanent storage of information, in many experiments these long-term effects can become confused with those due to STS. The long-term and short-term effects may be very different from each other. In the next section, for example, we shall consider an experiment in which the effects of a series of similar stimuli on the storage of information in LTS agree with predictions from classical interference

theory, whereas the effect on the contents of STS is exactly the opposite. The overall behavior is, of course, a mixture of long- and short-term effects and thus, at first analysis, appears to show inconsistencies. In short, we do not feel that it is possible to study reinforcement variables without first making a careful analysis of the role of the two types of memory in the learning situation.

There are actually at least three sets of control processes by which information can be maintained in memory for later use. If the information is to be used immediately and then can be discarded, the subject may choose to simply maintain as much of it as possible in STS via rehearsal without any attempt to transfer it to LTS. With such a strategy the subject will be highly accurate at short lags, but performance will drop rapidly to chance thereafter. The second type of strategy also involves maintenance of information in STS via rehearsal, but this time in lesser quantity so that an attempt can be made to transfer it to LTS. Again, performance will be good at short lags, but now items tested at long delays will not experience as large a drop in performance. Finally, the subject may attempt to code the information and store it in LTS as it comes along without maintaining it in STS for any length of time. This set of control processes usually involves the retrieval of information from LTS to help generate a more robust image for permanent storage, usually by forming associations or by the use of mnemonic devices. The choice of which of these control processes to use is usually not freely available to the subject. The nature of the material that is presented frequently restricts the possibilities or even dictates exactly the method that must be used. The dynamics of the information processing that goes on in the three cases is different, however, and so the effect of an external manipulation will depend on the particular control processes that are used. In a later section on reinforcement magnitude, a case will be seen where a seemingly minor change in the stimuli led to a change in study procedure, which in turn resulted in vastly different reinforcement effects. An analysis of the information-transfer aspects of the situation is necessary before the role of reinforcement can be understood.

In spite of the restrictions that have been set forth in the previous paragraph, we shall now consider a general description of the reinforcement process. This formulation should not be thought of as an exact statement of the action of reinforcement, but as an outline which is frequently modified in its specifics. This description is, basically, an expectancy interpretation of reinforcement, and as such is in the tradition of the ideas set forth by Tolman (1932) and by Brunswik (Tolman and Brunswik, 1935). Essentially, it consists of two components: first, the formation of a prediction (and possibly the production of a response) based on the stimulus input and on correlated information retrieved from memory, and

second, the comparison of this prediction with subsequent events. It is the result of this comparison that determines whether information about the episode will or will not be transferred to LTS.

As noted in the section on attention, the transfer of information about an external event to STS involves more than simply a transfer from the SR to STS. In particular, a reference to LTS is required in order to generate a pertinence measure, and some of the recovered information will be entered into STS along with information from the SR. This information, along with other information that may be retrieved later from LTS, is used by the subject to select a response if one is necessary. In addition, this information allows the subject to generate an expectation or prediction about the events that will follow the stimulus. Any response that is required is based on this prediction, but the prediction usually is more elaborate than may be inferred from the observable response. When the outcome event in question occurs, it is compared with this prediction. The extent to which the outcome fails to agree with the prediction determines the degree and nature of the study the item receives. Usually, large discrepancies between the prediction and the outcome dispose the subject to apply control processes that maintain the relevant information in STS and induce the transfer of information to LTS. The information which is transferred is primarily associated with those components of the prediction that were most deviant from the actual outcome. The result is to reduce the disparity between the outcome and information now stored in LTS, so that if the same stimulus and outcome were to be presented again, the discrepancy would be smaller than the original one."

This special analysis simplifies considerably the factors that are involved in causing information to be maintained in STS. It is important to realize that STS is a system of limited capacity and that many potential sources of information are competing for access to it. At the same time that a comparison between a prediction and an outcome indicates a discrepancy, the processing capabilities of STS will also be demanded by external inputs and by other information that is already resident in STS. Whether the item in question will actually receive sufficient processing in STS to have an effect on later performance will depend upon the task in progress, the nature of the competing items, and any control processes

"The above hypothesis is similar to several other theories that have been proposed. The notion that the condition under which learning takes place involves a discrepancy between a prediction and an outcome is quite close to the expectancy hypothesis developed by Kamin (1969) and by Rescorla (1969). In the restriction of the stored information to that necessary to eliminate an observed discrepancy, our theory is similar to the discrimination net models of Feigenbaum and Simon (Feigenbaum, 1963) and Hintzman (1968). In this respect it also bears a resemblance to dissonance theory (Festinger, 1957; Lawrence and Festinger, 1962).

which may predispose the system to treat information of one type and not of another. This dynamic aspect of short-term processing is responsible for many of the effects of reinforcement, and we shall return to it in several of the applications that will be considered in the remainder of this paper.

Experimental Results

In this section the results of a number of experiments are considered in order to help clarify the role of the various stores and control processes and illustrate how reinforcement variables (e.g., the magnitude of reinforcement, the schedule of reinforcement, or the delay of its presentation) may be interpreted. In the original reports where these experiments were first described, they were given some form of quantitative analysis in terms of the theory. The details of these analyses can be found in the reference articles, so our discussion will be of a more qualitative nature. We hope that this simplification will allow us to consider the problems of reinforcement without becoming involved in questions of mathematical notation and proof.

Number of reinforcements and their presentation schedule. The first experiment is a fairly direct application of the theory to paired-associate learning (see Brelford, Shiffrin, and Atkinson, 1968, for a more complete treatment). It illustrates the way in which a series of reinforcements can act to build up the strength of a representation in LTS through the successive storage of information. Basically, the same continuous paired-associate task that has already been described in connection with the Loftus experiment is employed, although with several modifications. A new set of eight stimuli (random two-digit numbers) were chosen at the start of each session and were used throughout the session. As in the Loftus experiment, the responses were letters of the alphabet. Each trial of the experiment began with the presentation of a stimulus to which the subject had been instructed to respond with the most recently paired letter. This stimulus was chosen randomly from the set of eight stimuli, so the lags between study and test were again distributed geometrically with parameter $1/8$. Following his response, the subject was given three seconds to study the stimulus paired with a response. This ended the trial. Unlike the Loftus experiment, the study phase of the trial did not always involve pairing a new response with the stimulus. A stimulus-response pair might be given one, two, three, or four reinforcements, the probabilities of these frequencies being 0.3, 0.2, 0.4, and 0.1 respectively. Thus,

a stimulus selected for two reinforcements would be studied with the same response following the first test, but after the second test a new response would be introduced. This procedure continued for 220 trials per session. Each subject was run for at least ten sessions.

As in the previous experiment, the principal finding can be expressed in the form of lag curves (Fig. 4-4). Separate curves are presented showing the probability of a correct response, depending upon the number of prior reinforcements. Hence, there is a lag curve for stimulus-response pairs tested after one, two, and three reinforcements. By the nature of the presentation schedule, the number of observations at each point declines with increasing lag, and also with increasing number of reinforcements. Since at the time a subject was tested on an item, he had no way of knowing whether that item would be studied again, the first test of every item could be used in plotting the lag curve for one reinforcement. Similarly 70 per cent of the items received two or more reinforcements and therefore contributed to the second lag curve. Only in the case of the fourth reinforcements (which occurred for only 10 per cent of the items) were the frequencies too small to permit stable curves to be plotted. The three curves in Fig. 4-4 show a resemblance in form to the lag curves

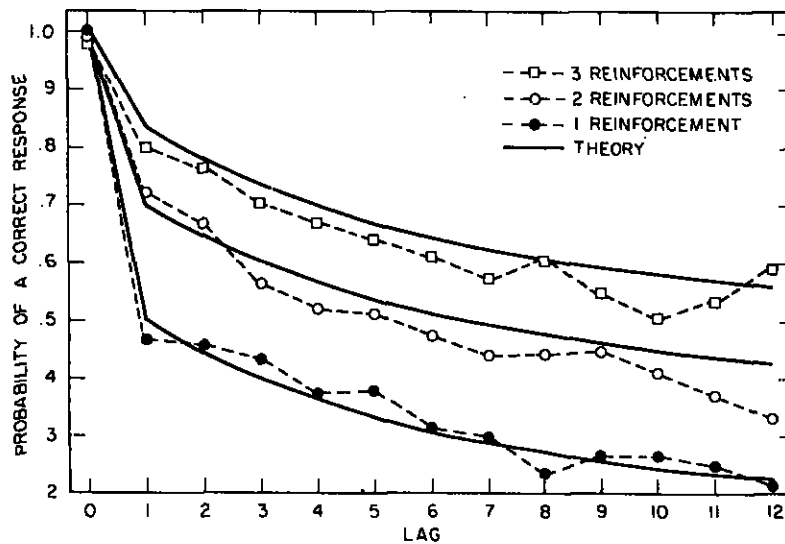

FIGURE 4-4. Observed and predicted probabilities of a correct response as a function of lag for items tested following their first, second, or third reinforcement.

obtained in Loftus' experiment. In particular, the curve for one reinforcement is quite similar to the comparable curve for the Loftus recall group. The curves in Fig. 4-4 also indicate that the proportion of errors at a given lag decreased as more reinforcements were given.

In order to account for the effects of multiple reinforcements, only a few minor changes need be made in the model used to analyze Loftus' data. As before, it is assumed that if a stimulus is presented for study paired with a new response and the stimulus is one of the r -items currently in the rehearsal buffer, then the subject will simply replace the old response with the new one. Otherwise, no change is made in the contents of the buffer. The case of an item which is not in the buffer at the time of presentation is somewhat more complicated.¹⁰ Whenever the stimulus for such an item is presented for test, the subject must retrieve information from LTS in order to make a response. Again we assume that the amount of available information can be represented as a d' -measure for that item. On the basis of this information, the subject generates a response, in this case his prediction about the outcome of the trial. Accordingly, we postulate that whenever the response is correct (indicating a good correspondence between the prediction and the outcome), the item will not receive additional study and hence will not be placed in the buffer. Whenever the correspondence is small (an error is made), the item will enter the buffer with probability α . The probability of failing to enter the buffer, $1 - \alpha$, represents the combined effects of the many sources of competition in STS that may take precedence over entry of an item; for example, the presence of a naturally compatible stimulus-response pair or of an easily rehearsable combination of items in the buffer. Once the item has entered the buffer, however, we assume that transfer to LTS takes place in the same manner as discussed before: For every trial in the buffer an amount of information Θ is transferred to LTS. Every trial in which the item is absent from STS results in a proportion $1 - \tau$ of the information in LTS becoming unavailable for recovery and response production. Like the recall condition in the previous experiment, the predictions of the theory depend on the four parameters: r , α , Θ , and τ . To make these estimations, the same type of pseudo-chi-square procedure employed in the Loftus study was used here, this time simultaneously on all three lag curves and also on the double lag curves presented in Fig. 4-5. From this

¹⁰The analysis used here is not quite identical to that used by Brelsford et al. (1968, p. 6), the principal change being in the mathematical form of the response-generation postulate. The quantitative predictions of the two formulations are virtually identical; the one that is presented here is more in line with our current thinking regarding reinforcement. In the version of the theory used by Brelsford et. al., the parameters have slightly different meanings, and hence their values cannot be directly compared with those estimated for the Loftus experiment.

minimization, a set of parameters was found which generated the predicted curves shown in Figs. 4-4 and 4-5 and in the subsequent figures. The estimated buffer size was $r = 3$.

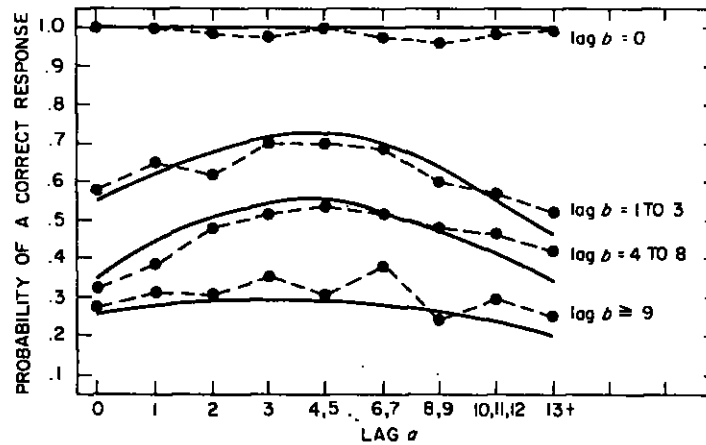
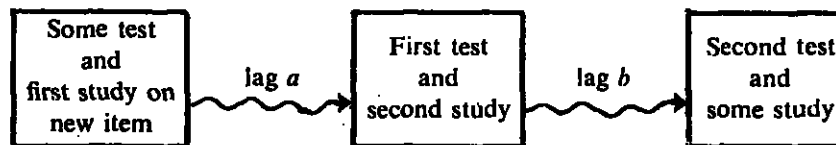

FIGURE 4-5. Observed and predicted probabilities of a correct response as a function of the spacing between the first and second reinforcement (lag a) and the lag between the second reinforcement and the final test (lag b).

The lag curves of Fig. 4-4 give a good idea of the general rate of learning, but they are not the best way to look at the effects of reinforcement. These effects are better examined by looking at sequential properties of the data; that is, at the effects of one reinforcement on a later one. Accordingly, in the next few paragraphs we consider a number of different summaries of the data, and show how they are predicted by the theory.

The first set of results to be examined relates the lag between the first study and test of an item to the performance on the second test. In particular, the presentation of an item with two or more reinforcements can be represented as follows:



This describes a new pair that is studied, then first tested at lag a , is studied again, and next tested at lag b . We wish to look at the way in which re-

sults of the second test depend on lag a , with lag b held roughly constant. Plots of this relation are shown in Fig. 4-5. For lag $b > 0$ these curves are bow-shaped, with fewer correct responses when lag a is either small or large. As would be expected from the curves in Fig. 4-4, more errors are made when lag b is large than when it is small. It is relatively easy to see how these curves are predicted by the model. For small values of lag a , little information will be transferred to LTS during the interval between trials, so the primary effect of the first reinforcement is to increase the likelihood that the pair is in STS when the second reinforcement occurs. This will slightly increase the probability of a correct response, particularly at short lag b . For somewhat longer values of lag a , this effect is coupled with the transfer of a considerable amount of information into LTS before the second study. Thus a facilitative effect of the first reinforcement is expected even when the item has been deleted from the buffer before the second test. Finally, when lag a is very large, the item will almost certainly have departed from the buffer and much of the information that had been deposited in LTS will have become unavailable (in this experiment the estimate of τ was 0.82, so the retrievable information in LTS had a half-life of only about three trials).

In the preceding paragraph the effect of the lag between the first and second reinforcement of a stimulus-response pair was examined. In this paragraph we shall again consider the effects of the lag between two successive reinforcements involving the same stimulus; however, in this case the two presentations represent the last occurrence of one pairing and the first occurrence of a new pairing:

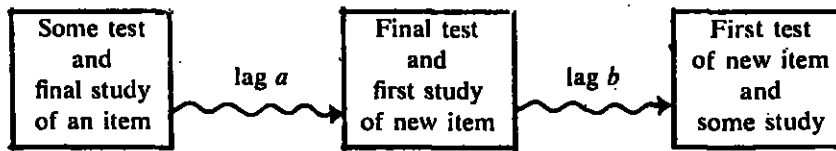

Here, a stimulus-response pair is given its last study and tested at lag a . A new response is then paired with the stimulus and is given its first test at lag b . The predictions for this case are somewhat surprising and are worth examining closely. If the item is not in the buffer at the end of lag a , it should have no effect on whether the new pairing is studied or not. If the previous stimulus-response pair is in the buffer, however, it should have a facilitative effect on the new learning; since the new item is now guaranteed to enter the buffer. In this case, the probability of a correct response on the new item should be relatively large. Unfortunately, the presence of the pair in the rehearsal buffer is not an observable event, but it is probabilistically related to the occurrence of an error and to lag a .

In particular, if an error was made on the final test of the old item, we know that it was not in the buffer, and therefore predict that the probability of a correct response on the new item, when tested later, will be independent of lag a . When a correct response is made on the old item, it may be in the buffer, and furthermore, it is more likely to be in the buffer if lag a is small. In this case, small values of lag a should be associated with fairly large probabilities of a correct response, and these probabilities should fall with increasing lag a . Note that this prediction is quite different from what would be predicted by interference theory, since it associates good performance on a transfer task with good performance on original learning.

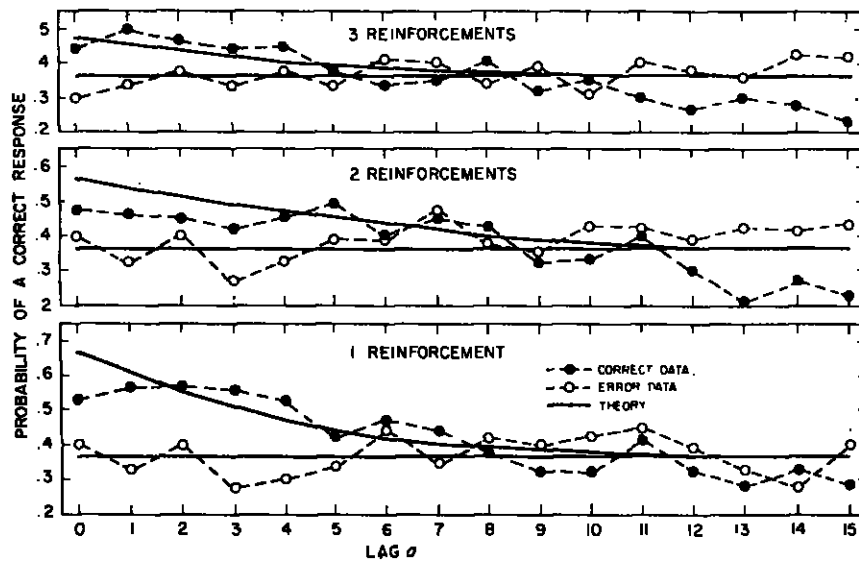

FIGURE 4-6. Observed and predicted probabilities of a correct response on the first test of an item as a function of the lag for the last item using that stimulus (lag a).

This prediction, however, seems to be well supported by the data as indicated by the functions plotted in Fig. 4-6. In this figure, unlike Fig. 4-5, the results have been averaged over all values of lag b . Three sets of curves have been plotted, depending upon whether the item given on trial $n + a + 1$ received its first, second, or third test. It is interesting to note that the magnitude of the difference between the correct and the error data declines as the number of prior reinforcements increases. This

may be attributed to the fact that the facilitation is purely a result of study in STS, and that this study takes place only when the subject's prediction based on LTS information is incorrect. When several reinforcements have been given, there is a greater likelihood that the item will be correctly recovered from LTS, and hence that no rehearsal in STS will take place. Accordingly, the proportion of correct responses that occur because the item was maintained in STS decreases, and with it the size of the facilitation effect. It should also be noted that the probability of a correct response to the new item, conditional on a correct response to the old one, appears to fall systematically below the prediction when a long lag intervenes between the two study trials. This effect, which is exactly the opposite of the one observed at short lags, is evidence for the activity of more conventional interference processes in LTS. Items that are correctly recalled at long lags are likely to have been recovered from a good representation in LTS. Apparently this strong trace interferes with the establishment of a new trace based on the same stimulus. Additional evidence for these interference effects will be presented in Fig. 4-8.

The last two results to be considered involve the effects of a sequence of similar or dissimilar stimuli and provide further evidence for some of our postulates about study effects in STS. Consider a series of consecutive trials all involving the same stimulus, but in which the response paired with the stimulus on the final study trial is different from that on the immediately preceding trial. The theory predicts that the longer the string of presentations, the more likely it is that the final item when eventually tested will be correctly recalled. This is so because the probability that a pair containing the stimulus is in the rehearsal buffer increases with the sequence of zero-lag presentations. On each successive trial of this sequence, a pair containing the stimulus may be entered into the buffer if it is not already there, and if there are no competing items to force it out. The resulting effect is shown in Fig. 4-7. In this figure the probability of correctly recalling the last item of a series of trials all involving the same stimulus (averaged over all test lags) is plotted as a function of the length of the series. As expected, this is an increasing function, and falls quite close to the predicted function. Note that again this effect is quite the opposite of predictions from a traditional interference theory. Such a theory would predict that the repeated presentations would interfere proactively with the new pair and that this would decrease the probability of responding correctly to the transfer item. It is important to realize that these effects are the result of activity in STS and say nothing about the nature of interference in LTS. Indeed, the long-term effects appear to be the opposite of the short-term effects. Figure 4-8 shows the probability that, on the first trial of a new item, the response that had been correct

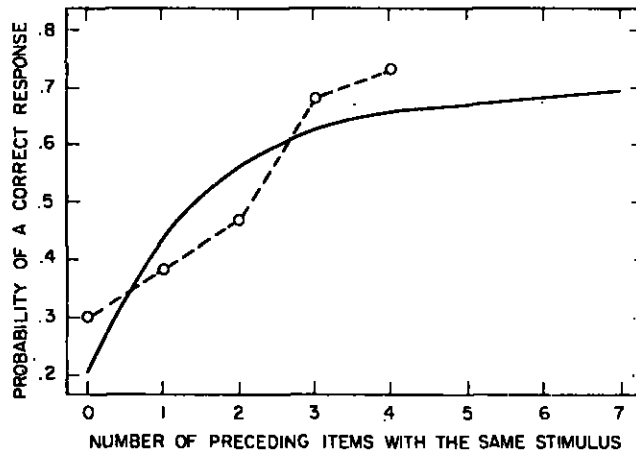

FIGURE 4-7. Observed and predicted probabilities of a correct response as a function of the number of consecutive preceding items using the same stimulus.

on the previous occurrence of the stimulus is given instead of the current correct response. The probability of these intrusion errors is plotted as a function of the lag at which the new item is tested (the three curves depend on the number of times that the previous pairing had been reinforced). Intrusion errors were more frequent when the previous item had been given several reinforcements than when it had received only a single reinforcement. The fact that the response is actually an error indicates

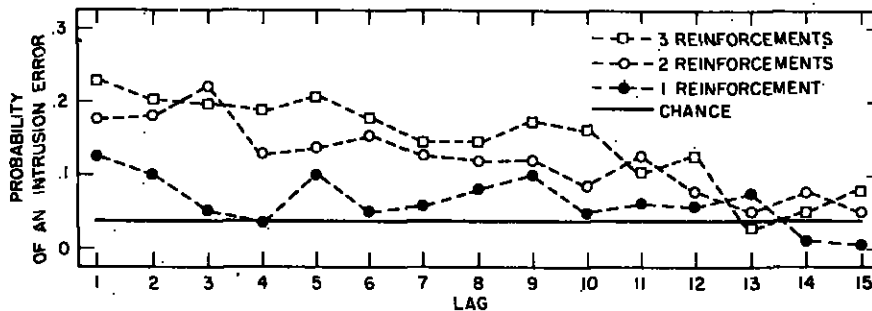

FIGURE 4-8. Probability that the correct response for the preceding item using a given stimulus will be made as an intrusion error to the present item.

that the item was not in the buffer at the time of test, hence that this more typical proactive effect is associated with long-term storage.

A series of consecutive trials using the same stimulus, as indicated in the preceding paragraph, tends to cause that stimulus to be entered into the rehearsal buffer, but will not create any further disruption of other items in the buffer. On the other hand, a series of items with different stimuli produces maximum disruption, since each of them will have some probability of being entered into the buffer. This effect is illustrated by the way that the items which intervene between study and test of a given item affect the probability of a correct response. In particular, suppose that the test of an item following its k^{th} study occurs at lag x . The case where all of the x intervening items involve the same stimulus and the case where they involve all different stimuli will be examined, with the prediction that the all-same condition will produce better performance than the all-different condition. For each of the three values of k , this prediction is supported (Fig. 4-9).

This experiment has illustrated the way in which the theory can be applied to show increases in LTS strength as a result of a series of reinforcements. It has also shown a simple way in which the correspondence

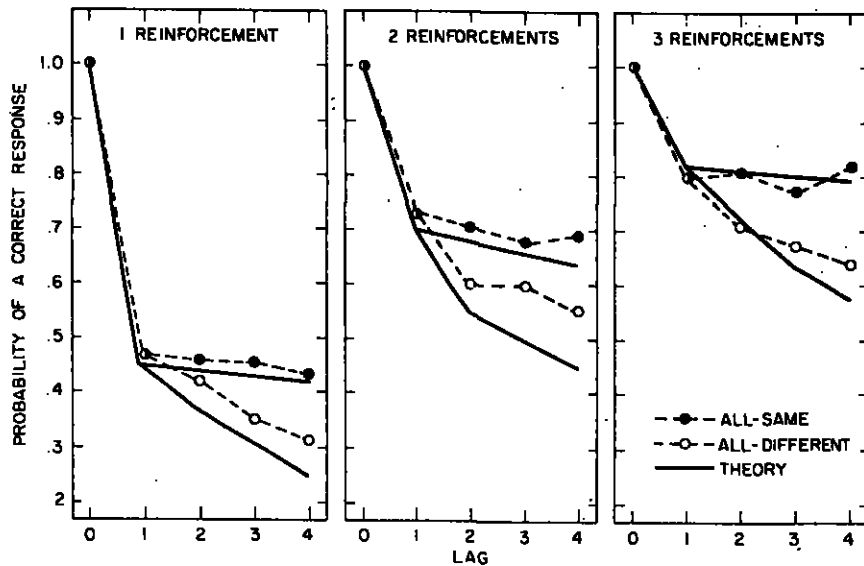

FIGURE 4-9. Observed and predicted probabilities of a correct response as a function of lag for the cases where the intervening stimuli are all identical or are all different.

between the subject's prediction and the outcome of a trial can determine rehearsal patterns. Finally, by considering the sequential properties presented in the last five figures, evidence has been given which supports our particular two-process formulation of memory.

Delay of reinforcement. The second experiment to be considered examines one of the most confusing issues in the area of human reinforcement: that of its delay. It appears that a delay in the feedback of information about a response can have many different effects. Some studies (Greenspoon and Foreman, 1956; Saltzman, 1951) have indicated that a delay will impair learning, others show no effect (Bilodeau and Ryan, 1960; Bourne, 1966; Hochman and Lipsitt, 1961), and still others appear to show a facilitative effect of delay (Buchwald, 1967, 1969; Kintsch and McCoy, 1964). We shall attempt to show that any of these effects can be accommodated by our analysis and shall discuss an experiment (Atkinson, 1969) in which all of these effects were obtained as the result of several fairly simple manipulations.

The basis of this experiment was a continuous paired-associate task similar to the one just described. The stimuli were randomly generated consonant trigrams and were paired with single-digit responses (digits 2 through 9). Every stimulus-response pair received between three and seven reinforcements, with each pair being equally likely to receive any number of reinforcements within this range. A stimulus was used only once during the course of the experiment; that is, a stimulus trigram would receive several study and test trials with a particular response number, and then would never be used again. The major difference between the presentation schedule in this experiment and those discussed earlier concerned the lag structure. Sixteen different stimuli were active at any time. The stimulus that was presented, however, was not chosen at random from this set, but only from the six stimuli that had not been presented on the previous ten trials. Thus, the minimum possible test lag was ten and the mean lag was fifteen items.

The manipulation in this experiment involved assigning each stimulus-response pair to one of fourteen conditions. This assignment was made randomly for each pair, but was the same for all reinforcements of that pair. All conditions were run simultaneously; that is, the set of items that were active at any time included ones assigned to many different conditions. The fourteen conditions resulted from combinations of three independent variables affecting reinforcement: (1) The first of these variables was the delay itself. The presentation of the stimulus was terminated by the response, then the feedback (reinforcement) appeared, either immediately or following a delay of three, six, or twelve seconds. (2) During

this delay, the subject was either allowed to do as he pleased or was instructed to count backwards from a randomly selected three-digit number. These conditions will be referred to as the *no-count* and the *count* conditions. (3) The feedback consisted either of the correct digit response presented alone or of both the stimulus trigram and the correct response. These conditions will be referred to as the *feedback-only* and the *stimulus-plus-feedback* conditions. In either case the duration of the reinforcement was four seconds. When the delay is zero, the count and no-count conditions are the same, hence only fourteen conditions are possible, instead of the $4 \times 2 \times 2 = 16$ conditions which might be expected.

The primary dependent variable considered in the experiment was the proportion of correct responses averaged over trials 2 through 7 (the initial trial, of course, was a random guess and has not been included in the average). In Fig. 4-10 this proportion is plotted as a function of the delay for the various reinforcement conditions. This figure shows all three of the trends which were mentioned above: the count, feedback-only condition shows a drop in the mean proportion correct as a function of delay;

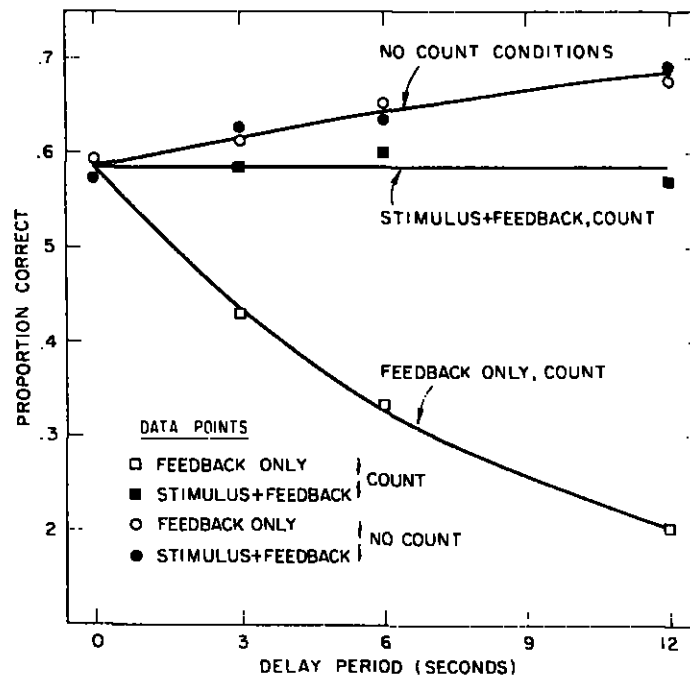

FIGURE 4-10. Observed and predicted probabilities of correct responses as a function of delay for two types of feedback and two types of delay activity.

the count, stimulus-plus-feedback condition shows no effect of delay; while both of the no-count conditions show an improvement with delay.

In interpreting the effects of reinforcement delay here, it is important to realize that the roles of rehearsal and of LTS are quite different in this task than they were in the two previous experiments. The presentation schedule was constructed so that there was always a substantial lag between successive appearances of an item. Because of this it was not practical for the subject to use a rehearsal buffer to maintain information until a response was required — too many of the items which intervened between study and test would have had to be ignored altogether. Instead, subjects were forced to rely primarily on LTS as a source of information storage. In such a case, subjects usually do not form a rehearsal buffer, but instead try to code each item as it is presented, and then turn their attention to the next item when it appears. The use of unique and relatively unfamiliar stimuli for each pair also increased the likelihood that this coding scheme was used.

The results of the count conditions are now fairly simple to interpret. The counting procedure had the effect of preventing rehearsal of information in STS; in particular, the subject could not readily remember the stimulus that was presented throughout the course of the delay period. Thus, in the feedback-only condition, the subject would frequently be unable to remember the stimulus by the time feedback was presented and would, therefore, be unable to associate the stimulus-response pair. In such a case, the probability of a correct response would drop toward chance as the likelihood increased that the stimulus could not be remembered; that is, as the delay interval increased. In the stimulus-plus-feedback condition, forgetting the stimulus during the delay period should have no effect since both members of the pair would always be available at the time of study. The counting task would, however, prevent any other processing from occurring during this interval, so the delay would be expected to have no effect at all.

In the no-count conditions the subject should have no problem in retaining the stimulus in STS during the delay interval; consequently, there should be no differences between the stimulus-plus-feedback and the feedback-only conditions. In fact, the delay interval can be spent in processing information in such a way as to make later LTS storage easier and more efficient. There are several ways in which this can be done; for example, the subject may engage in some sort of pre-processing of the stimulus, such as generating images or mnemonic codes which will aid in efficient storage once feedback is provided. Furthermore, after several reinforcements have been presented, the subject may be able to recover the response from LTS and recognize it as the correct one before the

feedback is presented. He can then use the delay interval to further study the item. Either of these two processes can generate the increasing delay function that was observed.

Atkinson (1969) has described the amount of information which was transmitted to LTS by each reinforcement by an increasing exponential function for the no-count conditions and by a decreasing exponential function for the count conditions. These functions have been used to generate the predictions shown in Fig. 4-10. Although the sort of sequential investigations illustrated by Figs. 4-6 through 4-9 have not been made, the overall accuracy of these predictions support the interpretation.

The above analysis was able to accommodate effects that at first appeared to be inconsistent into a fairly simple framework by focusing attention on the informative value of the reinforcement, rather than treating it as a simple event. A similar, if not identical, analysis, we feel, will be able to reconcile the discrepant results that have been found for the effects of delay of reinforcement by other workers. It is experimental results of this sort that make a particularly strong case for our contention that factors involved in learning and memory are fundamental in determining the phenomena of reinforcement rather than the other way around.

Concept identification. In the following section, the theory will be applied to a concept-identification paradigm in which the effects of reinforcing events are quite different from those that have been discussed so far. The concept-identification task requires the subject to observe a series of stimuli and to classify them, one by one, into a fixed set of categories. Following each response, the subject is told the correct classification of the stimulus, and it is this feedback that gives rise to learning. The concept-identification procedure differs from the paired-associate procedure in that the classification depends systematically on some property (or properties) of the stimuli. This means that once the subject has solved the problem and has learned the rule by which stimuli are classified, he will be able to classify a novel stimulus correctly. There are, of course, an infinitely large number of possible stimulus properties and rules that can be used to partition the stimuli. In the experiment to be discussed below, we shall treat only a very few of these possibilities, those where the stimuli are composed of orthogonal binary dimensions and where the classification rule depends on only one of these dimensions. The procedure for the experiment that will be discussed (for a complete treatment see Wickens, 1969) will show these restrictions more clearly.

Subjects were seated before a teletype keyboard and saw stimuli projected on a screen in front of them. These stimuli were pictures which were constructed to vary along twelve different dimensions. Each of these

dimensions, or attributes, of the pictures could take on either of two different values, only one value in each picture. One set of stimuli, for example, consisted of line drawings of houses in which the dimensions were represented by one or two windows, by a chimney on the left or on the right, and by ten other distinctions. From the twelve attributes a total of $2^{12} = 4,096$ distinct stimuli could be constructed. The rules used to determine the correct classifications were based on exactly one of these attributes; all stimuli for which that attribute took one value falling into one of two categories, all stimuli for which it took the other value falling into the other category. As each stimulus was presented, the subject indicated his choice of category by pressing the zero or the one key on the keyboard and was informed of the correct alternative by indicator lights mounted above the keyboard. A series of such trials was presented to the subject, the series continuing without interruption for the duration of a session. Whenever the subject had correctly identified the relevant attribute, as indicated by a string of twelve consecutive correct responses, he was signaled that the current problem was complete and was immediately started on a new problem, using a rule based on one of the eleven attributes that had not just been used. Subjects were run for two hours per day for five days. The number of problems solved by a subject during the experiment ranged from 53 to 115. During the first 25 problems or so, subjects showed improvement. After this point, however, the number of trials to solution remained approximately constant. The analysis to be discussed below is based on this stable, asymptotic data only.

The analysis that will be made of concept-identification is based upon the general idea of hypothesis testing (Bower and Trabasso, 1964; Restle, 1962). We assume that the subject solves concept problems by formulating hypotheses about the rule that determines the classification, then observing the sequence of classified stimuli to see whether the hypothesized rule is supported or not. A rule which is consistent with the true classification will enable the subject to respond correctly and thereby to solve the problem, whereas a rule that is inconsistent will cause errors to be made. When an inconsistency appears, the subject will abandon the rule under test and select a new one. It is apparent that this sort of solution is composed of two different processes: the selection of rules and their test. This dichotomy will represent an important part of our analysis of the role of reinforcement in concept identification.

We assume that initially there is a set of hypotheses which the subject considers to be potential solutions to the problem and which he wishes to test. The size of this pool depends on the nature of the task and on the subject's familiarity with it. In his first attempt to solve a concept-identification problem, a subject may have a large set of hypotheses which

he views as possible, many of which hypotheses are quite complicated and cannot be the true solution to the problem. In the case of the experiment mentioned above, in which considerable practice was given and the subject was adapted to the task, the set of hypotheses may reasonably be identified with the set of attributes of the stimuli. In the following discussion, we shall speak of sampling *attributes*, indicating the specific nature of this experiment. One may, however, think of this as sampling from a pool of much more general hypotheses.

When solving a concept-identification problem, it is assumed that the subject starts by choosing a sample of r attributes from the total set and maintains them in STS by rehearsal. The matching of the values taken by these attributes to the two response alternatives is assumed to show local consistency (Gregg and Simon, 1967); that is, the assignment is made in such a way as to be consistent with the outcome of the last trial that has taken place. By comparing this assignment to the values that these attributes take in a new stimulus, the subject makes several predictions regarding the outcome of the new trial. Each of these predictions is based on one attribute in the sample: If the value of this attribute is the same as the value it took in the previous stimulus, then the same classification is predicted; if the value is different, then the classification is predicted to change. If more than two attributes are sampled, it is possible that the set of predictions may have internal inconsistencies, since each attribute may be varied independently of the others. The subject's classification response is generated from these predictions in some manner or other. The actual method of generation is not crucial to our analysis: He may choose a prediction at random, may select the response indicated by the largest number of predictions, or may use any of several other strategies.

The outcome of the trial provides confirmation of some of these predictions and disconfirmation of others, implying that those attributes on which incorrect predictions were based are no longer tenable candidates for the solution. Accordingly, these attributes are dropped from the rehearsal buffer. On the following trials, this process is continued, either until the buffer is emptied or until the problem is solved, in the sense that only one attribute is being considered and this is the correct one. If the buffer is emptied, the subject is forced to draw a new sample of attributes for testing. Here, for the first time, LTS becomes important. While the first set of attributes was being tested, information about them was being transferred to LTS. Now, when resampling is taking place, this information in LTS may allow the subject to avoid resampling those attributes which have already been tested and rejected. Resampling of an attribute that has already been tested may take place, but only when

information about that attribute cannot be recovered from LTS, either because only a small amount of information was originally transferred or because of a failure of the search process. As more and more samples are drawn, there will be a greater and greater likelihood that the correct attribute will be selected and the problem solved.

The formulation of concept-identification learning given here is similar to a number of those that have been discussed in the literature, although it is not identical to any of them. In addition to the reference mentioned above, Trabasso and Bower have presented models in which questions of the delay of resampling (Trabasso and Bower, 1966) and the size of the test sample (Trabasso and Bower, 1968) have been discussed, while Gregg and Simon (1967) have considered a series of models which make a number of different assumptions about the selection of new hypotheses for test. All of these models, however, are different from our model in one critical respect, for they assume that the occurrence of an incorrect response causes the whole sample to be eliminated and redrawn. In contrast to this assumption, our theory makes a clear distinction between the effects of information feedback and the effects of reward. The important variable in determining what learning takes place is not whether the overt response was correct or in error, but rather the way in which the various predictions about the attributes were confirmed or disconfirmed. Since the subject can make a response that is not consistent with some of his predictions, it is possible for these predictions to be disconfirmed, and therefore rejected, at the same time that the response is correct. Only in the case where the buffer size is one (i.e., only a single attribute is under test) will the reward and information feedback aspects of the reinforcement be equivalent.

The fact that resampling does not take place on every error is central to our analysis of the role of reinforcement in this situation. It is relatively easy to demonstrate that this cannot occur as frequently as do errors. If resampling is postulated to take place after every error, the rate of learning for problems based on a particular attribute is independent of the value of r and can be represented by the probability that no more errors follow a given error; that is, by the probability that the correct attribute is both selected for rehearsal and is used as the basis for response generation. This solution probability can be estimated from the number of errors required to solve the problem. If m_i is the mean number of errors to solve problems based on the i th attribute, then the solution probability for that attribute, c_i , can be estimated as follows (Restle, 1962):

$$\hat{c}_i = \frac{1}{m_i + 1}$$

The c_i 's should form a probability distribution over the set of attributes. Using data from repeated problems for a typical subject, Wickens (1969) was able to determine \hat{c}_i for all twelve attributes in the stimulus. These estimates summed to 1.8, which was significantly larger than the maximum value of 1.0 that would be permitted for a true probability distribution. The conclusion must be that the subject was learning more rapidly than could be accounted for by a process that depended only on whether the response was correct or not. Subjects must have used rehearsal buffers with sizes that were greater than one and must have depended on outcome information to adjust the contents of STS.

In his treatment of the data from this experiment, Wickens used a somewhat simplified version of the LTS postulate put forward in the preceding paragraphs; indeed, he did not separate his analysis into short- and long-term components as we have done. He assumed that all items contained in a particular sample were unavailable to the next ℓ samples, where $\ell = 0; 1, 2, \dots$, and that this value of ℓ was constant for all attributes.¹¹ Using these assumptions, he was able to derive the distribution of the trial of last error and of the total number of errors, parametrized by combinations of r and ℓ . Figure 4-11 presents predictions for the mean trial of last error and compares them with the observed mean trial of last error for each of the forty-five subjects who served in the

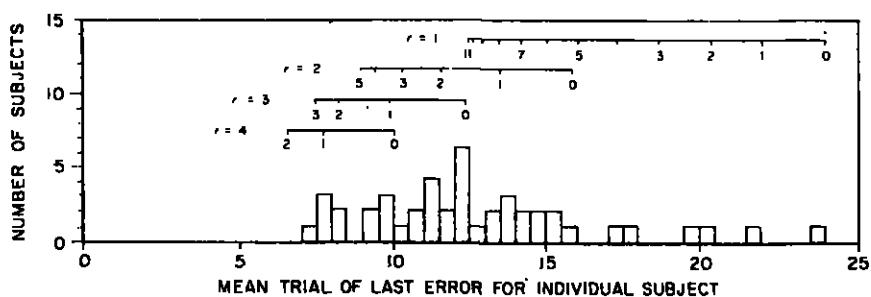

FIGURE 4-11. Frequency distribution of the mean trial of last error for individual subjects on a simple 12-dimensional concept-identification problem. Upper axes show theoretical predictions for four buffer sizes ($r = 1, 2, 3, 4$) and an appropriate range of delays in sampling replacement.

¹¹The model that we have proposed above would predict that items from the same sample could remain unavailable for different lengths of time, and that these periods should depend upon the number of trials that the attributes resided in the rehearsal buffer.

experiment. The observed means are plotted as a histogram at the bottom of the figure, while the predictions are plotted along four short axes; a separate axis for $r = 1, 2, 3,$ or 4 . Points along these axes indicate values of ℓ . For example, there were three subjects whose mean trial of last error over all problems fell between 9.5 and 10.0. Mean trials of last error in this range are predicted by strategies in which $r = 4$ and $\ell = 0$, in which $r = 3$ and $\ell = 1$, or, to reasonable accuracy, in which $r = 2$ and $\ell = 4$. None of the strategies with $r = 1$ would be satisfactory for these subjects since, even with perfect long-term retention ($\ell = 11$), a mean trial of last error smaller than about 12 would be extremely unlikely. It is apparent from Fig. 4-11 that there is a very large spread in the observed data and that no single set of parameters can adequately account for all of the subjects. It is clear, however, that subjects with low values for the mean trial of last error were using strategies which required an r of at least 3 or 4 and which made significant use of LTS. The presence of these subjects who used rehearsal buffers of larger than a single attribute is again evidence for our contention that it is the confirmation of predictions about the attributes rather than the reward of a response that dictates the course of learning.

Magnitude of reward. The amount of reward associated with a correct response or the punishment associated with an error are variables that have not received a great deal of systematic consideration in human learning. In general, the studies that have examined amount of reinforcement have varied the degree of information feedback made available to the subject after his response (e.g., Keller, Cole, Burke, and Estes, 1965) or the amount of time that he is given to study the item (e.g., Keller, Thomson, Tweedy, and Atkinson, 1967). When reward magnitude has been considered, however, the extent of its effects seem to depend upon whether reward conditions have been compared between or within subjects. Several experiments by Harley (1965a,b) illustrate this clearly. He ran subjects in a paired-associate experiment using an anticipation procedure to learn CVC pairs. Incentive was provided for some pairs by telling the subject that he would receive twenty-five cents for each one that he correctly anticipated on a later trial. In one experiment (1965b), Harley tested for the effects of this reward in an absolute manner by comparing two groups of subjects: One group received twenty-five cents for every correct anticipation, whereas the other group received no rewards at all. The rate of learning for these two groups was virtually identical (see Fig. 4-12). When both reward values were used simultaneously with the same subject, half of the pairs receiving a reward and half not, the rewarded items were correct significantly more often (Harley, 1965a). As Fig. 4-12

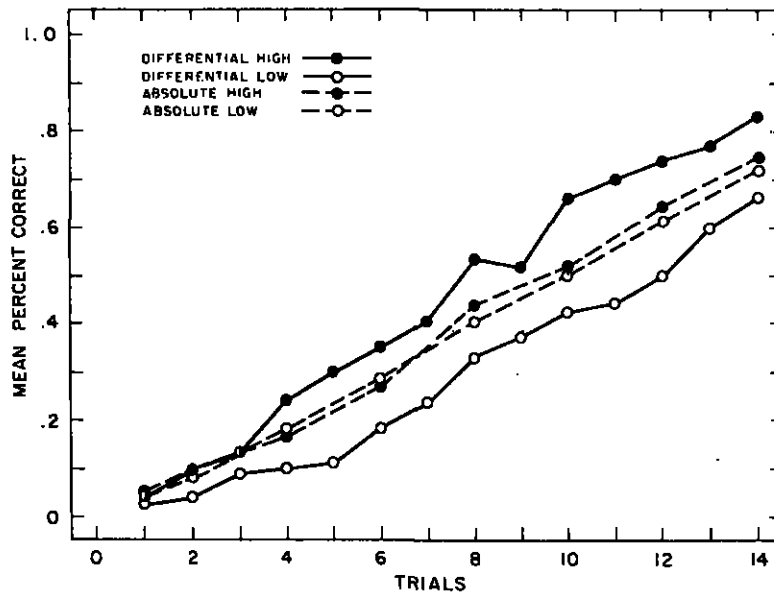

FIGURE 4-12. Learning curves for high- and low-rewarded paired-associate items tested with both reward values present at the same time (differential procedure) or with values presented alone (absolute procedure). Data is replotted from 4-second groups in Harley 1965a, b).

indicates, this effect appears to take the form of an improvement in performance on the rewarded items and a decrement in performance on the unrewarded items when compared to either of the absolute groups. This interpretation is placed in some doubt by a later experiment (Harley, 1968) which suggests that the reward effect should be attributed primarily to poorer performance on the low-incentive items rather than to an improvement on the high-incentive items. In any case, these experiments indicate that the relative reward was the important variable, not the absolute magnitude of the reward.

In the system of reinforcement considered here, the reward associated with an item can influence performance only by altering the way in which information about the item is processed in STS. With this view, it is relatively easy to see why absolute rewards may not be important. The subject

in a typical verbal-learning experiment is usually motivated to perform well, even in the absence of monetary incentive. The way in which information is processed in STS will be determined primarily by the nature of the test material and by the structure of the experiment. A difference in the absolute reward level will not make very much change in this scheme. When items with different reward values are presented, however, they may receive different treatments within the same general scheme. In particular, for tasks in which a rehearsal buffer is set up, the effects of differential rewards will be reflected in the relative probabilities of entering an item into the buffer or of deleting it once entered. Thus, high-reward items would be more likely to receive study than low-reward items, and so would be learned better. When only a single level of reinforcement is present, however, all items are equally likely to receive study, regardless of the level of reinforcement. The overall rate of learning in either case will be determined by the nature of the material to be learned and will not depend on the reward.

We have said that the effects of reward are determined by differences in the processing of high- and low-value items in STS. If this is the case, the nature of the reward effect should be influenced by the presence or absence of a rehearsal buffer. When a buffer is used, differential processing of high- and low-value items can occur easily, since high-point items may be entered into the buffer with a higher probability than low-point items, while low-point items (if recalled as such) may be more likely to be deleted from the buffer. On the other hand, if a coding strategy (similar to the one induced in the delay of reinforcement study) is used, each item will be studied as it is presented and there will be relatively little opportunity for an effect of reward magnitude to appear. Fortunately it is possible to predispose the subject to use either a rehearsal or a coding strategy by a fairly simple experimental manipulation. This effect has been demonstrated clearly in an experiment by Atkinson, Brelsford, and Shiffrin (1967) using two groups of subjects in a continuous paired-associate task in which number-letter pairs were given single reinforcements. In one group a fixed set of stimuli was used, pairing new responses with each stimulus throughout the course of a session. In the second group each stimulus was used only for a single pair, then retired (these two presentation procedures will be discussed more fully in the next paragraph). For the first group, clearly separate lag curves were obtained by varying the number of pairs that the subject was required to keep track of at any point in time; for the second group there was no effect of this manipulation on the lag curves. This difference is readily explained by assuming that subjects in the first group set up a rehearsal buffer, while subjects in the

second group attempted to code each item during the interval before the presentation of the next pair.¹²

An experiment which looks at reward effects while manipulating the stimuli in this way has been conducted by Kirk Gibson at Stanford University. The paradigm of this experiment was, in general, similar to those that we have already analyzed. Subjects were seated at teletypes and were presented with a series of pairs to be learned. The stimuli were CVC trigrams and the responses were the letters of the alphabet. Each pair received only a single study and a single test. Two groups of subjects were run: In the *fixed-stimulus* condition a set of nine stimuli were selected at random at the start of each session and were used throughout that session. After each test in this condition, the same stimulus was presented for study paired with a new response. The second group of subjects was run in a *variable-stimulus* condition. In this condition, the item just tested was permanently discarded and a new stimulus-response pair was presented during the study phase of the trial. As in the fixed group, however, the subject was trying to keep track of only nine stimulus-response pairs at any given point in time. The same random presentation schedule employed in most of the other experiments was used, so that the test lags were distributed geometrically beginning with lag zero.

The second aspect of the experiment concerned the reward values assigned to the pairs. As each new item was presented for study, a value of either 11, 22, or 99 points was randomly assigned to it (i.e., each of these three values was equally likely to appear). The values were assigned independently for each item; in particular, a stimulus in the fixed group could receive different reward values when paired with different responses. The subject was told that if he correctly recalled an item, its points would be credited to his score for the session. At the time of test, the subject was not shown the point value associated with the item. Indeed, subjects were given no immediate feedback on their accumulation of points, although at the start of each session they were informed what percentage of the total possible points had been obtained during the previous session. The subjects were paid for participation in the experiment in proportion to this percentage.

The results of this experiment are shown in the form of lag curves in Figs. 4-13 and 4-14. For the fixed-stimulus group (Fig. 4-13) there was

¹²In their original paper Atkinson et al. (1967, p. 295) interpreted the difference in the two conditions by assuming that, for the second group, items were maintained in the buffer even after they had been tested. In light of later evidence, it now appears that this explanation is unrealistic and that the results may be more reasonably explained, as we have done, by the failure to form a buffer.

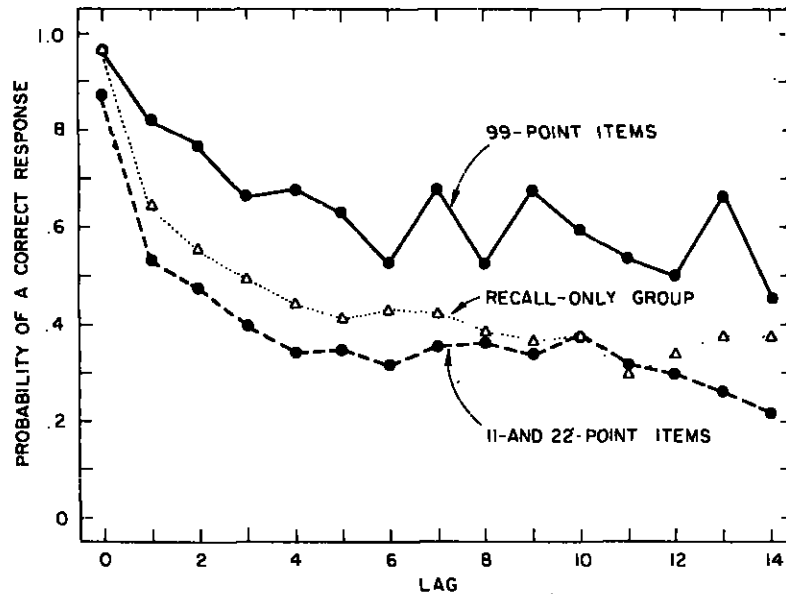

FIGURE 4-13. Probability of a correct response as a function of lag for items receiving different amounts of reward. The stimuli were a fixed set of trigrams.

a marked difference between performance on the 99-point items and on the other two types of items, although there was not a statistically significant difference between the 22- and the 11-point items. In contrast to these results there were no differences among the payoff conditions for the variable-stimulus procedure (Fig. 4-14). Apparently, varying the stimuli was sufficient to eliminate the basis for any reward effect.

The results of this experiment are in accord with our view of learning and reward. As indicated by subject reports at the conclusion of the experiment, the variable-stimulus pairs (a unique stimulus trigram and response letter) were fairly easy to code on an item-by-item basis. For this material, however, the subject experienced difficulty if he tried to maintain several items simultaneously in STS via rehearsal. Since it was much easier for the subject to code the items than to maintain a rehearsal buffer, he tended to study each item when it was presented and then turn his attention to the next item. Using this strategy, every item will be studied and the point

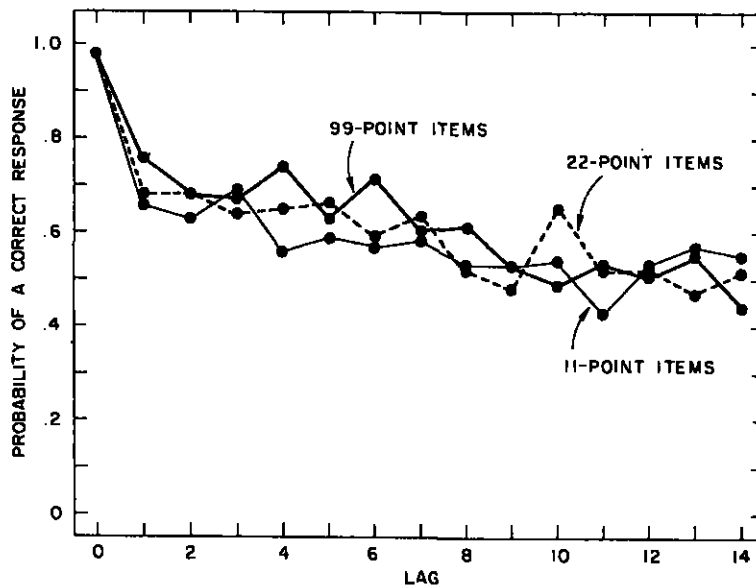

FIGURE 4-14. Probability of a correct response as a function of lag for items receiving different amounts of reward. A unique stimulus trigram was used for each item.

values will not play an important role in the amount of information transferred to LTS. Consequently, little or no effect of reward value should be observed, as indeed was the case for the variable-stimulus procedure.

On the other hand, for the fixed-stimulus procedure, the set of stimuli quickly became very familiar, and subjects reported that it was easy to set up a rehearsal buffer of three to five items. Coding, however, was much more difficult for this procedure, since it is almost impossible to generate noncompeting codes for the same trigram paired with many different letters during the course of a session. For this group, then, several items will be maintained in STS at any given time, and it will be easy to give preferential study to an item in the buffer by ignoring another item just presented. Similarly, a high-point item will almost always be entered into the buffer at the expense of some item that is already there. Thus the reward values will determine which items are studied and for how long they are maintained. Accordingly, a reward effect is predicted for the fixed-stimulus procedure, as was observed.

We do not want to argue from these results that a reinforcement effect cannot be obtained using the variable-stimulus procedure. If sufficiently large rewards are offered for correct responses to certain items, then there is no doubt that they will receive additional study, probably both by rehearsal and by coding. The point that we feel is important here is that with the particular payoff levels used in the study, a marked difference in reinforcing effects appeared between the fixed- and variable-stimulus procedures, two procedures which in a logical sense place identical demands on a subject. Although both procedures require the subject to keep track of the same number of stimulus-response pairs at any given point in time, the particular nature of the stimulus material caused different methods of study to be used, and in turn made reinforcement effects evident in one case and not in the other. This is another example where a given reinforcing operation can lead to markedly different effects depending on the particular information-processing requirements of the learning task.

One interesting feature of the experiment is the high accuracy of recall obtained for the variable-stimulus condition. Although there was no effect of the reward, the overall proportion of correct responses is approximately at the same level as the 99-point items for the fixed-stimulus group. This presumably reflects the fact that stimulus-response pairs in the variable-stimulus condition are less subject to interference from other pairs than in the fixed-stimulus condition. Further studies are currently in progress to investigate the exact form of the STS structure that is set up for the two conditions.

It is not possible to make a direct comparison of rewarded and unrewarded performance within this study. Some sort of comparison can be made, however, between another of Gibson's groups and a group from the experiment by Loftus reported in the first part of this paper. The group in question used a fixed-stimulus procedure, but with the digits 1 through 9 as stimuli instead of trigrams. This procedure is exactly the same as the recall-alone condition of the Loftus study, except for the presence of rewards. If these rewards are neglected, performance in the two experiments is almost exactly the same; if the three reward values are combined, the mean lag curve is indistinguishable from that observed by Loftus. The unrewarded responses of the recall-alone condition fall roughly between the items which had been given high and low incentives (see Fig. 4-15). In this figure the 11- and the 22-point items have been combined, hence each data point in this curve includes approximately twice the number of observations as the corresponding point in the high-reward curve (this means that the average of the two curves does not lie midway between them; in fact it falls almost exactly on the curve for the recall-alone group). While hardly conclusive, this comparison again suggests that the

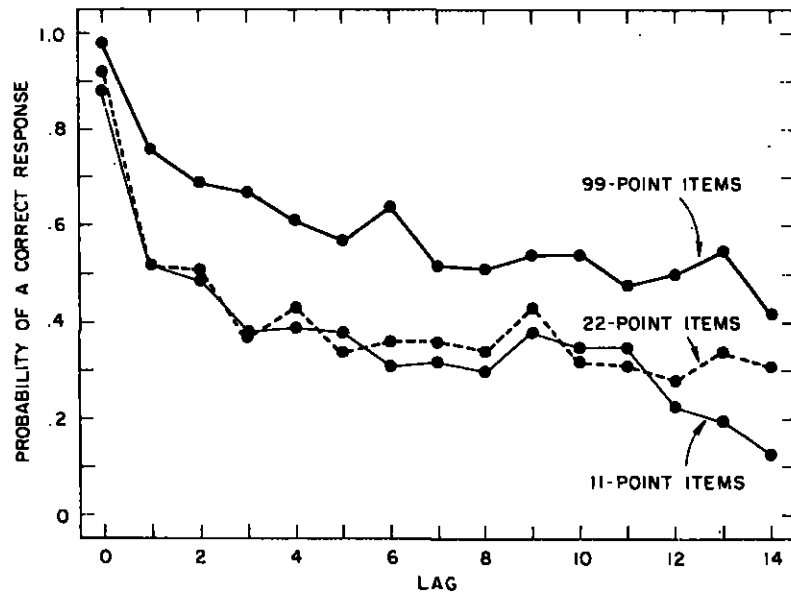

FIGURE 4-15. Probability of a correct response as a function of lag for items receiving different amounts of reward. The stimuli were a fixed set of numbers. The recall-alone condition, which received no reward, has been replotted from Fig. 4-2.

99-point items have been given additional study at the expense of the low-point items.

Effects of reinforcement on retrieval. Throughout this paper, a distinction has been made between storage and retrieval processes in learning. As noted in the introduction, this distinction is also relevant to an analysis of reinforcement. The applications considered so far have been primarily concerned with how reinforcement influences the study of items, hence the storage of information. The reason for not turning sooner to retrieval aspects of reinforcement is that there are few experiments dealing specifically with this topic (Wasserman, Weiner, and Houston, 1968; Weiner, 1966).

In an attempt to remedy this state of affairs, we have initiated some experiments in which the reward associated with paired-associates has been manipulated both at the time the item is first studied and later at test.

None of these experiments is yet complete, but we want to present some pilot data from an experiment by Geoffrey Loftus which illustrate some effects of interest. This experiment employed a continuous memory task that was almost identical to the fixed-stimulus procedure described in the section on reward magnitude. The stimuli were the digits from 1 to 9, and the responses were letters of the alphabet. Each new stimulus-response item was assigned a value of either 11, 22, or 99 points. When an item was presented for study, however, its point value was not always displayed. For about half of the items, no information about the reward was given at this time; the subject was instructed that the items for which no point values appeared had, nevertheless, been assigned one of the three values at random by the computer controlling the experiment, and that these values would count in his total score for the session. Similarly, when the items were tested, their reward value might or might not be displayed. Again, the reward value was presented on about half of the tests. The presentation of the reward value at test was independent of whether the reward had been presented during study; thus the subjects might receive information about the rewards assigned to a particular item at the time of study, at the time of test, at both times, or at neither time. If a reward value was presented at study and test, then the same value appeared both times.

Some preliminary results from this study are presented in Fig. 4-16. The graph gives the proportion of items correctly recalled, averaged over all test lags, as a function of the presentation schedule and reward value. The mean latencies of correct and error responses are also shown. As in Gibson's experiment, there was very little difference between the 11- and 22-point items, so these have been grouped together as low-value items. The two points on the left of the graph are for the conditions in which the subject was informed during study that he was being shown a high (i.e., 99) point item. One of the observations (HH) shows the results when the reward information was also presented at test, the other (H-) when it was not. Similarly, the three middle points (-H, --, -L) are associated with conditions in which no reward was presented at the time of study, while the two right-most points (L-, LL) give results for items studied with a low-point value (11 or 22). Although all test lags have been combined in this figure, the general form of the results appears to be the same at both short and long lags.

The major effects in Fig. 16 are due to the reward values displayed during study. Items that were assigned 99 points at study had a higher probability of being recalled than items for which no reward value was assigned. These items were, in turn, better remembered than the low-point items. The explanation that we offered for Gibson's data in the previous section is consistent with these findings if items with an unspecified reward

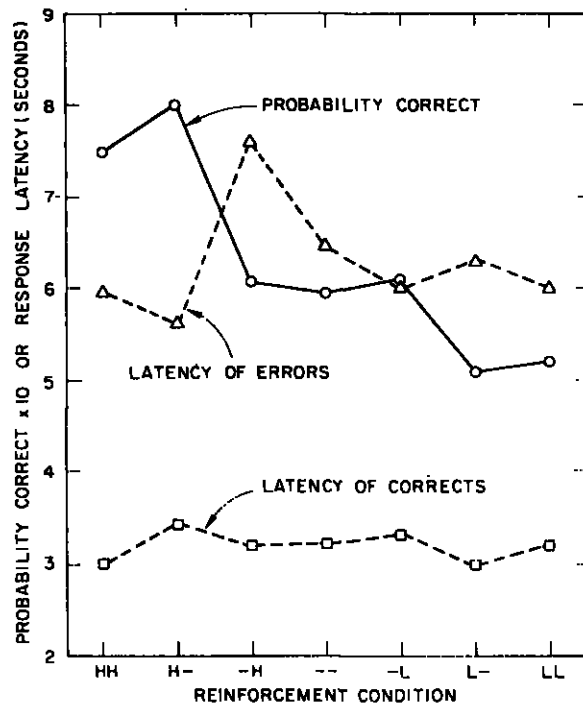

FIGURE 4-16. Probability of a correct response and latency of correct and error responses as a function of reward information given at study and test. The first letter in the condition label designates reward at study, the second designates reward at test; H indicates 99-point reward, L indicates 11- or 22-point reward, — indicates that no reward information was given.

are assumed to receive a level of study intermediate between that given to high- and low-point items.

In the introduction, two ways were mentioned by which reinforcement could aid retrieval. The first of these suggested that the reward value associated with an item might act as a cue to facilitate the retrieval of information from LTS. These preliminary data provide little support for this hypothesis, for there is no indication that items for which the reward value was presented on both study and test are better recovered than those that received reward only at the time of study. This result indicates that in this experiment the reward had negligible cue value. The second potential effect of reward on retrieval receives more support; namely, that a subject

would be willing to spend more time in attempting to retrieve items that had been assigned a high value than items that had been assigned low values. This effect is quite clearly shown in the latency of incorrect responses, particularly for the conditions in which the reward value had not been identified during study (i.e., conditions -H, --, and -L). The latency of errors shows the same effect for the two conditions where point values were presented during study, although not to as marked an extent. Curiously, this effect is totally lacking in both the latency and probability of a correct response. These results suggest that either the subject was able to retrieve an item without much difficulty (with a latency of about three seconds), or else no recovery was possible. When an item could not be recovered, the additional search time spent on items with large reward values was not of much help. There was no limit on the time that was available to make a response, so the failure to retrieve cannot be attributed to a premature termination of the trial.

These results must be regarded with some caution. The amount of data represented is not great, and it is likely that the specific characteristics of the task are not optimum for demonstrating retrieval effects. The fixed-number procedure that was used is one which almost invariably leads the subject to set up a rehearsal buffer. Indeed, several of the subjects reported being able to successfully set up a nine-item buffer by visualizing the responses arrayed in a 3×3 matrix! The process of retrieving items from the buffer is a fairly simple one and invariably will lead to a correct response. Items that are recovered in this manner will not contribute to any effects of reinforcement on the recovery of the item. We would expect that more substantial effects will be observed in a task in which the subject is forced to put greater reliance on LTS. Nevertheless, an effect of reinforcement on retrieval time was clearly evident in this study, showing, as expected, an incentive effect. This effect would not be predicted from a theory that assigned to reinforcement only the role of strengthening connections; it is, however, consistent with the view that reinforcement acts to direct attention and to control information flow.¹⁸

Conclusion

In this paper we have attempted to present a theoretical framework within which to view the phenomena of reinforcement. Basically, the

¹⁸A replication of this experiment (Loftus and Wickens, 1970), using a slightly modified procedure, demonstrated effects of study and test cueing of incentive on both the probability of a correct response and on response latency. These results are in agreement with the analysis presented here.

framework involves an account of learning and attention in terms of the storage of information in memory and its subsequent retrieval. Reinforcement is the modulation of this information flow as it influences both storage and retrieval processes. It is our belief that a given reinforcing operation can have many different and often seemingly contradictory effects depending on the particular study and test procedures that are used. In order to illustrate some of these effects, the theory was applied to results from several different experimental paradigms. These applications, we hope, have demonstrated the general principles by which the transfer of information in memory is controlled and shaped by reinforcement.

It is unfortunate that our discussion of reinforcement cannot be summed up in the form of a set of simple statements. Statements of this type, such as that of the law of effect, do not provide a consistent and unambiguous explanation of the range of reinforcement phenomena that have been observed. If the effects of reinforcement are analyzed in the context of an information-processing theory of the type outlined in this paper, we believe that they will appear relatively orderly and consistent.

REFERENCES

- Atkinson, R. C. Information delay in human learning. *Journal of Verbal Learning and Verbal Behavior*, 1969, 8, 507-511.
- Atkinson, R. C., Brelsford, J. W., Jr., and Shiffrin, R. M. Multiprocess models for memory with applications to a continuous presentation task. *Journal of Mathematical Psychology*, 1967, 4, 277-300.
- Atkinson, R. C., and Shiffrin, R. M. Mathematical models for memory and learning. Technical Report 79, Institute for Mathematical Studies in the Social Sciences, Stanford University, Stanford, California, 1965. (To be published in D. P. Kimble (Ed.), *Proceedings of the third conference on learning, remembering and forgetting*. New York: New York Academy of Sciences.)
- Atkinson, R. C., and Shiffrin, R. M. Human memory: A proposed system and its control processes. In K. W. Spence and J. T. Spence (Eds.), *The psychology of learning and motivation: Advances in research and theory*. Vol. 2. New York: Academic Press, 1968. Pp. 89-195. (a)
- Atkinson, R. C., and Shiffrin, R. M. Some speculations on storage and retrieval processes in long-term memory. Technical Report 127, Institute for Mathematical Studies in the Social Sciences, Stanford University, Stanford, California, 1968. (b)

- Bilodeau, E. A., and Ryan, F. J. A test for interaction of delay of knowledge of results and two types of interpolated activity. *Journal of Experimental Psychology*, 1960, 59, 414-419.
- Bourne, L. E. Information feedback: Comments on Professor I. McD. Bilodeau's paper. In E. A. Bilodeau (Ed.), *Acquisition of skill*. New York: Academic Press, 1966. Pp. 297-313.
- Bower, G. H. An association model for response and training variables in paired-associate learning. *Psychological Review*, 1962, 69, 34-53.
- Bower, G. H., and Trabasso, T. R. Concept identification. In R. C. Atkinson (Ed.), *Studies in mathematical psychology*. Stanford, Calif.: Stanford University Press, 1964. Pp. 32-94.
- Brelsford, J. W., Jr., and Atkinson, R. C. Short-term memory as a function of rehearsal procedures. *Journal of Verbal Learning and Verbal Behavior*, 1968, 7, 730-736.
- Brelsford, J. W., Jr., Shiffrin, R. M., and Atkinson, R. C. Multiple reinforcement effects in short-term memory. *British Journal of Mathematical and Statistical Psychology*, 1968, 21, 1-19.
- Broadbent, D. E. Flow of information within the organism. *Journal of Verbal Learning and Verbal Behavior*, 1963, 4, 34-39.
- Buchwald, A. M. Effects of immediate vs. delayed outcomes in associative learning. *Journal of Verbal Learning and Verbal Behavior*, 1967, 6, 317-320.
- Buchwald, A. M. Effects of "right" and "wrong" on subsequent behavior: A new interpretation. *Psychological Review*, 1969, 76, 132-143.
- Crowder, R. G., and Morton, J. Precategorical acoustic storage (PAS). *Perception and Psychophysics*, 1969, 5, 365-373.
- Elliot, P. B. Tables of d' . In Swets, J. A. (Ed.), *Signal detection and recognition in human observers: Contemporary readings*. New York: Wiley, 1964. Pp. 651-684.
- Estes, W. K. Reinforcement in human learning. In J. Tapp (Ed.), *Reinforcement and behavior*. New York: Academic Press, 1969. Pp. 63-94.
- Feigenbaum, E. A. The simulation of verbal learning behavior. In E. A. Feigenbaum and J. Feldman (Eds.), *Computers and thought*. New York: McGraw-Hill, 1963. Pp. 297-309.
- Festinger, L. *A theory of cognitive dissonance*. Evanston, Ill.: Row Peterson, 1957.
- Freund, R. D., Loftus, G. R., and Atkinson, R. C. Applications of multi-process models for memory to continuous recognition tasks. *Journal of Mathematical Psychology*, 1969, 6, 576-594.
- Greenspoon, J., and Foreman, S. Effect of delay of knowledge of results on learning a motor task. *Journal of Experimental Psychology*, 1956, 51, 226-228.

- Gregg, L. W., and Simon, H. A. Process models and stochastic theories of simple concept formation. *Journal of Mathematical Psychology*, 1967, 4, 246-276.
- Guthrie, E. R. Association of contiguity. In S. Koch (Ed.), *Psychology: A study of a science*. Vol. 2. New York: McGraw-Hill, 1959. Pp. 158-195.
- Harley, W. F., Jr. The effect of monetary incentive in paired-associate learning using a differential method. *Psychonomic Science*, 1965, 2, 377-378. (a)
- Harley, W. F., Jr. The effect of monetary incentive in paired-associate learning using an absolute method. *Psychonomic Science*, 1965, 3, 141-142. (b)
- Harley, W. F., Jr. Delay of incentive cues in paired-associate learning and its effect on organizing responses. *Journal of Verbal Learning and Verbal Behavior*, 1968, 7, 924-929.
- Hill, J. W., and Bliss, J. C. Modeling a tactile sensory register. *Perception and Psychophysics*, 1968, 4, 91-101.
- Hintzman, D. L. Explorations with a discrimination net model for paired-associate learning. *Journal of Mathematical Psychology*, 1968, 5, 123-162.
- Hochman, C. H., and Lipsitt, L. P. Delay-of-reward gradients in discrimination learning with children for two levels of difficulty. *Journal of Comparative and Physiological Psychology*, 1961, 54, 24-27.
- Kamin, L. J. Predictability, surprise, attention and conditioning. In B. A. Campbell and R. M. Church (Eds.), *Punishment and aversive behavior*. New York: Appleton-Century-Crofts, 1969. Pp. 279-296.
- Keller, L., Cole, M., Burke, C. J., and Estes, W. K. Reward and information values of trial outcomes in paired-associate learning. *Psychological Monographs*, 1965, 79 (Whole No. 605).
- Keller, L., Thomson, W. J., Tweedy, J. R., and Atkinson, R. C. Effects of reinforcement intervals in paired-associate learning. *Journal of Experimental Psychology*, 1967, 73, 268-277.
- Kintsch, W., and McCoy, D. F. Delay of information feedback in paired-associate learning. *Journal of Experimental Psychology*, 1964, 68, 372-375.
- Lawrence, D. H., and Festinger, L. *Deterrents and reinforcement: The psychology of insufficient reward*. Stanford, California: Stanford University Press, 1962.
- Loftus, G. R., and Wickens, T. D. The effect of incentive on storage and retrieval processes. *Journal of Experimental Psychology*, 1970, 85, 141-147.
- Millward, R. B. An all-or-none model for noncorrection routines with elimination of incorrect responses. *Journal of Mathematical Psychology*, 1964, 1, 392-404.

- Montague, W. E., Adams, J. A., and Kiess, H. O. Forgetting and natural language mediation. *Journal of Experimental Psychology*, 1966, 72, 829–833.
- Murdock, B. B., Jr. Recent developments in short-term memory. *British Journal of Psychology*, 1967, 58, 421–433.
- Norman, D. A. Toward a theory of memory and attention. *Psychological Review*, 1968, 75, 522–536.
- Peterson, L. R., and Peterson, M. J. Short-term retention of individual verbal items. *Journal of Experimental Psychology*, 1959, 58, 193–198.
- Phillips, J. L., Shiffrin, R. M., and Atkinson, R. C. The effects of list length on short-term memory. *Journal of Verbal Learning and Verbal Behavior*, 1967, 6, 303–311.
- Postman, L. Rewards and punishments in human learning. In L. Postman (Ed.), *Psychology in the making*. New York: Knopf, 1962. Pp. 331–401.
- Rescorla, R. A. Conditioned inhibition of fear. In W. K. Honig and N. J. Mackintosh (Eds.), *Fundamental issues in associative learning*. Halifax: Dalhousie University Press, 1969. Pp. 65–89.
- Restle, F. The selection of strategies in cue learning. *Psychological Review*, 1962, 69, 329–343.
- Rundus, D. Paired-associate recall following a distractor task: Initial and second choice performance. *Journal of Mathematical Psychology*, 1970, 7, 362–370.
- Rundus, D., and Atkinson, R. C. Rehearsal processes in free recall: A procedure for direct observation. *Journal of Verbal Learning and Verbal Behavior*, 1970, 9, 99–105.
- Saltzman, I. J. Delay of reward and human verbal learning. *Journal of Experimental Psychology*, 1951, 41, 437–439.
- Shiffrin, R. M. Search and retrieval processes in long-term memory. Technical Report 137, Institute for Mathematical Studies in the Social Sciences, Stanford University, Stanford, California, 1968.
- Shiffrin, R. M., and Atkinson, R. C. Storage and retrieval processes in long-term memory. *Psychological Review*, 1969, 76, 179–193.
- Simon, H. A., and Newell, A. Information processing in computer and man. *American Scientist*, 1964, 52, 281–300.
- Sperling, G. The information available in brief visual presentations. *Psychological Monographs*, 1960, 74 (Whole No. 498).
- Spring, C. Decay and interference theories of short-term forgetting. *Psychonomic Science*, 1968, 12, 373–374.
- Sternberg, S. High-speed scanning in human memory. *Science*, 1966, 153, 652–654.

- Thomson, W. J. Recall of paired-associate items as a function of interpolated pairs of different types. *Psychonomic Science*, 1967, 9, 629–630.
- Thorndike, E. L. *Human learning*. New York: Appleton-Century-Crofts, 1931.
- Tolman, E. C. *Purposive behavior in animals and men*. New York: Appleton-Century-Crofts, 1932.
- Tolman, E. C., and Brunswik, E. The organism and the causal texture of the environment. *Psychological Review*, 1935, 42, 43–77.
- Trabasso, T. R., and Bower, G. H. Presolution shifts in concept identification: A test of the sampling with replacement axiom in all-or-none models. *Journal of Mathematical Psychology*, 1966, 3, 163–173.
- Trabasso, T. R., and Bower, G. H. *Attention in learning: Theory and research*. New York: Wiley, 1968.
- Wasserman, E. A., Weiner, B., and Houston, J. P. Another failure for motivation to enhance trace retrieval. *Psychological Reports*, 1968, 22, 1007–1008.
- Weiner, B. Motivation and memory. *Psychological Monographs*, 1966, 80 (Whole No. 626).
- Wickens, T. D. Attribute elimination strategies for concept identification with practiced subjects. Technical Report 3, Laboratory of Human Learning, Brown University, Providence, R. I., 1969.

4 || Some Remarks on a Theory of Memory¹

R. C. ATKINSON AND K. T. WESCOURT

*Department of Psychology,
Stanford University, Stanford, California 94305, U.S.A.*

A system of human memory is described in terms of theoretical constructs involving information representation, storage, and retrieval. The system reflects a synthesis of ideas regarding some controversial issues in the analysis of memory. Information in memory is processed in several different "stores", each with different storage and retrieval characteristics; within these stores information can be coded in a number of alternative forms. Control processes act to regulate coding and information transfer so that optimally the system performs its activities in the most efficient way in a given task context. The system is intended to support a broad range of cognitive functions, from simple perceptual and memory tasks to complex activities like language understanding.

I. Introduction

This paper is an attempt to integrate several theoretical constructs about memory. We have considered certain ideas that seem central to current research in memory and have tried to determine their relation to one another by placing them within the theoretical description of a memory system. This is not a review paper and no attempt will be made to trace the development of these ideas in the literature; we refer only to research that seems particularly important for understanding the constructs of the memory system. A more complete consideration of several of the ideas to be discussed here is presented in an earlier paper (Atkinson, Herrmann, and Wescourt, 1974). The memory system to be described is extremely general. The intent is that it be capable of supporting a broad range of cognitive activities, from perception to language comprehension, that, in

¹This research was supported by grants from the National Institute of Mental Health (MH 21747) and the National Science Foundation (NSFGJ-443X3). During the period that this paper was written, the second author was a National Science Foundation Graduate Fellow. The authors wish to express their gratitude to Paul Matthews, Richard Mohs, Edward Shoben, and Robert Sternberg for their comments on an early draft of the paper.

common, depend on the utilization of stored information. No one of these activities requires the full complexity of the system for its theoretical analysis; the complexity exists because of our desire to endow the system with a capability to serve as an analytic tool for a wide range of experimental work.

The central theoretical elements of the system have appeared in other theories. The most basic construct in the system is the *feature*. Features are values on dimensions in terms of which information can be represented. Ordered sets of features comprise *information codes*. A code is an internal representation that defines a unit of experience—most simply an object in the system's environment. Codes are *linked* (connected, associated) together to form *memory structures*. These structures "represent" knowledge and events within the system. Codes and structures are stored in the different *memory stores* of the system. These stores are characterized by their internal structures and by the storage and retrieval processes that are used to manipulate information. The system also has *control processes* that regulate the representation, storage, and retrieval processes with respect to the context of the system's activities. Control processes act to develop efficient strategies for performing tasks under changing conditions. As these concepts are developed in the paper, mention will be made of how they represent a synthesis of views on certain issues: "boxes-in-the-head" v. levels-of-processing models of memory, single- v. multi-copy representation of information, and "distance" (structural) v. "process" (associationist) notions of information relatedness.

Our description of the system will be general and almost schematic in places. Certain aspects of the system intersect with more general issues: what is the nature of features; how does pattern recognition occur; how are inferences made from stored information? While we have ideas about these problems, they are beyond the scope of this chapter; our purpose here is to describe how certain constructs can be interrelated, and not to speculate about particular implementations of these constructs. Further, this chapter reflects no strong convictions that the ideas presented are the "correct" ones. Our motivation stems from a belief that there is value in theorizing about memory outside the context of particular tasks. This chapter attempts to integrate principles that have proved successful in one domain into a vocabulary of theoretical constructs that may be applied to other domains. Hopefully, the memory system we describe will prove to be a useful tool for thinking about a broad range of memory phenomena; but, we do not view it as a replacement for the type of careful, formal theorizing that characterizes research on some well-defined problem.

The discussion begins by describing the structural aspects of the memory system. These have been developed in detail elsewhere (Atkinson and Shiffrin, 1968, 1971) and the present account will be brief. The major part of the discussion, then, considers the representation of information

as codes, the organization of codes into memory structures, and the nature of the processes involved in the manipulation of information within memory.

II. Structural Aspects of the Memory System

The three main divisions of memory are the *sensory register* (SR), *short-term store* (STS) and *long-term store* (LTS). Information enters the system via its receptors and is transmitted to the SR in a relatively unprocessed form. The mosaic of sensory information in the SR is subject to *pattern recognition processes* that extract features and synthesize them to form codes. The information in the SR is lost rapidly either by decay or by being "written over" by new input. The STS is a working memory of limited capacity. Information is copied into STS either from the output of the pattern recognition processes or from LTS. Information is lost from STS unless maintained by particular control processes like rehearsal or imagery. The contents of STS may be thought of as a person's "current state of consciousness". Information in STS is immediately available to the system's processes without the need for a *directed search*; later the notion of a directed search will be developed with regard to its role in LTS.

The LTS is a large and essentially permanent memory bank. The memory structures stored there are normally never lost from the system, but the effectiveness of search and retrieval processes determines their availability for further use. These processes involve algorithms for content-addressable or heuristic search necessary for the practical operation of a large memory. Such algorithms are sensitive to changes in the contents of the store and so the storage of new information can affect the accessibility of old information (Newell and Simon, 1972).

Most activities of the memory system require many information transformations and transfers between the different memory stores. The activation of the SR, STS, and LTS need not occur sequentially during these operations. Instead, the different stores may be active *concurrently* during the processing required by some task. There is evidence, for example, that in certain recognition tasks STS and LTS are searched simultaneously for information needed to make a decision (Wescourt and Atkinson, 1973; Mohs, Wescourt, and Atkinson, 1973). Also, the different stores may be engaged in different tasks at the same time; consider the experience of driving a car over a familiar route while engrossed in other thoughts and subsequently realizing that all the turns and stops were made "unconsciously". It seems that the SR and LTS can be involved in driving the car, while at the same time STS and LTS can be active in other processes.

Although the SR, STS, and LTS have been referred to as "structural" elements of the memory system, they need not correspond to different neurological systems. Rather, the different memory stores may represent

different phases of activation of a single neurological system. The notion of degrees of activation is also consistent with theories of memory that account for certain results in terms of "levels-of-processing" (Craik and Lockhart, 1972; Restle, 1974), rather than in terms of different stores. From a levels-of-processing viewpoint, information entering memory is subject to a continuous process of organization and integration with other information; retention depends upon the degree of processing such that new sensory information is available only briefly, whereas highly processed information (e.g., at a semantic level of representation) is available for long durations. By itself, the idea of levels-of-processing (that information can be processed into different types of internal codes) is attractive because it can account for a large range of results from recognition tasks (e.g., Posner, 1969).

However, the assumption that there is a strict correspondence between coding level and availability of information in memory seems unwarranted (Posner and Warren, 1972)—as are assumptions that restrict particular coding levels to particular memory stores in a system like the one described here; for example, supposing that STS can contain only phonemic information. The present system incorporates both constructs of memory stores and of levels of coding. Information is represented by different types of codes which in some sense correspond to different levels of organization, and the various types are available for representation in both STS and LTS. The duration of information availability in memory depends primarily on the storage and retrieval processes that operate within the different stores, and is not directly determined by the coding format of the information.

II. Representations of Information in Memory

Information is represented in the memory system as codes. Each code is an ordered list of features that define an arbitrary unit of experience (an object, a relation, an abstract concept) on some set of dimensions. Two main classes of codes are distinguished on the basis of the types of features that comprise them: *perceptual codes* (p-codes) and *conceptual codes* (c-codes). The p-codes are generated from the mosaic of sensory information in the SR by pattern recognition processes. The effect of these processes is to "parse" sensory information into units characterized along dimensions which past experience and current context indicate as marking important distinctions. For example, information in the SR produced by the reception of spoken English contains components that have to do with whether the sounds were "voiced" or "unvoiced" and "aspirated" or "unaspirated"; while the former distinction is important for the correct perception of some consonant sounds, the latter distinction is not—English consonants are not distinguished by aspiration. The p-codes

produced by pattern recognition of spoken English contain only information about features like "voicing" that make useful distinctions. In general then, much of the information in a sensory pattern will not be encoded in p-codes, and as a result different patterns may be analyzed into the same p-code. On the other hand, past experiences and context can affect pattern recognition such that a given pattern of sensory information is parsed into different p-codes; referring to the previous example, a trained linguist, studying English dialects, would encode aspiration in his perception of speech.

As another example, consider a printed word. A printed word is an object distinct from its referent, if any. It has size, contours, colour, etc. A word is also composed of letters which themselves may be taken as distinct objects. Experimental evidence indicates that words are perceived differently in different contexts. In a visual search for a particular letter (Gibson, Tenney, Barron and Zaslou, 1972) each letter of a word seems to be perceived as a unit (each letter is represented by a p-code). In word recognition, larger units like spelling patterns (Gibson, 1969) or vocalic centre groups (Spoehr and Smith, 1973) seem to be the perceptual units (each unit is represented by a p-code). In reading (Manelis and Atkinson, 1974), the words themselves may be the perceptual units (there is a p-code for each word). In each of these cases, the p-codes, though they preserve different amounts of sensory information, could still be composed from the same set of features. However, it is possible that even the set of features which comprise codes changes with context; for instance, the features that characterize music are probably different from those for speech. That there are different sets of features even within sensory modalities serves to complicate notions about the organization of LTS and about storage and retrieval processes that will be described subsequently. For the sake of clarity in this discussion we assume that there is but a single set of perceptual features in each modality; that is, across contexts, a given sensory pattern may be pattern recognized into different p-codes, but the features of these p-codes are values on a single set of perceptual dimensions.

The p-codes play an important role in the internal representation of objects and relations in the environment. However they are not sufficient for the operation of human memory. The p-code for an object and the p-code of the written or spoken word that denotes an object are quite different types of information. The p-code of the word "table" conveys no information about the characteristics of a table, whereas the p-code(s) produced while looking at an actual table does represent the table's physical characteristics. One idea is to say that "table" is a symbol that has as its meaning the p-codes generated when one looks at, feels, smells, and tastes a table. However, this formulation is not adequate for defining the meaning of all words. Consider the word "justice"; it certainly has a meaning

and yet there is no single object or relation it refers to as in the case of "table".

An alternative idea is that there is a higher-order type of code that we will call a c-code. Let a *concept* be a collection of memory structures containing information about a particular object, relation, or another concept; for example, the concept of table is the information stored in memory from experiences with various tables. Then, a c-code is a characterization of a concept as an ordered list of conceptual features—it is, in a sense, an abbreviation of the concept. The system makes sense of the p-codes for words by retrieving the c-codes of the concepts the words refer to. Our intuition is that conceptual features that comprise c-codes indicate the types of relations a concept characteristically forms with other concepts. This idea can best be illustrated in terms of a conceptually based language representation (Fillmore, 1968; Schank, 1972). To qualify as the *actor* of some conceptualization, a concept (in our case, its c-code) must have a feature that marks it as denoting some animate object. Also certain *acts*² may require certain features of their *actors*, *objects* and other cases; for example, the *act* underlying the verb "to write" has in its representation that its *actor* should be "intelligent" and that its *instruments* must also have certain features.

How might memory be structured to allow rapid access to c-codes when words denoting concepts or objects are perceived? The perceptual features of the p-code produced when a table is seen could be similar to the conceptual features of the c-code of the concept table, but there could be no such relation between the c-code and the word "table" since the word is an arbitrary symbol for the concept. Thus, there must be arbitrary links between the c-code and the p-codes of its symbols. Such links are defined in a functional partition of LTS that we call the *conceptual store* (CS). Located in the CS are special memory structures called *nodes*. Each CS node is a collection of the alternative p-codes for the word and object (if any) that correspond to the c-code that is also stored at the node. For example, the node for *table* contains the c-code that is an abbreviation of the concept table and linked to it are the various p-codes that are produced when a table is seen, when the printed word "table" is seen, when the auditory word "table" is heard, etc.³

The CS has the property of being content-addressable on the basis of features comprising codes; there is an overall structure to the CS such that each node is stored at a location that has an address determined by all the features of all the codes stored there. Given a p-code or c-code, retrieval

²*Acts* are primitive concepts that underlie verbs. Schank (1972) has proposed that all English verbs map onto about 15 such acts.

³This means that p-codes for homographs and homophones are stored at more than one CS node with different c-codes. Also, p-codes of synonyms are represented at different nodes that contain identical c-codes.

of the node containing it is a process of generating an address from the code. This storage and retrieval scheme has the property of allowing rapid access to an abbreviated coding of the concept symbolized by a word, as well as to alternative p-codes.

The CS and c-code are useful constructs for explaining certain memory phenomena. First, the CS may be taken as a major locus for many types of "familiarity" effects observed in memory experiments. These effects are typified by subjects being able to make relatively rapid and preconscious recognition judgments. These judgments seem to reflect the existence of a "strength" value associated with each to-be-remembered item that is practically independent of how the items were learned (Atkinson and Juola, 1974). Many of the familiarity effects in memory experiments may reflect the activity of CS nodes. Whenever an item is perceived, the p-code leads to location of the CS node that contains it. The activity or "strength" of that node is then evaluated. The assumption is that accessing a node (regardless of context) temporarily raises its activity, relative to some base-line value. Very high or very low activity is evidence that the item represented at a node was or was not perceived recently, perhaps during study of a list of to-be-remembered items. At least two findings indicate that CS nodes are a locus of familiarity effects. First, the effects are independent of the modality in which the items are presented (Juola, 1973). Second, the effects are sensitive to perception of items outside the specific task context; specifically, the inclusion of certain words in the instructions to the subject can affect performance if these words are then used during the experiment as distractor items (Atkinson, Herrmann, and Wescourt, 1974).

The notion of c-codes composed of conceptual features is also consistent with data and models of semantic decision time (Rips, Shoben, and Smith, 1973). In tasks where subjects verify the truth value of predictions like "A canary is a bird" or "A canary has wings," decision time varies with normative judgments of the "typicality" or "relatedness" of the subject and predicate: for true statements times become faster with increasing relatedness, whereas for false statements the inverse relation holds. This result is difficult to account for with a semantic memory model that verifies statements by searching through a network representation of the concepts involved (e.g., Collins and Quillian, 1969). An alternative model (Rips *et al.*, 1973) proposes that predications are verified by comparing the features of the subject and predicate. If relatively many features match or mismatch, then a rapid true or false response can be made with reasonable accuracy. If, however, there is some intermediate degree of similarity, further information about the concepts involved must be considered in order to make a decision. In applying the present system to this model, the features used in the initial comparison are those of c-codes retrieved from the CS when the predication is presented.

The CS is also a useful construct in thinking about human language

understanding. Memory plays a central role in understanding, and a striking aspect of the process is its high speed. During at least the initial stages, which involve parsing the input, there is rapid access to the "meaning" of linguistic symbols. In terms of the constructs developed here, parsing involves using p-codes produced from the input stream to locate CS nodes and in turn retrieve the c-codes. The features of the c-codes suggest the conceptual relations that exist between the concepts symbolized in the input. This provides a basis for building an internal meaning representation that is then elaborated by reference to particular events and knowledge stored in memory.

There can be little doubt that coding is an important construct in understanding memory (cf., Melton and Martin, 1972). We have suggested a scheme for the generation and organization of alternative coding forms in the memory system. This scheme seems reasonable both in terms of experimental results and logical considerations of how the system operates. In the next section we will present some ideas about the use of codes to represent knowledge and events in memory and about the relation of the memory processes themselves to the other aspects of the system.

IV. Structure of Knowledge and Events in Memory

New information is stored in memory by linking together copies of codes that represent physical or conceptual events to form *memory structures*.⁴ Memory structures are first built in STS and are then copied into LTS. Memory structures (as distinct from nodes) are stored in a functional partition of LTS called the *event-knowledge store* (EKS). The EKS is distinguished from the CS in two main ways. First, memory structures in EKS represent a wide range of relationships between different code types, as compared to CS nodes. A CS node represents a simple linking of the abbreviated meaning of a concept to the alternative internal codings produced by perception of physical symbols or exemplars of that concept. An EKS memory structure, on the other hand, may have many internal organizations that reflect the relations between physical referents and/or abstract concepts in events and knowledge.⁵

The second distinction between EKS and CS involves storage, search

⁴A conceptual event is a conscious thought; for example, retrieval of a memory structure from LTS into STS.

⁵An event involves a particular set of referents in a particular spatio-temporal context. Knowledge represents relations between concepts that involve information abstracted from a number of events. For example, "John's dog bit Mary" is a statement generated from the representation of a particular event, whereas "Dogs can bite" is generated from knowledge abstracted from a number of events involving dogs. This latter type of memory has been called semantic memory (Tulving, 1972) and has been viewed as a partition of LTS distinct from episodic (event) memory.

and retrieval processes. A CS node is content-addressable through the features of any of the codes it contains. This type of storage organization is possible because of the restricted format of CS nodes; they contain only a single c-code and a p-code for each feature set, and therefore a node can have but a single value on any feature dimension. In contrast, EKS memory structures are composed of any number and variety of c-codes and p-codes. However, search through EKS is also directed; otherwise, search for a particular memory structure would be too time-consuming for the system to function. What we suggest is that only some of the features of some of the codes in a memory structure are used to determine the storage location of that structure. For example, a phone number may be stored on the basis of features of its owner's name and not on the basis of the number itself or the context in which it was learned. Alternatively, a structure might be stored on the basis of features of the context in which it was built and yet this context information may not be included in the actual memory structure. Consider a hypothetical example where a person is unable to retrieve an historical fact until he is cued with the information that his sixth grade teacher once made him stay after school for failing to answer the same question. Given this type of storage and retrieval, it follows that there are processes active at storage and search which select a subset of features to use in generating an EKS address. Further, the successful retrieval of a particular memory structure depends on whether the features selected at retrieval are the same as those selected at initial storage of the structure. Therefore, factors that encourage this consistency, for example, the availability of "retrieval cues" (cf., Tulving and Thomson, 1971), will aid retention and vice-versa.

The internal structure of EKS is similar to that of the CS; locations in the store are organized and addressable in terms of dimensions that represent the range of feature values of both p-codes and c-codes. On the average then, memory structures representing similar information tend to be stored at locations with similar addresses. The internal organization of CS and EKS is to be distinguished from the organization within memory structures. These two types of organization correspond to two different ways that information may be scaled as "related": either by being stored at locations with similar addresses (being stored "close together") or by being linked within a memory structure that is stored at a single location.

The organization of codes within a memory structure reflects the relations that existed between the units of experience of some event, or the relations between concepts in the encoding of abstract knowledge. The possible types of organization are perceptual and conceptual. By perceptual organization we mean that the codes representing an experience are linked by perceptible (spatio-temporal) relations (e.g., b is x units to the left of c ; or, d is y units more intense than e). Such organization is most

useful for encoding details of visual scenes or sound sequences.⁶ Conceptual organization links codes by conceptual relations. The idea of a conceptual representation has had extensive development in recent theories of language and memory (Anderson and Bower, 1973; Rumelhart, Lindsay, and Norman, 1972; Schank, 1972). Conceptual representation links units of experience and concepts with a restricted set of dependencies, cases, and causal relations (cf., Schank, 1972). One way of representing conceptual organization in memory is to link concepts and internal representations of particular physical referents into labelled associative networks. (A labelled association between two internal codes is a relation between them.) The system described here allows only simple (unlabelled) links between codes, and represents relations themselves as codes; that is, the relation "x is the subject of act y," is represented by linking the code for x to a code for "subject of" to a code for y. Features of the codes for relations serve to indicate the codes in the structure that are linked by that relation. However, there must still be a relatively fixed ordering of the codes so that the "meaning" stored in the structure can be interpreted by following links between adjacent codes (i.e., the structure would be interpreted incorrectly if codes were examined in the wrong order). Therefore, while the codes within a memory structure may assume various conceptual organizations, the actual links between codes are undifferentiated and connect them to form a linear array.

A major rationale for suggesting that all memory structures are linear arrays of codes reflects the representation of processes in the memory system. In our view, the processes that manipulate information in memory— inference, decision, abstraction, generalization, rehearsal, imagery, pattern recognition—are themselves stored in LTS and in the same format as the "data" they operate on (Rumelhart, Lindsay, and Norman, 1972). These processes are considered as "programs" stored in EKS with codes as individual "instructions". These particular codes may represent a set of mental actions that underlie events and linguistic statements involving the communication of information.⁷ For example, the concept of "comparison" can be described as the transfer of codes into STS followed by a feature matching operation. This meaning of comparison is stored in a memory structure(s) in EKS and may be entered as a procedure to compare two arrays of information stored elsewhere in memory. Alternatively,

⁶Note that either p-codes or c-codes representing units of experience may be organized perceptually. The organization of the structure must initially develop from p-codes, but before storage in EKS the corresponding c-code can be retrieved from CS and substituted into the structure. It is also the case that stored information can be similarly recoded when retrieved from EKS into STS. However, such recodings probably will not be the same as ones generated at the time of storage, since the contextual information that influenced generation of the-original p-codes will be different.

⁷See Schank, Goldman, Rieger, and Riesbeck (1972) for the description of such a set of mental actions.

this structure can be used as data for some other process as it was above when we gave its "definition." How the stored information is used depends upon the control process that accesses it.⁸ Further, since the processes are stored in memory, they can be accessed by other processes and modified so that they will operate differently the next time they are used as a procedure. This approach, though relatively unexplored, seems to be a powerful way to think about the development and change of task strategies. It also provides a mechanism for the ontological development of complex cognitive functions. The linear linking of codes within memory structures is reasonable if the structures are accessed as procedures that are executed to achieve some processing function. From a formal viewpoint, this type of internal organization is equivalent to a labelled associative network for the representation of events and knowledge.

Several additional remarks need to be made about EKS. Each memory structure in EKS is a discrete entity stored at an addressable location. The amount of information stored in any one structure depends upon the control processes that operate at storage, and perhaps by the limited capacity of S'IS since new structures are built there and then copied into EKS. Particular codes are stored in many different memory structures. In addition, the same event or knowledge may be represented in more than one memory structure and with alternative forms of codes, thus increasing the likelihood that the event or knowledge can be retrieved. The modification of information already in EKS involves copying old structures into S'IS, changing them, and then recopying the new structure into a location in EKS; the old structures are not erased from the system. This view of LTS contrasts with theories that suppose that each unit of experience or concept is represented by a single node in memory, and that events and knowledge are recorded by linking these nodes with relational associations (Anderson and Bower, 1973). In the present system, such organizations exist within each memory structure, but no links exist between these structures. To retrieve a structure, the address of its storage location must be generated. The individual codes within the structure are then available by a search along the links between them.

V. Concluding Remarks

We have presented a view of how different theoretical constructs, each developed from a consideration of some aspect of memory, can be integrated into a system that, in principle, is capable of accounting for a broad range of cognitive activities. The constructs of the system are in

⁸The control processes are themselves stored in EKS. The operation of memory therefore involves processes that invoke processes that invoke other processes, etc. Complex processes like language understanding may therefore be a hierarchical organization of more basic processes.

accord with both data and logical considerations of how memory must operate. The work of Sperling (1960) in vision and Massaro (1972) in audition agree with the notions of a SR and pre-perceptual representation. The idea of alternative internal codes is central to the explanation of studies of same-different recognition (Posner, 1969). The CS and c-codes reflect studies of recognition memory (Atkinson, Herrmann, and Wescourt, 1974), semantic decision time (Rips, Shoben, and Smith, 1973), and the requirements of a language understanding system that must have rapid access to the information needed to parse input (Schank, 1972). Other constructs (for example, those involving content-addressable storage and the representation of processes) reflect the influence of research in computer science and artificial intelligence.

One may ask what useful purpose such a general conception of memory serves, especially since no effort has been made to implement the system as a whole and investigate its operation over a range of tasks. This would constitute a basis for criticism if our goal were to offer a finished and testable theory of memory. However, our purpose here is more modest. We feel that the description of the memory system serves to introduce a language that is generally useful for thinking about memory. The memory system reflects that perception, simple retention, and complex cognitive activities all require the representation, storage and retrieval of information and it constitutes a way of talking about them in terms of these commonalities. Thus, it provides a means for thinking about different problems with a single vocabulary.

What we have presented then is not a theory of memory, but instead a language for formulating specific models of memory. While our own research has led us to test several models that seem well stated in this language (Atkinson, Herrmann, and Wescourt, 1974), the system might equally well be used to represent other models that lead to somewhat different predictions.

References

- Anderson, J. R. and Bower, G. H. (1973) "Human Associative Memory". V. II. Winston, Washington, D.C.
- Atkinson, R. C., Herrmann, D. J. and Wescourt, K. T. (1974) Search processes in recognition memory. *In* R. L. Solso (ed.), "Theories in Cognitive Psychology: The Loyola Symposium". Lawrence Erlbaum Associates, Potomac, Md.
- Atkinson, R. C. and Juola, J. F. (1974) Search and decision processes in recognition memory. *In* D. H. Krantz, R. C. Atkinson, R. D. Luce and P. Suppes (eds), "Contemporary Developments in Mathematical Psychology". W. H. Freeman, San Francisco.
- Atkinson, R. C. and Shiffrin, R. M. (1968) Human memory: A proposed system and its control processes. *In* K. W. Spence and J. T. Spence (eds), "The Psychology of Learning and Motivation: Advances in Research and Theory, Vol. II", Academic Press, New York and London.

- Atkinson, R. C. and Shiffrin, R. M. (1971) The control of short-term memory. *Scientific American*, 225, 82-90.
- Collins, A. M. and Quillian, M. R. (1969) Retrieval time from semantic memory. *Journal of Verbal Learning and Verbal Behavior*, 8, 241-248.
- Craik, F. I. M. and Lockhart, R. S. (1972) Levels of processing: A framework for memory research. *Journal of Verbal Learning and Verbal Behavior*, 11, 671-684.
- Fillmore, C. J. (1968) The case for case. In E. Bach and R. T. Harms (eds), "Universals in Linguistic Theory", Holt, Rinehart and Winston, New York.
- Gibson, E. J. (1969) "Principles of Perceptual Learning and Development". Appleton-Century-Crofts, New York.
- Gibson, E. J., Tenney, Y. J., Barron, R. W. and Zaslow, M. (1972). The effect of orthographic structure on letter search. *Perception and Psychophysics*, 11, 183-186.
- Juola, J. F. (1973) Repetition and laterality effects on recognition memory for words and pictures. *Memory and Cognition*, 1, 183-192.
- Manelis, I. and Atkinson, R. C. (1974) Tachistoscopic recognition of syllabicated words. *The Quarterly Journal of Experimental Psychology*, 26, 158-166.
- Massaro, D. W. (1972) Preperceptual and synthesized auditory storage. Report 72-1, Wisconsin Mathematical Psychology Program, Department of Psychology, University of Wisconsin, Madison, Wisconsin, October 1972.
- Melton, A. W. and Martin, E. (eds.) (1972) "Coding Processes in Human Memory". V. H. Winston, Washington, D.C.
- Mohs, R. C., Wescourt, K. T. and Atkinson, R. C. (1973) Effects of short-term memory contents on short- and long-term searches. *Memory and Cognition*, 1, 443-448.
- Newell, A. and Simon, H. A. (1972) "Human Problem Solving". Prentice-Hall, Englewood Cliffs, N.J.
- Posner, M. I. (1969) Abstraction and the process of recognition. In G. H. Bower and J. T. Spence (eds), "The Psychology of Learning and Motivation, Vol. III". Academic Press, New York and London.
- Posner, M. I. and Warren, R. E. (1972) Traces, concepts and conscious construction. In A. W. Melton and E. Martin (eds), "Coding Processes in Memory", V. H. Winston, Washington, D.C.
- Restle, F. (1974) Critique of pure memory. In R. L. Solso (ed.), "Theories in Cognitive Psychology". Lawrence Erlbaum Associates, Potomac, Md.
- Rips, L. J., Shoben, E. J. and Smith, E. E. (1973) Semantic distance and the verification of semantic relations. *Journal of Verbal Learning and Verbal Behavior*, 12, 1-20.
- Rumelhart, D. E., Lindsay, P. H. and Norman, D. A. (1972) A process model for long-term memory. In E. Tulving and W. Donaldson (eds.), "Organization of Memory". Academic Press, New York and London.
- Schank, R. C. (1972) Conceptual dependency: A theory of natural language understanding. *Cognitive Psychology*, 3, 552-631.
- Schank, R. C., Goldman, N., Rieger, C. J. and Riesbeck, C. K. Primitive concepts underlying verbs of thought. A. I. Memo No. AIM-162, Computer Science Department, Stanford University, Stanford, California, February, 1972.
- Sperling, G. (1960) The information available in brief visual presentations. *Psychological Monographs*, 74, (11, Whole No. 498).
- Spoehr, K. T. and Smith, E. E. (1973) The role of syllables in perceptual processing. *Cognitive Psychology*, 5, 71-89.

- Tulving, E. (1972) Episodic and semantic memory. In E. Tulving and W. Donaldson (eds), "Organization of Memory", Academic Press, New York and London.
- Tulving, E. and Thomson, D. M. (1971) Retrieval processes in recognition memory: Effects of associative content. *Journal of Experimental Psychology*, 87, 116-124.
- Wescourt, K. T. and Atkinson, R. C. (1973) Scanning for information in long- and short-term memory. *Journal of Experimental Psychology*, 98, 95-101.

SECTION II:

SEARCH AND DECISION PROCESSES
IN RECOGNITION MEMORY

- 5 Search processes in recognition memory. In Theories in Cognitive Psychology: The Loyola Symposium, edited by R. L. Solso, Hillsdale, New Jersey: Erlbaum Associates, 1974, 101-146 (with D.J. Herrmann and K. T. Wescourt).....193
- 6 Search and decision processes in recognition memory. In Contemporary Developments in Mathematical Psychology: Volume I, Learning, memory, and thinking, edited by D.H. Krantz, R. C. Atkinson, R. D. Luce, and P. Suppes, San Francisco: W.H. Freeman and Co., 1974, 243-293 (with J. F. Juola)..... 237

5 || SEARCH PROCESSES IN RECOGNITION MEMORY¹

Richard C. Atkinson, Douglas J. Herrmann, and Keith T. Wescourt
Stanford University

INTRODUCTION

This paper is concerned with a theoretical account of some phenomena in the field of recognition memory. Many tasks have been used to study the recognition process (for a review see McCormack, 1972, and Kintsch, 1970), but we will focus on a particular procedure that has been extensively investigated in recent years. This task, introduced by Sternberg (1966) and often referred to as "memory scanning," involves a series of discrete trials. On each trial a test stimulus is presented, and the subject is required to decide whether or not the stimulus is a member of a previously defined target set. The subject is instructed to make a positive ("yes") response if the test stimulus is from the target set, and a negative ("no") response otherwise. The target sets in the experiments to be discussed range in size from just a few to as many as 60 items (usually words). When the set is large, subjects are asked to memorize it prior to the sequence of test trials; when the set is relatively small, it is presented at the start of each trial and followed shortly thereafter by the test stimulus. Under either condition errors are infrequent and the principal data are reaction times (RT).

In this paper we examine a series of experiments on memory scanning in terms of an extremely simple set of models that are all variants of one basic model. The models incorporate only those assumptions necessary for treatment of the phe-

¹This research was supported by grants from the National Institute of Mental Health (MH21747) and the National Science Foundation (NSFGJ-443X3). The second author was on a Research Training Fellowship from the Social Science Research Council during the period this paper was written, and the third author was on a National Science Foundation Graduate Fellowship.

nomena under analysis. It should be noted, however, that the models can be regarded as special cases of a more general theory of memory (Atkinson & Shiffrin, 1968, 1971; Atkinson & Wickens, 1971; Atkinson & Juola, 1973, 1974). Thus, their evaluation has implications not only for the experiments examined here, but for the theory of which they are special cases. Before discussing specific studies, it will be useful to provide a brief overview of the theory.

Elements of the Memory System

The elements of the memory system are diagrammed in Fig. 1. The system is divided into a memory storage network and control processes. The sensory register (SR), short-term store (STS), and long-term store (LTS) comprise the memory storage network. Information from the environment enters the system

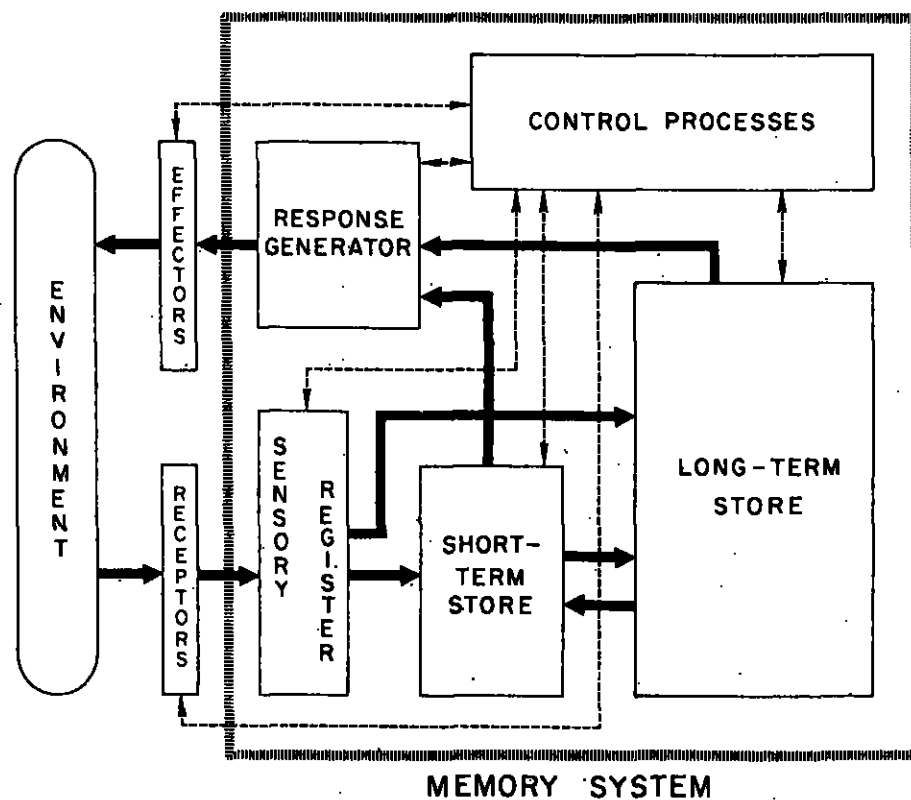

FIG. 1. A block diagram of the memory system. Solid lines indicate paths of information transfer. Dashed lines indicate connections that permit comparison of information arrays residing in different parts of the system; they also indicate paths along which control signals may be sent which modulate information transfer, activate rehearsal mechanisms, set decision criteria, alter biases of sensory channels, initiate the response generator, etc.

through the SR and is retained there briefly while pattern recognition is initiated. The STS is a working memory of limited capacity from which information decays fairly rapidly unless maintained by control processes such as rehearsal or imagery; the contents may be thought of as the "current state of consciousness" for the subject. The LTS is a large and essentially permanent memory bank. Information stored there is normally never lost, but the effectiveness of retrieval processes determines its availability for further use. Although the different components of the memory storage network are represented as separate boxes in the figure, these need not correspond to different neurological systems; rather, the different components of the system may simply represent different phases of activation of a single neurological system. The control processes regulate the flow of information between components of the network and the application of particular storage and retrieval processes within components. Control processes are adaptive with regard to the environment and demands of a task, and are in part under the conscious control of the subject. They include selective attention, rehearsal, choice of retrieval cues, and all types of decision strategies.

Representation of Information Within the System

Information enters the system from the environment at the SR. This information, if attended to, is processed by pattern-recognition routines. The function of these routines is to transform various exemplars of the "same" stimulus into a unitary representation within the particular physical modality (e.g., auditory or visual) of the input. We will refer to these representations of a stimulus as its *perceptual code*. A perceptual code is specified in terms of a set of primitive features and does not convey information about the referents or meanings of the stimulus. The code may be thought of as an ordered list of features sufficient to locate the stimulus in an n -dimensional space; the dimensions of the space represent the ranges of values of an orthogonal set of perceptual features.

We are not concerned in this paper with variability in the pattern recognition process that generates a perceptual code, because the tasks considered here do not involve perceptually ambiguous stimuli. In other situations, however, where stimuli are perceptually ambiguous, variability of the perceptual codes output by the pattern-recognition process may be a significant determiner of subsequent processing. In such cases, prior context may affect pattern recognition: Information already in the system creates expectations about information about to enter. These expectations are realized by feedback processes that change parameter values within the pattern-recognition process. Thus, a particular sensory pattern may result in different perceptual codes entering the system as context is varied; for example, an "ill-formed" stimulus being seen as the number "13" or the letter "B" (Bruner & Minturn, 1955). The experiments reported in this paper involve presenting subjects with words in a consistent context and in a consistent typeface;

thus our analyses will tend to ignore the variability that is possible in initial stages of perceptual processing.²

Perceptual codes represent stimuli along perceptual dimensions. It is the case, however, that stimuli may convey information at a second level. This is particularly evident for words; they have assigned meanings with little or no dependence on their physical form. Stimuli are therefore represented within the memory system in a second form; we will call these representations *conceptual codes*. As in the case of perceptual codes, a conceptual code may be thought of as an ordered list of features specifying a point in an n' -dimensional space, where the dimensions of the space correspond to some set of primitive conceptual features (Fillenbaum & Rapoport, 1971). The conceptual code for a word does not represent its definition or full meaning. Rather, a distinction may be made between the defining and characteristic features of meaning (Lakoff, 1972; Rips, Shoben, & Smith, 1973). In this view, conceptual codes primarily represent a subset of the characteristic features of meaning. Such features indicate the classes of conceptual relations that may be entered by the concept representing a word. Reference to the conceptual dependency theory of language understanding developed by Schank (1972) can make this more substantive. Consider the conceptual code for some verb. It indicates the class of ACTs (primitive actions) that the verb maps into, the classes of "picture-producers" (concrete nouns) that form conceptual dependencies with the verb, and perhaps those aspects of the verb's meaning that differentiate it from other verbs mapping into the same ACT class.

Conceptual codes available to the memory system are permanently stored and organized within a functional partition of LTS that will be referred to as the conceptual store (CS). Each conceptual code and the array of perceptual codes linked to it form what will be called a CS-node. Thus, the sight of an actual dog, the auditory perception of the spoken word, the display of the printed word, etc., each has a perceptual code; the linking of these perceptual codes to a single conceptual code form a CS-node. It is the case that synonymous stimuli will have their various perceptual codes linked to a single conceptual code, and homographic or homophonic stimuli will result in identical perceptual codes being linked to different conceptual codes.

Perceptual and conceptual codes are the basic elements of *memory structures* stored within a second partition of LTS that we call the event-knowledge store (EKS). Events and episodes are recorded in EKS by linking together copies of codes or parts of codes that correspond to the patterns of stimuli entering the system from the environment. The EKS may be represented as an n'' -dimensional space, where the dimensions are all those that characterize perceptual and con-

²Although we develop the memory system here on the basis of tasks involving words as stimuli, analogous processes are assumed to operate in the coding of visual scenes and nonverbal auditory stimuli. The sensory patterns produced by such stimuli are analyzed by the pattern recognition process and the resultant perceptual codes are then available for further processing. Just as for words, these codes characterize nonverbal stimuli as lists of primitive physical features.

ceptual codes and also include other dimensions (i.e., $n' > n + n'$). These other dimensions correspond to the temporal and spatial features between stimuli that underlie events and also to features (such as "superset," "subset," and "has-as-pari") that relate concepts to other concepts. Each memory structure is stored at a point in the EKS space. The position of this point in the n' -dimensional space may be a function of a subset of the features within the memory structure, but may also reflect features of codes processed at the time the structure was formed but not included in the structure. In this sense, the location of a memory structure in EKS is less determined by its contents than is the location of a node in the CS.

We wish to emphasize that the CS and EKS are not assumed to be independent structures. It seems intuitive that structures in CS evolve over a period of time as a result of repeated experience with some stimulus in a number of different episodes. These episodes provide a basis for inferring that a particular stimulus enters only particular classes of conceptual relations. For example, a bird tends to be an actor for only certain types of acts, and similarly, an act such as eating tends to have a restricted class of objects—namely, those that are "edible." Such generalizations develop with experience and are represented in the conceptual code that is linked to particular perceptual codes. Obviously, the perceptual code generated by the presentation of a novel stimulus, such as "durp," will not be located at any existing node in CS. However, if "durp" were to become the name of a new soft drink, a CS node for it would eventually be formed. The conceptual code at this node would be a list of features such as "liquid," "non-acting-picture-producer," "object-of-INGEST-ACT," etc. (These and any other "features" used in this paper are not intended as actual primitives but are used for illustrative purposes only.)

We next consider the processes by which information in LTS is retrieved. The organization of CS in terms of feature dimensions provides a basis for a content-addressable retrieval process (Shiffrin & Atkinson, 1969). Thus, the retrieval of information from CS can be quite rapid, requiring no "conscious" search. Once a CS node is located, all the codes stored there become available to the system. Difficulties may occur in this process only if perceptual input is "noisy," or if the perceptual code is stored at more than one CS node. In the former case, the perceptual code may be incomplete, requiring an examination of several nodes (possibly leading to errors based on physical similarity). In the latter case, only one of the nodes may be the "correct" one, in which case conceptual features of the context may serve to locate the appropriate node. The utilization of context in searching CS is obvious when we consider that homophonic and homographic words are seldom recognized as ambiguous in context. Puns and many jokes have their effect because they create a context that deliberately locates two senses for an ambiguous word.

The location of a memory structure in EKS is also a directed search process, but it is not strictly content-addressable like the CS search process. Since the original

placement of a memory structure may reflect only partially the features of its member codes, it will often be the case that several memory structures in EKS will need to be examined. The initial avenues of entry into EKS will be determined by the features of the retrieval context (Tulving & Thomson, 1973). Subsequent search may be directed by features of codes retrieved from other memory structures. Such a search will be relatively slow and will often become "conscious" as memory structures are examined and further dimensions of search are selected.

Application to Memory Scanning

The distinctions made here between perceptual codes, conceptual codes, CS nodes, and memory structures in EKS are not arbitrary. Rather, they reflect the subject's ability to process information at different levels of complexity (Craik & Lockhart, 1972). Two exemplars of a word, one in capitals and the other in lower case, may be judged "different" or "same" depending on whether the decision criteria involve physical or semantic similarity; in the former case, a comparison between two perceptual codes is the basis of the decision, whereas, in the latter case, two different perceptual codes associated with the same CS node lead to the judgment that the words mean the same. A somewhat analogous same-different decision is made in EKS if a subject must judge whether or not a given pair of test words are both members of a previously memorized list. In this case, a match must be sought between the codes for the two test words and the codes in the EKS structure associated with the memorized list.

In subsequent sections of this paper, we consider a series of memory-scanning experiments and analyze them in terms of models derived from the theory outlined above. To introduce these analyses, it will be helpful to provide a brief overview of how the theory is to be applied. We consider first the case where the target set is very large and stored in long-term memory, and then the case where the target set involves only a few items and is in short-term memory.

In the long-term case, the list of target words must be memorized prior to the sequence of test trials. As the subject attends to each word during learning, a perceptual code is produced by the pattern-recognition process. That code is then mapped onto the appropriate CS node. At that time, alternative perceptual codes and/or the conceptual code may be copied into STS. Because STS has limited capacity, the addition of new codes as more words are studied results in the loss of codes already in STS. We suppose that control processes act to organize the words on the target list, that is, the subject attempts to maintain in STS codes that are similar along some dimensions. This array of codes is then copied into a memory structure in EKS. The location of this structure can be thought of as a point in EKS defined by values on each of the dimensions of EKS; of course, for any particular structure many dimensions may not be specified. The values that define the point will be those that are common to codes in the memory structure;

they will also be determined by the context in which the list is learned (psychology experiment, etc.) and temporal factors. For simplicity, we usually assume that the entire target list is represented by a single memory structure located at a particular point in EKS. Obviously, this need not always be the case. There may be situations where a trade-off exists between one large structure and several smaller ones that are dispersed. In an experiment to be considered later (involving categorized memory lists) a single memory structure is formed for the entire list plus separate structures for each category sublist.

Once the memory structure for the list has been formed in EKS, the test phase of the experiment can begin. The subject's task is to compare a coded representation of the test stimulus against the codes in the memory structure, to determine if the probe is a target or a distractor. In our experiments the subject has no difficulty in locating the memory structure in EKS; this is evident by the fact that he can recall the list with no difficulty at any time during the experiment. Thus, we assume that contextual and temporal cues permit the search process to locate the memory-list structure rapidly and with little variability.

When a test word is presented, initial processing generates a perceptual code which is quickly mapped onto the appropriate CS node (see Fig. 2). Prior to extracting a code from the CS node to scan against the list's memory structure in EKS, the monitoring process may apply a special test. The test measures the activity level of the node associated with the test word; the node's activity level is a function of how frequently and how recently the node was accessed. We refer to the activity level of a CS node as its *familiarity value*. The node does not contain

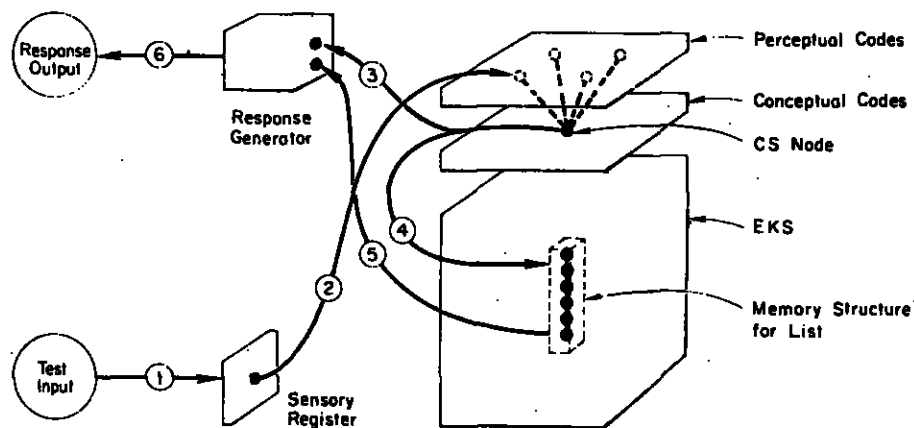

FIG. 2. A block diagram illustrating the processes involved in determining whether or not a test stimulus is a member of a "large" target set stored in LTS. Component processes are as follows: (1) input of test stimulus to sensory register; (2) pattern-recognition process leading to a mapping of test stimulus onto a perceptual code, and in turn access to the conceptual code; (3) immediate decision to respond based on familiarity; (4) selection of code to be scanned against memory structure in EKS; (5) decision to respond based on scan of the list's memory structure; (6) response output.

information about whether or not the test word was on the memory list, but its activity level does indicate the familiarity of the word.³ Under some conditions, the location of a node with a relatively high or relatively low familiarity value may lead the subject to respond immediately without searching EKS. If the retrieved familiarity value is above a "high criterion" value, the subject may assume that the item was recently presented and thus is very likely to be a member of the target list; for a familiarity value below a "low criterion," he assumes that the item has not been recently presented and thus is unlikely to be on the target list. In the former case, the subject makes a quick positive response; in the latter case, a quick negative response. For intermediate familiarity values, an appropriate code is extracted from the CS node and compared with codes of the list's memory structure in EKS. The success of the comparison will lead to either a positive or negative response, thereby terminating the trial.⁴

Similar processes are assumed to operate when the target set is small (1 to 5 items) and varies from trial to trial. In this case, the target set is represented in STS as an array of perceptual and/or conceptual codes. When a test word is presented, precisely the same process described above is involved in estimating the item's familiarity value. If the retrieved familiarity value is above a high criterion or below a low criterion, the subject makes an immediate response; otherwise, a code for the test stimulus is extracted from its CS node and compared with the set of codes in STS. Thus, the process underlying recognition of information in EKS and STS is the same. However, differences between the memory stores may cause different codes to be preferred in each; evidence for this comes from a number of sources (Broadbent, 1970). The experiments to be described here also support the view that information may be encoded differently in EKS and STS.

Decisions about which memory stores to search and in turn which information structures to examine depend upon the context in which testing occurs, as well as feedback to the subject about the effectiveness of prior processing strategies. For example, the specific instructions used in an experiment will determine whether a subject relies on familiarity alone to make a decision or executes an extended search of memory. If the experimenter's instructions emphasize speed, then fa-

³Stated more precisely, the familiarity value must be considered as current activity level *relative* to baseline level such that the relative increase in activity due to accessing a node is less for more frequently accessed nodes. This interpretation is necessary if we are to account for the fact that subjects do not generally false alarm to their names or other very high-frequency words when these are inserted as distractors in a recognition test. Atkinson and Juola (1973; p. 602) report a study which included word frequency as an independent variable. Subjects responded to low-frequency words (both targets and distractors) faster than to high-frequency words. This means that low-frequency target words had higher familiarity values than high-frequency target words, but that low-frequency distractors had lower values than high-frequency distractors. The former relation depends on low-frequency words getting a greater boost in familiarity during study, and the latter relation depends on high-frequency words having more fluctuations from baseline activity due to extra-experimental events.

⁴See Mandler, Pearlstone, and Koopmans (1969) for a similar conception of recognition memory.

miliarity will play a key role; if accuracy is emphasized, then the slower memory search will occur. Thus, the high and low criteria for judging familiarity are determined by the speed-accuracy trade-off that the subject regards as acceptable.

The theory has been described in very general terms, and we turn now to specific applications. The first application deals with experiments employing small target sets (1 to 5 items) stored in STS. The second application involves large memory sets (60 or more items in some cases) stored in EKS. The third application considers scanning experiments where the target set involves some items stored in STS and others in EKS; experiments of this sort permit us to make direct comparisons between search rates in EKS and STS, and to examine the parallel versus serial search of these stores. The last two applications deal with target lists that are categorized; the questions of interest are how and under what conditions the category information may be used in making a response decision. Because the memory system is stratified so that information can be represented in several different stores (and in different memory structures within a store), performance in even simple tasks often depends upon a complex "mixture" of underlying processes. Our goal is not to build the simplest possible model for the set of experiments examined, but rather to analyze these experiments within the framework of a theory that is applicable to a wide range of phenomena.

MEMORY SEARCH WITH SMALL TARGET SETS

The first experiments to be considered involve the search of short-term memory; the specific studies are variants on the type of scanning task investigated by Sternberg (1966, 1969a, 1969b, 1971). On each of a series of trials, the subject is presented with a memory set of from one to six words; the words in the memory set are "new" in the sense that they have not been presented on any prior trials of the experiment. When the subject has the memory set in mind, a test word is presented visually; the subject makes a positive response if the test word is in the memory set, and a negative response otherwise. The typical finding is that reaction time for both the positive and negative responses are linearly increasing functions of memory-set size, and that the slopes of the two functions are roughly equal.

The theoretical account of this type of experiment is schematically represented in Fig. 3. The memory set is temporarily stored in STS. When the test word is presented, it is encoded and mapped onto its CS node. Although the CS node does not contain a tag or marker indicating that the test word was in the memory set, it does have information about the familiarity of the word. If the subject finds a very high familiarity value, he gives an immediate positive response; if he finds an extremely low value, an immediate negative response is given. If the familiarity value is intermediate, the subject must then take the test word and scan it against the memory set in STS. If the scan yields a match, a positive response is made; otherwise, a negative response. When the familiarity value is intermediate,

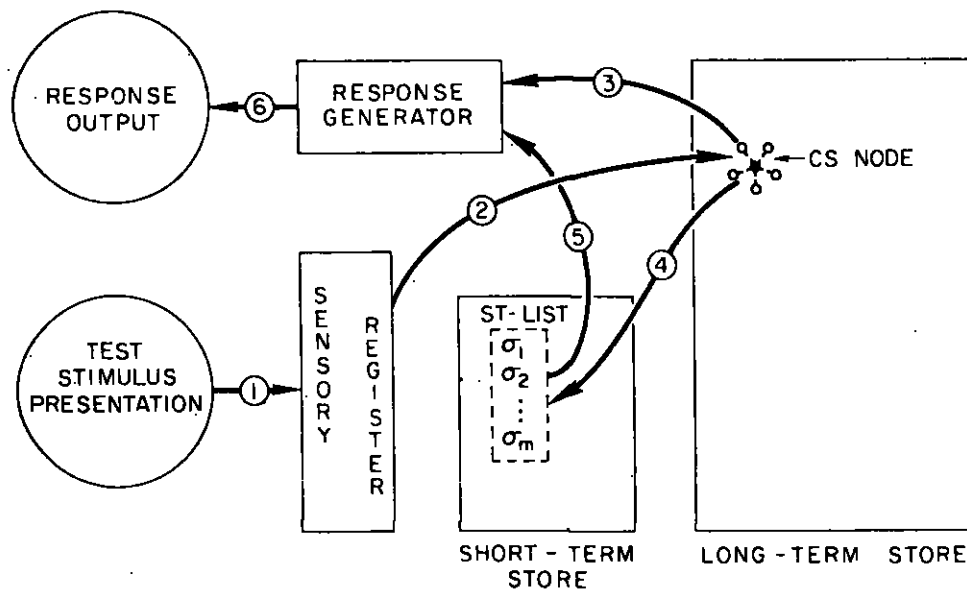

FIG. 3. A schematic representation of the search-and-decision processes in a short-term recognition memory study. A test stimulus is presented (1) and then matched to a CS node (2). The familiarity value associated with the node may lead to an immediate decision (3) and response output (6). Otherwise, a code is extracted and scanned against the target list in STS (4), which leads to a decision (5) and subsequent response (6). Path (1), (2), (3), (6) represents a much faster response process than Path (1), (2), (4), (5), (6), and it is independent of the size of the STS set.

the speed of the response is much slower and depends on the number of words in the memory set. Thus, for very high or very low familiarity values, the subject makes a fast response that does not depend on the memory-set size; for intermediate values a slower response occurs that is an increasing function of memory-set size.

The observed response latency averaged over trials is then a mixture of fast decisions based on familiarity alone (independent of memory-set size) and slower decisions based on a search of STS (dependent on memory-set size). The likelihood of bypassing the search of STS depends on the distribution of familiarity values associated with targets and distractors. Figure 4 presents familiarity distributions associated with a target word and a distractor. When a test word is presented, a familiarity value is sampled from the appropriate distribution. If the familiarity value is above a high criterion c_1 , the subject makes an immediate positive response; and below a low criterion c_0 , an immediate negative response. Otherwise, a search of STS is executed. It is assumed that the subject never makes an error if a search of STS occurs; however, if the search is bypassed, then an error will occur whenever the test word is a target with a familiarity value below c_0 or a distractor with a familiarity value above c_1 . Note that the proportion of test words that lead to a search of STS depends on the placement of the criteria. The probability distribution of familiarity values, x , for targets and dis-

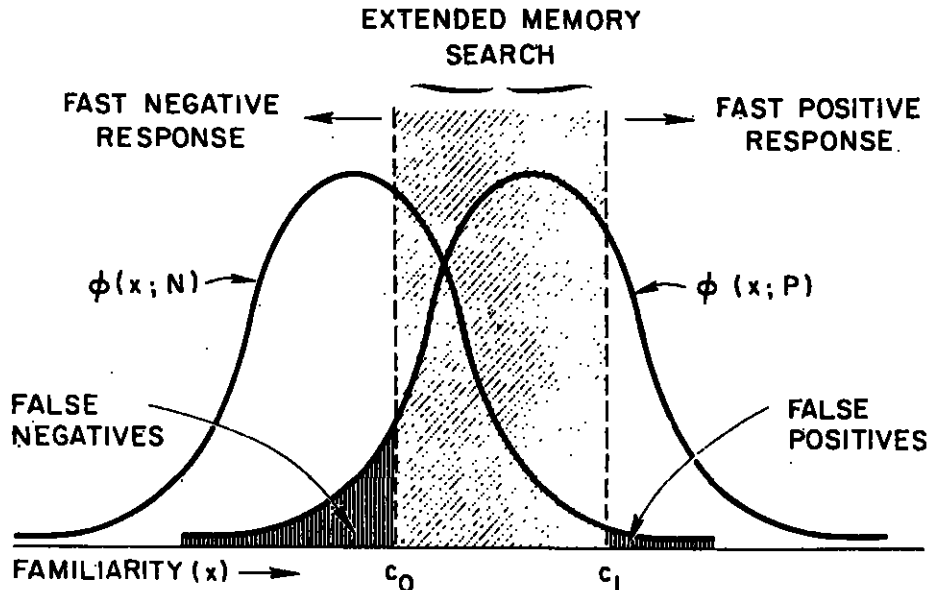

FIG 4. Distributions of familiarity values for distractor items, $\phi(x;N)$, and target items, $\phi(x;P)$.

tractors will be denoted as $\phi(x;P)$ and $\phi(x;N)$, respectively; for present purposes these distributions will be assumed to be unit-normal with means μ_P and μ_N . (We use P for the target distribution because a positive response to a target is correct, and N for the distractor distribution because a negative response to a distractor is correct.) Later it will prove useful to know the probability of having made a search of STS given that the subject generated a correct response; this probability is denoted as s for targets and s' for distractors. As shown in Fig. 4, the probability that a correct response to a target involved a search of STS is the probability of a positive response based on a search of STS divided by the overall probability of a positive response; namely,

$$s = \frac{\int_{c_0}^{c_1} \phi(x, P) dx}{\int_{c_0}^{\infty} \phi(x, P) dx} \quad (1)$$

Similarly, the probability that a correct response to a distractor involved a search of STS is

$$s' = \frac{\int_{c_0}^{c_1} \phi(x, N) dx}{\int_{-\infty}^{c_1} \phi(x, N) dx} \quad (2)$$

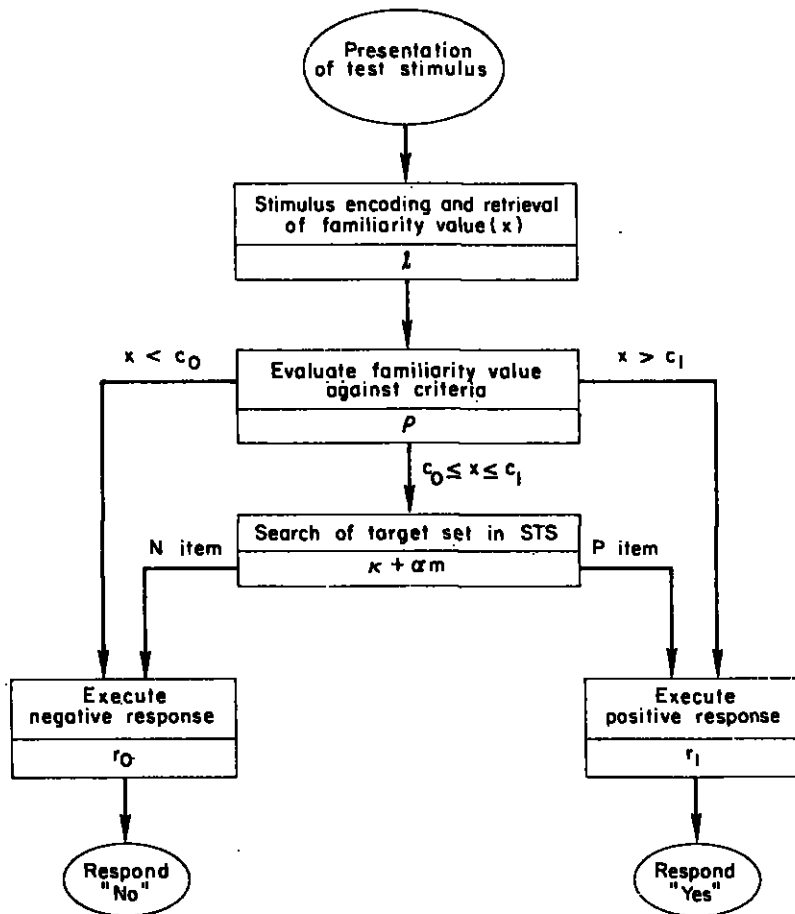

FIG. 5. Representation of the processing stages underlying recognition performance when the target set resides in STS. When stimulus familiarity is greater than c_1 or less than c_0 , a rapid positive or negative response is executed; otherwise, the encoded test stimulus is scanned against the contents of STS, leading to the appropriate response.

The preceding discussion can be summarized by referring to the flow chart in Fig. 5. Noted in the figure are the times associated with each stage. Certain stages must be executed for all probes; namely, encoding (l), evaluation of the familiarity value (ρ), and response execution (r_0 for a negative response and r_1 for a positive response). For probes of an intermediate familiarity value, the additional stage of searching STS is necessary. It is assumed that this search takes time $\kappa + \alpha m$ where m denotes the size of the memory set; κ is the time to initiate the search of STS, and the search is proportional (with parameter α) to the size of the memory set. This linear search function corresponds to the exhaustive case of the serial-scanning model proposed by Sternberg (1969a). While Sternberg's model has proved to be extremely valuable in interpreting a variety of memory-

search experiments, good fits between the model and data do not require that the underlying process be either serial or exhaustive (for a discussion of this point see Townsend, 1971, and Murdock, 1971). Thus the use of a linear search function does not commit us to specific assumptions about whether the search is serial or parallel, self-terminating or exhaustive.

In terms of the time constants given in Fig. 5, expressions can be written for the latency of various types of responses. First note that an error to a target item takes time $l + \rho + r_0$, whereas an error to a distractor takes time $l + \rho + r_1$.⁵ Expressions for correct responses are more complicated. We let $t(P)$ denote the response time for a correct response to a target (i.e., the time for a positive response) and $t(N)$ denote the response time for a correct response to a distractor (i.e., the time for a negative response). Recalling the definitions of s and s' , we can write the following expressions:

$$\begin{aligned} t(P) &= (1 - s)[l + \rho + r_1] + s[l + \rho + \kappa + \alpha m + r_1] \\ &= (l + \rho + r_1) + s(\kappa + \alpha m), \end{aligned} \quad (3)$$

$$\begin{aligned} t(N) &= (1 - s')[l + \rho + r_0] + s'[l + \rho + \kappa + \alpha m + r_0] \\ &= (l + \rho + r_0) + s'(\kappa + \alpha m). \end{aligned} \quad (4)$$

Examining these equations, we see that both $t(P)$ and $t(N)$ increase linearly with set size. In many experiments (see Sternberg, 1969a), the slope of the negative and positive functions are roughly equal, and this would be the case when s equals s' . The condition under which s equals s' requires that c_1 and c_0 be set symmetrically (i.e., the tail of the target distribution below c_0 must equal the tail of the distractor distribution above c_1). The linear predictions for $t(P)$ and $t(N)$ are based on the assumption that the criteria do not vary with m ; a correlated implication of this statement is that error rates also do not vary with m . Of course, in some experiments (especially where m is fixed over a block of trials), it is possible that the subject adjusts c_1 and c_0 as a function of the memory-set size. For example, when m is large the subject may anticipate a slow response and compensate by adjusting the criteria to generate more fast responses based on familiarity alone. Under these conditions errors would increase with m , and RT curves would be curvilinear.

The predictions outlined above are consistent with a number of experimental

⁵The model predicts that error latencies are "fast" since they are the result of decisions based upon familiarity alone: Whenever the memory set is searched, it is assumed that a correct response always occurs. While this assumption is reasonable for the tasks described here, it is the case that "slow" errors (resulting from a failure in the search process) will occur in other situations. Such errors would be expected when acquisition of the memory set is less than perfect. They might also occur when instructions emphasize speed of response; subjects in this case could establish an upper bound on the time they will search the stored memory set before "guessing."

results (Atkinson & Juola, 1973, 1974). In this sense, the model has proved to be quite satisfactory. However, these goodness-of-fit demonstrations have not directly tested the role of familiarity in a short-term-memory scanning task. With this in mind, Charles Darley and Phipps Arabie designed and ran a study at Stanford University which attempted to experimentally manipulate familiarity. The study was basically like the prototype experiment described at the beginning of this section. Memory-set size varied randomly from trial to trial, taking on values from 2 to 5 items. Each memory set involved new words (i.e., words that had not been used on any prior trial); the test word was a target on half the trials and a distractor on the other half. The only difference from the prototype experiment described at the outset of this section was that distractors were not always new words, thus permitting the experimenters to manipulate their familiarity values.

In accord with prior notation, the presentation of a target as the test word will be called a P-trial to indicate that a positive response is correct; the presentation of a distractor will be called an N-trial to indicate that a negative response is correct. In this experiment the distractors were of three types: new words never presented before in the experiment (denoted N_1 since the word was presented for the first time); words that had been presented for the first time in the experiment as distractors on the immediately preceding trial (denoted N_2 since the word was now being presented for the second time); and words that had been presented for the first time on the immediately preceding trial both as a member of the memory set and as a positive test word (denoted N_3 since the word was now being presented for the third time). Thus, there were four types of test words (P, N_1 , N_2 , and N_3), and we assume that different familiarity values are associated with each. Figure 6 presents a schematic representation of the four familiarity distributions. The mean of the P-distribution should be the largest since the test word on a P-trial is a member of the current memory set and should be very familiar; likewise, the mean of the N_1 -distribution should be smallest because N_1 words are completely new; the other two means should be intermediate since N_2 and N_3 words appeared on the prior trial. Also displayed in the figure are the criteria c_0

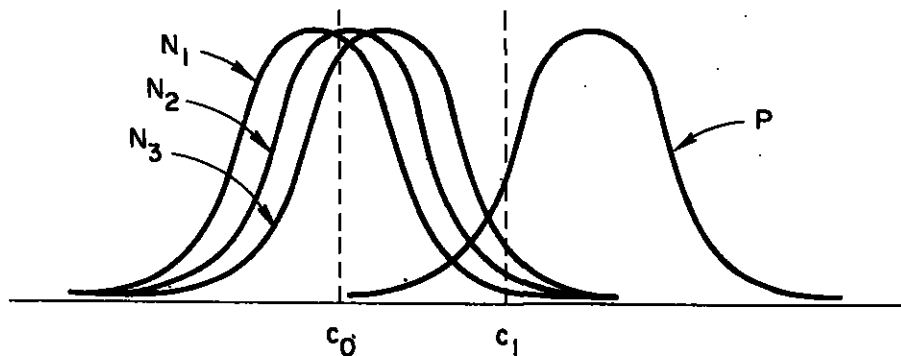

FIG. 6. Distributions of familiarity values for the three types of distractor items (N_1 , N_2 , N_3) and for target items (P).

and c_1 , which are assumed to be the same for all trial types. This assumption is reasonable since the subject cannot predict the type of test that will occur, and thus he has no basis for varying the criteria. As can be seen from Fig. 6, an increasing amount of the distribution falls between c_0 and c_1 as we move from N_1 to N_2 to N_3 . In terms of the mathematical formulation, s' defined in Eq. 2 increases from N_1 to N_2 to N_3 . Accordingly, the likelihood of searching STS in-

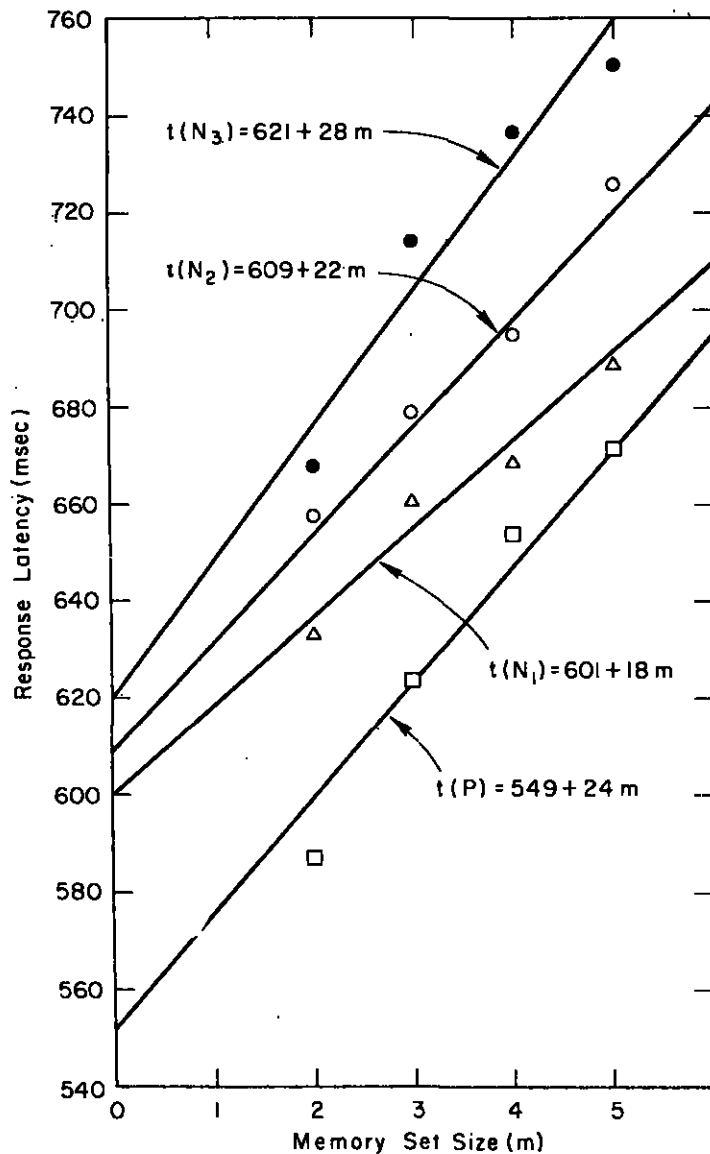

FIG. 7. Mean response latencies for the four probe types as a function of the size of the memory set. The straight lines fitted to the data represent theoretical predictions.

creases and thus the slope of the $t(N_i)$ function increases from N_1 to N_2 to N_3 ; for the same reason the intercept of the $t(N_i)$ function also increases from N_1 to N_2 to N_3 .

The latency data for the four types of probes are presented in Fig. 7. Note that latency increases with set size and is ordered such that P is fastest, and N_1 , N_2 , and N_3 are progressively slower. The straight lines in the figure represent theoretical predictions of the model. The derivation of theoretical equations and methods of parameter estimation are described in Atkinson and Juola (1974) and will not be reviewed here. It should be noted that the model not only predicts the response-time data, but also the probability of an error as response time varies over the four trial types. The complete set of parameter estimates is reported in Atkinson and Juola (1974), but several are given here since they play a role in later discussions, namely,

$$(l + \rho + r_1) = 499 \text{ msec} \quad \kappa = 70 \text{ msec}$$

$$(l + \rho + r_0) = 563 \text{ msec} \quad \alpha = 34 \text{ msec}$$

The results displayed in Fig. 7 indicate that the familiarity manipulation had a large and predictable effect. The predicted slope for P items was 24 msec, whereas the predicted slopes for N_1 , N_2 , and N_3 items ranged from 18 msec, to 22 msec, to 28 msec. If the subject ignored the familiarity value and searched STS on every trial, then all four functions would have a slope of 34 msec (the estimated value of α).⁶

Other experimental manipulations also should lead to variations in familiarity. The prototype experiment described at the start of this section can be viewed as involving an infinite pool of words from which the experimenter selects stimuli on each trial. Compare this procedure with one where the pool is restricted (say to 10 words), and on each trial stimuli are drawn without replacement from the pool. In the first procedure, words are never repeated during the course of an experiment; in the second procedure, repetitions occur frequently from trial to trial. The second case corresponds to the original memory-scanning study by Sternberg (1966) where the item pool was the digits from 0 to 9.

When no words are repeated, the familiarity index for targets should be substantially higher than for distractors, thereby making familiarity an effective dimension on which to make a decision. When a small pool of words is used, the

⁶Inspection of response time (in the final block of trials) for individual subjects indicates that they are bimodally distributed as would be expected from the theory; one mode, associated with a fast response based on familiarity alone, and the other mode for slower responses based on extended searches of memory. Analysis of RT distributions is complicated by the fact that there are too few observations on each subject, and further, that response times over-all tend to decrease during the course of the experiment. To fit the observed distributions one would have to elaborate the model to include assumptions about the distributions associated with each stage in the process, and about over-all decreases in response time with practice.

familiarity value of all items will be raised, thus tending to wash out differences in familiarity between targets and distractors. Under these conditions the familiarity index will be less useful and a search of STS will be required more frequently. Support for this view comes from a study by Rothstein and Morin (1972) who ran just this type of comparison. They reported steeper slopes and higher intercepts for RT functions when the memory sets were selected repeatedly from a small pool. The repeated presentation of items increases the familiarity of all items to a high level, thereby reducing the usefulness of the familiarity measure as a basis for responding. Consequently, the probability of searching STS should be high, causing the slope of the RT function to be near its maximal value.

In addition to the relative familiarity of targets and distractors, another factor influencing the likelihood of searching STS is the placement of a subject's criteria. For example, if the subject is instructed to avoid errors, the appropriate strategy would be to set c_0 and c_1 relatively far apart, thereby insuring that a search will be conducted on most trials. Since the time necessary to complete a search depends on memory-set size, both over-all latency and set-size effects should be increased. Alternatively, if response speed is emphasized in the instructions, the criteria c_0 and c_1 should be placed close together so that most responses will be based on familiarity alone. In this case, over-all latency would be decreased and minimally influenced by set size.

William Banks of Pomona College ran such an experiment in our laboratory with the anticipated results. An entirely new set of words was presented on each trial as the memory set; set sizes were 2, 3, 4, 5, and 6 and varied randomly over trials. Targets and distractors occurred equally often, and the distractors always involved new words. Subjects served in two experimental conditions: accuracy instructions and speed instructions. The RT data for correct responses are presented in Fig. 8. If the criteria are being adjusted as suggested above, then the model predicts that the slope and intercept of the RT functions under accuracy instructions should be greater than under speed conditions. The results shown in Fig. 8 support this prediction; also, the pattern of error data is consistent with the model. Similar results have been reported by Weaver (1972) with memory sets of letters and a wider range of set sizes. It should be noted that Swanson and Briggs (1969) and Briggs and Swanson (1970) have found no differences in slope of the RT-set size function across speed and accuracy conditions. Comparison of their payoff matrices with those of Banks and of Weaver, however, suggests that Briggs's and Swanson's incentive system was not strong enough to cause subjects to adjust their criteria and rely more heavily on the familiarity measure.

MEMORY SEARCH WITH LARGE TARGET SETS

A recognition task comparable to the one discussed in the last section can be formulated for very large target sets. Prior to the test session, the subject is required to learn a long list of words to a criterion of perfect recall; this list serves

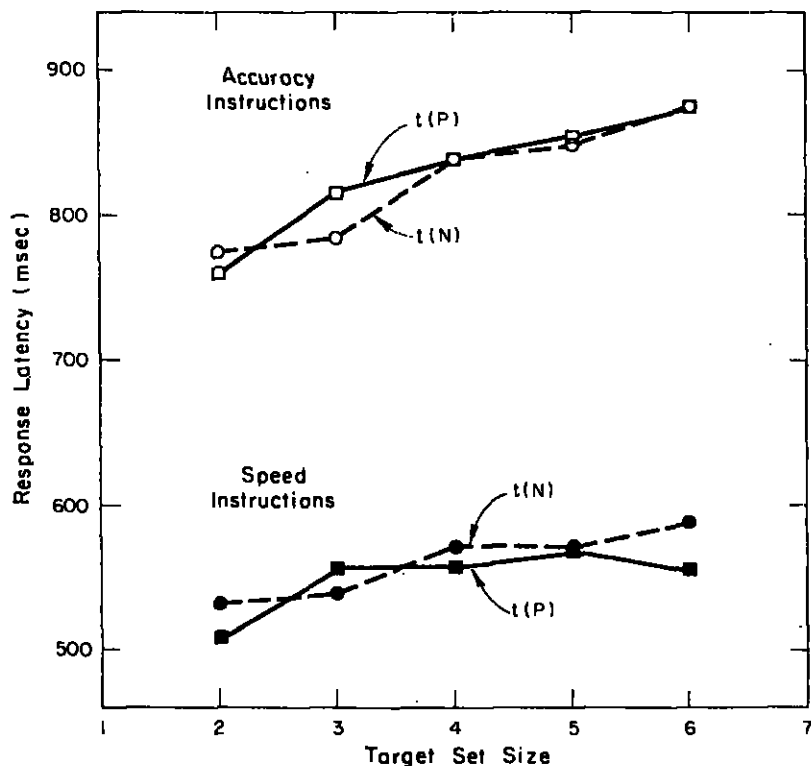

FIG. 8. Mean response latencies for P-items and N-items for five target-set-size conditions in an experiment manipulating instructions to subjects, emphasizing accuracy in one condition and speed in another.

as the memory set for the remainder of the experiment. The test session involves a series of trials where either a target word or a distractor is presented; the subject is instructed to make a positive response to an item from the list and a negative response otherwise. A number of studies have been done using this technique with target sets ranging from 10 to 60 words. These studies have been reviewed elsewhere (Atkinson & Juola, 1973) and interpreted in terms of the model presented here.

In this paper we will consider only one such study, which manipulated the size of the memory set (16, 24, and 32 words) and the number of times targets and distractors were presented during the test sequence; for a detailed account of the experiment see Atkinson and Juola (1974). Figure 9 presents RT data from the final block of test trials as a function of target set size; some words (whether targets or distractors) were presented for the first time during this final trial block, while others had been presented earlier in the test sequence and thus were receiving a repeated presentation. The left-hand panel presents RTs for correct responses to targets and distractors receiving their initial presentation in the final

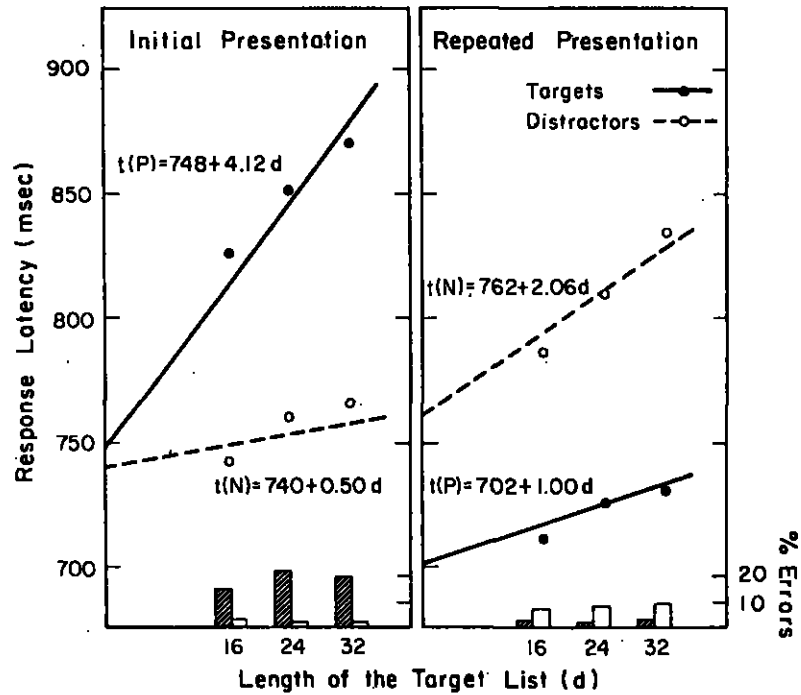

FIG. 9. Mean response latencies and error percentages as functions of target list length. The left panel presents data for initial presentations of target and distractor words, and the right panel presents data for repeated presentations. Incorrect responses to target words are indicated by the shaded bars, and errors to distractors by the open bars. The straight lines fitted to the data represent theoretical predictions.

block of test trials; the right-hand panel, for words receiving a repeated presentation. In both panels RTs increase with the size of the memory set; however, the slopes of the functions are much less than is observed when smaller memory sets are involved: It is interesting to note that repeating an item has a different effect if that item is a target word as compared with a distractor. Positive responses are slower and show a steeper slope to the initial presentation of a target word as compared to a repeated presentation of a target word; in contrast, negative responses are faster and have a more shallow slope to the initial presentation of a distractor than to a repeated presentation of one.

The model to be applied here is the same as the one developed in the last section. The only difference is that the memory set exceeds the capacity of STS, and it is assumed to be stored in EKS. Figure 10 presents a flow diagram of the process. The test item is encoded and the appropriate CS node is accessed, leading to the retrieval of a familiarity value. If the familiarity value is above c_1 or below c_0 , the subject gives a fast response. Otherwise, the subject retrieves a code for the test word to use in scanning the memorized list in EKS. Thus far the model is identical to that for the short-term case presented in the last section. How-

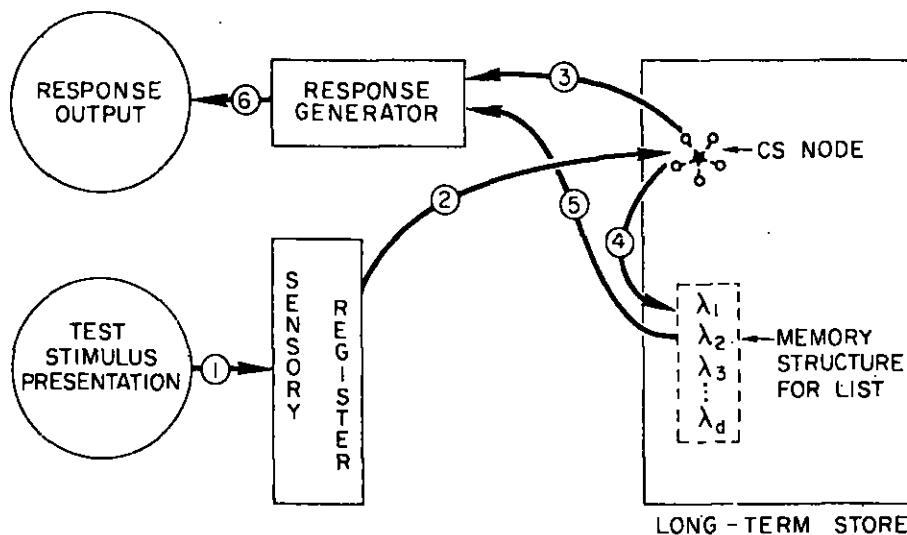

FIG. 10. A schematic representation of the search and decision processes in long-term recognition memory. A test stimulus is presented (1) and then encoded and matched to an appropriate CS node (2). The familiarity index associated with the node may lead to an immediate decision (3) and in turn to a response (6). Otherwise, an extended search of the stored target list is initiated (4), which eventually leads to a decision (5) and a subsequent response (6). Path (1), (2), (3), (6) represents a much faster response process than path (1), (2), (4), (5), (6), and one that is independent of target-set size.

ever, the code used to search the EKS may not be the same as that used in the short-term memory search. For example, Klatzky, Juola, and Atkinson (1971) present evidence that alternative codes for the same test stimulus can be generated and compared with either verbal, spatial, or conceptual representations of memory-set items. After retrieval of the appropriate code, a search of the memory set is executed, leading in turn to a correct response. Note that a response based on familiarity follows the same path as was proposed for familiarity decisions in the short-term case. However, when a search of EKS is required we assume that the time to initiate the search (κ) and the search rate per memory set item (α) will not be the same as in the short-term case; this difference in the search rate may be due either to the storage of different types of codes in STS and EKS, to differing search and comparison processes within the stores, or to both. Restated, the parameters l , ρ , r_1 , and r_0 are the same in the long-term and short-term cases; these cases differ only with respect to the values of κ and α . Thus, Eqs. (3) and (4) apply here, except that the estimates of κ and α should differ for experiments involving large memory sets.

For the conditions of this particular experiment, the criteria c_1 and c_0 are assumed to be fixed and independent of the size of the memory set. The effect of repeating a word during the test sequence is to boost its familiarity value; this boost in familiarity is assumed to occur for both repeated targets and repeated

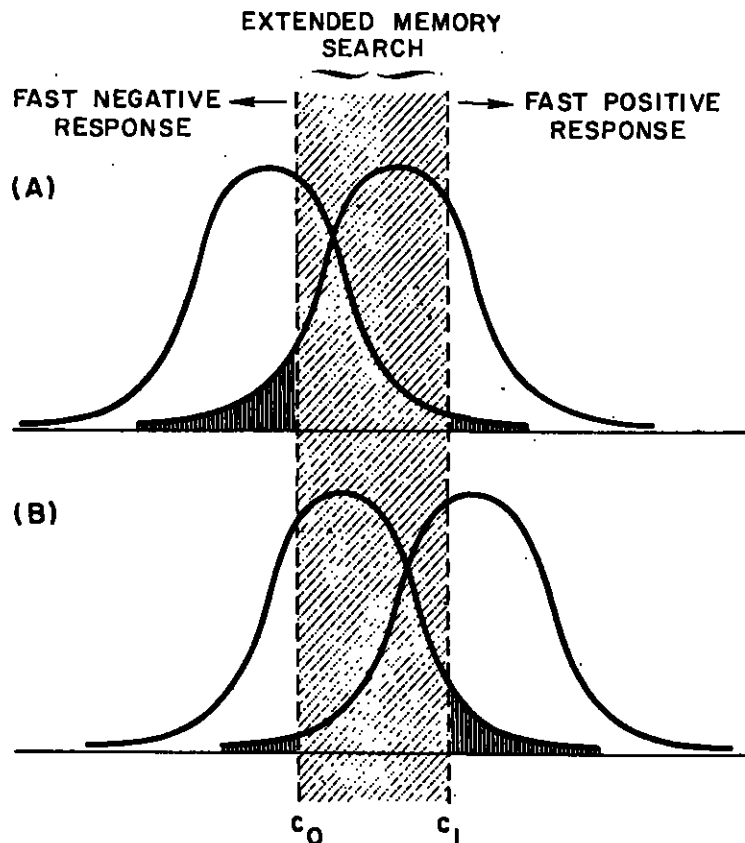

FIG. 11. Distributions of familiarity values for distractor and target items when presented for the first time (Panel A), and when receiving a repeated presentation (Panel B).

distractors. Figure 11 illustrates the familiarity distributions for targets and distractors when presented for the first time (top panel), and for targets and distractors when receiving a repeated presentation (bottom panel). Note that the likelihood of searching EKS is less on the repeated presentation of a target word than on the initial presentation of a target word; in contrast, the reverse holds for distractors. In terms of s and s' defined in Eqs. (1) and (2), s is less for a repeated presentation of a target and s' is greater for a repeated presentation of a distractor. Of course, the greater the likelihood of searching EKS, the steeper the slope of the RT function (i.e., the slopes of the target and distractor functions approach α as s and s' approach one, respectively).

A quantitative application of the model sketched above leads to the predicted functions displayed in Fig. 9. The slopes and intercepts for targets and distractors show the appropriate relationships for initial and repeated items. In addition, the theory accurately predicts error rates and RTs for errors. The details of the model

and its fit to these data are presented in Atkinson and Juola (1974). It is important to note that the parameter estimates for this case differ from the short-term study discussed in the last section. The time, κ , to initiate the EKS search is 137 msec, as compared to 70 msec for the STS search; in contrast, the search rate per memory-list item, α , is 10 msec for EKS compared to 34 msec for STS. Thus, the search is initiated more rapidly if it involves the STS, but comparison time per memory-set item is much faster for EKS.

To summarize, the same model is applicable to experiments using large memory sets as well as for those using small sets; the difference is in the extended search on those trials where familiarity is not used to make a decision. The complex pattern of data in Fig. 9 is interpretable in terms of the model if we assume that there is a boost in familiarity whenever a word is presented for test.⁷ It should be noted, however, that the increase in familiarity is short-lived. Juola, Fischler, Wood, and Atkinson (1971) found that the effect on RT of repeating an item diminished as the lag between the initial and repeated presentations increased, indicating that the boost in familiarity decays over time.

An interesting feature of the data reported in this section is the absence of a serial-position effect in RTs. If the time to make a response to a target word is plotted as a function of the serial position of that word in the original study list, the result is a flat line. There is absolutely no trend relating RT to serial position; that is true for initial and repeated presentations of target words separately, as well as for the combined data. The same phenomenon has been observed in other studies using a similar design (Atkinson & Juola, 1973) and is rather surprising since the subjects were required to master the list in a strict serial order. Theoretically, this means that both familiarity effects and the EKS search are independent of a target item's position in the memory list. The absence of a serial-position effect in these experiments, however, does not mean that organizational factors influencing the acquisition of a target set will not affect RTs in the recognition phase of the experiment. In one study reported by Atkinson and Juola (1973), the set of target words was organized and learned as a semantic hierarchy; under these conditions RTs on the recognition tests varied as a function of the placement of the word in the original hierarchy.

Another example, more closely related to the experiment reported in this section, is a study conducted by Susan LeVine at Stanford University. Her test

⁷An increase in familiarity is not restricted to presenting the word in a test sequence. We have run a study similar to the one described in this section, except that the target set involved 25 words and distractor words were never repeated during the sequence of test trials. The test sequence involved two blocks of 50 trials each with a brief break between trial blocks. During the break subjects were given written instructions regarding a task they supposedly were going to participate in immediately after completing the second block of test trials; subjects were required to read the instructions twice, once silently and once aloud. In actual fact, 10 words in the instructions served as distractor words in the second block of test trials. Comparing RTs for distractor words that had been in the instruction set with those that had not yielded a statistically significant difference. Distractor words used in the instructions were responded to more slowly, as would be expected if their familiarity value was increased by including them in the instruction set.

sequence involved a target set of 48 words; half of the test trials involved target words and half distractors. The unique aspect of the study was the method for memorizing the target set. The subject memorized the 48 words as 24 paired associates and used an anticipation procedure. Eight of the paired associates were tested and studied on every trial of the training session, eight pairs on every other trial, and eight pairs on every third trial; thus, by the end of learning some pairs had been brought to a "high" acquisition level, others to a "medium" level, and others to a "low" level. In the recognition phase of the experiment, there were 96 trials; 48 trials tested individual words from the study list (positive trials) and 48 involved words not previously studied (negative trials). The RTs for correct responses to target words are presented in Fig. 12 along with error rates; the RT for correct responses to distractors was 758 msec with an error rate of 3 percent. Inspection of Fig. 12 indicates that RT is faster to a word that was a response member of a paired associate as compared with a stimulus member. Even for those words that have been perfectly mastered (i.e., high acquisition set), the stimulus versus response role of a word had an effect on recognition performance.

It is interesting to note that RT is related to the acquisition level; the more times a word was presented during study, the faster the RT. The fact that RT varied

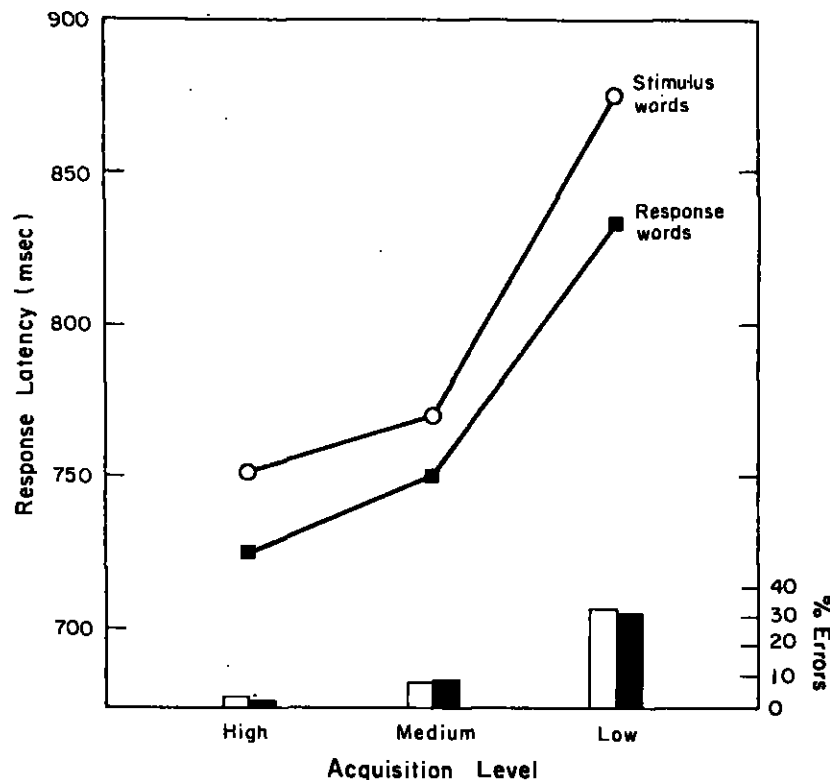

FIG. 12. Mean response latencies and error percentages across three conditions of acquisition for targets that were either stimulus or response members of paired associates.

with acquisition level suggests that the list-length effects in the prior study might be explained in the same way. One could assume that in mastering a memory list, the longer the list the lower the acquisition level at the start of the test series. Thus, the effect of list length on RT might be explained by a lower degree of mastery of the longer lists, rather than by a longer EKS search as we have done. This type of explanation could be accommodated by the theory, but we rejected it because of the error-rate data. In the paired-associate study, error rates increased as the acquisition level decreased (see Fig. 12). However, in the list-length study, both error rates and their reaction times were constant over list lengths; nevertheless, reaction times for correct responses increased with list length. For this reason we assumed in the theoretical analysis that all lists were equally well learned, that familiarity distributions were invariant over list lengths, and that the RT effects were to be explained by a longer (but equally accurate) search of the longer lists. This is an important point and emphasizes that we do not regard the linear search function postulated in this and the previous section as critical to the theory, rather, different search functions can be postulated depending on the organization

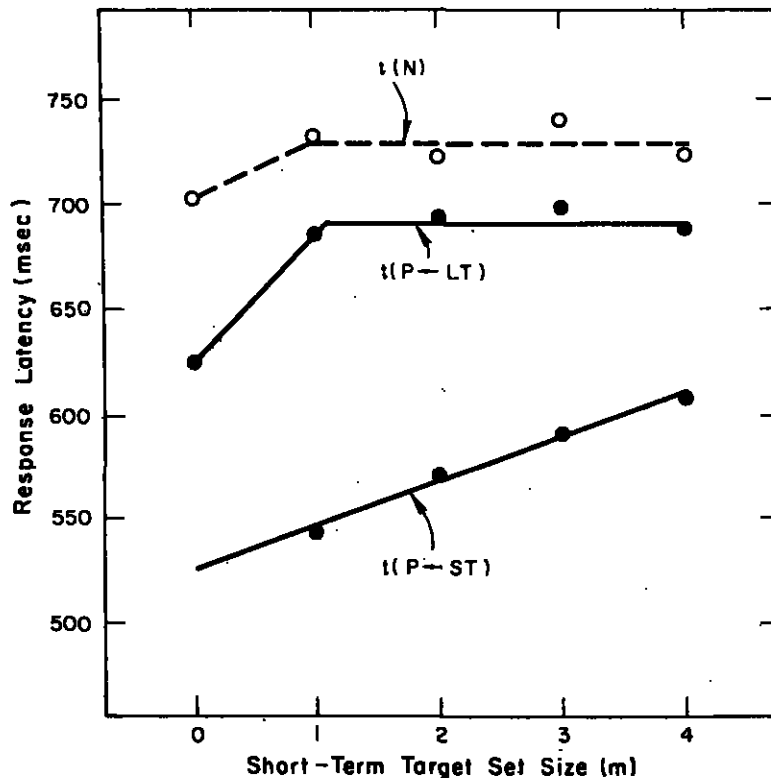

FIG. 13. Mean response latencies for targets ($P \leftarrow ST$, $P \leftarrow LT$) and distractors (N) as a function of ST set size in an experiment involving short- and long-term target sets. The straight lines fitted to the data represent theoretical predictions.

of the target list and the feature sets by which target items are coded in EKS. For the experiments considered in this paper a linear function appears to provide a good approximation.

MEMORY SEARCH WITH BOTH LARGE AND SMALL TARGET SETS

The experiments reported in this section involve a mix of the procedures discussed in the previous two sections. Prior to the test session, the subject memorizes a list of 30 words (designated the LT set) to a criterion of perfect mastery. In addition, each trial of the test session begins with the presentation of a short list of words (designated the ST set) that have never been shown before in the experiment. The test phase of the trial involves the presentation of a word, and the subject is required to make a positive response if the word is a member of either the LT set or the current ST set, and a negative response otherwise; thus a target is a word from either the LT or ST set, and a distractor is a word never previously used in the experiment. The size of the ST set varies from 1 to 4; half of the targets are from the ST set and half from the LT set. In addition, on some trials no ST set is presented, and then the target is necessarily from the LT set. Over trials, targets and distractors occur equally often.

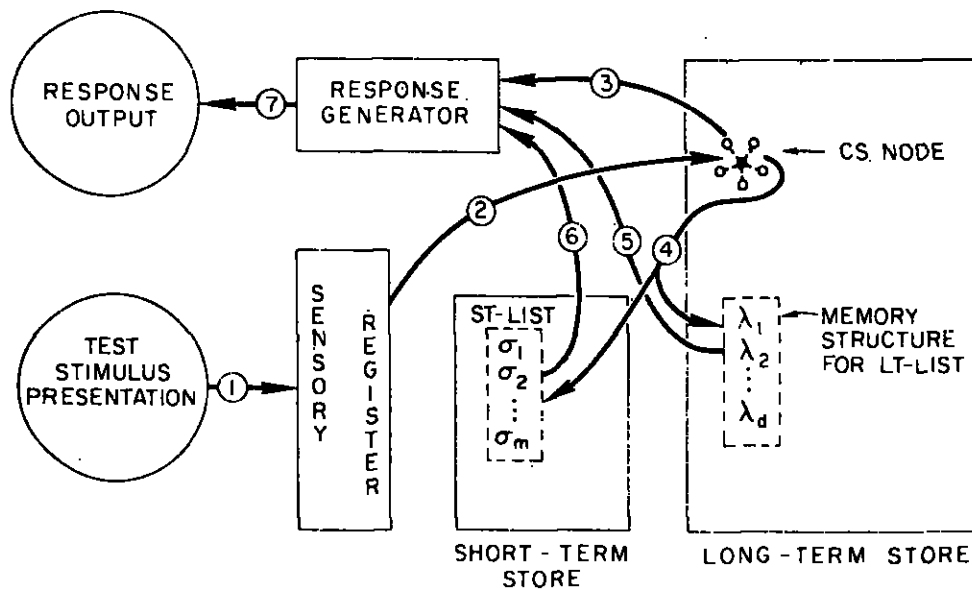

FIG. 14. A schematic representation when the target set is divided between STS and LTS. A test item is presented (1) and then matched to its CS node (2). The familiarity index of the node may lead to an immediate decision (3) and response output (7). Otherwise, appropriate codes are extracted from the CS node, and then used to simultaneously search STS and LTS (4). A decision about the test item is eventually made, based on the search of LTS (5) or of STS (6) and a response output (7).

Results from experiments by Wescourt and Atkinson (1973) and Mohs, Wescourt, and Atkinson (1973) are displayed in Fig. 13. RTs for targets and distractors are plotted as a function of m , the ST-set size; $t(P \leftarrow ST)$ and $t(P \leftarrow LT)$ denote the latency of a correct positive response to an ST and LT item, respectively, and $t(N)$ denotes a correct negative response to a distractor. Inspection of the figure indicates that $t(P \leftarrow ST)$ increases with the size of the ST set. In contrast, $t(P \leftarrow LT)$ and $t(N)$ seem to be independent of ST-set size as it varies from 1 to 4; however, the presence or absence of a ST set ($m = 0$ versus $m > 0$) has a marked effect on these two response times.

The model for this experiment is essentially the same as the one developed in the previous sections. A flow chart of the process is presented in Fig. 14. The LT set is assumed to reside in EKS, and each ST set is temporarily stored in STS. The recognition process first involves a check of the test word's familiarity value, which may lead to an immediate response. If not, a search of the EKS and STS will be required before a response can be emitted.

As described earlier, the decision to respond on the basis of familiarity alone is a function of the criteria c_0 and c_1 . Figure 15 presents a diagram of the familiarity distributions for ST-set words, LT-set words, and distractors. The relative positions of these distributions are not determined *a priori*, but are inferred from error rates associated with the three types of test items (i.e., the tail of the distractor distribution above c_1 determines the error rate associated with distractors; and the tails below c_0 for the ST and LT distributions, the error rates associated with ST and LT targets, respectively).⁸

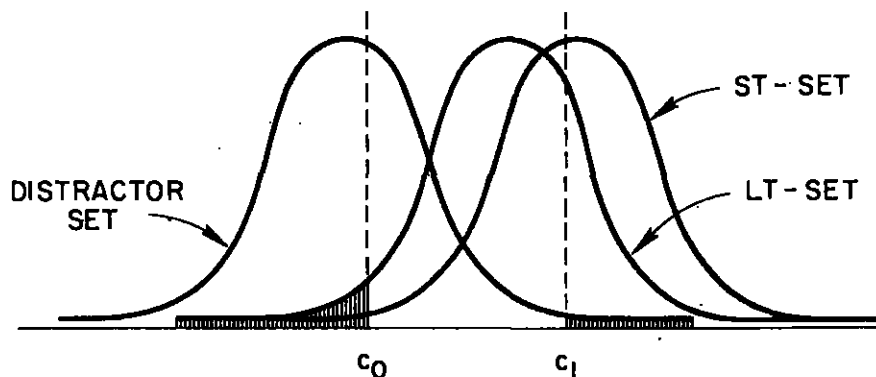

FIG. 15. Distributions of familiarity values for the three trial types.

⁸An experiment has been conducted by Richard Mohs in which elements of the LT set are included in the ST set on some trials; the time for a positive response to these items can be denoted as $t(P \leftarrow ST \& LT)$. The average response times in the experiment were ordered as follows: $t(P \leftarrow ST \& LT) < t(P \leftarrow ST) < t(P \leftarrow LT) < t(N)$. These results would be expected if the presentation of LT-set words within ST sets cause an additional boost of familiarity value for them.

When the retrieved familiarity value of a test word does not suffice for a decision to be made, then a search of STS and EKS is required. In this case, the principal issue is the order in which the two stores are searched. For example, the search could be first conducted in STS and if a match is not obtained, then continued in EKS. This scheme seems plausible since information in STS tends to be lost rapidly. However, if the two stores were searched in this order (and the time to search STS depended on the size of the ST set), then both $t(P \leftarrow LT)$ and $t(N)$ should increase as m goes from 1 to 4. Clearly, the data in Fig. 13 do not support this sequential search scheme. An alternative approach is to assume that STS and EKS are searched in parallel, and that if a match is found in either store, a positive response will be made; if both searches are completed and no match is established, then a negative response will be made.

The flow chart for the parallel-search process is shown in the right-hand panel of Fig. 16; the left-hand panel is for those trials on which the ST set is omitted and illustrates precisely the model developed in the previous section of this paper.

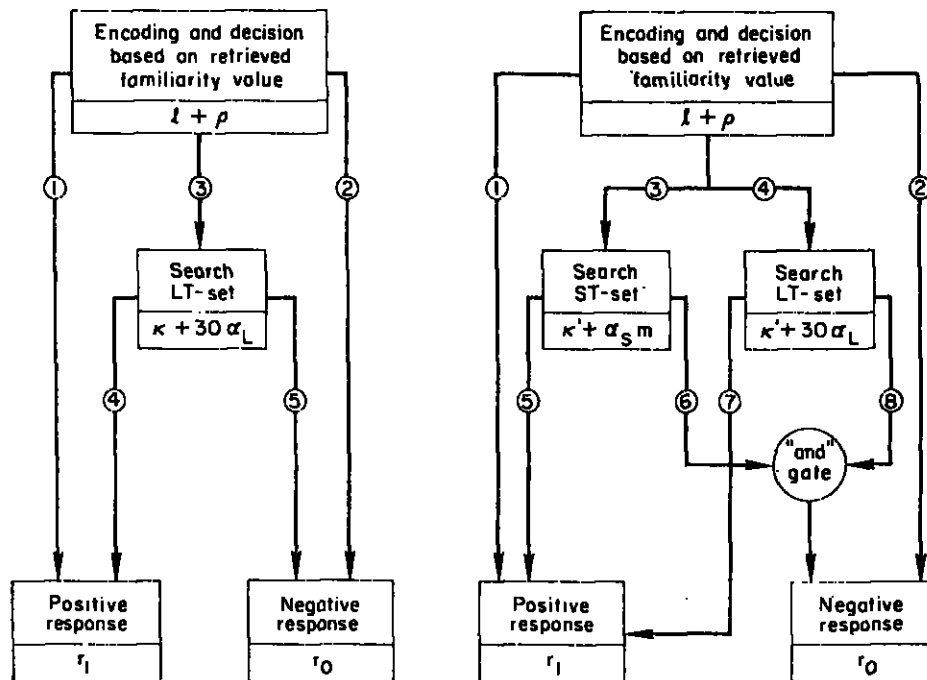

FIG. 16. Schematic representations of the processing strategies in searching the memory stores. The model when an ST set is omitted is shown in the left-hand panel; arrows (1) and (2) represent fast responses based on familiarity alone, whereas (4) and (5) represent responses after a search of EKS has occurred. In the right-hand panel a parallel-search model is presented for those trials on which an ST set is present. The arrows (1) and (2) represent fast responses based on familiarity. When a search is required, the ST and LT sets are searched simultaneously (3,4). If a match is found in the ST set (5) or in the LT set (7), a positive response will be made. If a match is not established in either set (6,8), a negative response will be made.

As indicated in the figure, the time κ' to initiate the search of both the EKS and STS (i.e., when $m > 0$) is assumed to be different from the time κ to initiate search of EKS alone (i.e., when $m = 0$). Once the search of a store is initiated, its rate is independent of whether or not any other store is being searched. We let α_S and α_L denote the search rates for the two stores. Thus, when an ST set is present, it takes time $\kappa' + \alpha_S m$ to search the STS store and time $\kappa' + 30\alpha_L$ to search EKS. When the ST set is omitted, it takes time $\kappa + 30\alpha_L$ to search EKS. Recall that the LT set is of size 30.

Since both stores are searched simultaneously when $m > 0$, the total search time will depend on which search required the most time. For the sizes of the ST and LT sets considered here, we assume that the STS search is always completed prior to the completion of the EKS search. Consequently, the search of STS will yield a match in time $\kappa' + \alpha_S m$ and the search of EKS will yield a match in time $\kappa' + 30\alpha_L$. If the test item is a distractor, then both searches will have to be completed (which takes time $\kappa' + 30\alpha_L$) before a negative response can be initiated. Thus, $t(P \leftarrow ST)$ will increase as m goes from 1 to 4, but both $t(P \leftarrow LT)$ and $t(N)$ will be independent of the size of the ST set. However, $t(P \leftarrow LT)$ and $t(N)$ will be faster when no ST set is present than when one is present, if κ is less than κ' .

A quantitative application of the model sketched out above leads to the predicted functions in Fig. 13. Not presented in the figure are error rates for the three types of test stimuli, but they also are accurately predicted by the model. (For a detailed account of this work, see Atkinson and Juola, 1974.) In fitting the model to these data, certain parameter estimates prove to be interesting:

$$\kappa' = 207 \text{ msec}$$

$$\kappa = 140 \text{ msec}$$

$$\alpha_S = 35 \text{ msec}$$

$$\alpha_L = 10 \text{ msec}$$

The κ and α_L recovered here are very close to the corresponding estimates made in the last section dealing with long-term target sets; similarly, the estimate of α_S is very close to the estimate of α recovered in the analysis of the short-term memory study. Finally, κ' , the time to initiate the joint search of EKS and STS, is significantly above κ , the time to initiate the search of EKS alone.

In the model, we assumed that α_L is independent of the size of the ST set; any difference in the search of EKS on trials with and without an ST set is simply due to κ' and κ , respectively. Independent support for this assumption comes from an experiment conducted by Keith Wescourt. The experiment exactly replicated the procedure described in this section, except for positive test words: All positive

test words were drawn from the LT set and the ST set was never tested. Subjects had to maintain 0 to 4 items in STS for recall at the end of the trial; however, they were told (and it was always the case) that the test word would be either an LT item or a distractor. Under these conditions, the latency of a positive response to an LT item and of a negative response to a distractor did not display a jump from the $m = 0$ condition to the $m > 0$ conditions; rather, both latency functions were constant as the ST-set size varied from 0 to 4. The parameters κ and α_t , estimated in the prior experiment can be used to predict these data; the parameter κ' was not required since only EKS needed to be searched even on those trials where an ST set was present. The existence of a load in STS *per se* had no effect on RT; what did affect performance in the original experiment was the relevance of the STS load for the scanning decision.

MEMORY SEARCH MODERATED BY SEMANTIC FACTORS

A number of studies, using both small and large memory sets, have shown that semantic factors can influence RT. In this section, recognition experiments involving semantic variables are considered, and the theory is employed to explain how they can affect search and decision processes.

A frequently used paradigm requires a subject to memorize a target set composed of sublists, where words on each sublist are from a given category. The number of sublists will be denoted by c , and the length of each sublist by d ; thus, the target set is composed of $c \cdot d$ words. For example, with $c = 2$ and $d = 3$, the target set might be

[(BEAR, LION, HORSE) (CARROTS, PEAS, BEANS)]

a total of six words from the categories *animal* and *vegetable*. Once the target set has been memorized, tests are initiated. On a test trial, one of three types of words is presented: (1) a word on the memory list (P-item) to which the subject is required to make a positive response; (2) a word not on the memory list but from a category represented on the list (N-items) to which the subject is required to make a negative response; and (3) a word not on the memory list and not a member of any of the categories represented on the list (N*-items) to which the subject also is required to make a negative response. In the above example, a P-item might be LION, an N-item might be DEER, and an N*-item might be NAIL. A target word (P-item) is presented with probability $\frac{1}{2}$, a related distractor (N-item) with probability $\frac{1}{2}\eta$, and an unrelated distractor (N*-item) with probability $\frac{1}{2}(1 - \eta)$. When $\eta = 1$, only P and N items are presented; when $\eta = 0$, only P and N* items; and when $0 < \eta < 1$, a mix of P, N, and N* items. The dependent variables of principal interest are again latencies of correct responses to P, N, and N* items and will be denoted as $t(P)$, $t(N)$, and $t(N^*)$, respectively.

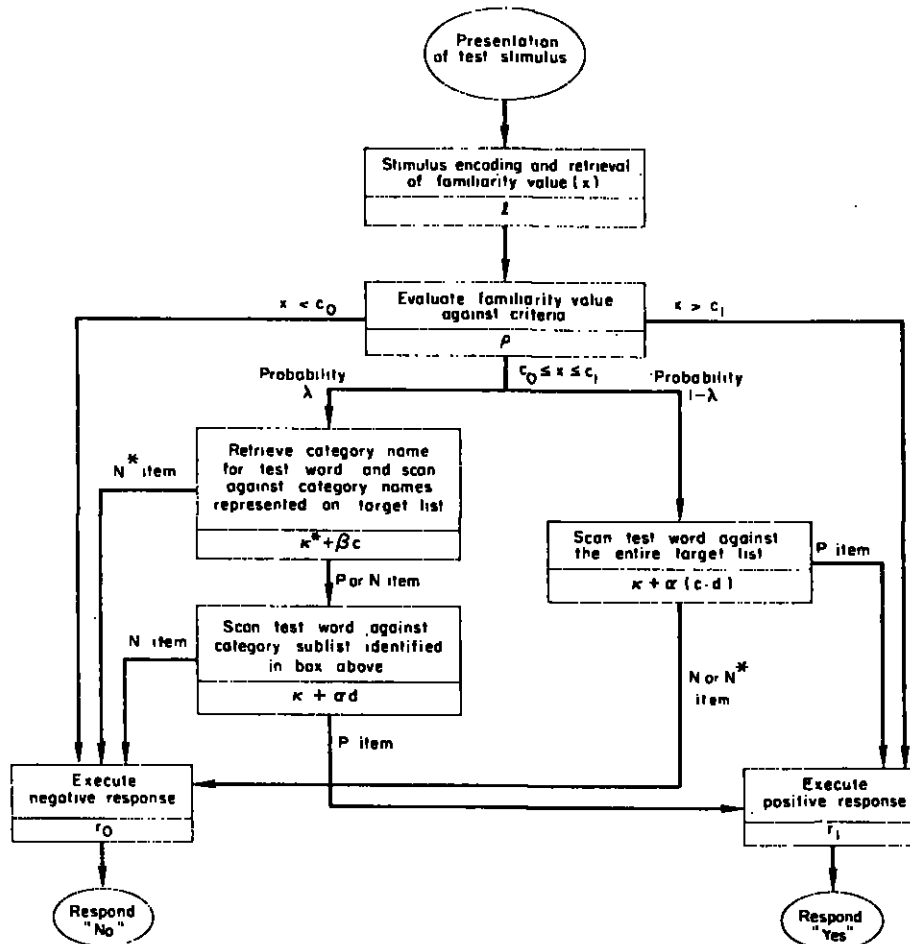

FIG 17. Representation of the processing stages underlying recognition performance when semantic factors may influence search in EKS. The subject may execute a rapid response based on familiarity or alternatively may search EKS. In the latter case, semantic information may be utilized to direct search on some proportion of trials; on other trials this information is ignored and the entire target set is scanned.

The theory as it applies in this situation is summarized in Fig. 17. A word is encoded (time t) and its familiarity value is retrieved and evaluated (time ρ). If the familiarity value is above c_1 , an immediate positive response is made; below c_0 , an immediate negative response. If the familiarity value is intermediate, the subject has two options. With probability λ he categorizes the test item and then scans its category name against the category names represented on the memory list. If no match occurs (N^* -item), a negative response is made; if a category-name match occurs, the subject then searches the appropriate category sublist of the memory set, making either a positive response (P -item) or a negative

response (N-item). Alternatively, with probability $1 - \lambda$ the subject ignores the semantic information in the test item and searches the entire memory list.

Given that the subject does categorize the test item, the time to retrieve its category name is κ^* , and the search rate among the c category names is β ; thus, the time for this stage is $\kappa^* + \beta c$. If the categorizing stage determines that the word is an N*-item, a negative response occurs. Otherwise, the subject next searches the sublist of the memory set identified by the categorization process; it takes time κ' to initiate the search, and its rate is α yielding time $\kappa' + \alpha d$ for this stage. Given that the subject does not categorize the item, the search of the entire memory list is presumed to take $\kappa + \alpha(c \cdot d)$; that is, time κ to initiate the search which proceeds at rate α for the total set of $c \cdot d$ items.

Figure 18 illustrates the familiarity distributions associated with P, N, and N* items. While not critical to the model, the N distribution is shown in the figure to have a higher mean than the N* distribution. The reason is that there is evidence to suggest that distractor items that are related to items on the memory list have a higher familiarity value than unrelated distractors (Juola et al., 1971; Underwood, 1972). This relation between the distributions would be expected if there were a spread of "activation" in the CS space in the areas of target-word nodes (Meyer & Schvaneveldt, 1971). Using Eq. (1), the quantity s can be defined for the P distribution. Similarly, using Eq. (2), the quantities s_N' and s_{N^*}' can be defined for the N and N* distributions. Once this has been done, the following expressions can be written for the time to make a correct response to each of the item types:

$$t(P) = (l + \rho + r_1) + s \{ \lambda [(\kappa^* + \beta c) + (\kappa' + \alpha d)] + (1 - \lambda) [\kappa + \alpha(c \cdot d)] \} \quad (5)$$

$$t(N) = (l + \rho + r_0) + s_N' \{ \lambda [(\kappa^* + \beta c) + (\kappa' + \alpha d)] + (1 - \lambda) [\kappa + \alpha(c \cdot d)] \} \quad (6)$$

$$t(N^*) = (l + \rho + r_0) + s_{N^*}' \{ \lambda [\kappa^* + \beta c] + (1 - \lambda) [\kappa + \alpha(c \cdot d)] \}. \quad (7)$$

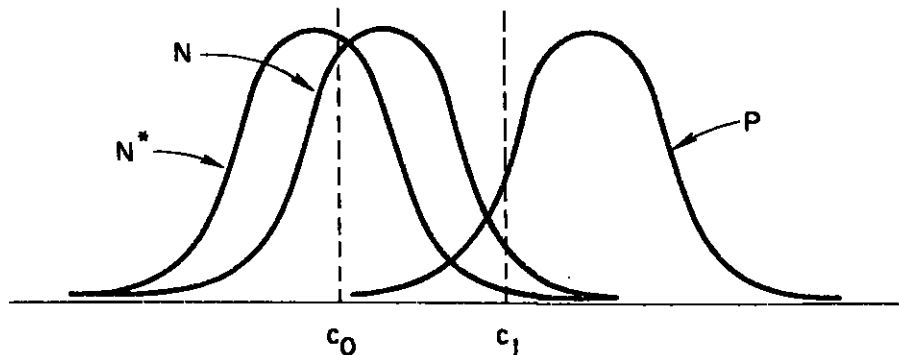

FIG. 18. Distributions of familiarity values for the two types of distractor items (N*, N) and for target items (P).

How does the subject select between his two options: Should he first categorize a test item or search the entire memory list? We offer no theory to explain this selection and propose to estimate λ from the data. However, if all parameters of the process are fixed and the subject is trying to minimize his average response time over all trial types, then λ should be selected as follows: If the quantity $[(\kappa^* + \beta c) + \frac{1}{2}(1 + \eta)(\kappa' + \alpha d)]$ is greater than $[\kappa + \alpha(c \cdot d)]$, set λ equal to 0; otherwise set λ equal to 1.⁹ Stated somewhat differently, an optimal setting for λ depends on an interplay of search parameters with the structure of the list (the values of c and d) and the nature of the test schedule (the value of η). Although estimates of the various search parameters vary from study to study (see Juola & Atkinson, 1971), the data indicate that (a) β is about three times as large as α , and that (b) κ^* and κ are fairly close to each other with κ' somewhat smaller.

Figure 19 presents unpublished data from two separate experiments, one conducted by Homa (1972) as part of a Ph.D. thesis at the University of Wisconsin, and the other as a pilot study at Stanford University. For the data displayed in the figure, $\eta = \frac{1}{2}$ and $c = 2$; the Homa data are for d equal to 2, 3, and 5, whereas

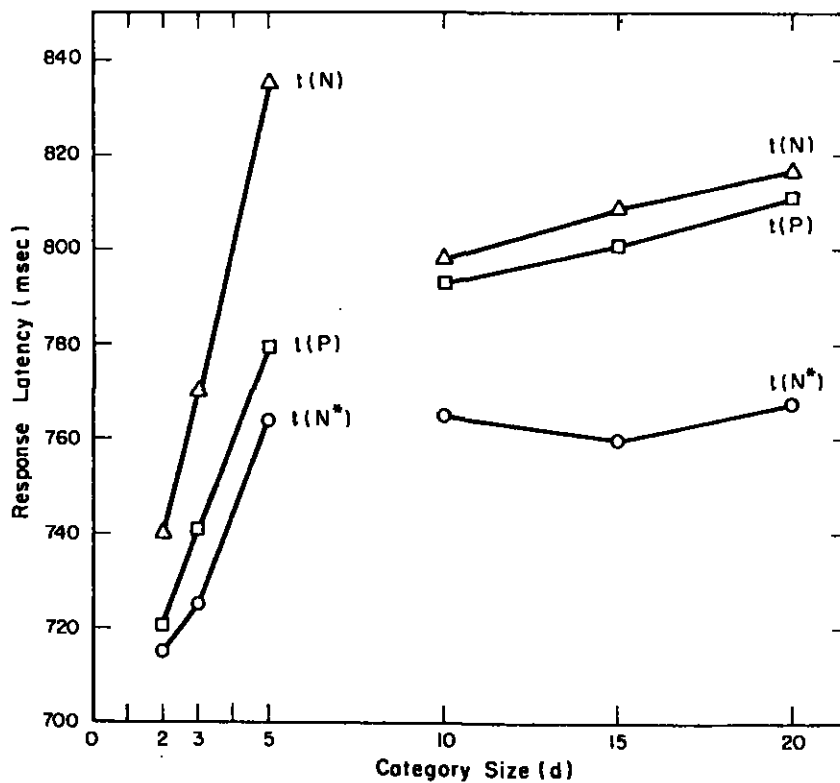

FIG. 19. Mean response latencies for positive items (P) and for semantically related (N) and unrelated (N*) negative items as a function of category size (d).

⁹A similar proposal has been made by Naus (1972).

the Stanford data are for d equal to 10, 15, and 20. No attempt will be made to generate quantitative predictions for these data; it is evident that appropriate parameter values can fit the results. The main point to consider is the effect of d on $t(N^*)$. In the Homa data, $t(N^*)$ is increasing and at about the same rate as $t(N)$, which indicates that λ is close to zero; thus, when d is relatively small, the subject is scanning the entire memory list and not attempting to categorize test items. For the Stanford data, $t(N^*)$ is relatively constant over the three values of d while $t(N)$ shows a sizable increase; this finding, of course, implies that λ must be equal to one (i.e., that the subject is categorizing each test item and processing the item accordingly).

These results are what one might expect if the subject is attempting to set λ optimally. When d is small, the slow scan of the category names is not warranted, but when d becomes large, there is an advantage to categorizing and, only if necessary, making a search of the appropriate sublist. Thus, the subjects appear to be selecting a value of λ in accordance with the specific parameters of the search task.¹⁰

There are other results that can be cited to support the λ -process proposed here. For example, Homa has data where $c = 12$ and $d = 1$ for which the estimate of λ is zero. On the other hand, Tarrow Indow (personal communication) has data for $c = 1$ and d varying from 5 to 27; these data are consistent with the view that λ is zero for small values of d , but increases to one for d greater than 10 or 12.

We have not provided a quantitative fit of the model to the data presented here. The reason is that the task is quite complex from a theoretical viewpoint; the subject has alternative strategies to apply, which means that different subjects may be electing different mixes of strategies in a given experimental condition. Hence, a quantitative evaluation of the model requires carefully designed experiments and a large sample of data for each subject. It is clear, however, that the basic outline of the theory is correct. An individual subject may or may not retrieve a category name for a test item, depending on the structure of the memory list (the values of c and d) and the nature of the test sequence (the value of η).¹¹

The experiments considered in this section have all used words for the stimulus materials. Comparable experiments have been run using letters and digits to distinguish between P, N, and N* items. For example, the memory set might be

¹⁰The model proposed here assumes that the subject selects between one of two search strategies with probability λ . Another approach is to assume that both searches (the search by categories and the search of the entire list) are initiated simultaneously and that the one finishing first determines the subject's response latency; this type of assumption is in accord with a model proposed by Naus, Glucksberg, and Ornstein (1972). Under certain conditions, the simultaneous search model generates the same predictions as the model developed in this paper. Thus, the particular interpretation that we offer is open to question, and an argument can be made for a simultaneous search.

¹¹Studies can be run that vary the length of sublists within a memory list. For example, the memory list can involve three categorized sublists with one having 4 words, the second 8 words, and the third 12 words for a total set of 24 (i.e., $c = 3$, $d_1 = 4$, $d_2 = 8$, $d_3 = 12$). Applications of the theory to these experiments is straightforward, but the equations are cumbersome.

composed of three letters, with the test involving a letter from the memory set (P-item), a letter not in the memory set (N-item), or a digit (N*-item). Results from these experiments have been somewhat variable. There are studies (Williams, 1971; Lively & Sanford, 1972) where the estimate of λ is significantly greater than zero for small memory sets of three or four items. For other studies, as we shall see in the next section, the estimate of λ is very close to, if not exactly, zero. It appears that when words are used as the stimulus materials, the estimate of λ is invariably zero for small memory sets; but when letters versus numbers are used, λ is sometimes greater than zero. Of course, when letters versus digits are used, it is conceivable that the subject may be classifying the probe on the basis of perceptual features; clearly, when words are used, there is no possibility for category classification based on perceptual cues, but with letters versus digits such a possibility may exist depending on the type font and displays used. A greater readiness to classify on the basis of perceptual factors than on semantic factors is consistent with the viewpoint developed in this paper, which distinguishes between perceptual codes and conceptual codes. Since a test stimulus will be represented in the memory system as a perceptual code before it can be represented as a conceptual code, strategies that allow accurate responding by processing perceptual codes will be preferred in those tasks where response speed is an important task demand.

MEMORY SEARCH INVOLVING A DUPLEX TARGET SET

In this section we examine an experiment that has similarities to the ones considered in the previous two sections; nevertheless, its theoretical analysis requires separate treatment. The experiment is one in a series of studies conducted by Charles Darley at Stanford University dealing with duplex target sets. His research on this problem is in an early stage, and the theoretical treatment given here may prove to be premature. The task is of such intrinsic interest, however, that some discussion of it seems warranted at this time.

On each trial the subject is presented with a target set composed of two subsets—one of letters and the other of digits. The target set is presented visually, with one subset on the left and the other on the right; whether letters or digits are on the left is determined randomly on each trial. The sizes of the two subsets are also randomly determined from trial to trial, each independently taking on the values 1, 2, or 3; the digits are drawn from the numbers 1 through 9 and the letters from a restricted alphabet with the vowels deleted. When the subject has the target set in mind, a test stimulus, which is either a letter or digit, is presented. The subject is required to make a positive response if the probe is from the target set, and a negative response otherwise. For example, the target set might be (D,B,K)(8,6); if any of these five items is presented at test, the subject should make a positive response; otherwise, a negative response. The subset that corresponds to the test stimulus will be called the *memory set* and the other the *load*

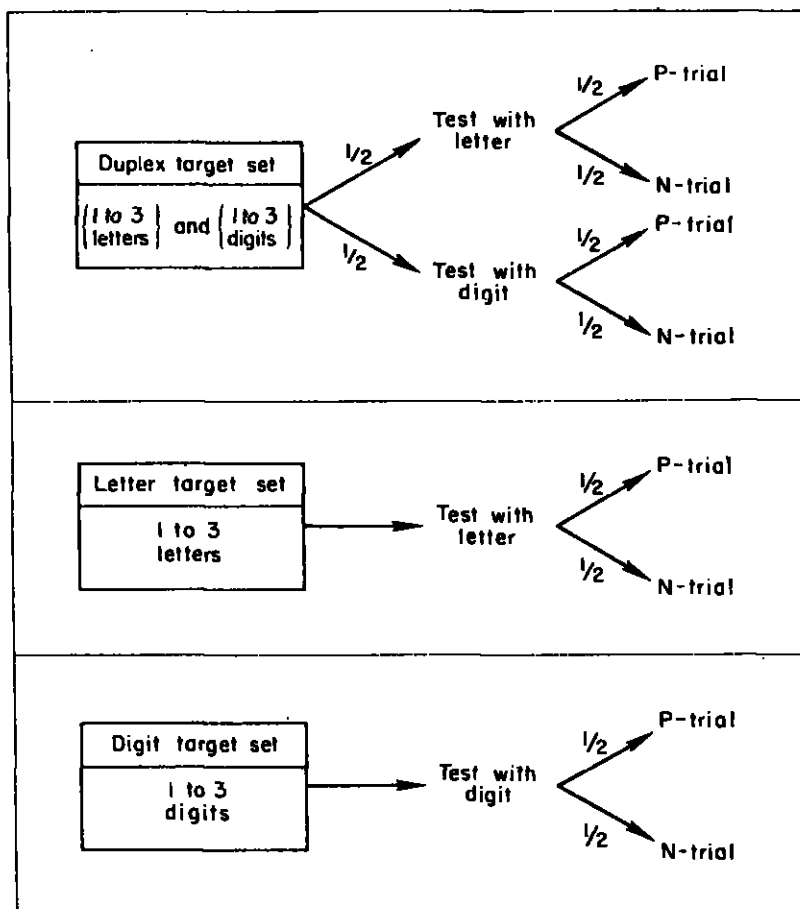

FIG. 20. Design of an experiment with duplex target sets. The upper panel describes trials presenting both a set of letters and a set of digits. The two lower panels describe trials presenting a homogeneous set of either letters or digits.

set. We let d_M denote the size of the memory set and d_L the size of the load set. In terms of the above example, if the test stimulus is a letter, then $d_M = 3$ and $d_L = 2$; if the test stimulus is a digit, then $d_M = 2$ and $d_L = 3$. Of course, until the test stimulus appears the subject does not know which array is the memory set and which is the load. The top panel of Fig. 20 presents a schematic account of a trial; letters and digits are tested equally often, and positive and negative trials are equally probable. The question of interest is how the scan of a memory set in STS is influenced by the size of a load set also in STS.¹²

¹²In this experiment, the subject was required to recall aloud the load set after he made his RT response; errors in this recall were extremely rare. The requirement to recall the load set does not seem to be an important factor, for Darley has run another study where the recall was omitted with results comparable to those to be reported here.

Mixed in with the duplex-type trials are others involving only a single target set (either 1 to 3 letters or 1 to 3 digits). These trial types are illustrated in the bottom two panels of Fig. 20; note that when the target set involves only letters, the test stimulus is a letter (and the same holds for digits). These trials correspond to the procedure used by Sternberg (1966) and will be called zero-load trials. In terms of the above notation, d_M takes on the values 1 to 3 and $d_T = 0$.

Average RT data for correct responses are shown in Fig. 21; error probabilities have not been presented since they were less than 3% overall. What is plotted is the average time for positive and negative responses as a function of memory-set size; each curve is for a different load size. The composition of the memory set did not have a statistically significant effect on RT, and consequently the data

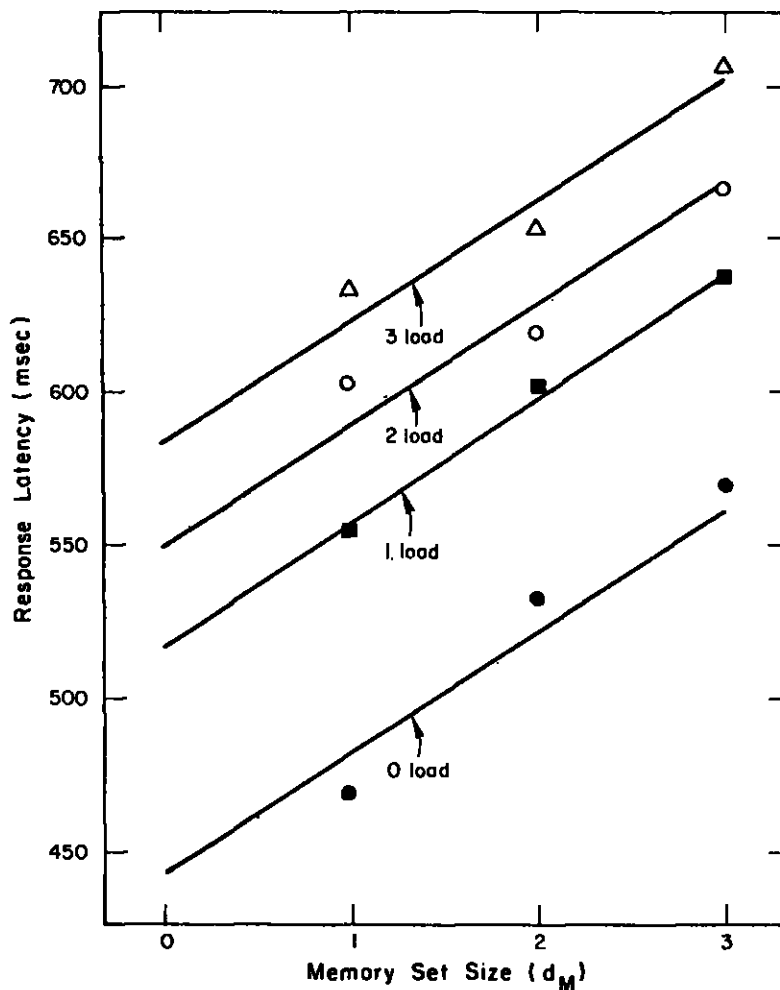

FIG 21. Mean response latencies (combining positive and negative trials) for four conditions of memory-load size as a function of three target set sizes.

have been averaged over both memory sets composed of letters and memory sets composed of digits. For example, in Fig. 21 the observed value of 601 msec for a memory set of two and a load of one is an average which includes positive and negative responses and memory sets of letters and of digits.

The results displayed in Fig. 21 indicate that the load has a clear effect on RTs, but only on the intercept of the functions. It appears that all four RT functions have approximately the same slope. The subject cannot simply be classifying the test stimulus as a letter or digit and then restricting the search to appropriate subset. If this were the case, the obtained equality of the slopes for the four functions would be predicted, but predictions for their intercepts would be incorrect. The three load functions would all have the same intercept, which would be above that

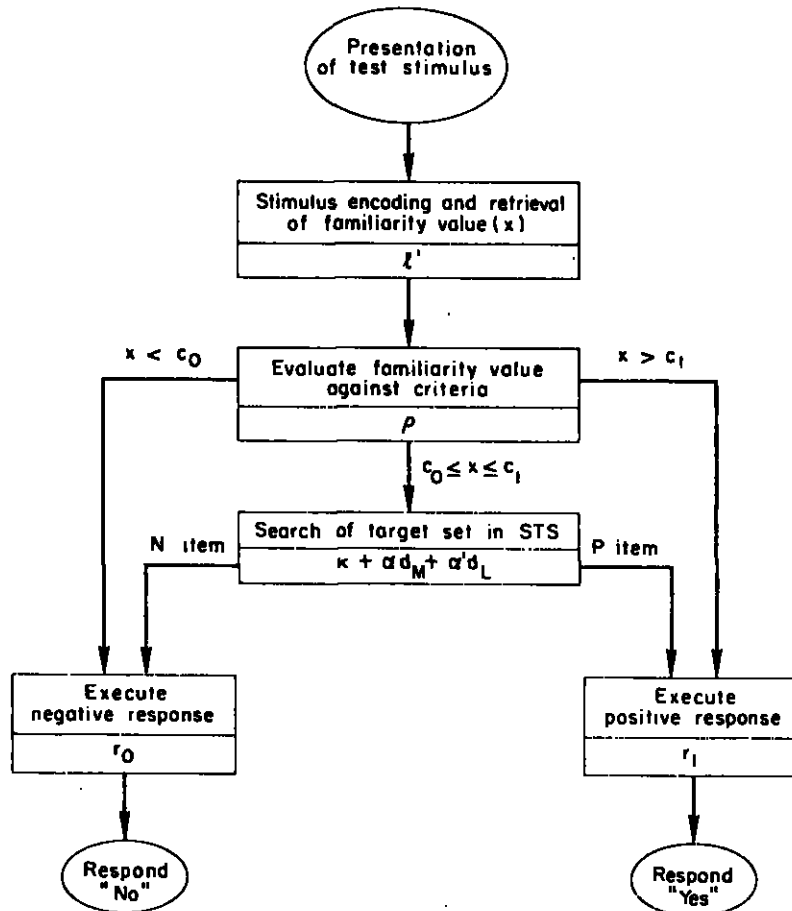

FIG. 22. Representation of the processing stages underlying recognition performance when there are two target sets in STS. A rapid response may be executed based on stimulus familiarity; otherwise, the encoded test stimulus is scanned against the contents of STS. The time of the search is a function of both target and load-set sizes.

for the zero-load functions; the intercept difference would reflect the time needed to determine which subset to search. A better fit to the data is not obtained by adding the assumption that maintaining a load set decreases the search rate for the memory set in proportion to load size. If this were the case, the three load functions would still all have the same intercept, and only their slopes would increase with load size.

It appears that the subject makes no attempt to limit the search by categorizing the test item but rather searches the entire target set; categorization would take time and is not warranted if that time is greater than the time required to search the load set. If target-set sizes were greater than those employed here, a categorization strategy might be used; in that case, a model like the one presented in the previous section would be appropriate.

Figure 22 presents the model for this experiment. As in previous sections, the familiarity distribution for a target item is assumed to have a mean above that for a distractor item, and to be independent of the size of the target set. First, the test stimulus is encoded and its familiarity value checked against the criteria c_0 and c_1 . Given a high or low familiarity value, the appropriate response is immediately executed. Otherwise, a search of STS occurs. The time to initiate the search of STS is κ . The search rate for items in the target set from the same class as the test item is α , and the search rate is α' for items from the other class. Thus, the search of STS on a duplex trial takes time $\kappa + \alpha d_M + \alpha' d_L$. When no load is present, the same process applies and is precisely the one presented in the second section of this paper (see Fig. 5). The only difference is with regard to the time parameter for encoding the test stimulus. In the zero-load conditions, the subject knows that the test stimulus will be from the same class as the target set; being able to anticipate which class the test stimulus will be from may facilitate the encoding process. To provide for this possibility, we let l represent the encoding time for the zero-load case in accord with previous notation and use l' for the load case. Otherwise, all parameter values are identical for the load and zero-load conditions; the target and distractor distributions for familiarity values, criteria values, and α are assumed to be the same on all trials.

For the zero-load case the equations for RT are identical to Eqs. (3) and (4). The proportion of positive and negative trials was equal in this experiment, and hence, averaging Eqs. (3) and (4), yields

$$t_M = (l + \rho + \bar{r}) + \bar{s}(\kappa + \alpha d_M) \quad (8)$$

Here t_M denotes average RT to a memory set of size d_M in the zero-load condition. The quantity $\bar{r} = (r_1 + r_0)/2$ and $\bar{s} = (s + s')/2$, where s and s' are as defined in Eqs. (1) and (2). Similarly, for the load conditions

$$t_{M,L} = (l' + \rho + \bar{r}) + \bar{s}(\kappa + \alpha d_M + \alpha' d_L) \quad (9)$$

where $t_{M,l}$ denotes average RT to a memory set of size d_M with a load set of size d_l . Note that t_M is a linear function of d_M with intercept $(l + \rho + \bar{r} + \bar{s}\kappa)$ and slope $\bar{s}\alpha$. Similarly, $t_{M,l}$ is a linear function of d_M with intercept $[(l' + \rho + \bar{r} + \bar{s}\kappa) + (\bar{s}\alpha'd_l)]$ and the same slope $\bar{s}\alpha$.

Fitting Eqs. (8) and (9) to the data using a least-squares method yields the predicted functions given by the straight lines in Fig. 21.¹³ There are only four identifiable parameters and their least-squares estimates are as follows:

$$(l + \rho + \bar{r} + \bar{s}\kappa) = 443 \text{ msec}$$

$$(l' - l) = 41 \text{ msec}$$

$$(\bar{s}\alpha) = 40 \text{ msec}$$

$$(\bar{s}\alpha') = 33 \text{ msec}$$

Note that α is greater than α' ; that is, the search rate for target items in the same class as the test stimulus is slower than the search rate for items in the other class. This relation is what would be expected if the time to establish a mismatch between two letters is slower than between a letter and a digit (and vice versa). Such a difference is consistent with representations of items as codes comprised of features. In general, fewer feature comparisons are necessary to find a mismatch between items in different classes than between items in the same class.

There are other interpretations that can be given to these data. For example, one might assume that the subject first decides which subset to search and then dumps the load set from memory before starting the search. If the time to dump the load set is a linear function of its size, this interpretation (properly formulated) generates the same predictions as the one presented above. For reasons that are too lengthy to discuss here we do not favor the latter interpretation. Nevertheless, until there is more research using this type of task, it will be difficult to choose between these and other explanations. In our view, however, familiarity plays the same role in the load and zero-load conditions, and an adequate model will have to take this factor into account.

DISCUSSION

The model described in this paper asserts that recognition memory involves the operation of a set of processes. The information processing stages that occur in a particular recognition task are determined by the physical parameters of the

¹³The model also has been fit to the data with the positive and negative RT's kept separate. The fits are comparable to those displayed here, but were not presented to simplify the discussion. It should be noted that the slope of the four positive functions was about 47 msec, whereas the slope of the four negative functions was about 33 msec. In the theory, this means that s is greater than s' . Similarly, the intercept of a negative function tended to be higher than the intercept of the corresponding positive function, indicating that r_0 is greater than r_1 .

experimental situation and by subjects' strategies. These strategies develop in accord with subjects' perceptions of task demands and abilities to apply alternative strategies. The experiments reviewed here support the model's major contention: Recognition decisions may be made quickly on the basis of partial information (familiarity), or they may be made more slowly, and more accurately, on the basis of an extended memory search. The data indicate that performance in a memory-scanning task represents a mixture of these two processes. Several factors have been shown to influence which of these processes subjects will tend to rely upon.

Besides these data, introspective reports seem to support the type of model developed here. Subjects report that sometimes they find themselves making immediate responses to a probe without "knowing for sure" whether or not it is a target item; on other trials, they report recalling portions of the target set before knowing how to respond. Subjects are almost always aware of their errors, indicating that although they may respond on the basis of familiarity, they continue processing by searching memory and thereby check their decision.

Limitations of the Mathematical Model

While we feel that the theory has wide applicability, certain qualifying comments need to be made about the specific models outlined in the previous sections. These models are reasonable approximations for the situations that have been investigated, but they do not reflect the full complexity of the theory. In particular, the assumption of independence of processing stages may not be justified. This assumption is reasonable in some cases, but generally processing in memory involves interactions between operations in different components of the system; processing operations selected at one stage can influence subsequent stages by restricting the number of alternative processes available, by altering the operating characteristics of these processes, or by both. The selection of internal codes could have such effects on subsequent stages of search and comparison when these depend on the nature of features comprising codes.

A second assumption made in the mathematical models is that the time to execute a memory search is a linear function of the target-set size. Corollary to this is the assumption that the search functions for both positive and negative probes are identical. There is no *a priori* reason for these assumptions; it is simply the case that much of our data are in accord with them. It is not necessary, however, that the search-and-comparison functions increase linearly with target-set size to account for the observed linear increase of RT. Both linear and nonlinear RT functions can be obtained from models that have mixtures of fast familiarity-based responses (which have times independent of target-set size) and slower responses based on extended searches (which have times either independent of or related nonlinearly to target-set size). This is the case, for example, if set size affects the mixture of the two processes; in terms of the model, the criteria that determine when familiarity-based decisions are made might vary as a function of

target-set size. Under these conditions, a linear RT function can be obtained, but, in general, nonlinear functions would be expected.¹⁴ Similar reasoning can be applied to the assumption that the scan time for both positive and negative probes is the same. Certain types of interactions between the encoding and search stages or between the search and decision stages may occur for positive and negative probes. In general, interactions would lead to differences between positive and negative probes, but in particular cases such differences may not be observed. For example, if negative probes are encoded more slowly than positive probes, but are scanned against the target set more rapidly, then the trade-off on times between stages might result in identical observed RTs for positives and negatives. The models presented here assume a linear search time that is the same for positive and negative probes, because it simplifies matters and still gives good fits to the data.

The Division of LTS

In describing the theory we proposed that LTS has two components, the conceptual store and event-knowledge store. Subdividing LTS is not a new idea (see, for example, Tulving, 1972). However, the distinctions between CS and EKS are different from the type of distinctions made in other theories. The main difference is that the CS is not a true lexicon or "semantic memory." It functions primarily as a high-speed interface between the perceptual processes and EKS. The conceptual code at each node in CS provides a very limited subset of information about a concept's full "meaning." One way to view this subset is that it provides information about the concept's relations to broad conceptual categories rather than to its relations with other specific concepts. Conceptual codes may be utilized initially to form the conceptual relations that characterize complex stimulus ensembles; subsequently, their dimensions suggest entry points into EKS where more detailed information about a concept may be located. The CS may be regarded as more analogous to an index for an encyclopedia rather than a dictionary. This index has the property of being organized on the basis of both the physical and conceptual elements of its entries, thereby allowing fast access to the stored information. While the particular description of the CS presented here does not depend directly upon any of our experimental results, it is consistent with research demonstrating that there are different levels of information representation (Posner, 1969, 1972). In addition, an experiment by Juola (1973) indicates that the familiarity of a stimulus does not depend on the specific mode of presentation; this supports our view of a CS node where the various perceptual representations of a concept are linked to one another. At an intuitive level, the CS also seems to be the type of memory required for the parsing of input by theories of language understanding (Schank, 1972); it allows high-speed access to the level of meaning.

¹⁴For example, linear RT functions could result if search time increased more than linearly with target-set size, while the proportion of familiarity decisions also increased in a positively accelerated manner.

necessary for determining the class of conceptual relations that a word can enter into, and mediates the search of EKS for additional information needed to specify the "meaning" of natural language input. Even though the division between CS and EKS may be taken as conjecture, our experiments call for some such separation in order to account for the range of effects observed.

Memory Structures in EKS

The term "memory structure" has been used here to refer to collections of perceptual and conceptual codes stored in EKS. These structures represent past events and episodes as well as the full meaning of concepts in terms of their relations to other concepts. For instance, when subjects in experiments learn word lists, copies of codes representing the words are linked together to form a memory structure in EKS. Since it is likely that the ability to locate particular codes within a memory structure depends on how the structure is organized internally, the nature of these structures is a relevant issue (Herrmann & McLaughlin, 1973). It seems reasonable that the organization of EKS structures should vary with the nature of the stored information. The elements of a visual scene could be stored by linking perceptual codes and/or conceptual codes in an organization maintaining some isomorphism to the original physical display. A second form of internal organization for memory structures could be similar to Schank's (1972) conceptual dependencies. In this case, the codes underlying an event are organized on the basis of their conceptual relations. For either type of structure, the codes themselves are linked together with other codes to define the particular type of relations between other codes. The internal organization of a memory structure therefore can be thought of as a simple linking of individual codes where some of the codes define a higher-order organization of other codes. That is, objects A and B of some visual scene have codes linked by another code that defines an "above" relation between A and B if A was above B in the scene (Clark & Chase, 1972). Similarly, there is a code for the relation "actor-of" that would be linked between the actor and ACT of an event, organized on the basis of conceptual relations. When necessary, the same information may be stored in more than one memory structure (contingent on the time available). Alternately, information can be translated from one type of memory organization to another at some subsequent time; an event originally stored on the basis of physical relations (e.g., visual coding) can be analyzed for conceptual relations in the same way the original scene might have been. To the extent, however, that the information about an event stored in EKS is not a perfect copy of all the information originally available, subsequent translations of memory structures into new ones with alternative organizations may be incomplete or otherwise distorted. Therefore, the control processes for building memory structures attempt to create structures organized in a way that reflect expectations of how the information will be used at some later time. A related assumption is that the specific codes and organization used to form a memory structure affect the search and retrieval processes that operate on it; that

is, there are alternative strategies that are more or less efficient, depending on the form and organization of the codes they manipulate.

Levels of Information Representation

As presented here, information codes in memory exist at two distinct levels, perceptual and conceptual. A code represents the set of primitive features or attributes that a stimulus or concept conveys; "primitive" should not be taken to mean innate in this context. Considerable research has been done on the internal coding of information (Melton & Martin, 1972), and undoubtedly the dichotomy presented in this paper is too simple to provide a detailed account of the various findings. While we do suppose that there are different perceptual codes for different sensory modalities, no distinctions have been made regarding the complexity of features within a modality. However, it is clear that there are several possible levels of analysis for any modality; for example, the evidence is that printed words produce perceptual codes that may reflect line segments, entire letters, or higher-order features like spelling patterns or vocalic center groups. A related issue is whether or not higher-order features map onto simple combinations of more basic features; if so, then different levels may be reduced to more basic ones, as we have suggested. The notion of different levels of perceptual codes adds considerable complexity to the scheme presented here, but it may prove necessary.

Fully and Partially Connected Memory Networks

The system described here differs conceptually from many other theories with regard to the overall organization of information within memory. A prevalent view is that memory is a *fully connected network* (Anderson & Bower, 1972; Rumelhart, Lindsey, & Norman, 1972). In such a network, events are stored by forming links between already existing internal nodes representing concepts. Usually, a distinction is made between type nodes and token nodes, and every token is linked to its type. In principle, it is possible to reach any node in the network from any other node by following the links from one node to the next. Our conception of LTS, in contrast, may be described as a *partially connected network*. While codes at a CS node may be viewed as types for which there are tokens present in memory structures in EKS, there are no direct links between codes in CS and in EKS. There also are no direct links between the various nodes in CS. Instead, related nodes in CS are stored "near" each other because their features tend to have similar dimension values in the CS space. Similarly, structures in EKS are not linked to one another, but similar or related events may be stored within a small neighborhood of the EKS space. The only connections in our system are those within a given CS node and within a given memory structure in EKS; thus, codes in memory form only partially connected networks. In our system, the ability to locate information in LTS depends on the ability to isolate those features of the retrieval context that index the area of memory containing the to-be-

remembered structure. The success of this process depends on whether the features used for placement of a memory structure during learning are those available (or utilized) during retrieval.

A corollary to our notion of separate memory structures is the notion that the same information may be multiply represented in LTS. Whenever a particular code underlies some to-be-remembered event, a copy of that code is stored in the newly formed EKS structure. Similarly, whenever old knowledge is updated, all or part of the existing memory structure is recopied along with the new information. This view is not economical in terms of "storage space," but it may provide a more efficient basis for retrieval and modification of information already in the system because these processes do not have to deal with all the irrelevant relations associated with a given code. In a fully connected network, it is necessary to decide which and how many of the multitude of links leading away from a node are to be examined during a memory search.

It is important to emphasize that on a strictly formal basis fully connected networks and partially connected networks with directed retrieval processes may lead to equivalent predictions for a wide class of phenomena. This does not mean, however, that they are identical in a wider sense. Given a particular theoretical representation for the coding and retrieval of information, it is difficult not to opt for one or the other type of network, as we have done.

Concluding Remarks

The theoretical divisions of the memory system described in this paper offer a framework for understanding how particular variables affect recognition performance. In addition, the theory provides a basis for considering recognition in terms of processes that underlie other types of behavior; aspects of the theory thereby may be generalized to other paradigms for investigating memory and, in principle, could be extended to higher-order functions such as the understanding of language. We recognize that a direct test of the theory is not possible; however, it has proved to be a useful tool for several reasons: (a) It has permitted us to formulate and test a series of quantitative models for specific experimental tasks; (b) at an intuitive level, it seems consistent with the memory demands of more complex cognitive behaviors; and (c) it has served to identify several factors that have been shown to significantly affect memory. The theory, thus, has value as a tool for analyzing particular experiments and as a framework within which to view the broad domain of memory and cognition.

REFERENCES

- Anderson, J. R., & Bower, G. H. Recognition and retrieval processes in free recall. *Psychological Review*, 1972, 79, 97-123.
- Atkinson, R. C., & Juola, J. F. Factors influencing speed and accuracy of word recognition. In S. Kornblum (Ed.), *Attention and performance IV*. New York: Academic Press, 1973.

- Atkinson, R. C., & Juola, J. F. Search and decision processes in recognition memory. In R. C. Atkinson, D. H. Krantz, & P. Suppes (Eds.), *Contemporary developments in mathematical psychology*. San Francisco: W. H. Freeman & Company, 1974, in press.
- Atkinson, R. C., & Shiffrin, R. M. Human memory: A proposed system and its control processes. In K. W. Spence & J. T. Spence (Eds.), *The psychology of learning and motivation: Advances in research and theory*. Vol. 2. New York: Academic Press, 1968.
- Atkinson, R. C., & Shiffrin, R. M. The control of short-term memory. *Scientific American*, 1971, **225**, 82-90.
- Atkinson, R. C., & Wickens, T. D. Human memory and the concept of reinforcement. In R. Glazer (Ed.), *The nature of reinforcement*. New York: Academic Press, 1971.
- Briggs, G. E., & Swanson, J. M. Encoding, decoding, and central functions in human information processing. *Journal of Experimental Psychology*, 1970, **86**, 296-308.
- Broadbent, D. E. Review lecture: Psychological aspects of short-term and long-term memory. *Proceedings of the Royal Society of London*, 1970, **175 B**, 333-350.
- Bruner, J. S., & Minturn, A. L. Perceptual identification and perceptual organization. *Journal of General Psychology*, 1955, **53**, 21-28.
- Clark, H. H., & Chase, W. G. On the process of comparing sentences against pictures. *Cognitive Psychology*, 1972, **3**, 472-517.
- Craik, F. I. M., & Lockhart, R. S. Levels of processing: A framework for memory research. *Journal of Verbal Learning and Verbal Behavior*, 1972, **11**, 671-684.
- Fillenbaum, S., & Rapoport, A. *Structures in the subjective lexicon*. New York: Academic Press, 1971.
- Herrmann, D. J., & McLaughlin, J. P. Effects of experimental and pre-experimental organization on recognition: Evidence for two storage systems in long-term memory. *Journal of Experimental Psychology*, 1973, **99**, 174-179.
- Homa, D. Organization and long-term memory search. Unpublished doctoral dissertation, University of Wisconsin, 1972.
- Juola, J. F. Repetition and laterality effects on recognition memory for words and pictures. *Memory & Cognition*, 1973, **1**, 183-192.
- Juola, J. F., & Atkinson, R. C. Memory scanning for words vs. categories. *Journal of Verbal Learning and Verbal Behavior*, 1971, **10**, 522-527.
- Juola, J. F., Fischler, I., Wood, C. T., & Atkinson, R. C. Recognition time for information stored in long-term memory. *Perception & Psychophysics*, 1971, **10**, 8-14.
- Kintsch, W. Models for free recall and recognition. In D. A. Norman (Ed.), *Models of human memory*. New York: Academic Press, 1970.
- Klatzky, R. L., Juola, J. F., & Atkinson, R. C. Test stimulus representation and experimental context effects in memory scanning. *Journal of Experimental Psychology*, 1971, **87**, 281-288.
- Lakoff, G. HEDGES: A study in meaning criteria and the logic of fuzzy concepts. Paper presented at the Eighth Regional Meeting, Chicago Linguistics Society. Chicago: University of Chicago Linguistics Department, 1972.
- Lively, B. L., & Sanford, B. J. The use of category information in a memory-search task. *Journal of Experimental Psychology*, 1972, **93**, 379-385.
- Mandler, G., Pearlstone, F., & Koopmans, H. S. Effects of organization and semantic similarity on recall and recognition. *Journal of Verbal Learning and Verbal Behavior*, 1969, **8**, 410-423.
- McCormack, P. D. Recognition memory: How complex a retrieval system? *Canadian Journal of Psychology*, 1972, **26**, 19-41.
- Melton, A. W., & Martin, E. (Eds.), *Coding processes in human memory*. Washington: Winston, 1972.
- Meyer, D. E., & Schvaneveldt, R. W. Facilitation in recognizing pairs of words: Evidence of a dependence between retrieval operations. *Journal of Experimental Psychology*, 1971, **90**, 227-234.

- Mohs, R. C., Wescourt, K. T., & Atkinson, R. C. Effects of short-term memory contents on short- and long-term searches. *Memory & Cognition*, 1973, *1*, 443-448.
- Murlock, B. B., Jr. A parallel processing model for scanning. *Perception & Psychophysics*, 1971, *10*, 289-291.
- Naus, M. J. Memory search of categorized lists: A consideration of alternative self-terminating search strategies. Unpublished doctoral dissertation, Princeton University, 1972.
- Naus, M. J., Glucksberg, S., & Ornstein, P. A. Taxonomic word categories and memory search. *Cognitive Psychology*, 1972, *3*, 643-654.
- Posner, M. I. Abstraction and the process of recognition. In G. H. Bower & J. T. Spence (Eds.), *The psychology of learning and motivation: Advances in research and theory*. Vol. III. New York: Academic Press, 1969.
- Posner, M. I. Coordination of internal codes. Paper presented at the 8th Carnegie Symposium on Cognitive Processes, Pittsburgh, May, 1972.
- Rips, L. J., Shoben, E. J., & Smith, E. E. Semantic distance and the verification of semantic relations. *Journal of Verbal Learning and Verbal Behavior*, 1973, *12*, 1-20.
- Rothstein, L. D., & Morin, R. E. The effects of size of the stimulus ensemble and the method of set size manipulation on recognition reaction time. Paper presented at the meeting of the Midwestern Psychological Association, Cleveland, May, 1972.
- Rumelhart, D. E., Lindsay, P. H., & Norman, D. A. A process model for long-term memory. In E. Tulving & W. Donaldson (Eds.), *Organization of memory*. New York: Academic Press, 1972.
- Schank, R. C. Conceptual dependency: A theory of natural language understanding. *Cognitive Psychology*, 1972, *3*, 552-631.
- Shiffrin, R. M., & Atkinson, R. C. Storage and retrieval processes in long-term memory. *Psychological Review*, 1969, *76*, 179-193.
- Sternberg, S. High-speed scanning in human memory. *Science*, 1966, *153*, 652-654.
- Sternberg, S. The discovery of processing stages: Extensions of Donder's method. In W. G. Koster (Ed.), *Attention and performance II*. *Acta Psychologica*, 1969, *36*, 276-315. (a)
- Sternberg, S. Memory scanning: Mental processes revealed by reaction-time experiments. *American Scientist*, 1969, *57*, 421-457. (b)
- Sternberg, S. Decomposing mental processes with reaction-time data. Invited address presented at the meeting of the Midwestern Psychological Association, Detroit, May, 1971.
- Swanson, J. M., & Briggs, G. F. Information processing as a function of speed versus accuracy. *Journal of Experimental Psychology*, 1969, *81*, 223-229.
- Townsend, J. T. A note on the identifiability of parallel and serial processes. *Perception & Psychophysics*, 1971, *10*, 161-163.
- Tulving, E. Episodic and semantic memory. In E. Tulving & W. Donaldson (Eds.), *Organization of memory*. New York: Academic Press, 1972.
- Tulving, E., & Thomson, D. M. Encoding specificity and retrieval processes in episodic memory. *Psychological Review*, 1973, *80*, 352-373.
- Underwood, B. J. Are we overloading memory? In A. W. Melton & E. Martin (Eds.), *Coding processes in human memory*. Washington: Winston, 1972.
- Weaver, F. S. Retrieval processes in short-term memory. Unpublished doctoral dissertation, University of Delaware, 1972.
- Wescourt, K. T., & Atkinson, R. C. Scanning for information in long- and short-term memory. *Journal of Experimental Psychology*, 1973, *98*, 95-101.
- Williams, J. D. Memory ensemble selection in human information processing. *Journal of Experimental Psychology*, 1971, *88*, 231-238.

6|| Search and Decision Processes in Recognition Memory

Richard C. Atkinson

STANFORD UNIVERSITY

James F. Juola

UNIVERSITY OF KANSAS

INTRODUCTION

In this chapter we develop and evaluate a mathematical model for a series of experiments on recognition memory. The model is extremely simple, incorporating only those assumptions necessary for treatment of the phenomena under analysis. It should be noted, however, that the model is a special case of a more general theory of memory (Atkinson & Shiffrin, 1968, 1971); thus its evaluation has implications not only for the experiments examined here, but also for the theory of which it is a special case.

Before discussing the model and the relevant experiments, it will be useful to provide a brief review of the general theory. The theory views memory as a dynamic and interactive system; the main components of the memory system and paths of information flow are diagrammed in Figure 1. Stimuli impinge on the system via the *sensory register*, and the system in turn acts upon its environment through the *response generator*. Within the system itself, a distinction is made between the *memory storage network*, in which information is recorded, and *control processes* that govern the flow and sequencing of information. The memory storage network is composed of the *sensory register*, a *short-term store* (STS), and a *long-term store* (LTS). The sensory register analyzes and transforms the input from the sensory system

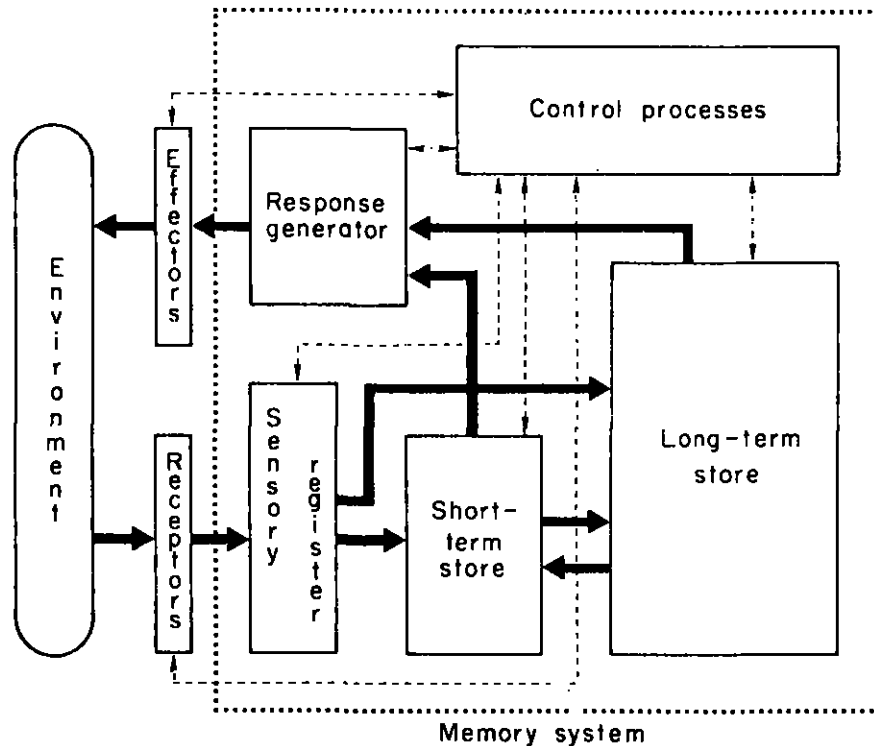

FIGURE 1.
 A flowchart of the memory system. Solid lines indicate paths of information transfer. Dashed lines indicate connections that permit comparison of information arrays residing in different parts of the system; they also indicate paths along which control signals may be sent which modulate information transfer, activate rehearsal mechanisms, set decision criteria, alter biases of sensory channels, initiate the response generator, etc.

and briefly retains this information while it is selectively read into one of the memory stores. The STS is a working memory of limited capacity from which information decays fairly rapidly unless it is maintained by control processes such as imagery or rehearsal. The contents of STS may be thought of as the 'current state of consciousness' for the subject. The LTS is a large and essentially permanent memory bank; information once recorded in this store does not decay, but its availability for further processing depends upon the effectiveness of retrieval processes. In the figure, STS and LTS are depicted as two separate boxes, but this is not meant to imply neurologically separate systems; it is quite possible that STS is simply the active phase of neural processes quiescent in LTS. The control processes regulate the transfer of information from one store to another, and the sequencing of operations within each memory store. These processes are labile strategies adopted by the subject in response to environmental and task conditions. They include

selective attention, rehearsal, coding, selection of retrieval cues, and all types of decision strategies.

Although the model developed in this paper is a special case of the theory represented in Figure 1, it also can be interpreted as consistent with a number of other theories.¹ It is possible to theorize about components of the memory process without making commitments on all aspects of a theory of memory. Component problems can be isolated experimentally and local models developed. Work of this sort eventually leads to modification of the general theory, but a close connection between local models and the general theory is not required at every stage of research.

The term 'recognition memory' covers a wide variety of phenomena in which the subject attempts to decide whether or not a given object or event has been experienced previously (Kintsch, 1970a, 1970b; McCormack, 1972). It is a common process in everyday life and one that is readily subject to experimentation. In the recognition task that we have been investigating, the subject must decide whether or not a given test stimulus is a member of a predefined set of target items. For any set S of stimuli, a subset S_1 is defined that is of size d . Stimuli in S_1 will be referred to as *target items*; subset S_0 is the complement of S_1 with respect to S , and its members will be called *distractor items*. The experimental task involves a long series of discrete trials with a stimulus from S presented on each trial. To each presentation the subject makes either an A_1 or A_0 response, indicating that he judges the stimulus to be a target or distractor item, respectively.

The target sets in our experiments involve fairly long lists of words (sometimes as many as 60 words) that are thoroughly memorized by the subject prior to the test session. During the test session individual words are presented, and the subject's task is to respond as rapidly as possible, indicating whether or not the test word is a member of the target set. Errors are infrequent, and the *principal data* are *response latencies* (i.e., the time between the onset of the test word and the subject's response). The length of the target list and other features of the experimental procedure prevent the subject from rehearsing the list during the course of the test session, thus requiring that the subject access LTS in order to make a decision about each test word.

In some respects this task is similar to that studied by Sternberg (1966) and others. In the Sternberg task, a small number of items (e.g., 1 to 6 digits) are presented at the start of each trial, making up the target set for the trial. The test item is then presented, and the subject makes an A_1 response if the item is a member of that trial's target set, or an A_0 otherwise. In the Sternberg task the subject does not need to master the target set, for it is small and can be maintained in STS while needed. This type of short-term recognition experi-

¹ See, for example, a collection of papers concerning models of memory edited by Norman (1970).

ment differs then from our long-term studies in terms of the size and mastery of the target set. The data from the two types of studies are similar in many respects, but there are some striking differences. In both types of studies, response latency is an increasing linear function of the size of the target set; however, the slope of the function is about 5 msec per item in the long-term studies, compared with about 35 msec in the short-term studies. Other points of comparison will be considered later.

From a variety of long-term recognition studies we have achieved a better understanding of how information is represented in memory and how it is retrieved and processed in making response decisions. A model based on this work is formally developed in the next section. First, however, a more intuitive account is given.

Consider the case in which the target set consists of a long list of words that the subject has thoroughly memorized prior to the test session. The initial problems are to postulate mechanisms by which this information is used to distinguish target words from distractors. It is assumed that every word in the subject's language has associated with it a particular long-term memory location that we refer to as a node in the lexical store (Miller, 1969; Rubenstein, Garfield, & Millikan, 1970). When a word is presented for test, the sensory input is encoded and mapped onto the appropriate node. This process is essential in identifying or naming the test stimulus as well as in retrieving other information that is associated with the item. Figure 2 shows a representation of a single node in the lexical store (panel A), along with an example of an associative network by which various nodes are interconnected (panel B). Each node is a functional unit representing a single word or concept (such as the relational concepts 'to the left of,' 'above,' or concepts dealing with size and shape). A variety of nodes and their associations in the lexicon is necessary in accounting for language use and other symbolic behavior (Schank, 1972), but for our purposes we need only consider nodes that correspond to potential test words.

At each node is stored an array of codes. The input codes represent the end results of the encoding processes that operate on the auditory, pictorial, or graphemic information in the sensory register. These codes serve as means to access the appropriate node in the lexicon. Internal codes are alternative representations of the stimulus word that can be used to locate the item if it is stored elsewhere in memory. The internal codes can be of various types; they may be abstract pictorial or auditory images, a list of semantic-syntactic markers, predicate relations, etc. Information recorded in memory involves an array of internal codes, and the same object or event may be represented by different codes depending on the memory store involved and related information. Finally, output codes, when entered into the response generator, permit the subject to produce the word in various forms (oral, written, etc.). The property of lexical nodes that allows transformation from one code to

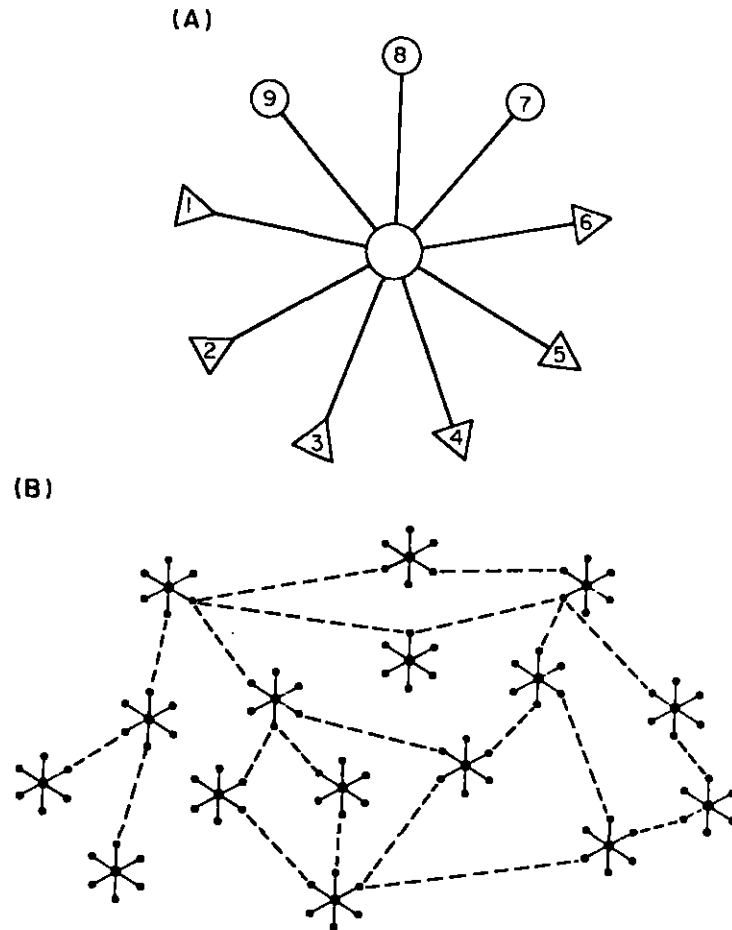

FIGURE 2. A schematic representation of the lexical store. Panel (A) illustrates a hypothetical node in the lexicon with associated input codes [(1) auditory, (2) pictorial, (3) graphemic], output codes [(4) written, (5) spoken, (6) imaged], and internal codes [(7) acoustical code for STS, (8) imaginal code for LTS, (9) verbal code for LTS]. Panel (B) illustrates a subset of nodes in the lexicon, with dashed lines indicating codes that are shared by more than one lexical node. For example, depending on an individual's experience, the nodes for mare and stallion could share a common internal code; if this code is used (along with others) to represent a particular episode, then information about the horse's sex will not be recorded in memory.

another has proved useful in other theories of memory, most notably in the logogen system of Morton (1969, 1970).

It is possible that information stored at the node representing the test word could lead directly to the decision to make an A_1 or A_0 response. This would be the case if, for example, each node corresponding to a target word has associated with it a marker or list tag that could be retrieved when the item is tested (Anderson & Bower, 1972). We take the alternative view, however, that information contained in the lexical store is relatively isolated from those parts of the memory system that record the occurrence of particular events, experiences, and thought processes. The lexical store contains the set of symbols used in the information-handling process, and the various codes associated with each symbol; these codes are the language in which experiences are recorded, but the actual record is elsewhere in memory. Thus, memorizing a list of words involves extracting appropriate codes from the lexicon and organizing these codes into an array to be recorded in a partition of LTS separate from the lexical store. There is no direct link between a word's node in the lexicon and its representation in the memory structure for the word list; to establish that a word is a member of the memorized list involves extracting an appropriate code from the word's lexical node and scanning it against the list for a possible match.

Thus, LTS is viewed as being partitioned into a lexical store and what we call the event-knowledge store (E/K store). As noted above, the lexical store maintains a set of symbols and codes that can be used by the subject to represent knowledge and the occurrence of particular events. When the subject is confronted with new information, he represents it in the form of an array of internal codes, and if it is to be retained on a long-term basis, that array is recorded in the E/K store.² Our representation of words resembles the model proposed by Kintsch (1970b), but differs from his model regarding the representation of a memorized list. Kintsch assumes that acquisition of a list involves increasing the familiarity or strength of an item in the lexical store. Although we agree with Kintsch up to this point, we also propose that the code or codes of a word in the lexical store are copied and placed in the E/K store. The organization of these codes in the E/K store, as suggested by Herrmann (1972), will depend on the particular study procedure used in acquisition (e.g., serial order, an arbitrary pairing of words, or clustering by a common meaning such as category membership). The division of LTS into

² In order to simplify the presentation, a sharp distinction has been made between the lexical store and the E/K store. The distinction is satisfactory for the experiments treated in this chapter. However, in general, we view LTS as a graded set of memories; those described here as lexical nodes represent one extreme, while event memories represent the opposite extreme. The lexical store evolves over a lifetime; by analysis of past memories the individual develops new codes that make the storage of future events more economical. Thus one's history of experiences determines the codes available in the lexical system and, in turn, the ability to store different types of information (Atkinson & Wescourt, 1974).

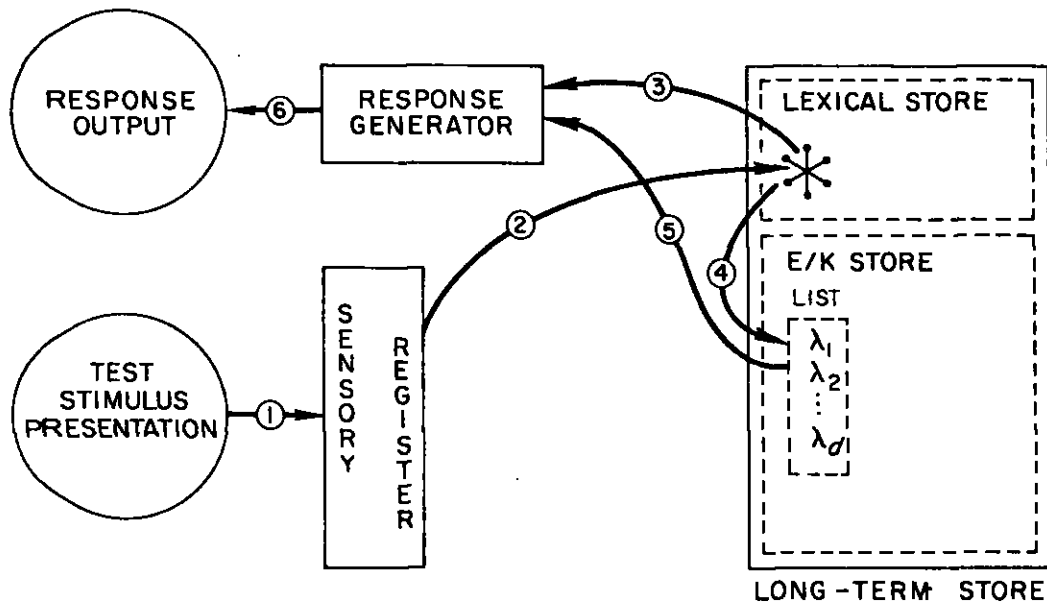

FIGURE 3.
 A schematic representation of the search and decision processes in long-term recognition memory. A test stimulus is presented (1) and then encoded and matched to the node in the lexicon (2). The familiarity index associated with the node may lead to an immediate decision (3) and in turn generate a response (6). Otherwise an extended search of the stored target list is initiated (4), which eventually leads to a decision (5) and a subsequent response (6). Path (1), (2), (3), (6) results in a faster response than path (1), (2), (4), (5), (6), and the response that is independent of target-set size.

a lexical store and an E/K store is similar to the distinction made by Tulving (1972) between semantic and episodic memory. In Tulving's taxonomy, the lexical store would be classified as semantic memory. The E/K store, however, might be classified by Tulving as either semantic memory or episodic memory, depending on the type of information in the E/K store. To Tulving, one's memory for a list learned in a psychology experiment constitutes an episodic memory, but the knowledge one learns in a chemistry course (such as the periodic table of elements) constitutes a semantic memory. It is maintained here that both kinds of information are held in the E/K store and are treated by the memory system in essentially the same manner (Atkinson & Wescourt, 1974).

Figure 3 presents a summary of the processes involved in recognition memory for words that are members of a list stored in long-term memory. When the test word is presented, it is encoded into an input code that allows direct access to the appropriate node in the lexical store. Although the node does not contain a tag or marker indicating list membership, it will be as-

sumed that by accessing the node the subject can arrive at an index of the test word's *familiarity*. The familiarity value for any node is a function of the time since that node was last accessed relative to the number of times the node had been accessed in the past. Infrequently occurring words receive a large increase in familiarity after a single test, whereas the test of a frequent word results in only a small increase in its familiarity. The familiarity value for any word is assumed to regress to its base value as a function of time since the last access of the node.³

In recognition experiments of the type described above, the familiarity value of a word sometimes can be a fairly reliable indicator of list membership. It will be assumed that, when the subject finds a very high familiarity value at the lexical node of the test word, he outputs an immediate A_1 response; if he finds a very low familiarity value, he outputs an immediate A_0 . If the familiarity value is intermediate (neither low nor high), the subject extracts an appropriate code for the test word and scans it against the target list in the E/K store. If the scan yields a match, an A_1 is made; otherwise A_0 . The recognition process sketched out above is similar to that proposed by Mandler, Pearlstone, and Koopmans (1969). In the next section, these ideas are quantified and tested against data involving both error probabilities and response latencies.

A MODEL FOR RECOGNITION

Several special cases of the model to be considered here have been presented elsewhere (Atkinson & Juola, 1973; Juola, Fischler, Wood, & Atkinson, 1971; Atkinson, Herrmann, & Wescourt, 1974). These papers may be consulted for further intuitions about the model, as well as for applications to a variety of experimental tasks.

It is assumed that each node in the lexicon has associated with it a familiarity measure that can be regarded as a value on a continuous scale. The familiarity values for target items are assumed to have a mean that is higher than the mean for distractors, although the two distributions may overlap. In many recognition studies (e.g., Shepard & Teghtsoonian, 1961), the target set is not well learned and involves stimuli that have received only a single study presentation. Under these conditions the familiarity value of the test

³ Familiarity as used here is not specific to particular events. It can be viewed as a reverberatory activity that dissipates over time. Whenever a node is accessed, it is set in motion. The amount of reverberation and its time course depend on the prior reverberation of the node and the reverberatory activity at neighboring nodes (Schvaneveldt & Meyer, 1973). When a node is accessed, the system can gauge the current reverberatory level of that node and use the measure as an item of information.

stimulus leads directly to the decision to make an A_1 or A_0 response; that is, the subject has a single criterion along the familiarity continuum that serves as a decision point for making a response. Familiarity values above the criterion lead to an A_1 response, whereas those below the criterion lead to an A_0 response (Banks, 1970; Kintsch, 1967, 1970a, 1970b; Parks, 1966; Shepard, 1967).

The studies that we consider differ from most recognition experiments in that the target stimuli are members of a well-memorized list. In this case, it is assumed that the subject can use the familiarity value to make an A_1 or A_0 response as soon as the appropriate lexical node is accessed, or can delay the response until a search of the E/K store has confirmed the presence or absence of the test item in the target set. These processes are shown in the flowchart of Figure 4. When a test stimulus is presented, the subject accesses the appropriate lexical node and obtains a familiarity value. This value is then used in the decision either to output an immediate A_1 or A_0 response (if the familiarity is very high or very low, respectively) or to execute a search of the E/K store before responding (if it is of an intermediate value).

A schematic representation of the decision process is shown in Figure 5. Here the distributions of familiarity values associated with a distractor item and a target item are plotted along the familiarity continuum (x). If the initial familiarity value is above a high criterion (c_1) or below a low criterion (c_0), the subject outputs a fast A_1 or A_0 response, respectively. If the familiarity value is between c_0 and c_1 , the subject searches the E/K store before responding; this search guarantees that the subject will make a correct response, but it takes time in proportion to the length of the target list.

On the n th presentation of a given item in a test sequence, there is a density function reflecting the probability that the item will generate a particular familiarity value x ; the density function will be denoted $\phi_{1,n}(x)$ for target items and $\phi_{0,n}(x)$ for distractor items. The two functions have mean values $\mu_{1,n}$ and $\mu_{0,n}$, respectively. Note that the subscript n refers to the number of times the item has been tested, and not to the trial number of the experiment. The effect of repeating specific target or distractor items in the test sequence is assumed to increase the mean familiarity value for these stimuli. This is illustrated in Figure 6 where $\mu_{1,n}$ and $\mu_{0,n}$ shown in the bottom panel ($n > 1$) have both been shifted to the right of their initial values $\mu_{1,1}$ and $\mu_{0,1}$ shown in the top panel. The effect of shifting up the mean familiarity values is to change the probability that the presentation of an item will result in a search of the E/K store.

We can now write equations for the probabilities that the subject will make a correct response to target and distractor items. As shown in Figure 5, it is assumed that the subject will make an error if the familiarity value of a target word is below c_0 , or if the familiarity of a distractor is above c_1 . In all

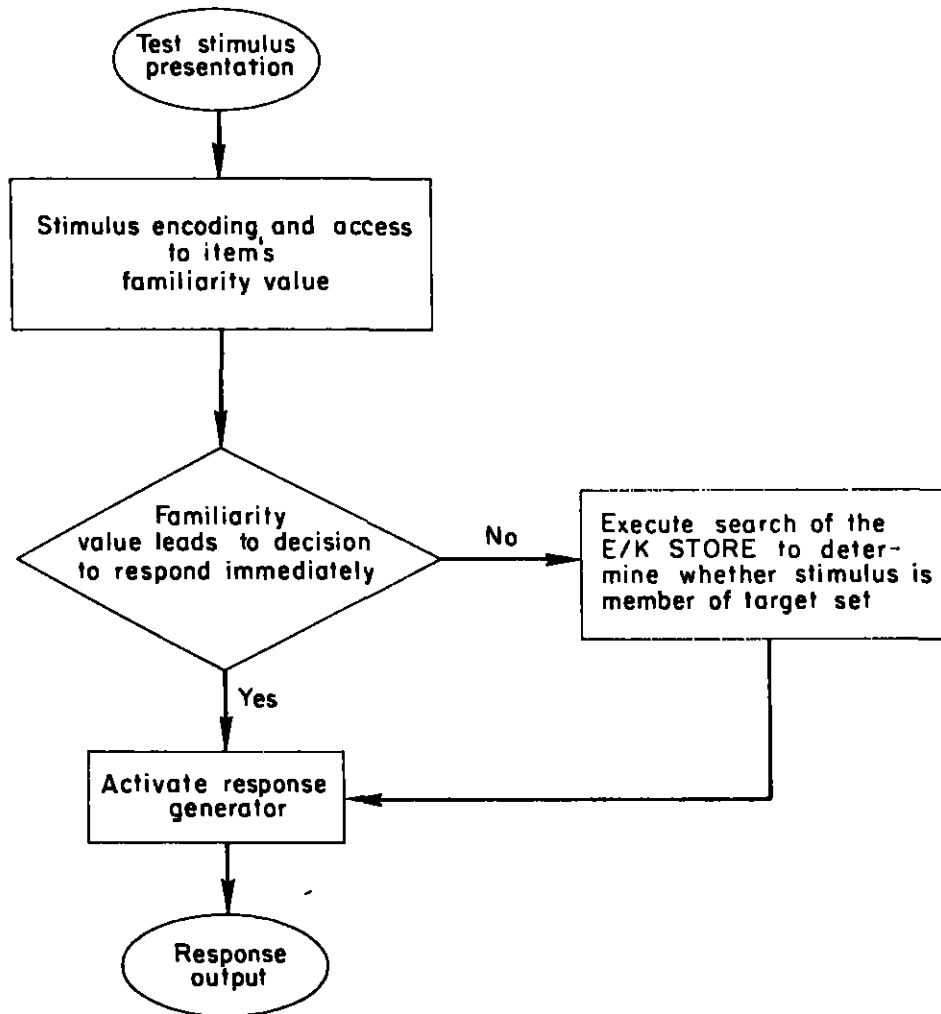

FIGURE 4.
Flowchart representing the memory and decision stages involved in recognition.

other cases, the subject will make a correct response. Thus the probability of a correct response to a target word presented for the n th time is the integral of $\phi_{1,n}(x)$ from c_0 to ∞ :

$$P(A_1 | S_{1,n}) = \int_{c_0}^{\infty} \phi_{1,n}(x) dx = 1 - \Phi_{1,n}(c_0). \quad (1)$$

Similarly, the probability of a correct response to a distractor presented for the n th time is the integral of $\phi_{0,n}(x)$ from $-\infty$ to c_1 :

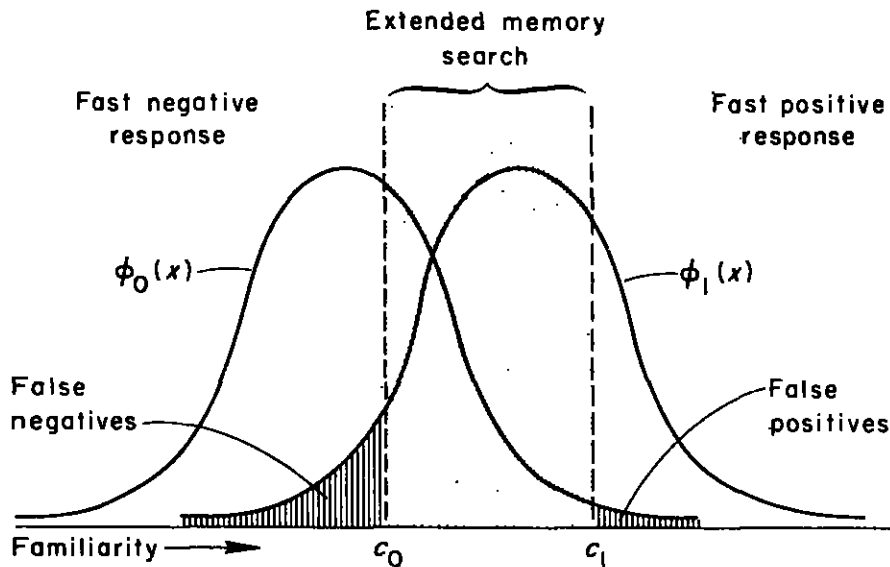

FIGURE 5. Distributions of familiarity values for distractor items, $\phi_0(x)$, and target items, $\phi_1(x)$.

$$P(A_0 | S_{0,n}) = \int_{-\infty}^{c_1} \phi_{0,n}(x) dx = \Phi_{0,n}(c_1). \quad (2)$$

Note that $\Phi(\cdot)$ designates the distribution function associated with the density function $\phi(x)$.

In deriving response latencies, we assume that the processes involved in encoding the test stimulus, retrieving information about the stimulus from memory, making a decision about which response to choose, and emitting a response can be represented as successive and independent stages. These stages are diagrammed in the flowchart in Figure 7. When the test stimulus is presented, the first stages involve encoding the item, accessing the appropriate node in the lexical store, and retrieving a familiarity value x . The times required to execute these stages are combined and represented by the quantity t in Figure 7. The next stage is to arrive at a recognition decision on the basis of x ; the decision time depends on the value of x relative to c_0 and c_1 , and is given by the function $r(x)$. If $x < c_0$, a negative decision is made; if $x > c_1$, a positive decision is made. If $c_0 \leq x \leq c_1$, a search of the E/K store is required. The time for this search is assumed to be a function of d , the size of the target set; namely, $\kappa + \theta_i(d)$. In this equation, κ denotes the time to extract an appropriate search code from the lexical node and initiate the scan of the target list; $\theta_i(d)$ is the time to execute the scan and depends upon d and upon whether the test item is a target ($i = 1$) or a distractor ($i = 0$).

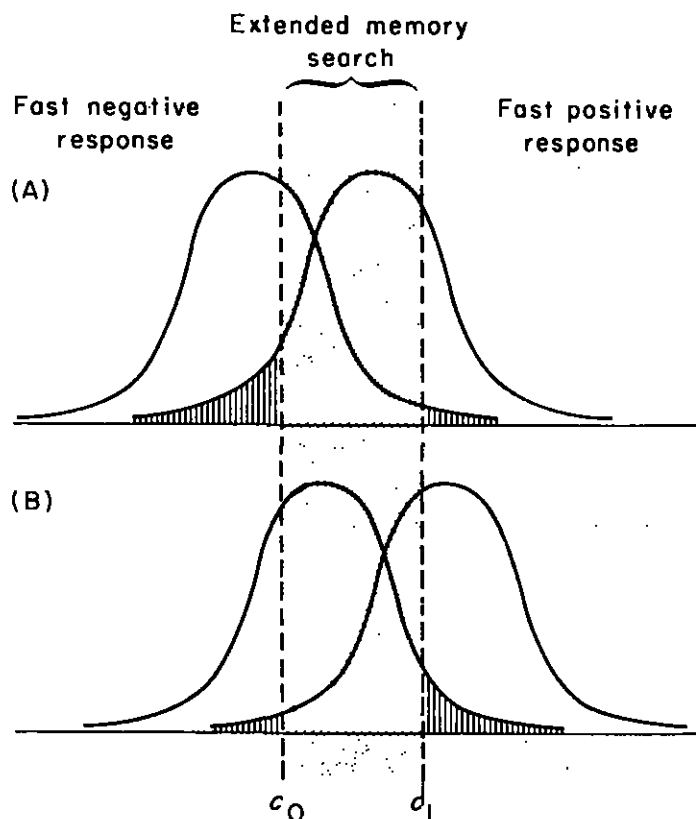

FIGURE 6.
Distributions of familiarity values for distractor items and target items that have not been tested (Panel A), and that have had at least one prior test (Panel B).

The final stage is to output a response once the decision has been made, the response time being r_0 for an A_0 response and r_1 for an A_1 response.⁴ The quantities t , $r(x)$, κ , $\theta_i(d)$, and r_i are expected values for the times necessary to execute each stage. If assumptions are made about the forms of the distributions associated with these expected values, then expressions for all moments of the latency data can be derived. Their derivation is complicated under some conditions of the model, but under others it simply involves a probabilistic mixture of two distributions; that is, the times resulting from

⁴ The successive and independent stages of the process, as represented by the blocks in Figure 7, should be regarded as an approximation to the true state of affairs (Egeth, Marcus, & Bevan, 1972). Psychological and physiological considerations make it doubtful that the phenomena considered here are composed of truly independent stages, but stage models tend to be mathematically tractable, and thus are useful analytic tools.

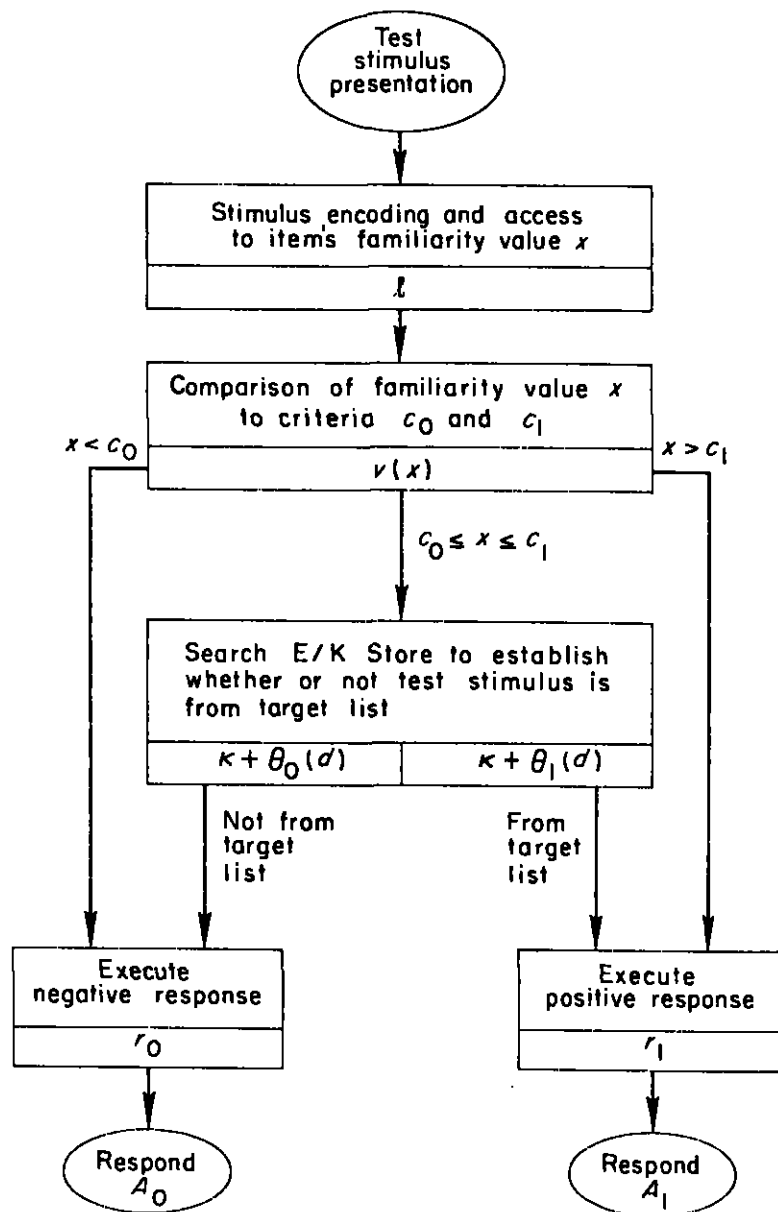

FIGURE 7. Flowchart representing memory search and decision stages of recognition. The bottom entry in each box represents the time required to complete that stage.

fast responses based on the familiarity value alone and times resulting from slow responses based on the outcome of the extended memory search. In this chapter, however, we only make assumptions about the expected value for each stage, thereby restricting the analysis to mean response data.

We let $t(A_i | S_{j,n})$ denote the expected time for an A_i response to the n th presentation of a particular stimulus drawn from set S , ($i, j = 0, 1$). Expressions can be derived from these quantities by weighting the times associated with each stage by the probability that the stage occurs during processing. Thus, for example, the time to make an A_1 response to the n th presentation of a given target item (S_1) is simply the time required to execute a response based on the familiarity value alone plus the time to execute a response based on a search of the E/K store, each weighted by their respective probabilities. If x is the familiarity value, then the time for a fast A_1 response is $\ell + v(x) + r_1$; if, however, a search of the E/K store is made, then response time is $\ell + v(x) + \kappa + \theta_1(d) + r_1$. The weighting probabilities must take account of the fact that we are concerned with the time for an A_1 response, conditional on its being correct. The probability of a fast A_1 response, conditional on the fact that it is correct, is the integral of $\phi_{1,n}(x)$ from c_1 to ∞ , divided by the probability of a correct A_1 response (the integral of $\phi_{1,n}(x)$ from c_0 to ∞). Similarly, the probability of a slow A_1 response, conditional on the fact that it is correct, is the integral $\phi_{1,n}(x)$ from c_0 to c_1 , divided by the integral of $\phi_{1,n}(x)$ from c_0 to ∞ . Thus the expected time for an A_1 response to the n th presentation of a particular target item is

$$\begin{aligned} & \left[\int_{c_1}^{\infty} [\ell + v(x) + r_1] \phi_{1,n}(x) dx \right] \left[\int_{c_0}^{\infty} \phi_{1,n}(x) dx \right]^{-1} \\ & + \left[\int_{c_0}^{c_1} [\ell + v(x) + \kappa + \theta_1(d) + r_1] \phi_{1,n}(x) dx \right] \left[\int_{c_0}^{\infty} \phi_{1,n}(x) dx \right]^{-1}. \end{aligned}$$

Note that ℓ and r_1 may be removed from under the integral. Doing this and rearranging terms yields

$$\begin{aligned} t(A_1 | S_{1,n}) = \ell + r_1 + & \left[\int_{c_1}^{\infty} v(x) \phi_{1,n}(x) dx \right. \\ & \left. + \int_{c_0}^{c_1} [\kappa + \theta_1(d) + v(x)] \phi_{1,n}(x) dx \right] \left[1 - \Phi_{1,n}(c_0) \right]^{-1}; \quad (3) \end{aligned}$$

where again $\Phi(\cdot)$ denotes the distribution function associated with the density function $\phi(x)$. Similarly,

$$\begin{aligned} t(A_0 | S_{0,n}) = \ell + r_0 + & \left[\int_{-\infty}^{c_1} v(x) \phi_{0,n}(x) dx \right. \\ & \left. + \int_{c_0}^{c_1} [\kappa + \theta_0(d) + v(x)] \phi_{0,n}(x) dx \right] \left[\Phi_{0,n}(c_1) \right]^{-1}; \quad (4) \end{aligned}$$

$$t(A_0 | S_{1,n}) = \ell + r_0 + \left[\int_{-\infty}^{c_1} v(x) \phi_{1,n}(x) dx \right] \left[\Phi_{1,n}(c_0) \right]^{-1}; \quad (5)$$

$$t(A_1 | S_{0,n}) = \ell + r_1 + \left[\int_{c_1}^{\infty} v(x) \phi_{0,n}(x) dx \right] [1 - \Phi_{0,n}(c_1)]^{-1} \quad (6)$$

Equations 3 and 4 are the expected times for correct responses, and Equations 5 and 6 are expected times for incorrect responses, to target and distractor items, respectively.

In fitting the model to data, we assume that $\phi_{i,n}(x)$ is normally distributed with unit variance for all values of i and n . Thus, the presentation of an item causes the distribution to be shifted up without changing its form or variance.⁵ No assumptions are made about how $\mu_{i,n}$ changes with n . Several assumptions seem reasonable on an a priori basis; rather than select among them, we bypass the issue by estimating $\mu_{i,n}$ from the data for each value of n . This approach is practical because the range on n is small for the experiments considered here.

It should be remarked that the criteria c_0 and c_1 are set by the subject. In the initial stages of an experiment, they would vary as the subject adjusted to the task, but it is assumed that in time they would stabilize at fixed values. Again, no theory is given of how c_0 and c_1 vary over initial trials, and thus data for the early stages of an experiment are not treated.

Yet another simplifying assumption should be mentioned at this point. Equations 1 and 2 indicate that errors are determined by the values of $\mu_{i,n}$, c_0 , and c_1 . In the experiments examined in this chapter, there is no evidence to suggest that error rates vary as a function of d , the size of the target list. Thus, in treating data we assume that $\mu_{i,n}$, c_0 , and c_1 are independent of d . Experimental procedures can be devised where this assumption would be violated (see Atkinson & Juola, 1973), but for the studies discussed here it is warranted.

What remains to be specified are the functions $r(x)$ and $\theta_i(d)$. It is assumed that $r(x)$ takes the following form:⁶

$$r(x) = \begin{cases} \rho e^{-(x-c_1)\beta}, & \text{for } x > c_1, \\ \rho, & \text{for } c_0 \leq x \leq c_1, \\ \rho e^{-(c_0-x)\beta}, & \text{for } x < c_0. \end{cases} \quad (7)$$

Figure 8 presents a graph of the equation. If the familiarity value x is far above the upper criterion or far below the lower criterion, the decision time approaches zero; for values close to the criteria, the decision time approaches ρ . A special case of interest is when $\beta = 0$; namely,

$$r(x) = \rho. \quad (8)$$

⁵ The assumption that only the mean and not the form of the distribution changes is made primarily to simplify the mathematics. Other assumptions, such as those considered by Suppes (1960) for a different problem, seem equally plausible and should be investigated in formulating a more general model of familiarity change.

⁶ The $r(x)$ function proposed here is similar to one investigated by Thomas (1971) for a signal-detection task.

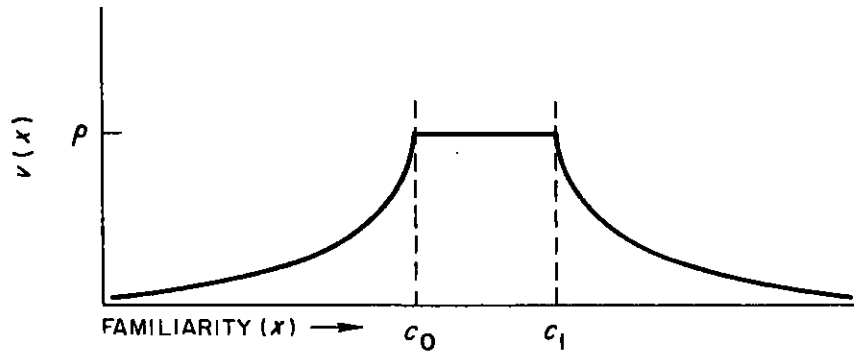

FIGURE 8.
The function $v(x)$.

In this case, the time to evaluate the familiarity value is constant regardless of its relation to c_1 and c_0 .

The quantity $\theta_i(d)$ represents the time to search the E/K store, and is assumed to be a linear function of target-set size. For the most general case we assume that search times on positive and negative trials vary independently; that is,

$$\theta_1(d) = \alpha d, \quad (9a)$$

$$\theta_0(d) = \alpha' d. \quad (9b)$$

As a special case of Equation 9, it is possible that the search times are identical for target and distractor items:

$$\theta_1(d) = \theta_0(d) = \alpha d. \quad (10)$$

Alternatively, it might be that the length of the memory search is shorter on positive trials than on negative trials. This situation would occur if the target items are stored as a list structure, and portions of the list are retrieved and scanned as the subject seeks a match for the test stimulus. When a match is obtained, the search ends; otherwise all the memory locations are checked. The time for this process is

$$\theta_1(d) = \alpha[(d + 1)/2], \quad (11a)$$

$$\theta_0(d) = \alpha d. \quad (11b)$$

The memory-search processes described by Equations 10 and 11 correspond to the exhaustive and self-terminating cases of the serial scanning model proposed by Sternberg (1966, 1969b). While Sternberg's models have proved to be extremely valuable in interpreting data from a variety of memory-search experiments, good fits between the models and data do not require that the underlying psychological process be serial in nature. There

are alternative models, including parallel scanning models, that are mathematically equivalent to those proposed by Sternberg and yield the same predictions as Equations 10 and 11 (Atkinson, Holmgren, & Juola, 1969; Murdock, 1971; Townsend, 1971; Shevell & Atkinson, 1974). Thus, the use of the above equations to specify the time to search the E/K store does not commit us to either a serial or parallel interpretation.

EFFECTS OF TARGET-LIST LENGTH AND TEST REPETITIONS

The first experiment we consider was designed primarily to replicate two earlier experiments, as well as to provide a large data base with which to test the model. Juola et al. (1971) demonstrated that recognition time is a straight-line function of the number of items in a large (10 to 26 items) target set: as the number of items in the target set increased, response latency increased linearly for both positive and negative trials. A second experiment (Fischler & Juola, 1971) showed that response latency depends on whether or not the test stimulus has been presented previously. The response latency for a repeated target item was more than 100 msec less than the latency for a target on its first presentation. For a distractor, repetitions increased latency, with response time being about 50 msec greater for a repeated distractor than for one receiving its first presentation.

Our study also included repeated tests of target and distractor items, and three target-list lengths were used. Groups of 24 subjects each were given lists of either 16, 24, or 32 words. Each list was constructed by randomly selecting d words from a pool of 48 common, one-syllable nouns. The words remaining in the pool after each list had been selected were used as the distractor set (S_0) to accompany that target set (S_1). Each subject was given a list about 24 hours before the experimental session, and instructed to memorize it in serial order.

At the start of the test session, each subject successfully completed a written serial recall of the target list. The subject was then seated in front of a tachistoscope, in which the test words were presented one at a time. To each presentation the subject made either an A_1 or A_0 response by depressing one of two telegraph keys with his right forefinger. The experimental procedure was identical to that of Fischler and Juola (1971).

The test sequence consisted of 80 consecutive trials that were divided into four blocks. For Block I, four target words and four distractors were randomly selected from S_1 and S_0 , respectively. For Block II, the eight Block I words were repeated, and four new targets and four new distractors were also shown. Block III included all the words presented in Block II with eight new words added (four targets and four distractors). Finally, Block IV

included all the words of Block III and eight new words (the remaining unused target and distractor items). Order of presentation within blocks was randomized.

With this method of presentation, 16 target words and 16 distractors were presented to each subject. The test words thus included all of S_1 for subjects with lists of 16 words. For the other groups, the 16 target words tested were either the first or last 16 words in the 24-word lists, or they were the first, middle, or last 16 in the 32-word lists. It should be pointed out that the specific part of the target list that was tested during the experimental session had no effect on response times or error rates. Thus, no further distinction on which part of the target list was tested is made between groups of subjects. The lack of any effects due to the list part that was tested is not surprising when it is noted that in several previous experiments (Atkinson & Juola, 1973; Fischler & Juola, 1971; Juola et al., 1971) no effects were observed due to the serial position of the target word, that is, positive response latencies plotted against the target words' serial position yielded a flat function. The overall effect of list length on latency is also uninfluenced by the testing scheme used; the magnitude of the list-length effect observed in this study is the same as in studies where all items of each list are tested (Juola et al., 1971). The procedure used here has the nice feature that the test sequence is the same for all groups, the only difference among groups being the length of the list memorized prior to the test session. The subjects who memorized the longer lists were not told that only part of the list would be used, and in the debriefing session at the end of the experiment no one commented on the fact that some items were not tested.

The mean latencies for correct responses are presented in Figure 9; the data are from the last two trial blocks only (Blocks III and IV). The effects shown in Figure 9 were also obtained in Trial Blocks I and II; however, response times were somewhat greater on these trials, presumably due to practice effects. The data from Blocks III and IV were very similar and will be regarded as representing asymptotic performance. In another paper (Atkinson & Juola, 1973), we used the model to make predictions about all the data, including practice effects, for a similar experiment, but here we are concerned only with the data presented in Figure 9. As shown in Figure 9, means were obtained separately for A_1 and A_0 responses to test words that were presented for the first, second, third, and fourth times ($n = 1, 2, 3, \text{ or } 4$). Because, within blocks, the presentation number was randomly ordered, the effects shown in Figure 9 are attributable only to the prior number of times the test word had been presented. In general, the results closely replicate the findings of earlier studies. By comparing the mean latencies as the presentation number increases from one to four in Figure 9, it can be seen that the targets and distractors yield opposite effects. Repetitions decrease response latencies for targets, and increase latencies for distractors. The line

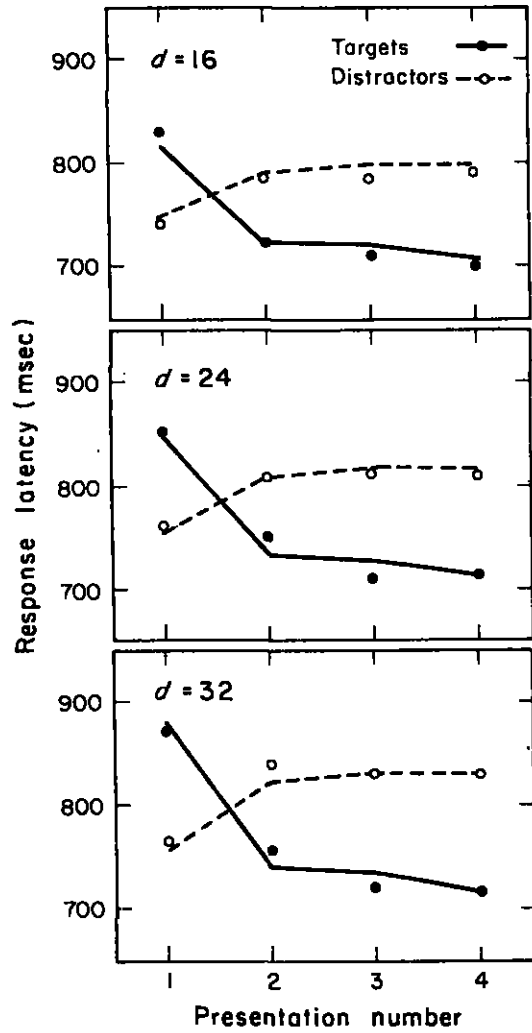

FIGURE 9.
 Correct response latencies as functions of presentation number for target and distractors for three list-length (d) conditions: the top panel presents data for $d = 16$, the middle panel for $d = 24$, and the bottom panel for $d = 32$. The broken lines fitted to the data represent theoretical predictions.

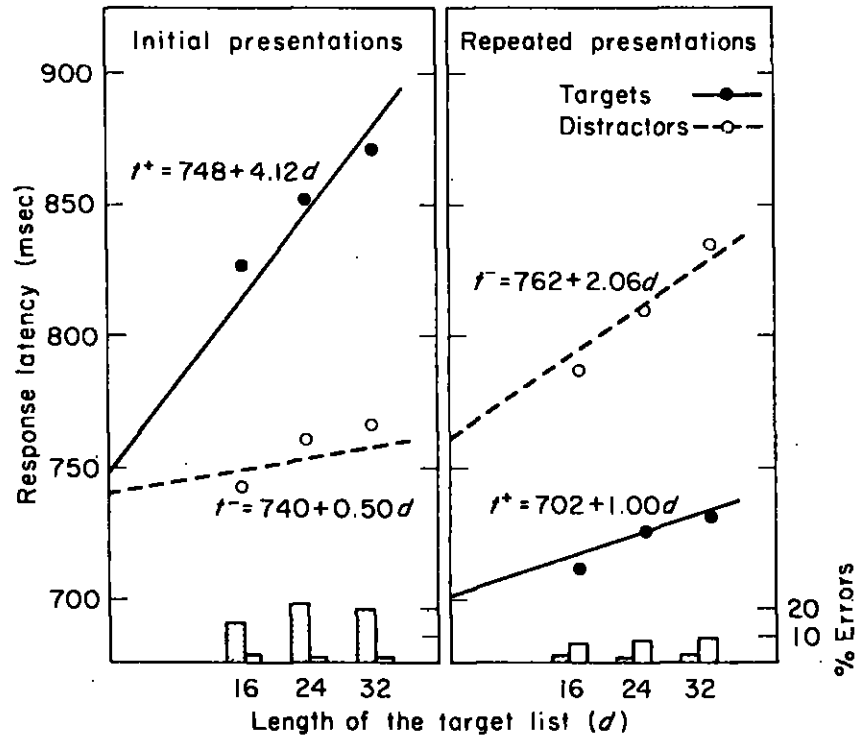

FIGURE 10. Correct response latencies and error percentages as functions of target-list length; the data represent a weighted average of response latencies from Trial Blocks III and IV. The left panel presents data for initial presentations of target and distractor words, and the right panel presents the data for repeated presentations. Incorrect responses to target words are indicated by the shaded bars, and errors to distractors by the open bars. The straight lines fitted to the data represent theoretical predictions.

segments fitted to the data were generated from the model and are discussed later.

The data from Figure 9 are replotted in Figure 10 so that mean response latencies are presented as functions of target-list length. The left panel includes the data for items receiving their first presentations ($n = 1$), whereas the right panel presents the average data for repeated presentations ($n = 2, 3, \text{ and } 4$) weighted by the number of observations for each value of n . Again the effects of repetitions are evident; repetitions decrease latency on positive trials by more than 100 msec, whereas repetitions increase negative latencies by about 50 msec, on the average. Similarly, repeated tests decreased errors to target words (shaded bars along the lower axis), and repetitions increased errors to distractors (open bars). The linear functions fitted to the data in Figure 10 are discussed later.

The number of target words affected response latency, with mean latency

being an approximately linear function of target size. By way of contrast, note that error rates do not increase with the number of target words, but are relatively constant across the three list lengths. Further, an examination of error latencies showed that there was no effect of list length on the speed of an incorrect response.

Perhaps most interesting, however, is the interaction between target-set size and the effects of repetitions. For target words, repetitions decrease the size of the list-length effect; that is, the slope of the function relating mean response latency to target-list length is less for repeated targets than for initially presented targets. The opposite is true for distractors; repeating distractors increases the slope of the latency function.

A discussion of these results is postponed until the end of the next section. We first demonstrate how parameters can be estimated and the model fitted to data.

THEORETICAL ANALYSIS OF THE LIST-LENGTH EXPERIMENT

There are several approaches that can be taken to estimate parameters. The method used here is not the most efficient, but it has the merit of being quite simple. It involves using the error probabilities to estimate the $\mu_{i,n}$ s. The estimates of the $\mu_{i,n}$ s are then substituted into the latency equations and treated as fixed values. The remaining parameters are estimated by selecting them so that the differences between observed and predicted latencies are minimized.⁷

Table 1 presents observed error probabilities for target and distractor items. These probabilities were obtained by averaging over the three list-length conditions, because there were no significant differences in error rates across

TABLE 1
Observed error probabilities
for targets and distractors

	$P(A_0 S_{1,n})$	$P(A_1 S_{0,n})$
$n = 1$	0.171	0.005
$n = 2$	0.016	0.039
$n = 3$	0.014	0.049
$n = 4$	0.007	0.049

⁷ There are methods that permit simultaneous estimates of all parameters, but practical limitations make them unfeasible except in special cases (see Atkinson & Juola, 1973).

groups. We use these data and Equations 1 and 2 to estimate the $\mu_{i,n}$ s. For example, $P(A_n | S_{1,1}) = \Phi_{1,1}(c_0)$ from Equation 1, and the observed value for this probability is 0.171 from Table 1. Consulting a normal probability table, $\mu_{1,1} = c_0 + 0.95$ in order for the error rate to be 0.171. Similarly $\mu_{1,2} = c_0 + 2.14$, $\mu_{1,3} = c_0 + 2.20$, and $\mu_{1,4} = c_0 + 2.46$, using the remaining error data in the first column of Table 1. Proceeding in the same way, using Equation 2 and the error data in the second column of the table, we obtain $\mu_{0,1} = c_1 - 2.58$, $\mu_{0,2} = c_1 - 1.76$, $\mu_{0,3} = c_1 - 1.66$, and $\mu_{0,4} = c_1 - 1.66$. Thus the observed error probabilities fix the estimates of $\mu_{1,n}$ in terms of c_0 , whereas $\mu_{0,n}$ is in terms of c_1 . It can be shown that the theoretical predictions for error probabilities and latencies do not depend on the absolute values of c_0 and c_1 , but only on their difference. Thus, one or the other can be set at an arbitrary value. For simplicity, we let $c_0 = 0$; note that no matter what value is selected for c_1 , the error data will be fit perfectly. By setting c_0 equal to zero and by assuming unit variance for the ϕ -distributions, we have in essence defined the zero point and measurement unit for the familiarity scale.

With $c_0 = 0$ and the $\mu_{i,n}$ s restricted by the error data, the remaining parameters can be estimated from the latency data. Six special cases of the general model are used to fit the latency data. As indicated in Table 2, the cases differ

TABLE 2
Six models defined in terms of the functions $v(x)$ and $\theta_i(d)$

$v(x)$ \ $\theta_i(d)$	Equation 9	Equation 10	Equation 11
Equation 8	Model I	Model II	Model III
	c_1	c_1	c_1
	$(\ell + \rho + r_1)$	$(\ell + \rho + r_1)$	$(\ell + \rho + r_1)$
	r	r	r
	κ	κ	κ
	α	α	α
Equation 7	Model IV	Model V	Model VI
	c_1	c_1	c_1
	$(\ell + r_1)$	$(\ell + r_1)$	$(\ell + r_1)$
	r	r	r
	κ	κ	κ
	α	α	α

Note: $r = r_0 - r_1$.

in how the functions $r(x)$ and $\theta_i(d)$ are defined. Equations 7 and 8 define two versions of $r(x)$, and Equations 9, 10, and 11 define three versions of $\theta_i(d)$. Listed in Table 2 are the parameters that must be estimated for each case; the parameter r is simply the difference between r_0 and r_1 . The parameters grouped in parentheses cannot be individually identified—that is, the predictions of the model depend only on the sum of these parameters, which means that they cannot be estimated separately.⁸ Note that the pair of models in each column of Table 2 are equivalent if $\beta = 0$; thus the lower model in a column must predict the data better than the one above it unless β is estimated to be zero. Similarly, Model I reduces to Model II and Model IV to V if $\alpha = \alpha'$; Model I must be better than II and Model IV better than V unless the estimates of α and α' are identical.

Our method of parameter estimation involves the 24 data points in Figure 9. Parameter estimates are selected that minimize the sum of the squared deviations (weighted by the number of observations) between the data points and theoretical predictions. Specifically, we define the root mean square deviation (RMSD) between observed and predicted values as follows:

$$\text{RMSD} = \left[(1/N) \sum_{i=1}^{24} n_i (t_{p,i} - t_{o,i})^2 \right]^{1/2}, \quad (12)$$

where N = the total number of observations; i = an index over the 24 data points shown in Figure 9; n_i = the number of observations determining data point i ; $t_{p,i}$ = predicted response latency for data point i ; and $t_{o,i}$ = observed response latency for data point i .

For each of the six models, the function defined in Equation 12 is to be minimized with respect to the parameter set given in Table 2. We have not attempted to carry out the minimization analytically, for it appears to be an impossible task; rather a computer was programmed to conduct a systematic search of the parameter space for each model until a minimum was obtained.⁹ The minimum RMSDs obtained are shown in Table 3, along with the number of parameters estimated in the computer search for each model. Models III and VI clearly yield the poorest fit and can be eliminated from contention. The fact that Models I and II are about equally good—as are Models IV and V—indicates that separate estimates of α and α' do not substantially improve the goodness of fit. The conclusion to be drawn from this observation is that the time to search the E/K store is approximately the same for both targets and distractors. Note also that Models I and IV are about equally good, as are Models II and V, suggesting that the more complicated $r(x)$ functions

⁸ Proof of this remark is straightforward and is not given here. Note that for Models I, II, and III the parameter ρ is not identifiable but is lumped in the quantity $(l + \rho + r_1)$, whereas for Models IV, V, and VI ρ is identifiable and only $(l + r_1)$ is lumped.

⁹ For a discussion of such search procedures, see Wilde (1964).

TABLE 3
Minimum RMSDs obtained in computer search

Model	Minimum RMSD	Number of parameters estimated
I	9.93	6
II	9.94	5
III	10.89	5
IV	9.86	8
V	9.92	7
VI	10.34	7

yield little improvement over the constant function. Add to these observations the fact that Model II with only five parameters produces virtually as good a fit as does Model IV with eight parameters.

In view of the preceding considerations, Model II is our preferred choice among the six models. Table 4 presents the parameter estimates for Model II;

TABLE 4
Parameter estimates
for Model II

Parameter	Estimate
c_1	1.02
$(\ell + \rho + r_1)$	687 msec
r	44 msec
κ	137 msec
α	9.9 msec

Note: $r = r_0 - r_1$.

the predicted response times from this model are shown in Figure 9 as connected lines. The straight lines shown in Figure 10 are the predicted functions based on Model II for initial presentations (left panel) and repeated presentations (right panel). The fits displayed in Figure 10 could be improved upon somewhat, but it should be kept in mind that they were obtained by using parameter estimates based on a different breakdown of the data (i.e., that shown in Fig. 9).¹⁰

¹⁰ Similarity factors not represented in the model could contribute to the list-length effects displayed in Figures 9 and 10. As the target set increases in size, the probability that any given distractor will be similar to a target item also increases. Visual (or graphemic) similarity could affect the speed with which the appropriate lexical node is accessed, leading to

The latency of an error response should be fast according to the theory, because errors can occur only if the subject responds before the extended memory search is made. The data support this prediction, and they accord well with the values predicted by Model II. Specifically, the latency of an error is close to the predicted value of $\ell + \rho + r_0 = 731$ msec for an S_1 item, and close to $\ell + \rho + r_1 = 687$ msec for an S_0 item. Furthermore, as predicted by the model, the observed error latencies do not appear to be influenced by the length of the target list.

A verbal interpretation of the results in terms of Model II reads as follows. When a target item is presented for the first time, the probability that a search of the E/K store will occur before a response is made exceeds the probability that a fast positive response will be emitted on the basis of the item's familiarity value alone. The opposite is true for initial presentations of distractors: most trials result in fast negative responses. Thus, the mean latency is longer for initial presentations of targets than for initial presentations of distractors, and the list-length effect is greater for targets than for distractors (because list-length effects depend only upon the search of the E/K store). The effect of repeated tests of words is to increase the familiarities of both targets and distractors. This results in an increased latency for responses to distractors, and a decrease in latency to targets; the magnitudes of the list-length effects are observed to change concomitantly.¹¹

APPLICATION OF THE MODEL TO RELATED EXPERIMENTS

Other experiments have been conducted to test various features of the theory. One such study involved target sets in which any specific word was included

confusions of identification. Direct evidence of this possibility is reported by Juola et al. (1971), who showed, among other things, that distractor words graphically very similar to target items were responded to more slowly. In this experiment, no estimate can be made of the contribution of similarity to the overall set-size effect. However, results from several long-term recognition studies indicate that both semantic and graphemic similarity cause increased error rates as well as increased response latencies (Atkinson & Juola, 1973; Juola et al., 1971). Because there were no differences in error rates among the three groups, it is unlikely that a significant proportion of the list-length effects is attributable to similarity factors.

¹¹ Variables other than those represented in the model influence familiarity. Of particular importance is the effect of the number of intervening trials between successive tests on a given item. Lag effects in response latency have been observed, with the magnitude of the effect decreasing with lag for both target and distractor items (Fischler & Juola, 1971; Juola et al., 1971). This phenomenon would be accounted for in the theory by assuming that the familiarity of an item increases immediately after presentation and then gradually declines over trials. To develop this idea mathematically would complicate the model. By design, lags were relatively constant for the data treated here and need not be represented explicitly in the model.

once, twice, or three times in the list memorized prior to the experimental session. If the number of occurrences of a word in the target list affects its familiarity value, then both error rate and latency should be less for multiply represented items than for items appearing only once in the list. If, however, the word's familiarity is unaffected by repetitions in the study list, then the error rate should be the same for all target items; further, any latency effects would have to be due to a faster search of the E/K store for an item multiply represented in the target list compared with one appearing only once. The results showed that error rate and response latency were less for items that occurred two or three times in the list than for items included only once. *Model II* was used to generate fits to the data, assuming that the expected familiarity value of a target word is an increasing function of the number of times it was included in the target list; the search of the E/K store was postulated to take the same time for all items. The model provided an excellent fit to the data (Atkinson & Juola, 1973).

Other experiments have demonstrated the importance of semantic properties of words in determining the familiarity value of an item. Juola et al. (1971) reported that if synonyms of target words were used as distractors both response latencies and error rates increased over the values obtained for semantically unrelated distractors. Another experiment (Atkinson & Juola, 1973) provided target sets arranged into a tree structure to reflect the semantic hierarchy from which the words were taken. During the test session target words were selected either from a 'dense' portion of the hierarchy (one of four nodes on a branch with up to four exemplar words under each node) or from a 'sparse' portion (one of two nodes with only two exemplar words under each node). The data showed that mean latencies for positive responses were less for targets from dense portions of the tree than for targets from the sparsely represented regions. The results from these two experiments indicate that the expected familiarity value of a word can be increased by testing semantically related words.

An experiment by Juola (1973) was designed to test the importance of stimulus-encoding factors in determining an item's familiarity value. The subjects memorized a list of 48 common nouns and then were tested with either words or simple outline drawings of the objects named by the words. Both words and pictures were presented as targets and distractors, and all items were tested twice. Of interest was the nature of the repetition effects when the second test of an item was either identical in form (e.g., 'CAT' followed by 'CAT') or different (e.g., 'CAT' followed by a picture of a cat). Repetition of the same pictorial form resulted in a faster encoding time; repetition (whether in the same or a different form) also increased the familiarity value of the items. The relative importance of these two effects was estimated by comparing mean latencies for repeated targets and distractors for the case in which the exact form of the stimulus was preserved on both

tests with the case in which different forms of the item were presented on successive tests. The results showed that subjects were faster on trials in which repeated items were presented in the same form (word or picture) as they had been shown on the first presentation. This was true for distractors as well as for target items. However, there were no significant differences in the error rates for items that were tested with the same or different stimulus forms on successive presentations. These results indicate that the familiarity value of an item is relatively independent of the form of the stimulus at the time of test. However, the form of the stimulus does have an effect on encoding time.

RECOGNITION MEMORY FOR ITEMS IN SHORT-TERM STORE

The theory presented in the previous sections was originally formulated to deal with recognition experiments involving large target sets stored in LTS. It is possible, however, to extend the model to the case in which the target set consists of a small number of items in STS. The results from experiments using small memory sets have generally shown that response latencies are linear, increasing functions of the number of target items, with roughly equal slopes for positive and negative responses. A model used to account for these findings is the serial scanning process proposed by Sternberg (1966, 1969a, 1969b). According to Sternberg's model, the subject encodes the test stimulus into a form that is comparable to the internal representations of the target items stored in STS. The encoded test item is scanned in serial fashion against each of the memory items, and then a decision is made about whether or not a match was obtained. The model predicts that latency will be a linear function of memory-set size, with both positive and negative responses having the same slope but possibly different intercepts.

Whereas the Sternberg model has proved adequate in explaining the results from many short-term recognition experiments, there are reports in the literature of systematic discrepancies between data and the model's predictions. It is not possible to review these results here (see Nickerson, 1970), but variations from the model have involved departures from linearity in the functions relating response latencies to target-set size, differences in slopes between the functions obtained for positive and negative responses (including cases in which the slope for positive responses is significantly greater than that for negatives), serial position effects in the latencies of positive responses, and trial-to-trial dependencies. These findings have led some authors (Baddeley & Ecob, 1970; Corballis, Kirby, & Miller, 1972) to propose alternative models for short-term recognition memory, suggesting that response decisions might be based solely on the test item's memory strength. Strength models

usually assume that there is a single criterion along the strength continuum; values above this criterion lead to positive responses. In addition, the decision time is assumed to be greater for values near the criterion, and both the criterion itself and the mean strength value of the target items are assumed to decrease as the number of targets increases.

It is our view that the test item's familiarity value (which in some sense is comparable to a strength notion) may play the same role in the short-term case as it does in long-term recognition studies. List-length effects are still to be explained in terms of a scan of the target set, but on occasion this search may be bypassed if the test item's familiarity is very high or very low; as in the long-term case, the probability of bypassing the target-set search will depend upon the reliability of the familiarity measure in generating correct responses.

The probability of bypassing the target-set search should be minimal in experiments using a small pool of items from which targets and distractors are to be drawn on each trial, as in the Sternberg (1966) study, which involved only the digits 0 to 9. The reason is that, during an experimental session, all items in the stimulus pool receive repeated presentations, and the resulting high familiarity values become less and less useful in distinguishing targets from distractors; thus a search of the target set will be made on most trials, resulting in large list-length effects. Support for this view comes from a study by Rothstein and Morin (1972), who reported much larger slopes for the response-time function in a short-term scanning task when the stimuli were selected from a small pool (10 words) than when selected, without replacement, from a very large pool of words. For the small item pool, we assume that repeated presentation increases the familiarity of all items to a uniformly high level, thereby reducing its usefulness as a basis for responding. Thus, the probability of executing a target-set search should be maximal, causing the slope of the response-time functions to take on its maximum value.

Figure 11 presents a flow diagram of the processes involved in recognition memory for items stored in STS. As in the case for target sets stored in the E/K store (Fig. 3), the test item is first encoded and the appropriate node in the lexical store is accessed, leading to the retrieval of a familiarity value for the item. If the familiarity value is very high or very low, the subject outputs a fast response that is independent of memory-set size. For intermediate familiarity values, the subject retrieves an internal code for use in scanning STS. Thus far, the processes proposed for short-term recognition are identical with those of the long-term case. However, the internal code used to search STS may not be the same as that used in the long-term memory search. For example, Klatzky, Juola, and Atkinson (1971) provided evidence that alternative codes for the same test item can be generated and compared with either verbal or spatial representations of target-set items. After retrieval of the appropriate internal code, a search of the target list stored in STS is

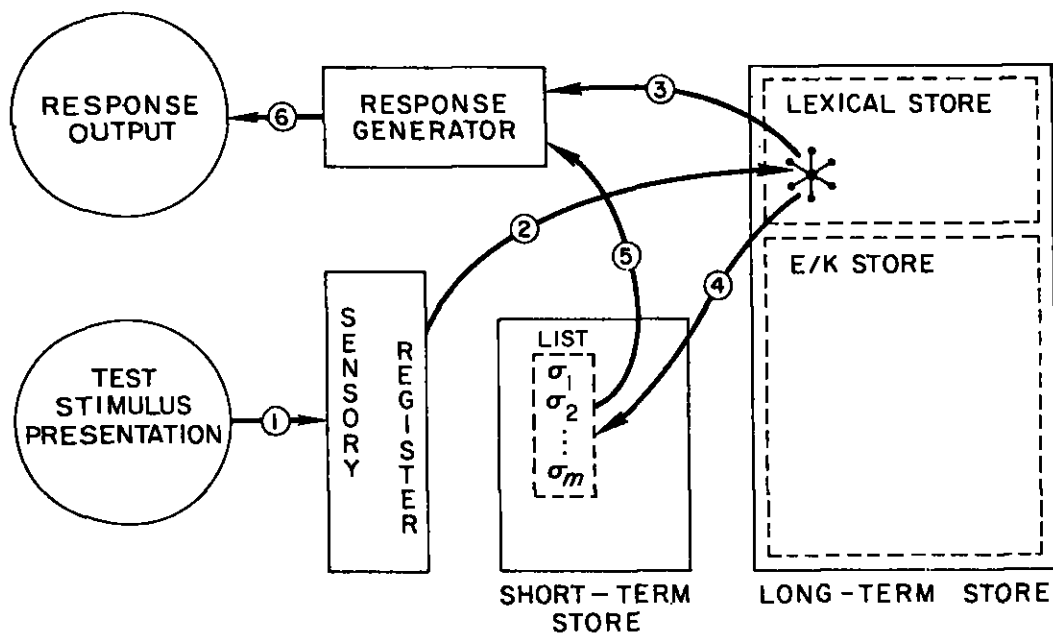

FIGURE 11.

A schematic representation of the search and decision processes in a short-term recognition memory study. A test stimulus is presented (1) and then matched to a node in the lexical store (2). The familiarity value associated with the node may lead to an immediate decision (3) and response output (6). Otherwise, a search code is extracted and scanned against the target list in STS (4), which leads to a decision (5) and subsequent response. Path (1), (2), (3), (6) results in a faster response than Path (1), (2), (4), (5), (6), and the response is independent of the size of the ST set.

executed, and a response based on the outcome of this scan is then made.

An unpublished study conducted by Charles Darley and Phipps Arabie at Stanford University was designed to assess the effects of item familiarity in a short-term memory task. The familiarity values of distractor items were manipulated to determine if this variable would affect the slopes and intercepts of the function relating latency to target-set size. On each of a long series of trials, a target set of from two to five words was presented auditorally, followed by the visual presentation of a single test word. The words used in the target sets were different on every trial of the experiment; that is, a word once used in a target set was never used in any other target set. On half the trials a word from the current target set was presented for test; these trials will be designated P trials to indicate that a 'positive response' is correct. On the other half of the trials, a distractor (a word not in the current target set) was presented for test; these trials will be called N trials because a 'negative response' is correct. The distractor words were of three types: new words never presented before in the experiment (denoted N_1 , because the word was presented for the first time); words that had been presented for the first time

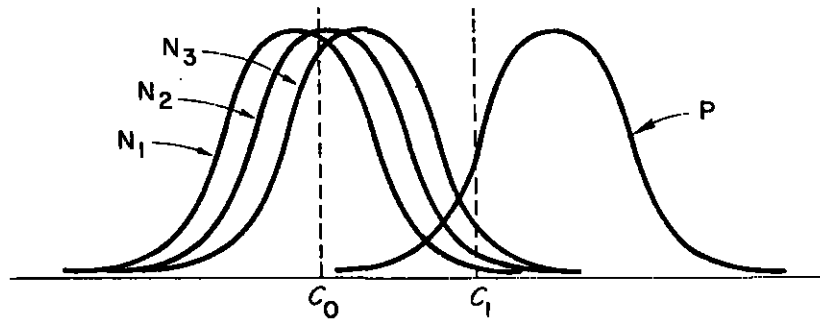

FIGURE 12.
Distributions of familiarity values for the three types of distractor items (N_1 , N_2 , N_3) and for target items (P).

in the experiment as distractors on the immediately preceding trial (denoted N_2 , because the word was now being presented for the second time); and words that had been presented for the first time both as a member of the memory set and as a positive test stimulus on the immediately preceding trial (denoted N_3 , because the word was now being presented for the third time). Thus there were four types of test items (N_1 , N_2 , N_3 , P), and we assume that different degrees of familiarity are associated with each.

Figure 12 presents a schematic representation of the four familiarity distributions. The density functions associated with the test word on an N_1 , N_2 , N_3 , or P trial are denoted $\phi(x; N_1)$, $\phi(x; N_2)$, $\phi(x; N_3)$, or $\phi(x; P)$, respectively; as in the previous application, these functions are assumed to be normally distributed with unit variance. Their expected values are denoted μ_{N_1} , μ_{N_2} , μ_{N_3} , and μ_P . The quantity μ_P should be largest because the test word on a P trial is a member of the current trial target set and should be very familiar; μ_{N_1} should be smallest because N_1 words are completely new; and μ_{N_2} and μ_{N_3} should be intermediate because N_2 and N_3 words appeared on the prior trial. The probabilities of errors for the four trial types are determined by the areas of the familiarity distributions above c_1 for distractors, and below c_0 for targets; that is,

$$P(\text{Error} | N_i) = \int_{c_1}^{\infty} \phi(x; N_i) dx, \quad \text{for } i = 1, 2, 3; \quad (13)$$

$$P(\text{Error} | P) = \int_{-\infty}^{c_0} \phi(x; P) dx. \quad (14)$$

Let us now derive expressions for reaction times in this situation. For simplicity, only Model II of the preceding section is considered. To obtain equations for response latencies, it is necessary to sum the time for the encoding and familiarity-retrieval process (time ℓ), the time for a fast response decision

based on the familiarity value alone (time ρ) weighted by its probability, the time for a search of the memory list in STS (time $\kappa + \alpha m$, with m defined as the size of the short-term target set) also weighted by its probability, and the time for response output (r_0 and r_1 for negative and positive responses, respectively). Thus, the expected time for a correct response is

$$t(N_i) = \ell + r_0 + \left[\int_{-\infty}^{c_0} \rho \phi(x; N_i) dx + \int_{c_0}^{c_1} (\rho + \kappa + \alpha m) \phi(x; N_i) dx \right] \left[\int_{-\infty}^{c_1} \phi(x; N_i) dx \right]^{-1} \quad (15)$$

for $i = 1, 2, 3$; and

$$t(P) = \ell + r_1 + \left[\int_{c_1}^{\infty} \rho \phi(x; P) dx + \int_{c_0}^{c_1} (\rho + \kappa + \alpha m) \phi(x; P) dx \right] \left[\int_{c_0}^{\infty} \phi(x; P) dx \right]^{-1} \quad (16)$$

The expression $t(N_i)$ gives the time to respond correctly to an N_i item, whereas $t(P)$ gives the time for a correct response to a P item. The preceding expressions can be written more simply if we define

$$s'_i = \left[\int_{c_0}^{c_1} \phi(x; N_i) dx \right] \left[\int_{-\infty}^{c_1} \phi(x; N_i) dx \right]^{-1}, \quad \text{for } i = 1, 2, 3; \quad (17)$$

$$s = \left[\int_{c_0}^{c_1} \phi(x; P) dx \right] \left[\int_{c_0}^{\infty} \phi(x; P) dx \right]^{-1}. \quad (18)$$

Then

$$t(N_i) = [\ell + \rho + r_0] + s'_i[\kappa + \alpha m], \quad \text{for } i = 1, 2, 3; \quad (19)$$

$$t(P) = [\ell + \rho + r_1] + s[\kappa + \alpha m]. \quad (20)$$

The quantities s'_i and s are determined by the familiarity distributions and c_1 and c_0 and are not influenced by m . Thus $t(N_i)$ and $t(P)$ plotted as functions of m yield straight lines with slopes $\alpha s'_i$ and αs , respectively.

The latency data from the experiment are presented in Figure 13. Note that latency increases with memory-set size and is ordered such that P is fastest, and N_1 , N_2 , and N_3 are progressively slower. To fit the model to these data, we proceed in the same way as we did for the long-term experiment. The observed probabilities of an error on N_1 , N_2 , and N_3 trials were 0.008, 0.018, and 0.058, respectively. Using these error probabilities and Equation 13 yields the following relations: $\mu_{N_1} = c_1 - 2.41$; $\mu_{N_2} = c_1 - 2.10$; $\mu_{N_3} = c_1 - 1.56$. The probability of an error on a P trial was 0.028; using Equation 13 yields $\mu_P = c_0 + 1.91$. Setting c_0 equal to zero leaves the following five parameters to be estimated from the latency data: c_1 , $(\ell + \rho + r_1)$, r , κ , α , where r is again defined as $r_0 - r_1$. An RMSD function equivalent to the one

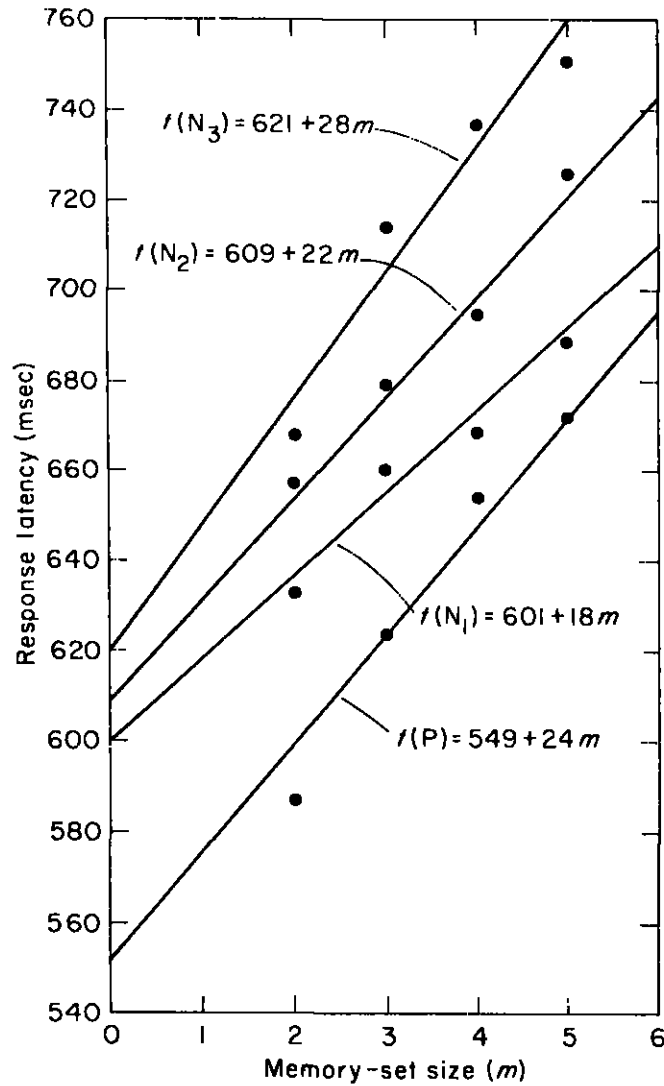

FIGURE 13. Correct response latencies as a function of the size of the memory set. The straight lines fitted to the data represent theoretical predictions.

presented in Equation 12 was specified for the 16 data points in Figure 13, and a computer was programmed to search the parameter space for a minimum.

Table 5 presents the parameter estimates, and the theoretical predictions are graphed as straight lines in Figure 13. In carrying out these fits, 9 parameters were estimated from the data; however, there are 4 error probabilities and 16 latency measures to account for. Thus 9 of 20 degrees of freedom

TABLE 5
Parameter estimates for the
short-term memory study

Parameter	Estimate
c_1	2.52
$(l + \rho + r_1)$	499 msec
r	64 msec
κ	70 msec
α	33.9 msec

Note: $r = r_0 - r_1$.

were used in the estimation process, leaving 11 against which to evaluate the goodness of fit.

The results in Figure 13 indicate that the familiarity value of the distractor item has a large effect, with the slopes and intercepts of the negative functions increasing with their expected familiarity values. These effects are captured by the model, which generally does a satisfactory job of fitting the data. The predicted slope of the $t(P)$ function is 24 msec, whereas the predicted slopes for $t(N_1)$, $t(N_2)$, and $t(N_3)$ go from 18 msec to 22 msec to 28 msec, respectively. If the subject ignored the familiarity measure and made a search of the memory list on every trial, then all four functions would have a slope equal to α , which was estimated to be 33.9 msec.¹²

The results shown in Figure 13 support the proposition that familiarity effects play a role in short-term memory scanning experiments. Further, these effects can be accounted for with the same model that was developed for long-term recognition studies. However, examination of the parameter estimates for the short- and long-term cases indicates that the time constants for the two processes are not the same (see Tables 4 and 5). For example, the time to initiate the extended search, κ , is 70 msec in the short-term study compared with 137 msec in the long-term study. In contrast, the search rate, α , is 33.9 msec in the short-term case and only 9.9 msec in the long-term case. Thus, the search is initiated more rapidly in the short-term case, but the search rate is faster in the long-term case. We will not pursue these comparisons here, but will return to them later.

In the next section the model is generalized to an experiment in which target items were stored in either STS or LTS, or in both. For this case, the theory must be elaborated to account for such possibilities as sequential or simultaneous search of the two memory stores and changes in the decision

¹² Similar fits were carried out using Model I, which involved estimating both α and α' . The estimate of α' was somewhat below that of α , but the goodness of fit was only slightly improved over that obtained for Model 11, using one less parameter.

criteria, depending on whether the test item is potentially a member of a list stored in LTS, in STS, or in both.

AN EXPERIMENT INVOLVING BOTH LONG- AND SHORT-TERM TARGET SETS

Experiments by Wescourt and Atkinson (1972) and Mohs, Wescourt, and Atkinson (1973) were designed to compare results for the cases in which the subject maintained target sets in LTS, in STS, or in both. Figure 14 presents a flow diagram for the case in which the test stimulus could be a member of a target set in either store. When the test stimulus is presented, it is encoded and the appropriate lexical node is accessed. If the familiarity value associated with that node is above the high criterion or below the low criterion, a fast response is emitted. If familiarity is of an intermediate value, the subject executes an extended search of the two memory stores. Again, it is likely that the internal representations of items in STS and the E/K store are different;

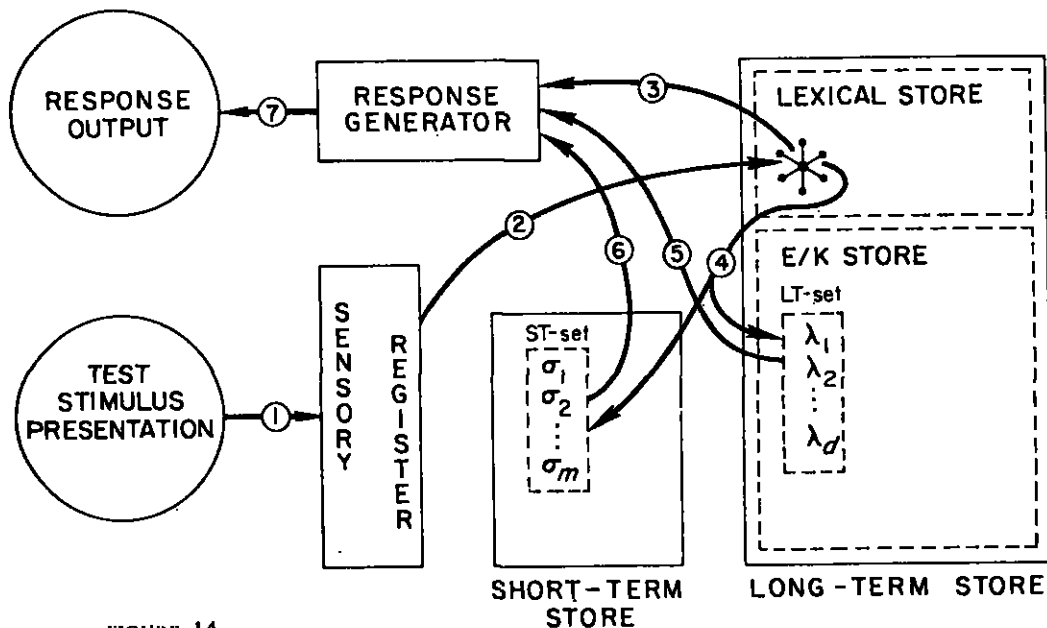

FIGURE 14. A schematic representation for the case where part of the target set is in STS and part is in LTS. A test item is presented (1) and then matched to its node in the lexical store (2). The familiarity index of the node may lead to an immediate decision (3) and response output (7). Otherwise, an ST code and an LT code are extracted for the lexical node, and then used to search STS and LTS (4). A decision about the test item is eventually made based on the search of LTS (5) or of STS (6), and a response is output (7).

thus, different codes of the test item must be extracted from the test item's lexical node before this search can begin. The search continues until a match is obtained or until both sets are searched without finding a match, and then the appropriate response is made.

In the study considered here, two types of trial blocks were used. For one type, designated the S Block, the target set consisted of only short-term items (ST set). For the other, the M Block, the target set involved a 'mix' of both an ST set and an LT set. The ST set is distinguished from the LT set in two ways:

- (1) The ST set was presented on each trial before the onset of the test stimulus; it always involved a new set of words never before used in the experiment. On the other hand, the LT set was thoroughly memorized the day before the first test session and used throughout the experiment.
- (2) The ST set contained a small number of words (1 to 4), which could readily be maintained in short-term memory without taxing its capacity. The LT set consisted of a list of 30 words (memorized in serial order) stored in long-term memory.

The subjects were tested in three consecutive daily sessions (the data from the first day are not included in the results reported here). Each session was divided into M and S Blocks. On each trial of an M Block, 0 to 4 words (ST set) were presented prior to the onset of the test word. On positive trials, the test word was selected from either the LT set or the ST set if the ST set was nonempty (load condition); or the test word was selected from the LT set if there were no ST items (no-load condition). On negative trials, the test word was not in either the ST or LT set and had never been used before in the experiment. On each trial of the S Block, an ST set of from 1 to 4 words was presented prior to the onset of the test stimulus; on positive trials a word from the ST set was presented for test, and on negative trials a word never used before was presented.

Trials in the S Block are like those in a short-term memory-scanning experiment and are referred to as S trials. The no-load trials of the M Block correspond to those in a long-term recognition task such as the one reported earlier in this chapter; because tests involve only the long-term target set, these trials are called L trials. The load trials of the M Block require the subject to evaluate a test word against both an ST set and the LT set, and they are called M trials. Thus, S trials involve a pure test of short-term memory, L trials a pure test of long-term memory, and M trials involve a mix of both short- and long-term memories.¹³ Figure 15 illustrates the various trial types.

¹³ Studies of this sort have been reported by Forrin and Morin (1969) and Doll (1971). However, they have employed very small LT sets, and there is the possibility that the subject could enter the entire LT set into short-term memory on some or all of the trials. Thus a complete separation of the long- and short-term searches might not have been achieved.

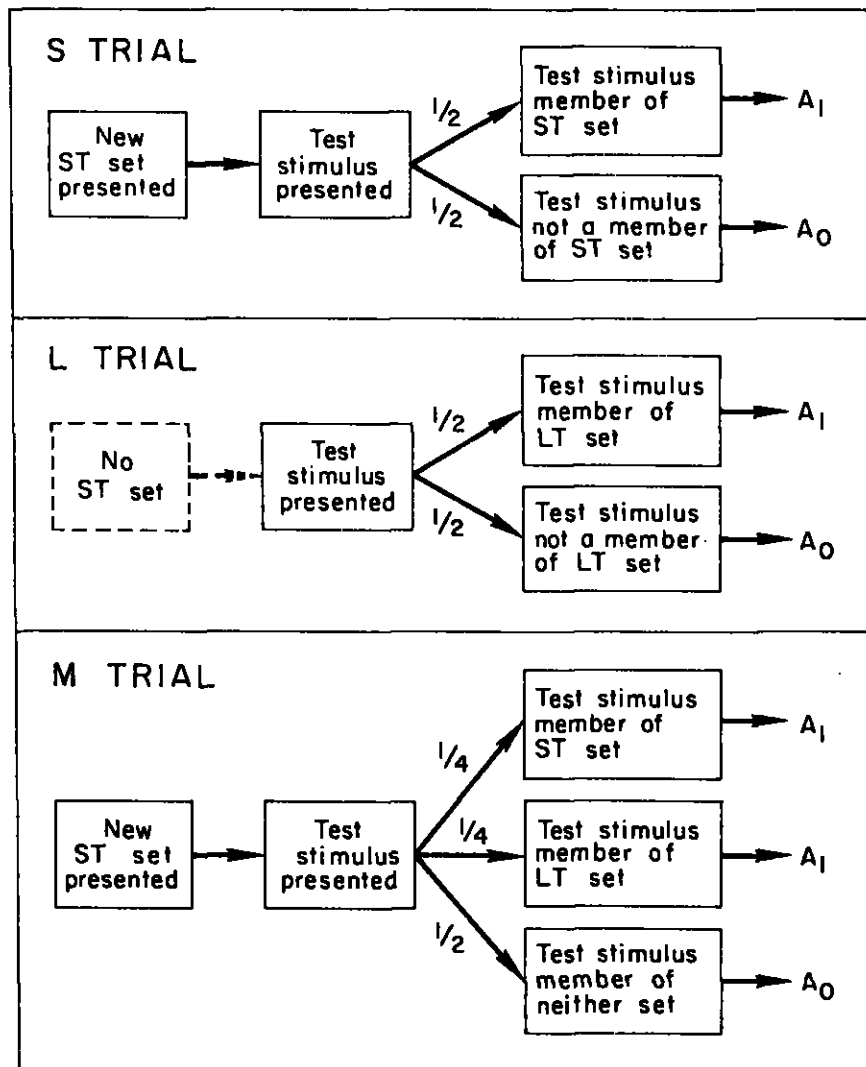

FIGURE 15.
Diagram representing the three types of trials. In all blocks, distractors involve words never presented before in the experiment.

Figure 16 presents the mean latencies of correct responses for the various trial types. The straight lines fitted to the data represent theoretical predictions and are discussed later. In discussing these results, it is useful to adopt the notation defined in Table 6. In all cases these measures refer to the latency of a correct response. The subscript on t indicates the trial type (S, L, or M); the P in parentheses indicates that a positive response was correct (i.e., a

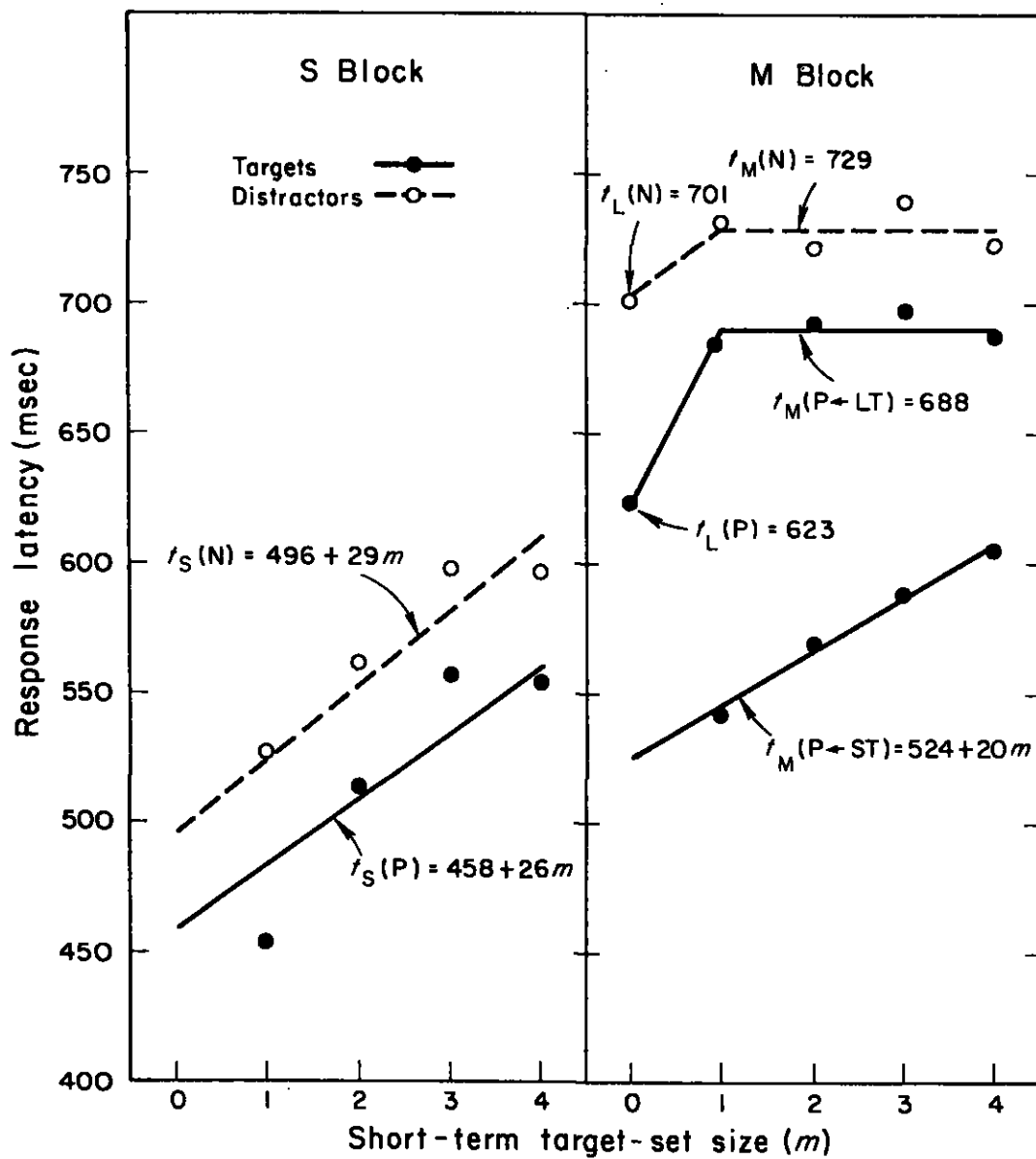

FIGURE 16. Mean response latencies as functions of ST-set size (m) for the S Block (left panel) and the M Block (right panel). The linear functions fitted to the data are explained in the text.

TABLE 6
Definition of notation

Notation	Definition
$t_R(P)$	Time for a positive response on an S trial
$t_R(N)$	Time for a negative response on an S trial
$t_L(P)$	Time for a positive response on an L trial
$t_L(N)$	Time for a negative response on an L trial
$t_M(P \leftarrow ST)$	Time for a positive response to a test item from the ST set on an M trial
$t_M(P \leftarrow LT)$	Time for a positive response to a test item from the LT set on an M trial
$t_M(N)$	Time for a negative response on an M trial.

target item was presented for test), whereas N indicates that a negative response was correct (i.e., a distractor was presented for test).

Inspection of Figure 16 shows that the observed values for $t_R(P)$, $t_R(N)$, and $t_M(P \leftarrow ST)$ are all increasing functions of m , the size of the ST set. In contrast, neither $t_M(P \leftarrow LT)$ nor $t_M(N)$ appears to be systematically influenced by the size of the ST set. The presence or absence of an ST set in the M Block, however, does have an effect, as is evident by comparing responses on L trials with comparable ones on M trials. Specifically, note that the four observed values for $t_M(P \leftarrow LT)$ are well above $t_L(P)$, and that the four $t_M(N)$ values are above $t_L(N)$.

The model to be tested against these data assumes that the extended searches are executed separately in STS and in the E/K store. The questions to be asked involve the notion of whether the two memory stores are searched sequentially or simultaneously. Figure 17 presents several flowcharts that represent the differences between serial and parallel searches of STS and the E/K store. The diagram in Figure 17(A) represents the sequence of events on an S trial and corresponds to the short-term recognition model presented

FIGURE 17. (*facing page*)

Flowcharts representing models for processing strategies in searching the memory stores. The model for S trials is shown in Panel A; arrows (1) and (2) represent fast responses based on familiarity alone, whereas (4) and (5) represent responses after a search of STS has occurred. The model for L trials is shown in Panel B and has the same interpretation as Panel A except that the search involves the E/K store. Two alternative models for M trials are presented in the bottom two panels. Panel C presents a parallel search. As before (1) and (2) indicate fast responses based on familiarity; (3) and (4) indicate that the searches of STS and the E/K store are done simultaneously. If the test item is found in the ST set (5) or in the LT set (7), a positive response is made; if the item is not found in the ST set (6) the subject has to wait for a similar outcome from the search of the LT set (8) before a negative response can be made. In Panel D, a sequential search model is presented for M trials. The arrows (1) and (2) represent fast responses based on familiarity. When a search is required, the ST set is examined first (3). If a match is found, a positive response is made (4); if not, the LT set is searched (5). When the LT-set search is complete, either a positive (6) or negative response (7) is output.

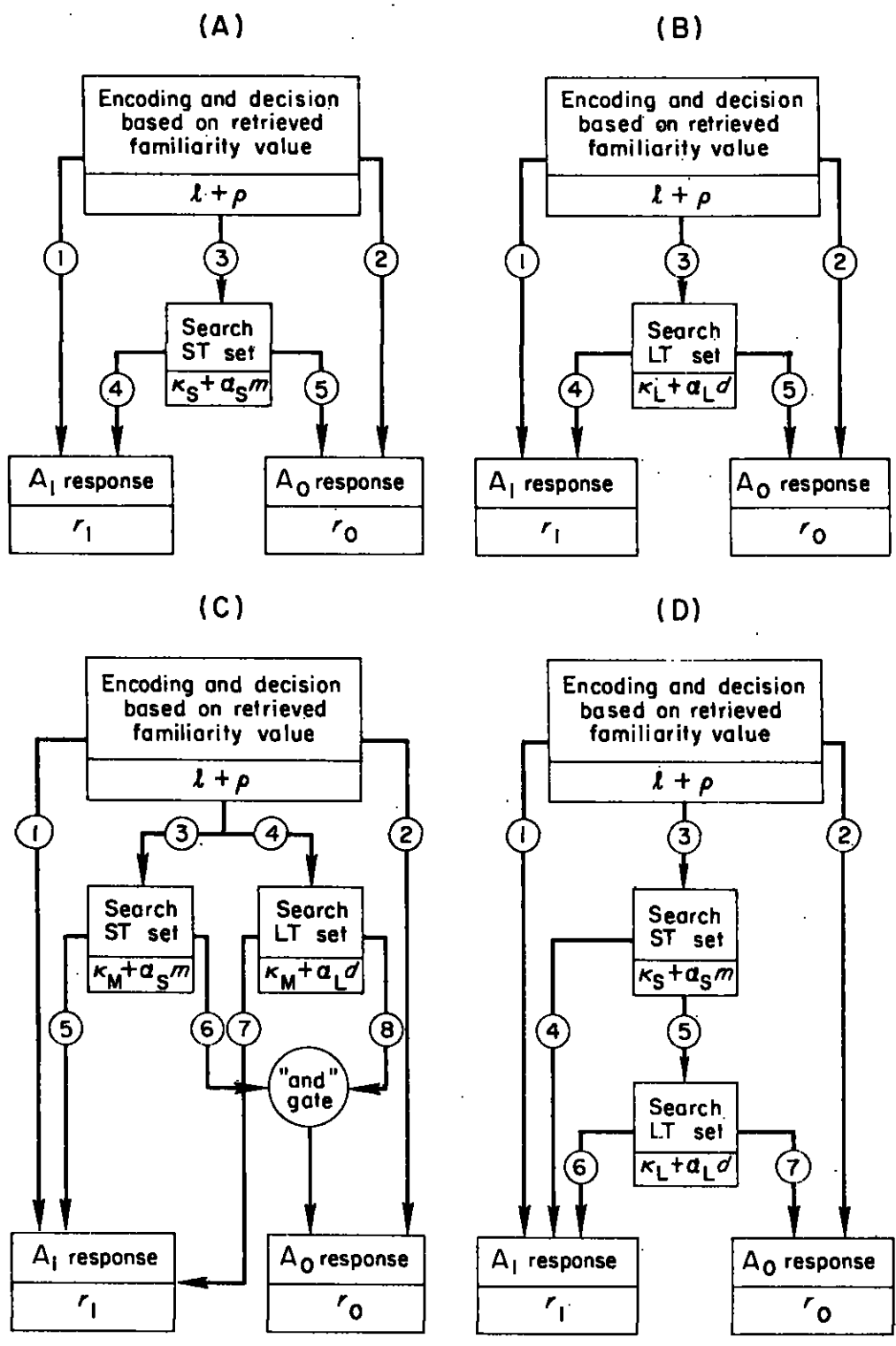

in the preceding section. It assumes that initially the subject makes a familiarity estimate of the test item, and on this basis he outputs a fast positive or negative response if its value is above the high criterion or below the low criterion, respectively. Otherwise, the subject delays his response until a search of STS has been made, the length of this search being a linear function of m (the size of the ST set). Figure 17(B) represents the stages involved on an L trial. Again, the subject can output a fast negative or positive response based on familiarity alone. Otherwise he initiates a search of the E/K store before responding; the time for this search is a linear function of d (the size of the LT set).¹⁴

For M trials there are at least two search strategies that suggest themselves. First, it is possible that the subject might search both STS and the E/K store simultaneously, outputting a response when the test item is found or when both stores have been searched exhaustively without finding the target. This strategy is represented in Figure 17(C). Alternatively, it is possible that the two memory stores are searched sequentially. Because response time is less to a test item from the ST set than to one from the LT set, we assume that STS is searched first, as shown in Figure 17(D). For both of these M -trial strategies, a fast response will be emitted before a search of either store is made if the retrieved familiarity value is above the high criterion or below the low criterion.

Examination of the data in Figure 16 indicates that the sequential model of Figure 17(D) can be rejected. In this model, the search of the E/K store cannot begin until the STS scan has been completed. Because the length of the STS search depends on the size of the ST set, the beginning of the search of the E/K store and, in turn, $t_M(P \leftarrow LT)$ and $t_M(N)$ should increase as the ST set increases. The data in Figure 16 indicate that this is not the case; both $t_M(P \leftarrow LT)$ and $t_M(N)$ appear to be independent of ST-set size. However, these data are compatible with a parallel search model of the type shown in Figure 17(C), if it is assumed that the rate of search in the E/K store is independent of the number of ST items. In order to make a detailed analysis of the models shown in Figure 17, we must derive theoretical equations and fit them to the data.

THEORETICAL PREDICTIONS FOR THE STS-LTS INTERACTION STUDY

The decision stage of the general model, as represented in Figure 5, must be adapted to account for the experimental conditions of the experiment. It is necessary to allow for differences in the decision process, depending on

¹⁴ Throughout this chapter, d is used to denote the size of a long-term target set and m to denote the size of a short-term target set.

whether the test item is potentially located in STS only, in the E/K store only, or in both. These differences may be included in the model either by allowing the means of the familiarity distributions to vary as a function of the trial type, or by allowing the decision criteria to change. For the present analysis, we assume that the means of the familiarity distributions are constant over all conditions. This seems to be the most parsimonious assumption; familiarity should be a property of the test stimulus, but the subject could be expected to adjust his decision criteria differently depending on whether it is an S trial, an L trial, or an M trial. Three familiarity distributions are specified: one associated with a test item drawn from the ST set; another for a test item from the LT set; and the third for a distractor item. These distributions are assumed to be unit-normal, with cumulative distribution functions $\Phi_S(\cdot)$, $\Phi_L(\cdot)$, and $\Phi_D(\cdot)$, respectively. The means of the distributions are designated μ_S , μ_L , and μ_D , and they are assumed to be fixed for the data analyzed in this chapter. The reasons for fixing the means are the following: distractor items and ST items appear only once during the experiment, and thus repetition effects on familiarity are not a factor; for the LT items, we treat data only after these items have had several prior tests, and their familiarity should be close to an asymptotic level.

Figure 18 presents a diagram of the familiarity distributions as they apply on S, L, and M trials. Note that the mean for each distribution is placed at the same point on the familiarity scale, no matter what type of trial is involved. Differences in the decision process arise because the subject can set his criteria at different values in anticipation of an S, L, or M trial. This possibility is indicated in Figure 18. The low and high criterion values are denoted as $c_{0,S}$ and $c_{1,S}$ for S trials; as $c_{0,L}$ and $c_{1,L}$ for L trials; and as $c_{0,M}$ and $c_{1,M}$ for M trials. How the subject sets the criteria depends on the trade-off he is willing to accept between speed and accuracy; the nature of the trade-off, of course, varies as a function of the trial type.

Notation comparable to that in Table 6 is used to denote error probabilities. For example, $E_S(P)$ denotes the probability of an error on an S trial for which the correct response was positive. This probability is the tail of the ST distribution to the left of $c_{0,S}$ in Figure 18. Table 7 presents theoretical expressions for the various types of errors.

As before, it is possible to derive equations for response latencies by weighting each stage of the process by the probability that it occurs, and then summing over stages. On every trial the test stimulus must be encoded and the appropriate node in the lexical store accessed; time for this stage is ℓ and is assumed to be the same for all trial types. Next, the subject must make a decision based on the retrieved familiarity value; using Model II, we assume that this decision time is ρ and also is independent of the trial type. If a fast positive or negative response is called for, based on the familiarity value, it will be executed with time r_1 or r_0 , respectively.

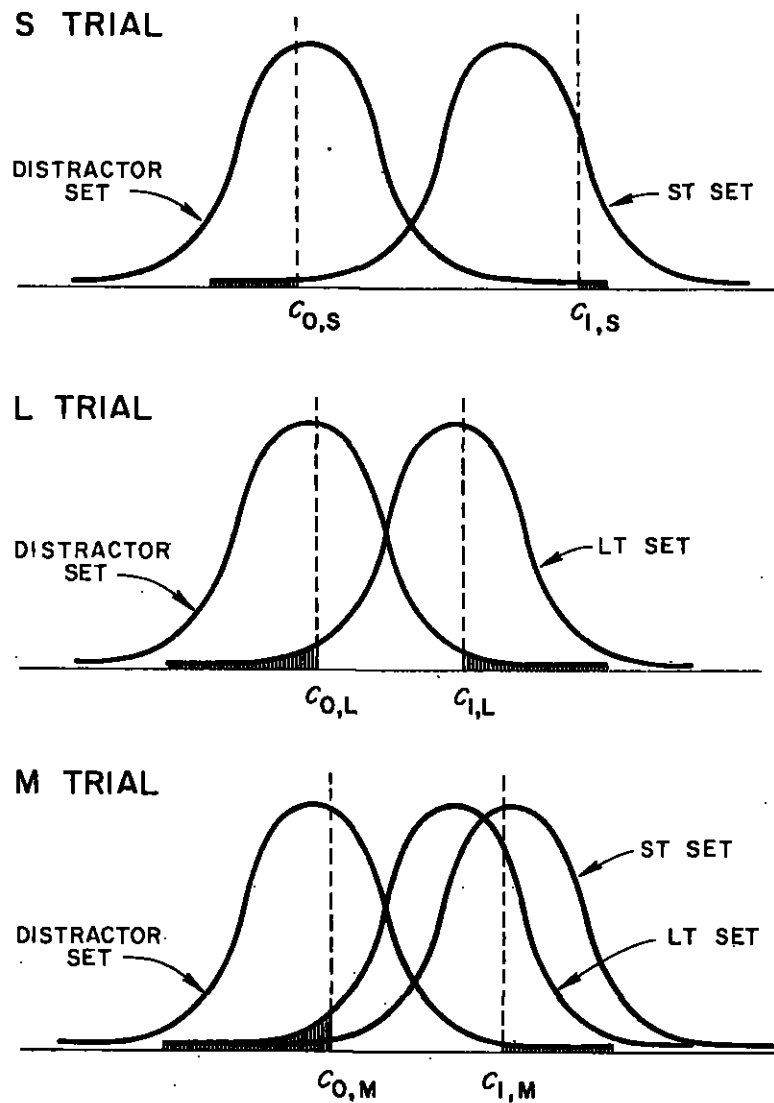

FIGURE 18.
Distributions of familiarity values for the three trial types.

When the familiarity value falls between the two criterion values, a search of the stored target list or lists is required. The nature of this search depends on the trial type because different internal codes may be used and different memory stores scanned. Three classes are to be considered.

S trials. An ST code is extracted from the test item's lexical node and then is scanned against the target set in STS; the time to extract the code

TABLE 7
Theoretical expressions for the probabilities of seven types of errors

S trials	L trials	M trials
$E_S(P) = \Phi_S(c_{0,S})$	$E_L(P) = \Phi_L(c_{0,L})$	$E_M(P \leftarrow ST) = \Phi_S(c_{0,M})$
$E_S(N) = 1 - \Phi_D(c_{1,S})$	$E_L(N) = 1 - \Phi_D(c_{1,L})$	$E_M(P \leftarrow LT) = \Phi_L(c_{0,M})$
		$E_M(N) = 1 - \Phi_D(c_{1,M})$

is denoted as κ_S , and then time $m \cdot \alpha_S$ is required to scan the m items in the ST set.¹⁵

L trials. An LT code is extracted from the lexical node, which takes time κ_L , and then is scanned against the d items in the LT set, which takes time $d \cdot \alpha_L$ (d in the experiment is 30).

M trials. Both an ST code and an LT code are extracted from the node, and each is scanned against the appropriate list. The extraction of the two codes takes time κ_M , and the respective scans take times $m \cdot \alpha_S$ and $d \cdot \alpha_L$. (Thus, a positive response to an ST or LT item takes time $m \cdot \alpha_S$ or $d \cdot \alpha_L$, respectively; a negative response takes time $d \cdot \alpha_L$, because both lists must be scanned, and the time is determined by the slowest scan which always involves the LT set.)

Whichever of these three cases applies, a positive or negative response—once a decision has been made—requires time r_1 or r_0 , respectively.¹⁶

In terms of these assumptions, we can derive expressions for the latency of a correct response for each of the trial types. The derivation is similar to that for Equations 15 and 16, and only the results are presented:

$$t_S(P) = (\ell + \rho + r_1) + s_S(\kappa_S + m\alpha_S); \quad (21a)$$

$$t_S(N) = (\ell + \rho + r_0) + s_S(\kappa_S + m\alpha_S); \quad (21b)$$

$$t_L(P) = (\ell + \rho + r_1) + s_L(\kappa_L + d\alpha_L); \quad (22a)$$

¹⁵ The parameters κ and α are used here in the same way as in earlier accounts of the theory. The subscript indicates that κ depends on the code(s) to be extracted, and α on the memory store to be scanned.

¹⁶ It is assumed that α_L is independent of the size of the ST set, and that any differences in scanning the LT set on L trials and on M trials is due to κ_L and κ_M , respectively. Independent support for this assumption comes from a study that replicated the M-Block trial sequence, except for the fact that all targets were drawn from the LT set. Subjects had to maintain a set of items in STS (that varied from 0 to 4 words); however, they knew that the test would involve either an LT item or a distractor. Under these conditions the latency of a positive response to an LT item and the latency of a negative response to a distractor were both constant as the ST-set size varied from 0 to 4 (i.e., no change in latency occurred when an ST set was or was not present). In this experiment the scan of the LT set was determined by α_L and κ_L on all trials; the parameter κ_M was not required because only the LT code had to be extracted from the lexical node on both L trials and M trials.

$$t_L(N) = (l + \rho + r_0) + s'_L(\kappa_L + d\alpha_L); \quad (22b)$$

$$t_M(P \leftarrow ST) = (l + \rho + r_1) + s_{M,S}(\kappa_M + m\alpha_S); \quad (23a)$$

$$t_M(P \leftarrow LT) = (l + \rho + r_1) + s_{M,L}(\kappa_M + d\alpha_L); \quad (23b)$$

$$t_M(N) = (l + \rho + r_0) + s'_M(\kappa_M + d\alpha_L). \quad (23c)$$

The s functions in these equations represent the probability of an extended search conditional on the occurrence of a correct response; they are comparable to those in Equations 17 and 18 and are given in Table 8.

TABLE 8
Probability of an extended memory search
conditional on a correct response

s function	Theoretical expressions
s_R	$[\Phi_S(c_{1,S}) - \Phi_S(c_{0,S})][1 - \Phi_S(c_{0,S})]^{-1}$
s'_R	$[\Phi_1(c_{1,S}) - \Phi_1(c_{0,S})][\Phi_1(c_{1,S})]^{-1}$
s_L	$[\Phi_L(c_{1,L}) - \Phi_L(c_{0,L})][1 - \Phi_L(c_{0,L})]^{-1}$
s'_L	$[\Phi_1(c_{1,L}) - \Phi_1(c_{0,L})][\Phi_1(c_{1,L})]^{-1}$
$s_{M,R}$	$[\Phi_S(c_{1,M}) - \Phi_S(c_{0,M})][1 - \Phi_S(c_{0,M})]^{-1}$
$s_{M,L}$	$[\Phi_L(c_{1,M}) - \Phi_L(c_{0,M})][1 - \Phi_L(c_{0,M})]^{-1}$
s'_M	$[\Phi_1(c_{1,M}) - \Phi_1(c_{0,M})][\Phi_1(c_{1,M})]^{-1}$

In fitting the model to the data, we used a procedure somewhat different from the one employed in the previous experiments. An RMSD function comparable to that given in Equation 12 was defined, but it was composed of two components that were weighted and summed. The first component involved deviations between the 7 observed and predicted error probabilities of Table 7, and the second component involved deviations between the 22 observed and predicted latencies given by Equations 21 through 23. Parameter estimates were then obtained by using a computer to search the parameter space and obtain values that minimized the RMSD function; in the search μ_D was arbitrarily set at zero. The parameter estimates are given in Table 9. Fifteen parameters were estimated from the data, but there are 7 error probabilities and 22 latency measures to be predicted; thus 15 of 29 degrees of freedom were used in parameter estimation, leaving 14 against which to judge the goodness of fits.

The theoretical fits for the latency data are presented as straight lines in Figure 16. The most deviant point is that for $t_S(P)$ when $m = 1$. This particular discrepancy is not unexpected in view of previous research (Juola & Atkinson, 1971); it appears that for a memory set of one item (in the pure

TABLE 9
Parameter estimates

Latency measures	Familiarity measures and decision criteria
$(t + \rho + r_s) = 408$ msec	$\mu_D = 0$
$r = 30$ msec	$\mu_L = 1.53$
$\kappa_S = 69$ msec	$\mu_N = 1.51$
$\kappa_L = 140$ msec	$c_{0,S} = -0.99$
$\kappa_M = 207$ msec	$c_{1,S} = 2.13$
$\alpha_S = 35.0$ msec	$c_{0,L} = -0.33$
$\alpha_L = 9.8$ msec	$c_{1,L} = 1.56$
	$c_{0,M} = -0.25$
	$c_{1,M} = 1.72$

Note: $r = r_n - r_s$.

short-term case) a decision can be based on a direct comparison between a sensory image of the memory item and the sensory input for the test item. Thus, a different process is operative on these particular trials, leading to unusually fast response times. Otherwise, the fits displayed in Figure 16 are quite good, given the linear character of the predictions.¹⁷ Also, the parameter estimates are ordered in the expected way. The estimate of κ_S is less than κ_L , as would be expected by comparing the κ values for the long-term and short-term recognition experiments given in Tables 4 and 5; κ_M is the largest of the group and should be since it involves extracting both an ST and LT code. There is close agreement between the estimate of κ_S in this study (69 msec) and in the short-term study (70 msec); similarly, the estimate of κ_L (140 msec) agrees with the corresponding estimate in the long-term study (137 msec). The α values are also ordered as expected, with a much slower search rate for the ST set than for the LT set. Note that the estimate of α_S (35.0 msec) is close to the α value estimated for the short-term study (33.9 msec), and that α_L (9.8 msec) is virtually identical to the α value estimated for the

¹⁷ The curvilinear component in the data of the left panel of Figure 16 [excluding $t_{8(P)}$ for $m = 1$] was unexpected, because a study by Juola and Atkinson (1971), using a similar procedure but employing only S-type trials, yielded quite straight lines. (For a comparison of the two procedures, see Wescourt & Atkinson, 1973.) The model presented in this chapter can be generalized to yield curvilinear predictions. One possibility is that the subject adjusts his decision criteria as a function of the ST-set size: when the large memory set is presented, he anticipates a slow response and attempts to compensate by adjusting the criteria to generate more fast responses based on familiarity alone. Another possibility is that, under certain experimental conditions, the familiarity of the target items depends on their serial position in the study list (Burrows & Okada, 1971). This assumption would lead to serial position effects and could also account for the curvilinear effects noted here. For a discussion of these possibilities see Atkinson, Herrmann, and Wescourt (1974).

long-term study (9.9 msec). Differences in response keys and stimulus displays make it doubtful that $(t + \rho + r_1)$ or r should agree across the three studies reported in this chapter. The parameters that one might hope to be constant over experiments do indeed seem to be, providing some support for the model beyond the goodness-of-fit demonstration.

SUMMARY AND CONCLUSIONS

In this chapter we have considered a model for recognition memory. The model assumes that, when a test stimulus is presented, the subject accesses the lexical store and retrieves a familiarity value for the stimulus. Response decisions based only on this familiarity value can be made very quickly, but result in a relatively high error rate. If the familiarity value does not provide the subject with sufficient information to respond with confidence, a second search of a more extended type is executed. This latter search guarantees that the subject will arrive at a correct decision, but with a consequent increase in *response latency*. By adjusting the criteria for emitting responses based on familiarity versus those based on an extended memory search, the subject can achieve a stable level of performance, matching the speed and accuracy of responses to the demand characteristics of the experiment.

The model provides a tentative explanation for the results of several recognition-memory experiments. The memory search and decision stages proposed in the present chapter are indicative of possible mechanisms involved in recognition. We do not, however, believe that they provide a complete description of the processes involved; the comparisons of data with theoretical predictions are reported mainly to demonstrate that many features of our results can be described adequately by the model.

There are several additional observations, however, that suggest that the memory and decision components of the model correspond to processing stages of the subject. Introspective reports indicate that subjects might indeed output a rapid response based on tentative, but quickly retrieved, information about the test stimulus. Subjects report that they are sometimes able to respond almost immediately after the word is presented without 'knowing for sure' if the item is a target or not. The same subjects report that on other trials they recall portions of the memorized list before responding. The fact that subjects are always aware of their errors supports the general outline of the model; even if the initial familiarity of an item produces a decision to respond immediately, the search of the appropriate memory store continues and, when completed, permits the subject to confirm whether or not his response was correct.

Additional support for the model comes from its generality to a variety of experimental paradigms (for examples, see Atkinson & Juola, 1973). As

reported here, the model can be used to predict response times in recognition tasks with target sets stored in LTS or STS, or in both. It can also handle results from other classes of recognition experiments, such as those employing the Shepard-Teghtsoonian paradigm (e.g., Hintzman, 1969; Okada, 1971). The differences in results from these various types of tasks can be explained in terms of the extended memory search stage; the likelihood that the subject delays his response and makes an extended search of memory is determined by the criteria he adopts to minimize errors while still insuring fast responses. Once the extended search is initiated, its exact nature depends on how the target set is stored in memory (Smith, 1968). If the target set is a well-ordered and thoroughly memorized list of words, the extended search will involve systematic comparisons between the test stimulus and the target items. On the other hand, the target set may be represented in memory as a list of critical attributes (Meyer, 1970). In this case, the extended search would involve checking features of the test stimulus against the attribute list (Neisser, 1967). The dependency of latency on target-set size then would be determined by the relationship between the number of attributes needed to unambiguously specify a target set and the set's size. Finally, target items may be weakly represented in memory (e.g., because they received only a single study presentation); then the extended search might be aimed at retrieving contextual information, with search time relatively independent of target-set size (Atkinson, Herrmann, & Wescourt, 1974; Atkinson & Wescourt, 1974).

These speculations about recognition memory and the nature of the specific task lead to certain testable hypotheses. If the subject adjusts his criteria to balance errors against response speed, different instructions could be used to alter the criteria. For example, if the target set is a well-memorized list of words, and the subject is instructed to make every effort to avoid errors, the appropriate strategy would be to always conduct the extended search before responding. Because the time necessary to complete this search depends on target-set size, both overall latency and list-length effects should increase. Alternatively, if response speed is emphasized in the instructions, the subject should respond primarily on the basis of familiarity. In this case, responses would be emitted without an extended search, and overall latency would decrease and there should be few, if any, list-length effects.

For the theory described in this chapter, the encoding process that permits access to the appropriate node in the lexical store is assumed to occur without error and at a rate independent of the size and make-up of the target set. For highly familiar and minimally confusable words, this assumption appears to be reasonable and is supported by our data. However, for many types of stimuli, increases in target-set size will lead to greater confusability and consequently to slower, as well as less accurate, responses (Juola et al., 1971). When this is the case, the explanation of the set-size effect given here will not be sufficient, for we have assumed that it is due entirely to the extended mem-

ory search. Analyses of set-size effects in the framework of this theory would be inappropriate if the experiment were not designed to minimize confusions among stimuli. The theory can be extended to encompass confusion effects by reformulating the encoding scheme and perhaps the extended search process. However, the result would be a cumbersome model with so many interacting processes that it would be of doubtful value as an analytic tool. Trying to account for stimulus confusability in a theory of recognition memory is too ambitious a project, given our current state of knowledge. Greater progress can be made by employing experimental paradigms specifically designed to study recognition memory and other paradigms specifically designed to study confusions among stimuli.

ACKNOWLEDGMENTS

This research was supported by grants from the National Institute of Mental Health (MH 21747) and the National Science Foundation (NSFGJ 443X3). The authors are indebted to J. C. Falmagne and D. J. Herrmann for comments and criticisms on an early draft of this paper.

REFERENCES

- Anderson, J. R., & Bower, G. H. Recognition and retrieval processes in free recall. *Psychological Review*, 1972, 79, 97-123.
- Atkinson, R. C., Herrmann, D. J., & Wescourt, K. T. Search processes in recognition memory. In R. L. Solso (Ed.), *Theories in cognitive psychology: The Loyola symposium*. Potomac, Md.: Erlbaum Assoc., 1974.
- Atkinson, R. C., Holmgren, J. E., & Juola, J. F. Processing time as influenced by the number of elements in a visual display. *Perception & Psychophysics*, 1969, 6, 321-326.
- Atkinson, R. C., & Juola, J. F. Factors influencing speed and accuracy of word recognition. In S. Kornblum (Ed.), *Fourth international symposium on attention and performance*. New York: Academic Press, 1973.
- Atkinson, R. C., & Shiffrin, R. M. Human memory: A proposed system and its control processes. In K. W. Spence and J. T. Spence (Eds.), *The psychology of learning and motivation*. Vol. II. New York: Academic Press, 1968.
- Atkinson, R. C., & Shiffrin, R. M. The control of short-term memory. *Scientific American*, 1971, 225, 82-90.
- Atkinson, R. C., & Wescourt, K. T. Some remarks on a theory of memory. In P. Rabbit and S. Dornic (Eds.), *Fifth international symposium on attention and performance*. London: Academic Press, 1974.
- Baddeley, A. D., & Ecob, J. R. *Reaction time and short-term memory: A trace strength alternative to the high-speed exhaustive scanning hypothesis*. Technical Report No. 13. San Diego: Center for Human Information Processing, University of California, 1970.

- Banks, W. P. Signal detection theory and human memory. *Psychological Bulletin*, 1970, **74**, 81-99.
- Burrows, D., & Okada, R. Serial position effects in high-speed memory search. *Perception & Psychophysics*, 1971, **10**, 305-308.
- Corballis, M. C., Kirby, J., & Miller, A. Access to elements of a memorized list. *Journal of Experimental Psychology*, 1972, **94**, 185-190.
- Doll, T. J. Motivation, reaction time, and the contents of active verbal memory. *Journal of Experimental Psychology*, 1971, **87**, 29-36.
- Egeth, H., Marcus, N., & Bevan, W. Target-set and response-set interactions: Implications for models of human information processing. *Science*, 1972, **176**, 1447-1448.
- Fischler, I., & Juola, J. F. Effects of repeated tests on recognition time for information in long-term memory. *Journal of Experimental Psychology*, 1971, **91**, 54-58.
- Forrin, B., & Morin, R. E. Recognition time for items in short- and long-term memory. *Acta Psychologica*, 1969, **30**, 126-141.
- Herrmann, D. J. The effects of organization in long-term memory on recognition latency. Unpublished doctoral dissertation, University of Delaware, 1972.
- Hintzman, D. Recognition time: Effects of recency, frequency, and the spacing of repetitions. *Journal of Experimental Psychology*, 1969, **79**, 192-194.
- Juola, J. F. Repetition and laterality effects on recognition memory for words and pictures. *Memory & Cognition*, 1973, **1**, 183-192.
- Juola, J. F., & Atkinson, R. C. Memory scanning for words vs. categories. *Journal of Verbal Learning and Verbal Behavior*, 1971, **10**, 522-527.
- Juola, J. F., Fischler, I., Wood, C. T., & Atkinson, R. C. Recognition time for information stored in long-term memory. *Perception & Psychophysics*, 1971, **10**, 8-14.
- Kintsch, W. Memory and decision aspects of recognition learning. *Psychological Review*, 1967, **74**, 496-504.
- Kintsch, W. *Learning, memory, and conceptual processes*. New York: John Wiley, 1970. (a)
- Kintsch, W. Models for free recall and recognition. In D. A. Norman (Ed.), *Models of human memory*. New York: Academic Press, 1970. (b)
- Klatzky, R. L., Juola, J. F., & Atkinson, R. C. Test stimulus representation and experimental context effects in memory scanning. *Journal of Experimental Psychology*, 1971, **87**, 281-288.
- Mandler, G., Pearlstone, F., & Koopmans, H. S. Effects of organization and semantic similarity on recall and recognition. *Journal of Verbal Learning and Verbal Behavior*, 1969, **8**, 410-423.
- McCormack, P. D. Recognition memory: How complex a retrieval system. *Canadian Journal of Psychology*, 1972, **26**, 19-41.
- Meyer, D. E. On the representation and retrieval of stored semantic information. *Cognitive Psychology*, 1970, **1**, 242-300.
- Miller, G. A. The organization of lexical memory: Are word associations sufficient? In G. A. Talland and N. C. Waugh (Eds.), *The pathology of memory*. New York: Academic Press, 1969.
- Mohs, R. C., Wescourt, K. T., & Atkinson, R. C. Effects of short-term memory

- contents on short- and long-term memory searches. *Memory & Cognition*, 1973, 1, 443-448.
- Morton, J. The interaction of information in word recognition. *Psychological Review*, 1969, 76, 165-178.
- Morton, J. A functional model for memory. In D. A. Norman (Ed.), *Models of human memory*. New York: Academic Press, 1970.
- Murdock, B. B., Jr. A parallel-processing model for scanning. *Perception & Psychophysics*, 1971, 10, 289-291.
- Neisser, U. *Cognitive psychology*. New York: Appleton-Century-Crofts, 1967.
- Nickerson, R. S. *Binary-classification reaction time: A review of some studies of human information-processing capabilities*. Technical Report No. 2004. Cambridge, Mass.: Bolt, Beranek, and Newman, 1970.
- Norman, D. A. (Ed.) *Models of human memory*. New York: Academic Press, 1970.
- Okada, R. Decision latencies in short-term recognition memory. *Journal of Experimental Psychology*, 1971, 90, 27-32.
- Parks, T. E. Signal-detectability theory of recognition-memory performance. *Psychological Review*, 1966, 73, 44-58.
- Rothstein, L. D., & Morin, R. E. The effects of size of the stimulus ensemble and the method of set size manipulation on recognition reaction time. Paper presented at the meetings of the Midwestern Psychological Association, Cleveland, Ohio, May 1972.
- Rubenstein, H., Garfield, L., & Millikan, J. A. Homographic entries in the internal lexicon. *Journal of Verbal Learning and Verbal Behavior*, 1970, 9, 487-492.
- Schank, R. Conceptual dependency: A theory of natural language understanding. *Cognitive Psychology*, 1972, 3, 552-631.
- Schvaneveldt, R. W., & Meyer, D. E. Retrieval and comparison processes in semantic memory. In S. Kornblum (Ed.), *Fourth international symposium on attention and performance*. New York: Academic Press, 1973.
- Shepard, R. N. Recognition memory for words, sentences, and pictures. *Journal of Verbal Learning and Verbal Behavior*, 1967, 6, 156-163.
- Shepard, R. N., & Teghtsoonian, M. Retention of information under conditions approaching a steady state. *Journal of Experimental Psychology*, 1961, 62, 302-309.
- Shevell, S., & Atkinson, R. C. A theoretical comparison of list scanning models. *Journal of Mathematical Psychology*, 1974, in press.
- Smith, E. E. Choice reaction time: An analysis of the major theoretical positions. *Psychological Bulletin*, 1968, 69, 72-110.
- Sternberg, S. High-speed scanning in human memory. *Science*, 1966, 153, 652-654.
- Sternberg, S. The discovery of processing stages: Extensions of Dander's method. In W. G. Koster (Ed.), *Attention and performance II. Acta Psychologica*, 1969, 36, 276-315. (a)
- Sternberg, S. Memory scanning: Mental processes revealed by reaction-time experiments. *American Scientist*, 1969, 57, 421-457. (b)
- Suppes, P. Stimulus-sampling theory for a continuum of responses. In K. J. Arrow, S. Karlin, and P. Suppes (Eds.), *Mathematical methods in the social sciences*. Stanford, Calif.: Stanford University Press, 1960.

- Thomas, E. A. C. Sufficient conditions for monotone hazard rate: An application to latency-probability curves. *Journal of Mathematical Psychology*, 1971, 8, 303-332.
- Townsend, J. T. A note on the identifiability of parallel and serial processes. *Perception & Psychophysics*, 1971, 10, 161-163.
- Tulving, E. Episodic and semantic memory. In E. Tulving and W. Donaldson (Eds.), *Organization of memory*. New York: Academic Press, 1972.
- Wescourt, K., & Atkinson, R. C. Memory scanning for information in short- and long-term memory. *Journal of Experimental Psychology*, 1973, 98, 95-101.
- Wilde, D. J. *Optimum seeking methods*. Englewood Cliffs, N.J.: Prentice-Hall, 1964.

SECTION III:

SIGNAL DETECTION AND RECOGNITION AS INFLUENCED
BY MEMORY AND LEARNING PROCESSES

- 7 A learning model for forced-choice detection experiments.
British Journal of Mathematical and Statistical
Psychology, 1965, 18, 184-206 (with R.A. Kinchla)..... 293
- 8 Signal recognition as influenced by information feedback.
Journal of Mathematical Psychology, 1970, 7, 259-274
(with T.A. Tanner, Jr., and J.A. Rauk)..... 317

A LEARNING MODEL FOR
FORCED-CHOICE DETECTION EXPERIMENTS¹

By R. C. ATKINSON
Stanford University
and
R. A. KINCIILA
New York University

Several signal detection experiments employing a forced-choice procedure are analysed in terms of a model that incorporates two distinct processes: a sensory process and a decision process. The sensory process specifies the relation between external signal events and hypothesized sensory states of the subject. The decision process specifies the relation between the sensory states and the observable responses of the subject. The sensory process is assumed to be fixed throughout an experiment, whereas the decision process is viewed as varying from trial to trial as a function of the particular sequence of preceding events. The changes in the decision process are assumed to be governed by a simple stochastic learning model. There are several ways of formulating the learning model and the experiments reported here were designed to select among these alternative approaches. The empirical results favour a linear-operator process with trial-to-trial changes in response probabilities that are a function not only of the signal and information events, but also of the particular sequence of sensory states activated.

1. INTRODUCTION

This paper examines a model for choice behaviour in a two-alternative forced-choice detection task. The model is restricted to experimental situations where the subject is given feedback on every trial regarding the correctness of his response, and to situations with a simple outcome structure. Thus the model has a limited range of applicability, but for appropriately contrived experiments it appears to provide an accurate account of the gross aspects of the data and certain sequential effects. The model represents a special case of a more general theory proposed by Luce (1963); it is also very similar in most details to a model of forced-choice behaviour proposed by Atkinson (1963). The relations of the model developed in this paper to these other theories of detection behaviour are examined in some detail by Atkinson, Bower and Crothers (1965, Chapter 5); they also discuss the relation of the model to various theories that have been proposed for probability learning experiments.

The model postulates that the observable relations between stimulus events and responses are a product of two processes: a sensory process and a decision process. The sensory process specifies the relation between the external stimulus event and hypothetical sensory states of the subject. The decision process

¹Support for this research was provided by the National Aeronautics and Space Administration, no. NGR-05-020-036.

specifies the subject's response in terms of his current sensory state and information that he has acquired during the course of a given experiment. The two processes interact as follows: the stimulus is fed into the sensory process which converts the pattern of external energy changes into sensory information (sensory events); the decision process then operates on the sensory information to determine a response. Some theories of detection have assumed a continuum of sensory states (Green, 1960; Swets, 1961; Tanner and Swets, 1954), whereas others have argued for a finite representation (Atkinson, Carterette and Kinchla, 1962; Fechner, 1860; Luce, 1963; Norman, 1964). Further, some have proposed that the sensory process is static over trials, whereas others have assumed that it varies within certain fixed limits from trial to trial as a function of preceding events (Atkinson, 1963). One point of agreement among all theories is that the decision process is dynamic, and undergoes change when the experimenter manipulates the presentation schedule or outcome structure. However, for a given experimental schedule some theories treat the decision process as fixed (independent over trials), whereas others represent it as changing from trial to trial as a function of the particular sequence of preceding events. This latter way of representing the decision process is an important feature of the model considered in this paper. The subject is viewed as adopting a pattern of decision making in each experimental situation by means of a simple stochastic learning mechanism. The learning mechanism that will be examined is similar to those proposed by Bush and Mosteller (1955).

As noted above, the type of psychophysical situation that we shall consider is a two-alternative forced-choice detection experiment. On each trial two temporal intervals are defined and the subject is instructed to report which interval contains a signal. It is a forced-choice task in that on each trial the subject must select one of the two intervals as containing a signal even if he is uncertain as to what occurred. The presentation of a signal plus noise in the first interval and noise alone in the second interval on trial n will be denoted as $S_{1,n}$ and the presentation of noise in the first observation interval followed by signal plus noise in the second observation interval as $S_{2,n}$. Further, the subject's responses will be denoted $A_{1,n}$ and $A_{2,n}$ to indicate which interval he reported contained the signal on trial n . Finally, $E_{1,n}$ and $E_{2,n}$ will denote the occurrence of an event at the end of trial n informing the subject that stimulus S_1 or S_2 , respectively, was presented. Thus

$S_{1,n}$ = the presentation of stimulus S_1 on trial n ,

$A_{j,n}$ = the occurrence of response A_j on trial n ,

$E_{k,n}$ = information event at the end of trial n indicating that stimulus S_k was presented.

Using this notation each trial can be described by the ordered triple $\langle S_i, A_j, E_k \rangle$.

In experiments of the type described above the following variables can be manipulated: (a) physical parameters of the signal and noise; (b) presentation schedule of signal events; (c) information feedback; and (d) the outcome structure

which specifies the payoffs associated with correct and incorrect responses. In this paper we shall examine how these variables influence detection behaviour, but the experiments reported here deal only with manipulations involving presentation schedules and information feedback. The presentation of signal events will be specified by a probabilistic schedule; namely, events S_1 and S_2 will form a binomial sequence with parameter γ . Further, the experiments employ a simple outcome structure. The subject is instructed to make a correct response as often as possible, and each trial terminates with an information event which tells him whether he was correct or not. There are no monetary payoffs or penalties for correct and incorrect responses as is frequently the case in detection experiments.

The major dependent variable is the probability of an A_j response on trial n , given that stimulus S_i occurred. The four outcomes can be represented by the matrix

$$P_n = \begin{matrix} & A_{1,n} & A_{2,n} \\ \begin{matrix} S_{1,n} \\ S_{2,n} \end{matrix} & \begin{bmatrix} Pr(A_{1,n} | S_{1,n}) & Pr(A_{2,n} | S_{1,n}) \\ Pr(A_{1,n} | S_{2,n}) & Pr(A_{2,n} | S_{2,n}) \end{bmatrix} \end{matrix} \quad (1)$$

This matrix will be called the *performance matrix*. In the literature the occurrence of an A_1 response to an S_1 stimulus is called a *hit*, and the occurrence of A_1 response to an S_2 stimulus is called a *false alarm*. We shall use this terminology, denoting them as H_n and F_n , i.e.,

$$\begin{aligned} Pr(H_n) &= Pr(A_{1,n} | S_{1,n}) \\ Pr(F_n) &= Pr(A_{1,n} | S_{2,n}). \end{aligned}$$

Fixing $Pr(H_n)$ and $Pr(F_n)$, then, completely specifies the performance matrix.

Other quantities of interest can be defined in terms of the hits and false alarms. Frequently we want to know the probability of an A_1 response on trial n independent of the stimulus event; namely,

$$Pr(A_{1,n}) = Pr(H_n)Pr(S_{1,n}) + Pr(F_n)Pr(S_{2,n}). \quad (2)$$

Also of interest is the probability of a correct response on trial n (which is denoted C_n):

$$Pr(C_n) = Pr(H_n)Pr(S_{1,n}) + [1 - Pr(F_n)]Pr(S_{2,n}). \quad (3)$$

2. ASSUMPTIONS AND RULES OF IDENTIFICATION

Sensory and Decision Processes

The model assumes that one and only one sensory state can occur on each trial of the experiment. The sensory states will be denoted as $s_0, s_1, s_2, s_3, \dots$. We do not suppose that the same sensory state necessarily results whenever a particular stimulus is presented, but rather that the state is determined by a random process. The sensory process on trial n of an experiment can be represented by the *sensory matrix*

$$\mathbf{S}_n = \begin{matrix} & s_0 & s_1 & s_2 & \dots & s_x \\ S_1 & a_{10}^{(n)} & a_{11}^{(n)} & a_{12}^{(n)} & \dots & a_{1x}^{(n)} \\ S_2 & a_{20}^{(n)} & a_{21}^{(n)} & a_{22}^{(n)} & \dots & a_{2x}^{(n)} \end{matrix}$$

where $a_{ij}^{(n)}$ denotes the probability of eliciting sensory state s_j on trial n given stimulus S_i on that trial. Similarly, the decision process can be represented by the matrix

$$\mathbf{D}_n = \begin{matrix} & A_1 & A_2 \\ s_0 & d_{01}^{(n)} & d_{02}^{(n)} \\ s_1 & d_{11}^{(n)} & d_{12}^{(n)} \\ s_2 & d_{21}^{(n)} & d_{22}^{(n)} \\ \dots & \dots & \dots \\ s_x & d_{x1}^{(n)} & d_{x2}^{(n)} \end{matrix}$$

where $d_{ij}^{(n)}$ is the probability of eliciting response A_j on trial n given sensory state s_i on that trial. Then the performance matrix specified by eqn. (1) is obtained by taking the product of the sensory matrix and the decision matrix; i.e.,

$$\mathbf{P}_n = \mathbf{S}_n \mathbf{D}_n.$$

The model that we shall examine postulates three sensory states for the two-alternative forced-choice task:

s_0 = no detection

s_1 = detection in observation interval 1

s_2 = detection in observation interval 2.

Further, the activation process and the decision process are defined by the following matrices:

$$\mathbf{S}_n = \begin{matrix} & s_0 & s_1 & s_2 \\ S_1 & 1-\sigma & \sigma & 0 \\ S_2 & 1-\sigma & 0 & \sigma \end{matrix} \quad (4)$$

$$\mathbf{D}_n = \begin{matrix} & A_1 & A_2 \\ s_0 & p_n & 1-p_n \\ s_1 & 1 & 0 \\ s_2 & 0 & 1 \end{matrix} \quad (5)$$

There are several points to note about these matrices. First, the entries in \mathbf{S}_n are constants independent of the trial number; thus the sensory process is assumed to be fixed over all trials of the experiment. In contrast, the decision process may vary as a function of the trial number, and this dependence is indicated by affixing the trial index n to p . Also, s_1 can occur only if S_1 is presented, and s_2 can occur only if S_2 is presented. Thus these sensory states

have an unambiguous relation to the stimulus, since the signal event can be inferred with probability 1 when they occur. In contrast, sensory state s_0 is ambiguously related to the stimulus, for it can occur following either signal event. The parameter σ characterizes this stimulus ambiguity in the output of the sensory system. Both loss of stimulus information due to external noise and loss due to limitations on the resolving power of the sensory system are summarized by σ . Thus σ may be interpreted as a measure both of the physical stimulus and of the subject's sensitivity; σ will be referred to as the *sensitivity parameter*.

The decision matrix D_n reflects the relative ambiguity of the sensory states. If the subject's instructions are to make an A_1 response given an S_1 stimulus, then the correct response is completely determined when an s_1 or s_2 sensory state occurs. However, the subject faces a dilemma if he must make a response on the basis of s_0 ; either stimulus could have evoked s_0 , so the subject needs some strategy by which he can resolve the ambiguity and select a response. The quantity p_n is a measure of the subject's tendency to resolve the ambiguity by making an A_1 response rather than an A_2 ; p_n will be referred to as the *response bias* on trial n .

For the experimental variables discussed earlier it will be assumed that the presentation schedule, information feedback and the outcome structure influence p_n , but do not affect the sensitivity parameter σ . Also, it will be assumed that the sensitivity parameter, for a given subject, is determined solely by the physical aspects of the experimental situation. It is, of course, necessary to show experimentally that these interpretations are correct, and to examine how the parameters σ and p_n are related to the physical characteristics of a given experimental situation.

In order to see how the sensitivity parameter and the bias parameter interact, consider the relation between hits and false alarms as one or the other of these parameters is manipulated. Taking the product of the matrices in eqns. (4) and (5) yields the performance matrix P_n for this model. The entries in the first column of P_n are as follows:

$$Pr(H_n) = (1 - \sigma)p_n + \sigma \quad (6a)$$

$$Pr(F_n) = (1 - \sigma)p_n. \quad (6b)$$

If σ is held constant and p_n is manipulated, an exchange relation is established between $Pr(H_n)$ and $Pr(F_n)$. The equation of this relation can be obtained by eliminating p_n from eqn. (6) yielding

$$Pr(H_n) = \sigma + Pr(F_n). \quad (7)$$

Thus, if σ is held constant (fixed signal and noise levels) and p_n is forced to vary (manipulations in the presentation schedule, outcome structure, etc.), the relation between hits and false alarms should be a linear function with slope 1. Plots of the relation between $Pr(H_n)$ and $Pr(F_n)$ under experimental conditions where the signal-to-noise ratio is held fixed and other variables are allowed to

vary are often referred to as receiver-operating-characteristic curves, or more simply as ROC curves.

If p_n is held constant and the sensitivity parameter changed, there is a well-defined relation between hits and false alarms. Eliminating σ from eqn. (6) yields

$$\Pr(H_n) = 1 - \Pr(F_n) \left[\frac{1 - p_n}{p_n} \right]. \quad (8)$$

Plots of the relation between $\Pr(H_n)$ and $\Pr(F_n)$ when p_n is constant and σ is varied are called *iso-bias curves*.

Learning Process

As indicated earlier, an important feature of the present analysis is to represent changes in the bias probability in terms of a learning process of the type proposed by Bush and Mosteller (1955). We assume that the bias on trial $n+1$ is a linear function of its value on trial n . Specifically, if s_n occurs and is followed by E_1 (i.e., the experimenter informs the subject that the signal was in the first interval) then p_n will increase. If s_n occurs and is followed by information event E_2 , then p_n will decrease. For all other contingencies no change will occur in p_n . These statements can be summarized as follows:

$$p_{n+1} = \begin{cases} (1 - \theta)p_n + \theta, & \text{if } s_{0,n} \text{ \& } E_{1,n} \\ (1 - \theta')p_n, & \text{if } s_{0,n} \text{ \& } E_{2,n} \\ p_n, & \text{otherwise.} \end{cases} \quad (9)$$

where $0 < \theta, \theta' \leq 1$. Justification for this equation is postponed until later.

We now want to derive an expression for the expected value of p_n as a function of the presentation schedule and the sensitivity parameter. Recall that γ is the probability of an S_1 signal event and $1 - \sigma$ is the probability of activating sensory state s_0 given either S_1 or S_2 . Hence

$$\begin{aligned} \Pr(s_{0,n} \text{ \& } E_{1,n}) &= \gamma(1 - \sigma) \\ \Pr(s_{0,n} \text{ \& } E_{2,n}) &= (1 - \gamma)(1 - \sigma) \\ \Pr(\text{otherwise}) &= \sigma. \end{aligned}$$

To compute the expected value of the bias probability on trial $n+1$, simply weight each of the possible outcomes listed in eqn. (9) by its probability of occurrence given above. That is, the expected value on trial $n+1$ given a fixed value p_n on trial n is

$$\begin{aligned} E(p_{n+1}) &= \gamma(1 - \sigma)[(1 - \theta)p_n + \theta] + (1 - \gamma)(1 - \sigma)(1 - \theta')p_n + \sigma p_n \\ &= [1 - (1 - \sigma)\{\theta\gamma + \theta'(1 - \gamma)\}]p_n + \theta\gamma(1 - \sigma). \end{aligned}$$

It can be shown that p_n in the above equation can be replaced by its expected value (Atkinson, Bower and Crothers, 1965). Consequently we have a linear first-order difference equation in $E(p_n)$ which has the solution

$$E(p_n) = p_\infty - (p_\infty - p_1)G^{n-1}.$$

where

$$p_{\infty} = \frac{\gamma}{\gamma + (1-\gamma)\phi}, \quad (10)$$

$$G = 1 - (1-\sigma)[\theta\gamma + \theta'(1-\gamma)]$$

and $\phi = \theta'/\theta$. Note that p_{∞} , which is defined as $\lim_{n \rightarrow \infty} E(p_n)$, does not depend on the absolute values of θ and θ' but only on their ratio.

Combining the results in eqns. (6) and (10) yields

$$Pr(H_n) = \sigma + (1-\sigma)[p_{\infty} - (p_{\infty} - p_1)G^{n-1}] \quad (11 a)$$

$$Pr(F_n) = (1-\sigma)[p_{\infty} - (p_{\infty} - p_1)G^{n-1}]. \quad (11 b)$$

From these equations it is clear that hits and false alarms will depend on p_1 at the start of an experimental session; however, over trials the subject's performance changes at a rate controlled by the quantity G , and approaches an asymptote determined by σ and p_{∞} . The change in performance predicted by eqn. (11) is a well-known experimental phenomenon. Generally, however, most research workers have tended to ignore the changes that occur at the beginning of an experimental session, and instead have concentrated on an analysis of data after performance has settled down to a stable level. For the experiments analysed in this paper we shall adopt this policy; to do so makes matters simpler because fewer parameters need to be estimated. Since asymptotic performance will be stressed in subsequent discussions, the following notation will be useful:

$$\lim_{n \rightarrow \infty} Pr(H_n) = Pr(H)$$

$$\lim_{n \rightarrow \infty} Pr(F_n) = Pr(F).$$

That is, asymptotic expressions will be indicated by simply deleting the trial subscript. Making the appropriate substitutions in eqn. (11) yields

$$Pr(H) = \sigma + \frac{(1-\sigma)\gamma}{\gamma + (1-\gamma)\phi} \quad (12 a)$$

$$Pr(F) = \frac{(1-\sigma)\gamma}{\gamma + (1-\gamma)\phi}. \quad (12 b)$$

Similarly, for the asymptotic proportion of correct responses (see eqn. (3))

$$Pr(C) = \sigma + (1-\gamma)(1-\sigma) + \frac{(1-\sigma)\gamma(2\gamma-1)}{\gamma + (1-\gamma)\phi}; \quad (13)$$

and for the asymptotic proportion of A_1 responses (see eqn. (2)),

$$Pr(A_1) = \gamma\sigma + \frac{\gamma(1-\sigma)}{\gamma + (1-\gamma)\phi}. \quad (14)$$

3. EXPERIMENTAL MANIPULATION OF THE PRESENTATION SCHEDULE

We now examine data collected from eight subjects in a forced-choice acoustic detection experiment. In this study the signal and noise levels were held

constant throughout the experiment and the subject was always given information at the end of each trial regarding the correctness of his response. The only experimental manipulation involved the use of three different presentation schedules. The probability, γ , of an S_1 event took on the following values:

Schedule A: $\gamma = 0.25$

Schedule B: $\gamma = 0.50$

Schedule C: $\gamma = 0.75$.

METHOD

Test sessions of 350 trials each were run on consecutive days. Each day a subject ran on one of the three schedules for the entire session. In successive 3-day blocks a subject ran one day on each of the three schedules; within each 3-day block the order was randomly determined. The experiment involved 15 experimental sessions and therefore each schedule was run on five separate days.

Band-limited Gaussian noise was presented binaurally in the subject's headphones throughout a test session and the signal was a 1,000 c.p.s. sinusoidal tone; the tone was presented for 100 msec, including equal fall and rise times of 20 msec. The subject was seated before a display board. On each trial three lights flashed on briefly in succession: a red light, an amber light, and another amber light. Each light was on for 100 msec with a 500 msec delay between each successive on-period. The red light was simply a warning light, while the amber lights defined two observation intervals. The onset of the signal occurred simultaneously with the onset of one of the amber lights. After the second amber light went off the subject had 2.5 sec to indicate his response by pressing a push-button located under the appropriate amber light. At the conclusion of the response period a green light flashed on for 700 msec above the correct response button. There was a 1.5 sec intertrial period, thus each trial lasted for 6 sec.

RESULTS

Table 1 presents the proportion of A_1 responses on both S_1 and S_2 trials over the last 250 trials of replications two through five of each presentation schedule; thus each estimate is based on $250 \times 4 = 1,000$ trials. The first replication of each presentation schedule has been deleted, because we view the subject as adapting to the detection task on early days of the experiment and want to treat his data only after he clearly understands the experimental routine and is well practised. Also, the first 100 trials of each of the subsequent experimental sessions were deleted because, as noted earlier, our analyses are going to be restricted to asymptotic performance.

In this experiment the signal and noise levels were constant over all sessions and only the presentation schedule varied. Therefore, σ should be fixed throughout the experiment, but p_s should vary with changes in γ . It has already been shown that hits and false alarms should fall on the straight line $Pr(H) = \sigma + Pr(F)$. We now wish to fit this equation to the three data points corresponding to presentation schedules A, B and C. Figure 1 presents plots of $Pr(H)$ and $Pr(F)$ for individual subjects. In order to fit the above equation to the three points for each subject we use the method of least squares, i.e., σ is selected so that it minimizes the sum of squared deviations between observed values and those

TABLE 1. PREDICTED AND OBSERVED PROPORTIONS OF $Pr(H)$, $Pr(F)$, $Pr(C)$ AND $Pr(A_i)$. (The observed proportions are in parentheses)

Subject	Schedule A			Schedule B			Schedule C		
	$Pr(H)$	$Pr(F)$	$Pr(C)$	$Pr(H)$	$Pr(F)$	$Pr(C)$	$Pr(H)$	$Pr(F)$	$Pr(C)$
1	0.601 (0.622)	0.154 (0.163)	0.785 (0.783)	0.744 (0.714)	0.297 (0.260)	0.724 (0.727)	0.521 (0.487)	0.430 (0.462)	0.800 (0.802)
2	0.543 (0.529)	0.125 (0.136)	0.792 (0.780)	0.680 (0.654)	0.262 (0.249)	0.709 (0.702)	0.471 (0.451)	0.414 (0.397)	0.771 (0.791)
3	0.597 (0.626)	0.106 (0.107)	0.820 (0.826)	0.716 (0.707)	0.225 (0.210)	0.746 (0.748)	0.470 (0.459)	0.358 (0.384)	0.797 (0.786)
4	0.529 (0.517)	0.127 (0.122)	0.787 (0.788)	0.669 (0.649)	0.267 (0.242)	0.701 (0.703)	0.486 (0.446)	0.424 (0.454)	0.763 (0.779)
5	0.520 (0.546)	0.120 (0.142)	0.790 (0.780)	0.658 (0.650)	0.258 (0.240)	0.704 (0.705)	0.458 (0.445)	0.416 (0.413)	0.758 (0.746)
6	0.542 (0.547)	0.141 (0.139)	0.780 (0.783)	0.689 (0.680)	0.257 (0.279)	0.701 (0.701)	0.488 (0.479)	0.440 (0.451)	0.771 (0.772)
7	0.618 (0.627)	0.125 (0.136)	0.810 (0.805)	0.744 (0.742)	0.252 (0.251)	0.746 (0.746)	0.498 (0.496)	0.379 (0.369)	0.809 (0.806)
8	0.570 (0.552)	0.125 (0.108)	0.799 (0.807)	0.704 (0.687)	0.258 (0.244)	0.723 (0.722)	0.481 (0.465)	0.401 (0.438)	0.785 (0.806)
Average	0.565 (0.571)	0.128 (0.132)	0.795 (0.794)	0.700 (0.685)	0.263 (0.247)	0.719 (0.719)	0.482 (0.466)	0.408 (0.421)	0.782 (0.786)

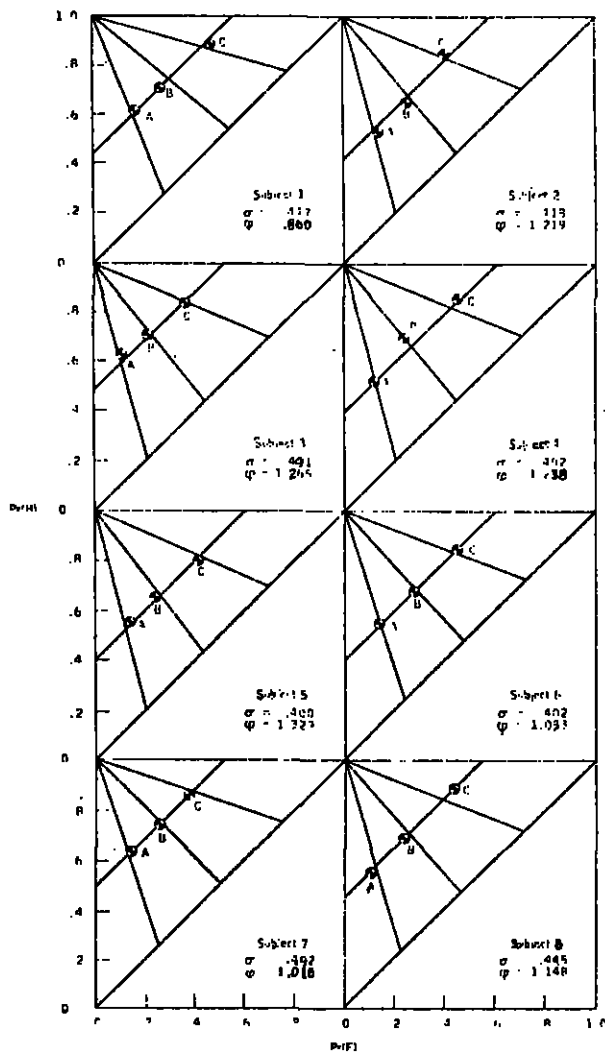

FIGURE 1. Observed and predicted values for $Pr(H)$ and $Pr(F)$.

predicted by the above equation. Applying the least squares method yields the estimates of σ that are given in Figure 1; these estimates were used to generate the ROC curves displayed in the figure. As indicated by the figures there is good agreement between the observed data points and the predicted ROC curves. Recall that the signal and noise levels were the same for all subjects

and consequently variations in σ represent inter-subject differences in sensitivity level.

Next we evaluate the proposed bias process with regard to the data presented in Table 1. Note that if γ and σ are fixed in eqn. (12) and ϕ is varied from 0 to ∞ , then the point $\{Pr(F), Pr(H)\}$ moves along the ROC curve and approaches the lower-left point $(0, \sigma)$ as $\phi \rightarrow \infty$, and the upper-right point $(1 - \sigma, 1)$ as $\phi \rightarrow 0$. Stated differently, no matter where the point may fall on the ROC curve (for fixed values of γ and σ) there exists a corresponding value of ϕ . Hence, if the three observed points $[Pr(F), Pr(H)]$ fall on a straight line with slope 1, then perfect fits of the data can be obtained by estimating separate values of ϕ for each presentation schedule.

However, obtaining an estimate of ϕ for each presentation schedule would violate the basic rationale for the model. In formulating eqn. (9) it was assumed that θ and θ' characterize trial-to-trial adjustments to stimulus and information events, and did not depend on the overall presentation schedule. The values of θ and θ' may vary from subject to subject reflecting individual differences; however, for a given subject θ and θ' are assumed to be fixed and invariant with regard to the presentation schedule and the signal intensity. Earlier it was assumed that σ was independent of the presentation schedule, and the same constraint is placed on ϕ . Thus for each subject we want a single estimate of ϕ which then can be used to make predictions for all three presentation schedules.

The observed proportion of A_1 responses given in Table 1 was used to estimate ϕ . Equation (14) gives the theoretical expression for $Pr(A_1)$; solving for ϕ yields

$$\phi = \frac{\gamma(1 - \sigma)}{[Pr(A_1) - \sigma\gamma](1 - \gamma)} - \frac{\gamma}{1 - \gamma}$$

For each presentation schedule we have substituted the estimated value of σ and the observed value of $Pr(A_1)$ in the above equation to obtain an estimate of ϕ . For example, for Subject 1, $\sigma = 0.447$, $Pr(A_1) = 0.278$, and $\gamma = 0.25$ on schedule A; hence substituting in the above equation yields $\hat{\phi}_A = 0.777$. Similarly $\hat{\phi}_B$ and $\hat{\phi}_C$ can be computed using the appropriate values of γ and $Pr(A_1)$. An overall

TABLE 2. ESTIMATES OF ϕ

Subject	$\hat{\phi}$	$\hat{\phi}_A$	$\hat{\phi}_B$	$\hat{\phi}_C$
1	0.860	0.777	1.099	0.705
2	1.219	1.162	1.400	1.096
3	1.265	1.155	1.390	1.251
4	1.238	1.324	1.446	0.945
5	1.329	1.065	1.449	1.472
6	1.083	1.085	1.147	1.018
7	1.016	0.914	1.028	1.105
8	1.148	1.384	1.264	0.775
Average	1.145	1.108	1.280	1.046

estimate of ϕ was obtained for each subject by taking the average of the three estimates; namely $\hat{\phi} = \frac{1}{3}(\hat{\phi}_A + \hat{\phi}_B + \hat{\phi}_C)$. The various estimates of $\hat{\phi}$ are presented in Table 2. Note that for all but one subject $\hat{\phi}$ is greater than one, indicating that $\theta' > \theta$. The interpretation of this result is that the E_2 event has a slightly greater effect on increasing the probability of an A_2 response than the E_1 event has on increasing the probability of an A_1 response.

Using the estimates of σ and ϕ , predictions can be computed for $Pr(H)$, $Pr(F)$, $Pr(C)$ and $Pr(A_1)$ from eqns. (12) to (14). These predicted values and the corresponding observed quantities are presented in Table 1. Also in Figure 1 the predicted and observed values of $Pr(H)$ and $Pr(F)$ are plotted in the ROC space. In this figure the predicted point for each presentation schedule is at the intersection of the predicted iso-bias curve and the ROC curve. Overall, the correspondence between predicted and observed values is quite good. Only Subject 8 appears to display systematic discrepancies. To a degree, this subject's performance deviated from the theoretical values in the direction of optimizing the probability of a correct response; that is, for fixed σ , to maximize the probability of a correct response the subject should set the bias parameter at unity when $\gamma > \frac{1}{2}$, and at zero when $\gamma < \frac{1}{2}$ (see eqn. (13)). If the subject adopted this strategy, then the ROC curve would reduce to three points; one at $(0, \sigma)$ for $\gamma < \frac{1}{2}$, another at $(1 - \sigma, 0)$ for $\gamma > \frac{1}{2}$, and a third point for the presentation schedule where $\gamma = \frac{1}{2}$. Undoubtedly if monetary payoffs for correct responses and penalties for incorrect responses were introduced into the experimental situation, more subjects would deviate from the theoretical values in the direction of optimization. We shall return to a discussion of this point later.

Time-order Effect

In the forced-choice detection task the term *time-order effect* is used to refer to the fact that subjects generally are more accurate in detecting signals embedded in the second observation interval than in the first. For example, on schedule B (which has S_1 and S_2 events occurring equally often), every subject had a higher probability of being correct when the signal was in the second interval than in the first interval. In terms of the present analysis there are two explanations for this time-order effect. One is that the bias parameter tends to favour the A_2 response. Hence when sensory state s_0 is activated, the subject makes the A_2 response more frequently, which insures that he will have a higher probability of being correct on S_2 than on S_1 trials. Another possibility is that the time-order effect occurs because the subject's sensitivity level changes from one observation interval to the next; specifically, that there are two sensitivity parameters σ_1 and σ_2 associated with the two intervals and $\sigma_2 > \sigma_1$. Thus a time-order effect can be accounted for by postulating a bias process that tends to favour the A_2 response, or by postulating a sensory mechanism that is more sensitive to stimuli presented in the second observation interval.

Both of these explanations are tenable and one would like to have some means for selecting between them; fortunately the model makes quite different

predictions depending on which explanation is offered. If the explanation is in terms of the bias function (as was the case in our analysis of these data) then the ROC curve has slope 1 and the time-order effect is simply due to the fact that $\phi > 1$. If, however, the effect is explained in terms of different sensitivity levels, then

$$Pr(H) = \sigma_1 + (1 - \sigma_1)\phi$$

$$Pr(F) = (1 - \sigma_2)\phi.$$

Under these conditions the ROC curve is

$$Pr(H) = \frac{1 - \sigma_1}{1 - \sigma_2} Pr(F) + \sigma_1.$$

If $\sigma_2 > \sigma_1$ the slope of the ROC curve is greater than one. Thus to decide whether the time-order effect is due to the bias process alone, or whether it also may be due to differential sensitivity levels, we must determine whether the ROC curve has slope greater than one. Inspection of Figure 1 indicates that there is no evidence (except possibly for Subject 2) to suggest that the observed points would be better fit by a line with slope greater than one. Therefore, for this experiment, the conclusion is that the time-order effect is due to the bias process, and there is no need to postulate changes in sensitivity over the two observation intervals.

4. BLANK TRIALS AND FALSE INFORMATION

We now examine two modifications of the forced-choice detection task used in the previous experiment. One involves the introduction of blank trials and the other the use of false-information feedback. By *blank trials* we mean that on occasion a trial will occur on which the signal has been omitted entirely; the subject is not told that blank trials are being introduced and (because of the forced-choice nature of the task) continues to make A_1 and A_2 responses. A blank trial will be denoted as S_0 . By *false-information feedback* we mean that on some trials the subject will be told that a signal occurred in a particular observation interval when in fact it did not. The introduction of these two modifications in the detection task permits us to make some sharp predictions that differentiate this model from others with similar assumptions.

In the present experiment the subject was given the same instructions that were used in the first experiment, i.e., he was told that a signal would occur on every trial and that the information events at the end of each trial indicated the interval in which the signal occurred. Actually, however, the presentation schedule involved S_1 , S_2 and S_0 type trials; on S_1 trials an E_1 always occurred, on S_2 trials an E_2 always occurred, and on S_0 trials sometimes E_1 occurred and sometimes E_2 . The presentation schedule used in this study can be characterized by the parameters γ , π and x as follows: (a) with probability $x\gamma$ a signal was presented in the first interval and, after the response, E_1 occurred, (b) with probability $x(1 - \gamma)$ a signal was presented in the second interval and followed by

E_2 , and (c) with probability $1-x$ a blank trial was presented and an E_1 occurred with probability π and an E_2 event with probability $1-\pi$. Thus, the probability of presenting a signal in the first interval was $x\gamma$; but the probability of telling the subject that the signal occurred in the first interval was $Pr(E_{1,n}) = x\gamma + (1-x)\pi$. Similarly, the probability of presenting the signal in the second interval was $x(1-\gamma)$; however, the probability that the subject was told that the signal occurred in the second interval was $Pr(E_{2,n}) = x(1-\gamma) + (1-x)(1-\pi)$. The model presented earlier is directly applicable to this experiment. No new assumptions are necessary; we need only apply the axioms and carry out the appropriate derivations. First of all, consider the sensory matrix for this experiment. In terms of the assumptions

$$S^* = \begin{matrix} & s_0 & s_1 & s_2 \\ \begin{matrix} S_1 \\ S_2 \\ S_0 \end{matrix} & \begin{bmatrix} 1-\sigma & \sigma & 0 \\ 1-\sigma & 0 & \sigma \\ 1 & 0 & 0 \end{bmatrix} \end{matrix}$$

Using the matrix S^* and the decision matrix D_n specified by eqn. (5), a performance matrix P_n^* can be derived whose rows are the events S_1 , S_2 and S_0 and whose columns are the responses A_1 and A_2 . The entries in the first column of the matrix P_n^* are:

$$Pr(H_n) = Pr(A_{1,n} | S_{1,n}) = \sigma + (1-\sigma)p_n \quad (15a)$$

$$Pr(F_n) = Pr(A_{1,n} | S_{2,n}) = (1-\sigma)p_n \quad (15b)$$

$$Pr(A_{1,n} | S_{0,n}) = p_n \quad (15c)$$

From eqns. (15a) and (15b) it is clear that the ROC curve is the same as one given in eqn. (7) for the first experiment. Also, from eqns. (15a) and (15c) it follows that $Pr(H_n)$ and $Pr(A_{1,n} | S_{0,n})$ are linearly related as follows:

$$Pr(H_n) = \sigma + (1-\sigma)Pr(A_{1,n} | S_{0,n}) \quad (16)$$

Equation (9) presented the axioms describing possible changes in p_n . These axioms are directly applicable to the present experiment. Given eqn. (9) we need only to compute the probability of the events ($s_{0,n}$ & $E_{1,n}$) and ($s_{0,n}$ & $E_{2,n}$). The tree in Figure 2 describes the possible events that can occur on a given trial. From the figure we obtain

$$Pr(s_{0,n} \& E_{1,n}) = x\gamma(1-\sigma) + (1-x)\pi$$

$$Pr(s_{0,n} \& E_{2,n}) = x(1-\gamma)(1-\sigma) + (1-x)(1-\pi)$$

$$Pr(\text{otherwise}) = x\sigma$$

Given these results an expression can be derived for $E(p_n)$. We shall not carry out the derivation, for it involves precisely the same arguments that were employed in developing eqn. (10). Invoking these arguments yields the following equation:

$$E(p_n) = p_\infty - (p_\infty - p_1)G^{n-1}$$

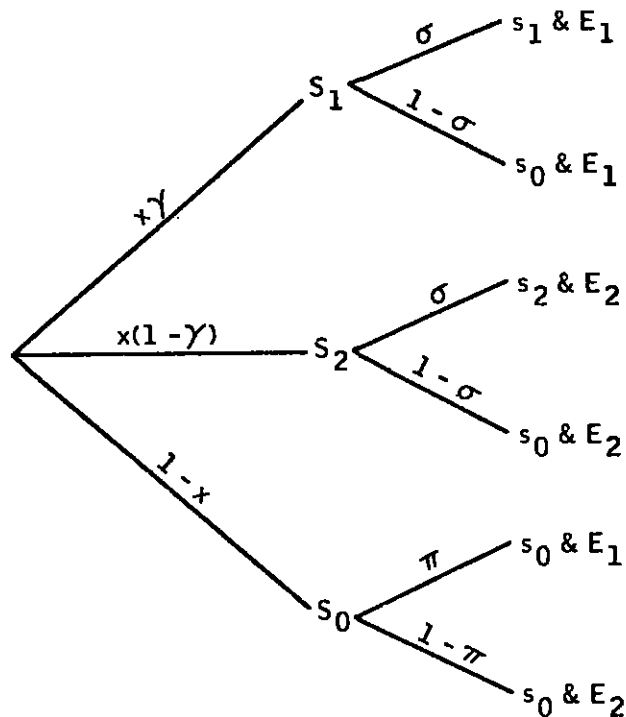

FIGURE 2. A tree describing possible events and their related probabilities for the blank-trial experiment.

Here

$$G = 1 - \theta[x\gamma(1 - \sigma) + (1 - x)\pi] - \theta'[x(1 - \gamma)(1 - \sigma) + (1 - x)(1 - \pi)],$$

and

$$p_o = \frac{x\gamma(1 - \sigma) + (1 - x)\pi}{[x\gamma(1 - \sigma) + (1 - x)\pi] + [x(1 - \gamma)(1 - \sigma) + (1 - x)(1 - \pi)]\phi}, \quad (17)$$

where $\phi = \theta'/\theta$.

METHOD

The same experimental procedures were employed in this study as in the first one except for the pretraining phase. Pretraining took three days and involved running each subject on the schedule B routine used in the first experiment. The signal intensity was held fixed throughout the experiment, but during pretraining the experimenter manipulated the noise level in an attempt to establish a signal-to-noise ratio for each subject that yielded a correct response percentage of approximately 79; the rationale for selecting this particular value will be given later. The manipulation of the noise was done strictly by trial and

error, but the procedure proved to be quite successful for by the end of pretraining a level had been established for each subject that yielded a correct response probability fairly close to the desired value. During the remainder of the experiment the noise level was fixed for each subject at the value determined for him during pretraining. Also, any subject who tended to strongly favour one response over the other, during pretraining, was eliminated from the experiment. Only subjects whose overall proportion of A_1 responses was between 0.40 and 0.60 for the second and third days of pretraining were included in the main experiment. Four subjects from a group of 18 were eliminated on this basis. Pretraining, therefore, involved two special features: (a) noise levels were determined individually for each subject, and (b) subjects were eliminated from the experiment who showed a strong preference for one of the response alternatives. The first requirement guaranteed that the sensitivity parameter α was approximately the same for all subjects. The second insured that ϕ was fairly close to 1 for all subjects. Thus, in a rough sense, a homogeneous group of subjects was formed by using this pretraining procedure; homogeneous in the sense that all subjects were characterized by approximately the same values of α and ϕ .

In the experiment proper, four presentation schedules were used. The probability τ of a signal trial was 0.50 for all schedules, but the schedules differed in the values of γ and π as follows:

	$\pi = 0.25$	$\pi = 0.75$
$\gamma = 0.25$	Schedule A'	Schedule C'
$\gamma = 0.75$	Schedule B'	Schedule D'

Test sessions of 400 trials were run on consecutive days. Each day a subject ran on one of the above presentation schedules for the entire session. In successive 4-day blocks a subject completed one day on each of the four schedules; within each 4-day block the order of schedules was randomly determined. The experiment involved 20 test sessions and therefore each schedule was repeated on five separate days.

RESULTS

Table 3 presents the average proportion of A_1 responses conditional upon the various trial types; these averages are based on 14 subjects. Proportions

TABLE 3. OBSERVED AND PREDICTED VALUES FOR THE BLANK-TRIAL STUDY

	Schedule A'		Schedule B'		Schedule C'		Schedule D'	
	Obs.	Pred.	Obs.	Pred.	Obs.	Pred.	Obs.	Pred.
$Pr(H)$	0.641	0.672	0.755	0.734	0.820	0.820	0.903	0.886
$Pr(F)$	0.086	0.100	0.174	0.162	0.227	0.248	0.344	0.314
$Pr(A_1 S_0)$	0.213	0.234	0.401	0.378	0.553	0.578	0.765	0.733
$Pr(I_1)$	0.219	0.238	0.505	0.485	0.464	0.484	0.764	0.738

were computed for each subject based on the last 350 trials of replications two through five of a given presentation schedule; thus the estimates for each subject are based on a sequence of $4 \times 350 = 1,400$ trials. The averages of these individual subject proportions are the quantities presented in the table. Although data were analysed for individual subjects in the first experiment, there is a theoretical rationale for treating group data in the present experiment. The rationale is based on the pretraining procedure, which was designed to insure that both α and ϕ would be approximately the same for all subjects. By inspection of eqns. (15) and (17) we see that $Pr(H)$, $Pr(F)$ and $Pr(A_1 | S_0)$ depend on only

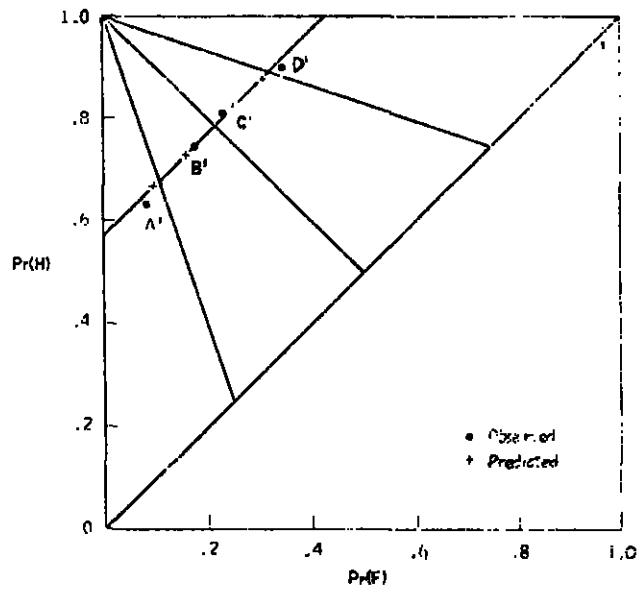

FIGURE 3. Observed and predicted values for $Pr(H)$ and $Pr(F)$.

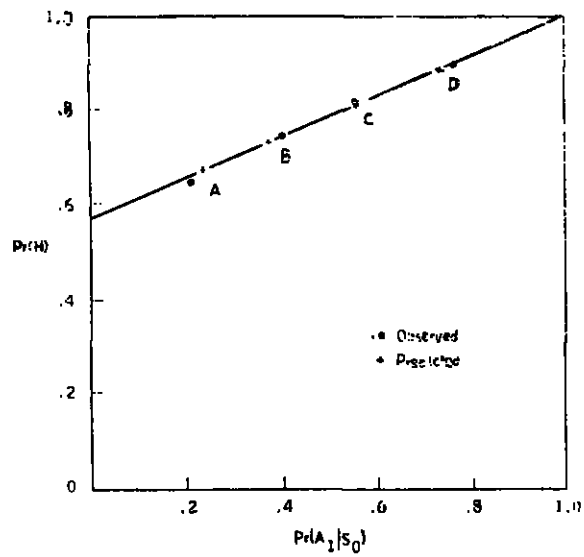

FIGURE 4. Observed and predicted values for $Pr(H)$ and $Pr(A_1 | S_0)$.

σ and ϕ . If σ and ϕ are identical for all subjects, then the model makes the same predictions for the group average as for individual subjects.

Figure 3 presents plots of the observed values of $Pr(H)$ and $Pr(F)$ as given in Table 3. The theory predicts that these points should fall on a linear curve with slope 1 and intercept σ . We estimated σ from these four data points by using the method of least squares and obtained $\hat{\sigma} = 0.572$. This estimate was used to generate the ROC curve displayed in Figure 3. The four observed points (one from each schedule) fall fairly close to the predicted line.

Figure 4 presents a plot of $Pr(A_1 | S_0)$ versus $Pr(H)$. As indicated in eqn. (16) these points should be related by a linear function with slope $1 - \sigma$ and intercept σ . The straight line in Figure 4 was generated using our previous estimate of σ . Once again the linear relation seems to be reasonably well supported.

To generate numerical predictions for $Pr(A_1 | S_i)$ an estimate of ϕ is required in addition to the estimate of σ . Estimation of this parameter is attained using the same method employed earlier. The overall probability of an A_1 response is

$$\begin{aligned} Pr(A_1) &= \alpha\gamma Pr(A_1 | S_1) + \lambda(1 - \gamma)Pr(A_1 | S_2) + (1 - \alpha)Pr(A_1 | S_0) \\ &= \alpha\gamma + (1 - \alpha\lambda)p_{11} \end{aligned} \quad (18)$$

Substituting in the expression for p_{11} given in eqn. (17) yields an expression in ϕ . For each presentation schedule we have substituted the estimated value of σ and the observed value of $Pr(A_1)$ in the above equation and solved for ϕ . For example, for schedule A the observed value of $Pr(A_1)$ is 0.219; letting $\hat{\sigma} = 0.572$, $\gamma = 0.25$ and $\lambda = 0.25$ in the above equation yields $\hat{\phi}_A = 1.281$. Similarly, for the other schedules we obtain $\hat{\phi}_B = 0.969$, $\hat{\phi}_C = 1.229$ and $\hat{\phi}_D = 0.897$. It is interesting to note that $\hat{\phi}$ seems to be correlated more with γ than with λ . Schedules A and C ($\gamma = 0.25$) both yield $\hat{\phi} > 1$, whereas schedules B and D ($\gamma = 0.75$) yield $\hat{\phi} < 1$. Recall that $\phi = \theta' / \theta$ and that γ is the probability of a signal in the first interval (if there is a signal). The present estimates of ϕ suggest that θ' is greater than θ if the probability of the signal being in the second interval exceeds $\frac{1}{2}$, whereas the reverse relation holds otherwise. Hence the change in the bias parameter p_{11} seems to be dominated by the interval with the higher probability of bracketing the signal. Despite this departure from independence of the parameters ϕ and γ , very little damage is done to the accuracy of the predictions from the model, as will be seen shortly.

To obtain an overall estimate of ϕ we have taken the average of the separate estimates of ϕ , i.e.,

$$\begin{aligned} \hat{\phi} &= \frac{1}{4}(\hat{\phi}_A + \hat{\phi}_B + \hat{\phi}_C + \hat{\phi}_D) \\ &= 1.094. \end{aligned}$$

With these estimates of σ and ϕ , eqns. (15) and (17) can now be used to generate predictions for $Pr(H)$, $Pr(F)$, $Pr(A_1 | S_0)$ and $Pr(A_1)$. These predicted quantities are given in Table 3; they also are displayed in Figures 3 and 4 as cross marks on the appropriate line segments. There are no constraints on the relations

among the quantities $Pr(A_1 | S_1)$, $Pr(A_1 | S_2)$ and $Pr(A_1 | S_0)$, and therefore twelve independent predictions are being made on the basis of two parameters. An inspection of the array of observed and predicted quantities indicates that the correspondence between theoretical and observed values is quite satisfactory.

For both schedules B' and C' the E_1 and E_2 events occurred equally often, i.e., on both schedules the subject was told (via the trial-to-trial feedback) that the signal was occurring equally often in the two observation intervals. However, the signal actually occurred more frequently in the first interval for schedule B' than for schedule C'. These experimental manipulations are clearly reflected in the data. On an S_0 trial the probability of an A_1 response was greater for schedule C' than for schedule B' (0.553 vs. 0.401), whereas over all trials the probability of an A_1 response was greater for schedule B' than for schedule C' (0.505 vs. 0.464). Both of these relations are predicted by the model.

Sequential Effects

The model predicts not only hit and false-alarm rates but also sequential properties of response protocols. In terms of the axioms, sequential effects in the observable response events are produced by trial-to-trial fluctuations in p_n . Such fluctuations, of course, can take place on any trial and are not restricted to pre-asymptotic data. For example, even at asymptote the likelihood of making a correct response to an S_1 stimulus depends in a very definite way on whether an E_1 or an E_2 occurred on the preceding trial. The sequential effects of particular interest deal with the influence of stimulus and response events on trial n as they influence the response on trial $n+1$; specifically

$$Pr(A_{1,n+1} | S_{1,n+1}, A_{j,n}, S_{k,n}).$$

However, we shall not examine the correspondence between these particular sequential effects and theoretical predictions, because there are 18 such independent quantities for each of the experimental conditions and the analysis would involve too much detail. Rather, we consider $Pr(A_{1,n+1} | E_{1,n})$ and $Pr(A_{1,n+1} | E_{2,n})$. For these probabilities the stimulus events on trials n and $n+1$ are suppressed, and we only ask for the overall likelihood of an A_1 response conditional on the information event of the preceding trial. The A_1 could be elicited by S_1 , S_2 , or S_0 on trial $n+1$; similarly the information event E_1 on trial n could follow an S_1 or S_0 stimulus, and the E_2 an S_2 or S_0 stimulus. Asymptotic expressions for these quantities can be readily obtained (see Atkinson, Bower and Crothers, 1965) and are as follows:

$$\begin{aligned} \lim_{n \rightarrow \infty} Pr(A_{1,n+1} | E_{1,n}) &= Pr(A_1) + (1 - \sigma x) \theta (1 - p_\infty) \frac{\pi(1-x) + x\gamma(1-\sigma)}{\pi(1-x) + x\gamma} \\ \lim_{n \rightarrow \infty} Pr(A_{1,n+1} | E_{2,n}) &= Pr(A_1) - (1 - \sigma x) \theta' p_\infty \frac{(1-\pi)(1-x) + x(1-\gamma)(1-\sigma)}{(1-\pi)(1-x) + x(1-\gamma)}, \end{aligned} \quad (19)$$

where p_∞ is given by eqn. (17) and $Pr(A_1)$ by eqn. (18).

Table 4 presents the observed values for $Pr(A_{1,n+1} | E_{1,n})$ and $Pr(A_{1,n+1} | E_{2,n})$. Estimates of these quantities were obtained for individual subjects; the average of these estimates are the quantities presented in the table. These

TABLE 4. OBSERVED AND PREDICTED SEQUENTIAL QUANTITIES FOR THE BLANK-TRIAL STUDY

	Schedule A'		Schedule B'		Schedule C'		Schedule D'	
	Obs.	Pred.	Obs.	Pred.	Obs.	Pred.	Obs.	Pred.
$\lim_{n \rightarrow \infty} Pr(A_{1,n+1} E_{1,n})$	0.255	0.267	0.529	0.503	0.475	0.503	0.784	0.748
$\lim_{n \rightarrow \infty} Pr(A_{1,n+1} E_{2,n})$	0.207	0.229	0.482	0.466	0.453	0.466	0.716	0.708

estimates are based on the same set of trials as the data presented in Table 3 and therefore will be regarded as asymptotic. The above equations can be used to generate predictions for these observed values. By inspection of the equations we see that values are needed for σ , θ and θ' in order to make numerical predictions. Since estimates of σ and ϕ have already been made, it is only necessary to estimate θ' ; that is, if we fix on some value of θ' then θ is determined because θ'/θ must equal the previous estimate of $\phi = 1.094$. For present purposes, one method for estimating θ' is to select its value so as to minimize the sum of squared deviations between the eight predicted and observed quantities displayed in Table 4. To carry out this minimization analytically yields unwieldy expressions, and to avoid this complication we have simply calculated the sum of the eight squared deviations for θ' ranging from 0.01 to 1.00 in successive increments of 0.01. Over this range of values the sum of squared deviations takes on its minimum when $\theta' = 0.08$. This value of θ' was used to generate the predictions in Table 4.

In general, the correspondence between predicted and observed sequential statistics is reasonably good. In evaluating the goodness-of-fit it should be kept in mind that all of the quantities in the table are independent, and thus there are eight degrees of freedom. The model requires that $Pr(A_{1,n+1} | E_{1,n}) > Pr(A_1) > Pr(A_{1,n+1} | E_{2,n})$; and this relation is supported by all four sets of data. Also the model requires that $Pr(A_{1,n+1} | S_{i,n+1} E_{1,n}) > Pr(A_{1,n+1} | S_{i,n+1} E_{2,n})$ for $i=0, 1, 2$. Although not presented here, a breakdown of the data into this form indicates that these inequalities hold over all four experimental conditions.

5. DISCUSSION

An alternative model for the bias process that has considerable intuitive appeal involves trial-by-trial changes in p_n that are determined solely by the information events E_1 and E_2 . Formally stated, the idea is that

$$p_{n+1} = \begin{cases} (1-\theta)p_n + \theta, & \text{if } E_{1,n} \\ (1-\theta')p_n, & \text{if } E_{2,n} \end{cases} \quad (20)$$

This formulation of the bias process (which will be called Model 2) is to be contrasted with eqn. (9) (Model 1), where changes in p_n can occur only when

sensory state s_0 is activated. In spite of the difference between these two sets of assumptions, the models yield identical predictions in the first experiment for the asymptotic probabilities of $Pr(H)$, $Pr(F)$, $Pr(A_1)$ and $Pr(C)$. Only by a detailed analysis of sequential statistics and pre-asymptotic data can it be shown that Model 1 is slightly better than Model 2.

However, the two models make strikingly different predictions in the second experiment even for asymptotic hit and false-alarm proportions. For example, applying Model 2 to the false-information study yields

$$p_{\infty} = \frac{x\gamma + (1-x)\pi}{[x\gamma + (1-x)\pi] + [x(1-\gamma) + (1-x)(1-\pi)]\beta}$$

From this equation, we see that p_{∞} is identical for both schedules B' and C' of the second experiment; whereas, using Model 1, p_{∞} is greater for schedule C' than for schedule B'. This relation, of course, is reflected in $Pr(H)$, and $Pr(F)$ and $Pr(A_1 | S_0)$. For Model 2

$$\begin{aligned} Pr^W(H) &= Pr^C(H) \\ Pr^W(F) &= Pr^C(F) \\ Pr^W(A_1 | S_0) &= Pr^C(A_1 | S_0) \end{aligned}$$

where $Pr^W(H)$ denotes the asymptotic probability of a hit on schedule B', etc. In contrast, for Model 1

$$\begin{aligned} Pr^W(H) &< Pr^C(H) \\ Pr^W(F) &< Pr^C(F) \\ Pr^W(A_1 | S_0) &< Pr^C(A_1 | S_0). \end{aligned}$$

The inequalities predicted by Model 1 for schedules B' and C' are borne out by the group averages presented in Table 3; it also is the case that the relations hold individually for all 14 subjects.

To further illustrate the differential predictions of Models 1 and 2 in the second experiment, we have plotted iso-bias curves in Figure 5 for the case where

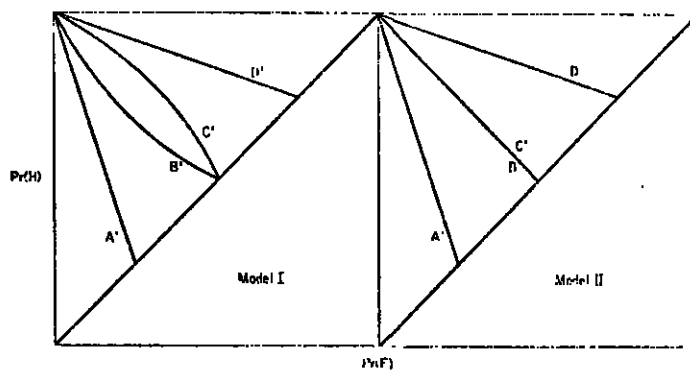

FIGURE 5. Iso-bias curves for Models 1 and 2.

$\phi = 1$. Note that the iso-bias curve for Model 2 is a straight line for all four presentation schedules, and also that the iso-bias curves for schedules B' and C' are identical. For Model 1 the iso-bias curves for schedules A' and D' are the same as for Model 2; however, under the assumptions of Model 1, schedules B' and C' generate different, non-linear curves.

Using Model 1, a distance function can be defined between corresponding points on the iso-bias curves for schedules B' and C'. The maximum of this function can be obtained by taking its derivative with respect to σ and setting the result equal to zero. Carrying out these operations yields

$$\sigma = 2 - \sqrt{2} \approx 0.59.$$

Therefore, under the assumptions of Model 1, the maximum difference between corresponding points on the iso-bias functions of schedules B' and C' will be observed when σ is approximately 0.59. One of the principal reasons for running the second experiment was to determine whether such a difference would be observed. Therefore, to maximize the likelihood of discovering an effect if it existed, we wanted to set the signal-to-noise level at a value corresponding to a σ of 0.59. Recall that pretraining involved only S_1 and S_2 trials, and they were presented with equal likelihood; hence $Pr(C) = \sigma + (1 - \sigma)\frac{1}{2}$. Consequently to fix σ at approximately 0.59 required adjusting the noise level during pretraining to yield a correct-response probability of approximately $0.79 \approx 0.59 + (0.41)\frac{1}{2}$. The pretraining procedure was fairly successful, inasmuch as the estimate of σ during the actual experiment was 0.572.

In both of the experiments reported in this paper, response times were obtained on each trial. The response-time data are reasonably orderly and are clearly affected by the presentation schedule. For example, in the first experiment the time for an incorrect response was about 50 msec longer than for a correct response. Also, the response time for an incorrect response appeared to be independent of the stimulus presentation schedule, whereas the time for a correct response decreased somewhat as γ increased. An attractive feature of the present model is that it can be easily generalized to treat response-time data. The generalization is simply to assume that response time on a given trial is determined by the sensory state activated on the trial. More specifically, we assume that if sensory state s_i ($i = 0, 1, 2$) occurs on trial n , then the response-time distribution for that trial has probability density $f_i(t)$ with mean t_i . On the basis of this assumption a number of predictions can be derived concerning the events on the current trial (and on preceding trials) as they influence response time. For example, in the first experiment the mean asymptotic response times conditional respectively on a correct and incorrect response are as follows:

$$E(T | C) = \frac{\sigma[\gamma t_1 + (1 - \gamma)t_2] + (1 - \sigma)[\gamma p_\infty + (1 - \gamma)(1 - p_\infty)]t_0}{\sigma + (1 - \sigma)[\gamma p_\infty + (1 - \gamma)(1 - p_\infty)]}$$

$$E(T | \bar{C}) = t_0.$$

If $t_1 < t_2 < t_0$ then these conditional response-time measures are appropriately

ordered as γ increases. We are currently analysing an experiment specifically designed to evaluate the response-time assumption outlined above. The analyses are still incomplete, but it appears that if parameter estimates are made from the time distributions conditional on correct and incorrect responses, then reasonably accurate predictions can be made for distributions conditional on responses and signal events of the current trial (and the immediately preceding trial). This approach to response times needs more exploration but appears promising.

The experiments and model analyses considered in this paper have been confined to symmetric outcome structures involving no explicit payoffs. If we were to generalize the model to situations involving manipulation of monetary payoffs then it would be necessary to offer a more general theory of the decision process. Obviously there are outcome structures that will displace the subject off the linear ROC curve specified by eqn. (7). For example, consider the payoff matrix

$$\begin{matrix} & A_1 & A_2 \\ S_1 & \begin{bmatrix} -1 & +10 \end{bmatrix} \\ S_2 & \begin{bmatrix} +10 & -1 \end{bmatrix} \end{matrix}.$$

In this case the subject is heavily rewarded for incorrect detection responses and penalized for correct ones. Undoubtedly, over time the subject would generate a point $[Pr(F), Pr(H)]$ that fell in the lower right-hand sector of the ROC space; i.e., $Pr(F) > Pr(H)$. Such effects cannot be predicted merely by generalizing the assumptions governing p_n . No matter how p_n is permitted to vary, the model still requires that performance points fall on a linear curve with intercept σ . Of course, several modifications of the theory seem able to account for experimental manipulations that generate performance points off the ROC curve. One approach is to develop a more elaborate conceptualization of the decision process. For example, one can redefine the decision matrix as

$$\mathbf{D}_n = \begin{matrix} & A_1 & A_2 \\ s_0 & \begin{bmatrix} p_n & 1-p_n \end{bmatrix} \\ s_1 & \begin{bmatrix} d_n^{(1)} & 1-d_n^{(1)} \end{bmatrix} \\ s_2 & \begin{bmatrix} 1-d_n^{(2)} & d_n^{(2)} \end{bmatrix} \end{matrix}.$$

For this process experimental manipulations of the outcome structure might affect not only p_n but also the values of $d_n^{(i)}$. Thus, depending on the postulated relation of $d_n^{(i)}$ to the payoff matrix it would be possible to generate virtually any ROC curve. When this type of modification is introduced one obtains a model that is very close in structure to those proposed for discrimination learning (Atkinson and Estes, 1963, p. 238; Bush, Luce and Rose, 1964). Another possible modification of the detection model would be to develop a more general formulation of the sensory process. Pursuing this line, one might assume that the subject's sensitivity level could vary within certain fixed limits as a function of the outcome structure and other variables. Both of these alternatives represent

potential lines of theoretical development for models of this type. They raise an important question: can changes in performance induced by manipulation of the outcome structure be explained by elaborating the theory of the bias process, or do they also necessitate postulating a more complex sensory mechanism?

REFERENCES

- ATKINSON, R. C. (1963). A variable sensitivity theory of signal detection. *Psychol. Rev.* **70**, 91-106.
- ATKINSON, R. C., BOWER, G. H. and CROTHERS, E. J. (1965). *An Introduction to Mathematical Learning Theory*. New York: Wiley.
- ATKINSON, R. C., CARTERETTE, E. C. and KINCHLA, R. A. (1962). Sequential phenomena in psychophysical judgements: a theoretical analysis. *Inst. Radio Engineers Trans. on Information Theory*, **11-8**, S155-162.
- ATKINSON, R. C. and ESTES, W. K. (1963). Stimulus sampling theory. In R. D. Luce, R. R. Bush and E. Galanter (Eds.), *Handbook of Mathematical Psychology*, Vol. II. New York: Wiley. Pp. 121-208.
- BUSH, R. R., LUCE, R. D. and ROSE, R. M. (1964). Learning models for psycho-physics. In R. C. Atkinson (Ed.), *Studies in Mathematical Psychology*. Stanford: Stanford University Press. Pp. 201-217.
- BUSH, R. R. and MOSTELLER, F. (1955). *Stochastic Models for Learning*. New York: Wiley.
- FECHNER, G. T. (1860). *Elemente der Psychophysik*. Leipzig: Breitkopf and Hartel.
- FRIEDMAN, M. P. and CARTERETTE, E. C. (1964). Detection of Markovian sequences of signals. *J. acoust. Soc. Amer.* **36**, 2334-2339.
- GREEN, D. M. (1960). Psychoacoustics and detection theory. *J. acoust. Soc. Amer.* **32**, 1189-1203. Reprinted in R. D. Luce, R. R. Bush and E. Galanter (Eds.), *Readings in Mathematical Psychology*, Vol. I. New York: Wiley, 1963. Pp. 41-66.
- LUCE, R. D. (1963). A threshold theory for simple detection experiments. *Psychol. Rev.* **70**, 61-79.
- NORMAN, D. A. (1964). Sensory thresholds, response biases, and the neural quantum theory. *J. math. Psychol.* **1**, 88-120.
- SWETS, J. A. (1961). Detection theory and psychophysics: a review. *Psychometrika*, **26**, 49-63.
- TANNER, W. P., Jr. and SWETS, J. A. (1954). A decision making theory of visual detection. *Psychol. Rev.* **61**, 401-409.



Signal Recognition as Influenced by Information Feedback

T. A. TANNER, JR., AND J. A. RAUK

*Ames Research Center, NASA,
Moffett Field, California 94035*

AND

R. C. ATKINSON¹

Stanford University, Stanford, California 94305

Eight human observers were tested on a signal recognition task involving two tones of different amplitudes. The independent variables were (a) three binomial schedules for presenting the two signals, with parameter values 0.2, 0.5, and 0.8, and (b) four conditions varying the information given to an observer about the signal presentation schedules. The information that an observer was given about the presentation schedules markedly influenced hit and false alarm rates (the probabilities of reporting a loud signal when a loud and soft signal, respectively, occurred). The influence of the preceding trial's signal and response on hits and false alarms also varied as a function of both the presentation schedule and the information given about the schedules. A mathematical model of signal recognition is shown to provide a fairly accurate account of the various conditions investigated.

Findings from experiments by Kinchla (1966) and Tanner, Haller, and Atkinson (1967) suggest that signal recognition is a function of both the signal presentation probabilities and the amount of information given observers about these probabilities. Both experiments involved the recognition of two amplitudes of a 1000 Hz tone; whenever a signal was presented, the observer was required to judge whether it was the louder or the softer of two tones. A major independent variable in both studies was the signal presentation schedule. The schedules were binomial sequences of loud and soft tones. For Kinchla the probability of the loud tone (γ) took on three values: 0.25, 0.50, and 0.75; for Tanner *et al.* five values were used: 0.1, 0.3, 0.5, 0.7, and 0.9. In order to compare their findings with research on signal detection (Green and Swets,

¹ The authors wish to thank Professor R. W. Haller for his comments and suggestions on an earlier version of this paper.

1966), these authors (Kinchla, 1966; and Tanner *et al.*, 1967) defined a *hit* as a report that the loud signal occurred when in fact it did occur, and a *false alarm* as a report that the loud signal occurred when the soft signal was presented.

In Kinchla's experiment two types of information were given to observers about the presentation schedules. In one condition observers were told the signal presentation probabilities at the start of each experimental session and were given feedback identifying the correct response on every trial. In the other condition they were told the presentation probabilities, but were not given trial-by-trial feedback. For both of these conditions Kinchla reported results that were similar to those of signal detection studies (Green and Swets, 1966), *viz.*, that both hit and false alarm probabilities increased as γ increased, although the effect was less pronounced when feedback was omitted.

In the study of Tanner *et al.*, however, observers were not told the signal presentation probabilities and were not given trial-by-trial feedback, and both hit and false alarm rates decreased as γ increased. Under the no-feedback conditions of both studies, hit and false alarm rates were strongly influenced by the signal and response that occurred on the immediately preceding trial; these sequential effects were in sharp contrast with the relatively weak sequential effects that typically have been reported for signal detection experiments (Atkinson and Kinchla, 1965). Results similar to those obtained by Tanner *et al.* have been reported by Parducci and Sandusky (1965) for recognition of visual displacement.

In order to provide a theoretical account of their results, Tanner *et al.* presented a model which incorporates both memory and detection processes. This model will be referred to as the Memory-Recognition Model or more simply, the MR-Model. Tanner *et al.* applied the model to their data and indicated how it might be modified to account for the data obtained in Kinchla's feedback condition.

The study reported here had the following objectives: (a) to replicate the findings of Kinchla in his feedback condition and of Tanner *et al.* in their no-feedback condition; (b) to determine whether the inverse relationship between γ and the hit and false alarm rates, reported by Tanner *et al.*, depends on observers not being informed about changes in the presentation schedule; and (c) to test the ability of the MR-Model to predict performance both in a feedback condition and in three no-feedback conditions.

The MR-Model

The following notation will be used in discussing the experiment and model: S_1 = presentation of the loud signal; S_0 = presentation of the soft signal; A_1 = the response identifying a signal as loud; A_0 = the response identifying a signal as soft; and γ = the presentation probability of the loud signal. Thus on any trial of an experimental session, either S_1 is presented with probability γ , or S_0 with probability $1 - \gamma$. After each presentation, the observer is required to make either an A_1 or A_0 response identifying his judgment of which signal was presented. The observer may or may not be told the signal presentation probabilities, and may or may not be given

feedback after each response. As defined here, the feedback condition involves both trial-by-trial feedback and telling the observer the signal presentation probabilities at the start of a session.

The principal dependent variables are the hit and false alarm probabilities and the (first order) sequential probabilities, defined as follows: $\Pr(A_1 | S_1)$ = the probability of a hit; $\Pr(A_1 | S_0)$ = the probability of a false alarm; $\Pr(A_1 | S_1 A_j S_k)$ = the probability of a hit, given that an A_j was made to an S_k on the preceding trial ($j, k = 0$ or 1); and $\Pr(A_1 | S_0 A_j S_k)$ = the probability of a false alarm, given that an A_j was made to an S_k on the preceding trial ($j, k = 0$ or 1).

A graphic representation of the MR-Model is shown in Fig. 1.² The model assumes three processes: a *memory process* which maintains an image of the signal presented on

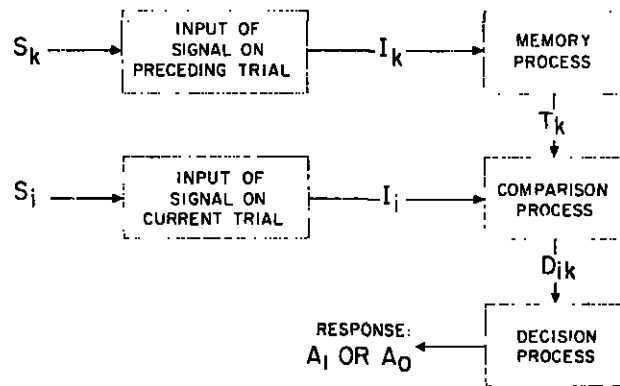

FIG. 1. Schematic representation of the MR-Model.

the preceding trial, a *comparison process* that calculates a difference function on the stored image and the incoming signal, and a *decision process* that selects a response on the basis of the comparing process. We assume that an observer has in memory an image of the signal presented on the immediately preceding trial. This stored image will be referred to as the *trace*. Due to the influence of various noise sources, the trace of signal S_i will take on different values from presentation to presentation and is best described as a random variable T_i . It is assumed that T_i is normally distributed with mean t_i and variance σ_T^2 . More specifically, the trace distributions for the signals S_1 and S_0 have different means, t_1 and t_0 , but a common variance σ_T^2 .

On each trial of the experiment, the observer processes both the presented signal and the trace of the last signal. We shall call the sensory event associated with the occurrence of S_i the *input*, a random variable denoted as I_i , which is normally distributed with mean s_i and variance σ_I^2 . Thus, the two signals S_1 and S_0 are characterized by two input distributions with means s_1 and s_0 but a common variance σ_I^2 .

² A similar model has been presented by Kinchla and Allan (1969) and Kinchla and Smyzer (1967).

The values of s_1 and s_0 are regarded as scaling parameters, and for mathematical convenience are set arbitrarily at $s_1 = 1$ and $s_0 = 0$. For reasons discussed by Haller (1969) it is assumed that t_1 and t_0 depend on γ . The postulated relationship is linear and is specified by the parameter α as follows:

$$t_1 = \alpha + (1 - \alpha)\gamma, \quad (1)$$

$$t_0 = (1 - \alpha)\gamma, \quad (2)$$

where $0 \leq \alpha \leq 1$. Thus, the more probable signal is remembered with the least amount of distortion, and the greater the value of α the more accurate the memory for both signals.

According to the model, on each trial the observer compares the trace from the preceding signal with the input of the current signal. He then computes the difference between the trace and the input on the relevant dimension (the dimension on which he is asked to base his judgment). If signal S_k was presented on the preceding trial and signal S_j is presented on the current trial, then the difference score d_{jk} is distributed as a random variable D_{jk} that is specified by the equation

$$D_{jk} = I_j - T_k. \quad (3)$$

To avoid confusion, it should be noted that whereas the trace on any trial is determined by the stimulus input on the preceding trial, the input on a trial is assumed to be independent of the trace active on that trial. Thus D_{jk} is normally distributed with mean $s_j - t_k$ and variance $\sigma_D^2 = \sigma_T^2 + \sigma_I^2$.

The decision process uses the output of the comparison process to generate a response as follows:

$$\text{If } \begin{cases} d_{jk} > \delta_0 \\ d_{jk} < \delta_1 \\ \text{otherwise} \end{cases} \text{ then } \begin{cases} \text{respond } A_1 \\ \text{respond } A_0 \\ \text{repeat response made on the preceding trial} \end{cases} \quad (4)$$

where $\delta_0 \geq \delta_1$. If the difference between the input and the trace is greater than some criterion value δ_0 , then A_1 occurs; if the difference is less than some criterion value δ_1 , then A_0 occurs; if the difference does not exceed either the lower or the upper criterion, then the response made on the preceding trial is repeated. In essence, when the observer subtracts the trace of the last signal from the image of the current signal and obtains a "large" positive difference, he calls the current signal loud; when he obtains a "large" negative difference, he calls the current signal soft; and when he obtains little or no difference, he identifies the current signal as a repetition of the preceding one and repeats his last response.

From the above assumptions, Haller (1969) and Tanner *et al.* (1967) have shown that

$$\Pr(A_1 | S_j A_j S_k) = \Phi \left(\frac{s_j - t_k - \delta_1}{\sigma_D} \right). \quad (5)$$

where i, j , and k can take on the values 0 or 1, and $\Phi(x)$ is the integral of the unit normal density function; i.e.,

$$\Phi(x) = \frac{1}{\sqrt{2\pi}} \int_{-\infty}^x e^{-(1/2)y^2} dy. \quad (6)$$

If the predicted sequential probabilities are plotted as points in a receiver-operating-characteristic (ROC) space, then the points $[\Pr(A_1 | S_0 A_j S_k), \Pr(A_1 | S_1 A_j S_k)]$ fall on a symmetric, bow-shaped curve that is defined by the parameter σ_D , and is of the type predicted by signal detectability theory (Green and Swets, 1966).³

For the feedback condition, Tanner *et al.* (1967) proposed that, if d_{ik} falls between the lower criterion δ_i and the upper criterion δ_0 , then the observer reports that S_k , the signal presented on the preceding trial, has been repeated. More specifically, in the feedback condition the observer always knows on a given trial which signal occurred on the last trial, since the feedback event has given him that information. Therefore, when the trace from S_k and the input from S_j are perceived to be approximately the same (i.e., when d_{ik} falls between δ_i and δ_0), the observer makes the response that was designated by feedback as correct on the last trial. For this assumption,

$$\Pr(A_1 | S_j A_j S_k) = \Phi\left(\frac{s_j - t_k - \delta_k}{\sigma_D}\right). \quad (7)$$

A more general assumption when d_{ik} falls between δ_i and δ_0 is that the observer's response strategy is influenced by any information from the preceding trial. Specifically, we assume that the observer responds according to a weighted combination of two tendencies, a tendency to repeat the response he made on the preceding trial and a tendency to report a repetition of the signal (signified by the feedback event) that occurred on the preceding trial. Under this assumption,

$$\Pr(A_1 | S_j A_j S_k) = \omega \Phi\left(\frac{s_j - t_k - \delta_k}{\sigma_D}\right) + (1 - \omega) \Phi\left(\frac{s_j - t_k - \delta_j}{\sigma_D}\right) \quad (8)$$

where ω is the weighting parameter. Note that Eq. 8 is simply a weighted average of Eqs. 5 and 7. The no-feedback condition of Tanner *et al.*, is a special case when $\omega = 0$ and Eq. 8 reduces to Eq. 5. At the other extreme, if the observer ignores his last response, then $\omega = 1$ and Eq. 8 reduces to Eq. 7.

For the feedback condition, the point $[\Pr(A_1 | S_0 A_j S_k), \Pr(A_1 | S_1 A_j S_k)]$ generated by Eq. 8 lies on a smooth ROC curve defined by σ_D only when $j = k$, i.e., when the response on the preceding trial was correct. When $j \neq k$, the points generated by Eq. 8 fall below the ROC curve that passes through the points generated when $j = k$. In fact, the points $[\Pr(A_1 | S_0 A_0 S_1), \Pr(A_1 | S_1 A_0 S_1)]$ and $[\Pr(A_1 | S_0 A_1 S_0), \Pr(A_1 | S_1 A_1 S_0)]$

³ A point in the ROC space is represented by the ordered pair (x, y) , where x denotes the value on the abscissa and y denotes the value on the ordinate.

generated by Eq. 8, each lie on a straight line between the corresponding points generated by Eqs. 5 and 7, which lie on the ROC curve.

METHOD

The observers were two male college sophomores (Nos. 1 and 3) and five female housewives (Nos. 2, 4, 5, 6, and 7) ranging in age from 20 to 21 and 31 to 42, respectively. Audiometric tests established that all observers had normal hearing. The observers were paid at the rate of \$2.25 per hour plus \$0.75 per hour upon completion of the experiment. In addition, they received \$0.01 for every 4 correct responses.

The task required the observer to judge which of two auditory amplitudes occurred on each of a series of trials. Responses were recorded by having the observer press one of two buttons on a panel directly before him. The buttons were separated horizontally 4.25 inches from each other. For three observers (Nos. 3, 6, and 7), the buttons were labeled from left to right, *loud signal*, *soft signal*; for the other four observers, the order was reversed.

The sequence of events on each trial of the experiment was as follows: a 1-sec ready period, designated by the illumination of a small white light on the observer's panel; the presentation of one of the two signals for 0.1 sec; a 1.9-sec response period, designated by both response buttons being illuminated; a 2-sec interval, followed by the ready light for the next trial. Thus, a total of 5 sec elapsed between signal presentations. When trial-by-trial feedback was given, a red light illuminated the correct response button during the last 2-sec interval of the trial; otherwise the interval contained no information.

The signals were 1000-Hz sinusoidal tones, presented through earphones for a duration of 100 msec. The equipment and method of tone generation were the same as reported by Tanner *et al.* (1967). No background noise was presented. The amplitude of S_1 , the loud signal, was constant throughout the experiment at a sound pressure level of 70 dB. The amplitude of S_0 , the soft signal, was adjusted individually for each observer, contingent on his performance during four practice sessions. The adjustment was made after each block of 50 trials so that by the end of the fourth practice session the observer was responding correctly on about 70% of the trials. At that time the amplitude settings of S_0 were as follows (Nos. 1 to 7): 67.4, 63.0, 67.4, 67.1, 65.6, 67.6, and 66.4 (mean = 66.4); these amplitudes were held constant for the remainder of the experiment. During the practice sessions γ was set at 0.5.

The experiment involved 63 sessions plus 4 practice sessions for each observer, who was tested individually for 2 sessions a day with a 15-min break between sessions. Each session consisted of 350 trials. Within a session the proportion of S_1 trials was determined by one of three presentation schedules defined by γ : $\gamma = 0.2, 0.5$, and 0.8 . Within each block of 50 trials, γ defined a random sequence with the restriction that

there were $\gamma \times 50$ loud signals and $(1 - \gamma) \times 50$ soft signals. The order of presenting the schedules was randomly determined with two restrictions: in successive 3-session blocks the observer was tested for 1 session on each of the three schedules, and he was not tested on the same schedule in any 2 consecutive sessions.

Observers were not given information about the signal presentation probabilities either before the experiment or during the practice sessions. Following the practice sessions the experiment involved four major parts (conditions), described in their order of occurrence: NF/N, F, NF/E, NF/EL.

Condition NF/N (no feedback/naive). The observer was not given trial-by-trial feedback and was not told that the presentation schedule varied from one session to another. This condition lasted for 12 sessions, 4 sessions with each of the three presentation schedules. Condition NF/N was designed to be comparable to the no-feedback condition of Tanner *et al.* (1967).

Condition F (feedback). This condition followed NF/N and lasted for 12 sessions, 4 with each schedule. On each trial during Condition F, the observer was given feedback identifying the signal that had occurred on that trial. In addition, he was told the presentation probabilities at the start of each session. Condition F was designed to be comparable to Kinchla's (1966) feedback condition.

Condition NF/E (no feedback/experienced). This condition followed Condition F and lasted for 30 sessions, 10 with each presentation schedule. As in Condition NF/N, the observer did not receive trial-by-trial feedback and was not told the presentation probabilities. However, since the observer had participated in Condition F, he was now aware that the presentation probabilities might be varying from session to session. The extended duration of this condition was designed to allow investigation of possible changes in performance as a function of elapsed time following Condition F.

Condition NF/EL (no feedback/experienced, later). This condition started 1 month after the completion of Condition NF/E and lasted for 9 sessions, 3 with each presentation schedule. Observers were not told at the end of Condition NF/E that they would be asked to return (No. 3 did not participate in Condition NF/EL). As in Condition NF/N and NF/E, the observer was not given trial-by-trial feedback and was not told the presentation probabilities. Condition NF/EL was included to determine if the elapse of a fairly long period of time would dissipate any influence that Condition F might have on subsequent performance in a no-feedback condition.

RESULTS AND DISCUSSION

Table 1 presents the sequential probabilities, hit and false alarm probabilities, the probability of an A_1 , and the probability of a correct response, $\text{Pr}(C)$. The figures also

TABLE 1

Observed (Ob) and Theoretical (Th) Response Probabilities and Parameter Estimates

RESPONSE PROBABILITIES AND PARAMETER ESTIMATES	NO FEEDBACK MAIVE			FEEDBACK			NO FEEDBACK EXPERIENCED			NO FEEDBACK EXPERIENCED, LATER														
	$\gamma=0.2$		$\gamma=0.5$		$\gamma=0.8$		$\gamma=0.2$		$\gamma=0.5$		$\gamma=0.8$		$\gamma=0.2$		$\gamma=0.5$		$\gamma=0.8$							
	Ob	Th	Ob	Th	Ob	Th	Ob	Th	Ob	Th	Ob	Th	Ob	Th	Ob	Th	Ob	Th						
$Pr(A_1 S_1 A_1 S_1)$.81	.85	.81	.79	.71	.71	.75	.72	.86	.87	.95	.94	.92	.94	.91	.92	.89	.89	.89					
$Pr(A_1 S_0 A_1 S_1)$.43	.45	.34	.36	.27	.28	.08	.08	.20	.20	.30	.35	.33	.36	.31	.26	.26	.22	.21	.21				
$Pr(A_1 S_1 A_1 S_0)$.87	.92	.86	.88	.79	.82	.54	.71	.79	.83	.92	.94	.96	.99	.94	.99	.93	.98	.91	.97	.97			
$Pr(A_1 S_0 A_1 S_0)$.61	.60	.55	.50	.38	.41	.10	.16	.32	.26	.62	.43	.68	.67	.62	.61	.58	.55	.54	.45	.46	.47		
$Pr(A_1 S_1 A_0 S_1)$.61	.69	.61	.60	.51	.51	.46	.57	.72	.71	.88	.83	.60	.56	.53	.53	.47	.46	.63	.65	.55	.57	.54	.55
$Pr(A_1 S_0 A_0 S_1)$.32	.25	.26	.18	.14	.13	.08	.06	.20	.15	.31	.26	.14	.04	.13	.03	.08	.02	.15	.05	.12	.03	.11	.03
$Pr(A_1 S_1 A_0 S_0)$.77	.81	.76	.73	.64	.65	.63	.62	.77	.77	.89	.92	.84	.83	.81	.81	.75	.76	.87	.87	.82	.82	.81	.80
$Pr(A_1 S_0 A_0 S_0)$.38	.38	.25	.30	.17	.22	.06	.05	.13	.11	.19	.28	.15	.17	.14	.15	.11	.11	.18	.18	.14	.13	.14	.12
$Pr(A_1 S_1)$.81	.85	.78	.76	.65	.65	.62	.63	.80	.81	.93	.93	.87	.88	.85	.86	.81	.81	.88	.90	.83	.84	.83	.83
$Pr(A_1 S_0)$.47	.47	.34	.34	.22	.23	.06	.06	.18	.16	.31	.34	.31	.33	.28	.27	.21	.21	.27	.27	.20	.18	.17	.18
$Pr(A_1)$.54	.55	.56	.55	.56	.57	.18	.17	.49	.49	.81	.81	.43	.44	.56	.56	.69	.69	.39	.40	.52	.51	.70	.70
$Pr(C)$.59	.59	.72	.71	.67	.68	.87	.88	.81	.82	.89	.88	.72	.71	.79	.80	.80	.81	.76	.76	.81	.83	.83	.83
σ_0	.12	.12					.78	.45	.02	.02			.39	.25	.17				.32	.23	.07			
σ_1	-.35	-.35					-.01	-.39	-.73	-.73			.34	-.44	-.53				-.17	-.27	-.48			
σ	.32	.32					.65	.65					.42	.42					.36	.36				
σ_D	.86	.86					.51	.51					.52	.52					.49	.49				
ω	—	—					.73	.73					—	—					—	—				
min	9.57	9.57					10.75	10.75					11.01	11.01					3.97	3.97				

present the sequential probabilities (Fig. 2), hit and false alarm rates (Fig. 3), and the A_1 probability (Fig. 4). These data were calculated for observers individually and for the group as a whole. To conserve space, data for individual observers are not presented; however, they are reasonably well represented by the group values. The adequacy of the representation is comparable to that displayed in Tanner *et al.* (1967).

The data represent performance over all of the sessions of a given schedule and a given condition. Data for single sessions were also examined to determine if there were systematic changes over sessions. Such changes were not observed, even for Condition NF/E where they were most expected. Thus the data presented are representative of individual sessions as well as individual observers.

To obtain predictions for the MR-Model, it is necessary to make estimates of α , σ_D , δ_0 , δ_1 , and ω . For the present study the parameters were estimated by minimizing the following function:

$$\xi(\alpha, \sigma_D, \delta_0, \delta_1, \omega) = \sum_{k=1}^2 \sum_{j=1}^2 \sum_{i=1}^2 \{[\hat{\Pr}(A_1 | S_i A_j S_k) - \Pr(A_1 | S_i A_j S_k)]^2 \text{fr}(A_1 S_i A_j S_k)\}, \quad (9)$$

where $\hat{\Pr}(A_1 | S_i A_j S_k)$ denotes the observed sequential probability and $\text{fr}(A_1 S_i A_j S_k)$ denotes the corresponding observed frequency. The parameter estimates were obtained using a high-speed computer to calculate the function $\xi(\alpha, \sigma_D, \delta_0, \delta_1, \omega)$ over a grid of possible values of the parameters, then selecting those values that approximated the minimum of the function (see Atkinson, Bower, and Crothers, 1965, p. 386).

Two estimation procedures, designated as Methods A and B, were employed. In Method A, which was used for Condition NF/N, the five parameter values were estimated simultaneously for all three presentation schedules. In Method B, δ_0 and δ_1 were estimated separately for each presentation schedule, while α , σ_D , and ω were estimated simultaneously over all three schedules. Thus in Method B, one value each for α , σ_D , and ω , but three values each for δ_0 and δ_1 (a total of nine parameters) were estimated. Method B was used for Conditions F, NF/E, and NF/EL, because it was assumed that δ_0 and δ_1 would vary with γ when observers were aware that the signal presentation probabilities were being varied from session to session. The parameter estimates and the minimum values of $\xi(\alpha, \sigma_D, \delta_0, \delta_1, \omega)$ are presented in Table 1.

The sequential probabilities are discussed first, since the principal predictions of the MR-Model are based on sequential relations. These probabilities are presented in Fig. 2. The columns of Fig. 2 correspond to the four experimental conditions, and the rows to the three presentation schedules. The circles and squares in each graph (see the figure legend) plot the observed points $[\Pr(A_1 | S_0 A_j S_k), \Pr(A_1 | S_1 A_j S_k)]$. The bow-shaped curves are the ROC functions predicted by the MR-Model. The curves are determined by the single parameter σ_D (Haller, 1969; Tanner *et al.*, 1967). Therefore, each condition (having its own estimated value of σ_D) has a different curve, but the three schedules of a condition (having the same value of σ_D) have the same curve.

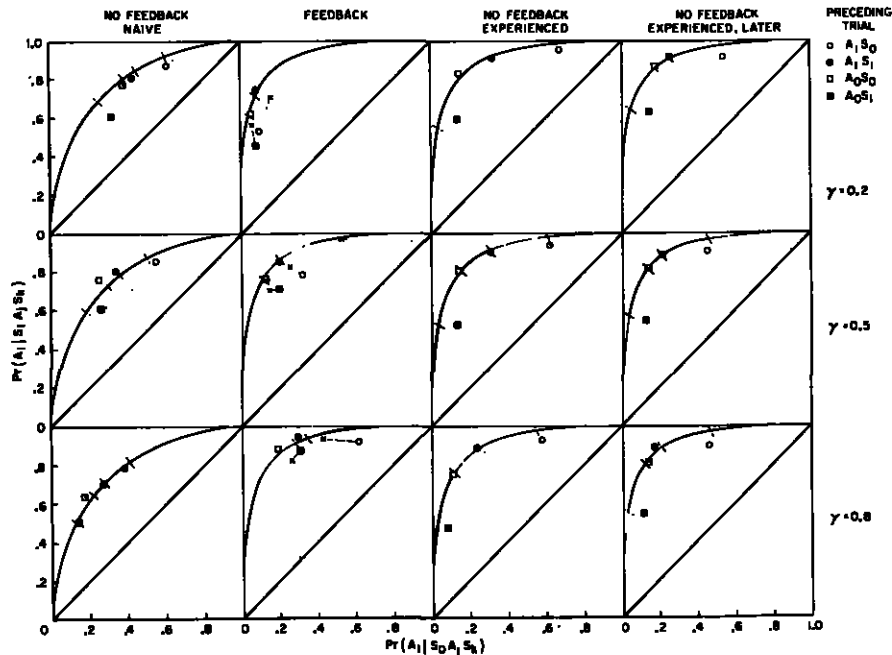

FIG. 2. ROC graphs of sequential response probabilities.

The intersections of the ROC curves and the short lines drawn perpendicularly to them plot the predicted points in Fig. 2. For the no-feedback (NF) conditions, the order of the predicted and observed points along the ROC curve is the same, and this order is independent of the presentation schedule. Both hit and false alarm rates increased as a function of the signal and response on the preceding trial as follows: an A_0 made to an S_1 , an A_0 made to an S_0 , an A_1 made to an S_1 , an A_1 made to an S_0 . Thus there was a general tendency to repeat the response made on the preceding trial but not to report the signal that occurred on the preceding trial. Also, there was a strong tendency to repeat a response that was incorrect on the preceding trial. The order of the observed points for all three NF conditions is the same as that reported by Kinchla (1966) and by Tanner *et al.* (1967) for their no-feedback conditions. Also, the accuracy of the MR-Model for predicting the sequential probabilities in the present study appears comparable to the accuracy reported by Tanner *et al.*

As noted above, for Condition F the model predicts that only two of the points for the sequential probabilities, *viz.*, $[\Pr(A_1 | S_0, A_0, S_0), \Pr(A_1 | S_1, A_0, S_0)]$ and $[\Pr(A_1 | S_0, A_1, S_1), \Pr(A_1 | S_1, A_1, S_1)]$ will fall on the ROC curve. The predicted values for these two points are indicated by the intersection of short lines with the ROC curve; the predicted and observed values for these two points have the same order in the ROC space. For the two points that are predicted to lie below the curve, *viz.*,

$\{\Pr(A_1 | S_0 A_1 S_0), \Pr(A_1 | S_1 A_1 S_0)\}$ and $\{\Pr(A_1 | S_0 A_0 S_1), \Pr(A_1 | S_1 A_0 S_1)\}$, the predicted values are designated by small crosses and a line connects these crosses with the corresponding observed points.

For Condition F (in contrast to the NF conditions) the order of the four observed points along the ROC curve is not consistent over presentation schedules. However, the order within each of the two pairs of points (the pair predicted to fall on the ROC curve, and the pair predicted to fall below the curve) is the same for each presentation schedule as the corresponding order in the three NF conditions; i.e., both hit and false alarm rates were greater when an A_1 was made to an S_1 than when an A_0 was made to an S_0 on the preceding trial, and were greater when an A_1 was made to an S_0 than when an A_0 was made to an S_1 . Inspection of Kinchla's data shows these same relationships when observers received trial-by-trial feedback.

Kinchla reported that the influence of the preceding trial's signal and response on hit and false alarm rates was much stronger when observers did not receive feedback than when they did. Similarly, in Fig. 1 of the present study, the sequential effects appear greater for the NF conditions than for Condition F; i.e., the spread of the four points in the ROC space is generally greater for the NF conditions than for Condition F. In both studies, however, the two points $\{\Pr(A_1 | S_0 A_0 S_0), \Pr(A_1 | S_1 A_0 S_0)\}$ and $\{\Pr(A_1 | S_0 A_1 S_1), \Pr(A_1 | S_1 A_1 S_1)\}$ were spread about as far apart when feedback was given as when it was not. The decrease in the overall spread for Condition F was due specifically to a decrease in the sequential effects when an error ($A_0 S_1$ or $A_1 S_0$) was made on the preceding trial. Thus in Condition F (in contrast to the NF conditions) there was not a consistent tendency to repeat a response that was incorrect on the preceding trial, but (similar to the NF conditions) there was a tendency to repeat a response made on the preceding trial whether or not it was correct.

The two points that are predicted to lie below the ROC curves in Condition F are not as well fit by the model as are the points (in all four conditions) that are predicted to lie on the curves. However, in all conditions the theoretical fits for the points that are predicted to lie on the ROC curves appear reasonably accurate; and, as noted previously, even for the points in Condition F that are predicted to lie below the curve, the relative location in the ROC space, with respect to the direction of shifts along the curve, is predicted.

Figure 3 presents observed values for hit and false alarm rates plotted on ROC graphs. As would be expected from previous research, hit and false alarm rates varied systematically as a function of γ in all experimental conditions. For all three NF conditions both the hit and false alarm probabilities decreased, as γ increased, the same relation reported by Tanner *et al.* (1967). Qualitatively then, the relationship between γ and hit and false alarm rates was the same for the three conditions. However, note that the spread of the points is greater in Condition NF/N than in Conditions NF/E and NF/EL. This evidence indicates that the influence of γ on hit and false alarm rates is reduced in a no-feedback condition that is presented after an observer

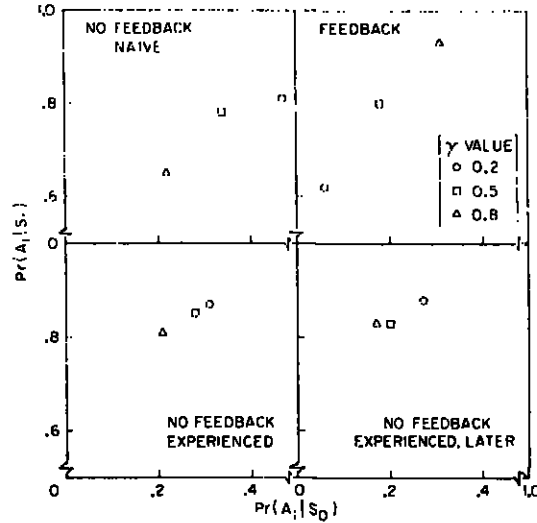

FIG. 3. ROC graphs of hit and false alarm probabilities.

has previously experienced feedback. This reduced influence apparently was not affected by the elapsed month between Conditions NF/E and NF/EL.

For Condition F both hit and false alarm rates increased as γ increased. This relationship is the same as that reported by Kinchla for his feedback condition. The influence of γ on hit and false alarm rates appears to have been stronger in Condition F than in Condition NF/N and this difference between the two conditions also is consistent with the results of previous research. Inspection of Kinchla's feedback data and Tanner and co-worker's no-feedback data suggests that the influence of γ on hit and false alarm rates was stronger in the former even though the range of γ values (0.25 to 0.75 and 0.1 to 0.9, respectively) was greater in the latter study.

Predicted values for $\Pr(A_1 | S_1)$ and $\Pr(A_1 | S_0)$ were obtained as weighted averages of appropriate sequential probabilities:

$$\Pr(A_1 | S_j) = \sum_{k=1}^2 \sum_{j=1}^2 [\Pr(A_1 | S_j A_j S_k) \Pr(A_j | S_k) \Pr(S_k)]. \quad (10)$$

The predictions for $\Pr(A_1 | S_1)$ and $\Pr(A_1 | S_0)$ are presented in Table 1, where they can be compared with observed values. For each of the four conditions the model predicts the observed values quite accurately. The largest discrepancy between observed and predicted values is 0.04, and the discrepancy for 17 of the 24 pairs of values is less than or equal to 0.01.

Figure 4 presents the observed values for $\Pr(A_1)$ as a function of γ . It is clear that feedback had a marked influence on $\Pr(A_1)$. While $\Pr(A_1)$ remained virtually constant

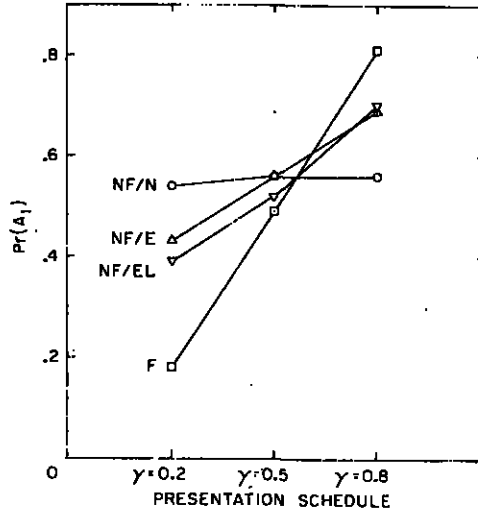

FIG. 4. Unconditional probability for reporting the loud signal.

over the presentation schedules in Condition NF/N, it approximately matched the value of γ in Condition F. These results are consistent with those of Tanner and co-worker's no-feedback condition and Kinchla's feedback condition. For Conditions NF/E and NF/EL, $\Pr(A_1)$ increased as γ increased but less markedly than in Condition F. Thus, Conditions NF/E and NF/EL lie between Conditions NF/N and F in their influence on the relationship between γ and the A_1 response probability, just as they did for the relationship between γ and the hit and false alarm rates. As in the case of hit and false alarm rates and sequential probabilities, the elapsed month between Conditions NF/E and NF/EL did not appear to influence $\Pr(A_1)$.

The predictions for $\Pr(A_1)$ and $\Pr(C)$ were obtained as weighted averages of the predicted hit and false alarm rates as follows:

$$\Pr(A_1) = \Pr(A_1 | S_1) \gamma + \Pr(A_1 | S_0)(1 - \gamma), \quad (11)$$

$$\Pr(C) = \Pr(A_1 | S_1) \gamma + [1 - \Pr(A_1 | S_0)](1 - \gamma). \quad (12)$$

The values of $\Pr(A_1)$ and $\Pr(C)$ are presented in Table 1; note that 23 of the 24 predictions are within 0.01 of the observed values.

In the application of the MIR-Model to Conditions F, NF/E, and NF/EL, certain assumptions were added to the basic model. To evaluate these additional assumptions some alternatives were considered.

For Condition F the predictions generated by Eq. 8 (shown in Table 1) were compared with those generated by Eq. 7. The estimation procedure used for Eq. 8 (Method B) was repeated for Eq. 7, since δ_0 and δ_1 obviously were dependent on γ (note in

Fig. 5 that for Condition F both δ_0 and δ_1 decreased markedly as γ increased). For $\Pr(A_1 | S_1)$, $\Pr(A_1 | S_0)$, $\Pr(A_1)$, and $\Pr(C)$, Eqs. 7 and 8 yielded essentially equivalent results; the predicted values for the two equations are all within 0.01 of each other. However, for the sequential probabilities, the predictions of Eq. 8 provided a far better fit to the data than those of Eq. 7; the respective minimum values of $\xi(\alpha, \sigma_D, \delta_0, \delta_1, \omega)$ are 10.8 and 27.9.

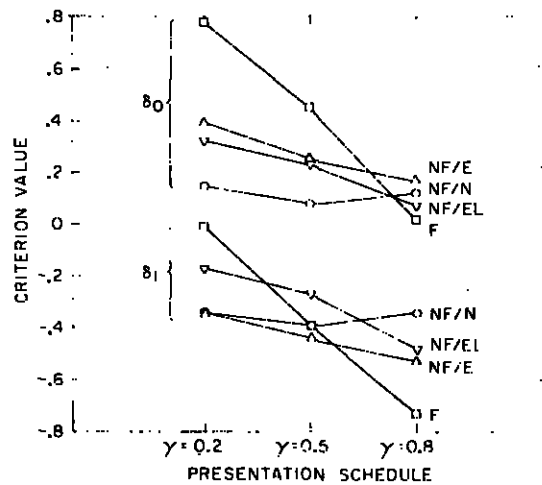

FIG. 5. Estimates of the criterion values.

Method B was used originally to estimate parameters for Conditions NF/E and NF/EL, since it was assumed that an observer might guess the values of the signal presentation probabilities and adjust his criterion values appropriately. Figure 5 shows that the estimates δ_0 and δ_1 decreased as γ increased in these two conditions, but the relationship was not as strong as it was for Condition F. Therefore, a new set of predictions was generated for Conditions NF/E and NF/EL using Method A, which required δ_0 and δ_1 to be constant over γ . Method B proved to be more accurate for all of the probabilities shown in Table 1 for the two conditions. For Conditions NF/E and NF/EL, respectively, the minimum values of $\xi(\alpha, \sigma_D, \delta_0, \delta_1, \omega)$ obtained by Method A are 75.6 and 40.2; these values are much larger than those obtained by Method B (see Table 1).

The data appear to support the assumption that δ_0 and δ_1 vary as a function of γ in Conditions F, NF/E, and NF/EL. As an additional test of the MR-Model another set of predictions was generated for Condition NF/N using Method B, i.e., allowing δ_0 and δ_1 to vary with γ . However, the estimation of additional parameters in Method B did not substantially improve the predictions for Condition NF/N. For all the response probabilities in Condition NF/N, the predictions generated by Methods A

and B are nearly identical. The values of δ_0 and δ_1 for Condition NF/N obtained using Method B are shown in Fig. 5, and it is apparent that they are virtually constant over γ . Thus the assumption that observers do not adjust their criterion values from one presentation schedule to the next in Condition NF/N appears to be supported.

CONCLUSION

The findings of this study, we believe, justify the following conclusions:

1. The results of Kinchla's (1966) feedback condition and Tanner and co-worker's (1967) no-feedback condition have been replicated in Condition F and NF/N, respectively. It has been verified that in a signal recognition task the relationship between γ and hit and false alarm probabilities depends on whether or not an observer is given information about the signal presentation probabilities.

2. The results of this study considered in relation to those of Kinchla (1966) and Tanner *et al.* (1967) suggest that the information an observer receives about the signal presentation probabilities and the influence this information has on his decisions are ordered along a dimension from (a) to (d) as follows: (a) At one end is Kinchla's feedback condition and Condition F of the present study; the observer is told the signal presentation probabilities and is given trial-by-trial feedback. As a result, the hit and false alarm rates clearly increase as γ increases. (b) Next on the dimension is Kinchla's no-feedback condition; the observer is told the signal presentation probabilities, but is not given trial-by-trial feedback. In this condition hit and false alarm rates also increase as γ increases but the effect is weaker than when trial-by-trial feedback is given. (c) Further along the dimension lie Conditions NF/E and NF/EL of the present study; the observer is not told of the signal presentation probabilities and is not given trial-by-trial feedback, but as a result of previous experience, he may realize that the signal presentation probabilities vary from session to session. Under these conditions hit and false alarm rates decrease slightly as γ increases. (d) At the other end of the dimension is Tanner and co-worker's no-feedback condition and Condition NF/N of the present study; the observer is not told that the signal presentation probabilities may change from session to session and is not given trial-by-trial feedback. With no information about the signal probabilities, the observer's hit and false alarm rates decrease markedly as γ increases.

3. The sequential effects appear to be stronger when trial-by-trial feedback is omitted than when it is given. The influence of the preceding trial's signal and response on hit and false alarm rates appears to have been equally strong in Kinchla's and Tanner and co-worker's no-feedback conditions, and the three NF conditions of the present study. The relationship was weaker in both Kinchla's feedback condition and Condition F of the present study.

4. The Memory-Recognition Model provided accurate predictions for $\Pr(A_1)$, $\Pr(A_1 | S_1)$, and $\Pr(A_1 | S_0)$ in all conditions of the present study. For the sequential probabilities, $\Pr(A_1 | S_i A_j S_k)$, the predictions are quite accurate for the three NF conditions. For Condition F, however, the predictions for two of the points in the ROC space, the points predicted to fall below the ROC curve, are less accurate; for the two points that are predicted to fall on the curve, the accuracy of the predictions is comparable to that of the NF conditions.

REFERENCES

- ATKINSON, R. C., BOWER, G. H., AND CROTHERS, E. J. *An introduction to mathematical learning theory*. New York: Wiley, 1965.
- ATKINSON, R. C., AND KINCHLA, R. A. A learning model for forced-choice detection experiments. *British Journal of Mathematical and Statistical Psychology*, 1965, 18, 183-206.
- GREEN, D. M., AND SWETS, J. A. *Signal detection theory and psychophysics*. New York: Wiley, 1966.
- HALLER, R. W. The role of information feedback in signal recognition. Unpublished doctoral dissertation, Stanford University, 1969.
- KINCHLA, R. A. A comparison of sequential effects in detection and recognition. Experimental Psychology Series, Psychology Department, New York University, Tech. Rep., 1, 1966.
- KINCHLA, R. A. AND ALLAN, LORRAINE G. A theory of visual movement perception. *Psychological Review*, 1969, 76, 537-558.
- KINCHLA, R. A. AND SMYZER, F. A diffusion model of perceptual memory. *Perception and Psychophysics*, 1967, 2, 219-229.
- PARDUCCI, A., AND SANDUSKY, A. Distribution and sequence effects in judgment. *Journal of Experimental Psychology*, 1965, 69, 450-459.
- TANNER, T. A., HALLER, R. W., AND ATKINSON, R. C. Signal recognition as influenced by presentation schedules. *Perception and Psychophysics*, 1967, 2, 349-358.

RECEIVED: February 19, 1969

SECTION IV:

OPTIMIZING THE LEARNING PROCESS

- 9 Adaptive instructional systems: Some attempts to optimize the learning process. In Cognition and Instruction, edited by D. Klahr, Hillsdale, New Jersey: Erlbaum Associates, 1976, 81-108. 335
- 10 Computerized instruction and the learning process. American Psychologist, 1968, 23, 225-239 363
- 11 Ingredients for a theory of instruction. American Psychologist, 1972, 27, 921-931 379
- 12 Mnemotechnics in second-language learning. American Psychologist, 1975, 30, 821-828..... 391

9

Adaptive Instructional Systems: Some Attempts to Optimize the Learning Process

Richard C. Atkinson¹

Stanford University

INTRODUCTION

One cannot help but question the significance of psychology's contribution to the development of effective instructional procedures. On the one hand, psychology has been very influential in the field of education. In the last 25 years almost every major innovation in education—programmed textbooks, behavioral objectives, ungraded schools, individually prescribed instruction, computer managed and assisted instruction, token economies, and tailored testing to name a few—can be traced to psychology. In many cases these innovations have not been due to psychologists primarily identified with education, but rather to laboratory scientists whose research has suggested new approaches to instruction. Psychology can be proud of that record of accomplishment. But upon closer examination, it is evident that these accomplishments are not as closely linked to psychological research as many might believe. Psychology has suggested new approaches to education, but these suggestions have not led to *sustained research programs that have the promise of producing a truly effective theory of instruction*. Rather, psychology seems to provide the stimulus for innovation, but innovation that has not in turn led to a deeper understanding of the learning process.

Why has psychology not had a more substantial impact? There are several reasons. The brightest and ablest young psychologists usually are not attracted to educational research, and the research that has been done tends to be piecemeal, not pursuing problems in real depth. This picture may change in the near future due to the limited number of jobs for new Ph.D.s and to society's

¹ Present affiliation: Deputy Director, National Science Foundation, Washington, D.C. 20550.

increasing emphasis on applied research. The more serious problem, however, is that psychologists know a great deal about the acquisition of individual facts and skills, but very little about how these combine to form a meaningful mental structure. Effective methods for acquiring skills and facts are important, but the major problem is the development of knowledge structures that are more than the sum of individual facts. In order to deal effectively with educational problems, we need theories that tell us how knowledge is represented in memory, how information is retrieved from that knowledge structure, how new information is added to the structure, and how the system can expand that knowledge structure by self-generative processes. The development of such theories is under way, and increasingly work in cognitive psychology is moving in that direction. The contributions of Anderson and Bower (1973), Newell and Simon (1972), Rumelhart, Lindsay, and Norman (1972), and Schank (1972) are examples of substantial efforts to develop comprehensive theories of cognition, and it is already evident that this work will have implications for education. Such theories will not simply add another wrinkle to educational research, but will lay the foundations for research encompassing a larger set of educationally significant problems than has been considered in the past.

In this paper I want to review the ongoing work in my laboratory that has implications for instruction. Some of that work represents attempts to deal with the issue of complex knowledge structures, whereas some is more restrictive dealing with the acquisition of specific skills and facts. All of the work involves computer-based programs of instruction used on a daily basis in schools and colleges. These programs can best be described as *adaptive instructional systems*. By that term I mean two things: (1) the sequence of instructional actions taken by the program varies as a function of a given student's performance history, and (2) the program is organized to modify itself automatically as more students complete the course and their response records identify defects in instructional strategies.

Our work on adaptive instructional systems has three foci. One is the development of a course in computer programming for junior college and college students; the second is a course for teaching reading in the first three grades of elementary schools; and the third is a foreign-language vocabulary program being used at the college level. Here I will review research on each of these projects.

INSTRUCTION IN COMPUTER PROGRAMMING

Our first efforts to teach computer programming involved the development of a computer-assisted instruction (CAI) curriculum to teach the AID (Algebraic Interpretive Dialogue) programming language; this course has been used extensively in colleges and junior colleges as an introduction to computer programming (Beard, Lorton, Searle, & Atkinson, 1973). However, it is a linear, "frame-

oriented" CAI program and does not provide individualized instruction during the problem-solving activity itself. After working through lesson segments on syntax, expressions, etc., the student is assigned a problem to solve in AID. He must then leave the instructional program, call up a separate AID interpreter, perform the required programming task, and return to the instructional program with an answer. As the student writes a program with AID, the only sources of assistance are the error messages provided by the noninstructional interpreter.

An inadequacy of the AID course, especially for research purposes, is its limited ability to characterize individual students' knowledge of specific skills, and its inability to relate students' skills to the curriculum as anything more than a ratio of problems correct to problems attempted. The program cannot make fine distinctions between a student's strengths and weaknesses, and cannot present instructional material specifically appropriate to that student beyond "harder" or "easier" lessons. In order to explore the effects of different curriculum selection strategies in more detail, we developed another introductory programming course, capable of representing both its subject matter and student performance more adequately. The internal representation of programming skills and their relationships to the curriculum is similar in some ways to the semantic networks used in the "generative" CAI programs developed by Carbonell and others (Carbonell, 1970; Collins, Carbonell, & Warnock, 1973).

The BASIC Instructional Program

An important feature of a tutorial CAI program is to provide assistance as the student attempts to solve a problem. The program must contain a representation of the subject matter that is complex enough to allow the program to generate appropriate assistance at any stage of the student's solution attempt. The BASIC (Beginners All-purpose Symbolic Instruction Code) Instructional Program (BIP) contains a representation of information appropriate to the teaching of computer programming that allows the program both to provide help to the student and to perform a limited but adequate analysis of the correctness of the student's program as a solution to the given problem.

To the student seated at a terminal, BIP looks very much like a typical time-sharing BASIC operating system. The BASIC interpreter, written especially for BIP, analyzes each program line after the student types it, and notifies the student of syntax errors. When the student runs his or her program it is checked for structural illegalities, and during runtime "execution" errors are indicated. A file storage system, a calculator, and utility commands are available.

Residing above the simulated operating system is the "tutor," or instructional program (IP). It overlooks the entire student/BIP dialogue and motivates the instructional interaction. In addition to selecting and presenting programming problems to the student, the IP identifies the student's problem areas, suggests simpler "subtasks," gives hints or model solutions when necessary, offers debug-

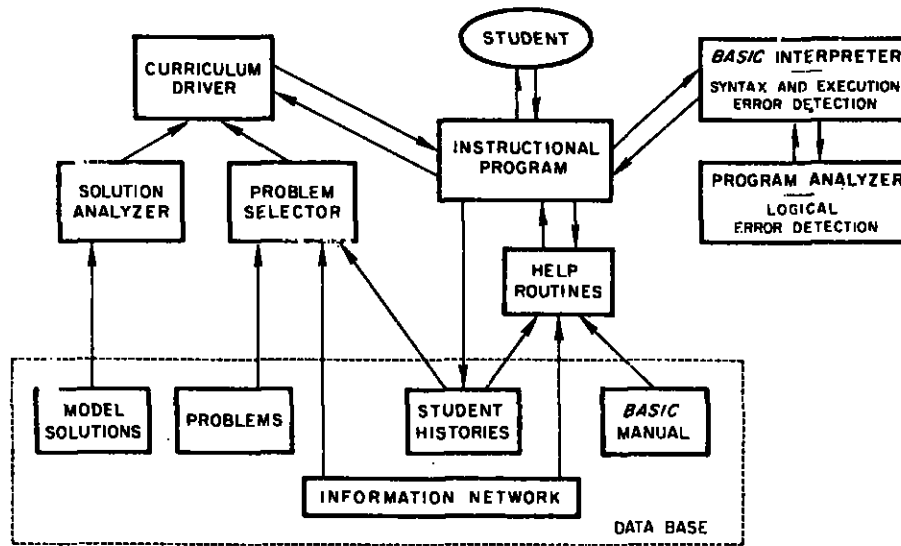

FIG. 1 BIP information flow diagram.

ging aids, and supplies incidental instruction in the form of messages, interactive lessons, or manual references.

At the core of BIP is an information network whose nodes are concepts, skills, problems, subproblems, prerequisites, BASIC commands, remedial lessons, hints, and manual references. The network is used to characterize both the logical structure of the course and our estimate of the student's current state of knowledge; more will be said about the network later. Figure 1 illustrates the interactions of the parts of the BIP program.

The curriculum is organized as a set of programming problems whose text includes only the description of the problem, not lengthy descriptions of programming structures or explanations of syntax. There is no fixed ordering of the tasks; the decision to move from one task to another is made on the basis of the information about the tasks (skills involved, prerequisites, subtasks available) stored in BIP's network.

A student progresses through the curriculum by writing, and running, a program that solves the problem presented on the terminal. Virtually no limitations are imposed on the amount of time the student spends, the number of lines he writes, the number of errors he is allowed to make, the number of times he chooses to execute the program, etc. The task on which the student is working is stored on a stack-like structure, so that he may work on another task, for whatever reason, and return to the previous task automatically. The curriculum structure can accommodate a wide variety of student aptitudes and skills. Most

of the curriculum-related options are designed with the less competent student in mind. A more competent student may simply ignore the options. Thus, BIP gives students the opportunity to determine their own "challenge levels" by making assistance available but not inevitable.

BIP offers the student considerable flexibility in making task-related decisions. The student may ask for hints and subtasks to help solve the given problem, or may ponder the problem, using only the manual for additional information. The student may request a different task by name either completing the new task or not, as he or she chooses. On the student's return to the original task, BIP tells him or her the name of the again-current task, and prints the text of the task if requested. The student may request the model solution for any task at any time, but BIP will not print the model for the current task unless the student has exhausted the available hints and subtasks. Taken together, the curriculum options allow for a wide range of student preferences and behaviors.

The Information Network of BIP

Task selection, remedial assistance, and problem area determination require that the program have a flexible information store interrelating tasks, hints, manual references, etc. This store has been built using the associative language LEAP, a SAIL (Stanford Artificial Intelligence Laboratory) sublanguage, in which set, list and ordered triple data structures are available (Feldman, Low, Swinehart, & Taylor, 1972; Swinhart & Sproull, 1971; VanLehn, 1973). Figure 2 presents a

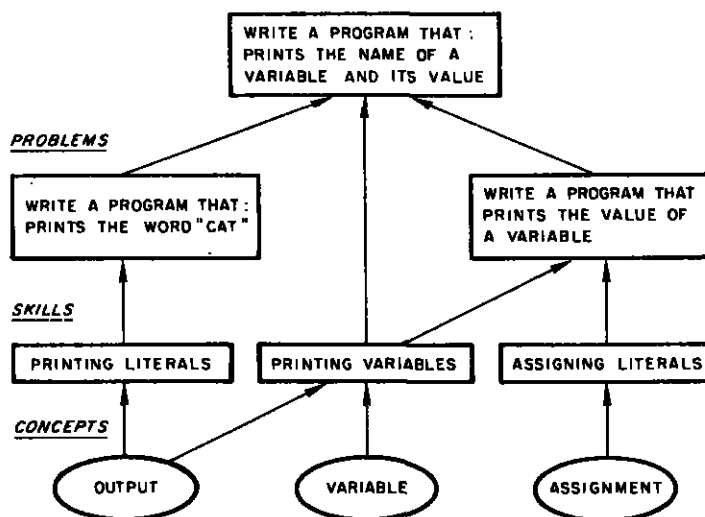

FIG. 2 A segment of BIP information network.

simplified relationship among a few programming concepts, specific observable skills that characterize the acquisition of the concepts, and programming problems that require the use of those skills. The network is constructed using the associative triple structure, and is best described in terms of the various types of nodes:

- TASKS:** All curriculum elements exist as task nodes in the network. They are linked to each other as subtasks, prerequisite tasks, or "must follow" tasks.
- SKILLS:** The skill nodes are intermediaries between the concept nodes and the task nodes (Fig. 2). Skills are very specific, e.g., "concatenating string variables" or "incrementing a counter variable." By evaluating success on the individual skills, the program estimates competence levels in the concept areas. In the network, skills are related to the tasks that require them and to the concepts that embody them.
- CONCEPTS:** The principal concept areas covered by BIP are the following: interactive programs; variables and literals; expressions; input and output; program control—branching; repetition—loops; debugging; subroutines; and arrays.
- OPERATORS:** Each BASIC operation (PRINT, LET, . . .) is a node in the network. The operations are linked to the tasks in two ways: either as elements that must be used in the solution of the problem, or as those that must not be used in the solution.
- HINTS:** The hint nodes are linked to the tasks for which they may be helpful. Each time a new skill, concept or BASIC operator is introduced, there is an extra hint that gives a suitable manual reference.
- ERRORS:** All discoverable syntax, structural, and execution errors exist as nodes in the network, linked to the relevant "help" messages, manual references and remedial lessons.

Clearly in some cases, a hierarchy among skills or problems is implicit; more frequently, however, such a relationship cannot be assumed. By imposing only a very loose hierarchy (e.g., requiring that all students begin the course with the same problem), it is possible to select curriculum and provide assistance on the basis of a student's demonstrated competence level on specific skills, rather than on the basis of a predetermined, nonindividualized, sequence of problems. Students who acquire competence in skills in some manner other than that assumed by subject-matter experts to be standard should benefit most from this potential for individualization.

Upon completion of a task, the student is given a "post task interview" in which BIP presents the model solution stored for that problem. The student is encouraged to regard the model as only one of many possible solutions. BIP asks the student whether he or she has solved the problem, then asks (for each of the

skills associated with the task) whether more practice is needed on that skill. In addition to the information gained from this student self-analysis, BIP also stores the result of a comparison between the student's program and the model solution, based on the output of both programs when run on a set of test data. The student's responses to the interview and the results of the program comparison are used in future BIP-generated curriculum decisions. BIP informs the student that the task has been completed, and either allows the student to select the next task by name (from an off-line printed list of names and problem texts), or makes the selection for the student.

An example of the role of the Information Network in BIP's tutorial capabilities is the BIP-generated curriculum decisions mentioned above. By storing the student's own evaluation of his or her skills, and by comparing the student's solution attempts to the stored models, BIP can be said to "learn" about each student as an individual who has attained a certain level of competence in the skills associated with each task. For example, BIP might have recorded the fact that a given student had demonstrated competence (and confidence) in the skill of assigning a literal value to a variable (e.g., $N = 1$), but had failed to master the skill of incrementing a counter variable (e.g., $N = N + 1$). BIP can then search the network to locate the skills that are appropriate to each student's abilities and present tasks that incorporate those skills. The network provides the base from which BIP can generate decisions that take into account both the subject matter and the student, behaving somewhat like a human tutor in presenting material that either corrects specific weaknesses or challenges and extends particular strengths, proceeding into as yet unencountered areas.

The BIP program has been running successfully with both junior college and university students. However, the program is still very much in an experimental stage. From a psychological viewpoint, the principal research issues deal with (1) procedures for obtaining on-line estimates of student abilities as represented in the information network, and (2) alternative methods for using the current estimates in the information network to make instructional decisions. Neither of these issues is restricted to this particular course, and a major goal in the development of BIP is to provide an instructional model suitable to a variety of different subject areas. Two topics must be discussed in relation to this goal: the nature of appropriate subject areas and the general characteristics of the BIP-like structure that make it particularly useful in teaching such subjects.

A subject well suited to this approach generally fits the following description: it has clearly definable, demonstrable skills, whose relationships are well known; the real content of the subject matter is of a problem-solving, rather than a fact-acquiring, nature; the problems presented to the student involve overlapping sets of skills; and a student's solution to a given problem can be judged as adequate or inadequate with some degree of confidence. The BASIC language, as taught by BIP, is one such subject, but the range of appropriate curriculums goes well beyond the area of computer science. For example, elementary statistics could be taught by a similar approach, as could algebra, navigation, accounting,

or organic chemistry. All these subject areas involve the manipulation of information by the student toward a known goal, all involve processes that can be carried out or simulated by a computer, and all are based on a body of skills whose acquisition by the student can be measured with an acceptable degree of accuracy.

Because they require the development of problem-solving skills, rather than the memorization of facts, these subject areas are frequently difficult to master and difficult to tutor, especially using standard CAI techniques. One limitation of such standard techniques is their dependence on a "right" answer to a given question or problem, which precludes active student participation in a problem-solving process consisting of many steps, none of which can be evaluated as correct or incorrect except within the context of the solution as a whole. In addition, standard CAI techniques usually consist of an instructional facility alone—a mechanism by which information is presented and responses are judged. This facility can be linked to a true problem-solving facility that allows the student to proceed through the steps to a solution, but the link does not allow the transfer of information between the instructional and the problem-solving portions of the program. The complete integration of the two parts is a key feature of BIP, making it appropriate to instruction in subject areas that have been inadequately treated in CAI.

The most general characteristics of the "network" structure include a representation of the curriculum in terms of the specific skills required in its mastery and a representation of the student's current levels of competence in each of the skills he has been required to use. Individual record-keeping relates each student's progress to the curriculum at all times, and any number of schemes may be used to apply that relationship to the selection of tasks or the presentation of additional information, hints, advice, etc.

An important element of our network structure is the absence of an established path through the curriculum, providing the built-in flexibility (like that of a human tutor) to respond to individual students' strengths and weaknesses as each student works with the course. This can only be accomplished through a careful analysis and precise specification of the skills inherent in the subject matter, the construction of a thorough curriculum providing in-depth experience with all the skills, and a structure of associations among elements of the curriculum that allows for the implementation of various instructional strategies. Instructional flexibility is complemented by research flexibility in such a structure, because the nature of the associations can be modified for different experimental purposes. Once the elements of the network have been established, it is easy, for example, to change the prerequisite relationship between two problems, or to specify a higher level of competence in a given skill as a criterion measure.

The considerable complexity involved in programming this kind of flexible structure imposes a certain limitation. Standard CAI "author languages" are not appropriate to this network approach, and constructing a CAI course on BIP's

pattern is not a task to be undertaken by the educator (or researcher) who has no programming support. The usefulness of author languages is their simplicity, which allows subject-matter experts to prepare course material relatively quickly and easily. Most author languages provide for alternative paths through a curriculum, for alternative answer-matching schemes, and so forth; considerable complexity is certainly possible. However, the limits, once reached, are real, and the author simply cannot expand the sophistication of his course beyond those limits.

The programming support required by the network approach, on the other hand, implies (1) the use of a general, powerful language allowing access to all the capabilities of the computer itself, and (2) a programming group with the training and experience to make full use of the machine. It has been our experience that the flexibility of a general purpose language, while expensive in a number of ways, is worth the costs by virtue of the much greater freedom it allows in the construction of the curriculum and the implementation of experimental conditions. For a more complete description of BIP and a review of our plans for further research see Barr, Beard, and Atkinson (1974).

INSTRUCTION IN INITIAL READING (GRADES 1-3)

Our first efforts to teach reading under computer control were aimed at a total curriculum that would be virtually independent of the classroom teacher (Atkinson, 1968). These early efforts proved reasonably successful, but it soon became apparent that the cost of such a program would be prohibitive if applied on a large-scale basis. Further, it was demonstrated that some aspects of instruction could be done very effectively using a computer, but that there were other tasks for which the computer did not have any advantages over classroom teaching. Thus, during the last four years, our orientation has changed and the goal now is to develop low-cost CAI that supplements classroom teaching and concentrates on those tasks in which individualization is critically important.²

Reading Curriculum

Reading instruction can be divided into two areas which have been referred to as "decoding" and "communication." Decoding is the rapid, if not automatic, association of phonemes or phoneme groups with their respective graphic repre-

²A student terminal in the current program consists only of a Model-33 teletypewriter with an audio headset. There is no graphic or photographic capability at the student terminal as there was in our first system, and the character set of the teletypewriter includes only uppercase letters. On the other hand, the audio system is extremely flexible and provides virtually instantaneous access to any one of 6,000 recorded words and messages.

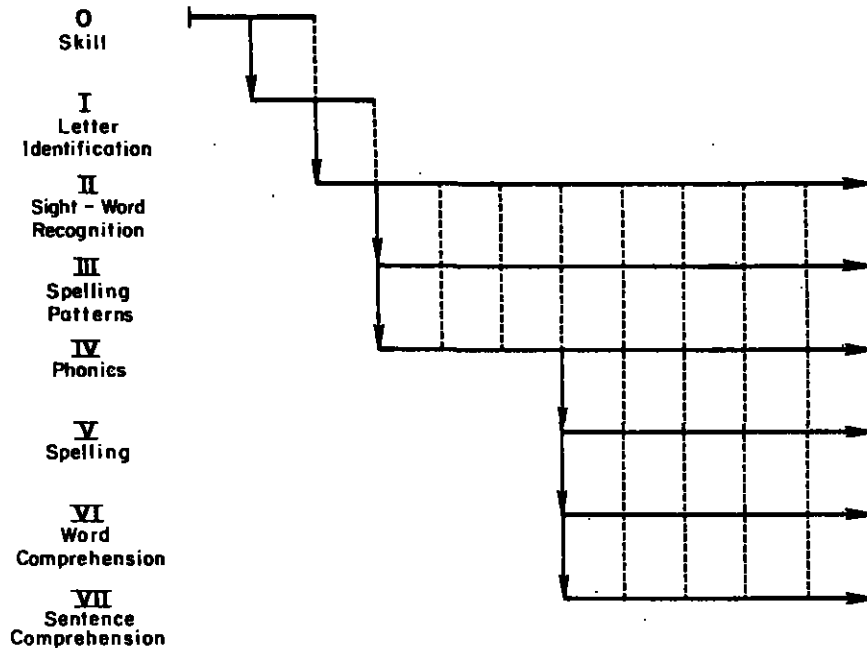

FIG. 3 Schematic presentation of the strand structure. Entry into each strand depends on a student's performance in earlier strands. The vertical dotted lines represent maximal rate contours which control the student's progress in each strand relative to the other strands.

sentations. Communication involves reading for meaning, aesthetic enjoyment, emphasis, and the like. Our CAI program provides instruction in both types of tasks, but focuses primarily on decoding. The program is divided into eight parts or strands. As indicated in Fig. 3, entry into a strand is determined by the student's level of achievement in the other strands. Instruction begins in Strand 0, which teaches the skills required to interact with the program. Entry into the other strands is dependent on the student's performance in earlier strands. For example, the letter identification strand starts with a subset of letters used in the earliest sight words. When a student reaches a point in the letter identification strand where he has exhibited mastery over the letters used in the first words of the sight-word strand, the student enters that strand. Similarly, entry into the spelling-pattern strand and the phonics strand is controlled by the student's placement in the sight-word strand. On any given day, a student may be seeing exercises drawn from as many as five strands. The dotted vertical lines in Fig. 3 represent "maximal rate contours," which control the student's progress in each strand relative to progress in other strands. The rationale underlying these contours is that learning particular material in one strand facilitates learning in another strand; thus, the contours are constructed so that the student learns specific items from one strand in conjunction with specific items from other strands.

The CAI program is highly individualized so that a trace through the curriculum is unique for each student. Our problem is to specify how a given subject's response history should be used to make instructional decisions. The approach that we have adopted is to develop mathematical models for the acquisition of the various skills in the curriculum, and then use these models to specify optimal sequencing schemes. Basically, this approach is what has come to be known in the engineering literature as "optimal control theory," or, more simply, "control theory." In the area of instruction, the system to be controlled is the human learner rather than a machine or group of industries. If a learning model can be specified, then methods of control theory can be used to derive optimal instructional strategies.

Some of the optimization procedures will be reviewed later, but in order for the reader to have some idea of how the CAI program operates, let me first describe a few of the simpler exercises used in Strands II, III, and IV. Strand II provides for the development of a sight-word vocabulary. Vocabulary items are presented in five exercise formats; only the copy exercise and the recognition exercise will be described here. The top panel of Table 1 illustrates the copy exercise, and the lower panel illustrates the recognition exercise. Note that when a student makes an error, the system responds with an audio message and prints

TABLE 1
Examples of Two Exercises Used in Strand II
(Sight-Word Recognition)^a

	Teletypewriter display	Audio message
Copy exercise		
The program outputs	PEN	(Type pen.)
The student responds by typing	PEN	
The program outputs	+	(Great!)
The program outputs	EGG	(Type egg.)
The student responds by typing	EFF	
The program outputs	///EGG	(No, egg.)
Recognition exercise		
The program outputs	PEN NET EGG	(Type pen.)
The student responds by typing	PEN	
The program outputs	+	
The program outputs	PEN EGG NET	(Type net.)
The student responds by typing	.NET	
The program outputs	+	(Fabulous!)

^aThe top panel displays the copy exercise and the bottom the recognition exercise. Rows in the table correspond to successive lines on the teletypewriter printout.

out the correct response. In earlier versions of the program, the student was required to copy the correct response following an error. Experiments demonstrated that the overt correction procedure was not particularly effective; simply displaying the correct word following an error provided more useful feedback.

Strand III offers practice with spelling patterns and emphasizes the regular grapheme-phoneme correspondences that exist in English. Table 2 illustrates exercises from this strand. For the exercise in the top panel of Table 2, the student is presented with three words involving the same spelling pattern and is required to select the correct one based on its initial letters. Once the student has learned to use the initial letter or letter sequence to distinguish between words, he moves to the recall exercise illustrated in the bottom panel of Table 2. Here the student works with a group of words, all involving the same spelling pattern. On each trial the audio system requests a word that requires adding an initial consonant or consonant cluster to the spelling pattern mastered in the preceding exercise. Whenever a student makes a correct response, a "+" sign is printed on the teletypewriter. In addition, every so often the program will give an audio feedback message; these messages vary from simple ones like "great," "that's fabulous," "you're doing brilliantly," to some that have cheering, clapping, or bells ringing in the background. These messages are not generated at random, but depend on the student's performance on that particular day.

When the student has mastered a specified number of words in the sight-word strand, he or she begins exercises in the phonics strand; this strand concentrates on initial and final consonants and consonant clusters in combination with medial vowels. As in most linguistically orientated curricula, students are not required to rehearse or identify consonant sounds in isolation. The emphasis is on patterns of vowels and consonants that bear regular correspondences to

TABLE 2
Examples of the Recognition and Recall Exercises Used in
Strand III (Spelling Patterns)

	Teletypewriter display	Audio message
Recognition exercise		
The program outputs	KEPT SLEPT CREPT	(Type kept.)
The student responds by typing	KEPT	
The program outputs	+	
Recall exercise		
The program outputs		(Type crept.)
The student responds by typing	CREPT	
The program outputs	+	(That's fabulous!)

TABLE 3
Examples of Two Exercises from Strand IV (Phonics)

	Teletypewriter display	Audio message
Recognition exercise		
The program outputs	-IN -IT -IG	(Type /IG/ as in fig.)
The student responds by typing	IG	
The program outputs	+	(Good!)
The program outputs	-IT -IN -IG	(Type /IT/ as in fit.)
The student responds by typing	IT	
The program outputs	+	
Build-a-word exercise		
The program outputs	-IN -IT -IG P--	(Type pin.)
The student responds by typing	PIN	
The program outputs	+	(Great!)
The program outputs	-IG -IN -IT F--	(Type fig.)
The student responds by typing	FIN	
The program outputs	////FIG	(No, we wanted fig.)

phonemes. The phonic strand is the most complicated one of the group and involves eight exercise formats; two of the formats will be described here. The upper panel of Table 3 illustrates an exercise in which the student is required to identify the graphic representation of phonemes occurring at the end of words. Each trial begins with an audio presentation of a word that includes the phonemes, and the student is asked to identify the graphic representation. After mastering this exercise the student is transferred to the exercise illustrated in the bottom panel of Table 3. The same phonemes are presented, but now the student is required to construct words by adding appropriate consonants.

Optimal Sequences for Individual Students

This has been a brief overview of some of the exercises used in the curriculum; a more detailed account of the program can be found in Atkinson, Fletcher, Lindsay, Campbell, and Barr (1973). The key to the curriculum is the optimization schemes that control the sequencing of the exercises; these schemes can be classified at three levels. One level involves decision making within each strand. The problem is to decide which items to present for study, which exercise formats to present them in, and when to schedule review. A complete response history exists for each student, and this history is used to make trial-by-trial

decisions regarding what to present next. The second level of optimization deals with decisions about allocation of instructional time among strands for a given student. At the end of an instructional session, the student will have reached a certain point in each strand and a decision must be made about the time to be allocated to each strand in the next session. The third level of optimization deals with the distribution of instructional time among students. The question here is to allocate computer time among students to achieve instructional objectives that are defined not for the individual student but for the class as a whole. In some global sense, these three levels of optimization should be integrated into a unified program. However, we have been satisfied to work with each separately, hoping that later they can be incorporated into a single package.

Optimization within a strand (what has been called Level I) can be illustrated using the sight-word strand. The strand comprises a list of about 1,000 words; the words are ordered in terms of their frequency in the student's vocabulary, and words at the beginning of the list have highly regular grapheme-phoneme correspondences. At any point in time a student will be working on a limited pool of words from the master list; the size of this working pool depends on the student's ability level and is usually between 5 and 10 words. When one of these words is mastered, it is deleted from the pool and replaced by the next word on the list or by a word due for review. Figure 4 presents a flow chart for the strand. Each word in the working pool is in one of five possible instructional states. A trial involves sampling a word from the working pool and presenting it in an appropriate exercise format. The student is pretested on a word the first few times it is presented to eliminate words already known. If the student knows the word it will be dropped from the working pool. If not, the student first studies the word using the recognition exercise. If review is required, the student studies the word again in what is designated in Fig. 4 as Exercises 4 and 5.

As indicated in Fig. 4, a given word passes from one state to the next when it reaches criterion. And this presents the crux of the optimization problem, which is to define an appropriate criterion for each exercise. This has been done using simple mathematical models to describe the acquisition process for each exercise and the transfer functions that hold between exercises (Atkinson & Paulson, 1972). These models are simple Markov processes that provide reasonably accurate accounts of performance on our tasks. Parameters of the models are defined as functions of two factors: (1) the ability of the particular student and (2) the difficulty of the particular word. An estimate of the student's ability is obtained by analyzing his or her response record on all previous words, and an estimate of a word's difficulty is obtained by analyzing performance on that

FIG. 4 Partial flow chart for Strand II (sight-word recognition). The various decisions represented in the bottom part of the chart are based on fairly complicated computations that make use of the student's response history. The same recognition exercise is used in both state S_3 and S_4 .

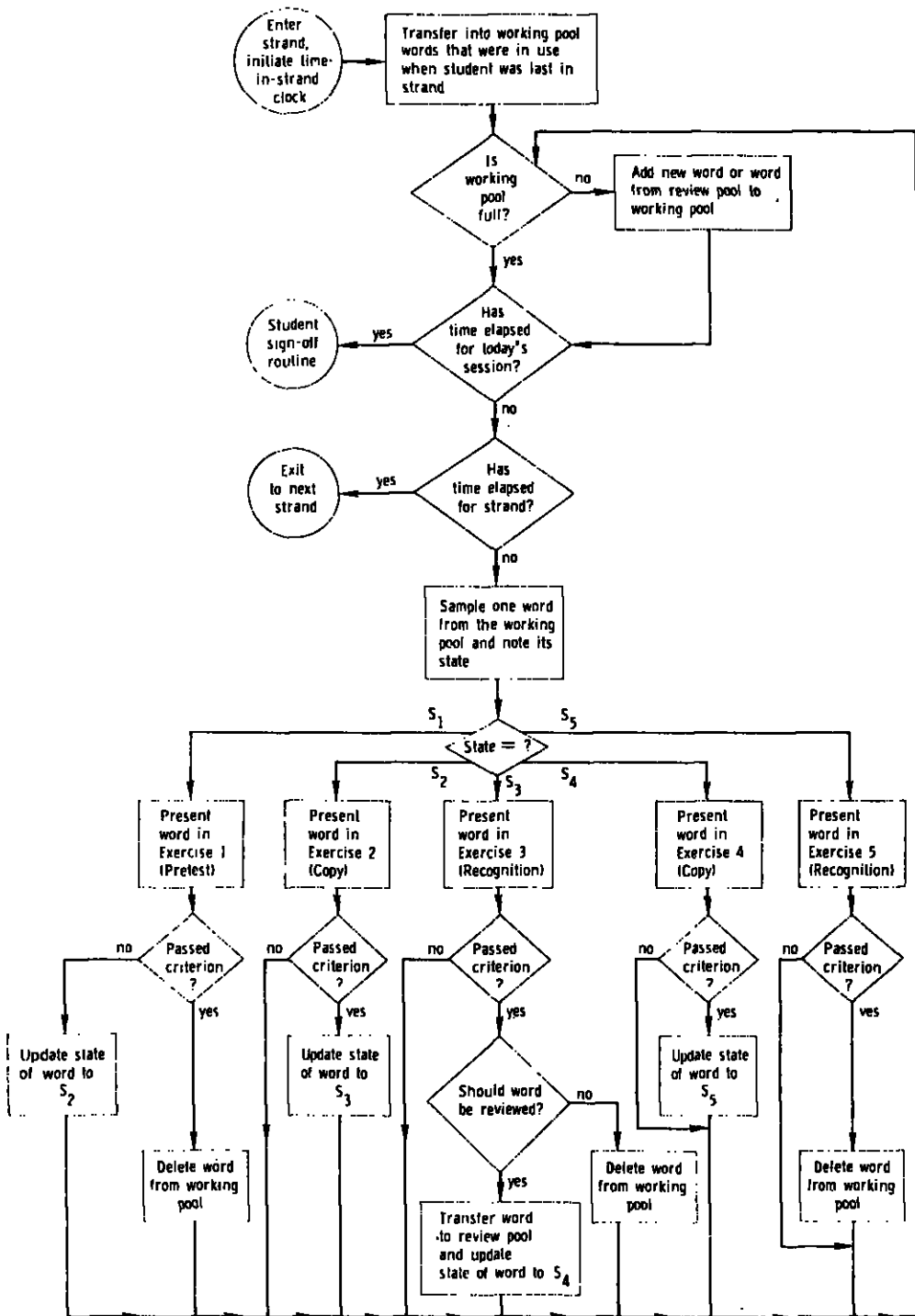

FIG. 4

particular word for all students run on the program. The student records are continually updated by the computer and are used to compute a maximum likelihood estimate of each student's ability factor and each word's difficulty factor. Given a well-defined model and estimates of its parameters, we can use the methods of control theory to define an optimal criterion for each exercise. The criterion will vary depending on the difficulty of the item, the student's ability level, and the precise sequence of correct and incorrect responses made by the student to the item. It is important to realize that the optimization scheme is not a simple branching program based on the student's last response, but depends in a complicated way on the student's complete response history.

Optimization between strands (what has been called Level II) was mentioned earlier in the description of maximum-rate contours. In some respects this optimization program is the most interesting of the group, but it cannot be explained without going into considerable mathematical detail. In essence, a learning model is developed that specifies the learning rate on each strand as a function of the amount of material that has been mastered in each of the other strands. Using mathematical methods of control theory, an optimal instructional strategy is determined based on the model. This strategy defines a closed-loop feedback controller that specifies daily instructional allocations for each strand based on the best current estimate of how much the student has mastered in each strand. An account of the theoretical rationale for the program is presented in Chant and Atkinson (1973).

Optimizing Class Performance

Next let us consider an example of optimization at what has been called Level III. The effectiveness of the CAI program can be increased by optimally allocating instructional time among students. Suppose that a school has budgeted a fixed amount of time for CAI and must decide how to allocate that time among a class of first-grade students. For this example, maximizing the effectiveness of the CAI program will be interpreted as meaning that we want to maximize the class performance on a standardized reading test administered at the end of the first grade.

On the basis of prior studies, the following equation has been developed to predict performance on a standardized reading test as a function of the time a student spends on the CAI system:

$$P(t; i) = A(i) - B(i) \exp[-tC(i)].$$

The equation predicts Student i 's performance on a standardized test as a function of the time, t , spent on the CAI system during the school year. The parameters $A(i)$, $B(i)$, and $C(i)$ characterize Student i , and vary from one student to another. These parameters can be estimated from scores on reading readiness tests and from the student's performance during his first hour of CAI. After

estimates of these parameters have been made, the above equation can be used to predict end-of-year test scores as a function of the CAI time allocated to that student.

Let us suppose that a school has budgeted a fixed amount of time T on the CAI system for a first-grade class of N students; further, suppose that students have had reading readiness tests and a preliminary run on the CAI system so that estimates of the parameters A , B , and C have been made for each student. The problem then is to allocate time T among the N students so as to optimize learning. In order to do this, it is first necessary to have a model of the learning process. Although the above equation does not offer a very detailed account of learning, it suffices as a model for purposes of this problem. This is an important point to keep in mind; the nature of the specific optimization problem determines the level of complexity that needs to be represented in the learning model. For some optimization problems, the model must provide a relatively detailed account of learning to specify a viable strategy, but for other problems a simple descriptive equation may suffice.

In addition to a model of the learning process, we must also specify an instructional objective. Only three possible objectives will be considered here:

- I. Maximize the mean value of P over the class of students.
- II. Minimize the variance of P over the class of students.
- III. Maximize the mean value of P under the constraint that the resulting variance of P is less than or equal to the variance that would be obtained if no CAI were administered.

Objective I maximizes the gain for the class as a whole; Objective II reduces differences among students by making the class as homogeneous as possible; and Objective III attempts to maximize the class performance while insuring that differences among students are not amplified by CAI. If we select Objective I as the instructional objective, then the problem of deriving an optimal strategy reduces to maximizing the function:

$$f[t(1), t(2), \dots, t(N)] = \sum_i \{ A(i) - B(i) \exp[-t(i)C(i)] \},$$

$$t(1) + t(2) + \dots + t(N) = T,$$

where $t(i)$ is the time allocated to Student i . This maximization can be done using the methods of dynamic programming. To illustrate the approach, computations were made for a first-grade class for which the parameters A , B , and C had been estimated for each student. Employing these estimates, computations were carried out to determine the time allocations that maximized the above equation. For the optimal policy, the predicted mean performance level of the class on the end-of-year tests was 14% higher than a policy that allocated time equally among students (i.e., an equal-time policy, where $t(i) = T/N$ for all i).

TABLE 4
Predicted Percent Gain in the Mean of *P* and
in the Variance of *P* When Compared with the
Mean and Variance of the Equal-Time Policy

	Instructional objective		
	I	II	III
Gain in mean of <i>P</i> (%)	14	-15	8
Gain in variance of <i>P</i> (%)	15	-12	-6

This gain represents a substantial improvement; the drawback is that the class variance is roughly 15% greater than the variance for the class using an equal-time policy. This means that if we are only interested in raising the class average, we will have to give the rapid learners substantially more time on the CAI system and let them progress far beyond the slow learners.

Although a time allocation that complies with Objective I does increase overall class performance, other objectives need to be considered. For comparison, time allocations also were computed for Objectives II and III. Table 4 presents the predicted gain in average class performance as a percentage of the mean value for the equal-time policy. Objective II yielded a negative gain in the mean; and so it should, since its goal was to minimize variability, which is accomplished by reducing the time allocations for rapid learners and giving more attention to the slower ones. The reduction in variability for Objective II is 12%. Objective III, which strikes a balance between Objective I and Objective II, yields an 8% gain in mean performance yet reduces variability by 6%.

In view of these results, Objective III would be preferred by most educators and laymen. It offers a substantial increase in average performance while maintaining a low level of variability. These computations make it clear that the selection of an instructional objective should not be done in isolation but should involve a comparative analysis of several objectives, taking into account more than one dimension of performance. Even if the principal goal is to maximize the class average, it is inappropriate in most educational situations to select Objective I over III if it is only slightly better for the class average, while permitting variability to mushroom.³

Effectiveness of the Reading Program

Several evaluation studies of the reading program have been conducted in the last few years. Rather than review these here, I would prefer to describe one in some detail (Fletcher & Atkinson, 1972). In this particular study, 50 pairs of

³For a more detailed discussion of some of the issue involved in selecting objective functions see Jamison, Fletcher, Suppes, and Atkinson (1975).

kindergarten students were matched on a number of variables, including sex and readiness scores. At the start of the first grade, one member of each pair was assigned to the experimental group and the other to the control group. Students in the experimental group received CAI, but only during the first grade; students in the control group received no CAI. The CAI lasted approximately 15 min per day⁴; during this period the control group studied reading in the classroom. Except for this 15 min period, the school day for the CAI group was like that of the control group. Standardized tests were administered at the end of the first grade and again at the end of the second grade. All the tests showed roughly the same pattern of results; to summarize the findings, only data from the California Cooperative Primary Reading Test will be described. At the end of the first grade, the experimental group showed a 5.05-month gain over the control group. The groups, when tested a year later (with no intervening CAI treatment), showed a difference of 4.90 months. Thus, the initial difference observed following one year of CAI was maintained, although not amplified, during the second year when no CAI was administered to either group.

No definitive conclusions can be drawn from evaluation studies of this sort about the specific contributions of CAI versus other aspects of the situation. Obviously the curriculum materials used in the CAI program are important, as well as other factors. To do the type of study that would isolate the important variables is too large an undertaking to be worthwhile at this juncture in the development of the reading program. Thus, to some extent it is a matter of judgment in deciding which variables account for the differences observed in the above study. In my view, individualizing instruction is the key factor in successfully teaching reading. This does not mean that all phases of instruction should be individualized, but certain skills can be mastered only if instruction is sensitive to the student's particular difficulties. A reading teacher interacting on a one-to-one basis with a student may be more effective than our CAI program. However, when working with a group of children (even as few as four or five), it is unlikely that the teacher can match the computer's effectiveness in making instructional decisions over an extended period of time.

SECOND-LANGUAGE VOCABULARY LEARNING

In this section, research on CAI programs for second-language vocabulary learning will be discussed. As noted elsewhere in this chapter, the principal goal of our research on computerized instruction has been to develop adaptive teaching procedures—procedures that make moment-by-moment decisions about which instructional action should be taken next based on the student's unique response history. To help guide the theoretical aspects of this work, some years ago we

⁴In this study no attempt was made to allocate time optimally among students in the experimental group; rather, an equal-time policy was employed.

initiated a series of experiments on the very restricted but well-defined problem of optimizing the teaching of a foreign-language vocabulary. This is an area where mathematical models provide an accurate description of learning, and these models can be used in conjunction with the methods of control theory to derive precise algorithms for sequencing instruction among vocabulary items. Although our original interest in this topic was primarily theoretical, the work has proved to have significant practical applications. These applications involve computerized vocabulary learning programs designed to supplement college-level courses in second-language instruction. A particularly interesting effort involves a supplementary Russian program in use at Stanford University. Students are exposed to approximately 1,000 words per academic quarter using the computer; in conjunction with normal classroom work this program enables them to develop a substantial vocabulary.⁵ Many foreign-language instructors believe that the major obstacle to successful instruction in a second language is not learning the grammar of the language, but rather in acquiring a sufficient vocabulary so that the student can engage in meaningful conversations and read materials other than the textbook.

In examining the work on vocabulary acquisition I will not describe the CAI programs, but will review some research on optimal sequencing schemes that provide the theoretical rationale for the programs. It will be useful to describe one experiment in some detail before considering more general issues.

An Experiment on Optimal Sequencing Schemes

In this study a large set of German-English items are to be learned during an instructional session that involves a series of trials. On each trial, one of the German words is presented and the student attempts to give the English translation; the correct translation is then presented for a brief study period. A predetermined number of trials is allocated for the instructional session, and after some intervening period a test is administered over the entire vocabulary. The problem is to specify a strategy for presenting items during the instructional session so that performance on the delayed test will be maximized.

Four strategies for sequencing the instructional material will be considered. The random-order strategy, (RO), is to cycle through the set of items randomly; this strategy is not expected to be particularly effective, but it provides a benchmark against which to evaluate other procedures. The self-selection strategy (SS), is to let the student determine how best to sequence the material. In this mode, the student decides on each trial which item is to be presented; the learner rather than an external controller determines the sequence of instruction.

⁵These CAI vocabulary programs make use of optimal sequencing schemes of the sort to be discussed in this section, as well as certain mnemonic aids. For a discussion of these mnemonic aids see Raugh and Atkinson (1975) and Atkinson and Raugh (1975).

The third and fourth schemes are based on a decision-theoretic analysis of the task. A mathematical model that provides an accurate account of vocabulary acquisition is assumed to hold in the present situation. The model is used to compute, on a trial-by-trial basis, an individual student's current state of learning. Based on these computations, items are selected for test and study so as to optimize the level of learning achieved at the termination of the instructional session. Two optimization strategies derived from this type of analysis will be examined. In one case, the computations for determining an optimal strategy are carried out assuming that all vocabulary items are of equal difficulty; this strategy is designated OE (i.e., optimal under the assumption of equal item difficulty). In the other case, the computations take into account variations in difficulty level among items; this strategy is called OU (i.e., optimal under the assumption of unequal item difficulty). The details of these two strategies will be described later.

The experiment was carried out under computer control; the details of the experimental procedure are given in Atkinson (1972b). The students participated in two sessions: an "instructional session" of approximately two hours and a briefer "delayed-test session" administered one week later. The delayed test was the same for all students and involved a test over the entire vocabulary. The instructional session was more complicated. The vocabulary items were divided into seven lists, each containing 12 German words; the seven lists were arranged in a round-robin order. On each trial of the instructional session a list was displayed on a projection screen, and the student inspected it for a brief period of time; the list involved only the 12 German words and not their English translations. Then one of the items on the list was selected for test and study. In the RO, OE, and OU conditions the item was selected by the computer; in the SS condition the item was chosen by the student. After an item was selected for test, the student attempted to provide a translation by typing it on the computer console; then feedback regarding the correct translation was given. The next trial began with the computer displaying the next list in the round robin, and the same procedure was repeated. The instructional session continued in this fashion for 336 trials.

The results of the experiment are summarized in Fig. 5. Data are presented on the left side of the figure for performance on successive blocks of trials during the instructional session; on the right are results from the test session administered one week after the instructional session. The data from the instructional session are presented in successive blocks of 84 trials; for the RO condition this means that on the average each item was presented once in each of these blocks. Note that performance during the instructional session is best for the RO condition, next best for the OE condition which is slightly better than the SS condition, and poorest for the OU condition. The order of the groups is reversed on the delayed test. (Two points are displayed in the figure for the delayed test to indicate that the test involved two random cycles through the entire vocabu-

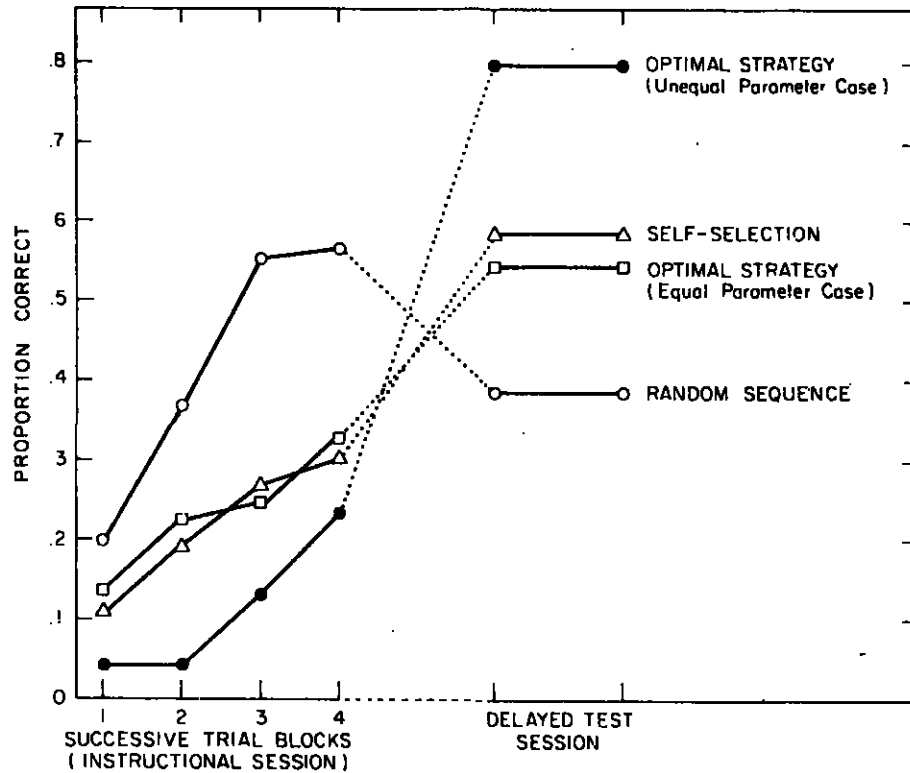

FIG. 5 Proportion of correct responses in successive trial blocks during the instructional session and on the delayed test administered one week later.

lary; however, the values given are the average over the two test cycles.) The OU condition is best with a correct response probability of .79; the SS condition is next with .58; the OE condition follows closely at .54 and the RO condition is poorest at .38. The observed pattern of results is what one would expect. In the SS condition, the students are trying to test themselves on items they do not know; consequently, during the instructional session, they should have a lower proportion of correct responses than students run on the RO procedure where items are tested at random. Similarly, the OE and OU conditions involve a procedure that attempts to identify and test those items that have not yet been mastered and should produce high error rates during the instructional session. The ordering of groups on the delayed test is reversed since all words are tested in a nonselective fashion; under these conditions the proportion of correct responses provides a measure of a student's true mastery of the total set of vocabulary items.

The magnitude of the effects observed on the delayed test are of practical significance. The SS condition (when compared to the RO condition) leads to a relative gain of 53%, whereas the OU condition yields a relative gain of 108%. It

is interesting that students were somewhat effective in determining an optimal study sequence, but not so effective as the best of the two adaptive teaching systems.

Rationale for Sequencing Scheme

Both the OU and OE schemes assume that vocabulary learning can be described by a fairly simple model. We postulate that a given item is in one of three states (P , T , and U) at any moment in time. If the item is in State P , then its translation is known and this knowledge is “relatively” permanent in the sense that the learning of other items will not interfere with it. If the item is in State T , then it is also known but on a “temporary” basis; in State T the learning of other items can give rise to interference effects that cause the item to be forgotten. In State U the item is not known, and the student is unable to give a translation.

When Item i is presented on a trial during the instructional session, the following transition matrix describes the possible change in its state:

$$L(i) = \begin{matrix} & \begin{matrix} P & T & U \end{matrix} \\ \begin{matrix} P \\ T \\ U \end{matrix} & \begin{bmatrix} 1 & 0 & 0 \\ x(i) & 1-x(i) & 0 \\ y(i) & z(i) & 1-y(i)-z(i) \end{bmatrix} \end{matrix}.$$

Rows of the matrix represent the state of the item at the start of the trial, and columns the state at the end of the trial. On a trial when some item other than Item i is presented for test and study, transitions in the state of Item i also may take place. Such transitions can occur only if the student makes an error to the other item; in that case the transition matrix applied to Item i is as follows:

$$F(i) = \begin{matrix} & \begin{matrix} P & T & U \end{matrix} \\ \begin{matrix} P \\ T \\ U \end{matrix} & \begin{bmatrix} 1 & 0 & 0 \\ 0 & 1-f(i) & f(i) \\ 0 & 0 & 1 \end{bmatrix} \end{matrix}.$$

Basically, the idea is that when some other item is presented that the student does not know, forgetting may occur for Item i if it is in State T .

To summarize, when Item i is presented for test and study, transition matrix $L(i)$ is applied; when some other item is presented that elicits an error, matrix $F(i)$ is applied. It is also assumed that at the start of the instructional session Item i is either in State P , with probability $g(i)$, or in State U , with probability $1 - g(i)$; the student either knows the translation without having studied the item or does not. The above assumptions provide a complete description of the learning process. The parameter vector $[x(i), y(i), z(i), f(i), g(i)]$ characterizes

the learning of Item i in the vocabulary set. The first three parameters govern the acquisition process; the next parameter, forgetting; and the last, the student's knowledge prior to entering the experiment.

We now turn to a discussion of how the OE and OU procedures were derived from the model. Prior to conducting the experiment reported here, a pilot study was run using the same word lists and the RO procedure described above. Data from the pilot study were employed to estimate the parameters of the model; the estimates were obtained using the minimum chi-square procedures described in Atkinson (1972b). Two separate estimates of parameters were made. In one case it was assumed that the items were all equally difficult, and data from all 84 items were lumped together to obtain a single estimate of the parameter vector; this estimation procedure will be called the equal-parameter case (E case). In the second case the data were separated by items, and an estimate of the parameter vector was made for each of the 84 items; this procedure will be called the unequal-parameter case (U case). The two sets of parameter estimates were then used to generate the optimization schemes previously referred to as the OE and OU procedures.

In order to formulate an instructional strategy, it is necessary to be precise about the quantity to be maximized. For the present experiment the goal is to maximize the total number of items the student correctly translates on the delayed test.⁶ To do this, we need to specify the relationship between the state of learning at the end of the instructional session and performance on the delayed test. The assumption made here is that only those items in State P at the end of the instructional session will be translated correctly on the delayed test; an item in State T is presumed to be forgotten during the intervening week. Thus, the problem of maximizing delayed-test performance involves maximizing the number of items in State P at the end of the instructional session.

Having numerical values for parameters and knowing a student's response history, it is possible to estimate the student's current state of learning.⁷ Stated

⁶Other measures can be used to assess the benefits of an instructional strategy: for example, in this case weights could be assigned to items measuring their relative importance. Also costs may be associated with the various actions taken during an instructional session. Thus, for the general case, the optimization problem involves assessing costs and benefits and finding a strategy that maximizes an appropriate function defined on them. For a discussion of these points see Dear, Silberman, Estavan, and Atkinson (1967), and Smallwood (1962, 1971).

⁷The student's "response history" is a record for each trial of the vocabulary item presented and the response that occurred. It can be shown that there exists a "sufficient history" that contains only the information necessary to estimate the student's current state of learning; the sufficient history is a function of the complete history and the assumed learning model (Groen & Atkinson, 1966). For the model considered in this paper the sufficient history is fairly simple. It is specified in terms of individual vocabulary items for each student; we need to know the ordered sequence of correct and incorrect responses to a given item plus the number of errors (to other items) that intervene between each presentation of the item.

more precisely, the learning model can be used to derive equations and, in turn, compute the probabilities of being in States P , T , and U for each item at the start of any trial, conditionalized on the student's response history up to that trial. Given numerical estimates of these probabilities, a strategy for optimizing performance is to select that item for presentation that has the greatest probability of moving into State P . This strategy has been termed the one-stage optimization procedure because it looks ahead one trial in making decisions. The true optimal policy (i.e., an N -stage procedure) would consider all possible item-response sequences for the remaining trials and select the next item so as to maximize the number of items in State P at the termination of the instructional session. Unfortunately, for the present case the N -stage policy cannot be applied because the computations are too time consuming even for a large computer. Monte Carlo studies indicate that the one-stage policy is a good approximation to the optimal strategy; it was for this reason, as well as the relative ease of computing, that the one-stage procedure was employed. For a discussion of one-stage and N -stage policies and Monte Carlo studies comparing them see Groen and Atkinson (1966), Calfee (1970), and Laubsch (1970).

The optimization procedure described above was implemented on the computer and permitted decisions to be made for each student on a trial-by-trial basis. For students in the OE group, the computations were carried out using the five parameter values estimated under the assumption of homogeneous items (E case); for students in the OU group the computations were based on the 420 parameter values estimated under the assumption of heterogeneous items (U case).

The OU procedure is sensitive to interitem differences and consequently generates a more effective optimization strategy than the OE procedure. The OE procedure, however, is almost as effective as having the student make his own instructional decisions and far superior to a random presentation scheme.

The study reported here is one in a series of experiments dealing with optimal sequencing schemes. It was selected because it is easily described and permits direct comparison between a learner-controlled procedure versus procedures based on a decision-theoretic analysis. For a review of other studies similar to the one reported above see Chiang (1974), Delaney (1973), Laubsch (1970), Kimball (1973), Paulson (1973), and Atkinson and Paulson (1972). Some of these studies examine procedures that are more powerful than the ones described here, but they are complicated and difficult to describe without going into mathematical detail. The major improvements involve two factors: (1) methods for estimating the model's parameters during the course of instruction, and (2) more sophisticated ways of interpreting the parameters of the model to take account of both differences among students and differences among items. For example, let $P(i, j)$ be a generic symbol for a parameter vector characterizing student i learning vocabulary item j . In these studies $P(i, j)$ is specified as a function of a vector $A(i)$ measuring the ability of student i and a vector $D(j)$

measuring the difficulty of item j . The problem then is to estimate the ability level of each student and the difficulty of each item while the student is running on the program. In a study reported in Atkinson and Paulson (1972), rather dramatic results were obtained using such a procedure. A special feature of the study was that students were run in successive groups, each starting after the prior group had completed the experiment. As would be expected, the overall gains increased from one group to the next. The reason is that for the first group of students the estimates of item difficulty, $D(j)$, were crude but improved with the accumulation of data from each successive wave of students. Near the end of the study estimates of $D(j)$ were quite precise and were essentially constants in the system. The only task that remained when a new student came on the system was to estimate $A(i)$; that is, the parameters characterizing his particular ability level. This study provides an example of an adaptive instructional system that meets both of the requirements stated earlier in this chapter. The sequencing of instruction varies as a function of each student's history record, and over time the system improved in efficiency by using data from previous students to sharpen its estimates of the difficulty of instructional materials.

CONCLUDING REMARKS

The projects described in this chapter have one theme in common, namely, developing computer-controlled procedures for optimizing the instructional process. For several of the instructional tasks considered here, mathematical models of the learning process were formulated which made it possible to use formal methods in deriving optimal policies. In other cases the "optimal schemes" were not optimal in a well-defined sense, but were based on our intuitions about learning and some relevant experiments. In a sense, the diversity represented in these examples corresponds to the state of the art in the field of instructional design. For some tasks we can use psychological theory to help define optimal procedures; for others our intuitions, modified by experiments, must guide the effort. Hopefully, our understanding of these matters will increase as more projects are undertaken to develop sophisticated instructional procedures.

Some have argued that any attempt to devise optimal strategies is doomed to failure, and that the learner is the best judge of appropriate instructional actions. I am not sympathetic to a learner-controlled approach to instruction, because I believe its advocates are trying to avoid the difficult but challenging task of developing a viable theory of instruction. There obviously is a place for the learner's judgments in making instructional decisions; for example, such judgments play an important role in several parts of our BIP course. However, using the learner's judgment as one of several items of information in making instructional decisions is different from proposing that the learner should have complete control. Results presented in this chapter and those cited in Beard,

Lorton, Scarle, and Atkinson (1973) indicate that the learner is not a particularly effective decision maker in guiding the learning process.

Elsewhere I have defined the criteria that must be satisfied before an optimal instructional procedure can be derived using formal methods (Atkinson, 1972a). Roughly stated, they require that the following elements of an instructional situation be clearly specified:

1. The set of admissible instructional actions.
2. The instructional objectives.
3. A measurement scale that permits costs to be assigned to each of the instructional actions and payoffs to the achievement of instructional objectives.
4. A model of the learning process.

If these four elements can be given a precise interpretation, then it is usually possible to derive an optimal-instructional policy. The solution for an optimal policy is not guaranteed, but in recent years powerful tools have been developed for discovering optimal, or near optimal, procedures if they exist. I will not discuss these four elements here except to note that the first three can usually be specified with a fair degree of consensus. Issues of short-term versus long-term assessments of costs and payoffs raise important questions regarding educational policy, but at least for the types of instructional situations examined here reasonable specifications can be offered for the first three elements. However, the fourth element—the specification of a model of the learning process—represents a major obstacle. Our theoretical understanding of learning is so limited that only in very special cases can a model be specified in enough detail to enable the derivation of optimal procedures. Until we have a much deeper understanding of the learning process, the identification of truly effective strategies will not be possible. However, an all-inclusive theory of learning is not a prerequisite for the development of optimal procedures. What is needed is a model that captures the essential features of that part of the learning process being tapped by a given instructional task. Even models that have been rejected on the basis of laboratory investigations may be useful in deriving instructional strategies. Several of the learning models considered in this chapter have proven unsatisfactory when tested in the laboratory and evaluated using standard goodness-of-fit criteria; nevertheless, the optimal strategies they generate are often quite effective. My own preference is to formulate as complete a learning model as intuition and data will permit and then use that model to investigate optimal procedures. When possible the learning model should be represented in the form of mathematical equations, but otherwise as a set of statements in a computer-simulation program. The main point is that the development of a theory of instruction cannot progress if one holds the view that a comprehensive theory of learning is a prerequisite. Rather, advances in learning theory will affect the development of a theory of instruction, and conversely the develop-

ment of a theory of instruction will influence the direction of research on learning.

ACKNOWLEDGMENTS

This research was supported by the Office of Naval Research, Contract No. N00014-67-A-0012-0054, by National Science Foundation Grant EC-43997, and by Grant MH-21747 from the National Institute of Mental Health.

RICHARD C. ATKINSON

Stanford University

IN recent years there has been a tremendous number of articles and news releases dealing with computer-assisted instruction, or as it has been abbreviated, CAI. One might conjecture that this proliferation is an indicant of rapid progress in the field. Unfortunately, I doubt that it is. A few of the reports about CAI are based on substantial experience and research, but the majority are vague speculations and conjectures with little if any data or real experience to back them up. I do not want to denigrate the role of speculation and conjecture in a newly developing area like CAI. However, of late it seems to have produced little more than a repetition of ideas that were exciting in the 1950s but, in the absence of new research, are simply well-worn clichés in the late 1960s.

These remarks should not be misinterpreted. Important and significant research on CAI is being carried on in many laboratories around the country, but certainly not as much as one is led to believe by the attendant publicity. The problem for someone trying to evaluate developments in the field is to distinguish between those reports that are based on fact and those that are disguised forms of science fiction. In my paper, I shall try to stay very close to data and actual experience. My claims will be less grand than many that have been made for CAI, but they will be based on a substantial research effort.

In 1964 Patrick Suppes and I initiated a project under a grant from the Office of Education to develop and implement a CAI program in initial reading and mathematics. Because of our particular research interests, Suppes has taken responsibility for the mathematics curriculum and I have been responsible for the initial reading program. At the beginning of the project, two major hurdles had to be overcome. There was no lesson material in either mathematics or reading suitable

for CAI, and an integrated CAI system had not yet been designed and produced by a single manufacturer. The development of the curricula and the development of the system have been carried out as a parallel effort over the last 3 years with each having a decided influence on the other.

Today I would like to report on the progress of the reading program with particular reference to the past school year when for the first time a sizable group of students received a major portion of their daily reading instruction under computer control. The first year's operation must be considered essentially as an extended debugging of both the computer system and the curriculum materials. Nevertheless, some interesting comments can be made on the basis of this experience regarding both the feasibility of CAI and the impact of such instruction on the overall learning process.

Before describing the Stanford Project, a few general remarks may help place it in perspective. Three levels of CAI can be defined. Discrimination between levels is based not on hardware considerations, but principally on the complexity and sophistication of the student-system interaction. An advanced student-system interaction may be achieved with a simple teletype terminal, and the most primitive interaction may require some highly sophisticated computer programming and elaborate student terminal devices.

At the simplest interactional level are those systems that present a fixed, linear sequence of problems. Student errors may be corrected in a variety of ways, but no real-time decisions are made for modifying the flow of instructional material as a function of the student's response history. Such systems have been termed "drill-and-practice" systems and at Stanford University are exemplified by a series of fourth-, fifth-, and sixth-grade programs in arithmetic and language arts that are designed to supplement classroom instruction. These particular programs are being used in several different areas of California and also in Kentucky and Mississippi, all under control of one central

¹ Invited address presented at the meeting of the Division of Educational Psychology, American Psychological Association, Washington, D. C., September 1967.

computer located at Stanford University. Currently as many as 2,000 students are being run per day; it requires little imagination to see how such a system could be extended to cover the entire country. Unfortunately, I do not have time to discuss these drill-and-practice programs in this paper, but there are several recent reports describing the research (Fishman, Keller, & Atkinson, 1968; Suppes, 1966; Suppes, Jerman, & Groen, 1966).

At the other extreme of our scale characterizing student-system interactions are "dialogue" programs. Such programs are under investigation at several universities and industrial concerns, but to date progress has been extremely limited. The goal of the dialogue approach is to provide the richest possible student-system interaction where the student is free to construct natural-language responses, ask questions in an unrestricted mode, and in general exercise almost complete control over the sequence of learning events.

"Tutorial" programs lie between the above extremes of student-system interaction. Tutorial programs have the capability for real-time decision making and instructional branching contingent on a single response or on some subset of the student's response history. Such programs allow students to follow separate and diverse paths through the curriculum based on their particular performance records. The probability is high in a tutorial program that no two students will encounter exactly the same sequence of lesson materials. However, student responses are greatly restricted since they must be chosen from a prescribed set of responses, or constructed in such a manner that a relatively simple text analysis will be sufficient for their evaluation. The CAI Reading Program is tutorial in nature, and it is this level of student-interaction that will be discussed today.

THE STANFORD CAI SYSTEM

The Stanford Tutorial System was developed under a contract between the University and the IBM Corporation. Subsequent developments by IBM of the basic system have led to what has been designated the IBM-1500 Instructional System which should soon be commercially available. The basic system consists of a central process computer with accompanying disc-storage units, proctor stations, and an interphase to 16 student terminals. The central process computer acts as

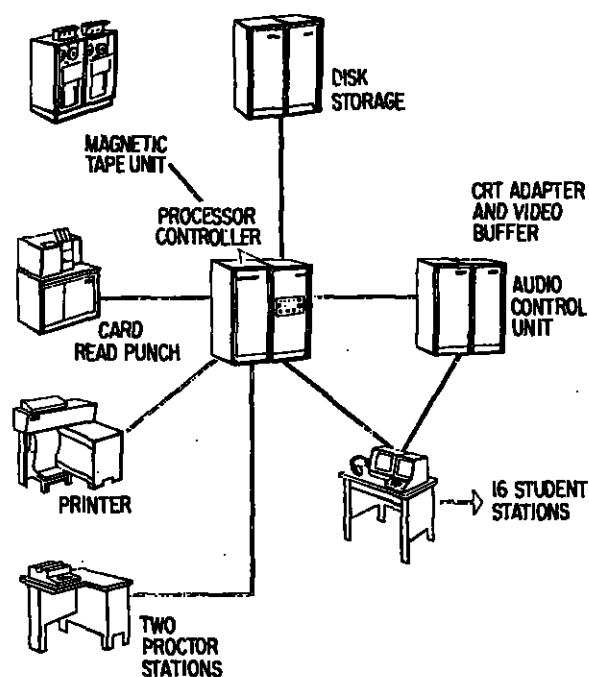

FIG. 1. System configuration for Stanford CAI System.

an intermediary between each student and his particular course material which is stored in one of the disc-storage units. A student terminal consists of a picture projector, a cathode ray tube (CRT), a light pen, a modified typewriter keyboard, and an audio system which can play pre-recorded messages (see Figure 1).

The CRT is essentially a television screen on which alpha-numeric characters and a limited set of graphics (i.e., simple line drawings) can be generated under computer control. The film projector is a rear-view projection device which permits us to display still pictures in black and white or color. Each film strip is stored in a self-threading cartridge and contains over 1,000 images which may be accessed very quickly under computer control. The student receives audio messages via a high-speed device capable of selecting any number of messages varying in length from a few seconds to over 15 minutes. The audio messages are stored in tape cartridges which contain approximately 2 hours of messages and, like the film cartridge, may be changed very quickly. To gain the student's attention, an arrow can be placed at any point on the CRT and moved in synchronization with an audio message to emphasize given words or phrases, much like the "bouncing ball" in a singing cartoon.

The major response device used in the reading program is the light pen, which is simply a light-sensitive probe. When the light pen is placed on the CRT, coordinates of the position touched are sensed as a response and recorded by the computer. Responses may also be entered into the system through the typewriter keyboard. However, only limited use has been made of this response mode in the reading program. This is not to minimize the value of keyboard responses, but rather to admit that we have not as yet addressed ourselves to the problem of teaching first-grade children to handle a typewriter keyboard.

The CAI System controls the flow of information and the input of student responses according to the instructional logic built into the curriculum materials. The sequence of events is roughly as follows: The computer assembles the necessary commands for a given instructional sequence from a disc-storage unit. The commands involve directions to the terminal device to display a given sequence of symbols on the CRT, to present a particular image on the film projector, and to play a specific audio message. After the appropriate visual and auditory materials have been presented, a "ready" signal indicates to the student that a response is expected. Once a response has been entered, it is evaluated and, on the basis of this evaluation and the student's past history, the computer makes a decision as to what materials will subsequently be presented. The time-sharing nature of the system allows us to handle 16 students simultaneously and to cycle through these evaluative steps so rapidly that from a student's viewpoint it appears that he is getting immediate attention from the computer whenever he inputs a response.

THE CAI READING CURRICULUM

The flexibility offered by this computer system is of value only if the curriculum materials make sense both in terms of the logical organization of the subject matter and the psychology of the learning processes involved. Time does not permit a detailed discussion of the rationale behind the curriculum that we have developed. Let me simply say that our approach to initial reading can be characterized as applied psycholinguistics. Hypotheses about the reading process and the nature of learning to read have been formulated on the basis of linguistic information, observations of

language use, and an analysis of the function of the written code. These hypotheses have been tested in a series of pilot studies structured to simulate actual teaching situations. On the basis of these experimental findings, the hypotheses have been modified, retested, and ultimately incorporated into the curriculum as principles dictating the format and flow of the instructional sequence. Of course, this statement is somewhat of an idealization, since very little curriculum material can be said to have been the perfect end product of rigorous empirical evaluation. We would claim, however, that the fundamental tenets of the Stanford reading program have been formulated and modified on the basis of considerable empirical evidence. It seems probable that these will be further modified as more data accumulate.

The introduction of new words from one level of the curriculum to the next is dictated by a number of principles (Rodgers, 1967). These principles are specified in terms of a basic unit that we have called the vocalic center group (VCG). The VCG in English is defined as a vowel nucleus with zero to three preceding and zero to four following consonants. The sequencing of new vocabulary is determined by the length of the VCG units, and the regularity of the orthographic and phonological correspondences. Typical of the principles are the following:

1. VCG sets containing single consonant elements are introduced before those containing consonant clusters (*tap* and *rap* before *trap*).
2. VCG sets containing initial consonant clusters are introduced before those containing final consonant clusters (*stop* before *post*).
3. VCG sets containing check (short) vowels are introduced before those containing letter name (long) vowels (*met* and *mat* before *meat* or *mate*).
4. Single VCG sequences are introduced before multiple VCG sequences (*mat* before *matter*, *stut* before *stutter*).

More detailed rules are required to determine the order for introducing specific vowels and consonants within a VCG pattern, and for introducing specific VCG patterns in polysyllabic words. These rules frequently represented a compromise between linguistic factors, pattern productivity, item frequency, and textual "usefulness," in that order of significance.

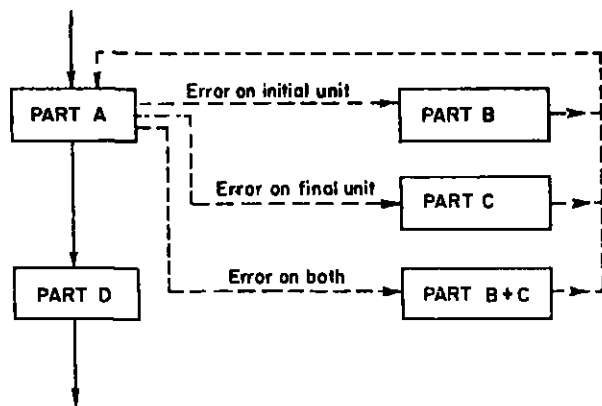

FIG. 2. Flow chart for the construction of a cell in the matrix construction task.

The instructional materials are divided into eight levels each composed of about 32 lessons.² The lessons are designed so that the average student will complete one in approximately 30 minutes, but this can vary greatly with the fast student finishing much sooner and the slow student sometimes taking 2 hours or more if he hits most of the remedial material. Within a lesson, the various instructional tasks can be divided into three broad areas: (a) decoding skills, (b) comprehension skills, (c) games and other motivational devices. Decoding skills involve such tasks as letter and letter-string identification, word list learning, phonic drills, and related types of activities. Comprehension involves such tasks as having the computer read to the child or having the child himself read sentences, paragraphs, or complete stories about which he is then asked a series of questions. The questions deal with the direct recall of facts, generalizations about main ideas in the story, and inferential questions which require the child to relate information presented in the story to his own experience. Finally, many different types of games are sequenced into the lessons primarily to encourage continued attention to the materials. The games are similar to those played in the classroom and are structured to evaluate the developing reading skills of the child.

Matrix construction. To illustrate the instructional materials focusing on decoding skills let me

²For a detailed account of the curriculum materials see Wilson and Atkinson (1967) and Rodgers (1967). See also Atkinson and Hansen (1966) and Hansen and Rodgers (1965).

describe a task that we have called matrix "construction." This task provides practice in learning to associate orthographically similar sequences with appropriate rhyme and alliteration patterns. Rhyming patterns are presented in the columns of the matrix, and alliteration patterns are presented in the rows of the matrix as indicated in Figure 4.

The matrix is constructed one cell at a time. The initial consonant of a CVC word is termed the initial unit, and the vowel and the final consonant are termed the final unit. The intersection of an initial unit row and a final unit column determines the entry in any cell.

The problem format for the construction of each cell is divided into four parts: Parts A and D are standard instructional sections and Parts B and C are remedial sections. The flow diagram in Figure 2 indicates that remedial Parts B and C are branches from Part A and may be presented independently or in combination.

To see how this goes, let us consider the example illustrated in Figure 3. The student first sees on the CRT the empty cell with its associated initial and final units and an array of response choices. He hears the audio message indicated by response request 1 (RR 1) in Part A of Figure 3. If the student makes the correct response (CA) (i.e., touches *ran* with his light pen), he proceeds to Part D where he sees the word written in the cell and receives one additional practice trial.

In the initial presentation in Part A, the array of multiple-choice responses is designed to identify three possible types of errors:

1. The initial unit is correct, but the final unit is not.
2. The final unit is correct, but the initial unit is not.
3. Neither the initial unit nor the final unit is correctly identified.

If, in Part A, the student responds with *fan* he is branched to remedial Part B where attention is focused on the initial unit of the cell. If a correct response is made in Part B, the student is returned to Part A for a second attempt. If an incorrect response (WA) is made in Part B, an arrow is displayed on the CRT to indicate the correct response, which the student is then asked to touch.

If, in Part A, the student responds with *rat*, he is branched to remedial Part C where additional instruction is given on the final unit of the cell.

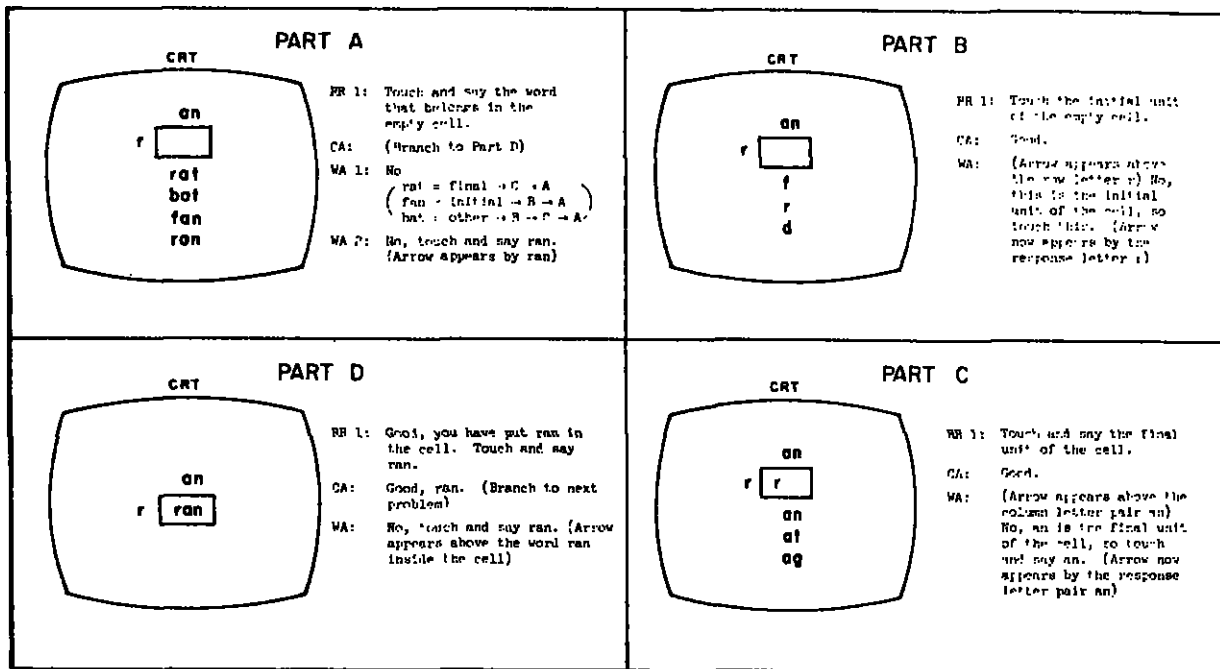

FIG. 3. First cell of the matrix construction task.

The procedure in Part C is similar to Part B. However, it should be noted that in the remedial instruction the initial letter is never pronounced (Part B), whereas the final unit is always pronounced (Part C). If, in Part A, the student responds with *bat*, then he has made an error on both the initial and final unit and is branched through both Part B and Part C.

When the student returns to Part A after completing a remedial section, a correct response will advance him to Part D as indicated. If a wrong answer response is made on the second pass, an arrow is placed beside the correct response area and held there until a correct response is made. If the next response is still an error, a message is sent to the proctor and the sequence is repeated from the beginning.

When a student has made a correct response on Parts A and D, he is advanced to the next word cell of the matrix which has a problem format and sequence identical to that just described. The individual cell building is continued block by block until the matrix is complete. The upper left-hand panel of Figure 4 indicates the CRT display for adding the next cell in our example. The order in which row and column cells are added is essentially random.

When the matrix is complete, the entries are re-

ordered and a criterion test is given over all cell entries. The test involves displaying the full matrix with complete cell entries as indicated in the lower left-hand panel of Figure 4. Randomized requests are made to the student to identify cell entries. Since the first pass through the full matrix is viewed as a criterion test, no reinforcement is given. Errors are categorized as initial, final, and other; if the percentage of total errors on the criterion test exceeds a predetermined value, then remedial exercises are provided of the type shown in the two right-hand panels of Figure 4. If all the errors are recorded in one category (initial or final), only the remedial material appropriate to that category is presented. If the errors are distributed over both categories, then both types of remedial material are presented. After working through one or both of the remedial sections, the student is branched back for a second pass through the criterion matrix. The second pass is a teaching trial as opposed to the initial test cycle; the student proceeds with the standard correction and optimization routines.

An analysis of performance on the matrix task is still incomplete, but some preliminary results are available. On the initial pass (Part A) our students were correct about 45% of the time; however, when an error did occur, 21% of the time it in-

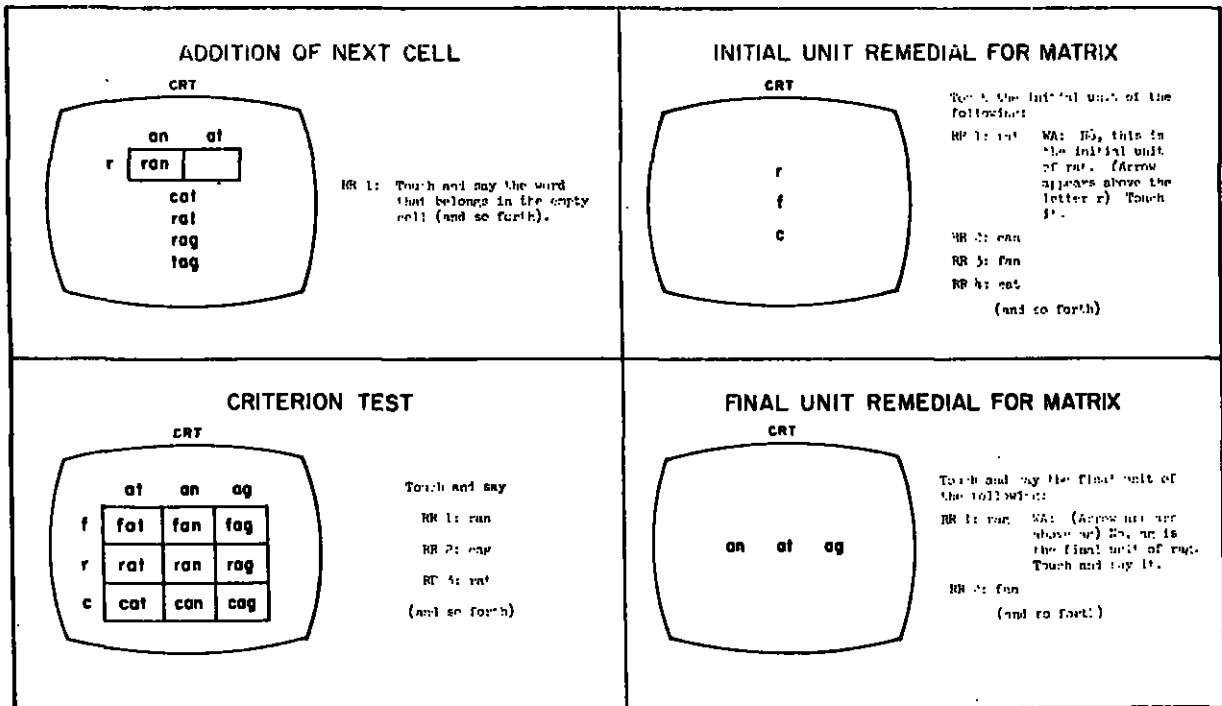

FIG. 4. Continuation of matrix construction task.

involved only the final unit, 53% of the time only the initial unit, and 26% of the time both initial and final units. The pattern of performances changed markedly on the first pass through the criterion test. Here the subject was correct about 65% of the time; when an error occurred, 32% of the time it involved only the final unit, 33% of the time only the initial unit, and 35% of the time both units. Thus performance showed a significant improvement from Part A to the criterion test; equally important, initial errors were more than twice as frequent as final errors in Part A, but were virtually equal on the criterion test.

The matrix exercise is a good example of the material used in the curriculum to teaching decoding skills. We now consider two examples ("form class" and "inquiries") of tasks that are designed to teach comprehension skills.

Form class. Comprehension of a sentence involves an understanding of English syntax. One behavioral manifestation of a child's syntactic sophistication is his ability to group words into appropriate form classes. This task provides lesson materials that teach the form-class characteristics of the words just presented in the matrix section of a lesson. The following type of problem is presented to the student (the material in the box is

displayed on the CRT and below are audio messages; the child answers by appropriately placing his light pen on the CRT):

Dan saw the	tan fat man run	hat.
-------------	--------------------------	------

Only one of the words in the column will make sense in the sentence. Touch and say the word that belongs in the sentence.

CA: Yes, Dan saw the tan hat. Do the next one.

WA: No, tan is the word that makes sense. Dan saw the tan hat. Touch and say tan. (An arrow then appears above tan.)

The sentence is composed of words that are in the reading vocabulary of the student (i.e., they have been presented in previous or current lessons). The response set includes a word which is of the correct form class but is semantically inappropriate, two words that are of the wrong form class, and the correct word. A controlled variety of sentence types is employed, and the answer sets are distributed over all syntactic slots within each sentence type. Responses are categorized in rather broad terms as *nouns*, *verbs*, *modifiers*, and *other*.

The response data can be examined for systematic errors over a large number of items. Examples of the kinds of questions that can be asked are: (a) Are errors for various form classes in various sentence positions similarly distributed? (b) How are response latencies affected by the syntactic and serial position of the response set within the sentence? Answers to these and other questions should provide information that will permit more systematic study of the relationship of sentence structure to reading instruction.

Inquiries. Individual words in sentences may constitute unique and conversationally correct answers to questions. These questions take the interrogative "Who? What? How?" etc. The ability to select the word in a sentence that uniquely answers one of these questions demonstrates one form of reading comprehension. The inquiry exercises constitute an assessment of this reading comprehension ability. In the following example, the sentence "John hit the ball" is displayed on the CRT accompanied by these audio messages:

Touch and say the word that answers the question.

RR 1 Who hit the ball?

CA: Yes, the word "John" tells us who hit the ball.

WA: No, John tells us who hit the ball. Touch and say John. (An arrow then appears on the CRT above John.)

RR 2 What did John hit?

CA: Yes, the word "ball" tells us what John hit.

WA: No, ball tells us what John hit. Touch and say ball. (An arrow then appears above ball.)

As in the form-class section, each sentence is composed of words from the student's reading vocabulary. A wide variety of sentence structures is utilized, beginning with simple subject-verb-object sentences and progressing to structures of increasing complexity. Data from this task bear on several hypotheses about comprehension. If comprehension is equated with a correct response to an inquiry question, then the following statements are verified by our data: (a) Items for which the correct answer is, in the medial position of the sentence are more difficult to comprehend than items in the initial or final positions; final position items are easier to comprehend than items in the initial position. (b) Items for which the correct answer is an adjective are more difficult to comprehend than items in which the correct answer is a noun or verb; similarly nouns are more difficult than verbs.

(c) Longer sentences, measured by word length, are more difficult to comprehend than shorter sentences.

These are only a few examples of the types of tasks used in the reading curriculum, but they indicate the nature of the student-system interaction. What is not illustrated by these examples is the potential for long-term optimization policies based on an extended response history from the subject. We shall return to this topic later.

PROBLEMS IN IMPLEMENTING THE CURRICULUM

Before turning to the data from last year's run, let me consider briefly the problem of translating the curriculum materials into a language that can be understood by the computer. The particular computer language we use is called Coursewriter II, a language which was developed by IBM in close collaboration with Stanford. A coded lesson is a series of Coursewriter II commands which causes the computer to display and manipulate text on the CRT, position and display film in the projector, position and play audio messages, accept and evaluate keyboard and lightpen responses, update the performance record of each student, and implement the branching logic of the lesson flow by means of manipulating and referencing a set of switches and counters. A typical lesson in the reading program, which takes the average student

TABLE 1

AUDIO SCRIP AND FILM CHIPS WITH
HYPOTHETICAL ADDRESSES

Address	Message
Audio information	
A01	Touch and say the word that goes with the picture.
A02	Good. Bag. Do the next one.
A03	No.
A04	The word that goes with the picture is bag. Touch and say bag.
A05	Good. Card. Do the next one.
A06	No.
A07	The word that goes with the picture is card. Touch and say card.
Film strip	
F01	Picture of a bag.
F02	Picture of a card.

TABLE 2

COMPUTER COMMANDS REQUIRED TO PRESENT TWO EXAMPLES OF THE PROBLEM DESCRIBED IN THE TEXT

Commands	Explanation
PR	Problem: Prepares machine for beginning of new problem.
LD 0/S1	Load: Loads zero into the error switch (S1). The role of switches and counters will be explained later.
FP F01	Film Position: Displays frame F01 (picture of a bag).
DT 5,18/bat/	Display Text: Displays "bat" on line 5 starting in column 18 on the CRT.
DT 7,18/bag/	Displays "bag" on line 7 starting in column 18 on the CRT.
DT 9,18/rat/	Displays "rat" on line 9 starting in column 18 on the CRT.
AUP A01	Audio Play: Plays audio message A01. "Touch and say the word that goes with the picture."
L1 EP 30/ABCD1	Enter and Process: Activates the light-pen; specifies the time limit (30 sec.) and the problem identifier (ABCD1) that will be placed in the data record along with all responses to this problem. If a response is made within the time limit the computer skips from this command down to the CA (correct answer comparison) command. If no response is made within the time limit, the commands immediately following the EP command are executed.
AD 1/C4	Add: Adds one to the overtime counter (C4).
LD 1/S1	Loads one into the error switch (S1).
AUP A04	Plays message A04. "The word that goes with the picture is bag. Touch and say bag."
DT 7,16/-/	Displays arrow on line 7, column 16 (arrow pointing at "bag").
BR L1	Branch: Branches to command labeled L1. The computer will now do that command and continue from that point.
CA 1,7,3,18/C1	Correct Answer: Compares student's response with an area one line high starting on line 7 and three columns wide starting in column 18 of the CRT. If his response falls within this area, it will be recorded in the data with the answer identifier C1. When a correct answer has been made, the commands from here down to WA (wrong answer comparison) are executed. Then the program jumps ahead to the next PR. If the response does not fall in the correct area, the machine skips from this command down to the WA command.
BR L2/S1/1	Branches to command labeled L2 if the error switch (S1) is equal to one.
AD 1/C1	Adds one to the initial correct answer counter (C1).
L2 AUP A02	Plays audio message A02. "Good. Bag. Do the next one."
WA 1,5,3,18/W1 } WA 1,9,3,18/W2 }	Wrong Answer: These two commands compare the student response with the areas of the two wrong answers, that is, the area one line high starting on line 5 and three columns wide starting in column 18, and the area one line high starting on line 9 and three columns wide starting in column 18. If the response falls within one of these two areas, it will be recorded with the appropriate identifier (W1 or W2). When a defined wrong answer has been made, the commands from here down to UN (undefined answer) are executed. Then the computer goes back to the EP for this problem. If the response does not fall in one of the defined wrong answer areas, the machine skips from this command down to the UN command.

Table 2—Continued

Commands	Explanation
AD 1/C2	Adds one to the defined wrong answer counter (C2).
L3 LD 1/S1	Loads one into the error switch (S1).
AUP A03	Plays message A03. "No."
AUP A04	Plays message A04. "The word that goes with the picture is bag. Touch and say bag."
DT 7,16/-/	Displays arrow on line 7, column 16.
UN	Undefined Wrong Answer: If machine reaches this point in the program, the student has made neither a correct nor a defined wrong answer.
AD 1/C3	Adds one to the undefined answer counter (C3).
BR L3	Branches to command labeled L3. (The same thing should be done for both UN and WA answers. This branch saves repeating the commands from L3 down to UN.)
FR	Prepares the machine for next problem.
LD 0/S1	These commands prepare the display for the 2nd problem. Notice the new film position and new words displayed. The student was told to "do the next one" when he finished the last problem so he needs no audio message to begin this.
FP F02	
DT 5,18/card/	
DT 7,18/cart/ DT 9,18/hard/	
L4 EP 30/ABCD2	Light-pen is activated.
AD 1/C4 LD 1/S1 AUP A07 DT 5,16/-/ BR L4	These commands are done only if no response is made in the time limit of 30 seconds. Otherwise the machine skips to the CA command.
CA 1,5,4,18/C2	
BR L5/S1/1	
AD 1/C1	
L5 AUP A05	
WA 1,7,4,18/W3 WA 1,9,4,18/W4	Compare response with defined wrong answer.
AD 1/C2 L6 LD 1/S1 AUP A06 AUP A07 DT 5,16/-/	Adds one to the defined wrong answer area and the error switch (S1) is loaded with one to show that an error has been made on this problem. The student is told he is wrong and shown the correct answer and asked to touch it. These commands are executed only if a defined wrong answer has been made.
UN	
AD 1/C3 BR L6	

about 30 minutes to complete, requires in excess of 9,000 coursewriter commands for its execution.

A simple example will give you some feeling for the coding problem. The example is from a task designed to teach both letter discrimination and the meaning of words. A picture illustrating the word being taught is presented on the projector screen. Three words, including the word illus-

trated, are presented on the CRT. A message is played on the audio asking the child to touch the word on the CRT that matches the picture on the film projector. The student can then make his response using the light pen. If he makes no response within the specified time limit of 30 seconds, he is told the correct answer, an arrow points to it, and he is asked to touch it. If he makes a response

within the time limit, the point that he touches is compared by the computer with the correct-answer area. If he places the light pen within the correct area, he is told that he was correct and goes on to the next problem. If the response was not in the correct area, it is compared with the area defined as a wrong answer. If his response is within this area, he is told that it is wrong, given the correct answer, and asked to touch it. If his initial response was neither in the anticipated wrong-answer area nor in the correct-answer area, then the student has made an undefined answer. He is given the same message that he would have heard had he touched a defined wrong answer; however, the response is recorded on the data record as undefined. The student tries again until he makes the correct response; he then goes on to the next problem.

To prepare an instructional sequence of this sort, the programmer must write a detailed list of commands for the computer. He must also record on an audio tape all the messages the student might hear during the lesson in approximately the order in which they will occur. Each audio message has an address on the tape and will be called for and played when appropriate. Similarly a film strip is prepared with one frame for each picture required in the lesson. Each frame has an address and can be called for in any order.

Table 1 shows the audio messages and film pictures required for two sample problems along with the hypothetical addresses on the audio tape and film strip. Listed in Table 2 are the computer commands required to present two examples of the problems described above, analyze the student's responses, and record his data record. The left column in the table lists the actual computer commands, and the right column provides an explanation of each command.

While a student is on the system, he may complete as many as 5 to 10 problems of this type per minute. Obviously, if all of the instructional material has to be coded in this detail the task would be virtually impossible. Fortunately, there are ways of simplifying coding procedure if parts of the instructional materials are alike in format and differ only in certain specified ways. For example, the two problems presented in Table 2 differ only in (a) the film display, (b) the words on the CRT, (c) the problem identifier, (d) the three audio addresses, (e) the row display of the arrow, (f) the

correct answer area, and (g) the correct answer identifier. This string of code can be defined once, given a two-letter name, and used later by giving a one-line macro command.

The use of macros cuts down greatly the effort required to present many different but basically similar problems. For example, the two problems presented in Table 2 can be rewritten in macro format using only two lines of code: Problem 1: CM PW]F01]bat]bag]rat]A01]ABCD1]A04]-A02]A03]7]1,7,3,18]C1]; Problem 2: CM PW]-F02]card]cart]hard]]ABCD2]A07]A05]A06]5]-1,5,4,18]C2]. The command to call a macro is CM, and PW is an arbitrary two-character code for the macro involving a picture-to-word match. Notice that in Problem 2 there is no introductory audio message; the "]" indicates that this parameter is not to be filled in.

The macro capability of the source language has two distinct advantages over code written command by command. The first is ease and speed of coding. The call of one macro is obviously easier than writing the comparable string of code. The second advantage is increase in accuracy. Not only are coding errors drastically curtailed, but if the macro is defective or needs to be changed, every occurrence of it in the lesson coding can be corrected by modifying the original macro; in general, the code can stay as it is. The more standard the various problem formats, the more valuable the macro capability becomes. Apart from a few non-standard introductory audio messages and display items, approximately 95% of the reading curriculum has been programmed using about 110 basic macros.

The macro command feature of the language has significant implications for psychological research. By simply changing a few commands in a particular macro, one can alter the flow of the teaching sequence whenever that macro is called in the program. Thus, the logic of an instructional sequence that occurs thousands of times in the reading curriculum can be redesigned by adding or modifying a few lines of code in a given macro. If, for example, we wanted to change the timing relations, the type of feedback, or characteristics of the CRT display in the task described above, it would require only a few lines of code in the PW macro and would not necessitate making changes at every point in the curriculum where the picture-to-word exercise occurred. Thus, a range of experimental

manipulations can be carried out using the same basic program and display materials, and requiring changes only in the command structure of the macros.

As indicated in Table 2, a bank of switches and counters is defined in the computer and can be used to keep a running record on each student. There is a sufficient number of these registers so that quite sophisticated schemes of optimization and accompanying branching are possible. Thus, one is in a position to present a series of words and to optimize the number of correct responses to some stipulated criteria, for example, five consecutive correct responses for each of the words. Or one can select from an array of phrases choosing those phrases for presentation that have the greatest number of previous errors. As a consequence of these decisions, each student pursues a fundamentally different path through the reading materials.

SOME RESULTS FROM THE FIRST YEAR OF OPERATION

The Stanford CAI Project is being conducted at the Brentwood School in the Ravenswood School District (East Palo Alto, California). There were several reasons for selecting this school. It had sufficient population to provide a sample of well over 100 first-grade students. The students were primarily from "culturally disadvantaged" homes. And the past performance of the school's principal and faculty had demonstrated a willingness to undertake educational innovations.

Computerized instruction began in November of 1966 with half of the first-grade students taking reading via CAI and the other half, which functioned as a control group, being taught reading by a teacher in the classroom. The children in the control group were not left out of the project, for they took mathematics from the CAI system instead. The full analysis of the student data is a tremendous task which is still underway. However, a few general results have already been tabulated that provide some measure of the program's success.

Within the lesson material there is a central core of problems which we have termed main-line problems. These are problems over which each student must exhibit mastery in one form or another. Main-line problems may be branched around by successfully passing certain screening

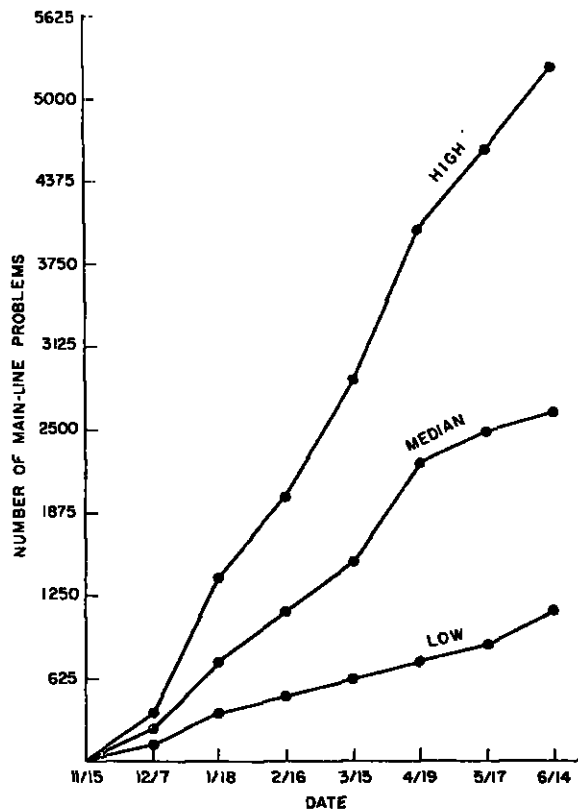

FIG. 5. Cumulative number of main-line problems for fastest, median, and slowest student.

tests, or they may be met and successfully solved; they may be met with incorrect responses, in which case the student is branched to remedial material. The first year of the project ended with a difference between the fastest and slowest student of over 4,000 main-line problems completed. The cumulative response curves for the fastest, median, and slowest students are given in Figure 5. Also of interest is the rate of progress during the course of the year. Figure 6 presents the cumulative number of problems completed per hour on a month-by-month basis again for the fastest, median, and slowest student. It is interesting to note that the rate measure was essentially constant over time for increase for the fast student.

From the standpoint of both the total number of problems completed during the year and rate of progress, it appears that the CAI curriculum is responsive to individual differences. The differences noted above must not be confused with a variation in rate of response. The difference in response rate among students was very small. The average response rate was approximately four per

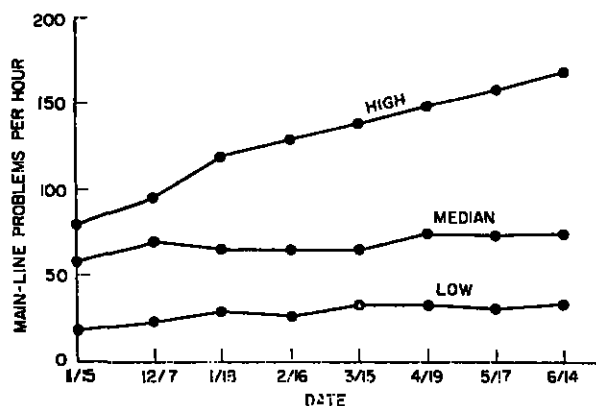

FIG. 6. Cumulative rate of progress for fastest, median, and slowest student.

minute and was not correlated with a student's rate of progress through the curriculum. The differences in total number of main-line problems completed can be accounted for by the amount of remedial material, the optimization routines, and the number of accelerations for the different students.

It has been a common finding that girls generally acquire reading skills more rapidly than boys. The sex differences in reading performance have been attributed, at least in part, to the social organization of the classroom and to the value and reward structures of the predominantly female primary grade teachers. It has also been argued on developmental grounds that first-grade girls are more facile in visual memorization than boys of the same age, and that this facility aids the girls in the sight-word method of vocabulary acquisition commonly used in basal readers. If these two arguments are correct, then one would expect that placing students in a CAI environment and using a curriculum which emphasizes analytic skills, as opposed to rote memorization, would minimize sex differences in reading. In order to test this hypothesis, the rate of progress scores were statistically evaluated for sex effects. The result, which was rather surprising, is that there was no difference between male and female students in rate of progress through the CAI curriculum.

Sex differences however might be a factor in accuracy of performance. To test this notion the final accuracy scores on four standard problem types were examined. The four problem types, which are representative of the entire curriculum, were Letter Identification, Word List Learning,

Matrix Construction, and Sentence Comprehension. On these four tasks, the only difference between boys and girls that was statistically significant at the .05 level was for word-list learning. These results, while by no means definitive, do lend support to the notion that when students are removed from the normal classroom environment and placed on a CAI program, boys perform as well as girls in overall rate of progress. The results also suggest that in a CAI environment the sex difference is minimized in proportion to the emphasis on analysis rather than rote memorization in the learning task. The one problem type where the girls achieved significantly higher scores than the boys, word-list learning, is essentially a paired-associate learning task.

As noted earlier, the first graders in our school were divided into two groups. Half of them received reading instruction from the CAI system; the other half did not (they received mathematics instruction instead). Both groups were tested extensively using conventional instruments before the project began and again near the end of the school year. The two groups were not significantly different at the start of the year. Table 3 presents the results for some of the tests that were administered at the end of the year. As inspection of the table will show, the group that received reading instruction via CAI performed significantly better on all of the posttests except for the comprehension subtest of the California Achievement Test. These results are most encouraging. Further, it should

TABLE 3
POSTTEST RESULTS FOR EXPERIMENTAL
AND CONTROL GROUPS

Test	Experimental	Control	p value
California Achievement Test			
Vocabulary	45.91	38.10	<.01
Comprehension	41.45	40.62	—
Total	45.63	39.61	<.01
Hartley Reading Test			
Form class	11.22	9.00	<.05
Verabulary	19.38	17.05	<.01
Phonetic discrimination	30.88	25.15	<.01
Pronunciation			
Nonsense word	6.03	2.30	<.01
Word	9.95	5.95	<.01
Recognition			
Nonsense word	18.43	15.25	<.01
Word	19.61	16.60	<.01

be noted that at least some of the factors that might result in a "Hawthorne phenomenon" are not present here; the "control" group was exposed to CAI experience in their mathematics instruction. While that may leave room for some effects in their reading, it does remove the chief objection, since these students also had reason to feel that special attention was being given to them. It is of interest to note that the average Stanford-Binet IQ score for these students (both experimental and control) is 89.³

Owing to systems and hardware difficulties, our program was not in full operation until late in November of 1966. Initially, students were given a relatively brief period of time per day on the terminals. This period was increased to 20 minutes after the first 6 weeks; in the last month we allowed students to stay on the terminal 30 to 35 minutes. We wished to find out how well first-grade students would adapt to such long periods of time. They adapt quite well, and next year we plan to use 30-minute periods for all students throughout the year. This may seem like a long session for a first-grader, but our observations suggest that their span of attention is well over a half hour if the instructional sequence is truly responsive to their response inputs. This year's students had a relatively small number of total hours on the system. We hope that by beginning in the early fall and using half-hour periods, we will be able to give each student at least 80 to 90 hours on the terminals next year.

I do not have time to discuss the social-psychological effects of introducing CAI into an actual school setting. However, systematic observations have been made by a trained clinical psychologist, and a report is being prepared. To preview this report, it is fair to say that the students, teachers, and parents were quite favorable to the program.

Nor will time permit a detailed account of the various optimization routines used in the reading curriculum. But since this topic is a major focus of our research effort, it requires some discussion here. As noted earlier, the curriculum incorporates an array of screening and sequencing procedures designed to optimize learning. These optimization schemes vary in terms of the range of curriculum included, and it has been convenient to classify

them as either short- or long-term procedures. Short-term procedures refer to decision rules that are applicable to specific problem formats and utilize the very recent response history of a subject to determine what instructional materials to present next. Long-term optimization procedures are applicable to diverse units of the curriculum and utilize a summarized form of the subject's complete response record to specify his future path through major instructional units.

As an example of a short-term optimization procedure, consider one that follows directly from a learning theoretic analysis of the reading task involved (Groen & Atkinson, 1966). Suppose that a list of m words is to be taught to the child, and it has been decided that instruction is to be carried out using the picture-to-word format described earlier. In essence, this problem format involves a series of discrete trials, where on each trial a picture illustrating the word being taught is presented on the projector screen and three words (including the word illustrated) are presented on the CRT. The student makes a response from among these words, and the trial is terminated by telling him the correct answer. If x trials are allocated for this type of instruction (where x is much larger than m), how should they be used to maximize the amount of learning that will take place? Should the m items be presented an equal number of times and distributed randomly over the x trials, or are there other strategies that take account of idiosyncratic features of a given subject's response record? If it is assumed that the learning process for this task is adequately described by the one-element model of stimulus sampling theory, and there is evidence that this is the case, then the optimal presentation strategy can be prescribed. The optimal strategy is initiated by presenting the m items in any order on the first m trials, and a continuation of this strategy is optimal over the remaining $x - m$ trials if, and only if, it conforms to the following rules:

1. For every item, set the count at 0 at the beginning of trial $m + 1$.
2. Present an item at a given trial if, and only if, its count is *least* among the counts for all items at the beginning of the trial.
3. If several items are eligible under Rule 2, select from these the item that has the smallest number of presentations; if several items are still eligible, select with equal probability from this set.

³ More details on these and other analyses may be found in Atkinson (1967) and Wilson and Atkinson (1967).

4. Following a trial, increase the count for presented item by 1 if the subject's response was correct, but set it at 0 if the response was incorrect.

Even though these decision rules are fairly simple, they would be difficult to implement without the aid of a computer. Data from this year's experiment establish that the above strategy is better than one that presents the items equally often in a fixed order.

This is only one example of the type of short-term optimization strategies that are used in the reading curriculum. Some of the other schemes are more complex, involving the application of dynamic programming principles (Groen & Atkinson, 1966), and use information not only about the response history but also the speed of responding. In some cases the optimization schemes can be derived directly from mathematical models of the learning process, whereas others are not tied to theoretical analyses but are based on intuitive considerations that seem promising.⁴

Even if short-term optimization strategies can be devised which are effective, a total reading curriculum that is optimal still has not been achieved. It is, of course, possible to optimize performance on each unit of the curriculum while, at the same time, sequencing through the units in an order that is not particularly efficient for learning. The most significant aspect of curriculum development is with regard to long-term optimization procedures, where the subject's total response history can be used to determine the best order for branching through major instructional units and also the proper balance between drill and tutorial activities. It seems clear that no theory of instruction is likely to use all the information we have on a student to make instructional decisions from one moment to the next. Even for the most sophisticated long-term schemes, only a sample of the subject's history is going to be useful. In general, the problem of deciding on an appropriate sample of the history is similar to the problem of finding an observable statistic that provides a good estimate of a population parameter. The observable history sample may be regarded as an estimate of the student's state of learning. A desirable property for such a

⁴The learning models and optimization methods that underlie much of the reading curriculum are discussed in Atkinson and Shiffrin (1968), Groen and Atkinson (1966), Rodgers (1967), and Wilson and Atkinson (1967).

history sample would be for it to summarize all information concerning the current learning state of the student so that no elaboration of the history would provide additional information. In the theory of statistical inference, a statistic with an analogous property is called a sufficient statistic. Hence, it seems appropriate to call an observable sample history with this property a "sufficient history."

In the present version of the reading curriculum, several long-term optimization procedures have been introduced with appropriate sufficient histories. As yet, the theoretical rationale for these procedures has not been thoroughly worked out, and not enough data have been collected to evaluate their effectiveness. However, an analysis of long-term optimization problems, and what data we do have, has been instructive and has suggested a number of experiments that need to be carried out this year. It is my hope that such analyses, combined with the potential for educational research under the highly controlled conditions offered by CAI, will lay the groundwork for a theory of instruction that is useful to the educator. Such a theory of instruction will have to be based on a model of the learning process that has broad generality and yet yields detailed predictions when applied to specific tasks.

In my view, the development of a viable theory of instruction and the corresponding learning theory will be an interactive enterprise, with advances in each area influencing the concepts and data base in the other. For too long, psychologists studying learning have shown little interest in instructional problems, whereas educators have made only primitive and superficial applications of learning theory. Both fields would have advanced more rapidly if an appropriate interchange of ideas and problems had existed. It is my hope that prospects for CAI, as both a tool for research and a mode of instruction, will act as a catalyst for a rapid evolution of new concepts in learning theory as well as a corresponding theory of instruction.

REFERENCES

- ATKINSON, R. C., & HANSEN, D. N. Computer-assisted instruction in initial reading: The Stanford Project. *Reading Research Quarterly*, 1966, 2, 5-25.
- ATKINSON, R. C., & SHIFFRIN, R. M. Human memory: A proposed system and its control processes. In K. W. Spence & J. T. Spence (Eds.), *The psychology of learning and motivation: Advances in research and*

- theory*. Vol. 2. New York: Academic Press, 1968, in press.
- FISHMAN, E. J., KELLER, L., & ATKINSON, R. C. Massed vs. distributed practice in computerized spelling drills. *Journal of Educational Psychology*, 1968, 59, in press.
- GROEN, G. J., & ATKINSON, R. C. Models for optimizing the learning process. *Psychological Bulletin*, 1966, 66, 309-320.
- HANSEN, D. N., & ROGERS, T. S. An exploration of psycholinguistic units in initial reading. Technical Report 74, 1965, Stanford University, Institute for Mathematical Studies in the Social Sciences.
- ROGERS, T. S. Linguistic considerations in the design of the Stanford computer-based curriculum in initial reading. Technical Report 111, 1967, Stanford University, Institute for Mathematical Studies in the Social Sciences.
- SUPPES, P. The uses of computers in education. *Scientific American*, 1966, 215, 206-221.
- SUPPES, P., JERMAN, M., & GROEN, G. J. Arithmetic drills and review on a computer-based teletype. *Arithmetic Teacher*, 1966, April, 303-308.
- WILSON, H. A., & ATKINSON, R. C. Computer-based instruction in initial reading: A progress report on the Stanford project. Technical Report 119, 1967, Stanford University, Institute for Mathematical Studies in the Social Sciences.

RICHARD C. ATKINSON²*Stanford University*

THE term "theory of instruction" has been in widespread use for over a decade and during that time has acquired a fairly specific meaning. By consensus it denotes a body of theory concerned with optimizing the learning process; stated otherwise, the goal of a theory of instruction is to prescribe the most effective methods for acquiring new information, whether in the form of higher order concepts or rote facts. Although usage of the term is widespread, there is no agreement on the requirements for a theory of instruction. The literature provides an array of examples ranging from speculative accounts of how children should be taught in the classroom to formal mathematical models specifying precise branching procedures in computer-controlled instruction.³ Such diversity is healthy; to focus on only one approach would not be productive in the long run. I prefer to use the term theory of instruction to encompass both experimental and theoretical research, with the theoretical work ranging from general speculative accounts to specific quantitative models.

The literature on instructional theory is growing at a rapid rate. So much so that, at this point, a significant contribution could be made by someone willing to write a book summarizing and evaluating work in the area. I am reminded here of Hilgard's (1948) book, *Theories of Learning*; it played an

¹ A briefer version of this article was presented as an invited address at the meetings of the American Educational Research Association, Chicago, April 1972. This research was sponsored in part by National Science Foundation Grant No. NSF GJ-443X2 and by Office of Naval Research Contract No. N00014-67-A-0112-0054.

² Requests for reprints should be sent to Richard C. Atkinson, Department of Psychology, Stanford University, Stanford, California 94305.

³ See, for example, Smallwood (1962), Carroll (1963), Hilgard (1964), Bruner (1966), Groen and Atkinson (1966), Crothers and Suppes (1967), Gagné (1970), Seidel and Hunter (1970), Pask and Scott (1971), and Atkinson and Paulson (1972).

important role in the development of learning theory by effectively summarizing alternative approaches and placing them in perspective. A book of this type is needed now in the area of instruction. The present article provides an overview of one of the chapters that I would like to see included in such a book; a title for the chapter might be "A Decision-Theoretic Analysis of Instruction." Basically, I consider here the factors that need to be examined in deriving optimal instructional strategies, and then I use this analysis to identify the key elements of a theory of instruction.

A DECISION-THEORETIC ANALYSIS OF INSTRUCTION

The derivation of an optimal strategy requires that the instructional problem be stated in a form amenable to a decision-theoretic analysis. Analyses based on decision theory vary somewhat from field to field, but the same formal elements can be found in most of them. As a starting point, I think it useful to identify these elements in a general way, and then to relate them to an instructional situation. They are as follows:

1. The possible states of nature.
2. The actions that the decision maker can take to transform the state of nature.
3. The transformation of the state of nature that results from each action.
4. The cost of each action.
5. The return resulting from each state of nature.

In the context of instruction, these elements divide naturally into three groups. Elements 1 and 3 are concerned with a description of the learning process; Elements 4 and 5 specify the cost-benefit dimensions of the problem; and Element 2 requires that the instructional actions from which the decision maker is free to choose be specified precisely.

For the decision problems that arise in instruction, Elements 1 and 3 require that a model of the learning process exist. It is usually natural to identify the states of nature with the learning states of the student. Specifying the transformation of the states of nature caused by the actions of the decision maker is tantamount to constructing a model of learning for the situation under consideration. The learning model will be probabilistic to the extent that the state of learning is imperfectly observable or the transformation of the state of learning that a given instructional action will cause is not completely predictable.

The specification of costs and returns in an instructional situation (Elements 4 and 5) tends to be straightforward when examined on a short-term basis, but virtually intractable over the long term. For the short term, one can assign costs and returns for the mastery of, say, certain basic reading skills, but sophisticated determinations for the long-term value of these skills to the individual and society are difficult to make. There is an important role for detailed economic analyses of the long-term impact of education, but such studies deal with issues at a more global level than are considered here. The present analysis is limited to those costs and returns directly related to a specific instructional task.

Element 2 is critical in determining the effectiveness of a decision-theory analysis; the nature of this element can be indicated by an example. Suppose one wants to design a supplementary set of exercises for an initial reading program that involve both sight-word identification and phonics. Assume that two exercise formats have been developed, one for training on sight words, the other for phonics. Given these formats, there are many ways to design an overall program. A variety of optimization problems can be generated by fixing some features of the curriculum and leaving others to be determined in a theoretically optimal manner. For example, it may be desirable to determine how the time available for instruction should be divided between phonics and sight-word recognition, with all other features of the curriculum fixed. A more complicated question would be to determine the optimal ordering of the two types of exercises in addition to the optimal allocation of time. It would be easy to continue generating different optimization problems in this manner. The main

point is that varying the set of actions from which the decision maker is free to choose changes the decision problem, even though the other elements remain the same.

Once these five elements have been specified, the next task is to derive the optimal strategy for the learning model that best describes the situation. If more than one learning model seems reasonable a priori, then competing candidates for the optimal strategy can be deduced. When these tasks have been accomplished, an experiment can be designed to determine which strategy is best. There are several possible directions in which to proceed after the initial comparison of strategies, depending on the results of the experiment. If none of the supposedly optimal strategies produces satisfactory results, then further experimental analysis of the assumptions of the underlying learning models is indicated. New issues may arise even if one of the procedures is successful. In the second example that I discuss, the successful strategy produces an unusually high error rate during learning, which is contrary to a widely accepted principle of programmed instruction (Skinner, 1968). When anomalies such as this occur, they suggest new lines of experimental inquiry, and often require a reformulation of the learning model.⁴

CRITERIA FOR A THEORY OF INSTRUCTION

The discussion to this point can be summarized by listing four criteria that must be satisfied prior to the derivation of an optimal instructional strategy:

1. A model of the learning process.
2. Specification of admissible instructional actions.
3. Specification of instructional objectives.
4. A measurement scale that permits costs to be assigned to each of the instructional actions and payoffs to the achievement of instructional objectives.

If these four elements can be given a precise interpretation, then it is generally possible to derive an optimal instructional policy. The solution for an optimal policy is not guaranteed, but in recent

⁴ For a more extensive discussion of some of these points, see Atkinson and Paulson (1972), Calfee (1970), Dear, Silberman, Estavan, and Atkinson (1967), Laubsch (1970), and Smallwood (1971).

years some powerful tools have been developed for discovering optimal or near optimal procedures if they exist.

The four criteria just listed, taken in conjunction with methods for deriving optimal strategies, define either a model of instruction or a theory of instruction. Whether the term theory or model is used depends on the generality of the applications that can be made. Much of my own work has been concerned with the development of specific models for specific instructional tasks; hopefully, the collection of such models will provide the groundwork for a general theory of instruction.

In terms of the above criteria, it is clear that a model or theory of instruction is in fact a special case of what has come to be known in the mathematical and engineering literature as *optimal control theory* or, more simply, *control theory* (Kalman, Falb, & Arbib, 1969). The development of control theory has progressed at a rapid rate both in the United States and abroad, but most of the applications involve engineering or economic systems of one type or another. Precisely the same problems are posed in the area of instruction except that the system to be controlled is the human learner, rather than a machine or group of industries. To the extent that the above four elements can be formulated explicitly, methods of control theory can be used in deriving optimal instructional strategies.

To make some of these ideas more precise, I consider here two examples. One involves a *response-insensitive strategy* and the other a *response-sensitive strategy*. A response-insensitive strategy orders the instructional materials without taking into account the student's responses (except possibly to provide corrective feedback) as he progresses through the curriculum. In contrast, a response-sensitive strategy makes use of the student's response history in its stage-by-stage decisions regarding which curriculum materials to present next. Response-insensitive strategies are completely specified in advance and consequently do not require a system capable of branching during an instructional session. Response-sensitive strategies are more complex, but have the greatest promise for producing significant gains, for they must be at least as good, if not better, than the comparable response-insensitive strategy.

OPTIMIZING INSTRUCTION IN INITIAL READING

The first example is based on work concerned with the development of a computer-assisted instruction (CAI) program for teaching reading in the primary grades (Atkinson & Fletcher, 1972). The program provides individualized instruction in reading and is used as a supplement to normal classroom teaching; a given student may spend anywhere from 0 to 30 minutes per day at a CAI terminal. For present purposes, only one set of results are considered, where the dependent measure is performance on a standardized reading achievement test administered at the end of the first grade. Using the Atkinson and Fletcher data, a statistical model can be formulated that predicts test performance as a function of the amount of time the student spends on the CAI system. Specifically, let $P_i(t)$ be student i 's performance on a reading test administered at the end of first grade, given that he spends time t on the CAI system during the school year. Then within certain limits, the following equation holds:

$$P_i(t) = \alpha_i - \beta_i \exp(-\gamma_i t)$$

Depending on a student's particular parameter values, the more time spent on the CAI program, the higher the level of achievement at the end of the year. The parameters α , β , and γ characterize a given student and vary from one student to the next; α and $(\alpha - \beta)$ are measures of the student's maximal and minimal levels of achievement, respectively, and γ is a rate of progress measure. These parameters can be estimated from a student's response record obtained during his first hour of CAI. Stated otherwise, data from the first hour of CAI can be used to estimate the parameters α , β , and γ for a given student, and then the above equation enables one to predict end-of-year performance as a function of the CAI time allocated to that student.

The optimization problem that arises in this situation is as follows: Suppose that a school has budgeted a fixed amount of time T on the CAI system for the school year and must decide how to allocate the time among a class of n first-grade students. Assume, further, that all students have had a preliminary run on the CAI system so that estimates of the parameters α , β , and γ have been obtained for each student.

Let t_i be the time allocated to student i . Then

the goal is to select a vector (t_1, t_2, \dots, t_n) that optimizes learning. To do this, one must check the four criteria for deriving an optimal strategy.

The first criterion is that there be a model of the learning process. The prediction equation for $P_i(t)$ does not offer a very complete account of learning; for purposes of this problem, however, the equation suffices as a model of the learning process, giving all of the information that is required. This is an important point to keep in mind: the nature of the specific optimization problem determines the level of complexity that must be represented in the learning model. For some problems, the model must provide a relatively complete account of learning in order to derive an optimal strategy, but for other problems a simple descriptive equation of the sort presented above will suffice.

The second criterion requires that the set of admissible instructional actions be specified. For the present case, the potential actions are simply all possible vectors (t_1, t_2, \dots, t_n) such that the t_i s are nonnegative and sum to T . The only freedom decision makers have in this situation is in the allocation of CAI time to individual students.

The third criterion requires that the instructional objective be specified. There are several objectives that could be chosen in this situation. Consider four possibilities:

- (a) Maximize the mean value of P over the class of students.
- (b) Minimize the variance of P over the class of students.
- (c) Maximize the number of students who score at grade level at the end of the first year.
- (d) Maximize the mean value of P satisfying the constraint that the resulting variance of P is less than or equal to the variance that would have been obtained if no CAI were administered.

Objective *a* maximizes the gain for the class as a whole; Objective *b* aims to reduce differences among students by making the class as homogeneous as possible; Objective *c* is concerned specifically with those students who fall behind grade level; Objective *d* attempts to maximize performance of the whole class but insures that differences among students are not amplified by CAI. Other instructional objectives can be listed, but these are the ones that seemed most relevant. For expository pur-

poses, I have selected *a* as the instructional objective.

The fourth criterion requires that costs be assigned to each of the instructional actions and that payoffs be specified for the instructional objectives. In the present case, one can assume that the cost of CAI does not depend on how time is allocated among students and that the measurement of payoff is directly proportional to the students' achieved value of P .

In terms of the four criteria, the problem of deriving an optimal instructional strategy reduces to maximizing the function

$$\begin{aligned}\phi(t_1, t_2, \dots, t_n) &= \frac{1}{n} \sum_{i=1}^n P_i(t_i) \\ &= \frac{1}{n} \sum_{i=1}^n [\alpha_i - \beta_i \exp(-\gamma_i t_i)]\end{aligned}$$

subject to the constraint that

$$\sum_{i=1}^n t_i = T$$

and

$$t_i \geq 0.$$

This maximization can be done by using the method of dynamic programming (Bellman, 1961). In order to illustrate the approach, computations were made for a first-grade class for which the parameters α , β , and γ had been estimated for each student. Employing these estimates, computations were carried out to determine the time allocations that maximized the above equation. For the optimal policy, the predicted mean performance level of the class, \bar{P} , was 15% higher than a policy that allocated time equally to students (i.e., a policy in which $t_i = t_j$ for all i and j). This gain represents a substantial improvement; the drawback is that the variance of the P scores is roughly 15% greater than for the equal-time policy. This means that if one were interested primarily in raising the class average, one would have to let the rapid learners move ahead and progress far beyond the slow learners.

Although a time allocation that complies with Objective *a* did increase overall class performance, the correlated increase in variance leads one to believe that other objectives might be more bene-

ficial. For comparison, time allocations also were computed for Objectives *b*, *c*, and *d*. Figure 1 presents the predicted gain in \bar{P} as a percentage of \bar{P} for the equal-time policy. Objectives *b* and *c* yield negative gains, and so they should since their goal is to reduce variability, which is accomplished by holding back on the rapid learners and giving a lot of attention to the slower ones. The reduction in variability for these two objectives, when compared with the equal-time policy, is 12% and 10%, respectively. Objective *d*, which attempts to strike a balance between Objective *a* on the one hand and Objectives *b* and *c* on the other, yields an 8% increase in \bar{P} and yet reduces variability by 6%.

In view of these computations, Objective *d* seems to be preferred; it offers a substantial increase in mean performance while maintaining a low level of variability. As yet, this policy has not been implemented, so only theoretical results can be reported. Nevertheless, these examples yield differences that illustrate the usefulness of this type of analysis. They make it clear that the selection of an instructional objective should not be done in isolation, but should involve a comparative analysis of several alternatives taking into account more than one dimension of performance. For example, even if the principal goal is to maximize \bar{P} , it would be inappropriate in most educational situations to select a given objective over some other if it yielded only a small average gain while variability mushroomed.

Techniques of the sort presented above have been developed for other aspects of the CAI reading program. One of particular interest involves deciding for each student, on a week-by-week basis, how time should be divided between training in phonics and in sight-word identification (Chant & Atkinson, in press). However, these developments are not considered here; it is more useful to turn to another example of a quite different type.

OPTIMIZING THE LEARNING OF A SECOND-LANGUAGE VOCABULARY

The second example deals with learning a foreign language vocabulary. A similar example could be given from our work in initial reading, but this particular example has the advantage of permitting us to introduce the concept of learner-controlled

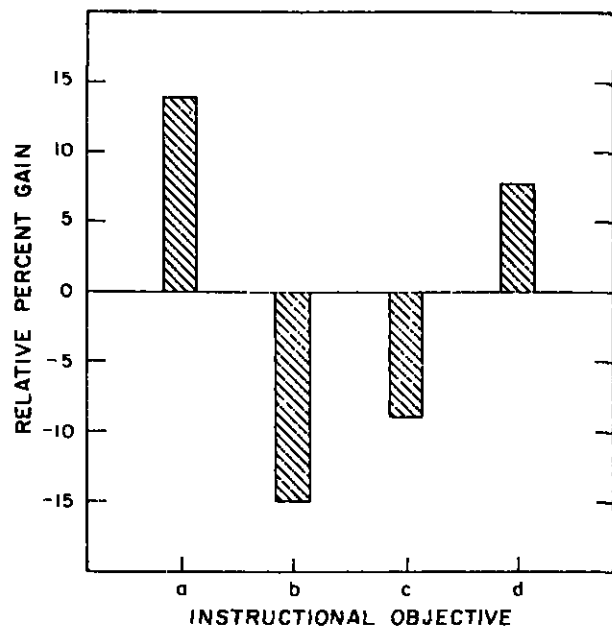

FIG. 1. Percentage gains in the mean value of P when compared with an equal-time policy for four policies each based on a different instructional objective.

instruction. In developing the example, I consider first some experimental work comparing three instructional strategies and only later explain the derivation of the optimal strategy.⁵

The goal is to individualize instruction so that the learning of a second-language vocabulary occurs at a maximum rate. The constraints imposed on the task are typical of a school situation. A large set of German-English items are to be learned during an instructional session that involves a series of trials. On each trial one of the German words is presented, and the student attempts to give the English translation; the correct translation then is presented for a brief study period. A predetermined number of trials is allocated for the instructional session, and after an intervening period of one week a test is administered over the entire vocabulary. The optimization problem is to formulate a strategy for presenting items during the instructional session so that performance on the delayed test will be maximized.

Three strategies for sequencing the instructional material are considered here. One strategy (designated the random-order strategy) is simply to cycle through the set of items in a random order; this

⁵ A detailed account of this research can be found in Atkinson (in press).

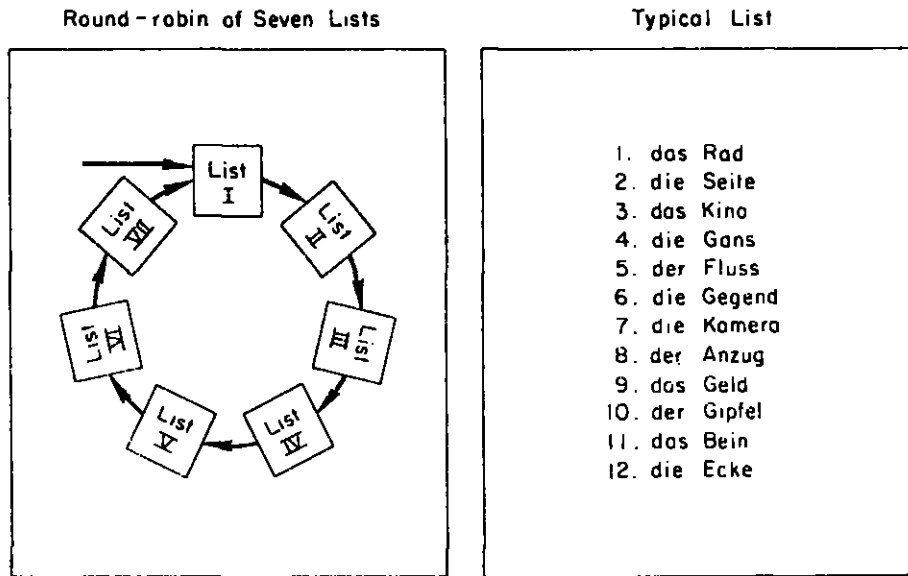

FIG. 2. Schematic representation of the round robin of display lists and an example of one such list.

strategy is not expected to be particularly effective, but it provides a benchmark against which to evaluate others. A second strategy (designated the learner-controlled strategy) is to let the student determine for himself how best to sequence the material. In this mode the student decides on each trial which item is to be tested and studied; the learner, rather than an external controller, determines the sequence of instruction. The third scheme (designated the response-sensitive strategy) is based on a decision-theoretic analysis of the instructional task. A mathematical model of learning that has provided an accurate account of vocabulary acquisition in other experiments is assumed to hold in the present situation. This model is used to compute, on a trial-by-trial basis, an individual student's current state of learning. Based on these computations, items are selected from trial to trial so as to optimize the level of learning achieved at the termination of the instructional session. The details of this strategy are complicated and can be discussed more meaningfully after the experimental procedure and results have been presented.

Instruction in this experiment is carried out under computer control. The students are required to participate in two sessions: an *instructional session* of approximately two hours and a briefer *delayed-test session* administered one week later. The delayed test is the same for all students

and involves a test over the entire vocabulary. The instructional session is more complicated. The vocabulary items are divided into seven lists, each containing 12 German words; the lists are arranged in a round-robin order (see Figure 2). On

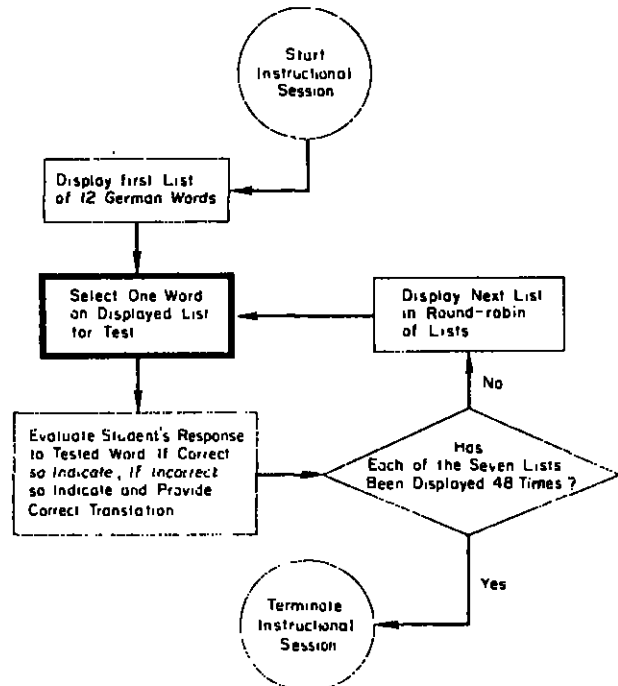

FIG. 3. Flow chart describing the trial sequence during the instructional session. The selection of a word for test on a given trial (box with heavy border) varied over experimental conditions.

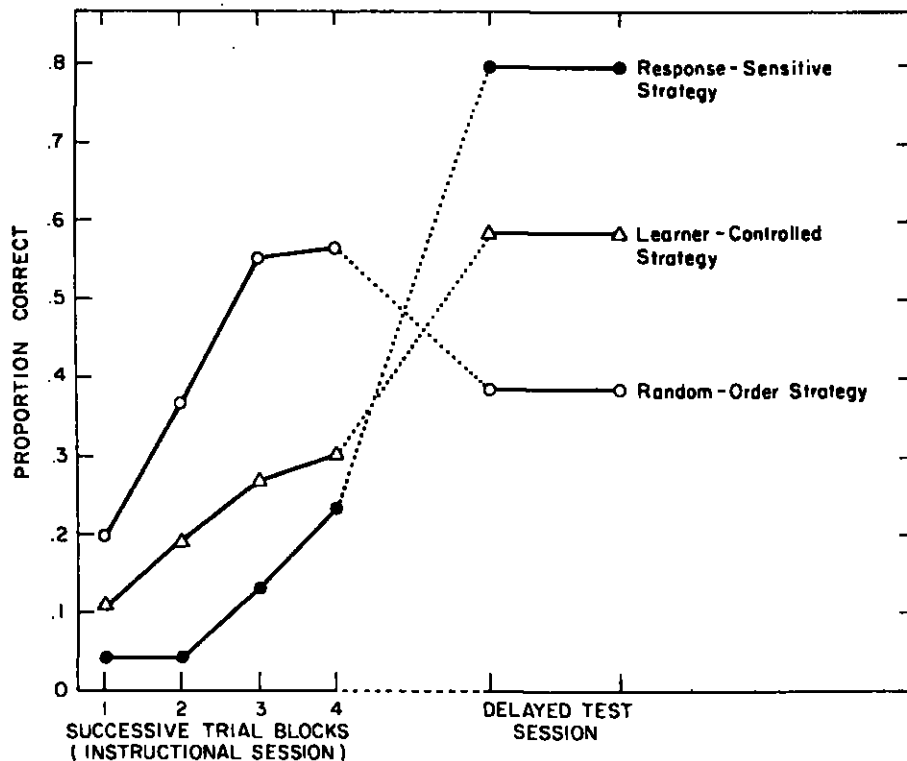

FIG. 4. Proportion of correct responses in successive trial blocks during the instructional session, and on the delayed test administered one week later.

each trial of the instructional session a list is displayed, and the student inspects it for a brief period of time. Then one of the items on the displayed list is selected for test and study. In the random-order and response-sensitive conditions, the item is selected by the computer. In the learner-controlled condition, the item is chosen by the student. After an item has been selected for test, the student attempts to provide a translation; then *feedback regarding the correct translation* is given. The next trial begins with the computer displaying the next list in the round robin, and the same procedure is repeated. The instructional session continues in this fashion for 336 trials (see Figure 3).

The results of the experiment are summarized in Figure 4. Data are presented on the left side of the figure for performance on successive blocks of trials during the instructional session; on the right side are results from the test session administered one week after the instructional session. Note that during the instructional session the probability of a correct response is highest for the random-order condition, next highest for the learner-controlled condition, and lowest for the response-sensitive condition. The results, however, are re-

versed on the delayed test. The response-sensitive condition is best by far with 79% correct; the learner-controlled condition is next with 58%; and the random-order condition is poorest at 38%. The observed pattern of results is expected. In the learner-controlled condition, the students are trying, during the instructional session, to test and study those items they do not know, and they should have a lower score than students in the random-order condition where testing is random and includes many items already mastered. The response-sensitive procedure also attempts to identify for test and study those items that have not yet been mastered and thus also produces a high error rate during the instructional session. The ordering of groups on the delayed test is reversed since now the entire set of words is tested; when all items are tested, the probability of a correct response tells how much of the list actually has been mastered. The magnitude of the effects observed on the delayed test is large and of practical significance.

Now that the effectiveness of the response-sensitive strategy has been established, I turn to a discussion of how it was derived. The strategy is

based on a model of vocabulary learning that has been investigated in the laboratory and has been shown to be quite accurate (Atkinson, in press; Atkinson & Crothers, 1964). The model assumes that a given item is in one of three states (P, T, and U) at any moment in time. If the item is in State P, then its translation is known, and this knowledge is "relatively" permanent in the sense that the learning of other vocabulary items will not interfere with it. If the item is in State T, then it is also known but on a "temporary" basis; in State T, other items can give rise to interference effects that cause the item to be forgotten. In State U, the item is not known, and the student is unable to provide a translation. Thus, in States P and T a correct translation is given with probability 1, whereas in State U the probability is 0.

When a test and study occur on a given item, the following transition matrix describes the possible change in state from the onset of the trial to its termination:

$$A = \begin{matrix} & \begin{matrix} P & T & U \end{matrix} \\ \begin{matrix} P \\ T \\ U \end{matrix} & \begin{bmatrix} 1 & 0 & 0 \\ a & 1-a & 0 \\ bc & (1-b)c & 1-c \end{bmatrix} \end{matrix}$$

Rows of the matrix represent the state of the item at the start of the trial, and the columns represent its state at the end of the trial. On a trial when some other item is presented for test and study, a transition in the learning state of the original item also may take place; namely, forgetting is possible in the sense that if the item is in State T, it may transit into State U. This forgetting can occur only if the student makes an error on the other item; in that case the transition matrix applied to the original item is as follows:

$$F = \begin{matrix} & \begin{matrix} P & T & U \end{matrix} \\ \begin{matrix} P \\ T \\ U \end{matrix} & \begin{bmatrix} 1 & 0 & 0 \\ 0 & 1-f & f \\ 0 & 0 & 1 \end{bmatrix} \end{matrix}$$

To summarize, consider the application of Matrices A and F to some specific item on the list; when the item itself is presented for test and study, transition Matrix A is applied; when some other item is presented that elicits an error, then Matrix F is applied. The above assumptions provide a complete account of the learning process. The parameters in Matrices A and F measure the dif-

ficulty level of a German-English pair and vary across items. On the basis of prior experiments, numerical estimates of these parameters exist for each of the items used in the experiment.

As noted earlier, the formulation of a strategy requires that one be precise about the quantity to be maximized. For the present task, the goal is to maximize the number of items correctly translated on the delayed test. To do this, a theoretical relationship must be specified between the state of learning at the end of the instructional session and performance on the delayed test. The assumption made here is that only those items in State P at the end of the instructional session will be translated correctly on the delayed test; an item in State T is presumed to be forgotten during the intervening week. Thus, the problem of maximizing delayed-test performance involves, at least in theory, maximizing the number of items in State P at the termination of the instructional session.

Having numerical values for parameters and knowing the student's response history, it is possible to estimate his current state of learning.⁶ Stated more precisely, the learning model can be used to derive equations and, in turn, compute the probabilities of being in States P, T, and U for each item at the start of trial n , conditionalized on the student's response history up to and including trial $n-1$. Given numerical estimates of these probabilities, a strategy for optimizing performance is to select that item for presentation (from the current display list) that has the greatest probability of moving into State P if it is tested and studied on the trial. This strategy has been termed the one-stage optimization procedure because it looks ahead one trial in making decisions. The true optimal policy (i.e., an N -stage procedure) would consider all possible item-response sequences for the remaining trials and select the next item so as to maximize the number of items in State P at the termination of the instructional session. For the present case, the N -stage policy cannot be applied

⁶ The student's response history is a record (for each trial) of the item presented and the response that occurred. It can be shown that a sufficient history exists which contains only the information necessary to estimate the student's current state of learning; the sufficient history is a function of the complete history and the assumed learning model. For the model considered here, the sufficient history is fairly simple but cannot be readily described without extensive notation.

because the necessary computations are too time consuming even for a large computer. Fortunately, Monte Carlo studies indicate that the one-stage policy is a good approximation to the optimal strategy for a variety of Markov learning models; it was for this reason, as well as the relative ease of computing, that the one-stage procedure was employed.⁷ The computational procedure described above was implemented on the computer and permitted decisions to be made on-line for each student on a trial-by-trial basis:

The response-sensitive strategy undoubtedly can be improved on by elaborating the learning model. Those familiar with developments in learning theory will see a number of ways of introducing more complexity into the model and thereby increasing its precision. I do not pursue such considerations here, however, since my reason for presenting the example was not to theorize about the learning process but rather to demonstrate how a simple learning model can be used to define an instructional procedure.

CONCLUDING REMARKS

Hopefully, these two examples illustrate the steps involved in developing an optimal strategy for instruction. Both examples deal with relatively simple problems and thus do not indicate the range of developments that have been made or that are clearly possible. It would be a mistake, however, to conclude that this approach offers a solution to the problems facing education. There are some fundamental obstacles that limit the generality of the work.

The major obstacles may be identified in terms of the four criteria that were specified as prerequisites for an optimal strategy. The first criterion concerns the formulation of learning models. The models that now exist are totally inadequate to explain the subtle ways by which the human organism stores, processes, and retrieves information. Until there is a much deeper understanding of learning, the identification of truly effective strategies will not be possible. However, an all-inclusive theory of learning is not a prerequisite for the development of optimal procedures. What is needed instead is a model that captures the es-

sential features of that part of the learning process being tapped by a given instructional task. Even models that may be rejected on the basis of laboratory investigation can be useful in deriving instructional strategies. The two learning models considered in this article are extremely simple, and yet the optimal strategies they generate are quite effective. My own preference is to formulate as complete a learning model as intuition and data will permit and then to use that model to investigate optimal procedures; when possible the learning model will be represented in the form of mathematical equations but otherwise as a set of statements in a computer-simulation program. The main point is that the development of a theory of instruction cannot progress if one holds the view that a complete theory of learning is a prerequisite. Rather, advances in learning theory will affect the development of a theory of instruction, and conversely the development of a theory of instruction will influence research on learning.

The second criterion for deriving an optimal strategy requires that admissible instructional actions be specified clearly. The set of potential instructional inputs places a definite limit on the effectiveness of the optimal strategy. In my opinion, powerful instructional strategies must necessarily be adaptive; that is, they must be sensitive on a moment-to-moment basis to a learner's unique response history. My judgment on this matter is based on limited experience, restricted primarily to research on teaching initial reading. In this area, however, the evidence seems to be absolutely clear: the manipulation of method variables accounts for only a small percentage of the variance when not accompanied by instructional strategies that permit individualization. Method variables like the modified teaching alphabet, oral reading, the linguistic approach, and others undoubtedly have beneficial effects. However, these effects are minimal in comparison to the impact that is possible when instruction is adaptive to the individual learner. Significant progress in dealing with the nation's problem of teaching reading will require individually prescribed programs, and sophisticated programs will necessitate some degree of computer intervention either in the form of CAI or computer-managed instruction. As a corollary to this point, it is evident from observations of students in our CAI reading program that the more effective the adaptive strategy the less important are extrinsic

⁷ For a discussion of one-stage and *N*-stage policies and Monte Carlo studies comparing them, see Groen and Atkinson (1966), Calfee (1970), and Laubsch (1970).

motivators. Motivation is a variable in any form of learning, but when the instructional process is truly adaptive the student's progress is sufficient reward in its own right.

The third criterion for an optimal strategy deals with instructional objectives, and the fourth with cost-benefit measures. In the analyses presented here, it was tacitly assumed that the curriculum material being taught is sufficiently beneficial to justify allocating time to it. Further, in both examples the costs of instruction were assumed to be the same for all strategies. If the costs of instruction are equal for all strategies, they may be ignored and attention focused on the comparative benefits of the strategies. This is an important point because it greatly simplifies the analysis. If both costs and benefits are significant variables, then it is essential that both be estimated accurately. This is often difficult to do. When one of these quantities can be ignored, it suffices if the other can be assessed accurately enough to order the possible outcomes. As a rule, both costs and benefits must be weighed in the analysis, and frequently subtopics within a curriculum vary significantly in their importance. In some cases, whether or not a certain topic should be taught at all is the critical question. Smallwood (1971) has treated problems similar to the ones considered in this article in a way that includes some of these factors in the structure of costs and benefits.

My last remarks deal with the issue of learner-controlled instruction. One way to avoid the challenge and responsibility of developing a theory of instruction is to adopt the view that the learner is the best judge of what to study, when to study, and how to study. I am alarmed by the number of individuals who advocate this position despite a great deal of negative evidence. Do not misinterpret this remark. There obviously is a place for the learner's judgments in making instructional decisions. In several CAI programs that I have helped develop, the learner plays an important role in determining the path to be followed through the curriculum. However, using the learner's judgment as one of several items of information in making an instructional decision is quite different from proposing that the learner should have complete control. My data, and the data of others, indicate that the learner is not a particularly effective decision maker. Arguments against learner-controlled programs are unpopular in the present climate of

opinion, but they need to be made so that one will not be seduced by the easy answer that a theory of instruction is not required because "who can be a better judge of what is best for the student than the student himself."

This article illustrates the steps involved in deriving an optimal strategy and their implications for a theory of instruction. I want to emphasize a point made at the outset—namely, that the approach is only one of many that needs to be pursued. Obviously the main obstacle is that adequate theories as yet do not exist for the learning processes that we most want to optimize. However, as the examples indicate, analyses based on highly simplified models can be useful in identifying problems and focusing research efforts. It seems clear that this type of research is a necessary component in a program designed to develop a general theory of instruction.

REFERENCES

- ATKINSON, R. C. Optimizing the learning of a second-language vocabulary. *Journal of Experimental Psychology*, in press.
- ATKINSON, R. C., & CROTHERS, E. J. A comparison of paired-associate learning models having different acquisition and retention axioms. *Journal of Mathematical Psychology*, 1964, 1, 285-315.
- ATKINSON, R. C., & FLETCHER, J. D. Teaching children to read with a computer. *The Reading Teacher*, 1972, 25, 319-327.
- ATKINSON, R. C., & PAULSON, J. A. An approach to the psychology of instruction. *Psychological Bulletin*, 1972, 78, 49-61.
- BELLMAN, R. *Adaptive control processes*. Princeton: Princeton University Press, 1961.
- BRUNER, J. S. *Toward a theory of instruction*. Cambridge: Harvard University Press, 1966.
- CALFEE, R. C. The role of mathematical models in optimizing instruction. *Scientia: Revue Internationale de Synthèse Scientifique*, 1970, 105, 1-25.
- CARROLL, J. B. A model of school learning. *Teachers College Record*, 1963, 64, 723-733.
- CHANT, V. G., & ATKINSON, R. C. Optimal allocation of instructional effort to interrelated learning strands. *Journal of Mathematical Psychology*, in press.
- CROTHERS, E. J., & SUPPES, P. *Experiments in second-language learning*. New York: Academic Press, 1967.
- DEAR, R. E., SILBERMAN, H. F., ESTAVAN, D. P., & ATKINSON, R. C. An optimal strategy for the presentation of paired-associate items. *Behavioral Science*, 1967, 12, 1-13.
- GAGNÉ, R. M. *The conditions of learning*. (2nd ed.) New York: Holt, Rinehart & Winston, 1970.
- GROEN, G. J., & ATKINSON, R. C. Models for optimizing

- the learning process. *Psychological Bulletin*, 1966, 66, 309-320.
- HILGARD, E. R. *Theories of learning*. New York: Appleton-Century-Crofts, 1948.
- HILGARD, E. R. (Ed.) *Theories of learning and instruction: The sixty-third yearbook of the National Society for the Study of Education*. Chicago: University of Chicago Press, 1964.
- KALMAN, R. E., FALB, P. L., & ARBIB, M. A. *Topics in mathematical system theory*. New York: McGraw-Hill, 1969.
- LAUBSCH, J. H. Optimal item allocation in computer-assisted instruction. *IAG Journal*, 1970, 3, 295-311.
- PASK, G., & SCOTT, B. C. E. Learning and teaching strategies in a transformational skill. *British Journal of Mathematical and Statistical Psychology*, 1971, 24, 205-229.
- SEIDEL, R. J., & HUNTER, H. G. The application of theoretical factors in teaching problem-solving by programmed instruction. *International Review of Applied Psychology*, 1970, 19, 41-81.
- SKINNER, B. F. *The technology of teaching*. New York: Appleton-Century-Crofts, 1968.
- SMALLWOOD, R. D. *A decision structure for teaching machines*. Cambridge: M.I.T. Press, 1962.
- SMALLWOOD, R. D. The analysis of economic teaching strategies for a simple learning model. *Journal of Mathematical Psychology*, 1971, 8, 285-301.

12 Mnemotechnics in Second-Language Learning

RICHARD C. ATKINSON *Stanford University*

For some time I have been involved in efforts to develop computer-controlled systems for instruction. One such effort has been a computer-assisted-instruction (CAI) program for teaching reading in the primary grades (Atkinson, 1974) and another for teaching computer science at the college level (Atkinson, in press). The goal has been to use psychological theory to devise optimal instructional procedures—procedures that make moment-by-moment decisions based on the student's unique response history. To help guide some of the theoretical aspects of this work, research has also been done on the restricted but well-defined problem of optimizing the teaching of a foreign language vocabulary. This is an area in which mathematical models provide an accurate description of learning, and these models can be used in conjunction with the methods of control theory to develop precise algorithms for sequencing instruction among vocabulary items. Some of this work has been published, and those who have read about it know that the optimization schemes are quite effective—far more effective than procedures that permit the learner to make his own instructional decisions (Atkinson, 1972a, 1972b; Atkinson & Paulson, 1972).

In conducting these vocabulary learning experiments, I have been struck by the incredible variability in learning rates across subjects. Even Stanford University students, who are a fairly select sample, display impressively large between-subject differences. These differences may reflect differences in fundamental abilities, but it is easy to demonstrate that they also depend on the strategies that subjects bring to bear on the task. Good learners can introspect with ease about a “bag of tricks” for learning vocabulary items, whereas poor

learners are incredibly inept when trying to describe what they are doing.

These subject reports, combined with our own intuitions, led Michael Raugh and me to carry out a series of studies on mnemonic techniques for vocabulary learning. Michael Raugh is a computer scientist and mathematician by training, but throughout his life he has been intrigued by mnemonics of one sort or another; he was the one who convinced me that this line of research was worth pursuing.

The Keyword Method

Our initial experiments were not as successful as we had anticipated, but they did help us to develop and refine a mnemonic aid for vocabulary learning that we have dubbed the *keyword method*. It is this method and related experiments that are discussed in this article. By a keyword we mean an English word that sounds like some part of the foreign word. In general, the keyword has no relationship to the foreign word except for the fact that it is similar in sound. The keyword method divides vocabulary learning into two stages. The first stage requires the subject to associate the spoken foreign word with the keyword, an association that is formed quickly because of acoustic similarity. The second stage requires the subject to form a mental image of the keyword “interacting” with the English translation; this stage is comparable to a paired-associate procedure involving the learning of unrelated English words. To summarize, the keyword method can be described as a chain of two links connecting a foreign word to its English translation. The spoken foreign word is linked to the keyword by a similarity in sound (what I call the *acoustic link*), and in turn the keyword is linked to the English translation by a mental image (what I call the *imagery link*).

Let us consider a few examples from Spanish and Russian, the two languages that we have used for most of our research on the keyword method. In Spanish the word *caballo* (pronounced something

This article is based on the presidential address presented to Division 3 at the meeting of the American Psychological Association, New Orleans, September 1974.

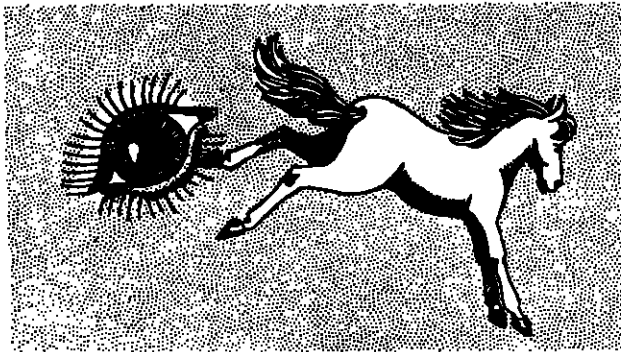

CABALLO — eye — HORSE

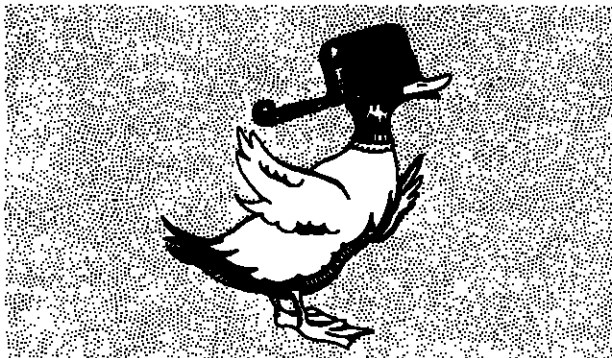

PATO — pot — DUCK

Figure 1. Two illustrations of how mental images might be used to associate a spoken Spanish word with its English translation.

like "cob-eye-yo") means horse. The pronunciation of the Spanish word contains a sound that resembles the English word *eye*. Employing the English word *eye* as the keyword, one might form a mental image of something like a cyclopean eye winking in the forehead of a horse, or a horse kicking a giant eye. As another example, the Spanish word for duck is *pato* (pronounced something like "pot-o"). Using the English word *pot* as the keyword, one could image a duck hiding under an overturned flower pot with its webbed feet and tufted tail sticking out below.

In Russian the word *zvonók*¹ means bell. Its pronunciation is somewhat like "zvahn-oak," with emphasis on the last syllable, and it contains a sound that resembles the English word *oak*. Employing the English word *oak* as the keyword, one

¹ Russian words are presented using a standard transliteration of the Cyrillic alphabet into the Roman alphabet; stress is marked.

could imagine something like an oak with little brass bells for acorns, or an oak in a belfry, or perhaps an oak growing beneath a giant bell jar. As another example, the Russian word for "building" (*zdánie*) is pronounced somewhat like "zdawn-yeh" with emphasis on the first syllable. Using *dawn* as the keyword, one could imagine the pink light of dawn reflected in the windows of a tall building. Additional Russian examples are given in Table 1.

One procedure for applying the keyword method is to present the subject with a series of foreign words. As each foreign word is pronounced, its keyword and the English translation are displayed. During the presentation of each item the subject must associate the sound of the foreign word to the keyword, and at the same time generate a mental image relating the keyword to the English translation. Because of the similarity in sounds, the acoustic link is formed easily; the imagery link is like learning to associate a pair of unrelated English words by using imagery as a mnemonic aid. One qualification must be added to the above description. The keyword need not always be a single word; for some items it may be a brief phrase if that phrase is particularly salient. What this means for a polysyllabic foreign word is that anything from a monosyllable to a longer word or even a short phrase that spans the whole foreign word might be used as the keyword.

We have been conducting experiments for almost two years on one or another aspect of the keyword

TABLE 1

Sixteen Items from the Russian Vocabulary with Related Keywords

Russian	Keyword	Translation
STRANÁ	[strawman]	COUNTRY
LINKÓR	[Lincoln]	BATTLESHIP
DÉLO	[jello]	AFFAIR
ZÁPAD	[zap it]	WEST
TOLPÁ	[tell pa]	CROWD
ROT	[rut]	MOUTH
GORÁ	[garage]	MOUNTAIN
DURÁK	[two rocks]	FOOL
ÓSEN'	[ocean]	AUTUMN
SÉVER	[saviour]	NORTH
DYM	[dim]	SMOKE
SELÓ	[seal law]	VILLAGE
GOLOVÁ	[Gulliver]	HEAD
TJÓTJA	[Churchill]	AUNT
PÓEZD	[poised]	TRAIN
CHELOVÉK	[chilly back]	PERSON

method. Let me describe in some detail one of the experiments using a Russian vocabulary and then use it as a springboard for discussing other results.²

In this experiment, subjects learned a vocabulary of 120 Russian words; the total vocabulary was divided into three comparable 40-word subvocabularies for presentation on separate days. The experiment was run under computer control and involved two independent groups of subjects—a keyword group and a control group. The computer presented prerecorded Russian words through headphones; keyword and English translations were presented on a cathode-ray-tube (CRT) display; and the subject entered his responses into the computer by means of a typewriter keyboard. The experiment began with an introductory session during which subjects were familiarized with the equipment and given some instruction in Russian phonics; subjects in the keyword group were also given instructions on the keyword method. On each of the following three days, one of the subvocabularies was presented for a cycle of three study/test trials. The study part of a trial consisted of a run through the subvocabulary; each Russian word was pronounced three times and simultaneously its English translation was displayed on the CRT. For the keyword subjects, the keyword, set off in brackets, was also displayed on the CRT. The test phase of a trial was exactly the same for both groups. It consisted of a run through the subvocabulary in which each Russian word was pronounced, and the subject had 15 seconds to type the translation; no feedback was given. A comprehensive test covering the entire vocabulary of 120 items was given on the fifth day of the experiment. Without warning, subjects were called back six weeks later for a second comprehensive test.

Figure 2 presents the probability of a correct response over test trials for each of the three instructional sessions. The keyword group in all cases obtained superior scores; in fact, each day the keyword group learned more words in two study trials than the control group did in three trials.

Table 2 gives results for the comprehensive test and for the delayed comprehensive test given six weeks later. Results are presented for the total

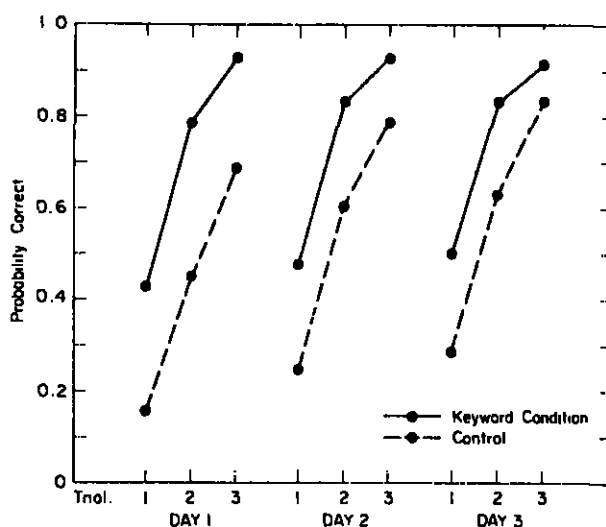

Figure 2. Probability of a correct response over test trials on Day 1, Day 2, and Day 3.

vocabulary and also for the subvocabularies learned during each of the three instruction sessions. I am not commenting on the results as a function of the day on which items were studied—the pattern of the data is what would be expected. The important observation is in the bottom row of the table. Note that for the total vocabulary the keyword group recalled 72% of the items on the comprehensive test, whereas the control group recalled only 46%. Six weeks later the keyword group recalled 43% of the words and the control group 28%. The ratio of control to experimental scores is .64 on the comprehensive test and .65 on the delayed comprehensive test. These are indeed large differences and highly significant statistically.

TABLE 2

Probability of a Correct Response on the Comprehensive and Delayed Comprehensive Tests as a Function of Experimental Treatment and Study Order

Vocabulary	Comprehensive test		Delayed comprehensive test	
	Keyword	Control	Keyword	Control
First subvocabulary	.64	.33	.48	.25
Second subvocabulary	.70	.43	.44	.30
Third subvocabulary	.81	.63	.36	.29
Total vocabulary	.72	.46	.43	.28

² An account of this and other experiments using a Russian vocabulary can be found in Atkinson and Raugh (1975).

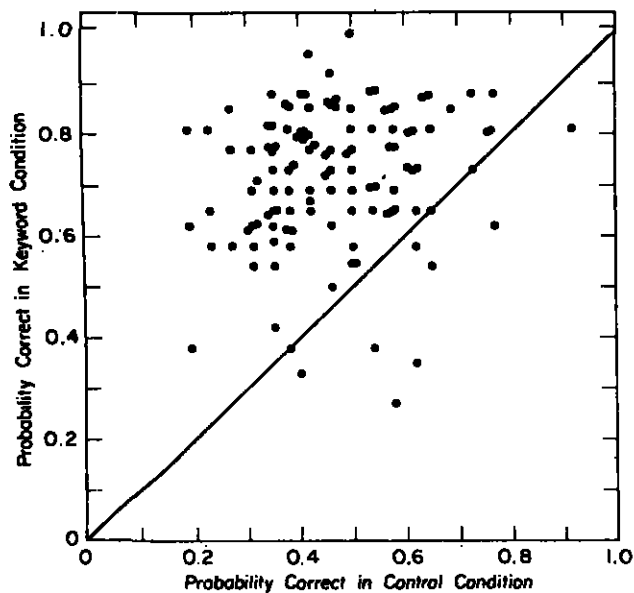

Figure 3. Scatterplot of performance levels on the comprehensive test. (Each point corresponds to an item; the ordinate gives the performance level when the item was studied in the keyword condition, and the abscissa its value when studied in the control condition.)

Figure 3 presents data on the comprehensive test in which each point refers to one of the vocabulary items. The value on the y-axis denotes the keyword group's performance on a word, and the x-axis the control group's performance. Points above the diagonal are for words that were learned best in the keyword condition; below the diagonal are the words learned best in the control condition. Of the 120 words, only 8 were learned better in the control condition. As we shall see later, the poor performance on certain items in the keyword condition can be predicted based on independent estimates of the ease of learning either the acoustic or the imagery link.

This experiment is one in a series of studies that have demonstrated the effectiveness of the keyword method. Our most dramatic demonstration involved a similar experimental design using a Spanish vocabulary.³ The principal difference was that the control group was told to use a rote rehearsal procedure when studying items. None of the control subjects objected to the rehearsal procedure or found it unnatural, but on a compre-

³ For a detailed account of this experiment and other work on the keyword method using a Spanish vocabulary, see Raugh and Atkinson (1975).

hensive test they recalled only 28% of the words. The keyword group recalled 88%. In the Russian experiment described above, the control subjects were highly motivated to do well and were encouraged to use whatever strategies they thought would be most effective. The observed difference between the keyword and control subjects was not a matter of motivation; both groups were highly motivated and very attentive to the task.

Questions about the Keyword Method

Let me now turn to some questions raised by the keyword method and provide what answers I can based on our other experiments.

Question: Should the experimenter supply the keyword or can the subject generate his own more effectively? The answer to this question is somewhat complicated, but, in general, our results indicate that providing the keywords for the subject is best. In a Russian experiment similar to the one described earlier, all subjects were given extensive instruction in the keyword method. During the actual experiment half of the items were presented for study with a keyword, whereas no keyword was provided for the other items. The subjects were instructed to use the keyword method throughout. When a keyword was provided they were to use that word; when no keyword was provided they were to generate their own. On the comprehensive test the subjects were significantly better on the keyword-supplied items than on the others, but the size of the difference did not approximate the difference observed in the last experiment. Instruction in the keyword method is helpful, but somewhat more so if the experimenter also supplies the keywords.

It should be kept in mind that these results are for subjects who have not had previous training in Russian. It may well be that supplying the keyword is most helpful to the beginner and becomes less useful as the subject gains familiarity with the language and the method. We have run another experiment in which subjects were instructed in the keyword method, but during study of an item they received a keyword only if they requested it by pressing an appropriate key on their computer console; we call this variant of the keyword method the *free-choice procedure*. When an item was initially presented for study, a keyword was requested 89% of the time; on subsequent presentations of the item, the subject's likeli-

hood of requesting the keyword depended upon whether he missed the item on the preceding test trial. If he missed it, his likelihood of requesting the keyword was much higher than if he had been able to supply the correct translation. Otherwise, however, the likelihood of requesting a keyword was remarkably constant from one day of the experiment to the next: that is, there was no decrease in keyword requests over the three study days, where on each day the subject learned a new vocabulary. It is interesting to note that performance on the comprehensive test for the free-choice group was virtually identical to the performance of a group that was automatically given a keyword on all trials. Not much of a difference would be expected between the two groups because the free-choice subjects had such a high likelihood of requesting keywords. Nevertheless, these findings suggest that the free-choice mode may be the preferred one. In the free-choice procedure, subjects reported that they generally wanted a keyword but that there were occasional items that seemed to stand out and could be mastered immediately without the aid of a keyword. In summary, the answer to the question is that subjects appear to be less effective when they must generate their own keywords; but results from the free-choice procedure indicate that keywords need only be supplied when requested by the subject.

Question: Does supplying the imagery link for the subject facilitate learning? The answer to this question seems to be no—it is better to have the subject generate his own image linking the keyword to the English translation. We have tried, for example, to supply the imagery link by using cartoonlike drawings and also by presenting brief phrases or sentences linking the keyword and English translation in a meaningful way. Although these experiments were more in the nature of pilot studies, results indicated that subjects performed best when required to generate their own imagery link.

Question: When a foreign word is presented, does the time to retrieve its English translation depend on the method of learning? Unfortunately, I can report on only one study that bears on this issue. A study-test procedure was used in which the subjects alternated between studying the vocabulary list and then being tested on the list. The tests were the same for all items, but two different study procedures were used. For half of the items a keyword was provided during study and subjects were instructed to learn these items by the keyword

method; for the other half of the items no keyword was provided and subjects were told to use only rote rehearsal. Subjects were run for a large number of trials. As would be expected, the keyword items were learned at a faster rate than were the rote-rehearsal items, but eventually performance was perfect for both groups. Our interest was in the speed of response. In general, the reaction times correlated very highly with the probability of a correct response, and otherwise did not depend on the method of learning. At asymptote, reaction times were the same for both groups of items. More work needs to be done using response-time measures. We need to extend our experiments over longer periods of time, and also determine if context effects that occur when one is actually trying to use a language influence retrieval processes. These are difficult questions to answer, but available evidence indicates that the method of learning does not affect retrieval times, particularly once an item has been thoroughly mastered.

Question: Are the imagery instructions critical in the keyword method, or can the subject do equally well when told to associate the keyword and English translation by generating a meaningful sentence connecting the two words? In paired-associate learning experiments in which both the stimulus and response are unrelated English words, Anderson and Bower (1973, p. 456) reported that imagery instructions yielded the same results as sentence-generation instructions. Their findings are not in accord with our own. Imagery instructions have a significant advantage over sentence-generation instructions when using the keyword method (73% versus 64%). We are not sure why our results do not accord with those reported by Anderson and Bower, but there are enough differences between the experimental situations that I do not consider it critical. Let me simply note that the imagery instructions are more effective in our situation. The reason, I believe, is a matter of elaboration. After being tested on an item, the subject often realizes that his initial image was not particularly effective; on the next study trial he elaborates and adds details to that image to make it more salient. If a sentence is generated on the initial study and it proves to be a poor mediator, the subject would not be able to elaborate it except by making the sentence longer and more complex—a procedure that intuitively does not seem particularly effective. From this viewpoint, imagery and sentence-generation instructions might be equally good for easy associations,

but imagery would be better as the task becomes more difficult.

Our present instructions for the keyword method in their most general form ask subjects to picture an imaginary interaction between the keyword and the English translation, but we also state that if an image does not come quickly to mind, they may want to try to relate the two words by generating a phrase or sentence. Subjects report that there are items where a sentence pops into mind and seems to be the most natural way of forming the association. The distinction between imagery and sentence generation may be debated on theoretical grounds, but most of our subjects report such differences when introspecting about their thought processes.

Question: How useful is the keyword method if the subject is asked to retrieve the foreign word when given its English translation? We have run one experiment that bears on this question using a Spanish vocabulary. One group of subjects learned by the keyword method and another by rote rehearsal. During learning, subjects studied and were tested on only the forward associations, that is, going from the foreign word to the English translation. All subjects were brought to the same criterion on the forward associations, which, of course, required fewer trials for the keyword group than for the rote-rehearsal group. Immediately thereafter they were tested on the backward associations—they were given the English word and asked to produce the foreign word. Judges blind to the experimental treatments evaluated the responses. On the backward associations the keyword subjects had a score 19% above that of the rote-rehearsal subjects. Even though the forward associations had been learned to the same criterion, the keyword group was significantly better on the backward associations.

Effectiveness of a Keyword

Let me now turn to a somewhat different issue. Data on individual items learned by the keyword method indicate that some keywords are clearly better than others. If an item does particularly poorly in one experiment, its performance can usually be improved in the next experiment by selecting a new keyword. Those familiar with the literature on word variables such as concreteness, imagery, and frequency will not be at a loss for possible explanations. We have examined some likely hypotheses in an article soon to be published,

but time does not permit me to review that work here. From a practical viewpoint, the important remark is that keywords should be selected using empirical criteria. When there is not enough time to make empirical determinations, a committee of individuals familiar with the language should select the keywords rather than having one person make the decisions. Experience indicates that individual experimenters can come up with some pretty bizarre keywords that work for them but for no one else. A committee approach seems to protect against this problem.

One empirical procedure for evaluating keywords involves having a group of subjects learn only the foreign-word-to-keyword link, and an independent group learn only the keyword-to-translation link. We have conducted such an experiment with the 120-word Russian vocabulary used in the study that I first described. For each item, an estimation was obtained for the probability of a correct response averaged over the first two test trials. Let me denote that probability as A for the group learning the acoustic link and I for the group learning the imagery link. Finally, let K be the probability of a correct response averaged over the first two test trials for an item in the keyword group in our original experiment. It turns out that the product of $A \times I$ (i.e., Probability of Knowing the Acoustic Link \times Probability of Knowing the Imagery Link) is a fairly good predictor of performance in the keyword condition. Table 3 displays the correlation matrix using rank-order correlations. Note that the correlation between A and I is near zero, indicating that the learning of the acoustic link is not related to the learning of the imagery link. Note also that the correlation between the product $A \times I$ and the variable K is .73; the product is a fairly accurate predictor of performance in the keyword condition. The C entry in the table is comparable to the K entry, except that it denotes performance for the control

TABLE 3
Rank-Order Correlation Matrix for the Variables $A \times I$, K , C , A , and I

Measure	1	2	3	4	5
$A \times I$ (1)	1.0	.73	.39	.68	.71
K (2)		1.0	.38	.53	.49
C (3)			1.0	.33	.19
A (4)				1.0	.02
I (5)					1.0

group in our original experiment. Note that *C* is not nearly as good a predictor of *K* as is the product of $A \times I$. These results suggest that initial learning in the keyword condition can be interpreted as the learning of two independent links—the acoustic link and the imagery link.

Early in the learning process, the memory structure for a given item involves only these two independent links; however, with continued practice a third link is formed directly associating the foreign word with its English translation. It is this direct link that sustains performance once an item is highly practiced; the subject may still access the keyword, but the retrieval process of the direct association is so rapid that the subject only recalls the keyword under special circumstances, such as when he is consciously trying to do so or when he has a retrieval failure in the main process. But the less direct chain of the acoustic and imagery links has the advantage that it is easily learned and provides a crutch, if you will, for the subject as he learns the direct association—it facilitates the learning of the direct association by insuring that the subject is able to recall items early in the learning process.

Applications of the Keyword Method

In deciding whether to use the keyword method, several problems need to be considered. One problem is that keywords might interfere with correct pronunciation. Our experiments do not deal with this issue, but we have discussed it with experts on language instruction. Opinions vary, but most believe that the keyword method may well facilitate, rather than interfere with, pronunciation. One reason is that the keyword method has features in common with the method of “contrasting minimal pairs”—a standard technique for teaching the phonetics of a foreign language. But even if there were some interference, the keyword method might still be warranted if the rate of vocabulary acquisition was improved substantially.

Another problem to be considered is whether items learned using the keyword method take longer to be recalled. We described some experimental results indicating that asymptotic response times are independent of the method of learning. These results reinforce our experiences with the keyword method. Once an item has been thoroughly learned, it comes to mind immediately, and rarely is the subject aware of the related keyword unless he makes a conscious effort to recall it. What evi-

dence we have indicates that the keyword does not slow down or otherwise interfere with the retrieval process.

Our experimental results convinced us and members of the Slavic Languages Department at Stanford that the keyword method needed to be evaluated in an actual teaching situation. Accordingly, we developed a vocabulary-learning program designed to supplement the second-year course in Russian. The program operates under computer control and follows a procedure similar to one used in our experiments. When a word is presented for study it is pronounced by the computer and simultaneously the English translation is displayed on a CRT. The student is free to study the item any way he pleases, but if he presses a button on his console the keyword is displayed instantly on the CRT. In our first evaluative efforts, students in the second-year course were run on the program for four 40-minute sessions per week over a 10-week period. Each week a new vocabulary of approximately 75 words was presented. The words were classifiable as either nouns, verbs, or adjectives; only the imperfective form of verbs was used. The analyses of these data are still incomplete, but several remarks can be made at this time. First, we experienced no difficulty in selecting keywords for such a large vocabulary and foresee no problems in generating keywords for even larger vocabularies. Second, students were enthusiastic about the procedure throughout the 10 weeks, and in interviews at the end of the program voiced the opinion that the keyword method was very helpful. When the computer program presented a word for the first time, students were likely to request a keyword; the request rate was about 72% during the first week and rose steadily over the 10 weeks to about 83% for the last week. In interviews at the end of the program, students reported that the keyword method worked best for nouns, less well for verbs, and least well for adjectives. However, on a delayed test over the entire vocabulary, subjects did equally well on nouns and verbs, with somewhat poorer performance on adjectives.

We plan to make several improvements in the vocabulary-learning program and to reevaluate it more extensively in the near future. But the first large-scale application of the keyword method proved to be very encouraging and was well received by the Slavic-language faculty. For Russian, more so than many languages, the mastery of a basic vocabulary is incredibly difficult. One of the instructors that we have worked with has

told me that he believes the major obstacle in teaching Russian is not learning the grammar but in mastering a sufficient vocabulary so that a student can engage in meaningful conversations and read materials other than the textbook.

Concluding Remarks

In recent years there has been a revival of interest in mnemonic techniques. Introductory psychology textbooks—mine included—that did not mention the topic a decade ago now give it a great deal of prominence. Some classroom demonstrations of mnemonics are indeed impressive; but beyond impressing one's students, it is difficult to identify instructional situations in which mnemonic aids are truly useful. In Cicero's time these aids may have had some usefulness, but in this age of cheap memory devices (including pencil and paper) the value of mnemonic aids is questionable. An exception may be the keyword method. If our instructional applications prove as successful as the experimental work, then the keyword method and variants thereof deserve a role in language-learning curricula. It may prove useful only in the early stages of learning a language and more so for some languages than others. But there is the promise that the poorer learners receive special benefits, particularly if given some coaching along the way. One limitation of our experiments is that we only provide students with written instructions in the keyword method, and thereafter they are on their own. In an ideal situation, students should be coached by an expert until they are proficient in the skill. Imagine trying to learn tennis by reading a set of instructions and then being left to perfect

the skill on your own. Coaching should involve having an expert in the keyword method discuss with the student problems that he may be having, critique the student's images suggesting improvements or alternatives, and in general help perfect the skill.

Our work on the keyword method has not led to any new theoretical insights or even to experiments that have direct relevance to current issues in the psychology of memory. But the research illustrates the steps necessary to take an idea that emerged in the confines of an experimental psychologist's laboratory and develop it to a point at which it can be used in a practical teaching situation.

REFERENCES

- Anderson, J. R., & Bower, G. H. *Human associative memory*. Washington, D.C.: Winston, 1973.
- Atkinson, R. C. Ingredients for a theory of instruction. *American Psychologist*, 1972, 27, 921-931. (a)
- Atkinson, R. C. Optimizing the learning of a second-language vocabulary. *Journal of Experimental Psychology*, 1972, 96, 124-129. (b)
- Atkinson, R. C. Teaching children to read using a computer. *American Psychologist*, 1974, 29, 169-178.
- Atkinson, R. C. Adaptive instructional systems: Some attempts to optimize the learning process. In D. Klahr (Ed.), *Cognition and instruction*. Hillsdale, N.J.: Erlbaum, in press.
- Atkinson, R. C., & Paulson, J. A. An approach to the psychology of instruction. *Psychological Bulletin*, 1972, 78, 49-61.
- Atkinson, R. C., & Raugh, M. R. An application of the mnemonic keyword method to the acquisition of a Russian vocabulary. *Journal of Experimental Psychology: Human Learning and Memory*, 1975, 104, 126-133.
- Raugh, M. R., & Atkinson, R. C. A mnemonic method for learning a second-language vocabulary. *Journal of Educational Psychology*, 1975, 67, 1-16.