

# UC Davis

## UC Davis Previously Published Works

### Title

A rare cryptic translation product is presented by Kb major histocompatibility complex class I molecule to alloreactive T cells.

### Permalink

<https://escholarship.org/uc/item/5vk8z1rr>

### Journal

Journal of Experimental Medicine, 182(6)

### ISSN

0022-1007

### Authors

Malarkannan, S  
Afkarian, M  
Shastri, N

### Publication Date

1995-12-01

### DOI

10.1084/jem.182.6.1739

Peer reviewed

# A Rare Cryptic Translation Product Is Presented by K<sup>b</sup> Major Histocompatibility Complex Class I Molecule to Alloreactive T Cells

By Subramaniam Malarkannan, Maryam Afkarian, and Nilabh Shastri

---

*From the Division of Immunology, Department of Molecular and Cell Biology, University of California, Berkeley, California 94720*

## Summary

The identity of allogeneic peptide/major histocompatibility complex (MHC) complexes that elicit vigorous T cell responses has remained an interesting problem for both practical and theoretical reasons. Although a few abundant MHC class I-bound peptides have been purified and sequenced, identifying the unique T cell-stimulating peptides from among the thousands of existing peptides is still a very difficult undertaking. In this report, we identified the antigenic peptide that is recognized by an alloreactive bm1 anti-B6 T cell clone using a novel genetic strategy that is based upon measurement of T cell receptor occupancy in single T cells. Using lacZ-inducible T cells as a probe, we screened a splenic cDNA library in transiently transfected antigen-presenting cells (APCs) and isolated a cDNA clone that allowed expression of the appropriate peptide/K<sup>b</sup> MHC complex in APC. The antigenic octapeptide (SVVEFSSL) exactly matched the consensus K<sup>b</sup> MHC motif, but was surprisingly encoded by a non-ATG defined translation reading frame. Furthermore, the abundance of the naturally processed analog in untransfected cells was estimated to be <10 copies per cell. These results illustrate a novel strategy for identifying T cell-stimulating antigens in general and directly show that alloreactive T cells can respond to rather rare peptide/MHC complexes. These results also suggest that the total pool of processed peptides expressed on the APC surface may include those generated by cryptic translation of normally expressed transcripts.

The clonotypic  $\alpha\beta$  antigen receptor of T cells recognizes peptide/MHC class I or class II complexes. Normally, T cells respond to foreign peptides presented by self-MHC molecules. T cells, however, also respond to allogeneic cells with a vigor that far exceeds normal responses to conventional foreign antigens (see references 1–3 for reviews). This response, referred to as the allogeneic response, involves T cell recognition of nonself, allogeneic MHC molecules. Compared to foreign antigens that are recognized by  $\sim 1$  in  $10^5$  T cells, alloantigens are recognized by up to  $\sim 1$  in  $10^2$  T cells. The high frequency of T cells responding to allo-MHC antigens is the basis for rapid rejection of allogeneic transplants and for graft versus host disease. Understanding the molecular basis of alloreactivity is therefore important, not only for manipulating T cell responses in these clinically relevant cases, but also for understanding the nature and recognition of ligands by the TCR in general.

Defining the ligands recognized by allogeneic T cells is key to understanding alloreactivity. At the present time, it is uncertain whether the individual responding T cells recognize nonself MHC molecules with or without peptides,

and whether the MHC-bound peptides represent a small set of highly abundant or rare sequences (3). Of the three examples where the actual peptides recognized by alloreactive (4, 5) and xenoreactive T cells (6) have been identified, the processed peptides were abundantly expressed by the APC. For two of these peptides presented by the L<sup>d</sup> and the Qa-1 MHC molecules, the donor proteins were also quite abundant (5, 7). No donor protein has yet been identified for the peptide presented by HLA-A2.1 MHC to xenogeneic murine T cells (6). These results have therefore favored the argument that alloreactivity is caused by T cells that recognize abundant peptide/nonself MHC complexes (8). By contrast, analysis of panels of alloreactive T cells specific for K<sup>b</sup> or its K<sup>bm</sup> mutant alleles has suggested that distinct peptides are presented by allogeneic MHC. By HPLC analysis of APC extracts, both the Rammensee and Sherman groups showed that different peaks contained alloreactive T cell-stimulating peptides (9, 10). Thus, alloreactivity could be attributed to recognition of many different peptides presented by MHC that stimulate different sets of T cells. This interpretation has, however, remained inconclusive because the T cell-stimulating peptide sequences or their relative abundance in APC is unknown.

Identifying MHC-bound peptides that actually stimulate

---

<sup>1</sup>Abbreviations used in this paper: CPRG, chlorophenol red  $\beta$ -galactoside; X-GAL, 5-bromo-4-chloro-3-indolyl  $\beta$ -D-galactopyranoside.

T cells is a daunting task. Biochemical purification of the peptides is difficult, not only because MHC molecules display thousands of different peptides on the cell surface (11–13), but also because individual antigenic peptides can represent only a few copies per cell (14, 15). Nevertheless, with remarkable efforts and sophisticated instrumentation, several groups have succeeded in determining the sequence of some T cell-stimulating peptides (4, 6, 14). These peptides, as well as those identified as simply MHC-bound peptides in APC, are related by MHC allele-specific consensus motifs and, where known, are derived from endogenously synthesized proteins (12, 13, 16). The latter fact has allowed an alternative strategy for identifying antigenic peptides by isolating the gene that allows generation of the T cell-stimulating peptide/MHC complexes in the APC. Boon and colleagues were the first to isolate T cell-defined tumor antigen genes by expression cloning (17, 18). The antigenic peptide can subsequently be identified by testing the activity of synthetic peptides that match the consensus motif (19) and/or by narrowing the antigenic activity in deletion constructs (20). We recently showed that expression-cloning strategies can be further generalized and improved by (a) generating the peptide/MHC complexes by transient rather than stable transfections, and (b) by using single T cell assays as an exquisitely sensitive read-out of peptide/MHC complexes generated in the APC (21, 22).

In this report, we applied this expression cloning strategy for identifying the T cell-stimulating antigens that are expressed by allogeneic cells. First, lacZ-inducible T cells specific for allogeneic peptide/K<sup>b</sup> MHC complexes expressed by wild-type B6 mice were generated in the congenic bm1 (K<sup>bm1</sup>) mice. By screening a spleen cDNA library in transfected APC with these T cells as a single-cell probe, we isolated a  $\alpha$ -tubulin cDNA that allowed antigen/MHC-specific lacZ response in the T cells. Curiously, the antigenic octapeptide JAL8 (SVVEFSSL) was not located within the open reading frame of the  $\alpha$ -tubulin sequence, but it was encoded at the vector/cDNA insert junction. Most surprisingly, this antigenic peptide was a cryptic translation product of this cDNA because it was encoded in a non-ATG-defined translational reading frame. Transfecting APCs with constructs containing an in-frame ATG as the translation initiation codon, or the addition of exogenous synthetic peptide, allowed expression of high levels of the T cell-stimulating peptide/K<sup>b</sup> complex. In contrast to the high abundance of all previously identified allogeneic T cell-stimulating peptides, the abundance of the naturally processed peptide in K<sup>b+</sup> cell extracts was <10 copies per cell. These results demonstrate that rare peptide/MHC complexes can stimulate alloreactive T cells, and that these methods are applicable to the identification of unknown T cell antigens in general.

## Materials and Methods

**Cell Lines and Cell Culture.** All cells were maintained in RPMI 1640 medium (Cellgro; Mediatech, Washington, DC) supplemented with 2 mM glutamine, 1 mM pyruvate, 50  $\mu$ M  $\beta$ -mercaptoethanol, 100 U/ml penicillin, 100  $\mu$ g/ml streptomycin, and 10% fetal

bovine serum (Hyclone Laboratories, Logan, UT) at 37°C in 5% CO<sub>2</sub>/air. K<sup>b</sup>-COS, D<sup>b</sup>-COS, and K89.7.5 (K<sup>b</sup>-L) cells have been described previously (20, 21). The T2-K<sup>b</sup> cell line was a kind gift from Dr. P. Cresswell (Yale University School of Medicine, New Haven, CT). EL4 (H-2<sup>b</sup>) cells were obtained from Dr. D. Raulet (University of California, Berkeley, CA). EG7 (OVA-transfected EL-4) was a kind gift from Dr. M.J. Bevan (University of Washington, Seattle, WA). HeLa cells (CCL 2.2) were obtained from American Type Culture Collection (Rockville, MD), and the liver tumor line Hepa1 was a kind gift from Dr. M. Nishimura, National Cancer Institute, Bethesda, MD), and their K<sup>b</sup>-expressing derivatives were generated as described (21, 23). K<sup>b+</sup> Hepa 1 cells were also stably transfected with JMAL9 or 44S1 constructs by electroporation (20). B3Z T cell hybrid is specific for OVA peptide SL8 (OVA 257-264)/K<sup>b</sup> complex and has been described previously (20, 21).

**Generation of LacZ-inducible bm1 Anti-B6 T Hybridomas.** C57BL/6 (B6) and its congenic strain B6.C-H2<sup>bm1</sup>/ByJ (bm1) mice were purchased from The Jackson Laboratory (Bar Harbor, ME). 2–4-mo-old bm1 mice were injected twice with  $2 \times 10^6$  B6 spleen cells intraperitoneally 7 d apart. Spleens of immunized bm1 mice were removed 1 wk after the second injection, and the CTL were enriched by coculture with fresh irradiated B6 spleen cells and rat Con A supernatant (10). CTL were fused with the lacZ-inducible fusion partner BWZ.36/CD8 as described earlier (24). Hybridoma cells were screened for their responsiveness to B6 spleen cells. Anti-B6, lacZ-inducible T cell hybrids were cloned by limiting dilution, and stable subclones were used in subsequent experiments.

**Construction and Screening the cDNA Library.** A unidirectional cDNA library using mRNA from Con A+LPS-activated B6 spleen cells was constructed in the BstXI/NotI sites of the mammalian expression vector pcDNA1 (Invitrogen, San Diego, CA). The cDNA inserts were ligated to the vector using the BstXI/EcoRI linker (5' GAATTCCACCACA 3') at the 5' end and primer/linker oligodT/NotI (5' AACCCGGCTCGAGCGGCCGCT<sub>18</sub> 3') at the 3' end. Recombinant plasmids were selected by transforming the MC1061/P3 competent bacteria in ampicillin and tetracycline in L broth/agar. The bacteria representing the cDNA library were divided into 15 different pools each comprising  $\sim 10^5$  CFU. For expression screens, aliquots of DNA (100 ng/ml) prepared from each bacterial pool were transiently transfected into  $2 \times 10^4$  K<sup>b</sup>-COS cells per well of 96-well plates. 2 d later,  $3 \times 10^4$  bm1BZ19.4 T cells were added to each well, and after overnight incubation, cultures were stained with the 5-bromo-4-chloro-3-indolyl  $\beta$ -D-galactopyranoside (X-GAL) substrate as described (21, 24). Positive pools were scored as an increase in average number of "blue" lacZ<sup>+</sup> T cells over the vector alone background control, as shown in the photomicrographs in Fig. 2. The single plasmid that was responsible for the positive signal was isolated by screening sequentially smaller pools of recombinant bacteria from the positive pool and repeating the transfection and T cell assays with DNA isolated from each bacterial pool. The number of CFU at each stage were estimated as, Iv2 ( $\sim 5$ – $10 \times 10^4$ ), Iv2.4 ( $\sim 2 \times 10^3$ ), Iv2.4.2 ( $\sim 100$ ), Iv2.4.5.2 ( $\sim 20$ ), and Iv2.4.5.2.44 (1).

**cDNA Expression Constructs.** Restriction maps and sequence of the isolated Iv44 cDNA were obtained by standard methods. The Iv44 deletion constructs were prepared as follows: 44S1 was prepared by removing the 3' 0.6-kb fragment from Iv44 plasmid between the internal and the flanking SphI sites in the polylinker, and then religating the large fragment. Similarly, the internal ClaI and the 3' flanking XbaI sites were used to remove the 0.86-kb fragment from 1-kb 44S1, and the remaining 134-bp insert-vec-

tor fragment was filled in with klenow and religated. For 44SBS1, DNA from the 44SC1 construct was obtained by excising the 5' flanking BamHI site in the vector, and the internal 3' SmaI site in the insert and was cloned into the BamHI/SmaI sites of the pEVRF1 vector (25). For RF1, RF2, and RF3 constructs, the 44SBS1 plasmid was cut at the EcoRI site at the vector-insert junction and was filled in with Klenow. The insert fragment was then removed by making a second cut at the internal SmaI site at the 3' end. This blunt fragment was then cloned into the SmaI sites of pEVRF0, pEVRF1, and pEVRF2 vectors that allow translation in each reading frame, as described previously (20, 25).

Constructs for expressing MGDDSFNTF ( $K^b$ 10), MFNTFFSET ( $K^b$ 11), and MASVVEFSSL (JMAL9) peptides were prepared using complementary synthetic oligonucleotides encoding these residues in the pcDNA1 vector. In addition, the oligonucleotides contained nucleotides complementary to restriction site overhangs (BstXI) at the 5' end, a termination codon, and the XbaI site overhang at the 3' end. MGDDSFNTF, 5' ATGGGAGGAGATGACTCCTTCAACACCTTCTAGA3', MFNTFFSET, 5' ATGTCCTTCAACACCTTCAGTGAGACCTAGA3', MASVVEFSSL, 5' ATGAGTGTGGTGGAAATTCTCCAGCCTGTAGA3'. Fidelity of all constructs was confirmed by nucleotide sequencing.

**Transient DNA Transfections.** Stable COS cell transfectants expressing  $K^b$  or  $D^b$  were transiently transfected with CsCl purified large scale or with mini prep plasmid DNAs by the DEAE-dextran/chloroquin protocol, as described in detail previously (20). Transfections were performed with  $3 \times 10^4$  COS cells per well in 96-well flat bottom tissue culture plates. Two days later, transfected cells were tested for the expression of specific peptide/MHC complexes by overnight coculture with  $3-10 \times 10^4$  T cells. LacZ response induced in activated T cells was measured as described below.

**T Cell Activation Assays.** Peptide/MHC ligand-specific T cell responses were measured by the lacZ activity induced in the T cells (24, 26).  $3-10 \times 10^4$  T cells were cocultured overnight with  $2-5 \times 10^4$  appropriate APC, (normal spleen cells, cell lines, or transfected cells) with or without exogenous peptides (synthetic or extracts) in 96-well plates. The ligand-induced T cell response was determined using the lacZ substrate chlorophenol red  $\beta$ -galactoside (CPRG), as described (20, 24). In each well of the 96-well plate, the conversion of CPRG to chlorophenol red was measured at 595 and 655 nm as reference wavelength with a plate reader (model 3550; Bio Rad Laboratories, Hercules, CA). Data shows the mean absorbance of replicate cultures, and they are representative of at least three independent experiments.

**Antibodies and Synthetic Peptides.** Antibody inhibition assay was performed to confirm the MHC restriction of T cell hybrids. Briefly,  $3 \times 10^4$  EL4 or  $K^b$ -L cells were incubated for 1 h with anti- $K^b$  antibody (Y3, ATCC, HB176) or anti- $D^b$  antibody (B22.249.RI; Cedar Lane, CA) and bm1BZ19.4 cells ( $10^5$  per well) were added. Plates were incubated overnight and T cell response was measured as above. Solid-phase synthesis of ASVVEFSSL (JAL9, 9 mer), SVVEFSSL (JAL8, 8 mer), SIINFEKL (SL8), GILQPDGQMPSDKTIGGGDDSFNTFFSETGAGKHVPR (37 mer), MPSDKTIGGGDDSFNTFFSETGAGKHVPR (29 mer), KTIGGGDDSFNTFFSETGAGKHVPR (25 mer), GGDDSFNTFFSETGAGKHVPR (21 mer), SFNTFFSETGAGKHVPR (17 mer), and FNTFFSET (8 mer) were performed using an automated synthesizer (model 421; Applied Biosystems, Inc., Foster City, CA). Peptides were purified by HPLC, and their synthesis was confirmed by mass spectrometry.

**Extraction of Processed Peptides.** Total acid soluble peptide pool from EG7 or EL4 cells was extracted by TFA, as described (27,

28). Briefly,  $10^7-10^8$  cells were washed with PBS, lysed in 2 ml 0.1% TFA in water, and homogenized by ultrasonication using a Sonic Dismembrator (Fisher Scientific, Pittsburgh, PA). The homogenate was spun at 12,000 g for 30 min. The supernatant was passed through a 10-kD filter (Ultra Free-MC; Millipore Corp., Bedford, MA). The filtrate was dried in a vacuum centrifuge, resuspended in PBS, and analyzed for processed peptides in T cell activation assays described above.

## Results

**Generation of Peptide/ $K^b$ -specific, LacZ-inducible T Cells.** Alloreactive T cells specific for the  $K^b$  MHC class I molecule were generated by immunizing the congenic bm1 mutant mice with the spleen cells of wild-type B6 mice. These strains were chosen because the bm1 mutant mice differ from the wild-type B6 mice in three amino acid substitutions within the  $K^b$  MHC  $\alpha$  chain alone, thus constraining the alloreactive bm1 anti-B6 T cell response to only the wild-type  $K^b$  MHC (29). After in vitro enrichment, the alloreactive T cells were fused with the BWZ.36/CD8 fusion partner to derive lacZ-inducible, T cell hybrids (24). Fig. 1 shows three representative T hybridoma clones responding to either the immunogen (B6 spleen) or to  $K^b$  cell lines. None of the T cells recognized T2- $K^b$  cells that express predominantly empty MHC class I molecules (30). Hybridoma bm1BZ3 recognized an antigen shared by the B6 spleen and  $K^b$ -COS cells, but absent on  $K^b$  L cells, while hybrids bm1BZ18 and bm1BZ19 recognized antigens shared by B6 spleen cells and  $K^b$  L cells, which were absent in  $K^b$ -COS cells. Further evidence that  $K^b$  MHC determined the responsiveness of these T cells was obtained by demonstrating that only anti- $K^b$ , but not anti- $D^b$  antibodies, inhibited their response (Fig. 1 B). This was observed when either EL-4 ( $K^b$ ,  $D^b$ ) or  $K^b$ -L ( $K^b$ , H-2<sup>k</sup>) were used as APCs. Hybridoma bm1BZ19.4 was chosen for use as a single T cell probe because of its low reactivity towards  $K^b$ -COS cells that were used as recipient APCs to screen for its cognate antigenic cDNA.

**Isolation of the bm1BZ19.4 T Cell-stimulating Antigen Gene.** To identify the gene that could generate the T cell-stimulating peptide/ $K^b$  complex, we screened a cDNA library prepared from B6 spleen cells.  $K^b$ -COS cells were transfected with pools of cDNAs clones in 96-well plates. 2 d later, the transfected cells were assayed for expression of the peptide/ $K^b$  MHC complex that stimulated lacZ response in individual bm1BZ19.4 T cells. Photomicrographs of representative cultures in Fig. 2 show that compared to the vector alone background, a few lacZ<sup>+</sup> blue T cells were present in one of the cultures, and that their number increased dramatically upon transfecting  $K^b$ -COS cells with yet smaller cDNA pools. By sequential sib-selection of cDNA pools of decreasing size, a single plasmid DNA (lv2.4.5.2.44) that allowed stimulation of the bm1BZ19.4 T cells was identified. This cDNA clone (referred to as lv44) specifically stimulated the T cells only upon transfection into  $K^b$ -COS, but not when it was expressed in  $D^b$ -COS or in parental COS cells (see below and data not shown). We conclude that APC

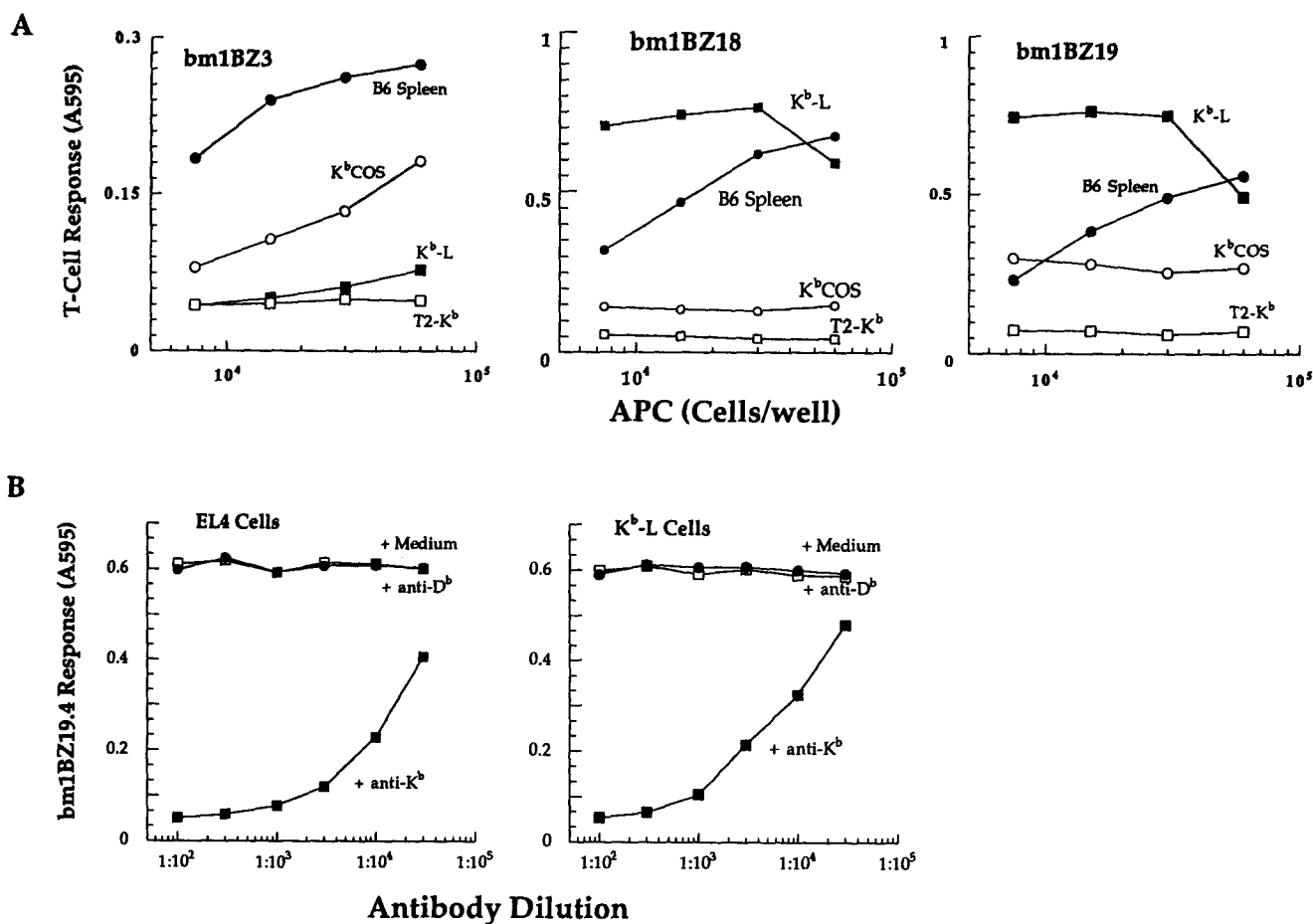

**Figure 1.** (A) Response of bm1 anti-B6 T hybridomas bm1BZ.3, bm1BZ.18, and bm1BZ19 towards the indicated K<sup>b</sup>+ cells: B6 spleen, K<sup>b</sup>-transfected human TAP mutant T2, mouse L- or monkey COS cells. 10<sup>5</sup> T cells were cocultured overnight with varying numbers of indicated K<sup>b</sup>+ cell lines as APC. The lacZ activity induced in the T cells was measured by the conversion of the CPRG substrate to the chlorophenol red product. Absorbance at 595 nm was read in a 96-well plate reader. (B) Anti-K<sup>b</sup> but not anti-D<sup>b</sup> mAbs inhibit bm1BZ19 response to either EL-4 (K<sup>b</sup>, D<sup>b</sup>) cells or to the K<sup>b</sup>-L transfectant APC. 10<sup>5</sup> T cells were cultured overnight with 5 × 10<sup>4</sup> EL-4 or K<sup>b</sup>-L cells in presence of varying dilution of Y3 (anti-K<sup>b</sup>) or B22 (anti-D<sup>b</sup>) ascites. LacZ response in activated T cells was measured as described above.

expressing the Iv44 plasmid DNA generated the peptide/K<sup>b</sup> complex, and that this was most likely caused by the antigenic peptide encoded within the cDNA insert.

**Location of the Antigenic Peptide in the Iv44 cDNA.** The cDNA insert in Iv44 plasmid was 1.6 kb in length. Partial sequence of ~300 nucleotides at both the 5' and 3' ends of the insert showed that Iv44 was identical to the mouse  $\alpha$ -tubulin mRNA sequence (MUSTUBA6M, GenBank/EMBL accession no. M13441). Iv44 cDNA, however, lacked the first 131 nucleotides of the full-length clone that included the natural ATG start codon. Nevertheless, a truncated tubulin polypeptide (414 versus 449 amino acids) could be generated from this cDNA using the second in-frame ATG codon as a translation initiation codon (31, 32). Examination of the  $\alpha$ -tubulin sequence for the consensus K<sup>b</sup> MHC-binding motif (xxxx[F,Y]xx[L,L,M,V]) revealed nine peptide sequences; K<sup>b</sup>1-9, which are schematically shown in Fig. 3 A. Using the indicated endonuclease restriction sites, we prepared a set of deletion constructs that contained only

K<sup>b</sup>1-7 (44S1), K<sup>b</sup>1 (44SC1) alone or with no K<sup>b</sup> motifs at all (44SBS1). These constructs were transfected into K<sup>b</sup>- or D<sup>b</sup>-COS cells that were tested for their ability to stimulate bm1BZ19.4 T cell response (Fig. 3 B-D). The T cell response clearly required both the cDNA constructs and the K<sup>b</sup> MHC molecule because no T cell response occurred when the same constructs were expressed in D<sup>b</sup>-COS cells. The smallest active construct that contained a K<sup>b</sup>1 motif was 44SC1, but surprisingly, the construct 44SBS1, lacking all but two residues of the K<sup>b</sup>1 motif, was as active as the parental clone Iv44. This result indicated that none of the nine K<sup>b</sup>-binding motifs represented the bm1BZ19.4 T cell-stimulating peptide. To directly test the activity of the K<sup>b</sup>1 motif that was present in 44SC1, but was disrupted in 44SBS1, we prepared a mini-gene construct (Fig. 3 A, K<sup>b</sup>1) that encoded only the peptide PRAVFDL and the translational initiation methionine codon. This construct was clearly inactive (Fig. 3 C), and it ruled out the possibility that the two K<sup>b</sup>1 residues shared between 44SC1 and

## Expression Screens with bm1BZ19.4 T cells

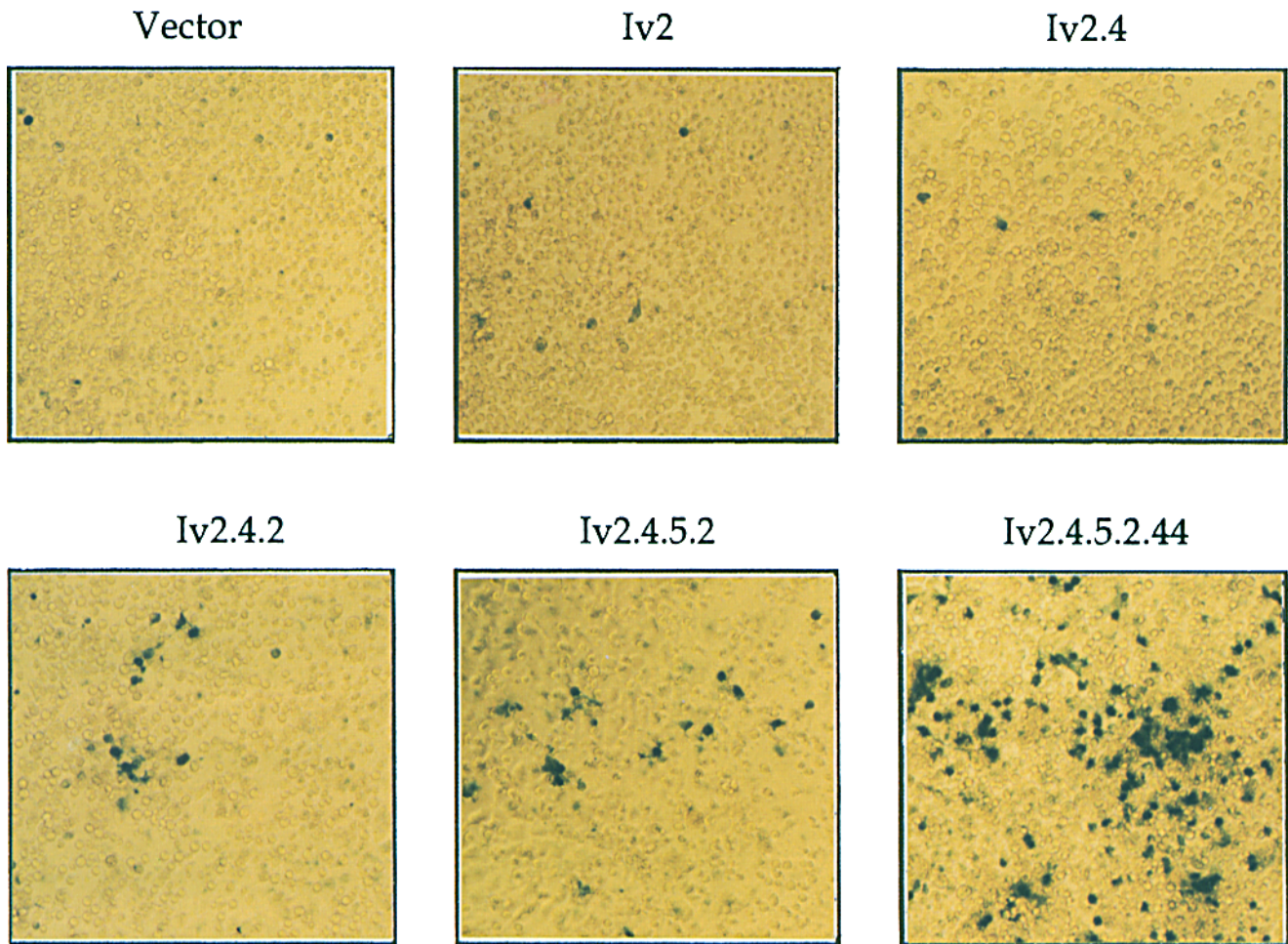

**Figure 2.** Isolation of the bm1BZ19.4-stimulating cDNA clone Iv2.4.5.2.44 (Iv44) by expression cloning. The B6 spleen cell cDNA library was screened by transient transfection into K<sup>b</sup>-COS cells that were then assayed for their APC function with the lacZ-inducible bm1BZ19.4 T cells. Individual lacZ<sup>+</sup> T cells were visualized by X-GAL staining as “blue” lacZ<sup>+</sup> cells. Panels show representative cultures when K<sup>b</sup>-COS cells were transfected with cDNA library pools of decreasing complexity. Note that the number of lacZ<sup>+</sup> T cells is related to the complexity of the cDNA pools estimated as Iv2 (~5–10 × 10<sup>4</sup>), Iv2.4 (~2 × 10<sup>3</sup>), Iv2.4.5 (~100), Iv2.4.5.2 (~20), and Iv2.4.5.2.44 (1). The enrichment of Iv44 cDNA, estimated by the number of blue cells observed, was ~10-fold at each step and 100-fold in the final step.

44SBS1 accounted for the antigenic activity of these two constructs. Thus, the T cell-stimulating activity of Iv44 could not be attributed to any of the consensus K<sup>b</sup> motifs in the open reading frame of the insert, but nevertheless required the first 102 nucleotides of the 44SBS1 construct.

*The bm1BZ19.4-stimulating Peptide Is a Cryptic Translation Product of Iv44 cDNA.* Three different hypotheses could account for the bm1BZ19.4-stimulating activity of the 44SBS1 construct. First, the T cell-stimulating peptide presented by K<sup>b</sup> MHC could differ from the classical K<sup>b</sup> consensus motif. Indeed the lung tumor specific peptide FEQNTAQP bears no relationship to the consensus K<sup>b</sup> motif (xxxx[F,Y]xx-[I,L,M]), yet it has been described as capable of being presented by K<sup>b</sup> MHC and eliciting tumor-specific CTL re-

sponses (33). Second, the antigenic peptide could be encoded by one of the other non-ATG-defined translational open reading frames in the construct. This unconventional mechanism has been observed to yield T cell-stimulating peptide/MHC complexes in several independent model systems (17, 20, 34). Finally, the peptide presented by K<sup>b</sup> need not have been encoded by the constructs at all, but instead, could have resulted from induction of yet another cellular gene in transfected APC. In this case, the minimal 44SBS1 construct would contain the transcription/translation-inducing activity for the induced antigen gene.

All attempts to localize the antigenic activity within the open reading frame of the  $\alpha$ -tubulin insert in the 44SBS1 construct failed. First, no T cell response was detected with

## A Expression constructs:

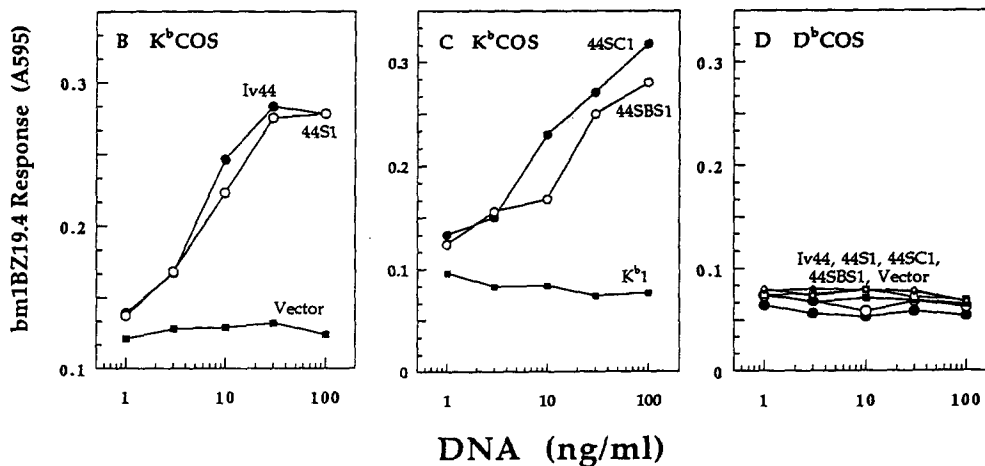
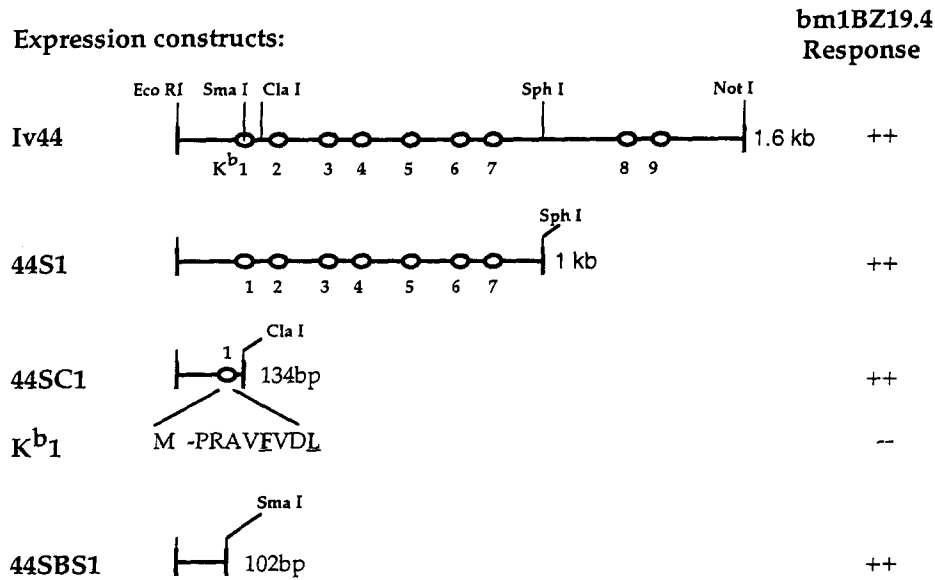

**Figure 3.** bm1BZ19.4 T cell-stimulating activity of Iv44 maps to the 5' 102 bp fragment (44SBS1 construct) and requires K<sup>b</sup> MHC. (A) Schematic representation of cDNA clone Iv44, its deletion constructs, and their activity in stimulating the bm1BZ19.4 T cell response. The location of consensus K<sup>b</sup>-binding peptide motifs (xxxx[F,Y]xx-[L,M,V]) is shown by open circles labeled K<sup>b</sup>1–9. (B) The T cell-stimulating antigenic activity requires K<sup>b</sup> MHC and the 5' 102-bp fragment of 44SBS1 construct. K<sup>b</sup>- or D<sup>b</sup>-COS cells were transfected with varying DNA amounts of the indicated constructs. 2 d later, the presence of peptide/MHC complexes was detected by overnight incubation with bm1BZ19.4 T cells. Data show lacZ activity that was induced in T cells and was measured by the CPRG assay.

a panel of overlapping synthetic peptides that corresponded to the entire  $\alpha$ -tubulin open reading frame (Fig. 4 A, frame a) in exogenous presentation assays, even at supraoptimal 100- $\mu$ M concentration (data not shown). Second, the mini-gene constructs K<sup>b</sup>10 and K<sup>b</sup>11, encoding partial (xxxx-[F]xxx) motifs that bind K<sup>b</sup> MHC in vitro with nonconsensus COOH-terminal anchor residues (35), (Fig. 4 A, K<sup>b</sup>10 and K<sup>b</sup>11) were inactive. Third, the RF1, RF2, and RF3 constructs designed to allow translation of each of the three reading frames of the insert sequence alone were also completely inactive (Fig. 4 C). Taken together, these results strongly suggested that the antigenic activity of the 44SBS1 construct was not caused by the insert sequence alone, but that it required both the insert and the vector sequences.

Examination of the sequence of the entire transcript of 44SBS1 in each of the three translational reading frames revealed a peptide sequence at the vector/cDNA insert junc-

tion that matched the consensus K<sup>b</sup> motif (Fig. 4 A). This sequence was indeed the bm1BZ19.4 T cell-stimulating antigenic peptide. The mini-gene construct (JMAL9) encoding only these residues (ASVVEFSSL) with a methionine codon added for translation initiation was at least 100-fold more active than either the Iv44 or 44SBS1 constructs (Fig. 4 D). This dramatic difference in endogenous presentation activity is consistent with the known differences in the translational efficiencies of ATG versus non-ATG codons (20). Based on our recent analysis of non-ATG codons that allow generation of peptide/MHC complexes (36), it is quite likely that translation of the antigenic precursor is initiated at the upstream TGG and/or GAT codons that are in-frame with the antigenic peptide (Fig. 4 A, arrows). Furthermore, the generation of the T cell-stimulating peptide via cryptic translation was not limited to transiently transfected DNAs, but was also observed in stably transfected Hepa1 cells (Fig.

**A 44SBS1:**

```

ctgtagaagcgctatggcttcgctggggatccactagtaacccccgccagGTGGTGGAAATTCCCAGCCTGATGGCCAGATGCCAAGT
a      M A S W G S T S N P R Q C G G I L Q P D G Q M P S -
b      * * P P P V W W N S P A * W P D A K * -
c      * K R V W L R G D P L V T P (A S V V E F S S L) M A R C Q V -
      JMAL9: M-----

```

GACAAGACCAATGGGGGAGGAGATGACTTCCTTCAACACCTTCTTCAGTGAGACAGGAGCTGGCAAGCATGTGCCCGggggagctctctag

K<sup>b</sup>10: M-----

K<sup>b</sup>11: M-----

```

a D K T I G (G G D (D S F N T E) F S E T) G A G K H V P R G A L * -
b Q D H W G R R * L L Q H L L Q * D R S W Q A C A P G S S L -
c T R P L G E E M T P S T P S S V R Q E L A S M C P G E L S L -

```

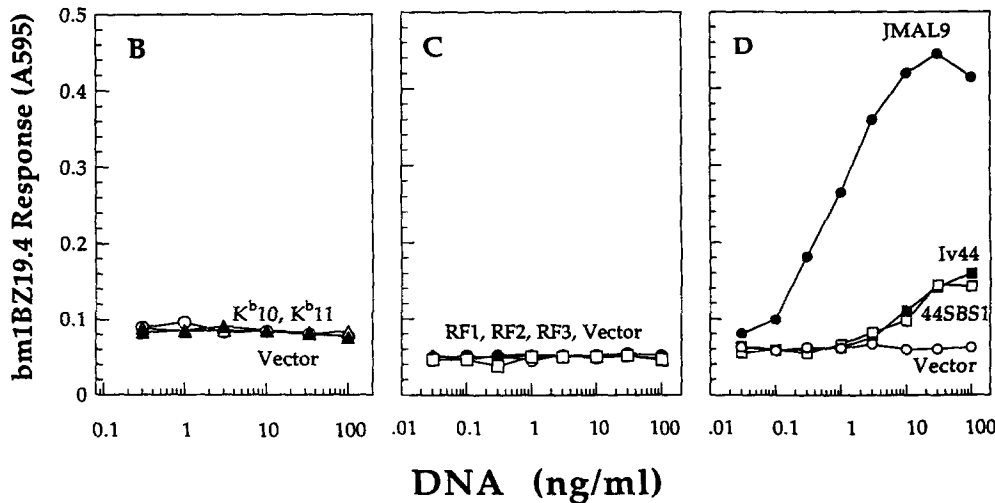

**Figure 4.** (A) Nucleotide sequence and predicted translation products of 44SBS1 construct. Insert sequence (uppercase letters) and its flanking pEVR.F0 vector DNA (lowercase letters) are shown with each of three translational reading frames (a-c) in single-letter amino acid code. Linker nucleotides for ligating the cDNA to the vector are underlined. The 5' flanking vector sequence provided an in-frame ATG initiation codon that is in-frame with the  $\alpha$ -tubulin open reading frame in frame a. The asterisks indicate termination codons, and vertical arrows show the presence of alternate non-ATG initiation codons that could be used for translating the peptide shown in frame c (36). The residues encoded by the oligo constructs JMAL9, K<sup>b</sup>10, and K<sup>b</sup>11 are indicated within parentheses and by dashed lines. An in-frame ATG codon (M) was added to each mini-gene construct to allow translation. (B-D) bm1BZ19.4 T cell-stimulating activity of 44SBS1 is encoded in a non-ATG-defined translational reading frame. Antigenic activity of the indicated cDNA constructs was tested by transient transfection into K<sup>b</sup>-COS cells, as described in legend to Fig. 3. Labeled curves show T cell responses obtained with the constructs shown in Fig. 4 A. The RF1, RF2, and RF3 constructs were identical to 44SBS1, except that the insert sequence alone, without the junction sequence, was placed downstream of an in-frame ATG codon (20, 25). Because of the rather high activity of the JMAL9 relative to the Iv44 or 44SBS1 constructs, the cultures were incubated with the lacZ substrate for only 1.5 h rather than the usual 4 h.

5 A). Thus, in accord with previous findings (17, 20, 34, 36), cryptic translation products generate peptide/MHC complexes both in transient and in stable transfections.

Conclusive proof that the "out-of-frame" JAL9 nucleotides did encode the antigenic peptide was obtained with synthetic peptides. By contrast to the synthetic peptides representing the ATG-defined open reading frame of the insert (Fig. 4 A, frame a), which were completely inactive, both the nona (ASVVEFSSL) and the octa (SVVEFSSL) peptides of translational frame c (Fig. 4 A), stimulated bm1BZ19.4 T cells strongly (Fig. 5 B). Note that the dose-response curves show that these peptides were active at even picomolar concentrations, and that the 8 mer was 3-10-fold more active than the 9 mer. These results are entirely consistent with previous analyses of naturally processed peptides presented by the K<sup>b</sup> MHC (12, 28, 37, 38). With the sole exception

of the tumor peptide FEQNTAQP (33), these peptides conform to the consensus motif xxxxFYxx[L,M], and exhibit T cell-stimulating activity at extremely low concentrations. Other K<sup>b</sup>-restricted T cells that recognize conventional (B3Z, anti-OVA257-264 (SL8)/K<sup>b</sup>) or allogeneic K<sup>b</sup> MHC (bm1BZ18.5) did not recognize the JAL8 or JAL9 peptides (Fig. 5, C and D). Similarly, none of eight other bm1 anti-B6 alloreactive T cells tested recognized either JAL8 or JAL9 peptides (data not shown). We conclude that the JAL8 octapeptide is a cryptic translation product presented by K<sup>b</sup> MHC, and that it serves as a unique ligand for bm1BZ19.4 T cells.

*Relative Abundance of the Naturally Processed Peptide/K<sup>b</sup> Complex in Normal APC.* What is the abundance of the naturally processed counterpart of JAL8 peptide? While the DNA constructs and the synthetic peptides allowed genera-



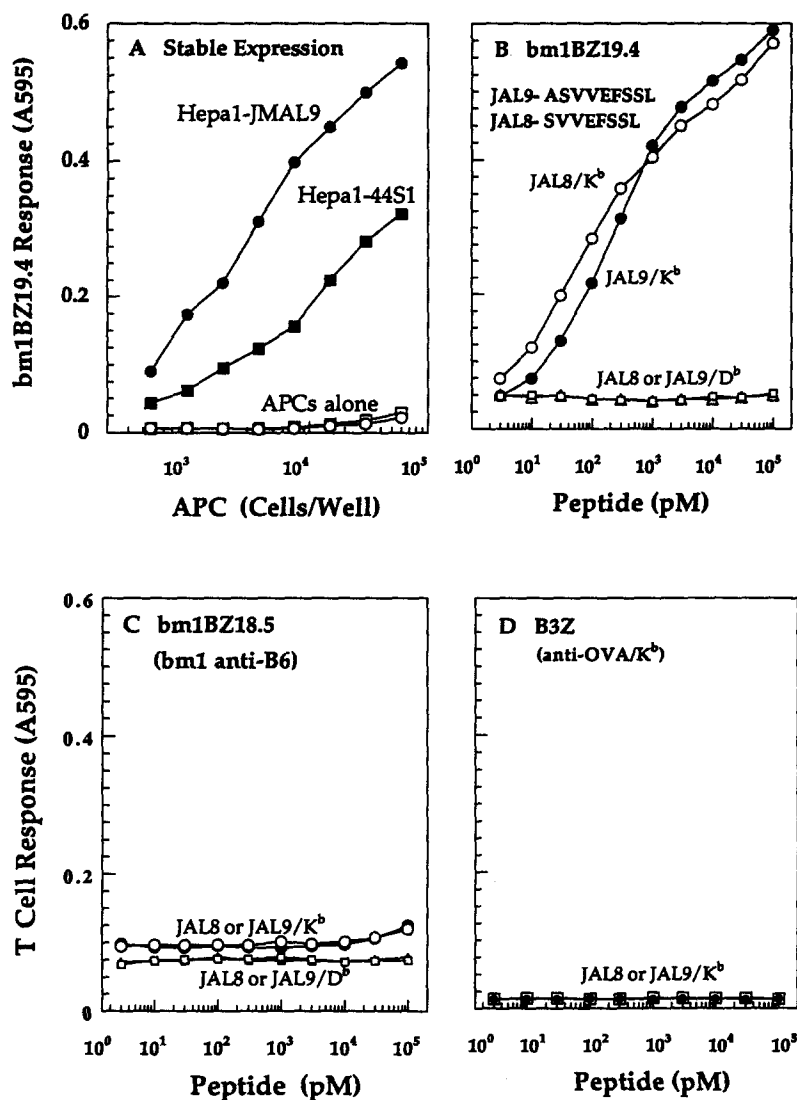

**Figure 5.** bm1BZ19.4 T cell-stimulating ligand is generated in (A) stable K<sup>b</sup> hepatoma (*Hepa1*) transfectants expressing either 44S1 or JMAL9 constructs, and in (B) K<sup>b</sup>-COS, but not D<sup>b</sup>-COS, incubated with synthetic peptides corresponding to the cryptic translation products. (C and D) JAL9 or JAL8 are not recognized by either bm1BZ18.5 (bm1 anti-K<sup>b</sup>) or B3Z (anti-OVA/K<sup>b</sup>) T cells. Amino acid sequences of synthetic peptides JAL9 and JAL8 are shown in single letter code. T cell responses were measured by the CPRG assay for lacZ activity as described in the legend to Fig. 1. See Materials and Methods for details.

tion of the bm1BZ19.4-stimulating complex, a similar complex was naturally expressed by normal B6 spleen cells as well as by other K<sup>b</sup> cell lines (Fig. 1, A and B). To analyze this naturally processed peptide, we extracted the total pool of processed peptides from EL-4 (H-2<sup>b</sup>) and its OVA-expressing derivative, EG-7 (39). Because EG-7 cells express the OVA-derived SL8/K<sup>b</sup> complex, the presence and amount of naturally processed SL8 peptide in the extracts provides a critical internal control. While both B3Z and bm1BZ19.4 T cells were capable of responding to similarly low concentrations (~1–3 pM) of the synthetic SL8 and JAL8 peptides, respectively (Fig. 6 A), only the naturally processed SL8 peptide was detected in extracts of EG-7 cells (Fig. 6 C). No bm1BZ19.4-stimulating activity was detected in either EL-4 or EG-7 extracts (Fig. 6 B) or in extracts of five B6 spleens (data not shown). From the sensitivity of the assay for detecting synthetic JAL8 peptide, we estimate that the abundance of the naturally processed JAL8 counterpart in EL-4 or in normal spleen cells is less than eight copies per cell. This estimate was validated by the fact that the same EG-7 extract yielded 90 SL8 copies per cell.

Remarkably, our result is virtually identical to the completely independent estimate of 88 SL8 copies/EG-7 cell by Ramnensee's group (40). Thus, the natural peptide/K<sup>b</sup> complex recognized by bm1BZ19.4 T cells is expressed at a very low level in K<sup>b</sup>-expressing cells.

What is the source of the naturally processed JAL8 analogue in untransfected K<sup>b</sup>-APC? A match for the JAL8 peptide sequence was not found in either the protein (Swiss-Prot release 37.0) or nucleic acid (GenBank/EMBL release 86.0) databases. Note that because peptides with amino acid substitutions can cross-react with T cells (41, 42), and that the low abundance of the naturally processed peptide in cell extracts precluded comparison of JAL8 peptide with its natural analogue by HPLC (28, 43), it is uncertain at this time whether the naturally processed peptide is identical to JAL8, and whether it is derived from a normal cellular protein or via cryptic translation of an alternate reading frame.

## Discussion

The bm1 anti-B6 alloreactive bm1BZ19.4 T-cells recognize the octapeptide SVVEFSSL (JAL8)/K<sup>b</sup> complex.

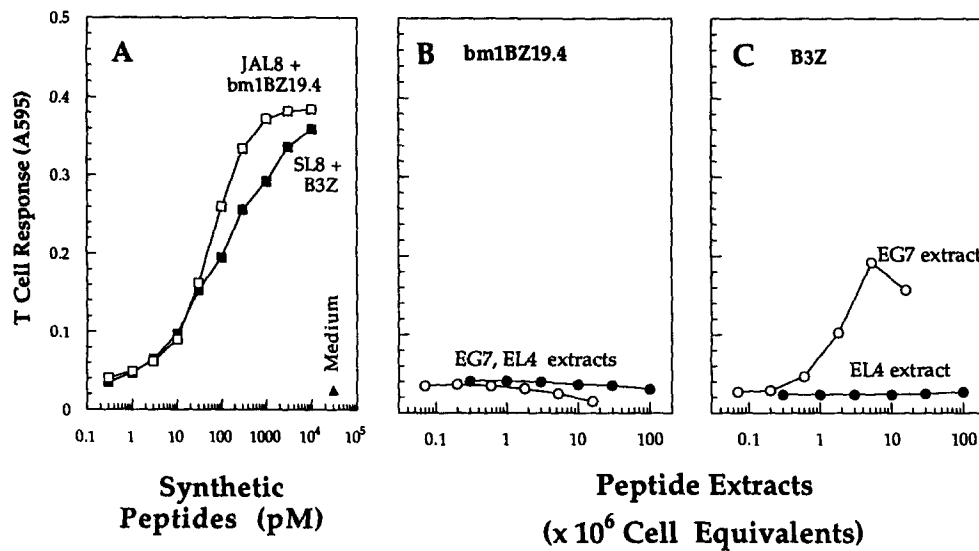

**Figure 6.** Analysis of naturally processed T cell-stimulating peptides in APC extracts. (A) Both bm1BZ19.4 and B3Z detect their cognate JAL8 and SL8 synthetic peptides with comparable sensitivity. (B) No bm1BZ19.4 stimulating, but only (C) B3Z stimulating, processed SL8 peptide is detected in cell extracts. Varying amounts of synthetic peptides or 0.1% TFA extracts of parental EL-4 cells or its OVA-expressing derivative, EG-7 cells, were incubated with K<sup>b</sup>-HeLa cells as APC and the T cells. After overnight culture, lacZ response induced in T cells was measured as described in the legend to Fig. 1.

The JAL8 peptide was identified by a novel genetic strategy for isolating cDNAs that allow expression of the T cell-stimulating complex in transfected APCs. Surprisingly, the JAL8 peptide was a cryptic translation product of this cDNA clone and its natural counterpart was present at <10 copies per cell in APCs. These results show that as for normal T cell responses to foreign antigens, alloreactive T cells can respond to rare peptide/MHC complexes.

The explanation for why allogeneic MHC molecules elicit vigorous T cell responses has remained elusive for decades. Early hypotheses (44), proposing structural or functional differences among TCRs expressed by alloreactive versus conventional antigen-specific T cells are currently less attractive, and attention has focused instead on the MHC ligands for the TCR (3). Strong evidence that peptides play a critical role in alloreactivity is now available with mutant cells that express empty MHC molecules on their surface, and are consequently not recognized by alloreactive T cells (e.g., Fig. 1) unless processed peptides from wild-type cells are added exogenously (9, 10, 45). Interestingly, each of the two allogeneic and one xenogeneic peptide/MHC complexes that have been characterized so far appear to be expressed as thousands of copies on APC surface (4–6). Based on the high level of expression of these peptides and the estimates of the frequency of T cells that recognize them, it has been argued that alloreactive T cells are primarily stimulated by abundant peptide/MHC complexes (8).

Identification of JAL8 peptide allowed us to estimate the level of expression of its naturally processed counterpart in APCs. Similar to all naturally processed peptides characterized so far, synthetic JAL8 peptide was active in stimulating bm1BZ19.4 T cells at low picomolar concentrations (Figs. 5 and 6). In contrast to the B3Z-stimulating SL8 peptide that was expressed at ~100 copies in EG-7 cells, the bm1BZ19.4-stimulating peptide was expressed below the detection threshold of 10 copies in the same extracts. This low level of expression is at the extreme end of the range recently established

for the minimum number of peptide/MHC complexes that are required for T cell stimulation (15). Interestingly, similar low levels of peptide expression (<30 copies per cell) were also estimated for expression of the processed OVA257–264 (SL8) peptide when it was generated as a cryptic translation product from experimental constructs (36). Thus, barring the unlikely but formal possibility that the natural analogue of JAL8 peptide is exceptional in being active only at very high concentrations, APCs express rather low levels of the bm1BZ19.4-stimulating peptide. Furthermore, the fact that of the eight bm1 anti-B6 hybrids that were tested, only bm1BZ19.4 cells were stimulated by JAL8/K<sup>b</sup> complex suggests that a diverse set of peptides are actually presented by allogeneic MHC molecules to a correspondingly diverse set of alloreactive T cells, fulfilling early predictions (1), and explaining the high frequency and vigor of alloreactive T cell responses.

It is interesting to contrast the peptide purification and our expression-cloning approaches to account for conflicting conclusions on the abundance of peptides recognized by alloreactive T cells. Because success of peptide purification depends on isolatable amounts of processed peptides expressed in the target cells, a correlation between peptide abundance and ease of its purification is expected. By contrast, the antigenic JAL8 peptide was identified using an expression cloning strategy that depends on the generation of MHC-bound peptides derived from the transfected donor gene in the APCs at a level sufficient to stimulate T cells. In addition to the differences in the mechanism (exogenous versus endogenous) for generation of the peptide/MHC complexes, we also used an exquisitely sensitive single T cell activation assay as a probe for ligand expression (21, 26). Thus, as demonstrated previously with model antigens (20, 21, 24), and here with the JAL8 peptide, rare peptide/MHC complexes may be more accessible by the expression-cloning methods described here. Furthermore, it is possible that different immunization procedures may favor

selection of T cells that respond to abundant or rare ligands. This is particularly relevant to xenogeneic immunizations where species-specific differences in MHC/CD8 coreceptor interactions markedly influence T cell responses (46). Future discoveries of other alloreactive T cell-stimulating antigens, particularly those presented by the same MHC molecule, are needed to clarify this issue.

The unexpected finding that JAL8 peptide was a cryptic translation product and was expressed in APC raises the issue of the source of peptides for display by MHC. Undoubtedly, MHC bind and present peptide fragments that are obtained from intracellular polypeptides (47). It is not clear, however, whether these peptides are solely byproducts of cellular protein turn-over or are also generated via alternate mechanisms. Intriguing observations in several experimental systems have demonstrated that peptide/MHC complexes are generated from donor genes that should not have been expressed (17, 20, 34). Boon and his colleagues were the first to formulate the "pepton" hypothesis explaining how gene fragments lacking obvious transcriptional promoters or translational control sequences could yield peptide/MHC complexes (48). Subsequent analysis from this laboratory showed that the generation of these peptides could be explained by cryptic translation initiated by non-ATG codons (20). By screening DNA constructs in APCs for their ability to generate T cell-stimulating peptide/MHC complexes, we identified the set of non-ATG translation initiation codons, and we determined that despite being below detection levels in cell extracts, the amount of these cryptic translation products in either transiently or stably transfected APC were sufficient to cause T cell activation (36). The fact that JAL8 peptide is a cryptic translation product of Iv44 cDNA and that it was initially identified in a complex cDNA mixture (Fig. 2) provides strong independent support to the notion that peptide/MHC complexes in APCs can be generated by cryptic translation.

Presentation of cryptic translation products can have a significant impact on the diversity of peptides displayed by

MHC. With current technology, it is not possible to directly determine what fraction, if any, of the large pool of naturally processed peptides includes cryptic translation products of normally expressed genes. Nevertheless, two recent observations merit attention. First, Townsend and colleagues showed that frame shift mutations in colon tumors can generate novel polypeptides that are presented by MHC and are recognized by T cells (49). Second and more intriguing, Nakayama's group identified a CTL-stimulating, tumor-specific peptide that was encoded within the 5' untranslated region of the *c-akt* gene (50). How an "untranslated" sequence served as a peptide source was, however, not explained. Conceivable mutations, for example, those that can introduce an upstream ATG codon to allow translation of the 5' *c-akt* sequence, may exist in these cells. Alternatively, the identified peptide may be derived from the translated open reading frame of some other gene that is yet absent from the databases. We have noticed, however, that the upstream nucleotide sequence of *c-akt* gene (MMSTPK, GenBank accession no. X65687) contains three in-frame CTG codons that can serve as cryptic translation initiators and can account for generation of the peptide/MHC complex recognized by the CTL (36). Regardless of the yet unknown mechanisms that generate frame-shift mutations or allow cryptic translation, our findings reported here, together with other independent examples, can be conceptualized as maximization of RNA coding information for antigen presentation. Note that from the point of view of T cell surveillance of novel antigens, such as viral gene products in the target cells, it is irrelevant whether the processed peptides arise via degradation of full-length proteins or of cryptic translation products. In fact, maximizing the input of peptide precursors may be the simplest solution to overcoming the bottlenecks in peptide/MHC display imposed by sequence specific motifs in peptide/MHC interactions (51, 52), as well as by sequence selectivity in peptide transport by TAP (53-56).

---

We acknowledge the gifts of reagents from other investigators, Mr. P. Paz for generating the K<sup>b</sup>-HeLa transfectants, and the excellent technical assistance of Mr. Vu Nguyen in DNA sequencing.

This study was supported by grants to N. Shastri from the National Institutes of Health and the University of California Tobacco-Related Disease Research Program. S. Malarkannan is a postdoctoral fellow of the California Division of the American Cancer Society. M. Afkarian was supported in part by the Summer Undergraduate Research Fellowship of the Howard Hughes Medical Institute.

Address correspondence to Nilabh Shastri, LSA 421, Department of Molecular and Cell Biology, University of California, Berkeley, CA 94720-3200.

*Received for publication 6 March 1995 and in revised form 19 June 1995.*

## References

1. Matzinger, P., and M.J. Bevan. 1977. Hypothesis: why do so many lymphocytes respond to major histocompatibility antigens? *Cell. Immunol.* 29:1-5.
2. Bevan, M.J. 1984. High determinant density may explain the phenomenon of alloreactivity. *Immunol. Today.* 5:128-130.
3. Sherman, L.A., and S. Chattopadhyay. 1993. The molecular basis of allorecognition. *Annu. Rev. Immunol.* 11:385-402.
4. Udaka, K., T.J. Tsomides, and H.N. Eisen. 1992. A naturally

- occurring peptide recognized by alloreactive CD8<sup>+</sup> cytotoxic lymphocytes in association with a class I MHC protein. *Cell*. 69:989–998.
5. Aldrich, C.J., A. DeCloux, A.S. Woods, R.J. Cotter, M.J. Soloski, and J. Forman. 1994. Identification of a TAP-dependent leader peptide recognized by alloreactive T cells specific for a class I b antigen. *Cell*. 79:649–658.
  6. Henderson, R.A., A.L. Cox, K. Sakaguchi, E. Appella, J. Shabanowitz, D.F. Hunt, and V.H. Engelhard. 1993. Direct identification of an endogenous peptide recognized by multiple HLA-A2.1-specific cytotoxic T cells. *Proc. Natl. Acad. Sci. USA*. 90:10275–10279.
  7. Udaka, K., T.J. Tsomides, P. Walden, N. Fukusen, and H.N. Eisen. 1993. A ubiquitous protein is the source of naturally occurring peptides that are recognized by a CD8<sup>+</sup> T-cell clone. *Proc. Natl. Acad. Sci. USA*. 90:11272–11276.
  8. Connolly, J.M. 1994. The peptide p2Ca is immunodominant in allorecognition of Ld by beta chain variable region Vβ8<sup>+</sup> but not Vβ8<sup>-</sup> strains. *Proc. Natl. Acad. Sci. USA*. 91:11482–11486.
  9. Heath, W.R., K.P. Kane, M.F. Mescher, and L.A. Sherman. 1991. Alloreactive T cells discriminate among a diverse set of endogenous peptides. *Proc. Natl. Acad. Sci. USA*. 88:5101–5105.
  10. Rötzschke, O., K. Falk, S. Faath, and H.-G. Rammensee. 1991. On the nature of peptides involved in T cell alloreactivity. *J. Exp. Med.* 174:1059–1071.
  11. Hunt, D.F., R.A. Henderson, J. Shabanowitz, K. Sakaguchi, H. Michel, N. Sevilir, A.L. Cox, E. Appella, and V.H. Engelhard. 1992. Characterization of peptides bound to the class I MHC molecule HLA-A2.1 by mass spectrometry. *Science (Wash. DC)*. 255:1261–1263.
  12. Falk, K., O. Rötzschke, S. Stevanovic, G. Jung, and H.-G. Rammensee. 1991. Allele-specific motifs revealed by sequencing of self-peptides eluted from MHC molecules. *Nature (Lond.)*. 351:290–296.
  13. Jardetzky, T.S., W.S. Lane, R.A. Robinson, D.R. Madden, and D.C. Wiley. 1991. Identification of self peptides bound to purified HLA-B27. *Nature (Lond.)*. 353:326–329.
  14. Cox, A.L., J. Skipper, Y. Chen, R.A. Henderson, T.L. Darrow, J. Shabanowitz, V.H. Engelhard, and D.F. Hunt. 1994. Identification of a peptide recognized by five melanoma-specific human cytotoxic T cell lines. *Science (Wash. DC)*. 264:716–719.
  15. Kageyama, S., T.J. Tsomides, Y. Sykulev, and H.N. Eisen. 1995. Variations in the number of peptide-MHC class I complexes required to activate cytotoxic T cell responses. *J. Immunol.* 154:567–576.
  16. Henderson, R.A., H. Michel, K. Sakaguchi, J. Shabanowitz, E. Appella, D.F. Hunt, and V.H. Engelhard. 1992. HLA-A2.1-associated peptides from a mutant cell line: a second pathway of antigen presentation. *Science (Wash. DC)*. 255:1264–1266.
  17. Boon, T., A. Van Pel, E. De Plaen, P. Chomez, C. Lurquin, J.-P. Szikora, C. Sibille, B. Mariame, B. Van Den Eynde, et al. 1989. Genes coding for T-cell-defined Tum transplantation antigens: point mutations, antigenic peptides, and subgenomic expression. *Cold Spring Harbor Symp. Quant. Biol.* 54:587–596.
  18. Boon, T., J.-C. Cerottini, B. Van Den Eynde, P. van der Bruggen, and A. Van Pel. 1994. Tumor antigens recognized by T lymphocytes. *Annu. Rev. Immunol.* 12:337–365.
  19. Pamer, E.G., J.T. Harty, and M.J. Bevan. 1991. Precise prediction of a dominant class I MHC-restricted epitope of *Listeria monocytogenes*. *Nature (Lond.)*. 353:852–855.
  20. Shastri, N., and F. Gonzalez. 1993. Endogenous generation and presentation of the OVA peptide/K<sup>b</sup> complex to T-cells. *J. Immunol.* 150:2724–2736.
  21. Karttunen, J., S. Sanderson, and N. Shastri. 1992. Detection of rare antigen presenting cells by the lacZ T-cell activation assay suggests an expression cloning strategy for T-cell antigens. *Proc. Natl. Acad. Sci. USA*. 89:6020–6024.
  22. Shastri, N. 1995. Single T-cell probes for peptide/MHC expression. *Curr. Opin. Immunol.* 7:258–262.
  23. Falk, K., O. Rötzschke, S. Faath, S. Goth, I. Graef, N. Shastri, and H.-G. Rammensee. 1993. Both human and mouse cells expressing H-2K<sup>b</sup> and ovalbumin process the same peptide SIINFEKL. *Cell. Immunol.* 150:447–452.
  24. Sanderson, S., and N. Shastri. 1994. LacZ inducible peptide/MHC specific T-hybrids. *Int. Immunol.* 6:369–376.
  25. Matthias, P., M.M. Muller, E. Schreiber, S. Rusconi, and W. Schaffner. 1989. Eukaryotic expression vectors for the analysis of mutant proteins. *Nucleic Acids Res.* 17:6418.
  26. Karttunen, J., and N. Shastri. 1991. Measurement of ligand induced activation in single viable T-cells using the lacZ reporter gene. *Proc. Natl. Acad. Sci. USA*. 88:3972–3976.
  27. Falk, K., O. Rötzschke, and H.-G. Rammensee. 1990. Cellular peptide composition governed by major histocompatibility complex class I molecules. *Nature (Lond.)*. 348:248–251.
  28. Malarkannan, S., S. Goth, D.R. Buchholz, and N. Shastri. 1995. The role of MHC class I molecules in the generation of endogenous peptide/MHC complexes. *J. Immunol.* 154:585–598.
  29. Nathenson, S.G., J. Geliebter, G.M. Pfaffenbach, and R.A. Zeff. 1986. Murine major histocompatibility complex class-I mutants: molecular analysis and structure-function implications. *Annu. Rev. Immunol.* 4:471–502.
  30. Wei, M.L., and P. Cresswell. 1992. HLA-A2 molecules in an antigen-processing mutant cell contain signal sequence-derived peptides. *Nature (Lond.)*. 356:443–446.
  31. Kozak, M. 1989. The scanning model for translation: an update. *J. Biol. Chem.* 108:229–241.
  32. Kozak, M. 1991. Structural features in eukaryotic mRNAs that modulate the initiation of translation. *J. Biol. Chem.* 266:19867–19870.
  33. Mandelboim, O., G. Berke, M. Fridkin, M. Feldman, M. Eisenstein, and L. Eisenbach. 1994. CTL induction by a tumour-associated antigen octapeptide derived from a murine lung carcinoma. *Nature (Lond.)*. 369:67–71.
  34. Fetteen, J.V., N. Roy, and E. Gilboa. 1991. A frameshift mutation at the NH2 terminus of the nucleoprotein gene does not affect generation of cytotoxic T lymphocyte epitopes. *J. Immunol.* 147:2697–2705.
  35. Matsumura, M., Y. Saito, M.R. Jackson, E.S. Song, and P.A. Peterson. 1992. In vitro peptide binding to soluble empty class I major histocompatibility complex molecules isolated from transfected drosophila melanogaster cells. *J. Biol. Chem.* 267:23589–23595.
  36. Shastri, N., V. Nguyen, and F. Gonzalez. 1995. Major histocompatibility class I molecules can present cryptic translation products to T-cells. *J. Biol. Chem.* 270:1088–1091.
  37. Van Bleek, G.M., and S.G. Nathenson. 1990. Isolation of an endogenously processed immunodominant viral peptide from the class I H-2K<sup>b</sup> molecule. *Nature (Lond.)*. 348:213–216.
  38. Joyce, S., K. Kuzushima, G. Kepecs, R.H. Angeletti, and S.G. Nathenson. 1994. Characterization of an incompletely assembled

- bled major histocompatibility class I molecule (H-2K<sup>b</sup>) associated with unusually long peptides: Implications for antigen processing and presentation. *Proc. Natl. Acad. Sci. USA.* 91: 4145–4149.
39. Moore, M.W., F.R. Carbone, and M.J. Bevan. 1988. Introduction of soluble protein into the class I pathway of antigen processing and presentation. *Cell.* 54:777–785.
  40. Rotzschke, O., K. Falk, S. Stevanovic, G. Jung, P. Walden, and H.-G. Rammensee. 1991. Exact prediction of a natural T cell epitope. *Eur. J. Immunol.* 21:2891–2894.
  41. Shastri, N., A. Oki, A. Miller, and E. Sercarz. 1985. Distinct recognition phenotypes exist for T cell clones specific for minimal peptide regions of proteins. Implications for the mechanisms underlying MHC-restricted antigen recognition and clonal deletion models of immune response gene defects. *J. Exp. Med.* 162:332–345.
  42. Gavin, M.A., B. Dere, A.G. Grandea III, K. Hogquist, and M.J. Bevan. 1994. Major histocompatibility complex class I allele-specific peptide libraries: identification of peptides that mimic an H-Y T cell epitope. *Eur. J. Immunol.* 24:2124–2133.
  43. Falk, K., O. Rotzschke, K. Deres, J. Metzger, G. Jung, and H.-G. Rammensee. 1991. Identification of naturally processed viral nonapeptides allows their quantification in infected cells and suggests an allele specific T cell epitope forecast. *J. Exp. Med.* 174:425–434.
  44. Jerne, N.K. 1971. The somatic generation of immune recognition. *Eur. J. Immunol.* 1:1–4.
  45. Heath, W.R., M.E. Hurd, F.R. Carbone, and L.A. Sherman. 1989. Peptide-dependent recognition of H-2K<sup>b</sup> by alloreactive cytotoxic T lymphocytes. *Nature (Lond.)*. 341:749–752.
  46. Sherman, L.A., S.V. Hesse, M.J. Irwin, D. La Face, and P. Peterson. 1992. Selecting T cell receptors with high affinity for self-MHC by decreasing the contribution of CD8. *Science (Wash. DC)*. 258:815–818.
  47. Rock, K.L., C. Gramm, L. Rothstein, K. Clark, R. Stein, L. Dick, D. Hwang, and A.L. Goldberg. 1994. Inhibitors of the proteasome block the degradation of most cell proteins and the generation of peptides presented on MHC class I molecules. *Cell.* 78:761–771.
  48. Boon, T., and A. Van Pel. 1989. T cell-recognized antigenic peptides derived from the cellular genome are not protein degradation products but can be generated directly by transcription and translation of short subgenic regions. A hypothesis. *Immunogenetics.* 29:75–79.
  49. Townsend, A., C. Ohlen, M. Rogers, J. Edwards, S. Mukherjee, and J. Bastin. 1994. Source of unique tumor antigens. *Nature (Lond.)*. 371:662.
  50. Uenaka, A., T. Ono, T. Akisawa, H. Wada, T. Yasuda, and E. Nakayama. 1994. Identification of a unique antigen peptide pRL1 on BALB/cRLO1 leukemia recognized by cytotoxic T lymphocytes and its relation to the Akt oncogene. *J. Exp. Med.* 180:1599–1607.
  51. Rammensee, H.-G., K. Falk, and O. Rotzschke. 1993. Peptides naturally presented by MHC class I molecules. *Annu. Rev. Immunol.* 11:213–268.
  52. Engelhard, V.H. 1994. Structure of peptides associated with class I and class II molecules. *Annu. Rev. Immunol.* 12:181–207.
  53. Powis, S.J., E.V. Deverson, W.J. Coadwell, A. Ciruela, N.S. Huskisson, H. Smith, G.W. Butcher, and J.C. Howard. 1992. Effect of polymorphism of an MHC-linked transporter on the peptides assembled in a class I molecule. *Nature (Lond.)*. 357:211–215.
  54. Momburg, F., J. Roelse, J.C. Howard, G.W. Butcher, G.J. Hammerling, and J.J. Neefjes. 1994. Selectivity of MHC-encoded peptide transporters from human, mouse and rat. *Nature (Lond.)*. 367:648–651.
  55. Schumacher, T.N.M., D.V. Kantesaria, M.-T. Heemels, P.G. Ashton-Rickardt, J.C. Shepherd, K. Fruh, Y. Yang, P. A. Peterson, S. Tonegawa, and H.L. Ploegh. 1994. Peptide length and sequence specificity of the mouse TAP1/TAP2 translocator. *J. Exp. Med.* 179:533–540.
  56. Heemels, M.-T., and H.L. Ploegh. 1994. Substrate specificity of allelic variants of the TAP transporter. *Immunity.* 1:775–784.