

## **UC Merced**

# **Proceedings of the Annual Meeting of the Cognitive Science Society**

### **Title**

A Plausible Micro Neural Circuit for Decision-Making

### **Permalink**

<https://escholarship.org/uc/item/65s227h7>

### **Journal**

Proceedings of the Annual Meeting of the Cognitive Science Society, 39(0)

### **Authors**

Hui, Wei

Dawei, Dai

Yijie, Bu

### **Publication Date**

2017

Peer reviewed

# A Plausible Micro Neural Circuit for Decision-Making

Wei Hui, Dai Dawei, BuYijie ([weihui@fudan.edu.cn](mailto:weihui@fudan.edu.cn), [dwdai14@fudan.edu.cn](mailto:dwdai14@fudan.edu.cn))

Laboratory of Cognitive Model and Algorithms, Department of Computer Science, Shanghai Key Laboratory of Data Science, Fudan University, Shanghai, China

## Abstract

An intermediate level between neural circuits and behaviors is neural computations, various behaviors that animals exhibit following some basic control laws can be implemented by some canonical neural computations [Carandini, 2012]. To explore how the microscopic activity of neurons leads to macroscopic behavioral control strategy, we consider basic logic-like operations as some canonical computations in the brain. In this paper, firstly we designed the functional circuits for basic logic-like operations based on the known neurophysiological properties. Secondly, using basic functional circuits constructed a possible neural network for decision logic of animal's behavior. This study provides a general approach for constructing the neural circuits to implement the behavioral control rules. Furthermore, this study will help us to establish a transitional bridge between the microscopic activity of the nervous system and the macroscopic animal behavior.

**Keywords:** Neural circuits; Logic; Neural computations;

## Introduction

Brain as a complex system, three distinct levels should be understood, i.e., behavior level, algorithm level and implementational level, which is famously known as Marr's tri-level hypothesis [Marr 1982]. The benefit of this clear distinction is that researchers can focus on a certain level and do researches purposefully. In [Carandini, 2012], the brain was analogized to a computer, as we know, all applications in the computer can be reduced to the most primitive operations (Logic instructions) of CPU, so is the brain. Researches indicate that the brain deal with different problems by combining and repeating a core set of canonical neural computations [Carandini & Heeger, 2011]. We understand the every detail of instructions, which were implemented in CPU; however, we know little about the details of circuit's constitution in brain. However, without a clear link to behavior and computational mechanism, it is hard to understand what is computed. Therefore, "We need a foundational mechanistic, computational framework to understand how the elements of the brain work together to form functional units and ultimately generate the complex cognitive behaviors" [Brown, 2014].

Obviously, understanding the canonical computations in the brain is helpful to reveal the computational framework from circuit to behavior. In this paper, we consider the basic logical operations as some kind of canonical computations in nervous system. Why can the logical operations be considered a kind of canonical computations in nervous system? We make the rational reasoning from the computational perspective, logic reflects the most basic requirement that any computation can be successfully implemented. Thus, the rules through which animals control their behavior can be described by logic language. In order for a biological nervous system to achieve a specific computation, its structure must be sufficiently complex to achieve the basic logic operations. Therefore, there must be many types of neural circuits to achieve various logical rules in the nervous system. Since, any type of behavioral logic can be formally described by propositional logical. With this reliable and complete formal language, we can describe the basic control rules accurately, with which behaviors comply. Furthermore, with different firing mode of neurons and the synergistic connections between pyramidal neurons and intermediate neurons, how does the nervous system assemble a circuit to achieve a set of specific logical rules?

The aim of our work is not to construct the neural network to achieve the logic operations. In this paper, we attempt to explore computational framework how the microscopic neural activities can systematically explain the macroscopic behavior from the logic view.

## Related works

Research indicates that the brain relies on a core set of computations to apply different functions for different problem [Carandini & Heeger, 2011]. Neural computations, which occur in populations of neurons, are a transitional level from circuit to behavior. Although, some computations have been discovered in nervous system, there are no details of such circuits' constitution. In order to reveal the true mechanism of nervous system the research works involve in different field. Table1 lists the related works.

Table1. List of related works

Category	Sub-category		Attributes
For Computational Purpose	Numerical modeling	MP model, BP model, CNN, RBM; [McCulloch,1943; Rumelhart et al,1986; Fischer & Ige, 2012; ]	. Limited function approximation; . Violating basic biological facts *;
	Spike modeling	HH model[Hodgkin & Huxley, 1952] HR [Hindmarsh& Rose, 1984]	. Good biological plausibility; . Low efficiency;[Izhikevich, 2004]
		A simple Spike model [Izhikevich, 2003, 2004]	. Good biological plausibility; . High efficiency; [Izhikevich, 2003, 2004]
		A cortical simulator [Aanthanarayanan & Modha, 2007]	. Coarse clique-level simulation; . No certain behavior interrelated to;

		Model of thalamocortical systems [Izhikevich & Edelman, 2008]	. Good biological plausibility; . No certain behavior interrelated to;
For Physiological Purpose	Sensor-motor circuit	Circuits for <i>C.elegans'</i> behaviors:	Using ANN to construct [Ferée et al, 1996, 1999]; .Circuit in ANN-mode is of poor biological plausibility;
			Using DNN to construct [Jian-Xin & Xin, 2013]; .Moderate biological plausibility; .No biological neuron was used;
	Reusable and combinable primitive circuit	Canonical neural computations	Linear filtering; Divisive; Normalization; Thresholding; [Carandini & Heeger, 2011; Wang, 2002; Carandini, 2005, 2012;] .Hypothesis on functionalism-level, not on implementation level .No constitution details of circuit;
	Decision-making circuit	Modulators of Decision-making [Kenji Doya, 2000, 2008]	. Good biological plausibility; . No detail constitution of circuit;
Model of two-choice decisions [Ratcliff & Rouder, 1998]		. Less biological details; . Numerical approximation only;	
Probabilistic model for decision making [Wang, 2002; Wei & Dai & Bu, 2017; Wei & Bu & Dai, 2017]		. Good biological plausibility; . Matching behaviorism data; . Statistical abstraction on group-level neural activities.	

\* **Violating basic biological facts includes:**(1) the activation mode of the MP model is two-valued, but that of biological neuron is impulse-firing; (2)the type of ANN's neuron is unitary, however, in the biological neural system, not only multiple types of neurons exist but also their proportion matters; (3)the numerical settings of threshold and connection weights of ANN being able to adjust at will are too idealistic; (4)numerical neurons in the same layer working with perfect synchronization are too idealistic, however, time differences of signal transmitting are more general.

## Biological neuron

### Neuron Model

Izhikevich proposed a simple spiking neuron model that reduces the HH model to a 2-D system [Izhikevich, 2003]. Ordinary differential equations are of the form:

$$\frac{dv}{dt} = 0.04v^2 + 5v + 140 - u + I \quad (1)$$

$$\frac{du}{dt} = a(bv - u)$$

$$\text{If } v \geq 30, \text{ Then } \begin{cases} v \leftarrow c; \\ u \leftarrow u + d; \end{cases}$$

Interpretation of parameters refers to [Izhikevich, 2003]. In the paper, typical values of parameters for excitatory neuron were:  $a = 0.02$ ,  $b = 0.25$ ,  $c = -65$ ,  $d = 8$ . **Average firing rate (AFR)** of pyramidal neuron was between 0 and 21 Hz. Typical values of parameters for inhibitory neuron were:  $a = 0.1$ ,  $b = 0.2$ ,  $c = -55 \sim -48$ ,  $d = 2$ . AFR of intermediate neuron was between 0 and 200 Hz.

### Time delays in AP transmission

Delay means the time of AP propagating from pre-synaptic neurons to post-synaptic neurons [Tolnai et al, 2009]. A wide range of time delays (up to 20 ms) could occur. Since most previous studies did not relate to specific behavioral control logic, which was easy to ignore. In fact, the duration from when the AP is generated to its arrival at the postsynaptic neuron is time-critical or time-sensitive. In this paper, the different delays of AP transmission may be similar to "time multiplexing" in signal processing, which plays an important role in behavioral decision logic.

In this paper, we simulated the propagation delays of AP using different queue lengths. For example, using four different queue lengths, as shown in Fig. 1 (b, Queue 1~4), simulated the different delays of AP propagating from the cell body to positions 1~4 in Fig. 1(a). If the length of a

queue is  $n$ , then the AP is delayed  $n$  milliseconds. Four queues with sequential increases in length indicated that as the location of the synapse on the axon moved away from the cell body, the delays increased. If an AP was generated in the pre-synaptic neuron, we added 1 to the head of the queue; otherwise, we added 0. When the end of queue element was 1, it indicated that the postsynaptic neuron received an AP. Delays of single neuron were limited; if large delays are required in the nervous system, Fig. 1(c) presents a possible way.

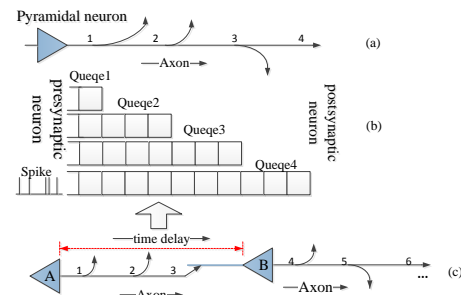

Figure 1. Simulation of the delays in AP transmission along an axon using queues.

### The firing rate of pyramidal neurons is adjustable

A study has indicated that intermediate neurons participate in regulating the firing rates of neural networks [Sanders, et al, 2013]. Fig. 2 shows a possible way of implementation that could achieve this regulation of AFR in the nervous system. This cooperative activity in which excitatory neurons and inhibitory neurons regulate the AFR of downstream neurons is a basic mechanism through which nervous systems function.

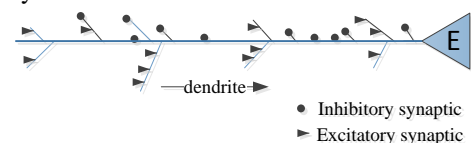

Figure 2. AFR of downstream neurons can be regulated by different combinations of upstream excitatory and inhibitory synapses.

In Fig. 2, if pyramidal neuron E received AP with a stable AFR from upstream excitatory neurons (Eneus), then the AFR of E could be regulated successfully by increasing or decreasing the firing rate of upstream inhibitory neurons (Ineus), as shown in Fig. 3. Table 2 shows changes in the range of neuron E's AFR with changes in the AFR of upstream Eneus and Ineus. This basic law revealed that nervous systems could regulate output firing rate through a precise configuration of types of neurons and connections.

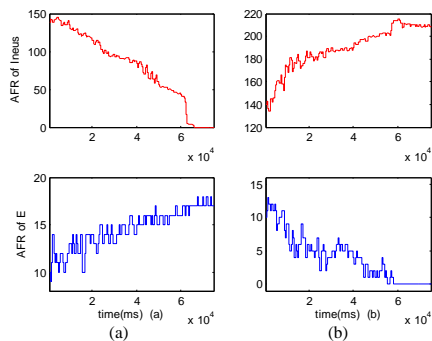

Figure 3. (a) The AFR of neuron E increased with a decrease in the AFR of upstream Ineus. (b) The AFR of E decreased with an increase in the AFR of upstream Ineus.

Table 2. Regulating the AFR of neurons within a certain range.

AFR of Eneus	17~19Hz			
AFR of Ineus	0~50Hz	50~100Hz	100~150Hz	150~200Hz
AFR of E	16~18Hz	13~16Hz	9~13Hz	3~9Hz
AFR of Ineus	75~80Hz			
AFR of Eneus	17~19Hz	12~16Hz	8~12Hz	5~8Hz
AFR of E	14~16Hz	12~16Hz	8~12Hz	5~8Hz

### Neural circuit designs for logic-like operations

AP from pre-synaptic neurons can produce excitatory post-synaptic potentials (EPSP) or inhibitory post-synaptic potentials (IPSP). Since, single AP generates too small EPSP or IPSP to activate or inhibit the post-synaptic neurons; we assume that a train of at least 40 AP could activate the postsynaptic neuron. We employ a group of neurons (neuron cluster) that included 50~100 neurons as a functional unit, which is used to construct circuits to achieve the basic logic-like operations. Since, any of the complex logic can be expressed as a logical expression by four basic logical operations: *And*, *Or*, *Negation*, and *Conditional*. We implement four circuits that are equivalent to the function of these basic logic operations. The circuits contain excitatory neurons and inhibitory neurons.

In the paper, when a constant stimulus 7.5 adding background noise is presented to a neuron cluster, AFR of cluster is higher than 10Hz; while a constant stimulus 3.8 adding background noises is presented, AFR of cluster is lower than 5Hz. If the AFR of a neuron cluster is higher than 10 Hz, then the proposition expressed by the neuron

cluster is *True*; if the AFR of a neuron cluster is lower than 7 Hz, then the propositions is *False*.

### And-like operation circuit

As we know that the concept of the neocortex is as an assemblage of the basic functional units [Jean-Vincent Le B 2007]. Neurons in the fourth layer accept the external signal input from the afferent fibers (area-b in Fig. 4). Small pyramidal cells and intermediate neurons in the second and third layers are responsible for processing the signal (area-a in Fig. 4). In the fifth layer, large pyramidal cells are responsible for propagating the “results” out of the cerebral cortex (area-c in Fig. 4). Axons are shown in black and dendrites are shown in blue.

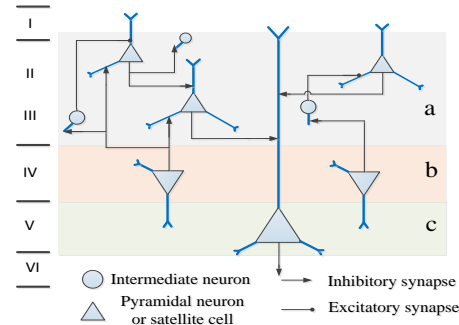

Figure 4. Morphological principles of connectivity between neocortical neurons (Corresponding to [Jean-Vincent Le B 2007]).

*And-like operation* is equivalent to that upstream neuron clusters A and B both fire AP at a high rate, followed by neuron cluster C firing at a high rate; otherwise, C fires at a low rate. As shown in Fig. 5-Left, neurons in A and B full connect to neurons in C. A and B represent two propositions, and C achieves the function of operation “A *And-like* B”. As shown in Fig.5-Right, A and B (corresponding to clusters A and B in Fig.5-Left) that represent the incoming information should be distributed in the fourth layer of the neocortex. C (corresponding to C in Fig.5-Left) that achieves the computation of the *And-like* operation for A and B should be distributed in the second and third layer. At last, the processing results are propagated out of neocortex by the large pyramidal cells in the fifth layers. We re-layout the Fig.5-Left and obtain the Fig.5-Right. The new circuit satisfies the anatomical discoveries and achieves the logic function. It is a feasible implementation in neurobiology.

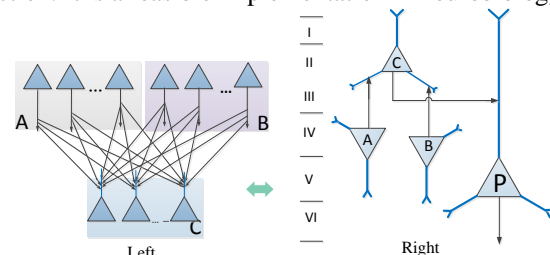

Figure 5. Circuit of And-like operation

AFR of A and B are stable due to the stable input. Neuron cluster C receives AP from A, and the time span is so long (about 20 ms) that the number of AP is small at any given

moment. The distribution property of AP from neurons in cluster B is similar to that of A. If neuron clusters A and B both fire at a high rate, AP trains from A and B at least partially overlap. The purpose of this design is that when only one of the two neuron clusters fires at a high rate, the strength of the subsequent EPSP is too weak to activate C fire at a high rate. However, when A and B both fire at a high rate, due to the overlap of EPSP, the strength of the EPSP is sufficiently strong that C fires at a high rate as well.

However, we found that C would not fire with a high rate every time during the experiment. The EPSP from A and B does not necessarily overlap because the overlap is time-critical or time-sensitive. Thus, it is possible that C fires at a low rate even if both A and B fire at high rate. To avoid such a situation, one feasible way that we used neuron clusters as functional units, and the properties of neurons in a cluster are different, including the model parameters and AP delays. Therefore, initiation of neuronal firing is asynchronous. As a result, EPSP always can be overlapped in C. When A and B both fire at high rate, and C fires with a high rate. Typical values for the delays of neuronal AP are 1 ms, 2 ms, ...20 ms in A and B; each delay has the same number of neurons, and the model parameters of each neuron is little different. As shown in Fig. 6, only when neuron clusters A and B both fire at a high rate, does C fire at a high rate [Fig. 6(d)]; otherwise, C fires at a low rate [Fig. 6(a), (b), and (c)]. This circuit performs the function of *And-like* operation.

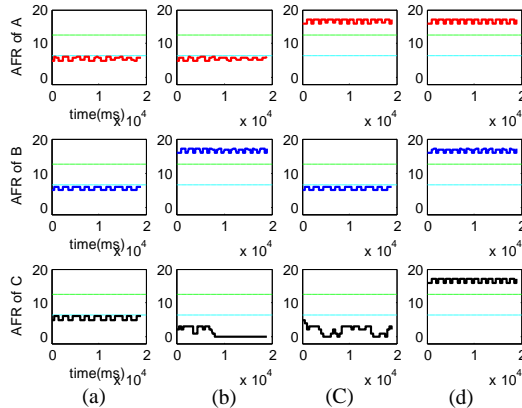

Figure 6. AFR of the And-like operation circuit

### Or-like operation circuit

*Or-like* operation is equivalent that if at least one of upstream neuron clusters A and B fires AP at a high rate, then C fires at a high rate; otherwise, C fires at a low rate. The structure in Fig5 can also achieve the function of *Or-like* operation through modifying the parameters to make sure that APs from neuron clusters A and B are synchronous and concentrated, and when one of the two clusters fires at a high rate, at least 40 AP have reached C at one given moment. Typical values for the delays of the neuronal AP are 1 ms for A and 5 ms for B. The purpose of this design is that when at least one of the two neuron clusters (A, B) fires at a high rate, the strength of subsequent EPSP is

sufficiently strong to make C fire at a high rate [as shown in Fig. 7(b), (c), and (d)]. Only when neuron clusters A and B both fire at a low rate, C fires at a low rate [as shown in Fig. 7(a)]. This circuit performs the function of “A *Or-like* B”.

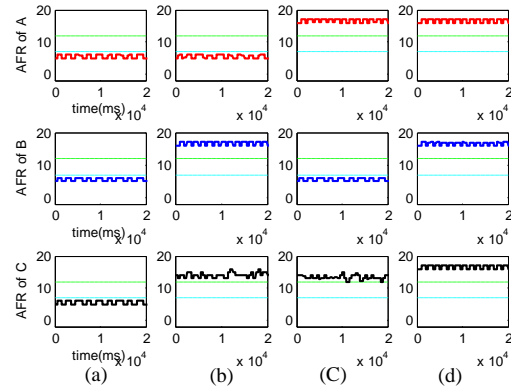

Figure 7. AFR of the Or-like operation circuit

### Conditional-like operation, Negation-like operation circuit

*Conditional-like* operation is equivalent to a simple projection relationship from upstream to downstream neurons, such that if upstream neurons fire with a high rate, then downstream neurons fire with a high rate; otherwise, downstream neurons fire at a low rate. *Negation-like* operation is equivalent that if A fires AP at a high rate, then C fires with a low rate; otherwise, C fires with a high rate. As shown in Fig.8-left, neurons in A fully connect to neurons in  $I_1 \dots I_m, E_1 \dots E_k$  and neurons in  $I_1 \dots I_m, E_1 \dots E_k$  full connect to neurons in C. In addition, for local circuits:  $E_1$  *Conditional-like* C, and  $E_k$  *Conditional-like* C. Neurons in  $I_1 \dots I_m$  are all inhibitory, and the others are excitatory. A represents a proposition, and C performs the function of operation “*Negation-like* A”. Its possible form in neocortex is shown in Fig. 8-right.

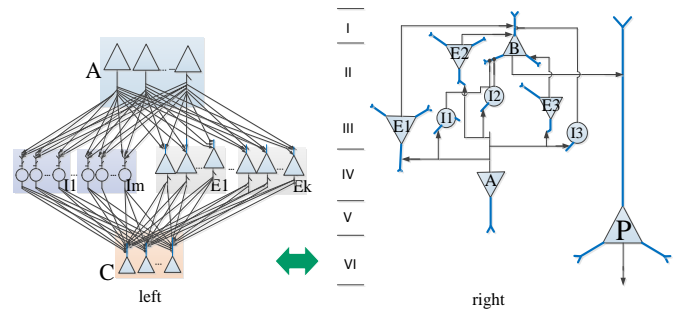

Figure 8. Circuit of Negation-like operation.

The circuit contains excitatory neurons and inhibitory neurons. When neuron cluster A fires at a high rate, which activate intermediate neuron firing at 60~110Hz, and the AP are asynchronous, which led to neuron cluster C receiving nearly continuous IPSP. Thus, neurons in C are inhibited, and C could not fire at a high rate. When A fires at a low rate, the intermediate neurons fire less than 60 Hz, which could not inhibit the activity of downstream neurons. Here, the excitatory signal that from A activated C with “time

division multiplexing” by neuron clusters  $E_1$ ,  $E_2$ , and  $E_3$  ( $m = 3, k = 3$ ). Thus, the AFR of C is about 3 times greater than that of A. Typical values of delays from A to  $I_1$ ,  $I_2$ , and  $I_3$  were 1 ms, 10 ms, and 20 ms, and AP delays from A to neuron clusters  $E_1$ ,  $E_2$ , and  $E_3$  are 20 ms, 40 ms, and 60 ms, respectively. AP delays from  $I_1$ ,  $I_2$ , and  $I_3$  to neuron cluster C are 1 ms, and AP delays from  $E_1$ ,  $E_2$ , and  $E_3$  to C are 30 ms. Each delay had about the same number of neurons. The above settings are not absolute. The circuit performs the transfer of a low firing rate to a high firing rate [Fig. 9(a)], and a high firing rate to a low firing rate [Fig. 9(b)].

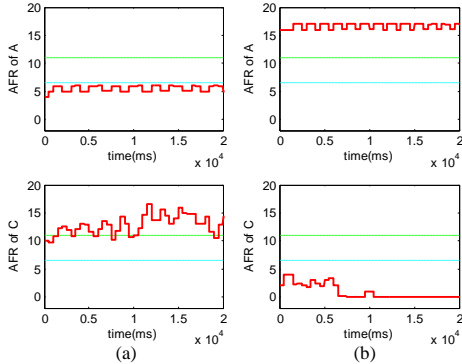

Figure 9. AFR of the Negation-like operation circuit

### Constructing a neural network for a specific behavior based on the logic-like operations

Any of the propositional logical expressions can be transferred into an equivalent conjunctive or disjunctive paradigm. Thus, the nervous system could possibly perform a logic function by realizing the corresponding paradigm.

We demonstrated the implementation of a neural circuit for decision-making logic using a rat’s behavioral decision. In the behavioral experiment [Yang et al., 2014], the rat was trained to go to alternate arms of a Y-maze for drinking, and after the training, the rat never made a mistake to the same side two times as shown in Fig. 10. This experiment verified that the rat formed a set of accurate rules for decision making (turning left or right), which depended on the information that the side from which the rat obtained the last drink, and whether the rat reached the neck of the Y-maze.

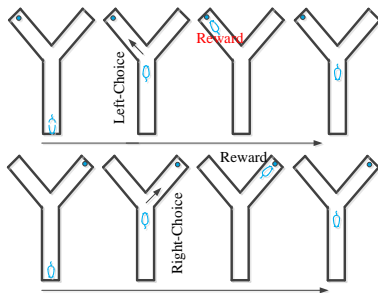

Figure 10. Behavior decision experiment of rat (Corresponding to [Yang et al, 2014]).

We outlined the behavior in a set of logical expressions:  $Drink_L$ , the rat last drank on the left side of the Y-maze;  $Drink_R$ , the rat last drank on the right side;  $Thirsty$ , the rat

was in a thirsty state;  $At\_Neck$ , the rat reached the neck of the Y-maze;  $Turn_L$ , the rat made a decision with turning left;  $Turn_R$ , the rat made a decision with turning right. The decision logic could be described such that the rat was thirsty, and working memory retained the left (or right) side of the Y-maze from which the rat last drank. Then, when the rat reached the neck of the Y-maze again, it executed the command of turning right (or turning left). The process of decision logic could be expressed by a proposition logical expression:  $(Thirsty \wedge Drink_L \wedge At\_Neck \rightarrow Turn_R) \vee (Thirsty \wedge Drink_R \wedge At\_Neck \rightarrow Turn_L)$ . A plausible neural network could achieve this decision logic, as shown in Fig. 11.

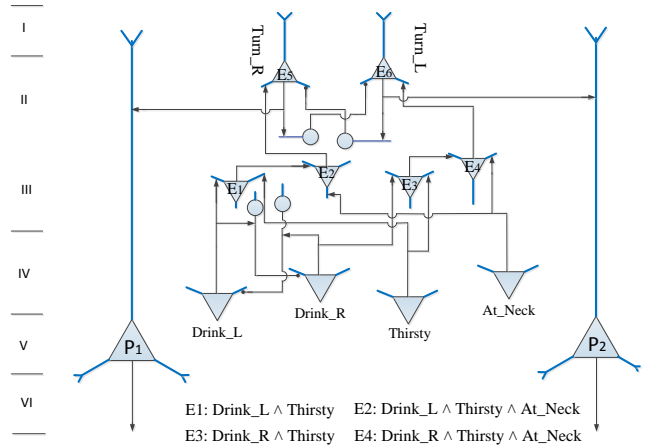

Figure11. Neural circuit for rat’s decision-making.

Taking the rat executing the turning-right command as an example, the details of the circuit were such that: First, four neuron clusters represented the four propositions,  $Thirsty$ ,  $Drink_L$ ,  $At\_Neck$ , and  $Turn_R$ . If the AFR of a neuron cluster was higher than 10 Hz, then the corresponding proposition was true; otherwise it was false. Second, we constructed the neural circuit for the logical expression:  $Thirsty \wedge Drink_L$  based on the **And-like** circuit. Third, we constructed the neural circuit for the logical expression:  $Thirsty \wedge Drink_L \wedge At\_Neck$  based on the **And-like** circuit. Finally, we constructed the circuit  $(Thirsty \wedge Drink_L \wedge At\_Neck) \rightarrow Turn_R$  based on the **Conditional-like** circuit. In addition, we designed two groups of intermediate neurons ( $I_3$  and  $I_4$ ) between  $Turn_R$  and  $Turn_L$  to avoid misuse;  $Drink_L$  and  $Drink_R$  were also mutually exclusive, if the two propositions were both true, the decision making would be disordered. When the rat was in a given status, the neuron cluster that expressed the opposite status was inhibited. The complete circuit for decision-making is shown in Fig. 11.

We simulated the process of decision-making for a rat in a Y-maze. As shown in Fig. 12, (L-Choice) If the rat last drank at the right side of the Y-maze ( $Drink_R= True$ ), then when the rat reached the neck of the Y-maze ( $At\_Neck= True$ ) it executed the command turning-left ( $Turn_L= True$ ); otherwise, the rat executed the command turning-right ( $Turn_L= False$ ). (R-Choice) If the rat last drank at the left side of the Y-maze, then when the rat reached the neck of Y-maze, rat executed the command turning-left; otherwise, the rat executed the command turning-right.



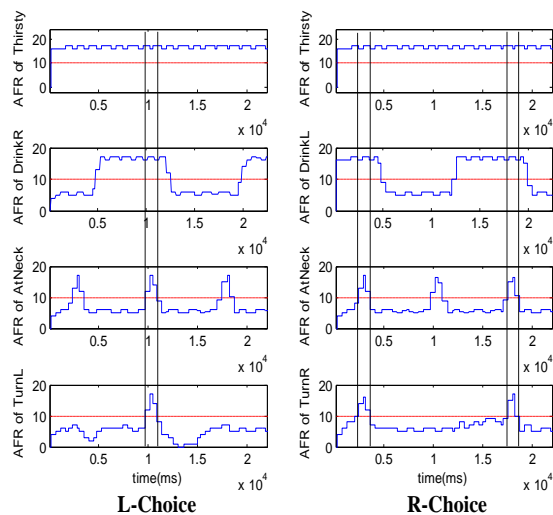

Figure 12. Decision-making in Y-maze

## Conclusion

Finally, we summarize our work through Marr's three-level hierarchy. (a) What is computed? Our answer is that some logical rules are computed. Modeling from this perspective can help us to understand the functional base line of it. (b) Why is it computed? For sake of accurate behavior-controlling, these logical rules must be computed, which is the fundamental demand to a specific behavior. (c) How is it computed? In this paper, we design some types of local neural circuits to achieve four basic logic-like operations as canonical computations and assemble them to simulate a rat's decision making behaviors in Y-maze. Firstly, our circuit design is highly faithful to neurobiological facts like neuron firing mode, two major types of neuron, the proportion constrain of their numbers, and pulse-based mode of communication. Secondly, in the scope of cortical column our logical-equivalent local circuits are biologically plausible to be implemented. Thirdly, these basic functional modular are configurable, reusable and combinable.

We lack a bridge theory from circuit to behavior [Carandini, 2012]. For example, how do microscopic activities of neurons and logical relationships in circuits support the achievement of cognitive ability? Our aim is to construct a biological neural network for behavioral control rules from a logic perspective. This study may be useful for gradually transitioning from microscopic neural activity to macroscopic behavioral control. In our future works, we will explore neural computational mechanism about how a proper circuit is formed.

## Acknowledgments

This work was supported by the NSFC project (Project No.61375122), and in part by Shanghai Science and Technology Development Funds (13dz2260200, 13511504300).

## References

- Carandini M. From circuits to behavior: a bridge too far? *Nature neuroscience*.2012; 15(4):507-509.
- Carandini M, Heeger D J. Normalization as a canonical neural computation[J].*Nature Reviews Neuroscience*,2012,13(1): 51-62.
- Brown JW. The tale of the neuroscientists and the computer: why mechanistic theory matters. *Frontiers in neuroscience*. 2014; 8: 349.
- Rumelhart, David E.; Hinton, Geoffrey E.; Williams, Ronald J. (8 October 1986). "Learning representations by back-propagating errors". *Nature* 323 (6088): 533–536.
- Hodgkin AL, Huxley AF. A quantitative description of membrane current and its application to conduction and excitation in nerve. *The Journal of physiology*. 1952; 117(4): 500.
- Hindmarsh J, Rose R. A model of neuronal bursting using three coupled first order differential equations. Proceedings of the Royal Society of London B: *Biological Sciences*. 1984; 221(1222):87-102.
- Izhikevich EM, et al. Simple model of spiking neurons. *IEEE Transactions on neural networks*. 2003; 14(6):1569-1572.
- Izhikevich EM. Which model to use for cortical spiking neurons? *IEEE transactions on neural networks*. 2004; 15(5): 1063-1070.
- Anathanarayanan R, Modha D S. Anatomy of a cortical simulator[C]. *Proceedings of the 2007 ACM/IEEE conference on Supercomputing*. ACM, 2007: 3.
- Izhikevich EM, Edelman GM. Large-scale model of mammalian thalamocortical systems. *Proceedings of the national academy of sciences*.2008; 105(9):3593-3598.
- Ferr ée, T.C., & Lockery, S.R. (1999). Computational rules for chemotaxis in the nematode *C.elegans*. *Journal of Computational Neuroscience*, 6(3), 263–277.
- Ferr ée, T.C., Marcotte, B.A., Lockery, S.R. (1996). Neural network models of chemotaxis in the nematode *Caenorhabditis elegans*. *Advances in Neural Information Processing Systems*, 9, 55–61.
- Xu J X, Deng X. Biological modeling of complex chemotaxis behaviors for *C. elegans* under speed regulation—a dynamic neural networks approach[J]. *Journal of computational neuroscience*, 2013, 35(1): 19-37.
- Wang, X.J. Probabilistic decision making by slow reverberation in cortical circuits. *Neuron* 36, 955–968 (2002).
- Wei, H., Dai, D. & Bu, Y. *Cogn Neurodyn* (2017). doi: 10.1007/s11571-017-9426-4
- Wei, H., Bu, Y. & Dai, D. *Cogn Neurodyn* (2017). doi: 10.1007/s11571-017-9436-2
- Carandini, M. et al. Do we know what the early visual system does? *J. Neurosci.* 25, 10577–10597 (2005).
- Le B é J V. Structure and dynamics of the neocortical microcircuit connectivity[J]. 2007.
- Tolnai S, Englitz B, Scholbach J, et al. Spike transmission delay at the calyx of Held in vivo: rate dependence, phenomenological modeling, and relevance for sound localization[J]. *Journal of neurophysiology*, 2009, 102(2): 1206-1217.
- Sanders, Z. Josh Huang & Adam Kepecs. (2013). Cortical interneurons that specialize in disinhibitory control. *Nature*, vol 503, 521-524
- Yang, S. T., Shi, Y., Wang, Q., Peng, J. Y., & Li, B. M. (2014). Neuronal representation of working memory in the medial prefrontal cortex of rats. *Molecular brain*, 7(1), 1.