

UC Berkeley

UC Berkeley Electronic Theses and Dissertations

Title

Reasoning about High-Level Constructs in Hardware/Software Formal Verification

Permalink

<https://escholarship.org/uc/item/66w7w52b>

Author

Long, Jiang

Publication Date

2017

Peer reviewed|Thesis/dissertation

**Reasoning about High-Level Constructs in Hardware/Software Formal
Verification**

by

Jiang Long

A dissertation submitted in partial satisfaction of the
requirements for the degree of

Doctor of Philosophy

in

Electrical Engineering and Computer Science

in the

Graduate Division

of the

University of California, Berkeley

Committee in charge:

Professor Robert K. Brayton, Chair
Professor Alberto Sangiovanni Vincentelli
Professor Xinyi Yuan

Summer 2017

**Reasoning about High-Level Constructs in Hardware/Software Formal
Verification**

Copyright 2017

by

Jiang Long

Abstract

Reasoning about High-Level Constructs in Hardware/Software Formal Verification

by

Jiang Long

Doctor of Philosophy in Electrical Engineering and Computer Science

University of California, Berkeley

Professor Robert K. Brayton, Chair

The ever shrinking feature size of modern electronic chips leads to more designs being done as well as more complex chips being designed. These in turn lead to greater use of high-level specifications and to more sophisticated optimizations applied at the word-level. These steps make it more difficult to verify that the final design is faithful to the initial specification. We tackle two steps in this process and their formal equivalence checking to help verify the correctness of the steps.

First, we present LEC, a combinational equivalence checking tool that is learning driven. It focuses on data-path equivalence checking with the goal of transforming the two logics under comparison to be more similar in order to reduce the complexity of a final Boolean (bit-level) solving. LEC does equivalence checking of combinational logic between two RTL (word-level) designs, one the original and one an optimized RTL version. LEC features an open architecture such that users and developers can learn with the system as new designs and optimizations are met, and then it can be modularly extended with new proof procedures as they are discovered.

To address the use of higher level specifications, we build a simple trusted C to Verilog translation procedure based on the LLVM compiler infrastructure. The translator was designed to implement an almost verbatim translation of the C language operators and control structures

into the Verilog *always_ff* and *always_comb* blocks through traversing LLVM Bytecode programs. The procedure reliably bridges the language barrier between software and hardware and allows hardware synthesis and verification techniques to be applied readily.

In combination, these two procedures allow for equivalence checking between a software-like specification and an optimized word-level RTL implementation.

Contents

Contents	i
List of Figures	v
List of Tables	vii
1 Introduction	1
1.1 Motivation	1
1.2 Thesis Contribution	3
2 Data-path Design Space and Verification	4
2.1 Introduction	5
2.2 Data-path Optimization: The Design Space	6
2.3 About Adding a Set of Numbers	10
2.4 Empirical Study: Eight-Operand Adder-Tree Equivalence Checking	11
2.5 Survey: Data-Path Formal Verification Techniques	15
3 LEC: Learning-Driven Equivalence Checking	29
3.1 Overview: A Learning Process - Philosophy	29
3.2 Tool Flow and Organization	31
3.3 The LEC Widgets	33
3.4 System Integration: Proof-tree Infrastructure	53
3.5 Case Studies	56
3.6 Experimental Results	61
3.7 Comparison with Related Work	65
3.8 Conclusion	67
4 A Simple Trusted Translation Procedure from C to Verilog	68
4.1 Introduction	69
4.2 Background	74
4.3 Translating SSA to Verilog	81
4.4 Experiments	90
4.5 Related works	95

4.6 Conclusions	96
5 Conclusion and Possible Future Extensions	97
Bibliography	99

Acknowledgments

First and foremost, I would like to thank my advisor Prof. Robert K. Brayton for accepting me into his PhD program in Fall 2008. I remembered his Phil Kaulfman award ceremony at DAC 2008, where he concluded this award speech by answering a question from the audience on what is his secrets in advising his students:

Leave them alone, don't mess them up, give a hand when they are in need of a help.

At times, I was indeed left alone, given space(maybe too much) to explore my interest, stretch my ability and forge forward on my own, but obtaining his guidance and support at times of doubt and breaking point which carried me through the PhD journey. I would not start nor reach the finishing point without Bob's support or guidance.

I would also like to thank Dr. Alan Mishchenko for introducing me to Bob's research group in the first place. His enthusiasm, deep devotion and expertise to the design and implementation of ABC not only provides us with a research foundation but also bring us closer to the industry for accessing real practical problems. In that, I would like to thank Dr. Mike Case for sharing an interesting problem with our research group which led to the starting point of this thesis work in data-path equivalence checking.

I am thankful to my Qual exam committee members, Prof. Sanjit Seisha, Prof. Andreas Kuehlmann, and Prof. Xinyi Yuan for overseeing the exam.

The thesis work is built upon Verific Inc.'s HDL compiler frontends, without them, it would not be possible. Personally, I would like to thank Baruch Sterin, Niklas Een, Yen-sheng Ho, Yu-yun Dai for the invigorating group discussions and introducing me to Python, bitbucket, hg and many other new tools which are the building blocks in the thesis implementation.

吾生也有涯，
而知也无涯。
以有涯随无涯，
殆已；
已而为知者，
殆而已矣。

庄子 (300. BC)

Life has its bound,
Thou learning does not.
With the bounded to follow the unbounded,
Trying thee;
Knowingly pursue the unknown,
Trying trying thee.

Zhuang Zi (300. BC)

List of Figures

1.1	Design Abstraction Levels	2
2.1	$A \times B =$ Sum of n^2 partial products	11
2.2	Linear Adder Tree described in Verilog	12
2.3	adder tree structure.	13
2.4	ABC's dcec results	14
2.5	Complexity scale of SAT-Sweeping	14
2.6	Bit-level to word-level transformation	15
2.7	Use of UIF	17
3.1	Miter logic	30
3.2	Overall tool flow	32
3.3	Illustration WNK node in C++ class	32
3.4	Proof process	34
3.5	Model Tree from Structural Hashing Widget	37
3.6	Model Tree from Constant Reduction Widget	38
3.7	Model Tree from PEP Reduction Widget	39
3.8	Model Tree from the Abstraction Widget	39
3.9	Case-split Transformation Widget	43
3.10	Algebraic Transformations	43
3.11	Algebraic transformation Widget	44
3.12	Miter network	46
3.13	Constant Learning and Reduction Widgets	48
3.14	PEP Learning and Reduction Widgets	49
3.15	Annotated reduced graph	52
3.16	Branching sub-model tree	54
3.17	Illustration of proof log	55
3.18	Sub-model proof tree	57
3.19	Addition implementation	59
3.20	Proof log	60

3.21 WNK network for adder-shift tree of lemma_64 (Figure 3.20 line 26, equation (3.33)) (pi , po . +, {}, [m:n] are input, output, <i>full-adder</i> , <i>concat</i> and <i>extract</i> operators. The number after '_' is the bit-width of the node.)	62
4.1 C vs RTL equivalence checking	70
4.2 sum02_true-unreach-call.c	71
4.3 C-to-Verilog Translation	73
4.4 A single-clock synchronous circuit	74
4.5 Verilog factorial implementation	76
4.6 Waveform for Module <i>verilog_factorialwithn = 6</i>	77
4.7 C to SSA IR illustration	78
4.8 LLVM CFG	80
4.9 SSA^b from SSA in Figure 4.7c with <i>phi</i> node reverted	82
4.10 Verilog Model	83
4.11 SSA access and utility functions	86
4.12 SSA^b to Verilog Translation	87
4.13 Translation to Verilog continued	88
4.14 Translated Verilog module from the SSA^b in Figure 4.9	89
4.15 Waveform for Verilog module factorial	90
4.16 test:bitvector-loops/overflow_false-unreach-call1.i	93
4.17 Software Verification Benchmark: bitvector category	94

List of Tables

2.1	Result of three data-path transformations	10
2.2	Internal similarities between Adder Trees in Figure 2.3	13
2.3	ACL2 Axioms	22
3.1	Supported operators (unsigned)	32
3.2	Lemma Types(M_M is the current model)	35
3.3	Rewriting rules	40
3.4	Rewriting Widget	41
3.5	Disjunctions of s-lemmas	54
3.6	Conjunction of e-lemmas	54
3.7	Benchmark comparison (Timeout 24 hours)	63
4.1	2015 Software Verification Competition: Bit-Vector category	72
4.2	Verilog language elements	75
4.3	C language elements	76
4.4	fpu_100 : 32-bit FPU	91
4.5	fpu_double: 64-bit FPU	92

Chapter 1

Introduction

One of the driving force of high-level language constructs is the need to raise the abstraction level for productivity.

1.1 Motivation

The technological driving force of the chip-design industry is the feature width in the semiconductor device fabrication process, which reduces from $10\mu m$ in 1971 to $10nm$ in 2016. As of 2014, leading SoC (System-on-Chip) designs, such as Apple A8 chip, contains over two billion transistors on a $89mm^2$ piece of silicon. Ignoring the manufacturing aspect of the chip production process, just focusing on the functions these chips implement, the sheer task of assembling two billion transistors together is a daunting one for human minds to attain. To achieve this, programming languages are relied on to design the functionality and compiler and synthesis technologies are used to generate the circuit.

Figure 1.1 illustrates the conceptual levels of abstraction encountered in a digital design process. The base mathematical model is the finite-state-machine, an enumeration of all states and transitions in the design. At the Boolean logic level (bit-level), design space and state-transitions are abstracted using Boolean variables and logic functions. At the RTL

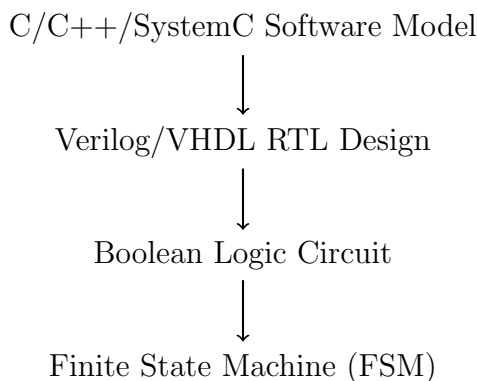

Figure 1.1: Design Abstraction Levels

level (word-level), the design functionalities are described using programming language constructs and the underlying mathematical model is bit-vector or integer arithmetic. High-level languages provide syntax and semantics for hierarchical and modular design methodologies, which makes it possible to build a chip with billions of transistors.

Hardware design languages, like Verilog or VHDL, have syntactical constructs for clocks, flops, logical gates, bit-vectors, etc. They statically allocate memory and computation resources which corresponds directly to the physical elements in the circuits. On the other hand, software based design languages do not have a clocking concept nor basic logic gates explicitly, but have constructs for integers, while/for loops, dynamic memory allocation, run-time function calls, and threads, etc. This expedites design productivity by describing the functionality through more powerful and expressive programming constructs. In industrial practice, software based languages have been used for prototyping, creating reference models and performance models. These are built in advance and maintained as the RTL design process progresses. In Colwell's "Pentium Chronicles" book[20], the idea for out-of-order pipelined micro-code instruction execution was first validated on VAX's instruction sequences using a software model. During Pentium's design creation at Intel, a behavior model in C was created first and maintained rigorously throughout the design process. The author attributed the use of a C-model as a crucial element in Pentium's product success.

As the design functionality is more frequently being captured in a C program, more recent efforts further utilizing these behavior models are being developed in the following two directions:

1. Conducting formal equivalence checking [15][38] between the software model and the RTL design.
2. High-level synthesis[14][21][27] is being used to synthesize C/C++/SystemC directly into RTL and Boolean logic circuit models.

1.2 Thesis Contribution

In this thesis, we focused on verification aspects of both of these developments. First, we present LEC: an open system for checking data-path logic equivalence to verify the correctness of high-level synthesis transformations. Second, we present a simple trusted C to Verilog translation procedure to build a finite state model for any C program as long as it does not use dynamic resource allocation. This can be used to build a golden RTL model that can be equivalence checked against the RTL created by the chip design team.

Chapter 2

Data-path Design Space and Verification

Know yourself, know your
enemy.

Art of War, Sunzi

At times, during the PhD years, I read a bit of Chinese and world history. For the past 2000+ years, history books are marked with battles and wars. Although these were fought individually to determine victories or defeats, winning and losing are mostly pre-determined many many years earlier.

There is a similar notion in designing an algorithm or software: we need to decide if we are fighting a battle or engaging in a war: e.g. are we solving a very specific problem or are we building a system to solve a large class of problems. The strategic planning and preparation phase in such a process decides what problem to solve: a long-term or short-term project, what are the existing techniques available, what will be the foreseeable and unforeseeable obstacles, and how to learn and tackle new obstacles so that the system can grow and evolve over time. These implicit understandings and decisions eventually determine the consequent software architecture and methodology.

In this chapter, we survey the design transformation space in the context of design optimization of arithmetic functions as an introduction to the type of the problems that will be

solved. A simple example of adder-tree equivalence checking is used to show that many data-path equivalence checking problems derived from arithmetic optimizations are very difficult to solve using just modern equivalence checking methods, such as Boolean SAT-sweeping: for those problems, we need different methods. We survey techniques in Boolean solving, SMT solving, and theorem proving to illustrate the strengths and weaknesses of existing approaches – which leads to the following strategic observation/conclusion:

There will be no single algorithmic procedure to solve all data-path equivalence checking problems within a practical time limit. Domain specific techniques are required. Therefore, we position the equivalence checking process that we address as a learning process. We build our solver system to be able to integrate existing and future techniques and provide users with aids to extract bottleneck logic and devise new solutions for new problem domains.

2.1 Introduction

From a general perspective, our objective is to compare two combinational logic designs for equivalence. Each logic design has its individual characteristics, so we are looking to take advantage of these during the proof process. At different stages in the chip design process, designs might be crafted or transformed to have very different structural characteristics. The data-path logic targeted in this thesis are inputs to and outputs of the high-level synthesis steps in the design flow. In such a setting, the data-path logic is either in the form of human-written Verilog or C programs obtained from high-level C/Verilog synthesis procedures. These can be created by either automated tools like [14][27] or by human designers. For these design styles, we will assume that they contain bit-vectors and bit-vector operators such as $+$, $-$, \times , $/$ etc. (we also refer to these as word-level operators in contrast to bit-level Boolean operators). Data-path equivalence checking is the procedure to validate the correctness of design transformations during this part of the design phase.

In addition to word-level operators, there are also many Boolean structures which we will refer to as control logic. Control logic is used to implement more complex design control structures such as case splitting, pipe-line control, exception handling etc. Thus, the design style being targeted is the implementation of complex arithmetic functions involving both bit and word-level operators. Before formal verification came into play, simulation was the sole

method in validating design correctness. In many cases, the result achieved using simulation was insufficient, as demonstrated by the infamous FPU bug of Intel [54], which cost hundreds of millions of dollars in product recall. There are also many designs such as mission critical applications in the security domain, which require more rigorous validation. In the SoC era, increasingly more complex computations are put into chip designs for image, video, and audio processing. It is beneficial and increasingly necessary to have an effective and efficient way to verify correctness through formal verification, improving both the quality and the productivity of validation.

We refer to the above combinational logic as data-path logic in this thesis. Recognizing the fact that arithmetic logic is a major component in data-path logic, in the next section 2.2 we survey the design scope of arithmetic logic transformations. In Section 2.3, we show that integer addition is a basic operator of these many arithmetic operations. In Section 2.4, a case-study is used to show how proving equivalence of adder-trees can be very challenging in the Boolean domain, leading to the conclusion that reasoning is needed at a higher level of abstraction than Boolean space. In Section 2.5, we survey existing data-path equivalence techniques ranging from Boolean solving to theorem proving.

2.2 Data-path Optimization: The Design Space

Many examples cited here are from the book [35]. The particular optimization techniques that lead to the various transformations are not relevant to this thesis; instead we highlight the possible end results to illustrate the amount of dissimilarities that can be created compared to the original design. This leads to the conclusion that pure Boolean techniques will not be able to solve many of the post-optimization data-path equivalence checking problems efficiently.

Constant Multiplication

Multiplication by a constant number is a basic operation implemented using adder trees. For example, decimal number 151 is 10010111_b in binary; and multiplication of 151 and x , $151 \cdot x$, can be decomposed into the addition of the following terms:

$$151 \cdot x = (x \ll 7) + (x \ll 4) + (x \ll 2) + (x \ll 1) + x \quad (2.1)$$

$$151 \cdot x = (x \ll 7) + (x \ll 5) - (x \ll 3) - x \quad (2.2)$$

Formula (2.1) adds 5 terms together while (2.2) adds/subtracts 4 terms together. Considering addition and subtraction as having the same cost using two's complement representation of the integers, (2.2) is a better implementation as it uses fewer computation elements. After the constant multiplication is broken up into linear sums, the optimization procedure would then decide on the construction of an adder tree by choosing the order of which pairs of terms are to be added.

Using two's complement representation, $-x$ is converted to $(\sim x) + 1$. Formula (2.3) is further optimized to have only adders plus an integer constant:

$$151 \cdot x = (x \ll 7) + (x \ll 5) + (\sim x) \ll 3 + (\sim x) + 9 \quad (2.3)$$

The final choice is determined by the overall optimization objective in the context of the surrounding logic.

Finite Impulse Response (FIR) Filter

One step more complex than constant multiplication is a sum of constant multiplication terms, which is a common form of computation for FIR (Finite Pulse Response) filters in Digital signal processing(DSP). An L-tap FIR filter involves a convolution of the L most recent input samples with a set of constants. This is denoted as

$$y[n] = \sum h[k] \cdot x[n - k], \quad k = 0, 1, \dots, L - 1 \quad (2.4)$$

in which, $h[k]$ are the constants, while $x[n - k]$ are the input bit-vector variables. For such a linear sum formula, the optimization procedure [35] would first decompose each constant multiplication term into a sum of shifted-terms (potentially signed) as those in (2.2) and then apply algebraic techniques to identify common sub-expressions and perform kernel extraction. The end result is an adder-tree structure.

Linear Transforms: Constant Matrix Multiplication

A linear transform, in the form of a constant matrix multiplication, is a set of linear sums. This allows even more complexity and transformation possibilities. We use $Y = C \cdot X$ to

represent constant matrix multiplication, where C is a constant matrix, X is a vector of input variables, Y is the resulting output vector:

$$Y[i] = \sum_{j=0}^{N-1} C_{i,j} X[j] \quad (2.5)$$

To illustrate the space of transform possibilities, the following [35] 4×4 constant matrix is used in a four-point discrete cosine transform(DCT) :

$$C = \begin{bmatrix} \cos(0) & \cos(0) & \cos(0) & \cos(0) \\ \cos(\pi/8) & \cos(3\pi/8) & \cos(5\pi/8) & \cos(7\pi/8) \\ \cos(\pi/4) & \cos(3\pi/4) & \cos(5\pi/4) & \cos(7\pi/4) \\ \cos(3\pi/8) & \cos(7\pi/8) & \cos(\pi/8) & \cos(5\pi/8) \end{bmatrix} \quad (2.6)$$

Using the identities $\cos(\pi/8) = -\cos(7\pi/8)$, $\cos(3\pi/8) = -\cos(5\pi/8)$ etc. and denoting $A = \cos(0)$, $B = \cos(\pi/8)$ etc. the matrix multiplication can be written concisely as,

$$\begin{bmatrix} y_0 \\ y_1 \\ y_2 \\ y_3 \end{bmatrix} = \begin{bmatrix} A & A & A & A \\ B & C & -C & -B \\ D & -D & -D & D \\ C & -B & B & -C \end{bmatrix} \begin{bmatrix} x_0 \\ x_1 \\ x_2 \\ x_3 \end{bmatrix} \quad (2.7)$$

The end result is a forest of adder-trees.

Approximation Algorithm

In the above examples, addition is the basic operator of the arithmetic expression. In the case of high-order polynomials, multiplication becomes the target operator for optimization considerations. Consider the Taylor expansion of $\sin(x)$ approximated with four terms:

$$\sin(x) = x - \frac{x^3}{3!} + \frac{x^5}{5!} - \frac{x^7}{7!} \quad (2.8)$$

This polynomial of degree 7 approximates the *sine* function very well. Assuming the terms,

$$S_3 = 1/3!, S_5 = 1/5!, S_7 = 1/7!$$

are pre-computed, the naive evaluation of the polynomial requires 3 additions/subtractions, 12 variable multiplications and 3 constant multiplications. However, it is possible to compute this using the following sequence:

$$d_1 = x \cdot x \tag{2.9}$$

$$d_2 = S_5 - S_7 \cdot d_1 \tag{2.10}$$

$$d_3 = d_2 \cdot d_1 - S_3 \tag{2.11}$$

$$d_4 = d_3 \cdot d_1 + 1 \tag{2.12}$$

$$\sin(x) = x \cdot d_4 \tag{2.13}$$

Thus only 3 additions/subtractions, 4 variable multiplications and one constant multiplication are needed.

Another example where high-order polynomials are used for approximation is in (2.14) below. This is used in computing quadratic splines, which are used in computer graphics. Such polynomials have degrees not more than 4, and are smooth in both the first and second derivative and continuous in the third derivative.

$$P = zu^4 + 4avu^3 + 6bu^2v^2 + 4uv^3w + qv^4 \tag{2.14}$$

The original formula (2.14) requires 23 multiplications and 4 additions. The following three techniques transform the above polynomial into different implementations.

1. Two-term CSE (common sub-expression) algorithm:

$$d_1 = u^2 \tag{2.15}$$

$$d_2 = v^2 \tag{2.16}$$

$$d_3 = uv \tag{2.17}$$

$$P = d_1z + 4ad_1d_3 + 6bd_1d_2 + 4wd_2d_3 + qd_2^2 \tag{2.18}$$

2. Using the Horner form:

$$P = zu^4 + v \cdot (4au^3 + v \cdot (6bu^2 + v \cdot (4uw + qv))) \tag{2.19}$$

3. Using algebraic factoring:

$$d_1 = u^2 \tag{2.20}$$

$$d_2 = 4v \tag{2.21}$$

$$P = u^3 \cdot (uz + ad_2) + d_1 \cdot (qd_1 + u \cdot (wd_2 + 6bu)) \tag{2.22}$$

Optimization Method	Num Multiply	Num Add
Two-term CSE	16	4
Horner	17	4
Algebraic	13	4

Table 2.1: Result of three data-path transformations

Table 2.1 shows the number of variable multiplications and addition operations needed after the design transformations. The actual implementation decision depends on the context, design constraints and the surrounding logic in which these polynomials are to be implemented.

Equivalence checking of individual multipliers is a well-known challenge already, but verification of these transformed polynomials is even more difficult. This further motivates the need to reason at a higher level rather than purely at the Boolean level.

2.3 About Adding a Set of Numbers

In the above data-path optimization procedures, addition is a basic operation. Multiplier design is a good example of this. An n -bit binary number itself, $A = a_{n-1}a_{n-2} \dots a_1a_0$, is defined using a binary integer format by adding n numbers together:

$$A = \sum_{i=0}^{n-1} 2^i \cdot a_i \tag{2.23}$$

$$B = \sum_{j=0}^{n-1} 2^j \cdot b_j \tag{2.24}$$

Then, the multiplication two n -bit binary numbers, equation (2.25), can be seen as a sum of $n \times n$ partial products of $2^i a_i \cdot 2^j b_j$, which forms an $n \times n$ matrix in Figure 2.1. While

implementing the multiplier, one has to decide the order in which these partial-products are be added, .e.g. equation (2.25) adds the columns first, while (2.26) adds the rows first.

$$A \times B = \sum_{i=0}^{n-1} \sum_{j=0}^{n-1} 2^{i+j} \cdot a_i \cdot b_j \quad (2.25)$$

$$B \times A = \sum_{j=0}^{n-1} \sum_{i=0}^{n-1} 2^{i+j} \cdot a_i \cdot b_j \quad (2.26)$$

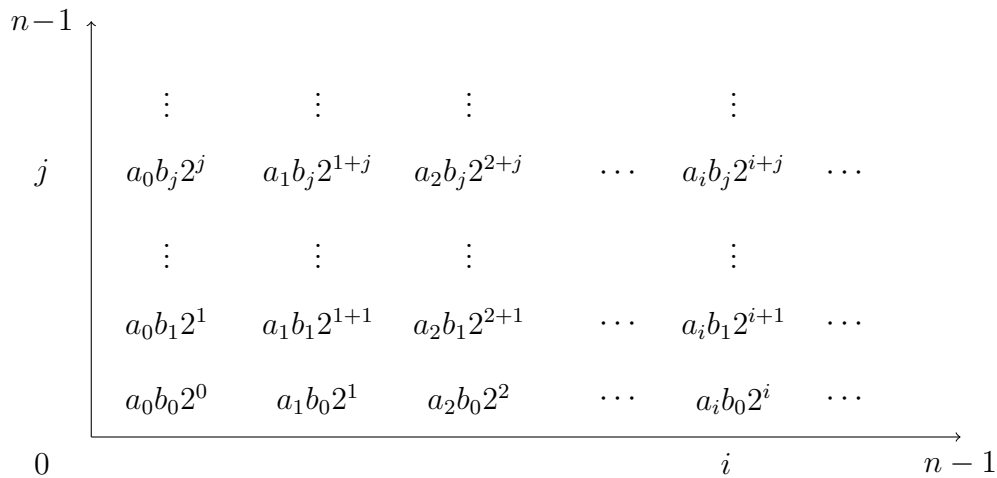

Figure 2.1: $A \times B = \text{Sum of } n^2 \text{ partial products}$

Multiplication is commutative: $A \times B \equiv B \times A$. However, these two multiplier implementations results in a Boolean satisfiability problem from $A \times B \equiv B \times A$ that is very difficult to solve at the bit level. This is because the two multiplier logics are completely different internally, and applying knowledge of the commutative law at the Boolean level is all but impossible.

2.4 Empirical Study: Eight-Operand Adder-Tree Equivalence Checking

From the above survey, addition is seen to be the basic operator for adder-trees and multiplier implementations. In this section, we evaluate the capacity and performance of the SAT-sweeping procedure in proving pure adder-trees equivalence. As SAT-solving is classified as an NP-complete algorithm, we wonder in what situations it gets easier and in what situations

it gets more difficult. We use the following case-study to help understand the strengths and weaknesses of Boolean methods. The objective is to show that a Boolean solving method has inherent limitations which cannot be resolved within itself; in order to solve these data-path equivalence checking problems, higher level information needs be captured to help reduce the problem complexity. This leads to our belief that we have to enable a tool to reason beyond Boolean logic.

```

module LinearAdderTree
#(
  parameter WIDTH = 16)
(
  input  [WIDTH-1:0]  a[7:0],
  output [WIDTH+4-1:0] y) ;

  reg  [WIDTH+4-1:0] ret;
  always_comb begin
    ret = 0 ;
    for (int i=0;i<7;i++)
      ret = ret + a[i];
  end

  assign y = ret;

endmodule

```

Figure 2.2: Linear Adder Tree described in Verilog

The Verilog code in Figure 2.2 implements an eight-operand addition in integer arithmetic: the use of the *WIDTH* parameter definition guarantees there are no overflow situations.

There are many ways to implement such an adder tree logic. Figure 2.3 shows four examples using linear tree or binary tree topologies, and with different orders of adding terms. Table 2.2 compares the internal similarities between the four structures. Columns 1 and 2 are the two structures being compared. Column 3 gives a ranking of the amount of internal structural similarity between the compared adder-trees. Column 4 shows terms where similarities exist. The first two pairs share the top similarity ranking as they are symmetric and have the same amount of internal similarities. The third pair has slightly more similarities than the remaining three pairs because the two adder tree structures are symmetric and both are full binary trees. The remaining three pairs are dissimilar in roughly the same degree. The

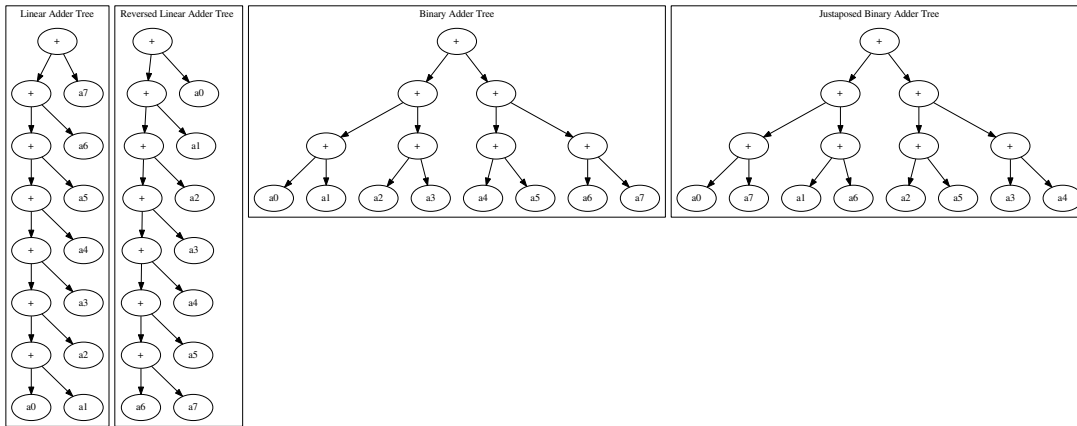

Figure 2.3: adder tree structure.

significance of the similarities are illustrated in the following experiments, which conducted equivalence checking between the various pairs.

$Adder_0$	$Adder_1$	Similarity Rank	Similarities
Linear	Binary	1 st	$a_0 + a_1, ((a_0 + a_1) + (a_2 + a_3))$
Reversed Linear	Binary	1 st	$a_6 + a_7, ((a_4 + a_5) + (a_6 + a_7))$
Binary	Juxtaposed Binary	3 rd	$a_0 + a_1, a_6 + a_7$ vs. $a_0 + a_7, a_1 + a_6$
Linear	Reversed Linear	4 th	None
Linear	Juxtaposed Binary	4 th	None
Reversed Linear	Juxtaposed Binary	4 th	None

Table 2.2: Internal similarities between Adder Trees in Figure 2.3

We conducted equivalence-checking between these four adder-tree structures using ABC[2]'s *dcec* command, which is a state-of-art combinational equivalence checking procedure using SAT-sweeping at the bit-level. Such a procedure uses SAT solvers as the main solving engine to establish equivalence by identifying and utilizing internal match-points, i.e. signals in the design that are functionally equivalent to each other. Figure 2.4 shows the run-time results on pair-wise equivalence checking with operand WIDTH from 1 to 35.

Comparing with Table 2.2, the run-times inversely follow the rankings in similarity. The first two pairs of comparison scale well with WIDTH while the others do not scale. As illustrated in Figure 2.5, the complexity of solving equivalence checking problem ranges from constant time to apparently exponential time; the actual difficulty depends on the amount of internal

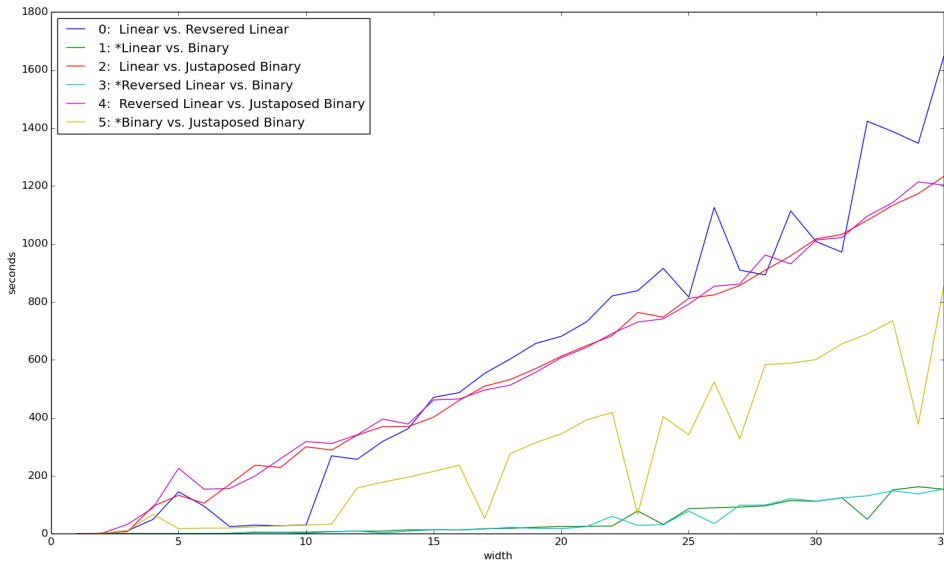

Figure 2.4: ABC’s dcec results

similarities. On the left side is the extreme case that both logic structures are exactly the same, then equivalence can be determined through structural hashing; the output functions are hashed into the same node value. On the right side is the other extreme; logic equivalence has to be established through exhaustively searching the entire Boolean function space: i.e. solving an NP-complete problem.

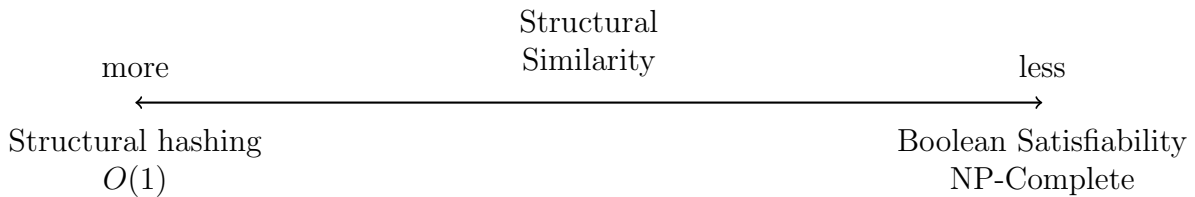

Figure 2.5: Complexity scale of SAT-Sweeping

The total number of different n operand adder trees is $P_n^n \times \prod_{i=n}^2 C_i^2$. From the complexity growth of the 8-operand adder tree example, it seems that pure Boolean methods are unable to solve problems where design transformations render them structurally dissimilar. Knowledge of high-level design functionality is seemingly required.

2.5 Survey: Data-Path Formal Verification Techniques

Boolean logic is defined over Boolean space B , $B = \{0, 1\}$. A Boolean function f of m variables is a mapping of $B^m \rightarrow B$. Boolean logic functions can be represented as a directed acyclic graph, with each node annotated as a Boolean function, such as an and-invertor graph (AIG). A bit-vector is a set of Boolean variables; a bit-vector function is a collection of Boolean functions.

For convenience, we will refer to a single Boolean variable as a bit, a bit-vector as a word, a function over words as a word-level function or word-level operators. A network which contains word-level operators is called a word-level network.

As illustrated in Figure 2.6, the bit-blasting procedure transforms a word-level operator into a set of bit-level functions; the inverse of this, the procedure to group bit-level functions into word-level operators is sometimes called reverse-engineering, a significantly difficult operation.

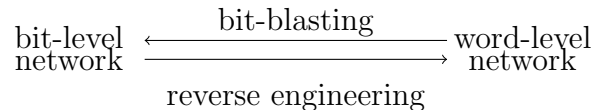

Figure 2.6: Bit-level to word-level transformation

The data-path logic discussed in this thesis refers to any set of arbitrary bit and word-level operators. The focus of the techniques to be developed in this thesis to analyze data-path logic, is to use reasoning on the word-level operators to help in checking bit-level equivalence.

Conceptually, data-path logic specification provides the following :

1. a directed graph, with nodes annotated as word level operators with specified input and output widths.
2. the word-level operators are from a known library of arithmetic functions.

The remaining sections in this chapter gives an overview of the various techniques available, from Boolean solving to pure theorem proving of first order logic.

Boolean Solvers

Boolean solving techniques are fundamental and generic in that all data-path logic can be converted into Boolean functions. There are essentially four basic categories for establishing that two Boolean networks are equivalent:

1. Structurally the same
2. Equivalence through exhaustive simulation
3. Equivalence established by SAT solving
4. Equivalence established by BDDs

One direction in optimizing Boolean solvers is to improve the performance of the SAT solver and BDD packages. The other direction is to simplify the Boolean logic structure through transformations. The technique of the SAT-sweeping procedures in [12] uses all four categories, structural hashing, simulation, SAT, and BDDs to identify and merge internal equivalent points, thus reducing overall complexity. In [70], the authors further attempted to find more internal points to merge by extending the definition of equivalent nodes under the condition of observability don't cares. [11] tries to minimize intermediate BDD size through converting a BDD relation into a corresponding parametric representation with a smaller set of BDD variables. State-of-art equivalence checking procedures [52] provides a highly integrated and optimized implementation of AIG [43] rewriting, simulation, SAT-sweeping and logic synthesis techniques. This has led to dramatic improvements over earlier implementations.

The advantage of these Boolean solvers is that they are generic and fully automated. They are very good at finding discrepancies and providing error traces if the designs are not equivalent. However, on proving equivalence, their strengths becomes their own weakness, as the complexity is NP-complete. If two designs are structurally dissimilar, then obtaining an equivalence proof can be very difficult. On the other hand, there can exist a trivial proof even when structural dissimilarity exists, e.g. for summing eight integers, equivalence can be established through commutative, associative and distributive laws of the '+' operator. Clearly an advantage can be obtained if knowledge of the '+' operator can be integrated into the Boolean solving methods.

The Use of Un-Interpreted Functions (UIFs)

The use of un-interpreted functions (UIFs) tries to simplify the equivalence checking program by introducing constraints from the functional level. The principle of UIF derives from the general definition of what is a function: a function is a mapping from its input domain to its output domain which requires that for the same inputs, the output is always the same:

$$\begin{aligned}
 & \text{if } f \equiv g \text{ then} \\
 & \forall X \forall Y, \quad \text{s.t. } X = Y \Rightarrow f(X) = g(Y)
 \end{aligned}$$

We use the miter logic formulation in Figure 2.7 to illustrate the utilization of the knowledge of a function. In Figure 2.7, the left side has two multiplier instances while the right side has only one; this might have been the result of minimizing the number of computation units during an optimization phase. If the multipliers are wide, it is a difficult problem to prove equivalence using purely Boolean techniques.

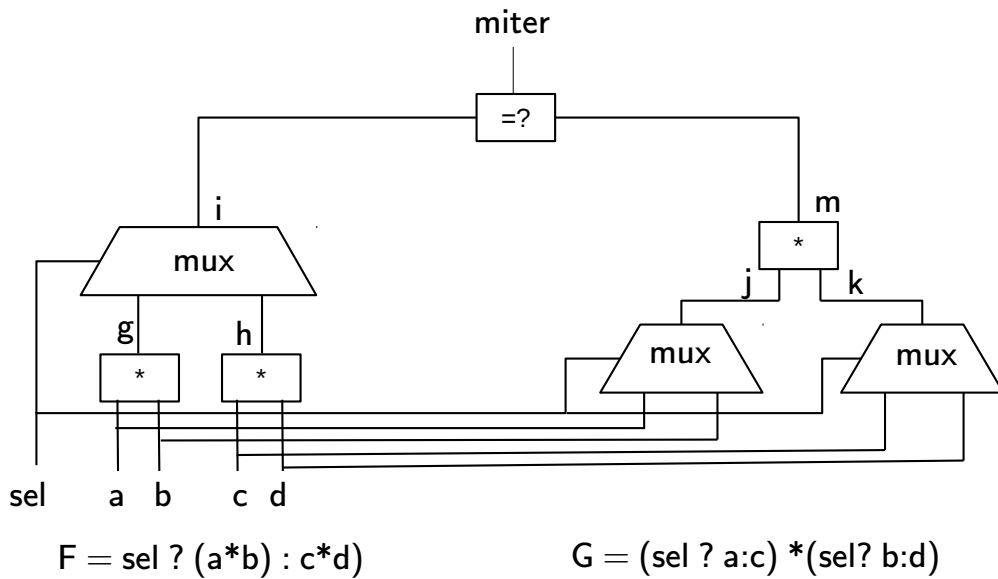

Figure 2.7: Use of UIF

For this particular design, the detailed functionality of the multiplier is not needed proving the logic equivalence. In this case, the multiplier function can be replaced with any function, and the equivalence would still hold provided the two functions being paired are the same function. The UIF technique utilizes such an observation and performs the following two steps:

- Remove the internal logic of each multiplier and create new free-input variables for each multiplier output.
- Add the following constraints/lemmas to the miter logic

$$(a = j) \ \& \ (b = k) \quad \Rightarrow \quad m = g \quad (2.27)$$

$$(c = j) \ \& \ (d = k) \quad \Rightarrow \quad m = h \quad (2.28)$$

and similarly when j and k are interchanged. Each of these implications is known as a UF constraint. In this case, a UF constraint is put between every multiplier on the left and every one on the right. By taking advantage of the knowledge that functions m , g and h are the same functions, the transformed Boolean satisfiability problem is then easily proven using SAT solvers, thereby proving the original problem. Note that even if the internal logic of the multipliers is not removed, the UF constraints still can be asserted and may be effective because they establish a relation between the two halves of the miter to be proved equivalent. Note also that although the UF constraints are implied by the Boolean logic of the miter, it would be essentially impossible to establish this from reasoning at the bit-level. This information comes from a higher level knowledge that m , g and h are the same functions.

Satisfiability Modulo Theory(SMT) Solvers

The UIF approach is the simplest framework to utilize the knowledge that part of the design is implementing a high-level function, while the details of the function's definition are not needed. To extend the use of high-level functions, the next level is to be able to reason about a function's input/output definition. In the data-path equivalence checking domain, it requires the prover to represent and reason about quantifier-free first order logic.

Formally, an SMT instance [59] is a formula in quantifier-free first-order logic, and SMT is the problem of determining whether such a formula is satisfiable. Imagine a Boolean SAT instance in which some of the binary variables are replaced by "predicates" over a suitable set of non-binary variables. A predicate is basically a binary-valued function of non-binary variables. Example predicates include (integer) linear inequalities (e.g., $3x + 2y > 6$, $z \geq 4$) or equalities involving so-called uninterpreted terms and function symbols (e.g., $f(f(u, v), v) = f(u, v)$ where f is some unspecified function of two unspecified arguments.) We are still dealing with a satisfiability problem, except that its solution now depends on our ability to determine the satisfiability of the underlying predicates.

In summary, an SMT instance is a generalization of a Boolean SAT instance in which various sets of variables are replaced by predicates from a variety of underlying theories. Practically, SMT formulas provide a much richer modeling language than what is possible with Boolean SAT formulas. In particular, for data-path equivalence checking, the QF_BV SMT [59] constructs allows us to model the data-path operations at the word rather than the bit level, which is equivalent in expressiveness to Verilog operators.

Early attempts at solving SMT instances involved translating them to Boolean SAT instances (i.e. bit-blasting the word-level operators into bits) and passing this (much larger) formula to a Boolean SAT solver. This approach has its merits: by pre-processing the SMT formula into an equivalent Boolean SAT formula we can use existing Boolean SAT solvers "as-is" and leverage their performance and capacity improvements over time. On the other hand, the loss of the high-level semantics of the underlying theories means that the Boolean SAT solver has to work a lot harder than necessary to discover "obvious" facts (such as $x \cdot y = y \cdot x$ for integer multiplication.) This observation was the impetus behind the development, over the last several years, of a number of SMT solvers that tightly integrate the Boolean reasoning of a *DPLL*-style search with theory-specific solvers that handle conjunctions (ANDs) of predicates from a given theory.

Dubbed DPLL(T) [63], or Generalized DPLL [50], this architecture gives the responsibility of Boolean reasoning to the DPLL-based SAT solver which, in turn, interacts with a solver for theory T through a well-defined interface. The theory solver need only worry about checking the feasibility of conjunctions of theory predicates passed on to it from the SAT solver as it explores the Boolean search space of the formula. For this integration to work well, however, the theory solver must be able to participate in both propagation and conflict analysis, i.e., it must be able to infer new facts from already established facts, as well as to supply succinct explanations of infeasibility when theory conflicts arise. In other words, the theory solver must be incremental and back-trackable while the theory's implementation varies and is domain-specific.

Relevant to the data-path equivalence checking problems is the SMT QF_BV(Quantifier Free Bit Vector Arithmetic) solvers. One of its contributions is the introduction of word-level operators that allows word-level structures to be represented in the problem formulation. In some of the leading SMT solvers [13][23][34], word-level techniques such as rewriting, abstraction refinement and reduction etc. are applied. Depending on the underlying theory

used or extracted from the QF_BV formulation, the generalized DPLL framework is used to integrate the Boolean SAT solvers. Furthermore, when the problem remains unsolved, bit-blasting the QF_BF formulation into a CNF formula is the last resort for most of the leading SMT bit-vector solvers, Boolector [13], z3 [23], Beaver [34]. If this bit-blasting does not solve the problem, the programs terminate without an answer.

The advantages of SMT solving using the Generalized DPLL framework are that it is a generic, automated method and empirically often effective in finding counterexamples if the designs are not equivalent. However, this strength leads to a weakness that the SMT solvers still treats the underlying problems as a Boolean satisfiability problem which is inherently NP-complete – potentially very difficult or impossible to solve.

Theorem Proving

While Boolean SAT solvers inherently are solving an NP-Complete problem, theorem prover attempts to provide an alternative. By reasoning in first order logic, a theorem prover integrates Boolean logic and high-level functions natively. In comparing to a pure theorem proving approach, SMT solving is a hybrid approach as it has the ability to represent first order logic for a specialized theory and integrates Boolean solvers at the same time. For theorem proving in the data-path equivalence checking domain, the subject of interest is quantifier-free first order logic. We use an example, from [36], to illustrate the thought process of theorem proving. We show that theorem proving is not only a method but also a necessity in its problem formulation. Theorem proving differs fundamentally from Boolean solvers because a proof is based on symbolic rewriting and mathematical induction rather than Boolean SAT solving – hence theorem proving does not try to solve the data-path equivalence checking problem as an NP-complete problem.

The Verilog module in Figure 2.8a implements a 32-bit ripple-adder and we create an equivalence checking problem by comparing it with `adder32` in Figure 2.8b:

$$ripple_adder32 \equiv adder32 \tag{2.29}$$

The proof objective is the following:

Does above (2.29) check that Verilog module `ripple_adder32` implement the addition of two binary integer numbers correctly.

```

module ripple_adder32(
  input cin,
  input [31:0] a0,
  input [31:0] a1,
  output reg [31:0] o,
  output reg cout ) ;

always_comb begin
  cout = cin;
  for (i=0;i<32;i++) begin
    o[i] = a0[i] ^ a1[i] ^ cout;
    cout = (a0[i] & a1[1])
      | (a0[i]& cout)
      | (a1[i] & cout);
  end
end
) ;
endmodule

```

(a) Verilog Ripple Adder

```

module adder32(
  input cin,
  input [31:0] a0,
  input [31:0] a1,
  output [31:0] o,
  output cout ) ;
  assign cout,o = a0 + a1 + cin;
endmodule

```

(b) Verilog Adder

The answer seems to be either “YES” or “NO”, but the truth is: the equivalence checking of (2.29) cannot answer the question. The reason is a problem formulation mismatch : the proof objective is about natural numbers adding together, whereas the Verilog module is in the Boolean domain which does not have the concept of what a natural number is. The above proof objective about integer addition can not be answered in the Boolean domain solely (i.e. using the formula 2.29), because in Boolean logic, one cannot reason about ‘+’ in integer domain. To prove *ripple_adder32* correctly adds two natural numbers together, first order logic is needed to express what is a natural number, as well as to formulate the definition of ‘+’ as a function connecting it to Boolean logic.

Thus the objective of the verification is no longer a data-path equivalence checking problem at the RTL level, but a mathematical one using first-order logic. We use ACL2 to illustrate such a process by constructing a ripple adder in ACL2 and illustrate the correctness formulation along with the proof procedure.

Name	Axiom, Definition, or Theorem
Thm 1	$t \neq nil$
AX 2	$x = nil \longrightarrow (if\ x\ y\ z) = z$
AX 3	$x \neq nil \longrightarrow (if\ x\ y\ z) = y$
Def not	$(not\ p) = (if\ p\ nil\ t)$
Ax 4	$(car\ (cons\ x\ y)) = x$
Ax 5	$(cdr\ (cons\ x\ y)) = y$
Ax 6	$(consp\ (cons\ x\ y)) = t$
Thm 7	$(endp\ x) = (not\ (consp\ x))$

Table 2.3: ACL2 Axioms

ACL2 Introduction

ACL2 functions and theorems are established using a small set of basic axioms and theorems. Everything else is constructed from these basic logic elements. Table 2.3 shows the list of Axioms and Theorems that are used by the ACL2 theorem prover [37]. The first four define two basic values t and nil , along with the definition of the if and not functions. Note, they are just symbols, although t and nil can be thought of as *true* and *false* in Boolean logic. Computation in ACL2 logic is symbolic, using the rules of substitution, inference, and mathematical induction. In ACL2, a list is also a first order object. $cons$ is the function that takes an element and a list as inputs, and prepends the element to the head of the list. The Operator car gets the first element of the list, while cdr gets the rest of the list by removing the head of the list.

To illustrate the semantics, we use Python to model the car and cdr functions as follows:

```
def car(lx) :
    if lx == nil :
        return nil
    assert len(lx) > 0
    return lx[0]

def cdr(lx):
    if lx == nil or len(lx) == 1:
        return nil
    else :
```

```

    return lx[:-1]
pass

```

By ACL2 definition, it is illegal to call *car* over an empty-list value, but *car* over *nil* returns *nil*, so does *cdr* (*nil* is not equivalent to the empty-list value). In Ax 6, the predicate 'consp' returns *t* if its operand can be represented as (*cons x y*). *endp* is the opposite of *consp*. So we have the following results:

```

( car nil ) = nil
( cdr nil ) = nil
( car (cons t nil) ) = t
( cdr (cons t nil) ) = nil
(endp (const t nil)) = nil
(consp (const t nil)) = t

```

ACL2 Boolean Logic Definition

Using ACL2 functions, the following defines Boolean-valued functions : *and* , *or* , *xor* and the majority function(*bmaj*).

```

(defun band (p q) (if p (if q t nil) nil))
(defun bor (p q) (if p t (if q t nil)))
(defun bxor (p q) (if p (if q nil t) (if q t nil)))
(defun bmaj (p q c)
  (bor (band p q)
        (band p c)
        (band q c)))

```

A full adder function has three inputs (bits) and returns a multi-value (*mv* is the keyword for multi-value) : a sum and a carry, which is defined as follows:

```

(defun full-adder (p q c)
  (mv (bxor p (bxor q c))
      (bor p (bor q c))))

```

```

    ( bmaj p q c)
  ) )

```

A serial-adder is defined as :

```

(defun serial-adder (x y c)
  ( if ( and (endp x) (endp y))
    (list c)
    (mv-let (sum cout)
      (full-adder (car x) (car y) c)
      (cons sum (serial-adder cdr x) (cdr y) cout )))))

```

This is a recursive definition of a ripple-adder tree. The bit-vectors x and y are ordered lists of binary values, i.e. nil and t . The least significant bit of the bit-vector (LSB) is the first element and most significant bit (MSB) is the last element in the lists x and y . The operation $(car x)$ returns the LSB of x and $(cdr x)$ returns the rest of the bits. In ACL2, value nil and a list of nil values are practically the same, as car and cdr on both values return nil . Because of this, the above formulation doesn't require x and y to have the same length. One can think of the shorter operand as having been appended with nil , just as the high order bits of a binary number is prepended with 0.

ACL2 Integer and Integer Addition Definition

The following function 'n' is defined that maps a binary integer number from the list of t and nil values:

```

(defun n (v)
  (cond ((endp v) 0)
        ((car v) (+ 1 ( * 2 (n (cdr v))))))
        (t (* 2 (n(cdr v))))))

```

To illustrate the above semantics in Python, the function n would be defined as follows:

```

def n(v):
    if len(v) == 0:

```

```

    return 0
  elif v[0] == True:
    return 1 + 2*n(v[1:])
  else :
    return 2 * n(v[1:])

```

ACL2 Proof of Serial Adder Implementation

Both $+$ and $*$ operators are first class objects and are just symbols, which carries no computational semantics. The proof obligation of correctness of the serial-adder is formulated as the following theorem:

```

(defthm serial-adder-correct
  (equal (n (serial-adder x y c)
           (+ (n x) (n y) (if c 1 0))))))

```

The above is essentially proving that adding x, y, c together using $+$ is the same as the natural number obtained after they are added together using the serial-adder function.

$$n(\text{serial-adder}(x, y, c)) \equiv n(x) + n(y) + n(c) \quad (2.30)$$

The proof is obtained by mathematical induction. The reader can check the basic step of the induction. For the inductive step, ACL2 effectively checks the following implication:

```

(implies (= (n (serial-adder x y c)
              (+ (n x) (n y) (n c)))
           (= (n (serial-adder (cons x0 x) (const y0 y) c)
              (+ (n (cons x0 x)) (n (cons y0 y)) (if c 1 0))))
  )

```

In English, the above is proving that if serial-adder is correct for list x and list y then serial-adder would be correct for list $(x0\ x)$ and list $(y0\ y)$, i.e. the lists with one more element prepended to the front. ACL2 has rigorous theories and procedures for reasoning using induction, and for the scope of this thesis, ACL2 obtains the proof by proving the following two lemmas first:

```
(defthm serial-adder-correct-nil-nil
  (equal (n (serial-adder x nil nil))
         (n x)
  ))
```

```
(defthm serial-adder-correct-nil-t
  (equal (n (serial-adder x nil t))
         (+ 1 (n x ))
  ))
```

Not so surprisingly, the above two lemmas are proving that the serial-adder is adding '0' and '1' correctly. Different from Boolean equivalence checking, the proof of correctness is generic over any length of input list x and list y .

The above proof formulation and proof is not a data-path equivalence checking problem where two Boolean logics are compared. However, the theorem prover approach can be applied to data-path equivalence checking as a bridge: the proof is obtained by proving both designs implement the same high-level function. In our example, the equivalence of the adder trees in Section 2.4 can be established if we can prove they all implement the same binary-number-adding function, e.g.

```
(defthm adder-tree-correct
  (equal (n (any-adder-tree x y c)
         (+ (n x) (n y) (if c 1 0 ))))))
```

Theorem Proving Summary

In the ACL2 methodology for data-path equivalence checking, SAT-sweeping in the Boolean domain is not used; instead, it uses a proxy function in first order logic to establish the equivalence. Theorem proving is a complementary approach to Boolean solvers as it does not explore the Boolean space, therefore it does not need to solve an NP-Complete problem.

First order logic is expressive enough to formulate any arithmetic or algebraic function. In theory, for equivalent data-path designs, a proof can always be constructed using a theorem

prover. Although this seems to be a promising technique by not casting into an NP-complete problem, in practice, theorem proving has very limited applications for three reasons:

1. It is a usability issue. Designs are mostly expressed in hardware or software programming languages. To reason in first order logic, designs must be translated into first order logic which imposes extra overhead required for debugging and validation. Also, first order logic is an abstract and difficult-to-use language for most people, and only for very specific application domains is the theorem proving method used.
2. The main strength of theorem proving is mathematical induction, which is also a weakness. For it to work, the target function needs to have a regular pattern such that it can be defined recursively. A recursive definition framework may fit for arithmetic functions such as integer addition, multiplications, divisions etc, but it is unsuited for arbitrary Boolean control logic. For this particular reason, theorem provers are limited practically to proofs in the purely arithmetic domain. There are two natural directions to improve the application of theorem proving. One is to build extensive libraries such that it can be applied to more complex functions. In ACL2, these are called ACL2 books. The other direction is to incorporate Boolean engines into the theorem prover by integrating the definitions of AIGs and SAT solvers in order to handle arbitrary Boolean logic. To preserve the rigor of theorem proving, AIG and SAT solvers need to be defined from the ground up. Once this is done, the usability of theorem proving can be extended to more complex design spaces.
3. Successful application of theorem proving techniques requires a deep understanding of the design implementation because the proof is obtained through breaking down internal structures. From the ripple-adder example, the proof is built upon the recursive structure of the ripple-adder implementation. The implication of such a proof is that the verification effort may not be reusable: a change in the design internals may potentially require a completely different proof. Also, it takes effort and is a productivity cost to gain such deep knowledge of a design's internal details. On the other hand, using simulation or Boolean solving methods, verification engineers only need to model the design functionality at the interface level and the validation model is reusable as long as the design functionality remains the same – the internal implementation decisions and changes do not impact the validation model.

In the next Chapter, we present our LEC data-path equivalence checking system which has the following characteristics:

- LEC's ultimate goal is to find a way to solve all data-path equivalence checking problems.
- For ease of use, LEC uses Verilog/VHDL as the input language and retains the original design structure throughout the proof finding process.
- Similar to ACL2 books, the LEC system achieves reuse by integrating new techniques into an existing system, and thus LEC becomes more powerful when it is applied to a new problem domain.
- As design knowledge is needed inevitably to obtain a proof, LEC is a learning aid to extract and understand logic that presents a *bottleneck* in the proof process.

LEC is extensible. Building and using LEC are both learning processes, while the learning is expedited by LEC.

Chapter 3

LEC: Learning-Driven Equivalence Checking

We build a system to learn, expand and grow with the unknown.

The problem formulation in this chapter is to compare two logic functions, F and G , for equivalence :

$$\forall \bar{x} \quad F(\bar{x}) = G(\bar{x}) \quad (3.1)$$

Both F and G are combinational logic circuits described in Verilog/VHDL. For equivalence checking, a miter logic, shown in Figure 3.1, is formed to compare the two. The formulation is also a Boolean satisfiability model of trying to satisfy $F \neq G$. The proof result is either UNSAT if $F \equiv G$, SAT if $F \neq G$ or UNRESOLVED if $F \equiv G$ can not be determined.

3.1 Overview: A Learning Process - Philosophy

One of the key aspects of this work is to view the equivalence checking problem as a learning process and to implement a Learning-Driven Equivalence Checking (LEC) tool flow to enable and expedite the process. Our learning process and our implementation of LEC recognizes that:

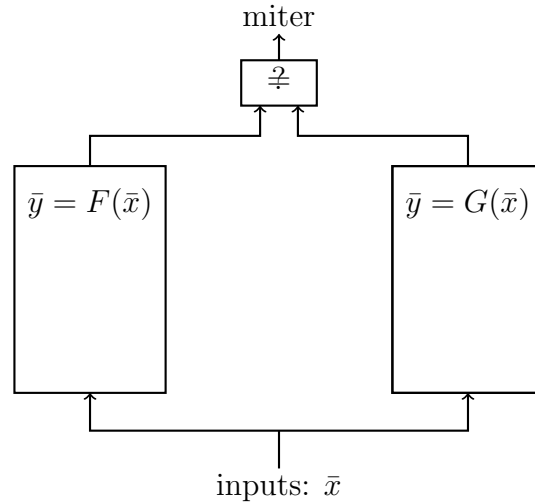

Figure 3.1: Miter logic

1. There will always be a new problem that can not be resolved,
2. But a LEC-type tool can be extended to solve many un-solved problems.

This is a limited claim because the data-path optimization techniques in the previous chapter would seem to be able to introduce a new miter problem that is beyond LEC’s current proof capabilities. On the other hand, LEC is implemented to enable learning about un-solved problems encountered, identifying bottleneck components and discovering and enabling new techniques to solve them. Hence, we expect that our LEC system (henceforth just called LEC) should evolve over time. We believe that

1. every unsolved miter logic is an opportunity for LEC to grow, improve and become more powerful,
2. by using LEC, we can gain knowledge of the underlying Boolean logic, identify bottleneck components, reverse engineer and abstract it into high-level arithmetic or algebraic formulae, and that
3. learning itself expedites future learning.

LEC is architected to facilitate the integration of different approaches, automate reuse of implemented methods, and enable the development of new techniques in future applications.

In some sense, every tool development is a learning process. However, we embrace this as a strategic view and try to build LEC to enable and expedite learning for both user and tool developer. The LEC system is designed with an open architecture so that it can be used also as a manual aid to unravel a miter logic. The process to get to a proof should be one that gradually learns about the design and develops/integrates new techniques which help to transform an unknown into an identified unknown, and eventually to a known.

3.2 Tool Flow and Organization

LEC takes Verilog/VHDL designs as inputs and is divided into a front-end and a back-end, with a WNK (word-level-network) as an intermediate representation. A WNK is a data-structure that explicitly represents the bit-vector arithmetic operators expressed in Verilog language or SMT QF_BF specification[59]. Shown in Figure 3.2, the LEC front-end uses a Verific RTL parser [64] to compile the input RTL into the Verific Netlist Database and then translates this into a WNK. The Verific Netlist Database is a graph structure that captures the design hierarchy and connectivity information. Our VeriABC[48] system processes a Verific Netlist, flattens the hierarchy and obtains a WNK representation, which captures the circuit function topologically. Except for the hierarchical information, WNK is a close-to-verbatim representation of the original RTL description. Most importantly, it keeps all high-level information of the original RTL. A WNK is the central core of the LEC infrastructure.

The LEC back-end consists of a set of *widgets* which perform various transformations, solving tasks, or learning tasks on WNK data structures. The use-model of LEC is a sequence of recursive applications of the LEC widgets.

Word-Level Network(WNK)

A LEC word-level network(WNK) is a directed acyclic graph representing the logic function. Each node in the graph contains three attributes: operator type, width, and an array of fanin nodes. In Figure 3.3 it is defined in the *C++* class definition.

(rkb you have two captions here???)

The type of operator indicates the logic function at the node. Table 3.1 lists the unsigned

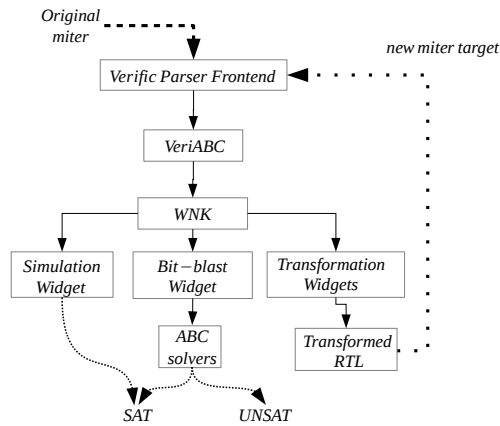

Figure 3.2: Overall tool flow

```

class wnode_s {
  const      operator_type_t _operator;
  const      int _width;

  const      int _num_fanins;
  wnode_s * _faninx[] ;
} ;

```

Figure 3.3: Illustration WNK node in C++ class

operators in WNK which correspond to the operators in the Verilog language definition. The operators also have their equivalents in the SMT QF_BV[59] specification. Along with the operator attributes, the node is associated with an integer *_width* to indicate the length of the bit-vector it represents. The incoming edges at a node are represented by the *_faninx* array.

	Verilog operator types	SMT QF_BV operator types
Boolean	&&, , !, ⊕, mux	and, or, not, xor, ite
bit-wise	&, , ~, ⊕, mux	bvand, bvor, bvnot, bvxor, bvite
arithmetic	+, -, *, /, %	bvadd, bvsub, bvmul, bvdiv, bvmod
extract	⌊	extract
concat	{ }	concat
comparator	<, >, ≤, ≥	bvugt, bvult, bvuge, bvule
shifter	⟨⟨, ⟩⟩	bvshl, bvshr

Table 3.1: Supported operators (unsigned)

Any synthesizable Verilog module can be translated to such a WNK, which has the same expressiveness as SMT Bit-Vector Arithmetic. Book-keeping information is kept during the translation so that the signal names in the Verilog source code are mapped onto the WNK nodes. A topological traversal of the network from inputs to outputs evaluates the output logic function depending on the input values. For LEC, the WNK structure is self-contained as it captures both the structural and functional information of the miter logic. Learning, reasoning and transformations are executed on this structure.

3.3 The LEC Widgets

The LEC back-end is organized as a collection of widgets. LEC proofs are obtained through iterative applications of these widgets. LEC has three categories of widgets based on their functionality:

1. Solver widget,
2. Transformation widget,
3. Learning widget.

The LEC proof process is illustrated in Figure 3.4. Solver widgets are used to solve the problem directly, which can return SAT, UNSAT or UNRESOLVED as the proof result. If it returns UNRESOLVED, then learning and transformation widgets are applied to try to transform the unresolved problem into a set of sub-models. These can be seen as lemmas derived/decomposed from the original model. Each such lemma sub-model is a possible proof target in the next LEC iteration. A LEC iteration basically calls LEC again so that all the widgets can be used to break down the unresolved parts further. The final LEC proof consists of an iterative application of these widgets.

Solver Widgets

The goal of a solver widget is to produce a definitive answer: SAT or UNSAT. The following lists the set of basic solver widgets currently implemented in LEC:

1. Random simulation using Verilator[60]

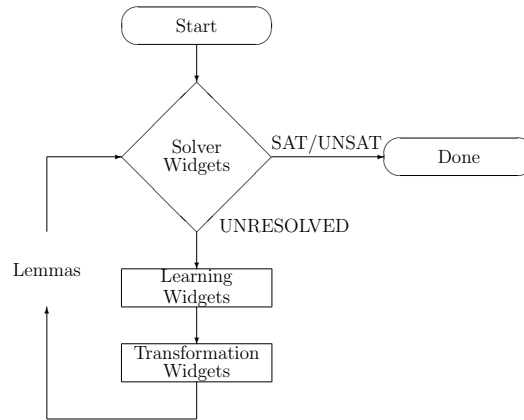

Figure 3.4: Proof process

2. Word-level network simulation using a WNK
3. Parallel bit-level simulation on an AIG model
4. SAT-sweeping using ABC's *dcec* and *improve* [52] commands
5. LEC's internal SAT solving over the AIG based on ABC's *minisat*[25] implementation.

The first three use simulations as the underlying algorithm and the other two use SAT sweeping algorithms. The set of solver widgets can be extended by integrating a set of widgets together into a single composite widget (solver widget script), as long as the result is able to return SAT, UNSAT given the proof target.

Transformation Widgets and Sub-model Trees

LEC proofs are built on the use of the transformation widgets. Each transformation widget performs a deterministic function following a set of input instructions to convert the root miter model into a set of sub-models. There is an implicit logical relationship between the root model the generated sub-models, where logical inference rules are applied to derive the sub-models from the root model. We would like to capture these inference rules explicitly to record the proof process.

For logical inference, the most generic rule is **modus ponens**:

”if p then q ” is accepted, and the antecedent (p) holds, then the consequent (q) may be inferred.

In LEC, this is cast as an assume-guarantee (A/G) framework:

if the assumptions hold (i.e. are proven) then the satisfiability of original miter model can be derived from the set of generated sub-model lemmas.

Lemma Types	Inference Rule	Example use scenario
pre-lemma _{<i>i</i>}	preconditions: must all be proven UNSAT	assume/guarantee reasoning
s-lemma	$UNSAT(\text{s-lemma}) \Rightarrow UNSAT(M_M)$ $SAT(\text{s-lemma}) \Rightarrow SAT(M_M)$	structural hashing
e-lemma _{<i>i</i>}	$\exists i SAT(\text{e-lemma}_i) \Rightarrow SAT(M_M)$ $\bigwedge_i UNSAT(\text{e-lemma}_i) \Rightarrow UNSAT(M_M)$	case-split enumeration
a-lemma	$UNSAT(\text{a-lemma}) \Rightarrow UNSAT(M_M)$	over-approximation
u-lemma	$SAT(\text{u-lemma}) \Rightarrow SAT(M_M)$	under-approximation

Table 3.2: Lemma Types(M_M is the current model)

Given the above insight, we explicitly captures the inference rules used in all LEC proofs through the five lemma-types in Table 3.2. The satisfiability of the original miter model M_M is inferred from the satisfiability of its sub-model lemmas. The presence of pre-lemma_{*i*} captures the assumption components in the A/G reasoning, all of which need to be proven UNSAT in order for this transformation to be valid. The rest of the lemma types are for the ”guarantees” which are used to infer M_M ’s proof results from its sub-model lemmas. An s-lemma indicates equisatisfiability: its (un)satisfiability is equivalent to the (un)satisfiability of original miter model M_M . The {e-lemma_{*i*}} set is the result of case-split enumerations where their conjunction is equivalent to M_M . An a-lemma is an over-approximation(e.g. resulting from abstraction techniques), while the u-lemma is an under-approximation of the original M_M .

The method of lemma generation from the transformation widgets allows transformations to be carried out arbitrarily, allowing both valid and invalid transformations during LEC proof process. The correctness of the final LEC proof is guaranteed through the existence of pre-lemma_{*i*}: transformations with falsified or unresolved pre-lemma_{*i*} are omitted from the

final proof construction. These invalid transformation intuitively corresponds to failed trial efforts.

In summary the transformation widgets and the generated lemma sub-models achieve the following:

1. The task of a LEC transformation widget is to perform an atomic operation which transforms the current model into a set of lemma sub-models using a specific set of inference rules. The widget is a deterministic function given a set of input instructions on how the transformation is to be carried out – no complex procedures such as Boolean solving, refinement, etc are involved.
2. The correctness of LEC’s implementation of the transformation widgets is highly assured due to the simpleness of the procedure itself.
3. The consistency of LEC proofs is ensured through the existence of pre-lemma_{*i*}, which need all be proven during the proof process. In doing so, the consistency of the final LEC proof is always guaranteed even though the transformation widgets can be used randomly to perform arbitrary transformations.

Structural Hashing Widget

This widget conducts structural hashing of the original miter model M_M on the WNK network and produces a simplified WNK M_S . This technique is similar to AIG rewriting except the underlying logic network is a WNK which has word-level operators. This procedure effectively conducts common sub-expression elimination and constant propagation. This widget produces two lemmas:

$$\text{pre-lemma : } M_M \equiv M_S \tag{3.2}$$

$$\text{s-lemma : } M_S \tag{3.3}$$

in which (3.3) is the new miter model after the transformation from M_M , while (3.2) is to prove that behavior between M_M and M_S is unchanged through the transformation.

Figure 3.5 shows the model tree spawned from M_M /miter.v in which:

- M_M : the root node for which miter.v is the original miter model M_M .

- M_S : hashed-miter.v is the miter model after structural hashing.
- $M_M \equiv M_S$: miter.v \equiv hashed-miter.v is the miter model to compare between the original miter.v and the structural-hashed miter model hashed-miter.v.

In this model tree, Figure 3.5, nodes M_{PRE} and M_S are for the generated two sub-models, labeled with the corresponding lemma type : pre-lemma and s-lemma. The node $M_{Structural-Hashing}$ is introduced as type s-lemma to bridge between M_M and the widget generated lemmas. The s-lemma, M_S , is the post-transformation miter model, while the pre-lemma, M_{PRE} is the pre-condition on which this transformation is correct. The model-tree structure captures the complete information about this transformation. By verifying the pre-lemma, the correctness of the LEC transformation is validated and therefore we obtain the guarantee that solving hashed-miter.v is equivalent to solving the original miter.v.

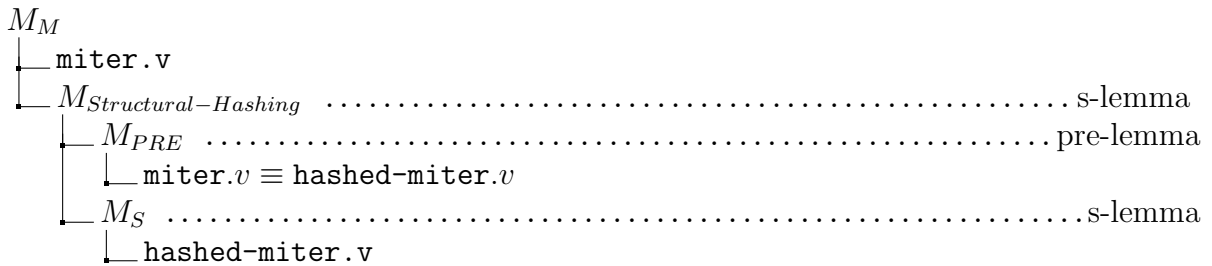

Figure 3.5: Model Tree from Structural Hashing Widget

Constant Reduction Widget

The constant reduction widget is the basic step in a logic simplification procedure using constant signals. This widget only performs the substitution operation where a node in the WNK network is replaced with a constant value, 0 or 1. The function of this widget is to create a miter model by replacing signals in the original miter.v with a constant value: 0 or 1. Figure 3.6 is the model tree structure. Input to this widget is miter.v and constant-signal.list which is a list of signal-value pairs: (s_i, v_i) with $v_i \in \{0, 1\}$. The output of the widget is the following two sub-model lemmas:

- prove-consts.v : proving $s_i = v_i$ is invariant in miter.v
- const-reduced-miter.v is the miter after s_i is substituted with value v_i from the constant-signal.list.

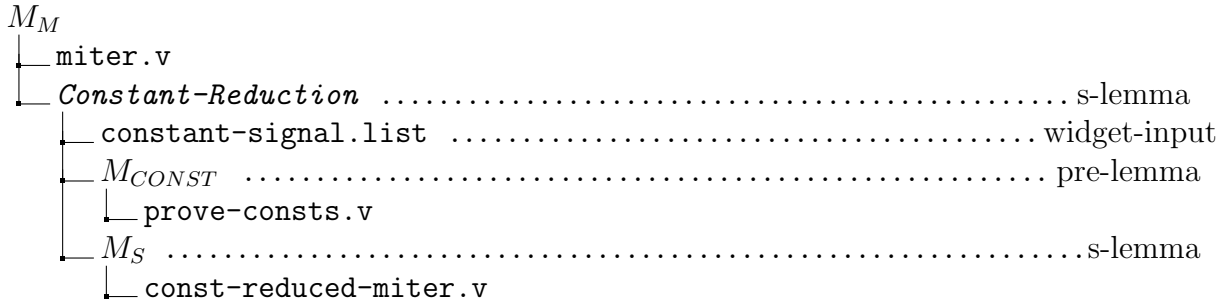

Figure 3.6: Model Tree from Constant Reduction Widget

Because the proposition $s_i = v_i$ must be proven invariant in the original miter design, in the sub-model tree in Figure 3.6, M_{CONST} is labeled as pre-lemma and M_S is the post-transformation s-lemma:

$$\begin{aligned} \text{pre-lemma} : M_{CONST} \quad \text{i.e.} \quad M_M \models s_i = v_i, \forall i \\ \text{s-lemma} : M_S \end{aligned}$$

This widget only replaces the signal with 0 or 1 structurally; a follow-up use of the structural-hashing widget conducts the actual constant propagation to simplify the generated miter model s-miter.v.

PEP(Potential equivalent pair) Reduction Widget

Figure 3.7 is the model tree for this widget, in which, pep.list is the input containing signal/value pairs (s_i, t_i) from miter.v. The PEP transformation substitutes signal t_i for signal s_i for all pairs (s_i, t_i) and creates a reduced model pep-reduced-miter.v as the s-lemma. The associated pre-lemma from prove-pep.v is to prove $s_i = t_i$ is invariant in miter.v:

$$\text{pre-lemma} : M_{PEP} \quad \text{i.e.} \quad M_M \models s_i = t_i, \forall i \tag{3.4}$$

$$\text{s-lemma} : M_S \tag{3.5}$$

For simplicity, this widget only conducts a structural substitution of t_i by s_i ; no other transformations are performed. To complete the simplification process, a follow-up use of

the structural hashing widget in the next LEC iteration conducts the actual simplification of the pep-reduced WNK.

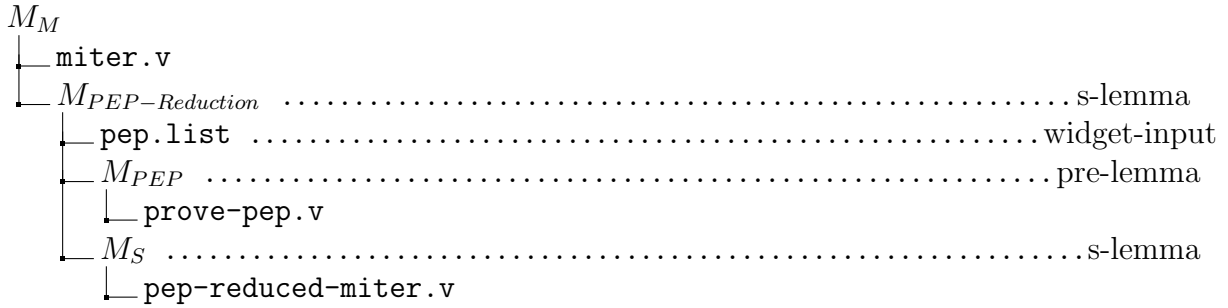

Figure 3.7: Model Tree from PEP Reduction Widget

Abstraction Widget

The model tree for this widget is shown in Figure 3.8. The input is a list of signals, `cut-set.list`, that are to be replaced by free inputs producing M_A /a-miter.v. This is the case of over-approximation reasoning, an a-lemma type, where the implication is one-directional and only infers an UNSAT proof result for M_M if M_A is proven UNSAT:

$$UNSAT(M_A) \Rightarrow UNSAT(M_M) \tag{3.6}$$



Figure 3.8: Model Tree from the Abstraction Widget

Word-level Rewriting Widget

Similar to [38], word-level rewriting transforms a WNK network into a structurally different but functionally equivalent one. Through rewriting, certain equivalence checking problems can become much simpler. Word-level rewriting is a local transformation widget and has a set of pre-defined rewriting rules. In LEC, a few rules are hard-coded through pattern matching applied to the WNK network. The goal is to normalize multiplications so that

they can be more easily matched for bit-level solving. This rewriting is implementation specific; for illustration purposes, we list a few rewriting rules in Table 3.3 using Verilog notation and the semantics of its operators.

The first rule is the normalization of multiplier operands. If a multiplier uses a partial product generator and a compressor tree, the equivalence checking problem resulting from $A \times B \equiv B \times A$ (i.e. switching the operands of the multiplication) is a very hard SAT problem because at the bit level the implementation is not symmetrical. It is almost imperative to apply this rewriting rule whenever possible. The second and third rules use respectively the distributive laws of multiplication over multiplexing. Rules 4 and 5 remove the shift operator \gg when it is used with *extract* and *concat* because it is hard for multiplication to be restructured through the \gg operator. Rule 6 distributes multiplication through the *concat* of two bit vectors using $+$. It uses the fact that the concatenation $\{a, b[n-1:0]\}$ is equivalent to $a * 2^n + b[n-1:0]$.

	Before	After
1	$a * b$	$b * a$
2	$mux(cond, d0, d1) * c$	$mux(cond, d0 * c, d1 * c)$
3	$mux(cond, d0, d1)[m:n]$	$mux(cond, d0[m:n], d1[m:n])$
4	$a[m:0] \gg n$	$\{ (m-n)'b0, a[m:n] \}$
5	$(a[m:0] \gg n)[m-n:0]$	$a[m:n]$
6	$\{a, b[n-1:0]\} * c$	$a * c \ll n + b[n-1:0] * c$

Table 3.3: Rewriting rules

The following is a more complex rule that distributes $+$ over the *extract* operator. The right hand side is corrected with a third term, which is the carry bit from adding the lower n bits of a and b .

$$(a + b)[m:n] = a[m:n] + b[m:n] + (a[n-1:0] + b[n-1:0])[n] \quad (3.7)$$

Repeatedly applying the above rules, LEC transforms the WNK network and keeps only the $*$ and $+$ operators, enhancing the possibility of multipliers to be matched. Note that the above rule (3.7) and Rules 4-6 in Table 3.3 are correct only for unsigned operators. Currently, for signed operators, due to sign extension and the two's complement representation of the operands, we have not implemented a good set of rewriting rules.

Conditional rewriting

The following equation

$$(a \ll c) * b = (a * b) \ll c \tag{3.8}$$

reduces the bit-width of a multiplier on the left hand side to a smaller one on the right. It is correct if a, b, c are integers but incorrect in Verilog semantics, which uses modulo integer arithmetic. However, if the following is true within the miter model in modulo integer semantics: the lower c bits of a are always zero and c is a design signal (i.e. not a constant)

$$\text{pre-lemma : } ((a \ll c) \gg c) == a \tag{3.9}$$

then Equation (3.8) is valid. In such a situation, LEC identifies the pattern on the left hand side of (3.8) in the WNK network and creates a pre-lemma to check 3.9 in an invariant. A s-lemma is also created by conducting the rewriting rule 3.8.

In summary, the rewriting widget would produce the following model-tree in which a pre-lemma, M_{PRE} is only present if the rewriting is a conditional one:

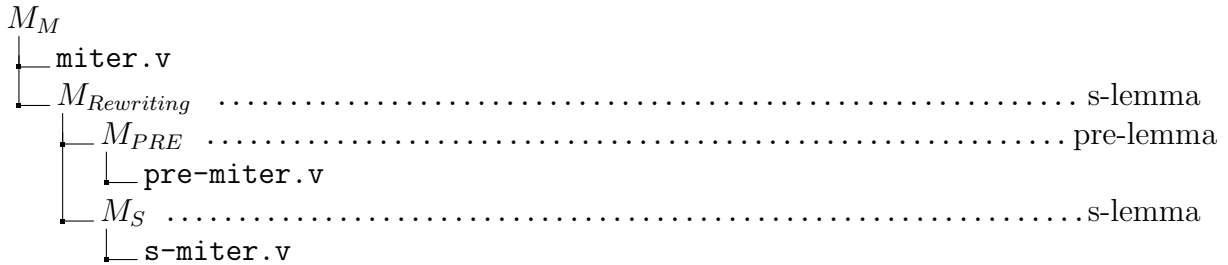

Table 3.4: Rewriting Widget

Case-split Widget

The principle of case-splitting is the Shannon expansion of a Boolean function over Boolean variable x :

$$M = \bar{x} \cdot M|_{x=0} + x \cdot M|_{x=1} \tag{3.10}$$

The Boolean space of n Boolean variables consists of 2^n minterms: a minterm is a complete assignment of the n variables. A case-split may not always be exponential in the number of

Boolean variables. By generalizing minterms to cubes, any disjoint decomposition of the 2^n possible minterms is a valid decomposition pattern. A cube is a partial assignment to the n variables. For example, the following is a decomposition of the 5 variable set (“_” is the don’t-care value):

```

----0
---01
--011
-0111
01111
11111

```

In this case, the case-split widget take 5 signals and produces 6 sub-model *e-lemmas* so it is linear in the number of variables rather than 2^6 possibilities. The case-split widget produces the following lemmas:

$$\text{pre-lemma} : \bigcup_i^n \text{cube}_i \equiv 1 \quad (3.11)$$

$$\text{e-lemma}_i : M_i \quad \forall i \quad (3.12)$$

The pre-lemma (3.11) is for self-checking purposes to ensure the case-split does not miss any Boolean values. The e-lemmas are created by applying the *cube_i* as constants in the original WNK, so that all e-lemmas must be proved UNSAT for the root to be UNSAT, and if SAT is produced by any, then the root is SAT. The sub-model tree is shown in Figure 3.9.

Algebraic Transformation Framework

We use F and G to denote the logic functions that form the two sides of the current miter model M_M :

$$M_M \models F \equiv G$$

and, f and g are two algebraic expressions:

1. $f(X)$ is an algebraic expression over n variables X : x_0, x_1, \dots, x_{n-1}

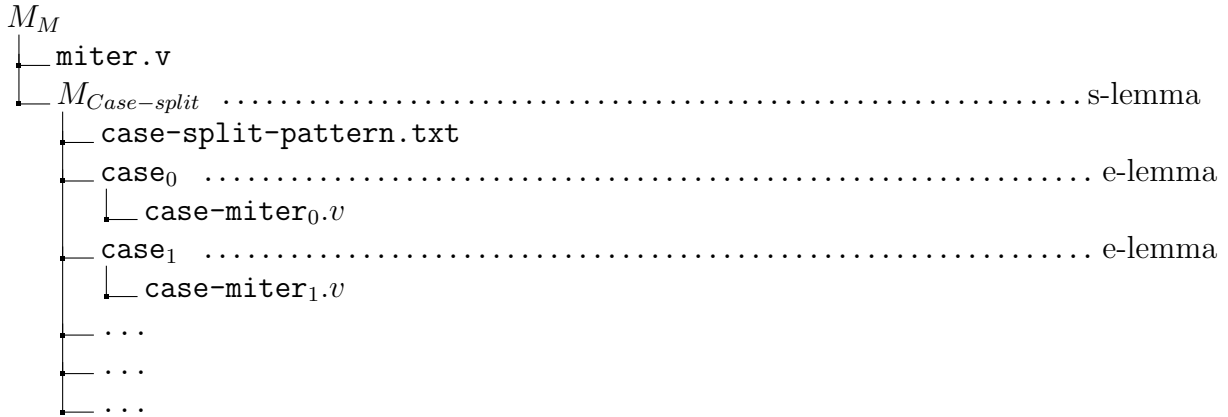

Figure 3.9: Case-split Transformation Widget

2. $g(X)$ is an algebraic expression over n variables $X: x_0, x_1, \dots, x_{n-1}$

$$\text{pre-lemma : } f = g \tag{3.13}$$

$$\text{pre-lemma : } F' \text{ implements } f \tag{3.14}$$

$$\text{pre-lemma : } G' \text{ implements } g \tag{3.15}$$

$$\text{pre-lemma : } F' \equiv F \tag{3.16}$$

$$\text{pre-lemma : } G' \equiv G \tag{3.17}$$

Figure 3.10: Algebraic Transformations

This widget generates five pre-lemmas listed in Figure 3.10, and all five must be proven UNSAT for the root result to be UNSAT. F' and G' are two logic designs that implement functions f and g respectively in the Boolean domain. As f is equivalent to g algebraically, we assume $F' \equiv G'$ by construction. Then, the lemmas in Figure 3.10 prove $F \equiv G$ if all five are proven. The step from f to F' is an Algebraic-to-Boolean procedure that is domain specific, which requires a special procedure for different algebraic domains. In this thesis, we use procedures to build adder-tree circuits from linear sum expressions.

Figure 3.11 is the generic model-tree structure for this widget, in which f and g are two algebraic functions, and the lemma $M_{f=g}$ is to prove f is equivalent to g in the algebraic domain. F' and G' are the Verilog modules that implement f and g , and the corresponding $M_{F \equiv F'}$ and $M_{G \equiv G'}$ are the generated pre-lemma proof obligations to prove $F \equiv F'$ and

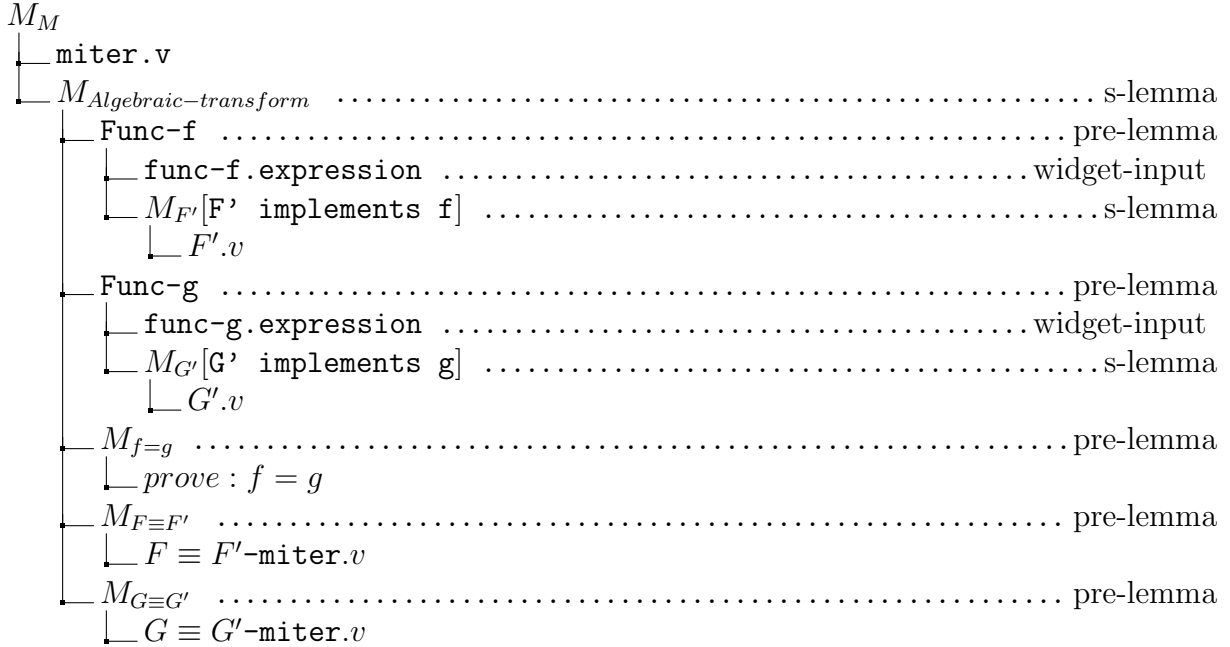

Figure 3.11: Algebraic transformation Widget

$G \equiv G'$. The final proof $F \equiv G$ is derived from the equivalence chain :

$$F \equiv F' \equiv f \equiv g \equiv G' \equiv G \tag{3.18}$$

Linear Sum Transformation Widget (lsum).

A linear sum expression has the following normalized form given variables x_i and constants a_i, b :

$$f(x_0, x_1, \dots, x_{n-1}) = \sum_{i=0}^{n-1} a_i \cdot x_i + b \tag{3.19}$$

However, each linear sum can have different expression structures, for example, the following function f and g are both adding eight numbers together, and $f \equiv g$:

$$f = ((x_0 + x_1) + (x_2 + x_3)) + ((x_4 + x_5) + (x_6 + x_7)) \tag{3.20}$$

and

$$g = (((((((x_0 + x_1) + x_2) + x_3) + x_4) + x_5) + x_6) + x_7) \tag{3.21}$$

By the definition of operator precedence, the order of adding two terms together is implicitly determined with the structure of the algebraic expression. Given the widths

of the input variables, the corresponding adder-tree logic F' and G' can be constructed for f and g following the order of evaluation. In this case, F' is a balanced adder-tree, while G' is a linear adder-tree. Using such a transformation procedure to create adder-tree logic from a linear sum expression, the original model M_M will be transformed into the five lemmas as shown in Figure 3.11 through the algebraic transformation widget.

Lsum2 Transformation. The above *lsum* transformation is performed on the output of the miter logic. A natural extension is to apply the linear sum transformation on any internal node when the internal node is identified as a linear sum over input signals. In such a case, the internal node S and its cone of logic is replaced with an linear tree S' while creating the following lemmas:

$$\begin{aligned} \text{pre-lemma} : S &\equiv S' \\ \text{s-lemma} : M'_M \end{aligned}$$

where M'_M is the miter model where the logic cone of signal S is replaced with S' .

Hier-lsum Transformation. The widget hier-lsum is a further extension to replace an inner sub-graph within the WNK network with a linear adder tree along with the following lemmas:

$$\begin{aligned} \text{pre-lemma}_i : S_i &\equiv S'_i \\ \text{s-lemma} : M'_M \end{aligned}$$

where S_i is a sub-graph in the original miter model M_M to be replaced with S'_i and M'_M is the post replacement miter model.

In summary, although the algebraic transformation framework is generic, the procedure to build a logic network from the algebraic expression is domain specific. As shown in the learning widget section, the key elements in applying the algebraic transformation procedure are to be able to reverse engineer the algebraic expression that matches the structure and functionality implemented in the Boolean logic network. Only by doing so, will there be enough similarity between F and F' such that $F \equiv F'$ can be solved using Boolean solving methods (e.g. through the solver widgets).

LEC Learning Widgets

The transformation widgets in the above section are mechanisms to decompose the current miter model into a set of sub-models. The objective of learning widgets is to identify heuristics and opportunities for applying the transformation widgets effectively. The results of the learning widget is to guide or decide which transformation widget to use and how to use it.

Information Widget

This widget merely collects structural and statistical information about the miter logic to give users an empirical measure of the design complexity and intuition about what the design characteristics are. A WNK netlist is a directed acyclic graph (DAG) of bit and word-level operators annotated with bit-width information. Because of the nature of equivalence checking between two designs F and G , the graph can be divided structurally into three regions as in Figure 3.12(b) based on cone-of-influence(COI) analysis:

- Red: if the node is in the COI of F only
- Blue: if the node is in the COI of G only
- Purple: the node is in the COI of both sides of the miter i.e. common logic

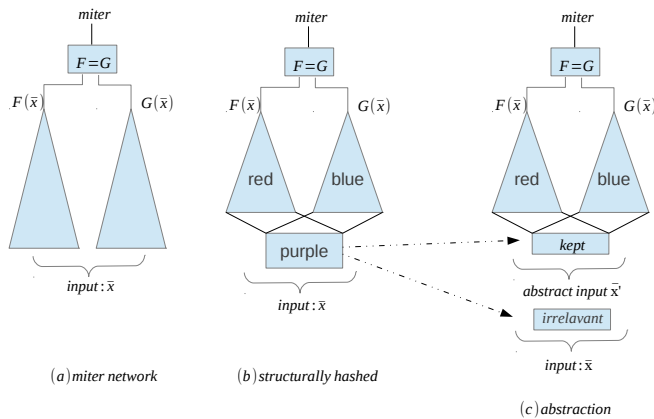

Figure 3.12: Miter network

The purple region is the portion of the miter logic that is shared between F and G . The sizes, complexities and dissimilarities of the red and blue regions dictate the complexity of the miter $F \equiv G$ problem. LEC makes progress by 1) reducing the red/blue regions, increasing the purple region and 2) transforming red and blue regions to be more similar to

each other. By the end, when $F \equiv G$ is proven, both F and G are merged into one entity and become common logic.

Cut Selection Widget

This learning widget tries to find a cut-set in the WNK network as the *cut-set.list* for the abstraction widget in Figure 3.8. A forward topological traversal (from inputs to outputs) is used on the nodes in the common logic (purple) region, testing one node at a time and using a SAT query to check if the node can be replaced with a free-input while still not rendering the miter to be satisfiable. The SAT query is given a relatively small resource limit such that the procedure can complete quickly. The accuracy of the learning is directly related to the resource limit given for each SAT query. The goal of the LEC abstraction procedure is to remove common logic to expose opportunities to use other widgets in subsequent LEC iterations. Our current implementation is simplistic, but more sophisticated abstraction techniques can involve automatic refinement processes. However, as LEC’s target application domain is for equivalent checking of data-path logic, the current implementation turns out to be effective enough for the test cases we have seen so far. Therefore, we did not pursue further optimization in this direction.

Constant Identification Widget

This learning widget tries to identify constant signals in the model M_M for use with the constant-reduction widget. It employs a generic random simulation to extract candidate constant signals and then uses SAT-solving to try to prove/disprove these candidates. This procedure can prove a set of signals to be constant and also identify a set of signals as potential constants - the SAT query returns UNRESOLVED results from them. The two sets of signals are generated into two separate files:

$$\left\{ \begin{array}{l} \textit{proven_constant.list} \\ \textit{unresolved_constant.list} \end{array} \right.$$

Figure 3.13 shows the model tree when both learning and transformation widgets are composed together. In this case, the constant reduction widget is applied to the set of proven candidates to generate the M_{CONST} and M_S nodes. For the unresolved constant candidates, $s_i = v_i$, $v_i \in \{0, 1\}$, the constant reduction widget is called on each of them, creating a list

of branch- c_i sub-model nodes. Each branch- c_i is a potential and optional proof obligation that the user can choose as the next LEC target. If const-reduced-miter $_i.v$ is proven UNSAT, then s-miter $_i$ will be the next proof target; all the other branches will be ignored. The current heuristic chooses the branch that has the smallest const-reduced-miter $_i$ in terms of the size of its WNK network. Intuitively, that will be the simplest proof target.

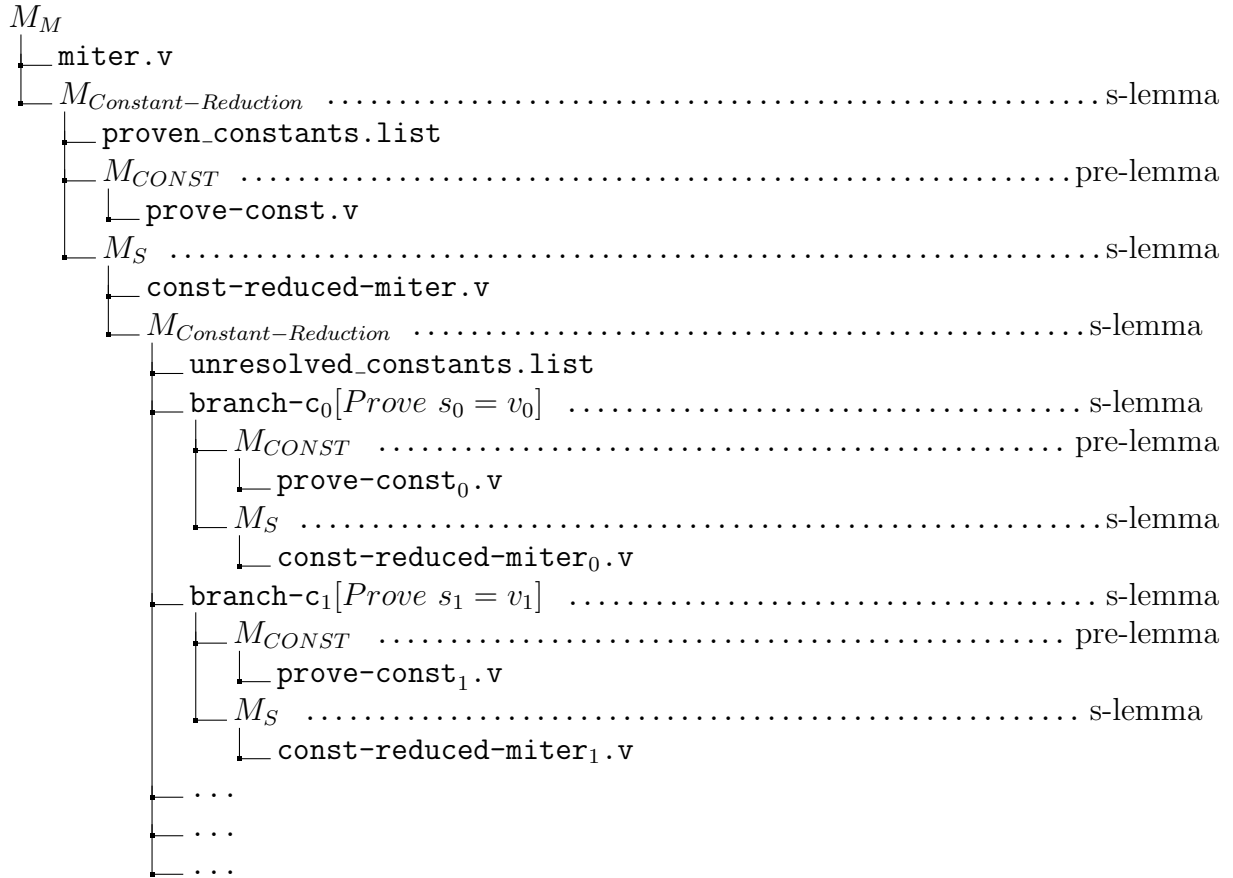

Figure 3.13: Constant Learning and Reduction Widgets

Potential Equivalent Pairs (PEPs) Learning Widget

This widget identifies PEP candidates for use with the PEP-reduction widget. This widget uses simulation and SAT queries to identify potential equivalent signals in the miter model M_M /miter.v. Each such SAT query is constructed and checked after the WNK is bit-blasted into an AIG. This widget produces two lists containing PEP signal pairs, $s_i = t_i$, for proven

and unresolved ones.

$$\left\{ \begin{array}{l} proven_peps.list \\ unresolved_peps.list \end{array} \right. \quad (3.22)$$

Similar to the constant learning widget in Figure 3.14, the proven PEPs are combined by one PEP reduction widget while unresolved ones are used to create sub-model branches, $branch_pep_i$, for each unresolved PEP candidate. Heuristically, the branch that has the smallest $pep_miter_i.v$ is used as the most likely choice to solve in the next iteration, which, if proven, can lead to further simplification of the miter logic.

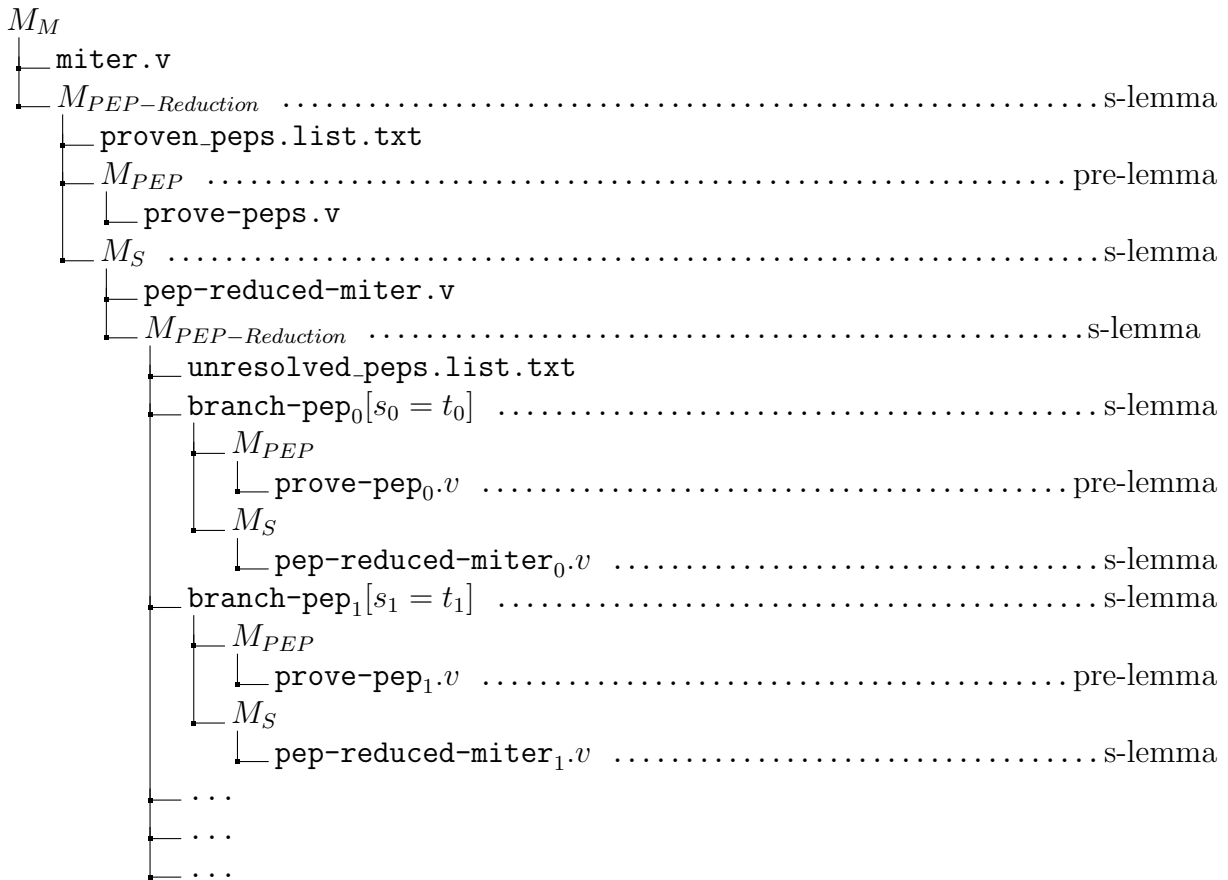

Figure 3.14: PEP Learning and Reduction Widgets

Case-split Ranking Widget

This widget ranks primary input signals in the miter logic as potentially good candidates for the case-split widget. For each input of the design, the widget computes the sizes of the

bit-blasted AIG logic (obtained after ABC’s structural hashing) after the input is replaced with 0 or 1. This is a fast $O(|N|)$ procedure for each input, where $|N|$ is the size of the WNK network. The ranking is sorted by $\min(|N_{v=0}|, |N_{v=1}|)$ in ascending order. This reflects the intuition that a good case-split choice would render one of the post-case-split AIG logics to be significantly smaller than the original one or split the original model into two non-overlapping partitions. Intuitively, a good candidate for the case splitting variable is the conditional expression in an if-else or case statement of the Verilog program.

Linear Sum Speculation Widget

In order to use the algebraic transformation framework, there is a reverse-engineering task to find out what is the algebraic function f . For the linear sum case, this widget tries to speculate if a logic design F is implementing a linear sum formula with the following form:

- Signed integer arithmetic. The numbers are in 2’s complement representation.
- F and G are implementing f and g :

$$f(\bar{x}) = \sum a_i \cdot x_i + b \quad (3.23)$$

$$g(\bar{x}) = \sum a'_i \cdot x_i + b' \quad (3.24)$$

Given the data-path logic F with n input signals and the linear sum formula (3.23), it only takes $n + 1$ simulation patterns on the n input variables to compute the coefficients:

$$\begin{aligned} b &= F(0, 0, \dots, 0) \\ a_0 &= F(1, 0, \dots, 0) - b \\ a_1 &= F(0, 1, \dots, 0) - b \\ &\dots \\ a_{n-1} &= F(0, 0, \dots, 1) - b \end{aligned} \quad (3.25)$$

Then random simulations are conducted on both F and f as a preliminary test to see if $F(\bar{x})$ seems to be equivalent to $f(\bar{x})$. A positive result of this speculative learning procedure is that f very likely matches what F is implementing. This procedure can be applied to any node in the WNK graph and depending on where they are in the WNK network, they are used as inputs to the lsum2 and hier-lsum widgets to conduct follow-up transformations.

First, we apply the procedure (3.25) to every node in the WNK network. A node is marked as a lsum-node if the above speculation procedure returns a matching linear sum formula : the cone of logic of this node is likely implementing this linear sum from primary inputs. Such marked lsum-nodes in the WNK form a skeleton graph of themselves, where the edges between lsum-nodes are the transitive fanin relationship inside the WNK graph. The roots of the skeleton graph and the corresponding learned linear sum are used by the lsum2 transformation widget.

To apply the hier-lsum widget, we need to identify linear sum components from internal sub-graphs in the WNK network. We use the above lsum-node skeleton graph to identify such sub-graphs in the WNK graph. Each lsum-node and its immediate fanins in the skeleton graph forms a local sub-graph in the original WNK network. For each such sub-graph, the above learning procedure (3.25) can be applied to obtain a matching linear sum of the local sub-graph. The learned linear sum function from each of the lsum-node's subgraph are the inputs to the hier-lsum widget. In the case study section, Section 3.5, a detailed example is presented in Figure 3.20 to illustrate the learned linear sum expressions used by the lsum2 and hier-lsum widgets.

Adder Tree Reconstruction Widget

The procedure (3.25) is used to reverse engineer the function of a logic as a linear sum, there is no structural information as to how the linear sum is realized in the logic design. This widget attempts to recover the overall adder tree structure if the linear sum is implemented as an adder-tree. Given a WNK network, with root node F , we first mark all nodes associated with arithmetic operators $+$, $-$. A reduced graph is then created from the marked nodes in the WNK graph maintaining the transitive input/output relations between marked nodes. This graph is a skeleton of the implementation structure of f (f is the learned linear sum function). For each of its nodes, we annotate it with a conjectured linear sum computed using procedure (3.25). The root node F is annotated with f . For illustration purposes, Figure 3.15(a) shows such an annotated skeleton graph for node w , and $f_w(\bar{x})$ is the learned linear sum function.

For an arbitrary node w in the skeleton graph with inputs from nodes s and t , from the

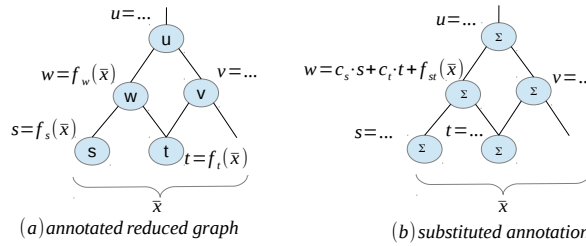

Figure 3.15: Annotated reduced graph

annotation we learned three functions over input variables \bar{x} using procedure (3.25)

$$s = f_s(\bar{x})$$

$$t = f_t(\bar{x})$$

$$w = f_w(\bar{x})$$

We would like to convert function $f_w(\bar{x})$ to a function of s and t , which would give a hierarchical definition of f , the linear sum at the root node. Because all the functions are linear sums, we can compute, using algebraic division, two constants c_s and c_t such that the following holds:

$$f_w = c_s \cdot s + c_t \cdot t + f_{st}(\bar{x}) \tag{3.26}$$

Through algebraic computation, c_s is the quotient of f_w/f_s and $c_t = (f_w - c_s \cdot f_s)/f_t$, while f_{st} is the remainder of the previous division f_w/f_s . From the above procedure, we obtain the function f_w at node w which is a function of s and t in (3.26). Applying the above procedure at each node in the skeleton graph, we then recover the linear-sum expression as a hierarchical adder-tree. This information is used by the lsum widget to create F' from f which would be similar to F structurally such that a proof of $F' \equiv F$ can be achieved, leading to the following proposition:

$$F' \equiv F \equiv f \tag{3.27}$$

This is the left half of the equation chain in (3.18) enroute to proving $F \equiv G$ through algebraic transformation widget.

Shift-adder Tree Reconstruction Widget

This widget is used to reconstruct the adder tree structure for a signed-digit sum implementation of constant multiplications. In this linear sum form, each term is optionally left-shifted

before being added. For example, the logic in Figure 3.21 is implementing a linear sum of the following form:

$$x55 \ll 8 + (x46 \ll 8 + (((x19 \ll 4 + (x0 + x2 \ll 1)) + x12 \ll 4) + x32 \ll 5))) \quad (3.28)$$

The goal of this widget is to reconstruct the shift amount and order of additions, which can not be extracted using the adder-tree reconstruction technique in Section 3.3. This widget uses a specialized procedure that utilizes the structural information of *concat* and *extract* operators to guess the amount of shifting before each adder node. In doing so, the shift-adder tree structure is extracted from the original WNK network into a linear sum formula in the form of (3.28). In the case-study of Section 3.5, an example of such an adder tree is shown in Figure 3.21 and the reverse-engineered shift-adder tree linear-sum expressions are shown in Figure 3.20.

The learning widgets, related to the above linear-sum, effectively reverse engineers the algebraic function of the underlying Boolean logic both functionally and structurally. Together they allow the application of the algebraic-transformation widget, which effectively allows LEC to reason beyond Boolean logic, taking on some of the power of a theorem prover.

3.4 System Integration: Proof-tree Infrastructure

Figure 3.16 shows the current solver and transformation widgets available in LEC. Because transformation widgets produce sub-model lemmas as proof obligations, the LEC proof process can be viewed as a spanning sub-model tree. The leaves of the tree are miter models which are to be solved by solver widgets, returning a proof result of SAT, UNSAT, and UNRESOLVED. Non-leaf nodes are marked with a lemma type from Table 3.2 during the widget's transformation. The lemma type indicates the inference rules used for the transformation; the parent proof result is then calculated by applying the inference rule over children's proof results.

To propagate proof results from children to the parent node, all *pre-lemma* child nodes must be proven UNSAT. Then, to calculate the proof-result from the rest of its immediate children, *s-lemma* children are disjunctive as an UNSAT or SAT result is propagated to the parent if any one of its *s-lemma* children is proven UNSAT or SAT respectively. The *e-lemma* is conjunctive for an UNSAT result because it requires all *e-lemma* children to evaluate to

UNSAT, but disjunctive for a SAT result because only one of *e-lemmas* is required to be proven SAT. The truth tables in Tables 3.5 and 3.6 reflect the above inference rules for a set of *s-lemmas* and a set of *e-lemmas*.

To complete the truth table, the *BOT* value is used as the initial value for all nodes. To reflect all possible truth table combinations, a *CON* value is used for when there is a conflict between *s-lemmas* where one returns SAT and another returns UNSAT. This situation indicates there is an internal software bug in LEC.

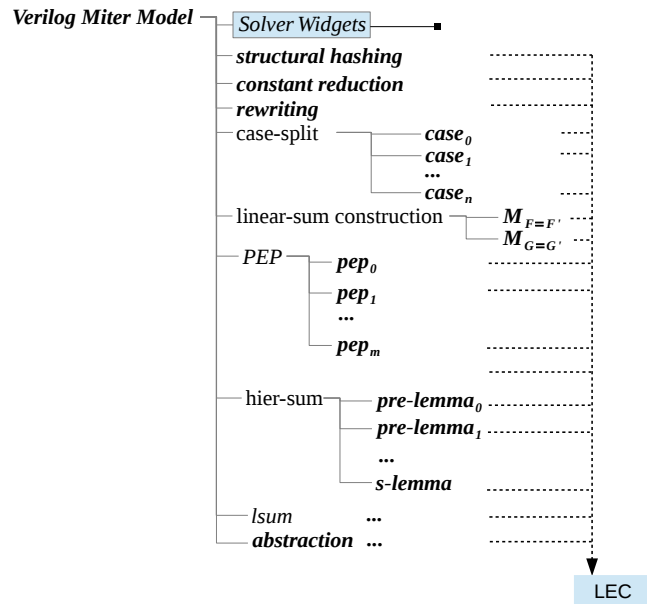

Figure 3.16: Branching sub-model tree

	SAT	UNS	UNK	CON	BOT
SAT	SAT	CON	SAT	CON	SAT
UNS	CON	UNS	UNK	CON	UNS
UNK	SAT	UNS	UNK	CON	UNK
CON	CON	CON	CON	CON	CON
BOT	SAT	UNS	UNK	CON	BOT

Table 3.5: Disjunctions of s-lemmas

&	SAT	UNS	UNK	CON	BOT
SAT	SAT	SAT	SAT	CON	SAT
UNS	SAT	UNS	UNK	CON	UNS
UNK	SAT	UNK	UNK	CON	UNK
CON	CON	CON	CON	CON	CON
BOT	SAT	UNS	UNK	CON	BOT

Table 3.6: Conjunction of e-lemmas

Using the truth tables and model trees, the status of a LEC proof can be evaluated at any time to give a clear view of the proof progress. The proof log in Figure 3.17 is an example sub-model spanning tree showing only the sub-tree that leads to the root’s UNSAT result. The *pre-lemma* used along the path is not shown. Indentation indicates the parent-child

relationship. Recursively, the proof result of the top level target is evaluated as UNSAT from the leaf nodes. In this proof log, the 'simplification' node is a composite LEC widget implementing a generic simplification procedure that repeatedly applies structural hashing, constant identification and reduction, PEP identification and reduction widgets to simplify the miter model. The decision for identifying constants, PEPs, abstraction cut-sets and case-split patterns are obtained using the learning widgets.

```
{
  "case split": {
    "case_0": "UNSAT by AIG"
    "case_1": {
      "simplification": {
        "abstraction": {
          "case split": {
            "case_00": "UNSAT by AIG",
            "case_01": "UNSAT by AIG",
            "case_10": "UNSAT by AIG",
            "case_11": "UNSAT by AIG"
          },
        },
      },
    },
  },
},
}
-----
Miter proof result: [Resolved: UNSAT]
-----
```

Figure 3.17: Illustration of proof log

Using the lemma annotated model-tree structure, LEC can be extended with new widgets or composite widgets which combine existing widgets. Because the sibling nodes in the model tree are independent of each other, all LEC widgets can be launched in parallel. The final proof result is computed from the leaves and the use of the pre-lemma guarantees that only valid transformations contribute to the root's proof result, which guarantees the correctness of LEC's proof.

3.5 Case Studies

Image Processing Design

The first case-study is an industrial example taken from the image processing application area. We verify specification = implementation where the “specification” is a manually-specified high-level description of the design. “Implementation” is a machine-generated highly-optimized RTL implementation of the same design using a high-level synthesis (HLS) tool like [14]. The miter logic is obtained through SLEC [15], a commercial C-to-Verilog equivalence checking tool. The miter problem is to verify that the HLS tool did not modify the design’s behavior.

This miter was sequential in nature, but here we examine a related bounded model checking (BMC) problem which checks the correctness of the implementation at cycle N. This renders the problem combinational. This is relevant because the sequential problem in this case is too hard to solve in general, and even the BMC problem at cycle N was too difficult for industrial tools.

The original design (specification) consists of 150 lines of C++. This was processed with the Calypto front end [15] and was synthesized into a word-level Verilog netlist. The generated miter model had 1090 lines of structural Verilog code with 36 input ports: 29 of which are 7 bits wide, 2 are 9 bits, 4 are 28 bits and one is a single-bit wire. The miter is comparing two 28-bit output values. We do not have knowledge about the design intent except through structural statistics: no multipliers, many adders, subtractors, comparators, shifters etc., together with Boolean logic. From a schematic produced from the Verilog, there seems to be a sorting network implemented using comparators, but we could not deduce anything further.

Figure 3.18 illustrates the compositional proof produced by LEC and shows the sub-model tree created during the proof process. The major steps it went through are case-split, simplification, abstraction, PEP transformation and linear-reconstruction. Indentations indicating parent and sub-model relations are listed in the order they were created. The three numbers on the right are the node counts in the red, blue and purple regions (common logic) of the WNK network as distinguished in Figure 3.12(a) which in this cases-study is an indication of the progress. Only those sub-models that contributed to the final proof are shown in the figure. Others are ignored because the sub-models, which were kept, are sufficient to obtain

the UNSAT result for the root model.

1.	original model	:	366	332	776
2.	case-split				
3.	case_0	:	366	331	844
4.	simplification	:			
5.	AIG solver	:	UNSAT		
6.	case_1	:	366	332	776
7.	simplification	:	344	289	675
8.	abstraction	:	344	289	29
9.	case-split				
10.	case_0	:	344	289	31
11.	AIG solver	:	UNSAT		
12.	case_1	:	344	289	31
13.	simplification	:	343	288	27
14.	PEP-reduction				
15.	pep_0	:	335	280	27
16.	linear sum re-construction				
17.	pre-lemma				
18.	f=g	:	UNSAT		
19.	pre-lemma_F=F'				
20.	AIG solver	:	UNSAT		
21.	pre-lemma_G=G'				
22.	AIG solver	:	UNSAT		
23.	s-lemma				
24.	simplification	:	10	10	305
25.	AIG solver	:	UNSAT		

Figure 3.18: Sub-model proof tree

As seen in Figure 3.18, the case-split procedure is applied twice, at lines 2 and 9. Both models have a single-bit input port, which was selected for cofactoring. ABC [2] immediately proves the first case-split case, case_0 (line 3 and 10), using SAT sweeping on the AIG model at line 5 and 11 using ABC's *dcec* [52] with a time-out of two seconds. The abstraction widget was applied at line 8, reducing the common logic (purple) from 675 to 29 WNK nodes. This happens to remove all the comparator logic. The case-split procedure applied at line 2 is important; we tried abstraction on the original model (at line 1) directly, but it failed to produce a useful abstracted sub-model.

Model 15 is the smallest unproved PEP from model 13. It is proven using the linear sum re-construction widget at line 16, which we will describe in more detail below. Model 23 is

the *s-lemma* after merging pep_0 in the PEP-reduction transformation step at line 15.

After simplification at line 24, most of the post pep_0 -merging logic in model 23 (red and blue) became common logic (purple) through structural hashing, leaving only 10 nodes in each of the blue and red regions. Model 25 was proved quickly by ABC which concludes the proof of the original miter at the root of the model-tree. In this case, the linear re-construction procedure was crucial in attaining the proof. However, the case-split, simplification, abstraction, and PEP transformations are necessary enabling steps leading to the applicability of the linear sum transformation widget for model 15.

Linear Sum Re-construction

For model 15 in Figure 3.18, the WNK network contains many $+$, $-$, \ll and \gg operators along with *extract* and *concat* operators, but contains no Boolean operators or *muxes*. This is an indication that the WNK is likely implementing a pure algebraic function. The input ports consist of twenty-five 7-bit or 12-bit wide ports. The miter is comparing two 15-bit wide output ports. At this point, simplification and abstraction can not simplify the model further. Also, there are no good candidates for case-splitting. The local rewriting rules can not be applied effectively without having some global information to help converge the two sides of the miter logic. High-level information must be extracted and applied to prove this miter model.

The linear sum learning widget shows the following linear sum function is found on both sides of the miter logic:

$$\begin{aligned}
 & -16 * x_0 + 2 * x_1 + 2 * x_2 + 2 * x_3 + 2 * x_4 + 2 * x_5 + 2 * x_6 + 2 * x_7 + 2 * x_7 + 2 * x_8 + 2 * x_9 \\
 & \quad + 2 * x_{10} + x_{11} + x_{12} + 2 * x_{13} + 2 * x_{14} + 2 * x_{15} + 2 * x_{16} + 2 * x_{17} + 2 * x_{18} + 2 * x_{19} \\
 & \quad \quad - 2 * x_{20} + 2 * x_{21} + 2 * x_{22} + 2 * x_{23} + 2 * x_{24} + 14
 \end{aligned}$$

Then the adder-tree-reconstruction widget returns that one side of the miter implements the above sum as a plain linear adder chain Figure 3.19(a), the other side is a highly optimized implementation using a balanced binary tree structure (Figure 3.19(b)) and using optimization tricks, which we don't fully understand.

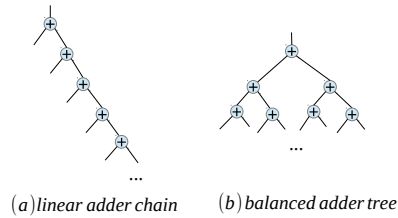

Figure 3.19: Addition implementation

The above learning results allow the linear-sum transformation widget to proceed and create the lemmas as in Figure 3.11, which lead to the final UNSAT result at the root node.

A More Complex Adder-Tree

The sub-model lemma tree of the second case-study is shown in Figure 3.20. In this example, we use x_i to denote a node in the miter network M_M at each sub-model node. LEC applies the learning widgets to identify sub-graphs rooted at node x_i which are implementing linear sum functions and transforms them using `lsum2` or `hier-lsum` widgets. At a high level, the design under comparison has a sub-graph which adds four constant multiplications of 17-bit signed-integers functionally:

$$181 \cdot x_1 - 181 \cdot x_{18} - 181 \cdot x_{33} + 181 \cdot x_4 \quad (3.29)$$

where x_1 , x_{18} , x_{33} and x_4 are the input nodes to the subgraph in M_M .

LEC's proof steps are shown in Figure 3.20 as a spanning sub-model tree. In getting the LEC proof, LEC's learning widgets are able to reveal in great detail how these numbers are added in the circuit. For the miter network model at each sub-model tree node, $lemma_i$ indicates that a subgraph rooted at node x_i is identified as a linear sum; the reverse engineered formula is shown on the right side. For example, at line 23, $lemma_{161}$ and the learned expression

$$x_{101} + 2 \cdot x_{107} + 16 \cdot x_{116} + 16 \cdot x_{122} + 32 \cdot x_{135} + 256 \cdot x_{148} + 256 \cdot x_{156} \quad (3.30)$$

shows the subgraph rooted at node x_{161} and bounded by nodes x_{101} , x_{107} , x_{116} , x_{122} , x_{135} , x_{148} , and x_{156} is implementing the formula (3.30). Similarly, at line 17, node x_{135} is identified as $2 \cdot x_{32} + 1$.

```

0 root                                UNSAT <- ['simplification']
1 simplification                       UNSAT <- ['abstraction']
2 abstraction                           UNSAT <- ['simplification']
3 simplification                        UNSAT <- ['lsum2 ']

4 lsum2                                UNSAT <- all sub-model UNSAT
5 lemma_212                            UNSAT <- ['linear_construction']# 362*x1-362*x18-362*x33+362*x4
6 linear_construction                  UNSAT <- all sub-model UNSAT
7 lemma_F=F'                           UNSAT <- ['simplification']
8 simplification                       UNSAT <- ['dcec']
9 lemma_G=G'                           UNSAT <- ['dcec']
10 lemma_166                            UNSAT <- ['hier-lsum'] # 181*x1-181*x18-181*x33+181*x4
11 hier-lsum                            UNSAT <- all sub-model UNSAT
12 lemma_0                              UNSAT <- ['dcec'] # x0
13 lemma_51                             UNSAT <- ['dcec'] # x50
14 lemma_2                              UNSAT <- ['dcec'] # x0
15 lemma_3                              UNSAT <- ['dcec'] # x3
16 lemma_5                              UNSAT <- ['dcec'] # x3
17 lemma_135                            UNSAT <- ['dcec'] # 2*x32+1
18 lemma_10                              UNSAT <- ['dcec'] # x8
19 lemma_17                              UNSAT <- ['dcec'] # x17
20 lemma_18                              UNSAT <- ['dcec'] # -x17-1
21 lemma_20                              UNSAT <- ['dcec'] # x18
22 lemma_32                              UNSAT <- ['dcec'] # x32
23 lemma_161                            UNSAT <- ['simplification'] # x101+2*x107+16*x116+16*x122+32*x135+256*x148+256*x156

24 simplification                       UNSAT <- ['adder-shift-tree']
25 adder-shift-tree                    UNSAT <- all sub-model UNSAT
26 lemma_64                              UNSAT <- ['dcec'] # (x55*256+(x46*256+((x19*16+(x0+x2*2))+x12*16)+x32*32))
27 s-lemma                              UNSAT <- ['linear_construction']
28 linear_construction                  UNSAT <- all sub-model UNSAT
29 lemma_F=F'                           UNSAT <- ['dcec']
30 lemma_G=G'                           UNSAT <- ['dcec']
31 lemma_34                              UNSAT <- ['dcec'] # 2*x32+1
32 lemma_163                             UNSAT <- ['dcec'] # x161+x82
33 lemma_165                             UNSAT <- ['dcec'] # x164
34 lemma_166                             UNSAT <- ['dcec'] # x165
35 lemma_42                              UNSAT <- ['dcec'] # -x0-1
36 lemma_171                             UNSAT <- ['dcec'] # x0
37 lemma_44                              UNSAT <- ['dcec'] # x42
38 lemma_45                              UNSAT <- ['dcec'] # -x3-1
39 lemma_174                             UNSAT <- ['dcec'] # x3
40 lemma_47                              UNSAT <- ['dcec'] # x45
41 lemma_49                              UNSAT <- ['dcec'] # x44+x47
42 lemma_179                             UNSAT <- ['dcec'] # x32
43 lemma_180                             UNSAT <- ['dcec'] # -x179
44 lemma_181                             UNSAT <- ['dcec'] # x180
45 lemma_186                             UNSAT <- ['dcec'] # x17
46 lemma_187                             UNSAT <- ['dcec'] # -x186
47 lemma_188                             UNSAT <- ['dcec'] # x187
48 lemma_190                             UNSAT <- ['dcec'] # x181+x188
49 lemma_193                             UNSAT <- ['dcec'] # x174+x191
50 lemma_196                             UNSAT <- ['dcec'] # x171+x194
51 lemma_198                             UNSAT <- ['dcec'] # 181*x197
52 lemma_199                             UNSAT <- ['dcec'] # x198
53 lemma_200                             UNSAT <- ['dcec'] # x199
54 lemma_73                              UNSAT <- ['dcec'] # 2*x71+1
55 lemma_82                              UNSAT <- ['adder-shift-tree'] # 4*x12+4*x20+8*x34+64*x53+64*x59+128*x73+x8

56 adder-shift-tree                    UNSAT <- all sub-model UNSAT
57 lemma_68                              UNSAT <- ['dcec'] # ((x38*64+((x8*4+x0)+x2*4)+x21*8))+x31*64)+x51*128)
58 s-lemma                              UNSAT <- ['linear_construction']
59 linear_construction                  UNSAT <- all sub-model UNSAT
60 lemma_F=F'                           UNSAT <- ['dcec']
61 lemma_G=G'                           UNSAT <- ['dcec']
62 lemma_85                              UNSAT <- ['dcec'] # x71
63 lemma_7                               UNSAT <- ['dcec'] # x2+x5
64 lemma_71                              UNSAT <- ['dcec'] # -x32-1
65 lemma_98                              UNSAT <- ['dcec'] # -x17+511
66 lemma_59                              UNSAT <- ['dcec'] # x17
67 lemma_100                             UNSAT <- ['dcec'] # x85+x98
68 lemma_107                             UNSAT <- ['dcec'] # 2*x71+1
69 lemma_148                             UNSAT <- ['dcec'] # x18
70 lemma_122                             UNSAT <- ['dcec'] # x17
71 s-lemma                              UNSAT <- ['linear_construction'] # None
72 linear_construction                  UNSAT <- all sub-model UNSAT
73 lemma_F=G'                           UNSAT <- ['dcec']
74 lemma_G=G'                           UNSAT <- ['dcec']
75 s-lemma                              UNSAT <- ['dcec'] # None

```

Figure 3.20: Proof log

From the sub-model tree, widget lsum2 is applied to line 4 over lemma_212 (line 5) and lemma_166 (line 10) which are identified as top-level linear sums:

$$\text{lemma_212@line5} : \quad 362 * x1 - 362 * x18 - 362 * x33 + 362 * x4 \quad (3.31)$$

$$\text{lemma_166@line10} : \quad 181 * x1 - 181 * x18 - 181 * x33 + 181 * x4 \quad (3.32)$$

and hier-lsum widget is applied at line 11.

Lemma_212 is proven quickly using the linear sum construction widget at line 6, while Lemma_166 is more complex because it internally contains many sub-graph adder trees (hier-lsum widget applicable) and two adder-shift trees at lines 23 and 56 with the following linear sum expressions:

$$\text{lemma_64@line26} : \quad (x55 * 256 + (x46 * 256 + (((x19 * 16 + (x0 + x2 * 2)) + x12 * 16) + x32 * 32))) \quad (3.33)$$

$$\text{lemma_68@line57} : \quad (((x38 * 64 + (((x8 * 4 + x0) + x2 * 4) + x21 * 8)) + x31 * 64) + x51 * 128) \quad (3.34)$$

Both are specific adder-shift adder trees because all the coefficients are powers of 2. Figure 3.21 is the actual WNK network for the adder-shift tree for lemma_64@line26. It is rather surprising to learn that such a complex logic network is a simple linear sum function. Once the adder-shift tree is discovered, the algebraic transformation widget is then applied to establish the proof through the chain of equations: $F' \equiv F \equiv f \equiv g \equiv G \equiv G'$.

In this case study, the iterative applications of LEC learning and transformation widgets allow a very detailed reverse-engineering of the underlying linear sum formula that was implemented. In order to establish a proof using algebraic reasoning, both the functional and structural information of the linear sum formula are identified which are crucial in establishing LEC's proof.

3.6 Experimental Results

Table 3.7 shows the experimental results comparing Boolector [13], Z3 [23] and iprove [52] using a 24-hour time-out limit on a 2.6 Ghz Intel Xeon processor. These models are generated

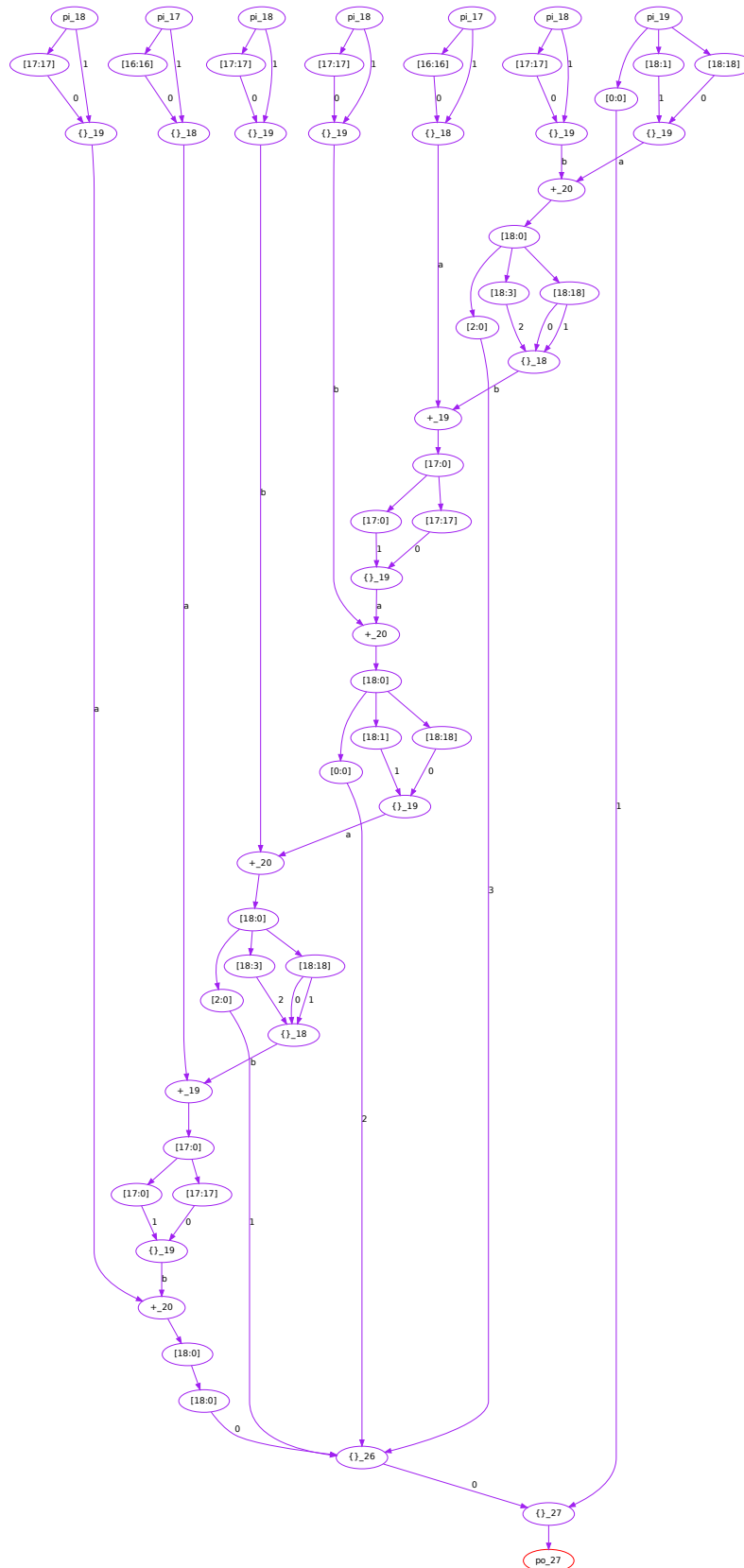

Figure 3.21: WNK network for adder-shift tree of lemma₆₄ (Figure 3.20 line 26, equation (3.33)) (pi , po , $+$, $\{\}$, $[m:n]$ are input, output, *full-adder*, *concat* and *extract* operators. The number after ‘_’ is the bit-width of the node.)

directly using SLEC [15] for checking C-to-RTL equivalence or extracted as a sub-target from PEPs. The first column is the miter design name. The second column is the number of lines of Verilog for the miter model specification. Run-time or time-out results are reported for each solver in columns 3 to 6. Although the miter models are not large in terms of lines of Verilog, they are quite challenging for Boolector, Z3 and iprove. The run-time of LEC is the total CPU time including Verilog compilation. It was expected that iprove would not prove any of these designs because it works on the bit-blasted model without any high-level information which the other solvers have.

Design	Lines	Boolector	z3	iprove	LEC
mul_64_64	125	20 sec	200 sec	timeout	10 sec
d1	24	time-out	time-out	time-out	15 sec
d2	507	time-out	time-out	time-out	2 min
d3	191	time-out	time-out	time-out	15 min
d4	473	time-out	time-out	time-out	1 min
d5_case_1	1090	time-out	time-out	time-out	10 min
d5_case_1_pep_0	674	time-out	9 hour	time-out	4 min
d6_case_2	205	time-out	time-out	time-out	10 min

Table 3.7: Benchmark comparison (Timeout 24 hours)

The miter, mul_64_64, compares a 64x64 multiplier in the LHS with an implementation using four 32x32 multipliers using the following equation:

$$\{a_H, a_L\} \cdot \{b_H, b_L\} = (a_H \cdot b_H) \ll 64 + (a_H \cdot b_L + a_L \cdot b_H) \ll 32 + a_L \cdot b_L$$

where a_H , a_L , b_H , b_L are the 32-bit slices of the original 64-bit bit-vectors. Both Boolector and Z3 are able to prove it. LEC proves it by first utilizing rewriting rules to transform the 64x64 multiplier into four 32x32 multipliers, matching the other four in the RHS of the miter. Because they are matched exactly, they become common logic in the miter model. LEC then produces an abstraction and obtains a reduced model with all the multipliers removed: the outputs of the multipliers become free inputs in the abstract model. The abstract model is then proven instantly by ABC's "dcec" algorithm on the AIG model.

Miter d1, extracted from a PEP sub-model, is a demonstration of rewrite Rule 6 (distribution of multiplication over concat operator) in Table 3.3 using 32-bit multiplication. As both Boolector and Z3 fail to prove equivalence within the time-limit, they likely do not have this rewriting rule implemented.

To prove d2, LEC executes a conditional rewriting using rule (3.8) by first statically proving an invariant in the form of (3.9). After the transformation, the multipliers are matched exactly on both sides of the miter and removed in the subsequent abstract model. The final miter model is proved instantly by ABC on the bit level AIG.

The miter model d3 has part of its logic that is similar to `mul_64_64` embedded inside. LEC proves d3 by first applying rewriting rules repeatedly until no more rewriting is possible. Then, LEC computes a reduced model through abstraction. In the reduced model, LEC executes a case-split on a one-bit input. The case-0 AIG model is proven instantly, while case-1 is proven in about 10 minutes by ABC.

Miter d4 is proven by first executing a case-split of two bit-vector inputs. Three of the four co-factored cases are proven instantly. The one that is unresolved goes through a round of simplification and abstraction. On the resulting sub-model, three one-bit inputs are identified and co-factored through case-split procedures. LEC proves all resulting eight cases within a few seconds.

Miter `d5_case_1` is the top-level model presented in the first case study in Section 3.5. LEC completes the proof in 10 minutes while all other solvers time out. Miter `d5_case_1_pep_0` is extracted from this miter model at line 15 in Figure 3.18, which is the linear sum miter. For this simpler miter, Z3 is able to prove it in 9 hours while both `iprove` and `Boolector` time out. This shows that by using collaborating procedures through simplification, abstraction and case-split widgets, LEC's transformations successfully reduce the surrounding logic in the original model, which was preventing Z3 from proving it in 24 hours.

Miter `d6_case_2` is the top-level model presented in the second case-study in Section 3.5. Figure 3.20 shows the procedures that lead to the proof. The overall run-time for LEC is 10 minutes, while all three other solvers time out.

The above experiments demonstrate the effectiveness of LEC's collaborating procedures of simplification, rewriting, case-splitting and abstraction computations. The LEC architecture allows these procedures to be applied recursively through a sub-model tree: the model obtained by one widget introduces new opportunities for applying other widgets in the next iteration. As exemplified in Miter d4, the initial case-split gives rise to new opportunities for simplification as new constants are introduced by cofactoring. Then a new round of abstraction is able to remove enough common logic and expose three one-bit inputs as case-split

candidates in the reduced model, which in turn gives rise to another case-split transformation that leads to the final proof. None of this seems possible without the transformations being applied in sequence.

3.7 Comparison with Related Work

In bit-level equivalence-checking procedures [42] [52] [55], simulation, SAT-sweeping, AIG rewriting and internal equivalence identification are all relevant to data-path equivalence-checking. In LEC, these types of procedures are conducted at the word-level. Word-level rewriting is difficult if only a bit-level model is available. For example, with no knowledge of the boundary of a multiplier, normalizing its operands is impractical at the bit-level. Although abstraction and case-split techniques in LEC can be applied at the bit-level in theory, these are not used due to the difficulty of computing an abstraction boundary or of finding good cofactoring candidates.

SMT solving is relevant because a data-path is a subset of QF_BV theory. Methods such as [4] [13] [23] [18] [24] [34], are state-of-art QF_BV solvers. These employ different implementations of word-level techniques in rewriting, abstraction, case-splitting, and simplification, and interleave Boolean and word-level reasoning via a generalized DPLL framework or through abstraction refinements of various forms. In our experience, the SMT solvers are very efficient on SAT instances.

Hector[38] is closest to LEC in terms of technology and targeted application domains, and has a rich set of word-level rewriting rules along with some theorem prover [4] procedures to validate every rewriting applied. Hector also has an orchestration of a set of bit-level solvers using SAT and BDD engines to employ once the bit-level miter model is constructed. Strategically, LEC relies less on the capacity of a SAT solver and instead builds a compositional proof infrastructure and employs iterative transformations to obtain a proof through sub-model trees.

The techniques in [56] [62] [68] also try to reconstruct an algebraic model from the underlying logic, but they employ a bottom up approach and their primitive element is a half-adder. The method in [5] simplifies the algebraic construction by solving an integer linear programming problem. The limitation of these approaches is that they rely on the structural pattern of the underlying logic to reconstruct the algebraic model. On the other hand, the

linear construction case-study in Section 3.5 constructs the polynomial through probing with simulation patterns. This is more general as it uses only the functional information of the data-path logic. For different domains, other techniques may well be more applicable such as the bottom-up approach. The use of vanishing polynomials and Grobner bases in [57][58] to prove equivalence between polynomials in the modulo integer domain can be utilized once a polynomial form is reconstructed in LEC. However, in many data-path miter models, such a polynomial in a certain domain or theory is likely embedded in other control and data-path logic. Direct application of algebraic techniques is often not practical. Thus the collaborating procedures in LEC are designed to bridge this gap and isolate such polynomials so that these high level theories can then be applied.

Recent developments in [47] [46] try to recognize high-level constructs from a bit-level sequential network, while LEC establishes linear-sum relationships using functional and structural information of the WNK word level network. The work in [44] tries to reconstruct the factored form for constant-coefficient multiplication using partial products at the bit-level, while our method is effective at the word-level WNK network. In conducting consistency checking between C and Verilog RTL, the work [39] focuses on how to process a C program to generate formal models. The tool relies on SMT solvers [13] [18] [23] as the back-end solving engines.

Clearly, LEC is not a theorem prover, however, there is some similarity at the high-level view. Both require design knowledge in order to reason beyond Boolean logic. Using first order logic, a theorem prover is expressive enough and very rigorous in reasoning between the Boolean and algebraic domains. However, LEC uses an Algebraic-to-Boolean procedure to covert an algebraic expression into Boolean logic. Also, LEC is more applicable and easier to use as it works on general RTL directly, using learning and transformation widgets to unravel the underlying algebraic function.

In terms of tool architecture, [6] [12] [41], all employ a sophisticated set of transformations to simplify the target model during verification. These are done at the bit-level. The LEC infrastructure allows future extension to take advantage of multi-core parallelization as demonstrated in [61]. Methods in [17] and [66], use dedicated data-structures to represent the proof-obligations, while LEC relies on the sub-model tree to track the compositional proof strategy used at each node.

3.8 Conclusion

In LEC, we designed and implemented a system of collaborating procedures for data-path equivalence-checking problems found in industrial settings. The strategy is to utilize Boolean-level solvers, conduct transformations at the word-level and to synthesize internal similarities by lifting the reasoning to the algebraic level. Using real industrial case-studies, we demonstrated with LEC the applicability of the sub-tree infrastructure for integrating a compositional proof methodology, LEC was able to prove problems within a few minutes that were unsolved in 24 hours by three other competing methods.

Chapter 4

A Simple Trusted Translation Procedure from C to Verilog

Simplicity is the prerequisite of
reliability.

Edsger Dijkstra

Make things as simple as
possible, but not simpler.

Albert Einstein

The objective of this chapter has two goals:

1. Build a simple trusted translator from C programs to a hardware description language (in this case Verilog).
2. Apply this to the formal verification of hardware and software systems using highly developed hardware model checking systems and methods.

In combination, these comprise a C-based model checker.

To achieve the first goal, we used the LLVM compiler infrastructure [45] to compile C programs into LLVM Bytecode, and used a straightforward method to translate these into Verilog circuits. The implementation is able to handle most C constructs, including some problematic ones such as arbitrary loops and static array access.

For the second goal, both equivalence checking and property checking will be illustrated. For *equivalence checking*, related IEEE 754 [32] compliant floating point units (FPUs) were compared; namely *OpenCores* VHDL or Verilog hardware models were compared with related C-coded *SoftFloat* versions [30]. Interestingly, this revealed several bugs in the *OpenCores* hardware models. For *model checking* safety properties, benchmarks from the 2015 Software Verification Competition were examined. This also revealed discrepancies with some of the expected results (truth values), assigned by the competition committee, with the correct results. In both situations, counterexamples were generated and cross-checked against the original C-program to validate their correctness.

4.1 Introduction

In the previous chapter, some very difficult equivalence checking problems were tackled, where different Verilog word-level models were compared for combinational equivalence. In this chapter, we move up a level of initial description to the C language and address an increasingly popular way of designing hardware, using software specifications. We also look at the verification of software directly.

This work was motivated by a growing interest in reasoning about and proving properties specifically about C software programs. C is also of increasing interest in the hardware domain, where C is used as a hardware specification language. While the actual implemented hardware is typically described in Verilog and synthesized from that, it is the C model that is usually certified by massive simulations. In this sense, the C model represents the golden model and is used to compare against a related Verilog model using equivalence checking. This requires a highly trusted translation from C to Verilog to create a golden Verilog model for comparing against the Verilog implementation model used by the designers.

In the software domain, formally verifying a program against a set of properties has been a subject of interest and active research for many years. Great strides have been made in formal verification of both hardware and software. Our aim here is to bring the state-of-the-

art in hardware verification to the software domain and take advantage of advances made in hardware verification methods.

We first focus on creating a translation tool that is as simple as possible using trusted and well established intermediate tools to accomplish the task. We eschew optimization of the generated Verilog model which can add complications and therefore can increase the potential for introducing bugs. This allows existing hardware formal verification flows such as equivalence and property checking of safety and liveness properties to be applied readily, with a very high confidence that the translation process has not corrupted the golden model and therefore the results can be trusted.

We use the LLVM compiler infrastructure and a straight-forward translation of its produced LLVM Bytecode to create a Verilog program from a single thread C program. At this point, an equivalence-checking Verilog (miter) model can be created comparing the actual hardware model used for implementation with the synthesized-from-C model. Figure 4.1 shows the high-level C-to-Verilog translation flow and how it fits into a C-to-RTL equivalence checking methodology using hardware verification methods. Such a flow can also be used in the software verification of C programs where C *assert* statements are translated into System Verilog Assertions [1] (SVA) and compiled into logic using, for example *Verific*[64].

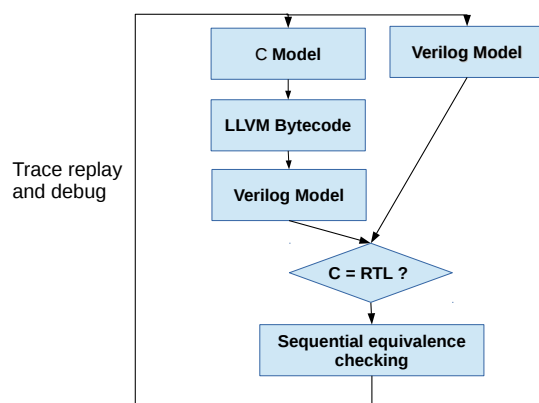

Figure 4.1: C vs RTL equivalence checking

Motivation

A language front-end to compile C programs into finite-state-machines can be an intricate matter. An obvious concern is that the compilation procedure may incorrectly reproduce the original C program semantics. This is a real concern as illustrated in the C program in Figure 4.2, which is one of the test cases in the Bit-Vector category of the 2015 Software Verification Competition [7]. In this category, only integer arithmetic and control flow structures in the C language are allowed.

```
extern unsigned int __VERIFIER_nondet_uint();
int main() {
    unsigned int i, n=__VERIFIER_nondet_uint(), sn=0;
    for(i=0; i<=n; i++) {
        sn = sn + i;
    }
    __VERIFIER_assert(sn==(n*(n+1))/2 || sn == 0);
}
```

Figure 4.2: sum02_true-unreach-call.c

This test case was officially classified incorrectly as “unreach”, i.e. the assertion is considered *true* by the software competition committee. It is one of the initial regression tests imposed on any entry software in the competition. However, the assertion fails when $n = 65536$, in which case, $n * (n + 1)$ overflows while the addition inside the loop does not. Table 4.1 shows the results on this example for all eight entries in this category of the competition. Four, [40], [53], [67], and [65], out of eight of the competition participants produced the incorrect *true* result. (Participants [40] and [53] were recognized as the top two winners in this category). The other four participants, [28], [26], [31], and [8], had one or more incorrect results on other test cases. Thus none of participants was one hundred percent correct; producing a wrong answer on at least one of the benchmark test cases.

It is not known where bugs got introduced into the various tool flows, but for any such tool, the very first step is to compile the C program into an internal representation of the C execution semantics. To many, this is a complex and time-consuming task, yet a preliminary step.

We believe simplicity results in fewer bugs. The focus on our procedure for translating C to a circuit model, was to make it as simple as possible and hence less error-prone by construction.

Solvers	Rank	Consistency	#Errors
ESBMC[53]	1st	Buggy	1
CBMC[40]	2nd	Buggy	1
CPAChecker[8]	3rd	Buggy	1
Beagle 1.1[65]		Buggy	1
Cascade 2.0[67]		Buggy	1
Seahorn[28]		Buggy	> 1
Ultimate Automizer [31]		Buggy	> 1
Ultimate Kojak[26]		Buggy	> 1

Table 4.1: 2015 Software Verification Competition: Bit-Vector category

Our simple/trusted C-to-Verilog compilation should take the translation procedure out of the verification equation, and reliably bridge the gap between software and hardware. This allows existing hardware synthesis and verification techniques to be applied reliably in the software domain.

Why Verilog

Verilog was chosen as the intermediate representation for the circuit model for the following reasons:

- It is almost the industrial de facto standard for hardware description from which hardware is synthesized and verified.
- Verilog's *always_ff* and *always_comb* blocks can be used to express a finite state machine model as sequential and combinational logic respectively.
- Verilog has been precisely defined by IEEE standards. Its well-defined syntax and semantics make it easier to map the C semantics into Verilog constructs.
- Synthesis, simulation, emulation, validation and verification tool flows for Verilog can be utilized readily after the translation.
- Validation of the translation procedure can be conducted by simulating the Verilog model and comparing against the C-code program using random input vectors. In our case, we used Verilator[60] to compile the generated Verilog code back to C++ to be simulated.

- Verilog has sufficient constructs to capture all the original C constructs. This is important for retaining the original control flow and word-level operators after the translation.

A constraint imposed by the Verilog language is that the computation resources must be statically resolvable at synthesis time. In contrast, C programs support dynamic resource management such as memory allocation/de-allocation, run-time function call-stacks and run-time parallel threads. Therefore, in this work, we limit the scope of translating from single-thread C programs with arbitrary control flows, without those dynamic resource management features.

Main Contributions

1. A simple procedure is presented, based on the LLVM compiler infrastructure, in which a subset of C (excluding dynamic memory management, recursive functions and parallelism), can be mapped into a Verilog module using the *always_ff* and *always_comb* blocks.
2. Experiments demonstrating C-to-RTL equivalence checking and software property checking, show that such a flow allows existing hardware verification tool chains to be used, producing promising results. The results also indicate that our flow is more reliable than existing methods available.

Organization

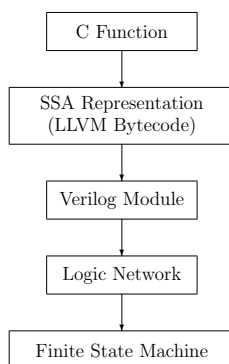

Figure 4.3: C-to-Verilog Translation

In Section 4.2, we review a) the circuit computation model, b) Verilog HDL, c) the C language characteristics, d) static-single-assignment(SSA) [22] and e) the LLVM Bytecode [45]. In Section 4.3, the overall tool flow and translation procedure are illustrated in Python code. Experimental results are presented in Section 4.4 followed by discussions of related work in Section 5 and conclusions in Section 6.

4.2 Background

The ultimate objective of C to Verilog translation is to build a finite-state machine(FSM) model from the C program such that existing model checking algorithms can be applied. Figure 4.3 shows the steps that lead to the finite-state machine from a C Function. In this section, we will describe some background theory on logic networks, the Verilog language, the C programming language, SSA intermediate representation and LLVM.

Logic Network and the Circuit

A logic network N is a directed graph (V, E) with node set V and edge set E . Each node is labeled with a node type and a width. A node type is one of $\{input, output, operator, flip-flop\}$. An *input* node has zero incoming edges; an *output* has zero outgoing edges, and a *flip-flop* has a single incoming edge. An operator node is an arithmetic function of its immediate fanin nodes.

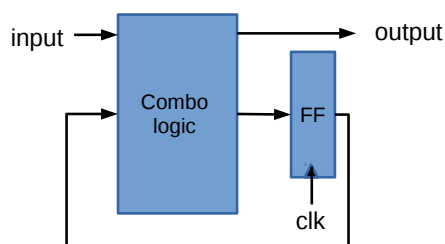

Figure 4.4: A single-clock synchronous circuit

Such a logic network can express the functionality of a synchronous sequential circuit shown in Figure 4.4, which contains inputs, outputs, combinational logic, flip-flops and a single clock input. The combinational logic can be represented by a WNK network. The network has the following characteristics:

- The logic network topology is statically determined and does not change during evaluation of the network.
- The circuit evaluates at every clock cycle and infinitely over time.

The goal is to map a C program into a logic network such that an evaluation of it produces the same input/output behavior as the original C program.

Verilog HDL

Verilog is an almost de facto standard used by industry for specifying hardware designs. Table 4.2 summarizes its language constructs. The *always_ff* block is used to describe sequential logic where flip-flops are inferred, while *always_comb* is for combinational logic. According to Verilog's event-driven semantics, for the circuit in Figure 4.4, the *always* blocks are evaluated every clock cycle, and the computation is infinite over time.

Language elements	Verilog Constructs
variables	wire /reg
control flow	if/else/case
sequential block	always_ff @(posedge clk)
combo block	always_comb
operators	+, -, *, /, &, , etc.

Table 4.2: Verilog language elements

Figure 4.5 is a Verilog module for factorial computation. In addition to the integer n as the input and output *ret* for the factorial function $ret = factorial(n)$, the module also has an input *start* and output *ready* signals: *start* and *ready* are used to indicate the starting time and ending time of the computation. The waveform in Figure 4.6 illustrates the Verilog computation of $factorial(6)$ by plotting the value of signals at every cycle. The computation starts at cycle 0 and ends at cycle 6, between the rising edge of *start* and *ready*. Signal values that are not relevant during the computation are grayed out in the waveform. The goal in our translation procedure from C to Verilog is to build a Verilog module that implements the C function such that the computation of the original C function can be obtained between the rising edges of *start* and *ready*.

```

module verilog_factorial
  ( input clock,
    input [31:0] n,
    input START,
    output reg READY,
    output reg [31:0] ret
  ) ;

  reg [31:0] n_reg;
  reg [31:0] i_reg;

  reg [31:0] ret_cur;
  reg [31:0] i_cur;

  reg READY_cur;
  always_comb begin
    ret_cur = ret_reg * i_reg;
    i_cur= i_reg + 1;
    READY_cur= i_reg==n_reg;
  end

  always_ff @(posedge clock)
  if(START) begin
    n_reg<=N;
    i_reg<=1;
    READY<=0;
    ret_reg <= 1;
  end else if (i<=n_reg) begin
    ret <= ret_cur;
    i <= i_cur;
    READY <= READY_cur;
  end
endmodule

```

Figure 4.5: Verilog factorial implementation

The C Programming Language

The C language has two major features. One is the control flow structure that defines the order of computation; the other is the resource allocation, which can be dynamic at run-time. Conceptually, resources refer to those computation elements that either hold the value of a variable, or implement some arithmetic function. Static resources are allocated at compile time, while dynamic resources can be acquired and released during run-time. Table 4.3 lists the major C features and their category, static or dynamic.

Language Elements	C Constructs	Resource
variable	local/global	static
control flow	if/case/for/while	static
memory	malloc/free	dynamic
parallelism	pthread	dynamic
call stack	function calls	dynamic
pointers	pointer arithmetic	aliasing

Table 4.3: C language elements

Pointers are simply aliases for objects in the C program. Although they can be complex to

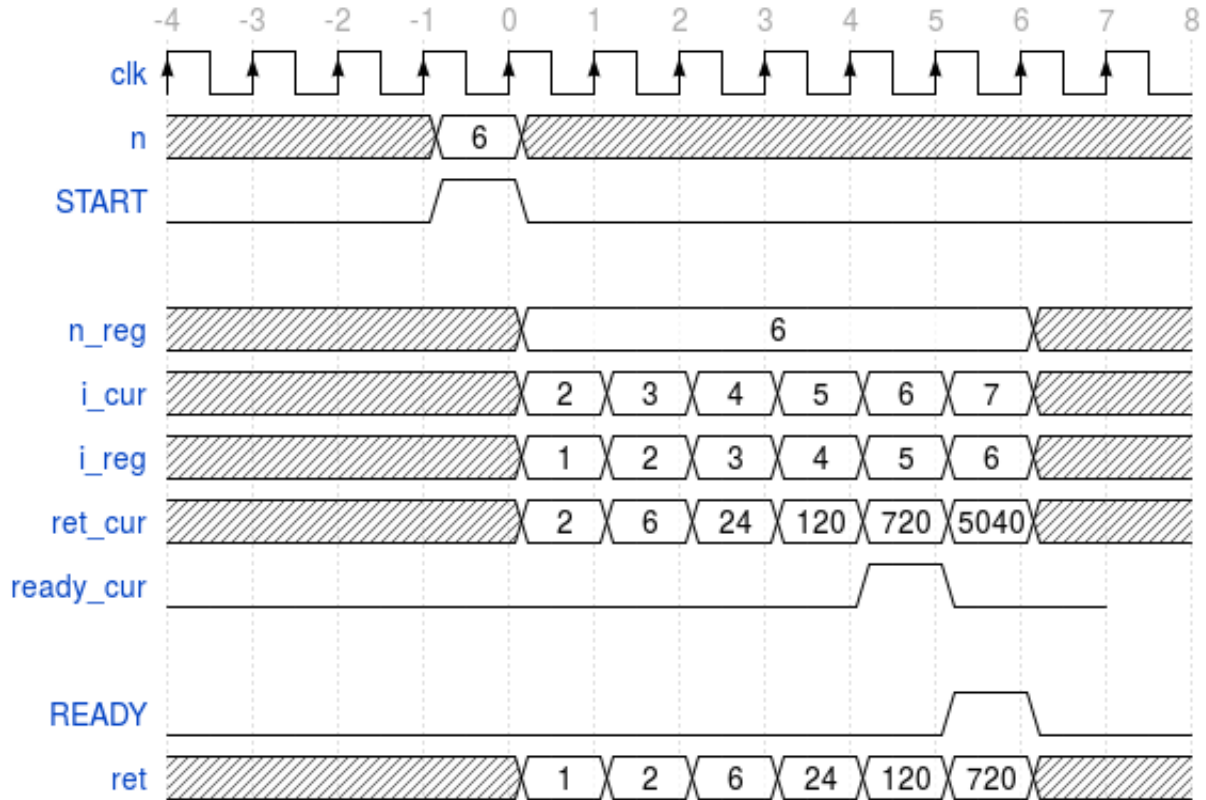

Figure 4.6: Waveform for Module `verilog_factorialwithn = 6`

reason about, there is no resource allocation involved in their use, and thus not a fundamental barrier in translating to a circuit model. On the other hand, run-time function calls can dynamically allocate resources for the stack space to hold local variables. Nested non-recursive function calls can be eliminated at compile time by function inlining. Dynamic threads also require run-time acquisition of local variable space and operator nodes. Although the behavior of loops can vary at run time, the computational resources for variable space can be statically determined during compilation. Therefore if the resources required for a C program to execute can be statically determined, then the C program execution is mathematically a finite-state-machine model which can be constructed through Verilog as a logic network.

Static Single Assignment (SSA)

Static single assignment (SSA) [22] is a break-through concept and technique in compiler theory and implementation. It is used as an intermediate representation (IR) by translating

a program into a sequence of basic blocks with only assignment statements, branching statements and function calls, and most importantly, each variable in SSA is assigned exactly once. Our translation procedure is based on this principle of the SSA IR. To illustrate the basic ideas behind static single assignment, we use an example in Figure 4.7 to show how SSA IR is obtained through a normalization step where the C program's loop constructs are rewritten into *if-else* and *goto* statements.

<pre>int factorial(int n) { int ret = 1; int i; for(i=1;i<=n;i++) { ret = ret*i; } return ret; }</pre> <p>(a) C function</p>	<pre>int factorial (int n) { entry: ret = 1; i = 1; goto for_cond; for_cond: cond = i<=n; if (cond) goto for_body; else goto for_end; for_body: ret = ret*i; goto for_inc for_inc: i = i+1; goto for_cond; for_end: return ret; }</pre> <p>(b) Normalized C</p>	<pre>entry: ret0 = 1 i0 = 1 br for_cond for_cond: ret1=phi(ret0, ret2) i1 =phi(i0, i2) cond i1<=n br cond for_body for_end for_body: ret2 = ret1*i1; br for_inc for_inc: i2 = i1+1 br for_cond for_end: return ret1</pre> <p>(c) SSA IR</p>
--	--	--

Figure 4.7: C to SSA IR illustration

In Figure 4.7b, the *for* loop construct in the *factorial* function in Figure 4.7a is rewritten using *if-else* and *goto* statements, with four blocks labeled as *for_cond*, *for_body*, *for_inc* and *for_end*. Following the C language semantics, this transformation is a syntactical rewrite and can rewrite arbitrary nested loops. It normalizes any C program into a sequence of basic blocks with the following characteristics:

1. The resulting C program uses only assignment statements, *if-else*, *goto* statements

(function calls are not considered as they can be eliminated through an inlining procedure during preprocessing).

2. After normalization, the program is partitioned into a sequence of basic blocks: a label is defined at the beginning of each block; each block starts with a sequence of assignment statements; the last statement of the block is either a *goto* or a *return* statement. The *if-else* construct can only be used with the *goto* statement for conditional branching. There is a unique basic block labeled with *entry* which corresponds to the starting point of the C program.

Compiler theory states that any C program can be normalized into such a basic block format. This basic block format in 4.7b is almost a compliant SSA form in 4.7c except for two differences. First, SSA introduces a *br* operator as a shorthand for *goto* statement and conditional branching: "br label" is the same as "goto label" and "br cond label_true label_false" is the same as

```
if (cond)
    goto label_true;
else
    goto label_false;
```

The other difference between the program in Figure 4.7b and the SSA form in Figure 4.7c is that variables in 4.7b can be assigned in multiple locations (SSA requires each variable be assigned only once), e.g. *ret* is assigned in both *entry* and *for_body* blocks. The rule of the SSA form is that each variable is assigned only once in the entire program. To achieve this, at each assignment statement, the left-hand variable is assigned a unique variable id. For example, in Figure 4.7c, *ret0* and *ret2* are used for the assignment to *ret* in the *entry* and *for_body* blocks.

However, this leads to the problem that *ret1* referenced in the right-hand side of

```
ret2 = ret1*n
```

needs be resolved to either *ret0* or *ret2* because variable *ret* is assigned at two different locations. SSA introduces a new operator $\phi(v_0, v_1, \dots, v_i, \dots)$ which returns the resolved

value. When the $\text{phi}(v_0, v_1, \dots, v_i, \dots)$ operator is executed, it evaluates to one of the v_i based on the execution history: i.e. the sequence of basic blocks it has visited before entering the current basic block. In the *factorial* example,

`for_cond:`

```
ret1 = phi(ret0,ret2)
```

ret1 is resolved to *ret0* if the previous basic block's label is *entry*, otherwise *ret1* is resolved to *ret2* if the previous block's label is *for_inc*.

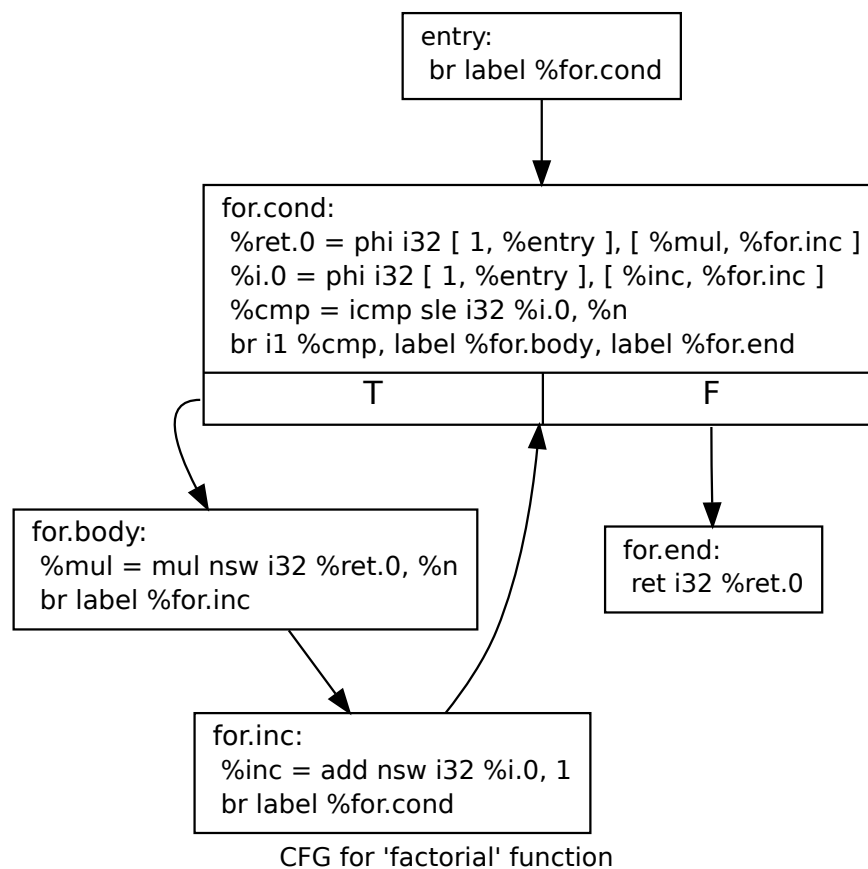

Figure 4.8: LLVM CFG

The introduction and resolution of the *phi* operator is one of the original contributions of the SSA form [22]; readers should refer to [22] for a complete and rigorous presentation of

the SSA form. Once the SSA form is obtained from the C compilation, the translation of SSA into Verilog is relatively simple.

LLVM Bytecode

The reason we chose the LLVM compiler infrastructure in this project is that the LLVM tool chain translates C programs into LLVM Bytecode which is an SSA implementation. Figure 4.8 is the actual translated LLVM Bytecode of the *factorial* function in Figure 4.7a illustrated as a control flow graph(CFG). Each node in the CFG is a labeled basic block, while the edges in the CFG are derived from the branching operator *br*. We leave the reader to refer to the LLVM reference manual [45] for further details on the definition of LLVM syntax and internal implementations.

4.3 Translating SSA to Verilog

We will describe our translation procedure in terms of SSA terminology because the specifics of LLVM Bytecode is not as important as the fact that the correctness of our algorithm is based on the principles of SSA.

From SSA to SSA^b : Reverting the *phi* operator

The first step in the translation process is to revert the *phi* operator in the SSA intermediate representation. For each $v_{phi} = phi(v_0, v_1, \dots)$ statement, we do the following:

1. Immediately after the location where v_i is assigned, add the following assign statement

$$v_{phi} = v_i$$

2. Remove this $v_{phi} = phi(v_0, v_1, \dots)$ statement from the SSA representation

Figure 4.9 shows the reverted SSA representation after the *phi* statement in Figure 4.7c is reverted to actual assignments. We call this the SSA^b form because after the reverting step, it no longer satisfies the SSA rule that each variable is assigned only once. However, SSA^b still has the following two characteristics:

1. It is in normalized C form. This ensures that each C operator in the SSA IR has a corresponding Verilog operator for translation.
2. Within each basic block, each SSA variable is assigned only once. This is important as it simplifies the algorithm when mapping a C variable to the corresponding Verilog signal during translation.

As described in the next section, translation to Verilog is conducted over the basic blocks one-by-one; there is no need to require that each variable is globally assigned once. The above two properties that the SSA^b IR satisfies, allows a simple translation procedure from C to Verilog.

```

entry:
    ret0 = 1
    ret1 = ret0 // added from tmp=phi(ret0,ret2)
    i0 = 1
    i1 = i0     // added from i1=phi(i0,i2)
    br for_cond
for_cond:
    //removed: ret1=phi(ret0, ret2)
    //removed: i1 =phi(i0, i2)
    cond i1<=n
    br cond for_body for_end
for_body:
    ret2 = ret1*i1
    ret1 = ret2 // added from tmp=phi(ret0, ret2)
    br for_inc
for_inc:
    i2 = i1+1
    i1 = i2     // added from i1=phi(i0,i2)
    br for_cond
for_end:
    return ret1

```

Figure 4.9: SSA^b from SSA in Figure 4.7c with *phi* node reverted

Verbatim Translation to Verilog

The goal of the translation procedure is to create a Verilog module that can be synthesized to the logic network in Figure 4.10 where the execution of the C program is mapped to

a sequential network. We would like to map the C function $y = f(x)$ over a multi-cycle computation on the logic network between the rising edges of *start* and *ready*, i.e. $y@ready = f(x@start)$. This is similar to the concept where *verilog_factorial* in Figure 4.5 is configured to compute *factorial(6)* as shown in the waveform in Figure 4.6. For ease and preciseness of the presentation, we use Python code to define what is an SSA as well as the translation procedure, which is largely based on string manipulation and formatting while traversing the SSA internals.

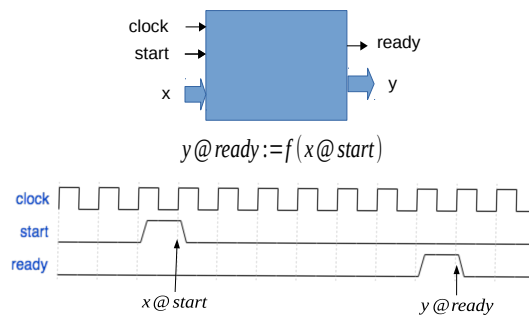

Figure 4.10: Verilog Model

Figure 4.11 shows the Python code to access and traverse the contents of an SSA intermediate representation, plus a few helper functions that are used in the translation procedure. Any function's name ending with an 'x' indicates it returns a Python list value. We use Python list comprehension to traverse the list and use "%s" constructs to print out the generated Verilog code.

We use a global Python variable *SSA* as the top-level *SSA*^b structure to be translated into Verilog. An *SSA* has respective lists for inputs, outputs and basic blocks, which are accessed through *inputx*, *outputx*, and *blockx*. Each input and output is an SSA variable. The basic block structure contains the label symbol and a sequence of SSA statements. There are only three types of SSA statements: branching(*br*), assignment(*lhs=rhs*) and return statements. The branching statement can be conditional or un-conditional depending on if *cond(br)* equals *None* or not. Each SSA variable has a unique name accessed by the *symbol(var)* function. For each SSA variable *var*, two Verilog signals, named by calling *FF(var)* and *COMB(var)*, are declared with the corresponding types. The *FF(var)* is assigned in the *always_ff* block functioning as a flip-flop while *COMB(var)* is assigned in the *always_comb* block as a combinational signal. The widths of the two Verilog signals are obtained from the *vtype(var)* function which is derived from *sizeof(var)* in C semantics. The function

$DEFx(var)$ returns a list of the SSA assignments where var is assigned on the left-hand side (i.e. where $lhs(stmt)$ equals var). By definition of the SSA form, the length of the returned list from $DEFx(var)$ should always be one, except for those variables (call them phi variables) that are obtained from reverting the phi statement in the rewriting step.

Figure 4.12 shows the complete implementation of the translation procedure to Verilog given the above SSA traversal and access functions. The code for gen_rhs and gen_from_stmt are described and defined in Figure 4.13. For demonstration, Figure 4.14 shows the resulting Verilog module translated from the SSA structure in Figure 4.9.

The strategy of the translation is to build a logic network such that at each cycle exactly one basic block is executed. For each basic block's label in the SSA, we define a LABEL signal in the Verilog module functioning as a flip-flop: it is assigned to zero or one depending on whether the corresponding basic block is to be executed in the next cycle. In the generated Verilog, it has one *always_ff* block and one *always_comb* block. The *always_comb* basically translates all SSA assignment statements into corresponding Verilog blocking assignments by following the order within each basic block. The ordering between basic blocks can be arbitrary.

Function $gen_from_basic_block(b)$ shows each basic block is converted to an *if(cond)* block in the *always_ff* block and the conditional expression *cond* is signal $LABEL(b)$. Signal $LABEL(b)$ is cleared to zero in the very first statement entering the *if* block. In the function $gen_from_br(br, block)$ in Figure 4.13, the corresponding LABEL signal is set to one for the next basic block to be entered. In addition, function $gen_START_block(SSA)$ is used to trigger the starting point of the execution by setting $LABEL_entry$ to one if $START$ is one. In the Verilog module, when translating the SSA variable var to the corresponding Verilog signal, we need to choose between $COMB(var)$ and $FF(var)$. The resolution algorithm is implemented using function $PHI(var, stmt, b)$ in Figure 4.12, where var is referenced in $stmt$ in block b . This function returns $COMB(var)$ if the var has only one location where it is assigned (i.e. $len(DEFx(var)) == 1$), and that location is before the $stmt$ (i.e. $DEFx(var)[0] < stmt$) and within the current block b (i.e. $DEFx(var)[0]$ in $stmtx(b)$). The PHY function returns $FF(var)$ if otherwise. If the var has more than one location where it is assigned, then they must not be in the block b , because they were created from SSA to SSA^b for the phi operators when they were reverted to assignment statements in a different basic block. Hence, these var references would be resolved to the $FF(var)$ signals.

For the return statement, the *READY* signal is assigned 1 and because the rest of the *LABEL* signals are cleared to 0, then the execution terminates there after.

Our actual implementation is based on LLVM Bytecode. After the LLVM Bytecode is obtained from LLVM compilation of the C program, the C-to-Verilog procedure mainly involves list traversal, string manipulation, and formatting to write out the Verilog code. There is no cone-of-influence analysis, such that the procedure basically traverses the SSA twice to generate one *always_comb* and one *always_ff* block. Figure 4.15 shows the waveform that *c2v_factorial* is evaluated to between *START* and *READY*, calculating the *ret@READY* to be 720 given the input $n@START = 6$.

In summary, the C-to-Verilog translation procedure build a logic network that can be used to model the execution semantics of the original C program. Using the LLVM compiler infrastructure to compile the C program into LLVM Bytecode, the translation procedure is built by traversing the LLVM Bytecode which is an SSA intermediate representation. To build the logic network from the SSA representation, we use Verilog as the intermediate language to declare LABEL, FF and COMB signals. The control flow of the SSA is implemented using the LABEL signals by mapping the basic block into an *if* block in the *always_ff* block. Variable reference resolution is implemented using the *PHI(var, stmt, block)* function, resolving the signal value to either the FF or the COMB signal. In doing so, although the final logic network can be redundant and not optimized at all, the translation procedure is so simple it basically traverses the SSA basic blocks one by one and conducts an almost verbatim translation. In the next section, experimental results show promising and competitive results in applying this translation procedure to sequential equivalence checking between C and Verilog as well as in the software verification domain.

Assertions

In the above framework, a C assertion *assert(a)* is translated into SystemVerilog Assertions (SVA) [1] with the following form:

```
assert property (@(posedge clk) label_t|-> v_a );
```

where *label.t* is the condition in entering the basic block of *assert(a)* and *v_a* is the corresponding value of *a* at the time of executing the *assert(a)* statement in this basic block. The

```

global SSA
##
## SSA construct
##
def inputx(ssa):
    # return input variables
def outputx(ssa):
    # return output variables
def blockx(ssa):
    # return basic blocks
def ssaAssignStmtx(ssa):
    # return all assignment
    # statements
##
## SSA variable
##
def symbol(var):
    #return :
    # the name of var as a string
def width(var):
    #return sizeof(var) in C
def vtype(var):
    return "" if width(var)==1
        else "[%d:0]"% (width(var)-1)
def COMB(var):
    return "%s_COMB" % symbol(var)
def FF(var):
    return "%s_FF" % symbol(var)
def DEFx(var):
    return [i for i in
            ssaAssignStmtx(SSA)
            if lhs(i) == var]
##
## SSA Basic block
##
def label(b):
    # return :
    # label of the basic block
def LABEL(b):
    return "LABEL_%s" % label(b)
def stmtx(b)
    # return :
    # the list of the statements
    # in basic block b
def assignStmtx(b):
    # return :
    # the list of assign statements
    # i.e. lhs=rhs
##
## Br Statement:
## br <label>
## br <cond> <l_true> <l_false>
##
def label(br):
    return <label>
def cond(br):
    return <cond>
def label_true(br):
    return <l_true>
def label_false(br):
    return <l_false>
##
## Assignment Statement: lhs=rhs
##
def lhs(assign_stmt):
    #return the lhs variable
def rhs(assign_stmt):
    #return the rhs expression
##
## Return Statement:
## return val
##
def retval(ret_stmt):
    #return val
##
## The PHI func
##
def PHI(var, stmt, b):
    assert stmt in stmtx(b)
    assert var is rhs(stmt)
    if len(DEFx(var))==1 and
        DEFx(var)[0] in stmtx(b) and
        DEFx(var)[0] < stmt :
        return COMB(var)
    else:
        return FF(var)

```

Figure 4.11: SSA access and utility functions

```

def C_to_verilog_translate(SSA):
    # step 1.1
    print ""
    module c2v_%s(
        input clock,
        input START,
        output READY,
    """ %(symbol(SSA))
        # step 1.2
        delclare_input_ports(SSA)
        # step 1.3
        declare_output_ports(SSA)
        print ');'

        # step 2.1
        declare_input_signals(SSA)
        # step 2.2
        declare_label_signals(SSA)
        #step 2.3
        delclare_lhs_signals(SSA)
        #step 3
        print 'always_comb begin'
        gen_always_comb(SSA)
        print 'end // always_comb'
        #step 4
        print 'always_ff @(posedge clock)'
        print 'begin'
        #step 4.1
        gen_START_block(SSA)
        print ' else begin'
        #step 4.2
        for b in blocks(SSA):
            gen_from_basic_block(b)
        print ' end'
        print 'end // always_ff'

        print 'endmodule'
        return
def declare_input_ports(SSA):
    for i in inputx(SSA):
        print 'input %s %s;'
            % (vtype(i), symbol(i))

def declare_output_ports(SSA):
    for i in outputx(SSA):
        print 'output reg %s %s;'
            % (vtype(i), symbol(i))

def declare_input_signals(SSA):
    for i in inputx(SSA):
        print 'reg %s %s %s;'
            %(vtype(i), FF(i), COMB(i))

def declare_label_signals(SSA):
    for i in blockx(SSA):
        print 'reg %s;'%(LABEL(i))

def declare_lhs_signals(SSA):
    for i in assignStmtx(SSA):
        v = lhs(i)
        print 'reg %s %s, %s;'
            % (vtype(v), FF(v), COMB(v))

def gen_always_comb(SSA):
    for b in blockx(SSA):
        for i in assignStmtx(b):
            print '%s = %s;'
                % (COMB(lhs(i)),
                    gen_rhs(i,b))

def gen_START_block(SSA):
    print 'if (START) begin'
    for i in inputx(SSA):
        print '%s<=%s;'%(FF(i),symbol(i))
    print 'LABEL_entry<=1;'
    for i in blockx(SSA):
        if label(i)!='entry':
            print '%s<=0;' %LABEL(i)
    print 'end'

def gen_from_basic_block(b):
    print '''if(%s) begin
        %s<=0;
        ''' % (LABEL(b), LABEL(b))
    for i in stmtx(b):
        gen_from_stmt(i,b)

```

Figure 4.12: SSA^b to Verilog Translation

```

def gen_from_stmt(stmt,block):
    # based on type of stmt
    # call one of
    #     gen_from_br
    #     gen_from_return
    #     gen_from_assign

def gen_from_br(br,block):
    if(cond(br)): # conditional
        print '''
            if(%s) %s <= 1;
            else %s <= 0;
            '''
        %(PHI(cond(br)),br,block),
        LABEL(label_true(br)),
        LABEL(label_false(br))
    else: # unconditional
        print '%s<=1;'
            % LABEL(label(br))

def gen_from_return(ret,block):
    print "ret <= %s;"
        %(PHI(retval(ret),ret,block))
    print 'READY<=1;'

def gen_from_assign(assign, block):
    print '%s<=%s;'
        %(FF(lhs(a)), gen_rhs(a))

def gen_rhs(assign,block):
    # write out the Verilog equivalent
    # expression for rhs(assign)
    # 1.map the operator to the
    # Verilog equivalent
    # 2.replace each operand opnd
    # in the rhs expression with
    # PHI(opnd,assign,block)

```

Figure 4.13: Translation to Verilog continued

semantics of the assertion, checks that if *label_t* is true then *v_a* must be true in the same cycle.

Similarly, a termination conditional check of the C program becomes a liveness check on the Verilog module in the following SVA assertion:

```

assert property (@(posedge clk)
    start|-> eventually ready);

```

where *start* and *ready* are the signals in the translated Verilog model illustrated in Figure 4.10. The *start |-> eventually ready* expression means that if *start* is true, then *ready* will be true eventually (sometime in the future).

Memory errors in C that result in signal SIGSEGV will cause the C program to stop. In the Verilog model, such an error will result in an undefined state in the circuit. Extra logic

```

module c2v_factorial(
  //step 1.1
  input clock,
  input START,
  output reg READY,
  //step 1.2
  input [31:0] n,
  //step 1.3
  output reg [31:0] ret) ;
  // step 2.1
  reg[31:0] n_FF, n_COMB;
  // step 2.2
  reg LABEL_entry;
  reg LABEL_for_cond;
  reg LABEL_for_body;
  reg LABEL_for_inc;
  reg LABEL_for_end;
  // step 2.3
  reg[31:0] ret0_FF, ret0_COMB;
  reg[31:0] i0_FF, i0_COMB;
  reg[31:0] ret1_FF, ret1_COMB;
  reg[31:0] ret2_FF, ret2_COMB;
  reg[31:0] i1_FF, i1_COMB;
  reg cond_FF, cond_COMB;
  reg[31:0] i2_FF, i2_COMB;
  // step 3
  always_comb begin
    // step 3.1
    n_COMB = n;
    // step 3.2
    ret0_COMB = 1;
    ret1_COMB = ret0_COMB;
    i0_COMB = 1;
    i1_COMB = i0_COMB;
    cond_COMB = i1_FF <= n_FF;
    ret2_COMB = ret1_FF * i1_FF;
    ret1_COMB = ret2_COMB;
    i2_COMB = i1_FF+1;
    i1_COMB = i2_COMB;
  end // always_comb
  //step 4
  always_ff @(posedge clock) begin
    //step 4.1
    if(START) begin
      READY<=0;
      n_FF <=n; // input
      LABEL_entry<=1; // label
      LABEL_for_cond<=0;
      LABEL_for_body<=0;
      LABEL_for_inc<=0;
      LABEL_for_end<=0;
    end else begin
      // step 4.2
      if (LABEL_entry) begin
        LABEL_entry<=0;
        ret0_FF<=1;
        ret1_FF<= ret0_COMB;
        i0_FF<= 1;
        i1_FF<= i0_COMB;
        LABEL_for_cond <= 1;
      end
      // step 4.2
      if(LABEL_for_cond) begin
        LABEL_for_cond<=0;
        cond_FF = i1_FF<= n_FF;
        if(cond_COMB) LABEL_for_body<=1;
        else LABEL_for_end<=1;
      end
      // step 4.2
      if (LABEL_for_body) begin
        LABEL_for_body<=0;
        ret2_FF<= ret1_FF*i1_FF;
        ret1_FF<=ret2_COMB;
        LABEL_for_inc <=1;
      end
      // step 4.2
      if (LABEL_for_inc) begin
        LABEL_for_inc<=0;
        i2_FF<=i1_FF+1;
        i1_FF<= i2_COMB;
        LABEL_for_cond <=1;
      end
      // step 4.2
      if (LABEL_for_end) begin
        LABEL_for_end <=0;
        ret <= ret1_FF; // output
        READY<= 1;
      end
    end
  end // always_ff
endmodule

```

Figure 4.14: Translated Verilog module from the SSA^b in Figure 4.9

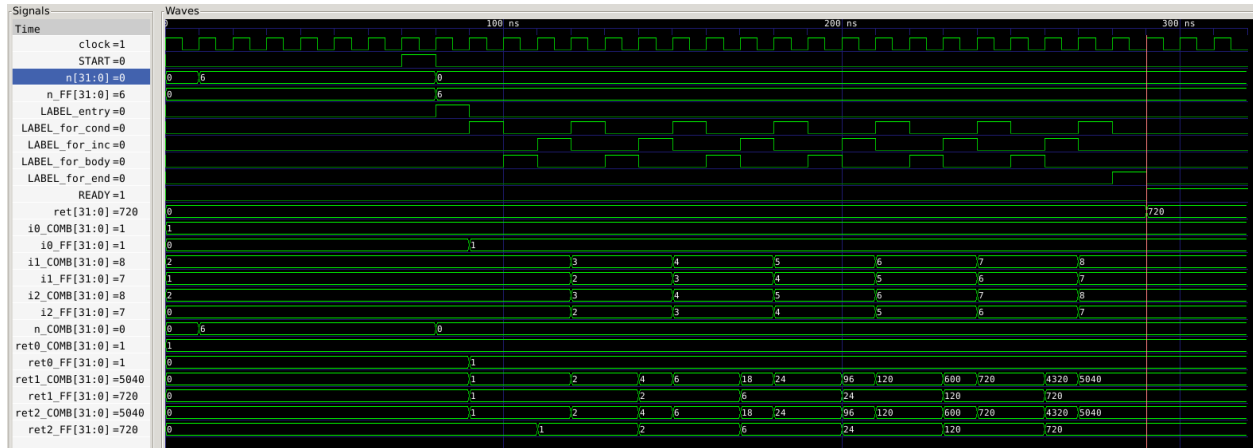

Figure 4.15: Waveform for Verilog module factorial

or assertions can be added to detect such an error condition when it happens. For memory error-free C programs, the above translation captures the exact semantics of the C program.

4.4 Experiments

The following experiments were conducted on a 32-core Intel Xeon 2.6GHz machine running Ubuntu Linux. For equivalence checking between a C program and a Verilog program as well as model checking a C program for safety properties, the model checker *suprove* (aka *super_prove*) from ABC[2] was used with a timeout set to 900 seconds. *suprove* was the winner of the last four Hardware Model Checking Competitions (HWMCC - 2012, 2013, 2014 and 2015) in the single-output safety category [29]; *suprove* is a parallel proof engine that uses multiple model checking algorithms.

Equivalence Checking - C vs. RTL, FPU Verification

In this experiment, we conducted FPU verification of two OpenCores FPU designs: *fpu_100* and *fpu_double*. Both were designed in Verilog and were intended to implement and conform to the IEEE 754 standard: *fpu_100* is a 32-bit and *fpu_double* a 64-bit floating point unit. A floating point number is represented using 3 components starting from the left of a 32- or 64-bit-vector (i.e. MSB): a single-bit sign bit, an exponent, and a mantissa. In such a number system, two special numbers, *sNaN* and *qNaN*, are used to represent non-real numbers (not-a-number) - useful for handling exceptions. For both *sNaN* and *qNaN*, the exponent needs be

all 1's and the mantissa to be non-zero. A floating point operation is a function that takes two floating point numbers as inputs and produces a floating point number as the result, as well as a set of exception flags: *inexact*, *underflow*, *overflow*, *invalid* and *divide – by – zero*. For equivalence checking, the computed floating-point number and exception flags are all outputs of the logic design to be compared in the miter model. The goal of equivalence checking is not to tell which model is correct, but to tell if the two models are functionally equivalent – producing the same results for any legal input values.

Both designs, *fpu_100* and *fpu_double*, support add, subtract, multiply, divide, and square-root operations. Conforming to the IEEE standards, all operators raise exception flags if the computation underflows, overflows, or produces inexact results. Both designs are configured to run in the *round_to_nearest_even* mode and are pipe-lined implementations. They have the same start-ready model as in Figure 4.10, where an input is driven when *start* is asserted, and the result of the FPU operation is available when *ready* is asserted a number of cycles later after *start*.

Two miter models are constructed to compare *fpu_100* and *fpu_double* against the C model from the SoftFloat[30] C library, which is the de facto standard for floating point implementations. After the C translation to a Verilog model, a miter model is constructed between the generated Verilog model and the OpenCore model design, comparing the outputs and the exception flags when both *ready* signals are asserted. The run-time for each equivalence checking problem was set to timeout at 900 seconds.

No.	Opcode	Inputs	Softfloat Result	RTL Result	Pipeline Depth
1	add32	matched			6
2	mul32	000017f0 * 43360000	001104a0	00008825	10
3	div32	4fdb9bf / ff800000	80000000	ff800000	33
4	sqrt32	0000f7c0	1e321421	1dfbd75a	33

Table 4.4: *fpu_100* : 32-bit FPU

The Verilog models for opcodes *add32* and *mul32* are combinational, while *div32* and *sqrt32* are sequential. Table 4.4 shows the results of comparing the translated SoftFloat program versus the Verilog *fpu_100*. It turns out that only for opcode *add32* does *fpu_100* match with SoftFloat, while the three other opcodes all have mismatches as shown in the table.

These equivalence checking problems were done under the constraint that no exception flag

is generated in the Verilog models, because in the IEEE standard, when an exception is raised, the result is not defined in certain situations. The input numbers and corresponding mismatching output results are captured in Table 4.4. Column six is the pipeline depth for the corresponding operation in the *fpu_100* implementation.

No.	Opcode	Inputs	Softfloat Result	RTL Result	Pipeline Depth
1	add64	fff8000000000000 + 7ff8000000000000	7ff8000000000000	fff8000000000000	20
2	add64	d172dd2000000000 + 4175c97000000000	inexact	no exception	20
3	sub64	fdf88d1fffe7ba4 - ff88d20001e45dc	ff88d20001e45dc	7ff88d20001e45dc	21
4	sub64	d13060000400000 - b131a0020000a41f	inexact	no exception	21
5	mul64	8000006e00008194 * 8000001e9e8d5048	inexact , underflow	no exception	24

Table 4.5: *fpu_double*: 64-bit FPU

We also compared the Verilog *fpu_double* with SoftFloat’s 64-bit FPU routines. In addition to comparing the results of each operation, we also conducted equivalence checking of the exception generation logic. Table 4.5 shows the experiments for opcodes *add*, *subtract* and *multiply*. All three models generated from the C functions are combinational. Column 2 in Table 4.5 is the opcode. Column 3 is the inputs to the floating point operation and Column 4 and Column 5 show the difference between the two models under comparison: Tests 1 and 3 produce different output values, while Tests 2, 4, and 5 differ in generating exceptions flags.

Both *fpu_double* and *fpu_100* were completed several years ago and reportedly have been incorporated into silicon and FPGAs. From the *OpenCores* repository, each benchmark includes a random test framework which compares it to *SoftFloat* for validation. Each have passed millions of random test vectors. However, from the counterexamples, we observe that the input numbers that cause the mismatches either contain 10+ consecutive 0s or 1s (e.g. *fff8000000000000 + 7ff8000000000000*), or the values of both numbers are close to each other in term Hamming distance (e.g. *d172dd2000000000 + 4175c97000000000*). These situations are very unlikely to be generated by a random number generator and thus a random test bench would most likely miss those unusual scenarios. On the other hand once a miter model is constructed to compare the two designs, sequential/combinational equivalence checking is much more effective in exposing discrepancies using model-checking methods. As far as we know, this is the first time these bugs have been reported for this set of *OpenCores* designs.

Software Verification of Safety Properties

We conducted C verification on the bit-vector benchmarks of the 2015 Software Verification Competition[7].

Although all participants had bugs, we chose to compare against *CPAChecker* because it is an unbounded solver while the other two winners are bounded model checkers. Therefore, we thought its results are more comparable, although it does produce an incorrect TRUE result on the function in Figure 4.16.

```
int main(void) {
    unsigned int x = 10;
    while (x >= 10) {
        x += 2;
    }
    __VERIFIER_assert(x % 2);
}
```

Figure 4.16: test:bitvector-loops/overflow_false-unreach-call1.i

In the C program under verification, the dummy function `__VERIFIER_nondet_int`, used to indicate a random number generator, was converted into a new free primary inputs in the Verilog modules. The calls to the error flagging function, `__VERIFIER_error`, was converted into SVA assertions. Our program, VeriABC[48], which interfaces with Verific[64] was then used to compile the generated Verilog and SVA into an AIG[10]. *suprove* from ABC [2] was used to prove or dis-prove the target properties.

Figure 4.17 shows the results. *CPAChecker*'s results were obtained from the official competition website, which were run on a 3.4Ghz Intel Quad-core i7 platform, while ours were run on an 32-core Intel Xeon 2.6Ghz host. The second and third columns show ABC's *suprove* results, while the fourth and fifth columns are the published results from the competition's website. Of the 46 tests, ABC resolved 30 while *CPAChecker* resolved 40. There are 4 tests that ABC resolved but *CPAChecker* did not. The capital letters, TRUE and FALSE, are indicating the test is solved by only one of the two solvers being compared. The results seem rather promising for our approach in that *suprove* is only optimized to run on hardware model checking problems that have been bit-blasted. Thus no software related heuristics nor word-level information could be utilized by *suprove*.

So far, we believe our proof results are more trust-worthy because the C-compilation procedure is simple and less error-prone and no inconsistency of the results have been found yet for *suprove*.

Test	suprove	Time	CPA	Time
byte_add_1_true-unreach-call	timeout	900	TRUE	34.56
byte_add_2_true-unreach-call	timeout	900	TRUE	78.33
byte_add_false-unreach-call	false	7.70	false	63.58
diamond_false-unreach-call2	false	0.48	false	1.78
gcd_1_true-unreach-call	true	2.14	true	2.29
gcd_2_true-unreach-call	true	13.82	true	2.31
gcd_3_true-unreach-call	true	10.12	true	2.26
gcd_4_true-unreach-call	true	0.12	true	1.38
implicitunsignedconversion_false-u	false	0.10	false	1.59
implicitunsignedconversion_true-un	true	0.09	true	1.40
integerpromotion_false-unreach-cal	false	0.11	false	2.30
integerpromotion_true-unreach-call	true	0.09	true	1.57
interleave_bits_true-unreach-call	true	0.66	true	16.63
jain_1_true-unreach-call	true	0.10	true	2.52
jain_2_true-unreach-call	true	0.10	true	2.61
jain_4_true-unreach-call	true	0.11	true	2.59
jain_5_true-unreach-call	TRUE	0.10	timeout	930.61
jain_6_true-unreach-call	true	0.12	true	2.65
jain_7_true-unreach-call	true	0.12	true	4.97
modulus_true-unreach-call	TRUE	35.57	timeout	903.46
num_conversion_1_true-unreach-ca	true	0.09	true	1.40
num_conversion_2_true-unreach-ca	true	0.90	true	17.07
overflow_false-unreach-call1	timeout	900	TRUE	122.57
parity_true-unreach-call	timeout	900	timeout	906.63
s3_cnt_1_false-unreach-call.BV	false	99.51	false	5.75
s3_cnt_1_true-unreach-call.BV	timeout	900	TRUE	32.85
s3_cnt_2_false-unreach-call.BV	timeout	900	FALSE	87.28
s3_cnt_2_true-unreach-call.BV	timeout	900	TRUE	29.56
s3_cnt_3_false-unreach-call.BV	false	16.77	false	4.48
s3_cnt_3_true-unreach-call.BV	timeout	900	TRUE	34.83
s3_srvr_1_alt_true-unreach-call	TRUE	518.21	aborted	128.31
s3_srvr_1_true-unreach-call.BV	timeout	900	TRUE	63.91
s3_srvr_2_alt_true-unreach-call	timeout	900	TRUE	62.97
s3_srvr_2_true-unreach-call.BV	timeout	900	TRUE	62.91
s3_srvr_3_alt_true-unreach-call	timeout	900	TRUE	63.48
s3_srvr_3_true-unreach-call.BV	timeout	900	TRUE	63.86
signextension2_false-unreach-call	false	0.08	false	2.12
signextension2_true-unreach-call	true	0.09	true	1.54
signextension_false-unreach-call	false	0.12	false	2.18
signextension_true-unreach-call	true	0.09	true	1.56
soft_float_1_true-unreach-call	timeout	900	TRUE	11.35
soft_float_2_true-unreach-call	true	119.53	true	12.70
soft_float_3_true-unreach-call	TRUE	300.46	timeout	930.46
soft_float_4_true-unreach-call	timeout	900	TRUE	63.56
soft_float_5_true-unreach-call	true	138.73	true	13.25
sum02_true-unreach-call	timeout	900	timeout	903.20

Figure 4.17: Software Verification Benchmark: bitvector category

4.5 Related works

Because we are building a finite state machine model directly from a C program, it is more suitable to compare our work with those software verification flows that do symbolic exploration of the state space using model checking algorithms.

The SLAM model checker [3] introduced Boolean programs – imperative programs where each variable is Boolean – as an intermediate language to represent program abstractions. A tool flow was created to convert C programs and predicates to Boolean programs and then to employ follow-up model checking using abstraction/refinement.

The Blast [9] model checker implements an optimization of CEGAR (Counter Example Guided Abstraction Refinement) called lazy abstraction. The internal model of the C program is built incrementally, based on an error trace and an unrolling of the CFG. A similar internal representation is used in the IMPACT [49] model checker.

The C verifiers f-soft [33] and CPAchecker [8] internally build a finite state machine model using their own internal representations. The finite state machine definition is conceptually the same as the circuit model. Our approach is simpler because Verilog has well defined syntax and semantics. LLBMC [51] also uses the LLVM infrastructure to translate the C program only for bounded model checking through loop unrolling.

In the hardware design area, high level synthesis tools Catapult [14] and Forte [27] build circuits from a subset of the C language. Their primary focus is to optimize the generated hardware to satisfy user-defined timing, power, and area constraints. In contrast, our goal is for verification purposes; the translation procedure does not consider memories and does not restrict the number of flip-flops to use in the Verilog model; optimization is not our concern at the translation stage because abstraction and optimization can be conducted later on the Verilog model instead of on the original C program.

The tools AutoPilot [69] and LegUp [16], translate a C program for FPGA synthesis or hardware and software co-simulation. They use the LLVM framework and translate LLVM Bytecode into Verilog. There is no detailed description of the underlying translation algorithm. By looking at the generated Verilog from LegUp, their principle seems to be similar to ours, except they use memory components to allocate memory spaces for each variable and introduce memory access latency for each read/write of variable values while the control

flow graph is instruction based rather than basic block based.

The tool in [19] processes a C program into an SSA-like internal format and conducts bounded model checking for C to RTL equivalence checking. Our model can be used for both bounded and unbounded model checking and our implementation is much simpler based on the LLVM infrastructure.

4.6 Conclusions

In this chapter, we observed that the gap between a C program and a circuit computational model is due to the use of dynamic resources in the C language: run-time memory allocation/de-allocation, run-time function call stacks, and parallel threads. We build a simple translation procedure from a single thread non-recursive C program to a semantically equivalent Bytecode network using the LLVM compiler. The mapping from LLVM Bytecode to a Verilog module is then almost verbatim. Experiments show promising and more consistent results compared to existing software verification approaches.

Chapter 5

Conclusion and Possible Future Extensions

In this thesis, we tackled the two top-level verification tasks of a compilation from the software language C to an optimized RTL (word-level Verilog description) implementation. This was broken down into two aspects in reasoning about high-level constructs in software and hardware verification. The C-to-Verilog procedure of Chapter 4, translates a C-program into a semantically equivalent but non-optimized Verilog description which preserves the original high-level control and data structures. The "verification" here is done by using the LLVM compiler in a straight-forward manner which relies on the maturity of this compiler and its extensive use over many years. Thus it is reasonable to rely on the LLVM compiler producing correct LLVM Bytecode. A step from Bytecode to Verilog was implemented which relies on the almost verbatim translation of LLVM Bytecode into Verilog. Because of its simplicity it is reasonable to assume that this step is correct.

The second aspect of the verification is the formal verification step. This intermediate Verilog output from the C to Verilog step can be compared to another Verilog description which may be the result of an automatic or manual optimization of this.

The LEC system was created for this step in order to be enhance our ability to verify difficult equivalence checking of industrial problem created by sophisticated data-path optimizations. LEC is an open system created to reason about and utilize high-level constructs for data-path equivalence checking. LEC consists of solver widgets, transformation widgets and learning widgets. Solver widgets are procedures which produces either SAT, UNSAT or

UNRESOLVED results of the underlying miter model. The inference rules used in LEC's proof are carried out by the transformation widgets while the learning widgets collect structural and function information of the design so that LEC can heuristically select and decide how to apply particular transformation widgets. Such an architecture allows a LEC user to tackle a new miter problem by identifying the bottleneck logic, learn about the design and to eventually automatically reason at a higher-level to finally establish a composite proof.

In this thesis research we built a practical tool flow to reason about high-level constructs in C and Verilog programs for formal verification. For future work, LEC could be extended with new learning widgets to be more powerful in solving data-path equivalence problems as they arise in practice. Hopefully, because of LEC's modular structure, these extensions are made more feasible and easier.

On the software verification front, once a C program is translated into Verilog, existing hardware verification techniques can be adapted to take advantage of the characteristics of a software program to improve performance and capacity. A tighter integration of the two components with GUI and debugging capabilities could transform this thesis work into a practical industrial strength tool flow for C and RTL data-path formal verification or for property checking of software programs.

Bibliography

- [1] *1800: IEEE Standard for System Verilog - Unified Hardware Design, Specification, and Verification Language*. IEEE Computer Society, 2005.
- [2] “ABC - A System for Sequential Synthesis and Verification”. In: Berkeley Verification and Synthesis Research Center, <http://www.bvsrc.org>.
- [3] Thomas Ball and Sriram K Rajamani. “The SLAM project: debugging system software via static analysis”. In: *ACM SIGPLAN Notices*. Vol. 37. 1. ACM. 2002, pp. 1–3.
- [4] Clark Barrett et al. “Cvc4”. In: *Computer Aided Verification*. Springer. 2011, pp. 171–177.
- [5] Mohamed Abdul Basith et al. “Algebraic approach to arithmetic design verification”. In: *Formal Methods in Computer-Aided Design (FMCAD), 2011*. IEEE. 2011, pp. 67–71.
- [6] Jason Baumgartner et al. “Scalable sequential equivalence checking across arbitrary design transformations”. In: *Computer Design, 2006. ICCD 2006. International Conference on*. IEEE. 2007, pp. 259–266.
- [7] Dirk Beyer. “Software Verification and Verifiable Witnesses”. In: *Tools and Algorithms for the Construction and Analysis of Systems*. Springer, 2015, pp. 401–416.
- [8] Dirk Beyer and M Erkan Keremoglu. “CPACHECKER: A tool for configurable software verification”. In: *Computer Aided Verification*. Springer. 2011, pp. 184–190.
- [9] Dirk Beyer et al. “The software model checker Blast”. In: *International Journal on Software Tools for Technology Transfer* 9.5-6 (2007), pp. 505–525.
- [10] Armin Biere, Keijo Heljanko, and Siert Wieringa. “AIGER 1.9 and Beyond”. In: *Available at <http://fmv.jku.at/hwmcc12/beyond1.pdf>* (2012).

- [11] Per Bjesse and Koen Claessen. “SAT-Based Verification without State Space Traversal”. In: *FMCAD '00: Proceedings of the Third International Conference on Formal Methods in Computer-Aided Design*. London, UK: Springer-Verlag, 2000, pp. 372–389. ISBN: 3-540-41219-0.
- [12] Robert Brayton and Alan Mishchenko. “ABC: An academic industrial-strength verification tool”. In: *Computer Aided Verification*. Springer. 2010, pp. 24–40.
- [13] Robert Brummayer and Armin Biere. “Boolector: An efficient SMT solver for bit-vectors and arrays”. In: *Tools and Algorithms for the Construction and Analysis of Systems*. Springer, 2009, pp. 174–177.
- [14] “Calypto[®] Catapult Design Product”. In: <http://www.calypto.com>.
- [15] “Calypto[®] SLEC”. In: <http://www.calypto.com>.
- [16] Andrew Canis et al. “LegUp: high-level synthesis for FPGA-based processor/accelerator systems”. In: *Proceedings of the 19th ACM/SIGDA international symposium on Field programmable gate arrays*. ACM. 2011, pp. 33–36.
- [17] Michael L Case, Alan Mishchenko, and Robert K Brayton. “Automated extraction of inductive invariants to aid model checking”. In: *Formal Methods in Computer Aided Design, 2007. FMCAD'07*. IEEE. 2007, pp. 165–172.
- [18] Alessandro Cimatti et al. “The MathSAT5 SMT Solver”. In: *Tools and Algorithms for the Construction and Analysis of Systems*. Springer, 2013, pp. 93–107.
- [19] Edmund Clarke, Daniel Kroening, and Karen Yorav. “Behavioral consistency of C and Verilog programs using bounded model checking”. In: *Design Automation Conference, 2003. Proceedings*. IEEE. 2003, pp. 368–371.
- [20] Robert P Colwell. *The Pentium Chronicles: The People, Passion, and Politics Behind Intel's Landmark Chips (Software Engineering Best Practices)*. Wiley-IEEE Computer Society Pr, 2005.
- [21] Jason Cong et al. “High-level synthesis for FPGAs: From prototyping to deployment”. In: *Computer-Aided Design of Integrated Circuits and Systems, IEEE Transactions on* 30.4 (2011), pp. 473–491.
- [22] Ron Cytron et al. “Efficiently computing static single assignment form and the control dependence graph”. In: *ACM Transactions on Programming Languages and Systems (TOPLAS)* 13.4 (1991), pp. 451–490.

- [23] Leonardo De Moura and Nikolaj Bjørner. “Z3: An efficient SMT solver”. In: *Tools and Algorithms for the Construction and Analysis of Systems*. Springer, 2008, pp. 337–340.
- [24] Bruno Dutertre and Leonardo De Moura. “The yices smt solver”. In: *Tool paper at <http://yices.csl.sri.com/tool-paper.pdf>* 2 (2006), p. 2.
- [25] Niklas Een and Niklas Sorensson. “MiniSat-A SAT Solver with Conflict-Clause Mini”. In: *SAT 2005*.
- [26] Evren Ermis et al. “Ultimate Kojak”. In: *Tools and Algorithms for the Construction and Analysis of Systems*. Springer, 2014, pp. 421–423.
- [27] “Forte Design Systems”. In: <http://www.fortedes.com>.
- [28] Arie Gurfinkel, Temesghen Kahsai, and Jorge A Navas. “SeaHorn: A framework for verifying C programs (Competition contribution)”. In: *Tools and Algorithms for the Construction and Analysis of Systems*. Springer, 2015, pp. 447–450.
- [29] *Hardware model checking competition 2014*. 2014.
- [30] John Hauser. “SoftFloat”. In: *available from <http://www.jhauser.us/arithmetic/SoftFloat.html>* (2002).
- [31] Matthias Heizmann et al. “Ultimate Automizer with Unsatisfiable Cores”. In: *Tools and Algorithms for the Construction and Analysis of Systems*. Springer, 2014, pp. 418–420.
- [32] *IEEE standard for binary floating-point arithmetic*. Note: Standard 754–1985. New York: Institute of Electrical and Electronics Engineers, 1985.
- [33] F Ivančić et al. “F-Soft: Software verification platform”. In: *Computer Aided Verification*. Springer. 2005, pp. 301–306.
- [34] Susmit Jha, Rhishikesh Limaye, and Sanjit A Seshia. “Beaver: Engineering an efficient smt solver for bit-vector arithmetic”. In: *Computer Aided Verification*. Springer. 2009, pp. 668–674.
- [35] Ryan Kastner, Anup Hosangadi, and Farzan Fallah. *Arithmetic optimization techniques for hardware and software design*. Cambridge University Press, 2010.
- [36] Matt Kaufmann, Panagiotis Manolios, and J Strother Moore. *Computer-aided reasoning: ACL2 case studies*. Vol. 4. Springer Science & Business Media, 2013.

- [37] Matt Kaufmann, J. Strother Moore, and Panagiotis Manolios. *Computer-Aided Reasoning: An Approach*. Norwell, MA, USA: Kluwer Academic Publishers, 2000. ISBN: 0792377443.
- [38] Alfred Koelbl et al. “Solver technology for system-level to RTL equivalence checking”. In: *Design, Automation & Test in Europe Conference & Exhibition, 2009. DATE’09*. IEEE. 2009, pp. 196–201.
- [39] Daniel Kroening, Edmund Clarke, and Karen Yorav. “Behavioral Consistency of C and Verilog Programs Using Bounded Model Checking”. In: *Proceedings of DAC 2003*. ACM Press, 2003, pp. 368–371. ISBN: 1-58113-688-9.
- [40] Daniel Kroening and Michael Tautschnig. “CBMC–C bounded model checker”. In: *Tools and Algorithms for the Construction and Analysis of Systems*. Springer, 2014, pp. 389–391.
- [41] Andreas Kuehlmann and Jason Baumgartner. “Transformation-based verification using generalized retiming”. In: *Computer Aided Verification*. Springer. 2001, pp. 104–117.
- [42] Andreas Kuehlmann and Florian Krohm. “Equivalence Checking Using Cuts and Heaps”. In: *Proceedings of the 34th Annual Design Automation Conference. DAC ’97*. Anaheim, California, USA: ACM, 1997, pp. 263–268. ISBN: 0-89791-920-3. DOI: 10.1145/266021.266090. URL: <http://doi.acm.org/10.1145/266021.266090>.
- [43] A. Kuehlmann et al. “Robust Boolean reasoning for equivalence checking and functional property verification”. In: *IEEE Transactions on Computer-Aided Design of Integrated Circuits and Systems, Volume 21, Issue 12*. Dec, 2002, pp. 1377–1394.
- [44] Chao-Yue Lai, Chung-Yang Huang, and Kei-Yong Khoo. “Improving constant-coefficient multiplier verification by partial product identification”. In: *Design, Automation and Test in Europe, 2008. DATE’08*. IEEE. 2008, pp. 813–818.
- [45] Chris Lattner and Vikram Adve. “LLVM: A compilation framework for lifelong program analysis & transformation”. In: *Code Generation and Optimization, 2004. CGO 2004. International Symposium on*. IEEE. 2004, pp. 75–86.
- [46] Wenchao Li, Zach Wasson, and Sanjit A. Seshia. “Reverse engineering circuits using behavioral pattern mining”. In: *HOST*. 2012, pp. 83–88.

- [47] Wenchao Li et al. “WordRev: Finding word-level structures in a sea of bit-level gates”. In: *HOST*. 2013, pp. 67–74.
- [48] Jiang Long et al. “Enhancing ABC for LTL Stabilization Verification of SystemVerilog/VHDL Models”. In: *DIFTS* (2011).
- [49] Kenneth L McMillan. “Lazy abstraction with interpolants”. In: *Computer Aided Verification*. Springer. 2006, pp. 123–136.
- [50] Kenneth L McMillan, Andreas Kuehlmann, and Mooly Sagiv. “Generalizing DPLL to richer logics”. In: *Computer Aided Verification*. Springer. 2009, pp. 462–476.
- [51] Florian Merz, Stephan Falke, and Carsten Sinz. “LLBMC: Bounded model checking of C and C++ programs using a compiler IR”. In: *Verified Software: Theories, Tools, Experiments*. Springer, 2012, pp. 146–161.
- [52] A. Mishchenko et al. “Improvements to Combinational Equivalence Checking”. In: *Computer-Aided Design, 2006. ICCAD '06. IEEE/ACM International Conference on*. 2006, pp. 836–843. DOI: 10.1109/ICCAD.2006.320087.
- [53] Jeremy Morse et al. “ESBMC 1.22”. In: *Tools and Algorithms for the Construction and Analysis of Systems*. Springer, 2014, pp. 405–407.
- [54] T Nicely. “Bug in the pentium fpu”. In: *E-mail to Intel 30* (1994).
- [55] V. Paruthi and A. Kuehlmann. “Equivalence checking combining a structural SAT-solver, BDDs, and simulation”. In: *Computer Design, 2000. Proceedings. 2000 International Conference on*. 2000, pp. 459–464. DOI: 10.1109/ICCD.2000.878323.
- [56] Evgeny Pavlenko et al. “STABLE: A new QF-BV SMT solver for hard verification problems combining Boolean reasoning with computer algebra”. In: *Design, Automation & Test in Europe Conference & Exhibition (DATE), 2011*. IEEE. 2011, pp. 1–6.
- [57] Namrata Shekhar, Priyank Kalla, and Florian Enescu. “Equivalence verification of polynomial datapaths using ideal membership testing”. In: *Computer-Aided Design of Integrated Circuits and Systems, IEEE Transactions on* 26.7 (2007), pp. 1320–1330.
- [58] N. Shekhar et al. “Equivalence verification of polynomial datapaths with fixed-size bit-vectors using finite ring algebra”. In: *Computer-Aided Design, 2005. ICCAD-2005. IEEE/ACM International Conference on*. 2005, pp. 291–296. DOI: 10.1109/ICCAD.2005.1560081.

- [59] “smtlib”. In: <http://www.smt-lib.org>.
- [60] W Snyder, P Wasson, and D Galbi. *Verilator: Convert Verilog code to C++/SystemC*. 2012.
- [61] Baruch Sterin et al. “The benefit of concurrency in model checking”. In: IWLS. 2011.
- [62] D. Stoffel and W. Kunz. “Equivalence checking of arithmetic circuits on the arithmetic bit level”. In: *Computer-Aided Design of Integrated Circuits and Systems, IEEE Transactions on* 23.5 (2004), pp. 586–597. ISSN: 0278-0070. DOI: 10.1109/TCAD.2004.826548.
- [63] Cesare Tinelli. “A DPLL-based calculus for ground satisfiability modulo theories”. In: *European Workshop on Logics in Artificial Intelligence*. Springer. 2002, pp. 308–319.
- [64] “Verific Design Automation: <http://www.verific.com>”. In:
- [65] Dexi Wang et al. “Beagle: <http://sts.thss.tsinghua.edu.cn/beagle>”. In: 2015.
- [66] Dong Wang and Jeremy Levitt. “Automatic assume guarantee analysis for assertion-based formal verification”. In: *Proceedings of the 2005 Asia and South Pacific Design Automation Conference*. ACM. 2005, pp. 561–566.
- [67] Wei Wang, Clark Barrett, and Thomas Wies. “Cascade 2.0”. In: *Verification, Model Checking, and Abstract Interpretation*. Springer. 2014, pp. 142–160.
- [68] Markus Wedler et al. “A normalization method for arithmetic data-path verification”. In: *Computer-Aided Design of Integrated Circuits and Systems, IEEE Transactions on* 26.11 (2007), pp. 1909–1922.
- [69] Zhiru Zhang et al. “AutoPilot: A platform-based ESL synthesis system”. In: *High-Level Synthesis*. Springer, 2008, pp. 99–112.
- [70] Qi Zhu et al. “SAT sweeping with local observability don’t-cares”. In: *Proceedings of the 43rd annual Design Automation Conference*. ACM. 2006, pp. 229–234.