

UC Davis

UC Davis Previously Published Works

Title

Field Evaluation of Daikin Rebel Advanced Heat Pump Rooftop Unit

Permalink

<https://escholarship.org/uc/item/6b4676c9>

Author

Woolley, Jonathan

Publication Date

2015-05-01

FIELD EVALUATION OF DAIKIN REBEL ADVANCED HEAT PUMP ROOFTOP UNIT



May 1 2015

Prepared by:

Jonathan Woolley, Ben Holmquist and Caton Mande
Western Cooling Efficiency Center
University of California, Davis

Bruce Baccei
Sacramento Municipal Utility District



ACKNOWLEDGEMENTS

This research project was conducted as collaboration between the University of California, Davis, Western Cooling Efficiency Center and Sacramento Municipal Utility District, Advanced Technologies Program. The research team facilitated the overarching execution of the research project, developed installed and managed all data acquisition systems, then conducted data analysis in preparation for the report. A number of other individuals contributed critically to execution of the project including Bruce Baccej, Hanah Mirzah, Nelson Dichter, Daniel Berman, Steven Rutter, Bill Sherbert, Steve VanPeurse, Philip Johnston, John Lund, Mark Modera, and Jerine Ahmed. Their input and support is appreciated.

The research team is grateful for guidance and technical support from Daikin, and acknowledges the manufacturer's leadership and initiative in developing and commercializing advanced high efficiency rooftop packaged air conditioners. The field evaluation was hosted by Harley Davidson of Sacramento who were encouraging and accommodating in all aspects of the project. The installation was engineered, installed, and commissioned by Air Systems of Sacramento, who were instrumental in all aspects surrounding the physical setup and control of the equipment.

ABOUT THE CUSTOMER ADVANCED TECHNOLOGIES PROGRAM:

SMUD's Customer Advanced Technologies (CAT) program works with customers to encourage the use and evaluation of new or underutilized technologies. The program provides funding for customers in exchange for monitoring rights. Completed demonstration projects include lighting technologies, light emitting diodes (LEDs), indirect/direct evaporative cooling, non-chemical water treatment systems, daylighting and a variety of other technologies.

For more information about the program please visit:

<https://www.smud.org/en/business/save-energy/rebates-incentives-financing/customer-advanced-technologies.htm>

LEGAL STATEMENT

The information in this report is provided by SMUD as a service to our customers. SMUD does not endorse products or manufacturers. Mention of any particular product or manufacturer in this report should not be construed as an implied endorsement.

ACRONYMS AND SYMBOLS

TABLE 1: ACRONYMS AND SYMBOLS CONTAINED IN REPORT

| Acronym | Definition |
|---------|--|
| CEC | California Energy Commission |
| CFM | Cubic Feet Per Minute |
| COP | Coefficient of Performance |
| CPUC | California Public Utilities Commission |
| D | Diameter |
| DOE | US Department of Energy |
| EER | Energy Efficiency Ratio |
| EERE | Office of Energy Efficiency and Renewable Energy (US Department of Energy) |
| HP | Horsepower |
| HVAC | Heating, Ventilation, and Air Conditioning |
| IEER | Integrated Energy Efficiency Ratio |
| OSA | Outside Air |
| RA | Return Air |
| RPM | Revolutions Per Minutes |
| RTU | Rooftop Unit |
| SA | Supply Air |
| SEER | Seasonal Energy Efficiency Ratio |
| T | Temperature |
| UCD | University of California, Davis |
| VRF | Variable Refrigerant Flow |
| VSSF | Variable Speed Supply Fan |
| WCEC | Western Cooling Efficiency Center |
| ρ | Density |

CONTENTS

ACKNOWLEDGEMENTS I

ABOUT THE CUSTOMER ADVANCED TECHNOLOGIES PROGRAM:..... I

LEGAL STATEMENT I

ACRONYMS AND SYMBOLS II

CONTENTS III

INTRODUCTION 1

PROJECT OBJECTIVES 1

TECHNOLOGY OVERVIEW - ADVANCED ROOFTOP PACKAGED AIR CONDITIONERS..... 2

DAIKIN REBEL 4

 VARIABLE SPEED SUPPLY FAN 4

 VARIABLE CAPACITY COMPRESSORS..... 4

 MICROCHANNEL CONDENSER COILS AND VARIABLE SPEED CONDENSER FANS 4

 MODULATING OUTSIDE AIR DAMPER AND DEMAND CONTROLLED VENTILATION 5

 ADVANCED ECONOMIZER CONTROLS 5

 ELECTRONICALLY CONTROLLED EXPANSION VALVES 5

OVERVIEW OF FIELD EVALUATION AND STUDY METHODOLOGY..... 6

RESULTS 9

 SYSTEM EFFICIENCY 9

 SENSIBLE CAPACITY 10

 SYSTEM POWER DRAW 11

 SUPPLY AIRFLOW RATE 12

 VENTILATION RATE 13

 CUMULATIVE CAPACITY IN EACH MODE OF OPERATION 14

 DISTRIBUTION OF PART CAPACITY OPERATION 15

 DISTRIBUTION OF PART AIRFLOW OPERATION 16

 DISTRIBUTION OF CAPACITY BY EFFICIENCY 17

 DISTRIBUTION OF EFFICIENCY BY TIME 18

 COMPARISON TO BASELINE 19

CONCLUSIONS 20

REFERENCES 21

INTRODUCTION

Approximately 35% of all electricity generated in the United States is consumed in commercial buildings; on average roughly 30% of this is used for heating, cooling, and ventilation. When fuel combustion for heating is included, HVAC accounts for more than 35% of the primary fuel consumption associated with commercial buildings (EIA 2012). In California, cooling and ventilation usually account for more than 25% of the annual electricity use in commercial buildings (CEC 2006) - and roughly 5-10% of the total statewide annual electricity use. While the fraction of electricity use for cooling and ventilation in California commercial buildings is somewhat smaller than other regions, when fuel combustion for heating is considered HVAC still accounts for 30% of primary fuel consumption for these facilities. Furthermore, HVAC accounts for more than 30% of the greenhouse gas emissions associated with commercial buildings in California, this amounts to statewide annual emissions of more than 23 MMT CO₂e (CEC 2006, CARB 2014). Increases in HVAC efficiency have enormous potential to reduce our energy consumption and carbon footprint.

Heating cooling and ventilation in commercial buildings is served predominately by rooftop packaged air conditioners (RTUs). RTUs are used widely throughout the world for their ease of installation and minimal engineering requirements. However, these systems have only advanced in incremental ways since the form factor became popular; and they utilize technology that has not evolved to keep pace with the efficiency improvements that have been implemented in other key end-use sectors. Many studies have shown that these systems provide improper ventilation rates, result in poor occupant comfort, and cause significant energy waste. Industry estimates suggest that more than 70% of rooftop units are single speed systems, that 40-50% of these systems are oversized, and that 60-85% of them suffer from major inefficiencies such as economizer malfunctions or improper charge and airflow (Jacobs 2003, Woolley 2011). In light of the need to reduce greenhouse gas emissions, there is a monumental need to improve the efficiency of these systems.

Moreover, air conditioning is the largest single contributor to peak electricity demand. Rooftop units are usually the largest connected load in a building, and can account for more than 50% of the on-peak demand from commercial buildings. The electric grid in California is especially stressed during summer periods when generation requirements can be twice as high as other seasons. On the hottest summer days, air conditioning alone accounts for more than 30% of the peak demand on the statewide electric network (EIA 2014, CEC 2006). Grid management is anticipated to become more challenging as a larger number of intermittent renewable generators are brought on to the network. Since air conditioning loads are such a singularly large fraction of statewide demand, these systems will play a key role in for the future of grid management.

There are a variety of strategies to improve the efficiency of rooftop air conditioners. This study evaluates the observed performance for the Daikin Rebel, the first RTU designed to meet US DOE EERE's "High Performance Rooftop Unit" specification (DOE 2014). In addition to several specific functional capabilities, the specification requires cooling performance with a minimum Integrated Energy Efficiency Ratio (IEER) of 18. The Daikin Rebel surpassed DOE's integrated efficiency requirements with an IEER of 20.6 (Daikin 2015). Compared to current ASHRAE 90.1 standards, equipment in this category can reduce annual energy consumption for cooling and ventilation by more than 50% (DOE 2014, ASHRAE 2013).

In addition to an assessment of cooling performance, this study also presents heat pump heating performance. As part of the strategic effort to reduce greenhouse gas emissions and to support advancement of zero net energy buildings, California envisions a major shift toward electrification for heating. Traditionally, electric heating has been less efficient and more costly than heating with natural gas. However, as modern heat pumps can operate with a COP that is greater than 4.0, heating with electricity can consume less primary energy and result in fewer greenhouse gas emissions than heating with gas. Heat pumps are especially efficient for heating in California, where winters are mild. Electric heat pumps will become even more advantageous as the electric grid incorporates a larger fraction of renewable generation.

PROJECT OBJECTIVES

The HVAC industry, policy leaders, and market stakeholders are making a concerted effort to improve efficiency for HVAC. The Daikin Rebel represents an important step in this direction. The use of variable speed vapor compression systems will almost certainly become a mainstay in future HVAC standards. However, these solutions are currently new to the market; manufacturers and practitioners do not yet fully understand the proper approach to design, installation, control, and optimization; nor do most recognize the practical limitations and the extended implications of their application. This study develops a deeper understanding about this class of variable speed multistage rooftop units, and provides insight into the real benefits that can be expected from such technologies.

Overall performance of a new technology can vary by location and application, and can be impacted by the quality of installation and ongoing service. As a result, industry standard ratings and manufacturer specifications do not provide enough information to convince customers and efficiency practitioners about the value of a new solution. This study provides new information to the growing body of documented performance for the Rebel and other variable speed rooftop

units. By mapping efficiency, capacity, power draw, and air flow rates, in every operating mode and across a range of climate conditions, this study paints a clear picture of the Rebel’s characteristic performance capabilities. The study also presents an application specific assessment of performance for the installation observed to better understand the system’s advantages in a particular application that posed a number of unique challenges.

Another objective of this project was to document practical challenges associated with installation and operation of this new type of system. With seven distinct modes of operation and a number of variable speed components the Rebel is significantly more complex than a conventional rooftop unit. Engineers, contractors, and end users are not familiar with the capabilities and setup requirements for these systems. The lessons learned through this study broaden our understanding of the technology, and should support the evolution of design guidelines, industry standards, and technology function.

Finally, field measured performance for the unit was compared to manufacturer stated performance data for a conventional rooftop unit that complies with 2013 California Building Energy Efficiency Standards (CEC 2012). This comparison allows for direct assessment of the energy benefits for the Rebel across a range of modes and operating conditions. It should be noted that California’s Building Energy Efficiency Standards are already more advanced than ASHRAE 90.1, and incorporate prescriptive requirements for some of the features US DOE EERE advanced specifications only encourage. Most importantly Title 24 prescriptively requires new vapor compression equipment >65,000 btu/hr to adjust fan speed and compressor operation in response to load:

Section 140.4 (e) 5.B

Direct Expansion (DX) units [>65,000 btu/hr] that control ... mechanical cooling [capacity in response to the] occupied space temperature shall have a minimum of 2 stages of mechanical cooling capacity

Section 140.4 (m)

[Direct Expansion (DX) units [>65,000 btu/hr] ... shall ... vary fan airflow as a function of load and shall ... (i) have a minimum of 2 stages of fan control with no more than 66 percent speed when operating on stage 1; and (ii) draw no more than 40 percent of the full speed fan power when operating at 66 percent speed.

TECHNOLOGY OVERVIEW - ADVANCED ROOFTOP PACKAGED AIR CONDITIONERS

In 2011, US DOE EERE released the “High Performance Rooftop Unit” specification (DOE 2015) as part of the High Performance Rooftop Unit Challenge that encourages manufacturers to introduce systems with best-in-class efficiency. The specification outlines several specific functional capabilities for high performance rooftop units, and requires cooling performance with a minimum IEER of 18. These rooftop units can reduce annual energy use for cooling and ventilation by more than 50% compared to current ASHRAE Standard 90.1 compliant equipment (DOE 2014). The Daikin Rebel surpassed DOE’s Challenge requirements, with an AHRI certified IEER of 20.6 (Daikin 2015). Four other manufacturers have since met DOE’s “High Performance Rooftop Unit” challenge specification – Carrier, Lennox, 7AC Technologies, and Rheem. Also, review of manufacturer literature indicates that there are other products that would meet DOE’s Challenge requirements, including Trane’s Voyager e-Flex with a stated IEER of 20 (Trane 2014).

In a related effort, EERE’s Better Building Alliance is leading the Advanced Rooftop Unit Campaign – an initiative that encourages commercial building owners to replace and retrofit existing rooftop units with equipment that meets:

For Equipment Replacement

1. CEE Tier 2 specified rated efficiency of EER =12 and IEER = 13.8 (for package units 65,000 – 135,000 btu/hr)
2. DOE EERE Better Buildings Alliance “High Efficiency RTU Specification”, which additionally requires:
 - a. Variable speed fan control for part speed operation in ventilation mode
 - b. ASHRAE Standard 90.1 2010 compliant economizer
 - c. Ongoing quality maintenance performed according to ASHRAE Standard 180

and which encourages performance beyond CEE Tier 2, or in line with DOE EERE’s “High Performance Rooftop Unit” specification

For Equipment Retrofits

1. DOE EERE Better Buildings Alliance “Advanced RTU Controller Specification”, which requires:
 - a. Variable speed fan control for part capacity operation and ventilation mode
 - b. Modulating outside air damper to maintain ventilation rates at part fan speed

and which encourages several other functional capabilities including:

- a. Demand controlled ventilation
- b. Integrated economizer and differential dry bulb control

- c. Automated fault detection and diagnostics
- d. Variable capacity compressor control

DOE suggests that replacement of an older rooftop with these advanced systems can reduce electric bills by \$1,000-\$3,700 annually. In order to encourage more rapid uptake of the solutions, the Advanced Rooftop Unit Campaign provides a range of technical resources, market information, case studies, and market recognition for commercial building owners that participate in the campaign.

There are four key efficiency advantages provided by advanced rooftop air conditioners:

- Variable speed fans reduce fan energy used for continuous ventilation and for part capacity cooling and heating.
- Staged or variable speed compressors can adjust capacity dynamically and avoid losses associated with cycling.
- Advanced economizer controls minimize the need for mechanical cooling
- Modern controls and automated fault detection avoid excessive operation and help to keep efficiency on point

Beyond these key improvements, advanced rooftop units can incorporate a number of other efficiency features including demand controlled ventilation, electronic control for expansion valves, demand response capabilities and variable speed condenser fan controls. There are a variety of standards and specifications that identify system characteristics to achieve efficiency beyond ASHRAE 90.1. Table 2 summarizes the details of each in comparison to capabilities for the Daikin Rebel evaluated in this study.

| | Standard or Specification | Title 24 Requirements ¹ | High Efficiency RTU Specification | High Performance Rooftop Unit specification | Advanced RTU Controller Specification | Daikin Rebel ³ |
|---|---------------------------|-------------------------------------|-------------------------------------|---|---------------------------------------|-------------------------------------|
| ☑ Required (included) Features or Capabilities ✓ Recommended (optional) Features or Capabilities | | | | | | |
| Nominal Cooling Capacity Range Addressed (tons) | | All | All | 10-20 | >7.5 | 3-15 |
| Rated Cooling Efficiency (AHRI 340/360) ² | | | | | | |
| EER | | 11.2 | 12.2 | NA | NA | 12.6 |
| IEER | | 11.4 | 14.0 | 18.0 | NA | 20.6 |
| Rated Heat Heating Efficiency (AHRI 340/360) | | | | | | |
| Thermal Efficiency | | NA | >80% | >80% | NA | 80% |
| COP @47/43 | | NA | 3.4 | NA | NA | 3.66 |
| COP @ 17/15 | | NA | 2.4 | NA | NA | 2.9 |
| Fan Operation | | | | | | |
| Part speed for ventilation mode | | <input type="checkbox"/> | <input checked="" type="checkbox"/> | <input checked="" type="checkbox"/> | <input checked="" type="checkbox"/> | <input checked="" type="checkbox"/> |
| Part speed for part capacity cooling | | <input checked="" type="checkbox"/> | <input checked="" type="checkbox"/> | <input checked="" type="checkbox"/> | <input checked="" type="checkbox"/> | <input checked="" type="checkbox"/> |
| Part speed for part capacity heating | | <input checked="" type="checkbox"/> | <input checked="" type="checkbox"/> | <input checked="" type="checkbox"/> | <input checked="" type="checkbox"/> | <input checked="" type="checkbox"/> |
| Compressor Operation | | | | | | |
| Staged capacity compressor control | | <input checked="" type="checkbox"/> | ✓ | <input type="checkbox"/> | ✓ | <input checked="" type="checkbox"/> |
| Variable capacity compressor control | | <input type="checkbox"/> | ✓ | <input type="checkbox"/> | ✓ | <input checked="" type="checkbox"/> |
| Advanced Economizer Capabilities | | | | | | |
| Integrated economizer control | | <input checked="" type="checkbox"/> | <input checked="" type="checkbox"/> | <input type="checkbox"/> | <input type="checkbox"/> | <input checked="" type="checkbox"/> |
| Modulating damper for minimum supply air temperature | | <input checked="" type="checkbox"/> | <input type="checkbox"/> | <input type="checkbox"/> | <input type="checkbox"/> | <input checked="" type="checkbox"/> |
| Differential dry bulb economizer control | | ✓ | <input type="checkbox"/> | <input checked="" type="checkbox"/> | ✓ | ✓ |
| Ventilation | | | | | | |
| Modulating damper to maintain ventilation with reduced fan speeds | | <input type="checkbox"/> | <input checked="" type="checkbox"/> | <input type="checkbox"/> | <input checked="" type="checkbox"/> | <input checked="" type="checkbox"/> |
| Demand controlled ventilation | | <input checked="" type="checkbox"/> | ✓ | <input type="checkbox"/> | ✓ | ✓ |
| Low Leakage dampers | | <input checked="" type="checkbox"/> | <input checked="" type="checkbox"/> | <input checked="" type="checkbox"/> | <input type="checkbox"/> | <input checked="" type="checkbox"/> |
| Control | | | | | | |
| Remote monitoring and control | | <input type="checkbox"/> | <input checked="" type="checkbox"/> | <input type="checkbox"/> | ✓ | ✓ |
| Automated Fault Detection and Diagnostics | | <input checked="" type="checkbox"/> | <input type="checkbox"/> | <input type="checkbox"/> | <input type="checkbox"/> | <input type="checkbox"/> |
| Demand response capabilities | | <input checked="" type="checkbox"/> | <input type="checkbox"/> | <input type="checkbox"/> | <input type="checkbox"/> | ✓ |
| Other | | | | | | |
| Variable speed condenser fan control | | <input type="checkbox"/> | <input type="checkbox"/> | <input type="checkbox"/> | ✓ | <input checked="" type="checkbox"/> |
| Electronically Controlled Expansion Valves | | <input type="checkbox"/> | <input type="checkbox"/> | <input type="checkbox"/> | <input type="checkbox"/> | <input checked="" type="checkbox"/> |
| Quality Installation and Maintenance | | <input checked="" type="checkbox"/> | <input checked="" type="checkbox"/> | <input type="checkbox"/> | <input type="checkbox"/> | <input type="checkbox"/> |

1. Some features listed as required are only required in particular circumstances. Some features listed are mandatory, and some are prescriptive requirements.
2. EER and IEER values listed for air cooled equipment 65 – 135 kBtu/hr
3. Daikin Rebel nominal performance ratings listed for 7.5 ton model

DAIKIN REBEL

The Daikin Rebel is one of the most advanced vapor compression rooftop air conditioners currently available. The system incorporates a variety of measures to increase efficiency, some of which are highlighted specifically as required features in the previously discussed specifications and standards, but some of which are not. The Rebel's main efficiency features, and their particular advantages are summarized in the following sections.

Figure 2 provides a schematic illustration of the rooftop unit and identifies all major components. Figure 3 illustrates the vapor compression heat pump circuit specifically, and identifies all significant sub-components.



FIGURE 1: THE DAIKIN-MCQUAY REBEL

VARIABLE SPEED SUPPLY FAN

The supply fan in conventional rooftop units has traditionally operated continuously during all scheduled occupancy hours to provide code required ventilation air by mixing some fraction of outside air into a recirculated air stream. While ventilation is important for indoor air quality, the traditional approach is wasteful because it moves much more air than is required. A variable speed supply fan allows for substantial energy reduction during ventilation periods by reducing the continuous supply air volume moved. According to the fan affinity laws, power tends to scale with the cube of speed:

$$P_2 = P_1 \cdot \left(\frac{rpm_2}{rpm_1}\right)^3 \quad 1$$

The energy savings associated with part speed fan operation in ventilation mode can constitute the major portion of energy savings achieved by an advanced rooftop unit, especially considering the fact that cooling hours only account for a small portion of the year, but ventilation is required during all occupied periods in every season.

Variable speed fan operation is also useful for part capacity heating and cooling, where airflow rates can be adjusted in sequence with compressor speed to provide an appropriate amount of cooling with substantially reduced fan power. Recent research suggests that the interplay between fan speed and compressor speed has important implications to the system efficiency and to the balance of sensible and latent cooling capacity. According to a study by Pistochini and Modera, while total cooling efficiency tends to increase at part fan speed, the amount of dehumidification also tends to increase, such that in certain scenarios, the sensible system cooling efficiency can be higher at full fan speed than at part fan speed (Pistochini 2015).

VARIABLE CAPACITY COMPRESSORS

Multiple stage, and variable capacity compressors allow a system to adjust the instantaneous cooling capacity to match the cooling load, instead of cycling compressors on and off over a period of time to provide the cooling needed. This can result in a steadier room temperature, and avoids any losses and inefficiencies associated with compressor cycling. For example, in applications where dehumidification is needed, compressor cycling will degrade the amount latent cooling generated because condensation accumulated on the coil will re-evaporate into the circulated air stream as during those periods when the compressor turns off (Shirey 2006). For conventional machines, this can be especially challenging during part load periods because cycling at a 50% runtime fraction can effectively eliminate all capacity for dehumidification.

Part speed compressor operation also improves efficiency of the vapor compression cycle because heat exchange effectiveness increases when mass flow rates decrease, and because compressor efficiency is higher at part speed.

The Rebel uses one fixed-speed compressor, and one variable speed compressor. These two compressors operate in parallel on a single refrigerant circuit and allow for continuous modulation of capacity from ~0-100%. The variable speed compressor operates alone for lower capacity ranges, and then the fixed speed compressor switches on to serve as a base load, while the second compressor adjusts to provide the appropriate overall cooling capacity.

MICROCHANNEL CONDENSER COILS AND VARIABLE SPEED CONDENSER FANS

The Rebel utilizes a microchannel heat exchanger for the condenser, and variable speed condenser fans. Microchannel heat exchangers provide superior heat transfer in a compact footprint, which allow for smaller fans, lower pressure drop, quieter operation, and reduced weight compared to conventional copper and aluminum fin and tube heat exchangers. The variable speed condenser fans take advantage of significant fan power savings at part speed when reduced condenser airflow is adequate for heat rejection.

MODULATING OUTSIDE AIR DAMPER AND DEMAND CONTROLLED VENTILATION

Conventional rooftop units use a fixed damper position and continuous fan operation to satisfy code required ventilation rates during all occupied hours. The Rebel continuously modulates the outside air damper and return air damper position to maintain prescribed ventilation rates as the supply fan changes speed in sequence with cooling capacity. Therefore, a modulating outside air damper is an essential feature for any rooftop unit that operates with variable fan speed. An added advantage of this modulating damper capability is that it easily allows for application of demand controlled ventilation. Demand controlled ventilation reduces annual fan runtime and avoids excess conditioning loads, while also ensuring adequate indoor air quality.

ADVANCED ECONOMIZER CONTROLS

The Daikin Rebel allows for integrated economizer operation, which allows for compressor operation at the same time as economizer cooling. This is an important feature for all of the periods when outside air is cooler than room air, but when the full supply airflow at that temperature is not adequate to maintain room set point. Additionally, the Daikin Rebel allows for differential enthalpy economizer control which makes an economizer changeover decision by comparing temperature and humidity for the return air and outside air. Surprisingly, the Rebel does not feature differential dry bulb temperature control – a feature that is recommended by California Building Energy Efficiency Standards, and by DOE EERE’s “Advanced RTU Controller Specification”, required by DOE’s “High Performance Rooftop Unit” specification, and generally advocated for by industry research studies (Taylor 2010) in preference to differential enthalpy control.

ELECTRONICALLY CONTROLLED EXPANSION VALVES

Traditionally, rooftop air conditioners utilized a fixed orifice expansion valve as the refrigerant metering device in a vapor compression circuit. More modern systems use thermostatic expansion valves (TXV) to meter refrigerant more optimally as load and ambient conditions change. The Daikin Rebel uses electronically controlled expansion valves at the indoor coil and outdoor coil which allow for accurate metering of the refrigerant flow rate in response to measured temperature and pressure conditions throughout the refrigerant circuit. These electronically controlled expansion valves also allow the heat pump system to switch from cooling to heating without the need for an expansion valve bypass circuit.

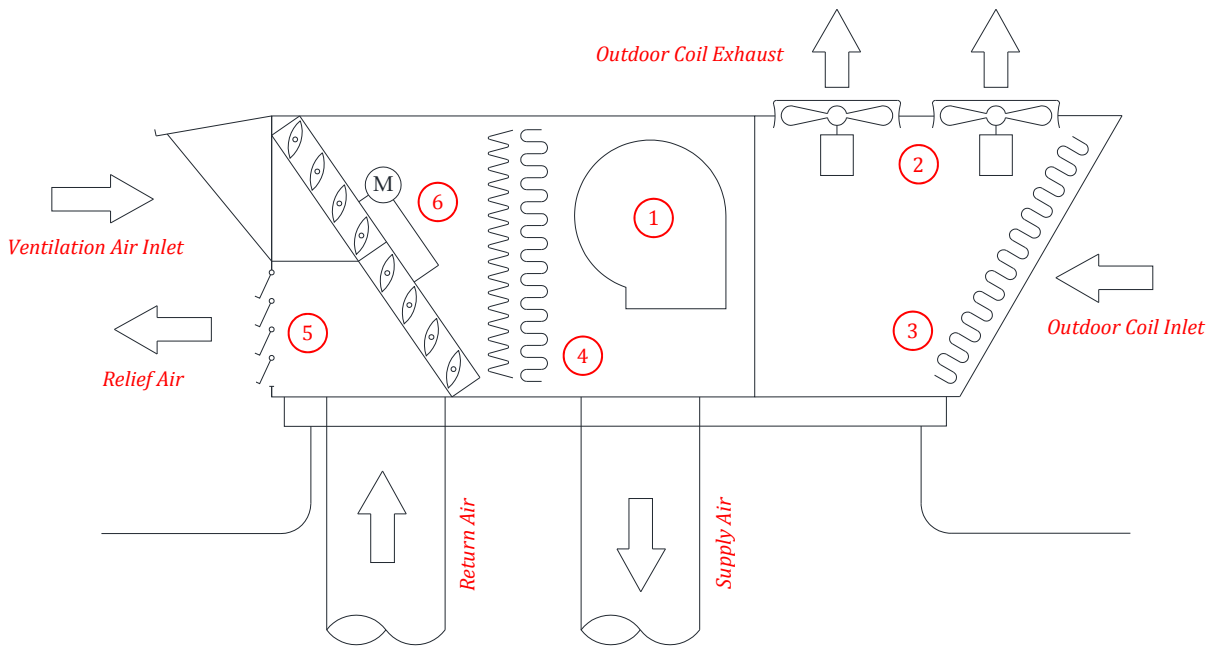

| | | | | | |
|---|--------------------------|---|---------------------------|---|------------------------------|
| 1 | Var. Speed Supply Fan | 2 | Var. Speed Condenser Fans | 3 | Outside Air & Outdoor Coil |
| 4 | Indoor Air & Indoor Coil | 5 | Barometric Relief | 6 | Outside & Return Air Dampers |

FIGURE 2: OVERALL SYSTEM SCHEMATIC FOR DAIKIN REBEL ROOFTOP UNIT

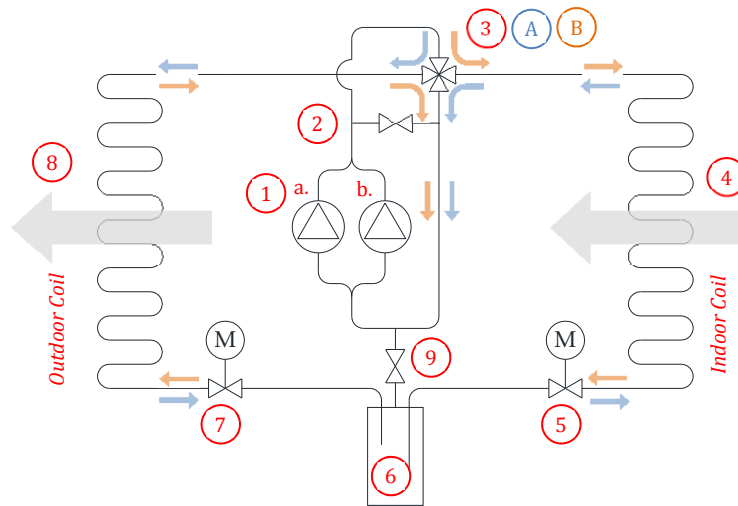

| | | | | | |
|---|---------------------------------------|---|-------------------------------------|---|------------------------------|
| ① | <i>a. Variable Speed Compressor</i> | ② | <i>Startup Bypass Sol. Valve</i> | ③ | <i>Reversing Valve</i> |
| | <i>b. Fixed Speed Compressor</i> | ④ | <i>Indoor Air & Indoor Coil</i> | ⑤ | <i>Elec. Expansion Valve</i> |
| ⑥ | <i>Receiver</i> | ⑦ | <i>Elec. Expansion Valve</i> | A | <i>Ref. Flow in Cooling</i> |
| ⑧ | <i>Outdoor Air & Outdoor Coil</i> | ⑨ | <i>Pump down Sol. Valve</i> | B | <i>Ref. Flow in Heating</i> |

FIGURE 3: SCHEMATIC OF VAPOR COMPRESSION CIRCUIT FOR DAIKIN REBEL HEAT PUMP

OVERVIEW OF FIELD EVALUATION AND STUDY METHODOLOGY

The Rebel was installed at the Harley Davidson of Sacramento dealership and service facility. The unit provides heating and cooling for the service facility, a 6,000-sq ft garage workshop for motorcycle service and repair. This application has a few atypical characteristics that set this application apart from what might be expected in other scenarios. First, the facility has multiple large garage doors that are opened for a significant portion of each day – this significantly increases the heating and cooling loads for the space. Since the facility is a garage, it is also not well insulated. Lastly, the ventilation rates required for auto repair workshops are much larger than what would be needed for a typical conditioned space. ASHRAE 62.1 and Title 24 120.1-A specify 1.5 cfm/ft² of continuous outside air supply. This should equate to 9,000 cfm ventilation for the garages space – which is much more than the rated supply air flow rate for the Rebel installed here. By comparison, a similarly sized retail facility would only require 1,200 cfm ventilation.

The project engineer and local code official negotiated a smaller “auto repair shop” floor area and resulting ventilation requirement based on 1,500 ft² of space that is actually occupied by repair work stations. As a result, the continuous ventilation rate was designed to be 2,250 cfm. In parallel, the project engineer designed a separate exhaust fan that operates during all scheduled occupied hours and moves a similar airflow rate.



FIGURE 4: PHOTOS OF TEST FACILITY



FIGURE 5: PHOTOS OF DAIKIN REBEL ON ROOFTOP

The contractor responsible for design, installation, and commissioning of the project encountered a number of challenges with application of the technology. The issues were mostly minor, and can be attributed to the lack of familiarity with the advanced system setup and operation on part of those involved with installation and startup. Some of the issues observed by the research team included:

1. The unit was initially setup so that the supply fan would run at full speed during all hours, regardless of cooling load, and whether or not the space was occupied. Before this issue was resolved, the setup had basically eliminated one of the greatest opportunities for energy savings with advanced rooftop units, and had added a number of unnecessary operation hours.
2. The modulating damper was not properly configured, and was setup to remain in a fixed position for all fan speeds. This resulted in excess ventilation at high fan speeds, and inadequate ventilation at lower fan speeds. The Rebel requires a field technician to choose the proper damper position at full speed, and the proper damper position at a minimum fan speed, then the unit will modulate linearly between these points as fan speed adjusts in response to cooling capacity, or for ventilation only mode.
3. The Rebel is delivered with a custom thermostat that controls the system's unique features in the appropriate way and allows for seven day scheduling of occupancy and set points. Initially, the contractor did not utilize this thermostat because it used an unfamiliar digital control interface. Instead, a series of timers and override switches were installed to control the unit. Incidentally, this arrangement is not allowed by Title 24 – California's Building Energy Efficiency Standards require the use of programmable thermostats.
4. Finally, the contractor did not properly configure an appropriate heating strategy for the whole building. The Daikin Rebel installed includes heat pump heating, which cannot respond to heating loads as fast as a natural gas furnace. Initially, since the unit was not set to maintain a setpoint during vacant hours, the space was very cold on winter mornings when staff arrived, and the unit was not able to recover from the deep setback to comfortable room temperatures in a reasonable amount of time. The eventual solution used a combination of the heat pump and two existing gas fired room heaters to pre-heat the space prior to occupancy on cold winter mornings.

These issues highlight the fact that many industry practitioners are not familiar with the unique needs for advanced rooftop air conditioners and heat pump systems. While these technologies offer the possibility of significant energy savings, it is very important that the industry develop stronger capabilities surrounding the proper application of these opportunities. The research team recommends that any efforts to advance the broader market adoption of these solutions must be accompanied by strong educational components, and should incorporate mechanisms that actively facilitate proper setup and commissioning. Utilities, manufacturers, regulators and industry associations need to work closely together in this regard because the higher degree of complexity with most advanced rooftop unit introduces more opportunity for failures.

The Rebel was originally installed in September, 2012. Commissioning, troubleshooting, and adjustments continued through July 2013. Following this, UC Davis installed a thorough package of instrumentation to monitor system operation and performance. The measurement strategy was designed to capture overall system performance characteristics such as cooling capacity and electricity consumption. The monitoring system was also designed to capture information about sub component operation and performance characteristics. For example, refrigerant temperatures and pressures were measured throughout the vapor compression circuit.

The detailed monitoring plan is illustrated in Figure 6 and Figure 7 on the following page.

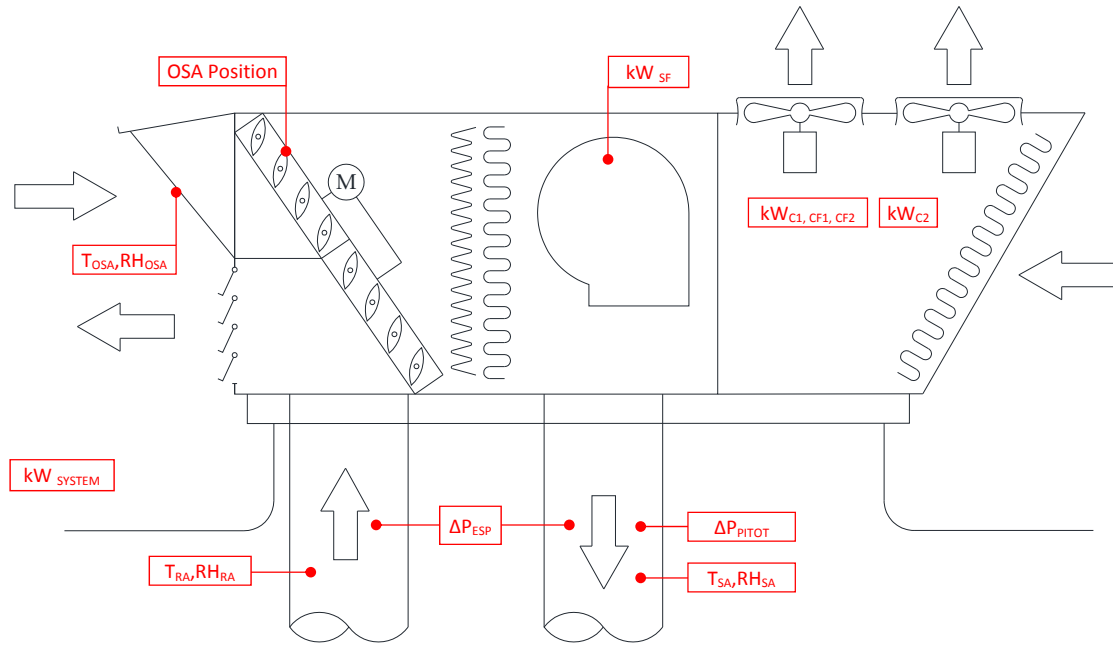

FIGURE 6: INSTRUMENTATION SCHEMATIC FOR DAIKIN REBEL AT HARLEY DAVIDSON, SACRAMENTO

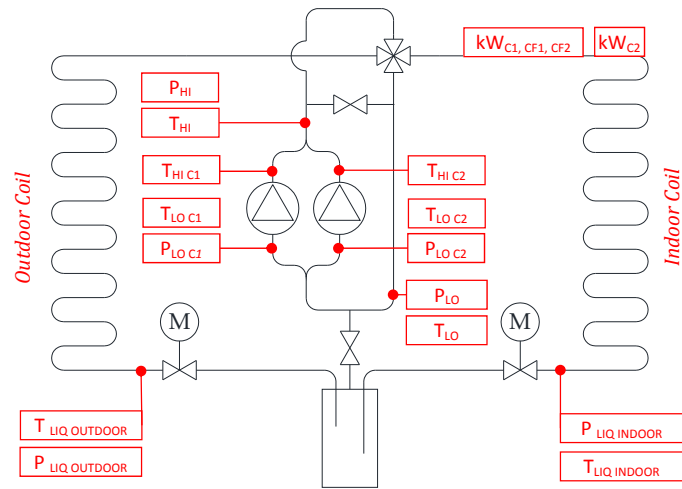

FIGURE 7: INSTRUMENTATION SCHEMATIC FOR DAIKIN REBEL AT HARLEY DAVIDSON, SACRAMENTO

Measurements were recorded on one minute intervals for the duration of the field evaluation, beginning in July 2013. The data was later concatenated, parsed, and analyzed to calculate performance metrics such as sensible cooling capacity and coefficient of performance. Since the supply fan, compressor speed, and damper positions modulate continuously, the Rebel operates in a very dynamic way. One major challenge with this behavior is that the supply airflow rate and outside air fraction change continuously from minute to minute. In order to assign appropriate airflow values to records in each minute, supply airflow velocity and outside air damper position were used as proxy indicators. UC Davis used a specially designed tracer gas airflow measurement system (Woolley 2015, ASTM 2011) to develop a map of the supply air flow rate and outside air fraction as a function of these two monitored variables, then used the records from each minute to calculate the supply airflow and outside air fraction.

The following pages present all performance results from three different months to represent typical operation in the summer, winter and shoulder seasons separately.

RESULTS

SYSTEM EFFICIENCY

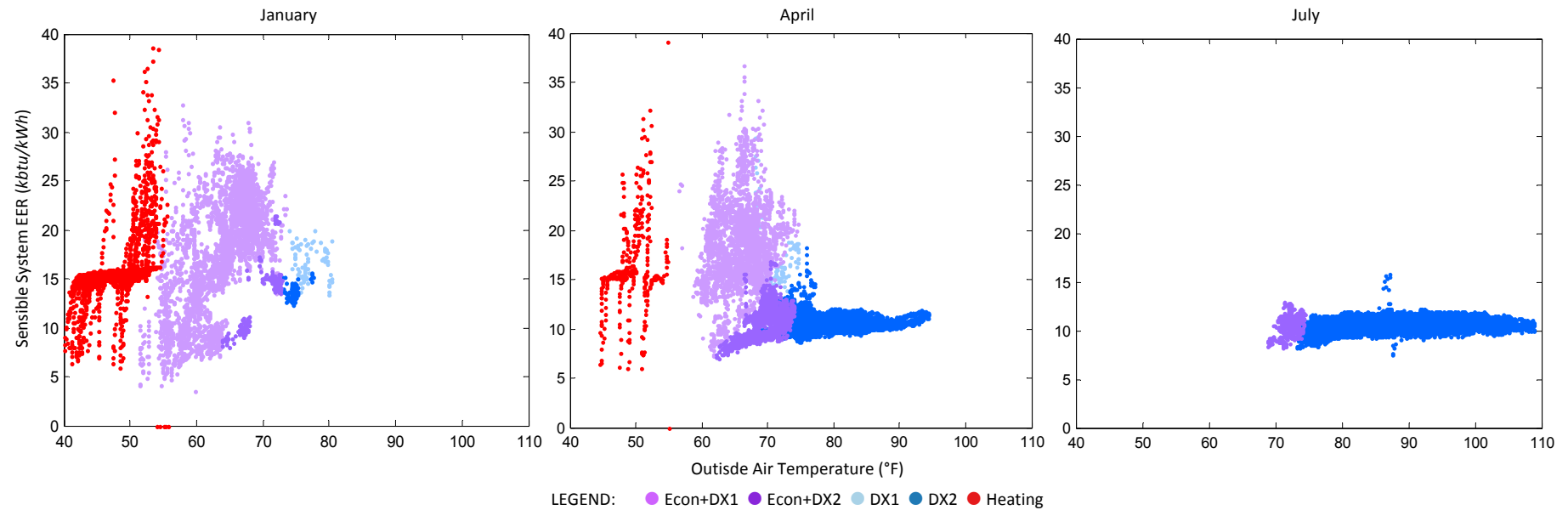

FIGURE 8: SENSIBLE SYSTEM EFFICIENCY IN EACH MODE OF OPERATION FOR THREE DIFFERENT SEASONS. DATA FOR ONE MONTH PERIODS IN ONE MINUTE INTERVALS.

Figure 8 presents the sensible system EER observed in each mode of operation across a range of outside air conditions for one month periods in three different seasons. The results in Figure 8 show that the system’s sensible efficiency is dynamic and can range anywhere from 5 to 35 for any particular instance. These results only count the sensible component of the system’s cooling capacity, and capture system performance over all ranges of supply airflow rate and ventilation rate observed. This chart does not capture the added value of room cooling in economizer modes – it only describes sensible efficiency for the machine in each mode of operation.

The AHRI nominal EER for the Rebel is given as 12.6. For comparison, minimally compliant new equipment must have a nominal EER of 11.2, and most existing RTUs have a rated nominal EER<10.

According to observations in Figure 8, at times the Rebel is able to achieve impressive EERs in part load and dynamic operating conditions. The part speed efficiency advantages for the machine appear to be effective. The system achieves the best efficiency during those periods when the first stage compressor operates alone and at variable speed. These high efficiency periods occur with and without coincident economizer cooling. Higher capacity modes where all components operate at full speed achieve modest efficiency gains compared to a conventional rooftop unit, but these periods do not benefit from the most significant energy saving capabilities.

It should be noted that many of the outlying points in Figure 8 are recorded during transient operating periods, and may not be representative of the performance that would be achieved under particular operating conditions at steady state. However, these observations also go to show that steady state performance metrics do not adequately capture the reality of real world operation. Typically, first stage compressor modes achieve EER of 15–20, and EER decreases by about 5 kbtu/kWh when the second stage compressor also operates

While heating, the Rebel most consistently maintains sensible system EER of 15, though there are many observations from transient periods as well.

SENSIBLE CAPACITY

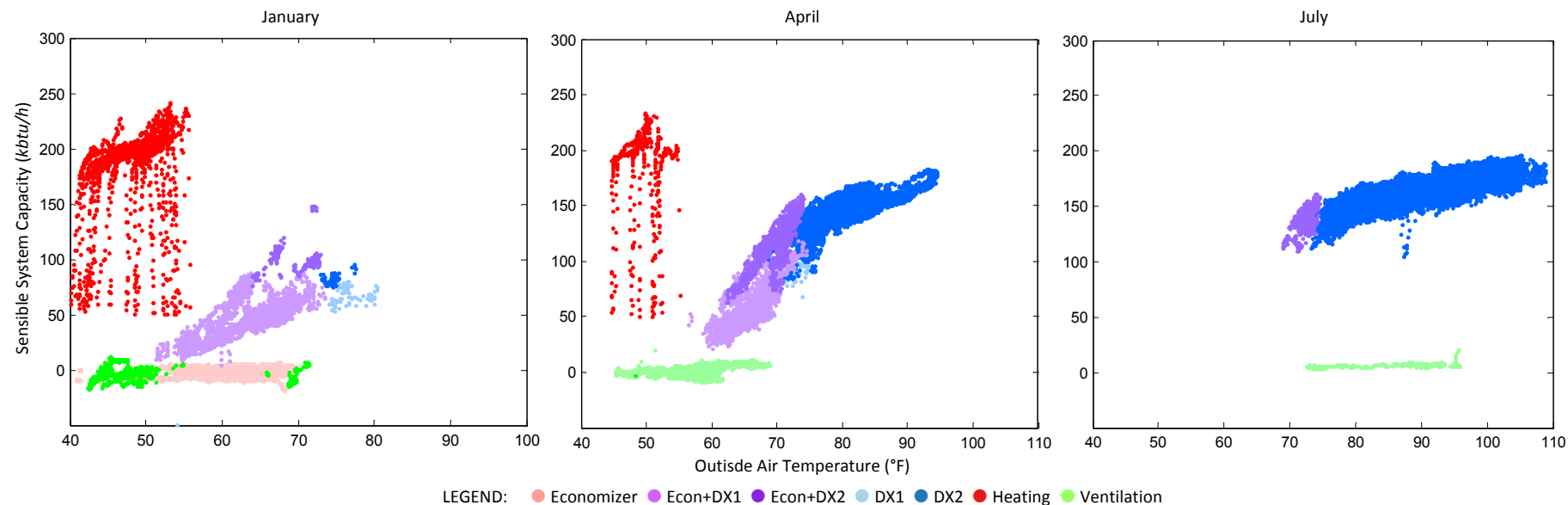

FIGURE 9: SENSIBLE SYSTEM CAPACITY IN EACH MODE OF OPERATION FOR THREE DIFFERENT SEASONS. DATA FOR ONE MONTH PERIODS IN ONE MINUTE INTERVALS.

Figure 9 presents the sensible system capacity observed in each mode of operation across a range of outside air conditions for one month periods in three different seasons. The figure does not capture the room cooling benefits for economizer modes, it only considers the thermal effects generated by the machine in each mode.

These results clearly illustrate that the Rebel has unique capability to adjust capacity continuously to match load; sensible cooling capacity is observed to span anywhere from 20 – 200 kbtu/hr. In heating mode the Rebel spent much less time in variable capacity states; and apart from transient observations, the heating capacity ranged from 160 kbtu/hr at 40°F to 225 kbtu/hr at 55°F.

The Rebel's first stage compressor can operate with variable speed, while the second compressor is fixed speed. The system layers operation of these two compressors to achieve a continuous range of operation. As outside temperature increase, the room cooling load increases, and capacity increases accordingly. However, these results indicate that for the application observed the Rebel tends to reach full speed operation when outside temperature is around 75°F. Above that point, sensible cooling capacity continues to increase, but the increase can be attributed to the changing inlet conditions and not the changing compressor speed. The distinction between variable speed periods and full speed periods can be readily observed for results from April, which show a distinct change in slope around 75°F. Almost all instances of in July operated at full speed.

These observations indicate that the unit was undersized for the application. In addition to the fact that the unit runs flat out for all periods above 75°F, return air temperature observations confirm that the system was not able to maintain a consistent room set point. This observation stands as evidence that proper sizing for variable capacity air conditioners can have a significant impact on the efficiency achieved in practice. In fact, counter to the conventional wisdom espoused for 'right sizing' of conventional air conditioners, it appears that 'oversizing' for variable speed air conditioners should achieve higher overall efficiency on account of the fact that more time is spent at higher efficiency part speed operation. Moreover, the same reasoning dictates that the average efficiency of a particular air conditioner will be depend significantly on the application in which it is installed.

SYSTEM POWER DRAW

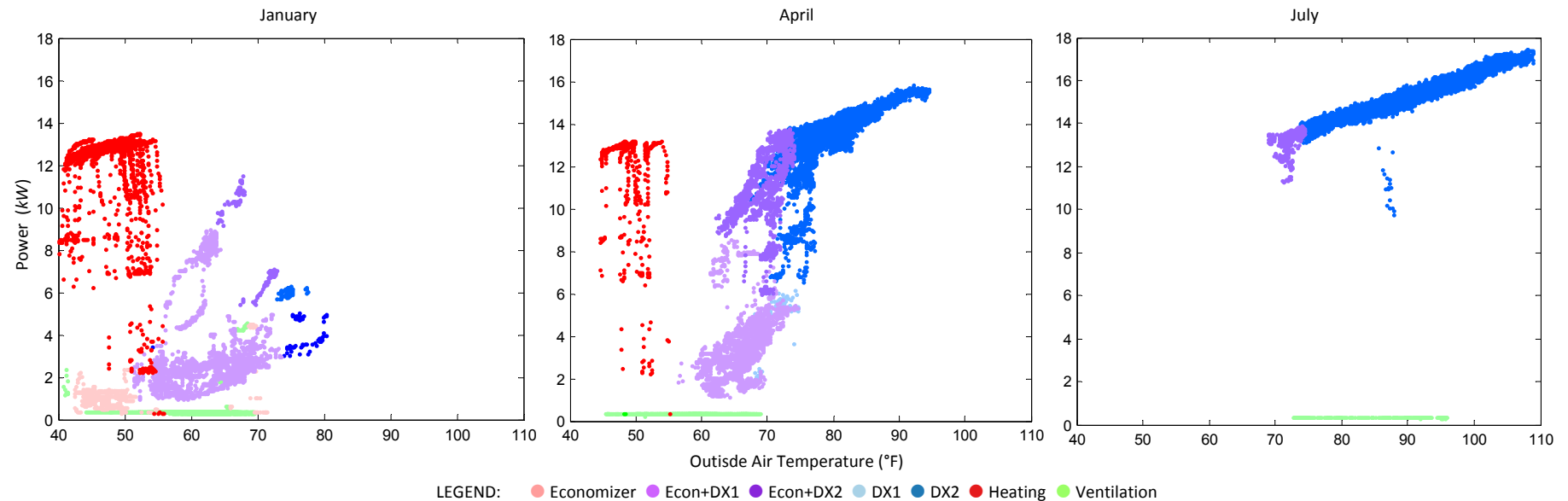

FIGURE 10: SYSTEM ELECTRIC POWER IN EACH MODE OF OPERATION FOR THREE DIFFERENT SEASONS. DATA FOR ONE MONTH PERIODS IN ONE MINUTE INTERVALS.

Figure 10 presents the electric power draw observed in each mode of operation across a range of outside air conditions for one month periods in three different seasons. System power draw in each cooling mode increases as outside temperature increases. As discussed for trends in cooling capacity, part of this increase is associated with variable speed fan and compressor operation, and part of the trend is associated with increased head pressure as the condensing temperature rises. The distinct change in slope at around 75°F is observed because the unit reaches full speed operation at this point. For outside air temperatures above this point, all change in power draw is associated with changes in the inlet conditions, and not with changes in fan and compressor speeds. Above 75°F, in this application, the Rebel behaves exactly like a conventional rooftop unit and power draw rises with outside air temperature at a rate of 0.1 kW/°F.

Consequently, while the full speed efficiency of advanced rooftop units achieves a modest improvement compared to minimum efficiency air conditioners, the technology does not deliver substantial peak demand savings.

Some of the most substantial energy benefits associated with variable speed rooftop units are achieved in ventilation mode – when room conditions are satisfied but the fan must still operate to provide fresh air for the purposes of indoor air quality. In this mode of operation, the Rebel reliably cuts fan power draw to approximately 0.35 kW – achieving an airflow efficacy of roughly 10 cfm/W. The continuous power draw for ventilation mode in a machine with a constant volume fan would be five times larger. Annually, for the approximately 1,500 hours of ventilation only operation, this capability achieves more than 2,000 kWh energy savings. In lower load buildings, ventilation mode occupies an even larger fraction of operation hours and the variable speed fan capability represents an even more significant benefit.

SUPPLY AIRFLOW RATE

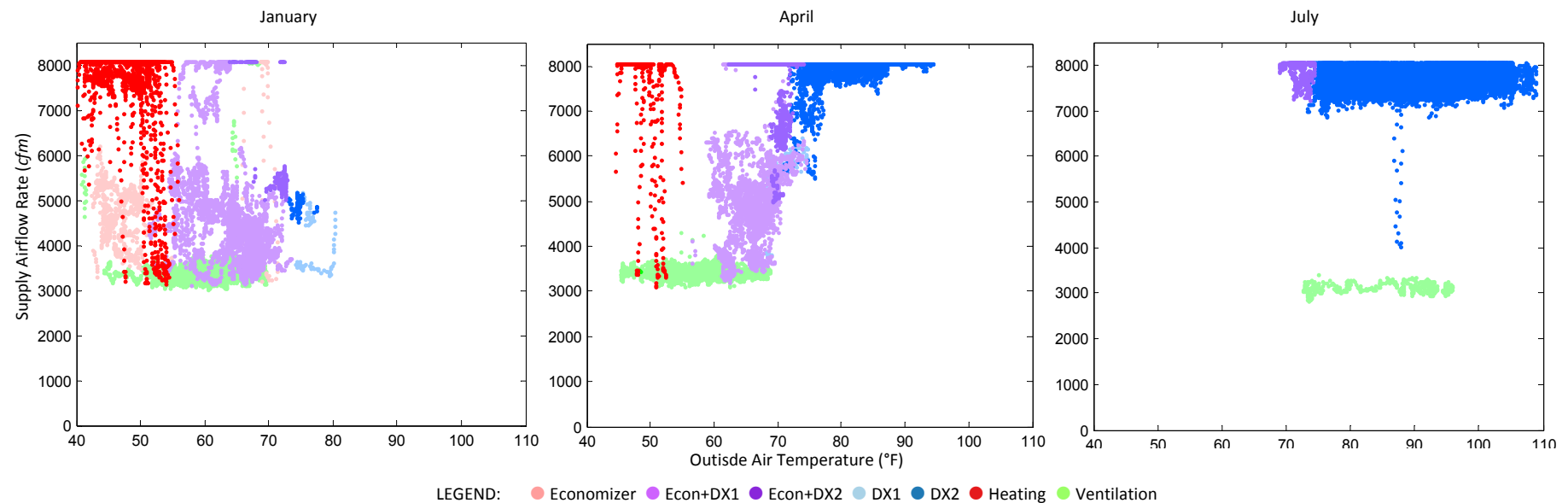

FIGURE 11: SUPPLY AIRFLOW RATE IN EACH MODE OF OPERATION FOR THREE DIFFERENT SEASONS. DATA FOR ONE MONTH PERIODS IN ONE MINUTE INTERVALS.

Figure 11 presents the supply airflow rate observed in each mode of operation across a range of outside air conditions for one month periods in three different seasons. This is the fan airflow rate. These observations provide insight about the periods in which the Rebel takes advantage of part airflow capabilities. The supply airflow in ventilation only mode is consistently around 3,500 cfm, while for modes with compressor operation the airflow rate increases in coordination with the compressor speed and cooling capacity. Above approximately 75°F the fan operates at full speed.

For the sake of comparison, the same plot for a conventional rooftop unit would either show operation at maximum speed or at zero speed. Therefore, all points in Figure 11 that are less than the maximum represent instances where energy savings can be attributed to the variable speed fan capabilities.

It should be noted that the full speed airflow for this unit was measured at slightly above 8,000 cfm. This is incredibly high for a rooftop unit of this size. The unit operates with full speed airflow rate of 640 cfm/ton, which is almost twice as high as rule of thumb guidelines for the supply airflow from constant volume vapor compression equipment. Consequently, the supply air temperature from this unit somewhat warmer than would be expected from a conventional rooftop unit. However, for full speed compressor operation, this large supply airflow rate increases both the total cooling capacity and sensible heat ratio, which may actually improve the overall sensible system cooling efficiency.

VENTILATION RATE

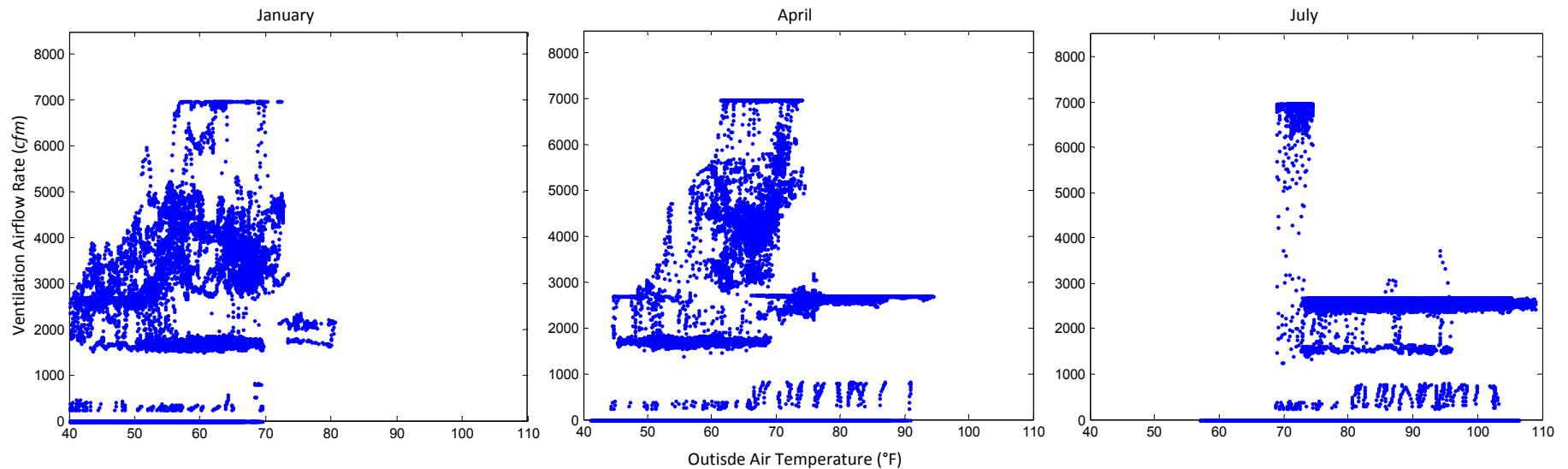

FIGURE 12: VENTILATION AIRFLOW RATE FOR ALL POINTS OBSERVED IN THREE DIFFERENT SEASONS. DATA FOR ONE MONTH PERIODS IN ONE MINUTE INTERVALS.

While the supply fan changes speed to adjust the overall airflow rate, the outside air damper modulates in sequence to adjust the amount of fresh ventilation air that is delivered for the purposes of indoor air quality. Figure 12 presents the ventilation airflow rate observed in all instances of operation across a range of outside air conditions for one month periods in three different seasons. These observations show that even though the damper adjusts in sequence with the fan speed, the amount of ventilation supplied to the building can vary dramatically.

The design ventilation rate for the unit was 2,250 cfm. Of course, when the unit operates in economizer modes the ventilation rate is much higher, and nearly equal to the supply airflow rate, but the figure indicates that there is also some variation in ventilation rate for non-economizer modes. Namely, during ventilation only operation the ventilation airflow rate appears to be about 1,800 cfm, while during modes with compressor operation the ventilation rate is more nearly 2,750 cfm. It's not clear whether or not these differences are a result of the equipment standard function, or the way that it was programmed by field technicians during setup and commissioning.

In consideration of the need to maintain continuous ventilation rates, a modulating outside air damper is an essential feature for any rooftop unit with variable speed fan, and ensuring proper setup requires more concerted attention in the commissioning process than is required for constant volume equipment.

CUMULATIVE CAPACITY IN EACH MODE OF OPERATION

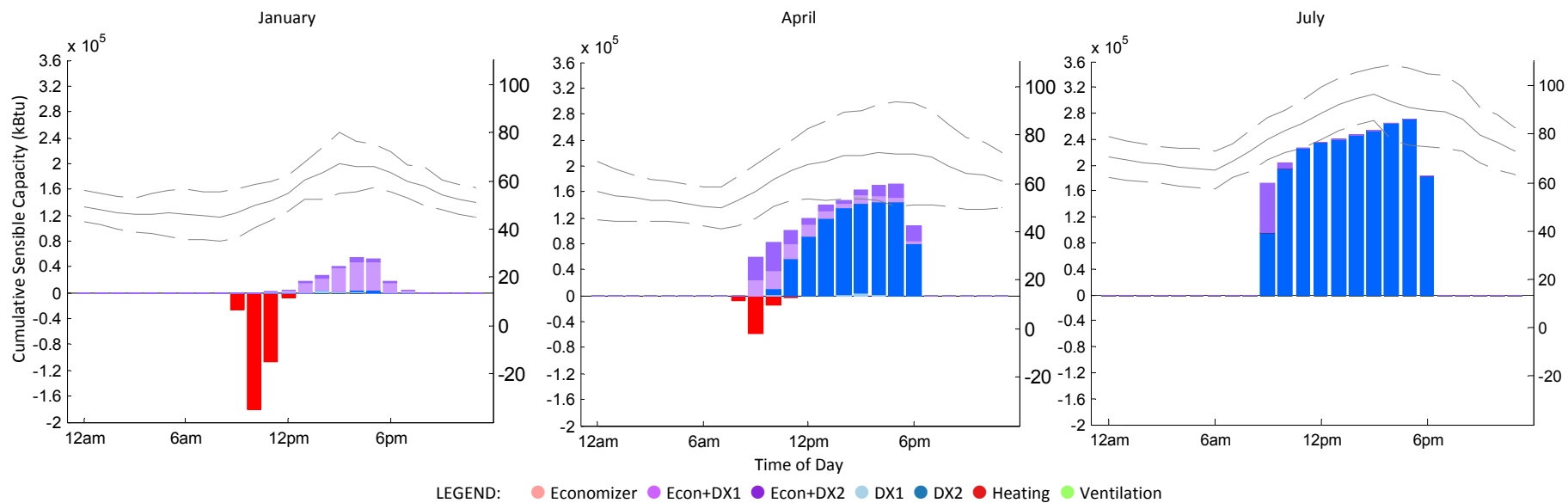

FIGURE 13: DISTRIBUTION OF SENSIBLE COOLING GENERATED IN EACH MODE OF OPERATION FOR EACH HOUR OF THE DAY IN THREE DIFFERENT SEASONS. CUMULATIVE SENSIBLE COOLING PRESENTED FOR ONE MONTH PERIODS.

DISTRIBUTION OF PART CAPACITY OPERATION

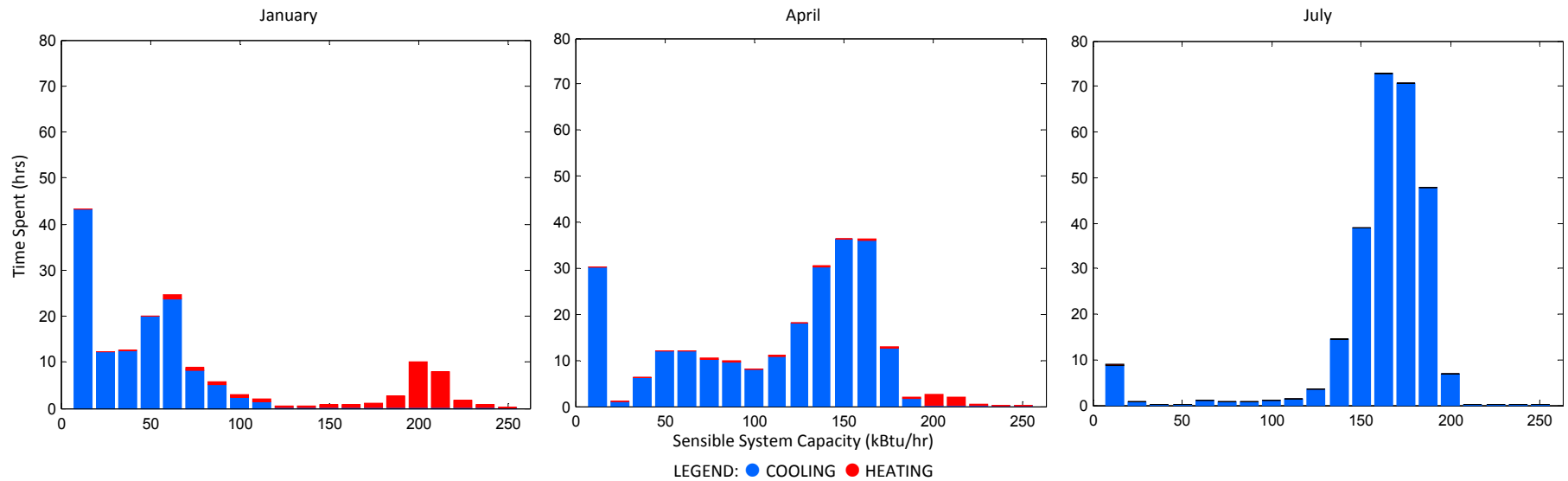

FIGURE 14: DISTRIBUTION OF TIME SPENT AT DIFFERENT LEVELS OF SENSIBLE SYSTEM CAPACITY. CUMULATIVE TIME PRESENTED FOR ONE MONTH PERIODS .

As described previously, maximum system capacity is a function of outdoor air temperature. Maximum capacity in April is lower than that in a hotter month such as July. This is important in understanding Figure 14. The large amount of time spent with capacity around 150 kBtu/hr in April represents the system running at maximum; the same can be said for the grouping of capacity around 180 kBtu/hr in July. The system is apparently undersized to meet the space’s cooling loads, as it spends a substantial amount of time at full capacity operation.

DISTRIBUTION OF PART AIRFLOW OPERATION

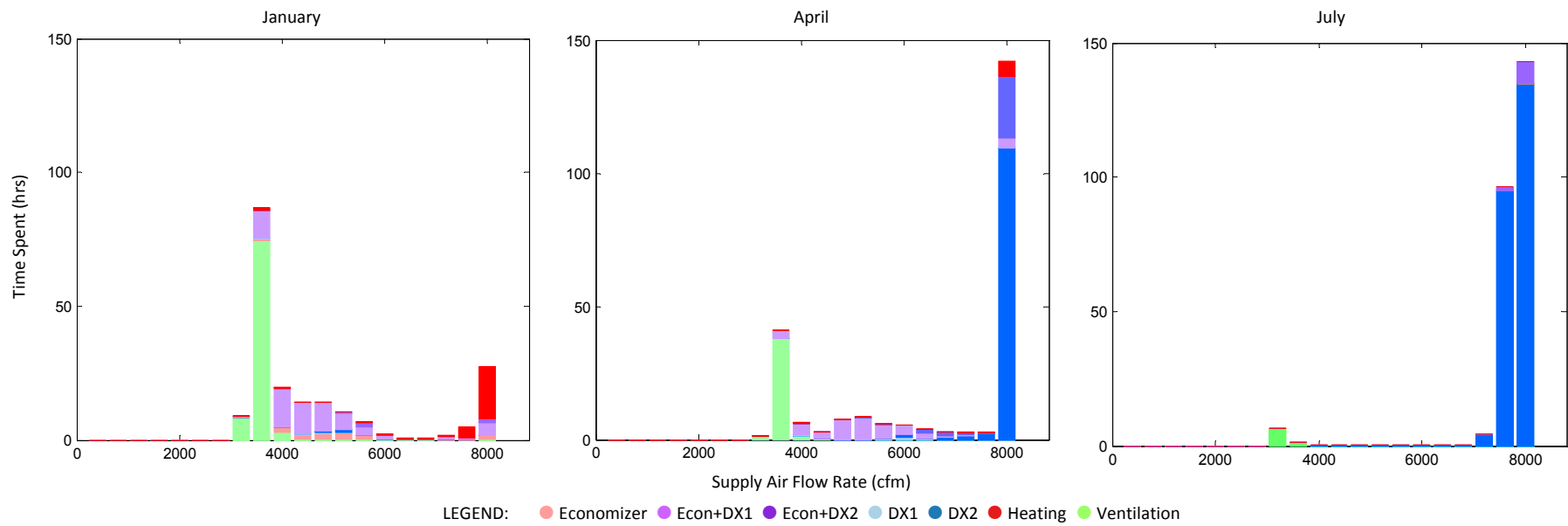

FIGURE 15: DISTRIBUTION OF TIME SPENT AT DIFFERENT SUPPLY AIRFLOW RATES IN EACH MODE OF OPERATION. CUMULATIVE TIME FOR ONE MONTH PERIODS .

DISTRIBUTION OF CAPACITY BY EFFICIENCY

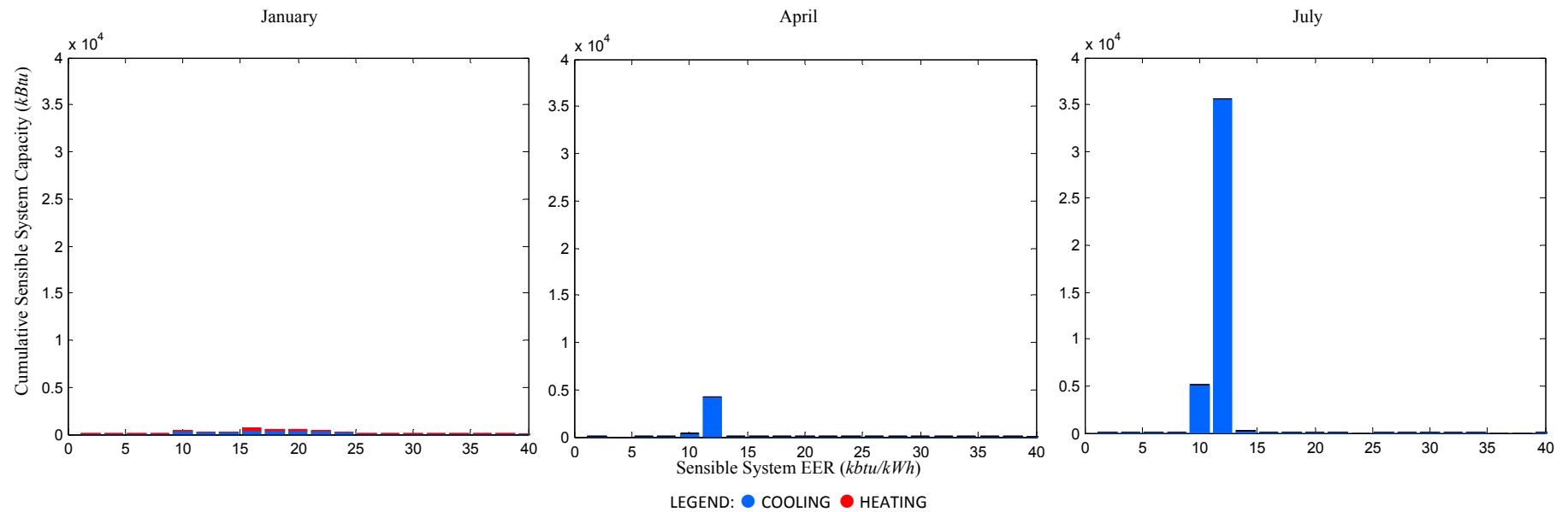

FIGURE 16: DISTRIBUTION OF SENSIBLE COOLING GENERATED AT DIFFERENT LEVELS OF SENSIBLE SYSTEM EFFICIENCY IN THREE DIFFERENT SEASONS. CUMULATIVE SENSIBLE COOLING PRESENTED FOR ONE MONTH PERIODS.

While it is clear the Rebel operates with higher efficiency during instances of part capacity operation, Figure 16 offers perspective on the significant of overall operation in the periods. Figure 16 presents the distribution of sensible system cooling generated across the range of energy efficiency that was observed. Although there are some periods when the system achieves sensible EER above 35, it is clear that the large majority of cooling is generated with sensible system EER of 12. This level of efficiency is achieved by many less advanced units.

It should be reinforced that the unit observed here was undersized for the application, and that a larger unit would have generate a more substantial amount of cooling with higher efficiency part capacity operation. Of course, these observations imply that the extent to which savings are achieved will hinge significantly on the application and operation of a machine. We recommend that efforts to advance advanced rooftop units should press the importance of strategic equipment sizing. In fact, it appears that the characteristics associated with variable speed equipment demand that conventional standards and guidelines for selection and ‘right sizing’ of efficient rooftop unit equipment should be revised. In particular, traditional concerns about negative impacts associated with oversizing air conditioners may be inappropriate for variable speed equipment and ‘over sizing’ equipment could actually be preferred.

DISTRIBUTION OF EFFICIENCY BY TIME

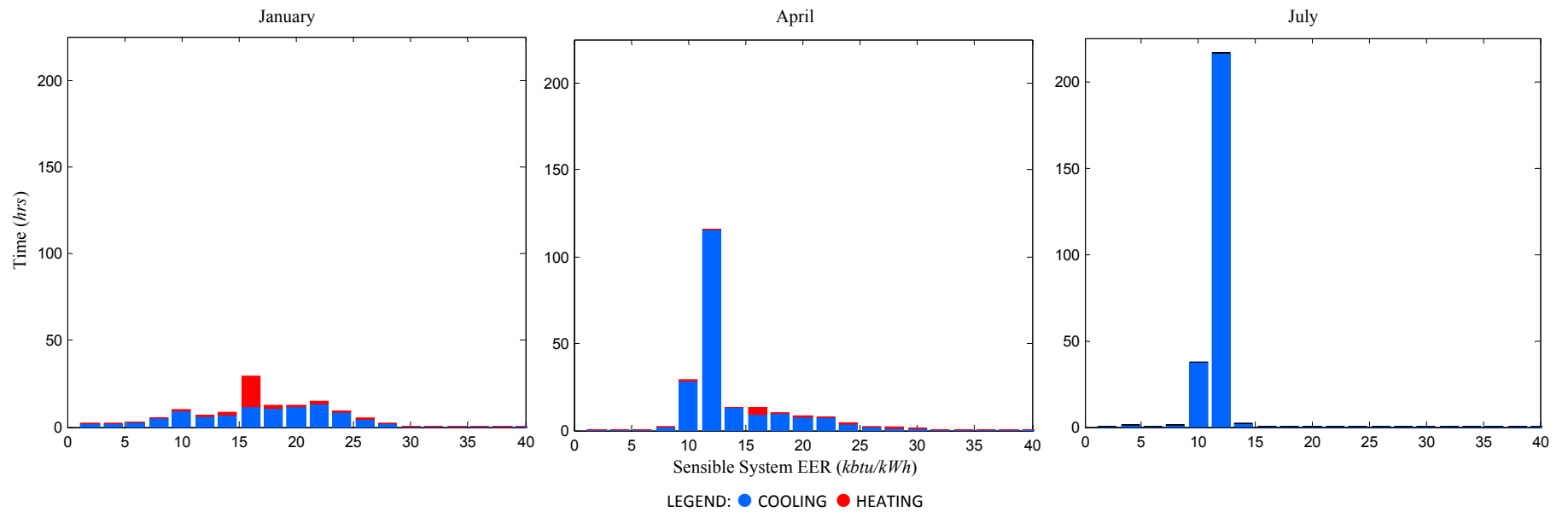

FIGURE 17: DISTRIBUTION OF TIME SPENT AT DIFFERENT LEVELS OF SENSIBLE SYSTEM EFFICIENCY IN THREE DIFFERENT SEASONS. CUMULATIVE TIME PRESENTED FOR ONE MONTH PERIODS .

COMPARISON TO BASELINE

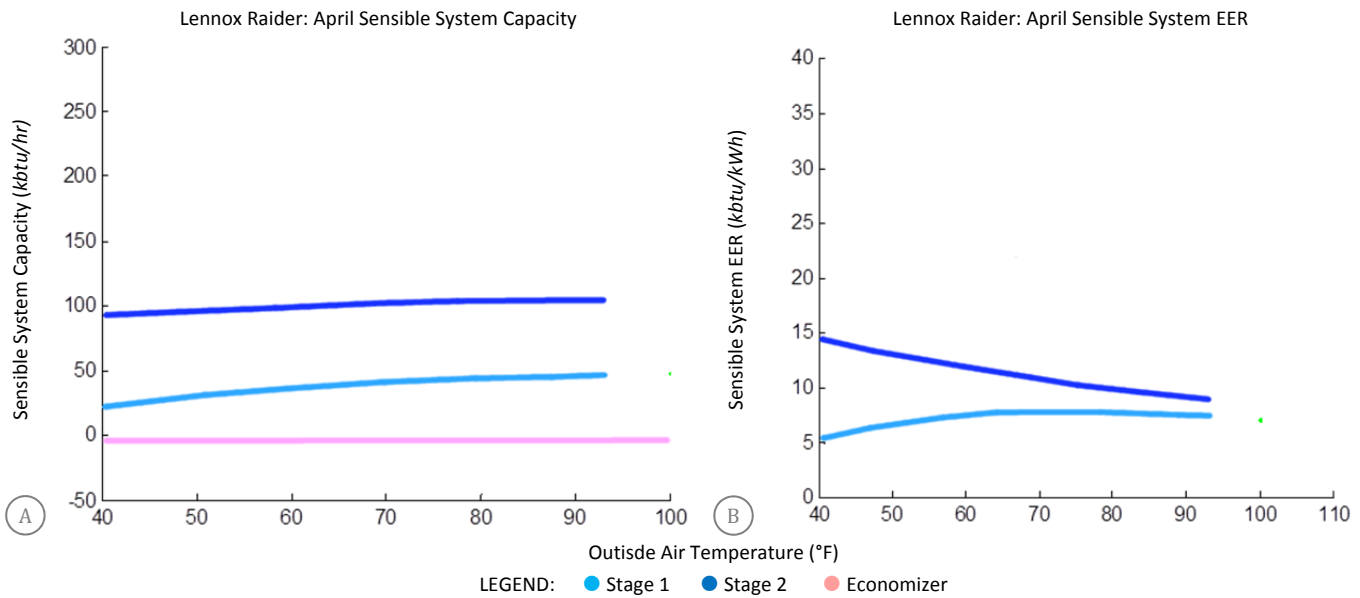

FIGURE 18: A. SENSIBLE SYSTEM CAPACITY, AND B. SENSIBLE SYSTEM EFFICIENCY, AS A FUNCTION OF OUTSIDE AIR TEMPERATURE FOR A MINIMUM EFFICIENCY STANDARD AIR CONDITIONER IN FIRST AND SECOND STAGE COOLING.

Figure 18 presents the cooling capacity and efficiency of a constant volume rooftop air conditioner that minimally complies with California 2013 Building Energy Efficiency Standards. This unit represents a standard baseline to be compared with the Rebel observed in this study. The data in Figure 18 was extracted from the stated performance tables for the 12-ton Lennox Raider ZCA150S4B constant supply air volume two stage rooftop air conditioner. The nominal performance characteristics for the ZCA150S4B and the Daikin Rebel are presented side-by-side in Table 2.

For the sake of comparison with field data, the baseline unit performance is presented in terms of the sensible system capacity, and sensible system efficiency, across a range of outside air temperature, for a fixed relative humidity of 30% and with an outside air fraction equivalent to what was observed for the Rebel. Figure 18 A can be compared directly to the characteristic trends for sensible system cooling capacity presented in Figure 9. Figure 18 B can be compared directly to Figure 8.

The comparison shows that the Rebel achieves better efficiency than a minimally compliant rooftop unit across the full range of operating conditions. Part load efficiency is improved most, and efficiency at peak operating conditions is improved modestly – achieving approximately 15% reduction in kW/ton at 95°F.

TABLE 2: MANUFACTURER LISTED SPECIFICATIONS FOR THE DAIKIN REBEL AND THE LENNOX RAIDER

| | DAIKIN REBEL | LENNOX RAIDER |
|-------------------------|-------------------------------|---------------|
| Cooling Capacity (tons) | 12 | 12.5 |
| Nominal Airflow (cfm) | 4200 | 4,400 |
| EER | 12.1 | 11.0 |
| IEER | 18.5 | 11.6 |
| Compressors | Scroll (2) (1 variable speed) | Scroll (2) |

CONCLUSIONS

The Daikin Rebel has a number differentiating features that offer significant energy savings. The most important of these are the variable speed compressor and supply fan, which allow the unit to fluidly match capacity to cooling load. At part speed the Rebel can achieve exceptional efficiency – the system averaged around $EER_{SENS} = 17.5$ for operation below 50% capacity, and reached as high as $EER_{SENS} = 40$ for some periods. In January, the unit spent a significant amount of time at part speed. In April and July, part capacity modes accounted for a much smaller number of operating hours, and the unit mostly operated continuously in DX2 with efficiency closer to $EER_{SENS} = 12.5$.

This study confirms that the Daikin Rebel can achieve very high efficiency at certain part load conditions, and that it also achieves good savings at peak cooling conditions compared to the standard alternative. In fact, the measurements in this study indicate that the unit uses 30% less electricity at peak than a minimum standard unit would in the same scenario.

The study also reveals the importance that system size plays in determining the energy efficiency achieved. The Rebel was somewhat undersized for the application studied, which resulted in many more full load operating hours than might be expected for a typical application. Full speed operation accounted for nearly 50% of all operating hours in April and practically 100% of operating hours in July. As a result, the unit had little opportunity to gain from some of its advanced features. Moreover, since the Rebel achieves much higher efficiency at part capacity, a system that is oversized for the application should generally use less energy than a system that is “right sized”. For comparison, the industry standard Integrated Energy Efficiency Ratio (AHRI 2011) supposes that 98% of the annual cooling need in a commercial building occurs below 82°F with less than 75% of the peak load; and that more than 35% of the annual cooling need occurs below 70F and with less than 50% of the peak load. The actual distribution of load in a particular building makes an enormous difference in the overall efficiency achieved. Furthermore, since variable speed air conditioners operate with higher efficiency at part speed, their broader application introduces some new challenges about how air conditioners and heat pumps should be properly selected.

This field installation offered many lessons for future application of advanced rooftop unit technologies. In particular, the experience highlights the need for increased education and training for industry practitioners. Initially, there were a number of problems with the equipment setup that caused the system to use substantially more energy than it should have. None of the problems resulted from technical failure for the unit, but the complexity for setup compared to a conventional rooftop air conditioner was a significant challenge for the installing contractor, and substantial effort was required to address even the most obvious problems. In the end the research team identified several smaller issues that were not initially apparent and which were never addressed.

We highly recommend that utility programs and standard regulations embrace the technical opportunity presented by this type of advanced rooftop air conditioner. We expect that the strategies introduced by these new products will become mainstay features for future HVAC equipment, but we recognize that in the interim there is a significant need for efforts and programs to introduce the broader market application for these solutions, to provide educational resources and training, and to facilitate successful application of the technology for more commercial buildings.

REFERENCES

- Jacobs, P. Higgins, C. *Small HVAC Problems and Potential Savings Reports*. Technical Report. California Energy Commission. #500-03-082-A-25. 2003. [Online](http://www.energy.ca.gov): www.energy.ca.gov
- Woolley, J. *Advanced Diagnostics & Service for Rooftop Air Conditioners*. A Case Study for the California Energy Commission Public Interest Energy Research Program. Prepared for California Institute for Energy and Environment, State Partnership for Energy Efficiency Demonstrations. 2011. [Online](http://wcec.ucdavis.edu): wcec.ucdavis.edu
- Daikin. *Rebel Commercial Packaged Rooftop Systems*. Catalog 256-11. Heating and Cooling Models DPS 003-015. Web 2015. [Online](http://www.daikin.com). www.daikin.com
- DOE. *High Efficiency RTU Specification*. Version 0.1. US Department of Energy. Energy Efficiency and Renewable Energy. Better Buildings Alliance. 2014. [Online](http://www.advancedrtu.org). www.advancedrtu.org
- DOE. *High Performance Rooftop Unit*. DOE RTU Challenge Specification. US Department of Energy. Energy Efficiency and Renewable Energy. Better Buildings Alliance. 2014. [Online](http://www4.eere.energy.gov/alliance/). www4.eere.energy.gov/alliance/
- DOE. *Advanced RTU Controller Specification*. Version 0.3. US Department of Energy. Energy Efficiency and Renewable Energy. Better Buildings Alliance. 2015. [Online](http://www.advancedrtu.org). www.advancedrtu.org
- CEC. 2013 Building Energy Efficiency Standards for Residential and Nonresidential Buildings. Title 24, Part 6 and Associated Administrative Regulations in Part 1. CEC-400-2012-004-CMF-REV2. California Energy Commission. 2012. [Online](http://www.energy.ca.gov): www.energy.ca.gov
- Trane. *Packaged Rooftop Air Conditioners. Voyager with e-Flex™ Technology*. Product Catalog. RT-PRC056A-EN. 2014. [Online](http://www.trane.com). www.trane.com
- Shirey, D. Henderson, H. Raustad, R. *Understanding the Dehumidification Performance of Air-Conditioning Equipment at Part-Load Conditions*. University of Central Florida. Florida Solar Energy Center. FSEC-CR-1537-05. DOE/NETL Project No. DE-FC26-01NT41253. 2006. [Online](http://www.fsec.ucf.edu) www.fsec.ucf.edu
- Taylor, S. Cheng, H. *Economizer High Limit Controls and Why Enthalpy Economizers Don't Work*. ASHRAE Journal. November 2010. P 12. [Online](http://ashrae.org). ashrae.org
- ASTM. *Standard Test Method for Volumetric and Mass Flow Rate Measurement in a Duct Using Tracer Gas Dilution*. ASTM International. E2029-11. 2011.
- Modera, M. *Commercialization of a Tracer Gas Airflow Measurement System*. Final Report. University of California Office of the President. UCRI Proof of Concept Program. PC-13-268468. 2015.
- Woolley, J. Mande, C. US Patent 61/989,352 (UC-2014-775-1). *Tracer Gas Airflow Measurement System with High Turndown Ratio*. Patent pending. 2015.
- AHRI. 2007 Standard for Performance Rating of Commercial and Industrial Unitary Air-Conditioning and Heat Pump Equipment. ANSI/AHRI Standard 340/360-2007 with Addenda 1 and 2. Air Conditioning, Heating, and Refrigeration Institute. American National Standards Institute. 2011. [Online](http://www.ahri.net). www.ahri.net
- ASHRAE. ANSI/ASHRAE/IES Standard 90.1-2013 - Energy Standard for Buildings Except Low-Rise Residential Buildings. 2013. [Online](http://www.ashrae.org). www.ashrae.org
- Pistochini, T. Modera, M. Laboratory Testing of Variable Speed Compressor and Fan Controls for RTU Optimization. Southern California Edison. Emerging Products. XXX-SCE-XXXX. (Draft in Review). 2015.
- Energy Information Administration. Commercial Buildings Energy Consumption Survey. 2012. Online. <http://www.eia.gov/consumption/commercial/>