

Lawrence Berkeley National Laboratory

Lawrence Berkeley National Laboratory

Title

EBQ CODE TRANSPORT OF SPACE-CHARGE BEAMS IN AXIALLY SYMMETRIC DEVICES

Permalink

<https://escholarship.org/uc/item/6bn084d5>

Author

Paul, A.C.

Publication Date

1982-11-01

Peer reviewed

DISCLAIMER

This report was prepared as an account of work sponsored by an agency of the United States Government. Neither the United States Government nor any agency thereof, nor any of their employees, makes any warranty, express or implied, or assumes any legal liability or responsibility for the accuracy, completeness, or usefulness of any information, apparatus, product, or process disclosed, or represents that its use would not infringe privately owned rights. Reference herein to any specific commercial product, process, or service by trade name, trademark, manufacturer, or otherwise does not necessarily constitute or imply its endorsement, recommendation, or favoring by the United States Government or any agency thereof. The views and opinions of authors expressed herein do not necessarily state or reflect those of the United States Government or any agency thereof.

ENT--13241

DEFC 011629

EBQ CODE:

TRANSPORT OF SPACE-CHARGE BEAMS IN

AXIALLY SYMMETRIC DEVICES

Arthur C. Paul

Computer Applications Department
Engineering and Technical Services Division
Lawrence Berkeley Laboratory
University of California
Berkeley, California 94720

November 1982

This work is jointly performed under the auspices of the U.S. Department of Energy under Contract Number DE-AC03-76SF00098, the Lawrence Livermore National Laboratory under Contract Number W-7405-ENG-48, and the Department of the Navy under Contract ONR #79-F-0004.

NOTICE

PORTIONS OF THIS REPORT ARE ILLEGIBLE.

It has been reproduced from the best available copy to permit the broadest possible availability.

CONTENTS

Abstract	v
Introduction	1
Computational Procedures	2
Equations of Motion.	3
Self Fields.	6
Charge Deposition.	9
External Magnetic Field.	14
Electrodynamic Potential	19
Boundary Mesh.	24
Poisson's Equation	32
Electric Field Coefficients.	48
Normal Output from EBQCODE	63
Controlling the Volume and Type of Output from EBQ	66
Phase Plotting	70
Field Free Data Input.	71
Data Input	73
Computer Field Array Limits.	76
EBQ Data Input Types	77
BOUNDARY.	78
BSCALE.	89
CALL.	90
CHARGE.	91
COILGEN	96
CONST	106
CURRENT	121
DEFINE.	122
DENSITY	123
DUMP.	126
ENDTRACK.	128
EQUIP	129
FIELD	130
IDRAY	131
IGNOR	132
INITIALIZE.	133
LAPLACE	134
LEDGE	135
MAP	137
MESH.	140
MOMENT.	142
OUTPUT.	143
PAGE.	144
PLOT.	145
POLAR	150
POT	151

PRINT	156
PUNCH	157
PUNCHB.	157
RAYGEN - Random KV and Kegular Grid	159
CHILD' , LAW STARTING.	166
RAYS.	172
REWIND.	180
RKSTEP.	181
SEGMENT	182
SKIP.	186
SLOPE	188
STOP.	189
TIME.	190
TITLE	191
TRACK	193
UNIT.	196
WALL.	197
XEQ	198
XYZ	198
Treating Rays with Different Z Starts.	199
Selecting Mesh Sizes	200
EBQ Units.	202
Running EBQ at LBL	206
Examples of the Use of the EBQ Code.	207

EBQ CODE
TRANSPORT OF SPACE CHARGE BEAMS IN
AXIALLY SYMMETRIC DEVICES

Arthur C. Paul

Computer Applications Department
Engineering and Technical Services Division
Lawrence Berkeley Laboratory
University of California
Berkeley, California 94720

Abstract

Such general-purpose space charge codes as EGUN,¹ BATES,² WOLF,³ and TRANSPORT⁴ do not gracefully accommodate the simulation of relativistic space-charged beams propagating a long distance in axially symmetric devices where a high degree of cancellation has occurred between the self-magnetic and self-electric forces of the beam.

The EBQ code was written specifically to follow high current beam particles where space charge is important in long distance flight in axially symmetric machines possessing external electric and magnetic field. EBQ simultaneously tracks all trajectories so as to allow procedures for charge deposition based on inter-ray separations.

¹Electron Trajectory Program, W. B. Herrmannsfeld, SLAC-166 (1973).

²A Computer Program for the Design of High Perveance Ion Sources, D. G. Bates, Culham Laboratories, CLM-R-53 (1966).

³WOLF, A Computer Ion Beam Simulation Package, A. C. Paul, W. S. Cooper, LBL-5373 (1976); Mathematical Models and Algorithms for the Computer Program WOLF, Klaus Halbach, LBL-4444 (1975).

⁴TRANSPORT, An Ion Optic Program, LBL Version, A. C. Paul, LBL-2697 (1975).

The orbits are treated in Cartesian geometry (position and momentum) with z as the independent variable. Poisson's equation is solved in cylindrical geometry on an orthogonal rectangular mesh.

EBQ can also handle problems involving multiple ion species where the space charge from each must be included. Such problems arise in the design of ion sources where different charge and mass states are present.

INTRODUCTION

The EBQ (electric field E , magnetic fields B , and space charge Q) code simulates steady state problems involving space charge transport of charged particles in cylindrically symmetric devices, providing a fairly flexible and forgiving data input structure.

This two dimensional program accepts data specifying the externally applied electric and magnetic fields. The electric and magnetic self fields of the particles are used to obtain a self-consistent azimuthally symmetric charge and current distributions. The code follows particles trajectories and employs a unique method of assigning values of the charge density to grid points. This method provides sufficient accuracy to model the cancellation that occurs between radial electric and magnetic self-forces in a relativistic beam.

A problem can be conceptually divided into four parts, specified by the 1) electrostatic boundary of the problem, 2) the externally applied magnetic fields, 3) the rays (charged particles) comprising the beam, and 4) special input instructing the computer code on output and plotting options, etc. The mathematical procedures used in processing the problem are described on pages 2 - 62, followed by a detailed description of the data input, pages 77 - 205, and twelve examples, pages 207 - 299.

COMPUTATIONAL PROCEDURE

The EBQ code solves Laplace's equation in cylindrical geometry by relaxation using the modified Lieberman procedure. Having thus obtained the electrostatic potential, the rays are tracked simultaneously using the local gradient of the potential to find the electric field from the electrodes. Space charge is calculated either by application of Gauss's Law or by the potential found from solution of Poisson's equation with a known charge distribution. The particles are ordered in ascending radius. The current enclosed by a ray is then used to find the radial electrical space charge field by Gauss's Law and the self-magnetic field by Ampere's Law. The inter-ray spacing is used to map the appropriate charge density onto a lattice which is used on the next cycle to find the space charge field in addition to the electrode field by solution of Poisson's equation. The axially symmetric external magnetic field is found from the local magnetic vector potential.

The next cycle is started by solving Poisson's equation. The rays are then reinitialized and simultaneous tracking performed with the rays depositing charge on the lattice for use on the next cycle. This set of calculations is repeated until a predetermined number of cycles have been performed or until the first moment of the particle distribution fails to change by a predetermined amount.

EQUATIONS OF MOTION

EBQ simultaneously track up to 100 trajectories paraxially propagating along some device made up of cylindrically symmetric electrodes and magnetic field lenses (solenoids). The independent variable is the axial position z . Due to the simultaneous processing of all rays, no retrograde motion is allowed. EBQ simulates the beam's space charge by solving Poisson's equation and the beam's self magnetic field by application of Ampere's Law to the current distribution within the beam.

The equations of motion are implemented in Cartesian coordinates to avoid the singularity at the origin ($R = 0$), while Poisson's equation and the expressions for the magnetic field are implemented in polar coordinates to take advantage of the assumed axial symmetry of the geometry. Seven equations of motion are simultaneously integrated for each ray, yielding the three dimensional position and momentum of the particle, its path length, and the time of flight.

The equations of motion are derived from the Lorentz equation:

$$\dot{\vec{P}} = \frac{eq}{c} (\vec{E} + \vec{v} \times \vec{B})$$

Eliminating time by the relation $d/dt = v_z d/dz$, we obtain for the components of the Lorentz equation:

$$P'_x = \frac{eq}{v_z} E_x + eq \left(\frac{v_y}{v_z} B_z - B_y \right)$$

$$P'_y = \frac{eq}{v_z} E_y + eq \left(B_x - \frac{v_x}{v_z} B_z \right)$$

$$P'_z = \frac{eq}{v_z} E_z + eq \left(\frac{v_x}{v_z} B_y - \frac{v_y}{v_z} B_x \right)$$

where ' denotes differentiation with respect to the longitudinal coordinate, z. The spatial coordinates can be found from their differentials

$$x' = P_x/P_z$$

$$y' = P_y/P_z$$

The path length differential is given by

$$S' = P/P_z$$

where P is the total momentum of the particle, derivable from the energy by the relativistic relation

$$E^2 = E_0^2 + c^2 P^2$$

The velocity of the particle can readily be found as

$$v = \frac{P}{E} c^2$$

c is the velocity of light, E_0 the rest energy in ev and P the momentum in ev/C. The flight time differential is now found to be

$$t' = S'/v$$

rewriting the equations:

$$\begin{aligned}
 P'_x &= \frac{eq}{c^2} \frac{E}{P_z} E_x + \frac{eq}{c} \left(y' B_z - B_y \right) \\
 P'_y &= \frac{eq}{c^2} \frac{E}{P_z} E_y + \frac{eq}{c} \left(B_x - x' B_z \right) \\
 P'_z &= \frac{eq}{c^2} \frac{E}{P_z} E_z + \frac{eq}{c} \left(x' B_y - y' B_x \right) \\
 x' &= P_x / P_z \\
 y' &= P_y / P_z \\
 S' &= P / P_z \\
 t' &= S' / v
 \end{aligned}$$

subject to the specification of the initial position in phase space, x, y, z, P_x, P_y, P_z .

The units for E and P are ergs and ergs sec/cm respectively, B in the gauss, c in cm/sec (3×10^{10}), e in esu (4.8×10^{-10}) and E in statvolts. Practically, for computer implementation, we will work in units of energy and momentum of ev and ev/c , and electric field in Volts/cm, the momentum equations now become

$$\begin{aligned}
 P'_x \left(\frac{ev}{cm} \right) &= q \frac{E(ev)}{P_z(ev/c)} E_x \left((V/cm) \right) + 300q \left[y' B_z(g) - B_y(g) \right] \\
 P'_y \left(\frac{ev}{cm} \right) &= q \frac{E(ev)}{P_z(ev/c)} E_y \left((V/cm) \right) + 300q \left[B_x(g) - x' B_z(g) \right] \\
 P'_z \left(\frac{ev}{cm} \right) &= q \frac{E(ev)}{P_z(ev/c)} E_z \left((V/cm) \right) + 300q \left[x' B_y(g) - y' B_x(g) \right]
 \end{aligned}$$

SELF-FIELDS

The beam carries charge along the z direction which is deposited on the mesh whenever a ray crosses a mesh line. The current enclosed by each ray is used to find the self magnetic fields by application of Ampere's Law. The paraxial flow guarantees only a B_ϕ component

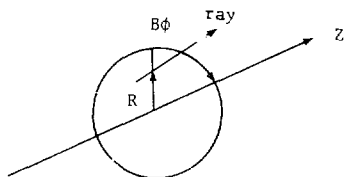

$$\oint B_\phi dl = \mu_0 i$$

where i is the beam current contained inside the orbit

$$B_\phi = \frac{\mu_0 i}{2\pi R}$$

where $\mu_0 = 4\pi \times 10^{-7}$ mks units. i is the total beam current enclosed by the ray and a consideration at radius R .

$$B_\phi(\text{gauss}) = 0.2 \frac{i(\text{amps})}{R(\text{cm})}$$

From symmetry, B_ϕ has an x and y component which enters the equations of motion depending on the ϕ coordinate of the ray, but no B_z component.

This is what I mean by paraxial approximation.

The space charge by application of Gauss's Law would give a radial electric field

$$\int E_r ds = \frac{1}{\epsilon_0} \Sigma Q$$

$$2\pi r E_r = \frac{Q}{\epsilon_0}$$

$$E_r = \frac{i}{2\pi\epsilon_0 r v}$$

$$E_r (\text{V/cm}) = \frac{50}{\pi\epsilon_0} \frac{i (\text{Amps})}{r(\text{cm}) v(\text{cm/sec})}$$

The constant has the numerical value 1.795775×10^{12} cm/farad; i is the same enclosed beam current used in calculating the self-magnetic field.

Gauss's Law is not a good approximation to the space charge in the presence of grid electrodes, since these structures short out any radial electric field. A scale factor is therefore made available for use with Gauss's Law to reduce the average field value on the first cycle when gridded guns are simulated. The subsequent cycles are based on solution of Poisson's equation and properly reflect the radial self-electric field in the vicinity of conductors.

The calculational procedure for self fields on any cycle n after the first uses the beam current i_n to find the self-magnetic field and the electric potential U_{N-1} of the preceding cycle to find the self-radial electric field. Care must be used, since for a beam initially slightly too small, the electric field will be too large and it will

blow up, while on the next cycle, the beam will see too small an electric field to balance the self-magnetic field and will therefore pinch on itself. This procedural instability can be damped by applying a correction to the beam radius used in determining the self-magnetic field based on the approximation of the radius of the beam on the previous cycle (N-1) locally determined from the radial electric field.

$$B\phi = 0.2 \frac{i}{R_N + C_{50} (R_{N-1} - R_N)}$$

Where R_N is the ray radius on this cycle, C_{50} is an input constant, and R_{N-1} is an approximation to the beam radius on cycle N-1 determined from the local radial electric field by Gauss's Law.

$$R_{N-1} \approx \frac{i}{E_r v}$$

For very high current beams it is necessary to keep the self-magnetic and electric field balanced, so $C_{50} = 1$ is a good guess; with not so high a current where the problem is dominated by the self-electric field the value of C_{50} is unimportant. Note, when iteratively calculated, the radial value is R_N regardless of the value of C_{50} .

CHARGE DEPOSITION

Self fields for intense beams must be started in a reasonable way. EQB provides several options.

- 1) Gauss's Law
- 2) Charge 3
- 3) Averaging Over Many Cycles
- 4) Self Force Damping
- 5) Charge Limit.

The space charge and self magnetic forces must be in proper balance or the beam will blow up from excessive space charges or self pinch from insufficient space charge. Since the space charge is evaluated for the previous cycle some care must be used to prevent the magnetic self field from pinching the beam. In reality as the beam pinches, the space charge provides a compensating restoring force. In the simulation code, when not using Gauss's Law, this restoring force is evaluated on the previous cycle and so is non-responsive till the next cycle. In order to stabilize the runs so they do not oscillate the self magnetic force can be artificially damped.

The charge and enclosed current can be calculated by one of two different methods.

Standard Method - The standard method calculates the enclosed current as the sum of current for all rays whose radius is less than that of the ray under consideration. The self current of a given ray is taken as $(4J-3)/(8J-4)$ times its current, so:

$$I_{\text{INSIDE}_j} = \sum_{\substack{K=1 \\ K \neq J}}^{\text{MAX}} I_K (R_K < R_j) + \frac{4J-3}{8J-4} I_j$$

The space charge is deposited on the two nearest mesh intersections by a linear interpolation based on the distance of approach. The charge carried by the JTH ray is

$$Q_j = \frac{I_j}{V_j}$$

where V_j is the velocity of the ray and I_j its current. If the ray is δ from the K^{th} mesh point, and Δ is the mesh interval, then

$$Q_{K,J} = Q_J \left(1 - \frac{\delta}{\Delta} \right)$$

$$Q_{K+1,J} = Q_J \left(\frac{\delta}{\Delta} \right)$$

The self magnetic field in equilibrium with this space charge is

$$B\phi = 0.2 \frac{I_{\text{inside } j}}{R}$$

Neil-charge Deposition - The Neil-charge deposition method is used when data is provided giving the charge density at the point of beam origin via the "DENSITY" input specification. This input gives the current density J in amperes/cm² as a function of R in cm at the place of beam origin. Conservation of charge requires that the charge between two adjacent rays be conserved,

$$Q = J(r)/V$$

the charge to be deposited on a mesh line of radius R_m separated from the adjacent mesh lines by the internal Δ is the charge between the cylinders of radius $R_m \pm \Delta/2$. This charge is calculated from a mapping of the known charge density at the location of beam origin onto the local lattice map, Figure A. Let $J_0(r_0)$ be the current density at the origin of the beam as a function of radius r_0 at which a given ray is born. Let r be the radius of the beam at the current location. Rays may in fact have crossed as shown in the figure represented by a multi-valued contribution of $J_0(r_0)$ to the current value at r . Figure B shows the charge deposition mesh lattice superimposed over the radial mapping function. The charge to be deposited on any mesh point is the integral of the charge along this mapping function.

Consider the charge to be deposited on mesh line n_1 , figure B

$$Q_{R1} = \frac{1}{n_1 \Delta^2} \int_A^B \frac{r_0 J(r_0) dr_0}{V(r)}$$

while the charge to be deposited on mesh line n_2 figure B is

$$Q_{R2} = \frac{1}{n_2 \Delta^2} \left[\int_C^D \frac{r_0 J(r_0) dr_0}{V(r_0)} + \int_E^F \frac{r_0 J(r_0) dr_0}{V(r_0)} + \int_G^H \frac{r_0 J(r_0) dr_0}{V(r_0)} \right]$$

The charge deposited on the axis is given by

$$Q_o = \frac{8}{\Delta^2} \int_0^{\Delta/2} \frac{r_o J(r_o) dr_o}{V(r_o)}$$

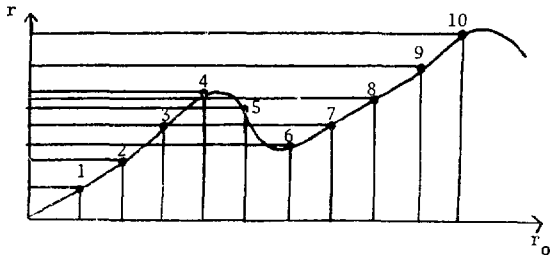

XBL 823-1900

Figure A. Radial mapping function of Neil charge deposition.

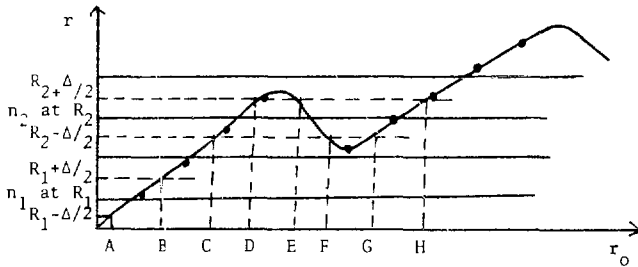

XBL 823-1901

Figure B. MESH lattice superimposed over the radial mapping function.

The self-magnetic field is determined from the current enclosed by a given ray. The enclosed current used with the Neil charge procedure is found from the ratio of areas of the ray as determined by the radial mapping function and the various ray currents which lie inside. For example, consider the current interior to ray 3 in Figure C. Here, all of the current rays 1, 2, and 6 and some fraction of the current carried by rays 3, 5, and 7 are inside ray 3.

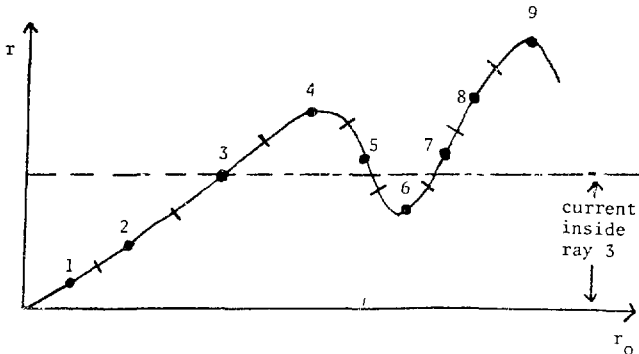

XBL 823-1902

Figure C. Finding current interior to a ray from the radial mapping function.

Each ray is assumed to be carrying its current over a radial interval extending half way to its nearest neighbors.

EXTERNAL MAGNETIC FIELD

The magnetic field from external lenses (solenoids) is calculated from the magnetic vector potential. This potential \tilde{A} can be found from the known radii a and the position Z_L of concentric circular loops.

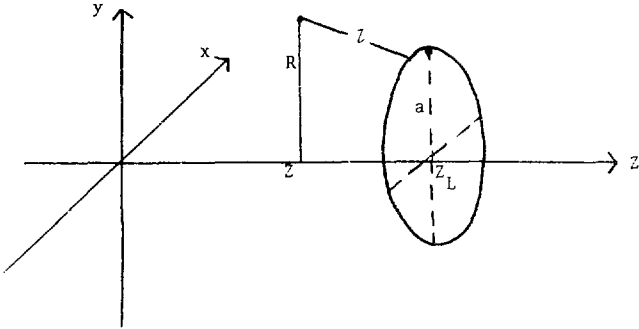

$$\tilde{A} = \frac{\mu_0 I}{4\pi} \sum \int \frac{d\mathbf{l}}{\rho}$$

The distance from a point on this loop to some point in space at R, Z, ϕ is

$$l = [(Z_L - Z)^2 + a^2 + R^2 - 2aR \cos\phi]^{1/2}$$

The only component which does not cancel is the tangential component in contribution to A at (R, Z) . The value of $d\mathbf{l}$ in this direction is $a d\phi \cos\phi$. Thus

$$A_\phi = \frac{\mu_0 I}{4\pi} 2 \int_0^\pi \frac{a \cos\phi \, d\phi}{[(Z_L - Z)^2 + a^2 + R^2 - 2aR \cos\phi]^{1/2}}$$

Evaluation of these elliptic integrals yield the magnetic vector potential.

The magnetic field is obtained from

$$\vec{B} = \nabla \times \vec{A}$$

$$\vec{B} = \left[\frac{1}{r} \frac{\partial A_z}{\partial \phi} - \frac{\partial}{\partial z} (rA_\phi) \right] \hat{r} + \left[\frac{\partial A_r}{\partial z} - \frac{\partial A_z}{\partial r} \right] \hat{\phi} + \frac{1}{r} \left[\frac{\partial (rA_\phi)}{\partial r} - \frac{\partial A_r}{\partial \phi} \right] \hat{z}$$

The azimuthal symmetry guarantees $A_r = A_z = 0$

$$B_z = \frac{\partial A_\phi}{\partial r} + \frac{A_\phi}{r} \qquad B_r = -\partial A_\phi / \partial z$$

The vector potential is known on the lattice points of the magnetic potential mesh defined by COILGEN data. The value of the potential and the field values within a lattice cell are derived by finite difference approximation. Consider a Taylor series expansion of the vector potential about some point R, Z . The central difference equation is obtained by representing $R = r_0 + r$, $Z = z_0 + z$ so that r, z are small displacements from r_0, z_0 .

$$A_\phi(r, z) = A_\phi(r_0, z_0) + \frac{\partial A_\phi}{\partial z} \left| z + \frac{\partial A_\phi}{\partial r} \left| r + \frac{1}{2} \frac{\partial^2 A_\phi}{\partial r^2} \right| r^2 \right.$$

$$\left. + \frac{1}{2} \frac{\partial^2 A_\phi}{\partial z^2} \left| z^2 + \frac{\partial^2 A_\phi}{\partial r \partial z} \right| rz \right.$$

Defining the expansion coefficients through second order by

$$A_\phi(r, z) = a_0 + a_1 z + a_2 r + a_3 r^2 + a_4 z^2 + a_5 rz$$

results in the finite difference approximation to the vector potential

$$A\phi(r,z) = A_0(r_0, z_0) + \left(\frac{A_4 - A_2}{2\ell}\right)z + \left(\frac{A_1 - A_3}{2h}\right)r + \left(\frac{A_1 + A_3 - 2A_0}{2h^2}\right)r^2 \\ + \left(\frac{A_2 + A_4 - 2A_0}{2\ell^2}\right)z^2 + \left(\frac{A_5 + A_0 - A_1 - A_4}{h\ell}\right)r z$$

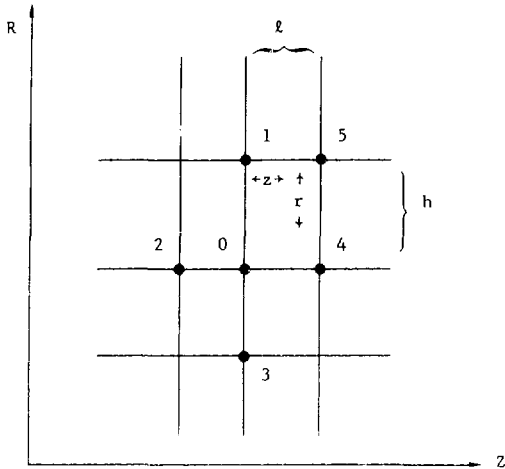

where $A_0, A_1, A_2, A_3, A_4,$ and A_5 are the potential values at the star mesh intersections 0, 1, 2, 3, 4, and 5 as shown above. h and ℓ are the radial and longitudinal mesh sizes and r and z are small displacements from the central point r_0, z_0 .

The magnetic field components are

$$B_r = -a_1 - 2a_4 z - a_5 r$$

$$B_z = a_2 + 2a_3 r + a_5 z + \frac{A\phi}{R}$$

Near the axis of cylindrical symmetry $R \rightarrow 0$ and a power series expansion for $A\phi$ based on the known symmetry must be used. Only even powers of R can exist in the expression for B_z , since it must be the same for $\pm r$.

Assuming the following expansion near the axis for B_z

$$B_z = 2[a_0 + a_3 z + a_5 z^2] + 4[a_2 + a_4 z + a_6 z^2]r^2$$

The vector potential is found by integrating B_z

$$A\phi = (a_0 + a_3 z + a_5 z^2)r + (a_2 + a_4 z + a_6 z^2)r^3$$

Dropping third order terms, we have

$$A\phi = a_0 r + a_3 r z$$

yielding

$$B_r = -a_3 r$$

$$B_z = 2(a_0 + a_3 z)$$

In terms of the lattice point values, we have

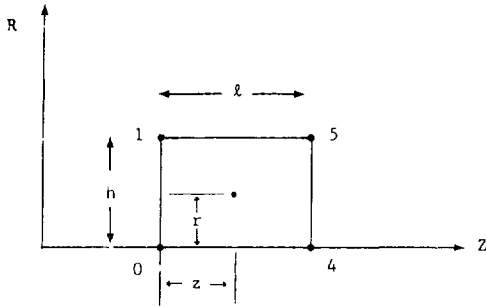

$$A_{\phi} = \left(\frac{A_1}{h} \right) r + \left(\frac{A_5 - A_1}{h l} \right) z r$$

$$B_r = - \left(\frac{A_5 - A_1}{h l} \right) r$$

$$B_z = \left(\frac{2A_1}{h} \right) + 2 \left(\frac{A_5 - A_1}{h l} \right) z$$

ELECTRODYNAMIC POTENTIAL

Poisson's equation is solved by the standard finite difference approximation in cylindrical coordinates. Consider the usual rectangular mesh shown:

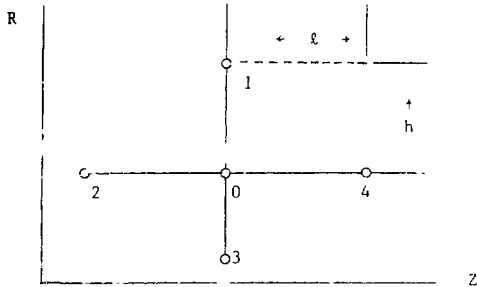

Here l is the longitudinal mesh size and h the radial mesh size.

The solution for the potential at point o satisfied the finite difference equation approximating $\nabla^2 U = \rho$

$$U_1 \left[\frac{1}{h^2} \left(1 + \frac{h}{2r_0} \right) \right] + U_3 \left[\frac{1}{h^2} \left(1 - \frac{h}{2r_0} \right) \right] + U_2 \frac{1}{l^2} + U_4 \frac{1}{l^2} - U_0 \left[\frac{2}{l^2} + \frac{2}{h^2} \right] = \rho$$

where U_0 , U_1 , U_2 , U_3 and U_4 are the potentials at the mesh intersections 0, 1, 2, 3, and 4 shown in the star diagram above.

Near the axis, the singularity generated by the $h/2r_0$ terms is removed by taking a power series expansion for u in even powers of r

$$U = a + cr^2 + \dots$$

The appropriate finite difference equation is

$$U_1 \left(\frac{z}{h^2} \right) + U_3 \left(\frac{z}{h^2} \right) + U_2 \left(\frac{1}{\ell^2} \right) + U_4 \left(\frac{1}{\ell^2} \right) - U_0 \left[\frac{4}{h^2} + \frac{2}{\ell^2} \right] = \rho$$

Several classes of mesh stars result when a boundary intersects the mesh. The irregular stars shown below result. Define β and β_5 as the unit normalized boundary intersections (if the boundary is dz from point o, then $\beta = dz/\ell$ such that when $0 \leq dz \leq \ell$, $0 \leq \beta \leq 1$) the Taylor series expansion coefficients for the potential becomes

$$U = a_0 + a_1 z + a_2 r + a_3 z^2 + a_4 z^2 + a_5 r z$$

where

$$a_0 = U_0$$

$$a_1 = (U_Q - U_N)/2L$$

$$a_2 = (U_N + U_Q - 2U_0)/2D_1^2$$

$$a_3 = (U_B - \beta^2 U_P - (1-\beta^2)U_0)/D_2^2(1+\beta)$$

$$a_4 = (U_P + \beta^2 U_B - (1+\beta)U_0)/D_2^2\beta(1+\beta)$$

$$a_5 = \left[\frac{U_Q}{2L} \left(\frac{1-\beta_5-\beta}{1+\beta} \right) U_P + \left[\frac{1+\beta_5}{\ell(1+\beta)} - \frac{1}{\ell_c} \right] U_B - \left(\frac{1-\beta+\beta_5}{\beta} \right) U_0 \right] / D_1 D_2$$

$$a_5 = (U_5 + U_0 - U_1 - U_4)/D_1 D_2$$

The value of I, J, K, L, D₁ and D₂ are determined by the boundary intersection quadrant. U_R is the fixed boundary point potential and is not relaxed during solution of the equations. The electric fields are:

$$E_r = \frac{\partial u}{\partial r} = a_2 + 2a_3r + a_5z$$

$$E_z = \frac{\partial u}{\partial z} = a_1 + 2a_4z + a_3r$$

For internal (not boundary points or electrode points) points, higher order terms can be included in the expression for E_r and E_z. This will slow down the calculation but might be necessary for very high current beams where significant depression of the potential on axis occurred. Control of this option is selected by the value of CONST(86). The additional terms are:

$$U_{ez} = U + a_6r^3 + (a_7r + a_8z) rz$$

$$E_r = E_r + 3a_6r^2 + 2a_7rz + a_8z^2$$

$$E_z = E_z + a_7r^2 + 2a_8rz$$

For axial points we have, to third order in the potential

$$U = U_0 + a_2z + a_4z^2 + (a_1 + a_3z) r^2 + a_6z^3$$

$$E_r = 2r (a_1 + a_3z)$$

$$\epsilon_z = a_2 + 2a_4z + a_3r^2 + 3a_6z^2$$

Higher order terms may also be included. These additional terms are:

$$u = u + a_5z^2r^2 + a_7r^4$$

$$\epsilon_r = E_r + 2a_5z^2r + 4a_7r^3$$

$$\epsilon_z = E_z + 2a_5r^2z$$

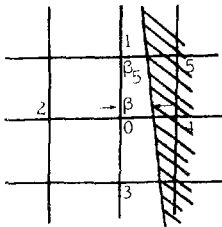
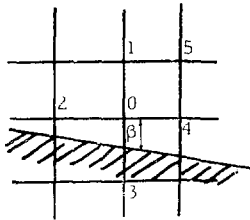
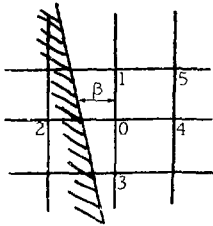
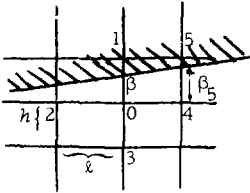

I	J	K	L	M	N	P	Q	a_5	D_1	D_2
1	4	2	3	1	2	3	4	$-^1 a_5$	ℓ	h
2	3	-1	4	2	3	4	1	$^2 a_5$	h	ℓ
1	4	-2	3	3	2	1	4	$^2 a_5$	ℓ	h
2	3	1	4	4	3	2	1	$-^1 a_5$	h	ℓ

BOUNDARY MESH

During processing of the boundary an array is set up specifying if a point is totally interior (i.e., not on the boundary or bordering an electrode, or a boundary point). If a point is interior, then the value of this mesh point is the index ICOEF used to find the finite difference coefficient for solving Poisson's equation. If the point is a boundary point, then three added quantities are masked into this array specifying the type of boundary IB, the index for the potential of the electrode IPOT, and the unit normalized displacement of the boundary β from the central mesh point.

The structure of this MESH () array in the sixty bit word of the CDC computer environment is

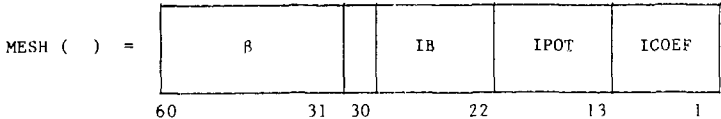

A boundary point is any point, I, whose mesh value, MESH(I), is greater than the maximum value allowed for coefficients, 4095-7777B. However, the array size of 6000 allows only 6000/6=1000 boundary points. The maximum order of mesh points is determined by the size of the U, MESH and RH arrays currently 6000 points.

A Neumann boundary is identified by a zero potential index flag (i.e., bits 13-21). The type of boundary is given by bits 22-29. A Neumann boundary on the axis of cylindrical symmetry is designated as type 003, while a left Neumann boundary is type 002 and a right end Neumann boundary is type 004.

A Dirichlet boundary refers to an electrode, frozen at a potential value given by POT(IPOT) where POT () is an user input array of potentials and IPOT is bits 13-21 of the mesh value associated with the given point.

A table of the mesh array can be printed by use of MAP 1 data input. The distance β of the electrode from the mesh point is stored in the high order 30 bits of the mesh array and can be printed by use of MAP 5 data input. This boundary intersection distance is associated with a given leg of the mesh according to the value of the boundary type, bits 22-29.

Bit 30 is used only during orbit tracking and is normally zero. If, however, bit 30 has been turned on, orbit tracking will terminate for any ray reaching this point.

Representation of the boundary intersection by 30 bits yields results accurate to five significant figures, as shown in table 1. Columns 2 and 3 show the 60 bit value in base 10 and octal while columns 4 and 5 show the effects of truncation of the word to the high order 30 bits.

TABLE 1

ER00001	17 JUN 77	10.33.51
0 1.0E-8 1.0E-7 1.0E-6 1.0E-5 1.0E-4 1.0E-3 .01 .1		
.25 .3333333333333333 .5 .6666666666666666 .75 .9375		
.99 .999 .9999 .99999 .999999 .9999999 .99999999 .999999999		
1.0		
5		
1 0.00000000 0000000000000000000000		0.00000000 0000000000 0000000000
2 .000000001 16655274616704302132		.000000001 1665527461 0000000000
3 .000000010 16706553762465362557		.000000010 1670655376 0000000000
4 .000000100 16744143367501327544		.000000100 1674414336 0000000000
5 .00001000 16775174265421615505		.00001000 1677517426 0000000000
6 .00010000 17026433342726161025		.00010000 1702643334 0000000000
7 .00100000 17064061115645706514		.00100000 1706406111 0000000000
8 .01000000 17115075341217270243		.00999999 1711507534 0000000000
9 .10000000 17146314631463146314		.09999999 1714631463 0000000000
10 .25000000 1716400000000000000000		.25000000 1716400000 0000000000
11 .33333333 17165252525252525251		.33333333 1716525252 0000000000
12 .50000000 17174000000000000000		.50000000 1717400000 0000000000
13 .66666667 17175252525252525251		.66666667 1717525252 0000000000
14 .75000000 1717600000000000000000		.75000000 1717600000 0000000000
15 .93750000 17177400000000000000		.93750000 1717740000 0000000000
16 .99000000 17177727024365605075		.98999786 1717772702 0000000000
17 .99900000 17177773716662132071		.99899673 1717777371 0000000000
18 .99990000 1717777456221642470		.99989789 1717777456 0000000000
19 .99999000 1717777753016451670		.99998876 1717777753 0000000000
20 .99999900 1717777775716204137		.99999619 1717777775 0000000000
21 .99999990 1717777777624500326		.99999619 1717777777 0000000000
22 .99999999 17177777777765206342		.99999619 1717777777 0000000000
23 1.00000000 1720400000000000000000		1.00000000 1720400000 0000000000

The following section now defines the individual mesh star types, their finite difference Poisson equation coefficients and electric field expansion coefficients used in the EBQ code.

The finite difference equations approximating Poisson's equation can be defined in terms of coupling coefficients sampling the potentials of points surrounding the center of the relaxation star.

$$\nabla^2 \phi = \rho$$

becomes

$$C_1 \phi_1 + C_2 \phi_2 + C_3 \phi_3 + C_4 \phi_4 - C_5 \phi_0 - C_6 \rho = 0$$

For regular stars there are no boundary or electrode intersections and the appropriate equations are: $r_0 \neq 0$

$$\nabla^2 \phi = \frac{1}{h^2} \left(1 + \frac{h}{2r_0}\right) \phi_1 + \frac{1}{h^2} \left(1 - \frac{h}{2r_0}\right) \phi_3 + \frac{1}{\ell^2} \phi_2 + \frac{1}{\ell^2} \phi_4 - \left(\frac{2}{h^2} + \frac{2}{\ell^2}\right) \phi_0 = \rho$$

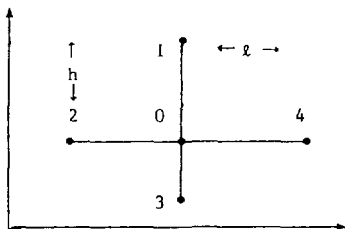

When solving Poisson's equation on the axis we take advantage of the required symmetry and the potential is developed in even powers of r . For regular stars with no electrode intersections the appropriate equation at $r_0 = 0$ is:

$$\nabla^2 \phi = \frac{4}{h^2} \phi_1 + \frac{1}{\ell^2} \phi_2 + \frac{1}{\ell^2} \phi_4 - \left[\frac{4}{h^2} + \frac{2}{\ell^2} \right] \phi_0 = \rho$$

When boundaries or electrodes occur in a mesh star we type them according to the following scheme.

IP > 0

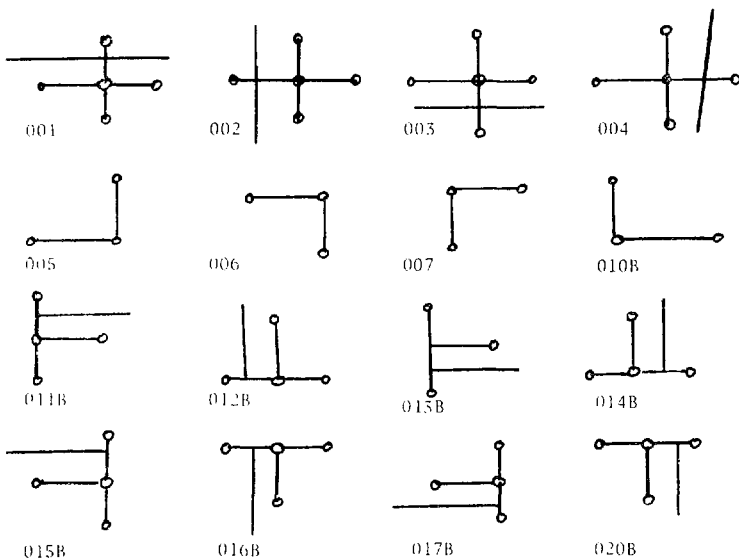

The displacement of the electrode from the central point 0 is defined as the unit normalized beta (β) while the complimented displacement from the relative star mesh point 5 is called β_5 etc.

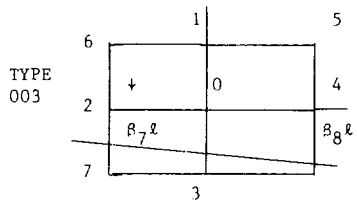
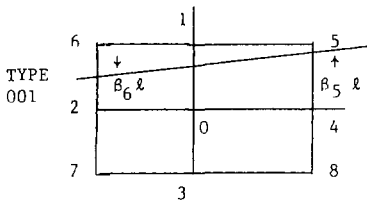
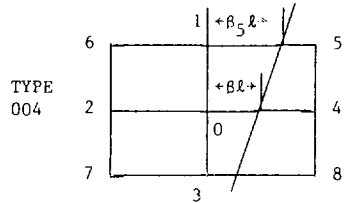
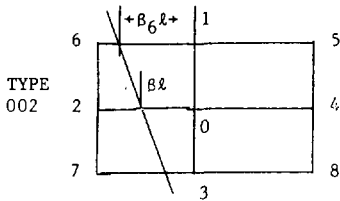

Neumann boundaries occur on the periphery of the problem and are identified by the convention of a zero potential index. Single Neumann boundaries of type 001, 002, 003 and 004 assume reflection about the mesh line upon which the boundary lies. For example, if the right end of the problem is a type 004 Neumann boundary, the potential of the star index 4 is taken as the potential of star index 2, guaranteeing left-right symmetry.

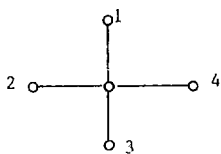

Regular Star

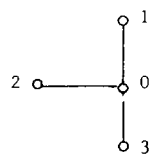

Neumann Star, Type 004

The single Neumann boundary types are

IP=0

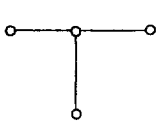

Type 001

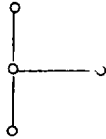

Type 002

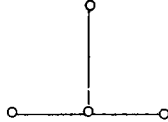

Type 003

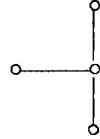

Type 004

Often the corners of a problem define a double Neumann boundary where there is both left-right and up-down reflection symmetry. In this case, the symmetry is guaranteed by replacing the regular star potential values outside the problem by the values inside the problem. The double Neumann boundary types are:

IP=0



005



006

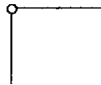

007



010B

POISSON'S EQUATION

Consider the type 001, 002, 003 and 004 irregular stars. The finite difference coupling coefficients now must reflect the electrode displacement distance β from the central point. The boundary or electrode potential will be designated ϕ_b . Then the finite difference approximations are:

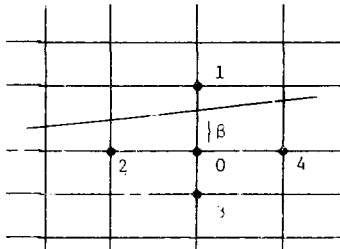

$$0 < \beta < 1$$

$$\begin{aligned} \nabla^2 \phi &= \frac{1}{\beta(1+\beta)h^2} \left[2 + \frac{h}{r} \right] \phi_b + \frac{\phi_2}{\ell^2} + \frac{1}{(1+\beta)h^2} \left[2 - \beta \frac{h}{r} \right] \phi_3 \\ &+ \frac{\phi_4}{\ell^2} - \left[\frac{1}{\beta h^2} \left(2 + (1-\beta) \frac{h}{r} \right) + \frac{2}{\ell^2} \right] \phi_0 \end{aligned}$$

TYPE 002

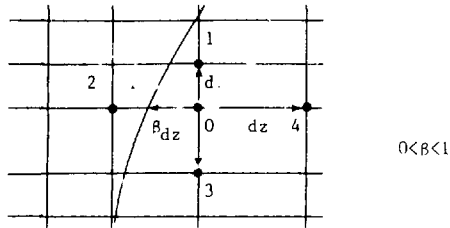

$$\nabla^2 \psi = \phi_1 \left[\frac{1}{r^2} \left(1 + \frac{dr}{2r} \right) \right] + \phi_B \left(\frac{2}{dz^2 (1+\beta)} \right)$$

$$+ \phi_3 \left[\frac{i}{r^2} \left(i - \frac{dr}{2r} \right) \right] + \phi_4 \left[\frac{2}{dz^2 (1+\beta)} \right] - \phi_0 \left[\frac{2}{r^2} + \frac{2}{dz^2 f} \right]$$

TYPE 003

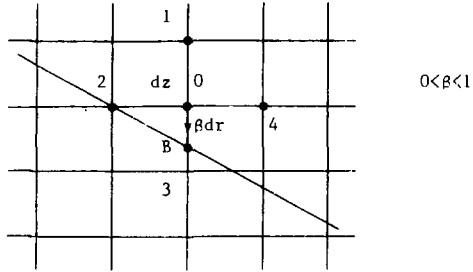

$$\begin{aligned} \nabla^2 \psi = & \psi_1 \left[\frac{2}{dr^2(1+\beta)} \left(1 + \frac{dr}{2r} \beta \right) \right] + \psi_2 \frac{1}{dz^2} + \psi_B \left\{ \frac{2}{dr^2(1+\beta)\beta} \left(1 - \frac{dr}{2r} \right) \right\} \\ & + \frac{1}{dz^2} \psi_4 - \psi_0 \left\{ \frac{2}{dz^2} + \frac{2}{dr^2\beta} \left(1 - \frac{dr}{2r} (1-\beta) \right) \right\} \end{aligned}$$

TYPE 004

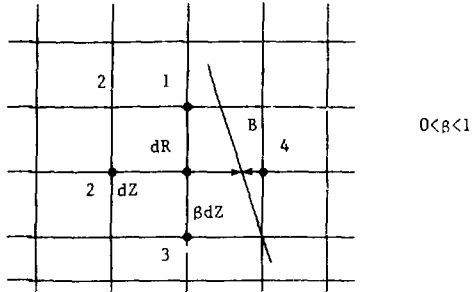

$$\begin{aligned} \sigma^2_{\phi} &= \phi_1 \left[\frac{1}{dr^2} \left(1 + \frac{dr}{2r} \right) \right] + \phi_3 \left[\frac{1}{dr^2} \left(1 - \frac{dr}{2r} \right) \right] + \phi_2 \left[\frac{2}{(1+\beta)dz^2} \right] \\ &+ \phi_B \left[\frac{2}{\beta(1+\beta)} \frac{1}{dz^2} \right] - \phi_0 \left[\frac{2}{dr^2} + \frac{2}{\beta dz^2} \right] \end{aligned}$$

Poisson equation coefficients.

Type 011, 012, 013, and 014

015, 016, 017, and 020

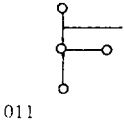

Same as type 001 with

$$C_2 = 0 \text{ and } C_4 = 2C_4$$

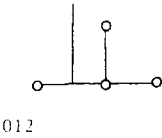

$$C_1 = 4/dr^2 \quad C_4 = 2/dz^2(1+\beta)$$

$$C_2 = C_4/\beta \quad C_5 = 4/dr^2 + \gamma/dz^2\beta$$

$$C_3 = 0$$

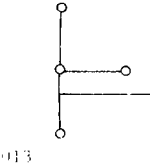

Same as type 003 with $C_2=0$, $C_4=2C_4$

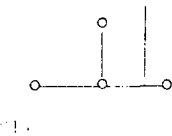

$$C_1 = 4/dr^2 \quad C_4 = C_2/\beta$$

$$C_2 = 2/dz^2(1+\beta) \quad C_5 = 4/dr^2 + 2/dz^2\beta$$

$$C_3 = 0$$

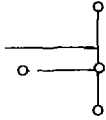

015

Same as type 1 with $C_2=2C_2$, $C_4=0$

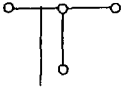

016

Same as type 2 with $C_1=0$, $C_3=2C_3$

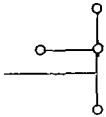

017

Same as type 3 with $C_4=0$, $C_2=2C_2$

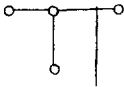

020

Same as type 4 with $C_1=0$, $C_3=2C_3$

When boundary electrodes intersect two legs of a mesh star, they are typed according to the following scheme:

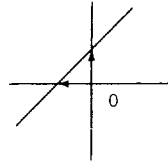
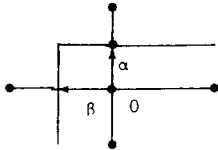

021B

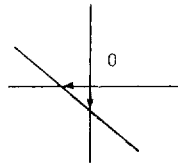
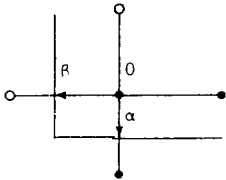

022B

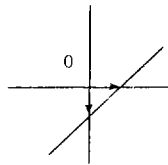
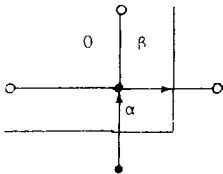

023B

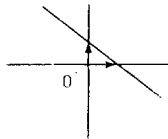
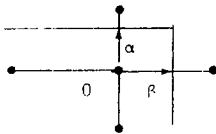

023B

Note that mathematically there is no distinction between the finite difference approximation to Poisson's equation for the inside corners and slant electrodes. These types are 021B-024B as shown above, where α is the unit normalized vertical leg electrode distance and β is the unit normalized horizontal leg electrode distance.

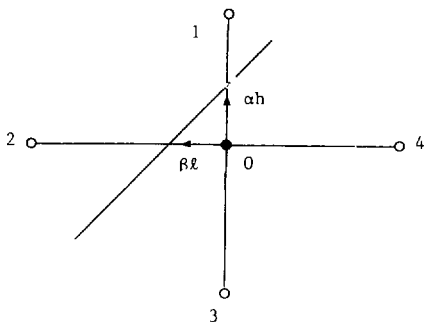
TYPE 021B

$$\begin{aligned} \sigma^2 \phi &= \frac{1}{\alpha(1+\alpha)h^2} \left(2 + \frac{h}{r_0} \right) \phi_B + \frac{2}{\beta(1+\beta)\ell^2} \phi_B + \frac{1}{(1+\alpha)h^2} \left[2 - \frac{\alpha h}{r_0} \right] \phi_3 \\ &+ \frac{2}{(1+\beta)\ell^2} \phi_4 - \left[\frac{1}{\alpha h^2} \left(2 + (1-\alpha) \frac{h}{r_0} \right) + \frac{2}{\beta \ell^2} \right] \phi_0 \end{aligned}$$

TYPE 022B

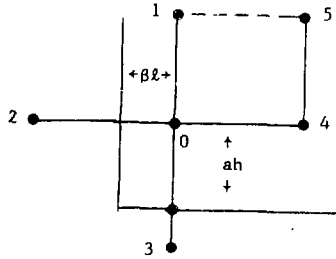

$$\begin{aligned} \nabla^2 \phi &= \frac{1}{h^2(1+\alpha)} \left[2 + \frac{\alpha h}{r_0} \right] \phi_1 + \frac{2}{\beta(1+\beta)\ell^2} \phi_{2B} \\ &+ \frac{1}{h^2(1+\alpha)\alpha} \left(2 - \frac{h}{r_0} \right) \phi_{3B} - \left[\frac{1}{\alpha h^2} \left(2 - (1-\alpha) \frac{h}{r_0} \right) + \frac{2}{\beta \ell^2} \right] \phi_0 \\ &+ \frac{2}{(1+\beta)\ell^2} \phi_4 \end{aligned}$$

TYPE 023B

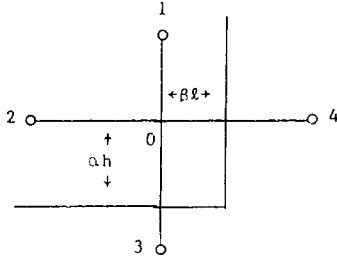

$$v^2 \phi = \frac{1}{(1+\alpha)h^2} \left[2 + \frac{\alpha h}{r_0} \right] \phi_1 + \frac{2}{(1+\beta)\ell^2} \phi_2 + \frac{1}{\alpha(1+\alpha)h^2} \left[2 - \frac{h}{r_0} \right] \phi_B$$

$$+ \frac{2}{\beta(1+\beta)\ell^2} \phi_B - \left[\frac{1}{\alpha h^2} \left(2 - (1-\alpha) \frac{h}{r_0} \right) + \frac{2}{\beta \ell^2} \right] \phi_0$$

TYPE 024B

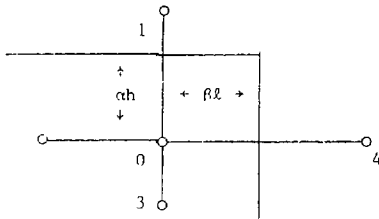

$$v^2 \phi = \frac{1}{\alpha(1+\alpha)h^2} \left[2 + \frac{h}{r_0} \right] \phi_B + \frac{2}{(1+\beta)\ell^2} \phi_2 + \frac{1}{(1+\alpha)h^2} \left[2 - \frac{\alpha h}{r_0} \right] \phi_3$$

$$+ \frac{2}{\beta(1+\beta)\ell^2} \phi_B - \left[\frac{1}{\alpha h^2} \left(2 + (1-\alpha) \frac{h}{r_0} \right) + \frac{2}{\beta \ell^2} \right] \phi_0$$

Several special star mesh definitions are shown below.

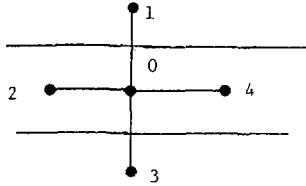

025B

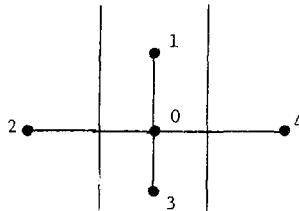

026B

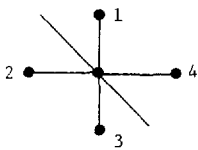

or

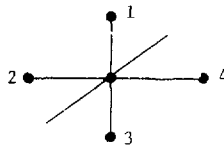

027B

When a boundary electrode intersects three legs of a mesh star, they are typed according to the following scheme:

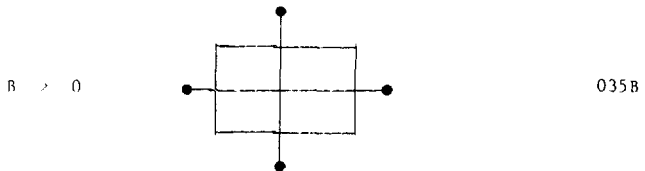
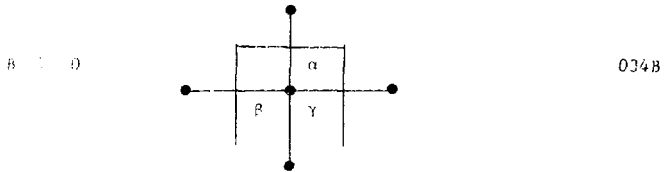
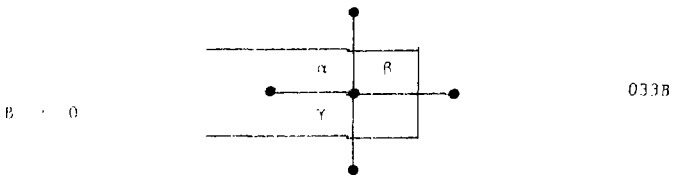
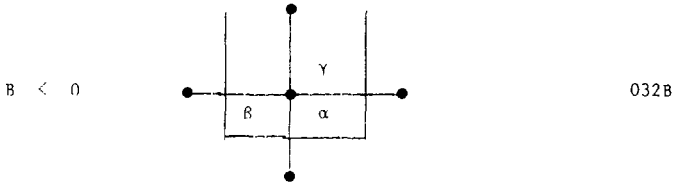
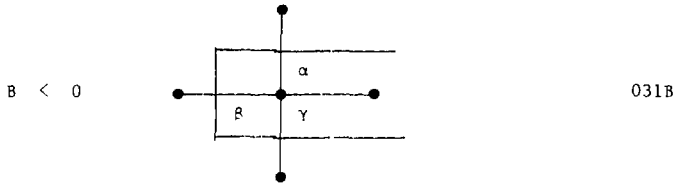

Mesh types 41B-50B define Poisson's equation coefficients and electric field approximations for slant electrodes intersecting the outer problem boundary.

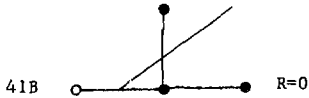

Treat as type 21B with $C_3=0$,
 $C_1=2C_1$

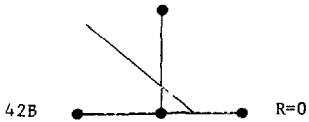

Treat as type 24B with $C_3=0$,
 $C_1=2C_1$

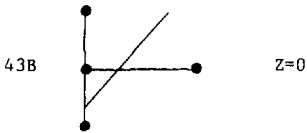

Treat as type 23B with
 $C_2=0$, $C_4=2C_4$

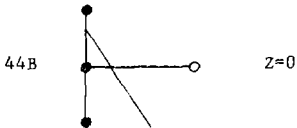

Treat as type 24B with
 $C_2=0$, $C_4=2C_4$

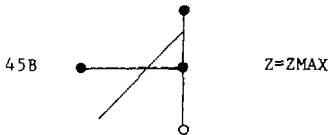

Treat as type 21B with
 $C_4=0$, $C_2=2C_2$

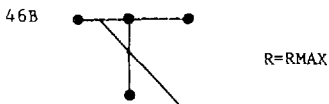

Treat as type 22B with
 $C_1=0$, $C_3=2C_3$

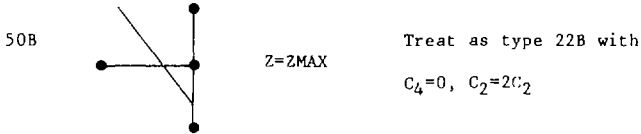
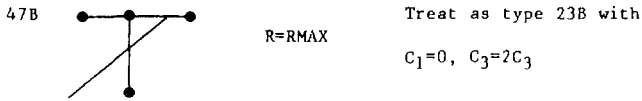

Mesh types 51B-54B define slanted electrodes running along the outer boundary. The Poisson equation coefficients for these types are modified 2, 3, and 4 types.

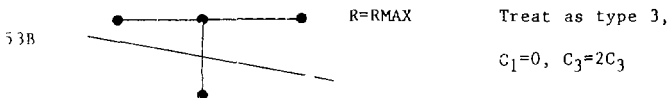
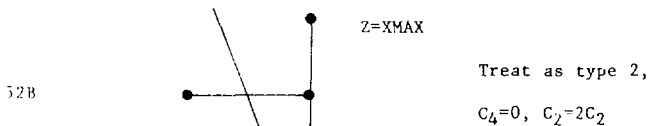
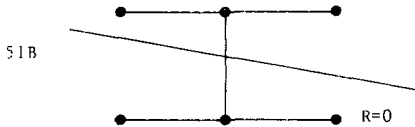

Mesh types 55B-60B define single point electrodes. They are treated as type 001-004 for Poisson's equation and totally interior (non-electrode intersecting) points for the electric field calculation. If a single point is defined with a displacement off the mesh in both r and z, it will be treated by convention as a vertical mesh pair, generating a type 55B and 57B mesh point.

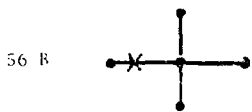
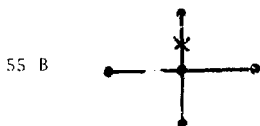

Single point on mesh intersection, set as type 55B.



If $DR > 10^{-5}$, treat as vertical pair. type 55B and 57B.

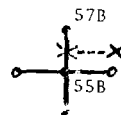

ELECTRIC FIELD COEFFICIENTS

Electric fields are calculated from a power series expansion of Π around the central mesh star located at R_0, Z_0 such that

$$-\frac{1}{2} \text{DRMESH} + R_0 \leq R \leq R_0 + \frac{1}{2} \text{DRMESH}$$

$$-\frac{1}{2} \text{DZMESH} + Z_0 \leq Z \leq Z_0 + \frac{1}{2} \text{DZMESH}$$

Defining $R = R_0 + r$ and $Z = Z_0 + z$, then r and z are small displacements from R_0, Z_0 .

The expansion used depends on the mesh star type. For regular stars, type 0 and interior electrode intersection stars, type 001, 002, 003, 004, 021, 022, 023, and 024, the expansion is

$$u = u_0 + a_1 z + a_2 r + a_3 r^2 + a_4 z^2 + a_5 rz$$

$$E_r = -a_2 + 2a_3 r + a_5 z$$

$$E_z = -a_1 + 2a_4 z + a_5 r$$

The coefficients a_1, a_2, a_3, a_4 and a_5 are given in Table 2.

The equation for a_5 depends in which quadrant of the star the off diagonal term is located.

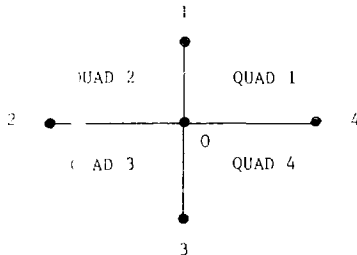

The expansion used for type 011B and 013B stars must be even in powers of z to reflect the left-right symmetry at the left edge and of the problem. Here

$$u = u_0 + a_2 r + a_3 r^2 + (a_4 + a_5 r) z^2$$

$$E_r = a_2 + 2a_3 r + a_5 z^2$$

$$E_z = 2a_4 z + 2a_5 r z$$

The expansion used for type 012B and 014B stars must be even in powers of r , since we are on the axis of rotational symmetry.

$$u = u_0 + a_1 z + a_4 z^2 + (a_3 + a_5 z) r^2$$

$$E_r = 2a_3 r + 2a_5 r z$$

$$E_z = a_1 + 2a_4 z + a_5 r z^2$$

These coefficients a_1, a_2, a_3, a_4 and a_5 are given in Table 3.

Electric field expansions for stars in which an electrode passes through and parallel to mesh points can take advantage of the required symmetry.

For types 001B and 003B we have $\beta = 0$ and $U_0 = U_2 = U_4 = \text{POT}$.

$$u = U_0 + a_1 z + a_2 r + a_3 r^2 + a_4 z^2 + a_5 r z$$

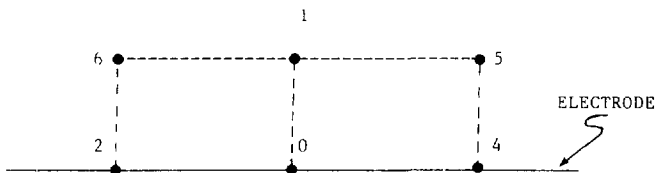

Assuming only a linear r dependence, then $A_3 = 0$. Symmetry requires

$$A_1 = A_4 = 0 \text{ so;}$$

$$a_2 = \frac{u_1 - u_0}{h}$$

$$a_5 = \frac{u_5 - u_6}{2h\ell}$$

$$u = a_0 + a_2 r + a_5 r z$$

$$E_r = a_2 + a_5 z$$

$$E_z = a_5 r$$

For types 002B and 004B we have $\beta = 0$ and $u_1 = u_0 = u_3 = \text{POT.}$

Assuming only a linear z dependence requires $A_4 = 0$, while symmetry demands $A_2 = A_3 = 0$, so;

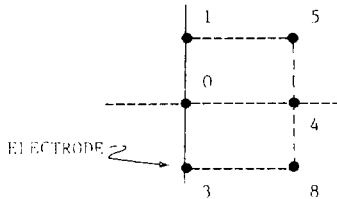

$$a_1 = \frac{u_4 - u_0}{h}$$

$$a_5 = \frac{u_5 - u_6}{2h\ell}$$

$$u = u_0 + a_1 z + a_5 z r$$

$$E_r = a_5 z$$

$$E_z = a_1 + a_5 r$$

Electric field expansions are not necessary for types 015B, 017B, 016B and 020B stars since $R = R_0 + r$, $Z = Z_0 + z$ would lie outside the problem boundary.

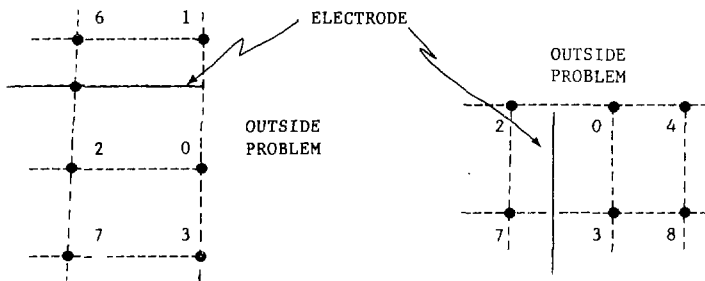

TYPE 015B, 017B

TYPE 016B, 020B

Electric field calculations for types 41B-54B

The electric field calculations for these types of mesh points are approximated by moving to an adjacent interior mesh point, ID, and treating as an expansion about that point in the appropriate displaced quadrant. This somewhat sloppy procedure is justified in that details finer than a mesh cell cannot be accurately modeled and really require a finer mesh.

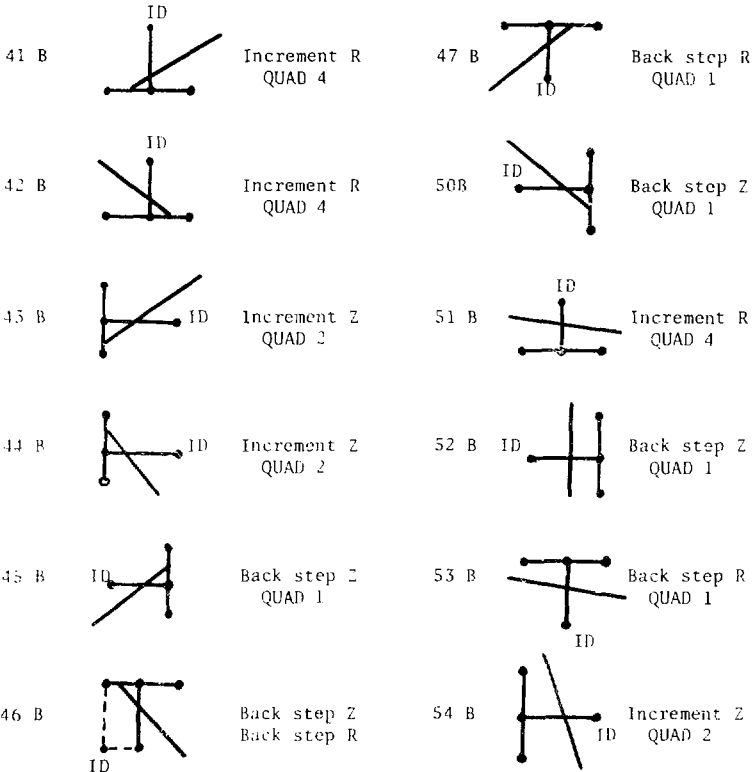

Electric field calculations for mesh types 55B-60B

Electric field expansions for boundary mesh types 55B-60B are approximated by those for mesh types 001-004. The expansions are totally interior, as if the single electrode intersection generating the 55B-60B type were not present. The electrode effects the fields only insofar as it determined the value of the potentials on the adjacent mesh points and therefore effects the calculations through its Poisson equation expansion coefficients.

Equipotential Calculation

Equipotential lines are calculated with the condition that the total derivative of the potential be zero. The initial value of the potential line is specified as input or taken as a tenth increment of the maximum potential of the problem. The axis of symmetry ($r=0$) is searched for a potential U_0 at Z_0 greater than the desired value U_D . The exact axial position z of the potential line U_D is then found as:

$$z = z_0 - \left(\frac{U_0 - U_D}{E_z} \right) ; R = 0$$

where E_z is the longitudinal electric field dU/dz . This linear correction to the starting position of the line is applied iteratively until sufficient accuracy is obtained.

The line is then tracked by advancing R or Z by a predetermined step ds according to the relative size of E_R or E_z .

$$dU = \frac{\partial U}{\partial r} dr + \frac{\partial U}{\partial z} dz = 0$$

$$E_r dr + E_z dz = 0$$

Table 2. Electric field coefficients, types 1-4.

	001	002	003	004
A1	$\frac{U_4 - U_2}{2\ell}$	$\frac{-U_B + U_4^2 + U_0(1 - \beta^2)}{\beta(1 + \beta)\ell}$	$\frac{U_4 - U_2}{2\ell}$	$\frac{U_B - \beta^2 U_2 - (1 - \beta^2)U_0}{\beta(1 + \beta)\ell}$
A2	$\frac{U_B - U_3 \beta^2 - (1 - \beta^2)U_0}{\beta(1 + \beta)h}$	$\frac{U_1 - U_3}{2h}$	$\frac{-U_B + U_1 \beta^2 + (1 - \beta^2)U_0}{\beta(1 + \beta)h}$	$\frac{U_1 - U_3}{2h}$
A3	$\frac{U_B + \beta U_3 - (1 + \beta)U_0}{\beta(1 + \beta)h^2}$	$\frac{U_1 + U_3 - 2U_0}{2h^2}$	$\frac{\beta U_1 + U_B - (1 + \beta)U_0}{\beta(1 + \beta)h^2}$	$\frac{U_1 + U_B - 2U_0}{2h}$
A4	$\frac{U_2 + U_4 - 2U_0}{2\ell^2}$	$\frac{U_B + \beta U_4 - U_0(1 + \beta)}{\beta(1 + \beta)\ell^2}$	$\frac{U_2 + U_4 - 2U_0}{2\ell^2}$	$\frac{\beta U_2 + U_B - (1 + \beta)U_0}{\beta(1 + \beta)\ell^2}$

Table 2. (Continued)

	001	002	003	004
QUAD 1 AS	$\frac{1}{h\tau} \left\{ \frac{1+\beta_5}{\beta_5} - \frac{1}{\beta_5} \right\} u_B$ $+ \frac{\beta-\beta_5}{1+\beta} u_3 - \frac{1+\beta_5-\beta}{\beta} + \frac{1+\beta_5-\beta}{\beta} u_0$	$\frac{1}{h\tau} \left\{ u_1 - u_4 + u_5 + u_0 \right\}$	$\frac{1}{h\tau} \left\{ -u_1 + u_3 - u_4 + u_0 \right\}$	$\frac{1}{h\tau} \left\{ \frac{u_1}{\beta_5} - \left(\frac{1+\beta_5}{\beta(1+\beta)} - \frac{1}{\beta_5} \right) u_B \right.$ $\left. + \frac{\beta-\beta_5}{1+\beta} u_3 + \frac{1+\beta_5-\beta}{\beta} u_0 \right\}$
QUAD 2 AS	$\frac{1}{h\tau} \left\{ \frac{u_2}{\beta_6} + \left(\frac{1+\beta_6}{\beta(1+\beta)} - \frac{1}{\beta_6} \right) u_B \right.$ $\left. - \frac{\beta-\beta_6}{1+\beta} u_3 - \frac{1+\beta_6-\beta}{\beta} u_0 \right\}$	$\frac{1}{h\tau} \left\{ \frac{u_1}{\beta_6} - \frac{1+\beta_6}{1+\beta} u_4 \right.$ $\left. + \left(\frac{1+\beta_6}{\beta(1+\beta)} - \frac{1}{\beta_6} \right) u_B \right.$ $\left. - \frac{1+\beta_6-\beta}{\beta} u_0 \right\}$	$\frac{1}{h\tau} \left\{ u_2 + u_5 + u_1 - u_0 \right\}$	$\frac{1}{h\tau} \left\{ u_1 - u_6 + u_2 - u_0 \right\}$
QUAD 3 AS	$\frac{1}{h\tau} \left\{ -u_3 + u_7 - u_2 + u_0 \right\}$	$\frac{1}{h\tau} \left\{ -\frac{u_3}{\beta_7} + \frac{\beta-\beta_7}{1+\beta} u_4 \right.$ $\left. - \left(\frac{1+\beta_7}{\beta(1+\beta)} - \frac{1}{\beta_7} \right) u_B \right.$ $\left. + \frac{1+\beta_7-\beta}{\beta} u_0 \right\}$	$\frac{1}{h\tau} \left\{ \frac{\beta-\beta_7}{1+\beta} u_1 - \left(\frac{1+\beta_7}{\beta(1+\beta)} - \frac{1}{\beta_7} \right) u_B \right.$ $\left. - \frac{u_2}{\beta_7} + \frac{1+\beta_7-\beta}{\beta} u_0 \right\}$	$\frac{1}{h\tau} \left\{ u_7 - u_3 - u_2 + u_0 \right\}$
QUAD 4 AS	$\frac{1}{h\tau} \left\{ u_3 - u_8 + u_4 - u_0 \right\}$	$\frac{1}{h\tau} \left\{ u_3 - u_8 + u_4 - u_0 \right\}$	$\frac{1}{h\tau} \left\{ \frac{\beta-\beta_8}{1+\beta} u_1 \right.$ $\left. + \left(\frac{1+\beta_8}{\beta(1+\beta)} - \frac{1}{\beta_8} \right) u_B \right.$ $\left. + \frac{u_4}{\beta} - \frac{1+\beta_8-\beta}{\beta} u_0 \right\}$	$\frac{1}{h\tau} \left\{ \frac{u_3}{\beta_8} + \left(\frac{1+\beta_8}{\beta(1+\beta)} - \frac{1}{\beta_8} \right) u_B \right.$ $\left. - \frac{\beta-\beta_8}{1+\beta} u_2 - \frac{1+\beta_8-\beta}{\beta} u_0 \right\}$

Table 3. Electric field coefficients.

	011	012	013	014
A1	0	$\frac{RU_A - U_B + (1-\beta^2)U_0}{\beta(1+\beta)\xi}$	0	$\frac{U_B - \beta^2 U_A - (1-\beta^2)U_0}{\beta(1+\beta)\xi}$
A2	$\frac{U_B - \beta^2 U_3 - (1-\beta^2)U_0}{\beta(1+\beta)h}$	0	$\frac{\beta^2 U_1 - U_B + (1-\beta^2)U_0}{\beta(1+\beta)h}$	0
A3	$\frac{U_B + \beta U_3 - (1+\beta)U_0}{\beta(1+\beta)h}$	$\frac{U_1 - U_0}{h^2}$	$\frac{U_B + \beta U_1 - (1+\beta)U_0}{\beta(1+\beta)h^2}$	$\frac{U_1 - U_0}{h^2}$
A4	$\frac{U_A - U_0}{\xi^2}$	$\frac{U_B + \beta U_A - (1+\beta)U_0}{\beta(1+\beta)\xi^2}$	$\frac{U_A - U_0}{\xi^2}$	$\frac{U_B + \beta U_2 - (1+\beta)U_0}{\beta(1+\beta)\xi^2}$

Table 3. (continued)

<p>A5</p>	$\frac{1}{h^2} \left\{ \frac{U_4}{\beta_5} + \frac{\beta-\beta_5}{1+\beta} U_3 \right. \\ \left. - \left(\frac{1+\beta_5}{\beta(1+\beta)} - \frac{1}{\beta_5} \right) U_B \right. \\ \left. + \frac{1+\beta_5-\beta}{\beta} U_0 \right\}$	$\frac{1}{h^2} \left\{ U_5 - U_1 - U_4 + U_0 \right\}$	$\frac{1}{h^2} \left\{ U_5 - U_4 - U_1 + U_0 \right\}$	$\frac{1}{h^2} \left\{ -\frac{U_1}{\beta_5} + \frac{\beta-\beta_5}{1+\beta} U_2 \right. \\ \left. - \left(\frac{1+\beta_5}{\beta(1+\beta)} - \frac{1}{\beta_5} \right) U_B \right. \\ \left. + \frac{1+\beta_5-\beta}{\beta} U_0 \right\}$
	$\frac{1}{h^2} \left\{ \frac{U_1}{\beta_6} - \frac{\beta-\beta_6}{1+\beta} U_4 \right. \\ \left. + \left(\frac{1+\beta_6}{\beta(1+\beta)} - \frac{1}{\beta_6} \right) U_B - \frac{1+\beta_6-\beta}{\beta} U_0 \right\}$	$\frac{1}{h^2} \left\{ \frac{U_4}{\beta_8} - \frac{\beta-\beta_8}{1+\beta} U_1 \right. \\ \left. + \left(\frac{1+\beta_8}{\beta(1+\beta)} - \frac{1}{\beta_8} \right) U_B \right. \\ \left. - \frac{1+\beta_8-\beta}{\beta} U_0 \right\}$	$\frac{1}{h^2} \left[U_2 - U_6 + U_1 - U_0 \right]$	

Table 4. Electric field coefficients
 α Vertical displacements
 β Horizontal displacements

	021	022	023	024
A1	$\frac{1}{\beta(1+\beta)^2} \left\{ u_{B2} + \beta^2 u_{B4} + (1-\beta^2)u_{\alpha} \right\}$	$\frac{1}{\beta(1+\beta)^2} \left\{ u_{B2} + \beta^2 u_{B4} + (1-\beta^2)u_{\alpha} \right\}$	$\frac{1}{\beta(1+\beta)^2} \left\{ u_{B2} - \beta^2 u_{B4} - (1-\beta^2)u_{\alpha} \right\}$	$\frac{1}{\beta(1+\beta)^2} \left\{ u_{B4} - \beta^2 u_{B2} - (1-\beta^2)u_{\alpha} \right\}$
A2	$\frac{1}{\alpha(1+\alpha)h} \left\{ u_{B1} - \alpha^2 u_{B3} - (1-\alpha^2)u_{\alpha} \right\}$	$\frac{1}{\alpha(1+\alpha)h} \left\{ u_{B3} + \alpha^2 u_{B1} + (1-\alpha^2)u_{\alpha} \right\}$	$\frac{1}{\alpha(1+\alpha)h} \left\{ -u_{B3} + \alpha^2 u_{B1} + (1-\alpha^2)u_{\alpha} \right\}$	$\frac{1}{\alpha(1+\alpha)h} \left\{ u_{B1} - \alpha^2 u_{B3} - (1-\alpha^2)u_{\alpha} \right\}$
A3	$\frac{1}{\alpha(1+\alpha)h^2} \left\{ u_{B1} + \alpha u_{B3} - (1+\alpha)u_{\alpha} \right\}$	$\frac{1}{\alpha(1+\alpha)h^2} \left\{ u_{B3} + \alpha u_{B1} - (1+\alpha)u_{\alpha} \right\}$	$\frac{1}{\alpha(1+\alpha)h^2} \left\{ u_{B3} + \alpha u_{B1} - (1+\alpha)u_{\alpha} \right\}$	$\frac{1}{\alpha(1+\alpha)h^2} \left\{ u_{B1} + \alpha u_{B3} - (1+\alpha)u_{\alpha} \right\}$
A4	$\frac{1}{\beta(1+\beta)^2} \left\{ u_{B2} + \beta u_{B4} - (1+\beta)u_{\alpha} \right\}$	$\frac{1}{\beta(1+\beta)^2} \left\{ u_{B2} + \beta u_{B4} - (1+\beta)u_{\alpha} \right\}$	$-\frac{1}{\beta(1+\beta)^2} \left\{ u_{B4} + \beta u_{B2} - (1+\beta)u_{\alpha} \right\}$	$\frac{1}{\beta(1+\beta)^2} \left\{ u_{B4} + \beta u_{B2} - (1+\beta)u_{\alpha} \right\}$

Table 4. (continued)

	021	022	023	024
A5	$\frac{1}{h^2} \left\{ U_0 \cdot a_1 l + a_2 h \right. \\ \left. + a_3 h^2 + a_4 l^2 - U_8 \right\}$ <p style="text-align: center;">with $h < 0$</p>	$\frac{1}{h^2} \left\{ U_0 + a_1 l + a_2 h \right. \\ \left. + a_3 h^2 + a_4 l^2 - U_5 \right\}$ <p style="text-align: center;">with $h, l > 0$</p>	$\frac{1}{h^2} \left\{ U_0 + a_1 l + a_2 h \right. \\ \left. + a_3 h^2 + a_4 l^2 - U_6 \right\}$ <p style="text-align: center;">with $l < 0$</p>	$\frac{1}{h^2} \left\{ U_0 + a_1 l + a_2 h \right. \\ \left. + a_3 h^2 + a_4 l^2 - U_7 \right\}$ <p style="text-align: center;">with $h, l < 0$</p>

Table 5. Poisson equation coefficients.

	ψ_1	ψ_2	ψ_3	ψ_4	ψ_0
001	$\frac{1}{\beta(1+\beta^2)h^2} \left(2 + \frac{h}{r}\right)$	$\frac{1}{t^2}$	$\frac{1}{(1+\beta)h^2} \left(2 - \beta \frac{h}{r}\right)$	$\frac{1}{t^2}$	$-\frac{1}{\beta h^2} \left[2 + (1-\beta)\frac{h}{r}\right] - \frac{2}{t^2}$
002	$\frac{1}{2h^2} \left(2 + \frac{h}{r}\right)$	$\frac{2}{\beta(1+\beta)t^2}$	$\frac{1}{2h^2} \left(2 - \frac{h}{r}\right)$	$\frac{2}{(1+\beta)t^2}$	$-\frac{2}{h^2} - \frac{2}{\beta t^2}$
003	$\frac{1}{(1+\beta)h^2} \left(2 + \frac{\beta h}{r}\right)$	$\frac{1}{t^2}$	$\frac{1}{\beta(1+\beta)h^2} \left(2 - \frac{h}{r}\right)$	$\frac{1}{t^2}$	$-\frac{1}{\beta h^2} \left[2 - (1-\beta)\frac{h}{r}\right] - \frac{2}{t^2}$
004	$\frac{1}{2h^2} \left(2 + \frac{h}{r}\right)$	$\frac{2}{(1+\beta)t^2}$	$\frac{1}{2h^2} \left(2 - \frac{h}{r}\right)$	$\frac{2}{\beta(1+\beta)t^2}$	$-\frac{2}{h^2} - \frac{2}{\beta t^2}$
021	$\frac{1}{\alpha(1+\alpha)h^2} \left(2 + \frac{h}{r_0}\right)$	$\frac{2}{\beta(1+\beta)t^2}$	$\frac{1}{\alpha(1+\alpha)h^2} \left(2 - \frac{\alpha h}{r_0}\right)$	$\frac{2}{\beta(1+\beta)t^2}$	$-\frac{1}{\alpha h^2} \left[2 + (1-\alpha)\frac{h}{r_0}\right] - \frac{2}{\beta t^2}$
022	$\frac{1}{\alpha(1+\alpha)h^2} \left(2 + \frac{\alpha h}{r_0}\right)$	$\frac{2}{\beta(1+\beta)t^2}$	$\frac{1}{\alpha(1+\alpha)h^2} \left(2 - \frac{\alpha h}{r_0}\right)$	$\frac{2}{\beta(1+\beta)t^2}$	$-\frac{1}{\alpha h^2} \left[2 - (1-\alpha)\frac{h}{r_0}\right] - \frac{2}{\beta t^2}$
023	$\frac{1}{\alpha(1+\alpha)h^2} \left(2 + \frac{\alpha h}{r_0}\right)$	$\frac{2}{\beta(1+\beta)t^2}$	$\frac{1}{\alpha(1+\alpha)h^2} \left(2 - \frac{h}{r_0}\right)$	$\frac{2}{\beta(1+\beta)t^2}$	$-\frac{1}{\alpha h^2} \left[2 - (1-\alpha)\frac{h}{r_0}\right] - \frac{2}{\beta t^2}$
024	$\frac{1}{\alpha(1+\alpha)h^2} \left(2 + \frac{\alpha h}{r_0}\right)$	$\frac{2}{\beta(1+\beta)t^2}$	$\frac{1}{\alpha(1+\alpha)h^2} \left(2 - \frac{\alpha h}{r_0}\right)$	$\frac{2}{\beta(1+\beta)t^2}$	$-\frac{1}{\alpha h^2} \left[2 + (1-\alpha)\frac{h}{r_0}\right] - \frac{2}{\beta t^2}$

When the radial electric field exceeds the longitudinal field,

$$z = z + ds ; \quad r = r - \frac{E_z}{E_r} ds ; \quad E_z < E_r$$

and when the radial electric field is less than the longitudinal field

$$r = r + ds ; \quad z = z - \frac{E_r}{E_z} ds ; \quad E_r < E_z$$

The equipotential line is tracked until it closes on itself, or until it leaves the problem boundary, or until more than 200 points have been found on a given line, or until both E_r and E_z vanish.

These calculations are controlled by the following data elements.

```
CONST (47) = NEQUIP
CONST (48) = DSEQUIP
CONST (49) = PRINT EQUIP LINE
CONST (51) = EQUIP ERROR E
CONST (52) = ITER MAX
PLOT EQUIP S
CONST (76) = R or Z OF !LINE SEARCH
```

NEQUIP specifies how many equipotential lines are to be followed. If zero, no lines will be generated. DSEQUIP is the interval of advancement for R or Z in following the line. The value of R, Z and $U(R,Z)$ will be printed as output if CONST (49) = 1; otherwise, no printed output is generated. The maximum error in the line is given by CONST (51) such that an iterative correction will be applied a maximum of CONST (52) times such that

$$\frac{U - U_i}{U_D} < E$$

A CalComp plot of the lines will appear on any trajectory plots specified by CONST (34) = 11. If no trajectories are calculated, a plot can still be generated by setting CONST (34) = 11 and using the PLOT EQUIP S data card.

The equipotential plots are made by a search along the Z direction at R=CONST (76) if the step, CONST (48), is positive or along the R direction at Z=CONST (76) if the step, CONST (48), is negative.

NORMAL OUTPUT FROM EBQCODE

Each data card encountered is printed into the output stream. After generation of MESH by boundary input, a map of the mesh array giving the index for the coupling coefficients is printed.

After Ray input, a table of the standard values of the RAYS, i.e., N, X, Y, Z, P_x, P_y, P_z, and current is printed followed by a summary table giving the average value of beam energy (ev), current (amps), momentum (ev/c), magnetic rigidity (g-cm), γ and R .

After TRACK input, a table of the current value of the CONST array is printed, followed by the standard orbit output. At the conclusion of ray tracing for each cycle, the longitudinal velocity V_z (cm/sec) of each ray will be printed. If a ray was lost on some aperture, its velocity will be printed as zero. If a ray encountered a stopping flag, bit 30 turned on, its velocity will be printed as -2. If a ray exceeded the allowed energy interval given by CONST (64-65), its velocity will be printed as -3. A map of the potential and charge array is then given.

After END a summary of the number of calls and accumulated CP time in seconds is printed.

Orbit output at a specified z value consists of a table of

RAY	E(ev)	X(cm)	Y(cm)	S(cm)	P _x (ev/c)	P _y (ev/c)	P _z (ev/c)	T(sec)	R(cm)
-----	-------	-------	-------	-------	-----------------------	-----------------------	-----------------------	--------	-------

For each ray traced, orbit output is printed for the initial particle distribution and the final particle distribution. If more than one Poisson-ray trace cycle is performed, then orbit output is generated for the particle distribution at the end of each cycle. Special output can be requested on the last cycle by the following data input:

CONST	19	DZOUT	output particle map every DZOUT cm.
CONST	20	1	output table of fields along with orbit
OUTPUT	Z()	S	output particle map at each given z value
PUNCH	Z()	S	the particle distribution is printed and written to tape 4 at each given z value
FIELD	Z()	S	a map of the electric and magnetic field experienced by each ray is printed for each Z value
PLOT PHASE	Z()	S	a plot of r vs dr/dz is made for each z value
PLOT DENSITY	Z()	S	a plot of ρ vs r is made for each Z value

If detailed output is desired on any intermediate cycle, the continue option on the track card should be used. Consider output at 10, 20, 22.5 cm on the 1st, 7th, and 8th cycles.

TRACK X 1	first iteration with output
TRACK CONTINUE 6	track next 6 cycles, output on last, 7th cycle
TRACK CONTINUE 1	track, 8th cycle

The amount of output generated during orbit integration is determined by the above specified output specifications. If a specified Z value does not fall on a usual RK step interval, the integrator will make a special stop at the required value. When tracking many rays, it is often useful to know the value of certain moments of the particle distribution

CONST *42 dZMOMENT

specifies a calculation of R , R_{rms} , P_r , P_{rms} every dZMOMENT cm along the beam path.

CalComp plots are available for the trajectory profiles of the rays selected by the PLOT TRAJ cards according to the value of CONST (34). CalComp phase plots are available for Z values selected by the PLOT PHASE card according to the value of CONST(37). CalComp plot of the charge density versus r is available for the Z values selected by the PLOT DENSITY card according to the value of CONST (44). If a density plot is desired on a regular interval, then alternatively the interval can be specified by

CONST *45 dZDENSITY

where dZDENSITY is in cm.

CONTROLLING THE VOLUME AND TYPE OF OUTPUT FROM EBO

Print of static fields can be specified in the following ways.

- PRINT FIELDS - Prints fields generated at specified locations B_r , B_z , A_ϕ , E_r , E_z , and U

- MAP 1 - Output map of MESH ARRAY
- MAP 2 - Output electrostatic potential array
- MAP 3 - Output charge density array
- MAP 4 - Output POISSON equation coefficients
- MAP 5 - Output map of boundary-mesh displacements R
- MAP 11 - Output map of BR, BZ fields on a specified grid
- MAP 13 - Output map of vector potential on a specified grid
- MAP 14 - Output map of ER, EZ fields on a specified grid
- MAP 15 - Output map of electrostatic potential on a specified grid

- OUTPUT POISSON - Output potentials at four R, Z locations during convergence of Poisson's equation

- CONST (18) - Poisson output print interval for residual and cycle number

- CONST (28) - COILGEN output giving the value of A_ϕ , B_r , B_z generated during evaluation of the elliptic integral while calculating the value of A_ϕ from the coil geometry.

Orbit output is controlled by the following data types:

- CONST (19) - Orbit print interval
- CONST (20) - Field output with orbit output
- CONST (27) - Diagnostic output ray number
- CONST (42) - Calculate moments for distribution CONST(42) cm.

FIELD Z () S - Output field values for values given in the
parameter list during orbit calculations

OUTPUT Z () S - Output rays for Z values given in the parameter
list during orbit tracking

PRINT RAYS - Output table of the initial values of the rays,
X, Y, Z, Px, Py, Pz.

PRINT CONST - Prints out the values of the CONST () array

PRINT POT - Prints out the electrode potential array

PRINT FIELDS - Prints out the fields on a specified grid

Plotted output is available on the CalComp device and on the printer. This output is controlled by the data summarized in the following list. The data controlling the plotting occurs in the input stream preceding the TRACK command - e.g.,

```
PLOT TRAJ S
PLOT PHASE 2.4 6.7 23.5 S
TRACK
```

The one exception is the PLOT PHASE S data with no z values producing a plot of the final ray data at whatever values are left after termination of the RK integration.

- TRAJECTORIES - PLOT TRAJ N() S
 - PLOT RAY N() S
 - CONST(34) - CalComp TRAJ if value is 10 or 11
 - CONST(35) - CalComp R axis length, inches
 - CONST(36) - CalComp Z axis length, inches
 - CONST(43) - Plot BZ on frame if value is 1.

- PHASE PLOTS - PLOT PHASE Z() S - specifies plot of phase space for Z values given in parameters list
 - CONST(37) - CalComp phase plot if value is 10 or 11
 - CONST(38) - CalComp dR/dZ axis length, inches
 - CONST(39) - CalComp R axis length, inches

- DENSITY PLOTS - CONST(44) - CalComp density profile if value is 10 or 11
Printer plot if value is 1 or 11
 - CONST(45) - DZ interval of plot of density profile

- PLOT DENSITY Z() S - specifies a plot of the charge density profile for Z values given in parameter list.
- PLOT BOUNDARY - CalComp plot of the electrode boundaries
- PLOT EQUIP S - CalComp plot of electrode boundaries and all equipotential lines specified by CONST(47), EQUIP, and PLOT EQUIP data
- PLOT ENERGY S - CalComp plot of the ion energy versus beam radius
- PLOT AMPS S - CalComp plot of the beam current versus beam radius
- PLOT PSI S - CalComp plot of the beam rotational angle ψ versus beam radius
- PLOT JDENSITY Z() S - specifies a plot of the current density profile for the Z values specified.

PHASE PLOTTING

EBQ can generate any one or combination of X-X', Y-Y', and r-r' phase plots according to the value of CONST(57). These phase plots can be produced for the rays which have not hit an electrode or exceed the maximum radius, all at a given Z, or all at a given energy, or all at arriving on a special surface. If more than one ray group has been generated, these plots can be produced separately for each ray group or for all groups together, according to the value of CONST(66).

Rays are eliminated from plotting at a given time when they have previously been lost by exceeding a maximum radial value, CONST(31), or by hitting a boundary region defined as "OUTSIDE". Rays which have not been so eliminated will be plotted at the longitudinal Z values specified on the PLOT PHASE Z() data entry. These phase plots might appear distorted by the space charge depression of the beam energy. CONST(64) and (65) may be set in order to produce a plot of all the rays at a given energy. CONST(64) and (65) specify the minimum and maximum beam energy, such that any ray whose energy falls outside this range is simply no longer integrated. After conclusion of the tracking, a phase plot made will be for values, which are left from the time the rays fell outside the allowed energy range. Consider producing a phase plot at 250 kV.

```
CONST *65 250E3 S
```

```
TRACK BEAM
```

```
PLOT PHASE S
```

Rays can also be plotted at the end of a TRACK by the PLOT PHASE S command when they have terminated by passing a "STOP" flag set in the boundary.

FIELD-FREE DATA INPUT

All data input are read in field-free format. As each card is read it is printed into the output stream. The field-free input may begin in any column of the card. All entries after a \$ are ignored by the program and may be used to place comments on the data cards. An unlimited number of comment cards, beginning with a \$ may be placed anywhere in the data deck. Alpha-numerical blocks are separated by blanks, equal signs, or commas. Numeric blocks consist of numbers or group of numbers which constitute the data input. These numbers may be integers (which will be considered as having unspecified decimal points and as such really be floating point numbers) floating point numbers, or exponential numbers in any mixed order with provision for repetition by use of the repeat specification R. Individual elements of an array may be entered by specifying the array element index preceded by an asterisk and the element value. A second value will be considered to be the next element of the array.

Blank cards in the data stream are ignored. Certain lists of data will be read on as many cards as necessary to satisfy the list or until an "S" is encountered designating the end of the data list. Such data lists are explicitly shown in the detailed description of each data type by specification of the S in the data stream.

Examples of legitimate numbers are:

INTEGERS	-	1,2,25 (interpreted as 1., 2., 25.)
FLOATING POINT	-	3.1456-5.2 .667 -0.0234
EXPONENTIALS	-	2.01E-6 1E8 2.3E+4
REPEATS	-	OR6, 6.75R3, 1.42E-3R4
ARRAY ELEMENTS	-	*7 3.14159 *72 1.0 2.0

DATA INPUT

Data for the EBQ code consists of one or more data cases. Each data case starts with a title cards and ends with an END card. A repeated END card (really a title card for the next case) signals the end of all data and terminates the execution of EBQ.

Between the title card and the END card any number of data entries can be made. These entries begin with a mnemonic name (called the data name or data type), followed by a parameter list, an array of values, or one or more special cards peculiar to the type of data being entered. The data types are:

BOUNDARY	IGNOR	PUNCHB
BSCALE	INITIALIZE	RAYGEN
CALL	LAPLACE	RAYS
CHARGE	LEDGE	REWIND
COILGEN	MAP	RKSTEP
CONST	MESH	SEGMENT
CURRENT	MOMENT	SKIP
DEFINE	OUTPUT	SLOPE
DNFSITY	PAGE	STOP
DUMP	PLOT	TIMEE
END	POISSON	TITLE
ENDTRACK	POLAR	TRACK
EQUIP	POT	UNIT
FIELD	PRINT	WALL
IDRAY	PUNCH	XEQ
		XYZ

Before discussing the input parameter or arrays associated with each of these data types in detail, I should make a few general remarks on the data input conventions that will be used.

- A) If a data type requires a parameter list, this list must appear on the same card as the mnemonic name.
- B) If a data type requires an array input, this array data can appear on the mnemonic name card and/or any number of subsequent cards until an S is encountered in the data stream - e.g.,

```
CONST *10 1.25
      *1 .511E6 *35 11 S
```

or

```
CONST
      *1 .511E6 *10 1.25 *35 11
      S
```

- C) In the detailed discussions to follow on the individual data types, the input of an array requiring a terminator S is written

```
CONST STUF( ) S
```

where the () signifies an array of name STUF and S is the explicit terminator - e.g., CONST 1.1 3.7 3.0 67 S gives the array the following values STUF(1)=1.1, STUF(2)=3.7, STUF(3)=3.0, and STUF(4)=67.

- D) The input of a parameter list is written in this report explicitly giving the list entries. Some data types do not require a parameter list, or some lists are optional. These choices are indicated by repeated data name entries as headings in the text - e.g.,

```
LAPLACE
LAPLACE SWITCH
LAPLACE SWITCH INITIALIZE
```

For the most part, the data input is order independent. There are some obvious exceptions which will be listed below. The general rule is input data types before they are to be used in execution called by some subsequent data entry. The recommended order is

```
TITLE
BOUNDARY
{
CONST
{
RAVS
{
TRACK
END
```

Obviously, if one were to solve Laplace's equation and print a potential map, he should first input his boundary and potentials

```
TITLE
BOUNDARY
{
POT
{
LAPLACE
MAP 2
END
```

COMPUTER FIELD ARRAY LIMITS

Several types of limits are imposed on the size of problems capable of simulation, size of array storage of rays and boundary impose the most severe limits. Additionally, the bit masking procedure used with the MESH array restricts the size of the potential array to 777B (511 decimal) and the size of the coefficient boundary array to 7777B (4095 decimal).

<u>QUANTITY</u>	<u>ARRAY SIZE</u>	<u>COMMON BLOCK</u>
MESH,U,RH	6000	BLANK COMMON
COEF	6000	BLANK COMMON
POT	300	BLANK COMMON
BOUNDARY POINTS	1000	LARGE CORE
XORB,YORB,ZORB PXORB,PYORB,PZORB, ZORB,TORB,CINSIDE	100	RAYS
ZPHASE EQUIPLOT ZDENPLT PUNCH PUNCHB	20	TRAJCC
BC ZONES MAGNETIC COILS IN GENERATION	10	FGRIDCM
APHI	500	JUNK
	6000	BAMAPX
RTRAJ	350	RAYPLTC
ZTRAJ	350	
EQUIP	100	
QLIMIT	100	QLIMIT

EBQ DATA INPUT

BOUNDARY

A boundary is made up of one or more segments defining a closed region inside of which Poisson's equation shall be solved. EBQ automatically generates a Neumann boundary around the outer edge of the problem. Neumann segments (if explicitly specified by the user) should be given first, followed by any Dirichlet segments. A boundary segment is a sequence of points ended by a "S". A point is specified by three numbers, (IPOT, R,Z) giving the potential index for the point and its R,Z coordinate in cm. If IPOT=0 the point is a Neumann point - e.g.,

IPOT R Z-----IPOT R Z S

These points will be connected by straight line segments. IPOT can take several special values:

- IPOT=0 ----- Neumann point.
- IPOT>0 ----- Dirichlet point - POT index.
- IPOT=FIT ----- Following two points will be fit by cubic.
- IPOT=OUTSIDE ----- R, Z point at an exterior point.
- IPOT=INCREMENT ----- IPOTMIN-IPOTMAX, any subsequent IPOT I will be incremented.
- IPOT=I ----- Use incremental IPOT.
- IPOT=S ----- End of line segment.
- IPOT=STOP ----- Followed by normal boundary data IPOT,R,Z...Defines a surface upon which rays will terminate.
- IPOT=REMOVE ----- Followed by normal boundary data-replaces a boundary by internal points.

If a single point is defined, then a test is made for

$$\begin{array}{l} |dr| < 10^{-5} \\ \text{otherwise} \end{array} \quad \begin{array}{c} \bullet \text{---} x \text{---} \bullet \\ | \\ \bullet \\ | \\ X \\ | \\ \bullet \end{array}$$

End of all boundary input is specified by an "3."

```

IPOT R Z ----- S
IPOT R Z ----- S
S

```

The potential array, $\mu(\)$, is initialized to the value of CONST(30), normally zero. IPOT specifies the index of the POT array in which the potential of the boundary is given. The IPOT index is given for the line segment beginning with the specified point--i.e., consider a connected segment specified as:

```

3 0 0 0 10 0 5 10 20 S

```

Potential 3 is associated with the line (0,0) + (10,0) Neumann boundary from (10,0) + (10,20) and potential 5 on the last point (10,20).

If a graded Dirichlet boundary is desired, this can be conveniently implemented by the INCREMENT procedure. Say the points along some line are to be associated with the sequence of potentials 15, 16 ----- 30 defining a fringing field at the end of some problem. The data could be given as:

```

-
-
-
INCREMENT 15 30
-
-
-
I 0 0 30 15. 0 S
-
-
-

```

The IPOT=I will cause IPOT=15 and be incremented by one up to the value of 30 for each subsequent point generated on the line segment.

Currently there is a limit of 6000 points in a problem and 1000 Boundary Points (6000/6). The maximum number of potentials is 100.

The Boundary data consists of at least four cards - the BOUNDARY card, the mesh size card, the line segment card, and ending S card. There can be an unlimited number of line segment cards.

BOUNDARY

```

NR NZ RMIN RMAX ZMIN ZMAX UNIT
}
{      Line segment cards, each segment ending with an S
S

```

RMIN is the minimum radius and must be 0 (zero). RMAX is the maximum radius in cm of the boundary. ZMIN and ZMAX are the longitudinal extent of the problem in cm. A mesh will be generated with NR X NZ points.

The mesh size is:

$$dR = \frac{RMAX}{NR-1}$$

$$dZ = \frac{ZMAX-ZMIN}{NZ-1}$$

The boundary points are processed in the order they are encountered in the data stream. A point will be redefined by a subsequent input point with a line segment. For this reason it is necessary that Neumann boundaries be processed first, followed by Dirichlet segments. The segments can be defined in any direction, any order, and do not have to be continuous or sequential. Electrodes can be defined. However, a continuous outer Neumann boundary will automatically generate a continuous processing of the user specified boundary segments.

If a seventh parameter is included in the second column of the boundary data, it will multiply all distances during input to convert from the data units to the EBQ distance unit of centimeters.

BOUNDARY X NOINIT

When the BOUNDARY data card has a third parameter, the charge and potential arrays U() and RH() will not be generated. Only the MESH() array will be generated by the boundary processing. This is useful when the charge and potential arrays are close to a solution left by some previous case, but several mesh modifications are required to be made.

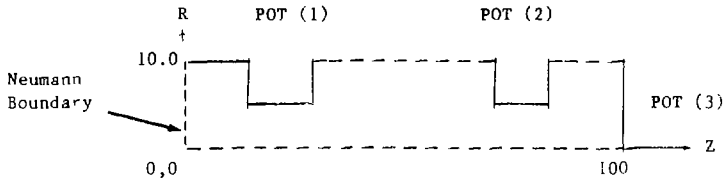

BOUNDARY

```

11 101 0 10. 0. 100 $ 1CMX 1CM grid
 1 R Z 1 R Z-----S $ Electrode, POT(1)
 2 R Z 2 R Z-----S $ Electrode, POT(2)
 3 0 100. 3 10. 100. S $ Electrode, POT(3)
; $ END all Boundary data

```

Note that in this example, the Neumann boundary is a rectangle around the problem defined by the code before processing the specified Dirichlet (electrode) points on the outer periphery.

When IPOT = the literal FIT, three points will be taken to find the radius and center of a circle. The section of the circle connecting the points will be used to generate the boundary.

```

BOUNDARY
-
-
FIT i1 r1 z1 i2 r2 z2 i3 r3 z3 . . . S
-
-

```

The points 1, 2, and 3 will be fitted. EBQ will print the radius and center of the circle it used, R, r_0, z_0

```

BOUNDARY
-
-
..... i1 r1 z1 FIT i2 r2 z2 i3 r3 z3 ... S
-
-
    
```

Here, FIT appears inside the boundary card, not the first entry, but will still fit points 1, 2 and 3 where point 1 is the point preceding the FIT.

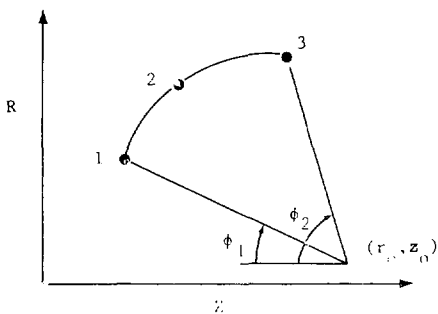

If one is inputting a circle, use diametrically opposite points, with the first and last point the same.

For example, --- 5 5 8 FIT 5 9 8 5 5 8 --- would produce the result

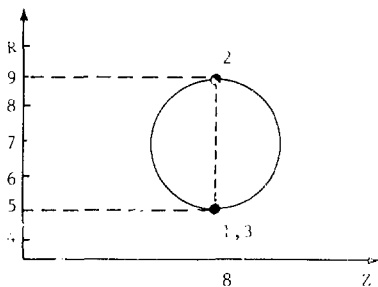

Alternatively, the fitting can be done by specification of the center and radius of the circle to be used. This is done by use of the FIT CURVE data.

--- i_1 r_1 z_1 FIT CURVE I R_o Z_o A PHI_1 PHI_2 ---

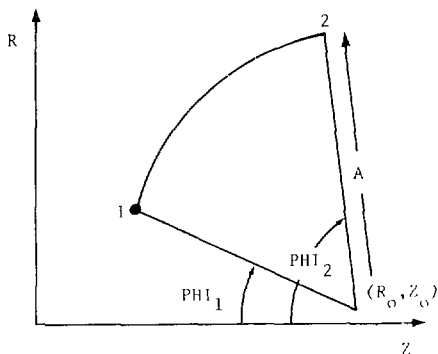

OUTSIDE RC ZC I_1 R_1 Z_1 ---- I_N R_N Z_N S

OUTSIDE data defines a simply connected closed Dirichlet region, inside of which all MESH() types are zero. The effect is to prevent solution of Poisson's equation and ray tracing in these areas. RC, ZC defines a point inside the closed region used for determining which side of the boundary is outside. This test can be ambiguous if the region is too complicated. For each line segment making up the region, one of the following two tests are performed depending on if the line segment is being followed by incrementing R or Z (more vertical or more horizontal).

HORIZONTAL:

$$R = R_N + \left(\frac{R_{N+1} - R_N}{Z_{N+1} - Z_N} \right) (Z_C - Z_N)$$

"outside" is above line segment if $R < RC$

VERTICAL:

$$Z = Z_N + \left(\frac{Z_{N+1} - Z_N}{R_{N+1} - R_N} \right) (RC - R_N)$$

"outside" is to right of line segment if $Z < ZC$.

Consider the slit shown below, designated electrode 3, which is to restrict beam flow from the cathode - extractor electrodes 1 and 2.

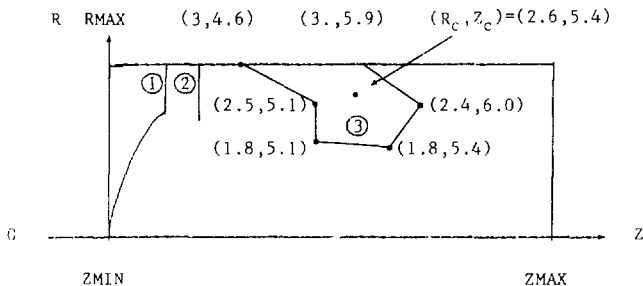

The data specification for this case would be:

```

BOUNDARY
NR  NZ  0  RMAX  ZMIN  ZMAX
1  0  0  -----  S          $ CATHODE
2  -----  S          $ EXTRACTOR
OUTSIDE  2.6  5.4  3  3.0  4.6  3  2.5  5.1  3  1.8  5.1
         3  1.8  5.4  3  2.4  6.0  3  3.0  5.9  3  3.0  4.6  S
S

```

The potential of the region outside the problem boundary can be optionally specified by giving either the potential value or the potential index from which the potential will be taken. In this case, the data following the "OUTSIDE" is either "I" or "U" and the value, followed by the value of R,Z pointing outside.

```

OUTSIDE R Z          $ NOT SETTING POTENTIAL AT R,Z
OUTSIDE I IPOT R Z   $ U(OUTSIDE) = POT(IPOT)
OUTSIDE U POT R Z    $ U(OUTSIDE) = POT

```

See example 4.

```

STOP  I1  R1  Z1  -----  IN  RN  ZN  S

```

A boundary segment starting with STOP defines a segment which will stop individual rays, whereas the same segment data not preceded by STOP is transparent to the rays. When I_1 is non-zero, an internal Dirichlet boundary will be defined in the usual way with bit 30 on. It is the unit value of bit 30 which the tracking routine tests to determine the transparency of the mesh. If I_1 is zero, the boundary segment will be followed turning bit 30 on without defining an actual boundary - i.e., leaving the Poisson coefficients set as interior points.

A STOP boundary will not be normally plotted. If it is desired for the boundary to be plotted along with the other normal boundaries, STOP must be followed by PLOT, i.e.,

```

                STOP PLOT I1 R1 Z1 ----- S
REMOVE I1 R1 Z1 ----- IN RN ZN S

```

A boundary segment can be removed by preceding the identical data which defined it in the first place by REMOVE. This procedure restores these boundary points to interior points.

```

REMOVE STOP I1 R1 Z1 ---- ----- IN RN ZN S

```

Preceding a boundary segment data string by REMOVE STOP allows the segment turning off bit 30 to restore transparency to the mesh for this segment.

BOUNDARY MODIFY

An existing problem boundary can be modified. This option prevents initializing the boundary and allows addition of electrodes or definition of "OUTSIDE" regions. This is useful when desiring to stop particles on an equipotential surface for phase plotting, when a solution to the whole problem must be obtained so space charge depression is properly evaluated. Then an "OUTSIDE" region can be inserted or a STOP segment defined to stop rays on the equipotential. The boundary modify data consists only of the boundary segments which constitute changes to be made -- e.g.,

```

BOUNDARY MODIFY
STOP 0 R1 Z1 0 R2 Z2 ----- S
OUTSIDE RX ZX
      I1 R1 Z1 I2 R2 Z2 ----- S
S

```

BOUNDARY MODIFY ALL

This option requires the input of the full boundary data set just as if a new problem was being defined, however, it doesn't initialize or redefine anything but the boundary data. This is useful when studying small perturbations in electrode structure.

BSCALE SCALE

Multiples vector potential array used for generation of external magnetic fields by Scale -- i.e., if IRBFLED *IZBFLDI=N and NCOILS≠0, then

$$A(I) = A\phi(I) * SCALE$$

for I = 1 to N.

The Scale value is referenced to the original value of A ϕ when generated. If a run is made at .9 of the original value, then a subsequent run at 0.8 of the original value would use BSCALE 0.8. The actual scaling is done by a call to FLDINIT generated by a TRACK, MAP, or XEQ card. B_r and B_z are calculated by differentiation of the vector potential.

Their values can be printed by

PRINT FIELDS

or

MAP 13, 14

R1 R2 DR Z1 Z2 DZ

A profile can be given to the vector potential by providing input of the form of a power series expansion for the scale factor.

BSCALE A B C D E

where the scale factor use by EBQ is calculated as

$$SCALE(Z) = A + B\left(\frac{Z-ZMIN}{L}\right) + C\left(\frac{Z-ZMIN}{L}\right)^2 + D\left(\frac{Z-ZMIN}{L}\right)^3 + E\left(\frac{Z-ZMIN}{L}\right)^4$$

Z is the longitudinal position and L=ZMAX-ZMIN.

CALL NAME

See Define.

CHARGE TYPE MAXRQ SCALE ADD DZSTEP ZQ1 ZQ2

RH() S

CHARGE LIMIT LQSKIP QSCALE

QLIMIT() S

The charge array RH() is initiated to zero, at the beginning of processing Boundary data. RH can be set initially by a read from a Tape 8 Dump or by the CHARGE data entry.

TYPE = 1 Input directly RH() ascending R, then Z, maximum of 3000 points.

RMAX

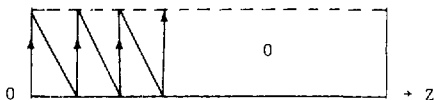

TYPE = 2 Input RH() ascending Z, then R, maximum 3000 points
R cut off is MAXRQ rows

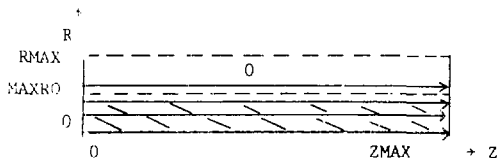

where RMAX, ZMAX are the values defined by the boundary grid mesh data. The potential produced by this charge array may be found by executing the POISSON data card. The RH() array is literally the right hand side of Poisson's equation and has units of volts/cm². This is related to the charge density in Coulombs/cm³ by:

$$RH = \frac{Q}{\epsilon_0} 100$$

where $\epsilon_0 \approx 8.854 \times 10^{-12}$ farads/m.

The longitudinal (Z) extent for the charge input is ZMIN - ZMAX. If the seventh and eighth parameters, ZQ1 and ZQ2, are given, then the longitudinal extent of the charge input is over the restricted range ZQ1 to ZQ2.

The values of the input array are multiplied by scale. If the fifth parameter is the Literal "ADD," then the charge is added to the charge array without initialization to zero.

TYPE = 3 Input initial charge density load based on uniform current density, beam profile and longitudinal beam energy

CHARGE 3 J SCALE ADD DZSTEP ZQ1 ZQ2

R() S \$ radius in cm

E() S \$ energy in ev

This input is used to start problems in the extreme space charge limit where the self-magnetic and electric fields cannot be neglected on the first cycle or fudged by the CONST(3), CONST(4) scale factors.

CHARGE 3 input will deposit charge according to a specified uniform current density J and a beam envelope radial profile R() for a beam whose energy E() varies along the Z direction. J is in amperes/cm², R() in cm, and E() in electron volts. The right hand side of Poisson's equation is then initialized as:

$$RH() = \frac{J_o R_o^2}{\epsilon_o c} \frac{E_o + E}{R^2 \sqrt{E^2 + 2E_o E}}$$

where c is the velocity of light, $\epsilon_o = 8.845 \times 10^{-14}$ f/cm; R_o the beam radius, E_o the beam particle rest mass and $RH()$ the charge density in volts/cm². Charge load assumes the beam energy has only a longitudinal variation, neglecting the space charge depression, but does take into account the charge density variation produced by a radial modulation of the beam profile.

If the DZSTEP is zero, then the initial charge array is specified on an irregular Z interval and a third array list must be included.

CHARGE 3 J Scale ADD 0

R() S \$ radius in cm

E() S \$ energy in ev

Z() S \$ longitudinal position in cm

If SCALE is non-zero for CHARGE 3 data, it will multiply the energy array making the units arbitrary; e.g., if the beam energy is in MeV, then SCALE = 1.0E6 and the E array is the energy in MeV.

CHARGE INITIALIZE

This data command causes the initialization of the charge array $RH()$ setting it to zero over the entire problem size.

CHARGE LIMIT LQSKIP QSCALE

QLIMIT() S

This data inputs an array QLIMIT() specifying the maximum charge density that will be allowed in the RH() array. The values of QLIMIT give the maximum charge density allowable along the z axis in volts/cm². The input can be scaled by the value of QSCALE if non-zero. Before solving Poisson equation each radial position of the RH(R,Z) array will be checked against the value of QLIMIT(Z) and any value of the RH array exceeding this limiting value will be constrained. The charge density at this point will be set to half the the limit value and half the excess charge density will be spread uniformly between the axis and this location, the other half of the excess charge density will be uniformly deposited on the next N = CONST(77) radial mesh points. If the radius corresponds to a radial mesh point less than M = CONST (78), then the excess charge density will only be deposited outward from the axis on the next N mesh points.

LQSKIP is normally 1 so there is a one to one correspondence between the longitudinal axis z and the values in the QLIMIT array. If LQSKIP has the value 2, then each QLIMIT point will be used for two z points in the RH array, and if LQSKIP has the value 3, then the points in the QLIMIT array will be used for three RH array points, etc. A maximum of 100 points can be specified in the QLIMIT array.

This procedure is turned on by setting $CONST(77) = N$, the number of radial positions over which the charge should be outwardly spread, and turned off by setting $CONST(77) = 0$, or by the data:

CHARGE LIMIT 0 0

with no input of the $QLIMIT()$ array. If no charge limit data has been included in the data deck, but $CONST(77)$ is greater than zero, then this value will be used everywhere as the limiting charge density in volts/cm². Any excess charge will simply be ignored, i.e., will be discarded.

COILGEN TYPE BLEFT BRIGHT RBMAX NZONES NREPEAT UNIT BZCUTOFF

The magnetic field from external coils can be given by directly reading a map of the A_ϕ component of the vector potential in gauss-cm or by reading the positions and currents of ideal, centered circular loops from which the vector potential will be calculated. During ray tracking, the vector potential is differentiated to obtain the values of B_r and B_z . A maximum of 6000 mesh points may be used in the vector potential array which can cover a region of space different from that covered by the electrostatic boundary region. The value of $A_\phi(R,Z)$ is initialized to zero before processing the COILGEN data if the value of CONST(75) is zero. The elements of the CONST array which affect the COILGEN data are elements 28, 43, 70 and 75.

The COILGEN data parameters are interpreted as follows:

- | | |
|------|--|
| TYPE | -1 Turns magnetic field back on after it has been disabled by TYPE 0. |
| | 0 Turns off external magnetic field. |
| | 1 input individual coils specifying z, r, I per card for each coil |
| | 2 Coil generator, specify grid of R,Z values for conductors at points of grid R1, R2, DR, Z1, Z2, DZ. Maximum of 500 coils per COILGEN data set. |
| | 3 input Z array values, R array values and current array values for the coils. |
| | 4 Constant BZ values of BLEFT, BRIGHT with $B_r=0$. |
| | 5 Read directly the A_ϕ array. This input must be terminated by an "S". |

6 Calls the coil generator for conducting loops with excitation in ampere-turns and data input of arrays of RMINS(), RMAXS(), ZS(), NRS(), and NZS().

9 Read directly the A_ϕ array from tape 9 in field free formatted form. This data must be terminated by an "S".

BLEFT B_z value for $Z < Z_{BMIN}$, B_r taken as zero.

BRIGHT B_z value for $Z > Z_{BMAX}$, B_r taken as zero.

RBMAX maximum radius of calculation of the external magnetic fields. If not specified, RMAX from the boundary is used.

NZONES number of field zones.

NREPEAT number of repeats of field zones.

UNIT If non-zero, multiplies the distances of the COILGEN data input to convert them to cm.

BZCUTOFF Calculation of $A_\phi(R,Z)$ will be terminated for a coil loop for which B_z at $R=0$ is less than this cutoff value in Gauss.

MAGNETIC FIELD ZONES

The magnetic field map must be divided into several zones if strong field changes occur. Consider a long solenoid lens whose B_z field along $R=0$ is as shown:

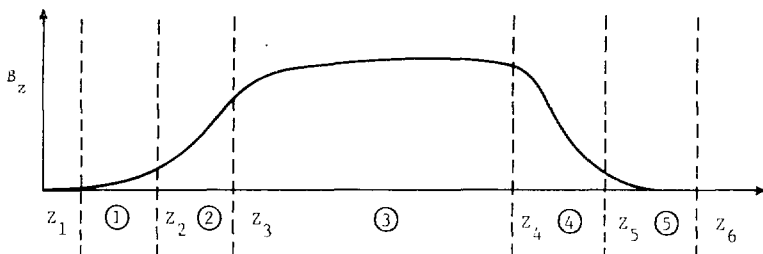

A zone of finer mesh should be used in the fringing field regions between Z_2 and Z_3 , and between Z_4 and Z_5 . This is accomplished by a division of the map into five zones as shown. The field grid card is now expanded to give an array of Z values, an array of DR values, and an array of DZ values.

```

COILGEN TYPE B1 B2 RBMAX 5 0
Z1 Z2 Z3 Z4 Z5 Z6
  DR1 DR2 --- DR5
  DZ1 DZ2 --- DZ5
Scales S
  {coil data

```

Z_{MIN} is taken as Z_1 and Z_{MAX} is taken as Z_6 . The Z , DR , and DZ values may appear on one or as many cards as desired. The total number of mesh points generated is:

$$N = \sum_{j=1}^{\dots} \left[\frac{Z_{j+1} - Z_j}{dZ_j} + 3 \right] \left[\frac{RBMAX}{dR_j} + 2 \right]$$

CARDS FOLLOWING COILGEN CARD:

When $3 \geq \text{TYPE} \geq 1$ several cards follow the COILGEN card. These specify the magnetic field grid and scale factors, followed by the coil or vector potential data. Consider the simple coil data with NZONES=0.

COILGEN TYPE B1 B2 RBMAX 0 0

ZBMIN ZBMAX DR DZ

SCALES S

Coil Data

A vector potential map will be generated by the coil data extending from $ZBMIN-dZ \leq Z \leq ZBMAX+dZ$ and $0 \leq R \leq RBMAX+dr$. The cell size of this map is specified by DR, DZ in cm. A fictitious boundary is taken around the map - i.e., the vector potential is calculated and stored for one dz mesh line to the left and right of ZBMIN, ZBMAX and one dR mesh line above RBMAX. Magnetic field values are only calculated, however, within the real specified map values (0,RBMAX) (ZBMIN--ZBMAX)

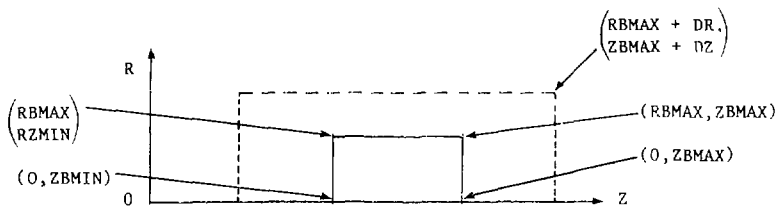

outside this map, the field values are taken as $B_r=0$, and $B_z=B_1$,
 $Z < Z_{BMIN}$ or $B_z=B_2$, $Z > Z_{BMAX}$.

REPETITION OF ZONES

Magnetic field zones can be considered to slide along the Z axis in the sense that when Z is larger than ZBMAX, the zones are moved such that ZBMIN is now at the previous ZBMAX value. Consider three identical short solenoids as shown:

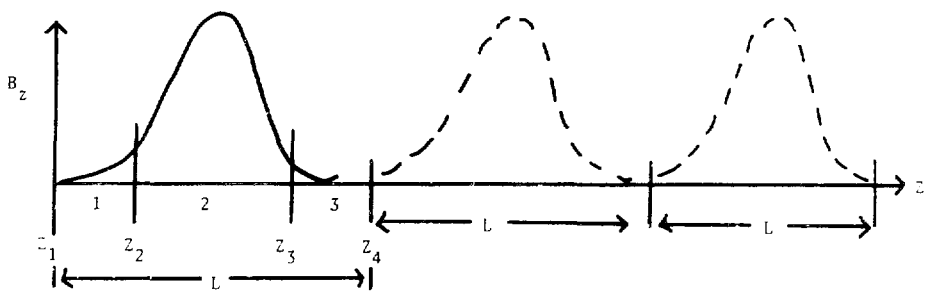

COILGEN TYPE B1 B2 RBMAX 3 3

Z1 Z2 Z3 Z4 dR₁ dr₂ dR₃ dZ₁ dZ₂ dZ₃

SCALES S

coil data

COIL DATA

When coils are specified, their R, Z values are in cm and their current is in amperes.

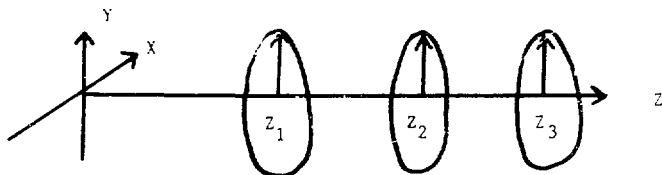

The number of COILS is given by the number of scale values read for type 1 and 3 input, and the number of COIL GROUPS is given by the number of scale values read for type 2 input with the number of coils in each group determined by the coil generator.

Consider 3 coils of 100, 250 and 100 amps then the scale and coil cards for type 1 data would be:

100.	250.	100.	S
Z1	R1	1.	
Z2	R2	1.	
Z3	R3	1.	

or alternatively

1k3	S	
Z1	R1	100.
Z2	R2	250.
Z3	R3	100.

Note, the current is the product of the scale value for each coil and the coil current.

TYPE=2 coil data generates a loop for each point of the given grid. The scale values are really the coil currents given for the grid:

```
CURRENTS ----- S
RMIN RMAX dR ZMIN ZMAX dZ
•
•
•
•
•
```

TYPE=3 coil data specifies the Z, R, and I arrays and is useful when all coils have, say, the same R, and I values--e.g., consider seven 10 cm radius, 563.2 amp coils at Z1---Z7. Input

```
1.0R7 S
Z1 Z2 ----- Z7
10R7
563.2R7
```

TYPE=4 input specifies only a constant BZ value with BR=0 everywhere. Only three entries are required and no other cards of the COILGEN set can be used.

```
COILGEN 4 BZ 0 0 0 0
```

TYPE=5 input specifies input of the vector potential directly at mesh points compatible with the specifications on the COILGEN and subsequent data cards. The input would be:

```
COILGEN 5 BLEFT BRIGHT RBMAX
ZBMIN ZBMAX DR DZ
Scale S
Aφ( )
S
```

Note, the $A\phi()$ array data must be terminated by an "S" and specifies the vector potential component in ascending R, then ascending Z. This array of numbers extend from ZBMIN-DZ to ZBMAX+DZ in the radial range from 0 to RMAX+DR to cover the phantom edge shown in the field map, page 100. The scale data is also terminated by an "S" and consists of a single number, which will multiply the $A\phi()$ data when non-zero or non-unity.

COILGEN 9

Same as COILGEN 5 except data is read from tape 9. The data consists of the COILGEN 9 card, grid card, scale card, and then as many cards as necessary to input the field.

Type 6 input specifies input for the coil generator in the format shown below. This data generates COILGEN 2 data which is used to calculate the vector potential magnetic field array.

```
COILGEN 6 ...
ZMIN ZMAX DR DZ
AMPTURNS( ) S          $ N ENTRIES, MAX OF 100
RMINS( )              $ N
RMAXS( )              $ N
ZS( )                 $ 2N ENTRIES
NRS( )                $ N
NZS( )                $ N
```

The first data array gives the ampere-turns of the coil set and must end with the "S" terminator. The next three arrays give the coil cross-section dimensions in cm. The ZS() array give the longitudinal position of the start and end of each coil cross section in turn. The NRS() and NZS() arrays specify the number of R and Z layers into which each coil will be divided. Consider the diagram below, the data might be:

```

COILGEN 6 0 0 7
0 150 1 2.5
1000 1500 4250 S
6.5R2 5
8R2 6.0
30 40 44 60 70 120
2 3 1
3 4 5

```

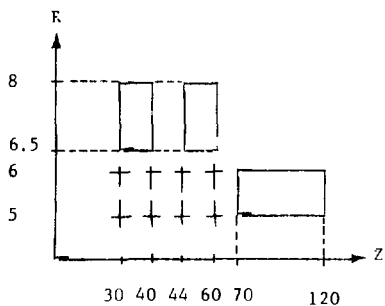

The coil cross sections are replaced by circular loops as shown in the second part of the diagram.

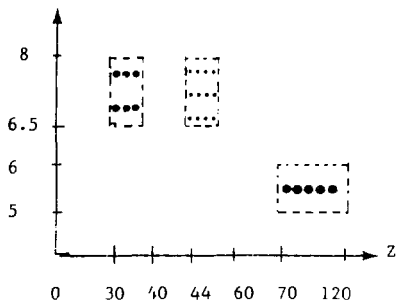

In cartesian geometry, only a constant B_y field can be used

COILGEN 4

CONST LIST () S

An array of parameters whose elements have the meaning shown in the table can be set via the CONST data entry. The input is field-free and only those elements whose value are to be altered from the default value need be given. To change the 18th and 19th value:

```
CONST *18 20 25 S
```

or

```
CONST *18 20 25  
S
```

etc.

The current values of the CONST () array are printed to the output file on execution of a TRACK or PRINT CONST data entry.

Summary table of EBQ CONST() array with default values.

CONST(1)=REST MASS IN ELECTRON VOLTS	0.511E6
CONST(2)=CHARGE	-1.0
CONST(3)=GAUSS LAW SPACE CHARGE FACTOR, 1ST CYCLE	1.
CONST(4)=SELF BPHI FIELD FACTOR 1-ST CYCLE ONLY	1.
CONST(5)=C VELOCITY OF LIGHT IN CM/SEC	2.998E10
CONST(6)=EQMB	-299.7921
CONST(7)=EQMEE	-1.
CONST(8)=1/EPILON =1/8.854E-12 FARADS/METER	1.1294E11
CONST(9)=0 RAY INPUT IS Z WITH S=0, OTHERWISE S WITH Z=CONST(9)	
CONST(10)=RUNGA KUTTA INTEGRATION STEP CM	DZMESH
CONST(11)=RAD	.0174529
CONST(12)=PI	3.14159
CONST(13)=DATA ANGLE INPUT RAD(1) .01745(DEG)	1.
CONST(14)=BEAM LINE GRAPH INTERVAL IZSKIP (0 NO GRAPH)	1
CONST(15)=OMEGA POISSON OVER-RELACATION FACTOR	1.8
CONST(16)=EPS MAXIMUM POISSON CHANGE IN VOLTS	1E-5(PMAX-MIN)
CONST(17)=MAXIMUM NUMBER OF POISSON ITERATIONS	200
CONST(18)=POISSON PRINT INTERVAL	10
CONST(19)=ORBIT OUTPUT STEP CM	ZMAX
CONST(20)=FIELD OUTPUT ON TRAJ 1, NO OUTPUT IF 0	0
CONST(21)=MAX NUMBER OF RAY TRACE CYCLES	1
CONST(22)=RAY TRACE CONVERGENCE FACTOR	.01
CONST(23)=RAY Z ORIGIN SHIFT IN CM	0
CONST(24)=R,Z RAY INPUT FACTOR TO CONVERT TO CM	1.
CONST(25)=Z(CM) RAY CONVERGENCE MOMENT CALL	ZMAX
CONST(26)=MAXIMUM TRAJ LENGTH ZMAX ORBITS	1.0E100
CONST(27)=DIAGNOSTIC ORBIT OUTPUT RAY NUMBER	0
CONST(28)=COILGEN OUTPUT	0
CONST(29)=NUMBER OF QDEP INTERVALS BETWEEN RAY TRAJ PLOT POINTS	
CONST(30)=POTENTIAL INITIAL MAP VALUE	0
CONST(31)=MAX RADIUS OF ORBIT INTEGRATION	RMAX
CONST(32)=DUMP NUMBER, TAPE# FOR MESH(),U(),RH() ETC	1
CONST(33)=DUMP TAPE# RAYS	0
CONST(34)=TRAJ CALCOMP (10), PRINT(01), BOTH (11)	10
CONST(35)=CALCOMP R AXIS LENGTH, INCHES	6.0
CONST(36)= CALCOMP Z AXIS LENGTH, INCHES	10.0
CONST(37)= PHASE PLOT CALCOMP (10), PRINT(01), BOTH(11)	01
CONST(38)= CALCOMP DR/DZ AXIS LENGTH, INCHES	5.0
CONST(39)= CALCOMP R AXIS LENGTH, INCHES	5.0
CONST(40)= CHARGE AVERAGING WEIGHT	0.
CONST(41)= NUMBER OF CYCLES FOR CHARGE AVERAGING	0
CONST(42)= DZ FOR CALLS TO MOMENT (CM)	0
CONST(43)= PLOT BZ ON FRAME 1, DO NOT PLOT 0	1
CONST(44)= DENSITY CALCOMP (10) PRINT (01) BOTH (11)	0
CONST(45)= DZ FOR PLOT OF DENSITY PROFILE (CM)	0
CONST(46)=N CALC CURRENT ENCLOSE EVERY N RK STEPS	0
CONST(47)=NUMBER OF EQUIPOTENTIAL LINES ON CALCOMP	0
CONST(48)=DS EQUIPOTS	.5*DRMESH
CONST(49)=EQUIP R,Z,U PRINT FLAG. PRINT IF 1	-1
CONST(50)=SELF B FIELD FACTOR FROM ER FIELD	0

Summary Table of EBQ CONST() Array with Default Values (Continued)

CONST(51)=EQUIPOTENTIAL ERROR	1.0E-4
CONST(52)=MAX NUMBER OF ITERATIONS TO FIND EQUIPOT	5
CONST(53)=NRSKIP U(I) PUNCH TAPE 4 WITH RAYS PUNCH Z S	1
CONST(54)=1 STOP ON RETROGRADE MOTION (0,DONT STOP)	0
CONST(55)=SELF B FIELD RADIAL CUTOFF	.01
CONST(56)=Z50. USE CONST(50) FOR Z.GT.Z50	0
CONST(57)=PHASE PLOT TYPE 100(X,XP) 10(Y,YP) 1(R,RP)	1
CONST(58)=N, PRINT EVERY N-TH RAY TRACKING OUTPUT	1
CONST(59)=1, OUTPUT FORCE TERMS WITH FIELD TRACKING	0
CONST(60)=Z(CM) TO THE LEFT SEGMENT RAY TRANSFER PNT.	0
CONST(61)=1, OUTPUT PREVIOUS ENVELOPED ON PLOTS DASHED	1
CONST(62)=S, SCALE RH(I) ARRAY FOR Z.GT.ZRETR0	.5
CONST(63)=1 CALC. EMITTANCE WITH MOMENT CALLS	1
CONST(64)=MINIMUM ENERGY (EV) FOR ORBITS	0
CONST(65)=MAXIMUM ENERGY (EV) KINETIC FOR ORBITS	1E100
CONST(66)=0 PLOT ALL RAY GROUPS TOGETHER, OTHERWISE SEPARATLY	1
CONST(67)=	
CONST(68)=Z SEGMENT BOUNDARY ADVANCE PER ITERATION	0
CONST(70)=PLOT COILGEN COILS ON CALCOMP FRAME	1
CONST(71)=PLOT RAY ENVELOP ON CALCOMP FRAME	1
CONST(72)=OUTPUT CHILDS LAW SURFACE	-1
CONST(73)=1 OUTPUT Z RELATIVE TO ZMIN, =0 REL ZSTART	1
CONST(74)=CHILDS LAW POTENTIAL UNDER-RELAXATION FACTOR	0.5
CONST(75)=0 INITLZ APHI=0, =1 APHI IS TOBE ACCUMULATED	0
CONST(76)=REQJIP, R OF LINE SEARCHED FOR EQUIPOTENTIALS	0
CONST(77)=MAX RH LIMIT V/CM**2 OR CHARGE LIMIT N	0
CONST(78)=CHARGE LIMIT MINIMUM RADIAL MESH	4
CONST(79)=CHILDS LAW RELAXATION ERROR LIMIT	0
CONST(80)= IXSW1 , POISSON ITERATION OMEGA=CONST(82)	40
CONST(81)= IXSW2 , POISSON ITERATION OMEGA=CONST(83)	100
CONST(82)= OMEGA FOR POISSON ITER=IXSW1	1.800
CONST(83)= OMEGA FOR POISSON ITER=IXSW2	1.900

ELEMENT

- 1 - Rest mass of beam particles in electron volts. The rest mass is related to the mass of the particle by $E_0 = MC^2/a$ where M is the mass in grams, C the velocity of light in cm/sec and a is the number of ergs per electron volt $\approx 1.6 \times 10^{-12}$. Default value is the rest mass of the electron, 0.511×10^6 eV.
- 2 - Charge of the particle in units of an electrical engineer, the charge of a standard electron. The default value is for electrons, -1.
- 3 - On the first cycle of a problem, the current enclosed by a ray is used to find a radial electric field by Gauss's Law. This field is scaled by CONST(3) and added to the radial electric field found from the gradient of the electric potential found from a solution of Laplace's equation.
- 4 - On the first cycle of a problem, the current enclosed by a ray is used to find the self-magnetic field by applications of Ampere's Law. This field is scaled by CONST(4).
- 5 - The velocity of light in cm/sec, 2.998×10^{10} .
- 6 - The magnetic field force is multiplied by CONST(6) before contribution to the equations of motion.
- 7 - The electric field force is multiplied by CONST(7) before contribution to the equations of motion.

- 8 - The reciprocal of the pervitivity of free space.
 $1/E_c = 36\pi \times 10^9$ meters/farad.
- 9 - Ray input from cards or dump files is Z with the path length S zero if CONST(9)=0. Otherwise, ray input is path length S with Z=CONST(9). RAYS 8 data always inputs the pathlength from the dump file with Z taken as the Z value from the dump plus the value of CONST(23). The path length for the RAYS 8 data can be set to zero by setting CONST(9)=0.
- 10 - The Runga-Kutta integration step in cm. This step must be equal to or smaller than the longitudinal (Z) mesh size.
- 11 - Radians per degree, 0.0174529.
- 12 - Pi = 3.14159
- 13 - Ray angle input conversion factor. This constant multiplies the ϕ , α , and RAYGEN angles to convert them to radians.
- 14 - A beam line paper plot is generated after each TRACK command showing the radial extent of the beam for every CONST(14) longitudinal mesh intervals, producing a plot of LMAX/CONST(14) lines in length. If CONST(14)=0, no paper plot will be generated.
- 15 - Poisson equation over-relaxation factor. Must be between 1.0 and 2.0 with 1.8 a good value for most problems.
- 16 - Poisson's equation will be relaxed until the maximum number of iterations (CONST(17)) has occurred or until the largest

change in potential mesh $U()$ is smaller than $CONST(16)$.

The default value is 10^{-5} times the maximum potential minus the minimum potential in the potential array $POT()$.

- 17 - Maximum number of iterations in relaxing Poisson's equations per cycle. Default value is 200.
- 18 - A line of output is generated every $CONST(18)$ Poisson iterations giving the iteration number, the sum of residuals, and the location and value of the largest change made in the scalar potential array $U()$.
- 19 - An orbit output table is generated every $CONST(19)$ cm along the beam path. The output gives the energy E , cartesian position X, Y , path length S , momentum components P_X, P_Y, P_Z , flight time t , radius R , and polar azimuth ϕ for each ray tracked.
- 20 - An output table of field values encountered by each ray is printed after the table generated by $CONST(19)$ if $CONST(20)=1$, no field table is printed if $CONST(20)=0$. The values printed give the electric and magnetic field at the current position of each ray.
- 21 - Number of Poisson equation - ray trace cycles to be processed.
- 22 - Poisson equation - ray trace cycles are processed until the maximum number, $CONST(21)$ has occurred or until either the fractional change of the RMS radius of the beam at

$Z=CONST(25)$ is smaller than $CONST(22)$, or, if using Child's Law Start, the fractional change of the total beam current is smaller than $CONST(22)$.

- 23 - The longitudinal origin of each ray is shifted by $CONST(23)$ cm such that $Z=Z(input)*CONST(24) + CONST(23)$.
- 24 - The ray input position R,Z is multiplied by $CONST(24)$ to convert R,Z to centimeters.
- 25 - Longitudinal location at which RMS beam radius is to be calculated to determine convergence of the Poisson-ray trace cycles. Default value is $ZMAX$.
- 26 - Maximum length of beam tracking. Default is $ZMAX$.
- 27 - Diagnostic ray number
- 28 - Output of external magnetic fields and vector potential during processing of COILGEN data if $CONST(28)=1$. No output if $CONST(28)=0$.
- 29 - A maximum of 2500 points is available for ray plot storage. $CONST(29)$ specifies the interval in mesh units at which rays are stored for plotting. $CONST(29)=1$ stores ray radii at every Z mesh crossing, while $CONST(29)=2$ stores the ray radii every other Z mesh crossing, etc.
- 30 - The potential array U is initialized to $CONST(30)$ before solving Poisson's equation if $CONST(30)$ is non-zero. Otherwise, the array is initialized to $1/2(MAX POT-MIN POT)$,
- 31 - Ray tracking for an individual ray stops when the radius exceeds $CONST(31)$.

- 32 - Dump number identifying a TAPE8 binary problem dump used in restarting the problem. CONST(32) can have any integer value greater than 0.
- 33 - Dump number identifying a TAPE8 binary ray dump used in continuing a beam.
- 34 - Specifies desired combination of ray plot output (R,Z) and/or CalComp plot for the rays designated on the PLOT TRAJ data cards. A CalComp plot is generated if the tens position is unity and print output is generated if the units position is unity. The allowed values are 0, 1, 10, and 11. Default = 10.
- 35 - CalComp R axis (transverse dimension) length in inches. Maximum value is 10.5 inches. If CONST(35) is negative, then it gives the R axis length in centimeters. Default 6.0 inches.
- 36 - CalComp Z axis (longitudinal dimension) length in inches. If CONST(36) is negative, then it gives the Z axis length in centimeters. Default 10.0 inches.
- 37 - Specifies desired combination of phase space plots on paper and/or CalComp. A CalComp plot is generated if the tens position is unity and a printer plot is generated if the units position is unity. The allowed values are 0, 1, 10, and 11. Default = 01.
- 38 - CalComp DR/DZ axis length for phase plots in inches maximum value is 10.5 inches. Default value is 5.0 inches.

- 39 - CalComp R axis length for phase plots in inches. Default value is 5.0 inches.
- 40 - Charge averaging weight factor - W. The ray charge density deposition array RH() is multiplied by W before ray tracing and divided by (W+1) after ray tracing to conserve charge. The effect is to reduce large fluctuations in the beam at the beginning of a problem. Default is 0.
- 41 - Number of Poisson-ray trace cycles over which charge averaging shall be done. Default is 0.
- 42 - Longitudinal interval in centimeters for which the ray moments shall be calculated. Default is 0.
- 43 - Plot of the axial external magnetic field will be superimposed on the ray CalComp plots if CONST(43)=1.
- 44 - Specifies desired combination of charge density paper and CalComp plots. These plots are generated for the Z values specified on the PLOT DENSITY data card or on the longitudinal intervals given by CONST(45). A CalComp plot is generated if the tens position is unity and a printer plot is generated if the units position is unity. The allowed combinations are 0, 1, 10, and 11. Default is 0.
- 45 - Longitudinal interval in centimeters for which a charge density profile shall be plotted. Default value of 0 is interpreted to mean no plots are generated via this data.

- 46 - A calculation of the current enclosed by each ray is normally done on crossing a longitudinal mesh line. CONST(46) different from 0 specifies calculation of the enclosed current every CONST(46) Runge-Kutta integration steps.
- 47 - Specifies the number of equipotential lines to be plotted along with the beam trace CalComp plots. Default is 0.
- 48 - Equipotential line differential increment step in centimeters. Default value is half the radial mesh size.
- 49 - A print of the equipotential line, R, Z, U, E_r and E_z found every N^{th} step is made if $\text{CONST}(49) \geq 1$, where $N = \text{CONST}(49)$. Default is 0. $\text{CONST}(49) = 0$ produces a summary list of the equipotential lines plotted. $\text{CONST}(49) = -1$ turns off the summary list.
- 50 - Self magnetic field radial correction factor. Default is 0. See self fields theory section for detailed discussion.
- 51 - Allowed error in finding equipotential line. Default is 10^{-4} .
- 52 - Maximum number of iterative corrections allowed to find equipotential line. Default is 3.
- 53 - When the potentials from $U(\)$ array are to be punched at some Z location every N^{th} radial mesh point, $N = \text{CONST}(53)$. The punching is initiated by PUNCH POT and PUNCH Z() S data.

- 54 - The default value 0 specifies that ray tracking is not to be terminated when retrograde motion is detected. The retrograde ray is ignored. When CONST(54)=1 ray tracking is terminated on retrograde motion.
- 55 - The self magnetic field is inversely proportional to the ray radius. CONST(55) is the small radius field cut off such that $R\phi \approx 1/(R+CONST(55))$.
- 56 - The self magnetic field radial correction factor CONST(56) will only be used for $Z > CONST(56)$. Default value is 0.
- 57 - Three types of phase plots are available according to the value of CONST(57).

	10	100	101	110	111
R-R'	Y-Y'	X-X'	X-X'	X-X'	X-X'
			R-R'	Y-Y'	Y-Y'
					R-R'

- 58 - Normally every ray is outputted during ray tracking every CONST(58) cm. This parameter specifies output of only every CONST(58) ray to include the value of output. The default value is 1.
- 59 - A print out of the transverse force terms of the equations of motion is made along with the field output generated by CONST(19), CONST(20) and FIELD data when CONST(59)=1.

These terms are:

$$-E_Y/P_{Y1}, -E_Y/P_{Y2}, -E_Z/P_{Z1}, -E_Z/P_{Z2}, -v\mathbf{B}|_X, -v\mathbf{B}|_Y, -v\mathbf{B}|_Z, P_X^1, P_Y^1, P_Z^1$$

- 60 - SEGMENT transfer back space in cm. During segmentation of a problem, ray transfer and left edge boundary conditions will be set CONST(60) cm to the left the terminating right boundary of the preceding segment.
- 61 - The beam envelope of the preceding cycle is made on the ray trace CalComp plot as a dashed curve if CONST(61)=1.
- 62 - Charge scale factor applied to the charge array, RH() for longitudinal positions Z greater than the longitudinal retrograde location beyond which rays are not tracked. Its effect is to prevent inhibition of ray tracking past a point of a high charge density such as a virtual cathode. Typically, CONST(62) = 0.9.
- 63 - Output of the beam emittance E in cm-mrad for the x-yp and y-yp planes along with the normalized emittance ERY is generated for any location where the beam moments are calculated. These locations are specified by the MOMENT and/or CONST(42) data. The normalized beam ellipse tilt, r_{12} is also printed.
- 64 - Minimum beam energy EMIN, normally 0. Any ray with kinetic energy in eV less than EMIN will be stopped. (VELD()=-3)
- 65 - Maximum beam energy EMAX, normally 10^{100} . Any ray with kinetic energy in eV greater than EMAX will be stopped (VELD()=-3).
- 66 - 0, plot all ray groups together. Otherwise, generate separate phase plots for each ray species type.

- 68 - SEGMENT expansion per major cycle. The longitudinal Z() values of the SEGMENT data will be incremented by DZ=CONST(68) cm per major iteration of the problem.
- 70 - If equal to 1, will cause a plot of the coil cross sections used in finding the magnetic field map during COILGEN input to appear on CalComp beam plots.
- 71 - If equal to 1, will cause CalComp plot of the beam envelope on the beam plots.
- 72 - Turn on Child Law output.
 - 1 default, no output, only current generated
 - 0 find Run Table at ZMAX on each iteration
 - 1 starting surface printed for each iteration.
- 73 - 0 output generated by CONST(19), (42), (45) relative to ZSTART ray origin.
 - 1 output generated by CONST(19), (42), (45) relative to ZMIN. Default is 1. The origin relation holds for calls to current and density.
- 74 - Over-relaxation parameter for Childs Law generation. Normally 0.5.
- 75 - Normally 0. If 1, specifies that the vector potential A_{PHI}() from which the external magnetic fields are calculated is to be accumulated as the sum of all COILGEN data sets encountered. If CONST(75)=0, then A_{PHI}() is initialized to zero before each COILGEN data set is processed.

- 76 - Normally 0. Specifies radius at which equipotentials will be found for CalComp plotting if $\text{CONST}(48) > 0$. Gives Z value at which equipotentials will be found if $\text{CONST}(48) < 0$.
- 77 - Normally 0. If nonzero, then a check of the charge array $\text{RH}()$ for charge exceeding the maximum allowed before solving Poisson's equation will be performed. If a point has too much charge, it will be frozen at the value specified by the value of $\text{CONST}(77)$. If CHARGE LIMIT data has been used, then $\text{CONST}(77)$ is the number of radial mesh points over which excess charge will be deposited.
- 78 - Normally 4. Minimum radial mesh number for which excess charge will be inwardly deposited, see CHARGE LIMIT data.
- 80 - $\text{CONST}(80)$, (81), (82) and (83) are used in solving Poisson's equation and determining the optimal value of its over-relaxation factor. The initial over-relaxation factor, ω , $\text{CONST}(15)$ as set by the data deck is used for the first $\text{CONST}(80)$ cycles, after which the optimal as determined by EBQ will be used. The last known value of this optimal factor is stored by EBQ as $\text{CONST}(83)$ and $\text{CONST}(80)$ set to zero at the conclusion of a Poisson equation solution, so any subsequent pass will start with this value of ω .
- 81 - Calculation of the optimal over-relaxation factor will be made every $\text{CONST}(81)$ cycles. The default value is 10.

82 - Maximum value ω_m of the optimal ω allowed. This is really determined as an offset ω_o as

$$\omega_o = 2.0 - \omega_m$$

83 - Last optimal Poisson over-relaxation factor ω is stored as CONST(83) for passage to tape dumps and subsequent problems.

84 -

85 - Constants 84 and 85 are used during Childs Law starting and have the default values of 0.5 and 2.0. During Childs law starting the current actually run is under-relaxed by CONST(74). The ratio of this under-relaxed current I_r to its value on the previous iteration is forced to lie within the range specified by CONST(84) and (85).

$$\text{CONST}(84) < \frac{I_{rN}}{I_{rN-1}} > \text{CONST}(85)$$

A quantity called FACTOR is printed as output. Factor is the ratio of I_r to the Childs Law current.

type code is also negative. Each of these RAYGEN data cards is preceeding by a CONST *1 MASS CHARGE S data card specifying the species rest mass and charge.

The data is shown in Figure 4.1. The plots are shown in Figure 4.2. The plot of the 10, 20, and 30th ray includes the beam envelope identified by the triangular symbol. Figure 4.2A, was generated by data line 32. The plot of all rays, Figure 4.2B was generated by data line 31 or 33.

DEFINE NAME

STOP

CALL NAME

Data input to EBQ can be saved in a special array (max. 100 numbers) under a NAME which can be used to refer to this data (max. 10 names). The general structure would be

```
EBQ data input
-
-
-
-
DEFINE NAME1
.
.
.
STOP
-
-
-
CALL NAME1
.
-
CALL NAME1
-
-
END
```

The data bracketed between the DEFINE and STOP entries is not processed, but merely read and stored. The two commands CALL NAME 1 in the above example actually cause execution of the data known as "NAME1."

DENSITY ON
DENSITY OFF
DENSITY TYPE SJ SR

CURDEN() S
 RODENJ() S

DENSITY UNIFORM J

Density input of initial current distribution and radius for each ray at origin--i.e., cathode. This data input selects the Neil procedure of charge deposition. SJ is a current scaling factor which multiplies each CURDEN value. SR is a radial scaling factor multiplying each RODENJ value. Type selects the input format for the CURDEN and RODENJ entries.

TYPE = ON Turns on Neil-charge deposition if previously turned off.

TYPE = OFF Turns off Neil-charge deposition, except with Childs law start.

TYPE = -1 Turns off Neil-charge deposition in problem using Childs law start.

TYPE = 1 The DENSITY card is followed by a list of CURDEN values in amperes/cm² terminated by an "S". There should be 1 value for each ray to be run in the problem. This list is then followed by a list of the radial values (in cm's) for each ray.

DENSITY 1

CURDEN ----- S

RODEN ----- S

TYPE = 2 Specifies input of CURDEN-RODENJ pairs of numbers, 1 pair for each ray to be run. The pair input is terminated by an "S".

DENSITY 2

J,R,----J,R,-----J,R,S

TYPE = 0 Turns off the Neil-charge procedure. Charge is then deposited according to a linear deposition based on individual ray distance of approach to mesh lines.

Consider a beam of six rays originating from a cathode with approximately uniform current density as shown in the sketch below.

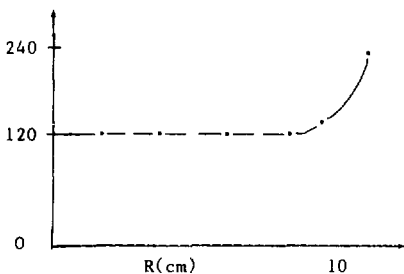

The data input would be:

DENSITY 1 120.

1. 1. 1. 1.05 1.34 2.10 S

1 3 5 7 9 11 S

EBQ can generate Neil-charge density data based on a uniform current density $J(\text{amp}/\text{cm}^2)$ by entering the single card:

DENSITY UNIFORM J

The Neil-charge array CURDEN() is set to J and the array RODENJ() is set to the radius of the rays in storage at this moment. The current carried by each ray is then set, based on the inter-ray separations for this uniform current density.

DENSITY UNIFORM

the value of J will be calculated from the total current for all rays.

DUMP IN
DUMP OUT

A problem may be continued for several reasons. One may wish to iterate the orbit -- Poisson equation additional cycles to improve the solution; or one may wish to propagate the trajectories further down the beam line. Whatever the reason for continuing, it may be facilitated by two types of dumps discussed in the data sections DUMP, RAYS 8, PUNCHB, and CONST (32 and 33). When DUMP OUT is encountered in the data stream, a binary file is written on tape 8.

The information dumped is 11 records in 1 file preserving the following data:

```
NDUMP,NAME,NX
TITLE (8+3)
SIZE common block,NRAYS,ICOEF,CONST( )
MESH (NTOT)
U (NTOT)
RH (NTOT)
COEF(ICOEF)
POT(MAXPOT)
NGOILS,MAG( ),A( ),BOUNDARY( )
XORB,YORB,ZORB,PXORB,PYORB,CURNT,TORB,SORB(100)
SPECIAL THINGS( )
EOF
```

Where NDUMP is the value of CONST(32), NTOT is the number of points in the boundary mesh, and ICOEF is the number of coupling coefficients generated. This information can be read from tape 8 to re-initialize a problem for continuation. The data would be, for example:

```
TITLE
CONST *32 1 S
DUMP IN
TRACK
END
```

Tape 8 is searched for a dump number CONST(32) written as NDUMP in the first record. The orbit arrays XORB(), YORB() etc. transfer the initial conditions of the rays. If it is desired to continue the problem from some intermediate position, Z, the rays can be dumped to tap 8 by the PUNCHB Z data and read by the RAYS 8 data. See example at end of this report.

DUMP CHARGE IN
DUMP CHARGE OUT

These two data cards define a read or write of binary disc file 8 transferring the potential and charge arrays, U(), RH() as two records. These records are identical with records 5 and 6 of the normal DUMP IN or DUMP OUT format.

DUMP CHARGE IN SKIP

Causes the reading of a standard tape 8 file, skipping the first four records, transferring records 5 and 6 to the U() and RH() arrays and then skipping pass the file mark on that dump.

DUMP IN X

This data, where X is the letteral X, will cause tape file 8 to be rewound and the first file dumped in regardless of the dump number found on that file.

DUMP IN FILE N

This causes tape 8 to be rewound and files skipped to the Nth file, which will be read as the current problem.

ENDTRACK

When ray cycle convergence has been achieved a flag is set which prevents further cycles on tracking. All further data in this deck is skipped until an ENDTRACK card is encountered, when normal processing of the data resumes. If no ENDTRACK card is found, the data is skipped to the END card for this case, at which point the next case is read. Ray convergence is defined as achieved when the rms (root mean square) value of the radii at some specified Z value changes by less than a pre-assigned value on an iteration. The Z value is given by CONST(25) and has the default value of ZMAX, while the specified change is given by CONST(22) and has the default value of 0.01.

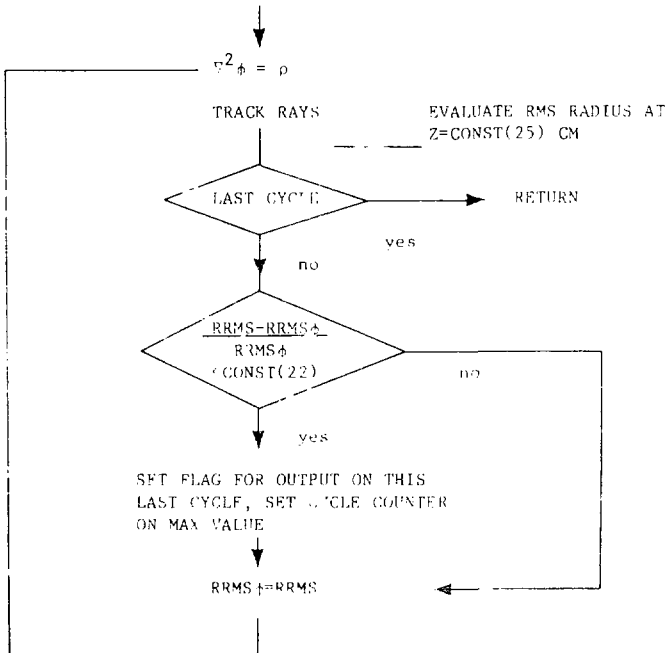

EQUIP V() S

EQUIP defines a list of up to 100 equipotentials values to be plotted and/or printed according to the value of CONST(47) and CONST(49). These equipotentials are plotted in addition to any specified by the CONST(47) value. Let there be N values in the V() list. Let $M=CONST(47)$, and let P_{MAX} and P_{MIN} be the maximum and minimum potentials in the POT() array. The total number of equipotentials is $N+M$ with the values given by $V()$ and $P_{MIN}+dP, P_{MIN}+2dP, \dots, P_{MAX}$ where $dP=(P_{MAX}-P_{MIN})/M$. Only those values and the Z-axis ($R=0$) will be followed and plotted. The other values will be ignored. Some other line, $R=CONST(76)$, can be searched for equipotentials if desired.

FIELD Z() S

This card specifies field output for each ray at the Z array values during orbit tracking. A maximum of 20 such values may be given, although the actual limit of 20 refers to the sum of all orbit output Z values.

IDRAY S

IDRAY 1 S

IDRAY ID() S

When rays are generated by RAYGEN or read by RAYS data, an ID number will be generated for each ray. This number is the ray number, $ID=1,2,3,\dots,\text{MAXRAY}$. Optionally, a user may assign a four digit ray number to the rays of EBQ for identification purposes. These ID numbers can be in the range of $-999 \leq ID \leq 9999$. This data is input via the IDRAY ID() S data and should precede the RAYGEN or RAYS data.

Two special exceptions exist with the RAYS 5 and RAYS 6 input. RAYS 5 input will have an additional input list if preceeded by an IDRAY 1 S data line, e.g.,

```
IDRAY 1 S
RAYS 5
X( ) S
Z( )
Y( )
E( )
DX/DZ( )
DY/DZ( )
AMPS( )
IDRAY( )
```

RAYS 6 input will assign the index N to IDRAY, i.e.,

```
RAYS 6
N X Z E DX/DZ I DY/DZ Y
.
.
.
```

will assign $IDRAY(K) = N$, where $K = 1,2,\dots,\text{MAXRAY}$. When IDRAY S data is read, with no parameter list, it turns off any special IDRAY options, such as the read of an eighth array list during RAYS 5 input.

Currently, this option is only available on the cartesian version of EBQ.

IGNOR ON

IGNOR OFF

IGNOR K() S

IGNOR S

Ignores rays K in calculation of moments and emittance (area).

INITIALIZE

INITIALIZE

This initializes certain constants. Mainly used when running many independent data cases.

MAC=0	Turning off external magnetic fields
MAXTRAJ=0	TRAJ OFF
MEQUPLT=0	PLOT EQUIP OFF
MPHZPLT=0	PLOT PHASE OFF
MRAYPLT=0	PLOT RAY OFF
NZSTOP=0	Turn off by reinitializing orbit integration stop at Z values. Specified on FIELD, PUNCH, OUTPUT and PLOT-PHASE cards.
CONST()=CONST()	Initial default values
NSCALEP=0	Cancel phase-plot scales
NSCALEE=0	Cancel ray-plot scales
NPOSOUT=0	
MAPON=1	Standard MAP OUTPUT TURNED ON
SCLMAPS()=1	Sets plot scales to unity

LAPLACE

LAPLACE SWITCH INITIALIZE

Causes solution of the electrostatic problem by solving Laplace's equation and printing a map of the potentials so obtained.

If the second parameter is SWITCH, then a call to subroutine LEDGE is made to switch potentials before solving Laplace's equation. The charge array (RH()) is initialized to zero. If the third parameter is INITIALIZE, the potential array is set to CONST(30); otherwise it is continued from whatever values exist. The "Boundary" input initially sets RH() = 0 and U() = CONST(30). After LAPLACE, a map of the U() array is normally printed.

POISSON

POISSON SWITCH INITIALIZE LIMIT

Same as Laplace, except is solves POISSON'S equation by not initializing the charge array to zero. If the fourth parameter is the literal "LIMIT", the procedure described under CHARGE LIMIT will be applied before solving Poisson's equation. After POISSON, a map of the U() and RH() array is normally printed.

LEDGE N1 N2 NRSKIP ZLOC SWITCH IP1 IP2

The LEDGE control card allows certain specified potentials to be switched after the first cycle. Its use is necessary when strongly space charge depressed beams are considered. On the first cycle the vacuum fields would be used; on subsequent cycles, the vacuum fields plus space charge field are used, requiring modifications of non-conductive boundary conditions.

LEDGE N1 N2 0 0 SWITCH IP1 IP2

will case the potential array, POT() defined on data input to be modified after the first RAY-POISSON cycle such that

$$\begin{aligned} \text{POT}(I) &= \text{POT}(N) \\ I &= \text{IP1}, \text{IP2}, \quad N = \text{N1}, \text{N2} \end{aligned}$$

If NRSKIP or ZLOC are non-zero, then the potentials stored in POT(N), N=N1,N2 will be taken from the potential array U() as calculated in the previous case or cycle. ZLOC is the Z index, $ZLOC=(Z-ZMIN)/DZMESH$, while every NRSKIP points will be skipped--e.g., consider skipping every other value of potential at $Z=ZLOC*DZMESH+ZMIN$, then

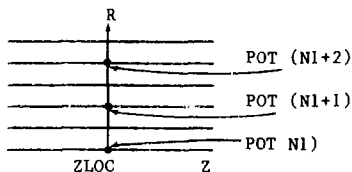

LEDGE N1 N2 2 ZLOC SWITCH IP1 IP2

If $NP2 - NP1 + 1 = IP2 - IP1 + 1$, then the potentials are swapped within the POT() array. If $NP2 - NP1 \neq IP2 - IP1$, then

$$POT(I) = POT(N), \quad I = IP1, IP2$$

and the values stored originally in POT(I) are lost.

MAP TYPEMAP SCALE TYPE SCLMAP SECTION LSTART LEND LSKIPMAP MESH LMAP1 LMAP2

There are several arrays which can be mapped onto the output file.

These arrays are:

	<u>TYPE</u>	<u>ARRAY</u>	<u>UNITS</u>
MESH	1	MESH() Low order 30 bits	-----
POTENTIAL	2	U()	Volts
CHARGE	3	RH()	Volts/cm ²
COEF	4	COEF()	-----
BMESH	5	MESH() High order 30 bits	-----
BR,BZ	11	-----	gauss
BX,BY	12	-----	gauss
VECPOT	13	AVEC()	gauss-cm
ER,EZ	14	-----	Volts/cm
POTENTIAL	15	U()	Volts
-----	OFF	Suppresses automatically generated maps.	

In order to generate a MAP of the mesh and potentials of the problem

MAP 1 2

In order to see the boundary deviations from the mesh intersections (high: order 30 bits of the MESH array) normalized to unity.

MAP 5

To see the charge array used in solving Poisson's equation

MAP 3

or to see this array multiplied by 10⁶,

MAP SCALE 3 1.0E6

The magnetic external fields are calculated from the vector potential $A_\phi(R,Z)$. A map of the B_r , B_z or A_ϕ value can be produced on a grid which must be given following the map specification. Consider a map of A_ϕ extending from R_1 to R_2 in steps of DR , and from Z_1 to Z_2 in steps of DZ , the data would be

MAP 13

R1 R2 dR Z1 Z2 dZ

Similarly, a map of the electric fields E_r , E_z or potential U can be produced on a grid which must be given following the map specification.

MAP 14 15

R1 R2 dR Z1 Z2 dZ

Produces a map of E_r , E_z (type 14) and a map of U (type 15).

MAP OFF

Will suppress the automatic MESH map after processing, the potential U after calculations and the ρ , U after ray tracking.

MAP ON

turns back on the usual map options.

MAP SECTION LSTART LEND LSKIP

A maximum of five such entries can be made which cause all maps produced by the MAP entries to be sectioned from LSTART to LEND in steps of LSKIP--e.g., say a map is desired from L of 25 to 75 in steps 5 and 150 to 180 in steps of two. The data would be:

MAP SECTION 25 75 5

MAP SECTION 150 180 2

L is the Longitudinal Index, $L=1+(Z-Z_{min})/DZ_{MESH}$.

A MAP SECTION data entry with no parameters restores the full map from 1 to LMAX1.

The extent of the boundary mesh map and electrode displacement (beta) map can be specified by the

MAP MESH LMAP1 LMAP2

data. The boundary mesh map would then extend radially from KMIN-KMAX (RMIN-RMAX) for the longitudinal range of LMAP1-LMAP2. The default values are LMAP1=1, LMAP2=LMAX1.

MESH IR IZ IB IP IC BETA C1 C2 C3 C4 C5 C6

The mesh coupling coefficients for solving Poisson's equation and the various flags can be user specified to create a special point in the problem or fix up an error if one exists. The mesh point is defined by IR IZ as

$$I = (IZ-1)KMAX1+IR$$

where KMAX1 is the number of columns in the mesh. IB is the boundary type and IP the potential index. IC is the coefficient index and is normally printed by map in octal. BETA is the unit normalized mesh displacement, and C1-C6 are the star coefficients.

```
MESH(I) = BETA.AND.7777777777000000000B.OR.  
LEFT(IB,21).OR.LEFT(IP,12).OR.IC
```

IB, IP, and IC can optionally be read as octal integers by following them with a B, such as 23B, etc. If only seven entries are used, then the coupling coefficients are not generated, only the MESH() type being re-defined. This situation occurs when the coupling coefficients have been calculated but the mesh type is to be changed. Should one desire to have the coupling coefficients calculated from the first seven entries, this can be accomplished by entering α as C1 and the Hollerith literal CALCULATE as C2.

```
MESH IR IZ IB IP IC  $\beta$   $\alpha$  CALCULATE
```

Representation of the boundary intersection by 30 bits yields results accurate to five significant figures, as shown in Table 1, page 26. Columns 2 and 3 show the bit value in base 10 and octal, while columns 4 and 5 show the effects of truncation of the word to the high order 30 bits.

MOMENT Z() S

Calculation of the moments of the ray distribution can be specified at several Z values given by the parameter list Z(). Z is in centimeters. A maximum of 20 such locations can be specified and count along with the Z value specified by FIELD Z(), OUTPUT Z(), PUNCH Z(), and DENSITY Z() value.

Moments can also be specified on a regular interval given by CONST(42), such that this calculation is performed every $\Delta Z = \text{CONST}(42)$ cm along the beam path. If CONST(25) is not the default ZMAX value, then the moments are additionally calculated at this location, also.

The moment calculation generates one line of output giving the iteration number, the average radius, the rms radius in cm, the average P_r and the rms P_r value in eV/c.

OUTPUT Z() SOUTPUT POLAR Z() S

Specifies a list of Z values for which the orbit output will be printed. A maximum of 20 such locations can be specified, including the locations given on FIELD, MOMENT, PUNCH and DENSITY cards. To turn off all special output, use the following

OUTPUT CRY

This will turn off phase plots, trajectory plots etc. and all output generated by OUTPUT, FIELD, MOMENT, PUNCH data.

If the second entry on the output card is the Hollerith literal "POISSON", then the other entries specify 4 mesh integer pairs for which the potential will be printed every CONST(18) Poisson cycles. The mesh coordinates are determined from the R,Z value as

$$IZ = (Z - ZMIN)/dZ + 1$$

$$IR = R/DR + 1$$

OUTPUT POISSON IR₁ IZ₁ IR₂ IZ₂ IR₃ IZ₃ IR₄ IZ₄

OUTPUT POLAR Z() S

Generates a polar ray output table at each Z value given in the Z() list along with the standard cartesian ray output table. The printed values are:

$$N \quad \beta_r \quad \beta_\phi \quad \beta_z \quad P_r \quad P_\phi \quad P_{TOTAL} \quad \alpha \quad \psi$$

See the DAYS section of this report for a definition of the coordinate system.

PAGE

Causes ejection of a page.

PLOT JDENSITY Z() S
PLOT TRAJ N() S
PLOT PHASE Z() S
PLOT BOUNDARY S
PLOT ENERGY S
PLOT AMPS S
PLOT PSI S
PLOT EQUIP V() S
PLOT SCALES TYPE
PLOT DENSITY Z() S

PLOT TRAJ N() S

PLOT TRAJ S

EBQ can produce several types of paper and/or CalComp plots. PLOT TRAJ specifies a print of the R and Z values for rays if CONST(34) has a unit value and produces a CalComp plot of those rays if CONST(34) has a decade value. If CONST(34) has both a unit and a decade value, (CONS 34)=1!), then both options are selected. If CONST(34) is zero, then neither option is produced. The rays which are selected are given by the N() array list. If ray 1, 2, 10, and 27 have been specified by the PLOT TRAJ card, then these rays will be plotted. A PLOT TRAJ S with no parameter list will produce a plot for the last defined ray number list.

Trajectory plots are produced at the end of a beam tracking when CONST(34)=10 or 11 and a PLOT TRAJ data entry preceded the TRACK command. Three different trajectory plot formats are possible. One plot will be made for each format used.

PLOT TRAJ S will produce a plot of all rays. PLOT TRAJ 1 2 10 ... S will produce a plot of the designated rays, and PLOT TRAJ 11-12 13-14...S e.g., PLOT TRAJ 10-15 37-48 91-97 S will produce a plot of the sequential ray groups specified--rays 11 through 12, 13 through 14, etc. When using more than one of these formats, they should occur in the data stream in the following order:

```
PLOT TRAJ S
PLOT TRAJ 11 12 ... S
PLOT TRAJ 11-12 13-14 ... S
TRACK

PLOT PHASE Z( ) S
PLOT PHASE S
```

Phase plots are available at any z value specified by the Z() array list of the PLOT PHASE card. A maximum of 20 locations can be specified. Paper and/or CalComp plots are rendered according to the boolean true or false value of the units or decade position of CONST(37). The physical size of the CalComp plot is set by the FRAME values specified by CONST(38) and CONST(39) giving the CalComp plot dr/4Z and R axis length in inches. The special PLOT PHASE S with no Z() array parameters produces a phase plot at the end of a run for the values of the rays regardless of where their integration terminated. This is useful in making phase plots at constant energy.

Phase plots can be made in x-x', y-y', and or r-r' coordinate according to the value of CONST(57).

PLOT BOUNDARY

A PLOT BOUNDARY data card causes the boundary to be plotted showing the electrodes and coils used in generating an COILGEN field. The plot of the axial magnetic field is controlled by CONST(43) in the usual way.

PLOT ENERGY S

A plot of the beam energy versus R is produced by this entry calculated from the ray information at the end of the preceding TRACK command.

PLOT AMPS S

A plot of the beam current versus R is produced by this entry.

PLOT PSI S

A plot of the rotational beam angle ψ is generated by this entry calculated from the ray information at the end of the preceding TRACK command.

$$\psi = \text{ASIN} \frac{P_y \cos \phi - P_x \sin \phi}{\left(P_x^2 + P_y^2 + P_z^2 \right)^{1/2}} ,$$

PLOT EQUIP V() S

A plot of up to 20 equipotential lines can be specified by the V() array list of the PLOT EQUIP data card. These equipotentials are drawn on the CalComp plot along with the electrode boundary, magnetic field $B_z(R=0)$ and other equipotential lines specified by the value of EQUIP V() and CONST(47). The physical size of the CalComp plot is set by the frame values specified by CONST(35) and CONST(36) giving the CalComp plot R and Z axis length in inches.

PLOT SCALES

The scales of any of the above described plots can be set by the PLOT SCALES data entries. The third parameter of such a card has one of eight values: 1) ' ' i.e., Blank, 2) TRAJ, 3) PHASE, 4) EQUIP, 5) AMPS, 6) PSI, 7) ENERGY, and 8) BFIELD. The blank entry zeros out (cancels) all previous scales specifications.

```

PLOT SCALES TRAJ                $ MAX 1
PLOT SCALES PHASE R1 R2 PR1 PR2 Z  $ MAX 10
PLOT SCALES PHASE R1 R2          $ SET JUST R SCALE
PLOT SCALES EQUIP                $ MAX 1
PLOT SCALES AMPS R1 R2 I1 I2
PLOT SCALES PSI  R1 R2 V1 V2
PLOT SCALES ENERGY R1 R2 E1 E2
PLOT SCALES BFIELD BZMIN BZMAX
PLOT SCALES JDENSITY R1 R2 J1 J2

```

The PLOT SCALES PHASE data sets the scales for the phase plots at the given Z value. If no Z entry is made, the plot scale data is used as the default scale for all Z values not explicitly specified.

PLOT JDENSITY Z() S

A plot of the local current density is R is made at the Z values specified in the Z() list. This current density J_k is calculated for each ray, k as

$$J_k = \frac{i_k}{2\pi R_k}$$

The scales of this plot can be set with the PLOT SCALES JDENSITY data.

PLOT DENSITY Z() S

A plot of charge density versus radius can be specified at any Z location by the PLOT DENSITY Z() S data. The plots are produced on paper and/or CalComp according to the value of CONST(44). Additionally, density plots can be produced on a regular interval specified by CONST(45).

POLAR

Polar coordinates is the default geometry of EBQ. In order to re-establish a polar geometry after the introduction of cartesian geometry, by an XYZ data card, the POLAR data card must be used. This data is to precede the boundary data:

TITLE

POLAR

BOUNDARY

.

.

.

.

ETC.

POT V() SPOT NULLPOT FITPOT INITIALIZE Z R1 R2 Z1 Z2 A B C SCALEPOT SWITCHPOT INITIALIZE R R1 R2 Z1 Z2 A B C SCALEPOT STOREPOT MAX N

Input of the potentials for the various electrodes defining the boundary of the problem is accomplished via the POT data. The potentials are in volts. Electrode 1 has POT(1), electrode 2 has POT(2), etc. The data might be:

```
POT 1.24ES 0 0 200 .0345 S
```

or

```
POT
1.24ES 0 0 200 .0345
S
```

If we want to change a potential from some previous value, then input just the array index preceded by an * and the value of the potential.

```
POT *4 205. S
```

This would change the fourth potential value to 205 volts.

POT SWITCH causes a switch of the potentials defined by a previous LEDGE input such that the potentials of index IP1 - IP2 are switched with the potentials of indexes N1 - N2, see the LEDGE data section for a description of this data.

Sometimes it is necessary to enter a graded Dirichlet boundary. This can be greatly aided by fitting the potentials of these boundary points to a few potentials given as data input.

```
POT FIT 2 I1 I2 V1 V2 . . . . . S
POT FIT 3 I1 I2 V1 V2 V3 . . . . . S
```

FIT as second entry on the pot specifies that potentials will be entered into the POT() array by a polynomial fit. The degree is specified by the third entry as either 2 for a linear interpolation or 3 for a quadratic interpolation, followed by a number of groups consisting of four numbers for linear fits and five numbers for quadratic fits.

The first two members of each group specifies the POT() array indices into which the fitted values will be stored, while the last two or three members of each group give the specified potentials to which the fit will be made. The end of input must be indicated by entry of S.

```
POT STORE R I1 I2 ZL R1 R2 DR
POT STORE Z I1 I2 RL Z1 Z2 DZ
```

The POT STORE data card causes storage of the potential $\Psi(R,Z)$ into the POT() array, elements I1-I2. The potential values $\Psi(R,Z)$ are selected either on a radial line at a constant z value or a longitudinal line at a constant radius according to the third parameter of the data card being R or Z. The positional values of the line being given by the next four parameters:

R_1, R_2 are the minimum and maximum values of the radius and dR the step, while Z_1, Z_2 are the minimum and maximum values of Z and dZ the step. Note, that

$$I_2 - I_1 + 1 = \frac{R_2 - R_1}{dR} + 1 \quad \text{or} \quad \frac{Z_2 - Z_1}{dZ} + 1$$

If I_2 is zero, then three special storage procedures will be used according to the value of I_1 :

$$I_1 = 0 \quad \text{i.e., POT STORE} \begin{array}{c} R \\ Z \end{array} 0 \ 0 \ . \ . \ . \ .$$

The values to be stored will be added to the end of the POT() array.

$$I_1 = I \quad \text{i.e., POT STORE} \begin{array}{c} R \\ Z \end{array} 9 \ 0 \ . \ . \ . \ .$$

The values to be stored will begin at the I -th location, in this example, $I = 9$.

$$I_1 = \text{LAST} \quad \text{i.e., POT STORE} \begin{array}{c} R \\ Z \end{array} \text{LAST} \ 0 \ . \ . \ . \ .$$

The values to be stored will start at the last value, note that this will replace the current last entry in the POT() array.

POT INITIALIZE R R1 R2 Z1 Z2 A B C D SCALE

POT INITIALIZE Z R1 R2 Z1 Z2 A B C D SCALE

This data will cause initialization of a part of the scalar potential array U() by a power series expansion. The U() array may thus be so initialized after its limits have been set by the BOUNDARY data and before attempting a solution of either Laplace's or Poisson's equation. The subregion Z1-Z2, R1-R2 will be set to U(R,Z) according to a polynomial for the R,Z values lying on the mesh points within this domain. The initialization region may extend out to the limits of the U() array. The POT INITIALIZE Z data sets radial equipotential lines along the longitudinal direction as

$$U(R,Z) = \left\{ A + B \left(\frac{Z-Z1}{Z2-Z1} \right) + C \left(\frac{Z-Z1}{Z2-Z1} \right)^2 + D \left(\frac{Z-Z1}{Z2-Z1} \right)^3 \right\} \text{SCALE}$$

where R,Z are on the mesh points of the U() array within the bounds

$$Z1 \leq Z \leq Z2 \quad , \quad R1 \leq R \leq R2$$

The POT INITIALIZE R data sets longitudinal equipotential lines along the radial direction as

$$U(R,Z) = \left\{ A + B \left(\frac{R-R1}{R2-R1} \right) + C \left(\frac{R-R1}{R2-R1} \right)^2 + D \left(\frac{R-R1}{R2-R1} \right)^3 \right\} \text{SCALE}$$

PRINT POT

PRINT R FIELDS ZL R1 R2 DR

PRINT FIELDS R ZMIN ZMAX DZ

PRINT Z FIELDS RL Z1 Z2 DZ

PRINT RAYS

PRINT BOUNDARY

PRINT CONST

PRINT DENSITY

The PRINT data entry causes the type of output specified by the second parameter to be generated. The PRINT POT card prints a list of the POT array. This is useful when some of the array has been generated by the code or when the LEDGE data is acted upon by the TRACK option.

PRINT FIELDS generates a table of field values by calling the FIELD routine at R, with $ZMIN \leq Z \leq ZMAX$ in steps of dZ. Output consists of Br, Bz, AVEC, Er, Ez and U.

PRINT Z FIELDS produces the same effect of PRINT FIELDS while PRINT R FIELDS generates a table of field values at $Z=ZL$ with $R1 \leq R \leq R2$ in steps of DR.

PRINT RAYS generates a table of the initial ray coordinates x, y, z, P_x , P_y , P_z , AMPS, R, E, α and ψ .

PRINT CONST outputs the values of the parameters stored in the CONST() array.

PRINT DENSITY outputs the radius and current density arrays used in the Neil charge deposition procedure.

PUNCH Z() S

MAX 20

Punch the ray values at the specified Z locations onto output file 4 in standard format--i.e., for each ray, write

X Y Z PX PY PZ CURRENT

in Format (7E11.4). The units are cm, eV/c and amperes. The potentials along the R axis are punched to tape 4 along with the rays at the Z values specified by the PUNCH Z() S data, taking every CONST(53) value. The format is (5E15.7). If the Neil charge deposition was being used, then the initializing current density and radial profile is also punched.

PUNCHB Z() S

Binary dump of ray output on tape 9 for restart. This dump is read by "RAYS 8 NDUM" input. The dump number is set by CONST(33) and is incremented by 1 before the writing of each dump. This writes three records in one file. Records 1 and 2 are for ID and record 3 is the binary orbit data.

PUNCH END S or PUNCHB END S

Writes either the tape 4 or tape 9 dump with the rays data for the ending point of the trajectory calculations. This option should be used if the rays have stopped at different Z values, as on a curved STOP boundary.

PUNCH POT

PUNCH POT NRSKIP ZLOC

Writes to tape 4 the POT() array. If NRSKIP and ZLOC are provided, then the potentials written to tape 4 are taken from the U() array along the Z=ZLOC line taking every NRSKIP point.

RAYGEN TYPE N IB IA E EM RB Z F RP ϕ ψ IRANDM S

RAYGEN data specifies generation of N rays in a random, two dimensional phase space with space charge depression of the beam energy. The beam emittance EM is tilted by RP specifying either the slope of the envelope of the r_{12} beam ellipse matrix correlation. The parameters are:

TYPE = 1	RP = r_{12}	beam ellipse matrix correlation
= 2	RP =	Slope of the beam envelope, see below. The units are normally radians, but can be scaled by CONST(13).
= -1, or -2		Same as above, except rays generated are added to the rays already existing.
= 3		Child's Law start with equal dR spacing
= 4		Child's Law start with rays of constant current
= ± 5		Brillou flow generation beam current and ψ will be proportional to R .
= ± 11 or ± 12		Calls for generation of a Kapchinsky-Vladimirsky (K-V) distribution on a four dimensional shell, while type = ± 1 or 2 calls for a generation in a four dimensional volume.

N = Number of rays to be generated

IB = Total beam current, Amperes, if zero, these rays will not be space charge depressed.

IA = Total current carried by the ray generated by this RAYGEN

E = Total beam energy, kinetic energy electron volts

EM = Beam emittance, cm-radians in units of CONST(13)

RB = Beam radius, cm

Z = Initial longitudinal coordinate, cm

F = Focal tilt produced by preceding focusing elements. Units of CONST(13), normally radians

RP = Transverse beam, see below

ϕ = Rotational angle of beam, polar angle in units of CONST(13), normally radians

ψ = Transverse angle ATAN (Rd ϕ /dz) in units of CONST(13), normally radians

IRANDM = 0 Use next random number generator seed

= 1 Use previously stored random number generator seed

= 2 Read in random number generator seed. The seed is read as a separate data card or cards following the "S" of the RAYGEN card. The 'seeds' are five 16 digit integers and the random number generator number, followed by an "S" -- e.g.,

```
RAYGEN .... 2 S
1048015011      2236846573      4216793093
7792106907      9630191977
1 S
```

= M Ray generation is on a regular grid (not random) of $M r'$ values for each of $J=N/M$ radial sections as shown in the case of $N=24$ and $M=6$.

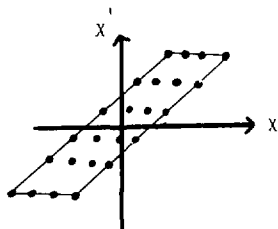

The beam phase can be tilted from two distinct sources: a) angular spread in the beam, and b) focusing action of preceding elements. Consider a beam of some angular divergence, X_M , passing through a drift distance S from a waist as shown below:

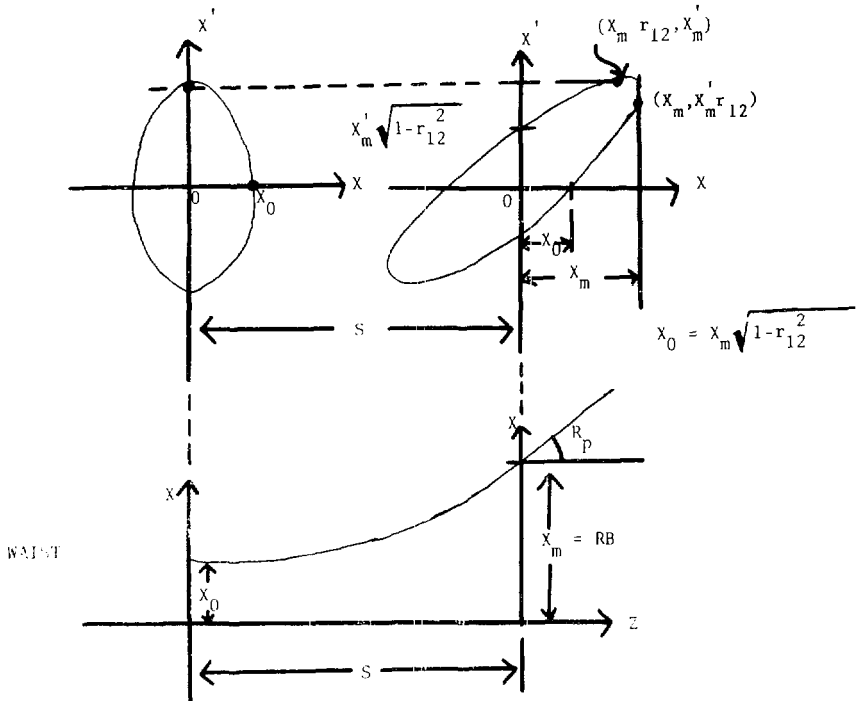

The angular divergence of the beam envelope is R_p . The value of R after the drift has increased from the angular divergence of the beam $X'_0 = X'_m$. If the beam has no initial angular divergence, so $EM=0$, but has passed through a focusing region, the phase space will be tilted as shown below:

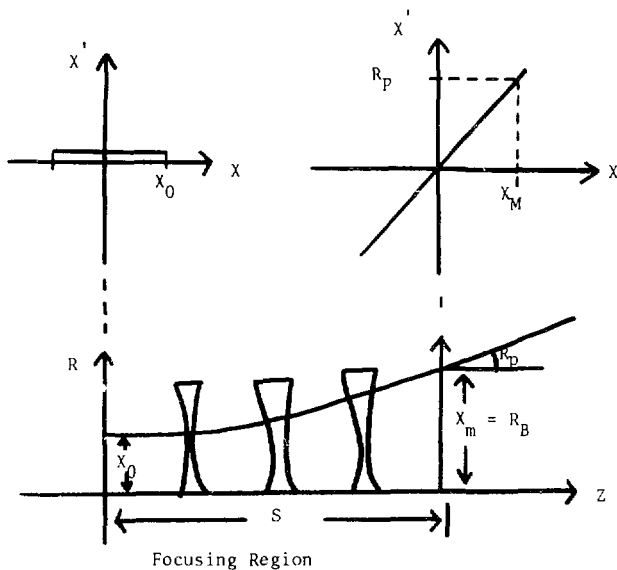

Consider generating a random phase space for a distribution tilted as shown. We know R_1 , R_B , R_m'

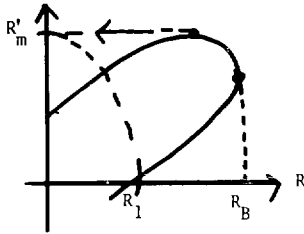

from a graph of the data. The emittance can be found by considering a drift backwards to where the ellipse is upright as shown. Then the input data values for r_{12} , E_m are found for type 1 data as

$$E_m = R'_m R_1$$

$$R_p = r_{12} = \left[1 - \left(\frac{R_1}{R_B} \right)^2 \right]^{1/2}$$

where the beam emittance area is πE_m .

ϕ and ψ give the transverse beam rotations out of the plane, such that ψ is an additional transverse angle, added to Y' as

$$P_y = P \sin (\psi + Y')$$

$$P_x = P \cos (\psi + Y') \sin (x')$$

$$P_z = P \cos (\psi + Y') \cos (x')$$

and ϕ specifies a rotation in the x-y plane so

$$P_x = P_x \cos \phi - P_y \sin \phi$$

$$P_y = P_x \sin \phi + P_y \cos \phi$$

The energy of the rays generated by RAYGEN will be spaced charge depressed if the total beam current I_B is non-zero. The current run by these rays is specified separately, as I_A . The magnitude of this energy depression is

$$E = E_{\max} - D_{eo} \left[1 - \left(\frac{R}{R_B} \right)^2 \right]^{1/2}$$

where D_{eo} is

$$D_{eo} = 25 I_B / (\epsilon_0 \pi V)$$

R , V the ray radius and velocity in cm and cm/sec. When generating a beam close to some electrode, such as a grid, the space charge depression of the beam energy should be turned off.

CHILD'S LAW

RAYGEN TYPE NRAYS KATHODE ZSTART VSTART MASK JLIM SMAX

The ray generator may be used to start electrons by application of Child's Law. The parameter list has a different interpretation than the other types of RAYGEN data.

TYPE = 3 Rays generated with equal ΔR spacing
 = 4 Rays generated with ΔR spacing yielding approximately equal
 current for all rays.

NRAYS Number of rays to be generated. Must be greater than four
 and ≤ 100 .

KATHODE Index pointer for potential of electrode from which emission
 will be allowed.

ZSTART Starting conditions are determined from a surface starting
 at $(R,Z) = (0,ZSTART)$

VSTART Potential V used in Child's Law on first iteration, if
 known. If VSTART is negative, it specifies the total beam
 current to be used on the first Child's law iteration.

MASK Index pointer for potential of electrode allowed to mask
 electron emission.

JLIM Maximum current density allowed, amps/cm^2 . If Child's Law
 exceeds the value, JLIM will be used. This simulates a
 temperature limited cathode.

SMAX Maximum length of starting surface cm. useful in problems involving a sharp corner at the end of the emission surface. If zero, SMAX is not used. If $SMAX > 0$ stop if surface length is $> SMAX$. If $SMAX < 0$ stop if cathode length $> SMAX$.

The Child's Law start finds the current density J (amperes/cm²) for electron emission from the cathode electrode from the potential and distance between the starting surface and cathode.

$$J = \frac{4}{9} \epsilon \sqrt{\frac{Ze}{m}} \frac{(\theta_0 - \theta)^{3/2}}{s^2}$$

The value of the dielectric constant ϵ , charge e , and mass are specified in the EBQ array CONST as the 8, 2 and 1 elements in units of Farads/meter, relative charge and electron volts. θ_0 is the potential of the cathode, θ the potential of the starting surface, and s the distance between the starting surface and the cathode. The emitting surface is given by specifying its potential index, KATHODE.

The current carried by an electron is found from

$$I = 2\pi r dr J$$

where r is the radius of the electron and dr is the radial extension of this ray. That is, half the difference of the radii of the rays on either side. The starting energy of the electron is found as

$$E = e (\theta_0 - \theta)$$

and the associated total momentum P is

$$P^2 C^2 = E^2 - E_0^2$$

P is resolved into three Cartesian components from the angles of radial and azimuthal slope, α and ψ .

The radial slope is determined from the assumption that the electrons are emitted normal to the starting surface. This surface is found by starting on the axis ($R=0$) at the given z value ZSTART and following the equipotential until:

- 1) Normal projection from this equipotential hits an electrode of potential index other than KATHODE or MASK,

or,

- 2) Leaves the boundary of the problem

or,

- 3) Requires more than 250 points.

If the surface is found, then from its known shape, the normal slope can be determined as

$$\alpha = -\text{ATAN}(dZ/dR)$$

The azimuthal slope of the trajectory is caused by a magnetic field threading the cathode surface. The magnitude of rotation imparted to the beam can be found from the conservation of angular momentum (Busch's theorem)

$$\dot{\theta} = \frac{e}{mcr^2} [r_c A(r_c) - rA(r)]$$

where r_c , $A(r_c)$ are the radius and vector potential of the ray at the cathode, and $r, A(r)$ are the radius and vector potential of this ray at the starting surface.

$$\psi = \text{ASIN} (P_\theta/P)$$

The three components of the momentum can now be found

$$P_x = P (\cos\psi \sin\alpha \cos\theta - \sin\psi \sin\theta)$$

$$P_y = P (\cos\psi \sin\alpha \sin\theta + \sin\psi \cos\theta)$$

$$P_z = P \cos\psi \cos\alpha$$

The computational procedure is to

- 1) Follow the equipotential line originating at $r, z=0, ZSTART$.
This line defines the starting surface.
- 2) Calculate the radii of all the rays, r_R .
- 3) For each ray, interpolate from the starting surface and the ray radius, the values for the longitudinal distance, Z_k , cathode ray distance S_k , and ray slope $\tan\alpha_k$.
- 4) Find the local current density for each ray

$$J_k = cv^{3/2}, S_k^2$$

- 5) Find the current carried by each ray

$$i_k = 2\pi r_R dr_k J_k$$

- 6) Find the beam rotation induced by any magnetic field threading the cathode

$$P_\theta = \frac{e}{cr^2} (r_c A(r_c) - rA(r))$$

$$\psi_k = \text{ASIN} (P_\theta/P)$$

- 7) Deposit charge on the mesh between the starting surface and the cathode.
- 8) Find the momentum components of the ray, P_X, P_Y, P_Z from the angles and total momentum, α, ψ, θ and P .
- 9) Integrate each ray to the same mesh line.
- 10) Turn on the Neil charge deposition procedure.

RAYGEN 3 ON

RAYGEN 3 OFF

These options can be used with either the TYPE 3 or 4 Childs Law start to turn on or off CHILDS law calculation of the beam.

RAYS TYPE NSTART UNIFORM TOTALIRAYS TYPE REPLACE K() SRAYS REMOVE K() SRAYS TYPE NSTART

Several different formats can be selected for specification of rays to be tracked by EBQ. The code converts each format into its standard form which is TYPE 1 consisting of specifying the three positional and three momentum components in Cartesian coordinates and the current.

The units are cm, ev/c and amperes.

TYPE 1 X Y Z P_x P_y P_z I

TYPE 2 X Y Z E α ψ I

TYPE 3 R Z ϕ E α ψ I

TYPE 4 R Z ϕ P_r P_z P_ϕ I

TYPE 5 R() S

Z()

ϕ ()

F()

α ()

ψ ()

I()

TYPE 6 N R Z E α I ψ ϕ

TYPE 7 Calls subroutine SPECIAL which must be user supplied.

TYPE 8 Reads Tape 9 Binary DUMP for ray coordinates.

The ray path length S is taken as zero if $\text{CONST}(9)=0$. If $\text{CONST}(9)$ is non-zero, its value is used as Z for each ray and the Z value specified in the above data is taken as the path length S .

The input unit for angles θ , ψ , and α is determined by the value of $\text{CONST}(13)$. If this value is 1 the angles are in radians, if its value is .01745 the input is in degrees, if its value is .001 the input is in milliradians, etc. That is, the value of $\text{CONST}(13)$ multiplies the angles to convert to the standard radian value.

The interpretation and definition of the ray input parameters are:

X, Y, Z ----- Cartesian location in cm
 R, ϕ, Z ----- Polar location in cm, radian, cm
 P_r, P_ϕ, P_z ----- Polar momenta in ev/c
 P_x, P_y, P_z ----- Cartesian momenta in ev/c
 E ----- Kinetic energy in ev
 α ----- Radial angle $\text{ATAN}(dR/dZ)$ in radians
 ψ ----- Transverse angle $\text{ATAN}(Rd\phi/dZ)$ in radians
 I ----- Current in amperes

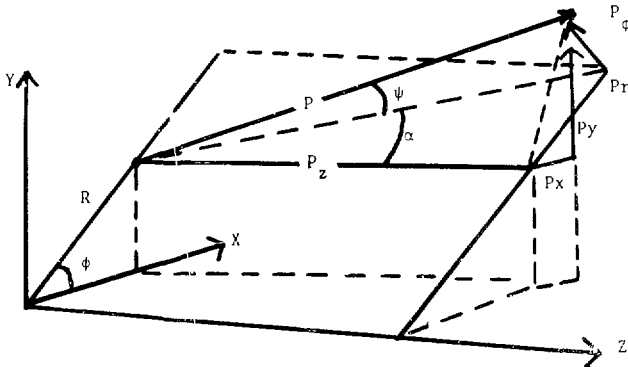

The total momentum P of a ray is determined from its energy. The required transformations between the various projections of momentum are:

$$P_z = P \cos \psi \cos \alpha$$

$$P_r = P \cos \psi \sin \alpha$$

$$P_\phi = P \sin \psi$$

$$P_x = P_r \cos \phi - P_\phi \sin \phi$$

$$P_y = P_r \sin \phi + P_\phi \cos \phi$$

Following the "RAYS TYPE" card, up to 100 cards are read giving the coordinates of the rays. This data is read until either a blank card is encountered or a card saying END except for TYPE 5 and 8 which are somewhat special, for example:

```

RAYS      1
X Y Z PX PY PZ I
.
.
.
.
.
END RAYS INPUT

```

TYPE 5 input consists of giving the like values of the coordinates for all rays together--i.e., all the R values until an S: is encountered. The number N of R values read determines the number of rays to be inputted; then N Z values will be read, followed by N ϕ values, etc. After the N I currents are read, an END cards should be used.

TYPE 8 input will cause a search of Tape 9 for a specified binary dump file which has previously been written. This dump file has the format structure described under the section "DUMP."

RAYS 8 NDUMP

Where NDUMP is the desired DUMP designation, some integer between 1 and ∞ .

This data causes tape 9 to be rewound and searched for the designated dump number.

RAYS 8 X

This data, where X is the literal X, will cause tape 9 to be rewound and the first file read regardless of the dump number read on the file.

When a rectangular problem has been initiated by the inclusion of XYZ data, the RAYS 5 data will have the following interpretation

<u>POLAR VALUE</u>		<u>XYZ VALUE</u>
R()	—————→	X()
Z()		Z()
ϕ ()	—————→	Y()
E()		E()
DR/DZ()	—————→	DX/DZ()
Rd ϕ /DZ()	—————→	DY/DZ()
AMPS()		AMPS()

More than one species of particles can be defined. This is useful in finding the space charge effects of multiple ion species in accelerating columns and heavy ion sources. The procedure for inputting more than one species is to read or generate each species after setting its mass and charge via the CONST(1) and CONST(2) input. These species will be tabulated separately in that each will have its own phase space plots, beam moments and emittance areas calculated. The species can be treated (printed and plotted) together if the value of CONST(66) is set to zero.

Example, consider input of protons, deuterons and charge five uraniums. The data would be

```

CONST *1  938E6  1  S           $ Protons mass and charge
RAY5 2  0           $ INPUT, SAY 7 P+
  { X Y Z E  $\alpha$   $\psi$  I
END  PROTONS INPUT

CONST *1  1876E6  1  S           $ Deuterons mass and charge
RAY5 2  7           $ INPUT, SAY 8 D+
  { X Y Z E  $\alpha$   $\psi$  I
END  D+

CONST *1  2.232E11  5  S         $ Uranium ion mass and charge
RAY5 2  15
  X Y Z E  $\alpha$   $\psi$  I

```

UNIFORM CURRENT DENSITY RAY INPUT

EBQ can calculate the current for rays from the inter-ray radial separation based on the assumption of a uniform current density by specifying the fourth parameter of the ray card as "UNIFORM" and giving the total beam current as the fifth parameter. Any of the ray input types can be used with this procedure except type 8. This procedure will calculate the current for the rays so they do not have to be specified and load the Neil charge deposition arrays. Standard charge deposition will be used, however, unless the Neil procedure is turned on by setting DENSITY ON. Consider the input of six type 3 rays comprising a uniform current density. The data would be:

```

RAYS 3 0 UNIFORM 12350
1 0 0 2.5E6 0 0 0 $ R Z PHI E ALPHA PSI I
5 $ VALUES NOT GIVEN WITH THIS CARD
10 $ TAKEN FROM THE PRECEDING CARD
11 $ DATA CARD.
12
12.7
END RAYS INPUT

```

If the Neil charge distribution is to be used during ray tracking, this data must be followed by DENSITY ON.

ADDING RAYS TO THOSE ALREADY SPECIFIED

Additional rays can always be added to those already in existence by giving a non-zero value to NSTART on the ray card. NSTART gives the ray index value after which the new rays will be specified.

Consider running 10 rays and then adding 7 additional rays to these 10 and running again with the 17 rays.

RAYS 3 0

} DATA FOR 10 RAYS

END INPUT OF RAYS

TRACK

RAYS 3 10

} DATA FOR ADDITIONAL 7 RAYS

END

TRACK \$ 17 RAYS

RAYS REMOVE K() S

Rays which have been previously defined or read, such as from a tape 8 dump or from the ray generator, can be removed by giving their number in the list K. To remove the second, third, and 19th rays, RAYS REMOVE 2 3 19 S.

RAYS NTYPE REPLACE K() S

Rays can be replaced by the values following the RAYS NTYPE REPLACE card. The rays to be replaced are specified by their rays number in the list K. If there are N entries in this list, then N ray cards must follow in the format specified by NTYPE.

RAYS	1	REPLACE	2	3	19	S
X ₂	Y ₂	Z ₂	PX ₂	PY ₂	PZ ₂	I ₂
X ₃	Y ₃	Z ₃	PX ₃	PY ₃	PZ ₃	I ₃
X ₁₉	Y ₁₉	Z ₁₉	PX ₁₉	PY ₁₉	PZ ₁₉	I ₁₉

The RAYS data does not require an END terminator when using the REMOVE or REPLACE options.

REWIND KTAPE NSKIP

Entire EBQ problems are dumped to tape 8 by DUMP OUT data and rays are dumped to tape 9 by PUNCHB data. The dumps are sequentially numbered from the values specified by CONST(32) are CONST(33) for tape 8 and 9 respectively. The files are not rewound. These files can be rewound by input of the REWIND data as

REWIND 8

or

REWIND 9

Reading the tapes by input of DUMP IN or RAYS 8 will automatically rewind the file and search it for the specified dump number, input this dump and leave the file at this position. Input of DUMP OUT or PUNCHB will then commence writing of the file from this position.

Entry of a third parameter will cause that number of files to be skipped after the rewind of the file. Consider positioning the ray dump tape, tape 9 past the fourth file mark. The input would be

REWIND 9 4

RKSTEP DZ Z S

The Runga-Kutta integration step is normally set in the tenth position of the CONST() array and has a default value of DZMESH. For some problems it may be desirable to have a finer integration step to properly pass through, say, a sharp magnetic fringe field. Up to 20 integration steps can be defined by the RKSTEP data. Pairs of DZ, Z entries give the step and ending Z value of this step in cm. The default CONST(10) step size is used for Z values greater than the largest Z given in a RKSTEP list. Consider the following scheme:

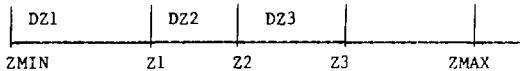

```
RKSTEP  DZ1  Z1  DZ2  Z2  DZ3  Z3  S
```

For $Z > Z3$, the step is the value given by CONST(10). The entry of RKSTEP or RKSTEP S cancels the variable step, forcing use of the CONST(10) value everywhere.

SFGMENT MINOR SEGERR Z() S

SEGMENT MINOR SEGERR S

SEGMENT S

Problems involving long transport distances might have a tendency to self collapse with subsequent beam blow off when there is a large degree of cancellation between the beams self magnetic field and the beams own space charge forces. To allow solution for such problems, EBQ can segment the problem either at longitudinal locations specified by the user, or upon detection of charge density larger than some specified value. The ray orbits will be calculated only a partial (segmented) distance, with a number of minor Poisson-ray trace cycles, N, performed until either N exceeds MINOR or until the relative RMS beam radius at the segment transfer position is constant to within SEGERR.

$$\left| \left(\frac{R_{NEW} - R_{OLD}}{R_{NEW}} \right) \right| < SEGERR$$

The beam is then continued from this transfer point into the next segment. The segment transfer point is set by CONST(60) which specifies the distance (in cm) to the left of any segment boundary at which point the rays for the next interval will be initialized. This process of segmentation is continued until the end of the problem is reached, at which time we have completed one whole (major) Poisson-ray trace iteration.

The longitudinal locations at which the problem will be broken are given by the longitudinal z values in the data list Z().

This list is terminated by a mandatory S and may have a maximum of ten entries. The first Z value defines the starting longitudinal position for segmentation. The rays will be tracked to this location and segmentation initiated from there. A fictitious Neumann boundary will be generated at segment ends and Poisson's equation solved only over this restricted range. The longitudinal boundary segment ends, $Z()$ will be increased at the end of each major iteration by the value of CONST(68). Consider the problem below:

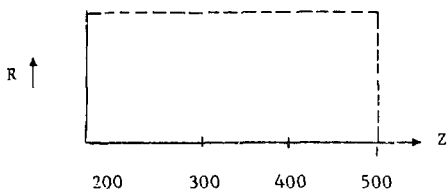

This segment data would be given as

```
SEGMENT 5 0.1 300 350 500 S
```

Forcing each major Poisson-ray race cycle to be calculated as

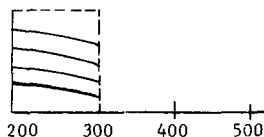

TRACK TO 300 CM

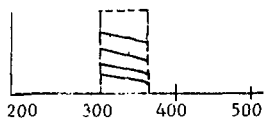

max of 5 cycles between
300 and 350 cm

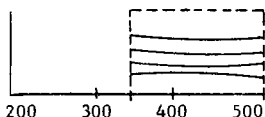

max of 5 cycles between
320 cm back spaced
point and 500 cm end.

With each minor segment iterated a maximum of 5 times (MINOR 5) or until the relative change in the beams RMS radius is less than 10%.

SEGMENT -MINOR

The amount of output generated by SEGMENT can be reduced by using a negative MINOR as flag for suppression of all output during the minor cycles. The only output will be the final output and plots prior to the continuation to the next major cycle. This output will be the same as that generated by a TRACK BEAM at the end of each major cycle.

Segmentation can be turned off by input of either SEGMENT or SEGMENT S with no parameter list.

It may be desirable to allow ERQ to decide on the locations to be used for segmentation upon detection of the beam self collapse. This is done by specifying the number of segment minor cycles and relative RMS radial error with no longitudinal list, and specifying a non-zero maximum charge density, CONST(77) in volts per cm^2 . Any Z location where the charge deposited exceeds this value will be treated as a segment end. The input would be:

```

CONST *77 75E3 S $CHARGE DENSITY LIMIT
SEGMENT 5 .1 S $ SET MINOR CYCLE AND ERROR LIMIT
TRACK

```

If the beam radius changes significantly along the problem, it may be necessary to specify the limiting charge density as a function of the longitudinal position via the CHARGE LIMIT ... input procedure. The value of CONST(77) must be non-zero, but the value is not used by the segmentation procedure. The limiting charge density being taken from the QLIMIT() list of the CHARGE LIMIT data. The data would be:

```

CONST *77-1 S $NON ZERO VALUE
CHARGE LIMIT 1 1 $INPUT CHARGE LIMIT DENSITY
               QLIMIT ( ) S $AS FUNCTION OF Z LOCATION
SEGMENT 5 .1 S $SET CYCLE AND ERROR LIMITS
TRACK $TRACK BEAM

```

Any Z location where the average charge deposited exceeds the limiting value given by the QLIMIT() list will be treated as a segment end.

If the value of CONST(77) is negative, then the charge limits given by this constant or the CHARGE LIMIT data input will apply only to this segmentation procedure and will not invoke the search and subsequent limiting of the charge array before solution of Poisson's equation.

If minor = 0, then the segment data will set the limits of the Poisson equation solver so that the potential portion of the problem is run only over this limited range, $Z(1) \leq Z \leq Z(2)$. The rays can be limited by the value of CONST(26). Input of

```

SEGMENT 0 0 Z1 Z2 S

```

will cause Poisson's equation to be solved only over this z interval $Z_1 \leq Z \leq Z_2$ with no fictitious Neuman boundaries. The orbits will be tracked out to the value specified by CONST(26).

SKIP

SKIP N

SKIP N MAX

SKIP causes skipping of data cases. This is useful when we have several data cases in deck which are not all necessary to be run

```
SKIP 2
Case 1 title
.
.
.
.
END
```

```
Case 2 title
.
.
.
  RAYS
  END
.
.
.
END
```

```
Case 3 title
.
.
.
.
END
END
```

Only Case 3 will be run.

SKIP can be embedded in a data case, in this case, the data will be skipped to the end of that case.

If we name multiple cases, and wish only to run a maximum of MAX case we use

SKIP N MAX

Say SKIP 5 2 will cause cases 1-5 to be skipped and case 6 and 7 to be executed.

SLOPE θ () S

The slope of the beam envelope can be forced to be within a given tolerance of the slope of the beam envelope of the preceding iteration so as to prevent a catastrophic beam collapse. The tolerance to be used on each iteration is specified by the slope data. The option of slope checking is turned on or off by setting CONST(60) to non-zero or zero.

Individual rays within the beam envelope are checked with a slope proportional to the ratio of their radius to the envelope radius. Should a ray be outside the range, its self magnetic field scale factor is adjusted so its slope is at the approximately positive or negatively deviated limit.

A maximum of fifteen values of θ can be specified for the first fifteen iterations. The units of θ is radians. The value of the self magnetic field factor used is printed at the end of each iteration for each ray at $Z=ZMAX$. Their normal value is 0.2.

STOP NAME

See DEFINE.

TIME

TIME OFF

TIME SWITCH S

TIME SWITCH CURNT() S

TIME A B C D E SCALE

TIME without any parameters request a print of the CP time in seconds from the last TIME data entry without any parameters. When TIME has a parameter list, it refers to a time varying simulation. The time of a ray can be given on input with the RAYS data in place of the current position by preceeding the RAYS data with

TIME SWITCH S

e.g., for RAYS 2 input, the data would be X Z Y E alpha, psi T, with T in seconds. The current of the rays will be set to the value of 10^{-16} amperes. If the current is to be given, then an array list should be included with the TIME SWITCH data, terminated by then mandatory S. When PUNCH Z() S data is executed, time will replace the current in the punched output written to tape 4. The current position will remain as the time until explicitly turned off by the

TIME OFF

data. TIME OFF also will set the flag to kill the time function scaling of the electric potential and fields.

In order to simulate a time varying problem, such as deflection of a beam between two parallel plate electrodes, the local electric potential and fields U_{RZ} , E_x , and E_z can be scaled by a power series function of the ray time

$$U_{RZ} = U(R,Z) f(t)$$

$$E_x = dU/dx f(t)$$

$$E_z = dU/dz f(t)$$

This function is

$$f(T) = a + bT + cT^2 + dT^3 + eT^4$$

where the coefficients a, b, c, d, and e are given as

TIME A B C D E SCALE

a = A

b = B*SCALE

c = C*SCALE

d = D*SCALE

e = E*SCALE

Only A must be given, the default values for B, C, D, and E are zero and the default value for SCALE is 1. In order to turn off the time variation once set, use

TIME OFF

Currently, this option is available only on the cartesian version of EBQ.

TITLE()

Entry of one card, defining a title line for output with all CalComp plots.

TRACK

TRACK BEAM

TRACK CONTINUE ITERATION IOOUTPUT

Causes tracking of rays. Output will be generated only on the last cycle. If output is desired on the first and last cycle, use the "continue" option where RH() charge array is not zeroed out -- i.e.,

```
TRACK X 1
TRACK CONTINUE 10
```

The calculation sequence is

```
ITMAX = CONST(21) = DIN(3)
EPS = CONST(22)
```

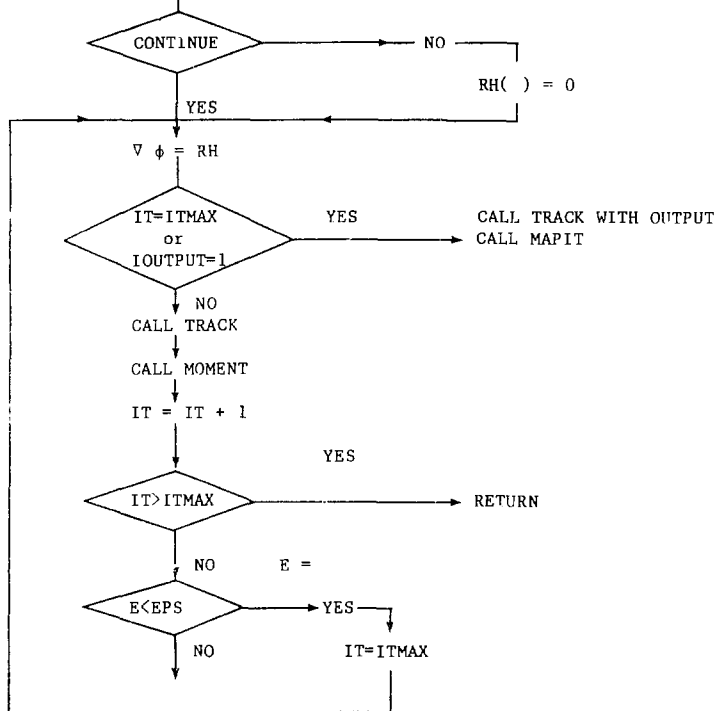

CONTINUE	-----	If = "CONTINUE," do not initialize ρ array
ITERATION	-----	(CONST(21)) if $\neq 0$, MAX number of ray trace cycles
IOOUTPUT	-----	0 Output only last cycle 1 Output every cycle

Sometimes one wishes to track the beam without disturbing the charge or potential arrays. This can be accomplished by the

TRACK BEAM

data entry. The rays are tracked without updating the RH() array for one cycle.

UNIT FACTOR SYMBOL

UNIT input changes the internal distance units of EBQ from CM to some new unit. FACTOR is the numerical value needed to multiply the new unit to convert it to cm. SYMBOL is a two character Hollorith name used to identify the internal unit in alpha-numeric output. The FACTOR values are not accumulative and are always relative to the original default value so that sequential UNIT cards do not interfere with each other. To change the internal units of EBQ to inches, the data input would be:

UNIT 2.54 IN

The unit conversion scales the constant array locations defining the distance units, locations 5, 8, 97, and 98.

CONST(5) = CONST(5)/FACTOR = Velocity of light
 CONST(8) = CONST(8)/FACTOR = Distance/farad
 CONST(97) = FACTOR
 CONST(98) = CONST(98)/FACTOR = Ampere's law constant

The units conversion effect the values of distance, current density, velocity, magnetic vector potential and charge, as shown

DISTANCE	CM	UNIT
CURRENT DENSITY	AMPS/CM ²	AMPS/UNIT ²
VELOCITY	CM/SEC	UNIT/SEC
VECTOR POTENTIAL	GAUSS-CM	GAUSS-UNIT
CHARGE	VOLTS/CM ²	VOLTS/UNIT ²

WALL RWALL R R₂ Z₁ Z₂

The WALL data entry instructs EBQ to include the self B_z magnetic field generated by the beam in addition to the self magnetic fields originating from the beams B_φ field component. This calculation requires specification of the beam pipe radius as this forms a boundary condition on the vector potential and return wall currents. Two models are included, a constant radius beam pipe of radius R,

WALL R

and a tapered beam pipe

WALL R R₂ Z₁ Z₂

where the wall radius r is R for z less than Z₁, R₂ for z greater than Z₂, and linearly interpolated for r in the range Z₁ < z < Z₂.

$$r = R + (R_2 - R) \left[\frac{z - Z_1}{Z_2 - Z_1} \right]$$

XEQ

This card causes a call to subroutine FLDINTL which scales any magnetic fields, ray currents and other necessary bookkeeping. Such calls are automatically produced by the appropriate data such as TRACK, so the XEQ cards is only needed when special data sequences are to be used, such as PUNCH rays after CURRENT change. The use of XEQ card never hurts, so when in doubt, use it.

CURRENT .01

XEQ

PRINT RAYS

XYZ

The XYZ data card request ELQ to generate a rectangular coordinate problem. This data must precede the boundary data.

```
TITLE
XYZ
BOUNDARY
      NX NZ XMIN XMAX ZMIN ZMAX
      † X Z ..... S
      .
      :
      .
REST OF DATA ETC.
```

The polar R axis becomes the transverse cartesian X axis, the polar θ rotation axis becomes the cartesian Y axis; in fact, everywhere the polar EBQ uses an R or θ , you may consider the XYZ coordinates to be X,Y. The longitudinal position and independent variable of the orbit integration remains the Z coordinate. This restricts the application to basically paraxial problems.

TREATING RAYS WITH DIFFERENT Z STARTS

EBQ simultaneously tracks all rays together. Two exceptions are allowed, appropriate to a convex and concave starting surface. A convex starting surface will yield rays starting at different z values with the inner ray farther down stream and the outer rays farther up stream. EBQ will integrate the outer ray first, picking up the next ray in order, until all rays are together. The concave starting surface will yield rays starting at different Z values with the inner rays farther up stream than the outer rays. EBQ will integrate the inner ray; first picking up the next rays in order, until all rays are together.

Integration then proceeds in the usual way. When all rays are together, the Neil charge deposition procedure can be used if the input data requests this. Prior to all rays having reached the same z value, only standard charge deposition can be used with a switch to the Neil procedure when all rays have come to the same longitudinal position.

SELECTING MESH SIZES

There are three independent characteristic dimensions used in the simulation of a problem: 1) potential boundary mesh size, 2) external magnetic field vector potential mesh size, and 3) Runge-Kutta integration step size. Some care should be exercised in selecting the values of these dimensions.

The boundary mesh reflects the smallest resolution possible for the external electrodes and determines the frequency of storage for trajectory plotting and ordering the rays to find the enclosed current for calculation of the self-magnetic field and Gauss's law electric self-space charge field, if used. When rays frequently cross, a Z mesh size smaller than the crossing distance should be used. The self field (current enclosed) calculational frequency can be forced to occur every Nth Runge-Kutta integration step by making $CONST(46)=N$. Normally $CONST(46)=0$ so the enclosed current is calculated whenever the rays advance a longitudinal mesh spacing.

The vector potential mesh from which the external magnetic field is calculated should be chosen so its derivatives are sufficiently accurate (these derivatives are the magnetic field components). To facilitate this, the vector potential mesh can be sub-divided into ten regions as described under COILGEN. For example, when long solenoids are used, the fringing field regions typically will require a finer mesh than the far exterior or far interior regions in order to properly calculate B_z and B_r . The accuracy of these calculations can be readily verified by printing the fields obtained from the data with the PRINT FIELDS option.

The Runge-Kutta integration step should be chosen so the rays do not make a large fraction of their wave length or experience a large change in external fields in one integration step. The user can check his step size by running at, say, half or twice his initial step to find if any significant change occurs in his results. If so, a different step should be used.

EBQ UNITS

EBQ code works in a standard set of units as shown in the Table below. If the units are changed via the UNIT input, then the altered units are also indicated.

<u>QUANTITY</u>	<u>STANDARD UNITS</u>	<u>ALTERED UNITS</u>
DISTANCE	CM	UNIT
CURRENT	AMPERES	-----
ENERGY	eV	-----
MOMENTUM	eV/C	-----
VELOCITY	cm/sec	UNIT/sec
TIME	seconds	-----
MAGNETIC FIELD	Gauss	-----
VECTOR POTENTIAL	Gauss-cm	Gauss-UNIT
SCALAR POTENTIAL	Volts	-----
CHARGE	Volts/cm ²	Volts/UNIT ²
CURRENT DENSITY	Amps/cm ²	Amps/UNIT ²

The internal unit of length (centimeters) is defined by the value of four constants:

CONST(5)	Velocity of light	3×10^{10} cm/sec
CONST(8)	Meters/Farad	1.129×10^{11} meters/Farad
CONST(67)	cm per unit length	1
CONST(68)	Ampere law constant	0.2

The internal units can be changed by making the appropriate change in the value of these constants as is done by the UNIT FACTOR data input. FACTOR is the number of centimeters in the new unit, i.e., the number by which the new unit must be multiplied to yield its value in cm. The UNIT input adjusts the values of the CONST array so the internal units is the new unit.

The BOUNDARY input data is normally in cm but can be in any units desired with all R,Z values being multiplied by the seventh parameter of the second boundary card to convert them into the internal units being used. If the seventh parameter is missing, then no unit conversion is done so that the data must be in whatever the internal input unit is. The default value is cm.

The COILGEN input can be in any units desired with all R,Z values being multiplied by the eighth parameter of the COILGEN card to convert them into the standard internal units. If the eighth parameter is missing, no unit conversion of the R,Z input values is done. The default value is cm.

No provision is made to change the units of the output specifications or ray generator data, as only a few numbers are involved. However, RAYS input can involve many cards, so that R,Z values can be converted from whatever their punched values are to the required internal units (default is cm) by the values of CONST(23) and CONST(24). The transformation is

$$R = R(\text{input}) \text{ CONST}(24)$$

$$Z = Z(\text{input}) \text{ CONST}(24) - \text{CONST}(23)$$

The Neil density input is normally in cm and amperes/cm². This data can be scaled on input by the third and fourth parameters of the DENSITY data card.

$$J = J(\text{input}) SJ$$

$$\rho = \rho(\text{input}) SR$$

If the value of SJ and or SR are missing, they are assumed to be unity.

All orbit (ray) input and output requests must be in the internal units. The boundary and coilgen data must be in the internal units or have been converted to the internal units by their individual unit scale factors. Consider the following three identical data cases, except for units.

```
FXR BALL (ALL INPUT AND OUTPUT IN CM)
BOUNDARY
41 26 0 10 0 6.25
1 2.54 0 1 2.54 2.54 1 0.75 2.54
1 0.75 2.75 1 0 2.75 1 0 0 1 2.54 0 S
3 9 0 3 9 2.54 3 10 2.54 3 10 0 3 9 0 S
4 0 6.25 4 10 6.25 S
S
POT 0 0 900E3 170E3 0 S
COILGEN 2 0 0 10
0 6.25 0.1 0.1
100 100 S
20 20 1 8 12 0.5 $ S10
10 10 1 20 30 I $ B0Y
RAYGEN 1 30 1.0E-6R2 100 .375 0.75 2.90 OR4 -3 S
PLOT PHASE 6.25 S
OUTPUT 3 4 6.25 S
PLOT TRAJ S
TRACK X 1
END
```

FXR BALL (UNITS INCHES, DATA IN CM)
UNIT 2.54 IN
BOUNDARY \$ INPUT CM, CONVERTED TO INCHES BY 7-TH PARAMETER
41 26 0 10 0 6.25 0.3937
1 2.54 0 1 2.54 2.54 1 0.75 2.54
1 0.75 2.75 1 0 2.75 1 0 0 1 2.54 0 S
3 9 0 3 9 2.54 3 10 2.54 3 10 0 3 9 0 S
4 0 6.26 4 10 6.25 S
S
POT 0 0 900E3 1170E3 0 S
COILGEN 2 0 0 10 0 0 0.3937 \$ CONVERTED IN BY 8-TH PARAM.
0 6.25 0.1 0.1
100 100 S
20 20 1 8 12 0.5 \$ S10
10 10 1 20 30 1 \$ BOY
RAYGEN 1 30 1.0E-6R2 100 .1476 .2953 1.142 OR4 -3 S
PLOT PHASE 2.4606 S
OUTPUT 1.1811 1.5748 2.4606 S
PLOT TRAJ S
TRACK X 1
END

FXR BALL (ALL INPUT IN INCHES)
UNIT 2.54 IN
BOUNDARY
41 26 0 3.937 0 2.4606
1 1 0 1 1 1 1 .2953 1
1 .2953 1.0827 1 0 1.0827 1 0 0 1 1 0 S
3 3.5433 0 3 3.5433 1. 3 3.937 1 3 3.937 0 3 3.5433 0 S
4 0 2.4606 4 3.937 2.4606 S
S
POT 0 0 900E3 1170E3 0 S
COILGEN 2 0 0 3.937
0 2.4606 .03937 .03937
100 100 S
7.87 7.87 1 3.15 4.72 .1969
3.94 3.84 1 7.87 11.81 .3937
RAYGEN 1 30 1.0E-6R2 100 .1476 .2953 1.142 OR4 -3 S
PLOT PHASE 2.4606 S
OUTPUT 1.1811 1.5748 2.4606 S
PLOT TRAJ S
TRACK X 1
END

RUNNING EBQ AT LBL

The EBQ program is available at LBL from GSS tape 12940. The control cards necessary to execute the program are:

```
JOBNAME,5,200,170000.ACT NUMBER, AND USER NAME
FETCHGS,LGO=EBQ/V4,12940.
RFL,,140000.
LINK,X.
789 + END OF RECORD
USER DATA FOR EBQ PROGRAM
.
.
.
.
.
END
END
6789 + END OF FILE
```

EBQ currently uses 170K of small core and 140K (octal) of large core.

EXAMPLES OF THE USE OF THE EBQ CODE

In the following section there are ten examples illustrating different features of the EBQ code's input and output. The following table lists some of the features of the examples.

- 1) Simple electrostatic problem showing the *data input and selected pages of the computer printout generated by EBQ.*
- 2) Simple constant magnetic field problem with a matched orbit and discussion of the units of energy, momentum and field.
- 3) Design of an atomic beam spectrometer illustrating:
 - a) boundary input in inches
 - b) ray generation on a regular $r-r'$ phase space grid
 - c) boundary modification to add an electrode
 - d) setting the Runge-Kutta integration step
 - e) *modifying the potential of an electrode to fine tune the device.*
- 4) RTNS example illustrates the data for:
 - a) running multiple ion species
 - b) defining regions outside the boundary
 - c) generating $x-x'$ phase plots
- 5) Xc^{+1} source problem showing:
 - a) ray orbit generation in a random phase space volume
 - b) tracking beams with different current
 - c) iterative solution to the space charge problem.

- 6) Continuation of problems
 - a) starting from a previous dump
 - b) graded Dirichlet incremental boundary input
 - c) shifting the orbit origin
 - d) dumping and reading ray data from case to case
 - e) LEDGE data for setting the potential on problems left edge.
- 7) High current, relativistic electron beam problem
 - a) Childs law start from cathode
 - b) STOP PLOT data input
 - c) stopping orbits at constant energy for phase plotting
 - d) forcing a given phase space plot scale.
- 8) Use of EBQ code in long transport problems illustrating:
 - a) Gauss's law approximation to the space charge
 - b) magnetic field zoning and repeated fields
 - c) RAYS 5 input with uniform current density generation.
- 9) Use of EBQ code in design of an X-ray tube illustrating:
 - a) PLOT BOUNDARY data
 - b) Global problem with expanded regions
 - c) storing values from the potential map into the POT array
 - d) removal of ray transferred from a tape dump.
- 10) Childs law electron source generating hollow beams via cathode masking.

Example 1

As a first example of the use of the EBQ code, consider the simulation of the motion of an electron initially at radius r_0 at zero slope ($dr/dz=0$) in the electric field between two concentric infinitely long cylinders of radius a and b . The equation of motion is

$$m \ddot{r} = e E_r$$

The potential V between the cylinders define a scaling constant E_0 .

By Gauss's law, $E_r = E_0/r$ so that

$$V = \int_a^b E_r dr = E_0 \ln(b/a)$$

Eliminating time as the independent variable, $d/dt = v d/dz$

$$r'' = \frac{e E_0}{m v^2} \frac{1}{r}$$

integrating

$$\frac{dr}{dz} = \sqrt{\frac{2 E_0 e}{m v^2} \ln(r/r_0)}$$

whose solution can be written in terms of the imaginary error function

$\operatorname{erfi}(z)$ (see Jahnke, Emde, Losch, table of Higher Functions, 1960 page

11) with $-v^2 = \ln(r/r_0)$

$$z = \sqrt{\frac{m v^2}{2 e}} \int_{r_0}^r \frac{dr}{r} \operatorname{erfi} \left(\sqrt{\frac{2 e}{m v^2}} \ln \frac{r}{r_0} \right)$$

$$z = \sqrt{\frac{m_e v^2}{2 e E_0}} 2 r_0 \operatorname{erfi}(X)$$

where $X = \ln(b/r_0)$.

For example, a 5 keV electron starting at $r_0 = 20$ cm in a 100 volt potential between cylinders of 10 and 30 cm radius yields $E_0 = 100/\ln(3) = 91.0239$ and $X = 0.63676$ such that it hits the wall at

$$z = \sqrt{\frac{m_e v^2}{2 e E_0}} 2 r_0 \operatorname{erfi}(0.6376) = 217.74 \text{ cm}$$

Figure 1.1 shows the problem geometry and Figure 1.2 gives the EBQ input data for this case.

The actual output from EBQ is shown for this example. Each data card read is immediately printed into the output stream. Each data type entry is preceded by 45 dashes, this is useful when some abortive error is encountered before completion of the data input, in as much as the type of input last recognized by the input routines was identified by the dashes.

The boundary input shown in Figure 1.2 (lines 4-7, is printed into the output stream, page 1, and is followed by output listing the mesh size, number of boundary points, number of Poisson coefficients etc. Next follows a map of the type array, output pages 2-5, of which only page 2 is reproduced here. Note, the boundary mesh as described previously under BOUNDARY shows interior points as small integers and boundary points and electrodes as actual numbers concatenating the type-potential and coupling coefficient indexes. There are large ten digit octal numbers on the mesh map.

The output on page 6 shows the next output generated by read of the potentials, problem constants, and ray data input lines 8-18. The particle input is followed by a table giving the values of the particles cartesian position x , y , z (cm), cartesian momentum components p_x , p_y , p_z (eV/c), current (amperes), radius (cm), energy (eV), radial slope ($\Delta\text{ALPHA} = dr/dz$), and transverse slope ($\text{PSI} = r d\phi/dz$). Next follows a table of the average beam energy in eV, momentum in eV/c current in amperes, β ($\text{beta} = v/c$), γ ($\text{gamma} = 1/\sqrt{1-\beta^2}$), and magnetic rigidity $B\rho$ in Gauss-cm

The actual calculations begin with the TRACK command, line 23, Figure 1.2. The first output is a listing of the present values of the problem constants, the CONST() array. Poissons equation is then soived with output every ten iterations showing the sum of the residuals, maximum potential change of any mesh point, and the potentials of the four potential points selected for display by the OUTPUT POISSON data line 20, Figure 1.2. This problem converged in 53 iterations where the maximum change of any mesh point was 81 milivolts, page 7 of the output. Next follows output of the orbit data as requested by the data of the CONST() array and special output data preceeding the TRACK command.

Output page 3 shows the ray trajectory output generated during tracking. The normal output consists of a print of the initial ray coordinates at the start of the problem, here at $z = 0$, and the final ray coordinates at the end of the problem. Since all rays hit the outer cylinder electrode in this case, the last position reached by the rays

was 248 cm where the final conditions are printed. Output at three special longitudinal z positions was generated by the data line 19. Notice, that rays lost to the boundary are not printed after their loss. The velocities printed at the end of the page for the rays are zero as the rays hit an electrode.

Page 9 shows the beam trace paper plot of the format indicated below:

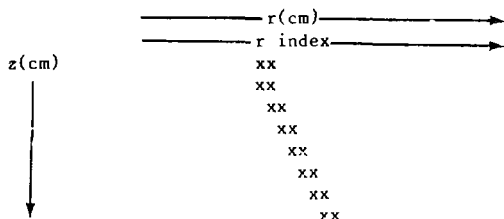

where the print of x simply occurs at each mesh point where the value of the charge array RH() mesh point is non-zero. If the beam current is zero, then every RH() mesh point is zero and there would be no beam trace plot, i.e., it would be blank; for this reason, I suggest that the user simulating a zero current beam uses actually a small infinitesimal but finite beam current.

Since the value of CONST(4) had been set to have a unit value component, a table of the R,Z points used in plotting the rays is generated after the beam trace plot, page 9 - 10 of the output. Next follows a map of the electric potential (Volts) and the charge RH() array (Volts/cm²), page 11 - 18 of which only pages 11 and 15 are reproduced here. The data case ends with a summary table giving the

number of calls and execution times of the main subroutines called in EBQ, page 19.

The CALCOMP plot of the boundary electrodes and the three rays traced in this problem is reproduced here in Figure 1.3.

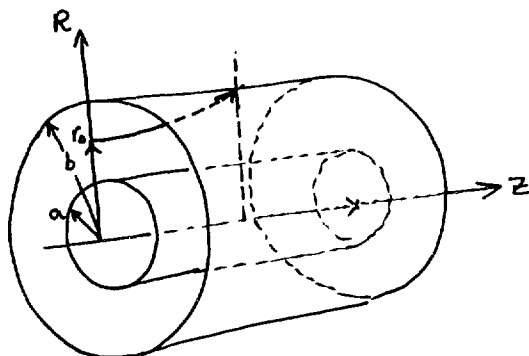

XBL 823-1941

Figure 1.1 Deflection of electron between two concentric cylinders.

```

ELECTRIC FIELD DEFLECTION BETWEEN TWO CONCENTRIC CYLINDERS 1
INITIALIZE 2
BOUNDARY----- 3
  31 31 0 30 0 300 4
  1 10 0 1 10 300 S $ ----- INNER ELECTRODE 5
  2 30 0 2 30 300 S $ ----- OUTER ELECTRODE 6
S 7
POI 0 100 S 8
CONST 9
*34 11 $ ----- PRINT AND PLOT RAYS 10
*63 0 $ ----- NO EMISSION CALCULATIONS 11
*71 0 $ DONT PLOT ENVELOP 12
S 13
RAYS 3 $ ----- R Z PHI E ALPHA PSI I 14
  14.81436 0 0 5.0E3 0 0 1.0E-6 15
  19.91750 0 0 5.0E3 0 0 1.0E-6 16
  25.14850 0 0 5.0E3 0 0 1.0E-6 17
END RAYS INPUT 18
OUTPUT 166.281 218.250 236.809 S 19
OUTPUT POISSON 20 1 20 11 20 21 20 31 $ ---- IR IZ PAIRS 20
PLOT FRAJ S----- 22
TRACK 23
END 24

```

Figure 1.2 EBQ code data input for two concentric cylinder example.

CELL 1.0000 X 10.0000
30.0

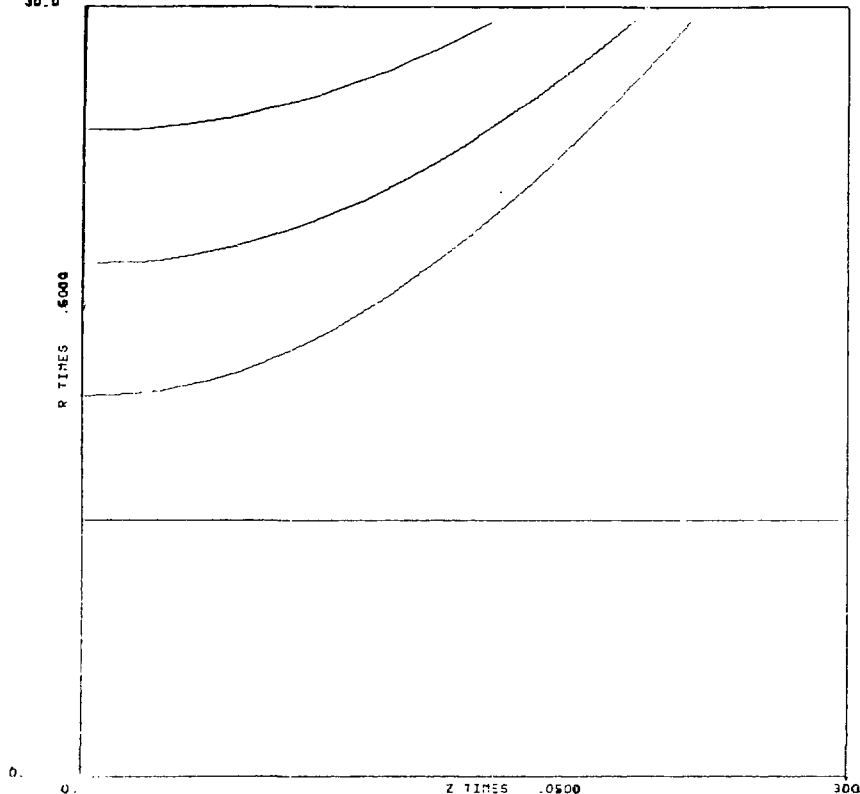

TITLE X1UC1D
ELECTRIC FIELD DEFLECTION BETWEEN TWO CONCENTRIC CYLINDERS

UCIDY00 24 OCT 78 ITER= 1 PLGT 1

XBL 823-1903

Figure 1.3 EBQ CALCOMP plot showing inner and outer electrode cylinders and the three deflected electron trajectories. The axial scale factor "z TIMES .05" and the radial scale factor "R TIMES .5" are the axis multipliers. This plot is half scale radially and 1/20 scale longitudinally. These factors are determined by RMAX, ZMAX-ZMIN and CONST(35) and CONST(36).

CASE NUMBER 1-----UCIDX00 7 24 OCT 78 13.09.15 -----CASE NUMBER 1

ELECTRIC FIELD DEFLECTION BETWEEN TWO CONCENTRIC CYLINDERS

TITLE UCID

INITIALIZ

BOUNDARY

31 31 0 30 0 300

1 10 0 1 10 300 S \$ ----- INNER ELECTRODE

2 30 0 2 30 300 S \$ ----- OUTER ELECTRODE

S

POISSON OUTPUT INDICES ARE 218 435 652 869

BOUNDARY MESH SIZE= 1.000000 X 10.000000

THE NUMBER OF MESH POINTS IS= 961

BOUNDARY POINTS= 180

COEFFICIENTS= 1080

BOUNDARY SEGMENTS= 3

-217-

ELECTRIC FIELD DEFLECTION BETWEEN TWO CO-AXIAL CYLINDERS

	1	2	3	4	5	6	7	8	9	10	
	0.0000	10.0000	20.0000	30.0000	40.0000	50.0000	60.0000	70.0000	80.0000	90.0000	
	31	32	33	34	35	36	37	38	39	310	
31	30.0000	0070020135	0010020134	0010020137	0010020140	0010020141	0010020142	0010020143	0010020144	0010020145	0010020146
32	29.0000	0020000227	30	30	30	30	30	30	30	30	30
29	28.0000	0020000226	29	29	29	29	29	29	29	29	29
28	27.0000	0020000225	28	28	28	28	28	28	28	28	28
27	26.0000	0020000224	27	27	27	27	27	27	27	27	27
26	25.0000	0020000223	26	26	26	26	26	26	26	26	26
25	24.0000	0020000222	25	25	25	25	25	25	25	25	25
24	23.0000	0020000221	24	24	24	24	24	24	24	24	24
23	22.0000	0020000220	23	23	23	23	23	23	23	23	23
22	21.0000	0020000217	22	22	22	22	22	22	22	22	22
21	20.0000	0020000216	21	21	21	21	21	21	21	21	21
20	19.0000	0020000215	20	20	20	20	20	20	20	20	20
19	18.0000	0020000214	19	19	19	19	19	19	19	19	19
18	17.0000	0020000213	18	18	18	18	18	18	18	18	18
17	16.0000	0020000212	17	17	17	17	17	17	17	17	17
16	15.0000	0020000211	16	16	16	16	16	16	16	16	16
15	14.0000	0020000210	15	15	15	15	15	15	15	15	15
14	13.0000	0020000207	14	14	14	14	14	14	14	14	14
13	12.0000	0020000206	13	13	13	13	13	13	13	13	13
12	11.0000	0020000205	12	12	12	12	12	12	12	12	12
11	10.0000	0010010234	0010010230	0010010231	0010010232	0010010233	0010010234	0010010235	0010010236	0010010237	0010010240
10	9.0000	0020000203	10	10	10	10	10	10	10	10	10
9	8.0000	0020000201	9	9	9	9	9	9	9	9	9
8	7.0000	0020000200	8	8	8	8	8	8	8	8	8
7	6.0000	0020000177	7	7	7	7	7	7	7	7	7
6	5.0000	0020000176	6	6	6	6	6	6	6	6	6
5	4.0000	0020000175	5	5	5	5	5	5	5	5	5
4	3.0000	0020000174	4	4	4	4	4	4	4	4	4
3	2.0000	0020000173	3	3	3	3	3	3	3	3	3
2	1.0000	0020000172	2	2	2	2	2	2	2	2	2
1	0.0000	0030000040	0030000041	0030000042	0030000043	0030000044	0030000045	0030000046	0030000047	0030000050	0030000051

POT 0 100 5
 CONST
 *34 11 % ----- PRINT AND PLOT RAYS
 *35 -15. -15.
 *63 0 \$ ----- NO EMITTANCE CALCULATIONS
 *71 0 \$ CONST PLOT ENVELOP

S
 RAYS 3 \$ ----- P Z PHT E ALPHA PSI I
 14.81436 C 0 5.0E3 0 0 1.0E-6
 19.91750 0 0 5.0E3 0 0 1.0E-6
 25.14850 0 0 5.0E3 0 0 1.0E-6
 ENO RAYS INPUT

N	X	Y	Z	PX	PY	PZ	AMPS	R	E	ALPHA	PSI
1	14.81436	0.00000	0.0000 0.	0.	0.	7.16589E+04	1.00000E-06	14.81436	5.00000E+03	0.000000	0.000000
2	19.91750	0.00000	0.0000 0.	0.	0.	7.16589E+04	1.00000E-06	19.91750	5.00000E+03	0.000000	0.000000
3	25.14850	0.00000	0.0000 0.	0.	0.	7.16589E+04	1.00000E-06	25.14850	5.00000E+03	0.000000	0.000000

RAY GROUP 1 RAYS 1 THROUGH 3 ----- MASS= 5.110000E+05 EV CHARGE -1 ----- ITERATION 0
 AVE BEAM ENERGY = 5.000000E+03 AVE GAMMA = 1.009785E+00
 TOTAL BEAM CURRENT= 3.000000E-06 AVE BETA = 1.388739E-01
 AVE BEAM MOMENTUM = 7.165891E+04 BRHO(GAUSS-CM)= 2.390287E+02

OUTPUT 166.281 218.250 238.809 S
 OUTPUT POSITION 20 1 20 11 20 21 20 31 \$ ---- IR IZ PAIRS

POISSON OUTPUT INDICES ARE 20 330 640 950

PLOT TRAJ 5
 TRACK

CONST(1)	51100000000	CONST(26)	1.0000000000E+100	CONST(51)	1.0000000000E-04	CONST(76)	0.
CONST(2)	-1.000000000	CONST(27)	0.	CONST(52)	3.000000000	CONST(77)	0.
CONST(3)	1.000000000	CONST(28)	0.	CONST(53)	1.000000000	CONST(78)	0.
CONST(4)	1.000000000	CONST(29)	1.000000000	CONST(54)	0.	CONST(79)	0.
CONST(5)	2.997760000E+10	CONST(30)	0.	CONST(55)	1.000000000E-02	CONST(80)	40.00000000
CONST(6)	-299.7921000	CONST(31)	0.	CONST(56)	0.	CONST(81)	100.0000000
CONST(7)	-1.200000000	CONST(32)	1.000000000	CONST(57)	1.000000000	CONST(82)	1.800000000
CONST(8)	1.129000000E+11	CONST(33)	0.	CONST(58)	1.000000000	CONST(83)	1.900000000
CONST(9)	0.	CONST(34)	11.000000000	CONST(59)	0.	CONST(84)	0.
CONST(10)	10.000000000	CONST(35)	-15.000000000	CONST(60)	0.	CONST(85)	0.
CONST(11)	1.745329250E-02	CONST(36)	-15.000000000	CONST(61)	1.000000000	CONST(86)	0.
CONST(12)	3.141592654	CONST(37)	1.000000000	CONST(62)	0.500000000	CONST(87)	0.
CONST(13)	1.000000000	CONST(38)	5.000000000	CONST(63)	0.	CONST(88)	0.
CONST(14)	1.000000000	CONST(39)	5.000000000	CONST(64)	0.	CONST(89)	0.
CONST(15)	1.800000000	CONST(40)	0.	CONST(55)	1.000000000E+100	CONST(90)	305.0000000
CONST(16)	1.000000000	CONST(41)	0.	CONST(66)	1.000000000	CONST(91)	2.611210000E+11
CONST(17)	200.0000000	CONST(42)	0.	CONST(67)	0.	CONST(92)	2.000000000
CONST(18)	10.000000000	CONST(43)	1.000000000	CONST(68)	0.	CONST(93)	2.000000000
CONST(19)	300.0000000	CONST(44)	0.	CONST(69)	0.	CONST(94)	-1.129400000E+13
CONST(20)	0.	CONST(45)	0.	CONST(70)	1.000000000	CONST(95)	-1.7974959273E+12
CONST(21)	1.000000000	CONST(46)	0.	CONST(71)	0.	CONST(96)	1.7974959273E+12
CONST(22)	1.000000000E-02	CONST(47)	0.	CONST(72)	-1.000000000	CONST(97)	1.000000000
CONST(23)	0.	CONST(48)	1.500000000	CONST(73)	1.000000000	CONST(98)	1.200000000
CONST(24)	1.000000000	CONST(49)	-1.000000000	CONST(74)	0.500000000	CONST(99)	0.
CONST(25)	300.0000000	CONST(50)	0.	CONST(75)	0.	CONST(100)	0.

-219-

1 ITERATION		-----POISSON EQUATION CYCLE TABLE-----							ITERATION 1	
CYCLE	SUM RESIDUALS	MAX RESIDUALS	I MAX RES	20	30	60	90			
				(19, 0)	(19, 10)	(19, 20)	(19, 30)			
OVER-RELAXATION FACTOR	ALTERN	0	1.8000E+00							
0	5.2200E+03	1.8000E+02	930	0.0000	0.0000	0.0000	0.0000			
10	1.3019E+04	7.5262E+01	920	0.0000	0.0000	0.0000	0.0000			
20	6.4534E+03	5.7680E+01	911	61.5260	52.6249	52.6249	58.4339			
30	8.5693E+02	6.6459E+00	911	58.5291	57.2571	57.2571	57.7412			
OVER-RELAXATION FACTOR	ALTERN	40	1.8000E+00							
40	1.4331E+02	1.3482E+00	911	58.4360	58.2038	58.2038	58.2958			
50	1.4963E+01	1.5684E-01	911	58.4253	58.3969	58.3969	58.4066			
53	9.1926E+00	8.1105E-02	911	58.4133	58.4305	58.4305	58.4247			

STANDARD DEPOSITION				CURRENT= 3.00000E-06				STANDARD DEPOSITION			
RAY	E	X	Y	Z=	S	PX	PY	PZ	T	R	PHI
1	5.00000E+03	14.81436	0.00000	0.00000	0.00000	0.	0.	7.16589E+04	0.	14.81436	0.00000
2	5.00000E+03	19.91750	0.00000	0.00000	0.00000	0.	0.	7.16589E+04	0.	19.91750	0.00000
3	5.00000E+03	25.14850	0.00000	0.00000	0.00000	0.	0.	7.16589E+04	0.	25.14850	0.00000
Z= 166.28100											
RAY	E	X	Y	Z=	S	PX	PY	PZ	T	R	PHI
1	5.03615E+03	22.26061	0.00000	166.50356	6.18547E+03	0.	0.	7.16523E+04	3.99461E-08	22.26061	0.00000
2	5.02265E+03	25.63285	0.00000	166.41357	4.84867E+03	0.	0.	7.16566E+04	3.99434E-08	25.63285	0.00000
3	5.01573E+03	29.74425	0.00000	166.36723	3.97054E+03	0.	0.	7.16522E+04	3.99402E-08	29.74425	0.00000
Z= 218.25000											
RAY	E	X	Y	Z=	S	PX	PY	PZ	T	R	PHI
1	5.05463E+03	27.26656	0.00000	218.71390	7.57144E+03	0.	0.	7.16523E+04	5.24316E-08	27.26656	0.00000
2	5.03583E+03	29.62405	0.00000	218.53625	6.10774E+03	0.	0.	7.16566E+04	5.24277E-08	29.62405	0.00000
Z= 238.80900											
RAY	E	X	Y	Z=	S	PX	PY	PZ	T	R	PHI
1	5.06182E+03	29.50811	0.00000	239.39478	8.04684E+03	0.	0.	7.16523E+04	5.73710E-08	29.50811	0.00000
Z= 248.80900											
RAY	F	X	Y	Z=	S	PX	PY	PZ	T	R	PHI
1	5.06240E+03	29.69528	0.00000	241.07192	8.08383E+03	0.	0.	7.16523E+04	5.77714E-08	30.00000	0.00000
2	5.03627E+03	29.76411	0.00000	220.20896	6.14457E+03	0.	0.	7.16566E+04	5.28281E-08	30.00000	0.00000
3	5.01602E+03	29.83660	0.00000	168.03645	4.00719E+03	0.	0.	7.16622E+04	4.03406E-08	30.00000	0.00000
VELOCITY OF RAYS CM/SEC											
	0.	0.	0.								

ENVELO

0.0000 10.0000 20.0000 30.0000 40.0000 50.0000 60.0000 70.0000 80.0000 90.0000 100.0000

```

1  0.00000 1  X  X  X  X  X  X  X  X  X  X
2  10.00000 1  X  X  X  X  X  X  X  X  X
3  20.00000 1  X  X  X  X  X  X  X  X  X
4  30.00000 1  X  X  X  X  X  X  X  X  X
5  40.00000 1  X  X  X  X  X  X  X  X  X
6  50.00000 1  X  X  X  X  X  X  X  X  X
7  60.00000 1  X  X  X  X  X  X  X  X  X
8  70.00000 1  X  X  X  X  X  X  X  X  X
9  80.00000 1  X  X  X  X  X  X  X  X  X
10 90.00000 1  X  X  X  X  X  X  X  X  X
11 100.00000 1  X  X  X  X  X  X  X  X  X
12 110.00000 1  X  X  X  X  X  X  X  X  X
13 120.00000 1  X  X  X  X  X  X  X  X  X
14 130.00000 1  X  X  X  X  X  X  X  X  X
15 140.00000 1  X  X  X  X  X  X  X  X  X
16 150.00000 1  X  X  X  X  X  X  X  X  X
17 160.00000 1  X  X  X  X  X  X  X  X  X
18 170.00000 1  X  X  X  X  X  X  X  X  X
19 180.00000 1  X  X  X  X  X  X  X  X  X
20 190.00000 1  X  X  X  X  X  X  X  X  X
21 200.00000 1  X  X  X  X  X  X  X  X  X
22 210.00000 1  X  X  X  X  X  X  X  X  X
23 220.00000 1  X  X  X  X  X  X  X  X  X
24 230.00000 1  X  X  X  X  X  X  X  X  X
25 240.00000 1  X  X  X  X  X  X  X  X  X
26 250.00000 1  X  X  X  X  X  X  X  X  X
27 260.00000 1  X  X  X  X  X  X  X  X  X
28 270.00000 1  X  X  X  X  X  X  X  X  X
29 280.00000 1  X  X  X  X  X  X  X  X  X
30 290.00000 1  X  X  X  X  X  X  X  X  X
31 300.00000 1  X  X  X  X  X  X  X  X  X

```

PLCT 1

PLCT RAY NUMBER	1	2	3	4	5	6	7	8	9	10
	14.8144	14.8144	14.8144	14.8861	15.0092	15.1933	15.4375	15.7409	16.1024	16.5207
	16.4666	17.5224	18.1023	18.3328	19.4172	20.1387	20.9108	21.7266	23.1442	24.0673
	25.0285	25.0282	27.0551	28.1398	29.4654					

PLCT RAY NUMBER	2	3	4	5	6	7	8	9	10	
	19.9175	19.9175	19.9175	19.9710	20.0000	20.2000	20.3826	20.6103	20.8824	21.1984
	21.5575	21.9589	22.4021	22.4962	23.4102	23.9733	24.5746	25.2132	26.3300	27.0619
	27.8275	28.6262	29.4568	30.0000	30.0000					

PLCT RAY NUMBER	3	4	5	6	7	8	9	10		
	25.1485	25.1485	25.1485	25.1910	25.2638	25.3727	25.5177	25.6984	25.9147	26.1663
	26.4520	26.7741	27.1295	27.5196	27.9409	28.3960	28.8833	29.4023	30.0000	30.0000
	30.0000	30.0000	30.0000	30.0000	30.0000					

Z-AXIS(CM)	0.0000	10.0000	20.0000	30.0000	40.0000	50.0000	60.0000	70.0000	80.0000	90.0000	100.0000
	196.2810	206.4810	216.2810	226.2530	238.2530	140.0000	150.0000	160.0000	176.2810	186.2810	

ENVELOPE AND Z-AXIS(CM)	1	2	3	4	5	6	7	8	9	10
	25.1485	25.1485	25.1910	25.2638	25.3727	25.5177	25.6984	25.9147	26.1663	26.4529
	26.7741	27.1295	27.5186	27.9409	28.3960	28.8833	29.4023	26.3300	27.0619	27.8276
	28.6262	29.4568	28.3398	24.4654						

0.0000	10.0000	20.0000	30.0000	40.0000	50.0000	60.0000	70.0000	80.0000	90.0000
100.0000	110.0000	120.0000	130.0000	140.0000	150.0000	160.0000	170.0000	180.0000	190.0000
200.0000	210.0000	220.0000	230.0000						

POV4*

ELECTRIC FIELD DEFLECTION BETWEEN TWO CONCENTRIC CYLINDERS		UII SCALE= 1.00000E+00									
		3	4	5	6	7	8	9	10		
		5.00000	10.00000	20.00000	30.00000	40.00000	50.00000	60.00000	70.00000	80.00000	90.00000
31	30.0000	100.00	100.00	100.00	100.00	100.00	100.00	100.00	100.00	100.00	100.00
30	29.0000	96.92	96.92	96.92	96.92	96.92	96.92	96.92	96.92	96.92	96.92
29	28.0000	93.72	93.72	93.72	93.72	93.72	93.72	93.72	93.72	93.72	93.72
28	27.0000	90.41	90.41	90.41	90.41	90.41	90.41	90.41	90.41	90.41	90.41
27	26.0000	86.97	86.97	86.97	86.97	86.97	86.97	86.97	86.97	86.97	86.97
26	25.0000	83.41	83.41	83.41	83.41	83.41	83.41	83.41	83.41	83.41	83.41
25	24.0000	79.68	79.68	79.68	79.68	79.68	79.68	79.68	79.68	79.68	79.68
24	23.0000	75.82	75.82	75.82	75.82	75.82	75.82	75.82	75.82	75.82	75.82
23	22.0000	71.76	71.76	71.76	71.76	71.76	71.76	71.76	71.76	71.76	71.76
22	21.0000	67.54	67.54	67.54	67.54	67.54	67.54	67.54	67.54	67.54	67.54
21	20.0000	63.09	63.09	63.09	63.09	63.09	63.09	63.09	63.09	63.09	63.09
20	19.0000	58.43	58.43	58.43	58.43	58.43	58.43	58.43	58.43	58.43	58.43
19	18.0000	53.49	53.49	53.49	53.49	53.49	53.49	53.49	53.49	53.49	53.49
18	17.0000	48.31	48.31	48.31	48.31	48.31	48.31	48.31	48.31	48.31	48.31
17	16.0000	42.77	42.77	42.77	42.77	42.77	42.77	42.77	42.77	42.77	42.77
16	15.0000	36.92	36.92	36.92	36.92	36.92	36.92	36.92	36.92	36.92	36.92
15	14.0000	30.62	30.62	30.62	30.62	30.62	30.62	30.62	30.62	30.62	30.62
14	13.0000	23.90	23.90	23.90	23.90	23.90	23.90	23.90	23.90	23.90	23.90
13	12.0000	16.59	16.59	16.59	16.59	16.59	16.59	16.59	16.59	16.59	16.59
12	11.0000	8.70	8.70	8.70	8.70	8.70	8.70	8.70	8.70	8.70	8.70
11	10.0000	0.00	0.00	0.00	0.00	0.00	0.00	0.00	0.00	0.00	0.00
10	9.0000	0.00	0.00	0.00	0.00	0.00	0.00	0.00	0.00	0.00	0.00
9	8.0000	0.00	0.00	0.00	0.00	0.00	0.00	0.00	0.00	0.00	0.00
8	7.0000	0.00	0.00	0.00	0.00	0.00	0.00	0.00	0.00	0.00	0.00
7	6.0000	0.00	0.00	0.00	0.00	0.00	0.00	0.00	0.00	0.00	0.00
6	5.0000	0.00	0.00	0.00	0.00	0.00	0.00	0.00	0.00	0.00	0.00
5	4.0000	0.00	0.00	0.00	0.00	0.00	0.00	0.00	0.00	0.00	0.00
4	3.0000	0.00	0.00	0.00	0.00	0.00	0.00	0.00	0.00	0.00	0.00
3	2.0000	0.00	0.00	0.00	0.00	0.00	0.00	0.00	0.00	0.00	0.00
2	1.0000	0.00	0.00	0.00	0.00	0.00	0.00	0.00	0.00	0.00	0.00
1	0.0000	0.00	0.00	0.00	0.00	0.00	0.00	0.00	0.00	0.00	0.00

- 224 -

ELECTRIC FIELD DEFLECTION BETWEEN TWO CONCENTRIC CYLINDERS

		RH(1) SCALE= 1.00000E+00									
		1	2	3	4	5	6	7	8	9	10
		0.00000	10.00000	20.00000	30.00000	40.00000	50.00000	60.00000	70.00000	80.00000	90.00000
31	30.0000	0.	0.	0.	0.	0.	0.	0.	0.	0.	0.
30	29.0000	0.	0.	0.	0.	0.	0.	0.	0.	0.	0.
29	28.0000	0.	0.	0.	0.	0.	0.	0.	0.	0.	0.
28	27.0000	0.	0.	0.	0.	0.	0.	0.	0.	0.	0.
27	26.0000	-2.550E-06	-2.550E-06	-3.274E-06	-4.508E-06	-6.341E-06	-8.759E-06	-1.173E-05	-1.524E-05	-1.937E-05	-2.41E-06
26	25.0000	-1.452E-05	-1.452E-05	-1.330E-05	-1.258E-05	-1.167E-05	-8.161E-06	-5.067E-06	-1.421E-06	0.	0.
25	24.0000	0.	0.	0.	0.	0.	0.	0.	0.	0.	0.
24	23.0000	0.	0.	0.	0.	0.	0.	0.	0.	0.	0.
23	22.0000	0.	0.	0.	0.	0.	0.	0.	0.	-4.740E-06	-1.117E-05
22	21.0000	0.	0.	0.	-1.349E-06	-4.27E-06	-8.106E-06	-1.279E-05	-1.824E-05	-2.433E-05	-3.164E-06
21	20.0000	-1.989E-05	-1.989E-05	-2.099E-05	-2.017E-05	-1.712E-05	-1.209E-05	-8.165E-06	-2.432E-06	0.	0.
20	19.0000	-1.788E-06	-1.788E-06	-5.272E-07	0.	0.	0.	0.	0.	0.	0.
19	18.0000	0.	0.	0.	0.	0.	0.	0.	0.	0.	0.
18	17.0000	0.	0.	0.	0.	0.	0.	0.	-2.745E-06	-1.06E-05	-2.527E-05
17	16.0000	0.	0.	0.	-2.645E-07	-5.493E-06	-1.224E-05	-2.033E-05	-2.407E-05	-1.753E-05	-1.373E-07
16	15.0000	-2.373E-05	-2.373E-05	-2.570E-05	-2.751E-05	-2.293E-05	-1.573E-05	-7.107E-06	0.	0.	0.
15	14.0000	-5.411E-06	-5.411E-06	3.304E-06	0.	0.	0.	0.	0.	0.	0.
14	13.0000	0.	0.	0.	0.	0.	0.	0.	0.	0.	0.
13	12.0000	0.	0.	0.	0.	0.	0.	0.	0.	0.	0.
12	11.0000	0.	0.	0.	0.	0.	0.	0.	0.	0.	0.
11	10.0000	0.	0.	0.	0.	0.	0.	0.	0.	0.	0.
10	9.0000	0.	0.	0.	0.	0.	0.	0.	0.	0.	0.
9	8.0000	0.	0.	0.	0.	0.	0.	0.	0.	0.	0.
8	7.0000	0.	0.	0.	0.	0.	0.	0.	0.	0.	0.
7	6.0000	0.	0.	0.	0.	0.	0.	0.	0.	0.	0.
6	5.0000	0.	0.	0.	0.	0.	0.	0.	0.	0.	0.
5	4.0000	0.	0.	0.	0.	0.	0.	0.	0.	0.	0.
4	3.0000	0.	0.	0.	0.	0.	0.	0.	0.	0.	0.
3	2.0000	0.	0.	0.	0.	0.	0.	0.	0.	0.	0.
2	1.0000	0.	0.	0.	0.	0.	0.	0.	0.	0.	0.
1	0.0000	0.	0.	0.	0.	0.	0.	0.	0.	0.	0.

```
----- TIME
TIME# 14245 Co SEC 7035. 01# 143040
----- END

SUMMARY - NUMBER OF SCHEDULED CALLS AND TIMES
READY NUMBER OF CALLS # 0 TOTAL TIME # 0.000 SECONDS
BLW NUMBER OF CALLS # 1 TOTAL TIME # 4.721 SECONDS
PCC# NUMBER OF CALLS # 1 TOTAL TIME # 4.683 SECONDS
PKT# NUMBER OF CALLS # 4 TOTAL TIME # 4.024 SECONDS
CPLCN NUMBER OF CALLS # 0 TOTAL TIME # 0.000 SECONDS
BRWMD# NUMBER OF CALLS # 1 TOTAL TIME # 4.018 SECONDS
NUMBER OF CALLS # 0 TOTAL TIME # 0.000 SECONDS
NUMBER OF CALLS # 0 TOTAL TIME # 0.000 SECONDS
```

EXAMPLE 2

As a second, simple example of the use of the EBQ code for a problem for which an analytic solution exist, consider the motion of a 2.5 MeV electron traveling down a pipe in the presence of a constant 1000 gauss magnetic field. Two trajectories will be calculated, a helical one such that the particle will move at constant radius, and the other will be mis-matched so it widely oscillates in radius. The momentum of the rays are given as:

$$P = \sqrt{E^2 - E_0^2} = \sqrt{(2.5 + .511)^2 - .511^2} \times 10^6$$

$$P = 2.967 \times 10^6 \text{ eV/c}$$

The magnetic rigidity is $B(\text{gauss}) \rho(\text{cm}) = P(\text{ergs})/e(\text{esu})$

$$B \rho (\text{g-cm}) = 3335.7 P (\text{MeV/c})$$

The cyclotron radius is the transverse radius in this B field of 1000 gauss. If we start the electron with $P_z = P_x$, then:

$$P_z = P_x = P/\sqrt{2} = 2.0982 \text{ MeV/c}$$

$$B \rho = 6.99896 \times 10^3 \text{ g-cm}$$

$$R = 6.998 \text{ cm}$$

The wave length of a single oscillation is given by

$$X = X_0 \sin \frac{2\pi z}{\lambda}$$

$$\frac{dx}{dz} = \frac{P_x}{P_z} = \frac{2\pi}{\lambda} X_0 \cos \frac{2\pi z}{\lambda} = 1$$

so that $\lambda = 2\pi X_0 = 43.944 \text{ cm}$.

The physical system is shown in Figure 2.1. The EBQ code data input for this case is shown in Figure 2.2.

The data input defines a 41×26 mesh extending to 20 cm. radius, and longitudinally from 0 to 100 cm, line 4. The boundary generator initializes a Neuman boundary on the left, right and $r=0$ axis. A conductive cylinder is used as the outer boundary, defined by line 5. The potential is set to zero, line 8. Lines 10-13 set the problem constants which are to differ from the default values. The high pitch of the orbit requires a Rungga kutta integration step smaller than the default value of the longitudinal mesh size. Lines 12-13 turn off the calculation of phase space area and beam envelop, as these make no sense for this example.

The ray data is given by lines 15-18. The input type 1 specifies input of X, Y, Z, PX, PY, PZ, and current. The input is terminated by the END card, line 18. A constant B_z field is defined by the COILGEN data, line 19. A CALCOMP beam trace plot is requested, line 20 with the default value of CONST(34)=10, shown in Figure 2.3.

The particle started at $R = 1.994$ cm with $P_x = P_z = 2.0982 \times 10^6$ ev/c moves at constant radius while the ray started with $R = 0$, $P_x = P_z = 2.0982 \times 10^6$ ev/c oscillates with $0 < R < 13.998$ cm.

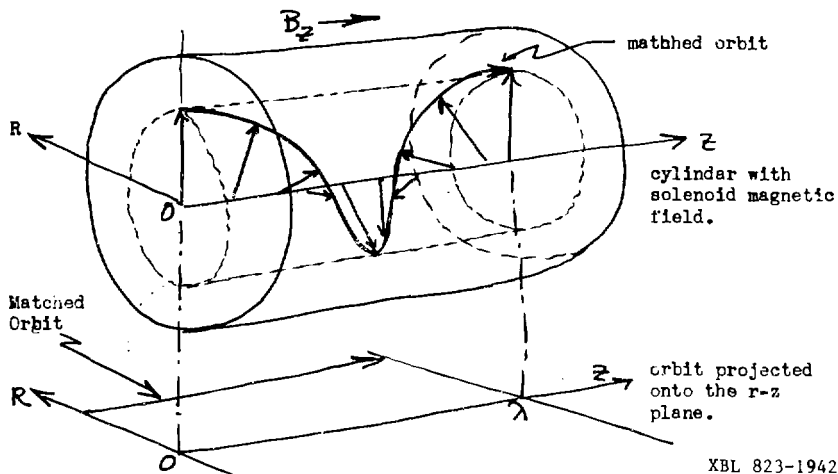
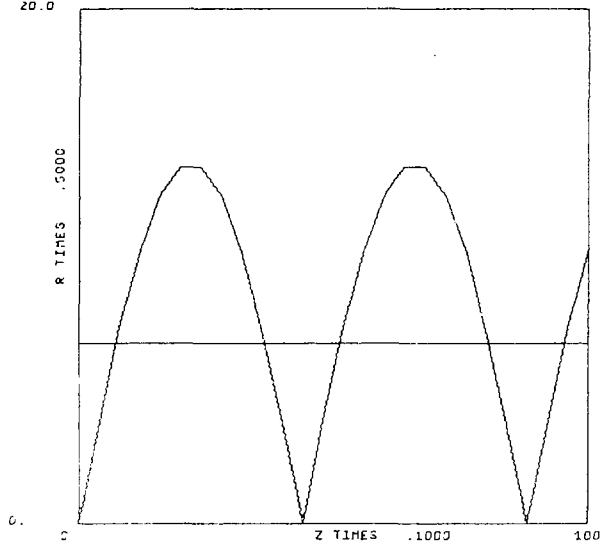

Figure 2.1 Constant B_z field, matched electron motion, showing three dimensional orbit and its projection onto a plane.

TEST 2.5 MEV ELECTRONS IN 1.000 KG FIELD	1
INITIALIZE	2
BOUNDARY	3
41 26 C 20 0 100	4
1 20 100 0 20 0	5
S	6
S	7
PC1 0 S	8
CCNST	9
*10 .05	10
*35 -10 -10 5 ---- CALCGMP PLOT SIZE 10X10 CM	11
*63 C \$ ----- NO EMITTANCE CALCULATIONS	12
*71 0 \$ CCNT PLOT ENVELOPE	13
S	14
RAYS 1	15
C 6.95395 0 2.09820E6 0 2.09820E6 1.0E-10	16
0 0 0 2.09820E6 0 2.09820E6 1.0E-10	17
END RAYS INPUT	18
COILGEN 4 1.0E3	19
PLCT TRAJ S	20
TRACK	21
END	22

Figure 2.2 EBQ data input for the constant B_z matched motion problem.

CELL .5000 X 4.0000
20.0



TEST 2.5 MEV ELECTRONS IN 1.000 K6 FIELD

UCIDX01

31 AUG 78

ITER= 1

PLOT

XBL 323-1904

Figure 2.3 EBQ trajectory CALCOMP plot showing the matched and mis-match electron trajectories for example 2.

EXAMPLE 3

This example demonstrates the use of EBQ in the design of an atomic beam spectrometer, originally performed with the EGUN program, UCID-3860, (1974). The particular features of the EBQ code data input exemplified in this example is the use of the BOUNDARY MODIFY to add an electrode to an existing problem, the use of the RAYGEN input to generate a particle distribution on a regular r - r' phase space grid, and the input of boundary data in inches.

The physical problem considered is a H^- beam produced by collision of an incident H^0 beam on the source electrode S at an energy of about 1/4 eV by a charge exchange reaction. The space charge of the H^- beam can be neglected. The simulations were performed for a two (S and Q), three (S, F1 and Q), and four (S, F1, F2, and Q) electrode structure shown in Figure 3.1. Figure 3.2 shows the EBQ data for the two and three electrode case. The focusing provided by the 3-rd electrode F2 is evident from the trajectory plots, Figures 3.3 and 3.4 and yields considerably higher acceptance to the mass-spectrometer quadrupole Q than the two electrode case.

The first data case has only two electrodes, the source and the quadrupole acting as an accelerating anode in this problem. The source is given as potential index 1 and the quadrupole given as potential index 3. The rays are generated by the RAYGEN data on a regular grid in the r - r' phase space with 7 values of r' and 8 = 56/7 values of r . The beam current is set to the infinitesimal value of 10^{-9} amperes. The RAYGEN data, line 19, has the following meaning:

RAYGEN

1	Type 1 data
56	Total of 56 rays to be generated
10 ⁻⁹	Beam current for this generation
10 ⁻⁹	Beam current in the total beam
0.25	Initial energy of the ions in eV
0.24	Phase space emittance, cm-rad.
0.6	Maximum beam radius, cm
3.81	Starting z location in cm
OR4	Four zeros for F, R', ϕ , and ψ
-7	Minus specifies regular grid of 7r' values
S	Terminates ray data input

A phase plot is requested at Z = 11.42 cm, line 20, and a CALCOMP plot of all trajectories is specified by the PLOT TRAJ S data, line 21. The actual calculations are performed on execution of the TRACK command, line 22.

The three electrode spectrometer is run using the same data defined by the two electrode case preceding, but adding the focus electrode (potential index 2) by the BOUNDARY MODIFY data, line 25-27. The TRACK command, line 28, executes the same rays as were generated by the RAYGEN data of the two electrode case.

The four electrode data is shown in Figure 3.5. The object of this example is to show the data to obtain the tuning characteristics of the focus electrode, F1. The problem is defined as in the two and three electrode case by the BOUNDARY, INST, RAYGEN data. The MAP SECTION, line 28 specifies that only every tenth longitudinal position will be used in generating the potential and charge array maps so as to reduce the volume of printed output. The EQUIP data, lines 22-25, specifies the equipotentials to be plotted so as to better show the curvature of

the field lines near the source which provides the focusing of the device. The equipotential lines calculated from the minimum - maximum potentials have been suppressed by setting $CONST(47) = 0$, line 18. The case is executed by the TRACK data, line 31. The focus electrode is at -300 volts and the beam plot generated by this run is shown on the bottom of Figure 3.6.

The next group of data cards, lines 33-44 reduce the potential of the focus electrode, potential index 2, set a new title to identify the focus potential on the plot, and execute the data. The plots generated at focus potentials of -295, -290, and -285 volts are shown in Figure 3.6.

The RAYGEN data has generated 30 rays on regular grid, Figure 3.7, with each value of radius given five rays of different initial slope. These rays have been phase plotted on the $r-r'$ phase plane at 12.7 and 27.0 cm. Figure 3.8 shows the $r-r'$ phase plot at 27 cm for the case of the focus electrode at -295 volts. Rays C, H, N, S, Y, and) were emitted from the source initially at zero slope and have been connected in the figure as shown. The other rays of the same initial starting radius, but different initial slope, have been connected to the central ray so as to demonstrate the non-linearity of the forces typical of such problems.

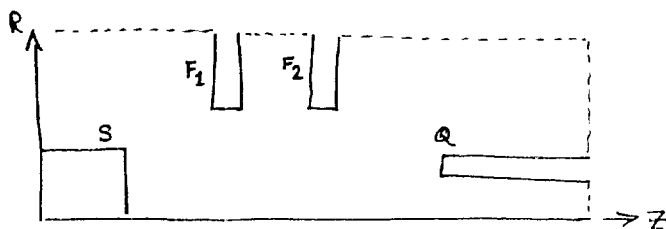
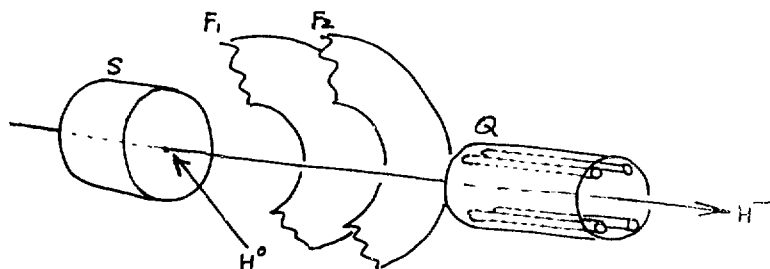

XBL 823-1943

Figure 3.1 Atomic beam spectrometer. Source electrode on which charge exchange occurs is indicated as S, F_1 and F_2 are the two focus electrodes introduced in the three and four electrode cases. Q is an electro-static quadrupole mass-spectrometer considered as cylindrically symmetric in this simulation.

```
ATOMIC BEAM APPARATUS -- TWO ELECTRODE CASE 1
TITLE RUN WITH EGIN UCID-3860 2
INITIALIZE 3
BOUNDARY 4
  41 61 0 2 0 6 2.54 $ CONVERT TO CM. DATA INPUT IN INCHES 5
  1 0 .25 1 .5 .25 1 .5 1.5 1 0 1.5 5 $ SOURCE 6
  3 .2 4.5 3 .2 6.3 .5 6 3 .5 4.5 3 .2 4.5 5 $ 7
  3 0 6 3 .2 6 5 $ END CLAMP 8
S 9
PRT -300 -300 0 5 10
CONST 11
  *1 93856 $ ----- H- TONS 12
  *16 0.1 $ POISSON ERROR .1 VOLTS 13
  *35 8 6 $ SCALE 4 X 1 14
  *47 20 15
S 16
MAP SECTION 1 121 10 17
LAPLACE 18
RAYGEN 1 56 1.0E-9 1.0E-9 .25 .254 .635 3.81 094 -7 5 19
PLOT PHASE 11.42 S $ ----- CM 20
PLOT TRAJ S 21
TRACK X 1 22
END 23
ATOMIC BEAM APPARATUS --- THREE ELECTRODE CASE 24
BOUNDARY MODIFY $ ----- ADD FOCUS ELECTRODE 25
  2 2. 2.25 2 1 2.25 2 1 2.5 2 2 2.5 2 2 2.25 S $ FOCUS ELECTRODE 26
c 27
TRACK X 1 28
END 29
END 30
31
32
```

Figure 3.2 EBQ data for the two and three electrode cases of example 3.

CELL .1270 X .254C
5.08

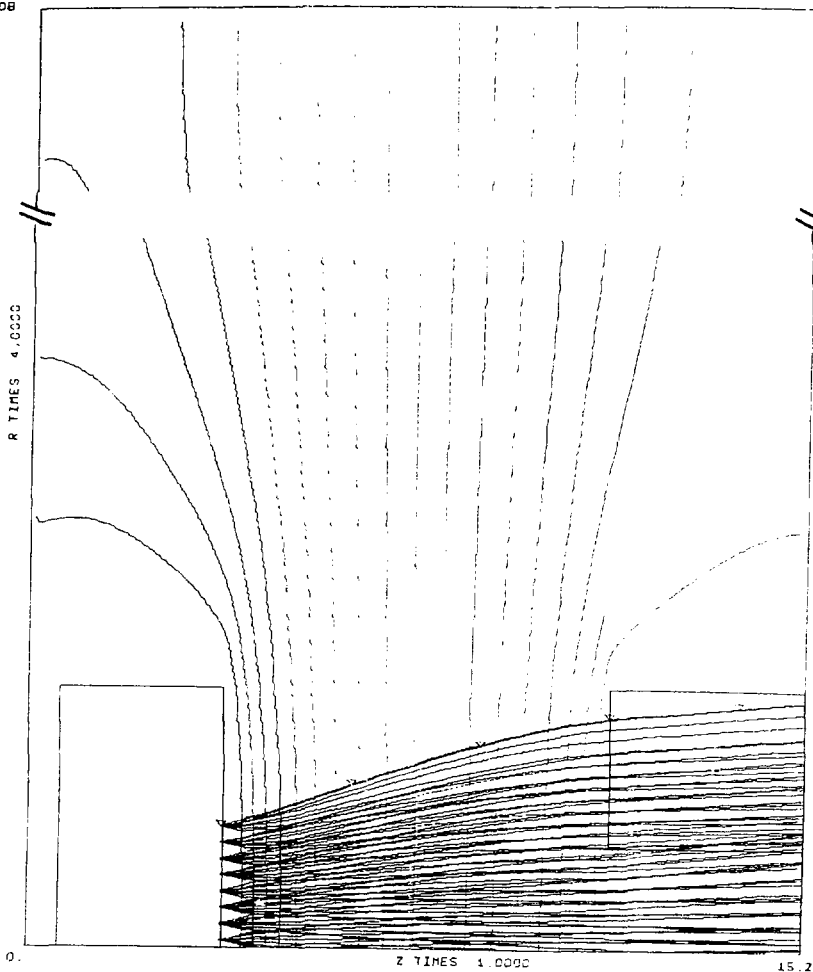

TITLE RUN WITH EGUN UCID-326D
ATOMIC BEAM APPARATUS -- TWO ELECTRODE CASE

UCIDX00 24 OCT 78 ITER= 1 PLOT 3

XBL 823-1905

Figure 3.3 Two electrode device showing ion trajectories and equipotential lines. This figure should be compared with the three electrode device shown in Figure 3.4.

CELL .1270 X .254C
G.08

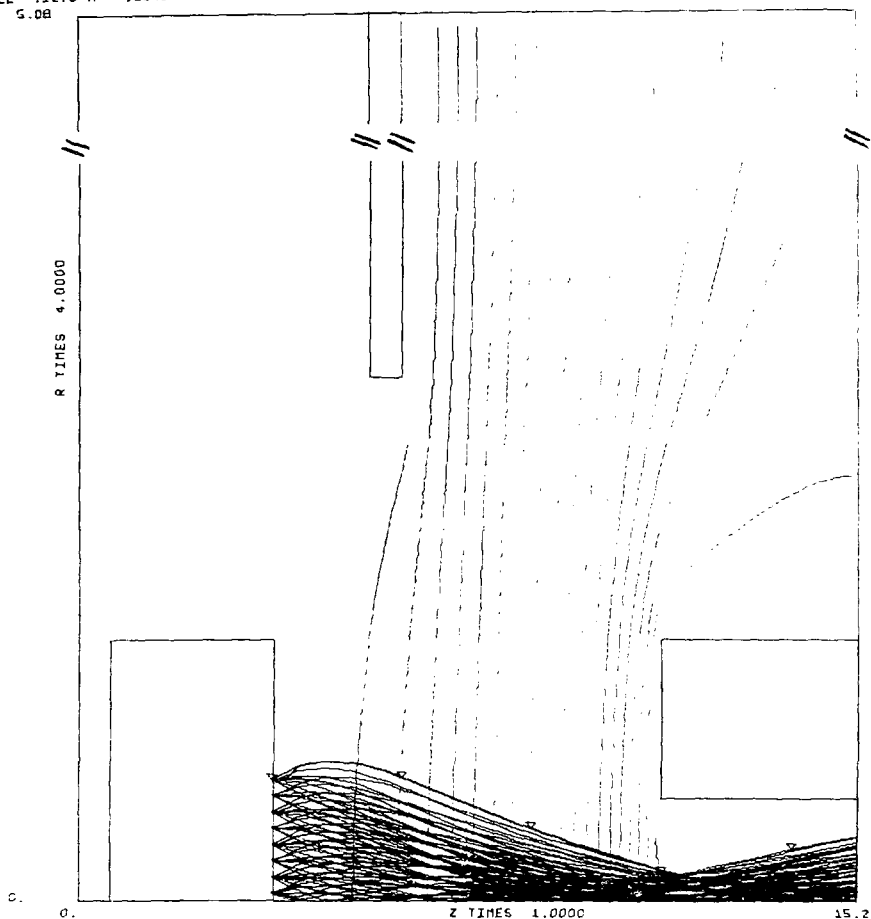

0. TITLE RUN WITH EGUN UC10-3B60

ATOMIC BEAM APPARATUS --- THREE ELECTRODE CASE

UCIDX00

24 OCT 78

ITER= 1

PLOT 4

15.2

XBL 823-1906

Figure 3.4 Three electrode device showing ion trajectories and equipotential lines. The presence of the third electrode has curved the equipotentials in the low energy region near the source so as to provide focusing.

ATOMIC BEAM APPARATUS -- FOUR ELECTRODE CASE		1
TITLE		2
INITIALIZE		3
BOUNDARY		4
29	11.4 0 1.0 0 11.5 2.54 \$ ---- INPUT INCHES, CONVERT TO CM	5
1	0.25 1.5 0.25 1.5 1.0 1.0 1.0 0.25 \$ SOURCE	6
2	1.4 3.5 2 1.0 3.5 2 1.0 3.75 2 1.4 3.5 \$ FOCUS 1	7
3	1.4 5.25 3 1.0 5.25 3 1.0 5.5 3 1.4 5.25 \$ FOCUS 2	8
4	.2 11.5 .2 10.65 4 .5 10.65 4 .5 11.5 4 .2 11.5 \$ QUADROPOLE	9
S		10
POT	-300 -3 -100 0 S	11
CONST		12
*1	93856 \$ HYDROGEN ION REST MASS	13
*3	0 0 \$ TURN OFF GAUSS LAW AND SELF MAGNETIC FIELD	14
*16	.1 150 \$ POSITION ERROR AND CYCLE LIMIT	15
*29	2 \$ STORE EVERY OTHER POINT FOR PLOTTING	16
*35	-3.5E -29.2 \$ CALCOMP PLOT SIZE IN CM	17
*47	0 \$ NO EQUIPOTENTIAL LINES	18
S		19
LAPLACE		20
PRINT FIELDS	0 0 29 0.5	21
EQUID		22
-295 -290	285 -280 -275 -270 -265 -260 -255 -250	23
-110 -105	100 -95 -90 -85 -80	24
S		25
PAYGEN	2 30 0.05-200.2 .25 .254 .635 2.54 0.4 -5 S	26
PLUT PHASE	2.7 27.0 S	27
MAP SECTION	116 10	28
RKSTEP	.025 3.81 .0508 5.08 .127 6.35 .254 100 S	29
PLOT TRAJECTORIES		30
TRACK X 1		31
END		32
ATOMIC BEAM APPARATUS -- FOUR ELECTRODE CASE		33
TITLE FOCUS ELECTRODE -285 VOLTS		34
POT	*2 -285	35
PLOT TRAJECTORIES		36
TRACK X 1		37
TITLE FOCUS ELECTRODE -290 VOLTS		38
POT	*2 -290	39
TRACK X 1		40
TITLE FOCUS ELECTRODE -285 VOLTS		41
POT	*2 -285	42
TRACK X 1		43
END		44

Figure 3.5 EBQ data for the 4 electrode case of example 3.

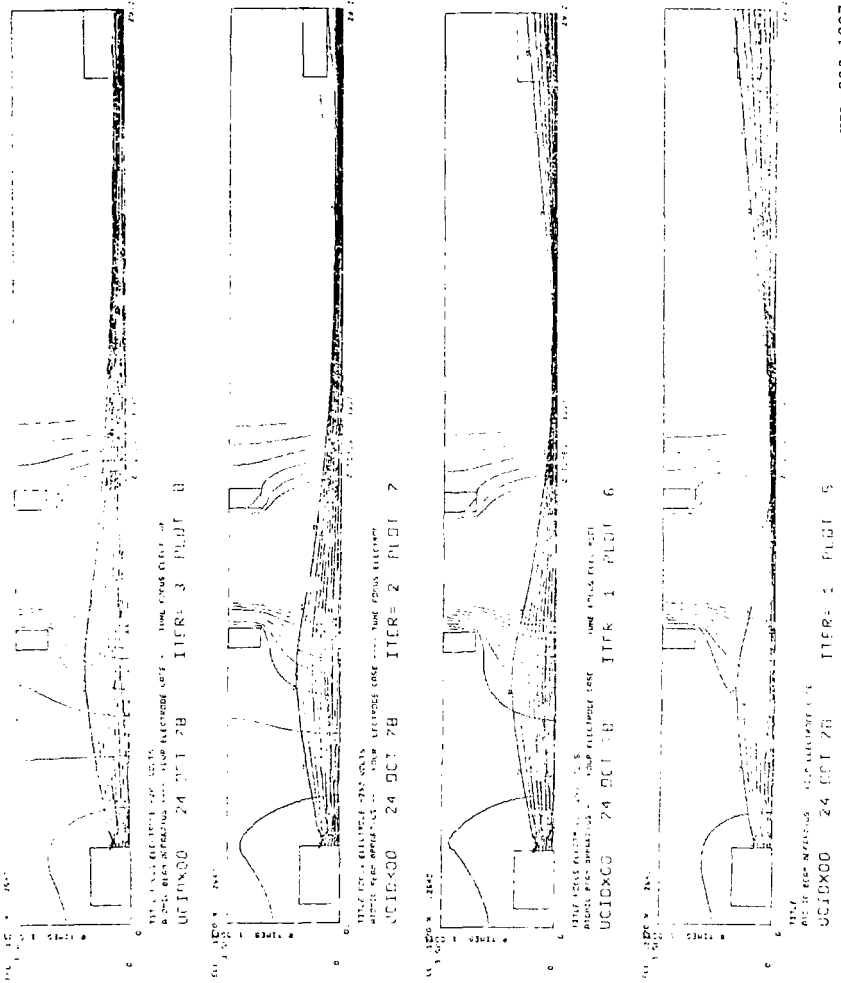
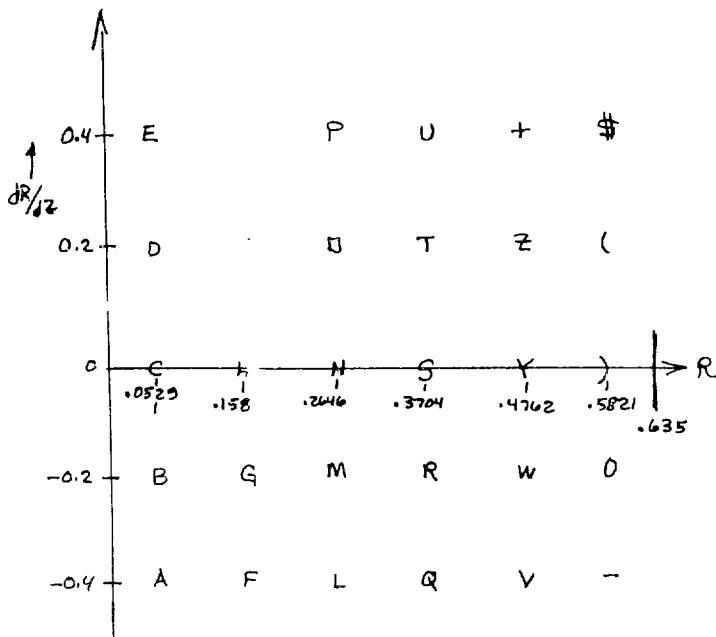

Figure 3.6 Four electrode geometry showing trajectories and equipotential lines for four different focusing electrode potentials as run by the data Figure 3.5.



XBL 823-1908

Figure 3.7 Initial phase space generated for the four electrode atomic beam example. The five rays at a given r are symmetrically centered on the ray of zero slope.

8.79952E-02
 7.66376E-02
 7.67568E-02
 7.48762E-02
 7.29952E-02
 7.11144E-02
 6.92336E-02
 6.73528E-02
 6.54720E-02
 6.35912E-02
 6.17104E-02
 5.98296E-02
 5.79488E-02
 5.60679E-02
 5.41871E-02
 5.23063E-02
 5.04255E-02
 4.85447E-02
 4.66639E-02
 4.47831E-02
 4.29023E-02
 4.10215E-02
 3.91407E-02
 3.72599E-02
 3.53791E-02
 3.34983E-02
 3.16175E-02
 2.97367E-02
 2.78559E-02
 2.59751E-02
 2.40943E-02
 2.22135E-02
 2.03327E-02
 1.84519E-02
 1.65711E-02
 1.46903E-02
 1.28095E-02
 1.09287E-02
 9.0477E-03
 7.1677E-03
 5.28627E-03
 3.40487E-03
 1.52347E-03
 -3.56140E-04
 -2.23694E-03
 -4.11775E-03
 -5.99855E-03
 -7.87935E-03
 -9.76015E-03
 -1.15410E-02

1.041E-02 8.406E-02 1.657E-01 2.433E-01 3.209E-01 3.986E-01 4.752E-01 5.538E-01 6.315E-01 7.091E-01 7.867E-01

(11)=7.763E-03 (12)=1.553E-02 (13)=2.329E-02 (14)=3.105E-02 (15)=3.882E-02 (16)=4.658E-02 (17)=5.434E-02 (18)=6.211E-02 (19)=6.987E-02
 ATOMIC BEAM APPARATUS ----- FOUR ELECTRODE CASE ----- TIME FOCUS ELECTRODE
 TITLE FOCUS ELECTRODE -245 VOLTS

Figure 3.8 Phase space at $z = 27$ cm for the initial phase space shown in Figure 3.7. The ion positions are labeled by alpha-numeric indicators which have been connected here to show the curvature introduced by the device.

EXAMPLE 4

This example shows the use of EBQ in running multiple ion species together in one problem. The phase space plots, beam moments and emittance can be individually calculated for each species present or calculated for the beam as a whole, depending on the value of CONST(66). In the following example, a beam of protons (H^+), deuterons (D^+) and singly charged molecular deuterium ions (D_2^+) were simultaneously tracked with space charge included for all species. The trajectories can be plotted in any desired combination as specified by the PLOT TRAJ cards.

PLOT TRAJ 10 20 30 S

request a plot of rays 10, 20, and 30, while

PLOT TRAJ 1-10, 11-20, 21-30 S

request a plot of the rays 1 through 10, 11 through 20, and 21 through 30 on a single CALCOMP plot.

The multiple species were generated by the RAYGEN data preceded by CONST data specifying the ions rest mass and charge. In Figure 4.1, the first RAYGEN data, lines 25-26, generates 10 deuterons. The second RAYGEN data, lines 27-28, adds 10 molecular deuterium ions to the first 10 rays since the type is negative, and the third RAYGEN data lines 29-30, adds 10 protons to the existing deuteron ions since the

type code is also negative. Each of these RAYGEN data cards is preceeding by a CONST *1 MASS CHARGE S data card specifying the species rest mass and charge.

The data is shown in Figure 4.1. The plots are shown in Figure 4.2. The plot of the 10, 20, and 30th ray includes the beam envelope identified by the triangular symbol. Figure 4.2A, was generated by data line 32. The plot of all rays, Figure 4.2B was generated by data line 31 or 33.

```
MULTIPAL ION SPECIES RUN D+1, D2+1, AND H+1 ICNS TOGETHER
TITLE RTNS 2ND COLUMN WITH 150 MA OF D+
-----
INITIALIZE
BOUNDARY
-----
13 111 0 6 0 55 $ ----- 0.5 X 0.5 CM CELLS
OUTSIDE 5.5 5.5
-----
1 5 0 1 5 12 1 6 12 1 6 0 1 5 0 S
2 5 17 2 5 18 2 6 18 2 6 17 2 5 17 S
-----
3 5 23 3 5 24 3 6 24 3 6 23 3 5 23 S
4 5 29 4 5 30 4 6 30 4 6 29 4 5 29 S
-----
OUTSIDE 5 50
5 4 36 5 4 55 5 6 55 5 6 36 5 4 36 S
-----
S
POT 400000 327000 218000 109000 0 S
-----
CONST
*1 1.876E9 $ ----- D+ REST. MASS EV
*2 1 $ ----- CHARGE + 1
*19 55 0 $ ----- TURN DEF OUTPUT
*34 11 $ CALCOMP AND PRINT BEAM LINE
*35 5 5.5 $ CALCOMP PLOT SIZE
-----
*47 50 $ NUMBER OF EQUIPOTENTIAL LINES
*55 .01 $ SELF FIELD RADIAL CUTOFF
*57 100 $ ----- X-XP PHASE PLOTS ONLY
S
CONST *1 1.876E9 1 S $ ----- D+1
RAYGEN 1 10 .05 .05 14320 .025 2.5 0 0 .92 0 0 0 S
-----
CONST *1 3.752E9 1 S $ ----- D2+1
RAYGEN -1 10 .05 .05 14320 .025 2.5 0 0 .92 0 0 0 S
CONST *1 .938E9 1 S $ ----- H+1
RAYGEN -1 10 .05 .05 14320 .025 2.5 0 0 .92 0 0 0 S
PLOT TRAJ S
PLOT TRAJ 10 20 30 S
-----
PLOT TRAJ 1-10 11-20 21-30 S
MAP SECTION 1 110 11
EQUIP
1000 2000 3030 4000 5000 6000 7000 8000 9000 1E4 5E4
10E4 2E4 3E4 4E4 350E3 375E3 376E3 377E3 378E3 379E3 380E3
381E3 382E3 383E3 384E3 385E3 386E3 387E3 388E3 389E3 390E3
391E3 392E3 393E3 394E3 395E3
-----
S
TRACK
END
END
```

Figure 4.1 EBQ data for the multiple species RTNS run.

CELL .5000 X .5000
6.00

I=5.00000E-02

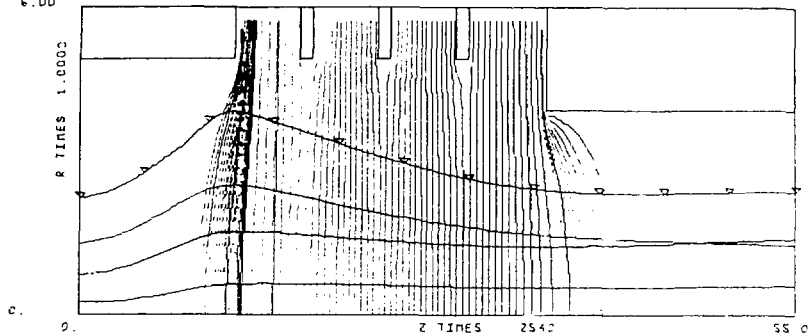

TITLE RTNS 2ND COLUMN WITH 150 PA OF D-
MULTIPAL ION SPECIES RUN D-1, D2+1, AND H+1 IONS TOGETHER

X4UCI00 30 NOV 78 ITER= 1 PLOT 1

CELL .5000 X .5000
6.00

I=5.00000E-02

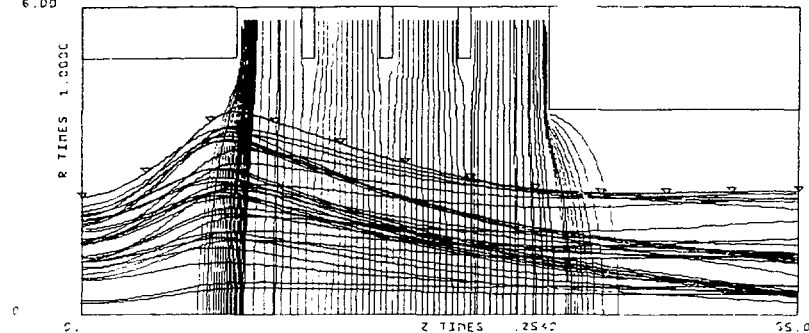

TITLE RTNS 2ND COLUMN WITH 150 PA OF D-
MULTIPAL ION SPECIES RUN D-1, D2+1, AND H+1 IONS TOGETHER

X4UCI00 30 NOV 78 ITER= 1 PLOT 2

XBL 823-1910

Figure 4.2 Trajectory plots showing plot of selected ions A) above and all ions B) below. The equipotential lines in the center of the plot were generated by CONST(47) while the higher density lines at each end were generated from the EQUIP data shown in figure 4.1.

EXAMPLE 5

This example demonstrates the use of EBQ to simulate a 750 kV accelerating electrostatic focusing column following a 30 ma 20 keV Xe⁺ ion source. This column is part of the injector for the 50 MeV proton linac at LBL. An iterative solution to the space charge problem was found and compared to the first cycle based on the use of Gauss's law. The effect of space charge is then demonstrated by setting the beam current to zero and running one additional cycle with only single particle motion in the external fields. The Xe source and quadrupole focusing system are up stream from the column, the ions are charge neutralized by the electrons generated by their propagation through the residual gas to the left of the boundary, with the Xe ions pulled from a pseudo plasma boundary waist at $z = 1$ cm. The typical emittance of such a heavy ion source is 70π cm-mr, Figure 5.1. The rays are generated in an upright phase ellipse randomly populated in a four dimensional volume by the RAYGEN data card, line 32, Figure 5.2.

The volume of output is reduced by taking every fifth point of the potential and charge deposition maps as specified by the MAP SECTION 1 131 5 data card, line 33. Phase space plots in the X-X', Y-Y', and R-R' planes are to be generated at $Z = 1$ and 25 cm, lines 24 and 34.

The first cycle of the calculation is based on a space charge evaluation from Gauss's law and should be very close to an iterative solution found from successive cycles of solving Poissons equation and ray tracking. To verify this supposition, a trajectory and phase plot is requested for the first cycle by lines 34-35. The iterative solution is initiated from the first cycle by a continuation for a maximum of 5

additional cycles, line 37, TRACK CONTINUE 5. Note the similarity in the Gauss's law and iterative solutions, Figure 5.3 and 5.4. The importance of space charge can be readily demonstrated by reducing the beam current to essentially zero and re-running, lines 40-42. The ray trace plot is shown in Figure 5.5 for the zero current case.

Unless specifically inhibited by $CONST(61) = 0$, EBQ will draw a dashed line marking the beam envelope projection of the previous cycle. This makes comparison of the 30 ma and 0 current beam profile easy, Figure 5.5

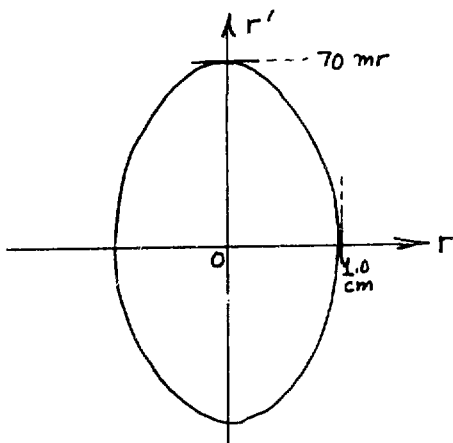

XBL 823-1944

Figure 5.1

Initial beam phase as given on the RAYGEN data card. The emittance of .070 cm-rad requires a 70 mr initial divergence for the 1 cm beam radius. The rays are randomly populated inside this area.

20 KV Xe+1 ESCAR COLUMN	1
TITLE	2
INITALIZE	3
BOUNDARY	4
26 131 0 5 0 26	5
1 2.6 0 1 2.6 2.8 1 1.2 2.8 1 1.2 3.0 1 5 4.6 S	6
2 5 8 2 1.2 6.4 2 1.2 5.6 2 5 8.2 S	7
3 5 11 3 1.4 10.2 3 1.4 10.4 3 5 11.2 S	8
4 5 14.4 4 1.6 14 4 1.6 14.2 4 5 14.6 S	9
5 5 17.2 5 1.8 17.0 5 1.8 17.2 5 5 17.4 S	10
6 5 19.8 6 1.8 19.6 6 1.8 19.8 6 5 20 S	11
7 5 22.6 7 2 22.4 7 2 22.6 7 5 22.8 S	12
S	13
POT 500E3 416.7E3 333.3E3 250E3 166.7E3 83.3E3 0 S	14
CONST	15
*1 1.223E11 \$ ----- YE REST MASS	16
*2 1 \$ ----- + 1 CHARGE	17
*19 26 \$ OUTPUT EVERY 25 CM	18
*22 .01 \$ ----- RAY CONVERGENCE FACTOR	19
*34 10 -10 -13 \$ ----- CALCOMP, RAXIS, ZAXIS	20
*42 2 \$ ----- CALCULATE MOMENTS EVERY 2 CM	21
*47 75 \$ ----- EQUIPOTENTIAL LINES EVERY 10 KV	22
*55 .01 \$ ----- SELF MAGNETIC FIELD CUT OFF	23
*57 100 \$ PHASE PLOT ONLY X-XP	24
S	25
EQUIP	26
15000 14000 13000 12000 11000 9000 8000 7000	27
6000 5000 4000 3000 2000 1000 500	28
749000 748000 747000 745000 745000	29
744000 743000 742000 741000 S	30
PRINT POT	31
RAYGEN 1 50 .03 .03 20000 .070 1 1 0 0 0 0 S	32
MAP SECTION 1 131 5	33
PLOT PHASE 1 25 S	34
PLOT TRAJ S	35
TRACK X 1 \$ ----- PLOT GAUSS-S LAW SOLUTION	36
TRACK CONTINUE 5 \$ SOLVES AFTER 3 ON ITERATION 4	37
ENCTRACK	38
\$ ----- NOW RUN AT INFINITESIMAL CURRENT	39
CURRENT 1.0E-10	40
PLOT TRAJ S	41
TRACK X 1	42
END	43
END	44

Figure 5.2 EBO data for the Xe⁺¹ source problem.

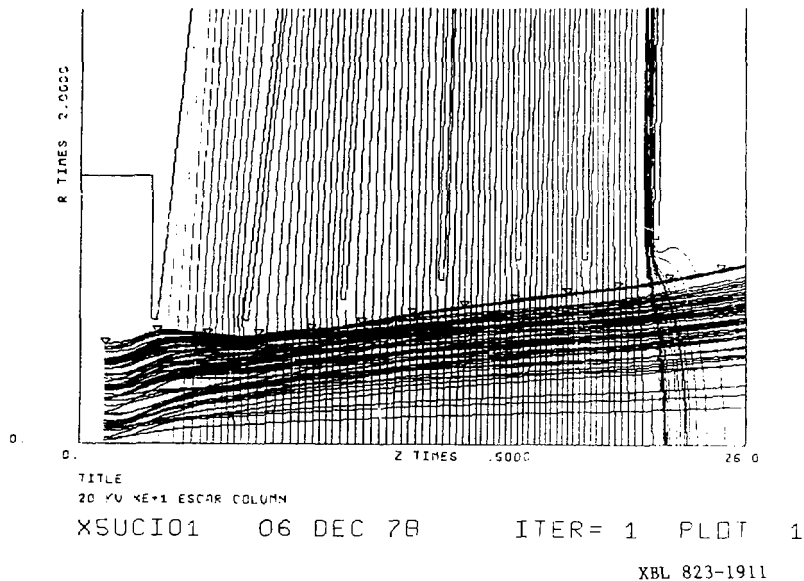

Figure 5.3 Plot on ion trajectories on the first iteration where space charge was calculated from Gauss's Law.

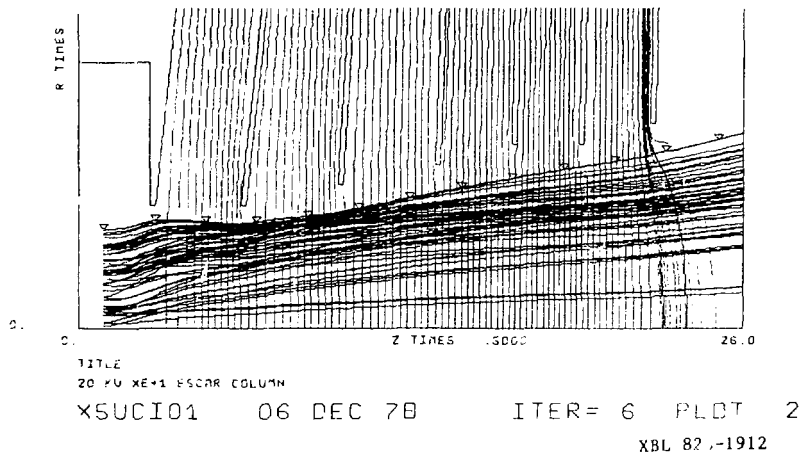
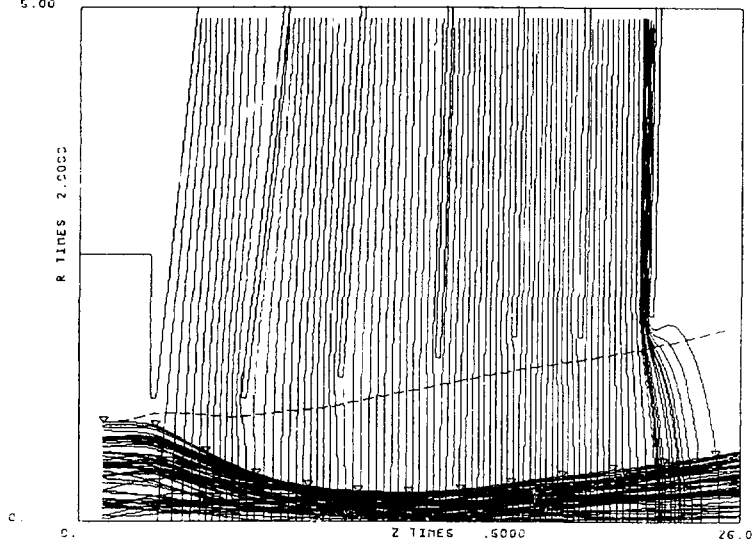

Figure 5.4 Final iterative solution of ion trajectories after six cycles. The space charge is now calculated from the solution of Poisson's equation.

CELL .2000 X .2000
5.00

I=3 00.000E-12



TITLE

20 KV Xe+1 ESCAR COLUMN

XSUCI01

06 DEC 78

ITER= 7

PLOT

3

XBL 823-1913

Figure 5.5 The seventh iteration of the Xe^{+1} source showing the ion trajectories run without space charge. Note the plot of the envelope of the sixth iteration showing the space charge beam extent, dashed curve.

EXAMPLE 6

This example considers the continuation of problems from one case to another. Problems can be continued for a variety of reasons which fall into two broad classes, those in a single run, and those of a subsequent run. This continuation example consists of three cases:

- A) A long transport system demonstrating the continuation of a problem inside a single data case.
- B) Continuation of a problem in separate runs where the entire problem is dumped to tape (or disk) and re-read.
- C) Continuing a problem (within one run or otherwise) where the rays are dumped after an iterative solution is found which modifies the Laplace solution to the potential problem. The rays must then be started from an interior point of the problem to avoid the fictitious Neumann boundary of the problem's right edge.

A) The first example of a continuation problem considers the transport of a 11.1 ampere beam of U^{238} , 50 meters in a constant solenoid field. The transverse beam size is initially 10 cm and the beam is confined to a vacuum pipe of 15 cm radius. The emittance of this beam is 1.94 cm-rad with about 49 kV of space charge depression. An unrealistically high value of the longitudinal solenoid magnetic field was chosen to reduce the ion wave length so many oscillations could be observed in the modest 50 meters of beam transport length.

The large beam emittance means that the rays frequently cross so application of Gauss's law to find the space charge electric radial field based on the enclosed current requires that the current inside

each ray be frequently calculated. In this run CONST(46) was set to unity so the enclosed current was found every Runge-Kutta integration step. A plot of the RMS beam radius was desired, so the moments of the beam distributions was calculated every 50 cm as requested by CONST(42) = 50. The 50 meter flight path was divided into five sections of 1000 cm each, Figure 6.1.

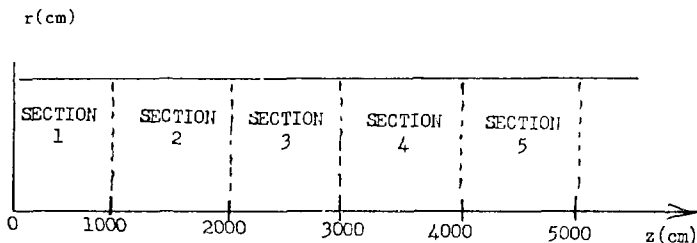

Figure 6.1

XBL 823-1945

The data is shown in Figure 6.2. The CONST *23 and the PUNCHB 1000 S data is global and crosses the problem boundary, producing a tape 9 ray dump at the end of each section of the problem. These dumps are automatically sequenced, as dumps 1, 2, 3, 4, and 5. These dumps are then read by the following section by RAYS 8 NDUMP, where NDUMP is the dump number appropriate to the start of that section. All other data being the same as in the first section, only the ray distribution changing.

Figure 6.3 shows the ray trace for the five sections into which this problem has been divided.

B) Next, consider the continuation of a previous run, say continuing the problem to improve the solution convergence from a previous run dumped to tape 8. The left column of the control cards and data in Figure 6.4 show the data generating the tape 8 dump after four ray-Poisson cycles, the right column shows the data which reads this tape and runs an additional two ray-Poisson cycles.

In this example, one file was written to tape 8 with a dump number 1 specified by the value of CONST(32). line 14. When the problem was to be continued, the value of CONST(32) had to be set to this desired value before DUMP IN. At this point, all necessary arrays have been read, and tracking can be initiated. The TRACK card must specify continue to prevent zeroing of the charge array, since the values of the potential array and the charge array are related by the solution of Poisson's equation.

C) Next, consider the continuation of a beam from some intermediate z position past the end of the initial problem after an iterative solution of the ray-Poisson equation has been obtained.

The Poisson ray trace cycles have altered the boundary potential values from the Laplace solution by the beam space charge depression. It therefore becomes necessary to set the potential on the left side of the continuation boundary as a graded Dirichlet boundary. This example might be essentially the same as A), the U238 beam transport example, except that the longitudinal transfer point is interior to the problem at, say, 8 meters rather than the boundary end of 10 meters, Figures 6.5 and 6.6.

When the transfer takes place, the potentials at 8 meters become the left edge of the continuation problem, as shown by the use of the increment option in the boundary data. The points in the POT() array are stored from the scalar potential array U() in the previous problem, shown on the left. The continuation is shown on the right of the control card and data below. The left column is the conceptual data for initializing the problem and propagating the rays, say to 10 meters. The right column shows a following run which takes the rays from a 8 meter dump and runs them an additional ten meters to 18 meters, Figure 6.5.

Consider the data on the left, Figure 6.5. Line 9' specifies the boundary mesh interval size as 0.5 cm radial x 20.0 cm longitudinally. The boundary might have been that shown in Figure 6.6. The left edge will be used as a starting edge of the continuation problem and should have a potential associated with each radial interval so that it appears as a graded Neumann boundary supporting the space charge depression of the beam. Say we assign potentials 4-24 to this edge by

```
BOUNDARY
 21 51 0 10 0 1000
 INCREMENT 4 24
 I 0 0 24 10. 0 5
 .
 .
 .
```

The initial potential array (line 11L) reserves space for these 21 values and 21 values to be stored from the potential U map at 8 meters. These values will then be switched in the subsequent run, line 15R, 16R right (R).

The dump numbers written to Tape 8 are specified on line 13L and 14L. Line 16L sets a pointer so that the ray values are dumped to Tape 9 on the final iteration at 800 cm. Line 20 L stores the potential at 800 cm (ZLOC = 40) in the pot() array positions 25-45. Line 21L dumps out all the pertinent arrays defining th problem.

The continuation run represented by the data on the right (lines - R) set the dump numbers to be read on Tape 8 and 9, lines 9R, 10R. The DUMP IN data initialize the arrays at the values written at the end of the previous problem including the particle load at 10 meters. The particle load is redefined from the rays dumped at 8 meters by line 14R. The z value of the rays is $800 + \text{CONST}(23) \approx 0$ initializing this load to the left hand boundary, a graded Dirichlet set by the switch options, lines 15R and 16R. These rays are then tracked an additional 10 meters.

```

$ -----
TRACK U238 IONS 0-10 METERS 1
TITLE 2
INITIALIZE 3
MAP OFF 4
BOUNDARY 5
  31 101 0 15 0 1000 $ ----- CELL 0.5 X 10.0 CM 6
  1 15 0 1 15 1100 S $ ----- BEAM PIPE R=15 CM 7
  S 8
POT 0 0 S 9
CONST 10
  *1 223.2954E9 $ ----- 1238 RESTMASS 11
  *2 1 $ ----- CHARGE= +1 12
  *10 1.0 $ ----- 1 CM PK STEP 13
  $ ----- PKSTEP=1 CM 50 RAYS 23.147 SECONDS 14
  *10 F. 15
  *19 1000 $ OUTPUT EVERY 10 METERS 16
  *35 -15.0 -22.0 $ ----- CALCOMP PLOT SIZE, CM 17
  *35 -7.5 -15.0 $ ----- CALCOMP PLOT SIZE 18
  *42 50 $ CALCULATE MOMENTS EVERY 50 CM 19
  *46 1. $ ----- CALC. ENCLOSED CURRENT EVERY P. K. STEP 20
S 21
COILGEN 4 248274.4 $ ----- CONSTANT BZ FIELD 22
$ 23
$ BETA**2GAMMA**3= 1.0E-4 PHO=30 CM 24
$ EPSILON 1.945608 CM*PAD EN=2.30945E11 /CM 25
$ N=50 P=10 CM B=248274.4 GAUSS 26
$ SPACE CHARGE DEPRESSION 49.4329 KV E=10.579 MEV 11.09626 27'S
$ 28
RAYGEN 2 50 11.09626 11.09626 10.656 1.945608 10 0 0 0 0 0 S 29
PINCHR 1000 S $ ----- RAY DUMP TO TAPE 9 FOR CONTINUATION 30
PLOT TRAJ S 31
TRACK 32
PLOT ENERGY S 33
PLOT PHASE S 34
END 35

```

Figure 6.2 U238 data for EBQ.

----- CONTINUE 10-20 METERS	36
CONST #23 -1000 S	37
RAYS 8 1 \$ ----- READ TAPE 9 DUMP 1	38
PLOT TRAJ S	39
TRACK	40
END	41
----- CONTINUE 20-30 METERS	42
RAYS 8 2 \$ READ TAPE 9 DUMP 2	43
PLOT TRAJ S	44
TRACK	45
END	46
----- CONTINUE 30-40 METERS	47
RAYS 8 3 \$ READ TAPE 9 DUMP 3	48
PLOT TRAJ S	49
TRACK	50
END	51
----- CONTINUE 40-50 METERS	52
RAYS 8 4 \$ READ TAPE 9 DUMP 4	53
PLOT TRAJ S	54
TRACK	55
END	

Figure 6.2 (continued)

CELL .5000 X 10.0000
15.0

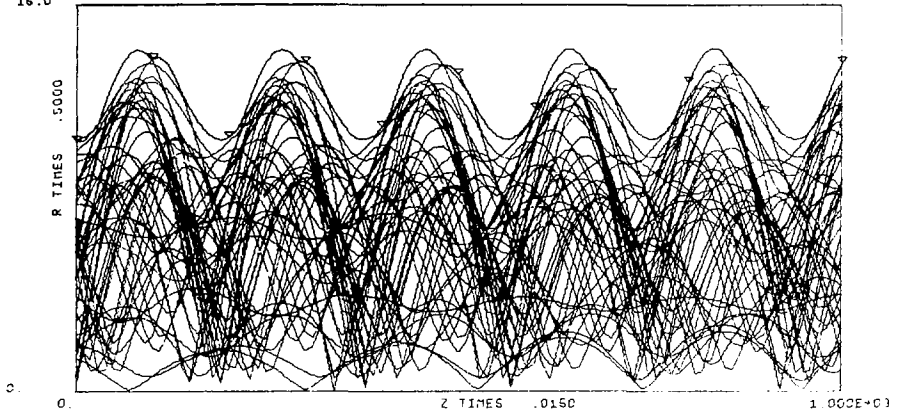

TITLE

TRACK U23U IONS 0-10 METERS

X6UCIO1 13 SEP 78

ITER= 1 PLOT 1

XBL 823-1914

Figure 6.3A

CELL .5000 X 10.0000
15.0

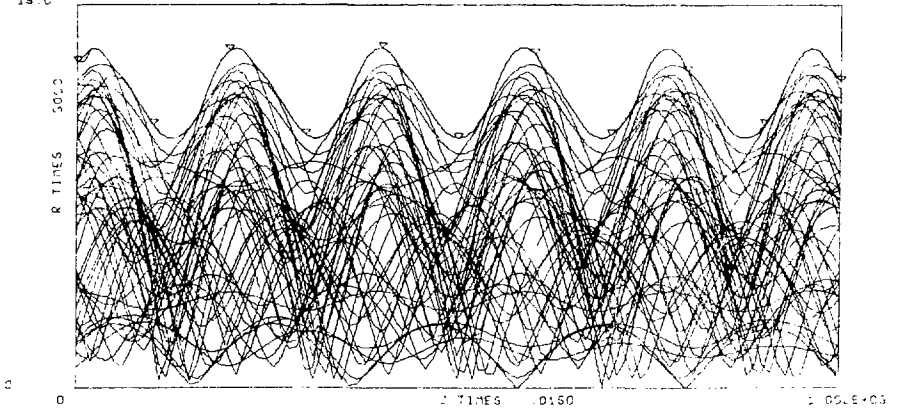

TITLE

----- CONTINUE 10-20 METERS

X6UCIO1 13 SEP 78

ITER= 1 PLOT 2

XBL 823-1915

CELL .5000 X 10.0000
16.0

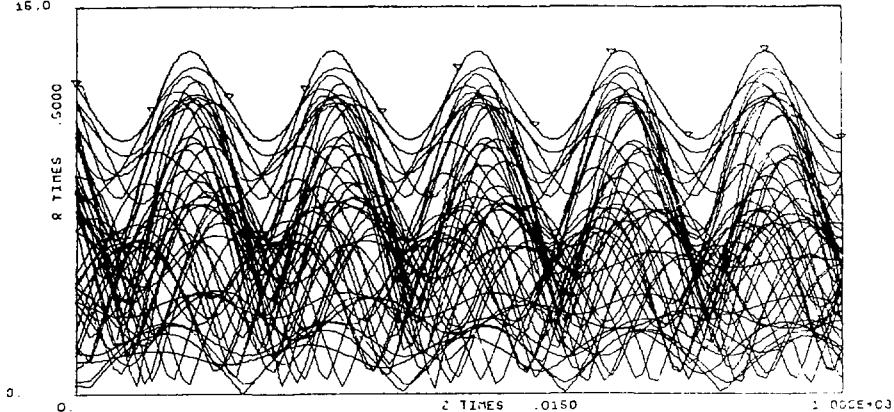

TITLE

----- CONTINUE 20-30 METERS

X6UCI01 13 SEP 78

ITER= 1 PLOT 3

Figure 6.3C

XBL 823-1916

CELL .5000 X 10.0000
16.0

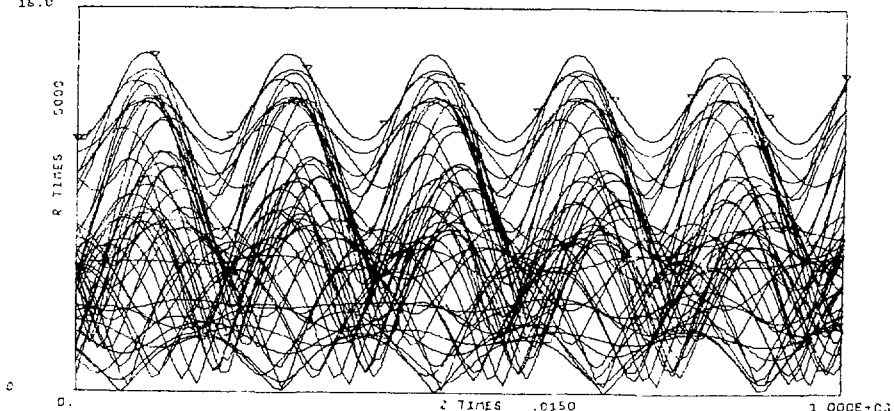

TITLE

----- CONTINUE 30-40 METERS

X6UCI01 13 SEP 78

ITER= 1 PLOT 4

XBL 823-1917

CELL .5000 X 10.0000
15.0

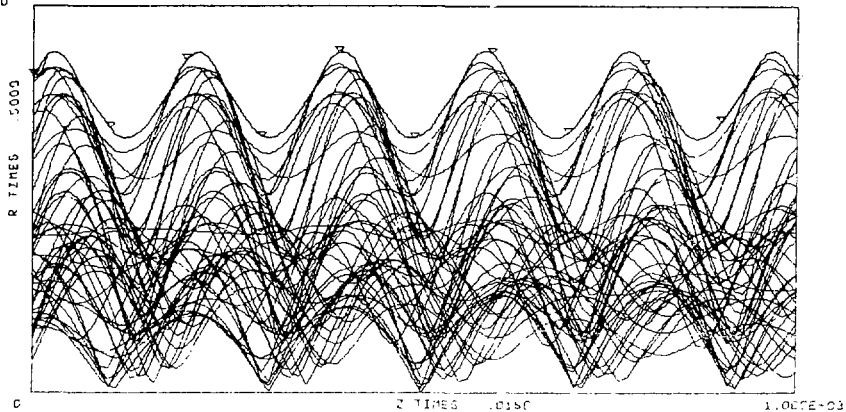

TITLE

----- CONTINUE 40-50 METERS

X6UC101

13 SEP 78

ITER= 1

PLOT

5

XBL 823-1918

Figure 6.3E Long transport of U238 ion beam in a constant solenoidal magnetic field. The space charge is calculated from application of Gauss's Law. Each section of the calculation shows the ion motion over a 1000 cm flight path. The ending ray distribution of a proceeding section is the initial starting distribution for the next section.

JOB.....	1 JOB.....
FETCHGS,LGO=EBQ/V3,12940.	2 FETCHGS,LGO=EBQ/V3,12940.
RFL,,70000.	3 FETCHMT,TAPE8,12345 INPUT DUMP
LINK,X.	4 RFL,,70000.
REQUEST,TAPE8,12345,W. OUTPUT DUMP	5 LINK,X.
EOR	6 EOR
EXAMPLE OF CYCLE CONTINUATION	7 CONTINUE PREVIOUS RUN 2 CYCLES
BOUNDARY	8 CONST *32 1 S \$DUMP NUMBER 1
-----	9 DUMP IN
-----	10 TRACK CONTINUE 2
POTS	11 END
CONST	12 END
*21 4 \$ N CYCLES	13 EOF
*32 1 \$ DUMP NUMBER	14
RAYS 1	15
-----	16
-----	17
END RAYS INPUT	18
TRACK	19
DUMP OUT	20
END	21
END	22
EOF	23

Figure 6.4 Schematic EBQ data showing transfer of whole problem to intermediate disk or tape file for restart at a later time via the DUMP OUT and DUMP IN data.

JOB.....	1 JOB.....
FETCHGS,LGO=EBQ/V3,12940.	2 FETCHGS,LGO=EBQ/V3,12940.
RFL,,70000.	3 FETCHMT,TAPE8,12345 INPUT DUMP
LINK,X.	4 RFL,,70000.
REQUEST,TAPE8,12345. OUTPUT DUMP	5 LINK,X.
EOR	6 EOR
TEM METER BEAM PROPAGATION	7 BEAM TRANSPORT, 8-18 METERS
BOUNDARY	8 CONST
21 51 0 10 0 1000	9 *32 11 \$ BOUNDARY DUMP 11,DUMP1
.....	10 *33 2 \$ 8 METER RAY DUMP,DUMP2
POT 1 2 3 OR21 S	11 *23 -800 \$ SHIFT RAYS 8 METERS
CONST	12 S
*32 11 \$ BOUNDARY DUMP NO.	13 DUMP 11
*33 2 \$ ORBIT DUMP NO.	14 RAYS 8 2 \$ READ 8 METER RAY DUMP
S	15 LEDGE 25 45 0 0 SWITCH 4 24
PUNCHB 800 \$ 8 METER RAY DUMP	16 POT SWITCH
COILGEN	17 TRACK X 5
.....	18 END
TRACK X 5	19 END
LEDGE 25 45 1 40 X 4 24	20 EOF
DUMP OUT	21
END	22
END	23
EOF	24

Figure 6.5 Schematic EBQ data showing continuation of a problem with orbit transfer at intermediate position via PUNCHB and RAYS 8. The boundary layer is shown in Figure 6.6.

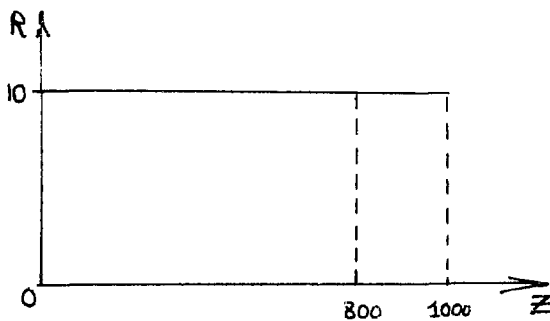

XBL 823-1919

Figure 6.6 Boundary layout showing orbit transfer and LEDGE cut for continuation data of Figure 6.5.

EXAMPLE 7

This example shows the data to study a space charge limited plane parallel diode. The initial conditions for the electrons emitted from the cathode is determined by application of Child's law. The boundary data sets up a cathode with an emission surface specified by potential index 1, line 6 and line 40, Figure 7.1, terminated by potential index 5 associated with the continuation of the cathode electrode. The grid is a finite set of concentric wire rings, lines 7-20. The expanded region around the wire grid requires a reasonably fine mesh precluding running the problem up to the actual anode, so the terminating potential is a curved surface following the space charge depressed surface of a 250 kV equipotential line determined in a previous run extending from the cathode out to the actual anode, lines 21-26. These points on the 250 kV equipotential line were found after solution of Poisson's equation in a previous problem by setting $CONST(49) = 1$, $CONST(47) = 0$, $EQUIP 250E3 S$, which causes a printing of a table of R,Z value along the specified equipotential lines in this region, a list of potentials to be plotted close to the grid potential is specified via the EQUIP data, line 39.

The electrons are generated by the RAYGEN 3 data, line 40, calling for 100 equispaced rays emanating from a equipotential surface crossing the z axis at $z = 0.6$ cm. The initial potential to be used in application of Child's law is given 25000 Volts. An iterative solution is sought until the change in the total beam current is less than 0.01% (1 amp in 10,000), line 32, or until 10 iterations have been completed, line 47.

Figure 7.2 shows the trajectories of these 100 electrons emanating from the equipotential lines at 0.6 cm, passing through a continuous plane grid at 1.5 cm and terminating on the 250 kV equipotential line. The phase space area occupied by the beam extracted from this diode is determined by the effect of the beam charge interior to its surface, radially defocusing the ions on this surface, Figure 7.3. Additionally, the construction of such a device with a mesh grid requires for transparency and reduction of grid power dissipation produces a local radial focusing of the beam, filamenting the phase space as shown in Figures 7.4-7.7. The grid would actually be constructed of a wire mesh which in the limit of a two dimensional axial simulation is modeled as concentric wire rings.

The orbits are terminated at an energy of 250 keV, CONST(65), along the curved equipotential line, data lines 37. The phase plot, Figure 7.7 at this energy is produced by the PLOT PHASE S, line 49 after the TRACK data, line 47. This figure shows the phase space approximately on the 250 kV equipotential surface where all orbits have the same energy.

The data required to modify the wire ring grid of Figures 7.4-7.7 into a continuous grid of Figures 7.2-7.3 is shown as case two of this example, lines 51-61. The boundary modify data does not initialize the problem, only alterations to the preceding cases are included, as shown.

Note that the phase plot scales of Figures 7.3 and 7.5 are not the same. If the user desires the wire mesh and continuous grid runs to have the same phase space plot scales, he must set them explicitly. The data lines shown as 42-44 should set the phase plot scales at the

longitudinal positions $z = 0.75, 1.5$ and 6.25 cm to the values shown, forcing these identical scales for the two cases.

```

GRID WIRE ANALYSIS ANODE AT 250 KV EQUIPOTENTIAL LINE          1
TITLE : ELL 0.25 X 0.25 CM PHASE SPACE FROM WIRE MESH GRID OF 1.0 CM 2
INITIALIZE                                                       3
BOUNDARY -----                                                4
  61 26 0 15 0 6.25                                             5
  1 0 0 5 12.7 0 5 15 0 S                                     6
  2 0.5 1.5 S                                                  7
  2 1.5 1.5 S                                                  8
  2 2.5 1.5 S                                                  9
  2 3.5 1.5 S -----                                         10
  2 4.5 1.5 S                                                 11
  2 5.5 1.5 S                                                 12
  2 6.5 1.5 S                                                 31
  2 7.5 1.5 S                                                 14
  7 8.5 1.5 S -----                                         15
  9.5 1.5 S                                                  16
  2 10.5 1.5 S                                               17
  2 11.5 1.5 S                                               18
  2 12.5 1.5 S                                               19
  2 12.7 1.5 2 15.0 1.5 S                                    20
STOP PLOT                                                       21
  3 0 6.088 3 1 6.057 3 2 5.965 3 3 5.815 -----         22
  3 4 5.615 3 5 5.375 3 6 5.108 3 7 4.827                 23
  3 8 4.544 3 9 4.273 3 10 4.019 3 11 3.792                24
  3 12 3.624 3 13 3.603 3 14 3.672 3 15 3.741              25
S                                                                26
S                                                                27
POT 0 85000 250000 0 0 0 S -----                          28
CONST                                                            29
*3 0 $ ----- GAUSS-S LAW OFF                               30
*10 .05 $ ----- RK STEP                                    31
*22 1.0E-4 $ ----- CHILDS LAW CONVERGENCE TO 1 AMPERE    32
*35 -15 -12.5 $ ----- CALCOMP PLOT SIZE IN CM           33
*37 11 $ ----- CALCOMP PHASE PLOTS                       34
*47 20 $ ----- NUMBER OF EQUIPOTENTIAL LINES             35
*54 0 $ ----- RETROGRADE MOTION                          36
*64 0 250000 $ ----- E-MIN E-MAX                         37
S                                                                38
EQUIP 6CE3 62.5E3 65E3 67.5E3 70E3 72.5E3 75E3 77.5E3 80E3 S 39
RAYGEN 3 100 1 .6 25000                                        40
PLGT PHASE 0.75 1.5 S                                         41
PLOT SCALES PHASE 0 15 -.175 0 1.5                          42
PLOT SCALES PHASE 0 15 -.025 0 6.25                         43
PLOT SCALES PHASE 0 15 -.05 .15 0.75                       44
PLOT TRAJ S                                                  45
RKSTEP .05 1.5 .25 10 S -----                             46
TRACK X 10                                                    47
ENDTRACK                                                       48
PLOT PHASE 5 $ ----- PHASE PLOT AT TERMINATION OF RAYS   49
END                                                            50
$ -----                                                      51
GRID WIRE ANALYSIS, ANODE AT 250 KV EQUIPOTENTIAL SURFACE   52
TITLE CELL 0.25 X 0.25 CM PHASE SPACE FROM CONTINUOUS GRID 53
BOUNDARY MODIFY                                               54
  2 0 1.5 2 12.7 1.5 2 15.0 1.5 S $ ----- CONTINUOUS GRID 55
S                                                                56
RAYGEN 3 100 1 .6 25000                                        57
TRACK X 10                                                    58
ENDTRACK                                                       59
PLOT TRAJ S                                                  60
TRACK CONTINUE 1                                             61
END

```

Figure 7.1 EBO data for high current grid wire analysis example.

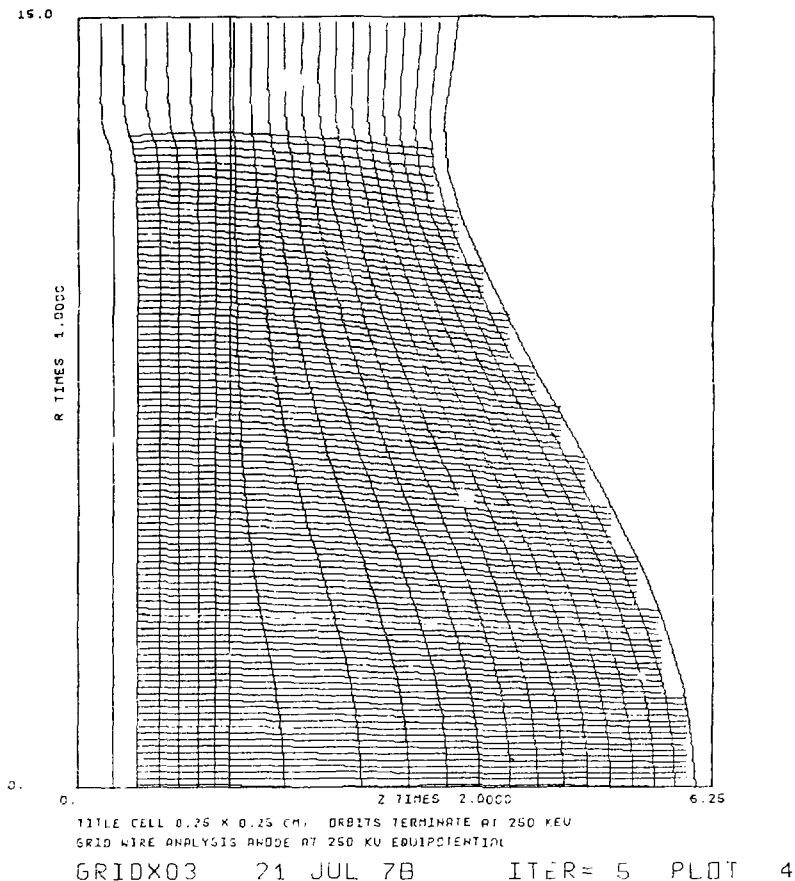

XBL 823-1920

Figure 7.2 R-Z plane showing equipotential lines and electron trajectories for a continuous grid extracting from a cathode emission surface extending to 12.7 cm radius. The electrons pass through a grid and terminate on a 250 keV equipotential line.

RAY GROUP 1 PR/PZ US R PHASE PLOT Z= .7600
I= 13442

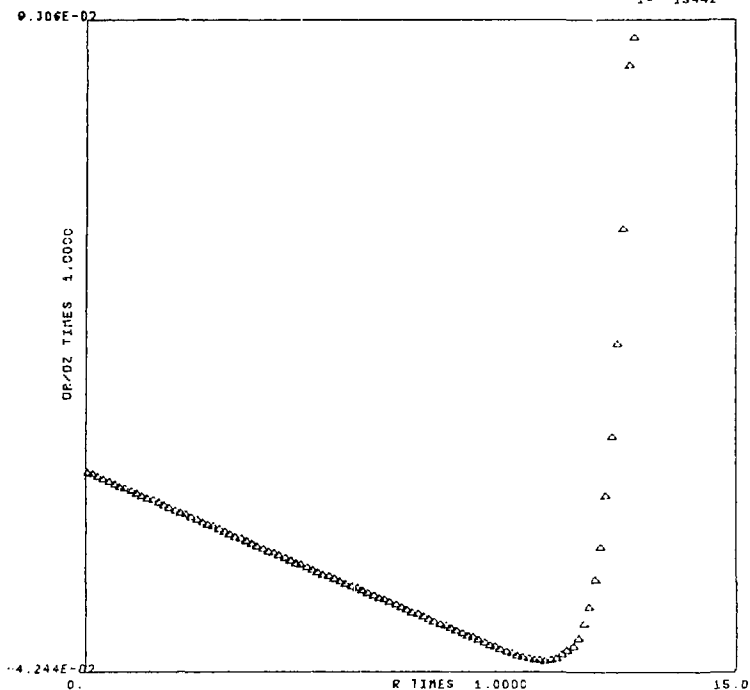

TITLE CELL 0.25 X 0.25 CM, DRIFTS TERMINATE AT 260 FEV
GRID WIRE ANALYSIS ANDDE AT 250 KV EQUIPOTENTIAL

GRIDX03 21 JUL 78 ITER= 5 PLOT 1

XBL 823-1921

Figure 7.3 Phase space produced half way between cathode and continuous grid. Note the dominant effect is the space charge defocusing of the outer edge of this non-Pierce corrected structure.

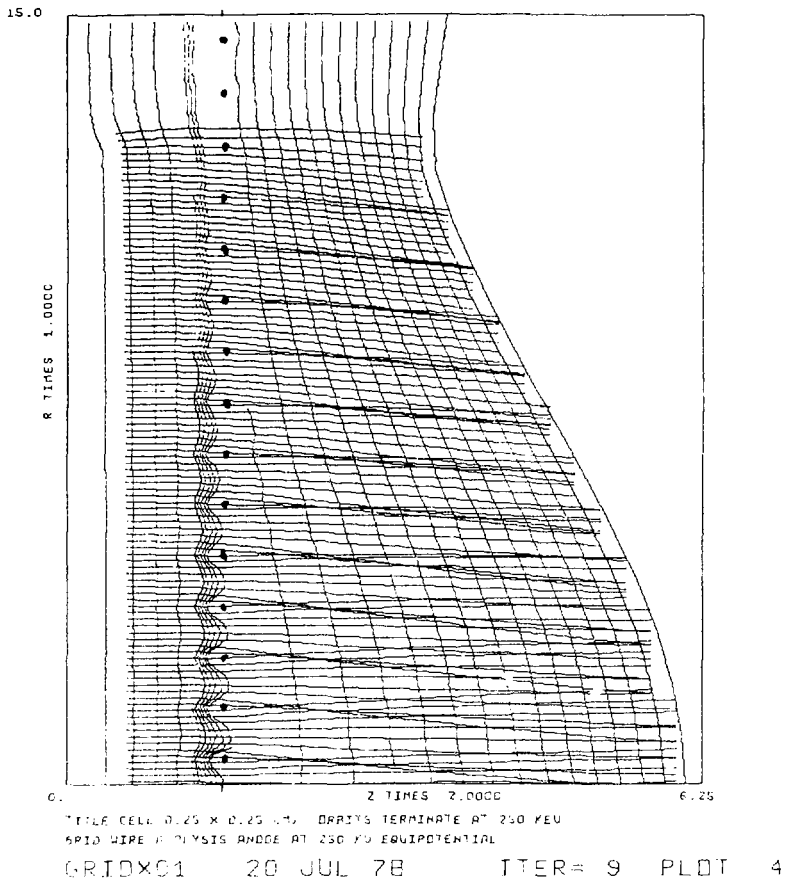

XBL 823-1922

Figure 7.4 R-Z plane showing equipotential lines and electron trajectories for the same geometry of Figure 7.2 where the continuous grid has been replaced by a set of concentric rings as shown. Note the local einzel lens focusing of the electron beam after passage through the grid electrode.

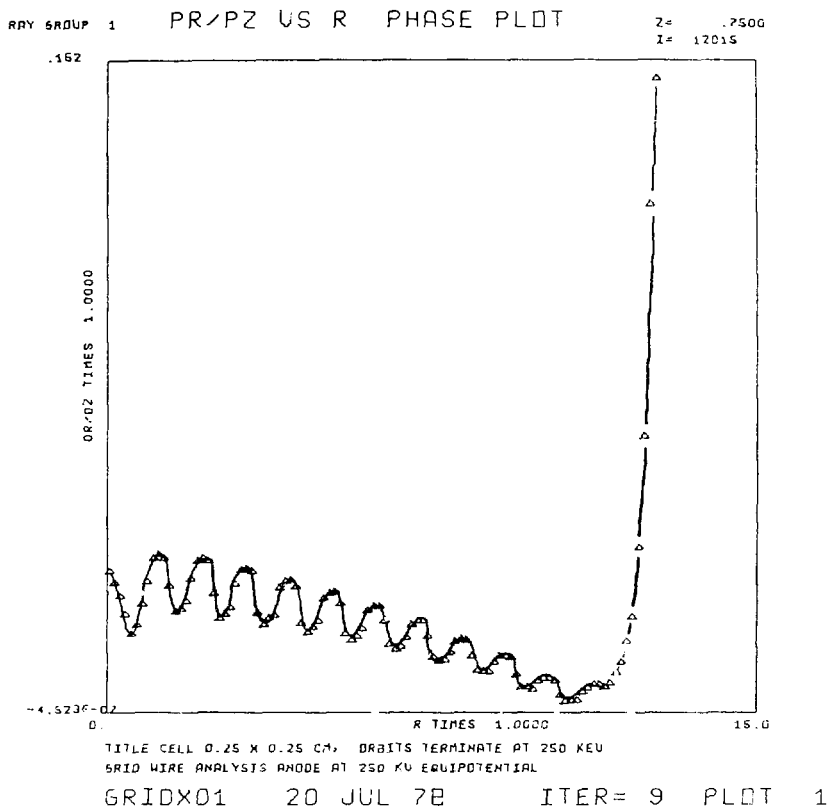

XBL 823-1923

Figure 7.5 Phase space produced half way between cathode and grid by local effect of finite grid wires prior to beam passing through the grid. Note the dominant effect is the space charge defocusing of the outer edge of this non-Pierce corrected structure.

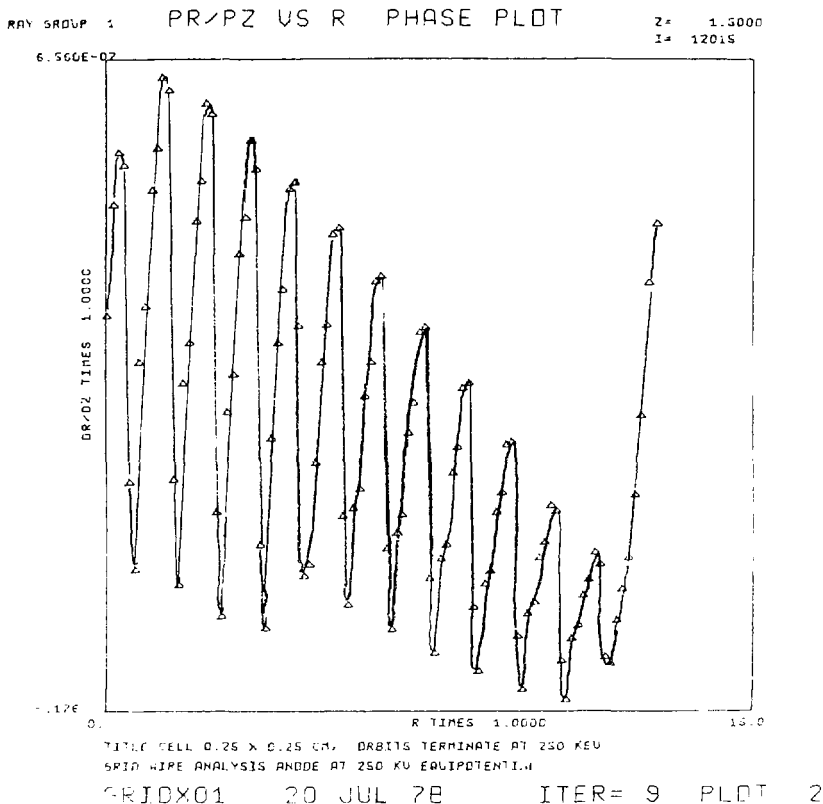

XBL 823-1924

Figure 7.6 Phase space at the grid. The maximum beam energy is 85 keV as that is the potential set by the grid wires every cm in radius. The beam is filamented by the focusing of the 1 cm grid wires on approach to the grid plane. This einzel lens effect is comparable to the non-Pierce corrected space charge defocusing of the outer edge of the beam.

RAY GROUP 1 PR/PZ US R PHASE PLOT 21 6 2500

.171

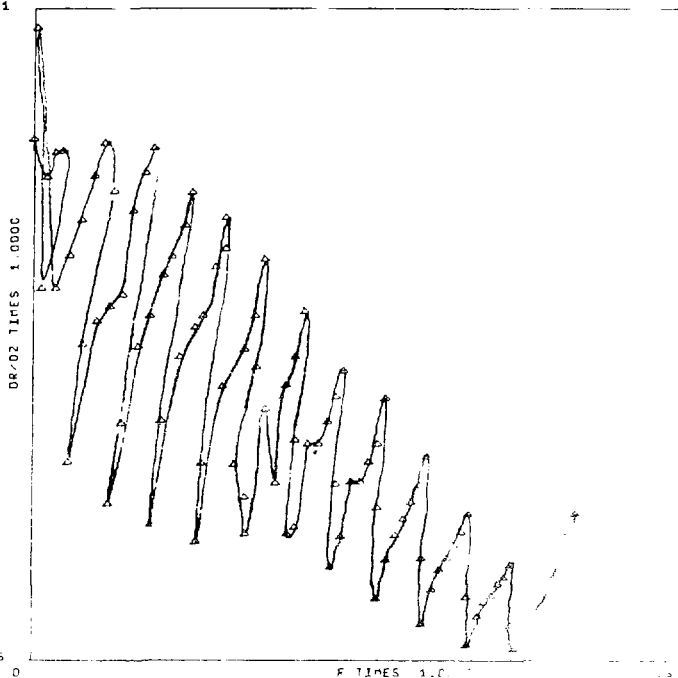

.755

TITLE CELL 0.25 X 0.25 CM. BEAMS TERMINATE AT 250 KE
 GRID WIRE ANALYSIS MADE AT 200 KE EQUIPOTENTIAL

GRIDX01 20 JUL 78 IT 9 PL

X-87-1925

Figure 7.7 Phase space plot at the energy of 100 keV. The curves show the radius of the grid region at 100 keV. The curves show the contribution to the space charge depression of the beam received a larger radial force producing a contribution at the smaller radii.

EXAMPLE 8

This example demonstrates a long transport system for a cesium ion beam (100 meters) in a computationally economical way. Space charge will be calculated from application of Gauss's law, the self magnetic field is unimportant for these low energy ions.

The problem has three distinct characteristic dimensions.

1) Boundary mesh - used only for plotting, i.e., ions trajectories are stored at each BZMESH interval for plotting. This mesh will not be used to solve Poisson's equation, as the space charge will be found from Gauss's laws.

2) Magnetic field array - the vector potential array is differentiated to find the components of the external magnetic field B_x and B_y . This array must be fine enough to allow accurate evaluation of these fields in the sharp fringing field region of the short field lenses.

3) Runge-Kutta integration step - this step must be smaller than distances over which field changes are appreciable or rays cross, since ray crossings effect the enclosed current used to find the space charge fields.

The magnetic field cell (0-300 cm) must be present over the entire length of the problem since the solenoids provide the restoring force against beam expansion from the beam emittance and space charge divergence. The shortness of the field lenses require a relatively fine mesh. It therefore becomes necessary to use the region--repeat parameters of the COLGEN data to divide the 3 meter magnetic field cell along the mesh of the beam propagator.

The data defining the basic problem is shown in Figure 8.1. MAOFF, Line 4 suppresses the boundary mesh map, (its quite long and uninteresting), the potential, and the charge maps normally generated after execution of TRACK. The various problem constants are defined by lines 10-19, with the meanings given as comments following the \$ on the data cards. The magnetic field is generated from the data lines 20-27. The field is rapidly varying in the coil region, an expanded grid is used in the longitudinal location of each coil requiring the 0-300 cm coil section to be divided into five regions. The positions, and grid mesh size dr, dz of each region are defined by the data lines 22-24. This entire 300 cm section is subjected to the 6000 point mesh restriction of the APHI array. As the orbit calculation proceeds, the field will be found by a z origin shift from this basic field section as specified by REPEATS = 100, line 20.

The rays to be run are specified, lines 29-37. The current data line is not used as the RAYS card, line 29 specified a total current of 0.25 amperes to be distributed amongst the rays according to their radial positions, line 30, so as to yield a starting beam of uniform current density.

This data is executed, line 39 producing the plot shown in Figure 8.2. The ten rays propagate from left to right, with the magnetic field shown as the wildly oscillating curve. The scale of the magnetic field is printed on the plot, BMIN, BMAX = -31801, 31801 Gauss. The zero line for the field plot is marked by the short ticks on the left and right of the plot, in this example, half way up as the field is symmetric. the

run is now repeated at essentially zero current, data lines 40-42, to demonstrate the importance of space charge for this beam, Figure 8.3. The dashed line of this figure is the space charged beam envelope of the preceding TRACK.

This first part of the data set used a mesh cell of 1.0 x 100 cm and a Runge-Kutta integration step of 2 cm. To better illustrate the magnetic field shape and orbit motion, an expanded region is now run. The accuracy of the calculations are not improved, as the mesh size in this example is unimportant, since Gauss's law is being used to evaluate the space charge forces and there are no external electric fields. The calculation of the current enclosed by the rays is performed each mesh interval, but this laminar beam does not cross. The data lines 45-49 set up an expanded section, from 0 -1000 cm with a mesh size of 1.0 x 10 cm. The beam current is reset to the initial 0.25 ampere value (line 51) and tracking initiated (line 52) Figure 8.1. The trajectory plot is shown in Figure 8.4. The current is then reduced to essentially zero and the beam tracked without space charge, Figure 8.5. The magnetic field is found from within the vector potential map generated for the preceding case, since this map covers the physical space simulated in case 2. Compare the first 1000 cm section of Figures 8.2, 8.3 with Figures 8.4, and 8.5.

\$	1
RUN CESIUM IONS IN LONG BROCKEN ALTERNATING POLARITY SOLENOID	2
TITLE	3
INITIALIZE	4
MAP OFF	5
BOUNDARY	6
11 101 0 10 0 10000 \$ 10 KM DRIFT DISTANCE, CELL=1X100 CM	7
1 10 0 1 10 10000 S \$ ---- CUTER CYLINDAR, BEAM PIPE	8
S	9
POT 0 0 S	10
CGASY	11
*1 137E9 \$ ----- CESIUM REST MASS	12
*10 1 \$ ----- 1 CM RK INTEGRATION STEP	13
*10 2 \$ ----- 2 CM INTEGRATION STEP	14
*14 0 \$ ----- PAPER PLOT BEAM LINE GRAPH INTERVAL	15
*14 2 \$ ----- PAPER PLOT BEAM LINE GRAPH INTERVAL	16
*19 1.0E100 \$ TURN OFF ORBIT OUTPUT	17
*34 10 \$ ----- CALCMP TRAJECTORIES	18
*35 -10 -20 \$ CALCMP AXIS LENGTH IN CM(R AND Z)	19
\$	20
\$ ----- MAGNETIC FIELD INPUT HERE	21
CULIGEN 1 0 0 10. 5 100 \$ ---- TYPE B1 B23 RMAG ZONES REPEATS	22
0 30 120 160 260 300 \$ ----- Z(I)	23
1.0R5 \$ ----- DR(I)	24
10 1 10 1 10 \$ ----- DZ(I)	25
1.0E0 -1.0E0 S \$ ----- CURRENT IN AMPS	26
75 10 1 \$ SINGLE TURN Z=75 CM F=10 CM SCALE=1	27
225 10 1 \$ SINGLE TURN COIL	28
\$ ----- END MAGNETIC FIELD INPUT	29
PRINT FIELDS 5 0 1000 10	30
RAYS 5 0 UNIFORM 0.25 \$ ---- GENERATE RAYS UNIFORM CURRENT DENSITY,	31
.25 .75 1.25 1.75 2.25 2.75 3.25 3.75 4.25 4.75 S \$ ----- 10 RAYS	32
DR10 \$ Z(I)	33
DR10 \$ PHI(I)	34
2.0E0H10 \$ ---- 2 MEV IONS	35
DR10 \$ ----- ALPHA	36
DR10 \$ PSI(I)	37
DR10 \$ CURRENT CALCULATED FOR UNIFORM DENSITY	38
END RAYS INPUT	39
PLT TRAJ 5	40
TRACK	41
CURRENT 1.0E-20	42
PLOT TRAJ 5	43
TRACK	44
END	45
\$	46
RUN 1000 CM, PROVIDE PLOT SHOWING DETAILS OF MAGNETIC FIELD AND ION	47
BOUNDARY	48
11 101 0 10 0 1000 \$ CELL=1X100 CM	49
1 10 0 1 10 1000 S	50
S	51
PLT TRAJ 5	52
CURRENT 1.0 \$ RESET CURRENT TO INITIAL VALUE, 0.25 AMPS	53
TRACK X 1	54
CURRENT 1.0E-10	55
TRACK X 1	
END	
END	

Figure 8.1 EBQ data demonstrating the use of a repetitive magnetic field zone.

CELL 1 0000 X100 0000
LD 0

1- 45000

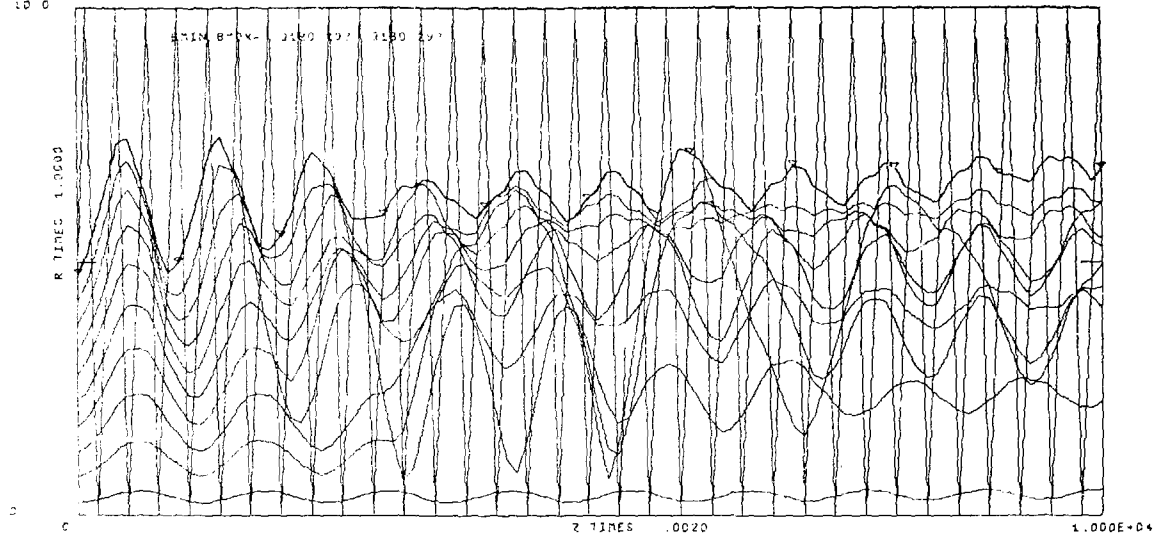

-278-

TITLE
RUN RESUME IONS IN LONG BROCKEN ALTERNATING POLARITY SLENDID
XBUCID0 30 NOV 78 ITER= 1 PLOT 1

XBL 823-1926

Figure 8.2 Plot of ion orbits and magnetic field for the cesium ion example. Space charge is included by Gauss's law.

CELL 1.0000 X100.0000
AD 0

I=2.5000E-2

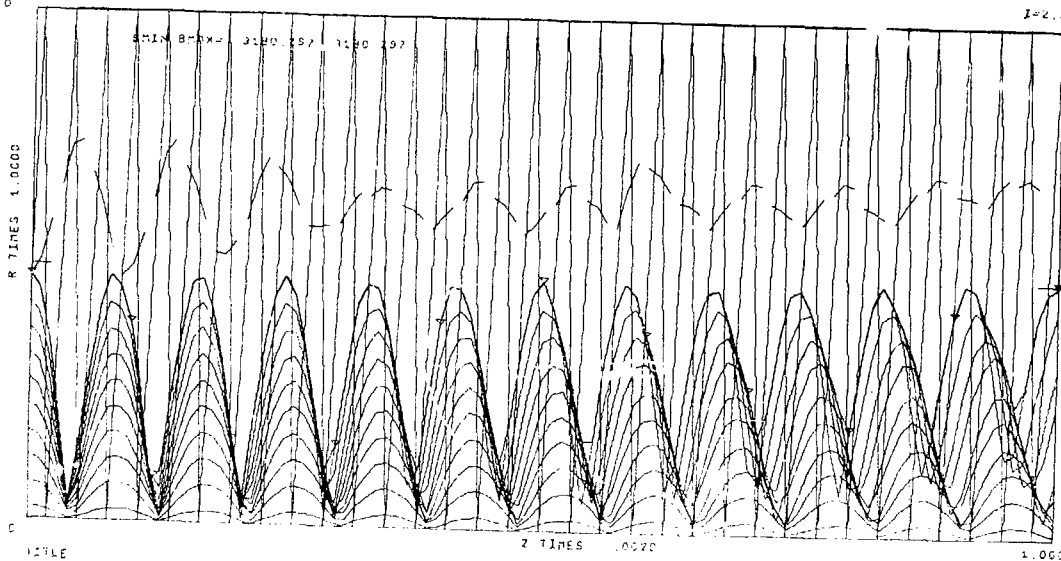

-279-

TITLE
PUN CESIUM IONS IN LONG BROKEN ALTERNATING POLARITY SOLENOID
XBUC100 30 NOV 78 ITER= 2 PLOT 2

Figure 8.3 Cesium ion example without space charge run as iteration two following a space charge run. Note the beam envelope (dashed curve) of the space charge cycle plotted for comparison.

XBL 823-1927

CELL 1.0000 X 10 1000
10 0

I= .25000

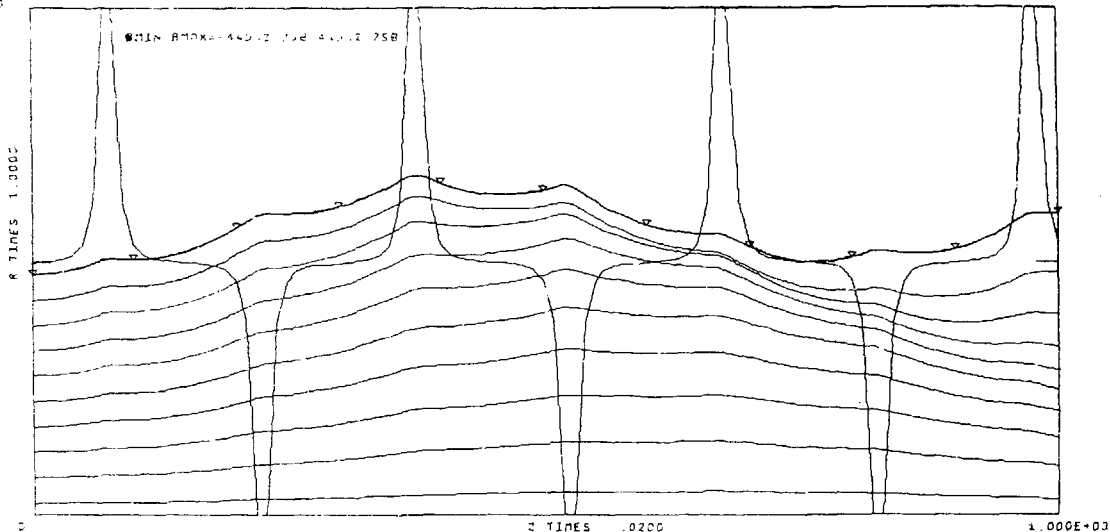

TITLE

PUN 1000 CA; PROVIDE PLOT SHOWING DETAILS OF MAGNETIC FIELD AND ION MOTION

XBUC100 30 NOV 78 ITER= 1 PLOT 3

XBL 823-1928

Figure 3.4 Expanded region of the cesium ion example showing more detail of the magnetic field and orbit profiles. Space charge is included via Gauss's law.

CELL 1 0000 X 10 0000
10.0

I=2.5000E-11

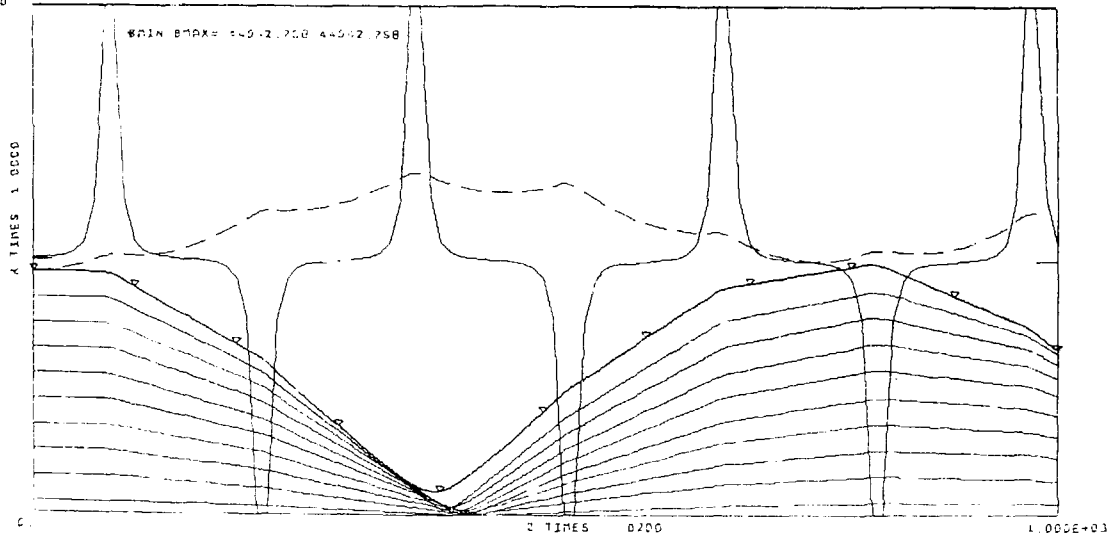

TABLE
RUN 10.1 CM. PROVIDE PLOT SHOWING DETAILS OF MAGNETIC FIELD AND ION MOTION
XBUCICD 30 NOV 78 ITER= 2 PLOT 4

YRI, 823-1929

Figure 8.5 Expanded region of the cesium ion example without space charge, compare with Figures 8.2, 8.3, and 3.4. Note the spac. charge envelope plotted as dashed line.

EXAMPLE 9

Consider the design of an X-ray tube with a point source of electrons. The details of the particle source region require running the problem as a sequence of several sub-cases so as to reflect the electro-static potential in the entire device from which is extracted the potentials to be used as boundary values for the source region problem. The electrons are then extracted from the emitter and run out to a reasonable energy and injected from this source region in to the rest of the device for transport to the target.

The data, Figure 9.2, divides the device, Figure 9.1A, into the regions delineated in Figure 9.1B. Section 1 of this data, lines 1-25, define the entire global problem comprising the wire cathode, focus electrode, anode and transport regions. This problem is solved to find the graded Dirichlet potentials to be used as boundary conditions in case 2 and 3 which expand the region around the cathode emission point to allow the required refinement of the mesh to simulate the high electric fields found around a point source. Laplace's equation is solved, line 17, on the global problem. Interpolated potentials along selected lines within this global problem are then stored in the POT() array for use as boundary conditions in the following sections of this data by the POT STORE data, lines 18-22.

Since no rays are tracked in this first section of this example, a plot of the boundary with the equipotential lines must be produced by specifically requesting it via the PLOT EQUIP data, line 24, or a PLOT BOUNDARY data.

The number of points to be stored in the POT() array and the specification of the interpolation line to use is determined from the mesh size and boundaries of the subsequent cases. Consider the left edge boundary of the emitter case, case 2, lines 26-50. The 31 x 26 mesh covers the radial region from 0 to 0.6 cm in the longitudinal section extending from 0.7 to 1.7 cm, line 29. The 31 potential values to be used as the radial boundary on the left edge of the problem are stored in the pot array in locations 11-41 as specified by the POT STORE R 11 41 data, line 18, and inserted into the mesh by the INCREMENT code in the boundary data of case 2, line 32. The actual potentials used are interpolated from the U() array along the radial line (R) at $z = 0.7$ cm extending from 0 to 0.6 cm in 0.02 cm steps, lines 18 and 32-33. Similarly, for the other boundary potentials of the subsequent cases.

The rays are generated in case 2, line 45. The 25 rays are to be started at a constant longitudinal value, $z = 1.02$ cm inside a regular, upright phase space grid with five radial values and five angular values. The radial values are determined from the maximum beam radius, RBEAM = 0.07 cm, so R takes the values .007, .021, .035, .049 and .063 cm. The radial angular emission value is determined from the beam emittance specified as 0.1 ($EM = RBEAM * RP_{MAX}$) as the five values $-10/7$, $-5/7$, 0, $5/7$, $10/7$ radians. The rays are to be traced and their values at the end, $z = 1.7$ cm, saved for continuance in the next case by writing a binary disk dump via the PUNCHB data, line 46. The rays are started at 2 eV in the very high electric field region around a point emitter, so the Runge-Kutta integration step must be adjusted so that the rays do not gain energy too rapidly. The RKSTEP data, line 49,

specifies a .001 cm step to 1.2 cm, and .0025 cm step to 1.4 cm, after which the value given by CONST(10) will be used.

Case 3 tracks these rays from the end of case 2 to the anode hole, data lines 52-77. The rays are read from the binary disk dump, line 46, by the RAYS 8 data, line 65. The last ray, ray 25, is to be removed, line 66.

The equipotential lines plotted in case 1 are turned off in this case by setting CONST(47) to zero and nulling the EQUIP array, lines 69 and 72. The rays are then tracked with phase plots taken at 2, 3, 4, 5 and 6 cm. The CALCOMP boundary and trajectory plots are shown as Figures 9.3-9.5.

A)

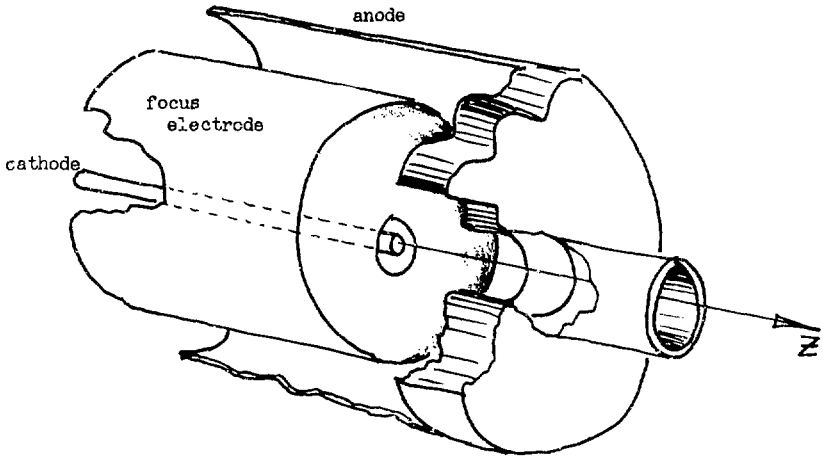

B)

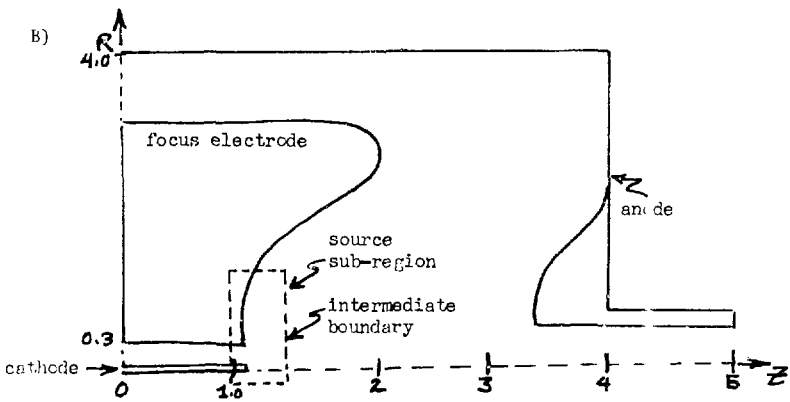

XBL 823-1930

Figure 9.1 X-ray tube electrodes A) and their EBQ boundary diagram B).

GLOBAL PROBLEM BOUNDARY

INITIALIZE

BOUNDARY

21 66 0 4. 0 6.5 S ----- CELL 0.2 X 0.1
 1 0 0 1 0 1.0 S \$ CATHODE NEEDLE
 2 3 0 2 3 1 2 4 1.1 2 5 1.15 2 2.5 2.45 2 2.85 2.75
 2 3.1 2.75 2 3.25 2.6 2 3.3 2.4 2 3.3 2 3 0 S
 3 4 0 3 4 5 3 .75 5 3 .75 6.5 3 0 6.5 3 4 6.5 3 4 5 S
 3 5 6.5 3 5 4 3 6 3.8 3 8 3.8 3 1 4 3 2 4.75 3 2.25 4.9 3 2.5

POT

0 -100 60E3 DR191 S

CONST

*16 1.0 \$ SOLVE POISSONS EQUATION TO 1 VOLT

*35 -20 -13 \$ CALCOMP PLOT SIZE IN CM

*47 20 \$ PLOT 20 EQUIPOTENTIALS ON CALCOMP PLGT

S

LAPLACE

POT STORE R 11 41 0.7 0.0 0.6 .02 \$ LEFT EDGE PROB 2

POI STORE Z 42 67 0.6 1.2 1.7 .04 \$ TOP OF PROB 2

POT STORE R 68 99 1.7 0.0 0.6 .02 \$ RIGHT EDGE OF PROB 2

POI STORE Z 131 150 0.6 1.7 3.8 .20 \$ TOP OF PROB 3

POT STORE R 151 182 1.7 0.0 0.6 .02 \$ LEFT EDGE OF PROB 3

PRINT POT

PLOT BOUNDARY 5 EQUIP 10 20 50 100 200 500 1000 S

END

\$ ----- BLOW UP CATHODE REGION -----

EXPAND REGION AROUND CATHODE POINT

BOUNDARY

31 26 0 .6 .7 1.7 S ----- CELL 0.02 X 0.04

1 .078 .7 1 .078 1.02 1 0 1.02 1 0 .7 1 .078 .7 S

2 .3 .7 2 .3 1.0 2 .35 1.07 2 .4 1.1 2 .6 1.2 S

INCREMENT 11 41 \$ ----- LEFT EDGE OF CATHOD FOCUS GAP

I 0 .7 2 .3 .7 S

INCREMENT 42 67 \$ ----- TOP OF PROBLEM

I .6 1.2 54 .6 1.7 S

INCREMENT 68 99 \$ ----- RIGHT EDGE OF PROBLEM

I 0 1.7 98 .6 1.7 S

S

LAPLACE

CONST

*10 .01 \$ RUNGGA-KUITA INTEGRATION SET

*35 -12 -10 \$ CALCOMP PLOT SIZE IN CM

*47 0

S

RAYGEN 2 25 1.0E-7 1.0E-7 2 .1 .07 1.02 0 0 0 0 -5 S

PUNCHB 1.7 S

PLOT PHASE 1.7 S

PLOT TRAJ S

RKST=P .001 1.2 .0025 1.4 S

TRACK X 1

END

1
2
3
4
5
6
7
8
9
10
11
12
13
14
15
16
17
18
19
20
21
22
23
24
25
26
27
28
29
30
31
32
33
34
35
36
37
38
39
40
41
42
43
44
45
46
47
48
49
50
51

```

$ ----- TRANSPORT ELECTRONS ON TO X-RAY TARGET ----- 50
TRANSPORT RAY S 53
BOUNDARY 54
  31 25 0 .6 1.7 6.5 $ ----- CELL .02 X .2 CM 55
  OUTSIDE .55 5.0 56
  3 .6 3.8 3 .54 3.82 3 .51 3.9 3 .5 4.0 3 .5 6.5 3 .6 6.5 3 .6 3.8 S 58
  INCREMENT 151 182 $ ----- LEFT EDGE OF PROBLEM 58
  I 2 1.7 162 .6 1.7 S 59
  INCREMENT 131 150 $ ----- POT EDGE OF PROBLEM 60
  131 .6 1.7 3 .6 3.8 S 61
  3 0 6.5 3 .6 6.5 S 62
S 63
LAPLACE 64
RAYS 8 1 $ ----- READ DUMP 1 65
RAYS REMOVE 25 S 66
PRINT RAYS 67
CONST 68
  *47 0 69
*34 11 $ PRINT ORBITS TRANSPORT SECTION, WHY CALL CCHLF Z=1.7 CM 70
S 71
EQUIP S $ TURN OFF PREVIOUS SPECIAL EQUIPOTENTIAL PLOT LINE VALUES 72
PLOT TRAJ S 73
PLOT PHASE 2 3 4 5 6 S 74
TRACK 75
END 76
END 77

```

Figure 9.2 EBQ data for x-ray tube. The data divides the problem into a "Global problem" from which potentials will be extracted for use as boundary conditions for a second problem "Region around cathode" used to find the electron orbits for injection into a third problem "TRANSPORT RAYS."

CELL .2000 X .1000
4.00

I-

IIII

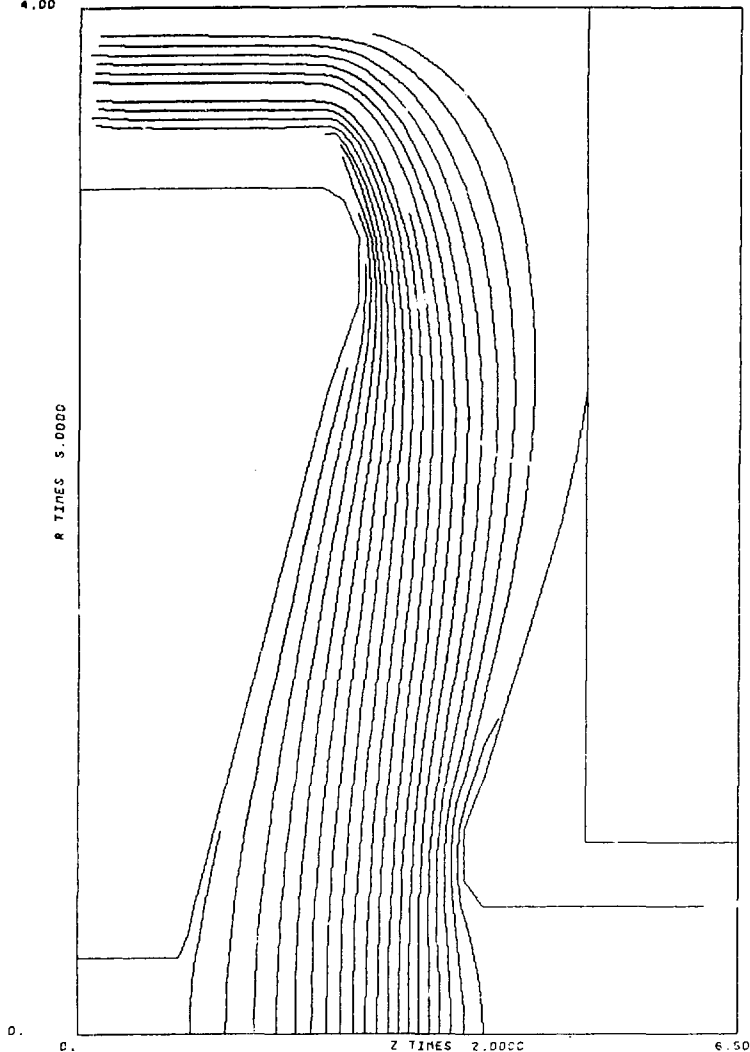

XBL 823-1931

Figure 9.3 X-ray tube global boundary plot showing electrodes and equipotential lines. The boundary covers the entire problem region and encloses the cathode and transport sub-problem regions. The EBQ POT STORE data commands will extract interpolated potentials from this problem to be used as boundary conditions for the two subsequent regions, Figure 9.4 and 9.5.

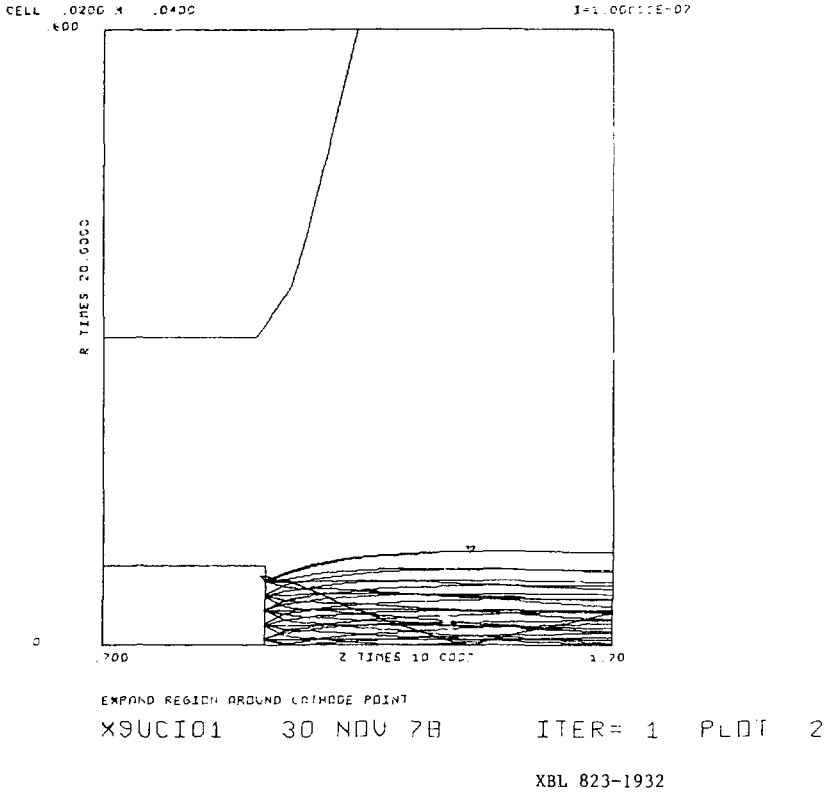

Figure 9.4 EBQ trajectory plot for the sub-problem "expanded region around the cathode" of the x-ray tube example. Note tip of the focus electrode on the upper left portion of the plot and the cathode electrode tip on the lower left. The electrons originate at $z = 1$ cm at essentially zero energy and are accelerated to $z = 1.7$ cm, at which point they will be transferred to the next problem, Figure 9.5.

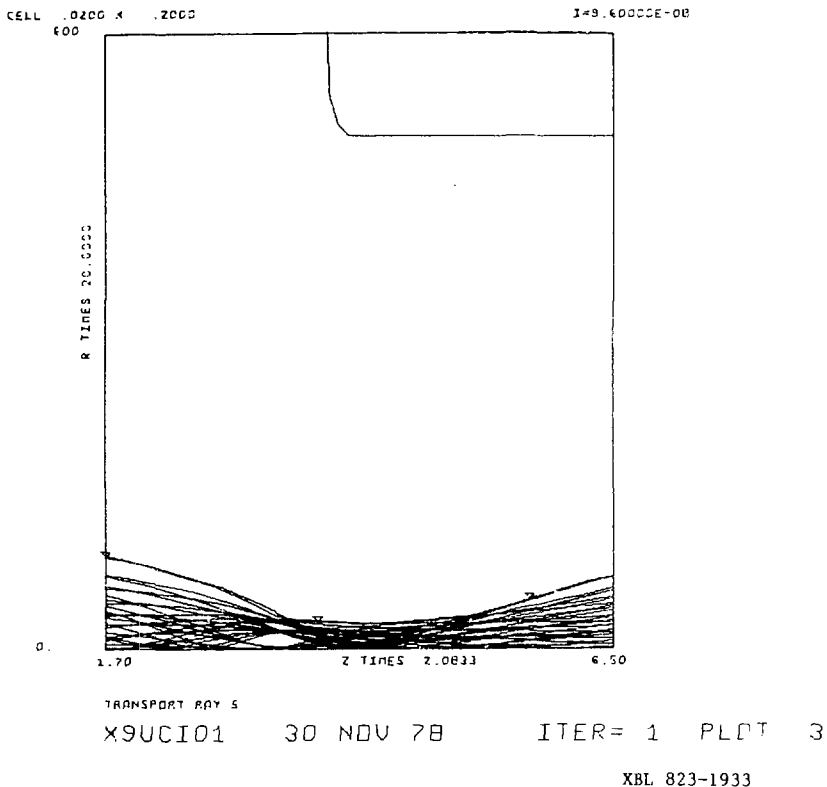

Figure 9.5 EBQ trajectory plot for the sub-problem "Transport Rays" of the x-ray tube example. Note the anode tip shown in the upper right of the plot. The trajectories begin at the left edge as transferred from the previous problem, Figure 9.4, and continue to the right. This problem is at the lower right portion of the Global problem shown in Figure 9.3

EXAMPLE 10

This example shows the use of a cathode masking with a Child's law start, to generate a hollow beam of electrons from a space charge limited diode. Consider two concentric plane disk electrodes, one a cathode with a ring treated for electron emission from 5 to 12.7 cm in radius, Figure 10.2. The Child's law start is defined by the RAYGEN data, line 15, Figure 10.1 specifies 50 equally space rays starting from a surface originating on the z axis at 0.6 cm. The rays will be distributed only over the radial interval of this surface which projects back to the cathode as defined by a potential index 1 surface, Figure 10.3. Note in the boundary data, the cathode electrode started as a potential 5 surface, from which no electron emission occurs. At 5 cm radius, the potential index of this surface changes to 1, from which electrons can be emitted. At a radius of 12.7 cm the potential index changes back to 5, terminating the emission surface. Both POT(1) and POT(5) have the potential of the cathode surface.

After iteratively converging the Poisson-ray trace cycles, the effect of the space charge is evident from the bows in the equipotential surface's away from the conductive electrode section Figure 10.4. The effect of the space charge is best displayed on a phase space plot, Figure 10.5. The beams self magnetic field generated a self focusing giving a general radial converging (inward slope) to the electrons, while the lack of electro-static space charge on the inside and outside of the beam (beam edges) causes a divergence of the outer edges of the beam away from its core, Figure 10.5.

As a further example of cathode masking, consider the case of a three concentric ring electron emitter shown in Figure 10.6. The data is shown in Figure 10.7 and shows two alternative ways of generating the cathode masking. The first method specifies a single boundary segment all at zero volts, but divided into sections with potential indexes 1, 5 and 10 (POT(1), POT(5), and POT(10) all zero volts) The RAYGEN data specifies emission from only potential index surfaces 1 and masking from potential index 5 surface, with termination of the cathode and mask at the encounter of any other potential index, such as index 10. The cathode generation (i.e., 10 is not index 1 or 5) is terminated at a radius of 6.5 cm in this example by the onset of any non cathodes or mask index in the mesh array. Recall, a potential index extends from the point of its occurrence (I,R,Z) in the mesh up to, but not including the next point (I,R,Z) in the mesh whose potential index is used.

The alternative method shown for the mesh generation of this three ring emission cathode demonstrates the redefinition of mesh points by subsequent electrode specification. Figure 10.7B shows the data where each boundary segment comprising the cathode electrode is given separately, using the potential index 1 for the electron emission sections, index 5 for the masks and index 10 for the cathode terminator section of the cathode electrode.

The ray and phase plots generated by this data is shown in Figures 10.8 and 10.9.

```

$ -----
TEST HOLLOW CATHODE
BOUNDARY
32 7 0 15.5 0 1.5
5 0 0 1 5 0 5 12.7 0 5 15.5 0 5
2 0 1.5 2 12.7 1.5 2 15.5 1.5 5
S
POT 0 85.0E3 0 0 0 5
CONST
*10 -1 $ RUNGGA-KUTTA INTEGRATION STEP, CM
*35 -7.75 6.0 $ CALCOMP PLOT SIZE
*37 11 $ CALCOMP AND PRINT PHASE PLOTS
*47 20 $ 20 EQUIPOTENTIAL LINES
S
RAYGEN 3 50 1 .6
TRACK X 10
ENDTRACK
PLOT SCALES PHASE 0 15.5 -.15 0
PLOT PHASE 1.5 S
PLOT TRAJ S
TRACK CONTINUE 1
END
$ -----
3 CONCENTRIC RING EMITTERS
INITIALIZE
BOUNDARY
51 10 0 10.0 0 0.9
10 0 0 1 1.25 0 5 2.5 0 1 3.25 0 5 4.5 0
1 5.25 0 10 6.5 0 10 10 0 5 $ ----- EMITTER AND MASKS
2 0 0.9 2 10 0.9 5 $ ----- ANODE
S
POT 0 85.0E3 0R8 5
CONST
*47 20 *35 -10 -9
S
RAYGEN 3 50 1 .5 0 5 1.0E8
PLOT SCALES PHASE 0 10 -.15 .05
PLOT PHASE 0.9 S
PLOT TRAJ S
TRACK X 10
END
$ -----
3 CONCENTRIC RING EMITTERS DEFINED BY POTENTIAL OVERLAY REGIONS
BOUNDARY
51 10 0 10 0 0.9
1 0 0 1 10 0 5 $ EMISSION SURFACE
10 0 0 10 1.25 0 5 $ ----- INNER MASK LIMIT
5 2.5 0 5 3.25 0 5 $ ----- INNER RING MASK
5 4.5 0 5 5.25 0 5 $ ----- OUTER RING MASK
10 6.5 0 10 10 0 5 $ ----- OUTER MASK LIMIT
2 0 .9 2 10 .9 5 $ ANODE
S
CONST
*47 20 $ NUMBER OF EQUIPOTENTIALS ON TRAJ PLOTS
*35 -10 -9 $ CALCOMP PLOT SIZE 10 X 9 CM
S
RAYGEN 3 50 1 .5 100 5 1.0E8
PLOT TRAJ S
PLOT PHASE 0.9 S
TRACK X 10
END

```

Figure 10.1 EBQ data for Child's law cathode masking example.

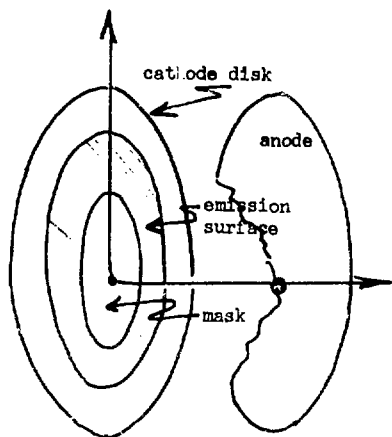

XBL 823-1934

Figure 10.2 Hollow cathode case.

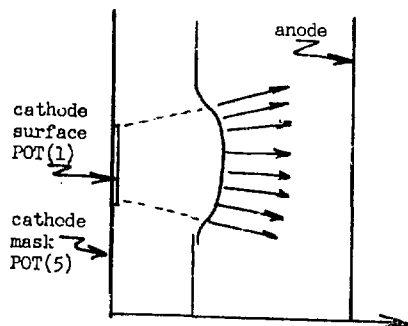

XBL 823-1935

Figure 10.3 EBQ simulation of hollow cathode. Note rays emanate only from region of potential 1 index.

CELL .5000 X .2500
15 5

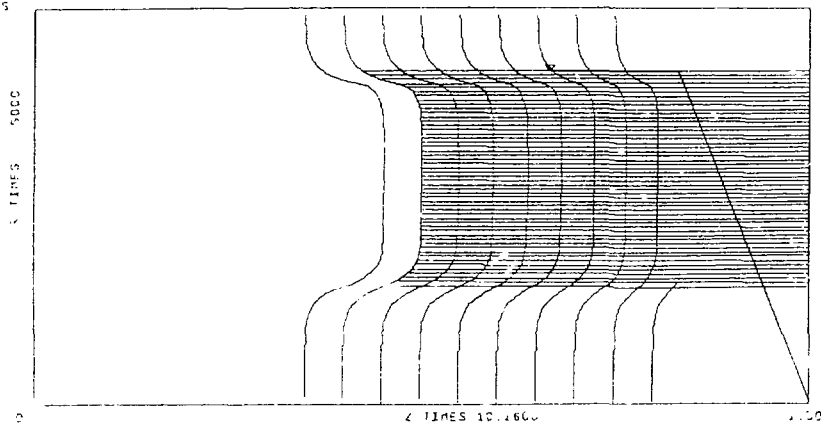

XBL 823-1936

Figure 10.4 EBQ trajectory plot showing the Child's law electrons beginning at the first mesh interval after the starting surface. The curvature in the equipotential lines results from the beams space charge.

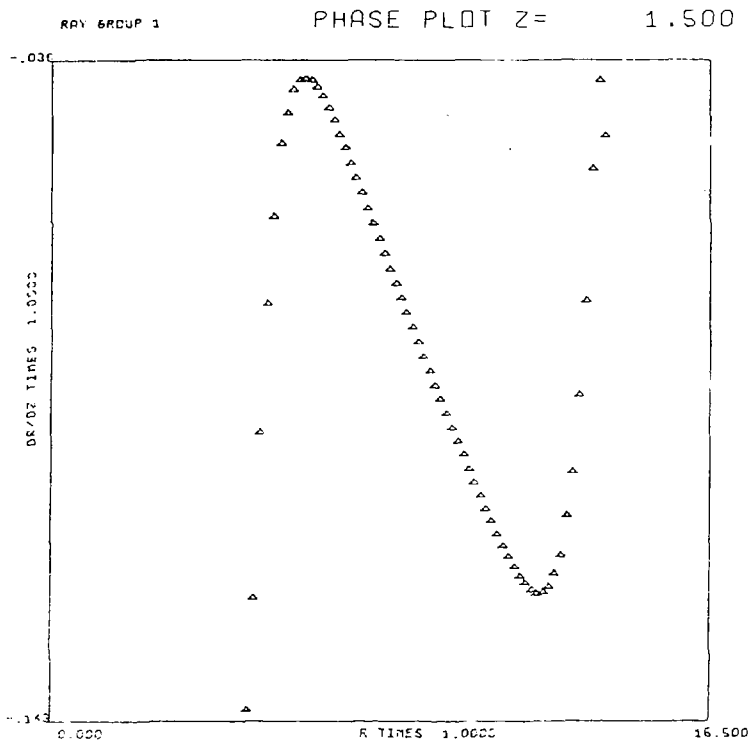

ETA HOLLOW CATHODE TEST

HOLLOD3 07 JUL 78

ITER= 6 PLOT 1

XBL 823-1937

Figure 10.5 Phase space for the hollow cathode beam shown in Figure 10.4. Note the space charge deflection of the electrons on the inner and outer edge of the beam.

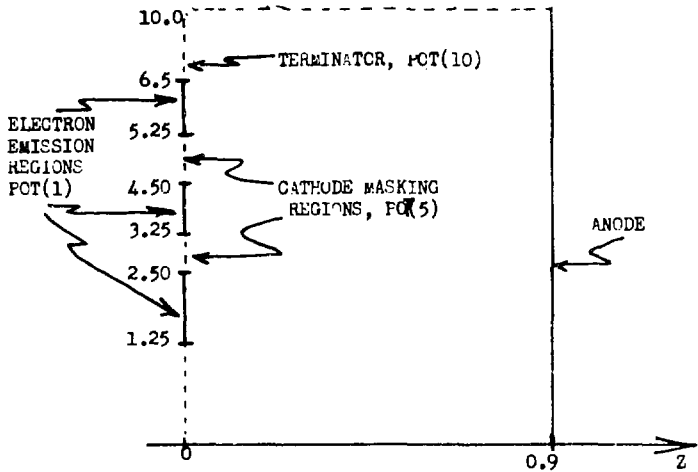

XBL 823-1938

Figure 10.6 Three concentric electron emission regions geometry example, illustrating the EBQ cathode masking procedure with Child's law starting.

3 CONCENTRIC RING EMITTERS

BOUNDARY

51 10 0 10 0 0.9

10 0 0 1 1.25 0 5 2.5 0 1 3.25 0 5 4.5 0 1 5.25 0 10 6.5 0 10 10 0 5

2 0 0.9 2 10 0.9 S \$ ----- ANODE

S

POT C 85.0E3 ORR S

RAYGEN 3 50 1 0.5 0 5 10000000

TRACK X 10

ENDTRACK

PLOT TRAJ S

TRACK CONTINJE 1

END

3 CONCENTRIC RINGS DEFINED BY POT OVERLAY S

BOUNDARY

51 10 0 10 0 0.9

1 0 0 1 10 0 S \$ ----- EMISSION

10 0 0 10 1.25 0 S \$ ----- INNER LIMIT

10 6.5 0 10 10 0 S \$ ----- OUTER LIMIT

5 2.5 0 5 3.25 0 S \$ ----- INNER MASK

5 4.5 0 5 5.25 0 S \$ ----- OUTER RING MASK

2 0 0.9 2 10 0.9 S \$ ----- ANODE

S

POT C 85000 ORR S

RAYGEN 3 50 1 0.5 100 5 10000000 \$ ---- RAYGEN TYPE N KATH Z ZLIM IMASK

TRACK X 10

END

Figure 10.7 EBQ data for the three concentric ring emitters shown in Figure 10.6. The boundary data is given in two alternate ways.

CELL .2000 X .1000
10 C

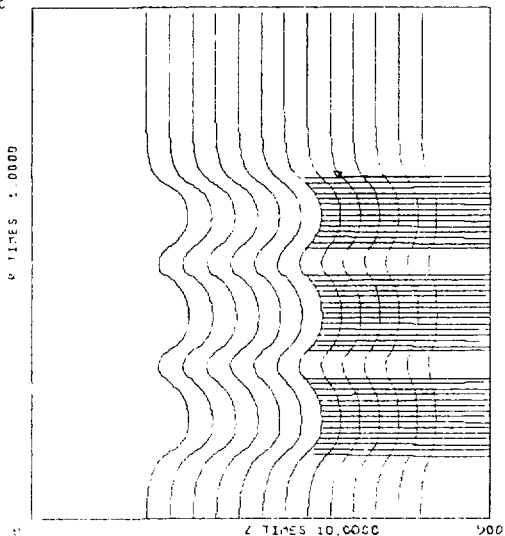

TITLE X100017

3 CO-CENTRIC RING EMITTERS

UCIDX13

11 OCT 78

ITER= 5

PLOT 11

XBL 823-1939

Figure 10.8 EBQ trajectory plot showing the Child's law emitted electron rings and the space charged altered equipotential surfaces for the data shown in Figure 10.7.

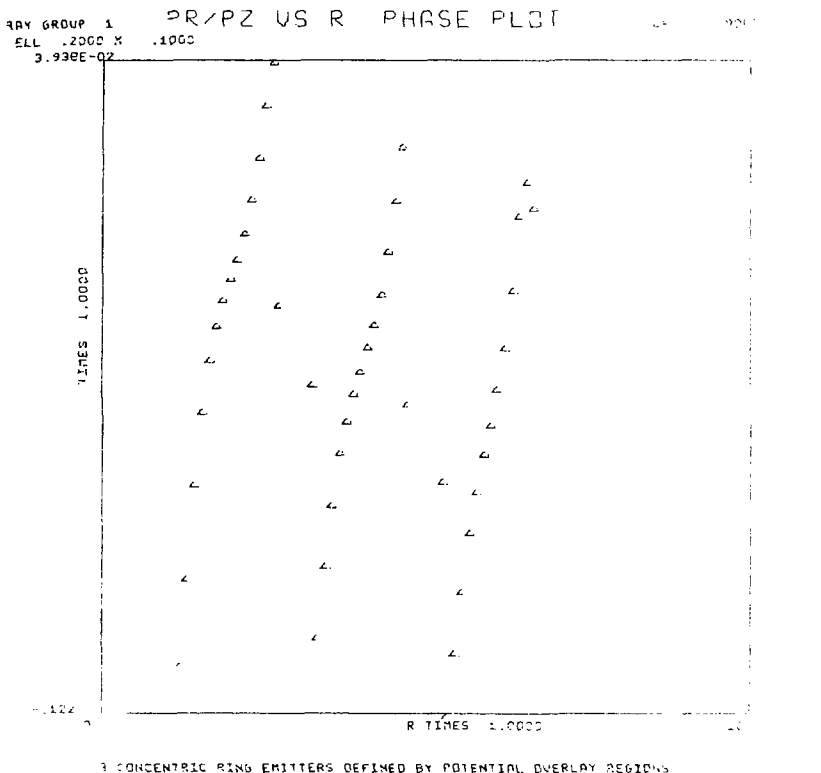

X100003 06 NOV 78 ITER= 9 PLOT 5

XBL 823-1940

Figure 10.9 Phase space of the three concentric emitter case. The rays are emitted normal to the equipotential surface of Figure 10.8 giving the particular M shaped phase space. Note the dr/dz axis extends from $-.122$ to $.039$ radians, with the asymmetry toward the converging side created by the focusing effect of the beams self magnetic field. The electrons on the six outer edges of the three beam rings are defocused via the beams space charge, as shown.