

UNIVERSITY OF CALIFORNIA

Los Angeles

Separating the effects of multiple processes on diversity patterns  
in an Amazonian tree community and the New World flora

A dissertation submitted in partial satisfaction of the  
requirements for the degree Doctor of Philosophy  
in Ecology and Evolutionary Biology

by

Ian Ramsey McFadden

2019

© Copywrite by

Ian Ramsey McFadden

2019

## ABSTRACT OF THE DISSERTATION

Separating the effects of multiple processes on diversity patterns  
in an Amazonian tree community and the New World flora

by

Ian Ramsey McFadden

Doctor of Philosophy in Ecology and Evolutionary Biology

University of California, Los Angeles, 2019

Professor Nathan Jared Boardman Kraft, Chair

What controls diversity? The high diversity of many tropical taxa and subsequent decline in diversity away from the Equator has inspired many theories and much debate. Theories attempt to explain these patterns through a combination of one or several processes that may leave signatures in the functional, spatial and phylogenetic structure of species assemblages. Unfortunately, the testing of these theories has been hampered by a limited ability to separate the effects of multiple processes on observed patterns. In this thesis, I use recent advances in functional, spatial and phylogenetic methods in ecology to parse the contributions of multiple processes generating patterns of diversity in a hyper-diverse tree community in the Ecuadorian Amazon and the New World flora.

In Chapter 1, I identify drought stress and herbivore pressure as key drivers of habitat associations and community structure in Amazonian trees using trait-based null models of community assembly. To do this I collected and analyzed leaf drought tolerance for 80 species and leaf lamina toughness for 454 species, both functional traits that are more tightly linked to a single assembly process than integrative traits such as specific leaf area.

In Chapter 2, I ask if spatial aggregation in Amazonian trees is primarily determined by habitat associations, dispersal limitation or both processes using spatial point process modeling. I found that both processes were important drivers of aggregation for the majority of species, but that leaf traits such as drought tolerance were most predictive of habitat associations while seed mass predicted the size and density of species clustering independent of the abiotic environment.

In Chapter 3, I test whether one proximate cause of latitudinal gradients in alpha diversity is a gradient in taxonomic or phylogenetic turnover, or beta diversity, with a large dataset of ~81,000 New World vascular plants. I found for both taxonomic and tip-weighted phylogenetic beta metrics that higher tropical diversity was associated with higher turnover. However, I found the opposite pattern for basal-weighted phylogenetic beta diversity, suggesting these metrics capture distinct aspects of biotic change across space. The results of this thesis suggest multiple processes combine and interact to create diversity patterns, but their influence can be separated with appropriate metrics.



The dissertation of Ian Ramsey McFadden is approved.

Lawren Sack

Matthew Fitzpatrick

Stephen P. Hubbell

Nathan Jared Boardman Kraft, Committee Chair

University of California, Los Angeles

2019

## TABLE OF CONTENTS

<b>List of Tables</b> .....	vi
<b>List of Figures</b> .....	vii
<b>Acknowledgments</b> .....	viii
<b>Vita</b> .....	xiv
<b>Introduction and scope of the thesis</b> .....	1
<b>Chapter 1: Hydraulic vulnerability and herbivore resistance traits influence community assembly in a hyperdiverse Amazonian forest</b> .....	7
<i>Tables and Figures</i> .....	23
<i>Supplementary Material</i> .....	29
<b>Chapter 2: Disentangling the functional trait correlates of spatial aggregation in tropical forest trees</b> .....	33
<i>Tables and Figures</i> .....	53
<i>Supplementary Material</i> .....	61
<b>Chapter 3: Climate shapes latitudinal gradients in plant taxonomic and phylogenetic <math>\beta</math> diversity across the Americas</b> .....	76
<i>Tables and Figures</i> .....	93
<i>Supplementary Material</i> .....	99
<b>Conclusions and future directions</b> .....	107
<b>Bibliography</b> .....	112

## LIST OF TABLES

<b>Table 1.1:</b> Definition, function, units and references for collected traits .....	23
<b>Table 2.1:</b> Spatial model categories .....	53
<b>Table 2.2:</b> Relationships between traits and spatial properties .....	54
<b>Table 3.1:</b> SAR <sub>err</sub> models predicting $\beta$ diversity from topoclimatic variables .....	93
<b>Table 3.2:</b> Bivariate relationships between topoclimatic variables and $\beta$ diversity .....	94

## LIST OF FIGURES

<b>Figure 1.1:</b> Correlations between measured traits and existing trait data .....	24
<b>Figure 1.2:</b> Trait values of habitat specialists and generalists groups .....	25
<b>Figure 1.3:</b> Trait means track elevation in the 25ha Yasuní plot. ....	26
<b>Figure 1.4:</b> Standardized effect sizes follow elevation in the 25ha Yasuní plot .....	27
<b>Figure 1.5:</b> Phylogenetic signal in functional trait and abundance data .....	28
<b>Figure 2.1:</b> Visual primer of spatial point process modeling .....	55
<b>Figure 2.2:</b> Percentage of focal species assigned to spatial aggregation categories .....	57
<b>Figure 2.3:</b> Habitat coefficient values for the four environmental attributes .....	58
<b>Figure 2.4:</b> Functional traits are related to spatial properties across species .....	60
<b>Figure 3.1:</b> Botanical $\beta$ diversity of the Americas .....	95
<b>Figure 3.2:</b> Tropical-temperate comparisons of $\beta$ diversity .....	96
<b>Figure 3.3:</b> $\beta$ diversity as a function of absolute latitude .....	97
<b>Figure 3.4:</b> Relationships between $\beta$ diversity and mean annual temperature .....	98

## ACKNOWLEDGMENTS

First and foremost, I want to thank my advisor Nathan Kraft for showing me every day what a scientist should be: thoughtful, diligent, careful, empathetic and long-sighted. Nathan helped me focus on what mattered and lead by example through every step of the scientific process. His broad interests, collaborative spirit and easy laughter helped make the thesis process a truly rewarding one and I am grateful for all he has given me.

Steve Hubbell, Lawren Sack and Matt Fitzpatrick strengthened this dissertation and my thinking by serving on my thesis committee at UCLA. Steve helped me question assumptions, Lawren sharpened my thinking about plant physiology and Matt taught me about spatial methods in ecology. Amy Zanne, Dan Gruner, Maile Neel and Matt helped shape this work at its early stages while serving on my thesis committee at the University of Maryland, College Park, as did Alex Forde who served as senior graduate student for my Second Advisory Meeting.

It has been an exciting and humbling experience to collaborate during my time in graduate school with many people including Megan Bartlett, Thorsten Wiegand, Ben Turner, Lawren Sack, Renato Valencia, Brody Sandel, Constantinos Tsirogiannis, Naia Morueta-Holme, Jens-Christian Svenning and Brian Enquist. The manuscripts published, in review and in preparation as part of this thesis have all benefitted immensely from their co-authorship. Nathan Kraft, Joe Wright, Nancy Garwood, the Smithsonian Forest Global Earth Observatory and the creators and custodians of the Botanical Information and Ecology

Network all graciously provided data for one or more chapters. Finally, ongoing collaborations on other projects with Claire Fortunel, Will Petry, Gaurav Kandlikar, Matthew Luskin, Camila Medeiros, Jeannine Cavender-Bares, Jesus Pinto Ledezma, Danilo Neves, Sabrina Russo and Jacob Usinowicz have broadened the scope of my work and I am grateful for my interactions with them.

The Kraft lab has been a wonderful place to grow as a scientist as the lab itself has grown over the years– from a two person operation to the bustling group it is now. I have benefited from the advice, friendship and perspective of Kristen Powell, Benoit Parmentier, Lei Chen, Rong Li, Marcos Carlucci, Cristina Bastias, Jeanne Osnas, Suzanne Ou, Mary Van Dyke, Andy Kleinhesselink, Kenji Hayashi and Aubrie James. Finally, I owe so much to my friends and lab mates that traveled from Maryland to Los Angeles with me: Claire Fortunel for her mentorship, collaboration, camaraderie and culinary guidance, Gaurav Kandlikar for his profound generosity, selflessness and very constructive criticisms, and finally Marcel Vaz for providing a new perspective on the Amazon, and many laughs and stimulating discussions.

The years I enjoyed in the Amazon demonstrated to me the immense value of successful international collaborations and the efforts required to achieve them. Renato Valencia made it all possible through years of work managing the Yasuní plot censuses and was always interested in what I was currently there to study. In a feat that never ceases to amaze me Pablo Alvia, Milton Zambrano, Anelio Loor and many others regularly census the hundreds of thousands of stems in the plot to paint a picture of forest dynamics, and this

thesis is possible only because of their efforts. I am indebted to the staff at Católica University in Quito and the Estación Científica Yasuní for going above and beyond in providing logistical support and accommodation, in particular David Lasso, Carlos Padilla, Cecilia Fernandez and Segundo Betancourt. I am eternally grateful to my field assistants Alex Dietrick, Anelio Loor and Soria Branco, who happily tromped across ridges and valleys in the heat, sometimes covered in sweat bees, and in particular to Micheal Alvarado of the Waorani community, who did all that while also teaching me about traditional uses of plants in the forest. Megan Bartlett showed me how to use an osmometer in field conditions to measure leaf drought tolerance and helped sample leaves in the plot. Thankfully, I had stimulating and fun colleagues to share the station with from time to time, including Andrew Muehleisen, Simon Queenborough, Rafael Cárdenas and Jens-Christian Svenning. I thank Brad Boyle, Mauricio Bonifacino, Amanda Grusz and the Organization for Tropical Studies for teaching me how to identify and collect tropical trees.

I am extremely grateful to the funding sources that made work in the field and on campus possible, in particular the Department of Ecology and Evolutionary Biology at UCLA and the Department of Biology at the University of Maryland, College Park. The National Science Foundation supported my research for three years through a Graduate Research Fellowship and continues to inspire me to ask important questions that impact society.

Completing a thesis is often a challenging and solitary endeavor, which is why I am grateful to my peers on both coasts that provided support, friendship and understanding. At Maryland, Grace DiRenzo, Edward Hurme, Danny Keil, Keith Hughitt, Carly Mueletz Wolz,

Elske Tielens, Christian Che-Castaldo, Josh Kiner, Alex Forde, Maria-Natalia Umaña and Andy Foss-Grant gave helpful feedback and shared in many DC adventures. At UCLA, Rachel Turba, Brandon MacDonald, Mairin Balisi, Zack Gold, Kelly Barr, Amisha Gadani, Maddi Cowen, Charlie de la Rosa, Emily Ryznar, Aji Wahyu, Winnie Promise and Nick Russo kept things in perspective and kept me going. In the Sack lab next door Megan Bartlett, Grace John, Leila Fletcher, Camila Medeiros, Jia Song, Joseph Zailaa, Santiago Trueba and many others livened up the hallway and life in Westwood.

I thank my friends in LA, Maryland and across the world that showed me there's life outside of academia and gave me much needed breaks. They include Victor Sinow, Dan Schwer, Tyler Colyer, Julian Rosenberg, Richard Pearson, Regis Verdin, Alex Akamine, Alexei Wajchman, Karl Smudski, Nejad Mahmud, Danny Garcia, Rachel Anicetti, George Tarlson, Farah Deby, Valine Moreno, Jessica Arriens, Marty Dertz, John Gill, Bobby Wolz, Anzela Niraula and Gwen Bagley.

So many wonderful people helped me realize I wanted to pursue ecology as a career and I am indebted to them all. At Dominican University of California Sibdas Ghosh and Mietek Kolipinski provided early field and lab experiences, and ample encouragement. At UC Santa Cruz Ingrid Parker, Barry Sinervo, Lesley Lancaster, Christy Hipsley, Laurel Fox, Erin Vogel and Nate Dominy provided valuable and exciting research experiences, and gave helpful input on my own work. Special thanks go to Cam Webb, who inspired my deep love of tropical forests and exciting science, and also guided several early research projects in Borneo. Frank Joyce taught me about Neotropical forests during my early days in Costa



Rica and Andy J. Marshall, Richard Corlett, Caroline Pannell, Bruce Beehler and Ferry Slik inspired and encouraged my interest in seed dispersal and geographic distributions.

Finally, at Berkeley Matthew Potts, Matthew Luskin, Hannah Doll, Nick Matzke, Andrew Rominger, Paul Fine, David Ackerly and many others showed me what it means to do good science and helped prepare me for graduate school.

I offer my sincerest thanks to my family for their love, encouragement and support. My parents Ruth, Tim, Kate and Steve nurtured a love of nature and science from the very beginning, and were always interested to hear what an ecologist actually does. Thanks also to my wife's family for supporting me as one of their own. Finally, perhaps no one has given more over the past six and a half years than my wife Jasmine. She has been a constant companion and friend on adventures both local and abroad, and has been one of the most loving and supportive persons I have ever known. I am forever grateful.

*Co-authored work*

Chapter 1 is from McFadden, I.R., Valencia, R. and Kraft, N.J.B. Hydraulic vulnerability and herbivore resistance traits influence community assembly in a hyperdiverse Amazonian forest. *In preparation*. R. Valencia provided forest census data and N.J.B. Kraft served as project supervisor.

Chapter 2 is from McFadden, I.R., Bartlett, M.K., Wiegand, T., Turner, B.L., Sack, L., Valencia, R. and Kraft, N.J.B. 2018. Disentangling the functional trait correlates of spatial aggregation in tropical forest trees. *Ecology*. DOI: <https://doi.org/10.1002/ecy.2591>. R. Valencia shared

forest census data, M.K. Bartlett and L. Sack helped collect and analyze leaf drought tolerance trait data, T. Wiegand helped design the spatial analyses, B. Turner helped collect and analyze soil nutrient data and also provided existing soils data, N.J.B. Kraft served as project supervisor and all co-authors helped revise manuscript drafts.

Chapter 3 is from McFadden, I.R., Sandel, B., Tsirogiannis, C., Morueta-Holme, N., Svenning, J.-C., Enquist, B.J. and Kraft, N.J.B. Climate shapes latitudinal gradients in plant taxonomic and phylogenetic  $\beta$  diversity across the Americas. *In review*. B. Sandel helped design the study and performed early analyses, Tsirogiannis, C. wrote the phylogenetic computation algorithms and B.J. Enquist, N. Morueta-Holme, J.-C. Svenning and N.J.B. Kraft helped develop the BIEN database, N.J.B. Kraft served as project supervisor and all provided input on manuscript revisions.

## VITA

### Education

- 2012 - 2016 Department of Biology, University of Maryland, College Park (UMCP)  
*Note: Began Ph.D. with N. Kraft at UMCP before moving to UCLA*
- 2008 B.S. in Ecology and Evolutionary Biology  
UC Santa Cruz

### Academic Appointments

- 2017 Dean's Research Excellence Fellow, UCLA
- 2012 - 2016 NSF Graduate Research Fellow in Ecology
- 2010 - 2011 Laboratory Assistant, Potts Group, ESPM, UC Berkeley
- 2008 - 2009 Primary Investigator, Seed dispersal study, Indonesian Borneo

### Publications (*published, in press and in revision*)

- McFadden, I.R.**, Sandel, B., Tsirogiannis, C., Morueta-Holme, N., Svenning, J.-C., Enquist, B.J. and Kraft, N.J.B. Climate shapes latitudinal gradients in plant taxonomic and phylogenetic  $\beta$  diversity across the Americas. *Ecology Letters*, *in revision*.
- Fortunel, C., **McFadden, I.R.**, Valencia, R. and Kraft, N.J.B. Neither species geographic range size, climatic envelope nor intraspecific leaf trait variability capture habitat specialization in a hyperdiverse Amazonian forest. *Biotropica*, *in press*.
- McFadden, I.R.**, Bartlett, M.K., Wiegand, T., Turner, B., Sack, L., Valencia, R. and Kraft, N.J.B. 2018. Disentangling the functional trait correlates of spatial aggregation in tropical forest trees. *Ecology*. DOI: <https://doi.org/10.1002/ecy.2591>.
- Cavender-Bares, J., Arroyo, M. (Coordinating Lead Authors), Abell, R., Ackerly, D. (and 20+ Lead Authors), ...**McFadden, I.R.** (and 50+ Contributing Authors). 2018. Chapter 3: Status, trends and future dynamics of biodiversity and ecosystems underpinning nature's contributions to people. **UN Intergovernmental Science-Policy Platform on Biodiversity and Ecosystem Services (IPBES) Regional Assessment for the Americas**. Bonn, Germany, pp. 171-293.
- Estrada, A., **McFadden, I.R.**, Butler, R. 2011. Beginning a 4th year of Tropical Conservation Science with OJS, a new publishing platform. *Tropical Conservation Science* 4, i-iii

### Awards, Grants and Fellowships

#### *Major funding*

- 2017 Dean's Research Excellence Fellowship, UCLA (\$18,000)
- 2012 - 2016 NSF Graduate Research Fellowship in Ecology (\$138,000)

### *Other grants and awards*

2016, 2018	Vavra Travel Grant for Organismal Plant Biology, UCLA (\$2,900)
2017	Student Poster Award, International Biogeography Society, Arizona
2014	Devra Kleiman Scholarship, UMCP (\$1,016)
2013	Howard Brinkley Travel Award, 2013, UMCP (\$600)
2012	Dean's Fellowship, UMCP (\$10,000)
2008	Deland Award, Harvard University, Arnold Arboretum (\$3,260)

### **Synergistic Activities**

#### *Participation in NCEAS\* working group meetings*

\*National Center for Ecological Analysis and Synthesis

The Botanical Information and Ecology Network (BIEN)

*Organizers:* Brian J. Enquist, Richard Condit, Robert Peet, Brad Boyle, Steven Dolins

*Meeting date:* January 2017, University of Arizona, Tucson, Arizona

Dance with neighbors: What have we learned about species coexistence in tree communities from the global stem-mapped forest plots?

*Organizers:* Fangliang He, Richard Condit, Steve Hubbell, Thorsten Wiegand

*Meeting dates:* November 2015, Sun Yat-Sen University, Guangzhou, China; March 2015, UFZ Helmholtz Center, Leipzig, Germany

#### *Mentoring*

Brooke Shimasaki	UCLA	Seed toughness of California annuals
Vivian Griffey	UCLA	Patterns and drivers of canopy height
Winnie Promise	UCLA	Teaching undergraduates in EEB
Micheal Alvarado	Field assistant in Ecuador	Field ecology techniques
Alex Dietrick	Field assistant in Ecuador	R, functional trait methods, field ecology

#### *Service*

Journal content manager, Tropical Conservation Science, 2010 - 2012

Session chair, Forest ecology and conservation, ATBC 2018 meeting, Kuching, Malaysia

Panel member, Applying for the NSF GRFP, 2012, University of Maryland, College Park

#### *Journal Referee*

Ecology Letters, American Naturalist, Ecography, Biotropica

#### *Education*

Developed inquiry-based assignments for the following courses at UCLA:

Ecology, Plant Physiology, Tropical Ecology and Why Ecology Matters

Served as Teaching Assistant, Associate or Fellow for the following courses:

UCLA: Ecology, Tropical Ecology, Conservation Biology, Plant Physiology,  
Why Ecology Matters

UMCP: Ecology, Ecology and Evolution

## **Introduction and scope of the thesis**

Two of the most striking diversity patterns are the high local richness of many tropical taxa and a decline in diversity away from the equator, also known as the latitudinal diversity gradient (Gentry 1982, Gaston 2000). For example, hundreds of tree species may co-occur in a single hectare of tropical forest while similar numbers of species make up entire temperate tree floras (Wright 2002). Which processes create, assemble and maintain diversity patterns and what are their relative importance? This long-standing question is perpetually debated and has led to the development of often disparate bodies of theory (Hubbell 2001, Chase and Leibold 2003), however, some consensus is beginning to emerge (Adler et al. 2007, Vellend 2010, 2016).

Unfortunately, determining the relative importance of multiple processes structuring species assemblages has been difficult for three main reasons. First, theory and empirical studies often focus on a subset of the major processes operating in communities (e.g. MacArthur and Wilson 1967, Tilman 1982, Chase and Leibold 2003). Second, multiple processes may create similar patterns (Chisholm and Pacala 2010, Mayfield and Levine 2010), making it difficult to parse the distinct contribution of each. For example, dispersal limitation and environmental filtering are distinct processes that can maintain diversity alone or in combination (Hurtt and Pacala 1995, Kraft et al. 2015), but both cause species to become spatially aggregated and are therefore difficult to disentangle empirically (Pinto

and MacDougall 2010). Third, limited data has made it difficult to test for the action of multiple processes within diverse assemblages and across large spatial extents (Feeley 2015).

This thesis is an attempt to overcome some of the difficulties in determining the relative importance of processes influencing biodiversity dynamics at both local and regional scales. My twin foci are a hyper-diverse Amazonian tree community in Yasuní National Park, Ecuador that is part of the Smithsonian Forest Global Earth Observatory (ForestGEO) network and the New World vascular plant flora using data assembled by the Botanical Information and Ecology Network (BIEN). To accomplish my goals I use data and inference from spatial modeling, functional trait and phylogenetic approaches.

Much of what we know about botanical diversity comes from spatially-mapped observations of individuals within plots or collections at specified localities (e.g. Kattge et al. 2011, Anderson-Teixeira et al. 2015). Spatial modeling approaches can harness this data to infer the relative importance of multiple processes acting at both local and macro scales. For example, within local communities, mechanistic point process models can simulate stem patterns which can then be compared with observed patterns to infer the action of the modeled process (Waagepetersen and Guan 2009, Wiegand et al. 2009, Shen et al. 2013). A benefit of such models is that multiple processes such as environmental filtering and dispersal limitation can be incorporated and tested for with each species in a community with sufficient abundance (Shen et al. 2013). At macro scales, information about the spatial distance between observation units can be used to control for spatial

autocorrelation, which is often inferred to be caused by processes such as dispersal limitation (Dormann et al. 2007, Kissling and Carl 2008).

It has long been known that plant traits reflect adaptations to current and past environments (Schimper 1898, Grime 1977, Westoby and Wright 2006), and traits are often used to infer demographic and fitness components in the absence of such data, particularly long-lived ones such as tropical trees (Wright et al. 2004, Kraft et al. 2008). When combined with spatial methods, variation in species functional traits can provide a second line of inference that a certain process is acting, and suggest which demographic and life history attributes that have shaped species responses. Despite the utility of many commonly-measured traits such as specific leaf area and seed mass (Westoby 1998), these traits reflect the integrated inputs of multiple demographic and fitness components and thus it is difficult to determine which specific processes have acted to create trait patterns. Recently, traits have been developed which quantify a narrower range of plant function, such as the mechanical toughness and hydraulics of leaves (Sack and Holbrook 2006, Onoda et al. 2011, Bartlett et al. 2012a), and can be used to narrow down specific causes of trait patterns such as insect herbivory and drought.

The phylogenetic relatedness of species within and among assemblages is also often used to infer the action of processes operating at both local and macro scales (Webb et al. 2002, Graham and Fine 2008, Cavender-Bares et al. 2009). Within a single community, phylogenies have been used to determine the distribution of ecological strategies and to ask if traits are conserved among community members, aiding in the imputation of trait

values for missing species (Cavender-Bares et al. 2004; Kraft & Ackerly 2010; Swenson 2014; but see Mayfield & Levine 2010). Across communities, phylogenetic beta diversity metrics have been developed which differ in sensitivity to recent and deep divergences that can be used to determine the importance of both types of speciation events for community turnover (Swenson 2011, Duarte et al. 2014).

In Chapter 1, my goal was to determine which specific processes drive observed habitat niche partitioning in the Yasuní tree community. Earlier trait-based analyses in this forest and elsewhere have shown for example that ridge-associated assemblages tend to have more resource conservative traits (e.g. Kraft et al. 2008), but the nature of the resources that lead to these associations is still poorly understood. To do this I measured two functional traits that are more tightly-linked to a single driver of habitat associations than more integrative traits: leaf drought tolerance (for 91 species) and leaf lamina toughness (for 454 species) (Onoda et al. 2011, Bartlett et al. 2012a). Using components of earlier trait-based community assembly analyses implemented in this forest, I found community-mean leaf drought tolerance and leaf mechanical toughness increased with elevation from valleys to ridges in the plot compared to a null expectation. These results suggest water availability and herbivore pressure specifically have contributed to habitat niche partitioning in this forest.

In Chapter 2, I quantify the relative strength of environmental filtering and dispersal limitation at the community level in the same Amazonian tree community and then asked which traits best predicted spatial properties across species. I first parametrized a range of



spatial point process models with data for 456 co-occurring tree species and found that most species are best described by a log-Gaussian Cox process model that incorporates associations with the abiotic environment as well as dispersal limitation. I found that estimates of these processes were correlated with different classes of functional traits. For example, leaf drought tolerance predicted associations with elevation and hydrology across the plot, while the degree of dispersal limitation was related to seed mass.

In Chapter 3, I ask if one proximate cause of the latitudinal diversity gradient is higher species turnover in the tropics. To answer this question I compared the degree of taxonomic and phylogenetic beta diversity between temperate and tropical regions in the New World flora. To accomplish this I analyzed a large dataset from the Botanical Information and Ecology Network (Enquist et al. 2016) which includes modeled geographic ranges and a phylogeny for ~81,000 species. I found turnover is higher in the tropics for beta diversity metrics emphasizing changes in species and recent phylogenetic divergences, but found a reverse latitudinal gradient in the turnover of deep phylogenetic structure. This suggests that differences in the rate of speciation and species turnover contribute to the latitudinal diversity gradient. In addition, the key climatic drivers associated with turnover were temperature and its annual variation, highlighting the importance of changes in temperature for plant community composition.

When viewed as a whole, the results of this thesis suggest the traits of plants shape the outcome of environmental filtering, including via increasing droughts, as well as dispersal limitation, which is often modeled as a stochastic process with respect to traits. In addition,

declines in diversity away from the equator appear to be due in part to a decrease in the magnitude of turnover, though the strength and more importantly the directionality of the pattern varies with the choice of metric. Finally, faster speciation rates in the tropics appears to be one important underlying driver of the latitudinal diversity gradient.

## CHAPTER 1

# **Hydraulic vulnerability and herbivore resistance traits influence community assembly in a hyperdiverse Amazonian forest**

This manuscript is currently in preparation as McFadden, I.R., Valencia, R. and Kraft, N.J.B. Hydraulic vulnerability and herbivore resistance traits influence community assembly in a hyperdiverse Amazonian forest.

### ABSTRACT

Tropical forest communities have long challenged ecologists seeking to explain how hundreds of tree species can co-occur within a single hectare. During the past decade, functional trait analyses have implicated life history strategy differentiation as a possible coexistence mechanism maintaining tropical forest diversity. Interspecific life history variation, when combined with local environmental variation, can result in distinct habitat preferences that allow multiple competing species to coexist. Despite this progress, the specific (a)biotic drivers that cause species to sort into distinct habitats remains unknown for many communities. This is in part because traits that are most often measured (e.g. specific leaf area, seed mass etc.) integrate species responses to many separate factors such as water, light and nutrient levels as well as herbivore pressure and interspecific competition. Here I quantify physiological and mechanical leaf traits that are predicted to be more tightly linked to a single mechanism than other commonly used traits for many co-occurring tree species in a hyper-diverse tropical forest in the Ecuadorian Amazon. I find

that species and quadrats associated with higher elevations (ridges) within the study plot have higher leaf drought tolerance and leaf mechanical toughness than those found in the stream-filled valleys. This suggests hydraulic gradients and insect herbivore pressure have contributed to habitat associations and species coexistence in this forest. These results, by indicating which specific (a)biotic factors have created species associations, bring us closer to a mechanistic and predictive understanding of high diversity species coexistence in tropical forests and suggest ways in which this forest may change as droughts become increasingly frequent in the future.

## INTRODUCTION

Explaining the high local diversity of tropical forest tree communities is an enduring challenge in ecology (Wright 2002, Usinowicz et al. 2017). One important mechanism thought to reduce competition and allow tree species to coexist is niche partitioning via divergent habitat preferences (Harms et al. 2001, Kraft et al. 2008). During the past several decades, analyses of functional traits such as specific leaf area (SLA), seed mass and plant height have revealed that interspecific variation in habitat preferences may be due to variation in resource use and life history strategies as reflected in trait-environment patterns (Russo et al. 2005, Turner et al. 2018). Unfortunately, it is often difficult to determine the specific factors or resources to which species are responding as these traits integrate across many environmental and competitive responses (Westoby et al. 2002). For example, trait-based studies have found that resource-limited environments tend to have communities characterized by resource conservative traits such as low SLA and large seeds (Coley et al. 1985, Engelbrecht et al. 2007, Kraft et al. 2008, Cornwell and Ackerly 2009).

However, whether this trait-environment covariation is due to species responses to light, water, soil nutrients, herbivores or other factors is not well known for many plant communities.

One potential way to unravel the effects of multiple factors on habitat niche partitioning is to examine traits more tightly-linked to a single mechanism (Yang et al. 2018) such as components of leaf hydrology and mechanical structure (Onoda et al. 2011, Bartlett et al. 2019). Studies that analyze several such traits can test multiple competing and often non-mutually-exclusive hypotheses about the specific drivers of community structure and dynamics. Hydraulic vulnerability and herbivore resistance specifically are both hypothesized to be important traits driving species interactions, species distributions and ecosystem properties in tropical forests (Fine et al. 2004, Cardenas et al. 2014, Bartlett et al. 2016). However, these traits have been examined less often than traits that integrate across multiple inputs such as seed mass and SLA. Hydraulic vulnerability to drought can be measured by many aspects of plant physiology and structure (Choat et al. 2018), with one important measure being the turgor loss point (Bartlett et al. 2012b). The leaf turgor loss point, measured in megapascals ( $M_{pa}$ ), represents the ability of leaves to resist wilting during drought by maintaining a sufficiently negative water potential and is an important component of whole-plant drought tolerance (Bartlett et al. 2012b). In contrast, leaf mechanical toughness measures the ability of leaves resist damage from herbivores and other physical factors such as falling tree limbs, and is an important predictor of leaf lifespan and rates of litter decomposition (Onoda et al. 2011). Though these traits, and trait-based approaches in general, cannot be used to rule out other casual factors, they can

be used to suggest specific mechanisms that drive the species and community patterns found in more integrative traits.

Two main approaches are commonly used to determine how traits shape ecological sorting and species coexistence. Species-based approaches estimate habitat preferences for species within a community using either discrete or continuous environmental variables and ask if traits are predictive of these preferences (e.g. Clark et al. 2017, McFadden et al. 2018).

Quadrat-based approaches instead quantify mean trait values of individuals within smaller sections of a larger community (quadrats) and then often ask if deviations from randomly-assembled quadrat communities vary systematically with environmental variation within the study area (Kraft et al. 2008, Wiegand et al. 2017). Finally, null models are also commonly-used to infer whether traits are significantly conserved across a community phylogeny, which has implications for phylogenetic imputation of traits for unsampled species and the ability to infer assembly processes from patterns of phylogenetic dispersion (Kraft and Ackerly 2010, Baraloto et al. 2012, but see Mayfield and Levine 2010).

Here I analyze physiological and mechanical leaf traits of species across habitat specialization groups and at the quadrat and community level in a null modeling framework in order to better identify specific (a)biotic drivers of habitat associations and niche partitioning in a hyperdiverse Amazonian tree community. In addition, I ask if leaf drought tolerance and lamina toughness have similar levels of phylogenetic conservatism compared to previously-measured traits in this forest that integrate species responses to a

wider range of factors. I hypothesize that ridge-associated species will have higher leaf drought tolerance than valley-associated species and that generalists will have values intermediate to these species, but that species will not differ in leaf mechanical toughness across habitat groupings. I also hypothesize that leaf drought tolerance will increase with elevation at the quadrat level but that leaf lamina toughness will be unrelated to elevation. If these traits show similar spatial patterns to those that have been previously-measured, this could indicate which specific resources (e.g. water, herbivores) have created observed patterns in more integrative traits such as SLA and seed mass.

## METHODS

My goal was to test whether i) ridge-associated species and quadrats have greater leaf drought tolerance and mechanical toughness than valley-associated species and ii) if generalist species have leaf drought tolerance and mechanical toughness intermediate to ridge and valley specialists. To do this I measured two leaf functional traits: the turgor loss point for 80 species (33 ridge-associated, 21 valley-associated and 26 habitat generalists) and specific force to punch for 454 species (215 ridge-associated, 151 valley-associated and 88 generalists). I largely replicated the leaf sampling methodology and portions of the null model analyses of Kraft et al. (2008) for the two focal physiological and mechanical traits: leaf turgor loss point and leaf specific force to punch (Table 1.1). For clarity I describe the trait sampling and null model analyses below and also detail the methodology used to estimate phylogenetic conservatism in these traits.

### *Study area*

I conducted this study in a 50ha forest dynamics plot in Yasuní National Park in eastern Ecuador, which is a global diversity hotspot for many groups (Bass et al. 2010). The forest is aseasonal with high year-round rainfall (Valencia et al. 2004), though infrequent El Niño drought events do occur in the region (Lewis et al. 2011). For detailed site descriptions see Valencia et al. (2004) and John et al. (2007). Tree location data is from the third census in 2008 of the western 25ha of the plot. All stems with diameter at breast height (dbh)  $\geq 1$ cm were identified to species or morphospecies, tagged and mapped according to Smithsonian Forest Global Earth Observatory (ForestGEO, Anderson-Teixeira et al. 2015) network protocols, of which this plot is a member.

### *Species and leaf selection*

I first determined species habitat associations using a Monte Carlo null modeling approach that randomizes topography while maintaining the observed degree of spatial autocorrelation, which serves to control for non-independence of spatial observations due to autocorrelation in environmental variation (Deblauwe et al. 2012). Standardized effect sizes (SES) were calculated by first quantifying observed Pearson correlations between plot-wide species abundance patterns and elevation. This observed value was then compared with a null distribution consisting of 999 correlations of the observed pattern with 999 randomized topographic maps. The SES value was then calculated as the number of standard deviations the observed value fell from the mean of the null distribution. I used the SES values to classify species as ridge-associated ( $SES > 1.96$ ), valley-associated ( $SES < -1.96$ ) or generalists ( $-1.96 \leq SES \leq 1.96$ ).



For both traits mature and not heavily damaged shade leaves were placed in humid, airtight bags to reduce water loss and then analyzed at the nearby field station. To estimate leaf turgor loss point two leaves were selected from three to eight individuals per species (mean = 4.9 individuals) and 80 species were measured in total. Habitat specialists were sampled primarily in the preferred habitat while generalists were sampled in both ridge and valley habitats. I measured leaf mechanical toughness for all species with abundances  $\geq 70$ , with the exception of two species, a palm and a tree fern, that could not be properly punctured with the penetrometer. The 70 individual cutoff was used to ensure a sufficient number of stems to infer habitat associations from spatial distributions (Wiegand et al. 2007). I sampled two leaves from three to five individuals per species, with 95% of species means calculated from three individuals. In total I measured this trait for 454 species representing  $\sim 90\%$  of the stems in the plot. Sampling for leaf turgor loss point occurred during the summer of 2016 and for leaf mechanical toughness during the fall of 2014 and summer of 2015, and was spread randomly across the plot to reduce any impacts of leaf removal on tree dynamics.

#### *Measuring physiological and mechanical traits*

I measured leaf drought tolerance via a recently developed osmometer method which is  $\sim 30x$  faster than traditional pressure chamber approaches (Bartlett et al. 2012a, Fig. S1.1). The method quantifies the osmotic or solute potential at full leaf turgor pressure, which is closely related to the water potential at which cells in the leaf lose turgor and the leaf wilts. Collected leaves were first rehydrated for eight hours in dark, humid conditions prior to sampling. For each sampled leaf a 0.5cm disc was removed using a cork borer, with care

taken to avoid secondary veins, then wrapped in aluminum foil and frozen in liquid nitrogen to break the cell walls. I then then placed the leaf discs in a vapor pressure osmometer (VAPRO 5600, Wescor Inc., South Logan, USA) which measured the osmotic potential at full turgor in units of mmols per kilogram of solute. Osmotic potentials were then converted to turgor loss point ( $M_{pa}$ ) using the following regression equation from Bartlett et al. (2012a):

$$\pi_{tlp} = \frac{-2.5 \times \pi_{osm}}{1000} \quad (1)$$

where  $\pi_{osm}$  is the leaf osmotic potential measured by the osmometer and  $\pi_{tlp}$  is the leaf turgor loss point.

To measure leaf specific force to punch I custom-built a penetrometer (Fig. S1.1) which simulated insect herbivory (Perez-Harguindeguy et al. 2013), an important process in tropical forests (Coley and Kursor 1996). The penetrometer consisted of a 2mm penetrating pin attached to a digital force gauge (DS2-11, Imada Inc., Northbrook, USA) and mounted on a testing stand (KV-11-S, Imada Inc., Northbrook, USA). In order to cleanly puncture circular holes in leaves a steel baseplate was machined and attached to the stand which provide a small hole through which the penetrating rod could pass narrowly but cleanly (Fig. S1.2). The force required to cut a 2mm disc from a leaf was divided by the disc's circumference and then by leaf thickness measured via micrometer to yield specific force to punch in units of N mm<sup>-2</sup>. I made force to punch and thickness measurements at

25%, 50% and 75% of the distance along the midrib of the leaf while avoiding the midrib and secondary veins. I calculated species mean trait values for both turgor loss point and specific force to punch by averaging measurements within leaves (for specific force to punch), leaves within individuals and individuals within species.

#### *Trait-based community assembly analyses*

I first compared the leaf drought tolerance and mechanical toughness of ridge-associated, valley-associated and generalist species groups via ANOVAs and Tukey's HSD post-hoc tests. In addition, I examined the Pearson correlation between the physiological and mechanical traits measured as part of this study and existing trait data for these sites. The previously-measured traits included SLA, wood density, seed mass, the 95<sup>th</sup> percentile of DBH and leaf nitrogen content. Then, to test whether local assemblages of species had non-random trait distributions the 25ha Yasuní plot was divided into 625 20x20m quadrats. For each quadrat a null trait distribution was calculated by making 999 abundance-weighted draws of equal richness from the pool of all trait values for species in the plot (Kraft et al. 2008). The rank of the observed quadrat mean trait value within the null distribution was then mapped across the plot for each quadrat. In addition, standardized effect sizes (SES) were calculated as the number of standard deviations observed quadrat values fell from mean of the null distribution and mapped across quadrats. Finally, I used regressions to examine how quadrat rank and SES values changed with elevation across the plot.

#### *Null models of phylogenetic conservatism*

To determine if related species were more similar in their traits than expected by chance I used a community phylogeny of 1032 species from Kraft et al. (2010)(Fig. S1.3). I first estimated the observed phylogenetic conservatism in all traits using Blomberg's K metric (Blomberg et al. 2003), after trimming the phylogeny to species with a given trait value. K values of one indicate trait evolution via Brownian motion while values above one indicate increasing trait conservatism. Values below one indicate that a trait is labile with respect to the phylogeny and not evolutionarily conserved. To calculate a null distribution of phylogenetic signal based on the community phylogeny I then calculated K for 999 phylogenies in which species trait values are chosen at random without replacement. By comparing observed K values to the null distribution I determined if traits were more or less conserved than expected by chance. This was done by calculating an effect size as the number of standard deviations the observed K value fell from the mean of the null distribution. Finally, to determine significance a two-tailed p-value was calculated from the rank of the observed K value in the null distribution. If the observed rank fell within the top or bottom 25 ranks of the null distribution the trait was considered to have significantly higher or lower (respectively) phylogenetic conservatism than expected by chance.

## RESULTS

The average leaf turgor loss point was  $-1.91M_{pa}$  ( $N=80$ ,  $sd=0.37$ ) and the average leaf specific force to punch was  $3.32 N mm^{-2}$  ( $N=454$ ,  $sd=1.37$ , Fig. S1.4). These traits were largely uncorrelated with existing functional trait data gathered in the Yasuní plot (Fig. 1.1), though specific force to punch correlated weakly and negatively with SLA and positively with wood density and seed mass.

### *Trait-based community assembly analyses*

Confirming my first hypothesis, I found that ridge-associated species had greater leaf drought tolerance (lower leaf turgor loss points) than valley-associated species, and that generalists had values intermediate to the two groups (Fig. 1.2A). Counter to my hypothesis, leaf toughness also varied significantly across habitat groupings and species associated with ridges within the plot had significantly higher leaf toughness while generalists did not differ significantly from either ridge or valley specialists (Fig. 1.2B). In addition, quadrat rank and SES values for both traits varied non-randomly across topography in the plot (Figs. 1.3 & 1.4). Specifically, ridge quadrats had greater than expected leaf drought tolerance as indicated by the lower leaf turgor loss point rank values and more-negative SES values. Again counter to my hypothesis, ridge quadrats also had higher than expected leaf toughness based on quadrat ranks and SES values, though the relationship was weaker than for turgor loss point.

### *Null models of phylogenetic signal*

Six of the eight traits examined were significantly more conserved than expected by chance (Fig. 1.5), while seed mass and abundance were not significantly different from the null expectation. SES values varied widely among traits from 31.33 to 0.24.

## DISCUSSION

Using both species-based approaches and quadrat-based null models I find leaf drought tolerance and mechanical toughness increases with elevation in this forest. This suggests

that water availability and herbivore pressure (and / or damage from falling tree limbs etc.) are important factors that have contributed to the elevational habitat specialization and community trait turnover observed in previous studies in this forest (Valencia et al. 2004, Kraft et al. 2008, Kraft and Ackerly 2010). The pattern of increasing drought tolerance at higher elevations is in line with other studies examining responses of species to water availability (Engelbrecht et al. 2007, Bartlett et al. 2016), but is somewhat unexpected as this forest is aseasonal (Valencia et al. 2004). This pattern could be the result of El Niño droughts that occur on multi-year timescales (Lewis et al. 2011), or alternatively it could be that the plot contains a sufficiently strong elevation gradient in water availability to produce the observed patterns in hydraulic traits, neither of which are mutually exclusive explanations. It remains to be seen if increasing El Niño droughts strengthen this pattern due to increased mortality of valley specialists, has been found for forests in the Colombian Amazon (Zuleta et al. 2017).

Both the values of species habitat groupings and community mean leaf mechanical toughness also increased with elevation, such that ridge specialists and quadrats at higher elevations tended to have higher leaf toughness. Due to a perception that herbivore abundance was relatively uniform across the plot, I did not hypothesize that there would be significant variation in this trait across the plot. These results could therefore mean there is greater herbivore pressure at higher elevations within the plot, but sufficient data to test this hypothesis does not currently exist. It is known however that tree species within the plot experience substantial herbivory (Cardenas et al. 2014), and that herbivory has been shown to vary with elevation in some tropical and temperate forests (Koptur 1985,

Reynolds and Crossley Jr 1997). Another potential factor driving the results could be that species at higher elevations invest in higher leaf toughness to produce longer leaf lifespans which are adaptive in resource poor environments. While light and water levels have not been mapped across the plot, the ridges appear to be more nutrient poor over most of their area (McFadden et al. 2018).

These results build on earlier work in this forest and other plant communities in which resource-conservative traits tended to be found at higher elevations and in lower nutrient zones (Kraft et al. 2008, Cornwell and Ackerly 2009, Ordoñez et al. 2009). However, as opposed to traits that capture multivariate strategy axes such as SLA and seed mass, I used physiological and mechanical traits more tightly-linked to a single ecological response to implicate specific abiotic and biotic factors. Neither of the two traits measured in this study were strongly correlated with existing trait data for the plot, suggesting these new traits capture orthogonal axes of variation. Leaf mechanical toughness was correlated positively with seed mass and wood density and negatively with SLA, suggesting it is however part of a suite of resource use-related traits. Leaf turgor loss point was more weakly correlated with existing trait data, but this could also be due to limited trait sampling compared with leaf mechanical toughness.

Six of the eight traits examined had significantly more phylogenetic signal than expected by chance. Of these six traits leaf turgor loss point had the smallest effect size and leaf mechanical toughness the largest. This suggests leaf mechanical toughness is more evolutionarily conserved than turgor loss point, which is known to have considerable

plasticity (Bartlett et al. 2014). Evolutionary lability of leaf-level drought tolerance would be beneficial as water regimes are shifting in many areas and causing drought-induced mortality to increase (Choat et al. 2015). This difference between the two traits measured for this study could also be due to the more extensive sampling of leaf mechanical toughness compared to leaf turgor loss point. Finally, the high proportion of traits with significant conservatism implies that phylogenetic distance captures strategy differences between species (Cavender-Bares et al. 2009, Godoy et al. 2014) and that the imputation of trait values using phylogenies (Swenson 2014) may be a viable option if data is lacking.

When analyzing functional trait and phylogenetic data at the community level there are several important limitations to consider. First, incomplete sampling of species at the whole community and quadrat level can underestimate the range of functional composition, particularly for rare species (Violle et al. 2017). This is an important issue in tropical forests which are often hyper-diverse and logistically difficult to sample in. For example in this study only 44% and 8% of species were sampled for leaf toughness and turgor loss point respectively. In the context of null models of community assembly this could increase the likelihood of inferring non-random assembly by decreasing the range of the null distribution and thus increasing effect sizes, which are measured based on where observed values fall within the null distribution. Second, species mean trait values were calculated from adult leaves and may not fully represent the traits of seedlings– a life stage where mortality due to (a)biotic factors sets the template of stems that recruit into the 1cm size class measured in the plot censuses.



Another important consideration is that when estimating trait conservatism incomplete species sampling results in incomplete community phylogenies. This may decrease the likelihood of observing significant phylogenetic conservatism if many clades are missing from the phylogeny. In addition, even with complete trait sampling at the community level phylogenetic information is often incomplete at or below the genus level. This can inflate estimates of conservatism via the K statistic due to polytomies (Davies et al. 2012). Lastly, as with all null models, it is difficult to be certain that the model accurately creates the patterns that would be formed if the process of interest, such as habitat filtering as was used in this study, were removed (Colwell and Winkler 1984). One important difference between the null model used here, in which species disperse randomly from the pool into quadrats, and what is known about tropical forests is that most tree species are dispersal limited, even at the scale of a 25-50ha plot (Hubbell 1979, Condit et al. 2000, Harrison et al. 2013). Limited dispersal could cause species to be found only in certain areas when they are in fact capable of surviving elsewhere (Pinto and MacDougall 2010, McFadden et al. 2018), which could yield patterns that would appear to indicate environmental filtering when analyzed with a null model.

### *Conclusions*

Species-level and community patterns of key physiological and mechanical traits can suggest specific (a)biotic mechanisms that influence community structure. This advances our understanding of the individual drivers of community structure relative to previous studies of traits that capture ecological strategies more broadly (e.g. Westoby 1998, Kraft et al. 2008). While these studies often found patterns in the distribution of traits more

generally related to resource conservation, it was not often clear which aspects of the (a)biotic environment were causing them. This study has highlighted the likely contribution of water availability and herbivore pressure to species habitat associations and community structure in this forest, but does not rule out other factors such as light availability, negative density dependence and dispersal limitation (Fortunel et al. 2016, McFadden et al. 2018). Further work in this forest should examine additional traits related to light acquisition and soil nutrient capture such as specific root length to better understand how variation in these resources shapes community patterns.

#### ACKNOWLEDGEMENTS

I thank M. Alvarado, A. Loor, A. Dietrick and S. Branco for assistance in the field. Megan Bartlett and Lawren Sack helped collect leaf drought tolerance trait data and Yusuke Onoda helped build the penetrometer used to measure leaf toughness. The University of Maryland, College Park (UMCP) and the University of California, Los Angeles partially funded this study. Joe Wright and Nancy Garwood provided unpublished wood density and seed mass data, the collection of which was funded by the Frank Levinson Family Foundation and NSF grants DEB-0614525 and DEB-1122634. I gratefully acknowledge the support of an NSF Graduate Research Fellowship (DGE-1650604) and the Behavior, Ecology, Evolution and Systematics graduate program at the University of Maryland, College Park. I also thank the Pontifical Catholic University of Ecuador, the Mellon Family Foundation, the National Science Foundation, the Smithsonian Tropical Research Institute and the Government of Ecuador (through Donaciones del Impuesto a la Renta) for funding plot censuses.

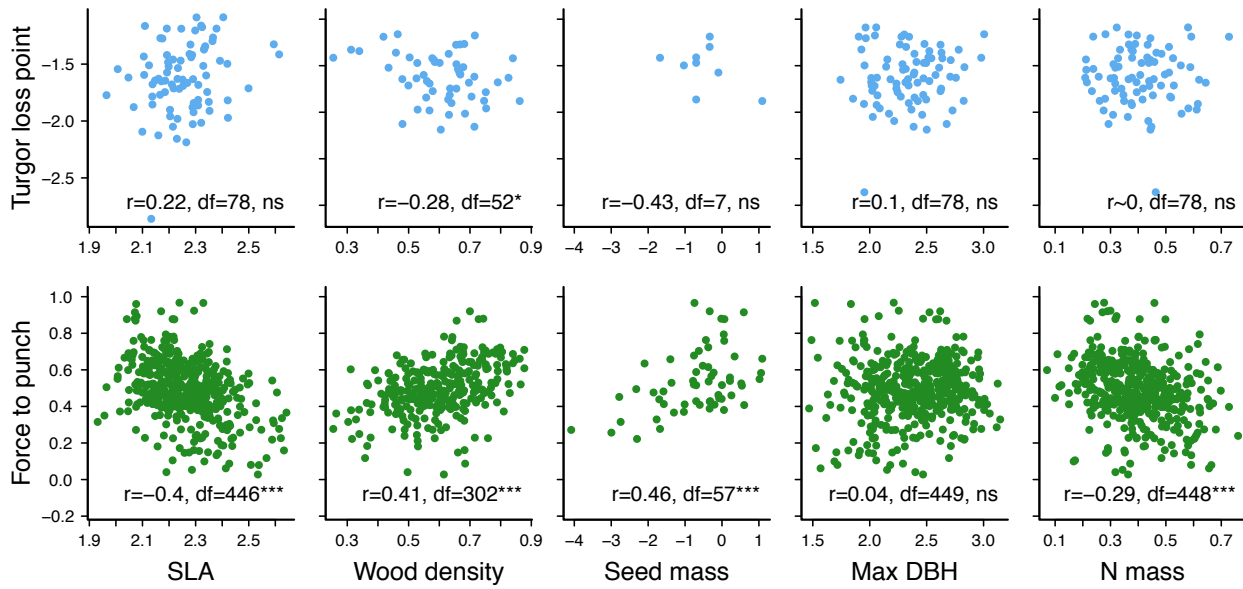
## TABLES AND FIGURES

**Table 1.1:** Definition, function, units and key references for the two physiological and mechanical resistance traits measured as part of this study.

<b>Trait</b>	<b>Definition</b>	<b>Functional significance</b>	<b>Units</b>	<b>References</b>
Leaf turgor loss point	Water potential at which leaf cells lose positive pressure and leaf wilts*	Estimate of leaf-level drought tolerance, a component of whole-plant drought tolerance	M <sub>pa</sub>	Bartlett <i>et al.</i> 2012a, Bartlett <i>et al.</i> 2012b
Leaf specific force to punch	Force required to puncture leaf lamina standardized by leaf thickness	Related to leaf lifespan, herbivore resistance and resource acquisition strategy	N/mm <sup>2</sup>	Onoda <i>et al.</i> 2011, Perez-Harguindeguy <i>et al.</i> 2013

\*Leaf turgor loss point was estimated from osmotic potential at full turgor via a regression equation from Bartlett *et al.* 2012a (*see Equation 1*).

**Figure 1.1:** Correlations between turgor loss point, specific force to punch and existing trait data collected in or near the Yasuní plot. Note strongest correlations are between force to punch and SLA, wood density and seed mass, and to a lesser extent leaf nitrogen ( $N_{mass}$ ). \*\*\* =  $p < 0.001$ , \*\* =  $p < 0.01$ , \* =  $p < 0.05$ , ns = not significant. See *Methods* for units.

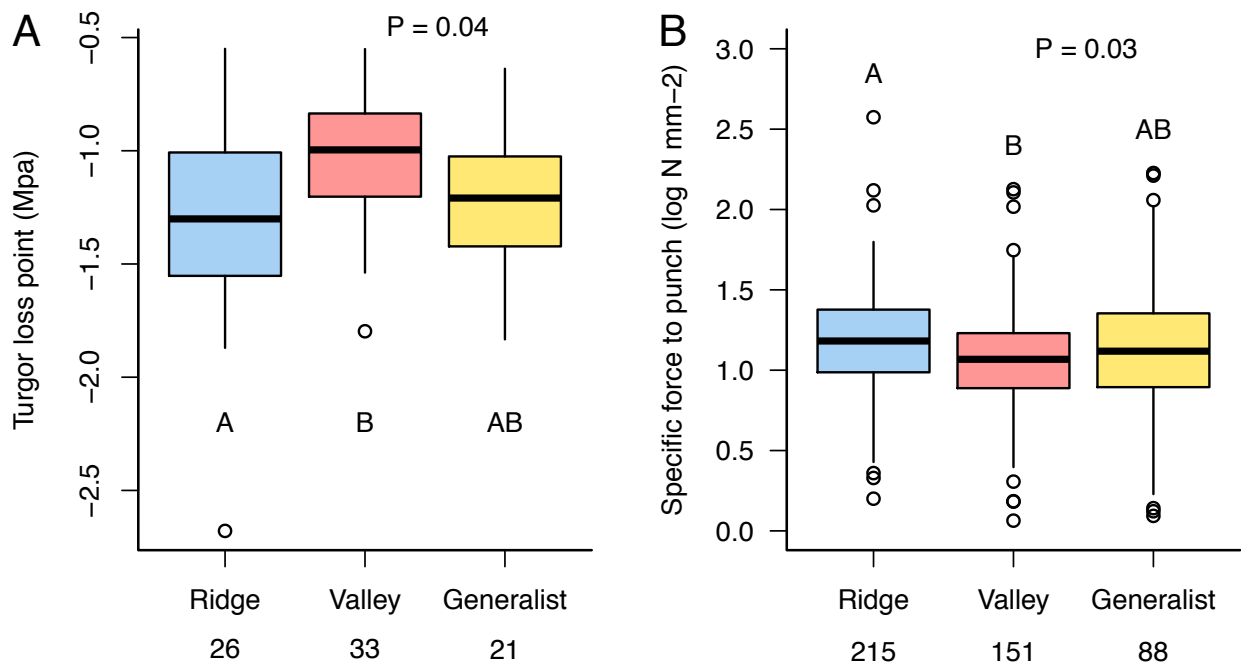


**Figure 1.2:** Habitat specialists differ in traits while generalists possess intermediate values.

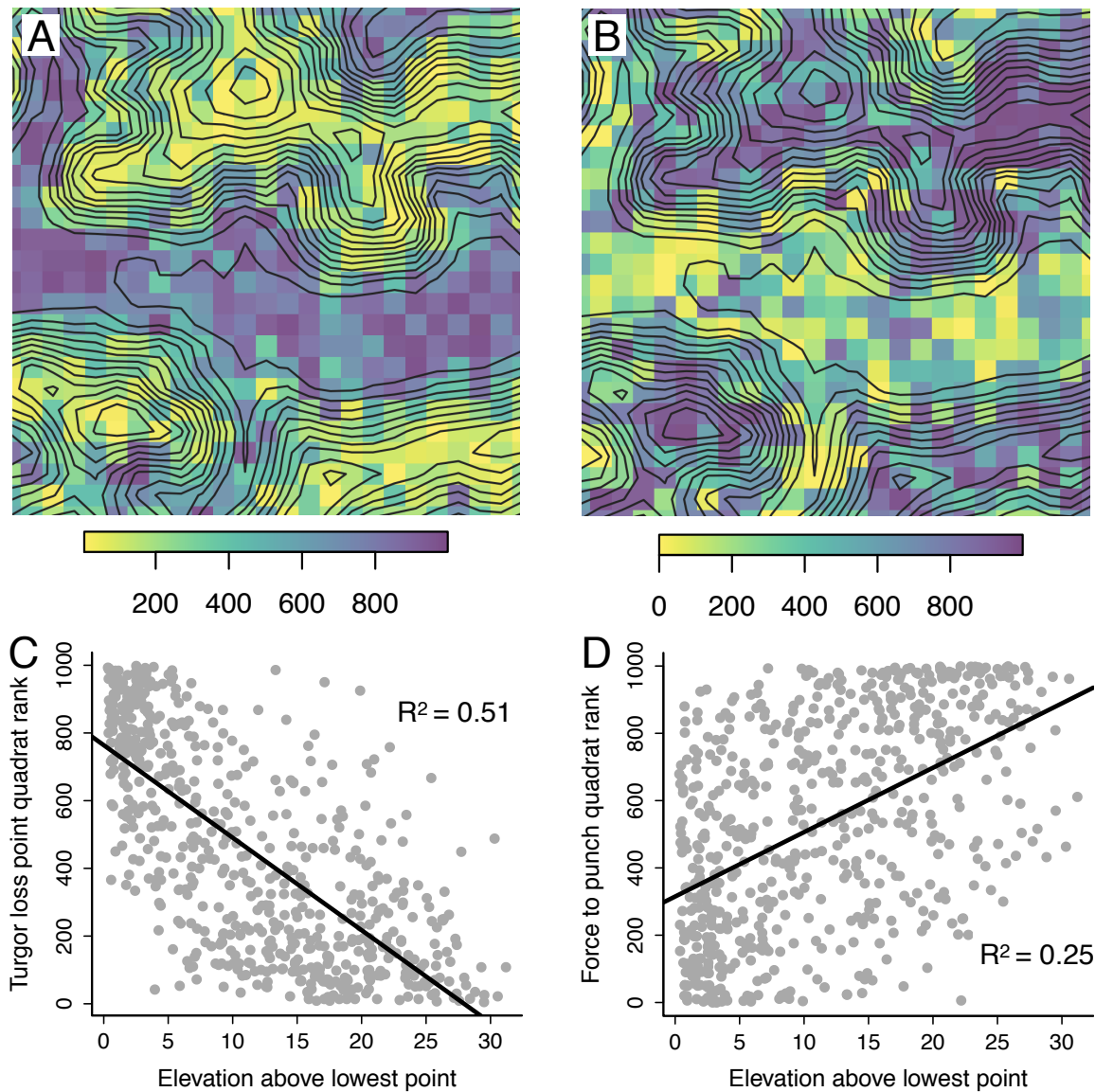
A: Ridge-associated species possess significantly greater leaf drought tolerance as indicated by the more negative turgor loss point compared with valley-associated species.

Generalists have drought tolerances intermediate to ridge and valley-specialists. B: Specific force to punch showed similar patterns, with ridge-associated species possessing greater leaf toughness than valley-associated species, while habitat generalists had values not significantly different from either ridge or valley specialist groups. P value is from the overall anova and letters when present are groupings from Tukey HSD posthoc tests.

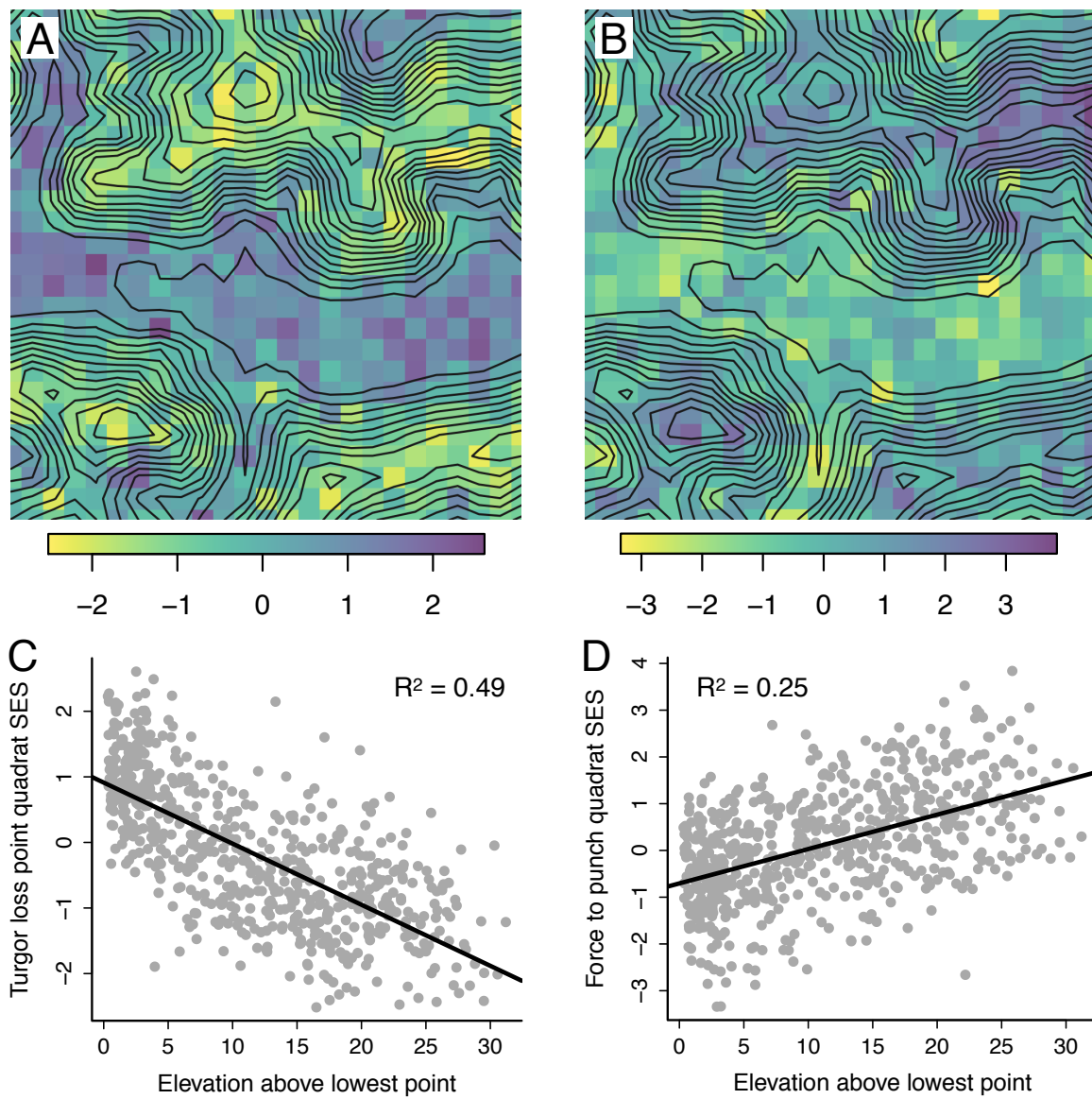
Sample sizes are given below habitat categories.



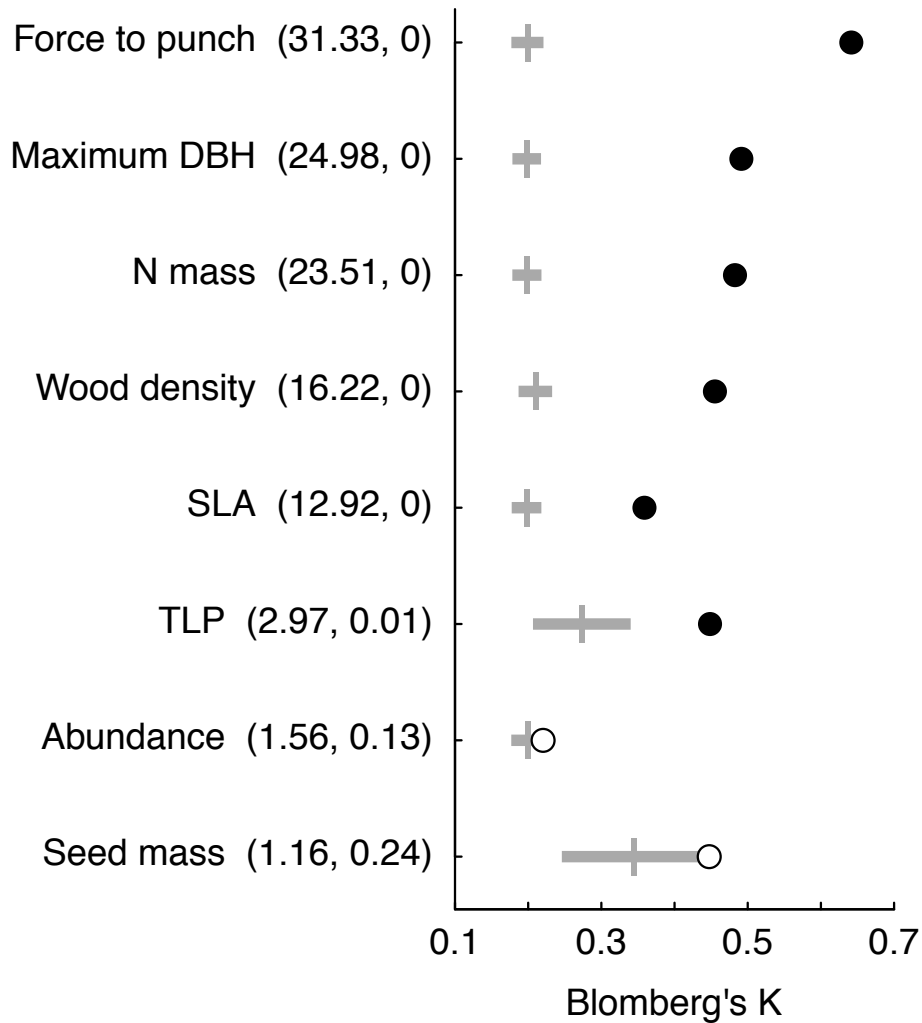
**Figure 1.3:** Trait means track elevation in the 25ha Yasuní plot. Panels A & B: Ranks of observed quadrat mean leaf turgor loss point and leaf specific force to punch (respectively) plotted across the 25ha plot, with topographic lines in black. Panels C and D: Turgor loss point ranks decrease and force to punch ranks increase with elevation, indicating ridge communities tend to have higher leaf drought tolerance and greater leaf toughness than those in valley bottoms.



**Figure 1.4:** Quadrat standardized effect size (SES) follows elevation in the 25ha Yasuní plot for both turgor loss point and force to punch. Panels are as in Figure 1.3 except quadrat SES is plotted instead of rank. Note force to punch SES values span a larger range than turgor loss point SES values (see scale bars in panels A and B).



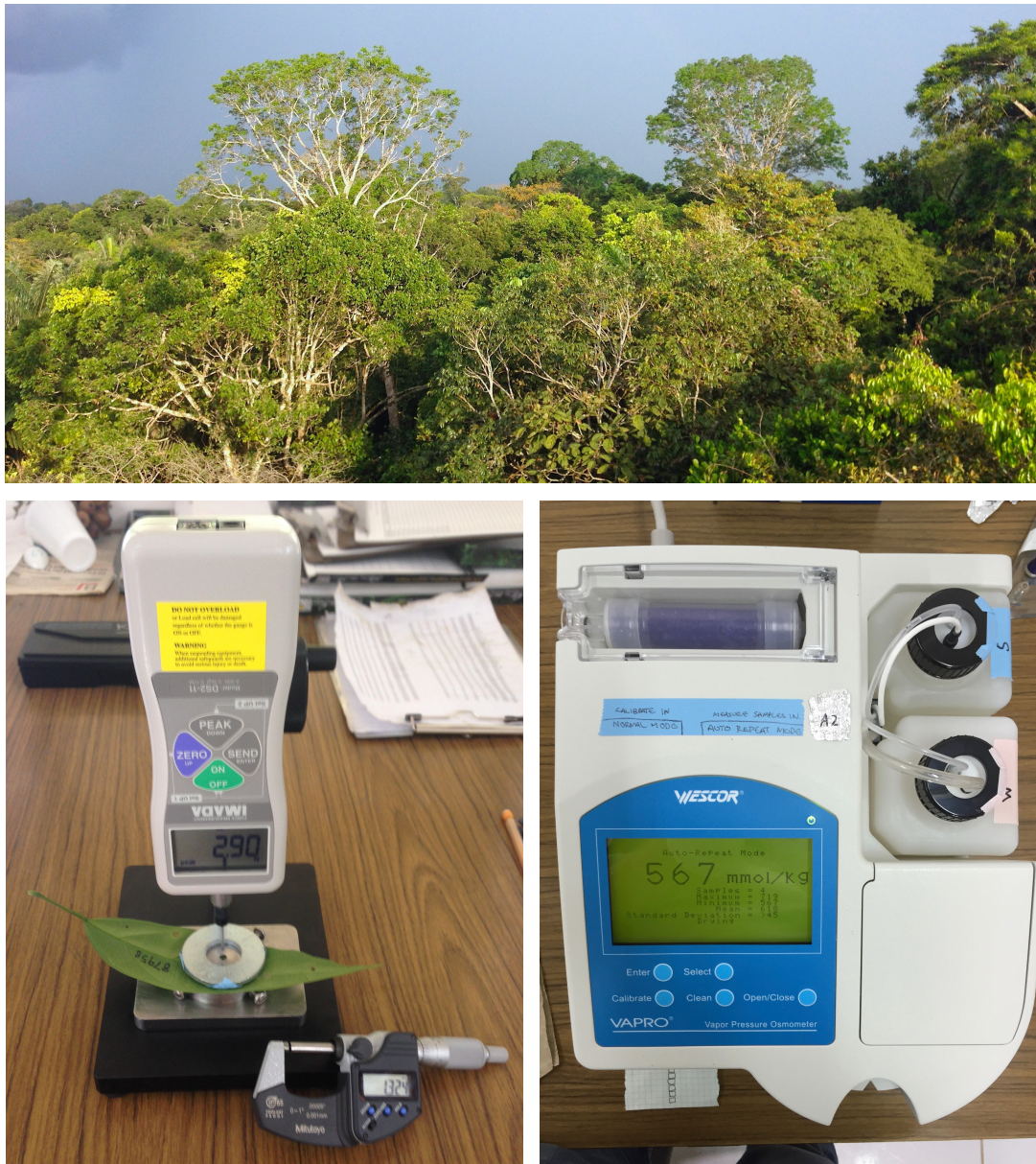
**Figure 1.5:** Phylogenetic signal in functional trait and abundance data collected in or nearby the Yasuní plot as measured by Blomberg's K. Vertical grey lines are means of null distributions of K values and horizontal grey bars are +/- one standard deviation. Points are observed K values with filled circles denoting significant phylogenetic structure at  $p < 0.05$  using rank-based p-values and open circles insignificant values. Numbers in parentheses are standardized effect sizes and p-values respectively. See Figure S1.3 for the community phylogeny used to create the null distribution.



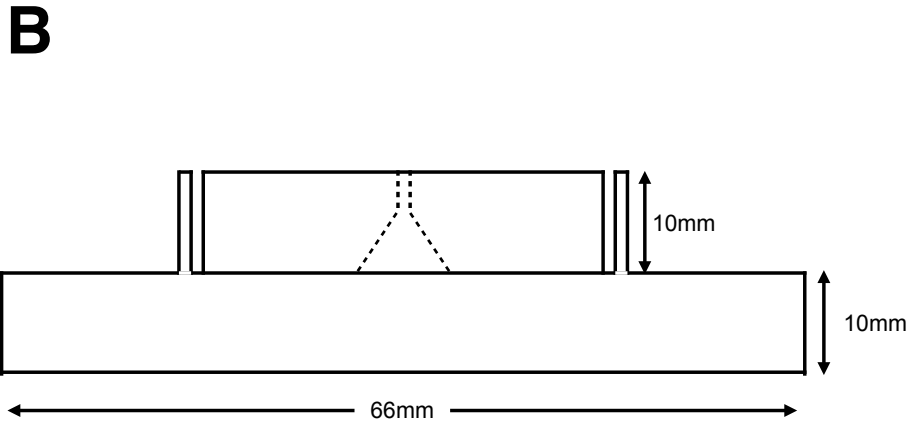
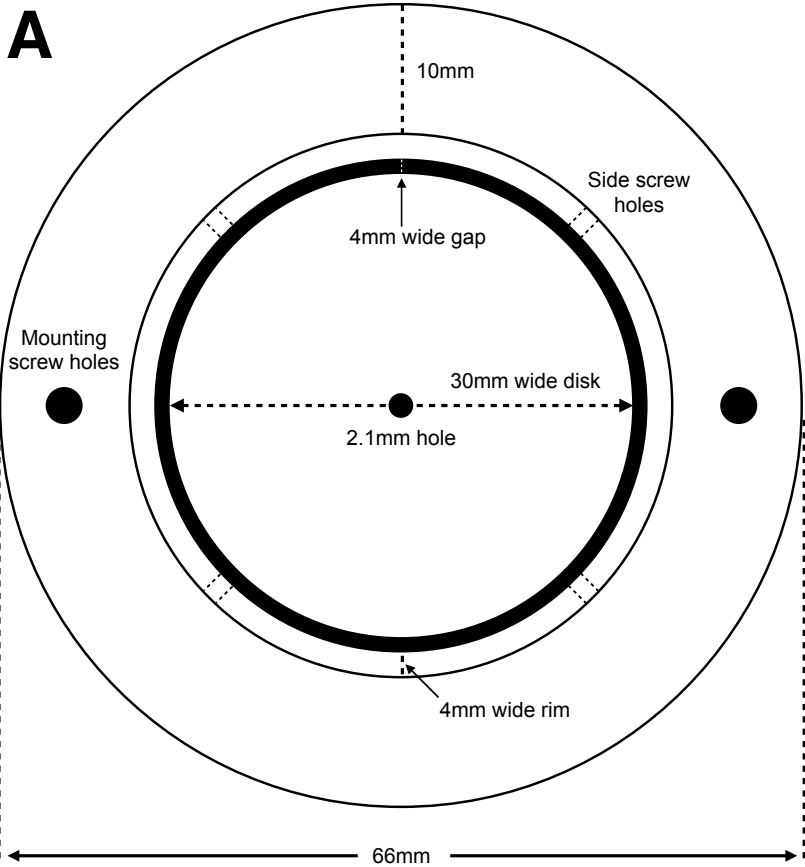


SUPPLEMENTARY MATERIAL: Supporting figures for Chapter 1

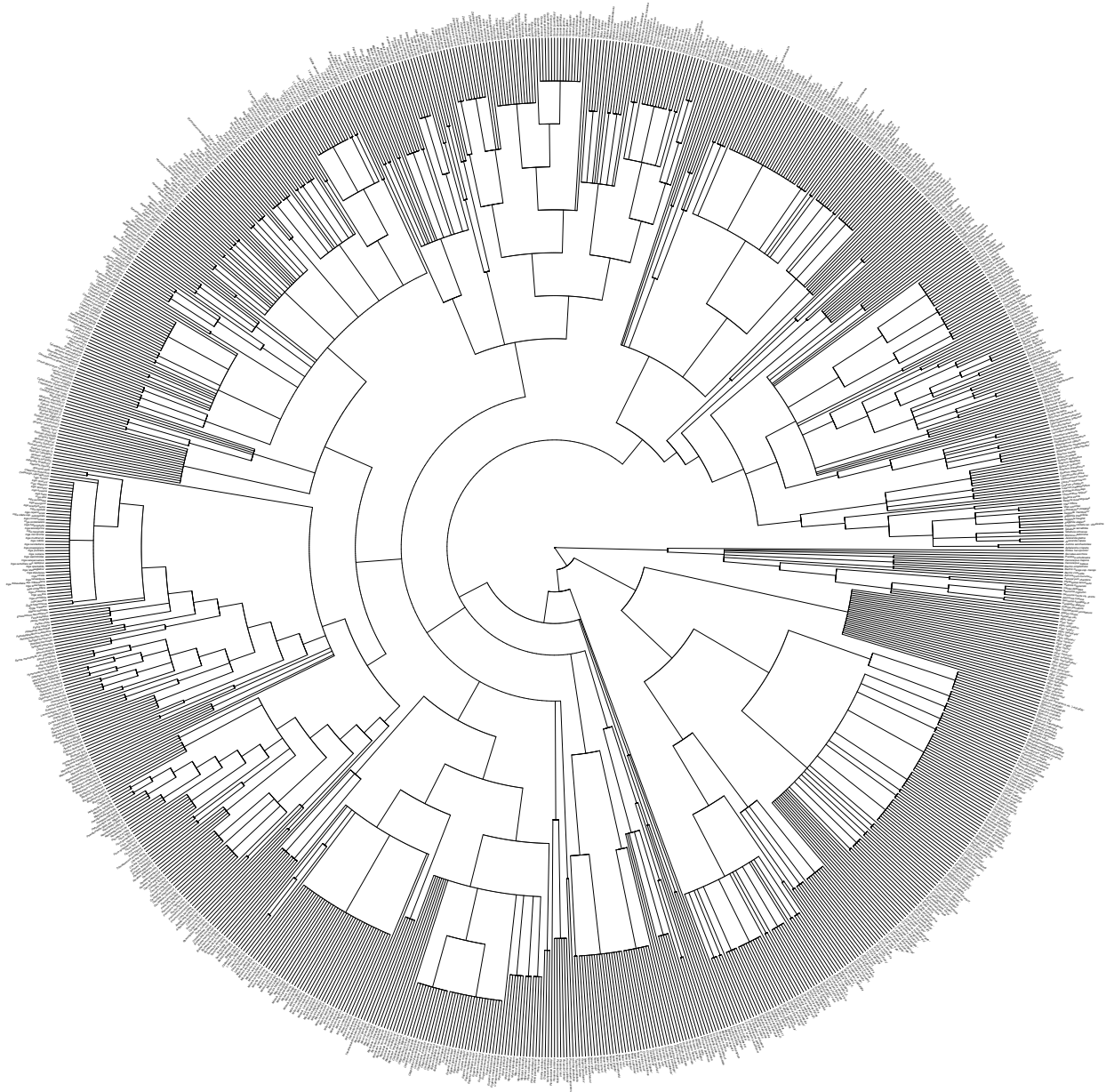
**Figure S1.1:** Top panel: Canopy view of Yasuní National Park near the 50ha plot. Lower left panel: Specific force to punch penetrometer (see Fig. S1.2 for baseplate schematics) and micrometer. Lower right panel: Osmometer used to estimate turgor loss point. Bottom pictures were taken at the Estación Científica Yasuní.



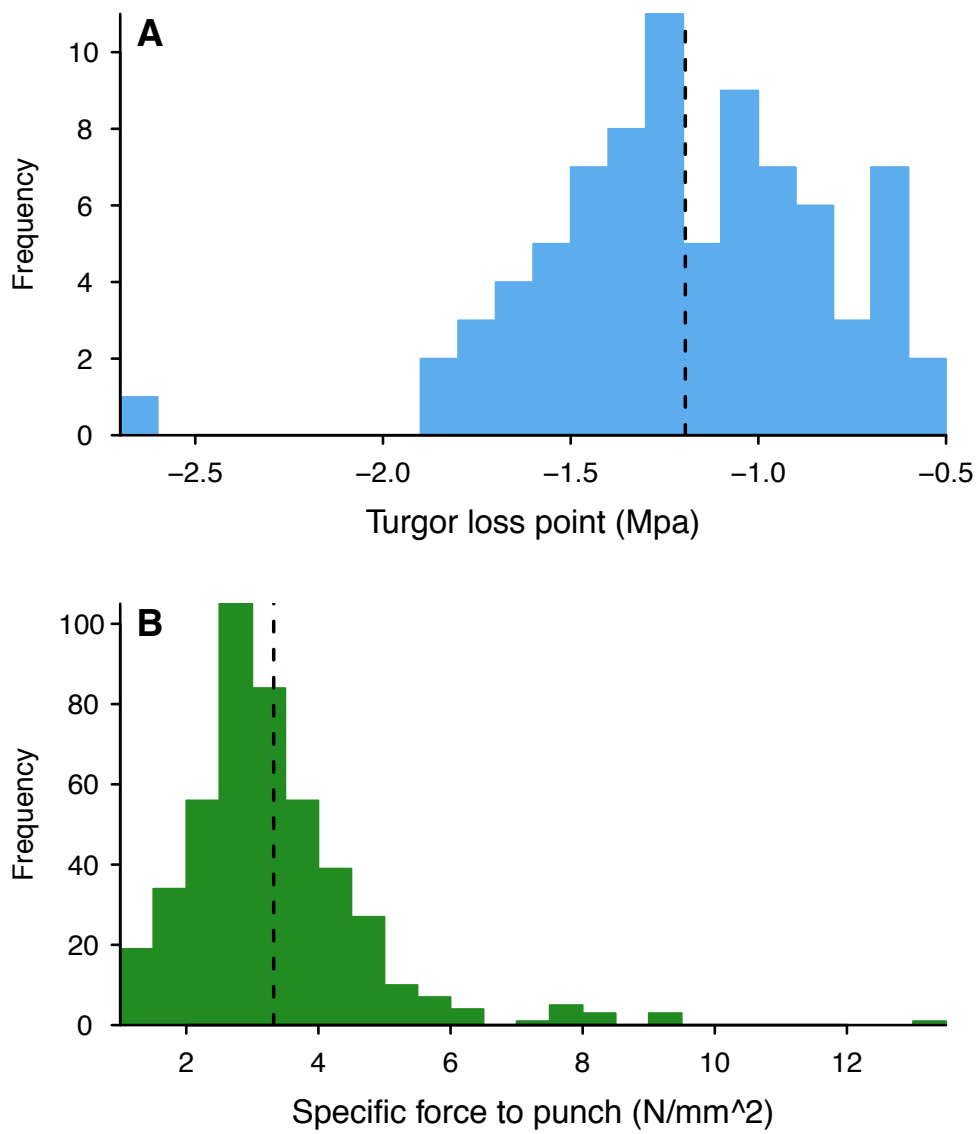
**Figure S1.2:** Schematic showing top (A) and side (B) views of penetrometer baseplate.



**Figure S1.3:** Community phylogeny of the Yasuní tree plot used to measure phylogenetic signal ( $K$ ) in functional traits (see Figure 1.5).  $N = 1032$  species and morphospecies. Note, phylogeny was trimmed to the focal species with a certain trait value when estimating  $K$ .



**Figure S1.4:** Trait value distributions for species sampled in Yasuní. A: Turgor loss point (N=80) and B: specific force to punch (N=454). Dashed lines indicate mean values across all species for each trait.



## CHAPTER 2

### **Disentangling the functional trait correlates of spatial aggregation in tropical forest trees**

Originally published as McFadden, I.R., Bartlett, M.K., Wiegand, T., Turner, B.L., Sack, L., Valencia, R. and Kraft, N.J.B. 2018. Disentangling the functional trait correlates of spatial aggregation in tropical forest trees. *Ecology*. DOI: <https://doi.org/10.1002/ecy.2591>

#### ABSTRACT

Environmental filtering and dispersal limitation can both maintain diversity in plant communities by aggregating conspecifics, but parsing the contribution of each process to community assembly has proven difficult empirically. Here we assess the contribution of filtering and dispersal limitation to the spatial aggregation patterns of 456 tree species in a hyperdiverse Amazonian forest and find distinct functional trait correlates of interspecific variation in these processes. Spatial point process model analysis revealed that both mechanisms are important drivers of intraspecific aggregation for the majority of species. Leaf drought tolerance was correlated with species topographic distributions in this aseasonal rainforest, showing that future increases in drought severity could significantly impact community structure. In addition, seed mass was associated with the spatial scale and density of dispersal-related aggregation. Taken together, these results suggest

variation in environmental filtering and dispersal limitation act in concert to influence the spatial and functional structure of diverse forest communities.

## INTRODUCTION

Explaining species coexistence in diverse communities is a perennial challenge for ecologists (Hart et al. 2017), and this challenge is particularly acute in tropical forests, where hundreds of tree species may co-occur within a single hectare (Valencia et al. 2004). In plant communities, diversity may be maintained by a variety of mechanisms (Wright 2002), including environmental filtering acting on interspecific variation in abiotic tolerances (Cornwell and Ackerly 2009), as well as limited seed dispersal (Hubbell 2001). Both of these processes aggregate conspecifics and therefore reduce competition with heterospecifics, which can then contribute to species coexistence (Chesson 2000). Intraspecific aggregation is a consistent feature of many plant communities (Levine and Murrell 2003), including tropical forests (Condit et al. 2000), which suggests that dispersal limitation, habitat filtering or both in combination are widespread structuring factors of plant assemblages (Shen et al. 2009, Pinto and MacDougall 2010).

Unfortunately, it is often difficult to quantify the relative importance of filtering and dispersal limitation as both can cause the same pattern of intraspecific aggregation when abiotic factors are spatially autocorrelated (Shen et al. 2013). In order to better understand the processes shaping plant communities it is therefore critical to disentangle the separate contribution of both processes. Intraspecific aggregation in plant communities has most often been studied through the lens of a single ecological process such as environmental

filtering, dispersal limitation, or biotic factors such as competition or natural enemies (e.g. Harms et al. 2001, Seidler and Plotkin 2006, Mangan et al. 2010), though studies examining multiple processes are becoming more common (Russo et al. 2007, Pinto and MacDougall 2010, Wiegand and Moloney 2014). As multiple processes can drive aggregation, studies that focus on a single mechanism may misinterpret the importance of the mechanism under study. For example, a species with limited dispersal potential may appear to be associated with spatially autocorrelated abiotic conditions found in its distribution, when in fact it is able to tolerate a far broader range of conditions (Pinto and MacDougall 2010).

One important way forward is to study empirical species distributions with recently developed spatial point process models (SPPMs) that estimate the strength of both environmental filtering and dispersal limitation (Fig. 2.1, Waagepetersen and Guan 2009, Jalilian et al. 2013). These models allow researchers to estimate associations with environmental variation as well as properties of species clustering independent of any environmental variation. If key environmental attributes have been included in the model, this residual clustering can be interpreted as a measure of aggregation due to dispersal limitation (Shen et al. 2013). SPPMs have several advantages over non-spatial methods and methods that average occurrences into quadrats. First and most important for the goals of our study is that SPPMs make it possible to control for the influence of dispersal limitation when estimating habitat associations. An additional advantage is that fine-scale spatial variation below the quadrat level is explicitly incorporated (Møller and Waagepetersen 2003).

While SPPMs provide a powerful way to disentangle the causes of species aggregation, SPPMs on their own do not offer easy ways to discover the underlying physiological or functional trait drivers. Conversely, many trait-based ecology studies to date disregard the fine-scale spatial structure of the community in question (reviewed in Wiegand et al. 2017) and focus on a small number of relatively easy to measure traits such as specific leaf area (SLA), plant height, seed size, and wood density (e.g. Silvertown 2004, Kraft et al. 2008, Cornwell and Ackerly 2009, Swenson et al. 2012). As the functional traits of plants are known to shape both environmental responses and dispersal ability (McGill et al. 2006, Cornwell and Ackerly 2009, Lowe and McPeck 2014), coupling functional trait analyses with SPPMs offers a promising path towards a more complete understanding of the drivers of spatial structure in forest communities. Specifically, insights into the mechanisms driving aggregation can come from relating spatial properties such as habitat associations and cluster properties with key functional traits (Seidler and Plotkin 2006, Wiegand et al. 2009).

Though the current core plant functional trait list is useful for understanding the mechanisms of species aggregation (e.g. variation in seed size is often implicated in driving variation in dispersal potential among species, Levine and Murrell 2003), it cannot provide the insight that more detailed physiological study of the species might bring. For example, core plant functional traits offer limited information about drought-tolerance (Bartlett et al. 2016), which is critical for understanding how species and communities are distributed with respect to water availability, and how they will respond to anthropogenic changes in water regimes (Bartlett et al. 2012b, Choat et al. 2015). To address this limitation, we



capitalize on recent methods developments (Bartlett et al. 2012a) that have made assessing drought tolerance more tractable in high diversity communities.

Here we integrate spatial process modeling and functional trait approaches to better understand how environmental filtering, dispersal limitation and species traits create variation in the spatial structure of a high-diversity forest in the Ecuadorian Amazon. We first use SPPMs to infer the relative importance of environmental filtering and dispersal limitation as drivers of spatial aggregation for 456 co-occurring tree species. To accomplish this we used a decision tree (Fig. S2.1) to categorize each species based on whether a single process, both processes or neither process is required to describe its spatial aggregation patterns. We then test whether the physiological and functional traits of species are correlated with variation in the strength of processes inferred from the spatial models.

We predict that because of the strong topographic and edaphic heterogeneity within this forest (Valencia et al. 2004), the distribution and aggregation of species will be primarily driven by abiotic gradients, as opposed to dispersal limitation or both in combination (H1). Next, we predict that ridge-associated species will have more resource-conservative traits (e.g. higher leaf drought tolerance, lower SLA, larger seed mass) than valley-associated species (H2). Finally, we predict species with larger seeds and taller statures will be less dispersal limited, i.e. have larger clusters with fewer stems per cluster (H3). Most tree species in this forest are dispersed by animals (Bemmels et al. 2018) and in tropical forests heavier seeds tend to be dispersed by larger birds and primates with larger home ranges (Holbrook and Smith 2000). In addition, tree height has been shown to influence dispersal

distances for wind-dispersed species (Thomson et al. 2011). We find that the majority of species are best described by a model that includes both filtering and dispersal limitation, and that traits related to resource use and seed mass are important drivers of habitat preferences and clustering due to dispersal limitation respectively.

## METHODS

### *Study area and environmental data*

We conducted our research in the Yasuní Forest Dynamics Plot (FDP), a 50ha tree plot containing over 1,100 tree species in which all stems above one centimeter diameter at breast height (DBH) have been identified, mapped and censused at regular intervals (R. Valencia unpublished, Valencia et al. 2004 ). Given constraints of existing trait data from the site (e.g. Kraft et al. 2008), we focus our analyses on the better sampled western 25ha. The Yasuní FDP is part of the Smithsonian Forest Global Earth Observatory (ForestGEO) plot network (Anderson-Teixeira et al. 2015). Given the statistical demands of our spatial analyses, we limited our study to the 456 species with 70 or more individuals in the 25ha plot, which together account for over 90% of stems. The plot contains significant topographic and edaphic heterogeneity, with two main ridges running east to west separated by a central stream-filled valley (Fig. S2.2). The forest is aseasonal (Valencia et al. 2004) and is home to a largely intact fauna despite some nearby hunting (Bass et al. 2010). To assess the influence of abiotic environmental factors on tree species distributions (H1) we included four topographic and soil attributes mapped at 5x5 meter resolution (Figs. S2.2 & S2.3). Specifically, we used elevation, the topographic wetness index (TWI, Sørensen et al. 2006), and the first two PCA axes from a dataset of 15 soil nutrients and chemical

properties representing soil cations (axis 1) and major nutrients such as N, P and K (axis 2, see ‘Supplemental Soils Analysis Methods’ in Supplementary Material).

### *Overview of spatial modeling process*

We used a two-step approach to determine if the spatial aggregation of each focal species was driven by environmental filtering alone, dispersal limitation alone, neither process or both processes in combination (Table 2.1). First, to place species in one of the four above categories we implemented a decision tree using two increasingly complex SPPMs (Fig. S2.1). Second, to estimate habitat associations and or clustering parameters for species with non-random spatial structure we used SPPMs incorporating one or both processes (Table 2.1). We used goodness-of-fit tests (Loosmore and Ford 2006) to assess departures from these models as required by the decision tree, and the method of minimum contrast (Diggle and Gratton 1984) to fit the cluster parameters. Minimum contrast methods seek to minimize the difference between the observed dispersion of points (i.e. aggregated, random, disaggregated) and the patterns of dispersion generated by a model used to recreate the spatial pattern (Møller and Waagepetersen 2003). Our analysis generally follows the approach of Shen et al. (2009, 2013) , but for clarity below we expand on each step of the analysis in more detail.

### *Step one: Determine model category for each species*

To assign species to the four spatial aggregation categories (Table 2.1), we used the decision tree outlined above (Fig. S2.1). We first used goodness-of-fit tests with 999 simulations of complete spatial randomness (CSR, Baddeley et al. 2016) as a null model to

determine whether species exhibited non-random spatial structure over a range of scales. To quantify spatial structure we used three spatial summary statistics that capture distinct aspects of species aggregation patterns: the pair correlation function, the L-function and the empty space function. The pair correlation function  $g(r)$  is the expected density of stems at distance  $r$  from a given stem in the pattern normalized by stem density, the L-function is a transformed version of the K-function- the cumulative number of stems within distance  $r$  of a typical stem normalized by stem density, and the empty space function is the expected distance from a random location in the plot to the nearest stem in the pattern (Wiegand and Moloney 2014, Baddeley et al. 2016). We used the Benjamini-Hochberg correction for multiple comparisons when assessing significance.

If a species did not differ significantly from the CSR null model it was assigned to the 'complete spatial randomness' category (C1), and no habitat associations or clustering parameters were estimated. For species that did exhibit significant non-random spatial structure we used a heterogeneous Poisson model which correlates variation in the density of stems across the plot with the four environmental attributes. We determined the final set of environmental attributes included in the model through backwards selection via AIC. Next, we assessed whether species were further aggregated beyond any aggregation due to environmental attributes by testing for departures from the heterogeneous Poisson model via goodness-of-fit. Species associated with at least one environmental attribute but without significant departures from the heterogeneous Poisson model were placed in the 'habitat only' category (C2). Next, species with significant departures from the heterogeneous Poisson model but not associated with any environmental attributes were

placed in the 'dispersal only' category (C3). Finally, species associated with at least one habitat attribute and showing significant departures from the heterogeneous Poisson model were placed in the 'habitat and dispersal' category (C4). In species with departures from the heterogeneous Poisson model (C3 and C4), aggregation not explained by the abiotic environment is attributed to dispersal limitation, though as noted previously other factors such as canopy gaps could also contribute to these patterns.

*Step two: Estimate habitat associations and clustering parameters*

After placing species into categories based on properties of their spatial aggregation, we next estimated parameters related to habitat associations and or dispersal limitation for the species in categories C2-C4 (Table 2.1). For species in the 'habitat only' category (C2), we used a heterogeneous Poisson model to estimate standardized coefficients of association with the reduced set of environmental attributes. For species in the 'dispersal only' category (C3) a Thomas cluster process model was used to estimate only average cluster size and clustering intensity via a Matérn covariance function (MCF). Cluster size is an estimate of the spatial radius over which clustering occurs and clustering intensity represents the strength of association between points within a cluster, such that species with higher clustering intensity have more stems within a given cluster. To model negative exponential decay of pair correlation in the MCF we used a cluster shape value of 0.5, as this function is commonly used to estimate dispersal kernels (Nathan and Muller-Landau 2000). Finally, for species in the 'habitat and dispersal' category we used a log-Gaussian Cox process (LGCP) model in which the aggregation of stems is modeled by a random intensity function:

$$\log \Lambda(\mathbf{x}) = \lambda_H(\mathbf{x}) + D(\mathbf{x}) = \mu + \sum_i \beta_i H_i(\mathbf{x}) + D(\mathbf{x}). \quad (1)$$

This function combines i) a log-linear species distribution model to predict the intensity function  $\lambda_H(x)$  of stems at location  $x$  as a vector of coefficients of association  $\beta_i(x)$  with environmental attributes  $H_i(x)$ , and ii) a MCF to describe additional clustering  $D(x)$  independent of habitat associations, with  $\mu$  representing an intercept (Jalilian et al. 2013, Shen et al. 2013). Importantly, the LGCP updates the estimates of coefficients of association for each of the environmental attributes based on the pair correlation, or additional clustering. See Waagepetersen and Guan 2009, and Shen et al. 2013 Appendix B for a detailed description of the LGCP modeling process.

### *Functional traits*

To identify physiological and functional drivers of filtering and dispersal limitation we used seven leaf, seed, wood, and whole-plant traits related to leaf economics, resource capture, dispersal, and growth-mortality tradeoffs. We used previously published values for SLA, leaf nitrogen content, wood density and maximum DBH (as a proxy for maximum height) collected via established protocols (Cornelissen et al. 2003, Kraft and Ackerly 2010, Hietz et al. 2013). In addition, we collected new data on leaf drought tolerance (Bartlett et al. 2012a) and leaf tissue mechanical strength, an important trait for understanding leaf lifespan, herbivore defense and litter decomposition rates (Onoda et al. 2011). We also included seed mass data from ongoing work in the Yasuní plot (J. Wright and N. Garwood

*unpublished*). To ensure sufficient sample size for multivariate regressions using all traits, we used wood density and seed mass values for species too rare to sample at Yasuní (45 and 51% of species respectively) compiled from published studies from other sites or estimated from genus or family level means (Fortunel et al. 2016).

We assessed leaf drought tolerance by measuring the turgor loss point (TLP; units: MPa), or the leaf water potential at which the cells lose turgor and the leaf wilts (Bartlett et al. 2012b). We sampled TLP for 28 ridge-associated, 26 valley-associated and 26 habitat generalist species via the vapor pressure osmometer method (Bartlett et al. 2012a). To minimize damage to the trees and preserve the mission of the FDP to study forest dynamics, we modified earlier protocols by collecting leaves instead of entire branches. We sampled two leaves from four to six trees per species in double-bagged, humidified Whirl-Pak bags and then rehydrated leaves with the petioles in water for eight hours under dark, humid conditions before sampling. We measured leaf osmotic potential using a vapor pressure osmometer (VAPRO 5600, Wescor Inc., South Logan, USA) and then converted measurements to TLP values following Bartlett et al. (2012a).

We measured leaf mechanical strength for 454 of the 456 most abundant species (species with abundance  $\geq 70$ ) using a custom-built penetrometer constructed around a digital force gauge (DS2-11, Imada Inc., Northbrook, USA) and test stand (KV-11-S, Imada Inc., Northbrook, USA). We measured the specific force to punch ( $F_{ps}$ ; units:  $\text{N mm}^{-2}$ ), or the maximum force required to pass a circular metal rod through a leaf normalized by the circumference of the punch rod and the thickness of the leaf, following established

protocols (Perez-Harguindeguy et al. 2013). We sampled two leaves from three individuals per species at three positions along the midrib axis of the leaf (i.e., 25%, 50% and 75% of leaf length), avoiding the midrib and secondary veins.

### *Linking species traits and spatial properties*

To determine if functional traits are predictive of spatial properties across species we correlated our trait dataset with parameters estimated from the spatial models, specifically the strength of environmental association with the four habitat attributes, cluster size and clustering intensity. We first examined bivariate relationships between single traits and spatial properties inferred from our two-step decision tree approach. We then used multivariate regressions with all traits to predict spatial properties and model reduction via AIC to find best fitting trait combinations. To ensure sufficient sample size of spatial model parameters in multivariate regressions we used a LGCP model (C4, 'habitat and dispersal') for all species. All analyses were done in R 3.4.1 (R Core Team 2017).

## RESULTS

Contrary to our first hypothesis that environmental variation alone will structure the majority of species aggregation, we found that most species distributions (75.2%, 343/456) were best described by a LGCP 'habitat and dispersal' model (C4, Fig. 2.2). Similar numbers of the remaining species (12.1 and 11.6%, or 55 and 53 species, respectively) were placed in the 'habitat only' (C2, heterogeneous Poisson model) and null model (C1, CSR) categories. Only 5 species (1.1%) were placed in the 'dispersal only' category (C3, Thomas cluster process). Alternative analyses focused only on large-statured



species (maximum 95<sup>th</sup> percentile DBH  $\geq$  10cm) yielded qualitatively similar results, while restricting the analysis to smaller-statured species (maximum DBH < 10cm) increased the proportion of species in the 'habitat and dispersal' category (C4, Fig. 2.2). We found that most species (67.8%, 309/456) were significantly associated with one or more of the four environmental attributes (Fig. 2.3, Fig. S2.4). For those species in which clustering related to dispersal limitation was estimated (those in the 'dispersal only' and 'habitat and dispersal' categories), most had small clusters (mean  $\alpha$ =25.8m, sd=63.6m) with a mean intensity ( $\sigma^2$ ) of 2 (sd=1.2).

Functional trait differences were related to a number of the spatial patterns that we detected. Species with no detectable aggregation (C1), had higher seed masses and larger maximum DBHs than those in the 'habitat and dispersal' (C4) category (Fig. S2.5). Supporting our second hypothesis, we found that species with higher leaf drought tolerance tended to be associated with higher elevations and lower TWI values in the plot (Fig. 2.4A,  $R^2=0.16$ ,  $p=0.002$ , Table S2.1). We found mixed support for other traits. For example, ridge-associated species had lower SLA in bivariate comparisons but the relationship reversed in multivariate regressions, while ridge-associated species had higher seed masses in multivariate regressions but no significant relationship in bivariate comparisons (Table 2.2, Table S2.2). Finally, seed mass and maximum DBH were correlated positively with species cluster size and negatively with clustering intensity (Fig. 2.4B & C, Table 2.2), supporting for our third hypothesis.

Many of the functional traits in our study were weakly correlated with the six spatial parameters when considered individually (Table 2.2, Pearson correlation -0.41 to 0.36, Table S2.1), while multivariate models using combinations of traits increased predictive power somewhat (Table S2.2). For example, species with stronger clustering intensity tended to be smaller in stature and possess traits associated with pioneer strategies (e.g. higher SLA, smaller seed mass,  $R^2=0.24$ ). In addition, species positively associated with elevation (ridge and slope-associated species) had higher drought tolerance, larger seed size and lower leaf nitrogen as may be expected if these environments are resource poor, but also tended to have higher SLA and smaller DBHs ( $R^2=0.3$ ).

## DISCUSSION

Most species were best described by a model that included both habitat associations and dispersal limitation, suggesting both mechanisms are important in determining spatial structure in this forest. This joint effect has also been demonstrated in Asian and Central American forests (Shen et al. 2009, Jalilian et al. 2013, Shen et al. 2013), suggesting it may be a common feature of tree communities given sufficient environmental heterogeneity. While neutral theory (Hubbell 2001) might predict little or no habitat effects given the hyper-diversity of the local and regional tree community (Bass et al. 2010), we instead found consistent effects of environmental heterogeneity on species distributions within the plot, though they were often weak. We also found that dispersal limitation is pervasive in this forest as evidenced by the fact that most species were placed in a model category that included this process, which is counter to our hypothesis that the environment alone will be sufficient to describe most species distributions.

In our analyses we find that physiological and functional traits are correlated with key features of the spatial pattern of species. This broadens the utility of traits in community ecology by connecting them with spatially explicit measures of species distribution. For example, seed size was related to both the size and intensity of species clustering attributed to dispersal limitation. This could be due to seed size versus number tradeoffs, where larger seeded species have fewer offspring and therefore fewer individuals (Muller-Landau 2010). Alternatively, larger-seeded species in this plot may be preferentially dispersed by larger vertebrates such as toucans, toucanets and primates, leading to more widespread stem patterns. In line with our results, Seidler and Plotkin (2006) found that tree cluster size increased with seed mass and Russo et al. (2007) found that animal-dispersed tree species were less clustered at the 0-20m scale than those dispersed by gravity or wind. While dispersal limitation is often modeled as a stochastic process with respect to species (Lowe and McPeck 2014), these results suggest this process is determined in part by species traits. It may therefore be possible to predict the degree of dispersal limitation a species experiences using dispersal-related traits alone, which may inform studies of community dynamics, reforestation and forest management.

One of the strongest associations between traits and spatial properties was that ridge-associated species had more negative leaf turgor loss points than valley-associated species. This suggests that on average ridge-associated species may be more drought tolerant, though stomatal responses and stem and leaf hydraulic vulnerability data are lacking, which could be used to estimate thresholds beyond which hydraulic function is lost. While

leaf turgor loss point has been shown to shape topographic associations in seasonal tropical forests (e.g. Maréchaux et al. 2015, Bartlett et al. 2016), this study is the first to report this for an aseasonal forest. Amazonian forests are experiencing increased drought due to stronger and more intense El Niño events (Lewis et al. 2011), which may select for more drought tolerant species. For example, after the 2010 El Niño drought slope and ridge-associated species experienced lower mortality than those in valleys in a forest in the Colombian Amazon (Zuleta et al. 2017). This suggests droughts may cause ridge-associated species to increase in abundance and perhaps expand their elevational ranges.

Despite clear links between traits and species aggregation, many of the bivariate correlations between traits and spatial properties were somewhat weak or not significant. This is not unexpected as the spatial properties of species are a result of multiple processes acting over a variety of scales, thus any one functional trait may not be a strong predictor of spatial pattern. This lack of predictive ability could also be because traits have not been measured which may yield better predictive power. Predictive power increased somewhat in multivariate trait models, with largely similar results. This suggests that traits act in an integrative way to shape spatial structure. Our analysis of leaf lamina toughness extends previous work in the Yasuní FDP on this trait (Cardenas et al. 2014), which found that this trait, in combination with other leaf mechanical and chemical traits, predicted the degree of herbivore damage for 28 species. Lastly, our work on single species models of the most abundant species in the plot contrasts with previous analyses of community-weighted mean (CWM) trait values that compared observed trait distributions with a null model simulating random dispersal (Kraft et al. 2008, Kraft and Ackerly 2010). While this study

estimated the influence of additional habitat attributes including soil chemistry as well as properties of clustering due to dispersal limitation, these studies together suggest the abiotic environment and species traits have weak but consistent effects on community structure in this hyperdiverse forest.

A key result was that aggregated species with stronger clustering intensity were smaller, more resource acquisitive species. One possibility is that this result is driven by abundant, shrub-like species that have different spatial properties and traits than larger species. To examine this we compared the trait values and spatial properties of smaller-statured species ( $DBH_{max} < 10\text{cm}$ ) and larger-statured species ( $DBH_{max} \geq 10\text{cm}$ , Fig. S2.6 & 2.7). Smaller-statured species indeed had smaller and more dense clusters, but we found no difference in the trait values of the two groups. In addition, we examined the relationship between species abundance and spatial properties, and with traits (Fig. S2.8), and found most spatial properties and traits had no relationship with abundance. Counter to our expectations, more abundant species had lower clustering intensity, though the correlation was weak ( $r=-0.26$ ) and the relationship appeared triangular. More abundant species may be expected to cluster more intensely as a simple function of the number of individuals, but here we have estimated clustering intensity independent of aggregation due to the environment.

The generality of our findings should be further tested via comparisons with other tropical or temperate forests which differ in the strength of local environmental variation and in vertebrate seed disperser and predator community composition. For example, a recent

study (Clark et al. 2017) examined whether functional traits of trees and lianas predicted species spatial patterns in the Barro Colorado Island, Panama ForestGEO plot using a wavelet-based approach. While the study did not incorporate topographic or edaphic variation as model predictors and instead used canopy gaps, species with more resource conservative traits and larger statures were less spatially aggregated, which is in line with our results.

One potential limitation of our spatial modeling approach is that species may be aggregated due to unmeasured environmental variation, which could then be attributed to dispersal limitation in our analysis (Baldeck et al. 2013b). While we compiled detailed topographic and edaphic data, there is no existing canopy gap or light availability dataset for the Yasuní plot, which may be an important driver of aggregation for pioneer species. However, most gaps in Yasuní are small and pioneers make up a small fraction of the species and stems in the plot (Valencia et al. 2004). Further quantification of the abiotic environment such as light levels and canopy gaps could be included in future analyses, and this may increase the explanatory power of the environment. Another limitation is that the pattern of seed rain and thus cluster size is not determined solely by seed dispersal vectors such as wind, birds and mammals, but via topographic features that trap seeds and the distribution of reproductive adults, among other factors (Levine and Murrell 2003). This suggests that the clustering we observe may be shaped by additional factors besides dispersal limitation alone. Finally, it should be noted that conspecific negative density dependence would act to reduce the clustering of stems and is not estimated in this analysis.

## *Conclusions*

Spatial point process models provide tools to separate the effects of environmental filtering and dispersal limitation on community structure, and when combined with functional traits can indicate which aspects of plant morphology and physiology are linked to a specific process. Physiological traits in particular may better capture species responses to specific resources than traits that integrate multiple responses such as SLA. Additional studies that integrate spatially-explicit models of community dynamics with species traits are needed as communities become increasingly altered due to habitat loss, hunting and climate change.

## ACKNOWLEDGEMENTS

IM is grateful to M. Alvarado, A. Loor, A. Dietrick and S. Branco for field assistance. Leaf turgor loss point and fracture toughness collection was supported by University of Maryland, College Park (UMCP) and University of California, Los Angeles. We thank Joe Wright and Nancy Garwood for providing unpublished wood density and seed mass data. Wood density measurements were supported by the Frank Levinson Family Foundation. Seed mass collection efforts were supported by NSF grants DEB-0614525 and DEB-1122634. IRM thanks G. Shen for input on spatial analyses and Y. Onoda for assistance with building the penetrometer. We benefited from interactions with M. Vaz, C. Fortunel, G. Kandlikar, A. Kleinhesselink, L. Chen, M. Van Dyke, S. Ou, Y. Ding, K. Powell, A. Zanne, D. Gruner, M. Fitzpatrick and M. Neel. IM was partially supported by an NSF Graduate Research Fellowship (DGE-1650604) and ERC Advanced Grant #233066 awarded to TW. NK was partially supported by NSF DEB-1644641. IM thanks the Department of Biology at

UMCP, specifically the BEES graduate program. We thank Pontifical Catholic University of Ecuador, the Mellon Family Foundation, NSF, Smithsonian Tropical Research Institute and The Government of Ecuador (through Donaciones del Impuesto a la Renta) for funding the plot census. IM and NK designed the study with advice from TW. RV provided spatial structure data from the forest and NK provided leaf economics trait data. IM and MB collected leaf drought tolerance data and IM, MB and LS guided sampling and analysis of this trait. BT provided existing soils data and BT and IM collected soil N and P data. IM conducted analyses and led writing of the manuscript with substantial revisions from all authors. S.P. Hubbell provided comments on this manuscript.



## TABLES AND FIGURES

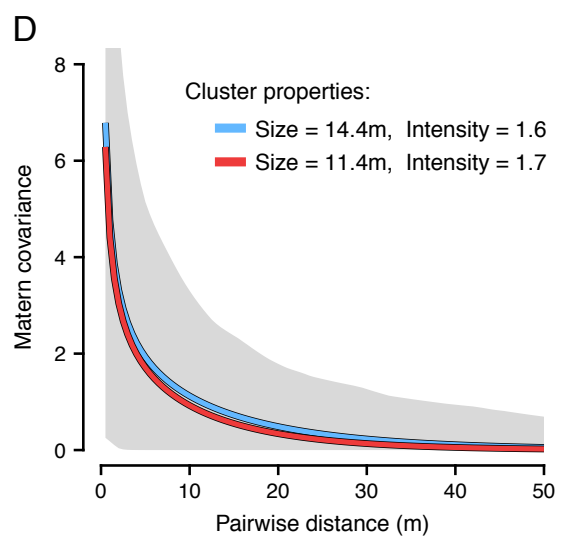
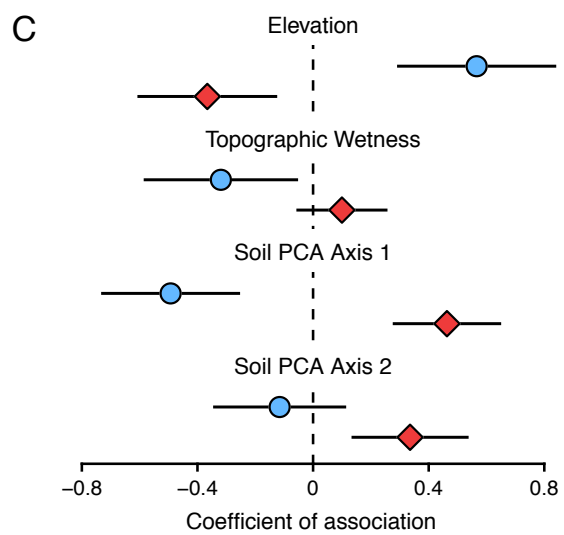
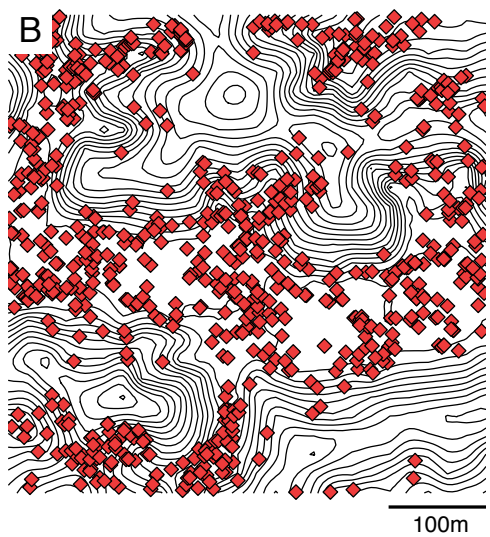
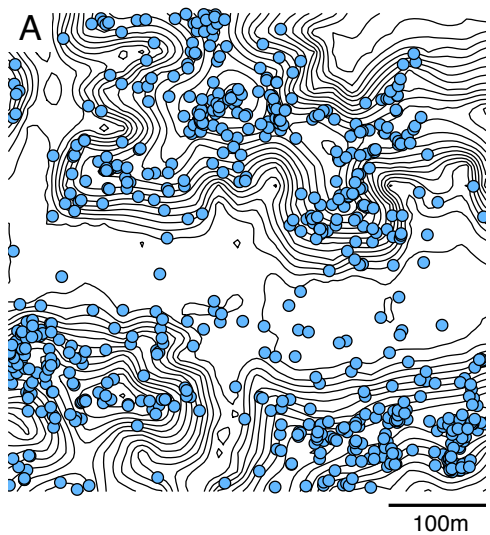
**Table 2.1:** Spatial model categories. Categories used to classify species based on spatial aggregation properties, the spatial models used to estimate parameters for species in each category in step two, and the parameters estimated from each spatial model. References: 1) Baddeley et al. 2016, 2) Jalilian et al. 2013, 3) Shen et al. 2013.

<b>Spatial aggregation category</b>	<b>Spatial model</b>	<b>Parameters estimated</b>
C1: Complete spatial randomness	Homogeneous Poisson <sup>1</sup>	None
C2: Habitat only	Heterogeneous Poisson <sup>1</sup>	Coefficients of association ( $\beta$ )
C3: Dispersal only	Thomas cluster process <sup>1</sup>	Cluster size ( $\alpha$ ) and intensity ( $\sigma^2$ )
C4: Habitat and dispersal	Log-Gaussian Cox process <sup>2,3</sup>	$\beta, \alpha, \sigma^2$

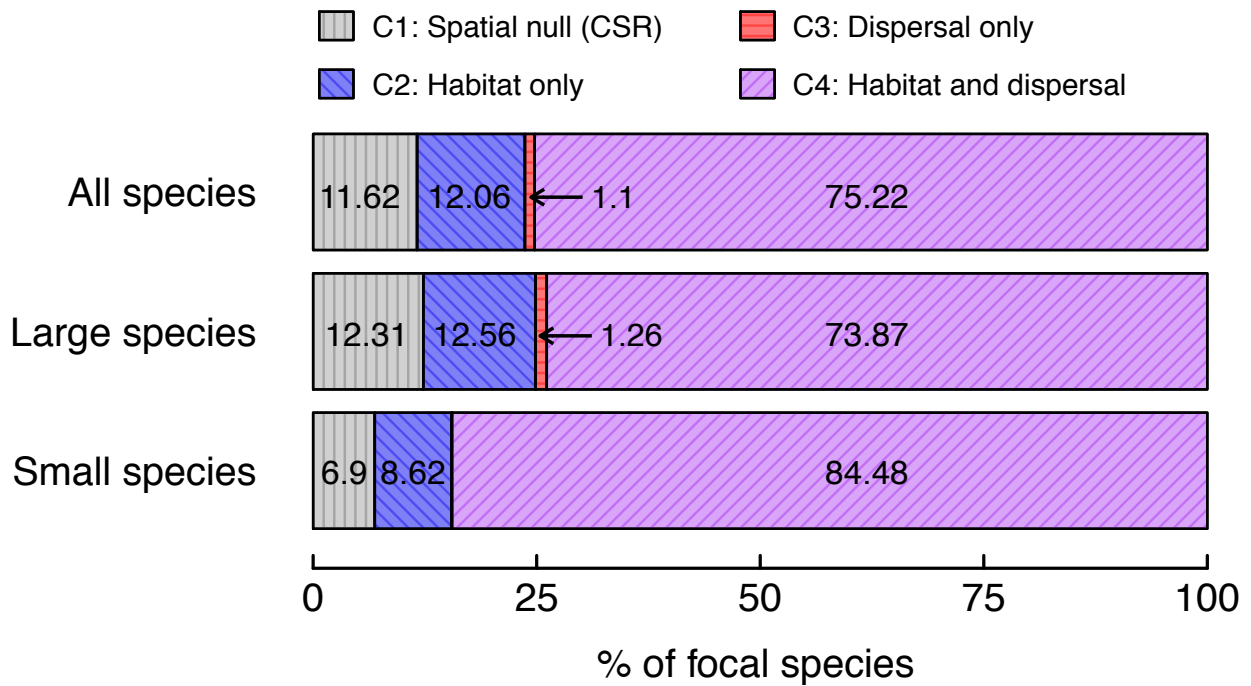
**Table 2.2:** Relationships between traits and spatial properties. Bivariate Pearson correlations between the leaf, wood, seed and stature traits used in the study and model parameters relating to habitat associations and dispersal limitation. The Benjamini-Hochberg correction for multiple comparisons was used when assessing significance, bold indicates a significant relationship. See Table S2.1 for p-values and degrees of freedom.

Functional trait	Spatial property					
	Elevation	TWI	Soil PCA 1	Soil PCA 2	Cluster size	Clustering intensity
Turgor loss point	<b>-0.41</b>	<b>0.36</b>	0.13	<b>0.29</b>	<b>-0.31</b>	0.04
Specific force to punch	<b>0.18</b>	<b>-0.27</b>	0.03	<b>-0.17</b>	<b>0.18</b>	<b>-0.23</b>
SLA	<b>-0.24</b>	<b>0.20</b>	0.06	<b>0.27</b>	-0.03	<b>0.20</b>
Leaf nitrogen concentration	<b>-0.17</b>	<b>0.20</b>	0.05	<b>0.18</b>	0.02	<b>0.12</b>
Wood density	<b>0.25</b>	<b>-0.25</b>	-0.15	-0.17	0.12	-0.12
Seed mass	-0.16	0.16	-0.19	-0.41	<b>0.35</b>	<b>-0.41</b>
Maximum DBH	<b>0.14</b>	0.06	<b>-0.18</b>	-0.10	<b>0.14</b>	<b>-0.28</b>

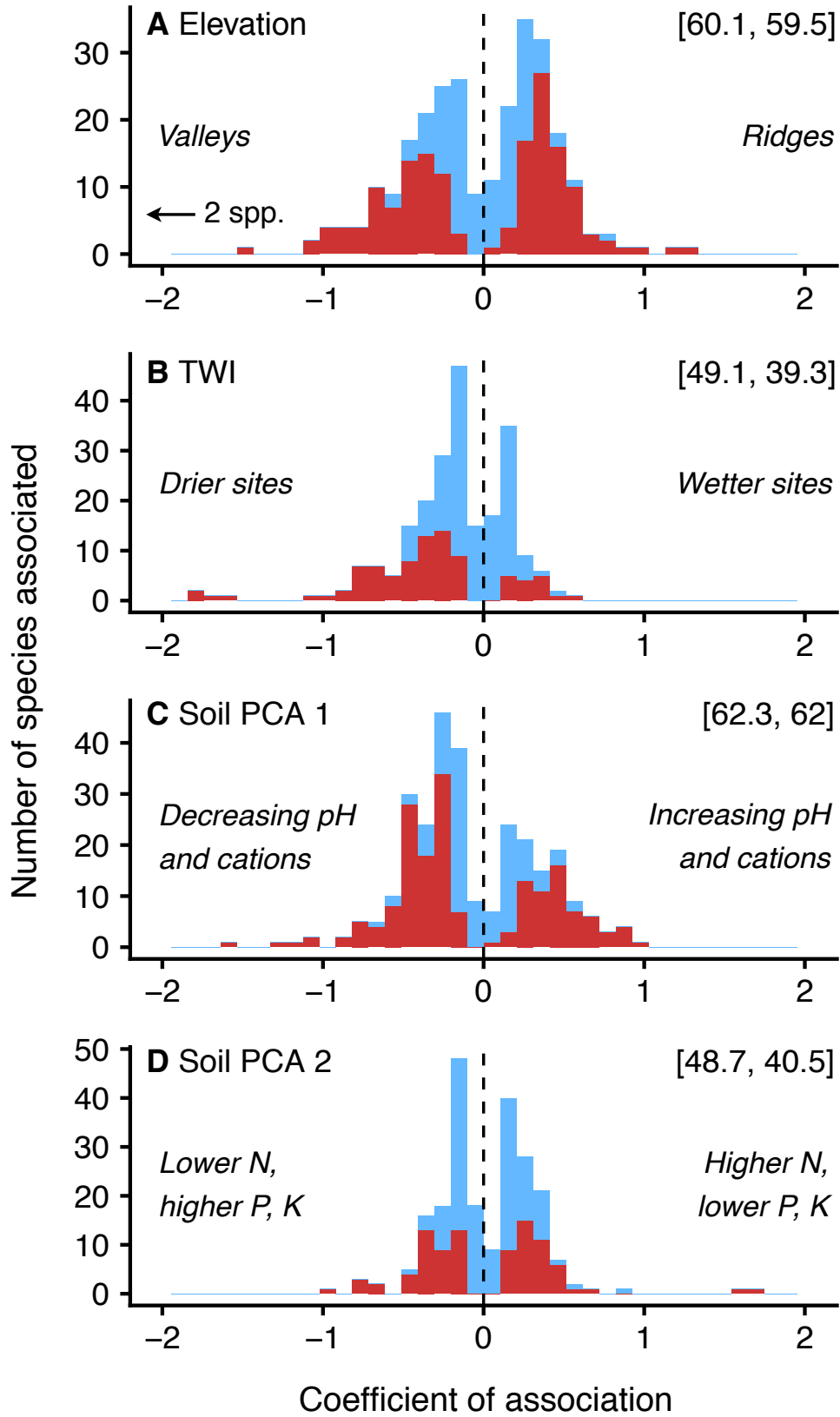
**Figure 2.1 (next page):** Visual primer of spatial point process modeling. Panels A and B are plot-wide stem maps, and panels C and D are model parameters for two exemplar species that are associated with different habitats but share similar clustering properties. Contours in A & B indicate plot topography. Light blue circles in A correspond to individual stems of *Faramea capillipes* (Rubiaceae). Panel C shows this species is positively associated with elevation, and is thus most often found on ridgetops and slopes, and is negatively associated with topographic wetness and soil PCA axis 1 (Fig. S2.2). Dark red diamonds in panel B are the stems of *Pentagonia williamsii* cf. (Rubiaceae), which are negatively associated with elevation but positively associated with both soil PCA axes. Horizontal bars in panel C represent 95% confidence intervals. The Matérn covariance function (MCF), which estimates the spatial correlation between pairs of stems within a species in the form of a dispersal kernel, is plotted for both species in panel D. Species cluster size and clustering intensity are used to calculate the MCF over a range of pairwise distances between stems. The grey polygon in panel D represents the 95% confidence interval of the MCF for the 348 species for which it was estimated, i.e. species in the ‘dispersal only’ or ‘habitat and dispersal’ categories.



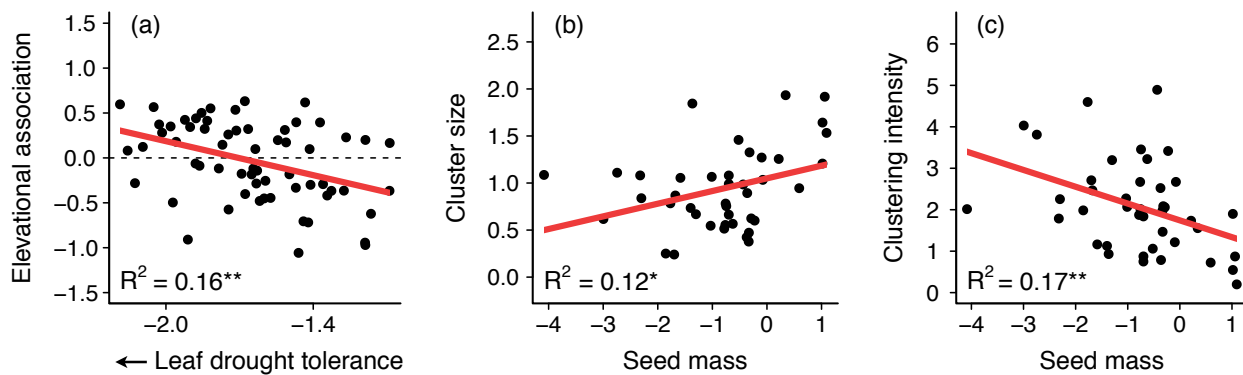
**Figure 2.2:** Percentage of focal species assigned to each of the four spatial aggregation categories (see Table 2.1). The majority of species (75.2%, 343/456) are best described by a model which incorporates both habitat associations and dispersal limitation ('habitat and dispersal', C4). Results are similar when only species with maximum DBH  $\geq 10$ cm are included ('Large species', N=398), while when only species with maximum DBH  $< 10$ cm are included ('Small species', N=58) no species remain in the 'dispersal only' category (C3) and more fall in the 'habitat and dispersal' (C4) category.



**Figure 2.3 (next page):** Frequency distribution of habitat coefficient values for the four environmental attributes. Species with significant positive or negative associations (95% confidence interval does not overlap zero) are in dark red, and species without significant association (confidence interval overlaps zero) are in light blue. Numbers in brackets indicate the percentage of species associated with the environmental attribute after model reduction (left), and the number of significant associations within this reduced group (right). *Italicized text gives the environmental attributes of the gradient extremes.* Fig. S2.4 gives the complete set of confidence intervals. Note in A two species with extreme spatial distributions were excluded for visual clarity and are shown in Fig. S2.9.



**Figure 2.4:** Functional traits are related to spatial properties across species. A: Species positively associated with elevation (i.e. ridge associated species) tend to have higher leaf drought tolerances, i.e. a more negative leaf turgor loss point. B & C: Seed mass is positively related to cluster size and negatively related to clustering intensity, such that larger-seeded species have fewer stems per cluster. A: N=64, B & C: N=41. Red lines are linear OLS fits, \*\*=  $p < 0.01$ , \* =  $p < 0.05$ . Leaf drought tolerance has units of megapascals (MPa), and seed mass is in log grams. Units of cluster size are log meters and elevational association and clustering intensity are unitless. In A one outlier, *Capparis sola*, was removed for visual clarity, which when included increases  $R^2$  to 0.17.





SUPPLEMENTARY MATERIAL: Supporting tables and figures for Chapter 2

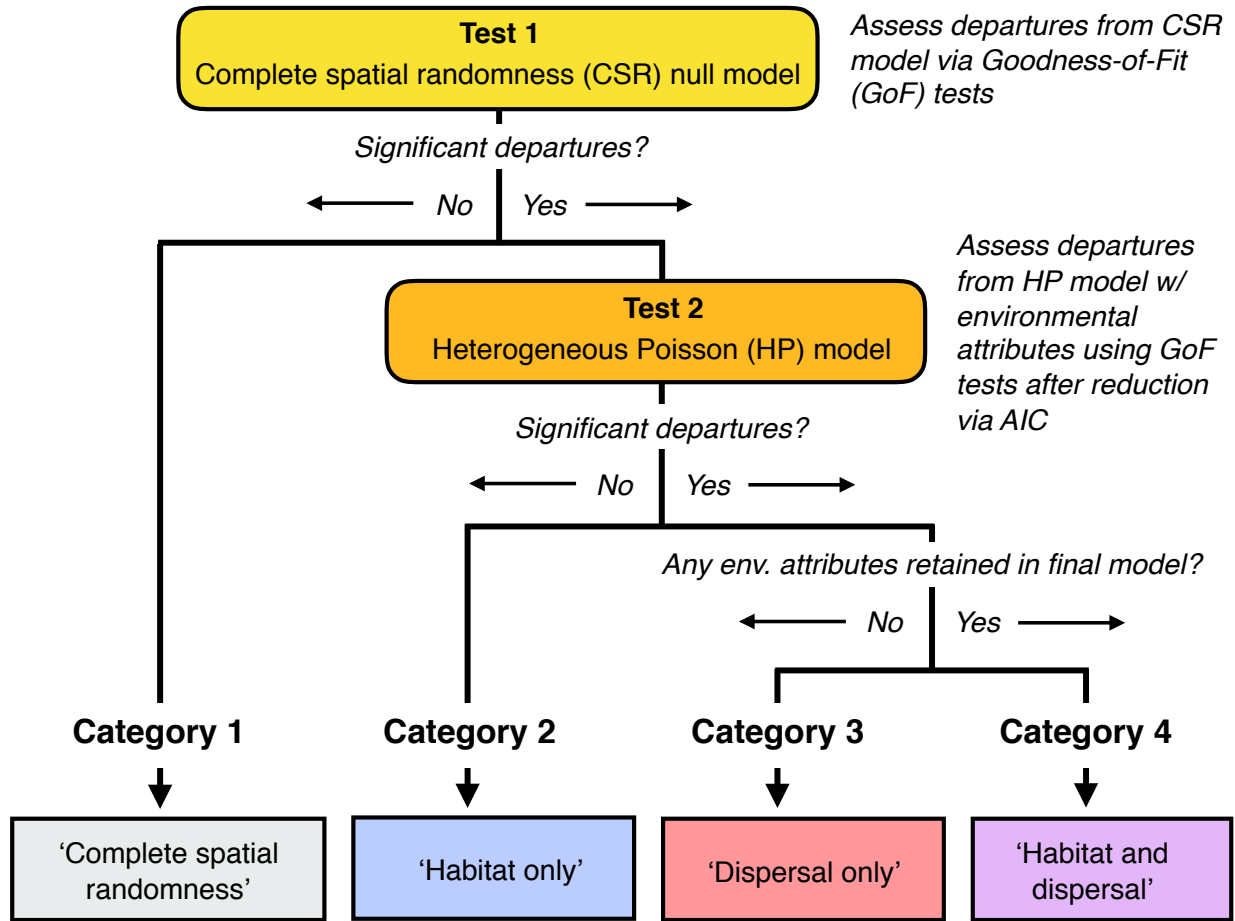
**Table S2.1:** Correlations, p-values and degrees of freedom for all pairwise comparisons of functional traits and spatial properties.

Functional trait	Parameter	Spatial property					
		Elevation	TWI	Soil PCA 1	Soil PCA 2	Cluster size	Clustering intensity
Turgor loss point	r	-0.41	0.36	0.13	0.29	-0.31	0.04
	p-value	0.004	0.022	0.366	0.046	0.018	0.738
	df	62	47	62	58	74	74
Specific force to punch	r	0.18	-0.27	0.03	-0.17	0.18	-0.23
	p-value	0.012	<0.001	0.647	0.024	0.004	<0.001
	df	269	219	279	219	343	343
SLA	r	-0.24	0.20	0.06	0.27	-0.03	0.20
	p-value	<0.001	0.011	0.366	<0.001	0.617	0.001
	df	269	219	280	217	342	342
Leaf nitrogen concentration	r	-0.17	0.20	0.05	0.18	0.02	0.12
	p-value	0.012	0.008	0.48	0.019	0.738	0.044
	df	271	220	281	219	344	344
Wood density	r	0.25	-0.25	-0.15	-0.17	0.12	-0.12
	p-value	0.005	0.006	0.063	0.056	0.104	0.108
	df	174	154	186	145	224	224
Seed mass	r	-0.16	0.16	-0.19	-0.41	0.35	-0.41
	p-value	0.415	0.522	0.366	0.063	0.044	0.018
	df	34	19	32	23	39	39
Maximum DBH	r	0.14	0.06	-0.18	-0.10	0.15	-0.28
	p-value	0.04	0.415	0.009	0.185	0.018	<0.001
	df	272	222	282	220	346	346

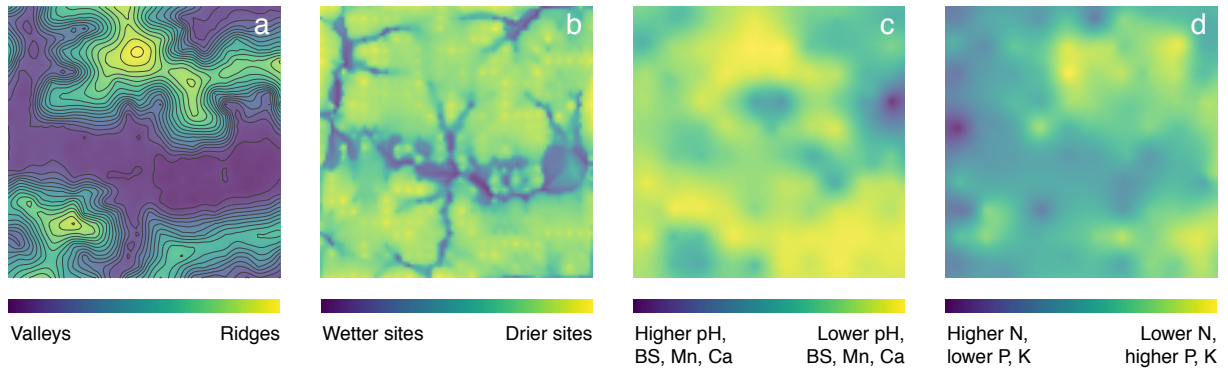
**Table S2.2:** Multivariate regressions predicting spatial properties of species from multiple functional traits. Backwards selection via AIC was used to determine final trait predictor sets. \*\*\*=  $p < 0.001$ , \*=  $p < 0.05$ , ns=not significant, -- indicates a trait was not retained in the final model. TLP: Turgor loss point,  $F_{ps}$ : Specific force to punch, SLA: Specific leaf area,  $DBH_{max}$ : 95<sup>th</sup> percentile of DBH. A log-Gaussian Cox process ‘habitat and dispersal’ model (C4) was used for all species this analysis in order to obtain sufficient sample size.

Spatial property	R <sup>2</sup>	df	Functional trait						
			TLP	$F_{ps}$	SLA	Leaf N	Wood density	Seed mass	$DBH_{max}$
Elevation	0.30***	74	-0.41	--	0.56	-1.03	--	0.14	-0.31
TWI	0.17***	77	0.28	--	--	--	--	--	0.23
Soil PCA Axis 1	0.09 (ns)	76	0.3	0.65	--	--	-0.53	--	--
Soil PCA Axis 2	0.10*	77	0.15	--	--	0.27	--	--	--
Cluster size	0.24***	75	-0.31	0.84	0.97	--	--	0.09	--
Clustering intensity	0.24***	76	--	--	1.43	--	--	-0.39	-0.62

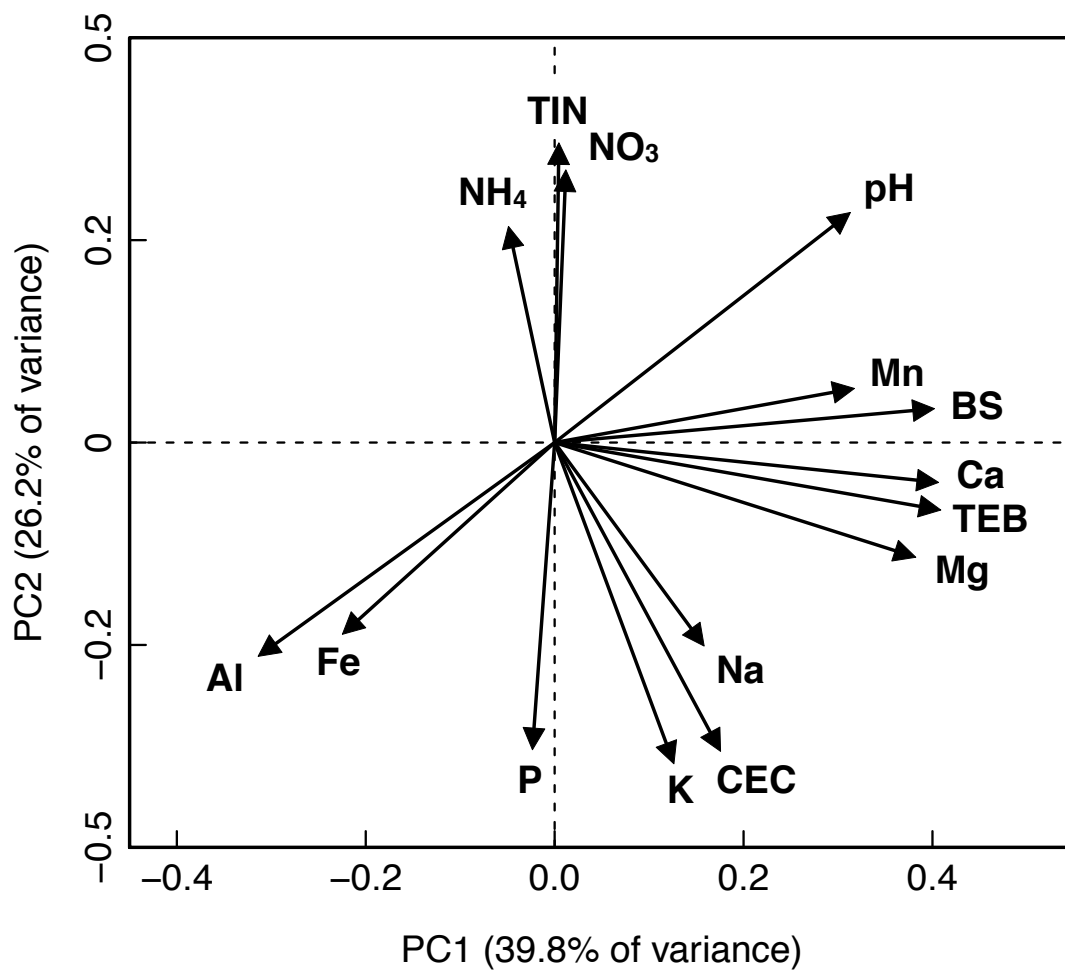
**Figure S2.1:** Decision tree used to assign species to spatial aggregation categories.



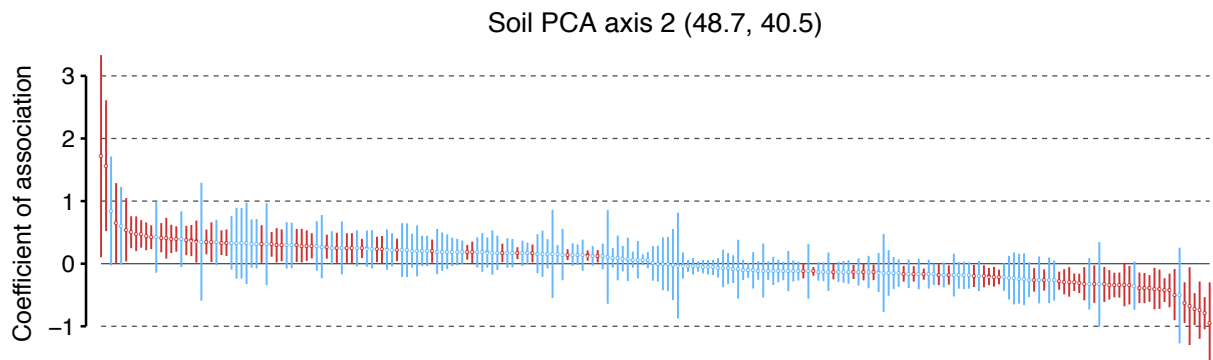
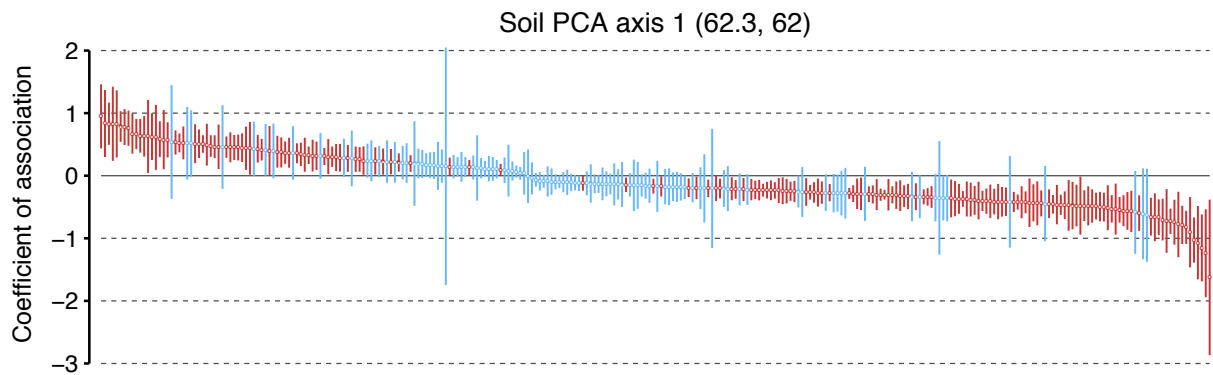
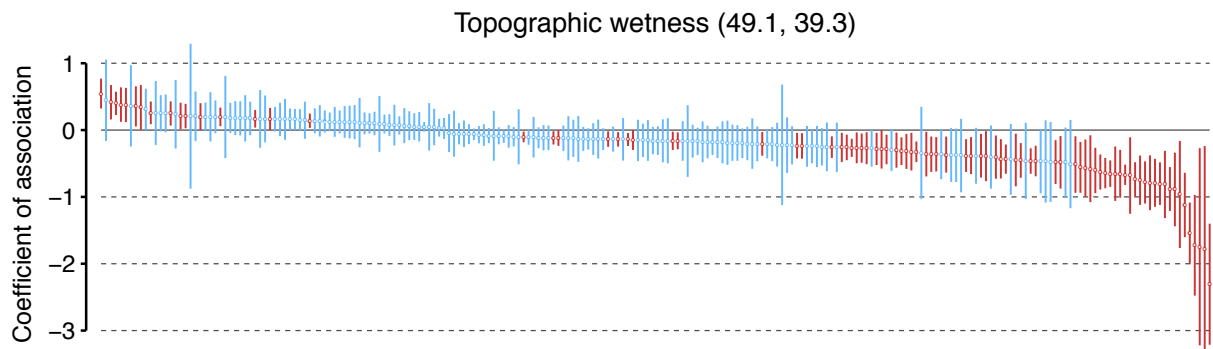
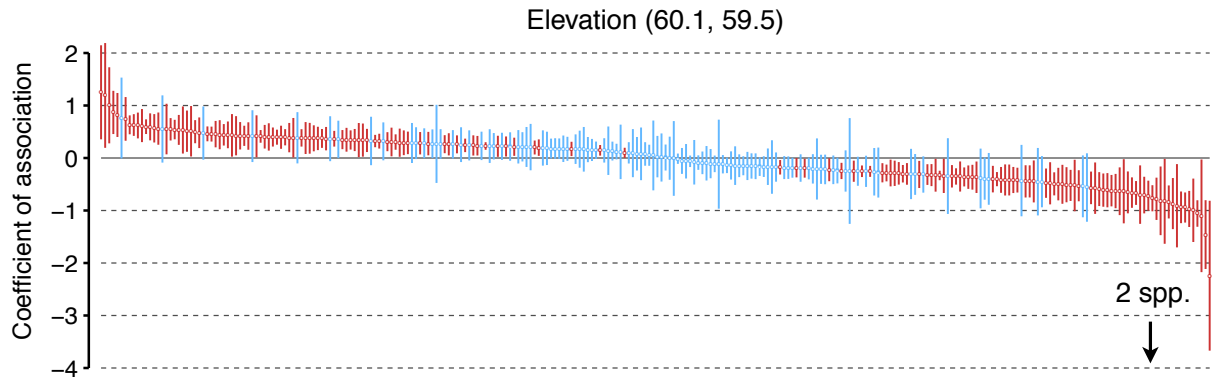
**Figure S2.2:** Environmental attributes used in the spatial model mapped at 5x5m resolution. Panel a: elevation with superimposed topographic lines, b: Topographic Wetness Index (TWI), c-d: PCA axes 1 and 2 respectively for 15 soil nutrient and chemistry properties (see Fig. S2.3 for complete set of soil properties). The TWI in panel b is highest (dark blue) in flatter regions with large amounts of upslope area, which correspond to streams and areas prone to flooding in the plot. In c and d darker colors represent higher PCA axis values.



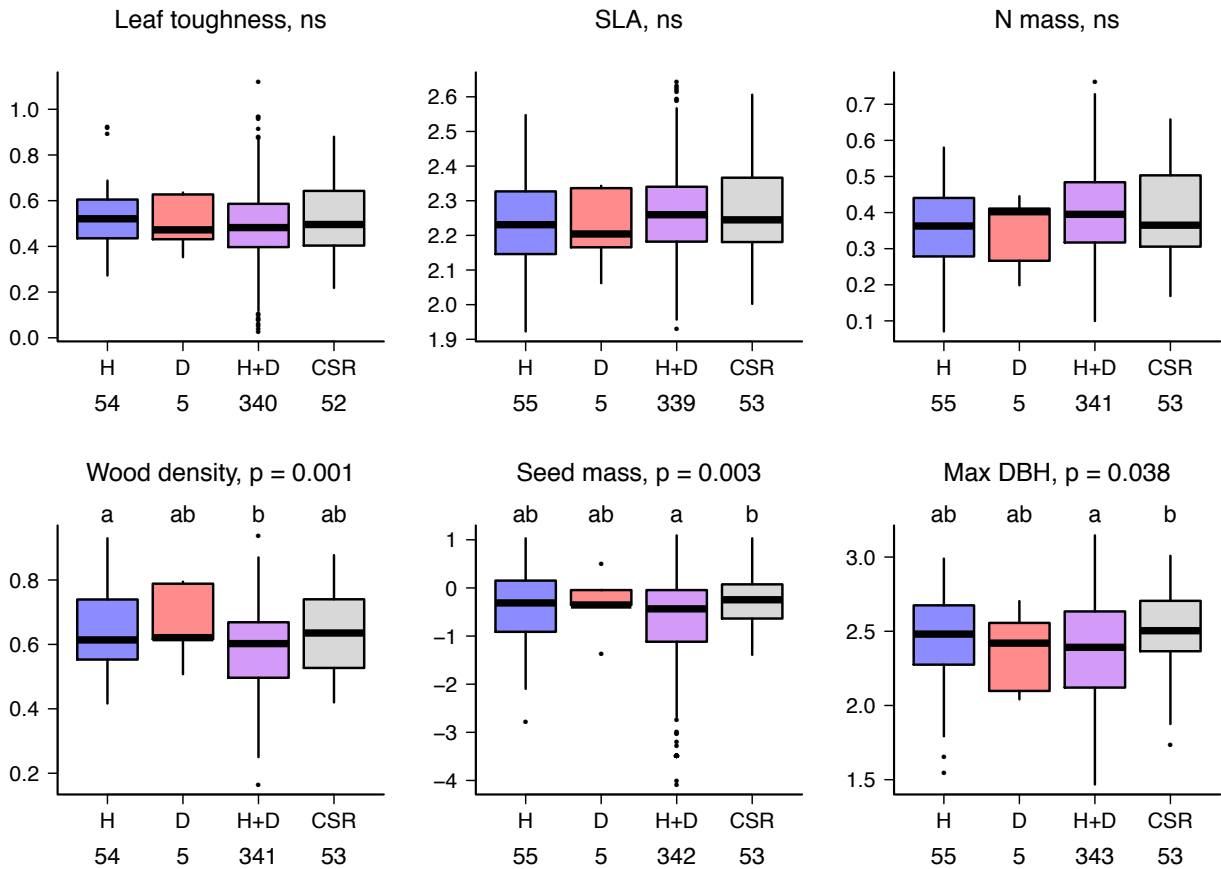
**Figure S2.3:** PCA axis loadings for the 15 soil properties used to make soil nutrient maps in Fig. S2.2C & D. TIN: total inorganic nitrogen, BS: base saturation, TEB: total exchangeable bases, CEC: cation exchange capacity.



**Figure S2.4 (next page):** Standardized coefficients of association between focal species and the four environmental attributes, shown as 95% confidence intervals. Species with confidence intervals that do not overlap zero are considered significantly associated and are in red, while those with confidence intervals overlapping zero are in blue. The first number in the parentheses is the percentage of species associated with the environmental attribute after model selection (out of 456 focal species), while the second is the percentage of species shown for which this association is significant. Note two species with extreme associations with elevation are shown in Fig. S2.9 instead of in the top panel.

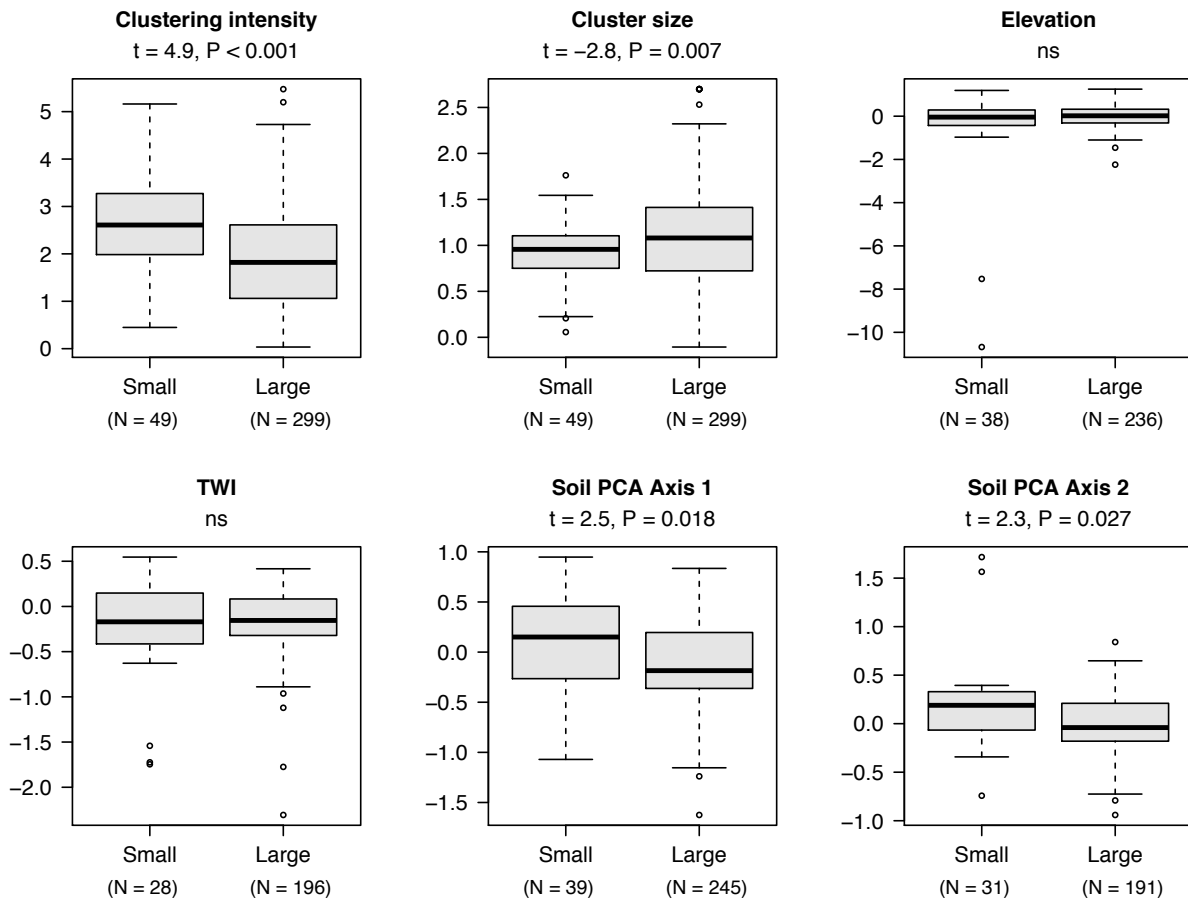


**Figure S2.5:** Boxplots comparing trait values of species across the four spatial model categories. Wood density, seed mass and max DBH differ significantly among model groupings. H: habitat only, D: dispersal only, H+D: habitat and dispersal, CSR: complete spatial randomness (spatial null), see *Methods* and Table 2.1 for description of spatial model categories. P-values are from overall ANOVAs across all groups, ns=not significant. Letters indicate pairwise differences from Tukey's HSD tests.

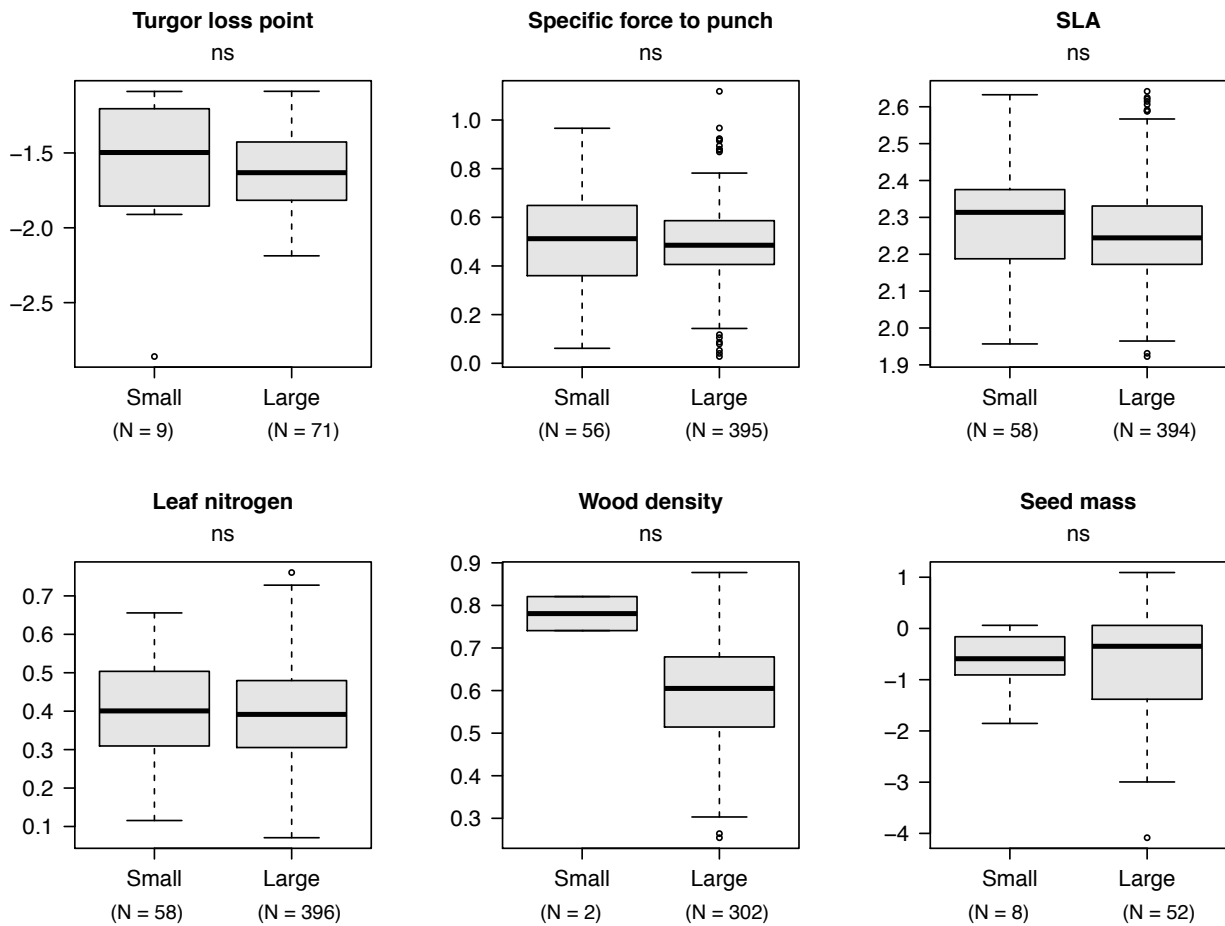




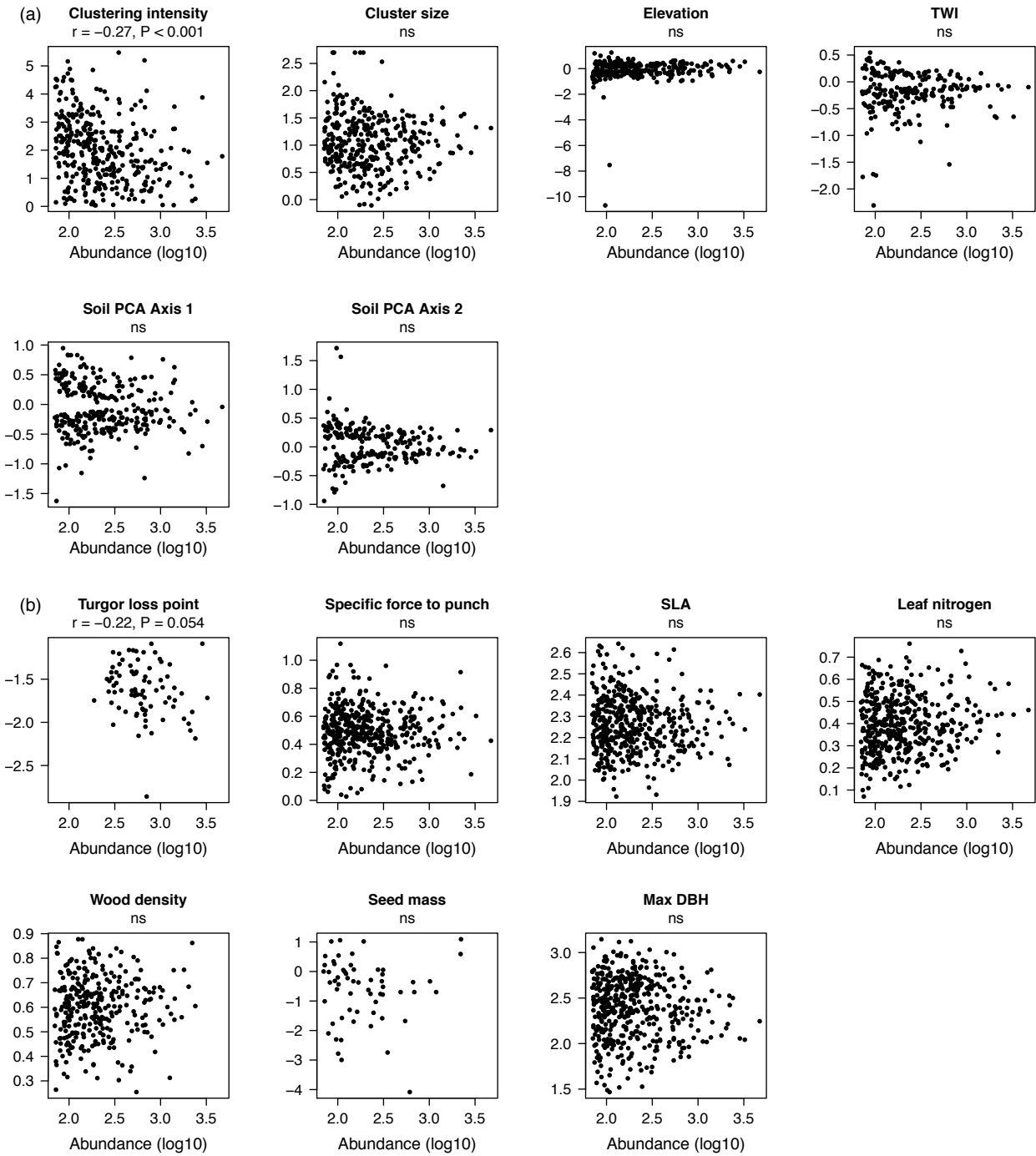
**Figure S2.6:** Spatial properties of small vs. large-statured species. Smaller-statured species have more dense and smaller clusters, and tend to be more positively-associated with both soil PCA axes (Fig. S2C & D). Smaller-statured species are those with 95<sup>th</sup> percentile of DBH ( $DBH_{max}$ ) < 10cm and larger-statured species are those with  $DBH_{max} \geq 10$ cm. P and t-values are from unpaired t-tests, ns=not significant. The number of species in each group with a given spatial property is indicated below boxplots. Units: Clustering intensity is unitless, cluster size is in log meters and all other dependent variables are standardized coefficients of association with environmental attributes.



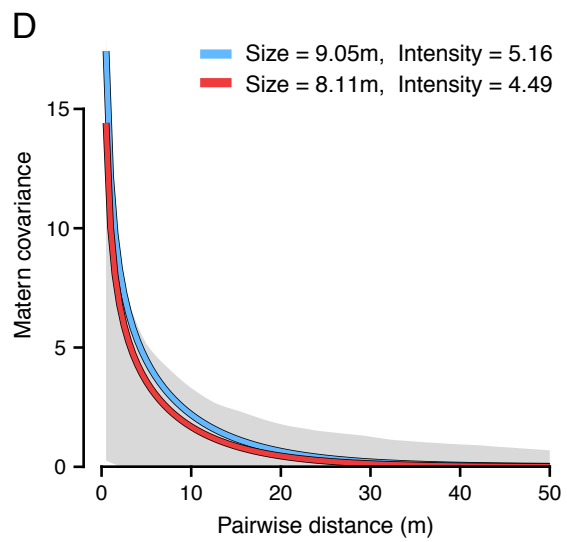
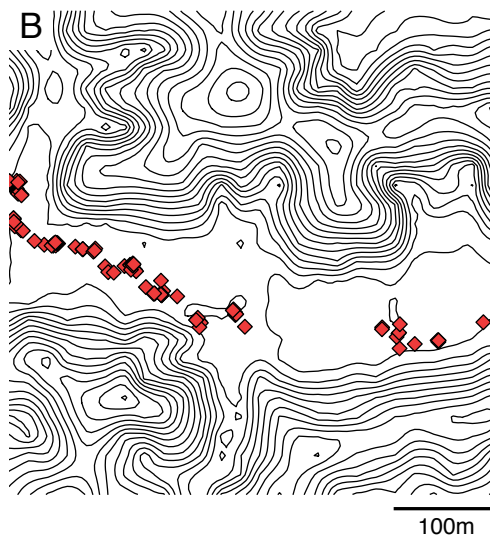
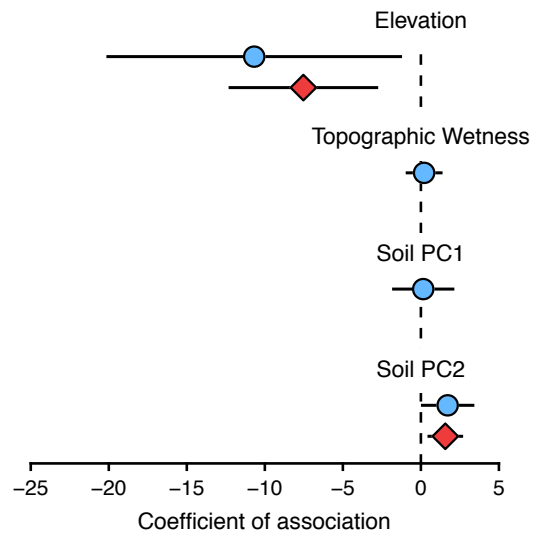
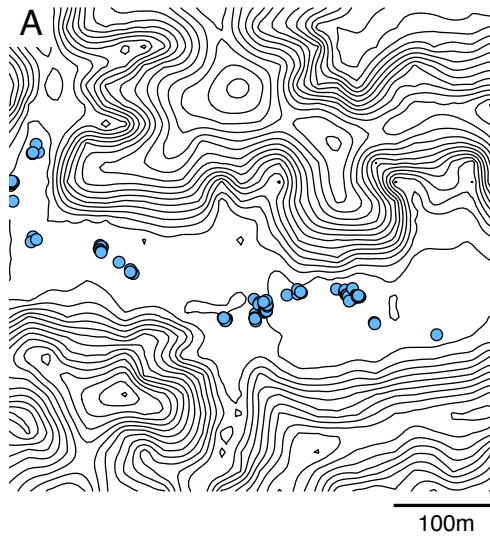
**Figure S2.7:** Trait values of small vs. large-statured species. No trait differed significantly between small and large-statured species in unpaired t-tests. DBH size cutoffs are as in Fig. S2.6, the number of species in each group with a given trait value is indicated below the boxplots.



**Figure S2.8 (next page):** Correlations between species abundances and spatial properties (a), and the eight focal functional traits (b). Note a significant relationship exists for clustering intensity, while turgor loss point is marginally significant and all others are not significant.



**Figure S2.9 (next page):** Stem maps and log-Gaussian Cox process (LGCP) parameters for two species with extreme spatial distributions: *Acalypha 'sharpdent'* (Euphorbiaceae), with stems denoted as blue circles in panel A, and *Aphelandra crispate* (Acanthaceae) denoted with red diamonds in panel B. Both species have strong negative associations with elevation (panel C) and are found exclusively along streams within the plot. Both species also have small and intense clusters (panel D). As in Fig. 2.1, horizontal bars in panel C represent 95% confidence intervals and a species is considered significantly associated with an environmental attribute if the interval does not overlap zero. Similarly, the grey polygon in panel D represents the 95% confidence interval of the value of the Matérn covariance function for the 348 species for which it was estimated.



### *Supplemental Soils Analysis Methods*

The soil properties used in this study (Fig. S2.2 & 2.3) include total inorganic nitrogen (TIN), NH<sub>4</sub> (ammonium), NO<sub>3</sub> (nitrate), P, K, pH, cation exchange capacity (CEC), base saturation (BS), total exchangeable bases (TEB), Al, Ca, Fe, Mg, Mn and Na. Soil nitrogen (TIN, NH<sub>4</sub>, NO<sub>3</sub>) and P were quantified in 2015 using resin extraction from resin bags deployed at a depth of 10 cm for ~1 month. Bags were cleaned in deionized water, extracted in 75 mL of 0.5 M HCl, and analyzed by automated colorimetry on a Lachat Quikchem 8500 (Hach Ltd., Loveland, USA). Exchangeable cations were measured on air-dried and sieved (<2mm) soils from the surface 10cm. Soils were extracted in 0.1 M BaCl<sub>2</sub> (2 h, 1:20 soil to solution ratio) with detection by inductively-coupled plasma optical emission spectrometry on an Optima 7300 DV (Perkin Elmer, Shelton, USA). Both resin bags and bulk soil were sampled in a 50 m grid across the plot following established ForestGEO protocols (e.g. John et al. 2007, Baldeck et al. 2013a) and then spatially averaged to yield individual nutrient maps. These values were then combined in a PCA (Fig. S2.3) to create maps of the two major orthogonal axes of soil variation across the plot: soil cations (axis 1, Fig. S2.2C) and major soil nutrients (NPK, axis 2, Fig. S2.2D).

### *References*

1. John R, *et al.* (2007) Soil nutrients influence spatial distributions of tropical tree species. *Proceedings of the National Academy of Sciences* 104(3):864-869.
2. Baldeck CA, *et al.* (2013) Habitat filtering across tree life stages in tropical forest communities. *Proceedings: Biological Sciences* 280(1766):1-8.

## CHAPTER 3

# Climate shapes latitudinal gradients in plant taxonomic and phylogenetic $\beta$ diversity across the Americas

This manuscript is currently in revision as McFadden, I.R., Sandel, B., Tsirogiannis, C., Morueta-Holme, N., Svenning, J.-C., Enquist, B.J. and Kraft, N.J.B. Climate shapes latitudinal gradients in plant taxonomic and phylogenetic  $\beta$  diversity across the Americas.

### ABSTRACT

Latitudinal and elevational richness gradients have received much attention from ecologists but there is little consensus on underlying causes. One possible proximate cause is that the tropics have increased levels of species turnover, or  $\beta$  diversity, compared to temperate regions. Here, I leverage a large botanical dataset to map taxonomic and phylogenetic  $\beta$  diversity across the Americas and determine the climatic drivers of turnover. I find taxonomic  $\beta$  diversity and terminal-weighted phylogenetic  $\beta$  diversity is higher in the tropics, but that basal-weighted phylogenetic  $\beta$  diversity is highest in temperate regions. Supporting Janzen's 'mountain passes' hypothesis, tropical mountainous regions had higher  $\beta$  diversity than temperate regions for taxonomic and terminal-weighted metrics. The strongest climatic predictors of all forms of turnover were annual mean temperature and temperature seasonality. Taken together, these results suggest  $\beta$  diversity influences latitudinal richness gradients and that temperature is a major driver of plant community composition and change.



## INTRODUCTION

The global distribution of biodiversity is highly heterogeneous. A core aim of both community ecology and biogeography is to determine how this variation is created and maintained (MacArthur 1972, Gaston 2000). Gradients in  $\alpha$  diversity across latitude and elevation in particular are a common pattern in many taxonomic groups, but there is still much debate about which processes have acted to create them (Hillebrand 2004, Schluter 2016). One potential way to infer how richness gradients are formed is to examine patterns of species turnover across localities, or  $\beta$  diversity (Harrison et al. 1992, Anderson et al. 2011). For example, it has been hypothesized that the higher diversity of the tropics may be caused by increased endemism and smaller range sizes, which could lead to higher species turnover compared to temperate regions (Stevens 1989, Koleff et al. 2003). The degree to which turnover is explained by geographic distance, regional or  $\gamma$  diversity, or topoclimatic variation can suggest which mechanism or combination of mechanisms may be driving richness gradients (McKnight et al. 2007, Qian and Ricklefs 2007, Kraft et al. 2011).

While classical measures of  $\beta$  diversity focus solely on the turnover of species, further insights may come from a consideration of turnover in additional dimensions of biodiversity (Graham and Fine 2008, Swenson 2011). Phylogenetic  $\beta$  diversity for example can quantify turnover in the evolutionary relatedness of assemblages across space and at both deep and shallow nodes (Graham and Fine 2008). Contrasting patterns of phylogenetic  $\beta$  diversity can therefore suggest whether community composition is most

influenced by ancient or more recent speciation events (e.g. Duarte et al. 2014). In addition, phylogenetic  $\beta$  diversity metrics can detect community similarity when two focal communities share few or no species, which is particularly useful in highly diverse regions where this is often the case (e.g. Fine and Kembel 2011). Examining taxonomic and phylogenetic  $\beta$  diversity can provide insights into both contemporary ecological and historical evolutionary and biogeographic factors shaping variation in local assemblages (Ricklefs 1987, Graham and Fine 2008).

While high rates of turnover within a region will tend to increase its richness compared to regions with lower turnover (Koleff et al. 2003), the amount of turnover alone provides little information about the processes that drive differences in diversity across regions (Mittelbach et al. 2007). One key process thought to influence species turnover is variation in climate, which can be amplified by elevational range and topographic complexity (Qian and Ricklefs 2007, Melo et al. 2009, Slavich et al. 2014). For example, Janzen's 'mountain passes' hypothesis states that the greater interannual temperature stability of tropical mountains compared with temperate mountains should lead to narrower thermal tolerances in tropical species compared to those in the temperate zone (Janzen 1967). The increased temperature stability of tropical regions, including longer-term stability at geological timescales (Dynesius and Jansson 2000), may lead to higher rates of allopatric speciation and thus higher species turnover (Janzen 1967, Ghalambor et al. 2006).

To date, many studies of  $\beta$  diversity have been focused at or below regional scales, often on narrowly defined taxonomic groups (e.g. Harrison et al. 1992, Novotny et al. 2007, Morlon

et al. 2011), with some important exceptions (McKnight et al. 2007, Kraft et al. 2011). It is therefore unclear whether drivers of turnover at small scales are the same at regional or continental scales. Here I use the Botanical Information and Ecology Network (BIEN, Enquist et al. 2016), a database that includes plant occurrences, modeled ranges and evolutionary relationships for over 81,000 species, to map and explore the topographic and climatic drivers of large-scale  $\beta$  diversity patterns across the Americas. This study has two main aims: to determine if taxonomic and phylogenetic  $\beta$  diversity vary systematically with latitude and elevation across the Americas, using metrics that largely control for the influence of regional or  $\gamma$  diversity, and to assess the climatic and topographic correlates of  $\beta$  diversity across this region. I hypothesize i) that the tropics will have overall higher  $\beta$  diversity than temperate regions, ii) that tropical mountains will have higher  $\beta$  diversity than temperate mountains as predicted by theory (Janzen 1967), and iii) that favorable climates (e.g. warm, low temporal variation etc.) will tend to increase  $\beta$  diversity. I find  $\beta$  diversity is higher in the tropics than the temperate zone for both taxonomic and tip-weighted phylogenetic measures but that a reverse latitudinal gradient exists in the turnover of deeper phylogenetic structure. Temperature was the strongest predictor of turnover, suggesting ongoing climate change may reshape patterns of biodiversity across the Americas.

## METHODS

### *Quantifying latitudinal and elevational $\beta$ diversity gradients*

To test my hypotheses about latitudinal trends and climatic correlates of  $\beta$  diversity I used modeled ranges and phylogenetic data for more than 81,000 vascular land plants found in

the Americas using the BIEN2 database (Enquist et al. 2016), which includes both collection records and plot-based observations. Species ranges were modeled via three different methods based on the total number of observations. For species with five or more observations ranges were modeled via MaxEnt (Phillips and Dudík 2008) using climatic data from World-Clim (Hijmans et al. 2005) and spatial filters to incorporate non-climatic factors such as dispersal limitation. For species with three to four observations convex hulls were used to determine range boundaries and for species with fewer than three observations ranges were defined as a 75,000 km<sup>2</sup> bounding box around occurrences. More details on range size estimation can be found in Goldsmith et al. (2016). Then, the land area of the Americas was divided into 100×100km grid cells and the species assemblage of each grid cell was defined as all species with ranges falling within the cell.

To examine  $\beta$  diversity patterns in space I included as focals only cells with seven or eight occupied neighboring cells, which caused some cells at continental margins and on islands to be removed. I then averaged the pairwise  $\beta$  diversity of the focal cell and all of its neighboring cells, 7-8 pairwise comparisons, to yield a single mean  $\beta$  diversity value for the focal cell. This value represents the average turnover across an area of 90,000km<sup>2</sup> in the case of a focal cell with eight neighbors and 80,000km<sup>2</sup> for cells with seven neighbors. I defined the tropics as the land area between 23.5 and -23.5 degrees of latitude and areas to the north and south of this band as the temperate zone. Mountainous areas were delineated following the United Nations Environment Programme (UNEP) definition based on elevation, slope and several other criteria (Blyth et al. 2002). The ~0.01<sup>2</sup> latitude resolution map of mountainous areas was upscaled and re-projected to 100×100km cells

and areas with fewer than three mountainous cells were excluded to focus solely on mountain ranges.

I mapped  $\beta$  diversity using one taxonomic and two phylogenetic metrics. I calculated phylogenetic metrics with a phylogeny of 81,274 terrestrial vascular plants assembled via the software program PHLAWD (Smith et al. 2009) from the BIEN2 database (Enquist et al. 2016). To minimize the influence of regional diversity I chose multivariate pairwise metrics in which  $\gamma$  is not included in calculations of  $\beta$  (Bennett and Gilbert 2016). Specifically, I used multivariate pairwise metrics that quantify the fraction of species or branch length unique to a single community in a pair of focal communities, as well as the average pairwise phylogenetic distance between members of two communities. I measured taxonomic  $\beta$  diversity with Jaccard dissimilarity, the fraction of species unique to a single community, and tip-weighted phylogenetic  $\beta$  diversity via the unique fraction of branch length (UniFrac, Lozupone and Knight 2005), a phylogenetic analog of Jaccard. Both Jaccard and UniFrac metrics are most sensitive to shallow turnover near the tips of phylogenies either in the form of species turnover or the turnover of more recently-diverged clades.

As an alternative, I estimated the turnover of earlier-diverging clades via the community distance phylogenetic  $\beta$  diversity metric, also called  $D_{pw}$  (Webb et al. 2008), which more heavily weights deeper divergences at the root of the phylogeny.  $D_{pw}$  measures the mean pairwise phylogenetic distance between all species pairs in both communities being compared and is therefore the multi-community equivalent of mean pairwise distance (MPD) at the level of a single community.  $D_{pw}$  more heavily weights deeper divergences

because measuring the pairwise distance between species often necessitates traversing to the root of the shared phylogeny. These three metrics can therefore be used to assess the relative contribution of ecological sorting, recent speciation and past extinctions and divergence events to diversity gradients across latitude and elevation. To determine whether  $\beta$  diversity patterns show latitudinal trends I regressed the  $\beta$  diversity of each focal cell with absolute latitude and compared tropical and temperate regions with two-sided *t*-tests. BIC was used to select the best regression model from among linear, exponential, 2<sup>nd</sup> and 3<sup>rd</sup> degree polynomial fits. To compare  $\beta$  diversity between tropical and temperate mountainous regions I subsetted the data to only mountains regions and reanalyzed the data in the same way.

#### *Climatic and topographic drivers of $\beta$ diversity*

To determine the climatic and topographic correlates of  $\beta$  diversity for the Americas I examined the spatial association between  $\beta$  diversity and several topoclimatic variables via both linear regression and multivariate simultaneous autoregressive (SAR) modeling following Kissling and Carl (2008) and Morueta-Holme *et al.* (2013). I used elevational range (m) within a cell to capture fine-scale topographic variation, as this contributes to the diversity of environmental variation in a given area (i.e. 'topoclimate' effects, Slavich *et al.* 2014). Annual precipitation (mm) and mean annual temperature (MAT, °C) were also included as these are important drivers of plant productivity and biome distribution (Whittaker 1970). Finally, I used temperature seasonality (TSEA, °C) to capture annual variability and late quaternary climate-change velocity (m/yr, Sandel *et al.* 2011) for longer-term variation in temperature. Climate-change velocity is a measure of how fast a

species would need to move to track a given change in climate (Loarie et al. 2009) and in this case incorporates climatic changes in MAT since the last glacial maximum ~21k years ago. For example, northeastern North America was covered by the Laurentide Ice Sheet during the last glacial maximum but has since warmed considerably– this region therefore has high late quaternary climate-change velocity (see Fig. S3.1E). I obtained climate-change velocity data from Sandel et al. (2011) and all other topoclimatic variables from the WorldClim database (V1.4, Hijmans et al. 2005) averaged over the years ~1960-1990. To match the scale of  $\beta$  diversity observations, topoclimatic predictor values for each cell were calculated as the average of the focal cell and all adjoining neighbors.

To examine how single topoclimatic variables influence  $\beta$  diversity I first regressed each  $\beta$  diversity metric against all climatic and topographic variables using bivariate linear OLS regressions. These calculations were performed for all areas and for mountainous regions only to understand the influence of climate in general and to test the climatic stability aspects of Janzen's 'mountain passes' hypothesis (Janzen 1967). I then used multiple regression to model  $\beta$  diversity with the complete set of topoclimatic predictors and found all model residuals exhibited significant spatial autocorrelation, which can affect parameter estimates and significance tests (Dormann et al. 2007). To correct for this autocorrelation I used a simultaneous autoregressive model ( $SAR_{err}$ ), which includes a spatial weights matrix as an additional error term (Kissling and Carl 2008). This allows the proportion of variance explained purely by spatial proximity to similar values to be estimated separately from the proportion explained purely by the topoclimatic predictors.

As the degree and structure of spatial autocorrelation varies by dataset I produced a set of SAR<sub>err</sub> models using a range of neighbor distances (100, 200, 300, 400, 500, 1000, 3000 and 5000km) and two ways of coding the neighbor spatial weights matrix. The first is binary, which codes locations as either neighbors or not, the second is row-standardized which takes into account the number of neighbors surrounding each cell. Models were then selected using minimum residual spatial autocorrelation (minRSA) criteria (Kissling and Carl 2008). minRSA is a measure of the autocorrelation of model residuals in space and is the sum of the absolute value of Moran's I at the first 20 distance classes, which should be minimized to ensure accurate parameter estimates. I then reduced the best models to significant predictor sets for each  $\beta$  diversity metric using minRSA and AIC as selection criteria, seeking to minimize both. All analyses were performed in R version 3.3.1 (R Core Team 2016).

## RESULTS

### *Latitudinal and elevational diversity gradients*

I found strong spatial variation in  $\beta$  diversity across the Americas with significant latitudinal trends, but major differences between metrics. The Andes, much of Central America and Mexico, the Caribbean and large portions of the United States were hotspots of taxonomic  $\beta$  diversity, with species turnover between adjacent cells of ~30-40% (Fig. 3.1A). The Atlantic Forest of Brazil and the Tepuis of Venezuela also had similarly high levels of taxonomic  $\beta$  diversity. In addition, much of the Amazon basin as well as the Cerrado of Brazil and parts Canada had turnover between 20 and 25%. Though most turnover was less than 40% (95<sup>th</sup> quantile=0.37), a small subset of cells had turnover



between 80-100% (Fig. 3.3A). These cells often contained small islands adjacent to more species-rich neighboring cells, with the resulting richness disparity leading to higher rates of turnover. Despite measuring different dimensions of diversity, Jaccard dissimilarity and UniFrac phylogenetic  $\beta$  diversity were highly correlated ( $r=0.92$ ), likely because much of the turnover at distances of 100km is at the species level, which both metrics emphasize. Though highly correlated with Jaccard dissimilarity, UniFrac values were in general lower, which is expected as phylogenetic metrics capture deeper evolutionary similarity in community composition. In contrast,  $\beta$  diversity as measured by  $D_{pw}$ , the metric most sensitive to deeper divergences, was highest in the North and South temperate zones.  $D_{pw}$  exhibited less spatial variation and was weakly and negatively correlated with both UniFrac and Jaccard (Fig. 3.1C,  $r=-0.15$  and  $=-0.32$  respectively). Interestingly, the Andes displayed elevated levels of  $D_{pw}$  despite the fact that most areas of the tropics had low levels of turnover using this metric.

When comparing tropical and temperate regions as a whole, Jaccard and UniFrac  $\beta$  diversity was significantly higher in the tropics (Fig. 3.2A & B), supporting the first hypothesis. Supporting the second hypothesis, results were similar when only mountainous regions were compared and the effect was stronger (Fig. 3.2A & B). Contrary to my hypotheses,  $D_{pw}$  displayed opposite patterns– with significantly higher levels of turnover in temperate regions and temperate mountainous regions than in the tropics (Fig. 3.2C). Similarly,  $\beta$  diversity increased towards the equator when regressed against absolute latitude for both Jaccard and UniFrac metrics (Fig. 3.3A & B,  $R^2=0.25$  and  $0.09$ , respectively), though the relationship was non-linear. This relationship strengthened when

only mountainous regions were included (Fig. 3.3D & E,  $R^2=0.61$  and  $0.48$ , respectively).  $D_{pw}$  again showed an opposite and stronger relationship with absolute latitude, rapidly increasing with distance from the equator (Fig. 3.3C & F).

### *Climatic drivers of $\beta$ diversity*

Multivariate  $SAR_{err}$  models significantly reduced the autocorrelation of residuals compared to multivariate OLS regressions (Table 3.1). Both elevational range and MAT were retained in all  $SAR_{err}$  models and climate-change velocity was retained in all but one subset.  $\beta$  diversity measured via Jaccard and UniFrac was positively related to MAT while  $D_{pw}$  was negatively related. In bivariate regressions MAT was the strongest predictor of all types of  $\beta$  diversity (Fig. 3.4), and TSEA was the second most important in all comparisons (Table 3.2), supporting the third hypothesis. Jaccard and UniFrac were related positively to MAT and negatively to TSEA, while  $D_{pw}$  showed the opposite pattern. Elevational range, annual precipitation and climate-change velocity had low predictive power for most  $\beta$  diversity metrics (Table 3.2).

## DISCUSSION

Here I leverage a large dataset of species occurrences and evolutionary relationships to map turnover across the Americas and find  $\beta$  diversity is higher in the tropics for both taxonomic and tip-weighted phylogenetic measures. This increase in  $\beta$  diversity towards lower latitudes is in line with my hypotheses and other studies of taxonomic and phylogenetic  $\beta$  diversity of North American vascular plants (Qian et al. 2013), and suggests that the greater rates of turnover in the tropics may be one proximate cause of the

latitudinal diversity gradient found in plants. These results differ from recent studies which found no latitudinal trends in the  $\beta$  deviation, an effect size measure which uses a null model to control for  $\gamma$  diversity when estimating  $\beta$  diversity (Kraft et al. 2011, Myers et al. 2013). This could be because this study did not calculate  $\beta$  deviation, which could be done in the future, though the pairwise metrics used in this study do not incorporate  $\gamma$  diversity and may therefore be invariant to it (Bennett and Gilbert 2016). Another possibility for this discrepancy is the much larger grain size used in this study. One potential underlying factor driving the results may be latitudinal variation in species range size (Stevens 1989). Supporting this idea, Morueta-Holme *et al.* (2013) found that mean range size for vascular plants increases northwards in North America, but found the opposite trend south of the equator. The higher  $\beta$  diversity in the tropics I find may therefore be driven in part by the larger range sizes in northern temperate regions, which have a larger geographic extent than south temperate regions. Supporting the climatic stability hypothesis, terminal-weighted  $\beta$  diversity correlated negatively with temperature seasonality and positively with temperature, precipitation, and local elevational range– all conditions which may favor local specialization, smaller ranges and higher species turnover.

Contrary to my first hypothesis, some temperate areas had high levels of Jaccard and UniFrac  $\beta$  diversity, including the southern temperate Andes in Argentina, the Rockies and the west coast of North America. Though  $\beta$  diversity is higher in the tropics overall for these metrics, some areas with high  $\alpha$  diversity such as the Amazon Basin had low  $\beta$  diversity. This may be due to the fact that many plant species collected in this region have large ranges (Morueta-Holme et al. 2013, ter Steege et al. 2013), which should decrease

rates of turnover. There may also be an issue of botanical under-collection in the Amazon Basin (Feeley 2015), which could result in the underestimation of  $\beta$  diversity for this region due to undiscovered small-ranged species (Hubbell et al. 2008). Conversely, the Caribbean islands had higher terminal-weighted  $\beta$  diversity despite low  $\alpha$  richness. This may be due to the smaller ranges of plants found on these islands (Morueta-Holme et al. 2013), or because this region is poorly-represented in the BIEN2 database.

The  $\beta$  diversity of montane areas increased more rapidly towards the equator than  $\beta$  diversity overall for terminal-weighted metrics and peaked in the tropical Andes. This may be due to the decrease in seasonality and increase in temperature towards the equator creating stable climatic zones and narrower thermal tolerances (e.g. Tewksbury et al. 2008), which may reduce range size and increase turnover (Ghalambor et al. 2006, McCain 2009). Montane  $\beta$  diversity was also elevated in other parts of the American Cordillera including central America and the eastern edge of the Rocky Mountains. This pattern of high  $\beta$  diversity in mountainous regions across the Americas has also been demonstrated in several vertebrate taxa (McKnight et al. 2007, Melo et al. 2009).

Montane  $\beta$  diversity was higher in the tropics than in the temperate zone for Jaccard and UniFrac metrics. Temperature seasonality was strongly and negatively related to montane  $\beta$  diversity for these metrics, supporting Janzen's (1967) proposed mechanism of climatic stability as a driver of higher  $\beta$  diversity in tropical mountains. One explanation for this pattern may be that average range sizes of plant in tropical mountains are smaller than in temperate mountains (Morueta-Holme et al. 2013), as has been found in several vertebrate

taxa (McCain 2009). This would be expected if climatic stability created distinct temperature bands across montane gradients in the tropics, and species were primarily found with only one or a few distinct bands (Janzen 1967, Ghalambor et al. 2006). Temperature seasonality also influenced  $\beta$  diversity in the same way across all regions of the Americas including lowlands, though the effect was somewhat weaker, possibly because climatic gradients tend to be less steep outside of mountainous regions. This indicates that climatic stability is an important driver of  $\beta$  diversity across all of the Americas. Though terminal-weighted  $\beta$  diversity patterns supported Janzen's hypothesis, the large spatial grain at which  $\beta$  diversity was analyzed may obscure patterns at smaller scales. An ideal test would involve replicated montane transects measuring  $\beta$  diversity and thermal tolerances spanning a range of latitudes.

In contrast to measures emphasizing recent divergences, turnover of deeper divergences was much higher in the temperate zone than in the tropics. In addition, counter to my expectations, this  $D_{pw}$   $\beta$  diversity was related positively to temperature seasonality and negatively to mean annual temperature and precipitation. One explanation could be these conditions favor lineages common to temperate regions such as gymnosperms and mosses, which tend to be less diverse in the tropics (Mateo et al. 2016). To test whether this pattern is driven by the inclusion of non-angiosperm lineages I reanalyzed the data using only angiosperm taxa, which comprise ~98% of species in the dataset (79591 spp.) and only gymnosperm taxa, which account for <1% of the species (289 spp.). For the angiosperm subset, though pairwise distances between communities were lower than when all taxa were included, temperate regions retained higher  $D_{pw}$   $\beta$  diversity compared

to the tropics (Fig. S3.4). This may be because temperate regions contain a mix of both tropical and temperate angiosperm lineages that contribute to the higher root-weighted  $\beta$  diversity. Indeed,  $D_{pw}$  was highest at +/-40 degrees latitude, which is a transition zone between subtropical and temperate regions. In contrast, gymnosperm  $\beta$  diversity as measured by  $D_{pw}$  was higher in the tropics (Fig. S3.5). This may be due to the fact that the tropics harbor both north and south-temperate gymnosperm clades, especially in mountainous regions (Graham 2010). The use of the  $D_{pw}$   $\beta$  diversity metric may inform conservation efforts emphasizing phylogenetic uniqueness and diversity, as losses of species within temperate communities may rapidly reduce root-weighted  $\beta$  diversity due to the loss from a locality of an entire large clade such as gymnosperms.

#### *Limitations of the data*

When working with datasets of this size and complexity there are several possible limitations to consider. First, range maps were made with estimated not observed diversity for many species. Thus, species with patchy distributions may not occur over all of their predicted range. Second, the incomplete detection of rare species and issues synonymizing names across locations can affect  $\beta$  diversity estimates, which rely on complete inventories of focal communities. I attempt to address these issues by including plot-based inventories which record all stems above a certain diameter cutoff, standardizing names with the Taxonomic Name Resolution Service (Boyle et al. 2013) to address synonymy issues and performing geographic name processing to reduce erroneous locality information. Finally, even with equal sampling effort, range sizes in the tropics may be underestimated due

simply to the higher richness and corresponding lower sampling effort per species in these regions (Colwell and Hurt 1994).

### *Conclusions*

In this hemisphere-scale analysis of land plant diversity patterns across the Americas I find that  $\beta$  diversity is higher in the tropics when assessed using metrics that emphasize turnover of species and more recent divergences, but find the opposite trend in the turnover of deeper clades. This pattern of more recent divergences in the tropics and deeper divergences in the temperate zone suggests that faster tropical speciation rates may be an important driver of the latitudinal diversity gradient, as emphasized by Rohde (1992). In addition, my results provide further evidence that the uplift of the Andean cordillera has had an outsized influence on patterns of Neotropical plant diversity and diversity of the Americas as a whole (Hoorn *et al.* 2010, but see Antonelli *et al.* 2018). Temperature and climatic stability emerged as strong drivers of  $\beta$  diversity and both of which are currently being altered through anthropogenic climate change (Xu *et al.* 2013), with potentially large effects on plant distribution and diversity. Finally, understanding how climate influences  $\beta$  diversity can assist conservation efforts that seek to identify high diversity areas without knowledge of the species in an area using abiotic variables alone (e.g. Raxworthy *et al.* 2003). Taken together, these results reveal new patterns and key correlates of plant  $\beta$  diversity gradients across the Americas which will help to conserve this hyperdiverse group as ongoing anthropogenic effects such as climate change strengthen into the future.

## ACKNOWLEDGMENTS

This study was conducted as a part of the Botanical Information and Ecology Network (BIEN) Working Group (PIs B.J.E., Richard Condit, Brad Boyle, Steve Dolins, Robert K. Peet) supported by the National Center for Ecological Analysis and Synthesis, a center funded by the National Science Foundation (NSF Grant EF-0553768), the University of California, Santa Barbara, and the State of California. The BIEN Working Group was also supported by iPlant (NSF Grant DBI-0735191). I thank all contributors for the invaluable data provided (<http://bien.nceas.ucsb.edu/bien/data-contributors/all>). I.R.M. was partially supported by an NSF Graduate Research Fellowship (DGE-1650604). J.-C.S. was supported by the European Research Council (grant ERC-2012-StG-310886-HISTFUNC). N.M.-H. acknowledges support from the Carlsberg Foundation, and from the Danish National Research Foundation for support to the Center for Macroecology, Evolution and Climate. I thank Matthew Fitzpatrick and Benoit Parmentier for spatial modeling advice. Claire Fortunel, Gaurav Kandlikar, Lei Chen, Marcel Vaz and Steve Hubbell provided valuable feedback on the analyses and manuscript.



## TABLES AND FIGURES

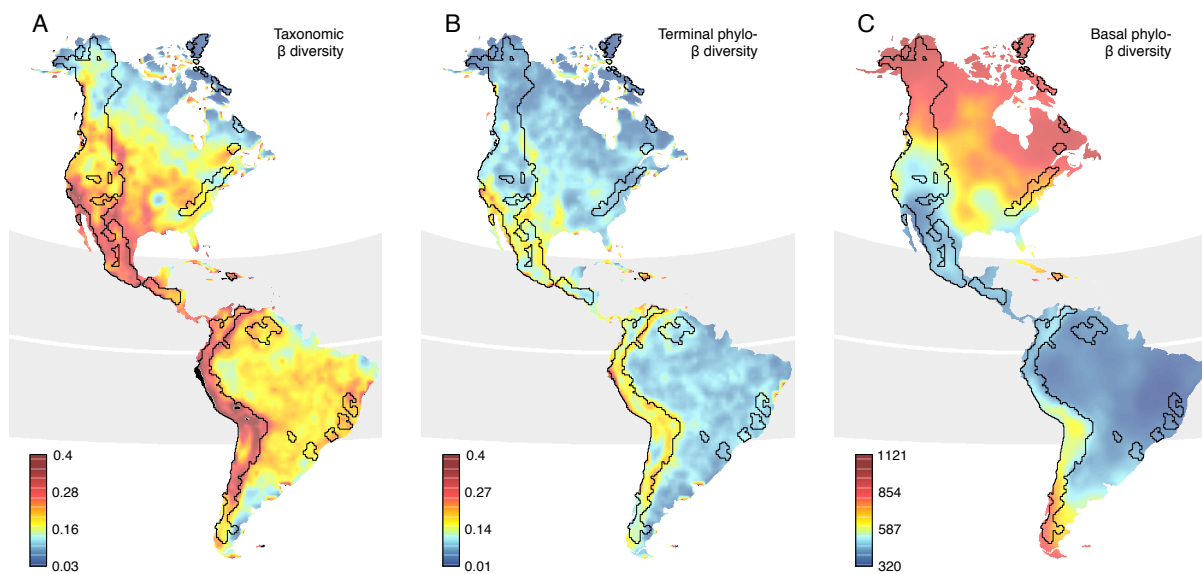
**Table 3.1:** Best fit SAR<sub>err</sub> models predicting log transformed taxonomic and phylogenetic  $\beta$  diversity, including all cells and mountain-only subsets. Distance: neighborhood matrix radius (km). Coding: Coding of the spatial weights matrix. AIC: Akaike’s information criterion; minRSA: minimum residual spatial autocorrelation (sum of the absolute value of Moran’s I over the first 20 distance classes); Max I: highest Moran’s I value in the first 20 distance classes; R<sup>2</sup>: pseudo-R<sup>2</sup>, the squared Pearson correlation of predicted and observed values. Jaccard: Jaccard dissimilarity (taxonomic); UniFrac: Unique fraction of branch length (phylogenetic), D<sub>pw</sub>: Community distance (phylogenetic). ER: Elevational range, AP: Annual precipitation, MAT: Mean annual temperature, TS: Temperature seasonality, CCV: Climate-change velocity. Predictor units are given in Table 3.2 and *Methods*. Topoclimatic variables were log-transformed and standardized before analysis.

$\beta$ metric	Subset	Distance	Coding	minRSA	Max I	R <sup>2</sup>	Final topoclimatic predictor set
Jaccard	All cells	200	B	1.03	0.34	0.88	ER (+), MAT (+), CCV (+)
Jaccard	Mountains	200	W	0.81	0.11	0.92	ER (+), MAT (+), AP (-)
UniFrac	All cells	200	W	0.86	0.26	0.84	ER (+), MAT (+), CCV (+), TSEA (+)
UniFrac	Mountains	100	W	0.87	0.12	0.89	ER (+), MAT (+), CCV (+), AP (-)
D <sub>pw</sub>	All cells	200	W	1.74	0.48	0.99	ER (+), MAT (-), CCV (+), TSEA (-), AP (+)
D <sub>pw</sub>	Mountains	200	W	1.10	0.33	0.99	ER (+), MAT (-), CCV (+), TSEA (-)

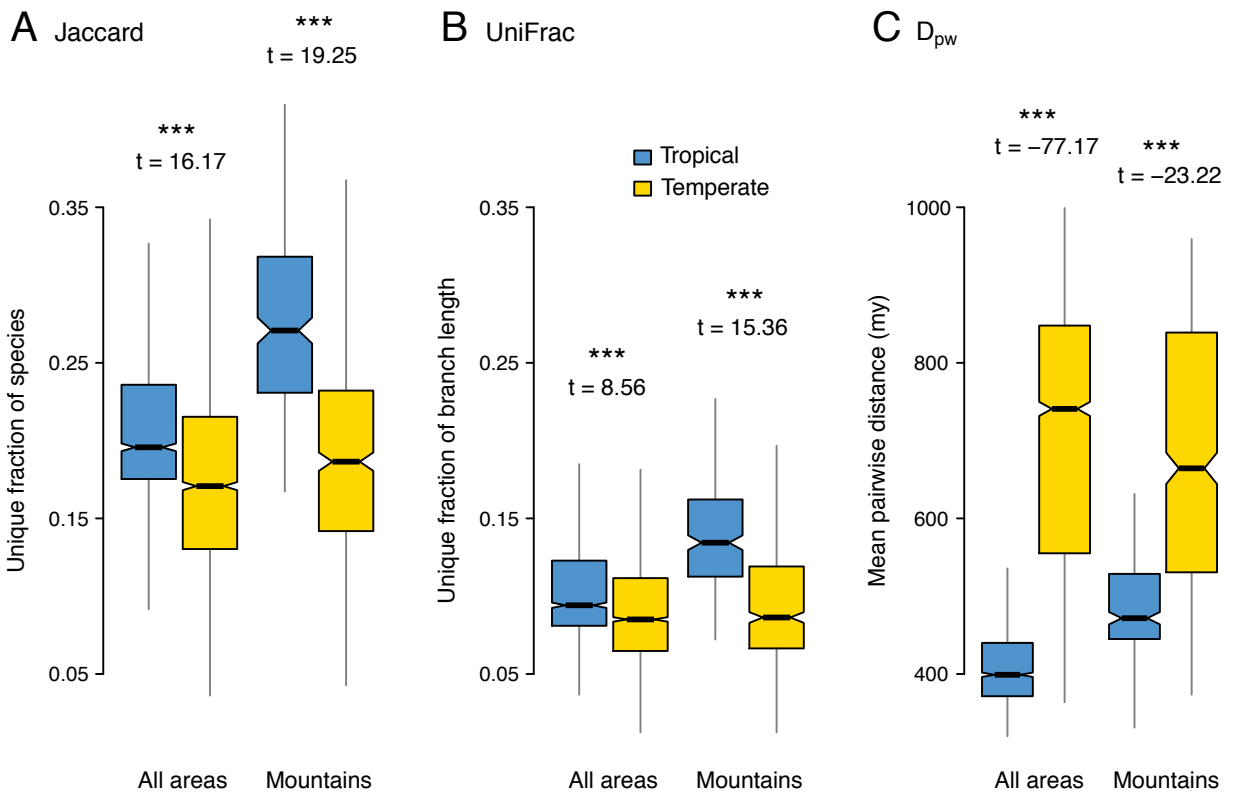
**Table 3.2:** Single-predictor  $R^2$  relationships of log-transformed and standardized topoclimatic predictors with log-transformed taxonomic and phylogenetic  $\beta$  diversity for the Americas. Values in parentheses indicate the sign of the slope. All relationships were significant at  $P < 0.01$ . The  $\beta$  diversity values of all cells and the subset of cells containing mountains were both used as response variables for each  $\beta$  diversity metric. Jaccard: Jaccard dissimilarity (taxonomic); UniFrac: Unique fraction of branch length (phylogenetic),  $D_{pw}$ : Community distance (phylogenetic).

$\beta$ metric	Subset	Elevational range (m)	Annual precipitation (mm)	Mean annual Temperature (C)	Temperature seasonality (C)	Climate-change velocity (m/yr)
Jaccard	All areas	0.05 (+)	0.06 (+)	0.30 (+)	0.14 (-)	0.06 (-)
Jaccard	Mountains	0.22 (+)	0.04 (+)	0.58 (+)	0.39 (-)	0.09 (-)
UniFrac	All areas	0.03 (+)	0.02 (+)	0.18 (+)	0.08 (-)	0.03 (-)
UniFrac	Mountains	0.19 (+)	0.03 (+)	0.53 (+)	0.36 (-)	0.07 (-)
$D_{pw}$	All areas	< 0.01 (+)	0.31 (-)	0.75 (-)	0.72 (+)	0.17 (+)
$D_{pw}$	Mountains	0.03 (-)	0.08 (-)	0.74 (-)	0.49 (+)	0.01 (+)

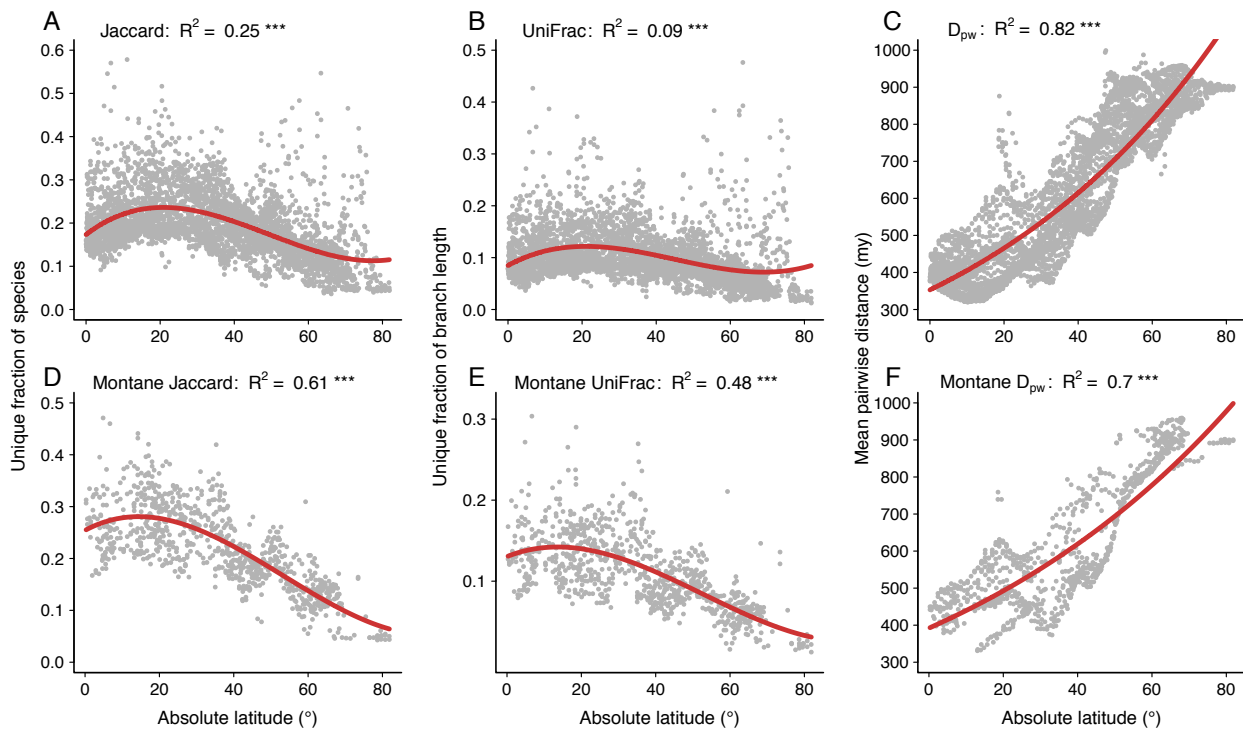
**Figure 3.1:** Botanical  $\beta$  diversity of the Americas. Colors represent the average of all pairwise comparisons between a cell and each of its adjoining neighbors, with warmer colors indicating higher turnover. As  $\sim 99\%$  of values in A & B were below 0.4, values above 0.4 are shown in black. Grey polygons represent the inter-tropical zone and the central white line denotes the Equator. Cells classified as containing mountains per the UNEP definition and that are part of a group of three or more such cells are outlined in black and represent mountain ranges. To better display land edges and mountainous area contours the resolution of the  $100 \times 100 \text{ km}$  grid cells used in the analyses was increased by a factor of five using local interpolation. See Fig. S3.2 for un-interpolated maps.



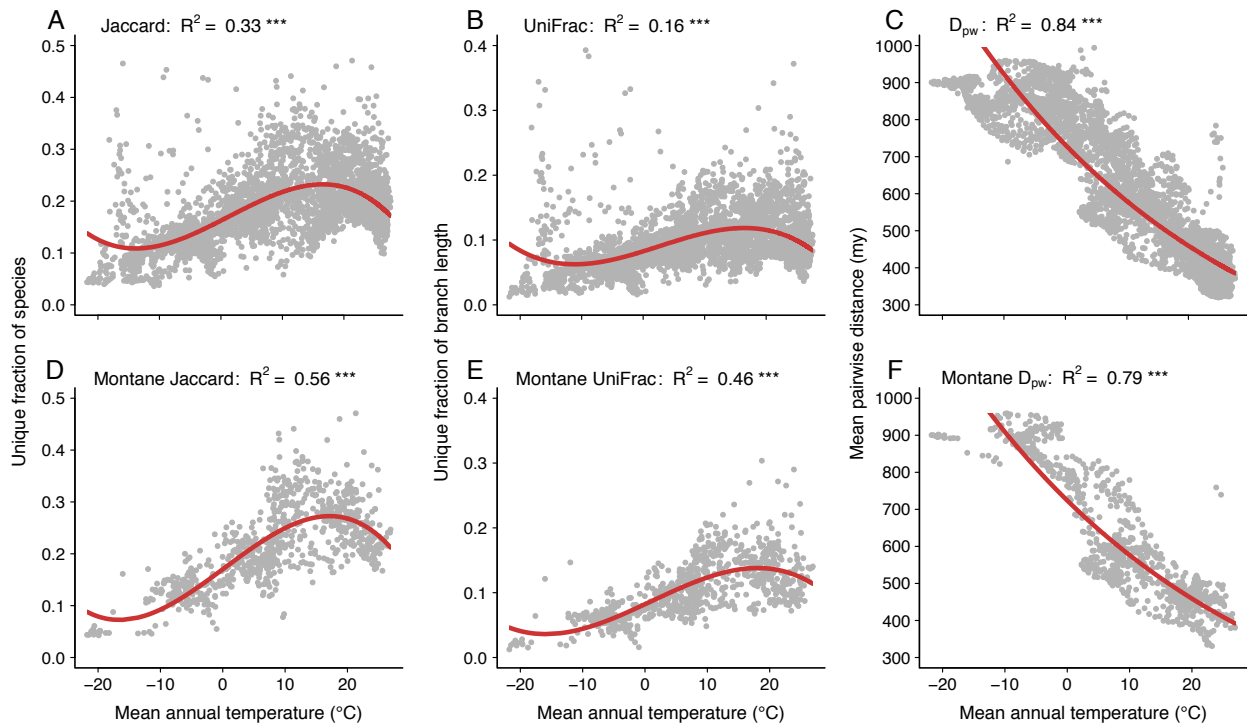
**Figure 3.2:** Tropical-temperate comparisons of  $\beta$  diversity for all areas and only mountainous regions. Cells north of the Tropic of Cancer ( $23.5^\circ$  latitude) and south of the Tropic of Capricorn ( $-23.5^\circ$  latitude) are classified as temperate and those in between the two tropics as tropical, \*\*\* symbols indicate p-value < 0.001.



**Figure 3.3:**  $\beta$  diversity as a function of absolute latitude. A-C: Jaccard dissimilarity, UniFrac and  $D_{pw}$  respectively for the Americas. For clarity in panels A, B and C five, five and one (respectively) cells with high  $\beta$  values were excluded. D-F: Montane-only cell subsets of Jaccard dissimilarity, UniFrac and  $D_{pw}$   $\beta$  diversity respectively. Jaccard and UniFrac data (A, B, D and E) were fit using a 3<sup>rd</sup> degree polynomial model and  $D_{pw}$  (C, F) were fit using an exponential model. \*\*\* indicates  $p < 0.001$ . Fig. S3.3 in shows  $\beta$  diversity as a function of increasing (non-absolute) latitude.

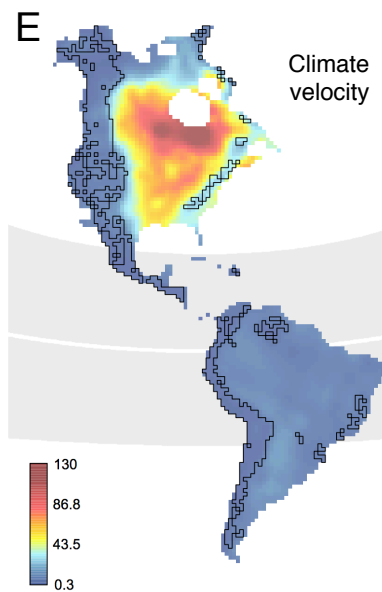
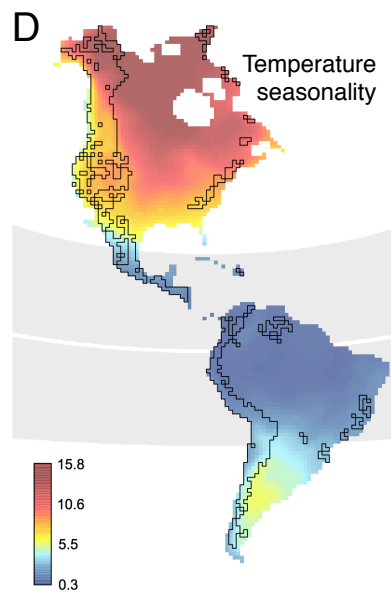
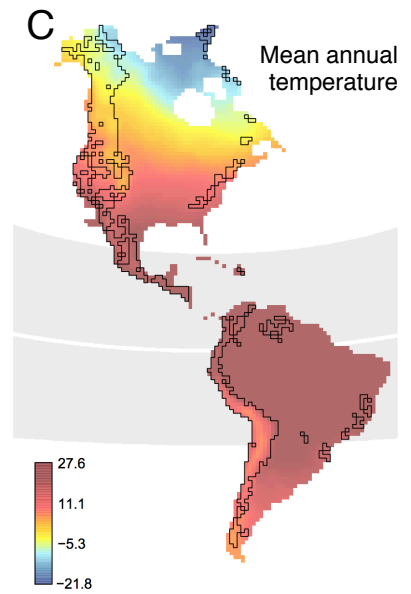
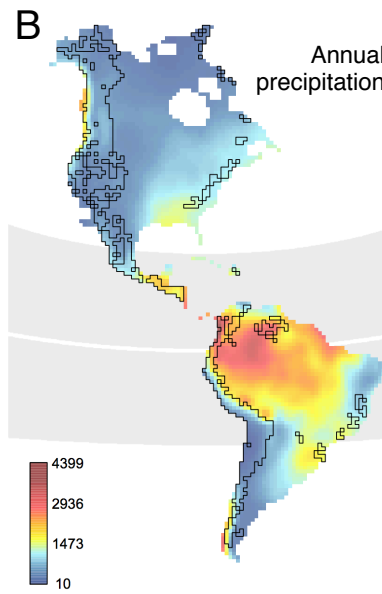
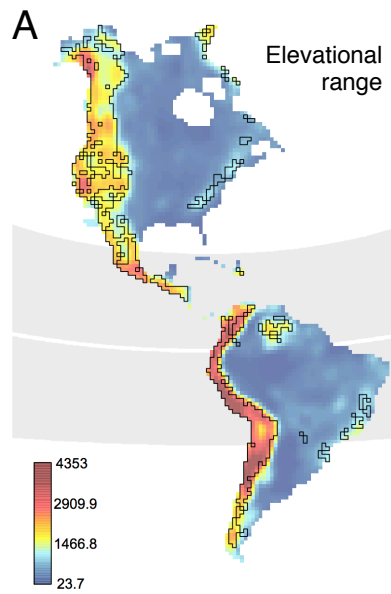


**Figure 3.4:** Relationships between  $\beta$  diversity and the strongest predictor for all metrics and subsets: mean annual temperature. Relationships for all regions (A-C) and montane subsets (D-E) are shown. For clarity in panels A and B one cell with a high  $\beta$  value was excluded. Jaccard and UniFrac  $\beta$  (A, B, D and E) was fit via a 3<sup>rd</sup> degree polynomial model and for  $D_{pw}$  (C, F) an exponential model was used. \*\*\* indicates  $p < 0.001$ .



SUPPLEMENTARY MATERIAL: Supporting figures for Chapter 3

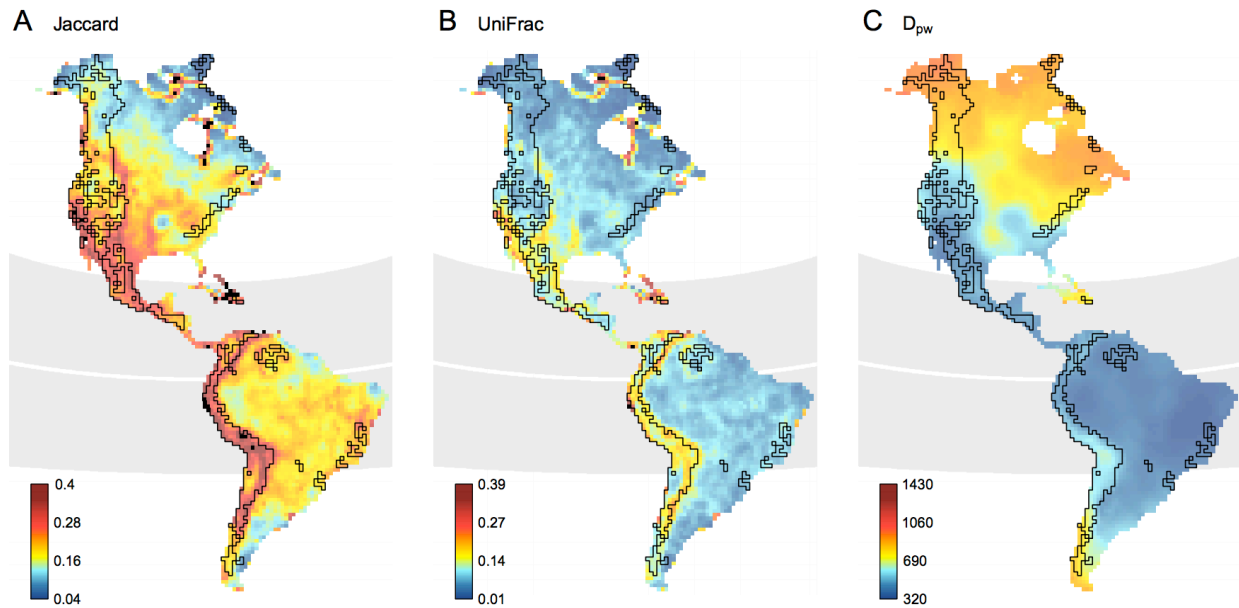
**Figure S3.1 (next page):** Topographic and climatic variables used in the analysis. As in Fig. 3.1, grey polygons represent tropical areas  $\pm 23.5^\circ$  latitude with inner white line at the equator. Mountainous areas are outlined in black. Cell values represent the average of the focal cell and all neighboring cells. Note climate velocity is calculated from the late quaternary to present (see *Methods*).



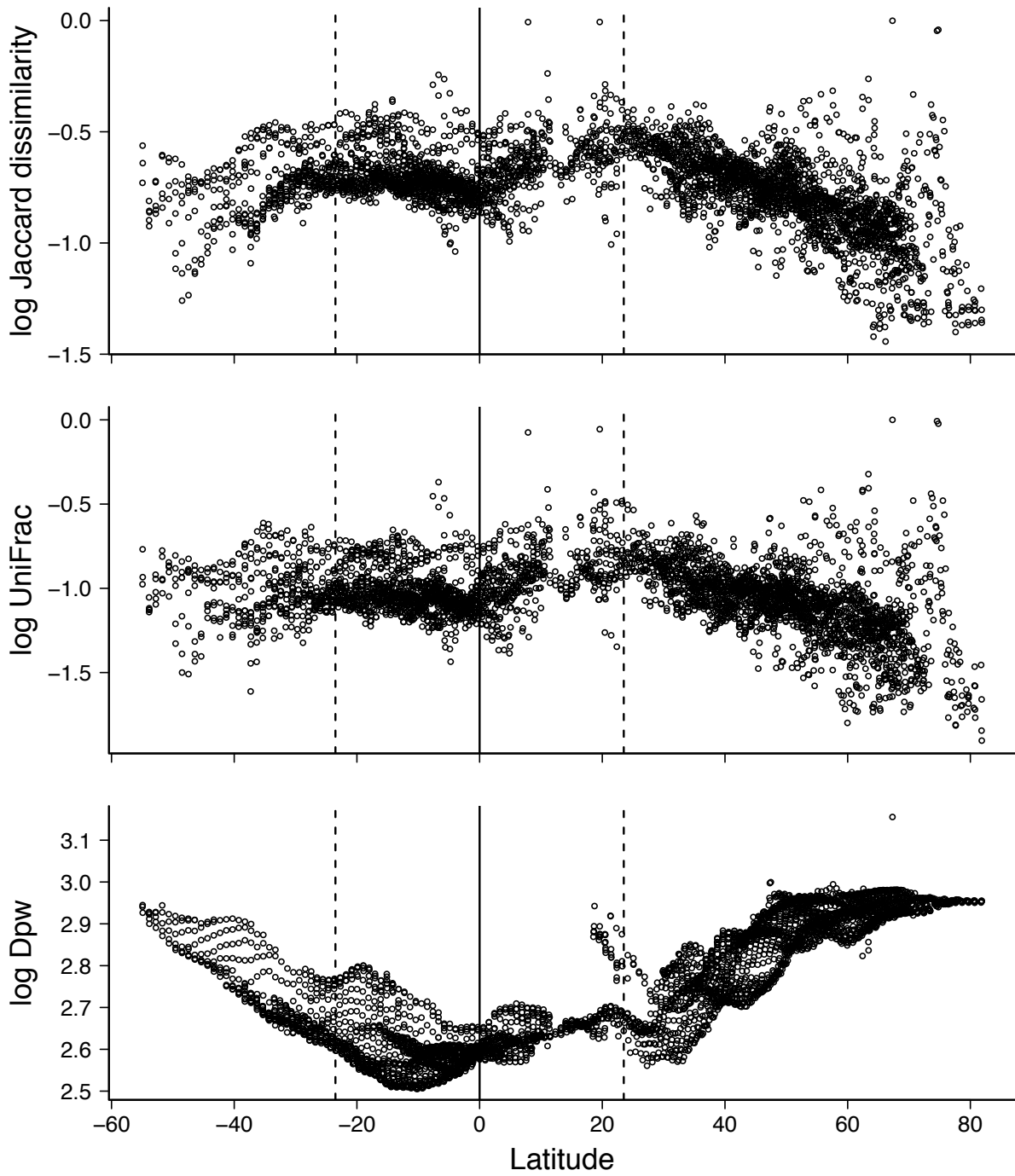


**Figure S3.2:**  $\beta$  diversity of the Americas showing 100×100km grid cells used in analyses.

Grey polygons represent the tropics and white lines the equator, black lines represent mountainous areas. In A and B, outlying focal cells with values above 0.4 are in black.

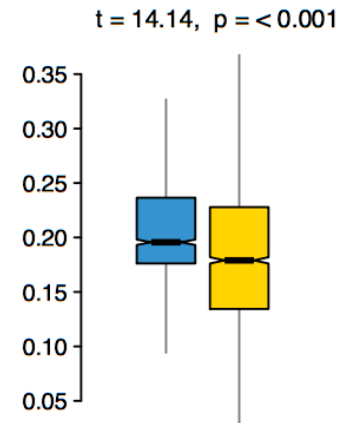
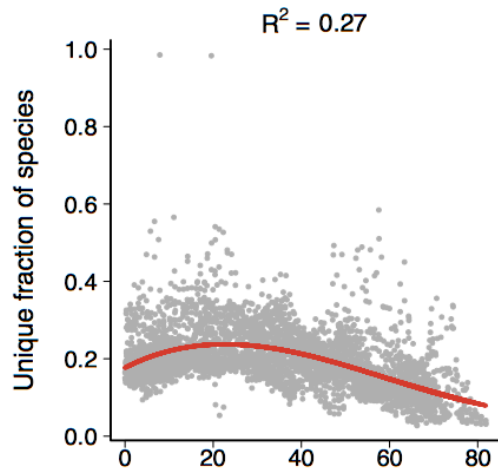
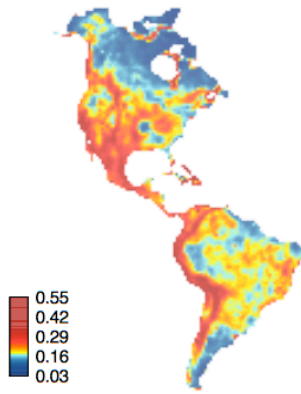


**Figure S3.3:** Log10 transformed  $\beta$  diversity as a function of non-absolute degrees latitude. Solid vertical line represents the equator and dashed vertical lines the boundaries of the tropics as defined in this study ( $\pm 23.5^\circ$  latitude).

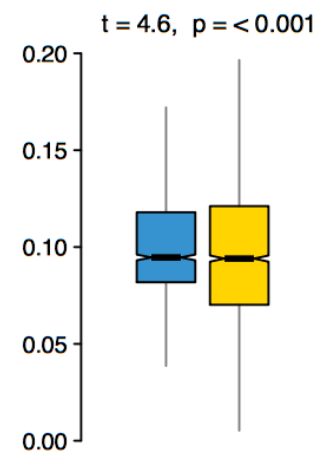
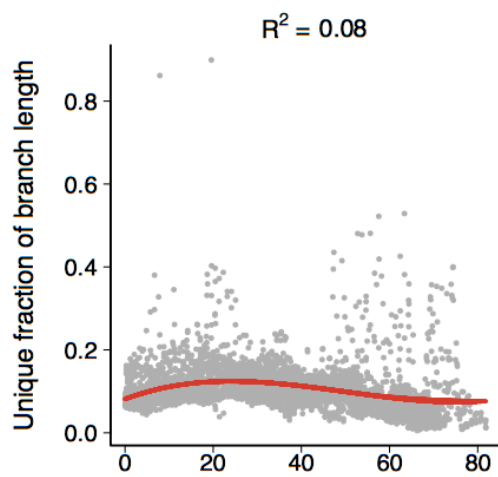
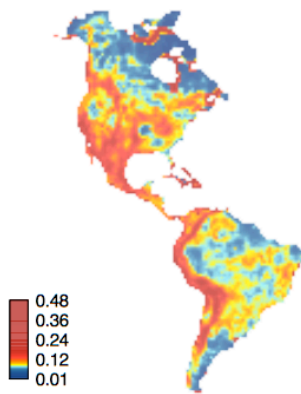


**Figure S3.4 (next page):** Analyses of taxonomic subsets: Angiosperms. First column: Diversity map, methods are as in Fig. 3.1, quantile coloration is used for rasters in panels A and B, note scale bar. Second column: Regression of  $\beta$  diversity against absolute latitude. Jaccard and UniFrac  $\beta$  are fit with 3<sup>rd</sup> degree polynomials and were selected from a range of models via BIC scores.  $D_{pw}$  was fit using a loess spline due to the strong non-linearity of the data. Third column: *t*-tests comparing temperate and tropical regions.

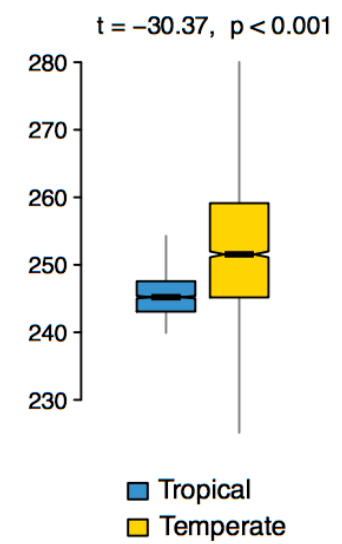
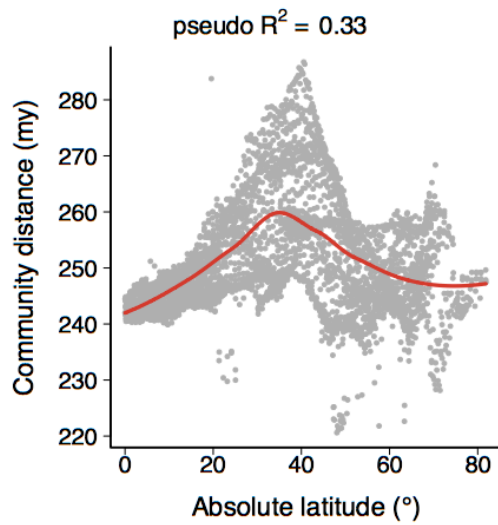
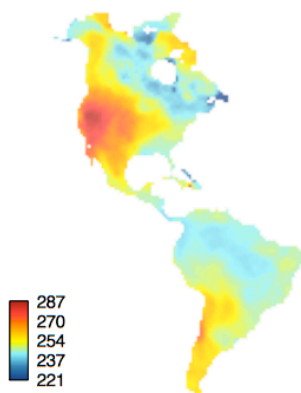
**A** Angiosperm Jaccard



**B** Angiosperm UniFrac

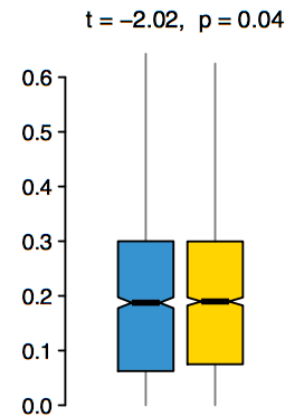
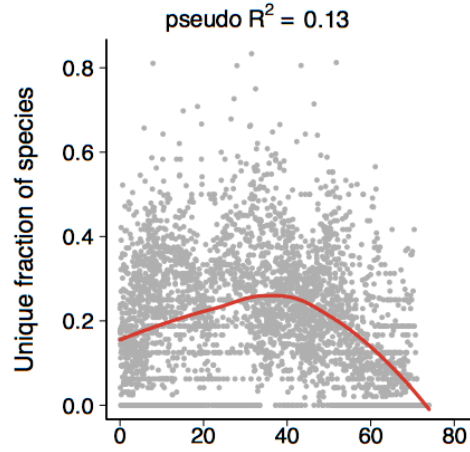
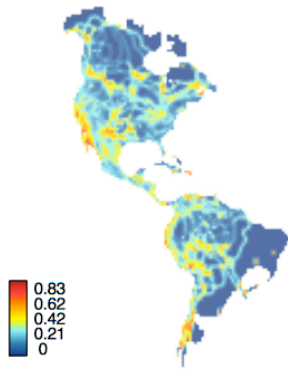


**C** Angiosperm  $D_{pw}$

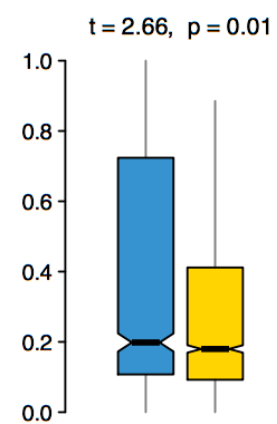
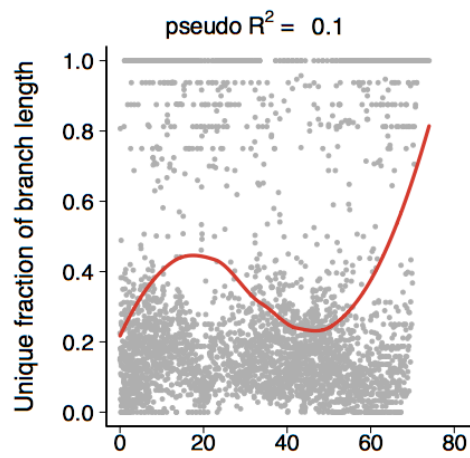
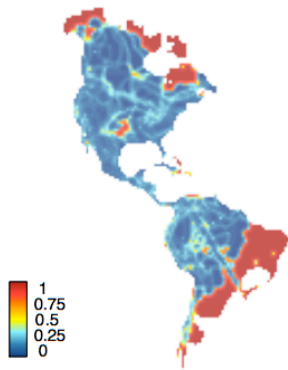


**Figure S3.5 (next page):** Analyses of taxonomic subsets: Gymnosperms. First column:  $\beta$  diversity maps, methods are as in Fig 3.1. Second column: Regression of  $\beta$  diversity against absolute latitude fitted with loess splines. Third column: *t*-tests comparing temperate and tropical regions. Note the number of gymnosperm taxa in any one cell (0-34) is significantly fewer than the average number of angiosperm taxa per cell.

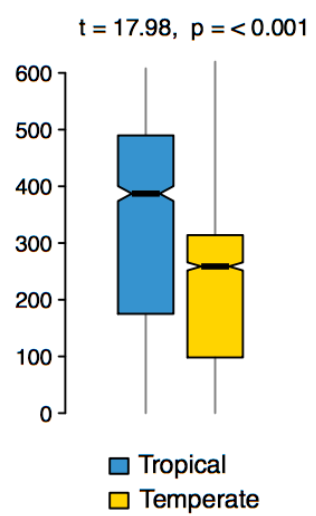
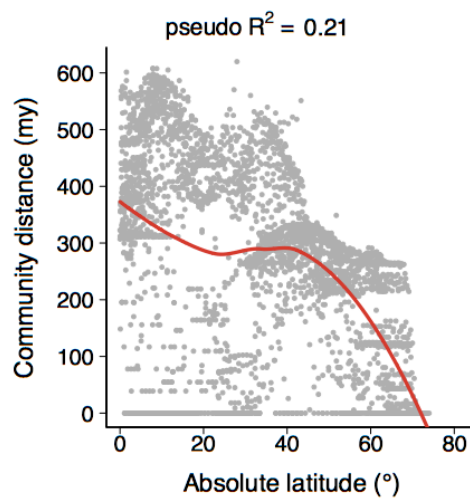
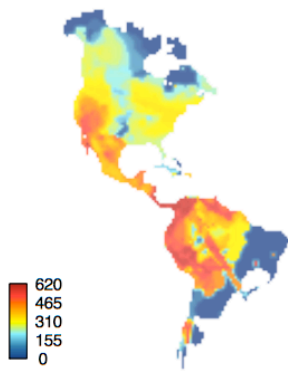
**A** Gymnosperm Jaccard



**B** Gymnosperm UniFrac



**C** Gymnosperm  $D_{pw}$



## Conclusions and future directions

### DRIVERS OF LOCAL AND REGIONAL DIVERSITY GRADIENTS IN PLANT ASSEMBLAGES

In what has been termed 'MacArthur's Paradox' (Schoener 1983), Robert MacArthur and colleagues developed theory explaining diversity in assemblages through both deterministic ecological strategy differentiation (MacArthur 1958, MacArthur and Levins 1967) and via stochastic dispersal balanced by drift (MacArthur and Wilson 1967). These and other related studies inspired largely separate bodies of theory and eventually evolved into the 'niche versus neutral debate' (Chesson 2000, Hubbell 2001, Adler et al. 2007). Specifically, niche-centered theory emphasizes stable coexistence via species differences (Chase and Leibold 2003), while neutral theory predicts a dynamic equilibrium of species extinctions due to drift offset by speciation and dispersal limitation (Hubbell 2001). Species aggregations caused by dispersal limitation can reduce competitive exclusion by increasing competition with conspecifics relative to heterospecifics (Hurtt and Pacala 1995). Much of the debate over the last several decades has centered around the relative role of niche versus dispersal assembly processes in creating diversity patterns (Kraft et al. 2008, Rosindell et al. 2012).

The question of what drives diversity in local assemblages and across latitude has, after much debate, inspired several integrative theoretical frameworks centered around high-level processes such as niche and fitness differences (Chesson 2000), as well as group of processes historically viewed as belonging to either niche-based or neutral theories (Adler

et al. 2007, Vellend 2010, 2016), specifically dispersal, drift, speciation and selection- or the favoring of one species over another through environmental filtering, competition, mutualism etc. Several important goals for community ecology and macroecology now are to determine the relative importance of these processes for biodiversity dynamics and to use this information to predict how assemblages will respond to ongoing and future changes.

At the local scale, I found that environmental filtering, a key niche-based process, and dispersal limitation, an important component of neutral models, were both important drivers of species aggregations and influenced by the functional traits of species (Chapters 2 and 3, McFadden et al. 2018). This is further evidence that both processes are important structuring factors in plant communities and that both processes, and dispersal limitation in particular, are controlled at least partially by species traits (Lowe and McPeck 2014). This has important implications for the many tropical forests experiencing losses of vertebrate dispersers (Wright et al. 2007), and suggests density dependent mortality via increased aggregation may preferentially reduce the populations of vertebrate-dispersed species (Harrison et al. 2013), the dominant dispersal mode in tropical forests (Howe and Smallwood 1982, Harrison et al. 2013, Bemmels et al. 2018).

In addition, I found the Yasuní forest possesses low drought tolerance on the global scale (Bartlett et al. 2012b), but that ridge specialists are more drought tolerant than valley specialists (Chapters 2 and 3, McFadden et al. 2018). This suggests ridge specialists may experience lower mortality during drought (as in Zuleta et al. 2017), which may shift the



composition of the community in favor of these species. Caution in interpretation should be used however, as less than 10% of the species in the Yasuní plot were sampled for leaf drought tolerance. Future work in this plot should survey additional species to confirm that the patterns observed are true for the majority of species.

At the regional scale of the Americas, I identified rates of turnover and speciation, as well as the average and variance of temperature, to be important factors contributing to the latitudinal gradient in plant diversity (Chapter 4). Because species pools or gamma diversity may potentially bias estimates of beta diversity (Kraft et al. 2011), multivariate pairwise metrics which do not include gamma diversity and only compare pairs of communities were used to estimate turnover. The fact that the tropics had higher taxonomic and tip-weighted phylogenetic turnover using these metrics could suggest that these regions do indeed have higher rates of turnover, but it is also possible that the larger community sizes caused by larger species pools in the tropics had an effect as well. An additional consideration is that beta diversity may be inflated in the tropics due to the failure to detect rare species (Hubbell et al. 2008 and pers. comm.). Given these caveats, this result suggests that one proximate cause of the latitudinal diversity gradient in the tropics is a decline in the rate of species turnover away from the equator.

An additional implication of this work is that ongoing and future changes in temperature should have large effects on the distribution and turnover of plant assemblages, as it was the most important climatic driver of species turnover for all metrics. Such effects are already measurable in the Andes (Morueta-Holme et al. 2015), and may also effect lowland

species in the tropics and the temperate zones. Despite these implications, it is difficult to know if the correlations observed are due to a directly causal relationship between temperature and turnover, and other factors certainly contribute to turnover across the region (Pennington and Dick 2010).

## SYNTHESIS AND FUTURE DIRECTIONS

Macroecology as a field has uncovered some of the most robust biodiversity patterns, including the latitudinal diversity gradient and species-area relationships (Rosenzweig 1995), but there is still little consensus as to which mechanisms are driving observed patterns (Gotelli et al. 2009). In addition, patterns across longitude have received comparatively less attention and may allow for the relative importance of biotic and abiotic factors on diversity gradients to be separated. Conversely, local coexistence studies often identify mechanisms that maintain diversity (Chesson 2000, Angert et al. 2009), but inference is usually confined to a small number of species or areas. Both of these deficiencies need to be addressed if a wholistic understanding of biodiversity dynamics at all scales is to be achieved.

Several existing fields and emerging approaches offer the potential to overcome some of the limitations of understanding the drivers of biodiversity patterns across scales. The field of landscape ecology for example works at scales intermediate to community and macroecology and is therefore well-suited to studying the relative roles of local and regional processes (Turner 1989). In addition, experimental macroecology approaches (Stokstad 2011, Alexander et al. 2016, Roslin et al. 2017) are overcoming the challenge of

making inferences from experiments across large spatial scales, but are still in their infancy. Finally, mechanistic models, especially those parametrized locally, should be used to understand broad diversity patterns across latitude (Usinowicz et al. 2017) as well as longitude.

## BIBLIOGRAPHY

Adler, P. B., J. HilleRisLambers, and J. M. Levine. 2007. A niche for neutrality. *Ecology Letters* 10:95-104.

Alexander, J. M., J. M. Diez, S. P. Hart, and J. M. Levine. 2016. When climate reshuffles competitors: a call for experimental macroecology. *Trends in Ecology and Evolution* 31:831-841.

Anderson, M. J., T. O. Crist, J. M. Chase, M. Vellend, B. D. Inouye, A. L. Freestone, N. J. Sanders, H. V. Cornell, L. S. Comita, K. F. Davies, S. P. Harrison, N. J. B. Kraft, J. C. Stegen, and N. G. Swenson. 2011. Navigating the multiple meanings of beta diversity: a roadmap for the practicing ecologist. *Ecology Letters* 14:19-28.

Anderson-Teixeira, K. J., S. J. Davies, A. C. Bennett, E. B. Gonzalez-Akre, H. C. Muller-Landau, S. J. Wright, K. Abu Salim, A. M. A. Zambrano, A. Alonso, J. L. Baltzer, Y. Basset, N. A. Bourg, E. N. Broadbent, W. Y. Brockelman, S. Bunyavejchewin, D. F. R. P. Burslem, N. Butt, M. Cao, D. Cardenas, G. B. Chuyong, K. Clay, S. Cordell, H. S. Dattaraja, X. Deng, M. Detto, X. Du, A. Duque, D. L. Erikson, C. E. N. Ewango, G. A. Fischer, C. Fletcher, R. B. Foster, C. P. Giardina, G. S. Gilbert, N. Gunatilleke, S. Gunatilleke, Z. Hao, W. W. Hargrove, T. B. Hart, B. C. H. Hau, F. He, F. M. Hoffman, R. W. Howe, S. P. Hubbell, F. M. Inman-Narahari, P. A. Jansen, M. Jiang, D. J. Johnson, M. Kanzaki, A. R. Kassim, D. Kenfack, S. Kibet, M. F. Kinnaird, L. Korte, K. Kral, J. Kumar, A. J. Larson, Y. Li, X. Li, S.

Liu, S. K. Y. Lum, J. A. Lutz, K. Ma, D. M. Maddalena, J.-R. Makana, Y. Malhi, T. Marthews, R. M. Serudin, S. M. McMahon, W. J. McShea, H. R. Memiaghe, X. Mi, T. Mizuno, M. Morecroft, J. A. Myers, V. Novotny, A. A. de Oliveira, P. S. Ong, D. A. Orwig, R. Ostertag, J. den Ouden, G. G. Parker, R. P. Phillips, L. Sack, M. N. Sainge, W. Sang, K. Sri-ngernyuang, R. Sukumar, I.-F. Sun, W. Sungpalee, H. S. Suresh, S. Tan, S. C. Thomas, D. W. Thomas, J. Thompson, B. L. Turner, M. Uriarte, R. Valencia, M. I. Vallejo, A. Vicentini, T. Vrska, X. Wang, X. Wang, G. Weiblen, A. Wolf, H. Xu, S. Yap, and J. Zimmerman. 2015. CTFS-ForestGEO: a worldwide network monitoring forests in an era of global change. *Global Change Biology* 21:528-549.

Angert, A. L., T. E. Huxman, P. Chesson, and D. L. Venable. 2009. Functional tradeoffs determine species coexistence via the storage effect. *Proceedings of the National Academy of Sciences* 106:11641-11645.

Antonelli, A., A. Zizka, F. A. Carvalho, R. Scharn, C. D. Bacon, D. Silvestro, and F. L. Condamine. 2018. Amazonia is the primary source of Neotropical biodiversity. *Proceedings of the National Academy of Sciences* 201713819.

Baddeley, A., E. Rubak, and R. Turner. 2016. *Spatial Point Patterns*. CRC Press, Boca Raton.

Baldeck, C. A., K. E. Harms, J. B. Yavitt, R. John, B. L. Turner, R. Valencia, H. Navarrete, S. Bunyavejchewin, S. Kiratiprayoon, A. Yaacob, M. N. N. Supardi, S. J. Davies, S. P. Hubbell, G. B. Chuyong, D. Kenfack, D. W. Thomas, and J. W. Dalling. 2013a. Habitat

filtering across tree life stages in tropical forest communities. *Proceedings: Biological Sciences* 280:1-8.

Baldeck, C. A., K. E. Harms, J. B. Yavitt, R. John, B. L. Turner, R. Valencia, H. Navarrete, S. J. Davies, G. B. Chuyong, D. Kenfack, D. W. Thomas, S. Madawala, N. Gunatilleke, S. Gunatilleke, S. Bunyavejchewin, S. Kiratiprayoon, A. Yaacob, M. N. N. Supardi, and J. W. Dalling. 2013b. Soil resources and topography shape local tree community structure in tropical forests. *Proceedings of the Royal Society B: Biological Sciences* 280:20122532-20122532.

Baraloto, C., O. J. Hardy, C. T. Paine, K. G. Dexter, C. Cruaud, L. T. Dunning, M. A. Gonzalez, J. F. Molino, D. Sabatier, and V. Savolainen. 2012. Using functional traits and phylogenetic trees to examine the assembly of tropical tree communities. *Journal of Ecology* 100:690-701.

Bartlett, M. K., M. Detto, and S. W. Pacala. 2019. Predicting shifts in the functional composition of tropical forests under increased drought and CO<sub>2</sub> from trade-offs among plant hydraulic traits. *Ecology Letters* 22:67-77.

Bartlett, M. K., C. Scoffoni, R. Ardy, Y. Zhang, S. Sun, K. Cao, and L. Sack. 2012a. Rapid determination of comparative drought tolerance traits: using an osmometer to predict turgor loss point. *Methods in Ecology and Evolution* 3:880-888.

Bartlett, M. K., C. Scoffoni, and L. Sack. 2012b. The determinants of leaf turgor loss point and prediction of drought tolerance of species and biomes: a global meta-analysis. *Ecology Letters* 15:393-405.

Bartlett, M. K., Y. Zhang, N. Kreidler, S. Sun, R. Ardy, K. Cao, and L. Sack. 2014. Global analysis of plasticity in turgor loss point, a key drought tolerance trait. *Ecology Letters* 17:1580-1590.

Bartlett, M. K., Y. Zhang, J. Yang, N. Kreidler, S. W. Sun, L. Lin, Y. H. Hu, K. F. Cao, and L. Sack. 2016. Drought tolerance as a driver of tropical forest assembly: resolving spatial signatures for multiple processes. *Ecology* 97:503-514.

Bass, M. S., M. Finer, C. N. Jenkins, H. Kreft, D. F. Cisneros-Heredia, S. F. McCracken, N. C. A. Pitman, P. H. English, K. Swing, G. Villa, A. Di Fiore, C. C. Voigt, and T. H. Kunz. 2010. Global Conservation Significance of Ecuador's Yasuní National Park. *PLoS ONE* 5:e8767.

Bemmels, J. B., S. J. Wright, N. C. Garwood, S. A. Queenborough, R. Valencia, and C. W. Dick. 2018. Filter-dispersal assembly of lowland Neotropical rainforests across the Andes. *Ecography* 41:1-13.

Bennett, J. R., and B. Gilbert. 2016. Contrasting beta diversity among regions: how do classical and multivariate approaches compare? *Global Ecology and Biogeography* 25:368-377.

Blomberg, S. P., T. Garland, and A. R. Ives. 2003. Testing for phylogenetic signal in comparative data: Behavioral traits are more labile. *Evolution* 57:717-745.

Blyth, S., B. Groombridge, I. Lysenko, L. Miles, and A. Newton. 2002. Mountain watch: Environmental change and sustainable development in mountains. UNEP-WCMC, Cambridge, UK.

Boyle, B., N. Hopkins, Z. Lu, J. A. Raygoza Garay, D. Mozzherin, T. Rees, N. Matasci, M. L. Narro, W. H. Piel, S. J. Mckay, S. Lowry, C. Freeland, R. K. Peet, and B. J. Enquist. 2013. The taxonomic name resolution service: an online tool for automated standardization of plant names. *BMC Bioinformatics* 14:16.

Cardenas, R. E., R. Valencia, N. J. Kraft, A. Argoti, and O. Dangles. 2014. Plant traits predict inter-and intraspecific variation in susceptibility to herbivory in a hyperdiverse Neotropical rain forest tree community. *Journal of Ecology* 102:939-952.

Cavender-Bares, J., D. Ackerly, D. Baum, and F. Bazzaz. 2004. Phylogenetic overdispersion in Floridian oak communities. *The American Naturalist* 163:823-843.



- Cavender-Bares, J., K. H. Kozak, P. V. A. Fine, and S. W. Kembel. 2009. The merging of community ecology and phylogenetic biology. *Ecology Letters* 12:693-715.
- Chase, J. M., and M. A. Leibold. 2003. *Ecological niches: linking classical and contemporary approaches*. University of Chicago Press, Chicago.
- Chesson, P. 2000. Mechanisms of Maintenance of Species Diversity. *Annual Review of Ecology and Systematics* 31:343-366.
- Chisholm, R. A., and S. W. Pacala. 2010. Niche and neutral models predict asymptotically equivalent species abundance distributions in high-diversity ecological communities. *Proceedings of the National Academy of Sciences*:201009387.
- Choat, B., T. J. Brodribb, C. R. Brodersen, R. A. Duursma, R. López, and B. E. Medlyn. 2018. Triggers of tree mortality under drought. *Nature* 558:531.
- Choat, B., S. Jansen, T. J. Brodribb, H. Cochard, S. Delzon, R. Bhaskar, S. J. Bucci, T. S. Feild, S. M. Gleason, U. G. Hacke, A. L. Jacobsen, F. Lens, H. Maherali, J. Martínez-Vilalta, S. Mayr, M. Mencuccini, P. J. Mitchell, A. Nardini, J. Pittermann, R. B. Pratt, J. S. Sperry, M. Westoby, I. J. Wright, and A. E. Zanne. 2015. Global convergence in the vulnerability of forests to drought. *Nature* 491:752-755.

- Clark, A. T., M. Detto, H. C. Muller-Landau, S. A. Schnitzer, S. J. Wright, R. Condit, and S. P. Hubbell. 2017. Functional traits of tropical trees and lianas explain spatial structure across multiple scales. *Journal of Ecology* 106:795–780.
- Coley, P. D., J. P. Bryant, and F. S. Chapin. 1985. Resource availability and plant antiherbivore defense. *Science* 230:895-899.
- Coley, P. D., and T. A. Kursor. 1996. Anti-Herbivore Defenses of Young Tropical Leaves: Physiological Constraints and Ecological Trade-offs. Pages 305-336. Springer, Boston, MA.
- Colwell, R., and G. Hurt. 1994. Nonbiological gradients in species richness and a spurious Rapoport effect. *The American Naturalist* 144:570-595.
- Colwell, R., and D. Winkler. 1984. A null model for null models in biogeography. Pages 344-359 in Strong, D.R., Simberloff, D., Abele, L.G. & Thistle A.B., eds. *Ecological communities: conceptual issues and the evidence*. Princeton University Press, Princeton, N.J.
- Condit, R., P. S. Ashton, P. Baker, S. Bunyavejchewin, S. Gunatilleke, N. Gunatilleke, S. P. Hubbell, R. B. Foster, A. Itoh, J. V. LaFrankie, H. S. Lee, E. Losos, N. Manokaran, R.

- Sukumar, and T. Yamakura. 2000. Spatial patterns in the distribution of tropical tree species. *Science* 288:1414-1418.
- Cornelissen, J., S. Lavorel, E. Garnier, S. Diaz, N. Buchmann, D. E. Gurvich, P. B. Reich, H. ter Steege, H. D. Morgan, M. van der Heijden, J. G. Pausas, and H. Poorter. 2003. A handbook of protocols for standardised and easy measurement of plant functional traits worldwide. *Australian Journal of Botany* 51:335-380.
- Cornwell, W. K., and D. D. Ackerly. 2009. Community assembly and shifts in plant trait distributions across an environmental gradient in coastal California. *Ecological Monographs* 79:109-126.
- Davies, T. J., N. J. Kraft, N. Salamin, and E. M. Wolkovich. 2012. Incompletely resolved phylogenetic trees inflate estimates of phylogenetic conservatism. *Ecology* 93:242-247.
- Deblauwe, V., P. Kennel, and P. Couteron. 2012. Testing pairwise association between spatially autocorrelated variables: A new approach using surrogate lattice data. *PLoS ONE* 7:e48766.
- Diggle, P. J., and R. J. Gratton. 1984. Monte Carlo methods of inference for implicit statistical models. *Journal of the Royal Statistical Society. Series B (Methodological)*:193-227.

Dormann, C. F., J. M. McPherson, M. B. Araujo, R. Bivand, J. Bolliger, G. Carl, R. G. Davies, A. Hirzel, W. Jetz, W. D. Kissling, I. Kuehn, R. Ohlemueller, P. R. Peres-Neto, B. Reineking, B. Schroeder, F. M. Schurr, and R. Wilson. 2007. Methods to account for spatial autocorrelation in the analysis of species distributional data: a review. *Ecography* 30:609-628.

Duarte, L. D. S., R. S. Bergamin, V. Marcilio-Silva, G. D. Dos Santos Seger, and M. C. Mendes Marques. 2014. Phylobetadiversity among forest types in the Brazilian Atlantic Forest complex. *PLoS ONE* 9:e105043.

Dynesius, M., and R. Jansson. 2000. Evolutionary consequences of changes in species' geographical distributions driven by Milankovitch climate oscillations. *Proceedings of the National Academy of Sciences* 97:9115-9120.

Engelbrecht, B. M., L. S. Comita, R. Condit, T. A. Kursar, M. T. Tyree, B. L. Turner, and S. P. Hubbell. 2007. Drought sensitivity shapes species distribution patterns in tropical forests. *Nature* 447:80.

Enquist, B. J., R. Condit, R. K. Peet, M. Schildhauer, and B. M. Thiers. 2016. Cyberinfrastructure for an integrated botanical information network to investigate the ecological impacts of global climate change on plant biodiversity. *PeerJ Preprints* e2615v1.

- Feeley, K. 2015. Are we filling the data void? An assessment of the amount and extent of plant collection records and census data available for tropical South America. *PLoS ONE* 10:e0125629.
- Fine, P. V., and S. W. Kembel. 2011. Phylogenetic community structure and phylogenetic turnover across space and edaphic gradients in western Amazonian tree communities. *Ecography* 34:552-565.
- Fine, P. V., I. Mesones, and P. D. Coley. 2004. Herbivores promote habitat specialization by trees in Amazonian forests. *Science* 305:663-665.
- Fortunel, C., R. Valencia, S. J. Wright, N. C. Garwood, and N. J. B. Kraft. 2016. Functional trait differences influence neighbourhood interactions in a hyperdiverse Amazonian forest. *Ecology Letters* 19:1062-1070.
- Gaston, K. J. 2000. Global patterns in biodiversity. *Nature* 405:220-227.
- Gentry, A. H. 1982. Patterns of neotropical plant species diversity. Pages 1-84 *Evolutionary biology*. Springer.
- Ghalambor, C. K., R. B. Huey, P. R. Martin, J. J. Tewksbury, and G. Wang. 2006. Are mountain passes higher in the tropics? Janzen's hypothesis revisited. *Integrative and comparative biology* 46:5-17.

- Godoy, O., N. J. Kraft, and J. M. Levine. 2014. Phylogenetic relatedness and the determinants of competitive outcomes. *Ecology Letters* 17:836-844.
- Gotelli, N. J., M. J. Anderson, H. T. Arita, A. Chao, R. K. Colwell, S. R. Connolly, D. J. Currie, R. R. Dunn, G. R. Graves, and J. L. Green. 2009. Patterns and causes of species richness: a general simulation model for macroecology. *Ecology Letters* 12:873-886.
- Graham, A. 2010. *A Natural History of the New World*. University of Chicago Press.
- Graham, C. H., and P. V. A. Fine. 2008. Phylogenetic beta diversity: linking ecological and evolutionary processes across space in time. *Ecology Letters* 11:1265-1277.
- Grime, J. P. 1977. Evidence for the existence of three primary strategies in plants and its relevance to ecological and evolutionary theory. *American Naturalist* 111:1169-1194.
- Harms, K. E., R. Condit, S. P. Hubbell, and R. B. Foster. 2001. Habitat associations of trees and shrubs in a 50-ha neotropical forest plot. *Journal of Ecology* 89:947-959.
- Harrison, R. D., S. Tan, J. B. Plotkin, F. Slik, M. Detto, T. Brenes, A. Itoh, and S. J. Davies. 2013. Consequences of defaunation for a tropical tree community. *Ecology Letters* 16:687-694.

Harrison, S., S. J. Ross, and J. H. Lawton. 1992. Beta-Diversity on Geographic Gradients in Britain. *Journal of Animal Ecology* 61:151-158.

Hart, S. P., J. Usinowicz, and J. M. Levine. 2017. The spatial scales of species coexistence. *Nature Ecology and Evolution* 1:1066-1073.

Hietz, P., R. Valencia, and S. Joseph Wright. 2013. Strong radial variation in wood density follows a uniform pattern in two neotropical rain forests. *Functional Ecology* 27:684-692.

Hijmans, R. J., S. E. Cameron, J. L. Parra, P. G. Jones, and A. Jarvis. 2005. Very high resolution interpolated climate surfaces for global land areas. *International Journal of Climatology* 25:1965-1978.

Hillebrand, H. 2004. On the generality of the latitudinal diversity gradient. *American Naturalist* 163:192-211.

Holbrook, K. M., and T. B. Smith. 2000. Seed dispersal and movement patterns in two species of *Ceratogymna* hornbills in a West African tropical lowland forest. *Oecologia* 125:249-257.

- Hoorn, C., F. Wesselingh, H. Ter Steege, M. Bermudez, A. Mora, J. Sevink, I. Sanmartín, A. Sanchez-Meseguer, C. Anderson, and J. Figueiredo. 2010. Amazonia through time: Andean uplift, climate change, landscape evolution, and biodiversity. *Science* 330:927-931.
- Howe, H. F., and J. Smallwood. 1982. Ecology of Seed Dispersal. *Annual Review of Ecology and Systematics* 13:201-228.
- Hubbell, S. P. 1979. Tree Dispersion, Abundance, and Diversity in a Tropical Dry Forest. *Science* 203:1299-1309.
- Hubbell, S. P. 2001. *The Unified Neutral Theory of Biodiversity and Biogeography*. Princeton University Press, Princeton, N.J.
- Hubbell, S. P., F. He, R. Condit, L. Borda-de-Água, J. Kellner, and H. ter Steege. 2008. How many tree species are there in the Amazon and how many of them will go extinct? *Proceedings of the National Academy of Sciences* 105:11498-11504.
- Hurt, G. C., and S. W. Pacala. 1995. The consequences of recruitment limitation: reconciling chance, history and competitive differences between plants. *Journal of Theoretical Biology* 176:1-12.



Jalilian, A., Y. Guan, and R. Waagepetersen. 2013. Decomposition of Variance for Spatial Cox Processes. *Scandinavian Journal of Statistics* 40:119-137.

Janzen, D. H. 1967. Why Mountain Passes are Higher in the Tropics. *American Naturalist* 101:233-249.

John, R., J. W. Dalling, K. E. Harms, J. B. Yavitt, R. F. Stallard, M. Mirabello, S. P. Hubbell, R. Valencia, H. Navarrete, M. Vallejo, and R. B. Foster. 2007. Soil nutrients influence spatial distributions of tropical tree species. *Proceedings of the National Academy of Sciences* 104:864-869.

Kattge, J., S. Diaz, S. Lavorel, C. Prentice, P. Leadley, G. Boenisch, E. Garnier, M. Westoby, P. B. Reich, I. J. Wright, J. H. C. Cornelissen, C. Violle, S. P. Harrison, P. M. van Bodegom, M. Reichstein, B. J. Enquist, N. A. Soudzilovskaia, D. D. Ackerly, M. Anand, O. Atkin, M. Bahn, T. R. Baker, D. Baldocchi, R. Bekker, C. C. Blanco, B. Blonder, W. J. Bond, R. Bradstock, D. E. Bunker, F. Casanoves, J. Cavender-Bares, J. Q. Chambers, F. S. I. Chapin, J. Chave, D. Coomes, W. K. Cornwell, J. M. Craine, B. H. Dobrin, L. Duarte, W. Durka, J. Elser, G. Esser, M. Estiarte, W. F. Fagan, J. Fang, F. Fernandez-Mendez, A. Fidelis, B. Finegan, O. Flores, H. Ford, D. Frank, G. T. Freschet, N. M. Fyllas, R. V. Gallagher, W. A. Green, A. G. Gutierrez, T. Hickler, S. I. Higgins, J. G. Hodgson, A. Jalili, S. Jansen, C. A. Joly, A. J. Kerkhoff, D. Kirkup, K. Kitajima, M. Kleyer, S. Klotz, J. M. H. Knops, K. Kramer, I. Kuehn, H. Kurokawa, D. Laughlin, T. D. Lee, M. Leishman, F. Lens, T. Lenz, S. L. Lewis, J. Lloyd, J. Llusia, F. Louault, S. Ma, M. D. Mahecha, P.

Manning, T. Massad, B. E. Medlyn, J. Messier, A. T. Moles, S. C. Mueller, K. Nadrowski, S. Naeem, U. Niinemets, S. Noellert, A. Nueske, R. Ogaya, J. Oleksyn, V. G. Onipchenko, Y. Onoda, J. Ordonez, G. Overbeck, W. A. Ozinga, S. Patino, S. Paula, J. G. Pausas, J. Penuelas, O. L. Phillips, V. Pillar, H. Poorter, L. Poorter, P. Poschlod, A. Prinzing, R. Proulx, A. Rammig, S. Reinsch, B. Reu, L. Sack, B. Salgado-Negre, J. Sardans, S. Shiodera, B. Shipley, A. Siefert, E. Sosinski, J. F. Soussana, E. Swaine, N. Swenson, K. Thompson, P. Thornton, M. Waldram, E. Weiher, M. White, S. White, S. J. Wright, B. Yguel, S. Zaehle, A. E. Zanne, and C. Wirth. 2011. TRY - a global database of plant traits. *Global Change Biology* 17:2905-2935.

Kissling, W. D., and G. Carl. 2008. Spatial autocorrelation and the selection of simultaneous autoregressive models. *Global Ecology and Biogeography* 17:59-71.

Koleff, P., J. J. Lennon, and K. J. Gaston. 2003. Are there latitudinal gradients in species turnover? *Global Ecology and Biogeography* 12:483-498.

Koptur, S. 1985. Alternative defenses against herbivores in *Inga* (Fabaceae: Mimosoideae) over an elevational gradient. *Ecology* 66:1639-1650.

Kraft, N. J. B., and D. D. Ackerly. 2010. Functional trait and phylogenetic tests of community assembly across spatial scales in an Amazonian forest. *Ecological Monographs* 80:401-422.

- Kraft, N. J. B., P. B. Adler, O. Godoy, E. C. James, S. Fuller, and J. M. Levine. 2015. Community assembly, coexistence and the environmental filtering metaphor. *Functional Ecology* 29:592-599.
- Kraft, N. J. B., L. S. Comita, J. M. Chase, N. J. Sanders, N. G. Swenson, T. O. Crist, J. C. Stegen, M. Vellend, B. Boyle, M. J. Anderson, H. V. Cornell, K. F. Davies, A. L. Freestone, B. D. Inouye, S. P. Harrison, and J. A. Myers. 2011. Disentangling the drivers of beta diversity along latitudinal and elevational gradients. *Science* 333:1755-1758.
- Kraft, N. J. B., R. Valencia, and D. D. Ackerly. 2008. Functional traits and niche-based tree community assembly in an Amazonian forest. *Science* 322:580-582.
- Levine, J. M., and D. J. Murrell. 2003. The community-level consequences of seed dispersal patterns. *Annual Review of Ecology, Evolution, and Systematics* 34:549-574.
- Lewis, S. L., P. M. Brando, O. L. Phillips, G. M. F. van der Heijden, and D. Nepstad. 2011. The 2010 Amazon Drought. *Science* 331:554-554.
- Loarie, S. R., P. B. Duffy, H. Hamilton, G. P. Asner, C. B. Field, and D. D. Ackerly. 2009. The velocity of climate change. *Nature* 462:1052.
- Loosmore, N. B., and E. D. Ford. 2006. Statistical inference using the G or K point pattern spatial statistics. *Ecology* 87:1925-1931.

Lowe, W. H., and M. A. McPeck. 2014. Is dispersal neutral? *Trends in Ecology and Evolution* 29:444-450.

Lozupone, C., and R. Knight. 2005. UniFrac: A new phylogenetic method for comparing microbial communities. *Applied and Environmental Microbiology* 71:8228-8235.

MacArthur, R., and R. Levins. 1967. The limiting similarity, convergence, and divergence of coexisting species. *The American Naturalist* 101:377-385.

MacArthur, R. H. 1958. Population Ecology of Some Warblers of Northeastern Coniferous Forests. *Ecology* 39:599-619.

MacArthur, R. H. 1972. *Geographical Ecology*. Princeton University Press, Princeton, N.J.

MacArthur, R. H., and E. O. Wilson. 1967. *The theory of island biogeography*. Princeton University Press, Princeton, N.J.

Mangan, S. A., S. A. Schnitzer, E. A. Herre, K. M. Mack, M. C. Valencia, E. I. Sanchez, and J. D. Bever. 2010. Negative plant–soil feedback predicts tree-species relative abundance in a tropical forest. *Nature* 466:752.

- Maréchaux, I., M. K. Bartlett, L. Sack, C. Baraloto, J. Engel, E. Joetzjer, and J. Chave. 2015. Drought tolerance as predicted by leaf water potential at turgor loss point varies strongly across species within an Amazonian forest. *Functional Ecology* 29:1268-1277.
- Mateo, R. G., O. Broennimann, S. Normand, B. Petitpierre, M. B. Araújo, J.-C. Svenning, A. Baselga, F. Fernández-González, V. Gómez-Rubio, and J. Muñoz. 2016. The mossy north: An inverse latitudinal diversity gradient in European bryophytes. *Scientific Reports* 6:25546.
- Mayfield, M. M., and J. M. Levine. 2010. Opposing effects of competitive exclusion on the phylogenetic structure of communities. *Ecology Letters* 13:1085-1093.
- McCain, C. M. 2009. Vertebrate range sizes indicate that mountains may be 'higher' in the tropics. *Ecology Letters* 12:550-560.
- McFadden, I. R., M. K. Bartlett, T. Wiegand, B. L. Turner, L. Sack, R. Valencia, and N. J. B. Kraft. 2018. Disentangling the functional trait correlates of spatial aggregation in tropical forest trees. *Ecology*. DOI: <https://doi.org/10.1002/ecy.2591>.
- McGill, B. J., B. J. Enquist, E. Weiher, and M. Westoby. 2006. Rebuilding community ecology from functional traits. *Trends in Ecology and Evolution* 21:178-185.

- McKnight, M. W., P. S. White, R. I. McDonald, J. F. Lamoreux, W. Sechrest, R. S. Ridgely, and S. N. Stuart. 2007. Putting beta-diversity on the map: Broad-scale congruence and coincidence in the extremes. *PLoS Biology* 5:2424-2432.
- Melo, A. S., T. F. L. Rangel, and J. A. F. Diniz-Filho. 2009. Environmental drivers of beta-diversity patterns in New-World birds and mammals. *Ecography* 32:226-236.
- Mittelbach, G. G., D. W. Schemske, H. V. Cornell, A. P. Allen, J. M. Brown, M. B. Bush, S. P. Harrison, A. H. Hurlbert, N. Knowlton, H. A. Lessios, C. M. McCain, A. R. McCune, L. A. McDade, M. A. McPeck, T. J. Near, T. D. Price, R. E. Ricklefs, K. Roy, D. F. Sax, D. Schluter, J. M. Sobel, and M. Turelli. 2007. Evolution and the latitudinal diversity gradient: speciation, extinction and biogeography. *Ecology Letters* 10:315-331.
- Møller, J., and R. P. Waagepetersen. 2003. *Statistical Inference and Simulation for Spatial Point Processes*. CRC Press, Boca Raton.
- Morlon, H., D. W. Schwilk, J. A. Bryant, P. A. Marquet, A. G. Rebelo, C. Tauss, B. J. M. Bohannan, and J. L. Green. 2011. Spatial patterns of phylogenetic diversity. *Ecology Letters* 14:141-149.
- Morueeta-Holme, N., K. Engemann, P. Sandoval-Acuña, J. D. Jonas, R. M. Segnitz, and J. C. Svenning. 2015. Strong upslope shifts in Chimborazo's vegetation over two

centuries since Humboldt. *Proceedings of the National Academy of Sciences*.  
112:12741-12745.

Morueta-Holme, N., B. J. Enquist, B. J. McGill, B. Boyle, P. M. Jorgensen, J. E. Ott, R. K. Peet, I. Simova, L. L. Sloat, B. Thiers, C. Violle, S. K. Wiser, S. Dolins, J. C. Donoghue, N. J. B. Kraft, J. Regetz, M. Schildhauer, N. Spencer, and J. C. Svenning. 2013. Habitat area and climate stability determine geographical variation in plant species range sizes. *Ecology Letters* 16:1446-1454.

Muller-Landau, H. C. 2010. The tolerance-fecundity trade-off and the maintenance of diversity in seed size. *Proceedings of the National Academy of Sciences* 107:4242-4247.

Myers, J. A., J. M. Chase, I. Jimenez, P. M. Jorgensen, A. Araujo-Murakami, N. Paniagua-Zambrana, and R. Seidel. 2013. Beta-diversity in temperate and tropical forests reflects dissimilar mechanisms of community assembly. *Ecology Letters* 16:151-157.

Nathan, R., and H. C. Muller-Landau. 2000. Spatial patterns of seed dispersal, their determinants and consequences for recruitment. *Trends in Ecology and Evolution* 15:278-285.

Novotny, V., S. E. Miller, J. Hulcr, R. A. I. Drew, Y. Basset, M. Janda, G. P. Setliff, K. Darrow, A. J. A. Stewart, J. Auga, B. Isua, K. Molem, M. Manumbor, E. Tamtiai, M. Mogia, and G. D. Weiblen. 2007. Low beta diversity of herbivorous insects in tropical forests. *Nature* 448:692-695.

Onoda, Y., M. Westoby, P. B. Adler, A. M. F. Choong, F. J. Clissold, J. H. C. Cornelissen, S. Diaz, N. J. Dominy, A. Elgart, L. Enrico, P. V. A. Fine, J. J. Howard, A. Jalili, K. Kitajima, H. Kurokawa, C. McArthur, P. W. Lucas, L. Markesteijn, N. Pérez-Harguindeguy, L. Poorter, L. Richards, L. S. Santiago, E. E. Sosinski Jr, S. A. Van Bael, D. I. Warton, I. J. Wright, S. Joseph Wright, and N. Yamashita. 2011. Global patterns of leaf mechanical properties. *Ecology Letters* 14:301-312.

Ordoñez, J. C., P. M. Van Bodegom, J. P. M. Witte, I. J. Wright, P. B. Reich, and R. Aerts. 2009. A global study of relationships between leaf traits, climate and soil measures of nutrient fertility. *Global Ecology and Biogeography* 18:137-149.

Pennington, R. T., and C. W. Dick. 2010. Diversification of the Amazonian Flora and its Relation to key Geological and Environmental Events: A Molecular Perspective. Pages 373-385 in *Amazonia: Landscape and Species Evolution*. Wiley-Blackwell Publishing Ltd.

Perez-Harguindeguy, N., S. Diaz, E. Garnier, S. Lavorel, H. Poorter, P. Jaureguiberry, M. S. Bret-Harte, W. K. Cornwell, J. M. Craine, D. E. Gurvich, C. Urcelay, E. J. Veneklaas, P. B.



- Reich, L. Poorter, I. J. Wright, P. Ray, L. Enrico, J. G. Pausas, A. C. de Vos, N. Buchmann, G. Funes, F. Quetier, J. G. Hodgson, K. Thompson, H. D. Morgan, H. ter Steege, L. Sack, B. Blonder, P. Poschlod, M. V. Vaieretti, G. Conti, A. C. Staver, S. Aquino, and J. H. C. Cornelissen. 2013. New handbook for standardised measurement of plant functional traits worldwide. *Australian Journal of Botany* 61:167-234.
- Phillips, S. J., and M. Dudík. 2008. Modeling of species distributions with Maxent: new extensions and a comprehensive evaluation. *Ecography* 31:161-175.
- Pinto, S. M., and A. S. MacDougall. 2010. Dispersal Limitation and Environmental Structure Interact to Restrict the Occupation of Optimal Habitat. *American Naturalist* 175:675-686.
- Qian, H., and R. E. Ricklefs. 2007. A latitudinal gradient in large-scale beta diversity for vascular plants in North America. *Ecology Letters* 10:737-744.
- Qian, H., N. G. Swenson, and J. Zhang. 2013. Phylogenetic beta diversity of angiosperms in North America. *Global Ecology and Biogeography* 22:1152-1161.
- R Core Team. 2016. R: A language and environment for statistical computing. R Foundation for Statistical Computing, Vienna, Austria.

- Raxworthy, C. J., E. Martinez-Meyer, N. Horning, R. A. Nussbaum, G. E. Schneider, M. A. Ortega-Huerta, and A. T. Peterson. 2003. Predicting distributions of known and unknown reptile species in Madagascar. *Nature* 426:837.
- Reynolds, B. C., and D. Crossley Jr. 1997. Spatial variation in herbivory by forest canopy arthropods along an elevation gradient. *Environmental Entomology* 26:1232-1239.
- Ricklefs, R. E. 1987. Community Diversity - Relative Roles of Local and Regional Processes. *Science* 235:167-171.
- Rohde, K. 1992. Latitudinal Gradients in Species Diversity: The Search for the Primary Cause. *Oikos* 65:514.
- Rosenzweig, M. L. 1995. *Species Diversity in Space and Time*. Cambridge University Press, Cambridge.
- Rosindell, J., S. P. Hubbell, F. He, L. J. Harmon, and R. S. Etienne. 2012. The case for ecological neutral theory. *Trends in Ecology and Evolution* 27:204-209.
- Roslin, T., B. Hardwick, V. Novotny, W. K. Petry, N. R. Andrew, A. Asmus, I. C. Barrio, Y. Basset, A. L. Boesing, and T. C. Bonebrake. 2017. Higher predation risk for insect prey at low latitudes and elevations. *Science* 356:742-744.

- Russo, S., M. Potts, S. J. Davies, and S. Tan. 2007. Determinants of Tree Species Distributions: Comparing the Roles of Dispersal, Seed Size and Soil Specialization in a Bornean Rainforest. Pages 499-518 in A. Dennis, E.W. Schupp, R. Green, & D. Westcott, eds. Seed Dispersal: Theory and its Application in a Changing World CAB International, New York.
- Russo, S. E., S. J. Davies, D. A. King, and S. Tan. 2005. Soil-related performance variation and distributions of tree species in a Bornean rain forest. *Journal of Ecology* 93:879-889.
- Sack, L., and N. M. Holbrook. 2006. Leaf hydraulics. *Annu. Rev. Plant Biol.* 57:361-381.
- Sandel, B., L. Arge, B. Dalsgaard, R. G. Davies, K. J. Gaston, W. J. Sutherland, and J. C. Svenning. 2011. The influence of Late Quaternary climate-change velocity on species endemism. *Science* 334:660-664.
- Schimper, A. 1908. *Pflanzen-geographie auf physiologischer Grundlage*. G. Fischer.
- Schluter, D. 2016. Speciation, Ecological Opportunity, and Latitude. *American Naturalist* 187:1-18.
- Schoener, T. W. 1983. Rate of species turnover decreases from lower to higher organisms: a review of the data. *Oikos*:372-377.

Seidler, T. G., and J. B. Plotkin. 2006. Seed Dispersal and Spatial Pattern in Tropical Trees.

*PLoS Biology* 4:e344.

Shen, G., F. He, R. Waagepetersen, I.-F. Sun, Z. Hao, Z.-S. Chen, and M. Yu. 2013. Quantifying

effects of habitat heterogeneity and other clustering processes on spatial

distributions of tree species. *Ecology* 94:2436-2443.

Shen, G., M. Yu, X.-S. Hu, X. Mi, H. Ren, I. Sun, and K. Ma. 2009. Species–area relationships

explained by the joint effects of dispersal limitation and habitat heterogeneity.

*Ecology* 90:3033-3041.

Silvertown, J. 2004. Plant coexistence and the niche. *Trends in Ecology and Evolution*

19:605-611.

Slavich, E., D. I. Warton, M. B. Ashcroft, J. R. Gollan, and D. Ramp. 2014. Topoclimate versus

macroclimate: how does climate mapping methodology affect species distribution

models and climate change projections? *Diversity and Distributions* 20:952-963.

Smith, S. A., J. M. Beaulieu, and M. J. Donoghue. 2009. Mega-phylogeny approach for

comparative biology: an alternative to supertree and supermatrix approaches. *BMC*

*Evolutionary Biology* 9:37.

- Sørensen, R., U. Zinko, and J. Seibert. 2006. On the calculation of the topographic wetness index: evaluation of different methods based on field observations. *Hydrology and Earth System Sciences Discussions* 10:101-112.
- Stevens, G. C. 1989. The latitudinal gradient in geographical range: how so many species coexist in the tropics. *The American Naturalist* 133:240-256.
- Stokstad, E. 2011. Open-Source Ecology Takes Root Across the World. *Science* 334:308.
- Swenson, N. G. 2011. Phylogenetic Beta Diversity Metrics, Trait Evolution and Inferring the Functional Beta Diversity of Communities. *PLoS ONE* 6:e21264.
- Swenson, N. G. 2014. Phylogenetic imputation of plant functional trait databases. *Ecography* 37:105-110.
- Swenson, N. G., J. Stegen, S. Davies, and D. L. Erickson. 2012. Temporal Turnover in the Composition of Tropical Tree Communities: Functional Determinism and Phylogenetic Stochasticity. *Ecology* 93:490-499.
- ter Steege, H., N. C. A. Pitman, D. Sabatier, C. Baraloto, R. P. Salomão, J. E. Guevara, O. L. Phillips, C. V. Castilho, W. E. Magnusson, J.-F. Molino, A. Monteagudo, P. Núñez Vargas, J. C. Montero, T. R. Feldpausch, E. N. H. Coronado, T. J. Killeen, B. Mostacedo,

R. Vasquez, R. L. Assis, J. Terborgh, F. Wittmann, A. Andrade, W. F. Laurance, S. G. W. Laurance, B. S. Marimon, B.-H. Marimon, I. C. Guimarães Vieira, I. L. Amaral, R. Brienen, H. Castellanos, D. Cárdenas López, J. F. Duivenvoorden, H. F. Mogollón, F. D. d. A. Matos, N. Dávila, R. García-Villacorta, P. R. Stevenson Diaz, F. Costa, T. Emilio, C. Levis, J. Schiatti, P. Souza, A. Alonso, F. Dallmeier, A. J. D. Montoya, M. T. Fernandez Piedade, A. Araujo-Murakami, L. Arroyo, R. Gribel, P. V. A. Fine, C. A. Peres, M. Toledo, G. A. Aymard C, T. R. Baker, C. Cerón, J. Engel, T. W. Henkel, P. Maas, P. Petronelli, J. Stropp, C. E. Zartman, D. Daly, D. Neill, M. Silveira, M. R. Paredes, J. Chave, D. d. A. Lima Filho, P. M. Jørgensen, A. Fuentes, J. Schöngart, F. Cornejo Valverde, A. Di Fiore, E. M. Jimenez, M. C. Peñuela Mora, J. F. Phillips, G. Rivas, T. R. van Andel, P. von Hildebrand, B. Hoffman, E. L. Zent, Y. Malhi, A. Prieto, A. Rudas, A. R. Ruschell, N. Silva, V. Vos, S. Zent, A. A. Oliveira, A. C. Schutz, T. Gonzales, M. Trindade Nascimento, H. Ramirez-Angulo, R. Sierra, M. Tirado, M. N. Umaña Medina, G. van der Heijden, C. I. A. Vela, E. Vilanova Torre, C. Vriesendorp, O. Wang, K. R. Young, C. Baider, H. Balslev, C. Ferreira, I. Mesones, A. Torres-Lezama, L. E. Urrego Giraldo, R. Zagt, M. N. Alexiades, L. Hernandez, I. Huamantupa-Chuquimaco, W. Milliken, W. Palacios Cuenca, D. Pauletto, E. Valderrama Sandoval, L. Valenzuela Gamarra, K. G. Dexter, K. Feeley, G. Lopez-Gonzalez, and M. R. Silman. 2013. Hyperdominance in the Amazonian tree flora. *Science* 342:1243092.

Tewksbury, J. J., R. B. Huey, and C. A. Deutsch. 2008. Putting the heat on tropical animals. *Science* 320:1296.

Thomson, F. J., A. T. Moles, T. D. Auld, and R. T. Kingsford. 2011. Seed dispersal distance is more strongly correlated with plant height than with seed mass. *Journal of Ecology* 99:1299-1307.

Tilman, D. 1982. Resource competition and community structure. Princeton University Press, Princeton, N.J.

Turner, B. L., T. Brenes-Arguedas, and R. Condit. 2018. Pervasive phosphorus limitation of tree species but not communities in tropical forests. *Nature* 555:367.

Turner, M. G. 1989. Landscape ecology: the effect of pattern on process. *Annual Review of Ecology and Systematics* 20:171-197.

Usinowicz, J., C.-H. Chang-Yang, Y.-Y. Chen, J. S. Clark, C. Fletcher, N. C. Garwood, Z. Hao, J. Johnstone, Y. Lin, and M. R. Metz. 2017. Temporal coexistence mechanisms contribute to the latitudinal gradient in forest diversity. *Nature* 550:105.

Valencia, R., R. B. Foster, G. Villa, R. Condit, J. C. Svenning, C. Hernández, K. Romoleroux, E. Losos, E. Magård, and H. Balslev. 2004. Tree species distributions and local habitat variation in the Amazon: large forest plot in eastern Ecuador. *Journal of Ecology* 92:214-229.

Vellend, M. 2010. Conceptual synthesis in community ecology. *The Quarterly Review of Biology* 85:183-206.

Vellend, M. 2016. *The Theory of Ecological Communities*. Princeton University Press.

Violle, C., W. Thuiller, N. Mouquet, F. Munoz, N. J. Kraft, M. W. Cadotte, S. W. Livingstone, and D. Mouillot. 2017. Functional rarity: the ecology of outliers. *Trends in Ecology and Evolution* 32:356-367.

Waagepetersen, R., and Y. Guan. 2009. Two-step estimation for inhomogeneous spatial point processes. *Journal of the Royal Statistical Society: Series B (Statistical Methodology)* 71:685-702.

Webb, C. O., D. D. Ackerly, and S. W. Kembel. 2008. Phylocom: software for the analysis of phylogenetic community structure and trait evolution. *Bioinformatics* 24:2098-2100.

Webb, C. O., D. D. Ackerly, M. A. McPeck, and M. J. Donoghue. 2002. Phylogenies and community ecology. *Annual Review of Ecology and Systematics* 33:475-505.

Westoby, M. 1998. A leaf-height-seed (LHS) plant ecology strategy scheme. *Plant and Soil* 199:213-227.



Westoby, M., D. S. Falster, A. T. Moles, P. A. Vesk, and I. J. Wright. 2002. Plant ecological strategies: Some leading dimensions of variation between species. *Annual Review of Ecology and Systematics* 33:125-159.

Westoby, M., and I. J. Wright. 2006. Land-plant ecology on the basis of functional traits. *Trends in Ecology and Evolution* 21:261-268.

Whittaker, R. H. 1970. *Communities and Ecosystems*. Macmillan, London.

Wiegand, T., S. Gunatilleke, and N. Gunatilleke. 2007. Species associations in a heterogeneous Sri Lankan dipterocarp forest. *The American Naturalist* 170:E77-E95.

Wiegand, T., I. Martinez, and A. Huth. 2009. Recruitment in Tropical Tree Species: Revealing Complex Spatial Patterns. *American Naturalist* 174:E106-E140.

Wiegand, T., and K. A. Moloney. 2014. *Handbook of Spatial Point-Pattern Analysis in Ecology*, Chapman and Hall / CRC Press, Boca Raton.

Wiegand, T., M. Uriarte, N. J. B. Kraft, G. C. Shen, X. G. Wang, and F. L. He. 2017. Spatially Explicit Metrics of Species Diversity, Functional Diversity, and Phylogenetic

Diversity: Insights into Plant Community Assembly Processes. *Annual Review of Ecology, Evolution, and Systematics*, 48:329-351.

Wright, I. J., P. B. Reich, M. Westoby, D. D. Ackerly, Z. Baruch, F. Bongers, J. Cavender-Bares, T. Chapin, J. H. Cornelissen, and M. Diemer. 2004. The worldwide leaf economics spectrum. *Nature* 428:821.

Wright, S. J. 2002. Plant diversity in tropical forests: a review of mechanisms of species coexistence. *Oecologia* 130:1-14.

Wright, S. J., K. E. Stoner, N. Beckman, R. T. Corlett, R. Dirzo, H. C. Muller-Landau, G. Nuñez-Iturri, C. A. Peres, and B. C. Wang. 2007. The plight of large animals in tropical forests and the consequences for plant regeneration. *Biotropica* 39:289-291.

Xu, L., R. B. Myneni, F. S. Chapin III, T. V. Callaghan, J. E. Pinzon, C. J. Tucker, Z. Zhu, J. Bi, P. Ciais, H. Tømmervik, E. S. Euskirchen, B. C. Forbes, S. L. Piao, B. T. Anderson, S. Ganguly, R. R. Nemani, S. J. Goetz, P. S. A. Beck, A. G. Bunn, C. Cao, and J. C. Stroeve. 2013. Temperature and vegetation seasonality diminishment over northern lands. *Nature Climate Change* 3:581-586.

Yang, J., M. Cao, and N. G. Swenson. 2018. Why Functional Traits Do Not Predict Tree Demographic Rates. *Trends in Ecology and Evolution* 33:326-336.

Zuleta, D., A. Duque, D. Cardenas, H. C. Muller-Landau, and S. J. Davies. 2017. Drought-induced mortality patterns and rapid biomass recovery in a terra firme forest in the Colombian Amazon. *Ecology* 98:2538-2546.