

# UCSF

## UC San Francisco Previously Published Works

### Title

Reactions of hemoglobin with phenylhydrazine: a review of selected aspects.

### Permalink

<https://escholarship.org/uc/item/6mz530p8>

### Authors

Shetlar, MD  
Hill, HA

### Publication Date

1985-12-01

### DOI

10.1289/ehp.8564265

Peer reviewed

# Reactions of Hemoglobin with Phenylhydrazine: A Review of Selected Aspects

by Martin D. Shetlar\*<sup>†</sup> and H. Allen O. Hill\*

It is well known that phenylhydrazine induces hemolytic anemia. This is thought to result from the reaction of phenylhydrazine with hemoglobin. The accompanying oxidation of phenylhydrazine leads to the formation of a number of products, including benzene, nitrogen, hydrogen peroxide, superoxide anion and the phenyl radical. The products formed depend critically on the conditions of the experiment, especially the amount of oxygen present. It is now known that oxyhemoglobin and myoglobin react with phenylhydrazine to yield a derivative of hemoglobin containing *N*-phenylprotoporphyrin in which the heme group is modified. The recent identification of  $\sigma$ -phenyliron(III) porphyrins in phenylhydrazine-modified metmyoglobin has aided elucidation of the mechanism of hemoglobin modification. Mechanistic schemes are proposed to account for product formation.

## Introduction

A number of hemolytic agents are known that induce nonindigenous redox processes in erythrocytes. These drugs, by reducing the life span of red blood cells below that deemed normal (about 120 days), can lower the circulating red blood cell population in susceptible individuals. Presumably, drug-mediated processes cause a large enough change in certain properties of a significant number of red blood cells, e.g., membrane deformability (1), that they are removed from circulation by the spleen and liver and then hemolyzed. Persons with genetic deficiencies in key enzymes involved in red cell metabolism (e.g., glucose-6-phosphate dehydrogenase, glutathione reductase, glutathione peroxidase) are particularly susceptible to induction of hemolytic anemia by these redox drugs. Such enzymes are important components of biochemical pathways that maintain hemoglobin in its functional reduced state and help avoid or repair the effects of redox processes that challenge the integrity of the erythrocyte. General reviews of drug-induced hemolytic anemias, including their clinical and genetic aspects, have been given in the literature (2-4).

Phenylhydrazine (PHZ), a particularly potent redox-active drug, can induce hemolytic anemia, even in individuals without erythrocytic enzyme deficiencies (2). Indeed, the ability of PHZ to cause removal of eryth-

rocytes from circulation was the basis of its former use as a therapeutic agent for polycythemia vera, a disorder in which increased red cell mass in the circulatory system is one symptom (5,6). This potency, as a hemolytic agent, likewise accounts for the use of PHZ in producing experimental anemia in test animals (?).

Observations in the last century indicated that PHZ could induce dramatic changes in erythrocytes *in vitro*, as well as *in vivo*. Hoppe-Seyler (8) found, in 1885, that blood from rabbits treated with PHZ was brown in color and that addition of PHZ to suspended erythrocytes gave them also a brown coloration; spectroscopic studies indicated that oxyhemoglobin (HbO<sub>2</sub>) had disappeared. In 1890 Heinz (9) likewise found that mixing either nucleated (from cold blooded animals) or nonnucleated erythrocytes with PHZ turned them green-brown. He also discovered that inclusion bodies (now termed Heinz bodies) were formed in erythrocytes exposed to PHZ and that a number of compounds closely related to PHZ, e.g., *N*-acetylphenylhydrazine (APHZ), could induce similar effects. Since these initial observations a large amount of research effort has been devoted to trying to understand the processes that occur in erythrocytes, or with oxyhemoglobin, on exposure to PHZ and related compounds and how PHZ-induced changes in erythrocytes lead to hemolytic anemia. As a result the cellular and chemical responses of the red blood cell to this agent have been quite thoroughly scrutinized. It has been found, for example, that lipid peroxidation occurs within the cellular membranes of erythrocytes (10) and that protein-protein crosslinking occurs within the supporting network associated with the membrane (11). Oxyhemoglobin forms methemoglobin (MHb) by PHZ-in-

\*Inorganic Chemistry Laboratory, University of Oxford, South Parks Road, Oxford, OX1 3QR, U.K.

<sup>†</sup>Permanent address: Department of Pharmaceutical Chemistry, School of Pharmacy, University of California, San Francisco, CA 94143.

duced processes and the reduction of MHb to deoxyhemoglobin (Hb) (in anaerobic systems) or the formation of HbO<sub>2</sub> (in aerobic environments) can also be induced to occur. These reactions of hemoglobin, promoted by PHZ, do not proceed without accompanying irreversible degradative reactions. Hemoglobin, whether free in solution or within erythrocytes, reacts with PHZ to yield "green hemoglobin", a form in which the heme group is modified (12). Processes induced by PHZ also cause destabilization of the globin portion of hemoglobin, leading to denaturation and precipitation (12). A number of small molecules have been experimentally detected as products of the reaction of hemoglobin with PHZ, some of them presumably acting as intermediates in inducing the irreversible products described above. This group of compounds includes benzene (12), nitrogen (13), hydrogen peroxide (14), superoxide anion (15), and the phenyl radical (16). Other species are suspected of being involved in the reaction of hemoglobin with PHZ, including phenyldiazene (12), phenylhydrazyl (17), and phenyldiazanyl radicals (18), and the benzenediazonium ion (17).

The catalog of chemical, macromolecular and cellular effects of PHZ on erythrocytes and hemoglobin, given above, provides a wealth of phenomena for any proposed chemical mechanism(s) for PHZ action to explain. Until recently, however, progress towards understanding how PHZ acts has been hindered by the lack of such basic knowledge as the nature of the modified heme of green hemoglobin in PHZ treated systems and the stoichiometric relationships between PHZ and oxygen consumption and product formation. This information has recently become available. Consequently the time appears ripe to assess our knowledge of the chemical mechanisms by which PHZ, and certain related compounds, interact with hemoglobin.

## Reaction of Hemoglobin with Phenylhydrazine: Products

In this section we will discuss the chemical products observed when three forms of hemoglobin (oxyhemoglobin, deoxyhemoglobin, and methemoglobin) are treated with phenylhydrazine. In the first subsection we will focus on the interaction of PHZ with Hb and MHb in the absence of oxygen. The material presented in this section will lay the basis for an appreciation of the importance of oxygen and hydrogen peroxide in the more complex chemistry occurring in the biologically relevant reactions of hemoglobin under aerobic conditions.

### Deoxyhemoglobin- and Methemoglobin-Phenylhydrazine Systems in the Absence of Oxygen

**The Hb-PHZ System.** Several lines of evidence indicate that Hb does not interact chemically with PHZ. Certain products, formed in the reaction of PHZ with

hemoglobin in other states, are not found. Beaven and White (12) noted that benzene is not formed when PHZ is added to Hb under nitrogen, while Ortiz de Montellano and Kunze (19), under similar conditions, showed that the chromophore of green hemoglobin was not found as a product in the Hb-PHZ system, after aerobic workup with acidified methanol. This latter substance is formed in the HbO<sub>2</sub>-PHZ system. Rostorfer and Totter (20) provided another piece of evidence that reaction with PHZ does not occur in the Hb-PHZ system. They reduced MHb anaerobically (see below) and found 2 moles of PHZ were needed to reduce 1 mole of MHb to Hb. Addition of excess PHZ did not lead to increased consumption of PHZ, over that required to complete the reduction.

A mode of interaction, not necessarily leading to decomposition of phenylhydrazine and covalent modification of hemoglobin, would be for PHZ and Hb to form a reversible heme-Fe<sup>II</sup>-PHZ complex. Evidence has not yet appeared to support this idea. If such a complex is formed, then the PHZ must be assumed to exert a weak perturbation on the heme as Itano and Robinson (21) noted that the absorption spectrum of Hb was unaltered by the presence of PHZ. Studying the related deoxymyoglobin (Mb)-methylhydrazine (MHZ) system, Mansuy et al. (22) noted that MHZ did not bind to Mb Fe<sup>II</sup>.

**The MHb-PHZ System.** Using results from gas volumetric and spectroscopic experiments, Rostorfer and Totter (20) concluded that benzene and nitrogen were formed in equimolar amounts as final products in the reduction of MHb with PHZ under anaerobic conditions. Based on studies of the uptake of carbon monoxide during the reaction, they also determined that Hb was being produced concurrently with benzene and N<sub>2</sub>. The same workers also established that two moles of PHZ were consumed per mole of MHb (4 moles of Fe<sup>III</sup>) reduced. Excess PHZ, over that required for stoichiometric purposes, did not cause additional reaction to occur and could be quantitatively accounted for as PHZ when the reaction was terminated.

The stoichiometric results, described above, require that PHZ itself be involved in reduction of only half of the Fe<sup>III</sup> in MHb; the remaining reduction is presumably carried out by one of its oxidation products. The phenylhydrazyl radical (PHZR) and phenyldiazene (PDA) are the two most likely candidates. Several considerations favor PHZR as the actual (or at least dominant) reductant of the remaining half of the heme in MHb. One electron oxidation of PHZ by Fe<sup>III</sup> to form Fe<sup>II</sup> requires that PHZR be produced as a product, which in turn must transfer a hydrogen atom or another electron to an acceptor to form PDA. If PDA is postulated to be the actual reductant, then one must account for the disposition of the hydrogen atom or electrons lost in converting PHZR to PDA. While it is conceivable that the globin or porphyrin portions of hemoglobin could act as hydrogen atom or electron acceptors for PHZR, experimental evidence is lacking. Secondly, Itano and Mannen (23) have shown that re-

action of MHb with PDA, under N<sub>2</sub>, gives both Hb and a substantial amount of a stable ferrihemochrome. However, the studies of Rostorfer and Totter (20) indicate essentially complete conversion of MHb to Hb and of the PHZ consumed to nitrogen and benzene, while Augusto et al. (24) and Itano and Matteson (25) did not observe formation of ferrihemochrome in spectrophotometric studies of the reduction of MHb by excess PHZ under argon (24), nitrogen (25), and carbon monoxide (25). Finally, Itano and Mannen (23) found that incubation of MHb in a mixture containing both PHZ and PDA under nitrogen, followed by extraction of the resultant ferrihemochrome under air, gave a product in which about one phenyl per heme was incorporated. On the other hand, Augusto et al. (24) showed that workup of the MHb-PHZ system, reacted under argon, with aerated acidified methanol gave no phenyl-heme adduct. While the incubation and workup conditions were not strictly comparable, the contrasting results suggest that PDA reacts with MHb to give products other than just Hb. This is contrary to the results actually observed in the MHb-PHZ system.

In view of the preceding evidence, it appears that a reasonable description of the reduction of MHb by PHZ in the absence of oxygen is given by Eqs. (1).

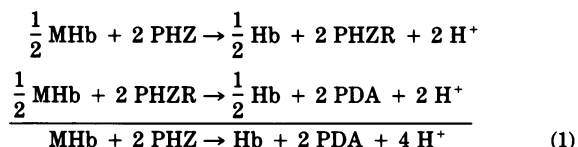

Why then are benzene and nitrogen observed as final products in the reduction of MHb with PHZ? This can be accounted for by the observation that PDA readily undergoes base catalyzed decomposition to give benzene and N<sub>2</sub> (18). For example, if OH<sup>-</sup> is the base, then the reaction (2) could occur.

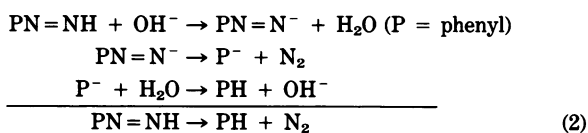

This leads to an overall reaction stoichiometry of:

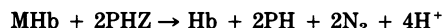

as is experimentally observed (20).

The reduction of MHb by PHZ in the absence of oxygen is a reaction that takes place on the time scale of an hour or so. For example, Augusto et al. (24) noted that 40 min was required to reduce 46% of the initial MHb concentration to Hb when 0.02mM MHb was incubated with 0.25 mM PHZ under argon. Similarly Rostorfer and Totter (20), using higher concentrations of reactants (0.95 mM MHb, 2.3 mM PHZ), found that 30 min sufficed to reduce 72% of the MHb initially present. The rate constant for the reduction under argon has

been determined to be 0.33 L/mole-sec at pH 7.4 (26). (Rostorfer and Totter (20) determined a value of 0.155 L/mole-sec for this constant, but their pH was unspecified.) The reduction of MHb to Hb by PHZ under anaerobic conditions is much slower than the reaction of MHb with PHZ under air to consume oxygen or give heme adducts. The rate constant for these latter reactions may be estimated to be about 99 and 16.5 L/mole-sec, by using the data of Augusto et al. (24) on initial rate of oxygen consumption for the HbO<sub>2</sub>-PHZ and MHb-PHZ systems, along with their rate constant for O<sub>2</sub> consumption in the HbO<sub>2</sub> system, and by assuming that 6 oxygen molecules are consumed per heme converted to adduct by PHZ. Thus the rate constants for oxygen consumption and conversion of MHb to heme adduct in the MHb-PHZ system are about 300 and 50 times larger, respectively, than the rate constant for reduction of MHb in the absence of O<sub>2</sub>.

### Reaction of HbO<sub>2</sub> and MHb with PHZ in the Presence of O<sub>2</sub>

**Heme Oxidation and Reduction.** Heinz, in 1890, discovered (9) that the reaction of PHZ with HbO<sub>2</sub> produces MHb. He observed that spectroscopic bands corresponding to MHb could be observed in suspensions of erythrocytes treated with PHZ. Since then the production of MHb in HbO<sub>2</sub>-PHZ systems has been often noted.

The amount of MHb present in a given reacting HbO<sub>2</sub> system appears to depend strongly on the ratio of initial PHZ concentration to initial HbO<sub>2</sub> concentration (P/H ratio), as well as, in a complex manner, on the time of observation after initiation of the reactions. The P/H ratio dependence was demonstrated by both Harley and Mauer (27) and Jandl et al. (28). Using intact erythrocytes, Harley and Mauer showed that as the P/H ratio increased from 0.25 to 2, the amount of MHb observed after 30 min reaction increased from about 2% to 33%. On increasing the period of observation from 30 min to 4 hr, however, the sample with P/H = 1 had increased from about 22% MHb to about 44%, while the sample with P/H = 2 had decreased slightly from 33% to 30%. Jandl et al. (18) also examined the effect of P/H ratio on the amount of MHb present after 2 hr incubation of HbO<sub>2</sub> (containing about 10% MHb) with PHZ. Increasing the P/H ratio from 0 to 40 resulted in a decrease in the HbO<sub>2</sub> concentration from 90% to 10%; however the MHb increased to reach a maximum of about 37% when P/H = 4 and then decreased to become insignificant when P/H = 40. The results of other more limited experiments, indicating that the amount of MHb present in a HbO<sub>2</sub>-PHZ system after a particular time depends on the P/H ratio, have been reported by Rostorfer and Cormier (29).

A kinetic study was also done by Jandl et al. (28), using a system in which P/H = 20. In this system the MHb amounted to about 33% of the initial Hb concentration after one minute of reaction; this quantity decreased, at first rapidly and then more slowly, until after

one hour it became negligible. The amount of MHb then gradually rose over the next eleven hours to reach a value of 9%. The rapid increase and decrease in MHb, observed in this study, demonstrates that failure to observe substantial amounts of MHb in a HbO<sub>2</sub>-PHZ reaction after a given period of time (in this case 1 hr) does not necessarily mean that it has not been a major component of the reaction mixture over some time period during its course. Castro et al. (26) reached a similar conclusion in experiments in which they reacted HbO<sub>2</sub> with PHZ in a vessel in which the overlying atmosphere was argon. They did not observe MHb formation and it appeared that HbO<sub>2</sub> was reduced directly to Hb. However, using excess cyanide to trap MHb, they found that MHbCN could be observed as the only product. The rate constants describing formation of Hb and MHbCN were identical and they concluded that the formation of MHb by PHZ was the rate determining step in the PHZ-induced reaction sequence (3):

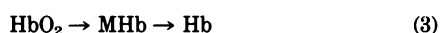

They suggested that oxidation products of PHZ, rather than PHZ itself, were able to react rapidly with MHb in the absence of cyanide to reduce it back to the Fe<sup>II</sup> state; in the presence of CN<sup>-</sup> this reaction was not competitive. Quantitative measurements support the idea that reaction of MHb itself with PHZ is not the process leading to reduction of MHb to Hb. The rate constant for reduction of MHb to Hb by PHZ under argon was determined to be 0.33 L/mole-sec, but the rate constant describing the conversion of HbO<sub>2</sub> to Hb via MHb was determined to be 45 L/mole-sec (26). Thus if PHZ was reducing MHb to Hb, then the rate determining step would not be the production of MHb from HbO<sub>2</sub>.

Phenylhydrazyl radical (PHZR) is the most likely candidate to carry out this reduction. One-electron transfers to O<sub>2</sub> from heme-Fe<sup>II</sup> and from PHZ would form PHZR and Fe<sup>III</sup> within the heme cavity. Since PHZR should be a much better reducing agent than PHZ itself, and since PHZR should not have to diffuse a significant distance to find Fe<sup>III</sup> to act as an electron acceptor, rapid reduction of MHb to Hb should ensue.

Consideration of the above paragraphs indicates that caution should be used in regarding the chemistry occurring in a given HbO<sub>2</sub>-PHZ or MHb-PHZ system as being exclusively due to the reactions of one species or the other. Depending on the initial reaction conditions, both of these species could be important contributors to the total chemistry observed during the time period of interest.

**Small Molecule Products.** Below we will discuss the various small molecules, both stable and unstable, that have been observed in the reaction of HbO<sub>2</sub> and MHb with PHZ. In view of the discussion above, caution must be exercised in assuming that these products arise only via reactive pathways from either HbO<sub>2</sub> or MHb, solely on the basis of the initial form of the hemoglobin used to initiate the reaction.

**Benzene and Nitrogen Formation.** Nitrogen was identified as a final product in the reaction of HbO<sub>2</sub> by Nizet (13) in 1946. Beaven and White (12) confirmed this and also determined that benzene (PH) was a final product in the reaction of oxyhemoglobin with PHZ; PH was also observed when MHb was reacted with PHZ in the presence of O<sub>2</sub> (12). The amount of benzene produced in the HbO<sub>2</sub>-PHZ reaction was found to be less when the atmosphere above the reacting system was anaerobic rather than aerobic (12). Augusto et al. (24) determined the relationship between the amount of oxygen consumed, PHZ consumption, and benzene formation as a function of initial PHZ/heme ratio in the "fast phase" of reaction in both the HbO<sub>2</sub>-PHZ and MHb-PHZ systems. They found that, in either system, one molecule of unbound oxygen was consumed per PHZ reacted. At high PHZ/heme ratios (eg. 75) the fraction of the phenyl groups from PHZ that could be recovered as benzene was about 5/6, the remainder becoming attached to heme. The same conclusions were reached for the MHb-PHZ system. In view of these observations, Augusto et al. (24) were able to write the partial stoichiometric relationship (4)

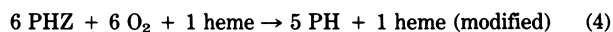

Goldberg and Stern (30) studied the kinetics of PH formation in both the MHb-PHZ and HbO<sub>2</sub>-PHZ systems. They found that addition of catalase almost completely inhibited the reaction in the MHb system, indicating a role for scavengable hydrogen peroxide in the oxidative pathway leading to PH formation. Catalase did not inhibit the corresponding reaction in the HbO<sub>2</sub>-PHZ system. Addition of thiocyanate also completely inhibited the rate of PH formation in the MHb-mediated oxidation of PHZ, but had a much smaller effect on the corresponding HbO<sub>2</sub> reaction. This was taken as an indication that MHb has a peroxidase-type activity for which PHZ and SCN<sup>-</sup> compete. This type of MHb-peroxidase activity evidently does not lie on all pathways of benzene formation mediated by HbO<sub>2</sub>.

Incubation of carbon monoxyhemoglobin (HbCO) with PHZ under air does not lead to benzene formation (30). This indicates that bound O<sub>2</sub> plays an essential role in the HbO<sub>2</sub>-mediated oxidation of PHZ to PH.

In summary, oxidation of PHZ to benzene by MHb requires that hydrogen peroxide be present; this H<sub>2</sub>O<sub>2</sub> evidently comes from the medium as it is accessible to catalase. In the corresponding HbO<sub>2</sub>-mediated oxidation, H<sub>2</sub>O<sub>2</sub> that is accessible to catalase is not essential. However O<sub>2</sub>, bound to the heme Fe<sup>II</sup>, is required in order for oxidation of PHZ to benzene to occur. The stoichiometry of both the MHb and HbO<sub>2</sub> reactions is such that for each molecule of PHZ reacted, one molecule of oxygen is consumed from the surrounding solution; at high PHZ/heme ratios five molecules of benzene are generated per phenyl moiety attached to a heme.

**Hydrogen Peroxide Formation.** Rostorfer and Cormier (29), using a chemiluminescence technique to

assay  $\text{H}_2\text{O}_2$ , provided the initial evidence that hydrogen peroxide (or compounds that behaved like  $\text{H}_2\text{O}_2$  in their reaction with luminol) were produced in reacting  $\text{HbO}_2$ -PHZ systems. The production of  $\text{H}_2\text{O}_2$  itself in the reaction of oxyhemoglobin with PHZ was more definitively demonstrated by Cohen and Hochstein (14). This conclusion, drawn from studies on  $\text{HbO}_2$ -containing erythrocytes, was based on an indirect detection technique that utilized the fact that catalase is irreversibly inactivated by 3-amino-1,2,4-triazole when  $\text{H}_2\text{O}_2$ , produced by the  $\text{HbO}_2$ -PHZ reaction, is metabolized.

There is not unequivocal evidence that MHb can interact with PHZ and oxygen to form hydrogen peroxide. The assay methods used by Rostorfer and Cormier (29) and Cohen and Hochstein (14) indicated that  $\text{H}_2\text{O}_2$  was formed when MHb (29) and MHb-erythrocytes (14) were incubated aerobically with PHZ. In both cases, however, the authors pointed out that  $\text{HbO}_2$ , produced by reduction of MHb followed by reoxygenation, could be the actual generator of hydrogen peroxide. Another potential contributor to formation of  $\text{H}_2\text{O}_2$  in any aerated PHZ system is the aerobic autooxidation of this compound. The formation of  $\text{H}_2\text{O}_2$  in aerated PHZ systems in the absence of MHb was noted by both Rostorfer and Cormier (29) and Cohen and Hochstein (14). Studies on the kinetics of oxygen uptake in reacting MHb-PHZ systems (24), discussed in a subsequent section, support the argument that an autooxidation reaction is the prime contributor to  $\text{H}_2\text{O}_2$  formation at the beginning of reaction, with other pathways strongly contributing at later times.

**Superoxide Anion.** Goldberg and Stern were the first to report (15) that superoxide anion is present in both reacting  $\text{HbO}_2$ -PHZ and MHb-PHZ systems. They based these conclusions on observations of the inhibitory effects of superoxide dismutase (SOD) on the rate of reduction of ferricytochrome C and the rate of oxidation of epinephrine; similar results were later obtained by Jain and Hochstein (31) with ferricytochrome C. Misra and Fridovich (17) reached the same conclusion for the  $\text{HbO}_2$ -PHZ system, finding the SOD inhibited the rate of reduction of nitroblue tetrazolium; however MHb was reported not to cause reduction of this compound under the same conditions. The identification of  $\text{O}_2^-$ , accomplished by the indirect assays described above, was confirmed by its direct detection in a reacting  $\text{HbO}_2$ -PHZ system, using stopped flow electron paramagnetic resonance (EPR) spectroscopy (32).

An extensive study of the inhibitory effects of various substances on the rate of production of  $\text{O}_2^-$  was carried out by Goldberg et al. (30). In the case of the MHb-PHZ system, they concluded that generation of superoxide was a consequence of peroxidase activity by MHb, acting on PHZ in the presence of  $\text{H}_2\text{O}_2$ . An earlier study by the same workers (15) had shown that catalase caused almost complete inhibition of superoxide production in this system. The mechanism of  $\text{O}_2^-$  formation differs in the  $\text{HbO}_2$ -PHZ system from that in the corresponding MHb system. Although addition of thiocyanate anion to MHb-PHZ systems effectively inhibited

superoxide production, it has only a partial inhibitory effect in the  $\text{HbO}_2$ -PHZ system. The  $\text{SCN}^-$  evidently acts as a substrate for the MHb peroxidase and thus effectively competes with PHZ for this activity (30). It can be concluded that a pathway, other than one involving MHb peroxidase action on PHZ, leads to superoxide formation in the oxyhemoglobin-PHZ system. That this pathway was not one involving simple autooxidative dissociation of  $\text{HbO}_2$  was shown by Goldberg et al. (30). The fact that partial inhibition is observed could indicate that MHb, generated from reaction with  $\text{HbO}_2$  by another pathway, does contribute, via the peroxidase reaction, to the oxidation of PHZ. In line with this idea is the observation that catalase also causes partial inhibition of superoxide formation in the  $\text{HbO}_2$ -PHZ system (15,30); almost total inhibition is observed in the MHb-PHZ system (15).

The noninvolvement of superoxide as a reactant in the pathway leading to PH formation, in either the  $\text{HbO}_2$ -PHZ or MHb-PHZ system, was demonstrated by Goldberg et al. (30) through the observation that SOD has no effect on the rate of production of this compound. The important role of bound oxygen in initiating those reactions leading to superoxide formation is indicated by the inability of carbon monoxyhemoglobin to produce  $\text{O}_2^-$  in aerated PHZ solutions (30).

To summarize, in the MHb-PHZ system both  $\text{O}_2^-$  formation and oxidation of PHZ to benzene are dependent on a MHb-peroxidase activity with hydrogen peroxide, accessible to catalase, being involved as an essential component of the reaction. In the oxyhemoglobin-PHZ system, two pathways to  $\text{O}_2^-$  and PH formation, one of them independent of this MHb-peroxidase activity, probably exist. In both systems, PHZ oxidation to benzene does not involve superoxide as reactant.

What is the source of superoxide in  $\text{HbO}_2$ -PHZ and MHb-PHZ systems? Goldberg et al. (30) suggest that, in each case, the operative reaction pathways lead to phenyldiazene (PDA) as a product. This substance is known to rapidly react with oxygen to yield PH and phenyl radical (18). When Goldberg et al. (30) generated PDA in aerated solution, they found that  $\text{O}_2^-$  was rapidly formed, supporting its candidacy as a precursor of superoxide anion in hemoglobin-PHZ reactions. Another possible precursor of  $\text{O}_2^-$ , suggested by Misra and Fridovich (17), is the phenylhydrazyl radical. This species should be a very good reducing agent and should readily react with  $\text{O}_2$  to yield  $\text{O}_2^-$ .

**The Phenyl Radical and Other Drug-Derived Radicals.** Goldberg and Stern first suggested (33) that the phenyl radical (PR) could play a role in the chemistry of hemoglobin-PHZ systems. Its actual presence in reacting  $\text{HbO}_2$ -PHZ and erythrocyte-PHZ systems, was demonstrated by Hill and Thornalley (16). They intercepted the PR in these systems, using 5,5-dimethyl-1-pyrroline-1-oxide (DMPO) as a spin trap and detected its characteristic EPR spectrum. A paper from the group of Ortiz de Montellano (34), appearing a short time later, indicated that they had also trapped this

radical using similar techniques. Later studies by Hill and Thornalley (35) showed that other spin traps were equally or more effective in trapping PR.

What is known about the reactive pathways leading to the PR observed in spin-trapping experiments? The most likely immediate precursor of PR is the phenyldiazanyl radical (PDAR), formed via loss of an electron from PDA to  $O_2$  (30,33). As will be discussed below, PDA is one of the probable products of the early steps of the reactions of either  $HbO_2$  or  $MHb$  with PHZ. It is also likely to be an intermediate in any chain mechanisms leading to PHZ oxidation. Thus there should be ample supplies of PDA around to act as a precursor for PDAR and PR formation.

Some information has been obtained, relevant to the mechanism of PR formation, via kinetic studies. Augusto et al. (24) and Hill and Thornalley (36) found that DMPO caused a significant lowering of the rate of  $O_2$  consumption in  $HbO_2$ -PHZ (24,36) and  $MHb$ -PHZ (24) systems during the "fast phase" of reaction. Since Augusto et al. (24) showed that 1 PHZ was consumed per  $O_2$  taken up from solution, this implies that interception of PR is reducing consumption of PHZ. The most likely explanation of this is that PR is a chain carrier in a chain reaction consuming  $O_2$  and PHZ.

Although the phenylhydrazyl radical (PHZR) and PDAR are almost certainly involved in the chemical processes occurring in hemoglobin-PHZ systems, and are discussed in this context throughout this review, there have not been full literature reports of their direct detection by spin-trapping or other techniques. However, in 1978, French et al. (37) cited unpublished work by Winterbourn and Gilbert that indicated that PHZR had been detected in the  $HbO_2$ -PHZ system, rather than PR, using EPR spectroscopy and spin trapping. Details have evidently not been published.

**Heme-Modified Products.** The brown coloration imparted to blood by PHZ (8) and the brown-green color given to erythrocyte suspensions by PHZ and *N*-acetylphenylhydrazine (APHZ) (9) has been known since the last century. Beaven and White (12) noted that incubation of  $HbO_2$  with various phenylhydrazines led to alteration of the protein and its precipitation as "green hemoglobin." Because of the likely involvement of this substance in Heinz body formation, a significant amount of research effort has been devoted to understanding the nature of green hemoglobin and the processes leading to its formation.

The first step towards determination of the chromophore responsible for the green color of the modified hemoglobin was taken by Beaven and White (12). They made green hemoglobin by reacting  $HbO_2$  with APHZ and extracted the green pigment from the precipitate with acetone. Using this extract, they demonstrated its protoheme nature, studied its electronic absorption spectrum, and determined some of its chemical properties.

The chemical nature of the modified heme, free from globin, was established almost simultaneously by papers from the laboratories of Ortiz de Montellano (19)

and Itano (38). Both groups isolated protoporphyrin IX-containing green pigment as the dimethyl ester by treating the product from reaction of  $HbO_2$  with PHZ with acidic methanol under air and used spectroscopic and mass spectrometric techniques to make structural assignments. The esterified pigment was shown to consist of compounds of structural type given by I. Using the  $Zn^{+2}$  complex, Ortiz de Montellano and Kunze (19) were able to demonstrate, via chromatographic and NMR techniques, the presence of four isomeric forms, while Saito and Itano (38) presented chromatographic evidence for at least three isomers. The latter workers also isolated and structurally characterized the same pigment from the oxymyoglobin ( $MbO_2$ )-PHZ system as well as an analogous product from the  $MbO_2$ -*p*-tolylhydrazine system.

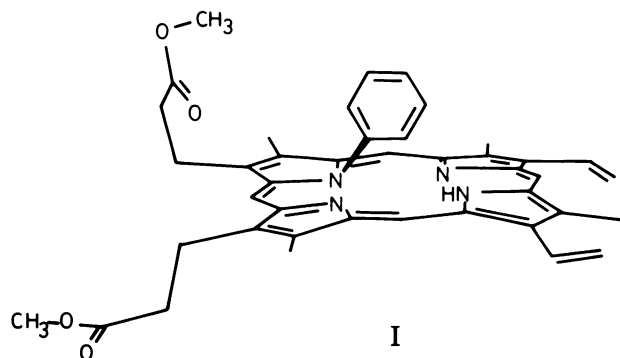

Using the same procedures, Saito and Itano (38) also isolated and characterized—although in significantly lower yields than I—blue pigments from reacted  $HbO_2$ -PHZ,  $MbO_2$ -PHZ, and  $MbO_2$ -*p*-tolylhydrazine systems. They established the structure of these pigments to be of the type shown in II. In the case of the  $HbO_2$ -PHZ system, an additional minor blue pigment was also noted.

The characterized blue pigment, which is a modified biliverdin, is evidently formed *via* a coupled process involving oxidative opening of the porphyrin ring and phenylation at carbon.

The *N*-phenylporphyrin formed in the  $HbO_2$ -PHZ reaction was also produced in the aerobic reaction of  $MHb$  with PHZ (19,24). Oxymyoglobin and metmyoglobin likewise reacted with PHZ to form *N*-phenylporphyrin that could be extracted as I; however these modified myoglobins do not precipitate as is observed in the case of the corresponding hemoglobins (39).

While esterified *N*-phenylprotoporphyrins are the products extracted from PHZ-treated  $HbO_2$  or  $MHb$  by acidified methanol, it is becoming evident that these species are derived from rearrangement of a globin-stabilized  $\sigma$ -bonded phenyl-iron complex (24, 39-41). The initial suggestion of the existence of such a complex in hemoglobin reacted with PHZ was contained in the work of Augusto et al. (24). Their conclusion was based, in part, on the observation that acidified methanol extraction of modified porphyrin yielded dramatically different amounts of green pigment, depending on whether

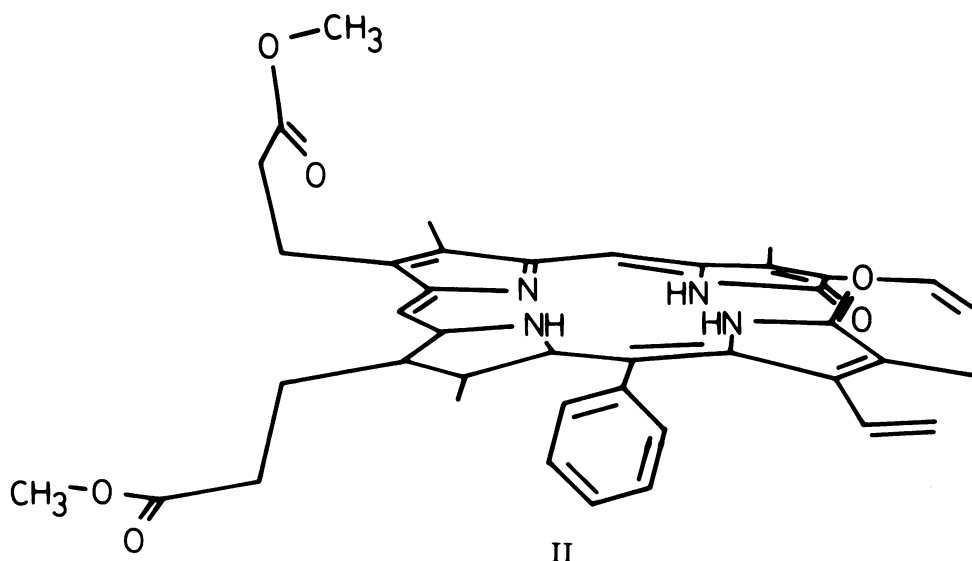

the extraction procedure was carried out under  $N_2$  or air. Much less I was obtained under  $N_2$  than under air; significant amounts of unmodified protoporphyrin IX dimethyl ester were also obtained under  $N_2$ , while under air almost no unmodified porphyrin was found. These observations are consistent with the existence of a globin-stabilized complex that can either revert to protoporphyrin IX or undergo rearrangement to give the *N*-phenylprotoporphyrin, depending on work-up conditions. Various experimental observations led Augusto et al. (24) to favor the  $\sigma$ -bonded phenyliron complex (III) as this intermediate, rather than a species involving coordination of PHZ or its oxidation product (PDA) to iron. For example, one observation that discounted the possibility of a PDA complex with iron was that cyanide, dithionite, and ferricyanide were without effect on the complex. However, these same reagents react readily with the nitrosobenzene-myoglobin complex (nitrosobenzene is isoelectronic with PDA).

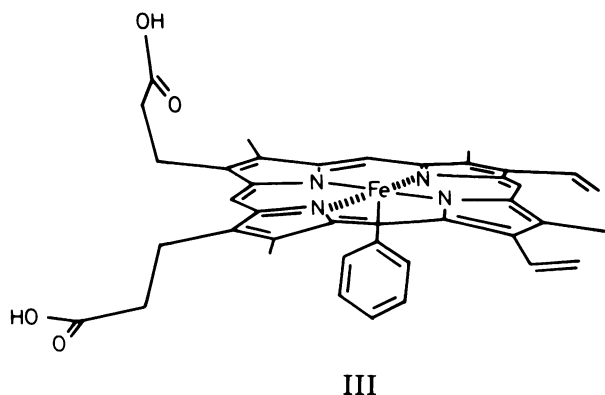

Later studies by the Ortiz de Montellano group (39,41) have supported their suggestion that a globin-stabilized  $\sigma$ -bonded phenyliron complex is the precursor to the *N*-phenylprotoheme extracted by acidified methanol. Kunze and Ortiz de Montellano (39) found the  $\sigma$ -

complex could be extracted from arylhydrazine-modified protein by treating it with argon-saturated 2-butanone containing butylated hydroxytoluene. They compared the ultraviolet spectrum of the extracted complex from PHZ-treated hemoglobin and an authentic complex of the phenyl-heme complex, prepared by a synthetic method, and found them to be identical. In addition, they obtained the 240 MHz NMR spectrum of both PHZ- and *p*-tolyl hydrazine-treated MbO<sub>2</sub> and showed that the observed peaks were consistent with those expected for a  $\sigma$ -bonded aryliron complex. Evidence from absorption spectroscopic studies also suggests the formation of III in the Mhb-PHZ system (41). Very recently X-ray diffraction studies have confirmed that the phenyl group is bound to iron in PHZ-modified metmyoglobin and, at the same time, shed light on the mechanism by which O<sub>2</sub> reaches the interior of oxygen-binding heme proteins (42).

The conversion of  $\sigma$ -bonded phenyliron porphyrins to *N*-phenylporphyrins has been studied in a number of model systems. Ortiz de Montellano et al. (43) synthesized the  $\sigma$ -bonded phenyliron complex of iron tetraphenylporphyrin (FeTTP) and showed that the spectral data for this complex were consistent with iron being in the ferric form. Though the solid complex was stable in air, it decomposed rapidly in solution, in the absence of butylated hydroxytoluene (BHT), to give benzene and FeTPPCl as products (43). Biphenyl and phenol were absent as products, suggesting that benzene was produced from reaction of the phenyl carbanion with water. Treatment of the phenyl FeTTP (PhFe<sup>III</sup>TTP) with acidified methanol, in the presence of BHT, led to formation of the *N*-phenyl FeTTP in 68% yield over the course of a couple of hours. When oxygen was excluded, the yield of *N*-phenyl FeTTP decreased dramatically. These workers also found that the same behaviour could be observed with the chemically synthesized  $\sigma$ -bonded phenyliron complex of protoporphyrin IX.

Mansuy and coworkers (40) also studied the phenyl



migration reactions of  $\text{PhFe}^{\text{III}}\text{TTP}$  and found that reversible transfer could be achieved. Upon treatment of  $\text{PhFe}^{\text{III}}\text{TTP}$  with the oxidizing agent,  $\text{FeCl}_3$ , the phenyl group is transferred from iron to nitrogen with accompanying reduction of the ferric iron form to the ferrous state. (This observation suggests that  $\text{O}_2$  also acts as an electron acceptor in the aerobic migration of phenyl from iron to nitrogen, described in the preceding paragraph. If so, then  $\text{O}_2^-$  should be an expected product in this reaction.) The reverse transfer, of a phenyl group from a pyrrole nitrogen to iron, occurred on treatment of the *N*-phenyl  $\text{FeTTPCl}$  with the reducing agent dithionite.

Are there detectable complexes, involving iron and PHZ (or PHZ oxidation products), that act as precursors to formation of the  $\sigma$ -bonded phenyliron complex in the reaction of  $\text{HbO}_2$  with PHZ? Such intermediates have been looked for, but not yet detected (22). However, they have been found in  $\text{HbO}_2$ - and  $\text{MbO}_2$ -methylhydrazine (MHZ) systems (22). The reactions of  $\text{HbO}_2$  or  $\text{MbO}_2$  with excess MHZ, in the presence of oxygen at a 10:1 molar rate to protein, gave almost quantitative yield of a complex with a characteristic visible absorption spectrum. Addition of the reducing agent dithionite to the Mb complex had no effect on the spectrum, but addition of CO resulted in formation of  $\text{MbCO}$ . Such observations led to the identification of such substances as Hb-methyldiazene (MDA) and Mb-MDA complexes, with the MDA probably bound to the  $\text{Fe}^{\text{II}}$  via the nitrogen  $\alpha$  to the methyl (22). A similar complex was observed when MDA was added under anaerobic conditions to Mb, supporting the above conclusions about the nature of the substance. That the  $\text{Fe}^{\text{II}}$ -diazene complex can act as a precursor for  $\sigma$ -bonded alkyliron complexes is indicated, for the Mb-MDA complex, by the observation that its treatment with either ferricyanide or oxygen leads to formation of a compound with a spectrum characteristic of the  $\sigma$ -bonded methyliron complex III. The same protocols, applied to the reaction of  $\text{HbO}_2$  and  $\text{MbO}_2$  with PHZ, or of Hb and Mb with PDA, did not lead to detection of similar observable heme-diazene intermediates (22). In this regard, it is interesting to note that Huang and Kosower (44) found that anaerobic addition of PDA itself, at a PDA/heme ratio of about 1.1, did not cause a change in the absorption spectrum of the protein. The added PDA could, however, be detected in the presence of Hb via its ultraviolet absorption spectrum. In anaerobic solution, in the absence of Hb, PDA undergoes a slow,  $\text{OH}^-$ -catalyzed decomposition process; however, when  $\text{O}_2$  is admitted, the PDA undergoes extremely rapid destruction (44). In the presence of Hb, however, this  $\text{O}_2$ -mediated destruction of PDA occurred at a much reduced rate, as monitored by disappearance of its UV spectrum (44). Huang and Kosower (44) suggested that the PDA had become complexed to Hb at a site located within the globin portion of the heme protein, rather than at the heme itself. Admission of  $\text{O}_2$  did not cause a change in the Hb absorption spectrum, other than that expected due to mere reoxygenation to  $\text{HbO}_2$ . Although the  $\text{HbO}_2$  spec-

trum did appear, it was reduced about 10–20% in intensity from that expected. This type of behavior, in fact, is that observed in the early stages of the reaction of  $\text{HbO}_2$  with PHZ to form III [see, for example, the spectra of Itano and Matteson (25)].

Somewhat analogous behavior of MDA and PDA, towards formation of complexes with  $\text{Fe}^{\text{II}}$ , has been observed in model heme systems. Reaction of  $\text{Fe}^{\text{II}}\text{TTP}$  with excess MDA, under anaerobic conditions, led to an isolatable complex whose structure was assigned to  $\text{Fe}^{\text{II}}\text{TPP}(\text{MDA})_2$  (45). Oxidation with  $\text{O}_2$  or  $\text{FeCl}_3$  gave the  $\sigma$ -bonded  $\text{Fe}^{\text{III}}\text{TPP}(\text{CH}_3)$  complex. Reaction of  $\text{Fe}^{\text{II}}\text{TPP}$  with PDA did not yield the corresponding isolatable product,  $\text{Fe}^{\text{II}}\text{TPP}(\text{PDA})_2$ , but instead the corresponding  $\sigma$ -bonded phenyl  $\text{Fe}^{\text{III}}(\text{TPP})$  complex was isolated. However, under strictly anaerobic conditions, a visible absorption spectrum attributed to a  $\text{Fe}^{\text{II}}\text{TPP}(\text{PDA})_2$  complex was observed. Even traces of  $\text{O}_2$  resulted in the fast transformation of this substance to the  $\sigma$ -phenyl  $\text{Fe}^{\text{III}}$  complex (45).

Summarizing, the experimental evidence points to at least one, and possibly two, intermediates on the pathway to formation of *N*-phenylated heme, the chromophore of the "green hemoglobin" of Beaven and White (12). The precursor of the *N*-phenylheme moiety is a globin-stabilized  $\sigma$ -bonded phenyliron complex (III) which rearranges in the presence of electron acceptors to give *N*-phenylated porphyrin. In  $\text{HbO}_2$ -MHZ systems, a heme  $\text{Fe}^{\text{II}}$ -MDA complex has been detected but is readily transformed into III. A similar heme  $\text{Fe}^{\text{II}}$ -PDA complex has not been detected; however, there is evidence that a globin-PDA complex exists and this could act as a precursor to III.

In addition to the knowledge concerning the nature of heme modification reactions, described above, there is also relevant published information concerning the kinetics of heme modification. Itano and Matteson (25) have spectroscopically studied the rate of disappearance of  $\text{HbO}_2$ , induced by PHZ, under conditions where  $\text{HbO}_2$  was present in excess. In the absence of catalase and SOD the system did not display second order kinetic behavior over the entire course of reaction. When catalase and SOD were both present in sufficiently large concentrations, however, strict second-order kinetic behavior was found. The corresponding rate law under these conditions was found to be  $d(\text{HbO}_2)/dt = -64 \text{ L/mole-sec} [\text{HbO}_2][\text{PHZ}]$ . These workers interpreted their data as indicating the  $\text{HbO}_2$  was disappearing via a bimolecular reaction to form a product with a characteristic visible absorption spectrum. Although they did not identify the product, they proposed that it resulted from a two electron transfer from PHZ to  $\text{HbO}_2$ . Comparison of the spectrum presented by Itano and Matteson (25), however, with the spectral data shown and described, respectively, by Mansuy et al. (22) for the myoglobin- $\sigma$ -phenyliron complex and the hemoglobin- $\sigma$ -phenyliron complex very strongly suggests that the absorbing product formed under their reaction conditions was hemoglobin containing the  $\sigma$ -phenyliron-heme complex III. If one assumes that  $\text{HbO}_2$ , under

these conditions, reacts exclusively in the presence of PHZ to form III then the rate law for formation of III will be given by  $d(\text{III})/dt = 256 \text{ L/mole-sec} [\text{HbO}_2][\text{PHZ}]$  (each hemoglobin contains four heme units). If other heme products with relatively small extinction coefficients over the spectral range between 500 and 600 nm (compared to  $\text{HbO}_2$  and hemoglobin containing III) are also formed, then 256 L/mole-sec would be an upper limit for the rate constant for formation of III.

In the absence of catalase and SOD, the rate constant for disappearance of  $\text{HbO}_2$  (evaluated from initial rate data) was found to be about 110 L/mole-sec (25). Addition of either catalase or SOD individually to such systems lowered the initial rate of disappearance, but did not cause strict second-order kinetic behavior to be followed. Only addition of both SOD and catalase to sufficiently high concentrations accomplished this. Itano and Matteson (25) interpreted this to indicate that reactions of  $\text{O}_2^-$  and  $\text{H}_2\text{O}_2$  with  $\text{HbO}_2$ , to form MHb, were important factors in causing the disappearance of  $\text{HbO}_2$  in the absence of catalase and SOD. Addition of SOD removed the contribution of superoxide to this process, but increased the level of  $\text{H}_2\text{O}_2$  present in the reacting system. Catalase addition resulted in the removal of hydrogen peroxide, but did not stop the reaction of  $\text{HbO}_2$  with  $\text{O}_2^-$ . Addition of both of these substances evidently is required to minimize removal of  $\text{HbO}_2$  via pathways forming MHb (25).

An independent estimate of the rate of formation of III in the  $\text{HbO}_2$ -PHZ system can be made by using the data of Augusto et al. (24). They found that the rate of  $\text{O}_2$  consumption was given by  $d(\text{O}_2)/dt = -55 \text{ L/mole-sec} [\text{heme}][\text{PHZ}]$  when PHZ was present in excess and when catalase and SOD were absent. Since, under these conditions, 6 oxygen molecules are consumed per heme modified (presumably to III) and since each  $\text{HbO}_2$  contains four heme groups, the above rate law can be rewritten as  $d(\text{III})/dt = 37 \text{ L/mole-sec} [\text{HbO}_2][\text{PHZ}]$ . This value for the second-order rate constant is considerably smaller than the maximal value obtained from the work of Itano and Matteson (25); however, it is probably not fruitful to worry about this until complete heme product characterization in the  $\text{HbO}_2$ -PHZ system is accomplished, using the conditions under which each of these studies was made.

As was pointed out above, calculations for the MHb-PHZ system, again using data from the paper of Augusto et al. (24), yield an estimate of 16.5 L/mole-sec for the rate constant for formation of III in this system.

## Reactions of Hemoglobin with Phenylhydrazine: Mechanism

### Introduction

In the last section we discussed the products formed in the reactions of  $\text{HbO}_2$  and MHb with PHZ, along with evidence relevant to understanding the pathways by which these individual products were formed. In this section we present a mechanistic scheme that attempts

to integrate this, and other experimental information, into a manageable overall picture of what happens chemically when  $\text{HbO}_2$  or MHb reacts with PHZ to form hemoglobin containing III under aerobic conditions. (A schematic representation of this mechanism is given in Figure 1.) As additional experimental evidence becomes available, the scheme presented here will undoubtedly require modification; however, it may be useful as a starting point for the design of experiments to fill gaps in our understanding of the mechanism of the reaction of hemoglobin with PHZ.

Before proceeding to our mechanistic discussion, some remarks will be made concerning the time scale over which aerobic reactions of hemoglobin with PHZ occur and about how PHZ, and its oxidation products, gain access to heme in their reactive encounters with hemoglobin.

Although the exact time required for destruction of  $\text{HbO}_2$  depends on the initial concentration of  $\text{HbO}_2$  and PHZ, it is on the order of minutes. With 5 $\mu\text{M}$   $\text{HbO}_2$  and 1.0mM PHZ, for example, the oxyhemoglobin present was almost completely converted to modified hemoglobin, probably predominately III, in about 2 min (24). A similar fast reaction leading to modification of heme, was observed in the MHb-PHZ system (24). In this system, however, an induction period on the order of a minute was required before the reaction, to form modified heme and oxidize PHZ, entered the fast reaction phase. Evidently hydrogen peroxide production, via an oxidative process not mediated by MHb, occurs during this induction period, and this  $\text{H}_2\text{O}_2$  is essential for the MHb-mediated oxidation to take place (24). This idea is supported by the fact that inclusion of  $\text{H}_2\text{O}_2$  in the MHb-PHZ system eliminates the induction period. After the fast phase of  $\text{O}_2$ , PHZ and hemoglobin consumption oxygen continues to be consumed in the presence of excess PHZ, although at a much reduced rate (24). This reaction, which is about twice as fast as consumption of  $\text{O}_2$  in the absence of hemoglobin, evidently does not involve either  $\text{HbO}_2$  or MHb (which are consumed during the preceding fast phase of reaction).

Because of the multiphase kinetic behavior in aerobic hemoglobin-PHZ systems, care must be taken in deciding whether data from the literature support a proposed mechanism for the processes occurring in these systems. In the following discussion, we will be interested in the mechanisms of the reactions occurring in the fast phase of reaction in hemoglobin-PHZ systems and thus we will emphasize data that have been gathered over reaction times that are reasonably close to those spanned by the fast reaction phase.

What is the spatial relationship between PHZ and the heme and globin portions of hemoglobin during redox processes involving PHZ and hemoglobin? Detailed information relative to this problem is not available; however recent X-ray diffraction studies by Ringe et al. (42) have shown that the phenyl moiety of the  $\sigma$ -phenyliron-heme complex (III), formed by the reaction of PHZ with metmyoglobin, is located in a channel that extends from the heme cavity to the protein surface. This channel

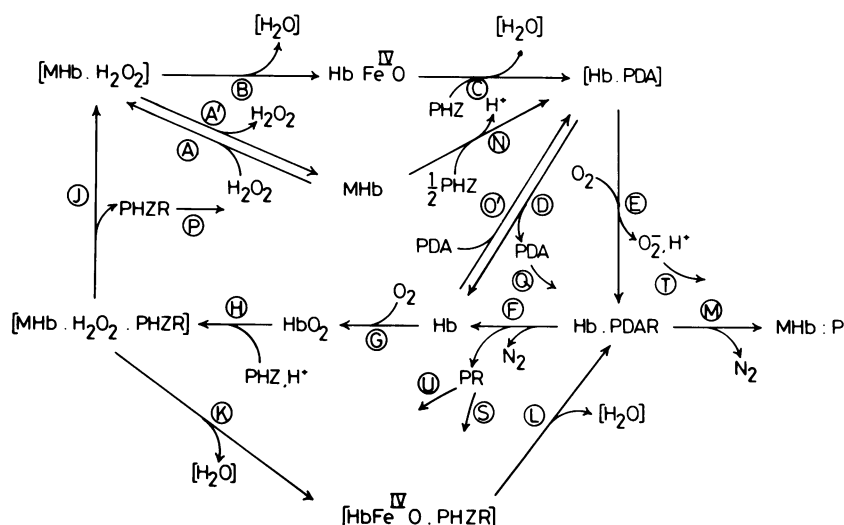

FIGURE 1. Proposed mechanistic scheme indicating the pathways of reaction of hemoglobin with phenylhydrazine. The bracketed term  $[H_2O]$  represents products of unknown identity, as discussed in the text.

the heme cavity to the protein surface. This channel results from significant displacement of several amino acid residues from their positions in unmodified metmyoglobin. Ringe et al. (42) have suggested that ligands, such as oxygen or carbon dioxide, binding at a site involving amino acids in, or close to, the site of channel formation, could trigger conformational changes that open the channel and allow access to the heme cavity. In view of the fact that the phenyl group occupies the channel in modified myoglobin, it seems reasonable to speculate that PHZ and its oxidation products (PHZR, PDA, and PDAR) occupy a channel of similar nature during their reactive interactions with heme groups in hemoglobin and that binding of these molecules at or near the site of channel formation increases the likelihood of hemoglobin being in a conformational state where the channel is open. Our proposed mechanistic scheme for formation of  $\sigma$ -phenyliron-heme in hemoglobin-PHZ systems (Figure 1) assumes that this is the case.

With regard to the possibility that PHZ and its oxidation products can act as effective triggers for channel formation in hemoglobin, it is interesting to note that diazene itself is isoelectronic with oxygen while hydrazine is isoelectronic with hydrogen peroxide. If indeed the opening of the channel, discovered by Ringe et al. (42), is triggered by binding of  $O_2$ , then it is not surprising that PDA, containing a group with marked electronic similarities to oxygen, could also cause the channel to be opened. One can further speculate that  $H_2O_2$  enters the heme cavity of hemoglobin via the same channel and has the same type of trigger mechanism as oxygen; then one would also expect PHZ to display the ability to trigger conformational changes that would bring the hydrazino group into the heme cavity. This could account, in part, for the high effectiveness of phenylhydrazine and related hydrazines as agents in carrying out reductive reactions in the heme cavity, as

compared to other reducing agents (26).

### Mechanisms of Formation of $\sigma$ -Phenyliron-heme Complexes (III)

In this section we focus on the means by which the interaction of PHZ with hemoglobin in aerated solution produces modified hemoglobin containing the heme complex III. As discussed above, there is strong evidence that production of benzene and  $O_2^-$  in  $HbO_2$ -mediated oxidation on PHZ occurs via at least two distinct pathways. One of these putatively involves the action of a Mhb peroxidase on PHZ, while the other(s) do not. There is not yet direct evidence available that III is similarly formed by more than one pathway in  $HbO_2$ -PHZ systems. However, as pointed out above, the rate of formation of III in the fast phase of reaction in the  $HbO_2$ -PHZ system is about 2.3 times as fast as the corresponding rate in the Mhb-PHZ system. This suggests that a second pathway exists for formation of III, not involving passage over the Mhb-mediated route to this substance.

In this section we first discuss our proposed route to formation of III in aerobic Mhb-PHZ systems. The same pathway also accounts for the formation of III as observed in anaerobic Mhb-PHZ- $H_2O_2$  systems (41). This pathway, steps A, B, C, E, and M in Figure 1, leads from Mhb to III without passage through Hb or  $HbO_2$ . [A second, much slower, pathway (reaction N) to the same product, also not involving  $HbO_2$ , will be discussed later.]

Several lines of evidence point to the involvement of  $H_2O_2$  as an essential reactant in the fast reaction of Mhb with PHZ to form III and PHZ oxidation products. The strongest indication is provided by the work of Ortiz de Montellano and Kerr (41), who incubated excess PHZ with Mhb under  $N_2$  for 30 min. During this period,

there was no spectroscopic indication of formation of III within the system. When  $\text{H}_2\text{O}_2$  was added to this anaerobic system, after the 30 minute incubation period, then the spectrum was immediately converted to that characteristic of ferrylhemoglobin ( $\text{HbFe}^{\text{IV}}\text{O}$ ) (46,47) and then, over a period of several minutes, to that of III. (Oxygen was not required for this transformation; presumably, under the anaerobic conditions used, step E is replaced by  $\text{OH}^-$ -mediated decomposition of PDA).

Formation of modified heme during the fast phase of the reaction of MHB with PHZ is coupled to consumption of  $\text{O}_2$  and PHZ and production of benzene by the stoichiometric relationship (24)

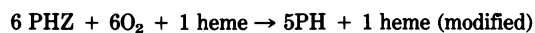

The addition of catalase to MHB-PHZ systems both lengthens the induction period preceding the fast reaction phase, as measured by oxygen consumption, and also lowers the rate of  $\text{O}_2$  consumption during the fast phase itself (24). The former effect is accounted for by assuming that the  $\text{H}_2\text{O}_2$  required to enter reaction A in a MHB-PHZ system, initially free of  $\text{H}_2\text{O}_2$ , must be generated by non-MHB-mediated autoxidation of PHZ; the presence of catalase increases the time required to produce an  $\text{H}_2\text{O}_2$  concentration high enough to form the levels of  $\text{MHB}\cdot\text{H}_2\text{O}_2$  needed to initiate the fast phase of reaction. Catalase, by lowering the concentration of  $\text{H}_2\text{O}_2$  during the fast phase of reaction, would also decrease the steady state concentration of  $\text{MHB}\cdot\text{H}_2\text{O}_2$  and  $\text{HbFe}^{\text{IV}}\text{O}$  present during this phase and thus lower the rates of consumption of PHZ and  $\text{O}_2$  and, by stoichiometry, the rate of formation of III. [Catalase also completely inhibits the formation of PH and  $\text{O}_2^-$  during the fast phase of reaction (15,30) as will be discussed in a subsequent section.]

Ferrylhemoglobin ( $\text{HbFe}^{\text{IV}}\text{O}$ ) is putatively the key component of the MHB-peroxidase activity discussed by Goldberg et al. (30). The mechanism in Figure 1 differs somewhat from their postulated mechanism which suggests that one molecule of PHZ reduces two ferrylhemoglobins to MHB and PDA. Our variation indicates that one molecule of PHZ transfers two electrons to  $\text{HbFe}^{\text{IV}}\text{O}$  to yield  $[\text{Hb}\cdot\text{PDA}]$ . This latter reaction leaves the heme group in the proper oxidation state for reaction M of Figure 1 to occur.

Statements as to the nature of  $\text{Hb}\cdot\text{PDA}$  are necessarily highly speculative. However several experimental observations provide some guidance for speculation. The existence of a  $\text{Hb}\cdot\text{PDA}$  complex, with the diazenyl moiety protected from oxidation by oxygen, is implied by the work of Huang and Kosower (44). Exposure of this complex to  $\text{O}_2$  results in decomposition within a half life of several hundred seconds, while PDA in solution is completely destroyed with 10–15 sec (44). Although PDA itself does not form a spectroscopically detectable complex with Hb- or Mb- heme  $\text{Fe}^{\text{II}}$ , the related methyldiazene (MDA) does (22). This complex is similarly protected from  $\text{O}_2$  in solution; indeed 15 minutes of exposure of the heme-MDA complex to oxygen is required

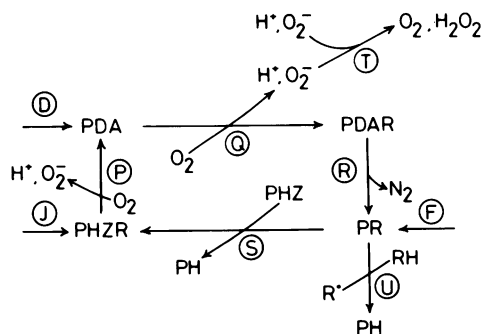

FIGURE 2. Proposed mechanistic scheme depicting the reactions involved in phenyl radical-mediated oxidation of phenylhydrazine.

for its conversion to a  $\sigma$ -methyliron-heme complex. The fact that Huang and Kosower (44) noted that about 10–20% of the  $\text{Hb}\cdot\text{PDA}$  complex was not recovered as  $\text{HbO}_2$  after admission of  $\text{O}_2$  suggests that an analogous reaction was occurring in this system. If one assumes that MDA is associated with Hb via embedment in a channel passing from the surface of the protein to the heme, with the diazenyl group complexed with the heme, then it is reasonable to assume that PDA is associated with the same channel. However, its position within the channel must be different, so as to account for the fact the diazenyl group does not interact strongly with heme. (Perhaps stronger hydrophobic interactions of the phenyl moiety with amino acids in the channel, as compared to the methyl group of MDA, or the additional bulk of the phenyl group tend to displace PDA to a position of diminished entry into the channel, as compared to MDA.) Presumably, oxygen gains access to diazene in  $\text{Hb}\cdot\text{diazene}$  complexes because they undergo conformational fluctuations that place the bound diazene in contact with the surrounding medium. Oxidation of the diazene to PDAR with accompanying formation of  $\text{O}_2^-$  (18, 30, 33), would follow reaction E. Another possibility is that  $\text{O}_2$  penetrates slowly to the heme cavity via an alternative channel and oxidation of PDA occurs within the cavity.

The PDAR formed in reaction E, retaining structural elements of the diazene moiety, is assumed in Figure 1 to remain bound to hemoglobin. However, PDAR is known to rapidly lose nitrogen to form phenyl radical (18,33). The proposed scheme in Figure 1 indicates that the resultant phenyl radical can react (reaction M) with heme  $\text{Fe}^{\text{II}}$  via a process that involves electron transfer from iron to the phenyl radical to form a complex in which iron is in the  $\text{Fe}^{\text{III}}$  state; this latter oxidation state is the one that has been observed in studies of the same types of reaction in model porphyrin systems (40,43,45). Alternatively, the phenyl radical can escape into the surrounding medium (reaction F) where it can react with PHZ or other ambient hydrogen donors to produce benzene (reaction S and U in Fig. 2).

The conversion of  $\text{MHB}\cdot\text{H}_2\text{O}_2$  to ferrylhemoglobin (step B of Fig. 1) is accompanied by the release of a stoichiometric equivalent of one molecule of  $\text{H}_2\text{O}^+$ . The

actual chemical nature of the product(s) released is unknown (46). The same statement holds for the stoichiometric equivalent of water or  $\text{H}_2\text{O}^+$  released in reactions C, K, and L.

In addition to the  $\text{H}_2\text{O}_2$ -mediated pathway leading from MHb to formation of the Hb·PDA complex, described above, an additional pathway to the same end should be considered, namely that indicated by N in Figure 1. This is the pathway leading to reduction of MHb by PHZ under anaerobic conditions. Under these conditions, one PHZ is able to reduce two heme units, one via electron transfer from PHZ itself to  $\text{Fe}^{\text{III}}$  and the second presumably via electron transfer from PHZR to  $\text{Fe}^{\text{III}}$ . This second step would be expected to produce a Hb·PDA complex, as indicated in reaction N. Two factors discount the possibility that reaction N is a significant pathway to III under aerobic conditions. Firstly, assuming the first step is rate-determining (26), the transfer of an electron from PHZ to  $\text{Fe}^{\text{III}}$  under anaerobic conditions is about 50 times slower than the reaction of MHb to yield modified hemoglobin under aerobic conditions. Secondly, the final part of the sequence (reaction of PHZR with  $\text{Fe}^{\text{III}}$  to form Mb·PDA) requires the transfer of PHZR from a channel on one heme unit to a channel on another, probably via emergence into the surrounding medium. Under aerobic conditions, reaction of PHZR (and its oxidation product PDA) with ambient oxygen would probably destroy these species before they relocated at another channel site.

As discussed above, it is likely that there are two pathways leading to formation of III in  $\text{HbO}_2$ -PHZ systems. Our proposed reaction scheme in Figure 1 indicates that one of these proceeds through a pathway involving reaction between ferrylhemoglobin and PHZ; this same reaction is postulated to be a key step in formation of III in MHb-PHZ systems. We visualize  $\text{HbO}_2$  interacting with PHZ, in the common first step H of these two reactive pathways, to give a  $\text{MHb}\cdot\text{H}_2\text{O}_2\cdot\text{PHZR}$  complex. Formation of this complex involves transfer of one electron each from heme  $\text{Fe}^{\text{II}}$  and PHZ to oxygen. The  $\text{MHb}\cdot\text{H}_2\text{O}_2\cdot\text{PHZR}$  complex constitutes a branch point in the reaction scheme of Figure 1. Loss of PHZR, before hydrogen peroxide converts MHb to  $\text{HbFe}^{\text{IV}}\text{O}$ , sends the reaction in the direction of step J; formation of III would then proceed as described above. The alternative step K (conversion of MHb to  $\text{HbFe}^{\text{IV}}\text{O}$  before PHZR leaves its putative binding site within a channel leading to the heme pocket) would lead to reaction L, which results in conversion of the resultant ferrylhemoglobin·PHZR complex to Hb·PDAR. This latter complex is thus the proposed immediate precursor of III in both reaction pathways.

We have not discussed, in this section, the formation of modified hemoglobins whose heme group can be extracted in the form of II (38). As little is known about possible intermediates on the pathway to this type of modified hemoglobin, there seems little to be gained by postulating possible mechanisms for its formation.

## Formation of MHb in the Reaction of $\text{HbO}_2$ with PHZ and of Hb in the Reaction of MHb with PHZ

As discussed above, reaction of PHZ with  $\text{HbO}_2$ , within the time frame encompassed by the fast phase of reaction, leads to formation of MHb as a product (25,28). This probably can be attributed, at least in part, to oxidation of  $\text{HbO}_2$  by  $\text{H}_2\text{O}_2$  and  $\text{O}_2^-$ , produced during the course of reaction (25). However, some MHb is produced during the fast phase of reaction when PHZ is present in limiting amounts, even in the presence of high concentrations of SOD and catalase (25). In our scheme, production of MHb occurs as a result of dissociation of  $\text{MHb}\cdot\text{H}_2\text{O}_2$  (reaction A'). The presence of high concentrations of catalase, and of limited amounts of PHZ, would result in some MHb being left over at the end of the fast phase of reaction.

The results of Castro et al. (26), in which they found that oxyhemoglobin, maintained under an argon atmosphere in excess of PHZ, was reduced to Hb via a pathway involving MHb production, can also be understood from the scheme presented in Figure 1. The reaction direction indicated by step J leads to Hb·PDA as an intermediate; however, with low oxygen concentrations in solution reaction D, yielding Hb as a product, could become the dominant pathway for decomposition of this complex. The MHb, trapped by cyanide ion in these experiments would be that produced by the highly competitive reaction of 1.6 mM  $\text{CN}^-$  with MHb from reaction A', as compared to the alternative reaction of MHb with the small amounts of  $\text{H}_2\text{O}_2$  released by this dissociative reaction. It is not yet known whether III is produced as a result of reaction of  $\text{HbO}_2$  with PHZ under the conditions employed by Castro et al. nor whether addition of  $\text{CN}^-$  under these conditions partially or totally blocks formation of other products associated with oxidation of PHZ by  $\text{HbO}_2$ .

How competitive in  $\text{HbO}_2$ -PHZ systems are processes producing Hb (reactions D and F) with reaction M, which produces III? Some idea can be obtained using the data of Castro et al. (26). These workers, in their study of the kinetics of disappearance of  $\text{HbO}_2$ , determined a rate law of  $d(\text{HbO}_2)/dt = -45 \text{ L/mole-sec} [\text{HbO}_2][\text{PHZ}]$  to describe this process. Under their conditions of low oxygen concentration, deoxyhemoglobin was the dominant product. Interpreting the above rate law in terms of Figure 1 indicates that 45 L/mole-sec is a maximal apparent rate constant describing the contribution of both reaction D and the reaction sequences (E, F) and (L, F) to formation of Hb under these low oxygen conditions. Increase of  $\text{O}_2$  concentration would increase the rate of reaction E and augment the rate of formation of Hb. Thus the apparent rate constant would become greater. Since the estimated value of the rate constant, describing formation of III in aerated  $\text{HbO}_2$ -PHZ systems, is 37 L/mole-sec and since the maximal apparent rate constant that would be measured in aerobic solution, describing the production of Hb, would be

larger than 45 L/mole-sec it can be concluded that non-destructive cycling of hemoglobin is likely to be competitive with pathways leading to modified hemoglobin in such systems. Even if the rate constant for formation of Hb under the conditions of Castro et al. (26) is considerably smaller than the maximal value of 45 L/mole-sec, this qualitative conclusion still holds. The same conclusions can be reached for the aerobic MHb-PHZ system where some of the same reactions (D, E, F and M) are involved in partitioning of Hb·PDA and Hb·PDAR between III and Hb.

### Mechanisms of Formation of Benzene, Superoxide Anion and Hydrogen Peroxide

The small molecule products, resulting from oxidation of PHZ by HbO<sub>2</sub> or MHb, cannot necessarily be described as being formed via a single pathway. Indeed, it is more likely that there are multiple pathways of formation for each of these products. In the following we will focus on these possible multiple pathways for formation of benzene, superoxide anion and hydrogen peroxide.

According to our mechanistic scheme, there are a variety of ways that PH could be generated in the fast phase of reaction in HbO<sub>2</sub>-PHZ and MHb-PHZ systems. Production of PR in reaction F (Fig. 1), followed by abstraction of hydrogen from ambient donors (reactions S and U), leads directly to benzene formation. However, the fact that the spin trap DMPO, which traps phenyl radicals (16,34), quenches the rate of oxygen consumption (24,36) in HbO<sub>2</sub>-PHZ and MHb-PHZ system (and hence, from stoichiometric considerations, also quenches the rate of PHZ consumption and benzene formation) suggests that PR is involved as a chain carrier in reactions leading to further consumption of PHZ and production of benzene. In Figure 2 we depict a cyclic process for destruction of PHZ involving PR as a chain carrier. Reaction steps P, Q, R and S are the key steps in an oxidation cycle using PHZ as an input substrate. Phenyl radicals react with PHZ to form PHZR and produce benzene in step S. The PHZR interacts with O<sub>2</sub> in step P to form superoxide anion and PDA. This latter substance, in turn, reacts with oxygen in R to form O<sub>2</sub><sup>-</sup> and PDAR, which rapidly decomposes to generate nitrogen and the phenyl radical, which can initiate another cycle. The reaction cycle can be terminated by reaction of PR with ambient hydrogen donors other than PHZ to yield benzene (step U). If superoxide disproportionation (step T) is included, then the stoichiometry of each revolution of the cycle works out to be



This is consistent with the findings of Augusto et al. (24) that for each molecule of PHZ consumed, one molecule of O<sub>2</sub> is consumed from the surrounding medium in HbO<sub>2</sub>- and MHb-mediated oxidations of PHZ.

Other species, generated in the reactions of Figure 1, can enter into the scheme of Figure 2 to undergo

further oxidation. In both the MHb-PHZ and HbO<sub>2</sub>-PHZ reactions, the PDA produced by reaction D can enter into the cycle via reaction Q; in the HbO<sub>2</sub>-PHZ system, PHZR, released in step J, can enter into the cycle by way of reaction P. As mentioned above phenyl radical, produced in reaction F in both systems, enters the cycle via reaction S.

In summary, much of the benzene produced in reacting hemoglobin systems may come about as a result of PHZ oxidation products, produced in reactions of PHZ with hemoglobin, entering into the cycle described in Figure 2.

If, in fact, chain mechanisms are operating in the HbO<sub>2</sub>-PHZ and MHb-PHZ systems, then one would expect the ratio of PHZ consumed, compared to the amount of phenyl attached to heme via reaction M in Figure 1, to decrease as the concentration of PHZ is decreased. Decreasing the PHZ concentration while holding heme concentration constant would lower the likelihood that PR would abstract hydrogen from PHZ, thus initiating another cycle of PHZ destruction, as compared to abstraction of a hydrogen atom from another donor (reaction U). Indeed this behavior is observed. Augusto et al. (24) found that when the HbO<sub>2</sub> concentration was maintained at  $5 \times 10^{-6}$  M and the concentration of PHZ was varied between  $40 \times 10^{-4}$  M and  $1 \times 10^{-4}$  M, then the ratio of oxygen consumed per heme modified decreased from 6 to 3.7. Stoichiometric considerations (one PHZ consumed per O<sub>2</sub> consumed) therefore requires that the amount of PHZ consumed per heme modified decrease as well. Similar behavior is observed in the MHb-PHZ system (24).

Another test that can be applied is to check whether the mechanisms for benzene and heme adduct formation, outlined in Figures 1 and 2, can account for the observed stoichiometries relating consumption of oxygen and PHZ and the production of benzene and heme adduct (24). When the stoichiometric equations are worked out for the various pathways leading from hemoglobin and PHZ to formation of benzene or heme adduct, the following equations are obtained: (note that reactions T and U in Fig. 2 are included in these equations.)

CASE 1. HbO<sub>2</sub>-mediated oxidation of PHZ, in which heme is not destroyed, but returned to the form HbO<sub>2</sub> at the end of the cycle.

CASE 1A. Reaction proceeds via steps

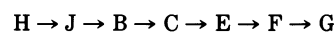

or

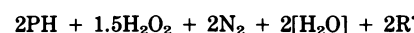
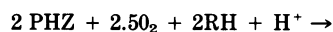
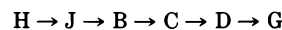

CASE 1B. Reaction proceeds via steps

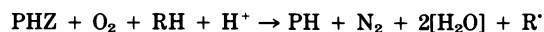

CASE 2: Mhb-mediated oxidation of PHZ, in which heme is not destroyed, but returned to the form of Mhb at the end of the cycle. Reaction proceeds by steps

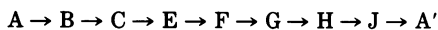

or

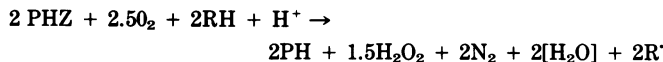
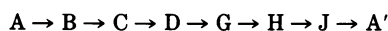

CASE 3. HbO<sub>2</sub>-mediated oxidation of PHZ, in which III is a product.

CASE 3A. Reaction proceeds via branch J.

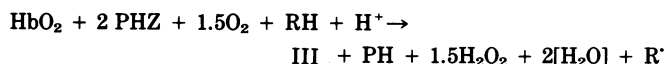

CASE 3B. Reaction proceeds via branch K.

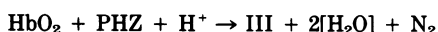

CASE 4. Mhb-mediated oxidation of PHZ in which III is a product. Reaction proceeds by steps

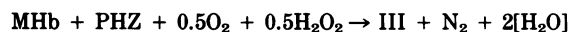
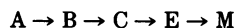

Not all of the above pathways display a stoichiometry that implies that one oxygen is consumed per PHZ oxidized. Yet Augusto et al. (24) found that the reactive processes occurring in both HbO<sub>2</sub>-PHZ and Mhb-PHZ systems consumed one O<sub>2</sub> per PHZ destroyed. How can this apparent inconsistency be understood? The answer, of course, is that the overall stoichiometry observed in reacting hemoglobin-PHZ systems is determined by the quantitative mix of processes actually occurring in the system being studied. Some simple examples illustrate this point. If, in the HbO<sub>2</sub>-PHZ system, one destructive reaction via the pathway of Case 3A occurred per nondestructive cycle over one of the pathways described by Case 1A, then the resultant observed stoichiometry would be:

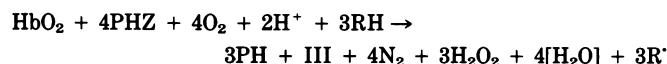

Thus we would observe that a one-to-one relationship existed between PHZ and O<sub>2</sub> consumption. If two cycles of the phenyl radical-mediated pathway for PHZ oxidation are included



then the observed overall stoichiometry would be:

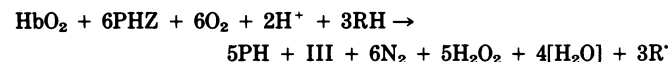

This stoichiometry, with respect to HbO<sub>2</sub>, PHZ, O<sub>2</sub>, and PH, is that observed by Augusto et al. (24) at high PHZ/HbO<sub>2</sub> ratios. Application of similar reasoning to combinations of some (but not all) of the above pathways (e.g., Case 1B + Case 3B, Case 2 + Case 4) yields the same one-to-one relationship between PHZ and oxygen consumption. Inclusion of the appropriate contribution of PR-mediated oxidation of PHZ, as above, allows the observed stoichiometries of benzene formed per heme modified to be explained. Other mixes of the same reactions can lead to nearly the same results. For example, there is no *a priori* reason why the probability of PHZ entering a reaction pathway leading to heme destruction should be the same as the probability of its entry into a cycle where heme is not destroyed. Consider again a HbO<sub>2</sub>-PHZ system where Case 1A + Case 3A obtains; if the probability of entrance of PHZ into Case 1A is twice that of entering into Case 3A, then the resultant observed stoichiometry would require that 6.5 O<sub>2</sub> be consumed per 6 PHZ used up and 5 benzenes be produced per heme modified. The value of 1.08 O<sub>2</sub> consumed per PHZ consumed would probably be rounded off to one to one stoichiometry, considering experimental error, and the total resultant stoichiometry would be that observed in HbO<sub>2</sub>-PHZ systems at high heme/PHZ concentrations (24).

In summary, the total chemistry occurring in hemoglobin-PHZ systems is probably a complex combination of the reactions of Figure 1, in which PHZ reaction leads to destruction of heme and generation of PHZ oxidation products, and the reactions of Figure 2, leading to conversion of PHZ oxidation products to benzene and other substances. The observed stoichiometry reflects the weighted contributions of these individual reactions to the total chemistry, rather than a requirement that each contributing pathway have the same stoichiometry as the observed overall reaction (e.g., 1:1 stoichiometry for PHZ and O<sub>2</sub> consumption).

The superoxide anion can be produced at three junctures in the reaction schemes displayed in Figures 1 and 2, namely steps E, P, and Q. As O<sub>2</sub><sup>-</sup> does not play a role in reactions leading to benzene formation, it is likely that it is destroyed by disproportionation as depicted by reaction T.

The effects of inhibitors of the rates of formation of benzene and superoxide in hemoglobin-PHZ systems can be profitably discussed together. Goldberg and Stern (15,30) found that both thiocyanate and catalase almost completely inhibited superoxide formation and benzene production in the Mhb-PHZ system. In the HbO<sub>2</sub>-PHZ system, however, these substances only partially inhibited the production of superoxide (15,30). Examination of the data taken by Goldberg and Stern (30) during the initial 3 min of the HbO<sub>2</sub>-PHZ reaction suggests that SCN<sup>-</sup> has some inhibitory effect on benzene formation, though catalase has no significant inhibitory effect on the production of this compound.

The effect of catalase on the rate of the Mhb-mediated production of benzene and superoxide can be understood if it recalled that this reaction requires a

buildup of  $H_2O_2$ , putatively via autoxidation of PHZ in solution, in order for hemoglobin-catalyzed oxidation to become rapid. Addition of catalase would increase the time required for the fast phase of PHZ oxidation to set in. Indeed, Augusto et al. (24) found that catalase at 390 and 871 units/mL resulted in the lag time in a Mhb-PHZ system increasing from 1.15 min to 1.35 and 1.70 min, respectively. Goldberg and Stern (15,30) used catalase at a concentration of 3500 units/mL in their studies of inhibition of  $O_2^-$  and benzene formation in the Mhb-PHZ system; they also employed about a sevenfold lower starting PHZ concentration than Augusto et al. (24). Under these conditions, it is not surprising that they saw little benzene or superoxide formation during the 5-min duration of their experiments. The inhibitory action of  $SCN^-$  on benzene and  $O_2^-$  production can be understood in terms of its ability to compete with PHZ for the peroxidase activity associated with Hb  $Fe^{IV}O$ . The experiments of Goldberg and Stern (30) used 80 mM  $SCN^-$  to compete with PHZ at a concentration of 0.2 mM (in the reaction where benzene was monitored). Complete diversion of Hb  $Fe^{IV}O$  to reaction pathways involving oxidation of  $SCN^-$  would prevent formation of the precursors of  $O_2^-$  and PH and hence  $O_2^-$  and PH themselves.

The effect of  $SCN^-$ , in causing partial inhibition of benzene and  $O_2^-$  formation in  $HbO_2$ -PHZ systems, can be understood by noting that  $SCN^-$  would once again compete with PHZ for Hb  $Fe^{IV}O$ . However, in contrast to the Mhb-PHZ system, there are several other pathways to these products not involving Hb  $Fe^{IV}O$  accessible to competitive thiocyanate inhibition. One of these (step J, followed by oxidation of PHZR as shown in Fig. 2) would lead to formation of benzene and  $O_2^-$  without accompanying formation of III. The second (steps K, L and F followed by entrance of P into the cycle of Fig. 2) would also yield PH and superoxide. In this latter pathway, Hb  $Fe^{IV}O$ -PHZR might be viewed as a complex in which the ferryl moiety is unavailable to  $SCN^-$  because its normal access channel to the heme cavity is blocked by PHZR.

The partial inhibitory effect of catalase on the rate of production of  $O_2^-$  can be explained by its effect on the concentration of  $Mhb \cdot H_2O_2$ , determined in part by the reactions A and A'. Consumption of  $H_2O_2$  by catalase would lower steady-state concentrations of  $Mhb \cdot H_2O_2$ , and hence Hb  $Fe^{IV}O$ , present. This would, in turn, lower the rate of formation of superoxide via pathways leading through uncomplexed ferryl hemoglobin. Inhibition would not be complete, as other pathways leading to  $O_2^-$  formation would not be affected.

It is not clear that an unambiguous interpretation can be made of the noninhibitory effect of catalase on benzene formation, reported by Goldberg et al. (30); recent studies have shown that catalase itself reacts with PHZ to generate benzene as a product (41).

Hydrogen peroxide appears as a product in step A' in Figure 1 and via disproportionation of  $O_2^-$  in step T of Figure 2. These two sources would account for the production of  $H_2O_2$  in  $HbO_2$ -PHZ systems described by

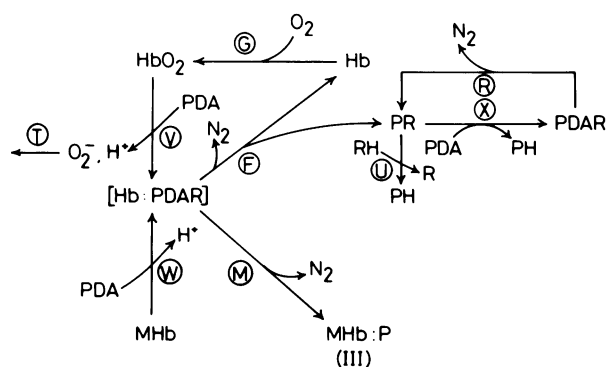

FIGURE 3. Proposed mechanistic scheme showing the pathways of reaction of hemoglobin with phenyldiazene.

Rostorfer and Cormier (29) and Cohen and Hochstein (14).

## Reactions of Phenyldiazene with Hemoglobin

In this section we will briefly discuss the question of what happens when PDA is mixed with  $HbO_2$  or Mhb. (As discussed above, PDA evidently forms a complex with the globin portion of deoxyhemoglobin, but does not react with the heme group to yield modified heme products.) Since the experimental information about  $HbO_2$ -PDA and Mhb-PDA systems is very sparse, compared to the corresponding PHZ systems, the mechanistic scheme proposed here (Fig. 3) is necessarily much more speculative than the mechanisms of Figures 1 and 2. Indeed, it would be considered more predictive in nature than descriptive. However, based on what is known about the reactions occurring in hemoglobin-PHZ systems, the reactions contained within Figure 3 seem reasonable.

It has been found that the products resulting from addition of PDA to  $HbO_2$  include methemoglobin (33) and a hemichrome (25,33) with an absorption spectrum very similar to that of hemoglobin containing III (33). The destruction of  $HbO_2$  was inhibited by catalase or SOD, while Hb-CO did not undergo reaction. Figure 3 contains a simple scheme that accounts for these results. Phenyldiazene serves as a one-electron reductant (reaction V), producing  $O_2^-$  and a Hb-PDAR complex analogous to that formed in reaction E of Figure 1. This complex, as before, collapses to form III via reaction M. Alternatively the Hb-PDAR complex, as was the case in Figure 1, can react to form phenyl radical and Hb. The PR formed could then abstract hydrogen from available hydrogen donors, including PDA. If PDA were the donor, then the benzene producing and PR regenerating cycle, described by reactions R and X, would be set up. Phenyl radicals, produced by the  $HbO_2$ -mediated oxidation of PDA, would be those putatively involved in initiation of lipid peroxidation reactions in the cell membrane when erythrocytes are treated with PDA (33).



The anaerobic reaction of MHb with PDA, to form a substance with a characteristic visible absorption spectrum, was described by Itano and Robinson (21) in 1961. The possible nature of this complex has been probed, or commented on, in a number of studies since that time (23,25,48). Very recent work, employing NMR spectroscopy to study the product of the anaerobic reaction of metmyoglobin with PDA, has demonstrated that III is the product in this case (Ortiz de Montellano and Kerr, unpublished results); this suggests that the same is true in the MHb-PDA system. This is in accord with the scheme presented in Figure 3. The scheme also predicts that Hb could be a product of the anaerobic reaction of MHb with PDA, if reaction F were competitive with reaction M. In fact, Itano and Mannen (23) reported that Hb was formed as a product in the MHb-PDA reaction, along with the complex that is probably III.

Information about stoichiometry of oxygen and PDA consumption and amount of modified heme produced per PDA consumed, for either the HbO<sub>2</sub>-PDA or MHb-PDA system, is unavailable. Thus little can be said, beyond the above presentation, concerning the viability of the mechanistic scheme proposed in Figure 3. Obviously this is an area where experimental work, to obtain quantitative information about stoichiometry and rates of product formation, would be welcome.

M. D. S. thanks the University of California, San Francisco, for sabbatical leave during the period in which this review was prepared. Helpful conversations with Drs. Monika Green, David Kerr, Paul Ortiz de Montellano, and David Tew are also gratefully acknowledged.

#### REFERENCES

- Clark, M. R., Mohandas, N., and Shohet, S. B. The red cell membrane in hemolytic anemias. In *Current Hematology*, Vol. 2 (V. F. Fairbanks, Ed.) John Wiley, New York, 1983, pp. 149-180.
- Beutler, E. Drug-induced hemolytic anemia. *Pharmacol. Rev.* 21: 71-103 (1969).
- Beutler, E. Hemolytic Anemia in Disorders of Red Blood Cell Metabolism. Plenum Press, New York, 1978.
- Gordon-Smith, E. C. Drug-induced oxidative hemolysis. *Clinics Hematol.* 9: 557-586 (1980).
- Giffin, H. Z., and Allen, E. V. The control and complete remission of polycythemia vera following the prolonged administration of phenylhydrazin hydrochlorid. *Am. J. Med. Sci.* 185: 1-13 (1933).
- Linman, J. A. Hematology. Macmillan, New York, 1975, p. 483.
- Hara, H., and Ogawa, M. Erythropoietic precursors in mice with phenylhydrazine induced anemia. *Am. J. Hematol.* 1: 453-458 (1976).
- Hoppe-Seyler, G. Ueber die Wirkung des Phenylhydrazins auf den Organismus. *Z. Physiol. Chem.* 9: 34-39 (1885).
- Heinz, R. Morphologische Veränderung der rothen Blutkörperchen durch Gifte. *Virchows Arch. Pathol.* 122: 112-116 (1890).
- Goldstein, B. D., and McDonagh, E. M. Spectrofluorometric detection of *in vivo* red cell lipid peroxidation in patients treated with diaminodiphenylsulfone. *J. Clin. Invest.* 57: 1302-1307 (1976).
- Hochstein, P., and Jain, S. K. Association of lipid peroxidation and polymerization of membrane proteins with erythrocyte aging. *Fed. Proc.* 40: 183-188 (1981).
- Beaven, G. H., and White, J. C. Oxidation of phenylhydrazine in the presence of oxyhemoglobin and the origin of Heinz bodies in erythrocytes. *Nature* 173: 389-391 (1954).
- Nizet, A. Une réaction de la phenylhydrazine avec l'oxyhemoglobine. Application au dosage de l'hémoglobine dans le sang. *Bull. Soc. Chim. Biol.* 28: 527-530 (1946).
- Cohen, G., and Hochstein, P. Generation of hydrogen peroxide in erythrocytes by hemolytic agents. *Biochemistry* 3: 895-900 (1964).
- Goldberg, B., and Stern, A. The generation of O<sub>2</sub><sup>-</sup> by the interaction of the hemolytic agent, phenylhydrazine, with human hemoglobin. *J. Biol. Chem.* 250: 2401-2403 (1975).
- Hill, H. A. O., and Thornalley, P. J. Phenyl radical production during the oxidation of phenylhydrazine and in phenylhydrazine-induced hemolysis. *FEBS Letters* 125: 235-238 (1981).
- Misra, H. P., and Fridovich, I. The oxidation of phenylhydrazine: superoxide and mechanism. *Biochemistry* 15: 681-687 (1976).
- Kosower, E. M. Monosubstituted diazenes (diimides). Surprising intermediates. *Accts. Chem. Res.* 4: 193-198 (1971).
- Ortiz de Montellano, P. R., and Kunze, K. L. Formation of N-phenylheme in the hemolytic reaction of phenylhydrazine with hemoglobin. *J. Am. Chem. Soc.* 103: 6534-6536 (1981).
- Rostorfer, H. H., and Totter, J. R. The reduction of methemoglobin by phenylhydrazine under anaerobic conditions. *J. Biol. Chem.* 221: 1047-1055 (1956).
- Itano, H., and Robinson, E. A. Evidence for coordination of monophenyl-diimide with heme proteins. *J. Am. Chem. Soc.* 83: 3339-3340 (1961).
- Mansuy, D., Battioni, P., Mahy, J.-P., and Gillet, G. Comparison of the hemoglobin reactions with methyl- and phenylhydrazine: Intermediate formation of a hemoglobin Fe(II)-methyl-diazene complex. *Biochem. Biophys. Res. Commun.* 106: 30-36 (1982).
- Itano, H., and Mannen, S. Reactions of phenyl-diazene and ring-substituted phenyl-diazenes with ferrihemoglobin. *Biochim. Biophys. Acta* 421: 87-96 (1976).
- Augusto, O., Kunze, K. L., and Ortiz de Montellano, P. R. N-Phenylprotoporphyrin IX formation in the hemoglobin-phenylhydrazine reaction. *J. Biol. Chem.* 257: 6231-6241 (1982).
- Itano, H., and Matteson, J. L. Mechanism of initial reaction of phenylhydrazine with oxyhemoglobin and effect of ring substitutions on the bimolecular rate constant of this reaction. *Biochemistry* 21: 2421-2426 (1982).
- Castro, C. E., Wade, R. S., and Belser, N. O. Conversion of oxyhemoglobin to methemoglobin by organic and inorganic reductants. *Biochemistry* 17: 225-231 (1978).
- Harley, J. D., and Mauer, A. M. Studies on the formation of Heinz bodies I. Methemoglobin production and oxyhemoglobin destruction. *Blood* 16: 1722-1735 (1960).
- Jandl, J. H., Engle, L. K., and Allen, D. W. Oxidative hemolysis and precipitation of hemoglobin. I. Heinz body anemias as an acceleration of red cell aging. *J. Clin. Invest.* 39: 1818-1836 (1960).
- Rostorfer, H. H., and Cormier, M. J. The formation of "hydrogen peroxide" in the reaction of oxyhemoglobin with methemoglobin forming reagents. *Arch. Biochem. Biophys.* 71: 235-249 (1957).
- Goldberg, B., Stern, A., and Peisach, J. The mechanism of superoxide anion generation by the interaction of phenylhydrazine with hemoglobin. *J. Biol. Chem.* 251: 3045-3051 (1976).
- Jain, S. K., and Hochstein, P. Generation of superoxide radical by hydrazine: Its role in phenylhydrazine-induced hemolytic anemia. *Biochim. Biophys. Acta* 586: 128-136 (1979).
- Goldberg, B., Stern, A., Peisach, J., and Blumberg, W. E. The detection of superoxide anion from the reaction of hemoglobin and phenylhydrazine using EPR spectroscopy. *Experientia* 35: 488-489 (1979).
- Goldberg, B., and Stern, A. The mechanism of oxidative hemolysis produced by phenylhydrazine. *Mol. Pharmacol.* 13: 832-839 (1977).
- Augusto, O., Ortiz de Montellano, P. R., and Quintanilha, A. Spin-trapping of free radicals formed during microsomal metabolism of ethylhydrazine and acetylhydrazine. *Biochem. Biophys. Res. Commun.* 101: 1324-1330 (1981).
- Hill, H. A. O., and Thornalley, P. J. Free radical production during phenylhydrazine-induced hemolysis. *Can. J. Chem.* 60: 1528-1531 (1982).
- Hill, H. A. O., and Thornalley, P. J. The effect of spin traps on phenylhydrazine-induced hemolysis. *Biochim. Biophys. Acta* 762: 44-51 (1983).

37. French, J. K., Winterbourn, C. C., and Carrell, R. W. Mechanism of oxyhemoglobin breakdown on reaction with acetylphenylhydrazine. *Biochem. J.* 173: 19–26 (1978).
38. Saito, S., and Itano, H. A. *meso*-Phenylbiliverdin IX and *N*-phenylprotoporphyrin IX, products of the reaction of phenylhydrazine with oxyhemoglobin. *Proc. Natl. Acad. Sci. (U.S.)* 78: 5508–5512 (1981).
39. Kunze, K. L., and Ortiz de Montellano, P. R. Formation of a  $\sigma$ -bonded aryliron complex in the reaction of arylhydrazines with hemoglobin and myoglobin. *J. Am. Chem. Soc.* 105: 1380–1381 (1983).
40. Mansuy, D., Battioni, J.-P., Dupre, D., Sartori, E., and Chotard, G. Reversible iron-nitrogen migration of alkyl, aryl, or vinyl groups in iron porphyrins: a possible passage between  $\text{Fe}^{\text{III}}(\text{porphyrin})(\text{R})$  and  $\text{Fe}^{\text{II}}(\text{N-R})(\text{porphyrin})$  complexes. *J. Am. Chem. Soc.* 104: 6159–6161 (1982).
41. Ortiz de Montellano, P. R., and Kerr, D. E. Inactivation of catalase by phenylhydrazine: formation of a stable aryl-iron heme complex. *J. Biol. Chem.* 258: 10558–10563 (1983).
42. Ringe, D., Petsko, G. A., Kerr, D. E., and Ortiz de Montellano, P. R. Reaction of myoglobin with phenylhydrazine: A molecular doorstop. *Biochemistry* 23: 2–4 (1984).
43. Ortiz de Montellano, P. R., Kunze, K. L., and Augusto, O. Hemoprotein destruction. Iron-nitrogen shift of a phenyl group in a porphyrin complex. *J. Am. Chem. Soc.* 104: 3545–3546 (1982).
44. Huang, P.-K. C., and Kosower, E. M. Complexes of phenyldiazene (phenyldiimide) with deoxyhemoglobin and ferroheme. *Biochim. Biophys. Acta* 165: 483–489 (1968).
45. Battioni, P., Mahy, J.-P., Gillet, G., and Mansuy, D. Iron porphyrin dependent oxidation of methyl- and phenylhydrazine: Isolation of iron (II)-diazene and  $\sigma$ -alkyliron (III) (or aryliron) (III) complexes. Relevance to the reactions of hemoproteins with hydrazines. *J. Am. Chem. Soc.* 105: 1399–1401 (1983).
46. Uyeda, M., and Peisach, J. Ultraviolet difference spectroscopy of myoglobin: Assignment of  $pK$  values of tyrosyl phenolic groups and the stability of the ferryl derivatives. *Biochemistry* 20: 2028–2035 (1981).
47. La Mar, G. N., de Ropp, J. S., Latos-Grazynski, L., Balch, A. L., Johnson, R. B., Smith, K. M., Parish, D. W., and Cheng, R.-J. Proton NMR characterization of the ferryl group in model heme complexes and hemoproteins: evidence for the  $\text{Fe}^{\text{IV}}=\text{O}$  group in ferryl myoglobins and Compound II of horseradish peroxidase. *J. Am. Chem. Soc.* 105: 782–787 (1983).
48. Itano, H. A., Hirota, K., and Vedvick, T. S. Ligands and oxidants in ferrihemochrome formation and oxidative hemolysis. *Proc. Natl. Acad. Sci. (U.S.)* 74: 2556–2560 (1977).