

# Lawrence Berkeley National Laboratory

## Recent Work

### Title

SLIP BEHAVIOR OF SINGLE CRYSTALS OF HEXAGONAL Ag-AI UNDER IMPULSIVE LOADING

### Permalink

<https://escholarship.org/uc/item/6sj5s3p2>

### Authors

Larsen, T.L.  
Rajnak, S.L.  
Hauser, F.E.  
et al.

### Publication Date

1963-06-05

**University of California**  
**Ernest O. Lawrence**  
**Radiation Laboratory**

**SLIP BEHAVIOR OF SINGLE CRYSTALS OF  
HEXAGONAL Ag-Al UNDER IMPULSIVE LOADING**

**TWO-WEEK LOAN COPY**

*This is a Library Circulating Copy  
which may be borrowed for two weeks.  
For a personal retention copy, call  
Tech. Info. Division, Ext. 5545*

**Berkeley, California**

## **DISCLAIMER**

This document was prepared as an account of work sponsored by the United States Government. While this document is believed to contain correct information, neither the United States Government nor any agency thereof, nor the Regents of the University of California, nor any of their employees, makes any warranty, express or implied, or assumes any legal responsibility for the accuracy, completeness, or usefulness of any information, apparatus, product, or process disclosed, or represents that its use would not infringe privately owned rights. Reference herein to any specific commercial product, process, or service by its trade name, trademark, manufacturer, or otherwise, does not necessarily constitute or imply its endorsement, recommendation, or favoring by the United States Government or any agency thereof, or the Regents of the University of California. The views and opinions of authors expressed herein do not necessarily state or reflect those of the United States Government or any agency thereof or the Regents of the University of California.

For Journal Trans. AIME

UCRL-10789

UNIVERSITY OF CALIFORNIA  
Lawrence Radiation Laboratory  
Berkeley, California

Contract No. W-7405-eng-48

SLIP BEHAVIOR OF SINGLE CRYSTALS  
OF HEXAGONAL Ag-Al UNDER IMPULSIVE LOADING

T. L. Larsen,<sup>1</sup> S. L. Rajnak,<sup>2</sup> F. E. Hauser<sup>3</sup>  
and J. E. Dorn<sup>4</sup>

June 5, 1963

<sup>1</sup> Formerly, Graduate Research Engineer with the Institute of Engineering Research, University of California, Berkeley; currently with Hewlett-Packard Associates, Palo Alto, California.

<sup>2</sup> Mathematician with the Lawrence Radiation Laboratory, Inorganic Materials Research Division, University of California, Berkeley.

<sup>3</sup> Associate Professor of Mechanical Engineering, and Research Engineer for the Inorganic Materials Research Division of the Lawrence Radiation Laboratory, University of California, Berkeley.

<sup>4</sup> Miller Professor of Materials Science (1962-1963), Department of Mineral Technology, and Research Metallurgist of the Lawrence Radiation Laboratory, University of California, Berkeley.

ABSTRACT

The dynamic behavior of single crystals of  $\text{Ag}_2\text{Al}$  was investigated at strain rates of 200 to 60,000 per sec. Basal slip was found to be strain-rate sensitive and the yield stress was found to increase with an increase in temperature. This behavior is explained in terms of Suzuki locking. In contrast, prismatic slip was found to be very strain rate sensitive. At high temperatures and low strain rates a diffusion mechanism is operative which is suppressed at high strain rates giving an increase in yield strength of a factor of 30. This behavior is explained in terms of the Peierls mechanism of kink pair formation.

## I. INTRODUCTION

This investigation was undertaken for the express purpose of studying the plastic behavior of single crystals under conditions of impulsive loading with specific emphasis on the significance of the dynamic behavior of dislocations to the formulation of the mathematical theory of plastic wave propagation. For this objective single crystals of the hexagonal phase containing 67 atomic percent Ag and 33 atomic percent Al were selected for study because of the variety of dislocation mechanisms they are known to exhibit under conditions of slow deformation.<sup>1</sup> It will be shown that when the plastic deformation is controlled by an athermal dislocation mechanism, the deformation stress is insensitive to the strain rate and temperature. In contrast, when the motion of dislocations at low temperatures is thermally activatable, the flow stress increases with an increase in strain rate and a decrease in temperature. However thermally activated deformations which are dependent on diffusion are supplanted by other mechanisms when the strain rate is so high that there is insufficient time for diffusion to take place.

## II. EXPERIMENTAL TECHNIQUE AND PROCEDURE

Specimen Preparation: Oriented single crystal rods of the intermetallic phase, 33 atomic percent Al-67 atomic percent Ag were grown from high purity Ag (99.995 weight percent) and Al (99.995 weight percent) in a vertical furnace under a positive argon atmosphere by the standard Bridgman technique. The rods were cut into specimens, annealed at 650°C to relieve residual stresses, and etched in nitric acid to remove the surface oxide.

For the purpose of studying the two slip systems of the hexagonal close-packed structure, specimens were oriented for basal slip by the  $\{0001\}\langle 11\bar{2}0\rangle$  mechanism or for prismatic slip by the  $\{\bar{1}100\}\langle 11\bar{2}0\rangle$  mechanism. Both compression and shear tests were performed. For the compression tests, cylindrical rods, one-half inch in diameter by one inch in length, were oriented for maximum resolved shear stress on the particular slip system tested as shown in Fig. 1a. As anticipated, specimens oriented for slip on the prismatic plane in the compression type test exhibited  $\{10\bar{1}2\}$  twinning. For this reason shear tests, as shown in Fig. 1b, were also made. In these tests the slip plane and the Burgers vector were oriented parallel to the shearing plane. The shear tests had the added advantage of providing very high rates of shear strain, in the vicinity of more than  $10^4$  per sec. for the dynamic tests.

Experimental Apparatus: The apparatus used to produce and measure the dynamic stresses and high strain rates, previously described in detail by Hauser and Winter<sup>2</sup> and Hauser, Simmons and Dorn,<sup>3</sup> is shown schematically in Fig. 2. The input and output bars used in this investigation were 1/2 inch diameter Ti-6Al-4V titanium alloy. Elevated temperatures were achieved by encasing the specimen and the ends of the bars in a small furnace. A

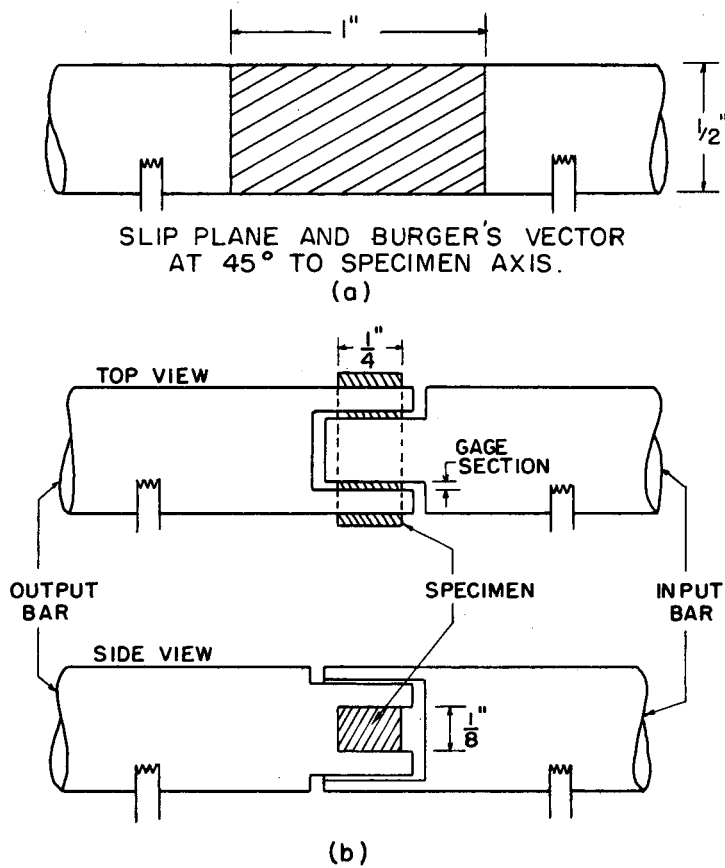

MU-30751

Fig. 1. Testing fixtures.



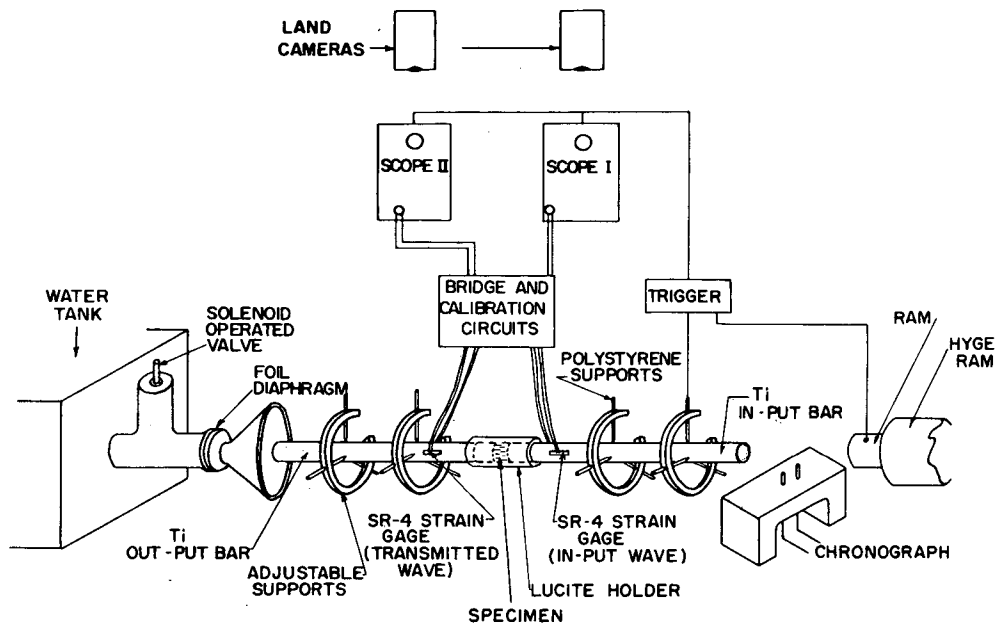

MU-30752

Fig. 2. Experimental arrangement and instrumentation.

thermocouple was attached directly to the specimen to measure the temperature. The electric strain gages on the input and output bars were water cooled and operated at room temperature.

Method of Analysis: The method of analysis for the dynamic compression tests followed that previously described by Hauser, Simmons and Dorn<sup>3</sup> from which the resolved shear stresses and shear strains were obtained. Analogous techniques were used in the shear tests from which the shear stress on the slip plane and the shear-strain rate over the operative gage section were determined. Although the shear-type tests were introduced primarily to study prismatic slip, their accuracy was established by comparison with compression types of test for basal slip. As will be shown, data obtained from the shear types of dynamic test agree well with those from compression types of dynamic test. Inasmuch as the previously reported data was obtained from single crystal tension tests, a number of "static" compression tests were also made for purposes of comparison.

### III. EXPERIMENTAL RESULTS

Basal Slip: The shear stress versus shear strain curves for basal slip at 300°K obtained from the various techniques that were employed are shown in Fig. 3. In general these various test techniques, despite the wide range of strain rates that were employed, give almost identical stress-strain curves. Certain minor differences, however, are apparent: whereas a single Luder's band formed in the slow tension test giving only an initial yield point, the slow compression test gave a serrated stress-strain curve suggestive of a rapid relaxation of the stress followed by either a reinitiation of the migration of the first band or the generation of a second Luder's band front, etc. It was not determined whether this difference arose as a result of a harder compression test set up or as a result of the differences in stress concentration at the Luder's band front in compression as compared with tension. The dynamic compression test also revealed serrations over the first part of the test, which were much greater than those usually observed that arise exclusively from the dynamic test conditions. In contrast, the stress-strain curves obtained from the dynamic shear tests were almost free from such serrations.

The nominal identity of the resolved shear stress versus resolved shear strain curves obtained by the various techniques clearly justify the use of the dynamic shear type of tests in this case. The results of all tests for basal slip are summarized in Table I. The upper yield point was selected from the maximum initial stress level whereas the lower yield point was selected from the minimum stress level following yielding.

The resolved shear stress at the upper and lower yield strengths for basal slip are recorded in Fig. 4 as a function of temperature. Since the oxide coating has been found to affect the strength of single crystals,

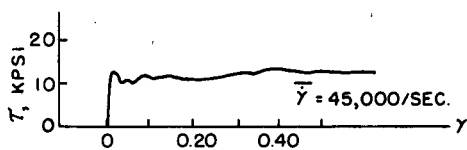

(a) DYNAMIC SHEAR TEST

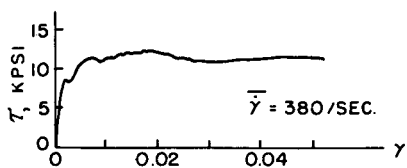

(b) DYNAMIC COMPRESSION TEST

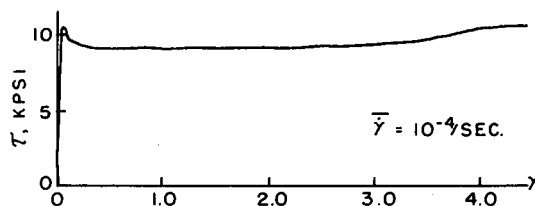

(c) STATIC TENSION TEST

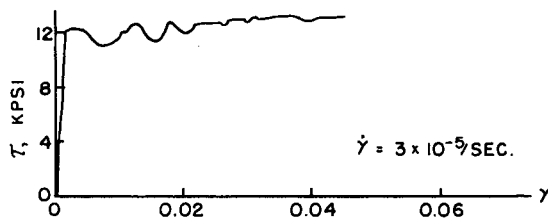

(d) STATIC COMPRESSION TEST

MU-30753

Fig. 3. Resolved shear stress-shear strain curves for basal slip at 300°K.

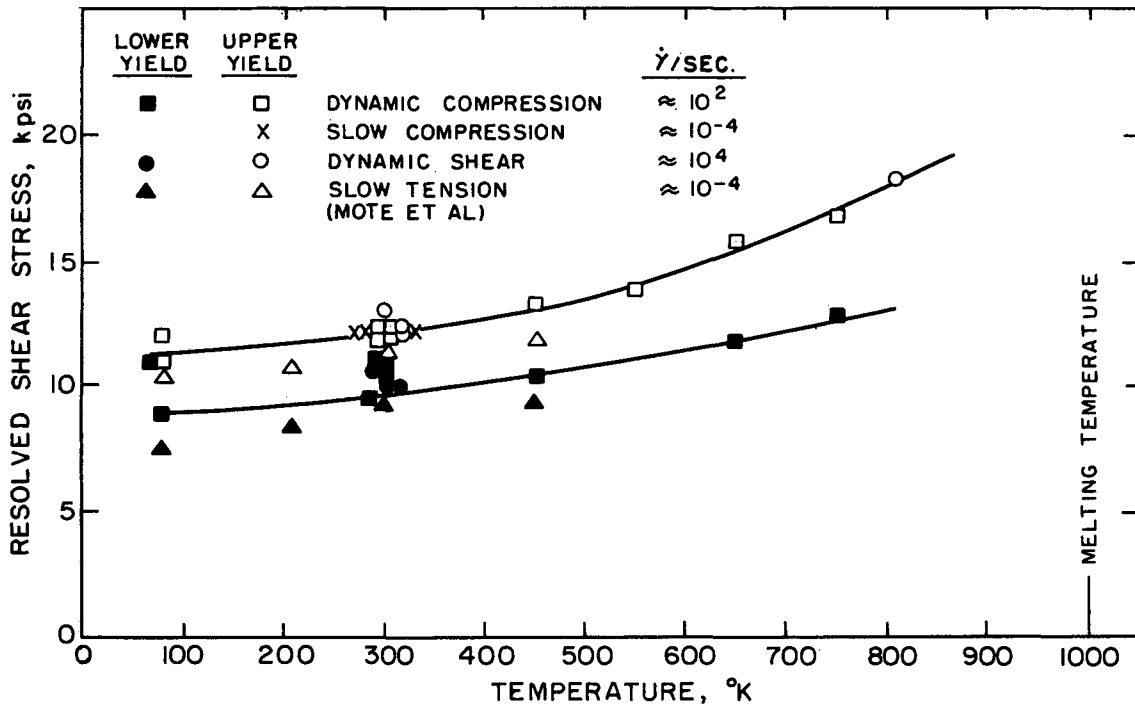

MU-30754

Fig. 4. Resolved shear stress vs. temperature for basal slip.

TABLE I  
YIELD STRENGTHS FOR BASAL SLIP

| Type of Test* | T°K | Upper Yield<br>K PSI | Lower Yield<br>K PSI | Ave. Shear<br>Strain rate/sec. |
|---------------|-----|----------------------|----------------------|--------------------------------|
| D. C.         | 77  | 11                   | 9                    | 820                            |
| D. C.         | 77  | 12                   | 11                   | 940                            |
| S. T.         | 77  | 10.6                 | 7.5                  | .0004                          |
| S. T.         | 194 | 11                   | 8.3                  | .0004                          |
| S. T.         | 300 | 11.5                 | 9                    | .0004                          |
| D. C.         | 300 | 12.5                 | 11                   | 1360                           |
| D. C.         | 300 | 12                   | 11                   | 380                            |
| D. C.         | 300 | 12                   | 9.5                  | 380                            |
| D. C.         | 300 | 12.5                 | 10.6                 | 140                            |
| D. S.         | 300 | 12.6                 | 10.1                 | 45,000                         |
| D. C.         | 300 | 12.4                 | 10.9                 | 43,000                         |
| D. S.         | 300 | 13.2                 | 10.1                 | 87,000                         |
| S. C.         | 300 | 12.4                 | 11.4                 | .0004                          |
| S. C.         | 300 | 12.8                 | 12.2                 | .0004                          |
| S. C.         | 300 | 12.5                 | 11.3                 | .0004                          |
| S. T.         | 450 | 12                   | 9.5                  | .0004                          |
| D. C.         | 450 | 13.5                 | 10.5                 | 560                            |
| D. C.         | 550 | 14                   | -                    | 340                            |
| D. C.         | 650 | 16                   | 12                   | 280                            |
| D. C.         | 750 | 17                   | 13                   | 480                            |
| D. S.         | 820 | 17.5                 | -                    | 52,000                         |

- \* S. T. Static tension<sup>1</sup>  
D. C. Dynamic compression  
S. C. Static compression  
D. S. Dynamic shear

errors introduced by atmospheric testing at high temperatures were investigated. Two crystals were heat treated in air at 650°K, the oxide coating removed from one, and then both were tested at 77°K. Since the difference in stress was within the scatter of the data, any effect due to the surface oxide was discounted.

The increase in the yield strength with increasing temperature is therefore ascribed to the operative dislocation mechanism.

Twinning: As expected compression specimens favorably oriented for slip on the prismatic plane twinned by the operation of the two most favorably oriented  $\{10\bar{1}2\}$  modes of twinning long before the resolved shear stress on the prismatic plane reached its critical value for slip. Several typical dynamic resolved shear stress-time records for twinning are reproduced in Fig. 5. Over the first regions of a test the flow stress remained substantially constant, but the curves always exhibited a rapid increase in stress level immediately following about 5% compression strain. Since the maximum compression strain for twinning alone is about 3-1/2%,<sup>4</sup> the data suggest that the rapid increase in stress level is due to the restraint of slip in the now twinned specimen. The data given in Fig. 6 refer to the possible effect of temperature on the critical resolved shear stress for twinning as deduced from the early horizontal portions of the types of records illustrated in Fig. 5. The dynamic data clearly reveal a decreasing critical resolved shear stress for twinning with increasing temperature, suggestive of a thermally activated twinning mechanism. This evidence for a thermally activated twinning mechanism is strengthened by the observation that the critical resolved shear stress for twinning increases at 77°K when the strain rate is increased.

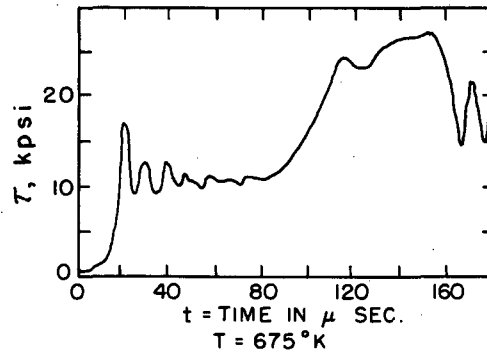
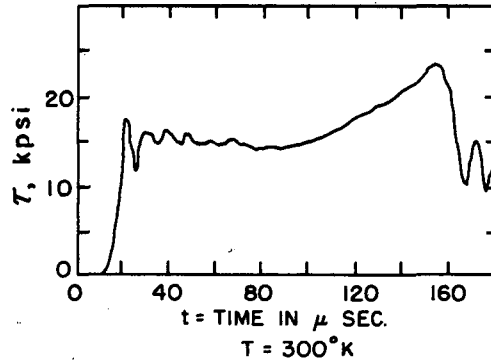

MU-30755

Fig. 5. Stress-time records for turning in compression.



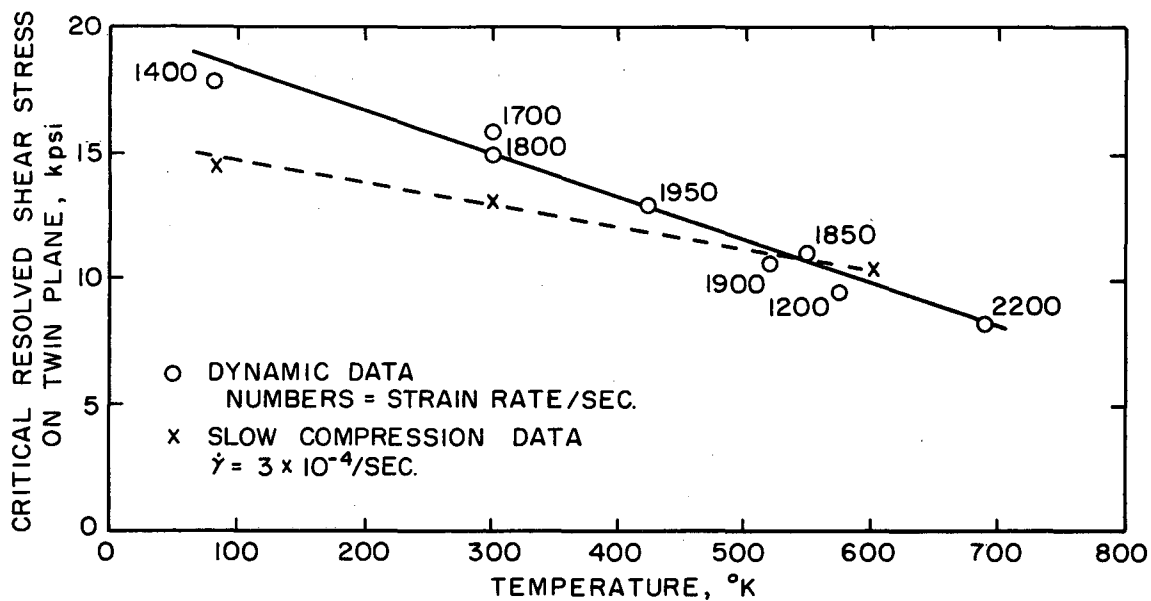

MU-30756

Fig. 6. Critical shear stress for twinning vs. temperature.

One dynamic test was run in which the stress was unloaded after 40  $\mu$  sec. This specimen was identical for those which were stressed for the full 200  $\mu$  sec. in that the twins completely traversed the crystal and their average width was the same. However, there were fewer twins, indicating that the observed flow stress may be primarily due to the formations of new twins and not to the growth of existing ones. Since twinning was not a major issue for this investigation, the definitive study of twinning was postponed for more detailed future investigations.

Prismatic Slip:

Because compression specimens favorably oriented for prismatic slip twinned before the critical resolved shear stress for slip was reached, the shear type tests were considered. The good agreement between the dynamic shear test data and the equivalent data that were obtained from the other types of test that were employed in studying basal slip attests to the nominal validity of the mechanics of the shear tests. All specimens that were tested in shear for prismatic slip did exhibit some microstructural evidence of twinning. But this was very small, particularly at the higher temperatures.

Typical dynamic test data for shear tests are shown in Fig. 7. Over the range of temperatures above 194°K stress-time records of the type shown in "b" of Fig. 7 were obtained which exhibited a small yield point drop followed by practically zero strain hardening with continued deformation. Specimens exhibiting this type of dynamic behavior experienced almost exclusively prismatic slip complicated with only very small amounts of twinning. This type of behavior was quite analogous to that obtained in the slow tension types of test where twinning was completely absent.<sup>1</sup> At temperatures of 194°K and below, however, records of the type shown in

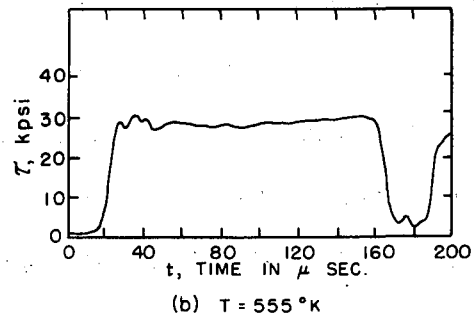
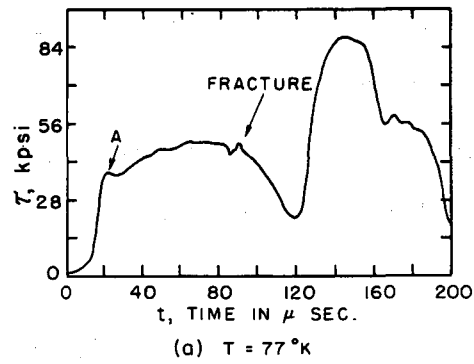

MU-30757

Fig. 7. Resolves shear stress-time record for prismatic shear tests.

"a" of Fig. 7 were obtained which exhibited considerable amounts of strain hardening. Specimens from such tests revealed considerable amounts of twinning which was evidently responsible for the strain hardening. Because of this complication these tests were not considered in the discussion in Section IVb. A summary of the initial yield strengths for both the slow tension and dynamic shear tests as a function of temperature and strain rate are recorded in Fig. 8.

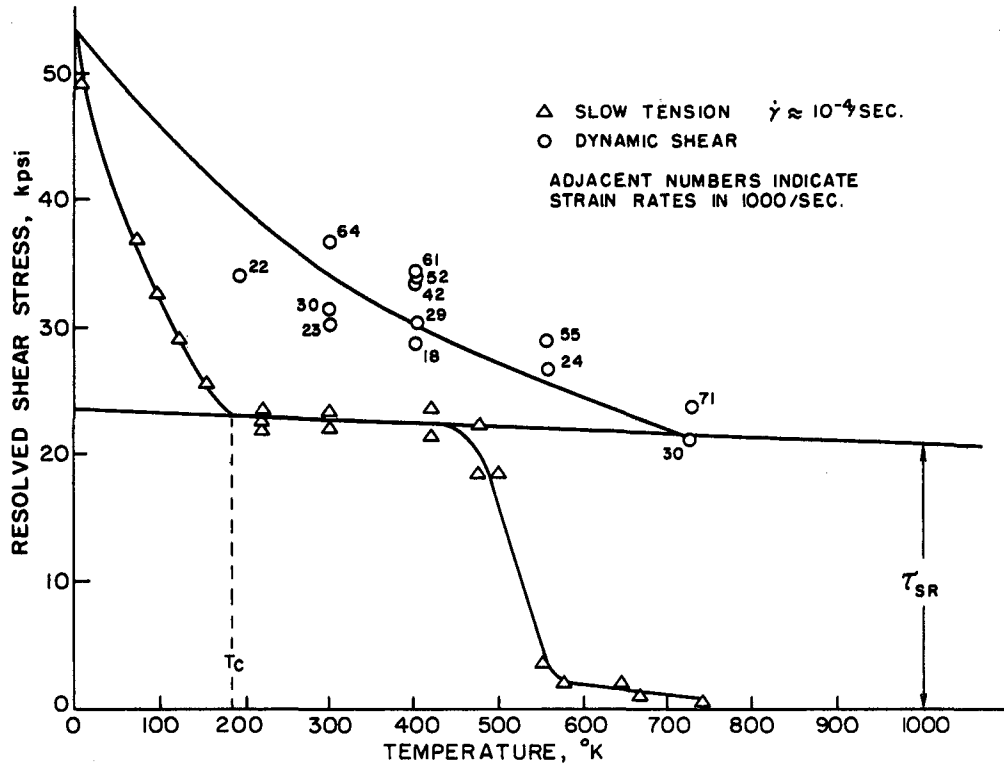

MU-30758

Fig. 8. Resolved shear stress vs. temperature for prismatic slip.

#### IV. DISCUSSION

##### A. Basal Slip

The presence of a yield point for basal slip in the Ag-33 atomic % Al alloy reveals that the dislocations that are initially present on the basal plane are locked in position. As shown in Fig. 4, the yield stress is not only insensitive to great changes in strain rate from  $10^{-4}$  to  $6 \times 10^4$  per sec. but remains substantially constant with temperature up to about  $400^\circ\text{K}$  and thereafter, in sharp contrast to the usual trends, it increases as the melting temperature is approached. Obviously, the operative deformation controlling dislocation mechanism is athermal. Such athermal resistance to the motions of dislocations can arise from long-range stress fields due to other dislocations, recombined dislocations, long-range order, short-range order, and Suzuki locking. Overcoming the long-range stress fields and the recombination forces will not provide a yield point and will give flow stresses that decrease linearly with an increase in temperature in a way that parallels the decrease in shear modulus of elasticity with temperature. As proposed by Flinn,<sup>5</sup> alloys exhibiting long-range order can exhibit strengthening with an increase in temperature up to about one-half of the melting temperature but x-ray diffraction analyses have shown that the Ag-Al hexagonal phase does not have long-range order. Whereas short-range order is known to be present in this alloy, the athermal yield stress for the short-range ordered alloys should decrease with an increase in temperature proportional to the decrease in the degree of order with temperature.<sup>6</sup> Having thus disqualified all other known athermal processes, we will now demonstrate that the experimental results can be rationalized in terms of Suzuki locking.

As shown in Fig. 9, when dislocations on the basal plane of a hexagonal CP structure dissociate, they form a stacking fault two atomic layers high ( $2h$ )

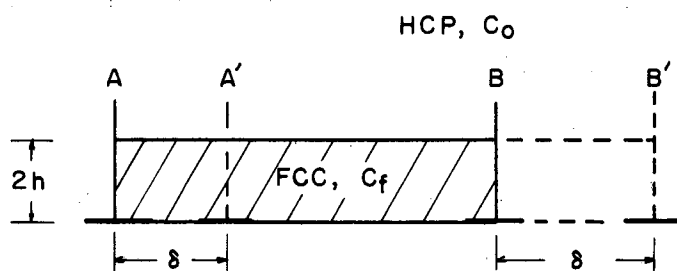

MU-30759

Fig. 9. Stacking fault on the basal plane of a HCP structure.

in which the packing of layers of atoms coincides with a FCC structure. At sufficiently high temperatures (e. g. above about 0.45 of the melting temperature) where diffusion can take place, the solute atoms will distribute themselves between the stacking fault and the surrounding ideal crystal as dictated by two phase equilibrium. Because of the small fraction of the volume occupied by the stacking fault, the ideal regions of the crystal retain approximately the average composition  $C_0$ , but the composition in the stacking fault changes to  $C_f$ .

Suzuki<sup>7</sup> has shown that when a sufficiently high stress,  $\tau_s$ , is applied in the direction of the Burgers vector, the dislocations move a distance  $\delta$ , as shown in Fig. 9. From the work done by the applied stress it follows that

$$\tau_s = \frac{2h}{Vb} \left\{ (F^f - F^h)_{C_0} - (F^f - F^h)_{C_f} \right\} \quad (1)$$

where  $h$  is the distance between adjacent slip planes,  $V$  is the molar volume of the crystal,  $b$  is the Burgers vector,  $F^h$  is the free energy per mole of the hexagonal phase and  $F^f$  is the free energy per mole of the fault. The subscripts  $C_0$  and  $C_f$  identify the compositions at which the free energies in the curved braces are to be evaluated. Since the set of partials were originally at equilibrium, the change in free energy given in the curved braces is always positive, and consequently a positive stress is always required to move Suzuki-locked dislocations.

Two features of the above discussion are significant to the problem under consideration. First the entire length of the partial dislocations move at the same time revealing that very high energies are required to activate the motion of Suzuki-locked dislocations. Consequently this mechanism is



athermal. Secondly, once the pair of partials have been moved past the region of composition  $C_f$  so fast that equilibrium cannot be reestablished in their new location, the subscript  $C_f$  in the last term of Eqn. 1 becomes  $C_o$ . Under these conditions the stress,  $\gamma_s$ , becomes small. Therefore a Suzuki-locked alloy will exhibit a yield point. Both of these requirements are satisfied by the data for basal slip.

It is not possible to calculate  $\gamma_s$  directly from Eqn. 1, since the required thermodynamic data for the free energies of the faulted region are presently unknown and are not easily established. However, it is possible to show that the experimentally determined values of  $\gamma_s$  and the increase with temperature are certainly within the theoretically acceptable range for Suzuki locking. For this purpose we follow the development by Suzuki, assuming that the thermodynamics of both the crystal and faulted regions may be approximated by the ideal solution laws. It has been shown<sup>7</sup> that for this limiting approximation,

$$\gamma_s = \frac{2h}{\sqrt{b}} (C_o - C_f) \Delta F = (C_o - C_f) \frac{1}{b} (\gamma_{AL} - \gamma_{Ag}), \quad (2)$$

where  $C_o$  and  $C_f$  refer to the mole fraction of Al in the alloy and in the stacking fault respectively,  $\gamma_{Al}$  and  $\gamma_{Ag}$  are the stacking fault energies per  $\text{cm}^2$  in pure hexagonal Al and pure hexagonal Ag respectively,

$$\Delta F = (F_{AL}^f - F_{AL}^h) - (F_{Ag}^f - F_{Ag}^h) \quad (3)$$

where  $F_{Al}^h$  and  $F_{Ag}^h$  refer to the free energies per mole of pure hexagonal Al and pure hexagonal Ag and  $F_{Al}^f$  and  $F_{Ag}^f$  refer to the free energies per mole in the stacking faults of pure hexagonal Al and pure hexagonal Ag.

(i. e., face-centered cubic phases). The equilibrium condition is given by

$$\frac{C_f}{1-C_f} = \frac{C_o}{1-C_o} e^{-\frac{\Delta F}{RT}} \quad (4)$$

Introducing the experimentally determined stress at the upper yield as representative of the Suzuki unlocking stress  $\tau_s$ , Eqns. 2 and 4 were solved simultaneously to give  $\gamma_{Al} - \gamma_{Ag}$  as a function of temperature. Such simultaneous solutions, however, are only valid above about 400°K since the composition  $C_f$  at lower temperatures refers to the frozen-in value at about 400°K. It is for this reason that the experimentally determined  $\tau_s$  is practically independent of the temperature below about 400°K.

As shown in Fig. 10, two possible sets of  $\gamma_{Al} - \gamma_{Ag}$  are obtained from the experimental data. Since, however, the stacking fault energy in cubic Al is greater than that for cubic Ag, the stacking fault energy for hexagonal Al is less than that for hexagonal Ag. On this basis the solid line of Fig. 10 represents the appropriate values. Both the order of magnitude of the stacking fault energies and the linear dependency in temperature are consistent with theoretical expectations. Consequently, theory strongly supports the concept that basal slip in the hexagonal Ag-33 at. % Al alloy is controlled by Suzuki locking.

### B. Prismatic Slip

As shown in Fig. 8, the yield stress for prismatic slip exhibits three distinct regions over each of which uniquely different dislocation mechanisms are operative. The flow in Region I, which is characterized by a rapidly decreasing yield stress with increasing temperature, must be controlled by a thermally activated mechanism. In view of the small activation volume that was observed, Mote, Tanaka and Dorn<sup>1</sup> tentatively attributed the observed behavior in Region I to the Peierls mechanism.

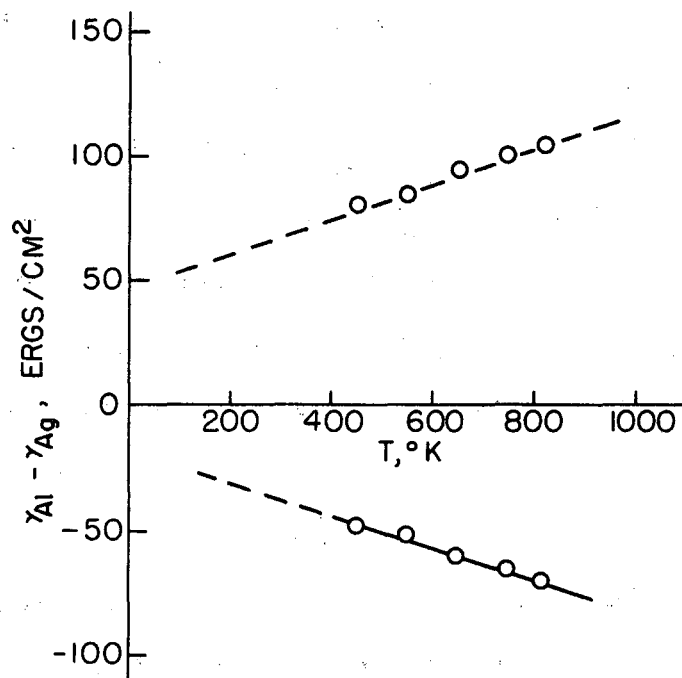

MU-30760

Fig. 10. Stacking fault energies vs. temperature.

Over Region II the yield stress decreases only mildly with temperature revealing that some athermal process is operative here. These results have been shown to be wholly consistent<sup>1</sup> with the concept that the deformation as a result of prismatic slip in this region results from short-range order. Extensive investigation by Howard, Barmore, Mote and Dorn<sup>8</sup> has shown that the strain rate (or creep rate) over all of Region III can be correlated by the equation

$$\dot{\gamma} = 3.89 \times 10^4 \tau^{3.6} e^{-\frac{33,000}{RT}} \quad (5)$$

where the activation energy approximates that for diffusion. Consequently, a thermally activated diffusion controlled plastic flow process is operative over Region III.

The dynamic yield stresses recorded in Fig. 8 coincide with the usual observations on thermally activated processes, namely, that an increase in strain rate at a constant temperature leads to results equivalent to a decrease in temperature at constant strain rate. The dynamic test data, therefore, suggest that for the high strain rates encountered in the dynamic tests, the low-temperature thermally activated process is operative over all of the test temperatures that were examined. It is expected, of course, that the diffusion controlled mechanism for prismatic slip, seen in Region III, would not have time enough to be operative under high strain rates that were used in the dynamic tests. We will now demonstrate that the extent of Region I increases with an increase in strain rate and that the slow tension test data obtained in Region I are wholly consistent with the dictates of the Peierls mechanism. Furthermore, we will show that all of the dynamic data are also in fair qualitative agreement with predictions based on the Peierls process.

Seeger,<sup>9</sup> Seeger, Donth and Pfaff,<sup>10</sup> Lothe and Hirth,<sup>11</sup> and Friedel<sup>12</sup> have discussed the Peierls mechanism. These earlier formulations of the theory, however, were only approximate and pertained accurately only for low stress levels. More recently Dorn and Rajnak<sup>13</sup> have completed a more rigorous and accurate theory for the Peierls process that is in excellent agreement with most of the experimental data pertaining to the Peierls mechanism in body-centered cubic metals. We will give a brief summary of this theory.

As shown in Fig. 11, the line energy of a dislocation has its minimum value when it lies parallel to certain closely packed rows of atoms. A single kink traverses the Peierls hill as shown in Fig. 11b, where as a result of its greater length, it has an energy  $U_k$  (the kink energy) which is greater than that of a dislocation lying exclusively in the valley. To move a dislocation lying exclusively in one valley to the next in the absence of a thermal fluctuation requires that a stress,  $\tau_p$ , equal to the Peierls stress be applied. If a stress  $\tau < \tau_p$  is applied, the dislocation, in the absence of thermal fluctuations, will move only part way up the Peierls hill as shown by the straight dislocation BB'. But at all temperatures above the absolute zero, thermal fluctuations will provide energy to form segments such as CPP'C'. Most of these will collapse back. But if the thermal fluctuation is great enough, a critical stage will be reached such that the pair of kinks so produced will move away from each other thereby advancing the dislocation forward by the periodicity,  $a$ , of the lattice. The theory for the Peierls process permits an accurate determination of the saddle point energy  $U_m$  for the nucleation of a pair of kinks. On this basis the shear strain rate,  $\dot{\gamma}$ , is given by the Boltzmann type of formulation as

$$\dot{\gamma} = (\rho L) (La) b (v b L / w b) e^{-\frac{U_m}{kT}}$$

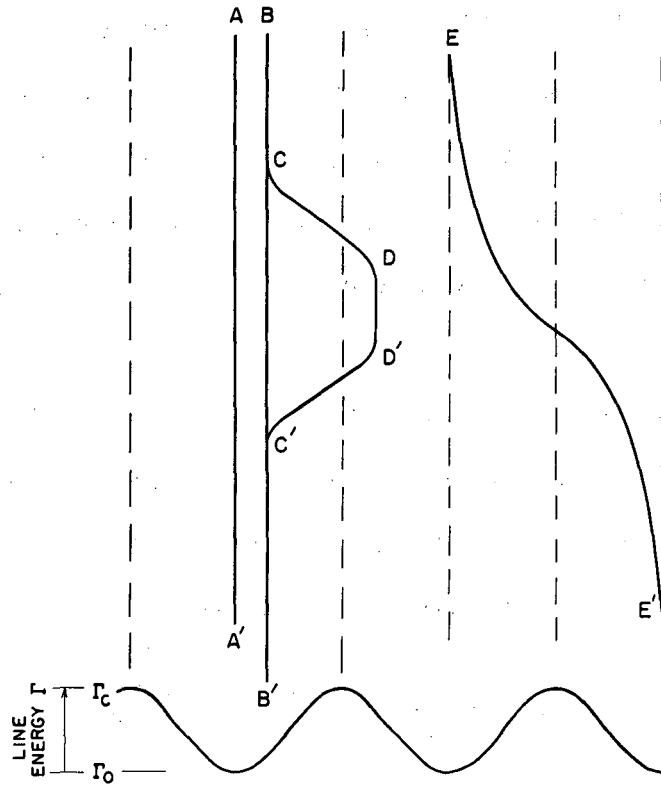

MU-30761

Fig. 11. Process of nucleation of a pair of kinks.

where  $L$  is the geometrically determined distance over which the pair of kinks move,  $\rho$  is the density of the freely movable dislocations,  $\nu$  is the Debye frequency,  $w$  is the width of the critical size of loop, and  $kT$  has its usual meaning. Eqn. 6, which assumes that only one pair of kinks is migrating in  $L$  at one time, must be replaced by a slightly more complicated relationship, as shown by Dorn and Rajnak,<sup>13</sup> when several kinks move at the same time in the geometric length  $L$ . Eqn. 6, however, will be adopted here because it predicts results in good agreement with the present experimental data.

Eqn. 6 is valid only up to a critical temperature,  $T_c$ , because the necessary thermal fluctuations at  $T_c$  and above are so frequent that even for an infinitesimal stress, no wait time is needed for nucleation of a pair of kinks. For this critical condition, Eqn. 1 becomes

$$\dot{\gamma} = \rho a b \nu L/w e^{-\frac{2U_k}{kT_c}} \quad (7)$$

Since  $w$  appears in the pre-exponential term and is furthermore only mildly sensitive to  $\tau^*$ , it can to a first approximation be treated as substantially constant. Therefore, for a given strain rate,  $\rho$  and  $L$  constant, Eqns. 6 and 7 give

$$\frac{U_m(\tau^*)}{2U_k} = \frac{T}{T_c} \quad (8)$$

The theoretical evaluation of  $U_m/2U_k$  as a function of  $\frac{\tau^*}{\tau_p}$  for the case where the Peierls hill is sinusoidal is given by the solid curve of Fig. 12.<sup>13</sup> This curve is universally valid for all materials: As  $\tau^*$  approaches zero, the energy that must be supplied by a thermal fluctuation to produce a pair of kinks is  $2U_k$ . When the stress,  $\tau^*$ , equals the Peierls stress,

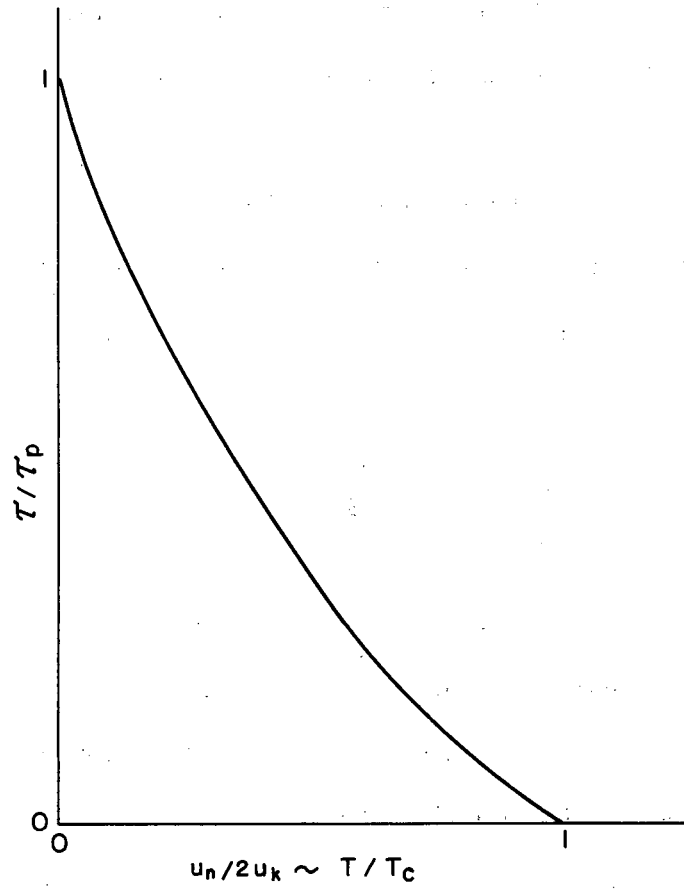

MU-30762

Fig. 12. Dependence of the energy to nucleate a pair of kinks on the applied stress.



no additional energy need be supplied by a thermal fluctuation to cause the forward motion of a dislocation and  $U_m$  becomes zero. As shown by Eqn. 8, the theory can be viewed in terms of  $\tau^*/\tau_p$  as a function of  $T/T_c$ . At the absolute zero, therefore, as shown in Fig. 12,  $\tau^* = \tau_p$ , whereas  $\tau^* = 0$  at  $T = T_c$ .

The slow tension test data given in Fig. 8 can now be correlated with the theoretical predictions based on the Peierls mechanism. For this purpose the stress required for aiding the thermal activation of the Peierls process is

$$\tau^* = \tau - \tau_{sh} \tag{9}$$

where  $\tau$  is the total applied stress and  $\tau_{sh}$  is the stress needed to overcome the athermal short-range order energy. Assuming the mild effect of temperature on  $\tau_{sh}$ , shown in Fig. 8, and neglecting the possible but negligible effect of temperature on the Peierls stress, we obtain the experimental datum points shown in Fig. 12. The agreement between theory and experiment is excellent. The solid curve given in Fig. 8 over Region I is the theoretical curve fitted to  $\tau^* = \tau_p$  at  $T = 0$  and  $\tau^* = 0$  at  $T = T_c$ .

We will now explore the dynamic test data for prismatic slip. For this purpose the best fit curve, shown broken in Fig. 8, was placed through the average of the scattered data approximating a strain rate of  $\dot{\gamma} = 30,000$  per sec., and the corresponding critical temperature,  $T_c$ , was estimated as indicated in the figure. Assuming that  $\rho$  and  $L$  were the same for the slow tension and dynamic shear tests, theory suggests that

$$\frac{\dot{\gamma}_1}{\dot{\gamma}_2} = e^{-\frac{2U_k}{RT_{c1}}} / e^{-\frac{2U_k}{RT_{c2}}} \tag{10}$$

On this basis it is found that  $2\mathcal{U}_k = 0.40 \text{ e.v.}$  . . . This seems to be about the right order of magnitude since the appropriate value for Fe is somewhat greater than this value.<sup>13</sup> When, however, this value of  $2\mathcal{U}_k$  is used to predict the flow stress for strain rates of about 60,000 per sec., the predicted values fall slightly below the experimental data. This suggests that  $\rho$ , the density of the free dislocations, is somewhat less in the dynamic tests than in the slow tension tests and correlates with the possibility that twinning in the dynamic tests provides some barriers for the motion of dislocations, whereas no twinning was encountered in the slow tension tests. Nevertheless, the general trends are consistent with the predictions based on the Peierls mechanism with modifications due to twinning in the dynamic tests.

### C. Plastic Waves

All theories of plastic wave propagation are based on the equations for dynamic equilibrium and the conditions for continuity and therefore differ from each other only with respect to the constitutive equations that describe the dynamic elastoplastic behavior of the material. Using only the Hugoniot equations for equilibrium and the condition for continuity, the velocity,  $\frac{d\alpha}{dt}$  of the propagation of a wave down a thin longitudinal bar is given by

$$\frac{d\alpha}{dt} = \sqrt{\frac{[\sigma]/[\epsilon]}{\rho}} \quad (11)$$

where

$[\sigma]$  = the shock in the engineering stress,

$[\epsilon]$  = the shock in the total engineering strain,

and  $\rho$  is the density of the material. For crystalline material, however, the shock in total strain,  $[\epsilon]$ , can only refer to the shock in elastic strain,

since the shock in plastic strain is zero. This follows because, as shown by Frank,<sup>14</sup> the energy per unit length,  $\Gamma$ , of a moving dislocation depends on its velocity  $v$ . For a screw dislocation,  $\Gamma$  is given by the relativistic-like equation

$$\Gamma(v) = \Gamma_0 \left( 1 - \left( \frac{v}{c} \right)^2 \right)^{-\frac{1}{2}}, \quad (12)$$

where  $\Gamma_0$  is the rest energy and  $c$  is the velocity of an elastic shear wave. As shown by Johnston and Gilman<sup>15</sup> in their investigations on LiF, the velocity of dislocations under high stress approaches the limiting value of  $c$ , as suggested by Eqn. 12. Because the energy of dislocations depends on their velocity, they have inertia, and as shown by expanding Eqn. 12 into a Taylor's series, for velocities less than about  $0.1c$  the effective mass of a dislocation is about  $\Gamma_0/c^2$ . Consequently the instant a shock in stress arrives at a dislocation which was originally at rest, the dislocation remains at its original position but it accelerates. Because there can be no abrupt change in the position of dislocations as a result of a shock in stress, there can be no shock in plastic strain. Therefore the shock in the total shown can only equal the shock in elastic strain and Eqn. 11 always reduces to

$$\frac{d\alpha}{d\tau} = \sqrt{E/\rho}, \quad (13)$$

where  $E$  is Young's modulus of elasticity.

Since the inertia of dislocations is very small, they accelerate rapidly to their limiting velocity. This concept has also been experimentally verified by Johnston and Gilman<sup>15</sup> who observed that the dislocations undertook the same displacement under a single stress pulse as under a series of stress

pulses of the same total duration. For example, neglecting damping, the accelerative period of a dislocation can be calculated by equating the rate of work done by the stress to the increase in line energy according to

$$\tau b v = \frac{d\Gamma}{d\pi} \quad (14)$$

When this is integrated, taking  $v = 0$  at  $t = 0$ , the result is

$$bc\pi = \frac{\Gamma_0}{c^2} v \left(1 - \left(\frac{v}{c}\right)^2\right)^{-1/2} \quad (15)$$

Using the values appropriate for Al, namely  $c = 5 \times 10^5$  cm/sec,  $b = 2.86 \times 10^{-8}$  cm and  $\Gamma_0 = Gb^2/2 = 1.1 \times 10^{-4}$  ergs/cm where  $G$  is the shear modulus of elasticity, we observe that for a stress as low as  $\tau = 10^8$  dynes/cm<sup>2</sup>, a dislocation will reach  $0.9c$  in about  $2 \times 10^{-11}$  sec. Furthermore the shear strain at this time is

$$\gamma = \int_0^{2 \times 10^{-11}} \rho b v d\pi = 1.4 \times 10^{-4} \quad (16)$$

assuming a density of dislocations of  $\rho = 10^8$  per cm<sup>2</sup>. Approximately the same answer is given by more sophisticated analyses on the dynamic behavior of a Frank-Read source.<sup>16</sup> At present there is no experimental equipment available to explore this accelerative period over such short intervals of time. Furthermore, engineering interest usually centers about the much longer times of  $10^{-8}$  sec. or greater and much higher plastic strains than about  $10^{-4}$ . Consequently, for most types of plastic wave problems, it is appropriate to neglect the accelerative period. For this reason the constitutive equations to be used in plastic wave propagation problems need not contain the rates of change of strain rates as would be necessary when the analysis must account for the acceleration of the dislocations.

All mechanisms of dislocation motion involve the absorption of energy. Therefore as a shock passes through material the stress level at the front of the shock is continually reduced by plastic deformation at the wave front until the stress decreases to such a low value that finally only elastic straining results at the shock front. Three classes of cases deserve consideration as shown in Table II.

Both Class I and Class II phenomenon give flow stresses that depend on the strain rate; the Liebfried equation for the interaction of phonons with dislocations, however, gives only small changes in stress with strain rate. The effect of strain rate on the flow stress can be great for several of the Class II phenomenon. This is easily verified in terms of the discussion in the text of this report on the Peierls process. For both Class I and Class II processes, however, the constitutive equations must be formulated in terms of the stress and strain rate as well as the strain. And under these conditions the plastic wave problem should be solved by means of the techniques suggested by Malvern.<sup>17</sup> Under dynamic conditions however, as previously discussed, the diffusion controlled processes do not have time enough to take place and will be superceded by other mechanisms.

If over the entire low temperature range only the athermal processes of Class III are operative, the deformation stress will depend only on the strain. Suzuki locking was the example given in the text. In this event the plastic wave propagation theory can be most readily approached by the von Karman and Taylor<sup>18</sup> types of theory.

TABLE II  
DISLOCATION MECHANISMS

| Class | Name  | Example   | Characteristics  |
|-------|---|---|--|
| I     | Athermal but velocity sensitive                           | (a) Phonon interactions with dislocations.  | $\dot{\gamma} = \frac{10^9 \rho \tau b^4}{3kT}$  |
| II    | Thermally activated (activation energies less than 50 kT) | (a) Peierls<br>(b) Intersection<br>(c) Cross-slip<br>(d) Motion jogged screws<br>(e) Climb of edges<br>(f) Viscous solute atom drag | $\dot{\gamma} \propto e^{-\frac{u}{kT}}$<br><br>u depends on $\tau$ and structure and only mildly on T |
| III   | Athermal (activation energies greater than 50 kT)         | (a) Long-range stress<br>(b) Recombination stresses<br>(c) Short-range order<br>(d) Long-range order<br>(e) Suzuki locking          | $\tau/G = f(\gamma)$   |

ACKNOWLEDGMENTS

This investigation was initially sponsored by the Lawrence Radiation Laboratory at Livermore, and more recently assigned to the Inorganic Materials Research Division of the Lawrence Radiation Laboratory in Berkeley. The authors wish to express their sincere appreciation to the United States Atomic Energy Commission for their support of this investigation.

BIBLIOGRAPHY

1. J. Mote, K. Tanaka, J. E. Dorn, *Trans. AIME* 221, 858 (1961).
2. F. E. Hauser and C. A. Winter, "An Experimental Method for Determining Stress-Strain Relations of High Strain Rates, University of California, MRL Pub., Series 133, Issue 4 (Dec. 1960)
3. F. E. Hauser, J. A. Simmons, and J. E. Dorn, Strain Rate Effects in Plastic Wave Propagation, in Response of Metals to High Velocity Deformation, Interscience (1961).
4. C. S. Barrett, *Structure of Metals*, McGraw-Hill, Inc., N. Y., N. Y. 315(1943).
5. P. A. Flinn, *Transactions AIME* 218, 145 (1960).
6. C. A. Fisher, *Acta Met.* 2, 9 (1954).
7. H. Suzuki, *Yield Strength of Binary Alloys*, in Dislocations and Mechanical Properties of Crystals, John Wiley and Sons, Inc., N. Y. 361 (1957).
8. E. Howard, W. Barmore, J. Mote and J. E. Dorn, "On the Thermally-Activated Mechanism of Prismatic Slip in the Ag-Al Hexagonal Intermediate Phase," accepted by *Trans. AIME*
9. A. Seeger, *Phil. Mag.* 1,651 (1956).
10. A. Seeger, H. Donth and F. Pfaff, *Disc. Faraday Soc.* 23, 19 (1957).
11. J. Lothe and J. P. Hirth, *Phys. Rev.* 115, 543 (1959).
12. J. Friedel, *Electron Microscopy and Strength of Crystals*, ed. by G. Thomas and J. Washburn, Interscience, 605 (1962).
13. J. Dorn and S. Rajnak, to be published.
14. F. Frank and W. Read, *Phys. Rev.* 79, 722 (1950).
15. W. Johnston and J. J. Gilman, *J. Appl. Phys.* 30, 129 (1959).
16. J. Campbell, J. Simmons and J. Dorn, *J. Appl. Mech.* 83, 447 (1961).
17. L. E. Malvern, *Quart. Appl. Math* 8, No. 4, 405 (1951).
18. T. von Karmen and P. Duwez, *J. Appl. Phys.* 21, 987 (Oct. 1950).



This report was prepared as an account of Government sponsored work. Neither the United States, nor the Commission, nor any person acting on behalf of the Commission:

- A. Makes any warranty or representation, expressed or implied, with respect to the accuracy, completeness, or usefulness of the information contained in this report, or that the use of any information, apparatus, method, or process disclosed in this report may not infringe privately owned rights; or
- B. Assumes any liabilities with respect to the use of, or for damages resulting from the use of any information, apparatus, method, or process disclosed in this report.

As used in the above, "person acting on behalf of the Commission" includes any employee or contractor of the Commission, or employee of such contractor, to the extent that such employee or contractor of the Commission, or employee of such contractor prepares, disseminates, or provides access to, any information pursuant to his employment or contract with the Commission, or his employment with such contractor.

[The page contains extremely faint and illegible text, likely bleed-through from the reverse side of the document.]

