

# Lawrence Berkeley National Laboratory

## Recent Work

### Title

Performance Monitoring of Residential Hot Water Distribution Systems

### Permalink

<https://escholarship.org/uc/item/6t15w282>

### Authors

Liao, Anna  
Lanzisera, Steven  
Lutz, Jim  
[et al.](#)

### Publication Date

2014-08-17



# ERNEST ORLANDO LAWRENCE BERKELEY NATIONAL LABORATORY

## Performance Monitoring of Residential Hot Water Distribution Systems

Anna Liao, Steven Lanzisera, Jim Lutz, Christian Fitting,  
Margarita Kloss, Christopher Stiles

Environmental Energy Technologies Division

August 2014

Presented at the  
*2014 ACEEE Summer Study on Energy Efficiency in Buildings*  
Pacific Grove, CA,  
August 17, 2014  
and to be published in  
the Proceedings

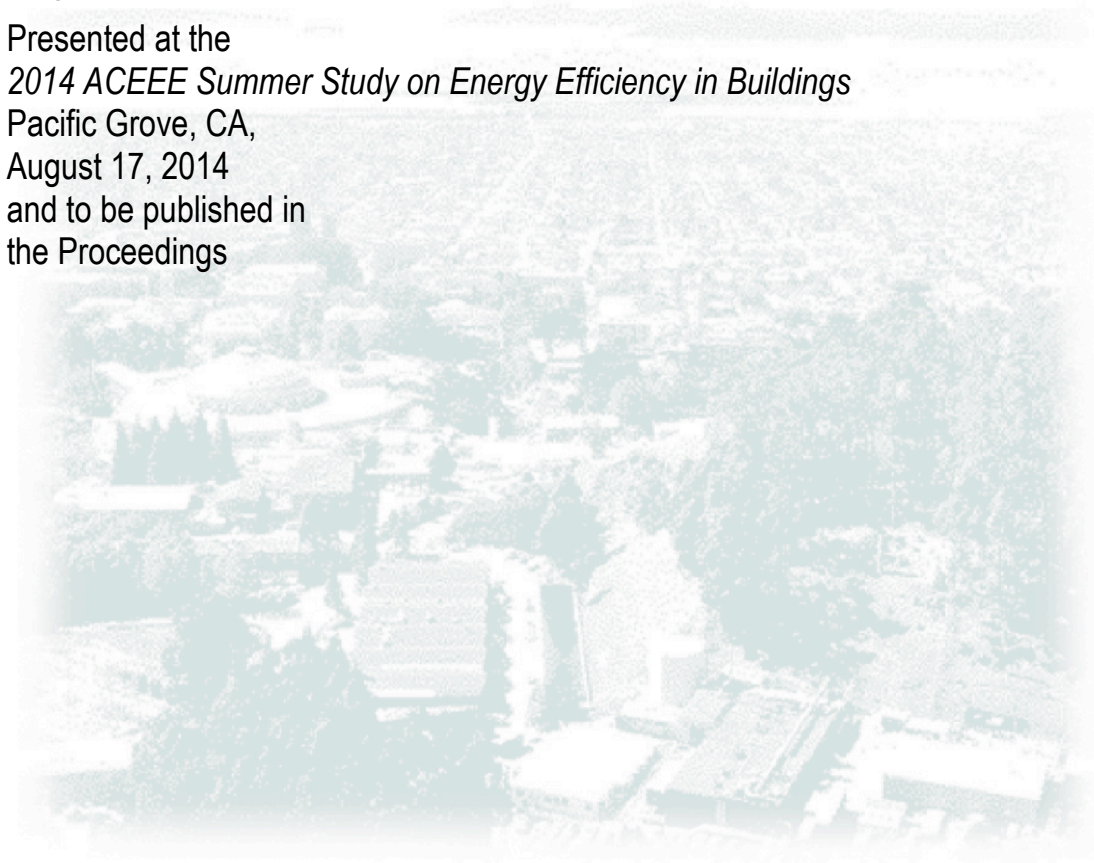

## **LEGAL NOTICE**

The Lawrence Berkeley National Laboratory, a laboratory owned by DOE, is located at 1 Cyclotron Rd., Berkeley, California is a national laboratory of the DOE managed by Regents of the University of California for the U.S. Department of Energy under Contract Number DE-AC02- 05CH11231. This report was prepared as an account of work sponsored by the Sponsor and pursuant to an M&O Contract with the United States Department of Energy (DOE). Neither Regents of the University of California, nor the DOE, nor the Sponsor, nor any of their employees, contractors, or subcontractors, makes any warranty, express or implied, or assumes any legal liability or responsibility for the accuracy, completeness, or usefulness of any information, apparatus, product, or process disclosed, or represents that its use would not infringe on privately owned rights. Reference herein to any specific commercial product, process, or service by trade name, trademark, manufacturer, or otherwise, does not necessarily constitute or imply its endorsement, recommendation, or favoring by Regents of the University of California, or the DOE, or the Sponsor. The views and opinions of authors expressed herein do not necessarily state or reflect those of Regents of the University of California, the DOE, or the Sponsor, or any of their employees, or the Government, or any agency thereof, or the State of California. This report has not been approved or disapproved by Regents of the University of California, the DOE, or the Sponsor, nor has Regents of the University of California, the DOE, or the Sponsor passed upon the accuracy or adequacy of the information in this report.

## **DISCLAIMER**

The government and the facility operator make no express or implied warranty as to the conditions of the research or any intellectual property, generated information, or product made or developed under this agreement, or the ownership, merchantability, or fitness for a particular purpose of the research or resulting product: that the goods, services, materials, products, processes, information, or data to be furnished hereunder will accomplish intended results or are safe for any purpose including the intended purpose; or that any of the above will not interfere with privately owned rights of others. Neither the government nor the facility operator shall be liable for special, consequential, or incidental damages attributed to such research or resulting product, intellectual property, generated information, or product made or delivered under this agreement.

## **ACKNOWLEDGEMENT**

This work was supported by the California Energy Commission, Public Interest Energy Research Program, under Agreement No. 500-10-052, and the U.S. Department of Energy under Contract No. DE-AC02-05CH11231.

# Performance Monitoring of Residential Hot Water Distribution Systems

*Anna Liao, Steven Lanzisera, Jim Lutz, Christian Fitting, Margarita Kloss and Christopher Stiles, Lawrence Berkeley National Laboratory*

## ABSTRACT

Current water distribution systems are designed such that users need to run the water for some time to achieve the desired temperature, wasting energy and water in the process. We developed a wireless sensor network for large-scale, long time-series monitoring of residential water end use. Our system consists of flow meters connected to wireless motes transmitting data to a central “manager” mote, which in turn posts data to our server via the internet. This project also demonstrates a reliable and flexible data collection system that could be configured for various other forms of end use metering in buildings. The purpose of this study was to determine water and energy use and waste in hot water distribution systems in California residences. We installed meters at every end use point and the water heater in 20 homes and collected 1s flow and temperature data over an 8 month period. For a typical shower and dishwasher events, approximately half the energy is wasted. This relatively low efficiency highlights the importance of further examining the energy and water waste in hot water distribution systems.

## Introduction

Heating water accounts for approximately 50% of California’s residential natural gas consumption (Palmgren 2010). What is the energy and water efficiency from water heater to end use (shower, faucet, dishwasher, washing machine)? Our data collection system and field study are designed to answer this question and provide specific data on hot water end uses and hot water distribution system (HWDS) efficiency. Figure 1 shows a schematic view of a typical hot water distribution system in a single-family residence. The line labeled “Hot Water” depicts the distribution system that conveys hot water from the water heater to each end use.

Hot water end uses in homes are primarily showers and tubs, faucets, dishwashers, and washing machines. Accurate measurements of hot water end use over a long time frame would be an aid to guiding energy efficiency standards and policy. Advances in wireless sensor network technology and software for streaming data to a remote server provides an efficient and low-cost system for a long-term field study on hot water use. For this paper, our HWDS monitoring systems were installed in 20 homes between July 2013 to February 2014. The field work has yielded as much as eight months of data at each house. Depending on changes in demographics and behavior over the years, there could be significant differences in hot water use patterns, as supported by the DOE 2001 Residential Energy Consumption Survey (DOE 2001). For example, only 30% of Pre-1949 built homes use the dishwasher at least once a week, while weekly dishwasher consumption jumps up to 80% of homes built in 1990-2001. Table 1 summarizes the general house specifications of each house, and Table 2 summarizes the types and quantity of water end uses in each houses.

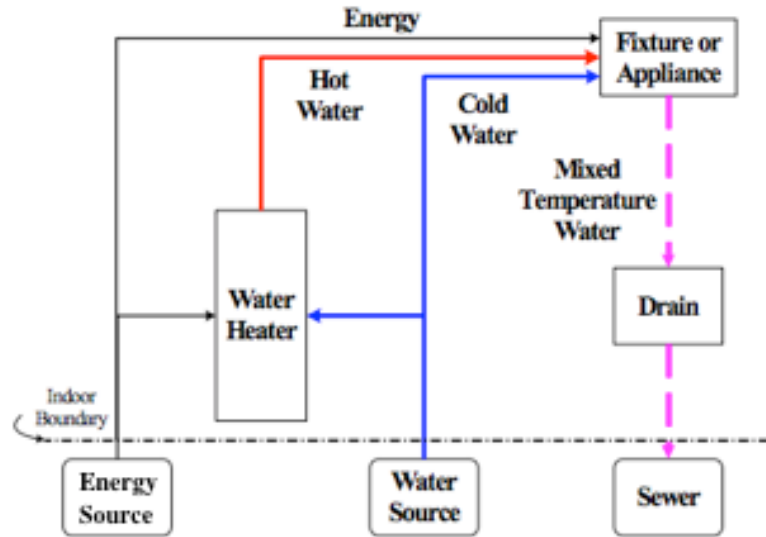

Figure 1. A conceptual schematic view of a typical hot water distribution system in a single-family residence, from source to end use.

Table 1. General house specifications of the single-family residences in the HWDS field study where houses in the study are located either in East Bay of the San Francisco Bay Area or near Sacramento

General House Data								
House#	Total Occupants	Square Footage	Number of Floors	Year Built	Architectural Style of Home	Foundation Type	Space Heating Gas/ Electric	Appliances (stove, dryer, etc.) Gas/ Electric
1	2	1001-1500	1	1904	Ranch	Crawl Space	Gas	Gas
2	3	1001-1500	1	1915	Bungalow	Crawl Space	Electric	Gas
3	2	1501-2000	2	1904	Bungalow	Crawl Space	Gas	Gas
4	3	2001-3000	1	2011	Ranch	Crawl Space	Gas	Electric
5	2	1501-2000	2	1935	Bungalow	Crawl Space	Gas	Gas
6	2	2001-3000	2	1967	2 story, attached garage	Crawl Space	Gas	Gas
7	2	1001-1500	2	1985	Split-Level	Slab and Crawlspace	Gas	Gas
9	2	2001-3000	1	1968	Ranch	Crawl Space	Gas	Gas
10	4	1001-1500	1	1981	Unknown	Slab Foundation	Gas	Electric
11	2	> 3000	2	1994	Contemporary	Slab Foundation	Gas	Gas
13	3	1501-2000	2	1909	Traditional Farmhouse	Crawl Space	Gas	Gas
14	4	2001-3000	2	2003	Bungalow	Crawl Space	Gas	Gas
16	2	1001-1500	1	1951	Post-WWII	Crawl Space	Gas	Gas
17	4	1501-2000	1	1970	Ranch	Crawl Space	Gas	Gas
18	5	> 3000	2	2008	Contemporary	Slab Foundation	Gas	Gas
19	1	1001-1500	3	2005	Townhouse	Slab Foundation	Gas	Gas
20	5	2001-3000	2	2000	Contemporary	Slab Foundation	Gas	Gas
21	3	2001-3000	1	1975	Ranch	Slab Foundation	Gas	Electric
22	2	1501-2000	1	1962	Single story, arch roof	Slab Foundation	Gas	Gas
24	3	1001-1500	2	1930	Craftsman	Basement	Electric	Gas

Table 2. Types and Quantity of Water End Uses at each house

### Water End Uses

House#	Water Heater Type	Water Heater Location	Total Metered Indoor Uses	Bathroom Sinks	Toilets (#) = Metered	Showers	Bathtubs	Kitchen Sinks	Dish Washer	Clothes Washer	Garage/Laundry Sink
1	Gas-Storage Tank	Kitchen Closet	9	2	2	2	2	1	1	1	0
2	Gas-Storage Tank	Outdoors	6	1	1	1	1	1	1	1	0
3	Gas-Storage Tank	Inside, Near Kitchen	11	3	3	2	2	1	1	1	0
4	Gas-On-demand	Outdoors	10	5	3 (0)	2	1	1	1	1	0
5	Gas-Storage Tank	Crawl Space	11	3	3	2	2	1	1	1	0
6	Gas-Storage Tank	Closet-Side of House	14	5	3	2	1	1	1	1	1
7	Gas-Storage Tank	Garage	9	2	2	2	1	1	1	1	0
9	Gas-Storage Tank	Garage	11	4	2	2	1	1	1	1	0
10	Gas-Storage Tank	Garage	8	2	2 (0)	2	1	1	1	1	1
11	Gas-Storage Tank	Closet-Side of House	13	4	3 (0)	2	1	1	1	1	1
13	Gas-Storage/On-demand	Outdoors	7	2	2 (0)	2	1	1	1	1	0
14	Gas-Storage Tank	Closet	13	3	3	2	2	1	1	1	0
16	Gas-Storage Tank	Garage	5	1	1 (0)	1	1	1	1	1	0
17	Gas-Storage Tank	Garage	5	2	2 (0)	2 (0)	1 (0)	1	1	1	1 (0)
18	Gas-Storage Tank	Garage	21	7	5	4	3	1	1	1	2
19	Gas-Storage Tank	Garage	8	2	2	1	1	1	1	1	0
20	Gas-Storage Tank	Closet-Side of House	15	5	3	3	1	1	1	1	1
21	Gas-Storage Tank	Laundry Room	9	2	2 (0)	3	2	1	1	1	1
22	Gas-Storage Tank	Outdoors	9	3	3 (0)	3	1	1	1	1	0
24	Gas-Storage Tank	Basement	7	1	1	1	1	1	1	1	2 (1)

Two major contributions of this study are demonstrating the feasibility of a wireless sensor network technology for the purpose of a long-term field study on hot water, as well as describing and analyzing patterns for hot water use over various types of single-family residential building types and occupant behaviors.

## Background

There have been numerous studies that have measured flow and temperature at the water heater outlet, along with temperature measurements at end uses [Weihl, 1986; Lowenstein, 1998; Tiller, 2004]. The benefit of our study is the additional measurement of flow at each end use for a more accurate assessment of the energy efficiency at each end use, particularly the ability to see fluctuations with *one second resolution*. Since many draws are short, it is very informative to have higher resolution data for analysis.

Previous field studies used an expensive flow meter at the water heater, on the order of \$1000 per flow meter, and instrumenting each end use with a thermocouple and running thermocouple wires to the data acquisition system (Tiller 2004). Our custom flow meters with a built-in thermistor probe are much *lower cost* (< \$1000 per house for hardware costs) and the custom flow meters consume *100x less power* than the most efficient units available on the market. For comparison, Sika flow meters consume 7.5 mW while our meters use 90 uW when active, which is approximately half the time. As an example, Tiller's measurement system hardware costs are \$4400 per house with the Kobold paddle wheel flowmeter. This is assuming a single measurement point. Each additional measurement point requires an additional flowmeter at \$900 each. The unit cost of our custom flow meters are \$60 each at volume and allows the ability to deploy meters with flow and temperature measurements to every end use. We metered a median number of 9 water end uses in each home. In addition, the wireless transmission system negates having to run wire from each end use back to the central embedded computer deployed in each home.

Prior studies deployed data collection systems that are either compact data loggers or data that is downloaded once a day. Our system *streams real-time data* to our server and has remote access from our server so that we can immediately detect faults and run diagnostics promptly.

## Our System

We developed a new, low-power, low-cost, end-use water meter for use in a hot water field study in California homes. The meters measure both flow rate and water temperature, and wirelessly transmit data to a cloud-based data management system. This meter uses 100x less power than meters on the market, enabling a year of battery powered operation in the field.

The wireless sensor network consists of flow meters connected to wireless motes transmitting data to a central “manager” mote, which in turn posts data to our server via the internet. A schematic of the wireless sensor network can be seen in Figure 2. Two flow meters can be monitored with each mote board. Multiple flow meters and mote boards are installed at water end uses throughout the residence. A single manager mote collects signals from all wireless motes within the building, and sends the information to an embedded computer which is running software to send the collected data through the internet to the server for archiving.

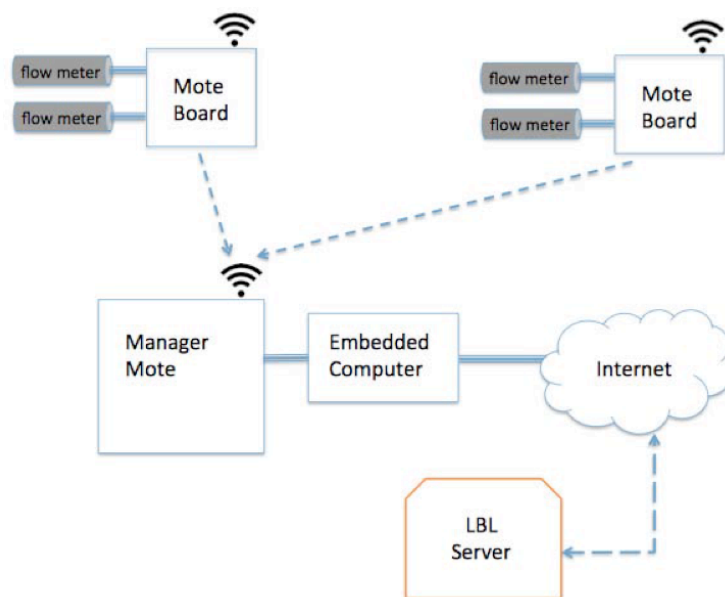

Figure 2. Schematic of wireless sensor network.

The system is designed to transmit data at smaller time increments during draws. When there is flow through the meter and for 20 seconds after the flow stopped, the data transmission rate for flow and temperature is once per second. When there is no flow through the meter, the data collection rate is once per 60 seconds.

Figure 3 (left) shows a fully assembled flow meter with a printed circuit board installed on the meter with epoxy. The black connector at the top of the board is used to connect to the wireless mote board, as shown in Figure 3 (right). Two flow meters can be connected to one wireless mote board. Typically, one port is connected to the hot water line and the other port is

connected to the cold water line, for each end use. For showers, the flow meter is typically installed at the showerhead, after the hot and cold water are mixed.

Each mote board contains another PCB with wireless chip and electronics programmed to transmit data to the “manager” mote, which is shown in Figure 4. The manager mote is connected to a Beaglebone Black embedded computer via USB serial. There is one manager and embedded computer per house, collecting data from all the flow meter and mote boxes.

The water meter uses a turbine method of flow measurement and is able to operate over a large flow range of 0.26 to 7.9 GPM, requires simple electronics, and has virtually no standby power when there is no water flow. The pickup for the flow meter is a reed switch, which is an electrical switch operated by a magnetic field. The reed switch detects a magnetic pulse for each revolution from a magnet mounted on the turbine blades. Temperature was measured with a thermistor probe inserted into the water flow. Thermistors are ceramic semiconductors whose resistance drops nonlinearly as temperature rises. We created a cloud-based ecosystem for data management and real-time data reporting, so that people will be able to easily use the technology.



Figure 3. Fully assembled flow meter (left) and two flow meters per mote board (right).



Figure 4. Manager mote and embedded computer.

Before continuing to mass production of our meters, the flow meter prototype was subjected to upper bound thermal and pressure tests. The prototype was robust enough to handle 24 hour thermal cycling between hot and cold water, for intervals of 2 minutes at 160 F and 2



minutes at 70 F (water input at room temperature) repeated 360 times. No water leaked from any point on the meter or fittings. The prototype was also tested to withstand 500 psi hydrostatic pressure for one minute.

## Calibration

The thermistor temperature sensors required calibration. Prior to installation each of the sensors was installed in a test rig to verify correct operation. This was done to check that the data acquisition elements in each sensor worked. Some of the sensors would only detect cold water flow. Those sensors were marked as cold only and installed on cold water only applications such as the cold line to sinks, clothes washers or toilets. The temperature of the hot water recorded by the sensors in the laboratory was compared to a reference temperature.

In the laboratory testing, researchers measured the accuracy of the temperature and flow measurements of the first flow meters. The flow rates were accurate for all the initial flow meters tested. We verified this by comparing the flow meter electronics readings with the reference flow meter installed in the lab. We did not record any data for this comparison. The temperature data from testing the first flow meters indicated the measurements were not sufficiently accurate to use as without correction. All the flow meters were tested with hot water in the laboratory before being installed the field. The temperatures recorded by the flow meters are corrected to match the temperatures measured by the reference equipment during the laboratory testing of each flow meter.

This temperature calibration process revealed that some of the flow meters report flow only intermittently when hot water was run through them. However, nearly all of the flow meters with this problem reported flow rates accurately when measuring cold water. Flow meters that only work with cold water were identified during calibration and are installed on cold water only locations. We believe that this problem is due to the thermal expansion of the epoxy used to adhere the circuit board. This may have affected the electronic pick up of the magnetic turbine.

The temperature calibration process consisted of two steps. The first step accounted for the unsynchronized clock in the reference temperature data logger. The second step was to calculate the coefficients to correct the flow meter temperature sensor data. The raw meter data was shifted relative to the reference data to find the time shift where the shape of the two curves are matched optimally. Then, a linear regression was applied to determine slope,  $m$ , and intercept,  $b$ , values for the calibration function of the form,  $T_{corrected} = mT_{raw} + b$  to be applied to the measured temperature data. This process is displayed in figure 5.

Detecting inoperative flow meters is not just a matter of not recording any flow at the water heater or at any end use. Because water use is determined by the behavior of the residents of the house, it is entirely possible that the residents were not using water at any given end use or even not using any water at all during the period in question. Expected examples of this behavior are unused bathrooms or times when no one is at home. An indication of an inoperative flow meter, instead of a lack of water use, would be if the water temperature changes quickly with no recorded water flow. Changes of temperature of more than a few degrees per minute without an associated water flow being recorded should be investigated further.

Unfortunately, a temperature change is not expected with every draw. It is entirely possible that the line supplying an end use is long enough, or the draw short enough, so that heated water from the water heater does not arrive at the end use before that draw ends. When it has been a sufficiently long time since the previous draw, all the water in the line will have

reached a condition representing the ambient temperature of the surrounding environment. In this case for a short draw, there would be water flow with no recorded change in water temperature.

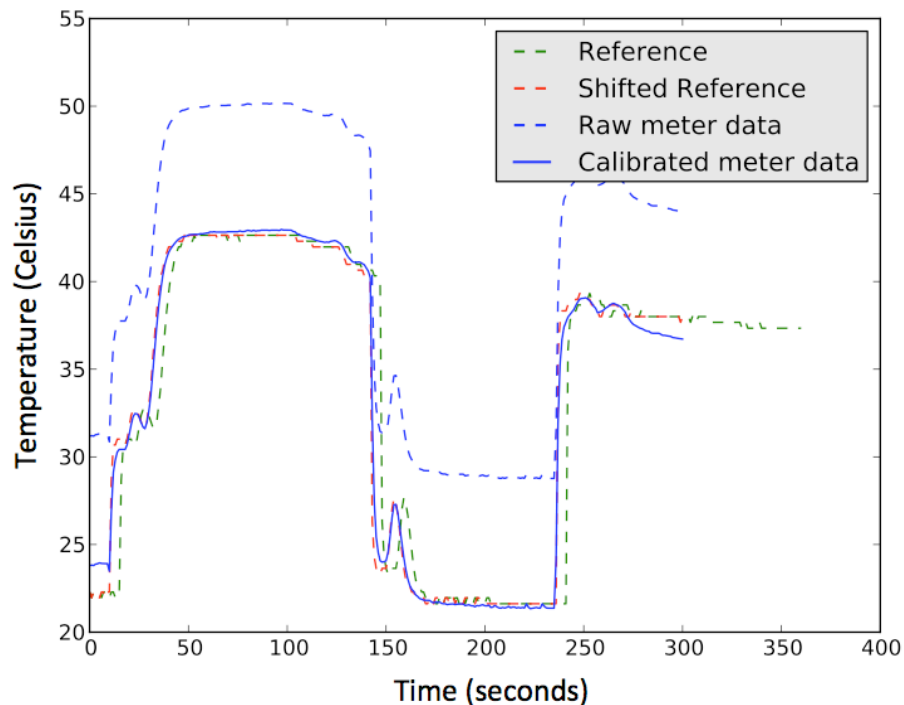

Figure 5. Example of a fitted calibration curve. In this case,  $m = 1.008$ ,  $b = -7.641$ , and  $R^2 = 0.993$ .

## Deployment Case Study

The house for the first deployment effort was a small (<less than 1,500 square feet), single-story ranch style house located in Oakland, CA with a crawl space foundation built in 1904. It has two bathrooms, and the gas storage water heater is located in a closet off the kitchen. The house has a dishwasher and clothes washer. The occupants are two working adults.

*Shower Event* – Figure 6 shows data from a shower event at this house. The first segment begins at 7:19:23 when water is turned on full hot. At this point nearly the entire flow of hot water, 1.4 GPM, is to the tub spout. Only a very slight amount of water flows through the shower head. At 7:21:38 the tub spout diverter is closed and water starts flowing to the shower head. The extra resistance of the tub spout diverter in the water path reduces the flow out of the water heater to 1.09 GPM. A slight amount of cold water is flowing to the shower head. 1.12 GPM is flowing through the shower head, but only 1.09 GPM is leaving the water heater. At 7:22:22 the person using the shower started adjusting the temperature by adjusting the mix of hot and cold water. At 7:23:21 the flow rates stabilize with only two minor adjustments, to modify the temperature slightly, until the end of the shower at 7:28:36. This last segment -- 5 minutes and 15 seconds -- can be assumed to be the actual useful portion of the shower event, totalling 9 minutes and 13 seconds. This suggests that only 57% of the time hot water is flowing from the water heater is being used.

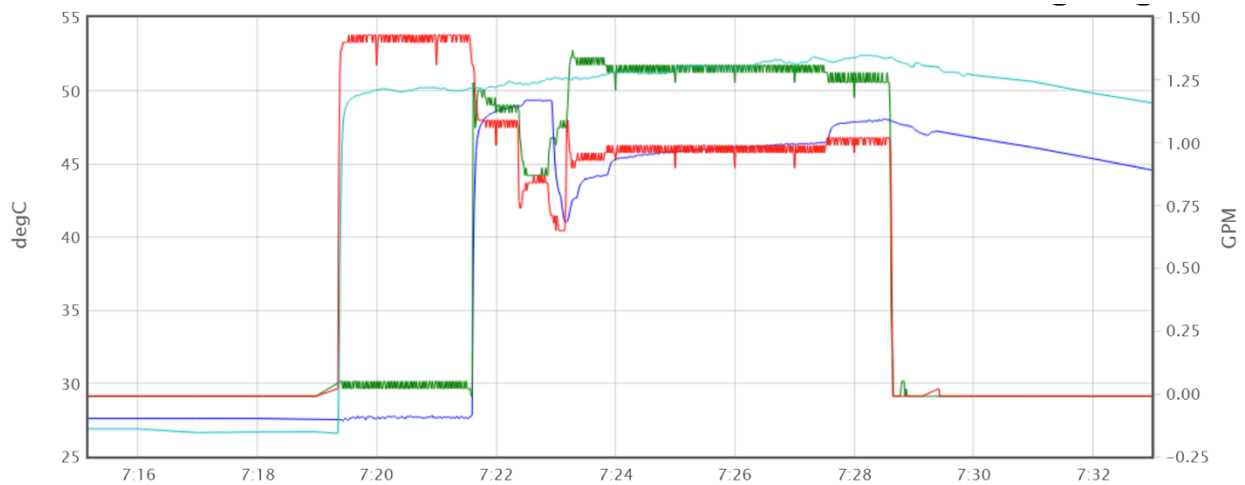

Figure 6. Shower event at 7:19 am from house1. The red trace is flow out of the water heater, in units of GPM on the right axis. The light blue trace is the temperature of the water as it leaves the water heater, in units degrees Celsius on the left axis. The green trace is water flow at the shower head, in units of GPM. The dark blue trace is the water temperature at the shower head, in units degrees Celsius.

### Kitchen Sink Event

Figure 7 shows a kitchen sink event from this same house. This series of events begins with two seconds of cold water flow at 0:05:36. It is followed by two cold water draws three and four minutes later at 1.18 and 1.21 GPM. The third cold water draw is followed almost immediately by a 45 second hot water draw at 1.02 GPM. Thirty seconds later it is followed by another one minute hot water draw at 1.02 GPM. After that there are 18 short draws in the next ten minutes. None of those draws last longer than 15 seconds. The hot water at the faucet does not get hot until the end of the second hot water draw, after nearly two gallons have been drawn. All but one of the 18 draws after the hot water draws are a mixture of hot and cold water. It is plausible that the two initial hot water draws were intended to bring hot water to the faucet. No water had been used at the kitchen sink for several hours prior to these draws. The temperature in the hot and cold faucets had stabilized to room temperature over this time. The temperature of the cold water draws dropped 3°C for about ten minutes then returned to room temperature. One likely explanation is that most of the cold water pipe within the building envelope and had reached room temperature. A small segment of that pipe may run closer to the outside wall. It would have lost more heat to the exterior than the pipes inside the building.

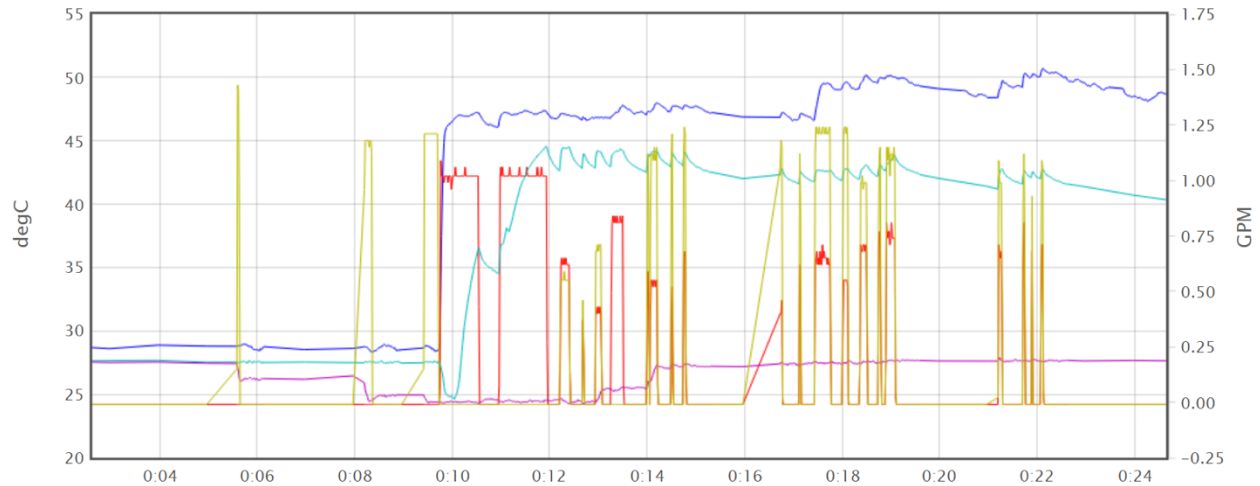

Figure 7. Data recorded during a series of kitchen sink events. The gold trace is flow through the cold water line. Red is flow through the hot water line. The dark blue trace is the temperature of water leaving the water heater. Light blue is the hot water temperature at the sink. The purple trace is the cold water temperature at the sink. (Note that wedges at the beginning of some of the flow events are artifacts of the display, and do not represent measured data.)

## Wireless Network Data Reliability

The wireless network performance used for data collection from the meters to the field client has proven to be highly reliable. Over the first ten days of metering in one house, the network collected 98,202 data packets and only lost 42 packets. The resulting data delivery reliability is 99.96%. With this high level of reliability, we expect to be able to produce very high quality data for this study.

## Flow Volumes

The total volume of hot water consumed daily can be determined. The daily volumes of hot and cold water can also be summarized by each indoor end use. For days with complete data, the total volume of water into and out of the water heater can be compared to the sum of the volume of hot water used at all of the end uses. A comparison of the total daily flow into and out of the water heater is shown in figure 8. Points on the red line show that the same amount of water was measured at the inlet and outlet of the water heater.

The daily sum of all the hot water measured at end uses may also not match the daily total flow from the water heater. There are two end uses where we did not measure hot water flow. At the shower heads, the measured flow is mixed hot and cold water. The fraction of hot water in the flow depends on the mixing ratio of hot to cold water. This is adjusted by the person taking the shower and cannot be measured directly. The installation protocol did not include any sensors at bath tub spouts. It was not feasible to install flow meters at each tub spout for this study without major/irreversible alteration to the house and plumbing. Any water, hot or cold, delivered directly to bath tubs was not measured in this project. If no other flow meters indicate flow and hot water is leaving the water heater it is likely to be going out a tub spout. Figure 8

shows that we need improved flow calibration to improve accuracy of flow measurements.

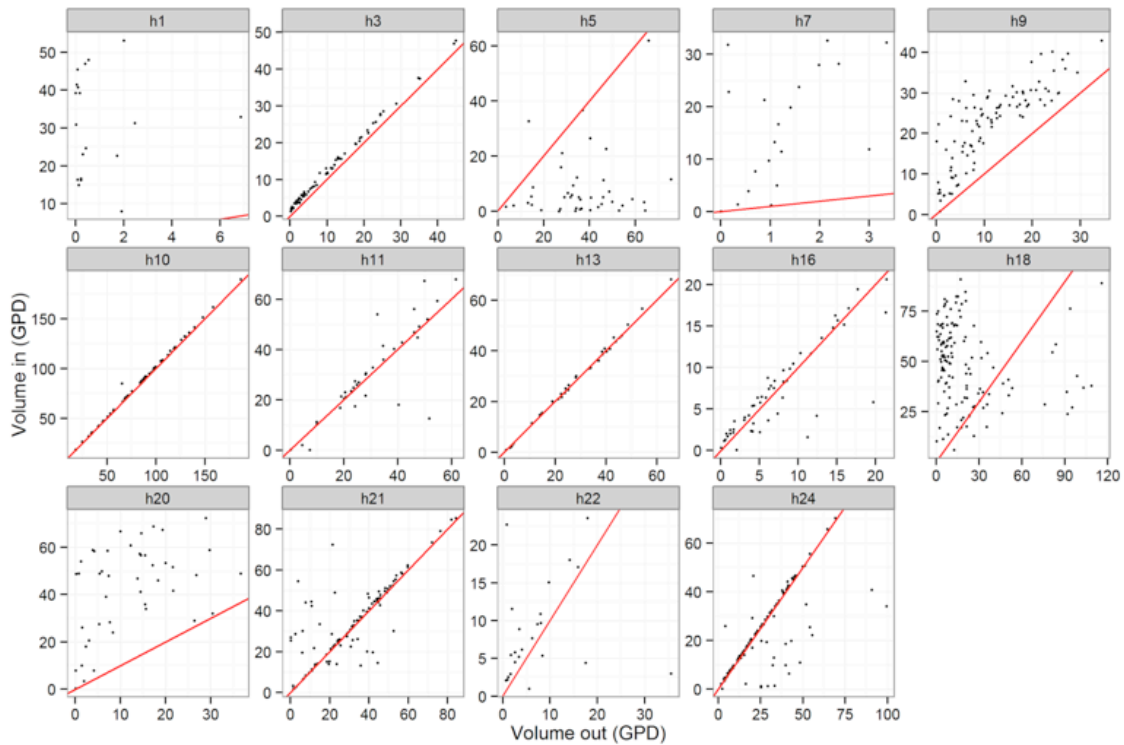

Figure 8. Daily volume of water measured at the inlet and outlet of the water heater by house.

## Energy Efficiency

The energy content of the water flowing through a sensor can be calculated. The energy content is relative to the same amount of water at some reference temperature. The energy content is calculated as:

$$Q = \rho V c_p (T - T_{ref})$$

Where:

- $Q$  = the energy content of the water in BTU or J,
- $\rho$  = the density of water at the point of measurement (lb/gallon or kg/L)
- $V$  = the volume of water at the point of measurement (gallon or L)
- $c_p$  = the specific heat of water (BTU/lb-°F or J/kg-°C)
- $T$  = temperature of water (°F or °C)
- $T_{ref}$  = the reference temperature

The appropriate reference temperature for this project can be either the temperature of the ambient air inside the house or the instantaneous cold water temperature entering the water heater.

Using the energy content of the water at the outlet of the water heater, and the energy content of the water at the end uses, the energy efficiency of the hot water distribution system can be calculated. The efficiency of the hot water plumbing is calculated as:

$$\eta = Q_{out}/Q_{in}$$

Where:

$Q_{out}$  = the energy content of the delivered water, and  
 $Q_{in}$  = the energy content of the water entering the hot water distribution system from the water heater.

The efficiency can be calculated for the entire hot water distribution system of a house for one or more days, or for just one draw or end use.

### Dishwasher Event – Case Study for Energy Efficiency Calculation

Figure 8 shows an example of a set of dishwasher events where the dishwasher end use temperature does not increase in time for the draws. The longer draws are approximately 2 minutes, while the shorter draws are approximately 1 minute. The volumes of each draw from the water heater to the dishwasher matches well. The total dishwasher energy is 1523 kJ with total volume of 5.658 gallons of water that passed through the system. The total water heater energy (only when there was flow at the dishwasher) is 3211 kJ. The total volume of water that passed through the water heater meter is 5.95 gallons. The average temperature of the water leaving the water heater during draws is 45 degrees Celsius. The delivery efficiency of this set of events is 47.4%. This makes for a case that plumbing hot water to the dishwasher is very inefficient and since dishwasher draws are so rapid, it does not receive the hot water in time and would require localized water heating at the end use.

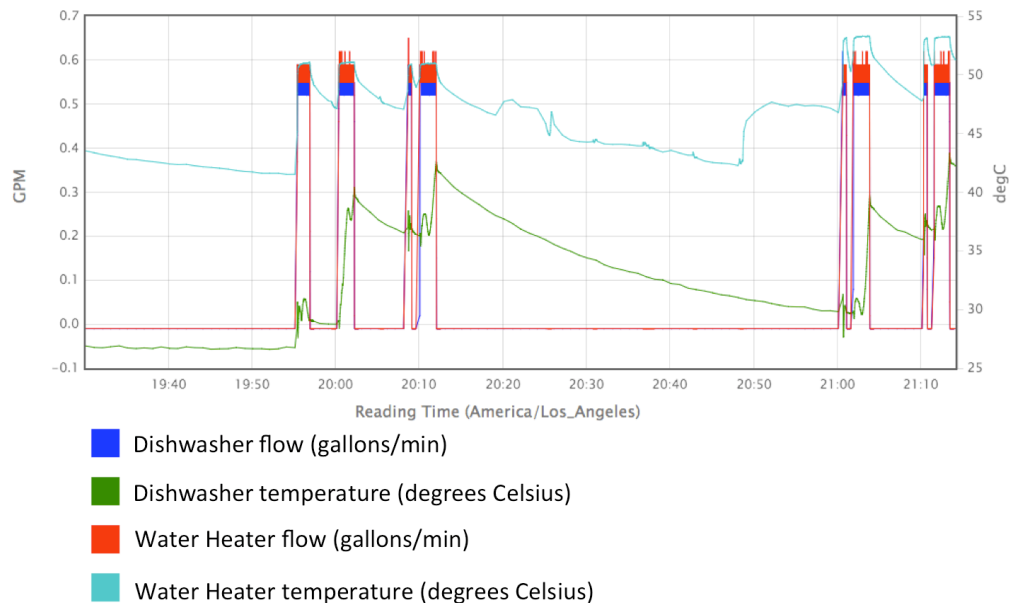

Figure 9. Set of dishwasher events at House 10 on the evening of January 25.

## Conclusion and Future Work

This project has developed a wireless sensor network technology, and networks have been successfully deployed in twenty houses to date. Water flow and temperature data are successfully being collected and uploaded to our local data server. The analysis methodologies described here are being implemented on the data. Preliminary analysis of a few datasets demonstrates that with shower events and dishwasher events, approximately half of the energy consumed to heat water at the water heater is actually being used at the end use. This supports the notion that having the dishwasher plumbed to the hot water line is wasteful and should instead be plumbed to the cold water line. It would be beneficial to compare the energy use of heating water at the source (water heater) versus all-electric booster heating at the dishwasher.

One of the uses for data gathered from this study is to improve hot water distribution system simulation modeling tools. As part of another task in this project, LBNL developed a computer simulation modeling tool for hot water distribution systems. (Grant 2013) The monitoring in the current task was done in existing buildings. We were not able to directly determine detailed characteristics of the plumbing system such as the layout, length, diameter, and material of the hot and cold water pipes. However it should be possible to reverse engineer the key characteristics of the hot water distribution system. This could be done by imposing the flow rates of the observed draw patterns on a simplified model of the HWDS and comparing the temperature profiles at the end uses in the simulation to the observed temperature profiles. By iteratively adjusting the characteristics of the links in the plumbing tree until the simulated temperature profiles best match the observed temperature profiles an optimized simplified model of the HWDS could be calculated for each house. These simplified simulation models could be used for creating design guidelines or improving building energy efficiency standards.

## References

- Grant, Peter, and James Lutz. 2013. *Water Heater Simulation Model Report*. Lawrence Berkeley National Laboratory for California Energy Commission.
- Lowenstein, Andrew, and Carl C. Hiller. 1996. "Disaggregating Residential Hot Water Use." *ASHRAE Transaction Symposia*. Atlanta, GA: ASHRAE.
- Lutz, Jim. 2011. "Water and Energy Wasted During Residential Shower Events: Findings from a Pilot Field Study of Hot Water Distribution Systems." *ASHRAE Transactions*, 118:1-11.
- Tiller, Dale K., and Gregor P. Henze. 2004. *Metering Residential Hot Water by End-Use Development of Standard Protocol*. ASHRAE project 1172 Final Report.
- Palmgren, C., N. Stevens, M. Goldberg, R. Barnes, and K. Rothkin. 2010. Consultant report: 2009 California Residential Appliance Saturation Study, Executive summary. California Energy Commission, Sacramento. October.
- Weihl, Jeffrey S., and Willett Kempton. 1985. "Residential Hot Water Energy Analysis: Instruments and Algorithms." *Energy and Buildings*, 8:197-204.
- U.S. Energy Information Administration. Residential Energy Consumption Survey, 2001.

## **DISCLAIMER**

This document was prepared as an account of work sponsored by the United States Government. While this document is believed to contain correct information, neither the United States Government nor any agency thereof, nor the Regents of the University of California, nor any of their employees, makes any warranty, express or implied, or assumes any legal responsibility for the accuracy, completeness, or usefulness of any information, apparatus, product, or process disclosed, or represents that its use would not infringe privately owned rights. Reference herein to any specific commercial product, process, or service by its trade name, trademark, manufacturer, or otherwise, does not necessarily constitute or imply its endorsement, recommendation, or favoring by the United States Government or any agency thereof, or the Regents of the University of California. The views and opinions of authors expressed herein do not necessarily state or reflect those of the United States Government or any agency thereof or the Regents of the University of California.