

# Lawrence Berkeley National Laboratory

## Recent Work

### Title

OBSTACLES TO THE USE OF EXTERIOR FENESTRATION AND DAYLIHGTING CONTROL SYSTEMS IN THE U.S

### Permalink

<https://escholarship.org/uc/item/6w66v8vf>

### Authors

Sweitzer, G.  
Johnson, R.

### Publication Date

1984-03-01

c.2



# Lawrence Berkeley Laboratory

UNIVERSITY OF CALIFORNIA

RECEIVED  
LAWRENCE  
BERKELEY LABORATORY

## APPLIED SCIENCE DIVISION

JUL 24 1984

LIBRARY AND  
DOCUMENTS SECTION

To be presented at Windows in Building Design and  
Maintenance, Gothenburg, Sweden, June 13-15, 1984

OBSTACLES TO THE USE OF EXTERIOR FENESTRATION AND  
DAYLIGHTING CONTROL SYSTEMS IN THE U.S.

G. Sweitzer and R. Johnson

March 1984

**TWO-WEEK LOAN COPY**

*This is a Library Circulating Copy  
which may be borrowed for two weeks.*

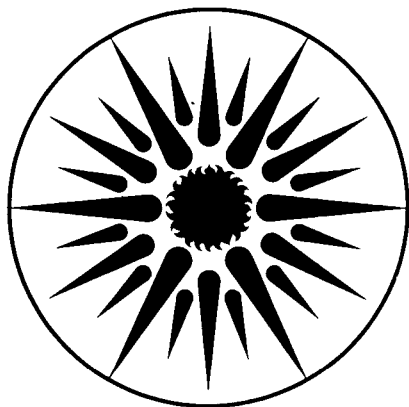

**APPLIED SCIENCE  
DIVISION**

LBL-17683  
c.2

## **DISCLAIMER**

This document was prepared as an account of work sponsored by the United States Government. While this document is believed to contain correct information, neither the United States Government nor any agency thereof, nor the Regents of the University of California, nor any of their employees, makes any warranty, express or implied, or assumes any legal responsibility for the accuracy, completeness, or usefulness of any information, apparatus, product, or process disclosed, or represents that its use would not infringe privately owned rights. Reference herein to any specific commercial product, process, or service by its trade name, trademark, manufacturer, or otherwise, does not necessarily constitute or imply its endorsement, recommendation, or favoring by the United States Government or any agency thereof, or the Regents of the University of California. The views and opinions of authors expressed herein do not necessarily state or reflect those of the United States Government or any agency thereof or the Regents of the University of California.

Paper to be presented at Windows in Building Design and Maintenance,  
Gothenburg, Sweden, June 13-15, 1984.

OBSTACLES TO THE USE OF EXTERIOR FENESTRATION AND DAYLIGHTING  
CONTROL SYSTEMS IN THE U.S.

Glenn Sweitzer and Richard Johnson

Applied Science Division  
Lawrence Berkeley Laboratory  
University of California  
Berkeley CA 94720 U.S.A.

March 1984

This work was supported by the Assistant Secretary for Conservation and Renewable Energy, Office of Building Energy Research and Development, Building Systems Division of the U.S. Department of Energy under Contract No. DE-AC03-76SF00098.

OBSTACLES TO THE USE OF EXTERIOR FENESTRATION AND  
DAYLIGHTING CONTROL SYSTEMS IN THE U.S.

Glenn Sweitzer and Richard Johnson

Applied Science Division  
Lawrence Berkeley Laboratory  
University of California  
Berkeley, CA 94720 U.S.A.

ABSTRACT

Exterior fenestration and daylighting control systems can provide excellent control of solar gain and glare and still be visually satisfying elements in the design of building envelopes. However, U.S. building industry experience with exterior fenestration and daylighting control systems suggests that durability and proper function of these systems is often unsatisfactory. Yet in Western Europe, exterior systems are a proven, cost-effective, and aesthetically accepted fenestration design element. We suggest that these contrasting operating experiences reflect differences in prevailing U.S./Western European approaches to building design, construction, and operation. Three representative U.S. building case studies are examined, each describing the application of exterior fenestration/daylighting control components previously untested as a system, and some unsatisfactory consequences. We suggest several changes that may assist in increasing the acceptance and success of these systems in the U.S. building industry.

Keywords: weathering, fenestration, daylighting controls.

## INTRODUCTION

Exterior fenestration and daylighting control systems are widely used in residential and commercial buildings throughout Western Europe. In the residential sector they provide varying degrees of thermal control, acoustic control, sun protection, privacy and security. In addition, in commercial buildings they can enhance daylight utilization while reducing glare and visual discomfort. These systems are familiar to building designers, builders, owners, and operators and are part of the everyday building vocabulary. Accordingly, a wide range of fenestration control systems are readily available for replacement, retrofit, and new building applications.

In the United States, however, concerns about durability, along with those of first costs and aesthetics, limit application of these systems. Accordingly, few building designers, owners, builders, or operators are familiar with proper system installation, management, or performance. Of the few noteworthy applications in the U.S.--excluding those that use products imported from Western Europe--most are unconventional designs, untested as systems, and each presents unique problems.

This approach to unconventional building and system design may be the key to differing levels of success with exterior fenestration and daylighting systems. In Western Europe these systems are considered part of the building from the beginning of a project, integrally designed and applied according to standard building practice. Most U.S. projects, however, are more speculative, depending on various combinations of owner financing, designer flair, and builder shortcuts to attract tenants and still show early profits. This approach, when involving exterior fenestration and daylighting control systems, frequently produces unique, untested systems that lack durability. The growing list of such questionable systems further discourages their development and application, while fueling criticism of their first costs and aesthetics.

This paper examines experiences with three unconventional fenestration systems in the U.S. Each case study involved a site visit and discussions with building operators concerning the project's history and current approaches to system operation.

Each case involves a different type of exterior fenestration/daylighting control system: Case 1 is fixed; Case 2, manually operable; and Case 3, automatically operable. The similarities among the cases include exposure to hot and freezing temperatures, significant amounts of rain and snowfall, and location in a temperate climate zone between 39° and 46° north latitude, as shown in Fig. 1.

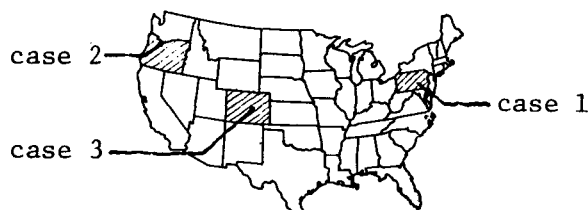
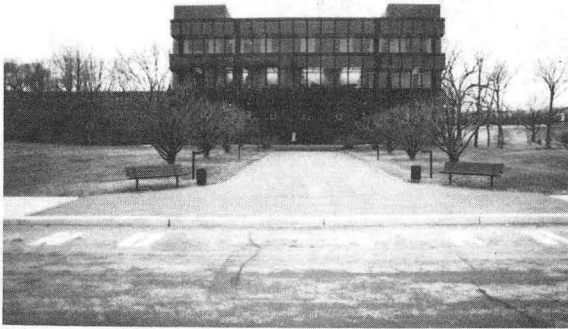

Fig. 1 Locations of case studies.

Case 1

Case 1, involving fixed exterior sunshades, concerns a four-story company headquarters office located in a rural setting near Philadelphia, Pennsylvania (Fig. 2). Completed in 1971, weathering steel (then newly available) was used for the exterior columns, spandrels, window frames, and the attached catwalks and framing for sunshades (Fig. 3) located on east, south, west, and partial north exposures.



CBB 843-2234

Fig. 2 Building view from east entrance.

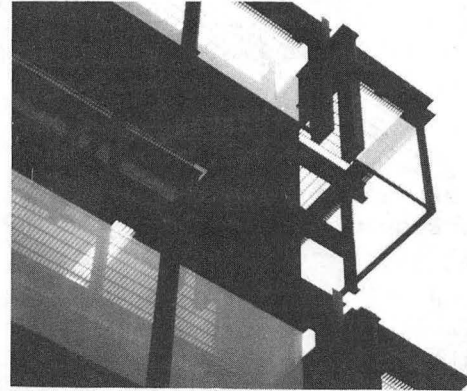

CBB 843-2232

Fig. 3 Sunshade framing at northwest glass atrium roof.

After three to four years of weathering, the planned uniform, protective patina covering the steel surfaces was incomplete; corrosion continued, not only giving the building an uneven, streaked, and discolored appearance, but also damaging facade elements, including the sunshade frames.

The original glass sunshade frames, hung from outside the catwalks, supported 3/8-inch-thick tinted glass panes measuring about 4 feet by 5 feet, and supported by welded angles and bar glazing stops, both made of weathering steel. The steel stops were fastened by screws to both vertical and top and bottom horizontal angles. The total shade frame was supported by a short weld at the top and bottom of each vertical angle (Fig. 4).

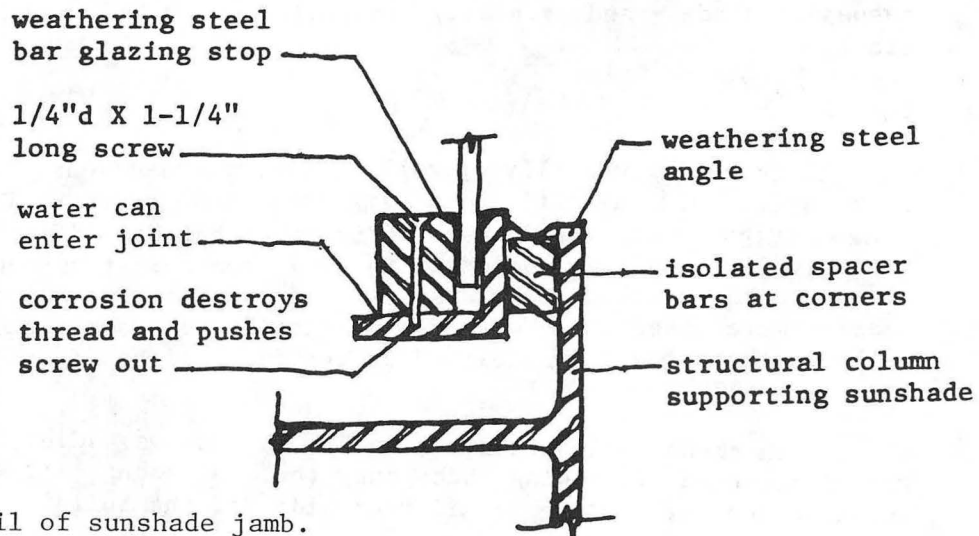
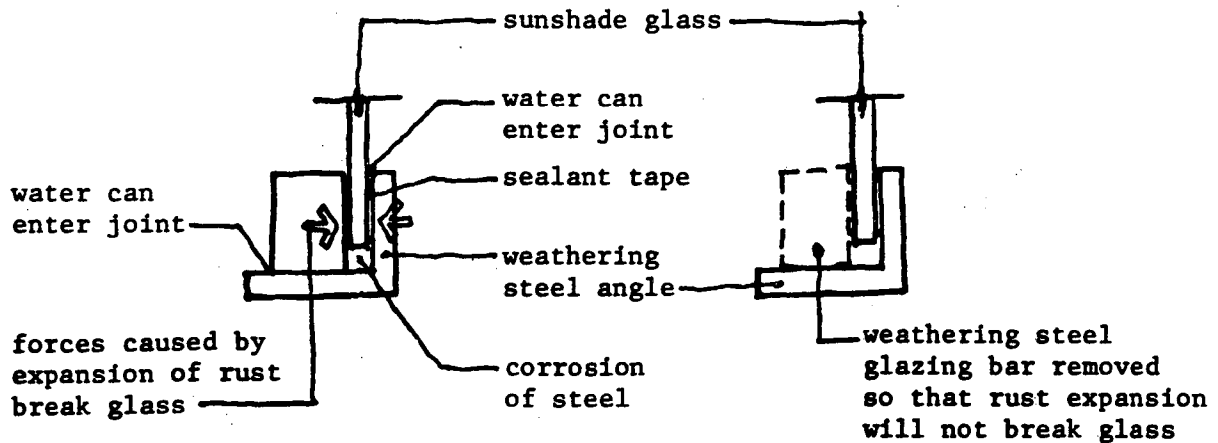

Fig. 4 Detail of sunshade jamb.

Corrosion caused many of the screws to loosen and sever at horizontal sill joints, which exerted pressure to break the glass panes, as shown in Fig. 5a. To remedy this, all sill bar stops were removed, as shown in Fig. 5b.



a) Section through sunshade frame showing cause of glass breakage

b) Section with bar removed

Fig. 5 Detail of sunshade sill.

To better assess total damage, the window walls, catwalks, and shading systems were evaluated by an independent team of building consultants (headed by a Danish-American). Their report confirmed the weathering damage to the shading system. Many screws were missing or falling out and many fillet welds to the angle frame were cracked and allowed moisture to penetrate.

This extensive damage to the weathering steel elements led to resetting the glass for all window walls and to redesigning glazing fasteners for resetting the tinted glass for all sunshades.

Despite the extent of damage, the decision to replace the sunshades with another (more conventional) design made of weathering steel was based primarily on building aesthetics. The project would have appeared boxlike without the cantilevered catwalks and suspended shades, and visually inconsistent without weathering steel.

## Case 2

Case 2, involving manually operable exterior sunscreens, concerns a 13-story medical office building located in downtown Portland, Oregon (Figs. 6 and 7). This squarish-plan building features perimeter offices and was converted in 1959 from a 9-story department store. Horizontal window bands, each of 1-inch-thick insulating glass, were added along with new spandrels, both separated vertically by channel mullions extending the full height of the building.

Along with these design changes, an HVAC system was added, but it was discovered following occupancy that not enough air capacity was provided for cooling on all four sides of the building simultaneously.





CBB 843-2230

Fig. 6 Building view from southeast.

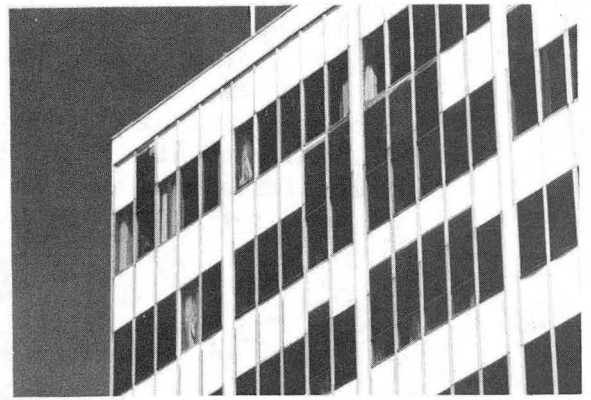

CBB 843-2228

Fig. 7 Detail of south elevation.

To reduce cooling loads, two different approaches were tried. First tinted polyester film was added to the inside surface of the insulated glass windows in one south-facing office. This trial resulted in unsatisfactorily high glass and room air temperatures and the approach was abandoned. Next, green-colored anodized aluminum sunscreens were framed and fitted between the window mullions on the southern exposure, allowing the screen to be positioned in front of, above, or below each window. This strategy reduced indoor air temperatures in the adjacent offices by up to 10°F by substantially reducing transmitted sunlight.

Later, additional screens were added on east- and west-facing windows at the request of individual office tenants.

Screen adjustment occurred seasonally along with window washing, and included cleaning the mullion tracks and repositioning screens over the windows. However, during recent years, successive operators have allowed individual tenant preferences to determine screen locations. Further, screens damaged by window washers or wind have been periodically removed but not replaced. The building elevations now appear irregular, with some screens up, some down, and others missing. To improve appearance, current management has decided to remove all screens and provide shading with interior venetian-type blinds. Over time, weathering has contributed to exposing the system limitations, preventing easy adjustment or replacement of screens. Had the system been integrally designed as part of a building retrofit, it might have continued in operation, avoiding the unaesthetic conditions that will cause its removal.

### Case 3

Case 3, involving an automatically controlled operable exterior louver system, concerns a two-year-old building complex located in a suburb of Denver, Colorado. The all-aluminum louvers cover a glazed circulation atrium with a south-facing vertical wall and sloped-glass roof (see Figs. 8 and 9). The system automatically tracks the sun during daylight hours to optimize shading and daylight control, and closes at night to reduce heat loss.

The louver system, installed by an electrical contractor unfamiliar with the system, began operation without a recommended snow dumper option that would provide quick open/close action. (The snow dumper had not been fully developed when the system was ori-

ginally installed.) During the first winter, which included record snowfall, the system operated satisfactorily, aided by snow melting from heat transmitted through the atrium's single layer of laminated glass. However, last winter's record cold caused icing in faulty conduit connections, halting louver operation. This time atrium heat was insufficient to aid thawing, which then required portable heaters.

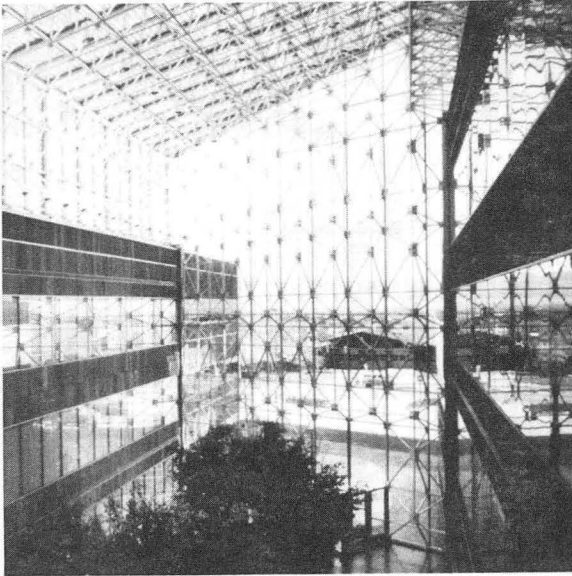

Figure 8. View of atrium interior.

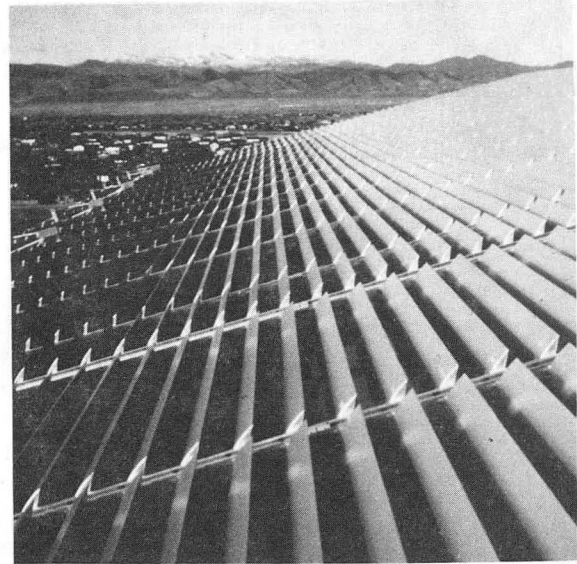

Figure 9. View of louvers on roof.

In this case a product already proven in other outdoor applications was applied for the first time as a sloped fenestration/daylighting control system. Operation was halted only by an extreme icing condition. Since then the recommended snow dumper option and new, waterproof conduit connections have been installed and checked by the louver system supplier. These changes should satisfy any remaining concerns about further winter operation of this system.

#### SUMMARY

Each of these cases involved application of exterior fenestration/daylight controls previously untested as a system. In time, the intended operation of each was further complicated by climatic factors and weathering. As the list of such cases grows, opportunities for system development and application in the U.S. are slowed.

Past experience with exterior fenestration controls has often been frustrating. However, we believe that a heightened recognition of the importance of carefully integrating proven designs into buildings, coupled with the inherent value of these systems, should increase the number of successful installations, which will then help to support overall acceptance of these systems in the U.S.

#### ACKNOWLEDGEMENT

This work was supported by the Assistant Secretary for Conservation and Renewable Energy, Office of Building Energy Research and Development, Building Systems Division of the U.S. Department of Energy under Contract No. DE-AC03-76SF00098.

This report was done with support from the Department of Energy. Any conclusions or opinions expressed in this report represent solely those of the author(s) and not necessarily those of The Regents of the University of California, the Lawrence Berkeley Laboratory or the Department of Energy.

Reference to a company or product name does not imply approval or recommendation of the product by the University of California or the U.S. Department of Energy to the exclusion of others that may be suitable.

TECHNICAL INFORMATION DEPARTMENT  
LAWRENCE BERKELEY LABORATORY  
UNIVERSITY OF CALIFORNIA  
BERKELEY, CALIFORNIA 94720